

# US Army Order of Battle 1919–1941

## Volume 1

### The Arms: Major Commands and Infantry Organizations, 1919–41

*by*

*Lieutenant Colonel (Retired) Steven E. Clay*



Combat Studies Institute Press  
US Army Combined Arms Center  
Fort Leavenworth, KS

## Library of Congress Cataloging-in-Publication Data

Clay, Steven E., 1957-

US Army order of battle, 1919-1941 / Steven E. Clay.

p. cm.

Includes bibliographical references.

1. United States. Army--Organization--History--20th century--Encyclopedias. I. Title. II. Title: United States Army order of battle, 1919-1941.

UA25.C59 2010

355.30973'09041--dc22

2010022326



CSI Press publications cover a variety of military history topics. The views expressed in this CSI Press publication are those of the author and not necessarily those of the Department of the Army or the Department of Defense. A full list of CSI Press publications, many of them available for downloading, can be found at <http://usacac.army.mil/CAC2/CSI/>.

The seal of the Combat Studies Institute authenticates this document as an official publication of the CSI. It is prohibited to use CSI's official seal on any republication of this material without the written permission of the Director of CSI.

## **Dedication**

### **Specialist Fourth Class Ival Lawhon**

11C (Mortarman)  
2d Battalion, 22d Infantry, 25th Infantry Division  
Lai Khe, Vietnam  
1968–69

*A good friend, a good soldier, and a good man.*



## Contents

	<i>Page</i>
Foreword .....	vii
Acknowledgments .....	ix
The Author .....	xi
Author's Note .....	xiii
Explanatory Notes .....	xv
Key to Abbreviations .....	xxiii
Military Map and Illustration Symbols .....	xxvii
<b>Part I. Organization of the US Army, 1919–41</b>	
<b>Chapter 1. Genesis of the Modern American Army .....</b>	<b>1</b>
<b>Chapter 2. Geographical Organization and Tactical Commands of the US Army,         1898–1920 .....</b>	<b>7</b>
<b>Chapter 3. Corps Areas and Departments .....</b>	<b>11</b>
<b>Chapter 4. General Headquarters and Field Armies .....</b>	<b>95</b>
<b>Chapter 5. Corps .....</b>	<b>137</b>
<b>Chapter 6. Corps Area Training Centers .....</b>	<b>187</b>
<b>Part II. Infantry Organizations</b>	
<b>Chapter 7. Infantry Divisions .....</b>	<b>193</b>
<b>Chapter 8. Infantry Brigades .....</b>	<b>291</b>
<b>Chapter 9. Infantry Regiments .....</b>	<b>351</b>
<b>Chapter 10. Infantry Battalions .....</b>	<b>519</b>
<b>Chapter 11. Tank Organizations .....</b>	<b>539</b>
<i>Follow-on volumes include—</i>	
<b>Volume 2. The Arms: Cavalry, Field Artillery, and Coast Artillery, 1919–41</b>	
Part III. Cavalry Organizations	
Chapter 12. Cavalry Divisions	
Chapter 13. Cavalry Brigades	
Chapter 14. Cavalry Regiments	
Chapter 15. Cavalry Squadrons	
Chapter 16. Machine Gun Squadrons	
Chapter 17. Armored Car Squadrons	
Part IV. Field Artillery Organizations	
Chapter 18. Field Artillery Major Commands	
Chapter 19. Field Artillery Brigades	
Chapter 20. Field Artillery Regiments	
Chapter 21. Field Artillery Battalions	
Chapter 22. Field Artillery Observation Battalions	
Chapter 23. Ammunition Trains	
Part V. Coast Artillery Organizations	
Chapter 24. Coast Artillery Major Commands	
Chapter 25. Coast Artillery Brigades	
Chapter 26. Coast Artillery Regiments and Battalions	
Chapter 27. Army Mine Planters	

### **Volume 3. The Services: Air Service, Engineers, and Special Troops, 1919–41**

#### Part VI. Air Service and Air Corps Organizations

- Chapter 28. Air Service and Air Corps Major Commands
- Chapter 29. Headquarters, Air Service
- Chapter 30. Groups
- Chapter 31. Squadrons, Heavier Than Air
- Chapter 32. Squadrons, Lighter Than Air
- Chapter 33. Squadrons, Non-Flying

#### Part VII. Engineer Organizations

- Chapter 34. Engineer Major Commands
- Chapter 35. Engineer Regiments
- Chapter 36. Engineer Battalions/Squadrons

#### Part VIII. Special Troops Organizations

- Chapter 37. Special Troops

### **Volume 4. The Services: Quartermaster, Medical, Military Police, Signal Corps, Chemical Warfare, and Miscellaneous Organizations, 1919–41**

#### Part IX. Quartermaster Corps Organizations

- Chapter 38. Quartermaster Trains
- Chapter 39. Field Remount Depots
- Chapter 40. Motor Repair Battalions, Quartermaster Corps
- Chapter 41. Service Battalions, Quartermaster Corps
- Chapter 42. Wagon Trains
- Chapter 43. Quartermaster Regiments and Squadrons
- Chapter 44. Port and Embarkation Units
- Chapter 45. US Army Transport Service

#### Part X. Medical Corps Organizations

- Chapter 46. Medical Headquarters
- Chapter 47. Medical Regiments, Battalions, and Squadrons
- Chapter 48. Hospitals, Hospital Centers, and Surgical Groups

#### Part XI. Military Police Organizations

- Chapter 49. Military Police Battalions

#### Part XII. Signal Corps Organizations

- Chapter 50. Signal Corps Battalions

#### Part XIII. Chemical Warfare Service Organizations

- Chapter 51. Chemical Regiments/Battalions

#### Part XIV. Miscellaneous Organizations

- Chapter 52. Border Commands
- Chapter 53. ROTC Units

### **Appendixes**

- Appendix A. Glossary of Terms
- Appendix B. Major Events of the US Army, 1919–41
- Appendix C. US Army Statistics, 1919–41
- Appendix D. Civilian Conservation Corps Organization, 1933–41
- Appendix E. Branch and Department Chiefs, 1917–41
- Appendix F. Annual Summer Training Camp Locations

## Foreword

Steve Clay's massive work, *US Army Order of Battle, 1919–1941*, is, in many respects, the story of the American Army, its units, and its soldiers, during a period of neglect by a parsimonious Congress and others who perhaps believed in the notion that a "War to End All Wars" had actually been fought. Indirectly, it tells the story of a diminutive Regular Army that continued to watch faithfully over the ramparts of freedom in far-flung outposts like Panama, Alaska, the Philippines, and China, as well as the many small and isolated garrisons throughout the United States; a National Guard that was called on frequently by various governors to prevent labor troubles, fight forest fires, and provide disaster relief to their state's citizens; and an Organized Reserve whose members attended monthly drills without pay and for 20 years creatively and conscientiously prepared themselves for another major war.

The *US Army Order of Battle, 1919–1941* is an important addition to the library of all Army historians, professional and amateur. More than a simple listing of units and the headquarters to which they were assigned, this book is an encyclopedia of information on Army tactical organizations in existence during the interwar period. This four-volume work, based on almost 20 years of research, fills a distinct void in the history of Army units, especially those of the Organized Reserve (now known as the US Army Reserve). Clay's comprehensive work details the history of every tactical organization from separate battalion to field army, as well as certain other major commands important to the Army in the 1920s and 1930s. It also includes the various units' changes of station, commanding officers, accomplishments, and key events such as major maneuvers and, for National Guard units, active duty periods for state emergencies. Also included are the organizations' distinctive unit insignia, as well as maps showing command boundaries and charts illustrating the assortment of tables of organization germane to the organizations of the time. In short, this *Order of Battle* is the "go to" reference for the historian who wishes to understand the history, organization, and evolution of Army units between the World Wars.



Gordon R. Sullivan  
General, US Army (Retired)





## Acknowledgments

These volumes were compiled from numerous archives and libraries from virtually around the world. At every available opportunity, I visited a library or archive that might contain useful information for this project and hunted through any file or book that might contribute to its completion. Some of those places were as far away as the 2d Infantry Division Museum at Camp Red Cloud, Korea; the Eighth Army Museum at Yongsan in Seoul, Korea; and the V Corps historian's office in Frankfurt, Germany. The primary sources of information in these volumes, however, are from Record Groups 394 and 407 in the National Archives II at College Park, MD. The people at National Archives II to whom I am particularly grateful are Mr. Mitchel Yockelson, Dr. Tim Nininger, and Mr. Shawn Smith. Mitch was particularly helpful with dropping pull slips for me before I arrived and for advising me on where to look for various interwar period documents. He was truly invaluable to my efforts for this work.

A close second for primary source documents and information was the Center of Military History in Washington, DC. My point of contact there, and someone to whom I am also greatly indebted, is Ms. Romana Danysh. Roma was a great help in showing me what the Center's archives held and allowing me access to unit data cards and other unit historical documents. The late Mr. John Slonaker of the Military History Institute at Carlisle Barracks, PA, was of great help in locating information and documents there. I am also indebted to the staff of the Combined Arms Research Library (CARL) at Fort Leavenworth, KS, particularly Mr. Ed Burgess, the director. Ed made possible the compilation of an extremely accurate and virtually complete listing of Regular Army unit commanders. Other CARL staff members who were of great assistance include Mr. Steven Brown, Mr. Ed Metz, Ms. Dorothy Rogers, Mr. Carl Fischer, Ms. Kathy Buker, Ms. Elizabeth Merrifield, and Ms. Pamela Kontowicz. The staff of the Air Force Historical Research Agency (AFHRA) at Maxwell Air Force Base, AL, was very helpful with the Air Service/Air Corps section. Mr. John T. O'Gorman of the US Army Quartermaster Museum provided useful help with the Army Transport Service portion of this project.

In terms of financial support, I would like to thank Dr. Jeff Clark and the Center of Military History. Without the Center's help, this information would probably never be available to Army historians and others. I also wish to thank General Gordon Sullivan, Mr. Roger Cirillo, and the Association of the United States Army. Early on General Sullivan and Mr. Cirillo recognized the value of this work and persuaded the Association to provide some of the early financial support to my research. The Fort Leavenworth Historical Society was also a backer, and I am grateful to that organization as well.

I would be remiss if I did not mention the outstanding support and encouragement I received from my bosses at the Combat Studies Institute, Fort Leavenworth, KS, my place of employment during much of the time I was writing these volumes. These included Colonel Jerry Morelock, Colonel Lawyn Edwards, and Dr. William G. Robertson, all of whom gave me encouragement and the time I needed to travel to the National Archives and other locations to compile much of this work. I would especially like to thank Colonel Timothy Reese who made the later stages of research and the actual publication of this work possible. For the assistance with the selection of military insignia and other illustrations used in this work, I am grateful for the help of Mr. Ival Lawhon of St. Joseph, MO. He ensured that the illustrations represent the actual insignia in use from 1919 to 1941. A big "thank you" goes to Lieutenant Colonel Drew Sullins, his wife Stacey, and Drew's parents for their willingness to put me up at their home when I did research at the National Archives in Maryland. I enjoyed the chance to visit with them when I was there and it made my own sparse dollars stretch a lot farther.

Most importantly, I want to thank my wife and best friend, Elizabeth. I spent 19 years researching and writing this work, but she never complained about the many times I was absent conducting research nor about the money I spent in doing so. She did not necessarily understand my passion for this project, but she always supported me in my efforts. I thank God for her and her friendship.



## **The Author**

Steven E. Clay was commissioned as a second lieutenant of infantry from North Georgia College in 1979. He served in various unit assignments in the 1st Infantry Division, 2d Armored Division, the Combined Field Army (ROK/US), and Combat Support Coordination Team #1, an element of the Combined Forces Command in Korea. He also served in several officer education assignments to include Professor of Military Science at Stephen F. Austin State University in Nacogdoches, TX; Assistant Professor in the Department of Military History at the US Army Command and General Staff College; and, at different times, as the Executive Officer, Chief of the Staff Ride Team, and Chief of the Research and Publications Team of the Combat Studies Institute at Fort Leavenworth, KS. He retired from the US Army as a lieutenant colonel in September 2006 after more than 27 years of service to his country. He is currently employed by Military Professional Resources, Inc., and is the lead author for the Contemporary Operations Study Team at the Combat Studies Institute.



## Author's Note

When thumbing through this work, I suspect many people would wonder what prompted somebody to put together a reference work that details the history of the US Army in peacetime, especially during a period that seems relatively uneventful. To explain, I have to go back a ways. This work is the result of over 19 years of research and writing that attempts to document adequately the organizations, commanders, and activities of the US Army from 1919 to 1941 in what is commonly known as “the interwar years.” The genesis of this project was my entry into the world of military insignia collecting when I was a teenager in 1972. At that time, I had little interest in the Army. In my mind, I was headed for Annapolis and a naval career. I joined the Army Junior Reserve Officers’ Training Course (ROTC) program at Baker High School in Columbus, Georgia, and there met Tom Stafford. At Tom’s house, I encountered a distinctive unit insignia (commonly referred to as “crests”) collection that his father, a retired sergeant major, had assembled over many years. I was fascinated by Sergeant Major Stafford’s collection. Upon inquiry, however, Tom’s father did not seem to know much about the history of the pre-World War II units in his “crest” collection that, for some reason, were the kinds of insignia to which I was particularly drawn. I started my own collection and wanted to know everything I could about those units. As I collected by attending militaria shows and traded insignia with many former soldiers of the World War II and Korean War eras, I discovered that, other than Regular Army units, the collectors did not seem to know much about most of the older National Guard and Organized Reserve units either. I started digging for information at the Infantry School library at Fort Benning, Georgia. I found some information on National Guard units, but could find almost nothing about the Organized Reserve. Those units seemed to have been lost to Army history. It was almost as if the units and their officers and men hardly even existed. The conundrum was also keen for the four, virtually unknown, cavalry divisions in the National Guard during that period. I read everything I could find about these Reserve Component units, but everywhere I looked, I seemed to come up with very little.

In 1990, while attending the Inspector General’s course at Fort Belvoir, VA, I decided to go to the National Archives in Suitland, MD, to see what I could find on these old outfits. There I discovered a treasure trove of documents in Record Group 394 that laid out much of the organization and activities of the interwar Army. I also discovered that here was an Army that was indeed genuine, composed of real people and units and not merely the “paper army” that I had come to believe was the Organized Reserve. I also learned that the Army was busier with training, maneuvers, and emergency duties than I imagined. The Regular Army was involved in a wide variety of duties that included activities as diverse as martial law duty in labor strikes to engineer surveys of the Nicaragua Canal project and deployments to Shanghai, China. I found that the National Guard was intended to be a much larger organization than what actually existed during this period; each state was allotted many more units than they could actually organize due to lack of funding by Congress and the sagging interest in military service after World War I. I discovered that members of the third component, the Organized Reserve, were an amazing collection of men who willingly participated in monthly training meetings without pay or retirement benefits. Unlike the National Guardsmen who were also paid for drills, these men were paid only for their attendance at the annual 2-week summer training camp. Yet, year after year, the Organized Reserve continued to grow, and it was this group of soldiers, especially the officers, who made possible the creation of the huge US Army of World War II. All of these men served at a time when the military, and especially the Army, was given short shrift by the Nation. Yet the men and the units to which they belonged continued to soldier on, almost forgotten yet still proud to do the job that so many others deigned to do. Here was a story that needed to be told, and I decided at that point that I would do it. In completing this work, it is my hope that this information will be found useful by command historians, especially unit historians, for all three components of the US Army, in helping them to tell the story of these organizations. Many of the units whose histories are contained herein still exist today, and it is important to make this kind of information available, especially now due to the reorganization of the Army to the modular tables of organization. To break with these long and storied histories is like throwing away a combat multiplier. The Army has already done that to some degree with units at the division level and above. Not one division, corps, or army, for example, has a history dating before

1917, except the 28th Division of the Pennsylvania National Guard (though the 27th Infantry Brigade of the New York National Guard carries the lineage of the pre-World War I predecessor of the 27th Division). The lineage of those proud divisions, corps, and armies of the Civil War and Spanish American War are no longer found in the Active force. The US Army has a great history, and its men and units made that history both in times of war and peace. The historical connection between yesterday's generation of soldiers and today's soldiers are the units themselves. That connection should never be broken lightly. Soldiers should have the opportunity to know what their predecessors did and accomplished, even in peacetime. I hope this work contributes to that goal.

## Explanatory Notes

### Example Unit Entry (battalions, regiments, brigades)

<i>Unit Title and Type</i>	<i>Parenthetical</i>	<i>Component and Geographic Allotment</i>
↓	↓	↓
<b>308th Cavalry Regiment</b> (62d Cavalry Division)		<b>Organized Reserve Maryland/Pennsylvania</b>
HQ—Cumberland, MD, 1921–22; Pittsburgh, PA, 1923–41 ← <i>Headquarters Location</i>		

Demobilized 22 December 1918 at Camp Kearny, CA, as the 65th and 66th Field Artillery Regiments, and on 21 December 1918 as the 22d Trench Mortar Battery. All elements reconstituted in the Organized Reserves on 15 October 1921 and consolidated as the 308th Cavalry, assigned to the 62d Cavalry Division, and allotted to the Third Corps Area. Organized 10 November 1921 with regimental headquarters at Cumberland, MD. Regiment relocated about October 1922 to western Pennsylvania. Regimental headquarters concurrently organized at Pittsburgh. Reorganized 1 July 1929 as a three-squadron regiment. Concurrently, entire regiment relocated to Pittsburgh, PA. Typically conducted its Inactive Training Period meetings at the 107th Field Artillery’s Hunt Armory at the Post Office Building in Pittsburgh. Members built the 308th Cavalry Club in 1928 on property owned by the Aspinwall Hospital in Aspinwall, PA, and conducted some Inactive Training there. Facilities included equestrian, pistol, and saber training areas. Conducted regular equestrian training with the horses of the 107th Field Artillery. Conducted summer training with the 3d Cavalry Regiment at Fort Myer, VA, and at Fort Belvoir, VA. Trained with the units of the 52d Cavalry Brigade at Mount Gretna, PA, in July 1928. Conducted cavalry Citizens Military Training Camp (CMTC) training at Fort Myer as an alternate form of training. Designated mobilization training station was the York Concentration Area, PA. Location 7 December 1941—Pittsburgh, PA.

Unit Service Narrative

**Organization Day:** 24 February. Chosen to commemorate the regiment’s organization on 24 February 1918.

**Status:** Disbanded 11 November 1944 as the 66th Tank Destroyer Battalion. ← *Unit status as of 2001*

**Events:** 301 ← *Events in which the unit participated 1919–41 (see appendix B).*

#### Commanders, 308th Cavalry Regiment

Col. John J. Boniface	24 February 1918–25 April 1918	Col. Jean H.A. Day	15 September 1926–ao October 1926
Col. Hugh D. Berkeley	26 April 1918–24 September 1918	Col. Josiah L. Reese	ao March 1927–25 February 1930
<i>Demobilized/Inactive</i>	21 December 1918–10 November 1921	Col. George H. Cherrington	25 February 1930–January 1941
Lt. Col. Elmer J. Kingsbury	10 November 1921–October 1922	Unknown	January 1941–5 May 1941
Col. Josiah L. Reese	October 1922–15 September 1926	Lt. Col. John H. Schenkel	5 May 1941–6 November 1941

### Purposes and Scope

The purposes of *US Army Order of Battle 1919–1941* are threefold. The first is to fill a void in the published record of US Army units documented by *Order of Battle of the United States Land Forces in the World War* published by the Center of Military History and Mr. Shelby L. Stanton’s *Order of Battle, U.S. Army World War II*. The second is to provide Army command historians, unit historians, and other individuals who are trying to research specific unit histories a basic overview of what these units were doing in the interwar period, where the units were located, and who commanded them. The third is to provide a private individual who had a relative who served during this period, and who wishes to know what that service may have consisted of, an account of the major activities in which the relative’s unit was involved. The scope of the work covers units from the size of separate battalions from all arms and services to field armies, as well as the actual order of battle of each as applicable.

Each unit is represented by a unit entry block. The entries contain a host of information that is standardized in its presentation as far as possible. Each entry includes the unit title and type, the headquarters to which the unit was assigned, the geographical area to which the unit was allotted (if National Guard or

Organized Reserve), the unit's headquarters location, the unit's physical location (or the unit's headquarters location if dispersed) on 7 December 1941, a unit service narrative, the unit's organization day, the unit's status as of 2001, and a chronological listing of the unit's commanding officers. Depending on the type of unit, additional information may include a listing of subordinate units and their years of assignment; "snapshot" orders of battle for divisions, corps, and armies for selected years; and the subordinate components of nonstandard units such as harbor defense commands. Also included in this work are the headquarters, a unit service narrative, commanders, and a "Major posts, camps, stations, airfields, and National Guard and Organized Reserve training facilities" section for each of the nine corps areas and three overseas departments. Though these were not tactical headquarters in the traditional sense, their importance to this period, and to this project, were such that I felt compelled to add their information.

### **Unit Title and Type**

The unit title, in most cases, is the designation by which the unit was known for most of the 1919–41 period. In some cases, most notably the Air Service/Air Corps units, several unit titles followed by dates are given due to numerous redesignations.

### **Parentheticals**

Titles are often followed by parenthetical information. Typically, the first of these will be the unit type or weapon, such as (**Antiaircraft**) or (**75-mm G**). These designations will always be in boldface type. The notation (C) will follow some units. This indicates the unit was designated as a "Colored" unit and manned by African American personnel. The term "Colored" and the designation (C) were the standard usage of the period in mobilization documents and elsewhere and are used here for historical purposes. These designations too will always be in boldface type. Some units held the same designation at different times, but are not the same organization. These titles will be followed by a Roman numeral in parentheses, e.g., (I), (II), etc., to clearly differentiate the separate units. These designations will always be in standard type. The final example of parenthetical information is the major headquarters to which the unit was assigned, for example: (1st Division). This is typically the brigade, division, corps, or army to which the unit was assigned. For National Guard units, these reflect planned mobilization assignments for wartime and do not necessarily reflect actual peacetime command and control relationships. In some cases, again most often Air Service/Air Corps units, the organization was assigned to several different headquarters from 1919 to 1941. In those cases, I have attempted to designate that headquarters to which the unit was assigned for the longest period or, in some instances, the headquarters to which it was assigned in the initial mobilization plans of 1921–23. Admittedly, there are a few instances where these two examples will not apply, but in each of these exceptional cases, the rationale was different and it is not feasible to explain every reason. The headquarters designations will also be in standard type.

### **Component and Geographic Allotment**

National Guard and Organized Reserve units are identified in this section of the unit entry. The state or states of allotment are also identified. In some cases, the unit was allotted for organization to more than one state. In those instances, the states of allotment will be identified with the conjunction "and" as such: **Alabama, Mississippi, and Louisiana National Guard**. Typically, the state to which the headquarters was allotted will appear first. In other cases, usually Organized Reserve units, the organization was withdrawn from allotment to one state or geographical area, and reallocated to another. In those instances, the initial state or states of allotment and the follow-on state or states will be differentiated with a slash "/", indicating the first, second, etc., areas of allotment as such: **Organized Reserve Missouri and Kansas/South Dakota**. In some cases for National Guard or Organized Reserve units, an organization was constituted but never allotted to a given state. In those instances, only the component (i.e., **National Guard** or **Organized Reserve**) is listed. Regular Army units that were generally in an inactive status between 1921 and 1939 are shown as **Regular Army Inactive** (RAI). The vast majority of RAI units were organized with Reserve personnel during this period and thus are differentiated in this manner from Organized Reserve units and active Regular Army units. Many Organized Reserve units were withdrawn from the Reserve and allotted



to the Regular Army between 1927 and 1940. These units are all listed herein as Organized Reserve units as that is the component in which they were originally allotted. Active Regular Army units below division level and which headquarters were active for the majority of 1919 to 1941 will have no component listed.

### **Headquarters Location**

The city or post and state or overseas location where the unit's headquarters was physically and permanently located, roughly between January 1919 and 7 December 1941, is listed here. Generally speaking, temporary locations are not included unless the absence from the permanent location was for 6 months or longer. The location and relocation dates for Regular Army and National Guard units are generally accurate, having been determined from unit data cards for the Regular Army and state annual or biennial reports and various other documents for National Guard units. While the majority of the initial organization dates and locations for Organized Reserve (O.R.) units are generally accurate, the relocation dates were somewhat problematic for these units. The primary document used to determine O.R. headquarters locations are 3"x5" index cards located at the Center of Military History at Fort McNair in Washington, DC. These cards were the methodology by which the Army tracked O.R. units in the interwar period. They usually (though not always) contain dates and headquarters location for the relocation of the units, but the relocation dates themselves are often that of the actual document that notified the individual who kept the cards rather than the actual date of the relocation. The date provided on the index card has typically been used as the date of relocation in the absence of the actual date. Those dates, however, while generally accurate, can be as much as a year off. In those instances where the actual relocation date has been located in other kinds of documents, the actual date has been used.

### **Unit Service Narrative**

The service narrative generally provides an overview of the unit's permanent changes of station, assignment and reassignment to major commands, allotment to and withdrawal from component (Regular Army [R.A.], National Guard [N.G.], O.R.), allotment to corps area or overseas department, initial organization date and location, training activities and locations, activation and inactivation, and the location of the unit (or of the unit headquarters if the unit was dispersed) on 7 December 1941. Special events and activities, awards, and deployments are also covered. For R.A. units, support to the Civilian Conservation Corps and training support to O.R. units are covered. For N.G. units, callups for state emergencies of battalion-size or larger, dates of Federal recognition, dates of induction into Federal service, summer training camp locations, and mobilization training stations are covered. For O.R. units, locations for Inactive Training Period meetings, summer training camp locations, mobilization training stations, and Reserve Officers' Training Corps (ROTC) feeder units are covered. Regular Army Inactive (RAI) units are covered similarly to O.R. units with the addition of information on Active Associate units and affiliation with ROTC units. Dates provided for unit movements are generally the dates of arrival at the new location by the unit headquarters, unless specifically given as a departure date from the losing duty station. Subordinate elements of the unit may have arrived before or after that date.

### **Organization Day**

The War Department's General Order #24, dated 10 June 1922, established the concept of "Organization Day" (sometimes referred to as "Regimental Day") for US Army units. The Organization Day was not necessarily the date on which the unit was organized. It could also be a special date in its history such as its baptism of fire in combat. In instances where an Organization Day had been adopted, the unit's chosen date for Organization Day, an explanation of the date's significance, and the date of adoption are given, if known.

### **Status**

The unit's status (active, inactive, disbanded, etc.) and designation as of 2001 is given if known.

### **Events**

The numbers represent events of significance in which the unit participated between 1919 and 1941. The details of each event number are located in appendix B.

## Commanders

Where known, the unit's commanders and their inclusive dates of command are provided for regiment-size units and above, and selected battalion-size units. The dates of command are for the period 1 January 1919 to 7 December 1941, or the end date of command for the last pre-World War II commander, whichever is later. For infantry, cavalry, field artillery, coast artillery, and engineer regiments, the commanders for the World War I period are also provided if known, because those commander lists were not previously provided in the Center of Military History's *Order of Battle of the United States Land Forces in the World War*. For some N.G. units, the commanders will have a state abbreviation in parentheses following their name (e.g., (GA) for the state of Georgia) in those instances where the unit was a multistate organization to identify from which state the commander was assigned. If the commander of a N.G. or O.R. unit was an R.A. officer, the name will be followed by the abbreviation (R.A.). If the commander of a N.G. or R.A. unit was an O.R. officer, the name will be followed by the abbreviation (O.R.). If the name is not followed by an abbreviation, the commander is of the component or state to which the unit headquarters was allotted. If a commander is not known for a given period, the entry "Unknown" and the inclusive dates (at least month and year) are provided. In some instances, especially for O.R. units, the inclusive dates for a given commander are not known. In those cases, the entry "ao" (for "as of") followed by a month and year indicates the earliest or latest date known for that commander to be in command of the unit indicated. The example below indicates that Colonel William J. Smith was known to be in command from at least July 1937 to at least April 1940.

**Example:** Col. William J. Smith

ao July 1937–ao April 1940

Additionally, a single asterisk (\*) beside a commander's name indicates he was an R.A. officer in command of an RAI unit. Two asterisks (\*\*) indicates a Reserve officer who was in command of an RAI unit. Note that relatively few O.R. brigades and no RAI brigades were assigned a brigadier general as commanding general. These headquarters functioned as such on few occasions, usually at a command post exercise or occasionally during annual training. The brigade was strictly a tactical command during this period and exercised no administrative duties or responsibilities. Those duties were performed at the division and regimental levels. For that reason, O.R. and RAI brigades were generally "commanded" by majors or lieutenant colonels whose duties were primarily limited to planning, conducting, or supervising training in the brigade headquarters during the inactive training period. More often than not, personnel assigned to brigade headquarters simply conducted their inactive training with one of the subordinate regiments. At summer training, the senior regimental commander often served as the brigade commander when the brigade headquarters was intended to function as such. When assignment of Reserve officers to RAI regiments began in 1926, only a single reserve major (later changed to a lieutenant colonel) was authorized as the commander though the regiment could acquire its full quota of captains and lieutenants from the officer's Reserve Corps. In 1927, the command of these regiments was, in many cases, passed to selected Active Duty R.A. colonels and lieutenant colonels who, for the most part, were the professors of Military Science and Tactics at the college or university with which the RAI unit was affiliated. This practice seems to have effectively ended on 1 October 1933, though in some instances it was ended earlier, after which command was exercised by the senior Reserve officer assigned. Most units not affiliated with an educational institution were commanded by Reserve officers, though in a few cases they were commanded by R.A. officers who were assigned as an additional duty. This practice also seems to have ended on 1 October 1933. In many instances, brigades and regiments were commanded by captains and even lieutenants. Those organizations seem to have served more as Reserve pool units for mobilization assignment purposes than actual functional units. This was usually because the assigned personnel were geographically dispersed so as to prevent regular assembly for inactive training periods. Nonetheless, the senior officer assigned acted as the commanding officer during summer training unless a higher ranking officer was temporarily attached to assume command for the camp period.

**Example Major Command Unit Entry** (divisions, corps, armies)

Major command unit entries generally follow the same pattern as those for smaller unit entries with the exceptions detailed below.

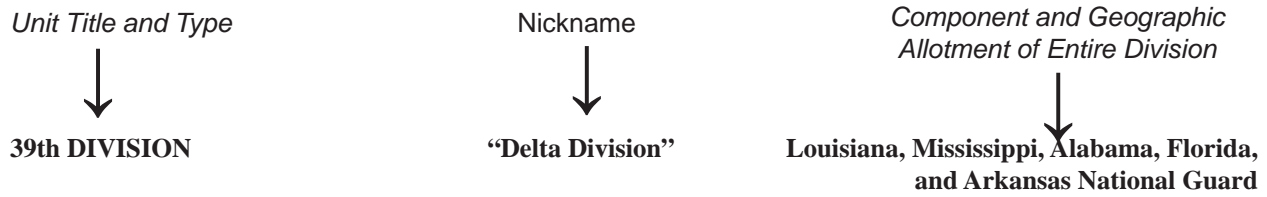

HQ—*Not organized, 1921–23* ← *Headquarters Location*

The 39th Division headquarters arrived at Newport News, VA, aboard the S.S. *Matoika* on 31 December 1918 after 4 months of overseas service and was demobilized 23 January 1919 at Camp Beauregard, LA. In accordance with the National Defense Act of 1920, the division was allotted to the states of Louisiana, Alabama, Mississippi, Florida, and Arkansas and assigned to the IV Corps in 1921. The division’s designated mobilization training station was Camp McClellan, AL. The division headquarters was not reorganized before the adjutants general of the several states from which the division was drawn petitioned the War Department to change the designation of the division to be formed as the 31st Division as that was the organization in which most of the states’ units served in World War I. The request was approved and the subordinate elements assigned to the 39th Division were withdrawn and assigned to the 31st Division, less the Arkansas elements, effective 1 July 1923.

Unit Service Narrative

**Status:** Headquarters and Headquarters Company currently active at Little Rock, AR, as HHC, 39th Infantry Brigade.

**Division Commanders**

*No commanders assigned*

**39th DIVISION  
Organization 1923**

<b>UNIT:</b>	<b>HQ LOCATION:</b>
<i>Headquarters</i>	<i>Alabama N.G.*</i>
<i>Headquarters, Special Troops</i>	<i>Alabama N.G.*</i>
<i>Headquarters Company</i>	<i>Mobile, AL</i>
<i>39th Military Police Company</i>	<i>Florida N.G.*</i>
<i>39th Signal Company</i>	<i>Alabama N.G.*</i>
<i>114th Ordnance Company (M)</i>	<i>Jacksonville, FL</i>
<i>39th Tank Company (L)</i>	<i>Ozark, AL</i>
<i>Motorcycle Company No. 114</i>	<i>Florida N.G.*</i>
<b>77th Infantry Brigade</b>	<i>Montgomery, AL</i>
<i>154th Infantry Regiment</i>	<i>Jacksonville, FL</i>
<i>167th Infantry Regiment</i>	<i>Gadsden, AL</i>
<b>78th Infantry Brigade</b>	<i>New Orleans, LA</i>
<i>155th Infantry Regiment</i>	<i>Vicksburg, MS</i>
<i>156th Infantry Regiment</i>	<i>New Orleans, LA</i>
<b>64th Field Artillery Brigade</b>	<i>Louisiana N.G.*</i>
<i>114th Ammunition Train</i>	<i>Elba, AL</i>
<i>116th Field Artillery Regiment</i>	<i>Florida N.G.*</i>
<i>141st Field Artillery Regiment</i>	<i>Alabama N.G.*</i>
<i>114th Engineer Regiment</i>	<i>Mississippi N.G.*</i>
<i>114th Medical Regiment</i>	<i>Louisiana N.G.*</i>
<i>39th Division Train, Q.M.C.</i>	<i>Mississippi N.G.*</i>
<i>39th Division Air Service</i>	<i>Birmingham, AL</i>

Organization/  
Order of Battle

\*Indicates state of headquarters allocation; headquarters not organized or inactive.

## **Nickname**

Many divisions adopted nicknames in the World War I period or, in a few cases, the nickname was adopted after the division was constituted or reconstituted in 1921. The nicknames are shown as illustrated.

## **Component and Geographic Allotment**

For corps and armies, only the state to which the headquarters was allotted are listed. For divisions, every state that was allotted a unit in the division's order of battle is listed. The state to which the headquarters was originally allotted and organized will be listed first.

## **Organization/Order of Battle**

Each division, corps, and field army has one or two "snapshot" orders of battle provided to illustrate how the command was organized at the time indicated. The 1939 order of battle provided for the R.A.'s 1st through 9th Divisions represent those divisions' final organization before the change to the "triangular" tables of organization in October 1939. Unit designations in italics indicate an inactive unit or a "not organized" or "not initiated" unit. Unit headquarters locations in italics represent the state of allotment for National Guard Inactive (NGI) units and the corps area of allotment for RAI and Organized Reserve Inactive (ORI) units. Partially active units (i.e., the headquarters was inactive, but some subordinate elements were active) are also shown in italics. For partially active units, the unit headquarters mobilization station/post is also shown in italics.

## **Division Commanders and Chiefs of Staff**

Note that about half of the O.R. divisions actually had at least one general officer assigned as division commander sometime during this period, and none had a general assigned for the entire period. In most cases, one of the R.A. brigade commanders in the corps area was assigned as the commanding general of one of the three O.R. divisions as an additional duty. This practice seems to have been most widely used in the Second, Fourth, Fifth, and Seventh Corps Areas. In some cases, the corps area commander assigned that duty to himself. In two instances, those of the 77th and 95th Divisions, Reserve divisions were actually commanded by a Reserve officer. Generally speaking, the division's chief of staff exercised routine command in the name of the corps area commander or the assigned division commander. Thus, the names of the R.A. chiefs of staff assigned to O.R. divisions have been included in this *Order of Battle*.

## **Terminology and Abbreviations**

The military and ethnic terminology and abbreviations used in this work are those that were used from 1919 to 1941; therefore, at the beginning of each volume is a Key to Abbreviations. See Appendix A, "Glossary of Terms," for definitions of the terminology used in this *Order of Battle*.

## **The National Guard**

The N.G. poses several problems in preparing a work such as this because the rules by which the Center of Military History (and the states themselves) trace each unit's lineage do not always mirror those for the R.A. and O.R./US Army Reserve. For example, when a unit in the O.R. was relocated from one community to another, the unit retained its history and designation. In the case of the N.G., however, when a unit designation was relocated to a unit in another community, the history of the unit was retained in the organization located in the first community. Also, if a unit was demobilized (i.e., disbanded) in one community, and then in another community a unit is organized with the same designation, there was, in theory, no relation between the two units other than the fact that they happened to have shared the same designation. For example, the 120th Ammunition Train was organized at Bristow, OK, in May 1923. The unit in Bristow was disbanded in May 1924. A new 120th Ammunition Train was organized at Sperry, OK, in June 1924 and later reorganized as Headquarters Battery, 160th Field Artillery in June 1926. Another new 120th Ammunition Train was organized at Haskell, OK, also in June 1926, and later reorganized as Battery B,

160th Field Artillery in January 1927. In theory, there were three different organizations with the designation “120th Ammunition Train” and as such, each should merit a separate Unit Entry in this *Order of Battle*. To complicate matters, regimental, brigade, and division headquarters appear not to have been considered state- or community-specific units. For example, the Headquarters, 108th Cavalry at New Orleans, LA, was withdrawn from the state of Louisiana on 15 March 1929 and allotted to the state of Georgia and reorganized at Hinesville, GA. There appears to have been no loss of identity or history in the transfer of that unit designation between states, much less between communities in the same state. It is the same unit with the same lineage. Additionally, the Center of Military History does not consider N.G. units “constituted,” even though the Federal designations of those units were clearly “placed on the rolls of the army” (this is especially pertinent since the vast majority of N.G. units used Federal designations and not state designations during the period) and allotted to the various states in 1920–21 in accordance with the guidelines laid out in the 1920 amendment to the National Defense Act of 1916. The methodology appears to assume that the designation does not exist (at least on the rolls of the Army) until the day the unit is organized and federally recognized, even though letters and memorandums allotting the unit designation to a state, mobilization plans, and numerous other documents clearly refer to the existence of the unit designation before it was actually organized. In light of these pre-existing designations, for the purposes of this *Order of Battle*, I have chosen to consider the designation of N.G. units to have been constituted in the same manner as R.A. and O.R. units (i.e., when the designation of a unit was placed on the rolls of the Army). Therefore, those units that have a clearly differentiated identity (in other words, separate battalions, regiments, divisions, etc.) are treated as one and the same organization in the Unit Entries. Only in rare instances are two (or more) N.G. units with the same designation treated as separate and distinctly different organizations. The Unit Entries for these units generally makes the purpose for differentiation self-evident.



## Key to Abbreviations

(AA)	antiaircraft	Aux	auxiliary
(C)	Colored	Avn.	aviation
(CA)	civilian airfield	AZ	Arizona
(CC)	civilian college	B.A.G.	Branch Assignment Group
(H)	heavy	Bkry	bakery
(HD)	horse drawn	Bln.	balloon
(HP)	heavy ponton	Bn.	battalion
(HT)	heavy tractor	Bomb.	bombardment
(HTA)	heavier-than-air	Brig.	brigade
(L)	light	Brig. Gen.	brigadier general
(LP)	light ponton	Btry	battery
(LT)	light tank	C.A.	coast artillery
(LTA)	lighter-than-air	C.A.C.	Coast Artillery Corps
(M&H)	medium & heavy	C.G.	commanding general
(M)	medium	C.O.	commanding officer
(MA)	military airfield	C.S.A.	Confederate States of America
(MC)	military college	C.W.S.	Chemical Warfare Service
(Mecz)	mechanized	C.Z.	Communications Zone
(MI)	military institute	CA	California
(MT)	medium tank	Camo	camouflage
(Mtd)	mounted	Capt.	Captain
(Mtzd)	motorized	CARL	Combined Arms Research Library
(NGF)	National Guard Aviation Facility	CARS	Combat Arms Regimental System
(PS)	Philippine Scouts	CASC	Corps Area Service Command
(RO)	railway operating	CASU	Corps Area Service Unit
(RY)	railway	Cav.	cavalry
(S&F)	sound and flash	Cbt	combat
(TD)	tractor/truck drawn	CCC	Civilian Conservation Corps
(Topo)	topographic	CCX	Command and Communications Exercise
(WS)	water supply	CD	Coast Defenses
A.A.	Active Associate	Chem.	Chemical
AAB	Army Air Base	CIA	Central Intelligence Agency
Abn	airborne	CM	civilian master
AC	Air Corps	Cmd	command
Adj.	adjutant	Cmpl.	Complement
Adm.	airdrome	CMTC	Citizens Military Training Camp
Admin	administration	CO	Colorado
AEF	American Expeditionary Force	Co.	company
AFG	American Forces, Germany	Col.	colonel
AFHRA	Air Force Historical Research Agency	Coll	collecting
AIT	advanced individual training	Commo	communications
AK	Alaska	Comp.	composite
AL	Alabama	Conv	convalescent
amb.	ambulance	Cos.	companies
ammo.	ammunition	Cpl.	Corporal
ao	as of	CPX	command post exercise
AP	airport	CST	common skills training
AR	Arkansas	CT	Connecticut
Armd.	armored	Ctr.	Center
Armt	armament	CZ	Canal Zone
Ars.	arsenal	DC	District of Columbia
Arty.	Artillery	DE	Delaware
AS	air service	Dent	dental
Ash.	airship	Dep	depot
Atk.	attack	Dept.	department
ATS	army transport service	Det.	detachment

Disch.	Discharge	Instr.	Instructor
Dispary.	Dispensary	Intel	intelligence
Dist.	District	KKK	Ku Klux Klan
Div. Arty.	division artillery	KS	Kansas
Div.	division	KY	Kentucky
DNG	Deferred National Guard	LA	Louisiana
Doc	document	Lab	laboratory
DT	dump truck	LB	light bridge
e.g.	for example	LM	light maintenance
EEN&T	eyes, ears, nose & throat	Lt.	lieutenant
elmts	elements	Lt. Col.	lieutenant colonel
Engr.	engineer	Lt. Gen.	lieutenant general
Engrs.	engineers	LUTC	Local Unit Training Camp
ERC	Enlisted Reserve Corps	M. Rep. Bn.	Motor Repair Battalion
etc.	and so forth	M. Rep. Sec	Motor Repair Section
Evac	evacuation	M. Rep.	motor repair
F.A.	field artillery	M.C.	Medical Corps
Fin.	Finance	M.P.	military police
FL	Florida	M.T. Cmd.	motor transport command
Fld	field	M.T. Co.	motor transport company
G	gun	M.T.	motor transport
G.O.	General Order	M.T.C.	Motor Transport Corps
G.P.F.	Grande Puissance Filloux	MA	Massachusetts
GA	Georgia	Maint	maintenance
Gen.	General	Maj.	major
G-H	gun, horse drawn	Maj. Gen.	major general
GHQ	General Headquarters	Man'g	maneuvering
GHQR	General Headquarters Reserve	Max-Fac	maxillo-facial
Gonio	goniological	MD	Maryland
G-P	gun, portee	ME	Maine
Gp.	group	mecz	mechanized
GS	general support	Med.	Medical
GUTC	General Unit Training Camp	Met	meteorology
H	howitzer	MG	machine gun
Haw Div	Hawaiian Division	MGM	Metro-Goldwyn Mayer
HB	heavy bridge	MI	Michigan
HD	Harbor Defenses	Mil.	Military
HHB	headquarters and headquarters battery	Misc	miscellaneous
HHC	headquarters and headquarters company	MN	Minnesota
HHD	headquarters and headquarters detachment	MO	Missouri
HHS	headquarters and headquarters squadron	mob.	Mobilization
HHSC	headquarters and headquarters and service company	MR	military reservation
HHT	headquarters and headquarters troop	MS	Mississippi
HI	Hawaii	MT	Montana
HM	heavy maintenance	Mtcyl	motorcycle
Hosp.	hospital	mtz	motorized
Hosp Ctr	hospital center	N.G.	National Guard
HQ	headquarters	NC	North Carolina
Hv	heavy	NCO	noncommissioned officer
i.e.	that is	ND	North Dakota
I.G.	inspector general	NE	Nebraska
IA	Iowa	NGI	National Guard Inactive
ID	Idaho	NGR	National Guard Reserve
IL	Illinois	NH	New Hampshire
IN	Indiana	NJ	New Jersey
Induct.	Induction	NM	New Mexico
Inf.	Infantry	No.	number
		NV	Nevada













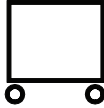









NY	New York	S.S.	steam ship
NYPOE	New York Port of Embarkation	San.	sanitary
O.R.	Organized Reserve	SC	South Carolina
Obsn.	observation	SCF	Southern Coastal Frontier
Ofc.	Office	Sch. B&C	School for Bakers and Cooks
OH	Ohio	Sch.	School
OK	Oklahoma	SD	South Dakota
Opns	operations	sec	section
OR	Oregon	Secr	secret
ORC	Officers Reserve Corps	Sect.	sector
Ord.	ordnance	Sel	selective
Org.	organization	Sep.	separate
ORI	Organized Reserve Inactive	SFPOE	San Francisco Port of Embarkation
OV	overseas	Sig.	signal
P.M.O.	Provost Marshal Office	Sp. Tps.	special troops
P2D	Provisional 2d Division	Sp.	Special
PA	Pennsylvania	Sq.	squadron
PC Div.	Panama Canal Division	SSD	Selective Service Detachment
Pers	personnel	Sta.	station
PG	Proving Ground	Sup	supply
Ph Div.	Philippine Division	Sup Dep	supply depot
PI	Philippine Islands	Surg.	surgeon/surgical
PID	Provisional Infantry Division	Sv	service
PL	Public Law	T/O	table of organization
Plt.	Platoon	TA	Territory of Alaska
PMS&T	Professor of Military Science and Tactics	Tact.	Tactical
POE	port of embarkation	TH	Territory of Hawaii
Port	portee	Tm	team
PR	Peurto Rico	TN	Tennessee
Prof Sv	professional services	Tn.	train
Prov.	provisional	Tng.	Training
Purs.	pursuit	Tp.	troop
Q.M.	quartermaster	Tr Mtr	trench mortar
Q.M.C.	quartermaster corps	Trans	transportation
R&I	Reception and Integration	Trk	truck
R.A.	Regular Army	TX	Texas
R.A.T.C.	Regular Army Training Center	U.S.A.C.S.	U.S. Army Cable Ship
Rad.	radio	U.S.A.J.M.P.	U.S. Army Junior Mine Planter
RAI	Regular Army Inactive	U.S.A.M.P.	U.S. Army Mine Planter
RAR	Regular Army Reserve	U.S.A.T.	U.S. Army Transport
Rcn.	reconnaissance	U.S.A.T.S.	U.S. Army Transport Service
Rct.	Recruit	U.S.C.G.C.	U.S. Coast Guard Cutter
Rctg.	Recruiting	U.S.C.G.T.	U.S. Coast Guard Tender
Rec'g	receiving	U.S.D.B.	United States Disciplinary Barracks
Recep.	Reception	U.S.L.H.T.	U.S. Light House Tender
Recr.	Recreation	U.S.M.C.	United States Marine Corps
Regt.	regiment	U.S.S.	United States Ship
Repl.	Replacement	U.S.V.	United States Volunteers
Res	reserve	US	United States
RI	Rhode Island	USARS	United States Army Regimental System
Rmt	remount	USN	United States Navy
Roent	roentgenology	UT	Utah
ROK	Republic of Korea	V.C.	Veterinary Corps
ROTC	Reserve Officers' Training Corps	VA	Virginia
RP	Republic of Panama	VI	Virgin Islands
Rpr	repair	VM	Vickers-Maxim
S.C.	Signal Corps	VT	Vermont
S.R.	sound ranging	WA	Washington

Wag	wagon
WDGMP	War Department General Mobilization Plan
WDGS	War Department General Staff
WI	Wisconsin
WPD	War Plans Division
WV	West Virginia
WX	weather
WY	Wyoming
XC	cross-country
Z.I.	Zone of the Interior

## Military Map and Illustration Symbols

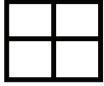
These symbols are used in the maps, tables of organization, and other illustrations presented in this *Order of Battle*. They reflect the common symbols in use from 1919 to 1941.

	Unit		Engineer unit
	Train or motorized unit		Special Troops unit
	Railway unit		Mine Planter
	Infantry unit		Quartermaster unit
	Cavalry unit		Transport unit
	Artillery unit		Military Police unit
	Ammunition unit		Signal Corps unit
	Tank unit		Ordnance unit
	Air service/air corps unit		Chemical Warfare unit
	Airship unit		Medical unit
	Balloon unit		Veterinary unit

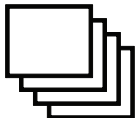
 multiple units of the same size and type

 machine gun

 animal drawn

 laboratory

 squad

 detachment/section

 platoon/flight

 company

 battalion/squadron

 regiment/group

 brigade

 division

 corps

 army

 GHQ or army group

# **Part I**

## **Organization of the US Army**

**1919–41**



## Chapter 1

### Genesis of the Modern American Army

Many historians consider the advent of Elihu Root as President William McKinley's Secretary of War in 1899 the beginning of the modern United States (US) Army. A remarkable man who never served a day in uniform, Root was responsible for a series of legislative bills passed through Congress between 1900 and 1903 that led to a major reorganization of the US Army and a substantial improvement in the officer education system. Root's most important accomplishments include the establishment of the US Army War College, US Army Command and General Staff School, and Army General Staff; and transition of the position of Commanding General of the Army to the Chief of Staff, US Army. These improvements to Army organization and education were the beginning of a series of long needed changes that would transform the US Army by the beginning of World War I into a relatively modern force that was more capable of assuming the missions, domestic and overseas, of a nation that had become a key player on the world scene.

The Root reforms, as they are often called, were complemented by another piece of legislation passed during this period—the 1903 Dick Act. This act thoroughly revamped the outdated Militia Act of 1792 that, up to then, had been the basis for mobilization, organization, administration, and training of the Army. The new act reorganized the Army's reserve forces into the Organized Militia (the National Guard [N.G.]) and the Reserve Militia, the latter force essentially consisted of all able-bodied male citizens ages 18 to 45. It provided for the reorganization of the N.G. to reflect a standardized organization along the lines of the Regular Army (R.A.) as well as authorization for Federal funding to N.G. units that met specific requirements in prescribed drill periods and annual Federal inspections. The act required each state and territory to appoint an adjutant general who would be responsible for implementing the Federal aspects of the act and report annually to the Secretary of War on the progress of implementation and maintenance of the act's provisions. Additionally, the act provided for the assignment of R.A. instructors to N.G. units and for periodic joint maneuvers with R.A. units. The Dick Act also outlined other needed improvements dealing with militia issues to include examinations for commissions, age and eligibility requirements, and the provision of pensions for militiamen killed during Federal service.

The Dick Act went a long way toward developing something closer to a "one Army" concept. However, it did not tackle many other issues confronting the US Army during its reorganization to address the complex challenges facing a modern military. Therefore, a series of other bills affecting the Army were passed between 1903 and 1916 that provided for, among other things, the establishment of the Medical Reserve Corps (1908) and an enlisted Regular Army Reserve (RAR) (1912), the latter being a pool of former enlisted men who were available to rapidly expand the small R.A. in times of emergency. The most sweeping legislation affecting the Army before World War I was the passage of the National Defense Act of 1916.

The 1916 act now defined the Army of the United States as the "Regular Army, the Volunteer Army, the Officers Reserve Corps, the Enlisted Reserve Corps, the National Guard while in the service of the United States, and other such land forces as are now or may hereafter be authorized by law." It provided for an increase of the R.A. to a peacetime strength of 175,000 and expansion to 300,000 in time of war. Like the Dick Act, the 1916 act brought sweeping changes to the N.G. The Guard was now increased to an authorized strength of 400,000. Significantly, the act required National Guardsmen to take both a state and Federal oath that would then allow the induction of N.G. units into Federal service for employment beyond the borders of the United States. It also provided Federal pay for 48 drill periods a year, identified standards for Federal recognition of Guard officers for Federal commissions, and authorized the president to determine numbers and types of units to be raised and maintained by each state. As implied above, the act also created the Officers' Reserve Corps (ORC) and the Enlisted Reserve Corps (ERC) to provide a pool of semi-trained reservists who could rapidly expand the Army in an emergency. In addition, the Reserve Officers' Training Corps (ROTC) was established to provide educated and trained young men from our Nation's colleges and universities who would enter the ORC as commissioned second lieutenants.

The implementation of the National Defense Act of 1916 came too late to have a significant impact on the Army's readiness for entry into World War I; however, it was not entirely ineffectual. The change to a dual-status N.G. avoided the political and legal wrangling over the use of the Guard for overseas service as experienced during the Spanish–American War. Perhaps the main effect of the act before the war was in the area of the ORC and ERC. Through the use of Regular Army Instruction Camps (nicknamed “Plattsburg Camps” after the prototype camp held at Plattsburg, NY, in 1915), the Army was able to commission over 21,000 Reserve officers by June 1917. These officers formed the leadership foundation of the huge American Army that would be raised for service in that war. By the end of the war in 1918, over 89,000 Reserve officers, of whom about 3,300 were commissioned from ROTC programs and 57,300 were products of Plattsburg-type camps, had entered the Army. By October 1917, over 55,000 enlisted reservists had been recruited for service. Ultimately, between the RAR and ERC over 80,000 enlisted reservists served in World War I.

World War I demonstrated that the sweeping changes wrought by the National Defense Act of 1916 were not broad enough to thoroughly modernize the Army. The 1916 act would be extensively amended by Congress in June 1920 through the passage of Public Law 242 (PL 242), typically referred to as the National Defense Act of 1920. This law reorganized the Army into the form that is more or less in existence today. It established the Army of the United States as a “one Army” concept that reorganized the Army into three distinct components—the R.A., the N.G. (the state Reserve force), and the new Organized Reserve (O.R.) (the Federal Reserve force that is now the US Army Reserve). Under the provisions of the act, the R.A.'s peacetime strength was expanded to 296,000 including the Philippine Scouts (although it would never approach this number until 1941—see appendix C) and its authorization for officers was increased to 17,726, which was a substantial increase over the Army's prewar authorization. The additional authorization for officers was a reflection of the added responsibilities imposed on the R.A. for training the Reserve Components. Thus, a sizable number of officers and noncommissioned officers (NCOs) would be assigned as instructors, trainers, and administrators to N.G. and O.R. units, as well as hundreds of senior and junior ROTC programs throughout the country. Additionally, the RAR was abolished and its role was to be subsumed into the newer ERC.

The N.G.'s strength was likewise increased to 435,000, but as with the R.A., the strength of the Guard would never exceed 200,000 until 1939 and would be at only about half its authorized strength when actually mobilized for World War II. Additionally, the act recognized the N.G. as the Nation's second line of defense for ground forces. This recognition brought with it more Federal dollars for increased and improved training, organization, equipment, and uniform standards for all three that were in line with those of the R.A. Of course, as always, the increase in Federal resources was bought with the price of increased Federal control in terms of standards, employment, and reporting.

The third component of the Army, the O.R., was created by combining the ORC with the ERC, and the constitution of hundreds of O.R. units. There was no set limit to the manpower size of the O.R.; however, the average strength hovered around 100,000 during the interwar period, the vast majority of whom were officers. Due to political maneuvers by N.G. lobbyists, the authorized strength of O.R. units was set at 100 percent wartime strength for officers, but only 33 percent wartime strength for enlisted personnel. The authorization for the wartime strength for officers was to absorb the large number of officers who would wish to continue participating in Reserve Component duties after World War I and to absorb the number of new officers being commissioned through the ROTC and the Citizens Military Training Camps (CMTC). The limitations placed on the ERC allowed O.R. units to fill key NCO positions, such as first sergeants, platoon sergeants, and squad leaders, in anticipation of filling the other ranks with drafted men on mobilization. More importantly to the Guard, it effectively prevented this new Federal Reserve force from becoming the Army's second string team and eliminated most of the competition for recruiting enlisted personnel from the same geographical area. One problem with the ERC program was the few venues through which someone could become an enlisted reservist. Just as with the old RAR, the intended primary means was through reenlisting men who had left service with the R.A. or N.G. However, the provision included in



the original RAR for a small annual stipend as an incentive for joining had not been included in the ERC. Another means to join the ERC was through the ROTC and CMTC programs. If a man had completed at least 1 year of ROTC training in college, or had completed one 4-week camp of the CMTC program, he could also enlist in the ERC. Each year of participation in ROTC and completion of each CMTC camp earned the participant promotions in the ERC. Many enlisted reservists were in this category and went on to receive a commission in a few years, thus leaving the ranks of the ERC. The final way one could enter the ERC was if he (or she, in the case of nurses) possessed an expert skill needed by the Army and that required no prior military training. This included skills such as nursing, railroad occupations, certain communications fields, and music. Interestingly, a substantial number of enlisted reservists in the interwar period, at least into the early 1930s, were bandsmen. Because of these restrictions, the ERC maintained an average strength of only about 3,500 men and women, and never more than 6,000 at anytime from 1919 to 1941.

Other legislation, both before and after World War II, would further change the US Army, but it was the National Defense Act of 1920 that provided much of the structure familiar to today's Army. Organizationally, that is in terms of the institutional army (i.e., schools, recruiting, training base, logistical base, etc.) and the field army (i.e., regiments, divisions, corps, etc.), the US Army also underwent numerous and important changes prior to and after World War I. The following chapter will provide an overview of the key changes to the Army's command structure before the Great War and the key changes to the Army at the major levels of command brought about by PL 242. The remainder of this work will primarily focus on the history and activities of the US Army's mobile units and a few other institutional and non-table of organization (T/O) units that are of historical significance to the structure, mobilization, training, and administration of the interwar US Army.



## Chapter 2

### Geographical Organization and Tactical Commands of the US Army, 1898–1920

Organizationally, the US Army went through few significant changes between the end of the Civil War and the beginning of World War I. At the highest level of organization below the War Department, the United States was divided into geographical commands designated as “departments,” which were often further divided into subordinate geographical commands known as “districts.” These commands provided for the command, control, and administration of Regular Army (R.A.) units (and National Guard [N.G.] units when in Federal service). Typically, there were no levels of combat command between the department and the primary mobile units of the Army—the regiment. Regimental commanders, if needed, wore a second hat as district commanders. No additional personnel were provided to man district staffs. Those officers and men were drawn “out of hide” from the regiment or regiments that composed the district. Except for short periods, such as Indian campaigns and the Spanish–American War, the brigade, division, and corps did not exist in the US Army as tactical units.

For Indian campaigns, a brigade might be provisionally formed with two or more regiments and then be immediately disestablished at the end of the operation. During the Spanish–American War, brigades, divisions, and corps were once again constituted for combat operations. Eight corps, each consisting of three or more divisions, numbered consecutively as 1st, 2d, 3d (as were each of the division’s three brigades), etc., were organized for service in the continental United States, Cuba, the Philippines, and Puerto Rico. The geographical departments were still retained and functioned as mobilization headquarters and logistics providers to the corps until they were deployed overseas. At the end of major hostilities in that conflict, the brigades, divisions, and corps were disbanded, and the system of departments and districts was now superimposed on America’s new overseas possessions in the Philippines, Hawaii, Puerto Rico, and later, the Panama Canal Zone.

Recognizing the need for mobile commands larger than the regiment, in 1905 the Army developed a scheme for organizing the R.A. and N.G. units into divisions and brigades. However, plans for organizing divisions were not put into operation until 1910, when the Army began organizing the First Field Army consisting of what were supposed to be three permanent divisions composed of three brigades each. No corps level of command was provided for in this arrangement. The brigades were to be comprised of selected R.A. and N.G. regiments. Due to the Mexican Revolution of 1911, the plan was implemented only on paper (i.e., the regiments were officially assigned to various brigades, etc., but never concentrated or trained). Instead, a single provisional organization, dubbed the “Maneuver Division,” made up of only R.A. brigades and regiments, was organized in the spring of that year and stationed at San Antonio, TX, for employment on the Mexican border should it become necessary. Several separate brigades were also organized and stationed at various posts in Texas and California near the border and potential ports of embarkation. By August 1911, the Maneuver Division and the separate brigades were disbanded.

The experience of mobilizing and organizing the Maneuver Division reinforced to Army planners both the need for permanent divisions and plans to mobilize the Army in case of an emergency. In 1912, Secretary of War Henry L. Stimson directed a review of national defense policies. The resulting report included a two-phased mobilization plan that organized the R.A. into infantry divisions and cavalry brigades for use as a wartime expeditionary force or other emergencies, and the N.G. into additional divisions to be available to reinforce the R.A. if required. Stimson largely adopted this plan and implemented it, along with several other organizational changes in 1913.

The “Stimson Plan” reorganized the continental United States into four geographic departments (Eastern, Western, Southern, and Central), provided for two overseas departments (Hawaiian and Philippine), and created three new coast artillery commands (North Atlantic, South Atlantic, and Pacific Coast Artillery Districts) to integrate the Nation’s system of coast defense installations. Units of the mobile army were

assigned to three infantry divisions and one cavalry division. Additional regiments were assigned to one separate cavalry brigade and a separate infantry brigade stationed in Hawaii. Additionally, 12 infantry divisions were organized, at least on paper, with units of the N.G. These commands, however, again proved to be largely paper units, though the 2d Division was actually mobilized and concentrated once again in Texas due to troubles in Mexico. By October 1915, the 2d Division headquarters was demobilized and its units returned to their home posts.

The Stimson Plan remained in effect until 1 May 1917. On that date, the continental territorial commands were again reorganized, this time into six departments. Concurrently, the number of coast artillery districts was expanded to five. Eight weeks later, on 26 June 1917, the Panama Canal Department and the Panama Coast Artillery District were created to provide command, control, and administration of Army mobile units and fixed coast defenses in the Canal Zone (which had been under the old Eastern Department). This structure remained in effect into 1920.

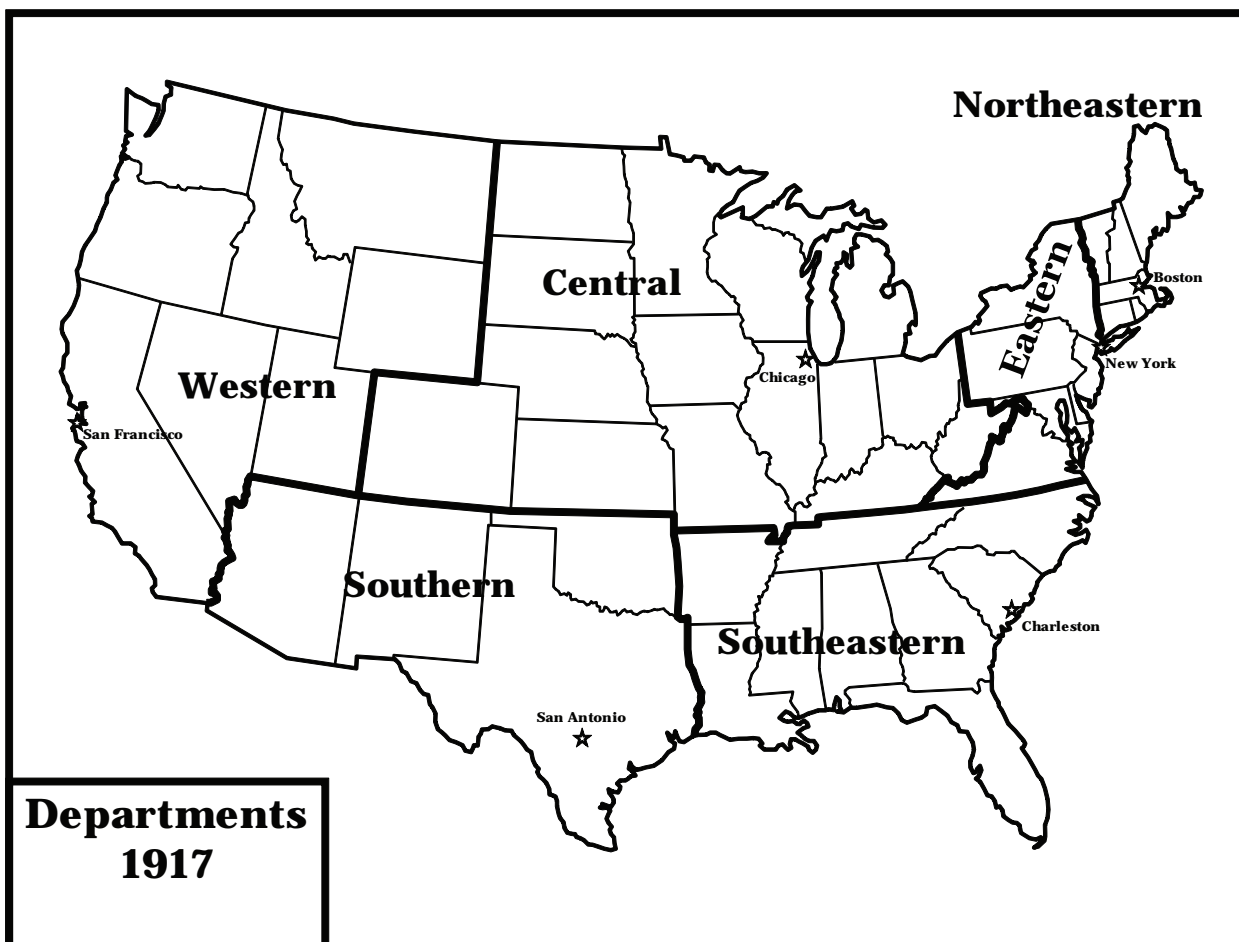

Department geographical areas, 1917.

In regard to mobile units, permanently existing brigades, divisions, corps, and field armies would finally be constituted in the US Army beginning with the 1st Division in June 1917. By the end of World War I, 3 field armies, 9 corps, 64 infantry divisions (20 R.A., 17 N.G., and 27 National Army), and 1 cavalry division would be constituted and almost all of these commands would be fully or partially organized. With the exception of the 10th through the 20th Divisions, the Puerto Rico Division, and the 15th Cavalry Division, all of these units are still carried on the rolls of the US Army today, though some have different designations.

After the Great War, the 1920 amendment to the National Defense Act of 1916 significantly altered the organization of the US Army, both in terms of its administrative geographic commands and its mobile units. Perhaps more importantly this reorganization set in place the first permanently retained framework for the efficient and orderly mass mobilization of the US Army for future conflict. Arguably, the key change in this plan was the establishment of a new type of geographic command called the “corps area.” On 20 August 1920, War Department General Order #50 reorganized the continental commands in the United States into nine corps areas that superseded the six previously existing departments.

The War Plans Division (WPD) of the General Staff developed the composition of the corps areas based on state lines and population densities. The intent was to organize the continental United States geographically into nine multistate area commands divided equally in terms of population. Each of the corps areas was responsible for organizing two corps consisting of three infantry divisions and a standard number of corps troops. Each corps area was also responsible for organizing various other field army, General Headquarters Reserve, Zone of the Interior (later designated as Corps Area Service Command), and Communications Zone units. Additionally, the First, Second, Third, Fourth, Eighth, and Ninth Corps Areas were responsible for organizing and mobilizing units to man the various fixed coast defenses along America’s sea coasts. The corps areas were further grouped into three army areas of two armies each.

War Department General Order #50 did not alter the status of the three overseas departments located in the Panama Canal Zone, the Territory of Hawaii, and the Philippine Islands. Each of the departments were allotted one infantry division and sufficient coast defense, air service, and housekeeping units to provide for the peacetime security and operations of those strategic overseas locations. The departments had essentially the same functions as the corps areas, but with the exception of the Hawaiian Department, which had responsibility for the Hawaii National Guard, the departments had few of the mobilization responsibilities of their continental counterparts. In wartime, each of these commands were also intended to function both as the combat command headquarters for its geographical area and as the headquarters for housekeeping or Zone of the Interior-type units. The provisions of the 1920 National Defense Act and War Department General Order #50 set the stage for developing the Army’s force structure and mobilization plans for the next 20 years.



## Chapter 3

### Corps Areas and Departments

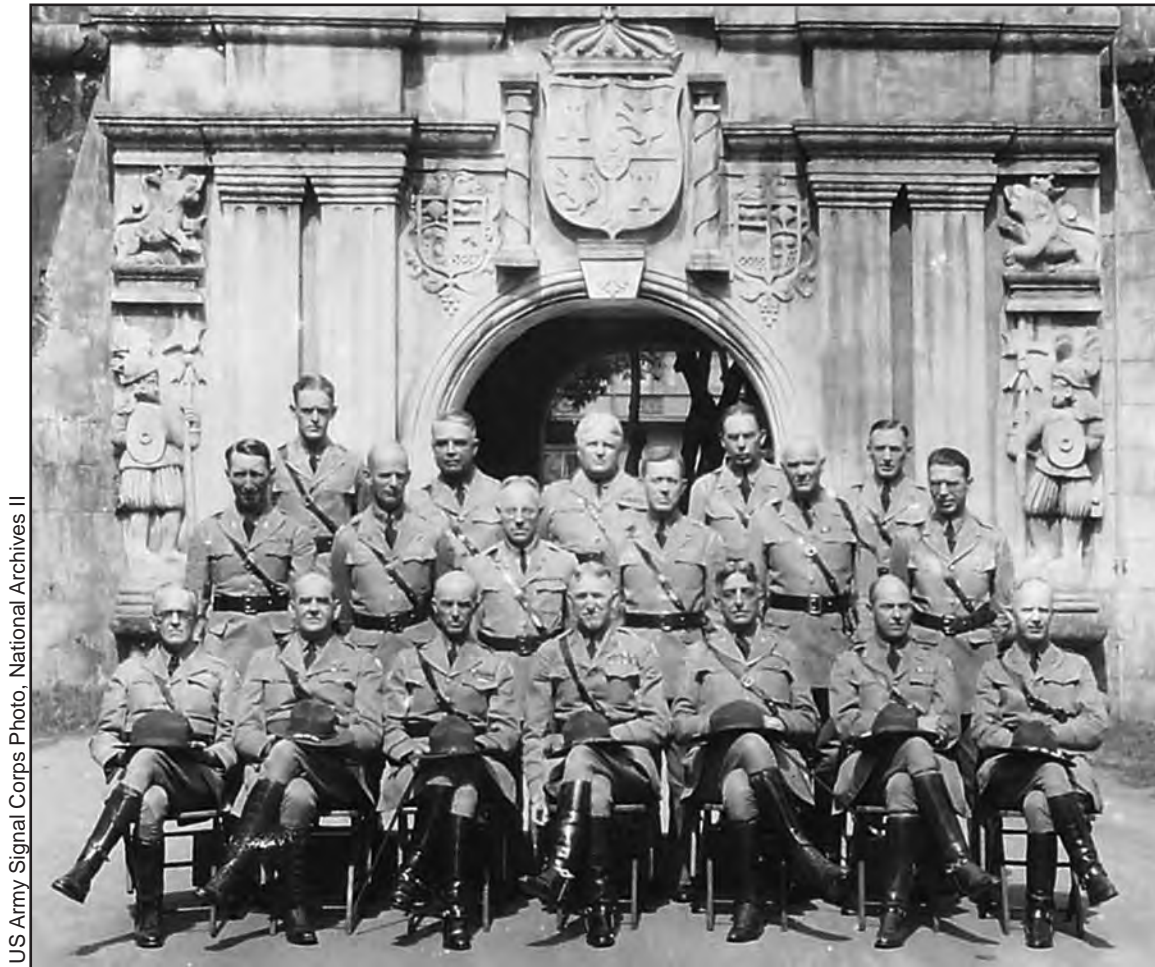

US Army Signal Corps Photo, National Archives II

Major General John G. Hines and the staff of the Philippine Department at the entrance to Fort Santiago in Manila, PI, 1930.

The nine corps area headquarters, established by War Department General Order #50 on 20 August 1920, assumed the same responsibilities for providing peacetime command, control, administrative, and logistical support to the army's mobile units as had the territorial department headquarters that preceded them. The corps areas, however, also had similar responsibilities for post and installation support units (i.e., Zone of the Interior units), which had been created during World War I. More importantly, the corps area headquarters now had the added the responsibility for planning and executing complex mobilization plans for all Regular Army (R.A.), National Guard (N.G.), and Organized Reserve (O.R.) mobile units in their respective geographic areas. These responsibilities included the development, organization, training, supply, and inspection of hundreds of new O.R. and Reserve Officers' Training Corps (ROTC) units and managing the personnel records system for thousands of Reserve officers, enlisted personnel, ROTC cadets, and Citizens Military Training Camp (CMTC) candidates. The corps areas determined where and when R.A., N.G., O.R., and ROTC units would be trained during the year and what resources would be applied toward each training event. This was equally true for the various CMTC camps held in the corps area.

The establishment of the three overseas departments—Hawaiian, Philippine, and Panama Canal—predated World War I and all remained in existence after the postwar reorganization. The responsibilities of

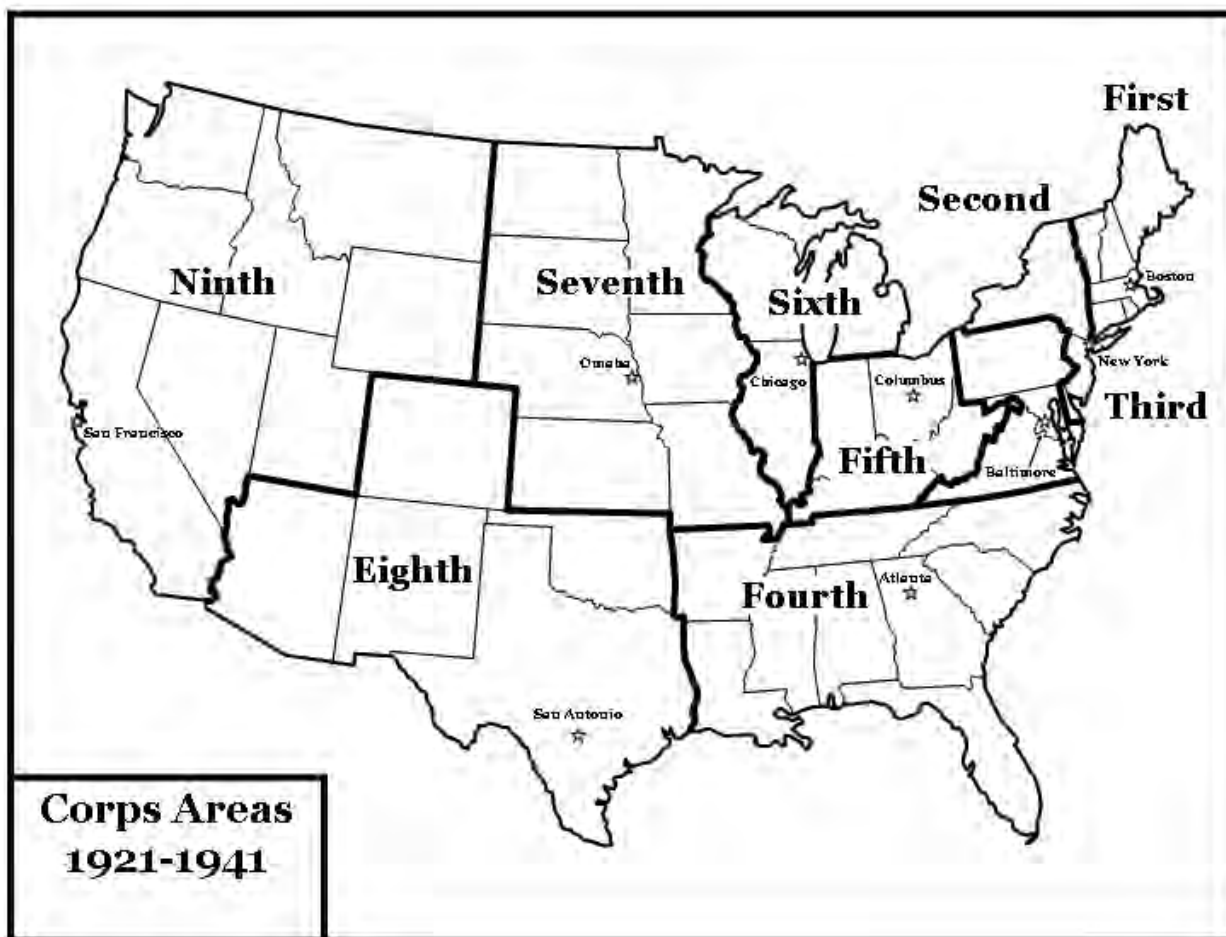

Map, corps areas, 1920.

the departments were in many ways similar to those of the corps areas, but the departments had few or no concerns with mobilizing, managing, and training the Reserve components. Only the Hawaiian Department, which contained two infantry regiments of the Hawaii N.G. and the University of Hawaii ROTC, had any substantial responsibilities for Reserve Component units in these matters. Each department had a small number of Reserve officers, but possessed no O.R. units as none were allotted by the War Department. The Reserve officers residing in the department's geographical area were given mobilization assignments to existing R.A. units and those units managed the training and administration of the reservists.

The overseas departments were clearly more heavily burdened than their stateside counterparts in the areas of wartime defense planning and joint operations with the US Navy. Each of the three departments was charged with preparing joint plans with local naval commands to defend the geographic area of the department. Though the corps areas did have similar responsibilities, the strategic position and sensitive installations of the overseas departments, and the very real possibility of an attack on those areas in the event of war, provided an urgency to the process that was not present in the planning efforts of corps areas and naval districts in the continental United States. Additionally, each department's war plans were regularly exercised through maneuvers with naval, marine, and air service units on an almost annual basis from 1923 to 1941.

Given their importance, each corps area and department was commanded by a major general. The corps area and department commanders were typically the senior major generals in the army. Short of being appointed the Army Chief of Staff, in the interwar period, these commands were considered to be the apex of an Army officer's career. For mobilization purposes, the corps area commanders were to take command



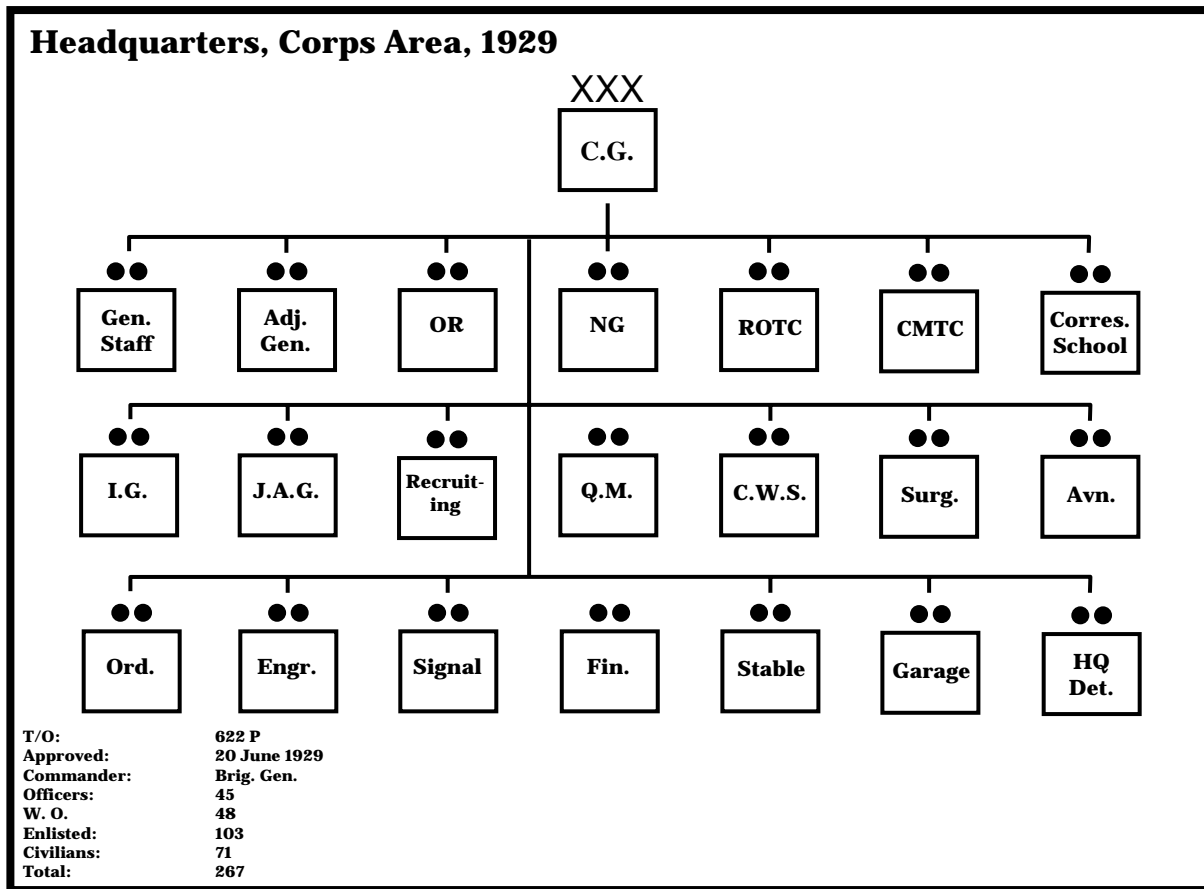

Corps area staff organization.

of an early mobilized corps or field army. During peacetime, these commanders also typically functioned as commanding generals for the O.R. corps and divisions in their corps area as an additional duty. By the late 1920s, many corps area commanders frequently delegated the Reserve division commander duty to more junior generals within the corps area, or in a few instances, to O.R. generals.

The corps area and department staffs, though slightly different in each case, were organized to address all facets of their mission responsibilities. Typical corps area and department staffs with subordinate tactical commands were organized as illustrated in the diagrams.

Each corps area was responsible for organizing and maintaining two “type” corps (see chapter 5). The corps were numbered in accord with the corps area designation. For example, the First Corps Area had responsibility for the I and XI Corps, the Second Corps Area was responsible for the II and XII Corps, and so forth. The lower numbered corps (I through IX Corps) were to consist of one R.A. and two N.G. divisions. The remaining corps troops would consist of R.A., N.G., and O.R. units of the various arms and services. These units were the highest in the priority for early mobilization and would assemble and train at the installations designated in the corps area’s mobilization plan. The higher numbered corps (XI through XIX Corps) consisted almost entirely of O.R. divisions and corps troops and would be mobilized later in the mobilization process. These corps would in turn assemble and train at installations already vacated by the lower numbered corps units once those units deployed to the area of operations.

In addition to field army and corps units, the corps areas were to organize, manage, and mobilize the General Headquarters Reserve (GHQR), Communications Zone (C.Z.), and Zone of the Interior (Z.I.) units as well. The GHQR organizations were overhead and specialized units that would be deployed to the combat zone to reinforce the armies and corps or, if necessary, be used to create additional corps and

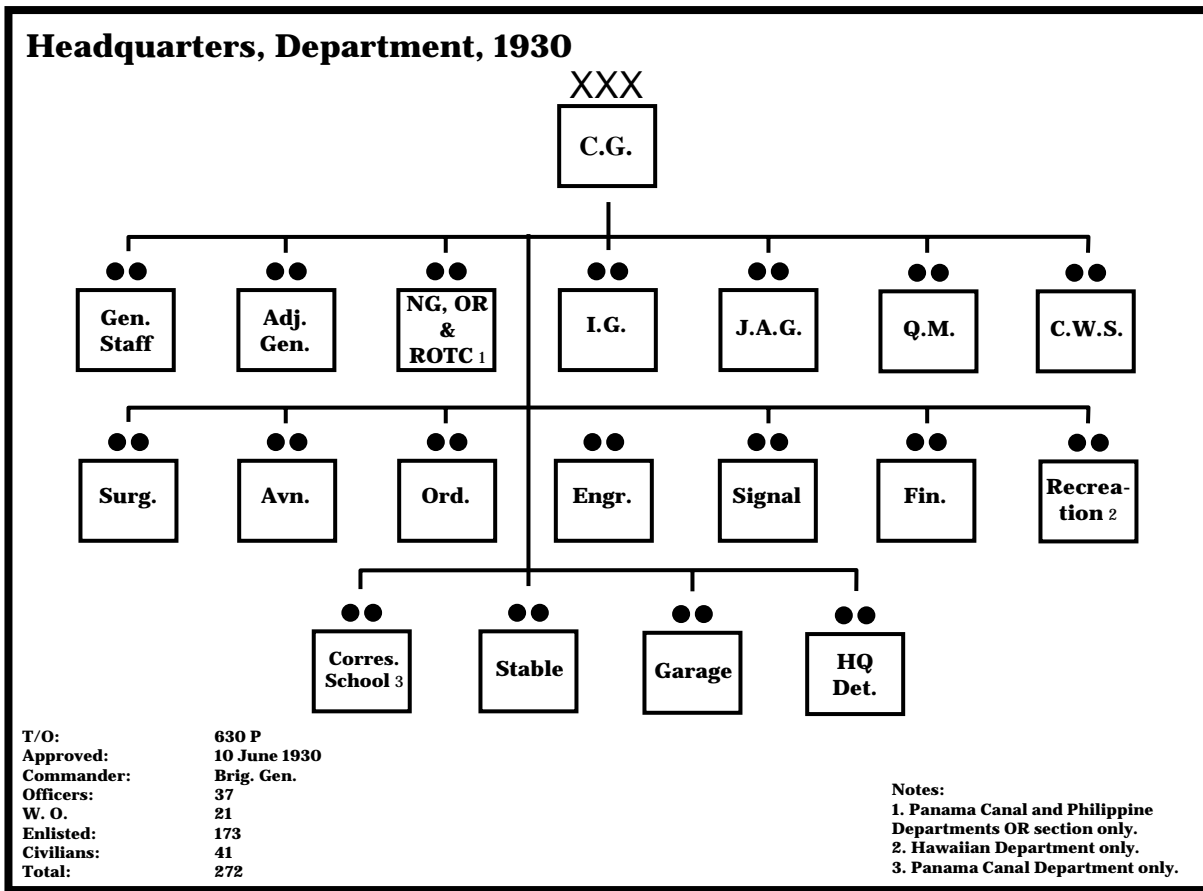

Department staff organization.

armies. As their name implies, C.Z. units were primarily logistics and medical units that provided C.Z. (i.e., rear area) support to the combat commands at the front. Z.I. units were those installation, support, security, and training units that remained in the continental United States to keep the machinery of mobilization and stateside logistics support rolling for the war effort. Beginning in 1928, these organizations became more commonly referred to as Corps Area Service Units (CASUs).

Although various Z.I. mobile units were constituted in 1921 to support the mobilization and training of wartime units, none were constituted for the specific purpose of supporting existing or planned posts, camps, stations, or activities necessary for the sustainment of the larger Army. The types of Z.I. organizations authorized in 1921 were units such as airdrome and school squadrons for the air corps, cavalry squadrons to support the cavalry replacement centers and schools, separate infantry battalions to support the infantry replacement centers and schools and perform special security duties, and so forth. No units were originally constituted for recruiting, reception, post support, mobilization area administration, etc. Based on World War I experience, as early as January 1925 some corps areas unilaterally began to organize these types of units in support of their own mobilization plans.

The War Plans Division (WPD), realizing the shortfall and need for such units, as well as an overall command to administer them, authorized Corps Area Service Commands (CASCs) in the War Department General Mobilization Plan (WDGMP) approved on 20 July 1928. The plan stipulated that the corps area headquarters itself would function as the service command headquarters on mobilization of the service command's subordinate units. The purpose of these commands and units was to provide each corps area commander with command, administrative, and housekeeping units to operate or augment the various service command installations and activities that would support the broader wartime Army. The 1928 WDGMP left to each corps area commander the discretion to determine the intent of the WPD in the

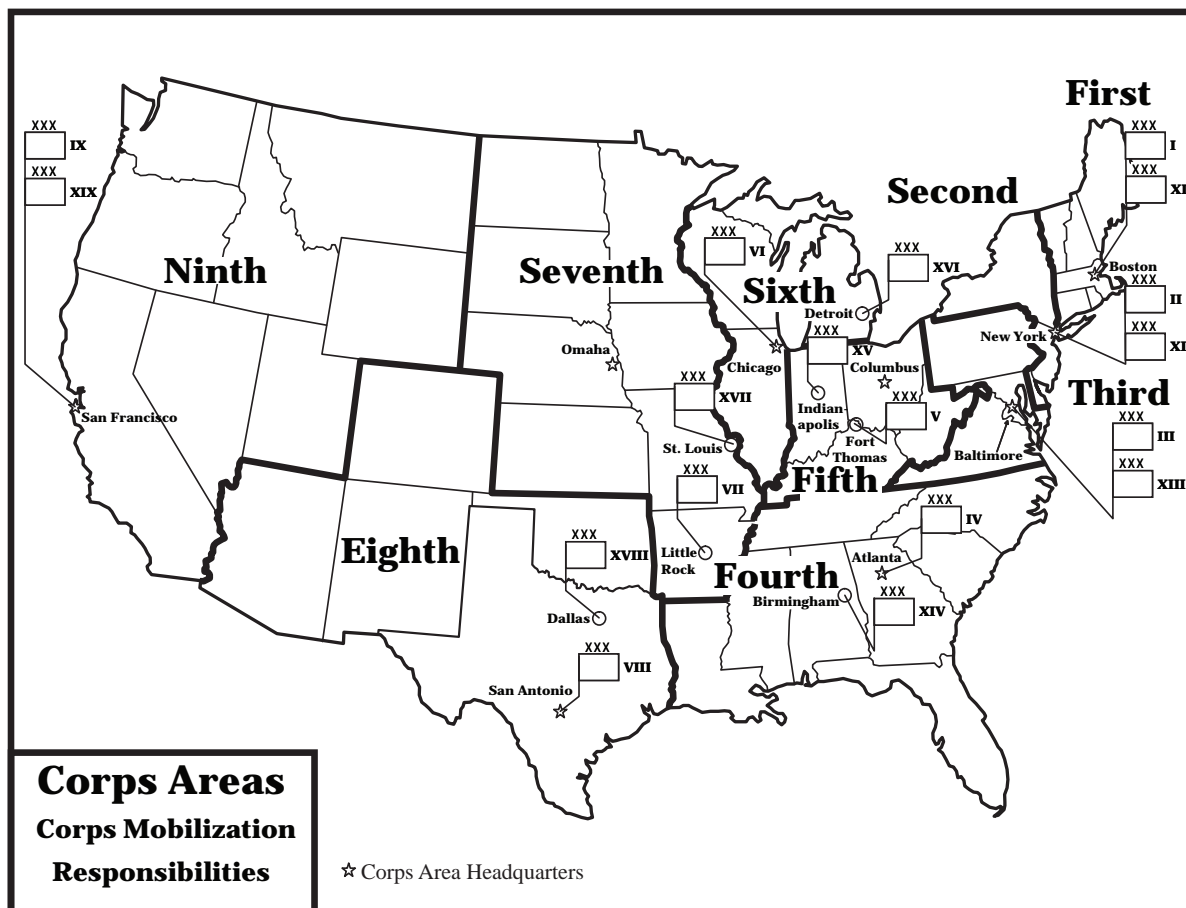

Map, corps areas with corps mobilization responsibilities, 1921.

organization and mission parameters of the service commands and its subordinate units. As a result, the number, type, and designation of the CASUs comprising the nine service commands originally varied widely from area to area. By late 1940, at least the designation of CASUs was more or less standardized across the nine corps areas. The numbering system adopted was aligned with the nine corps areas and only included units with numbers above 1000. For example, the CASUs for the Third CASC were designated as the 1301st, 1302d, 1303d, etc.; the Fourth CASC were designated as the 1401st, 1402d, 1403d, and so forth. As World War II approached, corps areas began mobilizing CASUs, primarily with reservists as the units' officer leadership. By December 1941, each corps area possessed a wide range of active CASUs all supporting the mobilization and sustainment of what would become the largest US Army in history.

The administration, logistics, and training of the Army's mobile units were major facets of the corps area mission. Though the mobilization structure provided for army and corps headquarters, those units, even during relatively short periods when they were in an Active Duty status before 1940, did not function so much as command and control headquarters as they were planning, training, and administrative units. For example, until 1940 the chain of command for R.A. divisional units went from the division headquarters (or a reinforced brigade headquarters if the division headquarters was inactive as in the case of the 4th through 9th Divisions) and proceeded to the corps area headquarters, not to a corps or army headquarters. For nondivisional troops, it typically went through the unit's post headquarters then directly to the corps area headquarters.

Corps area command and control of N.G. units was limited and primarily focused on tracking Federal training and readiness requirements and mobilization planning. Routine administration requirements, such

as personnel records, promotions, assignments, training plans and schedules, property books, and so forth, were managed or provided oversight by the various N.G. headquarters within the state. On the other hand, the corps area headquarters was responsible for managing all aspects of the administration, logistics, and training of the myriad O.R. and Regular Army Inactive (RAI) units within their jurisdiction. To address this major task, each corps area developed its own system to manage the O.R. Though these systems tended to be very similar, there was some variance between the corps areas.

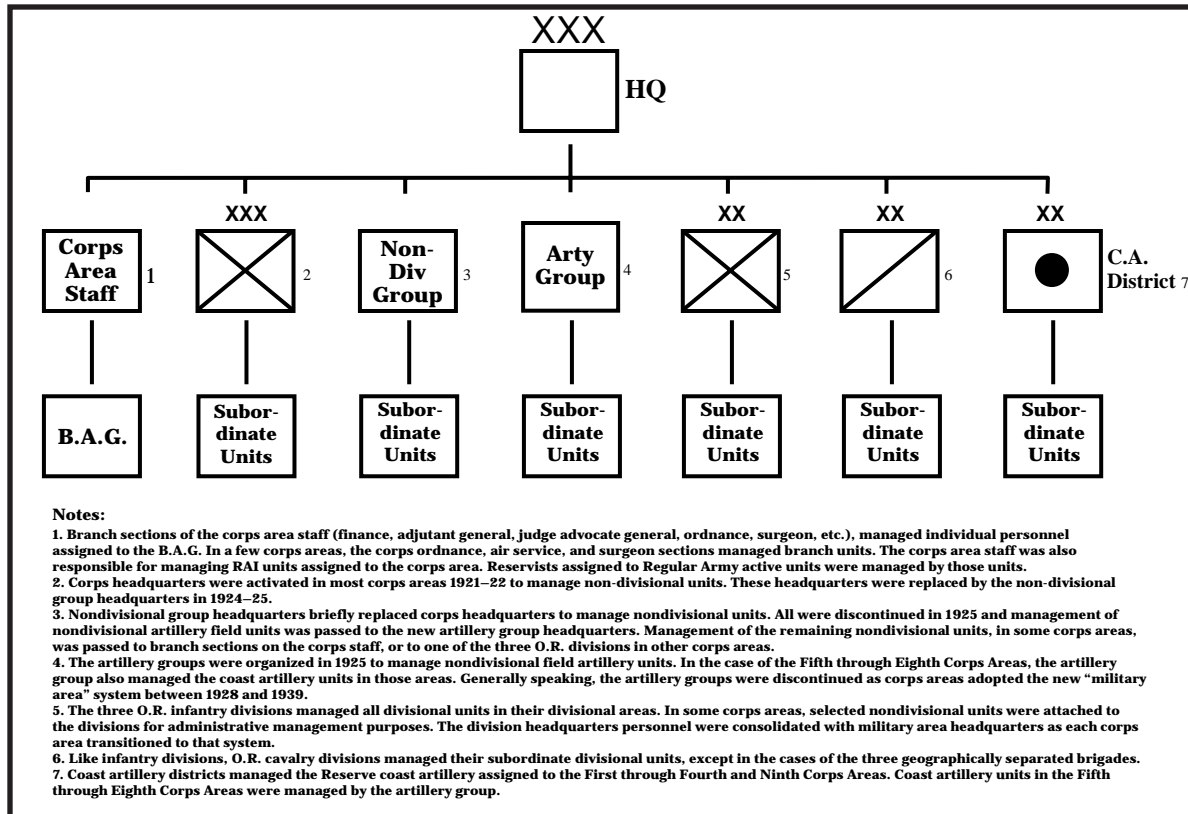

Corps Area Organized Reserve Management, 1921–28.

Each O.R. division had a small R.A. staff to administer the units of the division. The staff was managed by an R.A. full colonel who functioned as the chief of staff and ran the day-to-day operations of the division on behalf of the corps area commander. Most nondivisional units were initially managed by an R.A. staff assigned to a corps headquarters, of which one (with the possible exception of the Third Corps Area) was activated in each corps area for that purpose during 1921–22. Due to budget and personnel constraints, between 1923 and 1925 those nine corps headquarters were all relieved from Active Duty (though they remained active as Reserve units). On the inactivation of the corps headquarters, the administration of the nondivisional units were then, in most corps areas, taken over by two new headquarters—the Non-Divisional Group and the Artillery Group. As the names imply, the Non-Divisional Group managed all nondivisional units, less air service and nondivisional artillery organizations, and the Artillery Group managed all corps, army, and GHQR artillery units (divisional artillery remained under the control of their respective division districts headquarters). The Artillery Group also managed coast artillery (C.A.) organizations in those corps areas that possessed no C.A. district. The headquarters of C.A. districts managed the C.A. units located in their respective corps areas. Administration of air service units was somewhat problematic due to their highly technical nature. In some corps areas, the units were centrally managed by the Air Service Officer on the corps area staff, and assisted by the R.A. Air Service instructors who managed the O.R. air-dromes located in the corps area. In other corps areas, management of these units was delegated to a small

R.A. staff at a centrally located corps area airdrome set up to be the hub of Reserve air service activities in the corps area. Some corps areas used a management system similar to the air service for other branches. In a number of cases, nondivisional ordnance units were managed by the corps area staff's Ordnance Officer, and nondivisional medical units by the Corps Area Surgeon, etc.

In addition to O.R. units, corps areas had to manage a number of RAI units. An RAI unit was essentially the same as an O.R. unit. The primary difference between the two was that RAI units could be ordered to active service by the president without declaring a national emergency. By law, members of the Officers Reserve Corps (ORC) and Enlisted Reserve Corps (ERC) could only be ordered to Active Duty in the event of a national emergency declared by the president. Thus, reservists who volunteered for duty with RAI units had to sign an agreement acknowledging that they might be required to go on Active Duty without such a declaration. RAI units were also in the highest priority category for mobilization in any circumstance. Most RAI units were managed like other O.R. units with one distinct difference. At least until shortly before World War II, most RAI units were managed and administered directly by corps area headquarters, though in a few instances, combat arms regiments were attached to an O.R. division, and later to a military area, for those purposes.

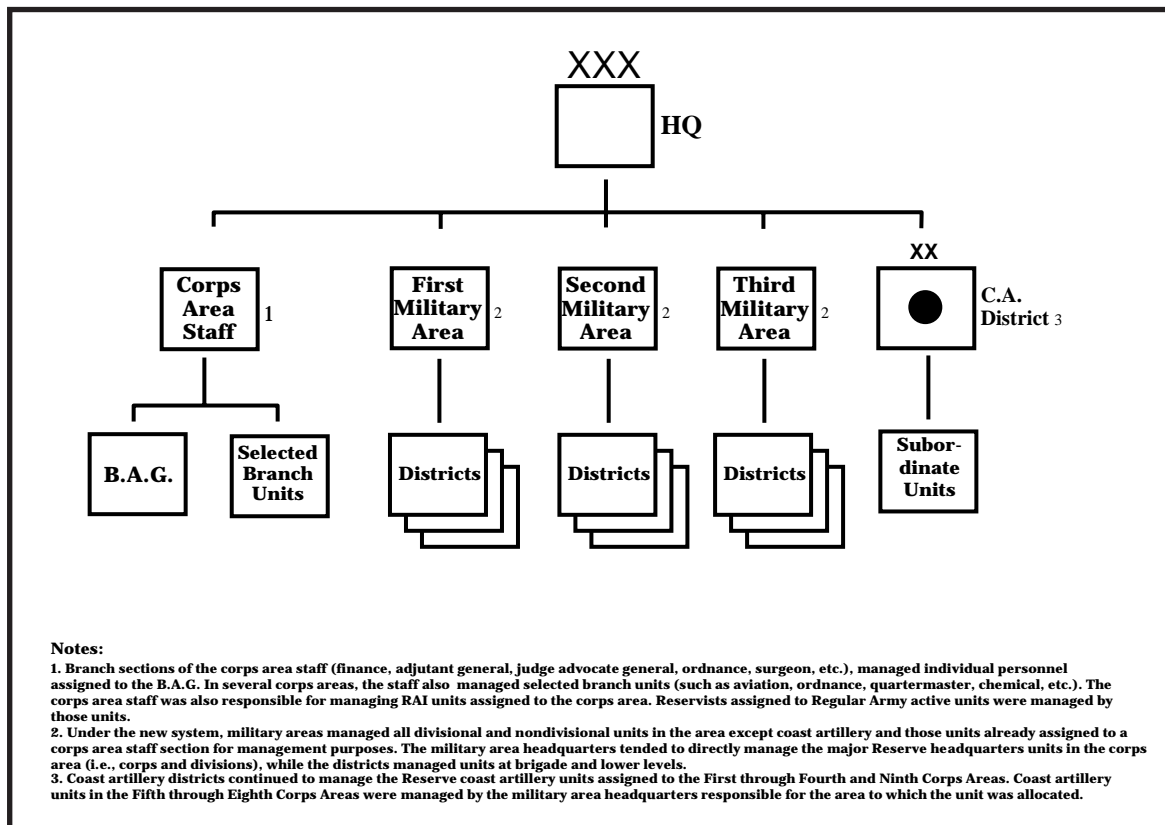

Corps Area Organized Reserve Management, 1928-41.

In 1928, the Ninth Corps Area radically changed its system for managing its O.R. program. The basic change was that it based the management and training responsibilities assigned to R.A. unit instructors on geography rather than units. Thus, the system reorganized the corps area into three "military areas," which were usually further divided into Reserve districts. The new military area headquarters were organized using the state boundaries and staffs of the existing O.R. divisions. These headquarters assumed control of both the O.R. division therein and all other O.R. units (less C.A. which remained under the C.A. district headquarters) located within the military area. The unit instructors, who had previously been assigned to manage particular units, usually branch-specific, were now responsible for managing all the units in the

Reserve district to which they were assigned. Under this system, the Ninth Corps Area inactivated the artillery and nondivisional groups and placed the units previously under those headquarters under the control of the military areas.

Though the new system soon proved to be clearly better in terms of efficient use of assigned support personnel and management of O.R. units and personnel, other corps areas did not immediately adopt it. Nevertheless, the new system gradually did take hold and all corps areas had followed suit by October 1939.

Most corps areas supervised two other specialized subordinate commands. These commands were the C.A. districts and corps area training centers. Only the First, Second, Third, Fourth, and Ninth Corps Areas supervised a C.A. district within their borders, because these areas possessed substantial lengths of coastline to protect (see chapter 24). The HQ, Eighth Corps Area supervised one harbor defense command at Galveston, TX, which was to be transferred to the Fourth C.A. District in the event of war. The nine corps area training centers were a short-lived experiment that lasted about 1 year. The mission of these centers was to train the N.G. and O.R. units within the corps area. Due to budget and manpower reductions, by the fall of 1922 these commands were disbanded (see chapter 6).

The final major program organized and managed by the corps areas in the interwar period was the Civilian Conservation Corps (CCC). This massive program, authorized and directed to be implemented by President Franklin D. Roosevelt in 1933, absorbed a huge amount of resources and attention by corps area commanders and staffs from its inception to its demise in 1942 (see appendix C).

## FIRST CORPS AREA

**HQ**—Army Base, Boston, MA, 20 August 1920—as of 7 December 1941

Established in the US Army on 20 August 1920 with headquarters at Army Base, Boston, and organized from the discontinued Northeastern Department. The First Corps Area included the states of Maine, New Hampshire, Vermont, Massachusetts, Connecticut, and Rhode Island. For administrative purposes and tactical control in connection with the coast defenses and field operations incident thereto, that part of the state of New York that lies east of west longitude 72 degrees, 30 minutes (which included Forts Terry and H.G. Wright, NY) was attached to the First Corps Area. HQ, First Corps Area was responsible for the mobilization, administration, and training of units of the First and Fourth Armies, I and XI Army Corps, coast defense units of the First C.A. District, select units of the GHQR, and the Z.I. support units of the First CASC. Mobile units of the corps area, less harbor defense, GHQR, and Z.I. units, were originally assigned to the First and Fourth Armies from 1921 to 1933. The coast defense units in the corps area were assigned to the various harbor defense commands of the First C.A. District. The First Corps Area Training Center was established in 1921 with headquarters at Army Base, Boston, to train R.A. and O.R. units, as well as ROTC cadets and CMTC candidates. Originally, the training was to be accomplished at Camp Devens, MA, for all arms and services, except cavalry and field artillery, which were to train at Fort Ethan Allen, VT. With the inactivation of the First Corps Area Training Center in 1922, Camp Devens became the primary training center for corps area infantry units only. Air corps units were sent to Mitchel Field, NY; engineer units were sent to Fort Du Pont, DE; and signal corps units were sent to Camp Alfred Vail (later renamed Fort Monmouth), NJ. Corps area maneuvers of R.A. mobile units were held, those years when funds were available, near Fort Ethan Allen. With the adoption of the four field army plan on 1 October 1933, the mobile units of the First Corps Area were reassigned to the First Army or GHQR, or were demobilized. For the administration of O.R. units, all organizations initially came under the control of the I Corps, or the 76th, 94th, and 97th Divisions. When the XI Corps was inactivated in 1925, the HQ, Non-Divisional Group was established to direct the organization, training, and administration of all nondivisional units. This arrangement was short-lived. On 8 September 1925, the Non-Divisional Group was discontinued and the HQ, Artillery Group was established. This new group managed only the corps area nondivisional field artillery units, the 158th Cavalry Brigade, and personnel assigned to the I and XI Corps. The rest of the nondivisional units were turned over to the three O.R. divisions for administrative control. The corps area was reorganized into three “military areas” on 19 August 1938. At that time, the 1st Military Area assumed control of the 97th Division area (Maine, New Hampshire, and Vermont), the 2d Military Area assumed control of the 94th Division area (Massachusetts), and the 3d Military Area assumed control of the 76th Division area (Rhode Island and Connecticut). The First Corps Area began assigning Reserve personnel to CASC units as early as 1925. At that time, the corps area originally referred to the CASC units as “Z.I. installation units” in mobilization plans and other documents. The HQ, First Corps Area actually began functioning as a service command headquarters in October 1940 and was redesignated HQ, First CASC in May 1941. It was further redesignated HQ, First Service Command on 22 July 1942.

**Events:** 95, 234

### Major Commands in the Corps Area

First Army (1936–38)  
I Corps: 9th Division, 26th Division, 43d Division  
XI Corps: 76th Division, 94th Division, 97th Division  
First Coast Artillery District  
First Corps Area Service Command

### Corps Area Commanders

Maj. Gen. David C. Shanks	1 September 1920–30 June 1921	Brig. Gen. Meriwether L. Walker	9 March 1930–7 October 1930
Maj. Gen. Clarence R. Edwards	30 June 1921–1 December 1922	Maj. Gen. Fox Conner	7 October 1930–30 September 1938
Brig. Gen. Mark L. Hersey	1 December 1922–1 January 1922	Maj. Gen. William H. Wilson	1 October 1938–3 February 1939
Maj. Gen. Andre W. Brewster	1 January 1922–28 November 1925	Brig. Gen. Joseph M. Cummins	3 February 1939–13 March 1939
Brig. Gen. John D. Barette	28 November 1925–2 January 1926	Maj. Gen. James A. Woodruff	13 March 1939–10 June 1941
Maj. Gen. Preston Brown	2 January 1926–9 March 1930	Maj. Gen. Francis B. Wilby	15 July 1941–11 January 1942

**First Corps Area Service Command  
Organization 1930**

UNIT:	LOCATION:
Headquarters	Army Base, Boston, MA
Headquarters Company, CASC	Army Base, Boston, MA
Corps Area Sup Point	Boston, MA
Boston Q.M. Dep	Boston, MA
Rctg Sv	Boston, MA
Air Corps School	Boston Airport, MA
Baxter Gen. Hosp.	New Haven, CT
Beale Gen. Hosp.	Boston, MA
Lovell Gen. Hosp.	Springfield, MA
1101st Gen. Dispry.	Boston, MA
1101st M.T. Cmd.	Army Base, Boston, MA
1101st M.T. Co.	Army Base, Boston, MA
1102d M.T. Co.	Army Base, Boston, MA
1103d M.T. Co.	Army Base, Boston, MA
1104th M.T. Co.	Army Base, Boston, MA
1101st M. Rep. Sec.	Army Base, Boston, MA
1102d M. Rep. Sec.	Army Base, Boston, MA
1101st Motorcycle Co.	Army Base, Boston, MA
HQ, Camp Devens Mob. Area	Camp Devens, MA
Engr. Recep. & Repl. Ctr. and Sch.	Camp Devens, MA
1101st Engr. Co.	Camp Devens, MA
1101st Ord. Co. (Maint)	Camp Devens, MA
1102d Ord. Co. (Dep.)	Camp Devens, MA
1101st M.P. Co.	Camp Devens, MA
1101st Sta. Hosp.	Camp Devens, MA
1101st Sig. Sv Co.	Camp Devens, MA
HQ, Connecticut Mil Area	Hartford, CT
Cav. Recep. & Repl. Ctr.	Willimantic, CT
HQ, Maine Mil. Area	Portland, ME
1107th Sta. Hosp.	Unknown
HQ, Eastern Massachusetts Mil. Area	Boston, MA
Inf. Recep. & Repl. Ctr. and Sch.	Andover, MA
1101st Inf. Tng. Regt.	Andover, MA
1102d Inf. Tng. Regt.	Andover, MA
1103d Inf. Tng. Bn.	Andover, MA
1104th Inf. Tng. Bn.	Andover, MA
1101st Bkry Co.	Boston, MA
1102d Gen. Dispry.	Boston, MA
1106th Sta. Hosp.	Andover, MA
HQ, Western Massachusetts Mil. Area	Springfield, MA
Cav. & F.A. Recep. & Repl. Ctr. & Sch.	Amherst, MA
Med. Recep & Repl. Ctr. and Sch.	Amherst, MA
1101st Med. Tng. Regt.	Amherst, MA
1102d Med. Tng. Regt.	Amherst, MA
1103d Bkry Co.	Amherst, MA
1103d Sta. Hosp.	Amherst, MA
1104th Sta. Hosp.	Amherst, MA
HQ, New Hampshire Mil. Area	Manchester, NH
C.A. Recep. & Repl. Ctr.	Portsmouth, NH
1101st C.A. Tng. Bn.	Portsmouth, NH
1102d C.A. Tng. Bn.	Portsmouth, NH
1102d Bkry Co.	Portsmouth, NH
1102d Sta. Hosp.	Portsmouth, NH
HQ, Rhode Island Mil. Area	Providence, RI
Inf. Recep. & Repl. Ctr.	Arctic Ctr., RI
1101st Inf. Tng. Bn.	Arctic Ctr., RI
1102d Inf. Tng. Bn.	Arctic Ctr., RI
1105th Sta. Hosp.	Arctic Ctr., RI
HQ, Vermont Mil. Area	Montpelier, VT

**First Corps Area Service Command  
Organization 1940**

UNIT:	LOCATION:
Headquarters	Army Base, Boston, MA
1100th CASU (HQ)	Army Base, Boston, MA
1101st CASU (1st Mil. Area)	Manchester, NH
1102d CASU (2d Mil. Area)	Boston, MA
1103d CASU (3d Mil. Area)	Hartford, CT
1104th CASU (Sta. Cmpl.)	Fort Williams, ME
1105th CASU (Sta. Cmpl.)	Camp Langdon, NH
1106th CASU (Sta. Cmpl.)	Fort Banks, MA
1107th CASU (Sta. Cmpl.)	Fort Rodman, MA
1108th CASU (Sta. Cmpl.)	Fort Adams, RI
1109th CASU (Sta. Cmpl.)	Fort H.G. Wright, NY
1110th CASU (Sta. Cmpl.)	Fort Ethan Allen, VT
1111th CASU (Sta. Cmpl.)	Fort Devens, MA
1112th CASU (Recep. Ctr.)	Fort Devens, MA
1113th CASU (Sch. B&C)	Fort Devens, MA
1114th CASU (Sta. Cmpl.)	Camp Edwards, MA
<i>1115th CASU</i>	<i>Inactive</i>
1116th CASU (Air Corps Det.)	Boston Airport, MA
1117th CASU (Rctg. Sv)	Army Base, Boston, MA
1118th CASU (ROTC Instr. Gp.)	Army Base, Boston, MA
1119th CASU (N.G. Instr. Gp.)	Boston, MA
1120th CASU (Fin. Ofc.)	Army Base, Boston, MA
1121st CASU (Gen. Dispry.)	Army Base, Boston, MA
1122d CASU (Med. Lab.)	Boston, MA
1123d CASU (Maint Sv)	Army Base, Boston, MA
1124th CASU (Sig. Sv)	Army Base, Boston, MA



**Major posts, camps, stations, airfields, and N.G. and O.R. training facilities in the corps area.**

**Regular Army**

Posts, Camps, Airfields, and Stations

**Fort Adams, RI.** Located 3 miles west of Newport, RI. Acquired in 1799. Established on 4 July 1799. Designated in honor of John Adams, second president of the United States.

**HQ**—HD of Narragansett Bay; 10th C.A. Regt. (1924–41); 13th Inf. Regt. (1928–31).

**Troops**—1st, 2d, and 3d Cos., CD of Narragansett Bay (1919–22); elements of 10th C.A. (1924–41); 2d Bn., 13th Inf. (1927–39).

**Units for Annual Summer Training**—HQ, 76th Div.; 304th Inf.; 385th Inf.; 417th Inf.; 68th C.A. (RAI); 197th C.A.; 501st C.A.; 542d C.A.; 543d C.A.; 544th C.A.; 606th C.A.; 613th C.A.; 615th C.A.; 616th C.A.; 618th C.A.; 901st C.A.; 902d C.A.; 903d C.A.; CMTC—C.A.C.

**Fort Ethan Allen, VT.** Located 6 miles east of Burlington, VT. Established on 5 August 1892. Designated in honor of Revolutionary War hero Ethan Allen. Designated as the O.R. training center for First Corps Area cavalry and artillery units, as well as Second Corps Area cavalry units.

**HQ**—7th F.A. Regt. (1922–40).

**Troops**—1st Sq., 3d Cav. (1919–41); 7th F.A., less 2d Bn. (1922–40); 3d Bn., 13th Inf. (1928–31); 2d Bn., 7th F.A. (1933–40); elements of 9th Q.M. Regt; 84th Q.M. Bn.

**Units for Annual Summer Training**—HQ, 43d Div.; HQ, 61st Cav. Div.; HQ, 97th Div.; HQ, 98th Div.; HHC, 85th Inf. Brig.; HHC, 86th Inf. Brig.; HHC, 188th Inf. Brig.; HHT, 51st Cav. Brig.; HHT, 151st Cav. Brig.; HHT, 152d Cav. Brig.; HHT, 158th Cav. Brig.; HHB, 51st F.A. Brig.; HHB, 68th F.A. Brig.; HHB, 151st F.A. Brig.; 302d Inf.; 376th Inf.; 385th Inf.; 386th Inf.; 387th Inf.; 388th Inf.; 417th Inf.; 418th Inf.; 101st Cav.; 301st Cav.; 302d Cav.; 303d Cav.; 304th Cav.; 315th Cav.; 316th Cav.; 51st MG Sq.; 151st MG Sq.; 152d MG Sq.; 158th MG Sq.; 461st Armd. Car Sq.; 26th F.A. (RAI); 34th F.A. (RAI); 37th F.A. (RAI); 152d F.A.; 172d F.A.; 192d F.A.; 301st F.A.; 302d F.A.; 303d F.A.; 352d F.A.; 355th F.A.; 356th F.A.; 364th F.A.; 365th F.A.; 388th F.A.; 389th F.A.; 390th F.A.; 392d F.A.; 393d F.A.; 431st F.A.; 461st F.A.; 861st F.A.; 101st Ammo. Tn.; 319th Ammo. Tn.; 322d Ammo. Tn.; 341st Ammo. Tn.; 314th F.A. Obsn. Bn.; 542d C.A.; 543d C.A.; 322d Engr. Regt.; 401st Engr. Sq.; 322d Med. Regt.; 361st Med. Sq.; elements of 43d Div. Q.M. Tn.; 61st Cav. Div. Q.M. Tn.; 97th Div. Q.M. Tn.; CMTC—Inf., Cav., F.A.; ROTC—Cav., F.A.

**Fort Andrews, MA.** Located 9 miles southeast of Boston on Pedcock's Island. A subpost of Fort Banks. Established in 1901. Designated in honor of Brig. Gen. George L. Andrews, U.S.V.

**HQ**—13th Inf. Regt. (1921–22 and 1925–28).

**Troops**—1st, 5th, 6th, and 8th Cos., CD of Boston (1919–22); 1st Bn, 13th Inf. (1921–22); 3d Bn, 13th Inf. (1922–27); elements of 9th C.A. (1924–41); 3d Bn., 9th C.A. (1941).

**Units for Annual Summer Training**—68th C.A. (RAI); 601st C.A.; 606th C.A.; 613th C.A.; 614th C.A.; 615th C.A.; 616th C.A.

**Fort Baldwin, ME.** Located at Sabino Head at the mouth of the Kenebec River. Reservation acquired by purchase in 1902. Designated in honor of Col. Jeduthan Baldwin, Continental Army.

**Troops**—C.A. caretaker detachments of the HD of Portland (1919–27).

**Fort Banks, MA.** Located 2 miles northeast of Boston, MA. Established in 1899. Designated in honor of Maj. Gen. Nathaniel P. Banks, commanding general of the Army of the Gulf during the Civil War and former governor of Massachusetts.

**HQ**—HD of Boston; 9th C.A. Regt. (1924–41).

**Troops**—2d, 4th, and 12th Cos., CD of Boston (1919–22); 59th, 120th, and 172d C.A. Cos. (1922–24); elements of 9th C.A. (1924–41); 3d Bn., 9th C.A. (1941).

**Army Base, Boston, MA.** Located at Boston, MA. Acquired on 5 April 1918.

**HQ**—First Corps Area (1920–41); First Corps Area Training Center (1921–22); First C.A. District (1920–41); 18th Inf. Brig. (1925–39); First Army (1936–38).

**Troops**—2d Bn., 13th Inf. (1925–26); elements of 9th and 54th Q.M. Regts; 9th Tank Co.

**Fort Constitution, NH.** Located 3 miles north of Portsmouth, NH. Established in 1791. Reconstructed in 1899.

**HQ**—HD of Portsmouth; 18th Inf. Brig. (1922–25); 22d C.A. Regt. (1940–41).

**Troops**—1st and 2d Cos., CD of Portsmouth (1919–22); 156th C.A. Co. (1922–24); elements of 8th C.A. (1924–41); Btry A, 22d C.A. (1940–41).

**Camp Devens, MA.** Located 1 mile south of Ayer, MA. Established on 18 July 1917. Designated in honor of Brig. Gen. Charles Devens, Civil War hero and former US Attorney General. Designated as a National Army cantonment for the mobilization of the 76th Div. in World War I. Designated as the training center for First Corps Area O.R. infantry units 1922–41. Redesignated Fort Devens on 5 November 1931.

**HQ**—36th Inf. Regt. (1919–20); 14th Inf. Brig. (1921); 18th Inf. Brig. (1921–22); 13th Inf. Regt. (1920–21, 1931–39); 16th Med. Regt. (1940–41); 1st Div. (1941).

**Troops**—36th Inf. (1919–20); 2d Bn., 13th Inf., (1926–27); 3d Bn., 13th Inf., (1931–39); 3d Bn, 66th Inf. (1932–39); elements of 84th Q.M. Bn. (1939–41).

**Units for Annual Summer Training**—HQ, 26th Div.; HQ, 27th Div.; HQ, 28th Div.; HQ, 29th Div.; HQ, 43d Div.; HQ, 44th Div.; HQ, 76th Div.; HQ, 94th Div.; HQ, 97th Div.; HHC, 51st Inf. Brig.; HHC, 52d Inf. Brig.; HHC, 85th Inf. Brig.; HHC, 86th Inf. Brig.; HHC, 151st Inf. Brig.; HHC, 152d Inf. Brig.; HHC, 187th Inf. Brig.; HHC, 188th Inf. Brig.; HHC, 193d Inf. Brig.; HHC, 194th Inf. Brig.; HHT, 51st Cav. Brig.; HHT, 4th Cav. Brig. (RAD); HHB, 51st F.A. Brig.; HHB, 68th F.A. Brig.; HHB, 151st F.A. Brig.; HHB, 169th F.A. Brig.; HHB, 172d F.A. Brig.; HHB, 180th F.A. Brig.; 101st Inf.; 103d Inf.; 104th Inf.; 169th Inf.; 181st Inf.; 182d Inf.; 301st Inf.; 302d Inf.; 303d Inf.; 304th Inf.; 3d Bn., 372d Inf.; 376th Inf.; 385th Inf.; 386th Inf.; 387th Inf.; 388th Inf.; 417th Inf.; 418th Inf.; 419th Inf.; 428th Inf.; 429th Inf.; 430th Inf.; 431st Inf.; 432d Inf.; 501st Inf. Bn.; 101st Cav.; 110th Cav.; 101st F.A.; 102d F.A.; 103d F.A.; 152d F.A.; 172d F.A.; 192d F.A.; 301st F.A.; 302d F.A.; 303d F.A.; 355th F.A.; 356th F.A.; 365th F.A.; 389th F.A.; 390th F.A.; 489th F.A.; 211th C.A.; 101st Ammo. Tn.; 301st Ammo. Tn.; 319th Ammo. Tn.; 341st Ammo. Tn.; 15th Engrs. (RAI); 101st Engrs.; 118th Engrs.; 301st Engr. Regt.; 319th Engr. Regt.; 322d Engr. Regt.; 341st Engr. Regt.; 371st Engr. Regt.; 372d Engr. Regt.; 305th Chem. Regt.; 101st Med. Regt.; 118th Med. Regt.; 301st Med. Regt.; 319th Med. Regt.; 322d Med. Regt.; IV Corps Q.M. Tn.; 26th Div. Q.M. Tn.; 76th Div. Q.M. Tn.; 97th Div. Q.M. Tn.; 101st Q.M. Regt.; 422d Q.M. Regt.; 101st Obsn. Sq.; CMTC—Inf., Cav., F.A.; ROTC—Cav., F.A.

**Fort Duvall, MA.** Located on Hogs Head Island in Boston Harbor, Boston, MA. Established in 1917 as Hogs Head Island Military Reservation. Redesignated in 1922 in honor of Maj. Gen. William P. Duvall, commanding general of the Division of the Philippines, 1909–10.

**Troops**—Caretaking detachment, 9th C.A. (1924–41).

**Fort Foster, ME.** Located 6 miles northeast of Portsmouth, NH, on Garrish Island. Established in 1873. Designated in honor of Maj. Gen. John G. Foster. A subpost of Fort Constitution.

**Troops**—Caretaking detachment, 8th C.A. (1924–41).

**Fort Getty, RI.** Located near Jamestown, RI, on Conanicut Island. Acquired by purchase in 1900. Designated in honor of Col. George W. Getty, 4th Arty., who served with distinction in the Mexican and Civil Wars.

**Troops**—Caretaking detachment, 10th C.A. (1924–41).

**Fort Greble, RI.** Located on Dutch Island, 5 miles west of Newport, RI. Acquired by purchase in 1864. Designated in honor of 1st Lt. John T. Greble, 2d Arty., who was killed in action 10 June 1861 at the Battle of Big Bethel, VA.

**Troops**—4th, 5th, and 6th Cos., CD of Narragansett Bay (1919–22); caretaking detachment, 10th C.A. (1924–41).

**Units for Annual Summer Training**—197th C.A.; 198th C.A.

**Fort Heath, MA.** Located at Great Head, 1½ miles northeast of Winthrop, MA. Acquired by purchase in 1890–94. Post established in 1899. Designated in honor of Maj. Gen. William Heath, Revolutionary War hero and delegate to the Constitutional Convention. A subpost of Fort Banks, MA.

**Troops**—Caretaking detachment, 9th C.A. (1924–41).

**Fort Philip Kearny, RI.** Located 1½ miles south of Saunderstown, RI. Acquired by purchase in 1901. Designated in honor of Maj. Gen. Philip Kearny, distinguished commander in the Mexican and Civil Wars; killed in action 1 September 1862 at the Battle of Chantilly. A subpost of Fort Greble, RI.

**Troops**—Caretaking detachment, 10th C.A. (1924–41).

**Fort Levett, ME.** Located on the south side of Cushing Island, 3½ miles southeast of Portland, ME. Acquired by purchase in 1894. Designated in honor of Christopher Levett, explorer of Portland Harbor, 1623. A subpost of Fort Williams.

**Troops**—6th and 9th Cos., CD of Portland (1919–21); caretaking detachment, 8th C.A. (1924–41).

**Fort Lyon, ME.** Located on Cow Island, Portland Harbor, ME. Acquired by purchase in 1873. Designated in honor of Brig. Gen. Nathaniel Lyon, who was killed in action 10 August 1861 at the Battle of Wilson's Creek, MO. A subpost of Fort Williams, ME.

**Troops**—Caretaking detachment, 8th C.A. (1924–41).

**Fort Mansfield, RI.** Located on Napatree Point, 2 miles west of Watch Hill, RI. Acquired by purchase in 1898. Designated in honor of Maj. Gen. J.F.K. Mansfield, commander of the II Corps, Army of the Potomac, who was killed in action 17 September 1862 at the Battle of Antietam. A subpost of Fort H.G. Wright, NY.

**Troops**—Elements of 11th C.A. (1924–41); 3d Bn., 11th C.A. (1924–36); 1st Bn., 11th C.A. (1936–41); 18th S.R. Btry (1929–30).

**Fort McKinley, ME.** Located 5 miles east of Portland, ME, on Great Diamond Island. A subpost of Fort Williams. Acquired in 1873. Designated in honor of William McKinley, 25th President of the United States.

**Troops**—2d, 5th, 7th, and 10th Cos., CD of Portland (1919–22); 6th and 9th Cos., CD of Portland (1921–22); 1st Bn., 5th Inf. (1922–25, 1927–39); 2d Bn., 5th Inf. (1922–23, 1927–28); 3d Bn., 5th Inf. (1925–27, 1928–39).

**Units for Annual Summer Training**—HQ, 97th Div.; 302d Inf.; 303d Inf.; 386th Inf.; 387th Inf.; 388th Inf.; 418th Inf.; 22d C.A. (RAI); 902d C.A.; 322d Engr. Regt.; CMTC—Inf.

**Fort Michie, NY.** Located on Great Gull Island, 11 miles southwest of New London, CT. Acquired from the Treasury Department in 1896. Designated in honor of 1st Lt. Robert L. Michie, who was killed in action 1 July 1898 at San Juan Hill. A subpost of Fort Terry, NY.

**Troops**—Caretaking detachment, 11th C.A.

**Fort Preble, ME.** Located 3 miles southeast of Portland, ME. Acquired in 1808. Designated in honor of Commodore Edward Preble, US Navy. A subpost of Fort Williams.

**HQ**—HD of Portland; 8th C.A. Regt. (1924–41).

**Troops**—8th Co., CD of Portland (1919–22); 24th C.A. Co. (1922–24); H Co., 5th Inf. (1922–39) and elements of 8th C.A. (1924–41).

**Fort Revere, MA.** Located at Nantasket Head, Hull, MA. Established in 1900. Designated in honor of Paul Revere, Revolutionary War hero and lieutenant colonel of artillery. A subpost of Fort Banks.

**Troops**—1st Co., CD of Boston (1919–22); 2d Bn., 13th Inf. (1922–25); elements of 9th C.A.

**Fort Rodman, MA.** Located 4 miles south of New Bedford, MA, on Clark's Point. Acquired in 1857. Designated in honor of Col. William L. Rodman, commander, 38th Massachusetts Volunteers during the Civil War. Designated a subpost of Fort Adams 1 February 1931.

**HQ**—HD of New Bedford (1919–41); 18th Inf. Brig. (1929); 23d C.A. (1940–41).

**Troops**—1st Co., CD of New Bedford (1919–22); 52d C.A. Co. (1921–24); elements of 10th C.A. (1924–41); Btry A, 23 C.A. (1940–41).

**Fort Ruckman, MA.** Located in Boston Harbor, Boston, MA. Established in 1902 as the Nahant Military Reservation. Redesignated Fort Ruckman in 1922. Designated in honor of Maj. Gen. John Wilson Ruckman, commanding general of the North Atlantic C.A. District, 1918–21.

**Troops**—Caretaking detachment, 9th C.A. (1924–41).

**Fort Standish, MA.** Located on Lovell's Island in Boston Harbor, 7 miles from Boston, MA. Acquired by purchase in 1825; post established in 1900. Designated in honor of Myles Standish, who came to America on the *Mayflower* in 1620 and served the Plymouth Colony as its military leader.

**Troops**—Caretaking detachment, 9th C.A. (1924–41).

**Fort Stark, NH.** Located at New Castle, NH, 3 miles from Portsmouth, NH. Acquired by purchase in 1873. Designated in honor of Brig. Gen. John Stark, Continental Army, victor of the battle of Bennington, VT, 1777. A subpost of Fort Constitution.

**Troops**—Caretaking detachment, 8th C.A. (1924–41).

**Fort Strong, MA.** Located 5 miles southeast of Boston on Long Island in Boston Harbor. Established in 1898. Designated in honor of Brig. Gen. George C. Strong who was mortally wounded in the attack on Battery Wagner 18 July 1863. A subpost of Fort Banks.

**Troops**—3d and 9th–11th Cos., CD of Boston (1919–22); 1st Bn., 13th Inf. (1922–29).

**Units for Annual Summer Training**—CMTC—C.A.C., Engr., S.C.

**Fort Terry, NY.** Located on Plum Island, 12 miles southwest of New London, CT. Established in 1898. Designated in honor of Maj. Gen. Alfred H. Terry, who commanded the successful attack on Fort Fisher, NC, in 1865 and commanding general of the ill-fated Centennial Campaign against the Sioux in June 1876.

**Troops**—6th–9th Cos., CD of Long Island Sound (1919–22); elements of 11th C.A.

**Units for Annual Summer Training**—258th F.A.; 431st F.A.; 489th F.A.; 211th C.A.; 242d C.A.; 542d C.A.; 543d C.A.; 544th C.A.

**Fort Warren, MA.** Located 7 miles from Boston on George’s Island in Boston Harbor. Acquired in 1825. Designated in honor of Maj. Gen. Joseph Warren who was killed in action 17 June 1775 at the battle of Bunker Hill. A subpost of Fort Banks.

**HQ**—13th Inf. Regt. (1922–25).

**Troops**—7th Co. CD of Boston (1919–22); HQ Co., 13th Inf. (1922–27); 3d Bn., 13th Inf. (1927–28).

**Fort Wetherill, RI.** Located on Conanicut Island, 2 miles from Newport, RI. Acquired by purchase in 1799. Designated in honor of Capt. Alexander M. Wetherill, who was killed in action 1 July 1898 at San Juan Hill. A subpost of Fort Adams, RI.

**Troops**—Caretaking detachment, 10th C.A. (1924–41).

**Fort Williams, ME.** Located 4 miles southeast of Portland, ME, at Portland Head. Acquired in 1872. Designated in honor of Brig. Gen. Seth Williams.

**HQ**—5th Inf. Regt. (1922–39); 68th C.A. Regt. (1939–41).

**Troops**—1st, 3d, and 4th Cos., CD of Portland (1919–22); 8th Co., CD of Portland (1921–22); 1st Bn., 5th Inf. (1925–27); 2d Bn., 5th Inf. (1923–27, 1929–39); 3d Bn., 5th Inf. (1922–25, 1927–28); 68th C.A. (1939–41).

**Units for Annual Summer Training**—HQ, 97th Div.; 303d Inf.; 385th Inf.; 386th Inf.; 387th Inf.; 388th Inf.; 240th C.A.; 614th C.A.; elements of 43d Div. Q.M. Tn.

**Fort H.G. Wright, NY.** Located 8 miles southeast of New London, CT, on Fisher’s Island. Acquired in 1898. Designated in honor of Maj. Gen. Horatio G. Wright who was commanding general of the VI Corps, Army of the Potomac, 1864–65.

**HQ**—HD of Long Island Sound; 11th C.A. Regt.

**Troops**—1st, 2d, 3d, 4th, and 5th Cos., CD of Long Island Sound (1919–22); 43d, 100th, 131st, 132d, and 133d C.A. Cos. (1922–24); elements of 11th C.A. (1924–41); 3d Bn., 11th C.A. (1924–36); 1st Bn., 11th C.A. (1936–41); 18th S.R. Btry (1929–30)

**Units for Annual Summer Training**—68th C.A. (RAI); 241st C.A.; 242d C.A.; 243d C.A.; 245th C.A.; 197th C.A.; 542d C.A.; 543d C.A.; 544th C.A.; 606th C.A.; 614th C.A.; 615th C.A.; 616th C.A.; 901st C.A.; 902d C.A.; 903d C.A.; 904th C.A.; 906th C.A.; 907th C.A.

### National Guard

**Brainard Field, CT (Civilian Airfield).** Airfield located at Hartford, CT. Dedicated 11 May 1921 in honor of the Stratford Mayor, Newton C. Brainard.

**Troops**—43d Div. Avn. (1923–29); 118th Obsn. Sq. (1923–41).

**Brewer, ME.** Located at Brewer, ME, 2 miles southeast of Bangor.

**Units for Annual Summer Training**—152d F.A.

**Camp Dyer, RI.** Located at Quonsett Point, RI. Established before 1898. Designated Camp Dyer 7 May 1898 for Rhode Island governor Elisha Dyer.

**Units for Annual Summer Training**—HHC, 85th Inf. Brig.; HHC, 86th Inf. Brig.; HHB, 68th F.A. Brig.; 110th Cav.; 103d F.A.; 118th Engrs.; 118th Med. Regt.

**Connecticut State Camp, CT.** Located at Niantic, CT, 7 miles southwest of New London. Established in 1873.

**Units for Annual Summer Training**—HQ, 43d Div.; HHC, 85th Inf. Brig.; HHC, 86th Inf. Brig.; HHB, 68th F.A. Brig.; 102d Inf.; 169th Inf.; 170th Inf.; 122d Cav.; 192d F.A.; 118th Engrs.; 30th Med. Regt. (RAI); 118th Med. Regt.; elements of 43d Div. Q.M. Tn.; 101st Q.M. Regt.; 43d Div. Avn.; 118th Obsn. Sq.

**Camp Edwards, MA.** Located at Falmouth, MA, in Barnstable County on Cape Cod. Established 1931–35 by acquisition of tracts of land between Falmouth, Bourne, and Sandwich, MA. Originally designated as the Massachusetts Military Reservation and later renamed for Maj. Gen. Clarence R. Edwards, World War I commander of the 26th Div. Reservation included Otis Field.

**Units for Annual Summer Training** (1935–40)—HQ, 26th Div.; HHC, 51st Inf. Brig.; HHC, 52d Inf. Brig.; HHB, 51st F.A. Brig.; 101st Inf.; 104th Inf.; 181st Inf.; 182d Inf.; 110th Cav.; 101st F.A.; 102d F.A.; 101st Ammo. Tn.; 101st Engrs.; 101st Med. Regt.; 101st Q.M. Regt.; 26th Div. Avn.; 101st Obsn. Sq.; 211th C.A.

**Camp Keyes, ME.** Located 3 miles southeast of Augusta, ME. Established in 1889. Designated in honor of Maj. Gen. Erasmus D. Keyes, Union general and commander of the IV Army Corps during the Civil War.

**Units for Annual Summer Training**—HQ, 43d Div.; HHC, 86th Inf. Brig.; HHB, 68th F.A. Brig.; 103d Inf.; 303d Inf.; 386th Inf.; 152d F.A.

**Marston Mills, MA (Civilian Airfield).** Airfield located on Cape Cod, 6 miles southwest of West Barnstable, MA.

**Units for Annual Summer Training**—26th Div. Avn.; 101st Obsn. Sq.; 301st Obsn. Sq.; 319th Obsn. Sq.; 322d Obsn. Sq.

**Massachusetts Military Reservation, Falmouth, MA.** See Camp Edwards.

**Niantic, CT.** See Connecticut State Camp.

**Quonsett Point, RI.** See Camp Dyer.

**Rye Beach, NH.** Located 7 miles south of Portsmouth Harbor at Rye Beach, NH.

**Units for Annual Summer Training**—197th C.A.

**South Sandwich, MA.** Located on Cape Cod at Peters Pond, South Sandwich, MA.

**Units for Annual Summer Training**—211th C.A.

**Trumbull Field, CT (Civilian Airfield).** Located at Hartford, CT. Established in 1929. Designated in honor of Jonathan Trumbull, governor of Connecticut, 1798–1809.

**Units for Annual Summer Training**—26th Div. Avn.; 101st Obsn. Sq.; 43d Div. Avn.; 118th Obsn. Sq.; 301st Obsn. Sq.; 319th Obsn. Sq.; 322d Obsn. Sq.

**Underhill Artillery Range, VT.** Located 2 miles southeast of Jericho, VT. Established in 1926. Along with nearby Fort Ethan Allen, served as the live-fire training center for First Corps Area O.R. and Vermont N.G. artillery units.

**Units for Annual Summer Training**—26th F.A. (RAI); 34th F.A. (RAI); 37th F.A. (RAI); 103d F.A.; 152d F.A.; 172d F.A.; 192d F.A.; 301st F.A.; 302d F.A.; 303d F.A.; 352d F.A.; 355th F.A.; 356th F.A.; 364th F.A.; 365th F.A.; 388th F.A.; 389th F.A.; 390th F.A.; 392d F.A.; 393d F.A.; 431st F.A.; 461st F.A.; 861st F.A.

**Vermont State Camp, VT.** Located 2 miles southeast of Jericho, VT, contiguous with the Underhill Artillery Range.

**Units for Annual Summer Training**—172d Inf.

**Warner, NH.** Located at Warner, NH.

**Units for Annual Summer Training**—172d F.A.; 197th C.A.

**Webster, NH.** Located at Webster, NH.

**Units for Annual Summer Training**—172d F.A.

#### **Organized Reserve**

**Boston Airport (Civilian Airfield/National Guard Aviation Facility).** Located at Jeffries Point on the Boston, MA, waterfront. Established in 1922. Designated as one of the original four O.R. airdromes in 1922. Formally opened on 8 September 1923. Intermediate landing field.

**Troops**—313th Purs. Gp. (1922–33); 101st Obsn. Sq. (1921–40); 319th Obsn. Sq. (1922–37); 445th Purs. Sq. (1922–33); 330th Sv Sq. (1922–33); 343d Sv Sq. (1922–37).

**Units for Annual Summer Training**—301st Obsn. Sq.; 319th Obsn. Sq.; 322d Obsn. Sq.

## SECOND CORPS AREA

**HQ**—Governor’s Island, NY, 20 August 1920–as of 7 December 1941

Established in the US Army on 20 August 1920 with headquarters at Governor’s Island, NY, and organized from portions of the discontinued Eastern Department. The Second Corps Area included the states of New York, New Jersey, and Delaware. The island of Puerto Rico (designated as the District of Puerto Rico) and the islands and keys adjacent thereto were, for administrative purposes, attached to the Second Corps Area. For administrative purposes and tactical control in connection with the coast defenses and field operations incident thereto, that part of the state of New York that lies east of west longitude 72 degrees, 30 minutes was attached to the First Corps Area (specifically Forts Terry and H.G. Wright, NY). HQ, Second Corps Area was responsible for the mobilization, administration, and training of units of the First and Fourth Armies, II and XII Army Corps, coast defense units of the Second C.A. District, select units of the GHQR, and the Z.I. support units of the Second CASC. Mobile units of the corps area, less coast defense, GHQR, and Z.I. units, were assigned to the First and Fourth Armies 1921–33. With the adoption of the four field army plan on 1 October 1933, the mobile units of the Second Corps Area previously assigned to the Fourth Army were reassigned to the First Army or GHQR, or were demobilized. The Second Corps Area Training Center was established in 1921 originally at Camp Dix, NJ, to train R.A. and O.R. units, as well as ROTC cadets and CMTC candidates. Originally, the training was to be accomplished at Camp Dix for all arms and services except field artillery units that were to train at Pine Camp, NY. With the inactivation of the Second Corps Area Training Center on 25 October 1922, Camp Dix became the primary training center for corps area infantry units only. Air corps units were sent to Mitchel Field, NY, engineer units were sent to Fort Du Pont, DE, and signal corps units were sent to Camp Alfred Vail (later Fort Monmouth), NJ. O.R. cavalry units trained at the First Corps Area cavalry training center at Fort Ethan Allen, VT. Corps area maneuvers of R.A. mobile units were held, those years when funds were available, at Camp Dix and Pine Camp. For the administration of O.R. units, all organizations initially came under the control of the XII Corps, or the 77th, 78th, and 98th Divs. When the XII Corps was inactivated on 10 October 1925, the HQ, Non-Divisional Group was established to direct the organization, training, and administration of all nondivisional units. The corps area was further reorganized into three “reserve areas” on 1 February 1937. At that time, HQ, Northern New York Reserve Area assumed control of the 98th Div. area (upstate New York); HQ, Southern New York Reserve Area assumed control of the 77th Div. area (metropolitan New York and Long Island); and HQ, New Jersey and Delaware Reserve Area assumed control of the 78th Div. area. These were further redesignated on 11 May 1937 as the First, Second, and Third Military Areas, respectively. Concurrently, the O.R. Section, US Troops, District of Puerto Rico was redesignated HQ, Fourth Military Area. Puerto Rico and the islands and keys adjacent thereto were released from corps area control on 1 July 1939 when the area was organized as the Puerto Rican Department. The Second Corps Area began assigning Reserve personnel to CASC units on 20 January 1926 and to “1200” series numbered units on 9 October 1929. The Second Corps Area activated its CASUs beginning 14 October 1940 with the 1213th CASU, which was mobilized at Fort Dix, NJ, as the post reception center. What made that mobilization unusual was that the unit was mobilized with its assigned complement of Reserve personnel. The HQ, Second Corps Area actually began functioning as a service command headquarters in October 1940 and was redesignated HQ, Second CASC in May 1941. It was further redesignated HQ, Second Service Command on 22 July 1942.

**Events:** 91, 168, 234

### Major Commands in the Corps Area

First Army (1921–36 and 1938–41)  
Fourth Army (1921–33)  
II Corps: 1st Division, 27th Division, 44th Division  
XII Corps: 77th Division, 78th Division, 98th Division  
Second Coast Artillery District  
Second Corps Area Service Command  
District of Puerto Rico (1921–37)

### Corps Area Commanders

Maj. Gen. Robert L. Bullard	20 August 1920–15 January 1925	Maj. Gen. Dennis E. Nolan	31 November 1931–30 April 1936
Maj. Gen. Charles P. Summerall	16 January 1925–20 November 1926	Maj. Gen. Frank R. McCoy	1 May 1936–30 July 1938
Brig. Gen. Hugh A. Drum	20 November 1926–8 January 1927	Brig. Gen. Evan H. Humphrey	30 July 1938–5 November 1938
Maj. Gen. James A. McRae	8 January 1927–1 December 1927	Lt. Gen. Hugh A. Drum	5 November 1938–December 1940
Maj. Gen. Hanson E. Ely	1 December 1927–30 November 1931	Maj. Gen. Irving J. Phillipson	December 1940–15 May 1942

**Second Corps Area Service Command  
Organization 1932**

<b>UNIT:</b>	<b>LOCATION:</b>
HQ, Second CASC	Governor's Island, NY
1200th CASU (HHC, Second CA)	Governor's Island, NY
1201st CASU (Sta. Cmpl.)	Fort Jay, NY
1202d CASU (Rctg. Sv)	New York City, NY
1203d CASU (Hoff Gen. Hosp.)	New York City, NY
1204th CASU (Sta. Cmpl.)	Fort Hamilton, NY
1205th CASU (Sta. Cmpl.)	Fort Wadsworth, NY
1206th CASU (Sta. Cmpl.)	Miller Field, NY
1207th CASU (Sta. Cmpl.)	Fort Slocum, NY
1208th CASU (Sta. Cmpl.)	Camp Smith, NY
1209th CASU (Sta. Cmpl.)	Pine Camp, NY
1210th CASU (Rctg. Sv)	Albany, NY
1211th CASU (Sta. Cmpl.)	Plattsburg Barracks, NY
1212th CASU (Sta. Cmpl.)	Fort Ontario, NY
1213th CASU (Sta. Cmpl.)	Fort Niagara, NY
1214th CASU (Sta. Cmpl.)	Madison Barracks, NY
1215th CASU (Rctg. Sv)	Syracuse, NY
1216th CASU	Buffalo, NY
1217th CASU (Bradley Gen. Hosp.)	Buffalo, NY
1218th CASU (Hammond Gen. Hosp.)	Saratoga, NY
1219th CASU (Sta. Cmpl.)	Fort Totten, NY
1220th CASU (Sta. Cmpl.)	Mitchel Field, NY
1221st CASU (Suffolk Mob. Area)	Suffolk County, NY
1222d CASU (Sta. Cmpl.)	Camp Upton, NY
1223d CASU (Rctg. Sv)	Newark, NJ
1224th CASU (Port of Embarkation)	Newark, NJ
1225th CASU (Sta. Cmpl.)	Fort Hancock, NJ
1226th CASU (Sta. Cmpl.)	Fort Monmouth, NJ
1227th CASU (Sta. Cmpl.)	Pedricktown, NJ
1228th CASU (O.C.S.)	Raritan Arsenal, NJ
1229th CASU (Sta. Cmpl.)	Camp Dix, NJ
1230th CASU (Rctg. Sv)	Camden, NJ
1231st CASU (Sta. Cmpl.)	Fort DuPont, DE
1232d CASU (PR)	San Juan, PR

**Second Corps Area Service Command  
Organization 1941**

<b>UNIT:</b>	<b>LOCATION:</b>
HQ, Second CASC	Governor's Island, NY
1200th CASU (HHC, Second CA)	Governor's Island, NY
1201st CASU (Sta. Cmpl.)	Fort Jay, NY
1202d CASU (R&I Sv)	New York City, NY
1203d CASU (Sta. Cmpl.)	Fort Dix, NJ
1204th CASU (Sta. Cmpl.)	Fort Hamilton, NY
1205th CASU (Sta. Cmpl.)	Fort Wadsworth, NY
1206th CASU (Sta. Cmpl.)	Fort Niagara, NY
1207th CASU (Sta. Cmpl.)	Fort Slocum, NY
1208th CASU (Sta. Cmpl.)	Camp Upton, NY
1209th CASU (Sta. Cmpl.)	Pine Camp, NY
1210th CASU (O.R. Instr. Gp.)	New York City, NY
1211th CASU (Sta. Cmpl.)	Plattsburg Barracks, NY
1212th CASU (Sta. Cmpl.)	Fort Ontario, NY
1213th CASU (Recep. Ctr.)	Fort Dix, NJ
1214th CASU (Sta. Cmpl.)	Madison Barracks, NY
1215th CASU (N.G. Instr. Gp.)	Second Corps Area
1216th CASU	Unknown
1217th CASU (ROTC Instr. Gp.)	Second Corps Area
1218th CASU (Sch. B&C)	Fort Jay, NY
1219th CASU (Sta. Cmpl.)	Fort Totten, NY
1220th CASU (Sta. Cmpl.)	Mitchel Field, NY
1221st CASU (Sch. B&C)	Fort Dix, NJ
1222d CASU (Recep. Ctr.)	Camp Upton, NY
1223d CASU	Unknown
1224th CASU (Gen. Dispry.)	New York City, NY
1225th CASU (Sta. Cmpl.)	Fort Hancock, NJ
1226th CASU (Sta. Cmpl.)	Fort Monmouth, NJ
1227th CASU (Lab)	New York City, NY
1228th CASU (OV. Rctg. Dep.)	Fort Slocum, NY
1229th CASU (Recep. Ctr.)	Fort Dix, NJ
1230th CASU (Fin. Ofc.)	Brooklyn, NY
1231st CASU (Sta. Cmpl.)	Fort DuPont, DE
1232d CASU (A.C. Det.)	Mitchel Field, NY
1233d CASU (Sch. B&C)	Pine Camp, NY
1234th CASU (Sel Sv Det., NY)	Albany, NY
1235th CASU (Sel Sv Det., NJ)	Trenton, NJ
1236th CASU (Sel Sv Det., DE)	Wilmington, DE
1237th CASU (Sel Sv NY)	Albany, NY
1238th CASU (Sel Sv NJ)	Trenton, NJ
1239th CASU (Sel Sv DE)	Wilmington, DE

**Major posts, camps, stations, airfields, and N.G. and O.R. training facilities in the corps area.**

**Regular Army**

**Camp Buchanan, PR.** Located 6 miles south of San Juan Bay, PR. Established in 1923 as an R.A. maneuver area and weapons range. Designated in honor of Lt. Col. James A. Buchanan, first commanding officer of the Puerto Rican Regiment (later redesignated as the 65th Inf.). Redesignated Fort Buchanan in May 1940.

**Units for Annual Summer Training**—42d Inf. (RAI); 373d Inf.; 516th Inf. Bn.

**Fort Delaware, DE.** Located on Pea Patch Island in the Delaware River, 1 mile east of Fort Du Pont, DE. Acquired from the state of Delaware in 1813. Named for the state of Delaware.

**Troops**—3d Co., CD of the Delaware (1919–22); elements of 7th C.A. (1924–41).

**Camp Dix, NJ.** Located 1 mile south of Wrightstown, NJ. Established 18 July 1917. Designated in honor of Maj. Gen. John A. Dix, who was commanding general of the Departments of Maryland and of the East during the Civil War. Designated as a National Army cantonment for the mobilization of the 78th Div. in World War I. Retained as a military

reservation and designated a mobilization and training station for the 77th and 78th Divs. Training center for Second Corps Area cavalry and artillery units, 1921–22, and infantry units, 1922–41. Redesignated Fort Dix on 2 March 1939.

**HQ**—1st Div. (1920–22); Second Corps Area Training Center (1921–22).

**Troops**—1st Div. (1920–22); 45th Inf. (1919–20); 50th Inf. (1919); 57th Inf. (1919–20).

**Units for Annual Summer Training**—HQ, 26th Div.; HQ, 27th Div.; HQ, 28th Div.; HQ, 29th Div.; HQ, 37th Div.; HQ, 38th Div.; HQ, 43d Div.; HQ, 44th Div.; HQ, 61st Cav. Div.; HQ, 77th Div.; HQ, 78th Div.; HQ, 98th Div.; HHC, 53d Inf. Brig.; HHC, 54th Inf. Brig.; HHC, 87th Inf. Brig.; HHC, 93d Inf. Brig.; HHC, 153d Inf. Brig.; HHC, 154th Inf. Brig.; HHC, 155th Inf. Brig.; HHC, 156th Inf. Brig.; HHC, 195th Inf. Brig.; HHC, 196th Inf. Brig.; HHT, 51st Cav. Brig.; HHT, 151st Cav. Brig.; HHT, 152d Cav. Brig.; HHB, 52d F.A. Brig.; HHB, 152d F.A. Brig.; HHB, 153d F.A. Brig.; HHB, 173d F.A. Brig.; 36th Inf. (RAI); 37th Inf. (RAI); 40th Inf. (RAI); 41st Inf. (RAI); 305th Inf.; 306th Inf.; 307th Inf.; 308th Inf.; 309th Inf.; 310th Inf.; 311th Inf.; 312th Inf.; 389th Inf.; 390th Inf.; 391st Inf.; 392d Inf.; 301st Cav.; 302d Cav.; 303d Cav.; 304th Cav.; 51st MG Sq.; 152d MG Sq.; HHB, 152d F.A. Brig.; HHB, 153d F.A. Brig.; 304th F.A.; 305th F.A.; 306th F.A.; 307th F.A.; 308th F.A.; 309th F.A.; 312th F.A.; 367th F.A.; 368th F.A.; 369th F.A.; 502d C.A.; 513th C.A.; 521st C.A.; 602d C.A.; 910th C.A.; 302d Ammo. Tn.; 303d Ammo. Tn.; 302d Engr. Regt.; 303d Engr. Regt.; 323d Engr. Regt.; 44th Div. Avn.; 119th Obsn. Sq.; 31st Med. Regt. (RAI); 302d Med. Regt.; 303d Med. Regt.; 323d Med. Regt.; 342d Med. Regt.; VI Corps Q.M. Tn.; 27th Div. Q.M. Tn.; 44th Div. Q.M. Tn.; 61st Cav. Div. Q.M. Tn.; 77th Div. Q.M. Tn.; 78th Div. Q.M. Tn.; 402d Q.M. Regt.; 403d Q.M. Regt.; 423d Q.M. Regt.; 492d Q.M. Regt.; 499th Q.M. Regt.; 511th Q.M. Regt.; 521st Q.M. Regt.; 592d Q.M. Regt.; 302d Sig. Bn.; 303d Sig. Bn.; 303d Chem. Regt.; CMTC—Inf., Cav., Engr.

**Fort Du Pont, DE.** Located 2 miles north of Delaware City, DE. Established in 1898. Designated in honor of Rear Admiral Samuel F. Du Pont, US Navy. Training center for First and Second Corps Area O.R. engineer units.

**HQ**—HD of the Delaware; 1st Engr. Regt. (1922–39); 21st C.A. (1940–41).

**Troops**—1st Co., CD of the Delaware (1919–21); 2d Co., CD of the Delaware (1919–22); 112th C.A. Co. (1922–24); 1st Engrs. (1922–41); elements of 7th C.A. (1924–41); Btry A, 22d C.A. (1940–41).

**Units for Annual Summer Training**—15 Engrs. (RAI); 21st Engrs. (RAI); 36th Engrs. (RAI); 40th Engr. Bn. (RAI); 301st Engrs.; 302d Engrs.; 303d Engrs.; 319th Engrs.; 322d Engrs.; 323d Engrs.; 332d Engrs.; 335th Engrs.; 341st Engrs.; 342d Engrs.; 351st Engrs.; 352d Engrs.; 353d Engrs.; 354th Engrs.; 360th Engrs.; 363d Engrs.; 368th Engrs.; 371st Engrs.; 372d Engrs.; 373d Engrs.; 374th Engrs.; 401st Engr. Sq.; 411th Engr. Bn.; 412th Engr. Bn.; 413th Engr. Bn.; 414th Engr. Bn.; 415th Engr. Bn.; 416th Engr. Bn.; 438th Engr. Bn.; 439th Engr. Bn.; 440th Engr. Bn.; 515th Engr. Bn.; 516th Engr. Bn.; 534th Engr. Bn.; 537th Engr. Bn.; 605th Engr. Bn. (Camo); 951st Engr. Bn. (HP); CMTC—C.A.C.

**Governor's Island, NY.** Located at the junction of the Hudson and East Rivers in New York Harbor.

**HQ**—First Army (1932–36, 1938–41); Second Corps Area (1920–41); Second C.A. District (1920–23).

**Fort Hamilton, NY.** Located at the south end of Brooklyn, NY. Acquired in 1814. Designated in honor of Alexander Hamilton, Revolutionary War hero, battery commander, and aide-de-camp to Gen. George Washington.

**HQ**—1st Div. (1922–41); HD of Southern New York; 5th C.A. Regt. (1924–41); 18th Inf. Regt. (1927–40); 1st Q.M. Regt. (1936–40); HQ, Sp. Tps., 1st Div. (1931–39).

**Troops**—1st, 2d, 3d, 4th, 7th, and 8th Cos., CD of Southern New York (1919–22); 6th Co., CD of Southern New York (1921–22); 98th C.A. Co. (1922–24); 51st Arty., C.A.C. (1919–20); 3d Bn., 18th Inf. (1922–27); elements of 5th C.A. (1924–41); HQ and M.P. Co., 1st Div. (1937–41).

**Units for Annual Summer Training**—HQ, 77th Div.; HQ, 78th Div.; 306th Inf.; 308th Inf.

**Fort Hancock, NJ.** Located 4 miles from Highland Beach, NJ, at the north end of Sandy Hook. Acquired in 1806. Designated in honor of Maj. Gen. Winfield Scott Hancock who was the commanding general of the II Corps, Army of the Potomac, 1862–65. Training center for Second Corps Area O.R. coast artillery and quartermaster units.

**HQ**—HD of Sandy Hook; 7th C.A. Regt. (1924–41); 52d C.A. Regt. (1929–41).

**Troops**—1st, 2d, 3d, 4th, 5th, 6th, and 7th Cos., CD of Sandy Hook (1919–22); 56th, 76th, 136th, and 137th C.A. Cos. (1922–24); 1st and 2d Bns., 7th C.A. (1924–41); elements of 1st Engr. Regt., 2d Bn., 52d C.A. (1929–41); 1st Bn., 52d C.A. (1941).

**Units for Annual Summer Training**—432d F.A.; 442d F.A.; 245th C.A.; 261st C.A. Bn.; 501st C.A.; 502d C.A.; 513th C.A.; 514th C.A.; 521st C.A.; 522d C.A.; 530th C.A.; 533d C.A.; 539th C.A.; 601st C.A.; 602d C.A.; 607th C.A.; 615th C.A.; 618th C.A.; 619th C.A.; 620th C.A.; 621st C.A.; 908th C.A.; First Army Q.M. Tn.; Fourth Army Q.M. Tn.; II Corps Q.M. Tn.; IV Corps Q.M. Tn.; VI Corps Q.M. Tn.; XII Corps Q.M. Tn.; 61st Cav. Div. Q.M. Tn.;



77th Div. Q.M. Tn.; 78th Div. Q.M. Tn.; 98th Div. Q.M. Tn.; CMTC—C.A.C.

**Henry Barracks, PR.** Located east of Cayey, PR. Acquired in 1903. Designated in honor of Maj. Gen. Guy V. Henry who earned the Medal of Honor at Cold Harbor in 1864, participated in the Battle of the Rosebud in June 1876, and served during the War with Spain in 1898. Designated as a subpost of the San Juan Garrison on 20 April 1921.

**Troops**—3d Bn., 65th Inf. (1920–31); 1st Bn., 65th Inf. (1931–40); 2d Bn., 25th F.A. (1939–41).

**Units for Annual Summer Training**—373d Inf.; 516th Inf. Bn.

**Fort Jay, NY.** Located on Governor's Island in New York Harbor. Fortified in the 1700s. Designated Fort Columbus in honor of Christopher Columbus in 1804. Redesignated Fort Jay in honor of the Honorable John Jay, first Supreme Court justice of the United States.

**HQ**—22d Inf. Regt. (1919–22); 36th Inf. Regt. (1920–21); 16th Inf. Regt. (1922–40); 1st Div. Q.M. Tn. (1925–31).

**Troops**—3d Bn., 22d Inf. (1920–22); 16th Inf., less 3d Bn. (1922–41); 3d Bn., 16th Inf. (1933–41); elements of 1st Div. Q.M. Tn. and later the 1st Q.M. Regt.

**Units for Annual Summer Training**—HQ, 77th Div.; 305th Inf.

**Madison Barracks, NY.** Located at Sackett's Harbor, NY. Established in 1815 as Fort Pike. Redesignated as Madison Barracks in honor of James Madison, Third President of the United States. Along with nearby Pine Camp, served as the training center for Second Corps Area O.R. and N.G. artillery units.

**HQ**—2d Inf. Brig. (1922–30).

**Troops**—63d Inf., less 2d and 3d Bns. (1919–21); 2d Bn., 7th F.A. (1922–34); 1st Bn., 5th F.A. (1930–40); 2d Bn., 25th F.A. (1934–39); 1st Ord. Co. (1933–39).

**Units for Annual Summer Training**—HHB, 52d F.A. Brig.; HHB, 152d F.A. Brig.; HHB, 153d F.A. Brig.; HHB, 173d F.A. Brig.; HHB, 181st F.A. Brig.; 304th F.A.; 305th F.A.; 306th F.A.; 307th F.A.; 308th F.A.; 309th F.A.; 352d F.A.; 367th F.A.; 368th F.A.; 369th F.A.; 391st F.A.; 432d F.A.; 442d F.A.; 461st F.A. Bn.; 472d F.A.; 490th F.A.; 495th F.A.; 570th F.A.; 861st F.A.; 302d Ammo. Tn.; 323d Ammo. Tn.; 342d Ammo. Tn.; CMTC—F.A.; ROTC—F.A.

**Miller Field, NY (Military Airfield).** Located on the southeast shore of Staten Island, NY. Established in World War I as the Staten Island Aviation Seacoast Defense Station. Acquired by purchase 12 March 1919. Redesignated Miller Field on 30 December 1919 in honor of Capt. James E. Miller, the first American flyer killed in action, who was shot down 10 March 1918 near Corbony, France. As a flying field, used primarily for aircraft participating in CD exercises with the HD in the greater New York City area. Made a subpost of Fort Wadsworth on 30 September 1931.

**HQ**—Sp. Tps., 1st Div. (1922–31).

**Troops**—1st Tank Co. (1922–41); 1st Ord. Co. (1922–31); 102d Obsn. Sq. (1922–40); 303d Atk. Gp. (1922–41); 325th Obsn. Gp. (1925–33); 369th Obsn. Sq. (1922–37); 394th HQ Sq. (1922–37); 399th Atk. Sq. (1921–37); 402d Atk. Sq. (1921–30).

**Units for Annual Summer Training**—HQ, 77th Div.; 424th Inf.; 306th Tank Regt.; 461st Armd. Car Sq.; 303d Tank Bn.; 304th Tank Bn.; 305th Tank Bn.; 306th Tank Bn.; 77th Tank Co.; 78th Tank Co.; 98th Tank Co.; 102d Obsn. Sq.

**Mitchel Field, NY (Military Airfield).** Located near Garden City, Long Island, NY. Established in 1917 as Hazelhurst Field #2. Redesignated in late July 1918 in honor of Maj. John P. Mitchel, former mayor of New York City, who was killed on 16 July 1918 in a flying accident in Louisiana. Training center for First and Second Corps Area O.R. air corps units.

**HQ**—4th Bomb. Wing (1940–41); 9th Obsn. Gp. (1922–35); 9th Bomb. Gp. (1935–40); 7th Purs. Wing (1940–41); 8th Purs. Gp. (1940–41).

**Troops**—1st Div. Avn. (1923–29); 9th Div. Avn. (1923–29); 1st Bomb. Sq. (1936–40); 1st Obsn. Sq. (1919–36); 2d Air Base Sq. (1936–40); 3d Aero Sq. (1919); 5th Obsn. Sq. (1920–40); 18th Rcn. Sq. (1936–40); 24th Purs. Sq. (1921–22); 35th Purs. Sq. (1940–41); 36th Purs. Sq. (1940–41); 61st Sv Sq. (1923–36); 88 Aero Sq. (1919); 97th Obsn. Sq. (1935–40); 99th Obsn. Sq. (1928–40); 314th Purs. Gp. (1921–33); 302d Obsn. Sq. (1921–37); 344th Sv Sq. (1922–37); 382d Sv Sq. (1921–37); 447th Purs. Sq. (1921–37); 448th Purs. Sq. (1921–37); 517th HQ Sq. (1922–33).

**Units for Annual Summer Training**—HQ, XII Corps Air Sv; 26th Div. Avn.; 101st Obsn. Sq.; 27th Div. Avn.; 102d Obsn. Sq.; 43d Div. Avn.; 118th Obsn. Sq.; 301st Obsn. Sq.; 302d Obsn. Sq.; 303d Obsn. Sq.; 319th Obsn. Sq.; 322d Obsn. Sq.; 323d Obsn. Sq.; 330th Sv Sq.; 331st Sv Sq.; 332d Sv Sq.; 333d Sv Sq.; 343d Sv Sq.; 344th Sv Sq.; 345th Sv Sq.; 351st Obsn. Sq.; 352d Obsn. Sq.; 353d Obsn. Sq.; 354th Obsn. Sq.; 369th Obsn. Sq.; 370th Obsn. Sq.; 366th Obsn. Sq.; 382d Sv Sq.; 392d Obsn. Sq.; 397th Purs. Sq.; 399th Atk. Sq.; 400th Atk. Sq.; 401st Atk. Sq.; 402d Atk. Sq.; 445th Purs. Sq.; 447th Purs. Sq.; 448th Purs. Sq.; 449th Purs. Sq.; 450th Purs. Sq.; 451st Obsn. Sq.; 452d Obsn.

Sq.; 861st Obsn. Sq.

**Fort Monmouth, NJ.** Established 16 May 1917 as Camp Alfred Vail. Redesignated 6 August 1925 as Fort Monmouth, NJ. Located 4 miles northwest of Long Branch, NJ. Primary training center for O.R. signal units.

**Troops**—1st Sig. Co. (1923–41); 51st Sig. Bn. (1921–41).

**Units for Annual Summer Training**—302d Sig. Bn.; 303d Sig. Bn.; 322d Sig. Bn.; CMTC—S.C.; ROTC—S.C.

**Fort Mott, NJ.** Located 6 miles northwest of Salem, NJ, on the Delaware River. Acquired in 1837. Designated in honor of Maj. Gen. Gershom Mott, a New Jersey native who served in both the War with Mexico and during the Civil War.

**Troops**—1st Co., CD of the Delaware (1921–22); 4th Co, CD of the Delaware (1919–21); elements of 7th C.A.; 1st Engrs.

**Fort Niagara, NY.** Located 14 miles below Niagara Falls, NY, on Lake Ontario at the mouth of the Niagara River. Acquired in 1841.

**HQ**—28th Inf. Regt. (1922–41).

**Troops**—2d Bn., 22d Inf. (1920–22); 2d Bn, 28th Inf. (1922–40); 1st Bn, 28th Inf. (1940–41).

**Units for Annual Summer Training**—HQ, 98th Div.; HHC, 54th Inf. Brig.; HHC, 155th Inf. Brig.; HHC, 195th Inf. Brig.; HHC, 196th Inf. Brig.; 36th Inf. (RAI); 37th Inf. (RAI); 40th Inf. (RAI); 41st Inf. (RAI); 174th Inf.; 307th Inf.; 389th Inf.; 390th Inf.; 391st Inf.; 392d Inf.; 323d Med. Regt.; 361st Med. Sq.; 98th Div. Q.M. Tn.; CMTC—Inf.

**Fort Ontario, NY.** Located in Oswego, NY, at the junction of the Oswego River and Lake Ontario. Surrendered to the United States by the British Army in 1796.

**HQ**—2d Inf. Brig. (1930–39).

**Troops**—3d Bn., 22d Inf. (1919–20); 2d Bn., 63d Inf. (1919–22); 3d Bn., 28th Inf. (1922–40).

**Units for Annual Summer Training**—HQ, 98th Div.; HHC, 195th Inf. Brig.; HHC, 196th Inf. Brig.; HHC, New York C.A. Brig.; 389th Inf.; 202d C.A.; 212th C.A.; 244th C.A.; 258th F.A.

**Plattsburg Barracks, NY.** Located on the west shore of Lake Champlain, NY, at Plattsburg, NY. Acquired in 1814.

**HQ**—14th Inf. Brig. (1921–22); 63d Inf. Regt. (1919–22); 64th Inf. Regt. (1921–22); 26th Inf. Regt. (1922–40).

**Troops**—3d Bn., 63d Inf. (1919–22); 64th Inf., less 3d Bn., (1921–22); 26th Inf. (1922–40).

**Units for Annual Summer Training**—HQ, 98th Div.; HHC, 153d Inf. Brig.; HHC, 154th Inf. Brig.; HHC, 156th Inf. Brig.; HHC, 195th Inf. Brig.; HHC, 196th Inf. Brig.; HHC, 173d F.A. Brig.; HHC, New York C.A. Brig.; 40th Inf. (RAI); 305th Inf.; 306th Inf.; 307th Inf.; 308th Inf.; 309th Inf.; 310th Inf.; 312th Inf.; 389th Inf.; 390th Inf.; 391st Inf.; 392d Inf.; 212th C.A.; 302d M.P. Bn.; 310th M.P. Bn.; 314th M.P. Bn.; 321st M.P. Bn.; 323d Med. Regt.; CMTC—Inf.; ROTC—Inf.

**Fort Porter, NY.** Located on the Niagara River in Buffalo, NY. Established in 1843. Designated in honor of Maj. Gen. Peter B. Porter, who was a brigade commander during the War of 1812 and later the US Secretary of War, 1828–29.

**Troops**—1st Bn., 22d Inf. (1920–22); 1st Bn., 28th Inf. (1922–29).

**San Juan Garrison, PR.** Located in San Juan, PR. Consisted of several posts including Casa Blanca, Infantry Barracks, El Morro, Artillery Park, San Cristobal, San Geronimo, La Palma Bastion, La Puntilla, and Santo Domingo Barracks.

**HQ**—65th Inf. Regt. (1919–41).

**Troops**—65th Inf., less 3d Bn.

**Units for Annual Summer Training**—HQ, 211th Inf. Brig.; 42d Inf. (RAI); 373d Inf.; 374th Inf.; 375th Inf.; 516th Inf. Bn.; CMTC—Inf.; ROTC—Inf.

**Fort Saulsbury, NJ.** Located 6½ miles east of Milford, DE. Acquired by purchase in 1917. Designated in honor of the Honorable Willard Saulsbury, Attorney General and US Senator from Delaware.

**Troops**—Caretaking detachment, 7th C.A. (1924–41).

**Fort Schuyler, NY.** Located 3 miles from Westchester, NY. Acquired by purchase in 1826. Designated in honor of Maj. Gen. Philip J. Schuyler, who served in the French and Indian War and was later one of the original four major generals appointed to serve under Gen. George Washington during the Revolutionary War. Control transferred in May 1934 to the State of New York for use as a maritime academy.

**Troops**—2d Bn., 18th Inf. (1922–31); 29th Engr. Bn. (Topo) (1932–35).

**Fort Slocum, NY.** Located on David's Island, 2 miles south of New Rochelle, NY. Acquired by purchase in 1867.

Designated in honor of Maj. Gen. Henry W. Slocum who served as commanding general for the XII, XIV, and XX Corps at various periods during the Civil War. Headquarters for the Second Corps Area Training Center 1921–22.

**HQ**—18th Inf. Regt. (1922–27).

**Troops**—18th Inf., less 2d and 3d Bns. (1922–27); 3d Bn., 18th Inf. (1927–38); elements of 95th Q.M. Bn.

**Units for Annual Summer Training**—HQ, 77th Div.; HQ, 78th Div.; HQ, 153d Inf. Brig.; HQ, 154th Inf. Brig.; HQ, 155th Inf. Brig.; HQ, 156th Inf. Brig.; HHB, 152d F.A. Brig.; 305th Inf.; 306th Inf.; 307th Inf.; 308th Inf.; 309th Inf.; 311th Inf.

**Fort Tilden, NY.** Located 3 miles southwest of Rockaway Park, Long Island, NY. Acquired by purchase in 1917. Designated in honor of Samuel J. Tilden, statesman from New York.

**Troops**—9th Co., CD of Southern New York (1919–22).

**Units for Annual Summer Training**—502d C.A.; 513th C.A.; 514th C.A.; 521st C.A.; 522d C.A.; 530th C.A.; 539th C.A.; 908th C.A.; 909th C.A.; 910th C.A.

**Fort Totten, NY.** Located on Willett's Point, 2 miles northeast of Whitestone, Long Island, NY. Acquired by purchase in 1851. Designated in honor of Brig. Gen. Joseph G. Totten, Chief of Engineers, 1838–64.

**HQ**—Second C.A. District (1923–30); HD of Eastern New York; 44th Arty. Regt., C.A.C. (1921–22); 62d C.A. Regt. (1921–41).

**Troops**—1st and 2d Cos., CD of Eastern New York (1919–22); 135th CD Co. (1922–24); 44th Arty., C.A.C. (1921–22); 62d C.A. (1921–41); elements of 5th C.A. (1924–41).

**Units for Annual Summer Training**—212th C.A.; 502d C.A.; 513th C.A.; 514th C.A.; 521st C.A.; 522d C.A.; 530th C.A.; 533d C.A.; 539th C.A.; 40th Engr. Bn. (RAI).

**Camp Alfred Vail, NJ.** See Fort Monmouth.

**Fort Wadsworth, NY.** Located on the northeast shore of Staten Island, NY. Acquired by purchase in 1847. Designated in honor of Brig. Gen. James S. Wadsworth.

**HQ**—1st Inf. Brig. (1922–31, 1938–39).

**Troops**—5th Co., CD of Southern New York (1919–22); 6th Co., CD of Southern New York (1919–21); 3d Bn., 16th Inf. (1922–33); elements of 1st Div. Q.M. Tn.; 2d Bn., 18th Inf. (1931–40); 3d Bn., 18th Inf. (1928–41).

**Units for Annual Summer Training**—HHC, 195th Inf. Brig.; HHC, 196th Inf. Brig.; 309th Inf.; 311th Inf.; 312th Inf.; 389th Inf.; 391st Inf.; 392d Inf.; 303d Engr. Regt.; 323d Engr. Regt.

**Camp Welsh, NY.** Located at Montauk Point, Long Island, NY. Established in 1918. Abandoned in 1923.

**Units for Annual Summer Training**—HHB, 52d F.A. Brig.; 104th F.A.; 105th F.A.; 112th F.A.; 258th F.A.

**Fort Wood, NY.** Located on Bedloe's (Liberty) Island in New York Harbor. Acquired in 1800. Designated in honor of Capt. E.D. Wood, Corps of Engineers, who was killed in action in 1814 at Fort Erie. A subpost of Fort Jay, NY. Control transferred to the US Department of the Interior on 24 September 1937.

**Troops**—B Co., 16th Inf. (1922–23); E Co., 16th Inf. (1923–24); A Co., 16th Inf. (1924–25); HQ and M.P. Co., 1st Div. (1925–37).

### National Guard

**Arecibo, PR.** Located at Arecibo, PR, 40 miles west of San Juan on the northern coast of Puerto Rico.

**Units for Annual Summer Training**—295th Inf.; 1st Bn., 296th Inf.

**Bethany Beach, DE.** Located at Bethany Beach, DE, 10 miles southeast of Indian River Bay.

**Units for Annual Summer Training**—198th C.A.

**Pine Camp, NY.** Located at Pine Plains, 11 miles east of Watertown, NY. Established in 1908. Redesignated Pine Plains Military Reservation in 1938. Along with nearby Madison Barracks, Pine Camp served as the training center for Second Corps Area O.R. and N.G. artillery units, as well as some mobile units of the New York N.G.

**Units for Annual Summer Training**—HHC, 54th Inf. Brig.; HHT, 51st Cav. Brig.; HHB, 52d F.A. Brig.; HHB, 152d F.A. Brig.; HHB, 153d F.A. Brig.; HHB, 173d F.A. Brig.; HHB, New York C.A. Brig.; 105th Inf.; 106th Inf.; 107th Inf.; 108th Inf.; 101st Cav.; 121st Cav.; 51st MG Sq.; 25th F.A. (RAI); 50th F.A. (RAI); 89th F.A. (RAI); 104th F.A.; 105th F.A.; 106th F.A.; 112th F.A.; 156th F.A.; 157th F.A.; 258th F.A.; 304th F.A.; 305th F.A.; 306th F.A.; 307th F.A.; 308th F.A.; 309th F.A.; 352d F.A.; 367th F.A.; 368th F.A.; 369th F.A.; 391st F.A.; 415th F.A.; 416th F.A.; 432d F.A.; 441st F.A.; 442d F.A.; 461st F.A. Bn.; 471st F.A.; 472d F.A.; 480th F.A.; 481st F.A.; 490th F.A.; 566th F.A.; 569th F.A.; 570th F.A.; 577th F.A.; 861st F.A.; 212th C.A.; 102d Ammo. Tn.; 132d Ammo. Tn.; 302d Ammo. Tn.; 303d Ammo. Tn.; 323d

Ammo. Tn.; 332d Ammo. Tn.; 342d Ammo. Tn.; 27th Div. Avn.; 102d Obsn. Sq.; 27th Div. Q.M. Tn.

**Ponce, PR.** Located at Ponce, PR.

**Units for Annual Summer Training**—295th Inf.; 1st Bn., 296th Inf.

**Sea Girt, NJ.** Located on the north side of Manasquan Inlet, 2 miles north of Point Pleasant, NJ. Established in 1885.

**Units for Annual Summer Training**—HQ, 44th Div.; HHC, 57th Inf. Brig.; HHT, 59th Cav. Brig.; HHB, 68th F.A. Brig.; 113th Inf.; 114th Inf.; 310th Inf.; 312th Inf.; 102d Cav.; 302d Cav.; 303d Ammo. Tn.; 104th Engrs.; 119th Med. Regt.; 44th Q.M. Tn.; 119th Q.M. Regt.

**Camp Smith, NY.** Located 2 miles northwest of Peekskill, NY, across the Hudson River from the US Military Academy. Established in May 1882 as the State Camp of Instruction. Redesignated Camp Smith in 1926 in honor of Alfred E. Smith, governor of New York.

**Units for Annual Summer Training**—HQ, 27th Div.; HHC, 53d Inf. Brig.; HHC, 54th Inf. Brig.; HHC, 87th Inf. Brig.; HHC, 93d Inf. Brig.; HHB, 52d F.A. Brig.; HHB, New York C.A. Brig.; 10th Inf. (New York N.G.); 14th Inf. (New York N.G.); 71st Inf.; 105th Inf.; 106th Inf.; 107th Inf.; 108th Inf.; 165th Inf.; 174th Inf.; 369th Inf.; 212th C.A.; 244th C.A.; 245th C.A.; 258th F.A.; 101st Sig. Bn; 102d Engrs.; 102d Med. Regt.; 27th Q.M. Tn.; 102d Q.M. Regt.

### Organized Reserve

**Camp Blauvelt, NY.** Located 3 miles southwest of Nyack, NY. Established as Bluefield Camp before World War I and used as a rifle range for the New York N.G. Reopened in 1923 as a contact camp for officers of the 77th Div.

**Units for Annual Summer Training**—HQ, 77th Div.; HQ, 153d Inf. Brig.; 154th Inf. Brig.; 305th Inf.; 306th Inf.; 307th Inf.; 308th Inf.; 441st F.A.; 401st Engr. Sq.

**Camp Silzer, NJ.** Located at the Sea Girt, NJ, N.G. training area. Established in 1923 as a contact camp for officers of the 78th Div.

**Units for Annual Summer Training**—HQ, 78th Div.; HQ, 155th Inf. Brig.; 156th Inf. Brig.; HHB, 153d F.A. Brig.; 309th Inf.; 310th Inf.; 311th Inf.; 312th Inf.; 152d MG Sq.

**Camp Upton, NY.** Located on Long Island near Manorville, NY, 63 miles east of New York City. Established 18 July 1917. Designated in honor of Maj. Gen. Emory Upton, who served as a brigade and division commander in the Army of the Potomac during the Civil War and subsequent leader in American military thought. Designated as a National Army cantonment for the mobilization of the 77th Div. in World War I. Retained as a military reservation and designated a mobilization and training station for O.R. antiaircraft artillery units.

**Troops**—41st Inf. (1919–21); 42d Inf. (1919–20).

**Units for Annual Summer Training**—71st Inf.; 198th C.A.; 212th C.A.; 502d C.A.; 513th C.A.; 521st C.A.; 533d C.A.; 539th C.A.; 602d C.A.

**Camp Wadsworth, NY.** Located on Long Point, Conesus Lake, NY. Established in 1923 on property owned by Congressman Robert Wadsworth as a contact camp for officers of the 98th Div.

**Units for Annual Summer Training**—HQ, 98th Div.; HQ, 195th Inf. Brig.; 196th Inf. Brig.; 389th Inf.; 390th Inf.; 391st Inf.; 392d Inf.

### THIRD CORPS AREA

**HQ**—Fort Howard, MD, 20 August 1920–12 May 1922; Baltimore, MD, 12 May 1922—as of 7 December 1941.

Established in the US Army on 20 August 1920 with headquarters at Fort Howard, MD, and organized from portions of the discontinued Eastern Department. The headquarters was moved to St. Paul Place and Franklin Street in Baltimore, MD, on 12 May 1922, to 311 St. Paul Street on 28 June 1928; and subsequently to the US Post Office and Federal Court Building on 13 June 1932. The Third Corps Area included the states of Pennsylvania, Maryland, Virginia, and the District of Columbia. The District of Columbia was organized into a separate command designated as “HQ, District of Washington” on 1 September 1921 and placed under the command of the Third Corps Area. The District of Washington was discontinued on 30 September 1927 and those duties were assumed by the 16th Inf. Brig. HQ, Third Corps Area was responsible for the mobilization, administration, and training of units of the First and Fourth Armies, III and XIII Army Corps, coast defense units of the Third Coast Artillery District, select units of the GHQR, and the Z.I. support units of the Third CASC. Mobile units of the corps area, less CD, GHQR, and Z.I. units, were assigned to the First and Fourth Armies, 1921–33. With the adoption of the four field army plan on 1 October 1933, the mobile units of the Third Corps Area previously assigned to the Fourth Army were reassigned to the First Army or GHQR, or demobilized. The Third Corps Area Training Center was established in 1921, originally at Camp George G. Meade, MD, to train R.A. and O.R. units of all arms and services, as well as ROTC cadets and CMTC candidates. With the inactivation of the Third Corps Area Training Center on 11 September 1922, Camp Meade became the primary training center for corps area infantry and tank units. Air corps units were sent to Langley Field, VA, engineer units were sent to Camp A.A. Humphreys, VA, and signal corps units were sent to Camp Alfred Vail (later renamed Fort Monmouth), NJ. Additionally, cavalry units were sent to Fort Myer, VA. Corps area maneuvers of R.A. mobile units were held, those years when funds were available, at Camp George G. Meade. For the administration of O.R. units, all organizations initially came under the control of the III Corps, or the 79th, 80th, and 99th Divs. When the III Corps was inactivated in 1925, the HQ, Non-Divisional Group was established to direct the organization, training, and administration of all nondivisional units. This arrangement was short-lived. On 22 April 1925, the Non-Divisional Group was discontinued and the HQ, Artillery Group was established. This new group managed the corps area non-divisional field artillery units. The rest of the nondivisional units were turned over to direct control of the HQ, Third Corps Area. The corps area was reorganized into three “military areas” on 1 October 1939. At that time, the 1st Mil. Area assumed control of the 79th Div. area (Eastern Pennsylvania), the 2d Mil. Area assumed control of the 80th Div. area (Virginia and Maryland), and the 3d Mil. Area assumed control of the 99th Div. area (Western Pennsylvania). The Third Corps Area began assigning Reserve personnel to “1300” series numbered CASC units on 12 August 1929. The HQ, Third Corps Area actually began functioning as a service command headquarters in October 1940 and was redesignated HQ, Third CASC in May 1941. It was further redesignated HQ, Third Service Command on 22 July 1942.

**Events:** 109, 234, 247

#### Major Commands in the Corps Area

III Corps: 8th Division, 28th Division, 29th Division  
XIII Corps: 79th Division, 80th Division, 99th Division  
Third Coast Artillery District  
District of Washington  
General Headquarters, Air Force (1935–41)  
2d Bombardment Wing  
Third Corps Area Service Command

#### Corps Area Commanders

Maj. Gen. Adelbert Cronkhite	1 September 1920–26 July 1921	Maj. Gen. Douglas MacArthur	1 August 1925–3 September 1928
Brig. Gen. Charles J. Bailey	26 July 1921–17 August 1921	Maj. Gen. Fred W. Sladen	14 September 1928–3 August 1931
Maj. Gen. Harry F. Hodges	17 August 1921–10 November 1921	Maj. Gen. Paul B. Malone	3 August 1931–18 February 1935
Maj. Gen. Charles J. Bailey	10 November 1921–1 December 1922	Maj. Gen. Robert E. Callan	18 February 1935–30 September 1935
Maj. Gen. Charles H. Muir	3 December 1922–18 July 1924	Maj. Gen. Albert J. Bowley	2 October 1935–1 February 1938
Maj. Gen. William R. Smith	19 July 1924–1 November 1924	Brig. Gen. John W. Gulick	16 February 1938–1 April 1938
Maj. Gen. Samuel D. Sturgis Jr.	2 November 1924–26 June 1925	Maj. Gen. James K. Parsons	1 April 1938–3 October 1940
Brig. Gen. Robert E. Callan	26 June 1925–1 August 1925	Maj. Gen. Walter S. Grant	11 October 1940–21 August 1941
	Maj. Gen. Henry C. Pratt		21 August 1941–4 January 1942

### Commanders, District of Washington

Brig. Gen. Harry H. Bandholtz 1 September 1921–4 November 1923 Brig. Gen. George C. Barnhardt 31 July 1927–23 September 1927  
 Brig. Gen. Hamilton S. Hawkins 5 November 1923–12 February 1924 Col. Guy V. Henry 23 September 1927–30 September 1927  
 Brig. Gen. Samuel D. Rockenbach 12 February 1924–12 July 1927 Brig. Gen. Thomas Q. Donaldson 1 October 1927–1 December 1927

#### Third Corps Area Service Command Organization 1930

UNIT:	LOCATION:
HQ, Third CASC	Baltimore, MD
Corps Area Sup Point	Philadelphia, PA
1300th CASU (HQ, CASC)	Baltimore, MD
1301st CASU	Philadelphia, PA
1302d CASU	Pittsburgh, PA
1303d CASU	Baltimore, MD
1304th CASU	Richmond, VA
1305th CASU	Baltimore, MD
1306th CASU	Harrisburg, PA
1307th CASU	Unknown
1308th CASU	Unknown
1309th CASU	Pittsburgh, PA
1310th CASU	Baltimore, MD
1311th CASU	Unknown
1312th CASU	Unknown
1313th CASU	Unknown
1314th CASU	Unknown
1315th CASU	Unknown
1316th CASU	Langley Field, VA
1317th CASU	Washington, DC
1318th CASU	Baltimore, MD
1319th CASU	Fort Monroe, VA
1320th CASU	Washington, DC
1321st CASU	Washington, DC
1322d CASU	Washington, DC
1323d CASU	Carlisle Barracks, PA
1324th CASU	Baltimore, MD
1325th CASU	Unknown
1326th CASU	Philadelphia, PA
1327th CASU	Baltimore, MD
1328th CASU	Fort Monroe, VA
1329th CASU	Philadelphia, PA
1330th CASU	Baltimore, MD
1331st CASU	Pittsburgh, PA
1332d CASU	Washington, DC
1333d CASU	Unknown
1334th CASU	Unknown
Eighth CASC Air Pool	Unknown

#### Third Corps Area Service Command Organization 1941

UNIT:	LOCATION:
HQ, Third CASC	Baltimore, MD
CASC Sup Point	Philadelphia, PA
1300th CASU (HQ, CASC)	Baltimore, MD
1301st CASU (Recep. Ctr.)	New Cumberland, PA
1302d CASU (Recep. Ctr.)	Fort G.G. Meade, MD
1303d CASU (Recep. Ctr.)	Camp Lee, VA
1305th CASU (M.P. Plt)	Baltimore, MD
1311th CASU (Rctg. Sv)	Baltimore, MD
1313th CASU (Fin. Ofc.)	Baltimore, MD
1314th CASU (Fin. Ofc.)	Philadelphia, PA
1315th CASU (Fin. Ofc.)	Fort Monroe, VA
1319th CASU (Sta. Cmpl.)	Fort Monroe, VA
1320th CASU (Sta. Cmpl.)	Fort Belvoir, VA
1321st CASU (Sta. Cmpl.)	Fort Eustis, VA
1322d CASU (Sta. Cmpl.)	Fort G.G. Meade, MD
1323d CASU (Sta. Cmpl.)	Fort Myer, VA
1325th CASU (Sta. Cmpl.)	Indiantown Gap MR, PA
1326th CASU (Sta. Cmpl.)	Camp Lee, VA
1327th CASU (Sta. Cmpl.)	Fort Story, VA
1328th CASU (Sta. Cmpl.)	Camp Pendleton, VA
1329th CASU (Sta. Cmpl.)	Arlington Cantonment, VA
1331st CASU (ROTC Instr. Gp.)	Baltimore, MD
1332d CASU (Sch. B&C)	Fort G.G. Meade, MD
1333d CASU (Gen. Dispry.)	Philadelphia, PA
1335th CASU (Gen. Dispry.)	Baltimore, MD
1336th CASU (Sta. Cmpl.)	Camp A.P. Hill, VA
1338th CASU (Recreation)	Washington, DC
1339th CASU (Recreation)	Anacostia, DC
1340th CASU (Sta. Cmpl.)	Aberdeen P.G., MD
1341st CASU (Sta. Cmpl.)	Edgewood Arsenal, MD
1342d CASU (Sta. Cmpl.)	Holabird Q.M. Dep, MD
Air Corps Det.	Logan Field, PA
Air Corps Det.	Pittsburgh Airport, MD
Air Corps Det.	Connellsville, PA

#### Major posts, camps, stations, airfields, and N.G. and O.R. training facilities in the corps area.

##### Regular Army

**Aberdeen Proving Ground, MD.** Located 35 miles northeast of Baltimore, MD. Established 16 October 1917.

**HQ**—69th C.A. Regt. (1930).

**Troops**—69th C.A. (1930); 49th Bomb. Sq. (1922–28).

**Units for Annual Summer Training**—514th C.A.; 522d C.A.; 530th C.A.; 533d C.A.; 539th C.A.; ROTC—Ord.

**Fort Armistead, MD.** Located 8 miles southeast of Baltimore, MD, on Hawkins Point, Ann Arundel County. Reservation acquired in 1896. Established in 1898. Designated in honor of Maj. George Armistead who was in command of Fort McHenry when that garrison successfully defended Baltimore from attack by the British fleet in 1814. A subpost of Fort Howard. All CD armament removed in 1920 and post inactivated.

**Troops**—Coast artillery elements of HD of Baltimore (1919–21).

**Fort Belvoir, Virginia.** See Camp A.A. Humphreys.

**Bolling Field, DC (Military Airfield).** Located 2 miles south of the capitol in Washington, DC, at Anacostia. Established 2 October 1917. Designated in honor of Col. Raynal C. Bolling, Assistant Chief of the Air Service, who was killed on an air mission 26 March 1918 over Amiens, France. Designated a Reserve Airdrome and Flying Field.

**HQ**—GHQ Air Force (1933–35 and 1941).

**Troops**—8th Div. Avn. (1923–29); 1st Photo Sq. (1940–41); 1st Staff Sq. (1936–41); 2d Staff Sq. (1936–41); 2d Bomb. Sq. (1940–41); Base HQ and 14th Air Base Sq. (1936–40); 14th Bomb. Sq. (1935–36); 18th HQ Sq. (1923–29); 21st Obsn. Sq. (1935–36); 41st Purs. Sq. (1940); 56th Sv Sq. (1923–28); 99th Aero Sq. (1919–21); 99th Obsn. Sq. (1921–27); 100th Sv Sq. (1935–36).

**Carlisle Barracks, PA.** Located on the outskirts of Carlisle, PA. Acquired in 1801. Transferred to the Department of the Interior and used as an Indian School, 1879–1918. Returned to the War Department on 16 July 1918. US Army Field Medical School established there in 1920. Training center for First, Second, and Third Corps Area O.R. medical units.

**HQ**—1st Med. Regt. (1922–41).

**Troops**—1st Med. Regt. (1922–41).

**Units for Annual Summer Training**—5th Med. Regt. (RAI); 8th Med. Regt. (RAI); 14th Med. Regt. (RAI); 15th Med. Regt. (RAI); 18th Med. Regt. (RAI); 31st Med. Regt. (RAI); 104th Med. Regt.; 301st Med. Regt.; 302d Med. Regt.; 303d Med. Regt.; 304th Med. Regt.; 305th Med. Regt.; 307th Med. Regt.; 308th Med. Regt.; 309th Med. Regt.; 312th Med. Regt.; 319th Med. Regt.; 322d Med. Regt.; 323d Med. Regt.; 324th Med. Regt.; 325th Med. Regt.; 341st Med. Regt.; 342d Med. Regt.; 343d Med. Regt.; 344th Med. Regt.; 350th Med. Regt.; 361st Med. Regt.; 361st Med. Sq.; 362d Med. Regt.; 362d Med. Sq.; 363d Med. Regt.; 364th Med. Regt.; 364th Med. Sq.; 365th Med. Regt.; 373d Med. Regt.; 374th Med. Regt.; 375th Med. Regt.; ROTC—M.C., Vet.

**Fort Carroll, MD.** Located 8½ miles southeast of Baltimore, MD, on Sollers Point Flats, Baltimore County. Reservation acquired in 1847. Established in 1898. Designated in honor of Charles Carroll, signer of the Declaration of Independence. A subpost of Fort Howard.

**Troops**—C.A. caretaker detachments of the HD of Baltimore (1919–27).

**Edgewood Arsenal, MD.** Located at Edgewood, MD, and contiguous with Aberdeen Proving Ground. Established 16 October 1917. Designated as Edgewood Arsenal in 1937. Training center for Chemical Corps units of the O.R. and ROTC.

**HQ**—1st Chem. Regt. (1920–35).

**Troops**—1st Chem. Regt. (1920–35); 2d Sep. Chem. Bn. (1935–41).

**Units for Annual Summer Training**—1st Chem. Regt. (RAI); 303d Chem. Regt.; ROTC.

**Camp Eustis, VA.** Located 18 miles northwest of Newport News, VA. Established 27 March 1918. Designated Fort Eustis in 1923 in honor of Col. Abraham Eustis, War of 1812 hero. The reservation included the balloon training center at Lee Hall, VA; consolidated with Camp Eustis on 31 March 1922. All C.A. units transferred away in 1930 and armament placed in caretaker status.

**HQ**—30th Brig., C.A.C. (1920–21, 1926–30); 34th Inf. Regt. (1922–34); Air Sv Bln. Tng. Ctr. (1919–22).

**Troops**—42d Arty. Regt., C.A.C. (1919–21); 43d Arty. Regt., C.A.C. (1919–21); 52d Arty. Regt., C.A.C. (1919–21); 53d Arty. Regt., C.A.C. (1919–21); 51st C.A. (1921–30); 52d C.A. (1921–29); 34th Inf., less 1st Bn. (1922–34); 1st S.R. Btry (1921–30).

**Units for Annual Summer Training**—313th Inf.; 314th Inf.; 315th Inf.; 316th Inf.; 317th Inf.; 318th Inf.; 319th Inf.; 320th Inf.; 393d Inf.; 394th Inf.; 395th Inf.; 396th Inf.; 192d F.A.; 244th C.A.; 258th F.A.; 310th F.A.; 314th F.A.; 394th F.A.; 395th F.A.; 462d F.A. Bn.; 473d F.A.; 482d F.A.; 491st F.A.; 495th F.A.; 573d F.A.; 578th F.A.; 580th F.A.; 132d Ammo. Tn.; 603d C.A.; 609th C.A.; 622d C.A.; 62d Cav. Div. Q.M. Tn.; CMTC—Inf.

**Holabird Quartermaster Depot, MD.** Located 5 miles southeast of Baltimore, MD. Authorized June 1918. Established 12 May 1919. Designated in honor of Brig. Gen. Samuel B. Holabird, Q.M. Gen. of the Department of the Gulf, 1862–62, and of the US Army in 1883.

**Troops**—1st M. Rep. Bn.

**Units for Annual Summer Training**—I Corps Q.M. Tn.; 62d Cav. Div. Q.M. Tn.; 76th Div. Q.M. Tn.; 77th Div. Q.M. Tn.; 79th Div. Q.M. Tn.; 80th Div. Q.M. Tn.; 97th Div. Q.M. Tn.; 99th Div. Q.M. Tn.; 403d Q.M. Regt.; 423d Q.M. Regt.; ROTC—Q.M.C. (M.T.C.).

**Fort Howard, MD.** Located 17 miles southeast of Baltimore, MD. Reservation acquired in 1896. Established in 1899. Designated in honor of Col. John E. Howard who was a Revolutionary War hero at the Battle of Cowpens, and subsequently a senator from Maryland and brigadier general, US Army in 1803.

**HQ**—Third Corps Area (1920–22); Third C.A. District (1920–24); HD of Baltimore; 16th Inf. Brig. (1922–24, 1926–28).

**Troops**—1st and 2d Cos., CD of Baltimore (1919–22); 164th C.A. Co. (1922–24); 12th Inf., less 2d and 3d Bns. (1922–40); Btry D, 12th C.A. (1924–32).

**Units for Annual Summer Training**—HHC, 197th Inf. Brig.; HHC, 198th Inf. Brig.; 313th Inf.; 314th Inf.; 315th Inf.; 316th Inf.; 319th Inf.; 320th Inf.; 393d Inf.; 394th Inf.; 395th Inf.; 396th Inf.; 428th Inf.; 429th Inf.; 430th Inf.; 431st Inf.; 432d Inf.; CMTC—Inf. (Colored).

**Fort Hoyle, MD.** Located at Edgewood, MD. Contiguous with Edgewood Arsenal. Established as a separate post 7 October 1922. Designated in honor of Brig. Gen. Eli D. Hoyle. Training center for Third Corps Area O.R. field artillery units. Reservation absorbed by Edgewood Arsenal on 10 September 1940.

**HQ**—1st F.A. Brig. (1922–39).

**Troops**—6th F.A. (1922–40); 1st Ammo. Tn. (1922–30); 99th F.A., less 2d Bn. (1940–41).

**Units for Annual Summer Training**—HHB, 152d F.A. Brig.; HHB, 154th F.A. Brig.; HHB, 155th F.A. Brig.; HHB, 174th F.A. Brig.; 182d F.A. Brig.; 28th F.A. (RAI); 41st F.A. (RAI); 42d F.A. (RAI); 304th F.A.; 305th F.A.; 306th F.A.; 308th F.A.; 310th F.A.; 311th F.A.; 312th F.A.; 313th F.A.; 314th F.A.; 315th F.A.; 366th F.A.; 370th F.A.; 371st F.A.; 372d F.A.; 394th F.A.; 395th F.A.; 396th F.A.; 462d F.A. Bn.; 566th F.A.; 570th F.A.; 571st F.A.; 578th F.A.; 580th F.A.; 862d F.A.; 302d Ammo. Tn.; 303d Ammo. Tn.; 304th Ammo. Tn.; 305th Ammo. Tn.; 324th Ammo. Tn.; 343d Ammo. Tn.; 347th Ammo. Tn.; CMTC—F.A.

**Camp A.A. Humphreys, VA.** Located 15 miles southeast of Washington, DC, in Fairfax County, VA. Acquired in 1910. Post established 23 December 1917. Designated in honor of Maj. Gen. Andrew A. Humphreys who served as a division and corps commander in the Army of the Potomac and subsequently as the Chief of Engineers, 1866–79. Redesignated Fort Humphreys on 7 September 1922. Redesignated Fort Belvoir on 14 February 1935. Training center for Third Corps Area O.R. engineer units.

**HQ**—13th Engr. Regt. (1921–36); 5th Engr. Regt. (1936–41).

**Troops**—13th Engr. Regt. (1921–36); 17th Engr. Bn. (1921–23); 29th Engr. Bn. (Topo) (1923–29); 5th Engr. Regt. (1936–41).

**Units for Annual Summer Training**—HQ, 29th Div.; HQ, 61st Cav. Div.; HHT, 151st Cav. Brig.; HHT, 152d Cav. Brig.; HHT, 153d Cav. Brig.; HHT, 154th Cav. Brig.; 301st Cav.; 302d Cav.; 303d Cav.; 304th Cav.; 305th Cav.; 306th Cav.; 307th Cav.; 308th Cav.; 12th Engr. Sq. (RAI); 22d Engrs. (RAI); 23d Engrs. (RAI); 24th Engrs. (RAI); 35th Engrs. (RAI); 37th Engrs. (RAI); 40th Engr. Bn. (RAI); 112th Engrs.; 121st Engrs.; 304th Engrs.; 305th Engrs.; 308th Engrs.; 309th Engrs.; 319th Engrs.; 322d Engrs.; 324th Engrs.; 325th Engrs.; 343d Engrs.; 375th Engrs.; 376th Engrs.; 402d Engr. Sq.; 404th Engr. Sq.; ROTC—Engrs.

**Fort Hunt, VA.** Located 11 miles south of Washington, DC. Acquired in 1863. Designated in honor of Maj. Gen. Henry J. Hunt, chief of artillery for the Army of the Potomac, on 13 April 1899. C.A. garrison reduced to caretaker status 3 July 1923. HD discontinued in December 1927. Made a subpost of Fort Humphreys, VA, 20 January 1928. The post was abandoned 28 July 1931.

**HQ**—16th Inf. Brig. (1928–31).

**Troops**—47th C.A. Co. (1922–24); caretaking detachment, 12th C.A. (1924–31).

**Units for Annual Summer Training**—428th Inf.; 429th Inf.; 430th Inf.; 431st Inf.; 432d Inf.

**Langley Field, VA (Military Airfield).** Located at Hampton, VA. Established 30 December 1916. Designated in honor of Professor Samuel P. Langley, pioneer aeronautical engineer. Designated a Reserve Flying Field. Training center for Third Corps Area O.R. air corps units.

**HQ**—HQ, GHQ Air Force (1935–41); HQ, 2d Wing (1919–29); HQ, 2d Bomb. Gp. (1922–41); HQ, 7th Obsn. Gp. (1919–21); HQ, 8th Purs. Gp. (1931–40); HQ, 2d Bomb. Wing (1929–41); HQ, 16th Bomb. Wing (1940–41); HQ, 22d Bomb. Gp. (1940–41); HQ, 36th Purs. Gp. (1940–41).

**Troops**—Base HQ and 1st Air Base Sq. (1936–40); 2d WX Sq. (1936–41); 2d Bomb. Sq. (1940–41); 3d Obsn. Sq. (1937–41); 6th Bomb. Sq. (1940); 10th Bln Co. (1919–21); 10th Bomb. Sq. (1940); 11th Bomb. Sq. (1922–27); 12th Bomb. Sq. (1940); 18th Recon. Sq. (1940–41); 19th Ash. Sq. (1919–36); 19th Bomb. Sq. (1940–41); 20th Bomb. Sq. (1922–41); 21st Obsn. Sq. (1936–39); 22d Purs. Sq. (1940–41); 23d Purs. Sq. (1940–41); 29th Bomb. Sq. (1940–41); 32d Purs. Sq. (1940–41); 33d Bomb. Sq. (1940–41); 33d Purs. Sq. (1932–40); 35th Purs. Sq. (1932–40); 35th Bomb. Sq. (1940–41); 36th Purs. Sq. (1932–40); 37th Bomb. Sq. (1935–38); 37th Purs. Sq. (1932–35); 41st Rcn. Sq. (1940–41); 49th Bomb. Sq. (1928–41); 50th Obsn. Sq. (1919–27); 52d Atk. Sq. (1940); 58th Sv Sq. (1923–29); 59th Sv Sq. (1923–36); 88 Aero Sq. (1919–21); 96th Bomb. Sq. (1922–41); 10th Bln Co. (1919–21).



**Units for Annual Summer Training**—HQ, 305th Atk. Gp.; 28th Div. Avn.; 29th Div. Avn.; 79th Div. Avn.; 80th Div. Avn.; 99th Div. Avn.; 101st Obsn. Sq.; 103d Obsn. Sq.; 104th Obsn. Sq.; 304th Obsn. Sq.; 305th Obsn. Sq.; 324th Obsn. Sq.; 335th Sv Sq.; 355th Obsn. Sq.; 356th Obsn. Sq.; 403d Purs. Sq.; 404th Purs. Sq.; 405th Purs. Sq.; 406th Purs. Sq.; 409th Atk. Sq.; 411th Obsn. Sq.; 453d Obsn. Sq.; 481st Bomb. Sq.; 482d Bomb. Sq.; 483d Bomb. Sq.; 501st Purs. Sq.; 502d Purs. Sq.; 503d Purs. Sq.; 504th Purs. Sq.; 862d Obsn. Sq.; 305th Bln. Co.; 306th Bln. Co.; 307th Bln. Co.; 355th Bln. Co.

**Lee Hall, VA.** See Camp Eustis, VA.

**Camp George G. Meade, MD.** Located 18 miles southwest of Baltimore, MD. Established 18 July 1917. Designated in honor of Maj. Gen. George G. Meade, commanding general, Army of the Potomac, 1863–65. Designated as a National Army cantonment for the mobilization of the 79th Div. in World War I. Redesignated as Fort Leonard Wood on 2 March 1928 and as Fort George G. Meade on 25 February 1929. Third Corps Area Training Center for O.R. infantry units.

**HQ**—7th Div. (1920–21); 16th Inf. Brig. (1924–26, 1936–40); 1st Tank Gp. (1921–29); Mechanized Force (1928–31).

**Troops**—17th Inf. (1919–20); 41st Inf. (1920–21); 12th Inf., less 2d Bn. (1919–22); 34th Inf. (1934–40); 16th Tank Bn. (1921–29); 17th Tank Bn. (1921–29); 1st Tank Regt., less 2d and 3d Bns. (1929–32); 2d Bn., 2d Tank Regt. (1929–32); 66th Inf., less 2d and 3d Bns. (1932–40); 8th Tank Co.; elements of 8th Q.M. Regt.

**Units for Annual Summer Training**—HQ, 28th Div.; HQ, 29th Div.; HQ, 62d Cav. Div.; HQ, 79th Div.; HQ, 80th Div.; HQ, 99th Div.; HHC, 55th Inf. Brig.; HHC, 56th Inf. Brig.; HHC, 57th Inf. Brig.; HHC, 58th Inf. Brig.; HHC, 91st Inf. Brig.; HHC, 157th Inf. Brig.; HHC, 158th Inf. Brig.; HHC, 159th Inf. Brig.; HHC, 160th Inf. Brig.; HHC, 197th Inf. Brig.; HHC, 198th Inf. Brig.; HHT, 52d Cav. Brig.; HHT, 153d Cav. Brig.; HHT, 154th Cav. Brig.; HHB, 53d F.A. Brig.; HHB, 154th F.A. Brig.; HHB, 155th F.A. Brig.; HHB, 174th F.A. Brig.; 1st Inf. (Virginia N.G.); 116th Inf.; 313th Inf.; 314th Inf.; 315th Inf.; 316th Inf.; 317th Inf.; 318th Inf.; 319th Inf.; 320th Inf.; 393d Inf.; 394th Inf.; 395th Inf.; 396th Inf.; 421st Inf.; 425th Inf.; 428th Inf.; 429th Inf.; 307th Tank Regt.; 310th Tank Regt.; 301st Tank Bn.; 303d Tank Bn.; 304th Tank Bn.; 305th Tank Bn.; 306th Tank Bn.; 307th Tank Bn.; 308th Tank Bn.; 309th Tank Bn.; 310th Tank Bn.; 311th Tank Bn.; 312th Tank Bn.; 315th Tank Bn.; 317th Tank Bn.; 318th Tank Bn.; 305th Cav.; 306th Cav.; 307th Cav.; 308th Cav.; 153d MG Sq.; 154th MG Sq.; 461st Armd. Car Sq.; 41st F.A. (RAI); 310th F.A.; 311th F.A.; 312th F.A.; 313th F.A.; 314th F.A.; 370th F.A.; 371st F.A.; 372d F.A.; 462d F.A.; 580th F.A.; 862d F.A.; 304th Ammo. Tn.; 304th Engr. Regt.; 305th Engr. Regt.; 354th Engr. Regt.; 104th Med. Regt.; 304th Med. Regt.; 305th Med. Regt.; 404th Q.M. Regt.; 405th Q.M. Regt.; CMTC—Inf., Cav., F.A., Engr., S.C.; ROTC—Inf., Cav., F.A., Engr.

**Fort Monroe, VA.** Located at Old Point Comfort at Hampton Roads, VA. Construction began in 1808. Designated in honor of James Monroe, Fifth President of the United States. Training center for Third Corps Area O.R. and N.G. coast artillery units.

**HQ**—Third C.A. District (1924–41); HD of Chesapeake Bay; 12th C.A. Regt. (1924–30); 2d C.A. Regt. (1930–41); 61st C.A. Regt. (1922–30).

**Troops**—1st, 3d, 4th, 5th, 6th, and 8th Cos., CD of Chesapeake Bay (1919–22); 35th, 41st, 58th, and 69th C.A. Cos. (1922–24); Btry C, E, and H, 2d C.A. (1932–41); 1st and 2d Bns., 2d C.A. (1940–41); Btry A, B, and C, 12th C.A. (1924–32); 3d Bn., 52d C.A. (1929–41); 61st C.A. (1922–30); 1st Bn., 57th C.A. (1930–41); 57th C.A. (1941); 2d Bn., 69th C.A. (1940–41); 70th C.A. (1939–40); 1st Bn., 74th C.A. (1940–41); 74th C.A. (1941); U.S.A.M.P. *Gen. John M. Schofield*.

**Units for Annual Summer Training**—HHB, 401st C.A. Brig.; HHB, 402d C.A. Brig.; HHB, 403d C.A. Brig.; 42d C.A. (RAI); 43d C.A. (RAI); 44th C.A. (RAI); 200th C.A.; 202d C.A.; 213th C.A.; 246th C.A.; 252d C.A.; 260th C.A.; 263d C.A.; 265th C.A.; 503d C.A.; 505th C.A.; 508th C.A.; 510th C.A.; 511th C.A.; 516th C.A.; 523d C.A.; 525th C.A.; 603d C.A.; 609th C.A.; 622d C.A.; 913th C.A.; 916th C.A.; 917th C.A.; CMTC—C.A.C.; ROTC—C.A.C.

**Fort Myer, VA.** Located 4 miles southwest of Washington, DC, on the Potomac River. Established in 1863 as Fort Whipple. Redesignated in 1881 in honor of Brig. Gen. Albert Myer, Chief Signal Officer of the US Army, 1866–80.

**HQ**—3d Cav. Regt. (1919–41).

**Troops**—3d Cav., less 1st Sq. (1919–41); 1st Bn., 16th F.A. (1922–41).

**Units for Annual Summer Training**—HQ, 61st Cav. Div.; HQ, 62d Cav. Div.; HHT, 151st Cav. Brig.; HHT, 152d Cav. Brig.; HHT, 153d Cav. Brig.; HHT, 154th Cav. Brig.; 301st Cav.; 302d Cav.; 303d Cav.; 304th Cav.; 305th Cav.; 306th Cav.; 307th Cav.; 308th Cav.; 153d MG Sq.; 154th MG Sq.; 462d Armd. Car Sq.; 402d Engr. Sq.

**Olmsted Field, PA (Military Airfield).** Located at Middletown, PA. Collocated with the Middletown Air Depot. Designated in honor of 1st Lt. Robert S. Olmsted who was killed 23 September 1923 when his balloon was struck by lightning near Nestlerode, The Netherlands, while representing the US Army in the James Gordon Bennett International Balloon Race.

**Troops**—Middletown Air Depot; Air Corps weather and signal detachments.

**Units for Annual Summer Training**—28th Div. Avn.; 103d Obsn. Sq.; 29th Div. Avn.; 104th Obsn. Sq.

**Phillips Field, MD (Military Airfield).** Located at Aberdeen Proving Ground, 35 miles northeast of Baltimore, MD. Established in 1922. Designated in honor of 1st Lt. Wendell K. Phillips who was killed 5 June 1923 in an aircraft accident at Aberdeen Proving Ground.

**Troops**—49th Bomb. Sq. (1922–28).

**Units for Annual Summer Training**—483d Bomb. Sq.

**Fort Smallwood, MD.** Located 11 miles southeast of Baltimore, MD, in Ann Arundel County, across the bay from Fort Howard. Reservation acquired in 1896. Designated in honor of Maj. Gen. William Smallwood, Continental Army, a hero of the Battle of Camden. All CD armament removed in 1927 and post inactivated.

**Troops**—C.A. caretaker detachments of the HD of Baltimore (1919–27).

**Fort Story, VA.** Located 18 miles northeast of Norfolk, VA. Acquired in 1914. Designated in honor of Maj. Gen. John P. Story, Chief of Artillery, 1904–05.

**Troops**—2d Co, CD of Chesapeake Bay (1919–22); elements of 12th C.A. (1924–32); elements of 2d C.A. (1932–41); 1st Bn., 71st C.A. (1941); 71st C.A. (1941).

**Units for Annual Summer Training**—213th C.A.; 246th C.A.; 260th C.A.

**Washington Barracks, DC.** Located on the old arsenal grounds at Greenleaf's Point, Washington, DC. Post established about 1797. Designated Washington Arsenal, 1816–81. Redesignated Washington Barracks in 1881.

**Troops**—Army War College, The Army Music School; Det., 17th Sig. Sv Co.

**Fort Washington, MD.** Located 12 miles south of Washington, DC, on the Potomac River in Prince Georges County. Acquired in 1808. Designated in honor of Gen. George Washington, First President of the United States and commanding general of the Continental Army.

**HQ**—HD of the Potomac (1919–39).

**Troops**—1st and 2d Cos., CD of the Potomac (1919–22); 3d Bn., 64th Inf. (1921–22); 3d Bn., 12th Inf. (1922–40); Btry E, 12th C.A. (1924–32).

**Units for Annual Summer Training**—HQ, 99th Div.; HHC, 197th Inf. Brig.; HHC, 198th Inf. Brig.; HHB, 174th F.A. Brig.; 313th Inf.; 314th Inf.; 317th Inf.; 320th Inf.; 393d Inf.; 394th Inf.; 395th Inf.; 396th Inf.; 428th Inf.; 429th Inf.; 430th Inf.; 431st Inf.; 432d Inf.; 370th F.A.; 371st F.A.; 372d F.A.; 121st Engr. Regt.; 324th Engr. Regt.; 324th Med. Regt.; 424th Q.M. Regt.

**Fort Leonard Wood, MD.** See Camp George G. Meade.

**Fort Wool, VA.** Located on the Rip Raps in Chesapeake Bay across from Fort Monroe, VA. Acquired from the state of Virginia in 1832 and originally named Fort Calhoun. Redesignated Fort Wool in 1863 in honor of Maj. Gen. John Ellis Wool, US Army, a distinguished commander in the War with Mexico.

**Troops**—Caretaker detachments of the 12th and 2d C.A. (1924–41).

### National Guard

**Camp Detrick/Detrick Field, MD (National Guard Aviation Facility).** Located at Frederick, MD. Established in 1931. Designated Camp Detrick about 1935 in honor of Maj. Frederick L. Detrick, flight surgeon of the 29th Div. Air Service.

**Units for Annual Summer Training**—29th Div. Avn.; 104th Obsn. Sq.

**Cascade, MD.** See Camp Albert C. Ritchie, MD.

**Indiantown Gap, PA.** Located near Annville, PA. Established in 1932. Primary Pennsylvania N.G. training area, 1935–41. Redesignated Indiantown Gap Military Reservation on 24 October 1940.

**Units for Annual Summer Training**—HQ, 28th Div.; HQ, 29th Div.; HQ, 80th Div.; HQ, 99th Div.; HHC, 55th Inf. Brig.; HHC, 56th Inf. Brig.; HHC, 91st Inf. Brig.; HHC, 159th Inf. Brig.; HHC, 160th Inf. Brig.; HHC, 197th Inf. Brig.; HHC, 198th Inf. Brig.; HHT, 52d Cav. Brig.; HHB, 53d F.A. Brig.; HHB, 54th F.A. Brig.; HHB, 69th F.A.

Brig.; HHB, 155th F.A. Brig.; HHB, 174th F.A. Brig.; 109th Inf.; 110th Inf.; 111th Inf.; 112th Inf.; 393d Inf.; 394th Inf.; 103d Cav.; 104th Cav.; 52d MG Sq.; 107th F.A.; 108th F.A.; 109th F.A.; 110th F.A.; 111th F.A.; 112th F.A.; 157th F.A.; 166th F.A.; 176th F.A.; 370th F.A.; 371st F.A.; 372d F.A.; 213th C.A.; 103d Engrs.; 125th Engr. Bn. (Mtd); 324th Engr. Regt.; 103d Med. Regt.; 324th Med. Regt.; 28th Q.M. Tn.; 103d Q.M. Regt.; 424th Q.M. Regt.; 28th Div Avn.; 103d Obsn. Sq.

**Logan Field, MD (Civilian Airfield/National Guard Aviation Facility).** Located 1 mile southeast of Dundalk, MD. Designated in honor of Lt. Patrick H. Logan, a Baltimore native, who was killed 5 July 1920 in an aircraft accident. Intermediate landing field.

**Troops**—29th Div. Avn. (1921–29); 104th Obsn. Sq. (1921–41).

**Units for Annual Summer Training**—29th Div. Avn.; 104th Obsn. Sq.

**Mount Gretna, PA.** Located at Mount Gretna, PA. Established in 1885. Primary Pennsylvania N.G. training area, 1919–35.

**Units for Annual Summer Training**—HQ, 28th Div.; HHC, 55th Inf. Brig.; HHC, 56th Inf. Brig.; HHT, 52d Cav. Brig.; HHB, 53d F.A. Brig.; 109th Inf.; 110th Inf.; 111th Inf.; 112th Inf.; 313th Inf.; 103d Cav.; 104th Cav.; 305th Cav.; 306th Cav.; 307th Cav.; 308th Cav.; 52d MG Sq.; 107th F.A.; 108th F.A.; 110th F.A.; 213th C.A.; 103d Engrs.; 125th Engr. Bn. (Mtd); 132d Engrs.; 103d Med. Regt.; 28th Q.M. Tn.; 103d Q.M. Regt.

**Camp Albert C. Ritchie, MD.** Located at Cascade, MD. Established in 1926. Designated Camp Albert C. Ritchie about 1935 in honor of Albert C. Ritchie, governor of Maryland, 1919–36.

**Units for Annual Summer Training**—HQ, 29th Div.; HHC, 58th Inf. Brig.; HHC, 91st Inf. Brig.; 1st Inf. (Maryland N.G.); 5th Inf. (Maryland N.G.); Co. A, 372d Inf.; 121st Engrs.; 104th Med. Regt.; 104th Q.M. Regt.

**Camp Simms, DC.** Located near Washington, in the southeast quarter of the District of Columbia. Established in 1904 as the District of Columbia N.G.'s rifle range. Used as an engineer training camp in World War I. Returned to the DC N.G. after World War I. Designated Camp Simms in 1922 in honor of Brig. Gen. Richard D. Simms, adjutant general of the District of Columbia National Guard.

**Units for Annual Summer Training**—260th C.A.; 121st Engrs.; Sp. Tps., 29th Div.

**Saunders Range, MD.** Located near Glen Burnie, MD, in Anne Arundel County.

**Units for Annual Summer Training**—1st Inf. (Maryland N.G.); 5th Inf. (Maryland N.G.); Co. A, 372d Inf.

**Tobyhanna Artillery Target Range, PA.** Located near Tobyhanna, PA, in Monroe and Wayne Counties. Training center for Third Corps Area O.R. and N.G. artillery units. Acquired in 1914–15.

**Units for Annual Summer Training**—HHB, 52d F.A. Brig.; HHB, 53d F.A. Brig.; HHB, 54th F.A. Brig.; 104th F.A.; 105th F.A.; 106th F.A.; 107th F.A.; 108th F.A.; 109th F.A.; 110th F.A.; 111th F.A.; 112th F.A.; 172d F.A.; 176th F.A.; 192d F.A.; 313th F.A.; 370th F.A.; 371st F.A.; 372d F.A.; 394th F.A.; 395th F.A.; 396th F.A.; 473d F.A.; 482d F.A.; 496th F.A.; 571st F.A.; 103d Ammo. Tn.

**Virginia Beach State Military Reservation, VA.** Located at Virginia Beach, VA. Established in 1912 as the Virginia State Rifle Range.

**Units for Annual Summer Training**—HQ, 29th Div.; HHC, 58th Inf. Brig.; HHC, 91st Inf. Brig.; 1st Inf. (Maryland N.G.); 1st Inf. (Virginia N.G.); 5th Inf. (Maryland N.G.); 116th Inf.; 183d Inf.; 318th Inf.; 213th C.A.; 121st Engrs.; 104th Q.M. Regt.; 29th Div. Avn.; 104th Obsn. Sq.

### Organized Reserve

**Rodgers Field (Civilian Airfield).** Located at Aspinwall, as a suburb of Pittsburgh, PA. Established in 1922. Designated in honor of Galbraith P. Rodgers, early aviation pioneer who was the first airman to fly across the United States in 1911. Designated as one of the original four O.R. airdromes in 1922. Intermediate landing field.

**Troops**—324th Obsn. Sq. (1923–41).

## FOURTH CORPS AREA

**HQ**—Charleston, SC, 20 August 1920–11 November 1920; Fort McPherson, GA, 12 November 1920–9 April 1923; Atlanta, GA, 10 April 1923–29 June 1927; Fort McPherson, GA, 30 June 1927–3 November 1934; Atlanta, GA, 4 November 1934–as of 7 December 1941.

Established in the US Army on 20 August 1920 and organized from the discontinued Southeastern Department. The HQ was originally located in Charleston, SC, but transferred to Fort McPherson, GA, on 11 November 1920. The HQ was relocated to the Rock Building at the corner of Spring and Cain Streets in Atlanta, GA, on 10 April 1923. It was returned to Fort McPherson on 30 June 1927 and moved to the new Post Office Building in Atlanta on 3 November 1934, where it was located at the beginning of World War II. The Fourth Corps Area initially included the states of North Carolina, South Carolina, Georgia, Alabama, Florida, Mississippi, Tennessee, Arkansas, and Louisiana. The state of Arkansas was transferred to the Seventh Corps Area on 1 December 1920. HQ, Fourth Corps Area was responsible for the mobilization, administration, and training of units of the Second and Fifth Armies, IV and XIV Army Corps, CD units of the Fourth Coast Artillery District, GHQR units, and Z.I. support units of the Fourth CASC. Mobile units of the corps area, less CD, GHQR, and Z.I. units, were assigned to the Second and Fifth Armies, 1921–33. With the adoption of the four field army plan on 1 October 1933, the mobile units of the Fourth Corps Area previously assigned to the Second and Fifth Armies were reassigned to the Third Army or GHQR or demobilized. The CD units in the corps area were assigned to the various HD commands of the Fourth C.A. District. The Fourth Corps Area Training Center was established in 1921, originally at Camp McClellan, AL, to train R.A. and O.R. units of all arms and services, as well as ROTC cadets and CMTC candidates. With the inactivation of the Fourth Corps Area Training Center in 1922, Camp McClellan became the primary training center for corps area infantry units only. Cavalry units were to train at Fort Oglethorpe, GA, field artillery units at Camp Bragg, NC, air corps units at Maxwell Field, AL, engineers units at Fort Benning, GA, and signal corps units were sent to Camp Alfred Vail (later renamed Fort Monmouth), NJ. Corps area maneuvers of mobile units were held, those years when funds were available, at Fort Benning. For the administration of O.R. units, all organizations initially came under the control of the IV Corps, or the 81st, 82d, and 87th Divs. When the IV Corps was inactivated 15 June 1925, the HQ, Artillery Group was established to direct the organization, training, and administration of all nondivisional field artillery units. Nondivisional cavalry squadrons were placed under the jurisdiction of the commander of Fort Oglethorpe, and all Reserve Air Service units were placed under the jurisdiction of the commander of Maxwell Field, AL. The remaining nondivisional units were placed under the jurisdiction of the HQ, Fourth Corps Area. The corps area was further reorganized into three “military areas” on 1 September 1939 to administer O.R. units. At that time, the 1st Mil. Area assumed control of the 81st Div. area (Tennessee and North Carolina), the 2d Mil. Area assumed control of the 82d Div. area (Florida, Georgia, and South Carolina), and the 3d Mil. Area assumed control of the 87th Div. area (Louisiana, Alabama, and Mississippi). Concurrently, the artillery group at Fort Bragg, which administered all nondivisional field artillery units, was abolished, and the military area headquarters assumed control of all of the nondivisional artillery units in their area. The Fourth Corps Area began assigning Reserve personnel to CASC units on 12 September 1929. The HQ, Fourth Corps Area actually began functioning as a service command HQ in October 1940 and was redesignated HQ, Fourth CASC in May 1941. It was further redesignated HQ, Fourth Service Command on 22 July 1942.

**Events:** 217

### Major Commands in the Corps Area

Third Army (1936–40)  
 IV Corps: 4th Division, 30th Division, 31st Division  
 XIV Corps: 81st Division, 82d Division, 87th Division  
 Fourth Coast Artillery District  
 3d Wing (1935–40)  
 Fourth Corps Area Service Command

### Corps Area Commanders

Maj. Gen. George G. Read	20 August 1920–27 September 1920	Brig. Gen. Albert J. Bowley	5 August 1927–18 October 1927
Maj. Gen. John F. Morrison	27 September 1920–25 October 1921	Maj. Gen. Richmond P. Davis	18 October 1927–1 September 1929
Brig. Gen. Walter H. Gordon	25 October 1921–13 July 1922	Brig. Gen. Harold B. Fiske	1 September 1929–3 October 1929
Maj. Gen. David C. Shanks	13 July 1922–17 January 1925	Maj. Gen. Frank R. McCoy	3 October 1929–1 February 1932
Brig. Gen. Albert J. Bowley	17 January 1925–1 May 1925	Maj. Gen. Edward L. King	5 February 1932–27 December 1933
Maj. Gen. Douglas MacArthur	1 May 1925–26 July 1925	Brig. Gen. James H. Reeves	28 December 1933–13 January 1934
Brig. Gen. Albert J. Bowley	26 July 1925–7 October 1925	Maj. Gen. George V. H. Moseley	13 January 1934–28 September 1938
Maj. Gen. Johnson Hagood	7 October 1925–19 March 1927	Brig. Gen. Robert O. Van Horn	28 September 1938–7 October 1938
Brig. Gen. Albert J. Bowley	19 March 1927–4 April 1927	Maj. Gen. Stanley D. Embick	7 October 1938–30 September 1940
Maj. Gen. Malin Craig	4 April 1927–5 August 1927	Maj. Gen. John P. Smith	11 October 1940–25 February 1942

**Fourth Corps Area Service Command  
Organization 1930**

<b>UNIT:</b>	<b>LOCATION:</b>
HQ, Fourth CASC	Fort McPherson, GA
Corps Area Sup Point	Atlanta, GA
HQ, CASC Fort Benning	Fort Benning, GA
HQ, CASC Fort Bragg	Fort Bragg, NC
HQ, CASC Fort McClellan	Fort McClellan, AL
HQ, CASC Fort McPherson	Fort McPherson, GA
HQ, CASC Fort Oglethorpe	Fort Oglethorpe, GA
HQ, CASC Camp Beauregard	Alexandria, LA
HQ, CASC Camp Jackson	Camp Jackson, SC
HQ, CASC Camp J. Clifford R. Foster	Jacksonville, FL
HQ, CASC Camp B.F. McClellan	Biloxi, MS
HQ, CASC HD of Charleston	Fort Moultrie, SC
HQ, CASC HD of Key West	Key West Barracks, FL
HQ, CASC HD of Pensacola	Fort Barrancas, FL
HQ, CASC Maxwell Field	Montgomery, AL
Mob. Area #1	Raleigh, NC
Mob. Area #2	Columbia, SC
Mob. Area #3	Atlanta, GA
Mob. Area #4	Jacksonville, FL
Mob. Area #5	Montgomery, AL
Mob. Area #6	Nashville, TN
Mob. Area #7	Jackson, MS
Mob. Area #8	New Orleans, LA
Eighth CASC Air Pool	Atlanta, GA
Cavalry Developing Bn.	Fort Oglethorpe, GA
1425th Tng. Bn. (Medical)	Fort Oglethorpe, GA

**Fourth Corps Area Service Command  
Organization 1941**

<b>UNIT:</b>	<b>LOCATION:</b>
HQ, Fourth CASC	Fort McPherson, GA
1400th CASU (HQ, CASC)	Atlanta, GA
1401st CASU (Q.M. M.T.)	Fort McPherson, GA
1404th CASU (Sig. Sv)	Atlanta, GA
1406th CASU (Maint)	Atlanta, GA
1407th CASU (Maint)	Atlanta, GA
1408th CASU (Dent Lab)	Fort McPherson, GA
1409th CASU (Rctg. Sv)	Fort McPherson, GA
1411th CASU (ROTC Instr. Gp.)	Fort McPherson, GA
1412th CASU (N.G. Instr. Gp.)	Fort McPherson, GA
1413th CASU (CCC)	Fort McPherson, GA
1420th CASU (Fin. Ofc.)	New Orleans, LA
1424th CASU (Recep. Ctr.)	Camp Blanding, FL
1425th CASU (Recep. Ctr.)	Fort Bragg, NC
1426th CASU (Recep. Ctr.)	Fort McPherson, GA
1427th CASU (Recep. Ctr.)	Camp Shelby, MS
1434th CASU (F.A. Repl. Ctr.)	Fort Bragg, NC
1435th CASU (Inf. Repl. Ctr.)	Camp Croft, SC
1436th CASU (Inf. Repl. Ctr.)	Camp Wheeler, GA
1444th CASU (Sta. Cmpl.)	Barksdale Field, LA
1445th CASU (Sta. Cmpl.)	Fort Barrancas, FL
1446th CASU (Sta. Cmpl.)	Camp Beauregard, LA
1447th CASU (Sta. Cmpl.)	Fort Benning, GA
1448th CASU (Sta. Cmpl.)	Camp Blanding, FL
1449th CASU (Sta. Cmpl.)	Fort Bragg, NC
1450th CASU (Sta. Cmpl.)	Fort Bragg, NC
1451st CASU (Sta. Cmpl.)	Brookley Field, AL
1452d CASU (Sta. Cmpl.)	Charleston Ord Dep, SC
1453d CASU (Sta. Cmpl.)	Camp Claiborne, LA
1454th CASU (Sta. Cmpl.)	Camp Croft, SC
1455th CASU (Sta. Cmpl.)	Camp Davis, NC
1456th CASU (Sta. Cmpl.)	Eglin Field, FL
1457th CASU (Sta. Cmpl.)	Camp Forrest, TN
1458th CASU (Sta. Cmpl.)	Fort Jackson, SC
1459th CASU (Sta. Cmpl.)	Key West Barracks, FL
1460th CASU (Sta. Cmpl.)	Camp Livingston, LA
1461st CASU (Sta. Cmpl.)	MacDill Field, FL
1462d CASU (Sta. Cmpl.)	Maxwell Field, AL
1463d CASU (Sta. Cmpl.)	Fort McClellan, AL
1464th CASU (Sta. Cmpl.)	Fort McPherson, GA
1465th CASU (Sta. Cmpl.)	Gunter Field, AL
1466th CASU (Sta. Cmpl.)	Fort Moultrie, SC
1467th CASU (Sta. Cmpl.)	Fort Oglethorpe, GA
1468th CASU (Sta. Cmpl.)	Orlando AAB, FL
1469th CASU (Sta. Cmpl.)	Camp Polk, LA
1470th CASU (Sta. Cmpl.)	Savannah AAB, GA
1471st CASU (Sta. Cmpl.)	Fort Screven, GA
1472d CASU (Sta. Cmpl.)	Craig Field, AL
1473d CASU (Sta. Cmpl.)	Camp Shelby, MS
1474th CASU (Sta. Cmpl.)	Camp Stewart, GA
1475th CASU (Sta. Cmpl.)	Mabry Field, FL
1476th CASU (Sta. Cmpl.)	Morrison Field, FL
1477th CASU (Sta. Cmpl.)	Camp Wheeler, GA
1478th CASU (Sta. Cmpl.)	Daniel Field, GA
1479th CASU (Sta. Cmpl.)	Baton Rouge AAB, LA
1480th CASU (Sta. Cmpl.)	Charlotte AAB, NC
1481st CASU (Sta. Cmpl.)	Jackson AAB, MS
1482d CASU (Sta. Cmpl.)	Lawson Field, GA
1483d CASU (Sta. Cmpl.)	Drew Field, FL
1484th CASU (Sta. Cmpl.)	Key Field, MS
1485th CASU (Sta. Cmpl.)	New Orleans AAB, LA

**Fourth Corps Area Service Command  
Organization 1941 (Cont)**

UNIT:	LOCATION:
1492d CASU (AL Sel Sv)	Montgomery, AL
1493d CASU (FL Sel Sv)	Tallahassee, FL
1494th CASU (GA Sel Sv)	Atlanta, GA
1495th CASU (LA Sel Sv)	Baton Rouge, LA
1496th CASU (MA Sel Sv)	Jackson, MS
1497th CASU (NC Sel Sv)	Raleigh, NC
1498th CASU (SC Sel Sv)	Columbia, SC
1499th CASU (TN Sel Sv)	Nashville, TN

**Major posts, camps, stations, airfields, and N.G. and O.R. training facilities in the corps area.**

**Regular Army**

**Barksdale Field, LA (Military Airfield).** Located at Bossier City, LA. Established 18 November 1930. Designated in honor of 2d Lt. Eugene H. Barksdale who was killed 11 August 1926 in an airplane crash.

**HQ**—3d Wing (1935–40); 3d Atk. Gp. (1935–40); 20th Purs. Gp. (1932–39); 27th Bomb. Gp. (1940–41).

**Troops**—3d WX Sq. (1936–41); Base HQ and 6th Air Base Sq. (1936–40); 8th Atk. Sq. (1935–39); 8th Bomb. Sq. (1939–40); 13th Atk. Sq. (1935–39); 13th Bomb. Sq. (1939–40); 15th Bomb. Sq. (1940); 37th Bomb. Sq. (1940); 55th Purs. Sq. (1932–39); 60th Sv Sq. (1935–36); 77th Purs. Sq. (1932–39); 79th Purs. Sq. (1932–39); 71st Sv Sq. (1932–36); 90th Atk. Sq. (1935–39); elements of 31st Q.M. Regt.

**Fort Barrancas, FL.** Located 7 miles from Pensacola, FL. Post established in 1739. Named by the Spanish for San Carlos de Barrancas. Acquired by the United States in 1820. Training center for Fourth Corps Area O.R. coast artillery units.

**HQ**—HD of Pensacola; 13th C.A. Regt. (1924–41).

**Troops**—2d and 5th Cos., CD of Pensacola (1919–22); 20th C.A. Co. (1922–24); Btry A and B, 13th C.A. (1924–41); 1st Bn., 13th C.A. (1940–41).

**Units for Annual Summer Training**—HQ, SCF; HQ, Carolina Sector, SCF; HQ, Florida Sector, SCF; HQ, Gulf Sector, SCF; HHB, 34th C.A. Brig. (RAI); HHB, 38th C.A. Brig. (RAI); HHB, 202d C.A. Brig.; HHB, 38th C.A. Brig. (RAI); 67th C.A. (RAI); 202d C.A.; 203d C.A.; 206th C.A.; 214th C.A.; 264th C.A.; 265th C.A.; 504th C.A.; 524th C.A.; 534th C.A.; 540th C.A.; 545th C.A.; 548th C.A. Bn.; 623d C.A.; 624th C.A.; 921st C.A.; 922d C.A.; 923d C.A.; 969th C.A.; 970th C.A.; 971st C.A.; 972d C.A.; 973d C.A.; 974th C.A.; 105th Obsn. Sq.; 106th Obsn. Sq.; 110th Obsn. Sq.; 154th Obsn. Sq.; 344th Med. Regt.; CMTC—C.A.C.; ROTC—C.A.C.

**Camp Benning, GA.** Located 10 miles southwest of Columbus, GA. Authorized October 1918. Designated in honor of Brig. Gen. Henry L. Benning, C.S.A. The Infantry School of Arms transferred on 12 September 1918 to Camp Benning from Fort Sill, OK. Redesignated Fort Benning in 1922. Training center for Fourth Corps Area O.R. engineer units.

**HQ**—The Infantry School (1919–41); 4th Div. (1940–41).

**Troops**—24th Inf. (1922–41); 29th Inf. (1919–41); 15 Tank Bn. (1921–29); 2d Bn., 66th Inf. (1932–39); 2d Bn., 67th Inf. (1939–40); 29th F.A. (1940); 33d F.A. (1921, 1940–41); 1st Bn., 83d F.A. (1921–27, 1930–40); Co. A, 4th Engr. Regt. (1921–27, 1933–40); Co. A, 7th Engr. Regt. (1927–33); elements of the following: 1st Gas Regt., 4th Q.M. Regt., 55th Q.M. Regt., 97th Q.M. Regt., and C Co., 2d Chem. Regt.

**Units for Annual Summer Training**—HHC, 163d Inf. Brig.; HHC, 164th Inf. Brig.; 325th Inf.; 328th Inf.; 422d Inf.; 448th Inf.; 118th F.A.; 485th F.A.; 4th Engrs. (RAI); 306th Engrs.; 307th Engrs.; 312th Engrs.; 344th Engrs.; 348th Engrs.; 355th Engrs.; 361st Engrs.; 377th Engrs.; 378th Engrs.; 384th Engrs.; 388th Engrs.; 63d Engr. Bn. (RAI); 64th Engr. Bn. (RAI); 65th Engr. Bn. (RAI); 66th Engr. Bn. (RAI); 67th Engr. Bn. (RAI); 403d Engr. Sq.; 422d Engr. Bn.; 428th Engr. Bn.; 448th Engr. Bn.; 449th Engr. Bn.; 450th Engr. Bn.; 451st Engr. Bn.; 452d Engr. Bn.; 453d Engr. Bn.; 454th Engr. Bn.; 455th Engr. Bn.; 456th Engr. Bn.; 457th Engr. Bn.; 495th Engr. Bn.; 498th Engr. Bn.; 499th Engr. Bn.; 500th Engr. Bn.; 524th Engr. Bn.; 525th Engr. Bn.; 528th Engr. Bn.; 541st Engr. Bn.; 588th Engr. Bn.; 957th Engr. Bn.; 958th Engr. Bn.; 2d Chem. Regt. (RAI); 301st Chem. Regt.; 407th Q.M. Regt.; ROTC—Inf., F.A., Engr.

**Camp Bragg, NC.** Located 10 miles northwest of Fayetteville, NC. Designated 21 August 1918 in honor of Lt. Gen. Braxton Bragg, C.S.A. Established as a major field artillery training and firing center. Redesignated Fort Bragg in 1922. Training center for Fourth Corps Area O.R. and N.G. field artillery units.

**HQ**—13th F.A. Brig. (1921–41); 9th Div. (1940–41).

**Troops**—40th Inf. (1940–41); 47th Inf. (1940–41); 60th Inf. (1940–41); 2d F.A. (1921–22); 1st Bn., 2d F.A. (1922–27); 4th F.A. (1940–41); 2d Bn., 4th F.A. (1931–41); 5th F.A. (1921–30); 2d Bn., 5th F.A. (1921–33); 2d Bn., 16th F.A. (1927–33); 17th F.A., less 3d Bn. (1921–41); 19th F.A. (1919–21); 20th F.A. (1919–21); 21st F.A. (1919–21); 26th F.A. (1940–41); 34th F.A. (1940–41); 2d Bn., 36th F.A. (1933–41); 36th F.A. (1939–41); 47th F.A. (1941); 72d F.A. (1941); 79th F.A. (1941); 81st F.A. (1921–22); 2d Bn., 83d F.A. (1933–41); 67th C.A. (1941); 76th C.A. (1941); 1st Bn., 76th C.A. (1940–41); 77th C.A. (1941); 1st Bn., 77th C.A. (1940–41); 8th Ammo. Tn. (1921–22); 13th Ammo. Tn. (1921–30); 344th Ammo. Tn.; 1st F.A. Obsn. Bn. (1934–41); elements of the following: 4th Engr. Regt., 4th Q.M. Regt., 55th Q.M. Regt.

**Units for Annual Summer Training**—HQ, 81st Div.; HHC, 161st Inf. Brig.; HHC, 162d Inf. Brig.; HHB, 55th F.A. Brig.; HHB, 56th F.A. Brig.; HHB, 156th F.A. Brig.; HHB, 157th F.A. Brig.; HHB, 162d F.A. Brig.; HHB, 183d F.A. Brig.; 321st Inf.; 322d Inf.; 323d Inf.; 324th Inf.; 328th Inf.; 22d F.A. (RAI); 29th F.A. (RAI); 30th F.A. (RAI); 36th F.A. (RAI); 57th F.A. (RAI); 58th F.A. (RAI); 85th F.A. (RAI); 86th F.A. (RAI); 94th F.A. (RAI); 107th F.A.; 108th F.A.; 109th F.A.; 111th F.A.; 113th F.A.; 114th F.A.; 115th F.A.; 116th F.A.; 117th F.A.; 118th F.A.; 141st F.A.; 178th F.A.; 306th F.A.; 309th F.A.; 312th F.A.; 316th F.A.; 317th F.A.; 318th F.A.; 319th F.A.; 320th F.A.; 320th F.A.; 321st F.A.; 334th F.A.; 335th F.A.; 336th F.A.; 372d F.A.; 392d F.A.; 397th F.A.; 398th F.A.; 399th F.A.; 427th F.A.; 432d F.A.; 433d F.A.; 434th F.A.; 442d F.A.; 444th F.A.; 448th F.A.; 452d F.A.; 459th F.A. Bn.; 463d F.A. Bn.; 477th F.A.; 478th F.A.; 496th F.A.; 560th F.A.; 562d F.A.; 571st F.A.; 576th F.A.; 577th F.A.; 578th F.A.; 580th F.A.; 590th F.A. Bn.; 863d F.A.; 13th Ammo. Tn. (RAI); 15th Ammo. Tn. (RAI); 105th Ammo. Tn.; 106th Ammo. Tn.; 114th Ammo. Tn.; 306th Ammo. Tn.; 307th Ammo. Tn.; 312th Ammo. Tn.; 344th Ammo. Tn.; 301st F.A. Obsn. Bn.; 306th F.A. Obsn. Bn.; 316th F.A. Obsn. Bn.; 319th F.A. Obsn. Bn.; 200th C.A.; 252d C.A.; 534th C.A.; 105th Engrs.; 114th Engrs.; 133d Engrs.; 164th Engrs.; 306th Engrs.; 307th Engrs.; 312th Engrs.; 344th Engrs.; 355th Engrs.; 361st Engrs.; 377th Engrs.; 105th Med. Regt.; 123d Med. Sq.; 366th Med. Regt.; CMTC—F.A., Engr.; ROTC—F.A.

**Fort Caswell, NC.** Located 2 miles from Southport, Brunswick County, NC. Acquired by purchase in 1825. Designated in honor of Maj. Gen. Richard Caswell, North Carolina Militia and first governor of North Carolina. Inactivated in 1924.

**HQ**—CD of Cape Fear until 1924.

**Troops**—1st and 2d Cos., CD of Cape Fear (1919–22); 19th CD Co. (1923–24); not garrisoned after 1924.

**Fort Dade, FL.** Located on Egmont Key at the entrance to Tampa Bay. Designated in honor of Capt. Francis L. Dade, 4th US Inf. in 1900.

**HQ**—CD of Tampa (1919–24).

**Troops**—1st and 2d Cos., CD of Tampa (1919–22); caretaking detachment, 13th C.A.; not garrisoned after 1926.

**Dorr Field, FL (Military Airfield).** Located 12 miles east of Arcadia, FL. Established 26 December 1917. Auxiliary flying field. Designated in honor of Flying Cadet Stephen Dorr who was killed 17 August 1917 in a training accident.

**Troops**—Not garrisoned after 1921.

**Fort Fremont, SC.** Located 4 miles southeast of Port Royal, SC, on St. Helena Island. Acquired by purchase in 1898. Designated in honor of Maj. Gen. John C. Fremont, famous explorer, topographical engineer, and Union commander in the Civil War.

**Troops**—Not garrisoned after 1924.

**Fort Gaines, AL.** Located on Dauphin Island, Mobile Bay, AL. Acquired by condemnation in 1853. Designated in honor of Brig. Gen. Edmund P. Gaines, War of 1812 hero. A subpost of Fort Morgan.

**Troops**—Caretaking detachment 1920–28; not garrisoned after 1928.

**Camp Jackson, SC.** Located 7 miles east of Columbia, SC. Established 18 July 1917. Designated in honor of Maj. Gen. Andrew Jackson, hero of New Orleans and Seventh President of the United States. Designated as a National Army cantonment for the mobilization of the 81st Div. in World War I. Retained as a military reservation and designated a mobilization and training station for the 30th Div. Garrisoned by N.G. caretakers (1921–39) until activation of the 6th Div. on 9 November 1939. Redesignated Fort Jackson on 15 August 1940.

**HQ**—5th Div. (1920–21); 39th Brig., C.A.C. (1919–21); 6th Div. (1939–41).

**Troops**—48th Inf. (1919–21); 44th Regt., C.A.C. (1920–21); 51st Regt., C.A.C. (1920–21); 56th Regt., C.A.C. (1919–21).

**Units for Annual Summer Training**—HQ, 30th Div.; HHC, 59th Inf. Brig.; HHC, 60th Inf. Brig.; HHB, 55th F.A. Brig.; HHB, 56th F.A. Brig.; 117th Inf.; 118th Inf.; 120th Inf.; 121st Inf.; 122d Inf.; 115th F.A.; 116th F.A.; 117th F.A.;

118th F.A.; 178th F.A.; 105th Engrs.; 133d Engrs.; 164th Engrs.; 30th Div. Avn.; 105th Obsn. Sq.; 105th Med. Regt.; 307th Med. Regt.; 30th Div. Q.M. Tn.

**Fort Jackson, LA.** Located on the west bank of the Mississippi River in Plaquemines Parish, 73 miles south of New Orleans. Established in 1814. Designated in honor of Maj. Gen. Andrew Jackson, hero of New Orleans and Seventh President of the United States. Placed in caretaker status in 1920. Retained as a station of the CD of New Orleans until it was sold in 1927.

**Camp Jesup, GA.** Located 4 miles southwest of Atlanta. A subpost of Fort McPherson. Authorized August 1918. Designated in honor of Brig. Gen. Thomas S. Jesup, US Army, Q.M. Gen., 1818. The post was closed 28 September 1927.

**Troops**—A/4th M. Rep. Bn.

**Key West Barracks, FL.** Located on Key West Island, FL. Established in 1831.

**HQ**—HD of Key West.

**Troops**—2d Co., CD of Key West (1919–22); 182d C.A. Co. (1922–24); Btry E, 13th C.A. (1924–41).

**Units for Annual Summer Training**—265th C.A.; 31st Div. Avn.; 106th Obsn. Sq.

**Lawson Field, GA (Military Airfield).** Located at Fort Benning, GA. Established 1 July 1931 originally as a balloon landing field. Designated in August 1931 in honor of Capt. Walter Lawson, a native of Georgia and highly decorated World War I pilot, who had been killed in an air accident.

**Troops**—Flight B, 16th Obsn. Sq. (1931–37), 97th Obsn. Sq. (1940–41), 16th Obsn. Sq. (1940–41).

**Units for Annual Summer Training**—800th Obsn. Sq.

**Camp McClellan, AL.** Located 6 miles north of Anniston, AL. Established in 1915. Designated 18 July 1917 as a N.G. cantonment for the mobilization of the 29th Div. in World War I. Designated in honor of Maj. Gen. George B. McClellan, commanding general of the Army of the Potomac, 1861–62. Training center for Fourth Corps Area O.R. and N.G. infantry units. Redesignated Fort McClellan on 30 October 1929.

**HQ**—69th C.A. Regt. (1930–35); 22d Inf. Regt. (1939–41).

**Troops**—69th C.A. (1930–35); elements of 22d Inf., 4th Q.M. Regt., and 4th Tank Co.

**Units for Annual Summer Training**—HQ, 31st Div.; HQ, 81st Div.; HQ, 82d Div.; HQ, 87th Div.; HHC, 59th Inf. Brig.; HHC, 61st Inf. Brig.; HHC, 62d Inf. Brig.; HHC, 77th Inf. Brig.; HHC, 78th Inf. Brig.; HHC, 161st Inf. Brig.; HHC, 162d Inf. Brig.; HHC, 163d Inf. Brig.; HHC, 164th Inf. Brig.; HHC, 173d Inf. Brig.; HHC, 174th Inf. Brig.; HHT, 155th Cav. Brig.; HHB, 56th F.A. Brig.; 117th Inf.; 118th Inf.; 121st Inf.; 122d Inf.; 155th Inf.; 156th Inf.; 167th Inf.; 321st Inf.; 322d Inf.; 323d Inf.; 324th Inf.; 325th Inf.; 326th Inf.; 327th Inf.; 328th Inf.; 345th Inf.; 346th Inf.; 347th Inf.; 348th Inf.; 422d Inf.; 447th Inf.; 448th Inf.; 454th Inf.; 313th Tank Bn.; 314th Tank Bn.; 108th Cav.; 109th Cav.; 310th Cav.; 55th MG Sq.; 398th F.A.; 105th Engrs.; 106th Engrs.; 114th Engrs.; 127th Engr. Sq.; 133d Engrs.; 164th Engrs.; 312th Engrs.; 344th Engrs.; 378th Engrs.; 301st Chem. Regt.; 105th Med. Regt.; 106th Med. Regt.; 376th Med. Regt.; 31st Div. Avn.; 106th Obsn. Sq.; 31st Div. Q.M. Tn.; 81st Div. Q.M. Tn.; 97th Div. Q.M. Tn.; 406th Q.M. Regt.; 412th Q.M. Regt.; CMTC—Inf., Cav.; ROTC—Inf., Cav.

**Fort McPherson, GA.** Located in Atlanta, GA. Established in 1867. Abandoned in 1881. Reacquired by purchase in 1885. Designated in honor of Maj. Gen. James B. McPherson who was commander of the Army of the Tennessee and killed in action in 1864 near Atlanta, GA. Fourth Corps Area Training Center, 1921–22.

**HQ**—Fourth Corps Area (1920–22, 1927–34); Fourth C.A. District (1920–22, 1927–41); 8th Inf. Brig. (1922–40).

**Troops**—22d Inf., elements of 86th Q.M. Bn.; 4th M. Rep. Bn.

**Units for Annual Summer Training**—HQ, 81st Div.; HQ, 82d Div.; HQ, 87th Div.; HHC, 161st Inf. Brig.; HHC, 7th Inf. Brig. (RAI); HHC, 162d Inf. Brig.; HHC, 163d Inf. Brig.; HHC, 164th Inf. Brig.; HHC, 173d Inf. Brig.; HHC, 174th Inf. Brig.; 39th Inf. (RAI); 47th Inf. (RAI); 321st Inf.; 322d Inf.; 323d Inf.; 324th Inf.; 325th Inf.; 326th Inf.; 327th Inf.; 328th Inf.; 345th Inf.; 346th Inf.; 347th Inf.; 348th Inf.; 252d C.A.; 306th Med. Regt.; 307th Med. Regt.; 366th Med. Regt.; 377th Med. Regt.; 301st Chem. Regt.; 63d Cav. Div. Q.M. Tn.; 81st Div. Q.M. Tn.; 82d Div. Q.M. Tn.; 87th Div. Q.M. Tn.; 406th Q.M. Regt.; 407th Q.M. Regt.; 412th Q.M. Regt.

**Fort McRee, FL.** Located 9 miles from Pensacola at entrance to Pensacola Bay. Set apart from public domain in 1842. Post established in 1833. Designated in honor of Lt. Col. William McRee, Corps of Engineers, War of 1812 veteran. CD disarmed in 1920.

**Troops**—C.A. Co. (1919–20).



**Maxwell Field, AL (Military Airfield).** Located at Montgomery, AL. Established 9 April 1918. Designated Maxwell Field 8 November 1922. Designated in honor of 2d Lt. William C. Maxwell who was killed 12 August 1920 in an airplane crash in the Philippine Islands. Training center for Fourth Corps Area O.R. air corps units.

**HQ**—8th Purs. Wing (1940–41).

**Troops**—4th Div. Avn. (1923–27); 1st Purs. Sq. (1940); 22d Obsn. Sq. (1921–31); 13th Air Base Sq.; 24th Bomb. Sq. (1940); 51st Atk. Sq. (1935–36); 54th Sch. Sq. (1923–35); 54th Bomb. Sq. (1935–36); 84th Sv Sq. (1935–36); 86th Obsn. Sq. (1935–36); 87th Purs. Sq. (1935–36); 91st Sch. Sq. (1936–41).

**Units for Annual Summer Training**—30th Div. Avn.; 31st Div. Avn.; 81st Div. Avn.; 82d Div. Avn.; 87th Div. Avn.; 105th Obsn. Sq.; 106th Obsn. Sq.; 114th Obsn. Sq.; 135th Obsn. Sq.; 136th Obsn. Sq.; 306th Obsn. Sq.; 307th Obsn. Sq.; 312th Obsn. Sq.; 346th Sv Sq.; 357th Obsn. Sq.; 358th Obsn. Sq.; 383d Sv Sq.; 412th Obsn. Sq.; 455th Purs. Sq.; 455th Bomb. Sq.; 456th Purs. Sq.; 457th Purs. Sq.; 458th Purs. Sq.; 458th Bomb. Sq.; 459th Obsn. Sq.; 863d Obsn. Sq.; ROTC—AS.

**Fort Morgan, AL.** Located on Mobile Point at the entrance to Mobile Bay, 30 miles southeast of Mobile, AL. Established in 1849. Designated in honor of Brig. Gen. Daniel Morgan, Continental Army.

**HQ**—CD of Mobile until 1924.

**Troops**—1st and 2d Cos., CD of Mobile (1919–22); 39th C.A. Co. (1922–24); not garrisoned after 1924.

**Fort Moultrie, SC.** Located on Sullivan's Island, north of main entrance to Charleston Harbor, 6 miles from Charleston, SC. Established in 1776. New fortification built in 1841. Designated Fort Moultrie in 1903 in honor of Maj. Gen. William Moultrie, Revolutionary War hero.

**HQ**—HD of Charleston; 8th Inf. Regt. (1930–39); 70th C.A. Regt. (1940–41).

**Troops**—1st, 2d, 3d, and 4th Cos., CD of Charleston (1919–24); 170th C.A. Co. (1922–24); 2d Bn., 8th Inf. (1923–40); and 3d Bn., 8th Inf. (1923–29); elements of 13th C.A. (1924–41); 70th C.A., less 2d Bn. (1940–41).

**Units for Annual Summer Training**—HQ, 82d Div.; HHC, 161st Inf. Brig.; HHC, 162d Inf. Brig.; HHC, 163d Inf. Brig.; HHC, 164th Inf. Brig.; 39th Inf. (RAI); 321st Inf.; 322d Inf.; 323d Inf.; 324th Inf.; 325th Inf.; 326th Inf.; 327th Inf.; 328th Inf.; 347th Inf.; 348th Inf.; 447th Inf.; 252d C.A.; 263d C.A.; 264th C.A. Bn.; 548th C.A. Bn.; 105th Engrs.; 307th Med. Regt.; 30th Div. Avn.; 105th Obsn. Sq.; 31st Div. Avn.; 106th Obsn. Sq.

**Fort Oglethorpe, GA.** Located 8 miles south of Chattanooga, TN, on the northeast boundary of the Chickamauga National Military Park. Established in 1906. Designated in honor of James E. Oglethorpe, first governor of Georgia. Training center for Fourth Corps Area O.R. and N.G. cavalry units. The Catoosa Rifle Range, located at Catoosa, GA, was a subfacility of Fort Oglethorpe.

**HQ**—46th Inf. Regt. (1919–20); 6th Cav. Regt. (1919–41).

**Troops**—6th Cav. (1919–41); 3d Bn., 22d Inf. (1927–35).

**Units for Annual Summer Training**—HQ, 31st Div.; HQ, 63d Cav. Div.; HQ, 64th Cav. Div.; HQ Tp., 23d Cav. Div.; HHC, 61st Inf. Brig.; HHC, 62d Inf. Brig.; HHC, 162d Inf. Brig.; HHT, 55th Cav. Brig.; HHT, 155th Cav. Brig.; HHB, 56th F.A. Brig.; 323d Inf.; 324th Inf.; 326th Inf.; 108th Cav.; 109th Cav.; 309th Cav.; 310th Cav.; 313th Cav.; 314th Cav.; 55th MG Sq.; 155th MG Sq.; 501st Cav. Sq.; 502d Cav. Sq.; 503d Cav. Sq.; 504th Cav. Sq.; 509th Cav. Sq.; 510th Cav. Sq.; 511th Cav. Sq.; 463d Armd. Car Sq.; 306th Engr. Regt.; 127th Engr. Sq.; 306th Engrs.; 403d Engr. Sq.; 123d Med. Sq.; 306th Med. Regt.; 307th Med. Regt.; 312th Med. Regt.; 344th Med. Regt.; 363d Med. Sq.; 366th Med. Regt.; 385th Med. Regt.; 63d Cav Div. Q.M. Tn.

**Fort Pickens, FL.** Located on Santa Rosa Island, a subpost of Fort Barrancas near Pensacola, FL. Acquired by purchase in 1828. Reconstructed in 1900. Designated in honor of Brig. Gen. Andrew Pickens, South Carolina State Troops.

**Troops**—1st Co., CD of Pensacola (1919–22); caretaking detachment, 13th C.A.

**Pope Field, NC (Military Airfield).** Located at Fort Bragg, NC. Established in 1919. Designated in honor of 1st Lt. Harley N. Pope who was killed 7 January 1919 in an aircraft accident near the Cape Fear River.

**Units for Annual Summer Training**—30th Div. Avn.; 105th Obsn. Sq.; 31st Div. Avn.; 106th Obsn. Sq.; 306th Obsn. Sq.

**Henry J. Reilly Field, AL (Military Airfield).** Located at Fort McClellan, AL. Designated in honor of Brig. Gen. Henry J. Reilly, commander of the 83d Inf. Brig. in World War I. Intermediate landing field.

**Fort St. Philip, LA.** Located on the east bank of the Mississippi River in Plaquemines Parish, 65 miles south of New Orleans. Established in 1814. Placed in caretaker status in 1920. Retained as a station of the CD of New Orleans until it was sold in 1927.

**Troops**—1st Co., CD of New Orleans (1919–20).

**Fort Screven, GA.** Located 18 miles southeast of Savannah, GA, on Tybee Island. Acquired by purchase in 1875. Post established in 1898. Designated in honor of Brig. Gen. James Screven, Georgia Militia, who was killed in action in 1778. CD of Savannah discontinued 24 November 1924.

**HQ**—CD of Savannah (1919–24); 8th Inf. Regt. (1923–29).

**Troops**—1st and 2d Cos., CD of Savannah (1919–22); 121st C.A. Co. (1922–24); 1st Bn., 8th Inf. (1923–40); 2d Bn., 70th C.A. (1940–41).

**Units for Annual Summer Training**—HHC, 163d Inf. Brig.; HHC, 164th Inf. Brig.; HHC, 174th Inf. Brig.; 39th Inf. (RAI); 47th Inf. (RAI); 325th Inf.; 326th Inf.; 327th Inf.; 328th Inf.; 347th Inf.; 348th Inf.; 448th Inf.; 450th Inf.; 454th Inf.

**Fort Sumter, SC.** Located on an island at the entrance to Charleston Harbor, 6 miles from Charleston, SC. Established in 1828. Designated in honor of Brig. Gen. Thomas Sumter, South Carolina Militia, a Revolutionary War hero.

**Troops**—Caretaking detachment, 13th C.A. (1924–41).

**Fort Taylor, FL.** Located at the southwestern extremity of the city of Key West, FL. Established in 1844. Acquired by purchase in 1845. Designated in honor of Maj. Gen. Zachary Taylor, US Army, commander of American forces in the Seminole War and the American Army in northern Mexico during the Mexican War; President of the United States.

**Troops**—1st Co., CD of Key West (1919–22); caretaking detachment, 13th C.A. (1924–41).

### National Guard

**Camp Beauregard, LA.** Located in Rapides Parrish 5 miles north of Alexandria, LA. Established in April 1917 as Alexandria Cantonment. Redesignated Camp Beauregard on 18 July 1917. Designated in honor of Lt. Gen. P.G.T. Beauregard, C.S.A. Designated as a N.G. cantonment for the mobilization of the 39th Div. in World War I. Transferred to the Louisiana N.G. on 21 October 1921.

**Units for Annual Summer Training**—HQ, 31st Div.; HHC, 61st Inf. Brig.; HHC, 62d Inf. Brig.; HHB, 56th F.A. Brig.; 47th Inf. (RAI); 155th Inf.; 156th Inf.; 323d Inf.; 324th Inf.; 325th Inf.; 345th Inf.; 346th Inf.; 347th Inf.; 348th Inf.; 450th Inf.; 108th Cav. (less 1st Sq.); HHB, 56th F.A. Brig.; 117th F.A.; 141st F.A. Bn.; 1st Bn., 141st F.A.; 178th F.A.; 336th F.A.; 397th F.A.; 427th F.A.; 106th Ammo. Tn.; 545th C.A.; 106th Engrs.; 312th Engrs.; 378th Engrs.; 31st Q.M. Tn.; 106th Q.M. Regt.; 106th Med. Regt.; 31st Div. Avn.; 106th Obsn. Sq.; CMTC—Inf.

**Camp Biloxi, MS.** See Camp Benjamin F. McClellan.

**Blackwood Field, TN (Civilian Airfield/National Guard Aviation Facility).** Located at Old Hickory, TN, on land adjacent to the Hermitage, home of President Andrew Jackson. Established in 1921; closed in 1928. Designated in honor of Mr. H.O. Blackwood, a Nashville native, who donated the land to the Tennessee N.G.

**Troops**—30th Div. Avn. (1923–28); 105th Obsn. Sq. (1923–28); 136th Obsn. Sq. (1921–23).

**Camp J. Clifford R. Foster, FL.** Located 12 miles southeast of Jacksonville, FL. Established in 1907 as the Florida Camp Grounds and State Rifle Range. Redesignated Camp Joseph E. Johnston in 1917 and used as a World War I cantonment. Returned to the Florida N.G. in 1921. Redesignated Camp J. Clifford R. Foster in 1929. Absorbed by Camp Blanding when it was established in 1940.

**Units for Annual Summer Training**—HQ, 31st Div.; HHC, 59th Inf. Brig.; HHC, 62d Inf. Brig.; 121st Inf.; 124th Inf.; 154th Inf.; 167th Inf.; 2d Bn., 106th Engrs.; 114th Engrs.; elements of 105th Q.M. Regt.; 106th Med. Regt.; 106th Q.M. Regt.

**Camp Glenn, NC.** Located at Morehead City, NC. Established in 1907. Designation in honor of Governor Robert B. Glenn.

**Units for Annual Summer Training**—HHC, 60th Inf. Brig.; 120th Inf.; elements of 30th Div. Q.M. Tn.

**Jackson Barracks, LA.** Located 6 miles southeast of New Orleans, LA. Acquired by purchase in 1833. Post established in 1834 as New Orleans Barracks. Redesignated Jackson Barracks in 1866. Designated in honor of Maj. Gen. Andrew Jackson, hero of New Orleans and Seventh President of the United States. Partially transferred to the Louisiana N.G. on 21 October 1921. Remainder of the post turned over to the Louisiana N.G. by the War Department after the inactivation of the CD of New Orleans in 1924.

**HQ**—CD of New Orleans (1919–24).

**Troops**—2d Co., CD of New Orleans (1919–21); 1st Co., CD of New Orleans (1920–21).

**Units for Annual Summer Training**—HQ and staff, 87th Div.

**Camp Joseph E. Johnston, FL.** See Camp J. Clifford R. Foster.

**Camp Benjamin F. McClellan, MS.** Located at Biloxi, MS. Designated in honor of Benjamin F. McClellan, lieutenant governor of Mississippi.

**Units for Annual Summer Training**—HHC, 61st Inf. Brig.; 155th Inf.; 106th Engrs.; 31st Q.M. Tn.; 31st Div. Avn.; 106th Obsn. Sq.

**Camp Peay, TN.** Located near Tullahoma, TN. Established in 1926. Designated in honor of Austin Peay, governor of Tennessee.

**Units for Annual Summer Training**—117th Inf.; 164th Engrs.; elements of 30th Div. Q.M. Tn.

**Roberts Field, AL (Civilian Airfield/National Guard Aviation Facility).** Located near Birmingham, AL. Established 5 June 1922. Designated in honor of Lt. Arthur Meredith Roberts, a native of Birmingham, who was killed 18 October 1918 in a flying accident in France.

**Troops**—31st Div. Avn. (1923–29); 106th Obsn. Sq. (1923–35); 114th Obsn. Sq. (1923); 135th Obsn. Sq. (1922–23).

**Camp John Sevier, SC.** Located 6 miles northeast of Greenville, SC. Established 18 July 1917. Designated in honor of Brig. Gen. John Sevier, Revolutionary War hero. Designated as a N.G. cantonment for the mobilization of the 30th Div. in World War I. Closed 8 April 1919. Transferred to the South Carolina N.G. in 1921.

**Units for Annual Summer Training**—117th Inf.; 118th Inf.; 109th Cav. (less 2d Sq.).

**Camp Shelby, MS.** Located 10 miles south of Hattiesburg, MS. Established 18 July 1917. Designated in honor of Col. Isaac Shelby, Virginia Militia, veteran of the Revolutionary War and War of 1812. Designated as an N.G. cantonment for the mobilization of the 38th Div. in World War I. The War Department decided to retain Camp Shelby as a Federal military reservation in April 1919. It was transferred to the Mississippi N.G. in 1934.

**Units for Annual Summer Training**—HQ, 31st Div.; HHC, 61st Inf. Brig.; HHB, 56th F.A. Brig.; 155th Inf.; 114th F.A.; 116th F.A.; 117th F.A.; 106th Engrs.; elements of 106th Q.M. Regt.

**St. Simons Island, GA.** Located 10 miles east of Brunswick, GA, on the Georgia coast.

**Units for Annual Summer Training**—HHC, 59th Inf. Brig.; 121st Inf.; 122d Inf.; 200th Inf.; 133d Engrs.; 164th Engrs.

**Tybee Island, GA.** Located at Savannah Beach, GA, 2 miles south of Fort Screven on the Georgia coast.

**Units for Annual Summer Training**—HHC, 59th Inf. Brig.; 121st Inf.; 122d Inf.; 200th Inf.; 133d Engrs.

#### **Organized Reserve**

**Candler Field, GA (Civilian Airfield).** Located at Atlanta, GA (also known as Atlanta Municipal Airport). Established in 1925. Designated in honor of Asa G. Candler, Atlanta businessman and owner of the Coca Cola Company. Designated as an O.R. airdrome and intermediate landing field.

**Units for Annual Summer Training**—306th Obsn. Sq.; 307th Obsn. Sq.; 312th Obsn. Sq.; 357th Obsn. Sq.; 358th Obsn. Sq.; 456th Purs. Sq.; 457th Purs. Sq.; 863d Obsn. Sq.

## FIFTH CORPS AREA

**HQ**—Fort Benjamin Harrison, IN, 20 August 1920–20 June 1922; Fort Hayes, OH, 20 June 1922–as of 7 December 1941.

Established in the US Army on 20 August 1920 with headquarters at Fort Benjamin Harrison, IN, and organized from portions of the discontinued Central Department. The headquarters was transferred to Fort Hayes, OH, on 20 June 1922. The Fifth Corps Area included the states of Ohio, West Virginia, Indiana, and Kentucky. HQ, Fifth Corps Area was responsible for the mobilization, administration, and training of units of the Second and Fifth Armies, the V and XV Army Corps, select GHQR units, and Z.I. support units of the Fifth CASC. Mobile units of the corps area, less GHQR, and Z.I. units, were assigned to the Second and Fifth Armies from 1921 to 1933. With the adoption of the four field army plan on 1 October 1933, the units of the Fifth Corps Area were reassigned to the Second Army, GHQR, or demobilized. The Fifth Corps Area Training Center was established in 1921, originally at Camp Knox, KY (redesignated Fort Knox in 1932), to train R.A. and O.R. units of all arms and services, as well as ROTC cadets and CMTC candidates. With the inactivation of the Fifth Corps Area Training Center in October 1922, Camp Knox became the primary training center for corps area infantry, cavalry, and field artillery units. Corps area maneuvers of mobile units were also held, those years when funds were available, at Camp Knox. For the administration of O.R. units, all organizations initially came under the control of the V Corps, or the 83d, 84th, and 100th Divs. When the V Corps was inactivated on 15 November 1924, the HQ, Non-Divisional Group was established to direct the organization, training, and administration of all nondivisional units. The HQ, Artillery Group was established on 5 September 1925 at Cincinnati, OH, to direct the organization, training, and administration of all nondivisional field artillery and coast artillery antiaircraft units. The corps area was further reorganized into four “military areas” on 28 September 1932. At that time, the Ohio Mil. Area assumed control of the 83d Div. area, the Indiana Mil. Area assumed control of the 84th Div. area, the West Virginia Mil. Area assumed control of the 100th Div. area less Kentucky, and the Kentucky Mil. Area assumed control of Kentucky elements of XV Corps, 100th Div., and 64th Cav. Div. Concurrently, the Artillery Group, which administered all nondivisional field artillery and coast artillery units, was abolished and the military area headquarters assumed control of the artillery units in their respective areas. The Fifth Corps Area began assigning Reserve personnel to “1500” series CASC units on 1 October 1932. The HQ, Fifth Corps Area actually began functioning as a service command headquarters in October 1940 and was redesignated HQ, Fifth CASC in May 1941. It was further redesignated HQ, Fifth Service Command on 22 July 1942.

**Events:** 85, 165, 213

### Major Commands in the Corps Area

Fifth Army (1921–33)  
 V Corps: 5th Division, 37th Division, 38th Division  
 XV Corps: 83d Division, 84th Division, 100th Division  
 Fifth Corps Area Service Command

### Corps Area Commanders

Maj. Gen. George W. Read	20 August 1920–29 August 1922	Maj. Gen. George V.H. Moseley	23 March 1933–12 January 1934
Brig. Gen. Dwight E. Aultman	29 August 1922–4 October 1922	Brig. Gen. Julian R. Lindsey	12 January 1934–1 May 1934
Maj. Gen. James H. McRae	4 October 1922–7 February 1924	Maj. Gen. Albert J. Bowley	1 May 1934–1 October 1935
Brig. Gen. Dwight E. Aultman	8 February 1924–12 July 1924	Brig. Gen. William K. Naylor	1 October 1935–25 January 1936
Maj. Gen. Omar Bundy	12 July 1924–17 June 1925	Maj. Gen. William E. Cole	25 January 1936–31 July 1938
Brig. Gen. Dwight E. Aultman	17 June 1925–16 July 1925	Maj. Gen. Daniel Van Voorhis	1 August 1938–21 January 1940
Maj. Gen. Robert L. Howze	16 July 1925–19 September 1926	Maj. Gen. David L. Stone	22 January 1940–25 April 1940
Brig. Gen. Dwight E. Aultman	19 September 1926–10 June 1927	Maj. Gen. Campbell B. Hodges	1 June 1940–18 October 1940
Maj. Gen. Dennis E. Nolan	10 June 1927–30 November 1931	Col. Edgar A. Fry	19 October 1940–1 November 1940
Maj. Gen. Hugh A. Drum	3 December 1931–22 February 1933	Brig. Gen. Clement A. Trott	2 November 1940–29 September 1941
Brig. Gen. George H. Jamerson	22 February 1933–23 March 1933	Lt. Gen. Daniel Van Voorhis	1 October 1941–October 1942

### Fifth Corps Area Service Command Organization 1932

UNIT:	LOCATION:
HQ, Fifth CASC	Fort Hayes, OH
HQ, Ohio Mil. Area	Fort Hayes, OH
Cincinnati Mil. District	Cincinnati, OH

### Fifth Corps Area Service Command Organization 1941

UNIT:	LOCATION:
HQ, Fifth CASC	Fort Hayes, OH
1500th CASU (HQ)	Fort Hayes, OH
1501st CASU (Med. Lab)	Fort Hayes, OH

**Fifth Corps Area Service Command  
Organization 1932 (Cont)**

UNIT:	LOCATION:
1511th HQ Co.	Cincinnati, OH
1518th Rec'g Bn.	Cincinnati, OH
1519th Rec'g Bn.	Dayton, OH
1508th Sp. Tng. Bn.	Cincinnati, OH
1510th M.P. Co.	Cincinnati, OH
1514th Sta. Hosp.	Cincinnati, OH
1515th Sta. Hosp.	Dayton, OH
1512th M.T. Co.	Cincinnati, OH
1513th Motor Maint Plt.	Cincinnati, OH
1510th Sv Co.	Cincinnati, OH
Cleveland Mil. District	Cleveland, OH
1510th HQ Co.	Cleveland, OH
1516th Rec'g Bn.	Cleveland, OH
1517th Rec'g Bn.	Cleveland, OH
1507th Sp. Tng. Bn.	Cleveland, OH
1509th M.P. Co.	Cleveland, OH
1512th Sta. Hosp.	Cleveland, OH
1513th Sta. Hosp.	Akron, OH
1511th M.T. Co.	Cleveland, OH
1512th M. Maint Plt.	Cleveland, OH
1509th Sv Co.	Cleveland, OH
Columbus Mil. District	Columbus, OH
1505th Ord. Co.	Columbus, OH
1508th M.P. Co.	Columbus, OH
1508th Sv Co.	Columbus, OH
1509th HQ Co.	Columbus, OH
1510th M.T. Co.	Columbus, OH
1511th Sta. Hosp.	Columbus, OH
1511th M. Maint Plt.	Columbus, OH
1515th Rec'g Bn.	Columbus, OH
1516th Sp. Tng. Bn.	Columbus, OH
Toledo Mil. District	Toledo, OH
1512th HQ Co.	Toledo, OH
1520th Rec'g Bn.	Toledo, OH
1509th Sp. Tng. Bn.	Toledo, OH
1511th M.P. Co.	Toledo, OH
1516th Sta. Hosp.	Toledo, OH
1513th M.T. Co.	Toledo, OH
1514th M. Maint Plt.	Toledo, OH
1511th Sv Co.	Toledo, OH
Corps Area Sup Point	Columbus, OH
Columbus Gen. Dep	Columbus, OH
HQ, CASC, Fort Hayes	Fort Hayes, OH
HQ, CASC, Fort Thomas	Fort Thomas, KY
Camp Perry School of Fire (AA)	Camp Perry, OH
HQ, Indiana Mil. Area	Indianapolis, IN
Indianapolis Mil. District	Indianapolis, IN
South Bend Mil. District	South Bend, IN
Vincennes Mil. District	Vincennes, IN
HQ, CASC, Fort Benjamin Harrison	Fort Benjamin Harrison, IN
HQ, Kentucky Mil. Area	Louisville, KY
Louisville Mil. District	Louisville, KY
Lexington Mil. District	Lexington, KY
HQ, CASC, Fort Knox, KY	Fort Knox, KY
Fifth Corps Area Rmt Dep	Lexington, KY
Fort Knox School of Fire	Fort Knox, KY
HQ, West Virginia Mil. Area	Charleston, WV
Charleston Mil. District	Charleston, WV
Clarksburg Mil. District	Clarksburg, WV

**Fifth Corps Area Service Command  
Organization 1941 (Cont)**

UNIT:	LOCATION:
1505th CASU (Maint Sv)	Fort Hayes, OH
1506th CASU (Sch. B&C)	Fort Ben Harrison, IN
1507th CASU (AC Det.)	Fort Hayes, OH
1508th CASU (ROTC Instr. Gp.)	Fort Hayes, OH
1509th CASU (O.R. Instr. Gp.)	Fort Hayes, OH
1515th CASU (N.G. Instr. Gp.)	Fort Hayes, OH
1516th CASU (Rctg. Sv)	Fort Hayes, OH
1517th CASU (CCC)	Fort Hayes, OH
1518th CASU (Sig. Co.)	Fort Hayes, OH
1519th CASU (Fin. Ofc.)	Columbus, OH
1520th CASU (Sta. Cmpl.)	Fort Hayes, OH
1521st CASU (Sta. Hosp.)	Fort Hayes, OH
1522d CASU (Q.M. Det.)	Fort Hayes, OH
1523d CASU (Sv Det.)	Fort Hayes, OH
1524th CASU (Recep. Ctr.)	Fort Hayes, OH
1530th CASU (Sta. Cmpl.)	Fort Ben Harrison, IN
1531st CASU (Sta. Hosp.)	Fort Ben Harrison, IN
1532d CASU (Q.M. Det.)	Fort Ben Harrison, IN
1533d CASU (Sv Det.)	Fort Ben Harrison, IN
1534th CASU (Recep. Ctr.)	Fort Ben Harrison, IN
1535th CASU (Fin. Det.)	Fort Ben Harrison, IN
1540th CASU (Sta. Cmpl.)	Fort Thomas, KY
1541st CASU (Sta. Hosp.)	Fort Thomas, KY
1542d CASU (Q.M. Det.)	Fort Thomas, KY
1543d CASU (Sv Det.)	Fort Thomas, KY
1544th CASU (Recep. Ctr.)	Fort Thomas, KY
1545th CASU (Fin. Det.)	Fort Thomas, KY
1550th CASU (Sta. Cmpl.)	Fort Knox, KY
1551st CASU (Sta. Hosp.)	Fort Knox, KY
1552d CASU (Q.M. Det.)	Fort Knox, KY
1553d CASU (Sv Det.)	Fort Knox, KY
1554th CASU (Recep. Ctr.)	Fort Knox, KY
1555th CASU (Fin. Det.)	Fort Knox, KY
1556th CASU (M.P. Co)	Fort Knox, KY
Air Corps Det.	Bowman Field, KY
Air Corps Det.	Lunken Airport, OH
Air Corps Det.	Port Columbus, OH
Air Corps Det.	Schoen Field, IN

**Major posts, camps, stations, airfields, and N.G. and O.R. training facilities in the corps area.**

**Regular Army**

**Godman Field, KY (Military Airfield).** Located at Fort Knox, KY. Established in July 1918 to support the field artillery training center at Camp Knox. Designated in honor of 1st Lt. Louis K. Godman, who was killed 28 September 1918 in an airplane crash near Columbia, SC.

**Troops**—12th Obsn. Sq. (1937–41).

**Units for Annual Summer Training**—37th Div. Avn.; 112th Obsn. Sq.; 38th Div. Avn.; 113th Obsn. Sq.; 325th Obsn. Sq.

**Fort Benjamin Harrison, IN.** Located 10 miles northeast of Indianapolis, IN. Acquired by purchase in 1903–04. Designated in honor of Benjamin Harrison, 23d President of the United States.

**HQ**—Fifth Corps Area (1920–22), 10th Inf. Brig. (1922–39).

**Troops**—3d Bn., 40th Inf. (1920–22); 11th Inf. (1922–39); 1st Bn., 3d F.A. (1921–34); 1st Bn., 19th F.A. (1934–40); 19th F.A. (1939–40); 5th Tank Co.; elements of 5th Q.M. Regt.

**Units for Annual Summer Training**—HQ, 83d Div.; HQ, 84th Div.; HHC, 167th Inf. Brig.; HHC, 168th Inf. Brig.; 60th Inf. (RAI); 61st Inf. (RAI); 329th Inf.; 330th Inf.; 331st Inf.; 332d Inf.; 333d Inf.; 334th Inf.; 335th Inf.; 336th Inf.; 397th Inf.; 398th Inf.; 399th Inf.; 400th Inf.; 426th Inf.; 19th F.A. (RAI); 322d F.A.; 323d F.A.; 324th F.A.; 325th F.A.; 326th F.A.; 374th F.A.; 402d F.A.; 435th F.A.; 7th Engrs. (RAI); 10th Engrs. (RAI); 308th Engrs.; 309th Engrs.; 325th Engrs.; 345th Engrs.; 356th Engrs.; 364th Engrs.; 366th Engrs.; 379th Engrs.; 380th Engrs.; 404th Engr. Sq.; 309th Med. Regt.; 64th Cav Div. Q.M. Tn.; 83d Div. Q.M. Tn.; 84th Div. Q.M. Tn.; 100th Div. Q.M. Tn.; CMTTC—Inf.

**Fort Hayes, OH.** Located in Columbus, OH. Acquired by purchase in 1863. Originally established as Columbus Arsenal. Redesignated Columbus Barracks in 1875. Redesignated Fort Hayes on 13 December 1922 in honor of Rutherford B. Hayes, 19th President of the United States.

**HQ**—Fifth Corps Area (1922–41).

**Troops**—3d Bn., 10th Inf. (1922–30); 1st Bn., 10th Inf. (1933–39); 1st Bn., 28th Inf. (1930–33).

**Jeffersonville Quartermaster Depot, IN.** Located at Jeffersonville, IN, across the Ohio River from Louisville, KY.

**Units for Annual Summer Training**—V Corps Q.M. Tn.; 6th Div. Q.M. Tn. (RAI); 8th Div. Q.M. Tn. (RAI); 64th Cav Div. Q.M. Tn.; 83d Div. Q.M. Tn.; 84th Div. Q.M. Tn.; 100th Div. Q.M. Tn.

**Camp Knox, KY.** Located 31 miles west/southwest of Louisville, KY. Established before World War I as Artillery Range, West Point, KY. Redesignated on 21 August 1918 as Camp Henry Knox in honor of Brig. Gen. Henry Knox, Revolutionary War hero and first US Secretary of War. Designated a permanent post on 1 January 1932 and renamed Fort Knox. Training center for Fifth Corps Area O.R. infantry, cavalry, field artillery, and engineer units.

**HQ**—10th Inf. Brig. (1921–22); 8th F.A. Brig. (1919–22); 7th Cav. Brig. (Mecz) (1932–40).

**Troops**—1st Cav. (1933–40); 13th Cav. (1936–40); 6th Inf. (1940–41); 3d F.A. (1921–22); 21st F.A. (1939–40); 1st Bn., 68th F.A. (1934–40); 8th Ammo. Tn. (1921); 12th Obsn. Sq. (1937–41); elements of 5th Q.M. Regt. and 4th Med. Sq.

**Units for Annual Summer Training**—HQ, 32d Div.; HQ, 33d Div.; HQ, 37th Div.; HQ, 38th Div.; HQ, 64th Cav. Div.; HQ, 83d Div.; HQ, 84th Div.; HQ, 85th Div.; HQ, 86th Div.; HQ, 100th Div.; HHC, 73d Inf. Brig.; HHC, 74th Inf. Brig.; HHC, 75th Inf. Brig.; HHC, 76th Inf. Brig.; HHC, 165th Inf. Brig.; HHC, 166th Inf. Brig.; HHC, 167th Inf. Brig.; HHC, 168th Inf. Brig.; HHC, 199th Inf. Brig.; HHC, 200th Inf. Brig.; HHT, 54th Cav. Brig.; HHC, 157th Cav. Brig.; HHB, 5th F.A. Brig. (RAI); HHB, 58th F.A. Brig.; HHB, 59th F.A. Brig.; HHB, 62d F.A. Brig.; HHB, 63d F.A. Brig.; HHB, 158th F.A. Brig.; HHB, 159th F.A. Brig.; HHB, 175th F.A. Brig.; HHB, 184th F.A. Brig.; 60th Inf. (RAI); 61st Inf. (RAI); 149th Inf.; 150th Inf.; 151st Inf.; 152d Inf.; 201st Inf.; 329th Inf.; 330th Inf.; 331st Inf.; 332d Inf.; 333d Inf.; 334th Inf.; 335th Inf.; 336th Inf.; 337th Inf.; 338th Inf.; 397th Inf.; 398th Inf.; 399th Inf.; 400th Inf.; 426th Inf.; 107th Cav.; 123d Cav.; 313th Cav.; 314th Cav.; 53d MG Sq.; 54th MG Sq.; 157th MG Sq.; 461st Armd. Car Sq.; 462d Armd. Car Sq.; 463d Armd. Car Sq.; 464th Armd. Car Sq.; 465th Armd. Car Sq.; 19th F.A. (RAI); 20th F.A. (RAI); 21st F.A. (RAI); 26th F.A. (RAI); 27th F.A. (RAI); 28th F.A. (RAI); 30th F.A. (RAI); 33d F.A. (RAI); 34th F.A. (RAI); 35th F.A. (RAI); 85th F.A. (RAI); 114th F.A.; 128th F.A.; 134th F.A.; 135th F.A.; 136th F.A.; 137th F.A.; 138th F.A.; 139th F.A.; 151st F.A.; 2d Bn., 178th F.A.; 181st F.A.; 185th F.A.; 322d F.A.; 323d F.A.; 324th F.A.; 325th F.A.; 326th F.A.; 327th F.A.; 373d F.A.; 374th F.A.; 375th F.A.; 377th F.A.; 378th F.A.; 392d F.A.; 400th F.A.; 401st F.A.; 402d F.A.; 403d F.A.; 407th F.A.; 434th F.A.; 435th F.A.; 440th F.A.; 445th F.A.; 449th F.A.; 455th F.A.; 464th F.A. Bn.; 474th F.A.; 475th F.A.; 476th F.A.; 479th F.A.; 480th F.A.; 483d F.A.; 484th F.A.; 485th F.A.; 489th F.A.; 492d F.A.; 563d F.A.; 565th F.A.; 574th F.A.; 864th F.A.; Second Army Ammo. Tn. (RAI); Fifth Army Ammo. Tn.

(RAI); 308th Ammo. Tn.; 309th Ammo. Tn.; 325th Ammo. Tn.; 345th Ammo. Tn.; 362d Ammo. Tn.; 370th Ammo. Tn.; 317th F.A. Obsn. Bn.; 505th C.A.; 506th C.A.; 507th C.A.; 511th C.A.; 525th C.A.; 527th C.A.; 528th C.A.; 531st C.A.; 532d C.A.; 535th C.A.; 536th C.A.; 537th C.A.; 538th C.A.; 945th C.A.; 946th C.A.; 947th C.A.; 948th C.A.; 949th C.A.; 950th C.A.; 954th C.A.; 955th C.A.; 958th C.A.; 960th C.A.; 7th Engrs. (RAI); 10th Engrs. (RAI); 38th Engrs. (RAI); 45th Engrs. (RAI); 112th Engrs.; 113th Engrs.; 308th Engrs.; 309th Engrs.; 325th Engrs.; 335th Engrs.; 345th Engrs.; 356th Engrs.; 364th Engrs.; 366th Engrs.; 379th Engrs.; 380th Engrs.; 389th Engrs.; 404th Engr. Sq.; Co. A, 104th M.P. Bn.; 305th M.P. Bn.; 305th Sig. Bn.; V Corps Q.M. Tn.; 5th Div. Q.M. Tn. (RAI); 38th Div. Q.M. Tn.; 64th Cav Div. Q.M. Tn.; 83d Div. Q.M. Tn.; 84th Div. Q.M. Tn.; 100th Div. Q.M. Tn.; 25th Q.M. Regt. (RAI); 48th Q.M. Regt. (RAI); 113th Q.M. Regt.; 408th Q.M. Regt.; 409th Q.M. Regt.; 425th Q.M. Regt.; 5th Med. Regt. (RAI); 15th Med. Regt. (RAI); 112th Med. Regt.; 113th Med. Regt.; 308th Med. Regt.; 309th Med. Regt.; 325th Med. Regt.; 345th Med. Regt.; 364th Med. Sq.; 377th Med. Regt.; 38th Div. Avn.; 113th Obsn. Sq.; CMTC—Inf., Cav., F.A., S.C.; ROTC—Inf., F.A.

**Patterson Field, OH (Military Airfield).** Located 10 miles northeast of Dayton, OH, at Fairfield. Originally designated Fairfield Intermediate Air Depot. Redesignated Patterson Field on 1 July 1931 in honor of Lt. Frank S. Patterson, who was killed 19 June 1918 in a flying accident at Wilbur Wright Field.

**Troops**—1st Trans Sq. (1935–41); 5th Trans Sq. (1939–41); 9th Trans Sq. (1940–41); 11th Trans Sq. (1940–41); 19th Bomb. Sq. (1940); 33d Bomb. Sq. (1940).

**Camp Sherman, OH.** Located 3 miles east of Chillicothe, OH. Established 21 July 1917. Designated in honor of Lt. Gen. William T. Sherman, commanding general of the Army of Tennessee and the Division of the Mississippi during the Civil War and later the US Army. Designated as a National Army cantonment for the mobilization of the 83d Div. in World War I. Abandoned in 1921, but not sold. Used as a small arms range by the Ohio N.G. in the interwar period.

**Fort Thomas, KY.** Located in the city of Fort Thomas, KY. Acquired by purchase in 1887. Designated in honor of Maj. Gen. George H. Thomas, commanding general of the XIV Corps and the Army of the Cumberland, 1862–65.

**HQ**—10th Inf. Regt. (1922–39).

**Troops**—10th Inf., less 3d Bn.

**Units for Annual Summer Training**—HQ, 83d Div.; HQ, 100th Div.; HHC, 9th Inf. Brig. (RAI); HHC, 165th Inf. Brig.; HHC, 166th Inf. Brig.; HHC, 199th Inf. Brig.; HHC, 200th Inf. Brig.; HHC, 8th Tank Gp.; 60th Inf. (RAI); 61st Inf. (RAI); 329th Inf.; 330th Inf.; 331st Inf.; 332d Inf.; 333d Inf.; 334th Inf.; 397th Inf.; 398th Inf.; 399th Inf.; 400th Inf.; 404th Engr. Sq.; 325th Med. Regt.; CMTC—Inf.

**Wright Field, OH (Military Airfield).** Located 5 miles east of Dayton, OH. Established 22 May 1917 as Wilbur Wright Field. Redesignated Wright Field on 12 October 1927. Designated in honor of Wilbur Wright, early American aviation pioneer and first man ever to fly in a heavier-than-air craft.

**HQ**—10th Transport Gp. (1937–41).

**Troops**—5th Div. Avn. (1923–27); 88th Obsn. Sq. (1922–27).

**Units for Annual Summer Training**—HQ, 317th Obsn. Gp.; HQ, 327th Purs. Gp.; 113th Obsn. Sq.; 137th Obsn. Sq.; 308th Obsn. Sq.; 309th Obsn. Sq.; 325th Obsn. Sq.; 359th Obsn. Sq.; 414th Purs. Sq.; 416th Purs. Sq.; 418th Obsn. Sq.; 460th Obsn. Sq.; 464th Purs. Sq.; 465th Purs. Sq.; 466th HQ Sq.

### National Guard

**Camp William G. Conley, WV.** Located at Point Pleasant, WV. Established in 1927. Designated in honor of William G. Conley, governor of West Virginia, 1929–33.

**Units for Annual Summer Training**—150th Inf.; 201st Inf.

**Camp Dawson, WV.** Located at Kingwood, WV. Established 7 May 1909 along the Cheat River in Preston County. Designated in honor of William M.O. Dawson, a native of Preston County and West Virginia governor, 1905–08. Abandoned in 1917; reestablished in 1928.

**Units for Annual Summer Training**—201st Inf.

**Camp Perry, OH.** Located just west of Newark, OH. Established about 1903. Designated in honor of Admiral Oliver Hazard Perry, USN, 1 May 1908.

**Units for Annual Summer Training**—HQ, 37th Div.; HHC, 73d Inf. Brig.; HHC, 73d Inf. Brig.; HHT, 54th Cav. Brig.; HHB, 62d F.A. Brig.; 145th Inf.; 147th Inf.; 148th Inf.; 166th Inf.; 107th Cav.; 2d Bn., 372d Inf.; 449th Inf.; 112th Engrs.; 112th Med. Regt.; 37th Div. Q.M. Tn.; 112th Q.M. Regt.; 37th Div. Avn.; 112th Obsn. Sq.; 308th Obsn. Sq.; 309th Obsn. Sq.; 325th Obsn. Sq.; 359th Obsn. Sq.; 464th Purs. Sq.; 465th Purs. Sq.; 466th HQ Sq.

**Stout Field, IN (Civilian Airfield).** Located 4½ miles southwest of Indianapolis, IN. Established in 1921. Originally named Mars Hill Airport. Redesignated in 1924 in honor of Lt. Robert L. Stout, World War I combat pilot and member of 113th Obsn. Sq., who was killed in 1924 in a flying accident.

**Troops**—38th Div. Avn. (1926–29); 113th Obsn. Sq. (1926–41).

**Wilbur Fagley Field, IN (Civilian Airfield).** Located at Kokomo, IN. Established in 1921. Designated in honor of Maj. Wilbur Fagley, commander of the 137th Obsn. Sq., who was killed 29 July 1922 in a flying accident.

**Troops**—38th Div. AS (1923–26); 137th Obsn. Sq. (1921–23); 113th Obsn. Sq. (1923–26).

#### **Organized Reserve**

**Bowman Field, KY (Civilian Airfield).** Located 2½ miles east of the city center of Louisville, KY, on Taylorsville Road. Established in 1919. Designated on 25 August 1923 in honor of Abram H. Bowman, early Louisville aviation pioneer. Designated as an O.R. airdrome and flying station in 1922. Intermediate landing field.

**Troops**—325th Obsn. Sq. (1931–41); 465th Purs. Sq. (1922–33).

**Lunken Airport, OH (Civilian Airfield).** Located at Cincinnati, OH. Established in December 1925. Named in honor of Mr. Eshelby Lunken, an early aviation enthusiast and founder of Lunken Airport. Designated as an O.R. airdrome and intermediate landing field.

**Troops**—325th Obsn. Sq. (1921–31); 359th Obsn. Sq. (1931–41).

**Norton Field, OH (Civilian Airfield).** Located at Columbus, OH. Dedicated 30 June 1923 by Capt. Eddie Rickenbacker in honor of Capt. Fred W. Norton, 27th Purs. Sq., a Columbus native and pilot, who was killed in action in July 1918 in an air battle over northern France. Designated as an O.R. airdrome and intermediate landing field.

**Troops**—308th Obsn. Sq. (1923–41); 416th Purs. Sq. (1922–33).

**Port Columbus Airport, OH (Civilian Airfield/Military Airfield).** Located 8 miles east of Columbus, OH. Dedicated 8 July 1929. US Army auxiliary flying field. O.R. airdrome and intermediate landing field.

**Schoen Field, IN (Military Airfield).** Located at Fort Benjamin Harrison, IN. Formally dedicated on 26 March 1922 in honor of 1st Lt. Karl Schoen, an Indianapolis native, who was shot down and killed on 28 October 1918 over Verdun, France. Designated as an O.R. airdrome and intermediate landing field.

**Troops**—309th Obsn. Sq. (1922–41); 348th Svc. Sq. (1922–41); 464th Purs. Sq. (1922–33).

**Units for Annual Summer Training**—309th Obsn. Sq.; 325th Obsn. Sq.; 359th Obsn. Sq.; 414th Purs. Sq.; 414th Purs. Sq.; 416th Purs. Sq.; 417th Purs. Sq.; 418th Obsn. Sq.



## SIXTH CORPS AREA

**HQ**—Fort Sheridan, IL, 20 August 1920–10 October 1921; Chicago, IL, 10 October 1921–as of 7 December 1941.

Established in the US Army on 20 August 1920 with headquarters at Fort Sheridan, IL. The headquarters was moved to the US Post Office Building at 1819 West Pershing Road in Chicago on 10 October 1921. The Sixth Corps Area was organized from portions of the discontinued Central Department and included the states of Illinois, Michigan, Wisconsin, and Jefferson Barracks, MO. HQ, Sixth Corps Area was responsible for the mobilization, administration, and training of units of the Second and Fifth Armies, VI and XVI Army Corps, select GHQR units, and Z.I. support units of the Sixth CASC. Mobile units of the corps area, less GHQR, and Z.I. units, were assigned to the Second and Fifth Armies from 1921 to 1933. With the adoption of the four field army plan on 1 October 1933, the units of the corps area were reassigned to the Second Army or GHQR or demobilized. The Sixth Corps Area Training Center was established in 1921, originally at Camp Custer, MI, to train R.A. and O.R. units of all arms and services, as well as ROTC cadets and CMTC candidates. With the inactivation of the Sixth Corps Area Training Center in 1922, Camp Custer became the primary training center for corps area infantry and field artillery units. Cavalry units were trained at Fort Sheridan, IL, and air corps units were trained at Selfridge Field, MI. Corps area maneuvers of mobile units were held, those years when funds were available, at Camp Custer. For the administration of O.R. units, all organizations initially came under the control of the VI Corps, or the 85th, 86th, and 101st Divs. The HQ, Artillery Group was established 27 May 1925 at Chicago to direct the organization, training, and administration of all nondivisional field artillery and coast artillery antiaircraft units. When the VI Corps was inactivated, all nondivisional units less those under the control of the Artillery Group, were placed under the jurisdiction of HQ, Sixth Corps Area. The corps area was further reorganized into three "Reserve districts" in November 1931. At that time, the Michigan Reserve District assumed control of the 85th Div. area, the Illinois Reserve District assumed control of the 86th Div. area, and the Wisconsin Reserve District assumed control of the 101st Div. area. Concurrently, the Artillery Group at Chicago, which administered all corps area nondivisional field artillery and coast artillery units, was abolished and the Reserve district headquarters assumed control of the artillery units in their respective areas. The reserve districts were redesignated "military areas" in December 1937. The Sixth Corps Area began assigning Reserve personnel to CASC units on 9 January 1925 and to "1600" series numbered units on 28 November 1929. The HQ, Sixth Corps Area actually began functioning as a service command headquarters in October 1940 and was redesignated HQ, Sixth CASC in May 1941. It was further redesignated the Sixth Service Command on 22 July 1942.

**Events:** 124, 148, 214, 274

### Major Commands in the Corps Area

Second Army (1921–40)  
I Cavalry Corps (RAI) (1927–40)  
VI Corps: 6th Division, 32d Division, 33d Division  
XVI Corps: 85th Division, 86th Division, 101st Division  
Sixth Corps Area Service Command

### Corps Area Commanders

Maj. Gen. Leonard Wood	20 August 1920–2 April 1921	Brig. Gen. Frank C. Bolles	16 October 1934–1 February 1935
Maj. Gen. George Bell Jr.	2 April 1921–3 October 1922	Maj. Gen. Frank R. McCoy	1 February 1935–1 May 1936
Brig. Gen. George V.H. Moseley	3 October 1922–2 December 1922	Maj. Gen. Johnson Hagood	2 May 1936–7 May 1936
Maj. Gen. Harry C. Hale	2 December 1922–10 July 1925	Brig. Gen. Dana T. Merrill	7 May 1936–14 May 1936
Maj. Gen. William S. Graves	12 July 1925–25 October 1926	Brig. Gen. Charles D. Herron	14 May 1936–1 June 1936
Brig. Gen. Michael J. Lenihan	25 October 1926–9 March 1927	Maj. Gen. Charles E. Kilbourne Jr.	1 June 1936–17 December 1936
Maj. Gen. William Lassiter	9 March 1927–17 March 1928	Maj. Gen. Charles D. Herron	17 December 1936–15 September 1937
Maj. Gen. Paul B. Malone	17 March 1928–6 April 1929	Maj. Gen. Hugh H. Drum	15 September 1937–31 October 1938
Maj. Gen. Frank Parker	7 April 1929–1 November 1933	Maj. Gen. Stanley H. Ford	5 November 1938–10 October 1940
Maj. Gen. Preston Brown	22 October 1933–16 October 1934	Maj. Gen. Charles H. Bonesteel	10 October 1940–26 July 1941
	Maj. Gen. Joseph M. Cummins		26 July 1941–28 March 1942

### Sixth Corps Area Service Command Organization 1932

UNIT:	LOCATION:
HQ, Sixth CASC	Chicago, IL
1600th CASU (HQ, Sixth CASC)	Chicago, IL
1601st CASU (IL Mil. Area)	Chicago, IL
1610th CASU (Mob. Ctr.)	Camp Grant, IL

### Sixth Corps Area Service Command Organization 1941

UNIT:	LOCATION:
HQ, Sixth CASC	Chicago, IL
1600th CASU (HQ)	Chicago, IL
1601st CASU (IL Mil. Area)	Chicago, IL
1602d CASU (MI Mil. Area)	Detroit, MI

**Sixth Corps Area Service Command  
Organization 1932 (Cont)**

UNIT:	LOCATION:
1630th CASU (Recep. Ctr.)	Chicago, IL
1631st CASU (Recep. Ctr.)	Peoria, IL
1632d CASU (Recep. Ctr.)	Springfield, IL
1633d CASU (Recep. Ctr.)	Centralia, IL
1640th CASU (Repl. Ctr.) (C.A.C.)	Fort Sheridan, IL
1641st CASU (Repl. Ctr.) (Inf.)	Camp Grant, IL
1642d CASU (Repl. Ctr.) (Engr.)	Springfield, IL
1643d CASU (Repl. Ctr.) (Sig.)	Springfield, IL
1644th CASU (Repl. Ctr.) (Ord.)	Chicago, IL
1645th CASU (Repl. Ctr.) (Q.M.C.)	Chicago, IL
1646th CASU (Repl. Ctr.) (Med.)	Chicago, IL
1647th CASU (Repl. Ctr.) (Basic)	Chicago, IL
1670th Gen. Hosp.	Chicago, IL
1602d CASU (MI Mil. Area)	Detroit, MI
1611th CASU (Mob. Ctr.)	Camp Custer, MI
1612th CASU (Mob. Ctr.)	Camp Grayling, MI
1634th CASU (Recep. Ctr.)	Grand Rapid, MI
1635th CASU (Recep. Ctr.)	Detroit, MI
1648th CASU (Repl. Ctr.) (C.A.C.)	Camp Custer, MI
1649th CASU (Repl. Ctr.) (Basic)	Detroit, MI
1650th CASU (Repl. Ctr.) (C.W.S.)	Camp Grayling, MI
1671st Gen. Hosp.	Chicago, IL
1603d CASU (WI Mil. Area)	Milwaukee, WI
1613th CASU (Mob. Ctr.)	Camp McCoy, WI
1636th CASU (Recep. Ctr.)	Milwaukee, WI
1637th CASU (Recep. Ctr.)	Madison, WI
1651st CASU (Repl. Ctr.) (F.A.)	Camp McCoy, WI
1652d CASU (Repl. Ctr.) (Basic)	Milwaukee, WI
1653d CASU (Repl. Ctr.) (Cav.)	Camp Williams, WI
1672d Gen. Hosp.	Milwaukee, WI
1605th CASU (Corps Area Sup. Point)	Chicago, IL
Chicago Q.M. Dep	Chicago, IL
1660th CASU (Distributing Point)	Chicago, IL
1661st CASU (Distributing Point)	Camp Grant, IL
1662d CASU (Distributing Point)	Champaign, IL
1663d CASU (Distributing Point)	East St. Louis, IL
1664th CASU (Distributing Point)	Camp Custer, MI
1665th CASU (Distributing Point)	Detroit, MI
1666th CASU (Distributing Point)	Fort Brady, MI
1667th CASU (Distributing Point)	Milwaukee, WI
1668th CASU (Distributing Point)	Camp McCoy, WI
1620th CASU (Rctg. & Recep.)	Chicago, IL
1621st CASU (Rctg. & Recep.)	Peoria, IL
1622d CASU (Rctg. & Recep.)	Springfield, IL
1623d CASU (Rctg. & Recep.)	Centralia, IL
1624th CASU (Rctg. & Recep.)	Detroit, MI
1625th CASU (Rctg. & Recep.)	Grand Rapids, MI
1626th CASU (Rctg. & Recep.)	Milwaukee, WI
1627th CASU (Rctg. & Recep.)	Madison, MI
Corps Area Field Rmt Dep	Chicago, IL
HQ, Fort Sheridan Mob. Ctr.	Fort Sheridan, IL
HQ, Camp Custer Mob. Ctr.	Camp Custer, MI
HQ, Camp Grayling Mob. Ctr.	Camp Grayling, MI
HQ, Camp McCoy Mob. Ctr.	Camp McCoy, WI
HQ, Camp Williams Mob. Ctr.	Camp Williams, WI
HQ, Camp Grant Mob. Ctr.	Camp Grant, IL
HQ, Scott Field Mob. Ctr.	Scott Field, IL
HQ, Chanute Field Mob. Ctr.	Chanute Field, IL
HQ, Peoria Tank Tng. Ctr.	Peoria, IL
Corps Area Med. Dep	Chicago, IL

**Sixth Corps Area Service Command  
Organization 1941 (Cont)**

UNIT:	LOCATION:
1603d CASU (WI Mil. Area)	Milwaukee, WI
1604th CASU (Sta. Cmpl.)	Fort Brady, MI
1605th CASU (Sta. Cmpl.)	Fort Custer, MI
1606th CASU (Sta. Cmpl.)	Camp McCoy, WI
1607th CASU (Sta. Cmpl.)	Fort Sheridan, IL
1608th CASU (Sta. Cmpl.)	Camp Grant, IL
1609th CASU (Recep. Ctr.)	Fort Custer, MI
1610th CASU (Recep. Ctr.)	Camp Grant, IL
1611th CASU (Recep. Ctr.)	Fort Sheridan, IL
1612th CASU (Sch B&C)	Fort Sheridan, IL
1613th CASU (AC Det.)	Chicago Airport, IL
1614th CASU (Rctg. Sv)	Chicago, IL
1615th CASU (ROTC Instr. Gp.)	Chicago, IL
1616th CASU (N.G. Instr. Gp.)	Chicago, IL
1617th CASU (Fin. Ofc.)	Chicago, IL
1618th CASU (Fin. Ofc.)	Detroit, MI
1619th CASU (Maint Sv)	Chicago, IL
1620th CASU (Sig. Sv Co.)	Chicago, IL
1621st CASU (Gen. Dispry.)	Chicago, IL
1622d CASU (M.P. Bn )	Fort Brady, MI
1623d CASU (Med. Lab)	Fort Sheridan, IL
1624th CASU (Recreation)	Chicago, IL
1625th CASU (Recreation)	Detroit, MI
1626th CASU (Recreation)	Decatur, IL
<i>1627th CASU</i>	<i>Inactive</i>
1628th CASU (Sta. Cmpl.)	Rock Island Arsenal, IL
1629th CASU (Sta. Cmpl.)	Savannah PG, IL
<i>1630th CASU</i>	<i>Inactive</i>
<i>1631st CASU</i>	<i>Inactive</i>
1632d CASU (Induct. Sta.)	Chicago, IL
1633d CASU (P.M.O.)	Chicago, IL
1634th CASU	<i>Inactive</i>
1635th CASU (Engr. Dist)	Sault Ste Marie, MI

**Sixth Corps Area Service Command  
Organization 1932 (Cont)**

UNIT:	LOCATION::
Forwood Gen. Hosp.	Chicago, IL
Morgan Gen. Hosp.	Detroit, MI
Smart Gen. Hosp.	Milwaukee, WI
Repl. Ctr. (Med.)	Chicago, IL
Cavalry & Coast Artillery School	Lansing, MI
Field Artillery & Signal Corps School	Madison, WI
Engineer & Ordnance School	Ann Arbor, MI
Officer Candidate School	Chicago, IL
Officer Candidate School (Inf.)	Urbana, IL
8th CASC Air Pool	Chicago, IL

**Major posts, camps, stations, airfields, and N.G. and O.R. training facilities in the corps area.**

**Regular Army**

**Fort Brady, MI.** Located in Sault St. Marie, MI. Established in 1892. Designated in honor of Col. Hugh Brady, 2d US Inf., veteran of the War of 1812.

**Troops**—3d Bn., 2d Inf. (1922–39); 3d Bn., 37th Inf. (1920–21).

**Units for Annual Summer Training**—404th Inf.; CMTC—Inf.

**Chanute Field, IL (Military Airfield).** Located 1 mile southeast of Rantoul, IL. Established 21 May 1917. Designated in honor of Gustave Chanute, pioneer aviation scientist.

**Troops**—6th Div. Avn. (1923–27); 1st Sch. Sq. (1936–41); 10th Air Base Sq. (1936–40); 15th Aero Sq. (1919–21); 15th Obsn. Sq. (1921–27); 43d Sch. Sq. (1933–35); 48th Sch. Sq. (1933–36); 98th Sv Sq. (1933–35).

**Units for Annual Summer Training**—HQ, 9th Atk. Wing; HQ, 309th Atk. Gp.; HQ, 319th Atk. Gp.; 85th Div. Avn.; 101st Div. Avn.; 310th Obsn. Sq.; 311th Obsn. Sq.; 326th Obsn. Sq.; 349th Sv Sq.; 361st Obsn. Sq.; 362d Obsn. Sq.; 358th Obsn. Sq.; 358th Obsn. Sq.; 419th Obsn. Sq.; 420th Obsn. Sq.; 423d Purs. Sq.; 424th Purs. Sq.; 425th Atk. Sq.; 427th Atk. Sq.; 467th Atk. Sq.; 468th Atk. Sq.; 469th Atk. Sq.; 470th Atk. Sq.; ROTC—AS.

**Camp Custer, MI.** Located 5 miles west of Battle Creek, MI. Established 18 July 1917. Designated in honor of Lt. Col. George Armstrong Custer (Maj. Gen., U.S.V.), commander of the 7th US Cav.; killed 25 June 1876 at the Battle of the Little Bighorn. Designated as a National Army cantonment for the mobilization of the 85th Div. in World War I. Training center for Sixth Corps Area O.R. infantry, field artillery, and engineer units. Redesignated Fort Custer on 14 June 1940.

**HQ**—14th Inf. Regt. (1919–20); 5th Div. (1940–41).

**Troops**—1st Bn., 10th Inf. (1920–22).

**Units for Annual Summer Training**—HQ, 6th Div. (RAI); HQ, 32d Div.; HQ, 33d Div.; HQ, 65th Cav. Div.; HQ, 85th Div.; HQ, 86th Div.; HQ, 101st Div.; HHC, 169th Inf. Brig.; HHC, 170th Inf. Brig.; HHC, 171st Inf. Brig.; HHC, 172d Inf. Brig.; HHC, 201st Inf. Brig.; HHC, 202d Inf. Brig.; HHC, 8th Tank Gp.; HHC, 9th Tank Gp.; HHT, 159th Cav. Brig.; HHT, 160th Cav. Brig.; HHB, 6th F.A. Brig. (RAI); HHB, 59th F.A. Brig.; HHB, 160th F.A. Brig.; HHB, 161st F.A. Brig.; HHB, 176th F.A. Brig.; 51st Inf. (RAI); 52d Inf. (RAI); 337th Inf.; 338th Inf.; 339th Inf.; 340th Inf.; 341st Inf.; 342d Inf.; 343d Inf.; 344th Inf.; 401st Inf.; 402d Inf.; 403d Inf.; 404th Inf.; 319th Tank Bn.; 320th Tank Bn.; 321st Tank Bn.; 322d Tank Bn.; 323d Tank Bn.; 324th Tank Bn.; 314th Cav.; 317th Cav.; 318th Cav.; 319th Cav.; 320th Cav.; 159th MG Sq.; 160th MG Sq.; 14th F.A. (RAI); 25th F.A. (RAI); 75th F.A. (RAI); 90th F.A. (RAI); 119th F.A.; 120th F.A.; 121st F.A.; 122d F.A.; 123d F.A.; 124th F.A.; 125th F.A.; 151st F.A.; 328th F.A.; 329th F.A.; 330th F.A.; 331st F.A.; 332d F.A.; 333d F.A.; 338th F.A.; 339th F.A.; 346th F.A.; 376th F.A.; 377th F.A.; 381st F.A.; 396th F.A.; 404th F.A.; 426th F.A.; 458th F.A.; 465th F.A. Bn.; 579th F.A.; 6th Ammo. Tn. (RAI); 310th Ammo. Tn.; 311th Ammo. Tn.; 326th Ammo. Tn.; 346th Ammo. Tn.; 202d C.A.; 505th C.A. Bn.; 10th Engrs. (RAI); 12th Engr. Sq. (RAI); 24th Engrs. (RAI); 39th Engrs. (RAI); 70th Engr. Bn. (RAI); 310th Engrs.; 311th Engrs.; 326th Engrs.; 345th Engrs.; 346th Engrs.; 357th Engrs.; 358th Engrs.; 380th Engrs.; 381st Engrs.; 382d Engrs.; 405th Engr. Sq.; 426th Engr. Bn.; 427th Engr. Bn.; 566th Engr. Bn.; 574th Engr. Bn.; 304th Chem. Regt.; 6th Med. Regt. (RAI); 310th Med. Regt.; 311th Med. Regt.; 326th Med. Regt.; 346th Med. Regt.; 369th Med. Regt.; 65th Cav. Div. Q.M. Tn.; 85th Div. Q.M. Tn.; 410th Q.M. Regt.; CMTC—Inf., F.A., Cav., Engr., S.C.; ROTC—Inf., S.C.

**Fox Field, MI (Military Airfield).** Located at Camp Custer, MI. Intermediate landing field.

**Jefferson Barracks, MO.** Located south of St. Louis on the west bank of the Mississippi River. Acquired by purchase in 1826. Designated in honor of Thomas Jefferson, Third President of the United States. Command and control of Jefferson Barracks passed to the Seventh Corps Area on 1 July 1939. The Arcadia Rifle Range, located at Arcadia, MO, was a subfacility of Jefferson Barracks.

**HQ**—6th Inf. Regt. (1921–40).

**Troops**—6th Inf. (1921–40); 6th Tank Co. (1922–40); Btry F, 3d F.A. (1927–30).

**Units for Annual Summer Training**—HQ, 102d Div.; HHC, 171st Inf. Brig.; HHC, 172d Inf. Brig.; HHC, 203d Inf. Brig.; HHC, 204th Inf. Brig.; HHC, 177th F.A. Brig.; 52d Inf. (RAI); 68th Inf. (RAI); 341st Inf.; 342d Inf.; 344th Inf.; 402d Inf.; 405th Inf.; 406th Inf.; 407th Inf.; 408th Inf.; 420th Inf.; 423d Inf.; 312th Tank Regt.; 311th Med. Regt.; 378th Med. Regt.; CMTC—Inf.

**Scott Field, IL (Military Airfield).** Located 6 miles east of Belleville, IL. Established 1 September 1917. Designated in honor of Cpl. Frank S. Scott, first US Army enlisted man to be killed in a military airplane crash.

**HQ**—1st Bln. Gp. (1921–23); 21st Ash. Gp. (1923–37); 21st Bln. Gp. (1937–39); Balloon and Airship School (1922–28).

**Troops**—8th Ash. Co. (1922–30); 9th Ash. Co. (1921–33); 9th Ash. Sq. (1933–37); 12th Ash. Co. (1922–29); 18th Ash. Co. (1926); 24th Ash. Sv Co. (1922–29); 24th Ash. Sv Sq. (1933–35); Base HQ and 7th Air Base Sq. (1936–40); 15th Obsn. Sq. (1930–41); 88th Aero Sq. (1919).

**Units for Annual Summer Training**—HQ, 548th Bln. Gp.; HQ, 551st Bln. Gp.; 311th Obsn. Sq.; 467th Atk. Sq.; 468th Atk. Sq.; 5th Bln. Co. (RAI); 5th Bln. Co. (RAI); 7th Bln. Co. (RAI); 8th Ash. Co. (RAI); 11th Bln. Co. (RAI); 18th Ash. Co. (RAI); 25th Ash. Sv Co. (RAI); 33d Bln. Sv Co. (RAI); 313th Bln. Co.; 314th Bln. Co.; 315th Bln. Co.; 316th Bln. Co.; 321st Bln. Co.; 322d Bln. Co.; 323d Bln. Co.; 324th Bln. Co.; 325th Bln. Co.; 326th Bln. Co.; 327th Bln. Co.; 328th Bln. Co.; 329th Bln. Co.; 330th Bln. Co.; 331st Bln. Co.; 332d Bln. Co.; 343d Bln. Sv Co.; 345th Bln. Sv Co.; 368th Bln. Co.; 370th Bln. Co.; 372d Bln. Co.; 389th Bln. Co.; 390th Ash. Co.; 398th Ash. Co.

**Selfridge Field, MI (Military Airfield).** Located 3 miles east of Mount Clemens, MI. Established 3 July 1917. Designated in honor of 1st Lt. Thomas Selfridge, killed 17 September 1908 in an airplane crash at Fort Myer, VA.

**HQ**—1st Purs. Gp. (1919–41); 6th Purs. Wing (1940–41); 31st Purs. Gp. (1940–41).

**Troops**—Base HQ and 3d Air Base Sq. (1936–40); 17th Purs. Sq. (1922–40); 27th Purs. Sq. (1922–40); 36th Purs. Sq. (1930–32); 38th Purs. Sq. (1933–35); 39th Purs. Sq. (1940–41); 40th Purs. Sq. (1940–41); 41st Purs. Sq. (1940–41); 57th Sv Sq. (1923–36); 94th Purs. Sq. (1921–41); 95th Aero Sq. (1919); 95th Purs. Sq. (1922–27).

**Units for Annual Summer Training**—HQ, 308th Purs. Gp.; HQ, 309th Atk. Gp.; HQ, 319th Atk. Gp.; HQ, 350th Bomb. Gp.; HQ, 351st Purs. Gp.; 86th Div. Avn.; 308th Obsn. Sq.; 309th Obsn. Sq.; 310th Obsn. Sq.; 311th Obsn. Sq.; 325th Obsn. Sq.; 326th Obsn. Sq.; 337th Sv Sq.; 338th Sv Sq.; 339th Sv Sq.; 349th Sv Sq.; 361st Obsn. Sq.; 362d Obsn. Sq.; 414th Purs. Sq.; 415th Purs. Sq.; 416th Purs. Sq.; 417th Purs. Sq.; 418th Obsn. Sq.; 419th Obsn. Sq.; 420th Obsn. Sq.; 421st Purs. Sq.; 422d Purs. Sq.; 423d Purs. Sq.; 424th Purs. Sq.; 425th Atk. Sq.; 426th Atk. Sq.; 427th Atk. Sq.; 428th Atk. Sq.; 459th Obsn. Sq.; 460th Obsn. Sq.; 461st Obsn. Sq.; 462d Purs. Sq.; 463d Purs. Sq.; 464th Purs. Sq.; 465th Purs. Sq.; 467th Atk. Sq.; 468th Atk. Sq.; 469th Atk. Sq.; 470th Atk. Sq.; 493d Bomb. Sq.; 494th Bomb. Sq.; 495th Bomb. Sq.; 496th Bomb. Sq.; 497th Purs. Sq.; 498th Purs. Sq.; 499th Purs. Sq.; 500th Purs. Sq.; 501st Purs. Sq.; 555th Obsn. Sq.; 556th Obsn. Sq.

**Fort Sheridan, IL.** Located adjacent to Lake Michigan north of Chicago, IL. Acquired by donation in 1887. Designated in honor of Lt. Gen. Philip H. Sheridan, commanding general of the US Army from 1883 to 1888. Training center for Sixth Corps Area O.R. cavalry and coast artillery units.

**HQ**—12th Inf. Brig. (1922–39); 6th F.A. Brig. (1934–40).

**Troops**—2d Inf., less 2d and 3d Bns. (1922–36); 61st C.A. (1930–41); 1st Sq., 14th Cav. (1920–40); 2d Bn., 3d F.A. (1927–40); 3d F.A., less 1st Bn. (1928–30); 1st Bn., 14th F.A. (1922–27); elements of 6th Q.M. Regt.

**Units for Annual Summer Training**—HQ, 65th Cav. Div.; HQ, 85th Div.; HQ, 86th Div.; HHC, 11th Inf. Brig. (RAI); HHC, 171st Inf. Brig.; HHC, 172d Inf. Brig.; HHC, 202d Inf. Brig.; HHT, 159th Cav. Brig.; HHT, 160th Cav. Brig.; HHC, 185th F.A. Brig.; HHC, 40th C.A. Brig. (RAI); HHC, 41st C.A. Brig. (RAI); 51st Inf. (RAI); 52d Inf. (RAI); 341st Inf.; 342d Inf.; 343d Inf.; 401st Inf.; 402d Inf.; 403d Inf.; 404th Inf.; 423d Inf.; 317th Cav.; 318th Cav.; 319th Cav.; 320th Cav.; 159th MG Sq.; 160th MG Sq.; 161st MG Sq.; 465th Armd. Car Sq.; 465th F.A. Bn.; 572d F.A.; 865th F.A.; 203d C.A.; 206th C.A.; 505th C.A.; 506th C.A.; 507th C.A.; 511th C.A.; 515th C.A.; 516th C.A.; 526th C.A.; 527th C.A.; 528th C.A.; 531st C.A.; 532d C.A.; 535th C.A.; 536th C.A.; 537th C.A.; 538th C.A.; 541st C.A.; 932d C.A.; 933d C.A.; 938th C.A.; 945th C.A.; 946th C.A.; 947th C.A.; 948th C.A.; 949th C.A.; 950th C.A.; 951st C.A.; 954th C.A.; 955th C.A.; 958th C.A.; 959th C.A.; 960th C.A.; 382d Engrs.; 426th Engr. Bn.; 427th Engr. Bn.; 6th

Med. Regt. (RAI); 19th Med. Regt. (RAI); 107th Med. Regt.; 311th Med. Regt.; 326th Med. Regt.; 346th Med. Regt.; 378th Med. Regt.; 6th Div. Q.M. Tn. (RAI); 65th Cav Div. Q.M. Tn.; 86th Div. Q.M. Tn.; 101st Div. Q.M. Tn.; 423d Q.M. Regt.; CMTC—Inf.; ROTC—Inf.

**Fort Wayne, MI.** Located on the Detroit River in the city of Detroit, MI. Acquired by purchase in 1842–44. Designated in honor of Maj. Gen. Anthony Wayne, War of 1812 hero.

**HQ**—37th Inf. Regt. (1920–21); 54th Inf. Regt. (1921–22); 2d Inf. Regt. (1936–39).

**Troops**—2d Bn., 2d Inf. (1922–39); 37th Inf., less 3d Bn. (1920–21).

**Units for Annual Summer Training**—68th Inf. (RAI); 339th Inf.

## National Guard

**Camp Douglas, WI.** See Camp Williams, WI.

**Camp Grant, IL.** Located 4 miles south of Rockford, IL. Established 18 July 1917. Designated in honor of Lt. Gen. Ulysses S. Grant, commanding general of the US Army from 1864 to 1866 and 18th President of the United States. Designated as a National Army cantonment for the mobilization of the 86th Div. in World War I. Transferred to the Illinois N.G. in April 1924.

**Troops**—6th Div. (1919–21).

**Units for Annual Summer Training**—HQ, 33d Div.; HHC, 65th Inf. Brig.; HHC, 66th Inf. Brig.; HHC, 169th Inf. Brig.; HHC, 172d Inf. Brig.; HHB, 58th F.A. Brig.; 8th Inf. (Illinois N.G.); 129th Inf.; 130th Inf.; 131st Inf.; 132d Inf.; 337th Inf.; 338th Inf.; 402d Inf.; 403d Inf.; 404th Inf.; 106th Cav., less 1st Sq.; 122d F.A.; 123d F.A.; 124th F.A.; 329th F.A.; 465th F.A. Bn.; 202d C.A.; 555th C.A. Bn.; 10th Engrs. (RAI); 39th Engrs. (RAI); 108th Engrs.; 311th Engrs.; 358th Engrs.; 108th Med. Regt.; 310th Med. Regt.; 108th Q.M. Regt.; 33d Div. Q.M. Tn.; 33d Div. Avn.; 108th Obsn. Sq.

**Camp Grayling, MI.** Located adjacent to Lake Margarethe, southwest of Grayling, MI. Established in 1914 as Hanson State Military Reservation. Redesignated Camp Grayling after World War I.

**Units for Annual Summer Training**—HQ, 32d Div.; HHC, 63d Inf. Brig.; HHC, 170th Inf. Brig.; HHB, 160th F.A. Brig.; 125th Inf.; 126th Inf.; 337th Inf.; 338th Inf.; 340th Inf.; 1st Sq., 106th Cav.; 119th F.A.; 182d F.A.; 328th F.A.; 329th F.A.; 579th F.A.; 202d C.A.; 107th Engrs.; 107th Med. Regt.; 32d Div. Q.M. Tn.; 32d Div. Avn.; 107th Obsn. Sq.

**Camp Lincoln, IL.** Located at Springfield, IL. Acquired in May 1886. Designated 6 July 1886 in honor of Abraham Lincoln, 16th President of the United States. Used primarily as a rifle and machine gun training range.

**Units for Annual Summer Training**—8th Inf. (Illinois N.G.); 132d Inf.; 2d Sq., 106th Cav.

**Camp Logan, IL.** Located at Zion, IL, just north of Waukegan. Acquired in 1892. Named for Maj. Gen. John A. Logan, Illinois' highest ranking volunteer general officer in the Civil War. Used primarily as a rifle and machine gun training range.

**Units for Annual Summer Training**—202d C.A.; 108th Obsn. Sq.

**Camp McCoy, WI.** Located 7 miles northwest of Sparta, WI. Established in 1909 as Camp Robinson. Redesignated Camp Sparta in 1917. Redesignated as Camp McCoy on 19 November 1926 in honor of Maj. Gen. Robert B. McCoy, commanding general of the 32d Div. Designated as the artillery training center for the Sixth Corps Area.

**Units for Annual Summer Training**—HQ, 32d Div.; HQ, 33d Div.; HQ, 37th Div.; HQ, 38th Div.; HQ, 64th Cav. Div.; HQ, 65th Cav. Div.; HQ, 85th Div.; HQ, 86th Div.; HQ, 100th Div.; HQ, 101st Div.; HHB, 6th F.A. Brig. (RAI); HHB, 7th F.A. Brig. (RAI); HHB, 22d F.A. Brig. (RAI); HHB, 57th F.A. Brig.; HHB, 58th F.A. Brig.; HHB, 59th F.A. Brig.; HHB, 160th F.A. Brig.; HHB, 161st F.A. Brig.; HHB, 163d F.A. Brig.; HHB, 176th F.A. Brig.; 3d F.A. (RAI); 9th F.A. (RAI); 14th F.A. (RAI); 22d F.A. (RAI); 25th F.A. (RAI); 27th F.A. (RAI); 43d F.A. (RAI); 52d F.A. (RAI); 67th F.A. (RAI); 69th F.A. (RAI); 75th F.A. (RAI); 78th F.A. (RAI); 80th F.A. (RAI); 90th F.A. (RAI); 119th F.A.; 120th F.A.; 121st F.A.; 122d F.A.; 123d F.A.; 124th F.A.; 125th F.A.; 147th F.A.; 151st F.A.; 185th F.A.; 328th F.A.; 329th F.A.; 330th F.A.; 331st F.A.; 332d F.A.; 337th F.A.; 338th F.A.; 339th F.A.; 340th F.A.; 341st F.A.; 352d F.A.; 376th F.A.; 377th F.A.; 378th F.A.; 403d F.A.; 404th F.A.; 405th F.A.; 407th F.A.; 408th F.A.; 410th F.A.; 436th F.A.; 437th F.A.; 465th F.A. Bn.; 473d F.A.; 477th F.A.; 479th F.A.; 486th F.A.; 487th F.A.; 494th F.A.; 497th F.A.; 567th F.A.; 572d F.A.; 575th F.A.; 579th F.A.; 581st F.A.; 865th F.A.; 202d C.A.; 531st C.A.; 960th C.A.; 6th Ammo. Tn. (RAI); 22d Ammo. Tn. (RAI); 107th Ammo. Tn.; 310th Ammo. Tn.; 311th Ammo. Tn.; 313th Ammo. Tn.; 326th Ammo. Tn.; 346th Ammo. Tn.; 363d Ammo. Tn.; 306th F.A. Obsn. Bn.; 326th Med. Regt.; 101st Div. Q.M. Tn.; 44th Q.M. Regt. (RAI); 426th Q.M. Regt.; ROTC—F.A.; CMTC—F.A.

**Camp Sparta, WI.** See Camp McCoy.

**Stackhouse Field, WI (National Guard Aviation Facility).** Located at Camp McCoy, WI. Intermediate landing field.

**Camp Williams, WI.** Located southwest of Wisconsin Rapids, WI. Established as a militia training area in 1889. Originally called Camp Douglas. Renamed in 1927 for Lt. Col. Charles R. Williams, post quartermaster, 1917–26.

**Units for Annual Summer Training**—HQ, 22d Cav. Div.; HHT, 53d Cav. Brig.; HQ, 32d Div., HHC, 64th Inf. Brig.; HHC, 201st Inf. Brig.; HHT, 53d Cav. Brig.; HHB, 6th F.A. Brig. (RAI); 127th Inf.; 128th Inf.; 401st Inf.; 402d Inf.; 403d Inf.; 404th Inf.; 105th Cav.; 121st F.A.; 151st F.A.; 6th Ammo. Tn. (RAI); 107th Ammo. Tn.; 107th Engrs.; 326th Engrs.; 32d Div. Q.M. Tn.; 135th Med. Regt.

#### **Organized Reserve**

**Chicago Municipal Airport (Civilian Airfield/National Guard Aviation Facility).** Located at Chicago, IL. Designated as an O.R. airdrome.

**Troops**—33d Div. Avn. (1927–29); 108th Obsn. Sq. (1927–41); 311th Obsn. Sq. (1922–41).

**Peoria Tank Training Center, IL.** Located south of Peoria, IL. Designated as the mobilization station and training center for all O.R. tank units in the Sixth Corps Area.

**Units for Annual Summer Training**—343d Inf.; 344th Inf.; HHC, 9th Tank Gp.; 309th Tank Regt.; 318th Tank Bn.; 319th Tank Bn.; 320th Tank Bn.; 321st Tank Bn.; 322d Tank Bn.; 323d Tank Bn.; 324th Tank Bn.; 6th Tank Co.; 85th Tank Co.; 86th Tank Co.; 101st Tank Co.

## SEVENTH CORPS AREA

**HQ**—Fort Crook, NE, 20 August 1920–27 May 1922; Fort Omaha, NE, 27 May 1922–25 March 1929; Omaha, NE, 25 March 1929–as of 7 December 1941.

Established in the US Army on 20 August 1920 with headquarters at Fort Crook, NE, and organized from portions of the discontinued Central Department. The corps area headquarters was transferred to Fort Omaha, NE, on 27 May 1922 and further moved to the Army Building at 15th and Dodge Streets in Omaha on 25 March 1929. The Seventh Corps Area initially included the states of Missouri (less Jefferson Barracks), Kansas, Iowa, Nebraska, Minnesota, North Dakota, and South Dakota. The state of Arkansas was transferred from the Fourth Corps Area to the Seventh Corps Area on 1 December 1920. HQ, Seventh Corps Area was responsible for the mobilization, administration, and training of units of the Third and Sixth Armies, VII and XVII Army Corps, GHQR units, and the Z.I. support units of the Seventh CASC. Mobile units of the corps area, less GHQR and Z.I. units, were assigned to the Third and Sixth Armies. With the adoption of the four field army plan on 1 October 1933, the units of the Seventh Corps Area were reassigned to Fourth Army or GHQR or demobilized. The Seventh Corps Area Training Center was established in 1921, originally at Fort Snelling, MN, to train R.A. and O.R. units of all arms and services, as well as ROTC cadets and CMTC candidates. With the inactivation of the Seventh Corps Area Training Center in 1922, Fort Snelling became the primary training center for corps area medical units. Infantry units trained at Forts Crook, Leavenworth, Riley, and Snelling; air corps units were sent to Marshal Field, KS; artillery units trained at Fort Riley; and cavalry units trained at Forts Riley and Des Moines. Corps area maneuvers of R.A. mobile units were also held, those years when funds were available, at Fort Riley or Camp Ripley, MN. For the administration of O.R. units, the corps area was originally organized into three division areas (88th, 89th, and 102d) and all divisional units, except cavalry, were administered by the headquarters of those three divisions. Cavalry units were administered by the 66th Cav. Div., and nondivisional units were administered by the Corps Area headquarters. On 27 January 1923, the HQ, Non-Divisional Group was established at the Army Building in Omaha to administer all corps- and army-level units. That headquarters was discontinued 21 August 1925 and the HQ, Seventh Corps Area assumed responsibility for the remainder of the corps- and army-level units. The HQ, Artillery Group was established 19 October 1925 at Sioux City, IA. This headquarters controlled only the corps- and army-level coast and field artillery units, while the Corps Area headquarters retained responsibility for the remainder of the corps- and army-level units. The Artillery Group was discontinued 1 October 1937. On 2 November 1937, the Seventh Corps Area was further reorganized into three “military areas” and the military area headquarters assumed control of the artillery units in their respective areas. Concurrently, the First Mil. Area assumed control of the 88th Div. area, the Second Mil. Area assumed control of the 89th Div. area, and the Third Mil. Area assumed control of the 102d Div. area. The Seventh Corps Area was assigning Reserve personnel to CASC units by December 1930 and to “1700” series numbered units on 2 August 1939. The HQ, Seventh Corps Area actually began functioning as a service command headquarters in October 1940 and was redesignated HQ, Seventh CASC in May 1941. It was further redesignated HQ, Seventh Service Command on 22 July 1942.

**Events:** 193, 274

### Major Commands in the Corps Area

Sixth Army (1921–33)  
Fourth Army (1932–33)  
VII Corps: 7th Division, 34th Division, 35th Division  
XVII Corps: 88th Division, 89th Division, 102d Division  
Seventh Corps Area Service Command

### Corps Area Commanders

Maj. Gen. Omar Bundy	1 September 1920–11 February 1922	Maj. Gen. Stuart Heintzelman	1 February 1935–6 July 1935
Maj. Gen. Francis J. Kernan	28 May 1922–15 September 1922	Maj. Gen. Frank C. Bolles	30 July 1935–30 September 1936
Maj. Gen. George B. Duncan	16 September 1922–10 October 1925	Brig. Gen. Charles M. Bundel	30 September 1936–4 October 1936
Maj. Gen. Benjamin A. Poore	15 October 1925–1 June 1927	Maj. Gen. Stanley H. Ford	4 October 1936–31 October 1938
Maj. Gen. Harry A. Smith	6 June 1927–21 May 1929	Brig. Gen. Guy V. Henry	1 November 1938–8 January 1939
Brig. Gen. Edward L. King	21 May 1929–11 July 1929	Maj. Gen. Percy P. Bishop	8 January 1939–8 October 1940
Brig. Gen. Stuart Heintzelman	11 July 1929–26 August 1929	Maj. Gen. Robert C. Richardson	8 October 1940–17 December 1940
Maj. Gen. Johnson Hagood	26 August 1929–2 October 1933	Maj. Gen. George V. Strong	17 December 1940–20 May 1941
Maj. Gen. Frank R. McCoy	3 October 1933–1 February 1935	Maj. Gen. Frederick E. Uhl	20 May 1941–15 January 1944

**Seventh Corps Area Service Command  
Organization 1930**

UNIT:	LOCATION:
HQ, Seventh CASC	Omaha, NE
Corps Area Sup Point	Kansas City, MO
HQ, Fort Leavenworth Mob. Cmd	Fort Leavenworth, KS
Recep. Ctr.	Fort Leavenworth, KS
Repl. Ctr.	Fort Leavenworth, KS
Sta. Hosp.	Fort Leavenworth, KS
Crane Gen. Hosp.	Kansas City, MO
Murray Gen. Hosp.	Kansas City, MO
HQ, Fort Riley Mob. Cmd	Fort Riley, KS
Recep. Ctr.	Fort Riley, KS
Repl. Ctr.	Fort Riley, KS
Sta. Hosp.	Fort Riley, KS
Vet. Sta. Hosp.	Fort Riley, KS
Officer Candidate School (Chaplain)	Fort Riley, KS
HQ, Fort Crook Mob. Cmd	Fort Crook, NE
Recep. Ctr.	Fort Crook, NE
Repl. Ctr.	Fort Crook, NE
Sta. Hosp.	Fort Crook, NE
HQ, Jefferson Barracks Mob. Cmd	Jefferson Barracks, MO
Recep. Ctr.	Jefferson Barracks, MO
Repl. Ctr.	Jefferson Barracks, MO
Sta. Hosp.	Jefferson Barracks, MO
Bache Gen. Hosp.	St. Louis, MO
HQ, Fort Des Moines Mob. Cmd	Fort Des Moines, IA
Recep. Ctr.	Camp Dodge, IA
Repl. Ctr.	Camp Dodge, IA
Sta. Hosp.	Fort Des Moines, IA
HQ, Fort Snelling Mob. Cmd	Fort Fort Snelling, MN
Recep. Ctr.	Fort Fort Snelling, MN
Repl. Ctr.	Fort Fort Snelling, MN
Sta. Hosp.	Fort Fort Snelling, MN
HQ, Fort Meade Mob. Cmd	Fort Meade, SD
Recep. Ctr.	Fort Meade, SD
Repl. Ctr.	Fort Meade, SD
Sta. Hosp.	Fort Meade, SD
HQ, Fort Lincoln Mob. Cmd	Fort Lincoln, ND
Sta. Hosp.	Fort Lincoln, ND
HQ, Camp Pike Mob. Cmd	Camp Pike, AR
Recep. Ctr.	Camp Pike, AR
Repl. Ctr.	Camp Pike, AR
Sta. Hosp.	Camp Pike, AR
Vet. Sta. Hosp.	Camp Pike, AR
Officer Candidate School (F.A.)	Camp Pike, AR

**Seventh Corps Area Service Command  
Organization 1939**

UNIT:	LOCATION:
HHD, 1700th Sv Cmd	Omaha, NE
1701st Q.M. Det.	Fort Omaha, NE
1702d Sta. Hosp.	Fort Omaha, NE
1703d Shipping Point	Minneapolis, MN
1704th Shipping Point	St. Louis, MO
1705th Shipping Point	Kansas City, KS
1710th HHD	Fort Snelling, MN
1711th Recep. Ctr.	Fort Snelling, MN
1712th Rec'g Bn.	Fort Snelling, MN
1713th Rec'g Bn.	Fort Snelling, MN
1714th Sta. Hosp.	Fort Snelling, MN
1715th Sv Co. (Q.M.C.)	Fort Snelling, MN
1716th Q.M. Det.	Fort Snelling, MN
1717th Sig. Det.	Fort Snelling, MN
1718th HHD	Fort Des Moines, IA
1719th Recep. Ctr.	Fort Des Moines, IA
1720th Rec'g Bn.	Fort Des Moines, IA
1721st Rec'g Bn.	Fort Des Moines, IA
1722d Sta. Hosp.	Fort Des Moines, IA
1723d Sig. Det.	Fort Des Moines, IA
1724th Q.M. Det.	Fort Des Moines, IA
1732d Caretaking Det.	Fort Lincoln, ND
1733d Sta. Hosp.	Fort Lincoln, ND
1740th Recep. Ctr.	Fort Leavenworth, KS
1741st Rec'g Bn.	Fort Leavenworth, KS
1742d Rec'g Bn.	Fort Leavenworth, KS
1743d Rec'g Bn.	Fort Leavenworth, KS
1744th Sta. Hosp.	Fort Leavenworth, KS
1745th Sv Co. (Q.M.C.)	Fort Leavenworth, KS
1746th Q.M. Det.	Fort Leavenworth, KS
1747th AC Sv Sta.	Fort Leavenworth, KS
1748th Caretaking Det.	Fort Meade, SD
1749th Sta. Hosp.	Fort Meade, SD
1750th HHD	Fort Crook, NE
1751st Sta. Hosp.	Fort Crook, NE
1752d Q.M. Det.	Fort Crook, NE
1753d AC Sv Sta.	Fort Crook, NE
1754th AC Sv Sta.	Richards Field, KS
1755th Sv Co. (Q.M.C.)	Fort Riley, KS
1756th AC Sv Sta.	Fort Riley, KS
1760th HHD	Jefferson Barracks, MO
1761st Recep. Ctr.	Jefferson Barracks, MO
1762d Rec'g Bn.	Jefferson Barracks, MO
1763d Rec'g Bn.	Jefferson Barracks, MO
1764th Sta. Hosp.	Jefferson Barracks, MO
1765th Sv Co. (Q.M.C.)	Jefferson Barracks, MO
1766th Det.	Jefferson Barracks, MO
1767th Tng. Ctr., HHD	Camp Robinson, AR
1768th C.W.S. Tng. Det.	Camp Robinson, AR
1769th Ord. Tng. Det.	Camp Robinson, AR
1770th M.P. Bn.	Fort Snelling, MN
1771st M.P. Bn.	Fort Leavenworth, KS
1772d M.P. Bn.	Jefferson Barracks, MO
1773d M.P. Bn.	Fort Crook, NE
1780th Sig. Det.	Camp Robinson, AR
1781st Sta. Hosp.	Camp Robinson, AR
1782d Railhead Co.	Little Rock, AR
1783d Q.M. Det.	Camp Robinson, AR
1784th Sig. Det.	Camp Robinson, AR
1785th Tng. Ctr., HHD	Camp Clark, MO



**Seventh Corps Area Service Command  
Organization 1939 (Cont)**

UNIT:	LOCATION:
1786th Sta. Hosp.	Camp Clark, MO
1787th Railhead Co.	Camp Clark, MO
1788th Q.M. Det.	Camp Clark, MO
1789th Sv Co. (Q.M.C.)	Jefferson Barracks, MO
1790th Sv Co. (Q.M.C.)	Camp Robinson, AR
1791st Sv Co. (Q.M.C.)	Camp Clark, MO

**Major posts, camps, stations, airfields, and N.G. and O.R. training facilities in the corps area.**

**Regular Army**

**Fort Crook, NE.** Located 11 miles south of Omaha, NE. Established 3 March 1891. Designated in honor of Maj. Gen. George Crook, US Army, who served as a division and corps commander during the Civil War and commanding general of the Department of the Platte and of the Division of the Missouri after the war.

**HQ**—Seventh Corps Area (1920–22); 17th Inf. Regt. (1922–39).

**Troops**—20th Inf. (1919–20); 1st Bn., 17th Inf. (1922–40); 2d Bn., 17th Inf. (1922–26 and 1940–41); 3d Bn., 17th Inf. (1922–31).

**Units for Annual Summer Training**—HQ, 7th Div. (RAI); HQ, 89th Div.; HHC, 177th Inf. Brig.; HHC, 178th Inf. Brig.; HHC, 204th Inf. Brig.; 54th Inf. (RAI); 353d Inf.; 354th Inf.; 355th Inf.; 356th Inf.; 406th Inf.; 407th Inf.; 314th Engrs.; 383d Engrs.; 372d Med. Regt.; VII Corps Q.M. Tn.; XVII Corps Q.M. Tn.; XIX Corps Q.M. Tn.; 7th Div. Q.M. Tn. (RAI); 102d Div. Q.M. Tn.; CMTC—Inf.

**Fort Des Moines, IA.** Located 5 miles south of Des Moines, IA. Established 4 April 1900. Training center for Seventh Corps Area O.R. cavalry units.

**HQ**—14th Cav. Regt. (1920–40).

**Troops**—14th Cav., less 1st Sq. (1920–40); 1st Bn., 9th F.A. (1922–27); 3d Bn., 80th F.A. (1933–40); 2d Bn., 17th Inf. (1926–29); 3d Bn., 17th F.A. (1931–33); 2d Bn., 17th Inf. (1927–33); elements of 18th Q.M. Sq.

**Units for Annual Summer Training**—HQ, 66th Cav. Div.; HHC, 175th Inf. Brig.; HHC, 177th Inf. Brig.; HHC, 178th Inf. Brig.; HHT, 3d Cav. Brig. (RAI); HHT, 4th Cav. Brig. (RAI); HHT, 5th Cav. Brig. (RAI); HHT, 6th Cav. Brig. (RAI); HHT, 161st Cav. Brig.; HHB, 7th F.A. Brig. (RAI); HHB, 163d F.A. Brig.; HHB, 164th F.A. Brig.; 53d Inf. (RAI); 349th Inf.; 350th Inf.; 353d Inf.; 354th Inf.; 355th Inf.; 356th Inf.; 317th Cav.; 318th Cav.; 319th Cav.; 320th Cav.; 321st Cav.; 322d Cav.; 4th Armd. Car Sq. (RAI); 80th F.A. (RAI); 337th F.A.; 338th F.A.; 339th F.A.; 380th F.A.; 407th F.A.; 478th F.A.; 488th F.A.; 313th Ammo. Tn.; 314th Ammo. Tn.; 25th Engrs. (RAI); 44th Engrs. (RAI); 45th Engrs. (RAI); 314th Engrs.; 327th Engrs.; 338th Engrs.; 359th Engrs.; 362d Engrs.; 383d Engrs.; 347th Med. Regt.; CMTC—Inf., Cav., F.A., S.C.

**Fort Leavenworth, KS.** Located 20 miles northwest of Kansas City. Established 8 May 1827. Designated in honor of Col. Henry Leavenworth, 3d US Inf. Training Center for Seventh Corps Area O.R. infantry units.

**HQ**—10th Cav. Regt. (1931–40).

**Troops**—3d Bn., 17th Inf. (1931–40); 49th Inf. (1919); 10th Cav., less 2d Sq. (1931–40); 3d Bn., 17th F.A. (1930–31); elements of 7th Q.M. Regt; 3d Staff Sq. (1936–41); 4th Bln Co.

**Units for Annual Summer Training**—HHC, 177th Inf. Brig.; HHC, 203d Inf. Brig.; HHC, 204th Inf. Brig.; 54th Inf. (RAI); 353d Inf.; 354th Inf.; 405th Inf.; 406th Inf.; 407th Inf.; 408th Inf.; 451st Inf.; 452d Inf.; 453d Inf.; 536th Inf. Bn.; 537th Inf. Bn.; 546th Inf. Bn.; 320th Cav.; 321st Cav.; 380th F.A.; 327th Engrs.; CMTC—Inf., Cav., F.A., S.C.; ROTC—Inf., C.A.C., Engr.

**Fort Lincoln, ND.** Located at Bismarck, ND, on the east bank of the Missouri River. Established 2 March 1895. Designated in honor of Abraham Lincoln, 16th President of the United States.

**Troops**—3d Bn., 4th Inf. (1927–40).

**Units for Annual Summer Training**—352d Inf.; 356th Inf.

**Marshall Field, KS (Military Airfield).** Located on the Republican Flats at Fort Riley, KS. Established in August 1921 as the Fort Riley Flying Field. Redesignated in 1923 in honor of Brig. Gen. Francis Marshall, Assistant Chief of Cavalry.

**Troops**—7th Div. Avn. (1923–29); 1st Obsn. Sq. (1936–41); 16th Obsn. Sq. (1921–31).

**Units for Annual Summer Training**—35th Div. Avn.; 110th Obsn. Sq.; 154th Obsn. Sq.; 313th Obsn. Sq.; 314th Obsn. Sq.; 327th Obsn. Sq.; 429th Purs. Sq.; 430th Purs. Sq.; 433d Obsn. Sq.; 471st Obsn. Sq.; 526th Purs. Sq.; 527th Purs. Sq.; 530th Purs. Sq.; 534th Purs. Sq.; 561st Obsn. Sq.; 803d Obsn. Sq.

**Fort Meade, SD.** Located 2 miles west of Sturgis, SD, on Bear Butte Creek. Established 28 August 1878. Designated in honor of Maj. Gen. George Gordon Meade, who was commanding general of the Army of the Potomac from 1863 to 1865.

**HQ**—4th Cav. Regt. (1927–41).

**Troops**—1st Sq., 4th Cav. (1924–41); 4th Cav. (1927–41).

**Units for Annual Summer Training**—HHT, 162d Cav. Brig.; HHT, 160th Cav. Brig.; 324th Cav.; 161st MG Sq.; 147th F.A.; 136th Engrs.

**Fort Omaha, NE.** Located in Omaha, NE. Established on 5 December 1868 as Camp Sherman in honor of Lt. Gen. William T. Sherman, commanding general, US Army. Redesignated Omaha Barracks in 1869 and Fort Omaha on 30 December 1878.

**HQ**—14th Inf. Brig. (1922–31).

**Troops**—Elements of 7th Q.M. Regt; 9th Bln. Co. (1919–20); 12th Bln. Co. (1919–21); 14th Bln. Co. (1919–20); 17th Bln. Co. (1919–20); 24th Bln. Co. (1919–20).

**Plattsmouth Rifle Range, NE.** Located at the junction of the Platte and Missouri Rivers, 8 miles southeast of Fort Crook, NE.

**Units for Annual Summer Training**—134th Inf.; 110th Med. Regt.; 35th Div. Q.M. Tn.

**Fort Riley, KS.** Located 4 miles northeast of Junction City, KS, at the confluence of the Republican and Smoky Hill Rivers. Established 17 May 1853 as Camp Center as it was believed to be at the geographical center of the United States. Redesignated Fort Riley on 27 June 1853 in honor of Col. Bennett Riley, 1st US Inf. Training Center for Seventh Corps Area O.R. cavalry, artillery, and engineer units.

**HQ**—The Cavalry School; 2d Cav. Div. (1940–41); 3d Cav. Brig. (1940–41); 4th Cav. Brig. (1940–41).

**Troops**—20th Inf. (1919); 2d Cav. (1919–41); 9th Cav. (1922–41); 10th Cav. (1940–41); 13th Cav. (1927–36); 14th Cav. (1940–41); 1st Bn., 3d F.A. (1939–41); 1st Bn., 14th F.A. (1934–36); 2d Bn., 18th F.A. (1933–34); 1st Bn., 84th F.A. (1936–39); Tp. A, 9th Engr. Sq. (1921–41).

**Units for Annual Summer Training**—HQ, 2d Cav. Div. (RAI); HQ, 3d Cav. Div. (RAI); HQ, 35th Div.; HQ, 66th Cav. Div.; HQ, 89th Div.; HHC, 69th Inf. Brig.; HHC, 177th Inf. Brig.; 178th Inf. Brig.; HHC, 203d Inf. Brig.; HHC, 204th Inf. Brig.; HHT, 3d Cav. Brig. (RAI); HHT, 4th Cav. Brig. (RAI); HHT, 5th Cav. Brig. (RAI); HHT, 57th Cav. Brig.; HHT, 161st Cav. Brig.; HHB, 7th F.A. Brig. (RAI); HHB, 17th F.A. Brig. (RAI); HHB, 60th F.A. Brig.; HHB, 163d F.A. Brig.; HHB, 164th F.A. Brig.; HHB, 177th F.A. Brig.; 134th Inf.; 137th Inf.; 353d Inf.; 406th Inf.; 407th Inf.; 408th Inf.; 15th Cav. (RAI); 113th Cav.; 114th Cav.; 321st Cav.; 322d Cav.; 161st MG Sq.; 2d Armd. Car Sq. (RAI); 3d Armd. Car Sq. (RAI); 466th Armd. Car Sq.; 25th F.A. (RAI); 44th F.A. (RAI); 45th F.A. (RAI); 69th F.A. (RAI); 70th F.A. (RAI); 79th F.A. (RAI); 80th F.A. (RAI); 84th F.A. (RAI); 99th F.A. (RAI); 100th F.A. (RAI); 128th F.A.; 130th F.A.; 142d F.A.; 161st F.A.; 329th F.A.; 337th F.A.; 338th F.A.; 339th F.A.; 340th F.A.; 341st F.A.; 342d F.A.; 379th F.A.; 380th F.A.; 381st F.A.; 406th F.A.; 408th F.A.; 443d F.A.; 466th F.A. Bn.; 498th F.A.; 499th F.A.; 866th F.A.; 7th Ammo. Tn. (RAI); 17th Ammo. Tn. (RAI); 313th Ammo. Tn.; 314th Ammo. Tn.; 327th Ammo. Tn.; 347th Ammo. Tn.; 7th F.A. Obsn. Bn. (RAI); 5th Engrs. (RAI); 9th Engr. Sq. (RAI); 12th Engr. Sq. (RAI); 13th Engrs. (RAI); 25th Engrs. (RAI); 44th Engrs. (RAI); 47th Engrs. (RAI); 313th Engrs.; 314th Engrs.; 327th Engrs.; 338th Engrs.; 347th Engrs.; 359th Engrs.; 362d Engrs.; 365th Engrs.; 367th Engrs.; 383d Engrs.; 387th Engrs.; 406th Engr. Sq.; 327th Med. Regt.; 66th Cav. Div. Q.M. Tn.; 427th Q.M. Regt.; CMTC—Inf. (Colored).

**Fort Robinson, NE.** Located on the White River, 3 miles southwest of Crawford, NE. Established on 8 March 1874 as Red Cloud Agency. Redesignated Fort Robinson in January 1878 in honor of 1st Lt. Louis H. Robinson, 14th US Inf.

**Troops**—4th F.A. Bn. (1928–30); 2d Bn., 4th F.A. (1930–31).

**Units for Annual Summer Training**—HHB, 164th F.A. Brig.; 341st F.A.; 342d F.A.; 343d F.A.

**Sherman Field, KS (Military Airfield).** Located on the Weston Bend of the Missouri River at Fort Leavenworth, KS. Established in 1923 as an emergency landing field. Made permanent in 1926 as the “Post Airdrome.” Designated in 1930 in honor of Maj. William Sherman, an early US Army Air Corps doctrine writer. Intermediate landing field.

**Troops**—3d Staff Sq. (1937–41); 124th Obsn. Sq. (1941); 127th Obsn. Sq. (1941).



**HQ**—3d Div. (1919–21).

**Troops**—4th Inf. (1919–21).

**Units for Annual Summer Training**—HHC, 203d Inf. Brig.; 153d Inf.; 405th Inf.; 406th Inf.; 407th Inf.; 142d F.A.; 206th C.A.; 16th Med. Regt. (RAI); 313th Med. Regt.; 314th Med. Regt.; 347th Med. Regt.; 366th Med. Sq.; 372d Med. Regt.

**Camp Rapid, SD.** Located at Rapid City, SD. Established in 1925.

**Units for Annual Summer Training**—147th F.A.; 109th Engrs.; elements of 34th Div. Q.M. Tn. and 109th Q.M. Regt.

**Camp Ripley, MN.** Located 15 miles southwest of Brainerd, MN. Designated in honor of Brig. Gen. Eleazar P. Ripley, War of 1812 hero. Established in 1931.

**Units for Annual Summer Training**—HQ, 34th Div.; HQ, 35th Div.; HQ, 88th Div.; HHC, 68th Inf. Brig.; HHC, 92d Inf. Brig.; HHB, 7th F.A. Brig. (RAI); HHB, 59th F.A. Brig.; HHB, 163d F.A. Brig.; HHB, 177th F.A. Brig.; 135th Inf.; 205th Inf.; 206th Inf.; 25th F.A. (RAI); 44th F.A. (RAI); 45th F.A. (RAI); 79th F.A. (RAI); 80th F.A. (RAI); 91st F.A. (RAI); 125th F.A.; 147th F.A.; 151st F.A.; 185th F.A.; 337th F.A.; 338th F.A.; 339th F.A.; 357th F.A.; 379th F.A.; 380th F.A.; 381st F.A.; 206th C.A.; 7th Ammo. Tn. (RAI); 313th Ammo. Tn.; elements of 109th Q.M. Regt.; 34th Div. Avn.; 109th Obsn. Sq.; 314th Obsn. Sq.; 430th Purs. Sq.

**Camp Joseph T. Robinson, AR.** See Camp Pike.

**Camp Whitside, KS.** Located at Pawnee Flats between Camp Funston and Fort Riley main post. Established in July 1924 as a subpost of Fort Riley for training units of the Kansas N.G. Named for Col. W.W. Whitside, the Fort Riley post quartermaster, on 5 August 1924.

**Units for Annual Summer Training**—HHC, 68th Inf. Brig.; HHB, 60th F.A. Brig.; 137th Inf.; 114th Cav.; 130th F.A.; 161st F.A.

### Organized Reserve

**Offutt Field, NE (Military Airfield).** Located at Fort Crook, 11 miles south of Omaha, NE. Established 10 September 1918 as a field for balloon units. Upgraded as a fixed-wing landing field in 1921. Designated 10 May 1924 in honor of 1st Lt. Jarvis J. Offutt, an Omaha native and pilot, killed in action in World War I. Designated an O.R. airdrome and intermediate landing field.

**Troops**—314th Obsn. Sq. (1921–39).

**Old Richards Field, MO (Civilian Airfield).** Located about 7 miles southeast of downtown Kansas City at Raytown, MO. Dedicated 11 November 1922 in honor of 1st Lt. John F. Richards II, a Kansas City native and pilot, killed in action during the Meuse-Argonne offensive in World War I. Designated as one of the original four O.R. airdromes in 1922. O.R. flying activities transferred in 1927 to the New Richards Field near downtown Kansas City, MO. Intermediate landing field.

**Troops**—430th Purs. Sq. (1922–27).

**Units for Annual Summer Training**—313th Obsn. Sq.; 314th Obsn. Sq.; 327th Obsn. Sq.; 430th Purs. Sq.; 431st Purs. Sq.; 432d Purs. Sq.

**New Richards Field/Kansas City Municipal Airport, MO (Civilian Airfield).** Located on the north bank of the Missouri River opposite the mouth of the Kansas River near downtown Kansas City, MO. Dedicated in 1927 by Charles Lindbergh in honor of 1st Lt. John F. Richards, a Kansas City native and pilot, killed in action during the Meuse-Argonne offensive in World War I. Renamed as the Kansas City Municipal Airport in late 1927 with only the O.R. flying activities retaining the name Richards Field. Richards Field became the primary training base for O.R. Air Service/Air Corps units in the Seventh Corps Area. O.R. airdrome and intermediate landing field.

**Troops**—430th Purs. Sq. (1927–39).

**Units for Annual Summer Training**—313th Obsn. Sq.; 314th Obsn. Sq.; 327th Obsn. Sq.; 430th Purs. Sq.; 431st Purs. Sq.; 432d Purs. Sq.

**Wold-Chamberlain Field, MN (Civilian Airfield).** Located at Minneapolis, MN. Established in 1921 as Speedway Field as it was built on the Twin Cities Motor Speedway. Redesignated in 1923 in honor of 1st Lt. Earnest G. Wold and 1st Lt. Cyrus F. Chamberlain, both pilots from Minneapolis, who were killed in action during the Meuse-Argonne offensive in World War I.

**Troops**—313th Obsn. Sq. (1931–39); 431st Obsn. Sq. (1922–31); 471st Obsn. Sq. (1921–33); 526th Purs. Sq. (1926–39).

**Units for Annual Summer Training**—34th Div. Avn.; 109th Obsn. Sq.; 313th Obsn. Sq.; 363d Obsn. Sq.

## EIGHTH CORPS AREA

**HQ**—Fort Sam Houston, TX, 20 August 1920—as of 7 December 1941.

Established in the US Army on 20 August 1920 with headquarters at Fort Sam Houston, TX, and organized from portions of the discontinued Southern Department. The Eighth Corps Area included the states of Texas, Oklahoma, Colorado, New Mexico, and Arizona. For administrative purposes and for tactical control in connection with the border patrol and field operations incident thereto, that part of the state of Arizona that lies west of the 114 degree meridian and south of the 33 degree parallel was attached to the Ninth Corps Area. In May 1927, the Pole Mountain Reservation and the post of Fort D.A. Russell (later renamed Fort Francis E. Warren) in Wyoming came under the control of the Eighth Corps Area when the 4th Inf. Brig. was transferred to that post from Fort Sam Houston. The installations were returned to control of the Ninth Corps Area on 1 July 1939. HQ, Eighth Corps Area was responsible for the mobilization, administration, and training of units of the Second and Fifth Armies, VIII and XVIII Army Corps, select GHQR units, and the Z.I. support units of the Eighth CASC. Mobile units of the corps area, less GHQR and Z.I. units, were assigned to the Third and Sixth Armies from 1921 to 1933. With the adoption of the four field army plan on 1 October 1933, the units of the Eighth Corps Area were reassigned to Third Army or GHQR or demobilized. The Eighth Corps Area Training Center was established in 1921, originally at Fort Sam Houston, to train R.A. and O.R. units of all arms and services, as well as ROTC cadets and CMTC candidates. With the inactivation of the Eighth Corps Area Training Center on 31 December 1922, Fort Sam Houston and Camp Bullis became the primary training centers for corps area infantry units. Infantry units also trained at Forts Huachuca and Sill; air corps units were sent to Kelly Field, TX; artillery units trained at Forts Sam Houston, Sill, and Bliss; and cavalry units trained at Forts Clark and Bliss. Corps area maneuvers of R.A. mobile units were also held, those years when funds were available, at Camp Bullis, near Fort Sam Houston, or in west Texas for the 1st Cav. Div. For the administration of O.R. units, all organizations initially came under the control of the VIII Corps, or the 90th, 95th, and 103d Divs. Just before HQ, VIII Corps was inactivated in November 1925, the HQ, Field Artillery Group was established on 15 October 1925, to direct the organization, training, and administration of all nondivisional field artillery and coast artillery units. The Artillery Group was short-lived. It was abolished on 20 September 1927 and all nondivisional artillery units were placed under the jurisdiction of one of the O.R. divisions. Coast artillery units were placed under the jurisdiction of the commander of Fort Crockett, TX. The Eighth Corps Area was further reorganized into three "military areas" in January 1939. At that time, the First Mil. Area assumed control of the 90th Div. area, the Second Mil. Area assumed control of the 95th Div. area, and the Third Mil. Area assumed control of the 103d Div. area. The Eighth Corps Area began assigning Reserve personnel to CASC units in April 1927. The HQ, Eighth Corps Area actually began functioning as a service command headquarters in October 1940 and was redesignated HQ, Eighth CASC in May 1941. It was further redesignated HQ, Eighth Service Command on 22 July 1942.

**Events:** 80, 217, 258, 299

### Major Commands in the Corps Area

Third Army (1933–36 and 1940–41)  
VIII Corps: 2d Division, 36th Division, 45th Division  
XVIII Corps: 90th Division, 95th Division, 103d Division  
1st Cavalry Division  
3d Wing (1932–35)  
24th School Wing (1927–31)  
Eighth Corps Area Service Command

### Corps Area Commanders

Maj. Gen. Joseph T. Dickman	1 September 1920–6 October 1921	Brig. Gen. Halstead Dorey	27 July 1930–21 November 1930
Maj. Gen. John L. Hines	7 October 1921–20 November 1922	Maj. Gen. Edwin B. Winans	22 November 1930–30 September 1933
Maj. Gen. Edward M. Lewis	20 November 1922–11 October 1924	Maj. Gen. Johnson Hagood	3 October 1933–27 February 1936
Maj. Gen. Charles P. Summerall	12 October 1924–15 January 1925	Maj. Gen. Henry W. Butner	27 February 1936–19 March 1936
Maj. Gen. Ernest Hinds	16 January 1925–3 January 1928	Brig. Gen. Hamilton S. Hawkins	19 March 1936–4 April 1936
Maj. Gen. Thomas Q. Donaldson	4 January 1928–28 April 1928	Maj. Gen. Frank Parker	4 April 1936–30 September 1936
Maj. Gen. Albert J. Bowley	29 April 1928–24 December 1928	Maj. Gen. Herbert J. Brees	1 October 1936–9 November 1940
Maj. Gen. William Lassiter	24 December 1928–27 July 1930	Maj. Gen. Richard Donovan	10 November 1940–August 1942

**Eighth Corps Area Service Command  
Organization 1930**

<b>UNIT:</b>	<b>LOCATION:</b>
HQ, Eighth CASC	Fort Sam Houston, TX
Corps Area Sup Point	San Antonio, TX
CASC Sup Point No. 1	Fort Sam Houston, TX
CASC Sup Point No. 2	Fort Worth, TX
CASC Sup Point No. 3	Oklahoma City, OK
CASC Sup Point No. 4	Fort Bliss, TX
CASC Distributing Point No. 1	Fort Worth, TX
CASC Distributing Point No. 2	El Paso, TX
CASC Distributing Point No. 3	Houston, TX
CASC Rmt Dep No. 1	Denver, CO
CASC Rmt Dep No. 2	Fort Worth, TX
CASC Rmt Dep No. 3	Oklahoma City, OK
HQ, CASC Fort Bliss	Fort Bliss, TX
Mob. Sta.	Fort Bliss, TX
Recep. Ctr.	Fort Bliss, TX
Cav. Repl. Ctr.	Fort Bliss, TX
Pack Tn. Repl. Ctr.	Fort Bliss, TX
HQ, CASC Fort Sam Houston	Fort Sam Houston, TX
Mob. Sta.	Fort Sam Houston, TX
Recep. Ctr.	Fort Sam Houston, TX
Inf. Repl. Ctr.	Fort Sam Houston, TX
Nurse Repl. Ctr.	Fort Sam Houston, TX
Sta. Hosp.	Fort Sam Houston, TX
Sch. for B&C	Fort Sam Houston, TX
HQ, CASC Fort Sill	Fort Sill, OK
Mob. Sta.	Fort Sill, OK
Recep. Ctr.	Fort Sill, OK
F.A. Repl. Ctr.	Fort Sill, OK
HQ, CASC Fort Brown	Fort Brown, TX
HQ, CASC Fort Clark	Fort Clark, TX
HQ, CASC Fort Huachuca	Fort Huachuca, AZ
HQ, CASC Fort Logan	Fort Logan, CO
HQ, CASC Fort Ringgold	Fort Ringgold, TX
HQ, CASC Fort McIntosh	Fort McIntosh, TX
HQ, CASC Camps Bullis & Stanley	Camp Bullis, TX
HQ, CASC Camp Marfa	Camp Marfa, TX
HQ, CASC Camp Harry J. Jones	Camp Harry J. Jones, NM
HQ, CASC Camp Stephen D. Little	Camp Stephen D. Little, AZ
HQ, AA Concentration	CampCorpus Christi, TX
HQ, Concentration Camp	Fort Worth, TX
HQ, Concentration Camp	Waco, TX
HQ, Concentration Camp	Oklahoma City, OK
HQ, N.G. Camp	Golden, CO
HQ, N.G. Camp	Palacios, TX
HD of Galveston	Galveston, TX
William Beaumont Gen. Hosp.	El Paso, TX
Fitzsimons Gen. Hosp.	Denver, CO
Finley Gen. Hosp.	Houston, TX
Tourney Gen. Hosp.	Fort Worth, TX
HQ, Air Corps Tng. Ctr.	Austin, TX
Air Corps Commo Sch.	Austin, TX
Air Corps Engr. Sch.	Austin, TX
Air Corps Tact. & Ops Sch.	Austin, TX
HQ, Air Corps Tng. Ctr.	Houston, TX
Org. Tng. Field (Atk.)	Fort Worth, TX
HQ, Air Corps Tng. Ctr.	Houston, TX
Org. Tng. Field (Atk.)	Fort Worth, TX
Org. Tng. Field (Bomb.)	Love Field, TX
Org. Tng. Field (Obsn.)	Ellington Field, TX
Org. Tng. Field (Purs.)	Houston, TX
HQ, Air Corps Tng. Ctr.	Kelly Field, TX

**Eighth Corps Area Service Command  
Organization 1939**

<b>UNIT:</b>	<b>LOCATION:</b>
HQ, Eighth CASC	Fort Sam Houston, TX
Corps Area Sup Point	San Antonio, TX
1802d CASU (HQ)	Fort Sam Houston, TX
1808th CASU (CA AC Det.)	Fort Sam Houston, TX
1809th CASU (Maint Sv)	Fort Sam Houston, TX
1810th CASU (Sig Sv Co.)	Fort Sam Houston, TX
1811th CASU (Sta. Hosp.)	Fort Sam Houston, TX
1812th CASU (Sch. B&C)	Fort Sam Houston, TX
1813th CASU (Dent Lab)	Fort Sam Houston, TX
1814th CASU (AA Tng. Ctr.)	Camp Hulen, TX
1815th CASU (Recep. Ctr.)	Fort Bliss, TX
1816th CASU (Recep. Ctr.)	Fort Sam Houston, TX
1817th CASU (Recep. Ctr.)	Fort Sill, OK
1818th CASU (Repl. Ctr.)	Camp Wallace, TX
1819th CASU (Repl. Ctr.)	Fort Sill, OK
1820th CASU (Repl. Ctr.)	Camp Wolters, TX
1821st CASU (AZ Rctg. Dist.)	Phoenix, AZ
1822d CASU (CO Rctg. Dist.)	Denver, CO
1823d CASU (NM Rctg. Dist.)	Sante Fe, NM
1824th CASU (OK Rctg. Dist.)	Oklahoma City, OK
1825th CASU (El Paso Rctg. Dist.)	Fort Bliss, TX
1826th CASU (Dallas Rctg. Dist.)	Dallas, TX
1827th CASU (Houston Rctg. Dist.)	Houston, TX
1828th CASU (San Antonio Rctg. Dist.)	San Antonio, TX
1831st CASU (AZ Sel Sv)	Phoenix, AZ
1832d CASU (CO Sel Sv)	Denver, CO
1833d CASU (NM Sel Sv)	Santa Fe, NM
1834th CASU (OK Sel Sv)	Oklahoma City, OK
1835th CASU (TX Sel Sv)	Austin, TX
1836th CASU (Fin. Ofc.)	Fort Bliss, TX
1837th CASU (Fin. Ofc.)	Denver, CO
1838th CASU (Fin. Ofc.)	Fort Sam Houston, TX
1848th CASU (Q.M. Det.)	Albuquerque, NM
1851st CASU (Sta. Cmpl.)	Camp Barkeley, TX
1852d CASU (Sta. Cmpl.)	Fort Bliss, TX
1853d CASU (Sta. Cmpl.)	Camp Bowie, TX
1854th CASU (Sta. Cmpl.)	Fort Brown, TX
1855th CASU (Sta. Cmpl.)	Fort Clark, TX
1856th CASU (Sta. Cmpl.)	Fort Crockett, TX
1857th CASU (Sta. Cmpl.)	Fort Sam Houston, TX
1858th CASU (Sta. Cmpl.)	Fort Huachuca, AZ
1859th CASU (Sta. Cmpl.)	Camp Hulen, TX
1860th CASU (Sta. Cmpl.)	Fort McIntosh, TX
1861st CASU (Sta. Cmpl.)	Normoyle Q.M. Dep, TX
1862d CASU (Sta. Cmpl.)	Fort Ringgold, TX
1863d CASU (Sta. Cmpl.)	Fort D.A. Russell, TX
1864th CASU (Sta. Cmpl.)	Fort Sill, OK
1865th CASU (Sta. Cmpl.)	Camp Wallace, TX
1866th CASU (Sta. Cmpl.)	Camp Wolters, TX
1871st CASU (1st Mil. Area)	San Antonio, TX
1872d CASU (2d Mil. Area)	Oklahoma City, OK
1873d CASU (3d Mil. Area)	Denver, CO
(1875th-1899th ROTC CASUs)	
Air Corps Det.	Brooks Field TX
Air Corps Det.	Dryden Airport, TX
Air Corps Det.	English Field, TX
Air Corps Det.	Hatbox Field, OK
Air Corps Det.	Hensley Field, TX
Air Corps Det.	Sanderson Field, TX
Air Corps Det.	Sloan Field, TX
Air Corps Det.	Stinson Field, TX

**Eighth Corps Area Service Command  
Organization 1930 (Cont)**

UNIT:	LOCATION:
Specialized Atk. Sch.	Waco, TX
Specialized Bomb. Sch.	Brooks Field, TX
Specialized Obsn. Sch.	Kelly Field, TX
Specialized Purs. Sch.	Beeville, TX
Specialized Purs. Sch.	Victoria, TX
School of Aviation Medicine	Brooks Field, TX
HQ, Air Corps Tng. Ctr.	Randolph Field, TX
Air Corps Primary Tng. Field	Floresville, TX
Air Corps Primary Tng. Field	Hondo, TX
Air Corps Primary Tng. Field	Jourdanton, TX
Air Corps Primary Tng. Field	Pearsall, TX
Air Corps Primary Tng. Field	Seguin, TX
HQ, Air Corps Tng. Ctr.	Wharton, TX
Air Corps Gunnery Sch.	Brownsville, TX
Air Corps Gunnery Sch.	Ricardo, TX
Air Corps Gunnery Sch.	Seadrift, TX
Air Corps Gunnery Sch.	Sinton, TX
Air Corps Gunnery Sch.	Velasco, TX
Air Corps Armt Sch.	Wharton, TX
Air Corps Repl. Ctr.	Giddings, TX

**Eighth Corps Area Service Command  
Organization 1939 (Cont)**

UNIT:	LOCATION:
Air Corps Det.	Winslow Field, AZ
Air Corps Det.	Oklahoma City, OK

**Major posts, camps, stations, airfields, and N.G. and O.R. training facilities in the corps area.**

**Regular Army**

**Biggs Field, TX (Military Airfield).** Located at Fort Bliss, TX. Established in 1920 on the site of Camp Owen Bierne as a dirigible field for the 8th Ash. Co. Upgraded to a fixed wing landing field about 1922. Designated 25 January 1925 in honor of Lt. James B. "Buster" Biggs, a local El Pasoan killed in action in 1918 over Belrain, France. Intermediate landing field.

**Troops**—3d Obsn. Sq. (1922–26); 12th Obsn. Sq. (1921–26); 13th Aero Sq. (1920–21); 8th Ash. Co. (1919–21).

**Units for Annual Summer Training**—328th Obsn. Sq.; 365th Obsn. Sq.; 366th Obsn. Sq.; 436th Purs. Sq.; 438th Purs. Sq.; 505th Purs. Sq.

**Fort Bliss, TX.** Located 3 miles northeast of El Paso, TX. Established 8 September 1849. Designated Fort Bliss on 8 March 1854. Designated in honor of Lt. Col. William Wallace Smith Bliss, 4th US Inf., a distinguished veteran of the Mexican War. Training center for Eighth Corps Area O.R. cavalry, artillery, and engineer units.

**HQ**—1st Cav. Div. (1921–41); 2d Cav. Brig. (1921–41).

**Troops**—5th Cav. (1919); 7th Cav. (1919–41); 8th Cav. (1919–41); 82d F.A. Bn. (1921–30); 1st Bn., 82d F.A. (1930–41); 82d F.A. (1934–41); 2d MG Sq. (1921–28); 8th Engr. Bn. (Mtd) (1919–27); 1st Cav. Div. Q.M. Tn. (1921–36); 16th Q.M. Sq. (1936–41); 1st Med. Sq. (1925–41); 1st Armd. Car Sq. (1928–40); 12th Obsn. Sq. (1920, 1921–26); 96th Aero Sq. (1919–20).

**Units for Annual Summer Training**—HHC, 205th Inf. Brig.; HHT, 3d Cav. Brig. (RAI); HHT, 4th Cav. Brig. (RAI); HHT, 156th Cav. Brig.; HHB, 178th F.A. Brig.; 111th Cav.; 3d Sq., 311th Cav.; 3d Sq., 312th Cav.; 505th Cav. Sq.; 506th Cav. Sq.; 507th Cav. Sq.; 508th Cav. Sq.; 512th Cav. Sq.; 513th Cav. Sq.; 514th Cav. Sq.; 156th MG Sq.; 1st Armd. Car Sq. (RAI); 158th F.A.; 349th F.A.; 382d F.A.; 383d F.A.; 384th F.A.; 328th Ammo. Tn.; 508th C.A.; 120th Engrs., less 1st Bn.; 137th Engrs.; 320th Engrs.; 328th Engrs.; 348th Engrs.; 432d Engr. Bn.; 433d Engr. Bn.; 434th Engr. Bn.; 328th Med. Regt.; 2d Cav. Div. Q.M. Tn. (RAI); 103d Div. Q.M. Tn.; 428th Q.M. Regt.; CMTC—Cav., F.A.; ROTC—Cav., F.A.

**Brooks Field, TX (Military Airfield).** Located at San Antonio, TX. Established 16 February 1918. Designated in honor of Cadet Sidney J. Brooks Jr., killed 13 November 1917 in an airplane crash at Kelly Field.

**HQ**—11th Sch. Gp. (1922–31); 12th Obsn. Gp. (1931–37); 21st Bln. Gp (1921–22); 1st Ash. Gp. (1922).

**Troops**—3d Obsn. Sq. (1937); HQ and 8th Air Base Sq. (1936–41); 12th Obsn. Sq. (1937–41); 22d Obsn. Sq. (1931–41); 46th Sch. Sq. (1922–36); 47th Sch. Sq. (1922–36); 50th Obsn. Sq. (1927); 51st Sch. Sq. (1931–35); 52d Sch. Sq. (1927–31); 58th Sv Sq. (1929–30); 62d Sv Sq. (1923–36); 88th Obsn. Sq. (1927–28, 1931–35); 4th Bln. Co. (1919–22); 5th Bln. Co. (1919–22); 6th Bln. Co. (1919–22); 8th Bln. Co. (1919–22).

**Units for Annual Summer Training**—315th Obsn. Sq.; 328th Obsn. Sq.; 371st Obsn. Sq.

**Fort Brown, TX.** Located on the Rio Grande River in Brownsville, TX. Established 28 March 1846 as Fort Taylor in honor of Zachary Taylor, 12th President of the United States. Redesignated Fort Brown in May 1846 in honor of Maj. Jacob Brown, 7th US Inf.

**HQ**—4th Cav. Regt. (1920–22); 5th Cav. Regt. (1920–21); 12th Cav. Regt. (1922–41); 16th Cav. Regt. (1919–20).

**Troops**—4th Cav., less 2d and 3d Sqs. (1920–22); 5th Cav. (1920–21); 12th Cav., less 2d Sq. (1922–41).

**Camp Bullis, TX.** Located 19 miles northwest of San Antonio, TX. Established 12 September 1917. Designated in honor of Brig. Gen. John L. Bullis, who was an extremely experienced Indian fighter and leader of the famed Seminole Indian Scouts in Texas and New Mexico. A subpost of Fort Sam Houston, TX.

**Troops**—One company of the 1st Inf. (1921–27); one company of the 9th Inf. (1927–39).

**Units for Annual Summer Training**—HQ, 30th Div.; HQ, 31st Div.; HQ, 36th Div.; HQ, 45th Div.; HQ, 63d Cav. Div.; HQ, 81st Div.; HQ, 82d Div.; HQ, 87th Div.; HQ, 90th Div.; HQ, 95th Div.; HQ, 103d Div.; HHC, 179th Inf. Brig.; HHC, 180th Inf. Brig.; HHC, 190th Inf. Brig.; HHB, 165th F.A. Brig.; 357th Inf.; 358th Inf.; 359th Inf.; 360th Inf.; 379th Inf.; 380th Inf.; 455th Inf.; 46th F.A. (RAI); 51st F.A. (RAI); 53d F.A. (RAI); 92d F.A. (RAI); 131st F.A.; 132d F.A.; 334th F.A.; 335th F.A.; 336th F.A.; 349th F.A.; 409th F.A.; 411th F.A.; 438th F.A.; 315th Ammo. Tn.; 315th Engrs.; 320th Engrs.; 306th Chem. Regt.; 315th Med. Regt.; 320th Med. Regt.; 328th Med. Regt.; CMTC—Inf., F.A., S.C.

**Fort Clark, TX.** Located adjacent to Brackettville, TX, about 90 miles west of San Antonio. Established 20 June 1852 as Fort Riley. Redesignated Fort Clark on 16 July 1852 in honor of Maj. John B. Clark, 1st US Inf. Included the Fort Clark airdrome. Intermediate landing field.

**HQ**—1st Cav. Brig. (1923–41).

**Troops**—5th Cav. (1921–40); 13th Cav., less 2d Sq. (1919–20); 1st MG Sq. (1923–28); elements of 17th Q.M. Sq.

**Units for Annual Summer Training**—HHT, 156th Cav. Brig., 311th Cav.; 312th Cav.

**Fort Crockett, TX.** Located at Galveston, TX. Acquired in 1897. Designated in 1903 in honor of Davy Crockett, US Senator from Tennessee, and famed hero of the Alamo. Post included the coast defense batteries at Forts Travis and San Jacinto and the Fort Crockett US Army Airdrome.

**HQ**—HD of Galveston (1919–41); 20th C.A. (1940–41); 69th C.A. Regt. (1935–41); 3d Atk. Gp. (1926–35); 3d Atk. Wing (1932–35).

**Troops**—1st, 2d, and 3d Cos., CD of Galveston (1919–22); 183d C.A. Co. (1922–24); Btry G, 13th C.A. (1924–41); Btry A, 20th C.A. (1940–41); 60th C.A. Bn. (1922–23); 69th C.A. (1935–41); 8th Atk. Sq. (1926–35); 13th Atk. Sq. (1926–35); 90th Atk. Sq. (1926–35); 60th Sv Sq. (1926–35).

**Units for Annual Summer Training**—HQ, 36th Div.; HHC, 71st Inf. Brig.; HHC, 72d Inf. Brig.; HHB, 404th C.A. Brig.; 141st Inf.; 142d Inf.; 143d Inf.; 144th Inf.; 624th C.A.; 969th C.A.; 970th C.A.; 972d C.A.; 974th C.A.; 624th C.A.; 628th C.A.; 969th C.A.; 969th C.A.; 970th C.A.; 971st C.A.; 972d C.A.; 973d C.A.; 974th C.A.; 111th Engrs.; 111th Med. Regt.; 36th Div. Q.M. Tn.; HQ, 321st Atk. Gp.; HQ, 338th Obsn. Gp.; 36th Div. Avn.; 111th Obsn. Sq.; 13th Atk. Sq. (RAI); 26th Atk. Sq. (RAI); 350th Sv Sq.; 366th Obsn. Sq.; 472d Atk. Sq.; 473d Atk. Sq.; 474th Atk. Sq.; 475th Atk. Sq.

**Dodd Field, TX (Military Airfield).** Located at Fort Sam Houston in San Antonio, TX. Established in 1915 as the Fort Sam Houston Airdrome. Served as a remount depot from 1917 to June 1925 when it was reestablished as a landing field. Designated 10 May 1928 in honor of Col. Townsend F. Dodd, commander of Langley Field, VA, who was killed 5 October 1919 in an aircraft accident at Bustleton Field, Philadelphia, PA.

**HQ**—12th Obsn. Gp. (1930–31).

**Troops**—3d Obsn. Sq. (1926–31); 12th Obsn. Sq. (1926–31).

**Units for Annual Summer Training**—HQ, 327th Purs. Gp.; HQ, 338th Obsn. Gp.; 45th Obsn. Sq. (RAI); 315th Obsn. Sq.; 320th Obsn. Sq.; 328th Obsn. Sq.; 365th Obsn. Sq.; 366th Obsn. Sq.

**Dryden Station, TX.** Located at Dryden, TX. Auxiliary flying field for the border patrol. Intermediate landing field.

**Troops**—Air Corps weather and signal detachments.

**Duncan Field, TX (Military Airfield).** Located 6 miles southwest of San Antonio, TX. Designated 13 February 1925 in honor of Maj. Thomas Duncan who was killed 25 May 1923 in an aircraft accident at Bolling Field, Anacostia, DC. Intermediate landing field.

**Troops**—HQ, Air Corps Tng. Ctr.; San Antonio Air Intermediate Depot.



**Camp Eagle Pass, TX.** Located at Eagle Pass, TX. Acquired in 1892 to support the expanded patrolling mission along the southern border during unrest brought about by the revolutions in Mexico. Designated a subpost of Fort Clark, TX. Placed in caretaker status in 1923. Transferred to the Q.M. Dept. on 8 February 1934.

**Troops**—3d Inf. (1919–21); 46th Inf. (1920–21); elements of 5th Cav. (1922–23).

**Camp Furlong, NM.** Located at Columbus, NM. Established about 1914 to support the expanded patrolling mission along the southern border during unrest in Mexico. Designated in honor of Maj. John H. Furlong, 13th Cav. about April 1916. Abandoned 31 March 1924.

**Troops**—24th Inf. (1919–22); 2d Bn. 25th Inf. (1922–24); 12th Cav. (1919–20); 96th Aero Sq. (1919).

**Fort Sam Houston, TX.** Located in San Antonio, TX. Established in 1879 as the San Antonio Q.M. Dep. Later renamed the Post of San Antonio. Redesignated Fort Sam Houston on 10 September 1890 in honor of Gen. Sam Houston, hero of the Battle of San Jacinto, president of the Republic of Texas, and US Senator from Texas.

**HQ**—Eighth Corps Area (1920–41); 2d Div. (1919–41); 3d Inf. Brig. (1919–39); 4th Inf. Brig. (1919–29); 2d F.A. Brig. (1919–39).

**Troops**—1st Inf. (1919–29); 9th Inf. (1919–41); 20th Inf. (1919–29); 23d Inf. (1919–41); 20th Inf. (1939–41); 38th Inf. (1940–41); 1st Sq., 4th Cav. (1921–24); 10th Cav. (1920–21); 12th F.A. (1919–40); 15th F.A., less 2d Bn. (1920–29 and 1934–40); 2d Engrs. (1919–27); 2d Med. Regt. (1920–40); 2d Div. Q.M. Tn. (1920–36); 2d Q.M. Regt. (1936–39); 2d Ammo. Tn. (1919–33); Sp. Tps., 2d Div. (1921–39); elements of 97th Q.M. Bn.

**Units for Annual Summer Training**—HQ, 90th Div.; HQ, 95th Div.; HHC, 179th Inf. Brig.; HHC, 180th Inf. Brig.; HHC, 205th Inf. Brig.; HHC, 206th Inf. Brig.; HHB, 162d F.A. Brig.; HHB, 165th F.A. Brig.; HHB, 187th F.A. Brig.; 357th Inf.; 358th Inf.; 359th Inf.; 360th Inf.; 334th F.A.; 336th F.A.; 343d F.A.; 344th F.A.; 345th F.A.; 409th F.A.; 410th F.A.; 411th F.A.; 438th F.A.; 2d Ammo. Tn. (RAI); 315th Ammo. Tn.; 335th Ammo. Tn.; 348th Ammo. Tn.; 315th Engrs.; 320th Engrs.; 359th Engrs.; 384th Engrs.; 388th Engrs.; 306th Chem. Regt.; 90th Div. Q.M. Tn.; 95th Div. Q.M. Tn.; VIII Corps Q.M. Tn.; XVI Corps Q.M. Tn.; XVIII Corps Q.M. Tn.; 428th Q.M. Regt.; 13th Med. Regt. (RAI); 415th Q.M. Regt.; 320th Med. Regt.; 327th Med. Regt.; 328th Med. Regt.; 348th Med. Regt.; 355th Med. Regt.; CMTC—Inf., Cav., F.A., C.A.C., Engr., S.C.; ROTC—Inf., F.A., Cav., Engr., S.C., Med.

**Fort Huachuca, AZ.** Located 22 miles southwest of Tombstone, AZ. Established 16 February 1877. Named for the nearby Huachuca Mountains.

**HQ**—10th Cav. Regt. (1919–31); 25th Inf. Regt. (1933–41).

**Troops**—10th Cav. (1919–31); 3d Bn., 25th Inf. (1929–41); 25th Inf. (1933–41); elements of 17th Q.M. Sq.

**Units for Annual Summer Training**—HHC, 89th Inf. Brig.; HHC, 205th Inf. Brig.; 158th Inf.; 409th Inf.; 410th Inf.; 2d Sq., 312th Cav.; CMTC—Inf., Cav.; ROTC—Cav.

**Camp Harry J. Jones, AZ.** Located at Douglas, AZ. Established in 1911 as Camp Douglas. Redesignated in February 1916 in honor of Cpl. Harry J. Jones who was killed 2 November 1915 by Villista soldiers while guarding the Douglas, AZ, customs house during the battle of Agua Prieta. Included the Camp Harry J. Jones Airdrome. Intermediate landing field. Abandoned 30 June 1933.

**HQ**—1st Cav. Brig. (1921–23).

**Troops**—48th Inf. (1921); 1st Bn., 25th Inf. (1920–33); 1st Cav. (1919–22); 1st MG Sq. (1921–22).

**Units for Annual Summer Training**—158th Inf.; CMTC—Inf.

**Kelly Field, TX (Military Airfield).** Located at San Antonio, TX. Established 7 May 1917. Designated in honor of 2d Lt. George M. Kelly, the US Army's first pilot casualty killed in a flying accident.

**HQ**—24th Sch. Wing (1927–31); 1st Purs. Gp. (1919–21); 3d Atk. Gp. (1919–26); 10th Sch. Gp. (1922–31); HQ, Advanced Flying Sch. (1931–41).

**Troops**—8th Surv. Sq. (1919); 8th Atk. Sq. (1921–27); 12th Air Base Sq. (1936–40); 12th Aero Sq. (1919–21); 13th Aero Sq. (1919); 13th Atk. Sq. (1921–27); 17th Aero Sq. (1919–21); 20th Aero Sq. (1919–22); 23d Purs. Sq. (1940); 27th Aero Sq. (1919–21); 32d Purs. Sq. (1940); 34th Purs. Sq. (1940); 41st Obsn. Sq. (1935–36); 42d Bomb. Sq. (1935–36); 43d Purs. Sq. (1935–36); 39th Sch. Sq. (1927–35); 40th Atk. Sq. (1935–36); 40th Sch. Sq. (1922–35); 41st Sch. Sq. (1922–35); 42d Sch. Sq. (1922–35); 43d Sch. Sq. (1922–35); 48th Sch. Sq. (1927–31); 50th Obsn. Sq. (1927); 60th Sv Sq. (1923–26); 61st Sv Sq. (1923–36); 61st Sch. Sq. (1936–41); 62d Sv Sq. (1923–31); 62d Sch. Sq. (1936–41); 63d Sch. Sq. (1936–41); 64th Sch. Sq. (1936–41); 67th Sv Sq. (1930–31); 68th Sv Sq. (1923–36); 70th Sv Sq. (1924–37); 81st Sv Sq. (1935–36); 88th Obsn. Sq. (1927–28, 1931–35); 90th Aero Sq. (1919–21); 90th Atk. Sq. (1921–27); 94th Aero Sq. (1919–21); 95th Aero Sq. (1919–21); 96th Aero Sq. (1920–21); 96th Bomb. Sq. (1921–22).

**Units for Annual Summer Training**—HQ, VIII Corps Air Sv; HQ, 311th Atk. Gp.; HQ, 321st Atk. Gp.; HQ, 327th Purs. Gp.; HQ, 338th Obsn. Gp.; HQ, 548th Bln. Gp.; 9th Bomb. Sq. (RAI); 14th Bomb. Sq. (RAI); 18th HQ Sq. (RAI); 30th Bomb. Sq. (RAI); 31st Bomb. Sq. (RAI); 32d Bomb. Sq. (RAI); 33d Purs. Sq. (RAI); 34th Bomb. Sq. (RAI); 35th Purs. Sq. (RAI); 36th Purs. Sq. (RAI); 50th Obsn. Sq. (RAI); 56th Sv Sq. (RAI); 64th Sv Sq. (RAI); 67th Sv Sq. (RAI); 69th Sv Sq. (RAI); 71st Sv Sq. (RAI); 73d HQ Sq. (RAI); 73d Purs. Sq. (RAI); 75th Atk. Sq. (RAI); 76th Obsn. Sq. (RAI); 77th Obsn. Sq. (RAI); 78th Obsn. Sq. (RAI); 79th Obsn. Sq. (RAI); 80th Obsn. Sq. (RAI); 81st Obsn. Sq. (RAI); 82d Obsn. Sq. (RAI); 83d Obsn. Sq. (RAI); 84th Sv Sq. (RAI); 315th Obsn. Sq.; 341st Sv Sq.; 350th Sv Sq.; 371st Obsn. Sq.; 380th Sv Sq.; 387th Sv Sq.; 435th Purs. Sq.; 436th Purs. Sq.; 437th Purs. Sq.; 438th Purs. Sq.; 472d Atk. Sq.; 473d Atk. Sq.; 474th Atk. Sq.; 475th Atk. Sq.; 505th Purs. Sq.; 506th Purs. Sq.; 507th Purs. Sq.; 508th Purs. Sq.; 804th Obsn. Sq.

**Camp Stephen D. Little, AZ.** Located at Nogales, AZ. Established in 1916. Designated in honor of Lt. Stephen D. Little, killed in action on 26 November 1915 by Mexican revolutionaries during the Battle of Nogales. Abandoned 5 May 1933.

**HQ**—25th Inf. Regt. (1919–33).

**Troops**—25th Inf., less 1st Bn. (1919–33); 12th Aero Sq. (1920–21).

**Units for Annual Summer Training**—HHC, 205th Inf. Brig.; 409th Inf.; 410th Inf.

**Fort Logan, CO.** Located 10 miles south of Denver, CO. Established 20 October 1887. Named on 5 April 1889 in honor of Maj. Gen. John A. Logan, US Army, who was a veteran of the War with Mexico and served as a division and corps commander in the Army of the Tennessee during the Civil War.

**HQ**—2d Engr. Regt. (1927–39).

**Troops**—1st Bn., 38th Inf. (1922–27); 2d Engrs. (1927–39).

**Units for Annual Summer Training**—HHC, 206th Inf. Brig.; HHB, 178th F.A. Brig.; 410th Inf.; 411th Inf.; 412th Inf.; 320th Ammo. Tn.; 328th Ammo. Tn.; 9th Engr. Sq. (RAI); 25th Engrs. (RAI); 58th Engr. Bn. (RAI); 73d Engr. Bn. (RAI); 313th Engrs.; 314th Engrs.; 320th Engrs.; 327th Engrs.; 328th Engrs.; 329th Engrs.; 338th Engrs.; 347th Engrs.; 348th Engrs.; 406th Engr. Sq.; 460th Engr. Bn.; 606th Engr. Bn.; 608th Engr. Bn.; 62d Q.M. Regt. (RAI); CMTC—Inf.; ROTC—Engr.

**Lowry Field, CO (National Guard Aviation Facility/Military Airfield).** Located 6 miles southeast of Denver, CO. Originally established as the Colorado N.G. Flying Field. Transferred to the Army Air Corps in 1936. Designated in honor of Lt. Francis B. Lowry, a Denver native, killed in action 26 September 1918 over Crepion, France, during World War I.

**Troops**—45th Div. Avn.; 120th Obsn. Sq.; 21st Air Base Sq. (1936–40); 36th Bomb. Sq. (1940–41); 37th Bomb. Sq. (1940–41).

**Camp Marfa, TX.** Located at Marfa, TX. Established in 1911. Redesignated Fort D.A. Russell, TX, 1 January 1930. Placed in caretaker status 23 March 1933. Reactivated in the summer of 1935 by occupation of the post by the 77th F.A. Included the Marfa US Army Airdrome, which was used for border patrol flights.

**HQ**—1st Cav. Regt. (1923–33); 5th Cav. Regt. (1919–21); 8th Cav. Regt. (1919); 77th F.A. Regt. (1935–41).

**Troops**—1st Cav. (1923–33); 5th Cav. (1919–20); 8th Cav. (1919); 2d Bn., 77th F.A. (1935–41).

**Units for Annual Summer Training**—53d F.A. (RAI); 77th F.A. (RAI); 345th F.A.; 349th F.A.; 382d F.A.; 383d F.A.; 411th F.A.; 438th F.A.; 443d F.A.; 494th F.A.

**Fort McIntosh, TX.** Located along the Rio Grande River in Laredo, TX. Established 3 March 1849 as Camp Crawford. Redesignated Fort McIntosh 7 January 1850 in honor of Col. James S. McIntosh, 5th US Inf. Included the Fort McIntosh Airdrome, which was used for border patrol flights. Intermediate landing field.

**HQ**—37th Inf. Regt. (1919–21); 17th Inf. Regt. (1920–22); 4th Cav. Regt., (1921–24); 4th F.A. Regt. (1923–27); 3d F.A. Regt. (1927–28); 8th Engr. Sq. (1927–40); 56th Cav. Brig. (1940–41).

**Troops**—4th Cav., less 1st Sq. (1921–24); 4th F.A., less 1st Bn. (1923–27), 3d F.A., less 1st and 2d Bns. (1927–28), 4th F.A. Bn. (1927–28); 8th Engr. Sq. (1927–40).

**Units for Annual Summer Training**—89th Engr. RY. HQ (RAI); 315th Engrs.; 320th Engrs.; 339th Engrs.; 461st Engr. Bn.; 462d Engr. Bn.; 463d Engr. Bn.; 511th Engr. Bn.; 513th Engr. Bn.; 607th Engr. Bn.

**Normoyle Quartermaster Depot, TX.** Located at San Antonio, TX, adjacent to Kelly Field. Established in 1917.

**Troops**—3d M. Rep. Bn. (1921–36); B Co., 4th M. Rep. Bn. (1922–27); 1st Bn., 55th Q.M. Regt. (1936–41).

**Units for Annual Summer Training**—55th Q.M. Regt. (RAI).

**Camp Owen Bierne, TX.** See Biggs Field, TX.

**Post Field, OK (Military Airfield).** Located at Fort Sill, OK. Established in January 1918 to support the Artillery School of Fire. Designated in honor of 2d Lt. Henry B. Post who was killed in an airplane crash on 9 February 1914 while attempting to establish a new high altitude record. Designated a Reserve Airdrome and Flying Field.

**Troops**—135th Aero Sq. (1919–21); 15th Obsn. Sq. (1941); 22d Obsn. Sq. (1921); 44th Obsn. Sq. (1922–27); 88th Obsn. Sq. (1928–31); 1st Bln. Co. (1929–33); 1st Bln. Sq. (1933–41); 23d Bln. Co. (1919–20).

**Units for Annual Summer Training**—35th Div. Avn.; 110th Obsn. Sq.; 45th Div. Avn.; 120th Obsn. Sq.; 154th Obsn. Sq.; 365th Obsn. Sq.; 366th Obsn. Sq.; 472d Atk. Sq.; 473d Atk. Sq.; 474th Atk. Sq.; 475th Atk. Sq.; 820th Obsn. Sq.; 329th Bln. Co.; 330th Bln. Co.; 331st Bln. Co.; 332d Bln. Co.; 345th Bln. Sv Co.

**Randolph Field, TX (Military Airfield).** Located 15 miles northeast of San Antonio, TX. Established 20 June 1930 as the US Army Air Corps' basic flight training center. Designated in honor of Capt. William M. Randolph who was killed in an airplane crash on 17 February 1928 at Gorman, TX.

**HQ**—HQ, Primary Flying School (1931–41).

**Troops**—HQ and 11th Air Base Sq. (1936–41); 46th Sch. Sq. (1936–41); 47th Sch. Sq. (1936–41); 52d Sch. Sq. (1935–36); 53d Sch. Sq. (1935–36); 67th Sv Sq. (1931–36).

**Fort Ringgold, TX.** Located on the Rio Grande River in Rio Grande City, TX. Established 26 October 1848 as the Post at David's Landing. Later renamed Camp Ringgold and finally, Ringgold Barracks on 16 July 1849. Further renamed Fort Ringgold on 30 December 1878. Designated in honor of Maj. Samuel Ringgold, 3d US Arty., who was mortally wounded at the Battle of Palo Alto, 11 May 1846. Included the Fort Ringgold US Army Airdrome which was used for border patrol.

**HQ**—4th Cav. Regt. (1919–20).

**Troops**—4th Cav. (1919–20); 2d Sq., 13th Cav. (1920); 2d Sq., 12th Cav. (1922–41); elements of 17th Q.M. Sq.

**Fort D.A. Russell, TX.** See Camp Marfa, TX.

**Fort San Jacinto, TX.** Located on the east end of Galveston Island, Galveston, TX. Established as a military reservation by the Republic of Texas in 1836. Acquired by the War Department in 1887 and established as a Federal military reservation 20 April 1898. Designated in commemoration of the battle of San Jacinto fought on 21 April 1836, which resulted in Texas' independence. A subpost of Fort Crockett.

**Troops**—Caretaking detachment, G Btry, 13th C.A. (1924–41).

**Camp Shannon, NM.** Located at Hachita, NM. Established in 1917 to support the expanded patrolling mission along the southern border during unrest in Mexico and in response to the Pancho Villa raid on Columbus, NM, 1916. Abandoned in June 1922.

**Troops**—2d Bn. 24th Inf. (1919–22); 2d Bn. 25th Inf. (1920–22); 2d Sq. 12th Cav. (1919–20).

**Fort Sill, OK.** Located 6 miles north of Lawton, OK. Established 7 January 1869 as Camp Wichita. Redesignated as Fort Sill on 2 July 1869. Designated in honor of Brig. Gen. Joshua Sill. The Field Artillery School was permanently transferred from Camp Knox, KY, to Fort Sill on 30 June 1922.

**HQ**—4th F.A. Brig. (1935–40); 18th F.A. Brig. (1940–41).

**Troops**—1st F.A. (1919–41); 349th F.A. (1940–41); 3d Bn. 20th Inf. (1925–27); 1st Bn., 38th Inf. (1927–33); 3d Bn., 29th Inf. (1933–38); 9th F.A. (1919–21); 2d Bn., 9th F.A. (1922); 14th F.A. (1919–21); 1st Bn., 18th F.A. (1922–41); 18th F.A. (1935–41); 1st Bn., 77th F.A. (1935–40); 2d Ammo. Tn. (1933–38); 3d Ammo. Tn. (1925–33).

**Units for Annual Summer Training**—HQ, 45th Div.; HQ, 95th Div.; HHC, 90th Inf. Brig.; HHC, 189th Inf. Brig.; HHC, 190th Inf. Brig.; HHB, 4th F.A. Brig. (RAI); HHB, 16th F.A. Brig. (RAI); HHB, 18th F.A. Brig. (RAI); HHB, 70th F.A. Brig.; HHB, 170th F.A. Brig.; 179th Inf.; 180th Inf.; 377th Inf.; 378th Inf.; 379th Inf.; 380th Inf.; 46th F.A. (RAI); 47th F.A. (RAI); 51st F.A. (RAI); 92d F.A. (RAI); 128th F.A.; 130th F.A.; 131st F.A.; 132d F.A.; 142d F.A.; 158th F.A.; 160th F.A.; 161st F.A.; 189th F.A.; 358th F.A.; 359th F.A.; 360th F.A.; 409th F.A.; 410th F.A.; 450th F.A.; 456th F.A.; Third Army Ammo. Tn. (RAI); 18th Ammo. Tn. (RAI); 120th Ammo. Tn.; 320th Ammo. Tn.; 8th F.A. Obsn. Bn. (RAI); 308th F.A. Obsn. Bn.; 312th F.A. Obsn. Bn.; 319th F.A. Obsn. Bn.; 141st Arty., C.A.C.; 203d C.A.; 206th C.A.; 506th C.A.; 508th C.A.; 527th C.A.; 529th C.A.; 537th C.A.; 120th Engrs.; 320th Engrs.; 120th Med. Regt.; 320th Med. Regt.; 379th Med. Regt.; VIII Corps Q.M. Tn.; XVIII Corps Q.M. Tn.; 45th Div. Q.M. Tn.; 120th Q.M. Regt.; 420th Q.M. Regt.; CMTC—Inf., F.A.; ROTC—Inf., F.A.

**Camp Stanley, TX.** Located 2 miles east of Leon Springs, TX. Acquired by purchase in 1906. Designated in honor of Maj. Gen. David S. Stanley who was commanding general, IV Corps, Army of the Cumberland during the Civil War. A subpost of Fort Sam Houston, TX.

**Troops**—One company of the 9th Inf.; 4th F.A. (1919–20).

**Units for Annual Summer Training**—HHT, 56th Cav. Brig.; HHB, 61st F.A. Brig.; HHB, 165th F.A. Brig.; 112th Cav.; 56th MG Sq.; 131st F.A.; 132d F.A.; 133d F.A.; 334th F.A.; 336th F.A.; 343d F.A.; 344th F.A.; 345th F.A.; 410th F.A.; 411th F.A.; 438th F.A.; 315th Ammo. Tn.; 335th Ammo. Tn.; 348th Ammo. Tn.; 111th Obsn. Sq.

**Stinson Field, TX (Civilian Airfield).** Located at San Antonio, TX. Established in 1915 to serve as San Antonio's municipal airport. Named for the local Stinson family, early aviation pioneers and owners of the Stinson Aviation Company. Used as an Air Service training facility in World War I. Intermediate landing field.

**Camp Travis, TX.** Located at San Antonio, TX. Established 18 July 1917. Designated in honor of Lt. Col. William Barrett Travis, hero of the Alamo. Designated as a National Army cantonment for the mobilization of the 90th Div. in World War I. A subpost of Fort Sam Houston. Absorbed by Fort Sam Houston on 13 December 1922.

**Troops**—Units of the 2d Div. (1919–22).

**Fort Travis, TX.** Located at Boliver Point, Galveston Island, Galveston, TX. Established as a military reservation by the Republic of Texas in 1836. Acquired by purchase in 1898 and established as a Federal military reservation on 8 April 1898. Designated in 1903 in honor of Lt. Col. William Barrett Travis, Republic of Texas Army, who was killed in action on 2 March 1836 commanding the garrison of the Alamo. A subpost of Fort Crockett.

**Troops**—Caretaking detachment, G Btry, 13th C.A. (1924–41).

**Fort Francis D. Warren, WY.** Located 3 miles from Cheyenne, WY, on the north bank of Crow Creek. Established 21 July 1867 as Fort D.A. Russell. Redesignated Fort Francis E. Warren 1 January 1930 in honor of Francis E. Warren, US Senator of Wyoming. Jurisdiction transferred from Ninth Corps Area to Eighth Corps Area 1 May 1927, and returned to the Ninth Corps Area 1 July 1939.

**HQ**—4th Inf. Brig. (1927–39).

**Troops**—1st Inf. (1927–40); 20th Inf. (1927–41); 76th F.A., less 2d Bn.; 13th Cav. (1921–26); elements of 28th and 39th Q.M. Regts.

**Units for Annual Summer Training**—HHC, 206th Inf. Brig.; HHB, 178th F.A. Brig.; HHB, 179th F.A. Brig.; 411th Inf.; 412th Inf.; 415th Inf.; HHB, 178th F.A. Brig.; HHB, 179th F.A. Brig.; 115th Cav.; 116th Cav.; 324th Cav.; 382d F.A.; 383d F.A.; 384th F.A.; 385th F.A.; 386th F.A.; 387th F.A.; 326th Ammo. Tn.; 328th Ammo. Tn.; 329th Ammo. Tn.; 328th Med. Regt.; 103d Div. Q.M. Tn.; 428th Q.M. Regt.; CMTC—F.A.; ROTC—F.A.

#### National Guard

**Ellington Field, TX (Civilian Airfield/National Guard Aviation Facility).** Located 17 miles southeast of Houston, TX. Established in September 1917. Designated in honor of 2d Lt. Eric L. Ellington who was killed in an airplane crash on 23 November 1913. Portions turned over to the Texas N.G. by the War Department in 1920. Designated a subpost of Fort Crockett, TX, 27 November 1926.

**HQ**—36th Div. Avn. (1923–40).

**Troops**—17th Purs. Sq. (1921–22); 95th Purs. Sq. (1921–22); 96th Aero Sq. (1919); 111th Obsn. Sq. (1923–40).

**Units for Annual Summer Training**—36th Div. Avn., 111th Obsn. Sq.

**Camp Hulén, TX.** Located 2 miles west of Palacios, TX, on Matagorda Bay. Established in 1925. Designated in honor of Maj. Gen. George A. Hulén, commanding general of the 36th Div., 1923–35.

**Units for Annual Summer Training**—HQ, 36th Div.; HHC, 71st Inf. Brig.; HHC, 72d Inf. Brig.; HHB, 61st F.A. Brig.; 141st Inf.; 142d Inf.; 143d Inf.; 144th Inf.; 131st F.A.; 132d F.A.; 133d F.A.; 111th Engrs.; 111th Med. Regt.; 36th Div. Q.M. Tn.; 111th Q.M. Regt.; 35th Div. Avn.; 110th Obsn. Sq.; 36th Div. Avn.; 111th Obsn. Sq.; 154th Obsn. Sq.

**Camp Mabry, TX.** Located 5 miles northwest of Austin, TX. Established in 1890. Designated in honor of Brig. Gen. Woodford H. Mabry, adjutant general of Texas.

**Units for Annual Summer Training**—HQ, 36th Div.; HHC, 71st Inf. Brig.; HHC, 72d Inf. Brig.; HHT, 56th Cav. Brig.; 141st Inf.; 142d Inf.; 143d Inf.; 144th Inf.; 111th Engrs.; 112th Cav.; 56th MG Sq.; 111th Med. Regt.; 36th Div. Q.M. Tn.; 36th Div. Avn.; 111th Obsn. Sq.; 154th Obsn. Sq.

**Camp Maximilliano Luna, NM.** Located near the town of Las Vegas, NM. Designated in honor of Capt. Maximilliano Luna, a member of Teddy Roosevelt's Rough Riders in 1898, who died by drowning in the Philippine Islands in 1901.

**Units for Annual Summer Training**—111th Cav.; 158th F.A.; 120th Engrs. (less 1st Bn); 320th Engrs.

**Fort Tuthill, AZ.** Located 15 miles south of Flagstaff, AZ. Established in 1928. Designated in honor of Maj. Gen. Alexander M. Tuthill, commanding general of the 45th Div., 1933–35.

**Units for Annual Summer Training**—HHC, 89th Inf. Brig., 158th Inf.; 45th Div. Avn.; 120th Obsn. Sq.

**Camp George West, CO.** Located at the city of Golden, CO. Established in 1903 as the Colorado State Rifle Range. Designated on 1 May 1934 in honor of George West, founder and publisher of the *Golden Transcript* newspaper.

**Units for Annual Summer Training**—HHB, 178th F.A. Brig.; 157th Inf.; 177th Inf.; 117th Cav. Sq.; 1st Bn., 158th F.A.; 168th F.A. Bn; 168th F.A.; 45th Div. Avn.; 120th Obsn. Sq.

**Camp Wolters, TX.** Located 1 mile east of Mineral Wells, TX. Established in 1925. Designated in honor of Brig. Gen. Jacob F. Wolters, commanding general of the 56th Cav. Brig., 1918–34.

**Units for Annual Summer Training**—HHT, 56th Cav. Brig.; 112th Cav.; 124th Cav.; 56th MG Sq.; elements of 36th Div. Q.M. Tn.; 111th Obsn. Sq.; 315th Obsn. Sq.; 359th Obsn. Sq.

### Organized Reserve

**Fort Crockett US Army Airdrome (Military Airfield).** See Fort Crockett.

**Hatbox Field, OK (Civilian Airfield).** Located at Muskogee, OK. Established in 1921 by 1st Lt. Joe Witt, a former World War I Air Service pilot. Named by Capt. Charles B. Oldfield, commander of the 95th Div. AS, in November 1924. Capt. Oldfield remarked that the small hanger looked like a “hatbox” from the air and the name stuck. Designated as an O.R. airdrome and intermediate landing field.

**Troops**—Det. 39th Sch. Sq.; Det. 40th Sch. Sq.; Det. 48th Sch. Sq.; 320th Obsn. Sq. (1921–27); Air Corps weather and signal dets.

**Hensley Field, TX (Civilian Airfield/Military Airfield).** Located at Grand Prairie, TX. Established about 1925. Designated in June 1930 in honor of Col. William N. Hensley, the first American flyer to cross the Atlantic in a dirigible and who was instrumental in helping to establish the field. O.R. airdrome and intermediate landing field. O.R. flying and training transferred from Love Field to Hensley Field in 1929.

**Troops**—315th Obsn. Sq. (1925–41); 366th Obsn. Sq. (1929–41); Air Corps support, weather, and signal dets. (1929–41).

**Units for Annual Summer Training**—HQ, 338th Obsn. Gp.; 45th Obsn. Sq. (RAI); 77th Obsn. Sq. (RAI); 315th Obsn. Sq.; 320th Obsn. Sq.; 328th Obsn. Sq.; 365th Obsn. Sq.; 366th Obsn. Sq.; 435th Purs. Sq.; 436th Purs. Sq.; 472d Atk. Sq.; 473d Atk. Sq.; 474th Atk. Sq.; 475th Atk. Sq.; 484th Bomb. Sq.

**Love Field, TX (Civilian Airfield/Military Airfield).** Located at Dallas, TX. Established 26 September 1917. Designated in honor of 1st Lt. Moss Lee Love, 11th Cav., who was killed in a flying accident on 4 September 1913. Turned over to civilian ownership about 1919. Intermediate landing field. O.R. flying and training transferred from Love Field to Hensley Field in 1929.

**Troops**—366th Obsn. Sq. (1922–29); Air Corps support, weather, and signal dets. (1922–29).

**Units for Annual Summer Training**—HQ, 338th Obsn. Gp.; 45th Obsn. Sq. (RAI); 315th Obsn. Sq.; 320th Obsn. Sq.; 328th Obsn. Sq.; 365th Obsn. Sq.; 366th Obsn. Sq.; 380th Sv Sq.; 435th Purs. Sq.

**Tucson Field, AZ (Civilian Airfield).** Located at Tucson, AZ. Established 6 October 1925. Designated Davis-Monthan Field on 27 September 1927 in honor of 2d Lt. Samuel H. Davis and 2d Lt. Oscar Monthan, both local Tucsonians and early members of the US Army Air Service, who were killed in separate flying accidents. Designated as an O.R. airdrome and intermediate landing field.

**Troops**—Air Corps weather and signal dets.

## NINTH CORPS AREA

**HQ**—Presidio of San Francisco, CA, 20 August 1920–7 December 1941.

Established in the US Army on 20 August 1920 with headquarters located in the Cavalry Barracks (Building 35) at the Presidio of San Francisco, and organized from portions of the discontinued Western Department. The Ninth Corps Area included the states of Washington, Oregon, Idaho, Montana, Wyoming, Utah, and Nevada. For administrative purposes and tactical control in connection with the US border patrol and field operations incident thereto, that part of the state of Arizona that lies west of the 114 degree meridian and south of the 33 degree parallel was attached to the Ninth Corps Area. The territory of Alaska was also attached to the Ninth Corps Area. In May 1927, the Pole Mountain Reservation and the post of Fort D.A. Russell (later redesignated Fort Francis E. Warren) came under the control of the Eighth Corps Area when the 4th Inf. Brig. was transferred to that post from Fort Sam Houston, TX. These reservations were returned to Ninth Corps Area control on 1 July 1939. Mobile units of the corps area, less CD, GHQR, and Z.I. units, were assigned to the Third and Sixth Armies. With the adoption of the four field army plan on 1 October 1933, the units of the Ninth Corps Area were reassigned to the Fourth Army or GHQR or demobilized. The Ninth Corps Area Training Center was established in 1921, originally with headquarters at the Presidio of San Francisco, to train R.A. and O.R. units of all arms and services, as well as ROTC cadets and CMTC candidates. With the inactivation of the Ninth Corps Area Training Center on 12 September 1922, infantry units trained at Forts Lewis and Douglas and the Presidio of Monterey; air corps units were sent to Crissey and Rockwell Fields; artillery units trained at Forts Lewis and Douglas; and cavalry units trained at Fort Douglas and Del Monte, CA. Corps area maneuvers of R.A. mobile units were also held, those years when funds were available, at Forts Lewis, Douglas, F.E. Warren, and/or the Gigling Military Reservation at Del Monte, CA. For the administration of O.R. units, all organizations initially came under the control of the IX Corps, or the 91st, 96th, and 104th Divs. When the IX Corps was inactivated, the HQ, Non-Divisional Group was established on 9 May 1924 to direct the organization, training, and administration of all nondivisional units. The HQ, Artillery Group was established on 1 May 1925 at the Presidio of San Francisco to administer all corps area nondivisional field artillery units. The corps area was further reorganized, on an experimental basis, into three "military areas" in July 1928. At that time, the First Military Area assumed control of the 91st Div. area, the Second Military Area assumed control of the 96th Div. area, and the Third Military Area assumed control of the 104th Div. area. Concurrently, the headquarters for the Non-Divisional and Artillery Groups were abolished and the military area headquarters assumed control of all O.R. units in their respective areas, less coast artillery which remained under the Ninth Coast Artillery District. The experiment was successful and all other corps areas adopted this system by 1939. The Ninth Corps Area was assigning Reserve personnel to CASC units by June 1931. The HQ, Ninth Corps Area actually began functioning as a service command headquarters in October 1940 and was redesignated HQ, Ninth CASC in May 1941. It was further redesignated HQ, Ninth Service Command on 22 July 1942.

**Events:** 193

### Major Commands in the Corps Area

Fourth Army (1933–41)  
IX Corps: 3d Division, 40th Division, 41st Division  
XIX Corps: 91st Division, 96th Division, 104th Division  
Ninth Coast Artillery District  
1st Wing  
Ninth Corps Area Service Command

### Corps Area Commanders

Maj. Gen. Hunter Liggett	1 September 1920–21 March 1921	Brig. Gen. Frank M. Caldwell	10 September 1930–2 October 1930
Brig. Gen. Richard M. Blatchford	21 March 1921–June 1921	Maj. Gen. Douglas MacArthur	2 October 1930–20 November 1930
Maj. Gen. Charles H. Muir	June 1921–July 1921	Maj. Gen. Malin Craig	21 November 1930–24 January 1935
Maj. Gen. William M. Wright	July 1921–29 January 1922	Brig. Gen. Otho B. Rosenbaum	1 February 1935–9 March 1935
Maj. Gen. Charles G. Morton	30 January 1922–15 January 1925	Maj. Gen. Paul B. Malone	9 March 1935–30 April 1936
Maj. Gen. William H. Johnson	15 January 1925–13 February 1925	Brig. Gen. Caspar H. Conrad Jr.	1 May 1936–20 June 1936
Maj. Gen. Charles T. Menoher	13 February 1925–23 March 1926	Maj. Gen. George S. Simonds	20 June 1936–8 March 1938
Brig. Gen. Henry D. Todd	23 March 1926–15 June 1926	Maj. Gen. Albert J. Bowley	8 March 1938–30 November 1939
Maj. Gen. James H. McRae	16 June 1926–31 December 1926	Lt. Gen. John L. DeWitt	5 December 1939–8 November 1940
Maj. Gen. John L. Hines	31 December 1926–10 September 1930	Maj. Gen. Ernest D. Peek	8 November 1940–30 September 1941
Maj. Gen. Jay L. Benedict			3 November 1941–2 April 1942

**Ninth Corps Area Service Command  
Organization 1932**

<b>UNIT:</b>	<b>LOCATION:</b>
HQ, Ninth CASC	Presidio of SF, CA
San Francisco Gen. Sup Dep	San Francisco, CA
Sacramento Gen. Sup Point	Sacramento, CA
Corps Area Rmt Dep	Sacramento, CA
Distributing Point	Los Angeles, CA
Distributing Point	Seattle, WA
Distributing Point	Salt Lake City, UT
Recep. Ctr.	Presidio of SF, CA
Recep. Ctr.	Ross Field, CA
Recep. Ctr.	Fort Douglas, UT
Recep. Ctr.	Fort Lewis, WA
Inf. Repl. Ctr.	San Diego, CA
Inf. Repl. Ctr.	Fort Lewis, WA
Inf. Repl. Ctr.	Jordan Narrows, UT
C.A. Repl. Ctr.	Fort MacArthur, CA
C.A. Repl. Ctr.	Fort Worden, WA
C.A. Repl. Ctr.	Fort Winfield Scott, CA
Mob. Ctr.	Benicia Arsenal, CA
Mob. Ctr.	Boise Barracks, ID
Mob. Ctr.	Chilkoot Barracks, TA
Mob. Ctr.	Crissey Field, CA
Mob. Ctr.	Gigling Reservation, CA
Mob. Ctr.	Presidio of Monterey, CA
Mob. Ctr.	Presidio of SF, CA
Mob. Ctr.	Fort Douglas, UT
Mob. Ctr.	Fort George Wright, WA
Mob. Ctr.	Fort W.H. Harrison, MT
Mob. Ctr.	Fort Stevens, OR
Mob. Ctr.	Fort Rosecrans, CA
HQ, Fort Francis E. Warren	Fort Francis E. Warren, WY
HQ, Fort McDowell	Fort McDowell, CA
HQ, Fort Missoula	Fort Missoula, MT
HQ, March Field	March Field, CA
HQ, Mather Field	Mather Field, CA
HQ, Vancouver Barracks	Vancouver Barracks, WA
Pacific Branch, U.S.D.B.	Alcatraz Island, CA
1901st Sta. Hosp.	Dillon, WY
1902d Sta. Hosp.	Missoula, MT
1903d Sta. Hosp.	Unknown
1904th Sta. Hosp.	Unknown
1905th Sta. Hosp.	Unknown
1906th Sta. Hosp.	San Diego, CA
1907th Sta. Hosp.	San Francisco, CA
1908th Sta. Hosp.	Los Angeles, CA
1909th Sta. Hosp.	Unknown
1910th Sta. Hosp.	San Francisco, CA
1911th Sta. Hosp.	Great Falls, MT
1912th Sta. Hosp.	Presidio of Monterey, CA
1913th Sta. Hosp.	Sacramento, CA
1901st M.T. Co.	Unknown
1902d M.T. Co.	San Diego, CA
1903d M.T. Co.	San Diego, CA
1904th M.T. Co.	Los Angeles, CA
1905th M.T. Co.	San Francisco, CA
1906th M.T. Co.	Unknown
1907th M.T. Co.	Sacramento, CA
1908th M.T. Co.	Sacramento, CA
1909th M.T. Co.	Sacramento, CA
1910th M.T. Co.	Sacramento, CA
1911th M.T. Co.	San Francisco, CA

**Ninth Corps Area Service Command  
Organization 1939**

<b>UNIT:</b>	<b>LOCATION:</b>
HQ, Ninth CASC	Presidio of SF, CA
1900th CASU (HQ)	Presidio of SF, CA
1901st CASU (Rctg. Sv)	Presidio of SF, CA
1902d CASU (N.G. Instr. Gp.)	Presidio of SF, CA
1903d CASU (ROTC Instr. Gp.)	Presidio of SF, CA
1904th CASU (1st Mil. Area)	Presidio of SF, CA
1905th CASU (2d Mil. Area)	Portland, OR
1906th CASU (3d Mil. Area)	Salt Lake City, UT
1907th CASU (Sta. Cmpl.)	Fort Lewis, WA
1909th CASU (Recep. Ctr.)	Fort Lewis, WA
1914th CASU (Sta. Cmpl.)	Fort Worden, WA
1919th CASU (Sta. Cmpl.)	Vancouver Barracks, WA
1923d CASU (CCC)	Presidio of SF, CA
1924th CASU (Sta. Cmpl.)	Fort Stevens, OR
1927th CASU (Sta. Cmpl.)	Presidio of SF, CA
1928th CASU (Sta. Cmpl.)	Camp Roberts, CA
1929th CASU (Sch. B&C)	Presidio of SF, CA
1930th CASU (Recep. Ctr.)	Presidio of Monterey, CA
1932d CASU (Sta. Cmpl.)	Fort Winfield Scott, CA
1934th CASU (Sta. Cmpl.)	Presidio of Monterey, CA
1938th CASU (Sta. Cmpl.)	Fort McDowell, CA
1943d CASU (Sta. Cmpl.)	Fort MacArthur, CA
1946th CASU (Sta. Cmpl.)	Hunter Liggett MR, CA
1947th CASU (Sta. Cmpl.)	Camp San Luis Obispo, CA
1952d CASU (Sta. Cmpl.)	Fort Rosecrans, CA
1953d CASU (Sta. Cmpl.)	Camp Callan, CA
1957th CASU (Sta. Cmpl.)	Fort Missoula, MT
1958th CASU (Sta. Cmpl.)	Camp McQuaide, CA
1959th CASU (Recep. Ctr.)	Fort MacArthur, CA
1961st CASU (Sta. Cmpl.)	Camp Seeley, CA
1962d CASU (Sta. Cmpl.)	Fort Ord, CA
1963d CASU (Sta. Cmpl.)	Camp Sibert, NV
1967th CASU (Sta. Cmpl.)	Camp Haan, CA
1968th CASU (Sta. Cmpl.)	Fort Douglas, UT
Air Corps Det.	Lindberg Field, CA
Air Corps Det.	Long Beach AP, CA
Air Corps Det.	Medford AP, OR
Air Corps Det.	Oakland AP, CA
Air Corps Det.	Pearson Field, WA
Air Corps Det.	Salt Lake City AP, UT
Air Corps Det.	Seattle AP, WA

**Ninth Corps Area Service Command  
Organization 1932 (Cont)**

<b>UNIT:</b>	<b>LOCATION:</b>
1912th M.T. Co.	San Francisco, CA
1913th M.T. Co.	San Francisco, CA
1914th M.T. Co.	Unknown
1915th M.T. Co.	Los Angeles, CA
1916th M.T. Co.	Unknown
1901st M. Rep. Sec	Sacramento, CA
1902d M. Rep. Sec	Sacramento, CA
1903d M. Rep. Sec	San Francisco, CA
1904th M. Rep. Sec	San Francisco, CA
1905th M. Rep. Sec	San Francisco, CA
1906th M. Rep. Sec	Unknown
1907th M. Rep. Sec	Unknown
1908th M. Rep. Sec	Unknown
1901st Mtcyl Co.	Presidio of SF, CA
1902d Mtcyl Co.	Sacramento, CA
Eighth CASC Air Pool	Presidio of SF, CA

**Major posts, camps, stations, airfields, and N.G. and O.R. training facilities in the corps area.**

**Regular Army**

**Fort Baker, CA.** Located at the entrance to San Francisco Bay, adjacent to Fort Barry on the Marin Headlands (north side of the Golden Gate Bridge). A subpost of Fort Winfield Scott. Acquired by purchase in 1866 and designated the Lime Point Military Reservation. Redesignated in 1897 in honor of Col. Edward D. Baker, commander, 71st Pennsylvania Volunteers, killed in action in October 1861.

**Troops**—11th Co., CD of San Francisco (1919–22); caretaking detachment, 6th C.A. (1924–41); Brtys I, K, L, M, 6th C.A. (1941).

**Fort Barry, CA.** Located at the entrance to San Francisco Bay, adjacent to Fort Baker on the Marin Headlands (north side of the Golden Gate Bridge). A subpost of Fort Winfield Scott. Set apart from Fort Baker in 1904 as the Point Bonita Military Reservation. Redesignated 27 December 1904 in honor of Col. William F. Barry, 2d Arty., who served as the chief of artillery for the Army of the Potomac during the Peninsula Campaign in 1862.

**Troops**—1st, 6th, and 14th Cos., CD of San Francisco (1919–22); Btry K, 6th C.A. (1924–41).

**Units for Annual Summer Training**—249th C.A.; 250th C.A.

**Camp Bonneville, WA.** Located 15 miles northwest of Vancouver, WA. Established on leased land in 1909 as a target range and maneuver area. Purchased in 1919. Designated Camp Bonneville in 1926 in honor of Lt. Col. Benjamin Bonneville, early explorer of the Oregon territory. A subpost of Vancouver Barracks.

**Units for Annual Summer Training**—116th Cav.; 148th F.A.

**Fort Canby, WA.** Located 2 miles from Ilwaco, WA, on Cape Disappointment. Acquired in 1852. Post established in 1863 and designated Fort Cape Disappointment. Redesignated in 1875 in honor of Brig. Gen. Edward R.S. Canby, distinguished commander in the Civil War; killed in action in 1873 by Modoc Indians. A subpost of Fort Stevens.

**Troops**—Caretaking detachment, 14th C.A. (1924–41).

**Fort Casey, WA.** Located 5 miles from Port Townsend, WA. Acquired by purchase in 1897. Designated in honor of Brig. Gen. Thomas L. Casey, Chief of Engineers, 1888–95.

**Troops**—9th, 10th, and 11th Cos., CD of Puget Sound (1919–22); 85th C.A. Co. (1922–24); 2d Bn., 14th C.A. (1924–41).

**Units for Annual Summer Training**—249th C.A.; ROTC—C.A.C.

**Chilkoot Barracks, AK.** Located at Haines, AK, on Chilkat Inlet. Established in 1898. Designated Fort William H. Seward 3 March 1904. Redesignated Chilkoot Barracks 13 December 1922.

**Troops**—2d Bn., 21st Inf. (1919–21); 2d Bn., 59th Inf. (1921–22); 2d Bn., 7th Inf. (1922–40); 3d Bn., 4th Inf. (1940–41); Cos A & B, 297th Inf. (1940–41).

**Units for Annual Summer Training**—549th Inf. Bn.





**Hamilton Field, CA (Military Airfield).** Located 7 miles north of San Rafael, CA. Established in 1929 as Air Corps Station, San Rafael. Redesignated 12 July 1932 in honor of 1st Lt. Lloyd A. Hamilton, a Marin County native and World War I ace, who was killed in action over Langrecourt, France, in World War I. Airfield opened for active operations on 27 June 1933.

**HQ**—7th Bomb. Gp. (1934–35 and 1937–40); 20th Purs. Gp.; 35th Purs. Gp.; 10th Purs. Wing (1940–41); 11th Purs. Wing (1940–41); 20th Purs. Gp. (1940–41); 35th Purs. Gp. (1940–41).

**Troops**—HQ and 5th Air Base Sq. (1936–40); 9th Bomb. Sq. (1934–40); 11th Bomb. Sq. (1934–40); 18th Purs. Sq. (1940–41); 20th Purs. Sq. (1940–41); 21st Purs. Sq. (1940–41); 22d Bomb. Sq. (1940); 31st Bomb. Sq. (1934–38); 34th Purs. Sq. (1940–41); 55th Purs. Sq. (1940–41); 69th Sv Sq. (1935–36); 70th Sv Sq. (1933–36); 77th Purs. Sq. (1939–41); 82d Obsn. Sq. (1940–41); 88th Obsn. Sq. (1935–40); 88th Recon. Sq. (1940–41).

**Units for Annual Summer Training**—316th Obsn. Sq.; 367th Obsn. Sq.

**Camp Lawrence J. Hearn, CA.** Located at Palm City, 14 miles south of San Diego, CA. Designated in honor of Maj. Lawrence J. Hearn, 21st US Inf. Placed in caretaker status 30 June 1929.

**Troops**—Elements of 11th Cav. (1919–29).

**Gray Field, WA (Military Airfield).** Located at Fort Lewis, WA. Established in 1936. Designated in honor of Maj. Hawthorne C. Gray who was killed 4 November 1927 while attempting to set a world altitude record in a balloon.

**Troops**—91st Obsn. Sq. (1936–41).

**Units for Annual Summer Training**—41st Div. Avn.; 116th Obsn. Sq.; 321st Obsn. Sq.

**Fort Lawton, WA.** Located 6 miles north of Seattle, WA. Acquired by donation in 1897. Designated in honor of Maj. Gen. Henry W. Lawton, killed in action 19 December 1899 at San Mateo, PI.

**HQ**—6th Engr. Regt. (1930–36).

**Troops**—3d Bn., 4th Inf. (1922–27); 6th Engrs., less 2d Bn. (1930–36); elements of 40th Q.M. Regt.

**Units for Annual Summer Training**—383d Inf.; 321st Engrs.; 329th Engrs.

**Camp Lewis, WA.** Located 17 miles south of Tacoma, WA. Established 18 July 1917. Designated in honor of Capt. Meriwether Lewis, co-commander of the Corps of Discovery. Designated as a National Army cantonment for the mobilization of the 91st Div. in World War I. Redesignated Fort Lewis on 30 September 1927.

**HQ**—4th Div. (1920–21); 3d Div. (1921–41); 5th Inf. Brig. (1921–22); 6th Inf. Brig. (1921–22); 3d F.A. Brig. (1921–39); 31st Brig., C.A.C. (1919–21).

**Troops**—15th Inf. (1938–41); 1st Bn., 9th F.A. (1930–40); 2d Bn., 9th F.A. (1939–40); 10th F.A. (1921–40); 1st Bn., 81st F.A. (1940); 83d F.A., less 3d Bn. (1939–40); 2d Bn, 99th F.A. (1940); 55th Regt., C.A.C. (1919–21); 57th Regt., C.A.C. (1919–21); 59th Regt., C.A.C. (1919–21); 3d Ammo. Tn. (1921–25); 6th Engrs. (1921–30, 1936–40); elements of 3d Div. Q.M. Tn.; Sp. Tps. 3d Div. (1921–39); 3d Med. Regt. (1921–22 and 1933–39); elements of 58th Q.M. Regt.; 91st Obsn. Sq. (1936–40); 3d Bln Sq. (1937–41); 14th Bln Co. (1921).

**Units for Annual Summer Training**—HQ, 34th Div.; HQ, 35th Div.; HQ, 40th Div.; HQ, 41st Div.; HQ, 66th Cav. Div.; HQ, 88th Div.; HQ, 89th Div.; HQ, 91st Div.; HQ, 96th Div.; HQ, 102d Div.; HQ, 104th Div.; HHC, 81st Inf. Brig.; HHC, 82d Inf. Brig.; HHC, 191st Inf. Brig.; HHC, 192d Inf. Brig.; HHB, 15th F.A. Brig. (RAI); HHB, 171st F.A. Brig.; HHB, 171st F.A. Brig.; HHB, 179th F.A. Brig.; 32d Inf. (RAI); 162d Inf.; 163d Inf.; 186th Inf.; 381st Inf.; 382d Inf.; 383d Inf.; 384th Inf.; 17th Cav. (RAI); 32d F.A. (RAI); 143d F.A.; 144th F.A.; 145th F.A.; 146th F.A.; 148th F.A.; 218th F.A.; 222d F.A.; 346th F.A.; 347th F.A.; 348th F.A.; 361st F.A.; 362d F.A.; 363d F.A.; 385th F.A.; 386th F.A.; 387th F.A.; 412th F.A.; 413th F.A.; 426th F.A.; 437th F.A.; 500th F.A.; 601st F.A.; 321st Ammo. Tn.; 328th Ammo. Tn.; 329th Ammo. Tn.; 331st Ammo. Tn.; 205th C.A.; 26th Engrs. (RAI); 74th Engr. Bn. (RAI); 76th Engr. Bn. (RAI); 316th Engrs.; 321st Engrs.; 329th Engrs.; 437th Engr. Bn.; 3d Med. Regt. (RAI); 17th Med. Regt. (RAI); 30th Med. Regt. (RAI); 316th Med. Regt.; 321st Med. Regt.; 329th Med. Regt.; 349th Med. Regt.; XIX Corps Q.M. Tn.; 96th Div. Q.M. Tn.; 416th Q.M. Regt.; 421st Q.M. Regt.; 41st Div. Avn.; 116th Obsn. Sq.; CMTC—Inf., Cav., F.A., Engr., S.C.; ROTC—F.A.; Engr.

**Fort MacArthur, CA.** Located 25 miles south of Los Angeles in San Pedro, CA, on Point Fermin. Set apart from public domain in 1888. Post established in 1908 on the “Lower Reservation.” “Upper Reservation” purchased that same year for construction of the coast defense batteries of the CD of Los Angeles. Designated in honor of Lt. Gen. Arthur MacArthur on 10 January 1914.

**HQ**—HD of Los Angeles (1919–41); 3d C.A. Regt. (1924–41).

**Troops**—2d, 3d, and 7th Cos., CD of Los Angeles (1919–22); 27th, 38th, and 158th C.A. Cos. (1922–24); 3d C.A., less 2d and 3d Bns.; 63d C.A. (1930–41).

**Units for Annual Summer Training**—57th C.A. (RAI); 250th C.A.; 251st C.A.; 509th C.A.; 517th C.A.; 518th C.A.; 519th C.A.; 529th C.A.; 604th C.A.; 605th C.A.; 608th C.A.; Btry A, 610th C.A.; Btry A, 625th C.A.; 626th C.A.; 628th C.A.; 975th C.A.; 976th C.A.; 977th C.A.

**McChord Field, WA (Military Airfield).** Located 10 miles south of Tacoma, WA. Established as Tacoma Field in 1937. Redesignated McChord Field on 17 December 1937. Designated in honor of Col. William C. McChord, killed in an airplane crash on 18 August 1937 near Goodland, VA.

**HQ**—17th Bomb. Gp. (1940–41).

**Troops**—34th Bomb. Sq. (1940–41); 73d Bomb. Sq. (1940–41); 89th Recon. Sq. (1940–41); 91st Obsn. Sq. (1940–41); 95th Bomb. Sq. (1940–41).

**Fort McDowell, CA.** Located 6 miles northeast of San Francisco on Angel Island. Established 12 September 1863 as Camp Reynolds. Redesignated Fort McDowell on 4 April 1900. Designated in honor of Maj. Gen. Irvin McDowell, US Army, who was the commanding general of the I Corps, Army of the Potomac and later of the Departments of the East and South after the war.

**Troops**—Overseas Discharge and Replacement Detachment.

**March Field, CA (Military Airfield).** Located 10 miles southeast of Riverside, CA. Established 23 March 1918. Designated in honor of 2d Lt. Peyton C. March Jr. who was killed in an airplane crash on 12 February 1918 at Fort Worth, TX. Designated a Reserve airdrome and flying field.

**HQ**—1st Bomb. Wing (1931–33 and 1940–41); 1st Purs. Wing (1933–35); 9th Purs. Wing (1940–41); 15th Bomb. Wing (1940–41); 7th Bomb. Gp. (1931–34 and 1935–37); 13th Sch. Gp. (1927–31); 17th Purs. Gp. (1940–41); 19th Bomb. Gp. (1935–41).

**Troops**—1st WX Sq. (1936–41); HQ and 4th Air Base Sq. (1936–40); 9th Aero Sq. (1919–21); 9th Obsn. Sq. (1921–23); 9th Bomb. Sq. (1931–34); 11th Bomb. Sq. (1931–34); 19th Purs. Sq. (1921–22); 23d Bomb. Sq. (1921–22); 30th Bomb. Sq. (1935–41); 31st Bomb. Sq. (1931–34); 32d Bomb. Sq. (1935–41); 34th Purs. Sq. (1931–35); 34th Atk. Sq. (1935–39); 34th Bomb. Sq. (1939–40); 36th Bomb. Sq. (1940); 38th Rcn. Sq. (1936–41); 44th Obsn. Sq. (1927); 47th Sch. Sq. (1927–31); 53d Sch. Sq. (1927–31); 54th Sch. Sq. (1927–31); 54th Bomb. Sq. (1935–36); 64th Sv Sq. (1930–36); 70th Sv Sq. (1927–33); 73d Purs. Sq. (1931–35); 73d Atk. Sq. (1935–39); 73d Bomb. Sq. (1939–41); 76th Sv Sq. (1932–36); 89th Rcn. Sq. (1940); 91st Obsn. Sq. (1940–41); 93d Bomb. Sq. (1935–41); 95th Purs. Sq. (1927 and 1931–35); 95th Atk. Sq. (1935–39); 95th Bomb. Sq. (1939–41).

**Fort Mason, CA.** Located within the city limits of San Francisco at Black Point on San Francisco Bay. Set apart from public domain in 1850. Post established in 1863 as Camp at San Jose Point. Redesignated Fort Mason in 1882 in honor of Col. Richard B. Mason, veteran of various Indian campaigns and the War with Mexico.

**HQ**—US Army Transport Sv (1919–41); San Francisco Port of Embarkation.

**Troops**—4th M. Rep. Bn. (1922–31); Det., 8th Sig. Sv Co.

**Mather Field, CA (Military Airfield).** Located east of Sacramento, CA. Established 21 February 1918. Designated in honor of 2d Lt. Carl S. Mather who was killed 20 January 1918 in an airplane crash at Ellington Field, TX. Designated a subpost of the Presidio of San Francisco on 21 October 1927; relieved as a subpost on 14 October 1930; closed on 15 October 1932. Redesignated a subpost of the Presidio of San Francisco on 8 November 1932; transferred as a subpost to the control of Hamilton Field on 13 May 1935.

**HQ**—20th Purs. Gp. (1930–32).

**Troops**—55th Purs. Sq. (1930–32); 77th Purs. Sq. (1930–32); 80th Sv Sq. (1930–32); 91st Aero Sq. (1919).

**Units for Annual Summer Training**—316th Obsn. Sq.; 367th Obsn. Sq.; 476th Purs. Sq.; 477th Purs. Sq.; 478th Purs. Sq.; 479th Purs. Sq.

**Fort McDowell, CA.** Located on Angel Island in San Francisco Bay, 7 miles north of San Francisco, CA. Set apart from public domain in 1850. Post established in 1864 as Camp Reynolds. Redesignated in 1900 in honor of Maj. Gen. Irvin McDowell, commander of the Army of the Potomac in 1861 and of the Department of the Pacific, 1864–72 and 1876–82.

**Troops**—OV Disch. and Repl. Dep (1919–41); Det., 8th Sig. Sv Co.

**Fort Miley, CA.** Located to the west and adjacent to Fort Winfield Scott, CA, at Point Lobos on the south side of the Golden Gate Bridge. A subpost of Fort Winfield Scott. Acquired by condemnation in 1893. Designated in 1900 in honor of Lt. Col. John D. Miley, who died in 1899 in Manila, PI.

**Troops**—18th Co., CD of San Francisco (1919–22); caretaking detachment, 6th C.A. (1924–41).

**Fort Missoula, MT.** Located on the east bank of the Bitter Root River, 4 miles southwest of Missoula, MT. Established in 1877.

**Troops**—1st Bn., 58th Inf. (1921–41); 1st Bn., 4th Inf. (1922–41).

**Units for Annual Summer Training**—163d Inf.; 384th Inf.; 414th Inf.; 416th Inf.; CMTC—Inf.

**Moffett Field, CA (Military Airfield).** Located 2 miles northeast of Mountain View, CA. Established 12 December 1930 as Sunnyvale Naval Air Station. Redesignated in honor of Rear Admiral William A. Moffett, Chief of the Navy Bureau of Aeronautics, who was killed 4 April 1933 in the crash of the dirigible U.S.S. *Akron*. Airfield transferred from the US Navy to the US Army on 25 October 1935.

**HQ**—20th Purs. Gp. (1939–40); 28th Bomb. Gp. (1940–41); 35th Purs. Gp. (1940–41).

**Troops**—HQ and 9th Air Base Sq. (1936–40); 18th Purs. Sq. (1940); 20th Purs. Sq. (1940); 21st Purs. Sq. (1940–41); 55th Purs. Sq. (1939–40); 77th Purs. Sq. (1939–40); 79th Purs. Sq. (1939–40); 82d Obsn. Sq. (1937–40); 19th Ash. Sq. (1936–37).

**Units for Annual Summer Training**—316th Obsn. Sq.

**Camp/Fort Ord, CA.** See Gigling Military Reservation.

**Pole Mountain Military Reservation, WY.** Located 30 miles west of Cheyenne, WY, in Albany County. Later redesignated Fort Francis E. Warren Target and Maneuver Reservation. A subpost of Fort D.A. Russell/Francis E. Warren, WY.

**Units for Annual Summer Training**—HHC, 206th Inf. Brig.; HHT, 58th Cav. Brig.; 414th Inf.; 115th Cav.; 324th Cav.; A/58th MG Sq.; 328th Ammo. Tn.

**Presidio of Monterey, CA.** Located in Monterey, CA. A Spanish military post named in honor of the Count of Monterey. Garrisoned during the Civil War, then abandoned. Reoccupied in 1902 and reconstructed. Designated Camp Ord in 1903. Redesignated the Presidio of Monterey in 1904.

**HQ**—11th Cav. Regt. (1919–41); 76th F.A. (1940–41).

**Troops**—11th Cav. (1919–41); 2d Bn., 76th F.A. (1922–41).

**Units for Annual Summer Training**—HQ, 40th Div.; HQ, 91st Div.; HHC, 79th Inf. Brig.; HHC, 181st Inf. Brig.; HHT, 4th Cav. Brig. (RAI); HHB, 166th F.A. Brig.; HHB, 171st F.A. Brig.; 361st Inf.; 362d Inf.; 363d Inf.; 364th Inf.; 17th Cav. (RAI); 323d Cav.; 162d MG Sq.; 31st F.A. (RAI); 346th F.A.; 347th F.A.; 346th F.A.; 347th F.A.; 348th F.A.; 414th F.A.; 426th F.A.; 439th F.A.; 446th F.A.; 447th F.A.; 453d F.A.; 316th Ammo. Tn.; 349th Ammo. Tn.; 309th Obsn. Bn.; 316th Engrs.; 349th Engrs.; 385th Engrs.; 386th Engrs.; 302d Chem. Regt.; 3d Med. Regt. (RAI); 17th Med. Regt. (RAI); 316th Med. Regt.; IX Corps Q.M. Tn.; XIX Corps Q.M. Tn.; 91st Div. Q.M. Tn.; CMTC—Cav., F.A.; ROTC—F.A.

**Presidio of San Francisco, CA.** Located in San Francisco, CA. Established by the Spanish in 1776. Occupied by US forces in 1849.

**HQ**—Fourth Army (1933–41); Ninth Corps Area (1920–41); Ninth CA District (1920–41); 30th Inf. Regt. (1922–41).

**Troops**—19th Inf. (1921–22); 32d Inf. (1920–21); 44th Inf. (1919–20); 30th Inf. (1922–41); 67th Arty. Regt., C.A.C.; 3d Div. Q.M. Tn.; elements of 58th Q.M. Regt and 98th Q.M. Bn.; 24th Bln Co. (1920).

**Units for Annual Summer Training**—HQ, 34th Div.; HQ, 35th Div.; HQ, 40th Div.; HQ, 41st Div.; HQ, 66th Cav. Div.; HQ, 91st Div.; HQ, 96th Div.; HQ, 104th Div.; HHB, 166th F.A. Brig.; 361st Inf.; 362d Inf.; 363d Inf.; 364th Inf.; 250th C.A.; 316th Ammo. Tn.; 349th Ammo. Tn.; 302d Chem. Regt.; 316th Med. Regt.; IX Corps Q.M. Tn.; 91st Div. Q.M. Tn.

**Rockwell Field, CA (Military Airfield).** Located on North Island in San Diego Harbor. Established in 1913 as North Island Field. Later renamed in honor of 2d Lt. Lewis G. Rockwell, killed 28 September 1912 in an airplane crash. Rockwell Field was transferred to the US Navy on 25 October 1935.

**HQ**—7th Bomb. Gp. (1928–31); 19th Bomb. Gp. (1932–35).

**Troops**—2d Aero Sq. (1919–20); 4th Obsn. Sq. (1922–27); 4th Trans. Sq. (1935–38); 9th Bomb. Sq. (1928–31); 11th Bomb. Sq. (1928–31); 18th Obsn. Sq. (1921–22); 30th Bomb. Sq. (1932–35); 32d Bomb. Sq. (1932–35); 76th Sv Sq. (1930–32); 91st Aero Sq. (1920); 95th Purs. Sq. (1928–31); 95th Bomb. Sq. (1940–41).

**Units for Annual Summer Training**—HQ, 329th Obsn. Gp.; 367th Obsn. Sq.; 368th Obsn. Sq.; 366th Obsn. Sq.; 372d Obsn. Sq.; 381st Sv Sq.; 440th Obsn. Sq.; 441st Obsn. Sq.; 476th Purs. Sq.; 477th Purs. Sq.; 478th Purs. Sq.; 479th Purs. Sq.; 489th Bomb. Sq.; 490th Bomb. Sq.; 509th Purs. Sq.; 510th Purs. Sq.; 511th Purs. Sq.; 512th Purs. Sq.; 514th Obsn. Sq.

**Fort Rosecrans, CA.** Located on the west side entrance of San Diego Harbor, 6 miles from San Diego, CA. Set apart from public domain in 1852. Designated in honor of Maj. Gen. William S. Rosecrans, commanding general of the Army of the Cumberland 1862–63.

**HQ**—6th Inf. Brig. (1927–31); HD of San Diego.

**Troops**—1st and 3d Cos., CD of San Diego (1919–22); 28th C.A. Co. (1922–24); 2d Bn., 3d C.A. (1924–41); 19th C.A. (1940–41).

**Units for Annual Summer Training**—976th C.A.

**Ross Field, CA (Military Airfield).** Located 16 miles northeast of Los Angeles near Arcadia, CA. Established 3 June 1918. Designated in honor of 1st Lt. Cleo J. Ross, 8th Bln. Co., who was killed in action 26 September 1918 over Brabant, France. Intermediate landing field. Returned to control of the state of California on 1 July 1930.

**Troops**—1st Bln Co. (1919–22); 2d Bln Co. (1919–22); 3d Bln Co. (1919–20); 13th Bln Co. (1919–22); 15th Bln Co. (1919–22); 16th Bln Co. (1919–22).

**Units for Annual Summer Training**—HQ, 549th Bln. Gp.; 333d Bln Co.; 334th Bln Co.; 335th Bln Co.; 336th Bln Co.; 373d Bln Co.; 374th Bln Co.; 375th Bln Co.; 376th Bln Co.; 346th Bln Sv Co.

**Fort D.A. Russell, WY.** Located 3 miles from Cheyenne, WY. Transferred to Eighth Corps Area jurisdiction in May 1927. Redesignated Fort Francis E. Warren, WY, 1 January 1930. Transferred to Ninth Corps Area jurisdiction on 1 July 1939.

**HQ**—12th Inf. Brig. (1921–22); 4th Inf. Brig. (1927–39); 15th Cav. Regt. (1919–20); 4th Cav. Regt. (1924–27); 13th Cav. Regt. (1920–26); 76th F.A. Regt. (1922–40).

**Troops**—1st Inf. (1927–39); 20th Inf. (1927–39); 53d Inf. (1921–22); 4th Cav., less 1st Sq. (1922–27); 13th Cav. (1920–27); 15th Cav. (1919–20); 76th F.A., less 2d Bn. (1922–40); elements of 28th Q.M. Regt. and 39th Q.M. Regt.

**Units for Annual Summer Training**—HHT, 58th Cav. Brig.; HHT, 162d Cav. Brig.; HHB, 178th F.A. Brig.; HHB, 179th F.A. Brig.; 324th Cav.; 385th F.A.; 386th F.A.; 387th F.A.; 328th Ammo. Tn.; 329th Ammo. Tn.; 329th Med. Regt.; 103d Div. Q.M. Tn.

**Fort Winfield Scott, CA.** Located contiguous to, and a subpost of, the Presidio of San Francisco. Established in 1853. Designated in honor of Lt. Gen. Winfield Scott, commanding general of the US Army in the Mexico Campaign, 1847, and of the US Army 1841–61.

**HQ**—HD of San Francisco (1919–41); 6th C.A. Regt. (1924–41); 63d C.A. Regt. (1921–30).

**Troops**—2d, 3d, 8th, 9th, 10th, 12th, 15th, 16th, and 19th Cos., CD of San Francisco (1919–22); 13th, 60th, 64th, and 67th C.A. Cos. (1922–24); 55th Arty., C.A.C. (1919); 57th Arty., C.A.C. (1919); 59th Arty., C.A.C. (1919); 63d C.A. (1921–30); 6th C.A. (1924–41); 65th C.A. (1938–41); 2d Bn., 18th C.A. (1940–41); West Point Preparatory School (1933–41); School for Cooks and Bakers.

**Units for Annual Summer Training**—57th C.A. (RAI); 517th C.A.; 518th C.A.; 604th C.A.; 605th C.A.; 606th C.A.; 608th C.A.; 624th C.A.; 625th C.A.; 626th C.A.; 627th C.A.; 628th C.A.; CMTC—C.A.C.

**Fort Stevens, OR.** Located 2 miles west of Warrenton, OR, on Point Adams. Established in 1852. Designated in honor of Maj. Gen. Isaac I. Stevens, killed in action 1 September 1862 at the Battle of Chantilly, VA.

**HQ**—HD of the Columbia (1919–41); 18th C.A. (1940–41).

**Troops**—1st, 2d, 3d, and 4th Cos., CD of the Columbia (1919–22); 34th C.A. Co. (1922–24); 3d Bn., 3d C.A. (1924–41); 18th C.A., less 2d Bn. (1940–41).

**Units for Annual Summer Training**—218th F.A.; 249th C.A.; 629th C.A.

**Fort Townsend, WA.** Located on the west side of Port Townsend Bay, 5 miles from Port Townsend, WA. Post established in 1856; set apart from public domain in 1859.

**Troops**—Caretaking detachment, 14th C.A. (1924–41).

**Vancouver Barracks, WA.** Located in Vancouver, WA. Established in 1848 as Columbia Barracks. Redesignated Vancouver Barracks in 1879 in honor of Capt. Vancouver, discoverer of the Columbia River.

**HQ**—8th Inf. Brig. (1921–22); 5th Inf. Brig. (1922–39).

**Troops**—7th Inf., less 2d Bn. (1922–41); 59th Inf. (1921–22).

**Units for Annual Summer Training**—HHC, 191st Inf. Brig.; 381st Inf.; 382d Inf.; 383d Inf.; 544th Inf. Bn.; CMTC—Inf.

**Fort Ward, WA.** Located at Bean Point on Bainbridge Island, 1 mile south of Port Blakely, WA. Acquired by condemnation in 1899. Designated in honor of Col. George H. Ward, 15th Massachusetts Volunteer Inf., who was mortally wounded at Gettysburg, 2 July 1863.

**Troops**—16th Co., CD of Puget Sound (1919–22); 150th C.A. Co. (1922–24); caretaking detachment, 14th C.A. (1924–41).

**Fort Francis E. Warren, WY.** See Fort D.A. Russell.

**Fort Whitman, WA.** Located on Goat Island, WA. Acquired by purchase in 1908. Designated in honor of Marcus Whitman, a distinguished American pioneer. A subpost of Fort Worden, WA.

**Troops**—Caretaking detachment, 14th C.A. (1924–41).

**Fort Worden, WA.** Located at Point Wilson, 2 miles north of Port Townsend, WA. Set apart from public domain in 1866. Designated in honor of Admiral John L. Worden, US Navy, captain of the U.S.S. *Monitor* during its battle with the C.S.S. *Virginia* in Hampton Roads, VA, in 1862.

**HQ**—HD of Puget Sound (1919–41); 14th C.A. Regt. (1924–41).

**Troops**—1st, 2d, 3d, 4th, and 5th Cos., CD of Puget Sound (1919–22); 106th and 108th C.A. Cos. (1922–24); 1st Bn., 14th C.A. (1924–41); 3d Bn., 14th C.A. (1924–35 and 1941).

**Units for Annual Summer Training**—205th C.A.; 248th C.A.; 249th C.A.; 509th C.A.; 529th C.A.; 628th C.A.; 629th C.A.; 630th C.A.; 979th C.A. CMTC—C.A.C.

**Fort George Wright, WA.** Located 4 miles west of Spokane, WA. Acquired by donation in 1895. Designated in honor of Brig. Gen. George Wright, U.S.V., veteran of the Indian wars.

**HQ**—21st Inf. Regt. (1919–21); 58th Inf. Regt. (1921–22); 4th Inf. Regt. (1922–41).

**Troops**—58th Inf., less 1st Bn. (1921–22); 4th Inf., less 1st and 3d Bns (1922–40).

**Units for Annual Summer Training**—384th Inf.; 414th Inf.; CMTC—Inf.

#### National Guard

**Boise Barracks, ID.** Located on the eastern edge of Boise, ID. Occupied 1869. Set apart from public domain 3 May 1873.

**Units for Annual Summer Training**—HQ, 24th Cav. Div.; HHT, 57th Cav. Brig.; HHT, 58th Cav. Brig.; 1st Bn., 200th Inf.; 414th Inf.; 116th Cav.; 116th Engrs.; 1st Bn., 148th F.A.; 385th F.A.; 386th F.A.; 387th F.A.; 24th Cav. Div. Avn.; 120th Obsn. Sq.

**Camp Clatsop, OR.** Located near Gearhardt, OR, 10 miles south of Astoria, OR. Established on leased land in early 1927. Purchased by the state of Oregon in the 1930s. Named for Clatsop County and the Clatsop Indians.

**Units for Annual Summer Training**—HQ, 41st Div.; HHC, 82d Inf. Brig.; 162d Inf.; 186th Inf., 218th F.A.; 249th C.A.; 116th Med. Regt.

**Felts Field, WA (Civilian Airport).** Located at Parkwater, WA, near Spokane. Established in February 1919 as Earl Hoisington Field; later redesignated Parkwater Field. Redesignated Felts Field in September 1927 in honor of Lt. James Buell Felts, who was killed 29 May 1927 in an airplane crash at the field.

**Troops**—116th Obsn. Sq. (1925–41).

**Units for Annual Summer Training**—41st Div. Avn.; 116th Obsn. Sq.

**Griffith Park Airport, CA (Civilian Airfield).** Located at Griffith Park near Los Angeles, CA. Established in 1912 as the Griffith Park Aerodrome. Abandoned in 1939.

**Troops**—40th Div. Avn. (1925–29); 115th Obsn. Sq. (1925–39).

**Units for Annual Summer Training**—40th Div. Avn.; 115th Obsn. Sq.

**Camp Guernsey, WY.** Located at Guernsey, WY. Established in 1938 as an alternative training site to the Pole Mountain Reservation as it was determined that the latter post was not adequate for cavalry training and would be an especially poor location if the state's National Guard units had to mobilize in the winter.

**Units for Annual Summer Training**—HQ, 24th Cav. Div.; HHT, 58th Cav. Brig., 115th Cav., 24th Rcn. Sq.

**Fort William Henry Harrison, MT.** Located 6 miles west of Helena, MT. Established 23 September 1895 as Fort Benjamin Harrison. Redesignated Fort William Henry Harrison in honor of the ninth president of the United States. Ownership transferred to the Montana National Guard in 1913.

**Units for Annual Summer Training**—HQ, 41st Div.; 163d Inf., 41st M.P. Co.; elements of 116th Q.M. Regt.

**Camp Jackson, OR.** Located 1 mile northeast of Medford, OR. Temporarily established in 1925 for the training of the Oregon National Guard. Purchased in 1927 but superceded as a training site by Camp Clatsop that same year. Subsumed by Camp White in World War II.

**Units for Annual Summer Training**—HQ, 41st Div.; HHC, 82d Inf. Brig.; 162d Inf.; 186th Inf., 218th F.A.; 249th C.A.; 116th Engrs.

**Camp McQuaide, CA.** Located at Capitola, CA. Established in 1926. Expanded in 1938. Designated in honor of Maj. Joseph P. McQuaide, Chaplain of the 250th C.A.

**Units for Annual Summer Training**—250th C.A.; 509th C.A.; 517th C.A.; 519th C.A.; 529th C.A.; 552d C.A. Bn.; 40th Div. Avn.; 115th Obsn. Sq.

**Camp Merriam, CA.** Located west of San Luis Obispo, CA. Established 4 July 1928 as Camp Merriam. Designated in honor of Frank F. Merriam, governor of California, 1934–39. Redesignated Camp San Luis Obispo in 1940.

**Units for Annual Summer Training**—HQ, 40th Div.; HHC, 79th Inf. Brig.; HHC, 80th Inf. Brig.; HHB, 65th F.A. Brig.; 159th Inf.; 160th Inf.; 184th Inf.; 185th Inf.; 143d F.A.; 144th F.A.; 115th Q.M. Regt.; 115th Med. Regt.; 40th Div. Avn.; 115th Obsn. Sq.; 367th Obsn. Sq.

**Camp Murray, WA.** Located at American Lake and adjacent to Camp Lewis, 17 miles south of Tacoma, WA. First used as a training area in 1890. Permanently established in 1903. Designated in honor of Isaiah G. Murray, early pioneer settler of the American Lake area.

**Units for Annual Summer Training**—HQ, 41st Div.; HQ Tp., 24th Cav. Div.; HHC, 81st Inf. Brig.; HHC, 82d Inf. Brig.; HHB, 66th F.A. Brig.; 160th Inf.; 161st Inf.; B/58th MG Sq.; 146th F.A.; 148th F.A.; 218th F.A.; 251st C.A.; 116th Engrs.; 116th Q.M. Regt.; 116th Med. Regt.

**Camp San Luis Obispo, CA.** See Camp Merriam.

**Camp W.G. Williams, UT.** Located 15 miles south of Salt Lake City at Lehi, UT. Established in 1914 as the Jordan Narrows Maneuver Grounds. Redesignated in 1928 in honor of Brig. Gen. William G. Williams, adjutant general of Utah.

**Units for Annual Summer Training**—HHB, 59th F.A. Brig.; 143d F.A.; 145th F.A.; 222d F.A.; 115th Med. Regt.

### Organized Reserve

**Boeing Field/Seattle Municipal Airport, WA (Civilian Airfield).** Located 5 miles south of Seattle, WA, in the Dumkimish Valley. Established in 1928. Designated in honor of William E. Boeing, founder of the Boeing Aircraft Company. Designated as an O.R. airdrome and intermediate landing field.

**Clover Field, CA (Civilian Airfield/National Guard Aviation Facility).** Located 4 miles southeast of Santa Monica, CA. Designated in honor of Lt. Greayer “Grubby” Clover. Opened in 1922. Designated as an O.R. airdrome and intermediate landing field. O.R. flying activities transferred on 1 July 1929 to Long Beach Municipal Airport.

**Troops**—40th Div. Avn. (1924–25); 115th Obsn. Sq. (1924–25).

**Units for Annual Summer Training**—322d Purs. Gp.; 40th Div. Avn.; 115th Obsn. Sq.; 476th Purs. Sq.; 477th Purs. Sq.; 478th Purs. Sq.; 479th Purs. Sq.; 385th Sv Sq.

**Lindbergh Field, CA (Civilian Airfield).** Located at San Diego, CA. Dedicated 16 August 1928 officially as San Diego Municipal Airport-Lindbergh Field. Designated in honor of Charles Lindbergh because San Diego was the city from which Lindbergh began the journey that would ultimately result in the first solo transatlantic flight. Designated as an O.R. airdrome. O.R. activities discontinued 21 October 1941.

**Long Beach Municipal Airport, CA (Civilian Airfield).** Located at Long Beach, CA. Designated as an O.R. airdrome. O.R. activities discontinued 21 October 1941.

**Units for Annual Summer Training**—HHS, 49th Obsn. Gp.; 77th Sv Sq. (RAI); 478th Purs. Sq.; 479th Purs. Sq.; 514th Obsn. Sq.

**Los Angeles Municipal Airport, CA (Civilian Airfield).** Located at Los Angeles, CA. Designated as an O.R. airdrome.

**Oakland Municipal Airport, CA (Civilian Airfield).** Located at Oakland, CA. Designated as an O.R. airdrome. O.R. activities discontinued 21 October 1941.

**Troops**—316th Obsn. Sq. (1936–37); 367th Obsn. Sq. (1922–37); 381st Sv Sq. (1936–37).

**Units for Annual Summer Training**—316th Obsn. Sq.; 367th Purs. Sq.; 381st Sv Sq.

**Pearson Field, WA (Military Airfield).** Located at Vancouver Barracks, WA. Established in 1905 as a dirigible field to support coast defenses; upgraded to a fixed wing landing field in 1921. Designated 16 September 1925 in honor of Lt. Alexander Pearson, who was killed in 1924 in an aircraft accident. Designated as an O.R. airdrome and intermediate landing field.

**Troops**—321st Obsn. Sq. (1922–41).

**Units for Annual Summer Training**—HQ, 349th Bomb. Gp.; 321st Obsn. Sq.; 489th Bomb. Sq.; 490th Bomb. Sq.; 492d Bomb. Sq.

**Sand Point Airdrome, WA (Civilian Airfield).** Located 8 miles northeast of Seattle, WA. Designated as an O.R. airdrome and intermediate landing field.

**Salt Lake City Municipal Airport, UT (Civilian Airfield).** See Woodward Field, UT.

**Woodward Field, UT (Civilian Airfield).** Located at Salt Lake City, UT. Established in 1920. Boxer Jack Dempsey christened the field in honor of John P. Woodward, a well-known aviation pioneer from Salt Lake City. Later redesignated the Salt Lake City Municipal Airport in 1930. Designated as an O.R. airdrome and intermediate landing field.

**Units for Annual Summer Training**—329th Obsn. Sq.



## HAWAIIAN DEPARTMENT

HQ—Honolulu, TH, 1 October 1911–18 June 1921; Fort Shafter, TH, 19 June 1921–as of 7 December 1941.

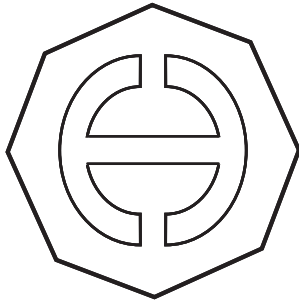

The Hawaiian Department was established in the US Army on 1 October 1911 as a separate department with headquarters at Honolulu, TH. The Hawaiian Department included all of the Hawaiian Islands and their dependencies. The department had the mission of the defense of the Hawaiian archipelago including all land areas, coastal defenses, harbor defenses, air defenses and, in coordination with the US Navy, sea defenses out to medium bomber range. Additionally, it had the responsibility to lay, maintain, and clear harbor defense minefields that would be emplaced in wartime. The department's main defense plan centered on a combination of land, sea, and air forces that would work together in joint operations to repel an invasion from the sea. The primary ground force was the Hawaiian Division, the US Army's most complete and largest division in the pre-World War II era. The division's mission called for the 21st

Inf. Brig. to defend landing areas on the north half of the island of Oahu, while the 22d Inf. Brig. defended the southern half. The outlying islands of Hawaii, Maui, Kauai, and Molokai were to be defended by the 298th and 299th Inf. Regts. of the Hawaii National Guard. The defense of Oahu's harbors was a joint responsibility of the US Army and US Navy. The Army's forces consisted of the HD of Pearl Harbor and the HD of Honolulu, which manned fixed and mobile coast artillery and antiaircraft artillery positions primarily in the Pearl Harbor and Honolulu harbor areas. Additionally, the US Army mine planter boats assigned to the Hawaiian C.A. District would place numerous sea mines in fields protecting the approaches to the harbor areas. The 5th Comp. Gp., and later the 18th Comp. Wing, protected the islands from air and sea attack out to medium bomber range. Beyond that limit, the Navy had responsibility for engaging enemy sea and air forces. The activities of the department in the prewar years consisted primarily of a series of exercises, usually in participation with the Navy, and generally held in February or March of each year. These operations exercised the full range of units and at times included marines providing an actual invasion force. The Hawaiian Department established the Hawaiian Department Service Command on 1 August 1935 and began assigning both R.A. and Reserve personnel to the service command a short time later. The mission of the command was to assist the department commander in ensuring that all military, civil, and industrial mobilization efforts were coordinated during an emergency. As World War II approached, the activities of the department increased as did the number of troops stationed in the islands. By October 1941, the Hawaiian Division had been reorganized into the 24th and 25th Divs, all C.A. assets were integrated into the Hawaiian C.A. Cmd, and the air corps units were assigned to the new Hawaiian Air Force. Such was the organization of the Hawaiian Department forces on 7 December 1941 when they participated in the defense of Pearl Harbor.

**Events:** 33, 75, 88, 120, 138, 141, 158

### Major Commands in the Department

Hawaiian Division  
 Hawaiian Coast Artillery District (1921–25)  
 Hawaiian Separate Coast Artillery Brigade (1925–41)  
 18th Composite Wing (1931–41)

### Department Commanders

Maj. Gen. Charles G. Morton	13 July 1919–5 August 1921	Maj. Gen. William Lassiter	24 October 1930–14 September 1931
Maj. Gen. Charles P. Summerall	5 August 1921–11 August 1924	Maj. Gen. Briant H. Wells	14 September 1931–30 September 1934
Maj. Gen. Charles T. Menoher	11 August 1924–12 January 1925	Maj. Gen. Halstead Dorey	1 October 1934–18 March 1935
Maj. Gen. Edward M. Lewis	12 January 1925–26 August 1927	Maj. Gen. Hugh A. Drum	18 March 1935–30 July 1937
Maj. Gen. William R. Smith	26 August 1927–24 January 1928	Maj. Gen. Andrew Moses	30 July 1937–16 March 1938
Maj. Gen. Fox Conner	25 January 1928–8 August 1930	Lt. Gen. Charles D. Herron	17 March 1938–7 February 1941
Maj. Gen. Edwin B. Winans	8 August 1930–23 October 1930	Lt. Gen. Walter C. Short	7 February 1941–16 December 1941

### Major posts, camps, stations, airfields, and N.G. and O.R. training facilities in the department.

#### Regular Army

**Fort Armstrong, TH.** Located on Kaakaukui Reef, Honolulu Harbor. Acquired from the Navy Department 1909–11. Designated in honor of Col. Samuel G. Armstrong, commander 8th US Colored Troops and brevet brigadier general, U.S.V.

**Troops**—6th and 8th Cos, CD of Oahu (1919–21); 104th C.A. Co. (1922–24); 8th Co., CD of Honolulu (1921–22); elements of 11th Q.M. Regt. and 90th Q.M. Bn. (1936–40).

**Fort Barrette, TH.** Located on the Kapolei military reservation. Designated by War Department GO #10, 23 November 1934. Designated in honor of Brig. Gen. John D. Barrette, C.A.C.

**Troops**—Battery C, 15th C.A. (1934–41).

**Fort De Russey, TH.** Located at Waikiki near Honolulu on Oahu, TH. Acquired by purchase 1904–15. Designated in honor of Col. René E. DeRussey, Corps of Engineers, brevet major general, and veteran of the War of 1812 and the Civil War.

**HQ**—Hawaiian C.A. District (1927–35); Hawaiian Sep. C.A. Brig. (1929–41); 16th C.A. (1924–27).

**Troops**—9th and 10th Cos, CD of Oahu (1919–21); 9th and 10th Cos., CD of Honolulu (1921–22); 10th C.A. Co. (1922–24); 1st and 2d Bns., 16th C.A. (1924–31); 2d Bn., 55th C.A. (1935–41).

**Hickam Field, TH.** Located at Halawa, 6 miles west of Honolulu, on Oahu, TH. Established 9 April 1935. Designated 6 June 1935 in honor of Lt. Col. Horace M. Hickam, killed in 1934 in an aircraft accident at Fort Crockett, TX.

**HQ**—18th Comp. Wing (1937–41); 5th Bomb. Gp. (1939–41); 11th Bomb. Gp. (1940–41).

**Troops**—4th Recon. Sq. (1939–41); Base HQ and 17th Air Base Sq. (1936–40); 23d Bomb. Sq. (1939–41); 26th Atk. Sq. (1930–39); 26th Bomb. Sq. (1940–41); 31st Bomb. Sq. (1938–41); 42d Bomb. Sq. (1940–41); 50th Rcn. Sq. (1939–41); 72d Bomb Sq. (1939–41).

**Fort Kamehameha, TH.** Located 9 miles west of Honolulu on Queen Emma Point, Oahu, TH. Acquired 1907–11. Originally named Fort Upton. Redesignated Fort Kamehameha in 1909 in honor of Kamehameha I, King of Hawaii.

**HQ**—HD of Pearl Harbor; 55th C.A. Regt. (1921–41).

**Troops**—1st, 2d, 3d, 4th, 5th, and 7th Cos, CD of Oahu (1919–21); 1st, 2d, 3d, 4th, 5th, and 7th Cos, CD of Pearl Harbor (1921–22); 68th, 75th, 125th, and 185th C.A. Cos. (1922–24); 1st Bn., 15th C.A. (1924–32); 41st C.A. (1921–41); 1st Bn., 41st C.A. (1931–41); 3d Bn., 55th C.A. (1921–25); 1st Bn., 55th C.A. (1925–41); 21st Bln Co. (1920–22).

**Luke Field, TH.** Located 9 miles from Honolulu on Ford's Island, Pearl Harbor, TH. Acquired in 1915. Designated in honor of 2d Lt. Frank J. Luke, AS, killed in action 28 September 1918 over Maraux, France. Designated a subpost of Hickam Field on 23 January 1939 and the designation of Luke Field discontinued.

**HQ**—5th Comp. Gp. (1921–39).

**Troops**—4th Aero Sq. (1920–22); 4th Obsn. Sq. (1927–39); 6th Purs. Sq. (1919–27); 19th Purs. Sq. (1924–27); 23d Bomb Sq. (1922–39); 50th Obsn. Sq. (1930–39); 65th Sv Sq. (1921–38); 72d Bomb. Sq. (1923–39).

**Fort Ruger, TH.** Located on Diamond Head, 6 miles from Honolulu. Set apart from public domain for military purposes in 1906. Designated in honor of Maj. Gen. Thomas H. Ruger who served as a division commander in the Army of the Potomac during the Civil War.

**HQ**—HD of Honolulu.; 16th C.A. Regt. (1927–41).

**Troops**—11th, 12th, 13th, and 14th Cos., CD of Oahu (1919–21); 11th, 12th, 13th, and 14th Cos., CD of Honolulu (1921–22); 105th C.A. Co. (1922–24); 2d Bn., 55th C.A. (1924–35); 1st Bn., 16th C.A. (1924–31); 2d Bn., 16th C.A. (1924–31); 3d Bln Co. (1920–22).

**Schofield Barracks, TH.** Located 25 miles north of Honolulu. Set apart from public domain for military purposes in 1899. Post established in 1909. Designated in honor of Lt. Gen. John M. Schofield, commanding general, US Army 1888–95.

**HQ**—Hawaiian Div. (1921–41); 21st Inf. Brig. (1921–41); 22d Inf. Brig. (1921–41); 11th F.A. Brig. (1921–41).

**Troops**—19th Inf. (1922–41); 21st Inf. (1921–41); 27th Inf. (1921–41); 35th Inf. (1920–41); 44th Inf. (1921); 17th Cav. (1919–21); 8th F.A. (1921–41); 11th F.A. (1921–41); 13th F.A. (1920–41); 11th Ammo. Tn. (1921–30); 3d Engrs. (1921–41); 11th Med. Regt. (1921–41); 11th Tank Co.; Hawaiian Div. Q.M. Tn. (1921–36); Sp. Tps., Hawaiian Div.; elements of 1st Gas Regt.; A Co., 1st Chem. Bn.; 75th Sv Sq. (1930–36).

**Units for Annual Summer Training**—298th Inf.; ROTC—Inf.

**Fort Shafter, TH.** Located at Kahuaiki, 3 miles northwest of Honolulu. Set apart from public domain for military purposes in 1899. Post established in 1907. Designated in honor of Maj. Gen. William R. Shafter, commanding general, V Corps, 1898.

**HQ**—Hawaiian Department (1919–41), Hawaiian C.A. District (1921–27); HD of Honolulu; Hawaiian Sep. C.A. Brig. (1925–29); 18th Comp. Wing (1931–38); 14th Purs. Wing (1940–41).

**Troops**—64th C.A. (1921–41); 1st Bn., 55th C.A. (1921–25).

**Fort Weaver, TH.** Located at Pearl Harbor, Oahu, TH. Established 27 March 1922. Designated in honor of Maj. Gen. Erasmus M. Weaver, Chief of C.A. Designated as a subpost of Fort Kamehameha on 1 November 1923.

**Troops**—Caretaking detachment, 15th C.A.

**Wheeler Field, TH.** Located at Schofield Barracks, TH. Established in February 1922 as a subpost of Schofield Barracks. Designated as the Hawaiian Division AS Flying Field on 10 March 1922. Redesignated Wheeler Field on 3 July 1922 in honor of Maj. Sheldon H. Wheeler, commander of nearby Luke Field, who was killed 13 July 1921 in a flying accident. Relieved as a subpost of Schofield Barracks on 31 August 1939 and made a separate station.

**HQ**—18th Purs. Gp. (1927–41).

**Troops**—4th Obsn. Sq. (1922–27); 6th Purs. Sq. (1927–41); Base HQ and 18th Air Base Sq. (1936–40); 19th Purs. Sq. (1921–22 and 1927–41); 26th Atk. Sq. (1930–39); 75th Sv Sq. (1930–38); 78th Purs. Sq. (1940–41); 86th Obsn. Sq. (1940–41).

### **National Guard**

**Kilauea Military Camp, TH.** Located on the island of Hawaii, west of the town of Hilo, TH. Established in 1916. Turned over to the R.A. in 1921, but still used by the Hawaii National Guard for training.

**Units for Annual Summer Training**—Hawaiian Div.; 298th Inf.; 299th Inf.

**Iolani Barracks, TH.** Located on Hotel Street, Honolulu Hawaii, TH. Acquired by the Hawaii National Guard in 1893. Turned over to the R.A. in 1895 and occupied until 1917. Returned to the state of Hawaii in 1931 and used as the HQ, Hawaii National Guard.

**Paukukalo Reservation, TH.** Located on the island of Maui, TH.

**Units for Annual Summer Training**—299th Inf.

**Wailuki Reservation, TH.** Located on the island of Maui, TH.

**Units for Annual Summer Training**—299th Inf.

## PHILIPPINE DEPARTMENT

HQ—Fort Santiago, PI, 6 February 1913—as of 7 December 1941.



The Philippine Department was established in the US Army on 6 February 1913 as a separate department with headquarters at Fort Santiago, Manila, PI. The Philippine Department included all of the Philippine Archipelago and the US Army Forces in China (except during the period 1 April 1923–11 February 1929). The department had the mission of the defense of the Philippine archipelago including all land areas, coastal defenses, harbor defenses, air defenses, and, in coordination with the US Navy, sea defenses out to medium bomber range. Additionally, it had the responsibility to lay, maintain, and clear harbor defense minefields that would be emplaced in wartime. The department's main defense plan consisted of a slow and determined retrograde operation by US and Philippine Army units southward on the island of Luzon onto the Bataan Peninsula. There, a defensive line would be established and anchored on the Mariveles Mountains. The 31st Inf. was to deploy to Corregidor as a beach defense force to assist the harbor defenses in holding Manila Bay. Department units would continue to defend until reinforcements from the United States and Hawaii relieved them,

in accordance with War Plan ORANGE. The primary ground forces were the several divisions of the Philippine Army and the US Army's Philippine Division, which was largely manned by Philippine Scouts. The Philippine Division's mission called for the 23d and 24th Inf. Brigs. to concentrate in the vicinity of Fort Stotsenberg, while the 26th Cav. screened forward of the division and its flanks. The defense of Manila and Subic Bays was a joint responsibility of the US Army and US Navy. The Army's forces consisted of the Harbor Defenses Manila and Subic Bays, which manned fixed and mobile coast artillery positions primarily on Forts Drum (El Fraile) and Mills (Corregidor) and the Bataan Peninsula. Additionally, the US Army Mine Planters, *Gen. Henry Knox* and *Gen. Henry J. Hunt*, and later the *Col. George F.E. Harrison*, assigned to the Harbor Defenses Manila and Subic Bays, would place numerous sea mines in fields protecting the approaches to the harbor areas. The 4th Comp. Gp. protected the islands from air and sea attack out to medium bomber range. Beyond that limit, the US Navy had responsibility for engaging enemy sea and air forces. The activities of the department in the prewar years consisted primarily of a series of joint exercises with the Navy, usually held in January or February of each year. The defense plan was practiced extensively by department units from 1922 to 1940 and essentially executed, in the macro sense, as planned from December 1941 to May 1942. The department also had under its command, at different times, the US Army Forces in China, which had the responsibility of providing protection and stability for the United States' interests and citizens in the American enclave in Tientsen, China. The mission of the US Army Forces in China was discontinued in April 1938 after it became apparent that its maintenance was no longer warranted. By April 1941, the Philippine Division had been provisionally reorganized into the "triangular" concept. The air corps units were assigned to the new Far East Air Force, and the HQ, Philippine Department was consolidated with HQ, US Army Forces, Far East on 27 July 1941. Such was the organization of the Philippine Department forces on 7 December 1941.

**Events:** 44, 51, 68

### Major Commands in the Department

Philippine Division  
Harbor Defenses of Manila and Subic Bays  
US Army Forces in China (1919–23 and 1929–38))

### Department Commanders

Brig. Gen. Francis H. French	16 February 1919–23 November 1919	Maj. Gen. John L. Hines	2 October 1930–9 April 1932
Maj. Gen. Francis J. Kernan	23 November 1919–6 March 1922	Maj. Gen. Ewing E. Booth	9 April 1932–7 September 1933
Maj. Gen. William M. Wright	6 March 1922–10 September 1922	Brig. Gen. Stanley H. Ford	7 September 1933–19 September 1933
Maj. Gen. Omar Bundy	10 September 1922–3 October 1922	Brig. Gen. Frank S. Cocheu	19 September 1933–16 December 1933
Maj. Gen. George W. Read	3 October 1922–18 November 1924	Maj. Gen. Frank Parker	16 December 1933–11 December 1935
Maj. Gen. James H. McRae	18 November 1924–24 February 1926	Maj. Gen. Charles E. Kilbourne	11 December 1935–13 February 1936
Maj. Gen. William Weigel	25 February 1926–4 May 1926	Maj. Gen. Lucius R. Holbrook	13 February 1936–25 February 1938
Maj. Gen. Fred W. Sladen	4 May 1926–30 April 1928	Maj. Gen. John H. Hughes	26 February 1938–24 July 1939
Maj. Gen. William Lassiter	30 April 1928–1 October 1928	Maj. Gen. Walter S. Grant	24 July 1939–10 June 1940
Maj. Gen. Douglas MacArthur	1 October 1928–2 October 1930	Maj. Gen. George Grunert	10 June 1940–December 1941

### Commanders, US Army Forces in China

Brig. Gen. William D. Connor	1 April 1923–May 1926	Col. Reynolds J. Burt	27 June 1932–7 July 1935
Brig. Gen. Joseph C. Castner	May 1926–14 April 1929	Col. George A. Lynch	7 July 1935–14 May 1937
Col. James D. Taylor	15 April 1929–27 June 1932	Col. Joseph A. McAndrew	14 May 1937–15 March 1938

#### Major posts, camps, stations, and training areas in the department.

**American Barracks, China.** Located at Tientsen, China. Abandoned in April 1938.

**HQ**—US Army Forces in China (1919–38).

**Troops**—15th Inf., less 1st Bn. (1919–38).

**Camp Burrowes, China.** Located on the coast at Chingwingtao, China. Used by companies of the 15th Inf. for tactical and marksmanship training during the summer months. Abandoned in April 1938.

**Clark Field, PI.** Located adjacent to Fort Stotsenburg, 57 miles north of Manila on the island of Luzon. Established in March 1912 as the Philippine Air School. Later redesignated Air Service Station, Camp Stotsenburg. Redesignated in November 1920 in honor of Maj. Harold M. Clark who was killed 2 May 1919 in a seaplane crash in Panama.

**Troops**—2d Obsn. Sq. (1940–41); 3d Purs. Sq. (1920–38); 14th Bomb. Sq. (1941); 17th Purs. Sq. (1941); 20th Purs. Sq. (1941); 28th Bomb. Sq. (1921–23 and 1938–41); 30th Bomb. Sq. (1941); 66th Sv Sq. (1921–29); 93d Bomb. Sq. (1941).

**Cuartel de España, Manila, PI.** Located in the southernmost portion of the Intramuros District of Manila. Former Spanish Army Barracks. Occupied 1911.

**HQ**—24th Inf. Brig. (1922–30); 31st Inf. Regt. (1920–41).

**Troops**—1st Bn., 31st Inf. (1920–41).

**Cuartel de Infanteria, Manila, PI.** Located on the west bank of the Pasig River, east of the Intramuros District of Manila. Also known as Estado Mayor. Former Spanish Army Barracks. Occupied 1911.

**Troops**—2d and 3d Bns., 31st Inf. (1920–41).

**Fort Drum, PI.** Located on the island of El Fraile in Manila Bay. Set apart from public domain for military purposes 21 January 1913. Designated in honor of Brig. Gen. Richard C. Drum, veteran of the Mexican War and Civil War. Commonly referred to as the “Concrete Battleship.”

**Troops**—2d and 19th Cos., CD of Manila and Subic Bays (1919–22); elements of the 59th and 91st C.A. Regts. (1924–41).

**Camp Eldridge, PI.** Located at Los Banos on the island of Luzon. Set apart from public domain for military purposes in 1903. Designated in honor of Capt. Bogardus Eldridge, 14th US Inf., killed in action during the Philippine Insurrection.

**Troops**—Elements of the 57th Inf.

**Fort Frank, PI.** Located on Carabao Island in Manila Bay. Established 31 January 1913. Designated in honor of Brig. Gen. Royal T. Frank, US Army, who served with distinction during the Civil War and the Spanish-American War. Maintained in a caretaker status 1924–40.

**Troops**—10th Co., CD of Manila and Subic Bays (1919–22); 276th C.A. Co. (1922–24).

**Camp John Hay, PI.** Located at Bagio on the island of Luzon. Set apart from public domain for military purposes in 1903. Designated in honor of Col. John Hay, U.S.V. and later Secretary of State.

**Troops**—Cos. A and B, 45th Inf. (1920–41).

**Fort Hughes, PI.** Located on Pulo Caballo Island in Manila Bay. Established 31 January 1913. Designated in honor of Maj. Gen. Robert P. Hughes, US Army, who served with distinction during the Civil War and the Spanish-American War. Maintained in a caretaker status 1924–40.

**Troops**—9th Co., CD of Manila and Subic Bays (1919–22); 23d C.A. Co. (1922–24).

**Kindley Field, PI.** Located near Fort Mills on the island of Corregidor in Manila Bay.

**Troops**—2d Obsn. Sq. (1920–29); 17th Bln Co. (1920–22).

**Fort William McKinley, PI.** Located at Rizal, 9 miles southeast of Manila. Acquired by purchase 1902–04. Designated in honor of William McKinley, 25th President of the United States.

**HQ**—Philippine Div. (1922–41); 23d Inf. Brig. (1921–41).

**Troops**—1st Bn., 15th Inf. (1921–29); 43d Inf. (1921–22); 45th Inf. less 1st Bn. (1921–41); 57th Inf. (1920–41); 60th C.A. (1923–29); 1st Bn., 14th Engrs. (1921–41); 12th Med. Regt. (1922–41); Sp. Tps., Philippine Div. (1922–41); 12th Q.M. Regt. (1936–41).

**Fort Mills, PI.** Located on the Island of Corregidor at the mouth of Manila Bay. Consisted of three garrison levels: “Topside,” “Middleside,” and “Bottomside.” Set apart from public domain for military purposes in 1902. Designated in honor of Brig. Gen. Samuel M. Mills, US Army, Chief of Artillery 1905–06.

**HQ**—HD of Manila and Subic Bays.

**Troops**—1st, 3d, 4th, 7th, 8th, 11th, 14th, 15th, 16th, 17th, 18th, and 20th Cos., CD of Manila and Subic Bays (1919–22); 4th, 36th, 42d, 95th, 111th, 275th, 277th–286th, and 289th C.A. Cos. (1922–24); 62d Inf. (1921); 59th C.A. (1922–41); 91st C.A. less 3d Bn. (1924–41); 92d C.A. (1924–41); 2d Aero Sq. (1919–20).

**Nichols Field, PI.** (See Camp Nichols)

**Camp Nichols, PI.** Located at Maricaban, Rizal, on the Island of Luzon, 6 miles from Manila. Established about 1912. Designated in honor of Capt. Taylor A. Nichols, Philippine Scouts. Redesignated Nichols Field on 10 June 1929.

**HQ**—4th Comp. Gp. (1921–41).

**Troops**—2d Obsn. Sq. (1929–40 and 1941); 3d Aero Sq. (1919–20); 3d Purs. Sq. (1938–40); Base HQ and 20th Air Base Sq. (1936–40); 17th Purs. Sq. (1940–41); 20th Purs. Sq. (1940–41); 21st Purs. Sq. (1941); 28th Bomb. Sq. (1923–38); 66th Sv Sq. (1929–36).

**Pettit Barracks, PI.** Located at Zamboanga, Island of Mindinao. Designated in honor of Lt. Col. James S. Pettit, 8th US Inf.

**Troops**—1st Bn. (less A and B Cos.), 45th Inf. (1920–41).

**Fort Santiago, PI.** Located in the northernmost portion of the Intramuros District of Manila, fronting the Pasig River. Former Spanish fortification. Rebuilt 1731. Occupied by the US Army in 1900.

**HQ**—Philippine Department (1919–41).

**Troops**—Philippine Div. Q.M. Tn. (1922–36).

**Camp Stotsenberg, PI.** Located at Angeles, 57 miles northeast of Manila on the Island of Luzon. Set apart from public domain for military purposes in 1903. Designated in honor of Col. John M. Stotsenberg, 1st Nebraska Volunteers, killed in action 23 April 1899 at Quiga, Bulacan Province, Luzon. Redesignated Fort Stotsenberg on 25 February 1929.

**HQ**—HHB, 12th F.A. Brig. (1921–22); Det., HQ, Philippine Div. (1922–41).

**Troops**—9th Cav. (1919–22); 26th Cav. (1922–41); 24th F.A. (1921–41); 25th F.A. (1921–22); 1st Bn., 23d F.A. (1936–41).

**Fort Wint, PI.** Located on Grande Island at the center of the entrance to Subic Bay. Set apart from public domain for military purposes in 1905. Designated in honor of Brig. Gen. Theodore J. Wint, US Army, who served with distinction during the Civil War, Indian Wars, and the Spanish-American War. Maintained in a caretaker status 1924–40.

## PANAMA CANAL DEPARTMENT

HQ—Ancon, CZ, 26 June 1917–1 April 1920; Quarry Heights, CZ, 1 April 1920–as of 7 December 1941.

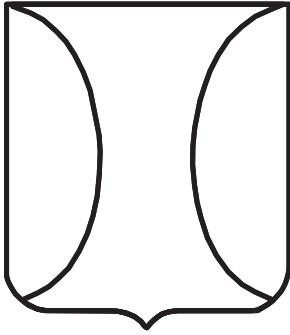

The Panama Canal Department was separated from the Eastern Department on 26 June 1917 and established in the US Army as a separate command. Initially, the department headquarters was at Ancon, CZ, then relocated to Quarry Heights on 1 April 1920. The Panama Canal Department included land and sea areas of the Canal Zone and had the mission of the defense of the Canal Zone including all land areas, coastal defenses, harbor defenses, air defenses, and sea defenses out to medium bomber range. Additionally, it had the responsibility to lay, maintain, and clear harbor defense minefields that would be emplaced at the entrances to the canal in wartime. The department's main defense plan consisted of opposing landings at either end of the Canal Zone in coordination with US naval forces. Initially, the Panama Canal Division was the major land force for the defense of the Canal Zone. The division assigned the 19th Inf. Brig. the mission to defend beaches and inland areas of the Atlantic side. The 20th Inf. Brig. was assigned the mission to defend beaches and inland areas of the Pacific side. The Panama C.A. District was to operate as a separate command under the Panama Canal Department and would provide coastal defense against naval vessels and landing craft. On 7 May 1931, Major General Preston Brown, the department commander, recommended to the War Department that the Panama Canal Division and Panama C.A. District be discontinued, and be replaced by two "groups," which would form integrated commands combining the units of the inactivated division and the existing coast artillery harbor defense headquarters. These two commands would be responsible for the defense of the Atlantic and Pacific areas. This recommended reorganization was tested during department maneuvers in early 1932, then approved by the War Department on 17 March 1932. The reorganization was made permanent on 15 April 1932. The changes included the activation of the Headquarters and Headquarters Companies of the Atlantic and Pacific Sectors; the integration of all active elements of the inactivated Panama Canal Division, and those of the 1st and 4th C.A. Regts. into the sectors. The reorganization also included the inactivation of the following units: HHC, 19th Inf. Brig.; HQ, Panama Canal Division; HQ, Special Troops, Panama Canal Division; HQ and M.P. Co., Panama Canal Division; HQ, Panama C.A. District; and the 2d and 65th C.A. Regts. The 1st and 4th C.A. Regts. were reorganized under special tables of organization to include both harbor defense and antiaircraft battalions in each regiment. Though the Panama Canal Division was inactivated, it was kept on the rolls of the Army in an inactive status until 1938 and, theoretically, could be reactivated in a matter of hours in the event it was needed for deployment outside of Panama. The sector organization (at least as tactical headquarters) was in effect until the C.A. units were relieved from the sectors and assigned to the newly organized Panama Separate C.A. Brig. on 1 November 1939. Shortly thereafter, on 16 February 1940, the Atlantic and Pacific Sectors were discontinued and the remaining ground units were reorganized into the Panama Mobile Force. To reinforce the Panama Canal Department, the 18th Inf. Brig. was transferred to the Canal Zone on 21 October 1939 and assigned to the Panama Mobile Force. The additional infantry regiments, which arrived with the 18th Inf. Brig., made the Panama Mobile Force essentially a division-size organization. Therefore, after the reorganization of 1939–40 the ground defense units in the Canal Zone were essentially back to the configuration under which they were originally organized in 1921.

**Events:** 26, 31, 36, 40, 43, 58, 69, 81, 101, 102, 119, 140, 167

### Major Commands in the Department

Panama Canal Division (1922–32)  
Pacific Sector (1932–40)  
Atlantic Sector (1932–40)  
Panama Mobile Force (1940–41)  
Panama Coast Artillery District (1919–32)  
Panama Separate Coast Artillery Brigade (1939–41)  
19th Composite Wing (1933–41)

### Department Commanders

Brig. Gen. Chase W. Kennedy	18 April 1919–23 May 1921	Maj. Gen. Preston Brown	24 November 1930–4 September 1933
Brig. Gen. Edwin B. Babbitt	24 May 1921–22 October 1921	Maj. Gen. Harold B. Fiske	5 September 1933–10 November 1935
Maj. Gen. Samuel D. Sturgis	22 October 1921–19 September 1924	Maj. Gen. Lytle Brown	10 November 1935–29 July 1936
Maj. Gen. William Lassiter	19 September 1924–10 October 1926	Maj. Gen. Henry W. Butner	30 July 1936–10 February 1937
Maj. Gen. Charles H. Martin	10 October 1926–1 October 1927	Brig. Gen. Frank W. Rowell	10 February 1937–12 April 1937
Maj. Gen. William S. Graves	2 October 1927–1 April 1928	Maj. Gen. David L. Stone	12 April 1937–7 January 1940
Maj. Gen. Malin Craig	1 April 1928–10 August 1930	Lt. Gen. Daniel Van Voorhis	7 January 1940–17 September 1941
Maj. Gen. George L. Irwin	10 August 1930–24 November 1930	Lt. Gen. Frank M. Andrews	17 September 1941–9 November 1942

### Major posts, camps, stations, airfields, and training areas in the department.

**Albrook Field, CZ.** Located 1 mile northwest of Panama City, CZ, contiguous with the Post of Corozal on the Corundu Military Reservation (Fort Clayton). Established in 1930 and opened for flight operations on 1 May 1932. Named for Lt. Frank P. Albrook who was killed in a flying accident at Chanute Field, IL, in 1924.

**HQ**—19th Comp. Wing (1933–41); 16th Purs. Gp. (1932–41); 37th Purs. Gp. (1940–41).

**Troops**—Base HQ and 15th Air Base Sq. (1936–40); 24th Purs. Sq. (1932–41); 28th Purs. Sq. (1940–41); 29th Purs. Sq. (1932–41); 30th Purs. Sq. (1940–41); 31st Purs. Sq. (1940–41); 34th Bomb. Sq. (1941); 43d Purs. Sq. (1940–41); 44th Obsn. Sq. (1932–37); 44th Recon. Sq. (1937–41); 74th Purs. Sq. (1933–37); 74th Atk. Sq. (1937–39); 74th Bomb. Sq. (1939–41); 78th Purs. Sq. (1932–37); 80th Sv Sq. (1932–37).

**Fort Amador, CZ.** Located on the Bay of Panama 1 mile east of Balboa on the Pacific side of the Zone. Established 25 November 1911. Named for Dr. Manuel Amador Guerrero, first president of the Republic of Panama.

**HQ**—Panama Canal Div. (1921–32); Panama C.A. District (1919–32); HD of Balboa; HHC, Pacific Sector (1932–40).

**Troops**—1st–10th Cos., CD of Balboa (1919–22); 8th, 40th, 45th, 73d, 81st, 87th, 116th, 144th C.A. Cos. (1923–24); 4th C.A. (1924–41); 65th C.A. (1924–32); HQ Btry, Sv Btry, Btrys B, C, D, E, F, G, I, K L, and O, 73d C.A. (1939–41).

**Fort Clayton, CZ.** Located at Miraflores on the Pacific side of the Zone. Originally named Corundu Military Reservation. Redesignated 30 December 1919 for Col. Bertram T. Clayton.

**HQ**—33d Inf. (1920–41).

**Troops**—33d Inf. (1920–41); 1st Bn., 2d F.A. (1934–41).

**Post of Corozal, CZ.** Located at Corozal, 2 miles west of Balboa. Included the Corundu Military Reservation. Established in May 1915.

**HQ**—11th Engrs. (1920–41).

**Troops**—11th Engrs. (1920–41); 1st Bn., 22d F.A. (1921); Panama Canal Div. Q.M. Tn. (1922–32), HHB, 3d Bn., and Btrys N, Q, R, S, T, 73d C.A. (1939–41).

**Fort William D. Davis, CZ.** Located at Gatun fronting Gatun Lake on the Atlantic side of the Zone. Established in 1916. Originally called the Post at Gatun. Redesignated Fort William D. Davis on 22 December 1919 in honor of Col. William D. Davis, 361st Inf., who was awarded the Distinguished Service Cross for actions in France, 1918.

**HQ**—19th Inf. Brig. (1921–32); 18th Inf. Brig. (1939–40).

**Troops**—13th Inf. (1939–40); 14th Inf. (1920–41); 33d Inf. (1919–20); 1st Bn., 4th F.A. (1921–27); 2d F.A. Bn. (1927–30); 1st Bn., 2d F.A. (1930–34); 1st Bn., 87th F.A. (1940); Btrys S and X, 72d C.A. (1939–41).

**Fort De Lesseps, CZ.** Located near Colon on Limon Bay on the Atlantic side of the Zone. Established in 1911 on land owned by the Panama Railroad Company. Designated in honor of Count Ferdinand de Lesseps, builder of the Panama Canal.

**HQ**—HD of Cristobal; 1st C.A. Regt. (1924–32); HHC, Atlantic Sector (1932–40).

**Troops**—6th Co., CD of Cristobal (1919–22); 119th, 192d C.A. Co. (1922–24); 1st C.A., less 3d Bn. (1924–32).

**Fort Grant, CZ.** Located on the Bay of Panama, 1 mile east of Fort Amador on the Pacific side of the Zone. A subpost of Fort Amador. Established 25 November 1911 in honor of Lt. Gen. Ulysses S. Grant, commanding general of the US Army from 1864 to 1869 and 18th President of the United States.

**Troops**—7th Co., CD of Balboa (1919–22); caretaker detachment, 4th C.A. (1924–39).



**France Field, CZ.** Located near Fort Randolph on Manzanillo Bay on the Atlantic side of the Zone. Established 9 April 1920. Designated in honor of Lt. Howard J. France, first US Army pilot killed in Panama.

**HQ**—6th Obsn. Gp. (1921–22); 6th Comp. Gp. (1922–37); 6th Bomb. Gp. (1937–41).

**Troops**—1st Dep. Sq. (1936–40); 3d Bomb. Sq. (1940–41); 7th Obsn. Sq. (1919–39); Base HQ and 16th Air Base Sq. (1936–40); 24th Purs. Sq. (1922–32); 25th Bomb. Sq. (1922–41); 39th Obsn. Sq. (1940–41); 44th Obsn. Sq. (1931–32); 63d Sv Sq. (1923–34); 78th Purs. Sq. (1931–32).

**Camp Gaillard, CZ.** Located at Culebra, 15 miles west of Panama City. Designated in honor of Lt. Col. David Gaillard, Corps of Engineers, who built the Culebra Cut.

**HQ**—20th Inf. Brig. (1921–27).

**Troops**—42d Inf. (1920–27); 1st Sq., 12th Cav. (1920–21).

**Fort Kobbe, CZ.** Located on Bruja Point on the west bank of the Panama Canal's Pacific entrance. Established in 1925 as the Bruja Point Military Reservation. Redesignated Fort Kobbe on 15 April 1932 in honor of Maj. Gen. William A. Kobbe, who was instrumental in the development of American C.A. tactical doctrine. C.A. batteries remained in caretaker status until 1939.

**Troops**—A/73d C.A. (1939–41); 3d Battalion, 4th C.A. (1940–41).

**Quarry Heights, CZ.** Located 1 mile south of Panama City at Ancon Hill. It was located on the site of a quarry from which stone was cut to build the Panama Canal. Designated 22 December 1919.

**HQ**—Panama Canal Department (1920–41); 12th Purs. Wing (1940–41); Panama Separate C.A. Brig. (1939–41).

**Troops**—Sp. Tps., Panama Canal Div. (1922–32).

**Fort Randolph, CZ.** Located on Margarita Island, 3 miles northeast of Cristobal. Established 24 November 1911. Named on 9 April 1920 in honor of Maj. Gen. Wallace F. Randolph, chief of artillery.

**HQ**—72d C.A. Regt. (1939–41).

**Troops**—7th, 8th, 9th, and 10th Cos., CD of Cristobal (1919–22); 15th, 21st, and 194th C.A. Cos. (1923–24); 1st and 3d Bns., 1st C.A. (1924–32); elements of the 65th C.A.; HQ Btry, Sv Btry, Btrys G, H, K L, M, N, O, P, Q, R, U, V, and W, 72d C.A. (1939–41).

**Fort Sherman, CZ.** Located on Toro Point, 3 miles northwest of Cristobal. Established 24 November 1911. Designated in honor of Lt. Gen. William T. Sherman, commanding general of the Army of the Tennessee and the Military Div. of the Mississippi during the Civil War and of the US Army from 1869 to 1883.

**HQ**—2d C.A. Regt. (1924–32); 1st C.A. Regt. (1932–41).

**Troops**—1st, 2d, 3d, 4th, 5th, and 11th Cos., CD of Cristobal (1919–22); 16th, 44th, 124th, and 192d C.A. Cos. (1923–24); 1st Bn., 1st C.A. (1932–41); 2d Bn., 1st C.A. (1932–41); 2d C.A. (1924–32); elements of the 65th C.A.; 1st Bn. and Btry E, 72d C.A. (1939–41); U.S.A.M.P. *Cyrus W. Field*; U.S.A.M.P. *Gen. William M. Graham*; U.S.A.J.M.P. *Lt. Col. Herman C. Schumm*.

**Rio Hato Field, Panama.** Located at Rio Hato, Panama, 55 miles southwest of Balboa in the Republic of Panama.

**Troops**—1st Bomb. Sq. (1940–41); 5th Bomb. Sq. (1940–41); 29th Purs. Sq. (1940); 31st Purs. Sq. (1940); 99th Bomb. Sq. (1940–41).



## Chapter 4

### General Headquarters and Field Armies

Using the 1920 National Defense Act as its basis for postwar organization of the Army, the War Department appointed a special committee on 21 June 1920 to “. . . define the general plan of organization to be adopted for the Army provided by the Act of June 4, 1920.” That committee ultimately submitted to the War Department a plan that called for a General Headquarters Reserve (GHQR) and six field armies consisting of about two million men. After a number of false starts, the concept of a six-army force took hold and was solidified in War Department mobilization planning by late 1921.

#### The General Headquarters (GHQ)

Ultimately, the War Plans Division (WPD) determined that another major headquarters (HQ) would be needed to assume control over the six field armies in the event of mobilization and function as a theater command in the event of an overseas deployment. This realization led to the constitution of the HQ, GHQ in 1927. Like most of the changes to the organization of the US Army in the immediate post-World War I era, the constitution of the GHQ was an outgrowth of the Army’s experiences with the American Expeditionary Force (AEF) in France. Thus, the WPD developed the concept of the GHQ to function as a HQ for commanding and controlling the postmobilization training of the six field armies and as an army group HQ within the theater of operations. Under this concept, the Chief of Staff, US Army was to take command as the army group and theater commander. The HQ for GHQ was to be organized, more or less, along the lines of the AEF, with the WPD forming the nucleus of the staff in the event of mobilization.

The subordinate units of the GHQ consisted of a number of headquarters support units and a number of major commands that controlled specialized units assigned to the GHQR, including engineer, signal, and chemical units. Other subordinate commands included the six field armies. Most of these elements were organized as Organized Reserve (O.R.) or Regular Army Inactive (RAI) units in the late 1920s and early 1930s, but none actually functioned as controlling HQ. At least once, for the GHQ command post exercise (CPX) held in New Jersey in 1934, the GHQ was organized provisionally (General Douglas MacArthur commanding) to function as a theater command for a homeland defense exercise. With the creation of the GHQ Air Force in 1935 and the Armored Force in 1940, those organizations were added to the list of GHQ subordinate commands.

When the GHQ was activated on 26 July 1940 at the War College in Washington, DC, the original mission of the headquarters was modified. Though he was the GHQ commanding general, General George C. Marshall, the Army’s Chief of Staff, chose to exercise actual command of the Army’s tactical units through the War Department General Staff rather than through the GHQ. Marshall delegated only the training functions to the GHQ and charged its chief of staff, Major General Lesley J. McNair, with the authority for supervision of the training of the Army’s mobile units. As World War II approached, the role of the GHQ remained a training function and a few months after Pearl Harbor, the command was redesignated as HQ, Army Ground Forces in recognition of its revised mission.

<b>T/O: 502W Approved: 11 June 1928</b>									
<b>General Headquarters</b>		<b>Commanding general and Aids</b>	<b>Chief of Staff</b>	<b>Deputy Chief of Staff</b>	<b>Secretary to the General Staff</b>	<b>Personnel Section G1</b>	<b>Intelligence Section G2</b>	<b>Operations and Training Section G3</b>	<b>Supply Section G4</b>
<b>Staff Group</b>	<b>General</b>	<b>General</b>	<b>General</b>	<b>General</b>	<b>General</b>	<b>General</b>	<b>General</b>	<b>General</b>	<b>General</b>
General	1	--	--	--	--	--	--	--	--
Major Generals	--	1	--	--	--	--	--	--	--
Brigadiers Generals	--	--	1	--	1	1	1	1	1
Colonels	3	--	--	1	2	2	2	2	2
Lieutenant Colonels	--	--	--	--	2	3	2	2	2
Majors	1	--	--	1	3	5	3	3	3
Captains	--	3	1	2	--	2	--	--	--
1st Lieutenants	--	--	--	1	--	--	--	--	--
2nd Lieutenants	--	--	--	--	--	--	--	--	--
Total Commissioned	5	4	2	5	8	13	8	8	8
Master Sergeants	1	1	--	--	1	2	2	2	2
Technical Sergeants	--	--	1	1	--	--	--	1	1
Staff Sergeants	--	1	--	1	1	2	2	2	2
Sergeants	1	--	--	--	--	5	--	1	1
Corporals	--	--	--	--	--	--	--	--	--
Privates First Class	2	--	1	1	3	5	4	3	3
Privates	--	--	--	1	4	5	5	5	5
Total Enlisted	4	2	2	4	9	19	13	14	14
Aggregate	9	6	4	9	17	32	21	22	22

	<b>Adjutant General's Section</b>	<b>Inspector's Section</b>	<b>Judge Advocate's Section</b>	<b>Provost Marshal's Section</b>	<b>Civilian Affairs Section</b>	<b>Finance Section</b>	<b>Chaplain's Section</b>	<b>Medical Section</b>
<b>Staff Group</b>	<b>Special</b>	<b>Special</b>	<b>Special</b>	<b>Special</b>	<b>Special</b>	<b>Special</b>	<b>Special</b>	<b>Special</b>
Brigadiers Generals	--	--	1	--	--	--	--	1
Colonels	--	--	--	1	1	1	1	12
Lieutenant Colonels	1	1	1	--	--	--	--	12
Majors	1	--	--	1	1	1	1	2
Captains	2	1	1	--	--	--	--	6
1st Lieutenants	5	--	--	1	1	1	--	2
2nd Lieutenants	6	1	--	--	--	--	--	--
Total Commissioned	4	--	3	3	3	3	2	13
Master Sergeants	1	--	1	--	--	1	--	1
Technical Sergeants	14	3	--	1	--	2	--	2
Staff Sergeants	3	1	1	1	1	2	--	3
Sergeants	--	--	--	--	1	--	--	4
Corporals	8	1	--	--	--	--	--	1
Privates First Class	5	--	1	1	1	4	1	3
Privates	--	--	2	2	2	8	2	6
Total Enlisted			5	5	5	17	3	20
Aggregate			8	8	8	20	5	33

General Headquarters table of organization and equipment.

HQ,

	Chemical Warfare Section	Ordnance Section	Quartermaster's Section	Signal Section	Engineer Section	Artillery Section	Aviation Section	Total
Staff Group	Special	Special	Special	Special	Special	Special	Special	
Brigadiers Generals	--	1	1	1	1	1	1	17
Colonels	1	1	--	--	--	--	--	21
Lieutenant Colonels	--	1	2	1	1	1	1	22
Majors	--	1	2	2	2	2	2	36
Captains	1	--	4	--	--	--	--	23
1st Lieutenants	--	--	--	--	--	--	--	8
2nd Lieutenants	--	--	--	--	--	--	--	1
Total Commissioned	2	4	9	4	4	4	4	128
Master Sergeants	1	1	1	1	1	1	1	23
Technical Sergeants	--	1	2	2	2	2	2	19
Staff Sergeants	1	1	4	2	2	2	2	36
Sergeants	--	2	9	1	--	--	--	28
Corporals	--	2	--	1	--	--	--	4
Privates First Class	1	3	4	3	3	3	3	57
Privates	2	6	8	6	6	6	6	94
Total Enlisted	5	16	21	16	14	14	14	253
Aggregate	7	20	30	20	18	18	18	381

General Headquarters table of organization and equipment (Cont).

### General Headquarters

HQ—*Not organized*, 1927–32; Washington, DC, 1932–41.

**Subordinate units:** HQ, First Army, 1927–41; HQ, Second Army, 1927–41; HQ, Third Army, 1927–41; HQ, Fourth Army, 1927–41; HQ, Fifth Army, 1927–33; HQ, Sixth Army, 1927–33; HQ, GHQ Air Force, 1935–41; HQ, Armd. Force, 1940–41; HQ, Sp. Tps., GHQ, 1927–41; Engr. HQ, GHQ, 1927–28; Engr. HQ, CZ, 1928–41; HQ, GHQ Sig. Sv, 1933–41; HQ, Chem. Tps., GHQ, 1931–41; HQ Co., GHQ, 1941.

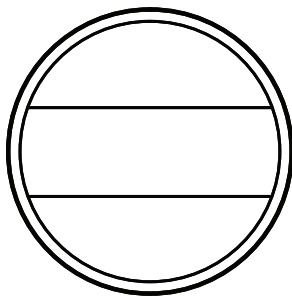

Constituted in the Regular Army (R.A.) on 15 August 1927 and allotted to the Adjutant General (Adj. Gen.) for mobilization responsibility. Partially organized 9 August 1932 at Washington, DC. GHQ (Initial) (Enlisted) was allotted 1 October 1933 to the Second Corps Area for the mobilization of enlisted personnel. The Adj. Gen. retained mobilization responsibility for officer personnel. The GHQ (Initial) (Enlisted) was further allotted 2 September 1939 to the Trenton (NJ) Military District. Partially activated 26 July 1940 at the Army War College, Washington, DC. HQ Co. GHQ was constituted 8 July 1941 and activated 14 July 1941 at the Army War College. Location 7 December 1941—Army War College, Washington, DC.

**Events:** 174, 328

#### Commanders, General Headquarters

Gen. Douglas MacArthur 9 August 1932–1 October 1935  
Gen. Malin Craig 2 October 1935–31 August 1939

Gen. George C. Marshall 1 September 1939–9 March 1940  
Maj. Gen. Leslie J. McNair\* 3 August 1940–9 March 1942

\*Technically Chief of Staff, HQ, GHQ, US Army. Effectively functioned as the acting commanding general on routine GHQ matters until reorganization of the command into HQ, Army Ground Forces on 9 March 1942.

## The Field Armies

With the adoption of a six field army force in the initial mobilization plans, the WPD further grouped the nine corps areas into three “army areas” for mobilization planning and concentration purposes. The army areas could have been used for delineating boundaries for continental defense as well, though there is little evidence that this use was ever contemplated. The First, Second, and Third Corps Areas constituted the First Army Area; the Fourth, Fifth, and Sixth Corps Areas constituted the Second Army Area; and the Seventh, Eighth, and Ninth Corps Areas constituted the Third Army Area. The boundaries for the first three field armies (First, Second, and Third) were identical with those for the second three field armies (Fourth, Fifth, and Sixth). The First through Third Armies would be composed primarily of R.A. and National Guard (N.G.) units and were to be in the first phase of mobilization priority. Most logistics and support units (i.e., quartermaster, medical, ordnance, etc.) assigned to the first three armies were O.R. units. The Fourth through Sixth Armies were to be composed almost entirely of O.R. units and would be mobilized in subsequent phases.

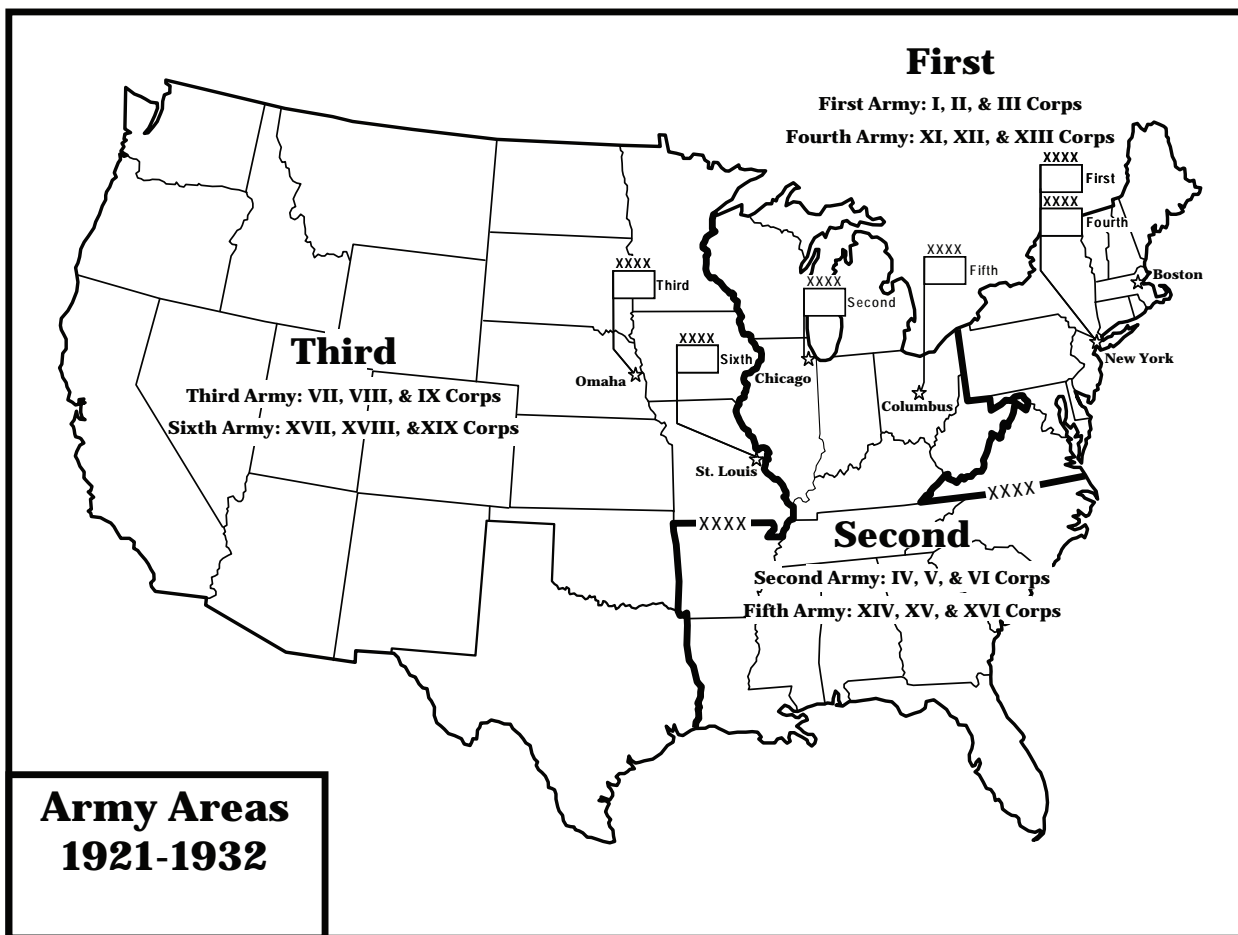

Map, Army areas, 1921.

Organizationally, the field armies before World War II were “type” organizations; that is, there was a standard table of organization for all armies. Though planners recognized that an army would need to be tailored for its specific theater mission, the units assigned to a type army were thought to be the minimum requirements for any given wartime mission. The army could then be supplemented as needed by GHQR forces if more combat power or support was needed. The 1921 version of a field army consisted of the following:

Table 201W

Approved: 29 November 1921

Commander: General

### **Personnel**

Commissioned officers:	15,467
Nurses:	990
Warrant officers:	395
Enlisted:	308,223
Aggregate:	325,075

### **Selected Key Equipment**

Airplanes:	591
Balloons:	12
Cars:	1,751
Horses and Mules:	91,482
Guns, 75-mm:	456
Guns, 155-mm:	72
Howitzers, 155-mm:	216
Machine Guns, AA:	1,170
Mortars:	108
Trucks:	13,818
Tanks:	225
Wagons:	7,056

### **Organization**

Army Headquarters

3 Army Corps

2 Cavalry Divisions

Headquarters, Army Special Troops

Headquarters Company, Army

1 Military Police Battalion

8 Service Battalions, Q.M.C.

1 Field Remount Depot, Q.M.C. (1,200 head)

3 Remount Troops

Headquarters, Army Artillery

1 Coast Artillery Brigade

1 Army Ammunition Train

1 Ordnance Company (Maintenance)

3 Coast Artillery Regiments (Antiaircraft)

Headquarters, Army Engineer Service

3 Engineer Regiments (General Service)

6 Engineer Battalions (Auxiliary)

1 Engineer Battalion (Topographic)

1 Engineer Train (Water Tank)

5 Engineer Trains (Heavy Bridge)

2 Engineer Trains (Light Bridge)

1 Engineer Train (Dump Truck)

1 Engineer Company (Camouflage)

Headquarters, Army Air Service

1 Headquarters Squadron

- 3 Airdrome Companies
- 1 Ordnance Company (Maintenance)
- 1 Headquarters, Attack Wing
  - 1 Attack Group
    - 4 Attack Squadrons
    - 1 Air Park
  - 2 Pursuit Groups
    - 8 Pursuit Squadrons
    - 2 Air Parks
  - 1 Observation Group
    - 4 Observation Squadrons
    - 1 Air Park
- Headquarters, Army Signal Service
  - 2 Signal Battalions
  - 1 Meteorological Company
  - 1 Pigeon Company
  - 1 Radio Company
- Headquarters, Army Ordnance Service
  - 1 Ordnance Company (Headquarters)
  - 1 Ordnance Company (Light Maintenance)
  - 3 Ordnance Companies (Depot)
  - 3 Ordnance Companies (Ammunition)
- Headquarters, Army Medical Service
  - 1 Army Medical Laboratory
  - 1 Medical Supply Depot
  - 4 Medical Regiments
  - 15 Evacuation Hospitals (750 bed)
  - 12 Surgical Hospitals (250 bed)
  - 1 Convalescent Hospital (5,000 bed)
  - 3 Veterinary Evacuation Hospitals (250 head)
  - 1 Veterinary Convalescent Hospital (500 horse)
- Headquarters, Army Train, Q.M.C.
  - 4 Motor Repair Battalions
  - 5 Motor Transport Commands
  - 20 Motor Transport Companies
  - 2 Motorcycle Companies
  - 4 Motor Repair Sections

The original mobilization planning that resulted in the constitution of six field army headquarters in 1921 did not envision the need for active army-level commands in peacetime. These units, therefore, were constituted in the O.R. rather than the R.A. The armies were to be manned in peacetime by reservists and mobilized in the event of war. Thus, no army headquarters were on Active Duty between 1921 and 1932, though most of these armies were active as O.R. pool units for mobilization assignments. None, however, exercised command and control of subordinate commands. Between 1927 and 1933, all six of the field army headquarters that had been constituted in the O.R. in 1921 were demobilized as the Army wrestled with structure, mobilization, and manpower issues.

The first change came in August 1927 when the HQ, First Army was demobilized at New York City due to the need for a three-corps contingency force headquarters around which all then existing active ground forces could be rapidly mobilized and employed in an emergency. O.R. units could only be mobilized for up to 14 days a year or in the event of a general mobilization for war. RAI units, however, could be mobilized



by the President for emergencies short of war. Therefore the new army, designated the Seventh Army, was constituted in the R.A. and organized as an RAI unit at New York City in place of the old First Army. Two months later, the Seventh Army was redesignated as the new First Army.

The next major change to the field armies came in 1931 when the Army's Chief of Staff, General Douglas MacArthur, directed the War Department General Staff (WDGS) to look at the feasibility of basing its mobilization plans on a four-army force, rather than the original six developed in 1921. MacArthur directed this study because he believed the previous mobilization plans were based on unsound assumptions and plans. MacArthur believed the Army would require active field army headquarters before the start of mobilization to manage the integration and training of subordinate units as they mobilized. The chief of staff judged, rightly, that trying to mobilize a headquarters at the same time as its subordinate commands were forming was an inefficient and unmanageable task. MacArthur felt that preexisting field army headquarters should fill the command void between the mobilizing field units and the War Department, thereby relieving the War Department of organization, supply, and administration of myriad individual units. MacArthur also thought that the existing system would be too ponderous in fielding a protective force that might be needed in a hurry. He further reasoned that existing mobilization plans were not flexible enough to tailor to the needs of the various war plans then in existence. Based on the findings of the directed study, MacArthur sent the corps area and department commanders a letter on 9 August 1932 that constituted three new army headquarters in the R.A. (the headquarters of the First Army was already constituted) and outlined the initial concept and organization for what became known as the "four army" plan. In the letter, MacArthur effectively abolished the six army/three army area scheme and directed that for future mobilization planning and execution, the US Army would be organized as follows:

#### GHQ

Commanding General: The Chief of Staff

Staff: War Plans Division, General Staff (and other personnel as designated)

#### Field Armies:

Commanding General: The senior corps area commander in the army area.

Staff: The corps area chief of staff and such other members of the corps area as designated by the commanding general.

First Army	Governors Island, NY	Maj. Gen. Dennis E. Nolan
Army Area Composition: First, Second, and Third Corps Areas		
Mission Area: North Atlantic coastal frontier		
Second Army	Fort Sheridan, IL	Maj. Gen. Frank Parker
Army Area Composition: Fifth and Sixth Corps Areas		
Mission Area: Great Lakes and northern land frontier		
Third Army	San Antonio, TX	Maj. Gen. Edwin B. Winans
Army Area Composition: Fourth and Eighth Corps Areas		
Mission Area: South Atlantic and Gulf of Mexico coastal frontiers and the southwest land frontier		
Fourth Army	Presidio of San Francisco, CA	Maj. Gen. Johnson Hagood
Army Area Composition: Seventh and Ninth Corps Areas		
Mission Area: Pacific coastal frontier		

All four of the new army headquarters were activated at the locations indicated in August or September 1932.

Under this new scheme, the senior corps commander in each army area was also designated as the army commander. He was given a small army staff to supplement his corps area staff. This new staff was charged with the mission of developing and coordinating training and defense plans for the army commander. It performed no functions for the corps area. Army commanders were responsible for developing frontier

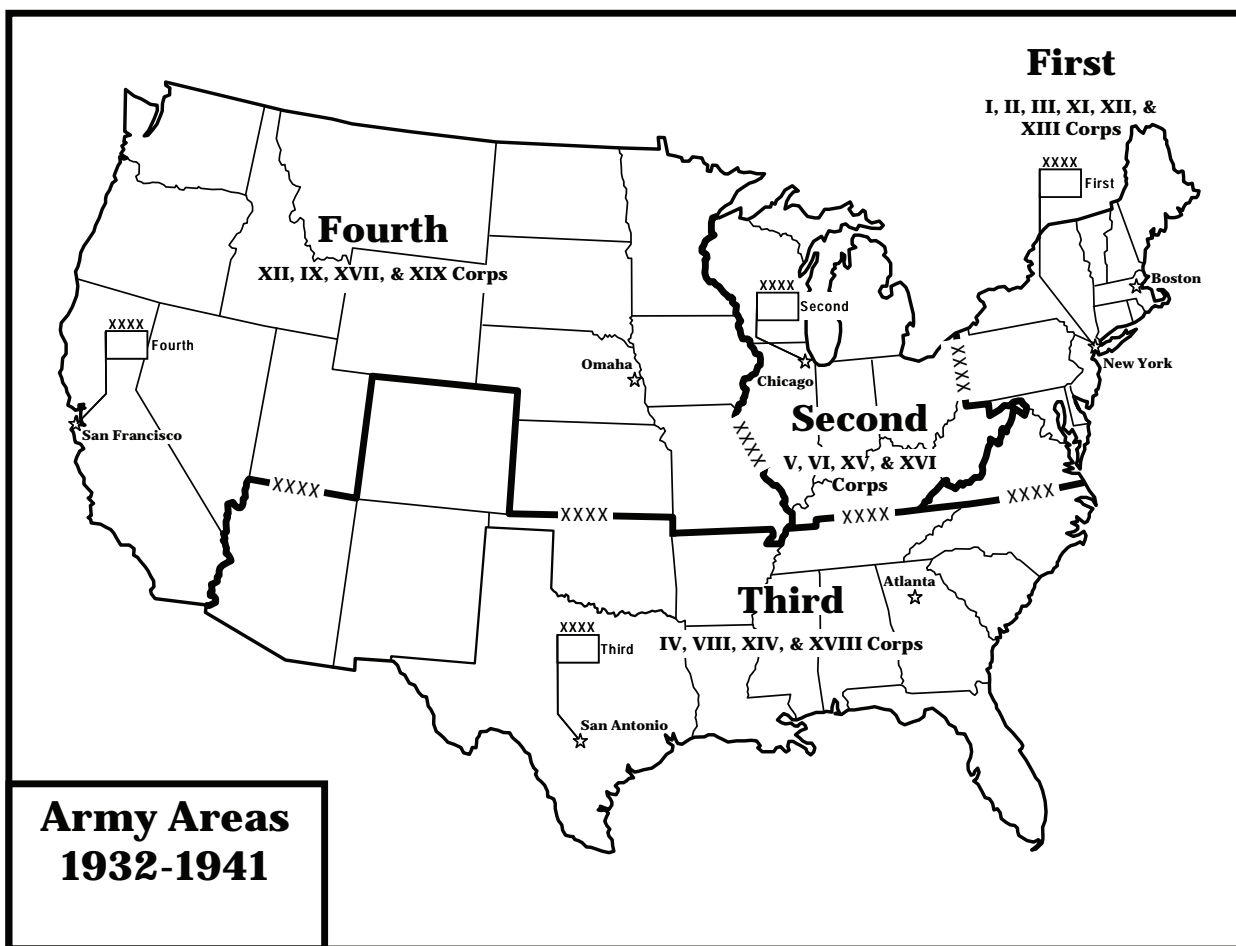

Map, Army areas, 1933.

defense and other operational plans as directed by the War Department; selecting, organizing, and training corps and army staffs; supervising assignment of personnel to maintain complete officer rosters for all units; conducting training for higher staffs and command echelons; and conducting maneuvers and command post exercises. With the adoption of the four army plan, a reorganization of the army areas was also required.

The change also required a massive reassignment of existing subordinate units in the field armies, the demobilization of unneeded units, and the constitution of new units. With the demobilization of the headquarters for the Fifth and Sixth Armies, many R.A., N.G., and O.R. units were either reassigned to another field army, to the GHQR, to the Zone of the Interior, or to the Communications Zone, or, if not needed in the new scheme, were demobilized. Additionally, an intent of these new field armies was that many of their subordinate units were to be mobilized rapidly in case of an emergency. Many of the organizations previously assigned to the armies were O.R. units that possessed the same mobilization limitations previously described. Thus, many of the field armies' O.R. units were relieved or demobilized and replaced in the field army structure by RAI units manned by reservists. All these changes to the new field army structure took effect on 1 October 1933. The type field army of 1936 was organized as follows:

### “Type” Army 1936

- Army Headquarters
- 3 Corps
- 2 Cavalry Divisions
- Headquarters, Army Special Troops

Headquarters Company, Army  
 1 Military Police Battalion  
 Army Artillery:  
 1 Coast Artillery Brigade  
 1 Army Ammunition Train  
 1 Ordnance Company (Maintenance)  
 3 Coast Artillery Regiments (Antiaircraft)  
 Army Engineers:  
 3 Engineer Regiments (General Service)  
 6 Engineer Battalions (Separate)  
 1 Engineer Battalion (Topographic)  
 1 Engineer Battalion (Water Supply)  
 1 Engineer Battalion (Camouflage)  
 1 Engineer Company (Depot)  
 1 Engineer Company (Shop)  
 1 Engineer Company (Dump Truck)  
 Army Aviation:  
 4 Airdrome Squadrons  
 1 Observation Group  
 3 Observation Squadrons  
 1 Service Squadron  
 1 Air Depot  
 2 Supply Squadrons  
 2 Repair Squadrons  
 Army Signal Service:  
 2 Signal Battalions  
 1 Meteorological Company  
 1 Pigeon Company  
 1 Radio Intelligence Company  
 1 Photographic Company  
 Army Ordnance:  
 1 Ordnance Company (Headquarters)  
 2 Ordnance Companies (Light Maintenance)  
 3 Ordnance Companies (Depot)  
 3 Ordnance Companies (Ammunition)  
 Headquarters, Army Medical Service  
 1 Army Medical Laboratory  
 1 Army Medical Supply Depot  
 6 Medical Regiments  
 16 Evacuation Hospitals (750 bed)  
 14 Surgical Hospitals (250 bed)  
 1 Convalescent Hospital (5,000 bed)  
 3 Veterinary Evacuation Hospitals (250 head)  
 1 Veterinary Convalescent Hospital (500 head)  
 Army Quartermaster:  
 2 Quartermaster Regiments (Truck–Army)  
 1 Quartermaster Regiment (Remount)  
 1 Quartermaster Battalion (Truck–Army)  
 1 Quartermaster Battalion (Car)  
 1 Quartermaster Battalion (Light Maintenance)

From 1933 to 1940 the major activities conducted by the field army headquarters were planning and executing a series of army-level CPXs and maneuvers. These training events were funded to the degree that one field army could conduct a CPX and another could conduct a maneuver each year. The intent was that the army holding the CPX would be the army that would hold the maneuver the following year. This system began in 1935 with the First Army maneuver held at Pine Camp, NY. Each year thereafter armies held the CPXs and maneuvers as planned until 1940, when all four armies took to the field to hold maneuvers. Each army also held maneuvers the following year after the mobilization of the N.G. and thousands of reservists.

A final major change to the army command structure occurred in October 1940 when the headquarters of the four field armies were physically separated from the corps areas. At that time each army was authorized to fully man its wartime staff and the army commanders were relieved of their duties as corps area commanders. Corps areas at that time were also limited to their Zone of the Interior functions as corps area service commands and the armies assumed control of all tactical units. Concurrently, command and control of the field armies for continental defense and training was transferred to GHQ. From that point forward and into World War II, the armies prepared their subordinate commands for war.

## HHC, FIRST ARMY (I)

## Organized Reserve New York

HQ—*Not organized, 1921–24; New York City, NY, 28 August 1924–15 August 1927*

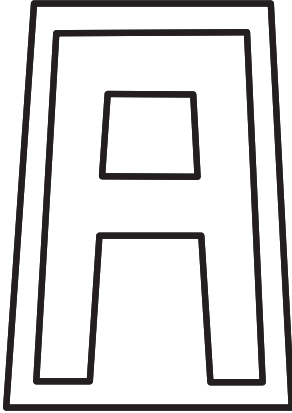

The First Army was authorized by the National Defense Act of 1920 and was to be composed of units primarily in the First, Second, and Third Corps Areas. The headquarters and headquarters company (HHC) were constituted in the O.R. on 15 October 1921 and allotted to the Second Corps Area. The HQ was initiated on 28 August 1924 at New York City, NY. The HHC were withdrawn from the O.R. on 15 August 1927 and demobilized.

### FIRST ARMY TROOPS 1923

#### UNITS:

#### COMPONENT:

#### HQ LOCATION:

<i>Headquarters, First Army</i>	<i>(ORI)</i>	<i>Second Corps Area</i>
I Corps	(O.R.)	Boston, MA
II Corps	(O.R.)	Manhattan, NY
III Corps	(O.R.)	Baltimore, MD
1st Cavalry Division	(R.A.)	Fort Bliss, TX
<i>21st Cavalry Division</i>	<i>(NGI)</i>	<i>New York N.G.</i>
Headquarters, Special Troops	(O.R.)	New York City, NY
<i>HQ Company, First Army</i>	<i>(ORI)</i>	<i>Second Corps Area</i>
324th Military Police Battalion	(O.R.)	Pittsburgh, PA
<i>116th Service Battalion, Q.M.C.</i>	<i>(NGI)</i>	<i>Virginia N.G.</i>
375th Service Battalion, Q.M.C.	(O.R.)	Pittsburgh, PA
376th Service Battalion, Q.M.C.	(O.R.)	Altoona, PA
377th Service Battalion, Q.M.C.	(O.R.)	Lewiston, PA
378th Service Battalion, Q.M.C. (C)	(O.R.)	Charlotte, NC
379th Service Battalion, Q.M.C. (C)	(O.R.)	Nashville, TN
380th Service Battalion, Q.M.C. (C)	(O.R.)	Conway, SC
381st Service Battalion, Q.M.C. (C)	(O.R.)	Atlanta, GA
<i>16th Field Remount Depot, Q.M.C.</i>	<i>(NGI)</i>	<i>New York N.G.</i>
<i>19th Remount Troop</i>	<i>(NGI)</i>	<i>New York N.G.</i>
<i>20th Remount Troop</i>	<i>(NGI)</i>	<i>New York N.G.</i>
<i>21st Remount Troop</i>	<i>(NGI)</i>	<i>New York N.G.</i>
Headquarters, First Army Artillery	(O.R.)	Fort Totten, NY
201st Coast Artillery Brigade (AA)	(O.R.)	New York City, NY
382d Ordnance Company (Maint)	(O.R.)	Brooklyn, NY
<i>141st Ammunition Train</i>	<i>(NGI)</i>	<i>Pennsylvania N.G.</i>
212th Coast Artillery Regiment (AA)	(N.G.)	New York City, NY
213th Coast Artillery Regiment (AA)	(N.G.)	Allentown, PA
533d Coast Artillery Regiment (AA)	(O.R.)	Manhattan, NY
Headquarters, First Army Engineer Service	(O.R.)	Manhattan, NY
<i>161st Engineer Regiment (GS)</i>	<i>(NGI)</i>	<i>New York N.G.</i>
<i>162d Engineer Regiment (GS)</i>	<i>(NGI)</i>	<i>Pennsylvania N.G.</i>
<i>163d Engineer Regiment (GS)</i>	<i>(NGI)</i>	<i>Pennsylvania N.G.</i>
524th Engineer Battalion (Aux) (C)	(O.R.)	Raleigh, NC
525th Engineer Battalion (Aux) (C)	(O.R.)	Memphis, TN
526th Engineer Battalion (Aux) (C)	(O.R.)	Greenville, SC
527th Engineer Battalion (Aux) (C)	(O.R.)	Atlanta, GA
590th Engineer Battalion (Aux) (C)	(O.R.)	New Haven, CT
<i>167th Engineer Battalion (Aux)</i>	<i>(NGI)</i>	<i>Virginia N.G.</i>
<i>175th Engineer Battalion (Topo)</i>	<i>(NGI)</i>	<i>New York N.G.</i>
534th Engineer Battalion (WS)	(O.R.)	Brooklyn, NY
474th Engineer Train (HB)	(O.R.)	Altoona, PA

475th Engineer Train (HB)	(O.R.)	Connelsville, PA
535th Engineer Train (HB)	(O.R.)	Bayside, NY
536th Engineer Train (HB)	(O.R.)	Hoboken, NJ
<i>177th Engineer Train (HB)</i>	<i>(NGI)</i>	<i>Pennsylvania N.G.</i>
537th Engineer Train (LB)	(O.R.)	Hamburg, NY
<i>178th Engineer Train (LB)</i>	<i>(NGI)</i>	<i>New York N.G.</i>
578th Engineer Train (DT)	(O.R.)	Philadelphia, PA
D Company, 40th Engineers (Camo)	(O.R.)	Boston, MA
Headquarters, First Army Air Service	(O.R.)	Dover, NH
446th Headquarters Squadron	(O.R.)	Dover, NH
20th Airdrome Company	(O.R.)	Albany, NY
21st Airdrome Company	(O.R.)	Albany, NY
22d Airdrome Company	(O.R.)	Harrisburg, PA
381st Ordnance Company (Maint)	(O.R.)	Hartford, CT
<i>3d Wing Headquarters</i>	<i>(RAI)</i>	<i>A.A. 2d Wing</i>
3d Attack Group	(R.A.)	Kelly Field, TX
8th Attack Squadron	(R.A.)	Kelly Field, TX
13th Attack Squadron	(R.A.)	Kelly Field, TX
26th Attack Squadron	(R.A.)	Kelly Field, TX
90th Attack Squadron	(R.A.)	Kelly Field, TX
Air Park No. 5	(R.A.)	Kelly Field, TX
315th Observation Group	(O.R.)	Harrisburg, PA
451st Observation Squadron	(O.R.)	Buffalo, NY
452d Observation Squadron	(O.R.)	Buffalo, NY
453d Observation Squadron	(O.R.)	Harrisburg, PA
454th Observation Squadron	(O.R.)	Harrisburg, PA
Air Park No. 345	(O.R.)	Harrisburg, PA
313th Pursuit Group	(O.R.)	Boston, MA
442d Pursuit Squadron	(O.R.)	Boston, MA
443d Pursuit Squadron	(O.R.)	Boston, MA
444th Pursuit Squadron	(O.R.)	Cambridge, MA
445th Pursuit Squadron	(O.R.)	Boston, MA
Air Park No. 343	(O.R.)	Boston, MA
314th Pursuit Group	(O.R.)	Mineola, Long Island, NY
447th Pursuit Squadron	(O.R.)	Mineola, Long Island, NY
448th Pursuit Squadron	(O.R.)	Mineola, Long Island, NY
449th Pursuit Squadron	(O.R.)	Albany, NY
450th Pursuit Squadron	(O.R.)	Rochester, NY
Air Park No. 344	(O.R.)	Mineola, Long Island, NY
Headquarters, First Army Signal Service	(O.R.)	Fort Jay, NY
<i>111th Signal Battalion</i>	<i>(NGI)</i>	<i>New Hampshire N.G.</i>
<i>112th Signal Battalion</i>	<i>(NGI)</i>	<i>New Jersey N.G.</i>
1st Meteorological Company	(O.R.)	Providence, RI
1st Pigeon Company	(O.R.)	Providence, RI
1st Radio Company	(O.R.)	Providence, RI
Headquarters, First Army Ordnance Service	(O.R.)	New York City, NY
630th Ordnance Company (Ammo)	(O.R.)	Manhattan, NY
631st Ordnance Company (Ammo)	(O.R.)	Dover, DE
635th Ordnance Company (Ammo)	(O.R.)	Lowell, MA
14th Ordnance Company (Maint)	(R.A.)	Springfield Armory, MA
73d Ordnance Company (Depot)	(R.A.)	Fort Bliss, TX
78th Ordnance Company (Depot)	(R.A.)	San Antonio Arsenal, TX
79th Ordnance Company (Depot)	(R.A.)	Augusta Arsenal, GA
904th Ordnance Company (HQ)	(O.R.)	Manhattan, NY
First Army Medical Headquarters	(O.R.)	New York City, NY
1st Army Medical Laboratory	(O.R.)	New York City, NY
1st Army Medical Supply Depot	(O.R.)	New York City, NY
<i>141st Medical Regiment</i>	<i>(NGI)</i>	<i>New York N.G.</i>
373d Medical Regiment	(O.R.)	Brooklyn, NY
374th Medical Regiment	(O.R.)	Manhattan, NY
375th Medical Regiment	(O.R.)	Greensburg, PA
1st Evacuation Hospital	(O.R.)	Baltimore, MD
2d Evacuation Hospital	(O.R.)	New York City, NY
3d Evacuation Hospital	(O.R.)	New York City, NY
15th Evacuation Hospital	(O.R.)	Jersey City, NJ

16th Evacuation Hospital	(O.R.)	New York City, NY
17th Evacuation Hospital	(O.R.)	Schenectady, NY
19th Evacuation Hospital	(O.R.)	Atlanta, GA
29th Evacuation Hospital	(O.R.)	Philadelphia, PA
30th Evacuation Hospital	(O.R.)	Washington, DC
31st Evacuation Hospital	(O.R.)	Washington, DC
32d Evacuation Hospital	(O.R.)	Pittsburgh, PA
38th Evacuation Hospital	(O.R.)	Greensboro, NC
39th Evacuation Hospital	(O.R.)	Knoxville, TN
40th Evacuation Hospital	(O.R.)	Augusta, GA
41st Evacuation Hospital	(O.R.)	Mobile, AL
2d Surgical Hospital	(O.R.)	Manchester, NH
3d Surgical Hospital	(O.R.)	Atlantic City, NJ
7th Surgical Hospital	(O.R.)	Scranton, PA
8th Surgical Hospital	(O.R.)	McKeesport, PA
9th Surgical Hospital	(O.R.)	Philadelphia, PA
10th Surgical Hospital	(O.R.)	New York City, NY
11th Surgical Hospital	(O.R.)	Long Island City, NY
17th Surgical Hospital	(O.R.)	Philadelphia, PA
22d Surgical Hospital	(O.R.)	Durham, NC
23d Surgical Hospital	(O.R.)	New Orleans, LA
24th Surgical Hospital	(O.R.)	Birmingham, AL
25th Surgical Hospital	(O.R.)	Jacksonville, FL
4th Convalescent Hospital	(O.R.)	Columbia, SC
12th Veterinary Evacuation Hospital	(O.R.)	Plattsburg, NY
14th Veterinary Evacuation Hospital	(O.R.)	Philadelphia, PA
16th Veterinary Evacuation Hospital	(O.R.)	Augusta, GA
1st Veterinary Convalescent Hospital	(O.R.)	Trenton, NJ
Headquarters, First Army Train, Q.M.C.	(O.R.)	Brooklyn, NY
306th Motor Repair Battalion	(O.R.)	Nashville, TN
313th Motor Repair Battalion	(O.R.)	Worcester, MA
314th Motor Repair Battalion	(O.R.)	Manhattan, NY
315th Motor Repair Battalion	(O.R.)	Grove City, PA
122d Motor Transport Command	(NGI)	Pennsylvania N.G.
376th Motor Transport Command	(O.R.)	Bronx, NY
377th Motor Transport Command	(O.R.)	Brooklyn, NY
378th Motor Transport Command	(O.R.)	Manhattan, NY
379th Motor Transport Command	(O.R.)	Jacksonville, FL
262d Motor Transport Company	(NGI)	Pennsylvania N.G.
263d Motor Transport Company	(NGI)	Pennsylvania N.G.
264th Motor Transport Company	(NGI)	Fifth Corps Area
265th Motor Transport Company	(NGI)	Fifth Corps Area
266th Motor Transport Company	(NGI)	Fifth Corps Area
658th Motor Transport Company	(O.R.)	Queens, NY
659th Motor Transport Company	(O.R.)	Brooklyn, NY
660th Motor Transport Company	(O.R.)	Brooklyn, NY
661st Motor Transport Company	(O.R.)	Manhattan, NY
662d Motor Transport Company	(O.R.)	Westfield, PA
663d Motor Transport Company	(O.R.)	Wellsboro, PA
664th Motor Transport Company	(O.R.)	Mansfield, PA
665th Motor Transport Company	(O.R.)	New York City, NY
666th Motor Transport Company	(O.R.)	Brooklyn, NY
667th Motor Transport Company	(O.R.)	Brooklyn, NY
672d Motor Transport Company	(O.R.)	Easton, MD
673d Motor Transport Company	(O.R.)	Easton, MD
674th Motor Transport Company	(O.R.)	Centerville, MD
675th Motor Transport Company	(O.R.)	Washington, DC
121st Motorcycle Company	(NGI)	Delaware N.G.
387th Motorcycle Company	(O.R.)	Manhattan, NY
171st Motor Repair Section	(NGI)	Pennsylvania N.G.
514th Motor Repair Section	(O.R.)	New London, CT
515th Motor Repair Section	(O.R.)	New York City, NY
516th Motor Repair Section	(O.R.)	York, PA

**HHC, FIRST ARMY (II)**

**HQ**—*Not organized*, 1927–32; Governor’s Island, NY, 8 September 1932–19 October 1936; Army Base, Boston, MA, 20 October 1936–26 October 1938; Governor’s Island, NY, 27 October 1938–5 October 1943

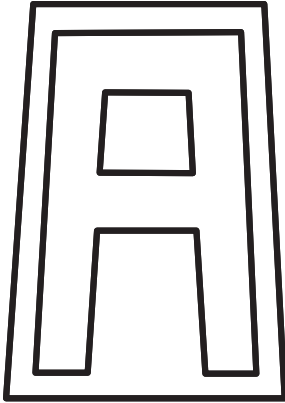

Constituted in the R.A. on 15 August 1927 as HHC, Seventh Army and allotted to the Second Corps Area. Redesignated HHC, First Army on 13 October 1927. HQ, First Army was activated 8 September 1932 at Governor’s Island, NY, and assumed control over the First, Second, and Third Corps Areas. HQ, First Army was transferred to Boston in October 1936 upon the assumption of command of Maj. Gen. Fox Conner, the senior corps area commander. It was again transferred to Governor’s Island when Maj. Gen. Hugh A. Drum took command in November 1938. The First Army mission was to develop defense and operational plans for contingencies in the North Atlantic area and the northeastern United States, review the mobilization plans of the First, Second, and Third Corps Areas, and oversee the training of mobile units in the Army area. As part of its responsibility to oversee training, the First Army planned and conducted three major maneuvers between 1935 and 1940. The 1935 maneuver was the first of the large pre-World War II army maneuvers and was held at Pine Camp, NY, in August 1935. Because of cost constraints, the troops from the Third Corps Area could not be transported to Pine Camp and so held their training at Mount Gretna and

Indiantown Gap, PA. This exercise was designed more to assemble and support a large body of troops than to conduct large-scale maneuvers, though some large unit tactical exercises were conducted. The next First Army maneuver was also a split exercise. Held in August 1939, the maneuver was conducted in the vicinity of Plattsburg, NY, for the First and Second Corps Area troops, and at Manassas, VA, for the Third Corps Area contingent. The primary focus of these exercises was to train the field army and corps staffs (all provisionally organized with corps area staffs and assigned O.R. officers) to plan and conduct large unit operations. The next maneuver held by the First Army included almost all R.A. and N.G. units of the First, Second, and Third Corps Areas in the vicinity of Canton, NY, 4–25 August 1940. Three corps headquarters (again organized provisionally), eight divisions, and numerous corps and army support units participated in this exercise. The 1940 maneuver was highly ambitious and included full-scale operations across the northern portion of the state of New York. Following the 1940 maneuver, the First Army’s order of battle was changed to reflect the assignment of the VI Corps to the troop list and the loss of the III Corps to the Fourth Army. Additionally, HQ Co., First Army, was activated 18 November 1940 at Governor’s Island. The last pre-World War II maneuver in which the First Army participated was the GHQ Carolina maneuvers held 16–27 November 1941. In this maneuver, the First Army faced a combined force of the IV Corps and the I Armored Corps along the North Carolina–South Carolina border 20 miles north of Camden, SC. This exercise was essentially a test between the old school of attrition warfare represented by the I, II, and VI Corps (composed predominantly of “square” N.G. divisions), and the new, highly mobile warfare of mechanized forces represented by the I Armored and IV Corps (composed predominantly of “triangular” R.A. infantry and armored divisions). The opposing forces each won a phase of the maneuver, so the main outcome of the exercise as determined by Gen. Lesley J. McNair was that the First Army was essentially ready for war, if given appropriate levels of manning and equipment. The units of the First Army began to return to home station at the beginning of December and the First Army HHC returned to Governor’s Island where they were located on 7 December 1941.

**Status:** HHC are active at Fort George G. Meade, MD, as HHC, First US Army.

**Events:** 174, 190, 215, 234, 280, 301, 326, 330

**Army Commanders**

Maj. Gen. Dennis E. Nolan	8 September 1932–30 April 1936	Maj. Gen. Frank R. McCoy	22 January 1938–29 July 1938
Maj. Gen. Fox Conner	1 May 1936–22 January 1938	Maj. Gen. James K. Parsons	30 July 1938–5 November 1938
	Lt. Gen. Hugh A. Drum		5 November 1938–7 October 1943

**FIRST ARMY TROOPS**

1933

**UNITS:**

Headquarters, First Army  
I Corps

**COMPONENT:**

(R.A.)  
(RAI)

**HQ LOCATION:**

Governor’s Island, NY  
Boston, MA



II Corps	(RAI)	Manhattan, NY
III Corps	(RAI)	Baltimore, MD
XI Corps	(O.R.)	Boston, MA
XII Corps	(O.R.)	Manhattan, NY
XIII Corps	(O.R.)	Baltimore, MD
Headquarters, Special Troops	(RAI)	Fort Jay, NY
HQ Company, First Army	(RAI)	Fort Jay, NY
321st Military Police Battalion	(O.R.)	New York City, NY
Army Artillery:		
31st Coast Artillery Brigade (AA)	(RAI)	Philadelphia, PA
<i>First Army Ammunition Train</i>	(RAI)	<i>Second Corps Area</i>
906th Coast Artillery Regiment (AA)	(O.R.)	Portland, ME
910th Coast Artillery Regiment (AA)	(RAI)	Garden City, NY
917th Coast Artillery Regiment (AA)	(RAI)	Roanoke, VA
29th Ordnance Company (Maint)	(R.A.)	West Point, NY
Attached Units:		
93d Infantry Brigade	(N.G.)	New York City, NY
10th Infantry Regiment	(N.G.)	Albany, NY
14th Infantry Regiment	(N.G.)	Brooklyn, NY
42d Infantry Regiment	(RAI)	Rio Piedras, PR
65th Infantry Regiment	(R.A.)	San Juan, PR
295th Infantry Regiment	(N.G.)	San Juan, PR
296th Infantry Regiment (1st Bn)	(N.G.)	Albonito, PR
369th Infantry Regiment (C)	(N.G.)	Harlem, NY
372d Infantry Regiment (C) (1 & 2 Bns)	(N.G.)	<i>(HQ allotted to Third Corps Area)</i>
373d Infantry Regiment	(O.R.)	San Juan, PR
<i>63d Infantry Battalion (Sep.) (C)</i>	(RAI)	<i>First Corps Area</i>
<i>64th Infantry Battalion (Sep.) (C)</i>	(RAI)	<i>Third Corps Area</i>
<i>66th Infantry Battalion (Sep.) (C)</i>	(RAI)	<i>Third Corps Area</i>
<i>67th Infantry Battalion (Sep.) (C)</i>	(RAI)	<i>Third Corps Area</i>
<i>68th Infantry Battalion (Sep.) (C)</i>	(RAI)	<i>Third Corps Area</i>
<i>69th Infantry Battalion (Sep.) (C)</i>	(RAI)	<i>Third Corps Area</i>
516th Infantry Battalion	(O.R.)	San Juan, PR
<i>31st Field Artillery Battalion (75-mm G)(C)</i>	(RAI)	<i>First Corps Area</i>
<i>32d Field Artillery Battalion (75-mm G) (C)</i>	(RAI)	<i>First Corps Area</i>
<i>33d Field Artillery Battalion (75-mm G) (C)</i>	(RAI)	<i>Third Corps Area</i>
<i>34th Field Artillery Battalion (75-mm G) (C)</i>	(RAI)	<i>Third Corps Area</i>
<i>35th Field Artillery Battalion (75-mm G) (C)</i>	(RAI)	<i>Third Corps Area</i>
Army Engineer Service:		
35th Engineer Regiment (GS)	(RAI)	Boston, MA
36th Engineer Regiment (GS)	(RAI)	Albany, NY
37th Engineer Regiment (GS)	(RAI)	Pittsburgh, PA
416th Engineer Battalion (Sep.)	(O.R.)	Schenectady, NY
438th Engineer Battalion (Sep.)	(O.R.)	Brooklyn, NY
439th Engineer Battalion (Sep.) (C)	(O.R.)	Bronx, NY
555th Engineer Battalion (Sep.) (C)	(O.R.)	Philadelphia, PA
626th Engineer Battalion (Sep.) (C)	(O.R.)	Roanoke, VA
627th Engineer Battalion (Sep.) (C)	(O.R.)	Washington, DC
653d Engineer Battalion (Topo)	(O.R.)	Hartford, CT
515th Engineer Battalion (WS)	(O.R.)	Summit, NJ
<i>84th Engineer Company (Depot)</i>	(RAI)	<i>Third Corps Area</i>
734th Engineer Company (Shop)	(O.R.)	Worcester, MA
578th Engineer Company (DT)	(O.R.)	Philadelphia, PA
601st Engineer Battalion (Camo)	(O.R.)	Reading, PA
Army Aviation:		
<i>10th Observation Group</i>	(RAI)	<i>Second Corps Area</i>
104th Observation Squadron	(N.G.)	Baltimore, MD
118th Observation Squadron	(N.G.)	Hartford, CT
119th Observation Squadron	(N.G.)	Newark, NJ
<i>69th Service Squadron</i>	(RAI)	<i>Second Corps Area</i>
<i>1st Air Depot</i>	(RAI)	<i>Second Corps Area</i>
<i>1st Supply Squadron</i>	(RAI)	<i>Second Corps Area</i>
2d Supply Squadron	(RAI)	New York City, NY
1st Repair Squadron	(RAI)	Rochester, NY
2d Repair Squadron	(RAI)	Rochester, NY

<i>15th Airdrome Squadron</i>	<i>(RAI)</i>	<i>Second Corps Area</i>
<i>16th Airdrome Squadron</i>	<i>(RAI)</i>	<i>Second Corps Area</i>
<i>17th Airdrome Squadron</i>	<i>(RAI)</i>	<i>Third Corps Area</i>
<i>18th Airdrome Squadron</i>	<i>(RAI)</i>	<i>Third Corps Area</i>
Army Signal Service:		
101st Signal Battalion	(N.G.)	Manhattan, NY
<i>112th Signal Battalion</i>	<i>(NGI)</i>	<i>New Jersey N.G.</i>
<i>12th Meteorological Company</i>	<i>(ORI)</i>	<i>Second Corps Area</i>
<i>4th Pigeon Company</i>	<i>(ORI)</i>	<i>Second Corps Area</i>
<i>7th Radio Intelligence Company</i>	<i>(ORI)</i>	<i>Second Corps Area</i>
<i>501st Photo Company</i>	<i>(ORI)</i>	<i>Second Corps Area</i>
Army Chemical Warfare Service:		
<i>1st Chemical Field Laboratory</i>	<i>(ORI)</i>	<i>Third Corps Area</i>
<i>412th Chemical Company (Depot)</i>	<i>(ORI)</i>	<i>Third Corps Area</i>
<i>422th Chemical Company (Maint)</i>	<i>(ORI)</i>	<i>Third Corps Area</i>
Army Ordnance Service:		
60th Ordnance Company (HQ)	(R.A.)	Syracuse, NY
36th Ordnance Company (Ammo)	(R.A.)	Delaware Ordnance Depot, DE
50th Ordnance Company (Ammo)	(RAI)	Delaware Ordnance Depot, DE
58th Ordnance Company (Ammo)	(R.A.)	Raritan Arsenal, NJ
13th Ordnance Company (Maint)	(RAI)	Fargo, ND
18th Ordnance Company (Maint)	(RAI)	Los Angeles, CA
<i>71st Ordnance Company (Depot)</i>	<i>(RAI)</i>	<i>Second Corps Area</i>
76th Ordnance Company (Depot)	(RAI)	Baltimore, MD
<i>82d Ordnance Company (Depot)</i>	<i>(RAI)</i>	<i>First Corps Area</i>
Army Medical Service:		
1st Army Medical Laboratory	(O.R.)	New York City, NY
4th Army Medical Supply Depot	(O.R.)	New York City, NY
31st Medical Regiment	(RAI)	Boston, MA
341st Medical Regiment	(O.R.)	Boston, MA
342d Medical Regiment	(O.R.)	Paterson, NJ
350th Medical Regiment	(RAI)	New York City, NY
361st Medical Regiment	(O.R.)	Newark, NJ
362d Medical Regiment	(O.R.)	Buffalo, NY
363d Medical Regiment	(O.R.)	Syracuse, NY
364th Medical Regiment	(RAI)	Washington, DC
365th Medical Regiment	(O.R.)	Scranton, PA
374th Medical Regiment	(RAI)	Manhattan, NY
375th Medical Regiment	(O.R.)	Pittsburgh, PA
1st Evacuation Hospital	(RAI)	Baltimore, MD
2d Evacuation Hospital	(RAI)	Springfield, MA
3d Evacuation Hospital	(RAI)	New York City, NY
5th Evacuation Hospital	(RAI)	Boston, MA
6th Evacuation Hospital	(RAI)	Providence, RI
7th Evacuation Hospital	(RAI)	Worcester, MA
9th Evacuation Hospital	(O.R.)	Hartford, CT
10th Evacuation Hospital	(RAI)	Brooklyn, NY
11th Evacuation Hospital	(RAI)	Rochester, NY
12th Evacuation Hospital	(RAI)	Hartford, CT
14th Evacuation Hospital	(O.R.)	New Haven, CT
15th Evacuation Hospital	(RAI)	Jersey City, NJ
16th Evacuation Hospital	(O.R.)	New York City, NY
17th Evacuation Hospital	(O.R.)	Schenectady, NY
20th Evacuation Hospital	(RAI)	New York City, NY
23d Evacuation Hospital	(RAI)	Carlisle Barracks, PA
27th Evacuation Hospital	(O.R.)	New York City, NY
28th Evacuation Hospital	(O.R.)	Brooklyn, NY
29th Evacuation Hospital	(RAI)	Philadelphia, PA
30th Evacuation Hospital	(O.R.)	Washington, DC
31st Evacuation Hospital	(RAI)	Washington, DC
32d Evacuation Hospital	(RAI)	Pittsburgh, PA
33d Evacuation Hospital	(O.R.)	Pittsburgh, PA
34th Evacuation Hospital	(O.R.)	Philadelphia, PA
2d Surgical Hospital	(RAI)	New York City, NY
3d Surgical Hospital	(O.R.)	Atlantic City, NJ

6th Surgical Hospital	(RAI)	Boston, MA
7th Surgical Hospital	(RAI)	Scranton, PA
8th Surgical Hospital	(O.R.)	McKeesport, PA
9th Surgical Hospital	(O.R.)	Philadelphia, PA
10th Surgical Hospital	(O.R.)	New York City, NY
11th Surgical Hospital	(O.R.)	Long Island City, NY
12th Surgical Hospital	(RAI)	Manchester, VT
13th Surgical Hospital	(O.R.)	Manhattan, NY
15th Surgical Hospital	(RAI)	Stamford, CT
17th Surgical Hospital	(O.R.)	Philadelphia, PA
18th Surgical Hospital	(RAI)	Baltimore, MD
19th Surgical Hospital	(RAI)	Trenton, NJ
28th Surgical Hospital	(RAI)	Washington, DC
29th Surgical Hospital	(RAI)	Pittsburgh, PA
37th Surgical Hospital	(O.R.)	New Haven, CT
40th Surgical Hospital	(O.R.)	Waterbury, CT
1st Convalescent Hospital	(O.R.)	Providence, RI
19th Veterinary Evacuation Hospital	(RAI)	Bangor, ME
20th Veterinary Evacuation Hospital	(RAI)	Passaic, NJ
21st Veterinary Evacuation Hospital	(RAI)	Baltimore, MD
1st Veterinary Convalescent Hospital	(O.R.)	Brooklyn, NY
Army Quartermaster Service:		
<i>1st Motor Transport Regiment</i>	<i>(RAI)</i>	<i>Second Corps Area</i>
<i>1st Motor Maintenance Battalion</i>	<i>(RAI)</i>	<i>Third Corps Area</i>
<i>1st Motorcycle Battalion</i>	<i>(RAI)</i>	<i>Second Corps Area</i>
<i>1st Quartermaster Remount Regiment</i>	<i>(RAI)</i>	<i>Third Corps Area</i>
81st Quartermaster Maint Battalion	(RAI)	Hartford, CT
302d Quartermaster Service Regiment	(O.R.)	Second Corps Area
303d Quartermaster Service Regiment	(O.R.)	Third Corps Area

## HHC, SECOND ARMY (I)

## Organized Reserve Illinois

HQ—*Not initiated*, 15 October 1921–15 September 1927

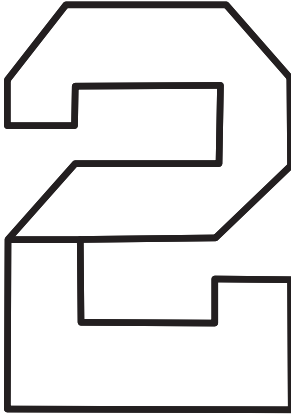

The Second Army was authorized by the National Defense Act of 1920 and was originally to be composed of units primarily from the Fourth, Fifth, and Sixth Corps Areas. The HHC were constituted in the O.R. on 15 October 1921 and allotted to the Sixth Corps Area. Chicago, IL, designated as headquarters on organization, but the unit was never organized at that location. The HQ Co. was initiated 5 August 1922 at Chicago. The HQ Co. was relocated 18 April 1924 to Oglesby, IL. The HHC were withdrawn from the O.R. on 15 September 1927 and demobilized.

### SECOND ARMY TROOPS 1923

#### UNITS:

#### COMPONENT:

#### HQ LOCATION:

<i>Headquarters, Second Army</i>	<i>(ORI)</i>	<i>Sixth Corps Area</i>
IV Corps	(O.R.)	Atlanta, GA
V Corps	(O.R.)	Fort Thomas, KY
VI Corps	(O.R.)	Chicago, IL
<i>2d Cavalry Division</i>	<i>(RAI)</i>	<i>Seventh Corps Area</i>
<i>23d Cavalry Division</i>	<i>(NGI)</i>	<i>Texas N.G.</i>
Headquarters, Special Troops	(O.R.)	Chicago, IL
<i>HQ Company, Second Army</i>	<i>(ORI)</i>	<i>Sixth Corps Area</i>
325th Military Police Battalion	(O.R.)	Chicago, IL
388th Service Battalion, Q.M.C. (C)	(O.R.)	Lexington, OH
389th Service Battalion, Q.M.C. (C)	(O.R.)	Dayton, OH
<i>390th Service Battalion, Q.M.C. (C)</i>	<i>(O.R.)</i>	<i>Fifth Corps Area</i>
391st Service Battalion, Q.M.C. (C)	(O.R.)	Clarksburg, KY
392d Service Battalion, Q.M.C. (C)	(O.R.)	Princeton, WV
393d Service Battalion, Q.M.C. (C)	(O.R.)	Flint, MI
394th Service Battalion, Q.M.C. (C)	(O.R.)	Murphysboro, IL
395th Service Battalion, Q.M.C. (C)	(O.R.)	Detroit, MI
44th Field Remount Depot, Q.M.C.	(O.R.)	Lexington, KY
22d Remount Troop	(O.R.)	Lexington, KY
23d Remount Troop	(O.R.)	Lexington, KY
24th Remount Troop	(O.R.)	Lexington, KY
Headquarters, Second Army Artillery	(O.R.)	Chicago, IL
202d Coast Artillery Brigade (AA)	(O.R.)	Raleigh, NC
386th Ordnance Company (Maint)	(O.R.)	Manitowoc, WI
370th Ammunition Train	(O.R.)	Shelbyville, KY
525th Coast Artillery Regiment (AA)	(O.R.)	Fort Wayne, IN
534th Coast Artillery Regiment (AA)	(O.R.)	Raleigh, NC
535th Coast Artillery Regiment (AA)	(O.R.)	Indianapolis, IN
Headquarters, Second Army Engineer Service	(O.R.)	Chicago, IL
356th Engineer Regiment (GS)	(O.R.)	Mansfield, OH
363d Engineer Regiment (GS)	(O.R.)	Manhattan, NY
364th Engineer Regiment (GS) (C)	(O.R.)	Columbus, OH
528th Engineer Battalion (Aux) (C)	(O.R.)	Troy, AL
<i>169th Engineer Battalion (Aux)</i>	<i>(NGI)</i>	<i>Mississippi N.G.</i>
<i>170th Engineer Battalion (Aux)</i>	<i>(NGI)</i>	<i>Louisiana N.G.</i>
<i>171st Engineer Battalion (Aux)</i>	<i>(NGI)</i>	<i>Alabama N.G.</i>
<i>172d Engineer Battalion (Aux)</i>	<i>(NGI)</i>	<i>South Carolina N.G.</i>
<i>173d Engineer Battalion (Aux)</i>	<i>(NGI)</i>	<i>North Carolina N.G.</i>
17th Engineer Battalion (Topo)	(R.A.)	Camp A.A. Humphreys, VA
486th Engineer Battalion (WS)	(O.R.)	Fond du Lac, WI
540th Engineer Train (HB)	(O.R.)	Hamlet, NC

542d Engineer Train (HB)	(ORI)	Fifth Corps Area
543d Engineer Train (HB)	(ORI)	Toledo, OH
545th Engineer Train (HB)	(O.R.)	Robinson, IL
546th Engineer Train (HB)	(O.R.)	Edwardsville, IL
481st Engineer Train (LB)	(O.R.)	Covington, KY
547th Engineer Train (LB)	(O.R.)	Wheaton, IL
579th Engineer Train (DT)	(O.R.)	Troy, AL
E Company, 40th Engineers (Camo)	(O.R.)	Indianapolis, IN
Headquarters, Second Army Air Service	(O.R.)	Dayton, OH
413th Headquarters Squadron	(O.R.)	Boone, WV
15th Airdrome Company	(O.R.)	Indianapolis, IN
23d Airdrome Company	(O.R.)	Harrisburg, PA
25th Airdrome Company	(O.R.)	Dayton, OH
9th Wing Headquarters	(O.R.)	Chicago, IL
402d Ordnance Company (M)	(O.R.)	Elizabeth, NJ
319th Attack Group	(O.R.)	Chicago, IL
467th Attack Squadron	(O.R.)	Chicago, IL
468th Attack Squadron	(O.R.)	Chicago, IL
469th Attack Squadron	(O.R.)	Moline, IL
470th Attack Squadron	(O.R.)	Chicago, IL
Air Park No. 349	(O.R.)	Chicago, IL
317th Observation Group	(O.R.)	Mansfield, OH
418th Observation Squadron	(O.R.)	Bowling Green, KY
459th Observation Squadron	(O.R.)	Memphis, TN
460th Observation Squadron	(O.R.)	Marion, OH
461st Observation Squadron	(ORI)	Fifth Corps Area
Air Park No. 337	(O.R.)	Chicago, IL
316th Pursuit Group	(O.R.)	Atlanta, GA
455th Pursuit Squadron	(O.R.)	Wilmington, NC
456th Pursuit Squadron	(O.R.)	Memphis, TN
457th Pursuit Squadron	(O.R.)	Atlanta, GA
458th Pursuit Squadron	(O.R.)	Atlanta, GA
Air Park No. 346	(O.R.)	Montgomery, AL
306th Pursuit Group	(O.R.)	Toledo, OH
414th Pursuit Squadron	(O.R.)	Cleveland, OH
415th Pursuit Squadron	(O.R.)	Toledo, OH
416th Pursuit Squadron	(O.R.)	Columbus, OH
417th Pursuit Squadron	(O.R.)	Cincinnati, OH
Air Park No. 336	(O.R.)	Cleveland, OH
Headquarters, Second Army Signal Service	(O.R.)	Chicago, IL
113th Signal Battalion	(NGI)	Wisconsin N.G.
114th Signal Battalion	(NGI)	Michigan N.G.
2d Meteorological Company	(O.R.)	Chicago, IL
2d Pigeon Company	(O.R.)	Lawrenceville, IL
2d Radio Company	(O.R.)	Chicago, IL
Headquarters, Second Army Ordnance Service	(O.R.)	Chicago, IL
632d Ordnance Company (Ammo)	(O.R.)	Louisville, KY
633d Ordnance Company (Ammo)	(R.A.)	Chicago, IL
52d Ordnance Company (Ammo)	(R.A.)	Savanna, IL
17th Ordnance Company (Maint)	(R.A.)	Fort Benning, GA
83d Ordnance Company (Depot)	(R.A.)	Savannah Proving Ground, IL
84th Ordnance Company (Depot)	(R.A.)	Erie Proving Ground, OH
805th Ordnance Company (Depot)	(ORI)	Fifth Corps Area
905th Ordnance Company (HQ)	(O.R.)	Danville, IL
Second Army Medical Headquarters	(O.R.)	Chicago, IL
2d Army Medical Laboratory	(O.R.)	Baltimore, MD
2d Army Medical Supply Depot	(O.R.)	Columbia, SC
144th Medical Regiment	(NGI)	Michigan N.G.
367th Medical Regiment	(O.R.)	Canton, OH
376th Medical Regiment	(O.R.)	Jackson, MS
377th Medical Regiment	(O.R.)	Cincinnati, OH
5th Evacuation Hospital	(O.R.)	Boston, MA
6th Evacuation Hospital	(O.R.)	Providence, RI
7th Evacuation Hospital	(O.R.)	Worcester, MA
8th Evacuation Hospital	(O.R.)	Springfield, MA

9th Evacuation Hospital	(O.R.)	Hartford, CT
18th Evacuation Hospital	(O.R.)	Indianapolis, IN
21st Evacuation Hospital	(O.R.)	Terre Haute, IN
47th Evacuation Hospital	(O.R.)	Columbus, OH
48th Evacuation Hospital	(O.R.)	Indianapolis, IN
49th Evacuation Hospital	(O.R.)	Fort Thomas, KY
50th Evacuation Hospital	(O.R.)	Fort Thomas, KY
51st Evacuation Hospital	(O.R.)	Camp Knox, KY
52d Evacuation Hospital	(O.R.)	Camp Knox, KY
53d Evacuation Hospital	(O.R.)	Camp Knox, KY
54th Evacuation Hospital	(O.R.)	Cleveland, OH
1st Surgical Hospital	(O.R.)	Manchester, NH
5th Surgical Hospital	(O.R.)	Cleveland, OH
6th Surgical Hospital	(O.R.)	Boston, MA
30th Surgical Hospital	(O.R.)	Fort Wayne, IN
31st Surgical Hospital	(O.R.)	Fort Thomas, KY
32d Surgical Hospital	(O.R.)	Fort Hayes, OH
33d Surgical Hospital	(O.R.)	Camp Knox, KY
34th Surgical Hospital	(O.R.)	Camp Knox, KY
35th Surgical Hospital	(O.R.)	Cleveland, OH
36th Surgical Hospital	(O.R.)	South Bend, IN
37th Surgical Hospital	(O.R.)	New Haven, CT
38th Surgical Hospital	(O.R.)	Stanford, CT
5th Convalescent Hospital	(O.R.)	Fort Benjamin Harrison, IN
3d Veterinary Evacuation Hospital	(O.R.)	Boston, MA
4th Veterinary Evacuation Hospital	(O.R.)	Lexington, KY
5th Veterinary Evacuation Hospital	(O.R.)	Fort Hayes, OH
2d Veterinary Convalescent Hospital	(O.R.)	Fort Thomas, KY
<i>Headquarters, Second Army Train, Q.M.C.</i>	<i>(NGI)</i>	<i>Illinois N.G.</i>
307th Motor Repair Battalion	(O.R.)	Salem, OH
317th Motor Repair Battalion	(O.R.)	Cleveland, OH
318th Motor Repair Battalion	(O.R.)	Detroit, MI
319th Motor Repair Battalion	(O.R.)	Rock Island, IL
<i>121st Motor Transport Command</i>	<i>(NGI)</i>	<i>Delaware N.G.</i>
<i>123d Motor Transport Command</i>	<i>(NGI)</i>	<i>Illinois N.G.</i>
<i>124th Motor Transport Command</i>	<i>(NGI)</i>	<i>Illinois N.G.</i>
<i>125th Motor Transport Command</i>	<i>(NGI)</i>	<i>Illinois N.G.</i>
380th Motor Transport Command	(O.R.)	Memphis, TN
<i>260th Motor Transport Company</i>	<i>(NGI)</i>	<i>First Corps Area</i>
<i>261st Motor Transport Company</i>	<i>(NGI)</i>	<i>Delaware N.G.</i>
<i>267th Motor Transport Company</i>	<i>(NGI)</i>	<i>Illinois N.G.</i>
<i>268th Motor Transport Company</i>	<i>(NGI)</i>	<i>Illinois N.G.</i>
<i>269th Motor Transport Company</i>	<i>(NGI)</i>	<i>Illinois N.G.</i>
<i>270th Motor Transport Company</i>	<i>(NGI)</i>	<i>Illinois N.G.</i>
<i>271st Motor Transport Company</i>	<i>(NGI)</i>	<i>Illinois N.G.</i>
<i>272d Motor Transport Company</i>	<i>(NGI)</i>	<i>Illinois N.G.</i>
<i>273d Motor Transport Company</i>	<i>(NGI)</i>	<i>Illinois N.G.</i>
<i>274th Motor Transport Company</i>	<i>(NGI)</i>	<i>Illinois N.G.</i>
<i>275th Motor Transport Company</i>	<i>(NGI)</i>	<i>Illinois N.G.</i>
<i>276th Motor Transport Company</i>	<i>(NGI)</i>	<i>Illinois N.G.</i>
617th Motor Transport Company	(O.R.)	Medina, NY
668th Motor Transport Company	(O.R.)	Vincennes, IN
669th Motor Transport Company	(O.R.)	Vincennes, IN
670th Motor Transport Company	(O.R.)	Cleveland, OH
671st Motor Transport Company	(O.R.)	Canton, OH
672d Motor Transport Company	(O.R.)	Chestertown, MD
673d Motor Transport Company	(O.R.)	Easton, MD
<i>122d Motorcycle Company</i>	<i>(NGI)</i>	<i>Illinois N.G.</i>
388th Motorcycle Company	(O.R.)	Frankfort, KY
509th Motor Repair Section	(O.R.)	<i>Unknown</i>
517th Motor Repair Section	(O.R.)	Graham, NC
518th Motor Repair Section	(O.R.)	Cincinnati, OH
519th Motor Repair Section	(O.R.)	Flint, MI

**HHC, SECOND ARMY (II)**

**HQ**—Chicago, IL, 22 August 1932–4 December 1940; Memphis, TN, 5 December 1940–10 June 1946

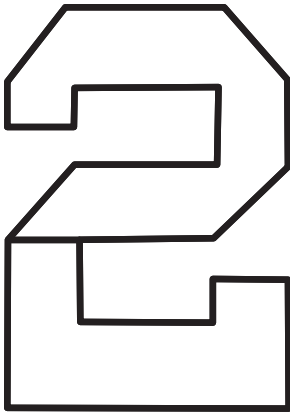

The Second Army was demobilized on 15 April 1919 in France. The HHC were reconstituted in the R.A. on 9 August 1932 and allotted to the Sixth Corps Area. The headquarters was organized 22 August 1932 at Chicago, IL. The HQ Co. was organized 26 February 1935 at Chicago. Due to the abandonment in 1933 of the “Six Army” plan in favor of the “Four Army” plan, the Second Army area was restructured to include only the Fifth and Sixth Corps Areas. The Fourth Corps Area was transferred to the Third Army. The Second Army mission was to develop defense and operational plans for contingencies near the Great Lakes and the north-central United States, review the mobilization plans of the Fifth and Sixth Corps Areas, and oversee the training of units in the Army area. As part of the responsibility to oversee training, the Second Army staff planned, conducted, and/or participated in three major maneuvers between 1936 and 1941. The August 1936 maneuvers were actually two separate exercises and were held at Fort Knox, KY, for the Fifth Corps Area troops, and at Camp Custer-Allegan, MI, for the Sixth Corps Area troops. The maneuvers, though in separate locations, were tied together by a common scenario and included significantly large numbers of

Army Air Corps and mechanized units. The next Second Army maneuver was also a split exercise, this time under the command of Lt. Gen. Stanley H. Ford. Held in August and September 1940, the maneuver was conducted near Fort Knox for the Fifth Corps Area troops, and at Camp McCoy, WI, for the Sixth Corps Area contingent. The primary focus of this exercise was to train the army and corps staffs, all of which had been provisionally organized with Reserve and R.A. officers and men from corps area staffs. Following the 1940 maneuver, the Second Army order of battle was changed to reflect the assignment of the VII Corps to the troop list, and the loss of the V and VI Corps to the Third and First Armies, respectively. Additionally, HQ Co., Second Army was activated 18 November 1940 at Chicago. To have more efficient command and control of the Second Army’s subordinate units, then mobilizing and concentrating in Missouri, Arkansas, and Louisiana, Lt. Gen. Ben Lear moved the army headquarters to 44 South Second Street, Memphis, TN, on 5 December 1940. The final maneuver in which the Second Army participated prior to World War II was the huge GHQ maneuvers in the Louisiana Maneuver Area in September 1941. The exercise included over 120,000 Second Army soldiers from R.A. and N.G. units. The maneuver was conducted against the units of the Third Army between Shreveport and Lake Charles, LA, 15–28 September 1941. Five corps, 18 divisions, and numerous support units participated in this exercise, which was the largest of all peacetime maneuvers ever conducted in the United States. These maneuvers were designed to test and validate myriad doctrinal and organizational ideas, and to provide a basis for modernizing the US Army. Following the maneuvers, the Second Army HHC returned to Memphis where they were located on 7 December 1941.

**Status:** Inactive in the R.A. as the Second US Army.

**Events:** 159, 174, 213, 214, 264, 302, 316, 324, 328

**Army Commanders**

Maj. Gen. Frank Parker	22 August 1932–22 October 1933	Maj. Gen. Charles Kilbourne	31 May 1936–17 December 1936
Maj. Gen. George Van Horn Moseley	22 October 1933–14 November 1933	Maj. Gen. William E. Cole	18 December 1936–15 September 1937
Maj. Gen. Preston Brown	14 November 1933–1 February 1935	Maj. Gen. Hugh A. Drum	15 September 1937–31 October 1938
Maj. Gen. Frank R. McCoy	1 February 1935–1 May 1936	Lt. Gen. Stanley H. Ford	5 November 1938– 1 October 1940
Maj. Gen. Johnson Hagood	1 May 1936–31 May 1936	Lt. Gen. Ben Lear	1 October 1940–25 April 1943

**SECOND ARMY TROOPS  
1933**

<b>UNITS:</b>	<b>COMPONENT:</b>	<b>HQ LOCATION:</b>
Headquarters, Second Army	(R.A.)	Chicago, IL
V Corps	(R.A.)	Columbus, OH
VI Corps	(R.A.)	Fort Sheridan, IL
XV Corps	(O.R.)	Indianapolis, IN
XVI Corps	(O.R.)	Detroit, MI
Headquarters, Special Troops	(RAI)	Chicago, IL
HQ Company, Second Army	(RAI)	Oglesby, IL

325th Military Police Battalion	(O.R.)	Chicago, IL
402d Field Remount Depot	(O.R.)	Milwaukee, WI
322d Remount Troop	(O.R.)	Milwaukee, WI
323d Remount Troop	(O.R.)	Milwaukee, WI
324th Remount Troop	(O.R.)	Milwaukee, WI
Army Artillery:		
33d Coast Artillery Brigade (AA)	(RAI)	Indianapolis, IN
Second Army Ammunition Train	(RAI)	Cincinnati, OH
932d Coast Artillery Regiment (AA)	(O.R.)	Columbus, OH
938th Coast Artillery Regiment (AA)	(RAI)	Cincinnati, OH
951st Coast Artillery Regiment (AA)	(RAI)	Chicago, IL
21st Ordnance Company (Maint)	(RAI)	Cincinnati, OH
Attached Units:		
8th Infantry Regiment (C)	(N.G.)	Chicago, IL
201st Infantry Regiment	(N.G.)	Morgantown, WV
372d Infantry Regiment (C) (2d Bn)	(N.G.)	Columbus, OH
42d Field Artillery Bn (75-mm G) (C)	(RAI)	Chicago, IL
52d Field Artillery Bn (155-mm G) (C)	(RAI)	Indianapolis, IN
53d Field Artillery Bn (155-mm G) (C)	(RAI)	Cincinnati, OH
54th Field Artillery Bn (155-mm G) (C)	(RAI)	Owensboro, KY
Army Engineer Service:		
38th Engineer Regiment (GS)	(RAI)	Moundsville, WV
39th Engineer Regiment (GS)	(RAI)	Chicago, IL
40th Engineer Regiment (GS)	(RAI)	Detroit, MI
441st Engineer Battalion (Sep)	(O.R.)	Versailles, KY
442d Engineer Battalion (Sep)	(O.R.)	Parkersburg, WV
529th Engineer Battalion (Sep) (C)	(RAI)	Sixth Corps Area
530th Engineer Battalion (Sep) (C)	(RAI)	Sixth Corps Area
531st Engineer Battalion (Sep) (C)	(RAI)	Sixth Corps Area
565th Engineer Battalion (Sep) (C)	(O.R.)	Louisville, KY
504th Engineer Battalion (Topo)	(O.R.)	Fort Wayne, IN
574th Engineer Battalion (WS)	(O.R.)	Ann Arbor, MI
86th Engineer Company (Depot)	(RAI)	Cleveland, OH
738th Engineer Company (Shop)	(O.R.)	Rock Island, IL
576th Engineer Company (DT)	(O.R.)	Steubenville, OH
602d Engineer Battalion (Camo)	(O.R.)	Columbus, OH
Army Aviation:		
11th Observation Group	(RAI)	Sixth Corps Area
15th Observation Squadron	(R.A.)	Scott Field, IL
360th Observation Squadron	(O.R.)	Bowman Field, KY
865th Observation Squadron	(O.R.)	Chicago, IL
84th Service Squadron	(RAI)	Sixth Corps Area
2d Air Depot	(RAI)	Detroit, MI
3d Supply Squadron	(RAI)	Detroit, MI
4th Supply Squadron	(RAI)	Detroit, MI
3d Repair Squadron	(RAI)	Detroit, MI
4th Repair Squadron	(RAI)	Detroit, MI
11th Airdrome Squadron	(RAI)	Youngstown, OH
12th Airdrome Squadron	(RAI)	Indianapolis, IN
13th Airdrome Squadron	(RAI)	Mt. Clemens, MI
14th Airdrome Squadron	(RAI)	Rantoul, IL
Army Signal Service:		
60th Signal Battalion	(RAI)	Fort Wayne, IN
114th Signal Battalion	(NGI)	Michigan N.G.
17th Meteorological Company	(ORI)	Fifth Corps Area
2d Pigeon Company	(ORI)	Sixth Corps Area
5th Radio Intelligence Company	(ORI)	Fifth Corps Area
502d Photo Company	(ORI)	Fifth Corps Area
Army Chemical Warfare Service:		
403d Chemical Field Laboratory	(ORI)	Fifth Corps Area
413th Chemical Company (Depot)	(ORI)	Fifth Corps Area
423d Chemical Company (Maint)	(ORI)	Fifth Corps Area
Army Ordnance Service:		
61st Ordnance Company (HQ)	(RAI)	Cincinnati, OH
52d Ordnance Company (Ammo)	(R.A.)	Savanna Ord. Depot, IL

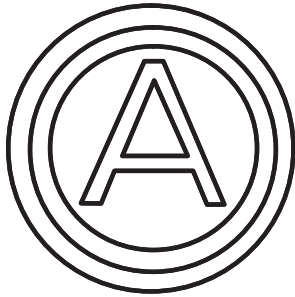

632d Ordnance Company (Ammo)	(O.R.)	Covington, KY
633d Ordnance Company (Ammo)	(O.R.)	Chicago, IL
47th Ordnance Company (Maint)	(RAI)	Cincinnati, OH
70th Ordnance Company (Depot)	(RAI)	Chicago, IL
83d Ordnance Company (Depot)	(RAI)	Chicago, IL
84th Ordnance Company (Depot)	(R.A.)	Erie Ord. Depot, OH
Army Medical Service:		
<i>2d Army Medical Laboratory</i>	<i>(ORI)</i>	<i>Fifth Corps Area</i>
<i>6th Army Medical Supply</i>	<i>(ORI)</i>	<i>Fifth Corps Area</i>
135th Medical Regiment	(N.G.)	Madison, WI
345th Medical Regiment	(O.R.)	Madisonville, KY
346th Medical Regiment	(RAI)	Chicago, IL
367th Medical Regiment	(O.R.)	Sistersville, WV
368th Medical Regiment	(RAI)	Cleveland, OH
370th Medical Regiment	(O.R.)	Milwaukee, WI
18th Evacuation Hospital	(RAI)	Bloomington, IN
21st Evacuation Hospital	(RAI)	Evansville, IN
22d Evacuation Hospital	(RAI)	Green Bay, WI
25th Evacuation Hospital	(RAI)	Oak Park, IL
47th Evacuation Hospital	(O.R.)	Columbus, OH
48th Evacuation Hospital	(O.R.)	Indianapolis, IN
49th Evacuation Hospital	(O.R.)	Covington, KY
50th Evacuation Hospital	(RAI)	Fort Thomas, KY
51st Evacuation Hospital	(O.R.)	Wheeling, WV
52d Evacuation Hospital	(O.R.)	Columbus, OH
55th Evacuation Hospital	(O.R.)	Oshkosh, WI
56th Evacuation Hospital	(O.R.)	Chicago, IL
57th Evacuation Hospital	(O.R.)	Detroit, MI
59th Evacuation Hospital	(RAI)	Rock Island, IL
60th Evacuation Hospital	(O.R.)	Detroit, MI
73d Evacuation Hospital	(RAI)	Chicago, IL
5th Surgical Hospital	(O.R.)	Bloomington, IN
30th Surgical Hospital	(RAI)	Fort Wayne, IN
31st Surgical Hospital	(RAI)	Cincinnati, OH
32d Surgical Hospital	(O.R.)	Columbus, OH
35th Surgical Hospital	(O.R.)	Youngstown, OH
36th Surgical Hospital	(O.R.)	South Bend, IN
39th Surgical Hospital	(RAI)	Columbus, OH
41st Surgical Hospital	(RAI)	Cleveland, OH
42d Surgical Hospital	(RAI)	Chicago, IL
43d Surgical Hospital	(RAI)	VT
44th Surgical Hospital	(O.R.)	Wauwatosa, WI
45th Surgical Hospital	(O.R.)	Grand Rapids, MI
46th Surgical Hospital	(O.R.)	Springfield, IL
47th Surgical Hospital	(RAI)	Highland Park, IL
2d Convalescent Hospital	(RAI)	Chicago, IL
5th Veterinary Evacuation Hospital	(RAI)	Maywood, IL
23d Veterinary Evacuation Hospital	(O.R.)	Springfield, OH
24th Veterinary Evacuation Hospital	(RAI)	Lexington, KY
2d Veterinary Convalescent Hospital	(RAI)	Chicago, IL
	(O.R.)	Springfield, OH
Army Quartermaster Service:		
<i>2d Motor Transport Regiment</i>	<i>(RAI)</i>	<i>Sixth Corps Area</i>
<i>2d Motor Maintenance Battalion</i>	<i>(RAI)</i>	<i>Sixth Corps Area</i>
<i>2d Motorcycle Battalion</i>	<i>(RAI)</i>	<i>Sixth Corps Area</i>
<i>2d Quartermaster Remount Regiment</i>	<i>(RAI)</i>	<i>Sixth Corps Area</i>
<i>82d Quartermaster Maint Battalion</i>	<i>(RAI)</i>	<i>Fifth Corps Area</i>
<i>305th Quartermaster Service Regiment</i>	<i>(O.R.)</i>	<i>Fifth Corps Area</i>
<i>306th Quartermaster Service Regiment</i>	<i>(O.R.)</i>	<i>Sixth Corps Area</i>

**HHC, THIRD ARMY (I)****Organized Reserve Missouri/Nebraska**HQ—*Not initiated*, 1921–24; Omaha, NE, 1924–33

The Third Army was authorized by the National Defense Act of 1920 and was originally to be composed of units primarily in the Seventh, Eighth, and Ninth Corps Areas. The HHC were constituted in the O.R. on 15 October 1921 and allotted to the Seventh Corps Area. The HQ Co. was initiated in April 1922 at St. Louis. The HQ was initiated 25 February 1924 at Omaha, NE. Concurrently, the HQ Co. was relocated to Omaha. The HQ Co. was withdrawn from the O.R. on 18 August 1933 and allotted to the R.A. Concurrently, the HQ was demobilized.

**THIRD ARMY TROOPS**  
1923

UNITS:	COMPONENT:	HQ LOCATION:
Headquarters, Third Army	(O.R.)	St. Louis, MO
VII Corps	(O.R.)	St. Louis, MO
VIII Corps	(O.R.)	San Antonio, TX
IX Corps	(O.R.)	San Francisco, CA
22d Cavalry Division	(N.G.)	Milwaukee, WI
24th Cavalry Division	(NGI)	Kansas N.G.
Headquarters, Special Troops	(O.R.)	St. Louis, MO
HQ Company, Third Army	(O.R.)	St. Louis, MO
112th Military Police Battalion	(NGI)	Iowa N.G.
382d Service Battalion, Q.M.C. (C)	(O.R.)	Swainsboro, GA
383d Service Battalion, Q.M.C. (C)	(O.R.)	Palm Beach, FL
384th Service Battalion, Q.M.C. (C)	(O.R.)	Atlanta, GA
385th Service Battalion, Q.M.C. (C)	(O.R.)	Rosedale, MS
386th Service Battalion, Q.M.C. (C)	(O.R.)	New Orleans, LA
387th Service Battalion, Q.M.C. (C)	(O.R.)	Baton Rouge, LA
396th Service Battalion, Q.M.C. (C)	(O.R.)	Kansas City, MO
397th Service Battalion, Q.M.C. (C)	(O.R.)	Little Rock, AR
45th Field Remount Depot, Q.M.C.	(O.R.)	Duluth, MN
25th Remount Troop	(O.R.)	Brainerd, MN
26th Remount Troop	(O.R.)	Crookston, MN
27th Remount Troop	(O.R.)	Des Moines, IA
Headquarters, Third Army Artillery	(O.R.)	Lincoln, NE
203d Coast Artillery Brigade (AA)	(O.R.)	Detroit, MI
380th Ordnance Company (Maint)	(O.R.)	Peoria, IL
142d Ammunition Train	(NGI)	Nebraska N.G.
536th Coast Artillery Regiment (AA)	(O.R.)	Detroit, MI
537th Coast Artillery Regiment (AA)	(O.R.)	Duluth, MN
538th Coast Artillery Regiment (AA)	(O.R.)	Lawrence, KS
Headquarters, Third Army Engineer Service	(O.R.)	Hot Springs, AR
165th Engineer Regiment (GS)	(NGI)	Minnesota N.G.
166th Engineer Regiment (GS)	(NGI)	Nebraska N.G.
365th Engineer Regiment (GS)	(O.R.)	Des Moines, IA
529th Engineer Battalion (Aux) (C)	(O.R.)	Mobile, AL
530th Engineer Battalion (Aux) (C)	(O.R.)	Canton, MS
531st Engineer Battalion (Aux) (C)	(O.R.)	Kansas City, MO
532d Engineer Battalion (Aux)	(O.R.)	Pierre, SD
533d Engineer Battalion (Aux)	(O.R.)	Grand Forks, ND
174th Engineer Battalion (Aux)	(NGI)	Arkansas N.G.
176th Engineer Battalion (Topo)	(NGI)	Iowa N.G.
548th Engineer Battalion (WS)	(O.R.)	St. Paul, MN
479th Engineer Train (HB)	(O.R.)	Indianapolis, IN
549th Engineer Train (HB) (C)	(O.R.)	Bauxite, AR
550th Engineer Train (HB)	(O.R.)	Wichita, KS
551st Engineer Train (HB) (C)	(O.R.)	Fort Dodge, IA
623d Engineer Train (HB)	(O.R.)	Cairo, IL

541st Engineer Train (LB)	(O.R.)	Greenwood, SC
552d Engineer Train (LB)	(O.R.)	St. Joseph, MO
580th Engineer Train (DT)	(O.R.)	St. Louis, MO
F Company, 40th Engineers (Camo)	(O.R.)	Los Angeles, CA
Headquarters, Third Army Air Service	(O.R.)	San Francisco, CA
480th Headquarters Squadron	(O.R.)	Oakland, CA
13th Airdrome Company	(O.R.)	Beaver Falls, PA
27th Airdrome Company	(O.R.)	Green Bay, WI
28th Airdrome Company	(O.R.)	St. Louis, MO
8th Wing Headquarters	(O.R.)	Kansas City, MO
321st Attack Group	(O.R.)	Tulsa, OK
472d Attack Squadron	(O.R.)	Tulsa, OK
473d Attack Squadron	(O.R.)	Tulsa, OK
474th Attack Squadron	(O.R.)	Okmulgee, OK
475th Attack Squadron	(O.R.)	San Antonio, TX
Air Park No. 350	(O.R.)	Tulsa, OK
320th Observation Group	(O.R.)	St. Louis, MO
154th Observation Squadron	(N.G.)	Little Rock, AR
419th Observation Squadron	(O.R.)	Detroit, MI
433d Observation Squadron	(O.R.)	Burlington, IA
471st Observation Squadron	(O.R.)	Minneapolis, MN
<i>Air Park No. 11</i>	<i>(NGI)</i>	<i>North Dakota N.G.</i>
304th Pursuit Group	(O.R.)	Baltimore, MD
403d Pursuit Squadron	(O.R.)	Baltimore, MD
404th Pursuit Squadron	(O.R.)	Baltimore, MD
405th Pursuit Squadron	(O.R.)	Baltimore, MD
406th Pursuit Squadron	(O.R.)	Cumberland, MD
Air Park No. 334	(O.R.)	Baltimore, MD
322d Pursuit Group	(O.R.)	San Diego, CA
476th Pursuit Squadron	(O.R.)	Eugene, O.R.
477th Pursuit Squadron	(O.R.)	San Francisco, CA
478th Pursuit Squadron	(O.R.)	Los Angeles, CA
479th Pursuit Squadron	(O.R.)	San Diego, CA
Air Park No. 351	(O.R.)	San Diego, CA
Headquarters, Third Army Signal Service	(O.R.)	St. Louis, MO
<i>115th Signal Battalion</i>	<i>(NGI)</i>	<i>South Dakota N.G.</i>
<i>116th Signal Battalion</i>	<i>(NGI)</i>	<i>New Mexico N.G.</i>
3d Meteorological Company	(O.R.)	St. Louis, MO
3d Pigeon Company	(O.R.)	St. Louis, MO
3d Radio Company	(O.R.)	St. Louis, MO
Headquarters, Third Army Ordnance Service	(O.R.)	<i>Unknown</i>
624th Ordnance Company (Ammo)	(O.R.)	Atlanta, GA
627th Ordnance Company (Ammo)	(O.R.)	Van Buren, AR
634th Ordnance Company (Ammo)	(O.R.)	St. Louis, MO
80th Ordnance Company (Depot)	(R.A.)	Benicia Arsenal, CA
<i>81st Ordnance Company (Depot)</i>	<i>(RAI)</i>	<i>A.A. 80th Ord. Co.</i>
<i>82d Ordnance Company (Depot)</i>	<i>(RAI)</i>	<i>A.A. 83d Ord. Co.</i>
47th Ordnance Company (HQ)	(R.A.)	Aberdeen Proving Ground, MD
Third Army Medical Headquarters	(O.R.)	Omaha, NE
3d Army Medical Laboratory	(O.R.)	Chicago, IL
3d Army Medical Supply Depot	(O.R.)	Chicago, IL
<i>142d Medical Regiment</i>	<i>(NGI)</i>	<i>Pennsylvania N.G.</i>
<i>145th Medical Regiment</i>	<i>(NGI)</i>	<i>Missouri N.G.</i>
378th Medical Regiment	(O.R.)	Chicago, IL
379th Medical Regiment	(O.R.)	Bismarck, ND
63d Evacuation Hospital	(O.R.)	Kansas City, KS
65th Evacuation Hospital	(O.R.)	Burlington, IA
66th Evacuation Hospital	(O.R.)	Des Moines, IA
69th Evacuation Hospital	(O.R.)	Fort Robinson, NE
70th Evacuation Hospital	(O.R.)	Fort Leavenworth, KS
76th Evacuation Hospital	(O.R.)	Fort Worth, TX
77th Evacuation Hospital	(O.R.)	Fort Worth, TX
78th Evacuation Hospital	(O.R.)	Oklahoma City, OK
79th Evacuation Hospital	(O.R.)	Oklahoma City, OK
80th Evacuation Hospital	(O.R.)	Fort Sam Houston, TX

81st Evacuation Hospital	(O.R.)	Los Angeles, CA
82d Evacuation Hospital	(O.R.)	Portland, O.R.
83d Evacuation Hospital	(O.R.)	Portland, O.R.
84th Evacuation Hospital	(O.R.)	Portland, O.R.
85th Evacuation Hospital	(O.R.)	Spokane, WA
52d Surgical Hospital	(O.R.)	Fort Riley, KS
53d Surgical Hospital	(O.R.)	Fort Crook, NE
55th Surgical Hospital	(O.R.)	Fort Snelling, MN
56th Surgical Hospital	(O.R.)	San Francisco, CA
66th Surgical Hospital	(O.R.)	Butte, MT
67th Surgical Hospital	(O.R.)	Los Angeles, CA
68th Surgical Hospital	(O.R.)	Seattle, WA
3d Convalescent Hospital	(O.R.)	San Francisco, CA
9th Veterinary Evacuation Hospital	(O.R.)	Camp Funston, KS
1st Veterinary Evacuation Hospital	(O.R.)	Boise, ID
2d Veterinary Evacuation Hospital	(O.R.)	San Francisco, CA
5th Veterinary Convalescent Hospital	(O.R.)	Fort Sam Houston, TX
Headquarters, Third Army Train, Q.M.C.	(O.R.)	Little Rock, AR
320th Motor Repair Battalion	(O.R.)	Des Moines, IA
327th Motor Repair Battalion	(O.R.)	Lincoln, NE
343d Motor Repair Battalion	(O.R.)	El Paso, TX
344th Motor Repair Battalion	(O.R.)	Los Angeles, CA
345th Motor Repair Battalion	(O.R.)	Seattle, WA
126th Motor Transport Command	(NGI)	South Dakota N.G.
381st Motor Transport Command	(O.R.)	Omaha, NE
382d Motor Transport Command	(O.R.)	Minneapolis, MN
383d Motor Transport Command	(O.R.)	Little Rock, AR
384th Motor Transport Command	(O.R.)	Des Moines, IA
283d Motor Transport Company	(NGI)	South Dakota N.G.
284th Motor Transport Company	(NGI)	South Dakota N.G.
285th Motor Transport Company	(NGI)	South Dakota N.G.
286th Motor Transport Company	(NGI)	South Dakota N.G.
287th Motor Transport Company	(NGI)	Minnesota N.G.
288th Motor Transport Company	(NGI)	Minnesota N.G.
289th Motor Transport Company (Car)	(NGI)	Arkansas N.G.
290th Motor Transport Company	(NGI)	Kansas N.G.
291st Motor Transport Company	(NGI)	Kansas N.G.
292d Motor Transport Company	(NGI)	Missouri N.G.
293d Motor Transport Company	(NGI)	Missouri N.G.
294th Motor Transport Company	(NGI)	Missouri N.G.
674th Motor Transport Company	(O.R.)	Centerville, MD
675th Motor Transport Company	(O.R.)	Salisbury, MD
676th Motor Transport Company	(O.R.)	Omaha, NE
677th Motor Transport Company	(O.R.)	Lincoln, NE
678th Motor Transport Company	(O.R.)	Osmund, NE
679th Motor Transport Company	(O.R.)	North Platte, NE
680th Motor Transport Company	(O.R.)	O'Neill, NE
123d Motorcycle Company	(NGI)	Illinois N.G.
389th Motorcycle Company	(O.R.)	Madison, WI
401st Motor Repair Section	(O.R.)	Canandaigua, NY
520th Motor Repair Section	(O.R.)	Kansas City, MO
521st Motor Repair Section	(O.R.)	El Paso, TX
522d Motor Repair Section	(ORI)	Seventh Corps Area

**HHC, THIRD ARMY (II)**

**HQ**—Fort Sam Houston, TX, 15 September 1932–5 October 1936; Atlanta, GA, 5 October 1936–30 September 1940; Fort Sam Houston, TX, 1 October 1940–11 November 1940; San Antonio, TX, 11 November 1940–20 December 1942

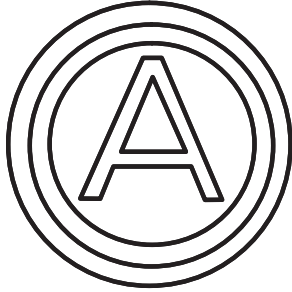

The Third Army was demobilized 2 July 1919 at Coblenz, Germany. The HHC were reconstituted in the R.A. on 9 August 1932 and allotted to the Eighth Corps Area. The headquarters was organized 15 September 1932 at Fort Sam Houston, TX. The headquarters was moved to Atlanta, GA, on 20 October 1936 upon the assumption of command of Maj. Gen. George Van Horn Moseley, the senior corps area commander. It was relocated in 1940 to the Smith-Young Tower in San Antonio when Lt. Gen. Herbert J. Brees took command. Due to the abandonment in 1933 of the “Six Army” plan in favor of the “Four Army” plan, the Third Army area was restructured to include only the Fourth and Eighth Corps Areas. The Seventh and Ninth Corps Areas were transferred to the Fourth Army. The Third Army mission was to develop defense and

operational plans for contingencies in the vicinity of the Gulf of Mexico and the southern United States, review the mobilization plans of the Fourth and Eighth Corps Areas, and oversee the training of units in the army area. As part of the responsibility to oversee training, the Third Army staff planned, conducted, and/or participated in four major maneuvers between 1938 and 1941. The August 1938 maneuvers, under the command of Maj. Gen. George Van Horn Moseley, were actually five separate exercises. Due to the widely scattered posts and size of the army’s two subordinate corps areas, it was too expensive to concentrate all Third Army units at one location. Therefore, the Fourth Corps Area held its maneuver in Mississippi’s DeSoto National Forest and the Eighth Corps Area held its major maneuver at Camp Bullis, TX, but also had smaller exercises at Fort Bliss, TX; Fort Huachuca, AZ; and Pole Mountain Reservation, WY. The maneuvers, though in separate locations, were tied together by a common scenario and included significantly large numbers of horse cavalry units. The next Third Army maneuver was held in the Kisatchie National Forest, LA, this time under the command of Lt. Gen. Stanley Embick. Held in May 1940, primary focus of this exercise was to train the army and corps staffs in the movement and employment of large troop concentrations and the new triangular divisions against a mobile enemy. These exercises included only R.A. units of the army area. This maneuver was followed in August by the concentration in Louisiana of the entire Third Army including N.G. units, the training of which was the primary goal of the effort. After the 1940 maneuvers, the organization of the Third Army was changed to reflect the addition of the V Corps to the Army’s troop list. Additionally, the Third Army HQ Co. was activated 23 November 1940 at Fort Sam Houston. The final maneuver in which the Third Army participated prior to World War II was the GHQ Maneuvers in the Louisiana Maneuver Area in September 1941. The exercise included over 280,000 Third Army soldiers from R.A. and N.G. units under the command of Lt. Gen. Walter Krueger. The maneuver was conducted against the Second Army between Shreveport and Lake Charles, LA, 15–28 September 1941. Five corps, 18 divisions, and numerous support units participated in this exercise, which was the largest of all peacetime maneuvers ever conducted in the United States. These maneuvers were designed to test and validate myriad doctrinal and organizational ideas, and to provide a basis for modernizing the US Army. On completion of the maneuvers, the Third Army HHC returned to San Antonio where they were located on 7 December 1941.

**Status:** HHC active in the R.A. at MacDill Air Force Base, FL, as HHC, Third Army.

**Events:** 217, 296, 300, 328

**Army Commanders**

Maj. Gen. Edwin B. Winans	15 September 1932–30 September 1933	Maj. Gen. George V. Moseley	1 October 1936–30 September 1938
Maj. Gen. Johnson Hagood	3 October 1933–27 February 1936	Lt. Gen. Stanley Embick	7 October 1938–28 September 1940
Maj. Gen. Frank Parker	8 April 1936–30 September 1936	Lt. Gen. Herbert J. Brees	28 September 1940–15 May 1941
	Lt. Gen. Walter Krueger		16 May 1941–16 February 1943

**THIRD ARMY TROOPS**

1933

**UNITS:**

Headquarters, Third Army  
 IV Corps  
 VIII Corps  
 XIV Corps

**COMPONENT:**

(R.A.)  
 (R.A.)  
 (R.A.)  
 (O.R.)

**HQ LOCATION:**

Fort Sam Houston, TX  
 Atlanta, GA  
 San Antonio, TX  
 Birmingham, AL

XVIII Corps	(O.R.)	Dallas, TX
Headquarters, Special Troops	(RAI)	Fort Sam Houston, TX
HQ Company, Third Army	(RAI)	Fort Sam Houston, TX
324th Military Police Battalion	(O.R.)	Winston-Salem, NC
403d Field Remount Depot	(O.R.)	Duluth, MN
325th Remount Troop	(O.R.)	Duluth, MN
326th Remount Troop	(O.R.)	Duluth, MN
327th Remount Troop	(O.R.)	Duluth, MN
Army Artillery:		
34th Coast Artillery Brigade (AA)	(RAI)	Columbia, SC
Third Army Ammunition Train	(RAI)	Tulsa, OK
67th Coast Artillery Regiment (AA)	(RAI)	Atlanta, GA
925th Coast Artillery Regiment (AA)	(O.R.)	Jacksonville, FL
972d Coast Artillery Regiment (AA)	(RAI)	Dallas, TX
Attached Units:		
24th Infantry Regiment (C)	(R.A.)	Fort Benning, GA
25th Infantry Regiment (C)	(R.A.)	Fort Huachuca, AZ
122d Infantry Regiment	(N.G.)	Atlanta, GA
447th Infantry Regiment (C)	(O.R.)	Tuskegee, AL
448th Infantry Regiment (C)	(O.R.)	Laurel, MS
450th Infantry Regiment (C)	(O.R.)	Shreveport, LA
454th Infantry Regiment (C)	(O.R.)	Americus, GA
455th Infantry Regiment (C)	(O.R.)	Austin, TX
178th Field Artillery Regiment	(NGI)	Mississippi N.G.
36th Field Artillery Battalion (75-mm G) (C)	(RAI)	Fourth Corps Area
37th Field Artillery Battalion (75-mm G) (C)	(RAI)	Fourth Corps Area
38th Field Artillery Battalion (75-mm G) (C)	(RAI)	Fourth Corps Area
39th Field Artillery Battalion (75-mm G) (C)	(RAI)	Fourth Corps Area
40th Field Artillery Battalion (75-mm G) (C)	(RAI)	Fourth Corps Area
41st Field Artillery Battalion (75-mm G) (C)	(RAI)	Fourth Corps Area
Army Engineer Service:		
41st Engineer Regiment (GS)	(RAI)	Vicksburg, MS
42d Engineer Regiment (GS)	(RAI)	Birmingham, AL
43d Engineer Regiment (GS)	(RAI)	San Antonio, TX
48th Engineer Battalion (Sep)	(RAI)	San Antonio, TX
64th Engineer Battalion (Sep) (C)	(RAI)	Memphis, TN
73d Engineer Battalion (Sep) (C)	(RAI)	Fort Logan, CO
511th Engineer Battalion (Sep) (C)	(O.R.)	San Antonio, TX
654th Engineer Battalion (Topo)	(O.R.)	San Antonio, TX
520th Engineer Battalion (WS)	(O.R.)	Columbia, SC
394th Engineer Company (Depot)	(O.R.)	Atlanta, GA
741st Engineer Company (Shop)	(O.R.)	Fourth Corps Area
585th Engineer Company (DT)	(O.R.)	New Orleans, LA
603d Engineer Battalion (Camo)	(O.R.)	Waycross, GA
Army Aviation:		
14th Observation Group	(RAI)	Sixth Corps Area
16th Observation Squadron	(R.A.)	Fort Sill, OK
56th Service Squadron	(RAI)	Hensley Field, TX
3d Air Depot	(RAI)	Eighth Corps Area
5th Supply Squadron	(RAI)	Eighth Corps Area
6th Supply Squadron	(RAI)	Eighth Corps Area
5th Repair Squadron	(RAI)	Eighth Corps Area
6th Repair Squadron	(RAI)	Eighth Corps Area
7th Airdrome Squadron	(RAI)	Fourth Corps Area
8th Airdrome Squadron	(RAI)	Fourth Corps Area
9th Airdrome Squadron	(RAI)	Waco, TX
10th Airdrome Squadron	(RAI)	Waco, TX
Army Signal Service:		
52d Signal Battalion	(RAI)	Eighth Corps Area
106th Signal Battalion	(NGI)	Colorado N.G.
17th Meteorological Company	(ORI)	Fifth Corps Area
2d Pigeon Company	(ORI)	Sixth Corps Area
5th Radio Intelligence Company	(ORI)	Fifth Corps Area
502d Photo Company	(ORI)	Fifth Corps Area
Army Chemical Warfare Service:		

<i>403d Chemical Field Laboratory</i>	<i>(ORI)</i>	<i>Unknown</i>
<i>413th Chemical Company (Depot)</i>	<i>(ORI)</i>	<i>Unknown</i>
<i>423d Chemical Company (Maint)</i>	<i>(ORI)</i>	<i>Unknown</i>
Army Ordnance Service:		
<i>62d Ordnance Company (HQ)</i>	<i>(RAI)</i>	<i>Eighth Corps Area</i>
59th Ordnance Company (Ammo)	(R.A.)	Fort Sill, OK
<i>60th Ordnance Company (Ammo)</i>	<i>(RAI)</i>	<i>Eighth Corps Area</i>
9th Ordnance Company (Maint)	(R.A.)	Fort Sill, OK
72d Ordnance Company (Depot)	(R.A.)	Fort Benning, GA
73d Ordnance Company (Depot)	(R.A.)	Fort Bliss, TX
79th Ordnance Company (Depot)	(R.A.)	Augusta Arsenal, GA
Army Medical Service:		
4th Army Medical Laboratory	(O.R.)	San Antonio, TX
3d Army Medical Supply Depot	(O.R.)	Charleston, SC
13th Medical Regiment	(RAI)	Dallas, TX
<i>137th Medical Regiment</i>	<i>(NGI)</i>	<i>Colorado N.G.</i>
344th Medical Regiment	(O.R.)	Baton Rouge, LA
366th Medical Regiment	(RAI)	Charlotte, NC
376th Medical Regiment	(O.R.)	Jackson, MI
377th Medical Regiment	(O.R.)	Eighth Corps Area
379th Medical Regiment	(O.R.)	Eighth Corps Area
385th Medical Regiment	(O.R.)	Birmingham, AL
19th Evacuation Hospital	(RAI)	Atlanta, GA
36th Evacuation Hospital	(RAI)	Augusta, GA
38th Evacuation Hospital	(RAI)	Greensboro, NC
39th Evacuation Hospital	(O.R.)	Knoxville, TN
41st Evacuation Hospital	(O.R.)	Mobile, AL
42d Evacuation Hospital	(O.R.)	Rome, GA
43d Evacuation Hospital	(O.R.)	Athens, GA
44th Evacuation Hospital	(O.R.)	Augusta, GA
45th Evacuation Hospital	(O.R.)	New Orleans, LA
46th Evacuation Hospital	(RAI)	Birmingham, AL
71st Evacuation Hospital	(RAI)	Fort Logan, CO
72d Evacuation Hospital	(RAI)	Colorado Springs, CO
76th Evacuation Hospital	(O.R.)	Fort Worth, TX
78th Evacuation Hospital	(O.R.)	Oklahoma City, OK
79th Evacuation Hospital	(RAI)	Fort Clark, TX
80th Evacuation Hospital	(RAI)	Fort Logan, CO
16th Surgical Hospital	(RAI)	El Paso, TX
22d Surgical Hospital	(RAI)	Durham, NC
23d Surgical Hospital	(RAI)	New Orleans, LA
24th Surgical Hospital	(O.R.)	Birmingham, AL
25th Surgical Hospital	(O.R.)	Jacksonville, FL
33d Surgical Hospital	(RAI)	Birmingham, AL
34th Surgical Hospital	(RAI)	Tampa, FL
<i>55th Surgical Hospital</i>	<i>(O.R.)</i>	<i>Fourth Corps Area</i>
<i>57th Surgical Hospital</i>	<i>(O.R.)</i>	<i>Eighth Corps Area</i>
58th Surgical Hospital	(O.R.)	Galveston, TX
60th Surgical Hospital	(O.R.)	Oklahoma City, OK
61st Surgical Hospital	(O.R.)	Tulsa, OK
64th Surgical Hospital	(RAI)	Fort Clark, TX
68th Surgical Hospital	(RAI)	Fort Sam Houston, TX
4th Convalescent Hospital	(RAI)	Columbia, SC
10th Veterinary Evacuation Hospital	(O.R.)	Atlanta, GA
22d Veterinary Evacuation Hospital	(RAI)	Fort Oglethorpe, GA
26th Veterinary Evacuation Hospital	(O.R.)	Fort Sam Houston, TX
4th Veterinary Convalescent Hospital	(O.R.)	Chattanooga, TN
Army Quartermaster Service:		
<i>3d Motor Transport Regiment</i>	<i>(RAI)</i>	<i>Eighth Corps Area</i>
<i>3d Motor Maintenance Battalion</i>	<i>(RAI)</i>	<i>Eighth Corps Area</i>
<i>3d Motorcycle Battalion</i>	<i>(RAI)</i>	<i>Eighth Corps Area</i>
<i>3d Quartermaster Remount Regiment</i>	<i>(RAI)</i>	<i>Eighth Corps Area</i>
<i>83d Quartermaster Maint Battalion</i>	<i>(RAI)</i>	<i>Fourth Corps Area</i>
<i>304th Quartermaster Service Regiment (C)</i>	<i>(O.R.)</i>	<i>Fourth Corps Area</i>
<i>308th Quartermaster Service Regiment (C)</i>	<i>(O.R.)</i>	<i>Eighth Corps Area</i>

## HHC, FOURTH ARMY (I)

HQ—*Not initiated*, 1921–33

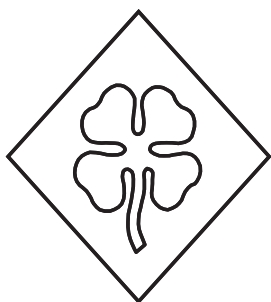

The Fourth Army was authorized by the National Defense Act of 1920 and was originally to be composed of O.R. units primarily from the First, Second, and Third Corps Areas. The HHC were constituted in the O.R. on 15 October 1921 and allotted to the Second Corps Area, New York City, NY, designated as headquarters upon organization, but the unit was never organized at that location. The HQ Co. was initiated in December 1922 at New York City. The HQ Co. was withdrawn from the O.R. on 18 August 1933 and allotted to the R.A. effective 1 October 1933. Concurrently, the HQ was demobilized.

## Organized Reserve New York

### FOURTH ARMY TROOPS 1923

UNITS:	COMPONENT:	HQ LOCATION:
<i>Headquarters, Fourth Army</i>	<i>(ORI)</i>	<i>Second Corps Area</i>
XI Corps	(O.R.)	Boston, MA
XII Corps	(O.R.)	Manhattan, NY
XIII Corps	(O.R.)	Fort Howard, MD
61st Cavalry Division	(O.R.)	New York City, NY
62d Cavalry Division	(O.R.)	Hagerstown, MD
Headquarters, Special Troops	(O.R.)	Manhattan, NY
<i>HQ Company, Fourth Army</i>	<i>(ORI)</i>	<i>Second Corps Area</i>
321st Military Police Battalion	(O.R.)	Manhattan, NY
351st Service Battalion, Q.M.C. (C)	(O.R.)	Fayetteville, NC
352d Service Battalion, Q.M.C. (C)	(O.R.)	Jackson, TN
353d Service Battalion, Q.M.C. (C)	(O.R.)	Greenwood, SC
354th Service Battalion, Q.M.C. (C)	(O.R.)	Aiken, SC
355th Service Battalion, Q.M.C. (C)	(O.R.)	Miami, FL
356th Service Battalion, Q.M.C. (C)	(O.R.)	Carrollton, GA
357th Service Battalion, Q.M.C. (C)	(O.R.)	Tampa, FL
358th Service Battalion, Q.M.C. (C)	(O.R.)	Birmingham, AL
41st Field Remount Depot, Q.M.C.	(O.R.)	Warren, PA
28th Remount Troop	(O.R.)	Harrisonburg, VA
29th Remount Troop	(O.R.)	Roanoke, VA
30th Remount Troop	(O.R.)	Suffolk, VA
Headquarters, Fourth Army Artillery	(O.R.)	Erie, PA
198th Coast Artillery Brigade (AA)	(O.R.)	Erie, PA
388th Ordnance Company (Maint)	(O.R.)	Minneapolis, MN
361st Ammunition Train	(O.R.)	Erie, PA
521st Coast Artillery Regiment (AA)	(O.R.)	Montclair, NJ
522d Coast Artillery Regiment (AA)	(O.R.)	Buffalo, NY
523d Coast Artillery Regiment (AA)	(O.R.)	Franklin, PA
Headquarters, Fourth Army Engineer Service	(O.R.)	Harrisburg, PA
351st Engineer Regiment (GS)	(O.R.)	Elizabeth, NJ
352d Engineer Regiment (GS)	(O.R.)	Troy, NY
353d Engineer Regiment (GS)	(O.R.)	Johnstown, PA
448th Engineer Battalion (Aux) (C)	(O.R.)	Durham, NC
449th Engineer Battalion (Aux) (C)	(O.R.)	Chattanooga, TN
450th Engineer Battalion (Aux) (C)	(O.R.)	Darlington, SC
451st Engineer Battalion (Aux) (C)	(O.R.)	Albany, GA
452d Engineer Battalion (Aux) (C)	(O.R.)	Tifton, GA
453d Engineer Battalion (Aux) (C)	(O.R.)	Waycross, GA
447th Engineer Battalion (Topo)	(O.R.)	Brooklyn, NY
473d Engineer Battalion (WS)	(O.R.)	Pittsburgh, PA
468th Engineer Train (HB)	(O.R.)	Boston, MA
469th Engineer Train (HB)	(O.R.)	Boston, MA
470th Engineer Train (HB)	(O.R.)	Boston, MA
471st Engineer Train (HB)	(O.R.)	Boston, MA
575th Engineer Train (HB)	(O.R.)	Connellsville, PA



472d Engineer Train (LB)	(O.R.)	Tonawanda, NY
476th Engineer Train (LB)	(O.R.)	Mauch Chuck, PA
587th Engineer Train (DT)	(O.R.)	Brooklyn, NY
G Company, 40th Engineers (Camo)	(O.R.)	Sunbury, PA
Headquarters, Fourth Army Air Service	(O.R.)	Fort Jay, NY
394th Headquarters Squadron	(O.R.)	New Dorp, Staten Island, NY
12th Airdrome Company	(O.R.)	New Dorp, Staten Island, NY
13th Airdrome Company	(O.R.)	Erie, PA
6th Wing	(RAI)	Erie, PA
366th Ordnance Company (Maint)	(ORI)	Sixth Corps Area
303d Attack Group	(O.R.)	New Dorp, Staten Island, NY
399th Attack Squadron	(O.R.)	New Dorp, Staten Island, NY
400th Attack Squadron	(O.R.)	Buffalo, NY
401st Attack Squadron	(O.R.)	Buffalo, NY
402d Attack Squadron	(O.R.)	New Dorp, Staten Island, NY
333d Air Park	(O.R.)	Syracuse, NY
307th Observation Group	(O.R.)	Springfield, MA
391st Observation Squadron	(O.R.)	Pittsfield, MA
392d Observation Squadron	(O.R.)	Worcester, MA
393d Observation Squadron	(O.R.)	Binghamton, NY
Air Park No. 301	(O.R.)	Holyoke, MA
302d Pursuit Group	(O.R.)	Buffalo, NY
394th Pursuit Squadron	(O.R.)	Schenectady, NY
395th Pursuit Squadron	(O.R.)	Syracuse, NY
396th Pursuit Squadron	(O.R.)	Syracuse, NY
397th Pursuit Squadron	(O.R.)	Troy, NY
332d Air Park	(O.R.)	Buffalo, NY
Headquarters, Fourth Army Signal Service	(O.R.)	Manhattan, NY
303d Signal Battalion	(O.R.)	Manhattan, NY
321st Signal Battalion	(O.R.)	Hartford, CT
4th Meteorological Company	(O.R.)	New York City, NY
4th Pigeon Company	(O.R.)	Trenton, NJ
4th Radio Company	(O.R.)	Schenectady, NY
Headquarters, Fourth Army Ordnance Service	(O.R.)	Newark, NJ
621st Ordnance Company (Ammo)	(O.R.)	Hartford, CT
622d Ordnance Company (Ammo)	(O.R.)	Schenectady, NY
623d Ordnance Company (Ammo)	(O.R.)	Lock Haven, PA
382d Ordnance Company (Maint)	(O.R.)	Brooklyn, NY
801st Ordnance Company (Depot)	(O.R.)	New Haven, CT
802d Ordnance Company (Depot)	(O.R.)	Jamestown City, NY
803d Ordnance Company (Depot)	(O.R.)	New Castle, PA
901st Ordnance Company (HQ)	(O.R.)	New Brunswick, NJ
Fourth Army Medical Headquarters	(O.R.)	New York City, NY
4th Army Medical Laboratory	(O.R.)	New Haven, CT
4th Army Medical Supply Depot	(O.R.)	Boston, MA
361st Medical Regiment	(O.R.)	Newark, NJ
362d Medical Regiment	(O.R.)	Buffalo, NY
363d Medical Regiment	(O.R.)	Syracuse, NY
364th Medical Regiment	(O.R.)	Harrisburg, PA
10th Evacuation Hospital	(O.R.)	Fall River, MA
11th Evacuation Hospital	(O.R.)	Bridgeport, CT
12th Evacuation Hospital	(O.R.)	Boston, MA
13th Evacuation Hospital	(O.R.)	Camp Devens, MA
14th Evacuation Hospital	(O.R.)	New Haven, CT
20th Evacuation Hospital	(O.R.)	New York City, NY
23d Evacuation Hospital	(O.R.)	Troy, NY
26th Evacuation Hospital	(O.R.)	New York City, NY
27th Evacuation Hospital	(O.R.)	New York City, NY
28th Evacuation Hospital	(O.R.)	Brooklyn, NY
33d Evacuation Hospital	(O.R.)	Pittsburgh, PA
34th Evacuation Hospital	(O.R.)	Philadelphia, PA
35th Evacuation Hospital	(O.R.)	Baltimore, MD
36th Evacuation Hospital	(O.R.)	Harrisburg, PA
37th Evacuation Hospital	(O.R.)	Philadelphia, PA
12th Surgical Hospital	(O.R.)	Yonkers, NY

13th Surgical Hospital	(O.R.)	New York City, NY
14th Surgical Hospital	(O.R.)	Binghamton, NY
16th Surgical Hospital	(O.R.)	Trenton, NJ
18th Surgical Hospital	(O.R.)	Baltimore, MD
19th Surgical Hospital	(O.R.)	Scranton, PA
20th Surgical Hospital	(O.R.)	Pittsburgh, PA
21st Surgical Hospital	(O.R.)	Reading, PA
39th Surgical Hospital	(O.R.)	Boston, MA
40th Surgical Hospital	(O.R.)	Waterbury, CT
41st Surgical Hospital	(O.R.)	Worcester, MA
42d Surgical Hospital	(O.R.)	New Bedford, MA
1st Convalescent Hospital	(O.R.)	Worcester, MA
11th Veterinary Evacuation Hospital	(O.R.)	Springfield, MA
13th Veterinary Evacuation Hospital	(O.R.)	Newark, NJ
15th Veterinary Evacuation Hospital	(O.R.)	Philadelphia, PA
4th Veterinary Convalescent Hospital	(O.R.)	Chattanooga, TN
Headquarters, Fourth Army Train, Q.M.C.	(O.R.)	Jersey City, NJ
301st Motor Repair Battalion	(O.R.)	Providence, RI
302d Motor Repair Battalion	(O.R.)	Orange, NJ
303d Motor Repair Battalion	(O.R.)	Syracuse, NY
304th Motor Repair Battalion	(O.R.)	Beaver, PA
361st Motor Transport Command	(O.R.)	Manhattan, NY
362d Motor Transport Command	(O.R.)	Jersey City, NJ
363d Motor Transport Command	(O.R.)	Jersey City, NJ
364th Motor Transport Command	(O.R.)	Buffalo, NY
365th Motor Transport Command	(O.R.)	Buffalo, NY
601st Motor Transport Company	(O.R.)	Manhattan, NY
602d Motor Transport Company	(O.R.)	Manhattan, NY
603d Motor Transport Company	(O.R.)	Manhattan, NY
604th Motor Transport Company	(O.R.)	Manhattan, NY
605th Motor Transport Company	(O.R.)	Bronx, NY
606th Motor Transport Company	(O.R.)	Mount Vernon, NY
607th Motor Transport Company	(O.R.)	Jersey City, NJ
608th Motor Transport Company	(O.R.)	Jersey City, NJ
609th Motor Transport Company	(O.R.)	Paterson, NJ
610th Motor Transport Company	(O.R.)	Passaic, NJ
611th Motor Transport Company	(O.R.)	Belleville, NJ
612th Motor Transport Company	(O.R.)	Buffalo, NY
613th Motor Transport Company	(O.R.)	Buffalo, NY
614th Motor Transport Company	(O.R.)	Dunkirk, NY
615th Motor Transport Company	(O.R.)	Lockport, NY
616th Motor Transport Company	(O.R.)	Lockport, NY
617th Motor Transport Company	(O.R.)	Medina, NY
618th Motor Transport Company	(O.R.)	Fairport, NY
619th Motor Transport Company	(O.R.)	Ironduquit, NY
381st Motorcycle Company	(O.R.)	Montclair, NJ
382d Motorcycle Company	(O.R.)	Brooklyn, NY
401st Motor Repair Section	(O.R.)	Conandagua, NY
505th Motor Repair Section	(O.R.)	Willimantic, CT
506th Motor Repair Section	(O.R.)	Jersey City, NJ
507th Motor Repair Section	(O.R.)	Chester, PA

## HHC, FOURTH ARMY (II)

**HQ**—Omaha, NE, 15 August 1932–2 October 1933; Presidio of San Francisco, CA, 3 October 1933–7 December 1941

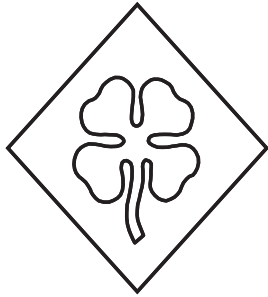

Headquarters, Fourth Army was constituted in the R.A. on 9 August 1932 and allotted to the Seventh Area. The headquarters was organized 15 August 1932 at Omaha, NE. The HQ Co. (constituted in the O.R. on 15 October 1921) was withdrawn from the O.R. 18 August 1933, and allotted to the R.A. effective 1 October 1933. The army headquarters was transferred to the Presidio of San Francisco on 3 October 1933 upon the assumption of command of Maj. Gen. Malin Craig, the senior corps area commander. Due to the abandonment in 1933 of the “Six Army” plan in favor of the “Four Army” plan, the Fourth Army area was restructured to consist of the Seventh and Ninth Corps Areas. The Fourth Army mission was to develop defense and operational plans for contingencies in the vicinity of the Pacific Coast and the western United States, review the mobilization plans of the Seventh and Ninth Corps

Areas, and oversee the training of units in the army area. As part of the responsibility to oversee training, the Fourth Army planned, conducted, and/or participated in three major maneuvers between 1937 and 1941. The 1937 maneuvers, under the command of Maj. Gen. George S. Simonds, were actually four separate exercises and were held at Fort Riley, KS, and Camp Ripley, MN, for the Seventh Corps Area troops, and at Camp San Luis Obispo, CA, and Fort Lewis, WA, for the Ninth Corps Area troops. The next Fourth Army maneuver was also a split exercise, this time under the command of Lt. Gen. John L. DeWitt. Held in August 1940, the maneuver was conducted near Camp Ripley for the Seventh Corps Area units and at Fort Lewis for the Ninth Corps Area contingent. A primary focus of this exercise was to train the army and corps staffs, all of which had been provisionally organized from the corps area staffs. Following the 1940 maneuver, the organization of the Fourth Army was changed to reflect the assignment of the III Corps to the troop list and the loss of the VII Corps to the Second Army. Additionally, the Fourth Army HQ Co. was activated on 18 November 1940 at the Presidio of San Francisco, CA. The final maneuver in which the Fourth Army participated prior to World War II was the GHQ Fourth Army Maneuver in southwest Washington State in August and September 1941. The exercise included over 120,000 Fourth Army soldiers from R.A. and N.G. units. Following the maneuvers, the Fourth Army returned to its station at the Presidio of San Francisco where it was located on 7 December 1941.

**Status:** Inactive in the R.A. as the Fourth US Army.

**Events:** 193, 279, 299, 304, 314, 326

### Army Commanders

Maj. Gen. Johnson Hagood	15 August 1932–2 October 1933	Maj. Gen. George S. Simonds	20 June 1936–8 March 1938
Maj. Gen. Malin Craig	3 October 1933–24 January 1935	Lt. Gen. Albert J. Bowley	8 March 1938–30 November 1939
Maj. Gen. Paul B. Malone	21 May 1935–30 April 1936	Lt. Gen. John L. DeWitt	1 December 1939–September 1943

### FOURTH ARMY TROOPS

1933

UNITS:	COMPONENT:	HQ LOCATION:
Headquarters, Fourth Army	(R.A.)	San Francisco, CA
VII Corps	(RAI)	St. Louis, MO
IX Corps	(RAI)	Seattle, WA
XVII Corps	(O.R.)	Omaha, NE
XIX Corps	(O.R.)	San Francisco, CA
Headquarters, Special Troops	(RAI)	San Francisco, CA
HQ Company, Fourth Army	(RAI)	San Francisco, CA
323d Military Police Battalion	(O.R.)	Moberly, MO
404th Field Remount Depot	(O.R.)	Corry, PA
328th Remount Troop	(O.R.)	Corry, PA
329th Remount Troop	(O.R.)	Corry, PA
330th Remount Troop	(O.R.)	Corry, PA
Army Artillery:		
35th Coast Artillery Brigade (AA)	(RAI)	Ventura, CA
Fourth Army Ammunition Train	(RAI)	Little Rock, AR
515th Coast Artillery Regiment (AA)	(O.R.)	Lincoln, NE

960th Coast Artillery Regiment (AA)	(RAI)	Manhattan, KS
979th Coast Artillery Regiment (AA)	(O.R.)	Seattle, WA
45th Ordnance Company (Maint)	(RAI)	Seventh Corps Area
Attached Units:		
92d Infantry Brigade	(N.G.)	Minneapolis, MN
205th Infantry Regiment	(N.G.)	Mankato, MN
206th Infantry Regiment	(N.G.)	St. Paul, MN
153d Infantry Regiment	(N.G.)	Conway, AR
200th Infantry Regiment	(NGI)	Idaho N.G.
549th Infantry Battalion	(O.R.)	Juneau, TA
44th Field Artillery Battalion (75-mm G) (C)	(RAI)	Seventh Corps Area
45th Field Artillery Battalion (75-mm G) (C)	(RAI)	Seventh Corps Area
46th Field Artillery Battalion (75-mm G) (C)	(RAI)	Oakland, CA
47th Field Artillery Battalion (75-mm G) (C)	(RAI)	San Francisco, CA
48th Field Artillery Battalion (75-mm G) (C)	(RAI)	Seattle, WA
Army Engineer Service:		
44th Engineer Regiment (GS)	(RAI)	Council Bluffs, IA
45th Engineer Regiment (GS)	(RAI)	St. Louis, MO
46th Engineer Regiment (GS)	(RAI)	San Bernardino, CA
429th Engineer Battalion (Sep) (C)	(O.R.)	Little Rock, AR
445th Engineer Battalion (Sep) (C)	(O.R.)	Hannibal, MO
464th Engineer Battalion (Sep)	(O.R.)	Los Angeles, CA
532d Engineer Battalion (Sep)	(O.R.)	Kansas City, MO
641st Engineer Battalion (Sep)	(O.R.)	Lincoln, NE
699th Engineer Battalion (Sep) (C)	(O.R.)	Oakland, CA
459th Engineer Battalion (Topo)	(O.R.)	St. Louis, MO
574th Engineer Battalion (WS)	(O.R.)	Ann Arbor, MI
85th Engineer Company (Depot)	(RAI)	Los Angeles, CA
736th Engineer Company (Shop)	(O.R.)	San Francisco, CA
580th Engineer Company (DT)	(O.R.)	Steubenville, OH
604th Engineer Battalion (Camo)	(O.R.)	Los Angeles, CA
Army Aviation:		
15th Observation Group	(RAI)	Los Angeles, CA
561st Observation Squadron	(O.R.)	Kansas City, MO
89th Service Squadron	(RAI)	Los Angeles, CA
4th Air Depot	(RAI)	Los Angeles, CA
7th Supply Squadron	(RAI)	Los Angeles, CA
8th Supply Squadron	(RAI)	Los Angeles, CA
7th Repair Squadron	(RAI)	Los Angeles, CA
8th Repair Squadron	(RAI)	Los Angeles, CA
3d Airdrome Squadron	(RAI)	Kansas City, MO
4th Airdrome Squadron	(RAI)	Kansas City, MO
5th Airdrome Squadron	(RAI)	Oakland, CA
6th Airdrome Squadron	(RAI)	Oakland, CA
Army Signal Service:		
54th Signal Battalion	(RAI)	San Francisco, CA
62d Signal Battalion	(RAI)	Seventh Corps Area
6th Meteorological Company	(O.R.)	San Francisco, CA
1st Pigeon Company	(ORI)	Seventh Corps Area
10th Radio Intelligence Company	(O.R.)	St. Paul, MN
504th Photo Company	(O.R.)	Los Angeles, CA
Army Chemical Warfare Service:		
405th Chemical Field Laboratory	(O.R.)	Minneapolis, MN
415th Chemical Company (Depot)	(O.R.)	Omaha, NE
425th Chemical Company (Maint)	(O.R.)	St. Louis, MO
Army Ordnance Service:		
63d Ordnance Company (HQ)	(RAI)	Los Angeles, CA
50th Ordnance Company (Ammo)	(RAI)	Seventh Corps Area
53d Ordnance Company (Ammo)	(RAI)	Seventh Corps Area
608th Ordnance Company (Ammo)	(ORI)	Seventh Corps Area
49th Ordnance Company (Maint)	(RAI)	Omaha, NE
78th Ordnance Company (Depot)	(RAI)	Davenport, IA
80th Ordnance Company (Depot)	(R.A.)	Benicia Arsenal, CA
81st Ordnance Company (Depot)	(RAI)	Benicia Arsenal, CA

Army Medical Service:		
3d Army Medical Laboratory	(O.R.)	Unknown
5th Army Medical Supply Depot	(O.R.)	Unknown
30th Medical Regiment	(RAI)	Butte, MT
349th Medical Regiment	(O.R.)	Seattle, WA
372d Medical Regiment	(O.R.)	Omaha, NE
4th Evacuation Hospital	(RAI)	St. Louis, MO
24th Evacuation Hospital	(RAI)	Little Rock, AR
63d Evacuation Hospital	(O.R.)	Kansas City, KS
64th Evacuation Hospital	(O.R.)	Kansas City, MO
65th Evacuation Hospital	(O.R.)	Burlington, IA
66th Evacuation Hospital	(O.R.)	Des Moines, IA
75th Evacuation Hospital	(RAI)	Rochester, MN
77th Evacuation Hospital	(RAI)	Little Rock, AR
81st Evacuation Hospital	(RAI)	Los Angeles, CA
82d Evacuation Hospital	(RAI)	Portland, O.R.
83d Evacuation Hospital	(RAI)	Portland, O.R.
84th Evacuation Hospital	(O.R.)	Portland, O.R.
85th Evacuation Hospital	(RAI)	Spokane, WA
86th Evacuation Hospital	(RAI)	Seattle, WA
87th Evacuation Hospital	(O.R.)	Portland, O.R.
88th Evacuation Hospital	(O.R.)	San Francisco, CA
4th Surgical Hospital	(RAI)	St. Louis, MO
51st Surgical Hospital	(RAI)	Minneapolis, MN
52d Surgical Hospital	(O.R.)	Fort Riley, KS
53d Surgical Hospital	(O.R.)	Fort Crook, NE
54th Surgical Hospital	(O.R.)	Ottumwa, IA
62d Surgical Hospital	(RAI)	Omaha, NE
63d Surgical Hospital	(RAI)	Omaha, NE
65th Surgical Hospital	(RAI)	San Francisco, CA
66th Surgical Hospital	(O.R.)	Butte, MT
67th Surgical Hospital	(O.R.)	Los Angeles, CA
69th Surgical Hospital	(O.R.)	Seattle, WA
70th Surgical Hospital	(O.R.)	Portland, O.R.
73d Surgical Hospital	(RAI)	Los Angeles, CA
74th Surgical Hospital	(RAI)	San Francisco, CA
3d Convalescent Hospital	(RAI)	San Francisco, CA
9th Veterinary Evacuation Hospital	(O.R.)	Kansas City, KS
25th Veterinary Evacuation Hospital	(RAI)	St. Louis, MO
27th Veterinary Evacuation Hospital	(RAI)	Sacramento, CA
6th Veterinary Convalescent Hospital	(O.R.)	San Francisco, CA
Army Quartermaster Service:		
4th Motor Transport Regiment	(RAI)	Sacramento, CA
<i>4th Motor Maintenance Battalion</i>	(RAI)	<i>Seventh Corps Area</i>
<i>4th Motorcycle Battalion</i>	(RAI)	<i>Seventh Corps Area</i>
<i>4th Quartermaster Remount Regiment</i>	(RAI)	<i>Seventh Corps Area</i>
84th Quartermaster Maint Battalion	(RAI)	Los Angeles, CA
<i>301st Quartermaster Service Regiment</i>	(O.R.)	<i>Fourth Corps Area</i>
<i>307th Quartermaster Service Regiment</i>	(O.R.)	<i>Seventh Corps Area</i>

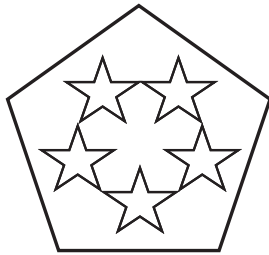
**HHC, FIFTH ARMY****Organized Reserve Ohio/Indiana****HQ**—*Not initiated, 1921–33*

The Fifth Army was authorized by the National Defense Act of 1920 and was originally to be composed of O.R. units primarily from the Fourth, Fifth, and Sixth Corps Areas. The HHC were constituted in the O.R. on 15 October 1921 and allotted to the Fifth Corps Area. Columbus, OH, was designated as headquarters upon organization, but the unit was never organized at that location. The HQ Co. was initiated in 1922 in Columbus. Columbus remained the Fifth Army's designated headquarters location upon the event of its activation until 16 July 1932 when Indianapolis, IN, was designated as the army's new headquarters location. Due to the abandonment of the "Six Army" plan in favor of the "Four Army" plan, the Fifth Army was deleted from the mobilization plans on 1 October 1933 and demobilized. Its subordinate units were reassigned to the Second Army, the GHQR, or demobilized.

**FIFTH ARMY TROOPS  
1923**

<b>UNITS:</b>	<b>COMPONENT:</b>	<b>HQ LOCATION:</b>
<i>Headquarters, Fifth Army</i>	(O.R.)	<i>Fifth Corps Area</i>
XIV Corps	(O.R.)	Birmingham, AL
XV Corps	(O.R.)	Columbus, OH
<i>XVI Corps</i>	(O.R.)	<i>Sixth Corps Area</i>
63d Cavalry Division	(O.R.)	Fort Oglethorpe, GA
64th Cavalry Division	(O.R.)	Louisville, KY
Headquarters, Special Troops	(O.R.)	Columbus, OH
HQ Company, Fifth Army	(O.R.)	Columbus, OH
322d Military Police Battalion	(O.R.)	Chicago, IL
359th Service Battalion, Q.M.C. (C)	(O.R.)	Aberdeen, MS
360th Service Battalion, Q.M.C. (C)	(O.R.)	Greenwood, MS
361st Service Battalion, Q.M.C. (C)	(O.R.)	De Ridder, LA
362d Service Battalion, Q.M.C. (C)	(O.R.)	Nachitoches, LA
363d Service Battalion, Q.M.C. (C)	(O.R.)	Texarkana, AR
364th Service Battalion, Q.M.C. (C)	(O.R.)	Cleburne, TX
365th Service Battalion, Q.M.C. (C)	(O.R.)	Laredo, TX
366th Service Battalion, Q.M.C. (C)	(O.R.)	Port Arthur, TX
42d Field Remount Depot, Q.M.C.	(O.R.)	Lansing, MI
31st Remount Troop	(O.R.)	St. Joseph, MI
32d Remount Troop	(O.R.)	Hillsdale, MI
33d Remount Troop	(O.R.)	Battle Creek, MI
Headquarters, Fifth Army Artillery	(O.R.)	Indianapolis, IN
199th Coast Artillery Brigade (AA)	(O.R.)	Indianapolis, IN
384th Ordnance Company (Maint)	(O.R.)	Savannah, GA
362d Ammunition Train	(O.R.)	Indianapolis, IN
206th Coast Artillery Regiment (AA)	(N.G.)	Arkansas N.G.
524th Coast Artillery Regiment (AA)	(O.R.)	Atlanta, GA
526th Coast Artillery Regiment (AA)	(O.R.)	Rock Island, IL
Headquarters, Fifth Army Engineer Service	(O.R.)	Indianapolis, IN
164th Engineer Regiment (GS)	(NGI)	<i>Georgia N.G.</i>
354th Engineer Regiment (GS)	(O.R.)	Butler, PA
355th Engineer Regiment (GS)	(O.R.)	Chapel Hill, NC
454th Engineer Battalion (Aux) (C)	(O.R.)	Huntsville, AL
455th Engineer Battalion (Aux) (C)	(O.R.)	Tupelo, MS
456th Engineer Battalion (Aux) (C)	(O.R.)	Marks, MS
457th Engineer Battalion (Aux) (C)	(O.R.)	Minden, LA
460th Engineer Battalion (Aux)	(O.R.)	Stillwater, OK
461st Engineer Battalion (Aux)	(O.R.)	El Paso, TX
458th Engineer Battalion (Topo)	(O.R.)	Madison, WS
544th Engineer Battalion (WS)	(O.R.)	Louisville, KY
477th Engineer Train (HB)	(O.R.)	Savannah, GA
478th Engineer Train (HB)	(O.R.)	Natchez, MS
482d Engineer Train (HB)	(O.R.)	Indiana
538th Engineer Train (HB)	(O.R.)	Philadelphia, PA

539th Engineer Train (HB)	(O.R.)	Philadelphia, PA
488th Engineer Train (LB)	(O.R.)	Watertown, SD
588th Engineer Train (LB)	(O.R.)	Traveres, FL
579th Engineer Train (DT)	(O.R.)	Eufala, AL
H Company, 40th Engineers (Camo)	(O.R.)	Wausau, WI
Headquarters, Fifth Army Air Service	(O.R.)	Henderson, KY
466th Headquarters Squadron	(O.R.)	Dayton, OH
16th Airdrome Company	(O.R.)	Janesville, WI
26th Airdrome Company	(O.R.)	Dayton, OH
7th Wing	(O.R.)	Pittsburgh, PA
385th Ordnance Company (M)	(ORI)	Fifth Corps Area
305th Attack Group	(O.R.)	Richmond, VA
407th Attack Squadron	(O.R.)	Hagerstown, MD
408th Attack Squadron	(O.R.)	Baltimore, MD
409th Attack Squadron	(O.R.)	Washington, DC
410th Attack Squadron	(O.R.)	Richmond, VA
335th Service Squadron	(O.R.)	Richmond, VA
315th Observation Group	(O.R.)	Harrisburg, PA
411th Observation Squadron	(O.R.)	Norfolk, VA
412th Observation Squadron	(O.R.)	High Point, MS
453d Observation Squadron	(ORI)	Fifth Corps Area
454th Observation Squadron	(ORI)	Fifth Corps Area
345th Service Squadron	(O.R.)	Harrisburg, PA
1st Pursuit Group	(R.A.)	Selfridge Field, MI
17th Pursuit Squadron	(R.A.)	Selfridge Field, MI
24th Pursuit Squadron	(R.A.)	Selfridge Field, MI
94th Pursuit Squadron	(R.A.)	Selfridge Field, MI
95th Pursuit Squadron	(R.A.)	Selfridge Field, MI
57th Service Squadron	(R.A.)	Selfridge Field, MI
308th Pursuit Group	(O.R.)	Bloomington, IL
421st Pursuit Squadron	(O.R.)	Equality, IL
422d Pursuit Squadron	(O.R.)	La Crosse, WI
423d Pursuit Squadron	(O.R.)	Chicago, IL
424th Pursuit Squadron	(O.R.)	Bloomington, IL
338th Service Squadron	(O.R.)	Chicago, IL
Headquarters, Fifth Army Signal Service	(O.R.)	Unknown
113th Signal Battalion	(NGI)	Wisconsin N.G.
324th Signal Battalion	(O.R.)	Chicago, IL
5th Meteorological Company	(O.R.)	Indianapolis, IN
5th Pigeon Company	(O.R.)	Louisville, KY
5th Radio Company	(O.R.)	Dayton, OH
Headquarters, Fifth Army Ordnance Service	(O.R.)	Unknown
625th Ordnance Company (Ammo)	(O.R.)	Cleveland, OH
626th Ordnance Company (Ammo)	(O.R.)	Chicago, IL
637th Ordnance Company (Ammo)	(ORI)	Fourth Corps Area
401st Ordnance Company (Maint)	(O.R.)	New Haven, CT
77th Ordnance Company (Depot)	(RAI)	Chicago, IL
804th Ordnance Company (Depot)	(O.R.)	New Orleans, LA
806th Ordnance Company (Depot)	(O.R.)	Rock Island, IL
902d Ordnance Company (HQ)	(O.R.)	Memphis, TN
Fifth Army Medical Headquarters	(O.R.)	Cleveland, OH
5th Army Medical Laboratory	(O.R.)	Chicago, IL
5th Army Medical Supply Depot	(O.R.)	Louisville, KY
365th Medical Regiment	(O.R.)	Scranton, PA
366th Medical Regiment	(O.R.)	Asheville, NC
369th Medical Regiment	(O.R.)	Battle Creek, MI
370th Medical Regiment	(O.R.)	Milwaukee, WI
22d Evacuation Hospital	(O.R.)	Milwaukee, WI
25th Evacuation Hospital	(O.R.)	Oak Park, IL
42d Evacuation Hospital	(O.R.)	Rome, GA
43d Evacuation Hospital	(O.R.)	Athens, GA
44th Evacuation Hospital	(O.R.)	Augusta, GA
45th Evacuation Hospital	(O.R.)	New Orleans, LA
46th Evacuation Hospital	(O.R.)	New Orleans, LA
55th Evacuation Hospital	(O.R.)	Oshkosh, WI

56th Evacuation Hospital	(O.R.)	Chicago, IL
57th Evacuation Hospital	(O.R.)	Detroit, MI
58th Evacuation Hospital	(O.R.)	Detroit, MI
59th Evacuation Hospital	(O.R.)	Detroit, MI
60th Evacuation Hospital	(O.R.)	Detroit, MI
61st Evacuation Hospital	(O.R.)	Racine, WI
62d Evacuation Hospital	(O.R.)	Chicago, IL
26th Surgical Hospital	(O.R.)	Birmingham, AL
27th Surgical Hospital	(O.R.)	Tampa, FL
28th Surgical Hospital	(O.R.)	Chattanooga, TN
29th Surgical Hospital	(O.R.)	Wilmington, NC
43d Surgical Hospital	(O.R.)	Wauwatosa, WI
44th Surgical Hospital	(O.R.)	Grand Rapids, MI
45th Surgical Hospital	(O.R.)	Springfield, IL
46th Surgical Hospital	(O.R.)	Ann Arbor, MI
47th Surgical Hospital	(O.R.)	Detroit, MI
48th Surgical Hospital	(O.R.)	Chicago, IL
49th Surgical Hospital	(O.R.)	Highland Park, IL
50th Surgical Hospital	(O.R.)	Milwaukee, WI
6th Convalescent Hospital	(O.R.)	Camp Funston, KS
6th Veterinary Evacuation Hospital	(O.R.)	La Crosse, WI
8th Veterinary Evacuation Hospital	(O.R.)	Ann Arbor, MI
17th Veterinary Evacuation Hospital	(O.R.)	Montgomery, AL
3d Veterinary Convalescent Hospital	(O.R.)	Niellsville, WI
Headquarters, Fifth Army Train, Q.M.C.	(O.R.)	Detroit, MI
305th Motor Repair Battalion	(O.R.)	Johnstown, PA
308th Motor Repair Battalion	(O.R.)	Columbus, OH
309th Motor Repair Battalion	(O.R.)	La Salle, IL
310th Motor Repair Battalion	(O.R.)	Dixon, IL
366th Motor Transport Command	(O.R.)	Detroit, MI
367th Motor Transport Command	(O.R.)	Detroit, MI
368th Motor Transport Command	(O.R.)	Detroit, MI
369th Motor Transport Command	(O.R.)	Detroit, MI
370th Motor Transport Command	(O.R.)	Detroit, MI
620th Motor Transport Company	(O.R.)	Detroit, MI
621st Motor Transport Company	(O.R.)	Detroit, MI
622d Motor Transport Company	(O.R.)	Detroit, MI
623d Motor Transport Company	(O.R.)	Detroit, MI
624th Motor Transport Company	(O.R.)	Detroit, MI
625th Motor Transport Company	(O.R.)	Detroit, MI
626th Motor Transport Company	(O.R.)	Detroit, MI
627th Motor Transport Company	(O.R.)	Detroit, MI
628th Motor Transport Company	(O.R.)	Detroit, MI
629th Motor Transport Company	(O.R.)	Detroit, MI
630th Motor Transport Company	(O.R.)	Detroit, MI
631st Motor Transport Company	(O.R.)	Detroit, MI
632d Motor Transport Company	(O.R.)	Detroit, MI
633d Motor Transport Company	(O.R.)	Detroit, MI
634th Motor Transport Company	(O.R.)	Detroit, MI
635th Motor Transport Company	(O.R.)	Detroit, MI
636th Motor Transport Company	(O.R.)	Detroit, MI
637th Motor Transport Company	(O.R.)	Detroit, MI
638th Motor Transport Company	(O.R.)	Detroit, MI
383d Motorcycle Company	(O.R.)	Detroit, MI
384th Motorcycle Company	(O.R.)	Detroit, MI
402d Motor Repair Section	(O.R.)	Detroit, MI
508th Motor Repair Section	(O.R.)	Georgetown, SC
509th Motor Repair Section	(O.R.)	Lexington, KY
510th Motor Repair Section	(O.R.)	Detroit, MI



**HHC, SIXTH ARMY****Organized Reserve Arkansas/Missouri**

HQ—*Not initiated*, 1921–24; St. Louis, MO, 1924–33

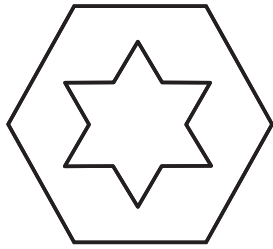

The Sixth Army was authorized by the National Defense Act of 1920 and was originally to be composed of O.R. units primarily from the Seventh, Eighth, and Ninth Corps Areas. The HHC were constituted in the O.R. on 15 October 1921 and allotted to the Seventh Corps Area. Little Rock, AR, was designated as headquarters upon organization, but the unit was never organized at that location. The HQ Co. was initiated 13 October 1922 at Little Rock. Little Rock remained the Sixth Army's headquarters location upon the event of its activation until 25 February 1924 when St. Louis, MO, was designated as the army's new headquarters location. The army headquarters was initiated in August 1924 at St. Louis. The HQ Co. was inactivated at Little Rock on 1 October 1924 and relocated to St. Louis. Due to the abandonment

of the "Six Army" plan in favor of the "Four Army" plan, the Sixth Army was deleted from the mobilization plans on 1 October 1933 and demobilized. Its subordinate units were reassigned to the Fourth Army, the GHQR, or demobilized.

**SIXTH ARMY TROOPS  
1923**

<b>UNITS:</b>	<b>COMPONENT:</b>	<b>HQ LOCATION:</b>
<i>Headquarters, Sixth Army</i>	<i>(ORI)</i>	<i>Seventh Corps Area</i>
XVII Corps	(O.R.)	Omaha, NE
XVIII Corps	(O.R.)	San Antonio, TX
XIX Corps	(O.R.)	San Francisco, CA
65th Cavalry Division	(O.R.)	Chicago, IL
66th Cavalry Division	(O.R.)	Omaha, NE
Headquarters, Special Troops	(O.R.)	Little Rock, AR
HQ Company, Sixth Army	(O.R.)	Little Rock, AR
323d Military Police Battalion	(O.R.)	Moberly, MO
367th Service Battalion, Q.M.C. (C)	(O.R.)	Poplar Bluff, MO
368th Service Battalion, Q.M.C. (C)	(O.R.)	Pine Bluff, AR
369th Service Battalion, Q.M.C. (C)	(O.R.)	Helena, AR
370th Service Battalion, Q.M.C.	(O.R.)	Minneapolis, MN
371st Service Battalion, Q.M.C. (C)	(O.R.)	Del Rio, TX
372d Service Battalion, Q.M.C.	(O.R.)	Denver, CO
373d Service Battalion, Q.M.C.	(O.R.)	St. Louis, MO
374th Service Battalion, Q.M.C.	(O.R.)	Oakland, CA
43d Field Remount Depot, Q.M.C.	(O.R.)	St. Paul, MN
34th Remount Troop	(O.R.)	Minneapolis, MN
35th Remount Troop	(O.R.)	Stillwater, MN
36th Remount Troop	(O.R.)	Mankato, MN
Headquarters, Sixth Army Artillery	(O.R.)	Kansas City, MO
200th Coast Artillery Brigade (AA)	(O.R.)	Des Moines, IA
387th Ordnance Company (Maint)	(O.R.)	Des Moines, IA
363d Ammunition Train	(O.R.)	Bismark, ND
527th Coast Artillery Regiment (AA)	(O.R.)	Kansas City, MO
528th Coast Artillery Regiment (AA)	(O.R.)	Minneapolis, MN
529th Coast Artillery Regiment (AA)	(O.R.)	Seattle, WA
Headquarters, Sixth Army Engineer Service	(O.R.)	Kansas City, MO
357th Engineer Regiment (GS)	(O.R.)	Escanaba, MI
358th Engineer Regiment (GS)	(O.R.)	Chicago, IL
359th Engineer Regiment (GS)	(O.R.)	Topeka, KS
462d Engineer Battalion (Aux)	(O.R.)	Dallas, TX
463d Engineer Battalion (Aux)	(O.R.)	Houston, TX
464th Engineer Battalion (Aux)	(O.R.)	Ft. Worth, TX
465th Engineer Battalion (Aux)	(O.R.)	Galveston, TX
466th Engineer Battalion (Aux)	(O.R.)	Beaumont, TX
467th Engineer Battalion (Aux)	(O.R.)	Austin, TX
459th Engineer Battalion (Topo)	(O.R.)	Lincoln, NE
487th Engineer Battalion (WS)	(O.R.)	Rapid City, SD
480th Engineer Train (HB)	(O.R.)	Maysville, KY
483d Engineer Train (HB)	(O.R.)	Monroe, MI

484th Engineer Train (HB)	(O.R.)	Monroe, MI
485th Engineer Train (HB)	(O.R.)	Muskegon, MI
622d Engineer Train (HB)	(O.R.)	Galveston, TX
589th Engineer Train (LB)	(O.R.)	San Francisco, CA
624th Engineer Train (LB)	(O.R.)	San Francisco, CA
577th Engineer Train (DT)	(O.R.)	El Paso, TX
I Company, 40th Engineers (Camo)	(O.R.)	Kansas City, MO
Headquarters, Sixth Army Air Service	(O.R.)	San Antonio, TX
439th Headquarters Squadron	(O.R.)	San Jose, CA
17th Airdrome Company	(O.R.)	Kansas City, MO
18th Airdrome Company	(O.R.)	Galveston, TX
19th Airdrome Company	(O.R.)	Aberdeen, WA
388th Ordnance Company (Maint)	(O.R.)	Minneapolis, MN
11th Wing Headquarters	(O.R.)	San Francisco, CA
309th Attack Group	(O.R.)	Chicago, IL
425th Attack Squadron	(O.R.)	Decatur, IL
426th Attack Squadron	(O.R.)	Belleville, IL
427th Attack Squadron	(O.R.)	Belleville, IL
428th Attack Squadron	(O.R.)	Bay City, MI
339th Service Squadron	(O.R.)	Chicago, IL
312th Observation Group	(O.R.)	San Francisco, CA
420th Observation Squadron	(O.R.)	Detroit, MI
434th Observation Squadron	(O.R.)	Bakersfield, CA
440th Observation Squadron	(O.R.)	Fresno, CA
441st Observation Squadron	(O.R.)	Sacramento, CA
342d Service Squadron	(O.R.)	San Francisco, CA
310th Pursuit Group	(O.R.)	Kansas City, MO
429th Pursuit Squadron	(O.R.)	Lincoln, KS
430th Pursuit Squadron	(O.R.)	St. Joseph, MO
431st Pursuit Squadron	(O.R.)	Minneapolis, MN
432d Pursuit Squadron	(O.R.)	St. Louis, MO
340th Air Park	(O.R.)	Kansas City, MO
311th Pursuit Group	(O.R.)	Galveston, TX
435th Pursuit Squadron	(O.R.)	Houston, TX
436th Pursuit Squadron	(O.R.)	Denver, CO
437th Pursuit Squadron	(O.R.)	Dallas, TX
438th Pursuit Squadron	(O.R.)	Santa Fe, NM
341st Air Park	(O.R.)	Galveston, TX
Headquarters, Sixth Army Signal Service	(O.R.)	San Francisco, CA
325th Signal Battalion	(O.R.)	St. Paul, MN
326th Signal Battalion	(O.R.)	Portland, O.R.
6th Meteorological Company	(O.R.)	San Francisco, CA
6th Pigeon Company	(O.R.)	San Francisco, CA
6th Radio Company	(O.R.)	San Francisco, CA
Headquarters, Sixth Army Ordnance Service	(O.R.)	Sioux City, IA
627th Ordnance Company (Ammo)	(O.R.)	Van Buren, AR
628th Ordnance Company (Ammo)	(O.R.)	Oklahoma City, OK
629th Ordnance Company (Ammo)	(O.R.)	Oakland, CA
142d Ordnance Company (Maint)	(NGI)	Pennsylvania N.G.
807th Ordnance Company (Depot)	(O.R.)	St. Paul, MN
808th Ordnance Company (Depot)	(O.R.)	Fresno, CA
809th Ordnance Company (Depot)	(O.R.)	Eugene, O.R.
903d Ordnance Company (HQ)	(O.R.)	Sioux City, IA
Sixth Army Medical Headquarters	(O.R.)	Omaha, NE
6th Army Medical Laboratory	(O.R.)	Fort Sam Houston, TX
6th Army Medical Supply Depot	(O.R.)	Los Angeles, CA
143d Medical Regiment	(NGI)	West Virginia N.G.
368th Medical Regiment	(O.R.)	Anderson, IN
371st Medical Regiment	(O.R.)	Kansas City, MO
372d Medical Regiment	(O.R.)	Omaha, NE
4th Evacuation Hospital	(O.R.)	St. Louis, MO
24th Evacuation Hospital	(O.R.)	Little Rock, AR
64th Evacuation Hospital	(O.R.)	Kansas City, MO
67th Evacuation Hospital	(O.R.)	St. Louis, MO
68th Evacuation Hospital	(O.R.)	Fort Des Moines, IA

71st Evacuation Hospital	(O.R.)	Fort Sam Houston, TX
72d Evacuation Hospital	(O.R.)	Fort Sam Houston, TX
73d Evacuation Hospital	(O.R.)	Fort Sam Houston, TX
74th Evacuation Hospital	(O.R.)	Dallas, TX
75th Evacuation Hospital	(O.R.)	Dallas, TX
86th Evacuation Hospital	(O.R.)	Seattle, WA
87th Evacuation Hospital	(O.R.)	Portland, O.R.
88th Evacuation Hospital	(O.R.)	San Francisco, CA
89th Evacuation Hospital	(O.R.)	Los Angeles, CA
90th Evacuation Hospital	(O.R.)	San Diego, CA
4th Surgical Hospital	(O.R.)	St. Louis, MO
16th Surgical Hospital	(O.R.)	El Paso, TX
51st Surgical Hospital	(O.R.)	St. Louis, MO
54th Surgical Hospital	(O.R.)	Fort Des Moines, IA
57th Surgical Hospital	(O.R.)	Fort Leavenworth, KS
58th Surgical Hospital	(O.R.)	Galveston, TX
59th Surgical Hospital	(O.R.)	Austin, TX
60th Surgical Hospital	(O.R.)	Tulsa, OK
69th Surgical Hospital	(O.R.)	Seattle, WA
70th Surgical Hospital	(O.R.)	Portland, OR
71st Surgical Hospital	(O.R.)	San Francisco, CA
72d Surgical Hospital	(O.R.)	Los Angeles, CA
2d Convalescent Hospital	(O.R.)	Fort Bliss, TX
1st Veterinary Evacuation Hospital	(O.R.)	Boise, ID
7th Veterinary Evacuation Hospital	(O.R.)	Pocatello, ID
10th Veterinary Evacuation Hospital	(O.R.)	Fort Des Moines, IA
6th Veterinary Convalescent Hospital	(O.R.)	San Francisco, CA
Headquarters, Sixth Army Train, Q.M.C.	(O.R.)	Des Moines, IA
311th Motor Repair Battalion	(O.R.)	Waterloo, IA
312th Motor Repair Battalion	(O.R.)	Oakland, CA
316th Motor Repair Battalion	(O.R.)	Gainesville, GA
346th Motor Repair Battalion	(O.R.)	San Antonio, TX
371st Motor Transport Command	(O.R.)	Des Moines, IA
372d Motor Transport Command	(O.R.)	Council Bluffs, IA
373d Motor Transport Command	(O.R.)	Sioux City, IA
374th Motor Transport Command	(O.R.)	Kansas City, MO
375th Motor Transport Command	(O.R.)	Kansas City, MO
639th Motor Transport Company	(O.R.)	Springfield, MO
640th Motor Transport Company	(O.R.)	Aurora, MO
641st Motor Transport Company	(O.R.)	Joplin, MO
642d Motor Transport Company	(O.R.)	Nevada, MO
643d Motor Transport Company (C)	(O.R.)	Pine Bluff, AR
644th Motor Transport Company (C)	(O.R.)	Jonesboro, AR
645th Motor Transport Company (C)	(O.R.)	Hot Springs, AR
646th Motor Transport Company (C)	(O.R.)	Fort Smith, AR
647th Motor Transport Company	(O.R.)	Des Moines, IA
648th Motor Transport Company	(O.R.)	Duluth, MN
649th Motor Transport Company	(O.R.)	East Grand Forks, MN
650th Motor Transport Company	(O.R.)	St. Paul, MN
651st Motor Transport Company	(O.R.)	Rochester, MN
652d Motor Transport Company	(O.R.)	Mankato, MN
653d Motor Transport Company	(O.R.)	St. Cloud, MN
654th Motor Transport Company	(O.R.)	Parker, SD
655th Motor Transport Company	(O.R.)	Sioux Falls, SD
656th Motor Transport Company	(O.R.)	Howard, SD
657th Motor Transport Company (Car)	(O.R.)	Des Moines, IA
385th Motorcycle Company	(O.R.)	Cedar Rapids, IA
386th Motorcycle Company	(O.R.)	Ottumwa, IA
403d Motor Repair Section	(O.R.)	Des Moines, IA
511th Motor Repair Section	(O.R.)	Kansas City, MO
512th Motor Repair Section	(O.R.)	Denver, CO
513th Motor Repair Section	(O.R.)	Tacoma, WA



## Chapter 5

### Corps

In July 1921, 18 corps headquarters were constituted in the US Army to support the six-army plan called for by the mobilization plans developed in 1920–21. Each field army was to consist of three corps. For some unknown reason, the lower numbered corps (i.e., the I through IX Corps), less the II Corps, were constituted or reconstituted in the Organized Reserve (O.R) even though these corps were to consist primarily of Regular Army (R.A.) and National Guard (N.G.) units. The II Corps was constituted in the N.G. Moreover, the higher numbered corps, the XI through XIX Corps (there was no X Corps), were constituted in the R.A. despite the fact that all of their subordinate units were O.R. units. Another anomaly was that only the VIII and IX Corps traced their lineages to their World War I counterparts. The remaining corps were newly constituted and bore no connection to previously existing units.

Each of the nine corps areas was allotted two “type” corps for mobilization responsibility. The designation of these corps were related to the corps area designation. For example, the First Corps Area was allotted the I and XI Corps, the Second Corps Area was allotted the II and XII Corps, and so forth. By the end of 1922, all of the corps headquarters had been organized or initiated except the II Corps. That corps was placed on the deferred list in July 1923, temporarily allotted to the O.R. as a Deferred National Guard (DNG) unit, and initiated shortly thereafter with Reserve personnel. None of the corps headquarters were assigned a commanding general, and it is unlikely that any of them were ever more than 50 percent complete in terms of their authorized officer strength and far less than that in regard to enlisted reservists.

Nine of the corps headquarters (one in each of the nine corps areas) were partially activated during 1921–22 to function as the administrative headquarters for O.R. nondivisional units (less coast artillery [C.A.] units in the five corps areas where the C.A. districts were located). The active headquarters included the III, IV, V, VI, VII, VIII, IX, XI, and XII Corps. These corps headquarters were largely organized with Reserve personnel, but possessed a small R.A. staff to carry out the headquarters administrative duties concerning the O.R. units under its control. The R.A. staff was organized as follows:

#### **Corps Staff:**

Chief of Staff	colonel
Adjutant General/G1	lieutenant colonel
Assistant Chief of Staff, General Staff G3	lieutenant colonel
Assistant Chief of Staff, General Staff G3	major
Senior Noncommissioned Officer (NCO)	staff sergeant
Administrative Sergeant	sergeant
Enlisted clerk	corporal
Enlisted clerk/driver	private

By 1925, these headquarters were inactivated due to budget constraints and congressional pressure to eliminate them, but remained organized with Reserve personnel. The functions of the corps headquarters, in most corps areas, were taken over by two new commands designated as the Non-Divisional Group and the Artillery Group.

Like their higher headquarters, the field armies, the interwar corps were “type” organizations. They consisted of a standard set of subordinate units necessary for wartime missions. The type corps of 1921 consisted of the following:

#### **“Type” Corps 1921**

Commander: Lieutenant General  
79,462 troops  
Corps Headquarters

- 3 Infantry Divisions
- Headquarters, Corps Special Troops
  - Headquarters Company, Corps
  - 1 Signal Battalion
  - 1 Military Police Battalion
  - 1 Ordnance Company (Heavy Maintenance)
  - 1 Ordnance Company (Ammunition)
  - 1 Service Battalion, Quartermaster Corps (Q.M.C.)
  - 1 Field Remount Depot, Q.M.C. (400 head)
    - 1 Remount Troop
- Headquarters, Corps Artillery
  - 1 Field Artillery Brigade
    - 1 Corps Ammunition Train
    - 1 Ordnance Company (Maintenance)
    - 1 Observation Battalion (Sound and Flash)
    - 3 Field Artillery Regiments (155-mm Howitzer)
    - 1 Field Artillery Regiment (155-mm Gun)
  - 1 Coast Artillery Regiment (Antiaircraft)
- Headquarters, Corps Engineer Service
  - 1 Engineer Regiment (General Service)
  - 3 Engineer Battalions (Auxiliary)
- Headquarters, Corps Air Service
  - 1 Observation Group
    - 2 Observation Squadrons
    - 1 Air Park
  - 1 Balloon Group
    - 4 Balloon Companies
    - 1 Balloon Park
- Headquarters, Corps Medical Service
  - 1 Medical Regiment
- Headquarters, Corps Train, Q.M.C.
  - 7 Motor Transport Commands
  - 24 Motor Transport Companies
    - 1 Motor Transport Company (Car)
    - 2 Motorcycle Companies
    - 8 Motor Repair Sections
  - 1 Wagon Train
    - 3 Wagon Companies

Beginning in 1927, a series of changes took place that affected the designation, component, and even the existence of the corps headquarters. In August 1927, the I, II, and III Corps were withdrawn from the O.R. and demobilized. Three new corps headquarters, the XX, XXI, and XXII, were constituted in the R.A. and allotted to the First, Second, and Third Corps Areas, respectively. These three corps were constituted and assigned to the new Seventh Army to form the basis of a contingency force around which all preexisting active ground forces could be rapidly mobilized and employed in an emergency. These corps were further redesignated as the new I, II, and III Corps that October.

Also in August 1927, the IV through VII Corps were withdrawn from the O.R. and allotted to the R.A. The remaining two lower numbered corps, the VIII and IX Corps, were not withdrawn from the O.R. and allotted to the R.A. until October 1933.

Additionally, the month of August 1927 also saw the addition of a new specialized corps to the US Army structure. This was the constitution of the I Cavalry Corps in the R.A. As originally contemplated, the I Cavalry Corps was to consist only of those elements needed to support the corps headquarters for limited tactical operations. However, up to three cavalry divisions, field artillery, and other logistics support units could be attached from the field army in theater, or attached from the General Headquarters Reserve (GHQR), for larger tactical operations. The operations of the I Cavalry Corps were to be of relatively short duration, then its attached elements would be returned to their parent headquarters.

With the implementation of the four army plan on 1 October 1933, many of the corps underwent changes to their field army reassignments. Concurrently, the nine high numbered corps were withdrawn from the R.A. and demobilized; new and identically numbered corps were constituted and allotted to the O.R. Additionally, the I through IX Corps were partially activated with dual-hatted R.A. personnel from corps area headquarters and Reserve personnel from each corps area at large. Even though these corps were partially active, they still were not assigned a commanding general, nor did they function as command and control headquarters.

By 1936, the structure of the corps troop list had changed slightly from the early 1920s. The primary difference being in the number of R.A. support units versus O.R. units and the structure of the corps logistics units. A type corps in 1936 was organized as follows:

### **“Type” Corps 1936**

#### Corps Headquarters

- 3 Infantry Divisions

- Headquarters, Corps Special Troops

  - Headquarters Company, Corps

  - 1 Signal Battalion

  - 1 Military Police Battalion

  - 1 Ordnance Company (Heavy Maintenance)

  - 1 Ordnance Company (Ammunition)

  - 1 Corps Field Remount Depot, Q.M.C. (400 horse)

    - 1 Remount Troop

#### Corps Artillery:

- 1 Field Artillery Brigade

  - 1 Corps Ammunition Train

  - 1 Ordnance Company (Maintenance)

  - 1 Observation Battalion (Sound and Flash)

  - 2 Field Artillery Regiments (155-mm Howitzer)

  - 1 Field Artillery Regiment (155-mm Gun)

- 1 Coast Artillery Regiment (Antiaircraft)

#### Corps Engineers:

- 1 Engineer Regiment (General Service)

- 3 Engineer Battalions (Separate)

- 1 Engineer Company (Depot)

#### Corps Aviation:

- 1 Observation Group

  - 2 Observation Squadrons

  - 1 Service Squadron

- 1 Balloon Group

  - 3 Balloon Companies

  - 1 Balloon Service Squadron

Corps Medical Service:

1 Medical Regiment

Corps Quartermaster Service

1 Quartermaster Regiment (Truck)

1 Quartermaster Regiment (Light Maintenance)

Although the corps headquarters were largely pool units in the 1920s and 1930s, some, mostly the lower numbered corps, still occasionally participated in major training events. Functioning in a provisional status, many corps headquarters were assembled for participation in a number of corps area and army command post exercises and maneuvers. Though these activities had no official standing in terms of Active Duty for the corps headquarters, they did give those regulars, guardsmen, and reservists who were permanently or temporarily assigned or attached to the headquarters an opportunity for staff training at higher levels of command.

In October 1939, the IV Corps Headquarters (HQ) was activated at Fort Benning, GA, to serve as a maneuver headquarters to test the new triangular division structure during a series of tests in the winter and spring of 1940. The remaining eight lower numbered corps were activated between August and December 1940 to assume command and control of the R.A. and N.G. divisions mobilizing across the United States for World War II service. None of the higher numbered corps were activated until after Pearl Harbor.



**HHT, I CAVALRY CORPS****Regular Army Inactive**

**HQ**—*Not organized*, 1927–32; Des Moines, IA, 1932–40; *Inactive*, 1 October 1940–as of 7 December 1941

Constituted in the R.A. on 15 August 1927 and allotted to the Seventh Corps Area. Under the original special instructions from the War Department, the corps headquarters and headquarters troop (HHT) would be organized from enlisted personnel from Fort Des Moines and Reserve personnel in the Des Moines area for mobilization purposes. The HQ was organized by November 1932 with O.R. personnel as a Regular Army Inactive (RAI) unit at Des Moines, IA (the HQ troop had been previously organized about August 1929 with O.R. personnel as a RAI unit also at Des Moines). The corps HQ was further partially activated on 1 October 1933 by the assignment of several R.A. officers for mobilization purposes. The personnel assigned to the corps HQ conducted summer training as individual attendees most years at Fort Des Moines and as a unit for at least 1 year, in July 1939, at Fort Riley. On several occasions, the corps HQ was provisionally organized for command post exercises (CPXs) such as the General Headquarters (GHQ) CPX held at Fort Monmouth, NJ, in August and September 1934. The designated mobilization station for the corps HQ was Fort Riley, KS, where it would assume command and control of its assigned subordinate corps troops, which would be mobilizing primarily in the Seventh Corps Area. The corps HQ was never fully activated and all personnel were relieved from assignment by 1 October 1940.

**Status:** Disbanded 26 October 1944.

**Events:** 148, 156, 174, 175, 217, 234, 264

**Corps Commanders**

Brig. Gen. Julian Lindsey*	8 November 1932–31 May 1934	Brig. Gen. Ben Lear*	July 1936–31 October 1938
Brig. Gen. Guy V. Henry*	31 May 1934–24 July 1935	Brig. Gen. Adna R. Chaffee*	1 November 1938–15 July 1940

\*These officers were the commanders of the 7th Cavalry Brigade (Mechanized) and for activation/mobilization exercise purposes were designated as the commanding general of the I Cavalry Corps.

**I CAVALRY CORPS  
Organization 1932**

<b>UNIT:</b>	<b>COMPONENT:</b>	<b>HQ LOCATION:</b>	<b>UNIT:</b>
HQ, I Cav. Corps	(RAI)	Des Moines, IA	C.A. Regt. (AA)*
Cav. Div.*			Engr. Regt.*
Cav. Div.*			Engr. Bridge Co.*
Cav. Div.*			Tank Bn. (Light)*
7th Cav. Brig. (Mecz)	(R.A.)	Fort Knox, KY	Obsn. Gp.*
15th Cav. Regt.	(RAI)	Kansas City, MO	Med. Regt.*
16th Cav. Regt.	(RAI)	Fort Myer, VA	Ord. Co.*
17th Cav. Regt.	(RAI)	Los Angeles, CA	HQ, Corps Q.M. Tn.*
4th Armored Car Sq.	(RAI)	Omaha, NE	Motor Transport Companies*
HQ Detachment	(RAI)	Des Moines, IA	Rmt Dep*
HQ, Special Troops	(RAI)	Des Moines, IA	Wagon Companies*
HQ Troop	(RAI)	Des Moines, IA	Pack Tns.*
4th Signal Troop	(RAI)	Omaha, NE	
16th F.A. Brig.	(RAI)	Tulsa, OK	
F.A. Regt.*			
F.A. Regt.*			
F.A. Regt.*			

\*These units would be detached from the field armies in theater and attached to the I Cavalry Corps for specific short-term operations and were not habitually assigned to the corps.

## HHC, I CORPS (I)

## Organized Reserve Massachusetts

HQ—*Not initiated*, 1921–23; Boston, MA, 1923–27

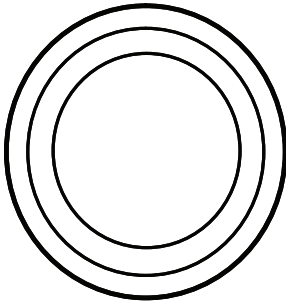

Constituted in the O.R. on 29 July 1921, allotted to the First Corps Area and assigned to the First Army. The headquarters and headquarters company (HHC) were initiated by September 1922 at the Army Base, Boston, MA. HHC, I Corps was withdrawn from the O.R. on 15 August 1927 and demobilized.

### Chiefs of Staff

Lt. Col. Theodore B. Taylor (R.A.)

15 September 1922–ao March 1923

### I CORPS Organization 1922

#### UNIT:

HQ, I Corps  
  9th Div.  
  26th Div.  
  43d Div.  
HQ, Special Troops  
  HQ Co., I Corps  
  51st Sig. Bn.  
  101st M.P. Bn.  
  510th Ord. Co. (HM)  
  610th Ord. Co. (Ammo.)  
  30th Sv Bn., Q.M.C.  
  30th Field Rmt Dep  
    1st Rmt Troop  
HQ, I Corps Arty.  
  81st F.A. Brig.  
    360th Ord. Co. (M)  
    131st Ammo. Tn.  
    101st Obsn. Bn. (Flash)  
    171st F.A. Regt.  
    172d F.A. Regt.  
    173d F.A. Regt.  
    192d F.A. Regt.  
    197th C.A. Regt. (AA)  
HQ, I Corps Engrs.  
  13th Engr. Regt. (GS)  
  438th Engr. Bn. (Aux)  
  439th Engr. Bn. (Aux)  
  440th Engr. Bn. (Aux)  
HQ, I Corps Air Service  
  323d Obsn. Gp.  
    131st Obsn. Sq.  
    132d Obsn. Sq.  
    Air Park No. 101  
  11th Bln. Gp.  
    101st Bln. Co.  
    102d Bln. Co.  
    103d Bln. Co.  
    104th Bln. Co.  
    Bln. Park No. 11  
I Corps Med. HQ  
  131st Med. Regt.

#### COMPONENT:

(O.R.)  
(RAI)  
(N.G.)  
(N.G.)  
(O.R.)  
(O.R.)  
(R.A.)  
(NGI)  
(O.R.)  
(O.R.)  
(O.R.)  
(O.R.)  
(O.R.)  
(O.R.)  
(O.R.)  
(O.R.)  
(NGI)  
(O.R.)  
(NGI)  
(NGI)  
(NGI)  
(N.G.)  
(NGI)  
(N.G.)  
(N.G.)  
(O.R.)  
(R.A.)  
(O.R.)  
(O.R.)  
(O.R.)  
(NGI)  
(O.R.)  
(NGI)  
(NGI)  
(NGI)  
(NGI)  
(NGI)  
(NGI)  
(NGI)  
(NGI)  
(NGI)  
(O.R.)  
(NGI)

#### HQ LOCATION:

Boston, MA  
First Corps Area  
Boston, MA  
South Manchester, CT  
Boston, MA  
Boston, MA  
Camp Alfred Vail, NJ  
New Hampshire N.G.  
Providence, RI  
Springfield, MA  
Buffalo, NY  
Utica, NY  
Utica, NY  
Boston, MA  
Massachusetts N.G.  
Springfield, MA  
Massachusetts N.G.  
Massachusetts N.G.  
Massachusetts N.G.  
Manchester, NH  
Connecticut N.G.  
New London, CT  
Concord, NH  
Boston, MA  
Camp A.A. Humphreys, VA  
Brooklyn, NY  
Bronx, NY  
Washington, DC  
Massachusetts N.G.  
Fitchburg, MA  
Massachusetts N.G.  
Rhode Island N.G.  
Massachusetts N.G.  
New Hampshire N.G.  
New Hampshire N.G.  
Rhode Island N.G.  
Maine N.G.  
Vermont N.G.  
Massachusetts N.G.  
Boston, MA  
Vermont N.G.

HQ, I Corps Tn., Q.M.C.	(O.R.)	Boston, MA
337th M.T. Cmd.	(O.R.)	Worcester, MA
338th M.T. Cmd.	(O.R.)	Malden, MA
339th M.T. Cmd.	(O.R.)	Boston, MA
402d M.T. Cmd.	(O.R.)	Providence, RI
403d M.T. Cmd.	(O.R.)	Bridgeport, CT
404th M.T. Cmd.	(O.R.)	Providence, RI
405th M.T. Cmd.	(O.R.)	Hartford, CT
548th M.T. Co.	(O.R.)	Rensselaer, NY
549th M.T. Co.	(O.R.)	Whitehall, NY
550th M.T. Co.	(O.R.)	Schenectady, NY
551st M.T. Co.	(O.R.)	Amsterdam, NY
552d M.T. Co.	(O.R.)	Malone, NY
553d M.T. Co.	(O.R.)	Potsdam, NY
554th M.T. Co.	(O.R.)	Watertown, NY
555th M.T. Co.	(O.R.)	Oswego, NY
556th M.T. Co. (Car)	(O.R.)	Albany, NY
768th M.T. Co.	(O.R.)	Woonsocket, RI
769th M.T. Co.	(O.R.)	Providence, RI
770th M.T. Co.	(O.R.)	Bristol, RI
771st M.T. Co.	(O.R.)	Natick, RI
772d M.T. Co.	(O.R.)	Bridgeport, CT
773d M.T. Co.	(O.R.)	Bridgeport, CT
774th M.T. Co.	(O.R.)	New Haven, CT
775th M.T. Co.	(O.R.)	New Haven, CT
776th M.T. Co.	(O.R.)	Hartford, CT
777th M.T. Co.	(O.R.)	Hartford, CT
778th M.T. Co.	(O.R.)	Waterbury, CT
779th M.T. Co.	(O.R.)	Waterbury, CT
780th M.T. Co.	(O.R.)	Buffalo, NY
781st M.T. Co.	(O.R.)	Rochester, NY
782d M.T. Co.	(O.R.)	Syracuse, NY
359th Mtcyl Co.	(O.R.)	Albany, NY
360th Mtcyl Co.	(O.R.)	Hudson, NY
380th M. Rep. Sec	(O.R.)	Glen Falls, NY
451st M. Rep. Sec	(O.R.)	Woonsocket, RI
452d M. Rep. Sec	(O.R.)	Providence, RI
453d M. Rep. Sec	(O.R.)	Bristol, RI
454th M. Rep. Sec	(O.R.)	Bridgeport, CT
455th M. Rep. Sec	(O.R.)	New Haven, CT
456th M. Rep. Sec	(O.R.)	Hartford, CT
457th M. Rep. Sec	(O.R.)	Waterbury, CT
62d Wagon Tn.	(O.R.)	Syracuse, NY
374th Wagon Co.	(O.R.)	Syracuse, NY
375th Wagon Co.	(O.R.)	Union, NY
376th Wagon Co.	(O.R.)	Ithaca, NY

## HHC, I CORPS (II)

## Regular Army Inactive

**HQ**—*Not organized*, 1927–33; Boston, MA, 1933–40; Columbia, SC, 1940–41; Fort Jackson, SC, 1941–42

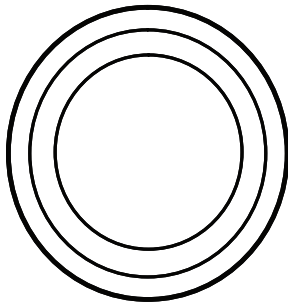

Constituted in the R.A. as HHC, XX Corps on 15 August 1927, allotted to the First Corps Area, and assigned to the Seventh Army. Redesignated HHC, I Corps on 13 October 1927 and concurrently assigned to the First Army. On 1 October 1933, the corps HQ was partially activated at Boston with R.A. personnel from HQ, First Corps Area and Reserve personnel from the corps area at large. As an RAI unit from 1933 to 1940, the corps HQ was occasionally organized provisionally for short periods using its assigned Reserve officers and staff officers from HQ, First Corps Area. These periods included several First Corps Area and First Army CPXs in the 1930s and the First Army Maneuvers in New York in 1935, 1939, and 1940. HQ, I Corps was fully activated 1 November 1940, less Reserve personnel, at 1429 Senate Street, Columbia, SC, and assumed command and control of the 8th, 9th, and 30th Divisions. The HHC

were transferred to Fort Jackson, SC, on 20 February 1941, once space for the corps HQ became available on the post. The I Corps participated in the Carolina Maneuvers in November 1941 as part of the First Army. After the maneuver, the I Corps returned to Fort Jackson, where it was located on 7 December 1941.

**Status:** Active in the R.A. at Fort Lewis, WA, as HHC, I Corps.

**Events:** 95, 174, 190, 280, 301, 330

#### Corps Commanders

Maj. Gen. Walter C. Short	1 November 1940–26 December 1940	Maj. Gen. William E. Shedd	1 April 1941–1 August 1941
Maj. Gen. Phillip B. Peyton	26 December 1940–28 February 1941	Maj. Gen. Charles F. Thompson	1 August 1941–24 June 1942

Prior to November 1940, the First Corps Area commander was generally designated as commanding general for activation/mobilization.

#### I CORPS Organization 1936

UNIT:	COMPONENT:	HQ LOCATION:
HQ, I Corps	(RAI)	Boston, MA
9th Div.	(RAI)	Boston, MA
26th Div.	(N.G.)	Boston, MA
43d Div.	(N.G.)	New London, CT
HQ, Special Troops	(O.R.)	Boston, MA
HQ Co., I Corps	(RAI)	Boston, MA
53d Sig. Bn.	(RAI)	Cambridge, MA
301st M.P. Bn.	(O.R.)	Boston, MA
32d Ord. Co. (HM)	(RAI)	First Corps Area
51st Ord. Co. (Ammo.)	(R.A.)	Pedricktown, NJ
I Corps Field Rmt Dep	(RAI)	Second Corps Area
I Corps Arty.:		
19th F.A. Brig.	(RAI)	Springfield, MA
8th Ord. Co. (M)	(RAI)	Boston, MA
19th Ammo. Tn.	(RAI)	Springfield, MA
314th Obsn. Bn. (Flash)	(RAI)	Haverhill, MA
37th F.A. Regt.	(RAI)	Springfield, MA
38th F.A. Regt.	(RAI)	Springfield, MA
88th F.A. Regt.	(RAI)	Springfield, MA
68th C.A. Regt. (AA)	(RAI)	Cambridge, MA
I Corps Engrs.:		
371st Engr. Regt. (GS)	(RAI)	Boston, MA
51st Engr. Bn. (Sep.)	(RAI)	Fort Devens, MA
413th Engr. Bn. (Sep.)	(O.R.)	Worcester, MA
590th Engr. Bn. (Sep.) (C)	(O.R.)	New Haven, CT
391st Engr. Co. (Dep)	(O.R.)	Boston, MA
I Corps Aviation:		
41st Obsn. Gp.	(RAI)	Providence, RI
101st Obsn. Sq.	(N.G.)	Boston, MA
118th Obsn. Sq.	(N.G.)	Hartford, CT
41st Sv Sq.	(RAI)	Providence, RI
541st Bln. Gp.	(O.R.)	New Haven, CT
301st Bln. Sq.	(O.R.)	Bangor, ME
302d Bln. Sq.	(O.R.)	Boston, MA
303d Bln. Sq.	(O.R.)	Boston, MA
338th Bln. Sv Sq.	(O.R.)	New Haven, CT
I Corps Med. Sv:		
14th Med. Regt.	(RAI)	Boston, MA
I Corps Q.M. Sv:		
21st Q.M. Regt. (Truck)	(RAI)	Fort Devens, MA
32d Q.M. Regt. (LM)	(RAI)	Concord, NH

## HHC, II CORPS (I)

## New York National Guard

HQ—*Not organized*, 1921–23; New York City, NY, 1923–27

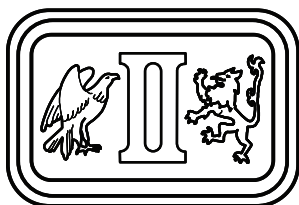

Constituted in the N.G. on 29 July 1921, allotted to the state of New York, and assigned to the First Army. HHC were placed on the Deferred List on 2 July 1923 and transferred to the O.R. as a DNG unit. The HQ was initiated in late 1923 with O.R. personnel at 39 Whitehall Street, New York City, NY. HHC, II Corps was withdrawn on 15 August 1927 from the N.G. and demobilized. Concurrently, O.R. personnel were relieved from assignment.

Events: 61

### II CORPS Organization 1922

UNIT:	COMPONENT:	HQ LOCATION:
<i>HQ, II Corps</i>	(NGI)	<i>New York N.G.</i>
1st Div.	(R.A.)	Fort Hamilton, NY
27th Div.	(N.G.)	New York City, NY
44th Div.	(N.G.)	Trenton, NJ
<i>HQ, Special Troops</i>	(NGI)	<i>New York N.G.</i>
<i>HQ Co., II Corps</i>	(NGI)	<i>New York N.G.</i>
101st Sig. Bn.	(N.G.)	New York City, NY
310th M.P. Bn.	(O.R.)	Manhattan, NY
511th Ord. Co. (HM)	(O.R.)	New York City, NY
611th Ord. Co. (Ammo.)	(O.R.)	Brooklyn, NY
31st Sv Bn., Q.M.C. (C)	(O.R.)	Brooklyn, NY
31st Field Rmt Dep	(O.R.)	Beacon City, NY
2d Rmt Troop	(O.R.)	Beacon City, NY
<i>HQ, II Corps Arty.</i>	(NGI)	<i>New York N.G.</i>
<i>F.A. Brig.</i>	(RAI)	<i>Not designated</i>
361st Ord. Co. (M)	(O.R.)	Yonkers, NY
132d Ammo. Tn.	(N.G.)	Middletown, NY
<i>102d Obsn. Bn. (Flash)</i>	(NGI)	<i>New York N.G.</i>
<i>F.A. Regt.</i>	(RAI)	<i>Not designated</i>
106th F.A. Regt.	(N.G.)	Buffalo, NY
258th F.A. Regt.	(N.G.)	New York City, NY
<i>F.A. Regt.</i>	(RAI)	<i>Not designated</i>
198th C.A. Regt. (AA)	(N.G.)	Wilmington, DE
<i>HQ, II Corps Engrs.</i>	(NGI)	<i>New York N.G.</i>
<i>131st Engr. Regt. (GS)</i>	(NGI)	<i>New York N.G.</i>
<i>139th Engr. Bn. (Aux)</i>	(NGI)	<i>New York N.G.</i>
441st Engr. Bn. (Aux)	(O.R.)	Fort Wayne, IN
442d Engr. Bn. (Aux)	(O.R.)	Louisville, KY
<i>HQ, II Corps Air Service</i>	(O.R.)	Manhattan, NY
325th Obsn. Gp.	(O.R.)	New Dorp, Staten Island, NY
369th Obsn. Sq.	(O.R.)	New Dorp, Staten Island, NY
370th Obsn. Sq.	(O.R.)	Mineola, Long Island, NY
310th Air Park	(O.R.)	Mineola, Long Island, NY
50th Bln. Gp.	(O.R.)	Rochester, NY
<i>14th Bln. Co.</i>	(RAI)	<i>A.A. 1st Bln Co.</i>
<i>15th Bln. Co.</i>	(RAI)	<i>A.A. 13th Bln Co.</i>
23d Bln. Co.	(RAI)	Post Field, OK
337th Bln. Co.	(O.R.)	Plattsburg, NY
40th Bln. Park	(O.R.)	Rochester, NY
II Corps Med. HQ	(O.R.)	Manhattan, NY
350th Med. Regt.	(O.R.)	Manhattan, NY
<i>HQ, II Corps Tn., Q.M.C.</i>	(NGI)	<i>New York N.G.</i>
<i>101st M.T. Cmd.</i>	(NGI)	<i>New York N.G.</i>
<i>102d M.T. Cmd.</i>	(NGI)	<i>New York N.G.</i>
<i>111th M.T. Cmd.</i>	(NGI)	<i>New York N.G.</i>
<i>112th M.T. Cmd.</i>	(NGI)	<i>New York N.G.</i>

406th M.T. Cmd.	(O.R.)	Schenectady, NY
407th M.T. Cmd.	(O.R.)	Albany, NY
408th M.T. Cmd.	(O.R.)	Watertown, NY
191st M.T. Co.	(NGI)	New York N.G.
192d M.T. Co.	(NGI)	New York N.G.
193d M.T. Co.	(NGI)	New York N.G.
194th M.T. Co.	(NGI)	New York N.G.
195th M.T. Co.	(NGI)	New York N.G.
196th M.T. Co.	(NGI)	New York N.G.
197th M.T. Co.	(NGI)	New York N.G.
198th M.T. Co.	(NGI)	New York N.G.
199th M.T. Co.	(NGI)	New York N.G.
200th M.T. Co.	(NGI)	New York N.G.
201st M.T. Co.	(NGI)	New York N.G.
202d M.T. Co.	(NGI)	New York N.G.
203d M.T. Co.	(NGI)	New York N.G.
450th M.T. Co.	(O.R.)	Queens, NY
451st M.T. Co.	(O.R.)	Jamaica, NY
452d M.T. Co.	(O.R.)	Glouster, NJ
453d M.T. Co.	(O.R.)	Camden, NJ
454th M.T. Co.	(O.R.)	Lambertville, NJ
455th M.T. Co.	(O.R.)	Pasaic, NJ
456th M.T. Co.	(O.R.)	Manhattan, NY
141st Mtcyl Co.	(NGI)	New York N.G.
142d Mtcyl Co.	(NGI)	New York N.G.
151st M. Rep. Sec	(NGI)	New York N.G.
152d M. Rep. Sec	(NGI)	New York N.G.
458th M. Rep. Sec	(O.R.)	Buffalo, NY
459th M. Rep. Sec	(O.R.)	Buffalo, NY
460th M. Rep. Sec	(O.R.)	Ithaca, NY
461st M. Rep. Sec	(O.R.)	Troy, NY
462d M. Rep. Sec	(O.R.)	Plattsburg, NY
51st Wagon Tn.	(NGI)	New York N.G.
161st Wagon Co.	(NGI)	New York N.G.
162d Wagon Co.	(NGI)	New York N.G.
163d Wagon Co.	(NGI)	New York N.G.

## HHC, II CORPS (II)

## Regular Army Inactive

HQ—*Not organized*, 1927–33; Fort Jay, NY, 1933–40; Fort George G. Meade, MD, 1940; Wilmington, DE, 1940–42



Constituted in the R.A. as HHC, XXI Corps on 15 August 1927, allotted to the Second Corps Area, and assigned to the Seventh Army. Redesignated HHC, II Corps on 13 October 1927 and concurrently assigned to the First Army. The designated HQ location for peacetime organization purposes was New York City. On 1 October 1933, the corps HQ was partially activated at Fort Jay, NY, with R.A. personnel from HQ, Second Corps Area and Reserve personnel from the corps area at large. Though an RAI unit from 1933 to 1940, the corps HQ was organized provisionally for short periods using its assigned Reserve officers and staff officers from HQ, Second Corps Area. These periods of provisional Active Duty were generally for CPXs and major maneuvers such as the First Army Maneuvers in 1935, 1939, and 1940. The II Corps HQ was fully activated on 1 August 1940, less Reserve personnel, at Fort Jay, and assumed command and control of the 1st, 27th, and 44th Divisions for participation in the 1940 First Army Maneuvers. After the maneuver, the 1st Division was transferred to the VI Corps, the 27th Division was transferred to the VII Corps, and the 28th

and 29th Divisions were assigned to the II Corps. The corps HHC were transferred temporarily to Fort George G. Meade, MD, from 10 to 26 December 1940, after which they were transferred to the Pennsylvania Railroad Building, Wilmington, DE, arriving there 26 December 1940. The corps participated in the Carolina Maneuvers in September–November 1941 as part of the First Army. After the maneuver, the corps HQ began to return to Wilmington and was en route to home station on 7 December 1941.

**Status:** Inactive in the R.A. as HHC, II Army Corps.

**Events:** 91, 168, 174, 190, 280, 301, 330

#### Corps Commanders

Maj. Gen. Henry C. Pratt      26 December 1940–20 August 1941      Maj. Gen. Lloyd R. Fredendall      21 August 1941–5 March 1943

Prior to December 1940, the Second Corps Area commander was generally designated as commanding general for activation/mobilization.

#### II CORPS Organization 1936

UNIT:	COMPONENT:	HQ LOCATION:
HQ, II Corps	(RAI)	Fort Jay, NY
1st Div.	(R.A.)	Fort Hamilton, NY
27th Div.	(N.G.)	New York City, NY
44th Div.	(N.G.)	Trenton, NJ
HQ, Special Troops	(RAI)	Manhattan, NY
HQ Co., II Corps	(RAI)	Manhattan, NY
51st Sig. Bn.	(R.A.)	Fort Monmouth, NJ
302d M.P. Bn.	(O.R.)	Brooklyn, NY
31st Ord. Co. (HM)	(RAI)	Second Corps Area
58th Ord. Co. (Ammo.)	(RAI)	Raritan Arsenal, NJ
II Corps Field Rmt Dep	(RAI)	Third Corps Area
II Corps Arty.:		
20th F.A. Brig.	(RAI)	Second Corps Area
29th Ord. Co. (M)	(RAI)	West Point, NY
342d Ammo. Tn.	(RAI)	Manhattan, NY
2d Obsn. Bn. (Flash)	(RAI)	Syracuse, NY
39th F.A. Regt.	(RAI)	New York City, NY
40th F.A. Regt.	(RAI)	New York City, NY
258th F.A. Regt.	(N.G.)	New York City, NY
502d C.A. Regt. (AA)	(O.R.)	Manhattan, NY
II Corps Engrs.:		
21st Engr. Regt. (GS)	(RAI)	Schenectady, NY
52d Engr. Bn. (Sep.)	(RAI)	Second Corps Area
414th Engr. Bn. (Sep.)	(O.R.)	Manhattan, NY
415th Engr. Bn. (Sep.)	(O.R.)	Jersey City, NY
392d Engr. Co. (Dep)	(O.R.)	Wilmington, DE
II Corps Aviation:		
42d Obsn. Gp.	(RAI)	Second Corps Area
102d Obsn. Sq.	(N.G.)	New Dorp, NY
302d Obsn. Sq.	(O.R.)	Manhattan, NY
42d Sv Sq.	(RAI)	Second Corps Area
542d Bln. Gp.	(O.R.)	Buffalo, NY
305th Bln. Sq.	(O.R.)	Trenton, NJ
306th Bln. Sq.	(O.R.)	Atlantic City, NJ
307th Bln. Sq.	(O.R.)	Wilmington, DE
339th Bln. Sv Sq.	(O.R.)	Buffalo, NY
II Corps Med. Sv:		
18th Med. Regt.	(RAI)	Rochester, NY
II Corps Q.M. Sv:		
22d Q.M. Regt. (Truck)	(RAI)	Second Corps Area
33d Q.M. Regt. (LM)	(RAI)	Englewood, NJ

## HHC, III CORPS (I)

## Organized Reserve Maryland/Pennsylvania

HQ—Baltimore, MD, 1921–22; Harrisburg, PA, 1922–27

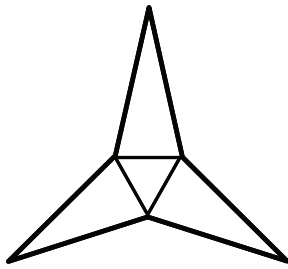

Constituted in the O.R. on 29 July 1921, allotted to the Third Corps Area, and assigned to the First Army. The corps HQ was initiated on 15 December 1921 at Baltimore, MD, with O.R. personnel. The corps HQ was activated about 10 April 1922 at the Dauphin Building, Harrisburg, PA, with R.A. personnel (Reserve personnel from the corps area at large remained assigned for administration, mobilization, and training purposes). The corps HQ was responsible for providing and planning administration, organization, supply, and training for army, corps, and other nondivisional O.R. units, less field and C.A., in the Third Corps Area. The HQ Co. was initiated in April 1923 with O.R. personnel at Norristown, PA. The HQ was relieved from Active Duty in early 1925 and all R.A. personnel were reassigned to the HQ, Non-Divisional Group,

Third Corps Area, which assumed the responsibilities previously held by the III Corps. Both the HQ and the HQ Co. remained active in the O.R. The III Corps HHC were withdrawn from the O.R. and demobilized on 15 August 1927. Concurrently, all O.R. personnel were relieved from assignment.

### Chiefs of Staff

Col. Clint C. Hearn (R.A.) 10 April 1922–ao January 1925

### III CORPS Organization 1922

UNIT:	COMPONENT:	HQ LOCATION:
HQ, III Corps	(O.R.)	Baltimore, MD
8th Div.	(RAI)	Third Corps Area
28th Div.	(N.G.)	Philadelphia, PA
29th Div.	(N.G.)	Washington, DC
HQ, Special Troops	(O.R.)	Lansdale, PA
HQ Co., III Corps	(O.R.)	Norristown, PA
102d Sig. Bn.	(NGI)	Pennsylvania N.G.
102d M.P. Bn.	(NGI)	Pennsylvania N.G.
512th Ord. Co. (HM)	(O.R.)	Philadelphia, PA
612th Ord. Co. (Ammo.)	(O.R.)	Newton, PA
32d Sv Bn., Q.M.C. (C)	(O.R.)	Media, PA
38th Field Rmt Dep	(NGI)	Pennsylvania N.G.
3d Rmt Troop	(NGI)	Pennsylvania N.G.
HQ, III Corps Arty.	(O.R.)	Norristown, PA
82d F.A. Brig.	(NGI)	Pennsylvania N.G.
362d Ord. Co. (M)	(O.R.)	Chester, PA
Ammo. Tn.	(RAI)	Not designated
310th Obsn. Bn. (Flash)	(O.R.)	Media, PA
F.A. Regt.	(RAI)	Not designated
108th F.A. Regt.	(N.G.)	Philadelphia, PA
176th F.A. Regt.	(N.G.)	Pittsburgh, PA
440th F.A. Regt.	(O.R.)	Pottstown, PA
510th C.A. Regt. (AA)	(O.R.)	Chester, PA
HQ, III Corps Engrs.	(O.R.)	Philadelphia, PA
132d Engr. Regt. (GS)	(NGI)	Pennsylvania N.G.
140th Engr. Bn. (Aux)	(NGI)	Maryland N.G.
141st Engr. Bn. (Aux)	(NGI)	Pennsylvania N.G.
142d Engr. Bn. (Aux)	(NGI)	District of Columbia N.G.
HQ, III Corps Air Service	(NGI)	Pennsylvania N.G.
328th Obsn. Gp.	(O.R.)	Reading, PA
133d Obsn. Sq.	(NGI)	Pennsylvania N.G.
134th Obsn. Sq.	(NGI)	Pennsylvania N.G.
Air Park No. 102	(NGI)	Pennsylvania N.G.
12th Bln. Gp.	(NGI)	Pennsylvania N.G.
105th Bln. Co.	(NGI)	Pennsylvania N.G.
106th Bln. Co.	(NGI)	Pennsylvania N.G.
107th Bln. Co.	(NGI)	Pennsylvania N.G.
108th Bln. Co.	(NGI)	Pennsylvania N.G.
Bln. Park No. 12	(NGI)	Pennsylvania N.G.



<i>III Corps Med. HQ</i>	<i>(NGI)</i>	<i>Pennsylvania N.G.</i>
<i>132d Med. Regt.</i>	<i>(NGI)</i>	<i>Pennsylvania N.G.</i>
<i>HQ, III Corps Tn., Q.M.C</i>	<i>(NGI)</i>	<i>Pennsylvania N.G.</i>
<i>16th M.T. Cmd.</i>	<i>(RAI)</i>	<i>Third Corps Area</i>
<i>25th M.T. Cmd.</i>	<i>(RAI)</i>	<i>Third Corps Area</i>
<i>103d M.T. Cmd.</i>	<i>(NGI)</i>	<i>Pennsylvania N.G.</i>
<i>104th M.T. Cmd.</i>	<i>(NGI)</i>	<i>Pennsylvania N.G.</i>
<i>113th M.T. Cmd.</i>	<i>(NGI)</i>	<i>Pennsylvania N.G.</i>
<i>114th M.T. Cmd.</i>	<i>(NGI)</i>	<i>Pennsylvania N.G.</i>
<i>340th M.T. Cmd.</i>	<i>(O.R.)</i>	<i>Lancaster, PA</i>
<i>204th M.T. Co.</i>	<i>(NGI)</i>	<i>Pennsylvania N.G.</i>
<i>205th M.T. Co.</i>	<i>(NGI)</i>	<i>Pennsylvania N.G.</i>
<i>206th M.T. Co.</i>	<i>(NGI)</i>	<i>Pennsylvania N.G.</i>
<i>207th M.T. Co.</i>	<i>(NGI)</i>	<i>Pennsylvania N.G.</i>
<i>208th M.T. Co.</i>	<i>(NGI)</i>	<i>Pennsylvania N.G.</i>
<i>209th M.T. Co.</i>	<i>(NGI)</i>	<i>Pennsylvania N.G.</i>
<i>210th M.T. Co.</i>	<i>(NGI)</i>	<i>Pennsylvania N.G.</i>
<i>211th M.T. Co.</i>	<i>(NGI)</i>	<i>Pennsylvania N.G.</i>
<i>212th M.T. Co.</i>	<i>(NGI)</i>	<i>Pennsylvania N.G.</i>
<i>213th M.T. Co.</i>	<i>(NGI)</i>	<i>Pennsylvania N.G.</i>
<i>214th M.T. Co.</i>	<i>(NGI)</i>	<i>Pennsylvania N.G.</i>
<i>215th M.T. Co.</i>	<i>(NGI)</i>	<i>Pennsylvania N.G.</i>
<i>216th M.T. Co.</i>	<i>(NGI)</i>	<i>Pennsylvania N.G.</i>
<i>783d M.T. Co.</i>	<i>(O.R.)</i>	<i>Washington, DC</i>
<i>784th M.T. Co.</i>	<i>(O.R.)</i>	<i>Washington, DC</i>
<i>785th M.T. Co.</i>	<i>(O.R.)</i>	<i>Washington, DC</i>
<i>786th M.T. Co.</i>	<i>(O.R.)</i>	<i>Washington, DC</i>
<i>787th M.T. Co.</i>	<i>(O.R.)</i>	<i>Washington, DC</i>
<i>788th M.T. Co.</i>	<i>(O.R.)</i>	<i>Washington, DC</i>
<i>789th M.T. Co.</i>	<i>(O.R.)</i>	<i>Washington, DC</i>
<i>143d Mtcyl Co.</i>	<i>(NGI)</i>	<i>Pennsylvania N.G.</i>
<i>144th Mtcyl Co.</i>	<i>(NGI)</i>	<i>Pennsylvania N.G.</i>
<i>153d M. Rep. Sec</i>	<i>(NGI)</i>	<i>Pennsylvania N.G.</i>
<i>154th M. Rep. Sec</i>	<i>(NGI)</i>	<i>Pennsylvania N.G.</i>
<i>463d M. Rep. Sec</i>	<i>(O.R.)</i>	<i>Washington, DC</i>
<i>464th M. Rep. Sec</i>	<i>(O.R.)</i>	<i>Washington, DC</i>
<i>465th M. Rep. Sec</i>	<i>(O.R.)</i>	<i>Washington, DC</i>
<i>466th M. Rep. Sec</i>	<i>(O.R.)</i>	<i>Washington, DC</i>
<i>467th M. Rep. Sec</i>	<i>(O.R.)</i>	<i>Washington, DC</i>
<i>52d Wagon Tn.</i>	<i>(NGI)</i>	<i>Pennsylvania N.G.</i>
<i>164th Wagon Co.</i>	<i>(NGI)</i>	<i>Pennsylvania N.G.</i>
<i>165th Wagon Co.</i>	<i>(NGI)</i>	<i>Pennsylvania N.G.</i>
<i>166th Wagon Co.</i>	<i>(NGI)</i>	<i>Pennsylvania N.G.</i>

## **HHC, III CORPS (II)**

**HQ**—*Not organized, 1927–33; Baltimore, MD, 1933–40; Presidio of Monterrey, CA, 1940–41*

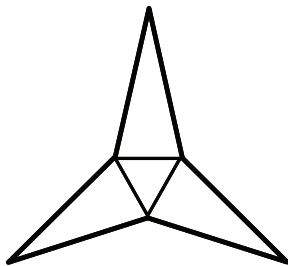

Constituted in the R.A. as HHC, XXII Corps, allotted to the Third Corps Area, and assigned to the Seventh Army. Redesignated HHC, III Corps on 13 October 1927 and concurrently assigned to the First Army. The designated HQ location for peacetime organization purposes was Baltimore, MD. On 1 October 1933, the corps HQ was partially activated at Baltimore with R.A. personnel from HQ, Third Corps Area and Reserve personnel from the corps area at large. Though an RAI unit from 1933 to 1940, the corps HQ was occasionally organized provisionally for short periods using its assigned Reserve officers and staff officers from HQ, Third Corps Area. These periods of provisional Active Duty were generally for CPXs and major maneuvers such as the First Army Maneuvers in 1935, 1939, and 1940. The designated mobilization station

## **Regular Army Inactive**

for the corps HQ was Camp George G. Meade, MD, where it would assume command and control of its assigned subordinate corps troops which would then be mobilizing primarily in the Third Corps Area. However, the III Corps was fully activated on 18 December 1940, less Reserve personnel, at the Presidio of Monterey, CA, and concurrently relieved from the First Army and assigned to the Fourth Army. Upon activation, the 8th, 28th, and 29th Divisions were relieved from the troop list and the corps assumed command and control of the 7th and 40th Divisions. The corps HQ Co. was activated on 10 February 1941 at Fort Ord. The corps participated in the Fourth Army Maneuvers in August 1941. After the maneuver, the corps returned to Monterey where it was located on 7 December 1941.

**Status:** Active in the R.A. at Fort Hood, TX, as HHC, III Corps.

**Events:** 109, 174, 191, 240, 247, 281, 301, 314, 326

### Corps Commanders

Maj. Gen. Walter K. Wilson      18 December 1940–25 July 1941      Maj. Gen. Joseph W. Stilwell      26 July 1941–21 December 1941

Prior to December 1940, the Third Corps Area commander was generally designated as commanding general for activation/mobilization.

### III CORPS Organization 1936

UNIT:	COMPONENT:	HQ LOCATION:
HQ, III Corps	(RAI)	Baltimore, MD
8th Div.	(RAI)	Philadelphia, PA
28th Div.	(N.G.)	Philadelphia, PA
29th Div.	(N.G.)	Washington, DC
HQ, Special Troops	(RAI)	Baltimore, MD
HQ Co., III Corps	(RAI)	Baltimore, MD
50th Sig. Bn.	(RAI)	Baltimore, MD
303d M.P. Bn.	(O.R.)	Columbia, PA
30th Ord. Co. (HM)	(R.A.)	Fort George G. Meade, MD
58th Ord. Co. (Ammo.)	(R.A.)	Raritan Arsenal, NJ
III Corps Field Rmt Dep	(RAI)	Seventh Corps Area
III Corps Arty.:		
21st F.A. Brig.	(RAI)	Philadelphia, PA
6th Ord. Co. (M)	(RAI)	Fort Monroe, VA
343d Ammo. Tn.	(RAI)	Altoona, PA
3d Obsn. Bn. (Flash)	(RAI)	Philadelphia, PA
41st F.A. Regt.	(RAI)	Wilkes-Barre, PA
42d F.A. Regt.	(RAI)	Pittsburgh, PA
89th F.A. Regt.	(RAI)	Third Corps Area
503d C.A. Regt. (AA)	(RAI)	Pittsburgh, PA
III Corps Engrs.:		
22d Engr. Regt. (GS)	(RAI)	Pittsburgh, PA
62d Engr. Bn. (Sep.)	(RAI)	Norfolk, VA
411th Engr. Bn. (Sep.)	(O.R.)	Chester, PA
412th Engr. Bn. (Sep.)	(O.R.)	Lynchburg, VA
84th Engr. Co. (Dep)	(RAI)	Philadelphia, PA
III Corps Aviation:		
<i>43d Obsn. Gp.</i>	(RAI)	<i>Third Corps Area</i>
103d Obsn. Sq.	(N.G.)	Philadelphia, PA
104th Obsn. Sq.	(N.G.)	Baltimore, MD
<i>43d Sv Sq.</i>	(RAI)	<i>Third Corps Area</i>
553d Bln. Gp.	(O.R.)	La Salle, IL
Bln. Sq.		(Unknown)
Bln. Sq.		(Unknown)
Bln. Sq.		(Unknown)
482d Bln. Sv Sq.	(O.R.)	Richmond, MI
III Corps Med. Sv:		
343d Med. Regt.	(RAI)	Mechanicsburg, PA
III Corps Q.M. Sv:		
23d Q.M. Regt. (Truck)	(RAI)	Third Corps Area at large
34th Q.M. Regt. (LM)	(RAI)	Havre de Grace, MD

## HHC, IV CORPS

## Organized Reserve Georgia

**HQ**—*Not initiated*, 1921–22; Atlanta, GA, 1922–39; Fort Benning, GA, 1939–40; Camp Blanding, FL, 1940; Jacksonville, FL, 1940–41

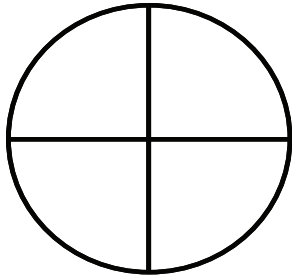

Constituted in the O.R. on 29 July 1921, allotted to the Fourth Corps Area, and assigned to the Second Army. Per General Order #12, Fourth Corps Area, the Corps HQ was activated 1 March 1922 at 25 West Peachtree Street, Atlanta, GA, with R.A. and O.R. personnel. The HQ Co. was initiated 29 March 1922 in Atlanta. The corps HQ was moved on 3 September 1924 to the Glenn Building at Spring and Marietta Streets. The corps HQ was responsible for providing and planning administration, organization, supply, and training for army, corps, and other nondivisional O.R. units, less field and C.A., in the Fourth Corps Area. The HQ was relieved from Active Duty on 15 June 1925 and all R.A. personnel reassigned to the HQ, Non-Divisional Group, Fourth Corps Area, which assumed the responsibilities previously held by the IV

Corps. Both the HQ and HQ Co. remained active in the O.R. HQ, IV Corps was withdrawn from the O.R. on 15 August 1927 and allotted to the R.A. The HQ Co. was withdrawn from the O.R. on 1 October 1933 and allotted to the R.A. Concurrently, the corps HQ was partially activated at Atlanta with R.A. personnel from HQ, Fourth Corps Area, and O.R. personnel from the corps area at large. As part of the reorganization of the four army plan put into effect on 1 October 1933, the IV Corps was relieved from the Second Army and assigned to the Third Army. Though an RAI unit from 1927 to 1940, the corps HQ was occasionally organized provisionally for short periods using its assigned Reserve officers and staff officers from HQ, Fourth Corps Area. These periods of provisional Active Duty were generally for CPXs and major maneuvers such as Third Army CPXs in the 1930s and the Third Army Maneuvers in the DeSoto National Forest in August 1938. The designated mobilization station for the corps HQ was Camp McClellan, AL, where it would assume command and control of its assigned subordinate corps troops, which would then be mobilizing primarily in the Fourth Corps Area. However, the HQ was fully activated on 20 October 1939, less Reserve personnel, at Fort Benning, GA, instead. There the corps assumed command and control of the 1st, 5th, and 6th Divisions for maneuvers at Fort Benning in April and for the Third Army Maneuvers against the IX Corps (Provisional) in May. Those divisions were relieved from the IV Corps on 1 August 1940 and the 4th, 30th, and 31st Divisions were assigned. With these divisions, the corps participated in the Louisiana Maneuvers in the Kisatchie National Forest in August 1940. Upon the IV Corps' arrival at Camp Blanding, FL, on 9 November 1940, the 31st Division was relieved from the corps' troop list and the 43d Division was assigned. On 20 November 1940, the corps HQ Co. was activated at Camp Blanding. Less than a month later, the HQ was transferred to its new location at 137 East Forsyth Street in Jacksonville, FL. In July 1941, the corps, now consisting of the 4th, 30th and 43d Divisions, departed for the Louisiana Maneuver Area to participate in the Third Army Maneuvers near Camp Beauregard. While there, the corps also participated in the GHQ Maneuvers in September–October 1941 near Oberlin, LA. After the 1941 Louisiana Maneuvers, the corps moved to the Carolina Maneuver Area near Chester, SC, to participate in the GHQ First Army Maneuver. After this active schedule, the corps HQ returned to Jacksonville where it was located on 7 December 1941.

**Status:** Inactive in the R.A. as HHC, IV Army Corps.

**Events:** 217, 255, 293, 296, 300, 310, 325, 328, 330

### Corps Commanders

Maj. Gen. David C. Shanks	13 July 1922–28 September 1924	Maj. Gen. Albert H. Blanding	1 August 1940–25 November 1940
Brig. Gen. Albert J. Bowley	28 November 1924–1 May 1925	Maj. Gen. Jay L. Benedict	25 November 1940–7 October 1941
Maj. Gen. Walter C. Short	20 October 1939–31 July 1940	Maj. Gen. Oscar W. Griswold	7 October 1941–April 1943

Prior to October 1939, the Fourth Corps Area commander was generally designated as commanding general for activation/mobilization if not otherwise specified.

### Chiefs of Staff

Col. William R. Dashiell (R.A.)	1 March 1922–30 June 1924	Col. Andrew E. Williams (R.A.)	1 July 1924–15 June 1925
---------------------------------	---------------------------	--------------------------------	--------------------------

**IV CORPS  
Organization 1922**

<b>UNIT:</b>	<b>COMPONENT:</b>	<b>HQ LOCATION:</b>
HQ, IV Corps	(O.R.)	Atlanta, GA
4th Div.	(RAI)	Fourth Corps Area
30th Div.	(N.G.)	Atlanta, GA
31st Div.	(N.G.)	St. Augustine, FL
HQ, Special Troops	(O.R.)	Atlanta, GA
HQ Co., IV Corps	(O.R.)	Atlanta, GA
103d Sig. Bn.	(NGI)	Georgia N.G.
103d M.P. Bn.	(NGI)	Tennessee N.G.
34th Ord. Co. (HM)	(R.A.)	Fort Bragg, NC
51st Ord. Co. (Ammo.)	(R.A.)	Pedricktown, NJ
111th Sv Bn., Q.M.C.	(NGI)	Mississippi N.G.
32d Field Rmt Dep	(O.R.)	Oxford, MS
4th Rmt Troop	(O.R.)	Oxford, MS
HQ, IV Corps Arty.	(O.R.)	Atlanta, GA
FA Brig.	(RAI)	Not designated
363d Ord. Co. (M)	(O.R.)	Chattanooga, TN
133d Ammo. Tn.	(NGI)	Georgia N.G.
311th Obsn. Bn. (Flash)	(O.R.)	Kearney, NJ
5th F.A. Regt.	(R.A.)	Fort Bragg, NC
117th F.A. Regt.	(NGI)	North Carolina N.G.
178th F.A. Regt.	(NGI)	Mississippi N.G.
441st F.A. Regt.	(O.R.)	Atlantic City, NJ
200th C.A. Regt. (AA)	(NGI)	Louisiana N.G.
HQ, IV Corps Engrs.	(O.R.)	Atlanta, GA
133d Engr. Regt. (GS)	(NGI)	Alabama N.G.
143d Engr. Bn. (Aux)	(NGI)	Georgia N.G.
144th Engr. Bn. (Aux)	(NGI)	Tennessee N.G.
443d Engr. Bn. (Aux)	(O.R.)	New Iberia, LA
HQ, IV Corps Air Service	(NGI)	Alabama N.G.
12th Obsn. Gp.	(RAI)	A.A. 2d Wing
10th Obsn. Sq.	(RAI)	A.A. 22d Obsn. Sq.
135th Obsn. Sq.	(N.G.)	Birmingham, AL
136th Obsn. Sq.	(NGI)	Tennessee N.G.
311th Air Park	(O.R.)	Chattanooga, TN
13th Bln. Gp.	(NGI)	Georgia N.G.
109th Bln. Co.	(NGI)	North Carolina N.G.
110th Bln. Co.	(NGI)	Alabama N.G.
111th Bln. Co.	(NGI)	Mississippi N.G.
112th Bln. Co.	(NGI)	Georgia N.G.
Bln. Park No. 13	(NGI)	Georgia N.G.
IV Corps Med. HQ	(O.R.)	Atlanta, GA
133d Med. Regt.	(NGI)	Louisiana N.G.
HQ, IV Corps Tn., Q.M.C.	(NGI)	South Carolina N.G.
105th M.T. Cmd.	(NGI)	South Carolina N.G.
106th M.T. Cmd.	(NGI)	Florida N.G.
341st M.T. Cmd.	(O.R.)	Rockingham, NC
342d M.T. Cmd.	(O.R.)	Collins, MS
409th M.T. Cmd.	(O.R.)	Dothan, AL
410th M.T. Cmd.	(O.R.)	Fayetteville, NC
411th M.T. Cmd.	(O.R.)	New Orleans, LA
217th M.T. Co.	(NGI)	Alabama N.G.
218th M.T. Co.	(N.G.)	Columbia, SC
219th M.T. Co.	(NGI)	South Carolina N.G.
220th M.T. Co.	(N.G.)	Jacksonville, FL
221st M.T. Co.	(NGI)	Florida N.G.
222d M.T. Co.	(NGI)	Louisiana N.G.
223d M.T. Co.	(NGI)	North Carolina N.G.
224th M.T. Co.	(NGI)	Mississippi N.G.
225th M.T. Co.	(N.G.)	Nashville, TN
790th M.T. Co.	(O.R.)	Lexington, NC
791st M.T. Co.	(O.R.)	Johnson City, TN

792d M.T. Co.	(O.R.)	Murfreesboro, TN
793d M.T. Co.	(O.R.)	Centerville, AL
794th M.T. Co.	(O.R.)	Geneva, AL
795th M.T. Co.	(O.R.)	Andalusia, AL
796th M.T. Co.	(O.R.)	St. Augustine, FL
797th M.T. Co.	(O.R.)	West Palm Beach, FL
798th M.T. Co.	(O.R.)	Fitzgerald, GA
799th M.T. Co.	(O.R.)	Franklin, NC
800th M.T. Co.	(O.R.)	Dillon, SC
801st M.T. Co.	(O.R.)	Lucedale, AL
561st M.T. Co. (Car)	(O.R.)	Upper Darby, PA
145th Mtcyl Co.	(NGI)	Alabama N.G.
146th Mtcyl Co.	(N.G.)	Jacksonville, FL
155th M. Rep. Sec	(NGI)	South Carolina N.G.
156th M. Rep. Sec	(NGI)	Florida N.G.
469th M. Rep. Sec	(O.R.)	Fort Lauderdale, FL
470th M. Rep. Sec	(O.R.)	Raeford, NC
471st M. Rep. Sec	(O.R.)	St. Mathews, SC
472d M. Rep. Sec	(O.R.)	Forest, MS
473d M. Rep. Sec	(O.R.)	Houston, MS
53d Wagon Tn.	(NGI)	Tennessee N.G.
167th Wagon Co.	(NGI)	Florida N.G.
168th Wagon Co.	(NGI)	Georgia N.G.
169th Wagon Co.	(NGI)	Tennessee N.G.

**IV CORPS**  
**Organization 1936**

<b>UNIT:</b>	<b>COMPONENT:</b>	<b>HQ LOCATION:</b>
HQ, IV Corps	(RAI)	Atlanta, GA
4th Div.	(RAI)	Atlanta, GA
30th Div.	(N.G.)	Macon, GA
31st Div.	(N.G.)	Bartow, FL
HQ, Special Troops	(RAI)	Atlanta, GA
HQ Co., IV Corps	(RAI)	Atlanta, GA
61st Sig. Bn.	(RAI)	Montgomery, AL
304th M.P. Bn.	(RAI)	Pittsburg Landing, TN
34th Ord. Co. (HM)	(R.A.)	Fort Bragg, NC
54th Ord. Co. (Ammo.)	(RAI)	Fayetteville, NC
304th Corps Field Rmt Dep	(ORI)	Fourth Corps Area
IV Corps Arty.:		
13th F.A. Brig.	(R.A.)	Fort Bragg, NC
48th Ord. Co. (M)	(RAI)	Montgomery, AL
13th Ammo. Tn.	(RAI)	Fayetteville, NC
1st Obsn. Bn. (Flash)	(RAI)	Fayetteville, NC
29th F.A. Regt.	(RAI)	Fayetteville, NC
36th F.A. Regt.	(RAI)	Gainesville, FL
178th F.A. Regt.	(NGI)	South Carolina N.G.
504th C.A. Regt. (AA)	(RAI)	Memphis, TN
IV Corps Engrs.:		
164th Engr. Regt. (GS)	(NGI)	Tennessee N.G.
68th Engr. Bn. (Sep.)	(RAI)	Birmingham, AL
420th Engr. Bn. (Sep.)	(O.R.)	Mobile, AL
421st Engr. Bn. (Sep.)	(O.R.)	Nashville, TN
394th Engr. Co. (Dep)	(RAI)	Atlanta, GA
IV Corps Aviation:		
44th Obsn. Gp.	(RAI)	Nashville, TN
105th Obsn. Sq.	(N.G.)	Sky Harbor, TN
106th Obsn. Sq.	(N.G.)	Birmingham, AL
44th Sv Sq.	(RAI)	Birmingham, AL
24th Bln. Gp.	(RAI)	Charlotte, NC
2d Bln. Sq.	(R.A.)	Fort Bragg, NC
5th Bln. Sq.	(RAI)	Charlotte, NC
6th Bln. Sq.	(RAI)	Winston-Salem, NC
24th Bln. Sv Sq.	(RAI)	Fort Bragg, NC

IV Corps Med. Sv: 10th Med. Regt.	(RAI)	Fayetteville, NC
IV Corps Q.M. Sv: 24th Q.M. Regt. (Truck)	(RAI)	Mobile, AL
35th Q.M. Regt. (LM)	(RAI)	Jacksonville, FL

## HHC, V CORPS

## Organized Reserve Indiana

**HQ**—*Not initiated*, 1921–22; Fort Thomas, KY, 1922–24; Indianapolis, IN, 1924–33; Fort Hayes, OH, 1933–40; Camp Beauregard, LA, 1940–41

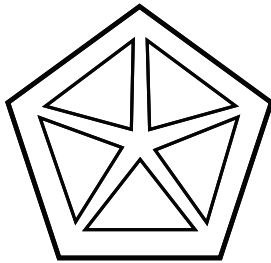

Constituted in the O.R. on 29 July 1921, allotted to the Fifth Corps Area, and assigned to the Second Army. Per General Order #5, HQ, Fifth Corps Area, the Corps HQ was activated on 17 February 1922 at Fort Thomas, KY, with R.A. and O.R. personnel. The HQ Co. was allotted to the Ohio N.G. but was placed on the DNG list on 2 July 1923. The HQ Co. was initiated in late 1924 with O.R. personnel at Columbus, OH. The Corps HQ was responsible for providing and planning administration, organization, supply, and training for army, corps, and other nondivisional O.R. units, less field and C.A., in the Fifth Corps Area. The HQ was relieved from Active Duty on 15 November 1924, and all R.A. personnel were reassigned to the HQ, Non-Divisional Group, Fifth Corps Area, which assumed the responsibilities previously

held by the V Corps. Both the HQ and HQ Co. remained active in the O.R. The Corps HQ was relocated in late 1924 to Indianapolis, IN, where most of the O.R. personnel assigned to the unit were located. HQ, V Corps was withdrawn from the O.R. on 15 August 1927 and allotted to the R.A. HQ Co., V Corps was withdrawn from the DNG list on 15 September 1927 and permanently allotted to the O.R. The Corps HQ Co. was further withdrawn from the O.R. on 1 October 1933 and allotted to the R.A. Concurrently, the Corps HQ was partially activated at Fort Hayes, OH, with R.A. personnel from HQ, Fifth Corps Area, and Reserve personnel from the corps area at large. Though an RAI unit from 1927 to 1940, the Corps HQ was organized provisionally for short periods using its assigned Reserve officers and staff officers from HQ, Fifth Corps Area. These periods of provisional Active Duty were generally for CPXs and major maneuvers. HQ, V Corps was fully activated on 20 October 1940, less Reserve personnel, at Camp Beauregard, LA. Concurrently relieved from the Second Army and assigned to the Third Army. At Camp Beauregard, it assumed command and control of the 32d, 34th, 37th, and 38th Divisions. The HQ Co. was activated at Camp Beauregard on 10 February 1941. The V Corps participated in the Louisiana Maneuvers in September–October 1941 as part of the Third Army. After the 1941 Louisiana Maneuvers, the Corps HQ returned to Camp Beauregard, where it was located on 7 December 1941.

**Status:** Active in the R.A. at Campbell Barracks, Heidelberg, Germany, as HHC, V Corps.

**Events:** 174, 213, 264, 302, 320, 328

### Corps Commanders

Maj. Gen. Hugh A. Drum	8 November 1932–22 February 1933	Maj. Gen. Campbell B. Hodges	20 October 1940–25 March 1941
	Maj. Gen. Edmund L. Daley		26 March 1941–3 May 1942

Prior to November 1940, the Fifth Corps Area commander was generally designated as commanding general for activation/mobilization if not otherwise specified.

### Chiefs of Staff

Col. Peter E. Traub (R.A.)	17 February 1922–23 November 1923	Lt. Col. Lawrence P. Butler (R.A.)	23 November 1923–1 September 1924
	Col. Mathew C. Smith (R.A.)		1 September 1924–18 November 1924

**V CORPS  
Organization 1922**

<b>UNIT:</b>	<b>COMPONENT:</b>	<b>HQ LOCATION:</b>
HQ, V Corps	(O.R.)	Fort Thomas, KY
5th Div.	(RAI)	HQ, Fifth Corps Area
37th Div.	(N.G.)	Columbus, OH
38th Div.	(N.G.)	Indianapolis, IN
HQ, Special Troops	(NGI)	Indiana N.G.
HQ Co., V Corps	(NGI)	Indiana N.G.
104th Sig. Bn.	(NGI)	Kentucky N.G.
104th M.P. Bn.	(NGI)	West Virginia N.G.
131st Ord. Co. (HM)	(NGI)	Kentucky N.G.
58th Ord. Co. (Ammo.)	(R.A.)	Raritan Arsenal, NJ
112th Sv Bn., Q.M.C.	(NGI)	West Virginia N.G.
33d Field Rmt Dep	(O.R.)	Bowling Green, KY
5th Rmt Troop	(O.R.)	Bowling Green, KY
HQ, V Corps Arty.	(NGI)	Indiana N.G.
83d F.A. Brig.	(NGI)	Indiana N.G.
364th Ord. Co. (M)	(O.R.)	Cincinnati, OH
134th Ammo. Tn.	(NGI)	Indiana N.G.
103d Obsn. Bn. (Flash)	(NGI)	Indiana N.G.
179th F.A. Regt.	(NGI)	Ohio N.G.
180th F.A. Regt.	(NGI)	Kentucky N.G.
181st F.A. Regt.	(N.G.)	Kokomo, IN
194th F.A. Regt.	(NGI)	Ohio N.G.
511th C.A. Regt. (AA)	(O.R.)	Laconia, IN
HQ, V Corps Engrs.	(NGI)	Ohio N.G.
134th Engr. Regt. (GS)	(NGI)	Ohio N.G.
145th Engr. Bn. (Aux)	(NGI)	Ohio N.G.
146th Engr. Bn. (Aux)	(NGI)	Ohio N.G.
147th Engr. Bn. (Aux)	(NGI)	Ohio N.G.
HQ, V Corps Air Service	(NGI)	Indiana N.G.
333d Obsn. Gp.	(O.R.)	Indianapolis, IN
137th Obsn. Sq.	(N.G.)	Kokomo, IN
138th Obsn. Sq.	(NGI)	Indiana N.G.
103d Air Park	(NGI)	Indiana N.G.
14th Bln. Gp.	(NGI)	Indiana N.G.
113th Bln. Co.	(NGI)	Indiana N.G.
114th Bln. Co.	(NGI)	Indiana N.G.
115th Bln. Co.	(NGI)	Indiana N.G.
116th Bln. Co.	(NGI)	Indiana N.G.
Bln. Park No. 14	(NGI)	Indiana N.G.
V Corps Med. HQ	(NGI)	Ohio N.G.
134th Med. Regt.	(NGI)	Kentucky N.G.
HQ, V Corps Tn., Q.M.C.	(O.R.)	Columbus, OH
13th M.T. Cmd.	(RAI)	Fifth Corps Area
22d M.T. Cmd.	(RAI)	Sixth Corps Area
343d M.T. Cmd.	(O.R.)	Indianapolis, IN
344th M.T. Cmd.	(O.R.)	Cincinnati, OH
412th M.T. Cmd.	(O.R.)	Dayton, OH
413th M.T. Cmd.	(O.R.)	Cleveland, OH
414th M.T. Cmd.	(O.R.)	Clarksburg, WV
562d M.T. Co.	(O.R.)	Cincinnati, OH
563d M.T. Co.	(O.R.)	Dayton, OH
564th M.T. Co.	(O.R.)	Springfield, OH
565th M.T. Co. (Car)	(O.R.)	Youngstown, OH
802d M.T. Co.	(O.R.)	Tiffin, OH
803d M.T. Co.	(O.R.)	Lima, OH
804th M.T. Co.	(O.R.)	Hamilton, OH
805th M.T. Co.	(O.R.)	Portsmouth, OH
806th M.T. Co.	(O.R.)	Columbus, OH
807th M.T. Co.	(O.R.)	Findlay, OH
808th M.T. Co.	(O.R.)	Marion, OH

809th M.T. Co.	(O.R.)	Covington, KY
810th M.T. Co.	(O.R.)	Louisville, KY
811th M.T. Co.	(O.R.)	Lexington, KY
812th M.T. Co.	(O.R.)	Peducah, KY
813th M.T. Co.	(O.R.)	Huntington, WV
814th M.T. Co.	(O.R.)	Charleston, WV
815th M.T. Co.	(O.R.)	Bluefield, OH
816th M.T. Co.	(O.R.)	Fairmont, OH
817th M.T. Co.	(O.R.)	Indianapolis, IN
818th M.T. Co.	(O.R.)	Fort Wayne, IN
819th M.T. Co.	(O.R.)	South Bend, IN
820th M.T. Co.	(O.R.)	South Bend, IN
821st M.T. Co.	(O.R.)	Jeffersonville, IN
822d M.T. Co.	(O.R.)	Richmond, IN
361st Mtcyl Co.	(O.R.)	Hamilton, OH
362d Mtcyl Co.	(O.R.)	Racine, WI
391st M. Rep. Sec	(O.R.)	Fairmont, WV
474th M. Rep. Sec	(O.R.)	Cincinnati, OH
475th M. Rep. Sec	(O.R.)	Hamilton, OH
476th M. Rep. Sec	(O.R.)	Columbus, OH
477th M. Rep. Sec	(O.R.)	Cleveland, OH
478th M. Rep. Sec	(O.R.)	Toledo, OH
479th M. Rep. Sec	(O.R.)	Zanesville, OH
480th M. Rep. Sec	(O.R.)	Youngstown, OH
71st Wagon Tn.	(O.R.)	Jeffersonville, IN
401st Wagon Co.	(O.R.)	Jeffersonville, IN
402d Wagon Co.	(O.R.)	Jeffersonville, IN
403d Wagon Co.	(O.R.)	Jeffersonville, IN

**V CORPS**  
**Organization 1936**

<b>UNIT:</b>	<b>COMPONENT:</b>	<b>HQ LOCATION:</b>
HQ, V Corps	(RAI)	Fort Hayes, OH
5th Div.	(RAI)	Fifth Corps Area
37th Div.	(N.G.)	Columbus, OH
38th Div.	(N.G.)	Indianapolis, IN
HQ, Special Troops	(RAI)	Columbus, OH
HQ Co., V Corps	(RAI)	Columbus, OH
57th Sig. Bn.	(RAI)	Columbus, OH
305th M.P. Bn.	(O.R.)	Cincinnati, OH
32d Ord. Co. (HM)	(RAI)	Williamson, WV
37th Ord. Co. (Ammo.)	(RAI)	Gary, IN
305th Corps Field Rmt Dep	(O.R.)	Lexington, KY
V Corps Arty.:		
14th F.A. Brig.	(RAI)	Cleveland, OH
22d Ord. Co. (M)	(RAI)	Indianapolis, IN
14th Ammo. Tn.	(RAI)	Vincennes, IN
14th Obsn. Bn. (Flash)	(RAI)	Lafayette, IN
30th F.A. Regt.	(RAI)	Columbus, OH
33d F.A. Regt.	(RAI)	Indianapolis, IN
35th F.A. Regt.	(RAI)	Akron, OH
505th C.A. Regt. (AA)	(RAI)	Cincinnati, OH
V Corps Engrs.:		
345th Engr. Regt. (GS)	(RAI)	Cleveland, OH
45th Engr. Bn. (Sep.)	(RAI)	Terre Haute, IN
425th Engr. Bn. (Sep.)	(O.R.)	Akron, OH
629th Engr. Bn. (Sep.)	(O.R.)	South Bend, IN
710th Engr. Co. (Dep)	(O.R.)	Akron, OH
V Corps Aviation:		
45th Obsn. Gp.	(RAI)	Cleveland, OH
112th Obsn. Sq.	(N.G.)	Cleveland, OH



113th Obsn. Sq.	(N.G.)	Indianapolis, IN
45th Sv Sq.	(RAI)	Dayton, OH
545th Bln. Gp.	(O.R.)	Akron, OH
317th Bln. Sq.	(O.R.)	Indianapolis, IN
318th Bln. Sq.	(O.R.)	Akron, OH
319th Bln. Sq.	(O.R.)	Cleveland, OH
342d Bln. Sv Sq.	(O.R.)	Akron, OH
V Corps Med. Sv:		
15th Med. Regt.	(RAI)	Dayton, OH
V Corps Q.M. Sv:		
25th Q.M. Regt. (Truck)	(RAI)	Akron, OH
36th Q.M. Regt. (LM)	(RAI)	Fort Wayne, IN

## HHC, VI CORPS

## Organized Reserve Illinois

**HQ**—*Not initiated*, 1921–22; Chicago, IL, 1922–27; *Inactive*, 1927–33; Chicago, IL, 1933–40; Fort Sheridan, IL, 1940–41; Providence, RI, 1941

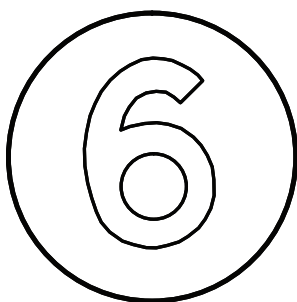

Constituted in the O.R. on 29 July 1921, allotted to the Sixth Corps Area and assigned to the Second Army. The Corps HQ was activated in March 1922 at 1819 West Pershing Road, Chicago, IL, with R.A. and O.R. personnel. The HQ Co. was initiated in March 1922 at Chicago. The Corps HQ was responsible for providing and planning administration, organization, supply, and training for army, corps, and other nondivisional O.R. units, less field and C.A., in the Sixth Corps Area. The HQ was relieved from Active Duty on 29 December 1925, and all R.A. personnel were reassigned to the HQ, Non-Divisional Group, Sixth Corps Area, which assumed the responsibilities previously held by the VI Corps. Both the HQ and the HQ Co. remained active in the O.R. The VI Corps HQ was withdrawn from the O.R.

on 15 August 1927 and allotted to the R.A. The HHC, VI Corps were inactivated on 12 October 1927 by relief of Reserve personnel. The HQ Co., VI Corps was withdrawn from the O.R. on 1 October 1933 and reallocated to the R.A. Concurrently, the Corps HQ was partially activated at Chicago with R.A. personnel from HQ, Sixth Corps Area and Reserve personnel from the corps area at large. The HQ Co. was reorganized 25 November 1935 with O.R. personnel as an RAI unit with HQ at Chicago. Although an RAI unit from 1933 to 1940, the Corps HQ was organized provisionally for short periods using its assigned Reserve officers and staff officers from HQ, Sixth Corps Area. These periods of provisional Active Duty were generally for CPXs and major maneuvers. The VI Corps HQ was fully activated on 1 August 1940, less Reserve personnel, at Fort Sheridan, IL. In November, the VI Corps moved to Fort Devens, MA, where it assumed command and control of the 1st and 26th Divisions. It was transferred again to Providence, RI, on 7 January 1941, and set up HQ at the Hope Street High School in that city. The corps participated in the Carolina Maneuvers in November 1941 as part of the First Army. After the Carolina Maneuvers, the Corps HQ returned to Providence, where it was located on 7 December 1941.

**Status:** Inactive in the R.A. as HHC, VI Army Corps.

**Events:** 159, 174, 214, 264, 302, 327a, 330

### Corps Commanders

Brig. Gen. Frank C. Bolles\*      November 1932–February 1935      Maj. Gen. Karl Truesdell      31 December 1940–15 December 1941

\*Designated as commanding general for activation/mobilization purposes only. Prior to October 1940, the Sixth Corps Area commander was generally designated as commanding general for activation/mobilization if not otherwise specified.

### Chiefs of Staff

Col. Frank D. Ely (R.A.)      15 September 1922–21 February 1924      Col. Manus McCloskey (R.A.)      1 July 1924–29 December 1925

**VI CORPS  
Organization 1922**

<b>UNIT:</b>	<b>COMPONENT:</b>	<b>HQ LOCATION:</b>
HQ, VI Corps	(O.R.)	Chicago, IL
6th Div.	(RAI)	Sixth Corps Area
32d Div.	(N.G.)	Lansing, MI
33d Div.	(N.G.)	Chicago, IL
HQ, Special Troops	(O.R.)	Chicago, IL
HQ Co., VI Corps	(O.R.)	Chicago, IL
59th Sig. Bn. (RAI)	(RAI)	A.A. 51st Sig. Bn.
105th M.P. Bn.	(NGI)	Michigan N.G.
33d Ord. Co. (HM)	(R.A.)	Rock Island Arsenal, IL
613th Ord. Co. (Ammo.)	(O.R.)	Savanna, IL
33d Sv Bn., Q.M.C. (C)	(O.R.)	Orangeburg, NC
34th Field Rmt Dep	(O.R.)	East St. Louis, IL
6th Rmt Troop	(O.R.)	East St. Louis, IL
HQ, VI Corps Arty.	(O.R.)	Chicago, IL
84th F.A. Brig.	(NGI)	Michigan N.G.
365th Ord. Co. (M)	(O.R.)	Chicago, IL
135th Ammo. Tn.	(NGI)	Michigan N.G.
Obsn. Co. (Flash)	(RAI)	Not designated
121st F.A. Regt.	(N.G.)	Milwaukee, WI
123d F.A. Regt.	(N.G.)	Monmouth, IL
182d F.A. Regt.	(N.G.)	Detroit, MI
442d F.A. Regt.	(O.R.)	Brooklyn, NY
202d C.A. Regt. (AA)	(N.G.)	Chicago, IL
HQ, VI Corps Engrs.	(O.R.)	Chicago, IL
135th Engr. Regt. (GS)	(NGI)	Illinois N.G.
148th Engr. Bn. (Aux)	(NGI)	Illinois N.G.
149th Engr. Bn. (Aux)	(NGI)	Illinois N.G.
150th Engr. Bn. (Aux)	(NGI)	Illinois N.G.
HQ, VI Corps Air Service	(NGI)	Illinois N.G.
335th Obsn. Gp.	(O.R.)	Detroit, MI
139th Obsn. Sq.	(NGI)	Wisconsin N.G.
140th Obsn. Sq.	(NGI)	Illinois N.G.
Air Park No. 104	(NGI)	Illinois N.G.
15th Bln. Gp.	(NGI)	Illinois N.G.
117th Bln. Co.	(NGI)	Illinois N.G.
118th Bln. Co.	(NGI)	Illinois N.G.
119th Bln. Co.	(NGI)	Illinois N.G.
120th Bln. Co.	(NGI)	Illinois N.G.
Bln. Park No. 15	(NGI)	Illinois N.G.
VI Corps Med. HQ	(NGI)	Wisconsin N.G.
135th Med. Regt.	(N.G.)	Milwaukee, WI
HQ, VI Corps Tn., Q.M.C.	(NGI)	Illinois N.G.
107th M.T. Cmd.	(NGI)	Illinois N.G.
108th M.T. Cmd.	(NGI)	Illinois N.G.
115th M.T. Cmd.	(NGI)	Illinois N.G.
116th M.T. Cmd.	(NGI)	Illinois N.G.
415th M.T. Cmd.	(O.R.)	Arbor Vitae, WI
416th M.T. Cmd.	(O.R.)	Brillion, WI
417th M.T. Cmd.	(O.R.)	Berlin, WI
226th M.T. Co.	(NGI)	Illinois N.G.
227th M.T. Co.	(NGI)	Illinois N.G.
228th M.T. Co.	(NGI)	Illinois N.G.
229th M.T. Co.	(NGI)	Illinois N.G.
230th M.T. Co.	(NGI)	Illinois N.G.
231st M.T. Co.	(NGI)	Illinois N.G.
232d M.T. Co.	(NGI)	Illinois N.G.
233d M.T. Co.	(NGI)	Illinois N.G.
234th M.T. Co.	(NGI)	Illinois N.G.
235th M.T. Co.	(NGI)	Illinois N.G.
236th M.T. Co.	(NGI)	Illinois N.G.
237th M.T. Co.	(NGI)	Illinois N.G.

238th M.T. Co.	(NGI)	Illinois N.G.
566th M.T. Co. (C)	(O.R.)	Cairo, IL
567th M.T. Co. (C)	(O.R.)	Alton, IL
568th M.T. Co. (C)	(O.R.)	Springfield, IL
569th M.T. Co.	(O.R.)	Detroit, MI
570th M.T. Co.	(O.R.)	Reedsburg, WI
571st M.T. Co.	(O.R.)	Racine, WI
572d M.T. Co.	(O.R.)	Marshfield, WI
573d M.T. Co.	(O.R.)	Marshfield, WI
823d M.T. Co.	(O.R.)	Algoma, WI
824th M.T. Co.	(O.R.)	Antigo, WI
825th M.T. Co.	(O.R.)	Delavan, WI
826th M.T. Co.	(O.R.)	Berlin, WI
147th Mtcyl Co.	(NGI)	Illinois N.G.
148th Mtcyl Co.	(NGI)	Illinois N.G.
157th M. Rep. Sec	(NGI)	Illinois N.G.
158th M. Rep. Sec	(NGI)	Illinois N.G.
392d M. Rep. Sec	(O.R.)	West Allis, WI
481st M. Rep. Sec	(O.R.)	Antigo, WI
482d M. Rep. Sec	(O.R.)	Fond du Lac, WI
483d M. Rep. Sec	(O.R.)	Fond du Lac, WI
484th M. Rep. Sec	(O.R.)	Jefferson, WI
54th Wagon Tn.	(NGI)	Illinois N.G.
170th Wagon Co.	(NGI)	Illinois N.G.
171st Wagon Co.	(NGI)	Illinois N.G.
172d Wagon Co.	(NGI)	Illinois N.G.

**VI CORPS  
Organization 1936**

<b>UNIT:</b>	<b>COMPONENT:</b>	<b>HQ LOCATION:</b>
HQ, VI Corps	(RAI)	Fort Sheridan, IL
6th Div.	(RAI)	Chicago, IL
32d Div.	(N.G.)	Lansing, MI
33d Div.	(N.G.)	Chicago, IL
HQ, Special Troops	(RAI)	Chicago, IL
HQ Co., VI Corps	(RAI)	Chicago, IL
58th Sig. Bn.	(RAI)	Chicago, IL
306th M.P. Bn.	(O.R.)	Milwaukee, WI
33d Ord. Co. (HM)	(R.A.)	Rock Island Arsenal, IL
38th Ord. Co. (Ammo.)	(RAI)	Chicago, IL
306th Corps Field Rmt Dep	(O.R.)	East St. Louis, IL
VI Corps Arty.:		
22d F.A. Brig.	(RAI)	Chicago, IL
23d Ord. Co. (M)	(RAI)	Chicago, IL
22d Ammo. Tn.	(RAI)	Chicago, IL
306th Obsn. Bn. (Flash)	(RAI)	Evanston, IL
43d F.A. Regt.	(RAI)	Champaign, IL
90th F.A. Regt.	(RAI)	Chicago, IL
182d F.A. Regt.	(N.G.)	Detroit, MI
506th C.A. Regt. (AA)	(RAI)	Madison, WI
VI Corps Engrs.:		
24th Engr. Regt. (GS)	(RAI)	Chicago, IL
46th Engr. Bn. (Sep.)	(RAI)	Milwaukee, WI
426th Engr. Bn. (Sep.)	(O.R.)	Aurora, IL
427th Engr. Bn. (Sep.)	(O.R.)	Chicago, IL
396th Engr. Co. (Dep)	(O.R.)	Lansing, MI
VI Corps Aviation:		
46th Obsn. Gp.	(RAI)	Detroit, MI
107th Obsn. Sq.	(N.G.)	Romulus, MI
108th Obsn. Sq.	(N.G.)	Chicago, IL
46th Sv Sq.	(RAI)	Detroit, MI
546th Bln. Gp.	(O.R.)	Fond du Lac, WI

321st Bln. Sq.	(O.R.)	Chicago, IL
322d Bln. Sq.	(O.R.)	Detroit, MI
323d Bln. Sq.	(O.R.)	Green Bay, WI
343d Bln. Sv Sq.	(O.R.)	Appleton, WI
VI Corps Med. Sv:		
19th Med. Regt.	(RAI)	Chicago, IL
VI Corps Q.M. Sv:		
26th Q.M. Regt. (Truck)	(RAI)	Springfield, IL
37th Q.M. Regt. (LM)	(RAI)	Moline, IL

**HHC, VII CORPS**

**Organized Reserve Missouri**

**HQ**—*Not initiated*, 1921–22; St. Louis, MO, 1922–33; Omaha, NE, 1933–40; Fort McClellan, AL, 1940–41; Birmingham, AL, 1941



Constituted in the O.R. on 29 July 1921, allotted to the Seventh Corps Area and assigned to the Third Army. Per General Order #2, HQ, Seventh Corps Area, the Corps HQ was activated on 9 January 1922 at the Old Customhouse, 3d and Olive Streets, St. Louis, MO, with R.A. and O.R. personnel. The Corps HQ was responsible for providing and planning administration, organization, supply, and training for army, corps, and other nondivisional O.R. units, less field and C.A., in the Seventh Corps Area. The HQ was relieved from Active Duty on 27 January 1923 and all R.A. personnel were reassigned to the HQ, Non-Divisional Group, Seventh Corps Area, which assumed the responsibilities previously held by the VII Corps. Both the HQ and the HQ Co. remained active in the O.R. The VII Corps HQ was withdrawn from the O.R. on 15 August 1927 and allotted to the R.A. As part of the reorganization of the four army plan put into effect on 1 October 1933, the VII Corps was relieved from the Third Army and assigned to the Fourth Army. Concurrently, the VII Corps HQ was partially activated

at Omaha, NE, with R.A. personnel assigned to HQ, Seventh Corps Area, and Reserve personnel from the corps area at large. On the same date, the HQ Co., VII Corps was withdrawn from the O.R. and allotted to the R.A. As an RAI unit, the Corps HQ was organized provisionally for short periods using its assigned Reserve officers and staff officers from HQ, Seventh Corps Area. These periods included several Second Army CPXs in the 1930s and the Fourth Army Maneuvers at Camp Ripley, MN, in August 1937. The designated mobilization station for the Corps HQ from 1927 to 1939 was Camp Pike, AR, where it would assume command and control of its assigned subordinate corps troops, which would then be mobilizing primarily in the Seventh Corps Area. Although the 1939 Protective Mobilization Plan changed the mobilization station for the Corps HQ to Fort Snelling, MN, the HQ, VII Corps was ultimately activated on 25 November 1940, less Reserve personnel, at Fort McClellan, AL. The HQ Co. had been activated there 2 weeks before on 10 November. At Fort McClellan, the VII Corps assumed command and control of the 27th, 33d, and 35th Divisions. The Corps HQ was transferred on 25 January 1941 to the Ramsey Building at 19th Street and North E Avenue, Birmingham, AL. The Corps participated in the Tennessee Maneuvers in May–June 1941 and the Louisiana Maneuvers in September–October 1941 as part of the Second Army. After the Louisiana Maneuvers, the Corps HQ returned to Birmingham, where it was located on 7 December 1941.

**Status:** Inactive in the R.A. as HHC, VII Corps.

**Events:** 193, 303, 316, 324, 328

**Corps Commanders**

Maj. Gen. Frederic H. Smith    31 December 1940–31 July 1941    Maj. Gen. Robert C. Richardson    1 August 1941–1 June 1943

Prior to December 1940, the Seventh Corps Area commander was generally designated as commanding general for activation/mobilization.

**Chiefs of Staff**

Col. John H. Parker (R.A.)    15 January 1922–15 December 1922    Maj. Joseph F. Taulbee (R.A.)    24 January 1923–27 January 1923

**VII CORPS  
Organization 1922**

<b>UNIT:</b>	<b>COMPONENT:</b>	<b>HQ LOCATION:</b>
HQ, VII Corps	(O.R.)	St. Louis, MO
7th Div.	(RAI)	Seventh Corps Area
34th Div.	(R.A.)	Council Bluffs, IA
35th Div.	(R.A.)	Kansas City, MO
HQ, Special Troops	(O.R.)	Des Moines, IA
HQ Co., VII Corps	(O.R.)	St. Louis, MO
117th Sig. Bn.	(NGI)	Missouri N.G.
106th M.P. Bn.	(NGI)	Minnesota N.G.
132d Ord. Co. (HM)	(NGI)	Iowa N.G.
52d Ord. Co. (Ammo.)	(R.A.)	Curtis Bay, MD
34th Sv Bn., Q.M.C. (C)	(O.R.)	Arkadelphia, AR
35th Field Rmt Dep (C)	(O.R.)	Omaha, NE
7th Rmt Troop	(O.R.)	Omaha, NE
HQ, VII Corps Arty.	(O.R.)	Minneapolis, MN
FA Brig.	(RAI)	Not designated
18th Ord. Co. (M)	(RAI)	A.A. 14th Ord. Co.
136th Ammo. Tn.	(RAI)	Minnesota N.G.
Obsn. Co. (Flash)	(RAI)	Not designated
127th Field Arty. Regt.	(NGI)	Nebraska N.G.
185th F.A. Regt.	(N.G.)	Davenport, IA
195th F.A. Regt.	(NGI)	Kansas N.G.
443d F.A. Regt.	(O.R.)	Kirksville, MO
203d C.A. Regt. (AA)	(N.G.)	Aurora, MO
HQ, VII Corps Engrs.	(O.R.)	Omaha, NE
136th Engr. Regt. (GS)	(NGI)	Kansas N.G.
151st Engr. Bn. (Aux)	(NGI)	Iowa N.G.
152d Engr. Bn. (Aux)	(NGI)	Missouri N.G.
153d Engr. Bn. (Aux)	(NGI)	Missouri N.G.
HQ, VII Corps Air Service	(NGI)	Missouri N.G.
336th Obsn. Gp.	(O.R.)	Lincoln, NE
141st Obsn. Sq.	(NGI)	Iowa N.G.
142d Obsn. Sq.	(NGI)	Nebraska N.G.
Air Park No. 105	(NGI)	Missouri N.G.
16th Bln. Gp.	(NGI)	Minnesota N.G.
121st Bln. Co.	(NGI)	Minnesota N.G.
122d Bln. Co.	(NGI)	Minnesota N.G.
123d Bln. Co.	(NGI)	Minnesota N.G.
124th Bln. Co.	(NGI)	Minnesota N.G.
Bln. Park No. 16	(NGI)	Minnesota N.G.
VII Corps Med. HQ	(O.R.)	Des Moines, IA
136th Med. Regt.	(N.G.)	Ames, IA
HQ, VII Corps Tn., Q.M.C.	(O.R.)	Grand Forks, ND
109th M.T. Cmd.	(NGI)	Minnesota N.G.
110th M.T. Cmd.	(NGI)	Arkansas N.G.
345th M.T. Cmd.	(O.R.)	Grand Forks, ND
346th M.T. Cmd.	(O.R.)	Topeka, KS
418th M.T. Cmd.	(O.R.)	Corwin, KS
419th M.T. Cmd.	(O.R.)	St. Louis, MO
420th M.T. Cmd.	(O.R.)	St. Paul, MN
574th M.T. Co.	(O.R.)	Fargo, ND
575th M.T. Co.	(O.R.)	Wahpeton, ND
576th M.T. Co.	(O.R.)	Jamestown, ND
577th M.T. Co.	(O.R.)	Minot, ND
578th M.T. Co. (Car)	(O.R.)	Bismarck, ND
827th M.T. Co.	(O.R.)	Council Bluffs, IA
828th M.T. Co.	(O.R.)	Sioux City, IA
829th M.T. Co.	(O.R.)	St. Louis, MO
830th M.T. Co.	(O.R.)	St. Louis, MO
831st M.T. Co.	(O.R.)	St. Louis, MO
832d M.T. Co.	(O.R.)	Hutchison, KS
833d M.T. Co.	(O.R.)	Kanopolis, KS

834th M.T. Co.	(O.R.)	Topeka, KS
835th M.T. Co.	(O.R.)	Wichita, KS
239th M.T. Co.	(NGI)	Minnesota N.G.
240th M.T. Co.	(NGI)	Minnesota N.G.
241st M.T. Co.	(NGI)	Minnesota N.G.
242d M.T. Co.	(NGI)	Minnesota N.G.
243d M.T. Co.	(NGI)	Minnesota N.G.
244th M.T. Co.	(NGI)	Minnesota N.G.
245th M.T. Co. (Car)	(NGI)	Minnesota N.G.
246th M.T. Co.	(NGI)	Arkansas N.G.
247th M.T. Co.	(NGI)	Arkansas N.G.
248th M.T. Co.	(NGI)	Arkansas N.G.
249th M.T. Co.	(NGI)	Arkansas N.G.
149th Mtcyl Co.	(NGI)	Minnesota N.G.
150th Mtcyl Co.	(NGI)	Minnesota N.G.
159th M. Rep. Sec	(NGI)	Minnesota N.G.
160th M. Rep. Sec	(NGI)	Minnesota N.G.
485th M. Rep. Sec	(O.R.)	Omaha, NE
486th M. Rep. Sec	(O.R.)	Duluth, MN
487th M. Rep. Sec	(O.R.)	Minneapolis, MN
488th M. Rep. Sec	(O.R.)	Fort Dodge, IA
489th M. Rep. Sec	(O.R.)	Cedar Rapids, IA
490th M. Rep. Sec	(O.R.)	St. Louis, MO
55th Wagon Tn.	(NGI)	Kansas N.G.
173d Wagon Co.	(NGI)	Kansas N.G.
174th Wagon Co.	(NGI)	Kansas N.G.
175th Wagon Co.	(NGI)	Kansas N.G.

**VII CORPS  
Organization 1936**

<b>UNIT:</b>	<b>COMPONENT:</b>	<b>HQ LOCATION:</b>
HQ, VII Corps	(RAI)	Omaha, NE
7th Div.	(RAI)	Seventh Corps Area
34th Div.	(N.G.)	Council Bluffs, IA
35th Div.	(N.G.)	Kansas City, MO
HQ, Special Troops	(RAI)	St. Louis, MO
HQ Co., VII Corps	(RAI)	St. Louis, MO
55th Sig. Bn.	(RAI)	Minneapolis, MN
307th M.P. Bn.	(RAI)	Little Rock, AR
35th Ord. Co. (HM)	(RAI)	Seventh Corps Area
36th Ord. Co. (Ammo.)	(RAI)	Kansas City, KS
307th Corps Field Rmt Dep	(O.R.)	Knoxville, TN
VII Corps Arty.:		
17th F.A. Brig.	(RAI)	St. Louis, MO
24th Ord. Co. (M)	(RAI)	Omaha, NE
17th Ammo. Tn.	(RAI)	Kansas City, MO
7th Obsn. Bn. (Flash)	(RAI)	Seventh Corps Area
44th F.A. Regt.	(RAI)	St. Louis, MO
45th F.A. Regt.	(RAI)	St. Louis, MO
91st F.A. Regt.	(RAI)	Kansas City, MO
507th C.A. Regt. (AA)	(RAI)	Minneapolis, MN
VII Corps Engrs.:		
25th Engr. Regt. (GS)	(RAI)	St. Paul, MN
47th Engr. Bn. (Sep.)	(RAI)	Kansas City, KS
430th Engr. Bn. (Sep.) (C)	(O.R.)	Davenport, IA
431st Engr. Bn. (Sep.)	(O.R.)	Davenport, IA
397th Engr. Co. (Dep)	(O.R.)	Kansas City, KS
VII Corps Aviation:		
47th Obsn. Gp.	(RAI)	Seventh Corps Area
109th Obsn. Sq.	(N.G.)	St. Paul, MN
110th Obsn. Sq.	(N.G.)	St. Louis, MO
47th Sv Sq.	(RAI)	Seventh Corps Area
547th Bln. Gp.	(O.R.)	St. Louis, MO

325th Bln. Sq.	(O.R.)	Omaha, NE
326th Bln. Sq.	(O.R.)	Omaha, NE
327th Bln. Sq.	(O.R.)	St. Louis, MO
344th Bln. Sv Sq.	(O.R.)	St. Louis, MO
VII Corps Med. Sv:		
16th Med. Regt.	(RAI)	Kansas City, MO
VII Corps Q.M. Sv:		
27th Q.M. Regt. (Truck)	(RAI)	Kansas City, KS
38th Q.M. Regt. (LM)	(RAI)	Little Rock, AR

**HHC, VIII CORPS**

**Organized Reserve Texas**

**HQ**—*Demobilized*, 1919–21; *Not initiated*, 1921–22; San Antonio, TX, 1922–33; Fort Sam Houston, TX, 1933–41; Camp Bowie, TX, 1941

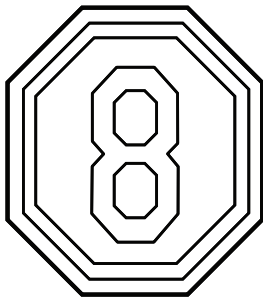

Demobilized on 20 April 1919 at Montigny-sur-Aube, France, as HQ, VIII Army Corps. Reconstituted in the O.R. on 29 July 1921 as the VIII Corps (HQ Co. concurrently constituted), allotted to the Eighth Corps Area, and assigned to the Third Army. Per Special Order #168, HQ, Eighth Corps Area, the corps HQ was activated on 18 July 1922 at the Maverick Building, San Antonio, TX, with R.A. and O.R. personnel. The corps HQ was responsible for providing and planning administration, organization, supply, and training for army, corps, and other nondivisional O.R. units, less field and C.A., in the Eighth Corps Area. The HQ was relieved from Active Duty 3 November 1925, and all R.A. personnel were reassigned to the HQ, Field Artillery Group or the newly organized HQ, Non-Divisional Group, Eighth Corps Area, which assumed most of the responsibilities previously held by the VIII Corps. Both the HQ and the HQ Co. remained active in the O.R. Concurrently, all Reserve personnel assigned

to HQ, VIII Corps; HQ Co., VIII Corps; and HQ, Special Troops, VIII Corps were attached to the 90th Division for organization, administration, and control. Reserve personnel assigned to the corps HQ attended summer training at Fort Sam Houston, TX. The corps staff conducted staff training with HQ, 2d Division at Fort Sam Houston 1–15 August 1925, 5–19 January 1926, and 3–17 July 1927. The HQ Co. conducted training with HQ Co., 2d Division from 20 July to 2 August 1930. The corps HHC were withdrawn from the O.R. on 1 October 1933 and allotted to the R.A. Concurrently, the corps HQ was partially activated at Fort Sam Houston with R.A. personnel from HQ, Eighth Corps Area and Reserve personnel from the corps area at large. As an RAI unit from 1933 to 1940, the corps HQ was occasionally organized provisionally for short periods using its assigned Reserve officers and staff officers from HQ, Eighth Corps Area. These periods included several Third Army CPXs in the 1930s, the Third Army Maneuvers at Camp Bullis, TX, in August 1938, and the 1940 Louisiana Maneuvers in the Kisatchie National Forest. The VIII Corps HHC were fully activated on 14 October 1940, less Reserve personnel, at Fort Sam Houston. At that time, the corps assumed command and control of the 2d, 36th, and 45th Divisions. The corps HHC were transferred on 8 March 1941 to Camp Bowie, TX. During August–October 1941, the VIII Corps participated in the Louisiana Maneuvers as part of the Third Army. After the Louisiana Maneuvers, the corps HQ returned to Camp Bowie, where it was located on 7 December 1941.

**Status:** Inactive in the R.A. as HHC, VIII Army Corps.

**Events:** 80, 258, 279, 300, 317, 328

**Corps Commanders**

Brig. Gen. Charles R. Howland*	22 June 1934–28 February 1935	Maj. Gen. Walter Krueger	27 June 1940–15 May 1941
	Maj. Gen. George V. Strong		15 May 1941–5 June 1942

\*Designated as commanding general for activation/mobilization purposes only. Prior to October 1940, the Eighth Corps Area commander was generally designated as commanding general for activation/mobilization if not otherwise specified.

**Chiefs of Staff**

Col. Pierce A. Murphy (R.A.)	18 July 1922–10 September 1923	Unknown	10 September 1923–3 November 1925
------------------------------	--------------------------------	---------	-----------------------------------

**VIII CORPS  
Organization 1922**

<b>UNIT:</b>	<b>COMPONENT:</b>	<b>HQ LOCATION:</b>
HQ, VIII Corps	(O.R.)	San Antonio, TX
2d Div.	(R.A.)	Fort Sam Houston, TX
36th Div.	(N.G.)	Houston, TX
45th Div.	(N.G.)	Oklahoma City, OK
HQ, Special Troops	(O.R.)	San Antonio, TX
HQ Co., VIII Corps	(O.R.)	San Antonio, TX
106th Sig. Bn.	(NGI)	Colorado N.G.
107th M.P. Bn.	(NGI)	Oklahoma N.G.
35th Ord. Co. (HM)	(RAI)	A.A. 32d Ord. Co.
55th Ord. Co. (Ammo.)	(RAI)	A.A. 56th Ord. Co.
35th Sv Bn., Q.M.C. (C)	(O.R.)	Houston, TX
36th Field Rmt Dep	(O.R.)	Phoenix, AZ
8th Rmt Troop	(O.R.)	Phoenix, AZ
HQ, VIII Corps Arty.	(O.R.)	San Antonio, TX
85th F.A. Brig.	(NGI)	Colorado N.G.
9th Ord. Co. (M)	(R.A.)	Fort Sill, OK
Ammo. Tn.	(RAI)	Not designated
312th Obsn. Bn. (Flash)	(O.R.)	Boulder, CO
F.A. Regt.	(RAI)	Not designated
187th F.A. Regt.	(NGI)	Colorado N.G.
188th F.A. Regt.	(NGI)	Texas N.G.
189th F.A. Regt.	(N.G.)	Enid, OK
204th C.A. Regt. (AA)	(NGI)	Texas N.G.
HQ, VIII Corps Engrs.	(O.R.)	San Antonio, TX
137th Engr. Regt. (GS)	(NGI)	New Mexico N.G.
154th Engr. Bn. (Aux)	(NGI)	Oklahoma N.G.
155th Engr. Bn. (Aux)	(NGI)	Texas N.G.
156th Engr. Bn. (Aux)	(NGI)	Texas N.G.
HQ, VIII Corps Air Service	(O.R.)	San Antonio, TX
338th Obsn. Gp.	(O.R.)	Houston, TX
143d Obsn. Sq.	(NGI)	Oklahoma N.G.
371st Obsn. Sq.	(O.R.)	Brownsville, TX
Air Park No. 106	(NGI)	Colorado N.G.
51st Bln. Gp.	(O.R.)	San Antonio, TX
125th Bln. Co.	(NGI)	Texas N.G.
126th Bln. Co.	(NGI)	Texas N.G.
424th Bln. Co.	(O.R.)	San Antonio, TX
425th Bln. Co.	(O.R.)	San Antonio, TX
Bln. Park No. 17	(NGI)	Colorado N.G.
VIII Corps Med. HQ	(O.R.)	San Antonio, TX
137th Med. Regt.	(NGI)	Colorado N.G.
HQ, VIII Corps Tn., Q.M.C.	(O.R.)	Oklahoma City, OK
347th M.T. Cmd.	(O.R.)	San Antonio, TX
348th M.T. Cmd.	(O.R.)	Mart, TX
421st M.T. Cmd.	(O.R.)	Guthrie, OK
422d M.T. Cmd.	(O.R.)	Enid, OK
423d M.T. Cmd.	(O.R.)	Ponca City, OK
424th M.T. Cmd.	(O.R.)	Englewood, CO
425th M.T. Cmd.	(O.R.)	Bisbee, AZ
250th M.T. Co.	(NGI)	Colorado N.G.
251st M.T. Co.	(NGI)	Texas N.G.
252d M.T. Co.	(NGI)	Arizona N.G.
253d M.T. Co.	(NGI)	New Mexico N.G.
254th M.T. Co.	(NGI)	Oklahoma N.G.
836th M.T. Co.	(O.R.)	San Antonio, TX
837th M.T. Co.	(O.R.)	San Antonio, TX
838th M.T. Co.	(O.R.)	San Antonio, TX
839th M.T. Co.	(O.R.)	Mercedes, TX
840th M.T. Co.	(O.R.)	El Paso, TX
841st M.T. Co.	(O.R.)	Waco, TX
842d M.T. Co.	(O.R.)	Paris, TX



843d M.T. Co.	(O.R.)	Greenville, TX
844th M.T. Co.	(O.R.)	Sulpher Springs, TX
845th M.T. Co.	(O.R.)	Galveston, TX
846th M.T. Co.	(O.R.)	Blackwell, OK
847th M.T. Co.	(O.R.)	Enid, OK
848th M.T. Co.	(O.R.)	Oklahoma City, OK
849th M.T. Co.	(O.R.)	Clinton, OK
850th M.T. Co.	(O.R.)	Ardmore, OK
851st M.T. Co.	(O.R.)	Loveland, CO
852d M.T. Co.	(O.R.)	Englewood, CO
853d M.T. Co.	(O.R.)	Greeley, CO
854th M.T. Co.	(O.R.)	Albuquerque, NM
855th M.T. Co.	(O.R.)	Seligman, AZ
149th Mtcyl Co.	(NGI)	Colorado N.G.
150th Mtcyl Co.	(NGI)	Colorado N.G.
393d M. Rep. Sec	(O.R.)	La Junta, CO
491st M. Rep. Sec	(O.R.)	San Antonio, TX
492d M. Rep. Sec	(O.R.)	Houston, TX
493d M. Rep. Sec	(O.R.)	El Reno, OK
494th M. Rep. Sec	(O.R.)	Norman, OK
495th M. Rep. Sec	(O.R.)	Stillwater, OK
496th M. Rep. Sec	(O.R.)	Englewood, CO
497th M. Rep. Sec	(O.R.)	Prescott, AZ
72d Wagon Tn.	(O.R.)	Perry, OK
404th Wagon Co.	(O.R.)	Oklahoma City, OK
405th Wagon Co.	(O.R.)	Oklahoma City, OK
406th Wagon Co.	(O.R.)	Perry, OK

**VIII CORPS  
Organization 1936**

<b>UNIT:</b>	<b>COMPONENT:</b>	<b>HQ LOCATION:</b>
HQ, VIII Corps	(RAI)	San Antonio, TX
2d Div.	(R.A.)	Fort Sam Houston, TX
36th Div.	(N.G.)	Fort Worth, TX
45th Div.	(N.G.)	Oklahoma City, OK
HQ, Special Troops	(RAI)	San Antonio, TX
HQ Co., VIII Corps	(RAI)	San Antonio, TX
106th Sig. Bn.	(NGI)	Colorado N.G.
316th M.P. Bn.	(O.R.)	Tucson, AZ
2d Ord. Co. (HM)	(RAI)	Eighth Corps Area
57th Ord. Co. (Ammo.)	(RAI)	Eighth Corps Area
308th Corps Field Rmt Dep	(O.R.)	Charlotte, NC
VIII Corps Arty.:		
18th F.A. Brig.	(RAI)	Oklahoma City, OK
25th Ord. Co. (M)	(RAI)	Omaha, NE
18th Ammo. Tn.	(RAI)	Chickasha, OK
8th Obsn. Bn. (Flash)	(RAI)	Tulsa, OK
46th F.A. Regt.	(RAI)	Oklahoma City, OK
51st F.A. Regt.	(RAI)	Tulsa, OK
92d F.A. Regt.	(RAI)	Tulsa, OK
974th C.A. Regt. (AA)	(O.R.)	Denver, CO
VIII Corps Engrs.:		
23d Engr. Regt. (GS)	(RAI)	San Antonio, TX
48th Engr. Bn. (Sep.)	(RAI)	San Antonio, TX
460th Engr. Bn. (Sep.)	(O.R.)	Tulsa, OK
461st Engr. Bn. (Sep.)	(O.R.)	El Paso, TX
89th Engr. Co. (Dep)	(RAI)	Fort McIntosh, TX
VIII Corps Aviation:		
48th Obsn. Gp.	(RAI)	Hensley Field, TX
111th Obsn. Sq.	(N.G.)	Houston, TX
120th Obsn. Sq.	(N.G.)	Denver, CO
48th Sv Sq.	(RAI)	Hensley Field, TX

26th Bln. Gp.	(RAI)	Eighth Corps Area
1st Bln. Sq.	(R.A.)	Fort Sill, OK
2d Bln. Sq.	(RAI)	Pope Field, NC
4th Bln. Sq.	(RAI)	Eighth Corps Area
31st Bln. Sv Sq.	(RAI)	Eighth Corps Area
VIII Corps Med. Sv:		
348th Med. Regt.	(RAI)	Tucson, AZ
VIII Corps Q.M. Sv:		
28th Q.M. Regt. (Truck)	(RAI)	Fort Worth, TX
39th Q.M. Regt. (LM)	(RAI)	San Antonio, TX

## HHC, IX CORPS

## Organized Reserve California

**HQ**—*Demobilized*, 1919–21; Presidio of San Francisco, CA, 1921–25; Seattle, WA, 1925–40; Fort Lewis, WA, 1940–41

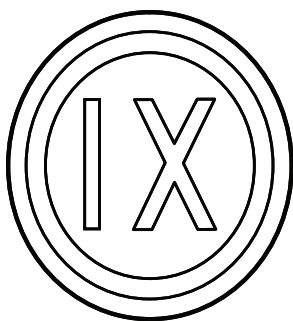

Demobilized on 5 May 1919 at Nogent-en-Bassigny, France, as HQ, IX Army Corps. Reconstituted in the O.R. on 29 July 1921 as the IX Corps (HQ Co. concurrently constituted), allotted to the Ninth Corps Area, and assigned to the Third Army. Per General Order #29, Ninth Corps Area, the corps HHC were activated on 7 October 1921 at the Presidio of San Francisco, CA, with R.A. and O.R. personnel. The corps HQ was responsible for providing and planning administration, organization, supply, and training for army, corps, and other nondivisional O.R. units, less field and C.A., in the Ninth Corps Area. The HQ was relieved from Active Duty on 9 May 24 and all R.A. personnel were relieved from assignment. Both the HQ and the HQ Co. remained active in the O.R. Concurrently, the corps' designated HQ location for peacetime organization purposes was transferred from San Francisco to Seattle, WA. Reserve personnel assigned to the corps HQ attended summer training at the Presidio of San

Francisco. Also, individual staff officers attended active training from time to time with the HQ, 3d Division at Fort Lewis, WA. The HQ conducted staff training with HQ, 30th Infantry at the Presidio of San Francisco from 5 to 19 June 1927. The IX Corps HHC were withdrawn from the O.R. on 1 October 1933 and allotted to the R.A. Concurrently, the corps HQ was partially activated with R.A. personnel from HQ, Ninth Corps Area and Reserve personnel from the corps area at large. As part of the reorganization of the four army plan put into effect on 1 October 1933, the IX Corps was relieved from the Third Army and assigned to the Fourth Army. As an RAI unit from 1933 to 1940, the corps HQ was occasionally organized provisionally for short periods using its assigned Reserve officers and staff officers from HQ, Ninth Corps Area. These periods included several Fourth Army CPXs in the 1930s and the Fourth Army Maneuvers at Fort Lewis, WA, in August 1940. The IX Corps HQ was activated on 24 October 1940, less Reserve personnel, at Fort Lewis where it assumed command and control of the 3d and 41st Divisions. The corps participated in the Fourth Army Maneuvers during May–August 1941 at Camp Hunter-Liggett, CA. After the maneuvers, the corps HQ returned to Fort Lewis where it was located on 7 December 1941.

**Status:** Inactive in the R.A. as HHC, IX Corps.

**Events:** 193, 279, 295, 296, 304, 309, 314, 326

### Corps Commanders

Maj. Gen. Kenyon A. Joyce      24 October 1940–10 April 1942

Prior to October 1940, the Ninth Corps Area commander was generally designated as commanding general for activation/mobilization.

### Chiefs of Staff

Col. Robert W. Mearns, Inf. (R.A.)      7 October 1921–31 December 1922      Unknown      31 December 1922–9 May 1924

### IX CORPS

#### Organization 1922

#### UNIT:

HQ, IX Corps  
3d Div.

#### COMPONENT:

(O.R.)  
(R.A.)

#### HQ LOCATION:

San Francisco, CA  
Fort Lewis, WA

40th Div.	(N.G.)	Berkeley, CA
41st Div.	(N.G.)	Portland, OR
HQ, Special Troops	(O.R.)	San Francisco, CA
HQ Co., IX Corps	(O.R.)	San Francisco, CA
107th Sig. Bn.	(NGI)	California N.G.
108th M.P. Bn.	(NGI)	California N.G.
133d Ord. Co. (HM)	(NGI)	California N.G.
59th Ord. Co. (Ammo.)	(R.A.)	Picatinny Arsenal, NJ
36th Sv Bn., Q.M.C.	(O.R.)	San Francisco, CA
37th Field Rmt Dep	(O.R.)	Leavenworth, KS
9th Rmt Troop	(O.R.)	Leavenworth, KS
HQ, IX Corps Arty.	(O.R.)	San Francisco, CA
86th F.A. Brig.	(NGI)	California N.G.
18th Ord. Co. (M)	(RAI)	A.A. 14th Ord. Co.
Ammo. Tn.	(RAI)	Not designated
Obsn. Bn. (Flash)	(RAI)	Not designated
F.A. Regt.	(RAI)	Not designated
190th F.A. Regt.	(NGI)	Idaho N.G.
191st F.A. Regt.	(NGI)	California N.G.
196th F.A. Regt.	(NGI)	California N.G.
63d C.A. Bn. (AA)	(R.A.)	Fort Winfield Scott, CA
HQ, IX Corps Engrs.	(O.R.)	San Francisco, CA
138th Engr. Regt. (GS)	(NGI)	Montana N.G.
444th Engr. Bn. (Aux)	(O.R.)	San Francisco, CA
445th Engr. Bn. (Aux)	(O.R.)	Duluth, MN
446th Engr. Bn. (Aux)	(O.R.)	St. Paul, MN
HQ, IX Corps Air Service	(O.R.)	San Francisco, CA
341st Obsn. Gp.	(O.R.)	Portland, OR
144th Obsn. Sq.	(NGI)	Oregon, N.G.
372d Obsn. Sq.	(O.R.)	San Francisco, CA
Air Park No. 312	(O.R.)	Los Angeles, CA
17th Bln. Gp.	(NGI)	California N.G.
127th Bln. Co.	(NGI)	California N.G.
128th Bln. Co.	(NGI)	California N.G.
129th Bln. Co.	(NGI)	Utah N.G.
130th Bln. Co.	(NGI)	Idaho N.G.
Bln. Park No. 18	(NGI)	California N.G.
IX Corps Med. HQ	(O.R.)	San Francisco, CA
138th Med. Regt.	(NGI)	California N.G.
HQ, IX Corps Tn., Q.M.C.	(O.R.)	San Francisco, CA
15th M.T. Cmd.	(RAI)	Ninth Corps Area
23d M.T. Cmd.	(RAI)	Ninth Corps Area
349th M.T. Cmd.	(O.R.)	San Francisco, CA
350th M.T. Cmd.	(O.R.)	Los Angeles, CA
426th M.T. Cmd.	(O.R.)	Modesto, CA
427th M.T. Cmd.	(O.R.)	Los Angeles, CA
428th M.T. Cmd.	(O.R.)	Los Angeles, CA
856th M.T. Co.	(O.R.)	San Francisco, CA
857th M.T. Co.	(O.R.)	San Francisco, CA
858th M.T. Co.	(O.R.)	San Francisco, CA
859th M.T. Co.	(O.R.)	San Francisco, CA
860th M.T. Co.	(O.R.)	Oakland, CA
861st M.T. Co.	(O.R.)	Oakland, CA
862d M.T. Co.	(O.R.)	Burlingame, CA
863d M.T. Co.	(O.R.)	Alameda, CA
864th M.T. Co.	(O.R.)	St. Helena,
865th M.T. Co.	(O.R.)	Stockton, CA
866th M.T. Co.	(O.R.)	Sacramento, CA
867th M.T. Co.	(O.R.)	Bakersfield, CA
868th M.T. Co.	(O.R.)	Los Angeles, CA
869th M.T. Co.	(O.R.)	Los Angeles, CA
870th M.T. Co.	(O.R.)	Los Angeles, CA
871st M.T. Co.	(O.R.)	Los Angeles, CA
872d M.T. Co.	(O.R.)	Los Angeles, CA
873d M.T. Co.	(O.R.)	Los Angeles, CA

874th M.T. Co.	(O.R.)	Los Angeles, CA
875th M.T. Co.	(O.R.)	Needles, CA
363d Mtcyl Co.	(O.R.)	St. Paul, MN
364th Mtcyl Co.	(O.R.)	Duluth, MN
488th M. Rep. Sec	(O.R.)	San Francisco, CA
489th M. Rep. Sec	(O.R.)	San Francisco, CA
500th M. Rep. Sec	(O.R.)	San Francisco, CA
501st M. Rep. Sec	(O.R.)	Bakersfield, CA
502d M. Rep. Sec	(O.R.)	Los Angeles, CA
503d M. Rep. Sec	(O.R.)	Los Angeles, CA
504th M. Rep. Sec	(O.R.)	Los Angeles, CA
73d Wagon Tn.	(O.R.)	St. Paul, MN
407th Wagon Co.	(O.R.)	St. Paul, MN
408th Wagon Co.	(O.R.)	Mankato, MN
409th Wagon Co.	(O.R.)	St. Cloud, MN

**IX CORPS  
Organization 1936**

UNIT:	COMPONENT:	HQ LOCATION:
HQ, IX Corps	(RAI)	Fort Lewis, WA
3d Div.	(R.A.)	Fort Lewis, WA
40th Div.	(N.G.)	Berkeley, CA
41st Div.	(N.G.)	Portland, OR
HQ, Special Troops	(RAI)	Fort Lewis, WA
HQ Co., IX Corps	(RAI)	Fort Lewis, WA
59th Sig. Bn.	(RAI)	San Francisco, CA
308th M.P. Bn.	(RAI)	Fresno, CA
3d Ord. Co. (HM)	(RAI)	San Francisco, CA
621st Ord. Co. (Ammo.)	(RAI)	Los Angeles, CA
IX Corps Arty.:		
15th F.A. Brig.	(RAI)	Los Angeles, CA
18th Ord. Co. (M)	(RAI)	Los Angeles, CA
15th Ammo. Tn.	(RAI)	Los Angeles, CA
15th Obsn. Bn. (Flash)	(RAI)	Los Angeles, CA
31st F.A. Regt.	(RAI)	Los Angeles, CA
32d F.A. Regt.	(RAI)	Corvallis, OR
86th F.A. Regt.	(RAI)	Los Angeles, CA
509th C.A. Regt. (AA)	(RAI)	Los Angeles, CA
IX Corps Engrs.:		
26th Engr. Regt. (GS)	(RAI)	San Francisco, CA
49th Engr. Bn. (Sep.)	(RAI)	Los Angeles, CA
444th Engr. Bn. (Sep.)	(O.R.)	San Francisco, CA
465th Engr. Bn. (Sep.) (C)	(O.R.)	Alhambra, CA
399th Engr. Co. (Dep)	(O.R.)	San Francisco, CA
IX Corps Aviation:		
49th Obsn. Gp.	(RAI)	Los Angeles, CA
115th Obsn. Sq.	(N.G.)	Los Angeles, CA
116th Obsn. Sq.	(N.G.)	Parkwater, WA
49th Sv Sq.	(RAI)	Los Angeles, CA
549th Bln. Gp.	(O.R.)	Los Angeles, CA
333d Bln. Sq.	(O.R.)	Los Angeles, CA
334th Bln. Sq.	(O.R.)	Los Angeles, CA
335th Bln. Sq.	(O.R.)	Los Angeles, CA
346th Bln. Sv Sq.	(O.R.)	Los Angeles, CA
IX Corps Med. Sv:		
17th Med. Regt.	(RAI)	Los Angeles, CA
IX Corps Q.M. Sv:		
29th Q.M. Regt. (Truck)	(RAI)	Los Angeles, CA
40th Q.M. Regt. (LM)	(RAI)	Los Angeles, CA

**HHC, XI CORPS (I)****Regular Army Inactive**

HQ—Boston, MA, 1921–33

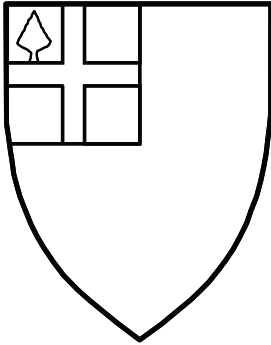

The XI Corps was authorized by the National Defense Act of 1920, and was to be composed of units of the O.R. located primarily in the First Corps Area. The HHC were constituted on 29 July 1921 in the R.A., allotted to the First Corps Area, and assigned to the Fourth Army. The HQ was activated about 24 October 1921 with R.A. and O.R. personnel at the Custom House Tower in Boston, MA. The HQ Co. was initiated at Boston about December 1922. For annual summer training, the corps HQ planned and conducted an officers' training school 3–15 September 1922 and a staff training exercise in July 1924 at Camp Devens, MA. The HQ was relieved from Active Duty in 1925 and all R.A. personnel were reassigned to the HQ, Non-Divisional Group, First Corps Area, which assumed the responsibilities previously held by the XI Corps. Both the HQ and the HQ Co. remained active in the O.R. The HQ was withdrawn from the R.A. on 1 October 1933 and demobilized.

**Events:** 59, 91**Chiefs of Staff**

Lt. Col. Emery T. Smith (R.A.) November 1921–30 June 1922

Col. Fred E. Buchan (R.A.) 1 July 1922–ao January 1925

**XI CORPS**  
**Organization 1922**

<b>UNIT:</b>	<b>HQ LOCATION:</b>	<b>UNIT:</b>	<b>HQ LOCATION:</b>
HQ, XI Corps	Boston, MA	HQ, XI Corps Tn., Q.M.C.	Boston, MA
76th Div.	Hartford, CA	301st M.T. Cmd.	Boston, MA
94th Div.	Boston, MA	302d M.T. Cmd.	Boston, MA
97th Div.	Manchester, NH	303d M.T. Cmd.	Boston, MA
304th M.T. Cmd.	Boston, MA	351st M.T. Cmd.	Northhampton, MA
		352d M.T. Cmd.	Lowell, MA
HQ, Special Troops	Boston, MA	353d M.T. Cmd.	Taunton, MA
HQ Co., XI Corps	Boston, MA	431st M.T. Co.	Holyoke, MA
301st Sig. Bn.	Boston, MA	432d M.T. Co.	Springfield, MA
301st M.P. Bn.	Boston, MA	433d M.T. Co.	Chicopee, MA
501st Ord. Co. (HM)	Springfield, MA	434th M.T. Co.	Worcester, MA
601st Ord. Co. (Ammo.)	Everett, MA	435th M.T. Co.	West Springfield, MA
21st Sv Bn., Q.M.C.	Boston, MA	436th M.T. Co.	Lynn, MA
21st Field Rmt Dep	Southboro, MA	437th M.T. Co.	Lowell, MA
10th Rmt Troop	Southboro, MA	438th M.T. Co.	Malden, MA
		439th M.T. Co.	Lawrence, MA
HQ, XI Corps Arty.	Boston, MA	440th M.T. Co.	Salem, MA
180th F.A. Brig.	Boston, MA	441st M.T. Co.	Chelsea, MA
351st Ord. Co. (M)	Holyoke, MA	442d M.T. Co.	Somerville, MA
341st Ammo. Tn.	Boston, MA	443d M.T. Co.	Cambridge, MA
301st Obsn. Bn. (Flash)	Hartford, CT	579th M.T. Co.	Boston, MA
388th F.A. Regt.	Taunton, MA	580th M.T. Co.	Boston, MA
389th F.A. Regt.	Lowell, MA	581st M.T. Co.	Boston, MA
399th F.A. Regt.	Pittsfield, MA	582d M.T. Co.	Boston, MA
431st F.A. Regt.	Boston, MA	583d M.T. Co.	Boston, MA
501st C.A. Regt. (AA)	Boston, MA	584th M.T. Co.	Boston, MA
		585th M.T. Co.	Boston, MA
HQ, XI Corps Engrs.	Boston, MA	586th M.T. Co.	Bridgeport, MA
341st Engr. Regt. (GS)	Boston, MA	587th M.T. Co.	New Bedford, MA
411th Engr. Bn. (Aux)	Brockton, MA	588th M.T. Co.	Taunton, MA
412th Engr. Bn. (Aux)	Lowell, MA	589th M.T. Co.	Brockton, MA
413th Engr. Bn. (Aux)	Worcester, MA	590th M.T. Co.	Fall River, MA
		341st Mtcyl Co.	Springfield, MA
HQ, XI Corps Air Service	Boston, MA	342d Mtcyl Co.	Worcester, MA
301st Obsn. Gp.	Worcester, MA	371st M. Rep. Sec	Webster, MA
351st Obsn. Sq.	Springfield, MA	372d M. Rep. Sec	Worcester, MA
352d Obsn. Sq.	New Haven, CT	394th M. Rep. Sec	Springfield, MA

330th Sv Sq.  
41st Bln. Gp.  
301st Bln. Co.  
302d Bln. Co.  
303d Bln. Co.  
304th Bln. Co.  
Bln. Park No. 31

Boston, MA  
Bangor, ME  
Bangor, ME  
Auburn, ME  
Bath, ME  
Concord, NH  
Auburn, ME

395th M. Rep. Sec  
396th M. Rep. Sec  
397th M. Rep. Sec  
398th M. Rep. Sec  
61st Wagon Tn.  
371st Wagon Co.  
372d Wagon Co.  
373d Wagon Co.

Lynn, MA  
Cambridge, MA  
Boston, MA  
Boston, MA  
Springfield, MA  
Springfield, MA  
Worcester, MA  
North Adams, MA

XI Corps Med. HQ  
341st Med. Regt.

Boston, MA  
Boston, MA

### HHC, XI CORPS (II)

### Organized Reserve Massachusetts

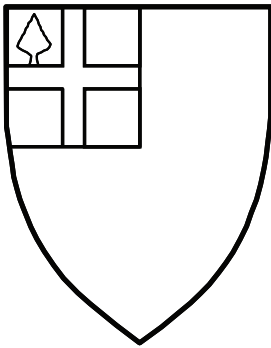

**HQ**—Boston, MA, 1933–41

Constituted in the O.R. on 1 October 1933, allotted to the First Corps Area, and assigned to the First Army. The HQ was concurrently organized with O.R. personnel previously assigned to the demobilized XI Corps (RAI). The designated mobilization station was Camp Devens, MA, where the corps HQ would assume command and control of the subordinate corps troops, which would then be mobilizing throughout the First Corps Area. The XI Corps was not activated prior to World War II and was located in Boston as of 7 December 1941 in a Reserve status.

**Status:** Inactive in the R.A. as HHC, XI Army Corps.

#### XI CORPS Organization 1936

**UNIT:**

HQ, XI Corps  
76th Div.  
94th Div.  
97th Div.  
HQ, Special Troops  
HQ Co., XI Corps  
301st Sig. Bn.  
314th M.P. Bn.  
501st Ord. Co. (HM)  
610th Ord. Co. (Ammo.)  
XI Corps Arty.:  
180th F.A. Brig.  
351st Ord. Co. (M)  
330th Ammo. Tn.  
315th Obsn. Bn. (Flash)  
357th F.A. Regt.  
388th F.A. Regt.  
431st F.A. Regt.  
542d C.A. Regt. (AA)

**HQ LOCATION:**

Boston, MA  
Hartford, CT  
Boston, MA  
Manchester, NH  
Boston, MA  
Boston, MA  
Boston, MA  
Hartford, CT  
Springfield, MA  
Quincy, MA  
  
Boston, MA  
Holyoke, MA  
New Haven, CT  
Boston, MA  
New Haven, CT  
Taunton, MA  
Boston, MA  
Manchester, NH

**UNIT:**

XI Corps Engrs.:  
332d Engr. Regt. (GS)  
642d Engr. Bn. (Sep.)  
643d Engr. Bn. (Sep.)  
692d Engr. Bn. (Sep.)  
725th Engr. Co. (Dep)  
XI Corps Aviation:  
301st Obsn. Gp.  
319th Obsn. Sq.  
322d Obsn. Sq.  
343d Sv Sq.  
550th Bln. Gp.  
308th Bln. Sq.  
337th Bln. Sq.  
355th Bln. Sq.  
347th Bln. Sv Sq.  
XI Corps Med. Sv:  
341st Med. Regt.  
XI Corps Q.M. Sv:  
471st Q.M. Regt. (Truck)  
491st Q.M. Regt. (LM)

**HQ LOCATION:**

Boston, MA  
First Corps Area  
First Corps Area  
First Corps Area  
Holyoke, MA  
  
Worcester, MA  
Boston, MA  
Bangor, ME  
Boston, MA  
Rochester, NY  
Buffalo, NY  
Plattsburg Barracks, NY  
Trenton, NJ  
Rochester, NY  
  
Boston, MA  
  
First Corps Area  
Boston, MA

**HHC, XII CORPS (I)****Regular Army Inactive**

HQ—Manhattan, NY, 1921–33

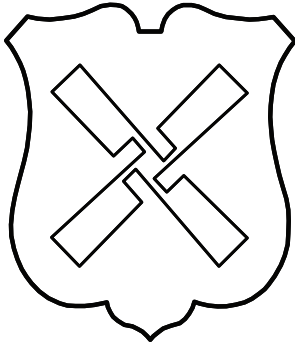

The XII Corps was authorized by the National Defense Act of 1920 and was to be composed of units of the O.R. located primarily in the Second Corps Area. The HHC were constituted on 29 July 1921 in the R.A., allotted to the Second Corps Area, and assigned to the Fourth Army. Both units were organized on 10 October 1921 with O.R. personnel at Manhattan, NY. Per General Order #11, Second Corps Area, the corps HQ was activated on 23 February 1922 at 39 Whitehall Street in Manhattan, NY, with R.A. personnel. The corps HQ was responsible for providing and planning administration, organization, supply, and training for army, corps, and other nondivisional O.R. units, less field and C.A., in the Second Corps Area. The HQ was relieved from Active Duty on 10 October 1925 and all R.A. personnel reassigned to the HQ, Non-Divisional Group, Second Corps Area, which assumed the responsibilities previously held by the XII Corps. Both the HQ and the HQ Co.

remained active in the O.R. as assignment units for O.R. personnel for wartime mobilization. The HQ was withdrawn from the R.A. on 1 October 1933 and demobilized.

**Events:** 61, 91**Deputy Corps Commanders**

Brig. Gen. William Weigel (R.A.) 23 February 1922–20 March 1924

**Chiefs of Staff**

Col. Elijah B. Martindale Jr. (R.A.) 23 February 1922–ao October 1923 Col. Michael J. Lenihan (R.A.) 1 June 1924–10 October 1925

**XII CORPS  
Organization 1922**

<b>UNIT:</b>	<b>HQ LOCATION:</b>	<b>UNIT:</b>	<b>HQ LOCATION:</b>
HQ, XII Corps	Manhattan, NY	HQ, XII Corps Tn., Q.M.C.	Yonkers, NY
77th Div.	Manhattan, NY	305th M.T. Cmd.	Yonkers, NY
78th Div.	Newark, NJ	306th M.T. Cmd.	Queens, NY
98th Div.	Rochester, NY	307th M.T. Cmd.	Passaic, NJ
		308th M.T. Cmd.	Catskill, NY
HQ, Special Troops	Manhattan, NY	354th M.T. Cmd.	Manhattan, NY
HQ Co., XII Corps	Manhattan, NY	355th M.T. Cmd.	Newark, NJ
302d Sig. Bn.	Manhattan, NY	356th M.T. Cmd.	New York City, NY
302d M.P. Bn.	Plainfield, NJ	444th M.T. Co.	Bronx, NY
502d Ord. Co. (HM)	Watervliet, NY	445th M.T. Co.	Bronx, NY
602d Ord. Co. (Ammo.)	Metuchen, NJ	446th M.T. Co.	Manhattan, NY
22d Sv Bn., Q.M.C.	Hoboken, NJ	447th M.T. Co.	Manhattan, NY
22d Field Rmt Dep	Mount Holly, NJ	448th M.T. Co.	Manhattan, NY
11th Rmt Troop	Mount Holly, NJ	449th M.T. Co.	Queens, NY
		450th M.T. Co.	Queens, NY
HQ, XII Corps Arty.	Manhattan, NY	451st M.T. Co.	Jamaica, L.I., NY
181st F.A. Brig.	Manhattan, NY	452d M.T. Co.	Gloucester, NJ
352d Ord. Co. (M)	Rochester, NY	453d M.T. Co.	Camden, NJ
342d Ammo. Tn.	Manhattan, NY	454th M.T. Co.	Lambertville, NJ
302d Obsn. Bn. (Flash)	Manhattan, NY	455th M.T. Co.	Passaic, NJ
306th F.A. Regt.	Bronx, NY	456th M.T. Co. (Car)	Manhattan, NY
309th F.A. Regt.	Brooklyn, NY	591st M.T. Co.	Manhattan, NY
391st F.A. Regt.	Manhattan, NY	592d M.T. Co.	Manhattan, NY
432d F.A. Regt.	Manhattan, NY	593d M.T. Co.	Brooklyn, NY
502d C.A. Regt. (AA)	Manhattan, NY	594th M.T. Co.	Brooklyn, NY
		595th M.T. Co.	Newark, NJ
HQ, XII Corps Engrs.	Manhattan, NY	596th M.T. Co.	Newark, NJ
342d Engr. Regt. (GS)	Manhattan, NY	597th M.T. Co.	Jersey City, NJ
414th Engr. Bn. (Aux)	Manhattan, NY	598th M.T. Co.	Hoboken, NJ
415th Engr. Bn. (Aux)	Jersey City, NJ	599th M.T. Co.	Bayonne, NJ
416th Engr. Bn. (Aux)	Schenectady, NY	681st M.T. Co.	Paterson, NJ
		682d M.T. Co.	Passaic, NJ

HQ, XII Corps Air Service  
 324th Obsn. Gp.  
 353d Obsn. Sq.  
 354th Obsn. Sq.  
 375th Sv Sq.  
 42d Bln. Gp.  
 305th Bln. Co.  
 306th Bln. Co.  
 307th Bln. Co.  
 308th Bln. Co.  
 Bln. Park No. 32

XII Corps Med. HQ  
 342d Med. Regt.

Albany, NY  
 Second Corps Area  
 Poughkeepsie, NY  
 Ithaca, NY  
 Albany, NY  
 Buffalo, NY  
 Trenton, NJ  
 Atlantic City, NJ  
 Wilmington, DE  
 Buffalo, NY  
 Buffalo, NY

Newark, NJ  
 Paterson, NJ

683d M.T. Co.  
 343d Mtcyl Co.  
 344th Mtcyl Co.  
 373d M. Rep. Sec  
 374th M. Rep. Sec  
 404th M. Rep. Sec  
 405th M. Rep. Sec  
 406th M. Rep. Sec  
 407th M. Rep. Sec  
 408th M. Rep. Sec  
 409th M. Rep. Sec  
 70th Wagon Tn.  
 398th Wagon Co.  
 399th Wagon Co.  
 400th Wagon Co.

Elizabeth, NJ  
 Brooklyn, NY  
 Trenton, NJ  
 Brooklyn, NY  
 Camden, NJ  
 Manhattan, NY  
 Manhattan, NY  
 Newark, NJ  
 Jersey City, NJ  
 Paterson, NJ  
 Manhattan, NY  
 South Orange, NJ  
 Bloomfield, NJ  
 Wallington, NJ  
 Freehold, NJ

**HHC, XII CORPS (II)**

**Organized Reserve New York**

HQ—*Not initiated*, 1933–34; Manhattan, NY, 1934–41

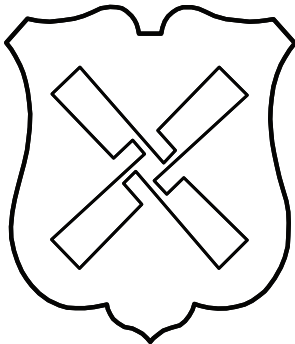

Constituted in the O.R. on 1 October 1933, allotted to the Second Corps Area, and assigned to the First Army. The HQ was initiated on 24 January 1934 at Manhattan, NY. In the event of mobilization, it was to be fully activated with R.A. officers from the Second Corps Area and with Reserve personnel already assigned to the corps HHC in peacetime. The designated mobilization station was Camp Dix, NJ, where the corps HQ would assume command and control of the subordinate corps troops, which would then be mobilizing throughout the Second Corps Area. It was redesignated on 1 January 1941 as HQ, XII Army Corps. The XII Army Corps was not activated prior to World War II and was located in Manhattan as of 7 December 1941 in a Reserve status.

**Status:** Inactive in the R.A. as HHC, XII Army Corps.

**Events:** 280

**XII CORPS  
 Organization 1936**

<b>UNIT:</b>	<b>HQ LOCATION:</b>	<b>UNIT:</b>	<b>HQ LOCATION:</b>
HQ, XII Corps	Manhattan, NY	XII Corps Engrs.:	
77th Div.	Manhattan, NY	342d Engr. Regt. (GS)	Manhattan, NY
78th Div.	Newark, NJ	416th Engr. Bn. (Sep.)	Schenectady, NY
94th Div.	Syracuse, NY	432d Engr. Bn. (Sep.)	Syracuse, NY
HQ, Special Troops	Manhattan, NY	433d Engr. Bn. (Sep.)	Rochester, NY
HQ Co., XII Corps	Manhattan, NY	711th Engr. Co.(Dep)	Peekskill, NY
302d Sig. Bn.	Manhattan, NY	XII Corps Aviation:	
310th M.P. Bn.	Manhattan, NY	307th Obsn. Gp.	Mitchel Field, NY
502d Ord. Co. (HM)	Watervliet, NY	303d Obsn. Sq.	Atlantic City, NJ
602d Ord. Co. (Ammo.)	Metuchen, NJ	353d Obsn. Sq.	Poughkeepsie, NY
XII Corps Arty.:		344th Sv Sq.	Mineola, NY
181st F.A. Brig.	Manhattan, NY	562d Bln. Gp.	Trenton, NJ
352d Ord. Co. (M)	Albany, NY	312th Bln. Sq.	Uniontown, PA
332d Ammo. Tn.	Manhattan, NY	355th Bln. Sq.	Trenton, NJ
302d Obsn. Bn. (Flash)	Manhattan, NY	356th Bln. Sq.	Rochester, NY
352d F.A. Regt.	Bronx, NY	357th Bln. Sq.	Philadelphia, PA
353d F.A. Regt.	Brooklyn, NY	349th Bln. Sv Sq.	Rochester, NY
432d F.A. Regt.	Manhattan, NY	XII Corps Med. Sv	
513th C.A. Regt. (AA)	Buffalo, NY	342d Med. Regt.	Englewood, NJ
		XII Corps Q.M. Sv:	
		472d Q.M. Regt. (Truck)	Manhattan, NY
		492d Q.M. Regt. (LM)	Manhattan, NY

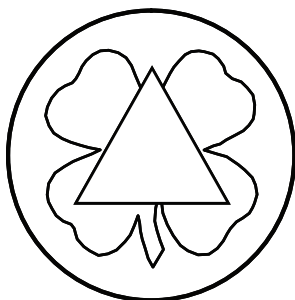

**HHC, XIII CORPS (I)****Regular Army Inactive**HQ—Fort Howard, MD, 1921–25; *Inactive*, 1925–33

The XIII Corps was authorized by the National Defense Act of 1920, and was to be composed of units of the O.R. located primarily in the Third Corps Area. The HHC were constituted on 29 July 1921 in the R.A., allotted to the Third Corps Area, and assigned to the Fourth Army. The HQ was organized about November 1921 with O.R. personnel at Fort Howard, MD. The HQ Co. was organized with O.R. personnel in February 1923 at York, PA. Though there seems to be no definitive information available, the corps HQ appears to have been inactivated sometime in 1925. The HQ Co. was inactivated on 19 July 1929 at Fort Howard. The HQ was withdrawn from the R.A. on 1 October 1933 and demobilized.

**XIII CORPS**  
**Organization 1922**

<b>UNIT:</b>	<b>HQ LOCATION:</b>	<b>UNIT:</b>	<b>HQ LOCATION:</b>
HQ, XIII Corps	Fort Howard, MD	HQ, XIII Corps Tn., Q.M.C.	Pittsburgh, PA
79th Div.	Philadelphia, PA	309th M.T. Cmd.	Pittsburgh, PA
80th Div.	Richmond, VA	310th M.T. Cmd.	Bedford, PA
99th Div.	Pittsburgh, PA	311th M.T. Cmd.	Oil City, PA
HQ, Special Troops	York, PA	312th M.T. Cmd.	Lewistown, PA
HQ Co., XIII Corps	York, PA	357th M.T. Cmd.	Baltimore, MD
303d Sig. Bn.	Philadelphia, PA	358th M.T. Cmd.	Greensburg, PA
303d M.P. Bn.	Columbia, PA	359th M.T. Cmd.	Baltimore, MD
503d Ord. Co. (HM)	Glen Rock, PA	457th M.T. Co. (C)	Winston-Salem, NC
603d Ord. Co. (Ammo.)	Littlestown, PA	458th M.T. Co. (C)	Charlotte, NC
23d Sv Bn., Q.M.C.	Oxford, PA	459th M.T. Co. (C)	Augusta, GA
23d Field Rmt Dep	Hanover, PA	460th M.T. Co. (C)	Macon, GA
12th Rmt Troop	Front Royal, VA	461st M.T. Co. (C)	Barnesville, GA
HQ, XIII Corps Arty.	Altoona, PA	462d M.T. Co. (C)	Halcyondale, GA
182d F.A. Brig.	Altoona, PA	463d M.T. Co. (C)	Buena Vista, GA
353d Ord. Co. (M)	Lewistown, PA	464th M.T. Co. (C)	Decatur, GA
343d Ammo. Tn.	Huntington, PA	465th M.T. Co. (C)	Valdosta, GA
303d Obsn. Bn. (Flash)	Johnstown, PA	466th M.T. Co. (C)	Brunswick, GA
394th F.A. Regt.	Emporium, PA	467th M.T. Co. (C)	Thomasville, GA
395th F.A. Regt.	Bedford, PA	468th M.T. Co. (C)	Griffin, GA
396th F.A. Regt.	Altoona, PA	469th M.T. Co. (C)	Fort Lauderdale, FL
433d F.A. Regt.	Waynestown, PA	684th M.T. Co.	Cumberland, MD
503d C.A. Regt. (AA)	Tyrone, PA	685th M.T. Co.	Cumberland, MD
HQ, XIII Corps Engrs.	Washington, DC	686th M.T. Co.	Hagerstown, MD
343d Engr. Regt. (GS)	Washington, DC	687th M.T. Co.	Frederick, MD
417th Engr. Bn. (Aux)	Christenburg, VA	688th M.T. Co.	Perryville, MD
418th Engr. Bn. (Aux)	Bethlehem, PA	689th M.T. Co.	Havre De Grace, MD
419th Engr. Bn. (Aux)	Charlotte, VA	690th M.T. Co.	Greensburg, PA
HQ, XIII Corps Air Service	Pittsburgh, PA	691st M.T. Co.	Duquesne, PA
330th Obsn. Gp.	Third Corps Area	692d M.T. Co.	Pittsburgh, PA
355th Obsn. Sq.	McKeesport, PA	693d M.T. Co.	Hagerstown, PA
356th Obsn. Sq.	Pittsburgh, PA	694th M.T. Co.	Washington, DC
376th Sv Sq.	Pittsburgh, PA	695th M.T. Co.	Washington, DC
43d Bln. Gp.	Pittsburgh, PA	345th Mtcyl Co.	Somerset, PA
309th Bln. Co.	Pittsburgh, PA	346th Mtcyl Co.	Meadville, MD
310th Bln. Co.	Greensburg, PA	375th M. Rep. Sec	Bedford, PA
311th Bln. Co.	Washington, PA	376th M. Rep. Sec	Erie, PA
312th Bln. Co.	Uniontown, PA	409th M. Rep. Sec	Baltimore, MD
Bln. Park No. 33	Pittsburgh, PA	410th M. Rep. Sec	Baltimore, MD
XIII Corps Med. HQ	Altoona, PA	411th M. Rep. Sec	Baltimore, MD
343d Med. Regt.	Du Bois, PA	412th M. Rep. Sec	Baltimore, MD
		413th M. Rep. Sec	Baltimore, MD
		63d Wagon Tn.	Reading, PA
		377th Wagon Co.	Boyertown, PA
		378th Wagon Co.	Birdsboro, PA
		379th Wagon Co.	Mohnton, PA

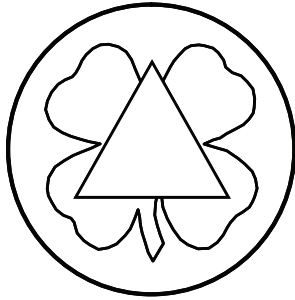
**HHC, XIII CORPS (II)****Organized Reserve Maryland**HQ—*Not initiated, 1933–41*

Constituted in the O.R. on 1 October 1933, allotted to the Third Corps Area, and assigned to the First Army. This new corps' designated HQ location for organization purposes was Fort Howard. In the event of mobilization, it was to be organized with R.A. officers from the Third Corps Area and with Reserve personnel already assigned to the corps HHC in peacetime. The designated mobilization station was Camp George G. Meade, MD, where the corps HQ would assume command and control of its subordinate corps troops, which would then be mobilizing throughout the Third Corps Area. It was redesignated on 1 January 1941 as HQ, XIII Army Corps. The XIII Corps was not initiated nor activated prior to World War II.

**Status:** Inactive in the R.A. as HHC, XIII Army Corps.**Events:** 217, 247, 281

**XIII CORPS**  
**Organization 1936**

<b>UNIT:</b>	<b>HQ LOCATION:</b>	<b>UNIT:</b>	<b>HQ LOCATION:</b>
<i>HQ, XIII Corps</i>	<i>Third Corps Area</i>	XIII Corps Engrs.:	
79th Div.	Philadelphia, PA	343d Engr. Regt. (GS)	Washington, DC
80th Div.	Richmond, VA	417th Engr. Bn. (Sep.)	Pittsburgh, PA
99th Div.	Pittsburgh, PA	419th Engr. Bn. (Sep.)	Charlottesville, VA
HQ, Special Troops	Third Corps Area	440th Engr. Bn. (Sep.)	Norfolk, VA
HQ Co., XIII Corps	Third Corps Area	723d Engr. Co. (Dep)	Baltimore, MD
322d Sig. Bn.	Philadelphia, PA	XIII Corps Aviation:	
<i>M.P. Bn.</i>	<i>Unknown</i>	315th Obsn. Gp.	Philadelphia, PA
538th Ord. Co. (HM)	Shenandoah, PA	304th Obsn. Sq.	Philadelphia, PA
623d Ord. Co. (Ammo.)	Ellwood City, PA	305th Obsn. Sq.	Richmond, VA
XIII Corps Arty.:		334th Sv Sq.	Richmond, VA
182d F.A. Brig.	Altoona, PA	543d Bln. Gp.	Pittsburgh, PA
362d Ord. Co. (M)	Baltimore, MD	309th Bln. Sq.	Pittsburgh, PA
333d Ammo. Tn.	Johnstown, PA	310th Bln. Sq.	Greensburg, PA
303d Obsn. Bn. (Flash)	Third Corps Area	311th Bln. Sq.	Washington, PA
394th F.A. Regt.	Emporium, PA	340th Bln. Sv Sq.	Pittsburgh, PA
395th F.A. Regt.	Clearfield, PA	XIII Corps Med. Sv:	
491st F.A. Regt.	Williamsport, PA	<i>Med. Regt.</i>	<i>Not designated</i>
510th C.A. Regt. (AA)	Philadelphia, PA	XIII Corps Q.M. Sv:	
		473d Q.M. Regt. (Truck)	Lancaster, PA
		493d Q.M. Regt. (LM)	Bedford, PA

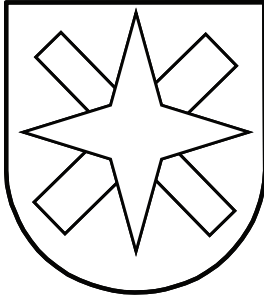
**HHC, XIV CORPS (I)****Regular Army Inactive**HQ—*Not organized, 1921–22; Birmingham, AL, 1922–33*

The XIV Corps was authorized by the National Defense Act of 1920 and was to be composed of units of the O.R. located primarily in the Fourth Corps Area. The HHC were constituted on 29 July 1921 in the R.A., allotted to the Fourth Corps Area, and assigned to the Fifth Army. The HQ was organized in January 1922 with O.R. personnel at Birmingham, AL. The HQ Co. was organized in April 1923 with O.R. personnel at Birmingham. The HQ was withdrawn from the R.A. on 1 October 1933 and demobilized.

**XIV CORPS**  
**Organization 1922**

<b>UNIT:</b>	<b>HQ LOCATION:</b>	<b>UNIT:</b>	<b>HQ LOCATION:</b>
HQ, XIV Corps	Birmingham, AL	HQ, XIV Corps Tn., Q.M.C.	Birmingham, AL
81st Div.	Knoxville, TN	313th M.T. Cmd.	Clayton, NC
82d Div.	Columbia, SC	314th M.T. Cmd.	Hohenwald, TN
87th Div.	New Orleans, LA	315th M.T. Cmd.	Greenville, SC
		316th M.T. Cmd.	Alexandria, LA
HQ, Special Troops	Birmingham, AL	360th M.T. Cmd.	Cullman, AL
HQ Co., XIV Corps	Birmingham, AL	385th M.T. Cmd.	Orlando, FL
304th Sig. Bn.	Atlanta, GA	386th M.T. Cmd.	Miami, FL
304th M.P. Bn.	Pittsburg Landing, TN	470th M.T. Co.	Marietta, GA
504th Ord. Co. (HM)	Birmingham, AL	471st M.T. Co.	Rome, GA
604th Ord. Co. (Ammo.)	Augusta, GA	472d M.T. Co.	Lafayette, LA
24th Sv Bn., Q.M.C. (C)	Talladega, AL	473d M.T. Co.	Lake Providence, LA
24th Field Rmt Dep	Oxford, MS	474th M.T. Co.	Biloxi, MS
13th Rmt Troop	Waynesville, NC	475th M.T. Co.	Moss Point, MS
		476th M.T. Co.	Laurel, MS
HQ, XIV Corps Arty.	Birmingham, AL	477th M.T. Co.	Dallas, NC
183d F.A. Brig.	Nashville, TN	478th M.T. Co.	Durham, NC
354th Ord. Co. (M)	Lenoir City, TN	479th M.T. Co.	Greenville, SC
344th Ammo. Tn.	Macon, GA	480th M.T. Co.	Greenville, SC
304th Obsn. Bn. (Flash)	New Orleans, LA	481st M.T. Co.	Greenville, SC
397th F.A. Regt.	Alexandria, VA	482d M.T. Co.	Jackson, TN
398th F.A. Regt.	Jackson, MS	696th M.T. Co.	Brewton, AL
399th F.A. Regt.	Charlotte, NC	697th M.T. Co.	Clanton, AL
434th F.A. Regt.	Hendersonville, TN	698th M.T. Co.	Monroeville, AL
504th C.A. Regt. (AA)	Chattanooga, TN	699th M.T. Co.	Jackson, AL
		700th M.T. Co.	Lake City, FL
HQ, XIV Corps Engrs.	Birmingham, AL	701st M.T. Co.	Marianna, FL
344th Engr. Regt. (GS)	Tuscaloosa, AL	702d M.T. Co.	Tampa, FL
420th Engr. Bn. (Aux) (C)	Auburn, AL	703d M.T. Co. (C)	Gastonia, NC
421st Engr. Bn. (Aux) (C)	Savannah, GA	704th M.T. Co. (C)	Monroe, NC
422d Engr. Bn. (Aux) (C)	Memphis, TN	705th M.T. Co.	Sumter, SC
		706th M.T. Co.	Winona, MS
HQ, XIV Corps Air Service	Atlanta, GA	707th M.T. Co.	Mendenhall, MS
331st Obsn. Gp.	Atlanta, GA	347th Mtcyl Co.	Shreveport, LA
357th Obsn. Sq.	Birmingham, AL	348th Mtcyl Co.	Raleigh, NC
358th Obsn. Sq.	Columbia, SC	377th M. Rep. Sec	Canton, GA
Air Park No. 304	Atlanta, GA	378th M. Rep. Sec	Alexandria, LA
44th Bln. Gp.	Charleston, SC	415th M. Rep. Sec	Opelika, AL
313th Bln. Co.	Jacksonville, FL	416th M. Rep. Sec	Ocala, FL
314th Bln. Co.	Tampa, FL	417th M. Rep. Sec	Tampa, FL
315th Bln. Co.	Augusta, GA	418th M. Rep. Sec	New Orleans, LA
316th Bln. Co.	Charleston, SC	419th M. Rep. Sec	Burlington, NC
341st Bln. Sv Co.	Spartanburg, SC	420th M. Rep. Sec	Kingstree, SC
		64th Wagon Tn.	West Point, MS
XIV Corps Med. HQ	Birmingham, AL	380th Wagon Co.	Meridian, MS
344th Med. Regt.	Baton Rouge, LA	381st Wagon Co.	Starkeville, MS
		382d Wagon Co.	New Albany, MS

**HHC, XIV CORPS (II)****Organized Reserve Alabama**

HQ—Birmingham, AL, 1933–41

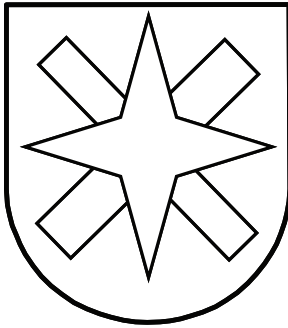

Constituted in the O.R. on 1 October 1933, allotted to the Fourth Corps Area, and assigned to the Third Army. The HQ was concurrently initiated at Birmingham, AL, with O.R. personnel previously assigned to the demobilized XIV Corps (RAI). The designated mobilization station was Camp McClellan, AL, where the corps HQ would assume command and control of its subordinate corps troops, which would then be mobilizing throughout the Fourth Corps Area. It was redesignated on 1 January 1941 as HQ, XIV Army Corps. The XIV Corps was not activated prior to World War II and was located in Birmingham as of 7 December 1941 in a Reserve status.

**Status:** Inactive in the R.A. as HHC, XIV Army Corps.**Events:** 255, 300

**XIV CORPS**  
**Organization 1936**

UNIT:	HQ LOCATION:	UNIT:	HQ LOCATION:
HQ, XIV Corps	Birmingham, AL	XIV Corps Engrs.:	
81st Div.	Knoxville, TN	344th Engr. Regt. (GS)	Birmingham, AL
82d Div.	Columbia, SC	422d Engr. Bn. (Sep.)	Anniston, AL
87th Div.	New Orleans, LA	428th Engr. Bn. (Sep.)	Birmingham, AL
HQ, Special Troops	Birmingham, AL	443d Engr. Bn. (Sep.)	Shreveport, LA
HQ Co., XIV Corps	Birmingham, AL	<i>Engr. Co. (Dep)</i>	<i>Unknown</i>
304th Sig. Bn.	Atlanta, GA	XIV Corps Aviation:	
312th M.P. Bn.	Sheffield, AL	331st Obsn. Gp.	Atlanta, GA
504th Ord. Co. (HM)	Birmingham, AL	306th Obsn. Sq.	Chattanooga, TN
<i>Ord. Co. (Ammo.)</i>	<i>Unknown</i>	307th Obsn. Sq.	Tampa, AL
XIV Corps Arty.:		388th Sv Sq.	Atlanta, GA
183d F.A. Brig.	Auburn, AL	544th Bln. Gp.	Charleston, SC
<i>Ord. Co. (M)</i>	<i>Unknown</i>	313th Bln. Sq.	Charleston, SC
344th Ammo. Tn.	Montgomery, AL	314th Bln. Sq.	Charleston, SC
316th Obsn. Bn. (Flash)	Tampa, FL	315th Bln. Sq.	Henderson, NC
392d F.A. Regt.	Birmingham, AL	341st Bln. Sv Sq.	Spartanburg, SC
397th F.A. Regt.	Tampa, FL	XIV Corps Med. Sv:	
427th F.A. Regt.	Charlotte, NC	344th Med. Regt.	Baton Rouge, LA
524th C.A. Regt. (AA)	Atlanta, GA	XIV Corps Q.M. Sv:	
		474th Q.M. Regt. (Truck)	Spartanburg, SC
		494th Q.M. Regt. (LM)	New Orleans, LA

**HHC, XV CORPS (I)****Regular Army Inactive**HQ—*Not organized*, 1921–22; Columbus, OH, 1922–33

The XV Corps was authorized by the National Defense Act of 1920 and was to be composed of units of the O.R. located primarily in the Fifth Corps Area. The HHC were constituted on 29 July 1921 in the R.A., allotted to the Fifth Corps Area, and assigned to the Fifth Army. The HQ was organized in January 1922 with O.R. personnel at Columbus, OH. The HQ Co. was organized about August 1924 with O.R. personnel at Cleveland, OH, and relocated on 9 July 1931 to Columbus. The HQ was withdrawn from the R.A. on 1 October 1933 and demobilized.

**Corps Commanders**

Brig. Gen. George H. Jamerson\*      8 November 1932–1 October 1933

\*Designated as commanding general for activation/mobilization.

**XV CORPS  
Organization 1922**

UNIT:	HQ LOCATION:	UNIT:	HQ LOCATION:
HQ, XV Corps	Indianapolis, IN	HQ, XV Corps Tn., Q.M.C.	Cleveland, OH
83d Div.	Columbus, OH	317th M.T. Cmd.	Charleston, WV
84th Div.	Indianapolis, IN	318th M.T. Cmd.	Jeffersonville, IN
100th Div.	Huntington, WV	319th M.T. Cmd.	Mansfield, OH
		320th M.T. Cmd.	Lakewood, OH
HQ, Special Troops	Columbus, OH	387th M.T. Cmd.	Wheeling, WV
HQ Co., XV Corps	Cleveland, OH	<i>388th M.T. Cmd.</i>	<i>Fifth Corps Area</i>
305th Sig. Bn.	Cleveland, OH	<i>389th M.T. Cmd.</i>	<i>Fifth Corps Area</i>
305th M.P. Bn.	Charleston, WV	483d M.T. Co.	Gary, IN
505th Ord. Co. (HM)	Cleveland, OH	484th M.T. Co.	Fort Wayne, IN
605th Ord. Co. (Ammo.)	Cleveland, OH	485th M.T. Co.	Indianapolis, IN
25th Sv Bn., Q.M.C.	Toledo, OH	486th M.T. Co.	Vincennes, IN
25th Field Rmt Dep	Madisonville, KY	487th M.T. Co.	Covington, KY
14th Rmt Troop	Akron, OH	488th M.T. Co.	Frankfort, KY
		489th M.T. Co.	Paducah, KY
HQ, XV Corps Arty.	Cleveland, OH	490th M.T. Co.	Wheeling, WV
184th F.A. Brig.	Cincinnati, OH	491st M.T. Co.	Huntington, WV
355th Ord. Co. (M)	Cleveland, OH	492d M.T. Co.	Charleston, WV
345th Ammo. Tn.	Cleveland, OH	493d M.T. Co.	Parkersburg, WV
305th Obsn. Bn. (Flash)	Columbus, OH	494th M.T. Co.	Morgantown, WV
400th F.A. Regt.	Dayton, OH	495th M.T. Co.	Clarksburg, WV
401st F.A. Regt.	Louisville, KY	708th M.T. Co.	Fairmont, WV
402d F.A. Regt.	Fort Wayne, IN	709th M.T. Co.	Bluefield, WV
435th F.A. Regt.	Cleveland, OH	710th M.T. Co.	Bowling Green, KY
505th C.A. Regt. (AA)	Cincinnati, OH	711th M.T. Co.	Ravenna, OH
		712th M.T. Co.	Zanesville, OH
HQ, XV Corps Engrs.	Chillicothe, OH	713th M.T. Co.	Toledo, OH
345th Engr. Regt. (GS)	Cleveland, OH	714th M.T. Co.	Findlay, OH
423d Engr. Bn. (Aux)	Columbus, OH	715th M.T. Co.	Lima, OH
424th Engr. Bn. (Aux)	Dover, OH	716th M.T. Co.	Delaware, OH
425th Engr. Bn. (Aux)	Cleveland, OH	717th M.T. Co.	Portland, OR
		349th Mtcyl Co.	Cleveland, OH
HQ, XV Corps Air Service	Wilmington, OH	350th Mtcyl Co.	Tiffin, OH
332d Obsn. Gp.	Cincinnati, OH	379th M. Rep. Sec	Findlay, OH
359th Obsn. Sq.	Cincinnati, OH	380th M. Rep. Sec	Cleveland, OH
360th Obsn. Sq.	Bowman Field, KY	421st M. Rep. Sec	Dayton, OH
377th Sv Sq.	Indianapolis, IN	422d M. Rep. Sec	Toledo, OH
45th Bln. Gp.	Gary, IN	423d M. Rep. Sec	Findlay, OH
317th Bln. Co.	Indianapolis, IN	424th M. Rep. Sec	Akron, OH
318th Bln. Co.	Akron, OH	425th M. Rep. Sec	Mansfield, OH
319th Bln. Co.	Cleveland, OH	65th Wagon Tn.	Bowling Green, KY
320th Bln. Co.	Huntington, WV	<i>383d Wagon Co.</i>	<i>Fifth Corps Area</i>
342d Bln. Sv Co.	Akron, OH	<i>384th Wagon Co.</i>	<i>Fifth Corps Area</i>
		<i>385th Wagon Co.</i>	<i>Fifth Corps Area</i>
XV Corps Med. HQ	Cincinnati, OH		
345th Med. Regt.	Toledo, OH		

**HHC, XV CORPS (II)**

**Organized Reserve Indiana**

**HQ**—Indianapolis, IN, 1933–41

Constituted in the O.R. on 1 October 1933, allotted to the Fifth Corps Area, and assigned to the Second Army. The HQ was concurrently initiated at Indianapolis, IN, with O.R. personnel previously assigned to the demobilized XV Corps (RAD). The designated mobilization station was Fort Hayes, OH, where the corps HQ would assume command and control of its subordinate corps troops which would then be mobilizing throughout the Fifth Corps Area. It was redesignated 1 January 1941 as HQ, XV Army Corps. The XV Corps was not activated prior to World War II and was located in Indianapolis as of 7 December 1941 in a Reserve status.

**Status:** Inactive in the R.A. as HHC, XV Army Corps.

**XV CORPS  
Organization 1936**

<b>UNIT:</b>	<b>HQ LOCATION:</b>	<b>UNIT:</b>	<b>HQ LOCATION:</b>
HQ, XV Corps	Indianapolis, IN	XV Corps Engrs.:	
83d Div.	Columbus, OH	337th Engr. Regt. (GS)	Terre Haute, IN
84th Div.	Indianapolis, IN	418th Engr. Bn. (Sep.) (C)	Gary, IN
100th Div.	Charleston, WV	423d Engr. Bn. (Sep.)	Youngstown, OH
HQ, Special Troops	Indianapolis, IN	424th Engr. Bn. (Sep.) (C)	Beckley, WV
HQ Co., XV Corps	Indianapolis, IN	395th Engr. Co. (Dep)	Fort Wayne, IN
305th Sig. Bn.	Fort Wayne, IN	XV Corps Aviation:	
311th M.P. Bn.	Fort Wayne, IN	317th Obsn. Gp.	Mansfield, OH
505th Ord. Co. (HM)	Akron, OH	308th Obsn. Sq.	Columbus, OH
612th Ord. Co. (Ammo.)	Cleveland, OH	309th Obsn. Sq.	Indianapolis, IN
XV Corps Arty.:		336th Sv Sq.	Cleveland, OH
184th F.A. Brig.	Cincinnati, OH	553d Bln. Gp.	La Salle, IL
355th Ord. Co. (M)	Cleveland, OH	351st Bln. Sq.	Lafayette, IN
341st Ammo. Tn.	Bloomington, IN	352d Bln. Sq.	Dayton, OH
305th Obsn. Bn. (Flash)	Columbus, OH	353d Bln. Sq.	Bowling Green, KY
401st F.A. Regt.	Toledo, OH	482d Bln. Sv Sq.	Richmond, VA
455th F.A. Regt.	Cincinnati, OH	XV Corps Med. Sv:	
574th F.A. Regt.	Paris, KY	331st Med. Regt.	South Bend, IN
511th C.A. Regt. (AA)	Cleveland, OH	XV Corps Q.M. Sv:	
		475th Q.M. Regt. (Truck)	Vincennes, IN
		495th Q.M. Regt. (LM)	Cincinnati, OH

**HHC, XVI CORPS (I)**

**Regular Army Inactive**

**HQ**—*Not organized*, 1921–22; Detroit, MI, 1922–33

The XVI Corps was authorized by the National Defense Act of 1920 and was to be composed of units of the O.R. located primarily in the Sixth Corps Area. The HHC were constituted on 29 July 1921 in the R.A., allotted to the Sixth Corps Area, and assigned to the Fifth Army. The HQ was organized in October 1922 with O.R. personnel at Detroit, MI. The HQ Co. was organized on 18 October 1922 with O.R. personnel at Saginaw, MI, and relocated on 1 October 1926 to Detroit. The HQ was withdrawn from the R.A. on 1 October 1933 and demobilized.

**Events:** 159

**Corps Commanders**

Col. Thomas E. Merrill\*      November 1932–1 October 1933

\*Designated as commanding general for activation/mobilization purposes only.

**XVI CORPS  
Organization 1922**

<b>UNIT:</b>	<b>HQ LOCATION:</b>	<b>UNIT:</b>	<b>HQ LOCATION:</b>
HQ, XVI Corps	Detroit, MI	HQ, XVI Corps Tn., Q.M.C.	Milwaukee, WI
85th Div.	Detroit, MI	321st M.T. Cmd.	Beloit, WI
86th Div.	Chicago, IL	322d M.T. Cmd.	Beloit, WI
101st Div.	Milwaukee, WI	323d M.T. Cmd.	Algoma, WI
		324th M.T. Cmd.	Antigo, WI
HQ, Special Troops	Saginaw, MI	390th M.T. Cmd.	Springfield, IL
HQ Co., XVI Corps	Saginaw, MI	391st M.T. Cmd.	Peoria, IL
306th Sig. Bn.	Lansing, MI	392d M.T. Cmd.	Peoria, IL
306th M.P. Bn.	Milwaukee, WI	496th M.T. Co.	Beloit, WI
506th Ord. Co. (HM)	Joliet, IL	497th M.T. Co.	Beloit, WI

606th Ord. Co. (Ammo.)	Chicago, IL	498th M.T. Co.	Kenosha, WI
26th Sv Bn., Q.M.C.	Chicago, IL	499th M.T. Co.	Kenosha, WI
26th Field Rmt Dep	Portage, WI	500th M.T. Co.	Baraboo, WI
15th Rmt Troop	Beaver Dam, WI	501st M.T. Co.	Baraboo, WI
		502d M.T. Co.	Racine, WI
HQ, XVI Corps Arty.	Milwaukee, WI	503d M.T. Co.	Reedsburg, WI
185th F.A. Brig.	Chicago, IL	504th M.T. Co.	Racine, WI
356th Ord. Co. (M)	Jackson, MI	505th M.T. Co.	Green Bay, WI
346th Ammo. Tn.	Chicago, IL	506th M.T. Co.	Antigo, WI
306th Obsn. Bn. (Flash)	Evanston, IL	507th M.T. Co.	Wausau, WI
403d F.A. Regt.	Moline, IL	508th M.T. Co.	Waukesha, WI
404th F.A. Regt.	Chicago, IL	720th M.T. Co.	Danville, IL
405th F.A. Regt.	Milwaukee, WI	721st M.T. Co.	Watseka, IL
436th F.A. Regt.	Battle Creek, MI	722d M.T. Co.	Bushnell, IL
506th C.A. Regt. (AA)	Milwaukee, WI	723d M.T. Co.	Springfield, IL
		724th M.T. Co.	Chicago, IL
HQ, XVI Corps Engrs.	Madison, WI	725th M.T. Co.	Chicago, IL
346th Engr. Regt. (GS)	Madison, WI	726th M.T. Co.	Chicago, IL
426th Engr. Bn. (Aux)	Peoria, IL	727th M.T. Co.	Chicago, IL
427th Engr. Bn. (Aux)	Chicago, IL	728th M.T. Co.	Chicago, IL
428th Engr. Bn. (Aux)	Racine, WI	729th M.T. Co.	Chicago, IL
		730th M.T. Co.	Chicago, IL
HQ, XVI Corps Air Service	Milwaukee, WI	731st M.T. Co.	Chicago, IL
334th Obsn. Gp.	Evanston, IL	351st Mtcyl Co.	Milwaukee, WI
361st Obsn. Sq.	Madison, WI	352d Mtcyl Co.	Fond du Lac, WI
362d Obsn. Sq.	Racine, WI	381st M. Rep. Sec	Kenosha, WI
378th Sv Sq.	Downer's Grove, IL	382d M. Rep. Sec	West Allis, WI
46th Bln. Gp.	Fond du Lac, WI	427th M. Rep. Sec	Springfield, IL
321st Bln. Co.	Chicago, IL	428th M. Rep. Sec	Sheldon, IL
322d Bln. Co.	Morenci, MI	429th M. Rep. Sec	Chicago, IL
323d Bln. Co.	Green Bay, WI	430th M. Rep. Sec	Chicago, IL
324th Bln. Co.	Appleton, WI	431st M. Rep. Sec	Chicago, IL
343d Bln. Sv Co.	Oshkosh, WI	432d M. Rep. Sec	Chicago, IL
		66th Wagon Tn.	Tomahawk, WI
XVI Corps Med. HQ	Detroit, IL	386th Wagon Co.	Wausau, WI
346th Med. Regt.	Chicago, IL	387th Wagon Co.	Oconto, WI
		388th Wagon Co.	Rhineland, WI

## HHC, XVI CORPS (II)

## Organized Reserve Michigan

HQ—Detroit, MI, 1933–41

Constituted in the O.R. on 1 October 1933, allotted to the Sixth Corps Area, and assigned to the Second Army. The HQ was concurrently initiated at Detroit, MI, with O.R. personnel previously assigned to the demobilized XVI Corps (RAI). The designated mobilization station was Camp Grant, IL, where the corps HQ would assume command and control of its subordinate corps troops, which would then be mobilizing throughout the Sixth Corps Area. It was redesignated on 1 January 1941 as HQ, XVI Army Corps. The XVI Corps was not activated prior to World War II and was located in Detroit as of 7 December 1941 in a Reserve status.

**Status:** Inactive in the R.A. as HHC, XVI Army Corps.

**Events:** 214, 302

### Corps Commanders

Col. Thomas E. Merrill\*      1 October 1933–February 1935

\*Designated as commanding general for activation/mobilization purposes only.

**XVI CORPS  
Organization 1936**

<b>UNIT:</b>	<b>HQ LOCATION:</b>	<b>UNIT:</b>	<b>HQ LOCATION:</b>
<i>HQ, XVI Corps</i>	<i>Sixth Corps Area</i>	XVI Corps Engrs.:	
85th Div.	Detroit, MI	346th Engr. Regt. (GS)	Madison, WI
86th Div.	Chicago, IL	566th Engr. Bn. (Sep.)	Houghton, MI
101st Div.	Milwaukee, WI	691st Engr. Bn. (Sep.)	Detroit, MI
HQ, Special Troops	Detroit, MI	696th Engr. Bn. (Sep.)	Highland Park, IL
HQ Co., XVI Corps	Detroit, MI	714th Engr. Co. (Dep)	Jackson, MI
306th Sig. Bn.	Detroit, MI	XVI Corps Aviation:	
313th M.P. Bn.	Detroit, MI	332d Obsn. Gp.	Champaign, IL
532d Ord. Co. (HM)	Milwaukee, WI	310th Obsn. Sq.	East St. Louis, MO
<i>613th Ord. Co. (Ammo.)</i>	<i>Sixth Corps Area</i>	311th Obsn. Sq.	Chicago, IL
XVI Corps Arty.:		337th Sv Sq.	Chicago, IL
185th F.A. Brig.	Chicago, IL	554th Bln. Gp.	Bay City, MI
356th Ord. Co. (M)	Jackson, MI	365th Bln. Sq.	Grand Rapids, MI
346th Ammo. Tn.	Oregon, IL	366th Bln. Sq.	Belleville, IL
318th Obsn. Bn. (Flash)	Quincy, IL	367th Bln. Sq.	Saginaw, MI
330th F.A. Regt.	Rockford, IL	398th Bln. Sv Sq.	Kalamazoo, MI
333d F.A. Regt.	Chicago, IL	XVI Corps Med. Sv:	
436th F.A. Regt.	Marquette, MI	378th Med. Regt.	Chicago, IL
950th C.A. Regt. (AA)	Chicago, IL	XVI Corps Q.M. Sv:	
		476th Q.M. Regt. (Truck)	Sheboygan Falls, WI
		496th Q.M. Regt. (LM)	Beloit, WI

**HHC, XVII CORPS (I)**

**Regular Army Inactive**

**HQ**—*Not organized*, 1921–22; Little Rock, AR, 1922–26; Omaha, NE, 1922–33

The XVII Corps was authorized by the National Defense Act of 1920 and was to be composed of units of the O.R. located primarily in the Seventh Corps Area. The HHC were constituted on 29 July 1921 in the R.A., allotted to the Seventh Corps Area, and assigned to the Sixth Army. The HQ was organized in April 1922 with O.R. personnel at Omaha, NE. The HQ Co. was organized in June 1922 with O.R. personnel at Little Rock, AR, and relocated on 26 May 1926 to Omaha. The HQ was withdrawn from the R.A. on 1 October 1933 and demobilized.

**Chiefs of Staff**

Lt. Col. Jay P. Hopkins

9 December 1921–August 1923

**XVII CORPS  
Organization 1922**

<b>UNIT:</b>	<b>HQ LOCATION:</b>	<b>UNIT:</b>	<b>HQ LOCATION:</b>
HQ, XVII Corps	Omaha, NE	HQ, XVII Corps Tn., Q.M.C.	Kansas City, MO
88th Div.	Minneapolis, MN	325th M.T. Cmd.	Hannibal, MO
89th Div.	Omaha, NE	326th M.T. Cmd.	St. Louis, MO
102d Div.	St. Louis, MO	327th M.T. Cmd.	Lincoln, NE
HQ, Special Troops	Kansas City, MO	328th M.T. Cmd.	Duluth, MN
HQ Co., XVII Corps	Little Rock, AR	393d M.T. Cmd.	Mankato, MN
307th Sig. Bn.	St. Louis, MO	394th M.T. Cmd.	St. Charles, MO
307th M.P. Bn.	Little Rock, AR	395th M.T. Cmd.	Independence, MO
507th Ord. Co. (HM)	Fort Smith, AR	509th M.T. Co.	Hannibal, MO
607th Ord. Co. (Ammo.)	Omaha, NE	510th M.T. Co.	Mexico, MO
27th Sv Bn., Q.M.C.	Manhattan, KS	511th M.T. Co.	Texarkana, AR
27th Field Rmt Dep	Kansas City, KS	512th M.T. Co.	El Dorado, AR
16th Rmt Troop	Kansas City, KS	513th M.T. Co.	Pittsburg, KS
HQ, XVII Corps Arty.	Omaha, NE	514th M.T. Co.	Kansas City, KS
		515th M.T. Co.	Grand Island, NE
		516th M.T. Co.	Beatrice, NE



186th F.A. Brig.	St. Louis, MO	517th M.T. Co. (Trk)	Des Moines, IA
357th Ord. Co. (M)	Des Moines, IA	518th M.T. Co. (Trk)	Council Bluffs, IA
347th Ammo. Tn.	Lincoln, NE	519th M.T. Co. (Trk)	Minneapolis, MN
307th Obsn. Bn. (Flash)	St. Paul, MN	520th M.T. Co. (Trk)	Brainerd, MN
406th F.A. Regt.	St. Louis, MO	521st M.T. Co. (Car)	Rapid City, SD
407th F.A. Regt.	Des Moines, IA	732d M.T. Co.	Minneapolis, MN
408th F.A. Regt.	Wichita, KS	733d M.T. Co.	St. Paul, MN
437th F.A. Regt.	St. Paul, MN	734th M.T. Co.	Waterloo, IA
507th C.A. Regt. (AA)	Des Moines, IA	735th M.T. Co.	Dubuque, IA
		736th M.T. Co.	Davenport IA
HQ, XVII Corps Engrs.	Des Moines, IA	737th M.T. Co.	Keokuk, IA
347th Engr. Regt. (GS)	Kansas City, MO	738th M.T. Co.	Kansas City, KS
429th Engr. Bn. (Aux)	Jonesboro, AR	739th M.T. Co.	St. Charles, MO
430th Engr. Bn. (Aux)	Des Moines, IA	740th M.T. Co.	Jefferson City, MO
431st Engr. Bn. (Aux)	Minneapolis, MN	741st M.T. Co.	Columbia, MO
		742d M.T. Co.	Chillicothe, MO
HQ, XVII Corps Air Service	Topeka, KS	743d M.T. Co.	St. Joseph, MO
337th Obsn. Gp.	St. Louis, MO	353d Mtcyl Co.	Hannibal, MO
363d Obsn. Sq.	Lincoln, NE	354th Mtcyl Co.	Louisiana, MO
364th Obsn. Sq.	Fargo, ND	383d M. Rep. Sec	Hannibal, MO
379th Sv Sq.	St. Louis, MO	384th M. Rep. Sec	Moberly, MO
47th Bln. Gp.	St. Louis, MO	433d M. Rep. Sec	Minneapolis, MN
325th Bln. Co.	Omaha, NE	434th M. Rep. Sec	St. Paul, MN
326th Bln. Co.	Lincoln, NE	435th M. Rep. Sec	Des Moines, IA
327th Bln. Co.	St. Louis, MO	436th M. Rep. Sec	Lincoln, NE
328th Bln. Co.	Leavenworth, KS	437th M. Rep. Sec	St. Joseph, MO
344th Bln. Sv Co.	St. Louis, MO	438th M. Rep. Sec	Chillicothe, MO
		67th Wagon Tn.	Moorhead, MN
XVII Corps Med. HQ	Minneapolis, MN	389th Wagon Co.	Duluth, MN
347th Med. Regt.	Des Moines, IA	390th Wagon Co.	Minneapolis, MN
		391st Wagon Co.	Fergus Falls, MN

## HHC, XVII CORPS (II)

## Organized Reserve Nebraska

HQ—*Not initiated*, 1933–41

Constituted in the O.R. on 1 October 1933, allotted to the Seventh Corps Area, and assigned to the Fourth Army. This new corps' designated HQ location for organization purposes was Fort Crook, NE. In the event of mobilization, it was to be organized with R.A. officers and Reserve personnel from the Seventh Corps Area. The designated mobilization station was Camp Pike, AR, where the corps HQ would assume command and control of its subordinate corps troops, which would then be mobilizing throughout the Seventh Corps Area. It was redesignated on 1 January 1941 as HQ, XVII Army Corps. The XVII Corps was not initiated nor activated prior to World War II.

**Status:** Disbanded 5 September 1945.

**Events:** 193, 279, 303

### XVII CORPS Organization 1936

UNIT:	HQ LOCATION:	UNIT:	HQ LOCATION:
<i>HQ, XVII Corps</i>	<i>Seventh Corps Area</i>	XVII Corps Engrs.:	
88th Div.	Minneapolis, MN	338th Engr. Regt. (GS)	St. Paul, MO
89th Div.	Omaha, NE	446th Engr. Bn. (Sep.)	Minneapolis, MN
102d Div.	St. Louis, MO	509th Engr. Bn. (Sep.)	Duluth, MN
HQ, Special Troops	Des Moines, IA	510th Engr. Bn. (Sep.)	Aberdeen, SD
<i>HQ Co., XVII Corps</i>	<i>Seventh Corps Area</i>	721st Engr. Co. (Dep)	East St. Louis, MO
307th Sig. Bn.	St. Louis, MO	XVII Corps Aviation:	
317th M.P. Bn.	Bismarck, ND	320th Obsn. Gp.	St. Louis, MO

507th Ord. Co. (HM)	Fort Smith, AR	313th Obsn. Sq.	Minneapolis, MN
607th Ord. Co. (Ammo.)	Omaha, NE	314th Obsn. Sq.	Omaha, NE
XVII Corps Arty.:		327th Obsn. Sq.	St. Louis, MO
187th F.A. Brig.	Fargo, ND	569th Sv Sq.	Winfield, KS
388th Ord. Co. (M)	Minneapolis, MN	566th Bln. Gp.	St. Louis, MO
347th Ammo. Tn.	Waterloo, IA	328th Bln. Sq.	Des Moines, IA
307th Obsn. Bn. (Flash)	St. Paul, MN	369th Bln. Sq.	St. Joseph, MO
393d F.A. Regt.	Minneapolis, MN	370th Bln. Sq.	Kansas City, MO
406th F.A. Regt.	Wichita, KS	399th Bln. Sv Sq.	Kansas City, MO
437th F.A. Regt.	St. Paul, MN	XVII Corps Med. Sv:	
527th C.A. Regt. (AA)	St. Louis, MO	347th Med. Regt.	Marshalltown, IA
		XVII Corps Q.M. Sv:	
		477th Q.M. Regt. (Truck)	Des Moines, IA
		497th Q.M. Regt. (LM)	Kansas City, MO

### HHC, XVIII CORPS (I)

### Regular Army Inactive

HQ—*Not organized*, 1921–22; Dallas, TX, 1922–33

The XVIII Corps was authorized by the National Defense Act of 1920 and was to be composed of units of the O.R. located primarily in the Eighth Corps Area. The HHC were constituted on 29 July 1921 in the R.A., allotted to the Eighth Corps Area, and assigned to the Sixth Army. Both units were organized on 23 August 1922 with O.R. personnel at Dallas, TX (HQ Co. was withdrawn from the Eighth Corps Area on 11 January 1927, allotted to the Seventh Corps Area, and organized on 3 August 1927 at Kansas City, MO; relocated 12 October 1931 to Sioux City, IA). Effective 3 November 1925, personnel assigned to HQ, XVIII Corps, HQ Co., XVIII Corps, and HQ, Special Troops, XVIII Corps were attached to the 90th Division for organization, administration, and control. The HQ conducted staff training with HQ, 2d Division at Fort Sam Houston, TX, 3–17 July 1927. The corps HQ was withdrawn from the R.A. on 1 October 1933 and demobilized. The HQ Co. remained allotted to the R.A.

#### XVIII CORPS Organization 1922

UNIT:	HQ LOCATION:	UNIT:	HQ LOCATION:
HQ, XVIII Corps	Dallas, TX	HQ, XVIII Corps Tn., Q.M.C.	Oklahoma City, OK
90th Div.	San Antonio, TX	329th M.T. Cmd.	Oklahoma City, OK
95th Div.	Oklahoma City, OK	330th M.T. Cmd.	Fort Worth, TX
103d Div.	Denver, CO	331st M.T. Cmd.	San Antonio, TX
		332d M.T. Cmd.	Trinidad, CO
HQ, Special Troops	Dallas, TX	396th M.T. Cmd.	Bartlesville, OK
HQ Co., XVIII Corps	Dallas, TX	397th M.T. Cmd.	Muskogee, OK
308th Sig. Bn.	Dallas, TX	398th M.T. Cmd.	Gila Bend, AZ
308th M.P. Bn.	Hillsboro, TX	522d M.T. Co.	Holdenville, OK
508th Ord. Co. (HM)	Denison, TX	523d M.T. Co.	Altus, OK
608th Ord. Co. (Ammo.)	Terrell, TX	524th M.T. Co.	Pawhuska, OK
28th Sv Bn., Q.M.C.	Palestine, TX	525th M.T. Co.	Durant, OK
28th Field Rmt Dep	Waco, TX	526th M.T. Co.	Wichita Falls, TX
17th Rmt Troop	Waco, TX	527th M.T. Co.	Dennison, TX
		528th M.T. Co.	Dallas, TX
HQ, XVIII Corps Arty.	Dallas, TX	529th M.T. Co.	Waco, TX
187th F.A. Brig.	Dallas, TX	530th M.T. Co.	Austin, TX
358th Ord. Co. (M)	Dallas, TX	531st M.T. Co.	Beaumont, TX
348th Ammo. Tn.	Waco, TX	532d M.T. Co.	Trinidad, CO
308th Obsn. Bn. (Flash)	Tucson, AZ	533d M.T. Co.	Salida, CO
409th F.A. Regt.	Tulsa, OK	534th M.T. Co.	Canyon City, CO
410th F.A. Regt.	Fort Worth, TX	744th M.T. Co.	Bartlesville, OK
411th F.A. Regt.	Dallas, TX	745th M.T. Co.	Tulsa, OK
438th F.A. Regt.	Houston, TX	746th M.T. Co.	Tulsa, OK
508th C.A. Regt. (AA)	El Paso, TX	747th M.T. Co.	Muskogee, OK

HQ, XVIII Corps Engrs.	Denver, CO	748th M.T. Co.	Fort Worth, TX
348th Engr. Regt. (GS)	Boulder, CO	749th M.T. Co.	Dallas, TX
432d Engr. Bn. (Aux)	Phoenix, AZ	750th M.T. Co.	Holyoke, CO
433d Engr. Bn. (Aux)	Walsenburg, CO	751st M.T. Co.	Akron, CO
434th Engr. Bn. (Aux)	Las Vegas, NM	752d M.T. Co.	Wray, CO
		753d M.T. Co.	Ajo, AZ
		754th M.T. Co.	Duncan, AZ
HQ, XVIII Corps Air Service	San Antonio, TX	755th M.T. Co.	Parker, AZ
339th Obsn. Gp.	Temple, TX	355th Mtcyl Co.	Shawnee, OK
143d Obsn. Sq.	Oklahoma N.G.	356th Mtcyl Co.	Okmulgee, OK
365th Obsn. Sq.	Oklahoma City, OK	385th M. Rep. Sec	Oklahoma City, OK
366th Obsn. Sq.	Sweetwater, TX	386th M. Rep. Sec	Fort Worth, TX
371st Obsn. Sq.	Brownsville, TX	439th M. Rep. Sec	Henryetta, OK
386th Sv Sq.	Cameron, TX	440th M. Rep. Sec	McAlester, OK
48th Bln. Gp.	Austin, TX	441st M. Rep. Sec	Claremore, OK
329th Bln. Co.	Oklahoma City, OK	442d M. Rep. Sec	Dallas, TX
330th Bln. Co.	San Antonio, TX	443d M. Rep. Sec	Julesburg, CO
331st Bln. Co.	Austin, TX	444th M. Rep. Sec	Williams, AZ
332d Bln. Co.	El Paso, TX	68th Wagon Tn.	101 Ranch, OK
345th Bln. Sv Co.	Austin, TX	392d Wagon Co.	101 Ranch, OK
		393d Wagon Co.	101 Ranch, OK
XVIII Corps Med. HQ	Dallas, TX	394th Wagon Co.	101 Ranch, OK
348th Med. Regt.	Dallas, TX		

## HHC, XVIII CORPS (II)

## Organized Reserve Texas

### HQ—San Antonio, TX, 1933–41

Constituted in the O.R. on 1 October 1933, allotted to the Eighth Corps Area, and assigned to the Third Army. The headquarters was concurrently initiated at San Antonio, TX, with O.R. personnel previously assigned to the demobilized XVIII Corps (RAI). Concurrently, the HQ Co., XVIII Corps was withdrawn from the Seventh Corps Area and reallocated to the Eighth Corps Area. HQ Co. was reorganized 25 February 1935 at Fort Sam Houston, TX. The XVIII Corps HQ designated mobilization station was Fort Sam Houston where it would assume command and control of its subordinate corps troops, which would then be mobilizing throughout the Eighth Corps Area. It was redesignated on 1 January 1941 as HQ, XVIII Army Corps. The XVIII Corps was not activated prior to World War II and was located in San Antonio as of 7 December 1941 in a Reserve status.

**Status:** Disbanded 5 September 1945.

**Events:** 217, 258, 259

### XVIII CORPS Organization 1936

UNIT:	HQ LOCATION:	UNIT:	HQ LOCATION:
HQ, XVIII Corps	San Antonio, TX	XVIII Corps Engrs.:	
90th Div.	San Antonio, TX	339th Engr. Regt. (GS)	San Antonio, TX
95th Div.	Oklahoma City, OK	462d Engr. Bn. (Sep.)	Dallas, TX
103d Div.	Denver, CO	463d Engr. Bn. (Sep.)	Houston, TX
HQ, Special Troops	Dallas, TX	Engr. Bn. (Sep.)	Unknown
HQ Co., XVIII Corps	Dallas, TX	Engr. Co. (Dep)	Unknown
308th Sig. Bn.	Dallas, TX	XVIII Corps Aviation:	
315th M.P. Bn.	Dallas, TX	339th Obsn. Gp.	Temple, TX
542d Ord. Co. (HM)	San Antonio, TX	315th Obsn. Sq.	Dallas, TX
605th Ord. Co. (Ammo.)	San Antonio, TX	320th Obsn. Sq.	Tulsa, OK
XVIII Corps Arty.:		350th Sv Sq.	Tulsa, OK
188th F.A. Brig.	Waco, TX	551st Bln. Gp.	San Antonio, TX
358th Ord. Co. (M)	Dallas, TX	329th Bln. Sq.	Hamilton, TX
335th Ammo. Tn.	Fort Worth, TX	330th Bln. Sq.	Gatesville, TX

319th Obsn. Bn. (Flash)  
 409th F.A. Regt.  
 411th F.A. Regt.  
 438th F.A. Regt.  
 969th C.A. Regt. (AA)

Oklahoma  
 Tulsa, OK  
 Dallas, TX  
 Fort Worth, TX  
 San Antonio, TX

331st Bln. Sq.  
 345th Bln. Sv Sq.  
 XVIII Corps Med. Sv:  
 355th Med. Regt.  
 XVIII Corps Q.M. Sv:  
 478th Q.M. Regt. (Truck)  
 498th Q.M. Regt. (LM)

MacGregor, TX  
 Bartlett, TX  
 Dallas, TX  
 San Antonio, TX  
 Eighth Corps Area

**HHC, XIX CORPS (I)**

**Regular Army Inactive**

HQ—*Not organized*, 1921–22; San Francisco, CA, 1922–33

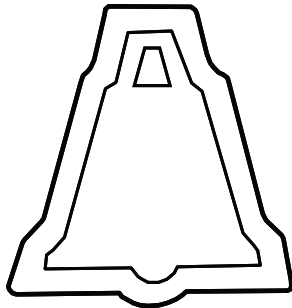

The XIX Corps was authorized by the National Defense Act of 1920 and was to be composed of units of the O.R. located primarily in the Ninth Corps Area. The HHC were constituted on 29 July 1921 in the R.A., allotted to the Ninth Corps Area, and assigned to the Sixth Army. The HQ was organized in February 1922 with O.R. personnel at San Francisco, CA. The HQ Co. was organized in February 1923 with O.R. personnel at San Francisco. The HQ conducted staff training 5–19 June 1927 with HQ, 30th Infantry at the Presidio of San Francisco, CA. The HQ was withdrawn from the R.A. on 1 October 1933 and demobilized.

**XIX CORPS  
 Organization 1922**

<b>UNIT:</b>	<b>HQ LOCATION:</b>	<b>UNIT:</b>	<b>HQ LOCATION:</b>
HQ, XIX Corps	San Francisco, CA	HQ, XIX Corps Tn., Q.M.C.	San Francisco, CA
91st Div.	Presidio of San Francisco, CA	333d M.T. Cmd.	San Francisco, CA
96th Div.	Salt Lake City, UT	334th M.T. Cmd.	Oakland, CA
104th Div.	Portland, OR	335th M.T. Cmd.	Portland, OR
		336th M.T. Cmd.	Seattle, WA
HQ, Special Troops	San Francisco, CA	399th M.T. Cmd.	Sacramento, CA
HQ Co., XIX Corps	San Francisco, CA	400th M.T. Cmd.	Portland, OR
309th Sig. Bn.	Seattle, WA	401st M.T. Cmd.	Spokane, WA
309th M.P. Bn.	Los Angeles, CA	535th M.T. Co.	Alemeda, CA
509th Ord. Co. (HM)	Portland, OR	536th M.T. Co.	Berkeley, CA
609th Ord. Co. (Ammo.)	Seattle, WA	537th M.T. Co.	Sacramento, CA
29th Sv Bn., Q.M.C.	Seattle, WA	538th M.T. Co.	San Jose, CA
29th Field Rmt Dep	Pleasanton, CA	539th M.T. Co.	Sawtelle, CA
18th Rmt Troop	Pleasanton, CA	540th M.T. Co.	San Francisco, CA
		541st M.T. Co.	Seattle, WA
HQ, XIX Corps Arty.	San Francisco, CA	542d M.T. Co.	Seattle, WA
188th F.A. Brig.	San Francisco, CA	543d M.T. Co.	Spokane, WA
359th Ord. Co. (M)	Berkeley, CA	544th M.T. Co.	Spokane, WA
349th Ammo. Tn.	Seattle, WA	545th M.T. Co.	Salem, OR
309th Obsn. Bn. (Flash)	San Francisco, CA	546th M.T. Co.	The Dalles, OR
412th F.A. Regt.	Portland, OR	547th M.T. Co.	Auburn, OR
413th F.A. Regt.	Seattle, WA	756th M.T. Co.	Chico, CA
414th F.A. Regt.	Los Angeles, CA	757th M.T. Co.	Sacramento, CA
439th F.A. Regt.	San Francisco, CA	758th M.T. Co.	Fresno, CA
509th C.A. Regt. (AA)	Seattle, WA	759th M.T. Co.	Everett, WA
		760th M.T. Co.	Tacoma, WA
HQ, XIX Corps Engrs.	San Francisco, CA	761st M.T. Co.	Olympia, WA
349th Engr. Regt. (GS)	Los Angeles, CA	762d M.T. Co.	Yakima, WA
435th Engr. Bn. (Aux)	San Diego, CA	763d M.T. Co.	Walla Walla, WA
436th Engr. Bn. (Aux)	Seattle, WA	764th M.T. Co.	Portland, OR
437th Engr. Bn. (Aux)	Medford, OR	765th M.T. Co.	Portland, OR
		766th M.T. Co.	Portland, OR

HQ, XIX Corps Air Service	Los Angeles, CA	767th M.T. Co.	Medford, OR
329th Obsn. Gp.	San Diego, CA	357th Mtcyl Co.	Spokane, WA
367th Obsn. Sq.	Los Angeles, CA	358th Mtcyl Co.	Portland, OR
368th Obsn. Sq.	Astoria, OR	387th M. Rep. Sec	Seattle, WA
Air Park No. 374	Los Angeles, CA	388th M. Rep. Sec	Portland, OR
49th Bln. Gp.	Los Angeles, CA	445th M. Rep. Sec	Richmond, CA
333d Bln. Co.	San Francisco, CA	446th M. Rep. Sec	Sacramento, CA
334th Bln. Co.	San Francisco, CA	447th M. Rep. Sec	Fresno, CA
335th Bln. Co.	Los Angeles, CA	448th M. Rep. Sec	Los Angeles, CA
336th Bln. Co.	Los Angeles, CA	449th M. Rep. Sec	Spokane, WA
346th Bln. Sv Co.	Los Angeles, CA	450th M. Rep. Sec	Salem, OR
		69th Wagon Tn.	Los Angeles, CA
XIX Corps Med. HQ	San Francisco, CA	395th Wagon Co.	Los Angeles, CA
349th Med. Regt.	San Francisco, CA	396th Wagon Co.	San Francisco, CA
		397th Wagon Co.	San Francisco, CA

**HHC, XIX CORPS (II)**

**Organized Reserve California**

HQ—San Francisco, CA, 1933–41

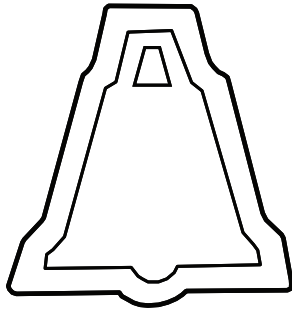

Constituted in the O.R. on 1 October 1933, allotted to the Ninth Corps Area, and assigned to the Fourth Army. The HQ was concurrently initiated at San Francisco, CA, with O.R. personnel previously assigned to the demobilized XIX Corps (RAI). The designated mobilization station was Presidio of San Francisco, where the corps HQ would assume command and control of its subordinate corps troops, which would then be mobilizing throughout the Ninth Corps Area. It was redesignated on 1 January 1941 as HQ, XIX Army Corps. The XIX Corps was not activated prior to World War II and was located in San Francisco as of 7 December 1941 in a Reserve status.

**Status:** Inactive in the R.A. as HHC, XIX Army Corps.

**Events:** 193, 279, 304

**XIX CORPS  
Organization 1936**

<b>UNIT:</b>	<b>HQ LOCATION:</b>	<b>UNIT:</b>	<b>HQ LOCATION:</b>
HQ, XIX Corps	San Francisco, CA	XIX Corps Engrs.:	
91st Div.	San Francisco, CA	349th Engr. Regt. (GS)	Los Angeles, CA
96th Div.	Portland, OR	436th Engr. Bn. (Sep.)	San Francisco, CA
104th Div.	Salt Lake City, UT	437th Engr. Bn. (Sep.)	Los Angeles, CA
HQ, Special Troops	San Francisco, CA	466th Engr. Bn. (Sep.)	San Francisco, CA
HQ Co., XIX Corps	San Francisco, CA	733d Engr. Co. (Dep)	Los Angeles, CA
309th Sig. Bn.	Seattle, WA	XIX Corps Aviation:	
309th M.P. Bn.	Los Angeles, CA	312th Obsn. Gp.	San Francisco, CA
535th Ord. Co. (HM)	San Francisco, CA	316th Obsn. Sq.	San Francisco, CA
646th Ord. Co. (Ammo.)	San Francisco, CA	321st Obsn. Sq.	Oakland, CA
XIX Corps Arty.:		381st Sv Sq.	San Francisco, CA
195th F.A. Brig.	Los Angeles, CA	549th Bln. Gp.	Los Angeles, LA
389th Ord. Co. (M)	Berkeley, CA	333d Bln. Sq.	Los Angeles, LA
349th Ammo. Tn.	Los Angeles, CA	334th Bln. Sq.	Los Angeles, LA
309th Obsn. Bn. (Flash)	Los Angeles, CA	335th Bln. Sq.	Los Angeles, LA
413th F.A. Regt.	San Francisco, CA	346th Bln. Sv Sq.	Los Angeles, LA
426th F.A. Regt.	Los Angeles, CA	XIX Corps Med. Sv:	
439th F.A. Regt.	San Francisco, CA	369th Med. Regt.	San Bernardino, CA
519th C.A. Regt. (AA)	Los Angeles, CA	XIX Corps Q.M. Sv:	
		479th Q.M. Regt. (Truck)	San Francisco, CA
		499th Q.M. Regt. (LM)	Oakland, CA



## Chapter 6

### Corps Area Training Centers



US Army Signal Corps, National Archives II

Artillerymen of the 102d Field Artillery, Massachusetts National Guard conduct live firing at Camp Devens.

The corps area training centers were a direct result of provisions of the National Defense Act of 1920 (Public Law 242), which provided for Regular Army (R.A.) oversight for training of the civilian components and programs of the Army of the United States. These included the National Guard (N.G.) (for which the centers would primarily provide only advisory and demonstration functions), the Organized Reserve (O.R.), the Reserve Officers' Training Corps (ROTC), and the Citizens Military Training Camps (CMTC). In addition to the officers and men assigned to function year-round as instructors and support staffs for these organizations, in the postwar army structure the War Plans Division provided for nine training centers, one for each corps area, which would support the summer training of the civilian components and programs.

Each of these centers was to be commanded by a brigadier general who answered to his respective corps area commander. Each training center was to consist of two distinct elements: a training group and a depot group. The training group was to consist of an infantry regiment, in most cases reduced to about one battalion's strength; a cavalry troop; an artillery battery; and an engineer company. These organizations would function as demonstration and training support units for the citizen soldiers performing their training at the training center. The depot groups were a holdover from the Army's World War I experience with depot brigades, which provided the same recruit in-processing, development, and basic training functions as those assigned to these new training centers. The depots were to consist of an illiterate and development

section for training marginally educated recruits and a recruit training section that performed basic training for the R.A. recruits of the corps area.

These training centers were a good step toward a cohesive system of developing the post-World War I Army, but the overhead units set aside specifically to support them soon became a luxury that could not be supported by diminishing military budgets. As a result, all nine centers were discontinued by December 1922 and their units were returned to the mobile army as active combat organizations. The roles and functions of the centers at that point were placed squarely on the mobile units of the R.A. burdening them with a mission that reduced their ability to prepare for the emergencies for which they might be called on to address.

### **HQ, First Corps Area Training Center**

**HQ**—Fort Andrews, MA, 1921; Fort Warren, MA, 1921–22; Camp Devens, MA, 1922

**Subordinate elements**—Headquarters and Headquarters and Service Company (HHSC), Depot Group; Recruit Section; Illiterate and Development Section; Training Depot; 13th Infantry Regiment (Training Center); Troop L, Cavalry Training Squadron No. 1; Artillery Training Battery No. 1; Engineer Training Company No. 1

Established in the R.A. on 7 July 1921. Organized on 9 November 1921 at Fort Andrews, MA. The HQ was transferred on 19 December 1921 to Fort Warren, MA. The First Corps Area Training Center was responsible for overseeing and assisting the annual summer training of all R.A., O.R., ROTC, and CMTC personnel and units from the states of Maine, New Hampshire, Vermont, Massachusetts, Connecticut, and Rhode Island. The training center was split into two training locations—Camp Devens, MA, and Fort Ethan Allen, VT. The center's training units at Camp Devens were responsible for training units of all arms and services except cavalry and field artillery, which were to train Fort Ethan Allen, VT. With the inactivation of the training center HQ in 1922, Camp Devens remained the primary training center for corps area infantry units—air corps units were sent to Mitchel Field, NY; engineers were sent to Fort Du Pont, DE; and signal corps units were sent to Camp Alfred Vail (later renamed Fort Monmouth), NJ. Fort Ethan Allen remained the training center for cavalry and field artillery units. The HQ, First Corps Area Training Center was discontinued on 8 July 1922 at Camp Devens.

#### **Commanders, First Corps Area Training Center**

Brig. Gen. Mark L. Hersey      9 November 1921–8 July 1922

### **HQ, Second Corps Area Training Center**

**HQ**—Fort Slocum, NY, 1921; Camp Dix, NJ, 1921–22; Fort Jay, NY, 1922

**Subordinate elements**—HHSC, Depot Group; Recruit Section; Illiterate and Development Section; Training Depot; 13th Infantry Regiment (Training Center); Troop L, Cavalry Training Squadron No. 1; Artillery Training Battery No. 1; Engineer Training Company No. 1

Established in the R.A. on 7 July 1921. Organized on 27 August 1921 at Fort Slocum, NY. The HQ was transferred on 30 December 1921 to Camp Dix, NJ. The Second Corps Area Training Center was responsible for overseeing and assisting the annual summer training of all R.A., O.R., ROTC, and CMTC personnel and units from the states of New York, New Jersey, and Delaware. The center's training units at Camp Dix were responsible for training units of all arms and services. With the inactivation of the training center HQ in 1922, Camp Dix remained the primary training center for corps area infantry units—air corps units were sent to Mitchel Field, NY; coast artillery units were generally sent to Fort Hancock, NJ; engineers were sent to Fort Du Pont, DE; and signal corps units were sent to Camp Alfred Vail (later renamed Fort Monmouth, NJ). Fort Ethan Allen was named the primary training center for Second Corps Area cavalry and field artillery units, though many artillery units would also later train at Pine Camp, NY. The HQ, Second Corps Area Training Center was discontinued on 25 October 1922 at Fort Jay, NY.

#### **Commanders, Second Corps Area Training Center**

Brig. Gen. William Weigel      27 August 1921–25 October 1922



### **HQ, Third Corps Area Training Center**

**HQ**—Camp George G. Meade, MD, 1921–22

**Subordinate elements**—HHSC, Depot Group; Recruit Section; Illiterate and Development Section; Training Depot; 12th Infantry Regiment (Training Center); Troop L, Cavalry Training Squadron No. 3; Artillery Training Battery No. 3; Engineer Training Company No. 3

Established in the R.A. on 7 July 1921. Organized on 4 October 1921 at Camp George G. Meade, MD. The Third Corps Area Training Center was responsible for overseeing and assisting the annual summer training of all R.A., O.R., ROTC, and CMTC personnel and units from the states of Pennsylvania, Maryland, Virginia, and the District of Columbia. The center's training units at Camp Meade were responsible for training units of all arms and services except cavalry and field artillery, which were to train at Fort Myer, VA, and Fort Hoyle, MD, respectively. With the inactivation of the training center HQ in 1922, Camp Meade remained the primary training center for corps area infantry units—air corps units were sent to Langley Field, VA; coast artillery units were sent to Fort Monroe, VA; engineers were sent to Camp A.A. Humphreys, VA (later renamed Fort Belvoir); and signal corps units were sent to Camp Alfred Vail, NJ (later renamed Fort Monmouth). Forts Myer and Hoyle remained the training centers for Third Corps Area cavalry and field artillery units, respectively. The HQ, Third Corps Area Training Center was discontinued on 11 September 1922 at Camp Meade.

#### **Commanders, Third Corps Area Training Center**

Col. Arthur Johnson

31 July 1921–4 October 1921

Col. George W. Helms

4 October 1921–11 September 1922

### **HQ, Fourth Corps Area Training Center**

**HQ**—Fort McClellan, AL, 1921–22

**Subordinate elements**—HHSC, Depot Group; Recruit Section; Illiterate and Development Section; Training Depot; 29th Infantry Regiment; Troop L, Cavalry Training Squadron No. 4; Artillery Training Battery No. 4; Engineer Training Company No. 4, Tank Platoon No. 4; 1st Battalion, 6th Infantry (attached only).

Established in the R.A. on 27 July 1921. Organized 14 January 1922 at Fort McClellan, AL. The Fourth Corps Area Training Center was responsible for overseeing and assisting the annual summer training of all R.A., O.R., ROTC, and CMTC personnel and units from the states of North Carolina, South Carolina, Georgia, Alabama, Florida, Mississippi, Tennessee, and Louisiana. The center's training units at Fort McPherson were responsible for training units of all arms and services except cavalry and field artillery, which were to train at Fort Oglethorpe, GA. With the inactivation of the training center HQ in 1922, Camp McClellan became the primary training center for corps area infantry units—air corps units were sent to Maxwell Field, AL; coast artillery units were sent to Fort Barrancas, FL; engineers were sent to Fort Benning, GA; and Fort Bragg, NC, became the training center for field artillery units. Fort Oglethorpe remained the training center for Fourth Corps Area cavalry units only. The HQ, Fourth Corps Area Training Center was discontinued on 18 September 1922 at Fort McClellan.

#### **Commanders, Fourth Corps Area Training Center**

Brig. Gen. Frank L. Winn

August 1921–14 September 1922

### **HQ, Fifth Corps Area Training Center**

**HQ**—Camp Knox, KY, 1921–22

**Subordinate elements**—HHSC, Depot Group; Recruit Section; Illiterate and Development Section; Training Depot; 10th Infantry Regiment (Training Center); Troop L, Cavalry Training Squadron No. 5; Artillery Training Battery No. 5; Engineer Training Company No. 5

Established in the R.A. on 27 July 1921. Organized 14 December 1921 at Camp Knox, KY. The Fifth Corps Area Training Center was responsible for overseeing and assisting the annual summer training of all R.A., O.R., ROTC,

and CMTC personnel and units from the states of Ohio, West Virginia, Indiana, and Kentucky. The center's training units at Camp Knox were responsible for training units of all arms and services. With the inactivation of the training center HQ in 1922, Camp Knox, KY, remained the primary training center for corps area infantry, cavalry, and artillery units—air corps units were sent to Wright Field, OH; coast artillery units were sent to Fort Sheridan, IL; and engineers were sent to Camp Custer, MI. The HQ, Fifth Corps Area Training Center was discontinued on 27 September 1922 at Camp Knox.

**Commanders, Fifth Corps Area Training Center**

Brig. Gen. Dwight E. Aultman      October 1921–27 September 1922

**HQ, Sixth Corps Area Training Center**

**HQ**—Fort Sheridan, IL, 1921–22; Camp Custer, MI, 1922

**Subordinate elements**—HHSC, Depot Group; Recruit Section; Illiterate and Development Section; Training Depot; 2d Infantry Regiment (Training Center); Troop L, Cavalry Training Squadron No. 6; Artillery Training Battery No. 6; Engineer Training Company No. 6

Established in the R.A. on 27 July 1921. Organized 20 December 1921 at Fort Sheridan, IL. The HQ was transferred on 18 April 1922 to Camp Custer, MI. The Sixth Corps Area Training Center was responsible for overseeing and assisting the annual summer training of all R.A., O.R., ROTC, and CMTC personnel and units from the states of Illinois, Michigan, and Wisconsin. The center's training units at Camp Custer were responsible for training units of all arms and services. With the inactivation of the training center HQ in 1922, Camp Custer remained the primary training center for corps area infantry, cavalry, and artillery units—air corps units were sent to Selfridge Field, MI; and coast artillery and cavalry units were sent to Fort Sheridan. The HQ, Sixth Corps Area Training Center was discontinued on 17 August 1922 at Camp Custer.

**Commanders, Sixth Corps Area Training Center**

Brig. Gen. Fred W. Sladen      August 1921–July 1922

**HQ, Seventh Corps Area Training Center**

**HQ**—Fort Snelling, MN, 1921–22

**Subordinate elements**—HHSC, Depot Group; Recruit Section; Illiterate and Development Section; Training Depot; 3d Infantry Regiment (Training Center); Troop L, Cavalry Training Squadron No. 7; Artillery Training Battery No. 7; Engineer Training Company No. 7

Established in the R.A. on 27 July 1921. Organized on 20 December 1921 at Fort Snelling, MN. The Seventh Corps Area Training Center was responsible for overseeing and assisting the annual summer training of all R.A., O.R., ROTC, and CMTC personnel and units from the states of Missouri, Kansas, Arkansas, Iowa, Nebraska, Minnesota, North Dakota, and South Dakota. The center's training units at Fort Snelling were responsible for training units of all arms and services. With the inactivation of the training center headquarters in 1922, the primary training centers for corps area infantry units were Fort Snelling; Fort Crook, NE; and Fort Leavenworth, KS. Cavalry and artillery units were trained at Fort Riley, KS, and Fort Des Moines, IA; air corps units were sent to Marshall Field, KS; and coast artillery units were sent to Fort Sheridan, IL. The HQ, Seventh Corps Area Training Center was discontinued on 4 August 1922 at Camp Custer and the existing HQ redesignated as HQ, Fort Snelling.

**Commanders, Seventh Corps Area Training Center**

Brig. Gen. Alfred W. Bjornsted      29 October 1921–4 August 1922

### **HQ, Eighth Corps Area Training Center**

**HQ**—Fort Sam Houston, TX, 1921–22

**Subordinate elements**—HHSC, Depot Group; Recruit Section; Illiterate and Development Section; Training Depot; 17th Infantry Regiment (Training Center); Troop L, Cavalry Training Squadron No. 8; Artillery Training Battery No. 8; Engineer Training Company No. 8

Established in the R.A. on 27 July 1921. Organized on 4 December 1921 at Fort Sam Houston, TX, by redesignation of HQ, Fort Sam Houston. The Eighth Corps Area Training Center was responsible for overseeing and assisting the annual summer training of all R.A., O.R., ROTC, and CMTC personnel and units from the states of Texas, Oklahoma, Colorado, New Mexico, and Arizona. The center's training units at Fort Sam Houston were responsible for training units of all arms and services. With the inactivation of the training center HQ in 1922, the primary training centers for corps area infantry units were Fort Sam Houston; Fort Huachuca, AZ; and Fort D.A. Russell, WY (later redesignated Fort Francis E. Warren). Cavalry units were trained at Fort Bliss, TX; Fort Clark, TX; and Fort Huachuca, AZ. Field artillery units were sent to Fort Sam Houston; Fort Sill, OK; and Fort Bliss, TX. Air corps units were sent to Kelly Field, TX. Coast artillery units were sent to Fort Bliss, TX, initially, then from 1934 to 1940, to Fort Crockett, TX. The HQ, Eighth Corps Area Training Center was discontinued on 31 December 1922 at Fort Sam Houston and the existing HQ redesignated as HQ, Fort Sam Houston.

#### **Commanders, Eighth Corps Area Training Center**

Brig. Gen. William R. Smith      September 1921–31 December 1922

### **HQ, Ninth Corps Area Training Center**

**HQ**—Presidio of San Francisco, CA, 1921–22

**Subordinate elements**—HHSC, Depot Group; Recruit Section; Illiterate and Development Section; Training Depot; 19th Infantry Regiment (Training Center); Troop L, Cavalry Training Squadron No. 9; Artillery Training Battery No. 9; Engineer Training Company No. 9

Established in the R.A. on 27 July 1921. Organized in September 1921 at the Presidio of San Francisco, CA. The Ninth Corps Area Training Center was responsible for overseeing and assisting the annual summer training of all R.A., O.R., ROTC, and CMTC personnel and units from the states of Washington, Oregon, Idaho, Montana, Wyoming, Utah, and Nevada. The center's training units at the Presidio were responsible for training units of all arms and services. With the inactivation of the training center HQ in 1922, the primary training centers for corps area infantry and artillery units were Camp Lewis, WA; Fort Douglas, UT; and Del Monte, CA (later redesignated Fort Ord). Cavalry units were also trained at Del Monte and at Fort D.A. Russell, WY (later redesignated Fort Francis E. Warren). Air corps units were sent to Hamilton Field, CA; March Field, CA; and Boeing Field, WA. Coast artillery units were sent to Fort Winfield Scott, CA, and Fort MacArthur, CA. The HQ, Ninth Corps Area Training Center was discontinued on 29 September 1922 at the Presidio of San Francisco.

#### **Commanders, Ninth Corps Area Training Center**

Brig. Gen. William C. Kennedy      September 1921–29 September 1922



# **Part II**

## **Infantry Organizations**

**1919–41**



## Chapter 7

### Infantry Divisions



USASC Photo, NA II

Motorized elements of the Hawaiian Division pass in review at Schofield Barracks, Territory of Hawaii, in 1939.

In the spring of 1919, General John J. Pershing convened the Superior Board to, among other things, analyze the performance of the heavy “square” division used by the American Expeditionary Force (AEF) in World War I. The board provided its recommendation that July which stated that, with a few minor modifications, the World War I infantry division was sound and should be retained. Consisting of two infantry brigades with a total of four infantry regiments, a field artillery brigade, and division support units, the AEF division possessed a strength of 29,000 men. In size it was essentially equivalent to a corps in a European army. Pershing, who favored a 17,000-man triangular division with three infantry regiments temporarily set the Superior Board report aside. About 1 year later, he forwarded the report, and his views on the triangular division concept, to the War Department’s Committee on Organization that was then struggling with the problem of developing the structure for the postwar division. This board gave way to still another, the Lassiter Committee that ultimately prepared the tables of organization for the postwar infantry division.

This division was not substantially different from the AEF model. Though it reduced the size of the division by about 9,000 men, it retained the square structure of two brigades and four infantry regiments, rather than the three regiments preferred by Pershing. Beyond that, the division support units were reorganized to include a battalion-size special troops unit that included a tank company, military police company, signal company, ordnance company, motorcycle company (attached), and the division headquarters (HQ)

1921 Infantry Division table of organization and equipment.

Division T/O: 1W Approved: 4 May 1921	Division Headquarters	Special Troops	Infantry Brigades (2)	Artillery Brigade	Engineer Regiment	Division Air Service	Medical Regiment	Quartermaster Train	Total	Medical Dept. Det. (attached)	Chaplains (attached)	Aggregate
Units:												
Officers	38	32	434	146	38	38	67	19	812	79	14	905
Warrant Officers	--	12	6	4	1	--	1	--	24	--	--	24
Enlisted	--	856	11976	3118	806	190	860	747	18553	515	--	19068
Aggregate	38	900	12416	3268	845	228	928	766	19389	594	14	19997
<b>Equipment</b>												
Horses, draft	--	16	4	1590	--	--	16	--	1626	--	--	1626
Horses, riding	--	105	498	1157	78	--	86	7	1931	159	11	2101
Mules, draft	--	62	1582	560	182	--	102	512	2950	120	--	3070
Mules, pack	--	--	--	--	16	--	--	--	16	--	--	16
Mules, riding	--	2	66	19	10	--	--	34	131	--	--	131
Ambulance, animal-drawn	--	--	--	--	--	--	20	--	20	--	--	20
Cart, ammunition, 37 mm	--	--	12	--	--	--	--	--	12	--	--	12
Cart, ammunition, M.G.	--	--	96	--	--	--	--	--	96	--	--	96
Cart, machine-gun	--	--	96	--	--	--	--	--	96	--	--	96
Cart, mortar	--	--	24	--	--	--	--	--	24	--	--	24
Cart, ration	--	5	74	20	--	--	--	--	99	--	--	99
Cart, reel, battery, 4-horse	--	--	--	12	--	--	--	--	12	--	--	12
Carts and reels, 6-horse	--	--	--	7	--	--	--	--	7	--	--	7
Cart, water	--	2	74	20	7	--	--	--	103	4	--	107
Cart, wire	--	4	2	--	--	--	--	--	6	--	-6	6
Kitchen, rolling	--	6	74	21	7	--	--	--	108	--	--	108
Wagon, battery	--	--	--	12	--	--	--	--	12	--	--	12
Wagon, combined btry & store	--	--	--	6	--	--	--	--	6	--	--	6
Wagon, escort	--	8	172	96	11	--	4	124	415	8	--	423
Wagon, spring	--	--	--	18	--	--	1	--	19	--	--	19
Wagon, store	--	--	--	12	--	--	--	--	12	--	--	12
Wagon, tool	--	--	--	--	24	--	--	--	24	--	--	24
Ambulance, motor	--	--	--	--	--	--	40	--	40	6	--	46
Bicycles	--	18	112	20	15	--	25	--	190	9	--	199
Car, motor, 5-passenger	--	3	8	6	2	2	11	21	53	--	--	53
Car, motor, 7-passenger	--	--	--	--	--	--	--	2	2	--	--	2
Car, reconnaissance	--	--	--	4	--	--	--	--	4	--	--	4
Motorcycle, solo	--	--	--	--	--	--	--	2	2	--	--	2
Motorcycle, with side car	--	26	52	37	16	8	11	39	189	23	--	212
Tractors, 5-ton	--	--	--	--	--	--	--	2	2	--	--	2
Trailer, Cargo, 1½-ton	--	--	--	--	--	6	--	--	6	--	--	6
Trailer, Kitchen	--	3	--	1	--	1	10	4	19	--	--	19
Trailer, photographic, 5-ton	--	--	--	--	--	2	--	--	2	--	--	2
Trailer, radio	--	--	6	--	--	--	--	--	6	--	--	6
Trailer, ration, ¼-ton	--	1	--	--	--	--	--	--	1	--	--	1
Trailer, spare parts, medical	--	--	--	--	--	--	2	--	2	--	--	2
Trailer, stockroom	--	--	--	--	--	--	--	2	2	--	--	2
Trailer, storage battery	--	1	--	--	--	--	--	--	1	--	--	1
Trailer, tank, 300-gallon	--	2	--	--	--	2	10	--	14	--	--	14
Trailer, tire press, 5-ton	--	--	--	--	--	--	--	2	2	--	--	2
Truck, artillery, repair	--	4	--	--	--	--	--	--	4	--	--	4
Truck, artillery supply, Load A	--	--	--	1	--	--	--	--	1	--	--	1
Truck, artillery supply, Load B	--	3	--	--	--	--	--	--	3	--	--	3
Truck, artillery supply, Load D	--	4	--	--	--	--	--	--	4	--	--	4
Truck, cargo, ¾-ton	--	8	10	3	3	--	34	13	71	3	--	74
Truck, cargo, 1½- to 2-ton	--	18	6	--	18	12	62	110	226	--	--	226



1921 Infantry Division table of organization and equipment (Cont.).

Truck, cargo, 3- to 5-ton	--	<b>3</b>	--	--	--	--	--	<b>2</b>	<b>5</b>	--	--	<b>5</b>
Truck, E. W. D.	--	--	--	<b>30</b>	--	--	--	--	<b>30</b>	--	--	<b>30</b>
Truck, field lighting	--	--	--	--	--	<b>1</b>	--	--	<b>1</b>	--	--	<b>1</b>
Truck, light repair	--	<b>2</b>	--	<b>1</b>	--	--	--	--	<b>3</b>	--	--	<b>3</b>
Truck, w/reinf springs, 5½-ton	--	<b>25</b>	--	--	--	--	--	--	<b>25</b>	--	--	<b>25</b>
Truck, M. T. machine shop	--	--	--	--	--	<b>1</b>	--	<b>2</b>	<b>3</b>	--	--	<b>3</b>
Truck, patrol , ¾-ton	--	<b>1</b>	--	--	--	--	--	--	<b>1</b>	--	--	<b>1</b>
Truck, photographic	--	--	--	--	--	<b>2</b>	--	--	<b>2</b>	--	--	<b>2</b>
Truck, radio, Air Service	--	--	--	--	--	<b>1</b>	--	--	<b>1</b>	--	--	<b>1</b>
Truck, radio, army	--	<b>1</b>	--	--	--	--	--	--	<b>1</b>	--	--	<b>1</b>
Truck, radio, divisional	--	<b>1</b>	--	--	--	--	--	--	<b>1</b>	--	--	<b>1</b>
Truck, radio, repair	--	--	--	--	--	<b>1</b>	--	--	<b>1</b>	--	--	<b>1</b>
Truck, small arms repair	--	<b>2</b>	--	--	--	--	--	--	<b>2</b>	--	--	<b>2</b>
Truck, tank, 750-gallon	--	<b>2</b>	--	--	--	<b>3</b>	--	<b>10</b>	<b>15</b>	--	--	<b>15</b>
Truck, tank, gas, ¾-ton	--	--	--	--	--	<b>3</b>	--	--	<b>3</b>	--	--	<b>3</b>
Truck, tank, water, ¾-ton	--	--	--	--	--	<b>1</b>	--	--	<b>1</b>	--	--	<b>1</b>
Truck, wrecking	--	--	--	--	--	--	--	<b>2</b>	<b>2</b>	--	--	<b>2</b>
Airplane	--	--	--	--	--	<b>13</b>	--	--	<b>13</b>	--	--	<b>13</b>
Caisson, 75-mm	--	--	--	<b>144</b>	--	--	--	--	<b>144</b>	--	--	<b>144</b>
Gun, 37-mm	--	<b>10</b>	<b>12</b>	--	--	--	--	--	<b>22</b>	--	--	<b>22</b>
Gun, 75-mm	--	--	--	<b>48</b>	--	--	--	--	<b>48</b>	--	--	<b>48</b>
Machine-gun	--	<b>14</b>	<b>96</b>	--	--	--	--	--	<b>110</b>	--	--	<b>110</b>
Machine-gun, anti-aircraft	--	--	--	<b>42</b>	--	<b>3</b>	--	--	<b>45</b>	--	--	<b>45</b>
Machine-gun, flexible	--	--	--	--	--	<b>26</b>	--	--	<b>26</b>	--	--	<b>26</b>
Machine-gun, synchronized	--	--	--	--	--	<b>26</b>	--	--	<b>26</b>	--	--	<b>26</b>
Mortar, 3-inch	--	--	<b>12</b>	--	--	--	--	--	<b>12</b>	--	--	<b>12</b>
Pistol	<b>38</b>	<b>704</b>	<b>5076</b>	<b>3268</b>	<b>214</b>	<b>228</b>	--	<b>206</b>	<b>9734</b>	--	--	<b>9734</b>
Rifle	--	<b>134</b>	<b>7014</b>	--	<b>631</b>	--	--	<b>570</b>	<b>8349</b>	--	--	<b>8349</b>
Rifle, automatic	--	--	<b>648</b>	<b>120</b>	<b>24</b>	--	--	--	<b>792</b>	--	--	<b>792</b>
Rifle, w grenade discharger	--	--	<b>648</b>	--	--	--	--	--	<b>648</b>	--	--	<b>648</b>
Tank, fighting, light	--	<b>24</b>	--	--	--	--	--	--	<b>24</b>	--	--	<b>24</b>
Tank, signal, light	--	<b>1</b>	--	--	--	--	--	--	<b>1</b>	--	--	<b>1</b>

company. The table also added a division air service, but eliminated, temporarily, the 155-mm heavy artillery regiment. Though the new division was to consist of 19,997 officers and enlisted men in wartime, the peacetime table of organization called for only about 11,000 troops. The peace tables were designed to allow expansion of the existing units rather than having to organize new ones.

The 1921 division experienced several changes to its structure over the next 15 years. These changes included the loss in 1929 of the Division Aviation (known as the Division Air Service until 1928) and its subordinate elements; the addition of a 155-mm H medium artillery regiment in 1929, the motorization of the field artillery brigade and light field artillery regiments in the 1930s, and the reorganization and expansion of the quartermaster train into a quartermaster regiment in 1936.

### Postwar Plans for Infantry Divisions

The postwar mobilization plans of the War Plans Division (WPD) called for 57 infantry divisions. Twelve of those divisions were to be in the Regular Army (R.A.); one each allotted to the nine corps areas and one each allotted to each of the three overseas departments. The National Guard (N.G.) was allotted 18 divisions, 2 in each corps area. The R.A. division and two N.G. divisions in each corps area were to be assigned to that corps area's lower numbered corps. Additionally each corps area was allotted 3 Organized Reserve (O.R.) divisions for a total of 27. The three O.R. divisions in each corps area were to be assigned to that corps area's higher numbered corps.

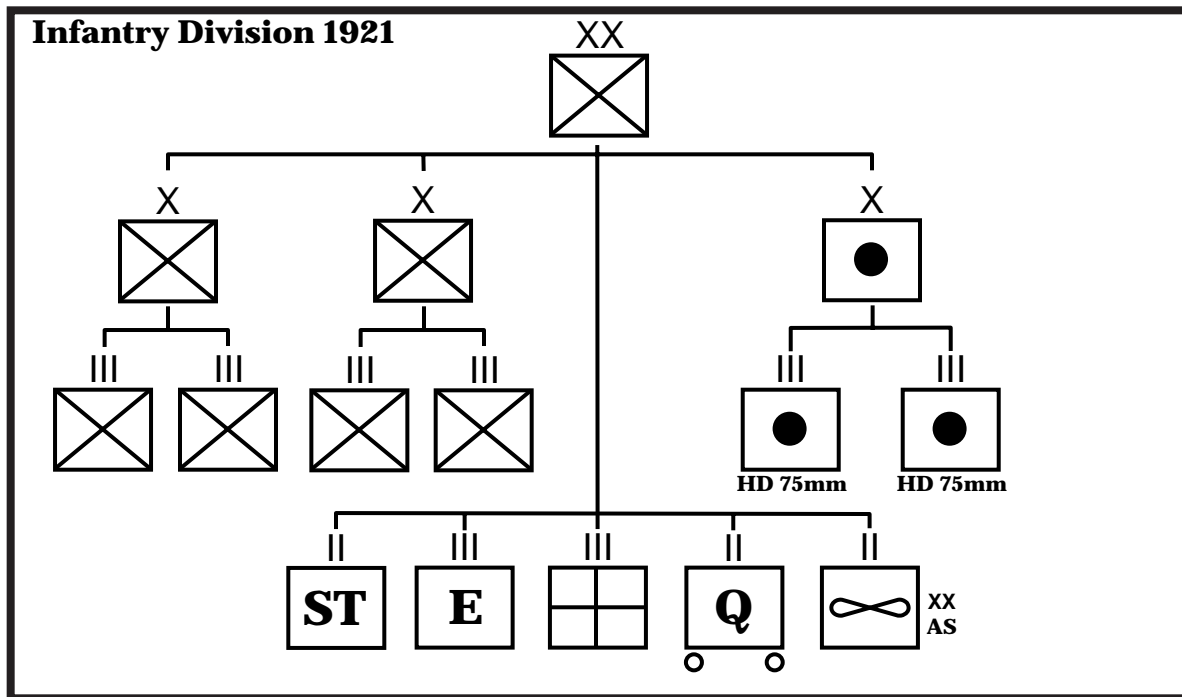

1921 Infantry Division organization.

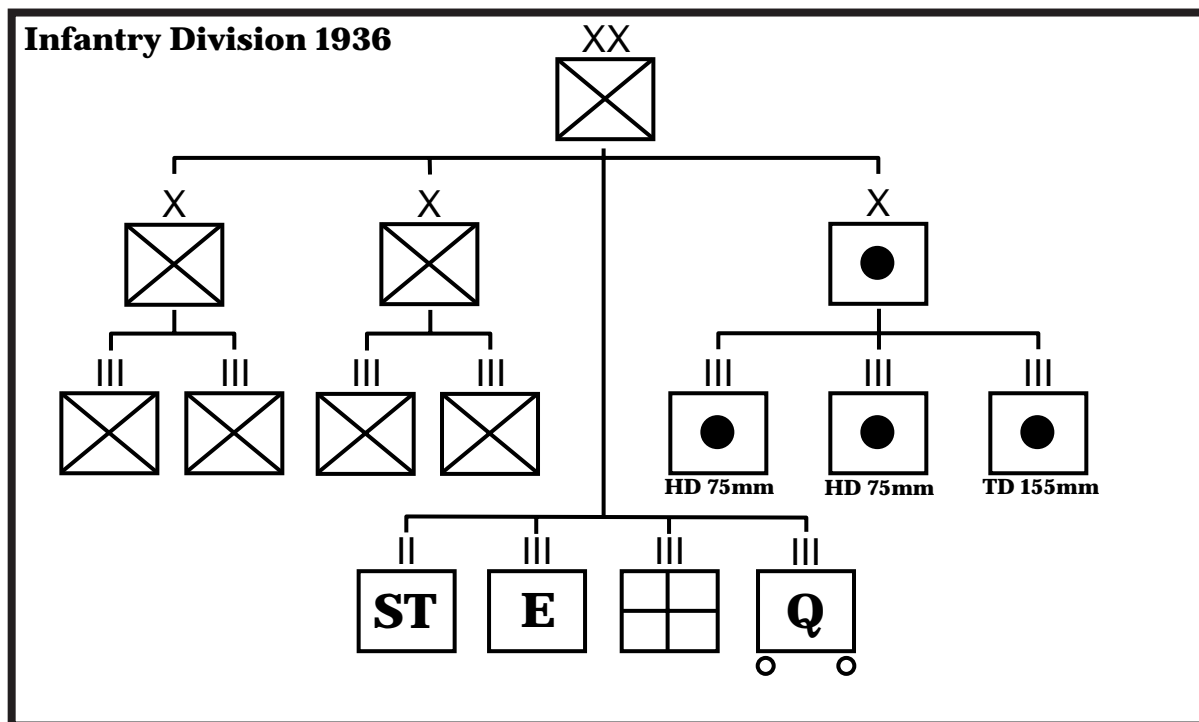

1936 Infantry Division organization.

## **Regular Army**

### *Organization*

The postwar R.A. divisions located in the continental United States consisted of the 1st through 9th Divisions. All had been constituted and organized during World War I though the 9th Division was never deployed to France. The three overseas divisions were newly constituted and designated as the Panama Canal, Hawaiian, and Philippine Divisions, after their respective departments. These divisions were named rather than numbered as they were tied to their geographical location for wartime employment. They were not expected to ever deploy outside the geographical area of their departments. The numbering scheme for the various division support troops for the named divisions reflected those of the former 10th, 11th, and 12th Divisions (Panama Canal, Hawaiian, and Philippine Divisions, respectively) although there were no lineal ties to those World War I-era commands.

By the summer of 1921, it was apparent to the WPD that the annual budget allocated to the Army by the country's parsimonious Congress would not allow the service to maintain nine fully active divisions. Thus, in September 1921, the 4th through the 9th Divisions were partially inactivated. These divisions were represented in the Active Army by their even numbered brigade, each of which was reinforced by at least one field artillery battalion, an observation squadron, and a few other selected division support units. Additionally, by the mid-1920s though most of their subordinate units remained active, the headquarters of 1st and 3d Divisions almost ceased to exist. Only the division commander and a few staff officers remained to carry out minimal division administrative functions, and neither division exercised true command functions over their units. Only the 2d Division headquarters remained functional due to its mission of watching the Mexican border and the fact that the entire division was concentrated entirely at Fort Sam Houston, TX.

By 1926, WPD planners and corps area commanders realized that the existing situation would not allow for a quick or efficient means to reorganize tactical divisions in the event of an emergency, so a number of actions were taken to remedy the problem. First, the Second and Ninth Corps Area commanders restored most command functions to the 1st and 3d Divisions and repopulated those division staffs. The War Department additionally developed a means by which the six inactive divisions could be more quickly brought up to strength in an emergency. The department authorized the assignment of Reserve officers to Regular Army Inactive (RAI) organizations. This authorization resulted in the partial organization of virtually all of the six RAI divisions' inactive units, including the division headquarters, as Reserve units. The Fifth Corps Area, responsible for the 5th Division, took this authorization to the greatest extent by organizing the division's HQ along the lines of an O.R. division and appointed a small Active Duty staff as well. A little over a year later, the personnel for the 5th Division's active staff were reassigned and only Reservists remained assigned to the HQ. None of the six RAI divisions were assigned a general officer (the respective corps area commanders functioned as such) and with the brief exception of the 5th Division, performed no command functions over subordinate units except during command post exercises (CPXs).

In 1927, the WPD took another step toward developing a more readily available emergency force by reassigning all the Army's active infantry brigades for the 4th through the 9th Divisions to the 4th, 5th, and 6th Divisions only. By each having two active brigades, it was reasoned, those three divisions could be mobilized much more quickly and made ready for active operations. Planners later realized, however, that the action would actually make little difference in the mobilization rate of the three divisions and by late 1933, all brigades were reassigned back to their original divisions. The status of the stateside R.A. divisions at that point (i.e., three active divisions and six reinforced brigades) remained more or less constant until October 1939 when the Army began to triangularize infantry divisions.

The overseas divisions, while suffering from many of the problems of their stateside counterparts, had the benefit of possessing actual wartime missions for which they had to prepare. Thus, those divisions were generally better manned, especially the Hawaiian Division which was the closest thing to a full-strength division in the interwar American Army and remained so throughout the period. All three of these divisions

began to organize in 1921 and by the following year, were anywhere from 70 to 100 percent complete. The Hawaiian Division was completed by the spring of 1922. The Philippine Division, a mixed formation of R.A. personnel and Philippine Scouts, was short one artillery regiment, an ammunition train, part of its engineer and medical regiments, and several of its smaller units in the quartermaster train and special troops. The Panama Canal Division was short one infantry regiment and an ambulance company. As was the case for the stateside divisions, this level of manning and organization would gradually deteriorate in the 1920s and 1930s as smaller budgets forced cuts in the divisions' structure. By 1931, though the Hawaiian Division remained fully organized, the Philippine Division had inactivated an entire infantry brigade. Likewise, the Panama Canal Division was short an infantry brigade, its entire field artillery brigade less one battalion, and its quartermaster train HQ. The following year, the latter division was inactivated and its subordinate units reorganized into two sector commands believed to be more efficient for the defense of the Panama Canal Zone. In the fall of 1941, the Hawaiian Division was reorganized into two triangular divisions—the 24th and 25th Divisions—as part of the US Army's overall defense preparations for entry into World War II. The Philippine Division, though officially retaining the square structure until its capture on Bataan in 1942, was reorganized in the fall of 1941 as a triangular division by the reassignment of the 31st Infantry. Before the attack on Pearl Harbor, the division had regained some of its formerly inactivated subordinate units, but was never fully reorganized. The Panama Canal Division was never reorganized, but a similar organization, the Panama Canal Mobile Force, a division-size force containing almost all of the former division's subordinate units that were still on the active rolls, was organized to replace the division in 1940.

### *Training*

Training opportunities for R.A. divisions during the interwar period, while clearly not ideal, were better than what many might believe. Commanders and staffs, especially those in the continental United States, were extremely imaginative at developing low cost ways to maintain functional proficiency at a time when Army budgets were sparse. These commanders looked for ways and opportunities to create situations and conditions under which they could train their staffs and subordinate units in the skills needed to operate large units in wartime. Army, corps area, division, and brigade maneuvers; CPXs; and command and communications exercises (CCXs) were all used to prepare commanders and staffs for division-level operations.

The early 1920s were easily the worst period for such training opportunities. The extreme reduction in the size of staffs for the 1st and 3d Divisions along with the corresponding lack of money made it useless to attempt anything except very low key CPXs. Only the 2d Division in Texas was maintained at a strength that made division-level training events beyond that feasible. Even so, it was not until 1926 when the 2d Division began holding a maneuver that would become an almost annual exercise until 1937. The division typically held those maneuvers at Camp Bullis northwest of San Antonio, and for a few years near Christine, TX. In 1927, the year after the 1st and 3d Division staffs were reorganized, those two divisions also began to hold annual division-level training events as well. The 3d Division (minus one brigade) typically held a maneuver at Fort Lewis and the 1st Division held a CCX each year at Camp Dix. The CCX was held in lieu of an annual maneuver due to the absence in either the First or Second Corps areas of a training area large enough to hold a division-level maneuver. Moreover, the cost of assembling the division from so many disparate posts was prohibitive.

Each of these divisions, at some point in the interwar years, participated in unique division-level training events. The 2d Division participated in the Joint Army–Air Corps Exercise at Camp Bullis in 1928 for example. The maneuver consisted of 12,000 soldiers and 108 aircraft and focused on air-ground operations. The 3d Division participated in the Army–Navy Landing Exercise No. 3 at San Clemente Island off Long Beach, CA, in 1937 to practice and develop amphibious landing operations. The 1st Division (at a much reduced strength) likewise participated in the Army–Navy Landing Exercise No. 4 at Culebra Island near Puerto Rico the following year. In 1937, the 2d Division was selected to test the feasibility of the triangular division concept. That year the division held a series of exercises called the Provisional Infantry Division

(PID) tests at Camp Bullis. Two years later it conducted the Provisional 2d Division (P2D) tests which were the final tests for the triangular division. These two tests resulted in the adoption of the triangular tables of organization for stateside infantry divisions in October 1939. Of course, all three of these divisions also participated in the various major field army maneuvers that took place in the late 1930s.

Training RAI divisions posed a different challenge. Typically, the personnel assigned to RAI division headquarters were geographically dispersed over the corps area that precluded their assembly for training during the year. Officers assigned to those staffs generally attended inactive training periods with other units or other types of training. The only time the officers might get a chance to function as a member of the staff was on those few occasions when the division HQ was assembled for a CPX, or more rarely, when the division HQ was organized provisionally to function with its active brigade in a maneuver. More often the division's staff officers attended training with the staff of a N.G. or R.A. division, or with the staff of a reinforced brigade.

The three overseas divisions were arguably the best trained and equipped divisions in the Army. Each had a wartime mission for the defense of its department and was considered to be in the first line of defense against any potential threats. Therefore, the War Department provided larger training and operations budgets to the overseas departments to support those divisions. Beginning in the fall of 1923 with the Philippine Division, these divisions also participated in annual department maneuvers to exercise, test, and help revise existing war plans and unit defensive positions. The exercises almost always included the participation of air corps and coast artillery units, as well as US Navy planes and ships. Occasionally, marine units would participate as enemy landing forces. Given their real-world nature and joint aspects, these maneuvers tended to be some of the best division-level training events in the interwar period.

## **National Guard**

### *Organization*

During 1920 a committee of R.A. and N.G. officers developed a plan for 18 N.G. divisions for the postwar army. The plan called for allotting the 26th through 45th Divisions, less two, to the 48 states. There were to be two divisions allotted to each corps area. In keeping with the requirements of the 1920 National Defense Act, as far as practicable the divisions were to be allotted to the corps areas containing those states from which the units were organized in World War I. The 42d Division was not included in the allotment as it had been organized from numerous states across the country. The 30th, 31st, and 39th Divisions had been originally organized in the Fourth Corps Area, and so all three designations were offered to that corps area. The 30th and 39th were initially selected and the 31st became the other division deleted from the original list of N.G. divisions. In 1923, the adjutants general of the several states from which the 39th Division was drawn petitioned the War Department to change the designation of the 39th to the 31st Division, which was the organization with which most of the affected states' units served in World War I. An allocation board approved the request and the subordinate elements assigned to the 39th Division were withdrawn and re-assigned to the 31st Division, less the Arkansas elements, effective 1 July 1923.

By the spring of 1921, most subordinate units had been allotted and efforts to organize the divisions were soon underway. Under the rules of organization, the formal organization of division HQ could not be effected until at least 75 percent of subordinate units had themselves been federally recognized. Even so, by the end of 1924, 13 of the 18 division HQ had been so recognized. After a 2-year suspension of the Federal recognition of new units due to the Army's budget shortfall, reorganization resumed, but the last division headquarters to be organized, that of the 35th Division of Kansas and Missouri, would not receive Federal recognition until 1935.

All but three of the postwar N.G. divisions had been active in World War I. The three new divisions, the 43d, 44th, and 45th, were newly constituted. In most instances, the Great War era divisions were successfully relocated to the states from whence they were derived in 1917, but the addition of the three

new divisions caused some shuffling of states within divisions. Units from the states of Connecticut, New Hampshire, Vermont, and Maine had been assigned to the 26th Division in the Great War, but that unit was now an all-Massachusetts outfit. Instead, units from these four New England states were now assigned to the new 43d Division. The 44th Division had been allotted predominately to the state of New Jersey, with one brigade allotted to New York and a field artillery regiment allotted to Pennsylvania. In 1917, those states' units had been part of the 29th, 27th, and 28th Divisions, respectively. The final division, the 45th, had been allotted to Oklahoma, Colorado, New Mexico, and Arizona. In World War I, Oklahoma units were part of the now all-Texas 36th Division. Units from the other three states had belonged to the 40th Division, which was now composed of units from California, Utah, and Nevada.

Organizationally, the N.G. divisions faced the same challenges in the interwar years as did their R.A. counterparts. Small budgets and a waning interest in things military meant that units struggled to recruit enough men to flesh out even the relatively weak peacetime tables of organization. Authorized about 11,000 officers and men under those tables, most N.G. divisions hovered between 6,000 and 8,000 men in the 1920s. All divisions were short some subordinate units. For example, no division organized a division service company. Only eight of the divisions ever organized an ammunition train, and only three of those trains lasted for more than a few years before they were demobilized. Other division elements frequently inactive were subordinate units of the quartermaster train, medical regiment, and special troops. On the other hand, all divisions had organized and federally recognized their infantry regiments, field artillery regiments, and engineer regiments by 1930.

### *Training*

Given that N.G. units could only assemble for about 38 days a year, and that most divisions and their staffs hailed from two or more states, the training challenges for N.G. divisions were even greater than those for the R.A. Training the division staffs to function as a team in the interwar years was somewhat easier than it was to train its component parts as a functional division. Solutions presented themselves in several ways. One way was to assemble the entire division HQ at the summer camp location of one of the constituent states. There, under the guidance of the division commander and R.A. instructors, the various officers and men from the different states and staff sections could get to know one another, develop standard operating procedures, train, and begin to mold themselves into a functional team. Another opportunity to do this was at various corps area and field army CPXs. Of course, the best training opportunity to train these divisions in their entirety was the large-scale army maneuvers of the late 1930s and early 1940s.

Training opportunities for the subordinate units of these divisions were primarily limited to inactive training periods and annual summer camps. For single state divisions, such as those from Texas, New York, and Pennsylvania, assembling the entire division for summer training posed few problems. Multistate divisions, however, when attempting to assemble the division for training, encountered coordination problems with other states, such as agreement on camp dates and location. Other problems included money to move troops and equipment out of state and loss of training time during travel. In spite of these challenges, various multistate divisions made attempts to assemble in their entirety at various times in the interwar years. One multistate division, the 38th Division from Indiana, Kentucky, and West Virginia, was lucky. The units from Indiana and Kentucky, the bulk of the division, typically trained at Camp Knox, KY, each year. Only West Virginia's 150th Inf. was needed to round out the division. Even so, that regiment assembled with the rest of the division only a few times in the 1930s. The first multistate division to completely assemble was the 30th Division from North Carolina, South Carolina, and Georgia. This division was gathered for the first time in 1928 at Camp Jackson, SC, during 8–22 July under a War Department experimental program designed to bring multistate N.G. divisions together for joint training. The experiment was a success, but due to budget constraints, the program was never fully implemented. Before the advent of the large army maneuvers beginning in 1935, most multistate divisions had the opportunity to assemble for at least one camp. Few were able to accomplish the feat more than once or twice.

## Organized Reserve

### *Organization*

In developing the structure for the postwar Army, the WPD planned for 33 O.R. infantry divisions. These consisted of the 76th through 91st and the 94th through 104th Divisions. The 76th through 101st Divisions had been completely or partially organized during World War I. The 102d, 103d, and 104th Divisions were completely new organizations. The 76th through 91st Divisions had all served in France. The all-black 92d and 93d Divisions had both served in France as well; however, the War Department's postwar policy prohibited the organization of black divisions in peacetime. Therefore, neither unit was allotted for reorganization. Mobilization planners did, however, contemplate the reactivation of both divisions, along with the Puerto Rican Division, in the event they were needed for an emergency. The Puerto Rican Division had been organized in Puerto Rico during World War I and it was often referred to in early postwar mobilization plans and other documents. The original allotment to Puerto Rico was a large infantry brigade of three regiments, a field artillery regiment, and various division support units, which could easily be expanded to a division if required. However, by 1927, WPD planners had apparently determined that the division was not needed and thus it was never reconstituted.

Each corps area was allotted three O.R. divisions that were to be assigned to the higher numbered corps. Like N.G. divisions, the O.R. organizations were to be allotted as far as practicable to the states from which the bulk of their men were derived in World War I. Also like the Guard units, the addition of the new divisions required some adjustment to the allotments and there was not always a perfect fit. Once the allotment was complete and a local board of officers determined the location of the division HQ as well as the division's subordinate elements, organization of the division began. First, a small R.A. staff was assigned to the division HQ. This staff advertised the organization of the division in local papers, radio spots, and other means. The staff, which had been provided a list of names and addresses of former and current Officer Reserve Corps (ORC) and National Army officers, also began contacting and recruiting these men for the new divisions.

Unlike the R.A. and N.G. divisions, officers for Reserve divisions could be recruited in peacetime to full-strength under the wartime tables of organization for an infantry division. However, due to Federal legislation passed through the pressures applied from N.G. lobbyists and associations to ensure that the O.R. would be no competitor as the second line of defense for the Army, Reserve units could only recruit up to 33 percent of their authorized enlisted strength. Since there were no enlistment or pay incentives for the Enlisted Reserve Corps (ERC), few men joined. As a result, O.R. divisions generally had less than 100 enlisted men on the rolls. On the other hand, due to the many World War I-era officers and commissionees from Reserve Officers' Training Corps (ROTC) programs and Citizens Military Training Camps (CMTCs), most of these divisions were at or near full strength in officer personnel from about 1925 until 1940.

Initially, and as an additional duty, corps area commanders functioned as the nominal commanding generals for all three of the O.R. divisions in their corps area. These duties were generally administrative in nature, but even then, the vast majority of general and special orders and other documents were promulgated for the commander by each division's chief of staff who ran the day-to-day operations of the division. In most cases, the chief of staff also functioned as the acting commander for CPXs and other training exercises. By the late 1920s, many corps area commanders frequently delegated the division commander duty to more junior generals within the corps area, or in a few instances, to O.R. generals. This practice was not common to all corps areas, however.

Each division's chief of staff also had a small R.A. staff of officers and enlisted men through which he administered and supervised the activities of the division's subordinate units. Additional R.A. officers were assigned as executive officers (later redesignated as unit instructors) to the various regiments and other units of the division, along with a few enlisted men. These staffs consisted of the following personnel:

### **O.R. Division Staff:**

Chief of Staff	colonel
Adjutant General/G1	lieutenant colonel
Assistant Chief of Staff, General Staff G3	lieutenant colonel
Assistant Chief of Staff, General Staff G3	major
Assistant Chief of Staff, G4	lieutenant colonel
Senior Noncommissioned Officer (NCO)	staff sergeant
Administrative Sergeant	sergeant
Supply NCO	sergeant
Enlisted clerk	corporal
Enlisted clerk/driver	private

### **Regiment:**

Executive officer*	lieutenant colonel
Enlisted clerk/driver	sergeant

\*Redesignated "unit instructor" in 1926.

Note: Ranks shown are highest authorized. Actual assigned personnel frequently held ranks lower, and sometimes higher, than those shown.

Unlike their R.A. and N.G. counterparts, the organization of Reserve division HQ and all the division's subordinate units was generally achieved by the end of 1922. Of course, for Reserve divisions all this really meant was that the unit was organized by the initial assignment of personnel. Most divisional subordinate organizations achieved somewhere near full strength in authorized officers by the mid-1920s and could be considered as functional cadre units.

Organizationally, the Reserve divisions went through the same interwar reorganizations as those in the other two components. Other than that, the composition of Reserve division subordinate units was essentially constant throughout 1921–41. With the exception of the exchange of infantry regiments in the brigades of the 102d Division, there were no other changes to the assignment of the Reserve divisions' subordinate units. Like those of the N.G., Reserve divisions were not reorganized into the triangular configuration until after Pearl Harbor.

### *Training*

The training difficulties facing the O.R. divisions were significantly much greater than those of the R.A. or N.G. due to the lack of enlisted personnel, equipment, and funding. In any given year, for example, the War Department had only enough funds to send about 25 percent of the O.R.'s personnel to summer camp. Still Reserve divisions made the effort to conduct adequate training for their staffs and subordinate units at the camps and during the inactive training period.

In the early 1920s, Reserve divisions held division-level group camps. Every person in the division, regardless of unit, attended as part of the division and not as part of any subordinate element. The training at these camps initially tended to be very general in content. Close order drill, rifle marksmanship, first aid, etc., were included, with perhaps a few rudimentary blocks of branch instruction. The camps were followed by increasingly more sophisticated methods. The July 1923 camp for the 83d, 84th, and 100th Divisions, and the 64th Cav. Division of the Fifth Corps Area held at Camp Knox was an example.

For that camp, the Reserve personnel, almost all officers, were divided into five groups:

Group 1—Infantry colonels, lieutenant colonels, and majors.

Group 2—Captains and lieutenants of infantry and engineers, and all military intelligence, signal corps, chemical warfare, and chaplain corps officers.

Group 3—All quartermaster, ordnance, adjutant general, sanitary, and medical corps officers.



Group 4—All field artillery officers.

Group 5—All cavalry officers.

Each group had a number of R.A. unit instructors who were responsible for preparing, conducting, and mentoring the training. The training took place 12–20 July in a field environment and consisted of a series of tactical walks (a tactical exercise without troops). The overall scenario was the movement of an infantry division into the line with a follow-on attack against an enemy force. At each stage of the first 7 days, various aspects of division operations were taught, explained, and/or otherwise illustrated. In some instances, an R.A. unit would actually perform some task as a demonstration on what a given maneuver, tactic, or support function looked like. After a demonstration or class was completed, a discussion would ensue as to how each type of unit or support function fit into the overall mission or task. Often one of the tactical walks was focused on a specific type of operation or support function—the use of the reserve or artillery support in the defense, for example. The final 2 days of the camp’s training was a CPX designed to familiarize the officers with the functions of a command post and communications in wartime.

These types of camps lasted until 1924, after which subordinate units were developed enough that they could hold unit camps and focus on higher levels of regimental, battalion, or company collective training. At that point Reserve division staffs also began to attend camps as a unit. Typically, however, Reserve division staffs were only able to assemble at a summer camp about once every 4 or 5 years. When they did, the HQ most often participated in CPXs for training. During those years that the division HQ did not go to camp as a unit, individual staff officers were trained in one of several ways for annual training. The most preferred assignment was to an R.A. or N.G. division staff during that unit’s own summer training period. Other methods included garrison work on a R.A. division staff, a corps area staff, or even the Reserve division’s own staff.

## 1st DIVISION

## “The Red One”

**HQ**—Camp Zachary Taylor, KY, 1919–20; Camp Dix, NJ, 1920–22; Fort Hamilton, NY, 1922–39; Fort Benning, GA, 1939–40; Fort Hamilton, NY, 1940–41; Fort Devens, MA, 1941

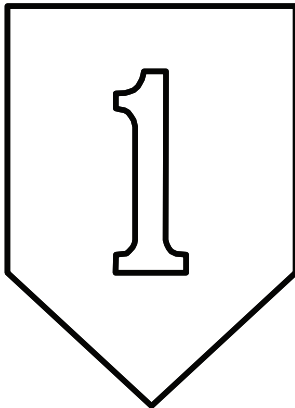

The 1st Div. arrived at Hoboken, NJ, in September 1919 after completing 9 months of occupation duty near and in Coblenz, Germany. Participated that month in the Victory Parades in New York City and Washington, DC. Proceeded to Camp Meade, MD, where all emergency period personnel were discharged from the service. Proceeded to Camp Zachary Taylor, KY, and took up temporary station there from 20 October 1919 to 8 October 1920. Dispatched elements of several regiments to quell striking coal miners in West Virginia in November 1919 and again to Lexington, KY, in February 1920. Transferred on a permanent change of station to Camp Dix, NJ, where it arrived on 10 October 1920. The division was allotted to the Second Corps Area and assigned to the II Corps in 1921. In August 1921, elements of the division were once again dispatched to West Virginia to control striking coal miners. In spring 1922, the division’s units were ordered to posts throughout the northeast United States with most units arriving at their new duty stations in June and July 1922. The division HQ was posted to Fort Hamilton, NY, arriving there on 6 June

1922. The 1st Inf. Brig. and the division special troops were concentrated at posts in the New York City area, while the 2d Inf. Brig. was scattered over posts in upstate New York. The 1st F.A. Brig.’s units were spread from Fort Ethan Allen, VT, to Fort Hoyle, MD. Training of the division’s maneuver units took place, for the most part, in the late summer and early fall after they assisted the training of O.R., CMTC, and ROTC units. The 1st Brig. conducted fall training at Camp Dix, where the brigade also trained its affiliate Reserve Component units during the summer. The 2d Brig. units usually conducted the training of its Reserve Component units at the brigade’s home posts, and afterwards, concentrated for training at Pine Camp, NY, in the fall. The first opportunity after 1922 to gather the division in one place came in 1927 when most of the “Red One” was assembled at Camp Dix for various training events during August through November. To prepare the staff for the maneuver, the division held a CCX at Camp Dix earlier that

spring. The exercise was apparently very successful as similar CCXs were held periodically thereafter. The next major training event for the division came in August 1935 when the First and Second Corps Area elements of the First Army were assembled at Pine Camp for small unit maneuvers. This maneuver was followed in turn by the First Army CPX held at Fort Devens in August 1937. Shortly afterward, in September 1937, the division, minus the 2d Brig. and some field artillery units, was concentrated at Indiantown Gap, PA, for maneuvers. Concurrently, the 2d Brig., reinforced by the artillery units from Fort Ethan Allen and Madison Barracks, assembled at Pine Camp for maneuvers. These maneuvers were followed by the first of several amphibious operations performed by the division's units prior to World War II. The first landing exercises were held by division elements in Puerto Rico and Culebra Island in January and February 1938. The amphibious training was followed by the next First Army Maneuver, held in the Plattsburg, NY, area in August 1939. The 1st Div. was reorganized into the "triangular" configuration in October 1939 when the 28th Inf. was relieved from the troop list and the division's field artillery regiments were reorganized into battalions. In November 1939, the division deployed to Fort Benning, GA, where it was assigned temporarily to the IV Corps to train and test the new triangular organization. These exercises were held in preparation for the maneuvers in Louisiana in May 1940 when the IV Corps was pitted against the provisional IX Corps. After the exercises in Louisiana, the "Red One" returned to New York to participate in the 1940 First Army Maneuver near Canton, NY, in August–September. For this maneuver, the 1st Div. was again part of the II Corps. In February 1941, the "Fighting First" was transferred to Fort Devens, MA, to concentrate the division for additional training. Concurrently, the division was relieved from the II Corps and assigned to the VI Corps. The following August, the division moved to the New River area of North Carolina for additional amphibious training. After the training at New River, the 1st Div. participated in the Carolina Maneuvers held in November 1941 near Charlotte, NC. Location of the division HQ on 7 December 1941 was Fort Devens, MA.

**Organization Day:** 21 October. Chosen to commemorate the division's baptism of fire in World War I when its subordinate infantry regiments entered the line in the Somervillier Sector on 21 October 1917.

**Status:** HHC are currently active in the R.A. at Würzburg, Germany, as HHC, 1st Inf. Div. (Mechanized).

**Events:** 60, 63, 72, 89, 91, 106, 153, 168, 174, 190, 215, 234, 240, 246, 280, 287, 293, 296, 301, 307, 323, 330

#### Division Commanders

Maj. Gen. Edward F. McGlachlin	21 November 1918–17 September 1919	Maj. Gen. Briant H. Wells	21 March 1930–19 September 1930
Maj. Gen. Charles P. Summerall	18 September 1919–1 July 1921	Brig. Gen. William P. Jackson	19 September 1930–7 October 1930
Maj. Gen. David C. Shanks	5 July 1921–7 November 1921	Maj. Gen. Lucius R. Holbrook	7 October 1930–9 November 1935
Brig. Gen. William S. Graves	7 November 1921–17 February 1922	Brig. Gen. Charles D. Roberts	9 November 1935–25 February 1936
Maj. Gen. Harry C. Hale	17 February 1922–13 November 1922	Maj. Gen. Frank S. Parker	25 February 1936–28 March 1936
Brig. Gen. William S. Graves	13 November 1922–7 July 1925	Maj. Gen. Stanley H. Ford	28 March 1936–30 September 1936
Maj. Gen. Preston Brown	8 July 1925–2 January 1926	Brig. Gen. Perry L. Miles	1 October 1936–31 October 1937
Brig. Gen. Frank S. Parker	2 January 1926–21 May 1926	Col. William P. Ennis	1 November 1937–2 December 1937
Brig. Gen. Hugh A. Drum	21 May 1926–1 May 1927	Brig. Gen. Walter C. Short	2 December 1937–9 December 1937
Maj. Gen. Fox Conner	1 May 1927–6 September 1927	Brig. Gen. Lawrence Halstead	9 December 1937–15 January 1938
Maj. Gen. Hugh A. Drum	6 September 1927–29 January 1930	Brig. Gen. Walter C. Short	15 January 1938–24 September 1940
Brig. Gen. William P. Jackson	30 January 1930–21 March 1930	Maj. Gen. Karl Truesdell	1 October 1940–13 January 1941
	Maj. Gen. Donald C. Cubbison		14 January 1941–24 May 1942

#### 1st DIVISION Organization 1923

UNIT:	LOCATION:
HQ	Fort Hamilton, NY
HQ, Special Troops	Camp Dix, NJ
HQ & M.P. Co.	Camp Dix, NJ
1st Sig. Co.	Camp Alfred Vail, NJ
1st Ord. Co. (M)	Miller Field, NY
1st Tank Co. (L)	Miller Field, NY
Mtscy Co. No. 1	Fort Wadsworth, NY
1st Inf. Brig.	Fort Wadsworth, NY
16th Inf. Regt.	Fort Jay, NY
18th Inf. Regt.	Fort Slocum, NY
2d Inf. Brig.	Madison Barracks, NY
26th Inf. Regt.	Plattsburg Barracks, NY
28th Inf. Regt.	Fort Niagara, NY

#### 1st DIVISION Organization 1939

UNIT:	LOCATION:
HQ	Fort Hamilton, NY
HQ, Special Troops	Fort Hamilton, NY
HQ & M.P. Co.	Fort Wood, NY
1st Sig. Co.	Fort Monmouth, NJ
1st Ord. Co. (M)	Madison Barracks, NY
1st Tank Co. (L)	Miller Field, NY
1st Inf. Brig.	Fort Wadsworth, NY
16th Inf. Regt.	Fort Jay, NY
18th Inf. Regt.	Fort Hamilton, NY
2d Inf. Brig.	Fort Ontario, NY
26th Inf. Regt.	Plattsburg Barracks, NY
28th Inf. Regt.	Fort Niagara, NY

1st F.A. Brig.	Fort Hoyle, MD
1st Ammo. Tn.	Fort Hoyle, MD
6th F.A. Regt.	Fort Hoyle, MD
7th F.A. Regt.	Fort Ethan Allen, VT
1st Engr. Regt.	Fort Du Pont, DE
1st Med. Regt.	Carlisle Barracks, PA
1st Div. Train, Q.M.C.	Fort Wadsworth, NY

1st F.A. Brig.	Fort Hoyle, MD
1st Ammo. Tn.	Second Corps Area
5th F.A. Regt.	Madison Barracks, NY
6th F.A. Regt.	Fort Hoyle, MD
7th F.A. Regt.	Fort Ethan Allen, VT
1st Engr. Regt.	Fort Du Pont, DE
1st Med. Regt.	Carlisle Barracks, PA
1st Q.M. Regt.	Fort Hamilton, NY

## 2d DIVISION

## “Indianhead”

HQ—Fort Sam Houston, TX, 1919–41

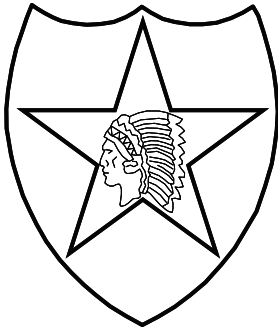

The 2d Div. arrived at Hoboken, NJ, on 3 August 1919 after completing 8 months of occupation duty near Coblenz, Heddesdorf, and Dierdorf, Germany. Moved to Camp Mills, NY, where all emergency period personnel were discharged from the service, and the 4th Marine Brig. was relieved from assignment to the division. Proceeded to Camp Travis, TX, on 16 August 1919 and took up temporary station from August 1919 until it moved to permanent quarters on Fort Sam Houston proper in 1923. The 4th Inf. Brig. (consisting of the 1st and 20th Inf. Regts.) was assigned to replace the 4th Marine Brig. in the division structure and activated in October 1920 at Camp Travis. The division was allotted to the Eighth Corps Area as VIII Corps troops in 1921. During the early post-World War I period, the division’s time was spent rebuilding and training on a limited scale. The slow pace left time for the division to assist Hollywood in making movies about the Army.

Division units participated in Metro-Goldwyn-Mayer’s movie “The Big Parade” in May and June 1925 and in “Wings” in April 1926. By 1926, however, maneuver training of divisional units was becoming more frequent leaving little time for movies. The maneuvers generally took place in May before the division’s units were busy assisting the training of O.R., CMTC, and ROTC units during the summer. Typically, the division would deploy to Camp Bullis, TX, or areas west of San Antonio, and perform field training, usually at company- and battalion-level. The division deployment would culminate in brigade versus brigade maneuvers near the end of the field training period. After transfer of the 4th Brig. to Fort D.A. Russell, WY (later renamed Fort Francis E. Warren), in 1927, the 1st Cav. Brig. began to road-march over from Fort Clark to participate in combined arms maneuvers each May. Once the division maneuvers were complete, the division shifted to training the Reserve Components. The 3d Brig. usually conducted the training of O.R. officers of the 90th Div., and infantry CMTC, and ROTC units. Units of the 2d F.A. Brig. trained the artillery officers of the 90th Div., the XVIII Corps, and several General Headquarters Reserve (GHQR) artillery units in the Eighth Corps Area. After transferring to Fort Francis E. Warren, the 4th Brig. conducted their maneuver training at the Pole Mountain Reservation where they also trained their affiliate Reserve Component units of the 104th Div. In 1936, the division participated in the Third Army CPX at Camp Bullis. The CPX was conducted to prepare army, corps, and division staffs for future large-scale army maneuvers. The next major training event for the division came in September 1937 when it participated in the Provisional Infantry Division (PID) tests at Camp Bullis. The “Indianhead” Division was temporarily reorganized with three regiments to test the concept of the “triangular” division. The exercise was apparently very successful as further tests were called for after analysis of the results by Army planners. The following year units of the Eighth Corps Area, including the 2d Div., were assembled at Camp Bullis for the Third Army Maneuvers. In January 1939, the division was reorganized for the second time as a triangular division, this time for the Provisional 2d Division (P2D) tests. These tests finalized the decision to adopt the new triangular organization for Regular Army divisions. As a result, in October 1939, the division’s 4th Brig. was disbanded, the 1st and 20th Inf. Regts. were relieved from assignment, and the 38th Inf. Regt. was assigned to the division to make its transition to the triangular concept complete. In May 1940, the “Indianhead” Division deployed to the vicinity of Horton, TX, to train under this new organization in preparation for the next Third Army Maneuver. The 1940 Third Army maneuvers were held in west central Louisiana in August 1940 and consisted primarily of the R.A. and N.G. divisions from the Fourth and Eighth Corps Areas. After the exercises in Louisiana, the “Indianhead” Division returned to Fort Sam Houston. The following June, the division moved to Brownwood, TX, to participate in the VIII Corps maneuver held there that month. In August 1941, the division returned to the Louisiana Maneuver Area for the GHQ Maneuvers between the Second and Third Armies, after which it returned to its home station. Location of the division HQ on 7 December 1941 was Fort Sam Houston, TX.

**Status:** HHC are currently active in the R.A. at Camp Red Cloud, Republic of Korea (ROK), as HHC, 2d Inf. Div.

**Events:** 45, 47, 55, 70, 74, 80, 105, 125, 147, 163, 217, 242, 258, 282, 288, 295, 296, 299, 300, 317, 328

#### Division Commanders

Maj. Gen. John Biddle	21 August 1919–1 February 1920	Maj. Gen. Halstead Dorey	12 November 1929–20 May 1934
Maj. Gen. James G. Harbord	1 February 1920–11 July 1921	Brig. Gen. Charles R. Howland	20 May 1934–28 February 1935
Maj. Gen. John L. Hines	11 July 1921–11 October 1921	Maj. Gen. Frank C. Bolles	1 March 1935–29 July 1935
Maj. Gen. Edward M. Lewis	11 October 1921–20 December 1922	Brig. Gen. Alexander Ovenshine	29 July 1935–3 April 1936
Brig. Gen. Dennis E. Nolan	21 December 1922–11 June 1923	Maj. Gen. Charles E. Kilbourne	3 April 1936–30 May 1936
Brig. Gen. Benjamin A. Poore	11 June 1923–3 July 1923	Brig. Gen. Alexander Ovenshine	30 May 1936–2 July 1936
Maj. Gen. Ernest Hinds	3 July 1923–17 October 1924	Maj. Gen. Herbert J. Brees	2 July 1936–1 October 1936
Brig. Gen. Preston Brown	17 October 1924–7 April 1925	Maj. Gen. James K. Parsons	4 October 1936–5 March 1938
Brig. Gen. Paul B. Malone	7 April 1925–13 June 1926	Brig. Gen. Charles F. Humphrey	5 March 1938–2 May 1938
Maj. Gen. William D. Connor	13 June 1926–17 December 1927	Maj. Gen. Frank W. Rowell	2 May 1938–23 March 1939
Brig. Gen. Thomas Q. Donaldson	24 December 1927–27 February 1928	Maj. Gen. Walter Krueger	31 March 1939–14 October 1940
Brig. Gen. Harold B. Fiske	27 February 1928–31 March 1928	Maj. Gen. James L. Collins Sr.	14 October 1940–1 March 1941
Brig. Gen. Albert J. Bowley	31 March 1928–13 April 1929	Maj. Gen. John N. Greely	1 March 1941–5 November 1941
Brig. Gen. Samuel D. Rockenbach	13 April 1929–12 November 1929	Maj. Gen. John C.H. Lee	5 November 1941–May 1942

#### 2d DIVISION Organization 1923

UNIT:	LOCATION:
HQ	Fort Sam Houston, TX
HQ, Special Troops	Fort Sam Houston, TX
HQ & M.P. Co.	Fort Sam Houston, TX
2d Sig. Co.	Fort Sam Houston, TX
2d Ord. Co. (M)	Fort Sam Houston, TX
2d Tank Co. (L)	Fort Sam Houston, TX
Mtcyl Co. No. 2	Fort Sam Houston, TX
3d Inf. Brig.	Fort Sam Houston, TX
9th Inf. Regt.	Fort Sam Houston, TX
23d Inf. Regt.	Fort Sam Houston, TX
4th Inf. Brig.	Fort Sam Houston, TX
1st Inf. Regt.	Fort Sam Houston, TX
20th Inf. Regt.	Fort Sam Houston, TX
2d F.A. Brig.	Fort Sam Houston, TX
2d Ammo. Tn.	Fort Sam Houston, TX
12th F.A. Regt.	Fort Sam Houston, TX
15th F.A. Regt.	Fort Sam Houston, TX
2d Engr. Regt.	Fort Sam Houston, TX
2d Med. Regt.	Fort Sam Houston, TX
2d Div. Tn., Q.M.C.	Fort Sam Houston, TX

#### 2d DIVISION Organization 1939

UNIT:	LOCATION:
HQ	Fort Sam Houston, TX
HQ, Special Troops	Fort Sam Houston, TX
HQ & M.P. Co.	Fort Sam Houston, TX
2d Sig. Co.	Fort Sam Houston, TX
2d Ord. Co. (M)	Fort Sam Houston, TX
2d Tank Co. (L)	Fort Sam Houston, TX
3d Inf. Brig.	Fort Sam Houston, TX
9th Inf. Regt.	Fort Sam Houston, TX
23d Inf. Regt.	Fort Sam Houston, TX
4th Inf. Brig.	Fort Francis E. Warren, WY
1st Inf. Regt.	Fort Francis E. Warren, WY
20th Inf. Regt.	Fort Francis E. Warren, WY
2d F.A. Brig.	Fort Sam Houston, TX
2d Ammo. Tn.	Eighth Corps Area
12th F.A. Regt.	Fort Sam Houston, TX
15th F.A. Regt.	Fort Sam Houston, TX
17th F.A. Regt.	Fort Bragg, NC
2d Engr. Regt.	Fort Logan, CO
2d Med. Regt.	Fort Sam Houston, TX
2d Q.M. Regt.	Fort Sam Houston, TX

#### 3d DIVISION

#### “Marne”

HQ—Camp Pike, AR, 1919–21; Fort Lewis, WA, 1921–41

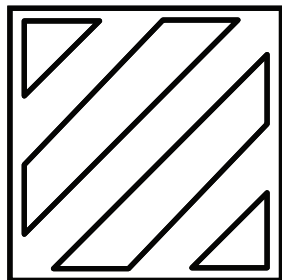

The 3d Div. arrived at Camp Merritt, Hoboken, NJ, between 23 and 28 August 1919, after completing 9 months of occupation duty near and in Mayen, Germany. At Camp Merritt, all emergency period personnel were discharged from the service. The division proceeded to Camp Pike, AR, where the division HQ arrived 31 August 1919. The division was allotted to the Ninth Corps Area as IX Corps troops in 1921, and as a result, the division was transferred on a permanent change of station to Camp Lewis, WA, where it arrived in September. The division's units were ordered to posts throughout the western United States and Alaska that fall and the early winter of 1922. The division HQ remained at Camp Lewis, as did the division's special troops. The 5th Inf. Brig. moved its HQ to Vancouver Barracks, WA, and its subordinate

units to posts in Washington, North Dakota, and Alaska. The 6th Inf. Brig. was headquartered at Fort Douglas, UT, as was the 38th Inf., while the 30th Inf. was stationed at the Presidio of San Francisco. The 3d F.A. Brig.'s units were located at Camp Lewis with the exception of the 76th F.A. Regt., which was split between Fort D.A. Russell, WY, and the Presidio of Monterey, CA. The division's units usually conducted the training of O.R., CMTC, and ROTC units at various posts throughout the Ninth Corps Area during the summer months. The officers of the IX Corps, XIX Corps, and the 91st, 96th, and 104th Divs., were habitually trained at the O.R. camps. Training of divisional units took place for the most part in the late summer and early fall after they assisted the training of the Reserve Components. The largest concentration of division units since 1921 occurred in 1927 when all units, except the 6th Inf. Brig., were assembled at Camp Lewis for division maneuvers that April. The next major training event for the division came in August 1931 when much of the "Marne" Division (not including the 5th Brig. and parts of the 3d F.A. Brig.), was assembled at the Gigling Reservation in California to maneuver against the 11th Cav. The first opportunity to assemble the entire division came in April 1937 when all elements, except one battalion in Alaska, converged on Fort Lewis for division maneuvers. Oddly, 3 months later the division did not participate in the Fourth Army Maneuvers as a complete unit, but was split between Fort Lewis, WA, and Camp Ord, CA. The 3d Div. reorganized into the "triangular" configuration in October 1939 when the 4th and 38th Inf. Regts. were relieved from the troop list, the 15th Inf. assigned, and the field artillery regiments reorganized into battalions. Beginning in December 1939, the division participated in numerous training exercises to better prepare it for the impending war. That month, the "Marne" Division deployed to California for amphibious operations at Monterey and maneuver training at Camp Ord to test the new triangular organization. After the exercises in California, the division returned to Fort Lewis to participate in the Fourth Army Maneuvers near Fort Lewis and Centralia, WA, in August 1940. In April 1941, the "Marne" Division participated in the IX Corps maneuver at Fort Lewis and operated against the 41st Div. in that exercise. The following month, the division moved to Hunter-Liggett Military Reservation, CA, to participate in the Fourth Army Maneuver there, which pitted the IX Corps against the III Corps. The 3d Div. returned to Fort Lewis in July and there participated in another Fourth Army Maneuver, this time in the vicinity of Fort Lewis-Centralia, WA, in August–September 1941. Location of the division HQ on 7 December 1941 was Fort Lewis, WA.

**Organization Day:** 15 July. Selected to commemorate the division's baptism of fire during the Marne Defensive, 15 July 1918. Adopted 24 March 1920.

**Status:** HHC are currently active in the R.A. at Fort Stewart, GA, as HHC, 3d Inf. Div (Mecz).

**Events:** 57, 114, 135, 145, 161, 193, 199, 204, 208, 221, 226, 238, 251, 273, 279, 289, 294, 304, 306, 309, 314, 326

#### Division Commanders

Maj. Gen. Samuel D. Sturgis	25 June 1919–21 November 1919	Brig. Gen. Michael J. Lenihan	May 1928–26 March 1929
Maj Gen. William M. Wright	21 November 1919–5 January 1920	Brig. Gen. Joseph C. Castner	15 April 1929–7 November 1933
Brig. Gen. Edward M. Lewis	5 January 1920–15 September 1921	Brig. Gen. Henry W. Butner	15 November 1933–1 February 1934
Maj. Gen. Charles H. Muir	16 September 1921–25 November 1922	Brig. Gen. Otho B. Rosenbaum	1 February 1934–16 August 1935
Brig. Gen. Ulysses G. McAlexander	25 November 1922–April 1923	Maj. Gen. Caspar H. Conrad Jr.	18 August 1935–31 August 1936
Brig. Gen. Robert Alexander	April 1923–1 November 1923	Maj. Gen. David L. Stone	21 September 1936–1 April 1937
Brig. Gen. Edwin B. Babbitt	1 November 1923–September 1924	Brig. Gen. Walter C. Sweeney	1 April 1937–1 July 1937
Brig. Gen. Joseph E. Kuhn	September 1924–3 December 1924	Brig. Gen. Alfred T. Smith	1 July 1937–31 May 1938
Maj. Gen. William H. Johnson	3 December 1924–19 October 1925	Brig. Gen. Thomas E. Merrill	31 May 1938–4 June 1938
Brig. Gen. Robert Alexander	19 October 1925–18 June 1927	Maj. Gen. Walter C. Sweeney	4 June 1938–15 January 1939
Brig. Gen. Joseph D. Leitch	18 June 1927–17 July 1927	Brig. Gen. Thomas E. Merrill	15 January 1939–1 June 1939
Brig. Gen. Richmond P. Davis	17 July 1927–5 October 1927	Maj. Gen. Walter C. Sweeney	1 June 1939–1 July 1940
Maj. Gen. Joseph D. Leitch	5 October 1927–5 March 1928	Maj. Gen. Charles F. Thompson	1 July 1940–July 1941
Brig. Gen. Michael J. Lenihan	5 March 1928–March 1928	Brig. Gen. Charles P. Hall	July 1941–11 August 1941
Brig. Gen. Charles R. Howland	March 1928–May 1928	Maj. Gen. John P. Lucas	11 August 1941–March 1942

#### 3d DIVISION Organization 1923

UNIT:	LOCATION:
HQ	Camp Lewis, WA
HQ, Special Troops	Camp Lewis, WA
HQ & M.P. Co.	Camp Lewis, WA
3d Sig. Co.	Camp Lewis, WA
3d Ord. Co. (M)	Camp Lewis, WA
3d Tank Co. (L)	Camp Lewis, WA
Mtcyl Co. No. 3	Camp Lewis, WA

#### 3d DIVISION Organization 1939

UNIT:	LOCATION:
HQ	Fort Lewis, WA
HQ, Special Troops	Fort Lewis, WA
HQ & M.P. Co.	Fort Lewis, WA
3d Sig. Co.	Fort Lewis, WA
3d Ord. Co. (M)	Fort Lewis, WA
3d Tank Co. (L)	Fort Lewis, WA

5th Inf. Brig.	Vancouver Barracks, WA	5th Inf. Brig.	Vancouver Barracks, WA
4th Inf. Regt.	Fort George Wright, WA	4th Inf. Regt.	Fort George Wright, WA
7th Inf. Regt.	Vancouver Barracks, WA	7th Inf. Regt.	Vancouver Barracks, WA
6th Inf. Brig.	Fort Douglas, UT	6th Inf. Brig.	Fort Douglas, UT
30th Inf. Regt.	Presidio of San Francisco, CA	30th Inf. Regt.	Presidio of San Francisco, CA
38th Inf. Regt.	Fort Douglas, UT	38th Inf. Regt.	Fort Douglas, UT
3d F.A. Brig.	Camp Lewis, WA	3d F.A. Brig.	Fort Lewis, WA
3d Ammo. Tn.	Camp Lewis, WA	3d Ammo. Tn. ***	Fort Lewis, WA
10th F.A. Regt.	Camp Lewis, WA	9th F.A. Regt.*	Fort Lewis, WA
76th F.A. Regt.	Fort D.A. Russell, WY	10th F.A. Regt.	Fort Lewis, WA
		76th F.A. Regt.	Fort D.A. Russell, WY
6th Engr. Regt.	Camp Lewis, WA	6th Engr. Regt.	Fort Lawton, WA
3d Med. Regt.	A.A.–HQ, Camp Lewis	3d Med. Regt.	Fort Lewis, WA
3d Div. Tn., Q.M.C.	Presidio of San Francisco, CA	3d Q.M. Regt.	Fort Lewis, WA

\*Indicates unit was partially active. HQ location shown was the unit's mobilization location.

\*\*Indicates unit was organized with O.R. personnel as an RAI unit.

\*\*\*Indicates unit was wholly inactive or not organized. HQ location shown is mobilization post.

#### 4th DIVISION

#### “Ivy Division”

**HQ**—Camp Dodge, IA, 1919–20; Camp Lewis, WA, 1920–21; *Inactive*, 1921–27; Fort McPherson, GA, 1927–40; Fort Benning, GA, 1940–41

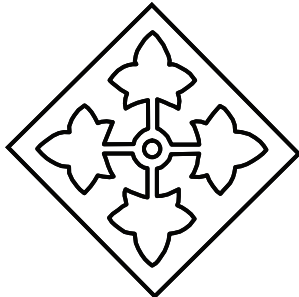

The 4th Div. arrived at Camp Merritt, NJ, on 1 August 1919, after completing 8 months of occupation duty near and in Bad Bertrich and Nieder-Breisig, Germany. Emergency period personnel were discharged from the service at Camp Merritt after arrival. The division proceeded to Camp Dodge, Iowa, and arrived 8 August. The division took up temporary station at Camp Dodge from August 1919 to January 1920. It was transferred to Camp Lewis, WA, in January 1920 for permanent station. The division was inactivated 21 September 1921, less the 8th Inf. Brig. and several other divisional elements, at Camp Lewis. The remaining division personnel and equipment were transferred to the 3d Div. Concurrently, the inactivated units were assigned to active associate units for mobilization purposes. For mobilization responsibility, the division was allotted to the Fourth Corps Area and assigned to the IV Corps. Camp McClellan, AL, was designated as the mobilization and training

station for the division upon reactivation. During the period 1921–39, the 4th Div. was represented by the 8th Inf. Brig. and other assorted active elements, which formed the base force from which the division would be reactivated in the event of war. The division HQ was organized by June 1927 with O.R. personnel as an RAI unit at Fort McPherson, GA. Many of the inactive elements of the division were also organized after mid-1927 as RAI units. The RAI units generally trained with the active elements of the division during summer training camps. Several units, such as the 4th Sig. Co., 4th Engrs., and the 39th Inf. were affiliated with various colleges and universities sponsoring ROTC and organized as RAI units with the R.A. cadre there and commissionees from the schools' programs. The active elements of the division also maintained habitual training relationships with many O.R. units of the IV Corps, XIV Corps, and the 81st, 82d, and 87th Divs. The training of those O.R. units was usually conducted at Camp McClellan, AL, and frequently, at regimental home stations located throughout the Fourth Corps Area. The 8th and 22d Inf. Regts. also supported the Reserve units' conduct of the CMTC held at Camp McClellan and Fort McPherson. The 8th Inf. Brig., reinforced by the active elements of the 4th Tank Co., 83d F.A., and 4th Engrs. held annual maneuvers at Fort Benning, GA. The division HQ was occasionally formed in a provisional status during summer camps or CPXs to train Regular and O.R. officers in division-level command and control procedures. It was provisionally formed on 5 September 1936 for the Third Army CPX held that month at Camp Bullis, TX. The division HQ was also provisionally formed for the August 1938 Third Army Maneuvers in the DeSoto National Forest in Mississippi. For that maneuver, the division (8th Brig. as the nucleus) was reinforced by the 17th Ord. Co., a detachment of the 51st Sig. Bn. and the

Georgia N.G.'s 122d Inf., in addition to the active divisional elements. The 4th Div. was reactivated 1 June 1940 at Fort Benning as part of the IV Corps under the new "triangular" tables of organization. The division participated in the Third Army Louisiana Maneuvers August–September 1940, in the GHQ Louisiana Maneuvers September–October 1941, and in the Carolina Maneuvers October–November 1941. Location of the division HQ on 7 December 1941 was Fort Benning, GA.

**Status:** HHC are currently active in the R.A. at Fort Hood, TX, as HHC, 4th Inf. Div. (Mecz).

**Events:** 217, 255, 310, 330

#### Division Commanders

Maj. Gen. John L. Hines	21 November 1919–31 December 1919	<i>No CG assigned*</i>	June 1927–16 June 1940
Brig. Gen. Edwin B. Babbitt	1 January 1920–30 September 1920	Maj. Gen. Walter E. Prosser	16 June 1940–9 October 1940
Maj. Gen. Charles H. Muir	30 September 1920–21 September 1921	Maj. Gen. Lloyd R. Fredendall	9 October 1940–18 August 1941
<i>HQ inactive*</i>	21 September 1921–June 1927	Maj. Gen. Oscar W. Griswold	18 August 1941–14 October 1941
	Maj. Gen. Fred C. Wallace		14 October 1941–30 June 1942

\*Commander, 8th Inf. Brig. designated CG for mobilization purposes 1921–40.

#### 4th DIVISION Organization 1923

UNIT:	LOCATION:
<i>HQ</i>	<i>A.A.–8th Inf. Brig.</i>
<i>HQ, Special Troops</i>	<i>A.A.–8th Inf. Brig.</i>
<i>HQ &amp; M.P. Co.</i>	<i>A.A.–8th Inf. Brig.</i>
<i>4th Sig. Co.</i>	<i>A.A.–3d Sig. Co.</i>
<i>4th Ord. Co. (M)</i>	<i>A.A.–3d Ord. Co.</i>
<i>4th Tank Co. (L)</i>	<i>A.A.–1st Tank Gp.</i>
<i>Mtcyl Co. No. 4</i>	<i>A.A.–Mtcyl Co. No. 3</i>
<i>7th Inf. Brig.</i>	<i>A.A.–8th Inf. Brig.</i>
<i>39th Inf. Regt.</i>	<i>A.A.–8th Inf. Regt.</i>
<i>47th Inf. Regt.</i>	<i>A.A.–22d Inf. Regt.</i>
8th Inf. Brig.	Fort McPherson, GA
8th Inf. Regt.	Fort Screven, GA
22d Inf. Regt.	Fort McPherson, GA
<i>4th F.A. Brig.</i>	<i>A.A.–3d F.A. Brig.</i>
<i>4th Ammo. Tn.</i>	<i>A.A.–3d Ammo Tn.</i>
16th F.A. Regt.*	Fort Myer, VA
<i>77th F.A. Regt.</i>	<i>A.A.–76th F.A. Regt.</i>
4th Engr. Regt.*	Fort Bragg, NC
<i>4th Med. Regt.</i>	<i>A.A.–HQ, Camp Lewis</i>
<i>4th Div. Tn., Q.M.C.</i>	<i>A.A.–Q. M. General</i>

#### 4th DIVISION Organization 1939

UNIT:	LOCATION:
<i>HQ**</i>	Fort McPherson, GA
<i>HQ, Special Troops</i>	Atlanta, GA
<i>HQ &amp; M.P. Co.</i>	Atlanta, GA
<i>4th Sig. Co.</i>	Fort Des Moines, IA
<i>17th Ord. Co. (M)</i>	Fort Benning, GA
<i>4th Tank Co. (L)*</i>	Fort McClellan, AL
<i>7th Inf. Brig.**</i>	Atlanta, GA
<i>29th Inf. Regt.</i>	Fort Benning, GA
<i>39th Inf. Regt.**</i>	Clemson, SC
8th Inf. Brig.	Fort McPherson, GA
8th Inf. Regt.	Fort Moultrie, SC
22d Inf. Regt.	Fort McPherson, GA
4th F.A. Brig.	Fort Sill, OK
<i>4th Ammo. Tn.</i>	<i>Fourth Corps Area</i>
1st F.A. Regt.	Fort Sill, OK
77th F.A. Regt.	Fort D.A. Russell, TX
83d F.A. Regt.*	Fort Benning, GA
4th Engr. Regt.**	Auburn, AL
4th Med. Regt.	Fort Benning, GA
4th Q.M. Regt.**	Atlanta, GA

\*Indicates unit was partially active. HQ location shown was the unit's mobilization location.

\*\*Indicates unit was organized with O.R. personnel as an RAI unit.

\*\*\*Indicates unit was wholly inactive or not organized. HQ location shown is mobilization post.

#### 5th DIVISION

#### "Red Diamond"

**HQ**—Camp Gordon, GA, 1919–20; Camp Jackson, SC, 1920–21; *Inactive*, 1921–26; Fort Benjamin Harrison, IN, 1926–27; Columbus, OH, 1927–39; Fort McClellan, AL, 1939–40; Fort Custer, MI, 1940–41

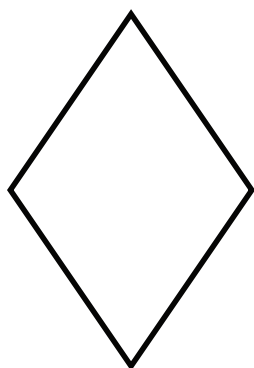

The 5th Div. arrived at Hoboken, NJ, on 21 July 1919, after completing 7 months of occupation duty near and in Esch-sur-Alzette, Luxembourg. On arrival, emergency period personnel were discharged from the service at Camp Merritt. The division proceeded to Camp Gordon, GA, arrived there 26 July and remained there until October 1920. It was transferred in October 1920 to Camp Jackson, SC, for permanent station. The division was inactivated, less the 10th Inf. Brig. and several smaller units, on 4 October 1921 at Camp Jackson. The 5th Div. was allotted to the Fifth Corps Area for mobilization responsibility and assigned to the V Corps. Camp Knox, KY, was designated as the mobilization and training station for the division upon reactivation. During the period 1921–39, the active elements of the 5th Div. consisted of the 10th Inf. Brig. and other assorted divisional elements which formed the base force from which the remainder of the division would be reactivated in the event of war. The division HQ was organized on 5 May 1926 as an RAI unit at Fort Benjamin Harrison, Indiana, and functioned essentially the same as an O.R. division.

The HQ, Fifth Corps Area subsequently ordered the division to close down operations on 1 September 1927 and all R.A. personnel assigned to the HQ were relieved. Though the command functions of the division ceased, Reserve personnel remained assigned to the division HQ for training mobilization and assignment purposes. By 1927, most of the inactive elements of the division were also organized with O.R. personnel as RAI units. The RAI units generally trained with the active elements of the division during summer training camps. Several units, such as the 5th Med. Regt., 19th and 21st F.A. Regts., and the 60th and 61st Inf. Regts. were affiliated with various colleges and universities sponsoring ROTC and organized as RAI units with the R.A. cadre there and commissionees from the schools' programs. The active elements of the division also maintained habitual training relationships with units of the V Corps, XV Corps, and the 83d, 84th, and 100th Divs. The training of those O.R. units was usually conducted at Camp Knox and at the regimental home stations of the 10th and 11th Inf. Regts. These two regiments also supported the Reserve units' conduct of the CMTC held at Camp Knox, Fort Benjamin Harrison, and Fort Thomas, KY. The 10th Inf. Brig., reinforced by the active elements of the 5th Tank Co., 3d F.A., 19th F.A., and 5th Q.M. Regt. held maneuvers, those years when funds were available, at Camp Knox. During these maneuvers, the 5th Div. HQ was occasionally formed in a provisional status to train Regular and Reserve officers in division-level command and control procedures. The division HQ was also provisionally formed for the August 1936 Second Army Maneuvers at Fort Knox. For that maneuver, the division (10th Brig. as the nucleus) was reinforced by the 1st Sig. Co. and the West Virginia N.G.'s 201st Inf., in addition to the other active divisional elements. Under the new "triangular" tables of organization, the 5th Div. was reactivated on 16 October 1939 at Fort McClellan, AL, relieved from the V Corps, and assigned to the Second Army. The division participated in the Second Army Maneuvers in August–September 1940 near Shamrock, WI. After it returned briefly to Fort McClellan, the Red Diamond Division was permanently transferred to Fort Custer, MI, on 13 December 1940. The division participated in the VII Corps Tennessee Maneuvers in May–June 1941, in the VII Corps Arkansas Maneuvers in August 1941, and the GHQ Louisiana Maneuvers in September–October 1941. Location of the division HQ on 7 December 1941 was Fort Custer, MI.

**Status:** HHC are currently inactive as HHC, 5th Inf. Div. (Mecz).

**Events:** 85, 264, 293, 296, 302, 316, 328

#### Division Commanders

Maj. Gen. Samuel D. Sturgis	May 1919–4 July 1919	Brig. Gen. George H. Jamerson***	22 February 1933–23 March 1933
Maj. Gen. Edward M. Lewis	4 July 1919–18 December 1919	Maj. Gen. George V.H. Moseley***	23 March 1933–12 January 1934
Maj. Gen. Wilds P. Richardson	18 December 1919–2 March 1920	Brig. Gen. Julian R. Lindsey***	12 January 1934–1 May 1934
Maj. Gen. William L. Sibert	2 March 1920–4 April 1920	Maj. Gen. Albert J. Bowley***	1 May 1934–1 October 1935
Maj. Gen. David C. Shanks	1 May 1920–27 August 1920	Brig. Gen. William K. Naylor***	1 October 1935–25 January 1936
Maj. Gen. John L. Hines	27 September 1920–7 July 1921	Maj. Gen. William E. Cole***	25 January 1936–31 July 1938
Maj. Gen. Samuel D. Sturgis	7 July 1921–4 October 1921	Maj. Gen. Daniel Van Voorhis***	1 August 1938–33 October 1939
<i>HQ inactive</i>	5 October 1921–4 May 1926	Brig. Gen. Campbell B. Hodges	24 October 1939–30 May 1940
Brig. Gen. Dwight E. Aultman**	5 May 1926–12 July 1927	Brig. Gen. Lloyd R. Fredendall	31 May 1940–3 September 1940
Col. George D. Freeman**	12 July 1927–1 September 1927	Maj. Gen. Joseph M. Cummins	3 September 1940–26 July 1941
Maj. Gen. Dennis E. Nolan***	1 September 1927–30 November 1931	Maj. Gen. Charles H. Bonesteel	26 July 1941–September 1941
Maj. Gen. Hugh A. Drum***	3 December 1931–22 February 1933	Maj. Gen. Cortlandt Parker	September 1941–June 1943

\*Commander, 10th Inf. Brig. designated CG for mobilization purposes 1921–26.

\*\*Concurrently commander, 10th Inf. Brig.

\*\*\*Concurrently commanding general, Fifth Corps Area.



**5th DIVISION  
Organization 1923**

<b>UNIT:</b>	<b>LOCATION:</b>
<i>HQ</i>	<i>A.A.–10th Inf. Brig.</i>
<i>HQ, Special Troops</i>	<i>A.A.–10th Inf. Brig.</i>
<i>HQ &amp; M.P. Co.</i>	<i>A.A.–10th Inf. Brig.</i>
<i>5th Sig. Co.</i>	<i>A.A.–2d Sig. Co.</i>
<i>5th Ord. Co. (M)</i>	<i>A.A.–15th Ord. Co.</i>
<i>5th Tank Co. (L)*</i>	Fort Benjamin Harrison, IN
<i>Mtcyl Co. No. 5</i>	<i>A.A.–Mtcyl. Co. No. 2</i>
<i>9th Inf. Brig.</i>	<i>A.A.–10th Inf. Brig.</i>
<i>60th Inf. Regt.</i>	<i>A.A.–10th Inf. Regt.</i>
<i>61st Inf. Regt.</i>	<i>A.A.–11th Inf. Regt.</i>
<i>10th Inf. Brig.</i>	Fort Benjamin Harrison, IN
<i>10th Inf. Regt.</i>	Fort Thomas, KY
<i>11th Inf. Regt.</i>	Fort Benjamin Harrison, IN
<i>5th F.A. Brig.</i>	<i>A.A.–1st F.A. Brig.</i>
<i>5th Ammo. Tn.</i>	<i>A.A.–1st Ammo. Tn.</i>
<i>19th F.A. Regt.</i>	<i>A.A.–6th F.A. Regt.</i>
<i>20th F.A. Regt.</i>	<i>A.A.–12th F.A. Regt.</i>
<i>7th Engr. Regt.*</i>	Fort Benning, GA
<i>5th Med. Regt.</i>	<i>A.A.–2d Med. Regt.</i>
<i>5th Div. Tn., Q.M.C.</i>	<i>A.A.–Q.M. General</i>

**5th DIVISION  
Organization 1939**

<b>UNIT:</b>	<b>LOCATION:</b>
<i>HQ**</i>	Columbus, OH
<i>HQ, Special Troops**</i>	Columbus, OH
<i>HQ &amp; M.P. Co.**</i>	Columbus, OH
<i>5th Sig. Co.**</i>	Columbus, OH
<i>21st Ord. Co. (M)**</i>	Cincinnati, OH
<i>5th Tank Co. (L)*</i>	Fort Benjamin Harrison, IN
<i>9th Inf. Brig.**</i>	Columbus, OH
<i>60th Inf. Regt.**</i>	Columbus, OH
<i>61st Inf. Regt.**</i>	Lexington, KY
<i>10th Inf. Brig.</i>	Fort Benjamin Harrison, IN
<i>10th Inf. Regt.</i>	Fort Thomas, KY
<i>11th Inf. Regt.</i>	Fort Benjamin Harrison, IN
<i>5th F.A. Brig.**</i>	Indianapolis, IN
<i>5th Ammo. Tn.**</i>	Lima, OH
<i>19th F.A. Regt.**</i>	Columbus, OH
<i>20th F.A. Regt.**</i>	Toledo, OH
<i>21st F.A. Regt.**</i>	Lafayette, IN
<i>7th Engr. Regt.**</i>	Cleveland, OH
<i>5th Med. Regt.**</i>	Akron, OH
<i>5th Q.M. Regt.**</i>	Dayton, OH

\*Indicates unit was partially active. HQ location shown was the unit's mobilization location.

\*\*Indicates unit was organized with O.R. personnel as an RAI unit.

\*\*\*Indicates unit was wholly inactive or not organized. HQ location shown is mobilization post.

**6th DIVISION**

**“Sight-Seeing Sixth”**

**HQ**—Camp Grant, IL, 1919–21; *Inactive*, 1921–26; Chicago, IL, 1926–39; Fort Lewis, WA, 1939–40; Fort Jackson, SC, 1940; Fort Snelling, MN, 1940–41; Fort Leonard Wood, MO, 1941

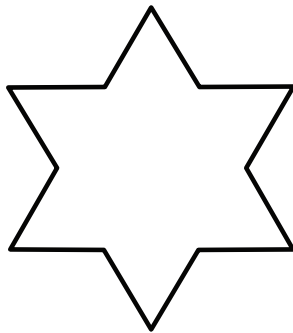

The 6th Div. arrived at Camp Mills, NY, on 10 June 1919 after completing 6 months of training at Aignay-le-Duc, France, and occupation duty near and in Bad Bertrich, Germany. On arrival, emergency period personnel were discharged from the service at Camp Mills. The division proceeded to Camp Grant, IL, arrived 17 June, and remained there until September 1921. The division was inactivated, less the 12th Inf. Brig. and several smaller units, on 30 September 1921 at Camp Grant. Concurrently, the inactivated units were assigned active associate units for mobilization purposes. The 6th Div. was allotted to the Sixth Corps Area for mobilization responsibility and assigned to the VI Corps. Camp Grant was designated as the mobilization and training station for the division upon reactivation. During the period 1921–39, the active elements of the 6th Div. consisted of the 12th Inf. Brig. and other assorted divisional elements that formed the base force from which the remainder of the division would

be reactivated in the event of war. The division HQ was organized on 17 April 1926 with O.R. personnel as an RAI unit at Chicago. Additionally, most of the division's inactive elements were also organized by mid-1927 as RAI units. Most of these units were organized in the Chicago area. The active elements of the division maintained habitual training relationships with divisional RAI units, as well as those of the VI Corps, XVI Corps, and the 85th, 86th, and 101st Divs. The RAI and O.R. units often trained with the active elements of the division during summer training camps which were usually conducted at Camp Custer, MI, Fort Sheridan, IL, and at the regimental home stations of the 2d and 6th Inf. Regts. These two regiments also supported the Reserve units' conduct of the CMTC held at Fort Sheridan and Jefferson Barracks, MO. The 12th Inf. Brig., reinforced by the active elements of the 6th Tank Co., 6th F.A. Brig., 3d F.A., 14th F.A., and 6th Q.M. Regt., held maneuvers, those years when funds were available, at Camp Custer. During these maneuvers, the 6th Div. HQ was often formed in a provisional status to train Regular and Reserve

officers in division-level command and control procedures. The division was also provisionally formed for the August 1936 Second Army Maneuvers at Camp Custer and Allegan, MI. For that maneuver, the division (12th Brig. as the nucleus) was reinforced by the Illinois N.G.'s 8th Inf. (Colored), in addition to the other active divisional elements. Under the new "triangular" tables of organization, the 6th Div. was reactivated 10 October 1939 at Fort Lewis, WA. It was transferred to Fort Jackson, SC, on 9 November 1939, relieved from the VI Corps, and attached to the IV Corps. After maneuvers in Louisiana in May 1940, the division was transferred to Fort Snelling, MN, and assigned to the Second Army. The division participated in the Second Army Maneuvers at Camp Ripley, MN, in August 1940, in the Second Army Maneuvers in Arkansas in August 1941, and in the GHQ Maneuvers in Louisiana in September–October 1941. After the GHQ Maneuvers the 6th Div. was moved to Fort Leonard Wood, MO, for permanent station and arrived there 10 October 1941. Location of the division HQ on 7 December 1941 was Fort Leonard Wood, MO.

**Status:** HHC are currently inactive as HHC, 6th Inf. Div. (Light).

**Events:** 148, 162, 264, 293, 296, 303, 316, 328

#### Division Commanders

Maj. Gen. George Bell Jr. <i>HQ inactive*</i> <i>No CG assigned*</i>	29 September 1919–30 September 1921 30 September 1921–16 April 1926 17 April 1926–9 October 1939	Brig. Gen. Clement A. Trott Brig. Gen. Frederick E. Uhl Maj. Gen. Clarence Ridley	10 October 1939–1 October 1940 1 October 1940–25 January 1941 25 January 1941–23 September 1942
----------------------------------------------------------------------------	--------------------------------------------------------------------------------------------------------	-----------------------------------------------------------------------------------------	-------------------------------------------------------------------------------------------------------

\*Commander, 12th Inf. Brig. designated CG for mobilization purposes 1921–39.

#### 6th DIVISION Organization 1923

UNIT:	LOCATION:
<i>HQ</i>	<i>A.A.–12th Inf. Brig.</i>
<i>HQ, Special Troops</i>	<i>A.A.–12th Inf. Brig.</i>
<i>HQ &amp; M.P. Co.</i>	<i>A.A.–12th Inf. Brig.</i>
<i>6th Sig. Co.</i>	<i>A.A.–13th Sig. Tp.</i>
<i>6th Ord. Co. (M)</i>	<i>A.A.–9th Ord. Co.</i>
<i>6th Tank Co. (L)*</i>	Jefferson Barracks, MO
<i>Mtcyl Co. No. 6</i>	<i>A.A.–Mtcyl Co. No. 1</i>
<i>11th Inf. Brig.</i>	<i>A.A.–12th Inf. Brig.</i>
<i>51st Inf. Regt.</i>	<i>A.A.–2d Inf. Regt.</i>
<i>52d Inf. Regt.</i>	<i>A.A.–6th Inf. Regt.</i>
<i>12th Inf. Brig.</i>	Fort Sheridan, IL
<i>2d Inf. Regt.</i>	Fort Sheridan, IL
<i>6th Inf. Regt.</i>	Jefferson Barracks, MO
<i>6th F.A. Brig.</i>	<i>A.A.–2d F.A. Brig.</i>
<i>6th Ammo. Tn.</i>	<i>A.A.–2d Ammo. Tn.</i>
<i>14th F.A. Regt.</i>	Fort Sheridan, IL
<i>78th F.A. Regt.</i>	<i>A.A.–15th F.A. Regt.</i>
<i>12th Engr. Regt.</i>	<i>A.A.–1st Engr. Regt.</i>
<i>6th Med. Regt.</i>	<i>A.A.–1st Med. Regt.</i>
<i>6th Div. Tn., Q.M.C.</i>	<i>A.A.–Q.M. General</i>

#### 6th DIVISION Organization 1939

UNIT:	LOCATION:
HQ**	Chicago, IL
HQ, Special Troops**	Chicago, IL
HQ & M.P. Co.**	Chicago, IL
6th Sig. Co. **	Chicago, IL
13th Ord. Co. (M)**	Chicago, IL
6th Tank Co. (L)	Jefferson Barracks, MO
11th Inf. Brig.**	Chicago, IL
51st Inf. Regt.**	Milwaukee, WI
52d Inf. Regt.**	Chicago, IL
12th Inf. Brig.	Fort Sheridan, IL
2d Inf. Regt.	Fort Wayne, MI
6th Inf. Regt.	Jefferson Barracks, MO
6th F.A. Brig.	Fort Sheridan, IL
6th Ammo. Tn.**	Quincy, IL
3d F.A. Regt.*	Fort Sheridan, IL
22d F.A. Regt.**	Chicago, IL
78th F.A. Regt.**	Chicago, IL
10th Engr. Regt.**	Chicago, IL
6th Med. Regt.**	Chicago, IL
6th Q.M. Regt.**	Chicago, IL

\*Indicates unit was partially active. HQ location shown was the unit's mobilization location.

\*\*Indicates unit was organized with O.R. personnel as an RAI unit.

\*\*\*Indicates unit was wholly inactive or not organized. HQ location shown is mobilization post.

**7th DIVISION**

**“Bayonet Division”**

**HQ**—Camp Funston, KS, 1919–20; Camp George G. Meade, MD, 1920–21; *Inactive*, 1921–40; Fort Ord, CA, 1940–41

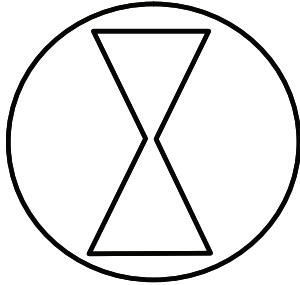

The 7th Div. arrived at Camp Mills, NY, 20 June 1919, after completing 6 months of training at the Colombey-Les Belles Training Area, France. On arrival, emergency period personnel were discharged from the service at Camp Mills. The division proceeded to Camp Funston, KS, arrived 29 June, and remained there until July 1920. The division was transferred to Camp George G. Meade, MD, in July 1920 for permanent station. It was inactivated, less the 14th Inf. Brig. and several smaller units, on 22 September 1921 at Camp Meade. Concurrently, the inactivated units were assigned active associate units for mobilization purposes. The 7th Div. was allotted to the Seventh Corps Area for mobilization responsibility and assigned to the VII Corps. Fort Snelling, MN, was designated as the mobilization and training station for the division upon reac-

tivation. During the period 1921–39, the 7th Div. was represented by the 14th Inf. Brig. and other assorted active elements that formed the base force from which the division would be reactivated in the event of war. Additionally, most of the inactive elements were organized by mid-1927 as RAI units with O.R. personnel. The active elements of the division maintained habitual training relationships with divisional RAI units, as well as with those of the VII Corps, XVII Corps, and the 88th, 89th, and 102d Divs. The RAI and O.R. units often trained with the active elements of the division during summer training camps usually conducted at Forts Riley, Crook, Snelling, and Leavenworth. The 3d and 17th Inf. Regts. also supported the Reserve units’ conduct of the CMTC held at Fort Leavenworth and Fort Des Moines. The 14th Inf. Brig., reinforced by the active elements of the 7th Tank Co., 9th F.A., 14th F.A., and 7th Q.M. Regt. held maneuvers, those years when funds were available, at Fort Riley or Camp Ripley, MN. During these maneuvers, the 7th Div. was occasionally formed in a provisional status to exercise division-level command and control procedures. The division HQ was also provisionally formed on 21 July 1937 for the August 1937 Fourth Army Maneuvers at Camp Ripley. For that maneuver, the division (14th Brig. as the nucleus) was reinforced by the Minnesota N.G.’s 92d Inf. Brig. in addition to the other active divisional elements. Under the new “triangular” tables of organization, the 7th Div. was reactivated 1 July 1940 at Fort Ord, CA, relieved from the VII Corps, and assigned to the III Corps. It participated in the Fourth Army Maneuvers in August 1941 at Hunter-Liggett Military Reservation, CA. Location of the division HQ on 7 December 1941 was Fort Ord, CA.

**Status:** HHC are currently active in the R.A. at Fort Carson, CO, as HHC, 7th Inf. Div., a command and control HQ for three enhanced infantry brigades of the N.G.

**Events:** 233, 314, 326

**Division Commanders**

Brig. Gen. Lutz Wahl	1 July 1919–30 September 1919	Col. Edson A. Lewis	26 July 1921–22 September 1921
Maj. Gen. Edward F. McGlachlin Jr.	30 September 1919–30 June 1921	<i>HQ inactive*</i>	22 September 1921–1 July 1940
Maj. Gen. Charles J. Bailey	19 July 1921–26 July 1921	Maj. Gen. Joseph W. Stilwell	1 July 1940–26 July 1941
	Maj. Gen. Charles H. White		4 August 1941–7 April 1942

\*Commander, 14th Inf. Brig. designated CG for mobilization purposes 1921–40.

**7th DIVISION  
Organization 1923**

<b>UNIT:</b>	<b>LOCATION:</b>
<i>HQ</i>	<i>A.A.–14th Inf. Brig.</i>
<i>HQ, Special Troops</i>	<i>A.A.–14th Inf. Brig.</i>
<i>HQ &amp; M.P. Co.</i>	<i>A.A.–14th Inf. Brig.</i>
<i>7th Sig. Co.</i>	<i>A.A.–1st Sig. Co.</i>
<i>7th Ord. Co. (M)</i>	<i>A.A.–8th Ord. Co.</i>
<i>7th Tank Co. (L)*</i>	Fort Snelling, MN
<i>Mtcyl Co. No. 7</i>	<i>A.A.–14th Inf. Brig.</i>

**7th DIVISION  
Organization 1939**

<b>UNIT:</b>	<b>LOCATION:</b>
<i>HQ***</i>	<i>Seventh Corps Area</i>
<i>HQ, Special Troops**</i>	Lincoln, NE
<i>HQ &amp; M.P. Co.**</i>	Lincoln, NE
<i>7th Sig. Co.**</i>	St. Paul, MN
<i>7th Ord. Co. (M)**</i>	St. Paul, MN
<i>7th Tank Co. (L)</i>	Fort Snelling, MN

13th Inf. Brig.	A.A.–14th Inf. Brig.	13th Inf. Brig.**	Minneapolis, MN
53d Inf. Regt.	A.A.–3d Inf. Regt.	53d Inf. Regt.**	Minneapolis, MN
54th Inf. Regt.	A.A.–17th Inf. Regt.	54th Inf. Regt.**	Omaha, NE
14th Inf. Brig.	Fort Omaha, NE	14th Inf. Brig.	Fort Snelling, MN
3d Inf. Regt.	Fort Snelling, MN	3d Inf. Regt.	Fort Snelling, MN
17th Inf. Regt.	Fort Crook, NE	17th Inf. Regt.	Fort Crook, NE
7th F.A. Brig.	A.A.–1st F.A. Brig.	7th F.A. Brig.**	Sioux City, IA
7th Ammo. Tn.	A.A.–1st Ammo. Tn.	7th Ammo. Tn.**	Sioux City, IA
9th F.A. Regt.*	Fort Des Moines, IA	14th F.A. Regt.*	Fort Snelling, MN
77th F.A. Regt.	A.A.–76th F.A. Regt.	79th F.A. Regt.**	Sioux City, IA
		80th F.A. Regt.**	Sioux City, IA
5th Engr. Regt.	A.A.–13th Engr. Regt.	5th Engr. Regt.	Fort Belvoir, VA
7th Med. Regt.	A.A.–1st Med. Regt.	7th Med. Regt.**	St. Paul, MN
7th Div. Tn., Q.M.C.	A.A.–Q.M. General	7th Q.M. Regt.**	Fort Leavenworth, KS

\*Indicates unit was partially active. HQ location shown was the unit's mobilization location.

\*\*Indicates unit was organized with O.R. personnel as an RAI unit.

\*\*\*Indicates unit was wholly inactive or not organized. HQ location shown is mobilization post.

## 8th DIVISION

## “Pathfinders”

HQ—Camp Lee, VA, 1919; *Inactive*, 1923–26; Philadelphia, PA, 1926–40; Fort Jackson, SC, 1940–41

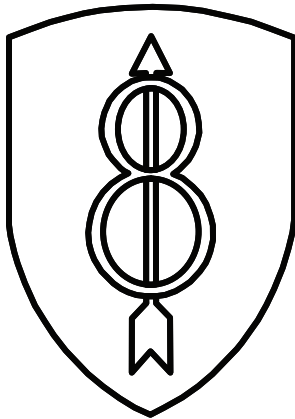

The 8th Div. was demobilized at Camp Lee, VA, on 5 September 1919. The division was reconstituted on 24 March 1923, allotted to the Third Corps Area for mobilization responsibility, and assigned to the III Corps. Camp George G. Meade, MD, was designated as the mobilization and training station for the division upon reactivation. The 16th Inf. Brig. and additional active and inactive elements were assigned to the division on 30 June 1923. The division's inactive units were assigned to active associate units for mobilization purposes. During the period 1923–39, the 8th Div. was represented by the 16th Inf. Brig. and other assorted divisional elements that formed the base force from which the remainder of the division would be reactivated in the event of war. The division HQ was organized in April 1926 with O.R. personnel as an RAI unit at Philadelphia, PA. Additionally, most of the division's inactive elements were also organized by mid-1927 as RAI units. The active elements of the division maintained habitual training relationships with divisional RAI units, as well as those of the III and XIII Corps and the 79th, 80th, and 99th Divs. For training and administration purposes, the division HQ was attached to the HQ, 16th Inf. Brig. in

August 1929. The RAI and O.R. units often trained with the active elements of the division during summer training camps usually conducted at Camp Meade. The 16th Brig.'s 12th and 34th Inf. Regts. additionally supported the Reserve units' conduct of the CMTC also held at Camp Meade. In late July 1932, the 16th Inf. Brig., reinforced by the 3d Cav. and the District of Columbia N.G.'s 260th Coast Artillery, was called out to quell potential trouble from the so-called “Bonus Army” in Washington, DC. The brigade was directed to clear the capital and Anacostia Flats of the veterans and did so in short order with relatively few injuries. When training funds were available, the 16th Brig., reinforced by the division's active elements, which included the 8th Tank Co. and 16th F.A., held maneuvers at Camp Meade during which the division HQ was occasionally formed in a provisional status. The division was also provisionally organized in 1939 for the First Army Maneuvers at Manassas, VA. For that maneuver, the division (16th Brig. as the nucleus) was reinforced by the 66th Inf. (Light Tanks), in addition to the other active divisional elements. Under the new “triangular” tables of organization, the 8th Div. was reactivated, less Reserve personnel, on 1 July 1940 at Fort Jackson, SC, and assigned to the I Corps. The division participated in the Carolina Maneuvers in September–November 1941. Location of the division HQ on 7 December 1941 was Fort Jackson, SC.

**Status:** HHC are currently inactive as HHC, 8th Inf. Div. (Mechanized).

**Events:** 330

### Division Commanders

<i>HQ demobilized/inactive</i>	5 September 1919–April 1926	Maj. Gen. James P. Marley	30 November 1940–18 February 1941
<i>No CG assigned*</i>	April 1926–30 June 1940	Maj. Gen. William E. Shedd	18 February 1941–March 1941
Maj. Gen. Philip B. Peyton	1 July 1940–30 November 1940	Maj. Gen. Henry Terrell Jr.	March 1941–3 April 1941
	Maj. Gen. James P. Marley		4 April 1941–22 June 1942

\*Commander, 16th Inf. Brig. designated CG for mobilization purposes 1923–40.

#### 8th DIVISION Organization 1923

UNIT:	LOCATION:
<i>HQ</i>	<i>A.A.–16th Inf. Brig.</i>
<i>HQ, Special Troops</i>	<i>A.A.–16th Inf. Brig.</i>
<i>HQ &amp; M.P. Co.</i>	<i>A.A.–16th Inf. Brig.</i>
<i>8th Sig. Co.</i>	<i>A.A.–Sig. Off., Third C.A.</i>
<i>15th Ord. Co. (M)</i>	Frankford Arsenal, PA
<i>8th Tank Co. (L)</i>	Camp George G. Meade, MD
<i>Mtcyl Co. No. 8</i>	<i>A.A.–Q.M. General</i>
<i>15th Inf. Brig.</i>	<i>A.A.–16th Inf. Brig.</i>
<i>40th Inf. Regt.</i>	<i>A.A.–12th Inf. Regt.</i>
<i>41st Inf. Regt.</i>	<i>A.A.–34th Inf. Regt.</i>
<i>16th Inf. Brig.</i>	Fort Howard, MD
<i>12th Inf. Regt.</i>	Fort Howard, MD
<i>34th Inf. Regt.</i>	Fort Eustis, VA
<i>8th F.A. Brig.</i>	<i>A.A.–1st Bn., 16th F.A.</i>
<i>8th Ammo. Tn.</i>	<i>A.A.–1st Bn., 16th F.A.</i>
<i>16th F.A. Regt.*</i>	<i>Fort Myer, VA</i>
<i>20th F.A. Regt.</i>	<i>A.A.–1st Bn., 16th F.A.</i>
<i>10th Engr. Regt.</i>	<i>A.A.–13th Engr. Regt.</i>
<i>8th Med. Regt.</i>	<i>A.A.–Surgeon General</i>
<i>8th Div. Tn., Q.M.C.</i>	<i>A.A.–Q.M. General</i>

#### 8th DIVISION Organization 1939

UNIT:	LOCATION:
HQ**	Philadelphia, PA
HQ, Special Troops**	Baltimore, MD
HQ & M.P. Co.**	Philadelphia, PA
8th Sig. Co.**	Fort Monmouth, NJ
15th Ord. Co. (M)	Fort Benning, GA
8th Tank Co.**	Baltimore, MD
15th Inf. Brig.**	New York City, NY
40th Inf. Regt.**	Ithaca, NY
41st Inf. Regt.**	Syracuse, NY
16th Inf. Brig.	Fort George G. Meade, MD
12th Inf. Regt.	Fort Howard, MD
34th Inf. Regt.	Fort George G. Meade, MD
8th F.A. Brig.**	Lynchburg, VA
8th Ammo. Tn.**	Roanoke, VA
16th F.A. Regt.*	Fort Myer, VA
28th F.A. Regt.**	Pittsburgh, PA
81st F.A. Regt.**	Lynchburg, VA
5th Engr. Regt.	Fort Belvoir, VA
8th Med. Regt.**	Albany, NY
8th Q.M. Regt.**	Baltimore, MD

\*Indicates unit was partially active. HQ location shown is mobilization post.

\*\*Indicates unit was organized with O.R. personnel as an RAI unit.

### 9th DIVISION

**HQ**—*Inactive*, 1923–26; Army Base, Boston, MA, 1926–40; Fort Bragg, NC, 1940–41

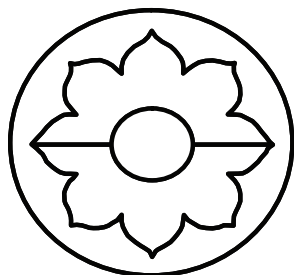

The 9th Div. was demobilized at Camp Sheridan, AL, on 15 February 1919. The division was reconstituted 24 March 1923, allotted to the First Corps Area for mobilization responsibility, and assigned to the I Corps. Camp Devens, MA, was designated as the mobilization and training station for the division upon reactivation. The 18th Inf. Brig. and additional active and inactive elements were assigned to the division on 24 March 1923. The division's inactive units were assigned to active associate units for mobilization purposes. During the period 1923–39, the 9th Div. was represented in the Active Army by the 18th Inf. Brig. and other assorted divisional elements that formed the base force from which the remainder of the division would be reactivated in the event of war. The division HQ was organized on 28 July 1926 as an RAI unit

with O.R. personnel at the Army Base, Boston, MA. Additionally, many of the inactive elements were organized as RAI units by mid-1927 in the First and Second Corps Areas. The active elements of the division maintained habitual training relationships with divisional RAI units, as well as those of the I Corps, XI Corps, and the 76th, 94th, and 97th Divs. The RAI and O.R. units often trained with the active elements of the division during summer training camps usually conducted at Camp Devens and Fort McKinley, ME. The 18th Brig.'s 5th and 13th Inf. Regts. additionally

supported the Reserve units' conduct of the CMTC also held at Camp Devens and Fort McKinley. When training funds were available, the 18th Brig. and the division's other active elements, which included the 9th Tank Co., 9th Ordnance Co., 9th Q.M. Regt., and 25th F.A., held maneuvers and CPXs at Camp Devens during which the division HQ was occasionally formed in a provisional status. The division HQ was also provisionally formed in 1939 for the First Army Maneuvers in upstate New York. Under the new "triangular" tables of organization, the 9th Div. was reactivated, less Reserve personnel, on 1 August 1940 at Fort Bragg, NC, and assigned to the I Corps. The division participated in the Carolina Maneuvers in September–November 1941. Location of the division HQ on 7 December 1941 was Fort Bragg, NC.

**Status:** HHC are currently inactive as HHC, 9th Inf. Div. (Motorized).

**Events:** 330

#### Division Commanders

<i>HQ demobilized/inactive</i>	15 February 1919–27 July 1926	Brig. Gen. Francis W. Honeycutt	14 September 1940–21 September 1940
<i>No CG assigned*</i>	28 July 1926–31 July 1940	Maj. Gen. Jacob L. Devers	9 October 1940–31 July 1941
Col. Charles B. Elliot	1 August 1940–14 September 1940	Maj. Gen. Rene' E. D. Hoyle	1 August 1941–26 June 1942

\*Commander, 18th Inf. Brig. designated CG for mobilization purposes 1923–40.

#### 9th DIVISION Organization 1923

UNIT:	LOCATION:
<i>HQ</i>	<i>A.A.–18th Inf. Brig.</i>
<i>HQ, Special Troops</i>	<i>A.A.–18th Inf. Brig.</i>
<i>HQ &amp; M.P. Co.</i>	<i>A.A.–18th Inf. Brig.</i>
<i>9th Sig. Co.</i>	<i>A.A.–Sig. Off. Ninth CA</i>
<i>8th Ord. Co. (M)</i>	<i>Watertown Arsenal, MA</i>
<i>9th Tank Co. (L)*</i>	<i>Army Base, Boston, MA</i>
<i>Mtcyl Co. No. 9</i>	<i>A.A.–Q.M. General</i>
<i>17th Inf. Brig.</i>	<i>A.A.–18th Inf. Brig.</i>
<i>36th Inf. Regt.</i>	<i>A.A.–5th Inf. Regt.</i>
<i>37th Inf. Regt.</i>	<i>A.A.–13th Inf. Regt.</i>
<i>18th Inf. Brig.</i>	<i>Fort Constitution, NH</i>
<i>5th Inf. Regt.</i>	<i>Fort McKinley, ME</i>
<i>13th Inf. Regt.</i>	<i>Army Base, Boston, MA</i>
<i>9th F.A. Brig.</i>	<i>A.A.–1st Bn., 18th F.A.</i>
<i>9th Ammo. Train</i>	<i>A.A.–1st Bn., 18th F.A.</i>
<i>18th F.A. Regt.*</i>	<i>Fort Sill, OK</i>
<i>21st F.A. Regt.</i>	<i>A.A.–1st Bn., 18th F.A.</i>
<i>15th Engr. Regt.</i>	<i>A.A.–13th Engr. Regt.</i>
<i>9th Med. Regt.</i>	<i>A.A.–Surgeon General</i>
<i>9th Div. Tn., Q.M.C.</i>	<i>A.A.–Q.M. General</i>

#### 9th DIVISION Organization 1939

UNIT:	LOCATION:
HQ**	Army Base Boston, MA
HQ, Special Troops**	Boston, MA
HQ & M.P. Co.**	Boston, MA
9th Sig. Co. **	Concord, NH
<i>5th Ord. Co. (M)***</i>	<i>Fort Devens, MA</i>
9th Tank Co. (L)**	Fort Devens, MA
17th Inf. Brig.**	Syracuse, NY
36th Inf. Regt.**	New York City, NY
37th Inf. Regt.**	Brunswick, NJ
18th Inf. Brig.	Army Base, Boston, MA
5th Inf. Regt.	Fort Williams, ME
13th Inf. Regt.	Fort Devens, MA
9th F.A. Brig.**	Lawrence, MA
9th Ammo. Tn.**	Pittsfield, MA
25th F.A. Regt.*	Madison Barracks, NY
26th F.A. Regt.**	Lawrence, MA
34th F.A. Regt.**	Providence, RI
15th Engr. Regt.**	Fort Devens, MA
9th Med. Regt.**	Ithaca, NY
9th Q.M. Regt.**	Providence, RI

\*Indicates unit was partially active. HQ location shown is mobilization post.

\*\*Indicates unit was organized with O.R. personnel as an RAI unit.

\*\*\*Indicates unit was wholly inactive or not organized. HQ location shown is mobilization post.

**26th DIVISION**

**“Yankee Division”**

**Massachusetts National Guard**

HQ—Boston, MA, 1923–41; Camp Edwards, MA, 1941

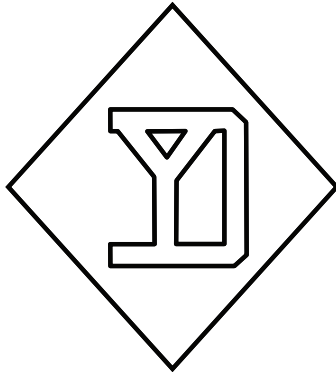

The 26th Div. HQ arrived at Boston, MA, aboard the U.S.S. *Mount Vernon* on 4 April 1918 after 18 months of overseas service and was demobilized 3 May 1919 at Camp Devens, MA. In accordance with the National Defense Act of 1920, the division was allotted to the state of Massachusetts and assigned to the I Corps in 1921. The HQ was reorganized and federally recognized 21 March 1923 at Boston, MA. The physical HQ was initially located at the Massachusetts State House in Boston and relocated to the Commonwealth Armory in Boston in February 1931. The designated mobilization training center for the “Yankee” Division was Camp Devens where much of the division’s training activities occurred between the wars. The mobilization training center was changed to Camp Jackson, SC, in 1939. The division conducted summer camp most years at Camp Devens and the Massachusetts Military Reservation at Falmouth from 1922 to 1939. Generally, the division staff conducted CPXs and staff training concurrent with the annual summer training camps. However, for some years

the division staff participated in First Corps Area or First Army CPXs such as those in July 1931 and 1934 held at Camp Dix, NJ. For the 1935 camp, the division participated in the First Army Maneuvers at Pine Camp. During that maneuver, the 26th Div. operated as part of the provisional I Corps. The “Yankee” Division also participated in the First Army Maneuvers of 1939 and 1940 held at Plattsburg and Canton, NY, respectively. In both maneuvers, the 26th Div. again operated as part of the provisional I Corps against the provisional II Corps. In addition to the summer training, most of the division was called up for emergency relief duties in March 1929 when the Connecticut and Merrimac Rivers severely flooded those respective valleys. The division was called up again in September 1938 in response to a hurricane that came ashore at Buzzards Bay and the concurrent flooding of the Merrimac and Housatonic Rivers. The division was relieved from the I Corps on 30 December 1940 and assigned to the VI Corps. It was inducted into active Federal Service at home stations on 16 January 1941, but instead of Camp Jackson, it was ordered to move to Camp Edwards, MA, where it arrived on 21 January 1941 to conduct mobilization training with selective service men. After the division’s initial train-up period, the 26th Div. participated in the Carolina Maneuvers in October–November 1941 near Oakboro-Monroe, NC. Location of the division HQ on 7 December 1941 was Camp Edwards, MA.

**Status:** HHC currently active at Springfield, MA, as HHC, 26th Brig., 29th Inf. Div. (Light).

**Events:** 59, 174, 190, 234, 280, 301, 330

**Division Commanders**

Maj. Gen. Edward L. Logan	22 March 1923–21 March 1928	Maj. Gen. Erland F. Fish	14 November 1930–16 November 1934
Maj. Gen. Alfred F. Foote	3 May 1928–14 November 1930	Maj. Gen. Daniel Needham	16 November 1934–15 November 1939
	Maj. Gen. Roger W. Eckfeldt		16 November 1939–22 August 1943

**26th DIVISION  
Organization 1924**

**26th DIVISION  
Organization 1939**

<b>UNIT:</b>	<b>HQ LOCATION:</b>	<b>UNIT:</b>	<b>HQ LOCATION:</b>
HQ	Boston, MA	HQ	Boston, MA
HQ, Special Troops	Allston, MA	HQ, Special Troops	Allston, MA
HQ Co.	Boston, MA	HQ Co.	Boston, MA
26th M.P. Co.	Massachusetts N.G.*	26th M.P. Co.	Boston, MA
26th Sig. Co.	Allston, MA	26th Sig. Co.	Allston, MA
101st Ord. Co. (M)	Massachusetts N.G.*	101st Ord. Co. (M)	Natick, MA
26th Tank Co. (L)	Boston, MA	26th Tank Co. (L)	Boston, MA
Mtcyl Co. No. 101	Massachusetts N.G.*		
51st Inf. Brig.	Boston, MA	51st Inf. Brig.	Quincy, MA
101st Inf. Regt.	Boston, MA	101st Inf. Regt.	Boston, MA
182d Inf. Regt.	Charlestown, MA	182d Inf. Regt.	Charlestown, MA
52d Inf. Brig.	Worcester, MA	52d Inf. Brig.	Worcester, MA

104th Inf. Regt.	Springfield, MA	104th Inf. Regt.	Springfield, MA
181st Inf. Regt.	Natick, MA	181st Inf. Regt.	Worcester, MA
51st F.A. Brig.	Allston, MA	51st F.A. Brig.	Allston, MA
101st Ammo. Tn.	Allston, MA	101st Ammo. Tn.	Massachusetts N.G.*
101st F.A. Regt.	Boston, MA	101st F.A. Regt.	Allston, MA
102d F.A. Regt.	Salem, MA	102d F.A. Regt.	Salem, MA
		172d F.A. Regt.	Manchester, NH
101st Engr. Regt.	Cambridge, MA	101st Engr. Regt.	Cambridge, MA
101st Med. Regt.	Massachusetts N.G.*	101st Med. Regt.	Boston, MA
26th Div. Tn., Q.M.C.	Boston, MA	101st Q.M. Regt.	West Newton, MA
26th Div. Air Service	Boston, MA		

\*Indicates state of HQ allocation; HQ not organized or inactive.

## 27th DIVISION

## “Empire”

## New York National Guard

HQ—Manhattan, NY, 1921–40; Fort McClellan, AL, 1940–41

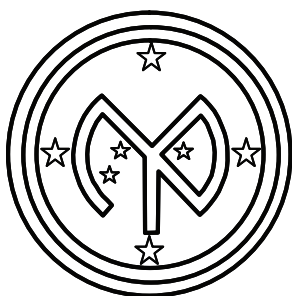

The 27th Div. HQ arrived at New York City aboard the U.S.S. *Leviathan* on 6 March 1919 after 10 months of overseas service and was demobilized 1 April 1919 at Camp Upton, NY. In accordance with the National Defense Act of 1920, the division was allotted to the state of New York and assigned to the II Corps in 1921. The division HQ was reorganized and federally recognized at New York City on 23 December 1921. The designated mobilization training center for the “Empire” Division was Camp Smith, NY, where much of the division’s training activities occurred between the wars. The mobilization training center was changed in 1939 to Camp J. Clifford R. Foster, FL. The division, less the 52d F.A. Brig., conducted summer camp most years at Camp Smith, Peekskill, NY, from 1922 to 1939. The 52d F.A. Brig. conducted its training most years at Pine Camp so that its subordinate batteries could conduct live-

fire training at the ranges located there. Generally, the division staff conducted CPXs and staff training concurrent with the camps. However, in 1929, the division staff participated in the Second Corps Area CPX 7–29 July at Camp Dix, NJ, and in the First Army CPXs in July 1931 and July 1934 also held at Camp Dix. For the 1935 camp, the division participated in the Second Corps Area phase of the First Army Maneuvers at Pine Camp. During that maneuver, the 27th Div. operated as part of the provisional II Corps against the provisional I Corps. The “Empire” division also participated in the First Army Maneuvers in 1939 and 1940 held at Plattsburg and Canton, NY, respectively. In both maneuvers, the 27th Div. again operated as part of the provisional II Corps against the provisional I Corps. The division was inducted into active Federal Service at home stations on 15 October 1940, relieved from the II Corps, and assigned to the VII Corps. Instead of Camp Foster, however, the Empire Division was ordered to move to Fort McClellan, AL, where it arrived on 25 October 1940. After the division’s initial train-up period, it participated in the Carolina Maneuvers in October–November 1941 as part of the VI Corps near Oakboro–Monroe, NC. Location of the division HQ on 7 December 1941 was Fort McClellan, AL.

**Status:** HHC are currently active at Syracuse, NY, as HHC, 27th Inf. Brig.

**Events:** 91, 174, 190, 234, 281, 286, 301, 316, 324, 328

### Division Commanders

Maj. Gen. John F. O’Ryan	23 December 1921–22 May 1923	Brig. Gen. George R. Dyer	31 December 1925–28 January 1926
Maj. Gen. Charles W. Berry Sr.	24 May 1923–31 December 1925	Maj. Gen. William M. Haskell	28 January 1926–21 November 1941
	Maj. Gen. Ralph M. Pennell (R.A.)		21 November 1941–19 November 1942

### 27th DIVISION Organization 1924

<b>UNIT:</b>	<b>HQ LOCATION:</b>
HQ	New York City, NY
HQ, Special Troops	New York City, NY
HQ Co.	New York City, NY

### 27th DIVISION Organization 1939

<b>UNIT:</b>	<b>HQ LOCATION:</b>
HQ	New York City, NY
HQ, Special Troops	New York City, NY
HQ Co.	New York City, NY



27th M.P. Co.	Yonkers, NY	27th M.P. Co.	Yonkers, NY
27th Sig. Co.	Brooklyn, NY	27th Sig. Co.	Yonkers, NY
102d Ord. Co. (M)	New York City, NY	102d Ord. Co. (M)	New York City, NY
27th Tank Co. (L)	New York City, NY	27th Tank Co. (L)	New York City, NY
Mtchl Co. No. 102	Yonkers, NY		
53d Inf. Brig.	Albany, NY	53d Inf. Brig.	Albany, NY
105th Inf. Regt.	Troy, NY	105th Inf. Regt.	Troy, NY
106th Inf. Regt.	Brooklyn, NY	106th Inf. Regt.	Brooklyn, NY
54th Inf. Brig.	Buffalo, NY	54th Inf. Brig.	Buffalo, NY
107th Inf. Regt.	New York City, NY	107th Inf. Regt.	New York City, NY
108th Inf. Regt.	Syracuse, NY	108th Inf. Regt.	Syracuse, NY
52d F.A. Brig.	Brooklyn, NY	52d F.A. Brig.	Brooklyn, NY
102d Ammo. Tn.	White Plains, NY	102d Ammo. Tn.	New York N.G.*
104th F.A. Regt.	New York City, NY	104th F.A. Regt.	New York City, NY
105th F.A. Regt.	New York City, NY	105th F.A. Regt.	New York City, NY
		106th F.A. Regt.	Buffalo, NY
102d Engr. Regt.	New York City, NY	102d Engr. Regt.	New York City, NY
102d Med. Regt.	New York City, NY	102d Med. Regt.	New York City, NY
27th Div. Tn., Q.M.C.	Brooklyn, NY	102d Q.M. Regt.	Brooklyn, NY
27th Div. Air Service	Miller Field, NY		

\*Indicates state of HQ allocation; HQ not organized or inactive.

## 28th DIVISION

## “Keystone”

## Pennsylvania National Guard

HQ—Philadelphia, PA, 1921–33; Harrisburg, PA, 1933–41; Indiantown Gap, PA, 1941

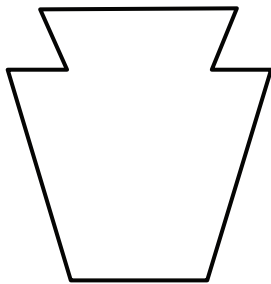

The 28th Div. HQ arrived at Philadelphia, PA, aboard the U.S.S. *Kroonland* on 30 April 1919 after 12 months of overseas service and was demobilized on 17 May 1919 at Camp Dix, NJ. In accordance with the National Defense Act of 1920, the division was allotted to the state of Pennsylvania and assigned to the III Corps in 1921. The division HQ was reorganized and federally recognized on 22 December 1921 at Philadelphia, PA. The HQ was relocated on 12 March 1933 to Harrisburg, PA. The designated mobilization training center for the “Keystone” Division was Camp Bullis, TX. The division, less the 53d F.A. Brig., conducted summer camp most years at Mount Gretna, PA, 1922–34, and at Indiantown Gap, PA, 1935–39. The 53d F.A. Brig. conducted its training most years at Tobyhanna, PA, so that its subordinate batteries could conduct live-fire training at the

ranges located there. Generally, the division staff conducted CPXs and staff training concurrent with the camps. The division staff also participated in the Third Corps Area CPX 6–19 July 1930 at Camp George G. Meade, MD; in the First Army CPXs in July of 1931 and 1934 held at Camp Dix; and the army-level CPX at Fort Devens, MA, in August 1936. For the 1935 camp, the division participated in the Third Corps Area phase of the First Army Maneuvers at Indiantown Gap. During that maneuver, the 28th Div. operated as part of the provisional III Corps. The “Keystone” Division also participated in the First Army Maneuvers in 1939 and 1940 held at Plattsburg and Canton, NY, respectively. In both maneuvers, the 28th Div. again operated as part of the provisional III Corps. In addition to the summer training, the entire division was called up for flood relief duty in March and April 1936 when Pennsylvania rivers overflowed in one of the worst floods in state history. The division was relieved from the III Corps on 30 December 1940 and assigned to the II Corps. The Keystone Division was inducted into active Federal Service at home stations on 17 February 1941. Instead of Camp Bullis, however, it was ordered to move to Indiantown Gap Military Reservation, where it arrived on 21 February 1941. After the division’s initial train-up period, it participated in the Carolina Maneuvers in October–November 1941 as part of the II Corps near Wadesboro, NC. Location of the division HQ on 7 December 1941 was in transit between Halifax, VA, and Indiantown Gap, PA.

**Status:** HHC are currently active at Harrisburg, PA, as HHC, 28th Inf. Div.

**Events:** 109, 174, 191, 203, 215, 234, 247, 281, 301, 330

### Division Commanders

Maj. Gen. William G. Price Jr. 22 December 1921–23 March 1933  
 Maj. Gen. Edward Martin

Maj. Gen. Edward C. Shannon 23 March 1933–24 June 1939  
 26 June 1939–27 January 1942

#### 28th DIVISION Organization 1924

UNIT:	HQ LOCATION:
HQ	Philadelphia, PA
HQ, Special Troops	Philadelphia, PA
HQ Co.	Philadelphia, PA
28th M.P. Co.	York, PA
28th Sig. Co.	Pittsburgh, PA
103d Ord. Co. (M)	Philadelphia, PA
28th Tank Co. (L)	Norristown, PA
Mtcyl Co. No. 103	Philadelphia, PA
55th Inf. Brig.	Washington, PA
109th Inf. Regt.	Scranton, PA
110th Inf. Regt.	Washington, PA
56th Inf. Brig.	Columbia, PA
111th Inf. Regt.	Philadelphia, PA
112th Inf. Regt.	Grove City, PA
53d F.A. Brig.	Pittsburgh, PA
103d Ammo. Tn.	Tamaqua, PA
107th F.A. Regt.	Pittsburgh, PA
109th F.A. Regt.	Wilkes-Barre, PA
103d Engr. Regt.	Philadelphia, PA
103d Med. Regt.	Harrisburg, PA
28th Div. Tn., Q.M.C.	Harrisburg, PA
28th Div. Air Service	Philadelphia, PA.

#### 28th DIVISION Organization 1939

UNIT:	HQ LOCATION:
HQ	Harrisburg, PA
HQ, Special Troops	Philadelphia, PA
HQ Co.	Philadelphia, PA
28th M.P. Co.	York, PA
28th Sig. Co.	Pittsburgh, PA
103d Ord. Co. (M)	Philadelphia, PA
28th Tank Co. (L)	Norristown, PA
55th Inf. Brig.	Washington, PA
109th Inf. Regt.	Scranton, PA
110th Inf. Regt.	Washington, PA
56th Inf. Brig.	Columbia, PA
111th Inf. Regt.	Philadelphia, PA
112th Inf. Regt.	Kane, PA
53d F.A. Brig.	Pittsburgh, PA
103d Ammo. Tn.	Tamaqua, PA
107th F.A. Regt.	Pittsburgh, PA
108th F.A. Regt.	Philadelphia, PA
109th F.A. Regt.	Wilkes-Barre, PA
103d Engr. Regt.	Philadelphia, PA
103d Med. Regt.	Lancaster, PA
103d Q.M. Regt.	Harrisburg, PA

### 29th DIVISION

### “Blue and Gray”

### District of Columbia, Virginia, and Maryland National Guard

**HQ**—Washington, DC, 1923–41; Fort George G. Meade, MD, 1941; A.P. Hill Military Reservation 1941

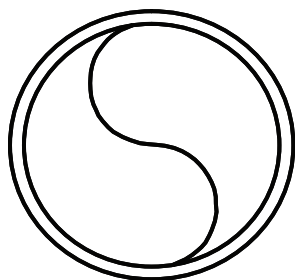

The 29th Div. HQ arrived at Newport News, VA, aboard the U.S.S. *Powhatan* on 20 May 1919 after 11 months of overseas service and was demobilized on 30 May 1919 at Camp Dix, NJ. In accordance with the National Defense Act of 1920, the division was allotted to the states of Maryland, Virginia, and the District of Columbia, and assigned to the III Corps in 1921. The division HQ was reorganized and federally recognized on 31 July 1923 at Washington, DC. The designated mobilization training center for the “Blue and Gray” Division was Fort Eustis, VA. From 1922 to 1936, the division’s subordinate units held separate summer camps at locations within their respective states: Cascade, MD, for Maryland and District units, Virginia Beach, VA, for Virginia units, and Tobyhanna, PA, for the artillery units. The division staff, composed of personnel from all four states, came together to conduct joint training most summers

before World War II. The division staff’s summer training periods were conducted most years at Camp Ritchie, MD, Virginia Beach, VA, or Fort George G. Meade, MD. The HQ also participated in several corps area and army-level CPXs during the interwar years. However, the first time the majority of the division’s subordinate units had the chance to operate together came in June 1935 during that portion of the First Army Maneuver held at Indiantown Gap, PA.

Unfortunately, the 91st Inf. Brig. and the 121st Engrs. did not attend the maneuver. The poliomyelitis epidemic, which had developed in Virginia that summer, prompted the governor of Pennsylvania to refuse the brigade's entry into the state. The next opportunity to train as one unit came in August 1939 when the entire division was assembled at Manassas, VA, for the Third Corps Area concentration of the First Army Maneuver. In that maneuver, the "Blue and Gray" Division operated as part of the provisional III Corps. For the additional week's training directed by the War Department for all N.G. units that winter, the Virginia elements of the 29th Div. assembled 12–18 November 1939 at the State Military Reservation in Virginia Beach, VA, while the Maryland and District elements assembled at the State Military Reservation at Cascade, MD. The final division training event before induction came in August 1940 when the 29th Div. participated in the First Army Maneuver near Canton, NY. The division again operated as part of the III Corps against the provisional I Corps. The division was relieved from the III Corps on 30 December 1940 and assigned to the II Corps. It was inducted into active Federal Service at home stations on 3 February 1941. Instead of Fort Eustis, however, it was ordered to move to Fort George G. Meade, MD, where it arrived on 4 and 5 February 1941. The division was transferred to the A.P. Hill Military Reservation in Virginia on 14 September 1941. After the division's initial train-up period, it participated in the Carolina Maneuvers in October–November 1941 as part of the II Corps in the vicinity of Hoffman-Oakboro, NC. Location of the division HQ on 7 December 1941 was in transit between North Carolina and Fort George G. Meade.

**Status:** HHC are currently active at Fort Belvoir, VA, as HHC, 29th Inf. Div. (Light).

**Events:** 109, 174, 191, 215, 234, 247, 280, 301, 330

#### Division Commanders

Maj. Gen. Anton Stephan (DC) 31 July 1923–10 April 1934

Maj. Gen. Milton A. Reckord (MD) 14 April 1934–February 1942

29th DIVISION Organization 1924		29th DIVISION Organization 1939	
UNIT:	HQ LOCATION:	UNIT:	HQ LOCATION:
HQ	Washington, DC	HQ	Washington, DC
<i>HQ, Special Troops</i>	<i>District of Columbia N.G.*</i>	HQ, Special Troops	Washington, DC
<i>HQ Co.</i>	<i>District of Columbia N.G.*</i>	HQ Co.	Washington, DC
29th M.P. Co.	Washington, DC	29th M.P. Co.	Washington, DC
29th Sig. Co.	Virginia N.G.*	29th Sig. Co.	Norfolk, VA
104th Ord. Co. (M)	<i>District of Columbia N.G.*</i>	104th Ord. Co. (M)	Washington, DC
29th Tank Co. (L)	Danville, VA	29th Tank Co. (L)	Danville, VA
<i>Mtchl Co. No. 104</i>	<i>Virginia N.G.*</i>		
58th Inf. Brig.	Baltimore, MD	58th Inf. Brig.	Baltimore, MD
1st Inf. Regt. (MD)	Frederick, MD	1st Inf. Regt. (MD)	Frederick, MD
5th Inf. Regt. (MD)	Baltimore, MD	5th Inf. Regt. (MD)	Baltimore, MD
91st Inf. Brig.	Front Royal, VA	91st Inf. Brig.	Richmond, VA
116th Inf. Regt.	Staunton, VA	1st Inf. Regt. (VA)	Richmond, VA
183d Inf. Regt.	Richmond, VA	116th Inf. Regt.	Lynchburg, VA
54th F.A. Brig.	Virginia N.G.*	54th F.A. Brig.	Norfolk, VA
104th Ammo. Tn.	Maryland N.G.*	104th Ammo. Tn.	Virginia N.G.*
110th F.A. Regt.	Maryland N.G.*	110th F.A. Regt.	Pikesville, MD
111th F.A. Regt.	Norfolk, VA	111th F.A. Regt.	Hampton, VA
		176th F.A. Regt.	Pittsburgh, PA
121st Engr. Regt.	Washington, DC	121st Engr. Regt.	Washington, DC
104th Med. Regt.	Baltimore, MD	104th Med. Regt.	Baltimore, MD
29th Div. Tn., Q.M.C.	Maryland N.G.*	104th Q.M. Regt.	Baltimore, MD
29th Div. Air Service	Baltimore, MD		

\*Indicates state of HQ allocation; HQ not organized or inactive.

**30th DIVISION**

**“Old Hickory”**

**Georgia, Tennessee, North Carolina,  
and South Carolina National Guard**

HQ—Atlanta, GA, 1926–32; Macon, GA, 1932–40; Camp Jackson, SC, 1940–41

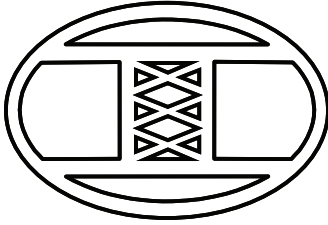

The 30th Div. HQ arrived at Charleston, SC, aboard the U.S.S. *Madawaska* on 2 April 1919 after 11 months of overseas service and was demobilized on 7 May 1919 at Camp Jackson, SC. In accordance with the National Defense Act of 1920, the division was allotted to the states of Georgia, North Carolina, South Carolina, and Tennessee, and assigned to the IV Corps. The division HQ was reorganized and federally recognized 24 August 1926 at 121 Capitol Square, Atlanta, GA. The division HQ was relocated on 20 September 1932 to Macon, GA. The designated mobilization training center for the “Old Hickory” Division was Camp Jackson, where much of the division’s training activities occurred between the wars. For

most years, the division’s subordinate units held separate summer camps at locations within their respective states: Camp Jackson for South Carolina and some Georgia units, Camp Glenn for North Carolina units, and Camp Peay or Camp John Sevier for the Tennessee units. The division staff, composed of personnel from all four states, came together to conduct joint training for several summers before World War II. The division staff usually assembled at Camp Jackson most summers, but conducted their training at Tybee Island, GA, for at least one camp. The division also participated in several corps area and army-level CPXs. The first opportunity that the division’s units had to operate together came in 1928 when the entire “Old Hickory” Division was assembled at Camp Jackson 8–22 July under a War Department experimental program designed to bring together multistate N.G. divisions for joint training. The experiment was declared a success, but due to budget constraints, the program was never fully implemented. The division was assembled again for the 1932 camp, but units were staggered over a 6-week period, so no large-scale training was conducted. The next opportunity came in August 1938 when the division was assembled at the DeSoto National Forest in Mississippi for the Fourth Corps Area concentration of the Third Army Maneuver. In that maneuver, the “Old Hickory” Division operated as part of the provisional IV Corps. The division’s final training event before induction came in August 1940 when the 30th Div. participated in the Third Army Maneuver in the Kisatchie National Forest near Alexandria, LA. For that maneuver, the division again operated as part of the IV Corps against the provisional VIII Corps. The division was inducted into active Federal Service at home stations on 16 September 1940, assigned to the IV Corps, and ordered to move to Camp Jackson, where it arrived about 20 September 1940. After the division’s initial train-up period, the division participated in the VII Corps Tennessee Maneuvers in May–June 1941, and in the Carolina Maneuvers as part of the I Corps near Cheraw-Chesterfield, SC, in November 1941. Location of the division HQ on 7 December 1941 was Camp Jackson, SC.

**Status:** HHC are currently active at Clinton, NC, as HHC, 30th Inf. Brig.

**Events:** 217, 255, 300, 316, 330

**Division Commanders**

Maj. Gen. Ezekiel J. Williams (R.A.) 24 August 1926–1 August 1929    Maj. Gen. Ephraim G. Peyton (R.A.) 1 August 1929–19 September 1932  
Maj. Gen. Henry D. Russell (GA) 20 September 1932–1 May 1942

<b>30th DIVISION Organization 1924</b>		<b>30th DIVISION Organization 1939</b>	
<b>UNIT:</b>	<b>HQ LOCATION:</b>	<b>UNIT:</b>	<b>HQ LOCATION:</b>
<i>HQ</i>	<i>Georgia N.G.*</i>	HQ	Macon, GA
<i>HQ, Special Troops</i>	<i>Georgia N.G.*</i>	HQ, Special Troops	Griffin, GA
HQ Co.	Griffin, GA	HQ Co.	Griffin, GA
<i>30th M.P. Co.</i>	<i>Tennessee N.G.*</i>	30th M.P. Co.	Springfield, GA
30th Sig. Co.	Canton, NC	30th Sig. Co.	Canton, NC
<i>105th Ord. Co. (M)</i>	<i>Georgia N.G.*</i>	105th Ord. Co. (M)	Nashville, TN
30th Tank Co. (L)	Forsyth, GA	30th Tank Co. (L)	Forsyth, GA
Mtcyl Co. No. 105	Knoxville, TN		

59th Inf. Brig.	Macon, GA	59th Inf. Brig.	Columbia, SC
118th Inf. Regt.	Columbia, SC	118th Inf. Regt.	Charleston, SC
122d Inf. Regt.	Macon, GA	121st Inf. Regt.	Macon, GA
<i>60th Inf. Brig.</i>	<i>North Carolina N.G.*</i>	60th Inf. Brig.	Graham, NC
117th Inf. Regt.	Knoxville, TN	117th Inf. Regt.	Knoxville, TN
120th Inf. Regt.	Graham, NC	120th Inf. Regt.	Raleigh, NC
55th F.A. Brig.	Savannah, GA	55th F.A. Brig.	Savannah, GA
105th Ammo. Tn.	Waynesboro, GA	<i>105th Ammo. Tn.</i>	<i>Georgia N.G.*</i>
115th F.A. Regt.	Memphis, TN	113th F.A. Regt.	Raleigh, NC
118th F.A. Regt.	Savannah, GA	115th F.A. Regt.	Memphis, TN
		118th F.A. Regt.	Savannah, GA
105th Engr. Regt.	Durham, NC	105th Engr. Regt.	Raleigh, NC
105th Med. Regt.	Henderson, NC	105th Med. Regt.	Henderson, NC
<i>30th Div. Tn., Q.M.C.</i>	<i>South Carolina N.G.*</i>	105th Q.M. Regt.	Charleston, SC
30th Div. Air Service	Nashville, TN		

\*Indicates state of HQ allocation; HQ not organized or inactive.

### 31st DIVISION

### “Dixie Division”

### Florida, Mississippi, Louisiana, and Alabama National Guard

HQ—St. Augustine, FL, 1924–33; Bartow, FL, 1933–40; Birmingham, AL, 1940; Camp Blanding, FL, 1940–41

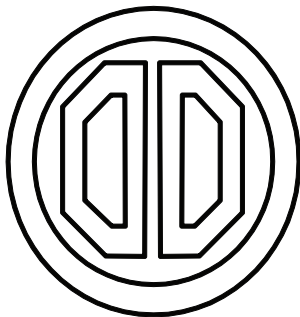

The 31st Div. HQ arrived at Camp Merritt, NJ, aboard the U.S.S. *Manchuria* on 20 December 1918 after 2 months of overseas service and was demobilized on 14 January 1919 at Camp Gordon, GA. In accordance with the National Defense Act of 1920, the division was allotted to the states of Florida, Mississippi, Louisiana, and Alabama, and assigned to the IV Corps on 1 July 1923. The division HQ was reorganized and federally recognized on 15 October 1924 at St. Augustine, Florida. The HQ was relocated on 4 March 1933 to Bartow, FL, and on 10 November 1940 to Birmingham, AL. The designated mobilization training center for the “Dixie” Division was Camp McClellan, AL, where much of the division’s training activities occurred between the wars. For most years, the division’s subordinate units held separate summer camps at locations within their respective states: Camp J. Clifford R. Foster for Florida units,

Camp Shelby for Mississippi units, Camp Beauregard for Louisiana and occasionally Mississippi units, and Camp McClellan for the Alabama units. The division staff, composed of personnel from all four states, came together to conduct joint training for most summers before World War II. The staff conducted their training at numerous locations over the period to include Camp McClellan in 1924–26 and 1929–31, Camp Beauregard in 1927, Camp Foster in 1928, and Fort Oglethorpe, GA. The staff also participated in several corps area and army-level CPXs to include the large Third Army CPX in San Antonio in September 1936. The division (minus the 124th Inf.) was assembled for the first time since World War I at Camp McClellan in August 1924. During that camp, training was conducted at the squad- and platoon-level due to the relative inexperience of the units’ soldiers. From roughly 23 April to 12 June 1927, all Louisiana and Mississippi elements were called up to perform emergency relief duties in connection with the massive flooding of the Mississippi River that spring. Virtually all Florida elements were called up several times for relief duties associated with hurricanes that hit Florida in September 1926, September 1928, and September 1935. Additionally, Florida elements participated in the Mediterranean Fruit Fly quarantine from July 1928 to June 1930. The next opportunity to bring the 31st Div. together came in August 1938 when it was assembled at the DeSoto National Forest in Mississippi for the Fourth Corps Area concentration of the Third Army Maneuver. In that maneuver, the “Dixie” division operated as part of the provisional IV Corps. The division staff was assembled at Jackson Barracks

in New Orleans 17–23 December 1939 for the additional winter training directed by the War Department for all N.G. units. The winter training was used as an opportunity to prepare for what was to be the final division training event before induction. That event came in August 1940 when the 31st Div. participated in the Third Army Maneuver in the Kisatchie National Forest near Alexandria, LA. The division again operated as part of the IV Corps, this time against the provisional VIII Corps. Shortly after the exercise, the division was inducted into active Federal Service at home stations on 25 November 1940 and assigned to the IV Corps. Instead of Fort McClellan, however, it was ordered to move to Camp Blanding, FL, where it arrived 22 December 1940. After the division's initial train-up period, it participated in the IV Corps Louisiana Maneuvers in August 1941, in the GHQ Maneuvers as part of the IV Corps near Good Hope Church, LA, in September–October 1941, and in the First Army Carolina Maneuvers as part of the IV Corps near Ruby–Chesterfield, SC, in October–November 1941. Location of the division HQ on 7 December 1941 was Camp Blanding, FL.

**Status:** HHC are currently inactive as HHC, 31st Armd. Brig.

**Events:** 56, 217, 255, 300, 325, 328, 330

#### Division Commanders

Maj. Gen. Albert H. Blanding (FL) 15 October 1924–30 January 1940    Maj. Gen. Albert H. Blanding (FL) 31 January 1940–18 November 1940  
 Brig. Gen. Louis F. Guerre (LA)\* 31 January 1936–30 January 1940    Maj. Gen. John C. Persons (AL) 19 November 1940–24 September 1944

\*Acting commander during MG Blanding's tenure as the Chief of the N.G. Bureau.

31st DIVISION Organization 1924		31st DIVISION Organization 1939	
UNIT:	HQ LOCATION:	UNIT:	HQ LOCATION:
HQ	St. Augustine, FL	HQ	Bartow, FL
<i>HQ, Special Troops</i>	<i>Alabama N.G.*</i>	HQ, Special Troops	Mobile, AL
HQ Co.	Mobile, AL	HQ Co.	Mobile, AL
<i>31st M.P. Co.</i>	<i>Alabama N.G.*</i>	31st M.P. Co.	Prichard, AL
31st Sig. Co.	Mobile, AL	31st Sig. Co.	Mobile, AL
<i>106th Ord. Co. (M)</i>	<i>Alabama N.G.*</i>	106th Ord. Co. (M)	Mobile, AL
31st Tank Co. (L)	Ozark, AL	31st Tank Co. (L)	Ozark, AL
Mtcyl Co. No. 106	Jacksonville, FL		
61st Inf. Brig.	New Orleans, LA	61st Inf. Brig.	Baton Rouge, LA
155th Inf. Regt.	Vicksburg, MS	155th Inf. Regt.	Vicksburg, MS
156th Inf. Regt.	New Orleans, LA	156th Inf. Regt.	Shreveport, LA
62d Inf. Brig.	Montgomery, AL	62d Inf. Brig.	Birmingham, AL
154th Inf. Regt.	Jacksonville, FL	124th Inf. Regt.	Jacksonville, FL
167th Inf. Regt.	Montgomery, AL	167th Inf. Regt.	Gadsden, AL
56th F.A. Brig.	New Orleans, LA	56th F.A. Brig.	Jacksonville, FL
106th Ammo. Tn.	Elba, AL	106th Ammo. Tn.	Luverne, AL
116th F.A. Regt.	Tampa, FL	114th F.A. Regt.	Greeneville, MS
141st F.A. Regt.	New Orleans, LA	116th F.A. Regt.	Tampa, FL
		117th F.A. Regt.	Floral, AL
<i>106th Engr. Regt.</i>	<i>Mississippi N.G.*</i>	106th Engr. Regt.	Jackson, MS
<i>106th Med. Regt.</i>	<i>Louisiana N.G.*</i>	106th Med. Regt.	New Orleans, LA
31st Div. Tn., Q.M.C.	Senatobia, MS	106th Q.M. Regt.	St. Augustine, FL
31st Div. Air Service	Birmingham, AL		

\*Indicates state of HQ allocation; HQ not organized or inactive.

**32d DIVISION****“Red Arrow”****Michigan and Wisconsin National Guard**

**HQ**—Sparta, WI, 1924–26; Lansing, MI, 1926–40; Camp Beauregard, LA, 1940–41; Camp Livingston, LA, 1941

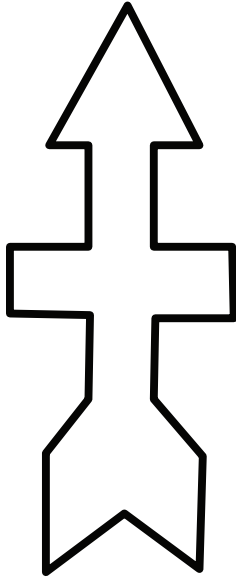

The 32d Div. HQ arrived at Hoboken, NJ, aboard the U.S.S. *George Washington* on 5 May 1919 after 16 months of overseas service and was demobilized 23 May 1919 at Camp Custer, MI. In accordance with the National Defense Act of 1920, the division was allotted to the states of Wisconsin and Michigan and assigned to the VI Corps in 1921. The division HQ was reorganized and federally recognized on 24 July 1924 at Sparta, WI. The HQ was relocated on 21 June 1926 to Lansing, MI, after Maj. Gen. Guy Wilson took command. The designated mobilization training center for the “Red Arrow” Division was Camp Custer, MI. For most years, the division’s subordinate units held separate summer camps at locations within their respective states: Camp Grayling for Michigan units, and Camp McCoy, Camp Williams, or Camp Douglas for the Wisconsin units. For at least 1 year, in 1937, the division’s subordinate units trained over 100 company-grade officers of the 101st Div. at Camp Williams. The division staff, composed of personnel from both states, came together to conduct joint training at Camp Grayling for many summers before World War II. The Wisconsin elements of the staff conducted their training at Camp Douglas those years when they did not go to Camp Grayling for joint training. The staff also participated in the Sixth Corps Area CPXs in 1931, 1932, and 1936, and the large Second Army CPXs in Chicago in 1933 and at Fort Knox in September 1938. The entire division was assembled for the first time at Camp Custer in August 1936 for the Second Army Maneuver. The division was pitted against the 33d Div. in a force-on-force exercise near Allegan. The next opportunity for the “Red Arrow” Division to work

together came in August 1940 when the division participated in the Second Army Maneuvers held at Camp McCoy. In that maneuver, the division operated as part of the provisional VI Corps. The division was inducted into active Federal Service at home stations on 15 October 1940 and assigned to the V Corps. Instead of Camp Custer, however, the “Red Arrow” Division was ordered to move to Camp Beauregard, LA, where it arrived on 21 October 1940. It was further transferred to Camp Livingston, LA, on 15 February 1941. After the division’s initial train-up period, it participated in the V Corps Louisiana Maneuvers in June 1941 and in the GHQ Maneuvers as part of the V Corps near Boyce-Oakdale, LA, August–September 1941. Location of the division HQ on 7 December 1941 was Camp Livingston, LA.

**Status:** HHC are currently active at Madison, WI, as HHC, 32d Brig., 34th Inf. Div.

**Events:** 124, 148, 159, 174, 214, 264, 302, 320, 328

**Division Commanders**

Maj. Gen. Robert B. McCoy (WI)	24 July 1924–5 January 1926	<i>No CG assigned</i>	17 August 1936–21 December 1938
Maj. Gen. Guy M. Wilson (MI)	22 March 1926–16 August 1936	Maj. Gen. Irving A. Fish (WI)	22 December 1938–8 February 1942

**32d DIVISION  
Organization 1924**

<b>UNIT:</b>	<b>HQ LOCATION:</b>
HQ	Sparta, WI
HQ, Special Troops	Detroit, MI
HQ Co.	Detroit, MI
32d M.P. Co.	Arcadia, WI
32d Sig. Co.	Ypsilanti, MI
107th Ord. Co. (M)	Pontiac, MI
32d Tank Co. (L)	Janesville, WI
Mtcyl Co. No. 107	Midland, MI
63d Inf. Brig.	Lansing, MI
125th Inf. Regt.	Flint, MI
126th Inf. Regt.	Grand Rapids, MI
64th Inf. Brig.	Sparta, WI
127th Inf. Regt.	Oconto, WI
128th Inf. Regt.	Superior, WI

**32d DIVISION  
Organization 1939**

<b>UNIT:</b>	<b>HQ LOCATION:</b>
HQ	Lansing, MI
HQ, Special Troops	Detroit, MI
HQ Co.	Detroit, MI
32d M.P. Co.	Arcadia, WI
32d Sig. Co.	Ypsilanti, MI
107th Ord. Co. (M)	Pontiac, MI
32d Tank Co. (L)	Janesville, WI
63d Inf. Brig.	Detroit, MI
125th Inf. Regt.	Detroit, MI
126th Inf. Regt.	Grand Rapids, MI
64th Inf. Brig.	Milwaukee, WI
127th Inf. Regt.	Crandon, WI
128th Inf. Regt.	Oshkosh, WI

57th F.A. Brig.	Wisconsin N.G.*	57th F.A. Brig.	Milwaukee, WI
107th Ammo. Tn.	River Falls, WI	107th Ammo. Tn.	Wisconsin N.G.*
119th F.A. Regt.	Lansing, MI	119th F.A. Regt.	Lansing, MI
120th F.A. Regt.	Milwaukee, WI	120th F.A. Regt.	Milwaukee, WI
		121st F.A. Regt.	Beloit, WI
107th Engr. Regt.	Michigan N.G.*	107th Engr. Regt.	Detroit, MI
107th Med. Regt.	Detroit, MI	107th Med. Regt.	Detroit, MI
32d Div. Tn., Q.M.C.	Rhineland, WI	107th Q.M. Regt.	Madison, WI
32d Div. Air Service	Michigan N.G.*		

\*Indicates state of HQ allocation; HQ not organized or inactive.

### 33d DIVISION

### “Prairie Division”

### Illinois National Guard

HQ—Chicago, IL, 1923–41; Camp Forrest, TN, 1941

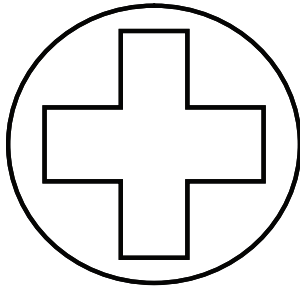

The 33d Div. HQ arrived at Hoboken, NJ, aboard the U.S.S. *Mount Vernon* on 17 May 1919 after 12 months of overseas service and was demobilized on 6 June 1919 at Camp Grant, IL. In accordance with the National Defense Act of 1920, the division was allotted to the state of Illinois and assigned to the VI Corps in 1921. The division HQ was reorganized and federally recognized on 13 December 1923 at 115 East Ontario Street, Chicago, IL. The designated mobilization training center for the “Prairie Division” was initially Camp Grant, where much of the division’s training activities occurred between the wars. The mobilization training center for the division was changed to Fort Huachuca, AZ, in the 1939 PMP. The division, less the 58th F.A. Brig., conducted summer camp most years at Camp Grant from 1922 to 1939. The 58th F.A. Brig. conducted most of its camps in the 1920s at Camp McCoy, WI, and Camp Knox, KY, so that its subordinate battalions could conduct live-fire training

at the ranges located there. For at least 1 year, in 1937, the division’s subordinate units trained over 170 company-grade officers of the 86th Div. at Camp Grant and Camp McCoy. The division staff usually conducted CPXs and staff training concurrent with the subordinate unit camps. However, in May 1932 the staff participated in the Sixth Corps Area CPX held at Camp Custer and in the corps area CPX held in Chicago in May 1936. Additionally, the division staff participated in the Second Army CPX in August 1938 held at Fort Knox. The division’s staff was generally acknowledged as one of the best in the N.G. and performed well in these CPXs. Much of the staff’s efficiency was attributed to Col. George C. Marshall, who was the senior R.A. instructor for the division 1933–36. For the 1936 camp, the division participated in the Sixth Corps Area phase of the Second Army Maneuvers at Camp Custer, MI. During that maneuver, the 33d Div. operated against the 32d Div. in a force on force exercise. The “Prairie Division” also participated in the Second Army Maneuvers in 1940 held at McCoy, WI. The division was relieved from the VI Corps on 30 December 1940 and assigned to the VII Corps. The Prairie Division was inducted into active Federal Service at home stations on 5 March 1941. Instead of Fort Huachuca, however, the 33d Div. was ordered to move to Camp Forrest, TN, where it arrived on 12 March 1941. After the division’s initial train-up period, it participated in the VII Corps Maneuver in August 1941 near Arkadelphia, AR, and in the GHQ Maneuvers in August–September 1941 near Clarence-Many, LA. Location of the division HQ on 7 December 1941 was Camp Forrest, TN.

**Status:** HHC are currently active at Chicago, IL, as HHC, 33d Area Support Group.

**Events:** 124, 148, 159, 174, 214, 264, 302, 316, 324, 328

#### Division Commanders

Maj. Gen. Milton J. Foreman	13 December 1923–27 January 1927	Maj. Gen. Roy D. Keehn	16 February 1927–May 1940
Brig. Gen. Abel Davis	27 January 1927–16 February 1927	Maj. Gen. Samuel T. Lawton	16 May 1940–30 April 1942



**33d DIVISION  
Organization 1924**

UNIT:	HQ LOCATION:
HQ	Chicago, IL
HQ	Chicago, IL
HQ Co.	Chicago, IL
33d M.P. Co.	Chicago, IL
33d Sig. Co.	Chicago, IL
108th Ord. Co. (M)	Chicago, IL
33d Tank Co. (L)	Evanston, IL
Mtcyl Co. No. 108	Chicago, IL
65th Inf. Brig.	Chicago, IL
129th Inf. Regt.	Sycamore, IL
130th Inf. Regt.	Delavan, IL
66th Inf. Brig.	Chicago, IL
131st Inf. Regt.	Chicago, IL
132d Inf. Regt.	Chicago, IL
58th F.A. Brig.	Illinois N.G.*
108th Ammo. Tn.	Illinois N.G.*
122d F.A. Regt.	Chicago, IL
124th F.A. Regt.	Chicago, IL
108th Engr. Regt.	Illinois N.G.*
108th Med. Regt.	Illinois N.G.*
33d Div. Tn., Q.M.C.	Illinois N.G.*
33d Div. Air Service	Illinois N.G.*

**33d DIVISION  
Organization 1939**

UNIT:	HQ LOCATION:
HQ	Chicago, IL
HQ, Special Troops	Chicago, IL
HQ Co.	Chicago, IL
33d M.P. Co.	Chicago, IL
33d Sig. Co.	Chicago, IL
108th Ord. Co. (M)	Chicago, IL
33d Tank Co. (L)	Maywood, IL
65th Inf. Brig.	Pontiac, IL
129th Inf. Regt.	Sycamore, IL
130th Inf. Regt.	Delavan, IL
66th Inf. Brig.	Chicago, IL
131st Inf. Regt.	Chicago, IL
132d Inf. Regt.	Chicago, IL
58th F.A. Brig.	Chicago, IL
108th Ammo. Tn.	Illinois N.G.*
122d F.A. Regt.	Chicago, IL
123d F.A. Regt.	Monmouth, IL
124th F.A. Regt.	Chicago, IL
108th Engr. Regt.	Chicago, IL
108th Med. Regt.	Chicago, IL
108th Q.M. Regt.	Chicago, IL

\*Indicates state of HQ allocation; HQ not organized or inactive.

**34th DIVISION**

**“Red Bull”**

**Iowa, Minnesota, South Dakota, and  
North Dakota National Guard**

**HQ**—Council Bluffs, IA, 1924–40; Camp Ripley, MN, 1940–41; Camp Claiborne, LA, 1941

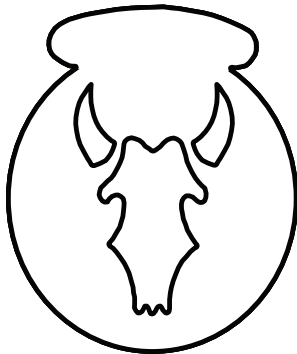

The 34th Div. HQ arrived at Hoboken, NJ, aboard the U.S.S. *General G. W. Goethals* on 24 January 1919 after 4 months of overseas service and was demobilized on 18 February 1919 at Camp Grant, IL. In accordance with the National Defense Act of 1920, the division was allotted to the states of Iowa, Minnesota, South Dakota, and North Dakota, and assigned to the VII Corps in 1921. The division HQ was reorganized and federally recognized on 14 July 1924 at Council Bluffs, IA. The division HQ was relocated on 14 July 1940 to Camp Ripley, MN. The designated mobilization training center for the “Red Bull” Division was Camp Dodge, IA, 1921–30, and Camp Ripley, 1931–40. From 1922 to 1936, the division’s subordinate units held separate summer camps at locations within their respective states: Camp Dodge for Iowa units, Lake City and Camp Ripley for Minnesota units, Camp Grafton for North Dakota units, and Rapid City for South Dakota units. For at least 1 year, in 1938, the division’s

subordinate units also trained over 80 company-grade officers of the 88th Div. at their various training camps in the division’s home area. The division staff, composed of personnel from all four states, came together to conduct joint training for several summers before World War II. The staff generally alternated years between Camp Dodge and Fort Snelling, and participated in several corps area and army-level CPXs. The first opportunity for the entire division to operate together came in August 1937 during that portion of the Fourth Army Maneuver held at Camp Ripley. The next opportunity came in August 1940 when the division again assembled at Camp Ripley for the Seventh Corps Area concentration of the Fourth Army Maneuver. In that maneuver, the “Red Bull” Division operated as part of the Red Army against the 35th Div. and the Blue Army. The division was relieved from the VII Corps on 30 December 1940 and assigned to the V Corps. The Red Bull Division was inducted into active Federal Service at home stations on

10 February 1941. Instead of Camp Ripley, however, it was ordered to move to Camp Claiborne, LA, where it arrived on 20 February 1941. After the division's initial train-up period, it participated in the V Corps Maneuver in June 1941 in Louisiana. The division also participated in the GHQ Maneuvers in August–September 1941 near Alexandria and Bon Ami, LA. Location of the division HQ on 7 December 1941 was Camp Claiborne, LA.

**Status:** HHC are currently active at Rosemount, MN, as HHC, 34th Inf. Div.

**Events:** 193, 233, 279, 303, 320, 328

#### Division Commanders

Maj. Gen. Mathew A. Tinley (IA)	14 July 1924–5 March 1940	Maj. Gen. Ellard A. Walsh (MN)	25 July 1940–16 August 1941
Maj. Gen. Lloyd D. Ross (IA)	5 March 1940–24 June 1940	Brig. Gen. Gordon C. Hollar (IA)	16 August 1941–6 November 1941
Maj. Gen. George A. Leach (MN)	24 June 1940–24 July 1940	Maj. Gen. Russell P. Hartle (R.A.)	7 November 1941–May 1942

#### 34th DIVISION Organization 1924

UNIT:	HQ LOCATION:
HQ	Council Bluffs, IA
<i>HQ, Special Troops</i>	<i>Iowa N.G.*</i>
<i>HQ Co.</i>	<i>Iowa N.G.*</i>
<i>34th M.P. Co.</i>	<i>Minnesota N.G.*</i>
<i>34th Sig. Co.</i>	<i>South Dakota N.G.*</i>
<i>109th Ord. Co. (M)</i>	<i>Minnesota N.G.*</i>
<i>34th Tank Co. (L)</i>	<i>Minnesota N.G.*</i>
<i>Mt cyl Co. No. 109</i>	<i>Iowa N.G.*</i>
67th Inf. Brig.	Des Moines, IA
133d Inf. Regt.	Des Moines, IA
168th Inf. Regt.	Des Moines, IA
68th Inf. Brig.	Minneapolis, MN
135th Inf. Regt.	Minneapolis, MN
164th Inf. Regt.	Valley City, ND
59th F.A. Brig.	<i>Minnesota N.G.*</i>
109th Ammo. Tn.	<i>Minnesota N.G.*</i>
125th F.A. Regt.	Duluth, MN
151st F.A. Regt.	Minneapolis, MN
109th Engr. Regt.	<i>South Dakota N.G.*</i>
109th Med. Regt.	<i>Iowa N.G.*</i>
34th Div. Tn., Q.M.C.	<i>Iowa N.G.*</i>
34th Div. Air Service	St. Paul, MN

#### 34th DIVISION Organization 1939

UNIT:	HQ LOCATION:
HQ	Council Bluffs, IA
HQ, Special Troops	Council Bluffs, IA
HQ Co.	Council Bluffs, IA
34th M.P. Co.	Aitkin, MN
34th Sig. Co.	Watertown, SD
109th Ord. Co. (M)	<i>Minnesota N.G.*</i>
34th Tank Co. (L)	Brainerd, MN
67th Inf. Brig.	Des Moines, IA
133d Inf. Regt.	Sioux City, IA
168th Inf. Regt.	Council Bluffs, IA
68th Inf. Brig.	Valley City, ND
135th Inf. Regt.	Minneapolis, MN
164th Inf. Regt.	Fargo, ND
59th F.A. Brig.	Minneapolis, MN
109th Ammo. Tn.	<i>Minnesota N.G.*</i>
125th F.A. Regt.	Duluth, MN
151st F.A. Regt.	Minneapolis, MN
185th F.A. Regt.	Davenport, IA
109th Engr. Regt.	Rapid City, SD
136th Med. Regt.	Ames, IA
109th Q.M. Regt.	Osceola, IA

\*Indicates state of HQ allocation; HQ not organized or inactive.

#### 35th DIVISION

#### “Santa Fe”

#### Missouri, Kansas, and Nebraska National Guard

HQ—Kansas City, MO, 1935–40; Camp Joseph T. Robinson, AR, 1940–41; Fort Ord, CA, 1941

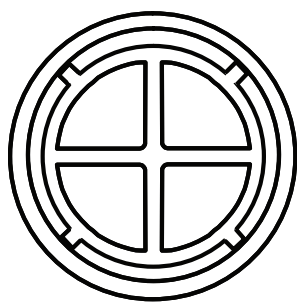

The 35th Div. HQ arrived at Newport News, VA, aboard the U.S.S. *DeKalb* on 20 April 1919 after 12 months of overseas service and was demobilized on 26 May 1919 at Camp Funston, KS. In accordance with the National Defense Act of 1920, the division was allotted to the states of Missouri, Kansas, and Nebraska, and assigned to the VII Corps in 1921. The designated mobilization training center for the “Santa Fe” Division was Camp Clark, MO. Due to funding shortages and disagreement between the states comprising the division, the HQ was not reorganized and federally recognized at Kansas City, MO, until 13 September 1935. As a result, before 1933 officers of the division staff generally conducted their summer training with units of

their respective states. However, beginning the summer of 1933, the division staff assembled at Fort Riley, KS, for consolidated staff training and did so for the next 2 years. In the fall of 1935, the staff participated in the Fourth Army CPX at Fort Lewis, WA, and went to camp at Ashland, NE, the following summer. The division staff trained at Camp Clark, MO, in 1938. That same year, the division's subordinate units trained over 180 company-grade Reserve officers of the 89th and 102d Divs. at various training camps in the division's home area. The division's subordinate units generally held separate summer camps at locations within their respective states: Camp Clark for Missouri units, Fort Riley for Kansas units, and Ashland for Nebraska units. The first opportunity since World War I for the entire division to operate together came in August 1937 during that portion of the Fourth Army Maneuver held at Fort Riley. The next opportunity came in August 1940 when the division was assembled at Camp Ripley, MN, for the Seventh Corps Area concentration of the Fourth Army Maneuver. The division was inducted into active Federal Service at home stations on 23 December 1940 and assigned to the VII Corps. Instead of Camp Clark, however, the division was ordered to move to Camp Joseph T. Robinson, AR, where it arrived on 29 December 1940. After the division's initial train-up period, it participated in the VII Corps Maneuver in August 1941 near Arkadelphia, AR, and in the GHQ Maneuvers in August–September 1941 near Clarence and Nachitoches, LA. Location of the division HQ on 7 December 1941 was Fort Ord, CA.

**Status:** HHC are currently active at Fort Leavenworth, KS, as HHC, 35th Inf. Div. (Mecz).

**Events:** 193, 236, 279, 303, 316, 324, 328

#### Division Commanders

Brig. Gen. Charles I. Martin (KS)* 7 June 1932–January 1935	Maj. Gen. Edward M. Stayton (MO) 7 November 1937–2 September 1938
Brig. Gen. Amos Thomas (NE)* January 1935–13 September 1935	Maj. Gen. Ralph E. Truman (MO) 28 October 1938–17 October 1941
Maj. Gen. Herbert J. Paul (NE) 13 September 1935–6 November 1937	Maj. Gen. William H. Simpson (R.A.) 17 October 1941–May 1942

\*Acting CG; these commanding generals were designated for mobilization purposes and functioned as division commanders even though the division HQ was not yet federally recognized.

35th DIVISION Organization 1924		35th DIVISION Organization 1939	
UNIT:	HQ LOCATION:	UNIT:	HQ LOCATION:
<i>HQ</i>	<i>Missouri N.G.*</i>	HQ	Kansas City, MO
<i>HQ, Special Troops</i>	<i>Missouri N.G.*</i>	HQ, Special Troops	St. Joseph, MO
HQ Co.	Warrensburg, MO	HQ Co.	Warrensburg, MO
<i>35th M.P. Co.</i>	<i>Kansas N.G.*</i>	35th M.P. Co.	Garden City, KS
35th Sig. Co.	Kansas City, KS	35th Sig. Co.	Kansas City, KS
<i>110th Ord. Co. (M)</i>	<i>Kansas N.G.*</i>	<i>110th Ord. Co. (M)</i>	<i>Kansas N.G.*</i>
35th Tank Co. (L)	St. Joseph, MO	35th Tank Co. (L)	St. Joseph, MO
<i>Mtchl Co. No. 110</i>	<i>Kansas N.G.*</i>		
69th Inf. Brig.	Topeka, KS	69th Inf. Brig.	Omaha, NE
134th Inf. Regt.	Omaha, NE	134th Inf. Regt.	Omaha, NE
137th Inf. Regt.	Horton, KS	137th Inf. Regt.	Horton, KS
70th Inf. Brig.	Jefferson City, MO	70th Inf. Brig.	Jefferson City, MO
138th Inf. Regt.	St. Louis, MO	138th Inf. Regt.	St. Louis, MO
140th Inf. Regt.	Caruthersville, MO	140th Inf. Regt.	Caruthersville, MO
60th F.A. Brig.	Topeka, KS	60th F.A. Brig.	Topeka, KS
<i>110th Ammo. Tn.</i>	<i>Kansas N.G.*</i>	<i>110th Ammo. Tn.</i>	<i>Kansas N.G.*</i>
130th F.A. Regt.	Topeka, KS	130th F.A. Regt.	Hutchinson, KS
161st F.A. Regt.	Topeka, KS	142d F.A. Regt.	El Dorado, AR
		161st F.A. Regt.	Topeka, KS
110th Engr. Regt.	Kansas City, MO	110th Engr. Regt.	Kansas City, MO
110th Med. Regt.	Lincoln, NE	110th Med. Regt.	Lincoln, NE
35th Div. Tn., Q.M.C.	Lincoln, NE	110th Q.M. Regt.	Lincoln, NE
35th Div. Air Service	St. Louis, MO		

\*Indicates state of HQ allocation; HQ not organized or inactive.

**36th DIVISION**

**“Texas Division”**

**Texas National Guard**

HQ—Houston, TX, 1923–30; Fort Worth, TX, 1930–36; San Antonio, TX, 1936–40; Camp Bowie, TX, 1940–41

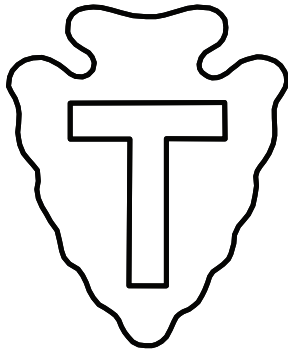

The 36th Div. HQ arrived at the port of New York aboard the U.S.S. *Patricia* on 4 June 1919 after 11 months of overseas service and was demobilized on 18 June 1919 at Camp Bowie, TX. In accordance with the National Defense Act of 1920, the division was allotted to the state of Texas and assigned to the VIII Corps in 1921. The designated mobilization training center for the “Texas Division” was Camp Hulen, TX, where much of the division’s training activities occurred between the wars. The division HQ was reorganized and federally recognized on 2 May 1923 at Houston, TX. The division HQ was relocated on 20 September 1930 to Fort Worth, TX, and on 22 September 1936 to San Antonio, TX. The division conducted its summer camp, less the 61st F.A. Brig., at Camp Mabry in Austin from 1922–23, Fort Crockett, TX, in 1924, back to Camp Mabry in 1925, and at Camp Hulen on Matagorda Bay near Palacios, TX, from 1926 to 1939. The 61st F.A. Brig. conducted its training every other year at Camp Bullis, TX, so that its subordinate batteries could conduct live-fire training at

the ranges located there. For at least 3 years, in 1931, 1932, and 1933, the division’s subordinate units trained over 170 company-grade officers of the 90th Div. at Camp Hulen and Camp Bullis. Like the 26th Div., the 36th Div. was one of the few divisions that was located all in one state and therefore could maximize the opportunity to train as one unit. From 1922 to 1935, the 36th Div. gradually increased the levels of training proficiency as its units became more skilled. The training was conducted at individual-level initially and up to regimental-level for the later camps. In 1936, the division and brigade staffs participated in the Third Army CPX at Camp Bullis. The CPX was designed to prepare the staffs for the large-scale maneuvers to be held in 1938. The division participated in the Eighth Corps Area concentration of the Third Army Maneuvers at Camp Bullis in August 1938. During that maneuver, the 36th Div. operated as part of the provisional Blue Corps against the 2d and 45th Divs. of the Brown Corps. In January 1940, the 36th Div. commanding general and his staff participated in the 2d Div.’s maneuver near Christine, TX. For the final phase of the exercise, the division commander and staff assumed control of the simulated combat actions of the 2d Div. In August 1940, the “Texas Division” again participated in the Third Army Maneuvers, this time near the Kisatchie National Forest in Louisiana as part of the provisional VIII Corps. The division was inducted into active Federal Service at home stations on 24 November 1940 and assigned to the VIII Corps. Instead of Camp Hulen, however, it was ordered to move to Camp Bowie, near Brownwood, TX, where it arrived on 14 December 1940. After the division’s initial train-up period, it participated in the VIII Corps Maneuver 1–18 June 1941 near Brownwood and in the GHQ Maneuvers in August–September 1941 near DeRidder and Peason, LA. Location of the division HQ on 7 December 1941 was Camp Bowie, TX.

**Status:** HHC are currently active at Austin, TX, as HHC, 36th Inf. Div.

**Events:** 80, 217, 258, 288, 300, 317, 328

**Division Commanders**

Maj. Gen. John A. Hulen (TX)	2 May 1923–9 September 1935
Maj. Gen. George P. Rains (TX)	26 September 1935–1 September 1936
Maj. Gen. Claude V. Birkhead (TX)	19 September 1936–13 September 1941
Maj. Gen. Fred L. Walker (R.A.)	13 September 1941–7 July 1944

**36th DIVISION  
Organization 1924**

**36th DIVISION  
Organization 1939**

<b>UNIT:</b>	<b>HQ LOCATION:</b>	<b>UNIT:</b>	<b>HQ LOCATION:</b>
HQ	Houston, TX	HQ	San Antonio, TX
<i>HQ, Special Troops</i>	<i>Texas N.G.*</i>	HQ, Special Troops	San Antonio, TX
HQ Co.	Galveston, TX	HQ Co.	San Antonio, TX
36th M.P. Co.	Corsicana, TX	36th M.P. Co.	San Antonio, TX
36th Sig. Co.	Denison, TX	36th Sig. Co.	Denison, TX
<i>111th Ord. Co. (M)</i>	<i>Texas N.G.*</i>	111th Ord. Co. (M)	San Antonio, TX
<i>36th Tank Co. (L)</i>	<i>Texas N.G.*</i>	36th Tank Co. (L)	Houston, TX
<i>Mtchl Co. No. 111</i>	<i>Texas N.G.*</i>		

71st Inf. Brig.	Fort Worth, TX	71st Inf. Brig.	San Antonio, TX
141st Inf. Regt.	Hillsboro, TX	141st Inf. Regt.	San Antonio, TX
142d Inf. Regt.	Gainesville, TX	142d Inf. Regt.	Fort Worth, TX
72d Inf. Brig.	Marshall, TX	72d Inf. Brig.	Dallas, TX
143d Inf. Regt.	Taylor, TX	143d Inf. Regt.	Waco, TX
144th Inf. Regt.	Fort Worth, TX	144th Inf. Regt.	Dallas, TX
61st F.A. Brig.	San Antonio, TX	61st F.A. Brig.	San Antonio, TX
<i>111th Ammo. Tn.</i>	<i>Texas N.G.*</i>	<i>111th Ammo. Tn.</i>	<i>Texas N.G.*</i>
131st F.A. Regt.	Amarillo, TX	131st F.A. Regt.	Austin, TX
132d F.A. Regt.	Dallas, TX	132d F.A. Regt.	Dallas, TX
		133d F.A. Regt.	San Antonio, TX
111th Engr. Regt.	Fort Worth, TX	111th Engr. Regt.	Fort Worth, TX
<i>111th Med. Regt.</i>	<i>Texas N.G.*</i>	111th Med. Regt.	Fort Worth, TX
<i>36th Div. Tn., Q.M.C.</i>	<i>Texas N.G.*</i>	111th Q.M. Regt.	Austin, TX
36th Div. Air Service	Houston, TX		

\*Indicates state of HQ allocation; HQ not organized or inactive.

### 37th DIVISION

### “Buckeye”

### Ohio National Guard

HQ—Columbus, OH, 1923–40; Camp Shelby, MS, 1940–41

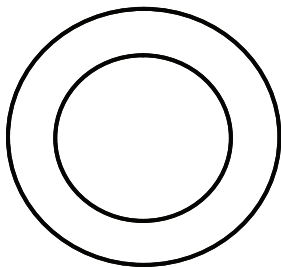

The 37th Div. HQ arrived at Newport News, VA, aboard the S.S. *Noordham* on 23 March 1919 after 10 months of overseas service and was demobilized on 23 June 1919 at Camp Sherman, OH. In accordance with the National Defense Act of 1920, the division was allotted to the state of Ohio and assigned to the V Corps. The division HQ was reorganized and federally recognized at Columbus, Ohio, on 31 May 1923. The designated mobilization training center for the “Buckeye Division” was Camp Perry, OH, where much of the division’s training activities occurred between the World Wars. The division, less the 62d F.A. Brig., conducted summer camp most years at Camp Perry from 1922 to 1939. The division’s infantry regiments provided basic branch indoctrination training during many of these camps to the newly commissioned infantry

lieutenants of the 60th and 61st Inf. Regts. (RAI) in the 1930s. The units of the 62d F.A. Brig. conducted summer camp most years at Camp Knox, KY, so that its subordinate batteries could conduct live-fire training at the ranges located there. The division staff generally assembled at Camp Perry for training, but also participated in the Fifth Corps Area CPX in May 1929 and in the Second Army CPX in September 1938 at Fort Knox. For the 1936 camp, the division participated in the Fifth Corps Area phase of the Second Army Maneuvers at Fort Knox. During that maneuver, the 37th Div. operated as part of the provisional V Corps. In 1940, the “Buckeye” Division again participated in the Second Army Maneuvers, this time near Camp McCoy, WI. In addition to summer training, the entire division was called up for emergency relief duty in January and February 1937 when the Ohio River overflowed in one of the worst floods in its history. The division was inducted into active Federal Service at home stations on 15 October 1940 and assigned to the V Corps. Instead of Camp Perry, however, it was ordered to move to Camp Shelby, MS, where it arrived on 20 October 1940. After the division’s initial train-up period, it participated in the V Corps Maneuver 16–27 June 1941 near Camp Beauregard, LA, and in the GHQ Maneuvers in August–September 1941 near Boyce-Nachitoches, LA. Location of the division HQ on 7 December 1941 was Camp Shelby, MS.

**Status:** HHC are currently active at North Canton, OH, as HHC, 37th Armd. Brig.

**Events:** 85, 174, 213, 220, 264, 302, 320, 328

#### Division Commanders

Maj. Gen. Benson W. Hough (OH) 31 May 1923–19 November 1935    Maj. Gen. Gilson D. Light (OH) 22 December 1936–1 October 1940  
 Maj. Gen. Dudley J. Hard (OH) 17 December 1935–14 August 1936    Maj. Gen. Robert S. Beightler (OH) 1 October 1940–September 1945

**37th DIVISION  
Organization 1924**

UNIT:	HQ LOCATION:
HQ	Columbus, OH
HQ, Special Troops	Toledo, OH
HQ Co.	Chillicothe, OH
37th M.P. Co.	Columbus, OH
37th Sig. Co.	Columbus, OH
112th Ord. Co. (M)	Alliance, OH
37th Tank Co. (L)	Port Clinton, OH
Mtcyl Co. No. 112	Columbus, OH
73d Inf. Brig.	Cleveland, OH
145th Inf. Regt.	Cleveland, OH
148th Inf. Regt.	Toledo, OH
74th Inf. Brig.	Columbus, OH
147th Inf. Regt.	Cincinnati, OH
166th Inf. Regt.	Columbus, OH
62d F.A. Brig.	Columbus, OH
112th Ammo. Tn.	Ohio N.G.*
134th F.A. Regt.	Columbus, OH
135th F.A. Regt.	Cleveland, OH
112th Engr. Regt.	Cleveland, OH
112th Med. Regt.	Columbus, OH
37th Div. Tn., Q.M.C.	Columbus, OH
37th Div. Air Service	Ohio N.G.*

**37th DIVISION  
Organization 1939**

UNIT:	HQ LOCATION:
HQ	Columbus, OH
HQ, Special Troops	Columbus, OH
HQ Co.	Columbus, OH
37th M.P. Co.	Columbus, OH
37th Sig. Co.	Columbus, OH
112th Ord. Co. (M)	Chillicothe, OH
37th Tank Co. (L)	Port Clinton, OH
73d Inf. Brig.	Cleveland, OH
145th Inf. Regt.	Cleveland, OH
148th Inf. Regt.	Columbus, OH
74th Inf. Brig.	Columbus, OH
147th Inf. Regt.	Cincinnati, OH
166th Inf. Regt.	Columbus, OH
62d F.A. Brig.	Cleveland, OH
112th Ammo. Tn.	Ohio N.G.*
134th F.A. Regt.	Columbus, OH
135th F.A. Regt.	Cleveland, OH
136th F.A. Regt.	Columbus, OH
112th Engr. Regt.	Cleveland, OH
112th Med. Regt.	Columbus, OH
112th Q.M. Regt.	Columbus, OH

\*Indicates state of HQ allocation; HQ not organized or inactive.

**38th DIVISION**

**“Cyclone Division”**

**Indiana, Kentucky, and  
West Virginia National Guard**

HQ—Indianapolis, IN, 1923–41; Camp Shelby, MS, 1941

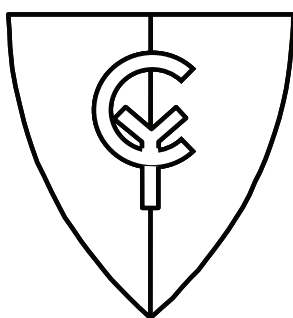

The 38th Div. HQ arrived at Newport News, VA, aboard the U.S.S. *Martha Washington* on 19 December 1918 after 4 months of overseas service and was demobilized on 8 January 1919 at Camp Zachary Taylor, KY. In accordance with the National Defense Act of 1920, the division was allotted to the states of Indiana, Kentucky, and West Virginia on 7 December 1920 and assigned to the V Corps in 1921. The division HQ was reorganized and federally recognized on 16 March 1923 at Indianapolis, IN. The designated mobilization training center for the “Cyclone Division” was Camp Knox, KY, where much of the division’s training activities occurred between the wars. The 38th Div. was fortunate in that it was one of the few multistate divisions that had the opportunity to train together each summer prior to World War II, and the entire division (except West Virginia’s 150th Inf.) conducted its summer camp most years at Camp

Knox from 1923 to 1939. For the 1936 camp, the division participated in the Fifth Corps Area phase of the Second Army Maneuvers at Fort Knox. During that maneuver, the 38th Div. operated as part of the provisional V Corps against the 10th Inf. Brig. Additionally, the division staff participated in the Fifth Corps Area CPX in May 1929 and in the Second Army CPX in September 1938 at Fort Knox. In 1940, the entire “Cyclone” Division again participated in the Second Army Maneuvers, this time near Camp McCoy, WI. In addition to summer training, the entire division, less the West Virginia elements, was called up for flood relief duty in January and February 1937 when the Ohio River overflowed in one of the worst floods in its history. The “Cyclone” Division was inducted into active Federal Service at home stations on 17 January 1941 and assigned to the V Corps. Instead of Fort Knox, however, it was ordered to move to Camp Shelby, MS, where it arrived on 26 January 1941. After the division’s initial train-up period, it participated in the V Corps Maneuver 16–27 June 1941 near Camp Beauregard, LA, and in the GHQ Maneuvers in August–September 1941 near Cooper, LA. Location of the division HQ on 7 December 1941 was Camp Shelby, MS.

**Status:** HHC are currently active at Indianapolis, IN, as HHC, 38th Inf. Div.

**Events:** 85, 174, 213, 220, 264, 302, 320, 328

**Division Commanders**

Maj. Gen. Robert H. Tyndall (IN) 16 March 1923–28 April 1941  
 Maj. Gen. Daniel I. Sultan (R.A.) 28 April 1941–6 April 1942

**38th DIVISION  
 Organization 1924**

**38th DIVISION  
 Organization 1939**

<b>UNIT:</b>	<b>HQ LOCATION:</b>	<b>UNIT:</b>	<b>HQ LOCATION:</b>
HQ	Indianapolis, IN	HQ	Indianapolis, IN
HQ, Special Troops HQ Co.	Indianapolis, IN Indianapolis, IN	HQ, Special Troops HQ Co.	Indianapolis, IN Indianapolis, IN
38th M.P. Co.	Jackson, KY	38th M.P. Co.	Jackson, KY
38th Sig. Co.	Gary, IN	38th Sig. Co.	Indianapolis, IN
<i>113th Ord. Co. (M)</i>	<i>Kentucky N.G.*</i>	113th Ord. Co. (M)	Bardstown, KY
38th Tank Co. (L)	Covington, KY	38th Tank Co. (L)	Harrodsburg, KY
<i>Mtcyl Co. No. 113</i>	<i>Indiana N.G.*</i>		
75th Inf. Brig.	Bowling Green, KY	75th Inf. Brig.	Bowling Green, KY
149th Inf. Regt.	Frankfort, KY	149th Inf. Regt.	Louisville, KY
150th Inf. Regt.	Welch, WV	150th Inf. Regt.	Welch, WV
76th Inf. Brig.	Muncie, IN	76th Inf. Brig.	Shelbyville, IN
151st Inf. Regt.	Shelbyville, IN	151st Inf. Regt.	Indianapolis, IN
152d Inf. Regt.	Indianapolis, IN	152d Inf. Regt.	Indianapolis, IN
63d F.A. Brig.	Louisville, KY	63d F.A. Brig.	Louisville, KY
<i>113th Ammo. Tn.</i>	<i>Kentucky N.G.*</i>	<i>113th Ammo. Tn.</i>	<i>Kentucky N.G.*</i>
138th F.A. Regt.	Louisville, KY	138th F.A. Regt.	Louisville, KY
139th F.A. Regt.	Indianapolis, IN	139th F.A. Regt.	Indianapolis, IN
		150th F.A. Regt.	Indianapolis, IN
113th Engr. Regt.	Gary, IN	113th Engr. Regt.	Gary, IN
113th Med. Regt.	Indianapolis, IN	113th Med. Regt.	Indianapolis, IN
<i>38th Div. Tn., Q.M.C.</i>	<i>Kentucky N.G.*</i>	113th Q.M. Regt.	Indianapolis, IN
38th Div. Air Service	Kokomo, IN		

\*Indicates state of HQ allocation; HQ not organized or inactive.

**39th DIVISION**

**“Delta Division”**

**Louisiana, Mississippi, Alabama, Florida  
 and Arkansas National Guard**

HQ—*Not organized, 1921–23*

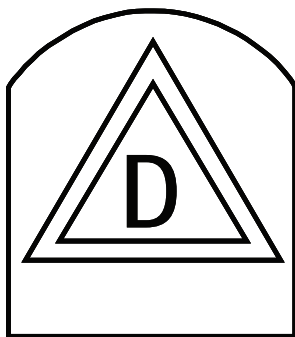

The 39th Div. HQ arrived at Newport News, VA, aboard the U.S.S. *Princess Matoika* on 31 December 1918 after 4 months of overseas service and was demobilized on 23 January 1919 at Camp Beauregard, LA. In accordance with the National Defense Act of 1920, the division was allotted to the states of Louisiana, Alabama, Mississippi, Florida, and Arkansas, and assigned to the IV Corps in 1921. The division’s designated mobilization training station was Camp McClellan, AL. The division HQ was not reorganized before the adjutants general of the several states from which the division was drawn petitioned the War Department to change the designation of the division to be formed as the 31st Div. as that was the organization in which most of the states’ units served in World War I. The request was approved and the subordinate elements assigned to the 39th Div. were withdrawn and assigned to the 31st Div., less the Arkansas elements, effective 1 July 1923.

**Status:** HHC are currently active at Little Rock, AR, as HHC, 39th Inf. Brig.

**39th DIVISION  
Organization 1923**

<b>UNIT:</b>	<b>HQ LOCATION:</b>
<i>HQ</i>	<i>Alabama N.G.*</i>
<i>HQ, Special Troops</i>	<i>Alabama N.G.*</i>
<i>HQ Co.</i>	<i>Mobile, AL</i>
<i>39th M.P. Co.</i>	<i>Florida N.G.*</i>
<i>39th Sig. Co.</i>	<i>Alabama N.G.*</i>
<i>114th Ord. Co. (M)</i>	<i>Jacksonville, FL</i>
<i>39th Tank Co. (L)</i>	<i>Ozark, AL</i>
<i>Mtcyl Co. No. 114</i>	<i>Florida N.G.*</i>
<i>77th Inf. Brig.</i>	<i>Montgomery, AL</i>
<i>154th Inf. Regt.</i>	<i>Jacksonville, FL</i>
<i>167th Inf. Regt.</i>	<i>Gadsden, AL</i>
<i>78th Inf. Brig.</i>	<i>New Orleans, LA</i>
<i>155th Inf. Regt.</i>	<i>Vicksburg, MS</i>
<i>156th Inf. Regt.</i>	<i>New Orleans, LA</i>
<i>64th F.A. Brig.</i>	<i>Louisiana N.G.*</i>
<i>114th Ammo. Tn.</i>	<i>Elba, AL</i>
<i>116th F.A. Regt.</i>	<i>Florida N.G.*</i>
<i>141st F.A. Regt.</i>	<i>Alabama N.G.*</i>
<i>114th Engr. Regt.</i>	<i>Mississippi N.G.*</i>
<i>114th Med. Regt.</i>	<i>Louisiana N.G.*</i>
<i>39th Div. Tn., Q.M.C.</i>	<i>Mississippi N.G.*</i>
<i>39th Div. Air Service</i>	<i>Birmingham, AL</i>

\*Indicates state of HQ allocation; HQ not organized or inactive.

**40th DIVISION**

**“Sunburst”**

**California, Utah, and  
Nevada National Guard**

**HQ**—Berkeley, CA, 1926–37; Los Angeles, CA, 1937–41; Camp San Luis Obispo, CA, 1941

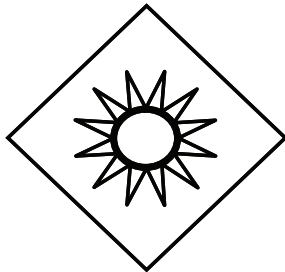

The 40th Div. HQ arrived at the port of New York aboard the U.S.S. *Artemas* on 13 March 1919 after 6 months of overseas service and was demobilized on 20 April 1919 at Camp Kearny, CA. In accordance with the National Defense Act of 1920, the division was allotted to the states of California, Utah, and Nevada, and assigned to the IX Corps. The division HQ was reorganized and federally recognized on 18 June 1926 at Berkeley, CA. The division HQ was relocated on 1 October 1937 to Los Angeles, CA. The designated mobilization training center for the “Sunburst” Division was Camp San Luis Obispo, where much of the division’s training activities occurred between the wars. The units of the 40th Div. were called up by the governor for various state emergencies and duties. The largest of these was a virtually state-wide strike in May and June 1934 by Longshoremen and other labor unions. Most of the division was called up to perform strike duty and crowd control. The division

staff, composed of personnel from all three states, came together to conduct joint training for several summers before World War II. The staff conducted their training at numerous locations over the period to include the Presidio of San Francisco, Camp San Luis Obispo, and at the Presidio of Monterey, CA. The division conducted summer camp every year at San Luis Obispo, CA, 1923 to 1939, minus the Utah elements, which held their training at Camp W.G. Williams, UT. Additionally, the division staff participated in the Fourth Army CPXs held at Fort Lewis, WA, in 1935 and 1936, and at the Presidio of San Francisco in 1939. For the 1937 camp, the division participated in the Ninth Corps Area phase of the Fourth Army Maneuvers at San Luis Obispo held 2–12 August. During that maneuver, the 40th Div. operated against the 6th Inf. Brig. of the R.A.’s 3d Div. In April 1940, the 40th Div. commanding general and his staff participated in the 3d Div.’s maneuver in the vicinity of Fort Ord, CA. For the final phase of the exercise, the division commander and staff assumed control of the simulated combat actions of the 3d Div. In August 1940, the “Sunburst”



Division again participated in the Fourth Army Maneuvers, this time at Fort Lewis as part of the provisional IX Corps. The division was relieved from the IX Corps on 30 December 1940 and assigned to the III Corps. The 40th Div. was inducted into active Federal Service at home stations on 3 March 1941, and ordered to move to Camp San Luis Obispo, where it arrived on 10 March 1941. After the division's initial train-up period, the 40th Div. participated in the Fourth Army Maneuver in August 1941 near Fort Lewis. Location of the division HQ on 7 December 1941 was Camp San Luis Obispo, CA.

**Status:** HHC are currently active at Los Alamitos, CA, as HHC, 40th Inf. Div. (Mecz).

**Events:** 193, 231, 279, 289, 294, 304, 314, 326

#### Division Commanders

Maj. Gen. David P. Barrows (CA)	18 June 1926–28 June 1937
Maj. Gen. Walter P. Story (CA)	28 June 1937–22 June 1941
Maj. Gen. Earnest J. Dawley (R.A.)	23 June 1941–11 April 1942

#### 40th DIVISION Organization 1924

UNIT:	HQ LOCATION:
HQ	California N.G.*
HQ, Special Troops	California N.G.*
HQ Co.	California N.G.*
40th M.P. Co.	Nevada N.G.*
40th Sig. Co.	San Francisco, CA
115th Ord. Co. (M)	Utah N.G.*
40th Tank Co. (L)	Salinas, CA
Mt cyl Co. No. 115	California N.G.*
79th Inf. Brig.	Sacramento, CA
159th Inf. Regt.	Berkeley, CA
160th Inf. Regt.	Los Angeles, CA
80th Inf. Brig.	California N.G.*
184th Inf. Regt.	Sacramento, CA
185th Inf. Regt.	California N.G.*
65th F.A. Brig.	Utah N.G.*
115th Ammo. Tn.	Utah N.G.*
143d F.A. Regt.	Oakland, CA
145th F.A. Regt.	Salt Lake City, UT
115th Engr. Regt.	Utah N.G.*
115th Med. Regt.	California N.G.*
40th Div. Tn., Q.M.C.	California N.G.*
40th Div. Air Service	Los Angeles, CA

#### 40th DIVISION Organization 1939

UNIT:	HQ LOCATION:
HQ	Los Angeles, CA
HQ, Special Troops	Berkeley, CA
HQ Co.	Los Angeles, CA
40th M.P. Co.	Reno, NV
40th Sig. Co.	San Francisco, CA
115th Ord. Co. (M)	Ogden, UT
40th Tank Co. (L)	Salinas, CA
79th Inf. Brig.	Sacramento, CA
159th Inf. Regt.	Oakland, CA
184th Inf. Regt.	Sacramento, CA
80th Inf. Brig.	Los Angeles, CA
160th Inf. Regt.	Los Angeles, CA
185th Inf. Regt.	Fresno, CA
65th F.A. Brig.	Salt Lake City, UT
115th Ammo. Tn.	Utah N.G.*
143d F.A. Regt.	Stockton, CA
145th F.A. Regt.	Salt Lake City, UT
222d F.A. Regt.	Salt Lake City, UT
115th Engr. Regt.	Salt Lake City, UT
115th Med. Regt.	Los Angeles, CA
115th Q.M. Regt.	Berkeley, CA

\*Indicates state of HQ allocation; HQ not organized or inactive.

#### 41st DIVISION

#### “Sunset”

#### Oregon, Washington, Montana, Idaho and Wyoming National Guard

HQ—Portland, OR, 1930–40; Camp Murray, WA, 1940–41; Fort Lewis, WA, 1941

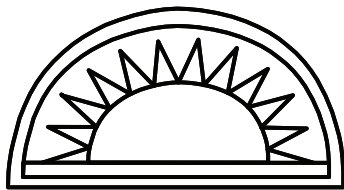

The 41st Div. HQ arrived at Hoboken, NJ, aboard the U.S.S. *Leviathan* on 12 February 1919 after 14 months of overseas service and was demobilized on 22 February 1919 at Camp Dix, NJ. In accordance with the National Defense Act of 1920, the division was allotted to the states of Washington, Oregon, Montana, Idaho, and Wyoming, and assigned to the IX Corps. The division HQ was reorganized and federally recognized on 3 January 1930 at Portland, OR. The designated mobilization training center for the “Sunset” Division was Camp

Murray, WA. The division staff, composed of personnel from all five states, came together to conduct joint training for several summers before World War II, usually at Fort Lewis or Camp Murray. However, for the 1938 camp, the staff assembled for training at Fort William Henry Harrison in Helena, MT. The division staff also participated in the Fourth Army CPXs at Fort Lewis in 1935 and 1936, and at the Presidio of San Francisco in 1939. From 1922 to 1939, the division's subordinate units generally held separate summer camps at locations within their respective states: Oregon units at the state military reservation at Clatsop; Washington units at Camp Murray, Montana units at Fort William Henry Harrison, and Idaho units at Boise Barracks. For the 1937 camp, the division participated in the Ninth Corps Area phase of the Fourth Army Maneuvers at Centralia-Fort Lewis held in August. During that maneuver, the 41st Div. operated against the 5th Inf. Brig. of the R.A.'s 3d Div. In 1940, the "Sunset" Division again participated in the Fourth Army Maneuvers, at Fort Lewis, this time as part of the provisional IX Corps. The 41st Div. was inducted into active Federal Service at home stations on 16 September 1940, assigned to the IX Corps, and ordered to move to Camp Murray, where it arrived on 20 September 1940. It was transferred to Fort Lewis on 20 March 1941. After the division's initial train-up period, the 41st Div. participated in the Fourth Army Maneuver in June-July 1941 near Hunter-Liggett Military Reservation, CA, and in the Fourth Army Maneuver in August 1941 near Fort Lewis. Location of the division HQ on 7 December 1941 was Fort Lewis, WA.

**Status:** HHC are currently active at Portland, OR, as HHC, 41st Armd. Brig.

**Events:** 193, 231, 279, 289, 294, 304, 314, 326

#### Division Commanders

Maj. Gen. George A. White (OR) 3 January 1930–23 November 1941

41st DIVISION Organization 1924		41st DIVISION Organization 1939	
UNIT:	HQ LOCATION:	UNIT:	HQ LOCATION:
<i>HQ</i>	<i>Oregon N.G.*</i>	HQ	Portland, OR
<i>HQ, Special Troops</i>	<i>Washington N.G.*</i>	HQ, Special Troops	Centralia, WA
<i>HQ Co.</i>	<i>Idaho N.G.*</i>	HQ Co.	Blackfoot, ID
<i>41st M.P. Co.</i>	<i>Wyoming N.G.*</i>	41st M.P. Co.	Green River, WY
<i>41st Sig. Co.</i>	<i>Washington N.G.*</i>	41st Sig. Co.	Portland, OR
<i>116th Ord. Co. (M)</i>	<i>Idaho N.G.*</i>	116th Ord. Co. (M)	Jerome, ID
41st Tank Co. (L)	Centralia, WA	41st Tank Co. (L)	Centralia, WA
<i>Mt cyl Co. No. 116</i>	<i>Washington N.G.*</i>		
81st Inf. Brig.	Seattle, WA	81st Inf. Brig.	Camp Murray, WA
161st Inf. Regt.	Spokane, WA	161st Inf. Regt.	Spokane, WA
186th Inf. Regt.	Portland, OR	163d Inf. Regt.	Whitefish, MT
82d Inf. Brig.	Portland, OR	82d Inf. Brig.	Portland, OR
162d Inf. Regt.	Portland, OR	162d Inf. Regt.	Portland, OR
163d Inf. Regt.	Bozeman, MT	186th Inf. Regt.	Portland, OR
<i>66th F.A. Brig.</i>	<i>Washington N.G.*</i>	66th F.A. Brig.	Seattle, WA
<i>116th Ammo. Tn.</i>	<i>Washington N.G.*</i>	<i>116th Ammo. Tn.</i>	<i>Washington N.G.*</i>
146th F.A. Regt.	Tacoma, WA	146th F.A. Regt.	Seattle, WA
<i>148th F.A. Regt.</i>	<i>Washington N.G.*</i>	148th F.A. Regt.	Tacoma, WA
		218th F.A. Regt.	Portland, OR
<i>116th Engr. Regt.</i>	<i>Idaho N.G.*</i>	116th Engr. Regt.	Boise, ID
<i>116th Med. Regt.</i>	<i>Washington N.G.*</i>	116th Med. Regt.	Seattle, WA
<i>41st Div. Tn., Q.M.C.</i>	<i>Washington N.G.*</i>	116th Q.M. Regt.	Seattle, WA
41st Div. Air Service	Spokane, WA		

\*Indicates state of HQ allocation; HQ not organized or inactive.

**43d DIVISION**

**“Winged Victory”**

**Connecticut, Maine, Rhode Island  
and Vermont National Guard**

**HQ**—South Manchester, CT, 1925; Hartford, CT, 1925–31; New London, CT, 1931–41; Camp Blanding, FL, 1941

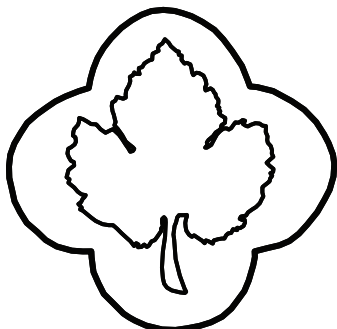

The 43d Div. was constituted in the N.G. on 19 October 1920, allotted to the states of Connecticut, Maine, Rhode Island, and Vermont, and assigned to the I Corps. The division HQ was organized and federally recognized at South Manchester, CT, on 21 March 1925. The HQ was relocated on 7 April 1925 to Hartford, CT, and finally on 3 June 1931 to New London, CT. The division staff, composed of personnel from all four states, came together each summer to conduct joint training usually at Niantic, CT. The staff participated in the First Army CPXs at Camp Dix, NJ, in 1931 and 1934, and at Fort Devens in 1936 and 1937. From 1922 to 1939, the division’s subordinate units generally held separate summer camps at locations within their respective states: Connecticut units at the state military reservation at Niantic; Rhode Island units at Quonsett Point; Maine units at Camp Keyes; and Vermont units at Fort Ethan Allen. The division was assembled in one place for

the first time at Fort Devens in June 1930. During that camp, training was conducted at the squad- and platoon-level due to the relative inexperience of the units’ soldiers. The next opportunity for the 43d Div. to function as a complete unit came in August 1935 when it participated in the First and Second Corps Area phase of the First Army Maneuvers at Pine Camp, NY. In 1939, the “Winged Victory” Division again participated in the First Army Maneuvers, this time at Plattsburg, NY, as part of the provisional I Corps. The 43d Div.’s last major training event before induction was the First Army Maneuver near Canton, NY, in August 1940. The division was relieved from the I Corps on 30 December 1940 and assigned to the IV Corps. It was inducted into active Federal Service at home stations on 24 February 1941 and ordered to move to Camp Blanding, FL, where it arrived on 13 March 1941. After the division’s initial train-up period, the 43d Div. participated in the IV Corps Louisiana Maneuvers in August 1941; in the GHQ Maneuvers near Bellwood, LA, in September 1941; and in the First Army Carolina Maneuvers near Peachland-Camden, SC, in October–November 1941. Location of the division HQ on 7 December 1941 was Camp Blanding, FL.

**Status:** HHC are currently active at Newington, CT, as HHC, 143d Area Support Group.

**Events:** 59, 174, 190, 234, 280, 301, 325, 328, 330

**Division Commanders**

Maj. Gen. Morris B. Payne (CT) 21 March 1925–13 October 1941 Maj. Gen. John H. Hester (R.A.) 13 October 1941–9 June 1942

<b>43d DIVISION Organization 1924</b>		<b>43d DIVISION Organization 1939</b>	
<b>UNIT:</b>	<b>HQ LOCATION:</b>	<b>UNIT:</b>	<b>HQ LOCATION:</b>
<i>HQ</i>	<i>Connecticut N.G.*</i>	HQ	New London, CT
<i>HQ, Special Troops</i>	<i>Connecticut N.G.*</i>	HQ, Special Troops	Danielson, CT
<i>HQ Co.</i>	Putnam, CT	HQ Co.	Putnam, CT
<i>43d M.P. Co.</i>	<i>Connecticut N.G.*</i>	43d M.P. Co.	Danielson, CT
<i>43d Sig. Co.</i>	Providence, RI	43d Sig. Co.	Providence, RI
<i>118th Ord. Co. (M)</i>	<i>Rhode Island N.G.*</i>	118th Ord. Co. (M)	Providence, RI
<i>43d Tank Co. (L)</i>	Branford, CT	43d Tank Co. (L)	Hartford, CT
<i>Mt cyl Co. No. 118</i>	Hartford, CT		
85th Inf. Brig.	New London, CT	85th Inf. Brig.	New Haven, CT
169th Inf. Regt.	Hartford, CT	102d Inf. Regt.	New Haven, CT
170th Inf. Regt.	New Haven, CT	169th Inf. Regt.	Hartford, CT
86th Inf. Brig.	Augusta, ME	86th Inf. Brig.	Rutland, VT
103d Inf. Regt.	Portland, ME	103d Inf. Regt.	Portland, ME
172d Inf. Regt.	Brattleboro, VT	172d Inf. Regt.	Bennington, VT
<i>68th F.A. Brig.</i>	<i>Rhode Island N.G.*</i>	68th F.A. Brig.	Providence, RI
<i>118th Ammo. Tn.</i>	<i>Vermont N.G.*</i>	<i>118th Ammo. Tn.</i>	<i>Vermont N.G.*</i>
103d F.A. Regt.	Providence, RI	103d F.A. Regt.	Providence, RI
152d F.A. Regt.	<i>Maine N.G.*</i>	152d F.A. Regt.	Bangor, ME
		192d F.A. Regt.	New London, CT

118th Engr. Regt.  
 118th Med. Regt.  
 43d Div. Tn., Q.M.C.  
 43d Div. Air Service

Rhode Island N.G.\*  
 New Haven, CT  
 Vermont N.G.\*  
 Hartford, CT

118th Engr. Regt.  
 118th Med. Regt.  
 118th Q.M. Regt.

Providence, RI  
 New Haven, CT  
 West Hartford, CT

\*Indicates state of HQ allocation; HQ not organized or inactive.

**44th DIVISION**

**New Jersey, Delaware, and  
 New York National Guard**

**HQ**—Trenton, NJ, 1924–25; Newark, NJ, 1925–36; Trenton, NJ, 1936–40; Fort Dix, NJ, 1940–41

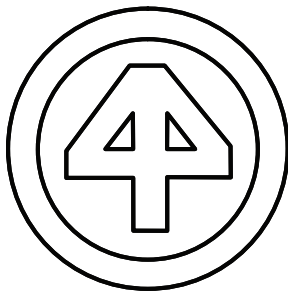

The 44th Div. was constituted in the N.G. on 19 October 1920; allotted to the states of New Jersey, Delaware, and New York; and assigned to the II Corps in 1921. The division HQ was organized and federally recognized on 26 March 1924 at Trenton, NJ. The HQ was relocated on 21 February 1925 to Newark, NJ, and back to Trenton on 5 October 1936. The designated mobilization training center for the 44th Div. was Camp Dix, NJ. The division staff, composed of personnel from all three states, came together each summer to conduct joint training at Sea Girt, NJ, where the New Jersey elements conducted summer camp every year. The New York units held their training at Camp Smith at Peekskill, NY. The division staff participated in the First Army CPXs at Camp Dix in 1931 and 1934 and at Fort Devens in 1936 and 1937. The division was assembled for the first time in August 1935 when it participated in the First and Second

Corps Area phase of the First Army Maneuvers at Pine Camp, NY. In 1939, the division again participated in the First Army Maneuvers, this time at Plattsburg, NY, as part of the provisional II Corps. The 44th Div.'s last major training event before induction was the First Army Maneuver involving the provisional I, II, and III Corps near Canton, NY, in August 1940. The division was inducted into active Federal Service at home stations on 16 September 1940, assigned to the II Corps, and ordered to move to Fort Dix, where it arrived on 23 September 1940. After the division's initial train-up period, the 44th Div. participated in the First Army Carolina Maneuvers near Wadesboro, NC, in October–November 1941. Location of the division HQ on 7 December 1941 was in transit between North Carolina and Fort Dix, NJ.

**Status:** HHC are currently active at Fort Dix, NJ, as HHC, 50th Brig., 42d Inf. Div.

**Events:** 59, 91, 174, 190, 234, 280, 301, 330

**Division Commanders**

Maj. Gen. Quincy A. Gillmore (NJ)	26 March 1924–30 November 1932	Maj. Gen. Winfield S. Price (NJ)	23 June 1936–21 June 1939
Maj. Gen. John J. Toffey (NJ)	1 January 1933–23 June 1936	Maj. Gen. Clifford R. Powell (NJ)	29 June 1939–8 October 1941
	Maj. Gen. James I. Muir (R.A.)		8 October 1941–August 1944

**44th DIVISION  
 Organization 1924**

<b>UNIT:</b>	<b>HQ LOCATION:</b>
HQ	Trenton, NJ
HQ, Special Troops	New Jersey N.G.*
HQ Co.	Plainfield, NJ
44th M.P. Co.	New Jersey N.G.*
44th Sig. Co.	Orange, NJ
119th Ord. Co. (M)	New Jersey N.G.*
44th Tank Co. (L)	New Jersey N.G.*
Mtcyl Co. No. 119	Flemington, NJ
57th Inf. Brig.	Newark, NJ
113th Inf. Regt.	Newark, NJ
114th Inf. Regt.	Camden, NJ
87th Inf. Brig.	New York City, NY
165th Inf. Regt.	New York City, NY
174th Inf. Regt.	Buffalo, NY

**44th DIVISION  
 Organization 1939**

<b>UNIT:</b>	<b>HQ LOCATION:</b>
HQ	Trenton, NJ
HQ, Special Troops	Orange, NJ
HQ Co.	Plainfield, NJ
44th M.P. Co.	Orange, NJ
44th Sig. Co.	Orange, NJ
119th Ord. Co. (M)	Trenton, NJ
44th Tank Co. (L)	Orange, NJ
57th Inf. Brig.	Trenton, NJ
113th Inf. Regt.	Newark, NJ
114th Inf. Regt.	Camden, NJ
87th Inf. Brig.	New York City, NY
71st Inf. Regt.	New York City, NY
174th Inf. Regt.	Buffalo, NY

69th F.A. Brig.	<i>New Jersey N.G.*</i>	69th F.A. Brig.	Camden, NJ
119th Ammo. Tn.	<i>New Jersey N.G.*</i>	119th Ammo. Tn.	<i>New Jersey N.G.*</i>
112th F.A. Regt.	Merchantville, NJ	112th F.A. Regt.	Trenton, NJ
156th F.A. Regt.	Newburgh, NY	156th F.A. Regt.	Newburgh, NY
		157th F.A. Regt.	Camden, NJ
104th Engr. Regt.	Englewood, NJ	104th Engr. Regt.	Teaneck, NJ
119th Med. Regt.	Trenton, NJ	119th Med. Regt.	Trenton, NJ
44th Div. Tn., Q.M.C.	<i>New Jersey N.G.*</i>	119th Q.M. Regt.	Trenton, NJ
44th Div. Air Service	<i>New Jersey N.G.*</i>		

\*Indicates state of HQ allocation; HQ not organized or inactive.

## 45th DIVISION

## Oklahoma, Arizona, New Mexico, and Colorado National Guard

**HQ**—Oklahoma City, OK, 1923–40; Phoenix, AZ, 1933–35; Oklahoma City, OK, 1935–40; Fort Sill, OK, 1940–41; Camp Barkeley, TX, 1941

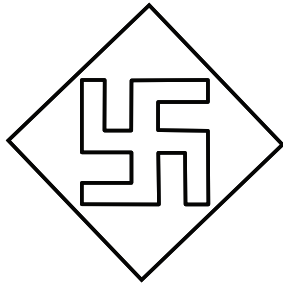

The 45th Div. was constituted in the N.G. on 18 October 1920; allotted to the states of Oklahoma, Arizona, New Mexico, and Colorado; and assigned to the VIII Corps in 1921. The division HQ was organized and federally recognized on 3 August 1923 at Oklahoma City, OK. The division HQ was relocated on 15 September 1933 to Phoenix, AZ, and back to Oklahoma City on 25 November 1935. The designated mobilization training center for the 45th Div. was Fort Sill, OK. From 1922 to 1936, the division's subordinate units generally held separate summer camps at locations within their respective states: Fort Sill for Oklahoma units; Fort Tuthill, near Flagstaff for Arizona units; Camp Maximilliano Luna for New Mexico units; and Golden State Military Reservation for Colorado units. For at least 3 years, in 1927, 1932, and 1933, the division's subordinate units trained over 250 company-grade officers of the 95th and 103d Divs. at the various state encampment locations. In 1936, the division and

brigade staffs participated in the Third Army CPX at Fort Sam Houston and Camp Bullis, TX, which was designed to prepare them for the large-scale army maneuvers to be held the summer of 1938. For participation in the Eighth Corps Area concentration of the Third Army Maneuvers in August 1938, the division was split between Camp Bullis (Oklahoma elements), Fort Bliss, TX (New Mexico and Colorado elements), and Fort Huachuca, AZ (Arizona elements). During the maneuver at Camp Bliss, the 45th Div. (-) operated as part of the provisional Brown Corps with the 2d Div. against the 36th Div. and the 56th Cav. Brig. of the Blue Corps. The following year (1939), the division adopted a new shoulder patch. The original patch was a red square, one point up, centered with the ancient Indian symbol of a yellow swastika. Due to its similarity to the symbol of Germany's National-Socialist Party (Nazis), the division adopted a golden thunderbird symbol that was also sacred in Indian mythology. In August 1940, the 45th Div. again participated in the Third Army Maneuvers, this time near the Kisatchie National Forest in Louisiana as part of the provisional VIII Corps. This was the first opportunity for all division elements to assemble and operate together since its organization. The 45th Div. was inducted into active Federal Service at home stations on 16 September 1940, assigned to the VIII Corps, and ordered to move to Fort Sill, where it arrived on 23 September 1940. The division was transferred to Camp Barkeley, TX, on 28 February 1941. After the division's initial train-up period, the 45th Div. participated in the VIII Corps Maneuver 1–18 June 1941 near Brownwood, TX, and in the GHQ Maneuvers in August–September 1941 near Mount Carmel, LA. Location of the division HQ on 7 December 1941 was Camp Barkeley, TX.

**Status:** HHC are currently active at Edmond, OK, as HHC, 45th Inf. Brig.

**Events:** 80, 217, 258, 300, 317, 328

### Division Commanders

Maj. Gen. Baird H. Markham (OK)	15 February 1923–April 1931	Maj. Gen. Alexander M. Tuthill (AZ)	14 June 1933–22 September 1935
Maj. Gen. Roy Hoffman (OK)	3 August 1931–13 June 1933	Maj. Gen. Charles E. McPherran (OK)	25 November 1935–29 July 1936
	Maj. Gen. William S. Key (OK)*		2 February 1937–13 October 1942

\*Acting commander 30 July 1936–1 February 1937; concurrently commanding the 70th F.A. Brig.

**45th DIVISION  
Organization 1924**

UNIT:	HQ LOCATION:
HQ	Oklahoma City, OK
HQ, Special Troops	Stillwater, OK
HQ Co.	Stillwater, OK
45th M.P. Co.	Maud, OK
45th Sig. Co.	Alva, OK
120th Ord. Co. (M)	Claremore, OK
45th Tank Co. (L)	Denver, CO
Mtcyl Co. No. 120	Muskogee, OK
<i>89th Inf. Brig.</i>	<i>Arizona N.G.*</i>
157th Inf. Regt.	Denver, CO
158th Inf. Regt.	Tucson, AZ
90th Inf. Brig.	Oklahoma City, OK
179th Inf. Regt.	Oklahoma City, OK
180th Inf. Regt.	Muskogee, OK
70th F.A. Brig.	Tulsa, OK
120th Ammo. Tn.	Bristow, OK
158th F.A. Regt.	Tulsa, OK
160th F.A. Regt.	Wewoka, OK
120th Engr. Regt.	Las Cruces, NM
120th Med. Regt.	Oklahoma City, OK
45th Div. Tn., Q.M.C.	Anadarko, OK
45th Div. Air Service	Denver, CO

**45th DIVISION  
Organization 1939**

UNIT:	HQ LOCATION:
HQ	Oklahoma City, OK
HQ, Special Troops	Stillwater, OK
HQ Co.	Wetumka, OK
45th M.P. Co.	Marlow, OK
45th Sig. Co.	Alva, OK
120th Ord. Co. (M)	Claremore, OK
45th Tank Co. (L)	Denver, CO
89th Inf. Brig.	Denver, CO
157th Inf. Regt.	Denver, CO
158th Inf. Regt.	Tucson, AZ
90th Inf. Brig.	Oklahoma City, OK
179th Inf. Regt.	Pawnee, OK
180th Inf. Regt.	Muskogee, OK
70th F.A. Brig.	Oklahoma City, OK
<i>120th Ammo. Tn.</i>	<i>Oklahoma N.G.*</i>
158th F.A. Regt.	Anadarko, OK
160th F.A. Regt.	Tulsa, OK
189th F.A. Regt.	Enid, OK
120th Engr. Regt.	Las Cruces, NM
120th Med. Regt.	Oklahoma City, OK
120th Q.M. Regt.	Oklahoma City, OK

\*Indicates state of HQ allocation; HQ not organized or inactive.

**76th DIVISION**

**“Onaway”**

**Organized Reserve Connecticut and  
Rhode Island**

HQ—Hartford, CT, 1921–41

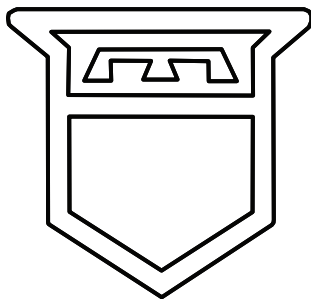

The 76th Div. HQ arrived at the port of Hoboken, NJ, aboard the U.S.S. *Kroonland* on 10 December 1918 after 6 months of overseas service and was demobilized on 14 January 1919 at Camp Devens, MA. The division was reconstituted in the O.R. on 24 June 1921, allotted to the First Corps Area, and assigned to the XI Corps. The division was further allotted to the states of Connecticut and Rhode Island as its home area. HQ of the “Onaway” Division was organized on 1 September 1921 at the State Armory in Hartford, CT. The HQ was subsequently relocated on 18 January 1928 to Room 411, Donaghue Building at 535 Main Street in Hartford, and finally to the Federal Building at Church and High Streets on 28 February 1933, and remained there until activated for World War II. Upon reorganization after the Great War, the division was slow to build its strength. By 1926, the division was still only about

67 percent complete with 605 officers assigned out of 905 authorized. This slow progression was due, in part, to the small number of ROTC programs located in the First Corps Area from which the division could draw its officers. To maintain communications with the officers of the division, the division headquarters published a newsletter named “The Spirit of ‘76” in keeping with division’s numerical designation and the military, geographical, and historical background of the region from which it drew its personnel. The newsletter informed the division’s members of such things as when and where the inactive training sessions were to be held, what the division’s summer training quotas were, where the camps were to be held, and which units would be assigned to help conduct the CMTC training. The designated mobilization and training station for the division was Camp Devens, the location where much of the 76th

Div.'s training activities occurred in the interwar years. For the few summers when it was called to duty for training as a unit, the HQ, 76th Div. often trained with the staff of the 18th Inf. Brig. at Camp Devens. The summer training for the personnel assigned to the division HQ was varied and included staff training, branch-specific training, and CPXs. For several summers, however, the division HQ conducted its summer training at the Connecticut Agricultural College in Storrs. The camp at Storrs was also designated the "Special Officers Camp" and consisted of training for unassigned officers, officers who could not attend training with their assigned units, and basic training for recent ROTC and CMTC commissionees. The division's subordinate units trained all over the First Corps Area. Divisional infantry regiments, for example, held their summer training primarily with the units of the 18th Inf. Brig. at Camp Devens, Fort Ethan Allen, VT, and Fort Adams, RI. Other units, such as the special troops, artillery, engineers, aviation, medical, and quartermaster, trained at various posts in the First, Second, and Third Corps Areas, usually with R.A. units of the same branch. For example, the 301st Engr. Regt. usually trained with the 1st Engr. Regt. at Fort Du Pont, DE; the 301st Med. Regt. trained with the 1st Med. Regt. at Carlisle Barracks, PA; and the 301st Obsn. Sq. trained with the 5th Obsn. Sq. at Mitchel Field, NY. In addition to the unit training camps, the infantry regiments of the division rotated the responsibility for conducting the CMTC held at Camp Devens each year. On a number of occasions, the 76th Div. participated in First Corps Area or First Army CPXs in conjunction with other R.A., N.G., and O.R. units. These training events gave division staff officers an opportunity to practice the roles they would be expected to perform in the event the division was mobilized. Unlike the R.A. and N.G. units in the First Corps Area, the 76th Div. did not participate in the First Corps Area maneuvers and the First Army Maneuvers of 1935, 1939, and 1940 as an organized unit due to lack of enlisted personnel and equipment. Instead, the officers and a few enlisted reservists were assigned to R.A. and N.G. units to fill vacant slots and bring the units up to war strength for the exercises. Additionally, some were assigned duties as umpires or as support personnel. Location of the division HQ on 7 December 1941 was Hartford, CT.

**Status:** HHC are currently inactive in the US Army Reserve as HHC, 76th Div. (Tng.).

**Events:** 69, 280

#### Chiefs of Staff

Lt. Col. Delphey T.E. Casteel, Cav.	1 September 1921–1 November 1921	Col. Rush S. Wells, Inf.	7 November 1928–12 December 1928
Col. George H. Cameron, Cav.	1 November 1921–31 July 1924	Col. George W. England, Inf.	12 December 1928–1 September 1930
Maj. William S. Pearson, Q.M.C.	31 July 1924–23 October 1924	Col. John B. Schoeffel, Inf.	1 September 1930–15 November 1933
Col. Charles H. Gerhardt, Inf.	23 October 1924–19 March 1927	Lt. Col. Edward L. Hooper, Inf.	15 November 1933–20 June 1934
Col. George W. England, Inf.	19 March 1927–7 November 1928	Col. George D. Freeman Jr., Inf.	20 June 1934–17 June 1940
	Col. Xavier F. Blauvelt, Inf.		17 June 1940–31 October 1941

#### 76th DIVISION Organization 1922

UNIT:	HQ LOCATION:
HQ	Hartford, CT
HQ, Special Troops	Hartford, CT
HQ Co.	Hartford, CT
76th M.P. Co.	Hartford, CT
76th Sig. Co.	New Haven, CT
301st Ord. Co. (M)	Bridgeport, CT
76th Tank Co. (L)	Providence, RI
Mtcyl Co. No. 301	Bridgeport, CT
151st Inf. Brig.	New Haven, CT
304th Inf. Regt.	Hartford, CT
385th Inf. Regt.	Providence, RI
152d Inf. Brig.	Hartford, CT
417th Inf. Regt.	New Haven, CT
418th Inf. Regt.	Bridgeport, CT
151st F.A. Brig.	New Haven, CT
301st Ammo. Tn.	Hartford, CT
302d F.A. Regt.	Providence, RI
355th F.A. Regt.	New Haven, CT

#### 76th DIVISION Organization 1939

UNIT:	HQ LOCATION:
HQ	Hartford, CT
HQ, Special Troops	Hartford, CT
HQ Co.	Hartford, CT
76th M.P. Co.	Providence, RI
76th Sig. Co.	New Haven, CT
301st Ord. Co. (M)	Bridgeport, CT
76th Tank Co. (L)	Providence, RI
151st Inf. Brig.	New Haven, CT
417th Inf. Regt.	New Haven, CT
418th Inf. Regt.	Bridgeport, CT
152d Inf. Brig.	Hartford, CT
304th Inf. Regt.	Hartford, CT
385th Inf. Regt.	Providence, RI
151st F.A. Brig.	New Haven, CT
301st Ammo. Tn.	Hartford, CT
302d F.A. Regt.	Providence, RI
355th F.A. Regt.	New Haven, CT
364th F.A. Regt.	New Haven, CT

301st Engr. Regt.  
301st Med. Regt.  
76th Div. Tn., Q.M.C.  
76th Div. Air Service

Providence, RI  
Hartford, CT  
Hartford, CT  
Hartford, CT

301st Engr. Regt.  
301st Med. Regt.  
401st Q.M. Regt.

New Haven, CT  
Hartford, CT  
Hartford, CT

## 77th DIVISION

## “Statue of Liberty”

## Organized Reserve New York

HQ—Manhattan, NY, 1921–41

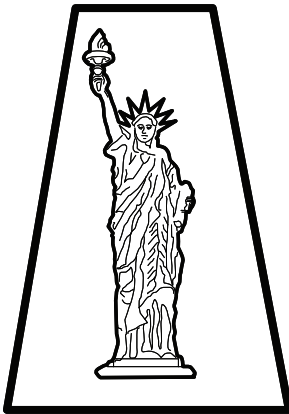

The 77th Div. HQ arrived at the port of Hoboken, NJ, aboard the U.S.S. *Mount Vernon* on 25 April 1919 after 12 months of overseas service and was demobilized on 9 May 1919 at Camp Upton, NY. It was reconstituted in the O.R. on 24 June 1921, allotted to the Second Corps Area, and assigned to the XII Corps. The division was further allotted to the southeastern portion of the state of New York, primarily the metropolitan area of New York City and Long Island as its home area. The division HQ was organized on 1 July 1921 at the Army Building, 39 Whitehall Street in Manhattan, relocated in 1933 to the Federal Building at 641 Washington Street, and remained there until activated for World War II. The initial formation of the division began with a rush, and by July 1923, the “Statue of Liberty” Division was up to full strength in its complement of officers as required by its peacetime tables of organization and was the first Reserve division to do so. Many of its officers were Great War veterans of the division, and so there was a direct tie to the World War I organization, which established an esprit de corps equaled by few O.R. divisions during the period between the world wars. Lt.

Col. Charles W. Whittlesey, the commander of the famous “Lost Battalion” during

World War I, was instrumental in the initial recruiting efforts to get the division up to strength in the early 1920s. The division established a clubhouse at 27 West 25th Street in Manhattan which added to the camaraderie. Over a number of years, most units of the division had bronze plaques cast and inscribed with the names of their war dead mounted in the sitting areas of the club. Some 300 officers and men of the division participated annually in the Army Day parade and over 550 participated in the homecoming parade for Charles Lindbergh on 13 June 1927. All of these served to increase the esprit and camaraderie of the Statue of Liberty Division. The designated mobilization and training station for the division was Camp Dix, NJ, the location where much of the 77th’s training activities occurred in the interwar years. The division HQ generally conducted summer training at Camp Dix, and in 1934 and 1937, conducted major division-level CPXs there. On a number of occasions, the division HQ also participated in Second Corps Area or First Army CPXs in conjunction with other R.A., N.G., and O.R. units. These training events gave division staff officers’ opportunities to practice the roles they would be expected to perform in the event the division was mobilized. The 77th Div. HQ occasionally trained with the staffs of the 1st Div. or the 1st Inf. Brig. at Camp Dix, or sometimes at Fort Slocum, NY. For 1 year, in 1926, the officers of the division HQ trained with the staff of the 27th Div. at Camp Smith, NY. In 1923, the division officers, with assistance from Col. Peter E. Traub, the division chief of staff, established Camp Blauvelt at Nyack, NY, for the purposes of providing a small training area for the division. Camp Blauvelt was frequently used for “contact camps” by subordinate units and occasionally by the division staff for mini-CPXs. The subordinate infantry regiments of the division generally held their summer training primarily with the units of the 1st Inf. Brig. at Camp Dix, but other units, such as the special troops, artillery, engineers, aviation, medical, and quartermaster, trained at various posts in the Second and Third Corps Areas usually with other units of the 1st Div. For example, the division’s artillery trained with the 7th F.A. at Pine Camp, NY; the 302d Engineer Regt. usually trained with the 1st Engr. Regt. at Fort Du Pont, DE; the 302d Med. Regt. trained with the 1st Med. Regt. at Carlisle Barracks, PA; and the 302d Obsn. Sq. trained with the 5th Obsn. Sq. at Mitchel Field, NY. In addition to the unit training camps, the infantry regiments of the division rotated responsibility to conduct the infantry CMTC held at Camp Dix and Plattsburg Barracks each year. The field artillery regiments conducted field artillery CMTC training at



Madison Barracks. Unlike the R.A. and N.G. units in the Second Corps Area, the 77th Div. did not participate in the Second Corps Area Maneuvers and the First Army Maneuvers of 1935, 1939, and 1940, as an organized unit due to lack of enlisted personnel and equipment. Instead, the officers and a number of the enlisted reservists were assigned to R.A. and N.G. units to fill vacant slots and bring the units up to war strength for the exercises. Additionally, some were assigned duties as umpires or as support personnel. Due to the mobilization of many officers beginning in 1939, all officers less those in the infantry and field artillery were relieved from their divisional assignments in July 1941 and assigned to branch pools instead. Location of the division HQ on 7 December 1941 was Manhattan, NY.

**Status:** HHC are currently inactive in the US Army Reserve as HHC, 77th Inf. Div.

**Events:** 61, 91, 153, 168, 280

#### Division Commanders

Brig. Gen. Cornelius Vanderbilt (O.R.)	6 May 1922–January 1929	Maj. Gen. William E. Cole (R.A.)*	March 1935–20 January 1936
Brig. Gen. Palmer E. Pierce (O.R.)	January 1929–13 November 1929	Brig. Gen. Perry L. Miles (R.A.)**	11 January 1937–11 October 1937
Brig. Gen. Cornelius Vanderbilt (O.R.)	13 November 1929–18 January 1935	Col. James E. Austin (O.R.)	11 October 1937–July 1941

\*Concurrently commanding general of the Second Coast Artillery District.

\*\*Concurrently commanding general of the 2d Inf. Brig.

#### Chiefs of Staff

Col. John J. Bradley, Inf.	1 July 1921–1 July 1923	Col. George M. Russell, Cav.	7 April 1937–7 December 1937
Col. Peter E. Traub, Inf.	1 October 1923–19 April 1928	Col. Hugo D. Selton, Inf.	7 December 1937–7 February 1939
Col. James T. Dean	19 April 1928–8 June 1928	Col. Bernard Lentz, Inf.	8 February 1939–6 June 1940
Col. Wallace B. Scales, Cav.	8 June 1928–29 September 1933	Col. H. Clay M. Supplee, Inf.	6 June 1940–September 1940
Col. Conrad S. Babcock, Cav.	2 October 1933–7 April 1937	Col. Hugo D. Selton, Inf.	September 1940–30 January 1942

#### 77th DIVISION Organization 1922

UNIT:	HQ LOCATION:
HQ	Manhattan, NY
HQ, Special Troops	Manhattan, NY
HQ Co.	Manhattan, NY
77th M.P. Co.	Manhattan, NY
77th Sig. Co.	Manhattan, NY
302d Ord. Co. (M)	Manhattan, NY
77th Tank Co. (L)	Manhattan, NY
Mtcyl Co. No. 302	Manhattan, NY
153d Inf. Brig.	Manhattan, NY
305th Inf. Regt.	Brooklyn, NY
306th Inf. Regt.	Flushing, NY
154th Inf. Brig.	Manhattan, NY
307th Inf. Regt.	Manhattan, NY
308th Inf. Regt.	Bronx, NY
152d F.A. Brig.	Manhattan, NY
302d Ammo. Tn.	Manhattan, NY
304th F.A. Regt.	Brooklyn, NY
305th F.A. Regt.	Manhattan, NY
302d Engr. Regt.	Manhattan, NY
302d Med. Regt.	Manhattan, NY
77th Div. Tn., Q.M.C.	Manhattan, NY
77th Div. Air Service	Garden City, NY

#### 77th DIVISION Organization 1939

UNIT:	HQ LOCATION:
HQ	Manhattan, NY
HQ, Special Troops	Manhattan, NY
HQ Co.	Manhattan, NY
77th M.P. Co.	Manhattan, NY
77th Sig. Co.	Manhattan, NY
302d Ord. Co. (M)	Manhattan, NY
77th Tank Co. (L)	Manhattan, NY
153d Inf. Brig.	Manhattan, NY
305th Inf. Regt.	Brooklyn, NY
306th Inf. Regt.	Flushing, NY
154th Inf. Brig.	Manhattan, NY
307th Inf. Regt.	Manhattan, NY
308th Inf. Regt.	Bronx, NY
152d F.A. Brig.	Manhattan, NY
302d Ammo. Tn.	Manhattan, NY
304th F.A. Regt.	Brooklyn, NY
305th F.A. Regt.	Manhattan, NY
306th F.A. Regt.	Bronx, NY
302d Engr. Regt.	Manhattan, NY
302d Med. Regt.	Manhattan, NY
402d Q.M. Regt.	Brooklyn, NY

## 78th DIVISION

## “Lightning Division”

## Organized Reserve New Jersey

HQ—Manhattan, NY, 1921–24; Newark, NJ, 1924–41

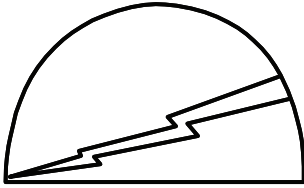

The 78th Div. HQ arrived at the port of Brooklyn, NY, aboard the U.S.S. *Santa Ana* on 6 June 1919 after 13 months of overseas service and was demobilized on 9 July 1919 at Camp Dix, NJ. It was reconstituted in the O.R. on 24 June 1921, allotted to the Second Corps Area, and assigned to the XII Corps. The division was further allotted to the state of New Jersey as its home area. The division HQ was organized on 1 July 1921 at 39 Whitehall Street in Manhattan, but relocated on 26 March 1924 to the Globe Indemnity Building, Washington Place, Newark, NJ. The HQ

was relocated on 25 July 1936 to the Federal Building, 1180 Raymond Boulevard in Newark and remained there until activated for World War II. Like the 77th Div., the initial formation of the “Lightning Division” was expedited by the enrollment of many officers who were World War I veterans of the division. To maintain communications with the officers of the division, the division staff published a newsletter, the “78th Division Gazette.” The newsletter informed the division’s members of such things as when and where the inactive training sessions were to be held, what the division’s summer training quotas were, where the camps were to be held, and which units would be assigned to help conduct the CMTC training. The designated mobilization and training station for the division was Camp Dix, the location where much of the 78th’s training activities occurred in the interwar years. The division HQ often conducted its summer training there, and on a number of occasions, participated in CPXs at Camp Dix as well. The 78th Div. HQ also occasionally trained with the staffs of the 1st Div. or the 1st Inf. Brig. at Camp Dix. In 1924, the division officers with assistance from Col. Edward A. Shuttleworth, the division chief of staff, established Camp Silzer at Sea Girt, NJ, for the purposes of providing a training area for the division. Camp Silzer was used some summers by the division staff for CPXs and frequently for “contact camps” by subordinate units. For the 1937 camp at Camp Dix, the division staff and subordinate units planned and conducted an unusual division night attack exercise in coordination with the 303d Chem. Regt. and the 40th Engr. Bn. (Camo). The subordinate infantry regiments of the division held their summer training primarily with the units of the 1st Inf. Brig. Other units, such as the special troops, artillery, engineers, aviation, medical, and quartermaster, usually trained at various posts in the Second and Third Corps Areas also with other units of the 1st Div. For example, the division’s artillery units trained with the 7th F.A. at Pine Camp, NY; the 303d Engr. Regt. usually trained with the 1st Engr. Regt. at Fort Du Pont, DE; the 303d Med. Regt. trained with the 1st Med. Regt. at Carlisle Barracks, PA; and the 303d Obsn. Sq. trained with the 5th Obsn. Sq. at Mitchel Field, NY. In addition to the unit training camps, the infantry regiments of the division rotated responsibility for conducting the infantry CMTC held at Camp Dix each year. On a number of occasions, the division participated in Second Corps Area or First Army CPXs in conjunction with other R.A., N.G., and O.R. units. These training events gave division staff officers’ opportunities to practice the roles they would be expected to perform in the event the division was mobilized. Unlike the R.A. and N.G. units in the First Corps Area, the 78th Div. did not participate in the Second Corps Area Maneuvers and the First Army Maneuvers of 1935, 1939, and 1940 as an organized unit due to lack of enlisted personnel and equipment. Instead, the officers and a few enlisted reservists were assigned to R.A. and N.G. units to fill vacant slots and bring the units up to war strength for the exercises. Additionally, some were assigned duties as umpires or as support personnel. Location of the division HQ on 7 December 1941 was Newark, NJ.

**Status:** HHC are currently active in the US Army Reserve at Edison, NJ, as HHC, 78th Div. (Tng. Support).

**Events:** 61, 91, 168, 229, 280

### Division Commanders

Brig. Gen. Otho B. Rosenbaum (R.A.)*	8 November 1929–10 January 1931	Brig. Gen. Stanley H. Ford (R.A.)*	10 September 1935–27 March 1936
Brig. Gen. Lucius R. Holbrook (R.A.)*	10 January 1931–6 May 1931	Brig. Gen. Perry L. Miles (R.A.)*	11 January 1937–31 October 1937
Brig. Gen. Howard L. Laubach (R.A.)*	6 May 1931–11 August 1934	Brig. Gen. Paul Debevoise (O.R.)	31 October 1937–15 June 1938
Brig. Gen. John L. DeWitt (R.A.)*	14 August 1934–26 April 1935	Brig. Gen. Walter C. Short (R.A.)*	15 June 1938–11 October 1939

\*Concurrently commanding general of the 1st Inf. Brig.

### Chiefs of Staff

Brig. Gen. William Weigel	1 August 1921–24 August 1921	Col. Edward A. Shuttleworth, Inf	5 August 1924–May 1929
Col. William M. Morrow, Inf	24 August 1921–1 November 1922	Col. Russell C. Langdon, Inf	25 May 1929–31 May 1930
Maj. Earl Biscoe, Inf	2 November 1922–3 July 1923	Col. Chalmers G. Hall, A.C.	21 June 1930–1 October 1935
Col. Isaac C. Jenks, Inf	3 July 1923–5 August 1924	Col. John P. Bubb, Inf.	28 December 1935–20 February 1940
	Col. Gordon R. Catts, Inf		14 March 1940–January 1942

**78th DIVISION  
Organization 1922**

UNIT:	HQ LOCATION:
HQ	Newark, NJ
HQ, Special Troops	Newark, NJ
HQ Co.	Newark, NJ
78th M.P. Co.	Newark, NJ
78th Sig. Co.	Newark, NJ
303d Ord. Co. (M)	New Brunswick, NJ
78th Tank Co. (L)	Elizabeth, NJ
Mtcyl Co. No. 303	New Brunswick, NJ
155th Inf. Brig.	Elizabeth, NJ
309th Inf. Regt.	Camden, NJ
310th Inf. Regt.	Jersey City, N
156th Inf. Brig.	Newark, NJ
311th Inf. Regt.	Trenton, NJ
312th Inf. Regt.	Newark, NJ
153d F.A. Brig.	Bayonne, NJ
303d Ammo. Tn.	Jersey City, NJ
307th F.A. Regt.	Perth Amboy, NJ
308th F.A. Regt.	Hoboken, NJ
303d Engr. Regt.	Paterson, NJ
303d Med. Regt.	Newark, NJ
78th Div. Tn., Q.M.C.	Newark, NJ
78th Div. Air Service	Atlantic City, NJ

**78th DIVISION  
Organization 1939**

UNIT:	HQ LOCATION:
HQ	Newark, NJ
HQ, Special Troops	Newark, NJ
HQ Co.	Newark, NJ
78th M.P. Co.	Newark, NJ
78th Sig. Co.	Newark, NJ
303d Ord. Co. (M)	Newark, NJ
78th Tank Co. (L)	Newark, NJ
155th Inf. Brig.	Englewood, NJ
309th Inf. Regt.	Camden, NJ
310th Inf. Regt.	Englewood, NJ
156th Inf. Brig.	Newark, NJ
311th Inf. Regt.	Elizabeth, NJ
312th Inf. Regt.	Newark, NJ
153d F.A. Brig.	Englewood, NJ
303d Ammo. Tn.	Trenton, NJ
307th F.A. Regt.	Trenton, NJ
308th F.A. Regt.	Hoboken, NJ
309th F.A. Regt.	Brooklyn, NY
303d Engr. Regt.	Paterson, NJ
303d Med. Regt.	Newark, NJ
403d Q.M. Regt.	Newark, NJ

**79th DIVISION**

**“Lorraine Division”**

**Organized Reserve Pennsylvania**

HQ—Philadelphia, PA, 1921–41

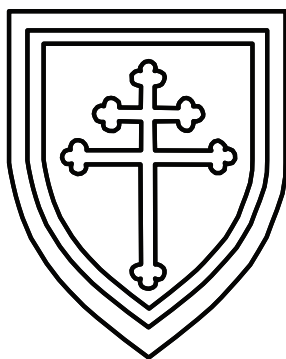

The 79th Div. HQ arrived at the port of Hoboken, NJ, aboard the U.S.S. *Kroonland* on 29 May 1919 after 10 months of overseas service and was demobilized on 2 June 1919 at Camp Dix, NJ. It was reconstituted in the O.R. on 24 June 1921, allotted to the Third Corps Area, and assigned to the XIII Corps. The division was further allotted to the eastern half of the state of Pennsylvania as its home area. HQ of the “Lorraine Division” was originally organized on 29 September 1921 at the Schuylkill Arsenal, 2620 Gray’s Ferry Road in Philadelphia. It was later relocated in 1930 to the Gimbal Building at 35 South Ninth Street. It was again relocated in 1935 to the New Custom House Building at Second and Chestnut Streets and remained there until activated for World War II. After activation, the division’s recruiting efforts were such that by 1926, the division was at 85 percent of its authorized strength. To maintain communications with the officers of the division, the division staff published a newsletter, the “79th Division Bulletin.” The newsletter informed the division’s members of such things as

when and where the inactive training sessions were to be held, what the division’s summer training quotas were, where the camps were to be held, and which units would be assigned to help conduct the CMTC training. The designated mobilization and training station for the division was Camp George G. Meade, MD, the location where much of the 79th’s training activities occurred in the interwar years. The division HQ usually conducted its summer training there, and on a number of occasions, participated in CPXs there as well. During these camps, the 79th Div. HQ occasionally trained with the staff of the 16th Inf. Brig. In May 1929, the 79th Div. conducted a contact camp at Conneaut, PA, and almost 500 of the division’s officers attended. The highlight of the camp was an aerial demonstration performed by the 99th Div.’s 324th Obsn. Sq. The subordinate infantry regiments of the division held their summer training

primarily with the units of the 16th Inf. Brig. Other units, such as the special troops, artillery, engineers, aviation, medical, and quartermaster trained at various posts in the Second and Third Corps Areas usually with units of the 1st Div. or the active elements of the 8th Div. For example, the division's artillery trained with the 16th F.A. at Camp Meade; the 304th Engr. Regt. usually trained with the 1st Engr. Regt. at Fort Du Pont, DE, or the 13th Engrs. at Camp Humphreys, VA; the 304th Med. Regt. trained with the 1st Med. Regt. at Carlisle Barracks, PA; and the 304th Obsn. Sq. trained with the 99th Obsn. Sq. at Bolling Field, DC. In addition to the unit training camps, the infantry regiments of the division rotated responsibility to conduct the CMTC training held at Camp Meade each year. On a number of occasions, the division participated in Third Corps Area or First Army CPXs in conjunction with other R.A., N.G., and O.R. units. Perhaps the division's most ambitious CPX was a division-level exercise conducted round the clock for almost 2 weeks from 31 July to 12 August 1938. These training events gave division staff officers' opportunities to practice the roles they would be expected to perform in the event the division was mobilized. In January 1940, many officers of the 79th Div. HQ attended a week of additional annual training performed by the HQ, 28th Div. The training was part of a War Department-directed effort to increase the readiness of N.G. units that winter. The 79th Div. officers voluntarily participated in the training without pay. Unlike the R.A. and N.G. units in the Third Corps Area, the 79th Div. did not participate in the Third Corps Area Maneuvers and the First Army Maneuvers of 1935, 1939, and 1940 as an organized unit due to lack of enlisted personnel and equipment. Instead, the officers and a few enlisted reservists were assigned to R.A. and N.G. units to fill vacant slots and bring the units up to war strength for the exercises. Additionally, some were assigned duties as umpires or as support personnel. Location of the division HQ on 7 December 1941 was Philadelphia, PA.

**Status:** HHC are currently inactive in the US Army Reserve as HHC, 79th Inf. Div.

**Events:** 109, 247, 281

#### Division Commanders

Maj. Gen. Harry F. Hodges (R.A.)\* 6 October 1921–22 December 1921 Maj. Gen. Charles J. Bailey (R.A.)\* 22 December 1921–1 December 1922

\*Concurrently commanding general of the Third Corps Area.

#### Chiefs of Staff

Col. Edward Carpenter, C.A.C.	13 August 1921–1 May 1924	Col. Jerome G. Pillow, Cav.	30 November 1936–28 February 1938
Col. Harold E. Cloke, C.A.C.	1 May 1924–18 April 1925	Col. John R. Starkey, F.A.	28 February 1938–17 August 1938
Col. Lewis S. Sorley, Inf.	18 April 1925–30 April 1931	Col. Selwyn D. Smith, Cav.	17 August 1938–June 1940
Col. Clarence R. Day, F.A.	30 April 1931–30 September 1936	Col. Phillip S. Gage, C.A.C.	28 June 1940–13 November 1940
	Col. Joseph C. King, Cav.		13 November 1940–February 1942

#### 79th DIVISION Organization 1922

UNIT:	HQ LOCATION:
HQ	Philadelphia, PA
HQ, Special Troops	Philadelphia, PA
HQ Co.	Philadelphia, PA
79th M.P. Co.	Columbia, PA
79th Sig. Co.	Doylestown, PA
304th Ord. Co. (M)	Pottstown, PA
79th Tank Co. (L)	Gettysburg, PA
Mtcyl Co. No. 304	Pottstown, PA
157th Inf. Brig.	Wilkes-Barre, PA
313th Inf. Regt.	Wilkes-Barre, PA
314th Inf. Regt.	Reading, PA
158th Inf. Brig.	Philadelphia, PA
315th Inf. Regt.	Philadelphia, PA
316th Inf. Regt.	Lancaster, PA
154th F.A. Brig.	Philadelphia, PA
304th Ammo. Tn.	Philadelphia, PA
310th F.A. Regt.	Philadelphia, PA
311th F.A. Regt.	Philadelphia, PA

#### 79th DIVISION Organization 1939

UNIT:	HQ LOCATION:
HQ	Philadelphia, PA
HQ, Special Troops	Philadelphia, PA
HQ Co.	Philadelphia, PA
79th M.P. Co.	Philadelphia, PA
79th Sig. Co.	Philadelphia, PA
304th Ord. Co. (M)	Philadelphia, PA
79th Tank Co. (L)	Philadelphia, PA
157th Inf. Brig.	Wilkes-Barre, PA
313th Inf. Regt.	Wilkes-Barre, PA
314th Inf. Regt.	Reading, PA
158th Inf. Brig.	Philadelphia, PA
315th Inf. Regt.	Philadelphia, PA
316th Inf. Regt.	Lancaster, PA
154th F.A. Brig.	Philadelphia, PA
304th Ammo. Tn.	Philadelphia, PA
310th F.A. Regt.	Philadelphia, PA
311th F.A. Regt.	Philadelphia, PA
312th F.A. Regt.	Philadelphia, PA



### Chiefs of Staff

Col. Joseph C. Castner, Inf.	1 September 1921–29 December 1921	Col. Melville S. Jarvis, Inf.	October 1928–15 June 1932
Lt. Col. James P. Robinson, F.A.	29 December 1921–1 July 1922	Col. Frank L. Wells, Inf.	15 June 1932–31 October 1932
Col. George H. Jamerson, Inf.	1 July 1922–25 March 1923	Col. Thomas H. Jackson, C.E.	1 November 1932–24 March 1933
Lt. Col. James P. Robinson, F.A.	25 March 1923–March 1924	Col. Kerwin T. Smith, Inf.	24 March 1933–3 February 1935
Col. Samuel F. Dallem, Inf.	22 September 1924–20 July 1928	Col. William E. Persons, Inf.	3 February 1935–1 June 1936
Col. Harrison J. Price, Inf.	20 July 1928–October 1928	Col. Louis C. Brinton, Jr. C.A.C.	1 June 1936–19 July 1938
	Col. Ellery Farmer, Inf.		19 July 1938–15 June 1942

#### 80th DIVISION Organization 1922

UNIT:	HQ LOCATION:
HQ	Richmond, VA
HQ, Special Troops	Richmond, VA
HQ Co.	Richmond, VA
80th M.P. Co.	Alexandria, VA
80th Sig. Co.	Washington, DC
305th Ord. Co. (M)	Richmond, VA
80th Tank Co. (L)	Richmond, VA
Mtcyl Co. No. 305	Richmond, VA
159th Inf. Brig.	Richmond, VA
317th Inf. Regt.	Lynchburg, VA
318th Inf. Regt.	Richmond, VA
160th Inf. Brig.	Baltimore, MD
319th Inf. Regt.	Baltimore, MD
320th Inf. Regt.	Washington, DC
155th F.A. Brig.	Washington, DC
305th Ammo. Tn.	Washington, DC
313th F.A. Regt.	Baltimore, MD
314th F.A. Regt.	Richmond, VA
305th Engr. Regt.	Richmond, VA
305th Med. Regt.	Richmond, VA
80th Div. Tn., Q.M.C.	Richmond, VA
80th Div. Air Service	Richmond, VA

#### 80th DIVISION Organization 1939

UNIT:	HQ LOCATION:
HQ	Richmond, VA
HQ, Special Troops	Richmond, VA
HQ Co.	Richmond, VA
80th M.P. Co.	Alexandria, VA
80th Sig. Co.	Baltimore, MD
305th Ord. Co. (M)	Richmond, VA
80th Tank Co. (L)	Baltimore, MD
159th Inf. Brig.	Richmond, VA
317th Inf. Regt.	Lynchburg, VA
318th Inf. Regt.	Richmond, VA
160th Inf. Brig.	Baltimore, MD
319th Inf. Regt.	Baltimore, MD
320th Inf. Regt.	Washington, DC
155th F.A. Brig.	Washington, DC
305th Ammo. Tn.	Washington, DC
313th F.A. Regt.	Washington, DC
314th F.A. Regt.	Richmond, VA
315th F.A. Regt.	Washington, DC
305th Engr. Regt.	Richmond, VA
305th Med. Regt.	Richmond, VA
405th Q.M. Regt.	Richmond, VA

### 81st DIVISION

### “Wildcat”

### Organized Reserve Tennessee and North Carolina

HQ—Knoxville, TN, 1921–41

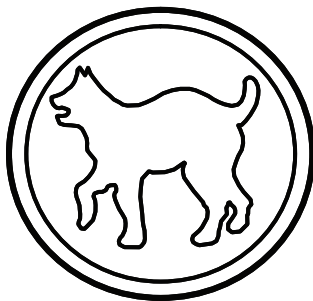

The 81st Div. HQ arrived at the port of Hoboken, NJ, aboard the U.S.S. *Cap Finisterre* on 11 June 1919 after 11 months of overseas service and was demobilized upon arrival. It was reconstituted in the O.R. on 24 June 1921, allotted to the Fourth Corps Area, and assigned to the XIV Corps. The division was further allotted to the states of Tennessee and North Carolina as its home area. The division HQ was organized on 23 September 1921 at the Arnstein Building in Knoxville, TN, and relocated in 1927 to the L.F.M. Building in Knoxville. It was again relocated in 1933 to the Post Office Building and remained there until activated for World War II. After activation, the division’s recruiting efforts were such that by February 1924, the division was at 100 percent of its authorized strength. To maintain communications with the officers of the division, the division staff published a newsletter, the “The

Wildcat.” The newsletter informed the division’s members of such things as when and where the inactive training sessions were to be held, what the division’s summer training quotas were, where the camps were to be held, and

which units would be assigned to help conduct the CMTC training. The designated mobilization and training station for the division was Camp McClellan, AL, the location where much of the 81st Div.'s training activities occurred in the interwar years. The division HQ usually conducted its summer training there, and on a number of occasions, participated in CPXs. The 81st Div. HQ occasionally trained with the staff of the 8th Inf. Brig. The subordinate infantry regiments of the division held their summer training primarily with the units of the 16th Inf. Brig. Other units, such as the special troops, artillery, engineers, aviation, medical, and quartermaster, trained at various posts in the Fourth Corps Area usually with the active elements of the 4th Div. or other R.A. units. For example, the division's artillery trained with the units of the 13th F.A. Brig. at Fort Bragg, NC; the 306th Engr. Regt. usually trained with the A Company, 4th Engr. Regt. at Fort Benning, GA; the 306th Med. Regt. trained at the medical officers training camp at Fort Oglethorpe, GA; and the 306th Obsn. Sq. trained with air corps units at Maxwell Field, AL. In addition to the unit training camps, the infantry regiments of the division rotated responsibility to conduct the CMTC training held at Camp McClellan, AL, each year. On a number of occasions, the division participated in Fourth Corps Area or Third Army CPXs in conjunction with other R.A., N.G., and O.R. units. These training events gave division staff officers' opportunities to practice the roles they would be expected to perform in the event the division was mobilized. Unlike the R.A. and N.G. units in the Third Corps Area, the 81st Div. did not participate in the Fourth Corps Area Maneuvers and the Third Army Maneuvers of 1938, 1940, and 1941 as an organized unit due to lack of enlisted personnel and equipment. Instead, the officers and a few enlisted reservists were assigned to R.A. and N.G. units to fill vacant slots and bring the units up to war strength for the exercises. For the 1938 Third Army Maneuver, for example, about 200 of the division's officers were attached to the provisional 4th Div. to allow that unit to function as an almost full-strength division. Additionally, some were assigned duties as umpires or as support personnel. Location of the division HQ on 7 December 1941 was Knoxville, TN.

**Status:** HHC are currently inactive in the US Army Reserve as HHC, 81st Inf. Div.

**Events:** 255, 300

#### Division Commanders

Maj. Gen. David C. Shanks (R.A.)*	13 July 1922–17 January 1925	Col. Albert U. Faulkner (R.A.)***	23 May 1931–June 1931
Col. Henry W. Butner (R.A.)**	16 May 1928–20 August 1929	Brig. Gen. Manus McCloskey (R.A.)**	June 1931–1 April 1938
Brig. Gen. Lucius R. Holbrook (R.A.)**	20 August 1929–5 October 1930	Col. Joseph A. Rogers (R.A.)**	1 April 1938–11 May 1938
Brig. Gen. Herbert J. Brees (R.A.)**	2 January 1931–23 May 1931	Brig. Gen. William Bryden (R.A.)**	11 May 1938–31 August 1939
	Col. Clifford Jones (R.A.)***		1 September 1939–16 March 1941

\*Concurrently commanding general of the Fourth Corps Area.

\*\*Concurrently commanding officer of the 13th F.A. Brig.

\*\*\*Concurrently division Chief of Staff.

#### Chiefs of Staff

Col. Willam R. Sample, Inf	29 September 1921–3 October 1923	Col. J. Millard Little, Inf.	31 December 1932–June 1934
Lt. Col. Robert O. Ragsdale, Inf.	3 October 1923–2 June 1924	Col. Charles B. Stone, Inf.	June 1934–28 January 1935
Col. J. Millard Little, Inf.	2 June 1924–1 April 1928	Col. Robert W. Collins, C.A.C.	28 January 1935–1 April 1936
Col. Charles B. Clark, Inf.	1 April 1928–November 1931	Lt. Col. Lawrence W. Young, Inf.	1 April 1936–15 September 1938
Col. Robert O. Ragsdale, Inf.	November 1931–10 December 1932	Col. Clifford Jones, C.A.C.	15 September 1938–16 March 1941

#### 81st DIVISION Organization 1922

UNIT:	HQ LOCATION:
HQ	Knoxville, TN
HQ, Special Troops	Knoxville, TN
HQ Co.	Knoxville, TN
81st M.P. Co.	Raleigh, NC
81st Sig. Co.	Nashville, TN
306th Ord. Co. (M)	Winston-Salem, NC
81st Tank Co. (L)	Charlotte, NC
Mtcyl Co. No. 306	Brownsville, TN
161st Inf. Brig.	Greensboro, NC
321st Inf. Regt.	Raleigh, NC
322d Inf. Regt.	Greensboro, NC

#### 81st DIVISION Organization 1939

UNIT:	HQ LOCATION:
HQ	Knoxville, TN
HQ, Special Troops	Knoxville, TN
HQ Co.	Knoxville, TN
81st M.P. Co.	Raleigh, NC
81st Sig. Co.	Nashville, TN
306th Ord. Co. (M)	Winston-Salem, NC
81st Tank Co. (L)	Charlotte, NC
161st Inf. Brig.	Raleigh, NC
321st Inf. Regt.	Raleigh, NC
322d Inf. Regt.	Charlotte, NC

162d Inf. Brig.	Nashville, TN	162d Inf. Brig.	Knoxville, TN
323d Inf. Regt.	Knoxville, TN	323d Inf. Regt.	Knoxville, TN
324th Inf. Regt.	Memphis, TN	324th Inf. Regt.	Memphis, TN
156th F.A. Brig.	Knoxville, TN	156th F.A. Brig.	Raleigh, NC
306th Ammo. Tn.	Greensboro, NC	306th Ammo. Tn.	Greensboro, NC
316th F.A. Regt.	Raleigh, NC	316th F.A. Regt.	Raleigh, NC
317th F.A. Regt.	Nashville, TN	317th F.A. Regt.	Nashville, TN
		318th F.A. Regt.	Greensboro, NC
306th Engr. Regt.	Columbia, TN	306th Engr. Regt.	Knoxville, TN
306th Med. Regt.	Franklinton, NC	306th Med. Regt.	Raleigh, NC
81st Div. Tn., Q.M.C.	Memphis, TN	406th Q.M. Regt.	Memphis, TN
81st Div. Air Service	Chattanooga, TN		

## 82d DIVISION

## “All American”

## Organized Reserve South Carolina, Georgia, and Florida

HQ—Columbia, SC, 1921–41



The 82d Div. HQ arrived at the port of New York aboard the S.S. *Alphonso XIII* on 5 May 1919 after 12 months of overseas service and was demobilized on 27 May 1919 at Camp Mills, NY. It was reconstituted in the O.R. on 24 June 1921, allotted to the Fourth Corps Area, and assigned to the XIV Corps. The division was further allotted to the states of South Carolina, Georgia, and Florida as its home area. The division HQ was organized on 23 September 1921 at 1202½ Main Street in Columbia, SC. The HQ was relocated in 1923 to the Post Office Building and remained there until activated for World War II. To maintain communications with the officers of the division, the division staff published a bulletin titled the “All American.” The newsletter informed the division’s members of such things as when and where the inactive training sessions were to be held, what the division’s summer training quotas were, where the camps were to be held, and which units would be

assigned to help conduct the CMTC training. The designated mobilization and training station for the division was Camp McClellan, AL, the location where much of the 82d’s training activities occurred in the interwar years. The division HQ usually conducted its summer training and participated in division CPXs at Camp McClellan as well. The 82d Div. HQ also occasionally trained with the staff of the 8th Inf. Brig. The subordinate infantry regiments of the division held their summer training primarily with the units of the 8th Inf. Brig. Other units, such as the special troops, artillery, engineers, aviation, medical, and quartermaster, trained at various posts in the Fourth Corps Area usually with the active elements of the 4th Div. or other R.A. units. For example, the division’s artillery trained with the units of the 13th F.A. Brig. at Fort Bragg, NC; the 307th Engr. Regt. usually trained with A Company, 4th Engr. Regt. at Fort Benning, GA; the 307th Med. Regt. trained at the medical officers training camp at Fort Oglethorpe, GA; and the 307th Obsn. Sq. trained with air corps units at Maxwell Field, AL. In addition to the unit training camps, the infantry regiments of the division rotated responsibility to conduct the CMTC training held at Camp McClellan each year. On a number of occasions, the division participated in Fourth Corps Area or Third Army CPXs in conjunction with other R.A., N.G., and O.R. units. These training events gave division staff officers’ opportunities to practice the roles they would be expected to perform in the event the division was mobilized. Unlike the R.A. and N.G. units in the Third Corps Area, the 82d Div. did not participate in the Fourth Corps Area maneuvers and the Third Army Maneuvers of 1938, 1940, and 1941 as an organized unit due to lack of enlisted personnel and equipment. Instead, the officers and a few enlisted reservists were assigned to R.A. and N.G. units to fill vacant slots and bring the units up to war strength for the exercises. Additionally, some were assigned duties as umpires or as support personnel. Location of the division HQ on 7 December 1941 was Columbia, SC.



**Status:** HHC are currently active in the R.A. at Fort Bragg, NC, as HHC, 82d Airborne Div.

**Events:** 255, 300

#### Division Commanders

Brig. Gen. Walter H. Gordon (R.A.)* 25 October 1921–13 July 1922	Col. Thomas S. Moorman (R.A.)** 25 August 1933–12 January 1934
Brig. Gen. Abraham G. Lott (R.A.)** 1 March 1928–3 September 1929	Brig. Gen. Robert O. Van Horn (R.A.)** 12 January 1934–31 August 1939
Brig. Gen. George H. Estes (R.A.)* 19 September 1929–25 August 1933	Col. William P. Ennis (R.A.)*** 1 September 1939–31 August 1941

\*Concurrently commanding general of the Fourth Corps Area.

\*\*Concurrently commanding officer of the 8th Inf. Brig.

\*\*\*Concurrently division chief of staff.

#### Chiefs of Staff

Col. Clark S. Smith, C.E. 23 September 1921–August 1922	Col. Frederick S.L. Price, Inf. 4 September 1928–March 1931
Lt. Col. Pat N. Stevens, Inf. August 1922–November 1923	Col. William B. Graham, Inf. April 1931–August 1932
Col. Alexander E. Williams, Q.M.C. November 1923–26 July 1926	Col. John A. Brockman, Inf. August 1932–10 October 1935
Col. Richard H. McMaster, F.A. 26 July 1926–4 September 1928	Col. Walter D. Smith, F.A. 10 October 1935–31 August 1939
Col. William P. Ennis, F.A.	1 September 1939–31 August 1941

#### 82d DIVISION Organization 1922

UNIT:	HQ LOCATION:
HQ	Columbia, SC
HQ, Special Troops	Columbia, SC
HQ Co.	Columbia, SC
82d M.P. Co.	Columbia, SC
82d Sig. Co.	Macon, GA
307th Ord. Co. (M)	Savannah, GA
82d Tank Co. (L)	Columbus, GA
Mtcyl Co. No. 307	Lawrenceville, GA
163d Inf. Brig.	Macon, GA
325th Inf. Regt.	Albany, GA
326th Inf. Regt.	Marietta, GA
164th Inf. Brig.	Jacksonville, FL
327th Inf. Regt.	Greenville, SC
328th Inf. Regt.	Tampa, FL
157th F.A. Brig.	Columbia, SC
307th Ammo. Tn.	Newberry, SC
319th F.A. Regt.	Decatur, GA
320th F.A. Regt.	Columbia, SC
307th Engr. Regt.	Jacksonville, FL
307th Med. Regt.	Macon, GA
82d Div. Tn., Q.M.C.	Athens, GA
82d Div. Air Service	Macon, GA

#### 82d DIVISION Organization 1939

UNIT:	HQ LOCATION:
HQ	Columbia, SC
HQ, Special Troops	Columbia, SC
HQ Co.	Columbia, SC
82d M.P. Co.	Columbia, SC
82d Sig. Co.	Macon, GA
307th Ord. Co. (M)	Savannah, GA
82d Tank Co. (L)	Columbus, GA
163d Inf. Brig.	Atlanta, GA
325th Inf. Regt.	Albany, GA
326th Inf. Regt.	Atlanta, GA
164th Inf. Brig.	Tampa, FL
327th Inf. Regt.	Greenville, SC
328th Inf. Regt.	Tampa, FL
157th F.A. Brig.	Spartanburg, SC
307th Ammo. Tn.	Newberry, SC
319th F.A. Regt.	Decatur, GA
320th F.A. Regt.	Spartanburg, SC
321st F.A. Regt.	Macon, GA
307th Engr. Regt.	Jacksonville, FL
307th Med. Regt.	Macon, GA
407th Q.M. Regt.	Augusta, GA

**83d DIVISION****“Ohio Division”****Organized Reserve Ohio**

HQ—Columbus Barracks, 1921–22; Fort Hayes, OH, 1922–41

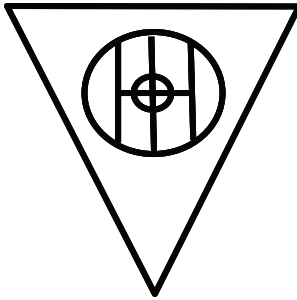

The 83d Div. HQ arrived at the port of Hoboken, NJ, aboard the U.S.S. *George Washington* on 21 January 1919 after 8 months of overseas service and was demobilized on 8 October 1919 at Camp Sherman, OH. It was reconstituted in the O.R. on 24 June 1921, allotted to the Fifth Corps Area, and assigned to the XV Corps. The division was further allotted to the state of Ohio as its home area. The division HQ was organized on 27 September 1921 at Columbus Barracks (redesignated as Fort Hayes in 1922) in Columbus, OH, and remained there until activated for World War II. To maintain communications with the officers of the division, the division staff published the “83d Division Bulletin,” which was renamed “The Ohioan” by 1926. The newsletter informed the division’s members of such things as when and where the inactive training sessions were to be held, what the division’s summer training

quotas were, where the camps were to be held, and which units would be assigned to help conduct the CMTC training. The 83d Div. HQ occasionally trained with the staff of the 10th Inf. Brig. at Fort Benjamin Harrison. The subordinate infantry regiments of the division held their summer training primarily with the units of the 10th Inf. Brig. at Camp Knox, Fort Thomas, or Fort Benjamin Harrison. Other units, such as the special troops, artillery, engineers, aviation, medical, and quartermaster, trained at various posts in the Fifth Corps Areas usually with active units of the 5th Div. For example, the division’s artillery trained with the 5th Div. F.A. units stationed at Camp Knox; the 308th Engr. Regt. usually trained at Fort Benjamin Harrison; the 308th Med. Regt. trained at Camp Knox; and the 308th Obsn. Sq. trained with the 88th Obsn. Sq. at Wright Field, OH. In addition to the unit training camps, the infantry regiments of the division rotated responsibility for conducting the infantry CMTC held at Camp Knox and Fort Thomas each year. On a number of occasions, the division participated in Fifth Corps Area or Second Army CPXs in conjunction with other R.A., N.G., and O.R. units. These training events gave division staff officers’ opportunities to practice the roles they would be expected to perform in the event the division was mobilized. Unlike the R.A. and N.G. units in the First Corps Area, the 83d Div. did not participate in the various Fifth Corps Area Maneuvers and the Second Army Maneuvers of 1936, 1940, and 1941 as an organized unit due to lack of enlisted personnel and equipment. Instead, the officers and a few enlisted reservists were assigned to R.A. and N.G. units to fill vacant slots and bring the units up to war strength for the exercises. Additionally, some officers were assigned duties as umpires or as support personnel. Location of the division HQ on 7 December 1941 was Fort Hayes, OH.

**Status:** HHC are currently inactive in the US Army Reserve as HHC, 83d Inf. Div.

**Events:** 85, 264

**Division Commanders**

Brig. Gen. George H. Jamerson (R.A.)*	6 February 1932–25 October 1933
Brig. Gen. William K. Naylor (R.A.)*	10 December 1933–30 November 1938

\*Concurrently commanding general of the 10th Inf. Brig.

**Chiefs of Staff**

Col. Glenn H. Davis, Inf.	27 September 1921–1 May 1922	Col. Orval P. Townshend, Inf.	15 September 1928–21 June 1930
Col. Charles G. Harvey, Q.M.C.	2 May 1922–5 May 1924	Lt. Col. Jason M. Walling, Inf.	21 June 1930–14 August 1930
Col. Richard H. McMaster, F.A.	5 May 1924–September 1924	Col. Wait C. Johnson, Inf.	14 August 1930–August 1936
Col. Charles C. Walcutt, Cav.	12 September 1924–20 June 1925	Col. Mathew A. Cross, C.A.C.	August 1936–3 January 1937
Col. Joseph E. Cusack, Cav.	20 June 1925–14 August 1925	Col. Francis C. Endicott, Inf.	3 January 1937–3 July 1939
Col. Richard H. McMaster, F.A.	14 August 1925–February 1927	Col. Henry W. Fleet, Inf.	3 July 1939–30 September 1939
Col. Pierce A. Murphy, F.A.	3 February 1927–13 May 1928	Col. Boltos E. Brewer, Inf.	5 January 1940–23 December 1940
Col. Charles W. Kutz, C.E.	May 1928–September 1928	Col. William K. Moore, F.A.	23 December 1940–January 1942

**83d DIVISION  
Organization 1922**

<b>UNIT:</b>	<b>HQ LOCATION:</b>
HQ	Columbus Barracks, OH
HQ, Special Troops	Columbus, OH
HQ Co.	Columbus, OH
83d M.P. Co.	Hicksville, OH
83d Sig. Co.	Columbus, OH
308th Ord. Co. (M)	Newton, OH
83d Tank Co. (L)	Cincinnati, OH
Mtchl Co. No. 308	Newton, OH
165th Inf. Brig.	Columbus, OH
329th Inf. Regt.	Dayton, OH
330th Inf. Regt.	Alliance, OH
166th Inf. Brig.	Toledo, OH
331st Inf. Regt.	Cleveland, OH
332d Inf. Regt.	Findlay, OH
158th F.A. Brig.	Columbus, OH
308th Ammo. Tn.	Cleveland, OH
322d F.A. Regt.	Cleveland, OH
323d F.A. Regt.	Columbus, OH
308th Engr. Regt.	Cleveland, OH
308th Med. Regt.	Columbus, OH
83d Div. Tn., Q.M.C.	Cleveland, OH
83d Div. Air Service	Columbus, OH

**83d DIVISION  
Organization 1939**

<b>UNIT:</b>	<b>HQ LOCATION:</b>
HQ	Columbus Barracks, OH
HQ, Special Troops	Columbus, OH
HQ Co.	Columbus, OH
83d M.P. Co.	Columbus, OH
83d Sig. Co.	Columbus, OH
308th Ord. Co. (M)	Columbus, OH
83d Tank Co. (L)	Cincinnati, OH
165th Inf. Brig.	Dayton, OH
329th Inf. Regt.	Dayton, OH
330th Inf. Regt.	Columbus, OH
166th Inf. Brig.	Toledo, OH
331st Inf. Regt.	Cleveland, OH
332d Inf. Regt.	Findlay, OH
158th F.A. Brig.	Columbus, OH
308th Ammo. Tn.	Columbus, OH
322d F.A. Regt.	Cleveland, OH
323d F.A. Regt.	Columbus, OH
324th F.A. Regt.	Akron, OH
308th Engr. Regt.	Cincinnati, OH
308th Med. Regt.	Columbus, OH
408th Q.M. Regt.	Cleveland, OH

**84th DIVISION**

**“Lincoln Division”**

**Organized Reserve Indiana**

HQ—Indianapolis, IN, 1921–41

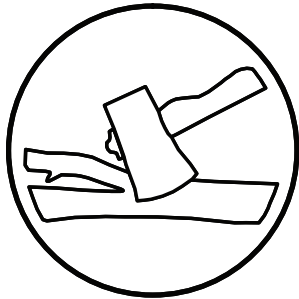

The 84th Div. HQ arrived at the port of Hoboken, NJ, aboard the U.S.S. *Wilhelmina* on 19 January 1919 after 4 months of overseas service and was demobilized on 26 July 1919 at Camp Zachary Taylor, KY. It was reconstituted in the O.R. on 24 June 1921, allotted to the Fifth Corps Area, and assigned to the XV Corps. The division was further allotted to the state of Indiana as its home area. The division HQ was organized on 6 September 1921 at room 408 in the Federal Building in Indianapolis, IN. The HQ was relocated in August 1922 to 24 East Michigan Street and moved again in 1928 to the Meridian Life Building. The HQ was moved twice more before World War II: first to the Chamber of Commerce Building in 1933; and finally back to the Federal Building in 1937. It remained there until activated for World War II. Though the designated mobilization and training station for the division was Camp Knox, KY, and

some of the division’s training occurred there, much of the training activities for the division HQ and its subordinate units transpired in other locations as well. For example, the 84th Div. HQ occasionally trained with the staff of the 10th Inf. Brig. at Fort Benjamin Harrison. The subordinate infantry regiments of the division held their summer training primarily with the units of the 10th Inf. Brig. at Fort Thomas, or Fort Benjamin Harrison, but some years they went to Camp Knox. For some years, the 167th and 168th Inf. Brigs. and their subordinate units conducted camp at the Culver Military Academy in Culver, IN. Other units, such as the special troops, artillery, engineers, aviation, medical, and quartermaster trained at various posts in the Fifth Corps Areas usually with similar active units of the 5th Div. For example, the division’s artillery trained with the 5th Div. F.A. units stationed at Camp Knox; the 309th Engr. Regt. usually trained at Fort Benjamin Harrison; the 309th Med. Regt. trained at Camp Knox; and the 309th Obsn. Sq. trained with the 88th Obsn. Sq. at Wright Field, OH. In addition to the unit training camps, the infantry regiments of the division rotated responsibility for conducting the infantry CMTC held at Fort Thomas and Camp Knox each year. On a number of occasions, the division participated in various Fifth Corps Area or Second Army CPXs in conjunction

with other R.A., N.G., and O.R. units. These training events gave division staff officers' opportunities to practice the roles they would be expected to perform in the event the division was mobilized. Unlike the R.A. and N.G. units in the First Corps Area, the 84th Div. did not participate in the Fifth Corps Area Maneuvers and the Second Army Maneuvers of 1936, 1940, and 1941 as an organized unit due to lack of enlisted personnel and equipment. Instead, the officers and a few enlisted reservists were assigned to R.A. and N.G. units to fill vacant slots and bring the units up to war strength for the exercises. Additionally, some were assigned duties as umpires or as support personnel. Location of the division HQ on 7 December 1941 was Indianapolis, IN.

**Status:** HHC are currently active in the US Army Reserve at Milwaukee, WI, as HHC, 84th Div. (Exercise).

**Events:** 85, 264

#### Division Commanders

Maj. Gen. George W. Read (R.A.)*	28 September 1921–1 September 1922
Brig. Gen. George H. Jamerson (R.A.)**	6 February 1932–25 October 1933
Brig. Gen. William K. Naylor (R.A.)**	10 December 1933–30 November 1938

\*Concurrently commanding general of the Fifth Corps Area.

\*\*Concurrently commanding general of the 10th Inf. Brig.

#### Chiefs of Staff

Col. Edwin A. Root, Inf.	6 September 1921–6 March 1922	Col. Henry R. Richmond, Cav.	22 August 1927–2 February 1928
Maj. Joseph F. Taulbee, Inf.	6 March 1922–31 July 1923	Col. Andrew J. Dougherty, Inf.	2 February 1928–14 January 1932
Col. Edwin A. Root, Inf.	1 August 1923–1 September 1923	Maj. Joseph H. Davidson, Inf.	14 January 1932–30 June 1933
Maj. Joseph F. Taulbee, Inf.	1 September 1923–21 November 1923	Col. Thomas L. Sherburne, Cav.	1 July 1933–26 February 1935
Lt. Col. John J. Miller, Inf.	21 November 1923–2 March 1924	Col. Albert E. Phillips, Cav.	26 February 1935–24 October 1937
Lt. Col. Francis W. Glover, Inf.	2 March 1924–9 September 1924	Col. Fred H. Turner, Inf.	24 October 1937–10 October 1940
Col. Grosvenor L. Townsend, Inf.	9 September 1924–22 August 1927	Col. Frederick M. Armstrong, Inf.	10 October 1940–January 1942

#### 84th DIVISION Organization 1922

UNIT:	HQ LOCATION:
HQ	Indianapolis, IN
HQ, Special Troops	Indianapolis, IN
HQ Co.	Indianapolis, IN
84th M.P. Co.	Vincennes, IN
84th Sig. Co.	Bloomington, IN
309th Ord. Co. (M)	Huntington, IN
84th Tank Co. (L)	Kokomo, IN
Mtcyl Co. No. 309	Huntington, IN
167th Inf. Brig.	Newcastle, IN
333d Inf. Regt.	Vincennes, IN
334th Inf. Regt.	Indianapolis, IN
168th Inf. Brig.	Montpelier, IN
335th Inf. Regt.	Muncie, IN
336th Inf. Regt.	Culver, IN
159th F.A. Brig.	Montpelier, IN
309th Ammo. Tn.	Fort Wayne, IN
325th F.A. Regt.	Indianapolis, IN
326th F.A. Regt.	Indianapolis, IN
309th Engr. Regt.	Indianapolis, IN
309th Med. Regt.	Indianapolis, IN
84th Div. Tn., Q.M.C.	South Bend, IN
84th Div. Air Service	Indianapolis, IN

#### 84th DIVISION Organization 1939

UNIT:	HQ LOCATION:
HQ	Indianapolis, IN
HQ, Special Troops	Indianapolis, IN
HQ Co.	Indianapolis, IN
84th M.P. Co.	Indianapolis, IN
84th Sig. Co.	Indianapolis, IN
309th Ord. Co. (M)	Indianapolis, IN
84th Tank Co. (L)	Indianapolis, IN
167th Inf. Brig.	Fort Wayne, IN
333d Inf. Regt.	Vincennes, IN
334th Inf. Regt.	Indianapolis, IN
168th Inf. Brig.	South Bend, IN
335th Inf. Regt.	Muncie, IN
336th Inf. Regt.	South Bend, IN
159th F.A. Brig.	Indianapolis, IN
309th Ammo. Tn.	Fort Wayne, IN
325th F.A. Regt.	Fort Wayne, IN
326th F.A. Regt.	Indianapolis, IN
327th F.A. Regt.	Hammond, IN
309th Engr. Regt.	Indianapolis, IN
309th Med. Regt.	Indianapolis, IN
409th Q.M. Regt.	Indianapolis, IN

## 85th DIVISION

## “Custer Division”

## Organized Reserve Michigan

HQ—Detroit, MI, 1921–41

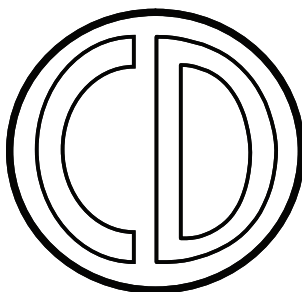

The 85th Div. HQ arrived at the port of Hoboken, NJ, aboard the S.S. *Aquitania* on 29 March 1919 after 6 months of overseas service and was demobilized on 18 April 1919 at Camp Custer, MI. The 85th Div. was reconstituted in the O.R. on 24 June 1921, allotted to the Sixth Corps Area, and assigned to the XVI Corps. The division was further allotted to the state of Michigan as its home area. The division HQ was organized on 10 September 1921 in Room 304, Old Customhouse Building in Detroit, relocated on 27 July 1922 to the Marquette Building, and moved again on 6 July 1923 to the New Telegraph Building. It was moved twice more before 1941; once to the Book Building at Washington and Grand River Avenues in 1926, and finally to the Federal Building in 1935 and remained there until activated for World War II. To maintain communications with the officers of the division, the division staff published

a newsletter named “The 85th Division Bulletin.” The newsletter informed the division’s members of such things as when and where the inactive training sessions were to be held, what the division’s summer training quotas were, where the camps were to be held, and which units would be assigned to help conduct the CMTTC training. The designated mobilization and training station for the division was Camp Custer, the location where much of the 85th Div.’s training activities occurred in the interwar years. The division HQ was called to duty for training there as a unit on a number of occasions, the first time being in April 1926. Oddly, the division HQ was ordered to Active Duty for a second time 5–19 July that same summer. The HQ attended summer training as a unit, other than for corps area and army-level CPXs, only twice more before World War II: once in the summer of 1928 and again in 1937. The HQ and staff usually trained with the staff of the 12th Inf. Brig., either at Camp Custer or at Fort Sheridan, IL. The subordinate infantry regiments of the division held their summer training primarily with the 2d Inf. Regt. at Camp Custer beginning in June 1923. Other units, such as the special troops, artillery, engineers, aviation, medical, and quartermaster trained at various posts in the Sixth and Seventh Corps Areas. For example, the division’s artillery trained with the 1st Bn., 14th F.A. at Camp Custer; the special troops trained with the special troops of the 32d Div. at Camp Grayling, MI, or Camp Sparta (later McCoy), WI; the 310th Med. Regt. trained at Fort Snelling, MN; and the 310th Obsn. Sq. trained with the 15th Obsn. Sq. at Chanute Field, IL. In addition to the unit training camps, the infantry regiments of the division rotated responsibility to conduct the CMTTC training held at Camp Custer each year. On a number of occasions, the division participated in Sixth Corps Area or Second Army CPXs in conjunction with other R.A., N.G., and O.R. units. These training events gave division staff officers’ opportunities to practice the roles they would be expected to perform in the event the division was mobilized. Unlike the R.A. and N.G. units in the Sixth Corps Area, the 85th Div. did not participate in the various Sixth Corps Area Maneuvers and the Second Army Maneuvers of 1935, 1939, and 1940 as an organized unit due to lack of enlisted personnel and equipment. Instead, the officers and a few enlisted reservists were assigned to R.A. and N.G. units to fill vacant slots and bring the units up to war strength for the exercises. Additionally, some were assigned duties as umpires or as support personnel. Location of the division HQ on 7 December 1941 was Detroit, MI.

**Status:** HHC are currently active in the US Army Reserve at Arlington Heights, IL, as HHC, 85th Div. (Exercise).

**Events:** 124, 148, 159, 214, 264, 302

### Division Commanders

Col. Edgar A. Sirmyer (R.A.)\*

May 1931–October 1935

\*Concurrently division chief of staff.

### Chiefs of Staff

Col. Thomas J. Powers, Inf. 22 October 1921–November 1923  
Col. James N. Munro, Inf. November 1923–20 September 1925  
Col. Raymond Sheldon, Inf. 20 September 1925–May 1928  
Col. Henry E. Eames, Inf. May 1928–June 1928  
Lt. Col. Arthur L. Bump, Inf. June 1928–August 1928  
Col. Joseph Andrews, F.A.

Col. Alvin C. Gillem, Cav. August 1928–October 1928  
Col. Russell V. Venable, Inf. October 1928–19 May 1931  
Col. Edgar A. Sirmyer, Cav. 19 May 1931–May 1935  
Col. Morris M. Keck, Inf. May 1935–9 June 1940  
Col. Chester B. McCormick, F.A. 9 June 1940–30 November 1941  
30 November 1941–January 1942

**85th DIVISION  
Organization 1922**

UNIT:	HQ LOCATION:
HQ	Detroit, MI
HQ, Special Troops	Detroit, MI
HQ Co.	Detroit, MI
85th M.P. Co.	Detroit, MI
85th Sig. Co.	Owasso, MI
310th Ord. Co. (M)	Highland Park, MI
85th Tank Co. (L)	Dearborn, MI
Mtcyl Co. No. 310	Mount Pleasant, MI
169th Inf. Brig.	Grand Rapids, MI
337th Inf. Regt.	Grand Rapids, MI
338th Inf. Regt.	Kalamazoo, MI
170th Inf. Brig.	Detroit, MI
339th Inf. Regt.	Detroit, MI
340th Inf. Regt.	Flint, MI
160th F.A. Brig.	Holland, MI
310th Ammo. Tn.	Sault Ste. Marie, MI
328th F.A. Regt.	Grand Rapids, MI
329th F.A. Regt.	Easanaba, MI
310th Engr. Regt.	Detroit, MI
310th Med. Regt.	Detroit, MI
85th Div. Tn., Q.M.C.	Kalamazoo, MI
85th Div. Air Service	Detroit, MI

**85th DIVISION  
Organization 1939**

UNIT:	HQ LOCATION:
HQ	Detroit, MI
HQ, Special Troops	Detroit, MI
HQ Co.	Detroit, MI
85th M.P. Co.	Detroit, MI
85th Sig. Co.	Detroit, MI
310th Ord. Co. (M)	Detroit, MI
85th Tank Co. (L)	Detroit, MI
169th Inf. Brig.	Grand Rapids, MI
337th Inf. Regt.	Grand Rapids, MI
338th Inf. Regt.	Kalamazoo, MI
170th Inf. Brig.	Detroit, MI
339th Inf. Regt.	Detroit, MI
340th Inf. Regt.	Saginaw, MI
160th F.A. Brig.	Detroit, MI
310th Ammo. Tn.	Detroit, MI
328th F.A. Regt.	Detroit, MI
329th F.A. Regt.	Grand Rapids, MI
403d F.A. Regt.	Moline, IL
310th Engr. Regt.	Detroit, MI
310th Med. Regt.	Detroit, MI
410th Q.M. Regt.	Detroit, MI

**86th DIVISION**

**“Black Hawk”**

**Organized Reserve Illinois**

HQ—Chicago, IL, 1921–41

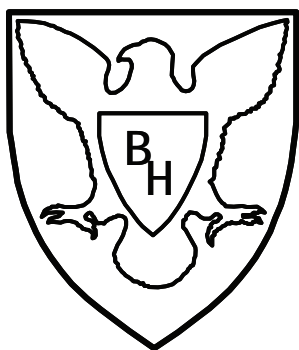

The 86th Div. HQ arrived at the port of Hoboken, NJ, aboard the U.S.S. *Siboney* on 3 January 1919 after 4 months of overseas service and was demobilized on 18 April 1919 at Camp Custer, MI. The 86th Div. was reconstituted in the O.R. on 24 June 1921, allotted to the Sixth Corps Area, and assigned to the XVI Corps. The division was further allotted to the state of Illinois as its home area. The division HQ was organized on 10 September 1921 at the Federal Building in Chicago. The HQ was relocated on 18 October 1921 to the Leiter Building at 14 East Congress Street and remained there until activated for World War II. To maintain communications with the officers of the division, the chief of staff published a newsletter named “The Blackhawk Bulletin” in keeping with the division’s nickname and the military, geographical, and historical background of the regions from which it drew its personnel. The newsletter informed the division’s members of such things as when and where the inactive training sessions were to be held, what the division’s summer training quotas were, where the camps

were to be held, and which units would be assigned to help conduct the CMTC training. The designated mobilization and training station for the division was Camp Custer, MI, the location where much of the 86th Div.’s training activities occurred in the interwar years. The HQ and staff usually trained with the staff of the 12th Inf. Brig., either at Camp Custer or at Fort Sheridan, IL. The subordinate infantry regiments of the division held their summer training primarily with the 2d Inf. Regt. at Camp Custer beginning in June 1923. Other units, such as the special troops, artillery, engineers, aviation, medical, and quartermaster, trained at various posts in the Sixth and Seventh Corps Areas. For

example, the division's artillery trained with the 1st Bn., 14th F.A. at Camp Custer; the special troops trained with the special troops of the 32d Div. at Camp Grayling, MI, or Camp Sparta (later McCoy), WI; the 310th Med. Regt. trained at Fort Snelling, MN; and the 310th Obsn. Sq. trained with the 15th Obsn. Sq. at Chanute Field, IL. In addition to the unit training camps, the infantry regiments of the division rotated responsibility to conduct the CMTC training held at Camp Custer and Fort Sheridan each year. On a number of occasions, the division participated in Sixth Corps Area or Second Army CPXs in conjunction with other R.A., N.G., and O.R. units. These training events gave division staff officers' opportunities to practice the roles they would be expected to perform in the event the division was mobilized. Unlike the R.A. and N.G. units in the Sixth Corps Area, the 86th Div. did not participate in the various Sixth Corps Area Maneuvers and the Second Army Maneuvers of 1935, 1939, and 1940 as an organized unit due to lack of enlisted personnel and equipment. Instead, the officers and a few enlisted reservists were assigned to R.A. and N.G. units to fill vacant slots and bring the units up to war strength for the exercises. Additionally, some were assigned duties as umpires or as support personnel. Location of the division HQ on 7 December 1941 was Chicago, IL.

**Status:** HHC are currently inactive in the US Army Reserve as HHC, 86th Inf. Div.

**Events:** 124, 148, 159, 162, 214, 264, 302

#### Chiefs of Staff

Lt. Col. Arthur M. Shipp, Inf.	7 August 1921–24 October 1921	Col. William W. Overton, Cav.	11 November 1933–15 June 1936
Col. Morris M. Keck, Inf.	24 October 1921–November 1924	Col. Ralph M. Parker, Cav.	15 June 1936–2 May 1940
Col. Howard R. Perry, Inf.	7 November 1924–19 June 1932	Col. Thomas G.M. Oliphant, F.A.	2 May 1940–March 1941
Col. Tenney Ross, Inf.	1 July 1932–11 November 1933	Lt. Col. Clyde Pickett, Cav.	March 1941–January 1942

#### 86th DIVISION Organization 1922

UNIT:	HQ LOCATION:
HQ	Chicago, IL
HQ, Special Troops	Chicago, IL
HQ Co.	Chicago, IL
86th M.P. Co.	Waukegan, IL
86th Sig. Co.	Waukegan, IL
311th Ord. Co. (M)	Rock Island, IL
86th Tank Co. (L)	Peoria, IL
Mtcyl Co. No. 311	Chicago, IL
171st Inf. Brig.	Chicago, IL
341st Inf. Regt.	Chicago, IL
342d Inf. Regt.	Chicago, IL
172d Inf. Brig.	Springfield, IL
343d Inf. Regt.	Champaign, IL
344th Inf. Regt.	Alton, IL
161st F.A. Brig.	Chicago, IL
311th Ammo. Tn.	Centralia, IL
331st F.A. Regt.	Chicago, IL
332d F.A. Regt.	Chicago, IL
311th Engr. Regt.	Urbana, IL
311th Med. Regt.	Springfield, IL
86th Div. Tn., Q.M.C.	Chicago, IL
86th Div. Air Service	Chicago, IL

#### 86th DIVISION Organization 1939

UNIT:	HQ LOCATION:
HQ	Chicago, IL
HQ, Special Troops	Chicago, IL
HQ Co.	Chicago, IL
86th M.P. Co.	Waukegan, IL
86th Sig. Co.	Chicago, IL
311th Ord. Co. (M)	Chicago, IL
86th Tank Co. (L)	Chicago, IL
171st Inf. Brig.	Chicago, IL
341st Inf. Regt.	Chicago, IL
342d Inf. Regt.	Chicago, IL
172d Inf. Brig.	Springfield, IL
343d Inf. Regt.	Peoria, IL
344th Inf. Regt.	Marion, IL
161st F.A. Brig.	Chicago, IL
311th Ammo. Tn.	Chicago, IL
331st F.A. Regt.	Chicago, IL
332d F.A. Regt.	Chicago, IL
404th F.A. Regt.	Chicago, IL
311th Engr. Regt.	Chicago, IL
311th Med. Regt.	Springfield, IL
411th Q.M. Regt.	Chicago, IL

**87th DIVISION****“Golden Acorn”****Organized Reserve Louisiana,  
Alabama, and Mississippi**

HQ—Jackson, MS, 1921; New Orleans, LA, 1921–41

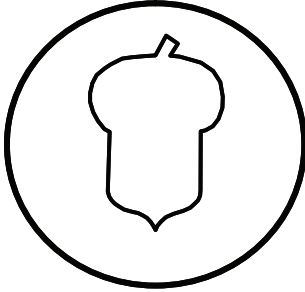

The 87th Div. HQ arrived at the port of Hoboken, NJ, aboard the U.S.S. *Manchuria* on 22 January 1919 after 5 months of overseas service and was demobilized on 14 February 1919 at Camp Pike, AR. The 87th Div. was reconstituted in the O.R. on 24 June 1921, allotted to the Fourth Corps Area, and assigned to the XIV Corps. The division was further allotted to the states of Louisiana, Alabama, and Mississippi as its home area. The division HQ was organized on 23 September 1921 at Jackson, MS. The HQ was subsequently relocated on 14 October 1921 to the New Orleans International Depot in New Orleans, LA, and once again relocated in April 1922 to Poland and Dauphine Streets where it remained until activated for World War II. To maintain communications with the officers of the division, the chief of staff published

a division newsletter named “The Acorn” in keeping with division’s nickname and the military, geographical, and historical background of the regions from which it drew its personnel. The newsletter informed the division’s members of such things as when and where the inactive training sessions were to be held, what the division’s summer training quotas were, where the camps were to be held, and which units would be assigned to help conduct the CMTC training. The designated mobilization and training station for the division was Camp McClellan, AL, the location where much of the 87th Div.’s training activities occurred in the interwar years. The division HQ was called to duty for training there as a unit on a number of occasions. The HQ and special staff usually trained with their counterparts on the staff of the 8th Inf. Brig., either at Camp McClellan, AL, or at Fort McPherson, GA. The subordinate infantry regiments of the division held their summer training primarily with the 8th or 22d Inf. Regts. at Camp McClellan, or at one of the R.A. regiment’s home stations. Other units, such as the special troops, artillery, engineers, aviation, medical, and quartermaster, trained at various posts in the Fourth Corps Areas, usually with the active units of the 4th Div. For example, the division’s artillery trained with units of the 2d Bn., 16th F.A. at Fort Bragg, NC; the 312th Engr. Regt. trained at Fort Benning, GA, with companies of the 4th and 7th Engrs.; the 312th Med. Regt. trained at Fort Oglethorpe, GA; and the 312th Obsn. Sq. trained with the 22d Obsn. Sq. at Maxwell Field, AL. In addition to the unit training camps, the infantry regiments of the division rotated responsibility to conduct the CMTC held at Camp McClellan and Fort McPherson each year. On a number of occasions, the division participated in Fourth Corps Area and Third Army CPXs in conjunction with other R.A., N.G., and O.R. units. These training events gave division staff officers’ opportunities to practice the roles they would be expected to perform in the event the division was mobilized. Unlike the R.A. and N.G. units in the Fourth Corps Area, the 87th Div. did not participate in the various Fourth Corps Area Maneuvers and the Third Army Maneuvers of 1938, 1940, and 1941 as an organized unit due to lack of enlisted personnel and equipment. Instead, the officers and a few enlisted reservists were assigned to R.A. and N.G. units to fill vacant slots and bring the units up to war strength for the exercises. Additionally, some officers were assigned duties as umpires or as support personnel. For the 1938 Third Army Maneuver, for example, about 200 of the division’s officers were attached to the N.G. 31st Div. to allow that unit to function as an almost full strength division. Location of the division HQ on 7 December 1941 was New Orleans, LA.

**Status:** HHC are currently active in the US Army Reserve at Birmingham, AL, as HHC, 87th Div. (Exercise).**Events:** 255, 300**Division Commanders**

Brig. Gen. Harold B. Fiske (R.A.)*	18 April 1930–January 1931	Col. William M. Colvin (R.A.)*	7 January 1937–1 April 1938
Brig. Gen. William S. McNair (R.A.)*	February 1931–20 September 1932	Brig. Gen. Fulton Q.C. Gardner (R.A.)*	9 June 1938–12 November 1938
Brig. Gen. James H. Reeves (R.A.)*	20 September 1932–30 September 1934	Maj. Gen. Stanley D. Embick (R.A.)***	13 November 1938–7 January 1939
Brig. Gen. Percy B. Bishop (R.A.)*	30 September 1934–15 July 1936	Brig. Gen. William E. Shedd Jr. (R.A.)*	7 January 1939–31 August 1939
Col. Robert Arthur (R.A.)*	16 July 1936–6 January 1937	Col. Emil Pierson (R.A.)*	1 September 1939–15 June 1940
	Col. George B. Hunter (R.A.)*		July 1940–June 1941

\*Concurrently commanding general of the Fourth Coast Artillery District.

\*\*Concurrently chief of staff, 87th Div. and HQ, Third Military Area, Fourth Corps Area.

\*\*\*Concurrently commanding general, Fourth Corps Area.



### Chiefs of Staff

Lt. Col. Robert F. McMillan, F.A. 23 September 1921–19 December 1921 Col. John W. Heard, Cav. 19 December 1921–2 February 1922 Lt. Col. Robert F. McMillan, F.A. 3 February 1922–30 June 1922 Col. Frank Armstrong, Cav. 1 July 1922–December 1922 Col. James H. Frier, Inf. 6 December 1922–18 August 1925 Col. Robert F. McMillan, C.A.C. August 1925–June 1927 Col. Hu B. Myers, Cav. June 1927–15 May 1930 Col. Reginald H. Kelley, Inf.	Col. Gideon H. Williams, Inf. 24 June 1930–September 1930 Col. Henry R. Richmond, Cav. 3 September 1930–1 January 1931 Col. George Vidmer, Cav. 1 January 1931–8 October 1933 Col. Henry R. Richmond, Cav. 8 October 1933–26 September 1936 Col. Emil Pierson, Cav. 8 October 1936–15 June 1940 Col. George B. Hunter, Cav. 27 July 1940–18 June 1941 Col. Elbert J. Lyman, Inf. 18 June 1941–25 August 1941 25 August 1941–January 1942
-------------------------------------------------------------------------------------------------------------------------------------------------------------------------------------------------------------------------------------------------------------------------------------------------------------------------------------------------------------------------------------------------------------------------------------------------------------------	---------------------------------------------------------------------------------------------------------------------------------------------------------------------------------------------------------------------------------------------------------------------------------------------------------------------------------------------------------------------------------------------------------------------------------------------------------------

#### 87th DIVISION Organization 1922

UNIT:	HQ LOCATION:
HQ	New Orleans, LA
HQ, Special Troops	New Orleans, LA
HQ Co.	New Orleans, LA
87th M.P. Co.	Jackson, MS
87th Sig. Co.	New Orleans, LA
312th Ord. Co. (M)	Birmingham, AL
87th Tank Co. (L)	Durant, MS
Mtcyl Co. No. 312	Ville Platte, LA
173d Inf. Brig.	Mobile, AL
345th Inf. Regt.	Birmingham, AL
346th Inf. Regt.	Selma, AL
174th Inf. Brig.	Shreveport, LA
347th Inf. Regt.	Alexandria, LA
348th Inf. Regt.	Columbus, MS
162d F.A. Brig.	Clarksdale, MS
312th Ammo. Tn.	Greenville, MS
334st F.A. Regt.	Montgomery, AL
336th F.A. Regt.	Baton Rouge, LA
312th Engr. Regt.	Meridian, MS
312th Med. Regt.	New Orleans, LA
87th Div. Tn., Q.M.C.	Pineville, LA
87th Div. Air Service	Montgomery, AL

#### 87th DIVISION Organization 1939

UNIT:	HQ LOCATION:
HQ	New Orleans, LA
HQ, Special Troops	New Orleans, LA
HQ Co.	New Orleans, LA
87th M.P. Co.	Jackson, MS
87th Sig. Co.	Jackson, MS
312th Ord. Co. (M)	Birmingham, AL
87th Tank Co. (L)	Durant, MS
173d Inf. Brig.	Birmingham, AL
345th Inf. Regt.	Birmingham, AL
346th Inf. Regt.	Mobile, AL
174th Inf. Brig.	Jackson, MS
347th Inf. Regt.	Baton Rouge, LA
348th Inf. Regt.	Jackson, MS
162d F.A. Brig.	New Orleans, LA
312th Ammo. Tn.	Greenville, MS
334th F.A. Regt.	Birmingham, AL
335th F.A. Regt.	Jackson, MS
336th F.A. Regt.	New Orleans, LA
312th Engr. Regt.	New Orleans, LA
312th Med. Regt.	New Orleans, LA
412th Q.M. Regt.	New Orleans, LA

## 88th DIVISION

## Organized Reserve Minnesota, Iowa, and North Dakota

HQ—St. Paul 1921; Minneapolis, MN, 1921–41

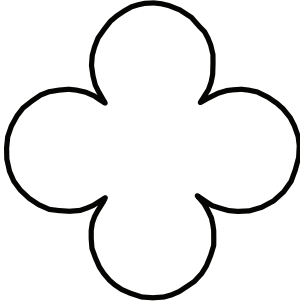

The 88th Div. HQ arrived at the port of Newport News, VA, aboard the U.S.S. *Pocahontas* on 1 June 1919 after 10 months of overseas service and was demobilized on 10 June 1919 at Camp Dodge, IA. The 88th Div. was reconstituted in the O.R. on 24 June 1921, allotted to the Seventh Corps Area, and assigned to the XVII Corps. The division was further allotted to the states of Minnesota, Iowa, and North Dakota as its home area. The division HQ was organized on 2 September 1921 at 1684 Van Buren Street in St. Paul, MN, and relocated on 29 September 1921 to the Kasota Building, Fourth and Hennepin Streets in Minneapolis, MN. The HQ was relocated again in August 1924 to 835 Palace Building. It was relocated once more in July 1937 to the new Post Office Building in Minneapolis and remained there until activated for World War II. To maintain communications with the officers of the division, the division staff

published a newsletter named “The Cloverleaf” after the unit’s shoulder patch. The newsletter informed the division’s members of such things as when and where the inactive training sessions were to be held, what the division’s summer training quotas were, where the camps were to be held, and which units would be assigned to help conduct the CMTC training. The designated mobilization and training station for the division was Camp Dodge. However, for summer training the HQ and staff usually trained with the staff of the 14th Inf. Brig., either at Fort Crook, NE, or at Fort Snelling, MN. The subordinate infantry regiments of the division held their summer training primarily with the 3d Inf. Regt. at Fort Snelling or with the 17th Inf. at Fort Des Moines, IA. Other units, such as the special troops, artillery, engineers, aviation, medical, and quartermaster, trained at various posts in the Sixth and Seventh Corps Areas, often with the active units of the 7th Div. or other Regular Army units. For example, the division’s artillery trained at Camp McCoy, WI; the 313th Engr. Regt. trained at Fort Riley, KS, with A Troop, 9th Engrs.; the 313th Med. Regt. trained at the medical corps training camp at Fort Snelling; and the 313th Obsn. Sq. trained with the 16th Obsn. Sq. at Marshall Field, KS. In addition to the unit training camps, the infantry regiments of the division rotated responsibility to conduct the CMTC training held at Fort Snelling, Fort Des Moines, and Fort Lincoln, ND, each year. On a number of occasions, the division participated in Seventh Corps Area and Fourth Army CPXs in conjunction with other R.A., N.G., and O.R. units. These training events gave division staff officers’ opportunities to practice the roles they would be expected to perform in the event the division was mobilized. Unlike the R.A. and N.G. units in the Fourth Corps Area, the 88th Div. did not participate in the Seventh Corps Area Maneuvers and the Fourth Army Maneuvers of 1937, 1940, and 1941 as an organized unit due to lack of enlisted personnel and equipment. Instead, the officers and a few enlisted reservists were assigned to R.A. and N.G. units to fill vacant slots and bring the units up to war strength for the exercises. Additionally, some were assigned duties as umpires or as support personnel. Location of the division HQ on 7 December 1941 was Minneapolis, MN.

**Status:** HHC are currently inactive in the US Army Reserve as HHC, 88th Inf. Div.

**Events:** 193, 233, 279, 303

### Division Commanders

Brig. Gen. Halstead Dorey (R.A.)*	30 January 1923–12 February 1925	Brig. Gen. David L. Stone (R.A.)*	7 July 1933–3 September 1936
Brig. Gen. John H. Hughes (R.A.)*	12 January 1931–5 July 1933	Maj. Gen. Stanley H. Ford (R.A.)**	4 October 1936–1 November 1937

\*Concurrently commanding general of the 14th Inf. Brig.

\*\*Concurrently commanding general of the Seventh Corps Area.

### Chiefs of Staff

Lt. Col. John H. Neff, Inf.	9 September 1921–12 October 1921	Lt. Col. D.B. Grafton, Inf.	21 September 1930–June 1931
Col. Harry O. Williard, Cav.	12 October 1921–15 April 1922	Col. Charles F. Leonard, Inf.	June 1931–12 October 1933
Lt. Col. John H. Neff, Inf.	15 April 1922–17 July 1922	Col. J. Alfred Moss, F.A.	12 October 1933–9 September 1936
Col. James N. Munro, Cav.	17 July 1922–24 September 1923	Col. John Randolph, Inf.	9 September 1936–20 December 1939
Col. Thomas A. Pearce, Inf.	24 September 1923–4 September 1929	Col. John L. Jenkins, Inf.	20 December 1939–12 February 1941
Col. Elliot M. Norton, Inf.	4 September 1929–21 September 1930	Col. Joseph J. Schmidt, Inf.	12 February 1941–January 1942

**88th DIVISION  
Organization 1922**

UNIT:	HQ LOCATION:
HQ	Minneapolis, MN
HQ, Special Troops	Minneapolis, MN
HQ Co.	Minneapolis, MN
88th M.P. Co.	Minneapolis, MN
88th Sig. Co.	Minneapolis, MN
313th Ord. Co. (M)	Minneapolis, MN
88th Tank Co. (L)	Minneapolis, MN
Mtcyl Co. No. 313	Waterloo, IA
175th Inf. Brig.	Mason City, IA
349th Inf. Regt.	Iowa City, IA
350th Inf. Regt.	Corning, IA
176th Inf. Brig.	St. Paul, MN
351st Inf. Regt.	St. Paul, MN
352d Inf. Regt.	Minneapolis, MN
163d F.A. Brig.	Des Moines, IA
313th Ammo. Tn.	Des Moines, IA
337th F.A. Regt.	Minneapolis, MN
338th F.A. Regt.	Muscatine, IA
313th Engr. Regt.	Minneapolis, MN
313th Med. Regt.	Minneapolis, MN
88th Div. Tn., Q.M.C.	Bismarck, ND
88th Div. Air Service	Des Moines, IA

**88th DIVISION  
Organization 1939**

UNIT:	HQ LOCATION:
HQ	Minneapolis, MN
HQ, Special Troops	Minneapolis, MN
HQ Co.	Minneapolis, MN
88th M.P. Co.	Minneapolis, MN
88th Sig. Co.	St. Paul, MN
313th Ord. Co. (M)	Manchester, IA
88th Tank Co. (L)	Allison, IA
175th Inf. Brig.	Mason City, IA
349th Inf. Regt.	Cedar Rapids, IA
350th Inf. Regt.	Des Moines, IA
176th Inf. Brig.	St. Paul, MN
351st Inf. Regt.	St. Paul, MN
352d Inf. Regt.	Fargo, ND
163d F.A. Brig.	Des Moines, IA
313th Ammo. Tn.	Council Bluffs, IA
337th F.A. Regt.	Minneapolis, MN
338th F.A. Regt.	Muscatine, IA
339th F.A. Regt.	Sioux City, IA
313th Engr. Regt.	Minneapolis, MN
313th Med. Regt.	Minneapolis, MN
413th Q.M. Regt.	Fargo, ND

**89th DIVISION**

**“Middle West Division”**

**Organized Reserve Nebraska,  
Kansas, and South Dakota**

HQ—Omaha, NE, 1921–41

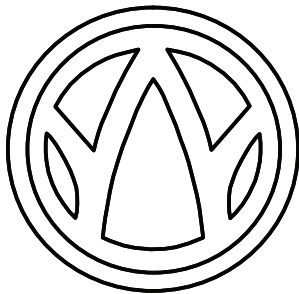

The 89th Div. HQ arrived at the port of Hoboken, NJ, aboard the S.S. *Rotterdam* on 31 May 1919 after 12 months of overseas service and was demobilized on 12 June 1919 at Camp Funston, KS. The 89th Div. was reconstituted in the O.R. on 24 June 1921, allotted to the Seventh Corps Area, and assigned to the XVII Corps. The division was further allotted to the states of Nebraska, Kansas, and South Dakota as its home area. The division HQ was organized on 2 September 1921 at the Army Building, in Omaha, NE, and relocated in April 1924 to 22d and Hickory Streets in Omaha. It was moved to Fort Omaha in the late 1920s, and relocated one more time to the Federal Building in Omaha on 18 January 1934. The HQ remained there until activated for World War II. After its reorganization, the division formed rapidly and by November 1922, the “Middle West Division” was up to 95 percent strength in its complement

of officers as required by its peacetime tables of organization. To maintain communications with the officers of the division, the division staff published a newsletter, “The Mid-West.” The newsletter informed the division’s members of such things as when and where the inactive training sessions were to be held, what the division’s summer training quotas were, where the camps were to be held, and which units would be assigned to help conduct the CMTC training. The designated mobilization and training station for the division was Fort Riley. The HQ and staff usually trained with the staff of the 14th Inf. Brig., either at Fort Crook, NE, or at Fort Snelling, MN. The subordinate infantry regiments of the division held their summer training primarily with the 17th Inf. Regt. at Fort Crook, NE, or Fort Leavenworth,

KS. Other units, such as the special troops, artillery, engineers, aviation, medical, and quartermaster, trained at various posts in the Sixth and Seventh Corps Areas, often with the active units of the 7th Div. For example, the division's artillery trained at various posts to include Fort Riley, KS; Fort Des Moines, IA; and Camp McCoy, WI, with the 9th and 14th F.A. Regts.; the 314th Engr. Regt. trained at Fort Riley, KS, with A Troop, 9th Engrs.; the 314th Med. Regt. trained at the medical corps training camp at Fort Snelling; and the 314th Obsn. Sq. trained with the 16th Obsn. Sq. at Marshall Field, KS. In addition to the unit training camps, the infantry regiments of the division rotated responsibility to conduct the CMTC held at Fort Crook, Fort Des Moines, IA, and Fort Leavenworth each year. On a number of occasions, the division participated in Seventh Corps Area and Fourth Army CPXs in conjunction with other R.A., N.G., and O.R. units. These training events gave division staff officers' opportunities to practice the roles they would be expected to perform in the event the division was mobilized. Unlike the R.A. and N.G. units in the Fourth Corps Area, the 89th Div. did not participate in the various Seventh Corps Area Maneuvers and the Fourth Army Maneuvers of 1937, 1940, and 1941 as an organized unit due to lack of enlisted personnel and equipment. Instead, the officers and a few enlisted reservists were assigned to R.A. and N.G. units to fill vacant slots and bring the units up to war strength for the exercises. Additionally, some officers were assigned duties as umpires or as support personnel. Location of the division HQ on 7 December 1941 was Omaha, NE.

**Status:** HHC are currently inactive in the US Army Reserve as HHC, 89th Div. (Training).

**Events:** 193, 233, 236, 279, 303

#### Division Commanders

Brig. Gen. Leroy Eltinge (R.A.)\* 9 September 1929–13 May 1931

\*Concurrently commanding general of the 14th Inf. Brig.

#### Chiefs of Staff

Col. Jay P. Hopkins, C.A.C.	27 August 1921–1 August 1923	Lt. Col. Oliver A. Dickinson, F.A.	1 March 1935–15 March 1935
Lt. Col. Frank P. Amos, Cav.	1 August 1923–1 February 1926	Col. Ralph W. Kingman, Inf.	15 March 1935–30 September 1937
Col. Dwight W. Ryther, Inf.	1 February 1926–November 1930	Col. Robert P. Glassburn, C.A.C.	30 September 1937–29 May 1939
Lt. Col. Forrest T. Overholser, Inf.	November 1930–1 March 1935	Col. Ralph W. Dusenbury, Inf.	29 May 1939–7 March 1942

#### 89th DIVISION Organization 1922

UNIT:	HQ LOCATION:
HQ	Omaha, NE
HQ, Special Troops	Omaha, NE
HQ Co.	Omaha, NE
89th M.P. Co.	Omaha, NE
89th Sig. Co.	Omaha, NE
314th Ord. Co. (M)	Gridley, KS
89th Tank Co. (L)	Columbus, KS
Mtcyl Co. No. 314	Independence, KS
177th Inf. Brig.	Le Harpe, KS
353d Inf. Regt.	Wichita, KS
354th Inf. Regt.	Kansas City, KS
178th Inf. Brig.	Omaha, NE
355th Inf. Regt.	Omaha, NE
356th Inf. Regt.	Sioux Falls, SD
164th F.A. Brig.	Topeka, KS
314th Ammo. Tn.	Topeka, KS
340th F.A. Regt.	Topeka, KS
341st F.A. Regt.	Omaha, NE
314th Engr. Regt.	Lawrence, KS
314th Med. Regt.	Kansas City, KS
89th Div. Tn., Q.M.C.	Mitchell, SD
89th Div. Air Service	Omaha, NE

#### 89th DIVISION Organization 1939

UNIT:	HQ LOCATION:
HQ	Omaha, NE
HQ, Special Troops	Omaha, NE
HQ Co.	Omaha, NE
89th M.P. Co.	Alliance, NE
89th Sig. Co.	Omaha, NE
314th Ord. Co. (M)	Beatrice, NE
89th Tank Co. (L)	Scottsbluff, NE
177th Inf. Brig.	Wichita, KS
353d Inf. Regt.	Wichita, KS
354th Inf. Regt.	Kansas City, KS
178th Inf. Brig.	Norfolk, NE
355th Inf. Regt.	Omaha, NE
356th Inf. Regt.	Sioux Falls, SD
164th F.A. Brig.	Topeka, KS
314th Ammo. Tn.	O'Neill, NE
340th F.A. Regt.	Wichita, KS
341st F.A. Regt.	Omaha, NE
342d F.A. Regt.	Lincoln, NE
314th Engr. Regt.	Grand Island, NE
314th Med. Regt.	Omaha, NE
414th Q.M. Regt.	Mitchell, SD

## 90th DIVISION

## “Alamo Division”

## Organized Reserve Texas

HQ—San Antonio, TX, 1921–41

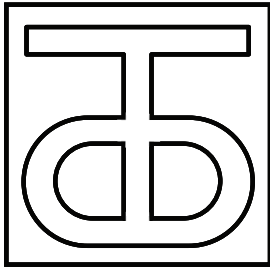

The 90th Div. HQ arrived at the port of Boston, MA, aboard the S.S. *Magnolia* on 7 June 1919 after 12 months of overseas service and was demobilized on 17 June 1919 at Camp Bowie, TX. The 90th Div. was reconstituted in the O.R. on 24 June 1921, allotted to the Eighth Corps Area, and assigned to the XVIII Corps. The division was further allotted to the state of Texas as its home area. The division HQ was organized on 8 August 1921 with its offices located in the library of the Eighth Corps Area HQ at Fort Sam Houston, TX. The HQ was relocated on 14 September 1921 to the Gunter Hotel in San Antonio, TX, and relocated again in June 1923 to Building 42-T at Fort Sam Houston. The HQ was relocated once more in July 1926 to the Alamo Building in San Antonio and remained there until activated for World War II. After activation, the division’s recruiting efforts were such that by January

1924, the division was at 99 percent of its authorized strength, which was the highest for any O.R. division at the time. To maintain communications with the officers of the division, the division staff published a newsletter titled “The 90th Division Bulletin.” The newsletter informed the division’s members of such things as when and where the inactive training sessions were to be held, what the division’s summer training quotas were, where the camps were to be held, and which units would be assigned to help conduct the CMTTC training. The designated mobilization and training station for the division was Fort Sam Houston and Camp Bullis, TX, the locations where much of the 90th Div.’s training activities occurred in the interwar years. The HQ and staff usually trained with the staff of the 2d Div. at Fort Sam Houston. The subordinate infantry regiments of the division held their summer training primarily with the 9th Inf. and 23d Inf. Regts. at Camp Bullis. Other units, such as the special troops, artillery, engineers, aviation, medical, and quartermaster, also trained at Fort Sam Houston or Camp Bullis with like units of the 2d Div. For the summer training camps of May 1932 and May 1933, the 90th Div. HQ, Special Troops, 315th Med. Regt., and 90th Div. Q.M. Tn. participated in maneuvers with the 2d Div. at Camp Bullis. In addition to the unit training camps, the infantry regiments of the division rotated responsibility to conduct the CMTTC training held at Fort Sam Houston each year. During the inactive training period, the 90th Div. staff would hold occasional contact camps at Texas A&M College in Bryan, TX. On a number of occasions, the division HQ and staff, and occasionally the three brigade HQ, participated in Eighth Corps Area and Third Army CPXs in conjunction with other R.A., N.G., and O.R. units. These training events gave division staff officers’ opportunities to practice the roles they would be expected to perform in the event the division was mobilized. Unlike the R.A. and N.G. units in the Eighth Corps Area, the 90th Div. did not participate in the various Eighth Corps Area Maneuvers and the Third Army Maneuvers of 1938, 1940, and 1941 as an organized unit due to lack of enlisted personnel and equipment. Instead, the officers and a few enlisted reservists were assigned to R.A. and N.G. units to fill vacant slots and bring those units up to war strength for the exercises. Additionally, some officers were assigned duties as umpires or as support personnel. But for each maneuver, the division maximized the number of participants. For example, for the 1938 maneuver at Camp Bullis, the 90th Div. provided 138 officers to the 2d Div. and 66 to the 36th Div. Similar numbers participated in the two succeeding exercises. Location of the division HQ on 7 December 1941 was San Antonio, TX.

**Status:** HHC are currently inactive in the US Army Reserve as HHC, 90th Inf. Div.

**Events:** 80, 146, 147, 163, 217, 258, 299, 300

### Chiefs of Staff

Col. Beaumont B. Buck, Inf.	31 August 1921–16 January 1924	Col. George W. Stuart, Inf.	February 1928–1 April 1928
Lt. Col. Edward R. Coppock, Cav.	16 January 1924–9 February 1924	Col. Charles B. Clark, Inf.	1 April 1928–April 1929
Maj. Elmer O. Desobry, Inf.	9 February 1924–20 June 1924	Col. Thomas L. Brewer, Inf.	April 1929–31 December 1930
Lt. Col. Eben Swift Jr., F.A.	20 June 1924–1 September 1924	Col. David H. Biddle, Cav.	31 December 1930–May 1931
Col. Robert O. Van Horn, Inf.	1 September 1924–3 August 1927	Lt. Col. Alfred A. Hickox, Inf.	May 1931–10 July 1931
Col. William S. Faulkner, Inf.	5 August 1927–February 1928	Col. Frederick R. de Funiak, Jr. Inf.	10 July 1931–1 March 1937
	Col. Charles L. Mitchell, Inf.		1 March 1937–January 1942

**90th DIVISION  
Organization 1922**

<b>UNIT:</b>	<b>HQ LOCATION:</b>
HQ	San Antonio, TX
HQ, Special Troops	San Antonio, TX
HQ Co.	San Antonio, TX
90th M.P. Co.	San Antonio, TX
90th Sig. Co.	San Antonio, TX
315th Ord. Co. (M)	San Antonio, TX
90th Tank Co. (L)	San Antonio, TX
Mtcyl Co. No. 315	Dallas, TX
179th Inf. Brig.	Fort Worth, TX
357th Inf. Regt.	San Antonio, TX
358th Inf. Regt.	Fort Worth, TX
180th Inf. Brig.	Houston, TX
359th Inf. Regt.	Dallas, TX
360th Inf. Regt.	Houston, TX
165th F.A. Brig.	Dallas, TX
315th Ammo. Tn.	Dallas, TX
343d F.A. Regt.	Fort Worth, TX
344th F.A. Regt.	Dallas, TX
315th Engr. Regt.	San Antonio, TX
315th Med. Regt.	San Antonio, TX
90th Div. Tn., Q.M.C.	San Antonio, TX
90th Div. Air Service	El Paso, TX

**90th DIVISION  
Organization 1939**

<b>UNIT:</b>	<b>HQ LOCATION:</b>
HQ	San Antonio, TX
HQ, Special Troops	San Antonio, TX
HQ Co.	San Antonio, TX
90th M.P. Co.	San Antonio, TX
90th Sig. Co.	San Antonio, TX
315th Ord. Co. (M)	San Antonio, TX
90th Tank Co. (L)	San Antonio, TX
179th Inf. Brig.	Fort Worth, TX
357th Inf. Regt.	San Antonio, TX
358th Inf. Regt.	Fort Worth, TX
180th Inf. Brig.	Houston, TX
359th Inf. Regt.	Dallas, TX
360th Inf. Regt.	Houston, TX
165th F.A. Brig.	Waco, TX
315th Ammo. Tn.	Waco, TX
343d F.A. Regt.	Bryan, TX
344th F.A. Regt.	Waco, TX
345th F.A. Regt.	Harlingen, TX
315th Engr. Regt.	San Antonio, TX
315th Med. Regt.	San Antonio, TX
415th Q.M. Regt.	San Antonio, TX

**91st DIVISION**

**“Wild West Division”**

**Organized Reserve California**

HQ—San Francisco, CA, 1921–41

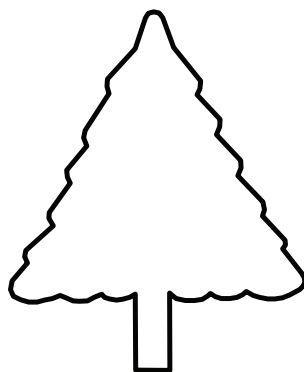

The 91st Div. HQ arrived at the port of Brooklyn, NY, aboard the U.S.S. *Calamares* on 16 April 1919 after 11 months of overseas service and was demobilized on 13 May 1919 at the Presidio of San Francisco, CA. The 91st Div. was reconstituted in the O.R. on 24 June 1921, allotted to the Ninth Corps Area, and assigned to the XIX Corps. The division was further allotted to the state of California as its home area. The division HQ was organized in November 1921 at Building 88 on the Presidio of San Francisco. The HQ was later moved to Building 172 at the Presidio and remained there until activated for World War II. To maintain communications with the officers of the division, the division staff published a newsletter titled “The 91st Division Bulletin.” The newsletter informed the division’s members of such things as when and where the inactive training sessions were to be held, what the division’s summer training quotas were, where the camps were to be held, and which units would be assigned to help conduct the CMTC training. The designated mobilization and training station

for the division was Del Monte, CA, the location where much of the 91st Div.’s training activities occurred in the interwar years. The subordinate infantry regiments of the division held their summer training with the 30th Inf. Regt. at Del Monte. Other units, such as the special troops, artillery, engineers, aviation, medical, and quartermaster, trained at various posts in the Ninth Corps Area, often with the active units of the 3d Div. For example, the division’s artillery trained at the Presidio of Monterey with the 2d Bn., 76th F.A.; the 316th Engr. Regt. trained at Fort Lewis, WA, with the 6th Engrs.; the 316th Med. Regt. trained at the medical corps training camp at the Presidio of San Francisco; and

the 316th Obsn. Sq. trained with the 91st Obsn. Sq. at Crissy Field, CA. In addition to the unit training camps, the infantry regiments of the division rotated responsibility to conduct the CMTC training held at Del Monte and the Presidio of California each year as well. On a number of occasions, the division participated in Ninth Corps Area and Fourth Army CPXs in conjunction with other R.A., N.G., and O.R. units. These training events gave division staff officers' opportunities to practice the roles they would be expected to perform in the event the division was mobilized. Unlike the R.A. and N.G. units in the Ninth Corps Area, the 91st Div. did not participate in the various Ninth Corps Area Maneuvers and the Fourth Army Maneuvers of 1937, 1940, and 1941 as an organized unit due to lack of enlisted personnel and equipment. Instead, the officers and a few enlisted reservists were assigned to R.A. and N.G. units to fill vacant slots and bring the units up to war strength for the exercises. Additionally, some officers were assigned duties as umpires or as support personnel. Location of the division HQ on 7 December 1941 was the Presidio of San Francisco.

**Status:** HHC are currently active in the US Army Reserve at Fort Baker, CA, as HHC, 91st Div. (Exercise).

**Events:** 193, 231, 279, 304

#### Chiefs of Staff

Col. Erneste V. Smith, Inf.	1 July 1921–18 November 1928	Col. Frank S. Bowen, F.A.	June 1930–5 December 1936
Col. Walter H. Johnson, Inf.	20 November 1928–June 1930	Col. Charles S. Mason, Inf.	5 December 1936–1 November 1940
	Lt. Col. Arthur H. Rogers, Inf.		1 November 1940–January 1942

#### 91st DIVISION Organization 1922

UNIT:	HQ LOCATION:
HQ	San Francisco, CA
HQ, Special Troops	San Francisco, CA
HQ Co.	San Francisco, CA
91st M.P. Co.	Alameda, CA
91st Sig. Co.	Los Angeles, CA
316th Ord. Co. (M)	San Francisco, CA
91st Tank Co. (L)	Stockton, CA
Mtchl Co. No. 316	Los Angeles, CA
181st Inf. Brig.	San Francisco, CA
361st Inf. Regt.	Sacramento, CA
362d Inf. Regt.	Oakland, CA
182d Inf. Brig.	Los Angeles, CA
363d Inf. Regt.	Fresno, CA
364th Inf. Regt.	Los Angeles, CA
166th F.A. Brig.	San Francisco, CA
316th Ammo. Tn.	San Francisco, CA
346th F.A. Regt.	San Francisco, CA
347th F.A. Regt.	Los Angeles, CA
316th Engr. Regt.	Los Angeles, CA
316th Med. Regt.	San Francisco, CA
91st Div. Tn., Q.M.C.	Los Angeles, CA
91st Div. Air Service	Los Angeles, CA

#### 91st DIVISION Organization 1939

UNIT:	HQ LOCATION:
HQ	San Francisco, CA
HQ, Special Troops	San Francisco, CA
HQ Co.	San Francisco, CA
91st M.P. Co.	San Francisco, CA
91st Sig. Co.	San Francisco, CA
316th Ord. Co. (M)	San Francisco, CA
91st Tank Co. (L)	San Francisco, CA
181st Inf. Brig.	San Francisco, CA
361st Inf. Regt.	Sacramento, CA
362d Inf. Regt.	San Francisco, CA
182d Inf. Brig.	Los Angeles, CA
363d Inf. Regt.	Fresno, CA
364th Inf. Regt.	Los Angeles, CA
166th F.A. Brig.	San Francisco, CA
316th Ammo. Tn.	San Francisco, CA
346th F.A. Regt.	San Francisco, CA
347th F.A. Regt.	Los Angeles, CA
348th F.A. Regt.	Los Angeles, CA
316th Engr. Regt.	Los Angeles, CA
316th Med. Regt.	San Francisco, CA
416th Q.M. Regt.	Los Angeles, CA

## 94th DIVISION

## Organized Reserve Massachusetts

HQ—Boston, MA, 1921–41



The 94th Div. was constituted in the O.R. on 24 June 1921, allotted to the First Corps Area, and assigned to the XI Corps. The division was further allotted to the state of Massachusetts as its home area. The division HQ was organized in November 1921 at the Customhouse Tower in Boston, MA, and remained there until activated for World War II. To maintain communications with the officers of the division, the division staff published a newsletter titled “The 94th Division Bulletin.” The newsletter informed the division’s members of such things as when and where the inactive training sessions were to be held, what the division’s summer training quotas were, where the camps were to be held, and which units would be assigned to help conduct the CMTC training. The designated mobilization and training station for the division was Camp Devens (redesignated Fort Devens in 1931), MA, the location where much of the 94th

Div.’s training activities occurred in the interwar years. For the few summers when it was called to duty for training as a unit, the HQ, 94th Div. often trained with the staff of the 18th Inf. Brig. at Camp Devens. The summer training for the personnel assigned to the division HQ was varied and included staff training, branch-specific training, and division-level CPXs. For several summers, however, the division conducted a “Special Officers Camp” at Camp Devens, which consisted of training for unassigned officers, officers who could not attend training with their assigned units, and basic officer training for recent ROTC and CMTC commissionees. The division’s subordinate units trained all over the First Corps Area. Divisional infantry regiments, for example, held their summer training primarily with the units of the 18th Inf. Brig. at Camp Devens and Fort Ethan Allen, VT. Other units, such as the special troops, artillery, engineers, aviation, medical, and quartermaster, trained at various posts in the First, Second, and Third Corps Areas, often with the active units of the 1st and 9th Divs. For example, the division’s artillery trained at Fort Ethan Allen with the 7th F.A.; the 319th Engr. Regt. trained at Fort DuPont, DE, with the 1st Engrs.; the 319th Med. Regt. trained at Carlisle Barracks, PA, with the 1st Med. Regt.; and the 319th Obsn. Sq. trained with the 5th Obsn. Sq. at Mitchel Field, NY. In addition to the unit training camps, the infantry regiments of the division rotated responsibility to conduct the CMTC training held at Camp Devens each year. On a number of occasions, the division participated in First Corps Area and First Army CPXs in conjunction with other R.A., N.G., and O.R. units. These training events gave division staff officers’ opportunities to practice the roles they would be expected to perform in the event the division was mobilized. Unlike the R.A. and N.G. units in the First Corps Area, the 94th Div. did not participate in the various First Corps Area Maneuvers and the First Army Maneuvers of 1935, 1939, and 1941 as an organized unit due to lack of enlisted personnel and equipment. Instead, the officers and a few enlisted reservists were assigned to R.A. and N.G. units to fill vacant slots and bring the units up to war strength for the exercises. Additionally, some officers were assigned duties as umpires or as support personnel. Location of the division HQ on 7 December 1941 was Boston, MA.

**Status:** HHC are currently inactive in the US Army Reserve as HHC, 94th Inf. Div.

**Events:** 59, 280

### Division Commanders

Maj. Gen. Andre Brewster (R.A.)\* 1 January 1922–28 November 1925      Maj. Gen. Fox Conner (R.A.)\* 7 October 1930–30 September 1938

\*Concurrently commanding general of the First Corps Area.

### Chiefs of Staff

Col. Frank C. Bolles, Inf.	2 July 1921–14 July 1924	Col. George D. Moore, Inf	29 November 1929–18 May 1930
Col. Charles A. Romeyn, Cav.	14 July 1924–2 December 1927	Col. Guy S. Norvell, Cav.	24 May 1930–June 1930
Lt. Col. Emmett Addis, Cav.	2 December 1927–25 July 1928	Col. Clement A. Trott, Inf.	30 June 1930–20 August 1934
Lt. Col. Charles B. Amory, Cav.	25 July 1928–14 March 1928	Col. Albert T. Rich, Q.M.C.	20 August 1934–1 November 1934
Col. William H. Raymond, C.A.C.	14 March 1928–7 August 1929	Col. Albert W. Foreman, Inf.	1 November 1934–5 July 1938
Lt. Col. Emmett Addis, Cav.	7 August 1929–29 November 1929	Col. James M. Petty, Inf.	5 July 1938–31 March 1942



**94th DIVISION  
Organization 1922**

<b>UNIT:</b>	<b>HQ LOCATION:</b>
HQ	Boston, MA
HQ, Special Troops	Boston, MA
HQ Co.	Boston, MA
94th M.P. Co.	Boston, MA
94th Sig. Co.	Boston, MA
319th Ord. Co. (M)	Springfield, MA
94th Tank Co. (L)	Worcester, MA
Mtchl Co. No. 319	Springfield, MA
187th Inf. Brig.	Boston, MA
301st Inf. Regt.	Boston, MA
302d Inf. Regt.	Brockton, MA
188th Inf. Brig.	Boston, MA
376th Inf. Regt.	Lynn, MA
419th Inf. Regt.	Springfield, MA
169th F.A. Brig.	Boston, MA
319th Ammo. Tn.	Worcester, MA
301st F.A. Regt.	Boston, MA
356th F.A. Regt.	Worcester, MA
319th Engr. Regt.	Boston, MA
319th Med. Regt.	Boston, MA
94th Div. Tn., Q.M.C.	Boston, MA
94th Div. Air Service	Boston, MA

**94th DIVISION  
Organization 1939**

<b>UNIT:</b>	<b>HQ LOCATION:</b>
HQ	Boston, MA
HQ, Special Troops	Boston, MA
HQ Co.	Boston, MA
94th M.P. Co.	Boston, MA
94th Sig. Co.	Boston, MA
319th Ord. Co. (M)	Springfield, MA
94th Tank Co. (L)	Worcester, MA
187th Inf. Brig.	Boston, MA
301st Inf. Regt.	Boston, MA
302d Inf. Regt.	Brockton, MA
188th Inf. Brig.	Worcester, MA
376th Inf. Regt.	Lynn, MA
419th Inf. Regt.	Worcester, MA
169th F.A. Brig.	Boston, MA
319th Ammo. Tn.	Worcester, MA
301st F.A. Regt.	Boston, MA
356th F.A. Regt.	Worcester, MA
390th F.A. Regt.	Pittsfield, MA
319th Engr. Regt.	Boston, MA
319th Med. Regt.	Boston, MA
419th Q.M. Regt.	Boston, MA

**95th DIVISION**

**“OK Division”**

**Organized Reserve Oklahoma**

**HQ**—Oklahoma City, OK, 1921–41

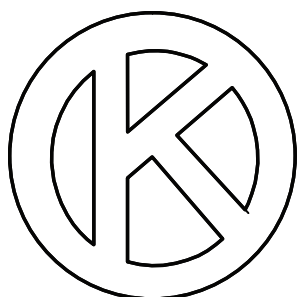

The 95th Div. was demobilized on 22 December 1919 at Camp Sherman, OH. It was reconstituted in the O.R. on 24 June 1921, allotted to the Eighth Corps Area, and assigned to the XVIII Corps. The division was further allotted to the state of Oklahoma as its home area. The division HQ was organized on 31 August 1921 at the State Capitol in Oklahoma City, OK. It was relocated on 3 May 1922 to the Tradesmen’s National Bank Building in Oklahoma City and relocated once again in August 1924 to 203½ West Grand Avenue. The HQ remained there until activated for World War II. To maintain communications with the officers of the division, the chief of staff published a newsletter titled “The Observation Post.” The newsletter informed the division’s members of such things as when and where the inactive training sessions were to be held, what the division’s summer training quotas were, where the camps were to be

held, and which units would be assigned to help conduct the CMTC training. The designated mobilization and training station for the division was Fort Sill, OK, the location where much of the 95th Div.’s training activities occurred in the interwar years. The subordinate infantry regiments of the division held their summer training with the 3d Bn., 20th Inf. Regt. 1925–27; 1st Bn., 38th Inf. Regt. 1927–33; and the 3d Bn., 29th Inf. Regt. 1933–39 at Fort Sill. Other units, such as the special troops, artillery, engineers, aviation, medical, and quartermaster, trained at various posts in the Eighth Corps Area. For example, the division’s artillery trained at Fort Sill with the 1st F.A.; the 320th Engr. Regt. trained at Fort Sam Houston, TX, and Fort Logan, CO, with the 2d Engrs.; the 320th Med. Regt. trained at Fort Sam Houston with the 2d Med. Regt.; and the 320th Obsn. Sq. trained at Brooks Field, TX. In addition to the unit training camps, the infantry regiments of the division rotated responsibility to conduct the CMTC training held at Fort Sill each year.

On a number of occasions, the division participated in Eighth Corps Area and Third Army CPXs in conjunction with other R.A., N.G., and O.R. units. These training events gave division staff officers' opportunities to practice the roles they would be expected to perform in the event the division was mobilized. Unlike the R.A. and N.G. units in the Eighth Corps Area, the 95th Div. did not participate in the various Eighth Corps Area Maneuvers and the Third Army Maneuvers of 1938, 1940, and 1941 as an organized unit due to lack of enlisted personnel and equipment. Instead, the officers and a few enlisted reservists were assigned to R.A. and N.G. units to fill vacant slots and bring the units up to war strength for the exercises. Additionally, some officers were assigned duties as umpires or as support personnel. But, for each maneuver, the division maximized the number of participants. For example, for the 1938 Maneuver at Camp Bullis, the 95th Div. provided 173 officers to the 2d Div. and 68 to the 45th Div. Similar numbers participated in the two succeeding exercises. Location of the division HQ on 7 December 1941 was Oklahoma City.

**Status:** HHC are currently active in the US Army Reserve at Oklahoma City, OK, as HHC, 95th Div. (Institutional Training).

**Events:** 80, 217, 258, 300

#### Division Commanders

Maj. Gen. John L. Hines (R.A.)*	8 October 1921–20 November 1922	Maj. Gen. Ernest Hinds (R.A.)*	5 April 1925–3 January 1928
Maj. Gen. Edward M. Lewis (R.A.)*	20 November 1922–11 October 1924	Brig. Gen. Roy Hoffman (R.A.)	ao August 1928–2 August 1931

\*Concurrently commanding general of the Eighth Corps Area.

#### Chiefs of Staff

Lt. Col. George F. Trumbo, Cav.	31 August 1921–21 December 1922	Lt. Col. Thomas J. Rogers, Inf.	14 January 1927–26 October 1928
Lt. Col. Rodman Butler, Q.M.C.	21 December 1922–29 September 1923	Col. Earnest E. Haskell, Inf.	26 October 1928–9 November 1932
Lt. Col. George C. Lewis, Inf.	29 September 1923–20 December 1923	Col. Edward A. Keyes, Cav.	9 November 1932–October 1936
Col. William O. Johnson, Inf.	20 December 1923–13 September 1926	Col. George A. Pollin, F.A.	October 1936–13 September 1937
Maj. Paul C. Potter, Inf.	13 September 1926–14 January 1927	Col. George C. Lawrason, Inf.	13 September 1937–8 December 1941

#### 95th DIVISION Organization 1922

UNIT:	HQ LOCATION:
HQ	Oklahoma City, OK
HQ, Special Troops	Oklahoma City, OK
HQ Co.	Oklahoma City, OK
95th M.P. Co.	Oklahoma City, OK
95th Sig. Co.	Oklahoma City, OK
320th Ord. Co. (M)	Oklahoma City, OK
95th Tank Co. (L)	Oklahoma City, OK
Mt cyl Co. No. 320	Oklahoma City, OK
189th Inf. Brig.	Muskogee, OK
377th Inf. Regt.	Tulsa, OK
378th Inf. Regt.	McAlester, OK
190th Inf. Brig.	Oklahoma City, OK
379th Inf. Regt.	Enid, OK
380th Inf. Regt.	Lawton, OK
170th F.A. Brig.	Oklahoma City, OK
320th Ammo. Tn.	Lawton, OK
358th F.A. Regt.	Muskogee, OK
359th F.A. Regt.	El Reno, OK
320th Engr. Regt.	Oklahoma City, OK
320th Med. Regt.	Okmulgee, OK
95th Div. Tn., Q.M.C.	Lawton, OK
95th Div. Air Service	Muskogee, OK

#### 95th DIVISION Organization 1939

UNIT:	HQ LOCATION:
HQ	Oklahoma City, OK
HQ, Special Troops	Oklahoma City, OK
HQ Co.	Oklahoma City, OK
95th M.P. Co.	Oklahoma City, OK
95th Sig. Co.	Oklahoma City, OK
320th Ord. Co. (M)	Oklahoma City, OK
95th Tank Co. (L)	Oklahoma City, OK
189th Inf. Brig.	Muskogee, OK
377th Inf. Regt.	Tulsa, OK
378th Inf. Regt.	McAlester, OK
190th Inf. Brig.	Oklahoma City, OK
379th Inf. Regt.	Enid, OK
380th Inf. Regt.	Oklahoma City, OK
170th F.A. Brig.	Oklahoma City, OK
320th Ammo. Tn.	Oklahoma City, OK
358th F.A. Regt.	Sapulpa, OK
359th F.A. Regt.	Ardmore, OK
360th F.A. Regt.	Edmond, OK
320th Engr. Regt.	Enid, OK
320th Med. Regt.	Oklahoma City, OK
420th Q.M. Regt.	Lawton, OK

## 96th DIVISION

## “Columbia Division” Organized Reserve Oregon and Washington

HQ—Portland, OR, 1921–41

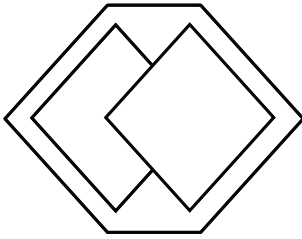

The 96th Div. was demobilized on 7 January 1919 at Camp Wadsworth, SC. It was reconstituted in the O.R. on 24 June 1921, allotted to the Ninth Corps Area, and assigned to the XIX Corps. The division was further allotted to the states of Oregon and Washington as its home area. The division HQ was organized on 7 October 1921 at the New Post Office Building in Portland, OR, and remained there until activated for World War II. To encourage esprit de corps, in September 1922 the division's officers adopted the nickname “Columbia Division” after the majestic Columbia River, which neatly ran through the middle of the division's home area. To maintain communications with the officers of the division, the division staff published a

newsletter appropriately nicknamed the “The Columbian.” The newsletter informed the division's members of such things as when and where the inactive training sessions were to be held, what the division's summer training quotas were, where the camps were to be held, and which units would be assigned to help conduct the CMTC training. The designated mobilization and training station for the division was Camp Lewis (later redesignated Fort Lewis in 1931), WA, the location where much of the 96th's training activities occurred over the next 20 years. For the few summers when the division HQ was called to duty for training as a unit, the 96th Div. usually trained with the staff of the 3d Div. at Camp Lewis. The subordinate infantry regiments of the division held their summer training primarily with the units of the 5th Inf. Brig. at Fort Lewis or Vancouver Barracks, WA. Other units, such as the special troops, artillery, engineers, aviation, medical, and quartermaster, trained at various posts in the Ninth Corps Area with R.A. units of the same branch. For example, the 321st Engr. Regt. usually trained with elements of the 6th Engr. Regt. at Fort Lewis or Fort Lawton, WA; the 321st Med. Regt. trained with the 3d Med. Regt. at Camp Lewis; and the 321st Obsn. Sq. trained with the 91st Obsn. Sq. at Crissy Field, CA. In addition to the unit training camps, the infantry regiments of the division rotated responsibility to conduct the CMTC training held at Camp Lewis each year. On a number of occasions, the division participated in Ninth Corps Area and Fourth Army CPXs in conjunction with other R.A., N.G., and O.R. units. These training events gave division staff officers' opportunities to practice the roles they would be expected to perform in the event the division was mobilized. Unlike the R.A. and N.G. units in the Ninth Corps Area, the 96th Div. did not participate in the various Ninth Corps Area Maneuvers and the Fourth Army Maneuvers of 1937, 1940, and 1941 as an organized unit due to lack of enlisted personnel and equipment. Instead, the officers and a few enlisted reservists were assigned to R.A. and N.G. units to fill vacant slots and bring the units up to full peace strength for the exercises. For the 1937 Maneuver, for example, about 200 of the division's officers were attached to the N.G. 41st Div. to allow that unit to function as an almost full-strength division. Additionally, some officers were assigned duties as umpires or as support personnel. Location of the division HQ on 7 December 1941 was Portland, OR.

**Status:** HHC are currently inactive in the US Army Reserve as HHC, 96th Inf. Div.

**Events:** 193, 238, 279, 304

### Chiefs of Staff

Col. Pegram Whitworth, Inf.	16 August 1921–1 July 1924	Col. William L. Luhn, Cav.	24 October 1931–May 1933
Col. William J. Barden, C.E.	1 July 1924–29 September 1924	Col. Ola W. Bell, Cav.	22 May 1933–31 May 1935
Col. Frederick T. Arnold, Cav.	30 September 1924–6 July 1928	Col. Alvord Van P. Anderson, Cav.	May 1935–30 April 1936
Col. William W. McCammon, Inf.	31 July 1928–10 March 1930	Col. Clenard McLaughlin, Inf.	September 1936–January 1938
Col. Archibald F. Commiskey, Cav.	10 March 1930–8 August 1931	Col. Owen R. Meredith, Inf.	January 1938–11 October 1939
	Col. John J. Fulmer, Inf.		11 October 1939–31 May 1942

**96th DIVISION  
Organization 1922**

UNIT:	HQ LOCATION:
HQ	Portland, OR
HQ, Special Troops	Portland, OR
HQ Co.	Portland, OR
96th M.P. Co.	Seattle, WA
96th Sig. Co.	Seattle, WA
321st Ord. Co. (M)	Seattle, WA
96th Tank Co. (L)	Portland, OR
Mtcyl Co. No. 321	Vancouver, WA
191st Inf. Brig.	Portland, OR
381st Inf. Regt.	Portland, OR
382d Inf. Regt.	Medford, OR
192d Inf. Brig.	Seattle, WA
383d Inf. Regt.	Seattle, WA
384th Inf. Regt.	Spokane, WA
171st F.A. Brig.	Portland, OR
321st Ammo. Tn.	Seattle, WA
361st F.A. Regt.	Portland, OR
362d F.A. Regt.	Seattle, WA
321st Engr. Regt.	Seattle, WA
321st Med. Regt.	Seattle, WA
96th Div. Tn., Q.M.C.	Portland, OR
96th Div. Air Service	Portland, OR

**96th DIVISION  
Organization 1939**

UNIT:	HQ LOCATION:
HQ	Portland, OR
HQ, Special Troops	Seattle, WA
HQ Co.	Portland, OR
96th M.P. Co.	Seattle, WA
96th Sig. Co.	Seattle, WA
321st Ord. Co. (M)	Seattle, WA
96th Tank Co. (L)	Portland, OR
191st Inf. Brig.	Portland, OR
381st Inf. Regt.	Portland, OR
382d Inf. Regt.	Medford, OR
192d Inf. Brig.	Seattle, WA
383d Inf. Regt.	Seattle, WA
384th Inf. Regt.	Spokane, WA
171st F.A. Brig.	Portland, OR
321st Ammo. Tn.	Seattle, WA
361st F.A. Regt.	Portland, OR
362d F.A. Regt.	Seattle, WA
363d F.A. Regt.	Portland, OR
321st Engr. Regt.	Seattle, WA
321st Med. Regt.	Seattle, WA
421st Q.M. Regt.	Portland, OR

**97th DIVISION**

**Organized Reserve New Hampshire,  
Maine, and Vermont**

HQ—Augusta, ME, 1921–22; Manchester, NH, 1922–37; Portland, ME, 1937–41

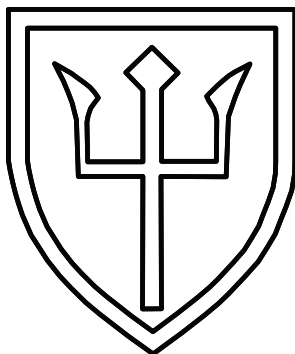

The 97th Div. was demobilized on 22 December 1918 at Camp Cody, NM. It was reconstituted in the O.R. on 24 June 1921, allotted to the First Corps Area, and assigned to the XI Corps. The division was further allotted to the states of New Hampshire, Maine, and Vermont as its home area. The HQ was organized in December 1921 initially at Augusta, ME, then relocated in September 1922 to the Bell Building at 922 Elm Street in Manchester, NH. The HQ was again relocated in August 1923 to the Federal Building in Manchester. In late 1937, the HQ was transferred to the new Post Office Building in Portland, ME, and remained there until activated for World War II. After its organization, the division rapidly built its strength. Although the 97th Div. area had virtually no major population centers and possessed a poor highway network, the division was above 90 percent complete by November 1923. Due to the poor road network and because the division's officers tended to be concentrated in the larger towns, the division's personnel, less those in the infantry regiments, tended

to hold their inactive training meetings as "group" meetings (i.e., without respect to unit assignment) rather than unit meetings. To maintain communications with the officers of the division, the division staff published a newsletter titled the "97th Division Bulletin." The newsletter informed the division's members of such things as when and where the inactive training sessions were to be held, what the division's summer training quotas were, where the camps were to be held, and which units would be assigned to help conduct the CMTC training. The mobilization and training station for the division was Camp Devens, MA, the location where much of the 97th's training activities occurred over the next 20 years. For the few summers when the division HQ was called to duty for training as a unit, the 97th Div. trained with the staff of the 18th Inf. Brig. at Camp Devens, and occasionally with the staff of the 5th Inf. Regt. at Fort Williams, ME. The summer training for the personnel assigned to the division HQ was varied and included staff training, branch-specific training, and division-level CPXs. For several summers, however, the division conducted a

“Special Officers Camp” at Fort Ethan Allen, which consisted of training for unassigned officers, officers who could not attend training with their assigned units, and basic officer training for recent ROTC and CMTC commissionees. The division also held periodic contact camps during the inactive training period, usually at Poland Spring, ME. The division’s subordinate units trained all over the First Corps Area. Divisional infantry regiments, for example, held their summer training primarily with the units of the 18th Inf. Brig. at Camp Devens; Fort Ethan Allen, VT; Fort Adams, RI; and Forts McKinley and Williams, ME. Other units, such as the special troops, artillery, engineers, aviation, medical, and quartermaster, trained at various posts in the First, Second, and Third Corps Areas with R.A. units of the same branch. For example, the 322d Engr. Regt. usually trained with elements of the 1st Engr. Regt. at Fort Du Pont, DE; the 322d Med. Regt. trained with the 1st Med. Regt. at Carlisle Barracks, PA; and the 322d Obsn. Sq. trained with the 5th Obsn. Sq. at Mitchel Field, NY. In addition to the unit training camps, the infantry regiments of the division rotated responsibility to conduct the CMTC held at Camp Devens, Fort McKinley, and Fort Etham Allen each year. On a number of occasions, the division participated in First Corps Area and First Army CPXs in conjunction with other R.A., N.G., and O.R. units. These training events gave division staff officers’ opportunities to practice the roles they would be expected to perform in the event the division was mobilized. Unlike the R.A. and N.G. units in the First Corps Area, the 97th Div. did not participate in the various First Corps Area Maneuvers and the First Army Maneuvers of 1935, 1939, and 1940 as an organized unit due to lack of enlisted personnel and equipment. Instead, the officers and a few enlisted reservists were assigned to R.A. and N.G. units to fill vacant slots and bring the units up to full peace strength for the exercises. Additionally, some officers were assigned duties as umpires or as support personnel. Location of the division HQ on 7 December 1941 was Portland, ME.

**Status:** HHC are currently inactive in the US Army Reserve as HHC, 97th Inf. Div.

**Events:** 59, 280

#### Chiefs of Staff

Lt. Col. Irvin L. Hunsaker, Cav.	24 August 1921–July 1922	Col. Staley A. Campbell, Inf.	2 July 1935–11 May 1938
Col. James B. Kemper, Inf.	July 1922–28 January 1927	Col. Charles S. Hamilton, Inf.	11 May 1938–28 February 1939
Col. Frederick G. Knabenshue, Inf.	28 January 1927–27 June 1930	Col. Isaac J. Nichol, Inf.	1 March 1939–8 March 1940
Col. James B. Kemper, Inf.	27 June 1930–2 July 1935	Col. Conrad H. Lanza, F.A.	8 March 1940–January 1942

#### 97th DIVISION Organization 1922

UNIT:	HQ LOCATION:
HQ	Augusta, ME
HQ, Special Troops	Augusta, ME
HQ Co.	Augusta, ME
97th M.P. Co.	Portland, ME
97th Sig. Co.	Claremont, NH
322d Ord. Co. (M)	Claremont, NH
97th Tank Co. (L)	Pittsfield, NH
Mtcyl Co. No. 322	Claremont, NH
193d Inf. Brig.	Augusta, ME
303d Inf. Regt.	Lewiston, ME
386th Inf. Regt.	Bangor, ME
194th Inf. Brig.	Concord, NH
387th Inf. Regt.	Laconia, NH
388th Inf. Regt.	Burlington, VT
172d F.A. Brig.	Concord, NH
322d Ammo. Tn.	Derry, NH
303d F.A. Regt.	Auburn, ME
365th F.A. Regt.	Manchester, NH
322d Engr. Regt.	Proctor, VT
322d Med. Regt.	Manchester, NH
97th Div. Tn., Q.M.C.	Springfield, VT
97th Div. Air Service	Bangor, ME

#### 97th DIVISION Organization 1939

UNIT:	HQ LOCATION:
HQ	Manchester, NH
HQ, Special Troops	Manchester, NH
HQ Co.	Augusta, ME
97th M.P. Co.	Portland, ME
97th Sig. Co.	Claremont, NH
322d Ord. Co. (M)	Claremont, NH
97th Tank Co. (L)	Pittsfield, NH
193d Inf. Brig.	Augusta, ME
303d Inf. Regt.	Lewiston, ME
386th Inf. Regt.	Bangor, ME
194th Inf. Brig.	Concord, NH
387th Inf. Regt.	Laconia, NH
388th Inf. Regt.	Burlington, VT
172d F.A. Brig.	Concord, NH
322d Ammo. Tn.	Portland, ME
303d F.A. Regt.	Portland, ME
365th F.A. Regt.	Manchester, NH
389th F.A. Regt.	Lowell, MA
322d Engr. Regt.	Proctor, VT
322d Med. Regt.	Augusta, ME
422d Q.M. Regt.	Rutland, VT

**98th DIVISION****“Iroquois”****Organized Reserve New York**

HQ—Syracuse, NY, 1921–41

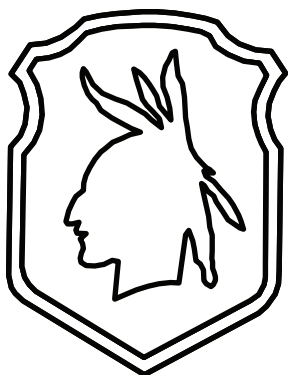

The 98th Div. was demobilized in November 1918 at Camp McClellan, AL. It was reconstituted in the O.R. on 24 June 1921, allotted to the Second Corps Area, and assigned to the XII Corps. The division was further allotted to the upstate areas of New York as its home area. The division HQ was organized on 18 August 1921 at the Federal Building in Syracuse, NY, and remained there until activated for World War II. The designated mobilization and training station for the division was the Syracuse Concentration Area for all elements except the division artillery units, which would mobilize at Pine Camp, NY. The division HQ was called to duty for training as a unit on a number of occasions, usually for CPXs. The 98th Div. HQ usually trained with the staff of the 2d Inf. Brig. at Madison Barracks, NY, 1924–30 (with the exception of the 1927 annual training at Fort Niagara), and at Fort Ontario, NY, 1931–39, after the 2d Brig. HQ was moved to that post. In December 1932, the division conducted a CPX at Plattsburg Barracks, NY, with the staffs of the 2d Inf. Brig. and the 26th Inf. The subordinate infantry regiments of the division generally held their summer

training with the units of the 2d Inf. Brig. at Plattsburg Barracks, Fort Niagara, or Fort Ontario. Other units, such as the special troops, artillery, engineers, aviation, medical, and quartermaster, trained at various posts in the Second and Third Corps Areas usually with other units of the 1st Div. For example, the division’s artillery trained with the 7th F.A. at Pine Camp; the 323d Engr. Regt. usually trained with the 1st Engr. Regt. at Fort Du Pont, DE; the 323d Med. Regt. trained with the 1st Med. Regt. at Carlisle Barracks, PA; and the 323d Obsn. Sq. trained with the 5th Obsn. Sq. at Mitchel Field, NY. In addition to the unit training camps, the infantry regiments of the division rotated responsibility to conduct the CMTTC held at Plattsburg Barracks and Fort Niagara each year. On a number of occasions, the division participated in Second Corps Area and First Army CPXs in conjunction with other R.A., N.G., and O.R. units. The first of these CPXs was held by the Second Corps Area at Camp Dix, NJ, 7–21 July 1929, followed by several First Army CPXs in the years leading up to World War II. These training events gave division staff officers’ opportunities to practice the roles they would be expected to perform in the event the division was mobilized. Unlike the R.A. and N.G. units in the First Corps Area, the 98th Div. did not participate in the various Second Corps Area Maneuvers and the First Army Maneuvers of 1935, 1939, and 1940 as an organized unit due to lack of enlisted personnel and equipment. Instead, the officers and a few enlisted reservists were assigned to R.A. and N.G. units to fill vacant slots and bring the units up to full peace strength for the exercises. Additionally, some officers were assigned duties as umpires or as support personnel. Location of the division HQ on 7 December 1941 was Syracuse, NY.

**Status:** HHC are currently active in the US Army Reserve at Rochester, NY, as HHC, 98th Div. (Institutional Training).

**Events:** 91, 168, 280

**Division Commanders**

Brig. Gen. Charles E. Kilbourne (R.A.)*	9 December 1928–11 October 1929	Brig. Gen. Perry L. Miles (R.A.)*	2 May 1936–8 January 1937
Brig. Gen. William P. Jackson (R.A.)*	18 November 1929–15 October 1931	Brig. Gen. Walter C. Short (R.A.)*	4 March 1937–15 June 1938
Col. Charles H. Morrow (R.A.)*	15 October 1931–8 February 1932	Col. Thomas L. Crystal (R.A.)*	15 June 1938–25 August 1938
Brig. Gen. Charles D. Roberts (R.A.)*	8 February 1932–31 March 1936	Brig. Gen. Irving J. Phillipson (R.A.)*	25 August 1938–1 March 1940

\*Concurrently commanding officer of the 2d Inf. Brig.

**Chiefs of Staff**

Col. Willis Uline, Inf.	1 August 1921–26 July 1923	Col. Ralph E. Ingram, Inf.	1 July 1928–23 October 1932
Lt. Col. Kerwin T. Smith, Inf.	26 July 1923–1 September 1923	Col. Conrad H. Lanza, F.A.	23 October 1932–30 September 1937
Col. Orrin R. Wolfe, Inf.	1 September 1923–1 July 1928	Col. James H. Bryson, F.A.	30 September 1937–30 May 1939
	Col. Russell V. Venable, Inf.		30 May 1939–January 1942

**98th DIVISION  
Organization 1922**

<b>UNIT:</b>	<b>HQ LOCATION:</b>
HQ	Syracuse, NY
HQ, Special Troops	Syracuse, NY
HQ Co.	Syracuse, NY
98th M.P. Co.	Buffalo, NY
98th Sig. Co.	Schenectady, NY
323d Ord. Co. (M)	Troy, NY
98th Tank Co. (L)	Buffalo, NY
Mtcyl Co. No. 323	Troy, NY
195th Inf. Brig.	Albany, NY
389th Inf. Regt.	Albany, NY
390th Inf. Regt.	Utica, NY
196th Inf. Brig.	Buffalo, NY
391st Inf. Regt.	Rochester, NY
392d Inf. Regt.	Buffalo, NY
173d F.A. Brig.	Syracuse, NY
323d Ammo. Tn.	Schenectady, NY
367th F.A. Regt.	Troy, NY
368th F.A. Regt.	Rochester, NY
323d Engr. Regt.	Rochester, NY
323d Med. Regt.	Buffalo, NY
98th Div. Tn., Q.M.C.	Syracuse, NY
98th Div. Air Service	Syracuse, NY

**98th DIVISION  
Organization 1939**

<b>UNIT:</b>	<b>HQ LOCATION:</b>
HQ	Syracuse, NY
HQ, Special Troops	Syracuse, NY
HQ Co.	Syracuse, NY
98th M.P. Co.	Syracuse, NY
98th Sig. Co.	Syracuse, NY
323d Ord. Co. (M)	Syracuse, NY
98th Tank Co. (L)	Syracuse, NY
195th Inf. Brig.	Syracuse, NY
389th Inf. Regt.	Albany, NY
390th Inf. Regt.	Syracuse, NY
196th Inf. Brig.	Rochester, NY
391st Inf. Regt.	Rochester, NY
392d Inf. Regt.	Buffalo, NY
173d F.A. Brig.	Syracuse, NY
323d Ammo. Tn.	Rochester, NY
367th F.A. Regt.	Albany, NY
368th F.A. Regt.	Buffalo, NY
369th F.A. Regt.	Buffalo, NY
323d Engr. Regt.	Buffalo, NY
323d Med. Regt.	Buffalo, NY
423d Q.M. Regt.	Syracuse, NY

**99th DIVISION**

**Organized Reserve Pennsylvania**

**HQ**—Pittsburgh, PA, 1921–41

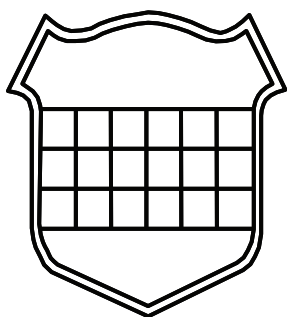

The 99th Div. was demobilized on 7 January 1919 at Camp Wadsworth, SC. It was reconstituted in the O.R. on 24 June 1921, allotted to the Third Corps Area, and assigned to the XIII Corps. The division was further allotted to the western half of the state of Pennsylvania as its home area. The division HQ was organized in November 1921 at 3939 Butler Street, Pittsburgh, PA. The HQ was relocated in December 1922 to Room 604 in the Chamber of Commerce Building. It was relocated again in October 1923 to Room 310 in the Westinghouse Building and remained there until activated for World War II. After its reorganization, the division slowly built its strength, and by July 1924, the division was at 100 percent strength in authorized officers, but dropped back to 91 percent by March 1926. Typically, many of the division's units in Pittsburgh conducted their inactive training period meetings at the N.G. armory in that city. The

designated mobilization and training station for the division was Camp George G. Meade (later redesignated Fort George G. Meade in 1929), MD, the location where much of the 99th's training activities occurred over the next 20 years. For the few summers when the division HQ was called to duty for training as a unit, the HQ, 99th Div. usually trained with the staff of the 16th Inf. Brig. at Camp Meade. The subordinate infantry regiments of the division held their summer training primarily with the units of the 16th Inf. Brig. at Fort Meade or Fort Eustis, VA. Other units, such as the special troops, artillery, engineers, aviation, medical, and quartermaster, trained at various posts in the Third Corps Area with R.A. units of the same branch. For example, the 304th Engr. Regt. usually trained with elements of the 1st Engr. Regt. at Fort DuPont, DE; the 304th Med. Regt. trained with the 1st Med. Regt. at Carlisle Barracks, PA; and the 304th Obsn. Sq. trained with the 50th and 21st Obsn. Sqs. at Langley Field, VA. In addition to the unit training camps, the infantry regiments of the division rotated responsibility to conduct the CMTC training held at Camp

Meade, Fort Eustis, and Fort Washington, MD, each year. On a number of occasions, the division participated in Third Corps Area and First Army CPXs in conjunction with other R.A., N.G., and O.R. units. Two of the more notable CPXs were the Third Corps Area CPX at Fort George G. Meade conducted 6–19 July 1930 and a division CPX conducted 23 August–5 September 1936 at Indiantown Gap, PA. These training events gave division staff officers’ opportunities to practice the roles they would be expected to perform in the event the division was mobilized. Unlike the R.A. and N.G. units in the Third Corps Area, the 99th Div. did not participate in the various Third Corps Area Maneuvers and the First Army Maneuvers of 1935 and 1939 as an organized unit due to lack of enlisted personnel and equipment. Instead, the officers and a few enlisted reservists were assigned to R.A. and N.G. units to fill vacant slots and bring the units up to full peace strength for the exercises. Additionally, some officers were assigned duties as umpires or as support personnel. Location of the division HQ on 7 December 1941 was Pittsburgh.

**Status:** HHC are currently inactive in the US Army Reserve as HHC, 99th Inf. Div.

**Events:** 109, 247, 281

#### Division Commanders

Brig. Gen. James B. Gowen (R.A.)\*

13 June 1929–23 August 1932

\*Concurrently commanding general of the 1st F.A. Brig.

#### Chiefs of Staff

Col. Frank F. Jewett, Inf.	5 October 1921–11 July 1922	Col. Thomas M. Anderson, Inf.	December 1928–5 September 1932
Col. Marcus D. Cronin, Inf.	11 July 1922–20 August 1926	Col. Howard L. Landers, F.A.	5 September 1932–January 1934
Col. Robert M. Bramblia, Inf.	20 August 1926–21 December 1926	Col. Frederick A. Prince, F.A.	January 1934–June 1936
Col. Edward T. Hartmann, Inf.	21 December 1926–April 1928	Col. Ephraim G. Peyton, Inf.	30 August 1936–30 September 1938
Col. Robert M. Bramblia, Inf.	May 1928–December 1928	Col. William A. Ganoë, Inf.	14 October 1938–January 1942

#### 99th DIVISION Organization 1922

UNIT:	HQ LOCATION:
HQ	Pittsburgh, PA
HQ, Special Troops	Pittsburgh, PA
HQ Co.	Pittsburgh, PA
99th M.P. Co.	Pittsburgh, PA
99th Sig. Co.	Pittsburgh, PA
324th Ord. Co. (M)	Pittsburgh, PA
99th Tank Co. (L)	Pittsburgh, PA
Mtcyl Co. No. 324	Pittsburgh, PA
197th Inf. Brig.	Pittsburgh, PA
393d Inf. Regt.	Pittsburgh, PA
394th Inf. Regt.	Uniontown, PA
198th Inf. Brig.	Erie, PA
395th Inf. Regt.	Franklin, PA
396th Inf. Regt.	Altoona, PA
174th F.A. Brig.	Pittsburgh, PA
324th Ammo. Tn.	Pittsburgh, PA
370th F.A. Regt.	Pittsburgh, PA
371st F.A. Regt.	Pittsburgh, PA
324th Engr. Regt.	Pittsburgh, PA
324th Med. Regt.	Pittsburgh, PA
99th Div. Tn., Q.M.C.	Pittsburgh, PA
99th Div. Air Service	Pittsburgh, PA

#### 99th DIVISION Organization 1939

UNIT:	HQ LOCATION:
HQ	Pittsburgh, PA
HQ, Special Troops	Pittsburgh, PA
HQ Co.	Pittsburgh, PA
99th M.P. Co.	Pittsburgh, PA
99th Sig. Co.	Pittsburgh, PA
324th Ord. Co. (M)	Pittsburgh, PA
99th Tank Co. (L)	Pittsburgh, PA
197th Inf. Brig.	Pittsburgh, PA
393d Inf. Regt.	Pittsburgh, PA
394th Inf. Regt.	Uniontown, PA
198th Inf. Brig.	Erie, PA
395th Inf. Regt.	Erie, PA
396th Inf. Regt.	Altoona, PA
174th F.A. Brig.	Pittsburgh, PA
324th Ammo. Tn.	Pittsburgh, PA
370th F.A. Regt.	Pittsburgh, PA
371st F.A. Regt.	Pittsburgh, PA
372d F.A. Regt.	Pittsburgh, PA
324th Engr. Regt.	Pittsburgh, PA
324th Med. Regt.	Pittsburgh, PA
424th Q.M. Regt.	Pittsburgh, PA



**100th DIVISION****“Century”****Organized Reserve West Virginia  
and Kentucky**

HQ—Charleston, WV, 1921–28; Huntington, WV, 1928–41

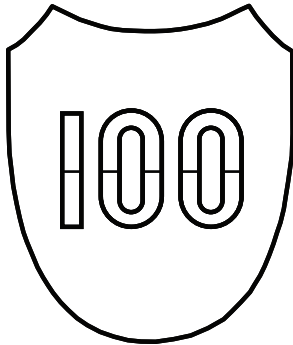

The 100th Div. was demobilized on 26 July 1919 at Camp Zachary Taylor, KY. It was reconstituted in the O.R. on 24 June 1921, allotted to the Fifth Corps Area, and assigned to the XV Corps. The division was further allotted to the states of West Virginia and Kentucky as its home area. The division HQ was organized on 27 September 1921 at 209 Greenbriar Street, Charleston, WV, but relocated in April 1922 to 815 Quarrier Street and moved again in September 1922 to the Morrison Building in Charleston. The HQ was relocated a final time on 30 June 1928 from 1313 Union Bank and Trust Building in Charleston to the Coal Exchange Building in Huntington, WV, and remained there until activated for World War II. To maintain communications with the officers of the division, the division staff published a newsletter titled “The Century,” which alluded to the division’s numerical designation. The newsletter informed the division’s members of such things as when and where the inactive training sessions were to be held, what the division’s summer training quotas were, when and where

the camps were to be held, and which units would be assigned to help conduct the CMTC training. The 100th Div. HQ occasionally trained with the staff of the 10th Inf. Brig. at Fort Benjamin Harrison. The subordinate infantry regiments of the division held their summer training primarily with the units of the 10th Inf. Brig. at Camp Knox, Fort Thomas, or Fort Benjamin Harrison. Some years, the 167th and 168th Inf. Brigs., and their subordinate units, conducted camp at the Culver Military Academy in Culver, IN. Other units, such as the special troops, artillery, engineers, aviation, medical, and quartermaster, trained at various posts in the Fifth Corps Areas, usually with active units of the 5th Div. For example, the division’s artillery trained with the 5th Div. field artillery units stationed at Camp Knox; the 309th Engr. Regt. usually trained at Fort Benjamin Harrison; the 309th Med. Regt. trained at Camp Knox; and the 309th Obsn. Sq. trained with the 88th Obsn. Sq. at Wright Field, OH. In addition to the unit training camps, the infantry regiments of the division rotated responsibility for conducting the infantry CMTC training held at Camp Knox and Fort Thomas each year. On a number of occasions, the division participated in Fifth Corps Area and Second Army CPXs in conjunction with other R.A., N.G., and O.R. units. These training events gave division staff officers’ opportunities to practice the roles they would be expected to perform in the event the division was mobilized. Unlike the R.A. and N.G. units in the First Corps Area, the 100th Div. did not participate in the various Fifth Corps Area Maneuvers and the Second Army Maneuvers of 1936, 1940, and 1941 as an organized unit due to lack of enlisted personnel and equipment. Instead, the officers and a few enlisted reservists were assigned to R.A. and N.G. units to fill vacant slots and bring the units up to war strength for the exercises. Additionally, some officers were assigned duties as umpires or as support personnel. Location of the division HQ on 7 December 1941 was Huntington, West Virginia.

**Status:** HHC are currently active in the US Army Reserve at Louisville, KY, as HHC, 100th Div. (Institutional Training).

**Events:** 85, 264

**Division Commanders**

Maj. Gen. George W. Read (R.A.)*	15 October 1921–1 September 1922	Col. Bruce Palmer (R.A.)**	10 September 1935–27 June 1936
Brig. Gen. Julian R. Lindsey (R.A.)**	1 March 1932–31 May 1934	Brig. Gen. Daniel Van Voorhis (R.A.)**	27 June 1936–8 October 1938
Brig. Gen. Guy V. Henry (R.A.)**	31 May 1934–24 July 1935	Col. Charles L. Scott (R.A.)**	8 October 1938–1 November 1938
Col. James P. Barney (R.A.)**	24 July 1935–10 September 1935	Brig. Gen. Adna R. Chaffee (R.A.)**	1 November 1938–15 July 1940

\*Concurrently commanding general of the Fifth Corps Area.

\*\*Concurrently commanding officer of the 7th Cav. Brig. (Mecz).

**Chiefs of Staff**

Col. Ivers W. Leonard, Inf.	15 August 1921–23 October 1923	Col. Leon L. Roach, Inf.	20 June 1927–1 October 1933
Lt. Col. Allen Parker, Inf.	23 October 1924–10 July 1924	Col. William H. Waldron, Inf.	1 October 1933–3 April 1937
Col. Leon L. Roach, Inf.	10 July 1924–15 September 1924	Col. Ford Richardson, Inf.	3 April 1937–22 February 1938
Col. William H. Waldron, Inf.	15 September 1924–June 1927	Col. Charles K. Nulson, Inf.	22 February 1938–1 January 1940
	Lt. Col. George W. Price, Inf.		5 January 1940–January 1942

**100th DIVISION  
Organization 1922**

<b>UNIT:</b>	<b>HQ LOCATION:</b>
HQ	Charleston, WV
HQ, Special Troops	Charleston, WV
HQ Co.	Charleston, WV
100th M.P. Co.	Charleston, WV
100th Sig. Co.	Charleston, WV
325th Ord. Co. (M)	South Charleston, WV
100th Tank Co. (L)	Charleston, WV
Mtcyl Co. No. 325	South Charleston, WV
199th Inf. Brig.	Parkersburg, WV
397th Inf. Regt.	Clarksburg, WV
398th Inf. Regt.	Huntington, WV
200th Inf. Brig.	Louisville, KY
399th Inf. Regt.	Lexington, KY
400th Inf. Regt.	Louisville, KY
175th F.A. Brig.	Parkersburg, WV
325th Ammo. Tn.	Shepardstown, WV
374th F.A. Regt.	Clarksburg, WV
375th F.A. Regt.	Charleston, WV
325th Engr. Regt.	Huntington, WV
325th Med. Regt.	Huntington, WV
100th Div. Tn., Q.M.C.	Charleston, WV
100th Div. Air Service	Cincinnati, OH

**100th DIVISION  
Organization 1939**

<b>UNIT:</b>	<b>HQ LOCATION:</b>
HQ	Huntington, WV
HQ, Special Troops	Huntington, WV
HQ Co.	Huntington, WV
100th M.P. Co.	Bluefield, WV
100th Sig. Co.	Wheeling, WV
325th Ord. Co. (M)	Moundsville, WV
100th Tank Co. (L)	Wheeling, WV
199th Inf. Brig.	Parkersburg, WV
397th Inf. Regt.	Clarksburg, WV
398th Inf. Regt.	Charleston, WV
200th Inf. Brig.	Louisville, KY
399th Inf. Regt.	Lexington, KY
400th Inf. Regt.	Louisville, KY
175th F.A. Brig.	Louisville, KY
325th Ammo. Tn.	Parkersburg, WV
373d F.A. Regt.	Lexington, KY
374th F.A. Regt.	Wheeling, WV
375th F.A. Regt.	Louisville, KY
325th Engr. Regt.	Charleston, WV
325th Med. Regt.	Fairmont, WV
425th Q.M. Regt.	Huntington, WV

**101st DIVISION**

**Organized Reserve Wisconsin**

HQ—Milwaukee, WI, 1921–41

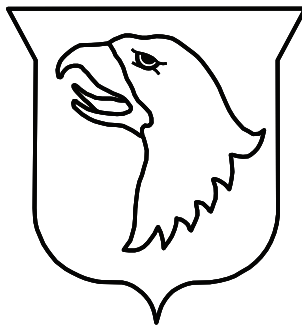

The 101st Div. was demobilized on 11 December 1918 at Camp Shelby, MS. It was reconstituted in the O.R. on 24 June 1921, allotted to the Sixth Corps Area, and assigned to the XVI Corps. The division was further allotted to the state of Wisconsin as its home area. The division HQ was organized on 10 September 1921 in Room 412, Federal Building in Milwaukee, WI, and relocated in July 1922 to the Pereles Building where it remained until activated for World War II. To maintain communications with the officers of the division, the division staff published a newsletter titled “The 101st Division Bulletin.” The newsletter informed the division’s members of such things as when and where the inactive training sessions were to be held, what the division’s summer training quotas were, where the camps were to be held, and which units would be assigned to help conduct the CMTC training. The designated mobilization and training station for the division was Camp Custer, the location where much of

the 101st Div.’s training activities occurred in the interwar years. The HQ and staff usually trained with the staff of the 12th Inf. Brig., either at Camp Custer or at Fort Sheridan, IL. The subordinate infantry regiments of the division held their summer training primarily with the 2d Inf. Regt. at Camp Custer. Other units, such as the special troops, artillery, engineers, aviation, medical, and quartermaster, trained at various posts in the Sixth and Seventh Corps Areas. For example, the division’s artillery trained with the 1st Bn., 14th F.A. at Camp Custer; the special troops trained with the special troops of the 32d Div. at Camp Grayling, MI, or Camp Sparta (later redesignated Camp McCoy), WI; the 326th Med. Regt. trained at Fort Snelling, MN; and the 326th Obsn. Sq. trained with the 15th Obsn. Sq. at Chanute

Field, IL, or at Selfridge Field, MI. In addition to the unit training camps, the infantry regiments of the division rotated responsibility to conduct the CMTC training held at Camp Custer each year. On a number of occasions, the division participated in Sixth Corps Area and Second Army CPXs in conjunction with other R.A., N.G., and O.R. units. These training events gave division staff officers' opportunities to practice the roles they would be expected to perform in the event the division was mobilized. Unlike the R.A. and N.G. units in the Sixth Corps Area, the 101st Div. did not participate in the various Sixth Corps Area Maneuvers and the Second Army Maneuvers of 1937, 1940, and 1941 as an organized unit due to lack of enlisted personnel and equipment. Instead, the officers and a few enlisted reservists were assigned to R.A. and N.G. units to fill vacant slots and bring the units up to war strength for the exercises. Additionally, some officers were assigned duties as umpires or as support personnel. Location of the division HQ on 7 December 1941 was Milwaukee, WI.

**Status:** HHC are currently active in the R.A. at Fort Campbell, KY, as HHC, 101st Airborne Div.

**Events:** 124, 148, 159, 214, 264, 302

#### Chiefs of Staff

Lt. Col. George R. Greene, F.A.	10 September 1921–27 February 1924	Col. William S. Wood, F.A.	April 1934–3 November 1935
Col. Girard Sturtevant, Inf.	27 February 1924–10 August 1928	Col. H. Clay M. Supplee, Inf.	3 November 1935–5 June 1940
Col. George R. Greene, F.A.	10 August 1928–26 September 1931	Col. Thomas A. Pierce, Inf.	5 June 1940–13 October 1940
Col. Thomas E. Merrill, F.A.	26 September 1931–28 December 1933	Col. Fred T. Cruse	13 October 1940–13 March 1941
Lt. Col. Albert H. Mueller, Cav.	December 1933–April 1934	Col. Claude K. Rhinehart, F.A.	13 March 1941–October 1941
	Lt. Col. George H. Cushman, F.A.		October 1941–January 1942

#### 101st DIVISION Organization 1922

UNIT:	HQ LOCATION:
HQ	Milwaukee, WI
HQ, Special Troops	Milwaukee, W
HQ Co.	Milwaukee, WI
101st M.P. Co.	Milwaukee, WI
101st Sig. Co.	Milwaukee, WI
326th Ord. Co. (M)	Milwaukee, WI
101st Tank Co. (L)	Milwaukee, WI
Mtcyl Co. No. 326	Eau Claire, WI
201st Inf. Brig.	Milwaukee, WI
401st Inf. Regt.	Milwaukee, WI
402d Inf. Regt.	Appleton, WI
202d Inf. Brig.	Madison, WI
403d Inf. Regt.	Madison, WI
404th Inf. Regt.	Eau Claire, WI
176th F.A. Brig.	Milwaukee, WI
326th Ammo. Tn.	Kenosha, WI
376th F.A. Regt.	Milwaukee, WI
377th F.A. Regt.	Manitowoc, WI
326th Engr. Regt.	Milwaukee, WI
326th Med. Regt.	Milwaukee, WI
101st Div. Tn., Q.M.C.	Milwaukee, WI
101st Div. Air Service	Ashland, WI

#### 101st DIVISION Organization 1939

UNIT:	HQ LOCATION:
HQ	Milwaukee, WI
HQ, Special Troops	Milwaukee, WI
HQ Co.	Milwaukee, WI
101st M.P. Co.	Milwaukee, WI
101st Sig. Co.	Milwaukee, WI
326th Ord. Co. (M)	Milwaukee, WI
101st Tank Co. (L)	Milwaukee, WI
201st Inf. Brig.	Milwaukee, WI
401st Inf. Regt.	Milwaukee, WI
402d Inf. Regt.	Fond du Lac, WI
202d Inf. Brig.	Madison, WI
403d Inf. Regt.	Madison, WI
404th Inf. Regt.	Eau Claire, WI
176th F.A. Brig.	Milwaukee, WI
326th Ammo. Tn.	Milwaukee, WI
376th F.A. Regt.	Milwaukee, WI
377th F.A. Regt.	Green Bay, WI
572d F.A. Regt.	Wausau, WI
326th Engr. Regt.	Milwaukee, WI
326th Med. Regt.	Milwaukee, WI
426th Q.M. Regt.	Milwaukee, WI

**102d DIVISION**

**“Ozark”**

**Organized Reserve Missouri  
and Arkansas**

**HQ—St. Louis, MO, 1921–41**



The 102d Div. was constituted in the O.R. on 24 June 1921, allotted to the Seventh Corps Area, and assigned to the XVII Corps. The division was further allotted to the states of Missouri and Arkansas as its home area. The division HQ was organized on 2 September 1921 at 3d and Olive Streets in St. Louis, MO, and relocated in 1923 to the Old Customhouse. The HQ remained there until activated for World War II. To encourage esprit de corps, the division adopted the nickname “Ozark” after the mountainous region that ran through both states and defined the division’s home area. To maintain communications with the officers of the division, the division staff published a newsletter appropriately titled “Ozark.” The newsletter informed the division’s members of such things as when and where the inactive training sessions were to be held, what the division’s summer training quotas were, where the camps were to be held, and which

units would be assigned to help conduct the CMTC training. The division formed rapidly and by November 1922, the “Ozark” division was up to 95 percent strength in its complement of officers as required by its peacetime tables of organization. The designated mobilization and training station for the division was Fort Riley, KS. The HQ and staff usually trained at Fort Leavenworth, KS. The subordinate infantry regiments of the division held their summer training primarily with the 17th Inf. Regt. at Fort Leavenworth. Other units, such as the special troops, artillery, engineers, aviation, medical, and quartermaster, trained at various posts in the Sixth and Seventh Corps Areas, often with the active units of the 7th Div. For example, the division’s artillery trained at Fort Riley; the 327th Engr. Regt. also trained at Fort Riley with A Troop, 9th Engrs.; the 327th Med. Regt. trained at the medical corps training camp at Fort Snelling; and the 327th Obsn. Sq. trained with the 16th Obsn. Sq. at Marshall Field, KS. In addition to the unit training camps, the infantry regiments of the division rotated responsibility to conduct the CMTC held at Fort Leavenworth each year. On a number of occasions, the division participated in Seventh Corps Area and Fourth Army CPXs in conjunction with other R.A., N.G., and O.R. units. These training events gave division staff officers’ opportunities to practice the roles they would be expected to perform in the event the division was mobilized. Unlike the R.A. and N.G. units in the Seventh Corps Area, the 102d Div. did not participate in the various Seventh Corps Area Maneuvers and the Fourth Army Maneuvers of 1937, 1940, and 1941 as an organized unit due to lack of enlisted personnel and equipment. Instead, the officers and a few enlisted reservists were assigned to R.A. and N.G. units to fill vacant slots and bring the units up to war strength for the exercises. Additionally, some officers were assigned duties as umpires or as support personnel. Location of the division HQ on 7 December 1941 was St. Louis, MO.

**Status:** HHC are currently inactive in the US Army Reserve as HHC, 102d Inf. Div.

**Events:** 193, 233, 236, 279, 303

**Chiefs of Staff**

Col. John N. Straat, Inf.	2 September 1921–16 August 1923	Col. Ola W. Bell, Cav.	9 October 1926–11 December 1930
Col. Thomas M. Anderson, Inf.	17 August 1923–October 1923	Col. Edmund L. Butts, Inf.	11 December 1930–15 June 1932
Maj. Fredrick H. Baird, Cav.	3 September 1923–1 February 1924	Col. John Randolph, Inf.	1 August 1932–10 August 1934
Lt. Col. William H. Clendenin, Inf.	6 February 1924–9 October 1926	Col. Carl H. Muller, Cav.	10 August 1934–30 January 1942

**102d DIVISION  
Organization 1922**

<b>UNIT:</b>	<b>HQ LOCATION:</b>
HQ	St. Louis, MO
HQ, Special Troops	
HQ Co.	St. Louis, MO
102d M.P. Co.	St. Louis, MO
102d Sig. Co.	St. Louis, MO
327th Ord. Co. (M)	St. Louis, MO
102d Tank Co. (L)	Kansas City, MO
Mtcyl Co. No. 327	Kansas City, MO
203d Inf. Brig.	Little Rock, AR
405th Inf. Regt.	Little Rock, AR

**102d DIVISION  
Organization 1939**

<b>UNIT:</b>	<b>HQ LOCATION:</b>
HQ	St. Louis, MO
HQ, Special Troops	St. Louis, MO
HQ Co.	St. Louis, MO
102d M.P. Co.	St. Louis, MO
102d Sig. Co.	St. Louis, MO
327th Ord. Co. (M)	St. Louis, MO
102d Tank Co. (L)	St. Louis, MO
203d Inf. Brig.	St. Louis, MO
406th Inf. Regt.	Springfield, MO

406th Inf. Regt.	Little Rock, AR	407th Inf. Regt.	St. Louis, MO
204th Inf. Brig.	St. Joseph, MO	204th Inf. Brig.	Kansas City, MO
407th Inf. Regt.	St. Louis, MO	405th Inf. Regt.	Little Rock, AR
408th Inf. Regt.	Kansas City, MO	408th Inf. Regt.	Kansas City, MO
177th F.A. Brig.	Kansas City, MO	177th F.A. Brig.	Kansas City, MO
327th Ammo. Tn.	Kansas City, MO	327th Ammo. Tn.	Joplin, MO
379th F.A. Regt.	Kansas City, MO	379th F.A. Regt.	Kansas City, MO
380th F.A. Regt.	St. Louis, MO	380th F.A. Regt.	St. Louis, MO
		381st F.A. Regt.	Little Rock, MO
327th Engr. Regt.	St. Louis, MO	327th Engr. Regt.	St. Louis, MO
327th Med. Regt.	St. Louis, MO	327th Med. Regt.	St. Louis, MO
102d Div. Tn., Q.M.C.	Little Rock, AR	427th Q.M. Regt.	Texarkana, AR
102d Div. Air Service	Little Rock, AR		

## 103d DIVISION

## “Cactus”

## Organized Reserve Colorado, Arizona, and New Mexico

HQ—Denver, CO, 1921–41

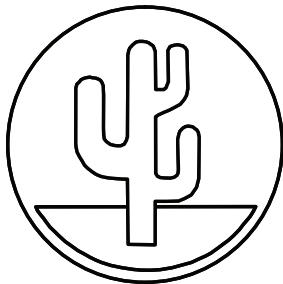

The 103d Div. was constituted in the O.R. on 24 June 1921, allotted to the Eighth Corps Area, and assigned to the XVIII Corps. The division was further allotted to the states of Colorado, Arizona, and New Mexico as its home area. The division HQ was organized on 31 August 1921, at the State Capitol in Denver, CO. The HQ was moved on 29 March 1922 to the Kittredge Building at 16th Street and Glenarm Place in Denver and remained there until activated for World War II. To encourage esprit de corps, in 1922 the division's officers adopted the nickname “Rocky Mountain Division” after the majestic mountain range that defined much of the division's home area. However, this nickname soon gave way to the moniker “Cactus Division” after the unit's shoulder patch. To maintain communications with the officers of the division, the division staff published a newsletter appropriately titled “The Cactus.” The newsletter informed the division's

members of such things as when and where the inactive training sessions were to be held, what the division's summer training quotas were, where the camps were to be held, and which units would be assigned to help conduct the CMTC training. The large geographical area of the division made it difficult to bring subordinate units of the division together for virtually any training events except for those units in Denver. The division HQ, special troops, 206th Inf. Brig. (less one regiment), 176th F.A. Brig. (less one regiment), and a few other assorted units were located in Denver. Inactive training period activities of the division were generally conducted at the local level near concentrations of division personnel. One event that turned out large numbers of the Denver members of the division was the Memorial Day parade held in that city each year. The subordinate infantry regiments of the division held their summer training with the 25th Inf. Regt. at Fort Huachuca and Camp Stephen D. Little, AZ, and with the 1st Bn., 38th Inf. Regt. at Fort Logan, CO. Other units, such as the special troops, artillery, engineers, aviation, medical, and quartermaster, trained at various posts in the Eighth Corps Area. For example, the division's artillery regiments trained at Fort Bliss with the 82d F.A. or at Fort Francis E. Warren with the 2d Bn., 76th F.A.; the 328th Engr. Regt. trained with the 2d Engrs. at Fort Sam Houston, TX, and later at Fort Logan, CO; the 320th Med. Regt. trained at Fort Sam Houston with the 2d Med. Regt.; and the 328th Obsn. Sq. trained at Brooks Field and some years at Fort Bliss, TX. On a number of occasions, the division participated in Eighth Corps Area and Third Army CPXs in conjunction with other R.A., N.G., and O.R. units. These training events gave division staff officers' opportunities to practice the roles they would be expected to perform in the event the division was mobilized. Unlike the R.A. and N.G. units in the Eighth Corps Area, the 103d Div. did not participate in the various Eighth Corps Area Maneuvers and the Third Army Maneuvers of 1938, 1940, and 1941 as an organized unit due to lack of enlisted personnel and equipment. Instead, the officers and a few enlisted reservists were assigned to R.A. and N.G. units to fill vacant slots and bring the units up to war strength for the exercises. Additionally, some officers were assigned duties as umpires or as support personnel. However, for each maneuver, the division maximized the number of participants. For example, for the 1938 maneuver at Fort Francis E. Warren, WY, Fort Bliss, TX, and Fort Huachuca, AZ, the 103d Div. provided 228 officers to R.A. units and 53 to units

of the 45th Div. Similar numbers participated in the two succeeding Army maneuvers. Location of the division HQ on 7 December 1941 was Denver.

**Status:** HHC are currently inactive in the US Army Reserve as HHC, 103d Inf. Div.

**Events:** 80, 146, 152, 166, 217, 232, 259, 260, 261, 300

#### Chiefs of Staff

Maj. Edgar M. Whiting, Inf.	31 August 1921–28 September 1921	Lt. Col. James Blyth, Inf.	21 September 1927–12 October 1927
Col. Harry R. Lee, Inf.	28 September 1921–15 December 1922	Col. Clarence Day, F.A.	12 October 1927–10 November 1928
Lt. Col. Kenneth C. Masteller, C.A.C.	15 December 1922–6 January 1924	Col. George W. Stuart, Inf.	10 November 1928–25 August 1933
Col. William D. Forsyth, Cav.	6 January 1924–31 October 1925	Col. Sheldon W. Anding, Inf.	25 August 1933–3 June 1934
Lt. Col. Kenneth C. Masteller, C.A.C.	1 November 1925–21 September 1927	Col. Robert T. Phinney, Inf.	3 June 1934–19 April 1939
Col. Thomas N. Gimperling, Inf.			19 April 1939–1 December 1941

#### 103d DIVISION Organization 1922

UNIT:	HQ LOCATION:
HQ	Denver, CO
HQ, Special Troops	Denver, CO
HQ Co.	Denver, CO
103d M.P. Co.	Denver, CO
103d Sig. Co.	Denver, CO
328th Ord. Co. (M)	Denver, CO
103d Tank Co. (L)	Denver, CO
Mtcyl Co. No. 328	Denver, CO
205th Inf. Brig.	Warren, AZ
409th Inf. Regt.	Tucson, AZ
410th Inf. Regt.	Roswell, NM
206th Inf. Brig.	Denver, CO
411th Inf. Regt.	Denver, CO
412th Inf. Regt.	Pueblo, CO
178th F.A. Brig.	Denver, CO
328th Ammo. Tn.	Denver, CO
382d F.A. Regt.	Prescott, AZ
383d F.A. Regt.	Denver, CO
328th Engr. Regt.	Denver, CO
328th Med. Regt.	Denver, CO
103d Div. Tn., Q.M.C.	Denver, CO
103d Div. Air Service	Denver, CO

#### 103d DIVISION Organization 1939

UNIT:	HQ LOCATION:
HQ	Denver, CO
HQ, Special Troops	Denver, CO
HQ Co.	Denver, CO
103d M.P. Co.	Denver, CO
103d Sig. Co.	Denver, CO
328th Ord. Co. (M)	Denver, CO
103d Tank Co. (L)	Denver, CO
205th Inf. Brig.	Tucson, AZ
409th Inf. Regt.	Tucson, AZ
410th Inf. Regt.	Phoenix, AZ
206th Inf. Brig.	Denver, CO
411th Inf. Regt.	Denver, CO
412th Inf. Regt.	Pueblo, CO
178th F.A. Brig.	Denver, CO
328th Ammo. Tn.	Denver, CO
382d F.A. Regt.	Phoenix, AZ
383d F.A. Regt.	Denver, CO
384th F.A. Regt.	Denver, CO
328th Engr. Regt.	Denver, CO
328th Med. Regt.	Denver, CO
328th Q.M. Regt.	Denver, CO

#### 104th DIVISION

#### “Frontier Division”

#### Organized Reserve Utah, Idaho, Montana, and Wyoming

HQ—Fort Douglas, UT, 1921–23; Salt Lake City, UT, 1923–41

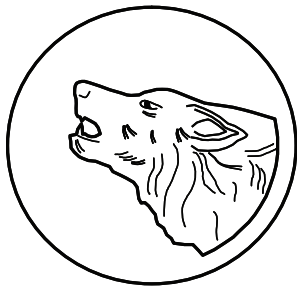

The 104th Div. was constituted in the O.R. on 24 June 1921, allotted to the Ninth Corps Area, and assigned to the XIX Corps. The division was allocated to the states of Utah, Idaho, Montana, and Wyoming as its home area. The HQ was organized on 7 October 1921 at Fort Douglas, UT, and relocated in May 1923 to Room 312, in the Commercial Building in Salt Lake City. The HQ was moved on 30 September 1926 to the Vermont Building where it remained until activated for World War II. To maintain communications with the officers of the division, the division staff published a newsletter titled “Frontier Division,” which was reflective of the unit’s geographical area. The newsletter informed the division’s members what the division’s summer training quotas were, where the camps were to be held, and which units would be

assigned to help conduct the CMTC training. For the few summers when the division HQ was called to duty for

training as a unit, the 104th Div. usually trained with the staff of the 6th Inf. Brig. at Fort Douglas. The subordinate infantry regiments of the division held their summer training primarily with the units of the 3d Div. at Fort Douglas and Fort Missoula, WY, and some years with the 4th Inf. Brig. at the Pole Mountain Reservation, WY. Other units, however, such as the special troops, artillery, engineers, aviation, medical, and quartermaster, trained at various posts in the Ninth Corps Area with R.A. units of the same branch. For example, the 329th Engr. Regt. usually trained with elements of the 6th Engr. Regt. at Camp Lewis, WA, and 329th Med. Regt. trained at the Post Hospital at Fort Francis E. Warren, WY. In addition to the unit training camps, the infantry regiments of the division rotated responsibility to conduct the CMTC held at Camp Lewis each year. On a number of occasions, the division participated in Ninth Corps Area and Fourth Army CPXs in conjunction with other R.A., N.G., and O.R. units. These training events gave division staff officers' opportunities to practice the roles they would be expected to perform in the event the division was mobilized. Unlike the R.A. and N.G. units in the Ninth Corps Area, the 104th Div. did not participate in the various Ninth Corps Area Maneuvers and the Fourth Army Maneuvers of 1936 and 1940 as an organized unit due to lack of enlisted personnel and equipment. Instead, the officers and a few enlisted reservists were assigned to R.A. and N.G. units to fill vacant slots and bring the units up to full peace strength for the exercises. Additionally, some officers were assigned duties as umpires or as support personnel. Location of the division HQ on 7 December 1941 was Salt Lake City.

**Status:** HHC are currently active in the US Army Reserve at Vancouver Barracks, WA, as HHC, 104th Div. (Institutional Training).

**Events:** 193, 238, 279, 304

#### Chiefs of Staff

Col. Frederick L. Knudsen, Inf.	2 October 1921–20 June 1923	Col. Paul H. McCook, Inf.	29 September 1927–5 November 1929
Lt. Col. James M. Petty, Inf.	20 June 1923–July 1923	Col. John E. Morris, Inf.	5 November 1929–1 May 1934
Col. Paul H. McCook, Inf.	July 1923–1 September 1923	Col. Andrew J. Daugherty, Inf.	5 May 1934–1 October 1935
Col. Thomas M. Anderson, Inf.	1 September 1923–20 June 1925	Col. James A. Higgins, Inf.	1 October 1935–25 January 1938
Col. John J. Boniface, Cav.	20 June 1925–29 September 1927	Col. Owen R. Meredith, Inf.	25 January 1938–November 1939
	Col. Jere Baxter, Inf.		5 December 1939–January 1942

#### 104th DIVISION Organization 1925

UNIT:	HQ LOCATION:
HQ	Salt Lake City, UT
HQ, Special Troops	Salt Lake City, UT
HQ Co.	Salt Lake City, UT
104th M.P. Co.	Idaho Falls, ID
104th Sig. Co.	Salt Lake City, UT
329th Ord. Co. (M)	Great Falls, MT
104th Tank Co. (L)	Casper, WY
Mtcyl Co. No. 329	Great Falls, MT
207th Inf. Brig.	Boise, ID
413th Inf. Regt.	Salt Lake City, UT
414th Inf. Regt.	Pocatello, ID
208th Inf. Brig.	Billings, MT
415th Inf. Regt.	Casper, WY
416th Inf. Regt.	Billings, MT
179th F.A. Brig.	Casper, WY
329th Ammo. Tn.	Casper, WY
385th F.A. Regt.	Salt Lake City, UT
386th F.A. Regt.	Helena, MT
329th Engr. Regt.	Salt Lake City, UT
329th Med. Regt.	Salt Lake City, UT
104th Div. Tn., Q.M.C.	Salt Lake City, UT
104th Div. Air Service	Salt Lake City, UT

#### 104th DIVISION Organization 1939

UNIT:	HQ LOCATION:
HQ	Salt Lake City, UT
HQ, Special Troops	Salt Lake City, UT
HQ Co.	Salt Lake City, UT
104th M.P. Co.	Idaho Falls, ID
104th Sig. Co.	Salt Lake City, UT
329th Ord. Co. (M)	Great Falls, MT
104th Tank Co. (L)	Casper, WY
207th Inf. Brig.	Boise, ID
413th Inf. Regt.	Salt Lake City, UT
414th Inf. Regt.	Pocatello, ID
208th Inf. Brig.	Billings, MT
415th Inf. Regt.	Casper, WY
416th Inf. Regt.	Billings, MT
179th F.A. Brig.	Casper, WY
329th Ammo. Tn.	Casper, WY
385th F.A. Regt.	Salt Lake City, UT
386th F.A. Regt.	Helena, MT
387th F.A. Regt.	Salt Lake City, UT
329th Engr. Regt.	Salt Lake City, UT
329th Med. Regt.	Salt Lake City, UT
429th Q.M. Regt.	Salt Lake City, UT

## PANAMA CANAL DIVISION

**HQ**—Quarry Heights, CZ, 1921; Fort Amador, CZ, 1921–32; Panama Canal Department, 1932–38

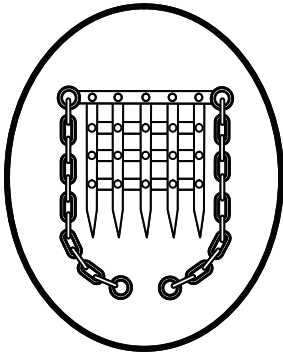

The Panama Canal Division was constituted in the R.A. on 3 June 1921 and activated with HQ at Quarry Heights, CZ, on 3 July 1921. The division HQ was moved on a permanent change of station to Fort Amador in October 1921. The Panama Canal Division was the primary ground force of the Panama Canal Department and was assigned the mission of defending the Canal Zone from potential invaders. It was organized around the nucleus of the 19th Inf. Brig., consisting of the 14th and the 33d Inf. Regts., the 42d Inf., the 1st Bn., 11th Engrs., and several of the companies in the division special troops. The division continued to activate units throughout 1921 adding the HHC, 20th Inf. Brig.; the HQ, Panama Canal Division Q.M. Tn., and several subordinate elements; and the 10th Mtcyl Co. in November. In December, the 1st Bn., 4th F.A. was added, followed by the 2d Bn., 11th Engrs., which rounded out the division in June 1922. Compared to other R.A. divisions of the time, the Panama Canal Division was fortunate in that it was located on the terrain on which it would fight if

the Canal Zone was ever invaded. Therefore, the training in which the division participated assumed a more important character than the scripted exercises that stateside units often conducted. The division's training cycle was regulated by Panama's weather patterns. Individual training, marksmanship training, and schools for unit specialists, for example, took place during the rainy months of May–August. The fairer months of September–December were devoted to officer and non-commissioned officer schools, garrison work details, inspections, and maneuver preparation. The early part of the year began with small unit training, reconnaissance of planned and existing defensive positions in the Canal Zone, and exercising transportation and communications systems. These activities were concurrent with, or followed by, the repair and construction of roads, and combined training with air corps and coast artillery units. The training year finally culminated in the large-scale division and department maneuvers held in February and March. The department maneuvers often included large surface squadrons from the US Navy and occasionally, amphibious invasion forces provided by the US Marine Corps. The Panama Canal Division was forced to inactivate several units over the years due to budget decreases. These inactivations included the 20th Inf. Brig., the 42d Inf., and the Panama Canal Division Q.M. Tn. HQ in 1931. Additionally, in 1931, the department commander recommended to the War Department an experimental reorganization of units in the Panama Canal Department. The new organization was tested in the February 1932 department maneuver and was subsequently approved by the War Department for permanent adoption. The reorganization resulted in the inactivation of the Panama Canal Division HQ and HHC, 19th Inf. Brig. on 15 April 1932. The remaining units of the division were assigned to the HQ of the newly organized Atlantic and Pacific Sectors, which also assumed control of all coast artillery elements on each sector's respective side of the Canal Zone. The Panama Canal Division's tables of organization were maintained at the department HQ in the unlikely event that there would be a requirement to reactivate the division for deployment outside the Canal Zone, which required a more mobile organization. The potential for this requirement was extremely limited, however, and as a result, the division was disbanded in 1938.

**Organization Day:** 3 July. Commemorates the initial activation of the division on 3 July 1921.

**Status:** Disbanded 10 October 1938.

**Events:** 26, 31, 36, 40, 43, 58, 69, 81, 101, 119, 140

### Division Commanders

Brig. Gen. Edwin B. Babbitt	3 July 1921–10 October 1921	Maj. Gen. Charles H. Martin	23 January 1925–10 October 1926
Maj. Gen. Samuel D. Sturgis Jr.	10 October 1921–17 April 1923	Maj. Gen. William S. Graves	13 December 1926–1 October 1927
Maj. Gen. Edwin B. Babbitt	17 April 1923–15 September 1923	Maj. Gen. Malin Craig	13 October 1927–31 March 1928
Maj. Gen. William Lassiter	October 1923–19 September 1924	Maj. Gen. George LeR. Irwin	1 April 1928–21 December 1930
Brig. Gen. Fox Conner	19 September 1924–January 1925	Brig. Gen. Charles D. Roberts	21 December 1930–3 April 1931
	Brig. Gen. Harold B. Fiske		3 April 1931–15 April 1932



**PANAMA CANAL DIVISION  
Organization 1923**

UNIT:	LOCATION:
HQ	Fort Amador, CZ
HQ, Special Troops	Quarry Heights, CZ
HQ & M.P. Co.	Quarry Heights, CZ
10th Sig. Co.	Corozal, CZ
10th Ord. Co. (M)	Corozal, CZ
10th Tank Co. (L)	A.A.—16th Tank Bn
Mtcyl Co. No. 10	Corozal, CZ
19th Inf. Brig.	Gatun, CZ
14th Inf. Regt.	Fort Davis, CZ
33d Inf. Regt.	Fort Clayton, CZ
20th Inf. Brig.	Camp Gaillard, CZ
42d Inf. Regt.	Camp Gaillard, CZ
32d Inf. Regt.	A.A.—14th Inf.
4th F.A. Regt.	Fort Sam Houston, TX
11th Engr. Regt.	Corozal, CZ
Panama Canal Div. Tn., Q.M.C.	Corozal, CZ
Ambulance Co. No. 57	A.A.—HQ, P.C. Dept.

**PANAMA CANAL DIVISION  
Organization 1933**

UNIT:	LOCATION:
HQ	Panama Canal Department
HQ, Special Troops	Panama Canal Department
HQ & M.P. Co.	Panama Canal Department
10th Sig. Co.	Panama Canal Department
10th Ord. Co. (M)	Corozal, CZ
19th Inf. Brig.	Panama Canal Department
14th Inf. Regt.	Fort Davis, CZ
33d Inf. Regt.	Fort Clayton, CZ
20th Inf. Brig.	Panama Canal Department
42d Inf. Regt.***	University of Puerto Rico
65th Inf. Regt.**	San Juan, PR
10th F.A. Brig.	Panama Canal Department
2d F.A. Regt.*	Fort Clayton, CZ
87th F.A. Regt.	Panama Canal Department
11th Engr. Regt.	Corozal, CZ
P.C. Div. Tn., Q.M.C.*	Corozal, CZ

\*Indicates unit was partially active. HQ location shown is the unit's mobilization post.

\*\*The 65th Inf. had a mobilization mission to reinforce the Canal Zone, if necessary, during the period 1922–27. On arrival it would become the second regiment of the 20th Inf. Brig. It was apparently never officially assigned to the brigade.

\*\*\*The 42d was inactivated in 1927, allotted to Puerto Rico for mobilization purposes, and organized with O.R. personnel at the University of Puerto Rico. The 65th and 42d Inf. Regts. were assigned dual missions in the defense of Puerto Rico and the Canal Zone 1927–38.

**HAWAIIAN DIVISION**

HQ—Schofield Barracks, TH, 1921–41

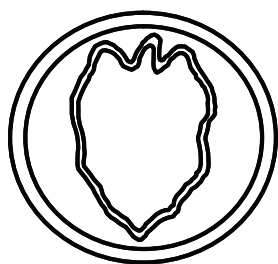

The Hawaiian Division was constituted in the R.A. on 1 February 1921 and activated at Schofield Barracks, Territory of Hawaii, on 1 March 1921. The division was the primary ground force of the Hawaiian Department and was given the mission of defending the Hawaiian Islands from potential invaders. The division had the primary responsibility to defend the island of Oahu, with the 21st Inf. Brig. defending the northern half of the island and the 22d Inf. Brig. responsible for the southern half. The other outlying islands were to be defended by the regiments of the Hawaii N.G. Throughout 1921–23, the division was busy with receiving newly assigned units, activating new units, and organizing the old ones into brigades in order to mold an effective fighting force. It was not until 1925 that the division was put into the field to begin practicing the mission with which it was tasked. In April of that year, the Hawaiian Division participated in large-scale joint Army–Navy maneuvers, which included protecting the islands from an invasion force provided by the US Marine Corps. The next major maneuver for the division was another Army–Navy exercise in February 1931, followed by Hawaiian Department Maneuvers in October and November. These exercises were the primary training events for the division during the interwar years and occurred about once a year from 1931 on. Due to the very small budgets of the time, units did not spend a lot of the time in the field. As a result, much of the soldiers' time was spent on police call, "rock painting," and other post beautification projects. In the Hawaiian Division, sports were high on the list of preferred activities. Competition was fierce, particularly between regiments, and all events drew a large crowd of both officers and men. Outings to Honolulu were the favorite form of pastime for the soldiers, but the isolated location of Schofield Barracks and the control of passes by company first sergeants made such trips less frequent than the soldiers would have preferred. The

Hawaiian Division was known as a “spit and polish” outfit in the interwar Army, and there was a lot of time to conduct drill and ceremonies. As a result, the division participated in reviews on a regular basis. The first division review was held on 24 June 1921 in honor of Brig. Gen. Joseph E. Kuhn, the division’s first commander. Throughout the interwar years, reviews were held to honor many well-known persons who were members of the division or were visitors to the Hawaiian Islands. Reviews for the incoming or departing division commanders were standard procedure, but reviews were also held for the governor of Hawaii, the secretary of war, and members of Congress. The most well-known honoree at a Hawaiian Division review, however, was President Franklin D. Roosevelt when he visited Schofield Barracks on 26 July 1934. By the late 1930s, the idyllic existence of the Hawaiian Division was fast coming to an end as tensions increased between the United States and Japan. The training of the division became more serious and more realistic, but before it could have its mettle tested in battle, the Hawaiian Division was split on 1 October 1941 to form the new triangular 24th and 25th Inf. Divs. The lineage and shoulder sleeve insignia of the division was assigned to the 24th Div.

**Organization Day:** 1 March. Commemorates the initial activation of the division on 1 March 1921.

**Status:** HHC are currently active in the R.A. at Fort Riley, KS, as HHC, 24th Inf. Div., a command and control HQ for three enhanced infantry brigades of the N.G.

**Events:** 33, 37, 75, 88, 120, 138, 141, 158, 189, 211, 225, 248, 276, 297, 312

#### Division Commanders

Brig. Gen. Joseph E. Kuhn	1 March 1921–22 December 1921	Brig. Gen. Otho B. Rosenbaum	1 September 1931–October 1931
Brig. Gen. John D. Barette	22 December 1921–February 1922	Maj. Gen. Albert J. Bowley	15 October 1931–16 April 1934
Maj. Gen. Charles T. Menoher	February 1922–10 August 1924	Brig. Gen. James C. Gowen	16 April 1934–2 June 1934
Brig. Gen. Thomas H. Slavens	10 August 1924–16 September 1924	Maj. Gen. Halstead Dorey	2 June 1934–5 December 1935
Maj. Gen. Edward M. Lewis	16 September 1924–13 January 1925	Brig. Gen. James C. Gowen	5 December 1935–11 March 1936
Brig. Gen. George Van Horn Moseley	13 January 1925–February 1925	Maj. Gen. Andrew Moses	11 March 1936–30 July 1937
Maj. Gen. William R. Smith	February 1925–25 August 1927	Brig. Gen. Robert C. Foy	30 July 1937–7 October 1937
Brig. Gen. George Van Horn Moseley	25 August 1927–October 1927	Maj. Gen. Charles D. Herron	7 October 1937–16 March 1938
Maj. Gen. Fox Conner	October 1927–25 January 1928	Maj. Gen. James A. Woodruff	16 March 1938–13 March 1939
Brig. Gen. Paul A. Wolf	25 January 1928–6 April 1928	Maj. Gen. William H. Wilson	13 March 1939–February 1941
Maj. Gen. Edwin B. Winans	6 April 1928–25 October 1930	Brig. Gen. Daniel I. Sultan	February 1941–25 April 1941
Maj. Gen. Briant H. Wells	25 October 1930–1 September 1931	Maj. Gen. Maxwell Murray	25 April 1941–1 October 1941

#### HAWAIIAN DIVISION Organization 1923

#### HAWAIIAN DIVISION Organization 1940

UNIT:	LOCATION:	UNIT:	LOCATION:
HQ	Schofield Barracks, TH	HQ	Schofield Barracks, TH
HQ, Special Troops	Schofield Barracks, TH	HQ, Special Troops	Schofield Barracks, TH
HQ & M.P. Co.	Schofield Barracks, TH	HQ & M.P. Co.	Schofield Barracks, TH
11th Sig. Co.	Schofield Barracks, TH	11th Sig. Co.	Schofield Barracks, TH
11th Ord. Co. (M)	Schofield Barracks, TH	11th Ord. Co. (M)	Schofield Barracks, TH
11th Tank Co. (L)	Schofield Barracks, TH	11th Tank Co. (L)	Schofield Barracks, TH
Mtchl Co. No. 11	Schofield Barracks, TH		
21st Inf. Brig.	Schofield Barracks, TH	21st Inf. Brig.	Schofield Barracks, TH
19th Inf. Regt.	Schofield Barracks, TH	19th Inf. Regt.	Schofield Barracks, TH
21st Inf. Regt.	Schofield Barracks, TH	21st Inf. Regt.	Schofield Barracks, TH
22d Inf. Brig.	Schofield Barracks, TH	22d Inf. Brig.	Schofield Barracks, TH
27th Inf. Regt.	Schofield Barracks, TH	27th Inf. Regt.	Schofield Barracks, TH
35th Inf. Regt.	Schofield Barracks, TH	35th Inf. Regt.	Schofield Barracks, TH
11th F.A. Brig.	Schofield Barracks, TH	11th F.A. Brig.	Schofield Barracks, TH
11th Ammo. Tn.	Schofield Barracks, TH	11th Ammo. Tn.	Schofield Barracks, TH
8th F.A. Regt.	Schofield Barracks, TH	8th F.A. Regt.	Schofield Barracks, TH
11th F.A. Regt.	Schofield Barracks, TH	11th F.A. Regt.	Schofield Barracks, TH
13th F.A. Regt.	Schofield Barracks, TH	13th F.A. Regt.	Schofield Barracks, TH
3d Engr. Regt.	Schofield Barracks, TH	3d Engr. Regt.	Schofield Barracks, TH
11th Med. Regt.	Schofield Barracks, TH	11th Med. Regt.	Schofield Barracks, TH
Hawaiian Div. Tn., Q.M.C.	Schofield Barracks, TH	11th Q.M. Regt.	Schofield Barracks, TH
Hawaiian Div. Air Service	Wheeler Field, TH	Hawaiian Div. Pack Tn.	Schofield Barracks, TH

## PHILIPPINE DIVISION

HQ—Fort McKinley, PI, 1922–41

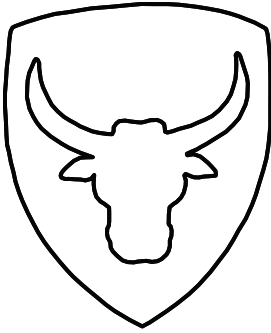

The Philippine Division was constituted in the R.A. on 7 December 1921 and activated at Fort McKinley, Philippine Islands, on 10 April 1922. The division was the primary ground force of the Philippine Department and was given the mission of defending the Philippine archipelago from potential invaders. The division began organizing around the nucleus of the 23d Inf. Brig. (consisting of the 45th and the 57th Inf. Regts.), which was activated on 15 December 1921. Additionally, the 31st Inf.; the 1st Bn., 24th F.A.; the 1st Bn., 14th Engrs.; and several of the companies in the division special troops were already organized and integrated into the division. The division continued to receive and activate units throughout 1922, adding HHC, 24th Inf. Brig.; HHC, 12th F.A. Brig.; HQ, Philippine Division Q.M. Tns., and several of the train's elements; and the 12th Mtcyl Co. by April. The 15th Inf. was assigned to the division in July 1922, however, only the 1st Bn. was stationed in the Philippines. The remainder of the regiment was posted to the American Barracks in Tientsin, China, and attached to HQ, American Forces in China. By the end of 1922, the 12th Med. Regt. was activated and rounded out the division's structure. The Philippine Division was forced to inactivate several units over the interwar years due to budget decreases, starting with the 12th F.A. Brig. HQ in 1922, followed by the 1st Bn., 15th Inf. in 1929, and the 24th Inf. Brig. HQ in 1930. With the relief of the 31st Inf. from the division in 1931, the 24th Brig. was redesignated as a Philippine Scout (PS) organization and the 43d and 44th Inf. Regts. (PS) were added to the brigade as inactive units. Additionally, the inactive 25th F.A. (PS) was relieved and the 23d F.A. (PS) replaced it as the division's other indirect fire regiment, also in an inactive status. Like other overseas divisions at the time, the Philippine Division was fortunate in that it was located on the terrain on which it would fight if the archipelago was ever invaded. Therefore, the training in which it participated tended to be more realistic and provided a more focused military environment. The environment helped to develop many of the Army officers who would lead the United States to victory in World War II. Due to the archipelago's seasonal weather patterns, the division conducted individual training, marksmanship training, and schools for specialists during the rainy months of June–August. The drier months of September–November were devoted to officer and noncommissioned officer schools, garrison work details, inspections, and maneuver preparation. The late part of the year began with small unit training, reconnaissance of the maneuver areas for the next major department exercise, and exercising transportation and communications systems. These activities were followed by the repair and construction of roads leading to and on the peninsula of Bataan. The preparations finally culminated in the large-scale division and department maneuvers in January and February. The maneuvers occasionally included large surface squadrons from the Navy as well as amphibious invasion forces provided by the US Marine Corps. In 1933, the Philippine Division began to train in earnest to prepare for an invasion, which Army planners believed would come at the beaches of Lingayan. The January 1934 maneuver was actually little more than a thorough reconnaissance of Bataan with particular emphasis on the Miraveles Mountains. This reconnaissance revealed the poor internal road net of the peninsula, and the 14th Engrs. and 23d F.A. were put to work improving the trails and roads. The 1935 maneuver was again held on Bataan. This exercise focused on determining the enemy avenues of approach and selecting defensive positions to block those approaches. The 1936 maneuver came uncannily close to rehearsing what would occur 6 years later when the Japanese invaded. The 26th Cav., with the 23d F.A. in support, was sent to scout the Lingayan landing areas and report movements of the invasion force, while the Philippine Division concentrated near Fort Stotsenberg. As the enemy forced the cavalry back, the Philippine Division fought a delaying action, fell back onto Bataan to defend the Olongopo Road, and then centered its defense on the Miraveles Mountains where the exercise ended. The next change to the division's structure came in 1936 with the reorganization of the Q.M. Tn. into the 12th Q.M. Regt. Shortly before Pearl Harbor, the 31st Inf. was reassigned to the Philippine Division, and the 1st Bns. of the 43d Inf. and the 23d F.A. were activated. Interestingly, the 24th Inf. Brig. was still assigned as an inactive unit; therefore, the Philippine Division was the only R.A. infantry division that retained the "square" structure (at least on paper) on entry into World War II. Location of the division HQ on 7 December 1941 was Fort William McKinley, Philippine Islands.

**Organization Day:** 10 April. Commemorates the initial activation of the division on 10 April 1922.

**Status:** Surrendered to the Japanese 14th Army in May 1942. Reactivated on 6 April 1946 at Angeles, Pampanga, PI, and redesignated as the 12th Inf. Div. (PS). Inactivated 30 April 1947.

**Events:** 27, 35, 41, 52, 68, 82, 100, 118, 139, 169, 179, 198, 224, 245, 270

### Division Commanders

Brig. Gen. Omar Bundy	10 April 1922–24 March 1924	Brig. Gen. Alfred T. Smith	28 June 1935–8 January 1937
Maj. Gen. James H. McRae	24 March 1924–17 November 1924	Brig. Gen. Evan H. Humphrey	9 January 1937–20 January 1937
Maj. Gen. Douglas MacArthur	18 November 1924–30 January 1925	Maj. Gen. John L. DeWitt	20 January 1937–8 April 1937
Maj. Gen. William Weigel	26 January 1925–16 February 1927	Brig. Gen. George Grunert	8 April 1937–3 July 1937
Brig. Gen. Frank M. Caldwell	16 February 1927–25 April 1927	Maj. Gen. John H. Hughes	3 July 1937–25 February 1938
Maj. Gen. Johnson Hagood	25 April 1927–22 June 1929	Maj. Gen. Percy P. Bishop	26 February 1938–31 October 1938
Maj. Gen. Paul B. Malone	22 June 1929–24 June 1931	Maj. Gen. Walter S. Grant	31 October 1938–24 July 1939
Brig. Gen. Caspar H. Conrad Jr.	24 June 1931–1 July 1933	Brig. Gen. Henry C. Pratt	25 July 1939–November 1939
Brig. Gen. Frank S. Cocheu	1 July 1933–8 May 1935	Maj. Gen. George Grunert	November 1939–May 1940
Brig. Gen. Stanley H. Ford	8 May 1935–27 May 1935	Brig. Gen. Henry C. Pratt	May 1940–November 1940
Col. Ralph H. Leavitt	28 May 1935–28 June 1935	Maj. Gen. Jonathan M. Wainwright	November 1940–28 November 1941
	Brig. Gen. Maxon S. Lough		28 November 1941–May 1942

#### PHILIPPINE DIVISION Organization 1923

UNIT:	LOCATION:
HQ	Fort William McKinley, PI
HQ, Special Troops HQ & M.P. Co.	Fort William McKinley, PI
12th Sig. Co. (PS)	Fort William McKinley, PI
12th Ord. Co. (M) (PS)	Camp Stotsenberg, PI
Mtcyl Co. No. 12	Fort William McKinley, PI
23d Inf. Brig. (PS)	Fort William McKinley, PI
45th Inf. Regt. (PS)	Fort William McKinley, PI
57th Inf. Regt. (PS)	Fort William McKinley, PI
24th Inf. Brig.	Manila, PI
31st Inf. Regt.	Manila, PI
15th Inf. Regt.	Tientsin, China
12th F.A. Brig.	A.A.–24th F.A. Regt.
12th Ammo. Tn.	Philippine Department
24th F.A. Regt. (PS)	Camp Stotsenburg, PI
25th F.A. Regt. (PS)	A.A.–24th F.A. Regt.
14th Engr. Regt. (PS)*	Fort William McKinley, PI
12th Med. Regt. (PS)	Fort William McKinley, PI
Philippine Div. Tn., Q.M.C. (PS)	Fort William McKinley, PI

#### PHILIPPINE DIVISION Organization 1940

UNIT:	LOCATION:
HQ	Fort William McKinley, PI
HQ, Special Troops HQ & M.P. Co.	Fort William McKinley, PI
12th Sig. Co. (PS)	Fort William McKinley, PI
12th Ord. Co. (M) (PS)	Fort Stotsenberg, PI
23d Inf. Brig. (PS)	Fort William McKinley, PI
45th Inf. Regt. (PS)	Fort William McKinley, PI
57th Inf. Regt. (PS)	Fort William McKinley, PI
24th Inf. Brig. (PS)	Philippine Department
43d Inf. Regt. (PS)*	Fort William McKinley, PI
44th Inf. Regt. (PS)	Philippine Department
12th F.A. Brig.	Philippine Department
12th Ammo. Tn.	Philippine Department
23d F.A. Regt. (PS)*	Fort Stotsenburg, PI
24th F.A. Regt. (PS)	Fort Stotsenburg, PI
14th Engr. Regt. (PS)*	Fort William McKinley, PI
12th Med. Regt. (PS)	Fort William McKinley, PI
12th Q.M. Regt. (PS)	Fort William McKinley, PI

\*Indicates unit was partially active. HQ location shown is mobilization post.

### PANAMA MOBILE FORCE

#### HQ—Balboa, CZ, 1939–41

The Panama Mobile Force was constituted and organized in the R.A. on 16 February 1940 and activated at Balboa, Panama Canal Zone. The organization of the Mobile Force was the culmination of a series of ideas and experiments on how to best defend the Panama Canal beginning with the organization of the Panama Canal Division in 1921. In 1932, the division was inactivated and its elements integrated into the Atlantic and Pacific Sectors. Under the sector concept, all ground and coast artillery forces were integrated into those two commands to better coordinate efforts to repel an invasion from the sea. The sector concept was not entirely successful as the need for better coordination with air defense led to the integration of not only all anti-aircraft units, but eventually, all coast defense units as well, into the Panama Separate Coast Artillery Brigade in October 1939. This left only the ground forces in the two sectors. A division-size “Mobile Force” to assume control of all ground units in the event of war had been provided for in mobilization plans since 1932 when the Panama Canal Division was inactivated. In February 1940, General Daniel Van Voorhis, the department commander, stating that units should train in peacetime as they will fight in war, ordered the activation of the Panama Mobile Force. As organized, the Panama Mobile Force was configured strikingly similar to the old Panama Canal Division. A significant difference was the provision for three infantry regiments for each brigade. However, as the new organization was tested in maneuvers in 1940–41, the tables of organization were

changed to drop the brigade-level HQ. Additionally, no more than four infantry regiments were ever assigned to the Mobile Force, even after World War II began. Like the Hawaiian and Philippine Divisions, the Panama Mobile Force was fortunate in that it was located on the terrain on which it would fight if ever the Canal Zone was ever invaded. The plan to defend the Canal Zone was to conduct a mobile defense in depth beginning at the beaches and not by preparing and holding static defense positions. The Atlantic side was considered the least likely invasion route because the few landing areas there were too small to allow the discharge of numerous forces simultaneously. The Pacific side was considered the primary route the enemy would take to seize the Canal. The basic plan called for the Mobile Force to conduct an economy of force role on the Atlantic side, while the units on the Pacific side would conduct a series of delaying actions and counterattacks until the enemy was destroyed by combined ground, air, and sea forces. The maneuvers conducted in 1940 and 1941 confirmed the validity of the reorganization of the Panama defenses and the Mobile Force plans for defense. However, the plan was never put to the real test. Location of the division HQ on 7 December 1941 was Balboa, Panama Canal Zone.

**Events:** 292, 308, 333

#### Mobile Force Commanders

Maj. Gen. Ben Lear      16 February 1940–September 1940      Maj. Gen. William E. Prosser      23 October 1940–March 1942

#### PANAMA MOBILE FORCE Organization 1940

UNIT:	LOCATION:
HQ	Balboa, CZ
Special Troops:	(not constituted)
HQ Co.	Fort Clayton, CZ
19th M.P. Co.	Fort DeLesseps, CZ
10th Sig. Co.	Fort Amador, CZ
10th Ord. Co. (M)	Corozal, CZ
1st Cav. Rcn. Troop	Fort William D. Davis, CZ
1st Sep. Chem. Co.	Corozal, CZ
18th Inf. Brig.	Camp Gaillard, CZ
5th Inf. Regt.	Camp Paraiso, CZ
13th Inf. Regt.	Fort William D. Davis, CZ
<i>Inf. Regt. (not designated)</i>	
19th Inf. Brig.	<i>First Corps Area</i>
14th Inf. Regt.	Fort William D. Davis, CZ
33d Inf. Regt.	Fort Clayton, CZ
<i>Inf. Regt. (not designated)</i>	
1st Bn., 2d F.A.	Fort Clayton, CZ
1st Bn., 87th F.A.	Fort William D. Davis, CZ
11th Engr. Regt.	Fort Clayton, CZ
61st Sep. Q.M. Troop (Pack)	Fort William D. Davis, CZ
62d Sep. Q.M. Troop (Pack)	Fort Clayton, CZ
3d Vet. Co.	Corozal, CZ
5th Med. Co.	Corozal, CZ

#### PORTO RICAN DIVISION

#### Organized Reserve Puerto Rico

**HQ**—*Not constituted.*

The Porto Rican Division was never constituted in the US Army, however, the War Department clearly contemplated its eventual constitution as evidenced by numerous references to it in the mobilization plans of the 1920s and in other documents. The genesis of this division was the World War I-era 94th Div., which was directed to be organized at Las Casas, San Juan, Puerto Rico, as a provisional division, but the 94th was never activated. Three of the regiments, the 373d, 375th, and 375th Inf. Regts. were organized, however, and assigned to a provisional brigade at Las Casas. The 373d and 374th Inf. Regts. were organized with Hispanic Puerto Ricans and the 375th Inf. with Negro Puerto Ricans during the summer of 1918. These three regiments were demobilized in January 1919 and were reconstituted in June

1921. Concurrently, the regiments were assigned to the 211th Inf. Brig., which would form the nucleus of the Porto Rican Division if it were ever reconstituted. To flesh out the 211th Brig.'s troop list, artillery, engineer, military police, and other support units were constituted and organized in Puerto Rico in the early 1920s. The brigade's special troop units, normally assigned to a division, were assigned the numerical designation "105th." This uniform designation also supports the notion that a division HQ for these Puerto Rican units was contemplated for eventual constitution. The wartime mission of this organization was to be the primary mobile force for the defense of Puerto Rico. By 1927, however, the Porto Rican Division, as well as the 211th Brig., was apparently determined by War Department planners to be excess to Army needs. That year, the 211th Inf. Brig. and most of its subordinate elements were demobilized and references to the "Porto Rican Division" in War Department documents ceased to appear.

**PORTO RICAN DIVISION**  
**Organization 1923**

<b>UNIT:</b>	<b>HQ LOCATION:</b>
<i>HQ</i>	<i>Not constituted*</i>
<i>HQ, Special Troops</i>	<i>Not constituted*</i>
<i>HQ Co.</i>	<i>Not constituted*</i>
105th M.P. Co.	San Juan, PR
105th Sig. Co.	San Juan, PR
211th Inf. Brig.	San Juan, PR
373d Inf. Regt.	San Juan, PR
374th Inf. Regt.	Mayaguez, PR
375th Inf. Regt.	Ponce, PR
564th F.A. Regt.	San Juan, PR
600th Engr. Bn. (Mtd)	San Juan, PR
601st Hosp. Co.	San Juan, PR
601st San. Co.	Ponce, PR
601st Amb. Co.	Mayaguez, PR
600th M.T. Co.	San Juan, PR
600th M. Rep. Sec	San Juan, PR

\*Although not officially constituted, these elements were clearly contemplated for eventual constitution in the 1923 War Department General Mobilization Plan and references to them are found in a number of other documents.

## Chapter 8

### Infantry Brigades



USASC photo, NA II

Soldiers of the 29th Infantry display an array of infantry weapons at Fort Benning, GA, 1930.

Infantry brigades provided command and control for assigned or attached infantry regiments and other elements attached for operations. Their mission was to plan, coordinate, and conduct operations to close with and destroy the enemy by fire and maneuver.

#### Organization

Infantry brigades, with one exception, were organized to consist of a headquarters (HQ), headquarters company (HQ Co.), and two infantry (Inf.) regiments (Regts.). The one exception was that of the 211th Infantry (Inf.) Brigade (Brig.) of Puerto Rico, which consisted of three regiments, a field artillery regiment, and a number of special troops as a separate brigade. New York's 93d Inf. Brig. also had three regiments, but the third regiment, the all-black 369th Inf., was attached for command and administration purposes.

The vast majority of Infantry Brigades in the interwar period were divisional brigades, but there were four separate brigades at various times. The organization of separate brigades mirrored that of the divisional brigades. Though all Regular Army (R.A.) brigades were assigned to divisions, only the even numbered brigades assigned to the 4th through 9th Divisions (Divs.) were in active service between 1921 and 1939. These brigades were reinforced with various divisional elements needed for adequate training and training support for Reserve Component units. These typically consisted of a field artillery battalion, tank platoon or engineer company, motor transportation company, and the division air service, though not every reinforced brigade was lucky enough to have all of these elements. By 1930, many of the elements of the reinforced

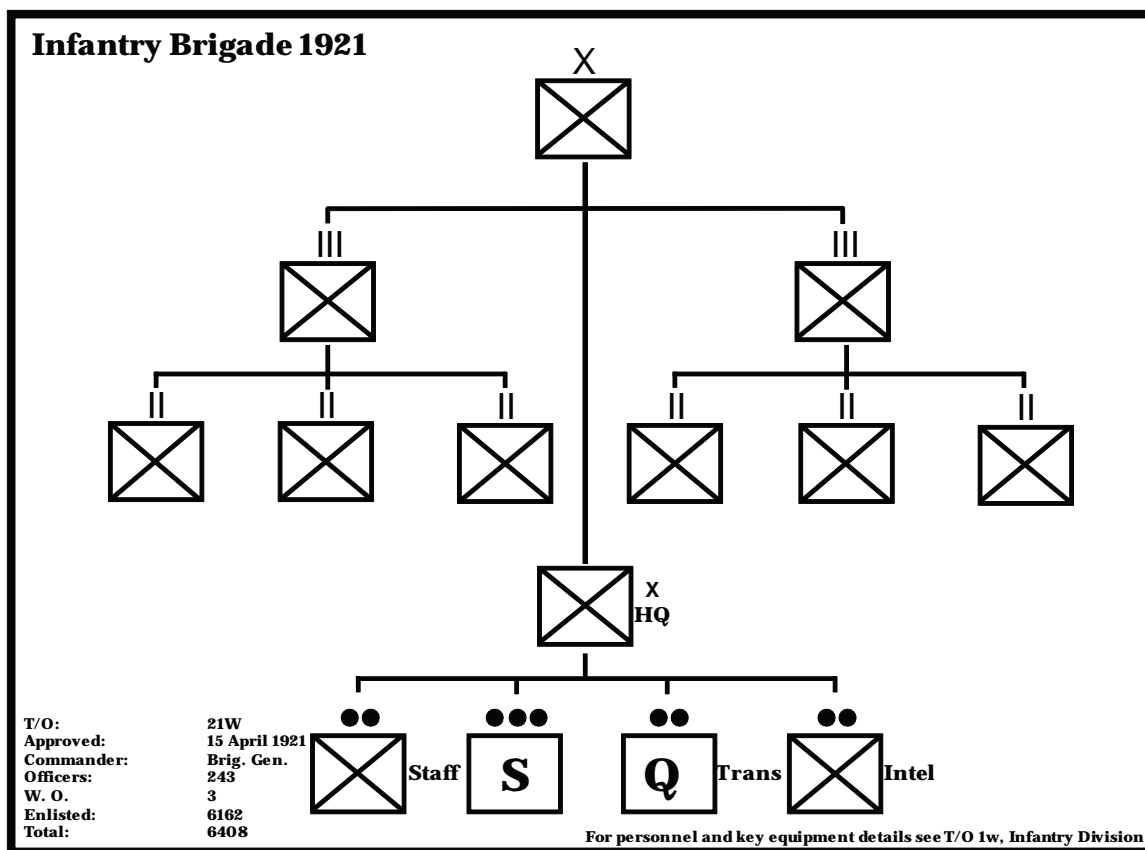

Infantry brigade organization.

brigades either had been withdrawn from the division or were inactivated due to budget cuts or the need to free up personnel spaces for the activation of new air corps units.

Though the odd-numbered brigades were not in active service after the fall of 1921, all were active as Regular Army Inactive (RAI) units at some point in the 1920s and 1930s. Though active as Reserve organizations, these brigades did not function as command and control HQ. They were typically used only as mobilization assignment units and rarely functioned as units in the inactive training period or during summer training.

Many brigades in the overseas departments suffered some of the same cuts as their stateside counterparts. Of the six overseas brigades, three were inactive by 1932. Only the Hawaiian Division retained both brigades intact. The Panama Canal Division lost the 20th Brig. in 1924 and the 19th Brig. in 1932. The Philippine Division lost the 24th Brig. in 1930.

There were 39 National Guard (N.G.) brigades in the interwar period, of which all but three were divisional brigades. The three separate brigades were all constituted and organized to provide several separate regiments a command and control HQ. The last of the three, the 92d Inf. Brig. of Puerto Rico, existed only long enough to be mobilized for service in World War II, then was disbanded a short time later.

Fifty-five brigades were constituted in the Organized Reserve (O.R.), of which all but one were divisional brigades. The separate 211th Inf. Brig. was demobilized in 1927 when that brigade was determined to be excess to needs for the defense of Puerto Rico, which was already allotted two N.G. infantry regiments. However, that same year, the 42d Inf. was allotted to Puerto Rico as an RAI unit, and the 516th Inf. Battalion (Bn.) was transferred from New York the following year to replace the two regiments lost with the demobilization of the 211th Brig. Most of the divisional brigades functioned as units and more than a



few functioned as command and control HQ in the inactive training period. Those brigades were generally commanded by a Reserve senior colonel or brigadier general. Additionally, a few of these brigades were occasionally commanded by R.A. brigadier generals who exercised command over the brigades during command post exercises (CPXs) or other training exercises.

## **Training**

The training of R.A. infantry brigades was conducted in a variety of venues in the interwar period. The venues were generally dictated by budgetary constraints. Though the desire of most commanders was to assemble active divisions and brigades at least once a year for collective maneuver training, this was not possible because of the lack of training dollars. As a result, infantry brigades were assembled in their entirety for training on the average of only twice every 3 years. This rate tended to improve in the 1930s and was always better for the overseas brigades than for the stateside units. Stateside R.A. divisional brigades generally trained as separate commands from their divisions, though in the 1930s, division-level or higher maneuvers became more commonplace. In years when money was available, the six reinforced brigades were assembled with all active brigades and division units, assigned Reserve officers, and often with other Active units within the corps area, for a "corps area maneuver." Though the title sounded grandiose, the actual number of Soldiers trained in these maneuvers tended to be less than 5,000. Most years, however, these were simply brigade-level maneuvers. In those years when money was not available, commanders usually substituted CPXs in place of the maneuver.

N.G. infantry brigade headquarters and headquarters companies (HHC) typically performed their drills during the inactive training period at their home armories one night a week or on the weekend depending on the planned training. The HQ and staff usually focused on staff skills while the various HQ Co. sections focused on support tasks. Occasionally N.G. brigade HQ participated in division or higher-level CPXs as part of their inactive training. Brigades assigned to single state divisions generally attended summer training at the same time as the rest of the division. Those brigades assigned to multistate commands usually attended camp within their home state. Several multistate divisions were able to assemble subordinate brigades from other states at a division camp in a few instances in the interwar years. Except for the army-level maneuvers in the late 1930s and early 1940s, however, combined camps for multistate divisions and brigades were uncommon.

Though most O.R. brigades functioned as units, their inactive training assemblies tended to be conducted with one of their subordinate regiments or with another HQ. Only occasionally did these brigades hold training periods that were conducted solely with the brigade's assigned personnel. In a few instances, these were rather creative affairs. For example, Brig. Gen. Palmer E. Pierce conducted a weekend staff ride at Gettysburg in May 1927 as a way of professionally developing the staff of the 153d Inf. Brig. Most of these brigades functioned as actual command and control HQ during summer training camps if they participated in a division or corps area CPX. Usually, if a senior officer was not already assigned to command the brigade, the senior regimental commander temporarily filled in as commander for the camp. More often, the brigade's personnel would attend the summer training attached to one of the brigade's subordinate regiments.

### HHC, 1st Infantry Brigade (1st Division)

**HQ**—Camp Zachary Taylor, KY, 1919–20; Camp Dix, NJ, 1920–22; Fort Wadsworth, NY, 1922–31; New York City, NY, 1931–33; Camp Dix, NJ, 1933–35; New York City, NY, 1935–38; Fort Wadsworth, NY, 1938–39

**Subordinate elements**—16th and 18th Inf. Regts., 1919–39

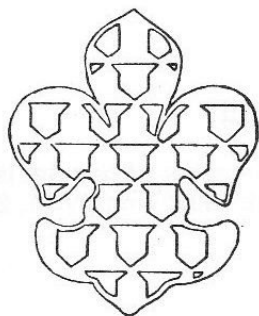

Arrived at the port of New York on the U.S.S. *Mobile* on 3 September 1919 after 9 months of occupation duty near Coblenz, Germany, as an element of the 1st Div. Participated in the 1st Div. victory parade down 5th Avenue in New York City on 10 September 1919 and in Washington, DC, on 17 September 1919. Temporarily posted to Camp George G. Meade, MD, where emergency period personnel were discharged. Transferred to Camp Zachary Taylor, KY, and arrived there on 4 October 1919. Transferred in September 1920 to Camp Dix, NJ. HHC transferred on 19 September 1922 to Fort Wadsworth, NY; subordinate regiments transferred to posts in the New York City area. The entire brigade participated in the 1st Div. parade down 5th Avenue in New York City on 3 October 1924 during the massive reunion of the Society of the 1st Div. Redesignated HHC, 1st Brig. on 23 March 1925. HQ transferred to 39 Whitehall Street, New York City, NY, on 10 October 1931. Concurrently, HQ Co. transferred to Fort Jay, NY. HQ Co. transferred

several more times in the 1930s: to 39 Whitehall Street on 13 February 1934; to Miller Field, NY, on 31 August 1935; and back to Fort Wadsworth on 3 January 1938. The Brig. HQ transferred on 8 April 1933 to Fort Dix, NJ, to assume command and control of the Southern Civilian Conservation Corps (CCC) District, Second Corps Area. As such, the brigade and subordinate units controlled CCC activities in New Jersey and Delaware. The HQ performed that mission until 30 October 1934, but remained at Camp Dix until 29 August 1935, when it returned to 39 Whitehall Street. Redesignated HHC, 1st Inf. Brig. on 24 August 1936. HQ transferred on 21 April 1938 back to Fort Wadsworth. Typically, each May brigade units road marched from home stations to Camp Dix, NJ, and provided training assistance during the summer to the Citizens Military Training Camp (CMTC) and the Reserve Officers' Training Corps (ROTC) camps, and to infantry elements of the 77th and 78th Divs. Subordinate regiments usually held marksmanship and tactical training in late summer and early fall at Camp Dix before marching back to home stations. Disbanded 11 October 1939 and personnel transferred to the Inf. Sec, HQ, 1st Div.; the 1st Div. HQ and Military Police Co.; or to the 18th Inf.

**Organization Day:** 29 December (HQ, 1st Brig.); 17 January (HQ Co.). Latter date chosen to commemorate the original date of organization at Camp Dix, NJ, on 17 January 1921.

**Status:** Active at Fort Riley, KS, as HHC, 1st Brig., 1st Inf. Div. (Mecz).

**Events:** 18, 22, 60, 63, 72, 89, 91, 106, 153, 168, 190, 240, 266, 280

#### Commanders, 1st Infantry Brigade

Brig. Gen. Frank S. Parker	August 1918–16 February 1919	Col. William F. McCammon	17 January 1931–5 May 1931
Col. Charles A. Hunt	16 February 1919–29 March 1919	Brig. Gen. Howard L. Laubach	5 May 1931–11 August 1934
Brig. Gen. Frank S. Parker	29 March 1919–3 September 1919	Col. Noble J. Wiley	11 August 1934–14 August 1934
Col. William F. Harrell	3 September 1919–17 December 1920	Brig. Gen. John L. DeWitt	14 August 1934–26 April 1935
Brig. Gen. William S. Graves*	17 December 1920–3 July 1924	Col. Albert S. Williams	26 April 1935–18 August 1935
Brig. Gen. Frank S. Parker	3 July 1924–24 July 1924	Brig. Gen. Stanley H. Ford*	18 August 1935–27 March 1936
Brig. Gen. William S. Graves*	24 July 1924–27 March 1925	Col. Albert S. Williams	28 March 1936–9 January 1937
Brig. Gen. Preston Brown	27 March 1925–17 December 1925	Brig. Gen. Perry L. Miles*	9 January 1937–31 October 1937
Col. John J. Bradley	17 December 1925–20 May 1926	Col. Karl Truesdell	1 October 1937–21 November 1937
Brig. Gen. Hugh A. Drum*	20 May 1926–20 October 1927	Col. Fay W. Brabson	21 November 1937–9 December 1937
Col. Edward Croft	20 October 1927–1 December 1927	Brig. Gen. Lawrence Halstead*	9 December 1937–14 January 1938
Col. Charles F. Humphrey Jr.	1 December 1927–3 February 1928	Col. Karl Truesdell	14 January 1938–14 March 1938
Brig. Gen. Otho B. Rosenbaum*	3 February 1928–17 January 1931	Col. Fay W. Brabson	14 March 1938–15 June 1938
	Brig. Gen. Walter C. Short		15 June 1938–11 October 1939

\*Concurrently commanding the 1st Div. for all or part of the period listed.

### HHC, 2d Infantry Brigade (1st Division)

**HQ**—Camp Zachary Taylor, KY, 1919–20; Camp Dix, NJ, 1920–22; Madison Barracks, NY, 1922–31; Fort Ontario, NY, 1931–39

**Subordinate elements**—26th and 28th Inf. Regts., 1919–39



Arrived at Hoboken, NJ, on 3 September 1919 after 9 months of occupation duty near Coblenz, Germany, as an element of the 1st Div. Participated in the 1st Div. parade down 5th Avenue in New York City on 10 September 1919 and in Washington, DC, on 17 October 1919. Temporarily posted to Camp George G. Meade, MD, where emergency period personnel were discharged. Transferred in October 1919 to Camp Zachary Taylor, KY. The entire 2d Brig. was sent to Lexington, KY, 9–11 February 1920, to enforce martial law in connection with a rape trial. Transferred in September 1920 to Camp Dix, NJ. HHC transferred in July 1922 to Madison Barracks, NY. Subordinate regiments concurrently transferred to posts in upstate New York. Redesignated HHC, 2d Brig. on 23 March 1925. HHC transferred 15 October 1931 to Fort Ontario, NY. In April 1933, the brigade assumed command and control of the Northern CCC District, Second Corps Area. Redesignated HHC, 2d Inf. Brig. on 24 August 1936. The brigade and its subordinate units continued to support CCC activities in the upstate area of New York until 1939. Typically, brigade units provided training assistance each summer to

CMTC and ROTC camps, and to infantry elements of the 98th Div. at the 2d Brig.'s regimental posts or some years at Pine Camp, NY. Subordinate regiments usually held marksmanship and tactical training in late summer and early fall at Pine Camp. Relieved from assignment to the 1st Div. on 11 October 1939 and concurrently attached to the Second Corps Area. Inactivated 1 June 1940 at Fort Ontario, NY.

**Organization Day:** 6 November. Chosen to commemorate the brigade's participation in the final phase of the Meuse-Argonne Campaign that began on 6 November 1918.

**Status:** Active at Conn Barracks, Schweinfurt, Germany, as HHC, 2d Brig., 1st Inf. Div. (Mecz).

**Events:** 18, 22, 60, 63, 72, 89, 91, 106, 133, 153, 168, 190, 219, 241, 265, 280

#### Commanders, 2d Infantry Brigade

Brig. Gen. Francis C. Marshall	26 October 1918–29 May 1919	Brig. Gen. Peter E. Traub	9 May 1928–1 September 1928
Col. Robert A. Brown	29 May 1919–6 June 1919	Col. John Madden	1 September 1928–9 December 1928
Brig. Gen. Frank E. Bamford	6 June 1919–24 July 1919	Brig. Gen. Charles E. Kilbourne	9 December 1928–11 October 1929
Col. Robert A. Brown	24 July 1919–17 November 1919	Col. John Madden	11 October 1929–12 November 1929
Brig. Gen. Francis C. Marshall	17 November 1919–16 March 1920	Brig. Gen. William P. Jackson*	13 November 1929–15 October 1931
Brig. Gen. Harry C. Hale	June 1920–8 September 1920	Col. Charles H. Morrow	15 October 1931–8 February 1932
Brig. Gen. Clarence R. Edwards	8 September 1920–3 June 1921	Brig. Gen. Charles D. Roberts*	8 February 1932–31 March 1936
Brig. Gen. William Weigel	16 July 1921–21 June 1922	Col. Hiram M. Cooper	31 March 1936–2 May 1936
Col. Charles D. Roberts	21 June 1922–1 October 1923	Brig. Gen. Perry L. Miles*	2 May 1936–8 January 1937
Brig. Gen. William Weigel	1 October 1923–20 November 1924	Col. Hiram M. Cooper	8 January 1937–4 March 1937
Brig. Gen. Fox Conner	20 November 1924–24 January 1925	Brig. Gen. Walter C. Short*	4 March 1937–15 June 1938
Brig. Gen. Frank S. Parker	24 January 1925–1 April 1927	Col. Thomas L. Crystal	15 June 1938–25 August 1938
Col. John H. Hughes	1 April 1927–1 September 1927	Brig. Gen. Irving J. Phillipson	25 August 1938–1 March 1940
Col. Ralph E. Ingram	1 September 1927–9 May 1928	Col. Cassius M. Dowell	1 March 1940–1 June 1940

\*Concurrently commanding the 1st Div. for all or part of the period listed.

### HHC, 3d Infantry Brigade (2d Division)

**HQ**—Camp Travis, TX, 1919–22; Fort Sam Houston, TX, 1922–39

**Subordinate elements**—9th and 23d Inf. Regts., 1919–39

Arrived at the port of New York on the U.S.S. *George Washington* on 3 August 1919 after 7 months of occupation duty in Coblenz, Germany, as an element of the 2d Div. Transferred 16 August 1919 to Camp Travis, TX. Transferred 13 December 1922 to Fort Sam Houston proper. Redesignated HHC, 3d Brig. on 23 March 1925. In April 1933, the brigade assumed command and control of the Texas CCC District until mid-1934. Redesignated HHC, 3d Inf. Brig. on

24 August 1936. The brigade and subordinate units continued to support CCC activities in Texas until 1939. Typically, brigade units provided training assistance each summer to CMTC and ROTC camps, and to infantry elements of the 90th Div. at Camp Bullis, TX, or Fort Sam Houston. Reserve officers assigned to the brigade HHC conducted summer training with the brigade at Camp Bullis and Fort Sam Houston. Participated in annual 2d Div. maneuvers at Camp Bullis typically held in May or August. Disbanded on 9 October 1939.

**Status:** Active at Camp Howze, Korea, as HHC, 3d Brig., 2d Inf. Div.

**Events:** 45, 47, 55, 70, 74, 80, 105, 125, 147, 163, 205, 216, 242, 258, 282

#### Commanders, 3d Infantry Brigade

Brig. Gen. Charles E. Kilbourne	23 November 1918–2 February 1919	Col. Robert McCleve	25 March 1925–9 February 1926
Brig. Gen. Thomas W. Darrah	23 February 1919–12 April 1919	Brig. Gen. Frank R. McCoy	9 February 1926–8 March 1927
Col. Harry A. Eaton	9 July 1919–August 1919	Col. Charles B. Clark	8 March 1927–9 June 1927
Brig. Gen. William S. Scott	October 1919–15 February 1920	Brig. Gen. Harold B. Fiske*	9 June 1927–13 November 1928
Col. Harry A. Eaton	15 February 1920–11 August 1920	Brig. Gen. Frank S. Cocheau	13 November 1928–19 December 1931
Col. Thomas H. Slavens	11 August 1920–5 September 1920	Col. Alexander T. Ovenshine	19 December 1931–18 March 1932
Brig. Gen. Hanson E. Ely	5 September 1920–16 July 1921	Brig. Gen. Charles R. Howland	18 March 1932–19 May 1934
Col. Alexander T. Ovenshine	16 July 1921–24 July 1921	Col. James A. Higgins	19 May 1934–28 May 1934
Lt. Col. Benjamin R. Nash	24 July 1921–11 August 1921	Brig. Gen. Alexander Ovenshine*	28 May 1934–30 June 1937
Brig. Gen. Preston Brown*	11 August 1921–25 March 1925	Brig. Gen. Charles F. Humphrey*	1 July 1937–23 September 1939
	Brig. Gen. Joseph W. Stilwell		23 September 1939–7 October 1939

\*Concurrently commanding the 2d Div. for all or part of the period listed.

#### HHC, 4th Infantry Brigade (2d Division)

**HQ**—Camp Travis, TX, 1920–22; Fort Sam Houston, TX, 1922–27; Fort Francis E. Warren, WY, 1927–39

**Subordinate elements**—1st and 20th Inf. Regts., 1920–39

Organized in the R.A. on 4 October 1920 at Camp Travis, TX, to fill the void in the 2d Div. left by the 4th Marine Brig. on its relief and departure for Quantico, VA. Transferred 13 December 1922 to Fort Sam Houston proper. Redesignated HHC, 4th Brig. on 23 March 1925. Brigade units provided training assistance each summer to CMTC and ROTC camps, and to infantry elements of the 90th Div. at Camp Bullis and Fort Sam Houston, 1922–26. Transferred on 28 June 1927 to Fort D.A. Russell, WY. Redesignated HHC, 4th Inf. Brig. on 24 August 1936. At Fort D.A. Russell (later renamed Fort Francis E. Warren), provided training assistance each summer to elements of the 208th Inf. Brig. 1927–41. Conducted annual brigade and regimental maneuvers at Pole Mountain Reservation in August and September during those years when funds were available. Disbanded on 16 October 1939.

**Status:** Active at Camp Casey, Korea, as HHC, 1st Brig., 2d Inf. Div.

**Events:** 45, 47, 55, 79, 83, 130, 152, 166, 212, 232, 260

#### Commanders, 4th Infantry Brigade

Brig. Gen. James H. McRae	4 October 1920–14 August 1921	Brig. Gen. Frank S. Cocheau	26 December 1931–16 May 1933
Brig. Gen. Edward M. Lewis*	20 September 1921–4 January 1922	Col. Kerwin T. Smith	16 May 1933–16 August 1933
Brig. Gen. Benjamin A. Poore*	4 January 1922–10 November 1924	Brig. Gen. Caspar H. Conrad Jr.	16 August 1933–15 June 1935
Brig. Gen. Harold B. Fiske	13 December 1924–9 June 1927	Col. Paul H. McCook	15 June 1935–14 September 1935
Brig. Gen. Dwight E. Aultman	30 June 1927–31 March 1928	Brig. Gen. Charles F. Humphrey	14 September 1935–25 June 1937
Brig. Gen. Frank C. Bolles	1 April 1928–21 May 1929	Col. Fred H. Turner	25 June 1937–30 August 1937
Brig. Gen. Charles R. Howland	26 May 1929–16 December 1931	Brig. Gen. Ernest D. Peek	30 August 1937–16 October 1939

\*Concurrently commanding the 2d Div. for all or part of the period listed.

**HHC, 5th Infantry Brigade (3d Division)****HQ**—Camp Pike, AR, 1919–21; Camp Lewis, WA, 1921–22; Vancouver Barracks, WA, 1922–39**Subordinate elements**—4th and 7th Inf. Regts., 1919–39

Arrived at the port of Philadelphia on the S.S. *El Sol* on 25 August 1919 after 7 months of occupation duty in Mayen, Germany, as an element of the 3d Div. Transferred with 3d Div. to Camp Pike, AR, and arrived there on 15 September 1919. Transferred to Camp Lewis, WA, and arrived there on 20 September 1921. Transferred 27 September 1922 to Vancouver Barracks. Redesignated HHC, 5th Brig. on 23 March 1925. In April 1933, the brigade assumed command and control of the Vancouver CCC District until mid-1934. Redesignated HHC, 5th Inf. Brig. on 24 August 1936. The brigade and subordinate units continued to support CCC activities in Oregon and Washington until 1939. Typically, brigade units provided training assistance each summer to CMTC and ROTC camps, and to infantry elements of the 96th Div. at Vancouver Barracks. Participated in annual 3d Div. maneuvers at Fort Lewis typically held in May or August. Disbanded on 16 October 1939.

**Status:** Active at Fort Benning, GA, as HHC, 2d Brig., 3d Inf. Div. (Mecz).**Events:** 57, 114, 135, 145, 161, 208, 226, 238, 251, 273**Commanders, 5th Infantry Brigade**

Lt. Col. Jesse Gaston	25 September 1919–4 December 1919	Brig. Gen. Joseph D. Leitch*	19 February 1927–13 October 1927
No commander assigned	5 December 1919–30 May 1921	Col. Henry A. Ripley	13 October 1927–26 January 1928
Col. Otho B. Rosenbaum	1 June 1921–14 July 1921	Brig. Gen. James H. Reeves	26 January 1928–6 September 1929
Col. Thomas J. Powers	14 July 1921–21 September 1921	Brig. Gen. Paul A. Wolf	5 October 1929–3 November 1932
Brig. Gen. George B. Duncan	21 September 1921–15 August 1922	Col. Dwight W. Ryther	3 November 1932–26 January 1933
Col. Charles C. Ballou	15 August 1922–27 September 1922	Brig. Gen. Stanley H. Ford	26 January 1933–28 May 1933
Brig. Gen. Richard M. Blatchford	27 September 1922–1 December 1922	Col. Wallace McNamara	28 May 1933–2 August 1933
Col. Charles C. Ballou	1 December 1922–April 1923	Brig. Gen. James K. Parsons	2 August 1933–24 June 1936
Col. Thomas M. Anderson	April 1923–26 October 1923	Col. Henry Hossfeld	24 June 1936–27 October 1936
Brig. Gen. Joseph E. Kuhn*	26 October 1923–13 July 1925	Brig. Gen. George C. Marshall	27 October 1936–2 July 1938
Brig. Gen. Paul A. Wolf	13 July 1925–27 September 1926	Col. Ralph R. Glass	3 July 1938–25 November 1938
Brig. Gen. Herbert O. Williams	27 September 1926–19 February 1927	Brig. Gen. George Grunert	25 November 1938–16 October 1939

\*Concurrently commanding the 3d Div. for all or part of the period listed.

**HHC, 6th Infantry Brigade (3d Division)****HQ**—Camp Pike, AR, 1919–21; Camp Lewis, WA, 1921–22; Fort Douglas, UT, 1922–27; Fort Rosecrans, CA, 1927–31; Fort Douglas, UT, 1931–39**Subordinate elements**—30th and 38th Inf. Regts., 1919–39

Arrived at the port of New York on the U.S.S. *Nansemond* on 25 August 1919 after 7 months of occupation duty in Mayen, Germany, as an element of the 3d Div. Transferred with 3d Div. to Camp Pike, AR, and arrived there in early September 1919. Transferred to Camp Lewis, WA, and arrived there 21 September 1921. Transferred to Fort Douglas, UT, and arrived there 9 June 1922. Redesignated HHC, 6th Brig. on 23 March 1925. Transferred 27 December 1927 to Fort Rosecrans, CA. Transferred to Fort Douglas and arrived there 8 October 1931. In April 1933, the brigade assumed command and control of the Fort Douglas CCC District until mid-1934. Redesignated HHC, 6th Inf. Brig. on 24 August 1936. The brigade and subordinate units continued to support activities of up to 30 CCC companies in Utah until 1939. Typically, brigade units provided training assistance each summer to elements of the 207th Inf. Brig. at Fort Douglas, 1922–27 and 1932–39. Also provided training assistance to CMTC and ROTC camps and to infantry elements of the 91st Div. at Del Monte, CA, 1922–39. Disbanded 12 October 1939.

**Status:** Active at Fort Benning, GA, as HHC, 3d Brig., 3d Inf. Div. (Mecz).**Events:** 57, 112, 134, 144, 226, 231, 273

### Commanders, 6th Infantry Brigade

Brig. Gen. Ora E. Hunt*	June 1919–December 1919	Col. Fred R. Brown	25 January 1930–1 July 1930
Col. Ephraim G. Peyton	January 1920–24 May 1920	Brig. Gen. Robert McCleave	1 July 1930–30 November 1932
No commander assigned	24 May 1920–October 1920	Col. Charles B. Stone	30 November 1932–13 June 1933
Brig. Gen. Robert C. Davis	9 October 1920–June 1921	Brig. Gen. Pegram Whitworth	13 June 1933–31 August 1935
No commander assigned	June 1921–October 1921	Col. Walter C. Sweeney	31 August 1935–6 September 1935
Brig. Gen. Ulysses McAlexander*	October 1921–21 July 1924	Brig. Gen. Clement A. Trott	6 September 1935–10 January 1936
Col. Walter B. McCaskey	21 July 1924–27 October 1925	Brig. Gen. Walter C. Sweeney*	10 January 1936–1 June 1938
Brig. Gen. Lucius R. Holbrook	27 October 1925–1 August 1926	Col. Irving J. Phillipson	1 June 1938–3 July 1938
Col. Frank C. Bolles	1 August 1926–26 November 1927	Brig. Gen. Donald C. Cubbison	3 July 1938–8 June 1939
Brig. Gen. Ralph H. Van Deman	26 November 1927–26 June 1929	Col. Robert L. Eichelberger	8 June 1939–2 July 1939
Brig. Gen. George C. Shaw	19 July 1929–25 January 1930	Brig. Gen. Walter E. Prosser	2 July 1939–16 October 1939

\*Concurrently commanding the 3d Div. for all or part of the period listed.

### HHC, 7th Infantry Brigade (4th Division)

### Regular Army Inactive

**HQ**—Camp Dodge, IA, 1919–20; Camp Lewis, WA, 1920–21; *Inactive*, 1921–27; Atlanta, GA, 1927–39

**Subordinate elements**—39th Inf. Regt. (RAI), 1919–39; 47th Inf. Regt. (RAI), 1919–33; 29th Inf. Regt., 1933–39

Arrived at the port of New York on the U.S.S. *Mobile* on 16 July 1919 after 7 months of occupation duty in Adenau and Ahrweiler, Germany, as an element of the 4th Div. Transferred to Camp Dodge, IA, and arrived there 2 August 1919. Transferred 2 August 1920 to Camp Lewis, WA. Inactivated 21 September 1921 at Camp Lewis and the 8th Inf. Brig. made the Active Associate (A.A.), 1921–27. Redesignated HHC, 7th Brig. on 23 March 1925. Allotted to the Fourth Corps Area on 28 February 1927. Relieved from assignment to the 4th Div. on 15 August 1927 and assigned to the 7th Div. HHC organized 26 October 1927 with O.R. personnel as an RAI unit at Atlanta, GA. Relieved from assignment to the 7th Div. on 1 October 1933 and assigned to the 4th Div. Redesignated HHC, 7th Inf. Brig. on 24 August 1936. Conducted summer training most years at Fort McPherson, GA. Subordinate regiments conducted training of CMTC at Camp Beauregard, LA. Designated mobilization training station was Fort Benning, GA, 1927–38, and Fort McClellan, AL, 1938–39. Disbanded on 16 October 1939.

**Status:** Active at Fort Hood, TX, as HHC, 2d Brig., 4th Inf. Div. (Mecz).

### Commanders, 7th Infantry Brigade

Brig. Gen. Benjamin A. Poore	4 April 1918–28 February 1920	Capt. William K. Meadow**	7 July 1928–14 November 1928
Col. Carl A. Martin	1 March 1920–21 September 1920	Unknown	15 November 1928–20 July 1932
Brig. Gen. George B. Duncan	21 September 1920–21 September 1921	Capt. Robert L. Wadlington**	21 July 1932–ao September 1937
<i>Inactive</i>	21 September 1921–26 October 1927	1st Lt. Jackson M. Howard**	ao November 1937–27 March 1938
1st Lt. Jackson M. Howard**	26 October 1927–7 July 1928	1st Lt. Graham Kirkpatrick**	27 March 1938–11 June 1939
	2d Lt. Taveau M. Simmons**		11 June 1939–16 October 1939

\*\*RAI commanders: O.R. officers.

### HHC, 8th Infantry Brigade (4th Division)

**HQ**—Camp Dodge, IA, 1919–20; Camp Lewis, WA, 1920–22; Vancouver Barracks, WA, 1922–22; Fort McPherson, GA, 1922–40

**Subordinate elements**—58th and 59th Inf. Regts., 1919–22; 8th and 22d Inf. Regts., 1923–40



Arrived at Camp Merritt, NJ, in August 1919 after 7 months of occupation duty in Adenau and Ahrweiler, Germany, as an element of the 4th Div. Transferred 8 August 1919 to Camp Dodge, IA. Transferred in September 1920 to Camp Lewis, WA. Transferred in September 1921 to Vancouver Barracks. Drawn down to zero personnel strength on 27 July 1922, but remained in an active status. Records and colors transferred to Fort McPherson, GA, and arrived there 15 September 1922. Filled to full strength with personnel from the 22d Inf. Redesignated HHC, 8th Brig. on 23 March 1925. Designated a “reinforced” brigade per Fourth Corps Area General Order (G.O.) #14, 6 April 1923 and all active 4th Div. elements (1st Bn., 2d Field Artillery [F.A.]; A Co., 4th Engineers [Engrs.]; 4th Tank Co.; and 22d

Observation [Obsn.] Squadron [Sq.] attached for command and control purposes. In April 1933, the brigade assumed command and control of CCC District B, Fourth Corps Area until mid-1934. Redesignated HHC, 8th Inf. Brig. on 24 August 1936. The brigade and subordinate units continued to support CCC activities in Georgia and Alabama until 1939. Typically, brigade units provided training assistance each summer to CMTC and ROTC camps, and to infantry elements of the 81st, 82d, and 87th Divs. at Fort Oglethorpe, GA, and/or Camp McClellan, AL, 1922–39. Reserve officers assigned to the brigade HQ or HQ Co. conducted summer training with the brigade at Fort Benning, GA. Conducted annual reinforced brigade maneuvers at Fort Benning with the 6th Cav., 24th and 29th Inf. Regts., as well as with other active elements of the 4th Div. Disbanded 1 July 1940.

**Status:** Active at Fort Carson, CO, as HHC, 3d Brig., 4th Inf. Div. (Mecz).

**Events:** 94, 96, 121, 143, 184, 209, 217, 228, 255, 275, 293, 296

#### Commanders, 8th Infantry Brigade

Brig. Gen. Frank E. Bamford	February 1919–June 1919	Brig. Gen. LeRoy Eltinge	7 August 1925–1 April 1926
Brig. Gen. Francis C. Marshall	June 1919–August 1919	Brig. Gen. Joseph D. Leitch	1 April 1926–25 January 1927
Col. Torrey B. Maghee	30 November 1919–2 January 1920	Col. Reynolds J. Burt	25 January 1927–17 March 1927
Brig. Gen. Edwin B. Babbitt	January 1920–30 September 1920	Brig. Gen. Herbert O. Williams	17 March 1927–24 December 1927
Brig. Gen. Richard M. Blatchford	30 September 1920–27 July 1922	Col. Reynolds J. Burt	24 December 1927–1 March 1928
No commander assigned	27 July 1922–15 September 1922	Brig. Gen. Abraham G. Lott	1 March 1928–3 September 1929
Brig. Gen. Frank L. Winn	15 September 1922–7 December 1922	Brig. Gen. George H. Estes	19 September 1929–25 August 1933
No commander assigned	7 December 1922–5 April 1923	Col. Thomas S. Moorman	25 August 1933–12 January 1934
Brig. Gen. Edwin B. Winans	5 April 1923–6 August 1925	Brig. Gen. Robert O. Van Horn	12 January 1934–1 July 1940

#### HHC, 9th Infantry Brigade (5th Division)

#### Regular Army Inactive

**HQ**—Camp Gordon, GA, 1919–20; Camp Jackson, SC, 1920–21; *Inactive*, 1921–28; Columbus, OH, 1928–40

**Subordinate elements**—60th and 61st Inf. Regts. (RAI), 1919–40

Arrived at the port of Hoboken, NJ, on the U.S.S. *Agamemnon* on 21 July 1919 after 6 months of occupation duty in Luxembourg, as an element of the 5th Div. Transferred 26 July 1919 to Camp Gordon, GA. Transferred in October 1920 to Camp Jackson, SC. Inactivated 2 September 1921 at Camp Jackson and the 10th Inf. Brig. made the A.A., 1921–27. Redesignated HHC, 9th Brig. on 23 March 1925. Allotted to the Fifth Corps Area on 28 February 1927. Relieved from assignment to the 5th Div. on 15 August 1927 and assigned to the 8th Div. HHC organized 10 January 1928 with O.R. personnel as an RAI unit at Columbus, OH. Relieved from assignment to the 8th Div. on 1 October 1933 and assigned to the 5th Div. Redesignated HHC, 9th Inf. Brig. on 24 August 1936. Conducted summer training most years at Fort Thomas, KY. Subordinate regiments conducted training of CMTC at Fort Thomas or Fort Benjamin Harrison, IN. Disbanded 1 July 1940.

**Status:** Inactive as HHC, 1st Brig., 5th Inf. Div. (Mecz).

#### Commanders, 9th Infantry Brigade

Brig. Gen. Joseph C. Castner	May 1918–July 1919	<i>Inactive</i>	2 September 1921–10 January 1928
Brig. Gen. Wilds P. Richardson*	October 1919–March 1920	Capt. Anthony O. Adams**	10 January 1928–ao February 1929
No commander assigned	March 1920–October 1920	1st Lt. Daniel P. King**	ao January 1930–ao July 1930
Brig. Gen. Ulysses G. McAlexander	October 1920–2 September 1921	Unknown	ao July 1930–1 July 1940

\*Concurrently commanding the 5th Div. for all or part of the period listed.

\*\*RAI commanders: O.R. officers.

#### HHC, 10th Infantry Brigade (5th Division)

**HQ**—Camp Gordon, GA, 1919–20; Camp Jackson, SC, 1920–21; Camp Knox, KY, 1921–22; Fort Benjamin Harrison, IN, 1922–39

**Subordinate elements**—6th Inf. Regt., 1919–21; 10th Inf. Regt., 1923–39; 11th Inf. Regt., 1919–39

Arrived at the port of New York on the U.S.S. *America* on 13 July 1919 after 6 months of occupation duty in Luxembourg, as an element of the 5th Div. Transferred to Camp Gordon, GA, and arrived there on 28 July 1919. Transferred

27 October 1920 to Camp Jackson, SC. Ordered to Jefferson Barracks, MO, and departed by marching on 2 September 1921. Orders changed en route to post the brigade at Camp Knox, KY. The brigade arrived there 28 October 1921. Transferred to Fort Benjamin Harrison, IN, and arrived there 24 October 1922. Designated a “reinforced” brigade per Fifth Corps Area G.O. #42, 13 October 1922, and all active 5th Div. elements (1st Bn., 3d F.A.; 5th Tank Co.; and 88th Obsn. Sq.) attached for command and control purposes. Redesignated HHC, 10th Brig. on 23 March 1925. In April 1933, the brigade assumed command and control of up to 12 companies in the Indiana Military Area and Eastern Kentucky CCC Districts until mid-1934. Redesignated HHC, 10th Inf. Brig. on 24 August 1936. The brigade and subordinate units continued to support CCC activities in Indiana and Kentucky until 1939. Typically, brigade units provided training assistance each summer to CMTC and ROTC camps, and to infantry elements of the 83d, 84th, and 100th Divs. at Camp Knox, Fort Benjamin Harrison, and/or Fort Thomas, KY, 1922–39. Reserve officers assigned to the brigade HQ or HQ Co. conducted summer training with the brigade at Fort Benjamin Harrison. Conducted reinforced brigade maneuvers at Camp Knox with the other active elements of the 5th Div. in those years when funds were available. Disbanded 9 October 1939.

**Status:** Inactive as HHC, 2d Brig., 5th Inf. Div. (Mecz).

**Events:** 85, 129, 165, 174, 185, 213, 220, 253, 264, 277

#### Commanders, 10th Infantry Brigade

Brig. Gen. Thomas B. Dugan	27 March 1919–23 June 1919	Col. Hunter B. Nelson	12 August 1921–11 September 1922
Coil. Isaac Newell	23 June 1919–10 August 1919	Brig. Gen. Dwight E. Aultman	11 September 1922–12 July 1927
Col. Robert H. Peck	10 August 1919–21 September 1919	Col. George D. Freeman	12 July 1927–16 December 1927
Unknown	21 September 1919–January 1920	Brig. Gen. George H. Jamerson	16 December 1927–25 October 1933
No commander assigned	January 1920–October 1920	Col. Dana T. Merrill	25 October 1933–10 December 1933
Brig. Gen. Andre W. Brewster	October 1920–12 August 1921	Brig. Gen. William K. Naylor	10 December 1933–30 November 1938
	Brig. Gen. Dana T. Merrill		30 November 1938–9 October 1939

#### HHC, 11th Infantry Brigade (6th Division)

#### Regular Army Inactive

**HQ**—Camp Grant, IL, 1919–21; *Inactive*, 1921–26; Chicago, IL, 1926–39

**Subordinate elements**—51st and 52d Inf. Regts. (RAI), 1919–40

Arrived at the port of New York on 13 June 1919 on the U.S.S. *Leviathan* after 6 months of occupation duty near Aignay-le-Duc, France, and Bad Bertrich, Germany, as an element of the 6th Div. Transferred to Camp Mills, NY. Transferred 17 June 1919 to Camp Grant, IL. Inactivated on 7 September 1921 at Camp Grant and the 12th Inf. Brig. made the A.A., 1921–27. Redesignated HHC, 11th Brig. on 23 March 1925. HHC organized on 9 September 1926 with O.R. personnel as an RAI unit at Chicago, IL. Relieved from assignment to the 6th Div. on 15 August 1927 and assigned to the 9th Div. Relieved from assignment to the 9th Div. on 1 October 1933 and assigned to the 6th Div. Redesignated HHC, 11th Inf. Brig. on 24 August 1936. Conducted summer training most years at Fort Sheridan, IL. Subordinate regiments conducted training of CMTC at Fort Sheridan or Camp Custer, MI. Disbanded 1 July 1940.

**Status:** Inactive as HHC, 1st Brig., 6th Inf. Div. (Light).

**Events:** 162

#### Commanders, 11th Infantry Brigade

Brig. Gen. William R. Dashiell	May 1919–June 1919	Col. Frank B. Watson	3 July 1921–7 September 1921
Col. Ernest V. Smith	June 1919–10 August 1919	<i>Inactive</i>	8 September 1921–8 September 1926
Col. Charles B. Stone	10 August 1919–4 October 1919	Capt. Henry Fulks**	9 September 1926–ao June 1935
Col. Carl Reichman	5 October 1919–1 June 1921	1st Lt. Roy W. Dart**	8 April 1936–June 1937
Brig. Gen. Eli Helmick	1 June 1921–3 July 1921	Maj. John A. Greene**	June 1937–ao July 1937
	Unknown	ao July 1937–1 July 1940	

\*\*RAI commanders: O.R. officers.



**HHC, 12th Infantry Brigade (6th Division)****HQ**—Camp Grant, IL, 1919–21; Fort D.A. Russell, WY, 1921–22; Fort Sheridan, IL, 1922–39**Subordinate elements**—53d and 54th Inf. Regts., 1919–23; 2d and 6th Inf. Regts., 1923–39

Arrived at the port of New York on 10 June 1919 on the U.S.S. *Mount Vernon* after 6 months of occupation duty near Aignay-le-Duc, France, and Bad Bertrich, Germany, as an element of the 6th Div. Transferred to Camp Grant, IL, and arrived there 15 June 1919. Conducted overland march with the 53d Inf. from Camp Grant to Dubuque, IA, then by rail to its new post at Fort D.A. Russell, WY, 22 September–3 October 1921. All personnel transferred out of HHC, 12th Inf. Brig. on 9 September 1922, but the brigade remained in an active status. The brigade records and colors were shipped to Fort Sheridan, IL, and arrived there 18 September 1922. HHC (formed on 11 September 1922 from personnel of the 2d Inf.) concurrently resumed unit functions at Fort Sheridan. Designated a “reinforced” brigade on 30 June 1923 and all active 6th Div. elements (1st Bn., 14th F.A.; 6th Tank Co.; and 15th Obsn. Sq.) attached for command and control purposes. Redesignated HHC, 12th Brig. on 23 March 1925. On 24 August 1936, redesignated HHC, 12th Inf. Brig. Typically, brigade units provided training assistance each summer to CMTC and ROTC camps, and to infantry elements of the 85th, 86th, and 101st Divs. at Camp Custer, MI, 1923–25 and 1933–36; Camp McCoy, WI, 1928–33 and 1937–39; and at Fort Sheridan, 1922–39. Reserve officers assigned to the brigade HQ or HQ Co. conducted summer training with the brigade at Fort Sheridan. Conducted reinforced brigade maneuvers typically in September at Camp Custer with the other active elements of the 6th Div. during those years when funds were available. Disbanded 2 October 1939.

**Status:** Inactive as HHC, 2d Brigade, 6th Inf. Div. (Light).**Events:** 32, 50, 123, 124, 148, 162, 172, 174, 207, 214, 237, 264, 274**Commanders, 12th Infantry Brigade**

Brig. Gen. Lucius L. Durfee	January 1919–June 1919	Col. Perry L. Miles	2 June 1928–5 September 1928
Col. Edmund L. Butts	June 1919–28 September 1919	Brig. Gen. Lytle Brown	5 September 1928–November 1928
Brig. Gen. Lucius L. Durfee	28 September 1919–5 November 1919	Col. Frederick B. Shaw	November 1928–20 January 1929
Col. Edmund L. Butts	5 November 1919–11 October 1920	Brig. Gen. Caspar H. Conrad Jr.	20 January 1929–4 August 1930
Col. William P. Jackson	11 October 1920–21 December 1920	Col. Pegram Whitworth	4 August 1930–1 September 1940
Brig. Gen. William H. Sage	21 December 1920–11 May 1922	Brig. Gen. Manus McCloskey	1 September 1930–23 May 1931
Brig. Gen. Edmund Wittenmyer	29 May 1922–9 September 1922	Col. Frederick L. Knudsen	23 May 1931–20 August 1931
Brig. Gen. George V.H. Moseley	18 September 1922–18 September 1924	Brig. Gen. Frank C. Bolles	20 August 1931–1 March 1935
Col. Cromwell Stacy	19 September 1924–13 November 1924	Brig. Gen. Dana T. Merrill	1 March 1935–2 June 1937
Brig. Gen. Benjamin A. Poore	13 November 1924–10 October 1925	Col. James M. Churchill	2 June 1937–14 August 1937
Brig. Gen. Michael J. Lenihan	7 November 1925–16 March 1928	Brig. Gen. Philip B. Peyton	14 August 1937–12 April 1938
Brig. Gen. Paul B. Malone	17 March 1928–2 June 1928	Brig. Gen. Karl Truesdell	15 April 1938–2 October 1939

**HHC, 13th Infantry Brigade (7th Division)****Regular Army Inactive****HQ**—Camp Funston, KS, 1919–20; Camp George G. Meade, MD, 1920–21; *Inactive*, 1921–27; Minneapolis, MN, 1927–40**Subordinate elements**—55th and 56th Inf. Regts., 1919–22; 53d and 54th Inf. Regts. (RAI), 1922–40

Arrived at the port of New York on the S.S. *Imperator* on 12 June 1919 after 6 months of occupation duty near Puvenelle Sector and the Colombey-les-Belles Training Area, France, as an element of the 7th Div. Transferred to Camp Funston, KS, and arrived there on 28 June 1919. Transferred to Camp George G. Meade, MD, and arrived there on 18 December 1920. Inactivated on 21 September 1921 at Camp George G. Meade and the 14th Inf. Brig. made the A.A., 1921–27. Redesignated HHC, 13th Brig. on 23 March 1925. Allotted to the Seventh Corps Area on 28 February 1927. HHC organized by February 1927 with O.R. personnel as an RAI unit at Minneapolis, MN. Redesignated HHC, 13th Inf. Brig. on 24 August 1936. Conducted summer training most years at Fort Snelling, MN. Subordinate

regiments conducted training of CMTC at Fort Snelling; Fort Leavenworth, KS; or Fort Crook, NE. Designated mobilization training station was Camp Pike, AR. Disbanded 1 July 1940.

**Status:** Inactive as HHC, 2d Brig., 7th Inf. Div. (Light).

#### Commanders, 13th Infantry Brigade

No commander assigned	January 1920–22 October 1920	<i>Inactive</i>	21 August 1921–ao April 1926
Brig. Gen. Harry H. Bandholtz*	22 October 1920–20 August 1921	Capt. Finley Baker	ao February 1927–ao June 1929
	Unknown	ao June 1929–1 July 1940	

\*Concurrently commanding the 7th Div. for part of the period listed.

#### HHC, 14th Infantry Brigade (7th Division)

**HQ**—Camp Funston, KS, 1919–20; Camp George G. Meade, MD, 1920–21; Plattsburg Barracks, NY, 1921–22; Camp Devens, MA, 1922; Fort Omaha, NE, 1922–31; Fort Snelling, MN, 1931–40

**Subordinate elements**—34th Inf. Regt., 1919–23; 64th Inf. Regt., 1919–22; 3d Inf. Regt., 1923–40; 17th Inf. Regt., 1923–40; 6th Inf. Regt., 1939–40

Arrived at the port of New York on the U.S.S. *America* on 18 June 1919 after 6 months of occupation duty near Puvenelle Sector, and the Colombey-les-Belles Training Area, France, as an element of the 7th Div. Transferred to Camp Funston, KS, and arrived there 26 June 1919. Transferred to Camp George G. Meade, MD, and arrived there 16 January 1921. Transferred with the 64th Inf. to its new post at Plattsburg Barracks, NY, and arrived there 27 October 1921. Transferred to Camp Devens, MA, and arrived there 15 June 1922. All personnel transferred out of HHC, 14th Inf. Brig. on 30 June 1922, but the brigade remained in an active status. Concurrently, 34th and 64th Inf. Regts. relieved from assignment to the brigade. The brigade records and colors were shipped to Fort Omaha, NE, and arrived there 28 July 1922. HHC reformed on 22 September 1922 from personnel of the 17th Inf. and the 19th Signal Service Company (Sig. Sv Co.), and unit functions as a brigade HQ resumed at Fort Omaha. Designated a “reinforced” brigade per Sixth Corps Area G.O. #80, 28 December 1922, and all active 7th Div. elements (1st Bn., 9th F.A.; 7th Tank Co.; and 16th Obsn. Sq.) attached for command and control purposes. The 3d and 17th Inf. Regts. were assigned to the brigade on 24 March 1923. Redesignated HHC, 14th Brig. on 23 March 1925. Transferred 27 July 1931 by rail to Fort Snelling, MN. In April 1933, the brigade assumed command and control of the Minnesota–North Dakota CCC District until mid-1934. Redesignated HHC, 14th Inf. Brig. on 24 August 1936. The brigade and subordinate units continued to support CCC activities in Minnesota and North Dakota until 1939. Typically, brigade units provided training assistance each summer to CMTC and ROTC camps, and to infantry elements of the 88th, 89th and 102d Divs. at Fort Crook, NE; Fort Leavenworth, KS; Fort Riley, KS; and/or Fort Snelling, 1922–39. Reserve officers assigned to the brigade HQ or HQ Co. conducted summer training with the brigade at Fort Snelling. Conducted reinforced brigade maneuvers at Camp Ripley, MN, or Camp McCoy, WI, with the other active elements of the 7th Div. during those years when funds were available. Inactivated 1 June 1940 at Fort Snelling and personnel transferred to the 3d Antitank Bn. and 2d Bn., 68th Inf.

**Organization Day:** 20 December. Chosen to commemorate the brigade’s initial organization at Fort Bliss, TX, 20 December 1917.

**Status:** Inactive as HHC, 3d Brig., 7th Inf. Div. (Light).

**Events:** 136, 150, 233, 256, 264, 274, 285

#### Commanders, 14th Infantry Brigade

Brig. Gen. Lutz Wahl	July 1919–November 1919	Brig. Gen. Hamilton S. Hawkins	4 September 1928–11 September 1929
Col. Edson A. Lewis	February 1920–September 1920	Brig. Gen. LeRoy Eltinge	11 September 1929–13 May 1931
No commander assigned	September 1920–15 January 1921	Col. David L. Stone	13 May 1931–1 November 1931
Col. Edson A. Lewis	16 January 1921–17 June 1921	Brig. Gen. John H. Hughes	1 November 1931–5 July 1933
Lt. Col. William L. Reed	17 June 1921–20 September 1921	Brig. Gen. David L. Stone	6 July 1933–3 September 1936
Lt. Col. Ode C. Nichols	20 September 1921–17 June 1922	Col. Charles F. Thompson	3 September 1936–21 January 1937
Brig. Gen. George B. Duncan	15 September 1922–23 November 1922	Col. Clyde R. Abraham	21 January 1937–16 February 1937
Brig. Gen. Halstead Dorey	30 January 1923–12 February 1925	Brig. Gen. Campbell B. Hodges	16 February 1937–27 July 1939
Brig. Gen. Alfred W. Bjornsted	16 February 1925–4 September 1928	Col. George F.N. Dailey	27 July 1939–9 February 1940
	Brig. Gen. Campbell B. Hodges		9 February 1940–June 1940

**HHC, 15th Infantry Brigade (8th Division)****Regular Army Inactive****HQ**—*Inactive*, 1923–26; Fort Howard, MD, 1926; *Inactive*, 1926–32; New York City, NY, 1932–39**Subordinate elements**—12th and 62d Inf. Regts., 1919; 40th and 41st Inf. Regts. (RAI), 1923–40

Stationed at Camp Mills, NY, where it was demobilized on 24 February 1919 as an element of the 8th Div. Reconstituted in the R.A. on 24 March 1923, assigned to the 8th Div., and allotted to the First Corps Area. The 16th Inf. Brig. made the A.A., 1923–27. Redesignated HHC, 15th Brig. on 23 March 1925. HHC organized 13 April 1926 with O.R. personnel as an RAI unit at Fort Howard, MD. Inactivated at Fort Howard on 24 November 1926 by relief of Reserve personnel. Withdrawn from the Third Corps Area on 19 February 1927 and allotted to the Second Corps Area. HHC organized by June 1932 with O.R. personnel as an RAI unit at New York City, NY. Redesignated HHC, 15th Inf. Brig. on 24 August 1936. Inactivated by June 1939 at New York City by relief of Reserve personnel. Designated mobilization training station was Fort Ontario, NY. Disbanded 1 July 1940.

**Status:** Inactive as HHC, 2d Brig., 8th Inf. Div. (Mecz).**Commanders, 15th Infantry Brigade**

1st Lt. Thomas S. Sommers**	13 April 1926–24 November 1926	Unknown	ao June 1932–ao January 1939
<i>Inactive</i>	24 November 1926–ao June 1932	<i>Inactive</i>	ao June 1939–1 July 1940

\*\*RAI commanders: O.R. officers.

**HHC, 16th Infantry Brigade (8th Division)****HQ**—Fort Howard, MD, 1922–28; Fort Hunt, VA, 1928–31; Washington, DC, 1931–36; Fort George G. Meade, MD, 1936–40**Subordinate elements**—8th and 13th Inf. Regts., 1919–23; 12th and 34th Inf. Regts., 1923–40

Stationed at the Pons-Saintes Training area where it was demobilized on 25 November 1918 as an element of the 8th Div. Reconstituted in the R.A. on 15 July 1922 and allotted to the Third Corps Area. Brigade HQ Co. reactivated 26 September 1922, with personnel from the 12th Inf., at Camp George G. Meade, MD. Brigade HQ reactivated on 1 October 1922 at Fort Howard, MD. The 12th and 34th Inf. Regts. were assigned to the brigade on 24 March 1923. Assigned 30 June 1923 to the 8th Div. Concurrently, designated a “reinforced” brigade and all active 8th Div. elements (1st Bn., 16th F.A.; 8th Tank Co.; and 99th Obsn. Sq.) attached for command and control purposes. The entire brigade participated in the funeral ceremonies of President Warren G. Harding, 6–12 August 1923, in Washington, DC. Redesignated HHC, 16th Brig. on 23 March 1925. Relieved from the 8th Div. on 15 August 1927 and assigned to the 4th Div. Assumed responsibility 30 September 1927 of those duties previously assigned to the discontinued District of Washington. Transferred 20 January 1928 to Fort Hunt, VA. The brigade and subordinate elements participated in the inaugural parade of President Herbert Hoover on 4 March 1929. The brigade HHC was reduced to four officers and two enlisted men on 31 August 1931, and transferred to Washington, DC, where the HQ was established in Room #1032 of the Munitions Building. As the HQ responsible for the former District of Washington, the brigade had responsibility for military funerals, parades, and reviews in the District of Columbia. It was also directed by the Commanding General, Third Corps Area to prepare and execute plans for use of troops for emergencies in the Washington, DC, area. As a result, HHC, 16th Inf. Brig. was the controlling HQ for mobile troops involved in the Bonus March Incident 28–29 July 1932. Additionally, managed the detail (at that time, one squad each from the 3d Cav., 13th Engrs., and the 12th Inf.) to perform honor guard duties for the Tomb of the Unknown Soldier at Arlington Cemetery. Relieved from the 4th Div. 1 October 1933, and assigned to the 8th Div. HQ Co. transferred 1 July 1935 to Fort George G. Meade, MD. Redesignated HHC, 16th Inf. Brig. on 24 August 1936. HQ, less commissioned personnel, transferred 2 September 1936 to Fort George G. Meade, MD. Concurrently, commissioned personnel formed the HQ for the Washington Provisional Brigade to assume planning for ceremonial and security responsibilities associated with the District of Columbia, thereby relieving the 16th Inf. Brig. of those duties. Typically, brigade units provided training assistance each summer to CMTC and ROTC camps, and to infantry elements of the 79th, 80th and 99th Divs. at Camp George G. Meade, MD; Fort Washington, MD; and/or Fort Eustis, VA, 1922–39. Conducted reinforced brigade maneuvers at Camp Meade, MD, with the other active elements of the 8th Div. during those years when funds were available. Inactivated 1 June 1940.

**Status:** Inactive as HHC, 3d Brig., 8th Inf. Div. (Mecz).

**Events:** 38, 66, 98, 109, 151, 155, 174, 176, 191, 214, 218, 240, 247, 263, 281

#### Commanders, 16th Infantry Brigade

Brig. Gen. Charles H. Martin	1 July 1922–30 September 1922	Col. James M. Petty	1 February 1932–1 April 1932
Brig. Gen. Harry A. Smith	1 October 1922–6 April 1923	Brig. Gen. Perry L. Miles	1 April 1932–1 April 1936
Col. George Helms	6 April 1923–2 May 1923	Brig. Gen. Charles D. Roberts	1 April 1936–12 September 1936
Brig. Gen. George LeR. Irwin	2 May 1923–11 June 1923	Brig. Gen. Lorenzo D. Gasser	26 October 1936–31 August 1937
Col. George W. Helms	11 June 1923–17 September 1923	Col. Eugene Santschi	31 August 1937–14 September 1937
Col. Henry S. Wagner	17 September 1923–23 November 1923	Brig. Gen. William Bryden	14 September 1937–5 May 1938
Brig. Gen. LaRoy S. Upton	23 November 1923–28 January 1927	Col. Eugene Santschi	5 May 1938–7 June 1938
Col. Thomas W. Darrah	28 January 1927–24 March 1927	Col. Simon B. Buckner	7 June 1938–1 September 1938
Brig. Gen. Thomas Q. Donaldson	24 March 1927–21 December 1927	Brig. Gen. Walter Krueger	1 September 1938–19 March 1939
Brig. Gen. Herbert O. Williams	21 December 1927–6 May 1930	Col. Charles B. Elliot	19 March 1939–26 August 1939
Col. Alfred T. Smith	6 May 1930–7 October 1930	Col. Marcus D. Welty	26 August 1939–6 September 1939
Brig. Gen. Edgar T. Collins	7 October 1930–1 February 1932	Unknown	6 September 1939–1 June 1940

#### HHC, 17th Infantry Brigade (9th Division)

#### Regular Army Inactive

**HQ**—Inactive, 1923–32; Syracuse, NY, 1932–39

**Subordinate elements**—45th and 67th Inf. Regts., 1919; 36th and 37th Inf. Regts. (RAI), 1923–40

Stationed at Camp Sheridan, AL, where it was demobilized on 5 February 1919 as an element of the 9th Div. Reconstituted in the R.A. on 24 March 1923, assigned to the 9th Div., and allotted to the First Corps Area. The 18th Inf. Brig. made the A.A., 1923–27. Redesignated HHC, 17th Brig. on 23 March 1925. Withdrawn from the First Corps Area on 19 February 1927 and allotted to the Second Corps Area. HHC organized by September 1932 with O.R. personnel as an RAI unit at Syracuse, NY. Redesignated HHC, 17th Inf. Brig. on 24 August 1936. Designated mobilization training station was Camp Dix, NJ. Disbanded 1 July 1940.

**Status:** Inactive as HHC, 2d Brig., 9th Inf. Div. (Mtz).

#### Commanders, 17th Infantry Brigade

Capt. Noah J. Hawkins**	ao September 1932–25 August 1938	Unknown	ao January 1939–ao May 1940
1st Lt. Burton N. Everett**	5 October 1938–ao January 1939	1st Lt. Ivan H. Harris**	ao May 1940–1 July 1940

\*\*RAI commanders: O.R. officers.

#### HHC, 18th Infantry Brigade (9th Division)

**HQ**—Camp Devens, MA, 1922; Fort Constitution, NH, 1922–23; Army Base, Boston, MA, 1923–27; Fort Rodman, MA, 1927–31; Army Base, Boston, MA, 1931–39; Fort William E. Davis, CZ, 1939–40

**Subordinate elements**—46th and 68th Inf. Regts., 1919; 5th and 13th Inf. Regts., 1922–40

Stationed at Camp Sheridan, AL, where it was demobilized on 5 February 1919 as an element of the 9th Div. Reconstituted in the R.A. on 30 June 1922. Reactivated 7 July 1922 at Camp Devens, MA. Transferred 30 September 1922 to Fort Constitution, NH. Transferred 9 October 1923 to Army Base, Boston, MA. Designated a “reinforced” brigade per G.O. 11, First Corps Area, 30 June 1923, and all active 9th Div. elements (9th Tank Co. and 1st Obsn. Sq.) attached for command and control purposes. Redesignated HHC, 18th Brig. on 23 March 1925. Transferred 10 August 1927 to Fort Rodman, MA. Transferred 15 February 1931 back to Army Base, Boston, MA. Designated by the War Department in 1934 as the force to reinforce the Panama Canal Zone in lieu of the inactivated 20th Inf. Brig. Redesignated HHC, 18th Inf. Brig. on 24 August 1936. HQ Co. transferred to Fort Devens, MA, on 3 December 1937. Typically, brigade units provided training assistance each summer to CMTC and ROTC camps, and to infantry elements of the 76th, 94th and 97th Divs. at Camp Devens, MA, 1922–39. Conducted reinforced brigade maneuvers at Camp Devens, MA, with the other active elements of the 9th Div. during those years when funds were available. The entire brigade departed Army Base Boston on 21 October 1939 on the U.S.A.T. *Hunter Liggett*. Arrived at Fort

Davis, CZ, on 27 October 1939 to reinforce the Panama Canal Department. Concurrently attached to the Atlantic Sector for command and control. Relieved from attachment to the Atlantic Sector on 16 February 1940 and assigned to the Panama Mobile Force. Disbanded 1 July 1940.

**Status:** Inactive as HHC, 3d Brig., 9th Inf. Div. (Mtz).

**Events:** 59, 62, 64, 78, 95, 132, 174, 192, 214, 234, 239, 262, 280

#### Commanders, 18th Infantry Brigade

Col. Farrand Sayre	30 June 1922–2 May 1923	Brig. Gen. Alfred T. Smith	3 February 1935–12 May 1935
Brig. Gen. Malvern H. Barnum	2 May 1923–6 July 1927	Brig. Gen. Frank W. Rowell	12 May 1935–6 March 1936
Col. Howard L. Laubach	6 July 1927–17 September 1927	Brig. Gen. Clement A. Trott	6 March 1936–15 May 1937
Col. William K. Naylor	17 September 1927–December 1927	Col. Wilson B. Burt	15 May 1937–16 June 1937
Brig. Gen. Halstead Dorey	December 1927–16 October 1928	Brig. Gen. Louis M. Nuttman	16 June 1937–19 January 1938
Brig. Gen. Meriwether L. Walker	16 October 1928–30 September 1933	Col. Matthew K. Thomlinson	19 January 1938–31 March 1938
Brig. Gen. Alexander T. Ovenshine	1 November 1933–2 April 1934	Brig. Gen. Joseph M. Cummins	31 March 1938–24 October 1939
Brig. Gen. Harry E. Knight	5 May 1934–1 February 1935	Brig. Gen. Richard C. Moore	24 October 1939–31 December 1939
	Brig. Gen. Joseph M. Cummins*		1 January 1940–1 July 1940

\*Concurrently commanding HQ, Atlantic Sector December 1939–February 1940.

#### HHC, 19th Infantry Brigade (Panama Canal Division)

**HQ**—Post at Gatun, CZ, 1921–28; Fort Davis, CZ, 1928–32; *Inactive*, 1932–41

**Subordinate elements**—14th and 33d Inf. Regts., 1921–32

Organized in the R.A. on 21 October 1920 as a provisional brigade at Gatun, CZ. Redesignated HHC, 19th Inf. Brig. on 19 March 1921 at Gatun and assigned to the Panama Canal Div. The 19th Inf. Brig. had the responsibility for the defense of the Atlantic side of the Panama Canal Zone. In March 1924, the brigade was temporarily detached from the Panama Canal Division and attached to operate directly under the control of the Panama Canal Department for maneuvers. Redesignated HHC, 19th Brig. on 23 March 1925. Inactivated 15 April 1932. Demobilized 27 November 1934. Reconstituted as an inactive unit and allotted to the Panama Canal Department on 21 January 1936. Redesignated HHC, 19th Inf. Brig. on 24 August 1936. Consolidated 21 September 1936 with the reconstituted 19th Inf. Brig., 10th Div. (a World War I unit organized 19 August 1918 at Camp Funston, KS; demobilized 13 February 1919 at Camp Funston). Withdrawn from the Panama Canal Department by 1939 and allotted to the First Corps Area. Designated mobilization training station was Fort Devens, MA. Location 7 December 1941—*Inactive*.

**Status:** Disbanded 11 November 1944.

**Events:** 26, 31, 36, 40, 43, 53, 58, 69, 81, 101, 119, 140

#### Commanders, 19th Infantry Brigade

Brig. Gen. Edwin B. Babbitt	21 October 1920–17 April 1923	Brig. Gen. Charles D. Rhodes	20 September 1927–5 September 1928
Col. William A. Johnson	17 April 1923–14 September 1923	Col. Joseph F. Gohn	5 September 1928–20 December 1928
Brig. Gen. John McA. Palmer	14 September 1923–14 May 1925	Brig. Gen. Lytle Brown	20 December 1928–7 September 1929
Brig. Gen. George S. Simonds	14 May 1925–5 October 1925	Col. Joseph F. Gohn	7 September 1929–17 December 1929
Col. Charles R. Howland	5 October 1925–6 March 1926	Brig. Gen. Charles D. Roberts	17 December 1929–25 November 1931
Brig. Gen. George S. Simonds	6 March 1926–19 September 1927	Col. James V. Heidt	25 November 1931–21 January 1932
	Brig. Gen. Thomas W. Darrah		21 January 1932–15 March 1932

#### HHC, 20th Infantry Brigade (Panama Canal Division)

**HQ**—Camp Gaillard, CZ, 1921–27; *Inactive*, 1927–41

**Subordinate elements**—32d Inf. Regt., 1922–27; 42d Inf. Regt., 1921–27; 65th Inf. Regt. (designated as a contingency reinforcement regiment, 1927–31)

Constituted in the R.A. on 17 October 1921, assigned to the Panama Canal Division, and allotted to the Panama Canal Department. Organized 24 November 1921 at Camp Gaillard, CZ. Temporarily inactivated on 21 August

1922. Reactivated 21 November 1922. Redesignated HHC, 20th Brig. on 23 March 1925. The 20th Brig. had the responsibility for the defense of the Pacific side of the Panama Canal Zone and the Culebra Cut. Inactivated 1 September 1927. Demobilized 27 November 1934. Reconstituted 21 January 1936 as an inactive unit and allotted to the Panama Canal Department. Redesignated HHC, 20th Inf. Brig. on 24 August 1936. Consolidated on 17 October 1936 with the reconstituted 20th Inf. Brig., 10th Div. (a World War I unit organized 19 August 1918 at Camp Funston, KS; demobilized 13 February 1919 at Camp Funston). Location 7 December 1941—*Inactive*.

**Status:** Disbanded 11 November 1944.

**Events:** 26, 31, 36, 40, 43, 53, 58

#### Commanders, 20th Infantry Brigade

Col. Farrand Sayre	14 November 1921–December 1921	Brig. Gen. George S. Simonds	26 January 1925–14 May 1925
Brig. Gen. Fox Conner	December 1921–15 August 1922	Col. Frederick G. Knabenshue	14 May 1925–5 October 1925
<i>Inactive</i>	21 August 1922–21 November 1922	Brig. Gen. George S. Simonds	5 October 1925–19 January 1926
Brig. Gen. Fox Conner	21 November 1922–2 September 1924	Col. John W. Heavey	19 January 1926–18 February 1926
Col. Frederick G. Knabenshue	2 September 1924–26 January 1925	Brig. Gen. Charles D. Rhodes	18 February 1926–1 September 1927

#### HHC, 21st Infantry Brigade (Hawaiian Division)

**HQ**—Schofield Barracks, TH, 1921–41

**Subordinate elements**—44th Inf. Regt., 1920–21; 35th Inf. Regt., 1921–22; 21st Inf. Regt., 1921–41; 19th Inf. Regt., 1922–41

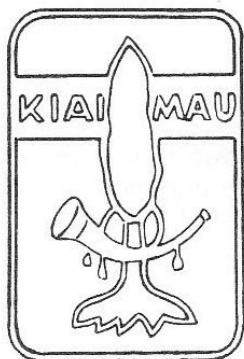

Organized in the R.A. on 28 September 1920 as a provisional brigade at Schofield Barracks, TH. Redesignated HHC, 21st Inf. Brig. on 1 March 1921 and assigned to the Hawaiian Div. The 44th Inf. was relieved from the brigade on 28 November 1921 and concurrently replaced by the 21st Inf. Regt. The 35th Inf. was relieved 14 October 1922 and assigned to the 22d Inf. Brig. The 19th Inf. was assigned to the brigade on 17 October 1922. Redesignated HHC, 21st Brig. on 23 March 1925. Redesignated HHC, 21st Inf. Brig. on 24 August 1936. Consolidated 25 September 1936 with the reconstituted 21st Inf. Brig., 11th Div. (a World War I unit organized in August 1918 at Camp George G. Meade, MD; demobilized in February 1919 at Camp Meade). The units of the 21st Brig. had the responsibility for the defense of the northern half of Oahu Island. Established annual brigade training encampment at Camp Kawaihapai, TH, typically in July and August. Disbanded 1 October 1941.

**Events:** 33, 37, 75, 88, 120, 138, 141, 158, 189, 211, 225, 248, 276, 297, 312

#### Commanders, 21st Infantry Brigade

Brig. Gen. Henry C. Hodges	28 September 1920–5 January 1921	Brig. Gen. John F. Madden	25 July 1931–28 September 1933
Col. Edwin A. Root	5 January 1921–19 March 1921	Col. Adolphe Huguet	28 September 1933–17 February 1934
Col. William K. Jones	19 March 1921–30 October 1921	Brig. Gen. James B. Gowen	17 February 1934–15 November 1934
Col. John J. Toffey Jr.	1 November 1921–21 November 1921	Col. H. Clay M. Supplee	15 November 1934–5 February 1935
Col. Howard R. Perry	21 November 1921–15 July 1922	Brig. Gen. James B. Gowen	5 February 1935–5 December 1935
Brig. Gen. Joseph E. Kuhn	15 July 1922–8 September 1923	Col. William J. O'Laughlin	5 December 1935–24 January 1936
Col. Howard R. Perry	8 September 1923–29 October 1923	Brig. Gen. James B. Gowen	24 January 1936–23 August 1936
Brig. Gen. Thomas H. Slavens	29 October 1923–25 January 1924	Col. Robert M. Lyon	23 August 1936–12 September 1936
Col. Howard R. Perry	25 January 1924–13 June 1924	Brig. Gen. Duncan K. Major Jr.	12 September 1936–6 October 1938
Brig. Gen. Thomas H. Slavens	13 June 1924–1 September 1926	Col. Martyn H. Shute	7 October 1938–16 December 1938
Col. Thomas O. Murphy	1 September 1926–6 October 1926	Brig. Gen. Philip B. Peyton	16 December 1938–15 November 1939
Brig. Gen. Paul A. Wolfe	6 October 1926–7 June 1929	Col. Martyn H. Shute	16 November 1939–11 May 1940
Col. George D. Arrowsmith	7 June 1929–19 September 1929	Unknown	11 May 1940–15 October 1940
Brig. Gen. James H. Reeves	19 September 1929–25 July 1931	Brig. Gen. Durward S. Wilson	15 October 1940–30 September 1941

### HHC, 22d Infantry Brigade (Hawaiian Division)

HQ—Schofield Barracks, TH, 1921–41

**Subordinate elements**—27th Inf. Regt., 1921–41; 35th Inf. Regt., 1922–41



Constituted in the R.A. on 22 October 1921, assigned to the Hawaiian Division, and allotted to the Hawaiian Department. Organized 16 November 1921 at Schofield Barracks, TH, with the assignment of the 27th Inf. The 35th Inf. was subsequently assigned on 14 October 1922. Redesignated HHC, 22d Brig. on 23 March 1925. Redesignated HHC, 22d Inf. Brig. on 24 August 1936. Consolidated 25 September 1936 with the reconstituted 22d Inf. Brig., 11th Div. (a World War I unit organized in September 1918 at Camp George G. Meade, MD; demobilized in February 1919 at Camp Meade). The units of

the 21st Brig. had the responsibility for the defense of the southern half of Oahu Island. Established annual training encampment at Waimanalo and Fort Ruger, TH, typically in July and August. Disbanded 1 October 1941.

**Events:** 33, 37, 75, 88, 120, 138, 141, 158, 189, 211, 225, 248, 276, 297, 312

#### Commanders, 22d Infantry Brigade

Col. William K. Jones	16 November 1921–5 January 1922	Col. Ira C. Welborn	12 June 1930–24 October 1930
Lt. Col. Shelby C. Leasure	5 January 1922–15 July 1922	Brig. Gen. William E. Cole	24 October 1930–6 January 1931
Col. Howard R. Perry	15 July 1922–15 January 1923	Col. Ira C. Welborn	6 January 1931–11 February 1931
Brig. Gen. Richmond P. Davis	15 January 1923–13 August 1924	Brig. Gen. Otho B. Rosenbaum	11 February 1931–30 September 1933
Col. Howard L. Laubach	13 August 1924–14 October 1924	Col. Frank B. Watson	1 October 1933–17 February 1934
Brig. Gen. Stuart Heintzelman	14 October 1924–22 June 1927	Brig. Gen. Louis M. Nuttman	17 February 1934–26 February 1937
Col. Laurence Halstead	22 June 1927–7 October 1927	Col. Earle M. Wilson	26 February 1937–19 June 1937
Brig. Gen. George C. Barnhardt	7 October 1927–12 June 1930	Brig. Gen. Clement A. Trott	19 June 1937–6 July 1939
	Brig. Gen. Daniel I. Sultan		6 July 1939–February 1941

### HHC, 23d Infantry Brigade (PS) (Philippine Division)

HQ—Fort William McKinley, PI, 1921–41

**Subordinate elements**—45th and 57th Inf. Regts. (PS), 1921–41

Constituted in the R.A. on 15 October 1921, assigned to the Philippine Division, and allotted to the Philippine Department. Organized 5 January 1922 at Fort William McKinley, PI. Redesignated HHC, 23d Brig. on 23 March 1925. Redesignated HHC, 23d Inf. Brig. on 24 August 1936. The units of the 23d Brig. had the wartime responsibility for the defense of the Lingayan area of Luzon Island. HHC inactivated 19 April 1941. Location 7 December 1941—*Inactive*.

**Organization Day:** 15 October. Chosen to commemorate the date of the brigade's constitution. Adopted 24 May 1926.

**Status:** Disbanded 11 November 1944.

**Events:** 27, 35, 41, 52, 68, 82, 100, 118, 139, 157, 169, 179, 198, 224, 245, 270

#### Commanders, 23d Infantry Brigade

Col. Charles H. Barth	5 January 1922–12 October 1922	Brig. Gen. James K. Parsons	23 June 1931–1 June 1933
Col. Henry E. Eames	12 October 1922–29 June 1923	Col. Ralph McCoy	1 June 1933–29 June 1933
Brig. Gen. Douglas MacArthur	29 June 1923–17 January 1925	Brig. Gen. Stanley H. Ford	29 June 1933–27 May 1935
Brig. Gen. Henry Eames	17 January 1925–31 January 1925	Col. Ralph Leavitt	27 May 1935–28 June 1935
Col. George L. Byroade	1 February 1925–20 April 1925	Brig. Gen. John L. DeWitt	28 June 1935–27 April 1936
Brig. Gen. Thomas Q. Donaldson	20 April 1925–16 February 1927	Col. Charles W. Martin	27 April 1936–2 May 1936
Col. Earle W. Tanner	16 February 1927–25 April 1927	Brig. Gen. Evan H. Humphrey	2 May 1936–21 January 1937
Brig. Gen. Henry G. Learnard	25 April 1927–10 April 1929	Col. Reginald H. Kelley	21 January 1937–24 January 1937
Col. Harry A. Eaton	10 April 1929–15 June 1929	Brig. Gen. George Grunert	24 January 1937–6 October 1938
Brig. Gen. Edgar T. Collins	15 June 1929–2 October 1930	Col. Melvin C. Faris	6 October 1938–24 October 1938
Brig. Gen. Caspar H. Conrad Jr.	2 October 1930–23 June 1931	Brig. Gen. Henry C. Pratt	24 October 1938–31 May 1942

### HHC, 24th Infantry Brigade (Philippine Division)

HQ—Fort Santiago, Manila, PI, 1922–30; *Inactive*, 1930–41

**Subordinate elements**—15th Inf. Regt., 1922–23; *43d Inf. Regt. (PS)*, 1922 and 1931–41; 1st Bn., 15th Inf., 1922–31; 31st Inf. Regt., 1922–31; *44th Inf. Regt. (PS)*, 1931–41

Organized in the R.A. on 26 August 1922 at Fort Santiago, Manila, PI, and assigned to the Philippine Division. Redesignated HHC, 24th Brig. on 23 March 1925. The units of the 24th Brig. had the wartime responsibility for the defense of the Lingayan area of Luzon Island. Brigade commanders exercised actual command of the brigade only for short periods during the annual department maneuvers. Though usually lacking a full-time commander (many of the assigned commanders listed below were concurrently the regimental commanders of the 31st Inf.), the HQ Co. and brigade staff remained in an active status at Fort Santiago. However, the brigade's staff officers were assigned additional duties within the Philippine Division or Philippine Department during periods when the brigade HQ was not functioning as such. Due to the lack of a general officer being assigned on a full-time basis, the HQ Co. actually functioned as the HQ Co. for the HQ, Philippine Department in Manila. With the relief of the 1st Bn., 15th Inf. and the 31st Inf. from the Philippine Division on 26 June 1929, the brigade was redesignated a "Philippine Scout" organization and the 43d and 44th Inf. Regts. (Philippine Scout) were assigned. Since there were no active elements in the brigade, the brigade HHC were both inactivated on 1 October 1930. Redesignated HHC, 24th Inf. Brig. on 24 August 1936. Location 7 December 1941—*Inactive*.

**Status:** Disbanded 11 November 1944.

**Events:** 27, 35, 41

#### Commanders, 24th Infantry Brigade

No commander assigned	26 August 1922–31 July 1924	Brig. Gen. Charles J. Symmonds	18 January 1926–22 February 1926
Col. Harry G. Bishop	1 August 1924–4 December 1924	Col. Daniel G. Berry	22 February 1926–15 February 1928
Col. Willis Uline	4 December 1924–21 December 1925	Col. James M. Kimbrough	15 February 1928–11 March 1930
Lt. Col. H. Clay M. Supplee	21 December 1925–17 January 1926	Col. Earle W. Tanner	11 March 1930–1 October 1930

### HHC, 51st Infantry Brigade (26th Division)

### Massachusetts National Guard

HQ—Boston, MA, 1921–26; Quincy, MA, 1926–41; Camp Edwards, MA, 1941

**Subordinate elements**—101st Inf. Regt., 1921–41; 104th Inf. Regt., 1921–23; 182d Inf. Regt., 1923–41



Arrived at the port of Boston 6 April 1919 on the U.S.S. *America* as the 51st Inf. Brig., an element of the 26th Div. Demobilized 29 April 1919 at Camp Devens, MA. Reconstituted in the N.G. in 1921, assigned to the 26th Div., and allotted to Massachusetts. HHC organized on 30 June 1921 and federally recognized at Boston, MA, as HHC, 1st Inf. Brig., Massachusetts N.G. Redesignated HHC, 51st Inf. Brig., on 30 September 1921. HQ relocated 1 June 1926 to Quincy, MA. HQ Co. called up to perform flood relief duties in the Merrimac Valley in western Massachusetts 21–28 March 1938. Brigade HHC called up to perform hurricane relief duties at Quincy and Buzzard's Bay, MA, in September 1938. Conducted annual summer training most years at Camp Devens, MA, and some years at the Massachusetts Military Reservation at Falmouth, MA. Inducted

into active Federal service at Quincy, MA, on 16 January 1941 and moved with the 26th Div. to Camp Edwards, MA, where it arrived 21 January 1941. Location 7 December 1941—Camp Edwards, MA.

**Events:** 90, 280, 301, 330

#### Commanders, 51st Infantry Brigade

Brig. Gen. Edward L. Logan	30 June 1921–22 March 1923	Brig. Gen. Albert C. Gray	18 May 1928–14 December 1931
Brig. Gen. Alfred F. Foote	22 March 1923–3 May 1928	Brig. Gen. Arthur W. Desmond	24 December 1931–23 December 1936
	Brig. Gen. William I. Rose		24 December 1936–12 February 1942



**HHC, 52d Infantry Brigade (26th Division)****Massachusetts National Guard****HQ**—*Not organized*, 1921–23; Worcester, MA, 1923–41; Camp Edwards, MA, 1941**Subordinate elements**—104th Inf. Regt., 1923–41; 181st Inf. Regt., 1921–41; 182d Inf. Regt., 1921–23

Arrived at the port of Boston 6 April 1919 on the U.S.S. *America* as the 52d Inf. Brig., an element of the 26th Div. Demobilized 29 April 1919 at Camp Devens, MA. Reconstituted in the N.G. in 1921, assigned to the 26th Div., and allotted to Massachusetts. HQ organized on 18 April 1923 and federally recognized at Worcester, MA. HQ Co. organized 11 May 1923 and federally recognized at Worcester. Brigade HHC called up to perform hurricane relief duties at Quincy and Buzzard's Bay, MA, in September 1938. Conducted annual summer training most years at Camp Devens, MA, and some years at the Massachusetts Military Reservation at Falmouth, MA. Inducted into active Federal service at Worcester, MA, on 16 January 1941 and moved with the 26th Div. to Camp Edwards, MA, where it arrived 21 January 1941. Location 7 December 1941—Camp Edwards, MA.

**Status:** HQ disbanded 3 February 1942; HQ Co. redesignated 26th Cav. Rcn. Tp.**Events:** 90, 280, 301, 330**Commanders, 52d Infantry Brigade**

Brig. Gen. Thomas F. Foley	18 April 1923–22 March 1928	Brig. Gen. Edmund J. Slate	8 June 1933–20 October 1937
Brig. Gen. John D. Murphy	28 May 1928–27 May 1933	Brig. Gen. Edgar C. Erickson	25 October 1937–12 January 1939
	Brig. Gen. Francis V. Logan		13 February 1939–12 February 1942

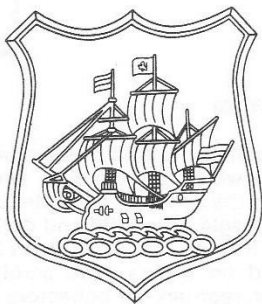
**HHC, 53d Infantry Brigade (27th Division)****New York National Guard****HQ**—Albany, NY, 1921–40; Fort McClellan, AL, 1940–41**Subordinate elements**—105th Inf. Regt., 1921–41; 106th Inf. Regt. (I), 1921–40; 10th New York Inf. Regt., 1940; 106th Inf. Regt. (II), 1940–41

Arrived at the port of New York 6 March 1919 on the U.S.S. *Leviathan* as the 54th Inf. Brig., an element of the 27th Div. Demobilized 1 April 1919 at Camp Upton, NY. Reconstituted in the N.G. on 30 December 1920 as the 53d Inf. Brig. assigned to the 27th Div., and allotted to New York. HQ Co. organized 21 August 1921 and federally recognized at Albany, NY. HQ organized 22 December 1921 and federally recognized at Albany. Conducted annual summer training most years at Camp Smith, Peekskill, NY, 1922–39. Inducted into active Federal service at Albany, NY, 15 October 1940. Moved with the 27th Div. to Fort McClellan, AL, where it arrived 25 October 1940. Location 7 December 1941—Fort McClellan, AL.

**Status:** Active in the New York N.G. as HHD, 53d Troop Command at Valhalla, NY.**Events:** 91, 190, 280, 301, 316, 324, 328**Commanders, 53d Infantry Brigade**

Brig. Gen. James W. Lester	1 June 1921–22 December 1921	Brig. Gen. Walter A. Delamater	7 July 1935–1 January 1936
Brig. Gen. Franklin W. Ward	22 December 1921–15 February 1926	Brig. Gen. Bernard W. Kearney	1 January 1936–12 September 1940
Brig. Gen. Ransom H. Gillett	6 July 1926–7 July 1935	Brig. Gen. Ogden J. Ross	12 September 1940–1 September 1942

**HHC, 54th Infantry Brigade (27th Division)****New York National Guard****HQ**—Buffalo, NY, 1921–40; Fort McClellan, AL, 1940–41**Subordinate elements**—107th Inf. Regt., 1921–40; 108th Inf. Regts., 1921–41; 165th Inf. Regt., 1940–41

Demobilized in 1919 as the 2d Provisional Depot Brigade. Reconstituted in the N.G. on 30 December 1920 as the 54th Inf. Brig., assigned to the 27th Div., and allotted to New York. HHC organized 5 July 1921 and federally recognized at Buffalo, NY. Conducted additional week-long winter training directed by the War Department at Chestnut Ridge Park near Buffalo in December 1939. Conducted annual summer training most years at Camp Smith, Peekskill, NY, 1922–39. Inducted into active Federal service at Buffalo, NY, 15 October 1940 and moved with the 27th Div. to Fort McClellan, AL, where it arrived 25 October 1940. Location 7 December 1941—Fort McClellan, AL.

**Events:** 91, 190, 301, 316, 324, 328**Commanders, 54th Infantry Brigade**

Brig. Gen. Edgar S. Jennings	5 July 1921–December 1930	Brig. Gen. Ralph K. Robertson	10 June 1937–17 July 1940
Brig. Gen. John S. Thompson	18 December 1930–3 June 1937	Brig. Gen. Alexander Anderson	17 July 1940–1 September 1942

**HHC, 55th Infantry Brigade (28th Division)****Pennsylvania National Guard****HQ**—Greensburg, PA, 1921–23; Washington, PA, 1923–41; Indiantown Gap, PA, 1941**Subordinate elements**—109th and 110th Inf. Regts., 1921–41

Arrived at the port of New York 3 May 1919 on the U.S.S. *Maui* as the 55th Inf. Brig., an element of the 28th Div. Demobilized 18 May at Camp Dix, NJ. Reconstituted in the N.G. in 1921, assigned to the 28th Div., and allotted to Pennsylvania. HQ Co. organized on 29 March 1921 by redesignation of D Company, 8th Inf., Pennsylvania N.G. at Harrisburg, PA. HQ organized on 20 December 1921 and federally recognized at Greensburg, PA. HQ relocated about January 1923 to Washington, PA. Called up to provide command and control for units performing relief duties in connection with the flooding of the Schuylkill and Susquehanna Rivers in April 1936. Conducted annual summer training at Mount Gretna, PA, 1922–33 and at Indiantown Gap, PA, 1934–38. Inducted into active Federal service at Washington, PA, 17 February 1941, and moved with the 28th Div. to Indiantown Gap Military Reservation where it arrived 21 February

1941. Location 7 December 1941—Indiantown Gap Military Reservation.

**Status:** Consolidated with HHC, 28th Inf. Div. on 1 June 1959 and consolidated unit active in the Pennsylvania N.G. at Harrisburg, PA, as HHC, 28th Inf. Div.**Events:** 109, 191, 203, 281, 301, 330**Commanders, 55th Infantry Brigade**

Brig. Gen. Richard Coulter	20 December 1921–3 May 1922	Brig. Gen. John Aiken	30 November 1939–24 September 1941
Brig. Gen. Edward Martin	15 December 1922–25 June 1939	Col. Albert O. King	24 September 1941–November 1941
Col. William R. Dunlap	25 June 1939–30 November 1939	Brig. Gen. William H. Gill (RA)	November 1941–17 February 1942

**HHC, 56th Infantry Brigade (28th Division)****Pennsylvania National Guard****HQ**—Columbia, PA, 1921–26; Philadelphia, PA, 1926–37; Columbia, PA, 1937–41; Indiantown Gap, PA, 1941**Subordinate elements**—111th and 112th Inf. Regts., 1921–41

Arrived at the port of Newport News 29 April 1919 on the U.S.S. *Aeolus* as the 56th Inf. Brig., an element of the 28th Div. Demobilized 3 May at Camp Dix, NJ. Reconstituted in the N.G. in 1921, assigned to the 28th Div., and allotted to Pennsylvania. HQ Co. organized 29 March 1921 by redesignation of C Company, 2d Sep. Inf. Bn., Pennsylvania N.G., at Columbia, PA. HQ organized 3 August 1921 and federally recognized at Columbia. HQ successively relocated as follows: to Philadelphia, PA, 12 March 1926; and Columbia 15 September 1937. Called up to provide command and control for units performing relief duties in connection with the flooding of the Schuylkill and Susquehanna Rivers in April 1936. Conducted annual summer training at Mount Gretna, PA, 1922–34 and at Indiantown Gap, PA, 1936–38. Inducted into active

Federal service at Columbia 17 February 1941 and moved with the 28th Div. to Indiantown Gap Military Reservation where it arrived 21 February 1941. Location 7 December 1941—Indiantown Gap Military Reservation.

**Status:** HQ disbanded 7 February 1942; HQ Co. redesignated HQ Co., 28th Inf. Div.**Events:** 109, 191, 203, 281, 301, 330**Commanders, 56th Infantry Brigade**

Brig. Gen. Edward C. Shannon	3 August 1921–15 February 1926	Brig. Gen. Charles B. Smathers	27 April 1937–20 September 1940
Brig. Gen. Robert M. Brookfield	15 February 1926–14 March 1937	Col. Frank A. Warner	20 September 1940–20 November 1940
Brig. Gen. Edward J. Stackpole			20 November 1940–5 February 1942

**HHC, 57th Infantry Brigade (44th Division)****New Jersey National Guard****HQ**—Newark, NJ, 1920–21; Camden, NJ, 1921–38; Trenton, NJ, 1938–40; Elizabeth, NJ, 1940; Fort Dix, NJ, 1940–41**Subordinate elements**—113th and 114th Inf. Regts., 1921–41

Arrived at the port of New York 13 May 1919 on the S.S. *Calamares* as the 57th Inf. Brig., an element of the 29th Div. Demobilized 16 May 1919 at Camp Dix, NJ. Reconstituted in the N.G. in 1921, relieved from the 29th Div., and assigned to the 44th Div. Allotted to New Jersey, and organized 17 June 1921 at Newark, NJ, by redesignation of HQ, 1st Brig., New Jersey N.G. (organized 21 December 1920 and federally recognized at Newark as HQ, 1st Brig. of Inf.). HQ successively relocated as follows: Camden, NJ, in October 1921; Trenton, NJ, 1 August 1938; and Elizabeth, NJ, 1 March 1940. HQ Co. organized 5 July 1921 and federally recognized at Newark, NJ; demobilized 27 November 1925. HQ Co. reorganized in February 1926 and federally recognized at Newark; relocated 9 March 1926 to Camden, NJ. Conducted annual summer training most years at Sea Girt, NJ, 1921–38. For at least 1 year, in 1931,

the brigade's subordinate regiments also trained some company-grade infantry officers of the 78th Div. at Sea Girt. Inducted into active Federal service at Trenton, NJ, 16 September 1940, and moved with the 44th Div. to Fort Dix, NJ, where it arrived 23 September 1940. Location 7 December 1941—Fort Dix, NJ.

**Status:** HQ disbanded on 20 February 1942; HQ Co. consolidated with HHB, 44th Div. Artillery on 1 August 1946 and consolidated unit active in the New Jersey N.G. at Fort Dix, NJ, as HHC, 50th Brig., 42d Inf. Div.**Events:** 91, 190, 280, 301, 330**Commanders, 57th Infantry Brigade**

Brig. Gen. Howard S. Borden	21 December 1920–4 February 1922	Col. Arthur W. Copp	8 September 1940–9 December 1940
No commander assigned	5 February 1922–December 1922	Col. Charles E. McCarthy (R.A.)	9 December 1940–13 July 1941
Brig. Gen. Quincy A. Gillmore	December 1922–26 March 1924	Col. Julius O. Adler (O.R.)	13 July 1941–23 July 1941
Brig. Gen. Winfield S. Price	7 April 1924–23 June 1936	Col. H. Norman Schwarzkopf	23 July 1941–25 July 1941
Brig. Gen. Clifford R. Powell	15 February 1937–28 June 1939	Brig. Gen. Ralph K. Robertson (NY)	25 July 1941–22 September 1941
Col. John F. Lee Jr.	28 June 1939–21 December 1939	Col. H. Norman Schwarzkopf	22 September 1941–October 1941
Brig. Gen. Edward J. Maloney	21 December 1939–8 September 1940	Brig. Gen. Franklin C. Siebert (R.A.)	October 1941–17 December 1941

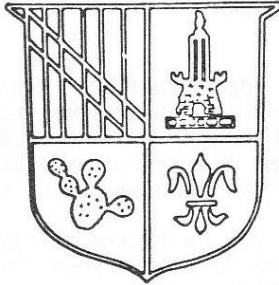
**HHC, 58th Infantry Brigade (29th Division)****Maryland National Guard****HQ**—*Not organized*, 1921–24; Baltimore, MD, 1924–41; Fort George G. Meade, MD, 1941**Subordinate elements**—1st Maryland Inf. Regt., 1921–41; 5th Maryland Inf. Regt., 1921–41; 115th Inf. Regt., 1941; 175th Inf. Regt., 1941

Arrived at the port of New York 22 May 1919 on the U.S.S. *Manchuria* as the 58th Inf. Brig., an element of the 29th Div. Demobilized 29 May 1919 at Camp George G. Meade, MD. Reconstituted in the N.G. in 1921 and assigned to the 29th Div. Allotted 20 September 1921 to Maryland. HQ Co. organized 6 March 1923, and federally recognized at Baltimore, MD. HQ organized 21 March 1924, and federally recognized at Baltimore. Conducted annual summer training most years at Camp Ritchie, Cascade, MD, and some years at Virginia Beach, VA. Inducted into active Federal service at Baltimore, MD, 3 February 1941 and moved with the 29th Div. to Fort George G. Meade, MD, where it arrived 5 February 1941. Transferred 14 September 1941 with the 29th Div. to the A.P. Hill Military Reservation, VA. Location 7 December 1941—en route to Fort George G. Meade, MD.

**Status:** HHC disbanded 28 February 1942.**Events:** 109, 191, 281, 301, 330**Commanders, 58th Infantry Brigade**

Brig. Gen. Milton A. Reckord 21 March 1924–14 April 1934  
 Brig. Gen. Amos W.W. Woodcock

Brig. Gen. Washington Bowie Jr. 18 May 1934–22 November 1936  
 23 November 1936–28 February 1942

**HHC, 59th Infantry Brigade (30th Division)****Georgia and South Carolina National Guard****HQ**—*Not organized*, 1921–23; Macon, GA, 1923–32; Columbia, SC, 1932–40; Fort Jackson, SC, 1940–41**Subordinate elements**—118th and 121st Inf. Regts., 1921–41

Arrived at the port of Charleston in early April 1919 as the 59th Inf. Brig., an element of the 30th Div. Demobilized 12 April 1919 at Fort Oglethorpe, GA. Reconstituted in the N.G. in 1921, assigned to the 30th Div., and allotted to Georgia. HQ Co. organized 28 November 1922 by redesignation of B Company, 122d Inf. at Macon, GA. HQ organized 8 January 1923, and federally recognized at Macon. HQ withdrawn from Georgia on 23 November 1932 and allotted to the South Carolina N.G. HQ concurrently organized at Columbia, SC. HQ Co. remained at Macon, GA. Brigade HQ called up to provide command and control for units performing strike duties during the textile workers' strike in Spartanburg, Greenville, and Chester, SC, in September 1934; concurrently, HQ Co. called up to provide riot control during the textile workers' strike in Griffin, GA. Conducted annual summer training most years at Camp Jackson, SC, and some years at

St. Simons Island, GA, Camp McClellan, AL, or Camp J. Clifford R. Foster, FL. Inducted into active Federal service at Columbia on 16 September 1940 and moved with the 30th Div. to Camp Jackson, SC, where it arrived 20 September 1940. Location 7 December 1941—Fort Jackson, SC.

**Status:** HQ disbanded 5 July 1946; HQ Co. active in the Georgia N.G. at Macon, GA, as HHC, 48th Inf. Brig.**Events:** 255, 300, 316, 330**Commanders, 59th Infantry Brigade**

Brig. Gen. Henry D. Russell (GA)  
 Brig. Gen. Trelawney E. Marchant (SC)

8 January 1923–20 September 1932  
 23 November 1932–7 February 1942

**HHC, 60th Infantry Brigade (30th Division)****North Carolina National Guard****HQ**—*Not organized*, 1921–26; Raleigh, NC, 1926–37; Graham, NC, 1937–40; Fort Jackson, SC, 1940–41**Subordinate elements**—117th and 120th Inf. Regts., 1926–41

Arrived at the port of New York 23 May 1919 on the S.S. *Kaiserin Augusta Victoria* as the 60th Inf. Brig., an element of the 30th Div. Demobilized 19 April 1919 at Camp Jackson, SC. Reconstituted in the N.G. in 1921, assigned to the 30th Div., and allotted to North Carolina. HQ organized 1 June 1926, and federally recognized at Raleigh, NC. HQ Co. organized 22 December 1927 and federally recognized at Leaksville, NC. Conducted annual summer training most years at Camp Jackson, SC, and some years at Camp Glenn, NC. HQ Co. called up in September 1934 to perform riot control duties in connection with the textile labor strikes in Burlington, NC. HQ relocated 25 January 1937 to Graham, NC. Inducted into active Federal service at Graham 16 September 1940, and moved with the 30th Div. to Camp Jackson, SC, where it arrived 20 September 1940. Location 7 December 1941—Fort Jackson, SC.

**Status:** HHC disbanded 7 February 1942.**Events:** 255, 300, 316, 330**Commanders, 60th Infantry Brigade**

Brig. Gen. John Van B. Metts	1 June 1926–12 December 1936	Brig. Gen. Don E. Scott	25 January 1937–16 February 1942
------------------------------	------------------------------	-------------------------	----------------------------------

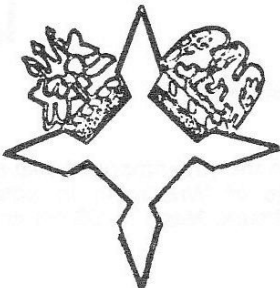
**HHC, 61st Infantry Brigade (31st Division)****Louisiana and Mississippi National Guard****HQ**—*Not organized*, 1921–23; New Orleans, LA, 1923–38; Baton Rouge, LA, 1938–40; New Orleans, LA, 1940; Camp Blanding, FL, 1940–41**Subordinate elements**—155th and 156th Inf. Regts., 1924–41

Arrived at the port of Hoboken in December 1918 as the 61st Inf. Brig., an element of the 31st Div. Demobilized in April 1919 at Camp Jackson, SC. Reconstituted in the N.G. in 1921. Allotted 12 May 1924 to Louisiana and Mississippi. HQ concurrently organized at New Orleans from HQ, 62d Inf. Brig. (federally recognized 23 November 1923 at New Orleans, LA, as HQ, 62d Inf. Brig.; redesignated HQ, 61st Inf. Brig. on 12 May 1924). HQ Co. organized 26 February 1925, by redesignation of HQ Co., 3d Bn., 155th Inf., at Amory, MS. Brigade HHC called up to provide command and control for units performing flood relief duties at Vicksburg, MS, and Baton Rouge, LA, 26 April–19 June 1927. Conducted annual summer training at various locations to include Camp Beauregard, LA; Camp McClellan, AL; Camp Benjamin F. McClellan, MS; Fort Oglethorpe, GA; and Camp Shelby, MS. Brigade HQ relocated on 7 July 1938

to Baton Rouge, LA, and back to New Orleans 1 June 1940. Inducted into active Federal service at Baton Rouge on 25 November 1940 and moved with the 31st Div. to Camp Blanding, FL, where it arrived 14 December 1940. Location 7 December 1941—Camp Blanding, FL.

**Status:** HHC are inactive in the Louisiana N.G. as HQ Co., 39th Inf. Div.**Events:** 56, 255, 300, 325, 328, 330**Commanders, 61st Infantry Brigade**

Brig. Gen. Louis A. Toombs (LA)	23 November 1923–21 June 1929	Brig. Gen. Louis F. Guerre (LA)	22 June 1929–27 January 1942
---------------------------------	-------------------------------	---------------------------------	------------------------------

**HHC, 62d Infantry Brigade (31st Division)****Alabama National Guard****HQ**—*Not organized*, 1921–22; Montgomery, AL, 1922–30; Birmingham, AL, 1930–40; Camp Blanding, FL, 1940–41**Subordinate elements**—124th and 167th Inf. Regts., 1924–41

Arrived at the port of New York 22 January 1919 on the U.S.S. *Manchuria* as the 62d Inf. Brig., an element of the 31st Div. Demobilized in April 1919 at Camp Gordon, GA. Reconstituted in the N.G. in 1921. Allotted to Alabama on 12 May 1924. HQ concurrently organized at Montgomery, AL, by redesignation of HHC, 61st Inf. Brig. (HQ federally recognized 17 June 1922 at Montgomery, AL, as HQ, 77th Inf. Brig., a component of the 39th Div.; redesignated HQ, 61st Inf. Brig. on 1 July 1923 a component of the 31st Div.; redesignated HQ, 62d Inf. Brig. on 12 May 1924). HQ Co. organized 20 February 1920 as E Company, 4th Inf., Alabama N.G. and federally recognized at Tuscaloosa, AL. Redesignated successively as HQ Co., 77th Inf. Brig., 5 May 1922; HQ Co., 61st Inf. Brig., 1 July 1923; and HQ Co., 62d Inf. Brig., 12 May 1924. HQ Co. redesignated 30 June 1929 as D Co., 167th Inf. Concurrently, a new HQ Co. organized by redesignation

of HQ Co., 1st Bn., 167th Inf. at Prattville, AL. HQ relocated 27 August 1930 to Birmingham, AL. Conducted annual summer training at various locations to include Camp Beauregard, LA; Camp McClellan, AL; Fort Oglethorpe, GA; and Camp Shelby, MS. HQ called up to provide command and control of units protecting civil prisoners against race riots in Birmingham, 2–4 October 1931. HQ Co. called up for hurricane relief duty in Bibb and Shelby Counties in May 1937 and for flood relief duty at Prattville, 16–19 April 1939. Entire brigade assembled at Camp J.C.R. Foster, FL, in December 1939 to conduct additional winter training directed by the War Department for all N.G. units. Inducted into active Federal service at Birmingham, AL, 25 November 1940 and moved with the 31st Div. to Camp Blanding, FL, where it arrived 22 August 1940. Location 7 December 1941—Camp Blanding, FL.

**Status:** HHC disbanded 10 February 1942.**Events:** 56, 255, 300, 325, 328, 330**Commanders, 62d Infantry Brigade**

Brig. Gen. William P. Screws (AL) April 1923–August 1926	Brig. Gen. John C. Persons (AL) 27 August 1930–18 November 1940
Brig. Gen. Walter E. Bare (AL) 24 August 1926–27 August 1930	Brig. Gen. Joseph Hutchinson (FL) 18 November 1940–21 February 1942

**HHC, 63d Infantry Brigade (32d Division)****Michigan National Guard****HQ**—*Not organized*, 1921–22; Lansing, MI, 1922–23; Flint, MI, 1923–26; Detroit, MI, 1926–33; Grand Rapids, MI, 1933–35; Detroit, MI, 1935–40; Camp Beauregard, LA, 1940–41; Camp Livingston, LA, 1941**Subordinate elements**—125th and 126th Inf. Regts., 1921–41

Arrived at the port of New York 9 May 1919 on the U.S.S. *Great Northern* as the 63d Inf. Brig., an element of the 32d Div. Demobilized 23 May 1919 at Camp Custer, MI. Reconstituted in the N.G. in 1921, assigned to the 32d Div., and allotted to Michigan. HQ Co. organized 14 March 1922 and federally recognized at Detroit, MI. HQ organized 15 March 1922 and federally recognized at Lansing, MI. HQ successively relocated as follows: to Flint, MI, in May 1923; Detroit, MI, 21 June 1926; Grand Rapids, MI, 16 July 1933; and Detroit, 6 July 1935. HQ Co. called up to perform riot control duties in connection with the automobile worker strikes at Flint, 13 January–17 February 1937. Conducted annual summer training most years at Camp Grayling, MI, 1922–39. For at least 2 years, the brigade and its subordinate regiments also conducted joint summer training at Camp Grayling with the 169th Inf. Brig. (1928) and the 170th Inf. Brig.

(1929). Inducted into active Federal service at Detroit, MI, 15 October 1940, and moved with the 32d Div. to Camp Beauregard, LA, where it arrived 21 October 1940. Transferred 15 February 1941 to Camp Livingston, LA. Location 7 December 1941—Camp Livingston, LA.

**Status:** HHC disbanded 16 January 1942.**Events:** 214, 302, 320, 328

### Commanders, 63d Infantry Brigade

Brig. Gen. Earl R. Stewart	15 March 1922–1 May 1923	Brig. Gen. Edgar H. Campbell	8 July 1933–5 July 1935
Brig. Gen. Guy M. Wilson	2 May 1923–22 March 1926	Brig. Gen. Heinrich A. Pickert	6 July 1935–23 April 1940
Brig. Gen. John H. Schouten	21 June 1926–7 July 1933	Brig. Gen. Thomas Colladay	10 June 1940–31 January 1942

### HHC, 64th Infantry Brigade (32d Division)

### Wisconsin National Guard

**HQ**—Sparta, WI, 1921–24; Oconto, WI, 1924–28; Madison, WI, 1928–29; Milwaukee, WI, 1929–40; Camp Beauregard, LA, 1940–41; Camp Livingston, LA, 1941

**Subordinate elements**—127th and 128th Inf. Regts., 1921–41



Arrived at the port of New York 5 May 1919 on the U.S.S. *Cap Finisterre* as the 64th Inf. Brig., an element of the 32d Div. Demobilized 17 May 1919 at Camp Grant, IL. Reconstituted in the N.G. in 1921, assigned to the 32d Div., and allotted to Wisconsin. HQ Co. organized 1 April 1921 by redesignation of the 33d Sep. Inf. Co., Wisconsin N.G., at Sparta, WI. HQ organized 15 March 1922 and federally recognized at Sparta. HQ successively relocated as follows: to Oconto, WI, 24 July 1924; Madison, WI, 27 June 1928; and to Milwaukee, WI, 2 February 1929. Conducted annual summer training most years at Camp Douglas, WI, 1922–27, and Camp Williams, WI, 1928–39. For the years 1927–30, the brigade and its subordinate regiments also conducted joint summer training at Camp Douglas with the 201st and 202d Inf. Regts., 101st Div. For at least 1 year, in 1937, the brigade's subordinate regiments also trained some 49 company-grade

infantry officers of the 101st Div. at Camp Williams. Inducted into active Federal service at Milwaukee, WI, 15 October 1940 and moved with the 32d Div. to Camp Beauregard, LA, where it arrived 21 October 1940. Transferred 15 February 1941 to Camp Livingston, LA. Location 7 December 1941—Camp Livingston, LA.

**Status:** HQ disbanded 16 January 1942; HQ Co. redesignated 32d Cav. Rcn. Tp.

**Events:** 214, 302, 320, 328

### Commanders, 64th Infantry Brigade

Brig. Gen. Robert B. McCoy	1 April 1921–24 July 1924	Brig. Gen. George F. O'Connell	1 June 1926–1 February 1929
Brig. Gen. Wilbur M. Lee	24 July 1924–29 May 1926	Brig. Gen. Paul B. Clemens	2 February 1929–16 January 1942

### HHC, 65th Infantry Brigade (33d Division)

### Illinois National Guard

**HQ**—*Not organized*, 1921–24; Chicago, IL, 1924–30; Pontiac, IL, 1930–41; Camp Forrest, TN, 1941

**Subordinate elements**—129th and 130th Inf. Regts., 1921–41



Arrived at the port of New York 20 May 1919 on the U.S.S. *Siboney* as the 65th Inf. Brig., an element of the 32d Div. Demobilized 28 May 1919 at Camp Grant, IL. Reconstituted in the N.G. in 1921, assigned to the 33d Div., and allotted to Illinois. HQ Co. organized 15 July 1924, and federally recognized at Oak Park, IL. HQ organized 24 July 1924, and federally recognized at Chicago, IL. HQ relocated 8 November 1930 to Pontiac, IL, by redesignation of HQ Co., 3d Bn., 129th Inf. Brig. HHC called up to perform martial law at Mundelein, IL, 23–25 June 1926. Conducted annual summer training most years at Camp Grant, IL, 1924–39. For at least 1 year, in 1937, the brigade's subordinate regiments also trained some 35 company-grade infantry officers of the 86th Div. at Camp Grant. Inducted into active Federal service at Pontiac, IL, 5 March 1941 and moved with

the 33d Div. to Camp Forrest, TN, where it arrived 12 March 1941. Location 7 December 1941—Camp Forrest, TN.

**Status:** HQ disbanded 12 February 1942; HQ Co. redesignated 33d Cav. Rcn. Tp.

**Events:** 214, 302, 316, 324, 328

### Commanders, 65th Infantry Brigade

Brig. Gen. John J. Garrity	24 July 1924–17 October 1930	Brig. Gen. Diller S. Myers	18 October 1930–12 February 1942
----------------------------	------------------------------	----------------------------	----------------------------------

**HHC, 66th Infantry Brigade (33d Division)****Illinois National Guard**

**HQ**—*Not organized*, 1921–22; Chicago, IL, 1922–40; Delavan, IL, 1940–41; Camp Forrest, TN, 1941

**Subordinate elements**—131st and 132d Inf. Regts., 1922–41



Arrived at the port of New York 17 May 1919 on the S.S. *Kaiserin Augusta Victoria* as the 66th Inf. Brig., an element of the 33d Div. Demobilized 5 June 1919 at Camp Grant, IL. Reconstituted in the N.G. in 1921, assigned to the 33d Div., and allotted to Illinois. HQ organized 12 October 1922 and federally recognized at Chicago, IL. HQ Co. organized 28 May 1924, and federally recognized at Chicago, IL. HQ Co. relocated 8 November 1930 to Oak Park, IL, by redesignation of HQ Co., 66th Inf. Brig. Conducted annual summer training most years at Camp Grant, IL, 1922–39. In 1929, the brigade and its subordinate regiments conducted joint summer training at Camp Grant with the 172d Inf. Brig., 86th Div. For at least 1 year, in 1937, the brigade's subordinate regiments also trained some 36 company-grade infantry officers of the 86th Div. at Camp Grant. HQ

relocated 18 July 1940 to Delavan, IL. Inducted into active Federal service at Delavan on 5 March 1941 and moved with the 33d Div. to Camp Forrest, TN, where it arrived 12 March 1941. Location 7 December 1941—Camp Forrest, TN.

**Status:** HHC disbanded 12 February 1942.

**Events:** 214, 302, 316, 324, 328

**Commanders, 66th Infantry Brigade**

Brig. Gen. Abel Davis	12 October 1922–19 September 1930	Brig. Gen. Thomas S. Hammond	27 November 1931–13 May 1940
Brig. Gen. John J. Garrity	18 October 1930–12 November 1931	Brig. Gen. Albert L. Culbertson	14 May 1940–21 February 1942

**HHC, 67th Infantry Brigade (34th Division)****Iowa National Guard**

**HQ**—*Not organized*, 1921–22; Council Bluffs, IA, 1922–24; Des Moines, IA, 1924–40; Sioux City, IA, 1940–41; Camp Claiborne, LA, 1941

**Subordinate elements**—133d and 168th Inf. Regts., 1922–41



Arrived at the port of Hoboken 24 January 1919 on the U.S.S. *General Goethals* as the 67th Inf. Brig., an element of the 34th Div. Demobilized 18 February 1919 at Camp Grant, IL. Reconstituted in the N.G. in 1921, assigned to the 34th Div., and allotted to Iowa. HQ Co. organized 20 July 1921, and federally recognized at Winterset, IA. HQ organized 21 February 1922, and federally recognized at Council Bluffs, IA. HQ successively relocated to Des Moines, IA, 23 August 1924, and to Sioux City, IA, 10 July 1940. HQ Co. relocated 2 March 1931 to Des Moines by redesignation of HQ Co., 1st Bn., 168th Inf. Designated mobilization training station was Camp Dodge, IA, 1921–30, and Camp Ripley, MN, 1931–40. Conducted annual summer training most years at Camp Dodge, IA, 1922–39. For at least 2 years, in 1938 and 1940, the brigade's

subordinate units also trained some 36 company-grade officers of the 88th Div. at Camp Dodge and Camp Ripley, MN. Inducted into active Federal service at Des Moines, IA, 10 February 1941, and moved with the 34th Div. to Camp Claiborne, LA, where it arrived 20 February 1941. Location 7 December 1941—Camp Claiborne, LA.

**Status:** HQ disbanded 30 January 1942; HQ Co. reorganized and redesignated 34th Cav. Rcn. Tp.

**Events:** 233, 303, 320, 328

**Commanders, 67th Infantry Brigade**

Brig. Gen. Mathew A. Tinley	21 February 1922–11 July 1924	Brig. Gen. Lloyd D. Ross	23 August 1924–8 July 1940
	Brig. Gen. Gordon C. Hollar		9 July 1940–16 January 1942



**HHC, 68th Infantry Brigade** (34th Division)**Minnesota/North Dakota National Guard****HQ**—Minneapolis, MN, 1920–28; Valley City, ND, 1928–41; Camp Claiborne, LA, 1941**Subordinate elements**—135th and 164th Inf. Regts., 1921–41

Arrived at the port of Hoboken 24 January 1919 on the U.S.S. *General Goethals* as the 68th Inf. Brig., an element of the 34th Div. Demobilized 18 February 1919 at Camp Grant, IL. Reconstituted in the N.G. in 1921, assigned to the 34th Div, and allotted to Minnesota. Organized 21 November 1921 at Minneapolis, MN, by redesignation of HHC, 2d Inf. Brig. Minnesota N.G. (organized 26 April 1920 in the Minnesota N.G. as HHC, 2d Inf. Brig. and federally recognized at Minneapolis). HQ withdrawn from Minnesota on 1 November 1928 and allotted to North Dakota. Concurrently, HQ reorganized at Valley City, ND, on the same date; HQ Co. remained at Minneapolis. Designated mobilization training station was Fort Snelling, MN, 1921–30, and Camp Ripley, MN, 1931–40. Conducted annual summer training at various locations to include Fort Snelling, MN; Lake City, MN; Camp Ripley, MN; Camp Grafton, ND; Camp

Dodge, IA; and Ashland, NE. For at least 3 years, 1938–40, the brigade's subordinate units also trained some 87 company-grade officers of the 88th Div. at Camp Ripley and Camp Grafton. HQ Co. relocated on 31 January 1938 to Northfield, MN, by redesignation of HQ Co., 1st Bn., 135th Inf. HQ transferred on 16 September 1940 to Dickinson, ND. HQ inducted into active Federal service at Dickinson on 10 February 1941. Concurrently, HQ Co. inducted into active Federal service at Northfield. HHC moved with the 34th Div. to Camp Claiborne, LA, where they arrived on 20 February 1941. Location 7 December 1941—Camp Claiborne, LA.

**Status:** HHC disbanded 30 January 1942.**Events:** 233, 303, 320, 328**Commanders, 68th Infantry Brigade**

Brig. Gen. Perry Harrison (MN)	26 April 1920–July 1926	Brig. Gen. Earle D. Luce (MN)	August 1926–31 October 1928
	Brig. Gen. David S. Ritchie (ND)		1 November 1928–30 January 1942

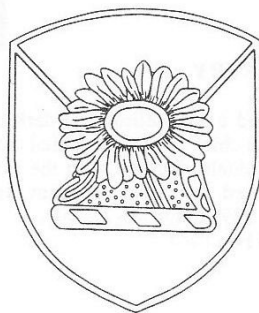
**HHC, 69th Infantry Brigade** (35th Division)**Kansas and Nebraska National Guard****HQ**—*Not organized*, 1921–22; Topeka, KS, 1922–25; Wichita, KS, 1925–30; National Military Home, Leavenworth, KS, 1930–32; Omaha, NE, 1932–41; Camp Joseph T. Robinson, AR, 1941**Subordinate elements**—134th and 137th Inf. Regts., 1921–41

Arrived at the port of Newport News 27 April 1919 on the U.S.S. *Princess Matoika* as the 69th Inf. Brig., an element of the 35th Div. Demobilized 8 May 1919 at Camp Funston, KS. Reconstituted in the N.G. in 1921, assigned to the 35th Div., and allotted to Kansas. HHC organized 24 October 1922 and federally recognized at Topeka, KS. HQ successively relocated as follows: to Wichita, KS, in 1925, and to the National Military Home, Leavenworth, KS, 15 January 1930. HQ inactivated at Leavenworth on 6 June 1932. HQ withdrawn from Kansas on 16 August 1932 and allotted to the Nebraska N.G. HQ concurrently organized at Omaha, NE. HQ Co. remained at Topeka. Brigade HQ called up 7–14 June 1934 to provide command and control for units performing riot control duties in connection with the streetcar labor strikes in Omaha. Designated mobilization training station was Camp Funston, KS. Conducted annual summer training most years at Fort Riley, KS, 1922–36, and Ashland, NE, 1938–39. For at least 3 years,

1938–40, the brigade's subordinate units also trained some 131 company-grade officers of the 89th Div. at Fort Riley, KS; Ashland, NE; and Camp Ripley, MN. Inducted into active Federal service at Omaha 23 December 1940, and moved with the 35th Div. to Camp Joseph T. Robinson, AR, where it arrived 7 January 1941. Location 7 December 1941—Camp Joseph T. Robinson, AR.

**Status:** HQ disbanded 3 February 1942; HQ Co. concurrently reorganized and redesignated 35th Cav. Rcn. Tp.**Events:** 236, 303, 316, 324, 328

### Commanders, 69th Infantry Brigade

Brig. Gen. Charles I. Martin (KS) 24 October 1922–6 June 1932    Col. Per Ramee (R.A.)    29 April 1941–22 October 1941  
Brig. Gen. Amos Thomas (NE) 16 June 1932–29 April 1941    Brig. Gen. Benjamin C. Lockwood (R.A.) 22 October 1941–3 February 1942

### HHC, 70th Infantry Brigade (35th Division)

### Missouri National Guard

**HQ**—Jefferson City, MO, 1920–25; Pierce City, MO, 1925–32; Kansas City, MO, 1932–38; Jefferson City, MO, 1938–40; Camp Joseph T. Robinson, AR, 1940–41; Fort Ord, CA, 1941

**Subordinate elements**—138th and 140th Inf. Regts., 1921–41



Arrived at the port of Newport News 20 April 1919 as the 70th Inf. Brig., an element of the 35th Div. Demobilized 14 May 1919 at Camp Funston, KS. Reconstituted in the N.G. in 1921, assigned to the 35th Div., and allotted to Missouri. Organized 1 October 1921 by redesignation of HQ, Inf. Brig. (organized 15 December 1920 in the Missouri N.G. as HQ, Inf. Brig. and federally recognized at Nevada, MO; relocated in April 1921 to Jefferson City, MO). HQ Co. organized 7 November 1921, and federally recognized at Warrensburg, MO. HQ Co. at Warrensburg redesignated 1 June 1923 as HQ Co., Sp. Tps., 35th Div. New brigade HQ Co. organized 3 June 1923, and federally recognized at Jefferson City. HQ successively relocated as follows: to Pierce City, MO, 7 January 1925; Kansas City, MO, 22 November 1932; and Jefferson City, MO, 7 March 1938.

HQ Co. called up to perform riot control duties in connection with railroad labor strikes at Poplar Bluffs, MO, July 1922. Brigade HHC called up to perform riot control duties in connection with the Missouri State Prison riots 25–27 March 1930. Designated mobilization training station was Camp Clark, MO. Conducted annual summer training most years at Camp Clark, 1921–39. For at least 3 years, 1938–40, the brigade's subordinate units also trained some 172 company-grade officers of the 102d Div. at Camp Clark and Camp Ripley, MN. Inducted into active Federal service at Kansas City, MO, 23 December 1940 and moved with the 35th Div. to Camp Joseph T. Robinson, AR, where it arrived 29 December 1940. Transferred October 1941 to Fort Ord, CA. Location 7 December 1941—Fort Ord, CA.

**Status:** HHC disbanded 3 February 1942.

**Events:** 236, 303, 316, 324, 328

### Commanders, 70th Infantry Brigade

Brig. Gen. Harvey C. Clark 15 December 1920–11 April 1921    Brig. Gen. Edward M. Stayton 18 November 1932–13 January 1938  
Brig. Gen. William A. Raupp 19 April 1921–17 November 1932    Brig. Gen. Lewis M. Means 9 February 1938–3 February 1942

### HHC, 71st Infantry Brigade (36th Division)

### Texas National Guard

**HQ**—*Not organized*, 1921–22; Fort Worth, TX, 1922–24; Austin, TX, 1924–26; Dallas, TX, 1926–27; San Antonio, TX, 1927–28; Hillsboro, TX, 1928–30; Taylor, TX, 1930–35; San Antonio, TX, 1935–40; Camp Bowie, TX, 1940–41

**Subordinate elements**—141st and 142d Inf. Regts., 1921–41

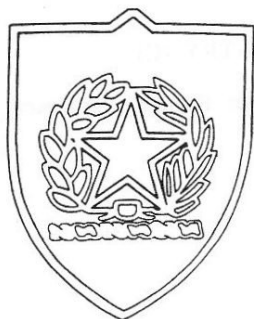

Arrived at the port of New York 4 June 1919 on the S.S. *Patricia* as the 71st Inf. Brig., an element of the 36th Div. Demobilized 19 June 1919 at Camp Bowie, TX. Reconstituted in the N.G. in 1921, assigned to the 36th Div, and allotted to Texas. HQ Co. organized 13 June 1922, and federally recognized at Sweetwater, TX. HQ organized 8 November 1922, and federally recognized at Fort Worth, TX. HQ successively relocated as follows: to Austin, TX, in August 1924; Dallas, TX, 2 January 1926; San Antonio, TX, 31 August 1927; Hillsboro, TX, 26 July 1928; Taylor, TX, 16 July 1930; and back to San Antonio, TX, 27 November 1935. HQ Co. at Sweetwater redesignated as Company E, 142d Inf. on 2 March 1927. A new brigade HQ Co. was organized 12 April 1927 and federally recognized at San Antonio. Conducted annual summer training most years at Camp Mabry, TX, 1922–24, and Camp Hulen, TX, 1925–39. For at least 1 year, in 1933, the

brigade's subordinate regiments also trained some 36 company-grade infantry officers of the 90th Div. at Camp Hulen. Inducted into active Federal service at San Antonio, TX, 24 November 1940, and moved with the 36th Div. to Camp Bowie, TX, where it arrived 14 December 1940. Location 7 December 1941—Camp Bowie, TX.

**Status:** Active in the Texas N.G. at Dallas, TX, as HHC, 1st Brig., 36th Inf. Div. (Mecz).

**Events:** 258, 300, 317, 328

#### Commanders, 71st Infantry Brigade

Brig. Gen. Henry Hutchings	8 November 1922–17 August 1927	Brig. Gen. Oscar E. Roberts	16 July 1930–3 October 1935
Maj. Loren W. Benton (Acting)	18 August 1927–31 May 1928	Brig. Gen. Charles W. Nimon	4 October 1935–20 June 1940
Brig. Gen. Will E. Jackson	1 June 1928–1 January 1930	Brig. Gen. John Watt Page	28 June 1940–January 1941
Maj. Loren W. Benton (Acting)	2 January 1930–15 July 1930	Brig. Gen. Eugene A. Eversberg	January 1941–31 December 1941

#### HHC, 72d Infantry Brigade (36th Division)

#### Texas National Guard

**HQ**—*Not organized*, 1921–22; Marshall, TX, 1922–37; San Antonio, TX, 1937–39; Dallas, TX, 1939–40; Marshall, TX, 1940; Camp Bowie, TX, 1940–41

**Subordinate elements**—143d and 144th Inf. Regts., 1921–41



Arrived at the port of New York 5 June 1919 on the S.S. *Pretoria* as the 72d Inf. Brig., an element of the 36th Div. Demobilized 20 June 1919 at Camp Bowie, TX. Reconstituted in the N.G. in 1921, assigned to the 36th Div., and allotted to Texas. HQ Co. organized 7 June 1922 and federally recognized at Marshall, TX. HQ organized 8 November 1922 and federally recognized at Marshall. HQ successively relocated as follows: to San Antonio, TX, 25 July 1937; Dallas, TX, 22 May 1939; and to Marshall in 1940. Conducted annual summer training most years at Camp Mabry, TX, 1922–24, and Camp Hulen, TX, 1925–39. For at least 1 year, in 1933, the brigade's subordinate regiments also trained some 36 company-grade infantry officers of the 90th Div. at Camp Hulen. Inducted into active Federal service at Marshall, TX, 24 November 1940, and moved with the 36th Div. to Camp Bowie, TX, where it arrived on 14 December 1940. Location 7 December 1941—Camp Bowie, TX.

**Status:** HHC disbanded 1 February 1942; reconstituted 25 August 1945 as HHSC, 146th Armd. Inf. Bn.; consolidated with the 144th Inf. on 16 March 1959.

**Events:** 258, 300, 317, 328

#### Commanders, 72d Infantry Brigade

Brig. Gen. George P. Rains	8 November 1922–9 September 1935	Brig. Gen. Oscar E. Roberts	4 October 1935–20 May 1939
Brig. Gen. Charles W. Nimon	19 September 1935–3 October 1935	Brig. Gen. Preston Weatherred	22 May 1939–31 January 1942

#### HHC, 73d Infantry Brigade (37th Division)

#### Ohio National Guard

**HQ**—Cleveland, OH, 1921–41; Camp Shelby, MS, 1941

**Subordinate elements**—145th and 148th Inf. Regts., 1921–41



Arrived at the port of Hoboken 31 March 1919 on the S.S. *Maui* as the 73d Inf. Brig., an element of the 37th Div. Demobilized 10 April 1919 at Camp Sherman, OH. Reconstituted in the N.G. in 1921, assigned to the 37th Div., and allotted to Ohio. HQ, 73d Inf. Brig. reorganized 1 July 1921 by redesignation of HQ, 1st Inf. Brig., Ohio N.G. (organized 10 May 1921, and federally recognized at Cleveland, OH). HQ Co. organized 21 June 1922, and federally recognized at Cleveland; demobilized 31 January 1926 at Cleveland; reorganized 2 February 1926 at Akron, OH. Brigade HHC called up to provide command and control for units performing duties for the following state emergencies: tornado relief

at Lorain-Sandusky, OH, 28 June–11 July 1924; riot control during a workers' strike at the Auto-Lite plant at Toledo, OH, 23 May–2 June 1934; Ohio River flooding in January–March 1937; and Mahoning Valley steel workers' strike 22 June–15 July 1937. Conducted annual summer training most years at Camp Perry, OH, 1922–39. Inducted into active Federal service at Cleveland, OH, 15 October 1940, and moved with the 37th Div. to Camp Shelby, MS, where it arrived 20 October 1940. Location 7 December 1941—Camp Shelby, MS.

**Events:** 213, 220, 302, 320, 328

**Commanders, 73d Infantry Brigade**

Brig. Gen. John R. McQuigg    10 May 1921–1 January 1929    Brig. Gen. Ludwig S. Conelly    3 January 1929–31 January 1942

**HHC, 74th Infantry Brigade (37th Division)**

**Ohio National Guard**

**HQ**—Columbus, OH, 1921–41; Camp Shelby, MS, 1941

**Subordinate elements**—147th and 166th Inf. Regts., 1921–41



Arrived at the port of Hoboken 23 March 1919 on the U.S.S. *Von Steuben* as the 74 Inf. Brig., an element of the 37th Div. Demobilized 8 April 1919 at Camp Sherman, OH. Reconstituted in the N.G. in 1921, assigned to the 37th Div., and allotted to Ohio. HHC, 74th Inf. Brig. reorganized 1 July 1921 by redesignation of HHC, 2d Inf. Brig., Ohio N.G. (HQ, 2d Inf. Brig. organized 10 December 1920, and federally recognized at Columbus, OH; HQ Co., 2d Inf. Brig. organized 29 April 1921 and federally recognized at Columbus). Brigade HHC called up to provide command and control for units performing duties for the following state emergencies: command and control during the Ohio State Penitentiary riot and fire, 21 April–3 June 1930; Ohio River flooding in

January–March 1937; and Mahoning Valley steel workers' strike, 22 June–15 July 1937. Conducted annual summer training most years at Camp Perry, OH, 1922–39. Inducted into active Federal service at Columbus, OH, 15 October 1940 and moved with the 37th Div., to Camp Shelby, MS, where it arrived 20 October 1940. Location 7 December 1941—Camp Shelby, MS.

**Status:** HQ consolidated with HQ, 37th Div. Arty., 17 November 1947; active as HHC, 16th Engr. Brig. at Columbus, OH.

**Events:** 213, 220, 302, 320, 328

**Commanders, 74th Infantry Brigade**

Brig. Gen. Frank D. Henderson    10 December 1920–21 August 1940    Brig. Gen. Robert S. Beightler    22 August 1940–8 October 1940  
 Brig. Gen. William L. Marlin    8 October 1940–31 January 1942

**HHC, 75th Infantry Brigade (38th Division)**

**Kentucky National Guard**

**HQ**—*Not organized*, 1921–23; Bowling Green, KY, 1923–41; Camp Shelby, MS, 1941

**Subordinate elements**—149th and 150th Inf. Regts., 1921–41



Arrived at the port of Newport News 19 December 1918 as the 75th Inf. Brig., an element of the 38th Div. Demobilized 8 January 1919 at Camp Zachary Taylor, KY. Reconstituted in the N.G. in 1921, assigned to the 38th Div., and allotted to Kentucky. HQ organized 1 March 1923 and federally recognized at Bowling Green, KY. HQ Co. organized 30 January 1924 and federally recognized at Bowling Green. HQ and/or HQ Co. called up to perform the following state duties: HQ Co. to preserve law and order at Sand Cave, KY, 13–24 February 1925 during the rescue attempt to save the celebrated cave explorer Floyd Collins; HQ Co. for preservation of order at a criminal trial at Elizabethtown, KY, 28 April–2 May 1931; HHC to provide command and control of flood relief duties along the Ohio River in western Kentucky in January–February 1937. Conducted annual

summer training most years at Camp Knox, KY, 1923–39. Inducted into active Federal service at Bowling Green, KY, 17 January 1941, and moved with the 38th Div. to Camp Shelby, MS, where it arrived 26 January 1941. Location 7 December 1941—Camp Shelby, MS.

**Status:** HHC disbanded 10 February 1942; reconstituted 25 August 1945; inactive as HHC, 75th Inf. Brig.

**Events:** 213, 220, 302, 320, 328

**Commanders, 75th Infantry Brigade**

Brig. Gen. Henry H. Denhardt	1 March 1923–20 September 1937	Vacant	21 September 1937–15 July 1941
	Brig. Gen. Roy W. Easley	16 July 1941–10 February 1942	

**HHC, 76th Infantry Brigade (38th Division)**

**Indiana National Guard**

**HQ**—*Not organized*, 1921–22; Muncie, IN, 1922–32; Fort Wayne, IN, 1932; Shelbyville, IN, 1932; Muncie, IN, 1932–33; Shelbyville, IN, 1933–41; Camp Shelby, MS, 1941

**Subordinate elements**—151st and 152d Inf. Regts., 1921–41



Arrived at the port of Newport News on 19 December 1918 as the 76th Inf. Brig., an element of the 38th Div. Demobilized 8 January 1919 at Camp Zachary Taylor, KY. Reconstituted in the N.G. in 1921, assigned to the 38th Div., and allotted to Indiana. HQ organized 24 November 1922 and federally recognized at Muncie, IN. HQ Co. organized 4 December 1923 and federally recognized at Muncie, IN. HQ successively relocated as follows: to Fort Wayne, IN, 13 February 1932; Shelbyville, IN, 2 May 1932; Muncie, IN, 13 December 1932; Shelbyville, IN, 11 April 1933. HQ and/or HQ Co. called up to perform the following state duties: HHC to perform tornado relief duty at Princeton, IN, 19–29 March 1929; HQ for riot control during a coal miners' strike at Sullivan County, IN, 9 October–15 November 1931; for guard and security duties in connection with the

visit of President Roosevelt to Vincennes, IN, 14 June 1936. Conducted annual summer training most years at Camp Knox, KY, 1923–39. Inducted into active Federal service at Shelbyville, IN, 17 January 1941, and moved with the 38th Div. to Camp Shelby, MS, where it arrived 26 January 1941. Location 7 December 1941—Camp Shelby, MS.

**Status:** HQ disbanded 10 February 1942; HQ Co. reorganized and redesignated 38th Cav. Rcn. Tp.

**Events:** 213, 220, 302, 320, 328

**Commanders, 76th Infantry Brigade**

Brig. Gen. William G. Everson	24 November 1922–30 November 1931	Brig. Gen. George H. Healy	30 November 1931–1 May 1932
	Brig. Gen. D. Wray DePrez	2 May 1932–10 November 1941	

**HHC, 77th Infantry Brigade (39th Division)**

**Alabama National Guard**

**HQ**—*Not organized*, 1921–22; Montgomery, AL, 1922–23

**Subordinate elements**—154th and 167th Inf. Regts., 1922–24

Arrived at the port of Newport News 31 December 1918 on the U.S.S. *Princess Matoika* as the 77th Inf. Brig., an element of the 39th Div. Demobilized 23 April 1919 at Camp Beauregard, LA. Reconstituted in the N.G. in 1921, assigned to the 39th Div., and allotted to Alabama. HQ organized 17 June 1922 and federally recognized at Montgomery, AL. Conducted annual summer training at Camp McClellan, AL, 1922–23. Designated mobilization training station was Camp McClellan, AL. Redesignated HHC, 61st Inf. Brig. 1 July 1923, and subsequently redesignated HHC, 62d Inf. Brig. 12 May 1924, as a component of the 31st Div.

**Commanders, 77th Infantry Brigade**

Brig. Gen. Robert E. Steiner	17 June 1922–March 1923	Brig. Gen. William P. Screws	April 1923–1 July 1923
------------------------------	-------------------------	------------------------------	------------------------

**HHC, 78th Infantry Brigade (39th Division)****Louisiana and Mississippi National Guard****HQ**—*Not organized*, 1921–22; New Orleans, LA, 1922–24**Subordinate elements**—155th and 156th Inf. Regts., 1921–24

Arrived at the port of Newport News on 31 December 1918 on the U.S.S. *Princess Matoika* as the 78th Inf. Brig., an element of the 39th Div. Demobilized 23 April 1919 at Camp Beauregard, LA. Reconstituted in the N.G. in 1921, assigned to the 39th Div., and allotted to Louisiana and Mississippi. Apparently the brigade HQ was organized at New Orleans, but was not federally recognized before the allotment was withdrawn. The HQ Co. was also organized in 1922 but not federally recognized. Conducted annual summer training at Camp McClellan, AL, 1923. Designated mobilization training station was Camp McClellan. HHC, 78th Inf. Brig. was withdrawn 1 July 1923, and HHC, 62d Inf. Brig., a component of the 31st Div., was allotted to Louisiana in its stead. This allotment was changed to HHC, 61st Inf. Brig. on 12 May 1924.

**Commanders, 78th Infantry Brigade**

Brig. Gen. Louis A. Toombs (LA)\*

\*Designated as CG on organization, but the HQ was not federally recognized before being withdrawn from allotment.

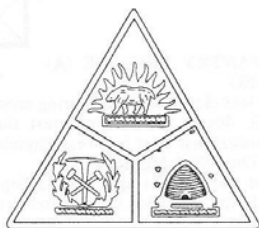
**HHC, 79th Infantry Brigade (I) (40th Division)****California National Guard****HQ**—*Not organized*, 1921–23; Sacramento, CA, 1923–25; Berkeley, CA, 1925–26; Los Angeles, CA, 1926–41; Camp San Luis Obispo, CA, 1941**Subordinate elements**—159th Inf. Regt., 1921–29; 160th Inf. Regt., 1921–29

Arrived at the port of New York on 5 April 1919 on the S.S. *Wilhelmina* as the 80th Inf. Brig., an element of the 40th Div. Demobilized 27 April 1919 at Camp Kearny, CA. Reconstituted in the N.G. in 1921, assigned to the 40th Div., and allotted to California. HQ organized 22 January 1923 and federally recognized at Sacramento, CA. HQ Co. organized in 1924 and federally recognized at San Francisco, CA. HQ relocated to Berkeley on 29 June 1925 and to Los Angeles, CA, on 6 July 1926. HQ Co. disbanded 10 November 1927 at San Francisco. A new HQ Co. organized 13 December 1927 and federally recognized at Los Angeles. Conducted annual summer training most years at

Camp San Luis Obispo, CA, and some years at Del Monte, CA. Redesignated 6 May 1929 at Los Angeles as HHC, 80th Inf. Brig. (see 80th Inf. Brig. below).

**Events:** 231, 304, 314, 326**Commanders, 79th Infantry Brigade**

Brig. Gen. James J. Borree

22 January 1923–12 December 1924  
Brig. Gen. Walter P. StoryBrig. Gen. David P. Barrows  
23 July 1926–6 May 1929

13 December 1924–23 July 1926

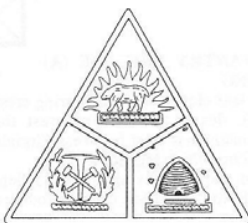
**HHC, 79th Infantry Brigade (II) (40th Division)****California National Guard****HQ**—*Not organized*, 1921–30; Sacramento, CA, 1930–41; Camp San Luis Obispo, CA, 1941**Subordinate elements**—159th and 184th Inf. Regts., 1929–41

Arrived at the port of New York on 5 April 1919 on the S.S. *Wilhelmina* as the 79th Inf. Brig., an element of the 40th Div. Demobilized 27 April 1919 at Camp Kearny, CA. Reconstituted in the N.G. in 1921, assigned to the 40th Div., and allotted to California. HQ organized 18 March 1930 and federally recognized at Sacramento, CA. HQ Co. organized 9 April 1936 by redesignation of HQ Co., 3d Bn., 184th Inf., at Sacramento. Conducted annual summer training most years at Camp San Luis Obispo, CA, 1930–39. Inducted into active Federal service at Sacramento, CA, 3 March 1941, and moved with the 40th Div. to Camp San Luis Obispo, CA, where it arrived 10 March 1941. Location 7 December 1941—Camp San Luis Obispo, CA.

### Commanders, 79th Infantry Brigade

Brig. Gen. Wallace A. Mason (CA) 18 March 1930–8 October 1938      Brig. Gen. Richard Mittelstaedt (CA) 8 October 1938–7 April 1941  
Brig. Gen. Albert E. Wilfong (UT)      8 April 1941–5 February 1942

### HHC, 80th Infantry Brigade (40th Division)

### California National Guard

**HQ**—*Not organized*, 1921–23; Los Angeles, CA, 1923–41; Camp San Luis Obispo, CA, 1941

**Subordinate elements**—159th Inf. Regt., 1921–29 (as a component of the 79th Inf. Brig.); 160th Inf. Regt., 1921–41; 185th Inf. Regt., 1929–41

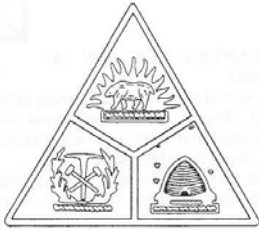

Arrived at the port of New York 5 April 1919 on the S.S. *Wilhelmina* as the 80th Inf. Brig., an element of the 40th Div. Demobilized 27 April 1919 at Camp Kearny, CA. Reconstituted in the N.G. in 1921, assigned to the 40th Div., and allotted to California. Organized by redesignation of HHC, 79th Inf. Brig. (federally recognized at Los Angeles, CA, 22 January 1923) on 6 May 1929 as HHC, 80th Inf. Brig. Conducted annual summer training most years at Camp San Luis Obispo, CA, 1930–39. Inducted into active Federal service at Sacramento, CA, 3 March 1941, and moved with the 40th Div. to Camp San Luis Obispo, CA, where it arrived 10 March 1941. Location 7 December 1941—Camp San Luis Obispo, CA.

**Status:** HQ disbanded 5 February 1942; HQ Co. reorganized and redesignated 40th Cav. Rcn. Tp.

**Events:** 231, 304, 314, 326

### Commanders, 80th Infantry Brigade

Brig. Gen. Walter P. Story 6 May 1929–13 July 1937      Brig. Gen. Harcourt Hervey 13 July 1937–10 April 1941  
Brig. Gen. Richard Mittelstaedt 10 April 1941–5 February 1942

### HHC, 81st Infantry Brigade (41st Division)

### Washington National Guard

**HQ**—*Not organized*, 1921–24; Seattle, WA, 1924–26; Spokane, WA, 1926–31; Walla Walla, WA, 1931–32; Seattle, WA, 1932–33; Spokane, WA, 1933–34; Camp Murray, WA, 1934–41; Fort Lewis, WA, 1941.

**Subordinate elements**—161st and 162d Inf. Regts., 1921–41



Arrived at the port of Hoboken on 12 February 1919 as the 81st Inf. Brig., an element of the 41st Div. Demobilized 3 March 1919 at Camp Dix, NJ. Reconstituted in the N.G. in 1921, assigned to the 41st Div., and allotted to Washington. HQ organized 23 February 1924 and federally recognized at Seattle, WA. HQ successively relocated as follows: to Spokane, WA, in April 1926; Walla Walla, WA, 1 July 1931; Seattle, 3 September 1932; Spokane, 21 June 1933; and Camp Murray, WA, 24 July 1934. HQ called up to provide command and control for units providing riot control during a timber workers' strike near Tacoma, WA, 1–30 June 1935. HQ Co. organized 20 April 1936 and federally recognized at Spokane. Conducted annual summer training most years at Camp Murray, WA, 1924–39. Inducted into active Federal service at Camp Murray, WA, 16 September

1940, and moved with the 41st Div. to Fort Lewis, WA, where it arrived 20 September 1940. Location 7 December 1941—Fort Lewis, WA.

**Status:** HHC disbanded 14 February 1942.

**Events:** 238, 304, 309, 314, 326

### Commanders, 81st Infantry Brigade

Brig. Gen. Clarence B. Blethen 23 February 1924–April 1926      Brig. Gen. Alvin H. Hankins 24 April 1933–July 1934  
Brig. Gen. Paul H. Weyrauch 7 June 1926–23 April 1933      Brig. Gen. Carlos A. Pennington 24 July 1934–13 December 1941  
Brig. Gen. Jesse C. Drain (R.A.) 13 December 1941–14 February 1942

**HHC, 82d Infantry Brigade (41st Division)**

**Oregon National Guard**

**HQ**—*Not organized*, 1921–23; Portland, OR, 1923–40; Camp Murray, WA, 1940–41; Fort Lewis, WA, 1941

**Subordinate elements**—163d and 186th Inf. Regts., 1921–41



Arrived at the port of Hoboken on 12 February 1919 as the 82d Inf. Brig., an element of the 41st Div. Demobilized 22 February 1919 at Camp Dix, NJ. Reconstituted in the N.G. in 1921, assigned to the 41st Div., and allotted to Oregon. HQ organized 23 July 1923, and federally recognized at Portland, OR. HQ Co. organized 15 August 1924, and federally recognized at Portland, OR. HQ Co. called up 19–30 July 1934 to quell civil disorders in Portland. Conducted annual summer training at various locations to include Camp Lewis, WA; Camp Jackson, OR; Camp Clatsop, OR; and Camp Murray, WA. Inducted into active Federal service at Portland, OR, 16 September 1940 and moved with the 41st Div. to Fort Lewis, WA, where it arrived 20 September 1940. Location 7 December 1941—Fort Lewis, WA.

**Status:** HQ disbanded 14 February 1942; HQ Co. reorganized and redesignated 41st Cav. Rcn. Tp.

**Events:** 238, 304, 309, 314, 326

**Commanders, 82d Infantry Brigade**

Brig. Gen. George A. White	23 July 1923–3 January 1930	Col. Hiram Welch	3 January 1930–8 January 1931
	Brig. Gen. Thomas E. Rilea		9 January 1931–16 February 1942

**HHC, 85th Infantry Brigade (43d Division)**

**Connecticut National Guard**

**HQ**—*Not organized*, 1921–23; New London, CT, 1923–31; New Haven, CT, 1931–41; Camp Blanding, FL, 1941

**Subordinate elements**—102d Inf. Regt., 1924–41; 169th Inf. Regt., 1921–41; 170th Inf. Regt., 1921–24

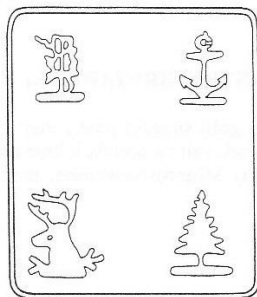

Constituted in the N.G. in 1921, assigned to the 43d Div., and allotted to Connecticut. HQ organized 21 June 1923 and federally recognized at New London, CT. HQ Co. organized 12 November 1923 and federally recognized at New London. HQ relocated 6 February 1931 to New Haven, CT. Brigade HHC called up to perform the following state duties: flood relief at Hartford, CT, 19 March–1 April 1936; hurricane relief near Rockville, CT, 22–27 September 1938. Conducted annual summer training most years at Niantic, CT, 1923–39. Inducted into active Federal service at New Haven, CT, 13 March 1941 and moved with the 43d Div. to Camp Blanding, FL, where it arrived 13 March 1941. Location 7 December 1941—Camp Blanding, FL.

**Status:** HHC disbanded 10 February 1942.

**Events:** 190, 280, 301, 325, 328, 330

**Commanders, 85th Infantry Brigade**

Brig. Gen. Morris B. Payne	21 June 1923–20 March 1925	Col. Joseph Nolan (acting)	16 July 1940–3 October 1940
Brig. Gen. James A. Haggerty	21 March 1925–15 July 1940	Brig. Gen. Thomas E. Troland	4 October 1940–30 January 1942



**HHC, 86th Infantry Brigade** (43d Division)**Maine and Vermont National Guard****HQ**—*Not organized*, 1921–23; Augusta, ME, 1923–38; Rutland, VT, 1938–41; Camp Blanding, FL, 1941**Subordinate elements**—103d Inf. Regt., 1921–41; 171st Inf. Regt., 1921; 172d Inf. Regt., 1921–41

Constituted in the N.G. in 1921, assigned to the 43d Div., and allotted to Maine. HQ Co. organized 17 January 1923 and federally recognized at Augusta, ME. HQ organized and federally recognized on 14 July 1923 at Augusta. HQ relocated 2 July 1938 to Rutland, VT; HQ Co. remained at Augusta. Conducted annual summer training at various locations to include Camp Keyes, ME; Fort Ethan Allen, VT; Fort Devens, MA; Niantic, CT; and Quonsett Point, RI. Inducted into active Federal service at Rutland, VT, 13 March 1941, and moved with the 43d Div. to Camp Blanding, FL, where it arrived 13 March 1941. Location 7 December 1941—Camp Blanding, FL.

**Status:** HQ disbanded 14 February 1942; HQ Co. converted and redesignated 354th Sig. Radar Maint Unit, 25 September 1946.

**Events:** 190, 280, 301, 325, 328, 330

**Commanders, 86th Infantry Brigade**

Brig. Gen. Albert Greenlaw (ME) 14 July 1923–2 July 1938

Brig. Gen. Leonard F. Wing (VT) 2 July 1938–14 February 1942

**HHC, 87th Infantry Brigade** (44th Division)**New York National Guard****HQ**—*Not organized*, 1921–22; New York City, NY, 1922–40; Fort Dix, NJ, 1940–41**Subordinate elements**—71st Inf. Regt., 1927–41; 165th Inf. Regt., 1921–27; 174th Inf. Regt., 1921–41

Arrived at the port of New York 6 March 1919 on the S.S. *Mauritania* the 53d Inf. Brig., an element of the 27th Div. Demobilized 1 April 1919 at Camp Upton, NY. Reconstituted in the N.G. on 30 December 1920 as the 87th Inf. Brig., assigned to the 44th Div., and allotted to New York. HQ Co. organized 23 May 1922 and federally recognized at New York City, NY. HQ organized 27 June 1922 and federally recognized at New York City. Conducted annual summer training most years at Camp Smith, Peekskill, NY, 1922–39. Inducted into active Federal service at New York City on 16 September 1940 and moved with the 44th Div. to Fort Dix, NJ, where it arrived 23 September 1940. Location 7 December 1941—in transit between North Carolina and Fort Dix, NJ.

**Status:** HQ disbanded 20 February 1942; HQ Co. converted and redesignated HQ Btry, 27th Div. Arty. in 1946.

**Events:** 61, 91

**Commanders, 87th Infantry Brigade**

Brig. Gen. George R. Dyer

27 June 1922–24 June 1933

Brig. Gen. Ralph K. Robertson

17 July 1940–22 July 1941

Brig. Gen. William R. Pooley

24 June 1933–5 October 1935

Brig. Gen. James I. Muir (R.A.)

22 July 1941–8 October 1941

Col. Ralph K. Robertson

5 October 1935–1 January 1936

Col. Gardiner J. Conroy

8 October 1941–17 December 1941

Brig. Gen. Walter A. De Lamater

1 January 1936–17 July 1940

Brig. Gen. Franklin C. Siebert (R.A.)

17 December 1941–20 February 1942

**HHC, 88th Infantry Brigade** (29th Division)**Virginia National Guard****HQ**—Richmond, VA, 1941; Fort George G. Meade, MD, 1941**Subordinate elements**—1st Virginia Inf. Regt., 1940–41; 176th Inf. Regt., 1941; 116th Inf. Regt., 1940–41

Organized in the Virginia N.G. on 1 January 1941 by the redesignation of HHC, 91st Inf. Brig., an element of the 29th Div. Inducted into active Federal service at Richmond, VA, 3 February 1941 and moved with the 29th Div. to Fort George G. Meade, MD, where it arrived 5 February 1941. Transferred 14 September 1941 with the 29th Div. to the A.P. Hill Military Reservation. Location 7 December 1941—Fort George G. Meade, MD.

**Status:** HQ disbanded 28 February 1942; HQ Co. reorganized and redesignated 29th Cav. Rcn. Tp.**Events:** 330**Commanders, 88th Infantry Brigade**

Brig. Gen. George M. Alexander      3 February 1941–28 February 1942

**HHC, 89th Infantry Brigade** (45th Division)**Arizona and Colorado National Guard****HQ**—*Not organized*, 1921–28; Phoenix, AZ, 1928–34; Denver, CO, 1934–40; Fort Sill, OK, 1940–41; Camp Barkeley, TX, 1941**Subordinate elements**—177th Inf. Regt., 1921; 157th Inf. Regt., 1921–41; 158th Inf. Regt., 1921–41

Constituted in the N.G. in 1921, assigned to the 45th Div., and allotted to Arizona. HQ Co. organized 1 September 1926 and federally recognized at Chandler, AZ. HQ organized 1 December 1928 and federally recognized at Phoenix, AZ. HQ withdrawn from Arizona on 19 February 1934 and allotted to Colorado. HQ concurrently reorganized 20 February 1934 and federally recognized at Denver, CO. HQ Co. remained at Chandler. Conducted annual summer training most years at Camp Tuthill, Flagstaff, AZ, 1928–33, and at Golden, CO, 1934–39. Inducted into active Federal service at Denver, CO, 16 September 1940, and moved with the 45th Div. to Fort Sill, OK, where it arrived 23 September 1940. Transferred 28 February 1941 with the 45th Div. to Camp Barkeley, TX. Location 7 December 1941—Camp Barkeley, TX.

**Status:** HQ disbanded 10 May 1946; HQ Co. consolidated with HQ Co., 158th Inf.**Events:** 261, 300, 317, 328**Commanders, 89th Infantry Brigade**

Brig. Gen. Alexander Tuthill (AZ)    1 December 1928–June 1933      Brig. Gen. William Guthner (CO)    15 February 1934–28 January 1942

**HHC, 90th Infantry Brigade** (45th Division)**Oklahoma National Guard****HQ**—Oklahoma City, OK, 1921–40; Fort Sill, OK, 1940–41; Camp Barkeley, TX, 1941**Subordinate elements**—179th and 180th Inf. Regts., 1921–41

Constituted in the N.G. in 1921, assigned to the 45th Div., and allotted to Oklahoma. HHC, 90th Inf. Brig. reorganized 14 October 1921 at Oklahoma City, OK, by redesignation of HHC, 1st Inf. Brig., Oklahoma N.G. (organized 7 January 1921 and federally recognized at Oklahoma City). HQ Co. organized 28 January 1922 and federally recognized at Durant, OK. Conducted annual summer training most years at Fort Sill, OK, 1921–39. For at least 1 year, in 1933, the brigade's subordinate regiments also trained some 42 company-grade infantry officers of the 95th Div. at Fort Sill. Inducted into active Federal service at Oklahoma City, OK, 16 September 1940, and moved with the 45th Div. to Fort Sill, OK, where it arrived 23 September 1940. Transferred 28 February 1941 with the 45th Div. to Camp Barkeley, TX. Location 7 December 1941—Camp Barkeley, TX.

**Status:** HQ disbanded 11 February 1942; HQ Co. reorganized and redesignated 45th Cav. Rcn. Tp.**Events:** 258, 300, 317, 328**Commanders, 90th Infantry Brigade**Brig. Gen. Charles E. McPherran    7 January 1921–24 November 1935      Brig. Gen. Ewell L. Head    17 March 1936–August 1939  
Brig. Gen. Louis A. Ledbetter      20 September 1939–22 February 1942

**HHC, 91st Infantry Brigade** (29th Division)

**Virginia National Guard**

**HQ**—Front Royal, VA, 1921–39; Richmond, VA, 1939–41

**Subordinate elements**—116th Inf. Regt., 1921–41; 1st Virginia Inf. Regt., 1921–22 and 1929–41; 183d Inf. Regt., 1922–29

Constituted in the N.G. in 1921, assigned to the 29th Div., and allotted to Virginia. HQ Co. organized 7 April 1922, and federally recognized at Berryville, VA. HQ organized 26 July 1922, and federally recognized at Front Royal, VA. Conducted annual summer training most years at Virginia Beach, VA, and some years at Camp Ritchie, Cascade, MD; or Indiantown Gap, PA. HQ relocated 5 October 1939 to Richmond, VA. Redesignated 88th Inf. Brig. on 1 January 1941.

**Events:** 109, 281, 301

**Commanders, 91st Infantry Brigade**

Brig. Gen. Samuel G. Waller 26 July 1922–6 June 1940

Brig. Gen. George M. Alexander 3 February 1941–28 February 1942

**HHC, 92d Infantry Brigade** (Separate) (I)

**Minnesota National Guard**

**HQ**—*Not organized*, 1926–27; St. Paul, MN, 1927–40

**Subordinate elements**—205th and 206th Inf. Regts., 1927–40



Constituted in the N.G. in April 1926 and allotted to Minnesota. HQ organized 22 April 1927 and federally recognized at St. Paul, MN. HQ Co. organized 1 March 1930 by redesignation of HQ Co., 1st Bn., 206th Inf. at White Bear Lake, MN. Assigned to the Fourth Army 1 October 1933. Conducted annual summer training at various locations to include Lake City, MN; Fort Snelling, MN; Camp Dodge, IA; and Camp Ripley, MN. Entire brigade called up while at summer training at Camp Ripley for riot control and enforcement of martial law during a commercial transit workers' strike in Minneapolis, MN, in May and again from 17 July to 23 August 1934. For at least 3 years, 1938–40, the brigade's subordinate units also trained some 97 company-grade officers of the 88th Div. at Camp Ripley. Reorganized and redesignated HHB, 101st C.A. Brig., 1 June 1940.

**Events:** 233

**Commanders, 92d Infantry Brigade**

Brig. Gen. Lucius C. Bennett (RA) 22 April 1927–18 February 1929

Brig. Gen. Frank E. Reed (MN) 19 February 1929–1 June 1940

**HHC, 92d Infantry Brigade** (Separate) (II)

**Puerto Rico National Guard**

**HQ**—San Juan, PR, 1940; Camp Tortuguero, PR, 1940–41

**Subordinate elements**—295th and 296th Inf. Regts., 1940–41

Constituted in the N.G. on 25 August 1940 and allotted to the commonwealth of Puerto Rico. HQ organized 26 September 1940, and federally recognized at San Juan, PR. Inducted into active Federal service at Camp Tortuguero, PR, on 15 October 1940 and assigned to the Puerto Rican Department. The brigade mission was to provide command and control of mobile units for the defense of Puerto Rico. Moved to Caguas, PR, where it arrived 26 September 1941, and returned to Camp Tortuguero on 11 October 1941. Location 7 December 1941—Camp Tortuguero, PR. (Inactivated 24 July 1942.)

**Events:** 280, 286

**Commanders, 92d Infantry Brigade**

Brig. Gen. Luis Raul Esteves

26 September 1940–24 July 1942

**HHC, 93d Infantry Brigade (Separate)****New York National Guard****HQ**—New York City, NY, 1926–40**Subordinate elements**—10th New York Inf. Regt., 1927–40; 14th New York Inf. Regt., 1926–40; 71st Inf. Regt., 1926–27; 165th Inf. Regt., 1927–40; 369th Inf. Regt., 1927–40

Constituted in the N.G. in April 1926 and allotted to New York. HQ organized 10 May 1926 at New York City, NY. HQ federally recognized on 26 January 1927. HQ Co. organized and federally recognized 2 April 1928 at New York City. Assigned to the First Army on 1 October 1933. Conducted annual summer training most years at Camp Smith, Peekskill, NY, 1927–39. Reorganized and redesignated HHB, 71st F.A. Brig. on 1 September 1940.

**Status:** Inactive in the New York N.G. as HQ, II Corps Artillery.**Events:** 61, 91, 280, 286**Commanders, 93d Infantry Brigade**

Brig. Gen. John J. Phelan	26 January 1927–3 June 1936	Brig. Gen. Alexander E. Anderson	25 August 1938–17 July 1940
Brig. Gen. Charles G. Blakeslee	3 June 1936–25 August 1938	Brig. Gen. Walter A. De Lamater	17 July 1940–14 August 1940
	Brig. Gen. Joseph A.S. Mundy		14 August 1940–1 September 1940

**HHC, 151st Infantry Brigade (76th Division)****Organized Reserve Connecticut****HQ**—*Not initiated*, 1921–22; New Haven, CT, 1922–41**Subordinate elements**—304th and 385th Inf. Regts., 1921–41

Arrived at the port of Hoboken, NJ, in January 1919 and transferred to Camp A.P. Hill, VA, as an element of the 76th Div. Transferred to Camp Devens, MA, where it was demobilized on 25 February 1919. Reconstituted in the O.R. on 24 June 1921, assigned to the 76th Div., and allotted to the First Corps Area. HHC initiated 27 February 1923 at New Haven, CT. Redesignated HHC, 151st Brig. on 23 March 1925. Redesignated HHC, 151st Inf. Brig. on 24 August 1936. Typically conducted Inactive Training Period meetings at the armory of the Governor's Foot Guards in New Haven. Conducted summer training most years at Camp Devens, MA, 1923–40. Subordinate regiments conducted training of CMTC at Camp Devens with assistance from the 5th and 13th Inf. Regts. Location 7 December 1941—New Haven, CT.

**Commanders, 151st Infantry Brigade**

Capt. William T. Granfield	27 February 1923–June 1925	Unknown	ao February 1928–ao July 1937
Maj. Bourdon A. Babcock	June 1925–December 1925	Maj. Carlton F. Small	ao July 1937–13 January 1939
Lt. Col. Joseph B. Maguire	December 1925–ao February 1928	Maj. Joseph E. Felsted	13 January 1939–ao August 1941

**HHC, 152d Infantry Brigade (76th Division)****Organized Reserve Connecticut****HQ**—*Not initiated*, 1921–22; Hartford, CT, 1922–41**Subordinate elements**—417th and 418th Inf. Regts., 1921–41

Arrived at the port of Hoboken, NJ, in January 1919 and transferred to Camp A.P. Hill, VA, as an element of the 76th Div. Transferred to Camp Devens, MA, where it was demobilized on 25 February 1919. Reconstituted in the O.R. on 24 June 1921, assigned to the 76th Div., and allotted to the First Corps Area. HHC initiated in August 1922 at Hartford, CT. Redesignated HHC, 152d Brig. on 23 March 1925. Redesignated HHC, 152d Inf. Brig. on 24 August 1936. Typically conducted Inactive Training Period meetings at the State Armory in Hartford. Conducted summer training

most years at Camp Devens, MA, 1923–40. Subordinate regiments conducted training of CMTC at Camp Devens with assistance from the 5th and 13th Inf. Regts. Location 7 December 1941—Hartford, CT.

**Commanders, 152d Infantry Brigade**

Maj. Harry L. Perkins	5 September 1922–January 1928	Capt. Morris G. Cohen	ao April 1934–ao June 1934
Capt. Morris G. Cohen	January 1928–ao January 1930	Unknown	ao June 1934–9 March 1941
Unknown	ao January 1930–ao April 1934	Capt. William O. Thompson	9 March 1941–ao December 1941

**HHC, 153d Infantry Brigade (77th Division)**

**Organized Reserve New York**

**HQ**—New York City, NY, 1921–41

**Subordinate elements**—305th and 306th Inf. Regts., 1921–41

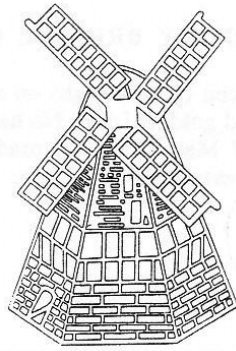

Arrived at the port of New York on 25 April 1919 on the U.S.S. *Mount Vernon* as the 153d Inf. Brig., an element of the 77th Div. Transferred 25 April 1919 to Camp Mills, NY. Transferred to Camp Upton, NY, where it was demobilized on 9 May 1919. Reconstituted in the O.R. on 24 June 1921, assigned to the 77th Div., and allotted to the Second Corps Area. HHC initiated on 30 August 1921 at Manhattan, NY. Redesignated HHC, 153d Brig. on 23 March 1925. Redesignated HHC, 153d Inf. Brig. on 24 August 1936. Brig. Gen. Pierce and the brigade staff conducted a staff ride to Gettysburg in May 1927 as a staff training event. Conducted summer training most years at Camp Dix, NJ, and some years at Fort Slocum, NY, 1922–40. Subordinate regiments conducted training of CMTC at Camp Dix, NJ, and some years at Plattsburg Barracks, NY, with assistance from the 16th, 18th, and 26th Inf. Regts. Location 7 December 1941—Manhattan, NY.

**Status:** Inactive in the US Army Reserve as HHC, 2d Brig., 77th Inf. Div.

**Events:** 91, 153, 168

**Commanders, 153d Infantry Brigade**

Lt. Col. Cornelius W. Wickersham	30 August 1921–25 January 1922	Col. Cornelius W. Wickersham	4 November 1929–8 October 1940
Col. James R. Howlett	25 January 1922–27 January 1922	Unknown	8 October 1940–30 July 1941
Brig. Gen. Palmer E. Pierce	27 January 1922–4 November 1929	Col. William H. Draper Jr.	30 July 1941–ao December 1941

**HHC, 154th Infantry Brigade (77th Division)**

**Organized Reserve New York**

**HQ**—New York City, NY, 1921–41

**Subordinate elements**—307th and 308th Inf. Regts., 1921–41

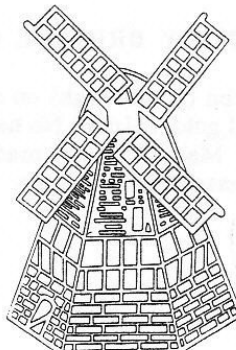

Arrived at the port of New York on 28 April 1919 on the U.S.S. *America* as the 154th Inf. Brig., an element of the 77th Div. Transferred to Camp Upton, NY, where it was demobilized on 9 May 1919. Reconstituted in the O.R. on 24 June 1921, assigned to the 77th Div., and allotted to the Second Corps Area. HHC initiated in November 1921 at Manhattan, NY. Redesignated HHC, 154th Brig. on 23 March 1925. Redesignated HHC, 154th Inf. Brig. on 24 August 1936. Conducted summer training most years at Camp Dix, NJ, and some years at Fort Slocum, NY, 1922–40. Subordinate regiments conducted training of CMTC at Camp Dix, NJ, and some years at Plattsburg Barracks, NY, with assistance from the 16th, 18th, and 26th Inf. Regts. Location 7 December 1941—Manhattan, NY.

**Status:** Inactive in the US Army Reserve as HHC, 3d Brig., 77th Inf. Div.

**Events:** 91, 153, 168

**Commanders, 154th Infantry Brigade**

Lt. Col. George E. Roosevelt	30 August 1921–20 April 1922	Col. Herbert T. Spooner	ao June 1936–September 1938
Brig. Gen. Charles I. Debevoise	20 April 1922–25 October 1925	Maj. George P. Brett Jr.	September 1938–ao October 1938
Brig. Gen. Cornelius Vanderbilt	25 October 1925–12 November 1929	Capt. Arthur H. Anderson	ao June 1939–ao October 1939
Col. Lemuel C. Bolles	13 November 1929–22 March 1934	Lt. Col. Charles M. Swezey	ao April 1940–10 March 1941
Unknown	22 March 1934–ao June 1936	Maj. William R. MacLeod	10 March 1941–30 July 1941
	Lt. Col. Harold A. Herrick		30 July 1941–ao December 1941

**HHC, 155th Infantry Brigade** (78th Division)

**Organized Reserve New Jersey**

**HQ**—Elizabeth, NJ, 1921–37; Englewood, NJ, 1937–41

**Subordinate elements**—309th and 310th Inf. Regts., 1921–41

Arrived at the port of Hoboken on 28 May 1919 on the S.S. *Santa Paula* as the 155th Inf. Brig., an element of the 78th Div. Arrived 28 May 1919 at Camp Merritt, NJ. Transferred to Camp Dix, NJ, where it was demobilized on 3 June 1919. Reconstituted in the O.R. on 24 June 1921, assigned to the 78th Div., and allotted to the Second Corps Area. HHC initiated on 6 December 1921 at Elizabeth, NJ. Redesignated HHC, 155th Brig. on 23 March 1925. Redesignated HHC, 155th Inf. Brig. on 24 August 1936. Relocated 5 April 1937 to Englewood, NJ. Conducted summer training most years at Camp Dix, NJ, 1922–40. Subordinate regiments conducted training of CMTC at Camp Dix, NJ, and some years at Fort Niagara, NY, with assistance from the 16th, 18th, and 28th Inf. Regts. Location 7 December 1941—Englewood, NJ.

**Status:** Active in the R.A. at Fort Bragg, NC, as HHC, 2d Brig., 82d Airborne Div.

**Events:** 91, 168

**Commanders, 155th Infantry Brigade**

Maj. Henry S. Hildreth	6 December 1921–12 March 1923	Unknown	ao June 1924–ao June 1929
Maj. George A. Reeder	12 March 1923–10 January 1924	Col. Harriot Van D. Moore	ao June 1929–31 March 1937
Maj. Charles S. Williams Jr.	10 January 1924–23 May 1924	Lt. Col. Edmund O. Howell	31 March 1937–13 May 1937
Maj. George A. Reeder	23 May 1924–ao June 1924	Col. Paul Debevoise	14 May 1937–ao April 1940
	Unknown		ao April 1940–7 December 1941

**HHC, 156th Infantry Brigade** (78th Division)

**Organized Reserve New Jersey**

**HQ**—Newark, NJ, 1921–41

**Subordinate elements**—311th and 312th Inf. Regts., 1921–41

Arrived at the port of New York on 24 May 1919 on the S.S. *Zeelandia* as the 156th Inf. Brig., an element of the 78th Div. Arrived 24 May 1919 at Camp Merritt, NJ. Transferred to Camp Dix, NJ, where it was demobilized on 26 May 1919. Reconstituted in the O.R. on 24 June 1921, assigned to the 78th Div., and allotted to the Second Corps Area. HHC initiated on 1 October 1921 at Newark, NJ. Redesignated HHC, 156th Brig. on 23 March 1925. Redesignated HHC, 156th Inf. Brig. on 24 August 1936. Conducted summer training most years at Camp Dix, NJ, 1922–40. Subordinate regiments conducted training of CMTC at Camp Dix, NJ, and some years at Plattsburg Barracks, NY, with assistance from the 16th, 18th, and 26th Inf. Regts. Location 7 December 1941—Newark, NJ.

**Status:** Active in the R.A. at Fort Bragg, NC, as HHC, 3d Brig., 82d Airborne Div.

**Events:** 91, 168

**Commanders, 156th Infantry Brigade**

1st Lt. Francis G. Russell	1 October 1921–21 October 1921	Col. Paul Debevoise	30 February 1930–14 May 1937
Capt. Charles A. Marshall	21 October 1921– December 1921	Col. Norman Meranus	14 May 1937–16 September 1937
Unknown	December 1921–ao June 1929	Lt. Col. Cornelius C. Vermeule	16 September 1937–30 January 1940
Col. John W. Reed	ao June 1929–30 February 1930	Lt. Col. Henry L. Butler	30 January 1940–15 March 1940
	Col. John H.M. Dudley		15 March 1940–19 May 1941

**HHC, 157th Infantry Brigade** (79th Division)**Organized Reserve Pennsylvania****HQ**—Wilkes-Barre, PA, 1921–41**Subordinate elements**—313th and 314th Inf. Regts., 1921–41

Arrived at the port of Newport News on 29 May 1919 on the S.S. *Antigone* as the 157th Inf. Brig., an element of the 79th Div. Transferred 29 May 1919 to Camp Merritt, NJ. Transferred to Camp Dix, NJ, where it was demobilized on 7 June 1919. Reconstituted in the O.R. on 24 June 1921, assigned to the 79th Div. Area, and allotted to the Third Corps. HHC initiated on 3 December 1921 at Wilkes-Barre, PA. Redesignated HHC, 157th Brig. on 23 March 1925. Redesignated HHC, 157th Inf. Brig. on 24 August 1936. Conducted summer training most years at Camp George G. Meade, MD, 1922–40. Subordinate regiments conducted training of CMTC at Camp George G. Meade; Fort Howard, MD; or Fort Eustis, VA; with assistance from the 12th and 34th Inf. Regts. Location 7 December 1941—Wilkes-Barre, PA.

**Status:** Active in the US Army Reserve as HHC, 5th Brig., 87th Div (Training Support) with HQ at Fort Jackson, SC.**Commanders, 157th Infantry Brigade**

Maj. William J. Wilcox	3 December 1921–ao June 1927	Lt. Col. Henry K. Seal	ao June 1930–ao September 1938
Unknown	ao June 1927–ao June 1930	Unknown	ao September 1938–7 December 1941

**HHC, 158th Infantry Brigade** (79th Division)**Organized Reserve Pennsylvania****HQ**—Philadelphia, PA, 1921–41**Subordinate elements**—315th and 316th Inf. Regts., 1921–41

Arrived at the port of New York on 28 May 1919 on the U.S.S. *Aeolus* as the 158th Inf. Brig., an element of the 79th Div. Transferred on 29 May 1919 to Camp Merritt, NJ. Transferred to Camp Dix, NJ, where it was demobilized on 6 June 1919. Reconstituted in the O.R. on 24 June 1921, assigned to the 79th Div., and allotted to the Third Corps Area. HHC initiated on 27 October 1921 at Philadelphia, PA. Redesignated HHC, 158th Brig. on 23 March 1925. Redesignated HHC, 158th Inf. Brig. on 24 August 1936. Conducted summer training most years at Camp George G. Meade, MD, 1922–40. Subordinate regiments conducted training of CMTC at Camp George G. Meade; Fort Howard, MD; or Fort Eustis, VA; with assistance from the 12th and 34th Inf. Regts. Location 7 December 1941—Philadelphia, PA.

**Status:** Active in the R.A. as HHC, 2d Brig., 87th Div. (Training Support) with HQ at Patrick AFB, FL.**Commanders, 158th Infantry Brigade**

Maj. Clifton Lisle	27 October 1921–2 March 1922	Maj. Carroll Missimer	7 September 1929–July 1930
Lt. Col. Thomas W. Miller	2 March 1922–31 January 1924	Lt. Col. William J.M. Turner	July 1930–24 December 1935
Lt. Col. Francis A. Awl	1 February 1924–ao June 1926	Unknown	24 December 1935–ao January 1937
Unknown	ao June 1926–ao August 1927	Maj. Walter A. Linn	ao January 1937–July 1938
Maj. William J.M. Turner	ao August 1927–7 September 1929	Col. Daniel B. Strickler	July 1938–July 1941
	Capt. Albert W. Hatch		July 1941–7 August 1941

**HHC, 159th Infantry Brigade** (80th Division)**Organized Reserve Virginia****HQ**—Richmond, VA, 1921–41**Subordinate elements**—317th and 318th Inf. Regts., 1921–41

Arrived at Boston, MA, in May 1919 as an element of the 80th Div. Transferred to Camp Lee, VA, where it was demobilized on 1 June 1919. Reconstituted in the O.R. on 24 June 1921, assigned to the 80th Div., and allotted to the Third Corps Area. HHC initiated on 16 December 1921 at Richmond, VA. Redesignated HHC, 159th Brig. on 23 March 1925. Redesignated HHC, 159th Inf. Brig. on 24 August 1936. Conducted summer training most years at Camp George G. Meade, MD, 1922–40. Subordinate regiments conducted training of CMTC at Camp George G. Meade; Fort Howard, MD; or Fort Eustis, VA; with assistance from the 12th and 34th Inf. Regts. Location 7 December 1941—Richmond, VA.

**Status:** Active in the R.A. at Fort Campbell, KY, as HHC, 2d Brig., 101st Airborne Div.

**Commanders, 159th Infantry Brigade**

2d Lt. Robert W. Savage	16 December 1921–ao September 1922	Unknown	ao June 1930–ao June 1932
Unknown	ao September 1922–ao September 1925	Lt. Col. Oswald L. Cole	ao June 1932–ao January 1937
Maj. Charles A. Rady	ao September 1925–ao June 1930	Maj. Ashby B. Land	ao June 1937–ao June 1940
	Unknown	ao June 1940–7 December 1941	

**HHC, 160th Infantry Brigade** (80th Division)

**Organized Reserve Maryland**

**HQ**—Baltimore, MD, 1921–37; Washington, DC, 1937–41

**Subordinate elements**—319th and 320th Inf. Regts., 1921–41

Arrived at the port of New York on 29 May 1919 on the U.S.S. *Mobile* as the 160th Inf. Brig., an element of the 80th Div. Transferred to Camp Lee, VA, where it was demobilized on 7 June 1919. Reconstituted in the O.R. on 24 June 1921, assigned to the 80th Div., and allotted to the Third Corps Area. HHC initiated 12 December 1921 at Baltimore, MD. Redesignated HHC, 160th Brig. on 23 March 1925. Redesignated HHC, 160th Inf. Brig. on 24 August 1936. Relocated 18 October 1937 to Washington, DC. Typically conducted Inactive Training Period meetings at the Post Office Building or the Emerson Hotel in Baltimore. Conducted summer training most years at Camp George G. Meade, MD, 1922–40. Subordinate regiments conducted training of CMTC at Camp George G. Meade; Fort Howard, MD; or Fort Eustis, VA; with assistance from the 12th and 34th Inf. Regts. Location 7 December 1941—Washington, DC.

**Status:** Active in the R.A. at Fort Campbell, KY, as HHC, 3d Brig., 101st Airborne Div.

**Commanders, 160th Infantry Brigade**

Capt. Arthur T. Brice Jr.	12 December 1921–15 June 1924	Maj. Mitchell H. Thomas	12 September 1928–2 November 1929
Capt. George R. Jackson	15 June 1924–ao July 1924	Lt. Col. William L. Peak	2 November 1929–21 September 1934
Unknown	ao July 1924–ao September 1925	Unknown	21 September 1934–17 January 1935
Maj. William L. Peak	ao September 1925–12 September 1928	Lt. Col. Charles P. Kerr	17 January 1935–October 1941

**HHC, 161st Infantry Brigade** (81st Division)

**Organized Reserve North Carolina**

**HQ**—*Not initiated*, 1921–22; Greensboro, NC, 1922–29; Raleigh, NC, 1929–41

**Subordinate elements**—321st and 322d Inf. Regts., 1921–41

Arrived at Newport News, VA, in June 1919 as an element of the 81st Div. Transferred to Camp Jackson, SC, where it was demobilized on 23 June 1919. Reconstituted in the O.R. on 24 June 1921, assigned to the 81st Div., and allotted to the Fourth Corps Area. HHC initiated on 9 March 1922 at Greensboro, NC. Redesignated HHC, 161st Brig. on 23 March 1925. Relocated 22 October 1929 to Raleigh, NC. Redesignated HHC, 161st Inf. Brig. on 24 August 1936. Conducted summer training at various locations to include Fort McPherson, GA; Fort Moultrie, SC; Fort Bragg, NC; and Camp McClellan, AL. Subordinate regiments conducted training of CMTC at Fort Moultrie with assistance from the 8th Inf. Regt. Location 7 December 1941—Raleigh, NC.

**Status:** Inactive in the US Army Reserve as HHC, 2d Brig., 81st Inf. Div.

**Commanders, 161st Infantry Brigade**

Brig. Gen. John Van B. Metts	9 March 1922–31 May 1926	Lt. Col. Robert W. Swatts	ao July 1936–2 October 1937
Unknown	31 May 1926–ao July 1936	Unknown	2 October 1937–7 December 1941

**HHC, 162d Infantry Brigade** (81st Division)

**Organized Reserve Tennessee**

**HQ**—*Not initiated*, 1921–22; Nashville, TN, 1922–29; Knoxville, TN, 1929–41

**Subordinate elements**—323d and 324th Inf. Regts., 1921–41



Arrived at Newport News, VA, in June 1919 as an element of the 81st Div. Transferred to Camp Devens, MA, where it was demobilized on 17 June 1919. Reconstituted in the O.R. on 24 June 1921, assigned to the 81st Div., and allotted to the Fourth Corps Area. HHC initiated on 9 January 1922 at Nashville, TN. Redesignated HHC, 162d Brig. on 23 March 1925. Relocated on 22 October 1929 to Knoxville, TN. Redesignated HHC, 162d Inf. Brig. on 24 August 1936. Conducted summer training at various locations to include Fort McPherson, GA; Fort Moultrie, SC; Fort Oglethorpe, GA; Fort Bragg, NC; and Camp McClellan, AL. Subordinate regiments conducted training of CMTC with assistance from the 22d Inf. Regt. at Camp McClellan or Camp Beauregard, LA. Location 7 December 1941—Knoxville, TN.

**Status:** Inactive in the US Army Reserve as HHC, 3d Brig., 81st Inf. Div.

**Commanders, 162d Infantry Brigade**

Capt. Robert W. Swatts	9 January 1922–9 March 1922	Unknown	20 January 1933–ao August 1936
Brig. Gen. Cary F. Spence	9 March 1922–20 January 1933	Lt. Col. James M. Waring	ao August 1936–ao September 1936
	Unknown		ao September 1936–7 December 1941

**HHC, 163d Infantry Brigade (82d Division)**

**Organized Reserve Georgia**

**HQ**—Macon, GA, 1921–29; Atlanta, GA, 1929–41

**Subordinate elements**—325th and 326th Inf. Regts., 1921–41

Arrived at the port of New York on 20 May 1919 on the S.S. *Sierra* as the 163d Inf. Brig., an element of the 82d Div. Transferred to Camp Mills, NY, where it was demobilized on 26 May 1919. Reconstituted in the O.R. on 24 June 1921, assigned to the 82d Div., and allotted to the Fourth Corps Area. HHC initiated on 23 October 1921 at Macon, GA. Redesignated HHC, 163d Brig. on 23 March 1925. Relocated 21 October 1929 to Atlanta, GA. Redesignated HHC, 163d Inf. Brig. on 24 August 1936. Conducted summer training most years at Fort McPherson, GA, 1922–40, and some years at Fort Screven, GA. Subordinate regiments conducted training of CMTC with assistance from the 8th and 22d Inf. Regts. at McClellan, Fort Screven, Fort Moultrie, or Camp Beauregard, LA. Location 7 December 1941—Macon, GA.

**Status:** Active in the R.A. at Fort Bragg, NC, as Headquarters and Headquarters Troop (HHT), 1st Sq., 17th Cav. (consolidated with HHT, 1-17th Cav. as 82d Airborne Rcn. Co. on 1 September 1957).

**Commanders, 163d Infantry Brigade**

Lt. Col. Ozzy R. Horton	14 January 1922–ao January 1937	Unknown	ao January 1937–7 December 1941
-------------------------	---------------------------------	---------	---------------------------------

**HHC, 164th Infantry Brigade (82d Division)**

**Organized Reserve Florida**

**HQ**—*Not initiated*, 1921–22; Jacksonville, FL, 1922–29; Tampa, FL, 1929–41

**Subordinate elements**—327th and 328th Inf. Regts., 1921–41

Arrived at the port of New York on 20 May 1919 on the S.S. *Sierra* as the 164th Inf. Brig., an element of the 82d Div. Transferred to Camp Mills, NY, where it was demobilized on 25 May 1919. Reconstituted in the O.R. on 24 June 1921, assigned to the 82d Div., and allotted to the Fourth Corps Area. HHC initiated in February 1922 at Jacksonville, FL. Redesignated HHC, 164th Brig. on 23 March 1925. Relocated 22 October 1929 to Tampa, FL. Redesignated HHC, 164th Inf. Brig. on 24 August 1936. Conducted summer training most years at Camp McClellan, AL, 1922–40; and some years at Fort MacPherson, GA; and Fort Screven, GA. Subordinate regiments conducted training of CMTC with assistance from the 8th and 22d Inf. Regts. at McClellan, Fort Screven, Fort Moultrie, or Camp Beauregard, LA. Location 7 December 1941—Jacksonville, FL.

**Commanders, 164th Infantry Brigade**

Unknown	February 1922–13 June 1922	Unknown	August 1925–ao December 1937
Lt. Col. Richard L. Boyd	13 June 1922–August 1925	Lt. Col. J. L. Chapman	ao December 1937–ao September 1940
	<i>Inactive</i>		ao September 1940–7 December 1941

**HHC, 165th Infantry Brigade** (83d Division)**Organized Reserve Ohio****HQ**—Cincinnati, OH, 1921–31; Columbus, OH, 1931–34; Dayton, OH, 1934–41**Subordinate elements**—329th and 330th Inf. Regts., 1921–41

Arrived at the port of New York on 24 January 1919 on the U.S.S. *George Washington* as the 165th Inf. Brig., an element of the 83d Div. Arrived 25 January 1919 at Camp Mills, NY. Transferred to Camp Sherman, OH, where it was demobilized on 12 February 1919. Reconstituted in the O.R. on 24 June 1921, assigned to the 83d Div., and allotted to the Fifth Corps Area. HHC initiated on 1 December 1921 at Cincinnati, OH. Redesignated HHC, 165th Brig. on 23 March 1925. Relocated on 15 April 1931 to Columbus, OH. Relocated on 23 April 1934 to Dayton, OH. Redesignated HHC, 165th Inf. Brig. on 24 August 1936. Conducted summer training most years at Camp Knox, KY, 1922–40, and some years at Fort Thomas, KY, or Fort Benjamin Harrison, IN. Subordinate regiments conducted training of CMTC at Fort Thomas, Fort Benjamin Harrison, or Camp Knox, with assistance from the 10th and 11th Inf. Regts. Location 7 December 1941—Cincinnati, OH.

**Status:** Inactive in the US Army Reserve as HHC, 2d Brig., 83d Inf. Div.**Commanders, 165th Infantry Brigade**

Maj. H.K. Martin	1 December 1921–13 December 1921	Unknown	ao September 1926–ao July 1934
Brig. Gen. Sanford B. Stanbery	13 December 1921–ao January 1923	Col. LaRue A. Boals	ao July 1934–ao August 1934
Unknown	ao January 1923–ao May 1926	Unknown	ao August 1934–ao June 1938
Col. R. L. Huber	ao May 1926–ao September 1926	Capt. Louis A. Makley	ao June 1938–ao July 1938
	Unknown	ao July 1938–7 December 1941	

**HHC, 166th Infantry Brigade** (83d Division)**Organized Reserve Ohio****HQ**—Bucyrus, OH, 1921–31; Toledo, OH, 1931–41**Subordinate elements**—331st and 332d Inf. Regts., 1921–41

Arrived at the port of New York on 24 January 1919 on the U.S.S. *George Washington* as the 166th Inf. Brig., an element of the 83d Div. Arrived 25 January 1919 at Camp Mills, NY. Transferred to Camp Sherman, OH, where it was demobilized on 11 February 1919. Reconstituted in the O.R. on 24 June 1921, assigned to the 83d Div., and allotted to the Fifth Corps Area. HHC initiated on 7 November 1921 at Bucyrus, OH. Redesignated HHC, 166th Brig. on 23 March 1925. Relocated 9 July 1931 to Toledo, OH. Redesignated HHC, 166th Inf. Brig. on 24 August 1936. Conducted summer training most years at Camp Knox, KY, 1922–40, and some years at Fort Thomas, KY, or Fort Benjamin Harrison, IN. Subordinate regiments conducted training of CMTC at Fort Thomas, Fort Benjamin Harrison, or Camp Knox, with assistance from the 10th and 11th Inf. Regts. Location 7 December 1941—Toledo, OH.

**Status:** Inactive in the US Army Reserve as HHC, 3d Brig., 83d Inf. Div.**Commanders, 166th Infantry Brigade**

Brig. Gen. C. Edward Vollrath	7 November 1921–28 June 1924	Unknown	ao June 1926–ao June 1934
Lt. Col. Daniel A. Schryver	28 June 1924–ao June 1926	Lt. Col. Earle Forster	ao June 1934–ao November 1937
	Unknown	ao November 1937–7 December 1941	

**HHC, 167th Infantry Brigade** (84th Division)**Organized Reserve Indiana****HQ**—Newcastle, IN, 1921–31; Indianapolis, IN, 1931–39; Fort Wayne, IN, 1939–41**Subordinate elements**—333d and 334th Inf. Regts., 1921–41

Arrived at Camp Merritt, NJ, in January 1919 as an element of the 84th Div. Transferred to Camp Zachary Taylor, KY, where it was demobilized in February 1919. Reconstituted in the O.R. on 24 June 1921, assigned to the 84th

Div., and allotted to the Fifth Corps Area. HHC initiated on 3 November 1921 at Newcastle, IN. Redesignated HHC, 167th Brigade on 23 March 1925. Relocated 9 July 1931 to Indianapolis, IN. Redesignated HHC, 167th Inf. Brig. on 24 August 1936. Relocated 13 June 1939 to Fort Wayne, IN. Conducted summer training most years at Camp Knox, KY, 1922–40, and some years at Fort Benjamin Harrison, IN, or Culver Military Academy. Subordinate regiments conducted training of CMTC at Fort Benjamin Harrison or Camp Knox with assistance from the 10th and 11th Inf. Regts. Location 7 December 1941—Fort Wayne, IN.

**Status:** Active in the R.A. at Schofield Barracks, HI, as HHC, 1st Brig., 25th Inf. Div. (Light).

**Commanders, 167th Infantry Brigade**

1st Lt. Robert S. Telfer	3 November 1921–23 November 1921	Unknown	ao September 1924–ao June 1930
Capt. H.L. Onesick	23 November 1921–June 1922	Lt. Col. Ralph R. Cross	ao June 1930–July 1930
Capt. Jacob J. Pfenninger	June 1922–9 September 1922	Lt. Col. Myron M. Andrews	July 1930–ao October 1930
Maj. Arthur C. Newkirk	9 September 1922–ao September 1924	Unknown	ao October 1930–7 December 1941

**HHC, 168th Infantry Brigade** (84th Division)

**Organized Reserve Indiana**

**HQ**—Montpelier, IN, 1921–31; Culver, IN, 1931–33; South Bend, IN, 1933–41

**Subordinate elements**—335th and 336th Inf. Regts., 1921–41

Arrived at Camp Merritt, NJ, in January 1919 as an element of the 84th Div. Transferred to Camp Zachary Taylor, KY, where it was demobilized in February 1919. Reconstituted in the O.R. on 24 June 1921, assigned to the 84th Div., and allotted to the Fifth Corps Area. HHC initiated on 7 December 1921 at Montpelier, IN. Relocated 9 July 1931 to Culver, IN, and to South Bend, IN, on 21 December 1933. Conducted summer training most years at Camp Knox, KY, 1922–40, and some years at Fort Benjamin Harrison, IN, or Culver Military Academy. Subordinate regiments conducted training of CMTC at Fort Benjamin Harrison or Camp Knox with assistance from the 10th and 11th Inf. Regts. Location 7 December 1941—South Bend, IN.

**Status:** Active in the R.A. at Schofield Barracks, HI, as HHC, 2d Brig., 25th Inf. Div. (Light).

**Commanders, 168th Infantry Brigade**

Maj. Harold C. Bays	7 December 1921–1 January 1922	Brig. Gen. Leigh R. Gignilliat	1 January 1922–4 July 1939
	Unknown	4 July 1939–7 December 1941	

**HHC, 169th Infantry Brigade** (85th Division)

**Organized Reserve Michigan**

**HQ**—*Not initiated*, 1921–23; Grand Rapids, MI, 1923–41

**Subordinate elements**—337th and 338th Inf. Regts., 1921–41

Arrived at the port of New York on 30 March 1919 on the S.S. *Aquitania* as the 169th Inf. Brig., an element of the 85th Div. Transferred 30 March 1919 at Camp Mills, NY. Transferred to Camp Custer, MI, where it was demobilized on 16 April 1919. Reconstituted in the O.R. on 24 June 1921, assigned to the 85th Div., and allotted to the Sixth Corps Area. HHC initiated in February 1923 at Grand Rapids, MI. Redesignated HHC, 169th Brig. on 23 March 1925. Redesignated HHC, 169th Inf. Brig. on 24 August 1936. Conducted summer training most years at Camp Custer, MI, 1922–40. Conducted summer training at Camp Grayling, MI, with the HQ, 63d Inf. Brig. in 1928. Subordinate regiments conducted training of CMTC at Camp Custer or Fort Brady, MI, with assistance from the 2d Inf. Regt. Location 7 December 1941—Grand Rapids, MI.

**Status:** Inactive in the R.A. as HHC, 1st Brig., 24th Inf. Div. (Mecz).

**Commanders, 169th Infantry Brigade**

Unknown	February 1923–30 October 1923	Lt. Col. John L. Boer	31 October 1923–ao October 1930
	Unknown	ao October 1930–7 December 1941	

**HHC, 170th Infantry Brigade** (85th Division)**Organized Reserve Michigan****HQ**—*Not initiated*, 1921–22; Detroit, MI, 1922–41**Subordinate elements**—339th and 340th Inf. Regts., 1921–41

Arrived at the port of New York on 2 April 1919 on the U.S.S. *Leviathan* as the 170th Inf. Brig., an element of the 85th Div. Transferred 2 April 1919 at Camp Mills, NY. Transferred to Camp Custer, MI, where it was demobilized on 23 April 1919. Reconstituted in the O.R. on 24 June 1921, assigned to the 85th Div., and allotted to the Sixth Corps Area. HHC initiated on 21 March 1922 at Detroit, MI. Redesignated HHC, 170th Brig. on 23 March 1925. Redesignated HHC, 170th Inf. Brig. on 24 August 1936. Conducted summer training most years at Camp Custer, MI, 1922–40, and some years at Fort Sheridan, IL. Conducted summer training at Camp Grayling, MI, with the 63d Inf. Brig. in 1929. Subordinate regiments conducted training of CMTC at Camp Custer or Fort Brady, MI, with assistance from the 2d Inf. Regt. Location 7 December 1941—Detroit, MI.

**Status:** Inactive in the R.A. as HHC, 2d Brig., 24th Inf. Div. (Mecz).**Commanders, 170th Infantry Brigade**

Brig. Gen. Edward G. Heckel	21 March 1922–ao October 1930	Unknown	10 November 1931–ao June 1939
Lt. Col. Jake H. Brownrigg	ao July 1930–10 November 1931	Lt. Col. William A. McDonald	ao June 1939–ao September 1939
	Unknown	ao September 1939–7 December 1941	

**HHC, 171st Infantry Brigade** (86th Division)**Organized Reserve Illinois****HQ**—*Not initiated*, 1921–22; Chicago, IL, 1922–41**Subordinate elements**—341st and 342d Inf. Regts., 1921–41

Arrived at Camp Mills, NY, in January 1919 as an element of the 86th Div. Transferred to Camp Grant, IL, where it was demobilized in January 1919. Reconstituted in the O.R. on 24 June 1921, assigned to the 86th Div., and allotted to the Sixth Corps Area. HHC initiated on 23 February 1922 at Chicago, IL. Redesignated HHC, 171st Brig. on 23 March 1925. Redesignated HHC, 171st Inf. Brig. on 24 August 1936. Conducted summer training most years at Fort Sheridan, IL, 1922–40, and some years at Camp Custer, MI, or Jefferson Barracks, MO. Subordinate regiments conducted training of CMTC at Fort Sheridan, IL, or Jefferson Barracks with assistance from the 2d and 6th Inf. Regts. Location 7 December 1941—Chicago, IL.

**Status:** Inactive in the R.A. as HHC, 171st Inf. Brig. (Sep.).**Events:** 162**Commanders, 171st Infantry Brigade**

Maj. William S. Maxwell	23 February 1922–22 June 1922	Lt. Col. Warren E. Pugh	ao June 1930–23 July 1930
Maj. Julius R. Offenbauer	22 June 1922–7 September 1922	Unknown	23 July 1930–27 November 1935
Brig. Gen. George H. Harries	7 September 1922–4 May 1925	Capt. Howard J. Brent	27 November 1935–11 January 1936
Unknown	4 May 1925–ao January 1927	Maj. Bruce W. Bell	11 January 1936–27 February 1936
Lt. Col. Walter B. Wolf	ao January 1927–ao June 1929	Lt. Col. Clarence J. Primm	27 February 1936–ao September 1939
Unknown	ao June 1929–ao June 1930	Unknown	ao September 1939–7 December 1941

**HHC, 172d Infantry Brigade** (86th Division)**Organized Reserve Illinois****HQ**—Springfield, IL, 1921–41**Subordinate elements**—343d and 344th Inf. Regts., 1921–41

Arrived at Camp Mills, NY, in January 1919 as an element of the 86th Div. Transferred to Camp Grant, IL, where it was demobilized in January 1919. Reconstituted in the O.R. on 24 June 1921, assigned to the 86th Div., and allotted to the Sixth Corps Area. HHC initiated on 28 December 1921 at Springfield, IL. Redesignated HHC, 172d

Brig. on 23 March 1925. Redesignated HHC, 172d Inf. Brig. on 24 August 1936. Conducted summer training most years at Fort Sheridan, IL, 1922–40, and some years at Camp Custer, MI, or Jefferson Barracks, MO. Conducted summer training at Camp Grant, IL, with the 33d Div. in 1929. Subordinate regiments conducted training of CMTC at Fort Sheridan, IL; Camp Custer; or Jefferson Barracks; with assistance from the 2d and 6th Inf. Regts. Location 7 December 1941—Springfield, IL.

**Status:** Active in the R.A. at Fort Wainwright, AK, as HHC, 172d Inf. Brig. (Sep.).

**Commanders, 172d Infantry Brigade**

Lt. Col. Paul L. Starnes	3 January 1922–22 September 1927	Maj. Earle A. Reed	ao January 1930–June 1930
Lt. Col. George G. Davis	27 September 1927–ao June 1929	Maj. Benjamin W. Landberg	July 1930–ao January 1935
Unknown	ao June 1929–ao January 1930	Col. Grant S. Miles	ao May 1935–August 1941

**HHC, 173d Infantry Brigade (87th Division)**

**Organized Reserve Alabama**

**HQ**—*Not initiated*, 1921–22; Mobile, AL, 1922–29; Birmingham, AL, 1929–41

**Subordinate elements**—345th and 346th Inf. Regts., 1921–41

Arrived at the port of Newport News on 10 January 1919 on the U.S.S. *Finland* as the 173d Inf. Brig., an element of the 87th Div. Transferred 10 January 1919 to Camp Mills, NY. Transferred to Camp Dix, NJ, where it was demobilized on 8 February 1919. Reconstituted in the O.R. on 24 June 1921, assigned to the 87th Div., and allotted to the Fourth Corps Area. HHC initiated on 30 January 1922 at Mobile, AL. Redesignated HHC, 173d Brig. on 23 March 1925. Relocated 22 October 1929 to Birmingham, AL. Redesignated HHC, 173d Inf. Brig. on 24 August 1936. Conducted summer training most years at Camp McClellan, AL, 1922–40, and some years at Fort McPherson, GA. Subordinate regiments conducted training of CMTC at Camp McClellan or Camp Beauregard, LA, with assistance from the 22d Inf. Regt. Location 7 December 1941—Birmingham, AL.

**Status:** Active in the R.A. at Vicenza, Italy, as HHC, 173d Airborne Brig.

**Commanders, 173d Infantry Brigade**

Unknown	30 January 1922–ao May 1936	Unknown	ao September 1936–ao Jul 37
Capt. Moffett T. G. Brown	ao May 36–ao September 36	Maj. John D. Higgins	ao July 1937–ao September 1940
	Unknown	ao September 1940–7 December 1941	

**HHC, 174th Infantry Brigade (87th Division)**

**Organized Reserve Louisiana/Mississippi**

**HQ**—*Not initiated*, 1921–22; Shreveport, LA, 1922–29; Jackson, MS, 1929–41

**Subordinate elements**—347th and 348th Inf. Regts., 1921–41

Arrived at the port of Newport News on 10 January 1919 on the U.S.S. *Madawaska* as the 174th Inf. Brig., an element of the 87th Div. Transferred 10 January 1919 to Camp Mills, NY. Transferred to Camp Dix, NJ, where it was demobilized on 5 February 1919. Reconstituted in the O.R. on 24 June 1921, assigned to the 87th Div., and allotted to the Fourth Corps Area. HHC initiated 2 December 1921 at Shreveport, LA. Redesignated HHC, 174th Brig. on 23 March 1925. Relocated 22 October 1929 to Jackson, MS. Redesignated HHC, 174th Inf. Brig. on 24 August 1936. Conducted summer training most years at Camp McClellan, AL, 1922–40, and some years at Fort Screven, GA, or at Fort McPherson, GA. Subordinate regiments conducted training of CMTC at Camp McClellan or Camp Beauregard, LA, with assistance from the 22d Inf. Regt. Location 7 December 1941—Jackson, MS.

**Status:** Active in the US Army Reserve as HHC, 2d Brig., 87th Div. (Tng. Support) with HQ at Cocoa Beach, FL.

**Commanders, 174th Infantry Brigade**

Maj. Joseph R. Bluck	2 December 1921–ao January 1922	Unknown	ao January 1922–7 December 1941
----------------------	---------------------------------	---------	---------------------------------

**HHC, 175th Infantry Brigade** (88th Division)**Organized Reserve Iowa****HQ**—Mason City, IA, 1921–40; Cedar Rapids, IA, 1940–41**Subordinate elements**—349th and 350th Inf. Regts., 1921–41

Arrived at the port of New York on 30 May 1919 on the U.S.S. *Rijndam* as the 175th Inf. Brig., an element of the 88th Div. Transferred 30 May 1919 to Camp Merritt, NJ. Transferred to Camp Dodge, IA, where it was demobilized on 11 June 1919. Reconstituted in the O.R. on 24 June 1921, assigned to the 88th Div., and allotted to the Seventh Corps Area. HHC initiated on 12 October 1921 at Mason City, IA. Redesignated HHC, 175th Brig. on 23 March 1925. Redesignated HHC, 175th Inf. Brig. on 24 August 1936. Relocated in 1940 to Cedar Rapids, IA. Conducted summer training most years at Fort Snelling, MN, 1922–40, and some years at Fort Des Moines, IA. Subordinate regiments conducted training of CMTC at Fort Snelling, MN, or Fort Des Moines with assistance from the 3d and 17th Inf. Regts. Location 7 December 1941—Cedar Rapids, IA.

**Commanders, 175th Infantry Brigade**

Brig. Gen. Hubert A. Allen	12 October 1921–26 November 1921	Maj. John H. Kelley	June 1927–ao October 1928
Brig. Gen. George W. Ball	24 December 1921–4 January 1924	Lt. Col. Charles W. DeJarnette	ao January 1929–ao June 1931
Maj. Charles B. Robbins	5 January 1924–June 1927	Unknown	ao June 1931–7 December 1941

**HHC, 176th Infantry Brigade** (88th Division)**Organized Reserve Minnesota****HQ**—*Not initiated*, 1921–22; St. Paul, MN, 1922–41**Subordinate elements**—351st and 352d Inf. Regts., 1921–41

Arrived at the port of Newport News on 31 May 1919 on the U.S.S. *Mercury* as the 176th Inf. Brig., an element of the 88th Div. Transferred 1 June 1919 to Camp Merritt, NJ. Transferred to Camp Dodge, IA, where it was demobilized on 7 June 1919. Reconstituted in the O.R. on 24 June 1921, assigned to the 88th Div., and allotted to the Seventh Corps Area. HHC initiated in February 1922 at St. Paul, MN. Redesignated HHC, 176th Brig. on 23 March 1925. Redesignated HHC, 176th Inf. Brig. on 24 August 1936. Conducted summer training most years at Fort Snelling, MN, 1922–40. Subordinate regiments conducted training of CMTC at Fort Abraham Lincoln, ND, or Fort Snelling, MN, with assistance from the 3d Inf. Regt. Location 7 December 1941—Minneapolis, MN.

**Commanders, 176th Infantry Brigade**

Brig. Gen. Harold P. Howard	February 1922–24 December 1926	Lt. Col. John H. Burgen	January 1931–ao June 1931
Maj. John J. Ahern	25 December 1926–January 1931	Unknown	ao June 1931–7 December 1941

**HHC, 177th Infantry Brigade** (89th Division)**Organized Reserve Kansas****HQ**—*Not initiated*, 1921–22; La Harpe, KS, 1922–24; Garden City, KS, 1924–26; Wichita, KS, 1926–41**Subordinate elements**—353d and 354th Inf. Regts., 1921–41

Arrived at the port of New York in May 1919 on the S.S. *Imperator* as the 177th Inf. Brig., an element of the 89th Div. Transferred to Camp Funston, KS, where it was demobilized on 1 June 1919. Reconstituted in the O.R. on 24 June 1921, assigned to the 89th Div., and allotted to the Seventh Corps Area. HHC initiated on 20 March 1922 at La Harpe, KS. Relocated 25 February 1924 to Garden City, KS. Redesignated HHC, 177th Brig. on 23 March 1925. Relocated 26 May 1926 to Wichita, KS. Redesignated HHC, 177th Inf. Brig. on 24 August 1936. Conducted summer training most years at Fort Leavenworth, KS, 1922–40, and some years at Fort Crook, NE, or Fort Des Moines, IA. Subordinate regiments conducted training of CMTC at Fort Leavenworth or Fort Crook with assistance from the 17th Inf. Regt. Location 7 December 1941—Wichita, KS.

**Status:** Active in the R.A. as HHC, 5th Brig., 87th Div. (Tng. Support) with HQ at Camp Shelby, MS.**Commanders, 177th Infantry Brigade**

Unknown	20 March 1922–ao September 1928	Capt. Paul H. Sprenkle	22 November 1938–ao July 1939
Maj. Chat A. Pickens	ao September 1928–22 November 1938	Unknown	ao July 1939–7 December 1941

**HHC, 178th Infantry Brigade** (89th Division)**Organized Reserve Nebraska****HQ**—*Not initiated*, 1921–22; Omaha, NE, 1922–26; Norfolk, NE, 1926–41**Subordinate elements**—355th and 356th Inf. Regts., 1921–41

Arrived at the port of New York on 27 May 1919 on the S.S. *Rotterdam* as the 178th Inf. Brig., an element of the 89th Div. Transferred to Camp Zachary Taylor, KY, where it was demobilized on 8 June 1919. Reconstituted in the O.R. on 24 June 1921, assigned to the 89th Div., and allotted to the Seventh Corps Area. HHC initiated in February 1922 at Omaha, NE. Redesignated HHC, 178th Brig. on 23 March 1925. Relocated 26 May 1926 to Norfolk, NE. Redesignated HHC, 178th Inf. Brig. on 24 August 1936. Conducted summer training most years at Fort Crook, NE, 1922–40, and some years at Fort Des Moines, IA. Subordinate regiments conducted training of CMTC at Fort Crook; Fort Des Moines; Fort Leavenworth; or Fort Abraham Lincoln, ND; with assistance from the 3d and 17th Inf. Regts. Location 7 December 1941—Norfolk, NE.

**Commanders, 178th Infantry Brigade**

Unknown	February 1922–ao September 1937	Maj. Arthur G. George	10 February 1938–ao January 1940
Lt. Col. Francis N. Jordan	ao September 1937–10 February 1938	Unknown	ao January 1940–7 December 1941

**HHC, 179th Infantry Brigade** (90th Division)**Organized Reserve Texas****HQ**—Fort Worth, TX, 1921–41**Subordinate elements**—357th and 358th Inf. Regts., 1921–41

Arrived at the port of Newport News on 8 June 1919 on the S.S. *Wilhelmina* as the 179th Inf. Brig., an element of the 90th Div. Arrived 9 June 1919 at Camp Stuart, VA. Transferred to Camp Pike, AR, where it was demobilized on 18 June 1919. Reconstituted in the O.R. on 24 June 1921, assigned to the 90th Div., and allotted to the Eighth Corps Area. HHC initiated on 26 November 1921 at Fort Worth, TX. Redesignated HHC, 179th Brig. on 23 March 1925. Redesignated HHC, 179th Inf. Brig. on 24 August 1936. Typically conducted Inactive Training Period meetings at the Texas Hotel in Fort Worth. Conducted summer training most years at Fort Sam Houston, TX, 1922–40, with the 2d Div. and some years at Camp Bullis, TX. Subordinate regiments conducted training of CMTC at Fort Sam Houston or Camp Bullis with assistance from the regiments of the 2d Div. Location 7 December 1941—Fort Worth, TX.

**Status:** Inactive in the US Army Reserve as HHC, 2d Brig., 90th Inf. Div.**Commanders, 179th Infantry Brigade**

1st Lt. Harry M. Warren	26 November 1921–9 January 1922	Maj. Joseph C. Clark	January 1926–ao November 1926
Lt. Col. Frank S. Roberts	9 January 1922–April 1925	Unknown	ao November 1926–ao April 1934
Col. Samuel F. Crecelius	April 1925–August 1925	Col. Jules Muchert	ao April 1934–ao May 1934
Capt. Charles H. Fleming	August 1925–January 1926	Unknown	ao May 1934–7 December 1941

**HHC, 180th Infantry Brigade** (90th Division)**Organized Reserve Texas****HQ**—Houston, TX, 1921–41**Subordinate elements**—359th and 360th Inf. Regts., 1921–41

Arrived at the port of Boston on 7 June 1919 on the S.S. *Mongolia* as the 180th Inf. Brig., an element of the 90th Div. Arrived in June 1919 at Camp Stuart, VA. Transferred to Camp Bowie, TX, where it was demobilized on 17 June 1919. Reconstituted in the O.R. on 24 June 1921, assigned to the 90th Div., and allotted to the Eighth Corps Area. HHC initiated on 8 November 1921 at Houston, TX. Redesignated HHC, 180th Brig. on 23 March 1925. Redesignated HHC, 180th Inf. Brig. on 24 August 1936. Typically conducted Inactive Training Period meetings at the Federal Building in Houston. Conducted summer training most years at Fort Sam Houston, TX, 1922–40, with the 2d Div. and some years at Camp Bullis, TX. Subordinate regiments conducted training of CMTC at Fort Sam Houston or Camp Bullis with assistance from the regiments of the 2d Div. Location 7 December 1941—Houston, TX.

**Status:** Inactive in the US Army Reserve as HHC, 3d Brig., 90th Inf. Div.

**Events: 216****Commanders, 180th Infantry Brigade**

Capt. William S. Blackshear	8 November 1921–23 August 1922	Lt. Col. Richard L. Coleman	ao October 1934–ao January 1935
Maj. Samuel A. Anderson	23 August 1922–25 January 1923	Unknown	ao January 1935–ao April 1936
Maj. Almer C. Burnett	25 January 1923–ao April 1924	Lt. Col. Rudolph E. Fried	ao April 1936–22 August 1936
Unknown	ao April 1924–ao May 1925	Brig. Gen. Alexander Ovenshine*	22 August 1936–8 September 1936
Maj. Richard T. Fleming	ao May 1925–ao November 1926	Lt. Col. Rudolph E. Fried	8 September 1936–ao December 1940
Unknown	ao November 1926–ao October 1934	Unknown	ao December 1940–7 December 1941

\*Concurrently commanding the 3d Inf. Brig.

**HHC, 181st Infantry Brigade (91st Division)****Organized Reserve California**

**HQ**—*Not initiated*, 1921–22; San Francisco, CA, 1922–41

**Subordinate elements**—361st and 362d Inf. Regts., 1921–41

Arrived at the port of New York on 2 April 1919 on the U.S.S. *Orizaba* as the 181st Inf. Brig., an element of the 91st Div. Transferred 2 April 1919 to Camp Merritt, NJ. Transferred to Camp Kearny, CA, where it was demobilized on 19 April 1919. Reconstituted in the O.R. on 24 June 1921, assigned to the 91st Div., and allotted to the Ninth Corps Area. HHC initiated on 21 January 1922 at San Francisco, CA. Redesignated HHC, 181st Brig. on 23 March 1925. Redesignated HHC, 181st Inf. Brig. on 24 August 1936. Conducted summer training most years at Del Monte, CA, 1922–40. Subordinate regiments conducted training of CMTC at the Presidio of San Francisco, CA; the Presidio of Monterey, CA; and Del Monte; with assistance from the 30th Inf. Regt. Location 7 December 1941—San Francisco, CA.

**Status:** Inactive in the US Army Reserve as HHC, 2d Brig., 63d Inf. Div.

**Commanders, 181st Infantry Brigade**

Maj. Edward J. Mitchell	21 January 1922–ao February 1922	Lt. Col. Henry R. Sanborn	ao June 1934–25 July 1935
Unknown	ao February 1922–ao November 1923	Lt. Col. Walter K. Knox	25 July 1935–5 December 1936
Lt. Col. Arthur St. J. Whitney	ao November 1923–ao July 1928	Lt. Col. Harry M. Thomas	5 December 1936–9 June 1937
Unknown	ao July 1928–ao June 1934	Col. Leonard M. Ferrell	10 June 1937–ao January 1940
	Unknown	ao January 1940–7 December 1941	

**HHC, 182d Infantry Brigade (91st Division)****Organized Reserve California**

**HQ**—Los Angeles, CA, 1921–41

**Subordinate elements**—363d and 364th Inf. Regts., 1921–41

Arrived at the port of Newport News on 1 April 1919 on the S.S. *Kentuckian* as an element of the 91st Div. Transferred 2 April 1919 to Camp Merritt, NJ. Transferred to Camp Lewis, WA, where it was demobilized on 28 April 1919. Reconstituted in the O.R. on 24 June 1921, assigned to the 91st Div., and allotted to the Ninth Corps Area. HHC initiated on 5 November 1921 at Los Angeles, CA. Redesignated HHC, 182d Brig. on 23 March 1925. Redesignated HHC, 182d Inf. Brig. on 24 August 1936. Conducted summer training most years at Del Monte, CA, 1925–40. Subordinate regiments conducted training of CMTC at the Presidio of San Francisco, CA; the Presidio of Monterey, CA; and Del Monte; with assistance from the 30th Inf. Regt. Location 7 December 1941—San Francisco, CA.

**Status:** Inactive in the US Army Reserve as HHC, 3d Brig., 63d Inf. Div.

**Commanders, 182d Infantry Brigade**

Lt. Col. Joseph W. Sutphen	5 November 1921–1 March 1933	Lt. Col. Bernard S. McMahon	13 February 1934–17 May 1939
Lt. Col. Esli L. Sutton	1 March 1933–13 February 1934	Lt. Col. Albert W. Roshe	17 May 1939–ao January 1940
	Unknown	ao January 1940–7 December 1941	



**HHC, 187th Infantry Brigade** (94th Division)**Organized Reserve Massachusetts****HQ**—Boston, MA, 1921–41**Subordinate elements**—301st and 302d Inf. Regts., 1921–41

Demobilized in an inactive status in December 1918 as an element of the 94th Div. Reconstituted in the O.R. on 24 June 1921, assigned to the 94th Div., and allotted to the First Corps Area. HHC initiated in December 1921 at Boston, MA. Redesignated HHC, 187th Brig. on 23 March 1925. Redesignated HHC, 187th Inf. Brig. on 24 August 1936. Typically conducted Inactive Training Period meetings at the Custom House Tower in Boston. Conducted summer training most years at Camp Devens, MA, 1922–40. Subordinate regiments conducted training of CMTC at Camp Devens, MA, or Fort McKinley, ME, with assistance from the 13th Inf. Regt. Location 7 December 1941—Boston, MA.

**Status:** Inactive in the US Army Reserve as HHC, 187th Inf. Brig. (Sep.).**Commanders, 187th Infantry Brigade**

No commander designated	December 1921–January 1923	Maj. A. B. Hitchcock (RA)	ao August 1928–ao August 1929
Capt. John A. Jeffries	January 1923–August 1923	Lt. Col. Harold R. Duffie	ao March 1930–ao June 1932
Capt. Cornelius F. Dineen	August 1923–ao September 1923	Unknown	ao June 1932–ao July 1939
Unknown	ao September 1923–ao March 1924	Lt. Col. Arthur J. Wicks	ao July 1939–ao January 1940
Maj. Charles P. Howard	ao March 1924–ao October 1927	Unknown	ao January 1940–7 December 1941

**HHC, 188th Infantry Brigade** (94th Division)**Organized Reserve Massachusetts****HQ**—Boston, MA, 1921–25; Worcester, MA, 1925–27; Springfield, MA, 1927–41**Subordinate elements**—376th and 419th Inf. Regts., 1921–41

Demobilized in an inactive status in December 1918 as an element of the 94th Div. Reconstituted in the O.R. on 24 June 1921, assigned to the 94th Div., and allotted to the First Corps Area. HHC initiated on 30 December 1921 at Boston, MA. Relocated 10 March 1925 to Worcester, MA. Redesignated HHC, 188th Brig. on 23 March 1925. Relocated 5 October 1927 to Springfield, MA. Redesignated HHC, 188th Inf. Brig. on 24 August 1936. Typically conducted Inactive Training Period meetings at the Chamber of Commerce Building or the State Armory in Worcester. Conducted summer training most years at Camp Devens, MA, 1922–40, and some years at Fort Ethan Allen, VT. Subordinate regiments conducted training of CMTC at Camp Devens, MA, with assistance from the 13th Inf. Regt. Location 7 December 1941—Boston, MA.

**Status:** Inactive in the R.A. as HHC, 188th Inf. Brig.**Commanders, 188th Infantry Brigade**

Capt. C. D. Carr	30 December 1921–ao June 1922	Maj. George C. Hall	ao July 1927–July 1929
Maj. Harold W. Schellenger	ao January 1923–May 1923	Lt. Col. Fred H. Thompson	July 1929–16 January 1931
Maj. William G. DeRosset	May 1923–ao April 1926	Lt. Col. Sherman O. Haight	16 January 1931–ao January 1941
Unknown	ao April 1926–ao July 1927	Unknown	ao January 1941–7 December 1941

**HHC, 189th Infantry Brigade** (95th Division)**Organized Reserve Oklahoma****HQ**—*Not initiated*, 1921–23; Muskogee, OK, 1923–41**Subordinate elements**—377th and 378th Inf. Regts., 1921–41

Demobilized in an inactive status in December 1918 as an element of the 95th Div. Reconstituted in the O.R. on 24 June 1921, assigned to the 95th Div., and allotted to the Eighth Corps Area. HHC initiated on 2 February 1923 at Muskogee, OK. Redesignated HHC, 189th Brig. on 23 March 1925. Redesignated HHC, 189th Inf. Brig. on 24 August 1936. Conducted summer training most years at Fort Sill, OK, 1922–40, with battalions of the 29th and 38th Inf. Regts. Subordinate regiments conducted training of CMTC at Fort Sill, OK, with assistance from the 29th and 38th Inf. Regts. Location 7 December 1941—Muskogee, OK.

**Status:** Inactive in the R.A. as HHC, 189th Inf. Brig.

### Commanders, 189th Infantry Brigade

Maj. Edwin H. Rolleston	2 February 1923–23 February 1923	Maj. Chauncey V. Crabb	ao August 1929–ao September 1929
Col. Ira L. Reeves	23 February 1923–January 1925	Unknown	ao September 1929–ao February 1931
Maj. Edwin H. Rolleston	January 1925–ao January 1927	Maj. John Mallon	ao February 1931–ao March 1931
Col. Patrick J. Hurley	ao September 1927–ao February 1928	Unknown	ao March 1931–ao December 1940
Unknown	ao February 1928–ao August 1929	Capt. James N. Hamilton Jr.	ao December 1940–ao January 1941
	Unknown	ao January 1941–7 December 1941	

### HHC, 190th Infantry Brigade (95th Division)

### Organized Reserve Oklahoma

HQ—Oklahoma City, OK, 1921–41

Subordinate elements—379th and 380th Inf. Regts., 1921–41

Demobilized in an inactive status in December 1918 as an element of the 95th Div. Reconstituted in the O.R. on 24 June 1921, assigned to the 95th Div., and allotted to the Eighth Corps Area. HHC initiated on 26 November 1921 at Oklahoma City, OK. Redesignated HHC, 190th Brig. on 23 March 1925. Redesignated HHC, 190th Inf. Brig. on 24 August 1936. Conducted summer training most years at Fort Sill, OK, 1922–40, with battalions of the 29th and 38th Inf. Regts. Subordinate regiments conducted training of CMTC at Fort Sill, OK, with assistance from the 29th and 38th Inf. Regts. Location 7 December 1941—Oklahoma City, OK.

Status: Inactive in the R.A. as HHC, 3d Brig., 24th Inf. Div. (Mecz).

### Commanders, 190th Infantry Brigade

Brig. Gen. Roy Hoffman	26 November 1921–2 August 1931	Lt. Col. John L. DeGroot	2 August 1931–ao September 1931
	Unknown	ao September 1931–7 December 1941	

### HHC, 191st Infantry Brigade (96th Division)

### Organized Reserve Oregon

HQ—*Not initiated* 1921–22; Portland, OR, 1922–41

Subordinate elements—381st and 382d Inf. Regts., 1921–41



Demobilized in an inactive status in December 1918 as an element of the 96th Div. Reconstituted in the O.R. on 24 June 1921, assigned to the 96th Div., and allotted to the Ninth Corps Area. HHC initiated on 17 April 1922 at Portland, OR. Redesignated HHC, 191st Brig. on 23 March 1925. Redesignated HHC, 191st Inf. Brig. on 24 August 1936. Conducted summer training most years at Camp Lewis, WA, 1922–40, and some years at Vancouver Barracks, WA. Subordinate regiments conducted training of CMTC at Vancouver Barracks with assistance from the 7th Inf. Regt. Location 7 December 1941—Portland, OR.

Status: Inactive in the R.A. as HHC, 191st Inf. Brig.

### Commanders, 191st Infantry Brigade

Capt. Franklin F. Korell	17 April 1922–ao May 1922	Unknown	9 May 1935–5 October 1937
Unknown	ao May 1922–ao June 1931	Lt. Col. Willard F. Daugherty	5 October 1937–25 August 1939
Lt. Col. Donald G. Able	ao June 1931–9 May 1935	Lt. Col. Thomas W. Gillard	3 October 1939–ao March 1940
	Unknown	ao March 1940–7 December 1941	

### HHC, 192d Infantry Brigade (96th Division)

### Organized Reserve Washington

HQ—*Not initiated*, 1921–22; Seattle, WA, 1922–41

Subordinate elements—383d and 384th Inf. Regts., 1921–41

Demobilized at Camp Wadsworth, SC, in December 1918 as an element of the 96th Div. Reconstituted in the O.R. on 24 June 1921, assigned to the 96th Div., and allotted to the Ninth Corps Area. HHC initiated on 1 March 1922 at

Seattle, WA. Redesignated HHC, 192d Brig. on 23 March 1925. Redesignated HHC, 192d Inf. Brig. on 24 August 1936. The 193d Inf. Brig. was one of the more active O.R. brigade HQ. It had some 23 enlisted reservists assigned in the mid-1920s and frequently held marksmanship training at Fort Lawton. Typically conducted Inactive Training Period meetings at Fort Lawton, WA. Conducted summer training most years at Camp Lewis, WA, 1922–40. Subordinate regiments conducted training of CMTC at Vancouver Barracks with assistance from the 7th Inf. Regt. Location 7 December 1941—Seattle, WA.

**Status:** Inactive in the US Army Reserve as HHC, 192d Inf. Brig.

**Commanders, 192d Infantry Brigade**

Capt. Winfield W. Smith	1 March 1922–April 1922	Unknown	ao April 1926–ao June 1933
Lt. Col. Burt C. Ross	April 1922–ao March 1925	Maj. Roy B. Childs	ao June 1933–20 May 1935
Unknown	ao March 1925–September 1925	Unknown	20 May 1935–31 October 1938
Capt. Francis C. Fitzgerald	ao September 1925–ao April 1926	Maj. Louis F. Derby	31 October 1938–ao June 1939
	Unknown	ao June 1939–7 December 1941	

**HHC, 193d Infantry Brigade (97th Division)**

**Organized Reserve Maine**

**HQ**—*Not initiated*, 1921–22; Augusta, ME, 1922–28; Bangor, ME, 1928–41

**Subordinate elements**—303d and 386th Inf. Regts., 1921–41

Demobilized in an inactive status in December 1918 as an element of the 97th Div. Reconstituted in the O.R. on 24 June 1921, assigned to the 97th Div., and allotted to the First Corps Area. HHC initiated in June 1922 at Augusta, ME. Redesignated HHC, 193d Brig. on 23 March 1925. Relocated 1 May 1928 to Bangor, ME. Redesignated HHC, 193d Inf. Brig. on 24 August 1936. Conducted summer training most years at Camp Devens, MA, 1922–40. Subordinate regiments conducted training of CMTC at Fort McKinley, ME, or Camp Devens with assistance from the 5th and 13th Inf. Regts. Location 7 December 1941—Augusta, ME.

**Status:** Inactive in the R.A. as HHC, 193d Inf. Brig. (Sep.).

**Commanders, 193d Infantry Brigade**

Maj. Clarence A. Whitney	June 1922–ao August 1926	Unknown	ao August 1926–7 December 1941
--------------------------	--------------------------	---------	--------------------------------

**HHC, 194th Infantry Brigade (97th Division)**

**Organized Reserve New Hampshire**

**HQ**—*Not initiated*, 1921–22; Concord, NH, 1922–41

**Subordinate elements**—387th and 388th Inf. Regts., 1921–41

Demobilized in an inactive status in December 1918 as an element of the 97th Div. Reconstituted in the O.R. on 24 June 1921, assigned to the 97th Div., and allotted to the First Corps Area. HHC initiated on 5 August 1922 at Concord, NH. Redesignated HHC, 194th Brig. on 23 March 1925. Redesignated HHC, 194th Inf. Brig. on 24 August 1936. Conducted summer training most years at Camp Devens, MA, 1922–40. Subordinate regiments conducted training of CMTC at Fort McKinley, ME, or Camp Devens with assistance from the 5th and 13th Inf. Regts. Location 7 December 1941—Concord, NH.

**Status:** Inactive in the R.A. as HHC, 194th Armd. Brig. (Sep.).

**Commanders, 194th Infantry Brigade**

Unknown	5 August 1922–ao June 1923	Lt. Col. John W. Keveney	ao July 1929–ao July 1934
Maj. Gerald Chittenden	ao June 1923–ao April 1926	Unknown	ao July 1934–ao August 1936
Unknown	ao April 1926–ao July 1928	Capt. Chester T. Brown	ao August 1936–ao July 1938
Capt. Charles C. Bond	ao July 1928–ao January 1929	Capt. Fred W. Hall	ao May 1939–ao June 1940
Unknown	ao January 1929–ao July 1929	Unknown	ao June 1940–7 December 1941

**HHC, 195th Infantry Brigade** (98th Division)**Organized Reserve New York****HQ**—*Not initiated*, 1921–22; Albany, NY, 1922–32; Syracuse, NY, 1932–41**Subordinate elements**—389th and 390th Inf. Regts., 1921–41

Constituted in the O.R. on 24 June 1921, assigned to the 98th Div., and allotted to the Second Corps Area. HHC initiated on 23 February 1922 at Albany, NY. Redesignated HHC, 195th Brig. on 23 March 1925. Redesignated HHC, 195th Inf. Brig. on 24 August 1936. Relocated 21 December 1932 to Syracuse, NY. Conducted summer training most years at Plattsburg Barracks, 1922–40, and some years at Fort Niagara, NY, or Camp Dix, NJ. Subordinate regiments conducted training of CMTC at Fort Niagara or at Plattsburg Barracks, NY, with assistance from the 26th and 28th Inf. Regts. Location 7 December 1941—Syracuse, NY.

**Status:** Active in the R.A. at Schofield Barracks, HI, as HHC, 3d Brig., 25th Inf. Div. (L).**Commanders, 195th Infantry Brigade**

Maj. Jesse S. Button	22 February 1922–22 December 1923	Maj. Paul B. Mattico	7 December 1928–21 December 1932
Capt. Douglas Drummond	22 December 1923–18 June 1924	Maj. Frank W. Broderick	21 December 1932–30 June 1934
Maj. Clayton J. Herman	18 June 1924–ao July 1924	Lt. Col. Stanley R. Putnam	30 June 1934–9 March 1937
Col. Edward H. Teall	ao December 1924–7 December 1928	Lt. Col. Henry S. Robertson	9 March 1937–ao September 1940
	Unknown		ao September 1940–7 December 1941

**HHC, 196th Infantry Brigade** (98th Division)**Organized Reserve New York****HQ**—*Not initiated*, 1921–22; Buffalo, NY, 1922–37; Rochester, NY, 1937–41**Subordinate elements**—391st and 392d Inf. Regts., 1921–41

Constituted in the O.R. on 24 June 1921, assigned to the 98th Div., and allotted to the Second Corps Area. HHC initiated in February 1922 at Buffalo, NY. Redesignated HHC, 195th Brig. on 23 March 1925. Redesignated HHC, 195th Inf. Brig. on 24 August 1936. Relocated 5 April 1937 to Rochester, NY. Conducted summer training most years at Plattsburg Barracks, 1922–40, and some years at Fort Niagara, NY, or Camp Dix, NJ. Subordinate regiments conducted training of CMTC at Fort Niagara; Camp Dix; or Plattsburg Barracks, NY; with assistance from the 16th, 26th, 28th Inf. Regts. Location 7 December 1941—Rochester, NY.

**Status:** Active in the R.A. at Fort Shafter, HI, as HHC, 196th Inf. Brig. (Tng. Support).**Commanders, 196th Infantry Brigade**

Maj. Thomas B. Lee	22 February 1922–ao March 1922	Lt. Col. John F. Williams	23 November 1932–29 July 1933
Unknown	ao March 1922–ao March 1929	Unknown	29 July 1933–18 December 1934
Lt. Col. Jacob S. Clinton	ao March 1929–ao August 1929	Lt. Col. John F. Williams	18 December 1934–23 October 1937
Unknown	ao August 1929–14 June 1932	Lt. Col. Thomas Remington	25 October 1937–21 September 1938
Lt. Col. Clayton J. Herman	14 June 1932–23 November 1932	Lt. Col. Carroll A. Edson	21 September 1938–24 November 1940
	Unknown		24 November 1940–7 December 1941

**HHC, 197th Infantry Brigade** (99th Division)**Organized Reserve Pennsylvania****HQ**—*Not initiated*, 1921–22; Pittsburgh, PA, 1922–41**Subordinate elements**—393d and 394th Inf. Regts., 1921–41

Constituted in the O.R. on 24 June 1921, assigned to the 99th Div., and allotted to the Third Corps Area. HHC initiated in May 1922 at Pittsburgh, PA. Redesignated HHC, 197th Brig. on 23 March 1925. Redesignated HHC, 197th Inf. Brig. on 24 August 1936. Conducted summer training most years at Camp George G. Meade, 1922–40, and some years at Fort Howard, MD. Subordinate regiments conducted training of CMTC at Camp George G. Meade; Fort Howard, MD; or Fort Eustis, VA; with assistance from the 12th and 34th Inf. Regts. Location 7 December 1941—Pittsburgh, PA.

**Status:** Inactive in the R.A. as HHC, 197th Inf. Brig. (Sep.).

### Commanders, 197th Infantry Brigade

Maj. Arthur M. Scully	18 April 1922–8 May 1923	Unknown	5 November 1935–ao June 1937
Maj. Wesley A. Wolfe	8 May 1923–ao January 1924	Lt. Col. Charles H. Farris	ao June 1937–ao June 1940
Lt. Col. John K. Stotz	ao June 1924–5 November 1935	Unknown	ao June 1940–7 December 1941

### HHC, 198th Infantry Brigade (99th Division)

### Organized Reserve Pennsylvania

**HQ**—*Not initiated*, 1921–22; Erie, PA, 1922–41

**Subordinate elements**—395th and 396th Inf. Regts., 1921–41

Constituted in the O.R. on 24 June 1921, assigned to the 99th Div., and allotted to the Third Corps Area. HHC initiated on 2 May 1922 at Erie, PA. Redesignated HHC, 198th Brig. on 23 March 1925. Redesignated HHC, 198th Inf. Brig. on 24 August 1936. Conducted summer training most years at Camp George G. Meade, 1922–40, and some years at Fort Howard, MD. Subordinate regiments conducted training of CMTC at Camp George G. Meade, or Fort Washington, MD, with assistance from the 12th and 34th Inf. Regts. Location 7 December 1941—Erie, PA.

**Status:** Inactive in the R.A. as HHC, 198th Inf. Brig. (Sep.).

### Commanders, 198th Infantry Brigade

Maj. Daniel H. McQuiston	2 May 1922–ao September 1925	Maj. Cecil R. Everette	August 1932–25 May 1935
Unknown	ao September 1925–ao June 1927	Lt. Col. Raymond P. Pennoyer	25 May 1935–ao January 1937
Lt. Col. Louie A. Cuthbert	ao June 1927–August 1932	Maj. Charles H. Main	ao June 1937–ao September 1941

### HHC, 199th Infantry Brigade (100th Division)

### Organized Reserve West Virginia

**HQ**—Parkersburg, WV, 1921–25; Charleston, WV, 1925–31; Parkersburg, WV, 1931–41

**Subordinate elements**—397th and 398th Inf. Regts., 1921–41

Constituted in the O.R. on 24 June 1921, assigned to the 100th Div., and allotted to the Fifth Corps Area. HHC initiated on 30 November 1921 at Parkersburg, WV. Relocated about 1925 to Charleston, WV. Redesignated HHC, 199th Brig. on 23 March 1925. Relocated 9 July 1931 to Parkersburg, WV. Redesignated HHC, 199th Inf. Brig. on 24 August 1936. Typically conducted Inactive Training Period meetings at the Masonic Temple in Charleston 1925–31. Conducted summer training most years at Camp Knox, 1922–40, with the 10th Inf. Brig. and some years at Fort Thomas, KY. Subordinate regiments conducted training of CMTC at Fort Thomas, Fort Benjamin Harrison, or Camp Knox with assistance from the 10th and 11th Inf. Regts. Location 7 December 1941—Parkersburg, WV.

**Status:** Inactive in the R.A. as HHC, 199th Inf. Brig. (Sep.).

### Commanders, 199th Infantry Brigade

Col. Robert L. Osborn	30 November 1921–ao February 1924	Lt. Col. George W. Wilson	ao June 1934–ao June 1937
Unknown	ao February 1924–ao June 1934	Unknown	ao June 1937–7 December 1941

### 200th Infantry Brigade (100th Division)

### Organized Reserve Kentucky

**HQ**—*Not initiated*, 1921–22; Louisville, KY, 1922–31; Frankfort, KY, 1931–33; Louisville, KY, 1933–41

**Subordinate elements**—399th and 400th Inf. Regts., 1921–41

Constituted in the O.R. on 24 June 1921, assigned to the 100th Div., and allotted to the Fifth Corps Area. HHC initiated in February 1922 at Louisville, KY. Redesignated HHC, 200th Brig. on 23 March 1925. Relocated 9 July 1931 to Frankfort, KY, and to Louisville, KY, in December 1933. Redesignated HHC, 200th Inf. Brig. on 24 August 1936. Conducted summer training most years at Camp Knox, 1922–40, and some years at Fort Thomas, KY. Subordinate regiments conducted training of CMTC at Fort Thomas, Fort Benjamin Harrison, or Camp Knox with assistance from the 10th and 11th Inf. Regts. Location 7 December 1941—Louisville, KY.

### Commanders, 200th Infantry Brigade

Brig. Gen. James R. Lindsay	February 1922–11 August 1929	Lt. Col. Forrest Moss	ao August 1933–ao June 1934
Unknown	11 August 1929–ao August 1933	Unknown	ao June 1934–7 December 1941

### HHC, 201st Infantry Brigade (101st Division)

### Organized Reserve Wisconsin

**HQ**—*Not initiated*, 1921–23; Milwaukee, WI, 1923–38; *Inactive*, 1938–41

**Subordinate elements**—401st and 402d Inf. Regts., 1921–41

Constituted in the O.R. on 24 June 1921, assigned to the 101st Div., and allotted to the Sixth Corps Area. HHC initiated in May 1923 at Milwaukee, WI. Redesignated HHC, 201st Brig. on 23 March 1925. Redesignated HHC, 201st Inf. Brig. on 24 August 1936. Inactivated by June 1938 at Milwaukee by relief of personnel. Conducted summer training most years at Camp Williams, WI, with the 64th Inf. Brig., 1922–40, and some years at Fort Sheridan, IL. Subordinate regiments conducted training of CMTC at Fort Sheridan; Jefferson Barracks, MO; or Fort Brady, MI; with assistance from the 2d and 6th Inf. Regts. Location 7 December 1941—*Inactive*.

### Commanders, 201st Infantry Brigade

Maj. Joseph W. Elliot	May 1923–ao June 1929	Lt. Col. Harry E. Ransom	ao June 1930–ao September 1935
Unknown	ao June 1929–ao June 1930	Maj. Louis W. Wille	April 1936–ao June 1937
	<i>Inactive</i>	ao June 1938–7 December 1941	

### HHC, 202d Infantry Brigade (101st Division)

### Organized Reserve Wisconsin

**HQ**—*Not initiated*, 1921–23; Madison, WI, 1923–37; *Inactive*, 1937–41

**Subordinate elements**—403d and 404th Inf. Regts., 1921–41

Constituted in the O.R. on 24 June 1921, assigned to the 101st Div., and allotted to the Sixth Corps Area. HHC initiated on 20 April 1923 at Madison, WI. Redesignated HHC, 202d Brig. on 23 March 1925. Redesignated HHC, 202d Inf. Brig. on 24 August 1936. Inactivated by June 1937 at Madison by relief of personnel. Conducted summer training most years at Camp Douglas, WI, with the 64th Inf. Brig., 1922–40, and some years at Camp Custer, MI, or Fort Sheridan, IL. Subordinate regiments conducted training of CMTC at Fort Sheridan; Camp Custer; or Fort Brady, MI; with assistance from the 2d and 6th Inf. Regts. Location 7 December 1941—*Inactive*.

### Commanders, 202d Infantry Brigade

Capt. Edward S. Hathaway	20 April 1923–11 March 1924	Maj. George L. Simpson	1 April 1925–ao January 1927
Maj. Purl L. Harms	11 March 1924–1 April 1925	Unknown	ao January 1927–ao June 1936
	<i>Inactive</i>	ao June 1937–7 December 1941	

### HHC, 203d Infantry Brigade (102d Division)

### Organized Reserve Arkansas/Missouri

**HQ**—Little Rock, AR, 1921–31; St. Louis, MO, 1931–41

**Subordinate elements**—405th Inf. Regt., 1921–30; 406th Inf. Regt., 1921–41; 407th Inf. Regt., 1930–41

Constituted in the O.R. on 24 June 1921, assigned to the 102d Div., and allotted to the Seventh Corps Area. HHC initiated on 5 November 1921 at Little Rock, AR. Redesignated HHC, 203d Brig. on 23 March 1925. Relocated in October 1931 to St. Louis, MO. Redesignated HHC, 203d Inf. Brig. on 24 August 1936. Conducted summer training most years at Fort Leavenworth, KS, 1922–40; and some years at Camp Pike, AR; or Fort Riley, KS. Subordinate regiments conducted training of CMTC at Fort Leavenworth or Camp Pike with assistance from the 17th Inf. Regt. Location 7 December 1941—St. Louis, MO.

**Status:** Inactive in the US Army Reserve as HHC, 2d Brig., 102d Inf. Div.

### Commanders, 203d Infantry Brigade

Lt. Col. Oscar D. Longstreth	5 November 1921–June 1927	Unknown	June 1927–7 December 1941
------------------------------	---------------------------	---------	---------------------------

**HHC, 204th Infantry Brigade** (102d Division)**Organized Reserve Missouri****HQ**—St. Joseph, MO, 1921–31; Kansas City, MO, 1931–41**Subordinate elements**—405th Inf. Regt., 1930–41; 407th Inf. Regt., 1921–30; 408th Inf. Regts., 1921–41

Constituted in the O.R. on 24 June 1921, assigned to the 102d Div., and allotted to the Seventh Corps Area. HHC initiated on 5 November 1921 at St. Joseph, MO. Redesignated HHC, 204th Brig. on 23 March 1925. Relocated in October 1931 to Kansas City, MO. Redesignated HHC, 204th Inf. Brig. on 24 August 1936. Conducted summer training most years at Fort Leavenworth, KS, 1922–40; and some years at Fort Riley, KS; or Fort Crook, NE. Conducted summer training at Camp Pike, AR, with the 153d Inf. in 1930. Subordinate regiments conducted training of CMTC at Fort Leavenworth or Camp Pike with assistance from the 17th Inf. Regt. Location 7 December 1941—Kansas City, MO.

**Status:** Inactive in the US Army Reserve as HHC, 3d Brig., 102d Inf. Div.**Commanders, 204th Infantry Brigade**

Maj. P.T. Hall	5 November 1921–20 January 1924	Unknown	ao June 1924–June 1927
Col. John B. Barnes	20 January 1924–ao June 1924	Maj. John P. Clegg	June 1927–ao July 1928
	Unknown		ao July 1928–7 December 1941

**HHC, 205th Infantry Brigade** (103d Division)**Organized Reserve Arizona****HQ**—*Not initiated*, 1921–22; Tucson, AZ, 1922; Warren, AZ, 1922–27; Tucson, AZ, 1927–41**Subordinate elements**—409th and 410th Inf. Regts., 1921–41

Constituted in the O.R. on 24 June 1921, assigned to the 103d Div., and allotted to the Eighth Corps Area. HHC initiated on 8 March 1922 at Tucson, AZ. Relocated 2 May 1922 to Warren, AZ. Redesignated HHC, 205th Brig. on 23 March 1925. Relocated 1 November 1927 to Tucson, AZ. Redesignated HHC, 205th Inf. Brig. on 24 August 1936. Conducted summer training most years at Camp Stephen D. Little, 1922–30, and Fort Huachuca, 1931–40, with units of the 25th Inf. Regt. Subordinate regiments conducted training of CMTC at Fort Logan, CO, with assistance from the 1st Bn., 38th Inf. Regt. and 2d Engrs. Location 7 December 1941—Tucson, AZ.

**Status:** Inactive in the R.A. as HHC, 205th Inf. Brig.**Commanders, 205th Infantry Brigade**

Brig. Gen. John C. Greenway	8 March 1922–19 January 1926	Capt. James T. Gentry	ao July 1928–ao October 1928
Lt. Col. Charles M. McKean	19 January 1926–ao January 1927	Lt. Col. Edward P. Conway	ao June 1929–ao May 1931
Unknown	ao January 1927–ao July 1928	Unknown	ao May 1931–7 December 1941

**HHC, 206th Infantry Brigade** (103d Division)**Organized Reserve Colorado****HQ**—*Not initiated*, 1921–22; Denver, CO, 1922–41**Subordinate elements**—411th and 412th Inf. Regts., 1921–41

Constituted in the O.R. on 24 June 1921, assigned to the 103d Div., and allotted to the Eighth Corps Area. HHC initiated on 15 June 1922 at Denver, CO. Redesignated HHC, 206th Brig. on 23 March 1925. Redesignated HHC, 206th Inf. Brig. on 24 August 1936. Conducted summer training most years at Fort Francis E. Warren, WY, 1922–40; and some years at Fort Logan, CO; or Fort Sam Houston, TX. Subordinate regiments conducted training of CMTC at Fort Logan, CO, with assistance from the 1st Bn., 38th Inf. Regt. and 2d Engrs. Location 7 December 1941—Denver, CO.

**Status:** Inactive in the US Army Reserve as HHC, 206th Inf. Brig.**Events:** 166, 232**Commanders, 206th Infantry Brigade**

Lt. Col. Homer C. Washburn	15 June 1922–11 August 1922	Unknown	ao May 1925–ao March 1926
Maj. Dallas D. Dennis	11 August 1922–ao January 1924	Lt. Col. Earle Wettengel	ao March 1926–ao February 1933
Maj. Ira C. Gromer	ao July 1924–ao May 1925	Unknown	ao February 1933–7 December 1941

**HHC, 207th Infantry Brigade** (104th Division)**Organized Reserve Idaho****HQ**—*Not initiated*, 1921–22; Idaho at large, 1922–30; Boise, ID, 1930–41**Subordinate elements**—413th and 414th Inf. Regts., 1921–41

Constituted in the O.R. on 24 June 1921, assigned to the 104th Div., and allotted to the Ninth Corps Area. HHC initiated on 25 January 1922 in Idaho. Redesignated HHC, 207th Brig. on 23 March 1925. HQ established by 1930 at Boise, ID. Redesignated HHC, 207th Inf. Brig. on 24 August 1936. Conducted summer training most years at Fort Douglas, UT, 1922–40. Subordinate regiments conducted training of CMTC at Fort Douglas or Fort Missoula, MT, with assistance from the 4th and 38th Inf. Regts. Location 7 December 1941—Boise, ID.

**Commanders, 207th Infantry Brigade**

Brig. Gen. Leroy V. Patch	3 January 1922–ao October 1925	Unknown	ao October 1925–7 December 1941
---------------------------	--------------------------------	---------	---------------------------------

**HHC, 208th Infantry Brigade** (104th Division)**Organized Reserve Montana****HQ**—*Not initiated*, 1921–23; Montana at large, 1923–30; Billings, MT, 1930–41**Subordinate elements**—415th and 416th Inf. Regts., 1921–41

Constituted in the O.R. on 24 June 1921, assigned to the 102d Div., and allotted to the Ninth Corps Area. Evanston, WY, initially designated in February 1922 as HQ location on organization, but the unit was never organized at that location. HHC initiated in June 1923 in Montana. Redesignated HHC, 208th Brig. on 23 March 1925. HQ relocated by 1930 to Billings, MT. Redesignated HHC, 208th Inf. Brig. on 24 August 1936. Conducted summer training most years at Fort Douglas, UT, 1922–40. Location 7 December 1941—Billings, MT.

**Commanders, 208th Infantry Brigade**

Unknown	February 1922–ao June 1936	Lt. Col. Joseph P. Sternhagen	ao June 1936–ao June 1938
	Unknown	ao June 1938–7 December 1941	

**HHC, 211th Infantry Brigade** (Separate)**Organized Reserve Puerto Rico****HQ**—*Not initiated*, 1921–22; San Juan, PR, 1922–27**Subordinate elements**—373d, 374th, and 375th Inf. Regts., 1921–27.

Constituted in the O.R. on 24 June 1921 and allotted to the Second Corps Area. HHC initiated in July 1922 at San Juan, PR, as a separate brigade, but apparently was intended to be the nucleus about which the Porto Rican Division would be organized during a mobilization. Redesignated HHC, 211th Brig. on 23 March 1925. Conducted summer training most years at San Juan with the 65th Inf. Regt. Subordinate regiments conducted training of CMTC at San Juan with assistance from the 65th Inf. Regt. Withdrawn from the Organized Reserve on 16 March 1927 and demobilized.

**Commanders, 211th Infantry Brigade**

Capt. John L. Gay	July 1922–ao August 1923	Unknown	ao August 1923–16 March 1927
-------------------	--------------------------	---------	------------------------------

**HHC, Washington Provisional Brigade****HQ**—Washington, DC, 1936–41**Subordinate elements**—3d Bn., 12th Inf. Regt.; 3d Cav. Regt. (less 1st Sq.); 1st Bn., 16th F.A.; F Troop, 10th Cav.; MG Tp., 10th Cav.

Organized provisionally on 1 September 1936 for the purpose of providing a HQ for a ready force to protect the District of Columbia and perform ceremonial duties, thereby relieving the 16th Inf. Brig. of those responsibilities. Organized with commissioned personnel from the 16th Inf. Brig. and enlisted personnel detached from HQ Co., US Army. Concurrently, HQ Co., US Army was attached for administrative control. The HQ was established at Room



#1027, Munitions Building in Washington, DC. The attached units came under the control of the brigade for specific training events related to the defense of Washington and ceremonies, otherwise for mobilization purposes the units belonged to other brigades. The 12th and 34th Inf. Regts. were attached 1 July 1940 for participation in the First Army Maneuver in August 1940. Location 7 December 1941—Washington, DC.

**Events:** 247

**Commanders, Washington Provisional Brigade**

Brig. Gen. Charles D. Roberts	1 September 1936–30 June 1937	Lt. Col. Charles B. Lyman	23 June 1940–10 July 1940
Brig. Gen. Dana T. Merrill	1 July 1937–30 November 1938	Brig. Gen. Bruce Magruder	10 July 1940–10 October 1940
Brig. Gen. Maxwell Murray	1 December 1938–23 June 1940	Brig. Gen. John N. Greeley	10 October 1940–28 July 1941
	Brig. Gen. Albert L. Cox (O.R.)		28 July 1941–5 May 1942



## Chapter 9

### Infantry Regiments



USASC photo, NA II

Troops of the 31st Infantry in battle positions, Shanghai, China, February 1932.

The mission of infantry regiments was to plan, coordinate, and conduct operations to close with and destroy the enemy by fire and maneuver.

#### **Organization**

In the infantry, as with the other combat arms branches, the regiment was considered the base unit for combat, training, and administrative operations in the interwar period. The infantry regiment, therefore, was considered the base upon which the rest of the field Army was built. Coming out of World War I and throughout the interwar period, the US Army's basic doctrine was that the infantry was the primary combat element and all other elements were organized and employed to support the infantry. Even so, the branch suffered as much, or more, from cuts in strength than any other branch in the Army. Of the 65 Regular Army (R.A.) infantry regiments authorized and active in 1921, 26 were inactivated or demobilized by the end of 1922. The Puerto Rican 42d Infantry was inactivated in 1927, and by 1938, 14 of the remaining 40 active regiments (the 66th and 67th Infantry Regiments, both tank units, were created in 1932) had at least one battalion inactive. The prime reasons for these cuts were the Army budget and the expansion of the Air Corps. It was not until the rapid expansion of the Army between 1939 and 1941 that the various inactive R.A. infantry regiments were reactivated to populate the newly activated infantry and armored divisions. Only one regiment of this period, the Infantry School's 29th Infantry, was fully organized with all subordinate elements at war strength.

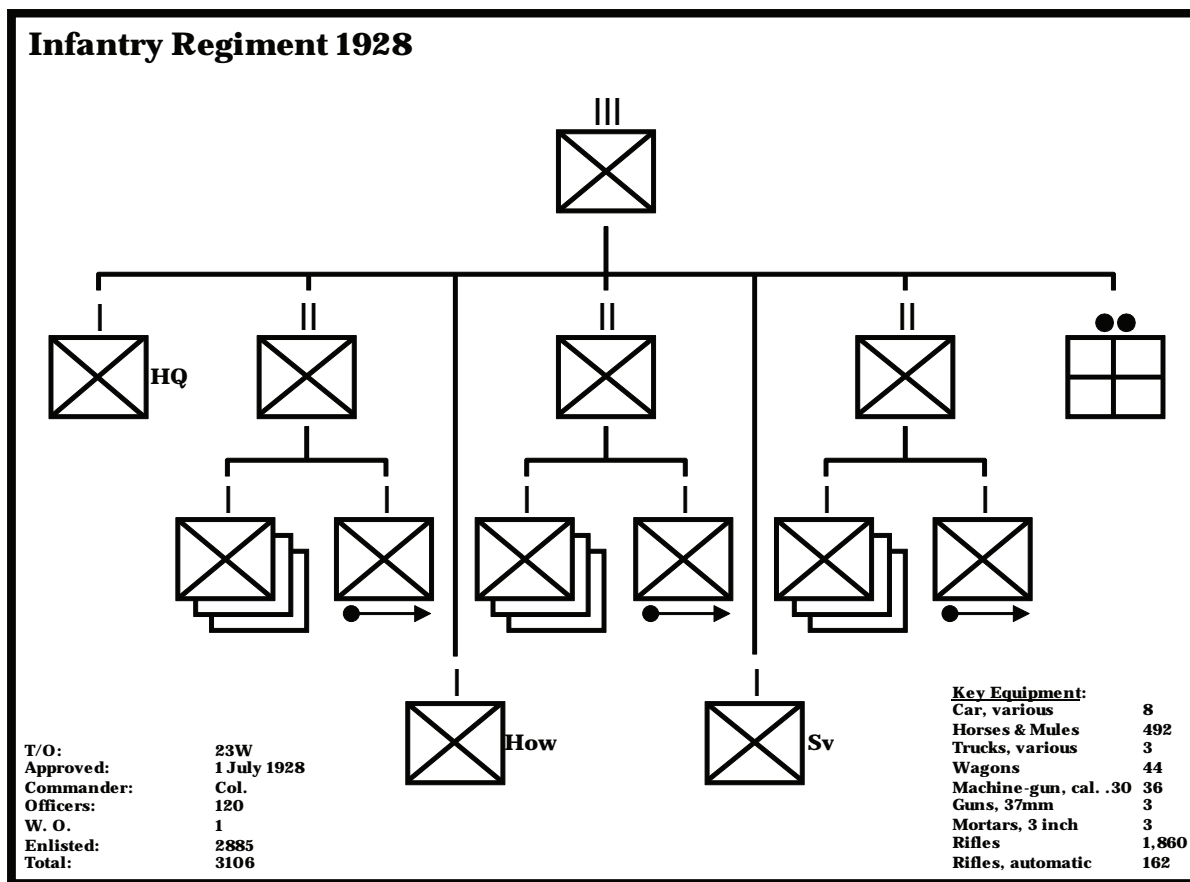

Infantry regiment organization.

Organizationally, the post-World War I infantry regiment was not significantly altered from its predecessor. The primary change came with the elimination of the infantry brigade's machine gun battalions and the integration of those weapons into Companies D, H, and M, which became the machine gun companies of the infantry regiment. Additionally, each line company was reduced from four to three infantry platoons. Although there were minor changes to the infantry regiment table of organization during the interwar period, this organization remained largely intact up to World War II.

By 1922, the vast majority of the R.A. infantry regiments, active and inactive, were assigned to the Army's 12 infantry divisions. Only a few, the African-American 24th and 25th Infantry Regiments and the Puerto Rican 65th Infantry among them, remained separate regiments after 1922. The 31st Infantry was relieved from the Philippine Division in 1931 and became a separate regiment when the 44th Infantry was constituted and assigned in its place. Four new regiments, the 66th through 69th Infantry, all tank units, were organized or constituted in 1932 and 1933 and remained separate regiments under the General Headquarters Reserve (GHQR). The assignment of regiments to brigades remained remarkably constant in the interwar period, though for a number, divisional assignments changed in 1927 when the Army attempted a means to create a ready force of four divisions immediately available for field service. That plan was abandoned in 1933 and the regiments' historic assignments to divisions were restored. Historic divisional assignments were affected once again in 1939 and 1940 when the R.A. infantry divisions each lost one of their regiments due to the adoption of the triangular table of organization and new armored divisions were created.

Almost all of the inactive R.A. regiments were organized as RAI units in the interwar period. The vast majority of these regiments were functional organizations and many were among the most active Reserve units in the Army. Most of these regiments were affiliated with ROTC programs between 1928 and 1930, but many of those affiliations were discontinued by 1940. Most RAI units were commanded by R.A. officers

prior to 1933, and most of the commanders were the PMS&T of the affiliated ROTC unit. How involved these commanders were in the activities of their RAI commands is unclear, but at least in one case, the 32d Infantry (Inf.) at the University of California at Los Angeles, the PMS&T took that role very seriously and was directly involved with all affairs of the regiment. In October 1933, this practice was eliminated and the senior Reserve officer assigned to the regiment was appointed as the acting commander to provide those officers with practical command experience. In almost all cases, the acting commander was a lieutenant colonel or major, which left the colonel's position open for a R.A. commander in the event of mobilization. In a few instances, a Reserve full colonel commanded these units, no doubt with the understanding that the officer would vacate the position in the event of mobilization.

About 80 National Guard (N.G.) infantry regiments were fully or partially organized between 1921 and 1939, though there were never that many organized at a single time. Several of these regiments underwent various redesignations during this period, and at least seven were originally reorganized after World War I with a state designation (i.e., 8th Inf., Illinois N.G.), which they retained, in most cases, up until 1940 or 1941.

The great majority of the Guard regiments were assigned to the 18 N.G. infantry divisions, but several were assigned to separate brigades and 12 were separate regiments under special allotment to the N.G. Three of the latter were African American regiments with lineages that extended back to units that served in World War I and before. Five of the separate organizations were located in overseas territories: two in Hawaii, two in Puerto Rico, and part of one, the 1st Battalion (Bn.), 297th Inf., was located in Alaska.

There were about 150 infantry regiments constituted in the Organized Reserve (O.R.) at various times during the interwar period. Of these, all but 14 were organized at some point, though a significant number of the nondivisional regiments were inactivated in the late 1920s. Others were organized in the late 1930s. One hundred and eight of the regiments were assigned to the 27 O.R. infantry divisions. The remaining regiments were a mixture of units with specialized functions. Eight were light or medium tank regiments and the remaining 32 were "Colored" regiments that had mobilization missions as either special security units (for airfields, key industrial sites, military installations, etc.) or infantry training center demonstration and training regiments. Most of the latter regiments were to be organized upon mobilization with white officers and African-American enlisted personnel. However, six of these regiments, all in the Third Corps Area, had black commissioned personnel (as did the N.G.'s 369th, 372d, and 8th Illinois Regiments).

A number of the R.A. and O.R. infantry regiments were actually tank organizations. In the case of the R.A., these units were either reorganized and redesignated as armored regiments in 1940 or disbanded. In the case of the O.R. regiments, none were activated for service in World War II, and all were disbanded sometime after Pearl Harbor (see chapter 11 for the early history, organization, and training of these units).

## **Training**

As with all other units in the Army, the quality and frequency of training for R.A. infantry regiments was directly affected by the small Army budgets of the 1920s and 1930s. Given the lack of funding, infantry regiments, like most Army units, were able to go to the field, at best, for 2 to 3 weeks a year. Most of that time was usually spent in brigade, division, or corps area maneuvers in the summer or fall. Additionally, the diminutive unit budgets often precluded the use of supplies like blank ammunition and the conduct of coordinated live-fire exercises with artillery and air corps units. These types of limitations often made the training events rather canned, unimaginative, and bordering, in many respects, on the unrealistic. Still, given the resources at hand, the various training events conducted during the interwar years by regiments of all three components were generally about as good as could be expected.

For most stateside R.A. regiments, there was a relatively standard pattern of annual training. Generally, the January to March period was used for sending soldiers to troop schools (driver training, chemical warfare training, armorer's course, horseshoeing and animal care classes, etc.) and other largely indoor training activities. The months of April and May would be used for squad and platoon training, physical conditioning

marches, and marksmanship training. In June, units would begin deploying to field sites to support the training of CMTC, ROTC, O.R., and N.G. camps. The training support for the civilian and Reserve Component camps would usually conclude in late August, but regiments would remain at field sites to participate in field maneuvers. The maneuvers would generally begin at the company or battalion level and, in building block fashion, progressively increase to the next higher level to the brigade or division level. On returning to garrison in mid- to late-October, the regiment would conduct post field recovery operations for a week or two, then spend the last 2 months of the year participating in the annual I.G. inspection, individual skills training, troops schools, individual and team sports, and, of course, holiday activities. This pattern varied slightly from Corps Area to Corps Area based on differences in weather, available training areas, Reserve Component training requirements, higher-level training events, and other considerations.

The training cycle for the overseas regiments was not unlike that for the stateside regiments, though only those of the Hawaiian Division had any responsibility for supporting the training of a N.G. unit. There were no CMTC camps or O.R. units to support. The few Reserve officers located in each of the three overseas departments were simply attached directly to the units for mobilization assignment and training. The training conducted by the overseas regiments had other advantages over that of its US-based counterparts. Given that the units were stationed in areas most likely to be attacked first in a conflict, the training budgets for these units tended to be more substantial. Thus the overseas regiments were able to go to the field more frequently. The other advantage was that these units had actual war plans on which they based their training. Thus the sense of urgency and the added benefit of training on the terrain over which the units would be expected to fight gave the training a sense of realism often lacking in the notional training carried out by units in the states. These units also profited from the opportunities to train more often with the same artillery, air support, and logistical support units with which they would fight in wartime.

N.G. infantry regiments followed a pattern not significantly different from R.A. regiments, though the pattern tended to change slightly during the interwar period. The most noticeable change was the timing of marksmanship training. With the push by Guard units to conduct ever larger and increasingly sophisticated maneuver training, units looked for ways to conduct marksmanship training outside the summer camp period to free up more time for maneuver. More and more Guard units thus found ways to conduct their weapons qualification training and firing during the inactive training period. Another training opportunity that added to many Guard units' level of readiness was the numerous times that these organizations were called up to support state emergencies. A few of these regiments had units that had spent as much or more time on state emergency duties in the interwar period than they had at summer training camps even if the time for all 20 or so camps were added together. All or part of the majority of these regiments were called up to support a wide variety of operations in response to state emergencies. These included flood and tornado relief duties, support to law enforcement, and riot control, particularly for the many labor strikes of the period. Though these were not military operations per se, these events did give Guard units the chance to exercise military skills that were directly or indirectly applicable to combat.

If the challenge of conducting quality training for R.A. and N.G. units in the interwar period was problematic, it was exponentially so for O.R. (and R.A. Inactive) regiments. In their favor, most O.R. infantry regiments were maintained at war strength in authorized officers. In fact, many far exceeded that strength if one counted the officers attached to those regiments for training. To their disadvantage, however, none ever achieved, indeed even approached, the 33 percent strength of enlisted personnel to which they were limited by law. Nor did these regiments possess much, if anything, in the way of equipment to support training in the inactive training period. In the early 1920s, many of these regiments were widely dispersed by company in many small communities in a similar fashion to N.G. regiments. Reserve commanders and their R.A. executive officers quickly realized that such dispersion made for very poor training opportunities. As a result, by the mid-1920s, dispersed O.R. infantry regiments began to concentrate organizationally in larger cities at the battalion and often regimental level. This concentration made for better training opportunities by assembling larger groups of officers (and the few assigned enlisted reservists) for unit training and other functions. This also fostered greater camaraderie and teamwork among the regiment's personnel. This was

especially critical in those regiments in the far west, where distances made assembly and training a far more difficult prospect. Not surprisingly, the best trained and most cohesive Reserve regiments tended to be concentrated in large cities where members could meet and train frequently and effectively.

Reserve infantry regiments conducted their training meetings in a variety of places. These included post office buildings, Federal buildings, chamber of commerce buildings, schools, ROTC buildings, R.A. installations, and N.G. armories among many others. Those lucky enough to meet at the latter two types of locality were particularly fortunate as local commanders often loaned the use of equipment or training facilities to enhance the reservists' training experiences. The opportunity for O.R. units to conduct meaningful field training during the inactive training period was far more limited than for R.A. and N.G. units. Therefore, most training for O.R. infantry regiments from September to May was largely indoor and theoretical, though not totally devoid of hands-on and more practical training.

Summer training camps brought the best variety of training opportunities for O.R. infantry regiments. The most common type of camp was the General Unit Training Camp (GUTC). This type of camp was often conducted with other regiments, but generally included no leadership opportunities with enlisted personnel. Most of the training consisted of normal infantry tasks, such as a battalion attack or defense, but with all enlisted personnel, enemy personnel, and most equipment merely simulated. Another type camp was the Citizens Military Training Camps. These camps gave the Reserve officers an opportunity to plan and perform the very type of training that they would be responsible for conducting upon mobilization. It was also an opportunity to exercise leadership skills that could only be practiced and honed when leading real troops. Regular Army Training Camps (R.A.T.C.) were typically performed with the Reserve officers shadowing their R.A. counterparts in the field on a training exercise for the first week. The second week the exercise would be conducted again, only with the reservists in actual command of the unit. A similar camp was conducted with N.G. units; however, the Guard officers never relinquished command to the reservists. The R.A.T.C. camps and major maneuvers were probably the best and most useful training experience for O.R. infantry regiments in the interwar period.

**1st Infantry Regiment (2d Division)**

**HQ**—Camp Lewis, WA, 1919–21; Fort Sam Houston, TX, 1921–27; Fort Francis E. Warren, WY, 1927–40; Fort Leonard Wood, MO, 1940–41



Stationed at Camp Lewis, WA, as of June 1919 as a separate regiment. Transferred 27 July 1921 to Fort Sam Houston, TX, and assigned to the 2d Div. Transferred 28 June 1927 to Fort D.A. Russell, WY (later redesignated Fort Francis E. Warren). In April 1933, the regiment assumed command and control of parts of the South Dakota CCC District. Assigned Reserve officers conducted summer training with the regiment at Fort Warren. Relieved from the 2d Div. on 16 October 1939 and assigned to the 6th Div. Transferred in May 1940 to Fort Leonard Wood, MO. Location 7 December 1941—Fort Leonard Wood, MO.

**Organization Day:** 17 May. Chosen to commemorate the regiment’s initial organization on 17 May 1815.

**Status:** Assigned to the USARS as the 1st Inf.; 1st Bn. active at the US Military Academy as school support troops; 2d Bn. active at Fort Richardson, AK, as an element of the 172d Inf. Brig.

**Events:** 1, 12, 14, 20, 45, 47, 55, 79, 130, 152, 166, 212, 232, 260, 293, 296, 303, 316, 328

**Commanders, 1st Infantry Regiment**

Col. Henry C. Hodges Jr.	12 March 1916–16 July 1917	Lt. Col. William J. O’Loughlin	28 November 1928–9 July 1929
Col. William Weigel	16 July 1917–3 September 1917	Col. Henry A. Hanigan	9 July 1929–26 May 1930
Col. Harvey W. Miller	30 September 1917–26 May 1919	Lt. Col. William J. O’Loughlin	26 May 1930–8 September 1930
Col. Francis C. Endicott	4 June 1919–15 March 1920	Col. Kerwin T. Smith	8 September 1930–6 March 1933
Col. Benjamin A. Poore	23 March 1920–18 November 1921	Col. Francis E. Endicott	6 March 1933–10 August 1934
Col. James H. Bradford	18 November 1921–26 August 1922	Col. Paul H. McCook	10 August 1934–3 February 1937
Col. Edward A. Shuttleworth	26 August 1922–1 March 1924	Lt. Col. Raymond C. Baird	3 February 1937–24 February 1937
Lt. Col. Lochlin W. Caffey	1 March 1924–December 1924	Col. Homer H. Slaughter	25 February 1937–15 June 1939
Col. John L. DeWitt	December 1924–1 October 1926	Lt. Col. Emil W. Leard	15 June 1939–17 August 1939
Lt. Col. Thomas J. Rogers	1 October 1926–30 December 1926	Col. John H. Hester	17 August 1939–July 1940
Col. John F. Preston Jr.	30 December 1926–20 November 1928	Col. Eugene Santschi, Jr.	July 1940–20 October 1941
	Col. John E. Ardery		20 October 1941–30 June 1942

**1st Infantry Regiment (29th Division)**

**Maryland National Guard**

**HQ**—Frederick, MD, 1921–41



Arrived at the port of Newport News on 24 May 1919 on the U.S.S. *Artemis* as the 115th Inf., an element of the 29th Div. Demobilized 7 June 1919 at Camp George G. Meade, MD. Reconstituted in the N.G. in 1921 and allotted to the state of Maryland. Organized as the 1st Inf., Maryland N.G., 1919–23, and assigned to the 29th Div. in 1921. Headquarters (HQ) federally recognized on 22 January 1921 at Frederick, MD. Co. G called up to perform flood relief duties in Cumberland, MD, 12–14 May 24. Conducted annual summer training at Virginia Beach, VA, 1921–24, and Camp Albert C. Ritchie, Cascade, MD, 1925–39. Redesignated 115th Inf. on 1 January 1941.

**Events:** 191, 281, 301

**Commanders, 1st Maryland Infantry Regiment**

Col. Charles A. Little	5 August 1917–5 December 1917	Col. Milton A. Reckord	17 April 1918–7 June 1919
Col. Thomas D. Landon	5 December 1917–29 December 1917	<i>Demobilized</i>	7 June 1919–21 January 1921
Col. Frank B. Watson	29 December 1917–17 April 1918	Col. John D. Markey	22 January 1921–1 January 1941



**1st Infantry Regiment (29th Division)**

**Virginia National Guard**

**HQ**—Richmond, VA, 1920–22, 1929–41



Arrived at the port of Newport News on 22 May 1919 on the U.S.S. *Matsonia* as elements of the 116th Inf., an element of the 29th Div. Demobilized on 30 May 1919 at Camp Lee, VA. Reconstituted in the N.G. in 1921 and allotted to the state of Virginia. Elements of the 116th Inf., less regimental HQ, reorganized 30 December 1919 as the 1st Provisional (Prov.) Inf., Virginia N.G. Redesignated 1st Inf., Virginia N.G. on 7 September 1920. Concurrently, HQ federally recognized at Richmond, VA. Assigned in 1921 to the 29th Div. Redesignated 183d Inf. on 9 March 1922 (a designation originally allotted to the Virginia N.G. in 1921) and assigned to the 29th Div. Redesignated 1st Inf., Virginia N.G. on 22 February 1929. Elements called up in January 1928 to serve in the “Oyster Navy” to prevent violence on the oyster boats in and near Seven Wharf, VA. Conducted annual summer training most years at Virginia Beach, VA, 1921–39. Co. C

awarded the National William Randolph Hearst Trophy for Marksmanship in 1937, 1938, and 1939. Redesignated 176th Inf. on 1 January 1941.

**Status:** HHC active in the Virginia N.G. as HHC, Engineer (Engr.) Brig, 28th Inf. Div.

**Events:** 281, 301

**1st Virginia Infantry Regiment**

Col. John F. Bright

22 February 1929–1 January 1941

**1st Infantry Regiment (Separate) (Colored)**

**Organized Reserve Ohio**

**HQ**—Cincinnati, OH, 1923–27

Constituted in the O.R. on 2 July 1923, assigned to the GHQR, and allotted to the Fifth Corps Area. Initiated in October 1923 with regimental HQ at Cincinnati, OH. Inactivated on 1 April 1924 by transfer of personnel to the 449th Inf. Regt. (C). Withdrawn from the Fifth Corps Area in January 1927.

**1st Infantry Regiment (Separate) (Colored)**

1st Lt. John W. Roe

14 December 1923–1 April 1924

**2d Infantry Regiment (6th Division)**

**HQ**—Camp Dodge, IA, 1919; Camp Sherman, OH, 1919–22; Fort Sheridan, IL, 1922–29; Fort Wayne, MI, 1929–40; Fort Custer, MI, 1940–41.



Stationed at Camp Dodge, IA, as of June 1919 as a separate regiment. The 1st and 2d Bns. transferred in September 1919 to Camp Sherman, OH. HQ and 3d Bn. transferred in November 1919 to Camp Sherman. Designated as a training center regiment on 27 July 1921 and assigned to the Sixth Corps Area Training Center. Reorganized as a combat regiment on 17 August 1922 upon the inactivation of the Sixth Corps Area Training Center. Regimental HQ transferred in August 1922 to Fort Sheridan, IL. Concurrently, 1st Bn. transferred to Fort Sheridan; 2d Bn. to Fort Wayne, MI; and 3d Bn. to Fort Brady, MI. Assigned to the 6th Div. on 24 March 1923. Regimental HQ transferred in 1929 to Fort Wayne. In April 1933, the regiment assumed command and control of the 1st Forest District CCC (later redesignated as the Fort Brady CCC District). Assigned Reserve officers, less the 2d and 3d Bns., conducted summer training with the regiment

at Fort Sheridan; those assigned to the 2d Bn. trained at Camp Custer, MI, and those assigned to the 3d Bn. trained at Fort Brady, MI. Reserve officers conducted infantry CMTC training at Camp Custer, MI, in 1939. Relieved from the 6th Div. on 16 October 1939 and assigned to the 5th Divn. Transferred 3 November 1939 to Fort McClellan, AL.

Transferred 1 June 1940 to Fort Wayne, MI. Transferred 25 September 1940 to Fort Custer, MI. Location 7 December 1941—Fort Custer, MI.

**Organization Day:** 2 July. Chosen to commemorate the regiment's participation in the battle of Gettysburg, 2 July 1863.

**Status:** Assigned to the USARS as the 2d Inf.; 2d Bn. active in Germany as an element of the 1st Inf. Div.(Mecz).

**Events:** 22, 32, 50, 123, 162, 172, 207, 214, 237, 274, 293, 296, 302, 316, 328

**Commanders, 2d Infantry Regiment**

Col. James A. Irons	3 February 1917–3 July 1917	Lt. Col. James G. Hannah	24 August 1925–14 September 1925
Col. Frank C. Bolles	22 August 1917–9 March 1918	Col. Perry L. Miles	15 September 1925–6 August 1928
Col. William C. Bennett	15 March 1919–14 March 1920	Col. Frederick B. Shaw	12 August 1928–13 November 1930
Col. Richard Wetherill	14 March 1920–5 April 1920	Col. Frederick L. Knudsen	13 November 1930–31 August 1932
Lt. Col. Ivers W. Leonard	5 April 1920–31 July 1920	Col. Russell C. Langdon	31 August 1932–1 September 1934
Col. Frederick B. Shaw	31 July 1920–12 October 1920	Col. Robert M. Lyon	1 September 1934–25 December 1935
Col. Ivers W. Leonard	12 October 1920–12 August 1921	Lt. Col. Charles W. Dyer	25 December 1935–19 January 1936
Maj. Franlin T. Burt	12 August 1921–1 September 1921	Col. James M. Churchill	19 January 1936–16 January 1939
Maj. Robert J. Binford	1 September 1921–16 October 1921	Lt. Col. James A. Ladd	19 January 1936–14 August 1939
Col. Frank B. Watson	16 October 1921–8 September 1923	Lt. Col. Hayes A. Kromer	14 August 1939–October 1939
Lt. Col. James G. Hannah	8 September 1923–16 September 1923	Col. Frederick M. Armstrong	October 1939–September 1940
Col. Cromwell Stacy	16 September 1923–24 August 1925	Col. Isaac Gill	20 November 1940–20 November 1942

**2d Infantry Regiment (Separate) (Colored)**

**Organized Reserve Kentucky**

**HQ**—Bowling Green, KY, 1923–27

Constituted in the O.R. on 2 July 1923, assigned to the GHQR, and allotted to the Fifth Corps Area. Initiated by December 1923 with regimental HQ at Bowling Green, KY. Inactivated 21 April 1924 by transfer of personnel to the 450th Inf. Regt. (C). Withdrawn from the Fifth Corps Area in January 1927.

**2d Infantry Regiment (Separate) (Colored)**

Capt. George J. Austin 14 December 1923–1 April 1924

**3d Infantry Regiment (7th Division)**

**HQ**—Eagle Pass, TX, 1919–20; Camp Sherman, OH, 1920–21; Fort Snelling, MN, 1921–41

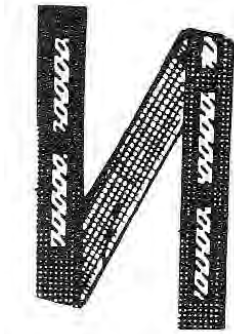

Stationed at Eagle Pass, TX, as of June 1919 as a separate regiment. Responsible for the Eagle Pass District of the Mexican Border Patrol. The subordinate battalions were posted as follows: 1st Bn. at Del Rio, TX; 2d Bn. at Fort Sam Houston, TX; and 3d Bn. at Eagle Pass. Transferred 14 October 1920 to Camp Sherman, OH. Designated as a training center regiment on 27 July 1921 and assigned to the Seventh Corps Area Training Center. Marched 940 miles from Camp Sherman beginning 26 September 1921 to Fort Snelling, MN, and arrived there 17 November 1921 in a severe snowstorm. Reorganized as a combat regiment on 8 June 1922. Relieved from the Seventh Corps Area Training Center on 8 August 1922. Assigned to the 7th Div. on 24 March 1923. Relieved from the 7th Div. on 15 August 1927 and assigned to the 6th Div. Elements served as the military guard for President Calvin Coolidge 8 June–4 September 1928. In April 1933, the regiment assumed command and control of the Minnesota CCC District. Relieved from the 6th Div. on 1 October 1933 and

assigned to the 7th Div. Conducted a review for Crown Prince Frederick and Princess Ingrid of Denmark on 22 April 1939. Relieved from the 7th Div. on 16 October 1939 and assigned to the 6th Div. Assigned Reserve officers conducted summer training with the regiment at Fort Snelling. The 1st Bn. transferred in November 1940 to Fort Crook, NE. The 3d Bn. transferred 20 January 1941 to St. John's, Newfoundland. Regiment relieved from the 6th Div. on 10 May 1941 and assigned to the Newfoundland Base Command. The 1st Bn. inactivated on 1 June 1941 and personnel and equipment transferred to newly activated 63d Inf. Location 7 December 1941—Fort Snelling, MN.

**Organization Day:** 21 September. Chosen to commemorate the regiment's participation in the battle of Monterrey, 21 September 1846. Adopted 1920.

**Status:** Assigned to the USARS as the 3d Inf.; 1st Bn. active at Fort Myer, VA, as an element of the Military District of Washington.

**Events:** 136, 150, 233, 256, 274, 285, 293, 296, 303, 316

#### Commanders, 3d Infantry Regiment

Col. Robert I. Hirst	10 February 1915–27 August 1917	Lt. Col. Bernard Lentz	29 June 1930–11 July 1930
Col. John W. Heavey	27 August 1917–22 November 1917	Col. David L. Stone	11 July 1930–25 July 1932
Col. Frederick R. Day	22 November 1917–22 October 1918	Col. Charles J. Nelson	26 July 1932–25 June 1924
Col. Gustave A. Weiser	23 October 1918–January 1920	Col. John Randolph	25 June 1934–24 April 1936
Col. Paul Giddings	January 1920–29 August 1921	Col. Charles F. Thompson	24 April 1936–21 January 1937
Col. Alfred W. Bjornstad	29 August 1921–10 September 1923	Lt. Col. Frank C. Mahin	21 January 1937–15 March 1937
Lt. Col. Elliot M. Norton	10 September 1923–3 December 1923	Col. John S. Upham	15 March 1937–30 May 1937
Col. William R. Sample	3 December 1923–April 1925	Lt. Col. Frank C. Mahin	30 May 1937–2 October 1937
Lt. Col. Elliot M. Norton	April 1925–4 June 1925	Col. Martin C. Shallenberger	2 October 1937–15 August 1939
Col. William E. Welsh	4 June 1925–25 June 1928	Lt. Col. Hardin C. Sweeney	15 August 1939–18 September 1939
Lt. Col. William B. Graham	25 June 1928–1 July 1928	Col. Maurice D. Welty	18 September 1939–31 October 1940
Col. Walter C. Sweeney	1 July 1928–29 June 1930	Col. Leland S. Hobbs	31 October 1940–May 1941
	Col. Paul H. Brown		May 1941–12 February 1943

#### 4th Infantry Regiment (3d Division)

**HQ**—Camp Pike, AR, 1919–21; Camp Lewis, WA, 1921–22; Fort George Wright, WA, 1922–40; Anchorage, TA, 1940–41



Arrived at the port of New York on 23 August 1919 on the U.S.S. *Huron* as an element of the 3d Div. Transferred that same day to Camp Merritt, NJ. Transferred 30 August 1919 to Camp Pike, AR. Transferred to Camp Lewis, WA, and arrived there 20 September 1921. Transferred to Fort George Wright, WA, and arrived there 21 June 1922. Concurrently, 1st Bn. transferred to Fort Missoula, MT; 2d Bn. to Fort George Wright; and 3d Bn. to Fort Lawton, WA. Initial wartime mission in accordance with established war plans was to conduct a mobile defense of possible amphibious landing areas in support of the Harbor Defenses of Puget Sound. The 1st Bn. conducted forest-fire fighting operations in the Blackfoot Forest and Glacier National Park 16 July–8 August 1926. Regiment participated in the making of the First National Production Co. movie “The Patent Leather Kid,” March–April 1927. The 3d Bn. transferred 11 October 1927 to Fort Lincoln, ND. In April 1933, the regiment assumed command and control of the Fort Missoula, Fort George Wright, and North Dakota CCC Districts. Reserve officers assigned to the 3d Bn. conducted summer training with the battalion at Fort Lincoln. The entire regiment, less the 3d Bn., transferred in December 1939 to Fort Lewis, WA, for permanent station.

Relieved 14 May 1940 from the 3d Div. The 3d Bn. transferred to Fort Lewis on 15 May 1940 and was inactivated there on 23 May 1940. The 3d Bn. was activated 22 June 1940 at Chilkoot Barracks, TA, with personnel and equipment from the inactivated 2d Bn., 32d Inf. The 1st Bn. sailed from Seattle on the U.S.A.T. *St. Mihiel* to Anchorage, TA, and arrived there 27 June 1940. Remainder of regiment sailed 26 December 1940 from Seattle on the U.S.A.T. *St. Mihiel* and arrived 3 January 1941 at Anchorage. Concurrently assigned to the Alaskan Defense Command. Location 7 December 1941—Anchorage, TA.

**Organization Day:** 7 November. Chosen to commemorate the regiment’s participation in the battle of Tippecanoe 7 November 1811. Organization Day later changed to 13 September to commemorate the regiment’s participation in the battle of Fort McHenry on 13 September 1812. Adopted 30 November 1928.

**Status:** Assigned to the USARS as the 4th Inf.; 1st Bn. active at the Opposing Force at the Combat Maneuver Training Center at Hohenfels, Germany.

**Events:** 6, 57, 135, 161, 208, 226, 233, 238, 273, 289, 294, 304

### Commanders, 4th Infantry Regiment

Col. Everhard E. Hatch	10 February 1915–5 August 1917	Col. Henry A. Ripley	13 September 1925–17 March 1928
Col. Charles Gerhardt	31 October 1917–3 May 1918	Lt. Col. Thomas W. Brown	17 March 1928–1 July 1928
Col. Halstead Dorey	3 May 1918–20 October 1918	Lt. Col. William J. O'Loughlin	1 July 1928–26 July 1928
Lt. Col. Rice W. Means	20 October 1918–1 November 1918	Lt. Col. William A. Alfonte	26 July 1928–16 August 1928
Col. William M. Inglis (WA)	1 November 1918–ao January 1919	Col. Joseph K. Partello	16 August 1928–27 August 1931
Unknown	ao January 1919–ao October 1919	Col. Wallace McNamara	27 August 1931–6 September 1933
Lt. Col. Sheppard B. Philpot	ao October 1919–November 1919	Maj. George S. Clarke	6 September 1933–15 September 1933
Lt. Col. Roland W. Boughton	November 1919–January 1920	Col. George W. Harris	15 September 1933–23 November 1933
Lt. Col. Gilbert M. Allen	January 1920–29 November 1920	Col. Frederick G. Knabenshue	23 November 1933–20 May 1935
Col. Thomas J. Powers	29 November 1920–21 August 1921	Col. Louis Farrell	20 May 1935–19 August 1936
Lt. Col. Elliot M. Norton	21 August 1921–21 September 1921	Lt. Col. Owen R. Meredith	19 August 1936–5 September 1936
Col. James N. Pickering	21 September 1921–21 June 1922	Col. Walter S. Drysdale	5 September 1936–18 April 1938
Col. Charles C. Ballou	21 June 1922–1 August 1923	Col. Langley F. Whitley	18 April 1938–13 July 1938
Lt. Col. Henry A. Ripley	1 August 1923–14 September 1923	Col. Walter R. Wheeler	13 July 1938–April 1940
Col. Ira C. Welborn	14 September 1923–13 September 1925	Col. Vernon G. Olsmith	April 1940–28 August 1940
	Col. Gregory Hoisington		29 August 1940–16 June 1942

### 5th Infantry Regiment (9th Division)

**HQ**—Camp Zachary Taylor, KY, 1919; Andernach, GE, 1919–22; Fort Williams, ME, 1922–39; Camp Paraiso, CZ, 1939–41



Stationed at Camp Zachary Taylor, KY, as of June 1919 as a separate regiment. Transferred 10 September 1919 to Camp George G. Meade, MD. Departed the port of Hoboken, NJ, on 16 October 1919 on the U.S.A.T. *President Grant*. Arrived in France on 30 October 1919. Transferred 6 November 1919 to Andernach, Germany. Concurrently assigned to the 2d Brig., American Forces in Germany (AFG) on the same day. Relieved from the 2d Brig., AFG in December 1921 and assigned to the 1st Brig., AFG. Relieved 10 March 1922 from the 1st Brig., AFG. Sailed from Antwerp, Belgium, on 11 March 1922 on the U.S.A.T. *Cantigny*. Arrived at Portland, ME, 21 March 1922 and transferred to Fort Williams, ME, on the same day. Companies H and L transferred to Fort Preble, ME, and Fort Constitution, NH, respectively. Initial wartime mission in accordance with established war plans was to conduct a mobile defense of possible amphibious landing areas in support of the Harbor Defenses of Portsmouth. Assigned to the 9th Div. on

24 March 1923. Relieved from the 9th Div. on 15 August 1927 and assigned to the 5th Div. Relieved from the 5th Div. on 1 October 1933 and assigned to the 9th Div. The 3d Bn. sailed 23 October 1939 from Portland, ME, on the U.S.A.T. *Chateau Thierry* as part of the 18th Inf. Brig. force sent to reinforce the Panama Canal Zone. The remainder of the regiment sailed 30 October 1939 from Portland, ME, on the U.S.A.T. *St. Mihiel* and arrived in the Canal Zone 7 November 1939. Entire unit transferred to Camp Paraiso, CZ. Relieved 1 July 1940 from the 18th Inf. Brig. Relieved from the 9th Div. on 15 July 1940 and assigned to the Panama Mobile Force. Location 7 December 1941—Camp Paraiso, CZ.

**Organization Day:** 6 July. Chosen to commemorate the regiment's participation in the battle of Lundy's Lane, 6 July 1814.

**Status:** Assigned to the USARS as the 5th Inf.; 1st and 2d Bns. active at Schofield Barracks, HI, as elements of the 25th Inf. Div. (Light).

**Events:** 19, 24, 59, 62, 64, 78, 95, 132, 192, 239, 262, 280, 292, 308, 333

### Commanders, 5th Infantry Regiment

Col. Evan M. Johnson	9 September 1916–5 May 1918	Col. Edgar A. Fry	15 September 1923–6 September 1925
Col. Benjamin C. Morse	5 May 1918–16 July 1918	Col. John W. Wright	7 September 1925–23 August 1929
Col. Harold L. Jackson	25 July 1918–22 April 1919	Col. Lucius C. Bennett	24 August 1929–31 July 1932
Col. William F. Clemry	27 April 1919–14 June 1919	Col. Joseph W. Beacham Jr.	1 August 1932–1 August 1934
Col. James A. Lynch	29 June 1919–25 July 1919	Col. Frederick F. Black	8 September 1934–4 July 1936
Col. Harold L. Jackson	25 July 1919–29 August 1919	Col. Wilson B. Burt	4 July 1936–19 January 1938
Col. Edgar A. Fry	7 September 1919–28 May 1920	Lt. Col. Robert J. Halpin	19 January 1938–17 May 1938
Lt. Col. Allen J. Greer	28 May 1920–12 December 1921	Col. Charles A. Hunt	17 May 1938–6 December 1939
Col. Harry E. Knight	12 December 1921–15 September 1923	Col. Louis P. Ford	7 December 1939–28 May 1941
	Col. Benjamin F. Delamater Jr.		29 May 1941–20 January 1942

### 5th Infantry Regiment (29th Division)

### Maryland National Guard

HQ—*Not organized*, 1921–23; Baltimore, MD, 1923–41



Arrived at the port of Newport News 24 May 1919 on the U.S.S. *Artemis* as elements of the 115th Inf., an element of the 29th Div. Demobilized 7 June 1919 at Camp George G. Meade, MD. Elements of the 115th Inf., less regimental HQ, reorganized as the 5th Inf., Maryland N.G., 1919–23. Assigned in 1921 to the 29th Div. HQ federally recognized on 1 May 1923 at Baltimore, MD. Conducted annual summer training most years at Virginia Beach, VA, 1921–24, and at Camp Albert C. Ritchie, Cascade, MD, 1925–39. Redesignated 175th Inf. on 1 January 1941.

Events: 191, 281, 301

### Commanders, 5th Maryland Infantry Regiment

Col. Washington Bowie	1 May 1923–17 May 1934	Col. Frank A. Hancock	26 June 1934–25 May 1939
	Col. Harry C. Ruhl		26 May 1939–1 January 1941

### 6th Infantry Regiment (6th Division)

HQ—Camp Gordon, GA, 1919–20; Camp Jackson, SC, 1920–21; Jefferson Barracks, MO, 1921–40; Fort Knox, KY, 1940–41



Arrived at the port of New York on 13 July 1919 on the U.S.S. *America* as an element of the 5th Div. Transferred 28 July 1919 to Camp Gordon, GA. Transferred 29 December 1920 to Camp Jackson, SC. Relieved in August 1921 from the 5th Div. Ordered 2 September 1921 to transfer to Jefferson Barracks, MO. Conducted a 1,200-mile foot march from Camp Jackson and arrived 3 November 1921 at Jefferson Barracks, MO. Regiment was reviewed 3 November 1921 by General John J. Pershing and Marshal Ferdinand Foch upon its arrival at St. Louis, MO. Assigned to the 6th Div. on 24 March 1923. Participated in tornado relief duties at St. Louis, MO, 3–7 October 1927. The 3d Bn. inactivated 31 October 1929 at Jefferson Barracks and reorganized soon after with O.R. personnel. Assigned Reserve officers conducted summer training with the regiment at Jefferson Barracks. In April 1933, the regiment assumed command and control of the Jefferson Barracks CCC District (later redesignated Missouri CCC District). Elements participated in the “Century of Progress” exposition in Chicago, IL, May–November 1933. Relieved from the 6th Div. 16 October 1939 and assigned

to the 14th Inf. Brig. The 3d Bn., less Reserve personnel, activated in early 1940 at Jefferson Barracks. Entire regiment temporarily transferred 2 March 1940 to Fort Knox, KY. Relieved 1 June 1940 from the 14th Inf. Brig. Regiment returned to Jefferson Barracks on 1 July 1940. Reorganized and redesignated 6th Inf. Regt. (Armd.) 15 July 1940 and assigned to the 1st Armd. Div. Transferred 7 August 1940 to Fort Knox, KY. Location 7 December 1941—Fort Knox, KY.

**Organization Day:** 4 November. Chosen to commemorate the regiment's assault crossing of the Meuse River during the Meuse–Argonne Campaign, 4 November 1918. Adopted 5 November 1934.

**Status:** Assigned to the USARS as the 6th Inf.; 1st and 2d Bns. active in Germany as elements of the 1st Armd. Div.

**Events:** 32, 50, 123, 172, 207, 214, 237, 274, 285, 296, 302, 328, 330

#### Commanders, 6th Infantry Regiment

Col. Robert H. Noble	4 November 1916–2 May 1918	Col. David L. Stone	9 September 1924–10 March 1926
Col. Edwin B. Winans	5 May 1918–11 July 1918	Lt. Col. George W. England	10 March 1926–1 May 1926
Lt. Col. Patrick Mulley	11 July 1918–28 July 1918	Col. Moor N. Falls	1 May 1926–15 March 1929
Col. Henry J. Hunt	28 July 1918–4 May 1919	Maj. Louis P. Ford	15 March 1929–1 June 1929
Col. Isaac Newell	4 May 1919–July 1919	Lt. Col. John Randolph	1 June 1929–14 July 1929
Col. Grosvenor L. Townsend	July 1919–3 October 1920	Col. Pegram Whitworth	14 July 1929–28 June 1932
Col. Hunter B. Nelson	3 October 1920–7 March 1922	Col. Walter Krueger	28 June 1932–11 July 1934
Lt. Col. Albert R. Dillingham	7 March 1922–21 March 1922	Col. Walter C. Short	11 July 1934–1 July 1936
Col. Halsey E. Yates	21 March 1922–31 May 1924	Col. Joseph A. Atkins	1 July 1936–10 February 1939
Lt. Col. George W. England	31 May 1924–9 September 1924	Col. Harry B. Crea	10 February 1939–25 November 1941
	Col. John W. Leonard		25 November 1941–October 1942

#### 7th Infantry Regiment (3d Division)

**HQ**—Camp Pike, AR, 1919–21; Camp Lewis, WA, 1921–22; Vancouver Barracks, WA, 1922–41; Fort Lewis, WA, 1941



Arrived at the port of New York on 22 August 1919 on the U.S.S. *Kaiserin Auguste Victoria* as an element of the 3d Div. Transferred 27 August 1919 to Camp Pike, AR. Transferred 20 September 1921 to Camp Lewis, WA. Transferred 27 September 1922 to Vancouver Barracks, WA. Concurrently, 2d Bn. transferred to Chilkoot Barracks, TA, where it absorbed the personnel and equipment of the inactivated 2d Bn., 59th Inf. Initial wartime mission in accordance with established war plans was to conduct a mobile defense of possible amphibious landing areas in support of the Harbor Defenses of the Columbia. Regiment participated in the making of the First National Production Company movie “The Patent Leather Kid” during March–April 1927. In April 1933, the regiment assumed command and control of the Vancouver Barracks CCC District. Co. D awarded the Edwin Howard Clark machine gun trophy for 1935. The 2d Bn. transferred

18 October 1939 to Camp Bonneville, ID, and to Vancouver Barracks on 7 May 1940. Entire regiment transferred 7 February 1941 to Fort Lewis, WA. Location 7 December 1941—Fort Lewis, WA.

**Organization Day:** 8 January. Chosen to commemorate the regiment's participation in the battle of New Orleans, 8 January 1814. Adopted 27 November 1923.

**Status:** Assigned to the USARS as the 7th Inf.; 1st and 2d Bns. active at Fort Stewart, GA, as elements of the 3d Inf. Div. (Mech).

**Events:** 57, 114, 135, 145, 161, 208, 226, 238, 251, 273, 289, 294, 304, 306, 309, 314, 326

### Commanders, 7th Infantry Regiment

Col. Frank B. Jones	10 February 1915–22 December 1917	Maj. Oscar W. Heep	10 August 1927–6 October 1927
Col. Thomas M. Anderson Jr.	22 December 1917–1 August 1918	Lt. Col. Francis E. Endicott	6 October 1927–8 January 1928
Col. Edmund L. Butts	1 August 1918–6 October 1918	Col. Frank W. Rowell	8 January 1928–20 October 1930
Lt. Col. Jesse Gaston	6 October 1918–19 October 1918	Lt. Col. Edward E. McCammon	20 October 1930–1 January 1931
Col. William M. Morrow	19 October 1918–18 April 1919	Col. Dwight W. Ryther	1 January 1931–30 May 1933
Col. Austin F. Prescott	18 April 1919–26 October 1919	Col. Harry A. Wells	30 May 1933–31 October 1934
Col. Mark Wheeler	26 October 1919–14 July 1920	Lt. Col. Courtney H. Hodges	31 October 1934–5 November 1934
Lt. Col. Charles F. Andrews	14 July 1920–6 November 1920	Col. Edwin S. Hartshorn	5 November 1934–25 June 1935
Col. Otho B. Rosenbaum	6 November 1920–14 June 1921	Maj. George F. Halloran	25 June 1935–29 June 1935
Lt. Col. Charles F. Andrews	14 June 1921–15 September 1921	Col. Henry Hossfeld	29 June 1935–9 August 1937
Col. Thomas M. Anderson Jr.	15 September 1921–16 August 1923	Lt. Col. Harrison McAlpine	9 August 1937–19 October 1937
Maj. Harrison C. Browne	23 August 1923–1 October 1923	Col. Ralph R. Glass	19 October 1937–30 September 1939
Col. Willey Howell	1 October 1923–1 July 1925	Col. George M. Parker Jr.	30 September 1939–6 May 1941
Col. Frank J. Morrow	1 July 1925–10 August 1927	Col. Harrison McAlpine	6 May 1941–ao July 1941
	Unknown	ao June 1941–7 December 1941	

### 8th Infantry Regiment (4th Division)

**HQ**—Coblentz, GE, 1919–23; Fort Screven, GA, 1923–29; Fort Moultrie, SC, 1929–40; Fort Benning, GA, 1940–41



Stationed at Coblentz, Germany, as of July 1919 as a separate regiment on occupation duty. Assigned to the 1st Brig., American Forces in Germany (AFG) in November 1919. Relieved in April 1922 from the 1st Brig., AFG. Sailed from Antwerp, Belgium, on 25 January 1923 on the U.S.A.T. *St. Mihiel*. Arrived 7 February 1923 at Savannah, GA. Regiment, less 2d and 3d Bns., transferred that same day to Fort Screven, GA. Concurrently, 2d and 3d Bns. transferred to Fort Moultrie, SC. Initial wartime mission in accordance with established war plans was to conduct a mobile defense against possible amphibious landing areas in support of the Harbor Defenses of Charleston and the Harbor Defenses of Savannah. Assigned to the 4th Div. on 24 March 1923. The 2d Bn. participated in fighting fires in the city of Charleston, SC, in late April 1927. Regimental HQ transferred 24 October 1929 to Fort Moultrie. The 3d Bn. inactivated

on 31 October 1929 at Fort Moultrie. Co. D awarded the Edwin Howard Clark machine gun trophy for 1930. In April 1933, the regiment assumed command and control of CCC Districts F and I, Fourth Corps Area. Assigned Reserve officers conducted summer training with the regiment at Fort Moultrie. Transferred 28 June 1940 to Fort Benning, GA. Location 7 December 1941—Fort Benning, GA.

**Organization Day:** 22 September. Chosen to commemorate the regiment's participation in the battle of Monterrey, Mexico, 22 September 1847.

**Status:** Assigned to the USARS as the 8th Inf.; 1st and 2d Bns. active at Fort Hood, TX, as elements of the 4th Inf. Div. (Mecz).

**Events:** 19, 24, 94, 96, 121, 143, 184, 209, 228, 242, 255, 275, 293, 296, 300, 310, 330

### Commanders, 8th Infantry Regiment

Col. Benjamin A. Poore	1 July 1916–5 August 1917	Lt. Col. Fred W. Bugbee	7 March 1929–4 July 1929
Unknown	5 August 1917–3 October 1917	Col. Willis P. Coleman	4 July 1929–1 September 1931
Col. Samuel E. Smiley	3 October 1917–10 June 1918	Col. Gilbert M. Allen	1 September 1931–30 June 1933
Lt. Col. Morris M. Keck	10 June 1918–July 1918	Col. George C. Marshall	30 June 1933–21 October 1933
Col. Peter W. Davidson	July 1918–16 September 1918	Lt Col. Clyde R. Abraham	21 October 1933–16 November 1933
Col. Walter C. Short	16 September 1918–3 October 1918	Col. Frank F. Jewett	16 November 1933–7 August 1935
Col. Morris M. Keck	3 October 1918–3 August 1919	Lt. Col. Jesse C. Drain	7 August 1935–5 September 1935
Col. Fred W. Sladen	3 August 1919–7 November 1919	Col. Charles A. Dravo	5 September 1935–18 May 1937
Col. Morris M. Keck	ao January 1920–17 July 1920	Col. William A. Ganoe	18 May 1937–6 June 1937
Lt. Col. Alex M. Hall	17 July 1920–November 1920	Col. Charles A. Dravo	6 June 1937–18 September 1937
Col. Walter T. Bates	November 1920–2 March 1923	Col. William A. Ganoe	18 September 1937–3 December 1937
Lt. Col. Collin H. Ball	2 March 1923–25 July 1923	Col. John J. Fulmer	3 December 1937–19 January 1939
Lt. Col. John E. Morris	25 July 1923–28 September 1923	Col. Frederick C. Rogers	19 January 1939–16 February 1939
Col. Raymond Sheldon	28 September 1923–29 July 1925	Col. John J. Fulmer	16 February 1939–30 August 1939
Lt. Col. Fay W. Brabson	29 July 1925–1 December 1925	Lt. Col. Francis A. Byrne	30 August 1939–November 1939
Col. Reynolds J. Burt	1 December 1925–25 July 1928	Lt. Col. Raymond O. Barton	November 1939–16 June 1940
Lt. Col. Fred W. Bugbee	25 July 1928–1 October 1928	Col. Carlin C. Stokely	1 July 1940–21 July 1941
Col. Ezekiel J. Williams	1 October 1928–7 March 1929	Col. James A. Van Fleet	21 July 1941–3 July 1944

### 8th Infantry Regiment (Colored) (Separate)

### Illinois National Guard

HQ—Springfield, IL, 1921–29; Chicago, IL, 1929–41

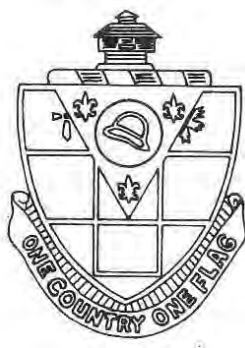

Arrived at the port of New York on 9 February 1919 on the S.S. *France* as the 370th Inf., an element of the 93d Div. Demobilized 11 March 1919 at Camp Grant, IL. Reorganized as the 8th Inf., Illinois N.G., 1919–21. HQ federally recognized 25 August 1921 at Springfield, IL. Assigned to the GHQR. Conducted a review 5 November 1921 for Marshal Ferdinand Foch during his visit to Chicago. HQ relocated 23 July 1929 to Chicago, IL. Assigned to the Second Army on 1 October 1933. Conducted annual summer training at Camp Grant, IL, 1921–40. For at least 1 year, in 1936, the regiment also trained five company-grade infantry officers of the 86th Div. at Camp Grant. Designated mobilization training station was Fort Huachuca, AZ. Regiment was converted and redesignated on 6 October 1940 as the 184th F.A. Regt.

**Status:** Assigned to the USARS as the 178th Inf.; 1st Bn. active at Chicago, IL, as an element of the 34th Inf. Div.

**Events:** 214, 302

### Commanders, 8th Illinois Infantry Regiment

Col. Franklin A. Denison	August 1917–12 July 1918	Col. Otis B. Duncan	25 August 1921–9 September 1929
Col. Thomas A. Roberts	12 July 1918–11 March 1919	Col. Spencer C. Dickerson	15 November 1929–25 February 1935
<i>Demobilized/Inactive</i>	12 March 1919–24 August 1921	Col. William J. Warfield	25 February 1935–6 October 1940



## 9th Infantry Regiment (2d Division)

HQ—Fort Sam Houston, TX, 1919–41



Arrived at the port of New York on 1 August 1919 on the U.S.S. *Princess Matoika* as an element of the 2d Div. Transferred 16 August 1919 to Camp Travis, TX. (Camp Travis consolidated 12 December 1922 with Fort Sam Houston, TX.) The regiment typically maintained one company at Camp Bullis, TX, and one company at Fort Crockett, TX, from 1921 to 1940. Participated 20 September–2 November 1926 in the production of the MGM movie “Wings” at Camp Stanley, TX. Co. M awarded the Edwin Howard Clark machine gun trophy for 1934. For the company stationed at Fort Crockett, its initial wartime mission in accordance with established war plans was to conduct a mobile defense of possible amphibious landing areas in support of the Harbor Defenses of Galveston. Location 7 December 1941—Fort Sam Houston, TX.

**Organization Day:** 18 July. Chosen to commemorate the regiment’s participation in the battle of Soissons, France, 18 July 1918. Adopted in 1920.

**Status:** Assigned to the USARS as the 9th Inf.; 1st and 2d Bns. active in Korea as elements of the 2d Inf. Div.

**Events:** 45, 47, 55, 70, 74, 105, 125, 147, 163, 205, 216, 242, 258, 282, 284, 288, 295, 296, 299, 300, 317, 328

### Commanders, 9th Infantry Regiment

Col. Harry R. Lee	15 May 1917–1 March 1918	Col. Ephraim G. Peyton	9 September 1926–4 June 1928
Col. La Roy S. Upton	3 March 1918–8 August 1918	Col. William R. Standiford	4 June 1928–11 August 1928
Col. George W. Stuart	25 August 1918–21 October 1918	Col. George McD. Weeks	11 August 1928–1 October 1930
Col. Robert O. Van Horn	21 October 1918–9 July 1919	Lt. Col. John R. Kelly	1 October 1930–6 November 1930
Col. Adna R. Chaffee Jr.	9 July 1919–10 August 1919	Col. Gideon H. Williams	6 November 1930–19 April 1932
Col. Harris Pendleton Jr.	10 August 1919–1 July 1920	Lt. Col. Augustus F. Dannemiller	19 April 1932–6 September 1932
Maj. Norman B. Howes	1 July 1920–15 August 1920	Col. Henry A. Ripley	6 September 1932–9 May 1934
Col. La Roy S. Upton	15 August 1920–2 September 1920	Lt. Col. Edward H. Tarbutton	10 May 1934–30 September 1934
Maj. Norman B. Howes	2 September 1920–1 October 1920	Col. Charles H. Mason	30 September 1934–17 October 1936
Lt. Col. Harrison Pendleton Jr.	1 October 1920–13 October 1920	Lt. Col. Henry Terrell Jr.	17 October 1936–9 November 1936
Col. Paul A. Wolf	13 October 1920–9 March 1922	Col. Henry W. Fleet	10 November 1936–2 April 1939
Lt. Col. Edward B. Mitchell	9 March 1922–1 September 1922	Col. Harrison C. Browne	2 April 1939–30 August 1940
Col. Robert O. Van Horn	1 September 1922–31 August 1924	Col. William H. Simpson	30 August 1940–4 October 1940
Maj. Xavier F. Blauvelt	31 August 1924–10 September 1924	Col. Walter M. Robertson	5 November 1940–April 1940
Col. Robert McCleave	10 September 1924–9 September 1926	Col. Clinton H. Walker	April 1941–10 July 1941
	Col. Walter M. Robertson		10 July 1941–May 1942

## 10th Infantry Regiment (5th Division)

HQ—Camp Custer, MI, 1919–20; Camp Sherman, OH, 1920–21; Camp Knox, KY, 1921–22; Fort Thomas, KY, 1922–39; Fort McClellan, AL, 1939–40; Fort Thomas, KY, 1940; Fort Custer, MI, 1940–41; Iceland 1941



Stationed at Camp Custer, MI, as of June 1919 as a separate regiment. Regiment, less 1st Bn., transferred 11 November 1920 to Camp Sherman, OH. Designated as a training center regiment on 27 July 1921 and assigned to the Fifth Corps Area Training Center. Regiment, less 2d and 3d Bns., transferred 16 December 1921 to Camp Knox, KY, and was reorganized as a training center regiment. Concurrently the 2d and 3d Bns. inactivated at Camp Sherman. The 2d and 3d Bns. were reactivated 7 June 1922 at Camp Knox when the regiment was relieved of training center duties and reorganized into a combat regiment. The 3d Bn. transferred on 23 July 1922 to Fort Hayes, OH. Regiment, less 3d Bn., transferred 22 October 1922 to Fort Thomas, KY. Assigned to the 5th Div. on 24 March 1923. Provided detachments to guard the tomb of President Warren G. Harding at Marion, OH, from August 1923 to May 1928. The 1st Bn. inactivated 31 October 1929 at Fort Thomas. The 3d Bn. transferred 28 October 1931 to Fort Thomas. In April 1933, the regiment assumed command and control of the Fort Thomas

CCC District. The 1st Bn. was reactivated 1 October 1933 at Fort Hayes, OH, with personnel and equipment from the inactivated 1st Bn., 28th Inf. Assigned Reserve officers conducted summer training with the regiment at Fort Thomas. Regiment transferred 7 November 1939 to Fort McClellan, AL. After participating in maneuvers in Louisiana in May 1940, regiment returned to Fort Thomas on 1 June 1940. Transferred 3 December 1940 to Fort Custer, MI. Departed New York Port of Embarkation on 5 September 1941 and arrived in Iceland on 16 September 1941. Location 7 December 1941—Reykjavik, Iceland.

**Organization Day:** 2 July. Chosen to commemorate the regiment's participation in the battles of Gettysburg (2 July 1863) and Santiago (2 July 1898).

**Status:** Assigned to the USARS as the 10th Inf.; 1st and 2d Bns. active at Fort Leonard Wood, MO, as training battalions.

**Events:** 22, 129, 165, 185, 213, 220, 253, 277, 293, 296, 302, 316, 328

#### Commanders, 10th Infantry Regiment

Col. Daniel B. Devore	1 July 1916–5 August 1917	Lt. Col. Richard Wetherill	30 June 1929–31 July 1929
Col. Edwin A. Root	7 September 1917–8 June 1918	Lt. Col. Alfred A. Hickox	31 July 1929–1 September 1929
Col. Russell C. Langdon	8 June 1919–22 September 1919	Col. Frederick S. Young	1 September 1929–9 May 1932
Col. Joseph P. O'Neill	22 September 1919–1 May 1920	Lt. Col. Everett M. Bowman	9 May 1932–24 July 1924
Col. Willis Uline	1 May 1920–12 October 1920	Col. Edward Croft	24 July 1932–25 May 1933
Col. William F. Creary	12 October 1920–17 November 1920	Lt. Col. Samuel J. Sutherland	26 May 1933–28 July 1933
Col. Daniel B. Devore	19 November 1920–15 May 1921	Col. Dana T. Merrill	28 July 1933–31 January 1935
Maj. Charles E. Coates	15 May 1921–7 September 1921	Lt. Col. John P. Bubb	31 January 1935–15 February 1935
Col. Robert M. Brambila	7 December 1921–15 September 1922	Col. Charles L. Mitchell	15 February 1935–15 February 1937
Col. Joseph F. Gohn	15 September 1922–1 September 1924	Col. Rowan P. Lemly	15 February 1937–4 March 1938
Lt. Col. William A. Castle	1 September 1924–18 September 1924	Lt. Col. Herbert A. Wadsworth	4 March 1938–13 August 1938
Col. Dana T. Merrill	18 September 1924–9 September 1927	Col. Arthur R. Underwood	13 August 1938–1 September 1940
Col. William H. Waldron	9 September 1927–30 June 1929	Lt. Col. James N. Peale	1 September 1940–March 1941
	Col. Matthew J. Gunner		March 1941–February 1942

#### 10th Infantry Regiment (93d Infantry Brigade)

#### New York National Guard

HQ—Albany, NY 1922–40



Arrived at the port of New York on 4 July 1919 on the U.S.S. *Wilhelmina* as the 51st Pioneer Inf. Demobilized 8 July 1919 at Camp Upton, NY. Reorganized 28 March–17 June 1921 by consolidation with, and redesignation as, the 10th Inf., New York N.G. Regimental HQ federally recognized on 22 May 1922 at Albany, NY. Attached to the 54th Inf. Brig. on 15 September 1923 for command, control, and administration. Relieved from attachment to the 54th Inf. Brig. on 26 January 1927 and assigned to the 93d Inf. Brig. The 2d Bn. was called up to perform flood relief work near Binghamton, NY, 18–20 March 1936. Conducted annual summer training most years at Camp Smith, Peekskill, NY, 1921–39. Relieved 1 June 1940 from the 93d Inf. Brig. Assigned to the 27th Div. on 1 September 1940. Inducted into active Federal service at Albany, NY, on 15 October 1940 and moved to

Fort McClellan, AL, where it arrived 25 October 1940. Regiment redesignated as the 106th Inf. Regt. on 11 December 1940.

**Organization Day:** 3 March. Chosen to commemorate the regiment's original organization on 3 March 1855.

**Status:** As the 210th Armor, consolidated with the 101st Cavalry on 1 September 1993 and assigned to the USARS as the 101st Cavalry; 1st Squadron active at Staten Island, NY, as an element of the 42d Inf. Div.

#### Commanders, 10th New York Infantry Regiment

Col. Charles E. Walsh	22 May 1922–15 May 1935	Col. Willard H. Donner	15 May 1935–4 August 1940
	Col. Thomas C. Dedell		12 August 1940–11 December 1940

## 11th Infantry Regiment (5th Division)

**HQ**—Camp Gordon, GA, 1919–20; Camp Jackson, SC, 1920–21; Camp Knox, KY, 1921–23; Fort Benjamin Harrison, IN, 1923–41; Fort Custer, MI, 1941

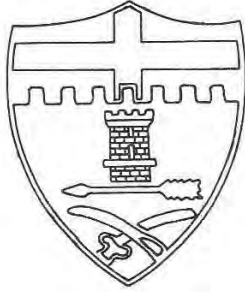

Arrived at the port of New York on 21 August 1919 on the U.S.S. *Plattsburg* as an element of the 5th Div. Transferred 26 July 1919 to Camp Gordon, GA. Transferred 27 October 1920 to Camp Jackson, SC. Conducted a 700-mile march from Camp Jackson to new duty stations in the summer of 1921. Regiment, less 2d and 3d Bns., arrived 19 October 1921 at Camp Knox, KY. Shortly thereafter, the 2d Bn. arrived at Fort Benjamin Harrison, IN, and the 3d Bn. arrived at Columbus Barracks, OH. Regimental HQ and 3d Bn. transferred 13 October 1922 to Fort Benjamin Harrison. The regiment typically maintained one company at Camp Knox throughout the year. A Co. was stationed there from 1923 to 1928 and B Co. from 1928 to 1935. Participated in tornado relief duties at Indianapolis, IN, 10–19 May 1927. Served as honor guard to President Herbert Hoover during his visit to Indianapolis on 15 June 1931. In April 1933, the regiment assumed command and control of the Ohio–West Virginia CCC District. Co. I served as honor guard to President Franklin D. Roosevelt during his visit to the Great Lakes Exposition at Cleveland, OH, in August 1936. Participated in flood relief duties along the Ohio River in January–February 1937. Constructed refugee camps in February 1937 for flood victims at Lawrenceburg, IN. Assigned Reserve officers conducted summer training with the regiment at Fort Benjamin Harrison. Transferred 10 November 1939 to Fort McClellan, AL. After participation in maneuvers in Louisiana in May 1940, returned to Fort Benjamin Harrison on 31 May 1940. Transferred 6 January 1941 to Fort Custer, MI. Location 7 December 1941—Fort Custer, MI

**Organization Day:** 5 November. Chosen to commemorate the regiment's forced crossing of the Meuse River at Dun-sur-Meuse during the Meuse-Argonne Campaign, 5 November 1918. Adopted 31 August 1926.

**Status:** Assigned to the USARS as the 11th Inf.; 1st and 2d Bns. active at Fort Benning, GA, as training battalions.

**Events:** 8, 129, 165, 185, 213, 220, 253, 277, 293, 296, 302, 316, 328

### Commanders, 11th Infantry Regiment

Col. Abner Pickering	12 May 1913–5 August 1917	Lt. Col. James G. McIlroy	15 March 1928–12 June 1928
Col. John B. Bennett	5 August 1917–20 October 1918	Col. Horace P. Hobbs	12 June 1928–1 May 1931
Maj. John H. Muncaster	21 October 1918–24 October 1918	Lt. Col. Hugo D. Selton	12 May 1931–20 September 1931
Lt. Col. R. John West	24 October 1918–1 November 1918	Col. William R. Standiford	20 September 1931–1 September 1933
Col. Robert H. Peck	1 November 1918–8 November 1920	Lt. Col. Luther R. James	1 September 1933–14 September 1933
Col. Milton L. McGrew	8 November 1920–6 December 1920	Col. Oliver P. Robinson	14 September 1933–4 September 1935
Col. Frank Halstead	6 December 1920–10 October 1921	Col. George V. Strong	4 September 1935–22 August 1937
Col. Reynolds J. Burt	19 October 1921–17 January 1922	Lt. Col. Walter Moore	22 August 1937–15 September 1937
Col. Frank Halstead	17 January 1922–12 December 1922	Col. Louis A. Kunzig	15 September 1937–16 March 1940
Col. James T. Dean	12 December 1922–24 February 1925	Col. Charles P. Hall	16 March 1940–17 February 1941
Lt. Col. Edwin J. Nowlen	25 February 1925–17 August 1925	Lt. Col. James N. Peale	17 February 1941–20 April 1941
Col. George D. Freeman Jr.	17 August 1925–15 March 1928	Col. Frank W. Milburn	28 May 1941–27 February 1942

## 12th Infantry Regiment (8th Division)

**HQ**—Camp George G. Meade, MD, 1919–22; Fort Howard, MD, 1922–40; Arlington Cantonment, VA, 1940–41; Fort Dix, NJ, 1941; Fort Benning, GA, 1941



Stationed at Camp George G. Meade, MD, as of June 1919 as a separate regiment. The 2d Bn. transferred in January 1921 to Camp Lee, VA. Designated as a training center regiment on 27 July 1921 and assigned to the Third Corps Area Training Center. The 2d Bn. was inactivated on 12 October 1921 at Camp George G. Meade. The 3d Bn. transferred in June 1922 to Fort Washington, MD. Reorganized as a combat regiment 11 September 1922 upon the inactivation of the Third Corps Area Training Center. Regiment, less 3d Bn., transferred 30 September 1922 to Fort Howard, MD. Assigned to the 8th Div. on 24 March 1923. The 2d Bn. was organized 30 March 1926 with O.R. personnel as a RAI unit with HQ at Fort Howard. The regiment temporarily transferred on 7 May 1926 to Camp Anthony Wayne, PA, and participated in the Sesquicentennial Exposition in Philadelphia until 11 December 1926. Relieved from the 8th Div. on 15 August 1927 and assigned to the 4th Div. Participated in the inaugural parades of President Herbert Hoover on 4 March 1929 and President Franklin D. Roosevelt on 4 March 1933. The 3d Bn. established the first CCC camp in the United States near Edinburg, VA, on 17 April 1933. Relieved from the 4th Div. on 1 October 1933 and assigned to the 8th Div. Assigned Reserve officers conducted summer training with the regiment at Fort Howard. Primary ROTC feeder school for new reserve lieutenants was Pennsylvania State College. The 3d Bn. transferred 27 June 1939 to Arlington Cantonment, VA. Regiment, less 3d Bn., transferred 3 September 1940 to Arlington Cantonment, VA. Entire regiment transferred 12 June 1941 to Fort Dix, NJ. Relieved from the 8th Div. on 10 October 1941 and assigned to the 4th Div. Transferred 24 October 1941 to Fort Benning, GA. Location 7 December 1941—Fort Benning, GA.

**Organization Day:** 3 July.

**Status:** Assigned to the USARS as the 12th Inf.; 1st Bn. active at Fort Hood, TX, as an element of the 4th Inf. Div. (Mecz).

**Events:** 38, 66, 98, 151, 155, 176, 191, 218, 240, 263, 281

### Commanders, 12th Infantry Regiment

Col. William H. Sage	7 February 1915–29 September 1917	Col. Joseph W. Beacham Jr.	7 December 1925–1 June 1927
Col. Lewis S. Sorley	29 September 1917–10 November 1917	Lt. Col. Albert S. J. Tucker	1 June 1927–31 August 1927
Col. Elmore F. Taggart	22 June 1917–24 May 1918	Col. Claude S. Fries	31 August 27–3 September 1930
Col. Charles B. Hagadorn	24 May 1918–16 September 1918	Col. William W. Taylor	3 September 1930–3 November 1932
Col. Alfred Aloe	16 September 1918–6 June 1919	Col. Walter L. Reed	3 November 1932–13 October 1934
Col. Jesse M. Cullison	13 August 1919–1 February 1921	Col. Laurence Halstead	13 October 1934–6 August 1935
Col. George W. Helms	1 February 1921–18 September 1923	Lt. Col. James G. Ord	6 August 1935–11 September 1935
Lt. Col. Frederick S. Young	18 September 1923–18 December 1923	Col. Jay L. Benedict	11 September 1935–1 December 1936
Col. George E. Thorne	18 December 1923–20 September 1925	Lt. Col. Gilbert R. Cook	1 December 1936–2 January 1937
Maj. James N. Peale	20 September 1925–25 October 1925	Col. Frederick W. Manley	2 January 1937–September 1939
Maj. Charles S. Little	25 October 1925–7 December 1925	Col. Oswald H. Saunders	September 1939–8 June 1941
	Col. Carroll A. Bagby		8 June 1941–15 July 1942

**13th Infantry Regiment** (9th Division)

**HQ**—Camp Merritt, NJ, 1919–20; Camp Devens, MA, 1920–21; Fort Andrews, MA, 1921–22; Fort Warren, MA, 1922–25; Fort Andrews, MA, 1925–28; Fort Adams, RI, 1928–31; Fort Devens, MA, 1931–39; Fort William D. Davis, CZ, 1939–40; Fort Jackson, SC, 1940–41



Stationed at Camp Merritt, NJ, as of June 1919 as a separate regiment. Transferred 1 February 1920 to Camp Devens, MA. Designated as a training center regiment on 27 July 1921 and assigned to the First Corps Area Training Center. Regiment, less the 2d and 3d Bns., transferred 22 October 1921 to Fort Andrews, MA. The 2d and 3d Bns. inactivated 15 December 1921 at Camp Devens. The 2d and 3d Bns. reactivated at Camp Devens on 10 June 1922 when the regiment was relieved of training center duties and reorganized into a combat regiment. Regimental HQ transferred 2 October 1922 to Fort Warren, MA. Battalions concurrently transferred as follows: 1st Bn. to Fort Strong, MA; 2d Bn. to Fort Revere, MA; and 3d Bn. to Fort Andrews, MA. Initial wartime mission in accordance with established war plans was to conduct a mobile defense of possible amphibious landing areas in support of the Harbor Defenses of Boston. Assigned to the 9th Div. on 24 March 1923. Regimental HQ transferred 18 September 1925 to Fort Andrews, MA. Relieved from the 9th Div. on 15 August 1927 and assigned to the 5th Div. The 3d Bn. transferred 30 August 1928 to Fort Ethan Allen, VT. Regimental HQ transferred 22 September 1928 to Fort Adams, RI. The 3d Bn. participated in the inaugural parade of President Herbert Hoover on 4 March 1929. The 1st Bn. inactivated on 31 October 1929 at Fort Strong, MA. Regimental HQ transferred 17 September 1931 to Camp Devens, MA. The 3d Bn. transferred 7 October 1931 to Camp Devens, MA. Relieved from the 5th Div. on 1 October 1933 and assigned to the 9th Div. Regiment sailed with the 18th Inf. Brig. from the port of Boston 21 October 1939 on the U.S.A.T. *Hunter Liggett* to reinforce the Panama Canal Zone. Arrived 27 October 1939 at Fort Davis, CZ. Inactivated 14 June 1940 at Fort Davis. Relieved from the 9th Div. on 22 June 1940 and assigned to the 8th Div. Activated 14 July 1940 at Camp Jackson, SC. Location 7 December 1941—Fort Jackson, SC.

**Organization Day:** 19 May. Chosen to commemorate the regiment’s participation in the first assault at Vicksburg where it was the first regiment in the Union Army to reach the Confederate works and plant its flag, earning the motto “First at Vicksburg.”

**Status:** Assigned to the USARS as the 13th Inf.; 2d and 3d Bns. active at Fort Jackson, SC, as training battalions.

**Events:** 59, 62, 64, 78, 95, 132, 192, 239, 262, 272, 280, 330

**Commanders, 13th Infantry Regiment**

Col. Benjamin C. Morse	1 March 1915–22 June 1917	Col. William K. Naylor	6 October 1926–21 May 1929
Col. Herbert J. Slocum	22 June 1917–9 November 1917	Maj. George W. Maddox	21 May 1929–16 June 1929
Col. Lewis S. Sorley	10 November 1917–19 May 1919	Maj. Oliver S. Wood	16 June 1929–8 July 1929
Col. Marcus B. Stokes	29 June 1919–19 August 1919	Lt. Col. Royden E. Beebe	8 July 1929–8 August 1929
Lt. Col. George F. Rozelle	19 August 1919–15 August 1919	Col. Fred V. S. Chamberlain	8 August 1929–1 July 1931
Col. Earnest E. Haskell	15 August 1919–September 1920	Lt. Col. Royden E. Beebe	1 July 1931–15 September 1931
Col. Patrick A. Connolly	September 1920–13 December 1920	Col. Albert W. Foreman	15 September 1931–1 November 1934
Col. Frederick S. L. Price	13 December 1920–July 1922	Col. Converse R. Lewis	1 November 1934–15 June 1936
Col. Paul Giddings	July 1922–9 July 1924	Col. Eugene Santschi	16 June 1936–6 October 1936
Lt. Col. George C. Shaw	9 July 1924–1 August 1924	Col. Matthew J. Thomlinson	7 October 1936–14 April 1939
Lt. Col. Charles F. Leonard	1 August 1924–31 July 1925	Lt. Col. George L. Smith	15 April 1939–30 June 1939
Col. Henry G. Learnard	31 July 1925–19 March 1925	Col. John H. Stutesman	30 June 1939–8 July 1940
Col. Howard L. Laubach	19 March 1926–5 October 1926	Lt. Col. Eustis L. Poland	8 July 1940–12 September 1940
	Col. Sumner Waite		12 September 1940–30 June 1942

**14th Infantry Regiment** (Panama Canal Division)

HQ—Camp Custer, MI, 1919–20; Fort Davis, CZ, 1920–41



Stationed at Camp Custer, MI, as of June 1919 as a separate regiment. Transferred 22 October 1920 to Fort Davis, CZ. Assigned to the Panama Canal Division on 3 July 1921. Primary wartime mission was to conduct a mobile defense of the beaches and inland sectors of the Atlantic side of the canal zone. Attached to HQ, Atlantic Sector 15 April 1932 upon inactivation of the Panama Canal Division. Relieved 10 October 1938 from the Panama Canal Division. Relieved from attachment to the Atlantic Sector 16 February 1940 and assigned to the Panama Mobile Force. Location 7 December 1941—Fort Davis, CZ.

**Organization Day:** 27 June. Chosen to commemorate the regiment’s participation in the battle of Gaines’ Mill on 27 June 1862.

**Status:** Assigned to the USARS as the 14th Inf.; 1st Bn. active at Schofield Barracks, HI, as an element of the 25th Inf. Div. (Light); 2d Bn. active at Fort Drum, NY, as an element of the 10th Mountain Div. (Light).

**Events:** 5, 26, 31, 36, 40, 43, 53, 58, 69, 81, 101, 119, 140, 167, 170, 180, 181, 202, 223, 271, 292, 308, 333

**Commanders, 14th Infantry Regiment**

Col. Richard H. Wilson	12 June 1910–10 June 1917	Maj. George W. C. Whiting	8 February 1928–19 April 1928
Col. Henry D. Styer	10 June 1917–5 August 1917	Col. Joseph F. Gohn	19 April 1928–8 April 1931
Col. Armand I. Lasseigne	17 April 1918–7 January 1920	Col. Oliver H. Dockery	8 April 1931–6 June 1931
Lt. Col. Ferdinand W. Kobbe	7 January 1920–17 June 1920	Maj. George W. C. Whiting	6 June 1931–19 August 1931
Col. Frederick R. Day	17 June 1920–8 October 1920	Lt. Col. Ray C. Hill	25 August 1931–16 March 1931
Col. William H. Oury	8 October 1920–17 September 1923	Col. James V. Heidt	16 March 1931–11 December 1934
Lt. Col. Roscoe H. Hearn	17 September 1923–4 December 1923	Col. Campbell B. Hodges	11 December 1934–14 August 1936
Col. Charles R. Howland	4 December 1923–4 August 1926	Lt. Col. Charles S. Buck	14 August 1936–9 September 1936
Lt. Col. Henry M. Nelly	4 August 1926–13 December 1926	Col. John L. Jenkins	9 September 1936–10 October 1939
Col. Hubert A. Allen	13 December 1926–8 February 1928	Col. Wallace C. Philoon	10 October 1939–9 July 1940
	Unknown		9 July 1940–7 December 1941

**14th Infantry Regiment** (93d Infantry Brigade)

**New York National Guard**

HQ—Brooklyn, NY, 1923–41

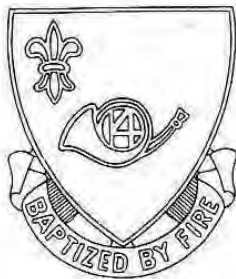

Arrived at the port of New York on 4 July 1919 on the U.S.S. *Lancaster* as the 2d Pioneer Inf. Demobilized 1 April 1919 at Camp Upton, NY. Demobilized 2 November 1919 at Camp Dix, NJ. Reorganized 22 March–1 November 1921 as the 14th Inf., New York N.G. Regimental HQ organized 12 January 1923 at Brooklyn, NY; HQ federally recognized 30 March 1923 at Brooklyn. Attached to the 53d Inf. Brig. on 15 September 1923 for command, control, and administration. Relieved from attachment to the 53d Inf. Brig. on 27 February 1927 and assigned to the 93d Inf. Brig. Conducted additional week-long winter training directed by the War Department at Camp Upton, NY, 26–31 December 1939. Relieved 1 June 1940 from the 93d Inf. Brig. Conducted annual summer training most years at Camp Smith, Peekskill, NY, 1923–39. Converted and redesignated 187th

F.A. on 16 September 1940.

**Status:** HQ active in the New York N.G. as Detachment 1, 1442d M.P. Co.; remaining elements assigned to the USARS as the 187th F.A.; no active elements.

**Events:** 61, 280

**Commanders, 14th New York Infantry Regiment**

Col. Frederick W. Baldwin	30 March 1923–May 1931	Col. William R. Jackson	7 May 1931–16 September 1940
---------------------------	------------------------	-------------------------	------------------------------

## 15th Infantry Regiment (Philippine Division)

HQ—Tientsen, China, 1919–38; Fort Lewis, WA, 1938–41

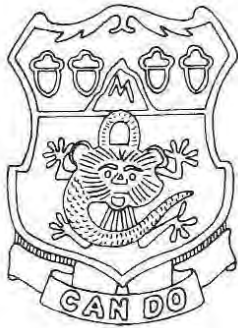

Stationed at the American Barracks, Tientsen, China, as of June 1919 as a separate regiment. The 1st Bn. transferred in September 1921 to Fort William McKinley, PI. Regiment assigned to the Philippine Division on 17 July 1922. Regiment, less 1st Bn., relieved from assignment to the Philippine Division on 1 April 1923 and assigned to the US Forces in China. During the Chihli–Fengtien War of 1925–26, the regiment, along with contingents of the other foreign military commands, was deployed south of Tientsen on 14 November 1925 to 31 March 1926 to guard stretches of the Tientsen–Pukow Railway, the Wei Ching Ho Canal, and the approaches into the city from bandits and stragglers from the warring factions. The regiment conducted its summer training at Camp Burrowes near Chingwangtao on the Gulf of Pei Chih-li, 1926–37. The 1st Bn. was inactivated 1 April 1929 at Fort William McKinley, PI. The 1st Bn. was relieved on 26 June 1931 from assignment to the Philippine Division. Regiment was relieved on

2 March 1938 from US Forces in China. Transferred to Fort Lewis, WA, on the U.S.A.T. *U.S. Grant* and arrived there 24 March 1938. Assigned to the 3d Div. on 12 January 1940. The 1st Bn. was activated 23 May 1940 at Fort Lewis. The regiment was employed in keeping order at a labor strike at the North American Aircraft Factory near Seattle, 9 June–12 July 1940. Location 7 December 1941—Fort Lewis, WA.

**Organization Day:** 2 May.

**Status:** Assigned to the USARS as the 15th Inf.; 1st and 3d Bns. active at Fort Stewart, GA, as elements of the 3d Inf. Div. (Mecz).

**Events:** 27, 35, 41, 52, 68, 82, 100, 251, 289, 294, 304, 306, 309, 314, 318, 326

### Commanders, 15th Infantry Regiment

Col. Harry C. Hale	30 November 1915–23 June 1917	Col. William K. Naylor	23 December 1924–21 January 1926
Col. Walter H. Gordon	23 June 1917–31 August 1917	Lt. Col. George C. Marshall	21 January 1926–6 March 1926
Unknown	31 August 1917–17 November 1917	Col. Isaac Newell	6 March 1926–16 February 1929
Col. William T. Wilder	17 November 1917–11 June 1919	Lt. Col. Joseph M. Cummins	16 February 1929–15 April 1929
Col. William M. Morrow	11 June 1919–20 May 1921	Col. James D. Taylor	15 April 1929–27 June 1932
Lt. Col. Albert B. Sloan	20 May 1921–27 September 1921	Col. Reynolds J. Burt	27 June 1932–7 July 1935
Col. William F. Martin	27 September 1921–18 November 1922	Col. George A. Lynch	7 July 1935–14 May 1937
Lt. Col. Albert B. Sloan	18 November 1922–12 April 1923	Col. Joseph A. McAndrew	14 May 1937–3 May 1939
Col. Campbell King	12 April 1923–23 July 1924	Lt. Col. Fred L. Walker	3 May 1939–8 December 1939
Maj. Edwin F. Harding	23 July 1924–8 September 1924	Col. Jesse A. Ladd	8 December 1939–11 August 1941
Lt. Col. George C. Marshall	8 September 1924–23 December 1924	Col. Thomas H. Monroe	16 September 1941–16 May 1943

## 16th Infantry Regiment (1st Division)

HQ—Camp Zachary Taylor, KY, 1919–20; Camp Dix, NJ, 1920–22; Fort Jay, NY, 1922–39; Fort Benning, GA, 1939–40; Fort Jay, NY, 1940–41; Fort Devens, MA, 1941

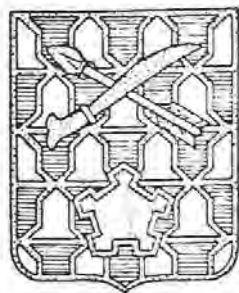

Arrived at the port of New York on 3 September 1919 on the Steam Ships *Amphion*, *Freedom*, *Suwanee*, and *Marica* as an element of the 1st Div. Transferred to Camp Merritt, NJ. Participated in the 1st Div. Victory Parades in New York City and Washington, DC, on 10 and 17 September 1919, respectively. Transferred 4 October 1919 to Camp Zachary Taylor, KY. Transferred 16 September 1920 to Camp Dix, NJ. Transferred 10 June 1922, less 3d Bn., to Fort Jay, NY. The 3d Bn. transferred in September 1922 to Fort Wadsworth, NY. Organized with elements of the 18th Inf. into the “Composite Regiment” and deployed to Washington, DC, to act as honor guard for the unveiling of the 1st Div. War Memorial on 4 October 1924. The 3d Bn. transferred 18 March 1933 to Fort Jay. In April 1933 the regiment assumed command and control of portions of the 1st CCC District (New Jersey), Second Corps Area. Elements served as honor guard and escort to President Manuel

Quezon of the Philippines on 24 February 1937; to President Franklin D. Roosevelt in October 1937 during his visit to Poughkeepsie, NY; and to King George VI and the Queen of England in June 1939 during their visit to New York City.

Regiment departed the New York Port of Embarkation on 1 November 1939 on the U.S.A.T. *Republic* and debarked at Charleston, SC, en route to Fort Benning, GA. Arrived at Fort Benning, GA, on 9 November 1939 to conduct training in preparation for the 1940 Louisiana Maneuvers. After maneuvers in Louisiana in May 1940, the regiment returned to Fort Jay, NY. Transferred 20 February 1941 to Fort Devens, MA. Location 7 December 1941—Fort Devens, MA.

**Organization Day:** 4 October. Chosen to commemorate the regiment's liberation of the village of Fleville, France, on 4 October 1918. The regiment's feat ensured that it was the only regiment in the entire First Army that secured its first day's objective during that phase of the Meuse-Argonne Campaign.

**Status:** Assigned to the USARS as the 16th Inf.; 1st Bn. active at Fort Riley, KS, as an element of the 1st Inf. Div. (Mecz).

**Events:** 10, 18, 22, 60, 63, 72, 87, 89, 106, 153, 168, 190, 240, 266, 280, 287, 293, 296, 301, 307, 323, 330

#### Commanders, 16th Infantry Regiment

Col. William H. Allaire	23 November 1915–25 August 1917	Lt. Col. Sheldon W. Anding	2 October 1924–10 December 1924
Lt. Col. Frank A. Wilcox	25 August 1917–2 November 1917	Col. Stanley H. Ford	10 December 1924–25 August 1926
Col. John L. Hines	2 November 1917–3 April 1918	Lt. Col. Nicholas Campanole	25 August 1926–27 October 1926
Col. Harry A. Smith	3 April 1918–10 July 1918	Lt. Col. Sheldon W. Anding	27 October 1926–20 December 1926
Col. Francis E. Bamford	11 July 1918–6 August 1918	Col. Edward Croft	20 December 1926–26 June 1928
Col. LaRoy S. Upton	5 August 1918–26 August 1918	Col. Stephen O. Fuqua	26 June 1928–28 March 1929
Lt. Col. Edward R. Coppock	27 August 1918–23 October 1918	Lt. Col. Irving Phillipson	28 March 1929–8 July 1929
Col. William F. Harrell	23 October 1918–29 June 1919	Col. Albert S. Williams	8 July 1929–12 July 1930
Col. William W. McCammon	29 June 1919–3 August 1919	Maj. Jens A. Doe	12 July 1930–28 July 1930
Maj. N. D. Bagnall	3 August 1919–September 1919	Col. William W. McCammon	28 July 1930–4 July 1932
Lt. Col. Clarence R. Huebner	September 1919–3 October 1919	Col. Joseph A. Marmon	15 July 1932–26 July 1934
Col. William F. Harrell	3 October 1919–20 June 1920	Lt. Col. Joseph J. O' Hare	26 July 1934–31 August 1934
Maj. Thomas J. Strangier	20 June 1920–October 1920	Col. Albert S. Williams	31 August 1934–1 July 1937
Lt. Col. Clenard McLaughlin	October 1920–30 November 1920	Col. Karl Truesdell	1 July 1937–1 April 1938
Col. Francis E. Lacey, Jr.	1 December 1920–1 September 1922	Lt. Col. James L. Bradley	1 April 1938–2 June 1938
Col. Charles Gerhardt	1 September 1922–1 September 1924	Col. Charles H. Rice	2 June 1938–7 June 1940
Maj. Nicholas Campanole	1 September 1924–2 October 1924	Col. Paul W. Baade	8 June 1940–10 July 1941
	Col. Henry B. Cheadle		11 July 1941–25 December 1942

#### 17th Infantry Regiment (7th Division)

**HQ**—Camp George G. Meade, MD, 1919–20; Fort McIntosh, TX, 1920–21; Fort Sam Houston, TX, 1921–22; Fort Crook, NE, 1922–40; Fort Ord, CA, 1940–41

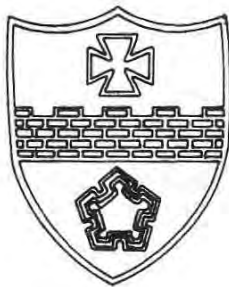

Stationed at Camp George G. Meade, MD, as of July 1919 as a separate regiment. Transferred 8 October 1920 to Fort McIntosh, TX. Designated as a training center regiment on 27 July 1921 and assigned to the Eighth Corps Area Training Center. The 2d and 3d Bns. inactivated on 1 October 1921 at Fort McIntosh. Transferred 5 November 1921 to Fort Sam Houston, TX. Regiment, minus 2d and 3d Bns., transferred 20 June 1922 to Fort Crook, NE. The 2d and 3d Bns. reactivated 24 June 1922 at Fort Crook, NE, when the regiment was relieved of training center duties and reorganized into a combat regiment. Assigned to the 7th Div. on 24 March 1923. The 2d Bn. transferred 23 June 1926 to Fort Des Moines, IA. Relieved from the 7th Div. on 15 August 1927 and assigned to the 6th Div. The 2d Bn. inactivated on 31 October 1929 at Fort Des Moines. The 3d Bn. transferred 10 September 1931 to Fort Leavenworth, KS. In April 1933 the regiment

assumed command and control of the Nebraska and Arkansas CCC Districts and portions of the South Dakota CCC District in February 1936. Relieved from the 6th Div. on 1 October 1933 and assigned to the 7th Div. The 2d Bn. activated 1 July 1940 at Camp Ord, CA. Regiment, less 2d Bn., transferred 10 September 1940 to Camp Ord, CA. Assigned Reserve officers conducted summer training with active elements of the regiment at Fort Crook. Location 7 December 1941—Fort Ord, CA.

**Organization Day:** 4 May. Chosen to commemorate the regiment's original date of constitution on 4 May 1861.

**Status:** Assigned to the USARS as the 17th Inf.; 1st Bn. active at Fort Richardson, AK, as an element of the 172d Inf. Brig.



**Events:** 136, 150, 236, 256, 274, 285, 303, 314, 326

**Commanders, 17th Infantry Regiment**

Col. Charles R. Noyes	March 1916–31 May 1919	Col. La Vergne L. Gregg	30 June 1930–15 November 1932
Col. William Weigel	15 June 1919–23 August 1919	Lt. Col. Felix Emmanuelli	15 November 1932–22 November 1932
Lt. Col. Arthur E. Ahrends	24 August 1919–6 October 1919	Col. Thomas M. Anderson	22 November 1932–15 November 1934
Col. Truman O. Murphy	6 October 1919–9 August 1920	Col. Samuel J. Sutherland	15 November 1934–5 August 1936
Col. John S. Switzer	9 August 1920–4 October 1920	Maj. Clarence P. Evers	5 August 1936–30 September 1936
Col. William B. Cochran	4 October 1920–30 November 1922	Lt. Col. John H. Van Vliet	30 September 1936–5 October 1936
Lt. Col. Guy E. Buckner	30 November 1922–19 July 1923	Col. Clyde R. Abraham	5 October 1936–1 May 1939
Col. Clifton C. Kinney	19 July 1923–2 October 1925	Lt. Col. Thomas F. Taylor	1 May 1939–23 May 1939
Lt. Col. Albert W. Foreman	2 October 1925–26 May 1926	Lt. Col. Max W. Sullivan	23 May 1939–30 June 1939
Col. Clement A. Trott	26 May 1926–20 June 1930	Col. George F. N. Dailey	30 June 1939–March 1941
Lt. Col. Joseph P. Vachon	20 June 1930–30 June 1930	Col. Jens A. Doe	March 1941–June 1942

**18th Infantry Regiment (1st Division)**

**HQ**—Camp Zachary Taylor, KY, 1919–20; Camp Dix, NJ, 1920–22; Fort Slocum, NY, 1922–27; Fort Hamilton, NY, 1928–39; Fort Benning, GA, 1939–40; Fort Hamilton, NY, 1940–41; Fort Devens, MA, 1941



Arrived at the port of New York on 3 September 1919 on the U.S.S. *Mobile* as an element of the 1st Div. Transferred to Camp Merritt, NJ. Participated in the 1st Div. Victory Parades in New York City and Washington, DC, on 10 and 17 September 1919, respectively. Transferred 4 October 1919 to Camp Zachary Taylor, KY. Transferred 14 September 1920 to Camp Dix, NJ. Regimental HQ transferred 10 September 1922 to Fort Slocum, NY. Battalions concurrently transferred as follows: 1st Bn. to Fort Slocum; 2d Bn. to Fort Schuyler, NY; and 3d Bn. to Fort Hamilton, NY. Organized with elements of the 16th Inf. into the “Composite Regiment” and deployed to Washington, DC, to act as honor guard for the unveiling of the 1st Div. War Memorial on 4 October 1924. Regimental HQ transferred 10 January 1928 to Fort Hamilton. Concurrently, 3d Bn.

transferred to Fort Slocum. Co. H awarded the Edwin Howard Clark machine gun trophy for 1928 and 1929. The 2d Bn. transferred 3 July 1931 to Fort Wadsworth, NY. Elements served as honor guard for Marshal Henri Petain during his visit to New York City on 24 October 1931. In April 1933 the regiment assumed command and control of portions of the 1st CCC District (New Jersey), Second Corps Area. The 3d Bn. transferred in June 1933 to Fort Wadsworth. Regiment departed the New York Port of Embarkation on 28 October 1939 on the U.S.A.T. *Republic* and debarked at Charleston, SC, en route to Fort Benning, GA. After maneuvers in Louisiana in May 1940, returned to Fort Hamilton on 5 June 1940. Transferred 27 February 1941 to Fort Devens, MA. Location 7 December 1941—Fort Devens, MA.

**Organization Day:** 3 May. Chosen to commemorate the regiment’s original date of constitution on 3 May 1861. Adopted 1920.

**Status:** Assigned to the USARS as the 18th Inf.; 1st Bn. active in Germany as an element of the 1st Inf. Div. (Mecz).

**Events:** 10, 18, 22, 60, 63, 72, 89, 106, 153, 168, 173, 190, 240, 266, 280, 287, 293, 296, 301, 307, 323, 330

**Commanders, 18th Infantry Regiment**

Col. Edwin F. Glenn	12 July 1916–12 June 1917	Col. William B. Graham	23 July 1929–6 July 1931
Col. James W. McAndrew	12 June 1917–22 July 1917	Col. John H. Hughes	6 July 1931–1 October 1931
Col. Ulysses G. McAlexander	22 July 1917–31 December 1917	Col. Claude H. Miller	5 November 1931–9 October 1933
Col. Frank Parker	1 January 1918–8 August 1918	Col. Nobel J. Wiley	10 October 1933–5 September 1935
Col. Charles A. Hunt	8 August 1918–16 June 1920	Lt. Col. Charles S. Hamilton	5 September 1935–17 September 1935
Maj. Oliver Allen	16 June 1920–2 August 1920	Col. Royden E. Beebe	17 September 1935–14 September 1937
Col. Orrin R. Wolfe	2 August 1920–30 August 1923	Col. Fay W. Brabson	14 September 1937–18 September 1939
Col. John J. Bradley	30 August 1923–20 July 1927	Col. Eley P. Denson	18 September 1939–18 August 1941
Col. Charles F. Humphrey Jr.	20 July 1927–23 July 1929	Col. Edward G. Sherburne	18 August 1941–11 July 1942

**19th Infantry Regiment (Hawaiian Division)**

**HQ**—Camp Harry J. Jones, AZ, 1919–20; Camp Sherman, OH, 1920–21; Presidio of San Francisco, CA, 1921–22; Schofield Barracks, TH, 1921–41



Stationed at Camp Harry J. Jones, AZ, as of June 1919 as a separate regiment. The 1st Bn. transferred 16 June 1919 to Fort Bliss, TX. Regiment transferred 21 October 1920 to Camp Sherman, OH. Designated as a training center regiment 27 July 1921 and assigned to the Ninth Corps Area Training Center. Moved to Newport News, VA, 30 September 1921. Sailed on the U.S.S. *Henderson* 6 October 1921 to the Presidio of San Francisco, CA, and arrived there 1 November 1921. Upon arrival, the 2d and 3d Bns. were inactivated and the remainder of the unit was reorganized as a training center regiment. Relieved on 16 June 1922 from the Ninth Corps Area Training Center. The 2d and 3d Bns. concurrently reactivated at the Presidio of San Francisco when the regiment was reorganized into a combat unit. Assigned to the Hawaiian Division on 17 October 1922. Further assigned

to the 21st Inf. Brig. on 19 October 1922. Sailed for Hawaii on 28 October 1922 on the U.S.A.T. *Thomas*. Arrived at Schofield Barracks, TH, 5 November 1922. Primary wartime mission was to conduct a mobile defense of the beaches and inland sectors of the northern half of the island of Oahu. Assigned to the 24th Div. on 26 August 1941. Location 7 December 1941—Schofield Barracks, TH.

**Organization Day:** 20 September. Chosen to commemorate the regiment’s participation in the battle of Chickamauga 20 September 1863 when its defense of the Kelly Field was instrumental in saving the Army of the Cumberland from total disaster and earned it the nickname “Rock of Chickamauga.”

**Status:** Assigned to the USARS as the 19th Inf.; 1st and 2d Bns. active at Fort Benning, GA, as training battalions.

**Events:** 3, 22, 33, 37, 75, 88, 120, 138, 141, 158, 189, 211, 225, 248, 276, 297, 312

**Commanders, 19th Infantry Regiment**

Col. Millard F. Waltz	14 July 1911–21 September 1917	Col. Robert M. Brambila	23 September 1922–23 May 1925
Col. Harry R. Lee	21 September 1917–1 March 1918	Lt. Col. Wallace McNamera	23 May 1925–12 September 1925
Col. Robert C. Williams	22 May 1918–16 October 1918	Lt. Col. Samuel T. Mackall	12 September 1925–20 October 1925
Col. Arthur M. Shipp	17 October 1918–5 January 1919	Col. Truman O. Murphy	20 October 1925–31 July 1928
Col. William O. Johnson	6 January 1919–20 May 1920	Maj. William L. Culberson	31 July 1928–26 January 1929
Maj. Garrison McCaskey	20 May 1920–17 July 1920	Col. Frederick R. de Funiak Jr.	26 January 1929–2 May 1931
Lt. Col. William G. Fleisenhauer	17 July 1920–1 October 1920	Lt. Col. Bloxham Hard	2 May 1931–25 September 1931
Col. Herman Hall	1 October 1920–June 1921	Col. Adolphe H. Huguet	25 September 1931–17 August 1934
Lt. Col. William G. Fleisenhauer	June 1921–August 1921	Col. William J. O’Loughlin	18 August 1934–7 July 1936
Col. Charles A. Martin	August 1921–2 November 1921	Col. Robert M. Lyon	7 July 1936–13 May 1938
Col. Thomas A. Pearce	2 November 1921–30 August 1922	Col. Charles H. Bonesteel	13 May 1938–17 May 1940
Lt. Col. Ralph B. Lister	30 August 1922–14 September 1922	Lt. Col. Martin Ackerson	17 May 1940–26 September 1940
Lt. Col. Wallace McNamera	14 September 1922–23 September 1922	Col. Durwood S. Wilson	26 September 1940–10 October 1940
	Col. Max W. Sullivan		10 October 1940–1 March 1942

**20th Infantry Regiment (2d Division)**

**HQ**—Fort Riley, KS, 1919; Fort Crook, NE, 1919–20; Fort Sam Houston, TX, 1920–27; Fort Francis E. Warren, 1927–39; Fort Jackson, SC, 1939–40; Fort Benning, GA, 1940; Fort Francis E. Warren, 1940–41; Fort Leonard Wood, MO, 1941

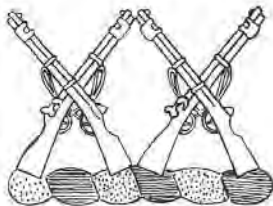

Stationed at Fort Riley, KS, as of June 1919 as a separate regiment. Transferred 1 July 1919 to Fort Crook, NE. Concurrently, 1st Bn. transferred to Fort Brady, MI, and 2d Bn. transferred to Fort Benjamin Harrison, IN. Assigned to the 2d Div. on 18 September 1920. The entire regiment transferred on 29 September 1920 to Fort Sam Houston, TX. The 3d Bn. transferred in March 1925 to Fort Sill, OK. The entire regiment transferred 28 June 1927 to Fort D.A. Russell, WY (later redesignated Fort Francis E. Warren). Deployed to Camp Stephen D. Little, AZ, 13 April–18 May 1929, and patrolled the Mexican border in response to the Escobar–Topete Revolution. Co. D awarded the

Edwin Howard Clark machine gun trophy for 1932. In April 1933 the regiment assumed command and control of the Wyoming CCC District. Assigned Reserve officers conducted summer training with the regiment at Fort Francis E. Warren. Relieved from the 2d Div. on 16 October 1939 and assigned to the 6th Div. Transferred 17 November 1939 to Fort Jackson, SC. Returned to Fort Francis E. Warren on 28 May 1940. Transferred to Fort Leonard Wood, MO, and arrived there 20 May 1941. Location 7 December 1941—Fort Leonard Wood, MO.

**Organization Day:** 9 October. Chosen to commemorate the birthday of the regiment's post-Civil War commander Colonel George Sykes on 9 October 1822. Sykes had commanded the Regular Division and the V Corps, of which the 20th Inf. was part, in the Civil War and commanded the regiment from 1868 until his death on 8 February 1880. The regiment is known as "Sykes' Regulars."

**Status:** Assigned to the USARS as the 20th Inf.; 5th Bn. active at Fort Lewis, WA, as an element of the 2d Inf. Div.

**Events:** 5, 45, 47, 55, 79, 83, 130, 152, 166, 212, 232, 260, 293, 296, 303, 316, 328

#### Commanders, 20th Infantry Regiment

Col. Alfred Hasbrouck	24 October 1915–15 May 1917	Col. John H. Neff	22 September 1929–22 September 1930
Col. Edward N. Jones Jr.	15 May 1917–17 November 1917	Lt. Col. George C. Lawrason	22 September 1930–30 October 1930
Col. Alfred Hasbrouck	17 November 1917–26 June 1918	Col. Elliot N. Norton	30 October 1930–15 December 1931
Unknown	26 June 1918–4 August 1919	Lt. Col. George C. Lawrason	15 December 1931–3 February 1922
Col. John E. Morris	4 August 1919–28 August 1920	Col. Andrew J. Dougherty	3 February 1932–4 May 1934
Col. Beaumont B. Buck	28 August 1920–15 August 1921	Lt. Col. Agard H. Baily	4 May 1934–20 August 1934
Lt. Col. George C. Lewis	15 August 1921–14 September 1921	Col. Clement A. Trott	20 August 1934–5 July 1935
Col. Arthur L. Conger	14 September 1921–29 September 1923	Maj. Lester L. Lampert	6 July 1935–11 September 1935
Col. George W. Stuart	29 September 1923–28 September 1925	Col. Fred H. Turner	11 September 1935–10 September 1937
Col. Fred L. Munson	29 September 1926–23 July 1928	Lt. Col. Carl J. Adler	10 September 1937–21 September 1937
Col. William S. Sinclair	23 July 1928–31 May 1929	Col. Ray C. Hill	21 September 1937–30 April 1939
Maj. Hardin C. Sweeney	31 May 1929–24 August 1929	Lt. Col. Robert E. Jones	30 April 1939–4 August 1939
Maj. Frank E. Benney	24 August 1929–9 September 1929	Col. Emil F. Reinhardt	4 August 1939–April 1941
Lt. Col. La Vergne L. Gregg	9 September 1929–21 September 1929	Col. Frank Milburn	28 May 1941–27 February 1942

#### 21st Infantry Regiment (Hawaiian Division)

**HQ**—Fort George Wright, WA, 1919–21; Schofield Barracks, TH, 1921–41

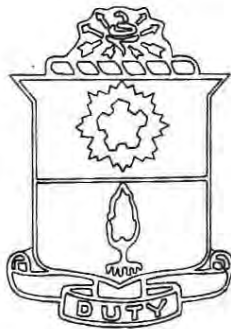

Stationed at Fort George Wright, WA, less 2d and 3d Bns., as of June 1919 as a separate regiment. The 2d Bn. located as follows: HQ and E Co. at Fort William H. Seward, TA; F Co. at Fort Liscum, TA; G Co. at Fort Gibbon, TA; H Co. at Fort St. Michael, TA. The 3d Bn. was stationed at Fort Douglas, UT. Assigned to the Hawaiian Division on 22 October 1921. Enlisted personnel at Fort George Wright transferred to the 53d, 58th, and 59th Inf. Regts. in late September–early October 1921. Enlisted personnel in Alaska concurrently transferred to the 7th Inf. Regt. Regimental officers, records, and colors transferred 7 October 1921, less enlisted personnel and equipment, to Schofield Barracks, TH. Regiment reorganized 28 November 1921 at Schofield Barracks with personnel and equipment of the inactivated 44th Inf. Primary wartime mission was to conduct a mobile defense of the beaches and inland sectors of the northern half of the island of Oahu. Assigned to the 24th Div. 26 August 1941. Location 7 December 1941—Schofield Barracks, TH.

**Organization Day:** 9 August. Chosen to commemorate the regiment's participation in the battle of Cedar Mountain on 9 August 1862. Adopted 31 January 1923.

**Status:** Assigned to the USARS as the 21st Inf.; 1st and 3d Bns. active at Schofield Barracks, HI, as elements of the 25th Inf. Div. (Light).

**Events:** 9, 20, 33, 37, 75, 88, 120, 138, 141, 158, 189, 211, 225, 248, 276, 297, 312

### Commanders, 21st Infantry Regiment

Col. Joseph P. O'Neil	November 1916–5 August 1917	Col. Ralph McCoy	25 October 1924–5 August 1927
Unknown	6 August 1917–28 November 1917	Maj. Lathé B. Row	5 August 1927–7 October 1927
Col. Willis Uline	29 November 1917–17 February 1919	Col. George D. Arrowsmith	7 October 1927–4 May 1930
Col. Frank H. Albright	17 February 1919–June 1919	Maj. John S. Switzer	4 May 1930–25 June 1930
Col. Walter H. Gordon	June 1919–16 October 1919	Lt. Col. John B. Corbley	25 June 1930–24 October 1930
Lt. Col. Ralph R. Glass	16 October 1919–February 1920	Col. Clenard McLaughlin	24 October 1930–28 July 1933
Col. George B. Duncan	February 1920–1 July 1920	Lt. Col. Thomas F. McNeill	28 July 1933–26 September 1933
Lt. Col. Americus Mitchell	1 July 1920–7 October 1920	Col. H. Clay M. Supplee	26 September 1933–2 September 1935
Maj. Paul H. Clark	7 October 1920–27 October 1920	Lt. Col. Thomas F. McNeill	2 September 1935–1 November 1935
Col. Charles C. Ballou	27 October 1920–6 October 1921	Col. Bernard H. Lentz	1 November 1935–26 November 1937
Lt. Col. John R. Kelly	6 October 1921–28 November 1921	Col. Martyn H. Shute	26 November 1937–11 May 1940
Col. Howard R. Perry	28 November 1921–12 July 1924	Col. Rapp Brush	July 1940–April 1941
Lt. Col. Charles W. Weeks	12 July 1924–25 October 1924	Col. Gilbert R. Cook	April 1941–15 April 1942

### 22d Infantry Regiment (4th Division)

**HQ**—Fort Jay, NY, 1919–22; Fort McPherson, GA, 1922–40; Fort McClellan, AL, 1939–41; Fort Benning, GA, 1941

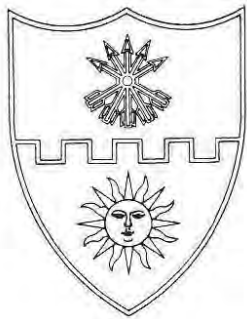

Stationed at Fort Jay, NY, as of June 1919 as a separate regiment. Provided guards for the US Sub-Treasury building at Wall and Nassau Streets after the 16 September 1920 Wall Street bombing by a Marxist dissident. The 2d Bn. transferred in 1921 to Fort Niagara, NY. The 3d Bn. transferred to Fort Ontario, NY. Entire regiment transferred 14 June 1922 to Fort McPherson, GA. Assigned to the 4th Div. on 24 March 1923. The 3d Bn. transferred 27 May 1927 to Fort Oglethorpe, GA. The 1st Bn. inactivated 30 June 1927 at Fort McPherson. Co. M awarded the Edwin Howard Clark machine gun trophy for 1931. In April 1933, the regiment assumed command and control of CCC District B, Fourth Corps Area. The regiment assumed command and control of CCC District D, Fourth Corps Area in May 1935 from the 69th Coast Artillery (C.A.). The 3d Bn. transferred on 28 May 1935 to Fort McClellan, AL. Assigned Reserve officers conducted summer training with the regiment at Fort McClellan. Entire regiment transferred in July 1940 to

Fort McClellan. Transferred 21 February 1941 to Fort Benning, GA. Location 7 December 1941—Fort Benning, GA.

**Organization Day:** 21 September. Chosen to commemorate the regiment's reorganization from the 2d Bn., 13th Inf. and designation as the 22d Inf. on 21 September 1866.

**Status:** Assigned to the USARS as the 22d Inf.; 1st Bn. active at Fort Hood, TX, as an element of the 4th Inf. Div. (Mecz); 2d Bn. active at Fort Drum, NY, as an element of the 10th Mountain Div. (Light).

**Events:** 94, 96, 121, 143, 184, 209, 228, 255, 275, 293, 296, 300, 310

### Commanders, 22d Infantry Regiment

Col. John C. F. Tillson	2 September 1916–26 May 1920	Col. Louis M. Nuttman	21 July 1930–1 February 1932
Lt. Col. Rinaldo R. Wood	26 May 1920–19 June 1920	Lt. Col. Daniel M. Cheston	1 February 1932–19 April 1932
Col. John McA. Palmer	19 June 1920–6 May 1921	Maj. Walter Moore	19 April 1932–15 May 1932
Lt. Col. William G. Doane	6 May 1921–19 July 1921	Maj. Stephen J. Chamberlain	15 May 1932–1 July 1932
Col. Samson L. Faison	19 July 1921–5 July 1922	Maj. Roger Williams	1 July 1932–23 July 1932
Col. Robert H. Peck	5 July 1922–20 January 1923	Lt. Col. Fay W. Brabson	23 July 1932–3 September 1932
Lt. Col. Roscoe H. Hearn	20 January 1923–5 February 1923	Col. Thomas S. Moorman	3 September 1932–8 August 1934
Lt. Col. James M. Kimbrough Jr.	February 1923–15 January 1924	Lt. Col. Cary I. Crockett	8 August 1934–6 May 1935
Col. Dwight W. Ryther	15 January 1924–1 November 1925	Col. George F. Baltzell	6 May 1935–3 May 1937
Lt. Col. William H. Patterson	1 November 1925–7 December 1925	Col. John W. Lang	3 May 1937–1 September 1938
Col. George F. Baltzell	7 December 1925–1 September 1928	Col. Simon B. Buckner	3 September 1938–16 October 1939
Col. Lochlin W. Caffey	1 September 1928–10 June 1930	Col. Albert S. Peake	16 October 1939–11 November 1941
Lt. Col. Daniel M. Cheston	10 June 1930–20 July 1930	Col. George H. Weems	12 November 1941–17 February 1942

## 23d Infantry Regiment (2d Division)

HQ—Fort Sam Houston, TX, 1919–41

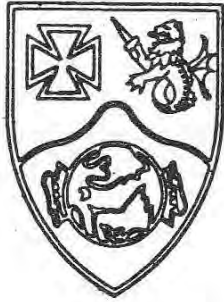

Arrived at the port of New York on 4 August 1919 on the U.S.S. *Virginian* as an element of the 2d Div. Transferred to Camp Merritt, NJ. Transferred in August 1919 to Fort Sam Houston, TX. Participated in the production of the MGM movie “Wings” at Camp Stanley, TX, 20 September–2 November 1926. Location 7 December 1941—Fort Sam Houston, TX.

**Organization Day:** 21 September. Chosen to commemorate the regiment’s initial organization 21 September 1866 (changed to 18 June in 1956).

**Status:** Assigned to the USARS as the 23d Inf.; 1st Bn. active at Fort Lewis, WA, as an element of the 2d Inf. Div.

**Events:** 45, 47, 55, 70, 74, 105, 125, 147, 163, 205, 216, 242, 258, 282, 288, 295, 296, 299, 300, 317, 328

### Commanders, 23d Infantry Regiment

Col. Walter K. Wright	7 July 1914–15 February 1918	Col. Charles B. Clark	15 September 1925–1 April 1928
Col. Paul B. Malone	15 February 1918–25 August 1918	Lt. Col. William R. Standiford	1 April 1928–11 April 1929
Col. Edward R. Stone	26 August 1918–14 December 1919	Col. Austin A. Parker	11 April 1928–24 June 1931
Lt. Col. Frederick C. Test	15 December 1919–1 March 1920	Lt. Col. Charles L. Mitchell	24 June 1931–22 July 1931
Col. Harry A. Eaton	2 March 1920–11 August 1920	Lt. Col. Jesse W. Boyd	22 July 1931–27 September 1931
Col. Thomas H. Slavens	11 August 1920–5 September 1920	Col. Alexander T. Ovenshine	27 September 1931–26 September 1933
Maj. David Bowers	5 September 1920–20 September 1920	Col. James A. Higgins	26 September 1933–20 September 1935
Col. Paul A. Wolfe	20 September 1920–11 October 1920	Lt. Col. Enrique Urrutia	20 September 1935–30 September 1935
Col. Alexander T. Ovenshine	29 October 1920–2 July 1923	Col. Thomas C. Musgrave	30 September 1935–28 December 1937
Lt. Col. Frederic G. Kellond	2 July 1923–26 July 1923	Col. Arthur W. Lane	28 September 1937–28 October 1939
Col. Lincoln F. Kilbourne	26 July 1923–14 September 1925	Col. Charles K. Nulsen	4 January 1940–28 July 1941
	Col. Roscoe B. Woodruff		1 August 1941–15 January 1942

## 24th Infantry Regiment (Colored) (Separate)

HQ—Camp Furlong, NM, 1919–22; Fort Benning, GA, 1922–41



Stationed at Camp Furlong, NM, as of June 1919 as a separate regiment. Transferred 12 June 1919 to Camp Owen Biernie, TX, to protect El Paso from a Villista incursion from Juarez, Mexico. During skirmishing that broke out along the border, the regiment suffered one KIA and three WIA. Returned 25 June 1919 to Camp Furlong. The 2d Bn. transferred 10 February 1920 to Camp Shannon, Hachita, NM. The 3d Bn. was reduced to minimal manning 24 September 1921 and personnel transferred to the 1st and 2d Bns. The 3d Bn. records transferred to Fort Benning, GA, and the battalion was reorganized there 1 December 1921 with 7 officers and 354 men from the Infantry School Detachment (Colored). The 2d Bn. transferred 30 June 1922 to Camp Furlong. Regiment, less 3d Bn.,

transferred by troop train to Fort Benning and arrived there 16 September 1922. Assigned to the Infantry School as the school support and demonstration regiment. Reorganized in conjunction with special tables of organization in May 1927. The 3d Bn. and Cos. D and H were inactivated 1 August 1927 at Fort Benning. In April 1933, the regiment assumed command and control of CCC District H, Fourth Corps Area. Assigned Reserve officers conducted summer training with the regiment at Fort Benning. The 3d Bn. and Cos. D and H activated at Fort Benning 15 January 1941. Location 7 December 1941—Fort Benning, GA.

**Organization Day:** 1 November. Chosen to commemorate the regiment’s organization by consolidation of the 38th and 41st Inf. Regts. and redesignation as the 24th Inf. on 1 November 1869. Adopted 1922.

**Status:** Assigned to the USARS as the 24th Inf.; 1st Bn. active at Fort Lewis, WA, as an element of the 25th Inf. Div. (Light).

**Events:** 3, 11, 54, 121, 143, 228, 293, 296, 325, 328, 330

**Commanders, 24th Infantry Regiment**

Col. Frank L. Winn	8 July 1916–17 August 1917	Col. Benjamin P. Nicklin	19 October 1922–20 December 1924
Col. Wilson Chase	15 September 1917–20 December 1918	Col. Wait C. Johnson	20 December 1924–30 June 1928
Col. G. Arthur Hadsell	21 December 1918–9 August 1919	Col. Paul C. Galleher	1 July 1928–26 May 1930
Col. William G. Doane	9 August 1919–5 November 1919	Maj. Charles E. Coates	26 May 1930–30 June 1930
Col. Lucius L. Durfee	5 November 1919–12 April 1920	Col. Lochlin W. Caffey	30 June 1930–31 July 1932
Lt. Col. William G. Doane	12 April 1920–7 June 1920	Col. Fred L. Munson	2 August 1932–31 July 1934
Col. William O. Johnson	7 June 1920–5 September 1920	Col. James M. Little	1 August 1934–20 March 1935
Col. John W. French	5 September 1920–4 November 1920	Col. V. M. Cummins	20 March 1935–2 June 1935
Lt. Col. William G. Doane	4 November 1920–22 November 1920	Col. Ellery Farmer	2 June 1935–30 August 1937
Col. John B. Schoeffel	24 November 1920–19 October 1922	Col. James M. Lockett	31 August 1937–10 February 1942

**25th Infantry Regiment (Colored) (Separate)**

**HQ**—Camp Stephen D. Little, AZ, 1919–33; Fort Huachuca, AZ, 1933–41



Stationed at Camp Stephen D. Little, AZ, as of June 1919 as a separate regiment. The 2d Bn. transferred in July 1922 from Camp Shannon, Hachita, NM, to Camp Furlong, NM. The 1st Bn. transferred in 1926 to Camp Harry J. Jones, AZ. The 3d Bn. transferred in March 1928 to Fort Huachuca, AZ. Regiment deployed 12 March 1929 to Naco, AZ, to conduct border patrols as a result of the Escobar–Topete Revolution. Remained on border patrols until 10 May 1929. The 1st Bn. transferred from Camp Harry J. Jones to Fort Huachuca and was inactivated there 6 January 1933. Concurrently, the 2d Bn. transferred from Camp Stephen D. Little to Fort Huachuca. In April 1933, the regiment assumed command and control of the Arizona CCC District. Regimental HQ transferred in December 1933 to Fort Huachuca. First Sergeant William McCauley, last Active Duty member of the regiment who participated in the charge at El Caney, Cuba, on 1 July 1898,

retired at Fort Huachuca in April 1934. Location 7 December 1941—Fort Huachuca, AZ.

**Organization Day:** 1 July. Chosen to commemorate the regiment’s participation in the charge at El Caney near Santiago, Cuba, on 1 July 1898.

**Status:** Inactive in the R.A. as the 25th Inf.

**Events:** 83, 110, 261, 300

**Commanders, 25th Infantry Regiment**

Col. Samson L. Faison	12 February 1916–22 June 1917	Col. Arthur M. Shipp	8 September 1928–20 January 1931
Col. Earl C. Carnahan	23 June 1917–19 June 1921	Lt. Col. Robert L. Moseley	20 January 1931–5 February 1931
Maj. John C. Fairfax	19 June 1921–25 August 1921	Col. Robert S. Knox	5 February 1931–2 September 1934
Lt. Col. Robert M. Wescott	25 August 1921–14 October 1931	Lt. Col. Matthew H. Thomlinson	2 September 1934–18 October 1934
Col. Alexander J. McNab Jr.	15 October 1921–14 October 1923	Col. John F. Franklin	18 October 1934–26 July 1936
Col. Woodson Hocker	15 October 1923–11 September 1925	Maj. Harry C. Luck	26 July 1936–2 August 1936
Lt. Col. William S. Faulkner	11 September 1925–12 October 1925	Col. William F. Robinson Jr.	2 August 1936–29 August 1938
Col. Andrew J. Dougherty	12 October 1925–7 January 1928	Maj. Edwin W. Grimer	29 August 1938–25 September 1938
Lt. Col. Hugh A. Parker	7 January 1928–8 September 1928	Col. Lee D. Davis	25 September 1938–13 February 1942

## 26th Infantry Regiment (1st Division)

**HQ**—Camp Zachary Taylor, KY, 1919–20; Camp Dix, NJ, 1920–22; Plattsburg Barracks, NY, 1922–41



Arrived at the port of New York on 3 September 1919 on the U.S.S. *Finland* as an element of the 1st Div. Participated in the 1st Div. Victory Parades in New York City and Washington, DC, on 10 and 17 September 1919, respectively. Transferred 4 October 1919 to Camp Zachary Taylor, KY. Transferred 10 September 1920 to Camp Dix, NJ. Transferred 1 July 1922 to Plattsburg Barracks, NY. Participated in the movie “Janice Meredith” in 1924. Actress Marion Davies presented the regiment a Tiffany’s silver service in appreciation of their participation. Awarded the Chief of Infantry’s Marksmanship Trophy for 1938. Assigned Reserve officers conducted summer training with the regiment at Plattsburg Barracks. Regiment departed the New York Port of Embarkation in October 1939 on the U.S.A.T. *Republic* and debarked at Charleston, SC, en route to Fort Benning, GA. After maneuvers in Louisiana in May 1940, returned to Plattsburg Barracks on 5 June 1940. The

2d Bn. transferred in August 1940 to Fort Devens, MA. Remainder of the regiment transferred 27 February 1941 to Fort Devens. Location 7 December 1941—Fort Devens, MA.

**Organization Day:** 18 July. Chosen to commemorate the regiment’s participation in the battle of Soisson during the Oisne–Marne Offensive on 18 July 1918.

**Status:** Assigned to the USARS as the 26th Inf.; 1st Bn. active in Germany as an element of the 1st Inf. Div. (Mecz).

**Events:** 10, 18, 22, 60, 63, 72, 89, 106, 133, 153, 168, 190, 219, 241, 265, 280, 287, 293, 296, 301, 323, 330

### Commanders, 26th Infantry Regiment

Col. Robert L. Bullard	31 August 1912–11 June 1917	Col. Charles D. Roberts	30 June 1922–19 October 1923
Col. George B. Duncan	11 June 1917–1 September 1917	Col. James M. Graham	20 October 1923–15 September 1925
Col. F. G. Lawton	3 September 1917–27 November 1917	Col. John H. Hughes	15 September 1925–1 October 1927
Col. Hamilton A. Smith	28 November 1917–21 July 1918	Lt. Col. Donald D. Hay	1 October 1927–18 November 1927
Lt. Col. Joseph M. Cullison	21 July 1918–20 September 1918	Col. James G. Hannah	18 November 1927–1 December 1927
Col. Hjalmar Erickson	20 September 1918–21 October 1918	Col. John F. Madden	1 December 1927–18 August 1930
Lt. Col. Theodore Roosevelt	21 October 1918–1 January 1919	Lt. Col. Donald D. Hay	18 August 1930–27 September 1930
Col. Frederick L. Knudson	2 January 1919–22 February 1919	Col. George H. Herbst	27 September 1930–4 September 1932
Col. Robert A. Brown	20 March 1919–13 August 1919	Maj. John E. Creed	4 September 1932–27 September 1932
Col. Hjalmar Erickson	14 August 1919–January 1920	Col. Harry E. Knight	27 September 1932–17 April 1934
Lt. Col. George W. Maddox	January 1920–11 October 1920	Lt. Col. Harry H. Pritchett	17 April 1934–20 May 1934
Maj. Goodwin Compton	11 October 1920–February 1921	Col. William B. Wallace	20 May 1934–7 March 1936
Col. George D. Arrowsmith	February 1921–3 September 1921	Lt. Col. Eley P. Denson	7 March 1936–1 September 1936
Col. Thomas M. Anderson Jr.	3 September 1921–20 September 1921	Col. Thomas L. Crystal	2 September 1936–20 June 1939
Maj. Adrian K. Polhemus	20 September 1921–6 January 1922	Col. James I. Muir	21 June 1939–20 April 1941
Lt. Col. William L. Read	6 January 1921–30 June 1922	Col. Theodore Roosevelt	21 April 1941–28 December 1941

## 27th Infantry Regiment (Hawaiian Division)

**HQ**—Khabarovsk, Russia, 1919; Verkne-Udinsk, Russia, 1919; Beresovka, Russia, 1919–20; Vladivostok, Russia, 1920; Manila, PI, 1920–21; Schofield Barracks, TH, 1921–41



Stationed at Khabarovsk, Russia, and assigned to the American Expeditionary Forces, Siberia, as of May 1919. Regiment was responsible for guarding the rail lines between Spasskoe and Ussuri. Transferred 11 May 1919 and arrived at Verkne-Udinsk, Russia, on 21 May 1919. Transferred to Beresovka, Russia, and arrived there 7 September 1919. Transferred to Vladivostok, Russia, and arrived there 23 January 1920. Departed Vladivostok on the U.S.A.T. *Thomas* on 10 March 1920 and arrived at Manila, PI, on 17 March 1920. Departed Manila on 15 December 1920 and arrived at Honolulu, TH, on 5 January 1921. Transferred to Schofield Barracks, TH, the same day. Concurrently attached to the 21st Inf. Brig. Assigned to the Hawaiian Division on 1 March 1921. Relieved from the 21st Inf. Brig. on 28 October 1921 and assigned to the 22d Inf. Brig. Primary wartime mission was to conduct a mobile defense of the beaches and inland sectors of the southern half of the

island of Oahu. Regiment motorized on 10 February 1928. Conducted an unusual 100-mile march 18–29 August 1930 from Schofield Barracks through Fort Ruger to Waimanalo Training Camp. Conducted a review for actress Shirley Temple at Fort DeRussey, TH, in May 1939. Relieved from the Hawaiian Division on 26 August 1941 and assigned to the 25th Div. Location 7 December 1941—Schofield Barracks, TH

**Organization Day:** 2 May. Chosen to commemorate the regiment's baptism of fire during the battle of Bayan in the Philippine Islands on 2 May 1901.

**Status:** Assigned to the USARS as the 27th Inf.; 1st and 2d Bns. active at Schofield Barracks, HI, as elements of the 25th Inf. Div. (Light).

**Events:** 33, 37, 75, 88, 120, 138, 141, 158, 189, 211, 225, 248, 276, 297, 312

#### Commanders, 27th Infantry Regiment

Col. Charles H. Barth	30 May 1914–17 May 1917	Lt. Col. Shelby L. Leasure	4 November 1921–13 February 1923
Lt. Col. William T. Wilder	17 May 1917–7 November 1917	Col. Howard L. Laubach	13 February 1923–1 December 1925
Maj. John B. Schoeffel	7 November 1917–15 March 1918	Maj. Sam P. Herren	1 December 1925–4 January 1926
Lt. Col. Gideon H. Williams	15 March 1918–15 June 1918	Col. Lawrence Halstead	4 January 1926–1 August 1928
Lt. Col. Charles H. Morrow	15 June 1918–5 August 1918	Lt. Col. James E. McDonald	1 August 1928–1 October 1928
Col. Henry D. Styer	5 August 1918–16 August 1918	Col. William E. Hunt	2 October 1928–27 June 1931
Lt. Col. Charles H. Morrow	16 August 1918–8 September 1918	Maj. Robert K. Alcott	27 June 1931–14 August 1931
Col. Henry D. Styer	8 September 1918–9 April 1919	Lt. Col. Anton C. Cron	14 August 1931–8 September 1931
Lt. Col. Charles H. Morrow	9 April 1919–9 March 1920	Col. Earnest Van D. Murphy	9 September 1931–17 August 1934
Col. Joseph D. Leitch	10 March 1920–11 October 1920	Maj. Alfred E. Sawkins	17 August 1934–12 November 1934
Lt. Col. Robert H. Sillman	11 October 1920–15 December 1920	Col. John Scott	12 November 1934–7 December 1936
Col. Edwin A. Root	15 December 1920–9 January 1921	Col. Ambrose R. Emery	7 December 1936–19 August 1938
Lt. Col. Robert H. Sillman	9 January 1921–6 March 1921	Lt. Col. William H. Gill	19 August 1938–30 September 1938
Col. William Wallace	6 March 1921–4 November 1921	Col. Edwin F. Harding	1 October 1938–30 September 1940
	Col. William A. McCulloch		7 July 1941–14 March 1943

#### 28th Infantry Regiment (1st Division)

**HQ**—Camp Zachary Taylor, KY, 1919–20; Camp Dix, NJ, 1920–22; Fort Niagara, NY, 1922–41



Arrived at the port of New York on 30 August 1919 on the U.S.S. *Orizaba* as an element of the 1st Div. Participated in the 1st Div. Victory Parades in New York City and Washington, DC, on 10 and 17 September 1919, respectively. Transferred 4 October 1919 to Camp Zachary Taylor, KY. Transferred 12 September 1920 to Camp Dix, NJ. The 3d Bn. transferred 21 June 1922 to Fort Ontario, NY. The 1st Bn. transferred 26 June 1922 to Fort Porter, NY. Regimental HQ and 2d Bn. transferred 27 June 1922 to Fort Niagara, NY. The 1st Bn. transferred 1 October 1926 to Madison Barracks, NY. Co. D awarded the Edwin Howard Clark machine gun trophy for 1927 and 1937. The 1st Bn. transferred 15 October 1931 to Fort Hayes, OH. The 1st Bn. inactivated on 30 September 1933 at Fort Hayes and personnel and equipment transferred to the 1st Bn., 10th Inf. In January 1934 the regiment assumed command and control of portions of the 4th CCC District (Northern

New York state), Second Corps Area. Regiment relieved from the 1st Div. on 16 October 1939 and attached to the Second Corps Area for command and control. Assigned to the 8th Div. on 22 June 1940. The 1st Bn. activated at Fort Niagara on 10 October 1940 and transferred to Fort Jackson, SC, shortly thereafter. Remainder of regiment transferred 2 December 1940 to Fort Jackson. Location 7 December 1941—Fort Jackson, SC.

**Organization Day:** 28 May. Chosen to commemorate the regiment's participation in the battle of Cantigny in France on 28 May 1918. Adopted 1920.

**Status:** Assigned to the USARS as the 28th Inf.; 1st and 2d Bns. active at Fort Jackson, SC, as training battalions.

**Events:** 18, 60, 63, 72, 89, 106, 133, 153, 164, 168, 190, 219, 241, 265, 280, 301, 330



### Commanders, 28th Infantry Regiment

Col. Elmore F. Taggart	6 April 1917–3 June 1917	Lt. Col. Benjamin R. Wade	1 February 1923–28 May 1923
Col. Hanson E. Ely	8 June 1917–16 July 1918	Col. Berkeley Enochs	28 May 1923–21 June 1925
Col. Conrad S. Babcock	16 July 1918–5 August 1918	Col. Ralph E. Ingram	21 June 1925–30 June 1928
Col. George C. Barnhardt	25 August 1918–16 October 1918	Col. George E. Stewart	30 June 1928–26 May 1930
Maj. Clarence R. Huebner	16 October 1918–30 October 1918	Lt. Col. John J. Fulmer	26 May 1930–1 June 1930
Lt. Col. Edward R. Coppock	30 October 1918–6 November 1918	Col. Charles H. Morrow	1 June 1930–21 December 1935
Col. Thomas W. Hammond	6 November 1918–19 December 1918	Col. Charles S. Caffery	21 December 1935–8 January 1936
Col. Adolphe H. Huguet	19 December 1918–31 December 1919	Col. Hiram M. Cooper	8 January 1936–2 March 1938
Col. William L. Patterson	31 December 1919–31 July 1920	Col. Ralph A. Jones	2 March 1938–14 May 1938
Col. James M. Graham	31 July 1920–30 September 1920	Col. Oliver S. Wood	14 May 1938–15 December 1938
Lt. Col. Leonard McLaughlin	30 September 1920–10 November 1920	Col. Cassius M. Dowell	15 December 1938–15 August 1940
Col. Adolphe H. Huguet	13 November 1920–1 February 1923	Col. Vernon G. Olsmith	15 August 1940–1 December 1941
	Col. Norman Randolph		1 December 1941–31 August 1942

### 29th Infantry Regiment (Separate)

HQ—Camp Shelby, MS, 1919; Fort Benning, GA, 1919–41



Stationed at Camp Shelby, MS, as of June 1919 as a separate regiment. Transferred in October 1919 to Camp Benning, GA. Assigned to the Infantry School as a school support and demonstration regiment. The 3d Bn. inactivated 3 October 1922 at Fort Benning. Reorganized in conjunction with special tables of organization in 1930 under which machine gun and cannon companies were constituted as components of the regiment and activated at Fort Benning. The 3d Bn. activated 1 October 1933 at Fort Sill, OK, by transfer of personnel and equipment from the inactivated 1st Bn., 38th Inf. Regt. concurrently assigned to the 4th Div. HHD, 4th Bn. (Special Weapons) constituted and organized 3 October 1936 at Fort Benning. HHD, 4th Bn. demobilized 1 August 1938. Regiment relieved 16 October 1939 from the 4th Div. Assigned Reserve officers (less those of the 3d Bn. at Fort Sill) conducted summer training with the regiment at Fort Benning; Reserve officers assigned to the 3d Bn. conducted summer training at Fort Sill, 1935–40. Location 7 December 1941—Fort Benning, GA.

**Organization Day:** 5 March. Chosen to commemorate the regiment's date of original organization on 5 March 1901 at Fort Sheridan, IL.

**Status:** Assigned to the USARS as the 29th Inf.; regimental HQ active at Fort Benning and assigned to the Infantry School as the HQ for school support troops; 1st and 2d Bns. active at Fort Benning, GA, as training battalions.

**Events:** 54, 121, 143, 209, 228, 293, 296, 310, 330

### Commanders, 29th Infantry Regiment

Col. John S. Mallory	10 September 1912–24 June 1917	Col. Duncan K. Major Jr.	7 July 1930–6 July 1932
Col. Charles B. Hagedorn	24 July 1917–2 March 1918	Lt. Col. Andrew D. Chaffin	6 July 1932–13 July 1932
Col. James A. Irons	22 June 1918–1 December 1918	Col. John J. Toffey Jr.	13 July 1932–21 December 1932
Col. Frank D. Ely	7 January 1919–3 August 1919	Lt. Col. Andrew D. Chaffin	21 December 1932–1 March 1933
Col. James T. Dean	15 August 1919–1 September 1920	Col. William E. Persons	1 March 1933–1 February 1935
Lt. Col. Gideon H. Williams	1 September 1920–1 October 1920	Lt. Col. Charles A. Dravo	1 February 1935–2 March 1935
Col. Charles W. Exton	1 October 1920–18 December 1920	Col. Asa L. Singleton	2 March 1935–1 October 1936
Lt. Col. Gideon H. Williams	18 December 1920–2 February 1921	Col. Philip B. Peyton	1 October 1936–20 July 1937
Col. George S. Goodale	2 February 1921–4 July 1923	Lt. Col. Ziba L. Drollinger	20 July 1937–1 August 1937
Col. Monroe C. Kerth	4 July 1923–4 July 1925	Lt. Col. Charles W. Thomas	1 August 1937–16 September 1937
Col. James B. Gowen	4 July 1925–29 July 1927	Col. Charles H. White	16 September 1937–8 August 1939
Lt. Col. Channing E. Delaplaine	29 July 1927–8 May 1928	Lt. Col. John C. Bartholf	8 August 1939–18 September 1939
Col. Harris Pendleton Jr.	8 May 1928–10 May 1930	Col. Oscar W. Griswold	18 September 1939–30 September 1940
Lt. Col. Thorne Strayer	10 May 1930–7 July 1930	Lt. Col. Harry F. Hazlett	December 1940–ao January 1941
	Col. Laurence B. Keiser		October 1941–18 April 1942

### 30th Infantry Regiment (3d Division)

**HQ**—Camp Pike, AR, 1919–21; Presidio of San Francisco, CA, 1921–40; Fort Ord, CA, 1940; Presidio of San Francisco, CA, 1940–41; Fort Lewis, WA, 1941

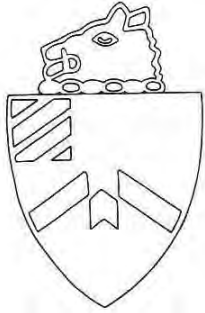

Arrived at the port of New York on 20 August 1919 on the U.S.A.T. *America* as an element of the 3d Div. Transferred 26 August 1919 to Camp Pike, AR. Transferred 21 September 1921 to Camp Lewis, WA. Sailed 26 August 1922 for San Francisco, CA, on the U.S.A.T. *Buford*. Arrived 30 August 1922 at the Presidio of San Francisco, CA, for permanent station. Initial wartime mission in accordance with established war plans was to conduct a mobile defense of possible amphibious landing areas in support of the Harbor Defenses of San Francisco. Sailed for Hawaii on 31 January 1932 on the U.S.A.T. *St. Mihiel*. Conducted experimental amphibious assault landings 12–16 February 1932 against the Hawaiian Division at Makua, Oahu, TH. Sailed for Fort Mason, CA, on 20 February 1932 on the U.S.A.T. *St. Mihiel* and arrived there 26 February 1932. Returned to the Presidio on the same date. Participated in the opening ceremonies for the Golden Gate Bridge in June 1937. Transferred 5 January 1940 to

Fort Ord, CA. Relieved 12 January 1940 from the 3d Div. Returned to the Presidio of San Francisco on 15 May 1940. Transferred 31 March 1941 to Fort Lewis, WA. Location 7 December 1941—Fort Lewis, WA.

**Organization Day:** 15 July. Chosen to commemorate the regiment's participation in the battle of Chateau Thierry on 15 July 1918. Adopted 5 February 1925.

**Status:** Assigned to the USARS as the 30th Inf.; 1st Bn. active at Fort Benning, GA, as an element of the 3d Inf. Div. (Mecz).

**Events:** 34, 57, 108, 111, 112, 134, 141, 144, 221, 226, 231, 273, 294, 304, 306, 309, 314, 326

#### 30th Infantry Regiment

Col. Abraham P. Buffington	1 July 1916–8 October 1917	Lt. Col. Harol D. Coburn	11 September 1925–31 October 1925
Col. Edmund L. Butts	15 October 1917–31 July 1918	Col. Frank C. Bolles	31 October 1925–6 March 1928
Col. Cromwell Stacy	31 July 1918–25 September 1918	Lt. Col. Walter H. Johnson	6 March 1928–6 June 1928
Col. John M. Jenkins	25 September 1918–29 October 1918	Col. Fred R. Brown	6 June 1928–30 August 1930
Col. W. M. Inglis	29 October 1918–1 November 1918	Lt. Col. Charles F. Thompson	30 August 1930–26 January 1931
Col. Howard R. Perry	1 November 1918–22 April 1919	Col. Charles B. Stone Jr.	26 January 1931–1 August 1933
Col. Berkeley Enochs	22 April 1919–30 July 1919	Col. Douglas Potts	1 August 1933–30 June 1935
Col. John M. Jenkins	31 July 1919–10 January 1920	Lt. Col. Charles L. Sampson	30 June 1935–16 July 1935
Col. Milton A. Elliott, Jr.	10 January 1920–15 February 1921	Maj. Jesse A. Ladd	16 July 1935–11 August 1935
Col. William Newman	15 February 1921–12 May 1922	Col. Irving J. Phillipson	15 August 1935–1 July 1938
Lt. Col. Charles R.W. Morison	12 May 1922–7 June 1922	Lt. Col. Francis B. Mallon	1 July 1938–16 January 1939
Col. Frank D. Wickham	7 June 1922–31 August 1922	Col. Robert L. Eichelberger	16 January 1939–1 October 1940
Col. Thomas A. Pearce	31 August 1922–2 September 1923	Lt. Col. Charles H. Corlett	1 October 1940–19 June 1941
Col. Charles S. Lincoln	2 September 1923–11 September 1925	Col. George Munteanu	19 June 1941–October 1941
	Col. William H. Hobson		October 1941–29 July 1942

### 31st Infantry Regiment (Philippine Division)

**HQ**—Vladivostok, Russia, 1919–20; Fort McKinley, PI, 1920; Post of Manila, PI, 1920–41



Stationed at Vladivostok, Russia, and assigned to the American Expeditionary Forces, Siberia, as of June 1919. Responsible for guarding the rail lines between Vladivostok and Ussuri. Co. A involved in a battle against 300 Bolshevik irregulars on 25 June 1919 at Romanovka, Siberia, along the Suchan Railroad. Part of the regiment sailed from Vladivostok on the U.S.A.T. *Crook* in late February 1920 and arrived at Manila, PI, near the end of the month. The remainder sailed from Vladivostok on the U.S.A.T. *South Bend* on 30 March 1920 and arrived at Fort William McKinley, PI, 16 April 1920. Transferred 16 December 1920 to the Post of Manila, PI, and posted as follows: regimental HQ and 1st Bn. garrisoned the Cuartel de España; the 2d and 3d Bns. garrisoned the Cuartel de Infanteria; and the Service and Antitank Companies garrisoned St. Lucia Barracks. Assigned to the Philippine Division on 22 October 1921. Relieved 26 June 1931 from assignment to the

Philippine Division. By presidential order, sailed for China on 2 February 1932 on the U.S.S. *Chaumont* to protect American lives and property in the International Settlement in Shanghai from Chinese warlords. Arrived 5 February 1932 at Shanghai. Sailed for the Philippines on 1 July 1932 on the U.S.A.T. *Republic* and arrived at Manila on 6 July 1932. Co. H awarded the Edwin Howard Clark machine gun trophy for 1936. The regiment's mission in the Philippine Department's defense plan was to deploy to Corregidor and act as the beach defense force for the Harbor Defenses of Manila and Subic Bays. Assigned to the Philippine Division in December 1941. Location 7 December 1941—Fort McKinley, PI.

**Organization Day:** 13 August. Chosen to commemorate the regiment's date of original organization on 13 August 1916 at Fort William McKinley, PI; 13 August was also the date the regiment sailed for Siberia in 1918. Adopted 2 August 1923.

**Status:** Assigned to the USARS as the 31st Inf.; 4th Bn. active at Fort Drum, NY as an element of the 10th Mountain Div. (Light).

**Events:** 27, 35, 41, 52, 68, 82, 100, 118, 139, 169, 179, 198, 245, 270

#### Commanders, 31st Infantry Regiment

Col. Walter H. Gordon	1 July 1916–26 June 1917	Col. Gustave A. Wieser	9 December 1930–29 January 1931
Col. Frederick H. Sargent	26 June 1917–1 October 1919	Maj. Russell P. Hartle	29 January 1931–24 February 1931
Col. Frederick W. Bugbee	1 October 1919–9 April 1920	Lt. Col. George A. Lynch	24 February 1931–18 June 1931
Col. Ralph H. Van Deman	9 April 1920–6 April 1923	Col. Lorenzo B. Gasser	18 June 1931–16 April 1934
Lt. Col. Francis E. Endicott	6 April 1923–17 October 1923	Lt. Col. Oliver S. Wood	16 April 1934–17 June 1934
Col. Willis Uline	17 October 1923–21 December 1925	Col. Samuel T. Mackall	17 June 1934–6 May 1936
Lt. Col. H. Clay M. Supplee	21 December 1925–22 February 1926	Col. Charles S. Hamilton	6 May 1936–20 February 1938
Col. Daniel G. Berry	22 February 1926–15 February 1928	Col. William A. Alfonte	21 February 1938–31 October 1938
Col. James M. Kimbrough Jr.	15 February 1928–11 March 1930	Col. Jesse C. Drain	31 October 1938–26 July 1940
Col. Earle W. Tanner	11 March 1930–10 October 1930	Lt. Col. Constant L. Irwin	26 July 1940–31 October 1940
Lt. Col. Edward L. Hooper	10 October 1930–22 November 1930	Col. Albert M. Jones	31 October 1940–1 October 1941
Maj. Russell P. Hartle	22 November 1930–9 December 1930	Col. Charles L. Steel	1 October 1941–5 April 1942

#### 32d Infantry Regiment (Separate)

#### Regular Army Inactive

**HQ**—Camp Kearny, CA, 1919–20; Presidio of San Francisco, CA, 1920–21; *Inactive*, 1921–26; Los Angeles, CA, 1926–40; Fort Ord, CA, 1940–41



Stationed at Camp Kearny, CA, as of June 1919 as a separate regiment. Transferred 8 September 1920 to the Presidio of San Francisco, CA. Concurrently, 1st and 3d Bns. transferred to Vancouver Barracks, WA. Inactivated 1 November 1921 at the Presidio of San Francisco; 38th Inf. Regt. previously designated as Active Associate on 27 July 1921. Those personnel at the Presidio concurrently transferred to the 19th Inf.; those at Vancouver Barracks transferred to the 59th Inf. The 38th Inf. Regt. relieved as the Active Associate on 17 July 1922 and the 14th Inf. Regt. designated as Active Associate. Concurrently allotted to the Panama Canal Department and assigned to the Panama Canal Division. Organized as an RAI unit about June 1926 at Los Angeles, CA. Withdrawn from allotment to the Panama Canal Department on 27 June 1927, relieved from the Panama Canal Division, and allotted to the Ninth Corps Area. Affiliated with the University of California at Los Angeles ROTC 8 February 1928 and organized with R.A. personnel assigned to the ROTC Detachment and

Reserve officers commissioned from the program. Many unit personnel participated in earthquake relief operations 14–22 March 1933 in the Los Angeles area. Conducted summer training at Del Monte, CA, and the Presidio of Monterey. The 2d Bn. activated 18 October 1939 with personnel and equipment of the 2d Bn., 7th Inf. at Chilkoot Barracks, TA. The 2d Bn. transferred 22 June 1940, less personnel and equipment, to Camp Ord, CA. Remainder of regiment assigned to the 7th Div. and activated 1 July 1940, less Reserve personnel, at Camp Ord. Location 7 December 1941—Fort Ord, CA.

**Organization Day:** 7 August. Chosen to commemorate the regiment's date of original organization on 7 August 1916 at Schofield Barracks, TH. Adopted 2 February 1920.

**Status:** Assigned to the USARS as the 32d Inf.); 1st Bn. active at Fort Drum, NY, as an element of the 10th Mountain Div. (Light).

**Events:** 314, 326

#### Commanders, 32d Infantry Regiment

Col. Lucius L. Durfee	5 August 1916–25 June 1918	Col. Perry L. Miles*	13 September 1928–31 March 1932
Col. Laurence A. Curtis	25 June 1918–16 April 1919	Lt. Col. Edward J. Moran**	17 July 1932–ao January 1933
Col. Allen Smith Jr.	16 April 1919–17 July 1920	Lt. Col. James H. O'Reilly**	ao June 1933–21 June 1935
Col. Thomas A. Pearce	17 July 1920–7 September 1921	Maj. William W. Vickery**	21 June 1935–November 1939
Col. Allen Smith Jr.	7 September 1921–5 November 1921	Col. Gregory Hoisington**	November 1939–30 June 1940
<i>Inactive</i>	5 November 1921–June 1926	Lt. Col. Robert McMillan	1 July 1940–18 August 1940
Lt. Col. Leonard M. Farrell**	June 1926–8 February 1928	Col. Franklin C. Sibert	18 August 1940–29 September 1941
Col. Robert O. Van Horn*	8 February 1928–13 September 1928	Col. Frank L. Culin, Jr.	29 September 1941–June 1943

\*RAI commanders: R.A. officers who were concurrently PMS&T at the University of California at Los Angeles.

\*\*RAI commanders: O.R. officers.

#### 33d Infantry Regiment (Panama Canal Division)

**HQ**—Gatun, CZ, 1919–20; Fort Clayton, CZ, 1920–41



Stationed at Gatun, CZ, as of June 1919 as a separate regiment. The 3d Bn. transferred in 1920 to Camp Gaillard, CZ. Regiment transferred 25 October 1920 to Fort Clayton, CZ. Assigned to the Panama Canal Division on 3 July 1921. Primary wartime mission was to conduct a mobile defense of the beaches and inland sectors of the Atlantic side of the canal zone. Assisted Panama police with riot control during the tenant strike 12–23 October 1925 in Panama City. Deployed to defensive positions 2 January 1931 to protect the Panama Canal during the Panamanian Revolution. Attached to HQ, Pacific Sector on 15 April 1932 upon inactivation of the Panama Canal Division. Provided the honor guard and security for President Roosevelt's brief visit to the Panama Canal Zone in October

1935. Relieved 10 October 1938 from the Panama Canal Division. Relieved from attachment to the Pacific Sector 16 February 1940 and assigned to the Panama Mobile Force. Location 7 December 1941—Fort Clayton, CZ.

**Organization Day:** 6 July. Chosen to commemorate the regiment's date of original organization on 6 July 1916 at Camp Empire, CZ. Adopted 26 March 1920.

**Status:** Inactive in the R.A. as the 33d Inf.

**Events:** 26, 31, 36, 40, 43, 53, 58, 69, 81, 101, 117, 119, 140, 167, 170, 180, 181, 223, 271, 292, 308, 333

#### Commanders, 33d Infantry Regiment

Col. Charles H. Muir	1 July 1916–5 August 1917	Lt. Col. Frederick J. Osterman	7 October 1931–31 October 1931
Col. Edward R. Chrisman	5 August 1917–1 September 1917	Col. Harol D. Coburn	31 October 1931–28 January 1933
Col. Edmund L. Butts	3 October 1917–15 October 1917	Lt. Col. Hugo D. Selton	28 January 1933–24 June 1933
Col. William P. Jackson	20 October 1917–9 July 1919	Col. Thomas W. Brown	24 June 1933–26 May 1935
Col. Benjamin C. Morse	9 July 1919–9 July 1920	Lt. Col. Jere Baxter	26 May 1935–19 June 1935
Lt. Col. Robert O. Ragsdale	10 July 1920–23 September 1920	Col. James V. Heidt	19 June 1935–10 November 1935
Col. William O. Johnson	23 September 1920–13 October 1923	Col. Charles F. Severson	10 November 1935–12 August 1937
Col. John W. Heavey	14 October 1923–14 September 1926	Lt. Col. Arthur R. Underwood	12 August 1937–5 September 1937
Col. Frank B. Hawkins	14 September 1926–21 August 1929	Col. John S. Sullivan	5 September 1937–14 August 1939
Lt. Col. Charles F. Severson	21 August 1929–27 September 1929	Col. Harry J. Keeley	14 August 1939–September 1940
Col. Frederic G. Kellond	27 September 1929–7 October 1931	Col. Clarence M. McMurray	September 1940–13 September 1941
	Col. Parley D. Parkinson		13 September 1941–October 1941

### 34th Infantry Regiment (8th Division)

**HQ**—Camp Funston, KS, 1919–21; Fort George G. Meade, MD, 1921; Madison Barracks, NY, 1921–22; Fort Eustis, VA, 1921–31; Fort George G. Meade, MD, 1931–40; Fort Benning, GA, 1940; Fort Jackson, SC, 1940–41

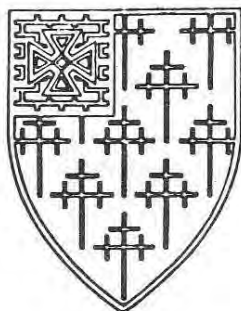

Arrived at the port of New York on 19 June 1919 on the S.S. *Nieuw Amsterdam* as an element of the 7th Div. Transferred 25 June 1919 to Camp Funston, KS. Transferred 16 January 1921 to Camp George G. Meade, MD. Regiment, less 1st, 2d, and 3d Bns. transferred 16 October 1921 to Madison Barracks, NY. Concurrently, subordinate battalions stationed as follows: 1st Bn. transferred by marching to Fort Wadsworth, NY; 2d Bn. transferred to Fort Ontario, NY; the 3d Bn. transferred to Fort Howard, MD. Entire regiment transferred 7 September 1922 to Camp Eustis, VA. The 1st Bn. transferred by marching from Fort Wadsworth to Fort Eustis and arrived there 26 September 1922. The 3d Bn. inactivated on 27 September 1922 at Fort Eustis. Initial wartime mission in accordance with established war plans was to conduct a mobile defense of possible amphibious landing areas in support of the Harbor Defenses of Chesapeake Bay. Regiment relieved from the 7th Div. on 24 March 1923 and assigned to the 8th Div. The 3d Bn. was organized on 30 March 1926

with O.R. personnel as an RAI unit with HQ at Fort Eustis. Entire regiment relieved from the 8th Div. on 15 August 1927 and assigned to the 4th Div. Partially mechanized in July 1928 and concurrently attached to the Experimental Mechanized Force at Camp George G. Meade, MD. The unit became first fully motorized infantry regiment in the US Army on 1 September 1929. Participated in the sesquicentennial celebration of the victory of Yorktown, 5–27 October 1931. Entire regiment transferred 4 November 1931 to Fort George G. Meade. Participated in the inaugural parade for President Franklin D. Roosevelt on 4 March 1933. Relieved from the 4th Div. on 1 October 1933 and assigned to the 8th Div. Assigned Reserve officers conducted summer training with the regiment at Fort George G. Meade. Primary ROTC feeder school for new Reserve lieutenants was Pennsylvania State College. Transferred 6 April 1940 to Fort Benning, GA. Inactivated 5 June 1940 at Fort Benning. Regiment activated 1 July 1940 at Camp Jackson, SC. Transferred 3 December 1941 to the San Francisco port of embarkation. Location 7 December 1941—San Francisco, CA.

**Organization Day:** 15 July. Chosen to commemorate the regiment's date of original organization on 15 July 1916 at El Paso, TX. Adopted February 1920.

**Status:** Assigned to the USARS as the 34th Inf.; 1st Bn. active at Fort Jackson, SC, as a training battalion.

**Events:** 38, 66, 98, 128, 137, 151, 155, 176, 191, 218, 240, 263, 281, 293, 296, 330

#### Commanders, 34th Infantry Regiment

Col. Edward C. Carey	30 July 1917–16 August 1917	Lt. Col. Ernest Van D. Murphy	20 September 1926–26 September 1926
Col. Robert C. Williams	16 August 1917–22 May 1918	Col. Thomas W. Darrah	26 September 1926–26 September 1928
Col. Fred L. Munson	22 May 1918–December 1919	Lt. Col. Charles R. W. Morrison	26 September 1928–18 November 1928
Col. La Vergne L. Gregg	December 1919–16 January 1920	Col. Alfred T. Smith	18 November 1928–2 January 1931
Lt. Col. John K. Cowan	16 January 1920–29 January 1920	Lt. Col. Arthur L. Bump	2 January 1931–30 June 1931
Maj. Richard C. Stickney	29 January 1920–7 February 1920	Col. Claude H. Miller	30 June 1931–3 November 1931
Maj. Alexander M. Weyand	7 February 1920–18 March 1920	Col. James M. Petty	4 November 1931–28 September 1933
Maj. Richard C. Stickney	18 March 1920–26 March 1920	Lt. Col. Charles B. Elliot	28 September 1933–2 December 1933
Col. Frederick R. de Funiak Jr.	26 March 1920–2 June 1921	Col. John R. Brewer	2 December 1933–11 October 1935
Lt. Col. John J. Miller	2 June 1921–21 July 1921	Col. Edgar A. Myer	16 October 1935–22 November 1936
Col. William M. Morrow	21 July 1921–17 August 1921	Lt. Col. Henry R. Perrine	22 November 1936–23 December 1936
Lt. Col. John J. Miller	17 August 1921–24 September 1921	Col. Eugene Santschi, Jr.	23 December 1936–9 June 1938
Col. Charles D. Roberts	19 October 1921–24 March 1922	Lt. Col. Henry R. Perrine	9 June 1938–7 September 1938
Lt. Col. John J. Miller	24 March 1922–27 May 1922	Col. Charles B. Elliott	7 September 1938–5 June 1940
Col. Henry S. Wagner	27 May 1922–15 June 1924	<i>Inactive</i>	5 June 1940–1 July 1940
Lt. Col. John L. Bond	18 June 1924–4 July 1924	Col. Joseph D. Patch	1 July 1940–October 1941
Col. Duncan K. Major Jr.	4 July 1924–20 September 1926	Col. Dennis E. McCunniff	November 1941–December 1941

### 35th Infantry Regiment (Hawaiian Division)

HQ—Camp Travis, TX, 1919; Camp Lewis, WA, 1919–20; Schofield Barracks, 1920–41

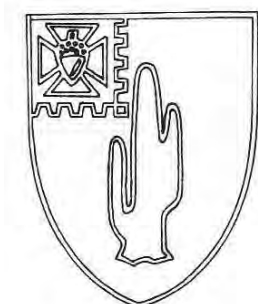

Stationed at Camp Travis, TX, as of June 1919 as a separate regiment. Transferred 16 November 1919 to Camp Lewis, WA. Sailed for Hawaii on 20 September 1920 on the U.S.A.T. *Great Northern*. Arrived at Schofield Barracks, TH, 25 September 1920, and assigned to the Provisional Infantry Brigade. Assigned to 21st Inf. Brig. on 4 February 1921. Further assigned to the Hawaiian Division on 1 March 1921. Relieved from the 21st Inf. Brig. on 14 October 1922 and assigned to the 22d Inf. Brig. Primary wartime mission was to conduct a mobile defense of the beaches and inland sectors of the southern half of the island of Oahu. Assigned to the 25th Div. on 26 August 1941. Location 7 December 1941—Schofield Barracks, TH.

**Organization Day:** 8 July. Chosen to commemorate the regiment's date of original organization on 8 July 1916 at Douglas, AZ. Adopted 27 January 1920.

**Status:** Assigned to the USARS as the 35th Inf.; 1st Bn. active at Schofield Barracks, HI, as an element of the 25th Inf. Div. (Light).

**Events:** 14, 20, 33, 37, 75, 88, 120, 138, 141, 158, 189, 211, 225, 248, 276, 297, 312

#### Commanders, 35th Infantry Regiment

Col. James H. Frier	8 July 1916–8 May 1919	Lt. Col. James M. Pruyn	16 April 1928–24 August 1928
Col. Milton L. McGrew	1 June 1919–8 August 1919	Col. Ira C. Welborn	24 August 1928–9 June 1931
Col. Herman Hall	8 August 1919–19 September 1920	Maj. Hugh B. Keen	9 June 1931–21 July 1931
Lt. Col. Lawrence P. Butler	19 September 1920–26 September 1920	Col. Frank B. Watson	21 July 1931–28 February 1934
Col. William R. Dashiell	26 September 1920–6 July 1921	Lt. Col. Ernest L. Pell	28 February 1934–5 April 1934
Lt. Col. Lawrence P. Butler	6 July 1921–6 August 1921	Col. Richard Wetherill	5 April 1934–23 April 1936
Col. John J. Toffey Jr.	6 August 1921–17 June 1924	Lt. Col. Marion O. French	23 April 1936–2 July 1936
Lt. Col. Thomas W. Brown	17 June 1924–3 December 1924	Col. Erle M. Wilson	2 July 1936–18 July 1938
Col. Alfred Aloe	3 December 1924–26 May 1926	Lt. Col. Harry P. Hazlett	18 July 1938–15 August 1938
Maj. Sheppard B. Philpot	26 May 1926–14 December 1926	Col. William R. Scott	15 August 1938–21 August 1940
Col. Charles W. Weeks	14 December 1926–16 April 1928	Lt. Col. William A. McCulloch	21 August 1940–26 September 1940
	Col. William J. Morrissey		26 September 1940–6 October 1942

### 36th Infantry Regiment (9th Division)

#### Regular Army Inactive

HQ—Camp Devens, MA, 1919–21; Fort Jay, NY, 1921; *Inactive*, 1921–26; First Corps Area, 1926–27; New York City, NY, 1927–41; Camp Beauregard, LA, 1941



Stationed at Camp Devens, MA, as of June 1919 as a separate regiment. Transferred by marching to Fort Jay, NY, and arrived there 13 October 1921. Inactivated 13 October 1921 at Fort Jay and personnel transferred to the 22d Inf.; 16th Inf. Regt. previously designated as Active Associate on 27 July 1921. Allotted to the First Corps Area on 17 July 1922. Concurrently, the 16th Inf. Regt. relieved as Active Associate and the 5th Inf. Regt. designated as Active Associate. Assigned to the 9th Div. on 24 March 1923. Organized by September 1926 with O.R. personnel as an RAI unit in the First Corps Area. Withdrawn from the First Corps Area on 28 February 1927 and allotted to the Second Corps Area. Concurrently, the 5th Inf. relieved as Active Associate. Organized on 9 September 1927 with O.R. personnel as an RAI unit with HQ at New York City.

Regiment, less 2d and 3d Bns., affiliated with New York University ROTC on 18 April 1930 at New York City and organized as an RAI unit with R.A. personnel assigned to the ROTC Detachment and Reserve officers commissioned from the program. Concurrently, the 2d Bn. affiliated with La Salle Military Academy, Oakdale, NY, and the 3d Bn.

affiliated with Bordentown Military Institute, Bordentown, NJ. Conducted summer training most years at Camp Dix, NJ. Designated mobilization training station was Camp Dix. Relieved 1 July 1940 from the 9th Div. Redesignated the 36th Inf. Regt. (Armd.) on 15 April 1941 and assigned to the 3d Armd. Div. Concurrently activated, less Reserve personnel, at Camp Beauregard, LA. Assigned O.R. personnel transferred 29 May 1941 to the 308th Inf. Regiment transferred 13 June 1941 to Camp Polk, LA. Location 7 December 1941—Camp Polk, LA.

**Organization Day:** 1 July. Chosen to commemorate the regiment's date of constitution on 1 July 1916.

**Status:** Assigned to the USARS as the 36th Inf.; 1st Bn. active in Germany as an element of the 1st Armored Div.

**Commanders, 36th Infantry Regiment**

Col. Almon L. Parmenter	1 July 1916–10 March 1920	Col. Russell C. Langdon*	9 September 1927–20 August 1928
Lt. Col. Sylvester Bonnaffon	10 March 1920–13 August 1920	Lt. Col. Stanley A. Campbell*	20 August 1928–1 October 1933
Lt. Col. Frederick S.L. Price	13 August 1920–11 November 1920	Lt. Col. John N. Andrews**	1 October 1933–9 May 1940
Col. Charles Gerhardt	11 November 1920–13 August 1921	Lt. Col. Curtis A. Noble**	9 May 1940–25 February 1941
Col. Englebert G. Ovenshine	15 August 1921–13 October 1921	Col. John N. Andrews**	25 February 1941–14 April 1941
<i>Inactive</i>	13 October 1921–9 September 1927	Col. Walton H. Walker	15 April 1941–18 July 1941
	Col. William L. Roberts		18 July 1941–September 1942

\*RAI commanders: R.A. officers who were concurrently PMS&T at New York University.

\*\*RAI commanders: O.R. officers.

**37th Infantry Regiment (9th Division)**

**Regular Army Inactive**

**HQ**—Fort McIntosh, TX, 1919–20; Fort Wayne, MI, 1920–21; *Inactive*, 1921–26; First Corps Area, 1926–27; Brunswick, NJ, 1927–41; Unalaska, TA, 1941



Stationed at Fort McIntosh, TX, as of June 1919 as a separate regiment. Responsible for the Laredo District of the Mexican Border Patrol. The 2d Bn. transferred in 1920 to Camp Marfa, TX. Regiment, less 3d Bn., transferred 17 October 1920 to Fort Wayne, MI. Concurrently, 3d Bn. transferred to Fort Brady, MI. Inactivated 20 October 1921 at Fort Wayne and personnel transferred to the 54th Inf.; 18th Inf. Regt. previously designated as Active Associate on 27 July 1921. The 18th Inf. Regt. relieved as Active Associate on 17 July 1922 and the 13th Inf. Regt. designated as Active Associate. Assigned to the 9th Div. on 24 March 1923. Organized 10 September 1926 with O.R. personnel as an RAI unit in the First Corps Area. Withdrawn from the First Corps Area on 10 October 1926 and allotted to the Second Corps Area. Concurrently, the 13th Inf. relieved as Active

Associate. Organized 9 September 1927 with O.R. personnel as an RAI unit with HQ at Brunswick, NJ. Regiment, less 2d and 3d Bns., affiliated with Rutgers University ROTC on 7 April 1928 and reorganized at Brunswick as an RAI unit with R.A. personnel assigned to the ROTC Detachment and Reserve officers commissioned from the program. Concurrently, the 2d Bn. affiliated with New York Military Academy, Cornwall-on-Hudson, NY, and the 3d Bn. affiliated with College of the City of New York, New York City, NY. The 2d and 3d Bns. relieved from the ROTC affiliation program on 5 March 1937 and allotted to the Newark and Englewood Military Districts, respectively. Concurrently organized with O.R. personnel at those locations. Conducted monthly meetings at the 114th Inf. armories in Camden and Elizabeth, NJ. Conducted summer training most years at Camp Dix, NJ. Designated mobilization training station was Camp Dix. Relieved 1 August 1940 from the 9th Div. O.R. personnel relieved 27 July 1941 and concurrently reassigned to the 311th Inf. Activated 1 August 1941 at Unalaska, TA, and assigned to the Alaskan Defense Command. Location 7 December 1941—Unalaska, TA.

**Organization Day:** 12 July. Chosen to commemorate the regiment's date of original organization on 12 July 1916 at Fort Sam Houston, TX. Adopted 1920.

**Status:** Inactive in the R.A. as the 37th Inf.

### 37th Infantry Regiment

Col. Robert C. Van Vliet	12 July 1916–19 June 1917	2d Lt. Leo W. Derosiers	10 September 1926–10 October 1926
Col. Henry T. Ferguson	19 June 1917–6 January 1919	<i>Inactive</i>	10 October 1926–15 September 1927
Col. Fine W. Smith	27 January 1918–31 March 1918	Col. Ralph McCoy*	15 September 1927–15 April 1932
Col. Edward A. Roche	1 April 1918–4 July 1919	Col. Otis R. Cole*	15 April 1932–1 October 1933
Col. Frank L. Winn	22 September 1919–31 August 1920	Lt. Col. John L. Ames Jr.**	1 October 1933–28 August 1935
Lt. Col. Lucius C. Bennett	31 August 1920–7 October 1920	Maj. Homer M. French**	28 August 1935–6 October 1940
<i>Inactive</i>	20 October 1921–10 September 1926	Lt. Col. Charles K. Dillingham**	6 October 1940–27 July 1941
Col. Henry E. Eames	7 October 1920–20 October 1921	<i>Inactive</i>	27 July 1941–1 August 1941
	Unknown	1 August 1941–7 December 1941	

\*RAI commanders: R.A. officers who were concurrently PMS&T at Rutgers University.

\*\*RAI commanders: O.R. officers.

### 38th Infantry Regiment (3d Division)

**HQ**—Camp Pike, AR, 1919–21; Camp Lewis, WA, 1921–22; Fort Douglas, UT, 1922–39; Camp Bullis, TX, 1939–41; Fort Sam Houston, TX, 1941



Arrived at the port of New York on 20 August 1919 on the U.S.S. *Matsonia* as an element of the 3d Div. Transferred on the same day to Camp Merritt, NJ. Transferred 23 August 1919 to Camp Pike, AR. Transferred 16 September 1921 to Camp Lewis, WA. Regiment, less 1st Bn., transferred 6 June 1922 to Fort Douglas, UT. Concurrently, 1st Bn. transferred to Fort Logan, CO. The 1st Bn. transferred in June 1927 to Fort Sill, OK. In April 1933, the regiment assumed command and control of the Fort Douglas CCC District. The 1st Bn. inactivated 1 October 1933 at Fort Sill. Personnel and equipment transferred to the 3d Bn., 29th Inf. The 1st Bn. activated 1 May 1939 at Fort Sill. Regiment relieved from the 3d Div. on 12 October 1939 and assigned to the 2d Div. Regiment transferred on 9 November 1939 to Camp Bullis, TX. Transferred 24 February 1941 to Fort Sam Houston, TX. Location 7 December 1941—Fort Sam Houston, TX.

**Organization Day:** 15 July. Chosen to commemorate the regiment's participation in the battle of Chateau Thierry on 15 July 1918.

**Status:** Assigned to the USARS as the 38th Inf.; 1st Bn. active at Fort Benning, GA, as a training battalion.

**Events:** 57, 134, 144, 226, 231, 273, 288, 295, 296, 299, 300, 317, 328

#### Commanders, 38th Infantry Regiment

Col. William R. Sample	15 May 1917–27 October 1917	Col. Walter B. McCaskey	15 October 1925–22 June 1928
Col. Joseph C. Castner	30 October 1917–2 May 1918	Maj. Joseph A. McAndrew	22 June 1928–18 August 1928
Col. Ulysses G. McAlexander	15 May 1918–25 August 1918	Col. Howard C. Price	18 August 1928–8 August 1931
Col. Frank H. Adams	25 August 1918–13 August 1919	Col. Shepard L. Pike	8 August 1931–30 January 1933
Unknown	14 August 1919–2 December 1919	Lt. Col. Edwin Butcher	30 January 1933–19 May 1933
Col. Emphraim G. Peyton	3 December 1919–24 May 1920	Col. Augustus F. Dannemiller	19 May 1933–18 April 1935
Maj. Leonard R. Boyd	24 May 1920–1 July 1920	Maj. Leland S. Devens	18 April 1935–24 April 1935
Maj. Elvin H. Wagner	1 July 1920–27 August 1920	Col. Walter C. Sweeney	24 April 1935–10 January 1936
Col. Frank D. Wickham	27 August 1920–1 June 1922	Lt. Col. Charles C. McCarthy	10 January 1936–13 February 1936
Maj. Burton E. Bowen	1 June 1922–25 July 1922	Col. Walter S. Fulton	13 February 1936–2 January 1939
Col. Frederick L. Knudsen	25 July 1922–22 August 1922	Lt. Col. Gabriel T. McKenzie	2 January 1939–29 June 1939
Lt. Col. William S. Mapes	22 August 1922–8 July 1923	Col. Frederick E. Uhl	29 June 1939–1 October 1940
Col. Frederick L. Knudsen	8 July 1923–8 July 1925	Lt. Col. Nicholas Szilagyi	1 October 1940–26 December 1940
Maj. Joseph C. Thomas	8 July 1925–15 October 1925	Col. Paul C. Paschal	26 December 1940–January 1942



**39th Infantry Regiment (4th Division)****Regular Army Inactive**

**HQ**—Camp Dodge, IA, 1919–20; Camp Lewis, WA, 1920–21; *Inactive*, 1921–26; Clemson, SC, 1926–39; Charleston, SC, 1939–40; Fort Bragg, NC, 1940–41

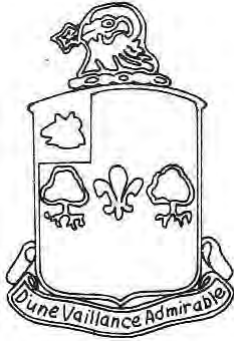

Arrived at the port of New York on 6 August 1919 on the U.S.S. *Leviathan* as an element of the 4th Div. Transferred 13 August 1919 to Camp Dodge, IA. Transferred 2 August 1920 to Camp Lewis, WA. Inactivated 21 September 1921 at Camp Lewis and allotted to the Fourth Corps Area; the 59th Inf. Regt. previously designated as Active Associate on 7 July 1921. Personnel concurrently transferred to the units of the 3d Div. The 59th Inf. Regt. relieved as Active Associate on 17 July 1922 and the 8th Inf. Regt. designated as Active Associate. Organized 26 July 1926 with O.R. personnel as an RAI unit with HQ at Clemson, SC. Regiment, less 3d Bn., affiliated with Clemson Agricultural College ROTC and organized on 25 February 1927 at Clemson as an RAI unit with R.A. personnel assigned to the ROTC Detachment and Reserve officers commissioned from the program. The 8th Inf. relieved as Active Associate on 30 June 1927. Relieved from the 4th Div. on 15 August 1927 and assigned to the 7th Div. Concurrently, the 3d Bn. affiliated with The Citadel and organized

at Charleston, SC. Conducted summer training most years at Fort Moultrie, GA. Relieved from the 7th Div. on 1 October 1933 and assigned to the 4th Div. HQ transferred by 1939 to Charleston. Relieved 16 October 1939 from the 7th Inf. Brig. Further relieved from the 4th Div. on 1 August 1940 and assigned to the 9th Div. O.R. personnel relieved on 4 August 1940. Activated 9 August 1940 at Fort Bragg, NC. Location 7 December 1941—Fort Bragg, NC.

**Status:** Assigned to the USARS as the 39th Inf.; 2d Bn. active at Fort Jackson, SC, as a training battalion.

**Events:** 330

**39th Infantry Regiment**

Col. William C. Bennett	23 June 1917–9 April 1918	1st Lt. William McK. Albergotti**	26 July 1926–19 November 1926
Col. Frank C. Bolles	9 April 1918–28 September 1918	Capt. Elmer H. Stambaugh**	19 November 1926–12 May 1927
Col. James K. Parsons	28 September 1918–11 October 1918	Maj. Carl Hanton**	12 May 1927–5 December 1928
Lt. Col. Troy H. Middleton	11 October 1918–14 October 1918	Col. John E. Morris*	30 June 1927–15 December 1927
Lt. Col. Oliver P. M. Hazzard	14 October 1918–12 November 1918	Lt. Col. Otis R. Cole*	15 December 1927–15 September 1928
Col. Frank C. Bolles	12 November 1918–1 August 1919	Col. Fred L. Munson*	15 September 1928–10 July 1932
Col. Paul H. McCook	1 August 1919–July 1920	Lt. Col. R. John West*	10 July 1932–1 October 1933
Maj. Robert B. Cole	July 1920–1 December 1920	Lt. Col. Herbert H. Stevens**	1 October 1933–11 October 1936
Maj. Jere Baxter	1 December 1920–15 February 1921	Unknown	11 October 1936–4 August 1939
Col. James N. Pickering	15 February 1921–21 September 1921	Col. Eley P. Denson	9 August 1940–August 1941
<i>Inactive</i>	21 September 1921–26 July 1926	Col. William R. Schmidt	August 1941–15 May 1942

\*RAI mobilization commanders: R.A. officers who were concurrently PMS&T at Clemson Agricultural College.

\*\*RAI commanders: O.R. officers.

**40th Infantry Regiment (8th Division)****Regular Army Inactive**

**HQ**—Camp Sherman, OH, 1919–21; *Inactive*, 1921–26; Washington, DC, 1926; *Inactive*, 1926–27; Ithaca, NY, 1927–41



Stationed at Camp Sherman, OH, as of June 1919 as a separate regiment. Transferred 27 June 1921 to Camp Knox, KY. Transferred 3 September 1921 to St. Albans, WV, to perform riot control during a coal miner's strike in Logan County. Inactivated 1 November 1921 at Danville, WV, and allotted to the Third Corps Area; 20th Inf. Regt. previously designated as Active Associate on 27 July 1921. Personnel concurrently transferred to the 10th and 11th Inf. Regts. The 20th Inf. Regt. relieved on 17 July 1922 as Active Associate and the 12th Inf. Regt. designated as Active Associate. Assigned to the 8th Div. on 24 March 1923. Organized 26 March 1926 with O.R. personnel as an RAI unit with HQ at the US Veterans Bureau building in Washington, DC. Inactivated by relief of Reserve personnel on 24 November 1926. Withdrawn from the Third Corps Area on 28 February

1927 and allotted to the Second Corps Area. Concurrently, the 12th Inf. relieved as Active Associate. Organized in June 1927 with O.R. personnel as an RAI unit with HQ at Ithaca, NY. Affiliated with Cornell University ROTC on 18 April 1930 and organized at Ithaca as an RAI unit with R.A. personnel assigned to the ROTC Detachment and Reserve officers commissioned from the program. Conducted summer training most years at Fort Niagara, NY, and some years at Camp Dix, NJ, or Plattsburg Barracks, NY. Relieved 1 July 1940 from the 8th Div. Location 7 December 1941—*Inactive*.

**Status:** Disbanded 11 November 1944.

**Events:** 22

**Commanders, 40th Infantry Regiment**

Col. Joseph D. Leitch	20 June 1917–29 July 1917	<i>Inactive</i>	24 November 1926–1 August 1927
Col. Samuel Burkhardt, Jr.	29 July 1917–14 September 1920	Col. Joseph W. Beacham, Jr.*	1 August 1927–June 1932
Col. Edward A. Shuttleworth	14 September 1920–1 November 1921	Col. John J. Fulmer*	28 June 1932–1 October 1933
<i>Inactive</i>	1 November 1921–26 March 1926	Maj. Claude L. Newman**	1 October 1933–6 May 1937
Lt. Col. Francis A. Awl**	26 March 1926–24 November 1926	Maj. Robert B. Warren**	6 May 1937–1 December 1938
	Col. Anson F. Robinson**		1 December 1938–ao December 1941

\*RAI commanders: R.A. officers who were concurrently PMS&T at Cornell University.

\*\*RAI commanders: O.R. officers.

**41st Infantry Regiment (8th Division)**

**Regular Army Inactive**

**HQ**—Camp Funston, KS, 1919; Camp Upton, NY, 1919–21; Camp George G. Meade, MD, 1921; *Inactive*, 1921–26; Fort Eustis, VA, 1926; *Inactive*, 1926–27; Syracuse, NY, 1927–40; Fort Benning, GA, 1940–41



Stationed at Camp Funston, KS, as of June 1919 as a separate regiment. Transferred 8 November 1919 to Camp Upton, NY. Transferred 18 November 1920 to Camp George G. Meade, MD. Inactivated 22 September 1921 at Camp George G. Meade and allotted to the Third Corps Area; 28th Inf. Regt. previously designated as Active Associate on 27 July 1921. Personnel concurrently transferred to the 34th Inf. The 28th Inf. Regt. relieved as Active Associate on 17 July 1922 and the 34th Inf. Regt. designated as Active Associate. Assigned to the 8th Div. on 24 March 1923. Organized 26 March 1926 with O.R. personnel as an RAI unit at Fort Eustis, VA. Inactivated by relief of Reserve personnel on 29 November 1926. Withdrawn from the Third Corps Area on 28 February 1927 and allotted to the Second Corps Area. Concurrently, the 34th Inf. relieved as Active Associate. Affiliated with Syracuse University ROTC and organized on 30 June 1927 at

Syracuse as an RAI unit with R.A. personnel assigned to the ROTC Detachment and Reserve officers commissioned from the program. Conducted summer training most years at Fort Niagara, NY, and some years at Camp Dix, NJ. Relieved 1 July 1940 from the 8th Div. Redesignated the 41st Inf. Regt. (Armd.) on 15 July 1940 and assigned to the 2d Armd. Div. Concurrently activated, less Reserve personnel, at Fort Benning, GA. Location 7 December 1941—Fort Benning, GA.

**Status:** Assigned to the USARS as the 41st Inf.; 1st Bn. active at Fort Riley, KS, as an element of the 1st Armd. Div.

**Events:** 310, 328, 330

**Commanders, 41st Infantry Regiment**

Col. Marcus D. Cronin	15 May 1817–22 July 1917	Maj. Rueben J. Sharp**	11 May 1926–29 November 1926
Col. Douglas Settle	1 September 1917–16 March 1918	<i>Inactive</i>	29 November 1926–30 June 1927
Unknown	17 March 1918–21 August 1918	Maj. George R. Harrison*	30 June 1927–5 September 1928
Col. George W. Kirkpatrick	22 August 1918–30 April 1919	Lt. Col. Frederick C. Test*	5 September 1928–1 October 1933
Col. Alfred J. Booth	ao January 1920–13 June 1920	Lt. Col. Frank L. Meagher**	1 October 1933–27 February 1937
Col. Arthur Johnson	13 June 1920–22 September 1921	Maj. Donald W. McLaren**	27 February 1937–20 March 1937
<i>Inactive</i>	22 September 1921–26 March 1926	Maj. Benjamin T. Anuskewicz**	20 March 1937–11 January 1938
Capt. John J. Francis**	26 March 1926–11 May 1926	Unknown	11 January 1938–15 July 1940
	Col. Paul W. Newgarden		15 July 1940–10 January 1942

\*RAI commanders: R.A. officers who were concurrently PMS&T at Syracuse University.

\*\*RAI commanders: O.R. officers.

### 42d Infantry Regiment (Puerto Rican) (Panama Canal Division)

**HQ**—Camp Upton, NY, 1919–20; Camp Gaillard, CZ, 1920–27; *Inactive*, 1927–29; Rio Piedras, PR, 1929–37; San Juan, PR, 1937–41

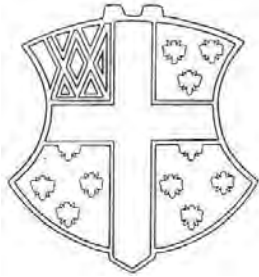

Stationed at Camp Upton, NY, as of June 1919 as a separate regiment. Regimental officers, records, and colors transferred to San Juan, PR, in late 1919 and regiment filled with Puerto Rican recruits and enlisted personnel transferred from the 65th Inf. Regt. Transferred 10 December 1920 to Camp Gaillard, CZ. Assigned to the Panama Canal Division on 3 July 1921. Primary wartime mission was to conduct a mobile defense of the beaches and inland sectors of the Pacific side of the canal zone. Enlisted personnel of the regiment rotated on 4-year tours with personnel of the 65th Inf. in Puerto Rico. Inactivated, less 3d Bn., at Camp Gaillard on 14 March–30 April 1927 and allotted to the Second Corps Area. The 3d Bn. transferred on 31 July 1927 to San Juan, PR, and inactivated. Personnel concurrently transferred to the 65th Inf. Relieved from the Panama Canal Division in

1928; however, the regiment's mobilization mission continued to be the reinforcement of the Canal Zone. Affiliated with the University of Puerto Rico ROTC and organized on 28 May 1929 at Rio Piedras, PR, as an RAI unit with R.A. personnel assigned to the ROTC Detachment and Reserve officers commissioned from the program. Regiment relocated on 30 September 1937 as follows: regimental HQ at San Juan, PR; 1st Bn. at San Juan, PR; 2d Bn. at Cayguas, PR; and 3d Bn. at Isabella, PR. Conducted summer training most years at Camp Buchanan, PR, and some years at San Juan, PR. Also conducted infantry CMTC training some years at Camp Buchanan as an alternate form of summer training. Location 7 December 1941—San Juan, PR.

**Organization Day:** 28 September.

**Status:** Disbanded 11 November 1944.

**Events:** 25, 31, 36, 40, 43, 53, 58

#### Commanders, 42d Infantry Regiment

Lt. Col. William C. Rogers	23 May 1917–22 June 1917	Col. Hunter B. Nelson	10 February 1922–13 October 1923
Col. Samson L. Faison	22 June 1917–20 August 1917	Lt. Col. Gustave A. Wieser	12 October 1923–25 January 1924
Col. Clarence E. Dentler	28 October 1917–18 May 1918	Col. Frederick C. Knabenshue	25 January 1924–14 September 1926
Col. Osmun Latrobe	18 May 1918–3 March 1919	Col. Samuel J. Sutherland	14 September 1926–3 February 1927
Col. James R. Lindsey	3 March 1919–5 October 1920	Col. James G. Hannah	3 February 1927–30 April 1927
Maj. George Blair	5 October 1920–16 December 1920	<i>Inactive</i>	30 April 1927–27 May 1929
Lt. Col. Rinaldo R. Wood	16 December 1920–22 January 1921	Maj. Arturo Moreno*	28 May 1929–June 1931
Col. Charles F. Crain	22 January 1921–25 October 1921	Lt. Col. Pascual Lopez*	15 June 1931–1 October 1933
Lt. Col. Gustave A. Wieser	25 October 1921–10 February 1922	Unknown	1 October 1933–7 December 1941

\*RAI commanders: R.A. officers who were concurrently PMS&T at the University of Puerto Rico.

\*\*RAI commanders: O.R. officers.

### 43d Infantry Regiment (PS) (Philippine Division)

### Regular Army Inactive

**HQ**—Camp Travis, TX, 1919; Camp Lee, VA, 1919–21; Fort William McKinley, PI, 1921; Fort Mills, PI, 1921–22; *Inactive*, 1922–41

Stationed at Camp Travis, TX, as of June 1919 as a separate regiment. Transferred 27 August 1919 to Camp Lee, VA. Officer cadre sailed on 28 February 1921 from San Francisco, CA, on the U.S.A.T. *Logan*. Arrived at Manila, PI, on 3 April 1921 and transferred to Fort William McKinley, PI, that same day. Reorganized as a Philippine Scout regiment on 4 April 1921 at various locations with enlisted personnel from the 2d, 8th, and 13th Bns., Philippine Scouts. Subordinate battalions stationed as follows: 1st Bn. at Camp John Hay, PI; 2d Bn. at Fort William McKinley, PI; 3d Bn. at Pettit Barracks, PI. HQ and 2d Bn. transferred on 10 October 1921 to Fort Mills, PI. Assigned to the Philippine Division on 22 October 1921. Inactivated at Fort Mills on 30 September 1922 and relieved from the Philippine Division. Personnel and equipment concurrently transferred to 45th Inf. (PS). Allotted to the Philippine Department and 45th Inf. designated Active Associate. Assigned to the Philippine Division on 26 June 1931. The 1st Bn. activated at Pettit Barracks on 1 April 1941. Location 7 December 1941—Pettit Barracks, PI (1st Bn. only).

**Organization Day:** 20 June. Chosen to commemorate the regiment's date of organization on 20 June 1917 at Fort Douglas, UT, by actual transfer of enlisted personnel from the 20th Inf. (regimental HQ organized 1 June; officers and select NCOs assigned 11 June; companies organized 20 June).

**Status:** Inactive in the R.A. as the 43d Inf.

**Commanders, 43d Infantry Regiment**

Col. William R. Dashiell	1 June 1917–6 May 1918	Col. Samson L. Faison	3 September 1919–12 February 1921
Col. Lambert W. Jordan Jr.	6 May 1918–3 September 1919	Col. Charles R. Noyes	4 March 1921–15 January 1922
	Col. Hubert A. Allen		15 January 1922–30 September 1922

**44th Infantry Regiment (Hawaiian Division)**

**HQ**—Presidio of San Francisco, CA, 1919–20; Schofield Barracks, TH, 1921

Stationed at the Presidio of San Francisco, CA, as of June 1919 as a separate regiment. Transferred to Schofield Barracks, TH, and arrived there 25 September 1920. Assigned to the Hawaiian Division on 1 March 1921. Relieved on 22 October 1921 from the Hawaiian Division. Inactivated 28 November 1921 at Schofield Barracks. Concurrently, personnel and equipment transferred to the 21st Inf. Regt. Demobilized 17 July 1922.

**Organization Day:** 20 June. Chosen to commemorate the regiment's date of organization on 20 June 1917 at Vancouver Barracks, WA, by actual transfer of enlisted personnel from the 14th Inf.

**Events:** 1, 2

**Commanders, 44th Infantry Regiment**

Col. Benjamin C. Morse	June 1917–5 August 1917	Lt. Col. Charles S. Hamilton	12 December 1918–January 1919
Col. Isaac Newell	5 August 1917–17 November 1917	Col. Benjamin B. Hyer	January 1919–2 April 1919
Col. Edward N. Jones Jr.	17 November 1917–12 December 1918	Col. William K. Jones	2 April 1919–14 September 1921
	Lt. Col. John R. Kelly		14 September 1921–28 November 1921

**44th Infantry Regiment (PS) (Philippine Division)**

**Regular Army Inactive**

**HQ**—*Not organized*, 1931–41

Constituted in the R.A. on 26 June 1931 as the 44th Inf. Regt. (Philippine Scouts), allotted to the Philippine Department, and assigned to the Philippine Division. Location 7 December 1941—*Not organized*.

**Status:** Disbanded 11 November 1944.

**45th Infantry Regiment (PS) (Philippine Division)**

**HQ**—Camp Gordon, GA, 1919; Camp Dix, NJ, 1919–20; Fort Mason, CA, 1920; Fort William McKinley, PI, 1920–41



Stationed at Camp Gordon, GA, as of June 1919 as a separate regiment. Transferred 4 September 1919 to Camp Dix, NJ. Transferred 25 October 1920, less enlisted personnel and equipment, to Fort Mason, CA. Sailed from Fort Mason on 5 November 1920 with officer cadre, records, and colors on the U.S.A.T. *Thomas*. Arrived 2 December 1920 at Manila, PI, and transferred to Fort William McKinley, PI, the following day. Reorganized as a Philippine Scout regiment on 3 December 1920 by assignment of personnel and equipment of the inactivated 1st Philippine Infantry Regiment (Provisional). The 1st Bn. (minus A and B Cos.) concurrently transferred to Camp John Hay, PI; A and B Cos. concurrently transferred to Pettit Barracks, PI. Assigned to the Philippine Division on 22 October 1921. Absorbed the personnel and equipment of the inactivated 43d Inf. on 30 September 1922. The regiment conducted quarantine enforcement operations in several central Luzon provinces to control the spread of anthrax, 1 November 1923–31 January

1924. The regiment's wartime mission was to concentrate as part of the 23d Inf. Brig. near Fort Stotsenberg and fight from a series of delaying positions back to the Bataan peninsula. From there the regiment would delay back to a final position anchored on Mariveles Mountain. Location 7 December 1941—Fort McKinley, PI.

**Status:** Disbanded 10 October 1951.

**Events:** 27, 35, 41, 52, 68, 82, 100, 118, 139, 157, 169, 179, 198, 224, 270

#### Commanders, 45th Infantry Regiment

Col. Edward M. Lewis	4 June 1917–5 August 1917	Col. James B. Kemper	5 May 1927–10 April 1929
Col. Melville S. Jarvis	5 August 1917–30 September 1918	Lt. Col. Corbit S. Hoffman	10 April 1929–15 June 1929
Col. Herman Glade	29 October 1918–1 July 1920	Col. Charles A. Martin	15 June 1929–5 July 1932
Maj. Harry A. Wells	1 July 1920–20 September 1920	Col. Ralph McCoy	5 July 1932–4 October 1933
Capt. Harry A. Twaddle	20 September 1920–9 October 1920	Lt. Col. Hugh Straughn	4 October 1933–16 December 1933
Col. Thomas R. Harker	9 October 1920–16 January 1923	Col. Ralph H. Leavitt	16 December 1933–16 November 1935
Maj. Thomas C. Fain	16 January 1923–30 March 1923	Col. Richard H. Kelley	16 November 1935–28 February 1938
Col. Henry B. Eames	30 March 1923–30 January 1925	Col. Melvin G. Faris	1 March 1938–26 July 1940
Lt. Col. H. Clay M. Supplee	30 January 1925–18 April 1925	Col. Clifford Bluemel	26 July 1940–20 September 1941
Col. Earle W. Tanner	18 April 1925–5 May 1927	Col. Thomas W. Doyle	1 October 1941–April 1942

#### 46th Infantry Regiment (Separate)

**HQ**—Fort Oglethorpe, GA, 1919–20; Eagle Pass, TX, 1920–21; Camp Travis, TX, 1921; Fort Knox, KY, 1941

Stationed at Fort Oglethorpe, GA, as of June 1919 as a separate regiment. Transferred in 1920 to Eagle Pass, TX. Transferred in September 1921, less 2d Bn., to Camp Travis, TX. The 2d Bn. transferred 4 November 1921 to Fort Sam Houston, TX. Inactivated on 16 November 1921 at Camp Travis and personnel concurrently transferred to units of the 2d Div. Demobilized on 31 July 1922. Reconstituted 28 August 1941 as the 46th Inf. (Armd.). Activated on 1 October 1941 at Fort Knox, KY. Location 7 December 1941—Fort Knox, KY.

**Status:** Assigned to the USARS as the 46th Inf.; 1st, 2d, and 5th Bns. active at Fort Knox, KY, as training battalions.

#### Commanders, 46th Infantry Regiment

Col. Isaac C. Jenks	21 August 1917–28 October 1917	Col. Charles C. Clark	26 March 1918–18 March 1920
Col. Charles C. Clark	31 December 1917–13 March 1918	Maj. Samuel A. Price	19 March 1920–15 August 1920
Col. Hugh D. Wise	13 March 1918–17 March 1918	Col. James H. Bradford Jr.	15 August 1920–16 November 1921

#### 47th Infantry Regiment (4th Division)

#### Regular Army Inactive

**HQ**—Camp Dodge, IA, 1919–20; Camp Lewis, WA, 1920–21; *Inactive*, 1921–27; Starkville, MS, 1927–39; Baton Rouge, LA, 1939–40; Fort Bragg, NC, 1940–41



Arrived at the port of New York on 16 July 1919 on the U.S.S. *Mobile* as an element of the 4th Div. Transferred 2 August 1919 to Camp Dodge, IA. Transferred 2 August 1920 to Camp Lewis, WA. Inactivated 22 September 1921 at Camp Lewis and allotted to the Fourth Corps Area; 58th Inf. Regt. previously designated as Active Associate on 27 July 1921. Personnel concurrently transferred to the 7th Inf. Regt. The 58th Inf. Regt. relieved as Active Associate on 17 July 1922 and the 22d Inf. Regt. designated as Active Associate. Organized 25 July 1926 with O.R. personnel as an RAI unit with HQ at Starkville, MS. Affiliated with the A&M College of Mississippi ROTC on 25 February 1927 and organized, less 3d Bn., at Starkville as an RAI unit with R.A. personnel assigned to the ROTC Detachment and Reserve officers commissioned from the program. Concurrently, the 3d Bn. affiliated with Louisiana State University and organized at Baton Rouge, LA. The 22d Inf. relieved on 30 June 1927 as Active Associate. Relieved from the 4th Div. on 15 August 1927 and assigned to the 7th Div. Relieved 1 October 1933 from the 7th Div. Participated in the 1938 Third Army Maneuver in the DeSoto National Forest by providing numerous Reserve officers as umpires. Regimental HQ transferred by 1939 to Baton Rouge, LA. Conducted summer training most years at Fort McPherson, GA, and some years at Fort Screven, GA. Also conducted infantry

CMTC training some years at Camp Beauregard, LA, as an alternate form of summer training. Assigned to the 9th Div. on 1 August 1940. Activated 10 August 1940, less Reserve personnel, at Fort Bragg, NC. Location 7 December 1941—Fort Bragg, NC.

**Status:** Assigned to the USARS as the 47th Inf.; 2d and 3d Bns. active at Fort Benning, GA, as training battalions.

**Events:** 330

#### Commanders, 47th Infantry Regiment

Col. Herman Hall	6 July 1917–23 August 1917	1st Lt. Broaddus B. Lipscomb**	26 July 1926–22 December 1926
Col. Leon S. Roudiez	30 September 1917–29 July 1918	Capt. William Schlitter**	22 December 1926–12 May 1927
Lt. Col. Robert H. Peck	29 July 1918–28 October 1918	Maj. William C. McGown**	12 May 1927–14 November 1928
Col. Troy H. Middleton	28 October 1918–6 July 1919	Lt. Col. Howard Parrish**	14 November 1928–22 February 1936
Lt. Col. Manton C. Mitchell	6 July 1919–1 August 1919	Maj. Roger V. St. Dezier **	22 February 1936–May 1936
Col. Carl A. Martin	ao January 1920–7 October 1920	Lt. Col. Harold L. Nickerson**	May 1936–10 August 1940
Maj. Walter P. Tyler	7 October 1920–22 October 1920	Maj. Forrest E. Ambrose	10 August 1940–2 September 1940
Col. Robert W. Mearns	22 October 1920–21 September 1921	Col. Alexander M. Patch, Jr.	2 September 1940–5 August 1941
<i>Inactive</i>	21 September 1921–25 July 1926	Lt. Col. Edwin H. Randle	5 August 1941–27 August 1941
	Col. Samuel A. Gibson		27 August 1941–25 January 1942
Col. Pegram Whitworth*	17 June 1927–15 June 1929	Col. William E. Persons*	31 December 1929–24 June 1932
Maj. William E. Brougner*	15 June 1929–31 December 1929	Maj. George C. Lawrason*	25 June 1932–1 October 1933

\*RAI mobilization commanders: R.A. officers who were concurrently PMS&T at the A&M College of Mississippi.

\*\*RAI commanders: O.R. officers.

#### 48th Infantry Regiment (Separate)

**HQ**—Camp Jackson, SC, 1919–20; Camp Harry J. Jones, AZ, 1920–21; Camp Travis, TX, 1921–22

Stationed at Camp Jackson, SC, as of June 1919 as a separate regiment. Transferred in 1920 to Camp Harry J. Jones, AZ. Concurrently, 1st Bn. transferred to El Paso, TX. Transferred in September 1921 to Camp Travis, TX. Inactivated 14 October 1921 at Camp Travis, TX. Personnel transferred to units of the 2d Div. Demobilized 31 July 1922.

**Status:** Assigned to the USARS as the 48th Inf.; 1st Bn. active at Fort Leonard Wood, MO, as a training battalion.

#### Commanders, 48th Infantry Regiment

Col. Harry R. Lee	4 June 1917–October 1917	Col. Harry R. Lee	21 March 1919–15 August 1921
Col. John J. Bradley	October 1917–5 December 1917	Maj. Charles H. Corlett	15 August 1921–3 September 1921
Col. William F. Grote	5 December 1917–21 March 1919	Lt. Col. Edward B. Mitchell	3 September 1921–14 October 1921

#### 49th Infantry Regiment (Separate)

**HQ**—Fort Leavenworth, KS, 1919; Fort Snelling, MN, 1919–21

Stationed at Fort Leavenworth, KS, as of June 1919 as a separate regiment. Transferred in August 1919 to Fort Snelling, MN. The 3d Bn. remained stationed at Fort Leavenworth. Inactivated 18 November 1921 at Fort Snelling. Personnel and equipment concurrently transferred to the 3d Inf. Regt. Demobilized 31 July 1922.

**Status:** Inactive in the R.A. as the 49th Inf.

#### Commanders, 49th Infantry Regiment

Col. Julius A. Penn Jr.	June 1917–5 August 1917	Unknown	22 June 1918–29 April 1919
Unknown	6 August 1917–16 September 1917	Col. Charles Gerhardt	30 April 1919–2 October 1920
Col. John B. Bennett	17 September 1917–20 March 1918	Maj. Charles G. Sturtevant	2 October 1920–26 October 1920
Col. James A. Irons	20 March 1918–22 June 1918	Col. Alfred W. Bjornstad	26 October 1920–29 August 1921
	Lt. Col. Paul C. Galleher		29 August 1921–18 November 1921

## 50th Infantry Regiment

**HQ**—Camp Dix, NJ, 1919; Mayen, Germany, 1919–21

Stationed at Camp Dix, NJ, as of June 1919 as a separate regiment. Departed the port of Hoboken on 16 October 1919. Stationed at Mayen, Germany, as an element of the 2d Brig., American Forces in Germany. Inactivated 31 December 1921 at Mayen. Demobilized 31 July 1922.

**Status:** Assigned to the USARS as the 50th Inf.; 1st Bn. active at Fort Benning, GA, as a training battalion.

**Events:** 19, 24

### Commanders, 50th Infantry Regiment

Col. James M. Arrasmith	1 June 1917–5 August 1917	Col. Lawrence B. Simonds	ao August 1918–6 August 1919
Col. Frank D. Webster	29 September 1917–17 December 1917	Col. Hansford L. Threlkeld	6 August 1919–8 September 1919
Unknown	18 December 1917–ao August 1918	Col. Francis J. McConnell	8 September 1919–7 August 1920
	Col. Harry E. Knight		7 August 1920–12 December 1921

## 51st Infantry Regiment (6th Division)

## Regular Army Inactive

**HQ**—Camp Grant, IL, 1919–21; *Inactive*, 1921–26; Madison, WI, 1926–41; Pine Camp, NY, 1941

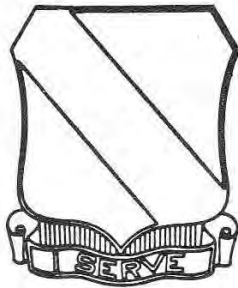

Arrived at the port of New York on 12 June 1919 on the U.S.S. *Leviathan* as an element of the 6th Div. Transferred to Camp Merritt, NJ. Transferred 19 June 1919 to Camp Grant, IL. Inactivated 22 September 1921 at Camp Grant and allotted to the Sixth Corps Area; 53d Inf. Regt. previously designated as Active Associate on 27 July 1921. Personnel concurrently transferred to the 53d Inf. The 53d Inf. Regt. relieved as Active Associate on 17 July 1922 and the 2d Inf. Regt. designated as Active Associate. Organized 9 May 1926 with O.R. personnel as an RAI unit with HQ at Madison, WI. Relieved from the 6th Div. on 15 August 1927 and assigned to the 9th Div. Concurrently, the 2d Inf. relieved as Active Associate. Regiment, less 2d and 3d Battalions, affiliated with the University of Wisconsin at Madison, WI, and organized on 15 April 1929 as an RAI unit with R.A. personnel assigned to the ROTC Detachment and Reserve officers commissioned from the program. Concurrently, the 2d Bn. affiliated with Michigan State College, Lansing, MI, and the 3d Bn. affiliated with the University of Michigan, Ann Arbor, MI. Attached to the 101st Div. for administrative purposes on 3 November 1930. Relieved from the 9th Div. on 1 October 1933 and assigned to the 6th Div. Relieved 16 October 1939 from the 6th Div. Conducted summer training at Fort Sheridan, IL. Also conducted infantry CMTC training some years at Fort Sheridan as an alternate form of summer training. Designated mobilization training station was Fort Sheridan. Redesignated the 51st Inf. Regt. (Armd.) on 15 April 1941, assigned to the 4th Armd. Div., and activated, less Reserve personnel, at Pine Camp, NY. Location 7 December 1941—Pine Camp, NY.

**Status:** Assigned to the USARS as the 51st Inf.

### Commanders, 51st Infantry Regiment

Col. Arthur Johnson	16 June 1917–30 September 1917	Maj. John W. Harris**	8 May 1926–13 December 1926
Unknown	30 September 1917–June 1918	Maj. Andre R. Crippin**	13 December 1926–18 March 1927
Col. Isaac Newell	June 1918–6 October 1918	Col. Thomas R. Harker*	18 March 1927–8 February 1929
Col. Thomas L. Slavens	6 October 1918–16 August 1919	Maj. Tom Fox*	8 February 1929–8 July 1932
Col. Charles B. Stone	16 August 1919–7 August 1920	Lt. Col. Christian Otjen**	8 July 1932–30 September 1933
Lt. Col. Guy E. Bucker	7 August 1920–4 November 1920	Maj. Howard J. Lowery**	30 September 1933–30 April 1936
Col. Carl Reichmann	4 November 1920–15 August 1921	Lt. Col. Haney E. Ihlenfeld**	30 April 1936–ao January 1940
Col. Earle W. Tanner	15 August 1921–22 September 1921	Unknown	ao January 1940–15 April 1941
<i>Inactive</i>	22 September 1921–8 May 1926	Col. Thomas J. Camp	15 April 1941–ao December 1941

\*RAI commanders: R.A. officers who were concurrently PMS&T at the University of Wisconsin.

\*\*RAI commanders: O.R. officers.

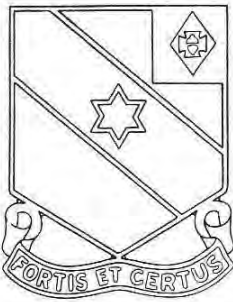
**52d Infantry Regiment (6th Division)****Regular Army Inactive****HQ**—Camp Grant, IL, 1919–21; *Inactive*, 1921–26; Urbana, IL, 1926–32; Champaign, IL, 1932–41

Arrived at the port of New York on 12 June 1919 on the U.S.S. *Leviathan* as an element of the 6th Div. Transferred 19 June 1919 to Camp Grant, IL. Inactivated 1 September 1921 at Camp Grant and allotted to the Sixth Corps Area; 54th Inf. Regt. previously designated as Active Associate. Personnel concurrently transferred to the 54th Inf. The 54th Inf. Regt. relieved as Active Associate on 17 July 1922 and the 6th Inf. Regt. designated as Active Associate. Organized 9 April 1926 with O.R. personnel as an RAI unit with HQ at Urbana, IL. The 6th Inf. relieved as Active Associate on 28 February 1927. Relieved from the 6th Div. on 15 August 1927 and assigned to the 9th Div. Affiliated, less the 3d Bn., with the University of Illinois ROTC and organized on 15 April 1929 as an RAI unit with R.A. personnel assigned to the ROTC Detachment and Reserve officers commissioned from the program. Concurrently, the 3d Bn. affiliated with Northwestern University ROTC at Evanston, IL. Attached to the 86th Div. for administrative purposes on 3 November 1930. Relocated 26 February 1932 to Champaign, IL. Relieved from the 9th Div. on 1 October 1933 and assigned to the 6th Div. Relieved on 12 October 1939 from the 6th Div. Typically conducted Inactive Training Period meetings at the 202d C.A. armory or at the Army and Navy Club in Chicago. Also conducted semiannual contact camps with the 12th Inf. at Fort Sheridan in the 1930s. Conducted summer training at Jefferson Barracks, MO, and Fort Sheridan, IL. Also conducted infantry CMTC training some years at Jefferson Barracks, Fort Sheridan, and Camp Custer, MI, as an alternate form of summer training. Designated mobilization training station was Jefferson Barracks. Location 7 December 1941—Champaign, IL.

**Organization Day:** 17 June. Chosen to commemorate the regiment's date of organization on 17 June 1917 at Chickamauga Park, GA. Adopted 1920.

**Status:** Assigned to the USARS as the 52d Inf.

**Commanders, 52d Infantry Regiment**

Col. Ernest V. Smith	22 June 1917–10 August 1919	<i>Inactive</i>	1 September 1921–8 May 1926
Unknown	11 August 1919–22 September 1919	Capt. Paige H. Crain**	9 April 1926–8 May 1926
Col. Harold L. Jackson	23 September 1919–8 February 1920	Maj. Edwin B. Callahan**	8 May 1926–18 March 1927
Lt. Col. Henry W. Gregg	8 February 1920–5 July 1920	Col. William T. Merry*	18 March 1927–17 August 1928
Col. Herschel Tupes	6 July 1920–11 May 1921	Col. Charles W. Weeks*	17 August 1928–26 July 1932
Lt. Col. Reulen Smith	11 May 1921–11 June 1921	Col. David L. Stone*	26 July 1932–24 June 1933
Col. Frank B. Watson	11 June 1921–1 September 1921	Col. William K. Naylor*	24 June 1933–1 October 1933
	Col. Warren E. Pugh**		1 October 1933–ao January 1941

\*RAI Commanders: R.A. officers who were concurrently PMS&T at the University of Illinois.

\*\*RAI Commanders: O.R. officers.

**53d Infantry Regiment (7th Division)****Regular Army Inactive****HQ**—Camp Grant, IL, 1919–21; Fort D.A. Russell, WY, 1921–22; *Inactive*, 1921–26; Minneapolis, MN, 1926–40; Fort Ord, CA, 1940–41

Arrived at the port of New York on 12 June 1919 on the U.S.S. *Leviathan* as an element of the 6th Div. Transferred 18 June 1919 to Camp Grant, IL. Transferred 3 October 1921 to Fort D.A. Russell, WY. Inactivated 23 September 1922 at Fort D.A. Russell and allotted to the Seventh Corps Area; the 3d Inf. Regt. previously designated as Active Associate on 27 July 1921. Relieved from the 6th Div. on 24 March 1923 and assigned to the 7th Div. Organized in October 1926 with O.R. personnel as an RAI unit with HQ at Minneapolis, MN. The 3d Inf. relieved as Active Associate on 28 February 1927. Affiliated with the University of Minnesota ROTC on 28 April 1930. Affiliation withdrawn on 6 October 1934. Typically conducted Inactive Training Period meetings at the University of Minnesota ROTC armory or the Federal Building in Minneapolis. Conducted summer training at Fort Snelling, MN, and some years at Fort Des Moines, IA. Also conducted infantry CMTC training some years at Fort Snelling as an alternate form of summer training. Designated mobilization training



station was Fort Snelling. Activated 1 August 1940, less Reserve personnel, at Fort Ord, CA. Relieved 29 November 1941 from the 7th Div. Location 7 December 1941—Fort Ord, CA.

**Status:** Inactive in the R.A. as the 53d Inf.

**Events:** 314, 326

**Commanders, 53d Infantry Regiment**

Col. Lambert W. Jordan Jr.	16 June 1917–24 April 1918	Col. William P. Jackson	11 October 1920–15 August 1921
Col. Charles E. Tayman	24 April 1918–26 June 1918	Col. Paul H. McCook	15 August 1921–23 September 1922
Col. Fred G. Stritzinger	26 June 1918–5 January 1919	<i>Inactive</i>	24 September 1922–October 1926
Col. Edmund L. Butts	5 January 1919–January 1920	Lt. Col. John H. Neff*	October 1926–ao September 1928
Col. Samuel W. Noyes	January 1920–30 September 1920	Lt. Col. George P. Gurley**	ao March 1929–11 November 1936
Col. Edmund L. Butts	30 September 1920–11 October 1920	Maj. Floyd E. Eller**	11 November 1936–30 June 1940
	Col. Bradford G. Chynoweth		1 July 1940–1 November 1941

\*RAI commanders: R.A. officers who were concurrently PMS&T at the University of Minnesota.

\*\*RAI commanders: O.R. officers.

**54th Infantry Regiment (7th Division)**

**Regular Army Inactive**

**HQ**—Camp Grant, IL, 1919–21; Fort Wayne, MI, 1921–22; *Inactive*, 1921–26; Omaha, NE, 1926–41

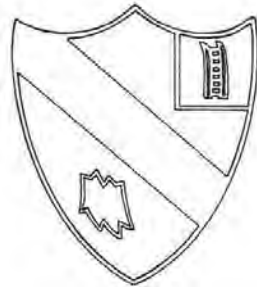

Arrived at the port of New York on 10 June 1919 on the U.S.S. *Mount Vernon* as an element of the 6th Div. Transferred 17 June 1919 to Camp Grant, IL. Transferred 18 October 1921 to Fort Wayne, MI. The 2d Inf. Regt. designated as Active Associate on 29 June 1922 pending the inactivation of the regiment. The 2d Inf. Regt. relieved as Active Associate on 17 July 1922 and the 17th Inf. Regt. designated as Active Associate. Inactivated 24 October 1922 at Fort Wayne and allotted to the Seventh Corps Area. Relieved from the 6th Div. on 24 March 1923 and assigned to the 7th Div. Organized by October 1926 with O.R. personnel as an RAI unit with HQ at Omaha, NE. The 17th Inf. relieved as Active Associate on 28 February 1927. Affiliated about April 1930 with the ROTC programs at the University of Nebraska and Creighton University. Conducted summer training at Fort Crook, NE. Also conducted infantry CMTC training some years at Fort Snelling, Fort

Crook, or Fort Leavenworth, KS, as an alternate form of summer training. Designated mobilization training station was Fort Crook. Relieved 1 October 1940 from the 7th Div. Location 7 December 1941—Omaha, NE.

**Organization Day:** 16 June. Chosen to commemorate the regiment’s date of organization on 16 June 1917 at Chickamauga Park, GA. Adopted 1920.

**Status:** Assigned to the USARS as the 54th Inf.; 2d Bn. active at Fort Benning, GA, as a training battalion.

**Commanders, 54th Infantry Regiment**

Col. Frank H. Albright	16 June 1917–5 August 1917	Maj Herbert H. Glidden**	7 October 1926–ao January 1927
Col. Matthias Crowley	5 August 1917–22 July 1919	Unknown	ao January 1927–ao February 1929
Col. Alfred T. Smith	22 July 1919–15 August 1920	Lt. Col. Ward L. Schrantz**	ao February 1929–ao August 1930
Lt. Col. Clement A. Trott	15 August 1920–28 January 1921	Unknown	ao August 1930–ao December 1937
Lt. Col. Leonard T. Baker	28 January 1921–21 February 1921	Maj. Harold F. Mattoon	ao December 1937–12 January 1938
Col. Howard R. Perry	21 February 1921–29 August 1921	Capt. Howard J. Hunter	12 January 1938–28 September 1939
Col. Henry E. Eames	29 August 1921–24 October 1922	Maj. William G. Browne	28 September 1939–ao January 1940
<i>Inactive</i>	24 October 1922–7 October 1926	Unknown	ao January 1940–7 December 1941

\*\*RAI commanders: O.R. officers.

### 55th Infantry Regiment (7th Division)

**HQ**—Camp Funston, KS, 1919–20; Camp George G. Meade, MD, 1920–21

Arrived at the port of New York in June 1919 as an element of the 7th Div. Transferred to Camp Merritt, NJ. Transferred in June 1919 to Camp Funston, KS. Transferred in July 1920 to Camp George G. Meade, MD. Inactivated 22 September 1921 at Camp George G. Meade. Personnel concurrently transferred to the 34th Inf. Demobilized 31 July 1922.

**Status:** Inactive in the R.A. as the 55th Armored Inf. Bn.

#### Commanders, 55th Infantry Regiment

Col. Charles H. Martin	17 May 1917–5 August 1917	Maj. Benjamin E. Grey	1 December 1918–13 May 1918
Col. Benjamin F. Hardaway	5 August 1917–1 December 1918	Col. James V. Heidt	13 May 1918–26 July 1920
	Lt. Col. Thomas S. Moorman		9 September 1920–22 September 1921

### 56th Infantry Regiment (7th Division)

**HQ**—Camp Funston, KS, 1919–20; Camp George G. Meade, MD, 1920–21

Arrived at the port of New York in June 1919 as an element of the 7th Div. Transferred to Camp Mills, NY. Transferred in July 1919 to Camp Funston, KS. Transferred in July 1920 to Camp George G. Meade, MD. Inactivated 21 September 1921 at Camp George G. Meade. Personnel concurrently transferred to units of the 1st Div. Demobilized 31 July 1922.

**Status:** Inactive in the R.A. as the 56th Armd. Inf. Bn.

#### Commanders, 56th Infantry Regiment

Maj. Edward S. Walton	20 June 1917–19 July 1917	Maj. William J. Fitzmaurice	26 March 1920–19 April 1920
Col. William P. Burnham	19 July 1917–5 August 1917	Lt. Col. Paul B. Parker	19 April 1920–3 October 1920
Maj. Charles A. Martin	5 August 1917–26 September 1917	Maj. Walter F. L. Hartigan	3 October 1920–20 April 1921
Col. William O. Johnson	30 September 1917–1 October 1918	Col. Frank L. Wells	25 April 1921–5 August 1921
Col. Arthur L. Bump	1 October 1918–26 March 1920	Col. Reynolds J. Burt	5 August 1921–21 September 1921

### 57th Infantry Regiment (PS) (Philippine Division)

**HQ**—Camp Pike, AR, 1919; Camp Dix, NJ, 1919–20; Fort William McKinley, PI, 1920–41



Stationed at Camp Pike, AR, as of June 1919 as a separate regiment. Transferred 11 November 1919 to Camp Dix, NJ. Enlisted personnel transferred in late October 1920 to the 1st Div. Sailed from San Francisco, CA, on 5 November 1920 with officer cadre, records, and colors on the U.S.A.T. *Thomas*. Arrived at Manila, PI, on 2 December 1920 and transferred to Fort William McKinley, PI, that same day. Reorganized on 3 December 1920 as a Philippine Scout regiment by transfer of the personnel and equipment of the inactivated 2d Philippine Infantry Regiment (Provisional). Assigned to the Philippine Division on 22 October 1921. The regiment's wartime mission was to concentrate as part of the 23d Inf. Brig. near Camp Stotsenberg and fight from a series of delaying positions back to the Bataan peninsula. From there the regiment would delay back to a final position anchored on Mariveles Mountain. Location 7 December 1941—Fort McKinley, PI.

**Organization Day:** 1 June. Chosen to commemorate the regiment's date of organization on 1 June 1917 at Camp Wilson, TX. Adopted 1 February 1920.

**Status:** Disbanded 10 October 1951.

**Events:** 27, 35, 41, 52, 68, 82, 100, 118, 139, 157, 169, 179, 198, 224, 245, 270

### Commanders, 57th Infantry Regiment

Col. Charles S. Farnsworth	1 June 1917–5 August 1917	Maj. Gunnar J. Mortenson	2 March 1931–17 April 1931
Col. David J. Baker, Jr.	5 August 1917–14 April 1921	Lt. Col. Henry Hossfeld	17 April 1931–3 October 1931
Lt. Col. G. Arthur Hadsell	14 April 1921–1 September 1921	Col. Howard C. Price	3 October 1931–23 June 1934
Col. Hubert A. Allen	1 September 1921–14 December 1921	Lt. Col. Merrill E. Spalding	23 June 1934–1 October 1934
Col. Charles H. Barth	14 December 1921–12 October 1922	Lt. Col. Francis C. Endicott	1 October 1934–10 May 1935
Col. Hubert A. Allen	20 October 1922–24 October 1923	Lt. Col. Matthew J. Gunner	10 May 1935–5 March 1936
Col. George L. Byroade	24 October 1923–9 September 1925	Col. Charles W. Mason	5 March 1936–2 May 1936
Maj. Thomas C. Fain	9 September 1925–30 September 1925	Col. Lloyd R. Fredendall	2 May 1936–16 May 1938
Col. Charles C. Todd	30 September 1925–26 August 1927	Lt. Col. Thomas K. Collins	16 May 1938–15 July 1938
Maj. Pedro D. Dulay	26 August 1927–13 September 1927	Col. James G. Ord	15 July 1938–31 May 1940
Col. Harry A. Eaton	13 September 1927–10 April 1929	Col. William E. Brougher	31 May 1940–September 1941
Col. Edgar A. Myer	10 April 1929–2 March 1931	Col. George S. Clarke	September 1941–15 January 1942

### 58th Infantry Regiment (4th Division)

**HQ**—Camp Dodge, IA, 1919–20; Camp Lewis, WA, 1920–21; Fort George Wright, WA, 1921–22

Arrived at the port of New York on 1 August 1919 on the U.S.S. *Mount Vernon* as an element of the 4th Div. Transferred to Camp Merritt, NJ, on the same day. Transferred in late August 1919 to Camp Dodge, IA. Transferred in January 1920 to Camp Lewis, WA. Transferred 21 September 1921, less 1st Bn., to Fort George Wright, WA. Concurrently, 1st Bn. transferred to Fort Missoula, MT. Inactivated on 21 June 1922 at Fort George Wright and personnel transferred to the 2d Bn., 4th Inf. Concurrently, personnel and equipment of 1st Bn. absorbed by the 1st Bn., 4th Inf. at Fort Missoula. Demobilized 31 July 1922.

**Status:** Assigned to the USARS as the 58th Inf.; 2d Bn. active at Fort Benning, GA, as a training battalion.

### Commanders, 58th Infantry Regiment

Lt. Col. Charles G. French	5 June 1917–23 June 1917	Maj. Gilbert R. Cook	20 October 1918–1 November 1918
Col. Mark L. Hersey	23 June 1917–17 August 1917	Lt. Col. Max B. Garber	1 November 1918–3 January 1919
Col. Lutz Wahl	18 August 1917–3 February 1918	Col. Fred R. Brown	3 January 1919–6 May 1919
Capt. George T. Everitt	3 February 1918–16 March 1918	Col. Fred C. Stritzinger Jr.	6 May 1919–19 June 1919
Col. Carroll F. Armistead	16 March 1918–25 August 1918	Col. Fred R. Brown	19 June 1919–1 August 1919
Col. George H. McMaster	25 August 1918–2 October 1918	Col. Gideon H. Williams	1 August 1919–20 August 1920
Lt. Col. Leonard T. Baker	2 October 1918–20 October 1918	Col. Patrick H. Mullay	20 August 1920–6 September 1921
	Col. Charles C. Ballou		6 September 1921–21 June 1922

### 59th Infantry Regiment (4th Division)

**HQ**—Camp Dodge, IA, 1919–20; Camp Lewis, WA, 1920–21; Vancouver Barracks, WA, 1921–22

Arrived at the port of New York in August 1919 as an element of the 4th Div. Transferred to Camp Merritt, NJ. Transferred in August 1919 to Camp Dodge, IA. Transferred in January 1920 to Camp Lewis, WA. Transferred in September 1922 to Vancouver Barracks, WA. Concurrently, 2d Bn. transferred to Fort William H. Seward, TA. Demobilized 28 September 1922 at Vancouver Barracks and personnel and equipment transferred to the 7th Inf.

**Status:** Assigned to the USARS as the 59th Inf.

### Commanders, 59th Infantry Regiment

Col. Benjamin W. Atkinson	5 June 1917–25 July 1918	Col. James S. Parker	30 January 1919–23 April 1919
Lt. Col. Charles F. Andrews	25 July 1918–7 August 1918	Col. Max B. Garber	23 April 1919–1 August 1919
Lt. Col. Max B. Garber	7 August 1918–21 August 1918	Col. William S. Mapes	1 August 1919–30 August 1920
Col. George H. McMaster	21 August 1918–25 August 1918	Col. William H. Jordan Jr.	30 August 1920–19 July 1922
Lt. Col. Max B. Garber	25 August 1918–3 September 1918	Lt. Col. Channing E. Delaplaine	19 July 1922–15 August 1922
Col. Frederick M. Wise (USMC)	3 September 1918–30 January 1919	Maj. Harrison C. Browne	15 August 1922–28 September 1922

**60th Infantry Regiment (5th Division)****Regular Army Inactive**

**HQ**—Camp Gordon, GA, 1919–20; Camp Jackson, SC, 1920–21; *Inactive*, 1921–27; Columbus, OH, 1927–40; Fort Bragg, NC, 1940–41



Arrived at the port of New York on 20 July 1919 on the S.S. *Aquitania* as an element of the 5th Div. Transferred 26 July 1919 to Camp Gordon, GA. Transferred 6 October 1920 to Camp Jackson, SC. Inactivated 2 September 1921 at Camp Jackson and allotted to the Fifth Corps Area; 6th Inf. Regt. previously designated as Active Associate on 27 July 1921. Personnel concurrently transferred to the 6th Inf. The 6th Inf. Regt. relieved as Active Associate on 17 July 1922 and the 10th Inf. Regt. designated as Active Associate. The 10th Inf. relieved as Active Associate on 28 February 1927. Organized about June 1927 with O.R. personnel as an RAI unit with HQ at Columbus, OH. Relieved from the 5th Div. on 15 August 1927 and assigned to the 8th Div. Affiliated with Ohio State University ROTC on 28 April 1930 and organized as an RAI unit at Columbus, OH, with

R.A. personnel assigned to the ROTC Detachment and Reserve officers commissioned from the program. Relieved from the 8th Div. on 1 October 1933 and assigned to the 5th Div. Conducted a mobilization test 13–26 October 1935 at Columbus. Relieved 16 October 1939 from the 5th Div. Assigned to the 9th Div. on 1 August 1940. Conducted summer training at Fort Thomas, KY, and some years at Fort Benjamin Harrison, IN, or Fort Knox, KY. Also conducted infantry CMTTC training some years at Fort Thomas or Fort Benjamin Harrison as an alternate form of summer training. Activated 10 August 1940, less Reserve personnel, at Fort Bragg, NC. Location 7 December 1941—Fort Bragg, NC.

**Status:** Assigned to the USARS as the 60th Inf.; 2d Bn. active at Fort Jackson, SC, as a training battalion.

**Events:** 330

**Commanders, 60th Infantry Regiment**

Col. Michael J. Lenihan	15 May 1917–3 October 1917	Col. Charles R. Noyes	1 November 1920–4 February 1921
Col. Charles Crawford	3 October 1917–17 December 1917	Lt. Col. Allen Parker	4 February 1921–August 1921
Col. J. Robertson	18 December 1917–17 March 1918	Col. Harold L. Jackson	April 1921–July 1921
Col. Douglas G. Settle	18 March 1918–11 August 1918	Lt. Col. Allen Parker	July 1921–August 1921
Col. Frank B. Hawkins	23 August 1918–November 1918	Maj. Enrique Urretia	August 1921–6 September 1921
Col. John W. Leonard	November 1918–December 1918	Lt. Col. Allen Parker	6 September 1921–12 May 1922
Unknown	December 1918–10 November 1919	<i>Inactive</i>	12 May 1922–1 August 1927
Col. Charles R. Noyes	11 November 1919–11 March 1920	Col. Grosvenor L. Townsend*	1 August 1927–1 October 1933
Lt. Col. William J. O'Loughlin	11 March 1920–5 September 1920	Lt. Col. Frank A. Hunter**	1 October 1933–10 August 1940
Lt. Col. Allen Parker	5 September 1920–12 October 1920	Capt. Robert C. Andrews**	10 August 1940–August 1940
Maj. William J. O'Loughlin	12 October 1920–1 November 1920	Maj. H. G. Edsen**	August 1940–2 September 1940
	Col. Frank C. Mahin		2 September 1940–January 1942

\*RAI commanders: R.A. officers who were concurrently PMS&T at Ohio State University.

\*\*RAI commanders: O.R. officers.

**61st Infantry Regiment (5th Division)****Regular Army Inactive**

**HQ**—Camp Gordon, GA, 1919–20; Camp Jackson, SC, 1920–21; *Inactive*, 1921–27; Lexington, KY, 1927–41

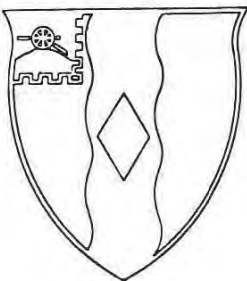

Arrived at the port of New York on 20 July 1919 on the S.S. *Aquitania* as an element of the 5th Div. Transferred 28 July 1919 to Camp Gordon, GA. Transferred 13 October 1920 to Camp Jackson, SC. Inactivated 2 September 1921 at Camp Jackson and allotted to the Fifth Corps Area; the 11th Inf. Regt. previously designated as Active Associate on 27 July 1921. Personnel concurrently transferred to the 11th Inf. The 11th Inf. relieved as Active Associate on 28 February 1927. Regiment, less the 3d Bn., affiliated with the University of Kentucky ROTC and organized about June 1927 as an RAI unit at Lexington, KY, with R.A. personnel assigned to the ROTC Detachment and Reserve officers commissioned from the program. Concurrently, the 3d Bn. organized at Louisville, KY. Relieved from the 5th Div. on 15 August 1927 and assigned to the 8th Div. Relieved from the 8th Div. on

1 October 1933 and assigned to the 5th Div. Conducted a mobilization test 13–26 October 1935 at Lexington. Relieved on 16 October 1939 from the 5th Div. Conducted summer training at Fort Knox, KY, and some years at Fort Benjamin Harrison, IN, or Fort Thomas, KY. Also conducted infantry CMTC training some years at Fort Benjamin Harrison as an alternate form of summer training. Location 7 December 1941—Lexington, KY.

**Status:** Assigned to the USARS as the 61st Inf.; 1st Bn. active at Fort Jackson, SC, as a training battalion.

#### Commanders, 61st Infantry Regiment

Col. Samuel W. Miller	10 June 1917–12 November 1917	Col. Horace P. Hobbs*	1 June 1927–28 July 1928
Col. Armand I. Lasseigne	12 November 1917–17 March 1918	Maj. Owen R. Meredith*	28 July 1928–10 July 1932
Col. Hugh D. Wise	18 March 1918–10 July 1918	Maj. Boltos E. Brewer*	10 July 1932–1 October 1933
Col. Lowe A. McClure	1 August 1918–19 October 1918	Lt. Col. D. Y. Dunn**	1 October 1933–31 July 1935
Col. Philip B. Peyton	19 October 1918–31 July 1919	Maj. Laurence J. Heyman**	31 July 1935–ao January 1937
Col. Lowe A. McClure	31 July 1919–30 June 1920	Lt. Col. Kenneth Little**	ao June 1937–ao June 1938
Lt. Col. Charles L. McCain	1 July 1920–4 November 1920	Unknown	ao June 1938–ao July 1940
Col. Glenn H. Davis	4 November 1920–8 August 1921	Maj. Alfred L. Marcum**	ao July 1940–ao January 1941
<i>Inactive</i>	8 August 1921–1 June 1927	Unknown	ao January 1941–7 December 1941

\*RAI commanders: R.A. officers who were concurrently PMS&T at University of Kentucky.

\*\*RAI commanders: O.R. officers.

#### 62d Infantry Regiment (PS)

**HQ**—Camp Lee, VA, 1919–21; Fort Mills, PI, 1921

Stationed at Camp Lee, VA, as of June 1919 as a separate regiment. Regimental officers, records, and colors transferred February 1921, with officer cadre only, to Fort Mills, PI. Organized 25 March 1921 as a Philippine Scout regiment by consolidation with the personnel and equipment of the 4th Philippine Infantry Regiment (Provisional). Partially inactivated 22 September 1921 at Fort Mills by transfer of Philippine Scout personnel to the 2d Bn., 14th Engr. Regt. Inactivated 25 November 1921 at Fort Mills. Demobilized 31 July 1922.

**Organization Day:** 1 June. Chosen to commemorate the regiment's date of organization on 1 June 1917 at the Presidio of San Francisco, CA, by transfer of enlisted personnel from the 12th Inf.

**Status:** Inactive in the R.A. as the 62d Inf.

#### Commanders, 62d Infantry Regiment

Col. James R. Lindsay	13 June 1917–10 October 1918	Col. Charles H. Barth	25 February 1919–29 August 1921
Col. James F. McKinley	10 October 1918–25 February 1919	Lt. Col. Everette R. Wilson	29 August 1921–25 November 1921

#### 63d Infantry Regiment (Separate)

**HQ**—Madison Barracks, NY, 1919–21; Plattsburg Barracks, NY, 1921–22; Fort Leonard Wood, MO, 1941

Stationed at Madison Barracks, NY, as of June 1919 as a separate regiment. Concurrently, 2d Bn. transferred to Fort Ontario, NY, and 3d Bn. transferred to Plattsburg Barracks, NY. Entire regiment transferred in September 1921 to Plattsburg Barracks, NY. Inactivated at Plattsburg Barracks and disbanded 31 July 1922. Reconstituted 10 May 1941. Activated 1 June 1941 at Fort Leonard Wood, MO. Concurrently assigned to the 6th Div. Location 7 December 1941—Fort Leonard Wood, MO.

**Status:** Inactive in the R.A. as the 63d Inf.

**Events:** 4

### Commanders, 63d Infantry Regiment

Col. Richard C. Croxton	1 June 1917–9 November 1917	Lt. Col. Halsey E. Yates	7 May 1921–25 June 1921
Col. Henry M. Dichman	9 November 1917–7 January 1918	Maj. Harry H. Bissell	25 June 1921–7 July 1921
Col. Richard C. Croxton	8 January 1918–30 December 1918	Col. Willis Uline	7 July 1921–18 August 1921
Unknown	31 December 1918–12 July 1919	<i>Demobilized</i>	31 July 1922–31 May 1941
Col. John F. Preston Jr.	13 July 1919–13 August 1919	Maj. Ernest H. Wilson	1 June 1941–4 June 1941
Col. Robert Alexander	7 October 1919–7 May 1921	Col. Edward C. Rose	4 June 1941–10 September 1942

### 64th Infantry Regiment (7th Division)

**HQ**—Camp Funston, KS, 1919–20; Camp George G. Meade, MD, 1920–21; Plattsburg Barracks, NY, 1921–22

Arrived at the port of New York on 18 June 1919 on the U.S.S. *America* as an element of the 7th Div. Transferred 18 June 1919 to Camp Mills, NY. Transferred in June 1919 to Camp Funston, KS. Transferred in July 1920 to Camp George G. Meade, MD. Transferred in September 1921 to Plattsburg Barracks, NY. Concurrently, 3d Bn. transferred to Fort Washington, MD. Inactivated at Plattsburg Barracks and disbanded on 31 July 1922. Reconstituted 18 July 1941. Location 7 December 1941—*Inactive*.

**Status:** Disbanded 4 August 1952.

### Commanders, 64th Infantry Regiment

Col. Ulysses G. McAlexander	15 May 1917–22 July 1917	Maj. William F. L. Hartigan	27 August 1921–11 November 1921
Col. William P. Jackson	30 August 1917–19 October 1917	Col. Robert C. Davis	11 November 1921–6 February 1922
Col. Edson A. Lewis	19 October 1917–22 October 1918	Maj. Austin M. Pardee	6 February 1922–24 March 1922
Col. George D. Guyer	21 October 1918–10 February 1919	Maj. John R. West	24 March 1922–5 April 1922
Col. Edson A. Lewis	24 August 1919–27 August 1921	Col. Charles D. Roberts	5 April 1922–30 June 1922

### 65th Infantry Regiment (Puerto Rican) (Separate)

**HQ**—San Juan, PR, 1919–40; Fort Buchanan, PR, 1940–41



Stationed at San Juan, PR, as of June 1919 as the Porto Rico Regiment of Infantry. Composed of American officers and Puerto Rican enlisted personnel. Redesignated 65th Inf. Regt. on 14 September 1920. Enlisted personnel of regiment rotated on 4-year tours with personnel of 42d Inf. in Panama. Mobilization assignment was the reinforcement of the 20th Inf. Brig. in the Canal Zone from 1922 to 1928. Regiment was ordered to perform emergency relief work in the vicinity of Cayey—San Juan after a major hurricane struck the island on 12 September 1928. As part of this mission, units of the regiment rebuilt the road from Cayey to San Juan from 13 September to 1 December 1928. The 3d Bn. inactivated 31 July 1931 at Henry Barracks, PR. Concurrently, 1st Bn. transferred to Henry Barracks, PR. Co. D awarded the Edwin Howard Clark machine gun trophy for 1937. Assigned Reserve officers conducted summer training with the regiment at Camp Buchanan, PR.

Reserve officers also conducted the infantry CMTTC training at Camp Buchanan in 1938 and 1939. Deployed on the U.S.S. *Wyoming* to St. Croix and St. Thomas, VI, on a defensive exercise on 8 December 1939–7 January 1940. Regiment transferred on 1 February 1940, less 1st and 2d Bns., to Fort Buchanan. The 3d Bn. concurrently activated at Fort Buchanan and 1st Bn. transferred to Borinquen Field, PR. Location 7 December 1941—Fort Buchanan, PR.

**Organization Day:** 24 March. Chosen to commemorate the regiment's date of organization on 24 March 1899 as the Puerto Rican Battalion of Volunteer Infantry at San Juan, PR.

**Status:** Allotted to the Puerto Rico N.G. as the 65th Inf., a parent regiment under the USARS; 1st Bn. active at Cayey, PR, as an element of the 92d Inf. Brig.

**Events:** 246, 329

**Commanders, 65th Infantry Regiment**

Col. Melville S. Jarvis	14 September 1920–5 May 1922	Maj. Leopold Mercader	27 May 1931–13 July 1931
Col. Tenney Ross	5 May 1922–30 January 1925	Col. George L. Byroade	13 July 1931–6 July 1934
Lt. Col. Samuel W. Noyes	30 January 1925–15 June 1925	Col. Otis R. Cole	6 July 1934–18 May 1936
Col. George H. Estes	15 June 1925–23 April 1928	Col. John W. Wright	18 May 1936–17 August 1939
Maj. Frank L. Purden	23 April 1928–6 June 1928	Col. Russel P. Hartle	17 August 1939–3 October 1940
Col. George W. Helms	6 June 1928–27 May 1931	Col. George J. Newgarden	3 October 1940–3 November 1941
	Col. John R. Mendenhall		3 November 1941–24 November 1943

**66th Infantry Regiment (Light Tanks)**

**HQ**—Fort George G. Meade, MD, 1932–38; *Inactive*, 1938–40; Fort Benning, GA, 1940

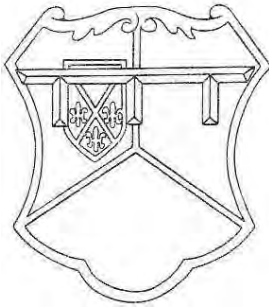

Arrived at the port of New York on 17 March 1919 on the U.S.S. *Patricia* as Headquarters and Headquarters Company (HHC), 304th Brig., Tank Corps. Transferred to Camp George G. Meade, MD. Consolidated with HHC, 305th Brig., Tank Corps on 22 June 1921 and reorganized and redesignated HHC, 1st Tank Group. Reorganized and redesignated HHC, 1st Tank Regt. on 1 September 1929. Remainder of regiment organized as follows: 16th Tank Bn. (Light) redesignated 1st Bn. at Camp George G. Meade; 15th Tank Bn. (Special) redesignated 2d Bn. at Camp Benning, GA; 18th Tank Bn. (Light), inactive, redesignated 3d Bn.; 21st Tank Maint Co. redesignated Service Company. The 3d Bn. was activated on 16 September 1931 at Camp Devens, MA. Regiment reorganized and redesignated 66th Inf. Regt. (Light Tanks) on 25 October 1932. HHC inactivated on 1 September 1938 at Fort George G. Meade. HHC reactivated 10 January 1940 at Fort Benning. Assigned Reserve officers, less the 2d Bn., conducted summer training with

active elements of the regiment at Fort George G. Meade; those assigned to the 2d Bn. trained at Fort Benning. Primary ROTC feeder school for new Reserve lieutenants was Western Maryland College. Redesignated 66th Armd. Regt. on 15 July 1940.

**Organization Day:** 12 September. Chosen to commemorate the baptism of fire for the US Tank Corps during the battle of St. Mihiel in France, 12 September 1918. Adopted 5 April 1930.

**Status:** Assigned to the USARS as the 66th Armor.

**Events:** 176, 209, 218, 228, 240, 262, 263, 280, 281, 293, 296, 310, 328, 330

**Commanders, 66th Infantry Regiment (Light Tanks)**

Col. Harry L. Hooper	25 October 1932–30 September 1933	Lt. Col. Lindsay D. Silvester	18 February 1937–3 March 1937
Maj. Robert L. Spragins	30 September 1933–1 December 1933	Col. Simon B. Buckner	3 March 1937–1 September 1938
Col. John P. McAdams	1 December 1933–30 June 1936	<i>Inactive</i>	1 September 1938–2 October 1939
Col. Bruce Magruder	3 July 1936–18 February 1937	Lt. Col. Bradford G. Chynoweth	2 October 1939–25 January 1940
	Col. Alvan C. Gillem		25 January 1940–25 June 1940

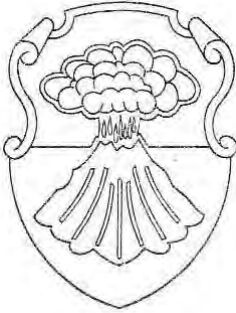
**67th Infantry Regiment (Medium Tanks)****Regular Army Inactive****HQ**—*Not organized*, 1932–36; Columbus, GA, 1936–40; Fort Benning, GA, 1940

Constituted in the R.A. as the 2d Tank Regt. on 1 September 1929 and allotted to the Fourth Corps Area. Remainder of regiment organized as follows: 19th Tank Bn. (Heavy), inactive, redesignated 1st Bn.; 17th Tank Bn. (Heavy) redesignated 2d Bn. at Camp George G. Meade, MD; 3d Bn., inactive, newly constituted; 22d Tank Maint Co., inactive, redesignated Service Company. The 2d Bn., less Co. F, inactivated at Camp Meade on 15 September 1931. Reorganized and redesignated 67th Inf. Regt. (Medium Tanks) on 31 October 1932. Organized 4 April 1936 with O.R. personnel as an RAI unit with HQ at Columbus, GA. The 2d Bn. and Co. D activated on 1 October 1939 at Fort Benning; remainder of regiment, less Reserve personnel, activated 5 June 1940 at Fort Benning. Assigned Reserve officers conducted summer training with active elements of the regiment at Fort Benning, GA. Redesignated 67th Armd. Regt. on 15 July 1940.

**Status:** Assigned to the USARS as the 67th Armor.**Events:** 190, 209, 293, 296, 310, 328, 330**Commanders, 67th Infantry Regiment (Medium Tanks)**

Maj. Clarence A. Will**	4 April 1936–4 June 1940	Col. Douglass T. Greene	5 June 1940–15 July 1940
		<b>2d Battalion:</b>	
Maj. John L. Pierce	1 October 1939–1 February 1940	Lt. Col. Roger B. Harrison	1 February 1940–15 July 1940
		<b>F Company:</b>	
Capt. Walter A. Bigby	1 October 1932–1 May 1937	Capt. Frank S. Ross	18 June 1937–26 August 1938
	Capt. William G. Cornog		1 September 1938–1 September 1940

\*\*RAI commanders: O.R. officers.

**68th Infantry Regiment (Light Tanks)****Regular Army Inactive****HQ**—Peoria, IL, 1933–37; Chicago, IL, 1937–40

Constituted in the R.A. as the 68th Inf. Regt. (Light Tanks) on 1 October 1933 and allotted to the Sixth Corps Area. Organized 1 October 1933 with O.R. personnel as an RAI unit with HQ at Peoria, IL. Entire regiment relocated on 7 April 1937 to Chicago, IL. Typically conducted Inactive Training Period meetings at the Illinois N.G. Armory in Peoria. Conducted summer training most years at Jefferson Barracks, MO, or the Peoria Tank Training Center, and at Rock Island Arsenal, IL, in 1936. The 1st and 2d Bns. activated on 1 January 1940, less Reserve personnel, at Fort Benning, GA, by redesignation of the 1st through 7th Tank Cos. Inactive elements withdrawn from the Sixth Corps Area on 29 March 1940 and allotted to the Fourth Corps Area. The 2d Bn. transferred on 30 May 1940 to Fort Lewis, WA. The 1st Bn. inactivated on 30 June 1940 at Fort Benning. Redesignated 68th Armd. Regt. on 15 July 1940.

**Status:** Assigned to the USARS as the 68th Armor.**Events:** 296, 304, 310, 328, 330**Commanders, 68th Infantry Regiment (Light Tanks)**

Lt. Col. Julius R. Offenbauer**	1 October 1933–12 August 1935	Lt. Col. James E. White**	12 August 1935–6 October 1938
	Lt. Col. Frederick E. Swanson**		6 October 1938–29 March 1940

\*\*RAI commanders: O.R. officers.



**69th Infantry Regiment (Light Tanks)****Regular Army Inactive****HQ**—*Not organized*, 1933–34; Minneapolis, MN, 1934–41

Constituted in the R.A. as the 69th Inf. Regt. (Light Tanks) on 1 October 1933 and allotted to the Seventh Corps Area. Organized by October 1934 with O.R. personnel as an RAI unit with HQ at Minneapolis, MN. Typically conducted Inactive Training Period meetings at the University of Minnesota ROTC armory or the Federal Building in Minneapolis. Conducted summer training at Fort Snelling, MN. Also conducted infantry CMTC training some years at Fort Snelling as an alternate form of summer training. Location 7 December 1941—Minneapolis, MN.

**Status:** Disbanded 11 November 1944.**69th Infantry Regiment (Light Tanks)**

Lt. Col. Walter D. Tobin

ao October 1934–December 1940

Unknown

December 1940–7 December 1941

**71st Infantry Regiment (44th Division)****New York National Guard****HQ**—New York City, NY, 1920–40; Fort Dix, NJ, 1940–41

Arrived at the port of New York on 26 June 1919 on the U.S.S. *Artemis* as the 54th Pioneer Inf. Demobilized on 8 July 1919 at Camp Grant, IL. Reorganized as the 71st Inf., New York N.G., 1919–20. HQ federally recognized on 30 January 1920 at New York City, NY. Attached 17 June 1922 to the 93d Inf. Brig. Relieved from attachment to the 93d Inf. Brig. on 12 January 1923 and attached to the 87th Inf. Brig. Assigned to the 87th Inf. Brig. on 27 February 1927. Participated in the parade held for Charles A. Lindberg in New York City in July 1927. Conducted a review for Marshal Henri Petain during his visit to New York City on 24 October 1931. Conducted additional week-long winter training directed by the War Department at Camp Dix, NJ, 12–19 November 1939. Conducted annual summer training most years at Camp Smith, Peekskill, NY. Inducted into active Federal service on

16 September 1940 at New York City, NY, and moved to Fort Dix, NJ, where it arrived 23 September 1940. Location 7 December 1941—Fort Dix, NJ.

**Status:** Allotted to the New York N.G. as the 71st Inf., a parent regiment under the USARS.**Events:** 61, 190, 280, 301, 330**Commanders, 71st Infantry Regiment**

Col. James H. Wells

30 January 1920–10 June 1924

Col. George F. Terry

18 July 1935–23 July 1939

Col. Walter A. Delamater

10 June 1924–4 July 1935

Col. James G. Conroy

27 September 1939–20 August 1940

Col. William R. Jackson

20 August 1940–7 March 1942

**101st Infantry Regiment (26th Division)****Massachusetts National Guard****HQ**—Boston, MA, 1921–41; Camp Edwards, MA, 1941

Arrived at the port of Boston on 6 April 1919 on the U.S.S. *America* as the 101st Inf., an element of the 26th Div. Demobilized 28 April 1919 at Camp Devens, MA. Reconstituted in the N.G. in 1921, assigned to the 26th Div., and allotted to the state of Massachusetts. Reorganized 30 September 1921 by redesignation of the 9th Inf., Massachusetts N.G. (organized 1919–20; HQ organized 20 January 1921 and federally recognized at Boston, MA), as the 101st Inf. Several companies called up to perform hurricane relief at Cape Cod in September 1938. Conducted annual summer training most years at Camp Devens, MA, 1921–34, and at the Massachusetts Military Reservation at Falmouth, MA, 1936–38. Inducted into active Federal service at Boston, MA, 16 January 1941, and moved to Camp Edwards, MA, where it arrived 23 January 1941. Location 7 December 1941—Camp Edwards, MA.

**Status:** Assigned to the Combat Arms Regimental System (CARS) as the 101st Inf. Regt.; all elements inactive in the Massachusetts N.G.

**Events:** 190, 280, 301, 330

**Commanders, 101st Infantry Regiment**

Col. Edward L. Logan	5 August 1917–29 October 1918	<i>Demobilized</i>	28 April 1919–30 September 1921
Lt. Col. John C. Greenway	29 October 1918–3 November 1918	Col. Thomas F. Foley	30 September 1921–18 April 1923
Col. Horace P. Hobbs	3 November 1918–4 February 1919	Col. John D. Murphy	18 April 1923–5 May 1927
Col. Edward L. Logan	4 February 1919–March 1919	Col. Arthur W. Desmond	5 May 1927–24 December 1931
Col. William R. Pooley	March 1919–28 April 1919	Col. Francis V. Logan	24 December 1931–29 December 1938
	Col. Paul G. Kirk	29 December 1938–September 1943	

**102d Infantry Regiment (43d Division)**

**Connecticut National Guard**

**HQ**—New Haven, CT, 1921–41; Camp Blanding, FL, 1941

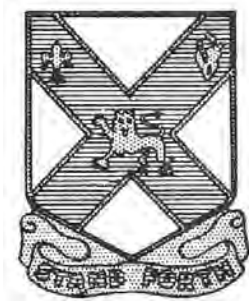

The 102d Inf., an element of the 26th Div., arrived at the port of Boston on 7 April 1919 on the U.S.S. *Agamemnon*. Demobilized 29 April 1919 at Camp Devens, MA. Reconstituted in the N.G. in 1921 as the 170th Inf., assigned to the 43d Div., and allotted to the state of Connecticut. Reorganized 20 October 1922 by withdrawal of the 2d Inf. Regt., Connecticut N.G., from the 169th Inf. (organized 23 May 1921 by consolidation and redesignation of the 1st and 2d Inf. Regts., Connecticut N.G. as the Connecticut Regiment of Infantry; redesignated 169th Inf. on 7 October 1921) and redesignation of the 2d Inf. as the 170th Inf. Regt. HQ organized 8 June 1923 and federally recognized at New Haven, CT. The 170th Inf. was redesignated as the 102d Inf. on 28 February 1924. The regiment, or elements thereof, were called up to perform the following state duties: riot control at the textile workers strike at Putnam, CT, in September 1934; flood relief at Hartford, CT,

19 March–1 April 1936; hurricane relief in the vicinity of Rockville, CT, 22–27 September 1938. Conducted annual summer training most years at Niantic, CT, 1921–38. Inducted into active Federal service at New Haven, CT, on 24 February 1941 and moved to Camp Blanding, FL, where it arrived 15 March 1941. Location 7 December 1941—Camp Blanding, FL.

**Status:** Assigned to the USARS as the 102d Inf.; 1st Bn. active at New Haven, CT, as an element of the 26th Brig., 29th Inf. Div. (Light).

**Events:** 190, 280, 301, 325, 328, 330

**Commanders, 102d Infantry Regiment**

Col. Ernest L. Isbell	5 August 1917–11 January 1918	Col. Douglas M. Potts	December 1918–29 April 1919
Col. John H. Paker	11 January 1918–31 July 1918	<i>Demobilized/Inactive</i>	29 April 1919–27 February 1924
Col. Horace H. Hobbs	31 July 1918–10 August 1918	Col. James A. Haggerty	28 February 1924–January 1925
Col. Hiram I. Bearrs (USMC)	10 August 1918–8 November 1918	Col. Lewis L. Field	January 1925–9 January 1940
Lt. Col. Evan E. Lewis	8 November 1918–December 1918	Col. Ernest E. Novey	9 January 1940–ao March 1942

**103d Infantry Regiment (43d Division)**

**Maine National Guard**

**HQ**—Farmington, ME, 1921–22; Portland, ME, 1922–41; Camp Blanding, FL, 1941



Arrived at the port of Boston on 6 April 1919 on the U.S.S. *America* as the 103d Inf., an element of the 26th Div. Demobilized 28 April 1919 at Camp Devens, MA. Reconstituted in the N.G. in 1921, assigned to the 43d Div., and allotted to the state of Maine. Reorganized 22 November 1921 at Farmington, ME, by consolidation of the 2d and 3d Inf. Regts., Maine N.G. and designated as the 171st Inf. Redesignated as the 103d Inf. on 31 December 1921. HQ relocated in 1922 to Portland, ME. Conducted annual summer training most years at Camp Keyes, ME, and some years at Camp Devens, MA, and Fort Ethan Allen, VT. Inducted into active Federal service at Portland, ME, on 24 February 1941 and moved to Camp Blanding, FL, where it arrived 13 March 1941. Location 7 December 1941—Camp Blanding, FL.

**Status:** Active at Portland, ME, as the 133d Engr. Bn. (Heavy).

**Events:** 190, 280, 301, 325, 328, 330

**Commanders, 103d Infantry Regiment**

Col. Frank Hume	5 August 1917–6 November 1918	Col. Frank Hume	4 February 1919–28 April 1919
Col. Cassius M. Dowell	6 November 1918–2 December 1918	<i>Demobilized/Inactive</i>	28 April 1919–15 January 1920
Col P. W. Arnold	2 December 1918–25 January 1919	Col. Harry M. Bigelow	15 January 1920–1 January 1932
	Col. Spaulding Bisbee	2 January 1932–ao January 1942	

**104th Infantry Regiment (26th Division)**

**Massachusetts National Guard**

**HQ**—Springfield, MA, 1921–41; Camp Edwards, MA, 1941

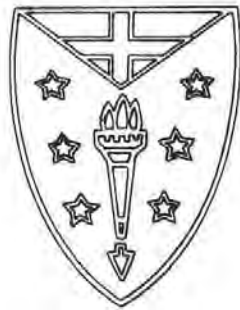

Arrived at the port of Boston on 4 April 1919 on the U.S.S. *Mount Vernon* as the 104th Inf., an element of the 26th Div. Demobilized 29 April 1919 at Camp Devens, MA. Reconstituted in the N.G. in 1921, assigned to the 26th Div., and allotted to the state of Massachusetts. Reorganized by redesignation of the 2d Inf., Massachusetts N.G. (organized 1919–21; HQ organized 22 June 1921 and federally recognized at Springfield, MA) as the 104th Inf. on 30 September 1921. The regiment, or elements thereof, called up to perform the following state duties: flood relief at Springfield in November 1927; flood relief at Springfield, 4 April–19 May 1936; hurricane relief at Cape Cod in September 1938. Conducted annual summer training most years at Camp Devens, MA, 1921–34 and at the Massachusetts Military Reservation at Falmouth, 1936–38. Inducted into active Federal service at Springfield, MA, on 16 January 1941 and moved to Camp Edwards, MA, where it arrived

25 January 1941. Location 7 December 1941—Camp Edwards, MA.

**Status:** Assigned to the USARS as the 104th Inf.; 1st Bn. active at Westfield, MA, as an element of the 26th Brig., 29th Inf. Div. (Light).

**Events:** 190, 280, 301, 330

**Commanders, 104th Infantry Regiment**

Col. William C. Hayes	5 August 1917–2 January 1918	Col. B. Frank Cheatham	2 October 1918–23 April 1919
Col. George H. Shelton	2 January 1918–11 July 1918	Lt. Col. Alfred F. Foote	23 April 1919–28 April 1919
Lt. Col. Alfred F. Foote	11 July 1918–16 July 1918	<i>Demobilized</i>	28 April 1919–22 June 1921
Col. Horace P. Hobbs	16 July 1918–31 July 1918	Col. Paul J. Norton	22 June 1921–June 1927
Col. Duncan K. Major Jr.	31 July 1918–13 August 1918	Col. Edmund J. Slate	19 July 1927–7 June 1933
Lt. Col. Garrison McCaskey	13 August 1918–2 October 1918	Col. Alexander MacDonald	6 July 1933–3 July 1940
	Col. John J. Higgins	5 July 1940–5 November 1942	

**105th Infantry Regiment (27th Division)**

**New York National Guard**

**HQ**—Troy, NY, 1920–40; Fort McClellan, AL, 1940–41



Arrived at the port of New York on 6 March 1919 on the U.S.S. *Leviathan* as the 105th Inf., an element of the 27th Div. Demobilized 1 April 1919 at Camp Upton, NY. Reconstituted in the N.G. on 30 December 1920, assigned to the 27th Div., and allotted to the state of New York. Reorganized 1 June 1921 by redesignation of the 2d Inf., New York N.G. (organized 3 August 1919; HQ organized 3 February 1920 and federally recognized at Troy, NY) as the 105th Inf. Conducted annual summer training most years at Camp Smith, Peekskill, NY, 1921–38. Inducted into active Federal service at Troy, NY, 15 October 1940, and moved to Fort McClellan, AL, where it arrived 25 October 1940. Location 7 December 1941—Fort McClellan, AL.

**Status:** Assigned to the USARS as the 105th Inf.; 1st Bn. active at Schenectady, NY, as an element of the 27th Inf. Brig. (Light).

**Events:** 190, 280, 301, 305, 316, 324, 328

**Commanders, 105th Infantry Regiment**

Col. James M. Andrews	5 August 1917–2 April 1919	Col. Walter G. Robinson	7 July 1926–November 1934
<i>Demobilized/Inactive</i>	2 April 1919–3 February 1920	Col. Bernard W. Kearney	27 December 1934–12 June 1937
Col. Ransom H. Gillett	3 February 1920–6 July 1926	Col. Ogden J. Ross	12 June 1937–12 September 1940
Col. Christopher B. Degenaar			12 September 1940–15 February 1942

**106th Infantry Regiment (I) (27th Division)**

**New York National Guard**

**HQ**—Brooklyn, NY, 1921–40



Arrived at the port of New York on 6 March 1919 on the U.S.S. *Leviathan* as the 106th Inf., an element of the 27th Div. Demobilized 2 April 1919 at Camp Upton, NY. Reconstituted in the N.G. on 30 December 1920, assigned to the 27th Div., and allotted to the state of New York. Reorganized by redesignation of the 23d Inf., New York N.G. (organized 1919–20; HQ organized 31 March 1920 and federally recognized at Troy, NY) as the 106th Inf. on 1 June 1921. Conducted a regimental review at Brooklyn for Queen Marie of Romania on 23 October 1926. Conducted annual summer training most years at Camp Smith, Peekskill, NY, 1921–38. Regiment, less 3d Bn., converted, reorganized, and redesignated as the 186th F.A. Regt. on 1 September 1940 and relieved from the 27th Div. Concurrently, the 3d Bn. converted, reorganized, and redesignated as the 101st M.P. Bn.

**Status:** Assigned to the CARS as the 186th F.A. Regt.; all elements inactive in the New York N.G.

**Events:** 61, 190, 301

**Commanders, 106th Infantry Regiment**

Col. Frank H. Norton	5 August 1917–26 April 1918	<i>Demobilized</i>	2 April 1919–31 March 1920
Col. Charles I. Debevoise	26 April 1918–26 June 1918	Col. Thomas Fairservis	31 March 1920–20 July 1931
Col. William A. Taylor	26 April 1918–October 1918	Col. William R. Wright	20 July 1931–12 January 1932
Col. Franklin W. Ward	October 1918–2 April 1919	Col. Frank C. Vincent	12 January 1932–12 August 1940

**106th Infantry Regiment (II) (27th Division)**

**New York National Guard**

**HQ**—*Not organized*, 1921–22; Albany, NY, 1922–40; Fort McClellan, AL, 1940–41



Arrived at the port of New York on 4 July 1919 on the U.S.S. *Wilhelmina* as the 51st Pioneer Inf. Demobilized 8 July 1919 at Camp Upton, NY. Reorganized 28 March–17 June 1921 by consolidation with, and redesignation as, the 10th Inf., New York N.G. Regimental HQ federally recognized on 22 May 1922 at Albany, NY. Attached to the 54th Inf. Brig. on 15 September 1923 for command, control, and administration. Relieved from attachment to the 54th Inf. Brig. on 26 January 1927 and assigned to the 93d Inf. Brig. The 2d Bn. was called up to perform flood relief work near Binghamton, NY, 18–20 March 1936. Conducted annual summer training most years at Camp Smith, Peekskill, NY, 1921–39. Relieved from the 93d Inf. Brig. on 1 June 1940. Assigned to the 27th Div. on 1 September 1940. Inducted into active Federal service at Albany, NY, on 15 October 1940 and moved to Fort McClellan, AL, where it arrived on 25 October 1940. Regiment redesignated as the

106th Inf. Regt. on 11 December 1940. Location 7 December 1941—Fort McClellan, AL.

**Organization Day:** 3 March. Chosen to commemorate the regiment's original organization on 3 March 1855.

**Status:** As the 210th Armor, consolidated with the 101st Cavalry on 1 September 1993 and assigned to the USARS as the 101st Cavalry; 1st Squadron active at Staten Island, NY, as an element of the 42d Inf. Div.,

**Events:** 316, 324, 328

**Commanders, 106th Infantry Regiment**

Col. Thomas C. Dedell	11 December 1940–9 January 1942
-----------------------	---------------------------------

**107th Infantry Regiment (27th Division)****New York National Guard**

**HQ**—*Not organized*, 1921–22; New York City, NY, 1922–40



Arrived at the port of New York on 6 March 1919 on the U.S.S. *Leviathan* as the 107th Inf., an element of the 27th Div. Demobilized 2 April 1919 at Camp Upton, NY. Reconstituted in the N.G. on 30 December 1920, assigned to the 27th Div., and allotted to the state of New York. Partially reorganized 1 June 1921 by consolidation with the active elements of the 7th Inf., New York N.G. and redesignation as the 107th Inf. Regimental HQ organized on 6 January 1922 and federally recognized at New York City, NY. Conducted annual summer training most years at Camp Smith, Peekskill, NY, 1921–38. Regiment converted, reorganized, and redesignated as the 207th C.A. Regt. on 1 August 1940.

**Status:** Active at New York, NY, as HHC, 107th Support Group.

**Events:** 61, 280, 301

**Commanders, 107th Infantry Regiment**

Col. Willard C. Fiske	5 August 1917–16 June 1918	<i>Demobilized/Inactive</i>	2 April 1919–6 January 1922
Col. Charles I. Debevoise	26 July 1918–20 October 1918	Col. Wade H. Hayes	6 January 1922–February 1930
Col. Mortimer D. Bryant	20 October 1918–2 April 1919	Col. Ralph C. Tobin	February 1930–1 August 1940

**108th Infantry Regiment (27th Division)****New York National Guard**

**HQ**—Syracuse, NY, 1920–40; Fort McClellan, AL, 1940–41



Arrived at the port of New York on 6 March 1919 on the S.S. *Mauritania* as the 108th Inf., an element of the 27th Div. Demobilized 31 March 1919 at Camp Upton, NY. Reconstituted in the N.G. on 30 December 1920, assigned to the 27th Div., and allotted to the state of New York. Reorganized 1 June 1921 by redesignation of the 3d Inf., New York N.G. (organized 1 August 1919; HQ organized 24 April 1920 and federally recognized at Syracuse, NY) as the 108th Inf. Elements were called up to perform flood relief work near Binghamton, NY, 18–20 March 1936. Conducted annual summer training most years at Camp Smith, Peekskill, NY, 1921–38. Inducted into active Federal service at Syracuse, NY, 15 October 1940, and moved to Fort McClellan, AL, where it arrived 26 October 1940. Location 7 December 1941—Fort McClellan, AL.

**Status:** Assigned to the USARS as the 108th Inf.; 1st Bn. active at Auburn, NY, and 2d Bn. active at Utica, NY, as elements of the 27th Inf. Brig. (Light).

**Events:** 190, 301, 316, 324, 328

**Commanders, 108th Infantry Regiment**

Col. Edgar S. Jennings	5 August 1917–31 March 1919	Col. John S. Thompson	24 April 1920–17 December 1930
<i>Demobilized/Inactive</i>	31 March 1919–24 April 1920	Col. Samuel H. Merrill	19 January 1931–23 September 1940
	Col. Charles N. Morgan		23 September 1940–February 1942

**109th Infantry Regiment (28th Division)****Pennsylvania National Guard**

HQ—Wilkes-Barre, PA, 1921–23; Scranton, PA, 1923–41; Indiantown Gap, PA, 1941



Arrived at the port of New York on 3 May 1919 on the U.S.S. *Maui* as the 109th Inf., an element of the 28th Div. Demobilized 20 May 1919 at Camp Dix, NJ. Reconstituted in the N.G. in 1921, assigned to the 28th Div., and allotted to the state of Pennsylvania. Reorganized 1 April 1921 by redesignation of the 13th Inf., Pennsylvania N.G. (organized 1919–20 as the 13th Inf., Pennsylvania N.G.) as the 109th Inf. HQ organized 20 December 1921 and federally recognized at Wilkes-Barre, PA. HQ relocated in 1923 to Scranton, PA. Entire regiment called up to perform relief duties in connection with the flooding of the Schuylkill and Susquehanna Rivers in April 1936. Conducted annual summer training most years at Mount Gretna, PA, 1921–34, and Indiantown Gap, PA, 1936–38. Inducted into

active Federal service at Scranton, PA, 17 February 1941, and moved to Indiantown Gap, PA, where it arrived 1 March 1941. Location 7 December 1941—Indiantown Gap, PA.

**Status:** Assigned to the CARS as the 109th Inf.; 1st Bn. active at Scranton, PA, as an element of the 28th Inf. Div.

**Events:** 191, 203, 281, 301, 330

**Commanders, 109th Infantry Regiment**

Col. Millard D. Brown	5 August 1917–31 December 1917	Lt. Col. Henry W. Coulter	9 September 1918–20 September 1918
Lt. Col. A. L. Fritzinger	31 December 1917–20 January 1918	Col. William M. Inglis (WA)	20 September 1918–1 October 1918
Lt. Col. Wallace W. Fetzer	20 January 1918–15 April 1918	Col. Austin F. Prescott	3 October 1918–8 March 1919
Col. Millard D. Brown	15 April 1918–31 July 1918	Col. William R. Dunlap	8 March 1919–16 May 1919
Lt. Col. Henry W. Coulter	15 April 1918–15 August 1918	<i>Demobilized</i>	16 May 1919–19 December 1921
Col. Samuel V. Ham	17 August 1918–6 September 1918	Col. Robert M. Vail	20 December 1921–12 January 1939
Lt. Col. Edward Martin	6 September 1918–9 September 1918	Col. Stanley F. Coar	13 January 1939–17 March 1942

**110th Infantry Regiment (28th Division)****Pennsylvania National Guard**

HQ—Waynesburg, PA, 1920–23; Washington, PA, 1923–41; Indiantown Gap, PA, 1941

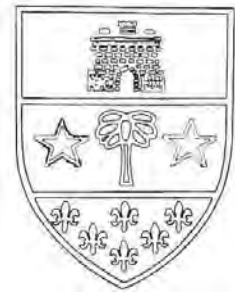

Arrived at the port of Philadelphia on 11 May 1919 on the U.S.S. *Luckenbach* as the 110th Inf., an element of the 28th Div. Demobilized 24 May 1919 at Camp Dix, NJ. Reconstituted in the N.G. in 1921, assigned to the 28th Div., and allotted to the state of Pennsylvania. Reorganized 1 April 1921 by redesignation of the 10th Inf., Pennsylvania N.G. (organized 16 October 1919; HQ organized 20 July 1920 and federally recognized at Waynesburg, PA) as the 110th Inf. HQ relocated in 1923 to Washington, PA. Entire regiment called up to perform relief duties in connection with the flooding of the Schuylkill and Susquehanna Rivers in April 1936. Conducted annual summer training most years at Mount Gretna, PA, 1921–34, and Indiantown Gap, PA, 1935–38. Inducted into active Federal service at Washington, PA, on 17 February 1941 and moved to Indiantown Gap, PA, where it arrived 28 February 1941. Location 7 December 1941—Indiantown Gap, PA.

**Status:** Assigned to the USARS as the 110th Inf.; 1st Bn. active at Mount Pleasant, PA, as an element of the 28th Inf. Div.

**Events:** 191, 203, 281, 301, 330

**Commanders, 110th Infantry Regiment**

Col. Richard Coulter	15 July 1917–5 August 1917	Maj. John Aiken	12 January 1919–22 January 1919
Lt. Col. Henry W. Coulter	5 August 1917–1 December 1917	Col. Henry L. Kinneson	22 January 1919–16 March 1919
Col. George E. Kemp	1 December 1917–28 December 1917	Lt. Col. John Aiken	16 March 1919–12 April 1919
Lt. Col. Henry W. Coulter	28 December 1917–3 July 1918	Col. Joseph H. Thompson	12 April 1919–15 May 1919
Col. George E. Kemp	3 July 1918–29 July 1918	Lt. Col. John Aiken	15 May 1919–23 May 1919
Col. Frank Tompkins	12 August 1918–7 September 1918	<i>Demobilized/Inactive</i>	23 May 1919–16 October 1919
Lt. Col. Edward Martin	7 September 1918–14 October 1918	Col. Edward Martin	29 July 1920–17 August 1922
Col. Blanton Winship	14 October 1918–26 November 1918	Col. John Aiken	17 August 1922–30 November 1939
Col. Samuel V. Ham	26 November 1918–12 January 1919	Col. Albert O. King	30 November 1939–26 December 1941

**111th Infantry Regiment (28th Division)****Pennsylvania National Guard**

HQ—Philadelphia, PA, 1921–41; Indiantown Gap, PA, 1941



Arrived at the port of New York on 27 April 1919 on the U.S.S. *Minnesotan* as the 111th Inf., an element of the 28th Div. Demobilized 24 May 1919 at Camp Dix, NJ. Reconstituted in the N.G. in 1921, assigned to the 28th Div., and allotted to the state of Pennsylvania. Reorganized 1 April 1921 by consolidation and redesignation of the 3d and 6th Inf. Regts., Pennsylvania N.G. (3d Inf. organized 16 October 1919; HQ concurrently organized and federally recognized at Philadelphia, PA) as the 111th Inf. Entire regiment called up to perform relief duties in connection with the flooding of the Schuylkill and Susquehanna Rivers in April 1936. Conducted annual summer training most years at Mount Gretna, PA, 1921–34, and Indiantown Gap, PA, 1935–38. Inducted into active Federal service at Philadelphia, PA, 17 February 1941, and moved to Indiantown Gap, PA, where it arrived 27 February 1941. Location 7 December 1941—Indiantown Gap, PA.

**Status:** Assigned to the USARS as the 111th Inf.; 1st Bn. active at Plymouth Meeting, PA, as an element of the 28th Inf. Div.

**Events:** 191, 203, 281, 301, 330

**Commanders, 111th Infantry Regiment**

Col. Edward L. Kearns	5 August 1917–6 December 1917	Col. Edward C. Shannon	15 November 1918–24 May 1919
Col. Edward C. Shannon	6 December 1917–1 January 1918	<i>Demobilized</i>	24 May 1919–3 August 1921
Lt. Col. Bertram L. Succop	1 January 1918–11 April 1918	Col. Robert M. Brookfield	3 August 1921–1 March 1926
Col. Edward C. Shannon	11 April 1918–11 October 1918	Col. Charles B. Finley	1 March 1926–15 February 1932
Col. Carroll F. Armistead	14 October 1918–15 November 1918	Col. Frank A. Warner	15 February 1932–19 November 1940
	Col. Franklin P. Holler		22 November 1940–January 1942

**112th Infantry Regiment (28th Division)****Pennsylvania National Guard**

HQ—Grove City, PA, 1921–37; Kane, PA, 1937–41; Indiantown Gap, PA, 1941

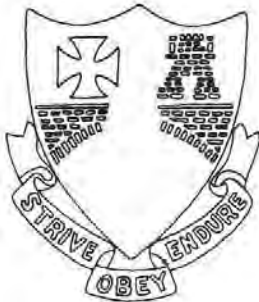

Arrived at the port of Newport News on 4 May 1919 on the U.S.S. *Mercury* as the 112th Inf., an element of the 28th Div. Demobilized 6 May 1919 at Camp Dix, NJ. Reconstituted in the N.G. in 1921, assigned to the 28th Div., and allotted to the state of Pennsylvania. Reorganized 1 April 1921 by redesignation of the 16th Inf., Pennsylvania N.G. (organized 16 October 1919; HQ organized 30 July 1920 and federally recognized at Grove City, PA) as the 112th Inf. Participated in the 150th Anniversary of Cornwallis' surrender at Yorktown, VA, in October 1931. The 2d Bn. called up for strike duty in the coal fields around Brownsville, PA, in June 1933. Entire regiment called up to perform relief duties in connection with the flooding of the Schuylkill and Susquehanna Rivers in April 1936. Regimental HQ relocated 1 August 1937 to Kane, PA. Conducted annual summer training most years at Mount Gretna, PA, 1921–34 and Indiantown Gap, PA, 1935–38. Inducted

into active Federal service at Kane, PA, 17 February 1941, and moved to Indiantown Gap, PA, where it arrived 27 February 1941. Location 7 December 1941—Indiantown Gap, PA.

**Status:** Assigned to the USARS as the 112th Inf.; 1st Bn. active at Erie, PA, and 2d Bn. active at Lewistown, PA, as elements of the 28th Inf. Div.

**Events:** 137, 191, 203, 281, 301, 330

**Commanders, 112th Infantry Regiment**

Col. George C. Rickards	5 August 1917–21 September 1918	Col. George C. Rikards	13 October 1918–6 May 1919
Lt. Col. John P. Bubb	21 September 1918–30 September 1918	<i>Demobilized</i>	7 May 1919–29 July 1920
Lt. Col. James A. Shannon	30 September 1918–7 October 1918	Col. Charles B. Smathers	30 July 1920–27 April 1937
Col. Blanton Winship	7 October 1918–13 October 1918	Col. Monroe A. Means	27 April 1937–28 November 1940
	Col. Joseph R. Carvolth		6 December 1940–January 1942

**113th Infantry Regiment (44th Division)****New Jersey National Guard**

HQ—Newark, NJ, 1921–40; Fort Dix, NJ, 1940–41



Arrived at the port of New York on 14 May 1919 on the U.S.S. *Calamares* as the 113th Inf., an element of the 29th Div. Demobilized 28 May 1919 at Camp Dix, NJ. Reconstituted in the N.G. in 1921 and allotted to the state of New Jersey. Concurrently relieved from the 29th Div. Reorganized 17 June 1921 by redesignation of the 6th Inf., New Jersey N.G. (organized 20 August 1919; HQ organized 13 November 1919 and federally recognized at Newark, NJ) as the 113th Inf. Concurrently assigned to the 44th Div. Conducted annual summer training most years at Sea Girt, NJ, 1921–38. Inducted into active Federal service at Newark, NJ, 16 September 1940 and moved to Fort Dix, NJ, where it arrived 25 September 1940. Location 7 December 1941—Fort Dix, NJ.

**Status:** Assigned to the USARS as the 113th Inf.; 2d Bn. active at Riverdale, NJ, as an element of the 42d Inf. Div. (Mecz).

**Events:** 190, 210, 280, 301, 330

**Commanders, 113th Infantry Regiment**

Col. John D. Fraser	5 August 1917–9 January 1918	Col. Edward Phillips	5 January 1921–4 May 1932
Col. Harry C. Jones	9 January 1918–18 September 1918	Col. Clyde E. Winterton	4 May 1932–29 January 1937
Lt. Col. William R. Pope	12 September 1918–2 October 1918	Col. John F. Lee, Jr.	29 January 1937–8 September 1940
Col. George M. Bomford	2 October 1918–9 October 1918	Lt. Col. Frederick S. Taggart	8 September 1940–7 October 1940
Col. William R. Rope	9 October 1918–24 December 1918	Col. Julius O. Adler (OR)	7 October 1940–13 July 1941
Col. Charles B. Finley	24 December 1918–28 May 1919	Lt. Col. Paul M. Cairn	13 July 1941–4 October 1941
<i>Demobilized/Inactive</i>	28 May 1919–4 January 1921	Col. Manton S. Eddy (RA)	5 October 1941–11 December 1941

**114th Infantry Regiment (44th Division)****New Jersey National Guard**

HQ—Paterson, NJ, 1921–22; Camden, NJ, 1922–40; Fort Dix, NJ, 1940–41

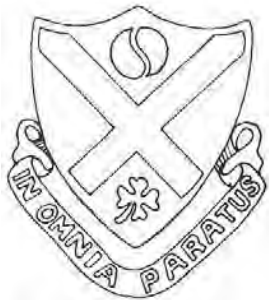

Arrived at the port of New York on 6 May 1919 on the U.S.S. *Madawaska* as the 114th Inf., an element of the 29th Div. Demobilized 14 May 1919 at Camp Dix, NJ. Reconstituted in the N.G. in 1921 and allotted to the state of New Jersey. Concurrently relieved from the 29th Div. Reorganized 17 June 1921 by redesignation of the 3d Inf., New Jersey N.G. (organized in 1920; HQ organized 3 December 1920 and federally recognized at Paterson, NJ) as the 114th Inf. Concurrently assigned to the 44th Div. HQ relocated in 1922 to Camden, NJ. Conducted annual summer training most years at Sea Girt, NJ, 1921–38. Inducted into active Federal service at Newark, NJ, 16 September 1940 and moved to Fort Dix, NJ, where it arrived 23 May 1940. Location 7 December 1941—Fort Dix, NJ.

**Status:** Assigned to the USARS as the 114th Inf.; 1st Bn. active at Woodbury, NJ, as an element of the 42d Inf. Div. (Mecz).

**Events:** 190, 210, 280, 301, 330

**Commanders, 114th Infantry Regiment**

Col. A. A. Van Walraven	5 August 1917–5 December 1917	<i>Demobilized</i>	15 May 1919–23 December 1920
Col. Thomas D. Landon	5 December 1917–18 January 1918	Col. Winfield S. Price	23 December 1920–10 December 1921
Lt. Col. Fred G. Stritzinger	18 January 1918–18 February 1918	Col. Walter E. Guthrie	10 December 1921–31 May 1924
Col. Thomas D. Landon	18 February 1918–7 August 1918	Col. Edward B. Stone	30 June 1924–ao September 1931
Lt. Col. George M. Buttle	7 August 1918–7 September 1918	Lt. Col. George L. Selby	ao July 1936–3 September 1936
Col. R. C. Williams	7 September 1918–27 September 1918	Col. Clifford R. Powell	4 September 1936–14 February 1937
Col. Hobart B. Brown	27 September 1918–14 May 1919	Col. George E. Jemison	29 March 1937–8 September 1940
	Col. Theodore F. Voelter		8 September 1940–12 December 1941



**115th Infantry Regiment (29th Division)****Maryland National Guard****HQ**—Frederick, MD, 1921–41; Fort George G. Meade, MD, 1941

Arrived at the port of Newport News on 24 May 1919 on the U.S.S. *Artemis* as the 115th Inf., an element of the 29th Div. Demobilized 7 June 1919 at Camp George G. Meade, MD. Reconstituted in the N.G. in 1921, assigned to the 29th Div., and allotted to the state of Maryland. Reorganized as the 1st Inf., Maryland N.G., 1919–23. HQ organized 22 January 1921 and federally recognized at Frederick, MD. Conducted annual summer training most years at Cascade, MD, 1921–39. Redesignated 115th Inf. on 1 January 1941. Inducted into active Federal service at Frederick on 3 February 1941 and moved to Fort George G. Meade, MD, where it arrived on 18 February 1941. Location 7 December 1941—Fort George G. Meade, MD.

**Status:** Assigned to the USARS as the 115th Inf.; 1st Bn. active at Silver Spring, MD, and 2d Bn. active at Chestertown, MD, as elements of the 29th Inf. Div. (Light).

**Events:** 191, 281, 330

**Commanders, 115th Infantry Regiment**

Col. Charles A. Little	5 August 1917–5 December 1917	Col. Milton A. Reckord	17 April 1918–7 June 1919
Col. Thomas D. Landon	5 December 1917–29 December 1917	<i>Demobilized</i>	7 June 1919–21 January 1921
Col. Frank B. Watson	29 December 1917–17 April 1918	Col. John D. Markey	22 January 1921–1 January 1941

**116th Infantry Regiment (29th Division)****Virginia National Guard****HQ**—*Not organized*, 1921–22; Staunton, VA, 1922–33; Lynchburg, VA, 1933–41; Fort George G. Meade, MD, 1941

Arrived at the port of Newport News on 22 May 1919 on the U.S.S. *Matsonia* as elements of the 116th Inf., an element of the 29th Div. Demobilized 30 May 1919 at Camp Lee, VA. Reconstituted in the N.G. in 1921, assigned to the 29th Div., and allotted to the state of Virginia. Reorganized 12 October 1921 as the 2d Inf., Virginia N.G. Redesignated 116th Inf. on 9 March 1922. HQ organized on 3 April 1922 and federally recognized at Staunton, VA. HQ relocated on 26 June 1933 to Lynchburg, VA. The regiment, or elements thereof, were called up to perform the following state duties: elements for assistance to law enforcement in capturing outlaws after the murder of a deputy sheriff at News Ferry, VA, in 1921; strike duty at the Dan River Cotton Mills, Schoolfield, VA, 25 November 1930–24 January 1931; elements for riot control in Rockingham County, April–May 1932.

Conducted annual summer training most years at Virginia Beach, VA, 1921–38. Inducted into active Federal service at Lynchburg on 3 February 1941 and moved to Fort George G. Meade, MD, where it arrived 20 February 1941. Location 7 December 1941—Fort George G. Meade, MD.

**Status:** Assigned to the USARS as the 116th Inf.; 1st Bn. active at Roanoke, VA, 2d Bn. active at Lynchburg, VA, and 3d Bn. active at Winchester, VA, as elements of the 29th Inf. Div. (Light).

**Events:** 191, 281, 301, 330

**Commanders, 116th Infantry Regiment**

Col. Robert F. Leedy	5 August 1917–29 December 1917	Col. Reginald Kelley	12 October 1918–1 December 1918
Col. Hansford L. Threlkeld	29 December 1917–18 January 1918	Col. George W. Ball	1 December 1918–23 April 1919
Col. William J. Perry	18 January 1918–1 June 1918	Col. FitzHugh L. Minnigerode	23 April 1919–30 May 1919
Lt. Col. Hobart B. Brown	1 June 1918–26 June 1918	<i>Demobilized/Inactive</i>	31 May 1919–2 April 1922
Col. Hansford L. Threlkeld	26 June 1918–21 August 1918	Col. Hierome L. Opie	3 April 1922–26 June 1933
Col. Archie J. Harris	21 August 1918–12 October 1918	Col. George M. Alexander	26 June 1933–6 June 1940
	Col. Evarts W. Opie		6 June 1940–10 October 1942

**117th Infantry Regiment (30th Division)****Tennessee National Guard****HQ**—Chattanooga, TN, 1918–23; Knoxville, TN, 1923–33; Jackson, TN 1933–40; Fort Jackson, SC, 1940–41

Arrived at the port of Charleston on 27 March 1919 on the U.S.S. *Pocahontas* as the 117th Inf., an element of the 30th Div. Demobilized 17 April 1919 at Fort Oglethorpe, GA. Reconstituted in the N.G. in 1921, assigned to the 30th Div., and allotted to the state of Tennessee. Reorganized 30 April 1921 by consolidation with the 4th Inf., Tennessee N.G. (HQ organized 28 April 1918 and federally recognized at Chattanooga, TN) and redesignation as the 117th Inf. Federal recognition withdrawn on 15 October 1921. HQ relocated to Knoxville, TN, and federally recognized on 24 April 1923. HQ relocated 1 October 1933 to Jackson, TN. The regiment, or elements thereof, were called up to perform the following state duties: two companies performed escort duty in connection

with protecting civil prisoners at Springfield, TN, 21 July 1932; flood relief duties along the Arkansas River near Memphis, TN, in January 1937; 1st Bn. for riot control at a workers strike at Alcoa, TN, 7–14 July 1937; riot control at the Democratic Party primary election in Memphis, TN, 30 July 1938. Conducted annual summer training at Camp John Sevier, SC; Camp Jackson, SC; and most years at Camp Peay, TN. Inducted into active Federal service at Jackson, TN, on 16 September 1940 and moved to Fort Jackson, SC, where it arrived 24 September 1940. Location 7 December 1941—Fort Jackson, SC.

**Status:** HHC active at Jackson, TN, as HHC, 230 Support Group; other elements active as units of the 278th Armd. Cav. Regt.

**Events:** 255, 300, 316, 330**Commanders, 117th Infantry Regiment**

Col. Cary F. Spence	5 August 1917–27 December 1917	<i>Demobilized/Inactive</i>	21 May 1919–11 November 1919
Col. Hugh D. Berkeley	28 December 1917–1 April 1918	Col. Herschel M. Candler	12 November 1919–23 April 1923
Col. Cary F. Spence	1 April 1918–20 May 1919	Col. Roy S. Rochelle	24 April 1923–1 October 1933
	Col. Robert H. Bond		1 October 1933–11 August 1942

**118th Infantry Regiment (30th Division)****South Carolina National Guard****HQ**—Columbia, SC, 1921–32; Charleston, SC, 1932–40; Fort Jackson, SC, 1940–41

Arrived at the port of Charleston on 27 March 1919 on the U.S.S. *Pocahontas* as the 188th Inf., an element of the 30th Div. Demobilized 1 April 1919 at Camp Jackson, SC. Reconstituted in the N.G. in 1921, assigned to the 30th Div., and allotted to the state of South Carolina. Reorganized 19 December 1921 by redesignation of the 1st Inf., South Carolina N.G. (HQ organized 28 April 1918 and federally recognized at Columbia, SC) as the 118th Inf. HQ relocated 5 December 1932 to Charleston, SC. The regiment, or elements thereof, called up to perform the following state duties: regiment performed riot control for merchant marine strike at Charleston in May 1921; 1st Bn. performed riot control for elections at Mayond, SC, in 1923; elements performed riot control duty in Abbeville and

Walterboro, SC, 8–19 April 1932; regiment performed riot control for textile workers' strike at Spartanburg, Greenville, and Chester, SC, in 1934. Conducted annual summer training most years at Camp Jackson, SC, 1921–39. Inducted into active Federal service at Charleston on 16 September 1940 and moved to Fort Jackson, SC, where it arrived 21 September 1940. Location 7 December 1941—Fort Jackson, SC.

**Status:** Assigned to the USARS as the 118th Inf.; 1st Bn. active at Mount Pleasant, SC, and 4th Bn. active at Union, SC, as elements of the 218th Inf. Brig. (Separate).

**Events:** 255, 300, 316, 330**Commanders, 118th Infantry Regiment**

Col. Peter K. McCully Jr.	5 August 1917–28 December 1917	Lt. Col. Thomas B. Spratt	March 1919–9 March 1919
Col. Harry H. Pattison	28 December 1917–1 April 1918	Col. George H. Healy	9 March 1919–31 March 1919
Col. Peter K. McCully Jr.	1 April 1918–ao July 1918	<i>Demobilized/Inactive</i>	1 April 1919–28 July 1921
Col. Orrin R. Wolfe	ao August 1918–March 1919	Col. Trelawney E. Marchant	28 July 1921–22 November 1932
	Col. Harry O. Withington		5 December 1932–ao September 1941

**120th Infantry Regiment (30th Division)****North Carolina National Guard****HQ**—Graham, NC, 1921–37; Raleigh, NC, 1937–40; Fort Jackson, SC, 1940–41

Arrived at the port of Charleston in April 1919 on the U.S.S. *Martha Washington* as the 120th Inf., an element of the 30th Div. Demobilized 17 April 1919 at Camp Jackson, SC. Reconstituted in the N.G. in 1921, assigned to the 30th Div., and allotted to the state of North Carolina. Reorganized 8 November 1921 by redesignation of the 1st Inf., North Carolina N.G. (organized 1919–20; HQ organized 2 May 1921 and federally recognized at Graham, NC) as the 120th Inf. HQ relocated 25 January 1937 to Raleigh, NC. The regiment, or elements thereof, called up to perform the following state duties: riot control for a race riot in Goldsboro, NC, in 1920; riot control for the railroad strike throughout North Carolina, 17 July–31 August 1922; riot control for elections at Mayodan, NC, in 1923; riot control for textile workers' strike at Kannapolis, NC, in 1923; riot control for workers' strike at Pittsboro, NC, in 1927; elements of 2d and 3d Bns. performed

riot control for textile workers' strike at Gastonia, NC, in April 1929; riot control for textile workers' strike in Burlingame and Alamance County, NC, 15–25 September 1934; riot control for textile workers' strike at Reidsville, NC, in September 1935. Conducted annual summer training most years at Camp Glenn, NC, and some years at Camp Jackson, SC. Inducted into active Federal service at Raleigh, NC, 16 September 1940, and moved to Fort Jackson, SC, where it arrived 22 September 1940. Location 7 December 1941—Fort Jackson, SC.

**Status:** Assigned to the USARS as the 120th Inf.; 1st Bn. active at Wilmington, NC, as an element of the 30th Inf. Brig.

**Events:** 255, 300, 316, 330

**Commanders, 120th Infantry Regiment**

Col. Sidney W. Minor	5 August 1917–28 December 1917	Col. Don E. Scott	9 March 1919–17 April 1919
Col. William B. Cochran	28 December 1917–9 April 1918	<i>Demobilized/Inactive</i>	17 April 1919–1 May 1921
Col. Sidney W. Minor	9 April 1918–9 March 1919	Col. Don E. Scott	2 May 1921–25 January 1937
	Col. John H. Manning	1 February 1937–October 1942	

**121st Infantry Regiment (30th Division)****Georgia National Guard****HQ**—Macon, GA, 1921–40; Fort Jackson, SC, 1940–41

Demobilized 14 January 1919 at Camp Gordon, GA, as the 121st Inf., an element of the 31st Div. Reconstituted in the N.G. in 1921 and allotted to the state of Georgia. Concurrently relieved from the 31st Div. and assigned to the 30th Div. Reorganized 27 April 1922 by redesignation of the 1st Inf., Georgia N.G. (organized 2 August–1929 November 1920 as 2d Bn., 1st Inf., Georgia N.G.; battalion expanded and reorganized 31 May 1921 as the 1st Inf., Georgia N.G.; HQ concurrently organized and federally recognized at Macon, GA) as the 122d Inf. Redesignated 121st Inf. on 9 June 1924 and assigned to the 30th Div. The regiment, or elements thereof, called up to perform the following state duties: entire regiment (already on Active Duty for training during the hurricane that struck its

camp at Tybee Island) for hurricane relief in July 1925 in southeast Georgia; entire regiment for riot control during the textile workers' strike in Griffin, Jackson, and Rome, GA, 16–24 September 1934. A regimental contingent was sent to Washington, DC, to march in the inaugural parade of President Franklin D. Roosevelt on 4 March 1933. Conducted annual summer training at numerous locations to include: St. Simons Island, GA; Tybee Island, GA; Camp McClellan, AL; Camp Jackson, SC; and Camp J. Clifford R. Foster, FL. Inducted into active Federal service at Macon, GA, 16 September 1940, and moved to Fort Jackson, SC, where it arrived 23 September 1940. Relieved from the 30th Div. on 22 November 1941 and assigned to the 8th Div. Location 7 December 1941—Fort Jackson, SC.

**Status:** Assigned to the USARS as the 121st Inf.; 1st Bn. active at Winder, GA, and 2d Bn. active at Albany, GA, as elements of the 48th Inf. Brig. (Mecz).

**Events:** 255, 300, 316, 330

### Commanders, 121st Infantry Regiment

Col. James A. Thomas	5 August 1917–27 December 1917	Lt. Col. William M. Wilder	16 October 1918–14 January 1919
Maj. William M. Wilder	27 December 1917–7 January 1919	<i>Demobilized/Inactive</i>	15 January 1919–30 March 1921
Col. Benjamin B. Hyer	7 January 1918–8 April 1918	Col. Henry D. Russell	31 March 1921–8 January 1923
Col. James A. Thomas	8 April 1918–16 October 1918	Col. Lewis C. Pope	8 January 1923–September 1941
	Col. Aaron J. Becker (RA)		September 1941–August 1942

### 122d Infantry Regiment (I) (30th Division)

### Georgia National Guard

HQ—Macon, GA, 1921–24

Demobilized 14 January 1919 at Camp Gordon, GA, as the 121st Inf., an element of the 31st Div. Reconstituted in the N.G. in 1921 and allotted to the state of Georgia. Concurrently relieved from the 31st Div. and assigned to the 30th Div. Reorganized 27 April 1922 by redesignation of the 1st Inf., Georgia N.G. (organized 2 August–29 November 1920 as 2d Bn., 1st Inf., Georgia N.G.; battalion expanded and reorganized 31 May 1921 as the 1st Inf., Georgia N.G.; HQ concurrently organized and federally recognized at Macon, GA) as the 122d Inf. The 3d Bn. called up to perform railroad strike duty at Waycross, GA, 18 July–16 September 1922. Conducted annual summer training at St. Simons Island, GA, 1921–24. Redesignated 121st Inf. on 9 June 1924 and assigned to the 30th Div.

### Commanders, 122d Infantry Regiment (I)

Col. James A. Thomas	5 August 1917–7 January 1918	Lt. Col. William M. Wilder	16 October 1918–14 January 1919
Col. Benjamin B. Hyer	7 January 1918–10 April 1918	<i>Demobilized/Inactive</i>	15 January 1919–30 March 1921
Col. James A. Thomas	10 April 1918–16 October 1918	Col. Henry D. Russell	31 March 1921–8 January 1923
	Col. Lewis C. Pope		8 January 1923–9 June 1924

### 122d Infantry Regiment (II) (Separate)

### Georgia National Guard

HQ—*Not organized*, 1921–24; Atlanta, GA, 1924–39

Demobilized 14 January 1919 at Camp Gordon, GA, as the 122d Inf., an element of the 31st Div. Reconstituted in the N.G. in 1921 and allotted to the state of Georgia. Reorganized 27 February 1924 by expansion and redesignation of the 2d Bn., 122d Inf. (organized 18 October 1921 as the 2d Bn., 1st Inf., Georgia N.G.; redesignated 27 April 1922 as the 2d Bn., 122d Inf.) as the 200th Inf. HQ organized 10 March 1924 and federally recognized at Atlanta, GA. Redesignated 122d Inf. on 9 June 1924. The regiment, or elements thereof, called up to perform the following state duties: 2d Bn. for riot duty in connection with mill workers strike in Waycross, GA, in September 1923; riot duty in connection with mill workers strike in Cartersville, GA, in October 1931; 3d Bn. for riot duty in connection with prisoners on trial in Elberton, GA, 18–30 May 1931; entire regiment for riot duty in Atlanta on 4 March 1933; entire regiment for riot control during the textile workers' strike at various locations in Georgia, 16–24 September 1934. Assigned to Third Army on 1 October 1933. Conducted annual summer training at numerous locations to include: Tybee Island, GA; St. Simons Island, GA; Camp Jackson, SC; and most years at Camp McClellan, AL. Regiment, less 3d Bn., converted, reorganized, and redesignated as the 179th F.A. Regt. on 1 July 1939. Concurrently, 3d Bn. converted, reorganized, and redesignated 2d Bn., 214th C.A.

**Status:** Assigned to the CARS as the 179th F.A. Regt.; all elements inactive in the Georgia N.G.

**Events:** 255

### Commanders, 122d Infantry Regiment (II)

Col. Orville H. Hall	5 August 1917–19 September 1918	Col. Charles H. Cox	10 March 1924–16 September 1929
Col. Campbell B. Hodges	20 September 1918–31 March 1919	Col. Gerald P. O'Keeffe	16 September 1929–12 June 1933
<i>Demobilized/Inactive</i>	15 January 1919–27 February 1924	Col. Thomas L. Alexander	12 June 1933–1 July 1939

**124th Infantry Regiment (31st Division)****Florida National Guard**

**HQ**—Jacksonville, FL, 1921–25; Plant City, FL, 1925–29; Jacksonville, FL, 1929–40; Camp Blanding, FL, 1940–41

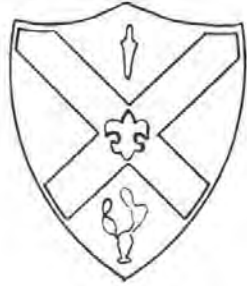

Demobilized 14 January 1919 at Camp Gordon, GA, as the 124th Inf., an element of the 31st Div. Reconstituted in the N.G. in 1921 and allotted to the state of Florida. Concurrently relieved from the 31st Div. and assigned to the 39th Div. Reorganized 19 December 1921 by redesignation of the 1st Inf., Florida N.G. (HQ organized 4 June 1921 and federally recognized at Jacksonville, FL) as the 154th Inf. Relieved from the 39th Div. on 1 July 1923 and assigned to the 31st Div. Redesignated 124th Inf. on 28 May 1924. HQ successively relocated as follows: to Plant City, FL, 7 October 1925, and to Jacksonville, FL, 26 January 1929. The regiment, or elements thereof, called up to perform the following state duties: relief work and guard duty to prevent looting after the hurricanes of September 1926, September 1928, and September 1935; 3d Bn. for riot duty and protection of jailed prisoners from a mob in Tampa, FL, 31 May–6 June 1927; 1st Bn.

and elements of the 2d and 3d Battalions for guard duties in connection with the Mediterranean Fruit Fly quarantine in South Florida in July 1928–June 1930; Co. H guarded Guiseppe Zangora, would-be assassin of President Franklin D. Roosevelt, at Raiford, FL, in March 1932; A & B Cos. for guard and security duties in connection with the visit of Cuban national officials to Hollywood, FL, 7–9 June 1932; elements for guard and security duties in connection with the visit of President Roosevelt to Winter Park, FL, in March 1935. Conducted annual summer training at Camp Joseph E. Johnston, FL, and Camp J. Clifford R. Foster, FL, and some years at Camp McClellan, AL. Inducted into active Federal service at Jacksonville on 24 November 1940 and moved to Camp Blanding, FL, where it arrived 18 December 1940. Location 7 December 1941—Camp Blanding, FL.

**Status:** Assigned to the USARS as the 124th Inf.; 1st Bn. active at Miami, FL, 2d Bn. active at Orlando, FL, and 3d Bn. active at Panama City, FL, as elements of the 53d Inf. Brig.

**Events:** 255, 300, 324, 328, 330

**Commanders, 124th Infantry Regiment**

Lt. Col. Samuel J. Wolf	4 September 1917–26 October 1917	Col. Ralph C. Turck	1 July 1923–29 September 1925
Col. William J. Vaiden	26 October 1917–1 January 1918	Col. Vivian Collins	30 September 1925–25 January 1929
Col. Walter S. McBroom	1 January 1918–13 April 1918	Col. Chester H. Wilson	26 January 1929–13 July 1934
Col. William J. Vaiden	14 April 1918–30 May 1918	Col. Preston Ayers	14 July 1934–20 August 1940
Col. Richmond Smith	19 September 1918–14 January 1919	Lt. Col. Joseph C. Hutchison	21 August 1940–19 November 1940
<i>Demobilized/Inactive</i>	15 January 1919–30 June 1923	Col. Fred A. Safay	19 November 1940–1 October 1942

**125th Infantry Regiment (32d Division)****Michigan National Guard**

**HQ**—*Not organized*, 1921–22; Flint, MI, 1922–27; Detroit, MI, 1927–40; Camp Beauregard, LA, 1940–41; Camp Livingston, LA, 1941



Arrived at the port of New York on 9 May 1919 on the U.S.S. *Great Northern* as the 125th Inf., an element of the 32d Div. Demobilized 22 May 1919 at Camp Custer, MI. Reconstituted in the N.G. in 1921, assigned to the 32d Div., and allotted to the state of Michigan. Reorganized 26 January 1922 and federally recognized with HQ at Flint, MI. HQ relocated 1 October 1927 to Detroit, MI. Called up to perform riot control during an automobile worker's strike in Flint, MI, 13 January–16 February 1937. Conducted annual summer training most years at Camp Grayling, MI, 1922–39. Conducted joint summer training at Camp Grayling with the 338th Inf. in 1928. Inducted into active Federal service at Detroit 15 October 1940 and moved to Camp Beauregard, LA, where it arrived 27 October 1940. Transferred 19 February 1941 to Camp Livingston, LA. Location 7 December 1941—Camp Livingston, LA.

**Status:** Assigned to the USARS as the 125th Inf.; 1st Bn. active at Flint, MI, as an element of the 38th Inf. Div.

**Events:** 214, 302, 320, 328

### Commanders, 125th Infantry Regiment

Col. John B. Boucher	5 August 1917–8 January 1918	Col. Edward G. Heckel	15 October 1918–22 May 1919
Col. Ambrose C. Pack	8 January 1918–5 February 1918	<i>Demobilized/Inactive</i>	23 May 1919–25 January 1922
Lt. Col. Edward G. Heckel	5 February 1918–5 April 1918	Col. Guy M. Wilson	26 January 1922–2 May 1923
Col. Robert B. McCoy	6 April 1918–3 July 1918	Col. Milton L. Hinkley	2 May 1923–30 September 1927
Col. William M. Morrow	4 July 1918–29 August 1918	Col. Thomas Colladay	1 October 1927–10 June 1940
Lt. Col. Edward G. Heckel	29 August 1918–9 September 1918	Col. Matthias A. Wiesenhoefer	10 June 1940–October 1941
Col. William M. Morrow	9 September 1918–15 October 1918	Lt. Col. Kenneth L. Hallenbeck	October 1941–ao December 1941

### 126th Infantry Regiment (32d Division)

### Michigan National Guard

HQ—Grand Rapids, MI, 1921–40; Camp Beauregard, LA, 1940–41; Camp Livingston, LA, 1941



Arrived at the port of Boston on 14 May 1919 on the U.S.S. *F.J. Luckenbach* as the 126th Inf., an element of the 32d Div. Demobilized 24 May–2 June 1919 at Camp Custer, MI. Reconstituted in the N.G. in 1921, assigned to the 32d Div., and allotted to the state of Michigan. Reorganized 1920–21 and federally recognized on 10 June 1921 with HQ at Grand Rapids, MI. Called up to perform riot control during an automobile worker's strike in Flint, MI, 13 January–16 February 1937. Conducted annual summer training most years at Camp Grayling, MI, 1921–39. Conducted joint summer training at Camp Grayling with the 337th Inf. in 1928, and with the 340th Inf. in 1929. Inducted into active Federal service at Detroit, MI, 15 October 1940, and moved to Camp Beauregard, LA, where it arrived 27 October 1940. Transferred 19 February 1941 to Camp Livingston, LA. Location 7 December 1941—Camp Livingston, LA.

**Status:** Assigned to the USARS as the 126th Armor; 1st Bn. active at Wyoming, MI, as an element of the 38th Inf. Div.

**Events:** 214, 302, 320, 328

### Commanders, 126th Infantry Regiment

Col. Joseph P. Westnedge	5 August 1917–9 November 1918	Col. Earl R. Stewart	10 June 1921–15 March 1922
Lt. Col. Elliot Caziare	9 November 1918–December 1918	Col. John Schouten	15 March 1922–23 March 1926
Maj. Guy Wilson	December 1918–January 1919	Col. Edgar A. Campbell	23 March 1926–July 1933
Col. William A. Mollison	January 1919–18 May 1919	Col. John Benner	July 1933–October 1935
<i>Demobilized/Inactive</i>	18 May 1919–9 June 1921	Col. William Haze	16 October 1935–ao January 1941
	Lt. Col. Sidney Z. Eleveld		ao June 1941–ao July 1941

### 127th Infantry Regiment (32d Division)

### Wisconsin National Guard

HQ—Oconto, WI, 1921–25; Madison, WI, 1925–28; Oconto, WI, 1928–30; Crandon, WI, 1930–40; Camp Beauregard, LA, 1940–41; Camp Livingston, LA, 1941

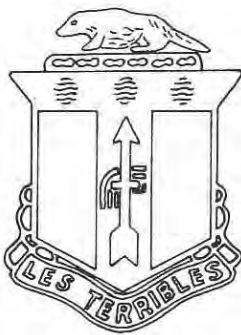

Arrived at the port of New York on 5 May 1919 on the U.S.S. *Cap Finisterre* as the 127th Inf., an element of the 32d Div. Demobilized 19 May 1919 at Camp Grant, IL. Reconstituted in the N.G. in 1921, assigned to the 32d Div., and allotted to the state of Wisconsin. Reorganized and federally recognized on 1 April 1921 with HQ at Oconto, WI. HQ relocated successively as follows: to Madison, WI, in 1925; Oconto on 27 June 1928; Crandon, WI, on 31 January 1930. The regiment, or elements thereof, called up to perform the following state duties: 1st Bn. to perform fire-fighting duties in Forest County, WI, 18–24 May 1925; four companies to perform riot control during the “Milk Strike” at Shawano, WI, 15–20 May 1933; elements to perform labor strike duties at Kohler, WI, 28 July–20 August 1934. Conducted annual summer training most years at Camp Douglas, WI, 1921–27, and Camp Williams, WI, 1928–39. Conducted joint summer training at Camp Douglas with the 401st Inf. in 1928 and at Camp Williams with the 404th Inf. in 1936. Inducted into active Federal service at Crandon, WI, 15 October 1940, and moved to Camp Beauregard, LA,

where it arrived 24 October 1940. Transferred 15 February 1941 to Camp Livingston, LA. Location 7 December 1941—Camp Livingston, LA.

**Status:** Assigned to the USARS as the 127th Inf.; 2d Bn. active at Appleton, WI, as an element of the 32d Inf. Brig.

**Events:** 214, 302, 320, 328

#### Commanders, 127th Infantry Regiment

Col. Wilbur M. Lee	5 August 1917–12 July 1918	Col. Wilbur M. Lee	14 July 1920–24 July 1924
Col. Russell C. Langdon	12 July 1918–February 1919	Col. George F. O'Connell	27 July 1924–30 May 1926
Col. Robert B. McCoy	February 1919–April 1919	Col. William B. Hall	30 May 1926–1 January 1930
Col. George T. Smith	April 1919–18 May 1919	Col. Forest H. Himes	1 January 1930–20 October 1940
<i>Demobilized/Inactive</i>	19 May 1919–13 July 1920	Col. J. Tracy Hale Jr.	20 October 1940–February 1942

#### 128th Infantry Regiment (32d Division)

#### Wisconsin National Guard

**HQ**—West Salem, WI, 1921–23; Superior, WI, 1923–25; Milwaukee, WI, 1925–29; Menomonie, WI, 1929–30; Sparta, WI, 1930–31; Oshkosh, WI, 1931–40; Camp Beauregard, LA, 1940–41; Camp Livingston, LA, 1941

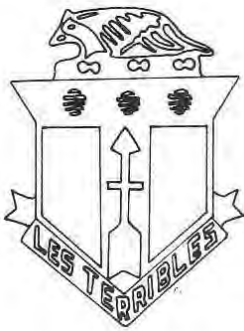

Arrived at the port of New York on 5 May 1919 on the U.S.S. *George Washington* as the 128th Inf., an element of the 32d Div. Demobilized 19 May 1919 at Camp Grant, IL. Reconstituted in the N.G. in 1921, assigned to the 32d Div., and allotted to the state of Wisconsin. Reorganized and federally recognized on 16 April 1921 with HQ at West Salem, WI. HQ successively relocated as follows: Superior, WI, in 1923; Milwaukee, WI, in 1925; Menomonie, WI, 20 February 1929; Sparta, WI, 14 April 1930; and to the Wisconsin Veteran's Home, Oshkosh, WI, 3 November 1931. The regiment, or elements thereof, called up to perform the following state duties: three companies to perform riot control during the "Milk Strike" at Shawano, WI, 15–20 May 1933; HQ, 1st Bn. and three companies to perform strike duty during the labor disturbances at Kohler, WI, 28 July–20 August 1934. Conducted annual summer training most years at Camp Douglas, WI, 1921–27, and Camp Williams, WI, 1928–39. Conducted joint summer training at Camp Douglas with the 404th Inf. in 1928. Inducted into active Federal service at Oshkosh on

15 October 1940 and moved to Camp Beauregard, LA, where it arrived 24 October 1940. Transferred 15 February 1941 to Camp Livingston, LA. Location 7 December 1941—Camp Livingston, LA.

**Status:** Assigned to the USARS as the 128th Inf.; 1st Bn. active at Eau Claire, WI, and 2d Bn. active at Madison, WI, as elements of the 32d Inf. Brig.

**Events:** 214, 302, 320, 328

#### Commanders, 128th Infantry Regiment

Col. John Turner	5 August 1917–2 July 1918	<i>Demobilized/Inactive</i>	19 May 1919–7 July 1919
Col. Robert B. McCoy	3 July 1918–28 October 1918	Col. Glenn W. Garlock	8 July 1919–9 April 1922
Lt. Col. John B. Schneller	29 October 1918–9 November 1918	Col. Paul B. Clemens	10 April 1922–2 February 1929
Lt. Col. Henry A. Meyers	9 November 1918–April 1919	Col. Albert Nathness	2 February 1929–1 March 1930
Col. George T. Smith	April 1919–19 May 1919	Col. William A. Holden	1 March 1930–January 1942

**129th Infantry Regiment** (33d Division)**Illinois National Guard**

**HQ**—*Not organized*, 1921–24; Pontiac, IL, 1924–30; Sycamore, IL, 1930–41; Camp Forrest, TN, 1941

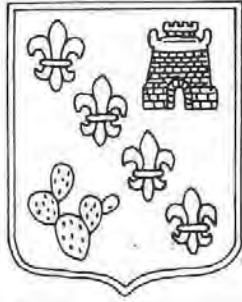

Arrived at the port of New York on 23 May 1919 on the U.S.S. *Leviathan* as the 129th Inf., an element of the 33d Div. Demobilized 6 June 1919 at Camp Grant, IL. Reconstituted in the N.G. in 1921, assigned to the 33d Div., and allotted to the state of Illinois. Partially organized in 1921 as the 3d Inf., Illinois N.G. Redesignated as the 129th Inf. on 13 December 1921. HQ organized on 30 January 1924 and federally recognized at Pontiac, IL. HQ relocated on 1 November 1930 to Sycamore, IL. The regiment, or elements thereof, called up to perform the following state duties: tornado relief work at Carbondale, IL, 18 March–13 April 1925; martial law in connection with civil disorders in Mundelein, IL, 23–25 June 1926; three companies for riot control at the Joliet Prison Riot, 18–23 March 1931; 3d Bn. acted as honor guard for President Herbert Hoover at the dedication of the Lincoln Memorial at Springfield, IL, 17 June 1931; entire regiment

for strike duty at a coal miners' strike at Springfield and Taylorville, IL, in March–April 1933; and three companies for strike duty at a labor strike in Freeport, IL, in June 1935. Conducted annual summer training most years at Camp Grant, IL, 1922–39. For at least 1 year, in 1936, the regiment also trained some 15 company-grade infantry officers of the 86th Div. at Camp Grant. Inducted into active Federal service at Sycamore on 5 March 1941 and moved to Camp Forrest, TN, where it arrived 20 March 1941. Location 7 December 1941—Camp Forrest, TN.

**Status:** Assigned to the CARS as the 129th Inf. Regt.; all elements inactive in the Illinois N.G.

**Events:** 214, 302, 316, 324, 328

**Commanders, 129th Infantry Regiment**

Col. Charles H. Greene	5 August 1917–January 1918	<i>Demobilized/Inactive</i>	6 June 1919–29 January 1924
Col. Mathew C. Smith	January 1918–21 February 1918	Col. Diller S. Myers	30 January 1924–17 November 1930
Col. Charles H. Payne	21 February 1918–July 1918	Col. William F. Hemenway	17 November 1930–February 1939
Col. Edgar A. Myer	July 1918–6 June 1919	Col. Cassius Poust	17 July 1939–5 May 1942

**130th Infantry Regiment** (33d Division)**Illinois National Guard**

**HQ**—*Not organized*, 1921–22; Delavan, IL, 1922–41; Carbondale, IL, 1940–41; Decatur, IL, 1941; Camp Forrest, TN, 1941



Arrived at the port of New York on 23 May 1919 on the U.S.S. *Siboney* as the 130th Inf., an element of the 33d Div. Demobilized 31 May 1919 at Camp Grant, IL. Reconstituted in the N.G. in 1921, assigned to the 33d Div., and allotted to the state of Illinois. Reorganized on 13 December 1921 by redesignation of the 4th Inf., Illinois N.G. (organized in early 1921; consolidated 22 June 1921 with the 5th Inf., Illinois N.G.) as the 130th Inf. HQ organized on 24 May 1922 and federally recognized at Delavan, IL. The regiment, or elements thereof, called up to perform the following state duties: 2d Bn. (+) to perform riot control at a coal miners' strike at Bloomington, IL, 9–19 July 1922; elements to perform riot control at a railroad strike at Hillsboro, IL, 11–26 August 1923; 3d Bn. (+) called up periodically to perform duties in connection with civil disorders at Herrin, Williamson County, IL, 30 August 1924–29 January 1925 and April–July 26; 1st and 3d Battalions to

perform tornado relief work at Carbondale and Murphysboro, IL, 18 March–13 April 1925; all elements, for various periods, to perform riot control at a coal miners' strike at Sangamon and Christian Counties, IL, for 14 months in 1932–33; entire regiment for flood relief work along the Ohio and Mississippi Rivers in southern Illinois, 21 January–5 April 1937. Conducted annual summer training most years at Camp Grant, IL, 1922–39. For at least 1 year, in 1936, the regiment also trained some 17 company-grade infantry officers of the 86th Div. at Camp Grant. HQ relocated 14 May 1940 to Carbondale, IL. Inducted into active Federal service at Decatur, IL, 5 March 1941, and moved to Camp Forrest, TN, where it arrived 21 March 1941. Location 7 December 1941—Camp Forrest, TN.



**Status:** Assigned to the USARS as the 130th Inf.; 2d Bn. active at Urbana, IL, as an element of the 34th Inf. Div.

**Events:** 214, 302, 316, 324, 328

**Commanders, 130th Infantry Regiment**

Col. Frank S. Wood	5 August 1917–1 January 1918	Col. John V. Clinnin	June 1918–31 May 1919
Col. Fine W. Smith	1 January 1918–April 1918	<i>Demobilized/Inactive</i>	1 June 1919–23 May 1922
Col. John J. Garrity	April 1918–3 May 1918	Col. Albert L. Culbertson	24 May 1922–14 May 1940
Lt. Col. Edward J. Lang	3 May 1918–June 1918	Col. Robert W. Davis	2 June 1940–16 August 1942

**131st Infantry Regiment (33d Division)**

**Illinois National Guard**

**HQ**—Chicago, IL, 1921–41; Camp Forrest, TN, 1941



Arrived at the port of New York on 17 May 1919 on the U.S.S. *Kaiserin Augusta Victoria* as the 131st Inf., an element of the 33d Div. Demobilized 6 June 1919 at Camp Grant, IL. Reconstituted in the N.G. in 1921, assigned to the 33d Div., and allotted to the state of Illinois. Reorganized on 13 December 1921 by redesignation of the 1st Inf., Illinois N.G. (organized 5 June 1919 with HQ at Chicago, IL) as the 131st Inf. HQ organized 18 August 1922 and federally recognized at Chicago. The regiment, or elements thereof, called up to perform the following state duties: 3d Bn. (-) to perform riot control at a coal miners' strike at Bloomington, IL, 9–19 July 1922; tornado relief work at Carbondale and Murhphysboro, IL, 18 March–13 April 1925; and I Co. for riot control at the Joliet Prison Riot, 18–23 March 1931. Conducted annual summer training most years at Camp Grant, IL, 1922–39. For at least 1 year, in 1936, the regiment also trained some 10 company-grade infantry officers of the 86th Div. at Camp Grant. Inducted into active Federal service at Chicago, IL, 5 March 1941, and moved to Camp Forrest, TN, where it arrived on 22 March 1941. Location 7 December 1941—Camp Forrest, TN.

**Status:** Assigned to the USARS as the 131st Inf.; 1st Bn. active at Joliet, IL, as an element of the 34th Inf. Div.

**Events:** 214, 302, 316, 324, 328

**Commanders, 131st Infantry Regiment**

Col. Joseph B. Sanborn	5 August 1917–6 June 1919	Col. Francis M. Allen	18 August 1922–June 1938
<i>Demobilized/Inactive</i>	7 June 1919–17 August 1922	Col. John M. Richmond	16 July 1938–11 December 1941

**132d Infantry Regiment (33d Division)**

**Illinois National Guard**

**HQ**—Chicago, IL, 1921–41; Camp Forrest, TN, 1941

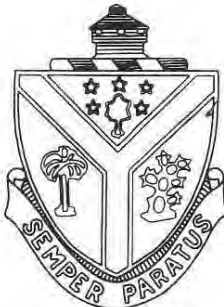

Arrived at the port of New York on 17 May 1919 on the U.S.S. *Mount Vernon* as the 132d Inf., an element of the 33d Div. Demobilized 31 May 1919 at Camp Grant, IL. Reconstituted in the N.G. in 1921, assigned to the 33d Div., and allotted to the state of Illinois. Reorganized on 13 December 1921 by redesignation of the 2d Inf., Illinois N.G. (organized 1920–21; HQ organized 7 July 1921 and federally recognized at Chicago, IL) as the 132d Inf. The regiment, or elements thereof, called up to perform the following state duties: 2d and 3d Battalions to perform riot control at a coal miners' strike at Bloomington, Clinton, and Joliet, IL, 25 July–18 September 1922; 3d Bn. for duties in connection with race riots at Herrin, Williamson County, IL, in June 1923 and 9–15 February 1924; martial law in connection with civil disorders in Mundelein, IL, 23–25 June 1926, and three companies for riot control at the Joliet Prison Riot, 18–23 March 1931. Conducted annual summer training most years at Camp Grant, IL, 1922–39. For at least 1 year, in 1936, the regiment also trained some 14 company-grade infantry

officers of the 86th Div. at Camp Grant. Inducted into active Federal service at Chicago, IL, 5 March 1941, and moved to Camp Forrest, TN, where it arrived 22 March 1941. Location 7 December 1941—Camp Forrest, TN.

**Status:** Inactive as the 132d Inf. Regt.

**Events:** 214, 302, 316, 324, 328

#### Commanders, 132d Infantry Regiment

Col. John J. Garrity	17 July 1917–21 December 1917	Lt. Col. Nelson Morris	27 July 1925–3 December 1925
Col. George E. Houle	21 December 1918–25 March 1918	Col. Frederick E. Rand	3 December 1925–15 November 1930
Col. Abel Davis	25 March 1918–31 May 1919	Col. Charles H. Davis	15 November 1930–3 July 1934
<i>Demobilized/Inactive</i>	31 May 1919–7 July 1921	Col. Herbert E. Algeo	3 July 1934–9 March 1937
Col. William E. Swanson	7 July 1921–27 July 1925	Col. Leroy C. Nelson	9 March 1937–15 September 1941
	Lt. Col. Andrew F. Casper		15 September 1941–15 December 1941

#### 133d Infantry Regiment (34th Division)

#### Iowa National Guard

**HQ**—Iowa City, IA, 1921–22; Des Moines, IA, 1922–27; Sioux City, IA, 1927–40; Waterloo, IA, 1940–41; Camp Claiborne, LA, 1941



Arrived at the port of New York on 24 January 1919 on the U.S.S. *General Goethals* as the 133d Inf., an element of the 34th Div. Demobilized 18 February 1919 at Camp Grant, IL. Reconstituted in the N.G. in 1921, assigned to the 34th Div., and allotted to the state of Iowa. Reorganized on 11 July 1921 by redesignation of the 134th Inf. (organized and federally recognized on 21 June 1919 as the 4th Inf., Iowa N.G. with HQ at Iowa City, IA; redesignated 134th Inf. on 29 March 1921) as the 133d Inf. HQ successively relocated as follows: Des Moines, IA, in 1922; Sioux City, IA, 22 September 1927; and Waterloo, IA, 19 July 1940. Entire regiment called up to perform the following state duties: riot control during the “Cow War” in Cedar County/Burlington, IA, 21 September–25 November 1931; riot control during a workers’ strike at the Swift Meat Packing Plant in Sioux City, IA, 19 October–21 November 1938. Conducted annual summer training most years at Camp Dodge, IA, 1921–39. For at least 2 years, in 1938 and 1940, the regiment also

trained some 18 company-grade officers of the 89th Div. at Camp Dodge and Camp Ripley, MN. Inducted into active Federal service at Sioux City, IA, 10 February 1941, and moved to Camp Claiborne, LA, where it arrived 1 March 1941. Location 7 December 1941—Camp Claiborne, LA.

**Status:** Assigned to the USARS as the 133d Inf.; 1st Bn. active at Waterloo, IA, as an element of the 34th Inf. Div.

**Events:** 233, 303, 320, 328

#### Commanders, 133d Infantry Regiment

Col. John E. Bartley	September 1917–ao April 1918	<i>Demobilized/Inactive</i>	18 February 1919–11 July 1921
Unknown	ao April 1918–ao June 1918	Col. Lloyd D. Ross	11 July 1921–15 August 1924
Col. George W. Ball	ao June 1918–30 November 1918	Col. Winfred H. Bailey	15 September 1924–June 1927
Unknown	30 November 1918–18 February 1919	Col. Gordon C. Hollar	7 July 1927–March 1940
	Col. Howard J. Rouse		March 1940–ao January 1942

**134th Infantry Regiment (35th Division)****Nebraska National Guard**

**HQ**—Omaha, NE, 1921–23; Falls, City, NE, 1923–25; Hastings, NE, 1925–32; Lincoln, NE, 1932–36; Omaha, NE, 1936–41; Camp Joseph T. Robinson, AR, 1941



Arrived at the port of New York on 24 January 1919 on the U.S.S. *General Goethals* as the 134th Inf., an element of the 34th Div. Demobilized on 18 February 1919 at Camp Grant, IL. Reconstituted in the N.G. in 1921 and allotted to the state of Nebraska. Concurrently relieved from the 34th Div. and assigned to the 35th Div. Reorganized on 25 October 1921 by redesignation of the 1st Inf., Nebraska N.G. (organized 1920–21; HQ organized 7 July 1921 and federally recognized at Omaha, NE) as the 134th Inf. HQ successively relocated as follows: to Falls, City, NE, 1923; Hastings, NE, 3 July 1925; Lincoln, NE, 10 September 1932; and Omaha, 30 December 1936. The regiment, or elements thereof, called up to perform the following state duties: riot control during a workers' strike at the Nebraska City Meat Packing Plant in Nebraska City, NE, in 1922; flood relief work along

the Republican River in 1935; martial law in connection with a street car workers' strike in Omaha, 7–19 June 1935. Regiment assembled at Fort Crook, NE, in January 1940 to conduct additional 2-week annual training directed by the War Department for all N.G. units. Conducted annual summer training most years at Ashland, NE, 1921–39. For at least 2 years, in 1938 and 1940, the regiment trained some 46 company-grade officers of the 89th Div. at Ashland and Camp Ripley, MN. Inducted into active Federal service at Omaha, NE, 23 December 1940, and moved to Camp Joseph T. Robinson, AR, where it arrived 7 January 1941. Location 7 December 1941—Camp Joseph T. Robinson, AR.

**Status:** Assigned to the USARS as the 134th Inf.; no active elements.

**Events:** 236, 303, 316, 324, 328

**Commanders, 134th Infantry Regiment**

Col. Herbert J. Paul	5 August 1917–18 February 1919	Col. Robert G. Douglas	10 September 1932–27 November 1936
<i>Demobilized/Inactive</i>	18 February 1919–7 July 1921	Col. Clyde E. McCormick	27 November 1936–6 May 1941
Col. Amos Thomas	7 July 1921–16 August 1932	Col. Butler B. Miltonberger	6 May 1941–24 February 1945

**135th Infantry Regiment (34th Division)****Minnesota National Guard**

**HQ**—Minneapolis, MN, 1921–30; Madison, MN, 1930–33; Minneapolis, MN, 1933–41; Camp Claiborne, LA, 1941



Arrived at the port of New York on 24 January 1919 on the U.S.S. *General Goethals* as the 135th Inf., an element of the 34th Div. Demobilized 18 February 1919 at Camp Grant, IL. Reconstituted in the N.G. in 1921, assigned to the 34th Div., and allotted to the state of Minnesota. Reorganized 21 November 1921 by redesignation of the 1st Inf., Minnesota N.G. (organized 1920–21; HQ organized 6 January 1921 and federally recognized at Minneapolis, MN) as the 135th Inf. HQ successively relocated to Madison, MN, 29 October 1930, and back to Minneapolis on 16 November 1933. The regiment, or elements thereof, called up to perform the following state duties: 1st Bn. to perform riot control during a railroad workers' strike in northern Minnesota in August 1922 and

October 1922; riot control during a truckers' strike in Minneapolis in May 1934. Conducted annual summer training at Lake City, MN; Fort Snelling, MN; and most years at Camp Ripley, MN. For at least 3 years, 1938–40, the regiment trained some 68 company-grade officers of the 88th Div. at Camp Ripley. Inducted into active Federal service at Minneapolis on 10 February 1941 and moved to Camp Claiborne, LA, where it arrived 27 February 1941. Location 7 December 1941—Camp Claiborne, LA.

**Status:** Assigned to the USARS as the 135th Inf.; 2d Bn. active at Mankato, MN, as an element of the 34th Inf. Div.

**Events:** 233, 303, 320, 328

**Commanders, 135th Infantry Regiment**

Col. Earle D. Luce	5 August 1917–18 February 1919	Col. Earle D. Luce	14 May 1921–August 1926
<i>Demobilized/Inactive</i>	19 February 1919–14 May 1921	Col. Otto I. Ronningen	20 April 1927–July 1935
	Col. Harold S. Nelson		19 August 1935–19 April 1942

**137th Infantry Regiment (35th Division)****Kansas National Guard**

HQ—Horton, KS, 1918–40; Wichita, KS, 1940–41; Camp Joseph T. Robinson, AR, 1941



Arrived at the port of New York on 24 April 1919 on the U.S.S. *Manchuria* as the 137th Inf., an element of the 35th Div. Demobilized on 26 May 1919 at Camp Funston, KS. Reconstituted in the N.G. in 1921, assigned to the 35th Div., and allotted to the state of Kansas. Reorganized 1 May 1921 by consolidation with the 4th Inf., Kansas N.G. (organized 29 November 1918; HQ concurrently organized and federally recognized at Horton, KS) as the 137th Inf. Co. D formed in 1922 entirely with American Indian personnel from Haskell Indian College in Topeka. The regiment, or elements thereof, called up to perform the following state duties: 1st and 3d Battalions for riot control during a coal miners' strike at Pittsburg, KS, 14 December 1921–26 February 1922; tornado relief duties at Augusta, KS, 13–16 July 1924; 2d Bn. to perform road patrols and bridge blocks in connection with the Kansas State Penitentiary breakout 19–20 January 1934; riot control during labor troubles at copper mines in Baxter Springs, KS, 8–27 June 1934; regimental HQ and 3d Bn. for riot control during a coal miners' strike at Columbus, KS, 17 June–6 August 1935. Conducted annual summer training most years at Fort Riley, KS, 1921–39. For at least 2 years, in 1939 and 1940, the regiment also trained some 85 company-grade officers of the 89th Div. at Fort Riley and Camp Ripley, MN. Inducted into active Federal service at Wichita, KS, 23 December 1940, and moved to Camp Claiborne, LA, where it arrived 1 March 1941. Location 7 December 1941—Camp Joseph T. Robinson, AR.

**Status:** Assigned to the USARS as the 137th Inf.; 2d Bn. active at Kansas City, KS, as an element of the 35th Inf. Div. (Mecz).

**Events:** 236, 303, 316, 324, 328

**Commanders, 137th Infantry Regiment**

Col. Perry M. Hoisington	1 October 1917–14 January 1918	Col. Joseph M. Cullison	13 October 1918–28 October 1918
Col. George H. McMaster	14 January 1918–20 April 1918	Lt. Col. Martyn H. Shute	28 October 1918–27 November 1918
Col. Claude Hamilton	20 April 1918–28 September 1918	Col. Ira L. Reeves	27 November 1918–26 May 1919
Maj. John H. O'Connor	28 September 1918–9 October 1918	<i>Demobilized/Inactive</i>	27 May 1919–30 April 1921
Maj. Edward C. Sammons	9 October 1918–13 October 1918	Col. Charles H. Browne	1 May 1921–25 February 1941
	Col. Arthur J. Ericsson		25 February 1941–March 1942

**138th Infantry Regiment (35th Division)****Missouri National Guard**

HQ—St. Louis, MO, 1921–41; Camp Joseph T. Robinson, AR, 1941



Arrived at the port of Newport News on 28 April 1919 on the U.S.S. *Aeolus* as the 138th Inf., an element of the 35th Div. Demobilized on 12 May 1919 at Camp Grant, IL. Reconstituted in the N.G. in 1921, assigned to the 35th Div., and allotted to the state of Missouri. Reorganized 1 October 1921 by redesignation of the 1st Inf., Missouri N.G. (organized 14 April 1921; HQ concurrently organized and federally recognized at St. Louis, MO) as the 138th Inf. The regiment, or elements thereof, called up to perform the following state duties: 1st Bn. for riot control during a railroad workers' strike at Poplar Bluff, MO, in July 1922; tornado relief duties in St. Louis, MO, 29 September–6 October 1927. Conducted annual summer training most years at Camp Clark, MO, 1921–39. For at least 3 years, 1938–40, the regiment also trained some 89 company-grade officers of the 102d Div. at Camp Clark and Camp Ripley, MN. Inducted into active Federal service

at St. Louis, MO, 23 December 1940, and moved to Camp Joseph T. Robinson, AR, where it arrived 5 January 1941. Location 7 December 1941—Camp Joseph T. Robinson, AR.

**Status:** Active at Jefferson Barracks, MO, as the 1138th Engr. Bn.

**Events:** 236, 303, 316, 324, 328

### Commanders, 138th Infantry Regiment

Col. Leroy K. Robbins	1 October 1917–3 November 1917	Maj. Norman B. Comfort	28 September 1918–9 October 1918
Col. Philip J. Kealy	3 November 1917–21 January 1918	Col. Americus Mitchell	9 October 1918–17 February 1919
Col. Julius T. Conrad	21 January 1918–9 April 1918	Lt. Col. James E. Rieger	17 February 1919–13 May 1919
Col. Edmund J. McMahon	9 April 1918–5 July 1918	<i>Demobilized/Inactive</i>	14 May 1919–13 August 1921
Col. George P. White	25 July 1918–14 September 1918	Col. Charles S. Thornton	14 August 1921–26 April 1924
Lt. Col. Henry W. Parker	14 September 1918–25 September 1918	Col. Auswell E. Dietsch	27 April 1924–30 January 1926
Col. Harry S. Howland	25 September 1918–26 September 1918	Col. Stephen E. Lowe	31 January 1926–13 December 1935
Lt. Col. Henry W. Parker	26 September 1918–28 September 1918	Col. Lawrence C. Kingsland	13 December 1935–12 July 1941
	Col. Bertram I. Lawrence		13 July 1941–17 September 1942

### 140th Infantry Regiment (35th Division)

### Missouri National Guard

**HQ**—Cape Girardeau, MO, 1921–23; Caruthersville, MO, 1923–40; Sikeston, MO, 1940; Camp Joseph T. Robinson, AR, 1941



Arrived at the port of Newport News on 28 April 1919 on the U.S.S. *Nansemond* as the 140th Inf., an element of the 35th Div. Demobilized on 12 May 1919 at Fort Riley, KS. Reconstituted in the N.G. in 1921, assigned to the 35th Div., and allotted to the state of Missouri. Reorganized 1 October 1921 by redesignation of the 6th Inf., Missouri N.G. (organized 31 March 1921; HQ concurrently organized and federally recognized at Cape Girardeau, MO) as the 138th Inf. Regimental HQ relocated about June 1923 to Caruthersville, MO. The regiment, or elements thereof, called up to perform the following state duties: riot control at a railroad workers' strike at Moberly, Macon, and Poplar Bluff, MO, 31 July–23 November 1922; workers' strike at New Madrid, MO, in May 1923; Mississippi River flood relief duty at Charleston, Sikeston, and Poplar Bluff, MO, 16 April–12 May 1927 and January 1937; St. Francis River flood relief duties in June

1928, and every spring, 1932–33 and 1935–38. Conducted annual summer training most years at Camp Clark, MO, 1921–39. For at least 3 years, 1938–40, the regiment also trained some 81 company-grade officers of the 102d Div. at Camp Clark and Camp Ripley, MN. Regimental HQ relocated in January 1940 to Sikeston, MO. Inducted into active Federal service at Sikeston on 23 December 1940, and moved to Camp Joseph T. Robinson, AR, where it arrived 4 January 1941. Location 7 December 1941—Camp Joseph T. Robinson, AR.

**Events:** 236, 303, 316, 324, 328

### Commanders, 140th Infantry Regiment

Col. Albert Linxwiler	1 October 1917–18 June 1918	Lt. Col. Fred L. Lemmon	29 March 1919–14 April 1919
Col. Pierce A. Murphy	18 June 1918–16 September 1918	Col. Albert Linxwiler	14 April 1919–14 May 1919
Maj. Fred L. Lemmon	16 September 1918–22 September 1918	<i>Demobilized/Inactive</i>	15 May 1919–30 March 1921
Lt. Col. Channing E. Delaplaine	22 September 1918–16 October 1918	Col. Warren L. Mabrey	31 March 1921–3 June 1923
Col. Alonzo Gray	16 October 1918–3 January 1919	Col. George W. Phipps	17 June 1923–31 December 1939
Lt. Col. Sidney D. Maize	3 January 1919–18 February 1919	Col. Harry E. Dudley	1 January 1940–February 1941
Lt. Col. Smith A. Harris	18 February 1919–29 March 1919	Lt. Col. Fred H. Stoll	February 1941–July 1941
	Col. Harry E. Dudley		July 1941–January 1942

**141st Infantry Regiment (36th Division)****Texas National Guard****HQ**—*Not organized*, 1921–22; Hillsboro, TX, 1922–28; Brenham, TX, 1928–33; Houston, TX, 1933; San Antonio, TX, 1933–40; Camp Bowie, TX, 1940–41

Arrived at the port of New York on 3 June 1919 on the S.S. *Troy* as the 141st Inf., an element of the 36th Div. Demobilized 3 July 1919 at Camp Travis, TX. Reconstituted in the N.G. on 3 December 1920, assigned to the 36th Div., and allotted to the state of Texas. Reorganized and federally recognized on 24 June 1922 with HQ at Hillsboro, TX. HQ successively relocated as follows: to Brenham, TX, 13 July 1928; Houston, TX, 27 February 1933; San Antonio, TX, 1 September 1933. Awarded the Pershing Trophy for Marksmanship (Infantry) in 1937 and 1938. Conducted annual summer training most years at Camp Mabry, TX, 1922–25, and Camp Hulen, TX, 1926–39. Inducted into active Federal service at San Antonio on 25 November 1940 and moved to Camp Bowie, TX, where it arrived 27 December 1940. Location 7 December 1941—Camp Bowie, TX.

**Status:** Assigned to the USARS as the 141st Inf.; 1st Bn. active at San Antonio, TX, and 3d Bn. active at Weslaco, TX, as elements of the 36th Inf. Div. (Mecz).

**Events:** 258, 300, 317, 328

**Commanders, 141st Infantry Regiment**

Col. Oscar C. Guessez	5 August 1917–April 1918	Col. Will E. Jackson	15 August 1922–31 May 1928
Col. Will E. Jackson	April 1918–19 October 1918	Col. Eugene A. Eversberg	1 June 1928–January 1941
Col. Luther R. James	19 October 1918–3 July 1919	Col. Earnest O. Thompson	14 June 1941–24 November 1941
<i>Demobilized/Inactive</i>	3 July 1919–14 August 1922	Col. Nat Perrine	24 November 1941–27 August 1942

**142d Infantry Regiment (36th Division)****Texas National Guard****HQ**—*Not organized*, 1921–22; Amarillo, TX, 1922–28; Fort Worth, TX, 1928–40; Camp Bowie, TX, 1940–41

Arrived at the port of New York on 31 May 1919 on the U.S.S. *Pueblo* as the 142d Inf., an element of the 36th Div. Demobilized 17 June 1919 at Camp Travis, TX. Reconstituted in the N.G. on 3 December 1920, assigned to the 36th Div., and allotted to the state of Texas (less Oklahoma elements). Reorganized and federally recognized on 16 May 1922 with HQ at Amarillo, TX. HQ relocated 21 August 1928 to Fort Worth, TX. The regiment, or elements thereof, called up to perform the following state duties: 2d and 3d Bns. to perform riot control during a workers' strike on the MKT Railway at Denison, TX, 23 July–21 October 1922; flood relief duties along the Colorado River at Brady, TX, in July 1938. Conducted annual summer training most years at Camp Mabry, TX, 1922–25, and Camp Hulen, TX, 1926–39. Inducted into active Federal service at Fort Worth, TX, 25 November 1940, and moved to Camp Bowie, TX, where it arrived 13 December 1940. Location 7 December 1941—Camp Bowie, TX.

**Status:** Assigned to the USARS as the 142d Inf.; 2d Bn. active at Lubbock, TX, as an element of the 36th Inf. Div. (Mecz).

**Events:** 258, 300, 317, 328

**Commanders, 142d Infantry Regiment**

Col. Alfred W. Bloor	5 August 1917–August 1918	Col. Charles W. Nimon	16 May 1922–18 September 1935
Col. Irving J. Phillipson	August 1918–18 October 1918	Col. J. Watt Page	18 September 1935–20 June 1940
Col. Alfred W. Bloor	18 November 1918–17 June 1919	Col. Nat Perrine	20 June 1940–October 1941
<i>Demobilized/Inactive</i>	18 June 1919–15 May 1922	Lt. Col. Carl E. Wallace	October 1941–24 March 1942

**143d Infantry Regiment (36th Division)****Texas National Guard**

**HQ**—*Not organized*, 1921–22; Taylor, TX, 1922–23; Houston, TX, 1923–31; Waco, TX, 1931–40; Camp Bowie, TX, 1940–41



Arrived at the port of Newport News on 2 June 1919 on the U.S.S. *Finland* as the 143d Inf., an element of the 36th Div. Demobilized on 3 July 1919 at Camp Travis, TX. Reconstituted in the N.G. on 3 December 1920, assigned to the 36th Div., and allotted to the state of Texas. Reorganized and federally recognized on 21 July 1922 with HQ at Taylor, TX. HQ successively relocated to Houston, TX, in 1923 and to Waco, TX, on 6 February 1931. The regiment, or elements thereof, called up to perform the following state duties: riot control during a workers' strike on the MKT Railway at Denison, TX, in 1923; flood relief duties along the Brazos River at Waco, TX, in September 1936. Conducted annual summer training most years at Camp Mabry, TX, 1922–25, and Camp Hulen, TX, 1926–39. Inducted into active Federal service at Waco on 25 November 1940 and moved to Camp Bowie, TX, where it arrived 5 January 1941. Location 7 December 1941—Camp Bowie, TX.

**Status:** Assigned to the USARS as the 143d Inf.; no active elements.

**Events:** 258, 300, 317, 328

**Commanders, 143d Infantry Regiment**

Col. John S. Hoover	5 August 1917–18 October 1918	<i>Demobilized/Inactive</i>	15 June 1919–20 June 1922
Col. Irving J. Phillipson	18 October 1918–14 June 1919	Col. Oscar E. Roberts	21 June 1922–1 January 1930
	Col. William C. Torrance		1 January 1930–ao February 1942

**144th Infantry Regiment (36th Division)****Texas National Guard**

**HQ**—*Not organized*, 1921–22; Fort Worth, TX, 1922–37; Dallas, TX, 1937–40; Camp Bowie, TX, 1940–41

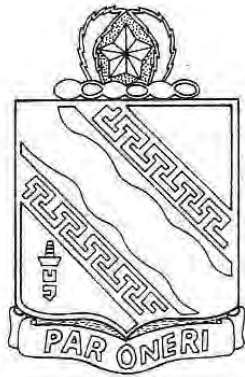

Arrived at the port of New York on 5 June 1919 on the U.S.S. *Pretoria* as the 144th Inf., an element of the 36th Div. Demobilized on 3 July 1919 at Camp Travis, TX. Reconstituted in the N.G. on 3 December 1920, assigned to the 36th Div., and allotted to the state of Texas. Reorganized and federally recognized on 19 May 1922 with HQ at Fort Worth, TX. HQ relocated on 16 March 1937 to Dallas, TX. The regiment, or elements thereof, called up to perform the following state duties: elements for riot control at Dallas, 21–24 May 1925; 1st Bn. and Co. L for crowd control during the race riot at Sherman, TX, 9–24 May 1930; elements for tornado relief duties at Oak Cliff, TX, 30–31 July 1933; elements for the New London School explosion in March 1937; elements for firefighting and crowd control during oil field fires at Kilgore, TX, in January 1938; elements for riot control during a workers' strike on the MKT Railway at Texarkana, TX, in June 1939. Co. E awarded the National William Randolph Hearst Trophy for Marksmanship in 1936.

Conducted annual summer training most years at Camp Mabry, TX, 1922–25, and Camp Hulen, TX, 1926–39. Inducted into active Federal service at Dallas on 25 November 1940 and moved to Camp Bowie, TX, where it arrived 7 January 1941. Location 7 December 1941—Camp Bowie, TX.

**Status:** Assigned to the USARS as the 144th Inf.; 3d Bn. active at Terrell, TX, as an element of the 36th Inf. Div. (Mecz).

**Events:** 258, 300, 317, 328

**Commanders, 144th Infantry Regiment**

Col. Jules E. Muchert	5 August 1917–July 1918	<i>Demobilized/Inactive</i>	21 June 1919–18 May 1922
Col. Edmund S. Wright	July 1918–4 September 1918	Col. Holman Taylor	19 May 1922–September 1936
Col. James S. Parker	4 September 1918–15 October 1918	Col. William E. Lake	19 September 1936–3 December 1941
Col. Oscar E. Roberts	16 October 1918–21 June 1919	Col. Earle D. Sandlin	3 December 1941–18 February 1943

**145th Infantry Regiment (37th Division)****Ohio National Guard**

HQ—Cleveland, OH, 1920–40; Camp Shelby, MS, 1940–41



Arrived at the port of New York on 27 March 1919 on the U.S.S. *Great Northern* as the 145th Inf., an element of the 37th Div. Demobilized on 22 April 1919 at Camp Sherman, OH. Reconstituted in the N.G. in 1921, assigned to the 37th Div., and allotted to the state of Ohio. Reorganized on 1 July 1921 by redesignation of the 3d Inf., Ohio N.G. (organized 1919–20; HQ organized 1 July 1920 and federally recognized at Cleveland, OH) as the 145th Inf. The regiment, or elements thereof, called up to perform the following state duties: riot control during a labor strike at New Lexington, OH, in July–August 1922; tornado relief duties at Lorain-Sandusky, OH, 28 June–16 July 1924; martial law in connection with civil disorders and KKK riots in Niles, OH, 2–5 November 1924; riot control during a coal miners’ strike at Cadiz, OH, 16 April–17 August 1932; riot control during a workers’ strike at the Auto-Lite plant at Toledo, OH, 23 May–2 June 1934; flood relief along the Ohio River, January–March 1937; riot control during a workers’ strike at the Mahoning Valley steel plants, 22 June 1–15 July 1937. Conducted annual summer training most years at Camp Perry, OH, 1921–39. Inducted into active Federal service at Cleveland on 15 October 1940 and moved to Camp Shelby, MS, where it arrived 22 October 1940. Location 7 December 1941—Camp Shelby, MS.

**Status:** Assigned to the CARS as the 145th Inf. Regt.; all elements inactive in the Ohio N.G.**Events:** 213, 220, 302, 320, 328**Commanders, 145th Infantry Regiment**

Col. Albert H. Davis	5 August 1917–19 November 1917	<i>Demobilized/Inactive</i>	22 April 1919–30 June 1921
Col. Sanford B. Stanbery	19 November 1917–29 October 1918	Col. Ludwig S. Conelly	1 July 1921–3 January 1929
Col. Frank C. Gerlach	30 October 1918–21 February 1919	Col. William L. Marlin	3 January 1929–22 December 1936
Col. Florence S. Van Gorder	22 February 1919–22 April 1919	Col. Luke P. Wolford	22 December 1936–14 November 1942

**147th Infantry Regiment (37th Division)****Ohio National Guard**

HQ—Cincinnati, OH, 1920–40; Camp Shelby, MS, 1940–41



Arrived at the port of New York on 25 March 1919 on the U.S.S. *Von Steuben* as the 147th Inf., an element of the 37th Div. Demobilized on 19 April 1919 at Camp Sherman, OH. Reconstituted in the N.G. in 1921, assigned to the 37th Div., and allotted to the state of Ohio. Reorganized 1 July 1921 by redesignation of the 1st Inf., Ohio N.G. (organized 1919–20; HQ organized 11 March 1920 and federally recognized at Cincinnati, OH) as the 147th Inf. The regiment, or elements thereof, called up to perform the following state duties: riot control during a coal miners’ strike at St. Clairsville, OH, 26 July–16 August 1922; riot control during a coal miners’ strike at Cadiz, OH, 16 April–17 August 1932; flood relief along the Ohio River, January–March 1937; riot control during a workers’ strike at the Mahoning Valley steel plants, 22 June–15 July 1937. Conducted annual summer training most years at Camp Perry, OH, 1921–39. Inducted into active Federal

service at Cincinnati on 15 October 1940 and moved to Camp Shelby, MS, where it arrived on 24 October 1940. Location 7 December 1941—Camp Shelby, MS.

**Status:** Assigned to the USARS as the 147th Armor; 1st Bn. active at Cincinnati, OH, as an element of the 38th Inf. Div.**Events:** 213, 220, 278, 302, 320, 328**Commanders, 147th Infantry Regiment**

Col. Frederick W. Galbraith Jr.	5 August 1917–10 April 1919	Col. Don L. Caldwell	18 December 1928–May 1930
<i>Demobilized/Inactive</i>	10 April 1919–28 February 1921	Col. Hugo Rudolph	15 May 1930–13 January 1936
Col. Simon Ross	1 March 1921–17 December 1928	Col. John A. Blount	18 January 1936–31 December 1941



**148th Infantry Regiment (37th Division)****Ohio National Guard**

**HQ**—Toledo, OH, 1921–26; Canton, OH, 1926–29; Toledo, OH, 1929–37; Columbus, OH, 1937–40; Camp Shelby, MS, 1940–41



Arrived at the port of New York on 23 March 1919 on the S.S. *Noordam* as the 148th Inf., an element of the 37th Div. Demobilized 19 April 1919 at Camp Sherman, OH. Reconstituted in the N.G. in 1921, assigned to the 37th Div., and allotted to the state of Ohio. Reorganized 1 July 1921 by redesignation of the 2d Inf., Ohio N.G. (organized 1919–21; HQ organized 23 March 1921 and federally recognized at Toledo, OH) as the 148th Inf. HQ relocated successively as follows: to Canton, OH, in 1926; to Toledo, OH, in January 1929, to Columbus, OH, 1 December 1937. The regiment, or elements thereof, called up to perform the following state duties: riot control during a coal miners' strike at Cadiz, OH, 20 July–17 August 1932; riot control during a workers' strike at the Auto-Lite plant at Toledo, OH, 23 May–2 June 1934; flood relief along the Ohio River, January–March 1937; riot control during a workers' strike at the Mahoning Valley steel plants, 22 June–15 July 1937. Conducted annual summer training most years at Camp Perry, OH,

1921–39. Inducted into active Federal service at Columbus on 15 October 1940, and moved to Camp Shelby, MS, where it arrived on 24 October 1940. Location 7 December 1941—Camp Shelby, MS.

**Status:** Assigned to the USARS as the 148th Inf.; 1st Bn. active at Lima, OH, as an element of the 38th Inf. Div.

**Events:** 213, 220, 302, 320, 328

**Commanders, 148th Infantry Regiment**

Col. Robert L. Hubler	5 August 1917–September 1918	Col. Gilson D. Light	23 March 1921–24 May 1924
Col. James A. Lynch	September 1918–9 October 1918	Col. William L. Marlin	24 May 1924–3 January 1929
Col. George W. Stuart	10 October 1918–December 1918	Col. Gilson D. Light	3 January 1929–20 November 1935
Col. Leigh R. Gignilliat	January 1919–19 April 1919	Col. Lee N. Murlin	20 November 1935–1 January 1937
<i>Demobilized/Inactive</i>	19 April 1919–22 March 1921	Col. Emil F. Marx	1 January 1937–13 October 1940
	Col. Stuart A. Baxter		14 October 1940–ao August 1943

**149th Infantry Regiment (38th Division)****Kentucky National Guard**

**HQ**—Frankfort, KY, 1921–27; Louisville, KY, 1927–41; Camp Shelby, MS, 1941

Arrived at the port of New York on 16 January 1919 on the S.S. *Belgic* as the 149th Inf., an element of the 38th Div. Demobilized in January 1919 at Camp Zachary Taylor, KY. Reconstituted in the N.G. in 1921, assigned to the 38th Div., and allotted to the state of Kentucky. Partially organized 1 July 1921 by redesignation of active elements of the 1st Inf., Kentucky N.G. (organized 1919–21). HQ organized 1 July 1922 and federally recognized at Frankfort, KY. HQ relocated 13 December 1927 to Louisville, KY. The regiment, or elements thereof, called up to perform the following state duties: strike duty at coal fields near Newport, KY, and at the Anderson Steel and Newport Rolling Mills, 25 December 1921–31 March 1922; Central City, KY, 8 July–30 August 1922; Corbin, KY, 30 September 1922–15 February 1923; and again at Newport, KY, 2 February–24 April 1923; preserve law and order at Sand Cave, KY, 2 February–18 March 1925, during the rescue attempt to save

the celebrated cave explorer, Floyd Collins; 2d Bn. and elements of 1st Bn. for preservation of order at a civil trial at Lexington, KY, 1–2 February 1926, and at a trial in Louisville, KY, 22–28 April 1926; flood relief duty at Hickman, KY, 16 April–27 May 1927; 3d Bn. for preservation of order at a rape trial of two Negro men at Madisonville, KY, 23–26 November 1927; entire regiment for strike duty at coal miners' strike in Harlan County, KY, 6 May–30 June 1931; flood relief along the Ohio River, January–March 1937. Conducted annual summer training most years at Camp Knox, KY, 1921–39. Inducted into active Federal service at Louisville on 17 January 1941 and moved to Camp Shelby, MS, where it arrived on 26 January 1941. Location 7 December 1941—Camp Shelby, MS.

**Status:** Assigned to the USARS as the 123d Armor; 1st Bn. active at Fort Knox, KY, and 2d Bn. active at Bowling Green, KY, as elements of the 35th Inf. Div. (Mecz).

**Events:** 213, 220, 302, 320, 328

**Commanders, 149th Infantry Regiment**

Col. Jouett Henry	5 August 1917–24 October 1917	Lt. Col. Issac H. Wilder Jr.	10 November 1922–22 September 1923
Lt. Col. Erskine B. Bassett	24 October 1917–December 1917	Col. Jackson Morris	22 September 1923–25 January 1932
Col. George T. Smith	December 1917–January 1919	Lt. Col. Issac H. Wilder Jr.	25 January 1932–9 July 1932
<i>Demobilized/Inactive</i>	January 1919–30 June 1922	Col. Frank D. Rash	21 July 1932–30 November 1935
Lt. Col. Henry H. Denhardt	1 July 1922–10 November 1922	Col. Roy W. Easley	6 December 1935–16 July 1941
	Col. William S. Taylor		16 July 1941–1 July 1944

**150th Infantry Regiment (38th Division)**

**West Virginia National Guard**

**HQ**—*Not organized*, 1921–22; Welch, WV, 1922–41; Camp Shelby, MS, 1941



Demobilized on 5 January 1919 at Camp Zachary Taylor, KY, as the 150th Inf., an element of the 38th Div. Reconstituted in the N.G. in 1921, assigned to the 38th Div., and allotted to the state of West Virginia. Reorganized 13 July 1922 with HQ organized and federally recognized at Welch, WV. Conducted annual summer training most years at Camp William G. Conley, WV, and some years at Camp Knox, KY. For at least 3 years, 1931–33, the regiment also trained some 33 company-grade infantry officers of the 100th Div. at Camp Conley. Inducted into active Federal service at Welch on 17 January 1941 and moved to Camp Shelby, MS, where it arrived 27 January 1941. Location 7 December 1941—Camp Shelby, MS.

**Status:** Assigned to the USARS as the 150th Armor; 1st Bn. active at Bluefield, WV, as an element of the 28th Inf. Div.

**Events:** 213, 302, 320, 328

**Commanders, 150th Infantry Regiment**

Col. Charles E. Morrison	5 August 1917–16 January 1918	<i>Demobilized/Inactive</i>	5 January 1919–28 February 1923
Col. Erskine B. Bassett	16 January 1918–5 January 1919	Col. William E. Eubank	1 March 1923–9 February 1942

**151st Infantry Regiment (38th Division)**

**Indiana National Guard**

**HQ**—Shelbyville, IN, 1921–32; Indianapolis, IN, 1932–41; Jonesboro, IN, 1933; Indianapolis, IN, 1933–41; Camp Shelby, MS, 1941



Demobilized on 8 March 1919 at Camp Zachary Taylor, KY, as the 151st Inf., an element of the 38th Div. Reconstituted in the N.G. in 1921, assigned to the 38th Div., and allotted to the state of Indiana. Reorganized 30 June 1921 with HQ organized and federally recognized at Shelbyville, IN. HQ successively relocated as follows: to Indianapolis, IN, 13 December 1932; to Jonesboro, IN, 1 June 1933; and back to Indianapolis on 23 September 1933. The regiment, or elements thereof, called up to perform the following state duties: riot control during a coal miners' strike at Staunton—Jasonville, IN, 2–19 August 1922; 1st Bn. called up to perform riot control during labor troubles in Vanderburg and Warwick Counties, 22 February–23 March 1926; riot control during a coal miners' strike at the Hoosier Mine in Sullivan County, 21–25 July 1931; entire regiment called up to perform riot control during a coal miners' strike at the Dixie Bee Mine, 2 August–October 1932; riot control during a coal miners' strike at the Starburn Mine, Sullivan County, 9–23 October 1933; six

companies for guard and security duties in connection with the visit of President Roosevelt to Vincennes, IN, 14 June 1936; entire regiment called up to perform flood relief along the Ohio River at Aurora, IN, in January–March 1937. Conducted annual summer training most years at Camp Knox, KY, 1921–39. Inducted into active Federal service at Indianapolis on 17 January 1941, and moved to Camp Shelby, MS, where it arrived 29 January 1941. Location 7 December 1941—Camp Shelby, MS.

**Status:** Assigned to the USARS as the 151st Inf.; 1st Bn. active at New Albany, IN, as an element of the 76th Inf. Brig. (Sep.).

**Events:** 213, 220, 302, 320, 328

#### Commanders, 151st Infantry Regiment

Col. Emmett F. Branch	5 August 1917–September 1918	Col. D. Wray De Prez	30 June 1921–2 May 1932
Col. George H. Healey	September 1918–8 March 1919	Col. Paul A. Seiberling	2 May 1932–23 September 1933
<i>Demobilized/Inactive</i>	8 March 1919–29 June 1921	Col. Albert H. Whitcomb	23 September 1933–ao August 1942

#### 152d Infantry Regiment (38th Division)

#### Indiana National Guard

**HQ**—Indianapolis, IN, 1921–32; Fort Wayne, IN, 1932–38; Indianapolis, IN, 1938–41; Camp Shelby, MS, 1941

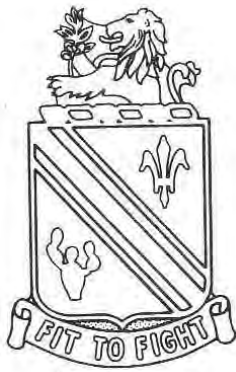

Demobilized on 8 March 1919 at Camp Zachary Taylor, KY, as the 152d Inf., an element of the 38th Div. Reconstituted in the N.G. in 1921, assigned to the 38th Div., and allotted to the state of Indiana. Reorganized on 15 November 1921 with HQ organized and federally recognized at Indianapolis, IN. HQ successively relocated to Fort Wayne, IN, on 13 February 1932, and back to Indianapolis on 19 April 1938. The regiment, or elements thereof, called up to perform the following state duties: tornado relief in southern Indiana in 1925; riot control during labor troubles in Vanderburg and Warwick Counties, 22 February–1923 March 1926; 3d Bn. for riot control during race troubles due to a lynching in Marion, IN, 9–11 August 1930; two companies for riot control during a coal miners' strike at Sullivan County, 9 October–15 November 1931; entire regiment for riot control during a coal miners' strike at the Dixie Bee Mine, 2 August–October 1932; 1st Bn. for guard and security duties in connection with the visit of President Roosevelt to Vincennes, IN, 14 June 1936; entire regiment for flood relief along the Ohio River, January–March 1937.

Conducted annual summer training most years at Camp Knox, KY, 1921–39. Inducted into active Federal service at Indianapolis on 17 January 1941 and moved to Camp Shelby, MS, where it arrived 30 January 1941. Location 7 December 1941—Camp Shelby, MS.

**Status:** Assigned to the USARS as the 152d Inf.; 1st Bn. active at Jasper, IN, as an element of the 76th Inf. Brig. (Sep.); and 2d Bn. active at Marion, IN, as an element of the 38th Inf. Div.

**Events:** 213, 220, 302, 320, 328

#### Commanders, 152d Infantry Regiment

Col. Thomas B. Coulter	25 March 1917–1 February 1918	<i>Demobilized/Inactive</i>	8 March 1919–14 November 1921
Col. Howard F. Noble	April 1918–ao November 1918	Col. George H. Healey	15 November 1921–30 November 1931
Unknown	ao November 1918–8 March 1919	Col. Clyde F. Dreisbach	30 November 1931–25 September 1940
	Col. Robert L. Stillwell		25 September 1940–12 February 1945

**153d Infantry Regiment (Separate)****Arkansas National Guard**

**HQ**—Little Rock, AR, 1921–24; Russellville, AR, 1924–25; Beebe, AR, 1925–28; Conway, AR, 1928–41; Camp Joseph T. Robinson, AR, 1941; Camp Murray, WA, 1941



Arrived at the port of Newport News on 31 December 1918 on the U.S.S. *Princess Matoika* as the 153d Inf., an element of the 39th Div. Demobilized on 23 January 1919 at Camp Beauregard, LA. Reconstituted in the N.G. in 1921, relieved from the 39th Div., and allotted to the state of Arkansas. Organized on 25 October 1921 by redesignation of the 5th Inf., Arkansas N.G. (organized 3 January 1920; HQ organized 25 June 1921 and federally recognized at Little Rock, AR) as the 153d Inf. HQ successively relocated as follows: to Russellville, AR, 16 June 1924; Beebe, AR, in November 1925; and Conway, AR, 28 April 1928. The regiment, or elements thereof, were called up to perform the following state duties: regiment (-) to perform flood relief duty at Forrest City and Pine Bluff, AR, 17 April–16 May 1927; provisional battalion (four companies) to perform

flood relief duty at Big Lake, AR, 30 June–14 July 1928; regiment (-) to perform flood relief duty at Forrest City and Jonesboro, AR, January–February 1937. Assigned to Fourth Army on 1 October 1933. Conducted annual summer training at Camp Pike (later redesignated Camp Joseph T. Robinson), AR, 1921–39. For at least 2 years, in 1938 and 1940, the regiment also trained some 55 company-grade officers of the 102d Div. at Camp Joseph T. Robinson and Camp Ripley, MN. Inducted into active Federal service at Conway on 23 December 1940, and moved to Camp Joseph T. Robinson where it arrived on 3 January 1941. Transferred 28 May 1941 to Camp Forrest, TN, and returned 1 July 1941 to Camp Joseph T. Robinson. Assigned to Fourth Army on 1 August 1941. Transferred 20 August 1941 to Camp Murray, WA. The 1st and 3d Battalions transferred 5 September 1941 to Seward, TA. Location 7 December 1941—Camp Murray, WA.

**Status:** Assigned to the USARS as the 153d Inf.; 1st Bn. active at Malvern, AR; 2d Bn. active at Searcy, AR; and 3d Bn. active at Warren, AR, as elements of the 39th Inf. Brig. (Light).

**Events:** 56, 236, 303, 324

**Commanders, 153d Infantry Regiment**

Col. Charles D. James	5 August 1917–24 January 1919	Col. Herbert L. McAlister	23 June 1922–16 June 1924
<i>Demobilized/Inactive</i>	24 January 1919–1 January 1920	Col. Ralph B. Andrews	16 June 1924–12 November 1925
Col. Ebenezer L. Compere	3 January 1920–24 June 1921	Col. James H. A. Baker	13 November 1925–10 May 1927
Col. Charles B. Moore	25 June 1921–21 June 1922	Col. Heber L. McAlister	11 May 1927–ao June 1941

**154th Infantry Regiment (39th Division)****Florida National Guard**

**HQ**—Jacksonville, FL, 1921–24

Arrived at the port of Newport News on 31 December 1918 on the U.S.S. *Princess Matoika* as the 154th Inf., an element of the 39th Div. Demobilized on 14 January 1919 at Camp Gordon, GA. Reconstituted in the N.G. in 1921, assigned to the 39th Div., and allotted to the state of Florida. Reorganized on 19 December 1921 by redesignation of the 1st Inf., Florida N.G. (organized 4 June 1921; HQ concurrently organized and federally recognized at Jacksonville, FL) as the 154th Inf. The 1st and 2d Bns. called up to perform railroad strike duty, 7–16 August 1922. Conducted annual summer training at Camp Joseph E. Johnston, FL, 1921–23. Relieved from the 39th Div. on 1 July 1923 and assigned to the 31st Div. Redesignated 124th Inf. on 28 May 1924.

**Commanders, 154th Infantry Regiment**

Col. Ralph C. Turck	6 June 1921–28 May 1924
---------------------	-------------------------

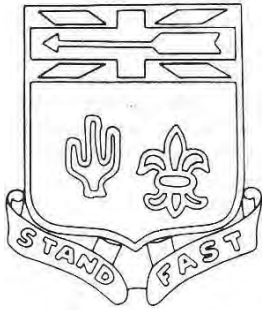
**155th Infantry Regiment (31st Division)****Mississippi National Guard****HQ**—*Not organized*, 1921–23; Vicksburg, MS, 1923–40; Camp Blanding, FL, 1940–41

Arrived at the port of Newport News on 31 December 1918 on the U.S.S. *Princess Matoika* as the 155th Inf., an element of the 39th Div. Demobilized 23 January 1919 at Camp Beauregard, LA. Reconstituted in the N.G. in 1921, assigned to the 39th Div., and allotted to the state of Florida. Reorganized on 2 November 1921 by redesignation of the 1st Inf., Mississippi N.G. (organized 1919–20 with HQ at Vicksburg, MS) as the 155th Inf. HQ federally recognized on 25 April 1923 at Vicksburg, MS. Relieved from the 39th Div. on 1 July 1923 and assigned to the 31st Div. The regiment, or elements thereof, called up to perform the following state duties: entire regiment to perform flood relief duty at communities flooded by the Mississippi River in April–June 1927; 1st Bn. to perform escort duty in connection with protecting Negro prisoners against race riots at Jackson and Magnolia, MS, 22–23 October 1931. Conducted annual summer training at numerous locations to include: Camp Williamson, MS; Camp Beauregard, LA; Camp Benjamin F.

McClellan, MS; Camp Shelby, MS; and Camp McClellan, AL. Inducted into active Federal service at Vicksburg on 20 November 1940 and moved to Camp Blanding, FL, where it arrived on 21 December 1940. Location 7 December 1941—Camp Blanding, FL.

**Status:** Assigned to the USARS as the 155th Inf.; 1st Bn. active at McComb, MS, as an element of the 155th Armd. Brig.

**Events:** 56, 255, 300, 325, 328, 330

**Commanders, 155th Infantry Regiment**

Col. George C. Hoskins  
*Demobilized/Inactive*

5 August 1917–23 January 1919  
23 January 1919–24 April 1923

Col. George E. Hogaboom  
Col. Thomas B. Birdsong Jr.

25 April 1923–4 July 1941  
5 July 1941–October 1942

**156th Infantry Regiment (31st Division)****Louisiana National Guard****HQ**—*Not organized*, 1921–22; New Orleans, LA, 1922–29; Lafayette, LA, 1929–37; Shreveport, LA, 1937–40; Lake Charles, LA, 1940; Camp Blanding, FL, 1940–41

Arrived at the port of Newport News on 31 December 1918 on the U.S.S. *Princess Matoika* as the 156th Inf., an element of the 39th Div. Demobilized on 23 January 1919 at Camp Beauregard, LA. Reconstituted in the N.G. in 1921, assigned to the 39th Div., and allotted to the state of Louisiana. Reorganized in June 1921 as seven separate companies of Infantry, Louisiana N.G. Reorganized, expanded, and redesignated on 2 November 1921 as the 156th Inf. Regimental HQ organized on 4 August 1922 and federally recognized at New Orleans, LA. Regimental HQ successively relocated as follows: to Lafayette, LA, 22 July 1929; and Shreveport, LA, 25 February 1937. Relieved from the 39th Div. on 1 July 1923 and assigned to the 31st Div. The regiment, or elements thereof, called up to perform the following state duties: six companies performed flood duty at communities flooded by the Mississippi River, 24 April–7 June 1922; regiment performed flood duty

at communities flooded by the Mississippi River, 26 April–19 June 1927. Conducted annual summer training most years at Camp Beauregard, LA, 1922–39. The 2d Bn. relieved and reorganized as the 204th C.A. in February 1940. Concurrently, new 2d Bn. organized. Regimental HQ relocated about March 1940 to Lake Charles, LA. Inducted into active Federal service at New Orleans on 20 November 1940, and moved to Camp Blanding, FL, where it arrived on 21 December 1940. Location 7 December 1941—Camp Blanding, FL.

**Status:** Assigned to the USARS as the 156th Inf.; 2d Bn. active at Abbeville, LA, and 3d Bn. active at Lake Charles, LA, as elements of the 256th Inf. Brig. (Mecz).

**Events:** 56, 255, 300, 325, 328, 330

**Commanders, 156th Infantry Regiment**

Col. Frank P. Stubbs <i>Demobilized/Inactive</i>	5 August 1917–23 January 1919 23 January 1919–4 August 1922 Col. James H. Kuttner	Col. Louis F. Guerre Col. Hollingsworth B. Barret 8 August 1936–ao June 1941	4 August 1922–10 June 1929 22 June 1929–8 August 1936
-----------------------------------------------------	-----------------------------------------------------------------------------------------	------------------------------------------------------------------------------------	----------------------------------------------------------

**157th Infantry Regiment (45th Division)**

**Colorado National Guard**

**HQ**—Denver, CO, 1921–41; Fort Sill, OK, 1940–41; Camp Barkeley, TX, 1941



Arrived at the port of New York on 11 April 1919 on the U.S.S. *Julia Luckenbach* as the 157th Inf., an element of the 38th Div. Demobilized 29 April 1919 at Fort D.A. Russell, WY. Reorganized as the 177th Inf. on 28 February 1921. HQ organized 26 October 1921 and federally recognized at Denver, CO. Redesignated as the 157th Inf. on 16 November 1921 and assigned to the 45th Div. The regiment, or elements thereof, called up to perform the following state duties: flood disaster at Pueblo, CO, in June 1921; 1st Bn. performed riot control during a coal miners' strike at Pueblo in July 1922; regimental HQ and three companies performed riot control during a coal miners' strike at Columbine Mine, near Boulder, CO, 21 November 1927–6 April 1928; regiment, less 2d Bn., performed duties

in connection with grasshopper infestations in eastern Colorado, 28 June–26 August 1937; performed riot control during a coal miners' strike at the Green Mountain Mine, 3–31 August 1939. Conducted annual summer training most years at Camp George West, CO, 1921–39. For at least 2 years, in 1932–33, the regiment also trained some 17 company-grade infantry officers of the 103d Div. at Camp George West. Inducted into active Federal service at Denver on 16 September 1940 and moved to Fort Sill, OK, where it arrived on 26 September 1940. Transferred 28 February 1941 to Camp Barkeley, TX. Location 7 December 1941—Camp Barkeley, TX.

**Status:** Assigned to the USARS as the 157th F.A.; 1st Bn. active at Longmont, CO, and 2d Bn. active at Colorado Springs, CO, as elements of the 169th F.A. Brig.

**Events:** 157, 260, 300, 317, 328

**Commanders, 157th Infantry Regiment**

Col. Patrick J. Hamrock	30 September 1917–October 1918	Col. William C. Danks	26 October 1921–9 December 1924
Lt. Col. Rice W. Means	October 1918–20 October 1918	Col. Arthur L. Hart	9 December 1924–6 January 1930
Unknown	20 October 1918–13 February 1919	Col. Rufus A. Johnston	6 January 1930–ao November 1939
Lt. Col. Rice W. Means	13 February 1919–29 April 1919	Col. Rudolph J. Seyfried	ao August 1940–16 September 1940
<i>Demobilized/Inactive</i>	29 April 1919–25 October 1921	Col. Charles M. Ankcorn	16 September 1940–September 1943

**158th Infantry Regiment (45th Division)**

**Arizona National Guard**

**HQ**—*Not organized*, 1921–24; Phoenix, AZ, 1924–32; Tucson, AZ, 1932–40; Fort Sill, OK, 1940–41; Camp Barkeley, TX, 1941



Arrived at the port of New York on 17 April 1919 on the U.S.S. *Ohioan* as the 158th Inf., an element of the 38th Div. Relieved 20 April 1919 from the 40th Div. Demobilized 3 May 1919 at Camp Kearny, CA. Reconstituted in the N.G. in 1921, assigned to the 45th Div., and allotted to the state of Arizona. Reorganized 1922–24. HQ organized 12 September 1924 and federally recognized at Phoenix, AZ. HQ relocated 11 October 1932 to Tucson, AZ. Enlisted personnel of Cos. D and F composed entirely of American Indians, 1924–38. Conducted annual summer training at Camp Harry H. Jones, AZ, 1921–24; Fort Huachuca, AZ, 1925–29; and Camp Tuthill, AZ, 1930–39. For at least 2 years, in 1932–33, the regiment also trained some 38 company-grade infantry officers of the 103d Div. at Camp Tuthill. Inducted into active Federal service at Tucson on

16 September 1940 and moved to Fort Sill, OK, where it arrived 23 September 1940. Transferred 28 February 1941 to Camp Barkeley, TX. Location 7 December 1941—Camp Barkeley, TX.

**Status:** Assigned to the CARS as the 158th Inf. Regt.

**Events:** 261, 300, 317, 328

**Commanders, 158th Infantry Regiment**

Col. Alexander M. Tuthill	5 August 1917–22 August 1917	Col. Albert Linxwiler	12 January 1919–13 February 1919
Lt. Col. Harry H. Donkersley	22 August 1917–18 December 1917	Col. Samuel P. Saltmarsh	14 February 1919–3 May 1919
Col. Harry D. Smith	18 December 1917–21 March 1918	<i>Demobilized/Inactive</i>	3 May 1919–13 September 1924
Col. Edgar P. Grinstead	21 March 1918–28 December 1918	Col. Power Conway	12 September 1924–May 1928
Maj. Horatio G. Coykendall	28 December 1918–11 January 1919	Col. Joseph F. Pomeroy	May 1928–11 October 1932
	Col. Prugh J. Herndon		11 October 1932–29 May 1944

**159th Infantry Regiment (40th Division)**

**California National Guard**

**HQ**—*Not organized*, 1921–22; Berkeley, CA, 1922–31; Oakland, CA, 1931–41; Camp San Luis Obispo, CA, 1941; Fort Ord 1941

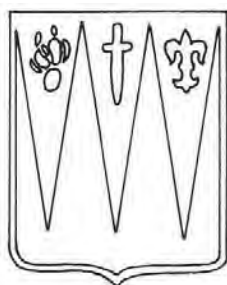

Arrived at the port of New York on 5 April 1919 on the U.S.S. *Edgar F. Luckenbach* as the 159th Inf., an element of the 38th Div. Demobilized on 1 May 1919 at the Presidio of San Francisco, CA. Reconstituted in the N.G. in 1921, assigned to the 40th Div., and allotted to the state of California. Reorganized 1920–21 as seven separate companies of infantry in the California N.G. Reorganized and redesignated on 2 October 1921 as the 159th Inf. HQ organized on 14 June 1922 and federally recognized at Berkeley, CA. HQ relocated on 23 March 1931 to Oakland, CA. Entire regiment called up to perform riot control during the San Francisco street car workers’ strike, 5–21 July 1934. Conducted annual summer training at Del Monte, CA, and Camp San Luis Obispo, CA. Inducted into active Federal service at Oakland on 3 March 1941 and moved to Camp San Luis Obispo where it arrived

on 14 March 1941. Relieved from the 40th Div. on 29 September 1941 and assigned to the 7th Div. Reorganized and redesignated 159th Inf. (Mtzd) on 29 October 1941. Transferred 3 December 1941 to Fort Ord, CA. Location 7 December 1941—Fort Ord, CA.

**Status:** Assigned to the USARS as the 159th Inf.; no active elements.

**Events:** 231, 304, 314, 326

**Commanders, 159th Infantry Regiment**

Col. Leonard M. Ferrell	31 March 1917–1 May 1919	Col. Adolphus J. Eddy	29 June 1925–31 August 1929
<i>Demobilized/Inactive</i>	1 May 1919–13 June 1922	Col. Wayne R. Allen	31 August 1929–30 September 1937
Col. David P. Barrows	14 June 1922–29 June 1925	Col. John U. Calkins	1 November 1937–1 July 1941
	Col. Ray W. Hays		1 July 1941–December 1941

**160th Infantry Regiment (40th Division)**

**California National Guard**

**HQ**—*Not organized*, 1921–22; Los Angeles, CA, 1922–41; Camp San Luis Obispo, CA, 1941



Arrived at the port of New York on 24 March 1919 on the U.S.S. *Matsonia* as the 160th Inf., an element of the 38th Div. Demobilized on 7 May 1919 at Camp Kearny, CA. Reconstituted in the N.G. in 1921, assigned to the 40th Div., and allotted to the state of California. Reorganized 23 August–6 October 1921 in southern California. HQ organized 31 January 1922 and federally recognized at Los Angeles, CA. The 1st Bn. was involved in a train collision on 19 July 1925 near Santa Barbara on its way back from summer training. The regiment, or elements thereof, called up to perform the following state duties: entire regiment to perform earthquake relief operations 14–22 March 1933 in the Los Angeles area; entire regiment to perform riot control during the San Francisco street car workers’ strike 5–21 July 1934. Conducted annual summer training at Del Monte, CA, and Camp San Luis Obispo, CA. Inducted into active Federal service at Los Angeles on

3 March 1941 and moved to Camp San Luis Obispo where it arrived 11 March 1941. Location 7 December 1941—Fort Ord, CA.

**Status:** Assigned to the USARS as the 160th Inf.; 3d Bn. active at Inglewood, CA, and 4th Bn. active at Santa Ana, CA, as elements of the 40th Inf. Div. (Mecz).

**Events:** 154, 231, 304, 314, 326

**Commanders, 160th Infantry Regiment**

Col. Charles F. Hutchins	26 March 1917–7 May 1919	Col. Harcourt Hervey	26 July 1926–13 July 1937
<i>Demobilized/Inactive</i>	7 May 1919–30 January 1922	Col. Wayne R. Allen	13 July 1937–4 March 1941
Col. Walter P. Story	31 January 1922–23 July 1926	Lt. Col. Henry C. Newton	4 March 1941–1 July 1941
	Col. Edward J. Murray	1 July 1941–February 1945	

**161st Infantry Regiment (41st Division)**

**Washington National Guard**

**HQ**—Spokane, WA, 1921–40; Camp Murray, WA, 1940–41



Arrived at the port of Newport News in February 1919 on the U.S.S. *Georgia* as the 161st Inf., an element of the 41st Div. Demobilized 1–8 May 1919 at Camp Dix, NJ, and Camp Dodge, IA. Reconstituted in the N.G. in 1921, assigned to the 41st Div., and allotted to the state of Washington. Reorganized 1 May 1921 by consolidation with the 2d Inf., Washington N.G. (organized in 1918; HQ organized 30 September 1918 and federally recognized at Spokane, WA) and redesignation as the 161st Inf. The regiment, or elements thereof, called up to perform the following state duties: 2d Bn. performed duties in connection with guarding prisoners at a penitentiary in Walla Walla, WA, 3–8 September 1926; 2d Bn. performed strike duties in connection with an agri-labor/I.W.W. strike at Yakima, WA, 24–27 August 1933; entire regiment for riot control duties in connection with a timber workers strike at Gray’s Harbor, Tacoma, and Aberdeen, WA, 12 July–9 August 1935. Conducted annual summer training at Camp Murray, WA, 1921–39. Inducted into active Federal service at Spokane

on 16 September 1940, and moved to Camp Murray where it arrived on 23 September 1940. Location 7 December 1941—Camp Murray, WA.

**Status:** Assigned to the USARS as the 161st Inf.; 1st Bn. active at Spokane, WA, as an element of the 81st Armd. Brig. (Sep.).

**Events:** 238, 304, 309, 314, 326

**Commanders, 161st Infantry Regiment**

Col. William M. Inglis	5 August 1917–20 September 1918	Col. William T. Patten (RA)	31 July 1920–17 April 1922
Unknown	21 September 1918–1 March 1919	Col. Thomas G. Aston	17 April 1922–23 December 1937
<i>Demobilized/Inactive</i>	1 March 1919–31 July 1920	Col. Clarence A. Orndorff	10 February 1938–22 January 1943

**162d Infantry Regiment (41st Division)**

**Oregon National Guard**

**HQ**—Portland, OR, 1921–40; Camp Murray, WA, 1940–41; Fort Lewis, WA, 1941

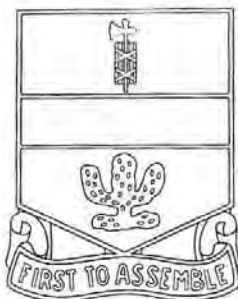

Arrived at the port of New York on 17 February 1919 on the S.S. *Canopec* as the 162d Inf., an element of the 41st Div. Demobilized on 1 March 1919 at Camp Dix, NJ. Reconstituted in the N.G. in 1921, assigned to the 41st Div., and allotted to the state of Oregon. Reorganized on 7 October 1921 by redesignation of the 5th Inf., Oregon N.G. (organized 30 June 1919 as the 3d Inf., Oregon N.G.; HQ organized on 17 September 1919 and federally recognized at Portland, OR; redesignated 5th Inf., Oregon N.G. on 5 May 1920) as the 162d Inf. Conducted annual summer training at Camp Lewis, WA, 1922–24; Camp Jackson, OR, 1925–26; and at Camp Clatsop, OR, 1927–39. Inducted into active Federal service at Portland on 16 September 1940 and moved to Camp Murray where it arrived 23 September 1940. Transferred 20 March 1941 to Fort Lewis, WA. Location 7 December 1941—Fort Lewis, WA.



**Status:** Assigned to the USARS as the 162d Inf.; 1st Bn. active at Forest Grove, OR, and 2d Bn. active at Cottage Grove, OR, as elements of the 41st Inf. Brig. (Sep.).

**Events:** 238, 304, 309, 314, 326

**Commanders, 162d Infantry Regiment**

Col. John L. May	5 August 1917–May 1919	Col. Eugene Moshberger	3 April 1925–15 April 1937
<i>Demobilized/Inactive</i>	May 1919–29 June 1919	Col. Harry C. Brumbaugh	16 April 1937–ao September 1940
Col. Creed C. Hammond	30 June 1919–3 April 1925	Unknown	ao September 1940–7 December 1941

**163d Infantry Regiment (41st Division)**

**Montana National Guard**

**HQ**—*Not organized*, 1921–24; Bozeman, MT, 1924–25; Helena, MT, 1925–39; Billings, MT, 1939–41; Camp Murray, WA, 1940–41; Fort Lewis, WA, 1941



Arrived at the port of New York on 12 February 1919 on the U.S.S. *Leviathan* as the 163d Inf., an element of the 41st Div. Demobilized on 21 February 1919 at Camp Dix, NJ. Reconstituted in the N.G. in 1921, assigned to the 41st Div., and allotted to the state of Oregon. Reorganized on 1 May 1922 by redesignation of the 2d Inf., Montana N.G. (organized 1921–22) as the 163d Inf. HQ organized on 20 January 1924 and federally recognized at Bozeman, MT. HQ successively relocated to Helena, MT, 9 March 1925, and to Billings, MT, 29 December 1939. Co. B formed in 1922 at Poplar, MT, entirely with American Indian personnel from the Fort Peck Reservation. Elements called up to conduct disaster relief duties in Helena, MT, due to an earthquake in October–November 1935. Conducted annual summer training most years at Fort William Henry Harrison,

MT, 1921–39. Inducted into active Federal service at Billings on 16 September 1940 and moved to Camp Murray, WA, where it arrived on 23 September 1940. Transferred 20 March 1941 to Fort Lewis, WA. Location 7 December 1941—Fort Lewis, WA.

**Status:** Assigned to the USARS as the 163d Inf.; 1st Bn. active at Bozeman, MT, as an element of the 116th Armd. Cav. Brig. (Sep.).

**Events:** 238, 304, 309, 314, 326

**Commanders, 163d Infantry Regiment**

Col. John J. MacGuinness	19 September 1917–21 February 1919	Col. Lyman E. Moore	15 April 1937–1 November 1939
<i>Demobilized/Inactive</i>	22 February 1919–19 January 1924	Col. Edward M. Birely	1 November 1939–16 October 1940
Col. Erastus H. Williams	20 January 1924–13 February 1937	Col. George F. Bloomquist (RA)	17 October 1940–June 1942

**164th Infantry Regiment (34th Division)**

**North Dakota National Guard**

**HQ**—*Not organized*, 1921–23; Valley City, ND, 1923–28; Fargo, ND, 1928–41; Camp Claiborne, LA, 1941



Arrived at the port of New York on 17 February 1919 on the U.S.S. *President Grant* as the 164th Inf., an element of the 41st Div. Demobilized on 28 February 1919 at Camp Dix, NJ. Reconstituted in the N.G. in 1921, assigned to the 34th Div., and allotted to the state of North Dakota. Reorganized on 16 May 1923 with HQ organized and federally recognized at Valley City, ND. HQ relocated on 14 December 1928 to Fargo, ND. The regiment, or elements thereof, called up to perform the following state duties: Co. A performed martial law at a workers' strike in Bismarck, ND, 1–3 June 1933; A Co. performed martial law in Bismarck during disputes over the gubernatorial accession, 17–24 July 1934. Co. E awarded the William Randolph Hearst National Marksmanship Trophy in 1934.

Conducted annual summer training most years at Camp Gilbert C. Grafton, Devil's Lake, ND, 1921–39. For at least 2 years, in 1938 and 1939, the regiment also trained some 19 company-grade officers of the 88th Div. at Camp Grafton. Inducted into active Federal service at Fargo on 10 February 1941 and moved to Camp Claiborne, LA, where it arrived 27 February 1941. Location 7 December 1941—Camp Claiborne, LA.

**Events:** 233, 303, 320, 328

**Commanders, 164th Infantry Regiment**

Col. John H. Fraine <i>Demobilized/Inactive</i>	5 August 1917–28 February 1919 28 February 1919–16 May 1923 Col. Earle R. Sarles	Col. David S. Ritchie Col. La Roy Baird October 1940–14 September 1942	16 May 1923–1 November 1928 1 November 1928–October 1940
----------------------------------------------------	----------------------------------------------------------------------------------------	------------------------------------------------------------------------------	-------------------------------------------------------------

**165th Infantry Regiment (44th Division)**

**New York National Guard**

**HQ**—New York City, NY, 1921–40; Fort McClellan, AL, 1940–41



Arrived at the port of New York on 21 April 1919 on the U.S.S. *Harrisburg* as the 165th Inf., an element of the 42d Div. Demobilized 7 May 1919 at Camp Upton, NY. Reconstituted in the N.G. on 30 December 1920 and allotted to the state of New York. Concurrently relieved from the 42d Div. and assigned to the 87th Inf. Brig., 44th Div. Reorganized on 11 October 1921 by redesignation of the 69th Inf., New York N.G. (HQ organized 7 January 1921 and federally recognized at New York City, NY) as the 165th Inf. Relieved from the 87th Inf. Brig. on 27 February 1927 and assigned to the 93d Inf. Brig. Conducted additional week-long winter training directed by the War Department at Camp Dix, NJ, 12–19 November 1939. Relieved from the 93d Inf. Brig. on 20 June 1940 and assigned to the 27th Div. Conducted annual summer training most years at Camp Smith, Peekskill, NY, and some years at Fort Niagara, NY. Inducted into active Federal service in New York City on 15 October 1940 and moved to Fort McClellan, AL, where it arrived 26 October 1940. Location 7 December 1941—Fort McClellan, AL.

**Status:** Assigned to the USARS as the 69th Inf.; 1st Bn. active at New York City, NY, as an element of the 42d Inf. Div. (Mecz).

**Events:** 61, 280, 316, 324, 328

**Commanders, 165th Infantry Regiment**

Col. Charles D. Hine	20 August 1917–9 January 1918	Col. Charles R. Howland	22 February 1919–28 April 1919
Col. John W. Barker	10 January 1918–7 May 1918	<i>Demobilized/Inactive</i>	28 April 1919–6 January 1921
Col. Frank R. McCoy	7 May 1918–16 August 1918	Col. John J. Phelan	7 January 1921–26 January 1927
Col. Harry D. Mitchell	16 August 1918–18 October 1918	Col. William J. Costigan	27 January 1927–24 May 1934
Col. Charles A. Dravo	19 October 1918–ao November 1918	Col. Alexander E. Anderson	25 May 1934–23 August 1938
Col. William J. Donovan	ao January 1919–22 February 1919	Col. John J. Mangan	23 August 1938–20 August 1940
	Col. Gardiner J. Conroy	20 August 1940–20 November 1943	

**166th Infantry Regiment (37th Division)**

**Ohio National Guard**

**HQ**—Columbus, OH, 1921–40; Camp Shelby, MS, 1940–41

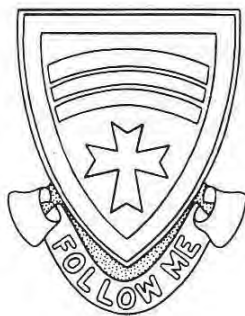

Arrived at the port of New York on 25 April 1919 on the U.S.S. *Leviathan* as the 166th Inf., an element of the 42d Div. Demobilized 17 May 1919 at Camp Sherman, OH. Reconstituted in the N.G. in 1921 and allotted to the state of Ohio. Concurrently relieved from the 42d Div. and assigned to the 37th Div. Reorganized 1 July 1921 by redesignation of the 4th Inf., Ohio N.G. (organized 1919–21; HQ organized 23 March 1921 and federally recognized at Columbus, OH) as the 166th Inf. and assigned to the 37th Div. The regiment, or elements thereof, called up to perform the following state duties: riot control during a coal miners' strike at Cadiz and Zanesville, OH, 14 July 1922–8 August 1922; escort duties at the funeral of President Warren G. Harding in August 1923; tornado relief duties at Lorain-Sandusky, OH, 28 June–16 July 1924; guard duties at the crash site of the dirigible U.S.S. *Shenandoah* in September 1925; riot control

during a coal miners' strikes at St. Clairsville and Nelsonville, OH, 4 August 1927–10 June 1928; riot control during the Ohio State Penitentiary riot and fire, 21 April–3 June 1930; riot control during a coal miners' strike at Cadiz, OH, 16 April–20 July 1932; flood relief along the Ohio River, January–March 1937; riot control during a workers' strike at the Mahoning Valley steel plants, 22 June–15 July 1937. Conducted annual summer training most years at Camp Perry, OH, 1921–39. Inducted into active Federal service at Columbus on 15 October 1940, and moved to Camp Shelby, MS, where it arrived 24 October 1940. Location 7 December 1941—Camp Shelby, MS.

**Status:** Assigned to the USARS as the 166th Inf.; no active elements.

**Events:** 213, 220, 302, 320, 328

#### Commanders, 166th Infantry Regiment

Col. Benson W. Hough	5 August 1917–17 May 1919	Col. George Florence	21 May 1920–21 January 1921
<i>Demobilized/Inactive</i>	18 May 1919–4 June 1919	Col. Robert Haubrich	21 January 1921–10 October 1940
Col. Benson W. Hough	5 June 1919–28 April 1920	Col. Herman C. Doellinger	11 October 1940–ao December 1941

#### 167th Infantry Regiment (31st Division)

#### Alabama National Guard

**HQ**—*Not organized*, 1921–22; Montgomery, AL, 1922–29; Birmingham, AL, 1929–32; Gadsden, AL, 1932–40; Camp Blanding, FL, 1940–41



Arrived at the port of New York on 25 April 1919 on the U.S.S. *North Carolina* as the 167th Inf., an element of the 38th Div. Demobilized on 19 May 1919 at Camp Shelby, MS. Reconstituted in the N.G. in 1921 and allotted to the state of Alabama. Concurrently relieved from the 42d Div. and assigned to the 39th Div. Reorganized on 16 December 1921 by redesignation of the 4th Inf., Alabama N.G. (organized 1 July 1919) as the 167th Inf. HQ organized on 10 April 1922 and federally recognized at Montgomery, AL. Relieved from the 39th Div. on 1 July 1923 and assigned to the 31st Div. HQ successively relocated to Birmingham, AL, September 1929, and to Gadsden, AL, 11 January 1932. The regiment, or elements thereof, called up to perform the following state duties: 3d Bn. performed riot control during a railroad workers' strike at Birmingham, AL, 4 August 1922–4 January 1923; performed border guard duty along the Florida state line in connection with the Mediterranean Fruit Fly quarantine, April–July 1929; 3d Bn. performed riot duty in connection with criminal trials at Eufaula, AL, July 1929, and Montgomery, AL, February–March 1930; Co. C performed a man-hunt and captured bank robbers in Dallas County, AL, in December 1930; 2d Bn. performed escort duty in connection with the famous "Scottsboro Boys" trial in Scottsboro, AL, 5–9 April 1931; 3d Bn. performed escort duty in connection with protecting Negro prisoners against race riots in Birmingham, 2–4 October 1931; 2d Bn. performed tornado relief at Northport, AL, 21–23 March 1932; several companies performed riot control during a workers' strike at cotton mills in Anniston, AL, in May 1933; 1st Bn. performed escort duty in connection with protecting Negro prisoners in Tuscaloosa, AL, July–August 1933. Conducted annual summer training most years at Camp McClellan, AL, 1921–39. Inducted into active Federal service at Gadsden on 25 November 1940, and moved to Camp Blanding, FL, where it arrived 20 December 1940. Location 7 December 1941—Camp Blanding, FL.

**Status:** Assigned to the USARS as the 167th Inf.; 1st Bn. active at Talladega, AL, as an element of the 31st Armd. Brig. (Sep.).

**Events:** 255, 300, 325, 328, 330

#### Commanders, 167th Infantry Regiment

Col. William P. Screws	5 August 1917–19 May 1919	Col. George A. Glenn	28 September 1926–May 1929
<i>Demobilized/Inactive</i>	19 May 1919–9 April 1922	Lt. Col. James A. Webb	May 1929–20 September 1929
Col. Walter E. Bare	10 April 1922–24 August 1926	Col. Walter M. Thompson	20 September 1929–ao January 1941
	Col. James A. Webb		ao August 1941–ao September 1941

**168th Infantry Regiment (34th Division)****Iowa National Guard**

**HQ**—Des Moines, IA, 1921–37; Council Bluffs, IA, 1937–41; Camp Claiborne, LA, 1941



Arrived at the port of New York on 25 April 1919 on the U.S.S. *Leviathan* as the 168th Inf., an element of the 42d Div. Demobilized on 17 May 1919 at Camp Dodge, IA. Reconstituted in the N.G. in 1921 and allotted to the state of Iowa. Concurrently relieved from the 42d Div. and assigned to the 34th Div. Reorganized 13 July 1921 with HQ organized and federally recognized at Des Moines, IA. Entire regiment, or elements thereof, called up to perform the following state duties: tornado relief work at Neola and Persia, IA, 7–8 June 1925; riot control during the “Cow War” at Cedar County/Burlington, IA, 21 September–25 November 1931; 1st and 3d Bns. performed martial law in Plymouth and Crawford counties, respectively, during the Farm Holiday Association disturbances,

28 April–17 May 1933; 1st Bn. performed martial law at Newton, IA, during the labor troubles at the Maytag Washing Machine plant, 19 July–6 August 1938. Regimental HQ relocated 27 January 1937 to Council Bluffs, IA. Conducted annual summer training most years at Camp Dodge, IA, 1921–39. For at least 2 years, in 1938 and 1940, the regiment also trained some 18 company-grade officers of the 88th Div. at Camp Dodge and Camp Ripley, MN. Inducted into active Federal service at Council Bluffs on 10 February 1941 and moved to Camp Claiborne, LA, where it arrived 3 March 1941. Location 7 December 1941—Camp Claiborne, LA.

**Status:** Assigned to the USARS as the 168th Inf.; 1st Bn. active at Council Bluffs, IA, as an element of the 34th Inf. Div.

**Events:** 233, 303, 320, 328

**Commanders, 168th Infantry Regiment**

Col. Ernest R. Bennett	5 August 1917–3 September 1918	Col. Guy S. Brewer	13 July 1921–November 1923
Col. Mathew A. Tinley	3 September 1918–17 May 1919	Col. Glenn C. Haynes	24 November 1923–26 October 1936
<i>Demobilized/Inactive</i>	17 May 1919–12 July 1921	Col. George F. Everest	26 October 1936–June 1942

**169th Infantry Regiment (43d Division)****Connecticut National Guard**

**HQ**—Hartford, CT, 1921–41; Camp Blanding, FL, 1941



Arrived at the port of Hoboken on 27 February 1919 as the 58th Pioneer Inf. Demobilized on 8 January 1919 at Camp Wadsworth, SC. Reconstituted in the N.G. on 25 November 1921 as the 169th Inf. Regt., assigned to the 43d Div., and allotted to the state of Connecticut. Reorganized on 23 May 1921 by consolidation and redesignation of the 1st and 2d Inf. Regts., Connecticut N.G. as the Connecticut Regiment of Infantry. HQ concurrently organized and federally recognized at Hartford, CT. Redesignated the 169th Inf. on 7 October 1921 (the 2d Inf. Regt., Connecticut N.G., withdrawn from the 169th Inf. on 20 October 1922 and redesignated the 170th Inf.; hereafter separate lineage). Entire regiment called up to perform the following state duties: riot control at the textile workers strike at Putnam and Danielson, CT, in September 1934; flood relief at Hartford, CT, 19 March–1 April 1936; hurricane relief in the vicinity of Rockville, CT, 22–27 September 1938. Conducted annual summer training most years at Niantic, CT, and some years

at Camp Devens, MA. Inducted into active Federal service at Hartford on 24 February 1941, and moved to Camp Blanding, FL, where it arrived 15 March 1941. Location 7 December 1941—Camp Blanding, FL.

**Status:** Reorganized and redesignated as the 169th Regt. (Leadership Training) with HQ at Niantic, CT.

**Events:** 190, 280, 301, 325, 328, 330

**Commanders, 169th Infantry Regiment**

Col. Edwin E. Lamb	23 May 1921–1 June 1922	Col. Orville A. Petty	2 September 1929–ao August 1933
Col. James A. Haggerty	1 June 1922–8 June 1923	Col. Joseph P. Nolan	20 February 1938–1 November 1940
Col. Gordon D. Hunter	3 July 1923–2 September 1929	Col. Kenneth F. Cramer	1 November 1940–August 1942

**170th Infantry Regiment (43d Division)****Connecticut National Guard****HQ**—*Not organized*, 1921–23; New Haven, CT, 1923–24

Arrived at the port of Boston on 7 April 1919 on the U.S.S. *Agamemnon* the 102d Inf., an element of the 26th Div. Demobilized on 29 April 1919 at Camp Devens, MA. Reorganized on 20 October 1922 by withdrawal of the 2d Inf. Regt., Connecticut N.G. from the 169th Inf. (organized 23 May 1921 by consolidation and redesignation of the 1st and 2d Inf. Regts., Connecticut N.G. as the Connecticut Regiment of Infantry; redesignated 169th Inf. on 7 October 1921) and redesignation of that regiment as the 170th Inf. Regt. HQ organized on 8 June 1923 and federally recognized at New Haven, CT. The 170th Inf. was redesignated as the 102d Inf. on 28 February 1924.

**Commanders, 170th Infantry Regiment**

Col. James A. Haggerty

8 June 1923–28 February 1924

**171st Infantry Regiment (43d Division)****Maine National Guard****HQ**—*Not organized*, 1921–22

Constituted in the N.G. as the 171st Inf. Regt. in 1921, assigned to the 43d Div., and allotted to the state of Maine. Withdrawn from the state of Maine on 1 January 1922.

**172d Infantry Regiment (43d Division)****Vermont National Guard****HQ**—*Not organized*, 1921–22; Brattleboro, VT, 1922–29; St. Johnsbury, VT, 1929–30; Northfield, VT, 1930–33; Rutland, VT, 1933–38; Bennington, VT, 1938–40; Brattleboro, VT, 1940–41; Camp Blanding, FL, 1941

Demobilized on 22 February 1919 at Camp Devens, MA, as the 57th Pioneer Inf. Reorganized 10 April 1922 by redesignation of the 1st Inf. Regt., Vermont N.G. (HQ organized on 25 June 1919 and federally recognized at Brattleboro, VT) as the 172d Inf. Regt. and assigned to the 43d Div. HQ relocated successively as follows: to St. Johnsbury, VT, 1 January 1929; Northfield, VT, 17 July 1930; Rutland, VT, 16 February 1933; Bennington, VT, 1 September 1938; and Brattleboro, VT, in 1940. HQ Co., 2d Bn., 172d Inf. was organized in December 1922 entirely with faculty members of Norwich University and cadets of the ROTC program. The unit remained organized as such until the eve of World War II. Regiment, or elements thereof, called up to perform the following state duties: riot control during labor troubles at paper mills in Bellows Falls and Wilder, VT, 25 July–5 August 1921; flood relief duty at Waterbury and Montpelier, VT, 3–21 November 1927; riot control during a granite workers' strike at Barre, VT,

8 May–3 June 1930; 3d Bn. performed flood relief duty at Bennington, Windsor, and Brattleboro, VT, 18–22 March 1936. Regiment conducted annual summer training most years at the Vermont State Camp at Fort Ethan Allen, VT, 1921–39. Inducted into active Federal service at Brattleboro on 24 February 1941 and moved to Camp Blanding, FL, where it arrived 5 March 1941. Location 7 December 1941—Camp Blanding, FL.

**Status:** Assigned to the USARS as the 172d Armor; 1st Bn. active at St. Albans, VT, and 2d Bn. active at Rutland, VT, as elements of the 42d Inf. Div. (Mecz).

**Events:** 67, 190, 280, 301, 325, 328, 330**Commanders, 172d Infantry Regiment**

Col. Ernest W. Gibson

17 March 1922–17 December 1923

Col. Leonard F. Wing

16 February 1933–2 July 1938

Col. John W. Tinker

27 December 1923–28 December 1929

Col. Reginald W. Buzzell

2 July 1938–November 1941

Col. Murdock A. Campbell

28 December 1929–16 February 1933

Col. John F. Goodman

November 1941–November 1942

**174th Infantry Regiment (44th Division)****New York National Guard****HQ**—*Not organized*, 1921–22; Buffalo, NY, 1922–40; Fort Dix, NJ, 1940–41

Demobilized 8 February 1919 at Camp A.P. Hill, VA, as the 55th Pioneer Inf. Reconstituted and partially organized 6 April–27 July 1921 as the 74th Inf., New York Guard. Active elements redesignated on 18 October 1921 as the 174th Inf. and assigned to the 44th Div. Regimental HQ organized on 15 May 1922 and federally recognized at Buffalo, NY. Conducted annual summer training most years at Camp Smith, Peekskill, NY, and some years at Fort Niagara, NY. Inducted into active Federal service at Buffalo on 16 September 1940 and moved to Fort Dix, NJ, where it arrived 24 September 1940. Location 7 December 1941—Fort Dix, NJ.

**Status:** Assigned to the USARS as the 174th Inf.**Events:** 190, 280, 301, 330**Commanders, 174th Infantry Regiment**

Col. William R. Pooley	15 May 1922–23 June 1933	Col. Joseph W. Becker	14 June 1937–22 September 1941
Col. Ralph K. Robertson	27 July 1933–10 June 1937	Col. Raymond L. Waite Jr.	22 September 1941–ao December 1941

**175th Infantry Regiment (29th Division)****Maryland National Guard****HQ**—*Not organized*, 1921–22; Baltimore, MD, 1923–41; Fort George G. Meade, MD, 1941

Arrived at the port of Newport News on 24 May 1919 on the U.S.S. *Artemis* as elements of the 115th Inf., an element of the 29th Div. Demobilized 7 June 1919 at Camp George G. Meade, MD. Reorganized as the 5th Inf., Maryland N.G., 1919–23, and assigned to the 29th Div. in 1921. HQ organized 1 May 1923 and federally recognized at Baltimore, MD. Conducted annual summer training most years at Camp Ritchie, Cascade, MD, and some years at Saunders Range, MD. Redesignated 175th Inf. on 1 January 1941. Inducted into active Federal service at Baltimore on 3 February 1941 and moved to Fort George G. Meade, MD, where it arrived on 17 February 1941. Location 7 December 1941—Fort George G. Meade, MD.

**Status:** Assigned to the USARS as the 175th Inf.; 1st Bn. active at Dundalk, MD, as an element of the 29th Inf. Div. (Light).**Events:** 281, 301**Commanders, 175th Infantry Regiment****(5th Maryland)**

Col. Washington Bowie	1 May 1923–17 May 1934	Col. Harry C. Ruhl	26 May 1939–1 October 1941
Col. Frank A. Hancock	26 June 1934–25 May 1939	Col. Phillip S. Woods	1 October 1941–1 May 1944

**176th Infantry Regiment (29th Division)****Virginia National Guard****HQ**—Richmond, VA, 1919–41; Fort George G. Meade, MD, 1941

Arrived at the port of Newport News on 22 May 1919 on the U.S.S. *Matsonia* as elements of the 116th Inf., an element of the 29th Div. Demobilized 30 May 1919 at Camp Lee, VA. Organized as the 1st Prov. Inf., Virginia N.G., 30 December 1919. Redesignated 1st Inf., Virginia N.G. on 7 September 1920. HQ concurrently organized and federally recognized at Richmond, VA. Redesignated 183d Inf. on 9 March 1922 and assigned to the 29th Div. Redesignated 1st Inf., Virginia N.G. on 22 February 1929. Co. C awarded the William Randolph Hearst National Marksmanship Trophy in 1937. Conducted annual summer training most years at Virginia Beach, VA, 1921–39. Redesignated 176th Inf. on 1 January 1941. Inducted into active Federal service at Richmond on 3 February 1941, and moved to Fort George G. Meade, MD, where it arrived 17 February 1941. Location 7 December 1941—Fort George G. Meade, MD.

**Status:** HHC active in the Virginia N.G. as HHC, Engr. Brig., 28th Inf. Div.**Events:** 330**Commanders, 176th Infantry Regiment****(1st Virginia)**

Col. John F. Bright

22 February 1929–1 February 1941

Col. Edwin P. Conquest

1 February 1941–30 January 1942

**177th Infantry Regiment (45th Division)****Colorado National Guard****HQ**—Denver, CO, 1921

Arrived at the port of New York on 11 April 1919 on the U.S.S. *Julia Luckenbach* as the 157th Inf., an element of the 38th Div. Demobilized on 29 April 1919 at Fort D.A. Russell, WY. Reorganized as the 177th Inf. on 28 February 1921. The 2d and 3d Bns. called up to perform flood duty at Pueblo, CO, 3 June–2 July 1921. Active elements conducted annual summer training at Golden, CO, in 1921. HQ organized on 26 October 1921 and federally recognized at Denver, CO. Redesignated as the 157th Inf. on 16 November 1921 and assigned to the 45th Div.

**Commanders, 177th Infantry Regiment**

Lt. Col. Paul P. Newlon

26 October 1921–16 November 1921

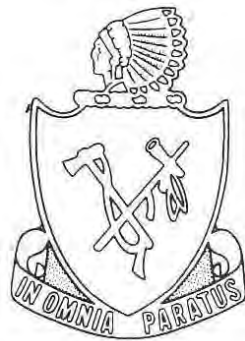
**179th Infantry Regiment (45th Division)****Oklahoma National Guard****HQ**—Oklahoma City, OK, 1921–25; Ardmore, OK, 1925–30; Pawnee, OK, 1930–40 ; Fort Sill, OK, 1940–41; Camp Barkeley, TX, 1941

Arrived at the port of New York on 31 May 1919 on the U.S.S. *Pueblo* as elements of the 142d Inf., an element of the 36th Div. Demobilized on 17 June 1919 at Camp Bowie, TX. Central Oklahoma companies of the 142d Inf. reorganized by consolidation in 1920–21 with the 2d Inf., Oklahoma N.G. (organized 31 August 1918; HQ concurrently organized and federally recognized at Oklahoma City, OK). Redesignated as the 179th Inf. on 14 October 1921 and assigned to the 45th Div. HQ successively relocated as follows: to Ardmore, OK, 5 May 1925; Pawnee, OK, 23 May 1930; Oklahoma City, OK, 1 September 1940. Entire regiment, or elements thereof, called up to perform the following state duties: 1st Bn. performed martial law during race riots at Tulsa, OK, 1–12 June 1921; an ad hoc battalion of four companies performed riot control during a railroad strike at Shawnee, OK, 9–25 August 1922; elements performed martial law duties throughout Oklahoma in connection with heavy floods, 13 September–8 October 1923; 1st Bn. performed oil well

disaster relief at Oklahoma City, 30 October–1 November 1930. Conducted annual summer training most years at Fort Sill, OK, 1921–39. Inducted into active Federal service at Oklahoma City on 16 September 1940 and moved to Fort

Sill where it arrived 26 September 1940. Transferred 28 February 1941 to Camp Barkeley, TX. Location 7 December 1941—Camp Barkeley, TX.

**Status:** Assigned to the USARS as the 179th Inf.; 1st Bn. active at Stillwater, OK, as an element of the 45th Inf. Brig. (Sep.).

**Events:** 258, 300, 317

**Commanders, 179th Infantry Regiment**

Col. Baird H. Markham	14 October 1921–14 February 1923	Col. Charles H. Johnson	21 May 1930–9 December 1939
Col. Charles F. Barrett	14 February 1923–1 January 1925	Col. Philip S. Donnell	20 January 1940–27 August 1940
Col. William Hutchinson	2 January 1925–20 May 1930	Col. Murray F. Gibbons	28 August 1940–February 1942

**180th Infantry Regiment (45th Division)**

**Oklahoma National Guard**

**HQ**—Muskogee, OK, 1921–40; Fort Sill, OK, 1940–41; Camp Barkeley, TX, 1941

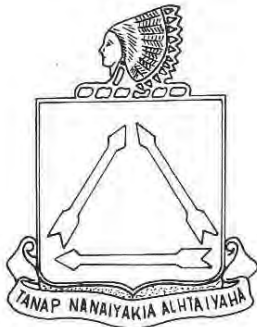

Arrived at the port of New York on 31 May 1919 on the U.S.S. *Pueblo* as elements of the 142d Inf., an element of the 36th Div. Demobilized 17 June 1919 at Camp Bowie, TX. Eastern Oklahoma companies of the 142d Inf. reorganized by consolidation in 1920–21 with the 3d Inf., Oklahoma N.G. (organized 3 September 1918; HQ concurrently organized and federally recognized at Muskogee, OK). Redesignated as the 180th Inf. on 14 October 1921 and assigned to the 45th Div. Co. L inducted as a unit composed entirely of American Indian personnel from reservations in and near Tulsa, OK. Entire regiment, or elements thereof, called up to perform the following state duties: 1st Bn. performed martial law at Tulsa, OK, 1–12 June 1921; martial law duties throughout Oklahoma in connection with heavy floods, 13 September–8 October 1923; Cos. A and D performed martial law at Wilburton, OK, 13 January–4 March 1926; riot control during

labor troubles at copper mines in Picher, OK, 27 May–26 June 1934. Conducted annual summer training most years at Fort Sill, OK, 1921–39. Inducted into active Federal service at Muskogee on 16 September 1940, and moved to Fort Sill where it arrived 26 September 1940. Transferred 28 February 1941 to Camp Barkeley, TX. Location 7 December 1941—Camp Barkeley, TX.

**Status:** Assigned to the USARS as the 180th Inf.; 1st Bn. active at Durant, OK, as an element of the 45th Inf. Brig. (Sep.).

**Events:** 258, 300, 317

**Commanders, 180th Infantry Regiment**

Col. Ewell L. Head	15 January 1921–1 February 1936	Lt. Col. Roy W. Cox	19 September 1939–27 August 1940
Col. Louis A. Ledbetter	1 March 1936–19 September 1939	Col. Philip S. Donnell	27 August 1940–12 June 1942

**181st Infantry Regiment (26th Division)**

**Massachusetts National Guard**

**HQ**—*Not organized*, 1921–22; Natick, MA, 1922–30; Worcester, MA, 1930–41; Camp Edwards, MA, 1941

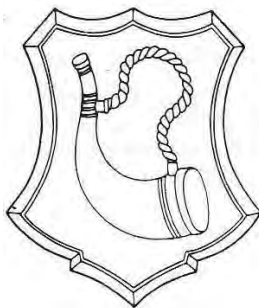

Demobilized 28 April 1919 at Camp A.P. Hill, VA, as the 4th Pioneer Inf. Reorganized as the 3d Inf., Massachusetts N.G. on 1 May 1921 with HQ at Natick, MA. Redesignated on 30 November 1921 as the 181st Inf. (constituted in the N.G. in 1921 and allotted to the state of Massachusetts) and assigned to the 26th Div. HQ organized on 30 March 1922 and federally recognized at Natick, MA. HQ relocated 24 October 1930 to Worcester, MA. Entire regiment, or elements thereof, called up to perform the following state duties: flood relief in the Merrimac Valley, 4 April–19 May 1936; hurricane relief duty at Cape Cod, September 1938. Awarded the Pershing Trophy for Marksmanship (Infantry) in 1939. Conducted annual summer training most years at Camp Devens, MA, 1921–34, and at the Massachusetts Military Reservation at Falmouth, 1935–39. Inducted into active Federal



service at Worcester on 16 January 1941, and moved to Camp Edwards, MA, where it arrived 25 January 1941. Location 7 December 1941—Camp Edwards, MA.

**Status:** Assigned to the USARS as the 181st Inf.

**Events:** 190, 280, 301, 330

**Commanders, 181st Infantry Regiment**

Col. John D. Murphy	1 May 1921–17 April 1923	Col. Edgar C. Erickson	22 October 1930–25 October 1937
Col. Frank L. Converse	15 August 1923–21 October 1930	Col. Roy W. Smith	28 January 1938–7 February 1944

**182d Infantry Regiment (26th Division)**

**Massachusetts National Guard**

**HQ**—*Not organized*, 1921–23; Charlestown, MA, 1923–41; Camp Edwards, MA, 1941

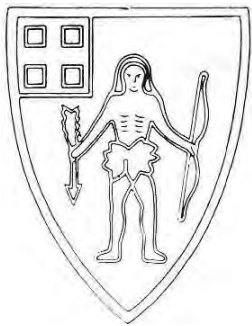

Arrived at the port of New York on 23 July 1919 on the U.S.S. *Mexican* as the 3d Pioneer Inf. Demobilized 25–31 July 1919 at Camp Devens, MA. Reorganized as the 5th Inf., Massachusetts N.G. on 5 July 1920 with HQ at Charlestown, MA. Redesignated on 21 March 1923 as the 182d Inf. (constituted in the N.G. in 1921 and allotted to the state of Massachusetts) and assigned to the 26th Div. HQ organized on 11 April 1923 and federally recognized at Medford, MA. Entire regiment, or elements thereof, called up to perform the following state duties: flood relief at Lowell and Haverhill, MA, in the Merrimac Valley, 4 April–19 May 1936; hurricane relief duty at Cape Cod, September 1938. Conducted annual summer training most years at Camp Devens, MA, 1921–34; and at the Massachusetts Military Reservation at Falmouth, 1935–39. Inducted into active Federal service at Boston, MA, on 16 January 1941, and moved to Camp Edwards, MA, where it arrived 25 January 1941. Location 7 December 1941—Camp Edwards, MA.

**Status:** Assigned to the USARS as the 182d Inf.; 1st Bn. active at Worcester, MA, and 2d Bn. active at Dorchester, MA, as elements of the 26th Brig., 42d Inf. Div. (Mecz).

**Events:** 190, 280, 301, 330

**Commanders, 182d Infantry Regiment**

Col. Albert C. Gray	11 April 1923–17 May 1928	Col. Henry C. Bacon	1 May 1931–28 June 1938
Col. George G. Moyse	22 June 1928–30 April 1931	Col. Carl D. Berg	28 June 1938–6 January 1939
	Col. Howard E. Fuller		6 January 1939–25 October 1942

**183d Infantry Regiment (29th Division)**

**Virginia National Guard**

**HQ**—Richmond, VA, 1921–29

Arrived at the port of Newport News on 22 May 1919 on the U.S.S. *Matsonia* as elements of the 116th Inf., an element of the 29th Div. Demobilized on 30 May 1919 at Camp Lee, VA. Organized 30 December 1919 as the 1st Prov. Inf., Virginia N.G. Redesignated 1st Inf., Virginia N.G. on 7 September 1920. HQ concurrently organized and federally recognized at Richmond, VA. Redesignated 183d Inf. on 9 March 1922 and assigned to the 29th Div. Conducted annual summer training most years at Virginia Beach, VA, 1921–28. Redesignated 1st Inf., Virginia N.G. on 22 February 1929.

**Commanders, 183d Infantry Regiment**

Col. John F. Bright	7 September 1920–22 February 1929
---------------------	-----------------------------------

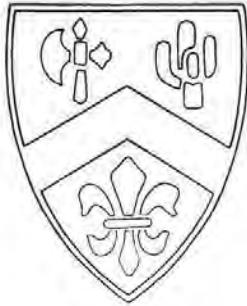
**184th Infantry Regiment (40th Division)****California National Guard****HQ**—*Not organized*, 1921–24; Sacramento, CA, 1924–41; Camp San Luis Obispo, CA, 1941

Demobilized 1–7 May 1919 at Camp Kearny, CA, as elements of the 159th and 160th Inf. Regts. Elements reorganized on 20 October 1924 as the 184th Inf. (constituted in the N.G. in 1921, assigned to the 40th Div., and allotted to the state of California). HQ concurrently organized and federally recognized at Sacramento, CA. Relieved from the 80th Inf. Brig. in 1925 and assigned to the 79th Inf. Brig. Relieved from the 79th Inf. Brig. in 1927 and assigned to the 80th Inf. Brig. Regiment, minus several companies, called up to perform riot control duty at the Folsom State Prison, 24–29 November 1927. Relieved from the 80th Inf. Brig. in 1929 and assigned to the 79th Inf. Brig. The entire regiment called up to perform riot control during the San Francisco street car workers' strike, 5–21 July 1934. Conducted annual summer training at Del Monte, CA, 1924–27, and Camp San Luis Obispo, CA, 1928–39. Inducted into active Federal service at Sacramento on 3 March

1941, and moved to Camp San Luis Obispo where it arrived 11 March 1941. Location 7 December 1941—Camp San Luis Obispo, CA.

**Status:** Assigned to the USARS as the 184th Inf.; 1st Bn. active at Modesto, CA, as an element of the 29th Inf. Brig.

**Events:** 231, 304, 314

**Commanders, 184th Infantry Regiment**

Col. Wallace A. Mason	10 October 1924–18 March 1930	Col. Edward J. Murray	9 November 1937–1 July 1941
Col. Charles R. Blood	8 May 1930–9 November 1937	Col. Curtis D. O'Sullivan	2 July 1941–ao October 1944

**185th Infantry Regiment (40th Division)****California National Guard****HQ**—*Not organized*, 1921–29; Fresno, CA, 1929–41; Camp San Luis Obispo, CA, 1941

Demobilized 1–7 May 1919 at Camp Kearny, CA, as elements of the 159th and 160th Inf. Regts. Elements reorganized as the 184th Inf., 1921–24. Central California area units (less those in San Francisco) withdrawn from the 184th Inf. on 18 February 1929, and reorganized and redesignated the 185th Inf. (constituted in the N.G. in 1921, assigned to the 40th Div., and allotted to the state of California). HQ organized on 1 April 1929 and federally recognized at Fresno, CA. The regiment, or elements thereof, called up to perform the following state duties: entire regiment to perform riot control during the street car workers' strike in San Francisco, 5–21 July 1924; entire regiment to perform riot control during the San Francisco street car workers' strike in July 1934. Conducted annual summer training most years at Camp San Luis Obispo, CA, 1929–39. Inducted

into active Federal service at Fresno on 3 March 1941, and moved to Camp San Luis Obispo where it arrived 15 March 1941. Location 7 December 1941—Camp San Luis Obispo, CA.

**Status:** Assigned to the USARS as the 185th Inf.; 1st Bn. active at Fresno, CA, as an element of the 40th Inf. Div. (Mecz).

**Events:** 231, 304, 314

**Commanders, 185th Infantry Regiment**

Col. Ray W. Hays	21 June 1929–1 July 1941	Col. John U. Calkins	1 July 1941–June 1944
------------------	--------------------------	----------------------	-----------------------

**186th Infantry Regiment (41st Division)****Oregon and Idaho National Guard****HQ**—*Not organized*, 1921–23; Portland, OR, 1923–40; Camp Murray, WA, 1940–41; Fort Lewis, WA, 1941

Constituted in the N.G. in 1921, assigned to the 41st Div., and allotted to the states of Oregon and Idaho. Regimental HQ and 1st and 2d Bns. allotted to the state of Oregon; 3d Bn. allotted to the state of Idaho. The 3d Bn. was organized in March 1922 with HQ at Boise, ID. Oregon elements reorganized, expanded, and redesignated as the 186th Inf. on 2 June 1923 from previously existing organizations (the 1st Bn. organized on 7 September 1921 as the Sep. Bn. Inf., Oregon N.G.; battalion HQ organized on 10 February 1922 and federally recognized at Woodburn, OR; redesignated 1st Bn., 186th Inf. on 2 June 1923). Regimental HQ concurrently organized and federally recognized at Portland, OR. The 3d Bn. withdrawn from Idaho on 5 August 1924 and allotted to Oregon. Concurrently, Idaho elements redesignated 1st Bn., 200th Inf. (hereafter separate lineage). New 3d Bn. organized with HQ organized on 24 June 1926 and federally recognized at Medford, OR. Conducted annual summer training at Fort Lewis, WA, 1922–24; Camp Jackson, OR, 1925–26; and Camp Clatsop, OR, 1927–39. Inducted into active Federal service at Portland on 16 September 1940 and moved to Camp Murray, WA, where it arrived 23 September 1940. Transferred 20 March 1941 to Fort Lewis. Location 7 December 1941—Fort Lewis, WA.

**Status:** Assigned to the USARS as the 186th Inf.; 1st Bn. active at Ashland, OR, as an element of the 41st Inf. Brig. (Sep.).

**Events:** 238, 304, 309, 314, 326

**Commanders, 186th Infantry Regiment**

Col. Hiram U. Welch	2 June 1923–April 1930	Col. Ralph R. Huron	20 November 1932–27 May 1934
Col. Eugene C. Libby	25 April 1930–20 November 1932	Col. Alvin C. Baker	9 June 1934–8 June 1940
	Col. Ralph P. Cowgill		9 June 1940–2 December 1941

**200th Infantry Regiment (Separate)****Georgia and Idaho National Guard****HQ**—Atlanta, GA, 1921–24; *Inactive*, 1924–40

Demobilized on 14 January 1919 at Camp Gordon, GA, as the 122d Inf., an element of the 30th Div. Reconstituted in the N.G. in 1921 and allotted to the state of Georgia. Reorganized on 27 February 1924 by expansion and redesignation of the 2d Bn., 122d Inf. (organized 18 October 1921 as the 2d Bn., 1st Inf., Georgia N.G.; redesignated 27 April 1922 as the 2d Bn., 122d Inf.) as the 200th Inf. HQ organized on 10 March 1924 and federally recognized at Atlanta, GA. The 1st Bn. concurrently allotted to the Idaho N.G. and organized by redesignation of the 3d Bn., 186th Inf. Georgia elements redesignated 122d Inf. on 9 June 1924 and all World War honors retained by that organization. Concurrently, Georgia elements of the 200th Inf. withdrawn and allotted to the Idaho N.G. as inactive units. The 1st Bn. in Idaho converted, reorganized, expanded, and redesignated as elements of the 116th Engrs. on 1 August 1926 and all elements of the 200th Inf. rendered inactive. Georgia elements conducted annual summer training at St. Simons Island, GA, 1921–24, and Idaho elements at Boise Barracks, ID, 1924–26. Assigned to the Fourth Army on 1 October 1933. Regiment remained allotted to the state of Idaho until 1940, but it was never reorganized.

**Commanders, 200th Infantry Regiment**

Col. Charles H. Cox	27 February 1924–9 June 1924
---------------------	------------------------------

**201st Infantry Regiment (Separate)****West Virginia National Guard**

**HQ**—*Not organized*, 1924–27; Fairmont, WV, 1927–30; Morgantown, WV, 1930–41; Fort Benjamin Harrison, IN, 1941; Camp Murray, WA, 1941; Kodiak Island, TA, 1941

Demobilized January–June 1919 as various elements of the 38th Div. Organized 1924–27 as the 1st Inf., West Virginia N.G. Redesignated 201st Inf. on 11 May 1926. HQ organized on 17 December 1927 and federally recognized at Fairmont, WV. HQ relocated on 5 June 1930 to Morgantown, WV. Assigned to the Second Army on 1 October 1933. The regiment, or elements thereof, were called up to perform the following state duties: 1st Bn. called up to perform martial law in connection with a mine explosion at Everettsville, WV, 1–5 May 1927; HQ company to perform fire-fighting duties at Terra Alta, WV, 9–10 February 1934. Conducted annual summer training most years at Camp Dawson, WV, and some years at Camp William G. Conley, WV, 1921–40. For at least 3 years, 1931–33, the regiment also trained some 26 company-grade infantry officers of the 100th Div. at Camp Dawson. Attached to the Second Army on 30 December 1940. Inducted into active Federal service at Morgantown on 6 January 1941, and moved to Fort Benjamin Harrison, IN, arriving there 10 January 1941. Transferred on 5 August 1941 to Camp Murray, WA. Relieved from the Second Army and attached to the Fourth Army on arrival. Departed the Seattle Port of Embarkation on 12 September 1941. Arrived at Kodiak Island, TA, 16 September 1941. Concurrently, relieved from the Fourth Army and assigned to the Alaskan Defense Command. Location 7 December 1941—Kodiak Island, TA.

**Status:** Assigned to the USARS as the 201st F.A.; 1st Bn. active at Fairmont, WV, as an element of the 196th F.A. Brig.

**Events:** 213, 302

**Commanders, 201st Infantry Regiment**

Col. Earle H. Smith	17 December 1927–11 February 1930	Lt. Col. Theron G. Methven	6 January 1941–15 August 1941
Col. Charles C. Robison	12 February 1930–5 January 1941	Col. John N. Robinson (RA)	16 August 1941–2 February 1943

**205th Infantry Regiment (92d Infantry Brigade)****Minnesota National Guard**

**HQ**—Mankato, MN, 1919–40



Organized on 17 January 1919 as the 5th Inf., Minnesota N.G. HQ concurrently federally recognized at Mankato, MN. Redesignated 205th Inf. Regt. on 1 December 1923. Assigned to the 92d Inf. Brig. on 22 April 1927. The regiment, or elements thereof, were called up to perform the following state duties: entire regiment for riot control during a workers' strike at the Swift and Armour meat packing plants in St. Paul, MN, 6 December 1921–11 February 1922; entire regiment for riot control during a commercial transit workers' strike at Minneapolis, MN, in May 1934 and 17 July–23 August 1934. Conducted annual summer training at Lake City, MN; Fort Snelling, MN; and Camp Ripley, MN. For at least 2 years, in 1938 and 1940, the regiment also trained some 48 company-grade officers of the 88th Div. at Camp Ripley. Regiment converted, reorganized and redesignated 1 July 1940 as the 215th C.A. and assigned to the 101st C.A. Brig.

**Events:** 233

**Commanders, 205th Infantry Regiment**

Col. Walter S. Fulton (R.A.)	24 September 1920–31 July 1924	Col. Maurice D. Welty (R.A.)	3 August 1924–4 September 1928
	Col. Ivan Bowen		4 September 1928–1 July 1940

**206th Infantry Regiment** (92d Infantry Brigade)**Minnesota National Guard**

HQ—St. Paul, MN, 1919–40



Organized on 30 January 1919 as the 6th Inf., Minnesota N.G. HQ concurrently federally recognized at St. Paul, MN. The 1st Bn., 151st F.A. (demobilized on 10 May 1919 at Camp Dodge, IA) reconstituted and consolidated with the 6th Inf. Redesignated 206th Inf. Regt. on 1 December 1923. Assigned to the 92d Inf. Brig. on 22 April 1927. Entire regiment called up for riot control during a commercial transit workers' strike at Minneapolis, MN, in May 1934 and 17 July–23 August 1934. Conducted annual summer training at Lake City, MN; Fort Snelling, MN; and Camp Ripley, MN. For at least 2 years, in 1938 and 1939, the regiment also trained some 48 company-grade officers of the 88th Div. at Camp Ripley. Regiment (less 2d and 3d Bns.) converted, reorganized and redesignated the 216th C.A. on 1 July 1940. Concurrently, the 2d and 3d Bns. consolidated with the newly organized 217th C.A. and assigned to the 101st C.A. Brig.

**Events:** 233**Commanders, 206th Infantry Regiment**

Col. James B. Woolnough (R.A.)	30 January 1919–27 January 1920	Col. Fred G. Stutz	20 March 1926–7 August 1938
Col. Thomas W. Hammond (R.A.)	17 July 23–5 January 1926	Lt. Col. William P. Townsend	7 August 1938–1 August 1939
	Col. Donald B. Robinson		1 August 1939–1 July 1940

**295th Infantry Regiment** (92d Infantry Brigade)**Puerto Rico National Guard**

HQ—San Juan, PR, 1922–24; Aguadilla, PR, 1924–36; San Juan, PR, 1936–40; Camp Tortuguero, PR, 1940–41



Organized on 9 July 1919–23 January 1922 as 1st Inf., Puerto Rico N.G. Regimental HQ organized on 24 January 1922 and federally recognized at San Juan, PR. Redesignated 295th Inf. Regt. on 23 January 1923. Regimental HQ relocated on 1 June 1936 to San Juan, PR. The 1st and 2d Bns. relieved and reorganized 1 June 1936 as elements of the 296th Inf. Remainder of regiment reorganized by expansion of the 1st Bn., 296th Inf. into two battalions in central and northeast Puerto Rico. New 3d Bn. organized 18–25 August 1940 and federally recognized at San Juan. Assigned to the 92d Inf. Brig. on 25 August 1940. Conducted annual summer training most years at Aricebo or Yauco, PR, 1922–40. Inducted into active Federal service at Camp Tortuguero, PR, on 15 October 1940. Location 7 December 1941—Camp Tortuguero, PR.

**Status:** Allotted to the Puerto Rico N.G. as the 295th Inf., a parent regiment under the USARS; 1st Bn. active at Caguas, PR, as an element of the 92d Inf. Brig.

**Events:** 246, 329**Commanders, 295th Infantry Regiment**

Lt. Col. Luis R. Estevez	24 January 1922–30 April 1923	Col. Luis R. Estevez	24 January 1922–26 September 1940
Col. Jaime Nadal	1 May 1923–29 July 1924	Col. Miguel A. Muñoz	26 September 1940–ao December 1941

**296th Infantry Regiment (92d Infantry Brigade)****Puerto Rico National Guard****HQ**—*Not organized*, 1921–36; San Juan, PR, 1936–40; Camp Tortuguero, PR, 1940–41

Constituted in the N.G. in 1921 and allotted to the Commonwealth of Puerto Rico. HQ, 1st Bn. organized on 30 January 1923 and federally recognized at San Juan, PR. The 1st Bn. redesignated 1 June 1936 as the 1st Bn., 295th Inf. Regt. Concurrently, the 1st and 2d Bns., 295th Inf. redesignated 1st and 2d Bns., 296th Inf., respectively; regimental HQ organized and federally recognized at San Juan, PR. New 3d Bn. organized 18–25 August 1940 with HQ federally recognized at Ponce, PR. Regiment assigned to the 92d Inf. Brig. on 25 August 1940. Conducted annual summer training most years at Aricebo or Yauco, PR, 1923–40. Inducted into active Federal service at Camp Tortuguero, PR, on 15 October 1940. Location 7 December 1941—Camp Tortuguero, PR.

**Status:** Allotted to the Puerto Rico N.G. as the 296th Inf., a parent regiment under the USARS; 1st Bn. active at Mayaguez, PR, as an element of the 92d Inf. Brig.

**Events:** 246, 329**Commander, 296th Infantry Regiment**

Col. Jose E. Colom

1 June 1936–31 October 1942

**297th Infantry Regiment (Separate)****Alaska Territorial Militia****HQ**—*Not organized*, 1939–41

Constituted in the N.G. on 21 October 1939 and allotted to the Territory of Alaska. The HQ, 1st Bn. organized on 11 January 1941 and federally recognized at Juneau, TA. The 1st Bn. inducted into active Federal service at Juneau, TA, on 15 September 1941 and transferred, less A and B Cos., to Fort Richardson, TA, where it arrived about 30 September 1941. Concurrently, A and B Cos. transferred to Chilkoot Barracks, TA. Assigned to the Alaskan Defense Command. Location 7 December 1941—Fort Richardson, TA (1st Bn. only).

**Status:** Allotted to the Alaska N.G. as the 297th Inf., a parent regiment under the USARS; 1st Bn. active at Nome, AK, 2d Bn. active at Bethel, AK, and 3d Bn. active at Juneau, AK, as elements of the 207th Inf. Group.

**Commander, 1st Battalion, 297th Infantry**

Maj. Charles G. Burdick

11 January 1941–27 June 1941

**298th Infantry Regiment (Separate)****Hawaii National Guard****HQ**—*Not organized*, 1919–24; Honolulu, TH, 1924–40; Schofield Barracks, TH, 1940–41

Demobilized 31 July 1919 at Fort Shafter, TH, as the 1st Hawaiian Inf. Reconstituted and reorganized on 1 October 1919 by consolidation with the 5th Inf., Hawaiian N.G. Redesignated 298th Inf. on 17 August 1923. HQ organized on 26 June 1924 and federally recognized at Honolulu, TH. Regiment's wartime mission was to defend the coastline positions in the vicinity of Coco Head on Oahu Island. Regiment (-) called up to perform duties in connection with a Filipino workers strike at Lihue, Kauai, TH, 9–24 September 1924. Conducted annual summer training most years at Schofield Barracks, TH. Attached to the 22d Inf. Brig. on 14 October 1940. Inducted into active Federal service at Honolulu, TH, on 15 October 1940, and moved to Schofield Barracks, TH. Assigned to the 25th Div. on 1 October 1941. Location 7 December 1941—Schofield Barracks, TH.

**Status:** Active as 298th Regt. (Regional Training Institute) with HQ at Waimanalo, HI.

**Events:** 37, 141

**Commanders, 298th Infantry Regiment**

Col. Sherwood M. Lowrey	26 June 1924–January 1926	Lt. Col. William Hoopai	May 1927–April 1928
Col. Lawrence M. Judd	January 1926–May 1927	Col. Perry M. Smoot	1 April 1928–1 July 1929
	Col. Wilhelm A. Anderson	1 July 1929–November 1942	

**299th Infantry Regiment (Separate)**

**Hawaii National Guard**

**HQ**—*Not organized*, 1921–27; Hilo, TH, 1927–34; Honolulu, TH, 1934–40; Schofield Barracks, TH, 1940–41; Iolani Barracks, TH, 1941



Demobilized on 14 February 1919 at Schofield Barracks, TH, as the 2d Hawaiian Inf. Reconstituted on 29 June 1921 as the 2d Inf., Hawaiian N.G. (Co. A organized and federally recognized on 29 June 1921 at Lahaina, TH; remaining elements of the regiment organized 1921–27). Redesignated 299th Inf. Regt. on 17 August 1923. Regimental HQ organized on 1 January 1927 and federally recognized at Hilo, TH. HQ relocated on 6 February 1934 to Honolulu, TH. Conducted annual summer training most years at Kilauea, Wailuku, or Paukukalo. Attached to the 21st Inf. Brig. on 14 October 1940. Inducted into active Federal service at Honolulu, TH, on 15 October 1940, and moved to Schofield Barracks, TH. Transferred on 4 June 1941 to Iolani Barracks, Honolulu, TH. Assigned to the 24th Div. on 1 October 1941. At the time of Pearl Harbor, the regiment was deployed as follows:

Regimental HQ at Iolani Barracks; 1st Bn. located on Maui; 2d Bn. located on Hawaii; 3d Bn., less Co. K, located on Kauai; and Co. K located on Molokai. Location 7 December 1941—Iolani Barracks, TH.

**Status:** Assigned to the USARS as the 299th Inf.; 2d Bn. active at Hilo, HI, as an element of the 29th Inf. Brig.

**Events:** 37, 141

**Commanders, 299th Infantry Regiment**

Col. Andrew T. Spaulding	1 January 1927–5 February 1934	Col. Gordon C. Ross	6 February 1934–ao September 1940
	Unknown		ao September 1940–7 December 1941

**301st Infantry Regiment (94th Division)**

**Organized Reserve Massachusetts**

**HQ**—Boston, MA, 1921–41



Demobilized 1–20 January 1919 at Camp Devens, MA, as an element of the 76th Div. Reconstituted in the O.R. on 24 June 1921, assigned to the 94th Div., and allotted to the First Corps Area. Initiated on 10 October 1921 with the entire regiment, less two companies, at Boston, MA. Typically conducted Inactive Training Period meetings at the South Armory or the Custom House Tower in Boston. Conducted summer training most years with the 5th and 13th Inf. Regts. at Camp Devens, MA, 1922–40. Also conducted infantry CMTC training some years at Camp Devens as an alternate form of summer training. Primary ROTC feeder school was Boston University. Designated mobilization training station was Camp Devens, MA. Location 7 December 1941—Boston, MA.

**Status:** Inactive in the Army Reserve as the 301st Inf.

**Commanders, 301st Infantry Regiment**

Col. Frank Tompkins	29 August 1917–ao September 1918	Col. James J. Fitzgerald	10 October 1921–June 1933
Col. Percy W. Arnold	ao November 1918–December 1918	Lt. Col. Edwin Hansen	June 1933–May 1937
Unknown	December 1918–20 January 1919	Col. Maurice H. Richardson	16 May 1937–ao January 1940
<i>Demobilized/Inactive</i>	20 January 1919–9 October 1921	Unknown	ao January 1940–7 December 1941

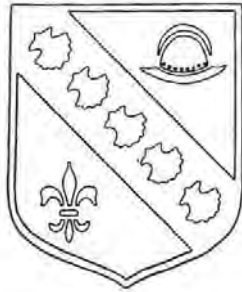
**302d Infantry Regiment (94th Division)****Organized Reserve Massachusetts****HQ**—Boston, MA, 1921–23; Brockton, MA, 1923–41

Demobilized 14–20 January 1919 at Camp Devens, MA, as an element of the 76th Div. Reconstituted in the O.R. on 24 June 1921, assigned to the 94th Div., and allotted to the First Corps Area. Initiated on 19 October 1921 with regimental HQ at Boston, MA. Subordinate battalion HQ concurrently organized as follows: 1st Bn. at Brookline, MA; 2d Bn. at Brockton, MA; and 3d Bn. at Fall River, MA. Regimental HQ relocated on 11 January 1923 to Brockton, MA. Typically conducted Inactive Training Period meetings at the South Armory or the Custom House Tower in Boston. Conducted summer training most years with the 5th and 13th Inf. Regts. at Camp Devens, MA. Also conducted infantry CMTC training some years at Camp Devens (and 1 year at Fort McKinley, ME) as an alternate form of summer training. Primary ROTC feeder school was Boston

University. Designated mobilization training station was Camp Devens, MA. Location 7 December 1941—Brockton, MA.

**Status:** Inactive in the Army Reserve as the 302d Inf.**Commanders, 302d Infantry Regiment**

Col. Charles C. Smith	22 August 1917–1 October 1918	Lt. Col. Fred H. Thompson	19 October 1921–1 November 1923
Unknown	2 October 1918–20 January 1919	Col. George B. Stebbins	1 November 1923–May 1939
<i>Demobilized/Inactive</i>	20 January 1919–19 October 1921	Lt. Col. Warren A. Fogarty	May 1939–ao October 1939
	Unknown	ao October 1939–7 December 1941	

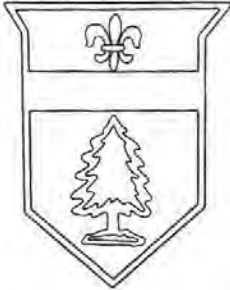
**303d Infantry Regiment (97th Division)****Organized Reserve Maine****HQ**—Lewiston, ME, 1921–41

Demobilized on 20 January 1919 at Camp Devens, MA, as an element of the 76th Div. Reconstituted in the O.R. on 24 June 1921, assigned to the 94th Div., and allotted to the First Corps Area. Initiated on 28 September 1921 with regimental HQ at Lewiston, ME. Subordinate battalion HQ concurrently organized as follows: 1st Bn. at Farmington, ME; 2d Bn. at Auburn, ME; and 3d Bn. at Portland, ME. Typically conducted Inactive Training Period meetings as follows: 1st Bn. at the City Hall in Portland; 2d Bn. at the US Post Office Building in Lewiston; and 3d Bn. at the American Legion Hall in Sanford, ME. Conducted summer training at numerous locations to include Camp Devens, MA; Fort McKinley, ME; Camp Keyes, ME; and Fort Williams, ME. Also conducted infantry CMTC training some years at Fort McKinley or Camp Devens as an alternate form of summer training. Primary ROTC feeder school was the University of Maine. Designated mobilization training station

was Camp Devens, MA. Location 7 December 1941—Lewiston, ME.

**Status:** Inactive in the Army Reserve as the 303d Inf.**Commanders, 303d Infantry Regiment**

Col. John F. Preston Jr.	5 September 1917–10 November 1918	Col. Henry G. Beyer	25 November 1922–30 April 1932
Unknown	11 November 1917–20 January 1919	Lt. Col. Edward J. Quinn	30 April 1932–15 August 1935
<i>Demobilized/Inactive</i>	20 January 1919–28 November 1921	Lt. Col. Cornelius A. Feury	15 August 1935–ao July 1937
Maj. Arthur G. Bouton	28 November 1921–19 January 1922	Col. Emery O. Beane	ao May 1938–ao July 1940
Lt. Col. George McL. Presson	19 January 1922–25 November 1922	Unknown	ao July 1940–7 December 1941



**304th Infantry Regiment (76th Division)****Organized Reserve Connecticut**

HQ—Hartford, CT, 1921–41



Demobilized 14–20 January 1919 at Camp Devens, MA, as an element of the 76th Div. Reconstituted in the O.R. on 24 June 1921, assigned to the 76th Div., and allotted to the First Corps Area. Initiated on 23 December 1921 with regimental HQ at Hartford, CT. Subordinate battalion HQ concurrently organized as follows: 1st Bn. at Manchester, CT; 2d Bn. at Hartford, CT; and 3d Bn. at Torrington, CT. Typically conducted Inactive Training Period meetings at the State Armory in Hartford. Conducted summer training most years with the 5th and 13th Inf. Regts. at Camp Devens, MA, or Fort Adams, RI. Also conducted infantry CMTC training some years at Camp Devens as an alternate form of summer training. Primary ROTC feeder school was Connecticut Agricultural College. Designated mobilization training station was Camp Devens, MA. Location 7 December 1941—Hartford, CT.

**Status:** Reorganized 1 May 1959 as the 304th Regt., an element of the 76th Div. (Training); reorganized 16 October 1996 to consist of the 1st, 2d, and 3d Bns., elements of the 98th Div. (Institutional Training).

**Commanders, 304th Infantry Regiment**

Col. Joseph S. Herron	29 August 1917–27 September 1918	Lt. Col. Emerson G. Taylor	23 August 1924–1 September 1926
Unknown	28 September 1918–20 January 1919	Lt. Col. Robson DeF. Brown	1 September 1926–6 December 1927
<i>Demobilized/Inactive</i>	20 January 1919–22 December 1921	Col. Emerson G. Taylor	6 December 1927–11 July 1929
Maj. Emerson G. Taylor	23 December 1921–1 November 1923	Lt. Col. Joseph F. Murtaugh	11 July 1929–10 June 1933
Maj. M. A. Conner	1 November 1923–23 August 1924	Col. Reginald B. DeLacour	10 June 1933–10 November 1939
	Col. Joseph F. Murtaugh		10 November 1939–January 1942

**305th Infantry Regiment (77th Division)****Organized Reserve New York**

HQ—Brooklyn, NY, 1921–41

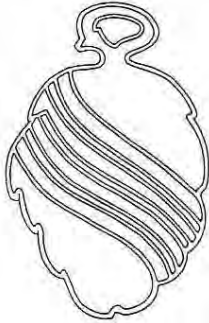

Arrived at the port of New York on 24 April 1919 on the S.S. *Aquitania* as the 305th Inf., an element of the 77th Div. Demobilized 9 May 19 at Camp Upton, NY. Reconstituted in the O.R. on 24 June 1921, assigned to the 77th Div., and allotted to the Second Corps Area. Initiated on 5 August 1921 with regimental HQ, 1st Bn., and 2d Bn. at Brooklyn, NY; and the 3d Bn. at Manhattan, NY. Conducted summer training most years with the 16th Inf. Regt. at Camp Dix, NJ; and some years at Plattsburg Barracks, NY; or Fort Slocum, NY. Also conducted infantry CMTC training some years at Camp Dix or Plattsburg Barracks as an alternate form of summer training. Primary ROTC feeder schools were the College of the City of New York and New York University. Designated mobilization training station was Camp Dix, NJ. Location 7 December 1941—Brooklyn, NY.

**Status:** Withdrawn from the CARS on 17 October 1999 and redesignated as the 305th Regt. to consist of the 1st, 2d, and 3d Bns., which were concurrently allotted to the R.A. Assigned to the 87th Div. (Training Support).

**Events:** 168**Commanders, 305th Infantry Regiment**

Col. William R. Smedberg Jr.	5 August 1917–26 October 1918	<i>Demobilized/Inactive</i>	9 May 1919–5 August 1921
Lt. Col. Lewis R. Morey	26 October 1918–10 November 1918	Col. Walter W. Metcalf	5 August 1921–10 May 1929
Lt. Col. Vernon W. Boller	10 November 1918–23 November 1918	Lt. Col. Moses King Jr.	10 May 1929–9 February 1932
Col. Raymond Sheldon	23 November 1918–15 February 1919	Col. Walter W. Metcalf	10 February 1932–24 April 1941
Lt. Col. Charles F. Herr	15 February 1919–9 May 1919	Col. Samuel Greason	24 April 1941–ao December 1941

**306th Infantry Regiment (77th Division)****Organized Reserve New York****HQ**—Flushing, NY, 1921–41

Arrived at the port of New York on 25 April 1919 on the U.S.S. *Mount Vernon* as the 306th Inf., an element of the 77th Div. Demobilized on 9 May 1919 at Camp Upton, NY. Reconstituted in the O.R. on 24 June 1921, assigned to the 77th Div., and allotted to the Second Corps Area. Initiated on 9 August 1921 with regimental HQ and 3d Bn. at Flushing, NY, and the 1st and 2d Bns. at Brooklyn, NY. Conducted summer training most years with the 16th and 18th Inf. Regts. at Camp Dix, NJ; Fort Hamilton, NY; or Fort Slocum, NY. Also conducted infantry CMTC training some years at Camp Dix and Plattsburg Barracks as an alternate form of summer training. Typically conducted Inactive Training Period meetings at the armory of the 165th Inf. in New York City. Primary ROTC

feeder schools were the College of the City of New York and New York University. Designated mobilization training station was Camp Dix, NJ. Location 7 December 1941—Flushing, NY.

**Status:** Withdrawn from the CARS on 17 October 1999 and redesignated as the 306th Regt. to consist of the 1st, 2d, and 3d Bns., which were concurrently allotted to the R.A. Assigned to the 87th Div. (Training Support).

**Events:** 168**Commanders, 306th Infantry Regiment**

Col. George Vidmer	22 August 1917–15 December 1918	Lt. Col. Archibald G. Thatcher	8 October 1921–12 August 1923
Lt. Col. Garrison McCaskey	15 December 1918–1 February 1919	Col. Cornelius W. Wickersham	12 August 1923–5 December 1924
Col. Frank S. Bowen	1 February 1919–1 May 1919	Col. Julius O. Adler	5 December 1924–1 October 1940
<i>Demobilized/Inactive</i>	9 May 1919–9 August 1921	Lt. Col. Edwin J. Mooney	1 October 1940–1 March 1941
Maj. Julius O. Adler	9 August 1921–8 October 1921	Lt. Col. Michael F. Rochel Jr.	1 March 1941–4 June 1941
	Lt. Col. Ernest C. Poillon		26 June 1941–26 September 1941

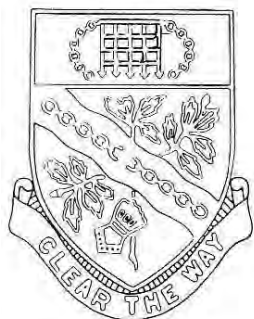
**307th Infantry Regiment (77th Division)****Organized Reserve New York****HQ**—Manhattan, NY, 1921–41

Arrived at the port of New York on 28 April 1919 on the U.S.S. *America* as the 307th Inf., an element of the 77th Div. Demobilized on 9 May 19 at Camp Upton, NY. Reconstituted in the O.R. on 24 June 1921, assigned to the 77th Div., and allotted to the Second Corps Area. Initiated on 5 August 1921 with the entire regiment at Manhattan, NY. Band organized about December 1922 at Manhattan. Conducted summer training most years with the 16th and 18th Inf. Regts. at Camp Dix, NJ, or Fort Slocum, NY, and some years with the 26th Inf. at Plattsburg Barracks, NY. Also conducted infantry CMTC training some years at Camp Dix and Plattsburg Barracks as an alternate form of summer training. Primary ROTC feeder schools were the College of the City of New York and New York University. Designated mobilization training station was Camp Dix, NJ. Location 7 December 1941—Manhattan, NY.

**Status:** Withdrawn from the CARS on 17 October 1999 and redesignated as the 307th Regt. to consist of the 1st, 2d, and 3d Bns., which were concurrently allotted to the R.A. Assigned to the 87th Div. (Training Support).

**Events:** 168**Commanders, 307th Infantry Regiment**

Col. Isaac Erwin	23 August 1917–30 August 1918	Col. Isaac Erwin	February 1919–9 May 1919
Lt. Col. E.A. Houghton	30 August 1918–25 October 1918	<i>Demobilized/Inactive</i>	9 May 1919–5 August 1921
Col. William R. Smedberg Jr.	25 September 1918–2 October 1918	Maj. Herbert T. Spooner	5 August 1921–5 October 1921
Lt. Col. E.A. Houghton	2 October 1918–21 October 1918	Col. William H. Meyers	5 October 1921–ao August 1925
Col. Raymond Sheldon	21 October 1918–23 November 1918	Col. Herbert T. Spooner	ao July 1926–26 September 1940
Col. John R.R. Hannay	23 November 1918–February 1919	Lt. Col. Michael F. Rochel	26 September 1940–31 May 1941

**308th Infantry Regiment (77th Division)****Organized Reserve New York****HQ**—Bronx, NY, 1921–41

Arrived at the port of New York on 28 April 1919 on the U.S.S. *America* as the 308th Inf., an element of the 77th Div. Demobilized on 14 May 1919 at Camp Upton, NY. Reconstituted in the O.R. on 24 June 1921, assigned to the 77th Div., and allotted to the Second Corps Area. Initiated on 6 August 1921 with regimental HQ at Bronx, NY. Subordinate battalion HQ concurrently organized as follows: 1st Bn. at Bronx, NY; 2d Bn. at Yonkers, NY; and 3d Bn. at Poughkeepsie, NY. Conducted summer training most years with the 16th and 18th Inf. Regts. at Camp Dix, NJ, or Fort Slocum, NY, and some years with the 26th Inf. at Plattsburg Barracks, NY. Also conducted infantry CMTC training some years at Camp Dix and Plattsburg Barracks as an alternate form of summer training. Typically conducted Inactive Training Period meetings at the auditorium of the New York Bar Association in New York City. Primary ROTC feeder schools were the College of the

City of New York and New York University. Designated mobilization training station was Camp Dix, NJ. Location 7 December 1941—Bronx, NY.

**Status:** Disbanded 14 March 1952.**Events:** 168**Commanders, 308th Infantry Regiment**

Col. Nathan K. Averill	22 August 1917–17 August 1918	Lt. Col. Charles F. Herr	12 November 1918–1 February 1919
Col. Austin E. Prescott	17 August 1918–27 September 1918	Col. Nathan K. Averill	1 February 1919–14 May 1919
Lt. Col. Fred E. Smith	27 September 1918–29 September 1918	<i>Demobilized/Inactive</i>	14 May 1919–5 August 1921
Col. Cromwell Stacey	29 September 1918–5 October 1918	Lt. Col. Charles W. Whittlesey	6 August 1921–26 February 1922
Maj. Lucien S. Breckenridge	5 October 1918–8 October 1918	Lt. Col. Lucien S. Breckenridge	1 March 1922–5 May 1923
Lt. Col. Gordon Johnston	8 October 1918–9 October 1918	Col. Nathan K. Averill	5 May 1923–ao July 1927
Col. John R.R. Hannay	9 October 1918–12 November 1918	Col. Lucien S. Breckenridge	ao May 1928–29 May 1941
	Col. John N. Andrews		29 May 1941–ao December 1941

**309th Infantry Regiment (78th Division)****Organized Reserve New Jersey and Delaware****HQ**—Camden, NJ, 1921–41

Arrived at the port of Hoboken on 28 May 1919 on the U.S.S. *Santa Paula* as the 309th Inf., an element of the 78th Div. Demobilized 30 May–6 June 1919 at Camp Dix, NJ, and Camp Upton, NY. Reconstituted in the O.R. on 24 June 1921, assigned to the 78th Div., and allotted to the Second Corps Area. Initiated on 1 October 1921 with regimental HQ at Camden, NJ. Subordinate battalion HQ concurrently organized as follows: 1st Bn. at Camden; 2d Bn. at Atlantic City, NJ; and the 3d Bn. at New Brunswick, NJ. The 3d Bn. was relocated in 1922 to Trenton, NJ. Subordinate battalions relocated on 5 April 1937 as follows: 2d Bn. at Trenton; 3d Bn. at Wilmington, DE. Conducted summer training most years with the 16th and 18th Inf. Regts. at Camp Dix, NJ, or Fort Wadsworth, NY. Also conducted infantry CMTC training some years at Camp Dix or Fort Niagara, NY, as an

alternate form of summer training. Typically conducted Inactive Training Period meetings at the armory of the 112th F.A. in Camden. Primary ROTC feeder school was Rutgers University. Designated mobilization training station was Camp Dix, NJ. Location 7 December 41—Camden, NJ.

**Status:** Reorganized on 1 May 1959 as the 309th Regt., an element of the 78th Div. (Training); reorganized 17 October 1999 to consist of the 1st, 2d, and 3d Bns., elements of the 78th Div. (Training Support).

**Events:** 168**Commanders, 309th Infantry Regiment**

Col. John M. Morgan	29 August 1917–6 June 1919	Col. John W. Reed	3 February 1930–19 October 1932
<i>Demobilized/Inactive</i>	6 June 1919–1 October 1921	Lt. Col. Louis H. Coxe, III	19 October 1932–July 1933
Maj. Jacob G. Sherman	1 October 1921–20 October 1921	Col. Edmund O. Howell Jr.	August 1933–ao May 1940
Col. Thomas D. Landon	20 October 1921–3 February 1930	Unknown	ao May 1940–7 December 1941

**310th Infantry Regiment (78th Division)****Organized Reserve New Jersey**

HQ—Jersey City, NJ, 1921–37; Englewood, NJ, 1937–41



Arrived at the port of New York on 31 May 1919 on the U.S.S. *Tiger* as the 310th Inf., an element of the 78th Div. Demobilized on 6 June 1919 at Camp Dix, NJ. Reconstituted in the O.R. on 24 June 1921, assigned to the 78th Div., and allotted to the Second Corps Area. Initiated on 5 October 1921 with regimental HQ at Jersey City, NJ. Subordinate battalion HQ concurrently organized as follows: 1st Bn. at Jersey City; 2d Bn. at Hoboken, NJ; and 3d Bn. at Bayonne, NJ. Band organized about 1930 at Jersey City. Regimental HQ relocated on 5 April 1937 to Englewood, NJ. Conducted summer training most years with the 16th and 18th Inf. Regts. at Camp Dix, NJ, and some years with the 26th Inf. at Plattsburg Barracks, NY. Also conducted infantry CMTC training some years at Camp Dix or Plattsburg Barracks as an alternate form of summer training. Primary ROTC feeder

school was Rutgers University. Designated mobilization training station was Camp Dix, NJ. Location 7 December 1941—Englewood, NJ.

**Status:** Reorganized 1 May 1959 as the 310th Regt., an element of the 78th Div. (Training); reorganized 17 October 1999 to consist of the 1st, 2d, and 3d Bns., elements of the 78th Div. (Training Support); 1st Bn. concurrently withdrawn from the Army Reserve and allotted to the R.A.

**Events:** 168**Commanders, 310th Infantry Regiment**

Col. Walter C. Babcock	22 August 1917–6 June 1919	Lt. Col. Arthur C. Judd	22 April 1922–1 May 1925
<i>Demobilized/Inactive</i>	6 June 1919–5 October 1921	Col. Harriot Van D. Moore	1 May 1925–14 May 1937
Maj. Arthur C. Judd	5 October 1921–19 October 1921	Col. Paul Debevoise	14 May 1937–ao April 1940
Lt. Col. Henry H. Burdick	19 October 1921–22 April 1922	Unknown	ao April 1940–7 December 1941

**311th Infantry Regiment (78th Division)****Organized Reserve New Jersey**

HQ—Trenton, NJ, 1921–28; Elizabeth, NJ, 1928–41

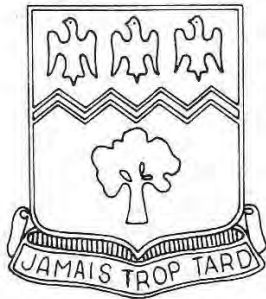

Arrived at the port of New York on 26 May 1919 on the U.S.S. *Ostego* as the 311th Inf., an element of the 78th Div. Demobilized 30 May–5 June 1919 at Camp Dix, NJ. Reconstituted in the O.R. on 24 June 1921, assigned to the 78th Div., and allotted to the Second Corps Area. Initiated on 27 September 1921 with regimental HQ at Newark, NJ. Subordinate battalion HQ concurrently organized as follows: 1st Bn. at New Brunswick, NJ; 2d Bn. at Elizabeth, NJ; and 3d Bn. at Hackensack, NJ. Regimental HQ relocated 27 August 1928 to Elizabeth, NJ. Conducted summer training most years with the 16th and 18th Inf. Regts. at Camp Dix, NJ, and some years at Forts Slocum or Wadsworth, NY. Also conducted infantry CMTC training some years at Camp Dix or Plattsburg Barracks as an alternate form of summer training. Typically conducted Inactive Training Period meetings at the armory of the 114th Inf. in Elizabeth. Primary ROTC feeder school was Rutgers University. Location 7 December 1941—Elizabeth, NJ.

**Status:** Reorganized 1 May 1959 as the 311th Regt., an element of the 78th Div. (Training); reorganized 17 October 1999 to consist of the 1st, 2d, and 3d Bns., elements of the 78th Div. (Training Support).

**Events:** 168**Commanders, 311th Infantry Regiment**

Col. Marcus B. Stokes	24 August 1917–30 May 1919	Col. James Eben	17 October 1924–26 April 1935
<i>Demobilized/Inactive</i>	5 June 1919–27 September 1921	Lt. Col. John H. M. Dudley	26 April 1935–18 August 1935
Maj. George T. Adee	27 September 1921–7 October 1921	Col. Norman Meranus	19 August 1935–29 January 1940
Lt. Col. Marshall Stearns	7 October 1921–ao December 1921	Lt. Col. Henry L. Butler	30 January 1940–15 March 1940
Col. William Haywood	Unknown	Lt. Col. Welton M. Modisette	29 March 1940–January 1941
Lt. Col. Gordon McDonald	11 April 1923–17 October 1924	Lt. Col. Arthur F. Bell	January 1941–ao March 1941

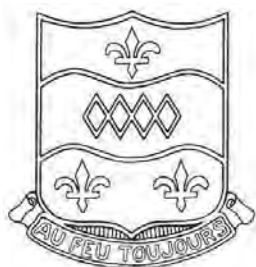
**312th Infantry Regiment (78th Division)****Organized Reserve New Jersey****HQ**—Newark, NJ, 1921–41

Arrived at the port of Hoboken on 24 May 1919 on the U.S.S. *Radnor* as the 312th Inf., an element of the 78th Div. Demobilized on 26 May 1919 at Camp Dix, NJ. Reconstituted in the O.R. on 24 June 1921, assigned to the 78th Div., and allotted to the Second Corps Area. Initiated on 17 August 1921 with regimental HQ at Newark, NJ. Subordinate battalion HQ concurrently organized as follows: 1st Bn. at Newark; 2d Bn. at East Orange, NJ; and 3d Bn. at Paterson, NJ. Conducted summer training most years with the 16th and 18th Inf. Regts. at Camp Dix, NJ, and some years at Fort Wadsworth, NY. Also conducted infantry CMTC training some years at Camp Dix or Plattsburg Barracks as an alternate form of summer training. Primary ROTC feeder school was Rutgers University. Location 7 December 1941—Newark, NJ.

**Status:** Reorganized on 1 May 1959 as the 312th Regt., an element of the 78th Div. (Training); reorganized 17 October 1999 to consist of the 1st, 2d, and 3d Bns., elements of the 78th Div. (Training Support); 1st Bn. concurrently withdrawn from the Army Reserve and allotted to the R.A.

**Events:** 168**Commanders, 312th Infantry Regiment**

Col. Alvord V.P. Anderson <i>Demobilized/Inactive</i>	24 August 1917–26 May 1919 26 May 1919–17 August 1921 Col. Robert E. Woodward	Col. Paul Debevoise Col. John H.M. Dudley 19 May 1941–January 1942	17 August 1921–14 May 1937 14 May 1937–19 May 1941
----------------------------------------------------------	-------------------------------------------------------------------------------------	--------------------------------------------------------------------------	-------------------------------------------------------

**313th Infantry Regiment (79th Division)****Organized Reserve Pennsylvania****HQ**—Wilkes-Barre, PA, 1921–41

Arrived at the port of Newport News on 27 May 1919 on the S.S. *Peysonder* as the 313th Inf., an element of the 79th Div. Demobilized 9–10 June 1919 at Camp George G. Meade, MD. Reconstituted in the O.R. on 24 June 1921, assigned to the 79th Div., and allotted to the Third Corps Area. Initiated on 31 October 1921 with regimental HQ at Wilkes-Barre, PA. Subordinate battalion HQ concurrently organized as follows: 1st Bn. at Scranton, PA; 2d Bn. at Towanda, PA; and 3d Bn. at Williamsport, PA. Conducted summer training most years with the 12th and 34th Inf. Regts. at Fort George G. Meade, MD, or Fort Washington, MD. Conducted summer training with the 28th Div. at Mount Gretna, PA, in 1928. Also conducted infantry CMTC training some years at Fort Meade, Fort Howard, MD, or Fort Eustis, VA, as an alternate form of summer training. Provided a number of officers to the 28th Div. for the 1939 and 1940 First Army Maneuvers. Primary ROTC feeder schools

were the Pennsylvania Military College, Gettysburg College, and Lehigh University. Location 7 December 1941—Wilkes-Barre, PA.

**Status:** Withdrawn from the CARS on 17 October 1999 and redesignated as the 313th Regt. to consist of the 1st, 2d, and 3d Bns. Assigned to the 78th Div. (Training Support).

**Commanders, 313th Infantry Regiment**

Col. Claude B. Sweezy Lt. Col. Charles B. Moore Lt. Col. Walter A. Delamater Col. William A. Rogers Col. Claude B. Sweezy <i>Demobilized/Inactive</i>	25 August 1917–30 September 1918 30 September 1918–30 October 1918 30 October 1918–31 October 1918 31 October 1918–January 1919 January 1919–10 June 1919 10 June 1919–31 October 1921	Col. Ernest G. Smith Lt. Col. James F. Cooper Col. Thomas F. Meehan Col. David R. Smith Col. James E. Davis Col. Daniel B. Strickler	31 October 1921–10 May 1930 11 May 1930–June 1930 June 1930–August 1935 August 1935–1 June 1937 1 June 1937–16 June 1939 16 June 1939–February 1942
----------------------------------------------------------------------------------------------------------------------------------------------------------------------	-------------------------------------------------------------------------------------------------------------------------------------------------------------------------------------------------------	-----------------------------------------------------------------------------------------------------------------------------------------------------	--------------------------------------------------------------------------------------------------------------------------------------------------------------------

**314th Infantry Regiment (79th Division)****Organized Reserve Pennsylvania**

HQ—Reading, PA, 1921–41

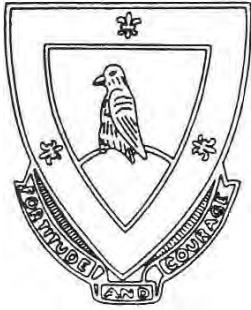

Arrived at the port of Newport News on 26 May 1919 on the U.S.S. *Princess Matoika* as the 314th Inf., an element of the 79th Div. Demobilized on 29 May 1919 at Camp George G. Meade, MD. Reconstituted in the O.R. on 24 June 1921, assigned to the 79th Div., and allotted to the Third Corps Area. Initiated on 22 October 1921 with regimental HQ at Reading, PA. Subordinate battalion HQ concurrently organized as follows: 1st Bn. at Allentown, PA; 2d Bn. at Reading, PA; and 3d Bn. at Harrisburg, PA. The regiment typically conducted its Inactive Training Period meetings at locations as follows: 126 North 5th Street in Reading; the American Legion Hall in Harrisburg; the Post Office Building in Allentown; and the N.G. armory in Lebanon. Conducted summer training most years with the 12th and 34th Inf. Regts. at Fort George G. Meade, MD, and some years at Fort Washington, MD, or Fort Eustis, VA. Also conducted infantry CMTC training some years at Fort Meade or Fort Eustis as an alternate form of summer training. Provided a number of officers to the 28th Div. for the 1939 and 1940 First Army Maneuvers. Primary ROTC feeder schools were the Pennsylvania Military College, Gettysburg College, and Lehigh University. Location 7 December 1941—Reading, PA.

**Status:** Withdrawn from the CARS on 17 October 1999 and redesignated as the 314th Regt. to consist of the 1st, 2d, and 3d Bns., which were concurrently allotted to the R.A. Assigned to the 78th Div. (Training Support).

**Commanders, 314th Infantry Regiment**

Col. Thomas W. Darrah	25 August 1917–12 April 1918	Maj. Harry C. Duncan	22 October 1921–23 January 1924
Col. William H. Oury	13 April 1918–29 May 1919	Col. Millard D. Brown	23 January 1924–5 December 1928
<i>Demobilized/Inactive</i>	29 May 1919–21 October 1921	Col. Harry C. Duncan	5 December 1928–ao June 1941

**315th Infantry Regiment (79th Division)****Organized Reserve Pennsylvania**

HQ—Philadelphia, PA, 1921–41

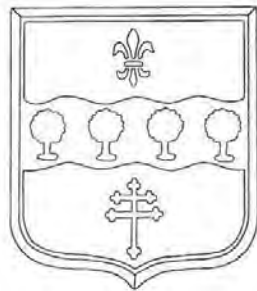

Arrived at the port of Newport News on 27 May 1919 on the U.S.S. *Maui* as the 315th Inf., an element of the 79th Div. Demobilized on 31 May 1919 at Camp George G. Meade, MD. Reconstituted in the O.R. on 24 June 1921, assigned to the 79th Div., and allotted to the Third Corps Area. Initiated 22 October 1921 with the entire regiment at Philadelphia, PA. Conducted summer training most years with the 12th and 34th Inf. Regts. at Fort George G. Meade, MD; Fort Howard, MD; or Fort Eustis, VA. Also conducted infantry CMTC training some years at Fort Meade or Fort Eustis as an alternate form of summer training. In the fall of 1936, the regiment formed a battalion of young men 16 to 18 years of age to train during the year i to prepare them for attendance at CMTC at Fort George G. Meade the following summer. Typically conducted Inactive Training Period meetings at

the 1st Regt. Armory in Philadelphia or at the Schuylkill Arsenal. Also frequently conducted drills and contact camps at Valley Forge Military Academy. Provided a number of officers to the 28th Div. for the 1939 and 1940 First Army Maneuvers. Primary ROTC feeder schools were Lehigh University and the Pennsylvania Military College. Location 7 December 1941—Philadelphia, PA.

**Status:** Withdrawn from the CARS on 17 October 1999 and redesignated as the 315th Regt. to consist of the 2d and 3d Bns., which were concurrently allotted to the R.A. Assigned to the 78th Div. (Training Support).

**Commanders, 315th Infantry Regiment**

Col. Otho B. Rosenbaum	25 August 1917–12 July 1918	Maj. Frank Lloyd	22 October 1921–4 November 1921
Col. Alden C. Knowles	12 July 1918–31 May 1919	Lt. Col. Ralph S. Croskey	4 November 1921–September 1926
<i>Demobilized/Inactive</i>	31 May 1919–21 October 1921	Col. Joseph K. Nicholls	September 1926–19 January 1940
	Col. James E. Butterworth		19 January 1940–7 August 1941

**316th Infantry Regiment (79th Division)****Organized Reserve Pennsylvania**

HQ—Lancaster, PA, 1921–41

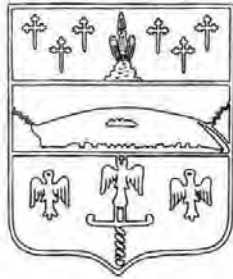

Arrived at the port of Newport News on 29 May 1919 on the U.S.S. *Antigone* as the 316th Inf., an element of the 79th Div. Demobilized on 9 June 1919 at Camp George G. Meade, MD. Reconstituted in the O.R. on 24 June 1921, assigned to the 79th Div., and allotted to the Third Corps Area. Initiated on 12 October 1921 with regimental HQ at Lancaster, PA. Subordinate battalion HQ concurrently organized as follows: 1st Bn. at Norristown, PA; 2d Bn. at Coatesville, PA; and 3d Bn. at York, PA. Regimental HQ was established at the Woolworth Building in Lancaster. The regiment typically conducted its Inactive Training Period meetings at locations as follows: the Wheatland Hotel in Lancaster, the Army and Navy Club or Walton Hotel in Philadelphia, or the ROTC armory at Gettysburg College. Conducted summer training most years with the 12th and 34th Inf. Regts. at Fort George G. Meade, MD. Also conducted infantry CMTC training some years at Fort Meade or

Fort Eustis as an alternate form of summer training. The regiment was selected to conduct summer training in 1928 at Fort Eustis with the Experimental Mechanized Force, the only O.R. unit to have such an opportunity. Conducted summer training in 1933 as a unit at Valley Forge Military Academy voluntarily without pay due to the depression. Participated as a unit in the 1939 First Army Maneuvers: regiment, less 3d Bn., participated in the Manassas phase; the 3d Bn. participated at Fort George G. Meade. Conducted a FTX in Lancaster County in October 1940 with CMTC candidates to prepare them for camp at Fort George G. Meade the following summer. Provided a number of officers to the 28th Div. for the 1939 and 1940 First Army Maneuvers. Typically conducted Inactive Training Period meetings at the armory of the First City Troop in Philadelphia. Also frequently conducted drills and contact camps at Valley Forge Military Academy. Primary ROTC feeder schools were Drexel Institute, Gettysburg College, and the University of Pennsylvania. Location 7 December 1941—Lancaster, PA (Inactivated 28 January 1942).

**Organization Day:** 6 November. Chosen to commemorate the regiment's seizure of la Borne de Cornouiller and Hill 378 north of Verdun during the Meuse-Argonne Campaign, 6 November 1918.

**Status:** Disbanded 14 March 1952

**Commanders, 316th Infantry Regiment**

Col. Oscar J. Charles	29 August 1917–5 October 1918	<i>Demobilized/Inactive</i>	9 June 1919–11 October 1921
Lt. Col. Robert L. Meador	5 October 1918–20 October 1918	Col. H. Harrison Smith	12 October 1921–15 June 1936
Col. George B. Williams	20 October 1918–12 November 1918	Col. Clifton Lisle	15 June 1936–25 July 1941
Col. Garrison McCaskey	12 November 1918–19 January 1918	Lt. Col. Merle M. Burkhardt	25 July 1941–10 August 1941
Lt. Col. George E. Haedicke	19 January 1919–9 June 1919	Maj. C. Fred Herbsleb	10 August 1941–28 January 1942

**317th Infantry Regiment (80th Division)****Organized Reserve Virginia**

HQ—Lynchburg, VA, 1921–41



Arrived at the port of Newport News on 2 June 1919 on the U.S.S. *Nansemond* as the 317th Inf., an element of the 80th Div. Demobilized 13–14 June 1919 at Camp Lee, VA. Reconstituted in the O.R. on 24 June 1921, assigned to the 80th Div., and allotted to the Third Corps Area. Initiated 19 October 1921 with regimental HQ at Lynchburg, VA. Subordinate battalion HQ concurrently organized as follows: 1st Bn. at Lynchburg; 2d Bn. at Roanoke, VA; and 3d Bn. at Staunton, VA. Conducted summer training most years with the 12th and 34th Inf. Regts. at Fort George G. Meade, MD; Fort Washington, MD; or Fort Eustis, VA. Also conducted infantry CMTC training some years at Fort Meade or Fort Eustis as an alternate form of summer training. Primary ROTC feeder schools were the Virginia Polytechnic Institute and the Virginia Military Institute. Location 7 December 1941—Lynchburg, VA.

**Status:** Reorganized 6 March 1959 as the 317th Regt., an element of the 80th Div. (Training); reorganized 1 October 1994 to consist of the 1st, 2d, and 3d Bns., elements of the 80th Div. (Institutional Training).

### Commanders, 317th Infantry Regiment

Col. George H. Jamerson	23 August 1917–1 May 1918	Lt. Col. William S. Woodruff	26 November 1922–ao December 1922
Col. Howard R. Perry	10 May 1918–8 October 1918	Col. William T. Chantland	ao July 1923–January 1926
Col. Charles Keller	9 October 1918–14 June 1919	Col. Winfield Scott	January 1926–23 March 1927
<i>Demobilized/Inactive</i>	14 June 1919–18 October 1921	Col. William T. Chantland	23 March 1927–6 July 1934
Lt. Col. Walter H. Adams	19 October 1921–26 November 1922	Col. Randolph E. B. McKenney	6 July 1934–28 June 1939
	Col. Edwin W. Jordan		28 June 1939–ao November 1941

### 318th Infantry Regiment (80th Division)

### Organized Reserve Virginia

HQ—Richmond, VA, 1921–41



Demobilized 1–5 June 1919 at Camp Lee, VA, as an element of the 80th Div. Reconstituted in the O.R. on 24 June 1921, assigned to the 80th Div., and allotted to the Third Corps Area. Initiated on 19 October 1921 with regimental HQ at Richmond, VA. Subordinate battalion HQ concurrently organized as follows: 1st Bn. at Richmond; 2d Bn. at Norfolk, VA; and 3d Bn. at Newport News, VA. Conducted summer training most years with the 12th and 34th Inf. Regts. at Fort George G. Meade, MD. Conducted summer training with the 116th Inf. Regt. at Virginia Beach, VA, in 1927. Also conducted infantry CMTC training some years at Fort Meade or Fort Eustis as an alternate form of summer training. Primary ROTC feeder schools were the Virginia Polytechnic Institute and the Virginia Military Institute. Location 7 December 1941—Richmond, VA.

**Status:** Reorganized 6 March 1959 as the 318th Regt., an element of the 80th Div. (Training); reorganized on 16 October–16 November 1996 to consist of the 1st, 2d, 3d, and 4th Bns., elements of the 80th Div. (Institutional Training).

### Commanders, 318th Infantry Regiment

Col. Briant H. Wells	21 August 1917–28 December 1917	Col. George D. Freeman Jr.	6 December 1918–5 June 1919
Lt. Col. Charles L. Mitchell	28 December 1917–6 March 1918	<i>Demobilized/Inactive</i>	5 June 1919–18 October 1921
Col. Ulysses G. Worriow	6 March 1918–11 October 1918	Lt. Col. John A. Cutcheons	19 October 1921–22 December 1922
Lt. Col. Charles L. Mitchell	11 October 1918–29 October 1918	Col. Edward E. Goodwyn	22 December 1922–28 September 1938
Col. Harry C. Jones	29 October 1918–6 December 1918	Lt. Col. Junius E. Dunford	28 September 1938–ao January 1941
	Unknown		ao January 1941–7 December 1941

### 319th Infantry Regiment (80th Division)

### Organized Reserve Maryland

HQ—Baltimore, MD, 1921–41



Arrived at the port of New York on 2 June 1919 on the U.S.S. *Graf Waldersee* as the 319th Inf., an element of the 80th Div. Demobilized 10 June–July 1919 at Camp Upton, NY, and Camp Shelby, MS. Reconstituted in the O.R. on 24 June 1921, assigned to the 80th Div., and allotted to the Third Corps Area. Initiated on 24 October 1921 with the entire regiment, less one company, at Baltimore, MD. Entire regiment relocated on 11 December 1929 to Baltimore. Typically conducted Inactive Training Period meetings at the armory of the 104th Med. Regt. or the Post Office Building in Baltimore. Conducted summer training most years with the 12th and 34th Inf. Regts. at Fort George G. Meade, MD, and some years at Fort Eustis, VA. Also conducted infantry CMTC training some years at Fort

Meade or Fort Howard, MD, as an alternate form of summer training. Primary ROTC feeder schools were the Johns-Hopkins University and the University of Maryland. Location 7 December 1941—Baltimore, MD.

**Status:** Reorganized 23 March 1959 as the 319th Regt., an element of the 80th Div. (Training); reorganized 19 October 2001 to consist of the 1st, 2d, and 3d Bns., elements of the 80th Div. (Institutional Training).



### Commanders, 319th Infantry Regiment

Col. Frank S. Cocheau	27 August 1917–1 October 1918	Col. Herbert A. Smith	1 July 1927–March 1931
Col. James L. Lowe, Jr.	2 October 1918–10 June 1919	Col. Harry C. Jones	March 1931–22 September 1933
<i>Demobilized/Inactive</i>	10 June 1919–23 October 1921	Col. Herbert A. Smith	16 October 1933–ao September 1935
Col. Harry C. Jones	27 October 1921–1 July 1927	Col. Edward T. Miller	ao June 1936–ao August 1941

### 320th Infantry Regiment (80th Division)

### Organized Reserve District of Columbia

HQ—Washington, DC, 1921–41

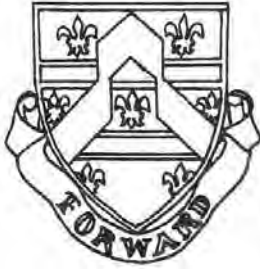

Arrived at the port of New York on 29 May 1919 on the U.S.S. *Mobile* as the 320th Inf., an element of the 80th Div. Demobilized on 7 June 1919 at Camp Sherman, OH. Reconstituted in the O.R. on 24 June 1921, assigned to the 80th Div., and allotted to the Third Corps Area. Initiated on 24 October 1921 with the entire regiment, less one company, at Washington, DC. Regiment participated in the Inaugural Parade of President Franklin D. Roosevelt in March 1929. Entire regiment relocated on 11 December 1929 to Washington. Typically conducted Inactive Training Period meetings at the Munitions Building in Washington. Conducted summer training most years with the 12th and 34th Inf. Regts. at Fort George G. Meade, MD, and some years at Fort Howard, MD, or Fort Eustis, VA. Also conducted infantry CMTC training some years at Fort Meade or Fort

Eustis as an alternate form of summer training. Primary ROTC feeder school was Georgetown University. Location 7 December 1941—Washington, DC.

**Status:** Withdrawn from the R.A. on 12 February 1959 and allotted to the Army Reserve as the 320th Regt.; reorganized 13 January 1995 to consist of the 1st and 2d Bns., elements of the 80th Div. (Institutional Training).

### Commanders, 320th Infantry Regiment

Col. Ora E. Hunt	14 August 1917–2 May 1918	Col. Glendie B. Young	27 October 1921–12 September 1927
Col. Sydney A. Cloman	2 May 1918–11 June 1918	Col. Winfield Scott	12 September 1927–29 May 1929
Col. Ephraim G. Peyton	30 July 1918–22 January 1919	Col. William H. England	29 May 1929–14 October 1937
Unknown	23 January 1919–7 June 1919	Col. John V. Richards	14 October 1937–ao December 1939
<i>Demobilized/Inactive</i>	7 June 1919–24 October 1921	Col. Paul B. Parker	ao September 1940–May 1941
	Lt. Col. Edward T. Fell		May 1941–ao July 1941

### 321st Infantry Regiment (81st Division)

### Organized Reserve North Carolina

HQ—*Not initiated*, 1921–22; Raleigh, NC, 1922–41



Arrived at the port of Newport News on 20 June 1919 on the U.S.S. *Manchuria* as the 321st Inf., an element of the 81st Div. Demobilized on 28 June 1919 at Camp Lee, VA. Reconstituted in the O.R. on 24 June 1921, assigned to the 81st Div., and allotted to the Fourth Corps Area. Initiated in March 1922 with regimental HQ at Raleigh, NC. Subordinate battalion HQ concurrently organized as follows: 1st Bn. at Raleigh; 2d Bn. at Goldsboro, NC; and 3d Bn. at Fayetteville, NC. Typically conducted Inactive Training Period meetings at the Cumberland County Courthouse in Fayetteville and the Robeson County Courthouse in Lumberton, NC. Conducted summer training most years with the 8th Inf. at Fort Moultrie, SC, and some years with the 22d Inf. at Camp McClellan, AL, or Fort

McPherson, GA. Also conducted infantry CMTC training some years at Fort Moultrie as an alternate form of summer training. Primary ROTC feeder school was North Carolina State College. Location 7 December 1941—Raleigh, NC.

**Status:** Reorganized 30 April 1959 as the 321st Regt., an element of the 108th Div. (Training); reorganized 19 October 2001 to consist of the 1st, 2d, 3d, and 4th Bns., elements of the 108th Div. (Institutional Training).

### Commanders, 321st Infantry Regiment

Col. Edward A. Shuttleworth	29 August 1917–5 April 1918	<i>Demobilized/Inactive</i>	28 June 1919–March 1922
Col. Samuel V. Ham	5 April 1918–27 June 1918	Col. James M. Little	March 1922–March 1931
Col. Frank Halstead	27 June 1918–28 June 1919	Col. Edgar H. Bain	March 1931–ao November 1941

### 322d Infantry Regiment (81st Division)

### Organized Reserve North Carolina

HQ—*Not initiated*, 1921–22; Greensboro, NC, 1922–29; Charlotte, NC, 1929–41

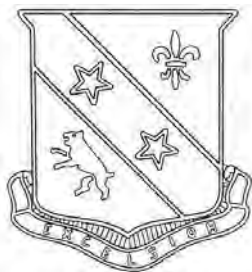

Arrived at the port of Newport News as the 322d Inf., an element of the 81st Div. Demobilized 22 June 1919 at Camp Lee, VA. Reconstituted in the O.R. on 24 June 1921, assigned to the 81st Div., and allotted to the Fourth Corps Area. Initiated on 9 January 1922 with regimental HQ at Greensboro, NC. Subordinate battalion HQ concurrently organized as follows: 1st Bn. at High Point, NC; 2d Bn. at Monroe, NC; and 3d Bn. at Weaverville, NC. Entire regiment relocated on 22 October 1929 to Charlotte, NC. Conducted summer training most years with the 8th Inf. at Fort Moultrie, SC, and some years with the 22d Inf. at Fort McPherson, GA; Fort McClellan, AL; or Fort Bragg, NC. Also conducted infantry CMTC training some years at Fort Moultrie as an alternate form of summer training.

Primary ROTC feeder schools were North Carolina State College and Davidson College. Location 7 December 1941—Charlotte, NC.

**Status:** Withdrawn from the CARS on 1 October 1993 and redesignated as the 322d Regt. to consist of the 2d, and 3d Bns., elements of the 78th Div. (Exercise); reorganized on 15 April 2000 to consist of the 1st Bn., an elements of the 78th Div. (Training Support).

### Commanders, 322d Infantry Regiment

Col. Lorrain T. Richardson	23 August 1917–1 January 1918	Unknown	ao February 1922–ao December 1923
Col. Robert W. Mearns	1 January 1918–April 1918	Lt. Col. James H. Howell	ao December 1923–ao February 1924
Col. Lorrain T. Richardson	20 August 1918–ao January 1919	Lt. Col. George K. Freeman	ao December 1924–17 March 1927
<i>Demobilized/Inactive</i>	22 June 1919–8 January 1922	Col. Roane Waring	17 March 1927–ao July 1937
Maj. Sidney S. Alderman	9 January 1922–ao February 1922	Unknown	ao July 1937–7 December 1941

### 323d Infantry Regiment (81st Division)

### Organized Reserve Tennessee

HQ—Knoxville, TN, 1921–41



Arrived at the port of Newport News on 14 June 1919 on the U.S.S. *Walter A. Luckenbach* as the 323d Inf., an element of the 81st Div. Demobilized 17–30 June 1919 at Camp Lee, VA; Camp Stuart, VA; Camp Jackson, SC; Camp Gordon, GA; Camp Upton, NY; and Camp Dix, NJ. Reconstituted in the O.R. on 24 June 1921, assigned to the 81st Div., and allotted to the Fourth Corps Area. Initiated on 14 December 1921 with regimental HQ at Knoxville, TN. Subordinate battalion HQ concurrently organized as follows: 1st Bn. at Knoxville; 2d Bn. at Chattanooga, TN; and 3d Bn. at Lebanon, TN. Band organized on 4 April 1923 at Chattanooga. Conducted summer training most years with the 8th and 22d Inf. Regts. at Camp McClellan, AL; and some years at Fort Oglethorpe, GA; Fort Moultrie, SC; Fort McPherson, GA; or Fort Bragg, NC. Also conducted infantry CMTC training some years at Camp McClellan, AL, or Camp Beauregard, LA, as an alternate

form of summer training. Primary ROTC feeder school was the University of Tennessee. Location 7 December 1941—Knoxville, TN.

**Status:** Reorganized on 30 April 1959 as the 323d Regt., an element of the 108th Div. (Training); reorganized on 17 October 2005 to consist of the 1st, 2d, 3d, and 4th Bns., elements of the 108th Div. (Institutional Training).

**Commanders, 323d Infantry Regiment**

Col. Peter E. Marquart	29 August 1917–3 April 1918	Col. Thomas J. Wyrick	14 December 1921–January 1938
Col. Thomas A. Pearce	3 April 1918–2 June 1919	Col. James M. Watkins	January 1938–12 February 1939
<i>Demobilized/Inactive</i>	30 June 1919–11 December 1921	Col. Ernest W. Andes	12 February 1939–ao June 1940
	Unknown	ao June 1940–7 December 1941	

**324th Infantry Regiment (81st Division)**

**Organized Reserve Tennessee**

HQ—Memphis, TN, 1921–41



Arrived at the port of Charleston on 18 June 1919 on the U.S.S. *Martha Washington* as the 324th Inf., an element of the 81st Div. Demobilized in June 1919 at Camp Jackson, SC. Reconstituted in the O.R. on 24 June 1921, assigned to the 81st Div., and allotted to the Fourth Corps Area. Initiated on 7 December 1921 with regimental HQ at Memphis, TN. Subordinate battalion HQ concurrently organized as follows: 1st Bn. at Memphis; 2d Bn. at Jackson, TN; and 3d Bn. at Nashville, TN. Conducted summer training most years with 22d Inf. Regt. at Camp McClellan, AL; Fort Oglethorpe, GA; or Fort McPherson, GA; and some years with the 8th Inf. Regt. at Fort Moultrie, SC. Also conducted infantry CMTC training some years at Camp McClellan, AL, or Camp Beauregard, LA, as an alternate form of summer training. Primary ROTC feeder school was the University of Tennessee. Location 7 December 1941—Memphis, TN.

**Status:** Consolidated with the 113th Inf., New Jersey N.G., a parent regiment of the USARS.

**Commanders, 324th Infantry Regiment**

Col. George M. Moses	25 August 1917–25 June 1919	Col. Roane Waring	ao December 1925–ao July 1931
<i>Demobilized/Inactive</i>	25 June 1919–6 December 1921	Unknown	ao July 1931–ao September 1936
Unknown	7 December 1921–12 December 1922	Lt. Col. James M. Watkins	ao September 1936–ao October 1936
Col. Charles F. Brown	12 December 1922–ao December 1924	Unknown	ao October 1936–ao October 1937
Unknown	ao December 1924–ao September 1925	Lt. Col. Thomas A. Thrash	ao October 1937–ao November 1937
	Unknown	ao November 1937–7 December 1941	

**325th Infantry Regiment (82d Division)**

**Organized Reserve Georgia**

HQ—Albany, GA, 1921–41

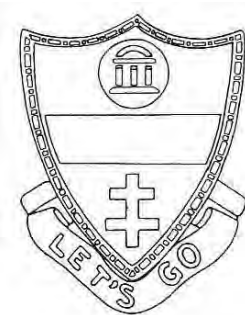

Arrived at the port of New York on 11 May 1919 on the U.S.S. *Alaskan* as the 325th Inf., an element of the 82d Div. Demobilized 18–25 May 1919 at Camp Upton, NY. Reconstituted in the O.R. on 24 June 1921, assigned to the 82d Div., and allotted to the Fourth Corps Area. Initiated on 14 December 1921 with regimental HQ at Albany, GA. Subordinate battalion HQ concurrently organized as follows: 1st Bn. at Columbus, GA; 2d Bn. at Waycross, GA; and the 3d Bn. at Savannah, GA. Conducted summer training most years with the 8th Inf. Regt. at Fort Screven, GA, and some years with the 22d Inf. Regt. at Camp McClellan, AL, or Fort McPherson, GA. Also conducted infantry CMTC training some years at Camp McClellan, Fort Screven, Fort Moultrie, or Camp Beauregard, LA, as an alternate form of summer training. Primary ROTC feeder school was the University of Georgia. Location 7 December 1941—Albany, GA.

**Status:** Assigned to the USARS as the 325th Inf.; 1st, 2d, and 3d Bns. active at Fort Bragg, NC, as elements of the 82d Airborne Div.

**Commanders, 325th Infantry Regiment**

Col. Walter M. Whitman	5 August 1917–25 May 1919	<i>Demobilized/Inactive</i>	25 May 1919–13 December 1921
	Col. William M. Wilder	14 December 1921–24 March 1942	

**326th Infantry Regiment (82d Division)****Organized Reserve Georgia**

HQ—*Not initiated*, 1921–22; Marietta, GA, 1922–27; Atlanta, GA, 1927–41



Arrived at the port of New York on 29 May 1919 on the U.S.S. *Kroonland* as the 326th Inf., an element of the 82d Div. Demobilized 3–11 June 1919 at Camp Upton, NY. Reconstituted in the O.R. on 24 June 1921, assigned to the 82d Div., and allotted to the Fourth Corps Area. Initiated on 14 January 1922 with regimental HQ at Marietta, GA. Subordinate battalion HQ concurrently organized as follows: 1st Bn. at Rome, GA; 2d Bn. at Augusta, GA; and the 3d Bn. at Atlanta, GA. Entire regiment relocated in 1927 to Atlanta, GA. Typically conducted Inactive Training Period meetings at the Chamber of Commerce Assembly Hall or the Courtland Street Armory in Atlanta. Conducted summer training most years with the 22d Inf. Regt. at Camp McClellan, AL; Fort McPherson, GA; or Fort Oglethorpe, GA; and some years with the 8th Inf. Regt. at Fort Moultrie, SC. Also

conducted infantry CMTC training some years at Fort Screven, GA; Camp McClellan; or Fort Moultrie, SC, as an alternate form of summer training. Primary ROTC feeder schools were North Georgia College and the University of Georgia. Location 7 December 1941—Atlanta, GA.

**Status:** Inactive in the Army Reserve as the 326th Glider Inf.

**Commanders, 326th Infantry Regiment**

Col. John C. McArthur	22 August 1917–31 October 1918	<i>Demobilized/Inactive</i>	11 June 1919–13 January 1922
Col. Pierce A. Murphy	31 October 1918–24 December 1918	Col. Homer H. Watkins	14 January 1922–27 March 1924
Col. John K. Miller	3 January 1919–6 June 1919	Col. Richard L. Boyd	27 March 1924–ao September 1929
	Col. Franklin S. Chalmers		ao July 1930–January 1942

**327th Infantry Regiment (82d Division)****Organized Reserve South Carolina**

HQ—Greenville, SC, 1921–41



Arrived at the port of New York on 19 May 1919 on the U.S.S. *Walter A. Luckenbach* as the 327th Inf., an element of the 82d Div. Demobilized on 26 May 1919 at Camp Upton, NY. Reconstituted in the O.R. on 24 June 1921, assigned to the 82d Div., and allotted to the Fourth Corps Area. Initiated on 7 December 1921 with regimental HQ at Greenville, SC. Subordinate battalion HQ concurrently organized as follows: 1st Bn. at Columbia, SC; 2d Bn. at Spartanburg, SC; and the 3d Bn. at Florence, SC. Band organized in 1926 at Greenville. The band was under the leadership of WO A.J. Garing who had spent 16 years in the U.S.M.C. Band under John Philip Souza. Conducted summer training most years with the 22d Inf. Regt. at Fort McPherson, GA, and some years with the 8th Inf. at Fort Moultrie, SC, or Fort Screven, GA. Also conducted infantry CMTC training some years at Fort Moultrie or Fort Screven as an alternate form of summer training. Primary ROTC

feeder schools were Clemson Agricultural College and the Citadel. Location 7 December 1941—Greenville, SC.

**Status:** Assigned to the USARS as the 327th Inf.; 1st, 2d, and 3d Bns. active at Fort Campbell, KY, as elements of the 101st Airborne Div.

**Commanders, 327th Infantry Regiment**

Col. William H. Simmons	4 September 1917–12 April 1918	<i>Demobilized/Inactive</i>	26 May 1919–6 December 1921
Col. Frank D. Ely	13 April 1918–4 November 1918	Col. Peter K. McCully	7 December 1921–June 1929
Lt. Col. Frank W. Blalock	4 November 1918–2 December 1918	Col. Lindsay C. McFadden	June 1929–30 December 1929
Col. John F. Preston, Jr.	2 December 1918–26 May 1919	Col. Warren Lott	30 December 1929–February 1941
	Unknown		February 1941–7 December 1941

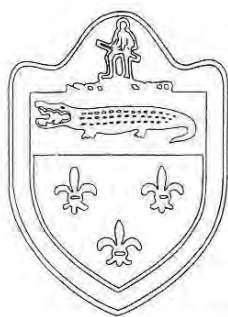
**328th Infantry Regiment (82d Division)****Organized Reserve Florida****HQ—Tampa, FL, 1921–41**

Arrived at the port of New York on 20 May 1919 on the U.S.S. *Sierra* as the 328th Inf., an element of the 82d Div. Demobilized 27–29 May 1919 at Camp Upton, NY. Reconstituted in the O.R. on 24 June 1921, assigned to the 82d Div., and allotted to the Fourth Corps Area. Initiated 18 November 1921 with regimental HQ at Tampa, FL. Subordinate battalion HQ concurrently organized as follows: 1st Bn. at Tampa; 2d Bn. at West Palm Beach, FL; and the 3d Bn. at Pensacola, FL. Entire regiment relocated on 22 October 1929 to Tampa. Conducted summer training most years with the 8th Inf. Regt. at Fort Screven, GA, and some years with the 22d Inf. Regt. at Camp McClellan, AL, or Fort McPherson, GA. Also conducted infantry CMTC training some years at Fort Screven, GA, or Fort Moultrie, SC, as an alternate form of summer training. Typically conducted Inactive Training Period meetings at the armory of the 116th F.A. in Tampa. Primary ROTC feeder school was the University of Florida. Location 7 December 1941—Tampa, FL.

**Status:** Consolidated with the 181st Inf., Massachusetts N.G., a parent regiment of the USARS.**Commanders, 328th Infantry Regiment**

Col. Julian R. Lindsey	18 August 1917–20 May 1918	<i>Demobilized/Inactive</i>	29 May 1919–17 November 1921
Lt. Col. Frank F. Jewett	20 May 1918–13 June 1918	Lt. Col. Fred J. Mack	18 November 1921–December 1921
Col. Hunter B. Nelson	13 June 1918–16 September 1918	Col. Harry C. Culbreath	December 1921–ao May 1940
Col. Richard Wetherill	16 September 1918–29 May 1919	Unknown	ao May 1940–7 December 1941

**329th Infantry Regiment (83d Division)****Organized Reserve Ohio****HQ—Dayton, OH, 1921–41**

Arrived at the port of New York on 1 February 1919 on the U.S.S. *Minnekahda* as the 329th Inf., an element of the 83d Div. Demobilized on 15 February 1919 at Camp Sherman, OH. Reconstituted in the O.R. on 24 June 1921, assigned to the 83d Div., and allotted to the Fifth Corps Area. Initiated on 21 December 1921 with regimental HQ at Dayton, OH. Subordinate battalion HQ concurrently organized as follows: 1st Bn. at Hamilton, OH; 2d Bn. at Columbus, OH; and the 3d Bn. at Bellefontaine, OH. Band organized on 8 December 1923 at Dayton; inactivated 3 October 1936. Typically conducted Inactive Training Period meetings at the Federal Building in Cincinnati, OH, or South Armory in Boston. Conducted summer training most years with the 10th Inf. Regt. at Fort Thomas, KY, or Camp Knox, KY. Also conducted infantry CMTC training some years at Fort Thomas or Fort Benjamin Harrison, IN, as an alternate form of summer training. Primary ROTC feeder school was the University of Dayton. Location 7 December 1941—Dayton, OH.

**Status:** Reorganized 1 May 1959 as the 329th Regt., an element of the 70th Div. (Training); reorganized 1 October 2004 to consist of the 1st, 2d, 3d, and 4th Bns., elements of the 100th Div. (Institutional Training).**Commanders, 329th Infantry Regiment**

Col. George C. Barnhardt	22 August 1917–26 August 1918	Maj. C.S. Dryer	21 December 1921–ao January 1922
Col. John J. Toffey	ao June 1918–ao July 1918	Col. Joseph W. Viner	ao July 1922–August 1927
Lt. Col. James C. MacDermott	ao November 1918–15 February 1919	Lt. Col. Robert DeS. Newhall	August 1927–July 1934
<i>Demobilized/Inactive</i>	15 February 1919–20 December 1921	Col. Harry A. Toulmin Jr.	July 1934–ao January 1940
	Unknown		ao January 1940–7 December 1941

**330th Infantry Regiment (83d Division)****Organized Reserve Ohio****HQ**—Alexandria, OH, 1921–23; Alliance, OH, 1923–31; Columbus, OH, 1931–41

Arrived at the port of New York on 30 January 1919 on the U.S.S. *Frederick* as the 330th Inf., an element of the 83d Div. Demobilized 13 February–10 April 1919 at Camp Sherman, OH. Reconstituted in the O.R. on 24 June 1921, assigned to the 83d Div., and allotted to the Fifth Corps Area. Initiated on 9 November 1921 with regimental HQ at Alexandria, OH. Subordinate battalion HQ concurrently organized as follows: 1st Bn. at Massillion, OH; 2d Bn. at Lancaster, OH; and the 3d Bn. at Alliance, OH. Regimental HQ relocated on 27 April 1923 to Alliance, OH. Regimental HQ relocated on 9 July 1931 to Columbus, OH. Conducted summer training most years with the 10th Inf. Regt. at Camp Knox, KY, and Fort Thomas, KY. Also conducted infantry CMTTC training some years at Fort Thomas, Fort Benjamin Harrison, IN, or Camp Knox as an alternate form of summer training. Primary ROTC feeder school was the University of Akron. Location 7 December 1941—Columbus, OH.

**Status:** Reorganized on 1 May 1959 as the 330th Regt., an element of the 70th Div. (Training); reorganized on 17 October 2005 to consist of the 1st, 2d, and 3d Bns., elements of the 100th Div. (Institutional Training).

**Commanders, 330th Infantry Regiment**

Col. Kenzie W. Walker	30 August 1917–27 March 1918	<i>Demobilized/Inactive</i>	10 April 1919–8 November 1921
Col. Samuel V. Ham	28 March 1918–12 August 1918	Lt. Col. Floyd L. Simmons	9 November 1921–27 April 1923
Lt. Col. Phillip McCabe	12 August 1918–10 April 1919	Col. Robert S. Harsh	27 April 1923–ao January 1941
	Unknown	ao January 1941–7 December 1941	

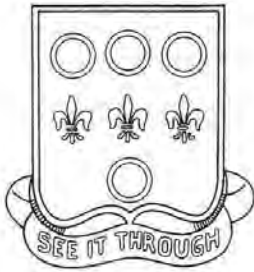
**331st Infantry Regiment (83d Division)****Organized Reserve Ohio****HQ**—Cleveland, OH, 1921–41

Arrived at the port of New York on 26 January 1919 on the S.S. *Caronia* as the 331st Inf., an element of the 83d Div. Demobilized 8–9 February 1919 at Camp Sherman, OH, as an element of the 83d Div. Reconstituted in the O.R. on 24 June 1921, assigned to the 83d Div., and allotted to the Fifth Corps Area. Initiated on 7 November 1921 with regimental HQ at Cleveland, OH. Subordinate battalion HQ concurrently organized as follows: 1st Bn. at Cleveland; 2d Bn. at Akron, OH; and the 3d Bn. at Youngstown, OH. Co. A organized and sponsored by the Cleveland Grays, a local Ohio N.G. organization with a long and storied history. Sponsorship withdrawn 28 September 1928. Typically conducted Inactive Training Period meetings at the Cleveland Grays Armory in Cleveland. Conducted summer training most years with the 10th Inf. Regt. at Camp Knox, KY, and

Fort Thomas, KY. Also conducted infantry CMTTC training some years at Fort Benjamin Harrison, IN, or Camp Knox as an alternate form of summer training. Primary ROTC feeder school was the University of Akron. Location 7 December 1941—Cleveland, OH.

**Commanders, 331st Infantry Regiment**

Col. Robert C. Williams	30 August 1917–ao November 1918	Col. Carl I. Best	7 November 1921–ao August 1928
Unknown	ao November 1918–9 February 1919	Unknown	ao August 1928–ao July 1930
<i>Demobilized/Inactive</i>	9 February 1919–7 November 1921	Col. Floyd L. Simmons	ao July 1930–ao July 1938
	Unknown	ao July 1938–7 December 1941	

**332d Infantry Regiment (83d Division)****Organized Reserve Ohio****HQ—Findlay, OH, 1921–41**

Arrived at the port of New York on 18 April 1919 on the S.S. *Dante Alhiere* as the 332d Inf., an element of the 83d Div. Demobilized on 1 July 1919 at Camp Sherman, OH, as an element of the 83d Div. Reconstituted in the O.R. on 24 June 1921, assigned to the 83d Div., and allotted to the Fifth Corps Area. Initiated 8 November 1921 with regimental HQ at Findlay, OH. Subordinate battalion HQ concurrently organized as follows: 1st Bn. at Paulding, OH; 2d Bn. at Lima, OH; and the 3d Bn. at Sandusky, OH. Conducted summer training most years with the 10th Inf. Regt. at Camp Knox, KY, and with the 11th Inf. at Fort Benjamin Harrison, IN. Also conducted infantry CMTC training some years at Fort Thomas, KY; Fort Benjamin Harrison; or Camp Knox as an alternate form of summer training. Primary ROTC feeder school was the University of Dayton. Location 7 December 1941—Cleveland, OH.

**Status:** Consolidated with the 3d Bn., 2d Inf.**Commanders, 332d Infantry Regiment**

Col. William Wallace	30 August 1917–5 May 1919	Col. Edward P. Campbell	8 April 1935–ao June 1937
<i>Demobilized/Inactive</i>	1 July 1919–7 November 1921	Lt. Col. Arthur D. Patterson	ao June 1938–ao June 1941
Col. Richard R. Groves	8 November 1921–8 April 1935	Unknown	ao June 1941–7 December 1941

**333d Infantry Regiment (84th Division)****Organized Reserve Indiana****HQ—Vincennes, IN, 1921–41**

Arrived at the port of New York on 24 January 1919 on the U.S.S. *General Goethals* as the 333d Inf., an element of the 84th Div. Demobilized on 31 January 1919 at Zachary Taylor, KY. Reconstituted in the O.R. on 24 June 1921, assigned to the 83d Div., and allotted to the Fifth Corps Area. Initiated on 1 October 1921 with regimental HQ at Vincennes, IN. Subordinate battalion HQ concurrently organized as follows: 1st Bn. at Terre Haute, IN; 2d Bn. at Washington, IN; and the 3d Bn. at Cannelton, IN. Conducted summer training most years with the 11th Inf. at Fort Benjamin Harrison, IN, and some years at Camp Knox, KY. Also conducted infantry CMTC training some years at Fort Benjamin Harrison or Camp Knox as an alternate form of summer training. Participated in division and brigade CPXs and contact camps at Culver Military Academy. Primary ROTC feeder school was Indiana University. Location 7 December 1941—Vincennes, IN.

**Status:** Inactive in the Army Reserve as the 333d Regt.**Commanders, 333d Infantry Regiment**

Col. August C. Nissen	29 August 1917–7 November 1918	Lt. Col. Edward J.W. Proffitt	28 September 1921–November 1921
Capt. Howard J. Thomas	8 November 1918–31 January 1919	Col. Thomas B. Coulter	November 1921–ao August 1937
<i>Demobilized/Inactive</i>	31 January 1919–30 September 1921	Lt. Col. Orion Norcross	ao May 1938–ao March 1940
	Unknown	ao March 1940–7 December 1941	

**334th Infantry Regiment (84th Division)****Organized Reserve Indiana****HQ—Indianapolis, IN, 1921–41**

Arrived at the port of New York on 24 January 1919 on the U.S.S. *General Goethals* as the 334th Inf., an element of the 84th Div. Demobilized on 18 February 1919 at Zachary Taylor, KY. Reconstituted in the O.R. on 24 June 1921, assigned to the 84th Div., and allotted to the Fifth Corps Area. Initiated on 1 October 1921 with regimental HQ at Indianapolis, IN. Subordinate battalion HQ concurrently organized as follows: 1st Bn. at Indianapolis; 2d Bn. at Connersville, IN; and 3d Bn. at Brookville, IN. Typically conducted Inactive Training Period meetings at the Lincoln Hotel in Indianapolis. Conducted summer training most years with the 11th Inf. at Fort Benjamin Harrison, IN, and some years at

Camp Knox, KY, or Culver Military Academy. Also conducted infantry CMTC training some years at Fort Benjamin Harrison as an alternate form of summer training. Participated in division and brigade CPXs and contact camps at Culver Military Academy. Primary ROTC feeder schools were Indiana University and Culver Military Academy. Location 7 December 1941—Indianapolis, IN.

**Status:** Reorganized on 18 May 1959 as the 334th Regt., an element of the 84th Div. (Training); reorganized on 1 October 2004 to consist of the 1st, 2d, and 3d Bns., elements of the 100th Div. (Institutional Training).

**Commanders, 334th Infantry Regiment**

Col. Frederick L. Knudsen	29 August 1917–24 April 1918	Lt. Col. Arthur J. Perry	28 September 1921–10 November 1921
Col. James Hanson	24 April 1918–9 August 1918	Col. Lemuel C. Bolles	10 November 1921–May 1924
Lt. Col. Theodore Schultz	9 August 1918–18 February 1919	Col. Charles O. Warfel	June 1924–ao August 1940
<i>Demobilized/Inactive</i>	18 February 1919–30 September 1921	Unknown	ao August 1940–7 December 1941

**335th Infantry Regiment (84th Division)**

**Organized Reserve Indiana**

HQ—Muncie, IN, 1921–41



Arrived at the port of New York on 24 January 1919 on the U.S.S. *General Goethals* as the 335th Inf., an element of the 84th Div. Demobilized on 18 February 1919 at Zachary Taylor, KY. Reconstituted in the O.R. on 24 June 1921, assigned to the 84th Div., and allotted to the Fifth Corps Area. Initiated on 1 October 1921 with regimental HQ at Muncie, IN. Subordinate battalion HQ concurrently organized as follows: 1st Bn. at Elkhart, IN; 2d Bn. at Anderson, IN; and 3d Bn. at Richmond, IN. Conducted summer training most years with the 11th Inf. at Fort Benjamin Harrison, IN, and some years at Camp Knox, KY, or Culver Military Academy. Also conducted infantry CMTC training some years at Fort Benjamin Harrison or Camp Knox as an alternate form of summer training. Participated

in division and brigade CPXs and contact camps at Culver Military Academy. Primary ROTC feeder schools were Indiana University and Culver Military Academy. Location 7 December 1941—Muncie, IN.

**Status:** Reorganized 1 June 1959 as the 335th Regt., an element of the 85th Div. (Training); reorganized 17 October 1999 to consist of the 1st, 2d, and 3d Bns., elements of the 85th Div. (Training Support); 2d and 3d Bns. concurrently allotted to the R.A.

**Commanders, 335th Infantry Regiment**

Col. Lincoln F. Kilbourne	26 August 1917–6 November 1918	Col. Philip W. McAbee	24 November 1922–ao July 1929
Unknown	7 November 1918–18 February 1919	Lt. Col. George A. Shipley	ao June 1930–ao July 1930
<i>Demobilized/Inactive</i>	18 February 1919–8 November 1921	Unknown	ao July 1930–ao May 1934
Lt. Col. Philip W. McAbee	28 September 1921–9 November 1921	Col. Cleon W. Mount	ao May 1934–ao July 1938
Col. William G. Everson	9 November 1921–24 November 1922	Unknown	ao July 1938–7 December 1941

**336th Infantry Regiment (84th Division)**

**Organized Reserve Indiana**

HQ—Culver, IN, 1921–41



Arrived at the port of New York on 24 January 1919 on the U.S.S. *General Goethals* as the 336th Inf., an element of the 84th Div. Demobilized on 18 February 1919 at Zachary Taylor, KY. Reconstituted in the O.R. on 24 June 1921, assigned to the 84th Div., and allotted to the Fifth Corps Area. Initiated on 28 September 1921 with regimental HQ at Culver, IN. Subordinate battalion HQ concurrently organized as follows: 1st Bn. at Laporte, IN; 2d Bn. at Culver, IN; and 3d Bn. at Waynetown, IN. Conducted summer training most years with the 11th Inf. at Fort Benjamin Harrison, IN, or Camp Knox, KY, and some years at Culver Military Academy. Also conducted infantry CMTC training some years at Fort Benjamin Harrison or Camp Knox as an alternate form of summer training. Participated in division



and brigade CPXs and contact camps at Culver Military Academy. Primary ROTC feeder school was Culver Military Academy. Location 7 December 1941—Culver, IN.

**Status:** Consolidated with the 3d Bn., 11th Inf.

**Commanders, 336th Infantry Regiment**

Col. Glenn H. Davis	25 August 1917–7 November 1918	Col. Howard F. Noble	28 September 1921–ao September 1924
Unknown	7 November 1918–18 February 1919	Unknown	ao September 1924–ao March 1938
<i>Demobilized/Inactive</i>	18 February 1919–28 September 1921	Col. Allen R. Elliot	ao March 1938–ao May 1940
	Unknown	ao May 1940–7 December 1941	

**337th Infantry Regiment (85th Division)**

**Organized Reserve Michigan**

HQ—Grand Rapids, MI, 1921–41

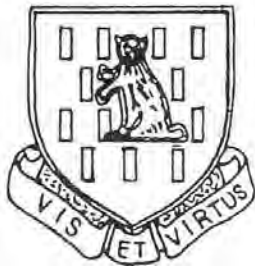

Arrived at the port of New York on 2 April 1919 on the U.S.S. *Leviathan* as the 337th Inf., an element of the 85th Div. Demobilized on 23 April 1919 at Camp Custer, MI. Reconstituted in the O.R. on 24 June 1921, assigned to the 85th Div., and allotted to the Sixth Corps Area. Initiated 25 November 1921 with regimental HQ and 1st and 2d Bns. at Grand Rapids, MI, and 3d Bn. at Sault Ste Marie, MI. The 2d and 3d Bns. relocated by 1929 to Muskegon and Cadillac, MI, respectively. Conducted summer training most years with the 2d Inf. at Camp Custer, MI. Conducted summer training with the 125th Inf. at Camp Grayling, MI, in 1928 and 1934. Also conducted infantry CMTC training some years at Camp Custer, MI, or Fort Brady, MI, as an alternate form of summer training.

Primary ROTC feeder school was Michigan State College of Agriculture and Applied Science. Location 7 December 1941—Grand Rapids, MI.

**Status:** Reorganized 1 June 1959 as the 337th Regt., an element of the 85th Div. (Training); reorganized on 17 October 1999 to consist of the 1st, 2d, and 3d Bns, elements of the 85th Div. (Training Support); 1st Bn. concurrently allotted to the R.A.

**Commanders, 337th Infantry Regiment**

Col. Robert H. Allen	September 1917–October 1918	<i>Demobilized/Inactive</i>	23 April 1919–25 November 1921
Col. Benjamin W. Atkinson	October 1918–23 April 1919	Col. Arthur F. Shaw	25 November 1921–ao July 1940
	Unknown	ao July 1940–7 December 1941	

**338th Infantry Regiment (85th Division)**

**Organized Reserve Michigan**

HQ—Kalamazoo, MI, 1921–23; Lansing, MI, 1923–32; Kalamazoo, MI, 1932–41



Arrived at the port of New York on 2 April 1919 on the U.S.S. *Leviathan* as the 338th Inf., an element of the 85th Div. Demobilized on 14 April 1919 at Camp Custer, MI. Reconstituted in the O.R. on 24 June 1921, assigned to the 85th Div., and allotted to the Sixth Corps Area. Initiated on 5 November 1921 with regimental HQ at Kalamazoo, MI. Subordinate battalion HQ organized as follows: 1st Bn. at Kalamazoo, MI; 2d Bn. at Lansing, MI; and 3d Bn. at Ann Arbor, MI. Regimental HQ was relocated on 20 July 1923 to Lansing, MI. The 2d and 3d Bns. were relocated by 1929 to Hastings and Jackson, MI, respectively. Regimental HQ was relocated on 26 September 1932 to Kalamazoo. Conducted summer training most years with the 2d Inf. at Camp Custer, MI. Conducted summer training with the 126th Inf. at Camp Grayling, MI, in 1928 and 1934. Also conducted infantry CMTC training some years at Camp Custer or Fort Brady, MI, as

an alternate form of summer training. Primary ROTC feeder school was Michigan State College of Agriculture and Applied Science. Location 7 December 1941—Lansing, MI.

**Status:** Reorganized 1 June 1959 as the 338th Regt., an element of the 85th Div. (Training); reorganized on 17 October 1999 to consist of the 1st, 2d, and 3d Bns., elements of the 85th Div. (Training Support).

**Commanders, 338th Infantry Regiment**

Col. Frank C. Wells	22 August 1917–21 June 1918	<i>Demobilized/Inactive</i>	14 April 1919–5 November 1921
Lt. Col. Douglas A. Potts	21 June 1918–ao July 1918	Col. Jay C. McCullough	5 November 1921–14 June 1927
Maj. Smith A. Harris	Unknown	Col. Gerald C. Cronin	14 June 1927–November 1931
Lt. Col. George E. Ball	Unknown	Col. Lee H. Cahill	November 1931–ao June 1939
Col. Daniel G. Berry	9 July 1918–12 April 1919	Unknown	ao June 1939–7 December 1941

**339th Infantry Regiment (85th Division)**

**Organized Reserve Michigan**

HQ—Detroit, MI, 1921–41



Arrived at the port of Boston on 12 July 1919 on the U.S.S. *President Grant* as the 339th Inf., an element of the 85th Div. Demobilized 18–22 July 1919 at Camp Custer, MI. Reconstituted in the O.R. on 24 June 1921, assigned to the 85th Div., and allotted to the Sixth Corps Area. Initiated on 14 October 1921 with the entire regiment at Detroit, MI. Band organized about August 1924 at Detroit. Conducted summer training most years with the 2d Inf. at Camp Custer, MI, or Fort Wayne, MI. Also conducted infantry CMTC training some years at Camp Custer, MI, or Fort Brady, MI, as an alternate form of summer training. Primary ROTC feeder school was the University of Michigan. Location 7 December 1941—Detroit, MI.

**Status:** Reorganized on 18 May 1959 as the 339th Regt., an element of the 84th Div. (Training); reorganized on 16 April 2006 to consist of the 2d and 3d Bns., elements of the 100th Div. (Institutional Training).

**Commanders, 339th Infantry Regiment**

Col. John W. Craig	21 August 1917–11 June 1918	Col. George W. Blackinton	15 January 1927–ao February 1932
Col. George E. Stewart	12 June 1918–22 July 1919	Unknown	ao February 1932–ao December 1933
<i>Demobilized/Inactive</i>	22 July 1919–14 October 1921	Col. Joel R. Moore	ao December 1933–January 1934
Lt. Col. Wesson Seyburn	3 November 1921–5 June 1922	Unknown	January 1934–ao July 1939
Col. Harry S. Gillespie	5 June 1922–ao September 1925	Lt. Col. Charles E.F. Clark	ao July 1939–ao February 1940
Lt. Col. Joel R. Moore	10 April 1925–15 January 1927	Unknown	ao February 1940–7 December 1941

**340th Infantry Regiment (85th Division)**

**Organized Reserve Michigan**

HQ—Flint, MI, 1921–25; Saginaw, MI, 1925–41



Arrived at the port of New York on 2 April 1919 on the U.S.S. *Leviathan* as the 340th Inf., an element of the 85th Div. Demobilized on 21 April 1919 at Camp Custer, MI. Reconstituted in the O.R. on 24 June 1921, assigned to the 85th Div., and allotted to the Sixth Corps Area. Initiated on 3 November 1921 with regimental HQ at Flint, MI. Subordinate battalion HQ organized as follows: 1st Bn. at Saginaw, MI; 2d Bn. at Flint, MI; and 3d Bn. at Port Huron, MI. Regimental HQ relocated on 2 June 1925 to Saginaw, MI. Entire regiment relocated on 28 July 1937 to Saginaw. Conducted summer training most years with the 2d Inf. at Camp Custer, MI. Conducted summer training at Camp Grayling, MI, with units of the 63d Inf. Brig. in 1929 and 1935. Also conducted infantry

CMTC training some years at Camp Custer, MI, or Fort Brady, MI, as an alternate form of summer training. Primary ROTC feeder schools were the University of Michigan and Michigan State College of Agriculture and Applied Science. Location 7 December 1941—Saginaw, MI.

**Status:** Reorganized on 1 June 1959 as the 340th Regt., an element of the 85th Div. (Training); reorganized on 17 October 1999 to consist of the 1st and 2d Bns., elements of the 85th Div. (Training Support).

### Commanders, 340th Infantry Regiment

Col. James S. Parker	22 August 1917–12 August 1918	Lt. Col. Augustus H. Gansser	ao June 1929–ao September 1930
Unknown	13 August 1918–21 August 1919	Unknown	ao September 1930–ao May 1932
<i>Demobilized/Inactive</i>	21 April 1919–3 November 1921	Col. George E. Haedicke	ao May 1932–ao June 1937
Lt. Col. Augustus H. Gansser	3 November 1921–4 May 1926	Unknown	ao June 1937–ao July 1939
Col. Carl F. Von dem Bussche	4 May 1926–ao September 1927	Lt. Col. Harold K. Van Allen	ao July 1939–ao September 1939
Unknown	ao September 1927–ao June 1929	Unknown	ao September 1939–7 December 1941

### 341st Infantry Regiment (86th Division)

### Organized Reserve Illinois

HQ—*Not initiated*, 1921–22; Chicago, IL, 1922–41



Arrived at the port of New York on 24 January 1919 on the U.S.S. *Wilhelmina* as the 341st Inf., an element of the 86th Div. Demobilized 17 February 1919 at Camp Grant, IL. Reconstituted in the O.R. on 24 June 1921, assigned to the 86th Div., and allotted to the Sixth Corps Area. Initiated on 21 March 1922 with the entire regiment, less 3d Bn., at Chicago, IL. The 3d Bn. organized at Elgin, IL. The 3d Bn. relocated by 1928 to Rockford, IL. Typically conducted Inactive Training Period meetings at the Army and Navy Club or the Naval Reserve armory in Chicago. Conducted summer training most years with the 2d Inf. at Camp Custer, MI, or Fort Sheridan, IL, and some years with the 6th Inf. at Jefferson Barracks, MO. Also conducted infantry CMTC training some years at Jefferson Barracks or Fort Sheridan as an alternate form of summer training. Primary ROTC feeder school was the University of Illinois. Location 7 December 1941—Chicago, IL.

**Status:** Inactive in the Army Reserve as the 341st Inf.

### Commanders, 341st Infantry Regiment

Lt. Col. C. DeGrasse Catlin	5 August 1917–September 1918	<i>Demobilized/Inactive</i>	17 February 1919–21 March 1922
Col. Guy Palmer	September 1918–June 1918	Maj. William R. Peck	21 March 1922–4 May 1922
Lt. Col. Willis P. Coleman	June 1918–17 February 1919	Col. Philip Fox	4 May 1922–March 1941
	Lt. Col. William A. Carroll	March 1941–ao April 1941	

### 342d Infantry Regiment (86th Division)

### Organized Reserve Illinois

HQ—*Not initiated*, 1921–22; Chicago, IL, 1922–41



Arrived at the port of New York on 24 January 1919 on the U.S.S. *Wilhelmina* as the 342d Inf., an element of the 86th Div. Demobilized on 17 February 1919 at Camp Grant, IL. Reconstituted in the O.R. on 24 June 1921, assigned to the 86th Div., and allotted to the Sixth Corps Area. Initiated on 4 February 1922 with the entire regiment, less 3d Bn., at Chicago, IL. The 3d Bn. was organized at Kankakee, IL. The 3d Bn. was relocated by 1928 to Joliet, IL. Band organized about August 1924 at Chicago. Typically conducted Inactive Training Period meetings at the Army and Navy Club in Chicago. Conducted summer training most years with the 2d Inf. at Camp Custer, MI, or Fort Sheridan, IL, and some years with the 6th Inf. at Jefferson Barracks, MO. Conducted summer training at Camp Grant, IL, with the 33d Div. in 1930. Also conducted infantry CMTC training some years

at Jefferson Barracks or Fort Sheridan as an alternate form of summer training. Primary ROTC feeder school was the University of Illinois. Location 7 December 1941—Chicago, IL.

**Status:** Inactive in the Army Reserve as the 342d Inf.

### Commanders, 342d Infantry Regiment

Col. Charles E. Stodter	22 August 1917–28 September 1918	Maj. John E. Morrison	4 February 1922–April 1922
Maj. A. A. Sprague, II	29 September 1918–17 February 1919	Col. John H. Doré	April 1922–ao July 1941
<i>Demobilized/Inactive</i>	17 February 1919–4 February 1922	Unknown	ao July 1941–7 December 1941

**343d Infantry Regiment (86th Division)****Organized Reserve Illinois**

**HQ**—*Not initiated*, 1921–22; Champaign, IL, 1922–25; Peoria, IL, 1925–41

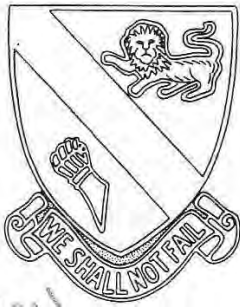

Arrived at the port of New York on 24 January 1919 on the U.S.S. *Wilhelmina* as the 343d Inf., an element of the 86th Div. Demobilized on 17 February 1919 at Camp Grant, IL. Reconstituted in the O.R. on 24 June 1921, assigned to the 86th Div., and allotted to the Sixth Corps Area. Initiated on 3 January 1922 with regimental HQ at Champaign, IL. Subordinate battalion HQ organized as follows: 1st Bn. at Champaign, IL; 2d and 3d Bns. at Minier, IL. The 3d Bn. was relocated by May 1923 to Peoria. Regiment relocated 28 July 1925 as follows: regimental HQ at Peoria, IL; 1st Bn. at Urbana, IL; 2d Bn. at Springfield, IL; and 3d Bn. at Galesburg, IL. The 1st Bn. relocated by 1934 back to Champaign. Entire regiment relocated on 28 July 1937 to Peoria, IL. Typically conducted Inactive Training Period meetings at the Post Office Building in Champaign, the Illinois N.G. Armory in Peoria, the American Legion Hall in Urbana, or Lincoln Hotel in Indianapolis. Conducted summer training most years with the 2d Inf. at Camp Custer, MI, or Fort Sheridan, IL, and some years with the 6th Inf. at Jefferson Barracks, MO. Conducted summer training in July 1926 and July 1930 at the Peoria Tank Training Center in Peoria. Also conducted infantry CMTTC training some years at Jefferson Barracks or Fort Sheridan as an alternate form of summer training. Primary ROTC feeder school was the University of Illinois. Location 7 December 1941—Peoria, IL.

**Status:** Inactive in the Army Reserve as the 343d Inf.

**Commanders, 343d Infantry Regiment**

Col. Charles R. Howland	22 August 1917–12 November 1918	Col. Grant M. Miles	July 1924–ao August 1935
Col. Henry A. Hanigan	13 November 1918–17 February 1919	Unknown	ao August 1935–ao May 1936
<i>Demobilized/Inactive</i>	17 February 1919–3 January 1922	Col. Alfred O. Brown	ao May 1936–ao January 1940
Lt. Col. William E. Culbertson	3 January 1922–July 1924	Unknown	ao January 1940–7 December 1941

**344th Infantry Regiment (86th Division)****Organized Reserve Illinois**

**HQ**—Alton, IL, 1921–25; Centralia, IL, 1925–37; Marion, IL, 1937–41



Arrived at the port of New York on 24 January 1919 on the U.S.S. *Wilhelmina* as the 344th Inf., an element of the 86th Div. Demobilized on 17 February 1919 at Camp Grant, IL. Reconstituted in the O.R. on 24 June 1921, assigned to the 86th Div., and allotted to the Sixth Corps Area. Initiated 20 December 1921 with regimental HQ at Alton, IL. Subordinate battalion HQ organized as follows: 1st Bn. at Collinsville, IL; 2d Bn. at Olney, IL; and 3d Bn. at Carbondale, IL. The 1st Bn. was relocated by May 1923 to Alton. Regiment relocated on 28 July 1925 as follows: regimental HQ to Centralia, IL; 1st Bn. remained at Alton, IL; 2d Bn. to Fairfield, IL; and 3d Bn. remained at Carbondale. Entire regiment relocated on 28 July 1937 to Marion, IL. The regiment's home area in southern Illinois was locally known as "Little Egypt." The officers of the regiment, therefore, adopted the nickname of the "Egyptian Fusiliers" in the 1920s. Conducted summer training most years with the 6th Inf. at Jefferson Barracks, MO. Conducted summer training in July 1930 at the Peoria Tank Training Center in Peoria, IL. Also conducted infantry CMTTC training some years at Jefferson Barracks or Camp Custer, MI, as an alternate form of summer training. Primary ROTC feeder school was the University of Illinois. Location 7 December 1941—Marion, IL.

**Status:** Disbanded 4 August 1952.

**Commanders, 344th Infantry Regiment**

Col. Benjamin T. Simmons	23 August 1917–14 June 1918	<i>Demobilized/Inactive</i>	17 February 1919–20 December 1921
Col. Henry A. Hanigan	15 June 1918–4 October 1918	Col. Lyman D. Turner	20 December 1921–17 October 1923
Lt. Col. Augustus B. Van Wormer	5 October 1918–25 October 1918	Col. Thomas B. F. Smith	17 October 1923–August 1927
Col. Henry A. Hanigan	25 October 1918–24 December 1918	Col. Robert L. Floyd	August 1927–27 February 1936
Lt. Col. Augustus B. Van Wormer	24 December 1918–17 February 1919	Lt. Col. Oldham Paisley	27 February 1936–ao July 1941

**345th Infantry Regiment (87th Division)****Organized Reserve Alabama**

HQ—Birmingham, AL, 1921–41

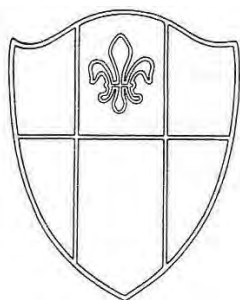

Arrived at the port of New York on 5 January 1919 on the U.S.S. *Agamemnon* as the 345th Inf., an element of the 87th Div. Demobilized on 10 March 1919 at Camp Upton, NY. Reconstituted in the O.R. on 24 June 1921, assigned to the 87th Div., and allotted to the Fourth Corps Area. Initiated on 12 December 1921 with regimental HQ at Birmingham, AL. Subordinate battalion HQ concurrently organized as follows: 1st Bn. at Jasper, AL; 2d Bn. at Albany, AL; and the 3d Bn. at Gadsden, AL. Entire regiment relocated on 1 July 1929 to Birmingham. Conducted summer training most years with the 22d Inf. at Fort McPherson, GA, and some years at Camp McClellan, AL. Also conducted infantry CMTC training some years at Camp McClellan or Camp Beauregard, LA, as an alternate form of summer training. Primary ROTC feeder school was the University of Alabama. Location 7 December 1941—Birmingham, AL.

**Status:** Withdrawn from the CARS on 1 October 1993 and redesignated as the 345th Regt. to consist of the 1st, 2d, and 3d Bns. Assigned to the 87th Div. (Training Support).

**Commanders, 345th Infantry Regiment**

Col. John O'Shea	September 1917–10 March 1919	Col. William G. Obear	12 December 1921–5 December 1928
<i>Demobilized/Inactive</i>	10 March 1919–12 December 1921	Col. John D. Hill	5 December 1928–ao May 1940
	Unknown	ao May 1940–7 December 1941	

**346th Infantry Regiment (87th Division)****Organized Reserve Alabama**

HQ—Selma, AL, 1921–29; Mobile, AL, 1929–41



Arrived at the port of Newport News on 30 March 1919 on the U.S.S. *Alaskan* as the 346th Inf., an element of the 87th Div. Demobilized 6–8 April 1919 at Camp Dix, NJ; Camp Upton, NY; and Camp Devens, MA. Reconstituted in the O.R. on 24 June 1921, assigned to the 87th Div., and allotted to the Fourth Corps Area. Initiated on 19 December 1921 with regimental HQ at Selma, AL. Subordinate battalion HQ concurrently organized as follows: 1st Bn. at Tuscaloosa, AL; 2d Bn. at Opelika, AL; and 3d Bn. at Mobile, AL. Band organized in April 1923. Entire regiment relocated on 22 October 1929 to Mobile. Conducted summer training most years with the 22d Inf. at Fort McPherson, GA, and some years at Camp McClellan, AL. Also conducted infantry CMTC training some years at Camp McClellan or Camp Beauregard, LA, as an alternate form of summer training.

Provided a number of officers to the 167th Inf. for the 1938 and 1940 Third Army Maneuvers. Primary ROTC feeder school was the University of Alabama. Location 7 December 1941—Mobile, AL.

**Status:** Redesignated on 1 October 1993 as the 346th Regt. to consist of the 1st, 2d, and 3d Bns., elements of the 87th Div. (Exercise); reorganized 17 October 1999 to consist of the 1st, 2d, and 3d Bns., elements of the 87th Div. (Training Support); 1st Bn. concurrently allotted to the R.A.

**Commanders, 346th Infantry Regiment**

Col. William E. Welsh	18 August 1917–1 October 1918	Unknown	ao May 1924–ao July 1930
Maj. George R. Bird	1 October 1918–ao October 1918	Col. Edwin McGowen	ao July 1930–ao September 1930
Maj. George H. Barngrover	ao November 1918–ao December 1919	Unknown	ao September 1930–ao July 1935
Maj. Ralph E. Butterfield	ao March 1919–8 April 1919	Col. Henry N. Coleman	ao July 1935–July 1939
<i>Demobilized/Inactive</i>	8 April 1919–19 December 1921	Lt. Col. T. L. Weaver	ao July 1939–ao May 1940
Col. Allen Crenshaw	19 December 1921–ao May 1924	Unknown	ao May 1940–7 December 1941

**347th Infantry Regiment (87th Division)****Organized Reserve Louisiana**

HQ—Alexandria, LA, 1921–29; Baton Rouge, LA, 1929–41

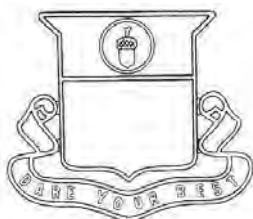

Arrived at the port of New York on 31 December 1918 on the S.S. *Mauretania* as the 347th Inf., an element of the 87th Div. Demobilized 22 January–4 February 1919 at Camp Dix, NJ. Reconstituted in the O.R. on 24 June 1921, assigned to the 87th Div., and allotted to the Fourth Corps Area. Initiated on 18 November 1921 with regimental HQ at Alexandria, LA. Subordinate battalion HQ concurrently organized as follows: 1st Bn. at New Orleans, LA; 2d Bn. at Baton Rouge, LA; and the 3d Bn. at Shreveport, LA. Entire regiment relocated 22 October 1929 to Baton Rouge. Conducted summer training most years with the 22d Inf. at Fort McPherson, GA, or Camp McClellan, AL, and some years with the 8th Inf. at Fort Screven, GA. Also conducted infantry CMTC training some years at Camp Beauregard, LA, as an alternate form of summer training. Primary ROTC feeder school was Louisiana State University and Agricultural and Mechanical College. Location 7 December 1941—Baton Rouge, LA.

**Status:** Redesignated 1 October 1993 as the 347th Regiment to consist of the 1st, 2d, and 3d Bns., elements of the 87th Div. (Exercise); reorganized 17 October 1999 to consist of the 1st, 2d, and 3d Bns., elements of the 87th Div. (Training Support).

**Commanders, 347th Infantry Regiment**

Col. S.J. Bayard Schindel	4 September 1917–11 June 1918	Unknown	ao December 1927–ao July 1929
Col. Pearl M. Shaffer	June 1918–4 February 1919	Col. Brett W. Eddy	ao July 1929–22 July 1930
<i>Demobilized/Inactive</i>	4 February 1919–18 November 1921	Col. Arie J. Sichtermann	22 July 1930–September 1937
Lt. Col. Oswald W. McNeese	23 November 1921–2 December 1921	Lt. Col. Otha E. Roddey	September 1937–1 January 1938
Lt. Col. Richard A. Young	2 December 1921–ao September 1925	Col. L. Kemper Williams	1 January 1938–ao November 1940
Col. William A. Kent	ao July 1927–ao December 1927	Unknown	ao November 1940–7 December 1941

**348th Infantry Regiment (87th Division)****Organized Reserve Mississippi**

HQ—Columbus, MS, 1921–29; Jackson, MS, 1929–41

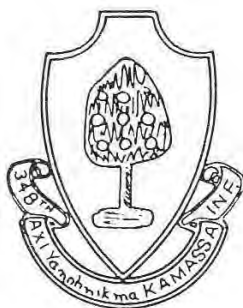

Arrived at the port of New York on 9 March 1919 on the S.S. *Chicago* as the 348th Inf., an element of the 87th Div. Demobilized in March 1919 at Camp Dix, NJ. Reconstituted in the O.R. on 24 June 1921, assigned to the 87th Div., and allotted to the Fourth Corps Area. Initiated 18 November 1921 with regimental HQ at Columbus, MS. Subordinate battalion HQ concurrently organized as follows: 1st Bn. at Moorhead, MS; 2d Bn. at Meridian, MS; and the 3d Bn. at Hattiesburg, MS. Entire regiment relocated on 22 October 1929 to Jackson, MS. Conducted summer training most years with the 22d Inf. at Camp McClellan, AL, and Fort McPherson, GA, and some years with the 8th Inf. at Fort Moultrie, SC, or Fort Screven, GA. Also conducted infantry CMTC training some years at Camp McClellan or Camp Beauregard, LA, as an alternate form of summer training. Primary ROTC feeder schools were the University of Mississippi and Mississippi State College. Location 7 December 1941—Jackson, MS.

**Status:** Disbanded on 11 November 1944; reconstituted on 1 October 1993 in the Army Reserve as the 348th Regt.; concurrently reorganized to consist of the 1st, 2d, and 3d Bns., elements of the 87th Div. (Exercise); reorganized on 17 October 1999 to consist of the 2d and 3d Bns, elements of the 87th Div. (Training Support).

**Commanders, 348th Infantry Regiment**

Col. Dwight W. Ryther	September 1917–13 November 1918	Maj. John E. Curtis	25 April 1923–ao September 1925
Col. Oscar J. Charles	14 November 1918–March 1919	Unknown	ao September 1925–20 April 1931
<i>Demobilized/Inactive</i>	March 1919–18 November 1921	Col. L. Kemper Williams	20 April 1931–1 January 1938
Maj. Henry M. Dent	23 November 1921–November 1921	Col. Paul B. Parker	1 January 1938–August 1938
Col. George E. Hogaboom	November 1921–25 April 1923	Col. J.W. Kennedy	August 1938–ao July 1940
	Unknown		ao July 1940–7 December 1941

**349th Infantry Regiment (88th Division)****Organized Reserve Iowa****HQ**—Iowa City, IA, 1921–26; Davenport, IA, 1926–28; Cedar Rapids, IA, 1928–41

Arrived at the port of New York on 30 May 1919 on the S.S. *Ryndam* as the 349th Inf., an element of the 88th Div. Demobilized on 12 June 1919 at Camp Dodge, IA. Reconstituted in the O.R. on 24 June 1921, assigned to the 88th Div., and allotted to the Seventh Corps Area. Initiated on 12 October 1921 with regimental HQ at Iowa City, IA. Subordinate battalion HQ concurrently organized as follows: 1st Bn. at Waterloo, IA; 2d Bn. at Cedar Rapids, IA; and the 3d Bn. at Ottumwa, IA. Regimental HQ relocated on 26 May 1926 to Davenport, IA, and again in 1928 to Cedar Rapids, IA. Typically conducted Inactive Training Period meetings at State University of Iowa ROTC Armory in Iowa City, the Russell–Lamson Hotel in Waterloo, the Federal Building in Cedar Rapids, and the Ballinghall Hotel in Ottumwa. Conducted summer training some years with the 3d Inf.

at Fort Snelling, MN. Also conducted infantry CMTC training many years at Fort Des Moines, IA, or Fort Snelling as an alternate form of summer training. With the 350th Inf., conducted the first CMTC training camp run solely by a Reserve unit in July 1927 at Fort Des Moines. Provided a number of officers to the 133d Inf. at Camp Ripley, MN, for the 1937 Fourth Army Maneuver. Primary ROTC feeder schools were Coe College and the State University of Iowa. Location 7 December 1941—Cedar Rapids, IA (Inactivated 22 January 1942).

**Status:** Redesignated on 17 October 1999 as the 349th Regt. and reorganized to consist of the 1st, 2d, and 3d Bns., elements of the 87th Div. (Training Support).

**Commanders, 349th Infantry Regiment**

Col. George E. Houle	28 August 1917–24 December 1917	Lt. Col. Hanford MacNider	24 December 1921–17 March 1922
Col. Girard Sturtevant	24 December 1917–23 February 1919	Col. Robert B. H. MacCrorie	17 March 1922–April 1927
Unknown	23 February 1919–12 June 1919	Col. Charles B. Robbins	April 1927–ao October 1927
<i>Demobilized/Inactive</i>	12 June 1919–12 October 1921	Lt. Col. Alfred T. Falk	ao August 1928–June 1929
Col. George W. Ball	12 October 1921–23 December 1921	Col. Charles B. Robbins	June 1929–August 1941
	Lt. Col. Thomas H. Tracy	August 1941–April 1942	

**350th Infantry Regiment (88th Division)****Organized Reserve Iowa****HQ**—Corning, IA, 1921–31; Des Moines, IA, 1931–41

Arrived at the port of New York on 27 May 1919 on the S.S. *Rotterdam* as the 350th Inf., an element of the 88th Div. Demobilized 5–8 June 1919 at Camp Dodge, IA. Reconstituted in the O.R. on 24 June 1921, assigned to the 88th Div., and allotted to the Seventh Corps Area. Initiated on 12 October 1921 with regimental HQ at Corning, IA. Subordinate battalion HQ concurrently organized as follows: 1st Bn. at Sioux City, IA; 2d Bn. at Council Bluffs, IA; and 3d Bn. at Des Moines, IA. Band organized in October 1923 at Des Moines. Regimental HQ relocated on 3 April 1928 to Des Moines. Entire regiment relocated on 12 October 1931 to Des Moines. Typically conducted Inactive Training Period meetings at the Federal Building or the New Armory in Des Moines, at the Chamber of Commerce building in Sioux City, and the Dodge Light Guard Armory

in Council Bluffs. Conducted summer training some years with the 3d Inf. at Fort Snelling, MN. Also conducted infantry CMTC training many years at Fort Des Moines, IA, or Fort Snelling as an alternate form of summer training. With the 349th Inf., conducted the first CMTC training camp run solely by a Reserve unit in July 1927 at Fort Des Moines. Primary ROTC feeder school was the State University of Iowa. Location 7 December 1941—Des Moines, IA (inactivated 22 January 1942).

**Status:** Redesignated on 17 October 1999 as the 350th Regt. and reorganized to consist of the 1st and 2d Bns., elements of the 87th Div. (Training Support).

### Commanders, 350th Infantry Regiment

Col. Charles W. Castle	1 September 1917–17 October 1917	Col. James A. Lynch	1 March 1919–5 June 1919
Col. Harrison J. Price	17 October 1917–18 October 1918	<i>Demobilized/Inactive</i>	8 June 1919–12 October 1921
Col. Charles B. Stone	18 October 1918–20 December 1918	Col. John E. Bartley	12 October 1921–June 1922
Lt. Col. Fred B. Ray	20 December 1918–1 March 1919	Col. Claude M. Stanley	July 1922–28 April 1936
	Col. Charles W. Dickson	29 April 1936–April 1942	

### 351st Infantry Regiment (88th Division)

### Organized Reserve Minnesota

HQ—St. Paul, MN, 1921–41



Arrived at the port of Newport News on 31 May 1919 on the U.S.S. *Mercury* as the 351st Inf., an element of the 88th Div. Demobilized on 7 June 1919 at Camp Dodge, IA. Reconstituted in the O.R. on 24 June 1921, assigned to the 88th Div., and allotted to the Seventh Corps Area. Initiated on 12 October 1921 with regimental HQ at St. Paul, MN. Subordinate battalion HQ concurrently organized as follows: 1st Bn. at St. Paul; 2d Bn. at Austin, MN; and the 3d Bn. at Willmar, MN. Typically conducted Inactive Training Period meetings at the N.G. Armory in St. Paul and at the American Legion Club in Austin. Conducted summer training most years with the 3d Inf. at Fort Snelling, MN. Also conducted infantry CMTC training some years at Fort Snelling as an alternate form of summer training. Primary ROTC feeder school was the University of Minnesota. Location 7 December 1941—St. Paul, MN (inactivated 22 January 1942).

**Status:** Activated on 18 May 1959 as the 351st Regt., an element of the 84th Div. (Training); reorganized on 17 October 1999 to consist of the 1st, 2d, and 3d Bns., elements of the 87th Div. (Training Support); concurrently 1st, 2d, and 3d Bns. allotted to the R.A.

### Commanders, 351st Infantry Regiment

Col. Herbert B. Crosby	30 August 1917–7 June 1919	Lt. Col. William S. McWade	11 April 1924–14 January 1926
<i>Demobilized/Inactive</i>	7 June 1919–12 October 1921	Col. Henry I. Church	14 January 1926–27 November 1939
Lt. Col. Clifton T. Smith	12 October 1921–11 April 1924	Col. William E. Per Lee	28 November 1939–May 1940
	Col. Lawrence L. Conrad	May 1940–April 1942	

### 352d Infantry Regiment (88th Division)

### Organized Reserve Minnesota and North Dakota

HQ—Minneapolis, MN, 1921–26; Bismarck, ND, 1926–31; Fargo, ND, 1931–41

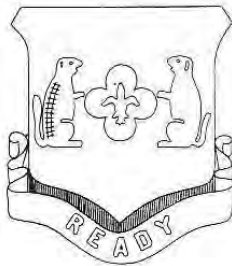

Arrived at the port of Newport News on 1 June 1919 on the U.S.S. *Pocahontas* as the 352d Inf., an element of the 88th Div. Demobilized on 15 June 1919 at Camp Dodge, IA. Reconstituted in the O.R. on 24 June 1921, assigned to the 88th Div., and allotted to the Seventh Corps Area. Initiated on 12 October 1921 with regimental HQ at Minneapolis, MN. Subordinate battalion HQ concurrently organized as follows: 1st Bn. at Minneapolis and 2d Bn. at Duluth, MN. The 3d Bn. was organized on 8 December 1921 at Bismarck, ND. Regiment relocated on 26 May 1926 as follows: regimental HQ to Bismarck; 1st Bn. to Devil's Lake, ND; 2d Bn. to Minot, ND; and 3d Bn. to Dickinson, ND. Regiment relocated on 12 October 1931 as follows: regimental HQ to Fargo, ND; 1st Bn. to Wahpeton, ND; 2d Bn. to Jamestown, ND; and 3d Bn. to Mandan, ND. Typically conducted Inactive Training Period meetings at Fort Abraham Lincoln or the Memorial Building in Bismarck and at the National Bank building in Minot. Conducted summer training most years with the 3d Inf. at Fort Snelling, MN. Provided a number of officers to the 164th Inf. at Camp Ripley, MN, for the 1937 Fourth Army Maneuver. Also conducted infantry CMTC training some years at Fort Snelling or Fort Lincoln, ND, as an alternate form of summer training. Primary ROTC feeder schools were the University of Minnesota, the University of North Dakota, and North Dakota State College. Location 7 December 1941—Fargo, ND (inactivated 22 January 1942).

Arrived at the port of Newport News on 1 June 1919 on the U.S.S. *Pocahontas* as the 352d Inf., an element of the 88th Div. Demobilized on 15 June 1919 at Camp Dodge, IA. Reconstituted in the O.R. on 24 June 1921, assigned to the 88th Div., and allotted to the Seventh Corps Area. Initiated on 12 October 1921 with regimental HQ at Minneapolis, MN. Subordinate battalion HQ concurrently organized as follows: 1st Bn. at Minneapolis and 2d Bn. at Duluth, MN. The 3d Bn. was organized on 8 December 1921 at Bismarck, ND. Regiment relocated on 26 May 1926 as follows: regimental HQ to Bismarck; 1st Bn. to Devil's Lake, ND; 2d Bn. to Minot, ND; and 3d Bn. to Dickinson, ND. Regiment relocated on 12 October 1931 as follows: regimental HQ to Fargo, ND; 1st Bn. to Wahpeton, ND; 2d Bn. to Jamestown, ND; and 3d Bn. to Mandan, ND. Typically conducted Inactive Training Period meetings at Fort Abraham Lincoln or the Memorial Building in Bismarck and at the National Bank building in Minot. Conducted summer training most years with the 3d Inf. at Fort Snelling, MN. Provided a number of officers to the 164th Inf. at Camp Ripley, MN, for the 1937 Fourth Army Maneuver. Also conducted infantry CMTC training some years at Fort Snelling or Fort Lincoln, ND, as an alternate form of summer training. Primary ROTC feeder schools were the University of Minnesota, the University of North Dakota, and North Dakota State College. Location 7 December 1941—Fargo, ND (inactivated 22 January 1942).



**Status:** Disbanded 11 November 1944.

**Commanders, 352d Infantry Regiment**

Col. Clyde E. Hawkins	25 August 1917–5 May 1919	Col. Ernest E. Watson	12 October 1921–August 1928
Lt. Col. Napoleon W. Riley	8 May 1919–15 June 1919	Col. George H. Russ Jr.	August 1928–14 May 1930
<i>Demobilized/Inactive</i>	15 June 1919–12 October 1921	Lt. Col. Horace E. Peterson	15 May 1930–15 November 1930
	Col. George H. Russ Jr.		16 November 1930–April 1942

**353d Infantry Regiment (89th Division)**

**Organized Reserve Kansas**

HQ—Winfield, KS, 1921–24; Wichita, KS, 1924–41



Arrived at the port of New York in May 1919 on the U.S.S. *Leviathan* as the 353d Inf., an element of the 89th Div. Demobilized on 2 June 1919 at Camp Funston, KS. Reconstituted in the O.R. on 24 June 1921, assigned to the 89th Div., and allotted to the Seventh Corps Area. Initiated on 17 November 1921 with regimental HQ at Winfield, KS. Subordinate battalion HQ concurrently organized as follows: 1st Bn. at Pittsburg, KS; 2d Bn. at Wichita, KS; and 3d Bn. at Fort Dodge, KS. Regimental HQ relocated on 10 January 1924 to Wichita. Entire regiment relocated on 12 October 1931 to Wichita. Conducted summer training with the 17th Inf. Regt. at Fort Leavenworth, KS, and some years at Fort Crook, NE; Fort Des Moines, IA; or Fort Riley, KS. Provided a number of officers to the 137th Inf. at Fort Riley, KS, for the 1937 Fourth Army Maneuver. Also conducted infantry CMTC training at Fort Leavenworth or Fort Riley as an alternate form of summer training.

Primary ROTC feeder schools were the Municipal University of Wichita and Kansas State College of Agriculture and Applied Science. Location 7 December 1941—Wichita, KS.

**Status:** Inactive in the Army Reserve as the 353d Regt.

**Commanders, 353d Infantry Regiment**

Col. James H. Reeves	27 August 1917–2 June 1919	Col. John H. O'Connor	17 November 1921–15 December 1930
<i>Demobilized/Inactive</i>	2 June 1919–17 November 1921	Col. William E. Pinkston	15 December 1930–ao January 1940
	Unknown		ao January 1940–7 December 1941

**354th Infantry Regiment (89th Division)**

**Organized Reserve Kansas**

HQ—Manhattan, KS, 1921–26; Kansas City, KS, 1926–41

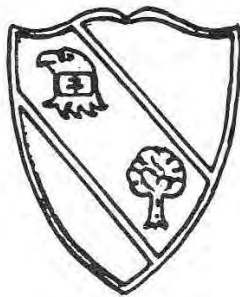

Arrived at the port of New York in May 1919 on the U.S.S. *Imperator* as the 354th Inf., an element of the 89th Div. Demobilized 2–3 June 1919 at Camp Funston, KS. Reconstituted in the O.R. on 24 June 1921, assigned to the 89th Div., and allotted to the Seventh Corps Area. Initiated on 17 November 1921 with regimental HQ at Manhattan, KS. Subordinate battalion HQ concurrently organized as follows: 1st Bn. at Olathe, KS; 2d Bn. at Leavenworth, KS; and 3d Bn. at Salina, KS. Conducted mobilization and training for over 300 Washburn College and local high school students 3–17 May 1925 at Gage Park, Topeka, KS, as part of a regimental LUTC held there. Regimental HQ relocated on 26 May 1926 to Kansas City, KS. Entire regiment relocated on 12 October 1931 to Kansas City. Conducted summer training with the 17th Inf. Regt. at Fort Leavenworth, KS; Fort Des Moines, IA; or Fort Crook, NE. Conducted infantry CMTC training at Fort Leavenworth

or Fort Crook as an alternate form of summer training. Primary ROTC feeder schools were the University of Kansas and Kansas State College of Agriculture and Applied Science. Location 7 December 1941—Kansas City, KS.

**Status:** Reorganized on 1 October 1959 as the 354th Regt., an element of the 89th Div. (Training); reorganized on 17 October 1996 to consist of the 1st and 2d Bns., elements of the 95th Div. (Institutional Training).

### Commanders, 354th Infantry Regiment

Col. Americus Mitchell	22 August 1917–20 July 1918	<i>Demobilized/Inactive</i>	3 June 1919–17 November 1921
Lt. Col. Warren W. Whitside	20 July 1918–3 August 1918	Lt. Col. G. J. Frank	17 November 1921–ao January 1922
Col. Americus Mitchell	3 August 1918–7 September 1918	Col. Clifton W. Sparks	ao February 1925–ao May 1925
Col. Conrad S. Babcock	7 September 1918–20 November 1918	Unknown	ao May 1925–ao August 1931
Lt. Col. Joseph H. Barnard	20 November 1918–10 December 1918	Lt. Col. Melvin Croan	ao August 1931–ao September 1931
Col. Conrad S. Babcock	10 December 1918–15 February 1919	Col. Fred H. Vaughn	ao May 1932–ao August 1938
Lt. Col. Thomas L. Crystal	15 February 1919–22 May 1919	Unknown	ao August 1938–7 December 1941

### 355th Infantry Regiment (89th Division)

### Organized Reserve Nebraska

HQ—Omaha, NE, 1921–41



Arrived at the port of New York in May 1919 on the U.S.S. *Leviathan* as the 355th Inf., an element of the 89th Div. Demobilized 1–3 June 1919 at Camp Funston, KS. Reconstituted in the O.R. on 24 June 1921, assigned to the 89th Div., and allotted to the Seventh Corps Area. Initiated on 4 October 1921 with regimental HQ at Omaha, NE. Subordinate battalion HQ concurrently organized as follows: 1st Bn. at Omaha; 2d Bn. at Lincoln, NE; and 3d Bn. at Hastings, NE. Entire regiment relocated on 12 October 1931 to Omaha. Conducted summer training most years with the 17th Inf. at Fort Crook, NE, and some years at Fort Des Moines, IA. Conducted summer training with the 134th Inf. at Camp Ashland, NE, in 1934 and 1936. Provided a number of officers to the 134th Inf. at Fort Riley, KS, for the 1937 Fourth Army Maneuver. Also conducted infantry CMTC many years at Fort Crook as an alternate form of summer training. Primary ROTC feeder schools were Creighton University and the University of Nebraska. Location 7 December 1941—Omaha, NE.

**Status:** Reorganized on 1 October 1959 as the 355th Regt., an element of the 89th Div. (Training); reorganized on 17 October 1996 to consist of the 1st, 2d, and 3d Bns., elements of the 95th Div. (Institutional Training).

### Commanders, 355th Infantry Regiment

Col. William C. Sills	27 August 1917–9 July 1918	Col. William A. Cavanaugh	16 November 1918–20 March 1919
Col. George H. McMaster	10 July 1918–16 August 1918	Lt. Col. Levi T. Brown	20 March 1919–3 June 1919
Col. James D. Taylor	16 August 1918–20 October 1918	<i>Demobilized/Inactive</i>	3 June 1919– 5 October 1921
Lt. Col. Thomas P. Bernard	20 October 1918–16 November 1918	Col. Philip L. Hall Jr.	4 October 1921–2 November 1939
	Lt. Col. Donald L. Wood		2 November 1939–1 February 1941

### 356th Infantry Regiment (89th Division)

### Organized Reserve South Dakota

HQ—Watertown, SD, 1921–22; Sioux Falls, SD, 1922–41

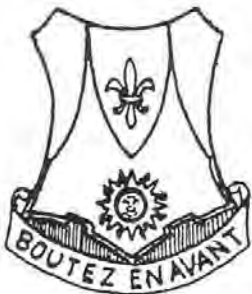

Arrived at the port of New York on 24 May 1919 on the U.S.S. *Agamemnon* as the 356th Inf., an element of the 89th Div. Demobilized on 11 June 1919 at Camp Funston, KS. Reconstituted in the O.R. on 24 June 1921, assigned to the 89th Div., and allotted to the Seventh Corps Area. Initiated in November 1921 with regimental HQ at Watertown, SD. Subordinate battalion HQ concurrently organized as follows: 1st Bn. at Webster, SD; 2d Bn. at Sioux Falls, SD; and 3d Bn. at Rapid City, SD. Regimental HQ relocated on 15 May 1922 to Sioux Falls. Entire regiment relocated on 12 October 1931 to Sioux Falls. Conducted summer training most years with the 17th Inf. at Fort Crook, NE, and some years at Fort Des Moines, IA, or Fort Lincoln, ND. Also conducted infantry CMTC many years at Fort Lincoln as an alternate form of summer training. Primary ROTC feeder school was the University of South Dakota and South Dakota State College of Agriculture and Mechanic Arts. Location 7 December 1941—Omaha, NE.

**Status:** Activated on 1 October 1959 as the 356th Regt., an element of the 89th Div. (Training); reorganized on 17 October 1999 to consist of the 1st, 2d, and 3d Bns., elements of the 91st Div. (Training Support).

### Commanders, 356th Infantry Regiment

Col. Louis M. Nuttman	5 September 1917–20 September 1918	<i>Demobilized/Inactive</i>	11 June 1919–4 October 1921
Lt. Col. Edward A. Keyes	20 September 1918–8 October 1918	Col. Charles H. Englesby	4 October 1921–ao March 1928
Col. Alonzo Gray	8 October 1918–20 October 1918	Unknown	ao March 1928–26 October 1930
Col. Robert H. Allen	20 October 1918–11 June 1919	Col. Clarence J. Frankforter	26 October 1930–ao November 1940
	Unknown	ao November 1940–7 December 1941	

### 357th Infantry Regiment (90th Division)

### Organized Reserve Texas

HQ—San Antonio, TX, 1921–41



Arrived at the port of Newport News on 7 June 1919 on the U.S.S. *Huron* as the 357th Inf., an element of the 90th Div. Demobilized 18–21 June 1919 at Camp Pike, AR. Reconstituted in the O.R. on 24 June 1921, assigned to the 90th Div., and allotted to the Eighth Corps Area. Initiated on 19 November 1921 with regimental HQ at San Antonio, TX. Subordinate battalion HQ concurrently organized as follows: 1st Bn. at San Antonio; 2d Bn. at Austin, TX; and 3d Bn. at Brownsville, TX. Typically conducted Inactive Training Period meetings at the Bexar County Courthouse, the Gunter Hotel, and later at the Smith-Young Tower in San Antonio. Conducted summer training with the 9th and 23d Inf. Regts. at Fort Sam Houston, TX, or Camp Bullis, TX. Conducted infantry CMTC training at Fort Sam Houston or Camp Bullis as an alternate form of summer training.

Conducted annual contact camps at Camp Bullis during the fall or winter months. Primary ROTC feeder school was the A&M College of Texas. Designated mobilization training station was Fort Sam Houston, 1922–40. Location 7 December 1941—San Antonio, TX.

**Status:** Withdrawn from the CARS on 17 October 1999 and redesignated as the 357th Regt. to consist of the 1st, 2d, and 3d Bns., elements of the 91st Div. (Training Support); concurrently, the 1st, 2d, and 3d Bns. allotted to the R.A.

### Commanders, 357th Infantry Regiment

Col. Edward T. Hartman	23 August 1917–21 June 1919	Col. Samuel F. Crecelius	ao December 1923–ao August 1932
<i>Demobilized/Inactive</i>	21 June 1919–18 October 1921	Col. Charles R. Tips	ao December 1932–ao August 1938
Maj. Arthur C. Kennedy	19 October 1921–July 1922	Unknown	ao August 1938–ao December 1939
Lt. Col. Uel Stephens	July 1922–ao August 1922	Col. Sylvan Lang	ao December 1939–21 December 1941

### 358th Infantry Regiment (90th Division)

### Organized Reserve Texas

HQ—Fort Worth, TX, 1921–41

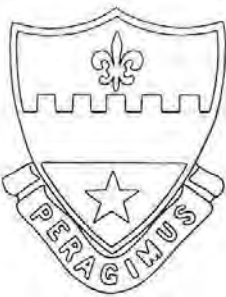

Arrived at the port of Boston on 7 June 1919 on the S.S. *Mongolia* as the 358th Inf., an element of the 90th Div. Demobilized on 22 June 1919 at Camp Pike, AR. Reconstituted in the O.R. on 24 June 1921, assigned to the 90th Div., and allotted to the Eighth Corps Area. Initiated in November 1921 with regimental HQ at Fort Worth, TX. Subordinate battalion HQ concurrently organized as follows: 1st Bn. at Fort Worth; 2d Bn. at Waco, TX; and 3d Bn. at Amarillo, TX. Regiment relocated on 15 April 1925 as follows: 1st Bn. at Weatherford, TX; 2d Bn. at Decatur, TX; and 3d Bn. at Cleburne, TX. Typically conducted Inactive Training Period meetings at the Texas Hotel in Fort Worth. Conducted summer training with the 9th and 23d Inf. Regts. at Fort Sam Houston or Camp Bullis, TX. Conducted infantry CMTC training at Fort Sam Houston or Camp Bullis as an alternate form of summer training.

Conducted contact camps at John Tarleton Agricultural College in Stephenville, TX, during the fall or winter months. Primary ROTC feeder schools were North Texas Agricultural College and John Tarleton Agricultural College. Designated mobilization training station was Fort Sam Houston, 1922–40. Location 7 December 1941—Fort Worth, TX.

**Status:** Withdrawn from the CARS on 17 October 1999 and redesignated as the 358th Regt. to consist of the 1st, 2d, and 3d Bns., elements of the 91st Div. (Training Support); concurrently, the 1st, 2d, and 3d Bns. allotted to the R.A.

**Commanders, 358th Infantry Regiment**

Col. Edwin C. Carey	23 August 1917–28 May 1918	Maj. Uel Stephens	28 October 1921–26 November 1921
Col. Edmund M. Leary	28 May 1918–23 November 1918	Maj. James D. Isaaks	26 November 1921–12 December 1921
Col. Woodson Hocker	23 November 1918–17 December 1918	Col. Joseph S. Barnett Jr.	12 December 1921–18 September 1922
Col. Edmund M. Leary	17 December 1918–18 February 1919	Col. Clark M. Mullican	19 September 1922–August 1932
Lt. Col. E.C. Waddell	18 February 1919–22 June 1919	Lt. Col. Ludie R. Barker	August 1932–ao August 1937
<i>Demobilized/Inactive</i>	22 June 1919–28 October 1921	Unknown	ao August 1937–7 December 1941

**359th Infantry Regiment (90th Division)**

**Organized Reserve Texas**

HQ—Dallas, TX, 1921–41



Arrived at the port of New York on 8 June 1919 on the U.S.S. *Wilhelmina* as the 359th Inf., an element of the 90th Div. Demobilized on 24 June 1919 at Camp Bowie, TX. Reconstituted in the O.R. on 24 June 1921, assigned to the 90th Div., and allotted to the Eighth Corps Area. Initiated in November 1921 with regimental HQ at Dallas, TX. Subordinate battalion HQ concurrently organized as follows: 1st Bn. at Dallas; 2d Bn. at Marshall, TX; and 3d Bn. at Greenville, TX. Band organized in 1923 at Dallas. Typically conducted Inactive Training Period meetings at the Liggett Building, the Federal Building, or the US Terminal Annex building in Dallas. Conducted summer training with the 9th and 23d Inf. Regts. at Fort Sam Houston or Camp Bullis, TX. Conducted infantry CMTC training at Fort Sam Houston or Camp Bullis as an alternate form of summer training.

Conducted annual contact camps at the Greenville Lake Country Club during the fall or winter months. Primary ROTC feeder school was North Texas Agricultural College. Designated mobilization training station was Fort Sam Houston, 1922–40. Location 7 December 1941—Dallas, TX.

**Status:** Withdrawn from the CARS on 17 October 1999 and redesignated as the 359th Regt. to consist of the 1st Bn., an elements of the 91st Div. (Training Support); concurrently, the 1st Bn. allotted to the R.A.

**Events:** 216

**Commanders, 359th Infantry Regiment**

Col. Howard L. Laubach	22 August 1917–7 December 1917	Maj. David E. Waggoner	November 1921–23 January 1922
Col. William A. Cavanaugh	17 December 1917–13 September 1918	Lt. Col. Hal C. Horton	23 January 1922–11 October 1922
Col. Edmund K. Sterling	13 September 1918–25 May 1919	Col. Jules E. Muchert	11 October 1922–19 July 1926
<i>Demobilized/Inactive</i>	24 June 1919–19 October 1921	Lt. Col. Thomas J. Moroney	20 July 1926–9 July 1930
Maj. Thomas J. Moroney	19 October 1921–November 1921	Col. Louis E. Duvall	10 July 1930–14 November 1935
	Col. Thomas J. Moroney		15 November 1935–25 March 1942

**360th Infantry Regiment (90th Division)****Organized Reserve Texas**

HQ—Houston, TX, 1921–41

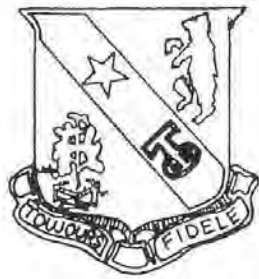

Arrived at the port of Boston on 7 June 1919 on the S.S. *Mongolia* as the 360th Inf., an element of the 90th Div. Demobilized 17 June 1919 at Camp Bowie, TX. Reconstituted in the O.R. on 24 June 1921, assigned to the 90th Div., and allotted to the Eighth Corps Area. Initiated in November 1921 with regimental HQ at Houston, TX. Subordinate battalion HQ concurrently organized as follows: 1st Bn. at Houston; 2d Bn. at Beaumont, TX; and 3d Bn. at Lufkin, TX. The 3d Bn. relocated on 15 April 1925 to Galveston, TX. Conducted summer training with the 9th and 23d Inf. Regts. at Fort Sam Houston or Camp Bullis, TX. Conducted infantry CMTC training at Fort Sam Houston or Camp Bullis as an alternate form of summer training. Conducted an annual contact camp at the A&M College of Texas in Bryan, TX, during the fall or winter months. Primary ROTC

feeder school was the A&M College of Texas. Designated mobilization training station was Fort Sam Houston, 1922–40. Location 7 December 1941—Houston, TX.

**Status:** Activated 1 May 1959 as the 360th Regt., an element of the 91st Div. (Training); reorganized 17 October 1999 to consist of the 1st, 2d, and 3d Bns., elements of the 91st Div. (Training Support); concurrently, the 1st Bn. allotted to the R.A.

**Events:** 216**Commanders, 360th Infantry Regiment**

Col. Caspar H. Conrad Jr.	25 August 1917–12 June 1918	<i>Demobilized/Inactive</i>	17 June 1919–19 October 1921
Col. Howard C. Price	12 June 1918–17 June 1919	Col. Isaac S. Ashburn	19 October 1921–ao March 1941
	Unknown	ao March 1941–7 December 1941	

**361st Infantry Regiment (91st Division)****Organized Reserve California**

HQ—Sacramento, CA, 1921–41



Arrived at the port of New York on 2 April 1919 on the U.S.S. *Orizaba* as the 361st Inf. Regt. an element of the 91st Div. Demobilized 22–30 April 1919 at Camp Lewis, WA. Reconstituted in the O.R. on 24 June 1921, assigned to the 91st Div., and allotted to the Ninth Corps Area. Initiated on 5 November 1921 with regimental HQ at Sacramento, CA. Subordinate battalion HQ concurrently organized as follows: 1st Bn. at Chico, CA; 2d Bn. at Santa Rosa, CA; and 3d Bn. at Sacramento. Entire regiment relocated on 28 January 1930 to Sacramento. Many unit personnel participated in earthquake relief operations 14–22 March 1933 in the Los Angeles area. Typically conducted Inactive Training Period meetings at the Plaza Building in Sacramento. Conducted summer training with the 30th Inf. Regt. at Del Monte, CA, or the Presidio of Monterey, CA. Also conducted infantry

CMTC training at Del Monte, the Presidio of Monterey, and the Presidio of San Francisco, CA, as an alternate form of summer training. Primary ROTC feeder school was Pamona College. Location 7 December 1941—Sacramento, CA (inactivated 21 January 1942).

**Status:** Reorganized 1 May 1959 as the 361st Regt., an element of the 91st Div. (Training); reorganized 17 October 1999 to consist of the 1st, 2d, and 3d Bns., elements of the 91st Div. (Training Support); concurrently, the 1st Bn. allotted to the R.A.

**Events:** 34**Commanders, 361st Infantry Regiment**

Col. William D. Davis	22 August 1917–1 November 1918	Lt. Col. Arthur St. J. Whitney	28 October 1935–ao November 1935
Col. Avery D. Cummings	1 November 1918–30 April 1919	Unknown	ao November 1935–ao March 1937
<i>Demobilized/Inactive</i>	30 April 1919–5 November 1921	Col. Leonard M. Ferrell	ao March 1937–10 June 1937
Col. Henry H. Brown	5 November 1921–28 October 1935	Col. Walter K. Knox	10 June 1937–ao September 1940
	Unknown	ao September 1940–7 December 1941	

**362d Infantry Regiment (91st Division)****Organized Reserve California**

HQ—Oakland, CA, 1921–30; San Francisco, CA, 1930–41

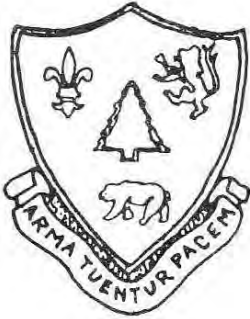

Arrived at the port of New York on 14 April 1919 on the U.S.S. *Edward Luckenback* as the 362d Inf. Regt. an element of the 91st Div. Demobilized 3 May 1919 at Fort D.A. Russell, WY. Reconstituted in the O.R. on 24 June 1921, assigned to the 91st Div., and allotted to the Ninth Corps Area. Initiated on 5 November 1921 with regimental HQ at Oakland, CA. Subordinate battalion HQ concurrently organized as follows: 1st Bn. at Stockton, CA; 2d Bn. at San Francisco, CA; and 3d Bn. at Oakland, CA. Entire regiment relocated on 28 January 1930 to San Francisco. Typically conducted Inactive Training Period meetings at the Presidio of San Francisco or the Commercial Club in San Francisco. Conducted summer training with the 30th Inf. Regt. at Del Monte, CA, or the Presidio of Monterey, CA. Also conducted infantry CMTC training at Del Monte, the Presidio of Monterey, and the Presidio of San Francisco, CA, as an alternate form of summer training. Primary

ROTC feeder school was Pamona College. Location 7 December 1941—San Francisco, CA (inactivated 21 January 1942).

**Status:** Reorganized 1 May 1959 as the 362d Regt., an element of the 91st Div. (Training); reorganized 17 October 1999 to consist of the 1st, 2d, and 3d Bns., elements of the 91st Div. (Training Support); concurrently, the 1st, 2d, and 3d Bns. allotted to the R.A.

**Events:** 168**Commanders, 362d Infantry Regiment**

Col. Pegram Whitworth	15 August 1917–16 September 1918	Col. Pegram Whitworth	11 November 1918–3 May 1919
Col. John H. Parker	16 September 1918–26 September 1918	<i>Demobilized/Inactive</i>	3 May 1919–5 November 1921
Lt. Col. James K. Woolnough	26 September 1918–12 October 1918	Col. Julian L. Dodge	5 November 1921–ao January 1924
Col. Pegram Whitworth	12 October 1918–30 October 1918	Col. Harold L. Mack	ao September 1924–ao September 1925
Lt. Col. James K. Woolnough	30 October 1918–11 November 1918	Col. Roy C. Ward	ao July 1926–ao August 1940
	Unknown		ao August 1940–7 December 1941

**363d Infantry Regiment (91st Division)****Organized Reserve California**

HQ—Fresno, CA, 1921–41



Arrived at the port of New York on 30 March 1919 on the U.S.S. *Siboney* as the 363d Inf., an element of the 91st Div. Demobilized 2 May 1919 at the Presidio of San Francisco, CA. Reconstituted in the O.R. on 24 June 1921, assigned to the 91st Div., and allotted to the Ninth Corps Area. Initiated on 5 November 1921 at the regimental HQ in Fresno, CA. Subordinate battalion HQ concurrently organized as follows: 1st Bn. at Fresno; 2d Bn. at Bakersfield, CA; and 3d Bn. at Santa Barbara, CA. Many unit members participated in earthquake relief operations 14–22 March 1933 in the Los Angeles area. Entire regiment relocated on 7 December 1937 to Fresno. Typically conducted Inactive Training Period meetings at the Brix Building in Fresno. Conducted summer training with the 30th Inf. Regt. at Del Monte, CA, or the Presidio of Monterey, CA. Conducted infantry CMTC

training at the Presidio of Monterey as an alternate form of summer training. Primary ROTC feeder school was Pamona College. Location 7 December 1941—Fresno, CA (inactivated 21 January 1942).

**Status:** Reorganized 1 May 1959 as the 363d Regt., an element of the 91st Div. (Training); reorganized 17 October 1999 to consist of the 1st, 2d, and 3d Bns., elements of the 91st Div. (Training Support).

**Commanders, 363d Infantry Regiment**

Col. Harry LaT. Cavanaugh	15 August 1917–2 May 1919	Unknown	ao July 1928–ao March 1929
<i>Demobilized/Inactive</i>	2 May 1919–5 November 1921	Col. Walter A. McCord	ao March 1929–30 April 1936
Col. Harold L. Mack	5 November 1921–ao January 1924	Col. Byron W. Allen	1 May 1936–3 November 1936
Col. Dan M. Smith	ao September 1924–ao July 1928	Col. Dallas D. Dennis	3 November 1936–ao January 1941

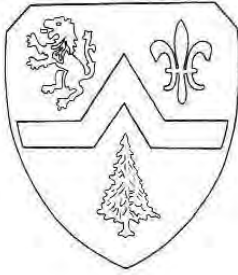
**364th Infantry Regiment (91st Division)****Organized Reserve California****HQ**—Los Angeles, CA, 1921–41

Arrived at the port of New York on 2 April 1919 on the U.S.S. *Orizaba* as the 364th Inf. Regt. an element of the 91st Div. Demobilized in April 1919 at Camp Lewis, WA. Reconstituted in the O.R. on 24 June 1921, assigned to the 91st Div., and allotted to the Ninth Corps Area. Initiated 5 November 1921 with regimental HQ at Los Angeles, CA. Subordinate battalion HQ concurrently organized as follows: 1st Bn. at Hollywood, CA; 2d Bn. at Santa Ana, CA; and 3d Bn. at San Diego, CA. Band organized by August 1927 at Los Angeles. Many unit members participated in earthquake relief operations 14–22 March 1933 in the Los Angeles area. Typically conducted Inactive Training Period meetings at the 160th Inf. armory at Exposition Park or at the Brownstein-Louis Building in Los Angeles. Conducted summer training with the 30th Inf. Regt. at Del Monte, CA, or the Presidio of Monterey, CA. Conducted infantry CMTC training at the Presidio of

Monterey some years as an alternate form of summer training. Primary ROTC feeder schools were the University of California at Los Angeles and University of California at Berkeley. Location 7 December 1941—Los Angeles, CA (inactivated 21 January 1942).

**Status:** Disbanded 2 April 1943; reconstituted 29 October 1998 as the 364th Inf.; redesignated 17 October 1999 as the 364th Regt. and organized to consist of the 1st, 2d, and 3d Bns., elements of the 91st Div. (Training Support); concurrently, the 3d Bn. allotted to the R.A.

**Commanders, 364th Infantry Regiment**

Col. Elmer W. Clarke	1 September 1917–31 January 1918	<i>Demobilized/Inactive</i>	April 1919–5 November 1921
Col. George McD. Weeks	September 1917–31 October 1918	Col. Arthur T. Balentine	5 November 1921–20 May 1924
Col. Lucius C. Bennett	1 November 1918–April 1919	Col. Dwight M. Green	20 May 1924–January 1941
	Lt. Col. Don L. Wells	January 1941–ao June 1941	

**369th Infantry Regiment (Colored) (Separate)****New York National Guard****HQ**—*Not initiated*, 1920–24; Harlem, NY, 1924–40

Demobilized 28 February 1919 at Camp Upton, NY, as an element of the 93d Div. Reconstituted in the N.G. on 19 October 1920 and allotted to the state of New York as a separate regiment. Partially organized on 11 October 1921 by redesignation of active elements of the 15th Inf., New York N.G. as the 369th Inf. Regimental HQ organized and federally recognized on 6 September 1924 at Harlem, NY. Attached 17 June 1922 to the 87th Inf. Brig. Conducted annual summer training most years at Camp Smith, NY, 1924–39. Assigned to the First Army on 1 October 1933 but remained attached to the 87th Inf. Brig. for command, control, and administration. Reorganized and redesignated the 369th C.A. Regt. on 30 August 1940.

**Status:** Active at New York, NY, as the 369th Corps Support Bn.

**Events:** 61**Commanders, 369th Infantry Regiment**

Col. William Hayward	5 August 1917–28 February 1919	Col. William A. Taylor	8 April 1925–8 December 1933
<i>Demobilized</i>	28 February 1919–6 September 1924	Col. John G. Grimley	8 December 1933–23 February 1938
Col. Arthur W. Little	6 September 1924–8 April 1925	Col. Joseph A. S. Mundy	23 February 1938–27 August 1938
	Col. Benjamin O. Davis, Sr. (RA)	27 August 1938–30 August 1940	

**372d Infantry Regiment (Colored) (Separate)**

**District of Columbia, Ohio, Massachusetts  
and New Jersey National Guard**

**HQ—Inactive, 1921–41**

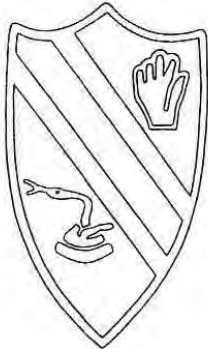

372d Inf, 1st Bn

Arrived at the port of Hoboken on 12 February 1919 on the U.S.S. *Leviathan* as the 372d Inf. Regt. an element of the 93d Div. Demobilized 6 March 1919 at Camp Sherman, OH. Reconstituted in the N.G. and allotted by January 1925 as follows: the 1st Bn. allotted to the District of Columbia; the 2d Bn. allotted to the state of Ohio; and the 3d Bn. allotted to the state of Massachusetts. Subordinate elements partially organized as follows: 1st Bn. reconstituted as the 142d Engr. Bn. (Co. A only organized and federally recognized on 19 April 1921 in Washington, DC), redesignated as 1st Sep. Bn. of Infantry on 1 April 1923, redesignated 1st Bn., 372d Inf. on 18 December 1925 (only Co. A active); 2d Bn. reorganized in the Ohio N.G. on 1 April 1924 as the 1st Sep. Bn. of Infantry with HQ federally recognized on 22 September 1924 at Columbus, OH, and redesignated 2d Bn., 372d Inf. on 1 April 1925; and 3d Bn. reorganized in the Massachusetts N.G. on 30 November 1920 as the 2d Sep. Bn. of Infantry with HQ federally recognized at Boston, MA, on 15 March 1922, redesignated 3d Bn., 372d Inf. on 1 January 1925. The 1st and 3d Bns. were assigned to the First Army and the 2d Bn. assigned to the Second Army on 1 October 1933. The 2d

Bn. called up to perform riot control duties during the Ohio State Penitentiary riot and fire, 21–23 April 1930, and flood relief duties along the Ohio River, January–March 1937. Elements conducted summer training most years, 1925–39, at camp locations as follows: Co. A, 372d Inf. at Saunders Range, MD, or Camp Ritchie, Cascade, MD; 2d Bn. at Camp Perry, OH (conducted some years with the 449th Inf.); 3d Bn. at Camp Devens, MA (conducted some years with the 428th Inf.) or at the Massachusetts Military Reservation at Falmouth. Co. A redesignated as regimental HQ Co. on 3 September 1940. The 1st Sep. Co., Maryland N.G. redesignated Service Company on 11 September 1940. New 1st Bn. organized by redesignation of the 1st Sep. Bn., New Jersey N.G. on 11 September 1940. All elements inducted into active Federal service at their respective home stations on 10 March 1941. All elements transferred to Fort Dix, NJ, where they arrived by 17 March 1941. The regiment was concurrently assigned to the First Army. Location 7 December 1941—Fort Dix, NJ.



372d Inf, 2d Bn

**Status:** Co. A active in the District of Columbia N.G. as HHD, 372d M.P. Bn.; HHC, 2d Bn. active in the Ohio N.G. as the as the 372d Maint Co.

**Events:** 302

**Commanders, 372d Infantry Regiment**

Col. Glendie B. Young	5 August 1917–12 July 1918	<i>Demobilized/Inactive</i>	28 February 1919–21 June 1940
Col. Herschel Tupes	12 July 1918–27 February 1919	Col. Howard C. Gilbert	22 June 1940–2 January 1942
		<b>1st Battalion</b>	
	Maj. George L. Eggleston		11 September 1940–ao December 1941
		<b>2d Battalion</b>	
	Maj. Howard C. Gilbert		22 September 1924–21 June 1940
		<b>3d Battalion</b>	
Maj. Larkland F. Hewitt	11 December 1923–31 December 1930	Vacant	June 1936–10 September 1936
Maj. Edward Dugger	1 January 1931–June 1936	Maj. Alexander R. Davis	11 September 1936–ao January 1941



**373d Infantry Regiment (211th Infantry Brigade)****Organized Reserve Puerto Rico**HQ—*Not initiated*, 1921–22; San Juan, PR, 1922–41

Demobilized 10 January 1919 at Camp Las Casas, PR, as an element of the Porto Rican Division. Reconstituted in the O.R. on 24 June 1921, assigned to the 76th Div., and allotted to the First Corps Area. New Haven, CT, designated as HQ on organization, but the unit was never organized at that location. Withdrawn from the First Corps Area on 29 December 1921 and allotted to the Second Corps Area. Concurrently relieved from the 76th Div. and assigned to the 211th Inf. Brig. Initiated on 17 June 1922 with regimental HQ at San Juan, PR. Subordinate battalion HQ concurrently organized as follows: 1st Bn. at Manati, PR; 2d Bn. at Cayguas, PR; and 3d Bn. at Fajoado, PR. Regiment reorganized on 5 January 1929 with personnel from the inactivated 374th and 375th Inf. Regts. Regiment concurrently relocated as follows: 1st Bn. at Cayguas; 2d Bn. at Ponce; and 3d Bn. at Mayaguez. The 1st Bn. relocated to San Juan on 3 October 1933. Conducted

summer training with the 65th Inf. Regt. at Camp Buchanan, Henry Barracks, or the Post of San Juan. Also conducted CMTC training at the Post of San Juan or Camp Buchanan some years as an alternate form of summer training. Primary ROTC feeder school was the University of Puerto Rico. Location 7 December 1941—San Juan, PR.

**Status:** Disbanded 11 November 1944.**Commanders, 373d Infantry Regiment**

Col. M.S. Taulbee	16 July 1918–10 January 1919	Capt. Angel W. Fernandez	17 June 1922–ao October 1923
<i>Demobilized/Inactive</i>	10 January 1919–17 June 1922	Col. Manuel Font	ao August 1924–ao January 1941
	Unknown		ao January 1941–7 December 1941

**374th Infantry Regiment (211th Infantry Brigade)****Organized Reserve Puerto Rico**HQ—*Not initiated*, 1921–22; Mayaguez, PR, 1922–27; *Inactive*, 1927–41

Demobilized on 10 January 1919 at Camp Las Casas, PR, as an element of the Porto Rican Division. Reconstituted in the O.R. on 24 June 1921, assigned to the 76th Div., and allotted to the First Corps Area. Bridgeport, CT, designated as HQ on organization, but the unit was never organized at that location. Withdrawn from the First Corps Area on 29 December 1921 and allotted to the Second Corps Area. Concurrently relieved from the 76th Div. and assigned to the 211th Inf. Brig. Regiment was organized on 17 June 1922 with regimental HQ at Mayaguez, PR. Subordinate battalion HQ concurrently organized as follows: 1st Bn. at Aricebo, PR; 2d Bn. at Aguadilla, PR; and 3d Bn. at Yauco, PR. Conducted summer training with the 65th Inf. Regt. at the Post of San Juan. Primary ROTC feeder school was the University of Puerto Rico. Withdrawn from Puerto Rico on 16 March 1927 and personnel transferred to the 373d Inf. or the 516th Inf. Bn. Location 7 December 1941—*Inactive*.

**Status:** Disbanded 13 April 1945.**Commanders, 374th Infantry Regiment**

Col. Robert H. Allen	16 July 1918–August 1918	Capt. Pedro J. Bras	17 June 1922–ao September 1923
Unknown	16 July 1918–10 January 1919	Unknown	ao September 1923–16 March 1927
<i>Demobilized/Inactive</i>	10 January 1919–17 July 1922	<i>Inactive</i>	16 March 1927–7 December 1941

**375th Infantry Regiment (211th Infantry Brigade)****Organized Reserve Massachusetts/Puerto Rico**HQ—Worcester, MA, 1921; *Inactive*, 1921–22; Ponce, PR, 1922–27; *Inactive*, 1927–41

Demobilized on 10 January 1919 at Camp Las Casas, PR, as an element of the Porto Rican Division. Reconstituted in the O.R. on 24 June 1921, assigned to the 94th Div., and allotted to the First Corps Area. Initiated 19 October 1921 with regimental HQ at Worcester, MA. Withdrawn from the First Corps Area on 29 December 1921 and allotted to the Second Corps Area. Concurrently relieved from the 76th Div. and assigned to the 211th Inf. Brig. Reorganized 17 June 1922 with regimental HQ at Ponce, PR. Subordinate battalion HQ concurrently organized as follows: 1st Bn. at Aricebo, PR; 2d Bn. at Guayamas, PR; and 3d Bn. at San Juan, PR. Conducted summer training with the 65th

Inf. Regt. at the Post of San Juan. Primary ROTC feeder school was the University of Puerto Rico. Withdrawn from Puerto Rico on 16 March 1927 and personnel transferred to the 373d Inf. or the 516th Inf. Bn. Location 7 December 1941—*Inactive*.

**Status:** Disbanded 13 April 1945.

**Commanders, 375th Infantry Regiment**

Unknown	16 July 1918–10 January 1919	<i>Inactive</i>	29 December 1921–16 June 1922
<i>Demobilized/Inactive</i>	10 January 1919–19 October 1921	Capt. Pedro M. Caratini	17 June 1922–ao September 1923
Maj. T. A. Brown	19 October 1921–4 November 1921	Unknown	ao September 1923–16 March 1927
Lt. Col. Duncan M. Stewart	4 November 1921–29 December 1921	<i>Inactive</i>	16 March 1927–7 December 1941

**376th Infantry Regiment (94th Division)**

**Organized Reserve Massachusetts**

HQ—Lynn, MA, 1921–41



Demobilized 11 January 1919 at Camp Las Casas, PR, as an element of the Porto Rican Division. Reconstituted in the O.R. on 24 June 1921, assigned to the 94th Div., and allotted to the First Corps Area. Initiated on 7 October 1921 with regimental HQ at Lynn, MA. Subordinate battalion HQ concurrently organized as follows: 1st Bn. at Watertown, MA; 2d Bn. at Winchester, MA; and 3d Bn. at Hamilton, MA. The 2d Bn. was relocated to Lynn in 1924. Typically conducted Inactive Training Period meetings at the Tomson Club in Lynn and the Custom House Tower in Boston. Conducted summer training most years with the 5th and 13th Inf. Regts. at Camp Devens, MA, and some years at Fort Ethan Allen, VT. Also conducted infantry CMTC training some years at Camp Devens as an alternate form of summer training. Primary ROTC feeder school was Boston University. Location 7 December 1941—Lynn, MA.

**Status:** Inactive in the Army Reserve as the 376th Inf.

**Commanders, 376th Infantry Regiment**

Col. Frank Tompkins	16 July 1918–11 August 1918	Maj. C.A. Ranlett	27 October 1921–21 November 1921
Unknown	11 August 1918–11 January 1919	Lt. Col. Theodore E. Burleigh	21 November 1921–4 January 1923
<i>Demobilized/Inactive</i>	11 January 1919–7 October 1921	Col. Arthur R. Payne	5 January 1923–26 July 1934
Maj. L.P. Swain	7 October 1921–27 October 1921	Col. Henry A. Hale Jr.	26 July 1934–March 1942

**377th Infantry Regiment (95th Division)**

**Organized Reserve Oklahoma**

HQ—Tulsa, OK, 1921–41

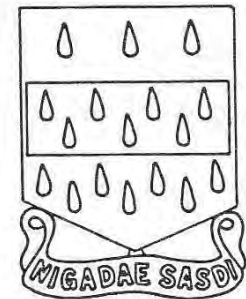

Demobilized 22 December 1918 as an inactive element of the 95th Div. Reconstituted in the O.R. on 24 June 1921, assigned to the 95th Div., and allotted to the Eighth Corps Area. Initiated 29 October 1921 with regimental HQ at Tulsa, OK. Subordinate battalion HQ concurrently organized as follows: 1st Bn. at Pawnee, OK; 2d Bn. at Wagoner, OK; and 3d Bn. at Claremore, OK. The 1st and 2d Bns. relocated on 22 August 1927 to Bartlesville and Miami, OK, respectively. Conducted summer training with battalions of the 38th and 29th Inf. Regts. at Fort Sill, OK. Also conducted infantry CMTC training some years at Fort Sill as an alternate form of summer training. Primary ROTC feeder school was Oklahoma A&M College. Location 7 December 1941—Tulsa, OK.

**Status:** Reorganized 1 April 1959 as the 377th Regt., an element of the 95th Div. (Training); reorganized 16 October 1996 to consist of the 1st, 2d, and 3d Bns., elements of the 95th Div. (Institutional Training).

### Commanders, 377th Infantry Regiment

<i>Demobilized/Inactive</i>	22 December 1918–29 October 1921	Unknown	ao April 1930–ao August 1931
Col. Ira L. Reeves	29 October 1921–24 February 1923	Lt. Col. Ralph R. Jarboe	ao August 1931–ao September 1931
Col. Patrick J. Hurley	25 February 1923–15 March 1929	Col. Bruce E. Clarke	ao August 1932–ao December 1940
Lt. Col. Theodore C. Hopkins	15 March 1929–ao April 1930	Unknown	ao December 1940–ao April 1941
	Col. Harry L. S. Halley	ao April 1941–ao November 1941	

### 378th Infantry Regiment (95th Division)

### Organized Reserve Oklahoma

HQ—*Not initiated*, 1921–22; McAlester, OK, 1922–41



Demobilized 22 December 1918 as an inactive element of the 95th Div. Reconstituted in the O.R. on 24 June 1921, assigned to the 95th Div., and allotted to the Eighth Corps Area. Initiated on 24 January 1922 with regimental HQ at McAlester, OK. Subordinate battalion HQ concurrently organized as follows: 1st Bn. at Weleetka, OK; 2d Bn. at Haileysville, OK; and 3d Bn. at Fort Gibson, OK. Regiment relocated 9 September 1923 as follows: 1st Bn. at Poteau, OK; 2d Bn. at Okmulgee, OK; and 3d Bn. at Atoka, OK. Band organized in September 1923 at McAlester, OK. Conducted summer training with battalions of the 38th and 29th Inf. Regts. at Fort Sill, OK. Also conducted infantry CMTC training some years at Fort Sill as an alternate form of summer training. Primary ROTC feeder school was Oklahoma A&M College. Location 7 December 1941—McAlester, OK.

**Status:** Reorganized 1 April 1959 as the 378th Regt., an element of the 95th Div. (Training); reorganized 16 October 1996 to consist of the 1st, 2d, and 3d Bns., elements of the 95th Div. (Institutional Training).

### Commanders, 378th Infantry Regiment

<i>Demobilized/Inactive</i>	22 December 1918–24 January 1922	Unknown	ao August 1931–ao August 1934
Maj. Harry H. Chaney	24 January 1922–1 June 1922	Lt. Col. Howard Jarrell	ao August 1934–ao September 1934
Lt. Col. Francis B. Eastman	1 June 1922–ao August 1922	Unknown	ao September 1934–ao June 1937
Col. Victor M. Locke Jr.	ao March 1923–January 1924	Col. Walton Brooks	ao June 1937–ao August 1937
Maj. Harry M. Chaney	January 1924–May 1924	Unknown	ao August 1937–ao October 1941
Col. Charles West	May 1924–ao August 1931	Col. Ralph W. Wolverton	ao October 1941–ao December 1941

### 379th Infantry Regiment (95th Division)

### Organized Reserve Oklahoma

HQ—Enid, OK, 1921–41



Demobilized 10–20 December 1919 at Camp Sherman, OH, as an element of the 95th Div. Reconstituted in the O.R. on 24 June 1921, assigned to the 95th Div., and allotted to the Eighth Corps Area. Initiated 28 October 1921 with regimental HQ at Enid, OK. Subordinate battalion HQ concurrently organized as follows: 1st Bn. at Guthrie, OK; 2d Bn. at Blackwell, OK; and 3d Bn. at Woodward, OK. Regiment relocated on 22 August 1927 as follows: 1st Bn. at Ponca City, OK; 2d Bn. at Alva, OK; and 3d Bn. at Enid, OK. Conducted summer training with battalions of the 38th and 29th Inf. Regts. at Fort Sill, OK. Also conducted infantry CMTC training some years at Fort Sill as an alternate form of summer training. Primary ROTC feeder school was Oklahoma A&M College. Location 7 December 1941—Enid, OK.

**Status:** Reorganized 1 April 1959 as the 379th Regt., an element of the 95th Div. (Training); reorganized 19 October 2001 to consist of the 1st, 2d, and 3d Bns., elements of the 95th Div. (Institutional Training).

### Commanders, 379th Infantry Regiment

Maj. Charles S. Williams	25 September 1918–26 September 1918	Col. Winfield Scott	May 1929–ao August 1930
Col. Julian G. Gaujot	26 September 1918–11 October 1918	Unknown	ao August 1930–ao August 1934
Lt. Col. Walter S. Greason	11 October 1918–1 November 1918	Lt. Col. Samuel H. Ladensohn	ao August 1934–ao September 1934
Col. Louis C. Scherer	1 November 1918–19 December 1918	Unknown	ao September 1934–ao August 1936
<i>Demobilized/Inactive</i>	20 December 1918–28 October 1921	Lt. Col. Charles H. McNeese	ao August 1936–ao September 1936
Col. Winfield Scott	28 October 1921–January 1926	Unknown	ao September 1936–ao December 1939
Lt. Col. Ralph R. Jarboe	January 1926–May 1929	Col. Ralph R. Jarboe	ao December 1939–ao January 1940
	Unknown		ao January 1940–7 December 1941

### 380th Infantry Regiment (95th Division)

### Organized Reserve Oklahoma

HQ—Lawton, OK, 1921–25; Oklahoma City, OK, 1925–41



Demobilized 17 December 1919 at Camp Sherman, OH, as an element of the 95th Div. Reconstituted in the O.R. on 24 June 1921, assigned to the 95th Div., and allotted to the Eighth Corps Area. Initiated 26 November 1921 with regimental HQ at Lawton, OK. Regiment relocated on 10 July 1925 as follows: regimental HQ and 1st Bn. at Oklahoma City, OK; 2d Bn. at El Reno, OK; and 3d Bn. at Shawnee, OK. Conducted summer training with battalions of the 38th and 29th Inf. Regts. at Fort Sill, OK. Also conducted infantry CMTTC training some years at Fort Sill as an alternate form of summer training. Primary ROTC feeder school was Oklahoma A&M College. Location 7 December 1941—Oklahoma City, OK.

**Status:** Disbanded 11 November 1944.

### Commanders, 380th Infantry Regiment

Lt. Col. Clark P. Chandler	25 September 1918–19 October 1918	Maj. Harry L. Findley	26 November 1921–21 December 1921
Col. Edward Croft	20 October 1918–17 December 1918	Col. Elta H. Jayne	21 December 1921–ao August 1932
<i>Demobilized/Inactive</i>	17 December 1918–26 November 1921	Unknown	ao August 1932–7 December 1941

### 381st Infantry Regiment (96th Division)

### Organized Reserve Oregon

HQ—Portland, OR 1921–41

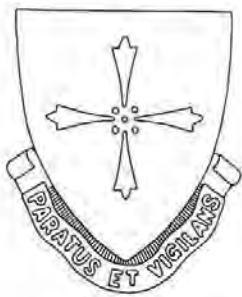

Demobilized 7 January 1919 as an inactive element of the 96th Div. Reconstituted in the O.R. on 24 June 1921, assigned to the 96th Div., and allotted to the Ninth Corps Area. Initiated 15 December 1921 with regimental HQ at Portland, OR. Subordinate battalion HQ concurrently organized as follows: 1st and 2d Bns. at Portland; and the 3d Bn. at Baker, OR. Entire regiment relocated on 28 January 1930 to Portland. Typically conducted Inactive Training Period meetings at the Multnomah Hotel in Portland. Conducted summer training with battalions of the 4th Inf. at Fort Lewis, WA, and with the 7th Inf. at Vancouver Barracks, WA. Also conducted infantry CMTTC training some years at Vancouver Barracks as an alternate form of summer training. Primary ROTC feeder schools were the University of Oregon and Oregon State Agricultural College. Location 7 December 1941—Portland, OR.

**Status:** Withdrawn from the CARS on 1 October 1993 and redesignated as the 381st Regt. to consist of the 1st Bn., an element of the 75th Div. (Exercise); reorganized 17 October 1999 to consist of the 1st, 2d, and 3d Bns., elements of the 75th Div. (Training Support); the 1st Bn. concurrently allotted to the R.A.

### Commanders, 381st Infantry Regiment

Col. Carle Abrams	15 December 1921–10 April 1923	Col. William A. Aird	10 April 1923–ao January 1941
	Unknown		ao January 1941–7 December 1941

**382d Infantry Regiment (96th Division)****Organized Reserve Oregon**

HQ—Medford, OR, 1921–23; Salem, OR, 1923–30; Medford, OR, 1930–41



Demobilized 7 January 1919 as an inactive element of the 96th Div. Reconstituted in the O.R. on 24 June 1921, assigned to the 96th Div., and allotted to the Ninth Corps Area. Initiated on 15 December 1921 with regimental HQ at Medford, OR. Subordinate battalion HQ concurrently organized as follows: 1st Bn. at Corvallis, OR; 2d Bn. at Marshfield, OR; and 3d Bn. at Salem, OR. Regimental HQ relocated 10 April 1923 to Salem. Entire regiment relocated on 28 January 1930 to Medford, OR. Conducted summer training with battalions of the 4th Inf. at Fort Lewis, WA, and with the 7th Inf. at Vancouver Barracks, WA. Also conducted infantry CMTC training some years at Vancouver Barracks as an alternate form of summer training. Primary ROTC feeder schools were the University of Oregon and Oregon State Agricultural College. Location 7 December 1941—Salem, OR.

**Status:** Withdrawn from the CARS on 17 October 1999 and redesignated as the 382d Regt. to consist of the 1st, 2d, and 3d Bns., elements of the 75th Div. (Training Support).

**Commanders, 382d Infantry Regiment**

Col. Gordon Voorhies

15 December 1921–31 March 1923

Col. Carle Abrams

10 April 1923–ao January 1941

**383d Infantry Regiment (96th Division)****Organized Reserve Washington**

HQ—Seattle, WA, 1921–41

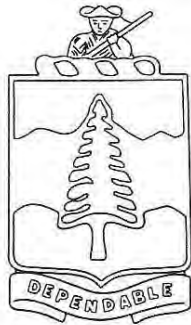

Demobilized 7 January 1919 at Camp Wadsworth, SC, as an element of the 96th Div. Reconstituted in the O.R. on 24 June 1921, assigned to the 97th Div., and allotted to the Ninth Corps Area. Initiated 31 December 1921 with regimental HQ at Seattle, WA. Subordinate battalion HQ concurrently organized as follows: 1st Bn. at Seattle; 2d Bn. at Bellingham, WA; and 3d Bn. at Tacoma, WA. Entire regiment relocated 7 April 1930 to Seattle. Conducted summer training most years with battalions of the 7th Inf. at Vancouver Barracks, WA, and some years with the 4th Inf. at Fort Lewis, WA, or Fort Lawton, WA. Also conducted infantry CMTC training some years at Vancouver Barracks as an alternate form of summer training. Primary ROTC feeder school was the University of Washington. Location 7 December 1941—Seattle, WA.

**Status:** Withdrawn from the CARS on 1 October 1993 and redesignated as the 383d Regt. to consist of the 1st Bn., an element of the 75th Div. (Exercise); reorganized 17 October 1999 to consist of the 1st, 2d, and 3d Bns., elements of the 75th Div. (Training Support).

**Commanders, 383d Infantry Regiment**

Lt. Col. Herbert W. Meyers

31 December 1921– September 1922

Col. William M. Inglis

15 March 1927–22 October 1932

Col. Alexander M. Wetherill

September 1922–15 March 1927

Col. Burt C. Ross

22 October 1932–ao July 1939

Unknown

ao July 1939–7 December 1941

**384th Infantry Regiment (96th Division)**

**Organized Reserve Washington**

**HQ**—Spokane, WA, 1921–41

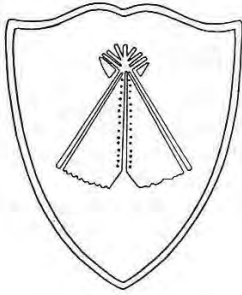

Demobilized on 7 January 1919 at Camp Wadsworth, SC, as an element of the 96th Div. Reconstituted in the O.R. on 24 June 1921, assigned to the 96th Div., and allotted to the Ninth Corps Area. Initiated 31 December 1921 with regimental HQ at Spokane, WA. Subordinate battalion HQ concurrently organized as follows: 1st Bn. at Spokane; 2d Bn. at Walla Walla, WA; and 3d Bn. at Yakima, WA. Entire regiment relocated on 7 April 1930 to Spokane. Conducted summer training with 2d Bn., 4th Inf. at Fort George Wright, WA. Also conducted infantry CMTC training some years at Fort George Wright as an alternate form of summer training. Primary ROTC feeder school was the University of Washington. Location 7 December 1941—Spokane, WA.

**Status:** Disbanded 11 November 1944.

**Commanders, 384th Infantry Regiment**

Lt. Col. George B. Bartlett	6 December 1918–30 December 1918	Col. William M. Inglis	ao January 1924–15 March 1927
<i>Demobilized/Inactive</i>	1 January 1919–31 December 1921	Col. Alexander M. Wetherill	15 March 1927–22 October 1932
Lt. Col. Jefferson H. Fulton	31 December 1921–ao February 1922	Col. Jefferson H. Fulton	22 October 1932–ao August 1939
Unknown	ao February 1922–ao January 1924	Unknown	ao August 1939–7 December 1941

**385th Infantry Regiment (76th Division)**

**Organized Reserve Rhode Island**

**HQ**—Providence, RI, 1921–41

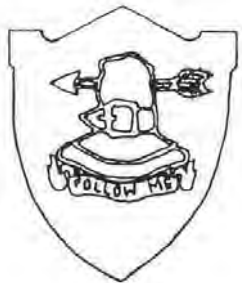

Demobilized on 22 December 1918 as an inactive element of the 97th Div. Reconstituted in the O.R. on 24 June 1921, assigned to the 76th Div., and allotted to the First Corps Area. Initiated 13 December 1921 with regimental HQ at Providence, RI. Subordinate battalion HQ concurrently organized as follows: 1st Bn. at Providence, RI; 2d Bn. at East Providence, RI; and 3d Bn. at Pawtucket, RI. Band organized on 23 January 1924 at Providence; inactivated in December 1925. Typically conducted Inactive Training Period meetings at the Benefit Street Arsenal or the Cranston Street Armory in Providence. Conducted summer training with the 5th and 13th Inf. Regts. at Camp Devens, MA, Fort Adams, RI, or Fort Ethan Allen, VT. Also conducted infantry CMTC training some years at Camp Devens or Fort Adams as an alternate form of summer training. Primary ROTC feeder school was Rhode Island State College. Location 7 December 1941—Providence, RI.

**Status:** Reorganized 1 May 1959 as the 385th Regt., an element of the 76th Div. (Training); reorganized 16 October–16 November 1996 to consist of the 1st, 2d, and 3d Bns., elements of the 98th Div. (Institutional Training).

**Commanders, 385th Infantry Regiment**

Col. G. Edward Buxton Jr.	13 December 1921–January 1931	Col. William F. Hoey Jr.	January 1931–May 1938
	Col. Clarke L. Dickson	May 1938–15 May 1942	

**386th Infantry Regiment (97th Division)****Organized Reserve Maine**

HQ—*Not initiated*, 1921–22; Bangor, ME, 1922–41



Demobilized on 22 December 1918 as an inactive element of the 97th Div. Reconstituted in the O.R. on 24 June 1921, assigned to the 97th Div., and allotted to the First Corps Area. Initiated 10 January 1922 with regimental HQ at Bangor, ME. Subordinate battalion HQ concurrently organized as follows: 1st Bn. at Willinocket, ME; 2d Bn. at Machias, ME; and 3d Bn. at Gardiner, ME. Typically conducted Inactive Training Period meetings at the Federal Building in Bangor. Conducted summer training with the 5th Inf. at Fort McKinley, ME, Fort Williams, ME, or Fort Ethan Allen, VT. Conducted summer training with the 103d Inf. at Camp Keyes, ME, in 1937. Also conducted infantry CMTC training some years at Fort McKinley as an alternate form of summer training. Primary ROTC feeder school was the University of Maine. Location 7 December 1941—Bangor, ME.

**Status:** Inactive in the Army Reserve as the 386th Inf.

**Commanders, 386th Infantry Regiment**

Lt. Col. Albert Greenlaw	10 January 1922–1 July 1923	Unknown	ao August 1932–ao August 1934
Maj. Clarence A. Whitney	1 July 1923–ao August 1923	Lt. Col. Jerold M. Ashley	ao August 1934–ao September 1934
Unknown	ao August 1923–ao May 1925	Unknown	ao September 1934–ao June 1938
Col. Earnest O. Wilcox	ao May 1925–March 1926	Maj. Wade L. Grindle	ao June 1936–ao August 1937
Col. Francis H. Farnum	March 1926–ao October 1930	Col. William G. Knight	a March 1938–March 1940
Lt. Col. Edward C. Call	ao June 1931–ao August 1932	Col. I.J. Nichol	March 1940–7 December 1941

**387th Infantry Regiment (97th Division)****Organized Reserve New Hampshire**

HQ—*Not initiated*, 1921–22; Nashua, NH, 1922–24; Laconia, NH, 1924–41

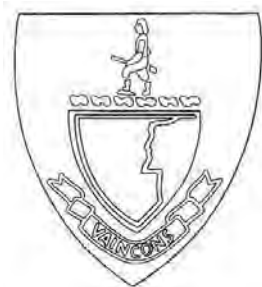

Demobilized 11 December 1918 at Camp Cody, NM, as an element of the 97th Div. Reconstituted in the O.R. on 24 June 1921, assigned to the 97th Div., and allotted to the First Corps Area. Initiated in June 1922 with regimental HQ at Nashua, NH. Subordinate battalion HQ concurrently organized as follows: 1st Bn. at Keene, NH; 2d Bn. at Berlin, NH; and 3d Bn. at Laconia, NH. Regimental HQ relocated on 25 January 1924 to Laconia, NH. Subordinate battalion HQ concurrently relocated as follows: 1st Bn. at Keene, NH; 2d Bn. at Manchester, NH; and 3d Bn. at Bristol, NH. Band organized on 12 August 1924 at Nashua, NH. Conducted summer training with the 5th Inf. at Fort McKinley, ME, Fort Williams, ME, or Fort Ethan Allen, VT. Also conducted infantry CMTC training some years at Fort McKinley or Fort Devens, MA, as an alternate form of summer training. Primary ROTC feeder school was the University of New Hampshire. Location 7 December 1941—Laconia, NH.

**Status:** Inactive in the Army Reserve as the 387th Inf.

**Commanders, 387th Infantry Regiment**

Col. Frank H. Norton	1 October 1918–11 December 1918	Lt. Col. Alcott F. Elwell	December 1925–ao June 1926
<i>Demobilized/Inactive</i>	11 December 1918–June 1922	Col. Fred B. Thomas	ao September 1926–ao November 1932
Lt. Col. Oscar P. Cole	June 1922–November 1922	Unknown	ao November 1932–ao June 1936
Col. Robert H. Murray	November 1922–November 1925	Col. John W. Keveney	ao June 1936–ao May 1940
	Unknown	ao May 1940–7 December 1941	

**388th Infantry Regiment (97th Division)****Organized Reserve Vermont**

HQ—*Not initiated*, 1921–22; Burlington, VT, 1922–41



Demobilized 11 December 1918 at Camp Cody, NM, as an element of the 97th Div. Reconstituted in the O.R. on 24 June 1921, assigned to the 97th Div., and allotted to the First Corps Area. Initiated on 10 January 1922 with regimental HQ at Burlington, VT. Subordinate battalion HQ concurrently organized as follows: 1st Bn. at Northfield, VT; 2d Bn. at Woodstock, VT; and 3d Bn. at Rutland, VT. Typically conducted Inactive Training Period meetings at 202 College Street in Burlington or at Fort Ethan Allen, VT. Conducted summer training with the 5th Inf. at Fort McKinley, ME, or Fort Williams, ME, and the 13th Inf. at Fort Ethan Allen. Also conducted infantry CMTC training some years at Fort McKinley or Fort Ethan Allen as an alternate form of summer training. Contact camp held at Fort Ethan Allen in October 1925 during worst blizzard in many years. Primary ROTC

feeder school was the University of Vermont and State Agricultural College. Location 7 December 1941—Laconia, NH.

**Status:** Disbanded 11 November 1944.

**Commanders, 388th Infantry Regiment**

Unknown	1 October 1918–11 December 1918	Col. Horatio N. Jackson	10 January 1922–September 1933
<i>Demobilized/Inactive</i>	11 December 1918–10 January 1922	Col. Norman E. Borden	September 1933–ao January 1940
	Unknown	ao January 1940–7 December 1941	

**389th Infantry Regiment (98th Division)****Organized Reserve New York**

HQ—Albany, NY, 1921–41



Demobilized on 30 November 1918 as an inactive element of the 98th Div. Reconstituted in the O.R. on 24 June 1921, assigned to the 98th Div., and allotted to the Second Corps Area. Initiated on 3 December 1921 with regimental HQ at Albany, NY. Subordinate battalion HQ concurrently organized as follows: 1st Bn. at Troy, NY; 2d Bn. at Schenectady, NY; and 3d Bn. at Plattsburg, NY. Conducted summer training most years with the 26th Inf. at Plattsburg Barracks, NY, and some years with the 16th Inf. at Fort Wadsworth, NY, and the 28th Inf. at Fort Ontario, NY. Also conducted infantry CMTC training some years at Plattsburg Barracks or Fort Niagara, NY, as an alternate form of summer training. Primary ROTC feeder schools were Syracuse University and Clarkson College. Designated mobilization training station was the Syracuse Concentration Area, NY. Location 7 December 1941—Albany, NY.

**Status:** Reorganized 1 May 1959 as the 389th Regt., an element of the 98th Div. (Training); reorganized on 16 October 1996 to consist of the 1st and 2d Bns., elements of the 98th Div. (Institutional Training).

**Events:** 168

**Commanders, 389th Infantry Regiment**

<i>Demobilized/Inactive</i>	30 November 1918–3 December 1921	Lt. Col. Henry J. Cookinham Jr.	5 December 1928–3 January 1929
Col. Edward H. Teall	3 December 1921–19 January 1924	Lt. Col. Jacob S. Clinton	3 January 1929–25 June 1935
Lt. Col. Henry J. Cookinham Jr.	19 January 1924–16 October 1925	Col. Harry B. Anderson	25 June 1935–7 May 1937
Col. Elisha E. Garrison	16 October 1925–5 December 1928	Col. Franklin A. Loomis	7 May 1937–June 1940
	Col. Henry S. Robertson	June 1940–ao January 1941	



**390th Infantry Regiment** (98th Division)**Organized Reserve New York**

HQ—Utica, NY, 1921–41



Demobilized on 30 November 1918 as an inactive element of the 98th Div. Reconstituted in the O.R. on 24 June 1921, assigned to the 98th Div., and allotted to the Second Corps Area. Initiated on 3 December 1921 with regimental HQ at Utica, NY. Subordinate battalion HQ concurrently organized as follows: 1st Bn. at Watertown, NY; 2d Bn. at Syracuse, NY; and 3d Bn. at Binghamton, NY. Typically conducted Inactive Training Period meetings at the Everson Building in Syracuse. Conducted summer training most years with the 28th Inf. at Fort Ontario, NY, or Fort Niagara, NY, or with the 26th Inf. at Plattsburg Barracks, NY. Also conducted infantry CMTC training some years at Plattsburg Barracks or Fort Niagara as an alternate form of summer training. Primary ROTC feeder schools were Syracuse University and Cornell University. Designated mobilization training station was the Syracuse Concentration Area, NY. Location 7 December 1941—Utica, NY.

**Status:** Reorganized on 1 May 1959 as the 389th Regt., an element of the 98th Div. (Training); reorganized on 16 October 1996 to consist of the 1st and 2d Bns., elements of the 98th Div. (Institutional Training).

**Events:** 168**Commanders, 390th Infantry Regiment**

<i>Demobilized/Inactive</i>	30 November 1918–3 December 1921	Col. Weston Jenkins	14 August 1927–9 July 1932
Lt. Col. Weston Jenkins	3 December 1921–7 April 1925	Col. Homer M. Wellman	25 November 1932–10 September 1940
Col. Rhinelanders Waldo	7 April 1925–14 August 1927	Col. Andrew E. Krieger	10 September 1940–ao December 1941

**391st Infantry Regiment** (98th Division)**Organized Reserve New York**

HQ—Rochester, NY, 1921–41

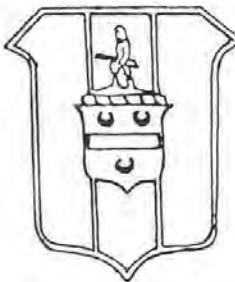

Demobilized 30 November 1918 as an inactive element of the 98th Div. Reconstituted in the O.R. on 24 June 1921, assigned to the 98th Div., and allotted to the Second Corps Area. Initiated 23 December 1921 with regimental HQ at Rochester, NY. Subordinate battalion HQ concurrently organized as follows: 1st Bn. at Auburn, NY; 2d Bn. at Elmira, NY; and 3d Bn. at Rochester. The 391st Inf. was authorized to raise the band for the 98th Div., but apparently the band was never organized. Conducted summer training most years with the 28th Inf. at Fort Niagara, NY, and some years with the 16th Inf. at Fort Wadsworth, NY. Also conducted infantry CMTC training some years at Plattsburg Barracks, NY, or Camp Dix, NJ, as an alternate form of summer training. Primary ROTC feeder school was Niagara University. Designated mobilization training station was the Syracuse Concentration Area, NY. Location 7 December 1941—Rochester, NY.

**Status:** Reorganized 1 May 1959 as the 391st Regt., an element of the 98th Div. (Training); reorganized 19 October 2001 to consist of the 1st, 2d, and 3d Bns., elements of the 98th Div. (Institutional Training).

**Events:** 168**Commanders, 391st Infantry Regiment**

<i>Demobilized/Inactive</i>	30 November 1918–23 December 1921	Col. Charles H. Thompson	ao August 1925–September 1928
Maj. Charleston H. Thompson	23 December 1921–3 January 1922	Col. Thomas H. Remington	September 1928–24 June 1938
Lt. Col. Thomas H. Remington	3 January 1922–ao September 1925	Col. Charles W. Rooth	24 June 1938–ao December 1941

**392d Infantry Regiment (98th Division)****Organized Reserve New York****HQ**—*Not initiated*, 1921–22; Buffalo, NY, 1922–41

Demobilized on 30 November 1918 as an inactive element of the 98th Div. Reconstituted in the O.R. on 24 June 1921, assigned to the 98th Div., and allotted to the Second Corps Area. Initiated on 25 January 1922 with regimental HQ at Buffalo, NY. Subordinate battalion HQ concurrently organized as follows: 1st Bn. at Niagara Falls, NY; 2d Bn. at Buffalo; and 3d Bn. at Jamestown, NY. Conducted summer training most years with the 28th Inf. at Fort Niagara, NY, and some years with the 16th Inf. at Fort Wadsworth, NY, or Camp Dix, NJ, and the 26th Inf. at Plattsburg Barracks, NY. Also conducted infantry CMTC training some years at Plattsburg Barracks, NY, Fort Niagara, NY, or Camp Dix as an alternate form of summer training. Typically conducted Inactive Training Period meetings at the armory of the 174th Inf. at Buffalo, NY. Primary ROTC feeder school

was Niagara University. Designated mobilization training station was the Syracuse Concentration Area, NY. Location 7 December 1941—Buffalo, NY.

**Status:** Inactive in the Army Reserve as the 392d Regt.**Events:** 168**Commanders, 392d Infantry Regiment**

<i>Demobilized/Inactive</i>	30 November 1918–25 January 1922	Col. George S. Minniss	25 January 1922–26 October 1935
	Col. Floyd D. McLean	26 October 1935–ao January 1941	

**393d Infantry Regiment (99th Division)****Organized Reserve Pennsylvania****HQ**—Pittsburgh, PA, 1921–41

Demobilized on 30 November 1918 as an inactive element of the 99th Div. Reconstituted in the O.R. on 24 June 1921, assigned to the 99th Div., and allotted to the Third Corps Area. Initiated 7 December 1921 with the entire regiment at Pittsburgh, PA. Band organized 12 July 1931 at Pittsburgh; still active as of December 1936. Conducted summer training most years with the 12th Inf. at Fort George G. Meade, MD, or Fort Howard, MD, and some years with the 34th Inf. at Fort Eustis, VA. Also conducted infantry CMTC training some years at Fort George G. Meade, Fort Eustis, Fort Howard, or Fort Washington, MD, as an alternate form of summer training. Typically conducted Inactive Training Period meetings at the armory of the 107th F.A. in Pittsburgh, PA. Primary ROTC feeder schools were Pennsylvania State College and Pennsylvania Military College. Location 7 December 1941—Pittsburgh, PA.

**Status:** Withdrawn from the CARS on 17 October 1999 and redesignated as the 393d Regt. to consist of the 1st, 2d, and 3d Bns., elements of the 75th Div. (Training Support); concurrently the 1st, 2d, and 3d Bns. allotted to the R.A.

**Commanders, 393d Infantry Regiment**

<i>Demobilized/Inactive</i>	30 November 1918–7 December 1921	Col. Charles I. Faddis	16 January 1934–17 January 1938
	Maj. William W. Gill	Col. William E. Barron	17 January 1938–ao August 1941
	Col. Jesse R. Langley	14 April 1922–16 January 1934	Unknown

**394th Infantry Regiment (99th Division)****Organized Reserve Pennsylvania**

HQ—Pittsburgh, PA, 1921–29; Uniontown, PA, 1929–41



Demobilized on 30 November 1918 as an inactive element of the 99th Div. Reconstituted in the O.R. on 24 June 1921, assigned to the 99th Div., and allotted to the Third Corps Area. Initiated on 7 December 1921 with regimental HQ at Pittsburgh, PA. Subordinate battalion HQ concurrently organized as follows: 1st Bn. at Washington, PA; 2d Bn. at Uniontown, PA; and 3d Bn. at Chambersburg, PA. Regimental HQ relocated on 11 December 1929 to Uniontown. Conducted summer training most years with the 12th Inf. at Fort George G. Meade, MD, or Fort Howard, MD, and some years with the 34th Inf. at Fort Eustis, VA. Also conducted infantry CMTTC training some years at Fort George G. Meade or Fort Howard as an alternate form of summer training. Typically conducted Inactive Training Period meetings at the armory of the 176th F.A. in Pittsburgh and at the county auditorium in Uniontown. Primary ROTC feeder schools were Pennsylvania State College and Pennsylvania Military College. Location 7 December 1941—Uniontown, PA.

**Status:** Withdrawn from the CARS on 17 October 1999 and redesignated as the 394th Regt. to consist of the 1st Bn., an element of the 75th Div. (Training Support); concurrently the 1st Bn. allotted to the R.A.

**Commanders, 394th Infantry Regiment**

<i>Demobilized/Inactive</i>	30 November 1918–7 December 1921	Unknown	ao July 1923–ao July 1924
Lt. Col. Elmer E. Kuhn	7 December 1921–ao July 1923	Lt. Col. Leopold W. Dupuy	ao July 1924–ao August 1925
	Col. Samuel J. Taylor	ao June 1926–ao July 1941	

**395th Infantry Regiment (99th Division)****Organized Reserve Pennsylvania**

HQ—Franklin, PA, 1921–41



Demobilized 30 November 1918 as an inactive element of the 99th Div. Reconstituted in the O.R. on 24 June 1921, assigned to the 99th Div., and allotted to the Third Corps Area. Initiated 7 December 1921 with regimental HQ at Franklin, PA. Subordinate battalion HQ concurrently organized as follows: 1st Bn. at Butler, PA; 2d Bn. at Kane, PA; and 3d Bn. at Ridgway, PA. Conducted summer training most years with the 12th Inf. at Fort George G. Meade, MD, or Fort Howard, MD, and some years with the 34th Inf. at Fort Eustis, VA. Also conducted infantry CMTTC training some years at Fort George G. Meade as an alternate form of summer training. Primary ROTC feeder schools were Pennsylvania State College and Pennsylvania Military College. Location 7 December 1941—Franklin, PA.

**Status:** Withdrawn from the CARS on 17 October 1999 and redesignated as the 395th Regt. to consist of the 1st, 2d, and 3d Bns., elements of the 75th Div. (Training Support); concurrently the 1st, 2d, and 3d Bns. allotted to the R.A.

**Commanders, 395th Infantry Regiment**

<i>Demobilized/Inactive</i>	30 November 1918–7 December 1921	Lt. Col. John S. Logan	ao June 1924–ao September 1925
Maj. James O. Campbell	7 December 1921–ao January 1923	Unknown	ao September 1925–ao June 1927
Unknown	ao January 1923–ao June 1924	Col. Daniel H. McQuiston	ao June 1927–ao August 1941

**396th Infantry Regiment (99th Division)****Organized Reserve Pennsylvania**

HQ—Altoona, PA, 1921–37; Johnstown, PA, 1937–41



Demobilized 30 November 1918 as an inactive element of the 99th Div. Reconstituted in the O.R. on 24 June 1921, assigned to the 99th Div., and allotted to the Third Corps Area. Initiated 7 December 1921 with regimental HQ at Altoona, PA. Subordinate battalion HQ concurrently organized as follows: 1st Bn. at Indiana, PA; 2d Bn. at Altoona; and 3d Bn. at State College, PA. Regimental HQ relocated in June 1937 to Johnstown, PA. Typically conducted Inactive Training Period meetings at the Hinman Building in Altoona, or the N.G. armory in Indiana, PA. Conducted summer training most years with the 12th Inf. at Fort George G. Meade, MD, Fort Washington, MD, or Fort Howard, MD, and some years with the 34th Inf. at Fort Eustis, VA. Also conducted infantry CMTC training some years at Fort George G. Meade or Fort Washington as an alternate form of summer training. Primary ROTC feeder schools were Pennsylvania State College and Pennsylvania Military College. Location 7 December 1941—Franklin, PA.

**Status:** Disbanded 11 November 1944.**Commanders, 396th Infantry Regiment**

<i>Demobilized/Inactive</i>	30 November 1918–7 December 1921	Lt. Col. Harry D. McCluskey	July 1927–ao August 1927
Maj. Charles S. McLain	7 December 1921–ao August 1923	Unknown	ao August 1927–ao June 1930
Unknown	ao August 1923–ao January 1924	Col. William W. Gill	ao June 1930–13 February 1939
Col. Frederick B. Kerr	ao July 1925–July 1927	Col. Raymond P. Pennoyer	13 February 1939–ao January 1941
	Unknown	ao January 1941–7 December 1941	

**397th Infantry Regiment (100th Division)****Organized Reserve West Virginia**

HQ—Clarksburg, WV, 1921–41



Demobilized 30 November 1918 as an inactive element of the 100th Div. Reconstituted in the O.R. on 24 June 1921, assigned to the 100th Div., and allotted to the Fifth Corps Area. Initiated 30 November 1921 with regimental HQ at Clarksburg, WV. Subordinate battalion HQ concurrently organized as follows: 1st Bn. at Clarksburg; 2d Bn. at Fairmont, WV; and 3d Bn. at Martinsburg, WV. Conducted summer training most years with the 10th Inf. at Fort Thomas, KY, and some years with the 11th Inf. at Camp Knox, KY. Also conducted infantry CMTC training some years at Fort Thomas or Fort Benjamin Harrison, IN, as an alternate form of summer training. Primary ROTC feeder school was West Virginia University. Location 7 December 1941—Clarksburg, WV.

**Status:** Reorganized 17 April 1959 as the 397th Regt., an element of the 100th Div. (Training); reorganized 16 October 1996 to consist of the 1st, 2d, and 3d Bns., elements of the 100th Div. (Institutional Training).**Commanders, 397th Infantry Regiment**

<i>Demobilized/Inactive</i>	30 November 1918–30 November 1921	Lt. Col. Emerett V. Selby	ao June 1934–ao July 1936
Col. Robert L. Osborn	30 November 1921–ao August 1933	Col. Walter C. Smith	ao June 1937–ao February 1941

**398th Infantry Regiment (100th Division)****Organized Reserve West Virginia**

HQ—Huntington, WV, 1921–31; Charleston, WV, 1931–41



Demobilized 30 November 1918 as an inactive element of the 100th Div. Reconstituted in the O.R. on 24 June 1921, assigned to the 100th Div., and allotted to the Fifth Corps Area. Initiated 30 November 1921 with regimental HQ at Huntington, WV. Subordinate battalion HQ concurrently organized as follows: 1st Bn. at Charleston, WV; 2d Bn. at Huntington; and 3d Bn. at Hinton, WV. Band organized in 1923 at Charleston. Band conducted a concert on 16 April 1924 for Governor Ephraim F. Morgan at Huntington. Entire regiment relocated on 9 July 1931 to Charleston. Typically conducted Inactive Training Period meetings at the Masonic Temple or the Charleston Public Library in Charleston. Conducted summer training most years with the 10th Inf. at Fort Thomas, KY, and some years with the 11th Inf. at Camp Knox, KY. Conducted summer training with the 150th Inf. at Camp W.G. Conley, WV, in 1926. Also conducted infantry CMTC training some years at Fort Thomas, Camp Knox, or Fort Benjamin Harrison, IN, as an alternate form of summer training. Primary ROTC feeder school was West Virginia University. Location 7 December 1941—Charleston, WV.

**Status:** Reorganized 17 April 1959 as the 398th Regt., an element of the 100th Div. (Training); reorganized 16 October 2004 to consist of the 1st, 2d, 3d, and 4th Bns., elements of the 100th Div. (Institutional Training).

**Commanders, 398th Infantry Regiment**

<i>Demobilized/Inactive</i>	30 November 1918–30 November 1921	Lt. Col. Antoine A. Gaujot	September 1924–June 1935
Maj. W. P. Tams	30 November 1921–ao January 1922	Lt. Col. William T. Lovins	ao June 1935–ao June 1937
Col. James R. Brockus	ao June 1922–September 1924	Col. Justus Stalnaker	ao November 1937–ao September 1941

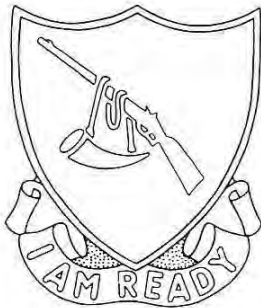
**399th Infantry Regiment (100th Division)****Organized Reserve Kentucky**HQ—*Not initiated*, 1921–22; Lexington, KY, 1922–41

Demobilized on 30 November 1918 as an inactive element of the 100th Div. Reconstituted in the O.R. on 24 June 1921, assigned to the 100th Div., and allotted to the Fifth Corps Area. Initiated in February 1922 with regimental HQ at Lexington, KY. Subordinate battalion HQ concurrently organized as follows: 1st Bn. at Frankfort, KY; 2d Bn. at Covington, KY; and 3d Bn. at Newport, KY. Typically conducted Inactive Training Period meetings at the Phoenix Hotel in Lexington. Conducted summer training most years with the 10th Inf. at Fort Thomas, KY, and some years with the 11th Inf. at Camp Knox, KY. Also conducted infantry CMTC training some years at Fort Thomas, Camp Knox, or Fort Benjamin Harrison, IN, as an alternate form of summer training. Primary ROTC feeder school was the University of Kentucky. Location 7 December 1941—Lexington, KY.

**Status:** Reorganized 17 April 1959 as the 399th Regt., an element of the 100th Div. (Training); reorganized 19 October 2001 to consist of the 1st, 2d, 3d, and 4th Bns., elements of the 100th Div. (Institutional Training).

**Commanders, 399th Infantry Regiment**

<i>Demobilized/Inactive</i>	30 November 1918–February 1922	Unknown	ao February 1924–ao July 1930
Maj. Hanson B. Hickman	February 1922–ao January 1923	Lt. Col. John A. Yancey	ao July 1930–ao August 1930
Maj. William F. Chambers	ao December 1923–ao February 1924	Col. Morris B. Gifford	ao June 1931–21 September 1934
	Col. John H. Terry	21 September 1934–ao November 1941	

**400th Infantry Regiment (100th Division)****Organized Reserve Kentucky**HQ—*Not initiated*, 1921–22; Louisville, KY, 1922–41

Demobilized 30 November 1918 as an inactive element of the 100th Div. Reconstituted in the O.R. on 24 June 1921, assigned to the 100th Div., and allotted to the Fifth Corps Area. Initiated in February 1922 with regimental HQ at Louisville, KY. Subordinate battalion HQ concurrently organized as follows: 1st Bn. at Louisville; 2d Bn. at Louisville; and 3d Bn. at Paducah, KY. Conducted summer training most years with the 11th Inf. at Camp Knox, KY, or Fort Benjamin Harrison, IN, and some years with the 10th Inf. at Fort Thomas, KY. Also conducted infantry CMTC training some years at Camp Knox or Fort Benjamin Harrison, IN, an alternate form of summer training. Primary ROTC feeder schools were the University of Kentucky and Western Kentucky State Teacher's College. Location 7 December 1941—Louisville, KY.

**Status:** Inactive in the Army Reserve as the 400th Regt.**Commanders, 400th Infantry Regiment**

<i>Demobilized/Inactive</i>	30 November 1918–February 1922	Col. Felix Kerrick	ao February 1924–ao June 1924
Lt. Col. Forrest C. Braden	February 1922–ao January 1923	Col. Erskine B. Bassett	ao September 1924–ao August 1930
	Col. George D. Caldwell	ao May 1931–ao August 1941	

**401st Infantry Regiment (101st Division)****Organized Reserve Wisconsin**

HQ—Milwaukee, WI, 1921–41



Demobilized 30 November 1918 as an inactive element of the 101st Div. Reconstituted in the O.R. on 24 June 1921, assigned to the 101st Div., and allotted to the Sixth Corps Area. Initiated on 13 October 1921 with the entire regiment at Milwaukee, WI. Conducted summer training most years with the 2d Inf. at Camp Custer, MI, and some years at Fort Sheridan, IL. Conducted summer training at Camp Williams, WI, with the 127th Inf. in 1928 and 1930. Conducted infantry CMTC training some years at Fort Sheridan as an alternate form of summer training. Primary ROTC feeder schools were the University of Wisconsin and Ripon College. Location 7 December 1941—Milwaukee, WI.

**Commanders, 401st Infantry Regiment**

<i>Demobilized/Inactive</i>	30 November 1918–13 October 1921	Col. Paul B. Ahnert	13 October 1921–18 September 1937
	Col. Christian J. Otjen	18 September 1937–12 January 1941	

**402d Infantry Regiment (101st Division)****Organized Reserve Wisconsin**

HQ—Appleton, WI, 1921–25; Oshkosh, WI, 1925–37; Fond Du Lac, 1937–41



Demobilized 30 November 1918 as an inactive element of the 101st Div. Reconstituted in the O.R. on 24 June 1921, assigned to the 101st Div., and allotted to the Sixth Corps Area. Initiated on 8 November 1921 with regimental HQ at Appleton, WI. Subordinate battalion HQ concurrently organized as follows: 1st Bn. at Rhinelander, WI; 2d Bn. at Stevens Point, WI; and the 3d Bn. at Oshkosh, WI. Regiment relocated on 2 June 1925 as follows: regimental HQ and 3d Bn. at Oshkosh; 1st Bn. at Wausau, WI; and the 2d Bn. at Green Bay, WI. Regimental HQ relocated on 28 July 1937 to Fond du Lac, WI. Typically conducted Inactive Training Period meetings at the Hotel Retlaw in Fond du Lac. Conducted summer training most years with the 2d Inf. at Camp Custer, MI, and some years at Fort Sheridan, IL. Conducted summer training at Camp Douglas, WI, with units of the 64th Inf. Brig. in 1927 and 1932. Also conducted infantry CMTC training

some years at Fort Brady, MI, or Jefferson Barracks, MO, as an alternate form of summer training. Primary ROTC feeder schools was Ripon College and St. Norbert's College. Location 7 December 1941—Fond Du Lac, WI.

**Status:** Disbanded 6 August 1942.

**Commanders, 402d Infantry Regiment**

<i>Demobilized/Inactive</i>	30 November 1918–8 November 1921	Lt. Col. Robert P. Boardman	3 December 1932–19 December 1933
Capt. Robert P. Boardman	8 November 1921–ao August 1922	Col. Harry E. Bradley	19 July 1933–ao August 1935
Col. Peter F. Piasecki	6 October 1923–3 December 1932	Col. Stephen A. Park	July 1936–ao July 1941

**403d Infantry Regiment (101st Division)**

**Organized Reserve Wisconsin**

**HQ**—Madison, WI, 1921–41



Demobilized 30 November 1918 as an inactive element of the 101st Div. Reconstituted in the O.R. on 24 June 1921, assigned to the 101st Div., and allotted to the Sixth Corps Area. Initiated on 8 November 1921 with regimental HQ at Madison, WI. Subordinate battalion HQ concurrently organized as follows: 1st Bn. at Waukesha, WI; 2d Bn. at Beloit, WI; and the 3d Bn. at Dodgeville, WI. Band organized about 1923 at Madison. Conducted summer training most years with the 2d Inf. at Camp Custer, MI, and some years at Fort Sheridan, IL. Conducted summer training at Camp Douglas, WI, with units of the 64th Inf. Brig. in 1927. Also conducted infantry CMTC training some years at Fort Brady, MI, or Fort Sheridan as an alternate form of summer training. Primary ROTC feeder school was the University of Wisconsin. Location 7 December 1941—Madison, WI.

**Status:** Disbanded 15 August 1942.

**Commanders, 403d Infantry Regiment**

Maj. George A. Shipley	8 November 1921–29 November 1921	Col. Roy F. Farrand	April 1927–ao August 1937
Lt. Col. Roy F. Farrand	29 November 1921–4 May 1926	Lt. Col. John K. Stotz	ao May 1938–ao August 1940
Col. Robert H. Murray	4 May 1926–April 1927	Unknown	ao August 1940–7 December 1941

**404th Infantry Regiment (101st Division)**

**Organized Reserve Wisconsin**

**HQ**—Eau Claire, WI, 1921–41



Demobilized 30 November 1918 as an inactive element of the 101st Div. Reconstituted in the O.R. 24 June 1921, assigned to the 101st Div., and allotted to the Sixth Corps Area. Initiated 29 November 1921 with regimental HQ and 1st Bn. at Eau Claire, WI; 2d Bn. at Superior, WI; and the 3d Bn. at La Crosse, WI. Conducted summer training most years with the 2d Inf. at Camp Custer, MI, and some years at Fort Sheridan, IL. Conducted summer training at Camp Williams, WI, with the 128th Inf. in 1928 and 1930 and with the 127th Inf. in 1936. Provided a number of officers to the 126th Inf. at Camp Custer, MI, for the 1936 Second Army Maneuver. Also conducted infantry CMTC training some years at Fort Brady, MI, or Camp Custer as an alternate form of summer training. Primary ROTC feeder school was the University of Wisconsin. Location 7 December 1941—Eau Claire, WI.

**Status:** Disbanded 11 November 1944.

**Events:** 214

**Commanders, 404th Infantry Regiment**

Lt. Col. Edgar A. Firth	29 November 1921–ao July 1923	Col. Edgar A. Firth	21 December 1929–June 1935
Unknown	ao July 1923–May 1927	Col. Marshall A. Goff	June 1935–ao January 1941
Col. Robert H. Murray	May 1927–21 December 1929	Unknown	ao January 1941–7 December 1941

**405th Infantry Regiment** (102d Division)**Organized Reserve Arkansas****HQ**—Little Rock, AR, 1921–22; Fort Smith, AR, 1922–23; Little Rock, AR, 1923–26; Jonesboro, AR, 1926–31; Little Rock, AR, 1931–41

Demobilized 30 November 1918 as an inactive element of the 102d Div. Reconstituted in the O.R. on 24 June 1921, assigned to the 102d Div., and allotted to the Seventh Corps Area. Initiated 12 October 1921 with regimental HQ at Little Rock, AR. Subordinate battalion HQ concurrently organized as follows: 1st Bn. at Fort Smith, AR; 2d Bn. at Little Rock; and 3d Bn. at Jonesboro, AR. Regimental HQ relocated as follows: to Fort Smith, AR, on 19 September 1922; to Little Rock on 20 August 1923; to Jonesboro on 26 May 1926; and to Little Rock on 12 October 1931. Relieved from the 203d Inf. Brig. on 6 March 1930 and assigned to the 204th Inf. Brig. Conducted summer training most years with the 17th Inf. at Fort Leavenworth, KS. Conducted summer training at Camp Pike, AR, with the 153d Inf. in 1936. Also conducted infantry CMTC training some years at Camp Pike as an alternate

form of summer training. Primary ROTC feeder schools were the University of Arkansas, Henderson State Teacher's College, and Ouachita College. Location 7 December 1941—Little Rock, AR (inactivated 6 January 1942).

**Status:** Consolidated with the 3d Bn., 9th Inf.**Commanders, 405th Infantry Regiment**

Col. Joe S. Harris	12 October 1921–ao September 1925	Col. Emmett M. Ratliff	ao May 1927–ao May 1935
Unknown	ao September 1925–ao May 1927	Col. Frederick E. Whitten	17 December 1935–13 April 1937
	Col. John W. Lee		13 April 1937–ao November 1941

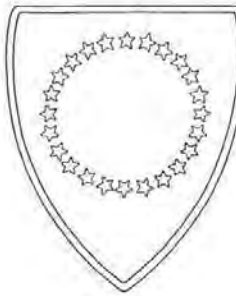
**406th Infantry Regiment** (102d Division)**Organized Reserve Arkansas/Missouri****HQ**—Little Rock, AR, 1921–26; Springfield, MO, 1926–41

Demobilized 30 November 1918 as an inactive element of the 102d Div. Reconstituted in the O.R. on 24 June 1921, assigned to the 102d Div., and allotted to the Seventh Corps Area. Initiated 12 October 1921 with regimental HQ at Little Rock, AR. Subordinate battalion HQ concurrently organized as follows: 1st Bn. at Hot Springs, AR; 2d Bn. at Pine Bluff, AR; and 3d Bn. at Camden, AR. Regimental HQ relocated 26 May 1926 to Springfield, MO. Subordinate battalion HQ concurrently relocated as follows: 1st Bn. to Springfield; 2d Bn. to Poplar Bluff, MO; and 3d Bn. to Cape Girardeau, MO. Conducted summer training most years with the 17th Inf. at Fort Leavenworth, KS, and some years at Fort Riley, KS, or Fort Crook, NE. Provided a number of officers to the 138th Inf. at Fort Riley, KS, for the 1937 Fourth Army Maneuver. Also conducted infantry CMTC training some years at Fort Leavenworth and Camp Pike, AR, as an alternate form of summer

training. Primary ROTC feeder school was the Missouri School of Mines. Location 7 December 1941—Springfield, MO (inactivated 6 January 1942).

**Status:** Consolidated with the 3d Bn., 14th Inf.**Commanders, 406th Infantry Regiment**

Col. Charles D. James	12 October 1921–ao September 1925	Col. Leroy K. Robbins	January 1928–September 1937
Unknown	ao September 1925–January 1928	Lt. Col. George T. Desloge	September 1937–ao November 1937
	Unknown		ao November 1937–7 December 1941



**407th Infantry Regiment** (102d Division)**Organized Reserve Missouri**

HQ—St. Louis, MO, 1921–41

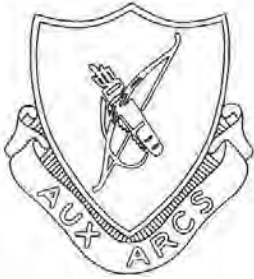

Demobilized 30 November 1918 as an inactive element of the 102d Div. Reconstituted in the O.R. on 24 June 1921, assigned to the 102d Div., and allotted to the Seventh Corps Area. Initiated 12 October 1921 with regimental HQ at St. Louis, MO. Subordinate battalion HQ concurrently organized as follows: 1st Bn. at Hannibal, MO; 2d Bn. at Jefferson City, MO; and 3d Battalion at Mexico, MO. Relieved from the 204th Inf. Brig. on 6 March 1930 and assigned to the 203d Inf. Brig. Typically conducted Inactive Training Period meetings at the Battery Armory on Grand Street in St. Louis. Conducted summer training most years with the 17th Inf. at Fort Leavenworth, KS, and some years at Fort Riley, KS, or Fort Crook, NE. Conducted summer training at Camp Pike, AR, with the 153d Inf. in 1931. Also conducted infantry CMTC training some years at Fort

Leavenworth and Camp Pike as an alternate form of summer training. Primary ROTC feeder school was the Missouri School of Mines. Location 7 December 1941—St. Louis, MO (Inactivated 6 January 1942).

**Status:** Consolidated with the 4th Bn., 6th Inf.**Commanders, 407th Infantry Regiment**

Col. Edmund J. McMahon	12 October 1921–ao October 1937	Unknown	ao October 1937–7 December 1941
------------------------	---------------------------------	---------	---------------------------------

**408th Infantry Regiment** (102d Division)**Organized Reserve Missouri**

HQ—Kansas City, MO, 1921–41

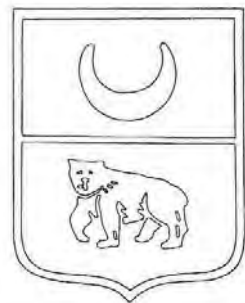

Demobilized 30 November 1918 as an inactive element of the 102d Div. Reconstituted in the O.R. on 24 June 1921, assigned to the 102d Div., and allotted to the Seventh Corps Area. Initiated 12 October 1921 with regimental HQ at Kansas City, MO. Subordinate battalion HQ concurrently organized as follows: 1st Bn. at St. Joseph, MO; 2d Bn. at Sedalia, MO; and 3d Bn. at Springfield, MO. Typically conducted Inactive Training Period meetings at the 110th Engrs. armory or the O.R. Center building at 20th and Vine Streets in Kansas City. Conducted summer training most years with the 17th Inf. at Fort Leavenworth, KS, and some years with the 137th Inf. at Fort Riley, KS. Also conducted infantry CMTC training some years at Fort Leavenworth and Fort Riley as an alternate form of summer training. Primary ROTC feeder schools were the Missouri School of Mines and the University of Kansas. Regimental commander, Col. Carl I. Ristine, would

be called to Active Duty in World War II and serve as the military defense attorney for Walter Dasch, one of the eight Nazi saboteurs captured in Florida and New York in 1942. Location 7 December 1941—Kansas City, MO (inactivated 6 January 1942).

**Status:** Disbanded 11 November 1944.**Commanders, 408th Infantry Regiment**

Col. John D. McNeely	12 October 1921–ao January 1922	Unknown	ao August 1927–ao July 1930
Unknown	ao January 1922–ao September 1925	Col. Carl I. Ristine	ao July 1930–13 April 1937
Lt. Col. Ward L. Schrantz	ao September 1925–ao August 1927	Col. Frederick E. Whitten	13 April 1937–ao January 1941
	Unknown	ao January 1941–7 December 1941	

**409th Infantry Regiment** (103d Division)**Organized Reserve Arizona**

HQ—Bisbee, AZ, 1921–22; Tucson, AZ, 1922–41



Constituted in the O.R. on 24 June 1921, assigned to the 103d Div., and allotted to the Eighth Corps Area. Initiated 19 October 1921 with regimental HQ at Bisbee, AZ. Subordinate battalion HQ concurrently organized as follows: 1st Bn. at Fort Huachuca, AZ; 2d Bn. at Camp Stephen D. Little, AZ; and 3d Bn. at Camp Harry J. Jones, AZ. Regimental HQ relocated on 2 May 1922 to Tucson, AZ. Conducted summer training most years with the 25th Inf. at Camp Stephen D. Little, 1922–32, and Fort Huachuca, 1933–41. Primary ROTC feeder school was the University of Arizona. Location 7 December 1941—Tucson, AZ.

**Status:** Withdrawn from the CARS on 17 October 1999 and redesignated as the 409th Regt. to consist of the 1st and 2d Bns., elements of the 85th Div. (Training Support); concurrently the 1st and 2d Bns. allotted to the R.A.

**Commanders, 409th Infantry Regiment**

Col. John C. Greenway	19 October 1921–15 March 1922	Lt. Col. Verling W. Marshall	ao July 1928–ao July 1929
Col. Edgar P. Grinstead	16 March 1922–4 October 1924	Col. Floyd E. Thomas	ao May 1930–September 1930
Lt. Col. Frank H. Hayes	4 October 1924–1 February 1925	Col. Philip S. Van Cise	September 1930–ao May 1931
Col. Charles G. Sturtevant	1 February 1925–ao January 1927	Unknown	ao May 1931–ao August 1936
Unknown	ao January 1927–ao July 1928	Col. Floyd E. Thomas	ao August 1936–ao January 1941

**410th Infantry Regiment** (103d Division)**Organized Reserve New Mexico**

HQ—Roswell, NM, 1921–41

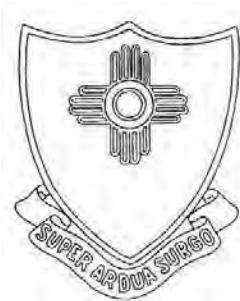

Constituted in the O.R. on 24 June 1921, assigned to the 103d Div., and allotted to the Eighth Corps Area. Initiated on 19 October 1921 with regimental HQ at Roswell, NM. Subordinate battalion HQ concurrently organized as follows: 1st Bn. at Roswell; 2d Bn. at Albuquerque, NM; and 3d Bn. at Las Cruces, NM. Band organized in December 1925. Conducted summer training most years with the 25th Inf. at Camp Stephen D. Little, AZ, 1922–32, and Fort Huachuca, AZ, 1933–41. Conducted summer training in 1925 with the 1st Bn., 38th Inf. at Fort Logan, CO. Also conducted infantry CMTC training some years at Fort Logan as an alternate form of summer training. Regiment provided about 30 officers attached to the 25th Inf. for the 1938 Third Army Maneuver at Fort Bliss, TX. Primary ROTC feeder school was the New Mexico Military Institute and New Mexico College of Agriculture and Mechanical Arts. Location 7 December 1941—Roswell, NM.

**Status:** Withdrawn from the CARS on 17 October 1999 and redesignated as the 410th Regt. to consist of the 1st, 2d, and 3d Bns., elements of the 85th Div. (Training Support); concurrently the 1st, 2d, and 3d Bns. allotted to the R.A.

**Commanders, 410th Infantry Regiment**

Col. Edgar P. Grinstead	19 October 1921–16 March 1922	Col. Jefferson D. Atwood	16 March 1922–ao January 1940
	Unknown	ao January 1940–7 December 1941	

**411th Infantry Regiment** (103d Division)**Organized Reserve Colorado****HQ**—Denver, CO, 1921–41

Constituted in the O.R. on 24 June 1921, assigned to the 103d Div., and allotted to the Eighth Corps Area. Initiated 19 October 1921 with regimental HQ at Denver, CO. Subordinate battalion HQ concurrently organized as follows: 1st Bn. at Denver; 2d Bn. at Greeley, CO; and 3d Bn. at Sterling, CO. Regimental HQ and 1st Bn. typically conducted Inactive Training Period meetings at the Kitteridge Building in Denver. Conducted summer training most years with the 1st Bn., 38th Inf. at Fort Logan, CO, and after 1927, with units of the 4th Inf. Brig. at Fort D.A. Russell/Francis E. Warren, WY, and the Pole Mountain Military Reservation, WY. Also conducted infantry CMTC training some years at Fort Logan as an alternate form of summer training. Primary ROTC feeder school was the Colorado State College of Agriculture and Mechanic Arts. Location 7 December 1941—Denver, CO.

**Status:** Withdrawn from the CARS on 17 October 1999 and redesignated as the 411th Regt. to consist of the 1st, 2d, and 3d Bns., elements of the 85th Div. (Training Support).

**Events:** 166, 232**Commanders, 411th Infantry Regiment**

Col. Homer C. Washburn	21 October 1921–8 February 1931	Col. William C. Danks	8 February 1931–25 August 1931
	Col. Philip S. Van Cise		25 August 1931–December 1941

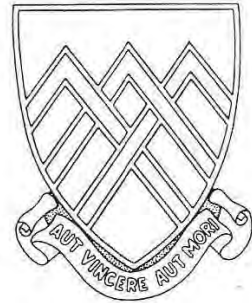
**412th Infantry Regiment** (103d Division)**Organized Reserve Colorado****HQ**—Pueblo, CO, 1921–41

Constituted in the O.R. on 24 June 1921, assigned to the 103d Div., and allotted to the Eighth Corps Area. Initiated 23 November 1921 with regimental HQ at Pueblo, CO. Subordinate battalion HQ concurrently organized as follows: 1st Bn. at La Junta, CO; and 2d Bn. at Trinidad, CO; and 3d Bn. at Pueblo. Conducted summer training most years with the 1st Bn., 38th Inf. at Fort Logan, CO, and after 1927, with units of the 4th Inf. Brig. at Fort D.A. Russell/Francis E. Warren, WY, and the Pole Mountain Military Reservation, WY. Also conducted infantry CMTC training some years at Fort Logan as an alternate form of summer training. Primary ROTC feeder school was the Colorado State College of Agriculture and Mechanic Arts. Location 7 December 1941—Pueblo, CO.

**Status:** Disbanded 11 November 1944.**Events:** 166**Commanders, 412th Infantry Regiment**

Maj. W.T. Little	23 November 1921–9 January 1922	Col. Patrick J. Hamrock	ao January 1924–ao January 1932
Lt. Col. John R. Youngblood	10 January 1922–ao October 1922	Unknown	ao January 1932–ao March 1936
Unknown	ao October 1922–ao January 1924	Col. John G. L. Hanlan	ao March 1936–ao January 1940
	Unknown		ao January 1940–7 December 1941

**413th Infantry Regiment** (104th Division)

**Organized Reserve Utah and Nevada**

**HQ**—*Not initiated*, 1921–22; Salt Lake City, UT, 1922–41



Constituted in the O.R. on 24 June 1921, assigned to the 104th Div., and allotted to the Ninth Corps Area. Initiated 25 January 1922 with regimental HQ at Salt Lake City, UT. Subordinate battalion HQ concurrently organized as follows: 1st Bn. at Salt Lake City; 2d Bn. at Reno, NV; and 3d Bn. at Ogden, UT. Typically conducted Inactive Training Period meetings at the Vermont Building in Salt Lake City. Conducted summer training most years with the 38th Inf. at Fort Douglas, UT. Also conducted infantry CMTC training some years at Fort Douglas as an alternate form of summer training. Primary ROTC feeder school were the University of Utah and the University of Nevada. Location 7 December 1941—Salt Lake City, UT.

**Status:** Reorganized 10 June 1959 as the 413th Regt., an element of the 104th Div. (Training); reorganized 16 April 1995 to consist of the 1st, 2d, and 3d Bns., elements of the 104th Div. (Institutional Training).

**Commanders, 413th Infantry Regiment**

Maj. Roy A. McIntyre	25 January 1922–ao April 1923	Maj. O. Duncan Davis	ao January 1925–ao September 1926
Unknown	ao April 1923–ao January 1925	Col. Jacob A. Johnston	ao December 1926–25 September 1941

**414th Infantry Regiment** (104th Division)

**Organized Reserve Idaho**

**HQ**—Pocatello, ID, 1921–41



Constituted in the O.R. on 24 June 1921, assigned to the 104th Div., and allotted to the Ninth Corps Area. Initiated 22 December 1921 with regimental HQ at Pocatello, ID. Subordinate battalion HQ concurrently organized as follows: 1st Bn. at Lewiston, ID; 2d Bn. at Pocatello; and 3d Bn. at Boise, ID. Entire regiment relocated on 28 January 1930 to Pocatello. Conducted summer training most years with the 38th Inf. at Fort Douglas, UT. Also conducted infantry CMTC training some years at Fort Douglas or Fort Missoula, MT, as an alternate form of summer training. Primary ROTC feeder school was the University of Idaho. Location 7 December 1941—Pocatello, ID.

**Status:** Reorganized 10 June 1959 as the 414th Regt., an element of the 104th Div. (Training); reorganized 16 October–16 November 1996 to consist of the 1st, 2d, and 3d Bns., elements of the 104th Div. (Institutional Training).

**Commanders, 414th Infantry Regiment**

Unknown	22 December 1921–13 March 1923	Col. Earle L. Shattuck	14 March 1923–ao November 1941
---------	--------------------------------	------------------------	--------------------------------

**415th Infantry Regiment (104th Division)****Organized Reserve Wyoming**

**HQ**—*Not initiated*, 1921–22; Casper, WY, 1922–40; *Inactive*, 1940–41

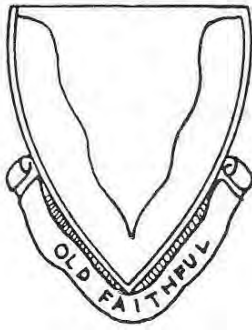

Constituted in the O.R. on 24 June 1921, assigned to the 104th Div., and allotted to the Ninth Corps Area. Initiated on 30 January 1922 with regimental HQ at Casper, WY. Subordinate battalion HQ concurrently organized as follows: 1st Bn. at Gillette, WY; 2d Bn. at Casper; and 3d Bn. at Laramie, WY. Band organized in 1923 at Roundup, MT; inactivated in 1929. Entire regiment relocated on 2 May 1930 to Casper. Conducted summer training most years with the 38th Inf. at Fort Douglas, UT, and after 1927, with units of the 4th Inf. Brig. at Fort D.A. Russell/Francis E. Warren, WY, and the Pole Mountain Military Reservation, WY. Primary ROTC feeder school was the University of Wyoming). Inactivated 27 December 1940 at Casper by relief of personnel. Location 7 December 1941—*Inactive*.

**Status:** Reorganized 10 June 1959 as the 415th Regt., an element of the 104th Div. (Training); reorganized 16 October 1996 to consist of the 1st, 2d, and 3d Bns., elements of the 104th Div. (Institutional Training).

**Commanders, 415th Infantry Regiment**

Unknown	30 January 1922–15 October 1922 <i>Inactive</i>	Col. Irwin A. Froyd 27 December 1940–7 December 1941	16 October 1922–27 December 1940
---------	----------------------------------------------------	---------------------------------------------------------	----------------------------------

**416th Infantry Regiment (104th Division)****Organized Reserve Montana**

**HQ**—*Not initiated*, 1921–22; Billings, MT, 1922–41



Constituted in the O.R. on 24 June 1921, assigned to the 104th Div., and allotted to the Ninth Corps Area. Initiated in January 1922 with regimental HQ at Billings, MT. Subordinate battalion HQ concurrently organized as follows: 1st Bn. at Great Falls, MT; 2d Bn. at Roundup, MT; and 3d Bn. at Missoula, MT. Entire regiment relocated on 28 January 1930 to Billings. Typically conducted Inactive Training Period meetings at the City Hall in Billings. Conducted summer training most years with the 1st Bn., 4th Inf. at Fort Missoula, MT, and some years with the 38th Inf. at Fort Douglas, UT. Primary ROTC feeder schools were Montana State University and Montana State College. Location 7 December 1941—Billings, MT.

**Status:** Inactive in the Army Reserve as the 416th Regt.

**Commanders, 416th Infantry Regiment**

Unknown	January 1922–ao April 1923	Maj. John G. Noren	ao September 1927–19 February 1930
Lt. Col. Stephen Tighe	ao April 1923–17 August 1924	Col. Frank M. Williams	19 February 1930–ao December 1934
Lt. Col. Ralph W. Reynolds	17 August 1924–ao July 1926	Unknown	ao December 1934–1 October 1939
Unknown	ao July 1926–ao September 1927	Col. Orrin W. Potter	1 October 1939–ao January 1940
	Unknown	ao January 1940–7 December 1941	

**417th Infantry Regiment (76th Division)****Organized Reserve Connecticut****HQ**—*Not initiated*, 1921–22; New Haven, CT, 1922–41

Constituted in the O.R. on 24 June 1921, assigned to the 76th Div., and allotted to the First Corps Area. Initiated on 9 March 1922 with regimental HQ at New Haven, CT. Subordinate battalion HQ concurrently organized as follows: 1st Bn. at New London, CT; 2d Bn. at Middletown, CT; and 3d Bn. at New Haven. Typically conducted Inactive Training Period meetings at the Meadow Street armory or the armory of the Governor's Foot Guards in New Haven. Conducted summer training most years with the 13th Inf. Regt. at Camp Devens, MA, or Fort Adams, RI. Also conducted infantry CMTC training some years at Camp Devens as an alternate form of summer training. Conducted an annual contact camp at Connecticut Agricultural College, Storrs, CT, during the fall or winter months. Primary ROTC feeder school was Connecticut Agricultural College. Location 7 December 1941—New Haven, CT.

**Status:** Reorganized on 1 May 1959 as the 417th Regt., an element of the 76th Div. (Training); reorganized on 17 October 2004 to consist of the 1st and 2d Bns., elements of the 98th Div. (Institutional Training).

**Commanders, 417th Infantry Regiment**

Unknown	9 March 1922–6 January 1923	Col. George E. Hall	18 February 1925–October 1932
Maj. Francis S. Dunn	6 January 1923–18 February 1925	Col. Charles C. Rossire Jr.	October 1932–ao November 1941

**418th Infantry Regiment (76th Division)****Organized Reserve Connecticut****HQ**—*Not initiated*, 1921–22; Bridgeport, CT, 1922–41

Constituted in the O.R. on 24 June 1921, assigned to the 76th Div., and allotted to the First Corps Area. Initiated on 31 January 1922 with regimental HQ at Bridgeport, CT. Subordinate battalion HQ concurrently organized as follows: 1st Bn. at Waterbury, CT; 2d Bn. at Bridgeport; and 3d Bn. at Stamford, CT. Band organized at Waterbury in December 1925 from the local American Legion Band. Typically conducted Inactive Training Period meetings at the armory of the 242d C.A., the Federal Building, or the University Club in Bridgeport. Conducted an annual contact camp at Connecticut Agricultural College, Storrs, CT, during the fall or winter months. Conducted an overland march from Bridgeport to Leitchfield and return in the summer of 1926. Conducted summer training most years with the 5th and 13th Inf. Regts. at Camp Devens, MA, or Fort Ethan Allen, VT.

Also conducted infantry CMTC training some years at Camp Devens or Fort Adams, RI, as an alternate form of summer training. Primary ROTC feeder school was Connecticut Agricultural College. Location 7 December 1941—Bridgeport, CT.

**Commanders, 418th Infantry Regiment**

Lt. Col. Henry H. Adams	31 January 1922–March 1924	Col. Frederic E. Adams	April 1931–17 January 1940
Lt. Col. Reginald B. De Lacour	March 1924–April 1931	Col. Roy E. Rice	17 January 1940–ao December 1941

**418th Infantry Regiment (Light Tanks)****Organized Reserve Pennsylvania****HQ**—Scranton, PA, 1932–33; Baltimore, MD, 1932

Constituted in the O.R. on 15 October 1921 as HHC, 7th Tank Group, allotted to the Third Corps Area, and assigned to the GHQR. Initiated in September 1922 at Scranton, PA. Reorganized and redesignated at Scranton as HHC, 307th Tank Regt. (Light) on 20 May 1930. Subordinate battalions organized from existing tank battalions as follows: the 307th Tank Bn. relocated to Nanticoke, PA, as the 1st Bn.; the 308th Tank Bn. at Milton, PA, as the 2d Bn.; and the 311th Tank Bn. at Sayre, PA, as the 3d Bn. Reorganized and redesignated 418th Inf. Regt. (Light Tanks) on 25 October 1932 and assigned to the GHQR. Redesignated 425th Inf. Regt. (Light Tanks) on 3 November 1932.

**Commanders, 418th Infantry Regiment (Light Tanks)**

Lt. Col. Anson Jackson

25 October 1932–3 November 1932

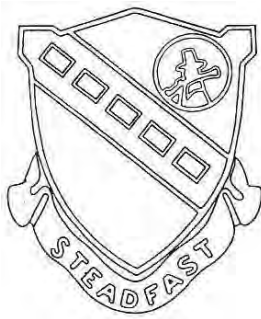
**419th Infantry Regiment (94th Division)****Organized Reserve Massachusetts****HQ**—Worcester, MA, 1921–25; Springfield, MA, 1925–41

Constituted in the O.R. on 24 June 1921, assigned to the 94th Div., and allotted to the First Corps Area. Initiated 29 December 1921 with regimental HQ at Worcester, MA. Subordinate battalion HQ concurrently organized as follows: 1st Bn. at Pittsfield, MA; 2d Bn. at Springfield, MA; and 3d Bn. at Worcester. Band organized 1 October 1924 at Worcester; inactivated about June 1929. Regimental HQ relocated on 23 March 1925 to Springfield, MA. Mobilized 50 officers to assist with hurricane relief efforts in Springfield, MA, 21–24 September 1938. Typically conducted Inactive Training Period meetings at the Chamber of Commerce Building in Worcester and the Springfield Armory in Springfield. Conducted summer training most years with the 5th and 13th Inf. Regts. at Camp Devens, MA, 1922–40. Also conducted infantry CMTC training some years at Camp Devens as an alternate form of summer training. Primary ROTC feeder school was Boston University. Location 7 December 1941—Springfield, MA.

**Status:** Disbanded 11 November 1944.**Commanders, 419th Infantry Regiment**

Col. Duncan Stewart  
Col. Easton T. Gibson  
Col. William H. Dolan  
Col. James T. Potter

29 December 1921–April 1922  
April 1922–January 1923  
January 1923–ao February 1923  
ao June 1923–ao January 1934

Col. Henry A. Hale Jr.  
Col. Maurice H. Richardson  
Col. Walter H. Butler  
Unknown

ao June 1934–26 July 1934  
26 July 1934–16 May 1937  
16 May 1937–ao August 1941  
ao August 1941–7 December 1941

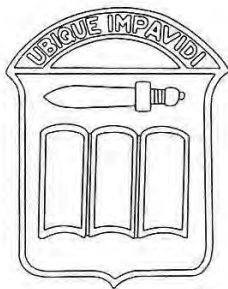
**420th Infantry Regiment (Light Tanks)****Organized Reserve Illinois****HQ**—Chicago, IL, 1932–38; Rockford, IL, 1938–41

Constituted in the O.R. on 15 October 1921 as HHC, 9th Tank Group, allotted to the Sixth Corps Area, and assigned to the GHQR. Initiated in April 1922 at Chicago, IL. Reorganized and redesignated at Chicago as HHC, 309th Tank Regt. (Light) on 20 May 1930. Subordinate battalions organized from existing tank battalions as follows: the 320th Tank Bn. at Champaign, IL, as the 1st Bn.; the 321st Tank Bn. at Chicago, IL, as the 2d Bn.; and the 322d Tank Bn. at Peoria, IL, as the 3d Bn. Reorganized and redesignated 420th Inf. Regt. (Light Tanks) on 25 October 1932 and assigned to the GHQR. Regimental HQ relocated by 1938 to Rockford, IL. The 3d Bn. typically conducted Inactive Training Period meetings at the Post Office Building in Quincy. Conducted summer training most years with the 6th Tank Co. at Jefferson Barracks, MO, and some years at the Peoria Tank Training Center, Peoria, IL. Location 7 December 1941—Chicago, IL.

**Events: 159**

**Commanders, 420th Infantry Regiment (Light Tanks)**

Lt. Col. Henry M. Huxley	24 October 1932–July 1934	Maj. Joseph H. McIntyre	1 September 1936–ao January 1940
Lt. Col. Wilfred S. Kay	July 1934–10 August 1936	Unknown	ao January 1940–7 December 1941

**421st Infantry Regiment (Heavy Tanks)**

**Organized Reserve Pennsylvania**

**HQ**—Scranton, PA, 1932; Philadelphia, PA, 1932–41



Constituted in the O.R. on 5 September 1928 as HHC, 10th Tank Group, allotted to the Third Corps Area, and assigned to the GHQR. Initiated in June 1929 at Scranton, PA. Reorganized and redesignated at Scranton as HHC, 310th Tank Regt. (Light) on 20 May 1930. Subordinate battalions organized from existing tank battalions as follows: the 309th Tank Bn. at Washington, PA, as the 1st Bn.; the 310th Tank Bn. at Wellsboro, PA, as the 2d Bn.; and the 312th Tank Bn. at Scranton, PA, as the 3d Bn. Reorganized and redesignated 421st Inf. Regt. (Heavy Tanks) on 25 October 1932 and assigned to the GHQR. Regimental HQ relocated on 15 December 1932 to Philadelphia, PA. Conducted summer training most years with the 66th Inf. (Light Tanks) at Camp George G. Meade, MD. Location 7 December 1941—Philadelphia, PA.

**Commanders, 421st Infantry Regiment (Heavy Tanks)**

Lt. Col. George F. Kemp	24 October 1932–16 June 1939	Lt. Col. Harry P. Holtz	16 June 1939–7 August 1941
-------------------------	------------------------------	-------------------------	----------------------------

**422d Infantry Regiment (Heavy Tanks)**

**Organized Reserve Georgia, Alabama,  
Indiana, and Kansas**

**HQ**—Columbus, GA, 1932–34; Atlanta, GA, 1934–41



Constituted in the O.R. on 5 September 1928 as HHC, 11th Tank Group; allotted to the Fourth Corps Area; and assigned to the GHQR. Initiated in June 1929 at Columbus, GA. Reorganized and redesignated at Columbus as HHC, 311th Tank Regt. (Light) on 20 May 1930. Subordinate battalions organized from existing tank battalions as follows: the 302d Tank Bn. at Wichita, KS, as the 1st Bn.; the 313th Tank Bn. at Tuscaloosa, AL, as the 2d Bn.; and the 318th Tank Bn. at Terre Haute, IN, as the 3d Bn. Reorganized and redesignated 422d Inf. Regt. (Heavy Tanks) on 25 October 1932 and assigned to the GHQR. Entire regiment relocated on 2 May 1934 to Atlanta, GA. Conducted summer training most years with the 4th Tank Co. at Fort Benning, GA, or Camp McClellan, AL. Also conducted infantry CMTC training some years at Camp McClellan as an alternate form of summer training. Location 7 December 1941—Atlanta, GA.

**Commanders, 422d Infantry Regiment (Heavy Tanks)**

Lt. Col. Charles E. Littlejohn	25 October 1932–19 July 1934	Lt. Col. Chester E. Martin	2 August 1934–ao May 1940
	Unknown	ao May 1940–7 December 1941	



### 423d Infantry Regiment (Heavy Tanks)

### Organized Reserve Illinois and Wisconsin

HQ—Chicago, IL, 1932–37; Green Bay, WI, 1937–41

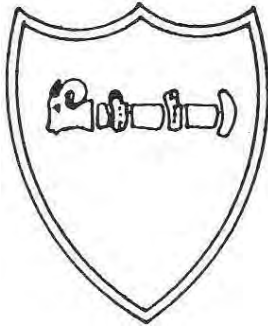

Constituted in the O.R. on 5 September 1928 as HHC, 12th Tank Group; allotted to the Sixth Corps Area; and assigned to the GHQR. Initiated in June 1929 at Milwaukee, WI. Reorganized and redesignated at Chicago as HHC, 312th Tank Regt. (Heavy) on 20 May 1930. Subordinate battalions organized from existing tank battalions as follows: the 319th Tank Bn. at Chicago as the 1st Bn.; the 323d Tank Bn. at Oshkosh, WI, as the 2d Bn.; and the 324th Tank Bn. at Milwaukee, WI as the 3d Bn. Reorganized and redesignated 423d Inf. Regt. (Heavy Tanks) on 25 October 1932. Assigned to the GHQR. Reorganized and redesignated 423d Inf. Regt. (Light Tanks) on 1 October 1933. Entire regiment, less the 3d Bn., relocated on 28 July 1937 to Green Bay, WI. The 3d Bn. concurrently relocated to Wausau, WI. Conducted summer training most years with the 6th Tank Co. at Jefferson Barracks, MO, or the 7th Tank Co. at Fort Snelling, MN. Also conducted infantry CMTC training some years at Jefferson Barracks or Fort Sheridan, IL, as an alternate form of summer training. Location 7 December 1941—Green Bay, WI.

Events: 159

#### Commanders, 423d Infantry Regiment (Heavy Tanks)

Lt. Col. Julius R. Offenbauer	25 October 1932–30 September 1933	Lt. Col. Walter H. Anschuetz	1 April 1936–June 1937
Lt. Col. Christian J. Otjen	1 October 1933–31 March 1936	Col. Norman B. Wood	June 1937–January 1941

### 424th Infantry Regiment (Light Tanks)

### Organized Reserve New York and New Jersey

HQ—New York City, NY, 1932–41



Constituted in the O.R. on 15 October 1921 as HHC, 6th Tank Group; allotted to the Second Corps Area; and assigned to the GHQR. Initiated in April 1922 at New York City, NY. Reorganized and redesignated at New York City as HHC, 306th Tank Regt. (Light) on 20 May 1930. Subordinate battalions organized from existing tank battalions as follows: the 303d Tank Bn. at Manhattan, NY, as the 1st Bn.; the 304th Tank Bn. at Newark, NJ, as the 2d Bn., and the 305th Tank Bn. at Albany, NY, as the 3d Bn. Reorganized and redesignated 424th Inf. Regt. (Light Tanks) on 25 October 1932 and assigned to the GHQR. Attached to the 77th Div. for organization and training. Conducted summer training most years with the 1st Tank Co. at Miller Field, NY. Primary ROTC feeder school was New York University. Designated mobilization training station was Camp Dix, NJ. Location 7 December 1941—New York City, NY.

Events: 173

#### Commanders, 424th Infantry Regiment (Light Tanks)

Col. Charles W. Dall	25 October 1932–July 1941
----------------------	---------------------------

**425th Infantry Regiment (Light Tanks)****Organized Reserve Pennsylvania/Maryland**

HQ—Scranton, PA, 1932–33; Baltimore, MD, 1933–41



Constituted in the O.R. on 15 October 1921 as HHC, 7th Tank Group; allotted to the Third Corps Area; and assigned to the GHQR. Initiated in September 1922 at Scranton, PA. Reorganized and redesignated at Scranton as HHC, 307th Tank Regt. (Light) on 20 May 1930. Subordinate battalions organized from existing tank battalions as follows: the 307th Tank Bn. relocated to Nanticoke, PA, as the 1st Bn.; the 308th Tank Bn. at Milton, PA, as the 2d Bn.; and the 311th Tank Bn. at Sayre, PA, as the 3d Bn. Reorganized and redesignated 418th Inf. Regt. (Light Tanks) on 25 October 1932 and assigned to the GHQR. Redesignated 425th Inf. Regt. (Light Tanks) on 3 November 1932. Regimental HQ relocated on 20 January 1933 to Baltimore, MD. Typically conducted Inactive Training Period meetings at the Post Office Building in Baltimore or at Fort George G. Meade in the 1930s. Conducted summer training most years with the 66th Inf. (Light Tanks) at Camp George G. Meade, MD. Location 7 December 1941—Baltimore, MD.

**Commanders, 425th Infantry Regiment (Light Tanks)**

Lt. Col. Anson Jackson	25 October 1932–ao January 1933	Lt. Col. George Ross	ao December 1934–3 January 1935
Unknown	ao January 1933–ao December 1934	Lt. Col. DeWitt C. Evans	3 January 1935–5 November 1936
	Lt. Col. Marcel A. Palle		4 December 1935–ao January 1941

**426th Infantry Regiment (Separate) (Colored)****Organized Reserve Virginia**HQ—*Not initiated*, 1924–25; Norfolk, VA, 1925–27

Constituted in the O.R. on 31 March 1924, assigned to the GHQR, and allotted to the Third Corps Area. Initiated in 1925 with regimental HQ at Norfolk, VA. Primary ROTC feeder school was Howard University. Withdrawn from the Third Corps Area on 22 April 1927 and demobilized.

**Commanders, 426th Infantry Regiment**

Unknown	ao December 1925–22 April 1927
---------	--------------------------------

**426th Infantry Regiment (Light Tanks)****Organized Reserve West Virginia/Illinois**

HQ—Charleston, WV, 1932–37; Rockford, IL, 1937–41

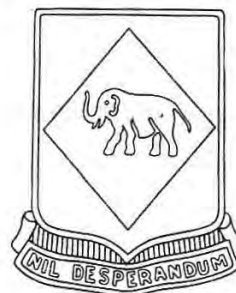

Constituted in the O.R. on 15 October 1921 as HHC, 8th Tank Group; allotted to the Fifth Corps Area; and assigned to the GHQR. Initiated in September 1922 at Charleston, WV. Reorganized and redesignated at Charleston as HHC, 308th Tank Regt. (Light) on 20 May 1930. Subordinate battalions organized from existing tank battalions as follows: the 315th Tank Bn. at Huntington, WV, as the 1st Bn.; the 316th Tank Bn. at Clarksburg, WV, as the 2d Bn., and the 317th Tank Bn. at Wheeling, WV, as the 3d Bn. Reorganized and redesignated 426th Inf. Regt. (Light Tanks) on 25 October 1932. Entire regiment relocated in 1937 to Rockford, IL. Conducted summer training at Camp Knox, KY. Also conducted infantry CMTC training some years at Fort Benjamin Harrison, IN, as an alternate form of summer training. Location 7 December 1941—Rockford, IL.

**Commanders, 426th Infantry Regiment (Light Tanks)**

Col. LaRue A. Boals	25 Oct. 1932–ao January 1941
---------------------	------------------------------

**427th Infantry Regiment (Separate) (Colored)****Organized Reserve Virginia****HQ**—Newport News, VA, 1925–27

Constituted in the O.R. on 31 March 1924, assigned to the GHQR, and allotted to the Third Corps Area. Initiated in 1925 with regimental HQ at Newport News, VA. Primary ROTC feeder school was Howard University. Withdrawn from the Third Corps Area on 22 April 1927 and demobilized.

**Commanders, 427th Infantry Regiment**

Unknown

ao December 1925–22 April 1927

**427th Infantry Regiment (Light Tanks)****Organized Reserve****HQ**—*Not initiated*, 1933–41

Constituted in the O.R. on 1 October 1933, assigned to the GHQR, and allotted to the Seventh Corps Area. Location 7 December 1941—*Not initiated*.

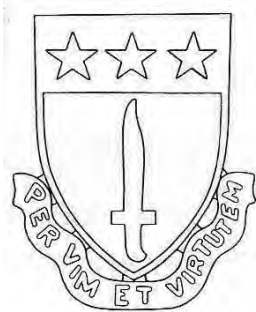
**428th Infantry Regiment (Separate) (Colored)****Organized Reserve District of Columbia****HQ**—*Not initiated*, 1924–25; Washington, DC, 1925–41

Constituted in the O.R. on 31 March 1924, assigned to the GHQR, and allotted to the Third Corps Area. Initiated on 15 May 1925 with the entire regiment at Washington, DC. This regiment was unusual in that it was one of only two “Colored” O.R. regiments in which the assigned officer personnel was composed of entirely African-Americans and were not pool units. Maj. Dwight D. Eisenhower and Lt. Col. Walter C. Short served as the regiment’s unit instructors in the 1930s. Awarded the Washington, DC, Army Day Parade Trophy in 1939. Provided the bulk of the officers for the 366th Inf. in November 1941 when that regiment was activated at Fort Devens, MA. Typically conducted Inactive Training Period meetings at the Howard University Army ROTC Armory or the Munitions Building in Washington. Conducted summer training many years with the 3d Bn., 372d Inf. at Camp Devens, MA. Also conducted “Colored” infantry CMTC training some years

at Fort Howard, MD, as an alternate form of summer training. Primary ROTC feeder schools were Georgetown University and Howard University. Location 7 December 1941—Washington, DC.

**Status:** Disbanded 4 August 1952.**Commanders, 428th Infantry Regiment**

Col. West A. Hamilton

15 May 1925–2 March 1941

**429th Infantry Regiment (Separate) (Colored)****Organized Reserve District of Columbia and Maryland****HQ**—*Not initiated*, 1924–25; Washington, DC, 1925–29; Baltimore, MD, 1929–38; *Inactive*, 1938–41

Constituted in the O.R. on 31 March 1924, assigned to the GHQR, and allotted to the Third Corps Area. Initiated in July 1925 with the entire regiment at Washington, DC. This regiment was unusual in that it was one of only two “Colored” O.R. regiments in which the assigned officer personnel was composed of African-Americans entirely and were not pool units. The regiment was relocated on 11 December 1929 to Baltimore, MD. Maj. Dwight D. Eisenhower and Lt. Col. Walter C. Short served as the regiment’s unit instructors in the 1930s. Typically conducted Inactive Training Period meetings at the Munitions Building in Washington, DC, or at the Post Office Building in Baltimore. Conducted summer training many years with the 3d Bn., 372d Inf. at Camp Devens, MA. Also conducted “Colored”

infantry CMTC training some years at Fort Howard, MD, as an alternate form of summer training. Primary ROTC feeder schools were Georgetown University and Howard University. Inactivated on 21 December 1938 at Baltimore by relief of personnel. Personnel concurrently reassigned to the 428th Inf. Location 7 December 1941—*Inactive*.

**Status:** Disbanded 11 November 1944.

**Commanders, 429th Infantry Regiment**

Unknown	July 1925–18 July 1930	Maj. Charles H. Fearing	18 July 1930–ao February 1938
Capt. Walter T. Webb	13 December 1926–18 July 1930	Lt. Col. Howard D. Queen	ao September 1938–21 December 1938

**430th Infantry Regiment (Separate) (Colored)**

**Organized Reserve Pennsylvania**

**HQ**—*Not initiated*, 1924–25; Philadelphia, PA, 1925–29; *Inactive*, 1929–41

Constituted in the O.R. on 31 March 1924, assigned to the GHQR, and allotted to the Third Corps Area. Initiated in 1925 with regimental HQ at Philadelphia, PA. This regiment functioned as a pool unit, primarily for Colored infantry and medical officers produced by ROTC programs and medical schools at historically black colleges and universities in the Third Corps Area. Conducted summer training with the 3d Bn., 372d Inf. at Camp Devens, MA. Also conducted summer training some years at Fort Hunt, MD; Fort Washington, MD; and Fort Howard, MD. Primary ROTC feeder school was Drexel University. Inactivated on 22 July 1929 at Philadelphia by relief of personnel. Location 7 December 1941—*Inactive*.

**Status:** Disbanded 11 November 1944.

**Commanders, 430th Infantry Regiment**

Unknown	ao December 1925–27 December 1926	Capt. Benjamin E. Ammons	27 December 1926–28 March 1929
	1st Lt. William H. Thompson		28 March 1929–22 July 1929

**431st Infantry Regiment (Separate)**

**Organized Reserve Pennsylvania**

**HQ**—*Not initiated*, 1924–25; Wilkinsburg, PA, 1925–29; *Inactive*, 1929–41

Constituted in the O.R. on 31 March 1924, assigned to the GHQR, and allotted to the Third Corps Area. Initiated in 1925 with regimental HQ at Wilkinsburg, PA. This regiment functioned as a pool unit, primarily for Colored infantry and medical officers produced by ROTC programs and medical schools at historically black colleges and universities in the Third Corps Area. Conducted summer training some years at Fort Hunt, MD; Fort Washington, MD; and Fort Howard, MD. Primary ROTC feeder school was Drexel University. Inactivated on 22 July 1929 at Wilkinsburg by relief of personnel. Location 7 December 1941—*Inactive*.

**Commanders, 431st Infantry Regiment**

Unknown	ao December 1925–27 December 1926	Capt. Harry W. Mills	27 December 1926–22 July 1929
---------	-----------------------------------	----------------------	-------------------------------

**432d Infantry Regiment (Separate)**

**Organized Reserve Pennsylvania/Virginia**

**HQ**—*Not initiated*, 1924–25; Harrisburg, PA, 1925–29; *Inactive*, 1929–41

Constituted in the O.R. on 31 March 1924, assigned to the GHQR, and allotted to the Third Corps Area. Initiated in 1925 with regimental HQ at Harrisburg, PA. This regiment functioned as a pool unit, primarily for Colored infantry and medical officers produced by ROTC programs and medical schools at historically black colleges and universities in the Third Corps Area. Conducted summer training with the 3d Bn., 372d Inf. at Camp Devens, MA. Also conducted summer training some years at Fort Hunt, MD; Fort Washington, MD; and Fort Howard, MD. Inactivated on 22 July 1929 at Harrisburg by relief of personnel. Personnel concurrently transferred to the 429th Inf. Petersburg, VA, was designated as the HQ on reorganization, but the unit was never organized at that location. Location 7 December 1941—*Inactive*.

**Status:** Disbanded 11 November 1944.

**Commanders, 432d Infantry Regiment**

Unknown                      ao December 1925–27 December 1926                      1st Lt. William A. Daniel                      27 December 1926–22 July 1929

**433d Infantry Regiment (Separate)**

**Organized Reserve Virginia**

**HQ**—Norfolk, VA, 1924–29; *Inactive*, 1929–41

Constituted in the O.R. on 31 March 1924, assigned to the GHQR, and allotted to the Third Corps Area. Initiated in 1924 with regimental HQ at Norfolk, VA. Inactivated on 17 July 1929 at Norfolk by relief of personnel. Personnel concurrently transferred to the 429th Inf.

**Status:** Disbanded 11 November 1944.

**Commanders, 433d Infantry Regiment**

Unknown                      ao December 1925–27 December 1926                      1st Lt. Pierce McM. Thompson                      27 December 1926–22 July 1929

**434th Infantry Regiment (Separate) (Colored)**

**Organized Reserve**

**HQ**—*Not initiated*, 1924–27

Constituted in the O.R. on 31 March 1924, assigned to the GHQR, and allotted to the Fourth Corps Area. Withdrawn from the Fourth Corps Area on 22 April 1927 and demobilized.

**435th Infantry Regiment (Separate) (Colored)**

**Organized Reserve Mississippi**

**HQ**—*Not initiated*, 1924–27

Constituted in the O.R. on 31 March 1924, assigned to the GHQR, and allotted to the Fourth Corps Area. Jackson, MS, designated as HQ on organization, but the unit was never organized at that location. Designated mobilization training station was Camp Wheeler, GA. Withdrawn from the Fourth Corps Area on 22 April 1927 and demobilized.

**436th Infantry Regiment (Separate) (Colored)**

**Organized Reserve South Carolina**

**HQ**—*Not initiated*, 1924–27

Constituted in the O.R. on 31 March 1924, assigned to the GHQR, and allotted to the Fourth Corps Area. Designated mobilization training station was Camp Wheeler, GA. Withdrawn from the Fourth Corps Area on 22 April 1927 and demobilized.

**437th Infantry Regiment (Separate) (Colored)**

**Organized Reserve**

**HQ**—*Not initiated*, 1924–27

Constituted in the O.R. on 31 March 1924, assigned to the GHQR, and allotted to the Fourth Corps Area. Withdrawn from the Fourth Corps Area 22 April 1927 and demobilized.

**438th Infantry Regiment (Separate) (Colored)**

**Organized Reserve**

**HQ**—*Not initiated, 1924–27*

Constituted in the O.R. on 31 March 1924, assigned to the GHQR, and allotted to the Fourth Corps Area. Withdrawn from the Fourth Corps Area on 22 April 1927 and demobilized.

**439th Infantry Regiment (Separate) (Colored)**

**Organized Reserve**

**HQ**—*Not initiated, 1924–27*

Constituted in the O.R. on 31 March 1924, assigned to the GHQR, and allotted to the Fourth Corps Area. Withdrawn from the Fourth Corps Area on 22 April 1927 and demobilized.

**440th Infantry Regiment (Separate) (Colored)**

**Organized Reserve**

**HQ**—*Not initiated, 1924–27*

Constituted in the O.R. on 31 March 1924, assigned to the GHQR, and allotted to the Fourth Corps Area. Withdrawn from the Fourth Corps Area on 22 April 1927 and demobilized.

**441st Infantry Regiment (Separate) (Colored)**

**Organized Reserve**

**HQ**—*Not initiated, 1924–27*

Constituted in the O.R. on 31 March 1924, assigned to the GHQR, and allotted to the Fourth Corps Area. Withdrawn from the Fourth Corps Area on 22 April 1927 and demobilized.

**442d Infantry Regiment (Separate) (Colored)**

**Organized Reserve**

**HQ**—*Not initiated, 1924–27*

Constituted in the O.R. on 31 March 1924, assigned to the GHQR, and allotted to the Fourth Corps Area. Withdrawn from the Fourth Corps Area on 22 April 1927 and demobilized.

**443d Infantry Regiment (Separate) (Colored)**

**Organized Reserve**

**HQ**—*Not initiated, 1924–27*

Constituted in the O.R. on 31 March 1924, assigned to the GHQR, and allotted to the Fourth Corps Area. Withdrawn from the Fourth Corps Area on 22 April 1927 and demobilized.

**444th Infantry Regiment (Separate) (Colored)**

**Organized Reserve**

**HQ**—*Not initiated, 1924–27*

Constituted in the O.R. on 31 March 1924, assigned to the GHQR, and allotted to the Fourth Corps Area. Jackson, MS, designated as HQ on organization, but the unit was never organized at that location. Designated mobilization training station was Camp Shelby, MS. Withdrawn from the Fourth Corps Area on 22 April 1927 and demobilized.

**445th Infantry Regiment (Separate) (Colored)****Organized Reserve****HQ**—*Not initiated, 1924–27*

Constituted in the O.R. on 31 March 1924, assigned to the GHQR, and allotted to the Fourth Corps Area. Withdrawn from the Fourth Corps Area on 22 April 1927 and demobilized.

**446th Infantry Regiment (Separate) (Colored)****Organized Reserve****HQ**—*Not initiated, 1924–27*

Constituted in the O.R. on 31 March 1924, assigned to the GHQR, and allotted to the Fourth Corps Area. Withdrawn from the Fourth Corps Area on 22 April 1927 and demobilized.

**447th Infantry Regiment (Separate) (Colored)****Organized Reserve Tennessee/Alabama****HQ**—Knoxville, TN, 1924–29; Tuskegee, AL, 1929–41

Constituted in the O.R. on 31 March 1924, assigned to the GHQR, and allotted to the Fourth Corps Area. Initiated in 1924 with regimental HQ at Knoxville, TN. Regiment was formed largely from officers transferred from the 322d Inf. Entire regiment relocated on 22 October 1929 to Tuskegee, AL. Conducted summer training most years with the 8th Inf. Regt. at Fort Moultrie, SC, and some years with the 22d Inf. Regt. at Camp McClellan, AL. Also conducted infantry CMTC training some years at Fort Moultrie as an alternate form of summer training. Provided officers to the 22d Inf. for the 1938 Third Army Maneuvers. Primary ROTC feeder school was the Tuskegee Institute, 1929–41. Location 7 December 1941—Tuskegee, AL.

**Status:** Disbanded 11 November 1944.**Commanders, 447th Infantry Regiment**

Unknown	ao December 1924–26 April 1937	Col. Robert W. Swatts	3 October 1937–8 January 1939
Col. Paul B. Parker	26 April 1937–8 August 1937	Col. James M. Watkins	12 February 1939–ao May 1940
Lt. Col. Wade H. Philips	8 August 1937–3 October 1937	Unknown	ao May 1940–7 December 1941

**448th Infantry Regiment (Separate) (Colored)****Organized Reserve Mississippi/South Carolina****HQ**—Laurel, MS, 1924–37; Florence, SC, 1937–41

Constituted in the O.R. on 31 March 1924, assigned to the GHQR, and allotted to the Fourth Corps Area. Initiated in 1924 with regimental HQ at Laurel, MS. Entire regiment relocated on 20 April 1937 to Florence, SC. Conducted summer training most years with the 22d Inf. Regt. at Camp McClellan, AL; Fort Benning, GA; or Fort McPherson, GA. Also conducted infantry CMTC training some years at Fort Screven, GA, as an alternate form of summer training. Designated mobilization training station was Camp Shelby, MS. Location 7 December 1941—Florence, SC.

**Status:** Disbanded 11 November 1944.**Commanders, 448th Infantry Regiment**

Unknown	ao December 1924–18 April 1937	Lt. Col. Charles W. Clarke	2 May 1937–9 January 1938
Lt. Col. James D. Fulp	18 April 1937–2 May 1937	Lt. Col. Henry C. Turner	18 September 1938–ao October 1940
	Unknown	ao October 1940–7 December 1941	

**449th Infantry Regiment (Separate) (Colored)****Organized Reserve Ohio and Kentucky****HQ**—Toledo, OH, 1924–31; Xenia, OH, 1931–34; Dayton, OH, 1934–41

Constituted in the O.R. on 31 March 1924, assigned to the GHQR, and allotted to the Fifth Corps Area. Initiated on 1 April 1924 with personnel transferred from the 1st Sep. Inf. Regt. (Colored) (organized in October 1923 at Toledo, OH). Regimental HQ organized at Toledo. Regimental HQ relocated on 9 July 1931 to Xenia, OH. Entire regiment relocated on 30 April 1934 to Dayton, OH. Attached to the 83d Div. for administration, supply, and training. Conducted summer training most years with the 2d Bn., 372d Inf. at Camp Perry, OH. Location 7 December 1941—Dayton, OH.

**Status:** Disbanded 11 November 1944.**Commanders, 449th Infantry Regiment**

Unknown	1 April 1924—ao May 1932	Maj. Amos A. Carter	ao May 1932—ao June 1932
	Unknown	ao June 1932—7 December 1941	

**450th Infantry Regiment (Separate) (Colored)****Organized Reserve Louisiana****HQ**—Fifth Corps Area, 1924–27; Alexandria, LA, 1927–40; Shreveport, LA, 1940–41

Constituted in the O.R. on 31 March 1924, assigned to the GHQR, and allotted to the Fifth Corps Area. Initiated on 21 April 1924 with personnel transferred from the 2d Sep. Inf. Regt. (Colored) (organized in October 1923 at Bowling Green, KY). Regiment organized at large in the Fifth Corps Area. Withdrawn from the Fifth Corps Area on 11 January 1927 and allotted to the Fourth Corps Area. Initiated on 21 April 1927 at Alexandria, LA. Entire regiment relocated on 4 March 1940 to Shreveport, LA. Conducted summer training most years with the 8th Inf. Regt. at Fort Screven, GA. Also conducted infantry CMTTC training some years at Camp Beauregard, LA, as an alternate form of summer training. Location 7 December 1941—Shreveport, LA.

**Status:** Disbanded 11 November 1944.**Commanders, 450th Infantry Regiment**

Capt. George J. Austin	21 April 1924—ao May 1924	Col. Paul B. Parker	8 August 1937—5 December 1937
Unknown	ao May 1924—18 April 1937	Col. Daniel W. Spurlock	5 December 1937—ao May 1940
Lt. Col. Wade H. Phillips	18 April 1937—7 August 1937	Unknown	ao May 1940—7 December 1941

**451st Infantry Regiment (Separate) (Colored)****Organized Reserve Missouri/Arkansas****HQ**—St. Louis, MO, 1924–28; Little Rock, AR, 1928–31; Joplin, MO, 1931–41

Constituted in the O.R. on 31 March 1924, assigned to the GHQR, and allotted to the Seventh Corps Area. Initiated in November 1924 with regimental HQ at St. Louis, MO. Regimental HQ relocated on 3 April 1928 to Little Rock, AR. Subordinate battalion HQ concurrently relocated as follows: 1st Bn. to Helena, AR; 2d Bn. to Pine Bluff, AR; and 3d Bn. to El Dorado, AR. Entire regiment relocated on 12 October 1931 to Joplin, MO. Conducted summer training most years with the 17th Inf. at Fort Leavenworth, KS. Location 7 December 1941—Joplin, MO.

**Status:** Disbanded 11 November 1944.**Commanders, 451st Infantry Regiment**

Col. Leroy K. Robbins	November 1924—January 1928	Unknown	January 1928—7 December 1941
-----------------------	----------------------------	---------	------------------------------



**452d Infantry Regiment (Separate) (Colored)****Organized Reserve Arkansas/Missouri****HQ**—Pine Bluff, AR, 1924–26; St. Louis, MO, 1926–31; Little Rock, AR, 1931–41

Constituted in the O.R. on 31 March 1924, assigned to the GHQR, and allotted to the Seventh Corps Area. Initiated in November 1924 with regimental HQ at Pine Bluff, AR. Subordinate battalion HQ concurrently organized as follows: 1st Bn. at Pine Bluff; 2d Bn. at Helena, AR; and the 3d Bn. at Little Rock, AR. Regimental HQ successively relocated on 26 May 1926 to St. Louis, MO, and on 12 October 1931 to Little Rock. Conducted summer training most years with the 17th Inf. at Fort Leavenworth, KS. Location 7 December 1941—Little Rock, AR.

**Status:** Disbanded 11 November 1944.**Commanders, 452d Infantry Regiment**

Unknown	November 1924–October 1925	Lt. Col. Gerald P. Murphy	October 1925–19 May 1930
	Unknown	19 May 1930–7 December 1941	

**453d Infantry Regiment (Separate) (Colored)****Organized Reserve Arkansas****HQ**—Marianna, AR, 1924–28; Little Rock, AR, 1928–31; Pine Bluff, AR, 1931–41

Constituted in the O.R. on 31 March 1924, assigned to the GHQR, and allotted to the Seventh Corps Area. Initiated in November 1924 with regimental HQ at Marianna, AR. Subordinate battalion HQ concurrently organized as follows: 1st Bn. at Marianna; 2d Bn. at Forrest City, AR; and the 3d Bn. at Blytheville, AR. Entire regiment relocated on 3 April 1928 to Little Rock, AR. Entire regiment relocated on 12 October 1931 to Pine Bluff, AR. Conducted summer training most years with the 17th Inf. at Fort Leavenworth, KS, and some years at Fort Crook, NE. Location 7 December 1941—Pine Bluff, AR.

**Status:** Disbanded 11 November 1944.**Commanders, 453d Infantry Regiment**

Unknown	November 1924–ao October 1925	Lt. Col. Curtis G. Rorebeck	ao October 1925–19 May 1930
	Unknown	19 May 1930–7 December 1941	

**454th Infantry Regiment (Separate) (Colored)****Organized Reserve Georgia/South Carolina****HQ**—*Not initiated*, 1924–25; Americus, GA, 1925–37; Spartanburg, SC, 1937–41

Constituted in the O.R. on 31 March 1924, assigned to the GHQR, and allotted to the Fourth Corps Area. Initiated in 1925 with regimental HQ at Americus, GA. Entire regiment relocated on 20 April 1937 to Spartanburg, SC. Conducted summer training most years with the 22d Inf. Regt. at Camp McClellan, AL. Also conducted infantry CMTC training some years at Fort Screven, GA, as an alternate form of summer training. Location 7 December 1941—Spartanburg, SC.

**Status:** Disbanded 11 November 1944.

Note: Withdrawn from the Eighth Corps Area on 11 January 1927 and allotted to the Fourth Corps Area.

**Commanders, 454th Infantry Regiment**

Unknown	ao December 1925–20 April 1937	Lt. Col. Albert H. Dorian	ao June 1939–ao October 1940
Col. Lindsay C. McFadden	23 April 1937–ao June 1938	Unknown	ao October 1940–7 December 1941

**455th Infantry Regiment (Separate) (Colored)****Organized Reserve Oklahoma/Texas****HQ**—*Not initiated*, 1924–29; Oklahoma City, OK, 1929–36; El Paso, TX, 1936–41

Constituted in the O.R. 31 March 1924, assigned to the GHQR, and allotted to the Eighth Corps Area. Initiated 11 June 1929 with HQ at Oklahoma City, OK. Entire regiment relocated 26 March 1936 to El Paso, TX. Conducted infantry CMTC training at Camp Bullis, TX, for summer training. Designated mobilization training station was the Oklahoma City Concentration Camp 1929–36. Location 7 December 1941—El Paso, TX.

**Status:** Disbanded 11 November 1944.**Commanders, 455th Infantry Regiment**

Unknown	11 June 1929–ao February 1936	Maj. Frank G. Carrico	ao February 1936–19 March 1936
	Col. James K. Weber	26 March 1936–February 1942	

**456th Infantry Regiment (Separate) (Colored)****Organized Reserve Texas****HQ**—Dallas, TX, 1924–27

Constituted in the O.R. 31 March 1924, assigned to the GHQR, and allotted to the Eighth Corps Area. Initiated 21 July 1924 with regimental HQ at Dallas, TX. Withdrawn from the Eighth Corps Area 22 April 1927 and demobilized.

**Commanders, 456th Infantry Regiment**

Unknown	21 July 1924–22 April 1927
---------	----------------------------

**457th Infantry Regiment (Separate) (Colored)****Organized Reserve Oklahoma/Texas****HQ**—Fort Sill, OK, 1924–25; Fort Worth, TX, 1925–27

Constituted in the O.R. 31 March 1924, assigned to the GHQR, and allotted to the Eighth Corps Area. Initiated 16 July 1924 with regimental HQ at Fort Sill, OK. Entire regiment relocated 15 April 1925 to Fort Worth, TX. Withdrawn from the Eighth Corps Area 22 April 1927.

**Commanders, 457th Infantry Regiment**

Unknown	16 July 1924–22 April 1927
---------	----------------------------

**458th Infantry Regiment (Separate) (Colored)****Organized Reserve Texas****HQ**—*Not initiated*, 1924–37; Austin, TX, 1937–41

Constituted in the O.R. 31 March 1924, assigned to the GHQR, and allotted to the Eighth Corps Area. Initiated 2 February 1937 with regimental HQ at Austin, TX. Typically conducted Inactive Training Period meetings at the Driskill Hotel in Austin. Location 7 December 1941—Austin, TX.

**Commanders, 458th Infantry Regiment**

Unknown	2 February 1937–7 December 1941
---------	---------------------------------

## Chapter 10

### Infantry Battalions

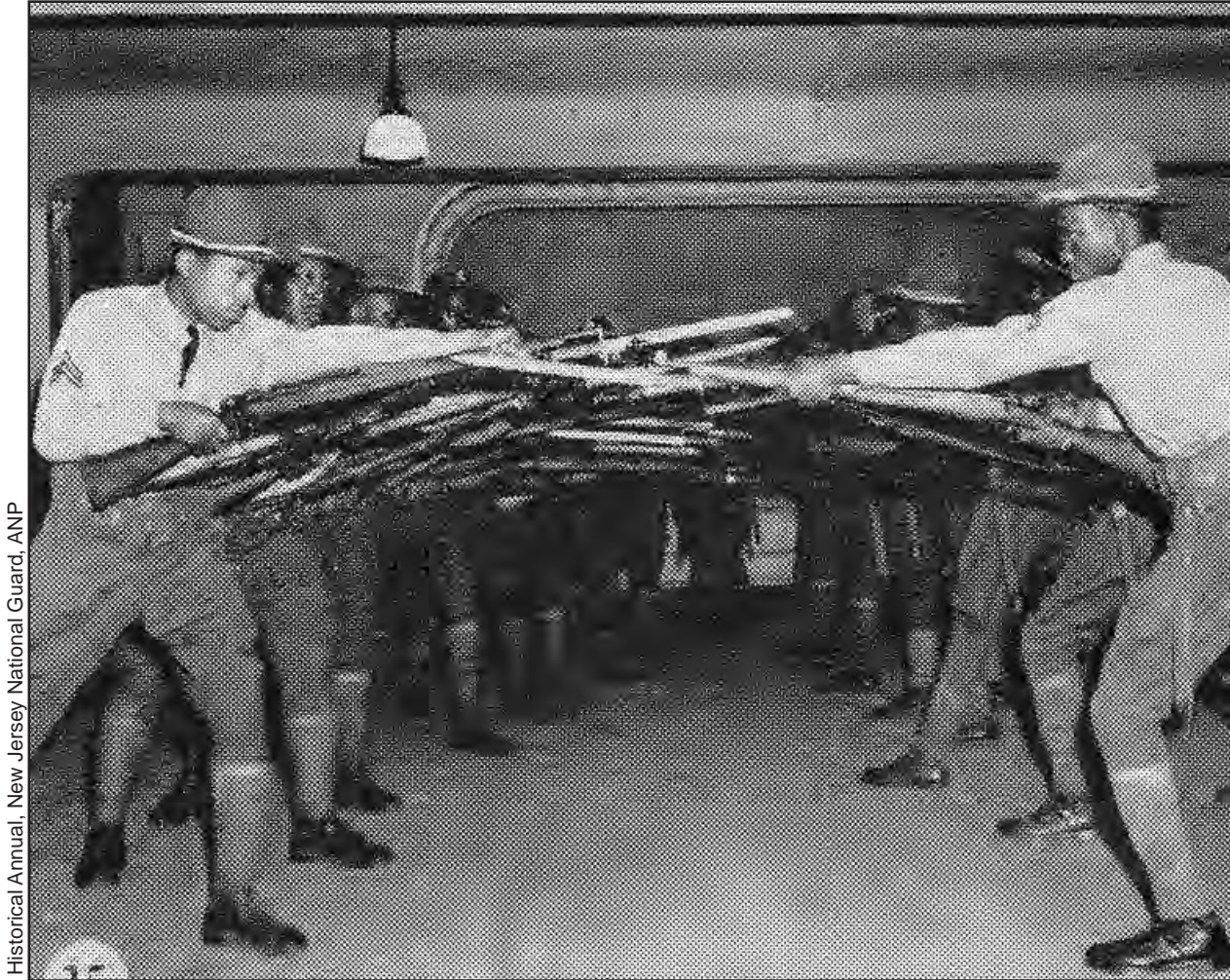

Historical Annual, New Jersey National Guard, ANP

Bayonet practice at the armory of the 1st Separate Infantry Battalion, New Jersey National Guard, about 1938.

The mission of infantry battalions was to plan and conduct operations to close with and destroy the enemy by fire and maneuver.

#### **Organization and Training**

The separate infantry battalion was an outgrowth of the World War I experience. The planners of the War Plans Division foresaw a need for a number of these organizations for special security missions (for airfields, key industrial sites, military installations, etc.) or for infantry training center support units. Organizationally, the separate infantry battalion was not appreciably different than those of their counterparts in an infantry regiment. Of these battalions, 51 were originally constituted in the Organized Reserve (O.R.) in 1923 and almost all were organized by 1925. Generally, these battalions tended to be geographically dispersed in state areas where population densities were light. Thus, few of these organizations appeared to have been functional units during the inactive training period and only a handful attended a summer camp as a unit. In 1928, given a revised analysis of manpower requirements for mobilization plans, all but two of these battalions

were withdrawn from the O.R. and demobilized. The two that remained, the 516th and 549th Inf. Bns., remained allotted to Puerto Rico and Alaska, respectively. The requirements for the withdrawn battalions were concurrently reduced to 37 and transferred to the Regular Army (R.A.) as “Colored” battalions. These battalions were not to be organized in peacetime, but only in the event of a national emergency. Inexplicably, several of them were organized in the Third Corps Area in 1936 and then inactivated about 6 months later. None of these battalions, however, were organized for service in World War II.

**1st Infantry Battalion (Separate) (Colored) (GHQR) Organized Reserve Indiana/Massachusetts**

**HQ**—Indianapolis, IN, 1923–24; Boston, MA, 1924–28

Constituted in the O.R. on 2 July 1923, allotted to the Fifth Corps Area, and assigned to the Zone of the Interior. Initiated on 14 December 1923 with HQ at Indianapolis, IN. Withdrawn from the Fifth Corps Area on 26 April 1924 and allotted to the First Corps Area. Reorganized by July 1925 with HQ at Boston, MA. Attached to the 94th Div. for administration and training. Inactivated on 2 May 1927 at Boston by relief of personnel. Withdrawn from the O.R. on 5 September 1928 and demobilized.

**Commanders, 1st Infantry Battalion (Separate) (Colored)**

Capt. Elder W. Diggs	14 December 1923–26 April 1924	Maj. Walter R. Sanders	ao July 1925–2 May 1927
Unknown	26 April 1924–ao July 1925	<i>Inactive</i>	2 May 1927–5 September 1928

**1st Separate Infantry Battalion (Colored) New Jersey National Guard**

**HQ**—Atlantic City, NJ, 1937–41; Camden, NJ, 1941; Fort Dix, NJ, 1941



Authorized in the New Jersey State Militia on 16 April 1930 as the 1st Sep. Inf. Bn. Cos. A and B organized on 25 and 23 September 1931 at Newark, NJ, and Atlantic City, NJ, respectively. Cos. A and B called up to participate in the rescue and recovery efforts for passengers of the S.S. *Morro Castle* in September 1934. Battalion HQ organized on 12 December 1934 at Atlantic City. Cos. C and D organized shortly thereafter. Integrated on 5 May 1937 into the New Jersey National Guard. Reorganized and redesignated 1st Bn., 372d Inf. on 12 December 1940. Federally recognized on 11 February 1941 with HQ at Camden, NJ. Conducted annual summer training most years at Sea Girt, NJ, 1932–40. Inducted into active Federal Service on 10 March 1941 at Camden. Transferred to Fort Dix, NJ, where it arrived 17 March 1941. Location 7 December 1941—Fort Dix, NJ.

**Status:** Disbanded 31 January 1946 at Fort Dix, NJ.

**Commanders, 1st Separate Infantry Battalion (Colored)**

Maj. George L. Eggleston	5 May 1937–10 March 1941
--------------------------	--------------------------

**3d Infantry Battalion (Separate) (Colored) (GHQR) Organized Reserve West Virginia/Connecticut**

**HQ**—Huntington, WV, 1923–24; Hartford, CT, 1924–27

Constituted in the O.R. on 2 July 1923, allotted to the Fifth Corps Area, and assigned to the Zone of the Interior. Initiated on 14 December 1923 with HQ at Huntington, WV. Withdrawn from the Fifth Corps Area on 26 April 1924 and allotted to the First Corps Area. Reorganized by July 1925 with HQ at Hartford, CT. Attached to the 76th Div. for administration and training. Typically conducted Inactive Training Period meetings at the State Armory in Hartford. Withdrawn from the First Corps Area on 23 April 1927 and allotted to the Fifth Corps Area. Inactivated on 2 May 1927 at Hartford by relief of personnel. Withdrawn from the O.R. on 5 September 1928 and demobilized.

**Commanders, 3d Infantry Battalion (Separate) (Colored)**

Capt. Gurnett E. Furgeson	14 December 1923–26 April 1924	Capt. Joseph M. Bullock	ao July 1925–2 May 1927
Unknown	26 April 1924–ao July 1925	<i>Inactive</i>	2 May 1927–5 September 1928

**63d Infantry Battalion (Separate) (Colored) (GHQR)**

**Regular Army Inactive**

**HQ**—*Not organized*

Constituted in the R.A. on 5 September 1928, allotted to the First Corps Area, and assigned to the Zone of the Interior. Designated mobilization station was Camp Dix, NJ. The 1st Div. had mobilization and training responsibility for this unit.

**64th Infantry Battalion (Separate) (Colored) (GHQR)**

**Regular Army Inactive**

**HQ**—*Not organized*, 1928–36; Burkeville, VA, 1936; *Inactive*, 1936–41

Constituted in the R.A. on 5 September 1928, allotted to the Third Corps Area, and assigned to the Zone of the Interior. Organized on 11 March 1936 as an RAI unit with graduates of Virginia Polytechnic Institute who resided in the east central Virginia area. Inactivated on 20 October 1936. Location 7 December 1941—*Inactive*.

**Commander, 64th Infantry Battalion (Separate) (Colored)**

Unknown	11 March 1936–2 October 1936
---------	------------------------------

**65th Infantry Battalion (Separate) (Colored) (GHQR)**

**Regular Army Inactive**

**HQ**—*Not organized*, 1928–41

Constituted in the R.A. on 5 September 1928, allotted to the Third Corps Area, and assigned to the Zone of the Interior.

**66th Infantry Battalion (Separate) (Colored) (GHQR)**

**Regular Army Inactive**

**HQ**—*Not organized*, 1928–36; Lynchburg, VA, 1936; *Inactive*, 1936–41

Constituted in the R.A. on 5 September 1928, allotted to the Third Corps Area, and assigned to the Zone of the Interior. Organized on 11 March 1936 as an RAI unit with graduates of Virginia Polytechnic Institute who resided in the central Virginia area. Inactivated on 20 October 1936 by relief of Reserve personnel. Location 7 December 1941—*Inactive*.

**Commander, 66th Infantry Battalion (Separate) (Colored)**

Unknown	11 March 1936–2 October 1936
---------	------------------------------

**67th Infantry Battalion (Separate) (Colored) (GHQR)**

**Regular Army Inactive**

**HQ**—*Not organized*, 1928–36; Hampton, VA, 1936; *Inactive*, 1936–41

Constituted in the R.A. on 5 September 1928, allotted to the Third Corps Area, and assigned to the Zone of the Interior. Organized on 11 March 1936 as an RAI unit with graduates of Virginia Polytechnic Institute who resided in the southeast Virginia area. Inactivated on 20 October 1936 by relief of Reserve personnel. Location 7 December 1941—*Inactive*.

**Commander, 67th Infantry Battalion (Separate) (Colored)**

Unknown	11 March 1936–2 October 1936
---------	------------------------------

**68th Infantry Battalion (Separate) (Colored) (GHQR)**

**Regular Army Inactive**

**HQ**—*Not organized*, 1928–36; Roanoke, VA, 1936; *Inactive*, 1936–41

Constituted in the R.A. on 5 September 1928, allotted to the Third Corps Area, and assigned to the Zone of the Interior. Organized on 11 March 1936 with graduates of Virginia Polytechnic Institute who resided in the west central Virginia area. Inactivated on 21 October 1936 by relief of Reserve personnel. Location 7 December 1941—*Inactive*.

**Commander, 68th Infantry Battalion (Separate) (Colored)**

Unknown

11 March 1936–2 October 1936

**69th Infantry Battalion (Separate) (Colored) (GHQR)**

**Regular Army Inactive**

**HQ**—*Not organized*, 1928–36; Warrenton, VA, 1936; *Inactive*, 1936–41

Constituted in the R.A. on 5 September 1928, allotted to the Third Corps Area, and assigned to the Zone of the Interior. Organized on 11 March 1936 as an RAI unit with graduates of Virginia Polytechnic Institute who resided in the north central Virginia area. Inactivated on 21 October 1936 by relief of Reserve personnel. Location 7 December 1941—*Inactive*.

**Commander, 69th Infantry Battalion (Separate) (Colored)**

Unknown

11 March 1936–2 October 1936

**70th Infantry Battalion (Separate) (Colored) (GHQR)**

**Regular Army Inactive**

**HQ**—*Not organized*, 1928–41

Constituted in the R.A. on 5 September 1928, allotted to the Fourth Corps Area, and assigned to the Zone of the Interior. Location 7 December 1941—*Not organized*.

**71st Infantry Battalion (Separate) (Colored) (GHQR)**

**Regular Army Inactive**

**HQ**—*Not organized*, 1928–41

Constituted in the R.A. on 5 September 1928, allotted to the Fourth Corps Area, and assigned to the Zone of the Interior. Location 7 December 1941—*Not organized*.

**72d Infantry Battalion (Separate) (Colored) (GHQR)**

**Regular Army Inactive**

**HQ**—*Not organized*, 1928–41

Constituted in the R.A. on 5 September 1928, allotted to the Fourth Corps Area, and assigned to the Zone of the Interior. Location 7 December 1941—*Not organized*.

**73d Infantry Battalion (Separate) (Colored) (GHQR)**

**Regular Army Inactive**

**HQ**—*Not organized*, 1928–41

Constituted in the R.A. on 5 September 1928, allotted to the Fourth Corps Area, and assigned to the Zone of the Interior. Location 7 December 1941—*Not organized*.

**74th Infantry Battalion (Separate) (Colored) (GHQR)**

**Regular Army Inactive**

**HQ**—*Not organized, 1928–41*

Constituted in the R.A. on 5 September 1928, allotted to the Fourth Corps Area, and assigned to the Zone of the Interior. Location 7 December 1941—*Not organized.*

**75th Infantry Battalion (Separate) (Colored) (GHQR)**

**Regular Army Inactive**

**HQ**—*Not organized, 1928–41*

Constituted in the R.A. on 5 September 1928, allotted to the Fourth Corps Area, and assigned to the Zone of the Interior. Location 7 December 1941—*Not organized.*

**76th Infantry Battalion (Separate) (Colored) (GHQR)**

**Regular Army Inactive**

**HQ**—*Not organized, 1928–41*

Constituted in the R.A. on 5 September 1928, allotted to the Fourth Corps Area, and assigned to the Zone of the Interior. Location 7 December 1941—*Not organized.*

**77th Infantry Battalion (Separate) (Colored) (GHQR)**

**Regular Army Inactive**

**HQ**—*Not organized, 1928–41*

Constituted in the R.A. on 5 September 1928, allotted to the Fourth Corps Area, and assigned to the Zone of the Interior. Location 7 December 1941—*Not organized.*

**78th Infantry Battalion (Separate) (Colored) (GHQR)**

**Regular Army Inactive**

**HQ**—*Not organized, 1928–41*

Constituted in the R.A. on 5 September 1928, allotted to the Fourth Corps Area, and assigned to the Zone of the Interior. Location 7 December 1941—*Not organized.*

**79th Infantry Battalion (Separate) (Colored) (GHQR)**

**Regular Army Inactive**

**HQ**—*Not organized, 1928–41*

Constituted in the R.A. on 5 September 1928, allotted to the Fourth Corps Area, and assigned to the Zone of the Interior. Location 7 December 1941—*Not organized.*

**80th Infantry Battalion (Separate) (Colored) (GHQR)**

**Regular Army Inactive**

**HQ**—*Not organized, 1928–41*

Constituted in the R.A. on 5 September 1928, allotted to the Fourth Corps Area, and assigned to the Zone of the Interior. Location 7 December 1941—*Not organized.*

**81st Infantry Battalion (Separate) (Colored) (GHQR)**

**Regular Army Inactive**

**HQ**—*Not organized, 1928–41*

Constituted in the R.A. on 5 September 1928, allotted to the Fourth Corps Area, and assigned to the Zone of the Interior. Location 7 December 1941—*Not organized.*

**82d Infantry Battalion (Separate) (Colored) (GHQR)**

**Regular Army Inactive**

**HQ**—*Not organized, 1928–41*

Constituted in the R.A. on 5 September 1928, allotted to the Fourth Corps Area, and assigned to the Zone of the Interior. Location 7 December 1941—*Not organized.*

**83d Infantry Battalion (Separate) (Colored) (GHQR)**

**Regular Army Inactive**

**HQ**—*Not organized, 1928–41*

Constituted in the R.A. on 5 September 1928, allotted to the Fourth Corps Area, and assigned to the Zone of the Interior. Location 7 December 1941—*Not organized.*

**84th Infantry Battalion (Separate) (Colored) (GHQR)**

**Regular Army Inactive**

**HQ**—*Not organized, 1928–41*

Constituted in the R.A. on 5 September 1928, allotted to the Fourth Corps Area, and assigned to the Zone of the Interior. Location 7 December 1941—*Not organized.*

**85th Infantry Battalion (Separate) (Colored) (GHQR)**

**Regular Army Inactive**

**HQ**—*Not organized, 1928–41*

Constituted in the R.A. on 5 September 1928, allotted to the Fourth Corps Area, and assigned to the Zone of the Interior. Location 7 December 1941—*Not organized.*

**86th Infantry Battalion (Separate) (Colored) (GHQR)**

**Regular Army Inactive**

**HQ**—*Not organized, 1928–41*

Constituted in the R.A. on 5 September 1928, allotted to the Fourth Corps Area, and assigned to the Zone of the Interior. Location 7 December 1941—*Not organized.*

**87th Infantry Battalion (Separate) (Colored) (GHQR)**

**Regular Army Inactive**

**HQ**—*Not organized, 1928–41*

Constituted in the R.A. on 5 September 1928, allotted to the Fourth Corps Area, and assigned to the Zone of the Interior. Location 7 December 1941—*Not organized.*



**88th Infantry Battalion (Separate) (Colored) (GHQR)**

**Regular Army Inactive**

HQ—*Not organized*, 1928–41

Constituted in the R.A. on 5 September 1928, allotted to the Fourth Corps Area, and assigned to the Zone of the Interior. Location 7 December 1941—*Not organized*.

**89th Infantry Battalion (Separate) (Colored) (GHQR)**

**Regular Army Inactive**

HQ—*Not organized*, 1928–41

Constituted in the R.A. on 5 September 1928, allotted to the Fourth Corps Area, and assigned to the Zone of the Interior. Location 7 December 1941—*Not organized*.

**90th Infantry Battalion (Separate) (Colored) (GHQR)**

**Regular Army Inactive**

HQ—*Not organized*, 1928–41

Constituted in the R.A. on 5 September 1928, allotted to the Fourth Corps Area, and assigned to the Zone of the Interior. Location 7 December 1941—*Not organized*.

**91st Infantry Battalion (Separate) (Colored) (GHQR)**

**Regular Army Inactive**

HQ—*Not organized*, 1928–41

Constituted in the R.A. on 5 September 1928, allotted to the Fourth Corps Area, and assigned to the Zone of the Interior. Location 7 December 1941—*Not organized*.

**92d Infantry Battalion (Separate) (Colored) (GHQR)**

**Regular Army Inactive**

HQ—*Not organized*, 1928–41

Constituted in the R.A. on 5 September 1928, allotted to the Fourth Corps Area, and assigned to the Zone of the Interior. Location 7 December 1941—*Not organized*.

**93d Infantry Battalion (Separate) (Colored) (GHQR)**

**Regular Army Inactive**

HQ—*Not organized*, 1928–34; Shreveport, LA, 1934–40; *Inactive*, 1940–41

Constituted in the R.A. on 5 September 1928, allotted to the Fourth Corps Area, and assigned to the Zone of the Interior. Organized by July 1934 as an RAI unit at Shreveport, LA. Inactivated by June 1940 at Shreveport by relief of Reserve personnel. Location 7 December 1941—*Inactive*.

**Commander, 93d Infantry Battalion (Separate) (Colored)**

Unknown                      ao July 1934–June 1940

**94th Infantry Battalion (Separate) (Colored) (GHQR)**

**Regular Army Inactive**

HQ—*Not organized*, 1928–41

Constituted in the R.A. on 5 September 1928, allotted to the Fourth Corps Area, and assigned to the Zone of the Interior. Location 7 December 1941—*Not organized*.

**95th Infantry Battalion (Separate) (Colored) (GHQR)**

**Regular Army Inactive**

**HQ**—*Not organized*, 1928–34; New Orleans, LA, 1934–40; *Inactive*, 1940–41

Constituted in the R.A. on 5 September 1928, allotted to the Fourth Corps Area, and assigned to the Zone of the Interior. Organized by July 1934 as an RAI unit at New Orleans, LA. Inactivated by June 1940 at New Orleans by relief of Reserve personnel. Location 7 December 1941—*Inactive*.

**96th Infantry Battalion (Separate) (Colored) (GHQR)**

**Regular Army Inactive**

**HQ**—*Not organized*, 1928–41

Constituted in the R.A. on 5 September 1928, allotted to the Fourth Corps Area, and assigned to the Zone of the Interior. Location 7 December 1941—*Not organized*.

**97th Infantry Battalion (Separate) (Colored) (GHQR)**

**Regular Army Inactive**

**HQ**—*Not organized*, 1928–41

Constituted in the R.A. on 5 September 1928, allotted to the Seventh Corps Area, and assigned to the Zone of the Interior. Fort Abraham Lincoln, ND, designated as HQ on organization, but the unit was never organized at that location.

**98th Infantry Battalion (Separate) (Colored) (GHQR)**

**Regular Army Inactive**

**HQ**—*Not organized*, 1928–41

Constituted in the R.A. on 5 September 1928, allotted to the Seventh Corps Area, and assigned to the Zone of the Interior. Fort Abraham Lincoln, ND, designated as HQ on organization, but the unit was never organized at that location.

**99th Infantry Battalion (Separate) (Colored) (GHQR)**

**Regular Army Inactive**

**HQ**—*Not organized*, 1928–41

Constituted in the R.A. on 5 September 1928, allotted to the Seventh Corps Area, and assigned to the Zone of the Interior. Fort Abraham Lincoln, ND, designated as HQ on organization, but the unit was never organized at that location.

**501st Infantry Battalion (ZI)**

**Organized Reserve Massachusetts**

**HQ**—*Not initiated*, 1923–25; Camp Devens, MA, 1925–28

Constituted in the O.R. on 2 July 1923, allotted to the First Corps Area, and assigned to the Zone of the Interior. Initiated on 15 August 1925 with HQ at Camp Devens, MA. Conducted summer training with the 5th and 13th Inf. Regts. at Camp Devens. Attached to the 94th Div. for administration and training. Withdrawn from the O.R. on 5 September 1928 and demobilized.

**Commanders, 501st Infantry Battalion**

Unknown

15 August 1925–ao April 1928

Lt. Col. Harold F. Moulton

ao April 1928–5 September 1928

**502d Infantry Battalion (ZI)****Organized Reserve New York****HQ**—*Not initiated*, 1923–24; Manhattan, NY, 1924–28

Constituted in the O.R. on 2 July 1923, allotted to the Second Corps Area, and assigned to the Zone of the Interior. Initiated by December 1924 with HQ at Manhattan, NY. Attached to the 77th Div. on 17 September 1925 for administration and training. Withdrawn from the O.R. on 5 September 1928 and demobilized.

**Commander, 502d Infantry Battalion**

Unknown	ao December 1924–5 September 1928
---------	-----------------------------------

**503d Infantry Battalion (ZI)****Organized Reserve****HQ**—*Not initiated*, 1923–25; Pittsburgh, PA, 1925–28

Constituted in the O.R. on 2 July 1923, allotted to the Third Corps Area, and assigned to the Zone of the Interior. Initiated by September 1925 with HQ in the Third Corps Area. Withdrawn from the O.R. on 5 September 1928 and demobilized. Concurrently, personnel transferred to the 303d M.P. Bn.

**Commanders, 503d Infantry Battalion**

Lt. Col. John V. Richards	ao September 1925–29 March 1926	Capt. Johns Hopkins	11 June 1926–13 January 1927
Capt. Baldwin W. Foote	29 March 1926–11 June 1926	Maj. Arthur W. Furbershaw	13 January 1927–5 September 1928

**504th Infantry Battalion (ZI)****Organized Reserve Georgia****HQ**—*Not initiated*, 1923–24; Bainbridge, GA, 1924–28

Constituted in the O.R. on 2 July 1923, allotted to the Fourth Corps Area, and assigned to the Zone of the Interior. Initiated about April 1924 with HQ at Bainbridge, GA. Mobilization assignment was to be school support troops for the US Army Infantry School at Fort Benning, GA. Designated mobilization station was Fort Benning. Withdrawn from the O.R. on 5 September 1928 and demobilized.

**Commander, 504th Infantry Battalion**

Unknown	April 1924–5 September 1928
---------	-----------------------------

**505th Infantry Battalion (ZI)****Organized Reserve West Virginia/Ohio****HQ**—*Not initiated*, 1923–25; West Virginia at large, 1925–27; *Inactive*, 1927–28

Constituted in the O.R. on 2 July 1923, allotted to the Fifth Corps Area, and assigned to the Zone of the Interior. Initiated by December 1924 in West Virginia. Inactivated by relief of personnel on 4 August 1927. Columbus, OH, designated as HQ on reorganization, but the unit was never organized at that location. Withdrawn from the O.R. on 5 September 1928 and demobilized.

**Commanders, 505th Infantry Battalion**

Unknown	ao December 1924–4 August 1927	Inactive	4 August 1927–5 September 1928
---------	--------------------------------	----------	--------------------------------

**506th Infantry Battalion (ZI)****Organized Reserve Michigan****HQ**—*Not initiated*, 1923–25; Bay City, MI, 1925–28

Constituted in the O.R. on 2 July 1923, allotted to the Sixth Corps Area, and assigned to the Zone of the Interior. Initiated on 10 December 1925 with HQ at Bay City, MI. Attached to the 85th Div. on 19 October 1925 for organization, administration, and training. Conducted summer training with the 2d Inf. Regt. at Fort Brady, MI. Conducted infantry CMTTC training at Fort Brady in 1928. Withdrawn from the O.R. on 5 September 1928 and demobilized.

**Commander, 506th Infantry Battalion**

Maj. John M. Thompson	10 December 1925–5 September 1928
-----------------------	-----------------------------------

**507th Infantry Battalion (ZI)****Organized Reserve Iowa****HQ**—*Not initiated*, 1923–25; Cedar Falls, IA, 1925–28

Constituted in the O.R. on 2 July 1923, allotted to the Seventh Corps Area, and assigned to the Zone of the Interior. Initiated by September 1925 with HQ at Cedar Falls, IA. Withdrawn from the O.R. on 5 September 1928 and demobilized.

**Commanders, 507th Infantry Battalion**

Maj. Walter L. Moore	ao September 1925–December 1925	Maj. Joseph P. O'Hara	December 1925–January 1926
	Maj. F.H. Winslow		January 1926–5 September 1928

**508th Infantry Battalion (ZI)****Organized Reserve Texas/Minnesota****HQ**—*Not initiated*, 1923–26; San Antonio, TX, 1926–27; Rochester, MN, 1927–28

Constituted in the O.R. on 2 July 1923, allotted to the Eighth Corps Area, and assigned to the Zone of the Interior. Initiated on 19 March 1926 with HQ at San Antonio, TX. Withdrawn from the Eighth Corps Area on 1 January 1927, and allotted to the Seventh Corps Area. Initiated by August 1927 with HQ at Rochester, MN. Withdrawn from the Seventh Corps Area on 5 September 1928 and demobilized.

**Commanders, 508th Infantry Battalion**

Unknown	19 March 1926–ao August 1927	Lt. Col. Oscar Seebach	ao August 1927–5 September 1928
---------	------------------------------	------------------------	---------------------------------

**509th Infantry Battalion (ZI)****Organized Reserve Washington****HQ**—*Not initiated*, 1923–25; Seattle, WA, 1925–28

Constituted in the O.R. on 2 July 1923, allotted to the Ninth Corps Area, and assigned to the Zone of the Interior. Initiated in September 1925 with HQ at Seattle, WA. Conducted summer training with the 7th Infantry at Vancouver Barracks, WA. Withdrawn from the O.R. on 5 September 1928 and demobilized.

**Commanders, 509th Infantry Battalion**

Capt. C.W. Watkins	September 1925–ao October 1925	Maj. John E. Carroll	ao June 1926–5 September 1928
--------------------	--------------------------------	----------------------	-------------------------------

**510th Infantry Battalion (ZI)****Organized Reserve Massachusetts****HQ**—*Not initiated*, 1923–25; Boston, MA, 1925–28

Constituted in the O.R. on 2 July 1923, allotted to the First Corps Area, and assigned to the Zone of the Interior. Initiated on 30 September 1925 with HQ at Boston, MA. Attached to the 94th Div. for administration and training. Withdrawn from the O.R. on 5 September 1928 and demobilized.

**Commander, 510th Infantry Battalion**

Unknown	30 September 1925–5 September 1928
---------	------------------------------------

**511th Infantry Battalion (ZI)****Organized Reserve Connecticut****HQ**—*Not initiated*, 1923–25; Hartford, CT, 1925–28

Constituted in the O.R. on 2 July 1923, allotted to the First Corps Area, and assigned to the Zone of the Interior. Initiated on 3 March 1925 with HQ at Hartford, CT. Attached to the 76th Div. for administration and training. Typically conducted Inactive Training Period meetings at the State Armory in Hartford. Withdrawn from the O.R. on 5 September 1928 and demobilized.

**Commanders, 511th Infantry Battalion**

Maj. Bourdon A. Babcock	March 1925–30 January 1928	Unknown	30 January 1928–5 September 1928
-------------------------	----------------------------	---------	----------------------------------

**512th Infantry Battalion (ZI)****Organized Reserve Massachusetts****HQ**—*Not initiated*, 1923–25; Boston, MA, 1925–28

Constituted in the O.R. on 2 July 1923, allotted to the First Corps Area, and assigned to the Zone of the Interior. Initiated on 30 September 1925 with HQ at Boston, MA. Conducted summer training with the 5th and 13th Inf. Regts. at Camp Devens, MA. Attached to the 94th Div. for administration and training. Withdrawn from the O.R. on 5 September 1928 and demobilized.

**Commander, 512th Infantry Battalion**

Lt. Col. Charles A. Ranlett	30 September 1925–5 September 1928
-----------------------------	------------------------------------

**513th Infantry Battalion (ZI)****Organized Reserve Rhode Island****HQ**—*Not initiated*, 1923–25; Providence, RI, 1925–28

Constituted in the O.R. on 2 July 1923, allotted to the First Corps Area, and assigned to the Zone of the Interior. Initiated on 1 June 1925 with HQ at Providence, RI. Attached to the 97th Div. for administration and training. Withdrawn from the O.R. on 5 September 1928 and demobilized.

**Commander, 513th Infantry Battalion**

Maj. Frederick W. Moore	1 June 1925–5 September 1928
-------------------------	------------------------------

**514th Infantry Battalion (ZI)****Organized Reserve New Jersey****HQ**—*Not initiated*, 1923–25; Trenton, NJ, 1925–28

Constituted in the O.R. on 2 July 1923, allotted to the Second Corps Area, and assigned to the Zone of the Interior. Initiated by December 1925 with HQ at Trenton, NJ. Attached to the 78th Div. on 17 September 1925 for administration and training. Withdrawn from the O.R. on 5 September 1928 and demobilized.

**Commander, 514th Infantry Battalion**

Unknown	ao December 1925–5 September 1928
---------	-----------------------------------

**515th Infantry Battalion (ZI)****Organized Reserve Delaware****HQ**—*Not initiated*, 1923–25; Wilmington, DE, 1925–28

Constituted in the O.R. on 2 July 1923, allotted to the Second Corps Area, and assigned to the Zone of the Interior. Initiated by December 1925 with HQ at Wilmington, DE. Attached to the 78th Div. on 17 September 1925 for administration and training. Withdrawn from the O.R. on 5 September 1928 and demobilized.

**Commander, 515th Infantry Battalion**

Unknown	ao December 1925–5 September 1928
---------	-----------------------------------

**516th Infantry Battalion (C) (ZI)****Organized Reserve New York/Puerto Rico****HQ**—*Not initiated*, 1923–25; Syracuse, NY, 1925–28; San Juan, PR, 1928–37; Cayguas, PR, 1937–41

Constituted in the O.R. on 2 July 1923, allotted to the Second Corps Area, and assigned to the Zone of the Interior. Initiated by September 1925 with HQ at Syracuse, NY. Attached to the 98th Div. on 17 September 1925 for administration and training. Relocated to San Juan, PR, on 17 April 1928 and reorganized with Colored personnel from the inactivated 374th and 375th Inf. Regts. Relocated to Cayguas, PR, on 30 September 1937. Conducted summer training with the 65th Inf. Regt. at San Juan. Conducted infantry CMTC training some years at Camp Buchanan as an alternate form of summer training. Camp Buchanan designated as the unit mobilization station. Location 7 December 1941—San Juan, PR.

**Status:** Disbanded 13 April 1945.**Commander, 516th Infantry Battalion**

Unknown            ao September 1925–7 December 1941

**517th Infantry Battalion (ZI)****Organized Reserve New York****HQ**—*Not initiated*, 1923–25; Peekskill, NY, 1925–28

Constituted in the O.R. on 2 July 1923, allotted to the Second Corps Area, and assigned to the Zone of the Interior. Initiated by December 1925 with HQ at Peekskill, NY. Attached to the 77th Div. on 17 September 1925 for administration and training. Withdrawn from the O.R. on 5 September 1928 and demobilized.

**Commander, 517th Infantry Battalion**

Unknown            ao December 1925–15 September 1928

**518th Infantry Battalion (ZI)****Organized Reserve****HQ**—*Not initiated*, 1923–25; Third Corps Area 1925–28

Constituted in the O.R. on 2 July 1923, allotted to the Third Corps Area, and assigned to the Zone of the Interior. Initiated by September 1925 with HQ in the Third Corps Area. Withdrawn from the O.R. on 5 September 1928 and demobilized. Concurrently, personnel transferred to the 12th Tank Group.

**Commander, 518th Infantry Battalion**

Maj. DeWitt M. Evans            ao September 1925–5 September 1928

**519th Infantry Battalion (ZI)****Organized Reserve District of Columbia****HQ**—*Not initiated*, 1923–25; Washington, DC, 1925–28

Constituted in the O.R. on 2 July 1923, allotted to the Third Corps Area, and assigned to the Zone of the Interior. Initiated by September 1925 with HQ at Washington, DC. Withdrawn from the O.R. on 5 September 1928 and demobilized. Concurrently, personnel transferred to the 12th Tank Group.

**Commander, 519th Infantry Battalion**

Maj. William H. McManus            ao September 1925–5 September 1928

**520th Infantry Battalion (ZI)****Organized Reserve Maryland****HQ**—*Not initiated*, 1923–25; Baltimore, MD, 1925–28

Constituted in the O.R. on 2 July 1923, allotted to the Third Corps Area, and assigned to the Zone of the Interior. Initiated by September 1925 with HQ at Baltimore, MD. Withdrawn from the O.R. on 5 September 1928 and demobilized.

**Commander, 520th Infantry Battalion**

Maj. Phillips B. Lee                      ao September 1925–5 September 1928

**521st Infantry Battalion (ZI)****Organized Reserve Virginia****HQ**—*Not initiated*, 1923–25; Third Corps Area 1925–28

Constituted in the O.R. on 2 July 1923, allotted to the Third Corps Area, and assigned to the Zone of the Interior. Initiated by September 1925 with HQ in Western Virginia. Withdrawn from the O.R. on 5 September 1928 and demobilized. Concurrently, personnel transferred to the 303d M.P. Bn.

**Commander, 521st Infantry Battalion**

Maj. Robert F. McDonald                      ao September 1925–5 September 1928

**522d Infantry Battalion (ZI)****Organized Reserve Florida****HQ**—*Not initiated*, 1923–24; Quincy, FL, 1924–28

Constituted in the O.R. on 2 July 1923, allotted to the Fourth Corps Area, and assigned to the Zone of the Interior. Initiated by December 1924 with HQ at Quincy, FL. Mobilization assignment was to be school support troops for the US Army Infantry School at Fort Benning, GA. Designated mobilization station was Fort Benning. Withdrawn from the O.R. on 5 September 1928 and demobilized.

**Commander, 522d Infantry Battalion**

Unknown                      ao December 1924–5 September 1928

**523d Infantry Battalion (ZI)****Organized Reserve Alabama****HQ**—*Not initiated*, 1923–24; Dothan, AL, 1924–28

Constituted in the O.R. on 2 July 1923, allotted to the Fourth Corps Area, and assigned to the Zone of the Interior. Initiated about April 1924 with HQ at Dothan, AL. Mobilization assignment was to be school support troops for the US Army Infantry School at Fort Benning, GA. Designated mobilization station was Fort Benning. Withdrawn from the O.R. on 5 September 1928 and demobilized.

**Commanders, 523d Infantry Battalion**

Unknown                      April 1924–12 May 1927                      Capt. Jack E. Demuth                      12 May 1927–5 September 1928

**524th Infantry Battalion (ZI)****Organized Reserve South Carolina****HQ**—*Not initiated*, 1923–24; Sumter, SC, 1924–28

Constituted in the O.R. on 2 July 1923, allotted to the Fourth Corps Area, and assigned to the Zone of the Interior. Initiated about April 1924 with HQ at Sumter, SC. Mobilization assignment was to be school support troops for the US Army Infantry School at Fort Benning, GA. Designated mobilization station was Fort Benning. Withdrawn from the O.R. on 5 September 1928 and demobilized.

**Commander, 524th Infantry Battalion**

Unknown                      April 1924–5 September 1928

**525th Infantry Battalion (ZI)****Organized Reserve Georgia****HQ**—*Not initiated*, 1923–24; McRae, GA, 1924–28

Constituted in the O.R. on 2 July 1923, allotted to the Fourth Corps Area, and assigned to the Zone of the Interior. Initiated about April 1924 with HQ at McRae, GA. Mobilization assignment was to be school support troops for the US Army Infantry School at Fort Benning, GA. Designated mobilization station was Fort Benning. Withdrawn from the O.R. on 5 September 1928 and demobilized.

**Commander, 525th Infantry Battalion**

Unknown                      ao April 1925–5 September 1928

**526th Infantry Battalion (ZI)****Organized Reserve West Virginia****HQ**—*Not initiated*, 1923–28

Constituted in the O.R. on 2 July 1923, allotted to the Fifth Corps Area, and assigned to the Zone of the Interior. Further allotted to the 100th Div. mobilization area (West Virginia). Withdrawn from the O.R. on 5 September 1928 and demobilized.

**527th Infantry Battalion (ZI)****Organized Reserve Ohio****HQ**—*Not initiated*, 1923–28

Constituted in the O.R. on 2 July 1923, allotted to the Fifth Corps Area, and assigned to the Zone of the Interior. Further allotted to the 83d Div. mobilization area (Ohio). Withdrawn from the O.R. on 5 September 1928 and demobilized.

**528th Infantry Battalion (ZI)****Organized Reserve Indiana****HQ**—*Not initiated*, 1923–28

Constituted in the O.R. on 2 July 1923, allotted to the Fifth Corps Area, and assigned to the Zone of the Interior. Further allotted to the 84th Div. mobilization area (Indiana). Withdrawn from the O.R. on 5 September 1928 and demobilized.

**529th Infantry Battalion (ZI)****Organized Reserve Ohio****HQ**—*Not initiated*, 1923–28

Constituted in the O.R. on 2 July 1923, allotted to the Fifth Corps Area, and assigned to the Zone of the Interior. Further allotted to the 83d Div. mobilization area (Ohio). Withdrawn from the O.R. on 5 September 1928 and demobilized.

**530th Infantry Battalion (ZI)****Organized Reserve Wisconsin****HQ**—*Not initiated*, 1923–25; Stevens Point, WI, 1925–28

Constituted in the O.R. on 2 July 1923, allotted to the Sixth Corps Area, and assigned to the Zone of the Interior. Initiated on 10 December 1925 with HQ at Stevens Point, WI. Attached to the 85th Div. on 19 October 1925 for organization, administration, and training. Conducted summer training with the 2d Inf. Regt. at Fort Brady, MI. Conducted infantry CMTC training at Fort Brady in 1928. Camp Custer, MI, designated as the unit mobilization station. Withdrawn from the O.R. on 5 September 1928 and demobilized.

**Commanders, 530th Infantry Battalion**

Maj. Edgar Combs            10 December 1925–27 February 1928            Maj. William A. McDonald            27 February 1928–5 September 1928



**531st Infantry Battalion (ZI)****Organized Reserve Illinois****HQ**—*Not initiated*, 1923–26; Vandalia, IL, 1926–28

The 531st was constituted in the O.R. on 2 July 1923, allotted to the Sixth Corps Area, and assigned to the Zone of the Interior. Initiated on 25 January 1926 with HQ at Vandalia, IL. Attached to the 86th Div. on 19 October 1925 for organization, administration, and training. Conducted summer training with the 6th Inf. Regt. at Jefferson Barracks, MO. Camp Custer, MI, designated as the unit mobilization station. Withdrawn from the O.R. on 5 September 1928 and demobilized.

**Commanders, 531st Infantry Battalion**

2d Lt. Curt H. Stout	26 January 1926–17 April 1926	Maj. Arthur R. McDonald	22 September 1927–26 February 1928
Maj. Jabish W. Woodward Jr.	17 April 1926–22 September 1927	Maj. Joseph H. McIntyre	26 February 1928–5 September 1928

**532d Infantry Battalion (ZI)****Organized Reserve Illinois****HQ**—*Not initiated*, 1923–26; Galoonda, IL, 1926–28

Constituted in the O.R. on 2 July 1923, allotted to the Sixth Corps Area, and assigned to the Zone of the Interior. Initiated on 20 January 1926 with HQ at Galoonda, IL. Attached to the 86th Div. on 19 October 1925 for organization, administration, and training. Conducted summer training with the 6th Inf. Regt. at Jefferson Barracks, MO. Camp Douglas, WI, designated as the unit mobilization station. Withdrawn from the O.R. on 5 September 1928 and demobilized.

**Commanders, 532d Infantry Battalion**

2d Lt. Jesse M. Holderby	26 January 1926–10 April 1926	Maj. Vernon W. Carris	10 April 1926–5 September 1928
--------------------------	-------------------------------	-----------------------	--------------------------------

**533d Infantry Battalion (ZI)****Organized Reserve Wisconsin****HQ**—*Not initiated*, 1923–26; Chippewa Falls, WI, 1926–28

Constituted in the O.R. on 2 July 1923, allotted to the Sixth Corps Area, and assigned to the Zone of the Interior. Initiated on 20 January 1926 with HQ at Chippewa Falls, WI. Attached to the 86th Div. on 19 October 1925 for organization, administration, and training. Conducted summer training with the 2d Inf. Regt. at Fort Sheridan, IL. Camp Douglas, WI, designated as the unit mobilization station. Withdrawn from the O.R. on 5 September 1928 and demobilized.

**Commanders, 533d Infantry Battalion**

2d Lt. Hugh E. Mogle	26 January 1926–20 February 1926	Capt. Grover C. Coil	13 December 1926–21 September 1927
Maj. Andre R. Crippen	20 February 1926–12 December 1926	Maj. Robert L. Jordan	22 September 1927–5 September 1928

**534th Infantry Battalion (ZI)****Organized Reserve Iowa****HQ**—*Not initiated*, 1923–25; Oskaloosa, IA, 1925–28

Constituted in the O.R. on 2 July 1923, allotted to the Seventh Corps Area, and assigned to the Zone of the Interior. Initiated by September 1925 with HQ at Oskaloosa, IA. Withdrawn from the O.R. on 5 September 1928 and demobilized.

**Commanders, 534th Infantry Battalion**

Maj. Walter N. Neal	ao September 1925–January 1926	Maj. C.E. Mohler	January 1926–5 September 1928
---------------------	--------------------------------	------------------	-------------------------------

**535th Infantry Battalion (ZI)****Organized Reserve Nebraska****HQ**—*Not initiated*, 1923–25; Norfolk, NE, 1925–28

Constituted in the O.R. on 2 July 1923, allotted to the Seventh Corps Area, and assigned to the Zone of the Interior. Initiated by September 1925 with HQ at Norfolk, NE. The battalion held a contact camp 6–20 June 1926 at Chautauqua Park in Beatrice, NE. Withdrawn from the O.R. on 5 September 1928 and demobilized.

**Commander, 535th Infantry Battalion**

Unknown                      ao September 1925–5 September 1928

**536th Infantry Battalion (ZI)****Organized Reserve Missouri****HQ**—*Not initiated*, 1923–25; Brookfield, MO, 1925–26; Lebanon, MO, 1926–28

Constituted in the O.R. on 2 July 1923, allotted to the Seventh Corps Area, and assigned to the Zone of the Interior. Initiated by September 1925 with HQ at Brookfield, MO. Relocated 26 May 1926 to Lebanon, MO. Conducted summer training with the 17th Inf. Regt. at Fort Leavenworth, KS. Withdrawn from the O.R. on 5 September 1928 and demobilized.

**Commander, 536th Infantry Battalion**

Unknown                      ao September 1925–5 September 1928

**537th Infantry Battalion (ZI)****Organized Reserve Missouri****HQ**—*Not initiated*, 1923–25; De Soto, MO, 1925–28; Wynne, AR, 1928

Constituted in the O.R. on 2 July 1923, allotted to the Seventh Corps Area, and assigned to the Zone of the Interior. Initiated by September 1925 with HQ at De Soto, MO. Relocated on 3 April 1928 to Wynne, AR. Conducted summer training with the 17th Inf. Regt. at Fort Leavenworth, KS. Withdrawn from the O.R. on 5 September 1928 and demobilized.

**Commander, 537th Infantry Battalion**

Unknown                      ao September 1925–5 September 1928

**538th Infantry Battalion (ZI)****Organized Reserve Texas/Arkansas****HQ**—*Not initiated*, 1923–26; San Antonio, TX, 1926–27; *Inactive*, 1927–28

Constituted in the O.R. on 2 July 1923, allotted to the Eighth Corps Area, and assigned to the Zone of the Interior. Initiated on 19 March 1926 with HQ at San Antonio, TX. Conducted summer training with the regiments of the 3d Inf. Brig. at Fort Sam Houston, TX. Withdrawn from the Eighth Corps Area on 1 January 1927 and allotted to the Seventh Corps Area. Fort Smith, AR, designated as HQ on organization, but the unit was never organized at that location. Withdrawn from the Seventh Corps Area on 5 September 1928 and demobilized.

**Commanders, 538th Infantry Battalion**Unknown                      19 March 1926–1 January 1927                      *Inactive*                      1 January 1927–5 September 1928

**539th Infantry Battalion (ZI)****Organized Reserve Texas/Minnesota****HQ**—*Not initiated*, 1923–26; San Antonio, TX, 1926–27; *Inactive*, 1927–28

Constituted in the O.R. on 2 July 1923, allotted to the Eighth Corps Area, and assigned to the Zone of the Interior. Initiated on 19 March 1926 with HQ at San Antonio, TX. Conducted summer training with the regiments of the 3d Inf. Brig. at Fort Sam Houston, TX. Withdrawn from the Eighth Corps Area on 1 January 1927, and allotted to the Seventh Corps Area. Fergus Falls, MN, designated as HQ on organization, but the unit was never organized at that location. Withdrawn from the Seventh Corps Area on 5 September 1928 and demobilized.

**Commanders, 539th Infantry Battalion**

Unknown	19 March 1926–1 January 1927	<i>Inactive</i>	1 January 1927–5 September 1928
---------	------------------------------	-----------------	---------------------------------

**540th Infantry Battalion (ZI)****Organized Reserve Texas/South Dakota****HQ**—*Not initiated*, 1923–26; San Antonio, TX, 1926–27; *Inactive*, 1927–28

Constituted in the O.R. on 2 July 1923, allotted to the Eighth Corps Area, and assigned to the Zone of the Interior. Initiated on 19 March 1926 with HQ at San Antonio, TX. Conducted summer training with the regiments of the 3d Inf. Brig. at Fort Sam Houston, TX. Withdrawn from the Eighth Corps Area on 1 January 1927 and allotted to the Seventh Corps Area. Aberdeen, SD, designated as HQ on organization, but the unit was never organized at that location. Withdrawn from the Seventh Corps Area on 5 September 1928 and demobilized.

**Commanders, 540th Infantry Battalion**

Unknown	19 March 1926–1 January 1927	<i>Inactive</i>	1 January 1927–5 September 1928
---------	------------------------------	-----------------	---------------------------------

**541st Infantry Battalion (ZI)****Organized Reserve Texas/North Dakota****HQ**—*Not initiated*, 1923–26; San Antonio, TX, 1926–27; *Inactive*, 1927–28

Constituted in the O.R. on 2 July 1923, allotted to the Eighth Corps Area, and assigned to the Zone of the Interior. Initiated on 19 March 1926 with HQ at San Antonio, TX. Conducted summer training with the regiments of the 3d Inf. Brig. at Fort Sam Houston, TX. Withdrawn from the Eighth Corps Area on 1 January 1927 and allotted to the Seventh Corps Area. Devil's Lake, ND, designated as HQ on organization, but the unit was never organized at that location. Withdrawn from the Seventh Corps Area on 5 September 1928 and demobilized.

**Commanders, 541st Infantry Battalion**

Unknown	19 March 1926–1 January 1927	<i>Inactive</i>	1 January 1927–5 September 1928
---------	------------------------------	-----------------	---------------------------------

**542d Infantry Battalion (ZI)****Organized Reserve California****HQ**—*Not initiated*, 1923–25; San Francisco, CA, 1925–28

Constituted in the O.R. on 2 July 1923, allotted to the Ninth Corps Area, and assigned to the Zone of the Interior. Initiated by September 1925 with HQ at San Francisco, CA. Conducted summer training with the 30th Inf. Regt. at Del Monte, CA. Withdrawn from the O.R. on 5 September 1928 and demobilized.

**Commanders, 542d Infantry Battalion**

Lt. Col. Walter K. Knox	ao September 1925–1 February 1928	Unknown	1 February 1928–5 September 1928
-------------------------	-----------------------------------	---------	----------------------------------

**543d Infantry Battalion (ZI)****Organized Reserve Utah****HQ**—*Not initiated*, 1923–25; Salt Lake City, UT, 1925–28

Constituted in the O.R. on 2 July 1923, allotted to the Ninth Corps Area, and assigned to the Zone of the Interior. Initiated by September 1925 with HQ at Salt Lake City, UT. Conducted summer training with the 38th Inf. Regt. at Fort Douglas, UT. Withdrawn from the O.R. on 5 September 1928 and demobilized.

**Commander, 543d Infantry Battalion**

Unknown                      ao September 1925–5 September 1928

**544th Infantry Battalion (ZI)****Organized Reserve Oregon****HQ**—*Not initiated*, 1923–25; Portland, OR, 1925–28

Constituted in the O.R. on 2 July 1923, allotted to the Ninth Corps Area, and assigned to the Zone of the Interior. Initiated on 8 August 1925 with HQ at Portland, OR. Conducted summer training with the 7th Inf. Regt. at Vancouver Barracks, WA, or Fort Lewis, WA. Withdrawn from the O.R. on 5 September 1928 and demobilized.

**Commanders, 544th Infantry Battalion**

Capt. Hugh J. Deeney	8 August 1925–ao September 1925	Unknown	ao September 1925–ao August 1926
	Lt. Col. Dallas D. Dennis		ao August 1926–5 September 1928

**545th Infantry Battalion (ZI)****Organized Reserve Utah****HQ**—*Not initiated*, 1923–25; Salt Lake City, UT, 1925–28

Constituted in the O.R. on 2 July 1923, allotted to the Ninth Corps Area, and assigned to the Zone of the Interior. Initiated by September 1925 with HQ at Salt Lake City, UT. Conducted summer training with the 38th Inf. Regt. at Fort Douglas, UT. Withdrawn from the O.R. on 5 September 1928 and demobilized.

**Commander, 545th Infantry Battalion**

Unknown                      ao September 1925–5 September 1928

**546th Infantry Battalion (ZI)****Organized Reserve Kansas/South Dakota****HQ**—*Not initiated*, 1923–25; Kansas City, KS, 1925–26; Topeka, KS, 1926–28; *Inactive*, 1928

Constituted in the O.R. on 2 July 1923, allotted to the Seventh Corps Area, and assigned to the Zone of the Interior. Mobilization assignment was to be school support troops for the Cavalry School at Fort Riley, KS. Initiated by September 1925 with HQ at Kansas City, KS. Conducted summer training with the 17th Inf. Regt. at Fort Leavenworth, KS. Conducted mobilization and training 2–16 May 1926 for over 300 Washburn College and local high school students at Gage Park, Topeka, KS. Relocated 26 May 1926 to Topeka, KS. Relocated 3 April 1928 to Watertown, SD, but the unit was never organized at that location. Withdrawn from the O.R. on 5 September 1928 and demobilized.

**Commanders, 546th Infantry Battalion**

Unknown	ao September 1925–3 April 1928	<i>Inactive</i>	3 April 1928–5 September 1928
---------	--------------------------------	-----------------	-------------------------------

**547th Infantry Battalion (ZI)****Organized Reserve Oklahoma****HQ**—*Not initiated*, 1923–28

Constituted in the O.R. on 2 July 1923, allotted to the Eighth Corps Area, and assigned to the Zone of the Interior. Fort Sill, OK, designated as HQ on organization, but the unit was never organized at that location. Withdrawn from the O.R. on 5 September 1928 and demobilized.

**548th Infantry Battalion (ZI)****Organized Reserve****HQ**—*Not initiated*, 1923–28

Constituted in the O.R. on 2 July 1923, allotted to the Eighth Corps Area, and assigned to the Zone of the Interior. Withdrawn from the O.R. on 5 September 1928 and demobilized.

**549th Infantry Battalion (ZI)****Organized Reserve Alaska****HQ**—*Not initiated*, 1923–25; Juneau, TA, 1925–29; *Inactive*, 1929–31; Juneau, TA, 1931–37; *Inactive*, 1937–41

Constituted in the O.R. on 2 July 1923, allotted to the Ninth Corps Area, and assigned to the Zone of the Interior. Initiated by December 1925 with HQ at Juneau, TA. Inactivated by June 1929 at Juneau by relief of personnel. Reorganized by June 1931 with HQ at Juneau. Inactivated 2 March 1937 at Juneau by relief of personnel. Mobilization assignment on organization was to relieve R.A. troops of responsibility of Chilkoot Barracks and the defense of southern portions of the Territory of Alaska. Conducted summer training with the 2d Bn., 7th Inf. at Chilkoot Barracks. Primary ROTC feeder school was the University of Alaska. Location 7 December 1941—Juneau, TA.

**Commanders, 549th Infantry Battalion**

Maj. Henry R. Sanborn	ao December 1925–ao June 1927	<i>Inactive</i>	ao June 1929–ao June 1931
Unknown	ao June 1927–ao June 1929	Lt. Col. Herbert W. Meyers	ao June 1933–2 March 1937
	<i>Inactive</i>	2 March 1937–7 December 1941	



## Chapter 11

### Tank Organizations



USASC photo, US Army Armor Center History Office

Reserve officers from Illinois and Wisconsin observe maneuvers of the 6th Tank Company at the Peoria Tank Training Center, IL, circa 1932.

The mission of tank organizations was to support the infantry in operations to close with and destroy the enemy by fire and maneuver. Specifically, the role of tanks was to “facilitate the uninterrupted advance of the infantry in the attack.”

#### Organization

After much discussion and debate within the Army about the role and future of what was then known as the Tank Corps, the National Defense Act of 1920 assigned the control of tank organizations to the Infantry branch. This move, and the cavalry’s corresponding reluctance to embrace the new weapon, directly affected the doctrinal employment and organizational development of tank units in the interwar period.

The Regular Army (R.A.) tank units of 1921 were directly related lineally to several of the tank organizations of World War I. That year, the 1st Tank Group and four battalions (one special, two light, one heavy) were organized from existing units at Camp Meade, MD. Like the rest of the Army, however, the group was soon forced to inactivate units as the Army drew down in strength due to budget reductions. Still, the War Plans Division constituted an additional heavy tank battalion in 1923 bringing to five the number of battalions in the group. Three of these battalions remained active in the 1920s and two were organized in 1926 as Regular Army Inactive (RAI) units in Maryland.

### Infantry Regiment (Heavy Tanks) 1933

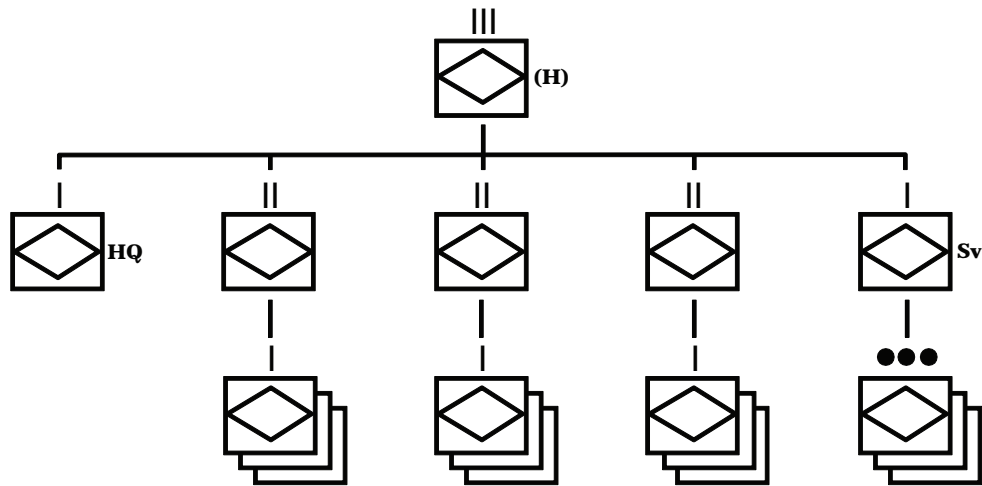

T/O: 550W  
 Approved: 1 Jul 33  
 Commander: Col.  
 Officers: 249  
 W. O.: 1  
 Enlisted: 2812  
 Total: 3062

**Key Equipment:**  
 Cars, various 21  
 Tanks, Heavy, Mk VIII 135  
 Trucks, various 199  
 Machine-gun, cal. .30 945  
 Gun, Tank, 2.24 in 270

### Infantry Regiment (Light Tanks) 1933

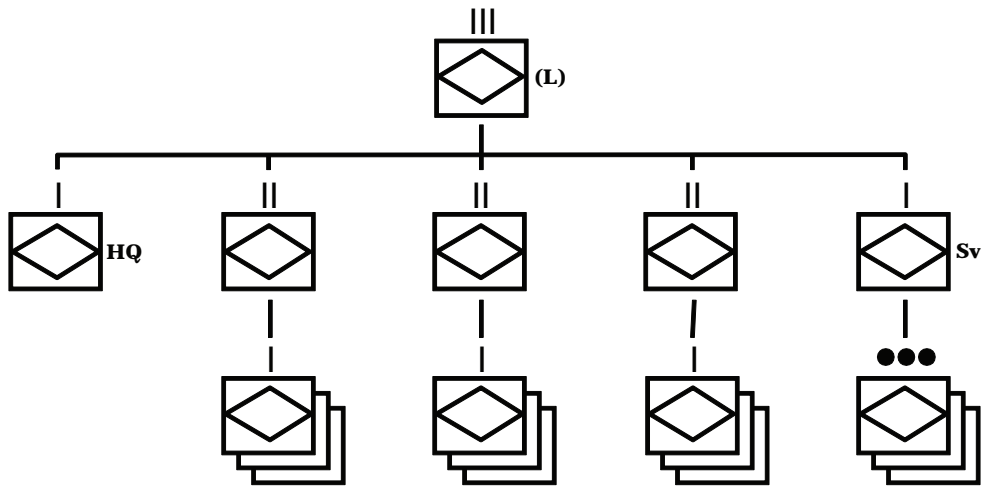

T/O: 551W  
 Approved: 1 Jul 33  
 Commander: Col.  
 Officers: 162  
 W. O.: 1  
 Enlisted: 1784  
 Total: 1,887

**Key Equipment:**  
 Cars, various 19  
 Tanks, Light, 6-ton 223  
 Trucks, various 132  
 Machine-gun, cal. .30 120  
 Gun, Tank, 37 mm 96

Infantry regiment organizations.



Also in 1921, the Army constituted 4 tank group headquarters and 21 battalions in the Organized Reserve (O.R.). This contingent was expanded by three battalions in 1924 and then reduced by three in 1928 when the 301st, 306th, and 314th Tank Battalions were disbanded. At about the same time, three new tank group headquarters were constituted. All of these units were initiated in the 1920s.

In 1930, all of the groups and battalions of both components were reorganized and redesignated as tank regiments. These designations gave way 2 years later when the units were all redesignated as infantry regiments with the parenthetical “light tanks,” “medium tanks,” or “heavy tanks” following the unit designation (see Chapter 9, Infantry Regiments, for information on these units after 1932).

A special tank-oriented organization during this period was the experimental mechanized force, two of which were organized provisionally: one in 1928 and another in 1930. The creation of these two organizations was a direct result of a similar effort by the British Army to experiment with developing a force that possessed both power and speed. These two essentially brigade-strength organizations were assembled from parts and pieces of various existing tank and motorized organizations from the Second and Third Corps Areas for the purpose of testing new mobile warfare concepts and equipment. The experiments showed enough promise that elements of the second force were reorganized into the provisional Mechanized Cavalry Regiment and ordered to reorganize at Camp Knox, KY, to assist in forming the new 7th Cavalry Brigade (Mechanized). This brigade would, in turn, morph into the 1st Armored Division in 1940.

## **Training**

Training opportunities for R.A. tank organizations was in some respects better than for other infantry organizations. While many infantry regiments never had the luxury of training with a tank unit in the interwar period, every tank unit was able to train with the infantry. Thus, on those occasions when tank units took to the field, they were able to conduct training that was more realistic. Of course, the opportunities for training were limited by the cost of repair parts and fuel for the tanks themselves. Additionally, like most R.A. units during this period, tank organizations supported the training of most of the National Guard (N.G.) and O.R. tank units scattered about the country.

The two RAI tank battalions, the 18th and 19th Battalions, were extremely lucky in that they were located at Camp George G. Meade, MD, the Army’s tank center and school, and home to the 1st Tank Group. The training activities for these battalions usually included direct integration with the units of the 1st Tank Group or direct involvement of group personnel and equipment in the reservists’ training events.

Most other Reserve tank units were not so lucky, but a few were close. Several of the tank battalions in New York, New Jersey, and Connecticut were able to occasionally train with the 1st Division’s 1st Tank Company at Miller Field, NY, during the inactive training period. This same type of arrangement was available to the tank battalions of Illinois with the 6th Tank Company at Jefferson Barracks, MO. Occasionally, the O.R. tank battalions in Pennsylvania were able to train on the tanks of the 28th Tank Company in Norristown. Most O.R. tank groups and battalions, however, were geographically dispersed and were not functional units during the inactive training period. Most of their personnel were spread out over long distances and were usually forced to attend meetings with other units or participate in local troop schools and generic training activities.

Summer training camps provided the most realistic training opportunities for O.R. tank units. Here again, R.A. and, to a lesser extent, N.G. tank organizations supported the training of the Reserve tank units. In most instances, these camps were conducted at R.A. training areas with the reservists usually attending as individuals rather than as organized units. The 9th Tank Group, however, often conducted joint training with the 6th Tank Company at the Sixth Corps Area Tank Training Center in Peoria, IL. This grandiose sounding installation was actually the Caterpillar Company’s proving grounds for testing new bulldozer and tractor designs. In the event of war, the company was apparently amenable to turning over the area to the Army for training tank units, but it was a plan that was never implemented for World War II.

### **HHD, Experimental Mechanized Force (I)**

**HQ**—Fort Leonard Wood, MD, 1928

**Subordinate elements**—1st Bn., 34th Inf.; E Tp., 3d Cav.; A Co., 1st Tank Regt.; 4th Tank Co.; 16th Tank Bn.; 17th Tank Bn.; 2d Bn., 6th Field Artillery (F.A.); 1st Ammunition (Ammo.) Train; B Battery (Btry), 61st Coast Artillery (C.A.); C Co., 1st Engineers (Engrs.); Dets from 1st Med. Regt., 1st Signal (Sig.) Co., and 30th Ordnance (Ord.) Co. Organized provisionally on 1 July 1928 at Fort Leonard Wood, MD (formerly Camp George G. Meade, MD), for the purpose of providing a HQ for the US Army's first mechanized force. Its mission was to conduct experiments in armored warfare and test experimental armored equipment. The attached subordinate units came under the control of the Mechanized Force for specific training events related to the testing of equipment or tactics. Otherwise, for mobilization purposes, the units belonged to other major HQ. Conducted a series of road marches through Maryland and Pennsylvania in July–September 1928. The Experimental Mechanized Force was discontinued on 1 October 1928 after the initial testing was completed and attached units returned to their parent headquarters.

#### **Commander, Experimental Mechanized Force**

Col. Oliver S. Eskridge                      1 July 1928–1 October 1928

### **HHC, Experimental Mechanized Force (II)**

**HQ**—Fort Eustis, VA, 1930–31

**Subordinate elements**—H Co., 34th Inf.; A Co., 1st Tank Regt.; A Tp., 2d Armored (Armd.) Car Sq.; A Btry, 6th F.A.; E Btry, 69th C.A.; C Co., 13th Engrs.; 19th Ord. Co.

Organized provisionally on 14 October 1930 at Fort Eustis, VA, for the purpose of providing a HQ for the US Army's second mechanized force. Like its forbear, its mission was to conduct experiments in armored warfare and test experimental armored equipment. The attached subordinate units came under the control of the Mechanized Force for specific training events related to the testing of equipment or tactics. Otherwise, for mobilization purposes, the units belonged to other major HQ. Conducted a 600-mile road march from Fort Eustis to Fort Bragg and back, from 12 to 31 May 1931. The Experimental Mechanized Force was directed to be discontinued by the Chief of Staff of the Army, Gen. Douglas MacArthur, and was broken up on 31 October 1931. Most attached units were returned to their parent HQ; however, some elements of the force were transferred to Camp Knox, KY, late that fall to assist in forming the new 7th Cav. Brig. (Mecz.).

#### **Commander, Experimental Mechanized Force**

Brig. Gen. Daniel Van Voorhis                      14 October 1930–31 October 1931

### **HHC, 1st Tank Group (GHQR)**

**HQ**—Camp George G. Meade, MD, 1921–29

**Subordinate elements**—15th Tank Bn., 16th Tank Bn., 17th Tank Bn., 18th Tank Bn. (RAI), and 21st Tank Maint. Co., 1921–29; 19th Tank Bn. (RAI) 1924–29.

Arrived at the port of New York on 17 March 1919 on the U.S.S. *Patricia* as Headquarters and Headquarters Company (HHC), 304th Brig., Tank Corps. Transferred to Camp George G. Meade, MD. Consolidated on 22 June 1921 with HHC, 305th Brig., Tank Corps and reorganized and redesignated HHC, 1st Tank Gp. Concurrently assigned to the General Headquarters Reserve (GHQR). Redesignated HHC, 1st Tank Regt. (Light) 1 September 1929 (15th–17th Tank Bns. and 21st Tank Maint. Co. concurrently redesignated as follows: 2d, 1st, and 3d Bns., and Service Co., respectively).

#### **Commanders, 1st Tank Group**

Col. Oliver S. Eskridge                      ao July 1923–1 July 1927                      Col. Harry L. Hooper                      1 June 1927–31 August 1929



**HHC, 10th Tank Group (GHQR)****Organized Reserve Pennsylvania****HQ**—*Not initiated*, 1928–29; Scranton, PA, 1929–30**Subordinate elements**—309th Tank Bn., 310th Tank Bn., and 312th Tank Bn. 1928–30.

Constituted in the O.R. on 5 September 1928, assigned to the GHQR, and allotted to the Third Corps Area. Initiated in June 1929 at Scranton, PA. Redesignated HHC, 310th Tank Regt. (Heavy) on 20 May 1930.

**Commander, 10th Tank Group**

Unknown                      June 1929–20 May 1930

**HHC, 11th Tank Group (GHQR)****Organized Reserve Georgia****HQ**—*Not initiated*, 1928–29; Columbus, GA, 1929–30**Subordinate elements**—302d Tank Bn., 313th Tank Bn., and 318th Tank Bn., 1928–30.

Constituted in the O.R. on 5 September 1928, assigned to the GHQR, and allotted to the Fourth Corps Area. Initiated on 19 July 1929 at Columbus, GA. Redesignated HHC, 311th Tank Regt. (Heavy) on 20 May 1930.

**Commanders, 11th Tank Group**

Capt. Murray B. Frazee      19 July 1929–25 February 1930                      Capt. Harry B. Miller      25 February 1930–20 May 1930

**HHC, 12th Tank Group (GHQR)****Organized Reserve Wisconsin****HQ**—*Not initiated*, 1928–29; Milwaukee, WI, 1929–30**Subordinate elements:** 319th Tank Bn., 323d Tank Bn., and 324th Tank Bn., 1928–30.

Constituted in the O.R. on 5 September 1928, assigned to the GHQR, and allotted to the Sixth Corps Area. Initiated on 19 July 1929 at Milwaukee, WI. Redesignated HHC, 312th Tank Regt. (Heavy) on 20 May 1930.

**Commanders, 12th Tank Group**

Capt. Frank D. Preston      19 July 1929–25 February 1930                      Capt. Melville B. Oakham      25 February 1930–20 May 1930

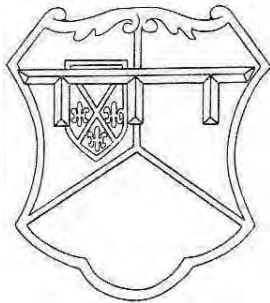
**1st Tank Regiment (Light) (GHQR)****HQ**—Camp George G. Meade, MD, 1929–32Arrived at the port of New York on 17 March 1919 on the U.S.S. *Patricia* as HHC, 304th Brig., Tank Corps. Transferred to Camp George G. Meade, MD. Consolidated on 22 June 1921 with HHC, 305th Brig., Tank Corps and reorganized and redesignated HHC, 1st Tank Gp. Concurrently assigned to the GHQR. Redesignated HHC, 1st Tank Regt. (Light) on 1 September 1929 (15th–17th Tank Bns. and 21st Tank Maint. Co. concurrently redesignated as follows: 2d, 1st, and 3d Bns., and Service Co., respectively). Reorganized and redesignated 66th Inf. Regt. (Light Tanks) on 25 October 1932.**Events:** 121, 143, 151**Commanders, 1st Tank Regiment**Lt. Col. Channing E. Delaplane      1 September 1929–26 October 1931                      Col. James M. Petty      26 October 1931– September 1931  
Col. Harry L. Hooper                      September 1931–25 October 1932

**2d Tank Regiment (Heavy) (GHQR)**

**HQ**—*Not organized, 1929–32*

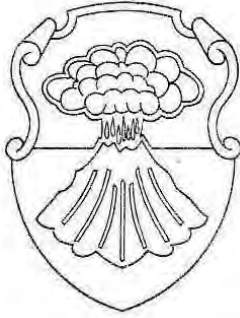

Constituted in the R.A. on 1 September 1929, assigned to the GHQR, and allotted to the Third Corps Area. Partially organized by redesignation as follows: 19th Tank Bn. (RAI) as the 1st Bn., and the 17th Tank Bn. (active at Camp George G. Meade, MD) as the 2d Bn. The 3d Bn. and Service Co. constituted as new units. Reorganized and redesignated 67th Inf. Regt. (Medium Tanks) on 25 October 1932.

**Commander, 2d Battalion, 2d Tank Regiment**

Maj. Floyd R. Waltz      1 July 1931–14 September 1931

**306th Tank Regiment (Light) (GHQR)**

**Organized Reserve New York**

**HQ**—New York City, NY, 1930–32

Constituted in the O.R. on 15 October 1921 as HHC, 6th Tank Gp., assigned to the GHQR, and allotted to the Second Corps Area. Initiated in June 1922 at New York City, NY. Redesignated HHC, 306th Tank Regt. (Light) on 20 May 1930. Subordinate elements organized by redesignation as follows: 303d Tank Bn. as the 1st Bn.; 304th Tank Bn. as the 2d Bn.; 305th Tank Bn. as the 3d Bn. Conducted summer training at Camp George G. Meade, MD, with the 1st Tank Regt. Reorganized and redesignated 424th Inf. Regt. (Light Tanks) on 25 October 1932.

**Commanders, 306th Tank Regiment**

Maj. Henry C. Bate      27 June 1931–25 January 1932      Lt. Col. Charles W. Dall      25 January 1932–25 October 1932

**307th Tank Regiment (Light) (GHQR)**

**Organized Reserve Pennsylvania**

**HQ**—Scranton, PA, 1930–32

Constituted in the O.R. on 15 October 1921 as HHC, 7th Tank Gp., assigned to the GHQR, and allotted to the Third Corps Area. Initiated in September 1922 at Scranton, PA. Redesignated HHC, 307th Tank Regt. (Light) on 20 May 1930. Subordinate elements organized by redesignation as follows: 307th Tank Bn. as the 1st Bn.; 308th Tank Bn. as the 2d Bn.; and 311th Tank Bn. as the 3d Bn. Conducted summer training at Camp George G. Meade, MD, with the 1st Tank Regt. Reorganized and redesignated 425th Inf. Regt. (Light Tanks) on 25 October 1932.

**Commanders, 307th Tank Regiment**

Col. William D. Chitty      20 May 1930–28 October 1930      Maj. Herbert L. Landolt      28 October 1930–19 October 1931  
Lt. Col. Anson Jackson      19 October 1931–24 October 1932

**308th Tank Regiment (Light) (GHQR)****Organized Reserve West Virginia/Ohio****HQ**—Charleston, WV, 1930–31; Akron, OH, 1931–32

Constituted in the O.R. on 15 October 1921 as HHC, 8th Tank Gp., assigned to the GHQR, and allotted to the Fifth Corps Area. Initiated in June 1922 at Charleston, WV. Conducted summer training at Fort Thomas, KY. Attached to the 100th Div. on 4 August 1927 for administration, supply, and training. Redesignated HHC, 308th Tank Regt. (Light) on 20 May 1930. Subordinate elements organized by redesignation as follows: 315th Tank Bn. as the 1st Bn.; 316th Tank Bn. as the 2d Bn.; and 317th Tank Bn. as the 3d Bn. HQ relocated on 9 July 1931 to Akron, OH. Reorganized and redesignated 426th Inf. Regt. (Light Tanks) on 25 October 1932.

**Commanders, 308th Tank Regiment**

Maj. Walter P.M. Young

20 May 1930–ao July 1930

Col. LaRue A. Boals

ao June 1931–24 October 1932

**309th Tank Regiment (Light) (GHQR)****Organized Reserve Illinois****HQ**—Chicago, IL, 1930–32

Constituted in the O.R. on 15 October 1921 as HHC, 9th Tank Gp., assigned to the GHQR, and allotted to the Sixth Corps Area. Initiated in April 1922 at Chicago, IL. Redesignated HHC, 309th Tank Regt. (Light) on 20 May 1930. Subordinate elements organized by redesignation as follows: 320th Tank Bn. as the 1st Bn.; 321st Tank Bn. as the 2d Bn.; and 322d Tank Bn. as the 3d Bn. Conducted summer training at Jefferson Barracks, MO, or the Peoria Tank Training Center, Peoria, IL, with the 6th Tank Co. and some years at Camp George G. Meade, MD, with the 1st Tank Regt. Reorganized and redesignated 420th Inf. Regt. (Light Tanks) on 25 October 1932.

**Commander, 309th Tank Regiment**

Lt. Col. Henry M. Huxley

20 May 1930–24 October 1932

**310th Tank Regiment (Heavy) (GHQR)****Organized Reserve Pennsylvania****HQ**—Scranton, PA, 1930–32

Constituted in the O.R. on 5 September 1928 as HHC, 10th Tank Gp., assigned to the GHQR, and allotted to the Third Corps Area. Initiated in June 1929 at Scranton, PA. Redesignated HHC, 310th Tank Regt. (Heavy) on 20 May 1930. Subordinate elements organized by redesignation as follows: 309th Tank Bn. as the 1st Bn.; 310th Tank Bn. as the 2d Bn.; and 312th Tank Bn. as the 3d Bn. Conducted summer training at Camp George G. Meade, MD, with the 1st Tank Regt. Reorganized and redesignated 421st Inf. Regt. (Heavy Tanks) on 25 October 1932.

**Commanders, 310th Tank Regiment**

Maj. Edward E. Odom

28 October 1930–7 January 1932

Lt. Col. George F. Kemp

7 January 1932–24 October 1932

**311th Tank Regiment (Heavy) (GHQR)****Organized Reserve Georgia****HQ**—Columbus, GA, 1930–32

Constituted in the O.R. on 5 September 1928 as HHC, 11th Tank Gp.; assigned to the GHQR; and allotted to the Fourth Corps Area. Initiated on 19 July 1929 at Columbus, GA. Redesignated HHC, 311th Tank Regt. (Heavy) on 20 May 1930. Subordinate elements organized by redesignation as follows: 302d Tank Bn. as the 1st Bn.; 313th Tank Bn. as the 2d Bn.; and 318th Tank Bn. as the 3d Bn. Conducted summer training at Fort Benning, GA, with the 4th Tank Co. Reorganized and redesignated 422d Inf. Regt. (Heavy Tanks) on 25 October 1932.

**Commanders, 311th Tank Regiment**

Lt. Col. Curtis G. Rorebeck	20 May 1930–1 June 1932	Maj. John W. Weinschenk	1 June 1932–28 June 1932
	Lt. Col. Charles E. Littlejohn		28 June 1932–24 October 1932

**312th Tank Regiment (Heavy) (GHQR)****Organized Reserve Wisconsin****HQ**—Milwaukee, WI, 1930–32

Constituted in the O.R. on 5 September 1928 as HHC, 12th Tank Gp.; assigned to the GHQR; and allotted to the Sixth Corps Area. Initiated on 19 July 1929 at Milwaukee, WI. Redesignated HHC, 312th Tank Regt. (Heavy) on 20 May 1930. Subordinate elements organized by redesignation as follows: 319th Tank Bn. as the 1st Bn.; 323d Tank Bn. as the 2d Bn.; and 324th Tank Bn. as the 3d Bn. Conducted summer training at Jefferson Barracks, MO, with the 6th Tank Co. Reorganized and redesignated 423d Inf. Regt. (Heavy Tanks) on 25 October 1932.

**Commander, 312th Tank Regiment**

Lt. Col. Julius R. Offenbauer	20 May 1930–24 October 1932
-------------------------------	-----------------------------

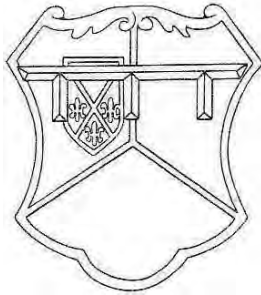
**15th Tank Battalion (Special) (1st Tank Group)****HQ**—Fort Benning, GA, 1921–29

Organized in the R.A. on 22 June 1921 and assigned to the 1st Tank Gp. Organized at Camp Benning, GA, by redesignation as follows: HHC, 344th Tank Bn. as HHC; A Co.; 344th Tank Bn. as A Co.; A Co., 301st Tank Bn. as B Co.; and C Co., 344th Tank Bn. as C Co. Entire unit deployed to assist the troops of A Co., 7th Engrs. in saving the Upatoi Creek bridge at the front entrance to Fort Benning from a major flood 5–6 March 1929. Redesignated 2d Bn., 1st Tank Regt. on 1 September 1929.

**Organization Day:** 12 September. Chosen to commemorate the 344th Tank Bn.'s accomplishments in the Battle of St. Mihiel, 12 September 1918.

**Status:** Active in the R.A. as elements of the 66th Armd. Regt.

**Commanders, 15th Tank Battalion**

Maj. John W. Leonard	7 August 1921–31 May 1923	Maj. Edgar S. Miller	25 March 1925–4 June 1929
Maj. Joseph Russ	31 May 1923–24 March 1925	Maj. Serano E. Brett	4 June 1929–31 August 1929

**16th Tank Battalion (Light) (1st Tank Group)**

**HQ**—Camp George G. Meade, MD, 1921–29

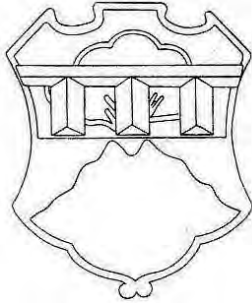

Organized in the R.A. on 22 June 1921 and assigned to the 1st Tank Gp. Organized at Camp George G. Meade, MD, by redesignation as follows: HHC, 345th Tank Bn. as HHC; A Co., 345th Tank Bn. as A Co.; B Co., 345th Tank Bn. as B Co.; and C Co., 301st Tank Bn. as C Co. Participated in the inaugural parade of President Calvin Coolidge on 4 March 1925. Participated in the experiments of the Mechanized Force from 1928 to 1931. Redesignated 1st Bn., 1st Tank Regt. on 1 September 1929.

**Status:** Active in the R.A. as elements of the 66th Armd. Regt.

**Commanders, 16th Tank Battalion**

Maj. Emile V. Cutrer	22 June 1921–10 May 1922	Maj. Edgar S. Miller	10 May 1922–23 March 1925
	Maj. James A. McGrath		24 March 1925–31 August 1929

**17th Tank Battalion (Heavy) (1st Tank Group)**

**HQ**—Camp George G. Meade, MD, 1921–29

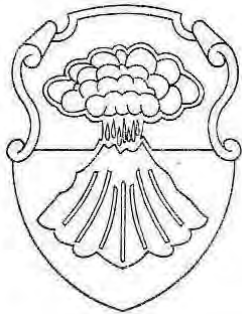

Organized in the R.A. on 22 June 1921 and assigned to the 1st Tank Gp. Organized at Camp George G. Meade, MD, by consolidation and redesignation as follows: HHC, 301st and 303d Tank Bns. as HHC; A Co.; 303d Tank Bn. as A Co.; B Co., 301st Tank Bn. as B Co.; and Cos. B and C, 303d Tank Bn. as C Co. Participated in the experiments of the Mechanized Force from 1928 to 1931. Relieved from the 1st Tank Gp. on 1 September 1929 and concurrently redesignated 2d Bn., 2d Tank Regt.

**Status:** Active in the R.A. as elements of the 67th Armd. Regt.

**Commanders, 17th Tank Battalion**

Unknown	22 June 1921–ao July 1923	Maj. Douglass T. Greene	10 September 1923–17 August 1928
Maj. Joseph Russ	ao July 1923–10 September 1923	Maj. Clarence M. Culp	18 August 1928–31 August 1929

**18th Tank Battalion (Light) (1st Tank Group)**

**HQ**—Camp George G. Meade, MD, 1921–22; *Inactive*, 1922–26; Camp George G. Meade, MD, 1926–29

Organized in the R.A. on 22 June 1921 and assigned to the 1st Tank Gp. Organized at Camp George G. Meade, MD, by consolidation and redesignation as follows: HHC, 328th and 329th Tank Bns. as HHC; A Co.; 329th Tank Bn. as A Co.; B Co., 329th Tank Bn. as B Co.; and C Co., 329th Tank Bn. as C Co. Inactivated on 29 July 1922 at Camp George G. Meade. Concurrently the 16th Tank Bn. made Active Associate. Organized on 1 April 1926 with O.R. personnel as an RAI unit at Camp George G. Meade, MD. Allotted to the Third Corps Area for mobilization purposes on 28 February 1927. Typically conducted Inactive Training Period meetings at Camp George G. Meade. Conducted summer training at Camp George G. Meade with the 17th Tank Bn. Redesignated 3d Bn., 1st Tank Regt. on 1 September 1929.

**Status:** Active in the R.A. as elements of the 66th Armd. Regt.

**Commanders, 18th Tank Battalion**

Capt. Thomas J. Holmes**	1 April 1926–ao June 1928	Unknown	ao June 1928–1 September 1929
--------------------------	---------------------------	---------	-------------------------------

\*\*RAI commanders: O.R. officers



**19th Tank Battalion (Heavy) (1st Tank Group)**

**HQ**—*Not organized*, 1923–26; Camp George G. Meade, MD, 1926–29

Constituted in the R.A. on 24 March 1923 and assigned to the 1st Tank Gp. The 17th Tank Bn. made Active Associate. Organized on 1 April 1926 with O.R. personnel as an RAI unit with HQ at Camp George G. Meade, MD. Allotted to the Third Corps Area for mobilization purposes on 28 February 1927. Typically conducted Inactive Training Period meetings at Camp George G. Meade. Conducted summer training at Camp George G. Meade with the 17th Tank Bn. Relieved from the 1st Tank Gp. on 1 September 1929 and concurrently redesignated 1st Bn., 2d Tank Regt.

**Status:** Active in the R.A. as elements of the 67th Armd. Regt.

**Commanders, 19th Tank Battalion**

1st Lt. Raymond McD. Mohr \*\*      1 April 1926–21 July 1928      1st Lt. Louis C. Rosenstein\*\*      21 July 1928–1 September 1929

\*\*RAI commanders: O.R. officers.

**301st Tank Battalion (Heavy) (6th Tank Group)**

**Organized Reserve Connecticut**

**HQ**—*Not initiated*, 1921–22; Waterbury, CT, 1922–27; *Inactive*, 1927–28

Constituted in the O.R. on 29 July 1921 and allotted to the First Corps Area. Assigned to the 6th Tank Gp. on 15 October 1921. Initiated by December 1922 at Waterbury, CT. Attached to the 76th Div. for administration and training. Conducted summer training at Miller Field, NY, with the 1st Tank Co. Withdrawn from the First Corps Area on 7 January 1927 and allotted to the Fifth Corps Area. Inactivated on 2 February 1927 at Waterbury by relief of personnel. Relieved 5 September 1928 from the 6th Tank Gp. Withdrawn from the First Corps Area on 6 October 1928 and demobilized.

**Commanders, 301st Tank Battalion**

Unknown      December 1922–ao January 1927      Maj. John L. Gray Jr.      ao February 1925–2 February 1927  
*Inactive*      2 February 1927–5 September 1928

**302d Tank Battalion (Light) (9th Tank Group)**

**Organized Reserve Kansas**

**HQ**—*Not initiated*, 1921–22; Wichita, KS, 1922–30

Constituted in the O.R. on 29 July 1921 and allotted to the Seventh Corps Area. Assigned to the 9th Tank Gp. on 15 October 1921. Initiated by December 1922 at Wichita, KS. Conducted summer training at Jefferson Barracks, MO, with the 6th Tank Co. Relieved from the 9th Tank Gp. on 5 September 1928 and concurrently assigned to the 11th Tank Gp. Redesignated 1st Bn., 311th Tank Regt. on 20 May 1930.

**Commander, 302d Tank Battalion**

Unknown      December 1922–20 May 1930

**303d Tank Battalion (Light) (6th Tank Group)**

**Organized Reserve New York**

**HQ**—*Not initiated*, 1921–22; Manhattan, NY, 1922–30

Constituted in the O.R. on 29 July 1921 and allotted to the Second Corps Area. Assigned to the 6th Tank Gp. on 15 October 1921. Initiated in June 1922 at Manhattan, NY. Attached to the 78th Div. on 17 September 1925 for administration and training. Conducted summer training at Miller Field, NY, with the 1st Tank Co. Redesignated 1st Bn., 306th Tank Regt. on 20 May 1930.

**Commanders, 303d Tank Battalion**

1st Lt. Glenn H. Markham      June 1922–4 November 1922      Unknown      4 November 1922–ao April 1930  
Maj. George M. Keese      ao April 1930–20 May 1930

**304th Tank Battalion (Light) (6th Tank Group)****Organized Reserve New Jersey****HQ**—*Not initiated*, 1921–22; Newark, NJ, 1922–30

Constituted in the O.R. on 29 July 1921 and allotted to the Second Corps Area. Assigned to the 6th Tank Gp. on 15 October 1921. Initiated in June 1922 at Newark, NJ. Attached to the 77th Div. on 17 September 1925 for administration and training. Conducted summer training at Miller Field, NY, with the 1st Tank Co. Redesignated 2d Bn., 306th Tank Regt. on 20 May 1930.

**Commanders, 304th Tank Battalion**

1st Lt. Joseph A. Schiller	June 1922–4 November 1922	Unknown	4 November 1922–20 May 1930
----------------------------	---------------------------	---------	-----------------------------

**305th Tank Battalion (Light) (6th Tank Group)****Organized Reserve New York****HQ**—*Not initiated*, 1921–22; Albany, NY, 1922–30

Constituted in the O.R. on 29 July 1921 and allotted to the Second Corps Area. Assigned to the 6th Tank Gp. on 15 October 1921. Initiated on 25 April 1922 at Albany, NY. Attached to the 98th Div. on 17 September 1925 for administration and training. Conducted summer training at Miller Field, NY, with the 1st Tank Co. Redesignated 3d Bn., 306th Tank Regt. on 20 May 1930.

**Commanders, 305th Tank Battalion**

2d Lt. Benjamin D. Kornfield	25 April 1922–4 November 1922	Unknown	4 November 1922–20 May 1930
------------------------------	-------------------------------	---------	-----------------------------

**306th Tank Battalion (Heavy) (6th Tank Group)****Organized Reserve New York****HQ**—*Not initiated*, 1921–22; Buffalo, NY, 1922–30

Constituted in the O.R. on 29 July 1921 and allotted to the Second Corps Area. Assigned to the 6th Tank Gp. on 15 October 1921. Initiated in June 1922 at Buffalo, NY. Attached to the 98th Div. on 17 September 1925 for administration and training. Conducted summer training at Miller Field, NY, with the 1st Tank Co. Relieved from the 6th Tank Gp. on 5 September 1928. Withdrawn from the Second Corps Area on 6 October 1928 and demobilized.

**Commanders, 306th Tank Battalion**

1st Lt. Joseph Lampert	June 1922–4 November 1922	Unknown	4 November 1922–5 September 1928
------------------------	---------------------------	---------	----------------------------------

**307th Tank Battalion (Light) (7th Tank Group)****Organized Reserve Pennsylvania****HQ**—*Not initiated*, 1921–22; Berwick, PA, 1922–29; *Inactive*, 1929–30

Constituted in the O.R. on 29 July 1921 and allotted to the Third Corps Area. Assigned to the 7th Tank Gp. on 15 October 1921. Initiated in September 1922 at Berwick, PA. Conducted summer training at Camp George G. Meade, MD, with the 16th Tank Bn. Inactivated on 19 July 1929 by relief of personnel. Personnel concurrently transferred to the 12th Tank Gp. Redesignated 1st Bn., 307th Tank Regt. on 20 May 1930.

**Commanders, 307th Tank Battalion**

Unknown	September 1922–ao May 1929	1st Lt. Charles T. Peck	ao May 1929–19 July 1929
	<i>Inactive</i>	19 July 1929–20 May 1930	

**308th Tank Battalion (Light) (7th Tank Group)****Organized Reserve Pennsylvania****HQ**—*Not initiated*, 1921–22; Milton, PA, 1922–30

Constituted in the O.R. on 29 July 1921 and allotted to the Third Corps Area. Assigned to the 7th Tank Gp. on 15 October 1921. Initiated in September 1922 at Milton, PA. Conducted summer training at Camp George G. Meade, MD, with the 16th Tank Bn. Redesignated 2d Bn., 307th Tank Regt. on 20 May 1930.

**Commanders, 308th Tank Battalion**

Unknown	September 1922–17 March 1923	Maj. Wade Goble	7 November 1924–12 June 1928
2d Lt. Clarence A. Homan	17 March 1923–7 November 1924	Capt. Horace C. Yocum	12 June 1928–22 July 1929
	Unknown	22 July 1929–20 May 1930	

**309th Tank Battalion (Light) (7th Tank Group)****Organized Reserve Pennsylvania****HQ**—Jersey Shore, PA, 1921–30

Constituted in the O.R. on 29 July 1921 and allotted to the Third Corps Area. Assigned to the 7th Tank Gp. on 15 October 1921. Initiated in November 1921 at Jersey Shore, PA. Relieved from the 7th Tank Gp. on 5 September 1928 and concurrently assigned to the 10th Tank Gp. Conducted summer training at Camp George G. Meade, MD, with the 16th Tank Bn. Redesignated 1st Bn., 310th Tank Regt. on 20 May 1930.

**Commanders, 309th Tank Battalion**

Unknown	November 1921–ao October 1925	Capt. John B. Shawn	29 September 1926–ao March 1927
Maj. Stuart H. Clapp	ao October 1925–29 September 1926	Maj. Edward E. Odom	ao June 1927–20 May 1930

**310th Tank Battalion (Light) (7th Tank Group)****Organized Reserve Pennsylvania****HQ**—Wellsboro, PA, 1921–30

Constituted in the O.R. on 29 July 1921 and allotted to the Third Corps Area. Assigned to the 7th Tank Gp. on 15 October 1921. Initiated in November 1921 at Wellsboro, PA. Conducted summer training at Camp George G. Meade, MD, with the 16th Tank Bn. Relieved from the 7th Tank Gp. on 5 September 1928 and concurrently assigned to the 10th Tank Gp. Redesignated 2d Bn., 310th Tank Regt. on 20 May 1930.

**Commanders, 310th Tank Battalion**

Unknown	November 1921–3 June 1925	Maj. Ira N. Craig	3 June 1925–25 February 1930
	Maj. Herbert L. Landolt	25 February 1930–20 May 1930	

**311th Tank Battalion (Light) (7th Tank Group)****Organized Reserve Pennsylvania****HQ**—Sayre, PA, 1921–30

Constituted in the O.R. on 29 July 1921 and allotted to the Third Corps Area. Assigned to the 7th Tank Gp. on 15 October 1921. Initiated in September 1921 at Sayre, PA. Conducted summer training at Camp George G. Meade, MD, with the 16th Tank Bn. Redesignated 3d Bn., 307th Tank Regt. on 20 May 1930.

**Commanders, 311th Tank Battalion**

Unknown	September 1921–ao July 1926	1st Lt. Del Rey W. Colman	ao July 1926–ao September 1926
	Unknown	ao September 1926–20 May 1930	

**312th Tank Battalion (Heavy) (7th Tank Group)****Organized Reserve Pennsylvania****HQ**—*Not initiated*, 1921–22; Scranton, PA, 1922–29; *Inactive*, 1929–30

Constituted in the O.R. on 29 July 1921 and allotted to the Third Corps Area. Assigned to the 7th Tank Gp. on 15 October 1921. Initiated on 3 February 1922 at Scranton, PA. Conducted summer training at Camp George G. Meade, MD, with the 17th Tank Bn. Relieved from the 7th Tank Gp. on 5 September 1928 and concurrently assigned to the 10th Tank Gp. Inactivated on 19 July 1929 at Scranton by relief of personnel. Personnel concurrently transferred to the 309th Tank Bn. Redesignated 3d Bn., 310th Tank Regt. on 20 May 1930.

**Commanders, 312th Tank Battalion**

Capt. John H. Dougherty	3 February 1922– <i>Inactive</i>	ao February 1923 19 July 1929–20 May 1930	Maj. Waldo W. Hull	ao October 1925–19 July 1929
-------------------------	-------------------------------------	----------------------------------------------	--------------------	------------------------------

**313th Tank Battalion (Light) (7th Tank Group)****Organized Reserve Alabama****HQ**—*Not initiated*, 1921–22; Tuscaloosa, AL, 1922–30

Constituted in the O.R. on 29 July 1921 and allotted to the Fourth Corps Area. Assigned to the 7th Tank Gp. on 15 October 1921. Initiated on 14 May 1923 at Tuscaloosa, AL. Conducted summer training at Camp McClellan, AL, with the 4th Tank Co. Designated mobilization training station was Fort Benning, GA. Relieved from the 7th Tank Gp. on 5 September 1928 and concurrently assigned to the 11th Tank Gp. Redesignated 2d Bn., 311th Tank Regt. on 20 May 1930.

**Commanders, 313th Tank Battalion**

Maj. Howard E. DeVaughn	14 May 1923–ao August 1925	Maj. John W. Farmer	ao February 1930–1 March 1930
Capt. Jesse S. Burbage	ao June 1926–ao June 1929	Lt. Col. Garnett W. Sage	12 April 1930–20 May 1930

**314th Tank Battalion (Heavy) (7th Tank Group)****Organized Reserve Tennessee****HQ**—*Not initiated*, 1921–22; Nashville, TN, 1922–28

Constituted in the O.R. on 29 July 1921 and allotted to the Fourth Corps Area. Assigned to the 7th Tank Gp. on 15 October 1921. Initiated in June 1922 at Nashville, TN. Conducted summer training at Camp McClellan, AL, with the 4th Tank Co. Designated mobilization training station was Fort Benning, GA. Relieved from the 6th Tank Gp. on 5 September 1928. Withdrawn from the Fourth Corps Area on 6 October 1928 and demobilized.

**Commanders, 314th Tank Battalion**

Unknown	June 1922–9 April 1923	Unknown	ao May 1924–ao September 1925
Maj. Carl M. Gevers	9 April 1923–ao May 1924	Capt. William P. Hardin	ao September 1925–25 October 1926
	Maj. William C. Miles		25 October 1926–11 October 1928

**315th Tank Battalion (Light) (8th Tank Group)****Organized Reserve West Virginia****HQ**—*Not initiated*, 1921–22; Huntington, WV, 1922–30

Constituted in the O.R. on 29 July 1921 and allotted to the Fifth Corps Area. Assigned to the 8th Tank Gp. on 15 October 1921. Initiated by December 1922 at Huntington, WV. Conducted summer training at Camp George G. Meade, MD, with the 16th Tank Bn. Attached to the 100th Div. on 4 August 1927 for administration, supply, and training. Redesignated 1st Bn., 308th Tank Regt. on 20 May 1930.

**Commanders, 315th Tank Battalion**

Unknown	December 1922–ao April 1930	1st Lt. Wade H. Ballard	ao April 1930–20 May 1930
---------	-----------------------------	-------------------------	---------------------------

**316th Tank Battalion (Light)** (8th Tank Group)**Organized Reserve West Virginia****HQ**—*Not initiated*, 1921–22; Clarksburg, WV, 1922–30

Constituted in the O.R. on 29 July 1921 and allotted to the Fifth Corps Area. Assigned to the 8th Tank Gp. on 15 October 1921. Initiated by December 1922 at Clarksburg, WV. Conducted summer training at Camp George G. Meade, MD, with the 16th Tank Bn. Attached to the 100th Div. on 4 August 1927 for administration, supply, and training. Redesignated 2d Bn., 308th Tank Regt. on 20 May 1930.

**Commanders, 316th Tank Battalion**

Unknown	December 1922–ao April 1930	Maj. Walter P.M. Young	ao April 1930–20 May 1930
---------	-----------------------------	------------------------	---------------------------

**317th Tank Battalion (Light)** (8th Tank Group)**Organized Reserve West Virginia****HQ**—*Not initiated*, 1921–22; Wheeling, WV, 1922–30

Constituted in the O.R. on 29 July 1921 and allotted to the Fifth Corps Area. Assigned to the 8th Tank Gp. on 15 October 1921. Initiated by December 1922 at Wheeling, WV. Conducted summer training at Camp George G. Meade, MD, with the 16th Tank Bn. Attached to the 100th Div. on 4 August 1927 for administration, supply, and training. Redesignated 3d Bn., 308th Tank Regt. on 20 May 1930.

**Commanders, 317th Tank Battalion**

Unknown	December 1922–20 May 1930
---------	---------------------------

**318th Tank Battalion (Heavy)** (8th Tank Group)**Organized Reserve Indiana****HQ**—*Not initiated*, 1921–23; Terre Haute, IN, 1923–30

Constituted in the O.R. on 29 July 1921 and allotted to the Fifth Corps Area. Assigned to the 8th Tank Gp. on 15 October 1921. Initiated on 29 September 1923 at Terre Haute, IN. Attached to the 100th Div. on 4 August 1927 for administration, supply, and training. Conducted summer training with the 6th Tank Co. at Jefferson Barracks, MO, and some years at the Peoria Tank Training Center, Peoria, IL. Relieved from the 8th Tank Gp. on 5 September 1928 and concurrently assigned to the 11th Tank Gp. Redesignated 3d Bn., 311th Tank Regt. on 20 May 1930.

**Commanders, 318th Tank Battalion**

1st Lt. William H. Phipps	29 September 1923–ao November 1923	Unknown	ao November 1923–20 May 1930
---------------------------	------------------------------------	---------	------------------------------

**319th Tank Battalion (Heavy)** (9th Tank Group)**Organized Reserve Illinois****HQ**—*Not initiated*, 1921–22; Chicago, IL, 1922–30

Constituted in the O.R. on 29 July 1921 and allotted to the Sixth Corps Area. Assigned to the 9th Tank Gp. on 15 October 1921. Initiated on 7 September 1922 at Chicago, IL. Attached to the 86th Div. on 19 October 1925 for organization, administration, and training. Relieved from attachment to the 86th Div. on 20 December 1926. Conducted summer training most years with the 6th Tank Co. at the Peoria Tank Training Center, Peoria, IL, and some years at Jefferson Barracks, MO. Relieved from the 9th Tank Gp. on 5 September 1928 and concurrently assigned to the 12th Tank Gp. Redesignated 1st Bn., 312th Tank Regt. on 20 May 1930.

**Commanders, 319th Tank Battalion**

Maj. Philip C. Leffel	7 September 1922–1 November 1923	Maj. Edwin B. Callahan	6 November 1924–23 April 1925
Capt. Samuel D. Mann	1 November 1923–6 November 1924	Maj. Maurice C. Johnson	23 April 1925–22 June 1929
	Maj. Wilfred S. Kay		22 June 1929–20 May 1930

**320th Tank Battalion (Light) (9th Tank Group)**

**Organized Reserve Illinois**

**HQ**—Champaign, IL, 1922–25; Bloomington, IL, 1925–30

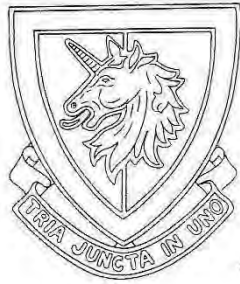

Constituted in the O.R. on 29 July 1921 and allotted to the Sixth Corps Area. Assigned to the 9th Tank Gp. on 15 October 1921. Initiated on 6 July 1922 at Champaign, IL. Relocated on 28 July 1925 to Bloomington, IL. Attached to the 86th Div. on 19 October 1925 for organization, administration, and training. Relieved from attachment to the 86th Div. on 20 December 1926. Conducted summer training most years with the 6th Tank Co. at the Peoria Tank Training Center, Peoria, IL, and some years at Jefferson Barracks, MO, or Camp George G. Meade, MD. Redesignated 1st Bn., 309th Tank Regt. on 20 May 1930.

**Commanders, 320th Tank Battalion**

2d Lt. William L. Hughes

6 July 1922–September 1922  
Maj. Vernon W. Carris

Maj. Bruce W. Benedict  
22 June 1929–20 May 1930

September 1922–22 June 1929

**321st Tank Battalion (Light) (9th Tank Group)**

**Organized Reserve Illinois**

**HQ**—*Not initiated*, 1921–22; Chicago, IL, 1922–30

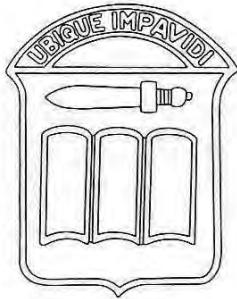

Constituted in the O.R. on 29 July 1921 and allotted to the Sixth Corps Area. Assigned to the 9th Tank Gp. on 15 October 1921. Initiated on 7 September 1922 at Chicago, IL. Attached to the 86th Div. on 19 October 1925 for organization, administration, and training. Relieved from attachment to the 86th Div. on 20 December 1926. Conducted summer training most years with the 6th Tank Co. at the Peoria Tank Training Center, Peoria, IL, and some years at Jefferson Barracks, MO. Redesignated 2d Bn., 309th Tank Regt. on 20 May 1930.

**Commanders, 321st Tank Battalion**

Maj. Edwin B. Callahan

7 September 1922–1 November 1923

Maj. Henry M. Huxley

24 November 1923–20 May 1930

**322d Tank Battalion (Light) (9th Tank Group)**

**Organized Reserve Illinois**

**HQ**—*Not initiated*, 1924–26; Peoria, IL, 1926–30

Constituted in the O.R. on 31 March 1924 and allotted to the Sixth Corps Area. Assigned to the 9th Tank Gp. Attached to the 86th Div. on 19 October 1925 for organization, administration, and training. Initiated on 20 January 1926 at Peoria, IL. Relieved from attachment to the 86th Div. on 20 December 1926. Conducted summer training most years with the 6th Tank Co. at the Peoria Tank Training Center, Peoria, IL, and some years at Jefferson Barracks, MO. Redesignated 3d Bn., 309th Tank Regt. on 20 May 1930.

**Commanders, 322d Tank Battalion**

Capt. Lee E. Thompson

20 January 1926–ao February 1926  
Unknown

Capt. Kenneth H. Smith  
ao June 1929–20 May 1930

ao December 1926–ao June 1929

**323d Tank Battalion (Light)** (9th Tank Group)**Organized Reserve Wisconsin****HQ**—*Not initiated*, 1924–25; Oshkosh, WI, 1925–30

Constituted in the O.R. on 31 March 1924 and allotted to the Sixth Corps Area. Assigned to the 9th Tank Gp. Attached to the 101st Div. on 19 October 1925 for organization, administration, and training. Initiated on 10 December 1925 at Oshkosh, WI. Relieved from attachment to the 101st Div. on 20 December 1926. Conducted summer training with the 6th Tank Co. at the Peoria Tank Training Center, Peoria, IL. Relieved from the 9th Tank Gp. on 5 September 1928 and concurrently assigned to the 12th Tank Gp. Redesignated 2d Bn., 312th Tank Regt. on 20 May 1930.

**Commanders, 323d Tank Battalion**

2d Lt. Lee A. O'Leary	10 December 1925–13 October 1926	Maj. Paul L. Harms	13 October 1926–20 May 1930
-----------------------	----------------------------------	--------------------	-----------------------------

**324th Tank Battalion (Light)** (9th Tank Group)**Organized Reserve Wisconsin****HQ**—*Not initiated*, 1924–25; Milwaukee, WI, 1925–30

Constituted in the O.R. on 31 March 1924 and allotted to the Sixth Corps Area. Assigned to the 9th Tank Gp. Attached to the 101st Div. on 19 October 1925 for organization, administration, and training. Initiated on 29 October 1925 at Milwaukee, WI. Relieved from attachment to the 101st Div. on 20 December 1926. Conducted summer training most years with the 6th Tank Co. at the Peoria Tank Training Center, Peoria, IL, and some years at Jefferson Barracks, MO. Relieved from the 9th Tank Gp. on 5 September 1928 and concurrently assigned to the 12th Tank Gp. Redesignated 3d Bn., 312th Tank Regt. on 20 May 1930.

**Commanders, 324th Tank Battalion**

Maj. Harry R. Brown	29 October 1925–26 January 1928	Capt. Adam A. Schaezner	26 January 1928–ao July 1928
	Unknown	ao July 1928–20 May 1930	

