

Assembly Instructions

For LS Bed Rails

Model Shown is an example. Styles may vary.

Furniture Care Instructions

Room Climate Control

Wood, when first cut contains more than 50 percent water. When it is prepared for furniture construction it is placed in a Kiln and the moisture content is brought down to 8 to 10 percent. Wood is porous and responds to its environment. If the room has high humidity it will absorb it and expand and if the humidity is low it will lose moisture and shrink.

It is important that the humidity levels in the room be controlled from extremes of too much humidity or too little. Furniture should not be placed close to air-conditioning outlets, fire places, radiators, space heaters, humidifiers or dehumidifiers. Exposure to extreme variations of temperature and humidity can damage any fine wood product.

The Ideal Environment for Fine Furniture

Fine wood furniture will have fewer problems when its environment is controlled at a temperature between 65 and 75 degrees and a relative humidity between 35 and 40 percent. Wood placed in an environment outside of those limits can and will shrink or expand and may develop some small cracks which are not material or structural defects.

Sticking Doors and Drawers

With the minor changes in temperature and humidity doors and drawers may swell and be difficult to open or close. Tolerances have been built into the units but extreme conditions may still cause sticking. This will adjust back to normal over time but until it does consider using a dehumidifier or rub candle wax or paraffin on the sides that stick.

Avoid Direct Sunlight

Keep the furniture out of direct sunlight. Ultraviolet rays will fade colors and in some cases darken them. It can also cause crazing or hair line cracks in the finish. White finishes will yellow naturally over time and exposure to direct sunlight will hasten this natural process along with some woods darkening naturally over time; this is not considered to be a quality defect.

Proper Storage

If you need to put your furniture in storage for any period of time do not store them in a damp basement or hot dry attic. Allow air movement around the furniture and do not stack anything on it.

In General

- Protect furniture surface from hot or extremely cold items.
- Use coasters under hot or cold beverages
- Do not use synthetic fabric under accessories or lamps
- Protect tops from pens, markers and crayons
- Oils from potpourri and other scented items can damage the furniture finish.
- Do not drag items across the surface of the furniture.
- Allow the surface to breath by rotating your accessories and lamps.
- Do not over polish the furniture, do it only two or three times a year. Over polishing can distort the natural finish of the product.
- Do not wax the furniture as wax build up can destroy the natural finish of the product.
- When moving furniture always lift the unit. Do not push or drag it to avoid damage to legs
- Keep the furniture level so doors and drawers open and close freely.
- Clean with a damp, not wet, cloth. Use only a mild soap. Do not use abrasive cleaners.

STOP

**IF YOU EXPERIENCE ANY
ISSUES WITH THIS PRODUCT**

**BEFORE YOU
RETURN THIS TO
THE RETAILER**

**PLEASE FOLLOW
PROCEDURES ON THE
REVERSE SIDE OF THIS FORM.**

Product Assistance Procedures

You have purchased a quality piece of furniture. Our international team has spent many hours designing and engineering this piece and packaging to ensure you will be satisfied with your purchase. But if for any reason you need help with your purchase please contact us at any time.

Procedures to follow should you have any questions:

For best and most timely service please contact us by e-mail at info@lajobi.com

Please provide the following information in your e-mail.

- 1. Your Name** _____
- 2. Address** _____

- 3. Phone number** _____
- 4. Place and date of purchase** _____

- 5. Item number and description of your product.** _____

The item number can be found on the back of the case or on the foot/headboard of the crib. Please include all numbers found on that label including the PO# and production date.

- 6. Short description of the issues and attach a photo if possible.**

Someone will contact you via e-mail or phone to help you with your issues.

If you do not have internet access, please fax the above information to 609-409-5809

If you do not have internet or fax access, please call us at 888-266-2848 and be sure to have all the above information ready to give to your Client Service Specialist.

Thank you for choosing a ISSI product. To ensure the best performance from your bed, please read the following instructions carefully. Carefully remove and lay out all parts. Familiarize yourself with all exhibits and diagrams to facilitate the assembly of your bed.

TOOLS REQUIRED:
Phillips head screwdriver.

PARTS ENCLOSED IN CARTON

Model shown is an example. Styles may vary.

A (2) Side Rails

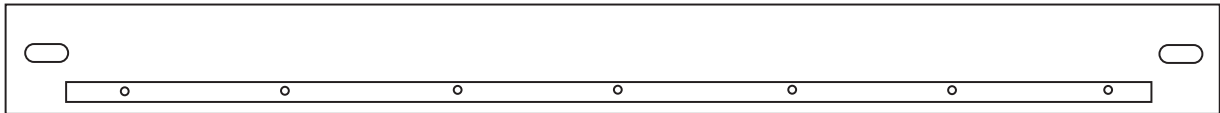

B (7) Plywood Slats

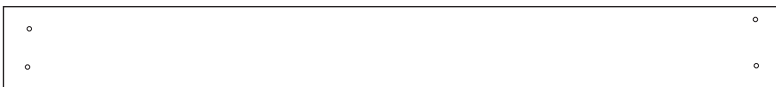

C (1) Allen Wrench

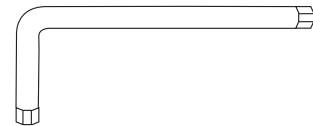

PARTS ENCLOSED IN HARDWARE BAG

D (28) Phillips head Screw 1-1/4"

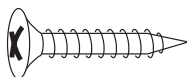

E (4) Allen head Bolt 2-1/2"

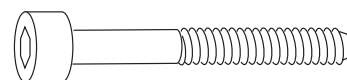

F (4) Bent Tab Washer

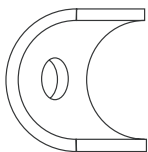

G (8) Metal Pins



STEP 1 Side Rail Installation

THIS STEP REQUIRES:

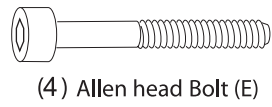
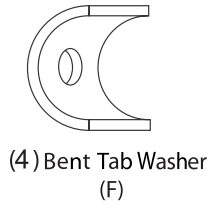
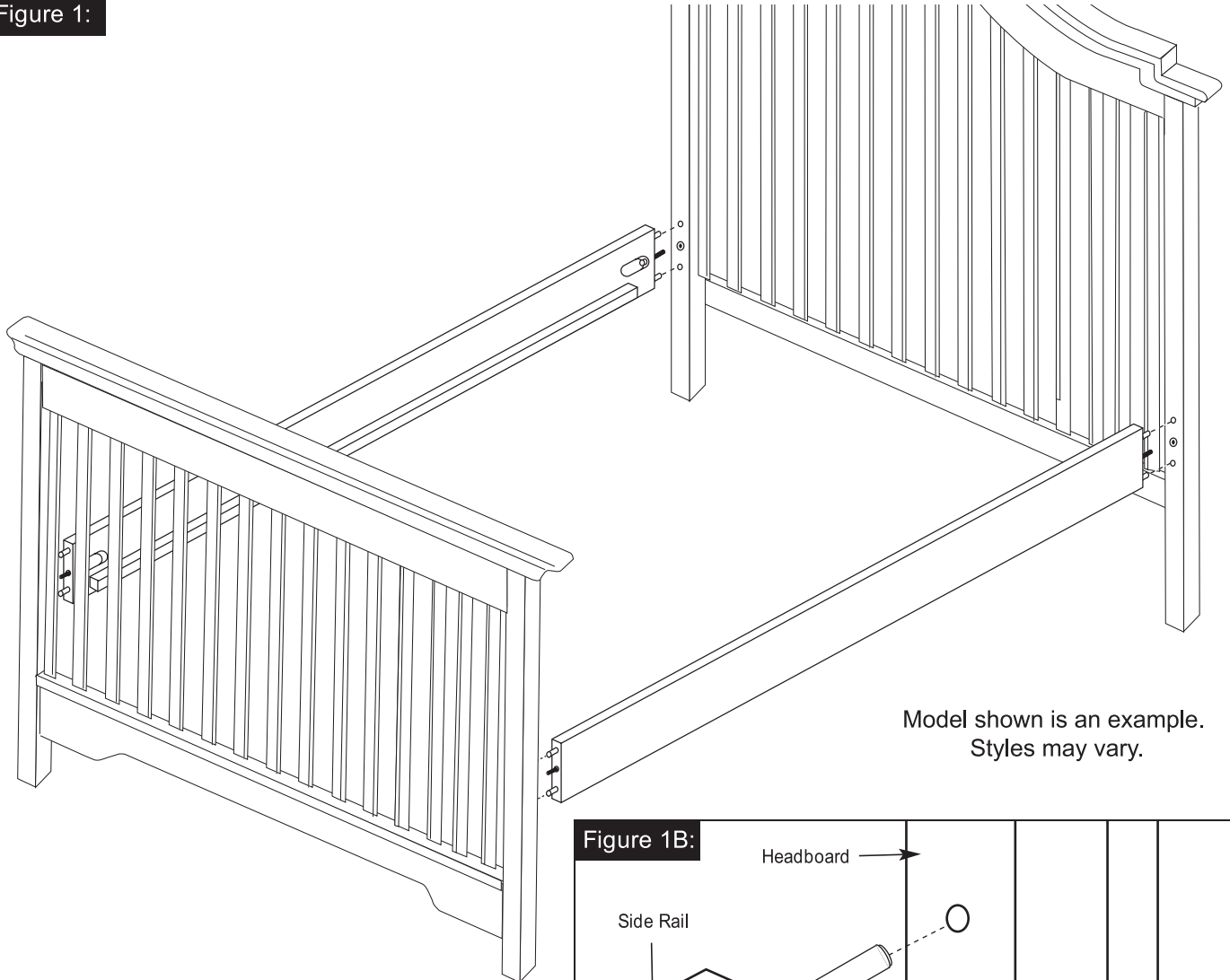

Figure 1:



Model shown is an example.
Styles may vary.

A. Attach side rails to headboard and footboard by first inserting the iron pins into the side rail. If necessary, tap gently with hammer.

B. Insert the bent tab washer into the opening in the side rail (position as shown in figure 1B).

C. Insert the allen head bolt through the bent tab washer and side rail and into the center hole in the headboard and/or footboard. Secure by tightening with the allen wrench. Repeat on all corners.

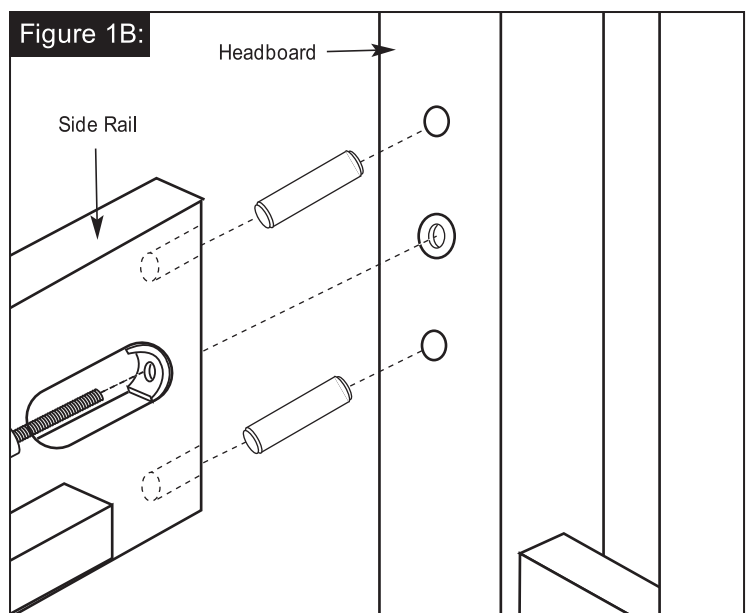

STEP 2 Slat Installation

THIS STEP REQUIRES:

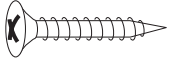

(28) Phillips head Screw (D)



(7) Plywood Slats (B)

Figure 2:

Model shown is an example.
Styles may vary.

