

B A S I C

RIDER COURSESM

RIDER HANDBOOK



Edition 7.1, Third Printing: January 2008

Copyright © 2001-2008 Motorcycle Safety Foundation, Inc.

All rights reserved. No part of this publication may be reproduced or transmitted in any form or by any means, electronic or mechanical, including photocopy, recording, or any information and retrieval system, without permission in writing from the Motorcycle Safety Foundation® (MSF). Under no circumstances may the material be reproduced for resale. Please send request in writing to Training Systems Dept., Motorcycle Safety Foundation, 2 Jenner Street, Suite 150, Irvine, California 92618-3806.

Portions of this book may be reproduced by the Motorcycle Safety Foundation certified RiderCoaches solely to facilitate their presenting this MSF Basic *RiderCourse*SM. Under no circumstances may a RiderCoach reproduce this material in its entirety.

The MSF Basic *RiderCourse* is based on years of scientific research and field experience. This current edition has been field tested and has proven to be successful in developing the entry-level skills for riding in traffic. Through its various iterations, more than three million riders have been trained since 1973.

The information contained in this publication is offered for the benefit of those who have an interest in riding motorcycles. In addition to the extensive research and field experience conducted by the MSF, the material has been supplemented with information from publications, interviews and observations of individuals and organizations familiar with the use of motorcycles and training. Because there are many differences in product design, riding styles, and federal, state and local laws, there may be organizations and individuals who hold differing opinions. Consult your local regulatory agencies for information concerning the operation of motorcycles in your area. Although the MSF will continue to research, field test and publish responsible viewpoints on the subject, it disclaims any and all liability for the views expressed herein.

Since 1973, the Motorcycle Safety Foundation has set internationally recognized standards that promote the safety of motorcyclists with rider education courses, operator licensing tests, and public information programs. The MSF works with the federal government, state agencies, the military, and others to offer training for all skill levels so riders can enjoy a lifetime of safe, responsible motorcycling. The MSF is a not-for-profit organization sponsored by BMW, BRP, Ducati, Harley-Davidson, Honda, Kawasaki, KTM, Piaggio/Vespa, Suzuki, Triumph, Victory and Yamaha. For *RiderCourse*SM locations, call 800.446.9227 or visit www.msf-usa.org.

Unit I – Course Introduction	ii	Contents
Course Requirements	2	
Course Structure	2	
Unit II – Introduction to Motorcycling		
Types of Motorcycles	3	
Risk Awareness	5	
Risk Acceptance	6	
Risk Management	8	
Unit III – Preparing to Ride		
Personal Protective Gear	10	
Pre-ride Inspection	14	
Routine Maintenance	15	
Controls	16	
Basic Riding Skills Information	19	
Range Safety Rules	24	
RiderCoach Signals	24	
Unit IV – Street Strategies		
Positioning	25	
Being Visible	26	
RiderRadar	27	
Mental Processing	28	
Common Riding Situations	30	
Maximum Braking and Swerving	37	
Special Situations	39	
Impairments	43	
Unit V – Wrap-Up	47	
Glossary	48	
Study Questions	51	
Evaluation Form	55	
Quick Tips Tear-out Page	57	

Welcome to the world of motorcycling. As a new rider participating in education and training activities, you're about to embark on an adventure that only motorcyclists can know. If you're an experienced rider who has taken some time off from the thrill only two-wheel exploits can bring, welcome back! You are certain to renew the habits and skills necessary for motorcycling enjoyment.

Motorcycling can be quite a challenge, not just in learning the controls and acquiring maneuvering skills, but also in finding a safe way through real-world traffic. If you're willing to embark on a journey that develops the special skills and strategies of a good motorcyclist, this course is for you. Your experience and participation will lead to a better understanding of the riding maneuvers and the mental skills necessary to enjoy motorcycling to the fullest. Through this process, you might even decide that motorcycling is not right for you.

This course covers the basic fundamentals for you to develop your capabilities to become a safe and responsible motorcyclist. It provides the opportunity for you to learn the physical and mental skills important for operating a motorcycle. In the classroom, you will learn ways to minimize risk and handle special riding situations. During the riding portions of the Basic *RiderCourse*SM, you will be coached to develop the physical skills of basic control that include: clutch/throttle control, straight line riding, stopping, turning, and shifting, and then move on to more advanced skills in stopping quickly, cornering, and swerving.

Your RiderCoach(es) are here to help guide you through your learning journey. Be sure to ask lots of questions and let them know how to help you.

The classroom activities include discussions with audiovisual support designed to prepare you with awareness and knowledge necessary for safe motorcycling. The riding exercises foster the development of fundamental skills and the riding finesse to handle complex traffic situations. Throughout the course you will have your questions answered and have your progress observed and coached.

The Motorcycle Safety Foundation offers other courses and training opportunities as part of its complete Rider Education and Training SystemSM (MSF RETS), which is designed to provide you with lifelong learning opportunities to keep your skills and safety strategies fresh. After you've successfully completed the BRC, consider enrolling in one of our Experienced *RiderCourses** (Skills Practice *RiderCourse*, Skills Plus *RiderCourse*, or License Waiver *RiderCourse*) as soon as you buy a bike – or right away if you already own one. To stay sharp and stay safe, you can take a formal MSF riding skills course every year and every time you buy another motorcycle; you can also practice your skills on your own, using the exercises outlined in MSF's "You and Your Motorcycle: Riding Tips" booklet (viewable on our website).

Several non-riding training opportunities are available also. These presently include *The MSF Guide to Group Riding* that provides tips and techniques for safely riding in a group; the *SeasonedRider Module*, which addresses the effects of aging on motorcycle operation, and the *Riding Straight Module* that provides information about separating the social activities of drinking and riding. There is also a special program designed to improve car and truck driver awareness of motorcycles, entitled *Intersection*. You may participate in these opportunities as a student, and when you feel comfortable, you could lead a group of people through the learning activities as a facilitator. Check the MSF Website (www.msf-usa.org) under "Host An Event" for details. There you will find information about training opportunities and Best Practices for conducting local seminars.

* Availability may vary by state or training site.

Section A Course Requirements

To successfully complete the course, you must: 1) attend all sessions, 2) achieve a minimum score on a knowledge test covering course material, and 3) achieve a passing score on a riding-skill evaluation. The riding-skill evaluation consists of four exercises that assess limited-space maneuvering skills as well as braking, cornering, and swerving competencies. Note your course schedule here:

Successfully completing the Basic *RiderCourse* is not a guarantee that you will be safe on the road. Only you can choose the level of safety you wish to maintain. The course will provide you with the opportunities and experiences to acquire the basic knowledge and skills that enable you to continue to practice and develop your safe riding habits. Safe riding is also a matter of attitude, and only you can provide that.

Section B Course Structure

While the topic of motorcycle safety is profoundly serious, the *RiderCourse* is designed to be quite enjoyable. The primary concerns in this course are your safety and learning. That is a responsibility shared by everyone. RiderCoaches will facilitate your development by using interactive classroom activities. On the range you will be coached in a way that guides your development in acquiring basic motorcycle maneuvering skills. You are not competing with anyone else in this course, so focus on your own learning and experience.

The Basic *RiderCourse* is conducted at a pace that results in successful completion for most novice riders. The RiderCoaches will help you learn to the best of your ability. If you have significant difficulty or become a risk to yourself or others, as determined by you or your RiderCoaches, you will not be permitted to continue to ride (other options may be available for developing your riding skills).

Types of Motorcycles Section A

Motorcycles have been around since the late 1800s, and they have been used for all sorts of riding activities. There are three basic types of motorcycles: street, dual-purpose, and off-highway. Street motorcycles are designed for use on public streets and highways. They have all the equipment for safe and enjoyable street operation. Dual-Purpose motorcycles are equipped for use on the street and off-road trails. Off-road motorcycles are not street-legal, and are typically used for recreational or competitive use. Each type of motorcycle is available in a variety of styles and sizes, and you can have fun shopping to determine which one is right for you.



Touring



Cruiser

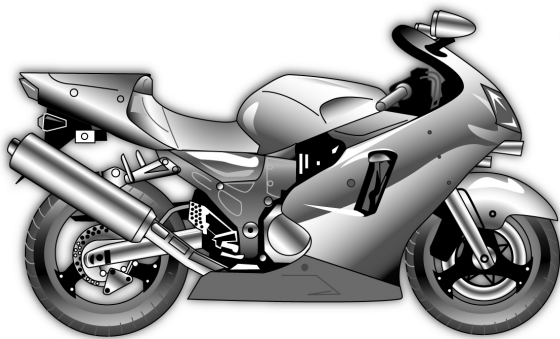

Sport



Standard

Street Motorcycles

Street Motorcycles (continued)

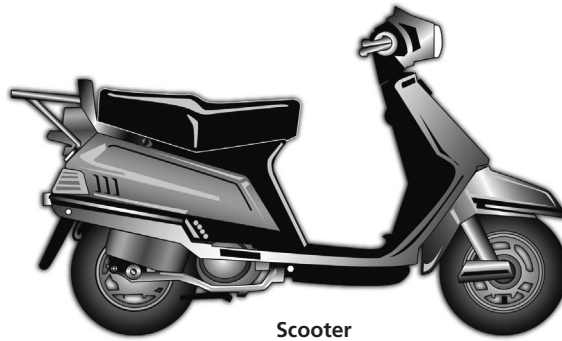

Scooter

ScooterSchool is a hands-on, half-day, entry-level training and education course, designed to help riders of scooters acquire skills and learn about important street-riding strategies. Students may use their own scooters (up to 200cc), and in some locations scooters are provided. For more information, call toll-free 800.446.9227 or visit www.msf-usa.org.

Dual-Purpose Motorcycle

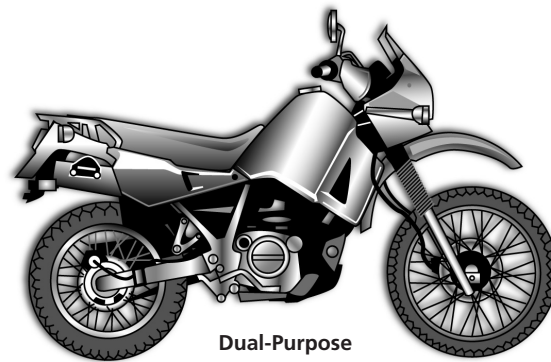

Dual-Purpose

Off-Road Motorcycles

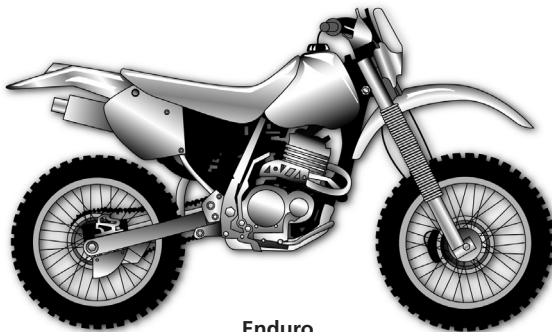

Enduro
(Recreational trail riding)

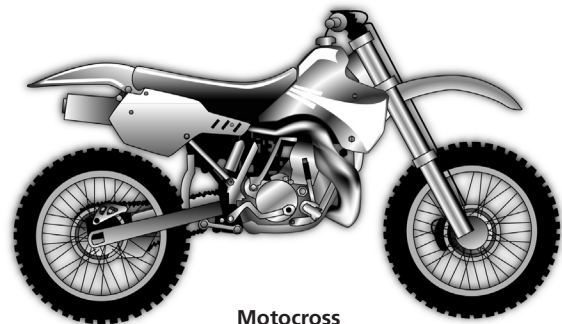

Motocross
(closed-course competition)

The MSF *DirtBike School* is an excellent introduction to motorcycling and can be beneficial for both new and experienced riders. Having off-road skills can enhance the on-road experience. *DirtBike School* is a one-day training course conducted off-road on enduro motorcycles, and content includes riding skills development, risk management and environmental awareness. For information, call toll-free: 877.288.7093 or visit www.dirtbikeschool.com



Trials
(low-speed skills competition)

Risk Awareness Section B

Riding a motorcycle involves some risks not encountered when driving cars and trucks. Motorcycles do not have the stability of cars because they must be balanced, and motorcycles leave you more vulnerable in a crash because there is less protection. Motorcycles are not as readily seen as cars, trucks, or other motor vehicles because of their size. Other motorists, particularly those who don't ride a motorcycle, may not be looking for motorcycles in traffic. This places the motorcyclist at risk, particularly at intersections.

A good question to ask is "How good am I as a car driver?" Most car drivers rate themselves above average when asked. Since no one is a perfect driver or rider, there is always room for improvement. Striving for excellence is one of the more challenging aspects of being a motorcyclist. No one expects to become a crash statistic. But the reality is that car drivers and motorcycle riders are involved in thousands of crashes each year.

Many motorcyclists say they are better, more alert car drivers because they have learned to be more attentive in traffic. Not all risks to a motorcyclist are due to the motorcyclist's own behavior. While it is possible to reduce much of your own risk, safety in traffic is a responsibility shared by everyone.

Section C Risk Acceptance

Have you ever thought about how much risk you accept? We each live with the results of our decisions, and we have full responsibility for the actions we take in traffic. A person who has several “close calls” or near misses when driving a car may be prone to similar behavior when operating a motorcycle. It’s something to think about....

People take a variety of risks every day, but some take more risks than others. For instance, imagine a “ladder of risk.” Picture a tall ladder reaching to the top of a building. For an experiment, would you climb up on the first rung and jump off to the ground? How about the second rung? Third? Do you know anyone that would climb up to a rung higher than you and jump onto the ground? Some people are higher risk takers than others, but the important point is to think about the risks you are willing to take. Only when you think about the risks of riding in traffic can you manage the variety of factors that happen while riding.

Once you become aware of the risks associated with motorcycling, and once you accept that risk, it is time to learn how risks can be managed. Choosing to accept the challenges of being a responsible motorcyclist means to think about the consequences of your riding behavior in traffic. It also means accepting personal responsibility for the results of your decisions and actions, as well as developing good skills and judgment.

Knowledge of what causes crashes is helpful in managing the complexity of riding situations. How would you answer this question: “What is the primary cause of motorcycle crashes?” There are several ways to answer. Perhaps you thought of such things as speeding, inattention, distraction, drinking, or carelessness. All are good answers. Read the following crash scenario, and see if you can determine the primary cause of the crash.

A rider is cruising a country road at 5:00 p.m. in the afternoon, heading home after finishing a grueling day at work. Still thinking about some of the projects not finished that will have to get completed tomorrow, the rider rounds a slight curve in the road and approaches an intersection. There is a car on the right and the rider thinks about slowing. Suddenly the vehicle pulls out. The rider tries to swerve around the car to the right, but the car stops in the middle of the lane. The front tire of the motorcycle hits the left rear of the car, sending it out of control and into the ditch along the road. The helmet saved the rider’s head, but the rider’s knees were bruised, and the bike couldn’t be ridden. Investigation showed that the car driver was a young person without a license, who was distracted by the glare of the setting sun. There was no alcohol involved, and no one was speeding.

What was the primary cause of this crash? Since there were multiple factors, it is difficult to determine the primary cause. So the lesson in this crash, as in most crashes, is that there is rarely a single cause. There is usually an interaction of factors that accumulate, and at some point in time they come together in such a way to produce a crash. Many safety professionals do not like to use the word "accident." Most crashes are predictable and preventable.

How could the above crash have been prevented? Would a cloudy day have prevented the sun glare from partially distracting the young driver? Should the car driver have paid more attention? Should that driver have been behind the wheel in the first place? Would a better prediction by the motorcyclist have provided that extra moment to stop or swerve to miss the car? If the rider had been less distracted by the events of the day, would the rider's response have been quicker? Remove just one factor, and this traffic conflict may not have developed into a crash.

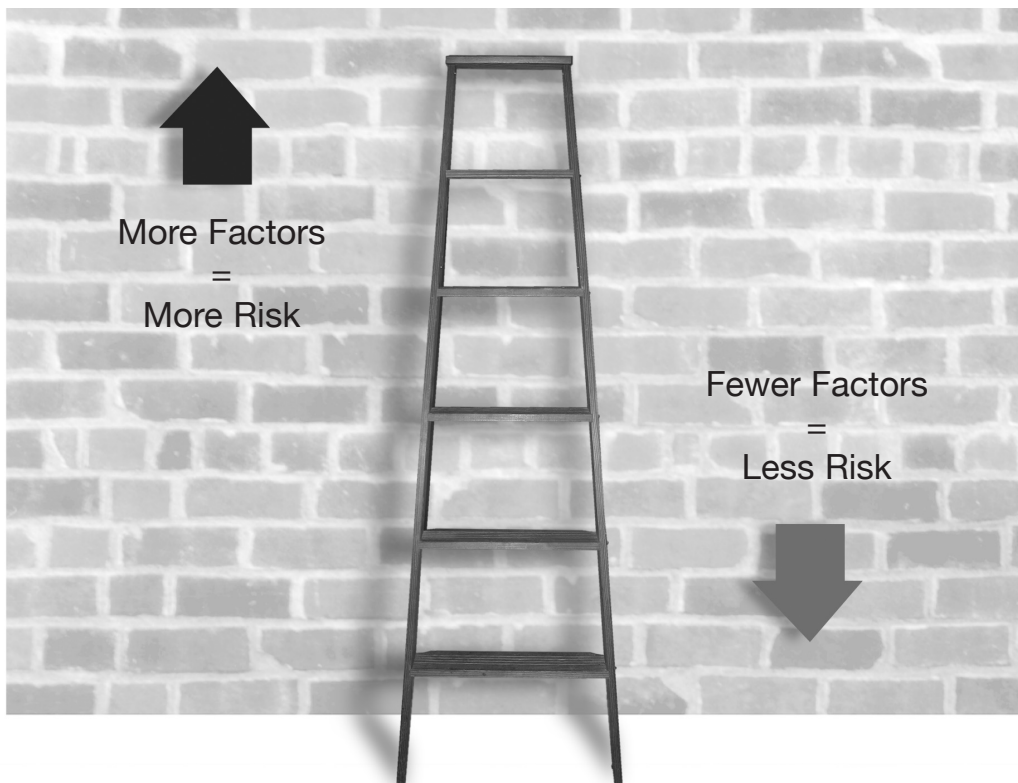

Ladder of Risk. Each rung of the ladder represents a factor. More factors result in more risk; fewer factors result in less risk. Good riders keep the number and significance of factors in check.

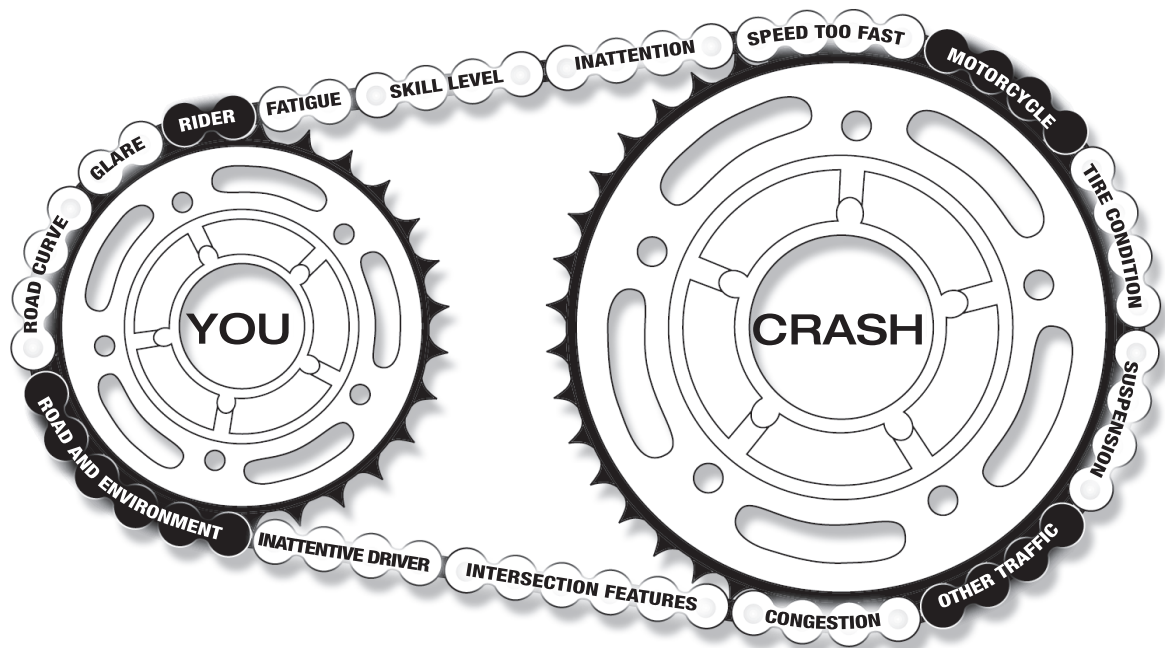

Crash Chain

Here's one time when breaking a chain is a good thing. In this diagram, factors from four categories (dark links) interact to form a chain of events that link you to a crash. Removing just one factor breaks the chain and may prevent the crash. To what degree do you control each of these factors?

One way to think about the causes of crashes is to imagine a crash chain. Crashes occur because factors interact and develop into a hazardous situation.

Have you ever had a close call while driving? What kept it from becoming a crash? Usually someone took action to prevent it. Good riders are ready to take action to minimize factors and maintain a margin of safety.

Hazards are everywhere, and good motorcyclists will be quick to notice what's going on all around them. Hazards can be anything from road debris, to sun glare, to other traffic. Sometimes one factor alone is hazardous and sometimes it takes several factors to produce trouble. Look for ways to break the crash chain of events. Sometimes removing just one factor prevents a crash, but continuously keeping the number of factors to a minimum is a good way to manage your risk.

Section D Risk Management

What do you think of when asked, "What is a good motorcyclist?" Is it one who obeys the laws? Is it one who has superior riding skill? Is it a rider who can negotiate curves fast? Is it one who rides slow and anticipates hazards? Is it one who doesn't crash?

Whatever your definition of a “good motorcyclist,” a key element for a good rider would be to have the desire and motivation to choose to reduce risk while riding. It takes superior riding skill; and of course, a positive mental attitude helps. But a fundamental trait of all good riders is that they have a strategy, a way of thinking and planning to avoid trouble.

A good motorcyclist reduces factors that lead to problems by applying a STRATEGY. Responsible riding is more than just having good skill, and more than simply having a good attitude. It means thinking before acting. It means considering the consequences of actions. This is the mental preparation that helps to reduce risk.

All physical activities have an element of risk. It is important to recognize that risks can seldom be completely eliminated, but they can usually be managed or minimized. One of the surest ways to manage risk is to first be aware of the potential risks, and second to have a specific plan for minimizing the risks.

One way to think about your personal safety when you ride is to consider your personal margin of safety. This means to consider the “margin for error,” or how much extra time and space you need given your skill level.

SEESM — a simple and powerful strategy of MSF — is to **S**earch, **E**valuate, **E**xecute. It is the strategy to help you understand what is going on in traffic and to be constantly planning and implementing a course of action. To SEE is to Search for factors that might lead to risky situations, to Evaluate how the factors might interact to create risk, and to Execute an action to maintain a margin of safety. To SEE is to ask yourself such questions as: What’s the other person going to do? What if that driver doesn’t see me? What if there’s gravel in that curve ahead? What if that car doesn’t yield the right-of-way at that intersection? These everyday riding situations have something in common: if a strategy for dealing with them isn’t employed, they can easily lead to a crash. To put it simply, you must continually **SEE**.

As you develop riding skills on the range, which is similar to mixing with other people on road, apply the SEE strategy to give yourself time and space. It works anywhere, and can help to ensure your safety and the safety of others.

Getting ready to ride is a matter of being responsible about preparation. It is important to know how to prepare yourself and your motorcycle, and to take the action steps to ensure a safe and enjoyable ride.

MSF's **SEESM** Strategy:
Search
Evaluate
Execute

Section A Personal Protective Gear

Protective gear has several purposes, including providing comfort, increasing visibility, and offering protection. Motorcycle protective gear helps you stay comfortable and provides improved visibility if it is brightly colored and reflective. Also, protective gear can provide protection against the elements in all kinds of riding conditions and, in the event of a crash, it may prevent or reduce injuries.

Most recreational activities and sports have their own protective clothing and equipment. Motorcycling is no exception. Every rider and passenger should wear sturdy over-the-ankle footwear with non-slip soles, long pants, a good jacket, full-fingered gloves and, above all, a helmet manufactured to meet Department of Transportation (DOT) standards with proper eye protection.

Helmets Helmets work well in accomplishing their intended function to protect the head and brain from injury. Some myths about helmets are that they cause neck injury, block vision, or impair hearing. However, helmet effectiveness has been confirmed by research, not just in the laboratory, but by decades of actual crash analysis as well. So, be safe and always wear a helmet while riding.

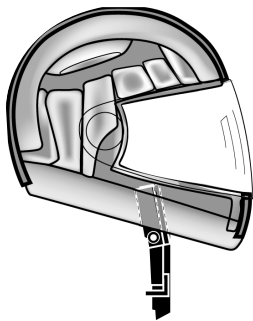

Cross-Section

a. Helmet Construction

There are four basic components of a DOT-compliant helmet that work together to provide comfort and protection. They are: 1) an outer shell, 2) an impact-absorbing liner, 3) comfort padding, and 4) a retention system.

The outer shell, often made of fiberglass, molded plastic, or polycarbonate composites, is a tough substance designed to keep sharp or hard objects from penetrating into the head, and to absorb impact energy by deforming. Impact damage may be invisible to the eye. So if a helmet takes an impact, it should be inspected and replaced as necessary.

The liner is usually made of impact-absorbing polystyrene. It is a dense layer that cushions and absorbs shock. It works in unison with the outer shell, and together they offer significant protection. They spread the forces of impact throughout the helmet's materials. The more impact energy that is deflected or absorbed, the less there is of it to reach the head and brain.

The comfort padding is the soft foam and cloth layer that sits next to the head. It helps maintain comfort and fit. In some helmets, this padding can be removed for cleaning.

The retention system, most commonly a chinstrap with D-rings, is very important. It keeps the helmet on your head in the event of a crash. Unless it is secured, the helmet may fall off and can't protect your brain.

b. Choosing a Helmet

While color, design and price will be a part of your decision about which helmet to buy, protection should be the first consideration. A full-face helmet gives the most protection since it covers all of the head and face. This design has a flip-up face shield that protects the eyes.

A three-quarter or open-face helmet can also offer protection. It is constructed with the same basic components, but doesn't offer the face and chin protection of full-face helmets. If you wear an open-face helmet, you should use a snap-on face shield or a pair of goggles. Ordinary glasses or sunglasses are not sufficient eye protection for a motorcyclist. They can shatter or fly off, and they allow wind and airborne objects to reach the eyes.

Helmets are available in many price ranges. One look around most any motorcycle retailer's helmet display is evidence that nearly any color, decoration, and design you could want is available. Consider a bright color and adding some reflective material to the helmet to help others see you.

The way to find a well-made helmet is to look for the DOT sticker inside or outside the helmet. The sticker means the helmet meets safety test standards required by federal law for all helmets sold in the U.S. There may also be a Snell Memorial Foundation sticker, which indicates that a helmet has passed Snell safety tests.

Since head injuries account for the majority of motorcycle fatalities, head protection is vital. The best helmet is no guarantee against injury, but statistics indicate that helmet use reduces the risk of brain injury by 67 percent.*

Most manufacturers will supply detailed instructions for helmet care. Generally, use only the mildest soap and avoid petroleum-based solutions to avoid breaking down helmet materials. Try not to place your helmet where it could fall to the ground and cause damage.



**Three-Quarter or
Open-Face**



Full-Face

*NHTSA 2004 "Traffic Safety Facts" report.

Eye and Face Protection

Any motorcyclist who has been hit by a stone or an insect while riding can tell you about the benefits of face protection. Windscreens and eyeglasses, even if legal eye protection in your state, may not provide adequate face and eye protection. Wind, insects, dust, and pebbles will be blown behind a windscreen. Eyeglasses with shatterproof lenses may protect the eyes, but may not seal out wind and dust that makes eyes water. Helmets providing full-face coverage provide the best protection.

a. Face Shields

Face shields come in a variety of designs to fit most any helmet. Some flip up for convenience. When using a face shield, be sure it is securely fastened to the helmet. It should be impact-resistant and free from scratches. Scratches can refract light and blur vision. Face shields can be cleaned with a mild solution of soap and water or with a quality plastic cleaner. Make sure that the face shield you choose is designed for your helmet and does not interfere with eyeglasses or sunglasses. Tinted shields are for daytime use only. Always wear a clear shield when riding at night or in conditions when illumination is less than ideal.

b. Goggles

Riders who wear goggles have good eye protection, but they are not protected from possible injuries to other areas of the face. Also, goggles can reduce peripheral vision. Goggles are worn over the helmet and should be securely fastened so they do not blow off.

As with face shields, the lenses of goggles should be clear when riding at night or in conditions when illumination is less than ideal.

Other Riding Gear

a. Footwear

Sturdy over-the-ankle boots help protect riders from a variety of riding hazards, such as stones that get thrown up from the roadway. They also prevent burns from hot exhaust pipes. Rubber-soled boots with low heels provide a strong grip on the pavement and help keep feet on the footrests. In the event of a crash, boots can provide valuable protection against foot and ankle injuries.

b. Gloves

Full-fingered gloves protect hands from the wind, sun, heat, and cold. Gloves that fit snugly will improve grip on the handlebars as well as help reduce hand fatigue. Sturdy, reinforced motorcycle gloves help protect hands in the event of a fall. Gloves made specifically for motorcyclists have seams on the outside to prevent irritation, and are curved to provide a natural grip when curled around the handgrips.

If gloves are too bulky, it may be difficult to operate the controls. If gloves are too tight, circulation could be restricted. Gauntlets keep cold air from going up sleeves and protect the wrists. Lighter gloves are good for summer, while heavier, well insulated gloves are best in the winter.

c. Jackets, Pants, Riding Suits

Quality motorcycle protective gear will provide comfort in all conditions, and it can help you avoid being distracted by adverse environmental elements. In case of a crash, good quality protective gear may prevent or reduce injury.

Protective gear sold specifically for motorcycling will provide the best combination of fit and protection. These garments are designed to fit while sitting in a riding position. They are cut longer in the sleeves and legs and are fuller across the shoulders. Flaps and fasteners seal out the wind while extra padding provides protection. Riding suits are available in both one-piece and two-piece sets.

Leather is a good choice because it is durable, wind-resistant, and provides protection against injury. Other abrasive-resistant protective gear made of synthetic fabrics are good choices, too. Wide-flared pants, flowing scarves and similar items should be avoided because they could become entangled in the motorcycle.

Protective gear should fit comfortably without binding. A jacket with a zippered front will be more wind resistant than a jacket with buttons or snaps. A flap of material over the zipper of a jacket gives additional protection against the wind along with protecting your motorcycle's paint from scratches. Jackets with snug cuffs and waist are recommended to keep wind from blowing in. Caution: a large, loose collar can flap when riding and may irritate skin or be a distraction.

In cold-weather riding, protect yourself against hypothermia. Hypothermia, a condition of subnormal body temperature, can cause loss of concentration, slowed reactions, and loss of smooth, precise muscle movement. In such conditions, proper protective gear like a windproof jacket and insulated layers of clothing are essential.

As an example, on a chilly day (50 degrees Fahrenheit) a motorcyclist riding at a speed of 30 mph experiences a chilling effect equivalent to 42 degrees.



Well-Dressed Riders

In hot-weather riding, protect yourself against heat exhaustion. Heat exhaustion, characterized by dizziness and headache, can affect clear thinking and concentration. Dressing for hot weather riding requires protective gear that breathes, and riders should drink plenty of water.

Protective gear that is appropriate for cold-weather riding may be too hot when stopped. It is wise to dress in layers so that layers can be removed as desired. Extra pants, shirts, and jackets can be layered underneath your protective gear to help body heat form a warm insulation. Topping the protective gear with a windproof outer layer can prevent cold air from reaching the skin.

The protective gear worn while riding can also help a rider be more visible. Wearing bright colors is a wise choice. If a dark jacket is worn, an inexpensive reflective vest can be worn over it. It is a good idea to put extra reflective tape on garments worn regularly while riding.

d. Rain Suits

For the avid motorcyclist, a rain suit or a waterproof riding suit is a must. A dry motorcyclist will be much more comfortable and alert than a rider who is wet and cold. One- or two-piece styles are available, and those designed specifically for motorcycling are best. High visibility orange or yellow colors are good choices. A feature to look for is elastic in the waist, pant legs, and sleeves. The jacket should have a high collar, and zip up with wide flaps across the opening. When purchasing a rain suit, consider adding waterproof gloves and boot covers.

e. Hearing Protection

When you ride, even if you have a quiet motorcycle and a full-face helmet, you may be exposed to wind noise. Long-term exposure to wind noise can cause irreversible hearing damage. Properly worn hearing protection can reduce wind (and engine) noise and make your ride more enjoyable, while allowing you to hear important sounds like car horns and sirens. You can choose from a variety of styles, from disposable foam plugs to reusable custom-molded devices. Make sure you are in compliance with state laws when using any hearing protection.

Pre-Ride Inspection

Pre-ride inspections help ensure a trouble-free ride and provide confidence that your motorcycle will respond properly. The primary source of information about how a motorcycle should be inspected and maintained is its owner's manual. Be sure to absorb all of its important information. A motorcycle will continue to ride like new if it is properly maintained and routine inspections become part of its maintenance cycle.

A pre-ride inspection of the motorcycle should be as routine and automatic as checking the weather forecast before heading out for the day. It's quick and easy to check the critical components, and a convenient reminder developed by MSF is T-CLOCS.SM To the right is a chart of a T-CLOCS inspection, all of which should be checked before every ride.

T — Tires and Wheels

- Air pressure
- Tread
- Cracks, dents, loose spokes
- Bearings
- Brakes

C — Controls

- Levers
- Switches
- Cables
- Hoses
- Throttle

L — Lights and Electrics

- Working condition

O — Oil and Other Fluids (coolant, hydraulic fluid, fuel)

- Levels
- Leaks

C — Chassis

- Suspension
- Drive components (chain, belt, or driveshaft)

S — Stands

- Side stand
- Center stand

A pre-ride inspection should not take more than a few minutes. If done before every ride, it can help you identify changes before they become a problem. A more detailed tear-out reference page on T-CLOCS inspection is provided at the end of this book.

Routine maintenance goes beyond a pre-ride inspection. Regular maintenance is as important for a motorcycle as routine checkups by your doctor are for you. Wear and tear is normal with use, and routine maintenance will help prevent more costly corrective maintenance that occurs when there is improper attention given to the routine checks. The schedule for regular upkeep for motorcycle parts and controls is contained in your motorcycle's owner's manual. Remember, a mechanical failure caused by neglect in an automobile may only be an inconvenience. The same failure on a motorcycle may result in having to leave your motorcycle parked on the side of the road.

Routine Maintenance

Section B Controls

Both hands and both feet are used in operating and controlling a motorcycle. It is important to know the location and operation of all of your motorcycle's controls, and to develop and practice smooth and precise coordination when using them.

Primary Controls

The handlebars are an important component of any motorcycle because it is the most common way to initiate and control motorcycle lean. Here are other primary controls found on a motorcycle, the ones that make it go and stop.

Throttle: It is the right handgrip and it controls engine speed. To increase engine speed, roll the throttle toward you. To decrease engine speed, roll the throttle away from you. The throttle should rotate back to the idle position when released.

Clutch Lever: The clutch lever is located in front of the left handgrip. It is operated with the fingers of the left hand. The clutch connects power from the engine to the rear wheel. The lever is "squeezed in" to disengage and "eased out" to engage.

Gearshift Lever: It is found on the left side of the motorcycle in front of the left footrest and is operated with the left foot. "Lift" up fully to go to a higher gear; "press" down fully to go to a lower gear. It shifts one gear with each lift or press. When the lever is released, it returns to center where the mechanism resets for the next shift up or down. A typical gear pattern is 1-N-2-3-4-5. The N is for neutral, which is selected by either a "half lift" from 1st gear or a "half press" from 2nd gear. Most motorcycles have five gears, but some have four or six gears.

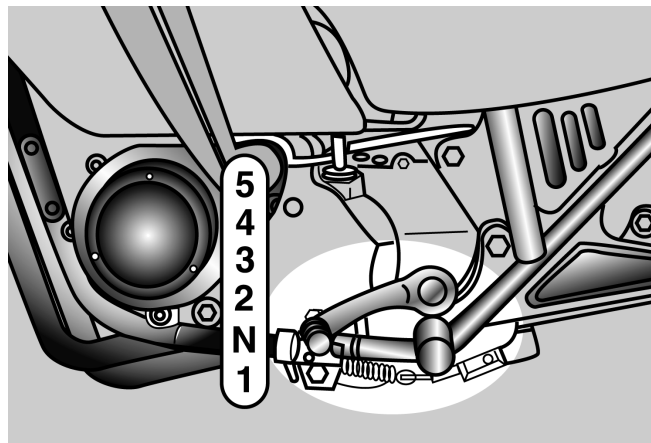

Shift Pattern

Front Brake Lever: It is found in front of the right handgrip and is operated with the right hand. "Squeeze" it in to operate.

Rear Brake Pedal: It is found in front of the right footrest and is operated with the right foot. "Press" it down to operate.

Name _____

Date _____

Motorcycle Controls

Identify the controls and indicators of a typical motorcycle by placing the number from the illustration beside the control name. Practice locating each control on your own motorcycle until you can find it without looking.

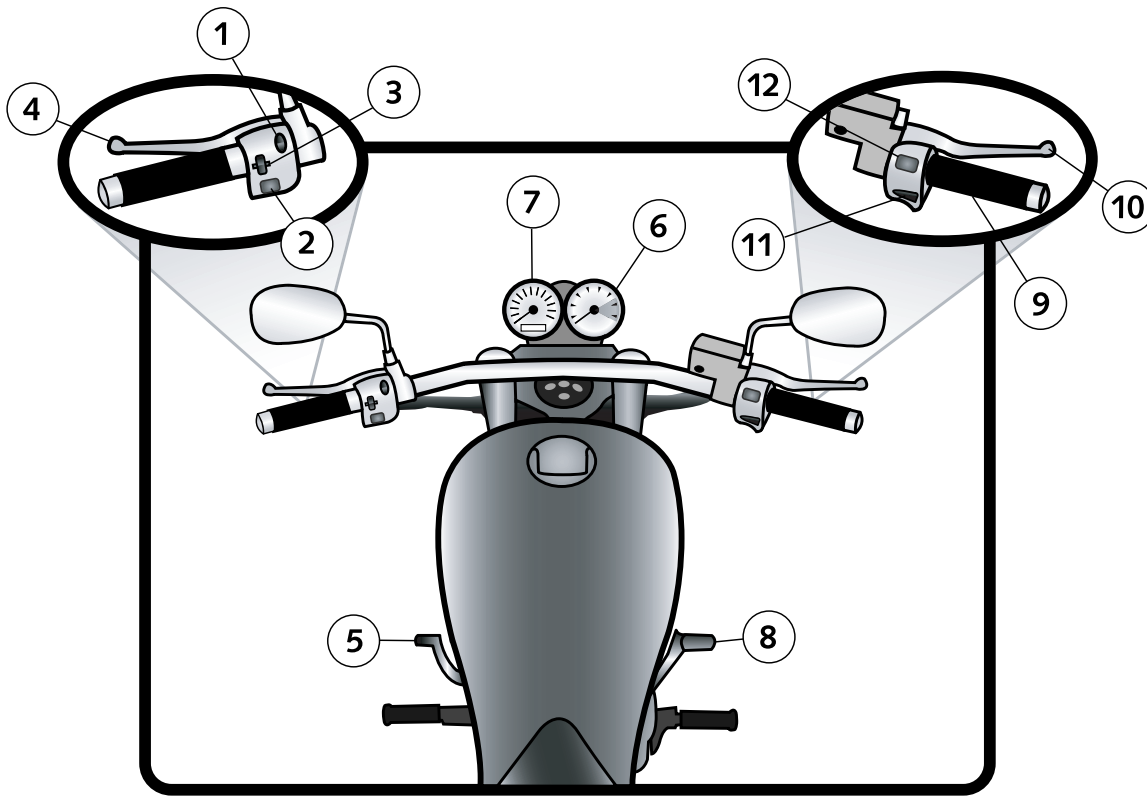

Electric Starter _____

Gear Shift Lever _____

Turn-Signal Switch _____

Clutch Lever _____

Engine Cut-Off Switch _____

Tachometer _____

Speedometer & Odometer _____

Front Brake Lever _____

Throttle _____

High/Low Beam Switch _____

Horn Button _____

Rear Brake Pedal _____

Other Controls and Equipment

The location and operation of many of these other controls/equipment vary from motorcycle to motorcycle. The best source of information for your motorcycle is its owner's manual.

Fuel Supply Valve: If your motorcycle has one, it is usually under the fuel tank and is operated with the left hand. It controls the flow of gasoline to the engine. Most motorcycles have one, but some are fully automatic and not accessible to the rider. For manually operated valves, the positions are ON, OFF, and RESERVE. The RESERVE position permits access to a small amount of fuel, which can be used to ride a short distance to a filling station after the main supply has been exhausted. Check your owner's manual for specific information.

Ignition Switch: It is usually located near the instrument cluster. Its positions usually include ON, OFF and LOCK, and some include a PARK position. The LOCK position allows the key to be removed and engages a steering-lock mechanism. The PARK position is a LOCK position that also sends power to the taillight to provide visibility when parked on a roadway at night. The switch may also have an accessory position.

Choke Control: It is located either on or near the handlebars, or on or near the engine. It provides an enriched fuel mixture to assist in starting a cold engine, and provides a fast idle to permit the engine to warm quickly. It should be turned OFF as soon as the engine is warmed.

Engine Cut-off Switch: It is near the right handgrip and is operated with the right thumb. It allows you to shut off the engine without removing your hand from the handlebar.

Turn Signal Switch: It is usually located near the left handgrip and is operated with your left thumb; most must be manually turned off after a turn or lane change, but some turn off automatically after a turn.

High/Low Beam Switch: It is used to select high or low beam for the headlight.

Horn Button: It is usually located near the left handgrip and is operated with your left thumb.

Starter Button: It is usually located near the right handgrip, and is operated with your right thumb.

Speedometer: It is part of the instrument cluster and shows the motorcycle's road speed. An odometer shows miles ridden, and a re-settable trip meter is often included.

Tachometer: If there is one, it is part of the instrument cluster and indicates engine speed. It has a "red line" that should never be exceeded.

Indicator Lights: These can include neutral, high beam, turn signal indicators, oil pressure, side stand down, and possibly others.

Side & Center Stands: They support the motorcycle when parked. Not all motorcycles have both stands. They are usually spring-loaded.

Basic Riding Skills Information Section C

Starting and Stopping the Engine

Here are a few of the basic procedures to help you on the range.

A procedure called FINE-C is used to start the engine. It stands for **F**uel, **I**gnition, **N**eutral, **E**ngine cut-off switch, and **C**hoke/**C**lutch.

Fuel Supply Valve: Turn the fuel valve ON (“vacuum” valves do not have an “off” position).

Ignition: Turn the ignition switch to the ON position. The indicator lights should come on.

Neutral: Shift the transmission to NEUTRAL; check to be sure by rolling the motorcycle with the clutch lever released and front brake released (don’t rely on the green light in the instrument cluster).

Engine Cut-Off Switch: Put the switch in the RUN/ON position.

Choke/Clutch: Set the choke as needed (ON for a cold engine). Some motorcycles require that the clutch be squeezed before the starter will operate. Even if this is not required, it is a good habit to squeeze the clutch lever as a precaution against starting in gear, just in case Neutral has not been selected prior to starting.

To start the engine with an electric starter, press the starter button. Note: When using the choke to start a cold engine, avoid using the throttle. Even a slight amount of throttle may prevent the engine from starting. Some motorcycles have a safety mechanism that prevents the motorcycle from starting if the clutch is not squeezed. Some won’t start if the side stand is down, while others allow the engine to start, but stall if the side stand is down and the gearshift lever is used.

To stop the engine, move the engine cut-off switch to OFF. Do this every time so you can reach the switch quickly if you need to. Turn the ignition switch to OFF. Turn the fuel valve to OFF if your motorcycle has a manual valve.

Engine Start Procedure	Engine Stop Procedure
(FINE-C)	(Thumb/Key/Valve)
F – Fuel Supply Valve	Engine Cut-off: Off
I – Ignition	Ignition
N – Neutral	Fuel Supply Valve
E – Engine Cut-off: On	
C – Choke/Clutch	

Using the Friction Zone

The friction zone is that area in the travel of the clutch lever that begins where the clutch starts to transmit power to the rear wheel and ends just before the clutch becomes fully engaged. It is a region of partial engagement in which the clutch “slips” to permit you to precisely control engine power to the rear wheel. Proper use of the friction zone is one of the most important skills you must develop as it is how motorcyclists get moving smoothly from a stop.

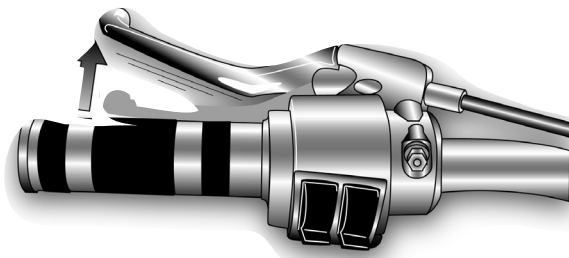

Friction Zone

Riding Posture

Good posture helps you maneuver the motorcycle more easily. Keep your back straight, and head and eyes up. Keep both feet on the footrests near the controls. Keep the knees and elbows comfortably in. Arms should be relaxed and bent. The wrist should be positioned flat on the throttle. On your first riding day during this *RiderCourse*, do not cover the front brake lever. Keep all four fingers around the throttle until there is a need to apply the brake for stopping or slowing.

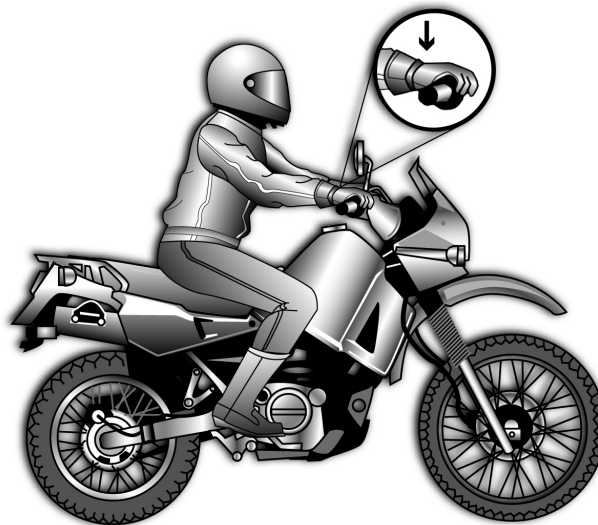

Riding Posture

Turning

Turning a motorcycle involves four primary steps: slow, look, press and roll. Although in reality these may not be distinct steps, they make a good starting point for learning to ride smoothly and safely through turns, corners and curves. Making good turns takes proper judgment and good timing.

Slow: Reduce speed as needed before entering a turn. This is accomplished by rolling off the throttle and/or using the brakes. Sometimes downshifting to a lower gear is necessary. The important point is to set up for the turn by establishing a good entry speed, which is a speed that won't require you to slow while in the turn.

Look: Search through the entire turn and keep your eyes moving. Evaluate the entire turn as soon as possible — surface characteristics, sharpness of the turn, and overall traffic conditions — so you have time to make decisions about speed and position. Sometimes turning your head in the direction of the turn helps in keeping a good visual picture.

Press: To initiate motorcycle lean, press forward on the handgrip in the direction of the turn. This is referred to as countersteering (the front wheel briefly points in the opposite direction of the turn). Press left handgrip, lean left, go left. Press right handgrip, lean right, go right.

Roll: Roll on the throttle to keep from losing speed, unless you identify trouble or entered the turn with too much speed. Maintaining or slightly increasing throttle will help you stabilize the motorcycle's suspension. Try to avoid rapid acceleration or deceleration when in a turn.

In most situations, you and the motorcycle should lean together. However, for slow, tight turns like a U-turn in a parking lot, use a counterweight technique by leaning your upper body toward the outside of the turn. Putting more pressure on the outside footrest can help too. Turn your head and look where you want to go. Turn the handlebars more in the direction you want to go for slower, tighter turns.



Turning Posture

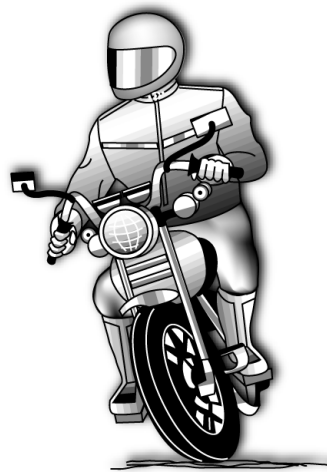

Counterweighting Posture

Shifting You must change gears to match the engine speed with road speed. Lower gears are used for lower speeds and higher gears are used for higher speeds, just like on a manual transmission car or truck.

Shifting to a higher gear: This is done as speed increases to a point where shifting is desired to match engine speed to road speed.

Shift up soon enough to avoid overrevving the engine, but not so soon as to cause the engine to lug.

Use a 3-step process: 1) Roll off the throttle as the clutch is squeezed, 2) lift the shift lever firmly as far as it will go, 3) smoothly ease out the clutch and adjust the throttle. Once the shift is completed, release the shift lever to permit it to reset for the next shift.

Shifting to a lower gear: This is done to match the engine speed with road speed or to have more power to accelerate. Be sure the motorcycle's speed is low enough for the next lower gear so as not to overrev the engine.

Use a 3-step process: 1) Roll off the throttle as the clutch is squeezed, 2) press the shift lever down firmly, 3) ease out the clutch lever as you roll on the throttle. Once the shift is completed, release the shift lever to permit it to reset for the next shift. Rolling on the throttle slightly while smoothly easing out the clutch can help the engine come up to speed more quickly and make the downshift smoother.

Shifting to a lower gear causes an effect similar to using the brakes. This is known as engine braking. To use engine braking, shift down one gear at a time and ease out the clutch through the friction zone between each downshift. Keep the clutch in the friction zone until the engine speed stabilizes. Then ease out the lever fully until ready for the next downshift.

Usually you shift gears one at a time, but it is possible to shift through more than one gear while the clutch is squeezed.

To stop, the hands and feet work together in a coordinated and smooth fashion. Squeeze the clutch and the front brake lever while pressing on the rear brake pedal and downshifting to first gear. The front brake provides 70% or more of the stopping power for your motorcycle.

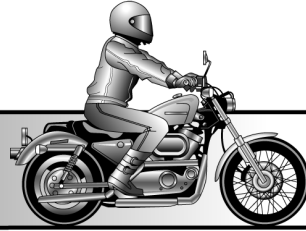
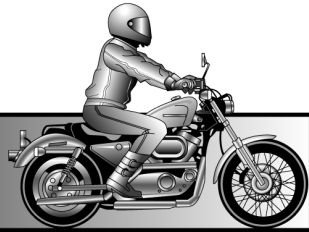
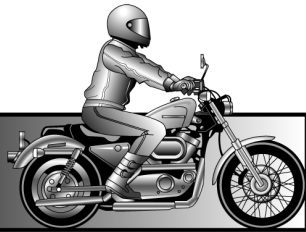
Stopping**Rear Brake Only****Front Brake Only****Both Brakes**

Both brakes should be applied at the same time when stopping. Even though the full braking potential of each wheel may not be required for normal, planned stops, it is important to develop the habit of using both brakes so that your reflexes will be ready to respond quickly and properly when an emergency situation occurs.

Be sure to develop your braking skills gradually. Learn to make smooth, controlled stops before practicing quick stops. It is important to have a good sense of touch when using the front brake lever and rear brake pedal. Too much pressure too quickly could cause a skid and loss of control.

Section D Range Safety Rules

Here are range rules that apply to the riding exercises. They are designed to provide a low risk and positive learning environment. You must abide by these rules:

1. Do not practice without RiderCoach permission.
2. Always wear proper protective gear when seated on the motorcycle.
3. Know the location of the engine cut-off switch and how to use it.
4. Keep the clutch “covered” during early skill development (generally the first riding day)—this enables a quick squeeze of the clutch to remove engine power to the rear wheel.
5. Start with a flat wrist position on the throttle.
6. Always keep a margin of safety, and check to the rear, sides, and in front before moving out.
7. Do not pass other riders unless directed to do so.
8. If you have a problem, move out of the path of travel. A RiderCoach will assist you.
9. Stop smoothly in position if you see or hear a group stop signal.
10. If you do not understand an exercise or become too uncomfortable to ride safely, notify a RiderCoach.

Section E RiderCoach Signals

RiderCoaches use hand signals during the riding exercises. These non-verbal signals are used to maximize safety and learning. There will also be times when a RiderCoach will provide verbal communication.

Positioning Section A

On the street, situations change constantly, and sometimes abruptly. As a responsible rider, you know how important it is to be in full control of the motorcycle and to be aware of time and space requirements. Proper preparation is a key to enjoyable, safe and responsible motorcycling. Thus far we have determined the significance of personal riding gear and the need for care and inspection of your motorcycle. Let's turn attention to an overall riding strategy to manage risk in traffic.

Choosing the best lane and your position in that lane can increase the margin of safety.

Lane Choice: For multi-lane roads, position yourself to be able to see well down the road and to be visible to others. Maintain as much space cushion as traffic and roadway conditions allow for your margin of safety.

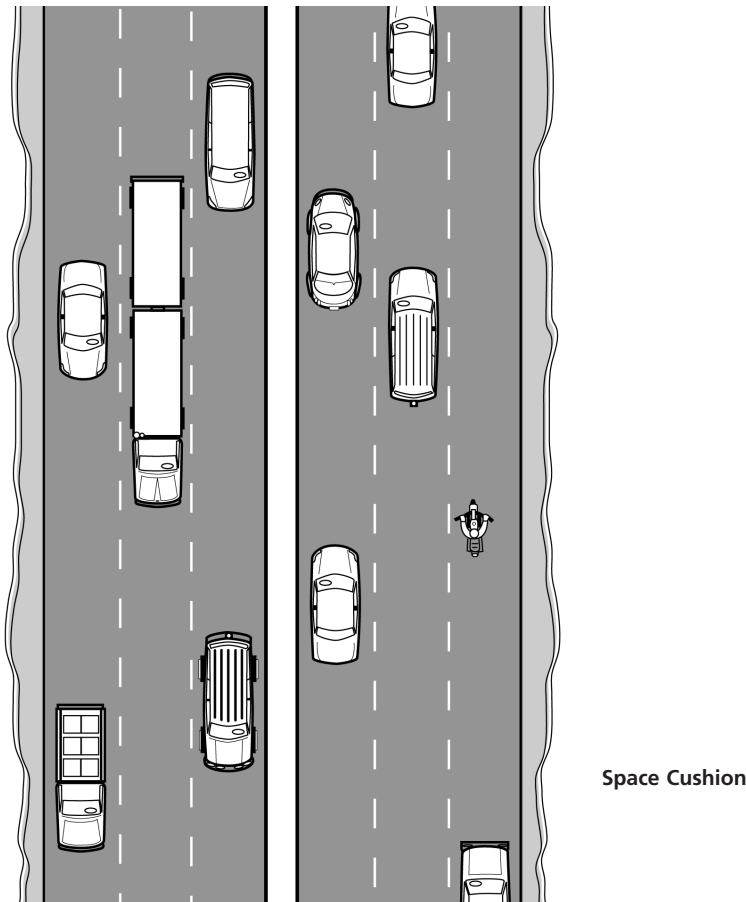

Lane Positions: Positioning yourself properly within a lane can help you avoid windblast from other vehicles, help you see and avoid roadway hazards, and help you

create and maintain a space cushion between yourself and other traffic.

Don't hide among other vehicles.

Position yourself so that drivers ahead can see you in their mirrors. Choosing a position that helps you see potential problems ahead can also help drivers see you sooner.

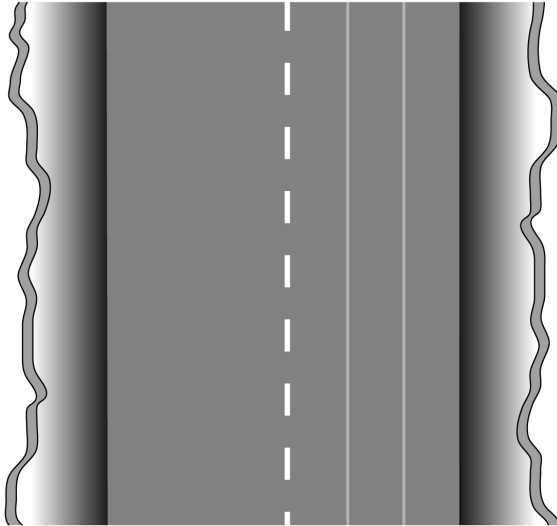

Lane Positions

Section B Being Visible

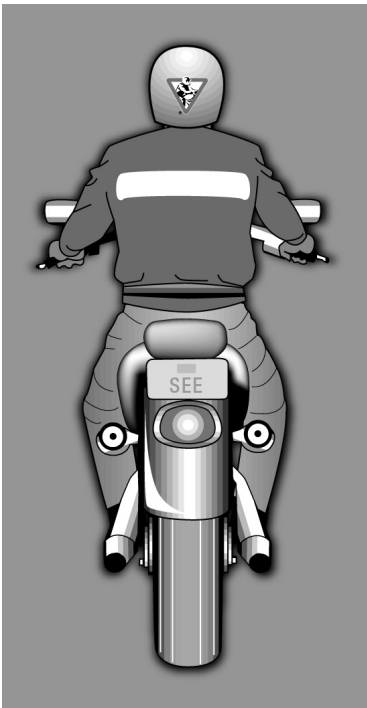

Reflective Attire

Many motorcycle crashes are a result of a motorist not seeing a motorcyclist until it is too late. Motorcycles are smaller and not as prevalent as cars and trucks, so they are more difficult to pick out in traffic and their speed may be difficult for others to judge. You must assume the responsibility to be visible in traffic. You must communicate your presence and intentions to other highway users. Here are some suggestions for becoming more visible to others:

Clothing: Wear bright colored clothing and a light colored helmet. Use reflective material on your clothing, helmet, and motorcycle.

Headlight: Ride with the headlight on during the daytime.

Signals: Communicate with other drivers by signaling intentions. Remember to cancel your turn signals. A false signal can create a conflict because it fails to accurately communicate intentions.

Brake Light: A flashing brake light is more visible than a steady one. Flash the brake light before and during stops (except of course for emergency stops).

Horn: Use the horn to gain attention, but don't rely on it. Many car and truck drivers may not be able to hear it.

RiderRadar Section C

“RiderRadar” helps you perceive the hazards ahead, which account for around three-fourths of all the hazards that affect you. Here are three “lead times” that you can use. They are the 2-second following distance, the 4-second immediate path, and the 12-second anticipated path.

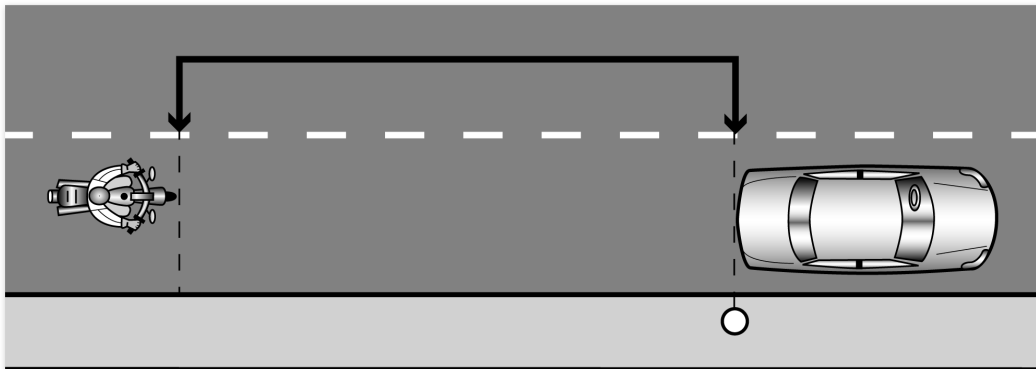

2-Second Following Distance

The first lead-time is the 2-second following distance. It is considered to be a minimum distance when conditions are ideal. Less than perfect riding conditions (e.g. reduced traction or visibility, rider fatigue, etc.) require increasing available time and space. Here’s how to establish 2-second following distance:

- Pick out a fixed point ahead, like a post or pavement marking.
- As the vehicle ahead passes the fixed object, count off “one-motorcycle-one, two-motorcycle-two”; if the fixed point has not been reached, following distance is at least 2 seconds.

3 Components of Total Stopping Distance

- Perception distance: distance traveled from the time something is present until you see it.
 - Reaction distance: distance traveled from the time you see a hazard to when you actually apply the brakes.
 - Braking distance: distance traveled from the time the brakes have been applied until stopped.
- The more time and attention you devote to perception distance, the greater your margin of safety will be.

Consider using a 3- or 4-second following distance for a greater margin of safety, or when less than ideal riding conditions exist.

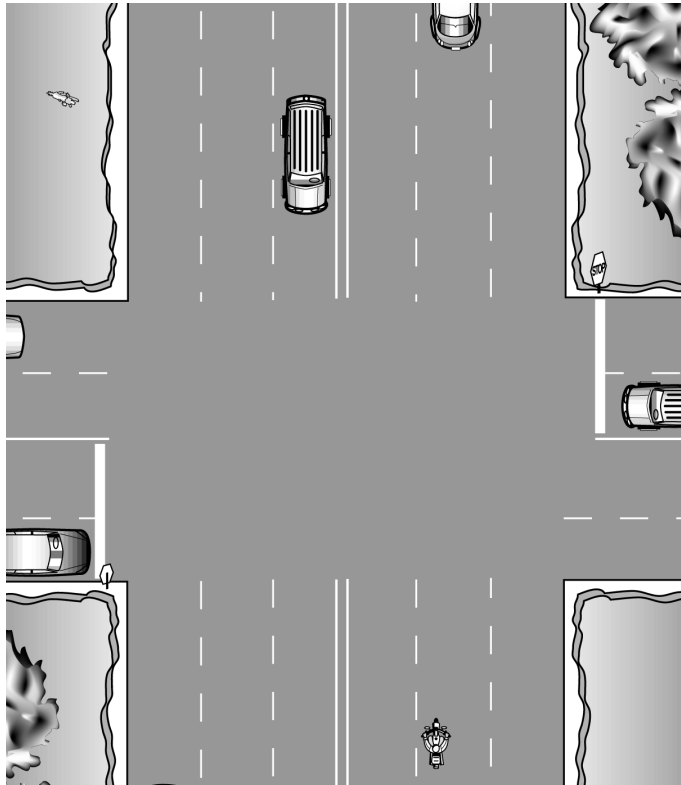

12-Second Anticipated Path

The second lead-time is the 4-second immediate path. Anything that is within 4 seconds of your path is considered immediate because a quick response is required if something should go wrong. Four seconds provides time and space to swerve and/or brake for fixed hazards or for someone or something entering your path.

The third lead-time is the 12-second anticipated path. Proper searching technique requires that you scan 12 seconds ahead. This means to look ahead to an area it would take that long to reach. It provides time to prepare for a situation before it becomes immediate.

Section D Mental Processing

Safe riding is more of a skill of the eyes and mind than of the hands and feet. You probably use some kind of mental strategy to deal with traffic. Some of these processes have been formalized, and all of them form a decision-making approach to increase safety. One good strategy to use is **SEE**. SEE is an acronym that represents **S**earch, **E**valuate, and **E**xecute. It is a process that can help you reduce risk in traffic.

Search: Search means to scan aggressively for potential factors and hazards. Searching provides you with information to make decisions. Searching means more than just what is in front of you. It also includes the areas behind and to the sides. Check the mirrors often and use head checks to notice what might be in a blind spot (that area to the side and behind that mirrors do not show). Remember that many motorcycles have convex mirrors that allow the rider to see farther to the sides, but they also distort depth perception (how far away the object is).

The eyes should not fixate on any one object for more than a split second. It is important to prioritize important elements in the traffic environment. Search in three categories: 1) road and surface characteristics, 2) traffic control markings and devices, and 3) other highway users. They all blend together into what is important at any given moment.

Evaluate: To evaluate means to anticipate problems. It means to constantly try to figure out how factors can accumulate and interact to form a hazard or conflict, which if not dealt with, could lead to a crash. It means to predict the worst to get the best results. It means to separate hazards before they develop into a potentially dangerous situation. Consider playing a “What if...” game; it can be fun and energizing. Traffic is such a puzzle at times because other highway users are often unpredictable.

It is important in good risk management to figure out time and space requirements so a safety margin can be maintained. Three factors affect your safety margin: 1) your capabilities and limitations, 2) the capabilities and limitations of your motorcycle, and 3) roadway/traffic conditions. For example, the safety margin is gone if a required maneuver calls for skill beyond your skill level; the safety margin is gone if a situation requires more steering and/or braking than the motorcycle is capable of providing; the safety margin is gone if there is no time and space available to maneuver.

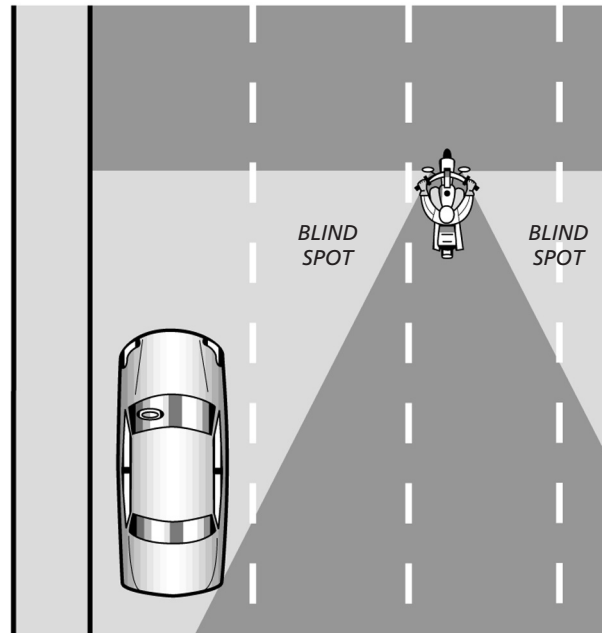

Motorcycle Blind Spots

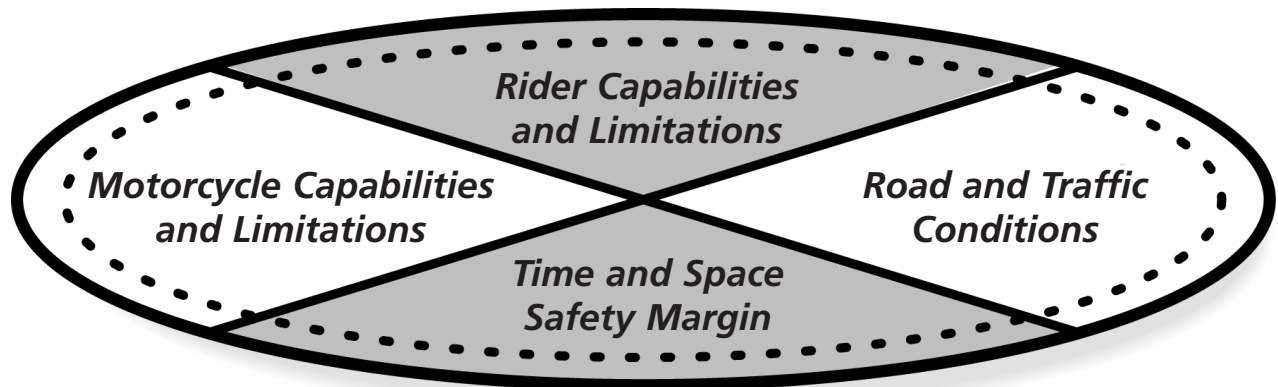

Oval of Safety

Risk is reduced by increasing your time and space safety margin

Execute: Safe riding requires a superior mental strategy to avoid the need for superior maneuvering skills. Good riders consciously reduce crash-producing factors they contribute into the traffic mix, but they possess well-developed maneuvering skills as well. Three action steps make up the execute phase. They are: 1) adjust speed, 2) adjust position, and 3) communicate your intentions.

Section E Common Riding Situations

It was noted earlier that the primary cause of crashes is an interaction of factors, and you can put yourself at an advantage by applying the strategy of SEE. Here are some common riding situations that you may encounter. It is always necessary to SEE, to maintain an adequate safety margin.

Intersections The greatest potential for a conflict between you and other traffic is at intersections. It's important to know what might happen long before reaching an intersection. Driveways and alleys should also be considered intersections. Traffic around driveways, parking lots, and side streets can quickly develop into a hazard. It is helpful to follow these four steps when around an intersection:

- Check for traffic behind
- Check for oncoming traffic
- Check traffic to the left
- Check traffic to the right

Be especially alert at intersections with limited visibility. Be aware of congested surroundings that could camouflage or hide you.

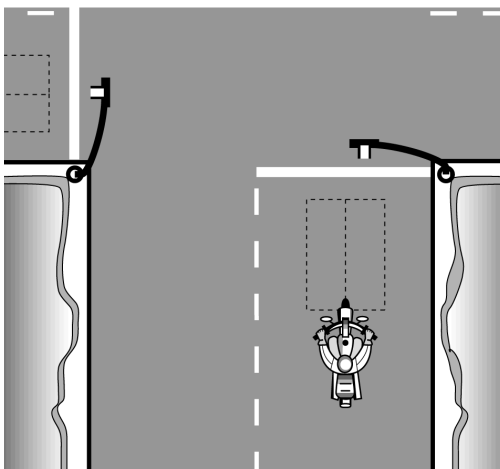

Traffic-Actuated Sensor Lines

When stopped, waiting to turn or for a light to change, check behind you occasionally for vehicles approaching. Flash the brake light as someone approaches from the rear. Have an escape plan and remain in 1st gear. When pulling out into an intersection, wait a second or two in case someone crosses after their light changes to red.

Traffic-actuated signal lights can be troublesome for motorcyclists. Sensors in the road surface detect the presence of a vehicle and cause the traffic light to change. Sometimes the sensor may not detect your presence. To ensure the best chance of being detected, stop where the sensors are located. They are usually visible in the road surface.

When turning from a stop, skillful clutch and throttle control will help you maintain proper lane position. Be sure to keep your head and eyes up, looking where you want to go.

Areas between intersections have their own unique hazards.

It is important when riding to find and maintain a space cushion. That means to avoid riding in a blind spot and to maintain similar speeds as other traffic. It is important to watch for vehicles pulling away from a parked position, and to notice pedestrians stepping into your path.

Traffic Between Intersections

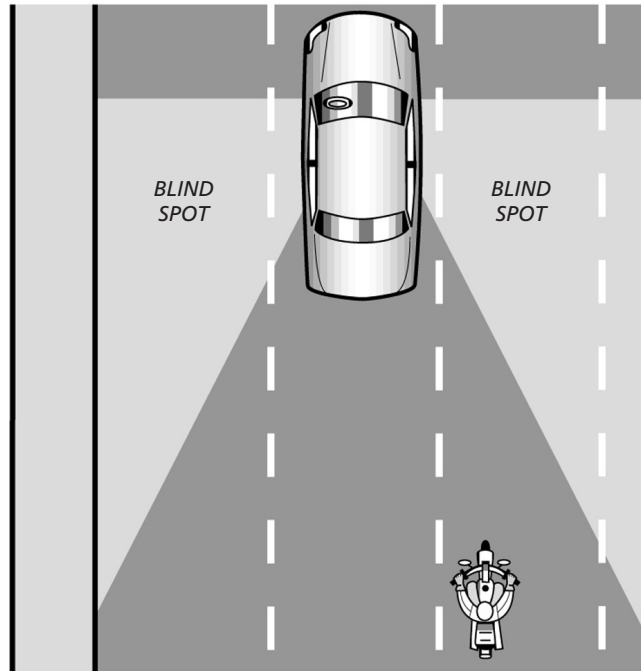

Automobile Blind Spots

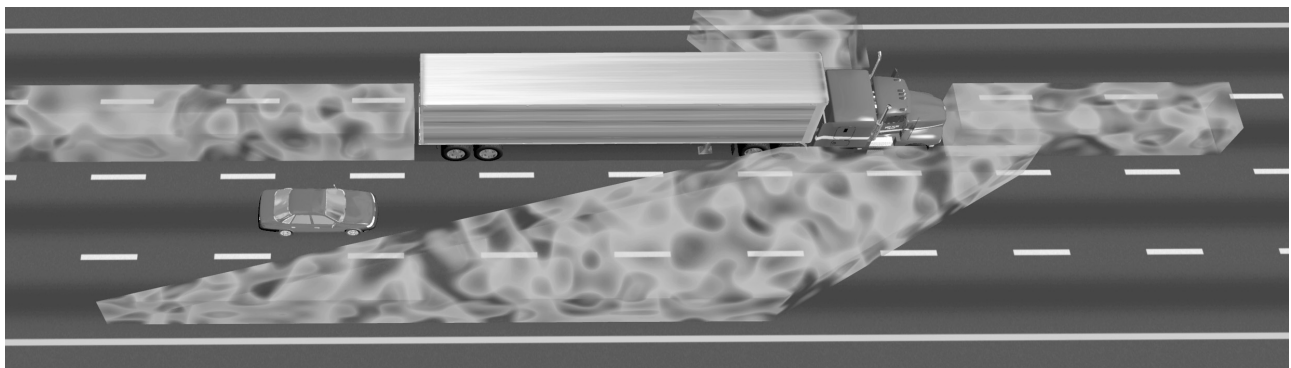

No-Zone: areas around a truck to avoid because the driver cannot see you.
(graphic compliments of the U.S. Department of Transportation)

Drivers that tailgate pose a hazard. They may not be able to stop as quickly as motorcyclists. It is important not to let a tailgating driver distract you from SEEing ahead. In general, it is best to increase your following distance from vehicles ahead to give yourself time and space to execute a smooth, gradual stop. This avoids putting tailgating drivers in a position that requires them to make a quick stop.

Some other options to respond to a tailgating driver are:

- Flash your brake light (communicate your intentions)
- Gradually reduce speed to create more space in front (adjust speed)
- Maintain a lane position that discourages sharing the lane (adjust position to protect your lane), or change lanes
- Turn at the next opportunity, into a street or parking lot, to allow the person tailgating you to pass by

Curves Roads that have a lot of curves can be great fun to ride, but the strategy of SEEing always applies. Crash studies show that running off the road, usually in a curve, accounts for about 37 percent* of total motorcycle fatalities. This is the primary situation in which motorcyclists have single-vehicle crashes. Watch for areas of reduced visibility and adjust speed accordingly to have an additional safety margin.

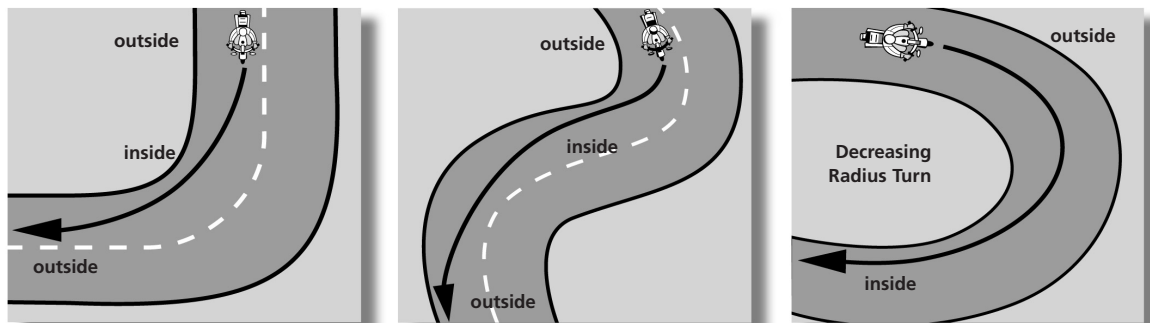

Path of Travel

The basic turning procedure – Slow, Look, Press, and Roll was provided earlier. It applies to all curves, modified slightly for decreasing radius turns where you hold the throttle steady after slow, look and press. The SEE strategy must be applied when all curves are encountered.

When approaching a curve you must Search for information about the curve: What is its radius and slope? What is the surface composition and condition? What other traffic is involved? Is the entire curve visible? What happens beyond the curve?

With this information, you must Evaluate the situation. The basic task is to plan an appropriate path and entry speed, being sure to stay in a good lane position while maintaining a steady speed, and be ready for any problems.

Then you Execute using a well timed Slow/Look/Press/Roll technique.

*NHTSA 2005 FARS data

While not as dangerous as intersections, limited-space maneuvers, like parking areas, can be quite a challenge. Practice turning at low speeds, and don't forget to use the counterweight technique. This means to put more pressure on the outside footrest, leaning the upper body outward opposite the turn. You can also move off the center of the seat, opposite from the turn, to improve balance and turning capability.

Limited-Space Maneuvers

Here are some tips for parking safely:

- If parking in a parallel parking space next to a curb, position the motorcycle at an angle with the rear wheel to the curb. (Note: Some cities have ordinances that require motorcycles to park parallel to the curb.)
- If using the side stand, turn the handlebars to the left for added stability; lock the forks for security.
- Always keep the ignition locked.
- Park in a secure and well-lighted area.
- Use non-branded motorcycle covers.
- Limit the amount of time your motorcycle is left unattended.
- Use a high-quality lock and chain; secure it through the frame instead of the wheels.
- Consider adding a motorcycle anti-theft or security system.
- The "feet" on side and center stands can sink onto soft surfaces (including hot asphalt) causing the motorcycle to fall. To prevent this, carry a flattened aluminum can or similar rigid object to put under the stand.

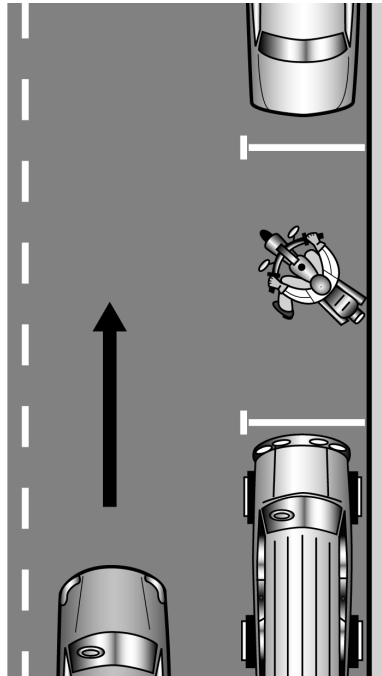

Curb Parking

Park the motorcycle in first gear for extra stability, particularly if on an incline.

Parking

Obstacles Searching and evaluating effectively can help you avoid obstacles such as potholes, speed bumps, or road debris such as gravel or solid objects. If an obstacle cannot be avoided, rise off the seat and use the legs as shock absorbers.

Here are some tips:

- Slow as much as traffic and time permit.
- Approach at a 90-degree angle if possible.
- Avoid target fixating on the obstacle, and keep eyes up and looking ahead once the path over the obstacle is determined; continue to SEE.
- Rise slightly off the seat before reaching the obstacle, keeping your knees bent and against the tank.
- Squeeze both handgrips firmly; do not cover either the brake lever or the clutch lever.
- Shift weight to the rear (don't pull back or jerk on the handlebars) and slightly roll on the throttle just before the front wheel makes contact (this lightens the weight on the front wheel, making it easier to climb over the obstacle).
- Upon contact with the object, roll off the throttle immediately so that the rear wheel is not under power when it rolls over the object.
- Do not sit down until the motorcycle is stabilized (you don't want to be sitting down when the seat is coming up).
- Continue to SEE.

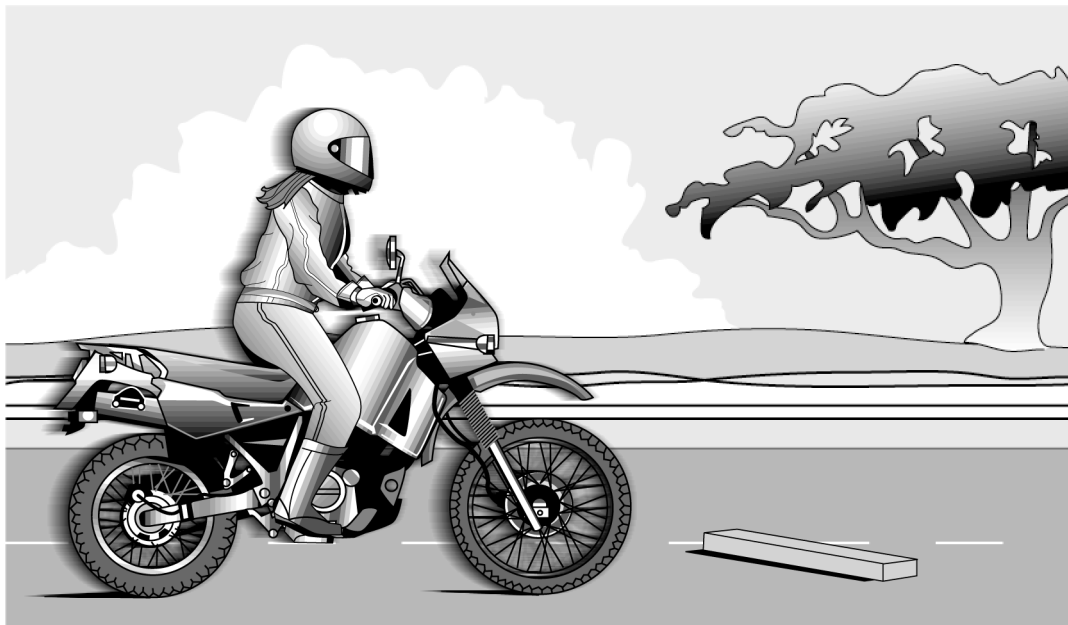

Crossing an Obstacle

The technique to change lanes is similar to when you drive a car. Be sure to check for traffic in the mirrors and to the side in the direction you are moving (with a head check to see what may be in the blind spot area). Don't forget the effect of convex mirrors, as objects are closer than they appear in the mirror. Signal well in advance, using a hand signal as needed to alert others. Be sure to cancel the signal once in a new lane.

Lane Changes

SEEing is critical when passing. You should not try to pass more than one vehicle at a time, as one of them may turn left in front of you. To complete a pass:

Passing

- Keep an appropriate following distance, and move to the left third of your lane.
- When a safe gap appears, signal a lane change.
- Check the mirrors and the blind spot (an impatient driver may be attempting to pass you and the vehicle ahead).
- Accelerate and change lanes, selecting a lane position that allows maneuvering time and space (Be cautious of wind blast and turbulence when passing large vehicles).
- Once well past the vehicle, signal a lane change.
- Check the spacing with a mirror check and head check.
- Return to a good lane position, and cancel the signal.
- Continue to SEE.

Be sure you have excellent basic skills before venturing out on the highway with a group. Riding alone, you only have to account for yourself. Riding with others, you must take into account the needs and abilities of other riders. Here are some tips for successful group riding:

Group Riding

- Arrive prepared and check specific information from the group leader.
- Use a staggered formation unless there is a need for single-file riding.
- Single-file formation is best for negotiating corners.
- Check riders ahead and/or behind to maintain a space cushion and safety margin.
- Know ahead of time the planned rest stops and destinations.
- Know the plan should riders in a group get separated by traffic or traffic controls.
- Passing procedures follow the rules for passing as an individual rider.
- Learn common group riding signals.

A tear-out reference page on group riding is provided at the end of this book.

Hills Just as it is important to match gears to road speed on level terrain, a rider must determine the best gear for riding in hilly country. A lower gear should be used for steep grades, both in ascending to maintain power and maneuvering speed, and

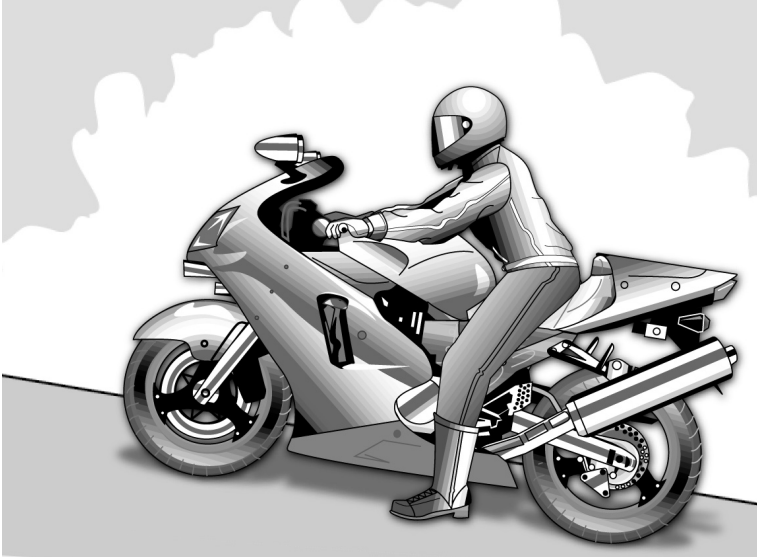

Starting on a Hill

in descending to use engine braking to help control speed. Total stopping distance increases on a downgrade, so allowing extra following distance is appropriate.

Special skill is required to start out on a hill. A good technique is to apply a brake to prevent the motorcycle from rolling backward while you move the clutch to the friction zone. Often the rear brake is used; but, if you need to keep both feet down for balance, you could use the front brake while easing out the clutch into the friction zone until you can release the brake and apply some throttle. Keeping the clutch in the friction zone can hold the motorcycle in position

until you are underway. It may be helpful to use more throttle than when starting on a level surface, and you may have to hold the clutch in the friction zone longer to get moving.

Night Riding Riding at night reduces visibility for you and for other drivers. To be more visible, wear bright, reflective materials. Use the motorcycle's lights wisely, particularly the high beam. Use signals when changing direction, and flash the brake light when slowing or when waiting at intersections.

Maintain good vision by using eye protection that is free of scratches and smudges. Avoid using tinted or colored lenses at night. One of the difficulties associated with night riding is overriding the headlight. This is when total stopping distance exceeds sight distance. Keep speed reasonable for conditions. Use the lights of other vehicles in front of you to help with visibility.



Over-Riding the Headlight

Maximum Braking and Swerving Section F

Most braking systems have a lever for application of the front brake and a pedal for application of the rear brake. But there are other variations, some of which may affect low-speed maneuvers. Check the owner's manual for information about your motorcycle's braking system.

Integrated Brakes: Application of the rear brake will cause some application of the front brake.

Linked Brakes: Application of either the front brake or rear brake will cause some pressure to be applied to the other brake.

Anti-Lock Brakes: These are designed to prevent or minimize skidding in a maximum-braking straight-line stop.

Stopping a motorcycle in the shortest possible distance is one of the most important skills to possess. Practice in a safe area as often as possible to keep the technique fresh.

The best way to achieve maximum braking is to apply both brakes fully without locking either wheel. Simultaneously squeeze the front brake lever and apply the rear brake pedal. Keep the body centered and look well ahead, not down; it helps you keep the motorcycle in a straight line.

It's important to remember when stopping in a curve that the amount of traction available for braking is reduced. This is because a portion of the total available traction is being used for turning, leaving less traction for braking.

The key to stopping quickly in a curve is to get the motorcycle straight up as soon as possible so that the maximum amount of traction is available for braking. If road and traffic conditions permit, straighten the motorcycle first and "square" the handlebar (center the steering) before the brakes are applied for a maximum-braking, straight-line stop.

There may be conditions that do not allow straightening first, such as running off the road in a left-hand curve or dealing with oncoming traffic in a right-hand curve. In such situations, apply the brakes smoothly and gradually. As the lean angle is reduced, more brake pressure can be applied.

It is best at the end of a stop to have the motorcycle straight up. This is the reason to "square" the handlebars near the end of the stop.

Braking Systems

Straight-Line Braking

Braking in Curves

Front-Tire Skid It is important to emphasize the need to smoothly and progressively squeeze the front brake lever. It takes time for the forward weight transfer to occur during deceleration. If the brake lever is grabbed abruptly and high brake pressure is applied before the extra traction due to the forward weight transfer is available, the wheel can lock and a front-tire skid will occur. This will result in immediate loss of steering control and the ability to balance. If such a front-tire skid occurs, immediately release the front brake to allow the wheel to resume rolling, and then reapply the brake properly. Improper application could lead to a “low side” fall.

Rear-Tire Skid Rear-tire skids can occur in quick stops or rapid speed reductions because the weight of the motorcycle and rider is transferred away from the rear wheel and to the front. This reduces the traction available to the rear tire and, consequently, the amount of brake pressure required to lock the wheel. When a rear tire skids, the ability to turn is lost.

The biggest danger in any rear-tire skid is releasing the rear brake when the rear wheel is out of alignment with the front wheel. If the rear wheel stops skidding and resumes rolling when it is out of line with the direction of travel, the motorcycle will immediately straighten and could result in loss of control. You could be thrown off in what is commonly called a “high-side” fall, and it is very likely to produce serious injury.

You can prevent a “high-side” by intentionally keeping the rear brake locked and skidding to a stop. If a fall occurs, it will be to the “low side,” and you will have only a short distance to fall.

If the rear wheel is nearly aligned with the front wheel, it is possible to regain control by releasing the rear brake and allowing the wheel to resume rolling. It is important to emphasize that releasing the rear brake should only be considered if both wheels are nearly aligned with the direction of travel. Even moderate misalignment can produce a “high-side.”

Swerving Good searching techniques can prevent situations where swerving becomes necessary. Swerving to avoid a crash may be appropriate if stopping isn't a solution. Research has shown that at speeds above about 18 mph, a motorcycle can swerve to avoid a car-sized obstacle in less distance than it takes to stop. Be sure you have enough time and space to swerve.

Swerving is basically two consecutive turns or countersteers, one to avoid an obstacle followed immediately by another to regain the original direction. As with all turns, both are made by applying forward pressure to the appropriate handgrip (press right-

go right, press left-go left). The initial press must be deliberately firm to cause the motorcycle to lean quickly and avoid the obstacle.

When swerving, keep the motorcycle lean independent of body lean; that is, keep your upper torso upright while the motorcycle leans. This will allow the motorcycle to lean more quickly. Keep your knees against the tank and your feet solidly on the footrests. Look toward the clear path you are trying to reach to avoid target fixation.

Maintain a steady throttle and do not brake while swerving. Swerving may require maximum-performance turns for which all available traction is needed to turn the motorcycle quickly. Any braking while swerving, even engine braking, may force the tires beyond their traction limit and cause a skid. If you have time and space to slow before swerving, brake first to slow, then completely release the brakes and swerve. If braking is required to avoid a second hazard in the recovery path, it might be best to delay braking until the recovery turn is complete and the motorcycle is going straight.

Special Situations Section G

Surface Features

We live in an imperfect world. Sometimes factors develop and interact in subtle ways. With knowledge and use of a good riding strategy, the risks can be managed.

Rain-slick surface: The surface is most slippery during the first few minutes of rain because oil and dirt combine with water; use the tire tracks left by other vehicles if surface conditions permit to help prevent hydroplaning (water buildup under the tread). It may be wise to avoid riding during the first part of a rainstorm because road surfaces are slickest then. Reduce speed to create a margin of safety and to minimize lean. Metal covers, bridge gratings, train tracks, painted/taped lines, leaves, and wood can be very treacherous when wet.

Worn pavement: Heavy traffic use can create a depression in the lane where automobile and truck tires touch the pavement; rain can accumulate in these areas increasing the likelihood of hydroplaning. Avoid these areas when possible, and try to stay on top of any depressions.

Loose surfaces and debris: This includes such things as sand, gravel, rocks, and trash, as well as liquids such as fuel, oil, or coolant. Watch for items that might cause tire damage such as nails or sharp metal objects. Give yourself plenty of time to SEE.

Crack sealant and tar strips: These can be slippery, especially in hot weather. Be sure to recognize them early and adjust lane position to avoid problems.

Ice/snow patches, mud, moss, algae: These areas can be very slippery. Identify them early and reduce speed. When crossing slick patches, you may want to keep the clutch squeezed and avoid excessive leaning.

Crowned roads: These are roads that are higher in the middle to provide drainage. Use caution when going around curves to the left because ground clearance is reduced and the lean angle available will be less than on a flat road.

Rain grooves and bridge gratings: These cause the motorcycle to feel “loose” and to wander, but they pose no serious threat to control. Keep steering relaxed and avoid abrupt maneuvers.

Bumps, cracks and tracks: These are like obstacles, so cross them at a 90-degree angle. Keep speed under control while maintaining momentum, and rise off the seat, keeping your weight balanced. For railroad crossings, it is usually safe to ride straight within your lane to cross the tracks. For tracks and road seams that run parallel to your path, move far enough away from the tracks to cross at an angle of at least 45 degrees, then make a quick, sharp turn.

Passengers and Cargo

Passengers: Carrying a passenger can affect the way a motorcycle handles. The weight makes starting out more difficult and reduces acceleration capability. More time and space will be required for passing. It may also increase stopping distance. Stability may be affected in turns and curves.

Here are some additional tips:

- Adjust the suspension and tire pressures as per operator’s manual recommendations.
- Be sure a passenger is properly attired.
- Keep both feet on the ground and the brakes applied while the passenger mounts. Have the engine started and the transmission in neutral.
- Avoid abrupt acceleration and deceleration, and go easy on lean angles when cornering, especially with inexperienced passengers.
- Have the passenger follow these rules:
 - a. Hold the operator’s waist or hips, or passenger hand-holds.
 - b. Keep feet on the passenger footrests at all times, including stop points.
 - c. Keep hands and feet away from hot or moving parts.
 - d. Look over the rider’s shoulder in the direction of turns and curves.
 - e. Avoid leaning or turning around; make no sudden moves that might affect stability.
 - f. When crossing an obstacle, rise slightly off the seat (abrupt acceleration should be avoided).

Cargo: There are three points to consider when carrying loads: weight, location, and security.

Weight: Every motorcycle has a maximum load specified by its manufacturer. It is the difference between empty weight and the maximum allowable weight of the motorcycle and its load, including the operator and passenger. Other things add weight too, such as saddlebags, tank bags, luggage racks, etc.; don’t overload these either. Check the owner’s manual for weight limitations and recommendations for tire pressure and suspension adjustments.

Location: Due to a motorcycle's size and weight, and the fact that it has two wheels, where a load is carried is important. Keep the weight low and as close to the center of the motorcycle as possible, and keep it evenly distributed side to side. Place heavier items in the "load triangle," the space formed within the top of your head and the two axles. If using a tank bag, be sure it doesn't interfere with your comfort or ability to steer. Although luggage racks and top trunks appear to be ideal places to pack things, carrying weight high and to the rear of the motorcycle will lighten the front wheel and may cause a degree of handling instability. Never strap items to the handlebar, front forks, or front fender. Even if the handlebars and suspension travel are unaffected, the extra weight can cause steering instability.



Load Triangle

Security: Be sure the load is secure. Use accessory racks and luggage designed for the motorcycle. Secure loose items with bungee cords and web straps. Don't block lights or moving suspension parts. And be sure there are no loose items to blow about or get caught in the wheels. Keep items away from mufflers.

Strong, steady winds or gusty winds can affect you and your motorcycle. The effects can occur anywhere and often happen in open areas or mountainous terrain. Steady winds require you to make pressure adjustments on the handlebars. Be prepared to respond as wind increases and decreases.

Windy Conditions

Wind turbulence can occur when you share the road with large vehicles like trucks, buses and recreational vehicles. Turbulence can occur as you pass traffic that is moving with you as well as when there is opposing traffic. Being passed can also cause you to be affected by wind turbulence. Constantly evaluate circumstances and be prepared to adjust lane position and handlebar pressure as the need arises.

Animals Dogs sometimes chase motorcycles. The danger is not so much from getting bitten, but from the animal getting under the wheels. Once an approaching dog is spotted, a good rider response is to slow, including a downshift, then accelerate past the point

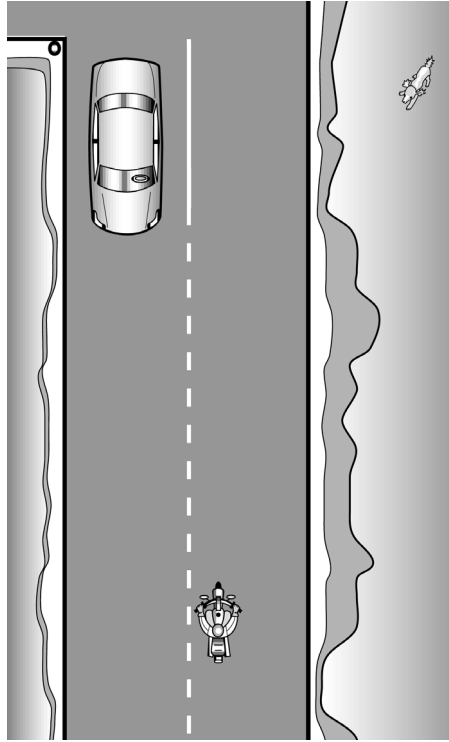

Dog's Interception Angle

of interception. Don't kick at the dog because it will make controlling the motorcycle difficult.

Larger animals such as deer or elk present a different problem. These animals are unpredictable, and hitting one can be as harmful as colliding with another vehicle. Use more aggressive SEE tactics for additional time and space in areas where larger animals may be present. If one of these animals is encountered on or near the roadway, the only reliable action is to stop before reaching it. Then wait until the animal leaves or move past the animal at walking speed.

Tire Failure With modern tubeless tires, actual blowouts are rare, but they can occur. The most common cause of tire failure is riding with the tire pressure too low. Check tires frequently and keep them inflated to the manufacturer's specifications.

If a puncture should occur, maintain a firm hold on the handgrips, but do not fight the steering to correct any wobble or weave that can develop. Avoid downshifting and braking until speed is low and under control. If traffic permits, slow gradually and move off to the side of the road. If braking is necessary, use the brake on the wheel with the good tire. Using the brake on the wheel with the bad tire can cause the tire to separate from the rim, and this can cause immediate loss of control. Be aware that integrated braking systems don't allow "rear brake only" application and linked braking systems do not allow any single-brake operation. On motorcycles equipped with either of these systems, braking with the "good tire only" may not be possible and any braking should be done as lightly as possible.

Some motorcycles have a cable-operated clutch. Should that cable break, the clutch will remain fully engaged. This will be inconvenient, but is not a cause for panic. If the cable breaks while stopped, keep the brakes held firmly to stall the engine. If it happens while riding, it will be more difficult to shift gears, but the motorcycle can still be ridden to a place where assistance is available. Extra caution is necessary. When a stop is to be made, slow gradually, shifting down when speed permits. Shift to neutral before stopping; otherwise the stop will be jerky and the engine will stall.

Broken Clutch Cable

A weave is a relatively slow oscillation of the rear of the motorcycle, while a wobble is a rapid, possibly strong shaking of the handlebar. These are related but distinct stability problems usually caused by excessive weight in the wrong place, or by a mechanical problem such as worn or loose bearings or under-inflated or unevenly worn tires.

Wobble/Weave

Your solution to both situations is the same. Keep a firm hold on the handlebars without locking arms or fighting the steering. Smoothly ease off the throttle to slow gradually. Do not apply the brakes, and do not accelerate to try to stop the wobble or weave. In some cases, it helps to shift your body weight forward by leaning over the tank.

Impairments Section H

Alcohol is a depressant drug that affects safety. It reduces the ability to search for hazards, to evaluate factors that lead to crashes, and to execute coordinated physical movement.

Alcohol

Riding a motorcycle requires a great amount of mental alertness and physical skill, and these chemicals have extraordinarily detrimental effects on a rider's capabilities. Alcohol is a major contributor to motorcycle crashes. Almost 50% of all riders killed had been drinking. One-third of these riders had a blood-alcohol concentration (BAC) above the legal limit. The remaining two-thirds had only a couple of drinks in their system, not enough to be legally intoxicated but more than enough to impair their mental and physical skills.

Alcohol Use and Misuse

Motorcyclists are more likely than car or truck drivers to be hurt in a crash because they are less protected. Some people would never ride a motorcycle after drinking alcohol. Others are willing to risk hurting themselves or others.

Depressant drugs, such as alcohol, slow down bodily functions. Alcohol enters the bloodstream quickly with the effects beginning after the first drink. The primary effects of alcohol are to diminish visual capabilities and alter good judgment.

Blood Alcohol Concentration

The more alcohol there is in the blood, the greater the degree of impairment. The adult male body is able to eliminate alcohol at the rate of almost “one drink” per hour. Women process alcohol at about three-fourths of that rate. If a person drinks at a rate faster than his or her body can eliminate it, the alcohol begins to accumulate in the bloodstream. At a BAC of approximately 0.05%, most people are impaired.

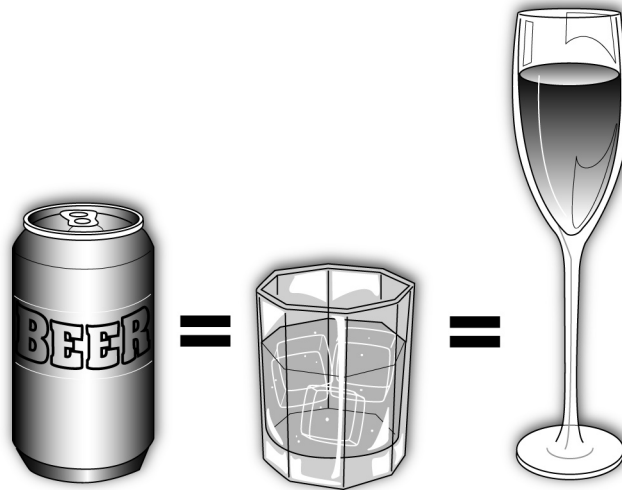

Drink Comparison

BAC is determined by three factors: 1) the amount of alcohol consumed, 2) the time within which it is consumed, and 3) body weight. An accepted definition of a drink is beverage alcohol that contains around one-half ounce of pure ethyl alcohol.

A 12-ounce can of beer, a 5-ounce glass of wine, or a shot of liquor (1.5 ounces) each contains about the same amount of alcohol.

The faster a person drinks the more the alcohol accumulates in the bloodstream. For example, if a man consumed two drinks in an hour, at the end of that hour the alcohol from one drink would be eliminated and the alcohol from one drink will remain in the bloodstream. If four drinks are consumed in an hour, at the end of that hour the alcohol from three drinks will remain in the bloodstream.

Physical size is also a factor in determining BAC. To reach a similar BAC level, a smaller person would consume less beverage alcohol than a larger person. This is because the smaller person has less blood volume on which to base the percentage.

People who try to control their BAC usually don't have much success because judgment is one of the first faculties to be impaired. And because impairment can occur long before a person reaches the legal limit, it is better to separate drinking from riding, period.

Alcohol is not the only drug that affects the ability to ride safely. Many over-the-counter and prescription drugs, as well as illegal drugs, have effects and side effects that increase risk. While it is difficult to accurately determine the effects of some drugs on individual rider performance and behavior, the effects of drugs on the processes necessary to ride safely are known.

Other Drugs

Alcohol/Drug Effects on Search-Evaluate-Execute

Processes	Definition	Effects	Other Drugs
Search	Riders must aggressively check the environment for hazards	Ability to identify single hazards and multiple factors	Marijuana Tranquilizers Barbiturates Antihistamines
Evaluate	Riders must constantly evaluate the interaction of factors	Ability to use good judgment	Marijuana Amphetamines
Execute	Coordinated operation of controls	Increased reaction time and errors	Tranquilizers Barbiturates Antihistamines

When someone has had too much to drink, it is the responsibility of others to keep that person from taking too many risks. No one likes being in a situation that requires intervention, but the payoff can be enormous.

Intervention

Here are some intervention tips:

- **Enlist others:** The more people supporting the intervention, the better the chance for success.
- **Arrange a ride:** Provide an alternate way home.
- **Slow the pace of drinking:** Direct attention to other activities.
- **Delay departure:** Find reasons to delay the rider from getting on the motorcycle. Provide non-alcohol drinks and food to help time to pass.
- **Keep the bike parked:** If the rider can't be stopped, consider hiding the keys.

Other Impairments

Fatigue/Drowsiness Riding when tired raises the level of risk because the mind and the senses are not as responsive. Being tired when riding invites disaster. Riding when fatigued requires you to allow extra time and space to identify important clues in traffic and to leave extra room for following and stopping. Drowsiness is increasingly becoming a contributing factor in crashes. It is more important than ever to ride only when fully alert so you can be responsive to traffic situations.

Emotions It is not easy to determine the personal effects of emotions on riding, but experts recognize that feeling angry, troubled, or stressed makes safe, responsible riding more difficult. Any emotion that distracts your attention away from being fully attentive in applying your strategy will increase risk.

Riding to the Limit Motorcycling is a great way to travel. Sometimes the exhilaration and sense of freedom can lead to poor judgment and increased risk. Aggressive riding, such as challenging the road or other riders, should be saved for race tracks and closed-course riding areas, and only after receiving proper instruction. Many schools are available to help you learn to ride your motorcycle more competitively.

The classroom wrap-up consists of topics to bring the course to successful completion. Topics are determined by the local program and may consist of, but are not limited to, the following:

- Licensing information
- Personal protective gear requirements
- State motorcycle equipment requirements
- State insurance requirements
- End-of-course knowledge test
- How to continue to practice and develop skills
- Evaluation of course and RiderCoach(es)
- Formal dismissal and graduation

We hope this course has been, for you, a great and valuable introduction to the wonderful world of motorcycling. The Motorcycle Safety Foundation provides additional training opportunities as part of its Rider Education and Training System (MSF RETS), which is designed to provide you with lifelong learning and safety renewal experiences. We hope you choose to take advantage of those courses and training opportunities as you continue your personal motorcycle adventure. The concepts discussed in this course are presented in greater detail in a variety of MSF publications, including the book "The Motorcycle Safety Foundation's Guide to Motorcycling Excellence," available through www.msf-usa.org. Check the MSF website often for information.

A Final Note

Accident – a pure chance occurrence; an unexpected and undesirable event; most are preventable; preferred term is “crash” or “collision”

Alcohol – specifically ethyl alcohol, a depressant drug consumed as a beverage

Anti-lock brakes – type of braking system that automatically releases brake pressure prior to wheel lockup

Apex – the sharpest point in a curve

BAC – Blood Alcohol Concentration; percentage by volume of ethyl alcohol in the blood stream

Blind spot – area behind or to the side not seen in the mirrors or blocked from view by an object

Braking distance – space traveled between brake application and completed stop

Center of gravity/Center of mass – that point around which mass of an object is evenly distributed or balanced

Conspicuous – be easily seen by others; to be highly visible

Contact patch – portion of a tire that touches the road surface

Convex mirrors – mirrors designed with an outwardly curved surface; shows more area but objects are closer than they appear in the mirror

Countersteer – a momentary steering deflection away from the intended direction of travel caused by pressing on the handgrip in the direction of the turn; used to produce a lean in the desired direction; press right, lean right, go right; press left, lean left, go left

Counterweight – use primarily in slow, tight turns; rider shifts weight opposite to the lean of the motorcycle

Crowned road – road surface that is higher in the middle to allow for water runoff

Decreasing – radius turn – a turn that becomes progressively tighter; use steady throttle to negotiate

DOT – stands for U.S. Department of Transportation. Used to note a helmet that has been manufactured to meet DOT performance standards as required by federal law for all helmets sold in the U.S.

Engine braking – slowing by shifting down and releasing the clutch to use the engine as a braking force

Entry speed – in turning and cornering, the motorcycle’s speed at the point where the steering input to lean into the turn occurs. The maximum desired entry speed is one that allows for some roll-on of throttle to maintain speed and stability while

cornering; one that assures no deceleration in a turn will be required, and one that provides time and space to “straighten and brake” if necessary

FINE-C – acronym for the engine pre-starting checklist (Fuel valve; Ignition switch; Neutral; Engine cut-off switch; Clutch/Choke)

Friction zone – area of clutch-lever movement that begins where the clutch starts to transmit power to the rear wheel and ends just prior to full clutch engagement. Used to get under way from a stop, to control speed when riding slowly, and to ensure smooth downshifts when engine braking

Gauntlets – refers to protective gloves that extend past the wrist

High-side crash – crash in which the rider loses control and is thrown to ground in front of the motorcycle’s path. This type of crash is likely to result in serious injury to the rider and is often the result of releasing the rear brake when a skidding rear tire is not aligned with the front

Hydroplaning – water buildup under the tires resulting in loss of traction

Hypothermia – subnormal body temperature due to the cooling effects of cold and wind on exposed skin

Integrated brake system – system that also applies partial front braking when the rear brake is applied

Legal limit – BAC level that a state names as the level of intoxication

Linked braking – system that applies brake pressure to both brakes when either brake is applied

Load triangle – area formed by the two axles and the top of the rider’s head; where weight should be placed

Lock-up – wheel(s) stop turning causing a skid; results from too much brake pressure

Low-side crash – crash in which the rider contacts the ground behind the sliding motorcycle, usually as the result of a front-tire skid

Lugging – rough or jerking engine operation due to selecting a gear that is too high for road speed

Maximum braking – application of both brakes simultaneously to a point just short of skidding; threshold braking

MOM – Motorcycle Operator’s Manual

No-Zone – the area around a truck or other vehicle that is a blind spot

Overriding the headlight – riding at a speed for which total stopping distance exceeds sight distance available from headlight illumination at night

Perception distance – space traveled between when a hazard is present to when it is first noticed

Peripheral vision – area to the sides that can be seen while looking straight ahead

Reaction distance – space traveled between perceiving a situation and taking action

Red line – the line on a tachometer that indicates maximum engine speed

Reflective – ability of a surface to reflect light

Rev – abbreviation for revolution; usually refers to inappropriately causing the engine run at high speed while the clutch lever is squeezed, or not shifting up soon enough

Safety margin – time and space that a rider chooses to create to allow for errors by her/himself or others; considers rider capabilities and limitations, motorcycle capabilities and limitations, and roadway/traffic conditions

SEE – an acronym for a dynamic strategy to see and be seen: Search/Evaluate/Execute

Space cushion – having a margin of safety

Square the handlebars – refers to centering the steering with the motorcycle upright and moving in a straight line

Tailgating – following at a distance of less than 2 seconds

Target fixation – to look at an object that you are trying to avoid, may result in failing to avoid the object

Threshold braking – to apply brake pressure to a point just short of lock-up; maximum braking

T-CLOCS – an acronym for the motorcycle pre-ride inspection checklist (Tires and Wheels; Controls; Lights and Electrics; Oil and Other Fluids, Chassis; Stands)

Traffic-actuated signal – a traffic light that senses vehicle presence before changing

Visibility – ability to see and/or be seen

Visual lead times – basis of a strategy to use the eyes and mind to reduce/manage risk: 2-second following distance; 4-second immediate path; 12-second anticipated path

Weave – a relatively slow oscillation of the rear of the motorcycle

Wobble – a rapid oscillation of the front wheel and steering components due to a mechanical problem or chassis instability

Name _____ Date _____

Unit II

1. List the 3 types of motorcycles and the primary use for each.
2. Name the distinguishing characteristics of each of the 3 types.
3. How can completing MSF's *DirtBike School* be a benefit for new or experienced riders?
4. **Name 2 primary differences between cars/trucks and motorcycles.**
5. **What are the problems that these differences cause?**
6. Describe one crash from your group's experience (or that you are aware of), and briefly describe the circumstances. What would some preventive measures be?
7. Who is responsible for safety?
8. How can someone tell if they would likely be dangerous on a motorcycle?
9. In what way does the Ladder of Risk illustration relate to safe riding?
10. What must happen before risks can be managed?
11. **Part of being responsible means to give a lot of thought to what?**
12. **What is the primary cause of motorcycle crashes?**
13. What leads up to most crashes?
14. In what way does the Crash Chain illustration relate to safe riding?
15. **How does the Handbook define a "good motorcyclist"?**
16. **How does a rider reduce factors that lead to crashes?**
17. **What does it mean to have a margin of safety?**
18. **What is SEE, and what does each letter stand for?**

Unit III

19. **Name several purposes of protective riding gear.**
20. List the 6 items named as proper, protective gear.
21. What is the function of a helmet?
22. List the 4 basic components of a helmet named on page 10.
23. What is the purpose of each of these 4 components?
24. **What's the difference between a full-face and three-quarter-coverage helmet?**
25. **Why aren't ordinary glasses or sunglasses sufficient eye protection?**
26. **What stickers are likely to indicate a well-made helmet?**

27. **What type of injury accounts for the majority of motorcycle deaths?**
28. Name 2 types of motorcyclist eye protection.
29. **What is the value of appropriate footwear?**
30. Name at least 3 considerations in choosing gloves.
31. **What is the value of motorcycle specific clothing?**
32. What are some considerations for choosing proper clothing?
33. **Define "hypothermia" and provide an example.**
34. **What is the value of dressing in layers?**
35. How can clothing make you more visible to others in traffic?
36. What are some considerations in choosing a rain suit?
37. What is the value of a pre-ride inspection?
38. **What is T-CLOCS and what does each letter stand for?**
39. Where can you find information about routine maintenance?
40. What is the value of routine maintenance?
41. **What are the primary motorcycle controls?**
42. **What is the most common way to initiate and control motorcycle lean (for turns)?**
43. How does a rider operate the throttle?
44. What does the clutch lever do?
45. What does lifting or pressing on the shift lever accomplish?
46. **What is meant by "shift pattern"?**
47. **Where are the brake controls found?**
48. What is the best source of information about your motorcycle?
49. **What does the fuel valve do?**
50. What are the positions on the fuel valve?
51. What does the choke control do?
52. Where is the engine cut-off switch located?
53. **What is the function of the tachometer?**
54. **What are some common indicator lights?**
55. **What are the steps in starting the engine?**
56. **What is the friction zone?**
57. **Describe good riding posture.**
58. **List the 4 steps in turning.**
59. What is the value of the "look" step?
60. What is the value of the "roll" step?
61. **When is the counterweight technique used?**

62. **Why do you change gears?**
63. **What is the 3-part shift process?**
64. **What is engine braking?**
65. **How much of a motorcycle's stopping power is available from the front brake?**
66. **Why should both brakes be used simultaneously?**
67. **What's the purpose of the range safety rules?**
68. Name 3 of the more important Range Safety Rules.
69. **How will the RiderCoaches communicate with you on the range?**

Unit IV

70. **What does it mean to have a space cushion?**
71. **How does a motorcyclist utilize lane positions?**
72. **Name some ways to be more visible to others in traffic.**
73. **What are the 3 "lead times" (RiderRadar)?**
74. **Why is the 2-second following distance considered minimum?**
75. Why is the 4-second lead-time called "immediate"?
76. What advantage is gained by using a 12-second anticipated path?
77. **Name the 3 components of total stopping distance.**
78. Safe riding is a skill of what kind?
79. **What does it mean to Search?**
80. **What is the characteristic of a convex mirror?**
81. What are the 3 general Search categories?
82. What does Evaluate mean?
83. What are the 3 action steps of Execute?
84. What 3 things in the Oval of Safety affect your margin of safety?
85. **Where is the greatest potential for conflict?**
86. **What 4 steps should you follow when around an intersection?**
87. What is significant about a traffic-actuated signal?
88. **What are some hazards between intersections?**
89. **What is the No-Zone?**
90. **How should you respond to a tailgating driver?**
91. **What are some factors to search for when approaching a curve?**
92. **How can an outside-inside-outside path of travel help you in curves?**
93. Name a couple of tips for parking your motorcycle.
94. **Why rise off the seat when crossing an obstacle?**

95. How is the throttle used when crossing an obstacle?
96. **Why make a head check before changing lanes?**
97. Is there a unique procedure when passing another vehicle on your motorcycle?
98. **What makes starting out on a hill (upgrade) more difficult?**
99. **What is "overriding the headlight" and what is the solution?**
100. **Name and explain the 3 variations to standard braking systems.**
101. **What is the best way to achieve maximum braking?**
102. **What complicates braking in a curve?**
103. **What is a key to stopping quickly in a curve?**
104. **What should you do if the front tire skids because of improper braking (front brake grab)?**
105. **What is the danger of a rear-tire skid?**
106. What is a "high-side"?
107. **In a swerve, how should you lean?**
108. **What action should be avoided when swerving?**
109. **Why is a surface most slippery as it begins to rain?**
110. **What is hydroplaning?**
111. **How can a crowned road affect riding?**
112. **How does carrying a passenger affect the operation of a motorcycle?**
113. **What are a few tips for carrying passengers?**
114. **What 3 points should be considered when carrying loads?**
115. What is the "load triangle"?
116. **How should you respond to a dog that approaches from the side?**
117. What is the primary cause of tire failure?
118. What is made more difficult by a broken clutch cable?
119. What is the solution for wobble or weave?
120. **What are the 2 primary effects of alcohol?**
121. **How fast is alcohol eliminated from the bloodstream?**
122. **How much beverage alcohol equals one drink?**
123. What are some other drugs that affect SEE?
124. **What is the best way to approach intervention?**
125. **What are some ways to intervene when someone has had too much to drink?**
126. What besides alcohol/other drugs can produce impairment?



MSF Student Satisfaction Survey Form for Basic RiderCourseSM

Please help the Motorcycle Safety Foundation maintain high-quality RiderCourses by providing feedback on your training experience. You can complete the following evaluation form online at www.msf-usa.org (click on "Participate"), or mail it to the MSF. To mail this form, fold it so that the MSF's address is facing outward, and attach first-class postage. All information will be held in strictest confidence. Your personal contact information will be used only for quality assurance purposes and may be shared with the training site or your state coordinator. This information will not be sold or provided for commercial use.

Rev 1/07

Course Site: _____ City: _____ State: _____ Date course began: ____ / ____ / ____

RiderCoach Names: 1. _____ 2. _____ 3. _____

Circle the number corresponding to your response to each question.

1. Overall satisfaction with course: 1 2 3 4 5 6 7 8 9 10
Very Low Very High
2. When you compare your overall riding skills and strategies after you completed the course with your riding skills and strategies prior to completion, how much improvement did you make? 1 2 3 4 5 6 7 8 9 10
Very Little A Whole Lot

*VSD=Very Strongly Disagree; SD=Strongly Disagree; D=Disagree; N=Neither Disagree nor Agree; A=Agree; SA=Strongly Agree; VSA=Very Strongly Agree

Overall	VSD	SD	D	N	A	SA	VSA	RiderCoach Instruction	VSD	SD	D	N	A	SA	VSA
3. Registering for this course was easy.	1	2	3	4	5	6	7	11. I felt respected by my RiderCoach(es).	1	2	3	4	5	6	7
3a. How many times did you try to register prior? _____															
4. There were many available classes in my geographic area.	1	2	3	4	5	6	7	12. I felt encouraged by my RiderCoach(es).	1	2	3	4	5	6	7
5. I was able to enroll in a course that was convenient to my schedule.	1	2	3	4	5	6	7	13. The RiderCoach(es) appeared to have prepared sufficiently for the class.	1	2	3	4	5	6	7
6. The time between registering for the class and attending the class was reasonable.	1	2	3	4	5	6	7	14. The RiderCoach(es) demonstrated effective communication skills.	1	2	3	4	5	6	7
6a. Your waiting time: _____ days															
7. The cost of the course was about right.	1	2	3	4	5	6	7	15. The RiderCoach(es) showed concern for my personal safety.	1	2	3	4	5	6	7
7a. Your tuition fee: \$ _____															
Classroom	VSD	SD	D	N	A	SA	VSA	Range	VSD	SD	D	N	A	SA	VSA
8. Overall, the pace of the classroom instruction was about right.	1	2	3	4	5	6	7	16. Overall, the pace of the range instruction was about right.	1	2	3	4	5	6	7
9. The quality of the classroom materials (handbook, videos, etc.) was high.	1	2	3	4	5	6	7	17. Overall, the time I had to practice riding was about right.	1	2	3	4	5	6	7
10. During the course, I was given the opportunity to participate in discussions.	1	2	3	4	5	6	7	17a. Total # of students on range _____							
								18. The quality/condition of the range equipment was high.	1	2	3	4	5	6	7

Comments and/or suggestions for improvement on any aspect of the course.

Demographics

(Providing responses to these questions is strictly voluntary.)

19. Do you currently ride a motorcycle regularly?
 No Yes — Estimated # of miles you ride annually _____
20. What was your skill level prior to the training class?
 Never ridden motorcycle prior Beginner Experienced
21. Did you pass the classroom knowledge test? No Yes
22. Did you pass the riding skill test? No Yes
23. Age
 Under 21 21-24 25-34 35-44 45-64 65 or Over
24. Gender
 Male Female
25. Which of the following RiderCourses would you be interested in attending?
 DirtBike School Skill Enhancement RiderCourse
 ScooterSchool On-Road RiderCourse
 Experienced RiderCourse None of the above

– Tape to close here –

To complete this evaluation form online, please visit **www.msf-usa.org** and click on "Participate," where you can also sign up to receive free safety and riding tips from the Motorcycle Safety Foundation.

----- FOLD HERE ----- FOLD HERE -----

STUDENT SURVEY

First
Class
Postage
Required

Motorcycle Safety Foundation
ATTN: Quality Assurance & Research
2 Jenner Street, Suite 150
Irvine, CA 92618-3806

----- FOLD HERE ----- FOLD HERE -----

FOLD THIS SECTION IN FIRST

Name: _____

Street Address: _____

City: _____ State: _____ ZIP Code: _____

E-mail Address: _____@_____

May the MSF contact you in the future? YES NO

For information on becoming an MSF RiderCoach, visit www.msf-usa.org and click on RiderCoach Info.

This information is not part of the Basic RiderCourse and is provided solely for your convenience. You can tear this page out and keep it with you when you ride.

QUICK TIPS: The MSF'S Guide to Group Riding

Motorcycling is primarily a solo activity, but for many, riding as a group – whether with friends on a Sunday morning ride or with an organized motorcycle rally – is the epitome of the motorcycling experience. Here are some tips to help ensure a fun and safe group ride:

Arrive Prepared. Arrive on time with a full gas tank.

Hold a riders' meeting. Discuss things like the route, rest and fuel stops, and hand signals (see diagrams at right). Assign a lead and sweep (tail) rider. Both should be experienced riders who are well-versed in group riding procedures. The leader should assess everyone's riding skills and the group's riding style.

Keep the group to a manageable size, ideally five to seven riders. If necessary, break the group into smaller sub-groups, each with a lead and sweep rider.

Ride prepared. At least one rider in each group should pack a cell phone, first-aid kit, and full tool kit, so the group is prepared for any problem that might be encountered.

Ride in formation. The staggered riding formation allows a proper space cushion between motorcycles so that each rider has enough time and space to maneuver and to react to hazards. The leader rides in the left third of the lane, while the next rider stays at least one second behind in the right third of the lane; the rest of the group follows the same pattern. A single-file formation is preferred on a curvy road, under conditions of poor visibility or poor road surfaces, when entering/leaving highways, or in other situations where an increased space cushion or maneuvering room is needed.

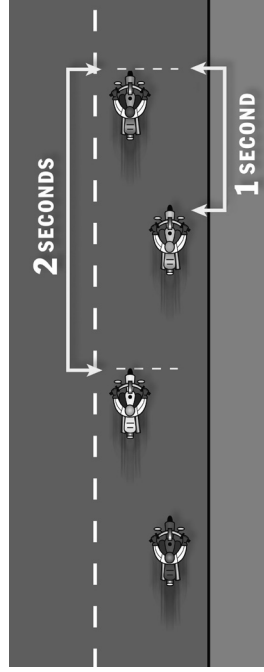













Avoid side-by-side formations, as they reduce the space cushion. If you suddenly needed to swerve to avoid a hazard, you would not have room to do so. You don't want handlebars to get entangled.

Periodically check the riders following in your rear view mirror. If you see a rider falling behind, slow down so he or she may catch up. If all the riders in the group use this technique, the group should be able to maintain a fairly steady speed without pressure to ride too fast to catch up.

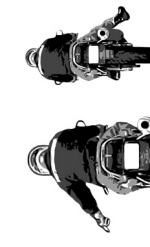
If you're separated from the group, don't panic. Your group should have a pre-planned procedure in place to regroup. Don't break the law or ride beyond your skills to catch up.

For mechanical or medical problems, use a cell phone to call for assistance as the situation warrants.

Group Riding Hand Signals

<p>Stop - arm extended out, palm facing back</p> 	<p>Single File - arm and index finger extended straight up</p> 	<p>Turn Signal On - open and close hand with fingers and thumb extended</p> 
<p>Slow Down - arm extended straight out, palm facing down, swinging down to your side</p> 	<p>Double File - arm with index and middle finger extended straight up</p> 	<p>Fuel - arm out to side pointing to tank with finger extended</p> 
<p>Speed Up - arm extended straight out, palm facing up, swinging upward</p> 	<p>Hazard in Roadway - on the left, point with left hand; on the right, point with right foot</p> 	<p>Refreshment Stop - fingers closed, thumb to mouth</p> 
<p>You Lead/Come - arm extended out, palm forward pointing with index finger, swinging in arc from back to front</p> 	<p>Highbeam - tap on top of helmet with open palm down</p> 	<p>Comfort Stop - forearm extended, fist clenched with short up and down motion</p> 
<p>Follow Me - arm extended straight up from shoulder, palm forward</p> 	<p>Pull Off - arm positioned as for right turn, forearm swung toward shoulder</p> 	

This information is not part of the Basic Rider Course and is provided solely for your convenience. You can tear this page out and keep it with you when you ride.

T-CLOCKS: Pre-Ride Inspection Checklist

T-CLOCKS ITEM	WHAT TO CHECK	WHAT TO LOOK FOR	CHECK-OFF
T-TIRES & WHEELS			
Tires	Condition	Tread depth, wear, weathering evenly seated, bulges, embedded objects.	Front Rear
	Air Pressure	Check when cold, adjust to load.	Front Rear
Wheels	Spokes	Bent, broken, missing tension; check at top of wheel; "ring" = OK — "thud" = loose spoke.	Front Rear
	Cast	Cracks, dents.	Front Rear
	Rims	Out of round/rue = 5mm; Spin wheel, index against stationary pointer.	Front Rear
	Bearings	Grab top and bottom of tire and flex; No freeplay (click) between hub and axle, no growl when spinning.	Front Rear
	Seals	Cracked, cut, or torn, excessive grease on outside, reddish-brown around outside.	Front Rear
Brakes	Function	Each brake alone keeps bike from rolling.	Front Rear
C-CONTROLS			
Levers and Pedal	Condition	Broken, bent, cracked, mounts tight, ball ends on handlebar levers, proper adjustment.	
	Pivots	Lubricated.	
Cables	Condition	Fraying, kinks, lubrication: ends and interior.	
	Routing	No interference or pulling at steering head, suspension; no sharp angles, wire supports in place.	
Hoses	Condition	Cuts, cracks, leaks, bulges, chafing, deterioration.	
	Routing	No interference or pulling at steering head, suspension; no sharp angles, hose supports in place.	
Throttle	Operation	Moves freely, snaps closed, no rewing when handlebars are turned.	
L-LIGHTS			
Battery	Condition	Terminals: clean and tight, electrolyte level, held down securely.	
	Vent Tube	Not kinked, routed properly, not plugged.	
Headlamp	Condition	Cracks, reflector, mounting and adjustment system.	
	Aim	Height and right/left.	
Tail lamp/brake lamp	Operation	Hi beam/low beam operation.	
	Condition	Cracks, clean and tight.	
Turn signals	Operation	Activates upon front brake/rear brake application.	Front/left Front/right
	Condition	Flashes correctly.	Rear/left Rear/right
Mirrors	Condition	Cracks, clean, tight mounts and swivel joints.	
	Aim	Adjust when seated on bike.	
Lenses & Reflectors	Condition	Cracked, broken, securely mounted, excessive condensation.	
	Fraying, chafing, insulation.		
Wiring	Condition	Pinched, no interference or pulling at steering head or suspension, wire looms and ties in place, connectors tight, clean.	
	Routing		
O-OIL			
Levels	Engine Oil	Check warm on center stand on level ground, dipstick, sight glass.	
	Hypoid Gear Oil Shaft Drive	Transmission, rear drive, shaft.	
	Hydraulic Fluid	Brakes, clutch, reservoir or sight glass.	
	Coolant	Reservoir and/or coolant recovery tank — check only when cool.	
Leaks	Fuel	Tank or gauge.	
	Engine Oil	Gaskets, housings, seals.	
	Hypoid Gear Oil Shaft Drive	Gaskets, seals, breathers.	
	Hydraulic Fluid	Hoses, master cylinders, callipers.	
	Coolant	Radiator, hoses, tanks, fittings, pipes.	
	Fuel	Lines, fuel valve, carbs.	

T-CLOCKS ITEM	WHAT TO CHECK	WHAT TO LOOK FOR	CHECK-OFF
C-CHASSIS			
Frame	Condition	Cracks at gussets, accessory mounts, look for paint lifting.	
	Steering-Head Bearings	No detent or tight spots through full travel, raise from wheel, check for play by pulling/pushing forks.	
Suspension	Swingarm Bushings/Bearings	Raise rear wheel, check for play by pushing/pulling swingarm.	
	Front Forks	Smooth travel, equal air pressure/damping, anti-dive settings.	Left Right
Chain or Belt	Rear Shock(s)	Smooth travel, equal pre-load/air pressure/damping settings, linkage moves freely and is lubricated.	Left Right
	Tension	Check at tightest point.	
Fasteners	Lubrication	Side plates when hot. Note: do not lubricate belts.	
	Spockets	Teeth not hooked, securely mounted.	
Fasteners	Threaded	Tight, missing bolts, nuts.	
	Clips	Broken, missing.	
C- STANDS	Cotter Pins	Broken, missing.	
	Center stand	Condition	Cracks, bent.
Side stand	Retention	Springs in place, tension to hold position.	
	Condition	Cracks, bent (safety cut-out switch or pad equipped).	
	Retention	Springs in place, tension to hold position.	

EMERGENCY INFORMATION

Rider's Name _____ Blood Type _____

Allergies/Medical Conditions _____

Doctor's Name/Phone _____

Cycle Insurer Name/Phone _____

Contact this person if rider is injured

Name _____ Home Phone _____

Work Phone _____ Cell Phone _____

Additional Resources

Your learning doesn't stop when you've completed the Basic *RiderCourse*. The Motorcycle Safety Foundation offers refresher hands-on rider courses (such as the Experienced *RiderCourses*) as well as several self-contained classroom-style safety programs ("modules") and publications. Our modules can help you learn more, and you can use them to teach others, whether you're a riding club leader, a schoolteacher, or just someone who enjoys riding a motorcycle. Please visit our website (www.msf-usa.org) to obtain these items and other information that can enhance your safety and enjoyment.



The **Intersection** module is MSF's newest approach to enhancing motorist awareness of motorcycles. The program combines personal stories and character development with a dramatic new look at a crash scene that's all too common. The DVD contains three separate 13-minute versions to appeal to teens (via driver education classes), adults (via traffic schools), and commercial drivers (via employee orientation). Includes Leader's Guide, ten Participant's Guides, and 25 Quick Tips brochures.

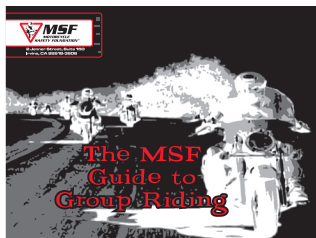

The **MSF Guide to Group Riding** module describes how to put safety first whenever participating in a group ride. Learn about ride preparation and organization, pre-ride meetings, hand signals, and proper riding formations in complex traffic situations. The module includes one Leader's Guide, 10 student workbooks and a 16-minute DVD video that depicts common group riding scenarios.

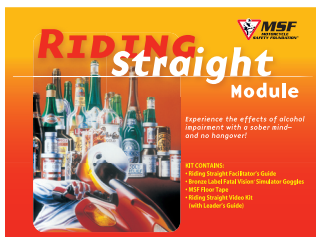

The **Riding Straight** module is a curriculum you can present to *all* roadway users to address the serious issue of impaired riding/driving. The program features interactive Fatal Vision® Simulator Goggles, which allow participants to experience alcohol impairment (at a 0.08 BAC level) with a sober mind...*and no hangover*. This fun demonstration shows that even legal levels of intoxication can have serious consequences when operating a motor vehicle. The module also contains a Facilitator's Guide, a 12-min. VHS video, and a roll of MSF floor tape to use with the goggles for conducting the "sobriety test."



The **SeasonedRider** module is a fun, activity-based learning module designed to help riders assess and compensate for the effects of aging on their ability to effectively manage risk when operating a motorcycle. The module includes an award-winning 13-minute DVD video, Facilitator's Guide, and props for several learning activities. Though the activities are targeted at riders over the age of 40, the sessions are appropriate for operators of any age and any type of vehicle.

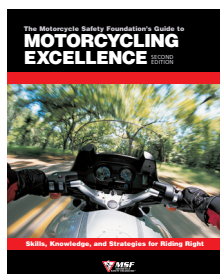

(Book) In a clear, engaging style with detailed diagrams and extensive full-color photographs and illustrations, **MSF's Guide to Motorcycling Excellence** complements *RiderCourse* instruction and addresses rider attitude, protective riding gear, pre-ride inspection, and basic and advanced street skills in a deeper manner. Tips on how to create a "space cushion" to avoid traffic hazards; stop quickly; manage traction; maneuver effectively and efficiently in off-highway riding; and much more, are included. The book also features advice from legendary racers and other experts on various aspects of motorcycling. 192 pages.



2 Jenner, Suite 150 • Irvine, CA 92618-3806
949.727.3227 • www.msf-usa.org

©2001-2008 Motorcycle Safety Foundation
PN MSCU4326NC00
Revision 1-08