

*Report of the
Defense Science Board Task Force*

on

**FUTURE DOD AIRBORNE
HIGH-FREQUENCY RADAR
NEEDS/RESOURCES**



April 2001

*Office of the Under Secretary of Defense
For Acquisition and Technology
Washington, D.C. 20301-3140*

20010705011

This report is the product of the Defense Science Board (DSB). The DSB is a Federal Advisory Committee established to provide independent advice to the Secretary of Defense. Statements, opinions, conclusions, and recommendations in this report do not necessarily represent the official position of the Department of Defense.

This report is UNCLASSIFIED

REPORT DOCUMENTATION PAGE

Form Approved
OMB No. 0704-0188

Public reporting burden for this collection of information is estimated to average 1 hour per response, including the time for reviewing instructions, searching existing data sources, gathering and maintaining the data needed, and completing and reviewing the collection of information. Send comments regarding this burden estimate or any other aspect of this collection of information, including suggestions for reducing this burden, to Washington Headquarters Services, Directorate for Information Operations and Reports, 1215 Jefferson Davis Highway, Suite 1204, Arlington, VA 22202-4302, and to the Office of Management and Budget, Paperwork Reduction Project (0704-0188), Washington, DC 20503.

| | | | | |
|---|---|---|--|--|
| 1. AGENCY USE ONLY (Leave blank) | | 2. REPORT DATE April 2001 | 3. REPORT TYPE AND DATES COVERED Final Technical, 2001 | |
| 4. TITLE AND SUBTITLE Future DoD Airborne High-Frequency Radar Needs/Resources | | | 5. FUNDING NUMBERS N/A | |
| 6. AUTHOR(S) Dr. David L. Briggs and Mr. Robert R. Everett, Task Force Co-Chairs | | | | |
| 7. PERFORMING ORGANIZATION NAME(S) AND ADDRESS(ES) Defense Science Board Office of the Under Secretary of Defense (AT&L) 3140 Defense Pentagon Room 3D865 Washington DC 20301-3140 | | | 8. PERFORMING ORGANIZATION REPORT NUMBER N/A | |
| 9. SPONSORING/MONITORING AGENCY NAME(S) AND ADDRESS(ES) Defense Science Board Office of the Under Secretary of Defense (AT&L) 3140 Defense Pentagon Room 3D865 Washington DC 20301-3140 | | | 10. SPONSORING/MONITORING AGENCY REPORT NUMBER N/A | |
| 11. SUPPLEMENTARY NOTES N/A | | | | |
| 12a. DISTRIBUTION AVAILABILITY STATEMENT Distribution Statement A: Unlimited Distribution | | | 12b. DISTRIBUTION CODE A | |
| 13. ABSTRACT (Maximum 200 words) | | | | |
| 14. SUBJECT TERMS | | | 15. NUMBER OF PAGES 70 | |
| | | | 16. PRICE CODE N/A | |
| 17. SECURITY CLASSIFICATION OF REPORT UNCLASSIFIED | 18. SECURITY CLASSIFICATION OF THIS PAGE UNCLASSIFIED | 19. SECURITY CLASSIFICATION OF ABSTRACT N/A | 20. LIMITATION OF ABSTRACT N/A | |



DEFENSE SCIENCE
BOARD

OFFICE OF THE SECRETARY OF DEFENSE

3140 DEFENSE PENTAGON
WASHINGTON, DC 20301-3140

MEMORANDUM FOR UNDER SECRETARY OF DEFENSE (ACQUISITION,
TECHNOLOGY & LOGISTICS)

SUBJECT: Defense Science Board Task Force Report on Future DoD Airborne High-Frequency
Radar Needs/Resources

I am pleased to forward the final report of the DSB Task Force on Future DoD Airborne High-Frequency Radar Needs/Resources. This study, chaired by Dr. David Briggs, was established to focus on the use of airborne X-band radar to serve the broad mission areas of air defense and ground surveillance. The findings and recommendations of the Task Force provide a clear path for development and utilization of Active Electronically Steered Arrays (AESAs) on a variety of systems and platforms.

The Task Force found that the technology supporting airborne X-Band AESAs has matured greatly during the last decade. AESAs provide 10-30 times more net radar capability plus significant advantages in the areas of range resolution, countermeasure resistance and flexibility. In addition, new designs simplify manufacture and support high reliability/low maintenance goals, which translates into lower lifecycle costs. The Task Force felt so strongly about the advances made to date that they concluded that it will be unlikely that any U.S. future fighter will be procured without AESA technology.

The Task Force strongly supports the infusion of AESA technology into several of the ground surveillance platforms, thereby providing a timely and cost effective plan for increasing the capability of JSTARS, U-2, and Global Hawk. The Task Force's recommendations will also help maintain a competitive U.S. radar industry that can compete in other international markets.

I endorse all the recommendations and propose you review the Chairman's letter and final report.

A handwritten signature in black ink, appearing to read "William Schneider Jr.", with a stylized flourish at the end.

William Schneider Jr.
Chairman



OFFICE OF THE SECRETARY OF DEFENSE

3140 DEFENSE PENTAGON
WASHINGTON, DC 20301-3140

23 March 2001

DEFENSE SCIENCE
BOARD

Dr. William Schneider Jr.
Chairman, Defense Science Board
3140 Defense Pentagon, Room 3D865
Washington, D.C. 20301-3140

Dear Dr. Schneider:

Attached is the final report of the Defense Science Board Task Force on Future DoD Airborne High-Frequency Radar Needs/Resources. The Task Force was formed to address questions related to the development and use of X-band Active Electronically Steered Arrays (AESAs) in airborne applications.

We addressed the problems of advanced ground surveillance and advanced air defense. The primary focus of our effort was the assessment of X-band AESA technology for use in side-looking radar surveillance systems, viz, the U-2, Global Hawk and JSTARS.

The Task Force found that the state-of-the-art in X-band AESAs is sufficiently advanced at this time to permit insertion into airborne side-looking radars with relatively low technical risk. To reduce developmental risk, we recommend that the considerable software needed for these agile-beam, multi-function systems be developed using a phased, incremental approach. The significant advantages of AESA technology including high sensitivity, simplified maintenance, counter-measure resistance, and overall multi-mission flexibility motivate early switchovers to this approach. The Task Force has addressed forward-fit strategies in the report. These AESA forward-fit strategies are shown to meet approved military requirements and to reduce overall program costs.

Family-of-radar and open-system approaches to stimulate innovation and upgradability and to control costs were given attention. The Task Force strongly supports these approaches and recommends the various government X-band AESA procurements be coordinated to a level that would permit the maximum benefits of these approaches to be realized by the industrial base.

We would like to express our appreciation to the members, the government advisors and to all others who provided their time and talents to the Task Force.

Handwritten signature of Dr. David L. Briggs in cursive.

Dr. David L. Briggs
Task Force Co-Chair

Handwritten signature of Mr. Robert R. Everett in cursive.

Mr. Robert R. Everett
Task Force Co-Chair

DLB:jt

TABLE OF CONTENTS

| | <u>Page</u> |
|---|-------------|
| Executive Summary | v |
| I. Introduction | 1 |
| II. Background Assessment for X-Band AESA Radar | 2 |
| III. Family of Airborne Radars | 10 |
| IV. Findings and Recommendations | 35 |
| Appendices | |
| A. Terms of Reference and Task Force Members | A-1 |
| B. Air Defense Assessment | B-1 |
| C. X-Band AESA Technology | C-1 |
| D. List of Acronyms | D-1 |

EXECUTIVE SUMMARY

The Defense Science Board Task Force was formed to address questions related to the development of X-band, active, electronically steered arrays (AESAs) for airborne platforms. Areas focused on were advanced radar capabilities for ground targets and air targets.

The airborne radar inventory can be divided into three broad categories:

- (1) Air target surveillance and cueing radars mounted in rotodomes (e.g., AWACS, E-2C).
- (2) Nose-mounted fighter radars for air and ground targets (e.g., F-15, F-16, F-22, JSF).
- (3) Side-looking radars for ground reconnaissance, surveillance, and cueing (e.g., U-2, JSTARS, Global Hawk).

Categories (2) and (3) are dominated by X-band radars; the insertion of AESA technology into category (3) was the primary subject for this task force.

The focus of airborne AESA technology is clearly aimed at fighter-class radars. At this time the DoD has plans to build AESAs for the F-22 (331 units), the F/A-18E/F (258 units), the F-15C (18 units), the F-16-UAE (80 units), and the JSF (about 3000 units). Raytheon (radar supplier for the F-15 and F-18) and Northrop Grumman (radar supplier for the F-22 and F-16) are the dominant U.S. contractors in this market. The very large, potential JSF procurement is in the competition phase, with Raytheon on the Boeing team and Northrop Grumman on the Lockheed Martin team. This procurement, which would extend through 2020, would require approximately 3.5 million transmit/receive modules, which is roughly 80% of the projected fighter market. These AESA fighter radars, in addition to air-to-air modes, support ground-surveillance for stationary and moving targets, i.e., SAR and GMTI.

The potential AESA, side-looking airborne radar market is much smaller and more speculative, viz., for the JSTARS (5 units — RTIP, Radar Technology Improvement Program), for the Global Hawk (10-50 units), for the U-2 (2-17 units), and for the NATO ground surveillance requirement (uncertain number of units). The proposed RTIP, Global Hawk, and U-2 programs would require less than 250,000 transmit/receive modules total, which is about 5% of the projected fighter radar market (or about 20% if JSF is excluded). The surface-based X-band AESA market is dominated by Raytheon-supplied products for ballistic missile defense and air defense, viz., THAAD (tactical missile defense) and GBR (national missile defense) on land, and MFR (multifunction radar) and HPD (high-power discrimination) on ships. The projected requirements for X-band transmit/receive modules for surface-based radar is substantial, but very speculative; rough projections for the next 15 years suggest the total surface market will be one to two million modules, which is about one-third the size of the projected airborne market. If JSF is excluded, the air and surface markets are comparable.

The Task Force found that the state of the art in airborne X-band AESAs has moved impressively in the last decade due to several prototyping efforts and the JSF Dem Val technology push. Factors of 3 to 5 or more in weight and cost reductions can be supported along with innovations in mechanical design to simplify manufacturability and maintenance. Transmit/receive modules are approaching commodity status, albeit with limited component suppliers. Each contractor has been motivated to follow the family-of-

radars construct to remain cost competitive. In all cases, components are being shared among various products, and in many cases, complete subsystems (in both hardware and software). For a given size and weight, AESA technology provides a factor of 10-30 times more net radar capability than competing approaches due to power increases, lower losses, and increased flexibility. Also, AESA designs provide inherently superior countermeasure resistance, enhanced range resolution (for target identification), and more flexibility to support nontraditional radar modes such as jamming and ESM. In addition, AESA technology supports high reliability/low maintenance designs with the promise of attractive life cycle costs. These advantages are so compelling that it is unlikely that any new U.S. fighter radar will be procured in the future without AESA technology.

It is the assessment of the Task Force that the technology of X-band AESAs is mature and ready for insertion, with little risk, into the existing ground surveillance radars on JSTARS (i.e., RTIP), the U-2 (i.e., ASARS Improvement Program), and Global Hawk. In the JSTARS and U-2 situations, we recommend that the technology follow a phased-insertion schedule starting with the AESA hardware being inserted into the radar system with minimal changes to the software and operating modes, i.e., the radar operates essentially as in the past, but with the "ether-to-bits" part of the radar changed to an active array of transmit/receive modules replacing the central power tube and passive array. (The AESA hardware installation alone will generally result in a factor of 7 to 10 improvement in sensitivity due to higher power and lower losses.) Estimates are that as little as 10% of the current radar software would need to be changed to accommodate AESA insertion. The new modes to exploit the capabilities of the AESA should then be phased in via a spiral approach to control development and testing costs, and reduce risks. Based on this approach of AESA hardware insertion followed by evolutionary software upgrades to exploit the new hardware, the Task Force recommends that the current radar system providers, i.e., Raytheon for the U-2 and Northrop Grumman for the JSTARS, be the lead contractors for these AESA upgrades.

The Task Force strongly supports the development of an X-band AESA for the Global Hawk in the near term. The Global Hawk, with modest prime power upgrades, can support an AESA radar that will provide excellent ground surveillance capability (SAR and GMTI) in the high-flying, long-endurance, unmanned mode, which is highly complementary to JSTARS. In addition, Global Hawk, with this radar technology, can provide significant capability against conventional (and modest signature reduction) air vehicles in the surveillance role for no-fly zones and drug enforcement; and in the role of supporting the fire control for over-the-horizon intercepts (frequently referred to as "ADSAM" — air-directed surface-to-air missile). We strongly support the development of Global Hawk for the two roles to decrease the load on the AWACS and JSTARS fleets, the so-called high-demand/low-density assets. A properly equipped Global Hawk fleet could potentially handle most of the non-hot war demands and could supplement the AWACS and JSTARS fleets in wartime situations.

The Terms-of-Reference for this Task Force requested a review of the National activities on Advanced Air Defense with an emphasis on theater cruise missile defense. However, the Defense Department focus on RTIP issues resulted in the Task Force spending most of its short tenure on surface-surveillance issues. The Task Force strongly supports the objective of meeting the land-attack cruise-missile threat by 2010.

essentially as in the past, but with the "ether-to-bits" part of the radar changed to an active array of transmit/receive modules replacing the central power tube and passive array. (The AESA hardware installation alone will generally result in a factor of 7 to 10 improvement in sensitivity due to higher power and lower losses.) Estimates are that as little as ten percent of the current radar software would need to be changed to accommodate AESA insertion. The new modes to exploit the capabilities of the AESA should then be phased in via a spiral approach to control development and testing costs, and reduce risks. Based on this approach of AESA hardware insertion followed by evolutionary software upgrades to exploit the new hardware, the Task Force recommends that the current radar system providers, i.e., Raytheon for the U-2 and Northrop Grumman for the JSTARS, be the lead contractors for these AESA upgrades.

The Task Force strongly supports the development of an X-band AESA for the Global Hawk in the near term. The Global Hawk, with modest prime power upgrades, can support an AESA radar that will provide excellent ground surveillance capability (SAR and GMTI) in the high-flying, long-endurance, unmanned mode, which is highly complementary to JSTARS. In addition, Global Hawk, with this radar technology, can provide significant capability against conventional (and modest signature reduction) air vehicles in the surveillance role for no-fly zones and drug enforcement; and in the role of supporting the fire control for over-the-horizon intercepts (frequently referred to as "ADSAM" — air-directed surface-to-air missile). We strongly support the development of Global Hawk for the two roles to decrease the load on the AWACS and JSTARS fleets, the so-called high-demand/low-density assets. A properly equipped Global Hawk fleet could potentially handle most of the non-hot war demands and could supplement the AWACS and JSTARS fleets in wartime situations.

The Terms-of-Reference for this Task Force requested a review of the National activities on Advanced Air Defense with an emphasis on theater cruise missile defense. However, the Defense Department focus on RTIP issues resulted in the Task Force spending most of its short tenure on surface-surveillance issues. The Task Force strongly supports the objective of meeting the land-attack cruise-missile threat by 2010. In the limited time spent on air defense, a brief assessment of progress in Advanced Air Defense was done and a summary is provided in Appendix B. The Task Force identified a critical need for increased attention to the systems engineering of intra- and inter-Service theater-air-defense activities; a review of security issues is recommended to

In the limited time spent on air defense, a brief assessment of progress in Advanced Air Defense was done and a summary is provided in Appendix B. The Task Force identified a critical need for increased attention to the systems engineering of intra- and inter-Service theater-air-defense activities; a review of security issues is recommended to help facilitate this systems engineering. References for a number of recent cruise missile defense studies are provided in Appendix B, including the report of a National Cruise Missile Defense Study which was in progress during the duration of this Task Force.

The Task Force spent considerable effort in addressing the family-of-radars issue and the way in which various approaches might affect the industrial base. The Task Force supports the family-of-radars concept and observes that each contractor is motivated to support such an approach to remain innovative and cost competitive. An important point is that the family concept is contractor based and derived from their fighter radar programs, which, as was previously illustrated, dominate the airborne X-band AESA business. The side-looking airborne business is much smaller and rides on the hardware and software technology advances in the fighter lines. Based on their robust fighter work, and in particular, the JSF technology development, and their experience base with the U-2 and JSTARS, the Task Force judges both Raytheon and Northrop Grumman are well equipped to compete in the hardware and software aspects of the side-looking AESA radar business.

The Task Force unanimously recommends the following for the JSTARS, U-2, and Global Hawk fleets:

1. JSTARS, U-2

Switch from passive-array/centralized-transmitter hardware architectures to AESAs in production of new radars to meet future requirements. New software modes to exploit the AESA capabilities should be phased in an orderly fashion in coordination with other evolutionary upgrades in the software.

In the JSTARS fleet, we recommend equipping aircraft number 16 (which is in long-lead procurement phase) with the AESA hardware rather than the old design. Any new JSTARS aircraft beyond number 16 (if built) would carry the AESA; the final fleet size would determine whether any retrofits are needed to meet the requirement for five RTIP aircraft. This approach has savings in the billion-dollar class (substantially because old technology tubes and passive arrays are not installed and then removed later to insert AESAs) and makes the RTIP aircraft available three to four years sooner (a year or two ahead of the desired 2010 date instead of two years late).

For the U-2, we recommend the two additional radars being considered be built with AESA hardware insertions rather than with the old design, which uses a passive array and tube transmitter; enhanced modes should be used to exploit the AESA capabilities in the spiral mode discussed for JSTARS. Retrofits of the old radars with AESAs, if any, would be done according to program needs.

2. Global Hawk

Conduct a competition to supply an X-band AESA for the Global Hawk fleet with requirements for ground targets (SAR, GMTI) and air targets (surveillance and fire control). A very desirable acquisition approach would include fly-offs between the two most qualified teams.

The government should coordinate requirements across the fighter, intell/reconnaissance, and wide-area surveillance communities to facilitate the family-of-radars coupling.

The Task Force believes the preceding recommendations provide a timely and cost-effective plan for JSTARS RTIP; provide a plan to bring next-generation ground surveillance capability to the U-2 and Global Hawk; and establish an air-target role for Global Hawk to help offset the extreme demands on AWACS. These recommendations will also help maintain a competitive U.S. radar industrial base that will be well prepared to compete in NATO and other international markets.

I. INTRODUCTION

The broad motivation for this Task Force arises from the need to consider advanced, side-looking radar technology for the JSTARS, U-2, and Global Hawk platforms. The side-looking radars on these platforms have the primary role of locating ground targets in the reconnaissance/intelligence role and/or in the surveillance and cueing role during military operations. In the case of the new Global Hawk platform, consideration is being given to the use of its radar for surveillance and cueing of airborne targets (to supplement AWACS) in addition to ground target capabilities.

After many years of component research and prototype system development, the last decade has seen X-band (10 GHz \pm) active electronically scanned arrays (AESAs) emerge as a mature technology that competes to replace other options for the power source and the antenna architecture. Two prominent early programs in X-band AESA technology development have been the Army family-of-radars program (which provided the basis for the X-band AESAs in the THAAD and GBR radars for theater and national missile defense systems, respectively), and the Air Force programs to produce X-band AESAs for the F-15 and the F-22. The investments in JSF radar technology have also fostered pivotal advances in reducing cost, weight, and mechanical complexity. JSF transmit/receive (T/R) modules are referred to as "fourth generation" T/R module technology.

The specific trigger for this Task Force concerned developing the preferred strategy for inserting AESA technology into JSTARS, including issues of timing, competition versus teaming approaches, and family-of-radars concepts and their meaning and applicability.

This Task Force met over a one-month period in a highly focused format to meet the decision schedule requested to support the FY02 budget cycle. All Task Force members had radar technology backgrounds and/or program-related experience to the topic at hand, so it was able to meet the required schedule.

Section II provides background material on X-band AESAs. Section III addresses the Global Hawk, the U-2, and the JSTARS RTIP. The findings and recommendations of the Task Force are presented in Section IV.

Appendix A includes the Terms of Reference, the Task Force member list, and a summary of the briefings received. A summary review of advanced air defense progress is given in Appendix B. In Appendix C, additional material is provided on AESA technology and future research directions, and Appendix D contains a list of acronyms.

II. BACKGROUND ASSESSMENT FOR X-BAND AESA RADAR

| SYSTEMS AND RADAR VENDORS | | |
|--|--|-------------------------|
| (X-band AESAs - High Power Density) | | |
| Fighters | <u>Raytheon</u> | <u>Northrop Grumman</u> |
| | F-15 V-2 - (18 units) | F-22 - (331 units)* |
| | F-18 E/F - (258 units) | F-16 UAE - (80 units) |
| | JSF - In competition | JSF - In competition |
| Surface | THAAD (10 units) XGBR (1 + ?) MFR (?) HPD (?) | |
| Others: MEADS (Lockheed Martin, et al.) | | |
| <hr style="width: 20%; margin-left: 0;"/> *Raytheon is a major subcontractor | | |

The fighter AESA market has Raytheon and Northrop Grumman as the primary competitors. Since Hughes and Texas Instruments (both now Raytheon) were involved in the F-22 radar, there is significant Raytheon participation in the F-22, although Northrop Grumman is the lead. The JSF competition, which has potentially 3000 or so units at stake, is the dominant factor in the future fighter market. The advances in X-band AESA technology are such that it is unlikely that any new U.S. fighter radar will be built without an AESA. (Additional discussion of X-band AESA technology and performance are given in Appendix C.)

The surface-based X-band AESA market is dominated by Raytheon. In the 1980s the Army developed a family of X-band radar concept for use in theater and national missile defense systems. Raytheon won the competition for this "family" and produced the early versions of the THAAD radar in the mid-1990s, viz., an approximately 10 m² AESA containing about 25,000 T/R modules. A prototype national missile defense radar followed and has been in operation at Kwajalein Missile Range for several years; this radar is an AESA with about a 100 m² aperture and contains about 17,000 modules (i.e., is partially filled). A portion of the Kwajalein radar T/R modules was previously used in THAAD, providing a demonstration of the family-of-radars concept at the module level. Raytheon won the Navy competition for the multi-function radar (MFR) based on an X-band AESA design. This radar, which is in the prototype stage, has about 5000 T/R modules (somewhat over 1 m² aperture). The concept is for a three-faced arrangement to cover 360° around the ship; the potential market is several hundred ship sets. The high-power discrimination (HPD) radar is a ship-based, X-band, AESA radar to support Naval capability in ballistic missile defense; this radar is in the early prototyping stage and is based on THAAD technology. The aperture size is 6.5 m² (about 16,000 T/R modules).

The MEADS surface-to-air missile system includes an X-band AESA fire control radar. Lockheed Martin is the prime contractor, with Germany and Italy as partners. The T/R modules are being manufactured in a work-share agreement among the partners with chip fabrication in the U.S., module integration in Germany, and module testing in Italy.

X-band AESAs are also being developed for the aerostat (JLENS Program — Raytheon) and satellites (Discoverer II Program — Raytheon and Northrop Grumman competing). However, because on aerostats and satellites power is at a premium and aperture size is less constrained, these designs tend to be low-power density concepts rather than the high-power density designs for fixed wing aircraft and surface use.

The U.S. X-band T/R module production capacity as presented to the Task Force was stated to be roughly two-thirds Raytheon, one-sixth Northrop Grumman and one-sixth other (including Lockheed Martin and M/A-COM). As concerns coupling to the commercial community, of the 11,000 wafers processed in the Raytheon gallium arsenide foundry (Andover, Mass.) this past year, only approximately 400 (3.6%) were for the military, and of those fewer than 200 (<2%) were for military radar. Once a foundry has matured a given chip-producing process, the chip designs may vary for various modules (e.g., airborne versus surface use) but the same underlying foundry process is employed for chip production. The complexity and level of integration in T/R module chips is very high compared with routine commercial-run chips.

In the international area, the Dutch company SIGNAAL has built two prototypes of an X-band AESA for ship defense. This radar has a less than 1 m² aperture (about 3000 T/R modules) and uses relatively low-power SIGNAAL T/R modules.

RADAR ARCHITECTURES

| <u>Power Source</u> | <u>Antenna</u> | <u>Beam Scanning</u> |
|---------------------|----------------|----------------------|
| Centralized | Reflector | Mechanical |
| Centralized | Passive Array | Electronic |
| Distributed | Active Array | Electronic |

Active Electronically Steered Arrays (AESAs)

By the 1990s, after more than 25 years of R&D, active arrays at X-band have become viable production candidates for wide-scale use in surface and airborne radars.

Led by fighter radar needs in the air and by ballistic missile defense and air defense needs on the surface, the X-band AESA market is very active.

High-frequency radar (for surface and airborne use) was developed during World War II using centralized power sources, e.g., the magnetron, and reflector antennas. By the 1960s, motivated by the strong desire for electronic beam control in such missions as ballistic missile defense, space surveillance, and air defense, passive array technology was rapidly maturing. The Patriot and AEGIS air defense radars are large production examples of passive arrays; the JSTARS radar is based on the mid-1980s state of the art in passive array technology.

Although passive array technology provides electronic beam control, it has the disadvantage that phase control must be accomplished at high power to position the transmit beam. High-power phase control technology is dominated by power loss concerns. Typical total losses in early systems resulted in a factor of 10 reduction in radiated power; in modern systems these losses are still in the factor of 5 range.

The active array concept has the planar antenna face populated by discrete elements referred to as transmit/receive modules (T/R modules). In an active array the power source is now distributed and phase control to provide electronic beam steering can be accomplished at low power (and with only minor losses). Since large numbers of T/R modules can be required, viz., 3000 - 4000 per square meter, module cost has always been a primary concern with active arrays.

After many years of technology investment, by circa 1990, X-band active arrays arrived as serious contenders in the radar market. Pivotal developments along the way included improvement of gallium arsenide material and the development of monolithic microwave integrated circuit (MMIC) technology. MMIC technology uses lithographic-type processes to produce microwave circuits on chips at very high levels of integration. A modern X-band T/R module, in addition to a radiating element, will contain five to seven chips (MMICs) produced in a foundry and later integrated into a substrate with a few discrete components and cooling provisions, all filling a space on the order of $1/4 \text{ in}^3$.

High-power radar applications, such as fighters and JSTARS RTIP, use "filled" apertures, which at X-band is generally about 3000 modules per square meter of antenna. Fighter radars are usually in the 1000 to 2000 modules size range. Modules that are readily available have peak powers of about 10 W with average power of about 2 W; hence, for a square meter of filled X-band aperture the peak power is typically 30 kW and the average power about 6 kW.

**PROJECTED AIRBORNE RADARS
(X-Band AESAs)**

| FY: | 2000 | | | | | 2005 | | | | | 2010 | | | 2013 | TO COMPLETE | TOTAL |
|--------------------|------|----|---|-------|----|------|----|----|----|----|------|-----|-----|------|-------------|-------------|
| F-22 | - | - | - | 10 | 16 | 24 | 36 | 36 | 36 | 36 | 36 | 36 | 36 | 29 | - | 331 |
| F/A-18E/F | - | - | - | - | - | 8 | 12 | 22 | 48 | 48 | 48 | 48 | 24 | - | - | 258 |
| F-15C | - | 13 | 5 | - | - | - | - | - | - | - | - | - | - | - | - | 18 |
| F-16 UAE | | | | | | 5 | 10 | 10 | 10 | 10 | 10 | 10 | 10 | 5 | | 80 |
| JSF | - | - | - | - | - | - | 10 | 22 | 61 | 88 | 108 | 154 | 194 | 194 | 2021 | 2852 |
| GHAWK | | | | | | 4 | 4 | 4 | 4 | 4 | 4 | 4 | 4 | 4 | 12 | 48 |
| JSTARS RTIP | | | | 0.75* | 1 | | | 1 | 1 | 1 | 1 | 1 | | | | 6.75 |

* Sub-scale Development Unit

| Total Modules | |
|----------------------|---------|
| F-22 | 496500 |
| F/A-18E/F | 283800 |
| F-15C | 27000 |
| F-16 UAE | 80000 |
| | |
| JSF | 3422400 |
| | |
| GHAWK | 96000 |
| JSTARS RTIP | 91125 |

The data in the table indicate the planned radar unit buys as a function of year. The F-22, F/A-18E/F, F-15C, and F-16 UAE programs have firm commitments to development and production although the final number of units is very likely to change. The potential very large JSF buy is, of course, tied to the vagaries of the airframe program. For JSF, Raytheon is providing the radar for the Boeing team and Northrop Grumman for the Lockheed team. Clearly, the current "winner-take-all" procurement strategy could have significant ramifications in the X-band AESA industrial base.

The two side-looking radars on the list are the Global Hawk and the JSTARS RTIP. The RTIP program shown follows the baseline DAB-approved program. The Global Hawk numbers do not correspond to an approved program, but reflect a program concept under discussion.

THIS PAGE INTENTIONALLY BLANK

AIRBORNE INTEL/RECON/SURVEILLANCE/CUEING

(Side Looking)

- Programs
 - U-2
 - JSTARS
 - Global Hawk
 - ASTOR
 - NATO: NATAR or SOSTAR or ASTOR Derivative
- The U-2, JSTARS, Global Hawk and ASTOR all currently employ X-band, passive array radars
- The JSTARS RTIP (Radar Technology Improvement Program) includes replacing the passive array with an AESA.
- The NATO requirement for ground surveillance is targeted to a 2007 decision timeframe (platform/radar technology is undecided)

The side-looking radar programs shown all currently employ passive array technology. As X-band AESA technology penetrates the side-looking market, the logical path being considered is to employ as much commonality in the hardware and software as possible; this approach has been referred to as a "family-of-radars." Global Hawk, the U-2, and JSTARS are each covered in some level of detail in the following section.

The United Kingdom's ASTOR program is a business-jet-based, ground-surveillance radar; this system employs a passive-array design. The contractor is Raytheon, and the current plan is for five aircraft to be operational in 2007.

The NATO ground-surveillance program (referred to as "Alliance Ground Surveillance" – or AGS) has been under consideration for some time and closure on the path to procurement will not occur soon. A brief record of the AGS effort is given below, derived from DoD briefings to the Task Force.

1992 AGS requirement confirmed.

1995 Validated that NATO should adopt a "minimum essential NATO owned and operated core capability supplemented by interoperable national assets."

1996 U.S. proposes "Fast Track" plan which offers six JSTARS aircraft for purchase.

1997 Fast-Track offer rejected; new approaches sought.

U.S. offers RTIP sensor for integration by NATO on a platform of their choice. A study produces an RTIP-class radar on a mid-sized jet, but no consensus is reached.

1999 The CNAD (Conference of National Armaments Directors) "welcomes" the formation of:

1. An RTIP Group (NATAR-NATO Transatlantic Advanced Radar) to pursue a two-year project definition phase based on RTIP. Nations involved include Norway, Canada, Denmark, Belgium, Luxembourg, and the United States.
2. Newly formed SOSTAR Group to pursue technology development of a new European sensor. Nations involved include France, Germany, Italy, and the Netherlands. The scale of this project is \$100M over five years to demonstrate a radar that "will duplicate or slightly exceed" JSTARS capability.

The NATAR and SOSTAR options are focused on procurement decisions that might occur in the 2007 timeframe. The architecture and technology of the ASTOR system is also expected to be proposed to compete with the NATAR and SOSTAR offerings. Of course, the ground segment of AGS must also be decided upon; that subject is beyond the scope of this discussion.

A major architectural choice in the airborne surface-surveillance platform is whether to have on-board command and control, and, if so, to what extent. Clearly, the large JSTARS aircraft utilizes most of its space for the extensive, on-board command-and-control capability. The fact that AESA technology permits much more radar in a small package enables modest-payload aircraft to have significant sensor capabilities if little or none of the payload is used for on-board command and control. The continuing evolution of network-centric warfare is presenting favorable opportunities for sensor-only platforms, viz., Global Hawk, in overall surveillance architectures.

III. FAMILY OF AIRBORNE RADARS

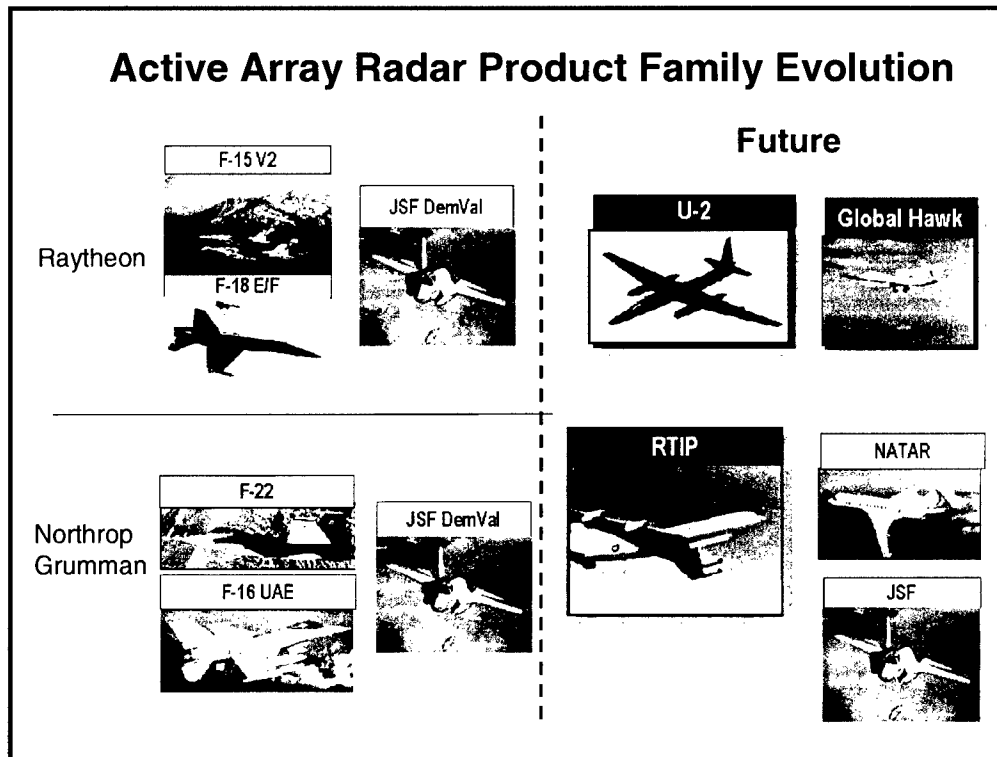

Modern fighter AESA radar technologies and family-of-radars concepts provide the basis for the next generation of highly capable AESA radars for airborne surveillance systems. The principal candidates for the applications of these technologies and concepts will be the JSTARS RTIP upgrade, improved radars for the Global Hawk and U-2, and the U.S. contribution to NATAR. A modular, scalar AESA approach will provide a common framework for the development of a family of radars that can accommodate the different size, weight, and power constraints of these platforms.

Broadly speaking, the future airborne surveillance platforms shown in the chart can be divided into two classes, the commercial airliner/business jet class capable of carrying a relatively large (18 to 24 ft) antenna, and the U-2/Global Hawk class, which is limited to smaller antennas on the order of 6 to 10 feet. A modular, scalable radar architecture, combined with a top level system engineering approach focused on addressing the radar design for both these classes of platforms, provides the opportunity for minimizing development costs, thus making an AESA, with its attendant benefits, an attractive alternative to sensors on current platforms (JSTARS, U-2, and Global Hawk).

In the following sections AESAs for JSTARS RTIP, the Global Hawk, and the U-2 are discussed. The potential benefit of an AESA upgrade for the Global Hawk is addressed

in more detail than the others to illustrate the surface target capability (SAR and GMTI) and air target capability that can be obtained from a modern X-band AESA.

Current Global Hawk Program

Global Hawk Sensor Payload

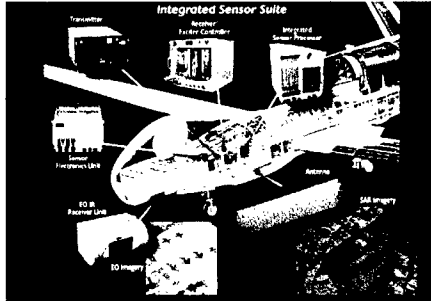

ACTD Radar

- 4.1 x 1.2 ft. Mechanical Scan Antenna
- 350 W Average Power
- 6600 W Prime Power to Radar
- 2 Channel Receiver
- Poor GMTI Accuracy

SAR Radar with GMTI as afterthought
 Factor of 10 to 20 Less Power
 Aperture than AESA Upgrade

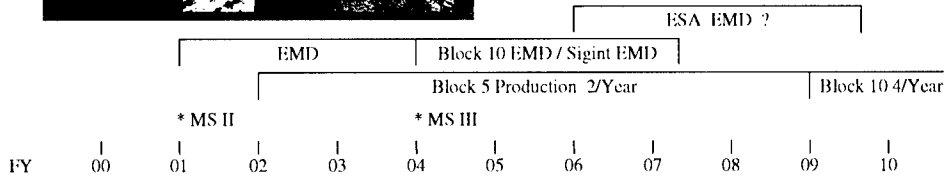

Global Hawk is currently an ACTD (advanced concepts technology demonstration) that has been undergoing evaluation over the past year. As a result of this evaluation, Global Hawk has recently gained military endorsement by the U.S. Joint Forces Command, which called for heavy involvement of the four existing Global Hawks in training, exercises, and actual operations. The potential value of Global Hawk as a way of coping with the high demand/low density (HDL) problem has increased interest in both accelerating the acquisition of additional Global Hawks, and in improving their capabilities beyond those on the current ACTD units. The radar is a prime candidate for such improvement.

The characteristics of the current "ACTD" radar are summarized in the chart. At the inception of the program in 1995, this choice of design parameters was dictated by a desire to minimize cost and risk, as well as allow both the radar and EO/IR unit to be carried simultaneously. As a result the radar is limited in capability. It was primarily aimed at SAR image collection, with GMTI added essentially as an afterthought. For example, mechanical scanning in both azimuth and elevation preclude all but the most basic GMTI search operation. The low power aperture product restricts the sensitivity to relatively large cross-section targets, short ranges, or long revisit times in GMTI search mode. The antenna length of about four feet, together with only two phase centers, limits GMTI accuracy and clutter rejection performance (which limits the minimum detectable velocity).

Replacing the current radar with an AESA will have a number of benefits which will be discussed in the following charts. As a basic measure of this improvement, a gain in the power aperture product by about a factor of 10 can be realized by an AESA when coupled with a modest increase in prime power available to the radar.

The currently planned program is summarized at the bottom of the chart. It is suggested that the addition of an AESA be part of the Block 10 upgrade, including power generation modifications to supply 20-30 kW of prime power to the radar.

Global Hawk AESA Point Design

- | | |
|--------------------|--|
| Objectives | - High Quality GMTI/SAR as First Priority |
| | - Air to Air Performance Consistent with Modest Prime Power Upgrade |
| Assumptions | - 20-30 KW Radar Prime Power |
| | - Internal Carriage Limits Antenna Length to ~7.5 Feet |
| | - Conservative Technology Assumption \cong 15% TR Module Efficiency |
| Design | - 7.5 x 1 foot Aperture |
| | - 2.5 to 4.5 KW Radiated Average Power |
| | - 4 Simultaneous Receive Beams |
| | - 5 Receiver Channels |
| | - Interleaved SAR/GMTI Modes |
| | - High Range Resolution (HRR) Modes for Target Classification |
| Performance | - Scan JSTARS GRCA in 30-40 Seconds (Comparable to JSTARS now) |
| Note | - Horizontal Aperture 3-4 Times Smaller than JSTARS/RTIP |
| | - Poorer Angle Accuracy will Impact Some Military Desires (e.g., Targeting for Long Range ATACMS) |

The potential for increasing the capabilities of Global Hawk by replacing the current radar with a more capable, electronically steered array has been addressed in a number of earlier studies. The 1998 Airborne Radar Study* considered a number of options, including some that required modifying the current airframe to get significantly more payload capacity (the so-called "Global Truck" option). Subsequently there have been numerous and ongoing studies by various organizations to explore additional design options reflecting the progress in fighter active array technology and scalable, modular, open architecture approaches. To illustrate the potential benefits of an AESA on Global Hawk, the Task Force selected the point design described in the chart.

The primary objective of this point design was to achieve high performance GMTI ground surveillance for moving targets, and high quality SAR for ground imaging and the detection and classification of non-moving targets. In addition, the radar includes air-to-air modes (surveillance and targeting) consistent with modest prime power upgrades to provide on the order of 20-30 kW prime power to the radar. This power requirement is based on a relatively conservative overall T/R module efficiency of 15%. Progress in module development can be expected to lead to improved module efficiencies, which would either further reduce the prime power requirements or result in increased radar performance.

* Airborne Radar Study, Executive Summary Briefing to USD(A&T), 3 March 1998

For improved GMTI performance, it is desirable to increase antenna length as much as possible to lower the minimum detectable velocity (MDV). Platform constraints limit the antenna length to 7.5 ft unless significant changes are made to the platform itself. GMTI performance is further enhanced by partitioning the array into multiple phase centers (subarrays) with individual receive channels and analog to digital converters (A/Ds) providing data from multiple channels to the signal processor. Multiple receive channels also provide a more robust ECCM capability. Both these benefits are realized through space-time adaptive processing (STAP), enabled by the multichannel radar data and an on-board digital signal processor. The capability to provide (a selectable number of) multiple simultaneous receive beams can be exploited to trade excess sensitivity at shorter ranges for increased area rate/coverage for both SAR and GMTI.

An AESA, by virtue of its inherent rapid steering capability and the ability to support wide bandwidths and waveform diversity, provides the opportunity to use the radar in a variety of distinct or interleaved modes. An example is interleaving SAR and GMTI where a high bandwidth (SAR) waveform may be intermixed with a lower bandwidth (GMTI) waveform. Another example is the use of high range resolution (HRR) waveform mode, which provides data for aided target recognition of moving targets. Clearly, fully exploiting this flexibility raises challenges in both the signal processor and radar resource scheduler/controller. However, with an open system architecture and modular approach, an evolutionary path toward achieving progressively more capability is provided without the need to redesign/rebuild the AESA (the "ether to bits" part of the system).

For reference purposes, the search time for a nominal JSTAR GRCA (ground reference coverage area) is shown to be comparable to that of the current JSTARS. Because the antenna is significantly shorter than that of JSTARS, GMTI MDV performance as well as position accuracy will not be as good as that provided by JSTARS, which may impact a single Global Hawk's ability to support targeting at long ranges for certain weapons (without autonomous homing capability). However, as discussed later, multiple Global Hawks may be used to improve accuracy by multilateration.

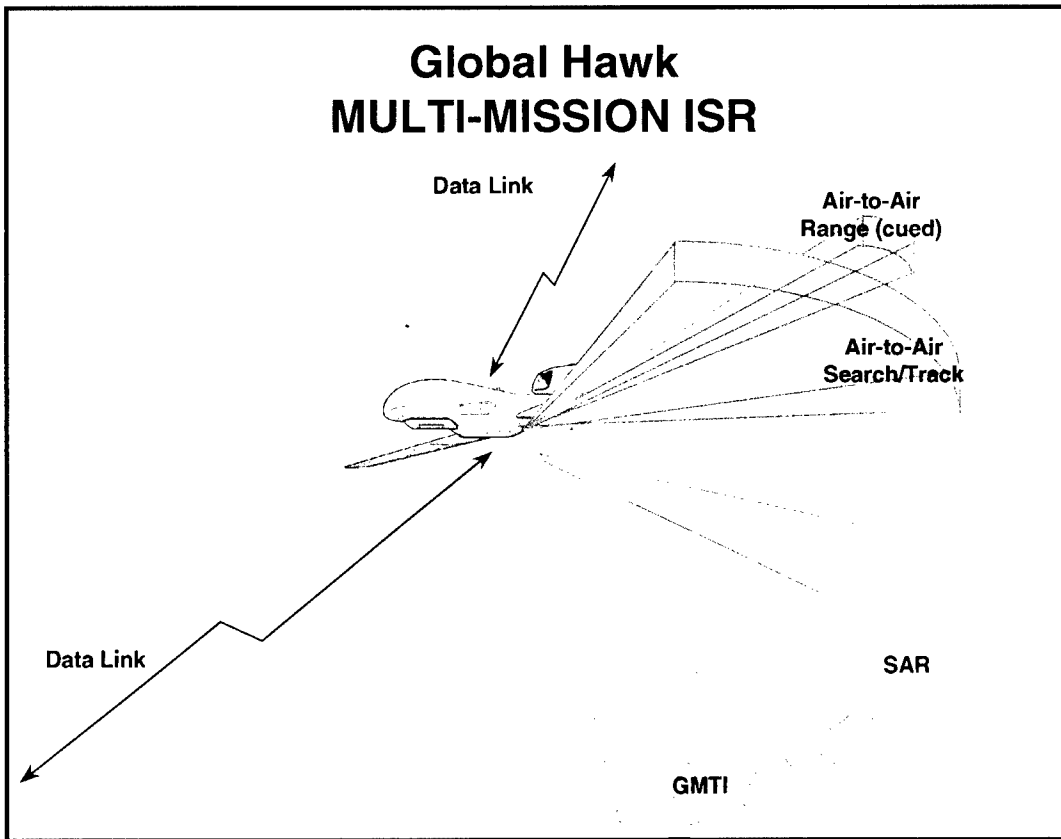

The addition of an AESA with the characteristics described in the previous chart can improve not only Global Hawk's ground surveillance (SAR and GMTI) capability, but add a very capable air-to-air mode for conventional targets. The air-to-air mode includes autonomous search, e.g., used in no-fly zone enforcement, as well as cued search and fire control support on selected targets. This latter capability can provide over-the-horizon targeting support for conventional targets with suitable surface-to-air missiles, also referred to as air directed surface-to-air missiles (ADSAM) engagements. Potential ADSAM capabilities of a Global Hawk equipped with the AESA point design are illustrated in a subsequent chart.

Rapid beam agility also allows interleaving various modes as illustrated in the chart, so that a combination of these modes can be exercised, depending on mission needs. To do so will, of course, require the software that can take full advantage of AESA capabilities. Phased introduction of this software can be used to add capabilities, starting with the current ground surveillance modes, but with greatly improved performance.

Leveraging AESA Capabilities High Range Resolution (HRR) Example

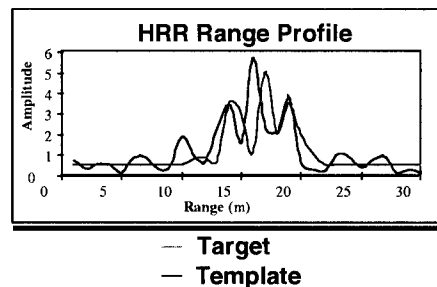
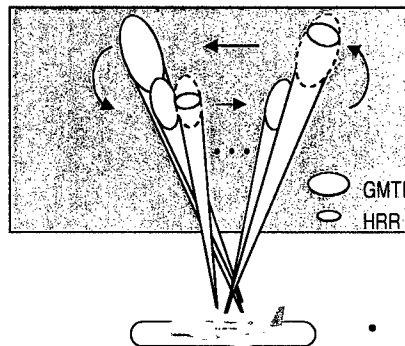

- Selects waveform to collect HRR data on specific targets interleaved with normal GMTI waveforms
- Compares to a database of HRR range profiles of targets of interest (e.g. TEL) for best matches
- Multiple revisits at different aspect angles (based on GMTI track) to enhance confidence

Another example of leveraging the added flexibility provided by an AESA is illustrated by the application to aided moving target tracking and recognition. For these functions a high range resolution (HRR) waveform is used to collect data on selected targets of interest to provide a range profile, or “1-D image,” of these targets. To optimize the benefit of range profiles, it is desirable to collect HRR data when targets are at favorable aspect angle (i.e., away from broadside). The HRR data collection is scheduled based on the GMTI track, and multiple targets in diverse locations can be revisited rapidly taking advantage of the AESA beam agility. If a target is to be tracked in a dense target environment, the HRR waveform may also be used to provide additional characterization of the target using range profile data to help distinguish it from “confusers,” which may be difficult to separate based only on kinematic measurements and tracks.

AESA Enables Extended Range Operation

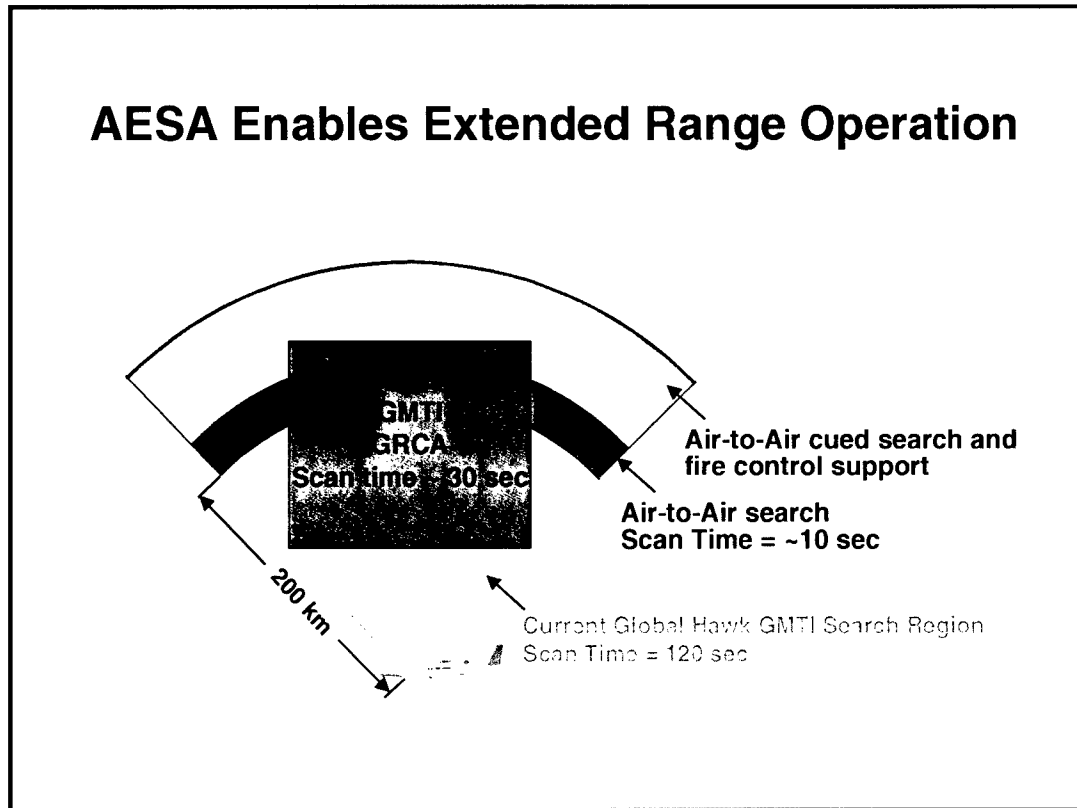

The figure indicates the comparative performance of the current Global Hawk radar and the extended range and additional air-to-air modes achieved with the point design AESA. In the GMTI ground surveillance mode the increased power aperture enables longer ranges and shorter revisit times, illustrated by the region labeled "GMTI GRCA". The added sensitivity and beam agility enables cued search and fire control support (e.g., tracking of multiple targets at high rate) in the air-to-air mode. Autonomous surveillance of a 90 deg sector can be carried out against a conventional aircraft (~3 m² radar cross section) to a range of about 230 km, with a scan time of 10 sec. A cued search in combination with precision tracking of a number of targets (~10) can be carried against the same class of targets to a range of about 300 km. While these values will vary with different assumption on targets, operational modes, and specific AESA design, they provide a general measure of increased capability afforded by an AESA for Global Hawk.

THIS PAGE INTENTIONALLY BLANK

Global Hawk AESA Capabilities DSB Point Design

Ground Surveillance - Peacetime Coverage
• 75 sec Revsist Time

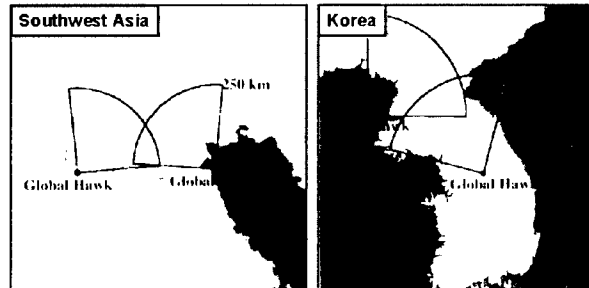

Air to Air Surveillance - Conventional Aircraft (3m²)
• 30 sec Frame Time

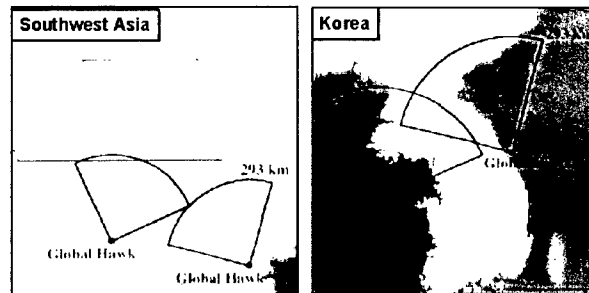

Global Hawk with an AESA with the power and aperture assumed for the DSB point design could be used in various mission roles. The coverage provided by such a system for two potential mission areas is illustrated in the chart: ground surveillance during peacetime and autonomous air surveillance, e.g. to monitor no-fly zone enforcement. These two applications address the HDLD problem by providing an alternative to the use of JSTARS and AWACS to perform these missions. The high endurance, unmanned operation, wideband data links, and remote basing also lead to much reduced infrastructure demands. In times of war, the Global Hawk would be more tightly integrated into the battlefield command-and-control infrastructure, possibly via interfaces to, for example, JSTARS in a "hen-and-chicks" concept, which is discussed further later in the report.

To provide a context for the potential Global Hawk capabilities in these mission applications, the preceding charts show the coverage achieved in two regions of tension, Southwest Asia, encompassing the no-fly zone in southern Iraq, and Korea. A brief discussion of each application follows. In all cases the DSB point design AESA is assumed.

Ground surveillance: Global Hawk can provide ground surveillance of ground moving targets (nominally 10 m² cross section) out to a range of about 250 km. The chart shows a notional deployment of two Global Hawks providing wide-area ground surveillance over regions in both geographic areas that provide wide buffer zones at the borders of Iraq and North Korea, which would enable monitoring any large scale military force movements (GMTI) and force buildups (SAR) that would constitute a threat. The assumed revisit time of 75 sec is adequate in this case since the interest is in detecting and tracking major military forces deploying to the border region, rather than tracking and targeting individual targets. Note also that since Global Hawk flies at much higher altitudes than JSTARS, terrain obscuration is less severe, an important benefit in mountainous terrain typical of the Korean region.

Air-to-Air Surveillance: The principal criterion underlying the DSB strawman point design for a Global Hawk AESA was to provide a robust ground surveillance capability. Given such a capability, the question was to what extent the AESA could support other mission areas by exploiting the inherent flexibility in waveform selection and radar control. One very important area considered is autonomous surveillance of the air space in no-fly zones (southern Iraq) or other areas of heightened interest during peacetime (e.g., North Korea near the border with South Korea). Because of the limit on power and aperture, Global Hawk would be most useful against larger, "conventional" aircraft with radar cross section on the order of 3 m² (5 dBsm). For these missions it is also not critical to have very short frame times. In the DSB analysis a frame time of 30 sec was assumed, together with a search volume extending over a 90 deg sector and from an altitude of 60 kft to the ground. With these assumptions, the Global Hawk can search out to a range of about 300 km. The second set of maps in the previous chart illustrates the coverage achieved using two platforms nominally stationed as shown. In the case of North Korea, these two platforms could completely cover the area near South Korea, including substantial regions over water that might serve as approach routes to South Korea.

In the example for Southwest Asia, two Global Hawks would cover a substantial portion of, but not the entire no-fly region. Additional platforms could be used to obtain greater coverage. However, if overflight of Iraq and other unfriendly territory is to be avoided, the range limitation would prevent total coverage of the region. The lower cost and higher altitude of operation combined with a modest level of self-protection, and the fact that no human lives are at stake makes overflight of Iraq an option if the situation demands it. In such a case several Global Hawks could provide a level of complete and continuous coverage not practical, even if possible, with the current high-valued, manned AWACS.

Finally, the potential air surveillance capability of Global Hawk could be quite helpful in reducing the demands on AWACS for counter-drug surveillance. The high range resolution waveforms in the X-band AESA also provide a significant source of non-cooperative identification information.

Global Hawk AESA Capabilities

DSB Point Design

ADSAM Coverage - Conventional Aircraft

- Wartime Coverage

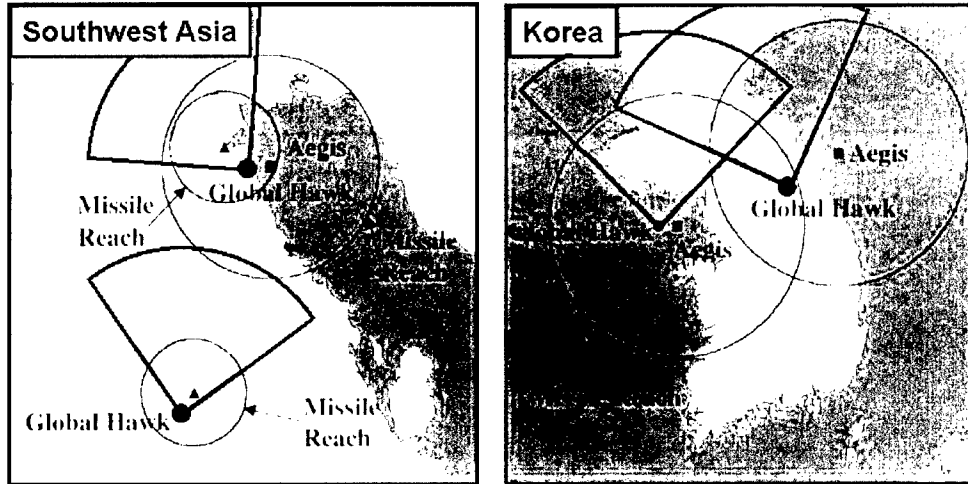

The previous two applications of an AESA-equipped Global Hawk were directed at satisfying key operational needs during peacetime and to cope more effectively with the HDLD problem than is possible with current assets. During wartime, an additional capability can be exploited — support of ADSAM engagements against airborne targets with modestly low radar cross section, representative of many of today's threats. The essence of the ADSAM concept is that the surface based magazine is to be utilized to its full kinematic range for low altitude targets. For those low altitude targets below the horizon of the surface based sensors, the airborne partner provides the needed surveillance and fire control data. Both sea- and land-launched SAMs could be supported, thereby adding to the depth-of-fire of magazines already in the force. Typical low altitude target horizons are 15 to 30 Km. These horizons are factors of 5 to 10 shorter than the kinematic range of Patriot and Aegis missiles. For lower cross-section targets, such as on the order of 0.1 m^2 , this coverage is reduced by a factor of 2. However, the notional deployment of two Global Hawks together with two Aegis ships for the Korean example shown in the chart would provide broad coverage to distances greater than ~50 km behind the border into North Korea. If warranted, Global Hawks could be added, or deployed further forward, to extend their reach into enemy territory. The potential benefit of forward deployment is discussed in the next section.

Standoff Considerations

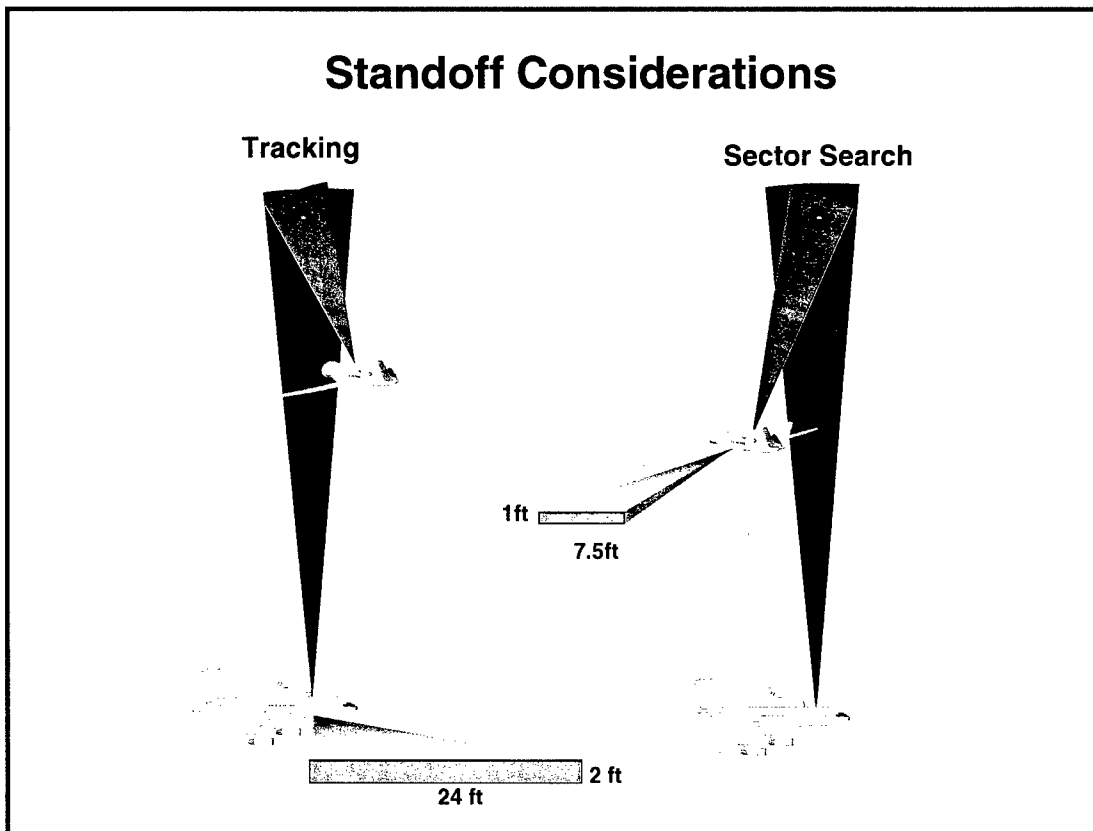

Any AESA on Global Hawk will have substantially lower power aperture than a radar on a large manned aircraft. The significantly lower cost and unmanned nature of Global Hawk present the opportunity to shorten the standoff compared to, for example, JSTARS. (Note that one of the attributes of Global Hawk was to be that it is "attritable", although there is no generally accepted agreement on what exactly is meant by that. An AESA equipped Global Hawk should cost about what an F-16 costs; JSTARS costs about what 6-8 F-16s cost.)

The potential shorter standoff of Global Hawk decreases the range to a target and thus increases the "effective" radar power aperture. The figure shows the relative location required for Global Hawk to have similar performance to a larger platform with an antenna aperture about six times larger in area. The assumption in this figure is that both radars are based on the modular, scalable family-of-radars concept, i.e., that the aperture power density is the same for both. This assumption implies that the power aperture for Global Hawk is about a factor of 40 lower than that for the large antenna. The reason that closer standoff is needed when tracking compared to searching is that to maintain tracking cross-range accuracy requires additional range compensation for the larger beam from the shorter aperture length.

“Hen-and-Chicks” Architecture Expanded Surveillance Coverage

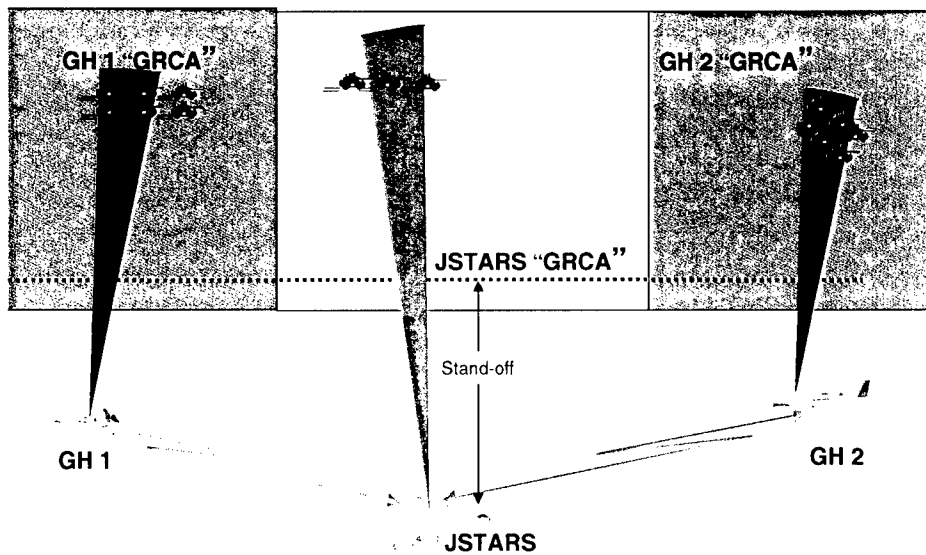

Improve detection and location

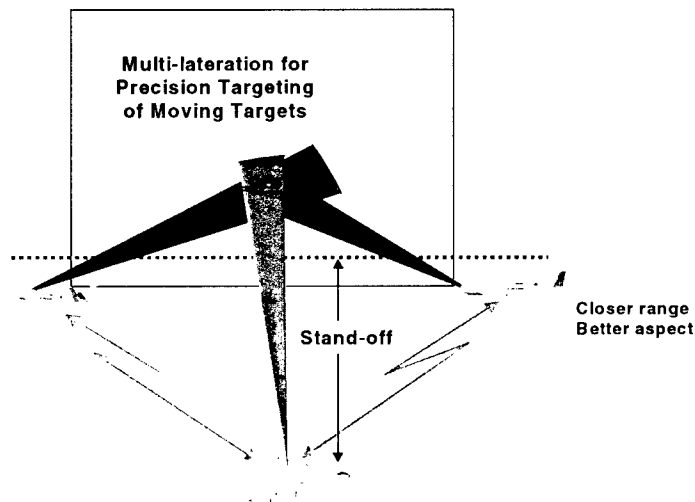

By virtue of its satellite communication links and direct downlink, Global Hawk is capable of operating independently from other surveillance assets. This situation is likely to be the normal use of Global Hawk. However, during times of tension and war, Global Hawk could be integrated with a manned platform such as JSTARS. In this “hen and chicks” concept, the Global Hawks are integrated into the overall ISR command-and-control structure to effectively augment JSTARS. In pre-hostilities this augmentation may be used to extend the JSTARS coverage as indicated in the figure. Shorter standoff of Global Hawk can further its reach and increase its performance.

In time of war the "hen and chicks" concept may be used to take advantage of shorter standoff Global Hawks and the geometric diversity offered by multiple platforms to support both deep reach and precision targeting. In this case the ability to get multilateration data on a target of interest, as well as simultaneous views of the target from different aspect angles, can help in target recognition and precision target location. The DARPA AMSTE (affordable moving surface target engagement) program relies on such multilateral measurements to achieve the needed accuracy for low cost precision-guided weapons.

U-2 ASARS Improvement Program



ASARS-2

- 1-D Passive ESA
- Strip SAR
- Spot SAR
- GMTI
- 10 U-2s currently equipped with ASARS-2
- 2 additional units to be equipped as part of program

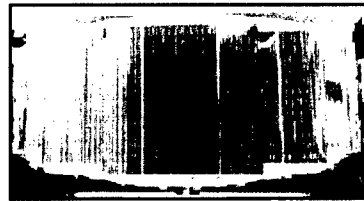

The U-2 is a major ISR platform with a diverse set of sensors, including radar, EO, and SIGINT sensors. It has been in operation for many years and has demonstrated its value in numerous missions during that time. Its radar capability focused primarily on radar imaging of ground scenes, including stationary targets, using the advanced synthetic aperture radar system (ASARS). The original ASARS was a mechanically steered array that represented a cost-effective solution to satisfying the beam agility requirements for SAR image collection, which typically necessitates relatively long dwell times to collect the data for high resolution imagery. (The U-2 SAR imaging capabilities have recently been declassified—they range from 3 m for low resolution strip maps to 1 ft resolution for spot mode.) In 1996 the ASARS improvement program (AIP) was initiated which replaced the radar with an improved version, referred to as ASARS-2. These improvements are aimed, in part, at adding to the U-2 the capability to detect and track moving targets. In particular, ASARS-2 has a 1-D electronically steered array that provides beam agility in azimuth, allowing rapid beam switching for tracking multiple targets as well as interleaving various radar modes. It is a passive array, similar in concept to the JSTARS 1-D passive array, i.e., radar power is provided by a high power central (tube) transmitter and is distributed to the array columns via a microwave power distribution network (for more discussion on passive vs. active ESAs see Appendix C).

THIS PAGE INTENTIONALLY BLANK

AESA for U-2 and Global Hawk

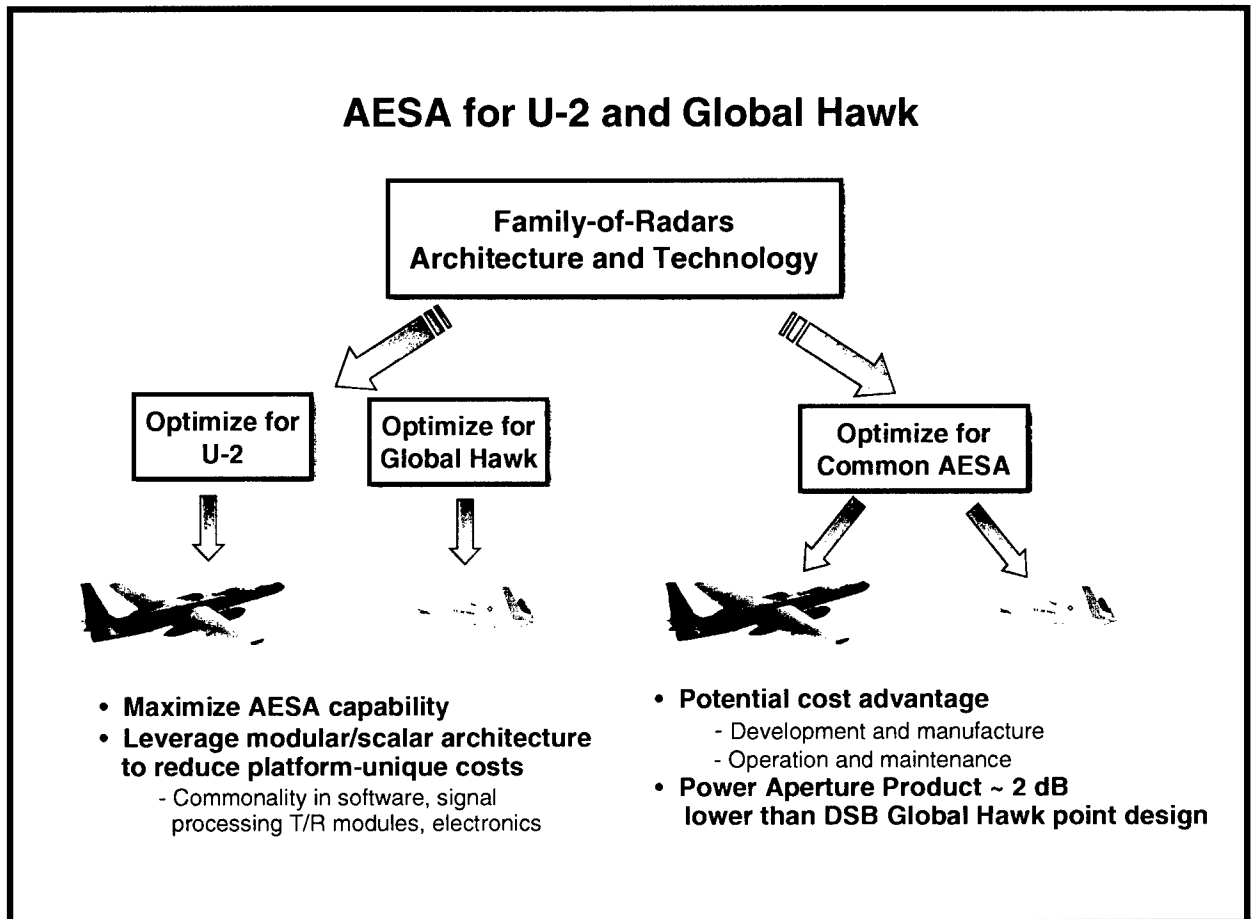

Global Hawk and the U-2 have a number of common system attributes. Both platforms operate at high altitude (the U-2 can fly somewhat higher) and are generally addressing similar operational needs. Also, for both platforms tasking, exploitation, and command and control are performed off-platform. Hence, on-board processing and sensor data link requirements can be expected to be similar. While differences in payload capacity allow the U-2 to carry more sensors simultaneously, the size, weight, and power constraints for the radar are sufficiently similar to make the family-of-radars concept particularly attractive in jointly addressing the AESA design for these two platforms. Two approaches are shown. In the first, the similarity between the two platforms and their ground surveillance missions can be exploited to design an overall common system architecture. The specific design of the AESA in this approach is optimized individually for the space available for each platform within the framework of a modular, scalable architecture and technology. This may be accomplished, for example, by suitably defining antenna modular building blocks (e.g., subarrays) that can be used to assemble different-sized antennas. Using the DSB point design for the Global Hawk AESA discussed previously, a scaled-down AESA for the U-2 (to conform to length constraints) would be ~2 dB lower in power aperture. This 2 dB reduction would result in a decrease in range of about 10% for sector search, and about 15% for track. This decrease would be approximately 20% for a fixed area search.

The second approach shown in the figure is to develop a single AESA design for both platforms. This approach may sacrifice some of the capability of Global Hawk that could be achieved with an aggressive development program that includes upgrading prime power. However, the potential cost savings, lower prime power requirements, and other benefits of common design and hardware may make this an attractive option, particularly if the U-2 and Global Hawk are both expected to play a significant role over the long term.

Radar Technology Insertion Program (RTIP)

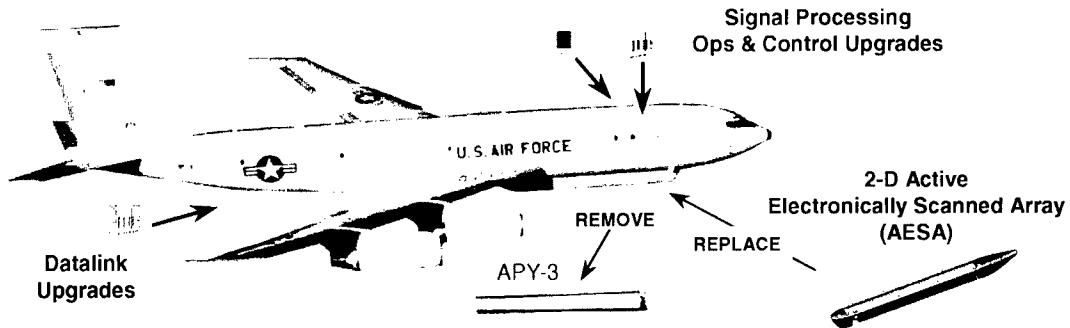

Technical Features:

- 25 Ft X 2 Ft
- T/R module Design
- Electronic AZ & EL
- Increased Power (factor of ≈ 9)
- Increased Bandwidth (factor of ≈ 9)
- Advanced Signal Processing

Operational Improvements:

- Faster MTI Revisit Rate (factor of 5)
- Auto Track All MTI Targets
- Improved MTI Classification
- Simultaneous SAR and MTI
- Increased SAR Resolution (factor of 10)
- Reduced Life Cycle Costs

The new AESA has the major advantages of significantly increased radiated power (about a factor of 10), higher efficiency, lower losses, lower noise figure, significantly increased bandwidth and resultant range-resolution capability (about a factor of 10), higher reliability, and simultaneous interleaved SAR and GMTI modes. A key benefit is the very fast beam-switching rates possible with the AESA, which greatly increases the flexibility of the radar to perform high data-rate tracking interleaved with other functions. The enhanced system results in about a 1000 lb increase in sensor weight, and when operated at maximum duty cycle requires a significant increase in prime electrical power (a factor of 4-6) which is available from the current E-8A engines.

THIS PAGE INTENTIONALLY BLANK

RTIP Schedule Comparisons - DAB Approved Program vs. Evolutionary Acquisition

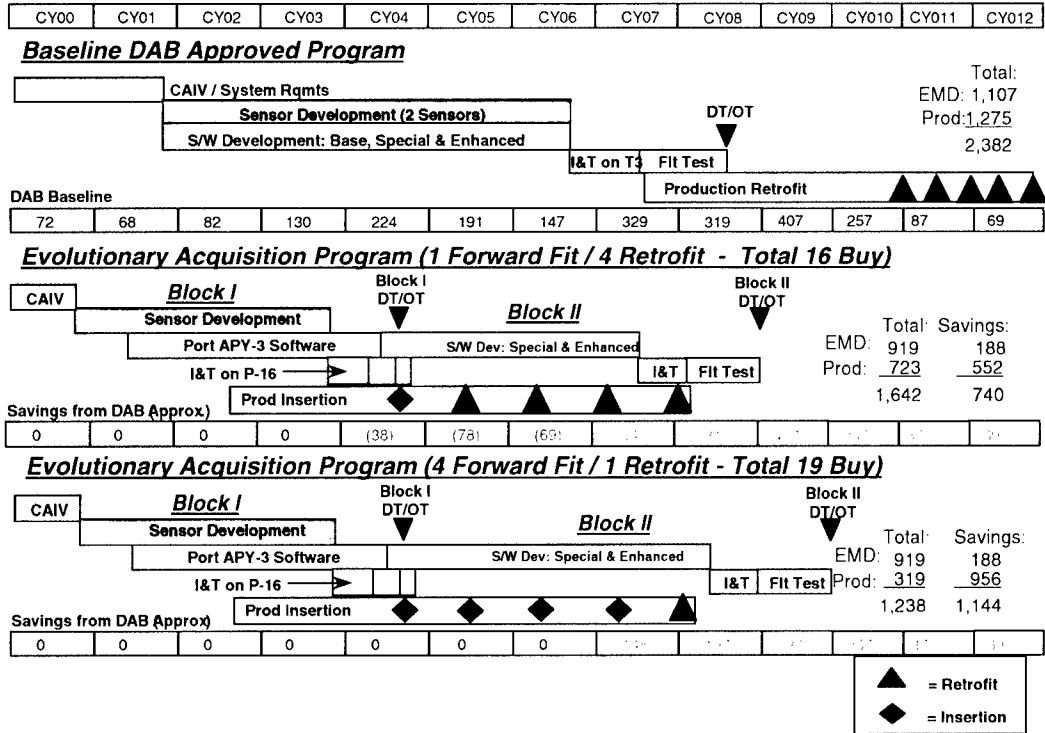

The baseline RTIP program was approved by the Defense Acquisition Board (DAB) in late 1999 for a program that delivers five production RTIP systems in CY 2012 for a total cost of \$2382M. The total cost includes \$1,107M for EMD and \$1,275M for production. The program is based on developing two RTIP EMD prototype sensors — one scaled lab sensor and one 24 ft flying prototype sensor that is to be installed and undergo DT/OT flight test on the modified Joint STARS T-3 aircraft in CY05. The prototype development plan includes fully developed software for all new base modes, including surface SAR/GMTI and classified special and enhanced modes. Production is to include the cost of complete modification of five current Joint STARS E-8A systems and replacement (retrofit) of current APY-3 radars with a new RTIP active ESA radar and complete software replacement.

The Task Force addressed the concern about the cost of the baseline program and not meeting the 2010 schedule goal. The Task Force investigated an alternative evolutionary approach that has two very cost-effective aspects:

- 1) Forward-Fit AESA Technology
 The U.S. Congress has put additional funds in the past three DoD budgets to add three additional Joint STARS production systems (P-14, P-15 and P-16). There is every indication that this will continue and will include P-17, 18, and 19. If the Air Force acts quickly, these new systems could be forward-fit with the new RTIP AESA sensors rather than incurring the cost of retrofit, with the attendant benefit that overall cost would be significantly reduced. It appears there is time to accomplish this goal with P-16, which is currently scheduled for production delivery in CY04 with the existing Joint STARS APY-3 sensor. Forward-fit of the RTIP AESA into P-16 is estimated to save \$70M. The Task Force feels that

AESA technology has progressed to such a point that no compelling reason exists for requiring a half-size lab sensor or an additional prototype sensor that would never be upgraded to a production unit.

2) AESA Hardware Insertion—Evolutionary Software Strategy

Additional time and risk savings are possible by using an evolutionary acquisition strategy (Block I/Block II) for the software development, where the radar hardware is upgraded to the new AESA radar hardware but is first operated with the existing Joint STARS APY-3 software. Block I software modifications to accomplish operation of the new hardware appear to be minor and would allow DT/OT of the new hardware with the same functionality of the existing APY-3 software system, but with a significant increase in radiated power that would allow integration times and dwells to be shortened. New software modes would then be incorporated sequentially in Block II in modular steps for new capability such as simultaneous SAR/GMTI vs. current single modes, multi-channel STAP vs. the current 3-channel DPCA, ultra-high resolution SAR imagery, high range resolution (HRR) for GMTI target recognition, simultaneous multi-beam modes, high update GMTI track modes, and special classified modes that utilize the significant increase in available radiated power. This would not only get AESA production hardware into the inventory several years earlier but would further reduce the program software development risk by allowing it to proceed in parallel rather than in series with the hardware introduction.

It is estimated that the new evolutionary approach can deliver five modified systems with new sensor hardware by FY07, with incremental software modifications completing DT/OT by CY09 at a total cost savings of \$740M and several years sooner than the current base plan. If the new RTIP AESA hardware can be forward-fit into four systems (P-16, 17, 18, 19), the total saving is estimated to be \$1,144M over the base plan. This saving is contingent on continuation of the current annual Congressional adds for additional aircraft, but outfitting them with the new radar rather than the older design. The same Block I/Block II evolutionary software approach would be utilized.

Early development, test, and evaluation of the new AESA hardware with proven software allows the hardware change to be decoupled from the complicated task of developing and integrating new system software. A separate, more graceful evolutionary insertion of new modular software modes to substantially improve the end product can then be tested in modular fashion on proven hardware. We feel the AESA hardware technology has reached a sufficient level of maturity to forgo the lab sensor development with little increased risk. In addition, based on the maturity seen in F-22 EMD and the JSF MIRFS (multifunction integrated RF system) test beds, we feel that the EMD prototype unit can be readily upgraded into a production system. Doing this in-line on a production E-8 rather than the T-3 test bed also represents a significant savings and reduces the number of hardware sets to 5 rather than the currently planned 6.5. A number of extra requirements are viewed as unneeded in the initial deliveries and can be postponed until after the baseline advanced system modes are proven.

SUMMARY OF ESTIMATED COST SAVINGS

EMD

| | |
|--------------------------------|--------|
| Eliminate Lab (Smaller) Sensor | \$100M |
| Eliminate Extra Requirements | \$140M |

PRODUCTION

| | |
|---|---------------|
| Avoid T-3 Install; Forward Fit EMD Sensor Directly to P-16 | \$ 70M |
| Use refurbished EMD sensor for production vice Buy 1 Additional | \$120M |
| Accelerate Time Span (eliminate 5 Years- gov't and industry) | <u>\$310M</u> |

TOTAL PROGRAM SAVINGS SUMMARY

| | |
|---|------------------|
| 1 Forward fit/4 Retrofit Option Total | \$740M |
| Additional Savings (4 Forward fit/1 Retrofit) | \$300M to \$450M |

Based on the maturity of X-band AESA technology the Task Force feels the cost savings are well worth the risk in a forward-fit hardware strategy. Quite simply, the strategy avoids building new, but old-technology radars, which are already relatively expensive, and then having to remove them for retrofit.

The evolutionary software strategy is also an important aspect of the recommended plan. The software modes of these systems are increasingly very complex, and using a sequenced development and test schedule controls cost and schedule risk.

IV. FINDINGS AND RECOMMENDATIONS

FINDINGS

- **We concur that meeting the land-attack cruise-missile threat by 2010 is high priority**
 - JROC approved
- **Good progress has been made in selected areas of advanced air defense**
 - Air Force has been the primary contributor beyond technology demonstrations
 - Overall system engineering needs more attention
 - Security rules should be reviewed to facilitate systems engineering
- **Unanimous support for keeping JSTARS AESA on track**
 - Responsive to verified needs
 - Important element in joint / allied warfare
 - Baseline program costs are high - opportunities to restructure
- **Platform Selection**
 - Not addressed in any detail
 - Complex / multidimensional decision for the Air Force - not likely to occur soon
 - Strong consensus not to delay recommended RTIP program to await platform decision
- **Global Hawk with an AESA**
 - Provides high-quality ground surveillance; first priority for additional ground surveillance capability
 - Provides capability for selected air targets (surveillance and fire control)
 - Enables closer standoff and penetration options
 - The most attractive option to offload JSTARS and AWACS (the HDLD problem)
- **Family-of-radars approach makes sense for airborne, X-band AESAs**
 - Fighters -- Global Hawk -- Business jets -- Large A/C
 - Fighter radars dominate business picture - drive technology
 - Family concept strongest in hardware; but significant in software also
 - Contractors have motivation to develop product families to compete
 - Do not see need for government to force to single family
 - Requirements coordination across varied government customers required to realize successful families
- **Unanimous opinion against “forced” contractor teaming on RTIP**
 - “Cream” from each unlikely when fighter AESA work dominates business picture
 - Either contractor has broad skills to do job
 - Impact of ACTD legacy (hardware/software) has been overcome by events
 - Activity-to-progress ratio concerns
 - Enough business for two teams
 - Should not erode future competitive position in domestic and international market
- **Technology needs for future combined function aircraft**
 - Lightweight, conformal arrays
 - High efficiency modules
 - Efficient prime power generation

The findings of the Task Force are discussed throughout the report and are presented here for completeness.

RECOMMENDATIONS

- **Proceed on RTIP program**
 - Restructure to forward-fit; EMD in-line; limited retrofit option
 - Evolutionary upgrades in software modes to manage risks / costs and meet 2010 goal
- **Support a “families-of-radar” airborne X-band AESA acquisition strategy**

| | | |
|--|--|--|
| <ul style="list-style-type: none">– Raytheon: F-15; F-18; JSF Demval; U-2– Northrop Grumman: F-22; F-16; JSF Demval; RTIP– Don't “force” teaming | | <p style="text-align: center;"><u>Future competitions</u></p> JSF -- Global Hawk – Army ACS – NATAR – business jets – large A/C |
|--|--|--|
- **Aggressively pursue a strategy leading to a multi-mission, X-band, AESA on Global Hawk**
 - Give high priority to offloading demands on AWACS and JSTARS in situations other than war
 - Competitive procurement: two-team fly-off
 - Phasing with RTIP and U-2 programs an important step in the family of radar concept
- **The cruise missile defense systems engineering role needs to be better defined and resources allocated**
 - Security review is an important part

The recommendations of the Task Force are discussed throughout the report and are presented here for completeness.

Appendix A. TERMS OF REFERENCE AND TASK FORCE MEMBERS

TERMS OF REFERENCE:



ACQUISITION AND
TECHNOLOGY

THE UNDER SECRETARY OF DEFENSE

3010 DEFENSE PENTAGON
WASHINGTON, DC 20301-3010

JUN 27

MEMORANDUM FOR CHAIRMAN, DEFENSE SCIENCE BOARD

SUBJECT: Terms of Reference - Defense Science Board Task Force
on Future DoD Airborne High-Frequency Radar
Needs/Resources

You are requested to form a Defense Science Board (DSB) Task Force to focus on the use of airborne X-band radars to serve the broad mission areas of air defense and ground surveillance.

Airborne and ground based X-band radars are found on many DoD applications including F-18, F-22, Joint Strike Fighter (JSF), Joint Surveillance Target Attack Radar System (JSTARS), Joint Land Attack Cruise Missile Elevated Netted Sensor (JLENS), Ground Based Radar (GBR) for Ballistic Missile Defense, Discover II and ship based systems, among others. Significant new developments are under way. X-band radar technology is moving rapidly on several fronts, especially in the area of more affordable, electronically steered arrays (ESAs) with high power levels, and in the area of increased multi-function capability made possible by rapid advances in signal processing and computational capabilities. For example, the new generation of fighter radars are all ESAs and possess the capability to conduct airborne and ground Moving Target Indicator (MTI), Synthetic Aperture Radar (SAR), jamming and ESM functions, as well as missile guidance.

The Task Force shall review the overall architectural approaches for DoD programs in advanced air defense with an emphasis on theater cruise missile defense. It shall review all elements of the kill chain with a focus on the needs for airborne X-band ESA systems.

The Task Force shall review the architectural approaches for DoD programs in advanced ground surveillance with an emphasis on airborne X-band ESA sensors. It will review all elements of the surveillance sensor network including the role of various classes and types of platforms, e.g. fixed wing; Unmanned Aerial Vehicles (UAV); satellites; and aerostats, with primary focus on fixed-wing/UAV options.

The Task Force shall identify and examine any overlap between the advanced air defense and advanced ground surveillance missions. Additionally, the Task Force should consider any overlap with Theater Ballistic Missile (TBM) defense and national cruise missile defense.



The Task Force shall conduct an overview of X-band ESA technology for military and civilian applications and examine current and future potential in the areas of commonality, open architectures, and "family of radar" approaches.

The Task Force should examine the U.S. technology and manufacturing base in X-band ESA and review trends and projections regarding the status and vitality of the technology and manufacturing base. Additional consideration should be given to assessing opportunities for international programs and X-band technology sharing.

A final report should be submitted in August with emphasis on the following:

- A prioritized investment strategy for X band ESAs to serve the advanced air defense mission, the advanced ground surveillance mission, and to serve multiple roles;
- Provide recommendations for DoD investment plans in X-band ESA technology with particular emphasis on family of radar approaches making maximum use of open architectures;
- Provide specific suggestions on approaches and programs designed to serve DoD current needs and to maintain a robust technology and manufacturing base in X-band ESAs;
- Provide a first level assessment of the opportunities for international programs and X-band ESA technology sharing.

The Study will be co-sponsored by the JSD (AT&L) and the Director, Strategic and Tactical Systems. Dr. David L. Briggs will serve as chairman of the Task Force. Dr. Glen Lamartin will serve as Executive Secretary; and LTC Scott McPheeters, USA, will serve as the Defense Science Board Secretariat representative.

The Task Force shall have access to classified information needed to develop its assessment and recommendations.

The Task Force will operate in accordance with the provisions of P.L. 92-463, the "Federal Advisory Committee Act," and DoD Directive 5105.4, the "DoD Federal Advisory Committee Management Program." It is not anticipated that this Task Force will need to go into any "particular matters" within the meaning of section 208 of Title 18, U.S. Code, nor will it cause any member to be placed in the position of acting as a procurement official.

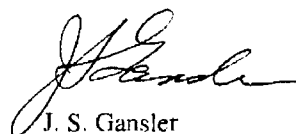
J. S. Gansler

TASK FORCE MEMBERSHIP:

Co-Chairs: Dr. David L. Briggs & Mr. Robert R. Everett

Members

Mr. John N. Entzminger
Dr. Theodore S. Gold
Dr. Matthew Ganz
Dr. Michael Gruber
Hon. Paul Kaminski
Hon. R. Noel Longuemare
Lt Gen George K. Muellner, USAF (Ret)
Dr. Dennis P. Murray
VADM James D. Williams, USN (Ret)

Executive Secretary

Dr. Glenn F. Lamartin

Executive Secretary Coordinators

Mr. Richard Burkholder
COL Thomas Cole

Military Assistant

LTC Scott McPheeters

Government Advisors

Dr. Emil R. Martinsek
Dr. John K. Smith
Dr. David A. Whelan

Meeting Schedule

29 Jun 00 Kickoff meeting
12-13 Jul 00
19-20 Jul 00
26-27 Jul 00
28 Jul 00 Brief-out

PRESENTATIONS TO TASK FORCE:

Air Force (SAF/AQI, AQL)
Northrop-Grumman
Raytheon
JTAMDO
International Programs – NATO
AGS (OSD)
DARPA Special Projects Office
Defense Industrial Base (OSD)
Navy Special Programs
JLENS Program (Army)
MEADS Program (Army)
MTI Data Fusion Study (ASD/J2)
BMDO Radar Programs
CAIG JSTARS RTIP Report

Appendix B. AIR DEFENSE ASSESSMENT

| Advanced Air Defense Capabilities | | | | |
|--|--------------------------|---------------------------------------|------|-----|
| (Table Entry is Unit Count) | | | | |
| | 00 | 05 | 10 | 15 |
| Surveillance | | | | |
| <input type="checkbox"/> AWACS Plus Old | | | | |
| ● AWACS | | | 5 | |
| ● E-2 | | ? Unfunded (must fund by 02 for 2010) | | |
| <input type="checkbox"/> AWACS | | | | |
| Fighters | | | | |
| ● F-22 | 50 | | 180 | 101 |
| ● F/A-18 E/F | 8 | | 130 | 72 |
| ● JSF | | | 93 | 738 |
| ● F-15 | 18 | | | |
| Weapon Systems | | | | |
| ● PAC-3 MSL/Radar | 212 / 54 | | 600 | 288 |
| <input type="checkbox"/> ADSAM | | | | |
| ● SM | Must fund by 02 for 2010 | | | |
| ● AMRAAM | 1794 | | 3584 | |
| <input type="checkbox"/> ADSAM | | | | |
| BMC4I | | | | |
| ● SIAP | ? | | | |
| ● JTIDS Improvements | ? | | | |
| ● JCTN | ? | | | |
| CEC | | | | |
| ● E-2 | 16 | | 25 | 12 |
| ● AEGIS | 24 | | 50 | 5 |
| ● CV | 7 | | 5 | |
| ● Amphib | 11 | | 24 | |

| | |
|--------------------------|------------------------|
| ● Green: | Significant Progress |
| <input type="checkbox"/> | |
| ● Red: | Limited or no Progress |

In the brief time of this Task Force, we were able to do a cursory assessment of overall advanced air defense activities. A summary of this assessment is presented in the Table. The fighter area is moving along well with AESA technology insertion. AMRAAM is a standout effort with substantial procurement in the near term. The area with considerable shortfall is the BMC4I area. Also, beyond demos, there is little commitment from the Navy and Army to preparing their missiles to permit airborne fire control (ADSAM).

Several studies, including DSB studies, have addressed the Advanced Air Defense/Cruise Missile problem in the recent past; see the references below*. The recent National Cruise Missile Defense Study report is due to be published soon. The overall architecture of these defenses has generally been agreed upon and many important "building blocks" have been demonstrated in ad hoc tests. Two potentially important concerns in the national effort are 1) the need for more focused systems engineering in bringing the family of systems/components together and 2) the improvement in long-range non-cooperative combat ID techniques. The very promising architectural concept of air-directed SAMs (ADSAM) can bring surface-based magazines to bear against low altitude targets in over-the-horizon engagements to the kinematic limit of the missiles. However, ADSAM requires strong systems engineering and solution of the combat ID problem to reach full utilization.

Finally, the cruise missile defense area must continue to compete with other defense needs for funding – in particular theater ballistic missile defense. Strong systems engineering can be helpful here as well, since the air target and ballistic target must both be accommodated by systems such as Aegis, Patriot, MEADS, and others.

* Report of the 1994 Defense Science Board Summer Study Task Force on Cruise Missile Defense; Final Report: January 1995; Dr. Theodore S. Gold and Mr. Walter E. Morrow, Jr., Co-Chairs.

Report of the 1996 Defense Science Board Task Force on Land-Attack Cruise Missile Defense; Final Report: May 1997; Dr. Theodore S. Gold, Chair.

National Cruise Missile Defense Study 2000 (NCMD Report to be published), sponsored by OUSD(A&T)/S&TS (MW) in response to Congressional direction; Lee O. Upton, Study Director.

Several studies, including DSB studies, have addressed the Advanced Air Defense/Cruise Missile problem in the recent past; see the references below*. The recent National Cruise Missile Defense Study report is due to be published soon. The overall architecture of these defenses has generally been agreed upon and many important "building blocks" have been demonstrated in ad hoc tests. Two potentially important concerns in the national effort are 1) the need for more focused systems engineering in bringing the family of systems/components together and 2) the improvement in long-range non-cooperative combat ID techniques. The very promising architectural concept of air-directed SAMs (ADSAM) can bring surface-based magazines to bear against low altitude targets in over-the-horizon engagements to the kinematic limit of the missiles. However, ADSAM requires strong systems engineering and solution of the combat ID problem to reach full utilization.

Finally, the cruise missile defense area must continue to compete with other defense needs for funding – in particular theater ballistic missile defense. Strong systems engineering can be helpful here as well, since the air target and ballistic target must both be accommodated by systems such as Aegis, Patriot, MEADS, and others.

* Report of the 1994 Defense Science Board Summer Study Task Force on Cruise Missile Defense; Final Report: January 1995; Dr. Theodore S. Gold and Mr. Walter E. Morrow, Jr., Co-Chairs.

Report of the 1996 Defense Science Board Task Force on Land-Attack Cruise Missile Defense; Final Report: May 1997; Dr. Theodore S. Gold, Chair.

National Cruise Missile Defense Study 2000 (NCMD Report to be published), sponsored by OUSD(A&T)/S&TS (MW) in response to Congressional direction; Mr. Lee O. Upton, Study Director.

THIS PAGE INTENTIONALLY BLANK

Appendix C. X-BAND AESA TECHNOLOGY

As pointed out in the body of this report, the maturation of AESA technology is enabling a major leap forward in radar capabilities, including greater flexibility and a broader range of missions that an AESA-based sensor can support. This appendix provides additional background material on AESA technology, its evolution, and future direction, as well as related areas of future research.

An overview of the differences between more traditional approaches to airborne radars and AESAs is given first. The objective is to summarize the factors that make AESAs such an attractive option for modern radars. The potential advantages offered by AESAs are well understood by the radar community, but may not be familiar to those outside that community. Recognition of this potential has motivated a great deal of research and development on the central building element of an AESA, the T/R module. Progress in both semiconductor device technology, as well as the integration and packaging of this technology into modules sufficiently small and low-cost has made AESAs a practical reality. This progress will be summarized in a chart showing T/R module evolution and alternative array designs (so-called brick and tile designs).

The appendix concludes with a review of the findings of the study as well as directions for future developments that contribute to expanding the capabilities of AESA-based radar systems.

MTI Radar Antenna Architectures

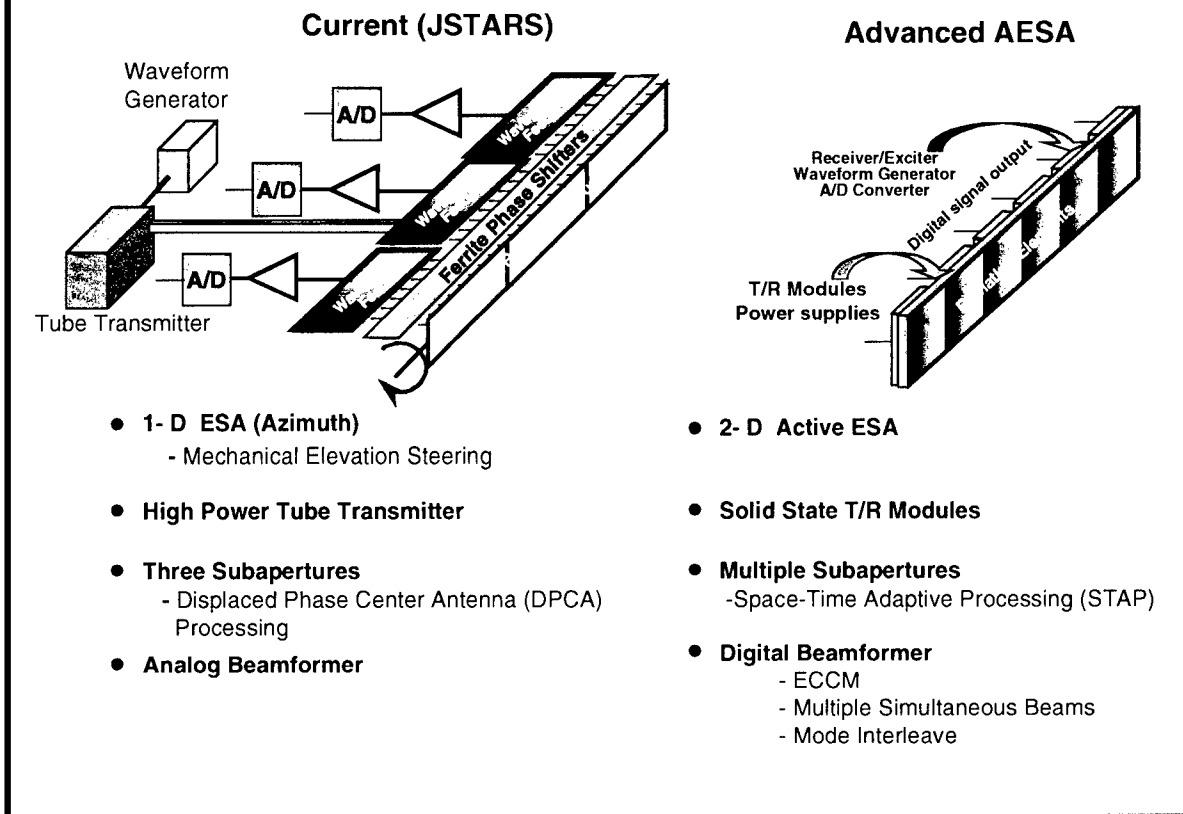

As an introduction to those not familiar with electronically steered array (ESA) antennas, a brief overview of some basic features of these antennas in general, and AESAs in particular is provided here.

The advantages of ESAs over mechanically steered antennas have long been recognized. The most important of these advantages is the ability of ESAs to rapidly (essentially instantaneously) steer the radar beam from any point within the field of view to any other point. ESAs accomplish the rapid steering by inserting an electronic phase shifter at each radiating element (or column of radiating elements in the case of electronic steering in only one dimension). Beam steering is accomplished by subjecting the signal at each radiating element to an additional phase shift such that the wavefront resulting at the antenna face from the coherent addition of the output of each element propagates in the desired beam direction. Similarly, on receive, the coherent addition of the signal from the elements will cause the gain of the antenna to be maximized in the direction selected by the phase shift at each element (beam pointing). Because the electronic phase shifters can be switched very rapidly, with no mechanical inertia, beams can be steered over even large angles in a small fraction of a pulse repetition interval (PRI), i.e., from pulse to pulse. The task of computing the appropriate phase shift for each element to achieve a particular beam steer direction is carried out by the beam steer controller, an important subsystem of any ESA.

Many current ESAs rely on passive components, typically ferrite phase shifters, at each controlled radiating element (or groups of elements) to achieve the necessary phase shift function. Such arrays are generally referred to as passive ESAs, in contrast to active ESAs (AESAs) which have active electronics, the T/R module, at each element that provide the transmit and receive functions in addition to the phase shift required for electronic steering. Although both passive and active ESAs share the benefit of rapid beam steering over mechanically steered antennas, there are some significant additional advantages that an AESA enjoys.

The chart highlights the basic differences between passive and active ESAs. For purpose of discussion, a 1-D array, exemplified by the current JSTARS and ASARS-2 radars, will be assumed for the passive ESA. As shown in the diagram, passive ESAs have a centralized, high power tube transmitter generating the required RF power. This power is distributed to the radiating element via a power dividing network (corporate feed) implemented in waveguide ("plumbing") to handle the large peak power (typically in the tens of kW range) of the tube transmitter. To generate this power, these transmitters need high voltage power supplies in the tens of kilovolts. At each controlled element (radiating column in this case) a ferrite phase shifter is inserted in the signal path as described previously. On receive, the signal travels the reverse path, through the phase shifter, possibly multiple corporate feeds (for multiple phase centers/antenna beams), to receivers with low noise amplifier (LNA) front ends, and then to A/D converters whose outputs are fed to the signal processor. Additional components in this signal chain are required to switch the elements between transmit and receive (T/R switches) and to provide isolation and protect against element mismatches (circulators). Each of the passive components introduces loss in the system, thus contributing to a degradation of radar sensitivity. In the case of the transmit path, RF power is lost in the power distribution network ("plumbing"), phase shifters, circulators, and T/R switches. On the return path these losses reduce the signal strength prior to the low noise amplifier, thereby reducing the received signal to noise. Combined, these losses can reduce the overall sensitivity on the order of 10 to 15 dB (a factor of 10 to 30).

By putting the final stage of transmit power generation, as well as the receive amplifier, at the radiating element, these losses can be greatly reduced. To accomplish this reduction, the T/R modules, containing the phase shifter, transmit power amplifier, T/R switch (possibly including a circulator), and the LNA/receiver are located as close to the radiating element as possible, with the radiating element in some cases being made an integral part of the module itself. Although signal distribution and combining networks are still required "behind" the modules, their losses are no longer important. In the transmit path these losses occur prior to the final transmit power amplifier and thus do not affect the final power output. In the receive path, the losses associated with the combining networks (analog beamformer) occur after the LNA and receiver preamplifier and hence do not reduce the incoming signal strength prior to amplification. The net result is that while not all losses can be eliminated (e.g., circulator losses) a reduction in overall losses in the order of a factor of 10 or greater is feasible in AESAs compared with passive ESAs.

Because losses in the RF circuitry behind the T/R module are less important, lower cost and lighter weight (as well as less bulky) distribution/combining techniques, essentially printed circuits, can be used instead of waveguide components. Similarly, the phase shifter, which is part of the T/R module, is also placed before the power amplifier and after the receive amplifier. This allows it to be implemented using solid state integrated circuitry

which, among other benefits compared to ferrite phase shifters, can be switched much more rapidly and with essentially no power.

Just as the RF power generation is distributed over the array, the regulated DC power supplies are similarly distributed, with one supply typically feeding multiple T/R modules. Unlike high power tube transmitters, voltages for T/R modules are low (~10 V) and distributing the power generation over multiple power supplies close to the T/R modules they supply is necessary to avoid high ohmic losses and problems with supply regulation. However, these supplies can be efficiently integrated into the antenna itself to simplify power interfaces.

A second, major advantage of an AESA over a passive ESA or a mechanical array is the mean time between critical failures (MTBCF). Since the power supplies, final power amplification and input receive amplification, are distributed, MTBCF is significantly higher, 10-100 times, than that of a passive ESA or mechanical array. This results in higher system readiness and significant savings in terms of life cycle cost of a weapon system, especially a fighter. For fighter and UAV applications, these large MTBCF may ultimately mean little or no radar array maintenance is required for the life of the platform.

THIS PAGE INTENTIONALLY BLANK

SOLID STATE PHASED ARRAY ANTENNAS

Key to Modularity

T/R Modules
1960 - present

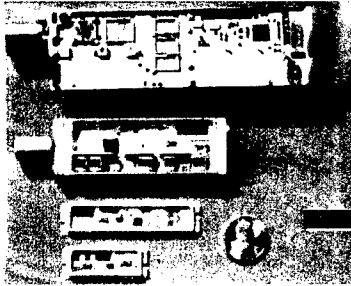

F-22 Aperture
1980s

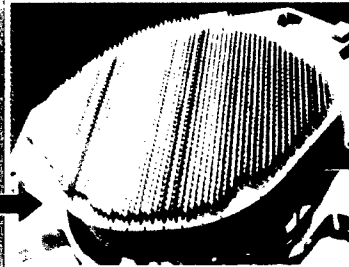

JSF Dem-Val Aperture
1990s

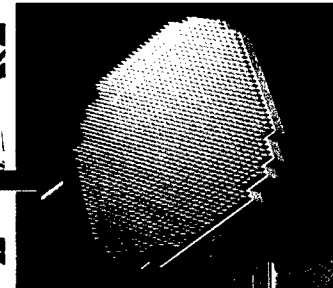

- Multifunction Arrays
 - AMTI, GMTI, SAR
 - Search, Track, Weapon Support
- Increased Performance, Lower Cost
- Highly Reliable, Low Weight

2000s

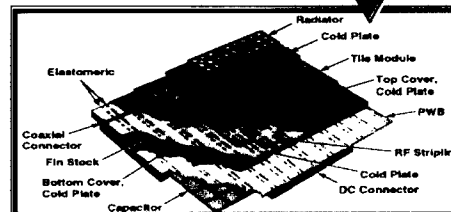

The potential advantages of AESAs have long been recognized by the radar community. The major challenge has been to develop the technology and manufacturing capability to achieve the size, weight, power, and cost necessary to make AESAs affordable and cost-effective alternatives to traditional approaches to airborne radar (such as mechanically steered antennas initially, and more recently, passive 1-D ESAs). A key pacing element in this development has been the T/R module. Developments in this area have focused on (a) semiconductor chip technology to achieve low noise figure receive amplifiers (LNAs) and high power transmit amplifiers (PAs) having high power-added efficiency (a crucial parameter in defining prime power and cooling requirements), and (b) integrating the various component chips (including digital logic) into a module that can be manufactured using a high degree of automation for both assembly and test. Although it took considerable time and investment, this technology has now matured to the point where AESAs have become the approach of choice for the high performance, multifunction radar sensors essential to continued dominance in modern weapon and ISR platforms.

The performance advantages offered by AESAs have been particularly important for modern fighter aircraft, and it is the application to fighter radars that has spurred on the rapid progress made in recent years. An illustration of this progress in T/R technology is the reduction in T/R module size over the past 40 years as shown in the chart. This reduction has allowed the development of compact, high power AESAs suitable for integration into the nose of a fighter. This is illustrated by the picture of the F-22 AESA shown above. Additional reduction in T/R module size, combined with even greater

levels of integration, has resulted in further reduction in the depth (and weight) of the AESA as shown by a dem-val version of the JSF radar. Reduction in the T/R module size requirements can be leveraged in the so-called tile approach, where the various functions required for the AESA (power distribution, RF distribution, timing and control) are implemented in a multi-layer "circuit board" which also contains layers for the T/R "modules" and antenna radiators. An example of such a highly integrated design concept for future AESAs is shown in the figure.

Aggressive Array Weight and Cost Reduction Demonstrated Since 1995

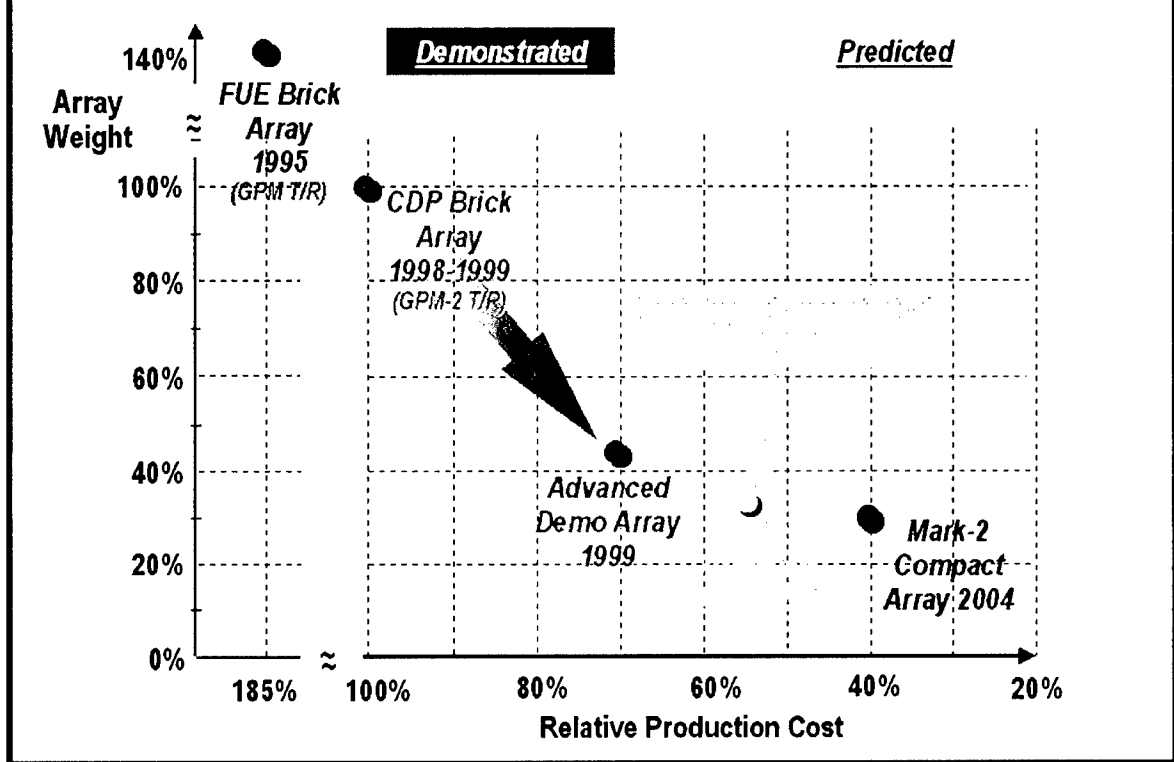

The trend in the reduction in both weight and cost resulting from advances in T/R module technology as well as higher levels of integration in the array itself are illustrated in this chart which appeared in a recent issue of *Aviation Week and Space Technology**. The chart shows the reduction in both weight and cost of representative arrays over the past five years, as well as an extrapolation into the near future where the large procurement expected for the JSF radar is expected to provide the fuel for further development leading to additional cost reductions. The examples in the chart show the significant reduction in weight and cost (by almost a factor of 5) over the past half-decade. As the technology matures, this trend will level off in the future. However, it has propelled T/R modules in particular, and AESAs in general to a position of dominance in future high-end airborne radar application — both for nose-mounted fighter radars and side-looking ISR platform radars (as well as others such as ground- and ship-based systems where AESAs provide comparable advantages over conventional radars).

* David A. Fulghum, "New Radar Design Uses Unique Building Blocks," *Aviation Week and Space Technology*, 11 September 2000

As mentioned previously, AESAs are well suited for a family-of-radars approach, which allows leveraging the gains already achieved for fighter radars to the next generation of side-looking radars for airborne ISR platforms, both manned and unmanned. Clearly the optimum level at which commonality is imposed will require careful assessment of trade-offs between the benefits (e.g., cost and schedule savings) and compromises (e.g., in performance) compared to highly customized designs.

Technology Findings

- **Future fighters radars will drive T/R module technology**
 - ISR modules must be part of this family of modules with possibly small changes to match power requirements
- **Family-of-radar/product line sensor concept is being adopted within each sensor house**
 - Commonality at a subarray level with fighters appears unlikely due to constraints on fighter integration
- **Open systems architecture must be applied to software**
 - A workable standard that allows upgrades to RF hardware as well as processors needs to be developed
- **RF hardware technology research in lightweight apertures, conformal array, and receiver/exciter will allow a large decrease in size, weight, power, and cost.**
- **Current UAV platforms are prime power limited**
 - Efficient prime power generation technology for high altitude platforms critical to fully exploit AESA potential

This chart summarizes, in broad terms, the technology findings of the Task Force. It is clear that T/R module technology will be driven by requirements imposed by fighter radars — the anticipated market for these radars far outweighs that for side-looking ISR radars. It is therefore imperative that ISR needs draw upon the family of modules that have been and will be developed for fighter radars. However, it may prove to be advantageous to customize modules by modifying (direct replacement) chips within the module to more efficiently match differences in power requirements between the two types of applications.

AESA architectures are inherently modular and provide a “natural” basis for a family-of-radars approach. It is therefore not surprising that both Raytheon and Northrop Grumman, the leading sensor houses for airborne radars, have adopted this approach to meeting diverse radar needs. The way in which members within this family differ may vary with the specifics of the approach. Within the class of fighter radars the degree of commonality is generally quite high. The level of commonality between fighter radars and ISR (side-looking) radars will undoubtedly have to be less. For example it is unlikely that subarrays (a system-level modular AESA building block discussed earlier) will be the same — fighter radars generally are circular apertures, whereas side-looking radars typically are rectangular with high length-to-width ratios (longer antennas are desirable

to achieve good GMTI performance). However, at higher levels, e.g. after the subarrays, a high degree of commonality should be possible. In particular, there is considerable functional commonality, i.e., both fighters and ISR platforms perform surveillance and target tracking. Consequently, a modular, open systems architecture for software is a key underpinning of the family-of-radars approach. In this context it is also considered essential that a workable standard be developed that supports upgrading the family-of-radars as improvements in RF and processor hardware are realized through technology growth.

Such technology growth will benefit all AESA applications, but is of special interest for platforms such as Global Hawk where size, weight, power, and cost play a particularly important role in enhancing the operational utility of these platforms, making them more capable and affordable. Research in lightweight apertures, conformal arrays, and improved receiver/exciters will help to take full advantage of available platform payload capacity and offer new opportunities for radar and other sensors (e.g., SIGINT) to be integrated with the platform.

The greater overall power efficiency offered by AESAs is an important factor in increasing the performance of airborne radars. However, in platforms such as the Global Hawk UAV, the extent of the performance improvements that can be realized is limited by the prime power available for the radar. While incremental improvements in T/R module efficiency and in the power efficiency of other components can alleviate the problem somewhat, to achieve a major increase in UAV operational capabilities in general, and radar sensitivity in particular, will require a significant increase in the available prime power. In the case of Global Hawk a two to threefold increase will be necessary to fully exploit the AESA potential. To reach this goal without a major impact on the endurance and altitude of Global Hawk (or requiring a major platform redesign), efficient generation of prime power at high altitude is essential. This should be possible by applying current power generation technology to the Global Hawk vehicle, with a small compromise in endurance. UAVs will benefit from power generation efficiencies in the future with the development of the internal engine starter/generator, which should have little impact on the engine efficiencies but increase power generation by about fivefold.

Appendix D. LIST OF ACRONYMS

| | |
|--------|--|
| A/D | Analog to Digital (Converter) |
| ACS | Aerial Common Sensor |
| ACTD | Advanced Concepts Technology Demonstration |
| ADSAM | Air Directed Surface-to-Air Missile |
| AESA | Active Electronically Steered Array |
| AGS | Alliance Ground Surveillance |
| AIP | ASARS Improvement Program |
| AMRAAM | Advanced Medium-Range Air-to-Air Missile |
| AMSTE | Affordable Moving Surface Target Engagement |
| ASARS | Advanced Synthetic Aperture Radar System |
| ASTOR | Airborne Stand-Off Radar (United Kingdom Program) |
| ATACMS | Army Tactical Missile System |
| AWACS | Airborne Warning and Control System |
| BMDO | Ballistic Missile Defense Organization |
| CAIG | Cost Analysis Improvement Group |
| CAIV | Cost as an Independent Variable |
| CLAWS | Close Combat Light Armor Weapon System |
| CNAD | Conference of National Armaments Directors (NATO) |
| DAB | Defense Acquisition Board |
| DARPA | Defense Advanced Research Projects Agency |
| DoD | Department of Defense |
| DPCA | Displaced Phase Center Antenna |
| DSB | Defense Science Board |
| DT/OT | Developmental Test/Operational Test |
| ECCM | Electronic Counter-Countermeasures |
| EMD | Engineering and Manufacturing Development |
| EO/IR | Electro-Optic/Infrared |
| ESA | Electronically Steered Array |
| ESM | Electronic Support Measures |
| GBR | Ground-Based Radar (X-band radar for National Missile Defense) |
| GHAWK | Global Hawk UAV |
| GMTI | Ground Moving Target Indicator |

| | |
|--------|---|
| GRCA | Ground Reference Coverage Area |
| HDLD | High Demand Low Density |
| HPD | High-Power Discrimination (Radar) |
| HRR | High Range Resolution |
| ISR | Intelligence, Surveillance, and Reconnaissance |
| JCTN | Joint Composite Tracking Network |
| JLENS | Joint Land Attack Cruise Missile Defense Elevated Netted Sensor |
| JSF | Joint Strike Fighter |
| JSTARS | Joint Surveillance Target Attack Radar System |
| JTAMDO | Joint Theater Air and Missile Defense Organization |
| JTIDS | Joint Tactical Information Distribution System |
| LNA | Low Noise Amplifier |
| MDV | Minimum Detectable Velocity |
| MEADS | Medium Extended Air Defense System |
| MFR | Multi-Function Radar |
| MIRFS | Multifunctional Integrated RF System |
| MMIC | Monolithic Microwave Integrated Circuit |
| MTBFC | Mean Time Between Critical Failures |
| NATAR | NATO Transatlantic Advanced Radar |
| NATO | North Atlantic Treaty Organization |
| PAC-3 | Patriot Advanced Capability Level-3 |
| RF | Radio Frequency |
| RTIP | Radar Technology Improvement Program |
| SAR | Synthetic Aperture Radar |
| SIAP | Single Integrated Air Picture |
| SIGINT | Signals Intelligence |
| SM | Standard Missile |
| SOSTAR | Stand-Off Surveillance Targeting and Acquisition Radar |
| STAP | Space-Time Adaptive Processing |
| T/R | Transmit/Receive (Module) |
| THAAD | Theater High Altitude Area Defense |
| UAE | United Arab Emirates |
| UAV | Unmanned Aerial Vehicle |