

MEMORANDUM
RM-4122-ARPA
AUGUST 1964

**THE RAND TABLET: A MAN-MACHINE
GRAPHICAL COMMUNICATION DEVICE**

M. R. Davis and T. O. Ellis

PREPARED FOR:
ADVANCED RESEARCH PROJECTS AGENCY

The **RAND** *Corporation*
SANTA MONICA • CALIFORNIA

MEMORANDUM
RM-4122-ARPA
AUGUST 1964

**THE RAND TABLET: A MAN-MACHINE
GRAPHICAL COMMUNICATION DEVICE**

M. R. Davis and T. O. Ellis

This research is supported by the Advanced Research Projects Agency under Contract No. SD-79. Any views or conclusions contained in this Memorandum should not be interpreted as representing the official opinion or policy of ARPA.

DDC AVAILABILITY NOTICE

Qualified requesters may obtain copies of this report from the Defense Documentation Center (DDC).

The **RAND** *Corporation*
1700 MAIN ST. • SANTA MONICA • CALIFORNIA • 90406

PREFACE

This Memorandum is a technical description of the RAND tablet, a graphical computer input device developed at The RAND Corporation. The RAND tablet is believed to be the first such graphic device that is digital, is relatively low-cost, possesses excellent linearity, and is able to uniquely describe 10^6 locations in the $10'' \times 10''$ active tablet area.

The development of the tablet at RAND has been pursued as a part of research performed for the Advanced Research Projects Agency, and is an aspect of a larger interest in the area of man-machine communication and interaction. Thus, the tablet has great potential not only in such applications as digitizing map information, but also as a working tool in the study of more esoteric applications of graphical languages for man-machine interaction. The tablet is being utilized both as a tool facilitating communication with the computer in production data processing, and for research aimed at improving our understanding of the human factors and the technical problems involved in developing more sophisticated interface modes.

SUMMARY

This Memorandum describes a low-cost, two-dimensional graphic input tablet and stylus developed at The RAND Corporation for conducting research on man-machine graphical communications. The tablet is a printed-circuit screen complete with printed-circuit capacitive-coupled encoders with only 40 external connections. The writing surface is a 10"x10" area with a resolution of 100 lines per inch in both x and y. Thus, it is capable of digitizing $>10^6$ discrete locations with excellent linearity, allowing the user to "write" in a natural manner. The system does not require a computer-controlled scanning system to locate and track the stylus. Several institutions have recently installed copies of the tablet in research environments. It has been in use at RAND since September 1963.

THE RAND TABLET: A MAN-MACHINE GRAPHICAL
COMMUNICATION DEVICE

Present-day user-computer interface mechanisms provide far from optimum communication, considerably reducing the probability that full advantage is being taken of the capabilities of either the machine or of the user. A number of separate research projects are underway, aimed at investigating ways of improving the languages by which man communicates with the computer, and at developing more useful and more versatile communication channels. Several of these projects are concerned with the design of "two-dimensional" or "graphical" man-computer links.

Early in the development of man-machine studies at RAND, it was felt that exploration of man's existent dexterity with a free, pen-like instrument on a horizontal surface, like a pad of paper, would be fruitful. The concept of generating hand-directed, two-dimensional information on a surface not coincident with the display device (versus a "light pen") is not new and has been examined by others in the field. It is felt, however, that the stylus-tablet device developed at RAND (see Fig. 1) is a highly practical instrument, allowing further investigation of new freedoms of expression in direct communications with computers.

The RAND tablet device generates 10-bit x and 10-bit y stylus position information. It is connected to an input channel of a general-purpose computer and also to an oscilloscope display. The display control multiplexes the stylus position information with computer-generated

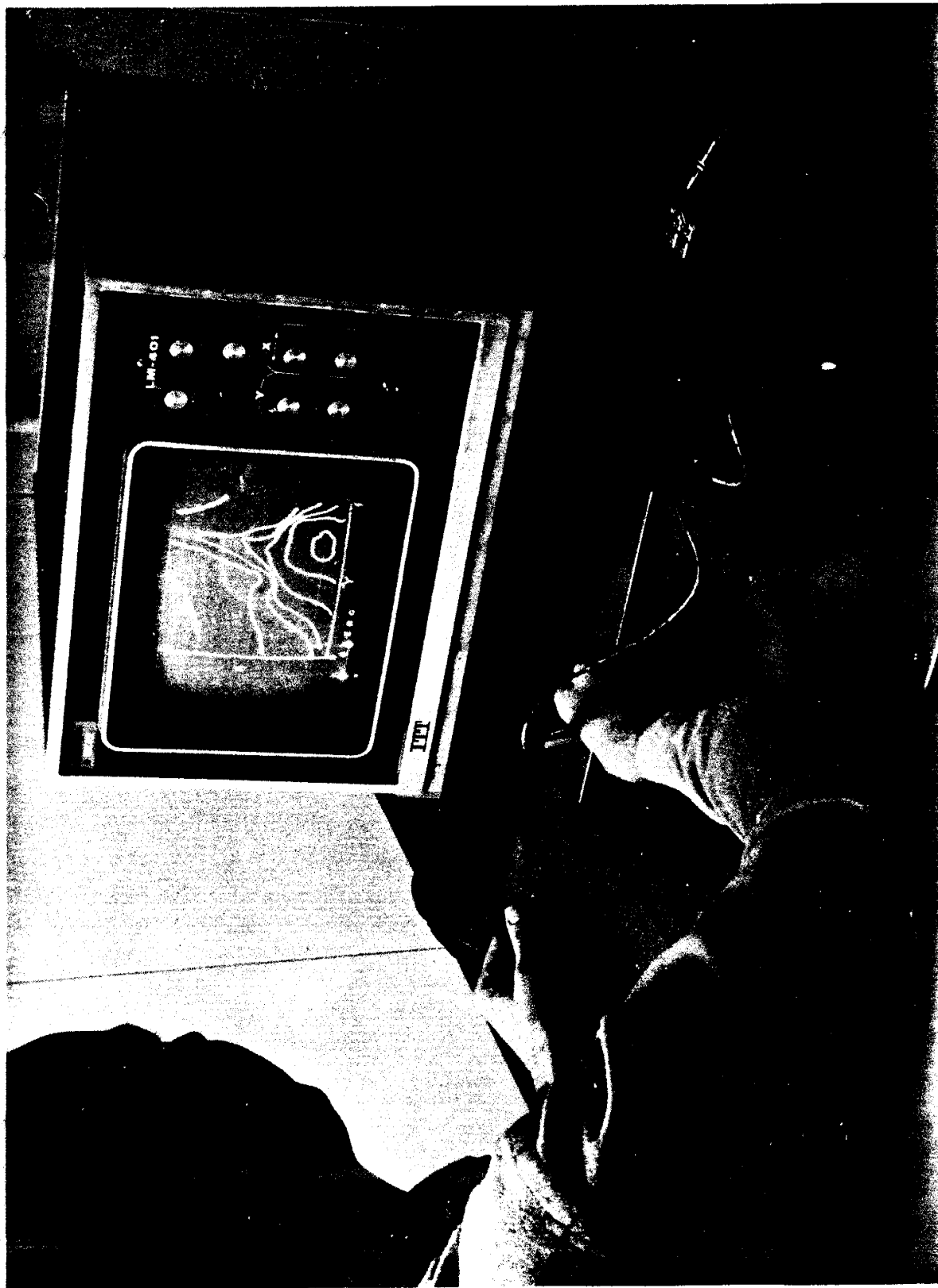

Fig. 1—Complete system in operation

information in such a way that the oscilloscope display contains a composite of the current pen position (represented as a dot) and the computer output. In addition, the computer may regenerate meaningful track history on the CRT, so that while the user is writing, it appears that the pen has "ink." The displayed "ink" is visualized from the oscilloscope display while hand-directing the stylus position on the tablet, as in Fig. 1. Users normally adjust within a few minutes to the conceptual superposition of the displayed ink and the actual off-screen pen movement. There is no apparent loss of ease or speed in writing, printing, constructing arbitrary figures, or even in penning one's signature.

To maintain the "naturalness" of the pen device, a pressure-sensitive switch in the tip of the stylus indicates "stroke" or intended input information to the computer. This switch is actuated by approximately the same pressure normally used in writing with a pencil, so that strokes within described symbols are defined in a natural manner.

In addition to the many advantages of a "live pad of paper" for control and interpretive purposes, the user soon finds it very convenient to have no part of the "working" surface (the CRT) covered by the physical pen or the hand.

The gross functioning of the RAND tablet system is best illustrated through a general description of the events that occur during a major cycle (220 μ sec; see timing diagram, Fig. 2). Figure 3 is the system block diagram with the information flow paths indicated by the heavier lines. The clock sequencer furnishes a time

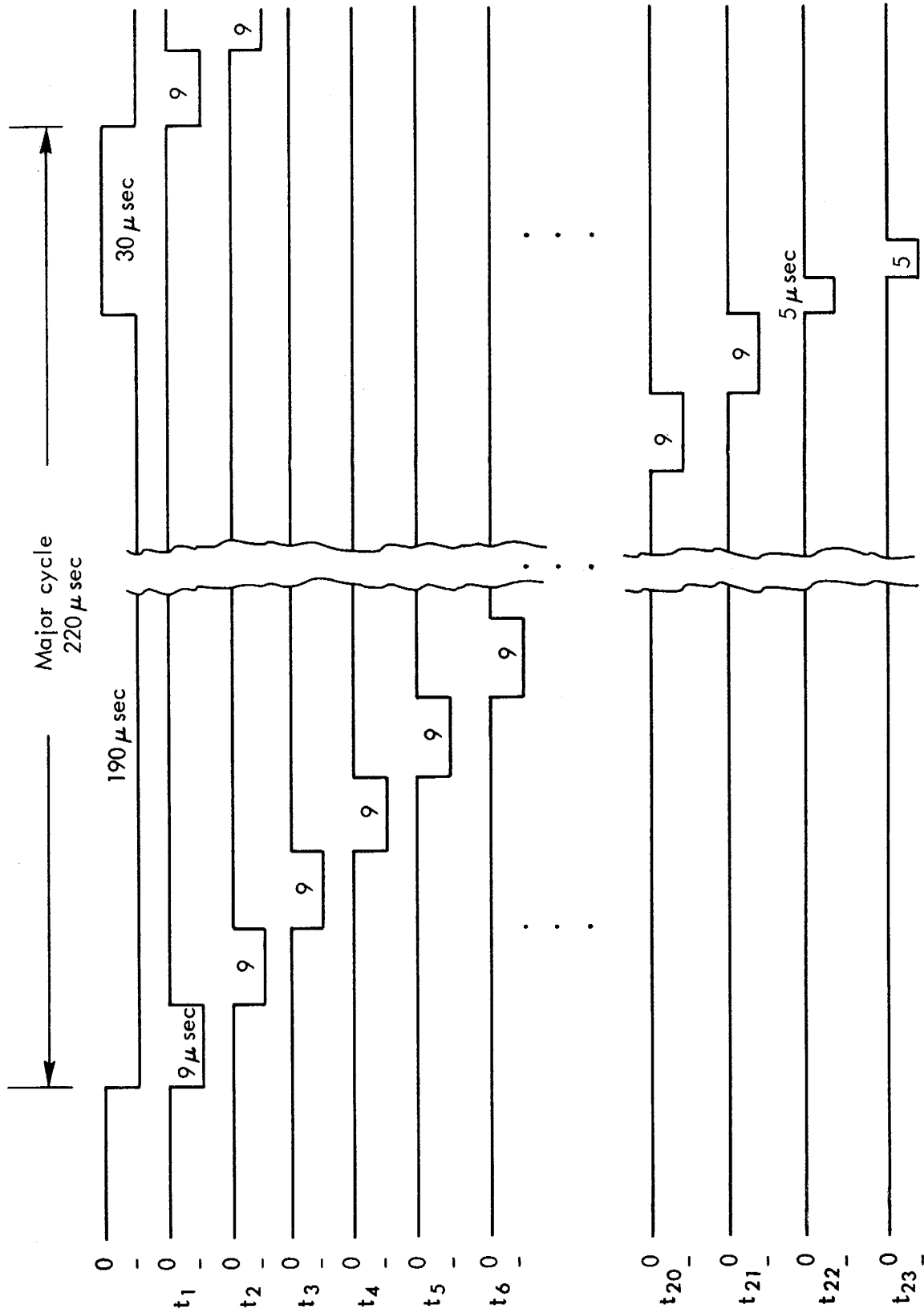

Fig. 2—Timing waveforms (μsec)

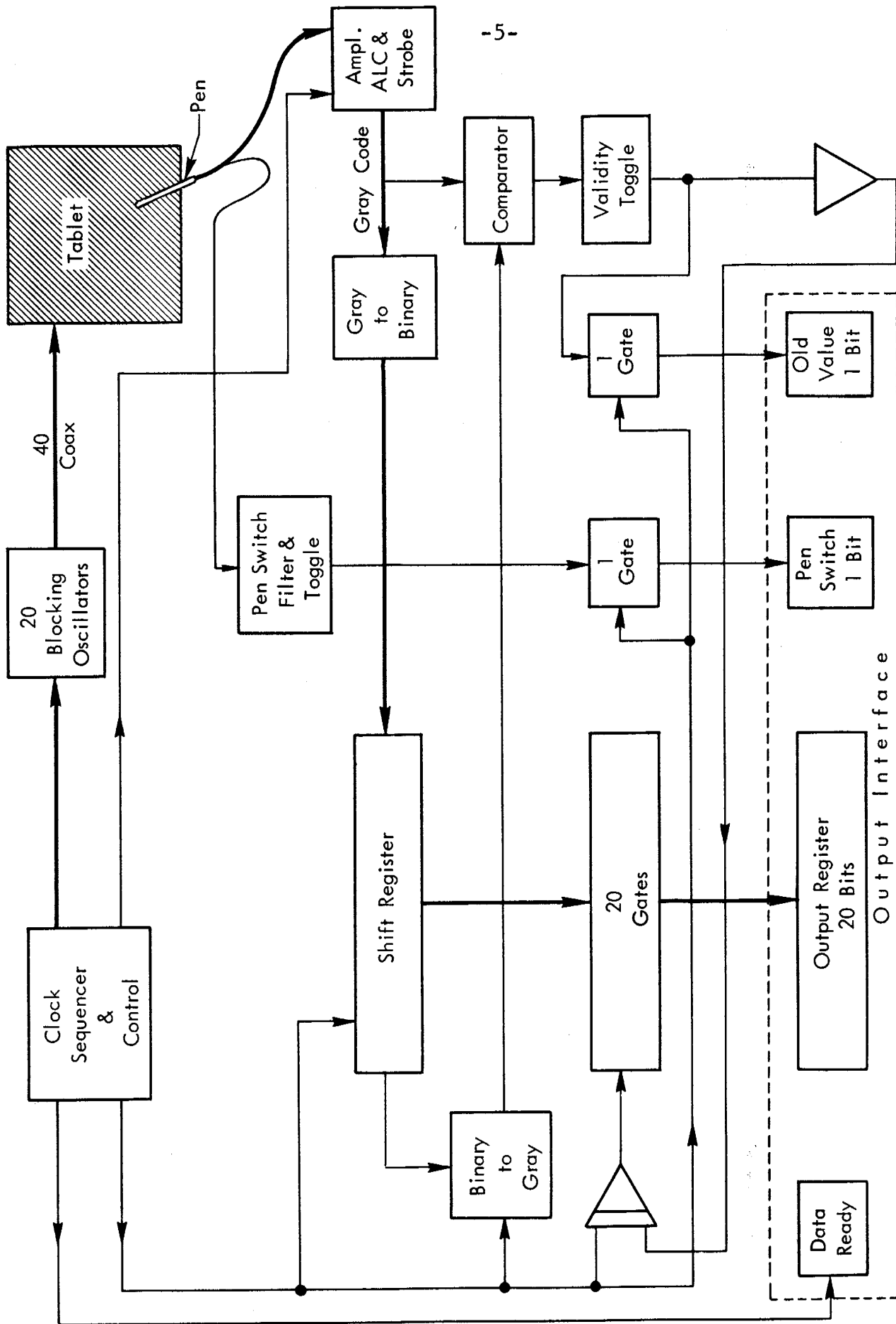

Fig. 3—Graphic input system block diagram

sequence of 20 pulses to the blocking oscillators. During each of the 20 timing periods, a blocking oscillator gives a coincident positive and negative pulse on two lines attached to the tablet.

The pulses are encoded by the tablet as serial (x,y) Gray-code position information which is sensed by the high-input-impedance, pen-like stylus from the epoxy-coated tablet surface. The pen is of roughly the same size, weight, and appearance as a normal fountain pen. The pen information is strobed, converted from Gray to binary code, assembled in a shift register, and gated in parallel to an interface register.

The printed-circuit, all-digital tablet, complete with printed-circuit encoding, is a relatively new concept made possible economically by advances in the art of fine-line photoetching. The tablet is the hub of the graphic input system, and its physical construction and the equivalent circuit of the tablet itself will be considered before proceeding to the system detail.

The basic building material for the tablet is 0.5-mil-thick Mylar sheet clad on both sides with 1/2-ounce copper (approximately 0.6 mils thick). Both sides of the copper-clad Mylar sheets are coated with photo resist, exposed to artwork patterns, and etched using standard fine-line etching techniques. The result is a printed circuit on each side of the Mylar, each side in proper registration with the other. (Accurate registration is important only in the encoder sections, as will be seen later.) Figure 4 is a photo of the printed circuit before it has been packaged. The double-sided, printed screen is

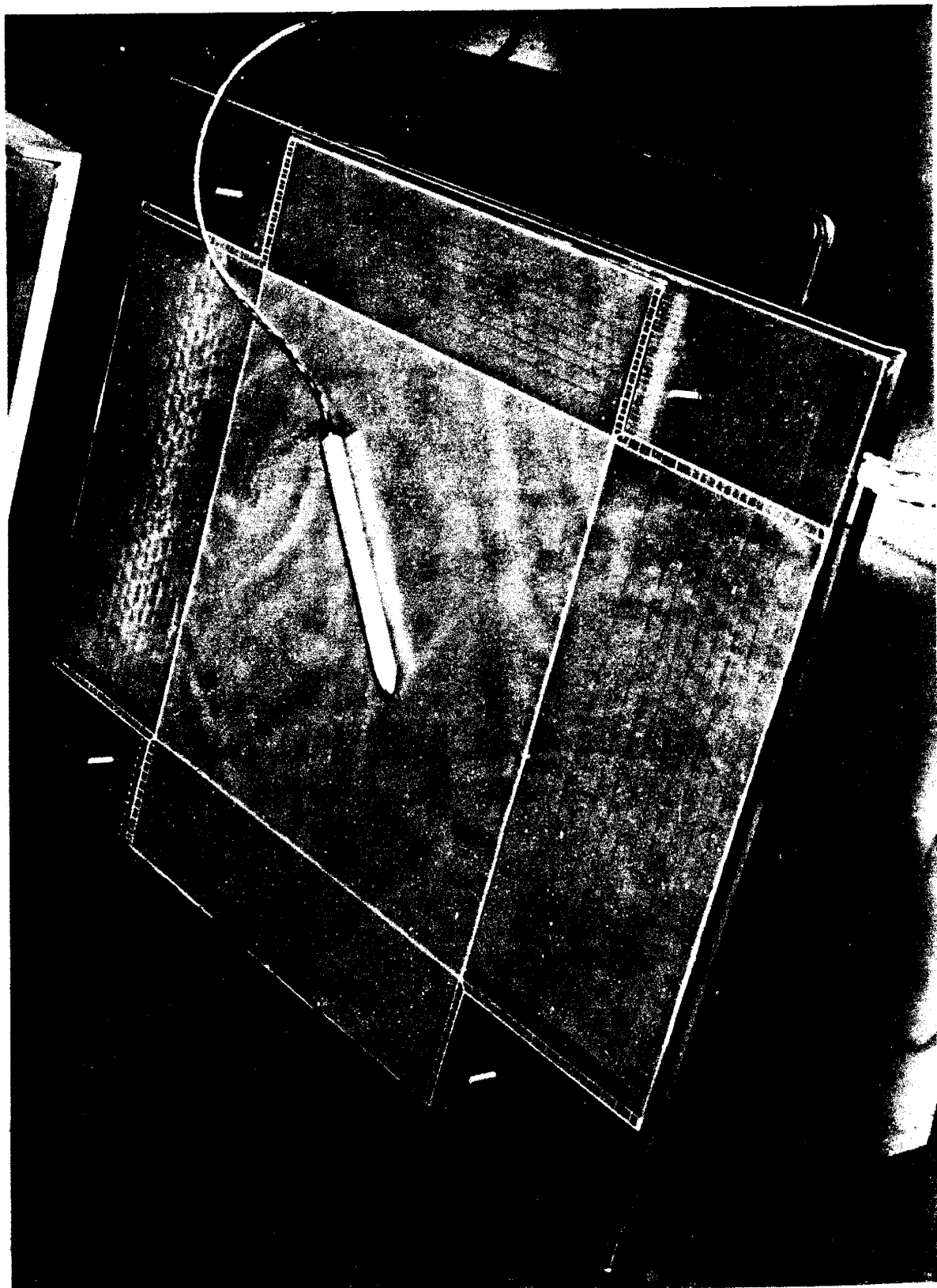

Fig. 4—Unmounted printed circuit

cemented to a smooth, rigid substrate and sprayed with a thin coat of epoxy to provide a good wear surface and to prevent electrical contact between the stylus and the printed circuit. The writing area on the tablet is 10.24×10.24 in. with resolution of 100 lines per inch. The entire tablet is mounted in a metal case with only the writing area exposed, as can be seen in Fig. 1.

Although it would be very difficult to fully illustrate a 1024×1024-line system, it does seem necessary, for clarity, to present all the details of the system. Thus, an 8×8-line system will be used for the system description and expansion of the concept to larger systems will be left to the reader.

Figure 5 shows the detailed, printed circuit on each side of the 0.5-mil Mylar for an 8×8-line system. The top circuit contains the x position lines and the two y encoder sections, while the bottom circuit has the y position lines and the two x encoder sections. It should be noted that the position lines are connected at the ends to wide, code-coupling buses. These buses are made as wide as possible in order to obtain the maximum area, since the encoding scheme depends on capacitive coupling from the encoder sections through the Mylar to these wide buses. It should be further noted that the position lines are alternately connected to wide buses on opposite ends. This gives symmetry to the tablet and minimizes the effect of registration errors.

With reference to Fig. 5, at time t_1 encoder pads p_1+ are pulsed with a positive pulse and pads p_1- are pulsed with a negative pulse. Pads p_1+ are capacitively

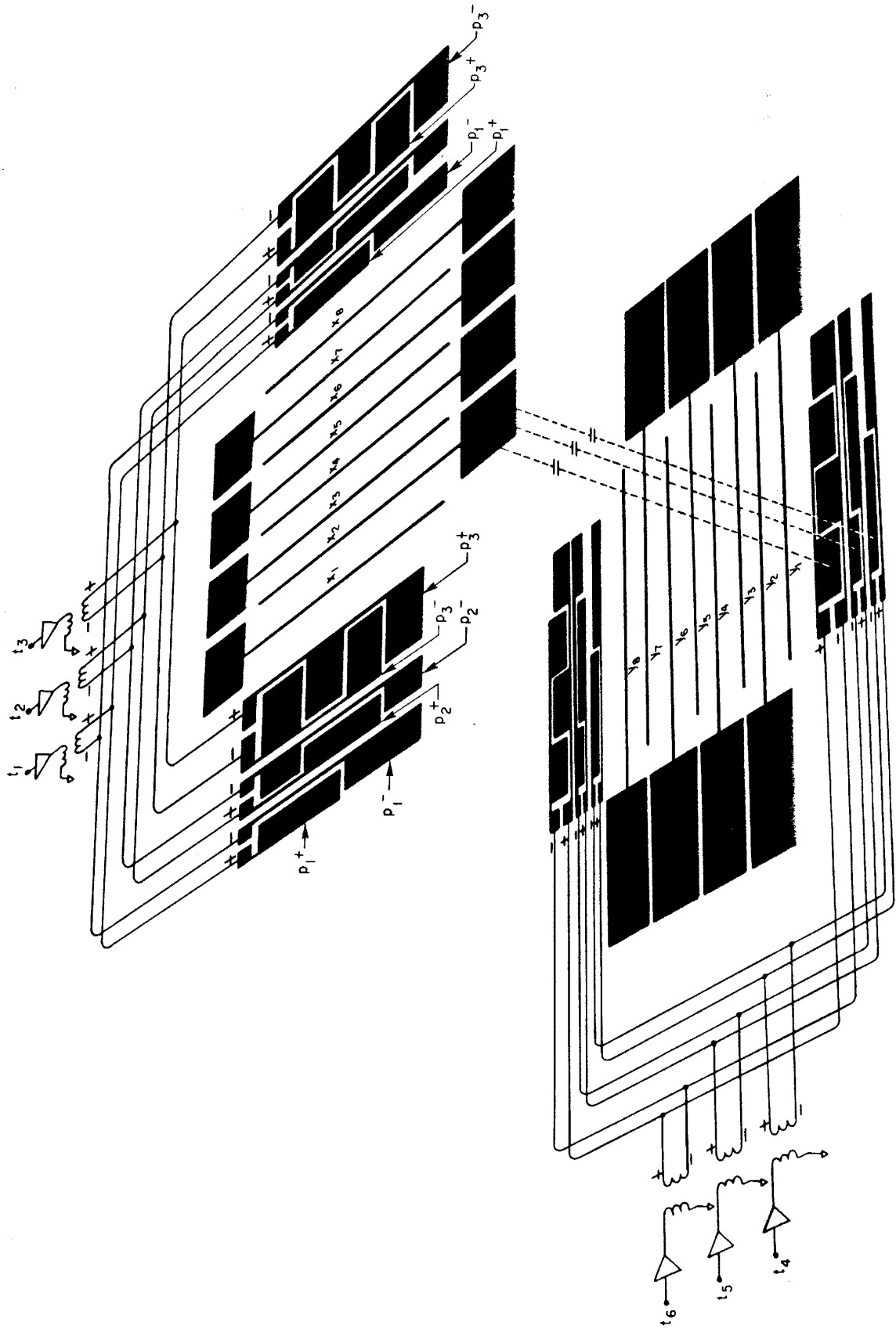

Fig. 5—Double-sided printed-circuit layout for 8x8 system

coupled through the Mylar to y position lines y_5 , y_6 , y_7 , and y_8 , thus coupling a positive pulse to these lines. Pads p_1^- are capacitively coupled to y position lines y_1 , y_2 , y_3 , and y_4 , putting a negative pulse on these lines. At time t_2 , encoder pads p_2^+ and p_2^- are pulsed plus and minus, respectively, putting positive pulses on y position lines y_3 , y_4 , y_5 , and y_6 , and negative pulses on y position lines y_1 , y_2 , y_7 , and y_8 . At the end of time t_3 , each y position line has been energized with a unique serial sequence of pulses. If positive pulses are considered as ones and negative pulses are zeros, the Gray-pulse code appearing on the y position wires is as follows:

y_1	000
y_2	001
y_3	011
y_4	010
y_5	110
y_6	111
y_7	101
y_8	100

The x encoder pads are now sequentially pulsed at times t_4 , t_5 , and t_6 , giving unique definitions to each x position line.

If a pen-like stylus with high input impedance is placed anywhere on the tablet, it will pick up a time

sequence of six pulses, indicating the (x,y) position of the stylus. It should be pointed out again that the stylus is electrostatically coupled to the (x,y) position lines through the thin, epoxy wearcoat.

If the stylus is placed on the tablet surface at a point (x_4, y_5) , the pulse stream appearing at the pen tip would be as indicated in Fig. 6. This detected pulse pattern will repeat itself every major cycle as long as the stylus is held in this position. If the stylus is moved, a different pulse pattern is sensed, indicating a new (x,y) position.

Since there are 1024 x position lines and 1024 y position lines, 20 bits are required to define an (x,y) position. The actual timing used in the RAND system was shown in Fig. 2. Timing pulses t_{21} , t_{22} , and t_{23} are additional pulses used for bookkeeping and data manipulation at the end of each major cycle.

The position lines on the full-size tablet are 3 mils wide with a 7-mil separation. The code-coupling pads are 16 to 17 mils wide with a 3- to 4-mil separation. Figure 4 shows that the encoding pads which couple to the lower set of position lines (y position lines) are enlarged. This greater coupling area increases the signal on the lower lines to compensate for the loss caused by the shielding effect of the upper lines (since they lie between the lower lines and the stylus pick-up). The encoding pad for the two least-significant bits in both x and y was also enlarged to offset the effect of neighboring-line cancellations. With these compensations, all pulses received at the stylus tip are of approximately the same amplitude.

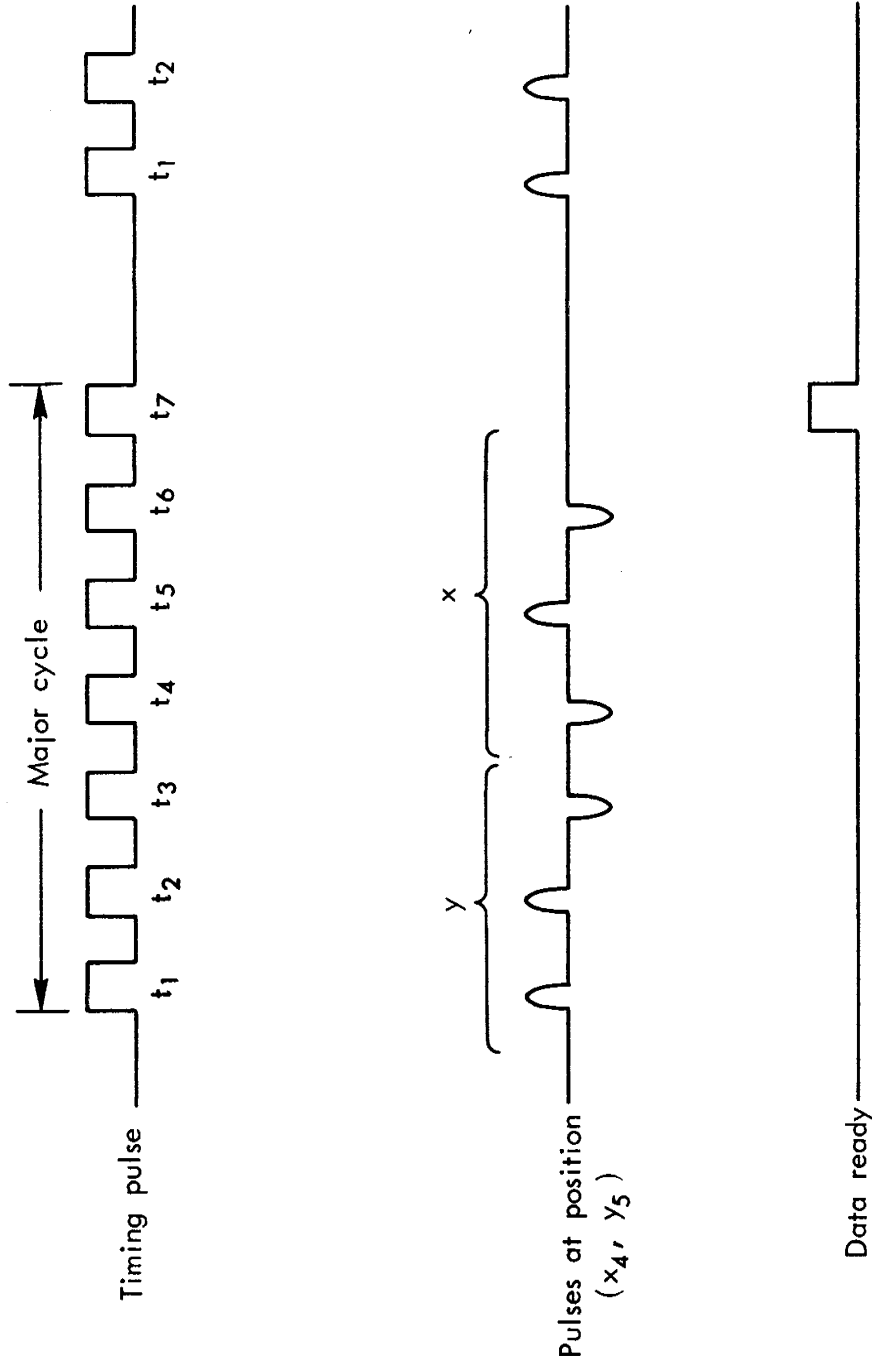

Fig. 6—Timing diagram and pen signals for the example 8x8 system

Figure 7 is an illustration of the approximate equivalent circuit of the encoder-tablet-stylus system, along with typical system parameter values. It is clear that the values of C_1 vary with encoder-pad size, and the value C_4 varies according to whether top or bottom lines are being considered. The value of C_4 is also dependent on the stylus-tip geometry and wearcoat thickness of the tablet. The signals arriving at the input to the stylus amplifier are approximately 1/300 of the drive-line signals. The character of the signals at the stylus input is greatly dependent on the drive-pulse rise time.

Figure 8 is an oscilloscope pattern of the amplified signals at the stylus output.* These signals are amplified again and strobed into a Gray-code toggle. An x bit at t_8 and a y bit at t_{17} are smaller than the rest. This indicates that the stylus tip is somewhere between lines and these are the bits that are changing.

Since the final stages of the amplification and the strobing circuit are dc-coupled, the system is vulnerable to shift in the dc signal level. For this reason, an automatic level control (ALC) circuit has been provided to insure maximum recognizability of signals. During the first 180 μ sec of a major cycle, the stylus is picking up bits from the tablet. During the last 40 μ sec, the tablet is quiet--i.e., the stylus is at its quiescent level. During this 40- μ sec interval, the quiescent level of the

* It will be noted in the oscilloscope pattern of Fig. 8 that the pulsing sequence is x first and y last. This is mentioned only because it is the opposite order of that shown in the 8x8-line example system discussed above; otherwise, it is unimportant.

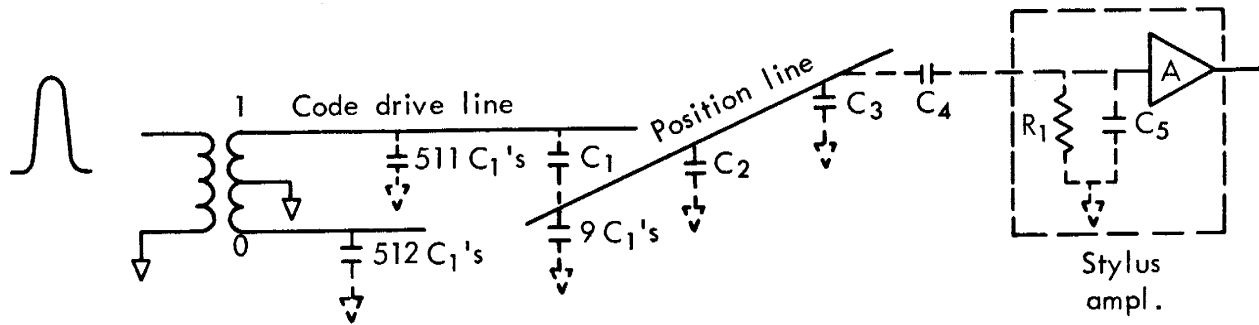

C_1 = Encoder pad coupling capacity ~ 5 pf

C_2 = Capacity to adjacent parallel wires in tablet ~ 10 pf

C_3 = Capacity to crossing lines in screen ~ 100 pf

C_4 = Stylus-to-tablet coupling capacity $\sim .5$ pf

C_5 = Stylus input shunt capacity ~ 5 pf

R = Stylus input resistance ~ 200 K Ω

Fig. 7—Equivalent circuit of encoder-tablet-stylus coupling and attenuating elements

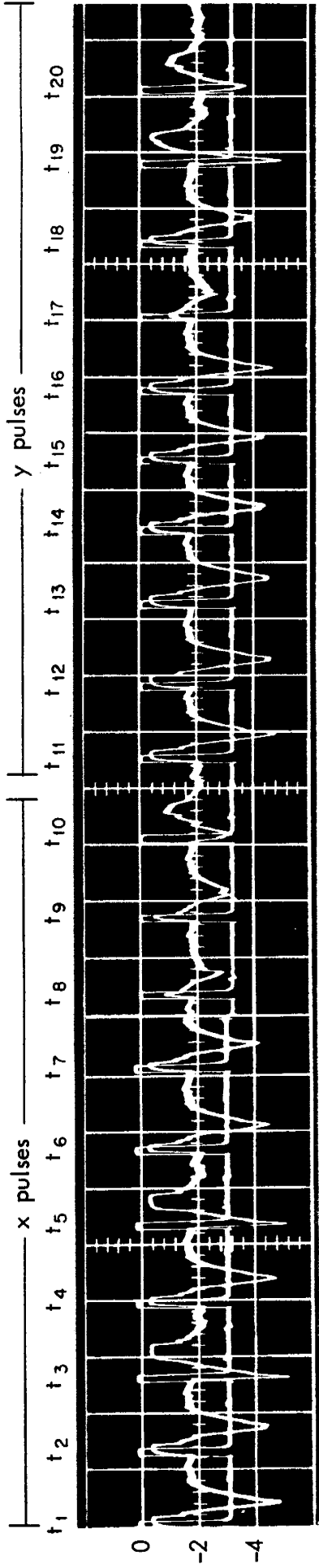

Fig. 8—Oscillogram of pen signal and strobe

pen is strobed into the ALC toggle. If the quiescent level is recognized as a zero, the ALC condenser changes slowly in the proper direction to change the recognition (via a bias circuit) to a one, and vice versa. For a perfectly balanced system, the ALC toggle would alternate between 1 and 0 with each major cycle.

A Gray code was selected so that only one bit would change value with each wire position, giving a complete and unambiguous determination of the stylus position. Furthermore, a reflected Gray code facilitates serial conversion to binary. The conversion logic for an N-bit number, when N is the most significant bit, is:

$$\text{Binary}_N = \text{Gray}_N$$

$$B_j = (\overline{B_{j+1}} \wedge G_j) \vee (B_{j+1} \wedge \overline{G_j}) \quad j < N$$

Time-wise, the bits are received from the stylus in the order N, ..., j+1, j, ..., 1. When all 20 bits have been assembled in the shift register, they are gated to the output register.

As a new (x,y) value is being converted to binary and shifted into one end of the shift register, the old binary value is being shifted out the other end. This old binary information is serially reconverted to Gray and compared to the new, incoming Gray value, one bit at a time. If the old Gray number and incoming Gray number differ in more than one bit in either x or y, a "validity" toggle is set to indicate an error. If the two Gray-code

series differ in more than one bit, this indicates that the pen has moved more than one line during the 220- μ sec interval. As this is not probable during normal usage, it is assumed that an error has occurred. If a set of data are determined as not valid, the output register is left with its previous value, and an "old-value" toggle is flagged.

The binary-to-Gray conversion logic is:

$$G_N = B_N$$

$$G_j = (\overline{B_{j+1}} \wedge B_j) \vee (B_{j+1} \wedge \overline{B_j}) \quad j < N$$

In practice, the validity check rarely detects errors while the pen is in contact with the tablet. The pen validity check is used to suppress the display of the pen position as the pen is lifted off the tablet.

The logic and clock systems are made up principally with state-of-the-art NOR circuits and univibrators. The blocking-oscillator circuit shown in Fig. 9 was designed to drive the encoder pads. This use of transformer coupling was found to be important since well-matched positive and negative pulses were required to obtain proper cancellation at the tablet surface. The stylus amplifier has a gain of approximately 30 db with an additional 30-db gain in the principal electronic package.

The total electronic system is assembled in a 5"x5"x19" printed-circuit card cage and contains some 400 transistors and about 220 diodes; however, little attempt has been made

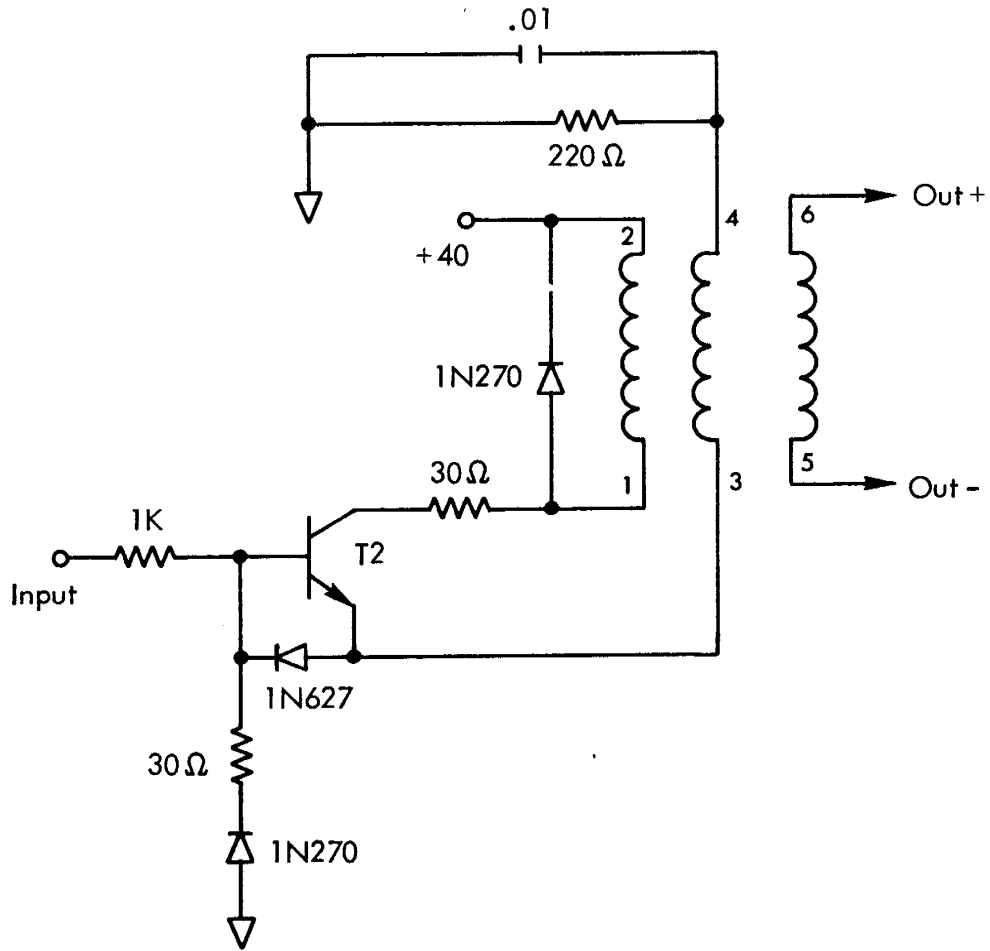

Fig. 9—Blocking oscillator

to minimize the number of components. Also, the electronics could be shared with a number of tablets in a multiple-tablet system.

Figure 10 is a block diagram showing the graphic input-output system as used at RAND for the evaluation of hardware, human engineering studies, and investigation of programming implications. The computer used was the JOHNNIAC, a tube machine of the Princeton class.

Preliminary studies indicate that with a great amount of care in construction, a 200-line-per-inch tablet could be achieved. The resolution of this line density would not present a major problem; on the other hand, 100 lines per inch is adequate for all current intended applications.

It is certainly within the state of the art to decrease the major cycle time; however, in usage at RAND, the 4.5-kc rate has been adequate. When the stylus is swept rapidly across the surface of the tablet, it has been found that an average of two or three complete sets of position data are obtained for each line. Setting the multiplexing switch (Fig. 10) to display the stylus position on the scope every 10 msec has proved adequate, and since only 50 μ sec are required to display the point, 99.5 per cent of the display scope time is left for the computer.

The tablet currently is in regular use at RAND in studies toward the development of on-line graphical programming languages and on-line interaction with problem parameters. In addition to its use at RAND, several copies of the tablet have been supplied to other researchers in the field.

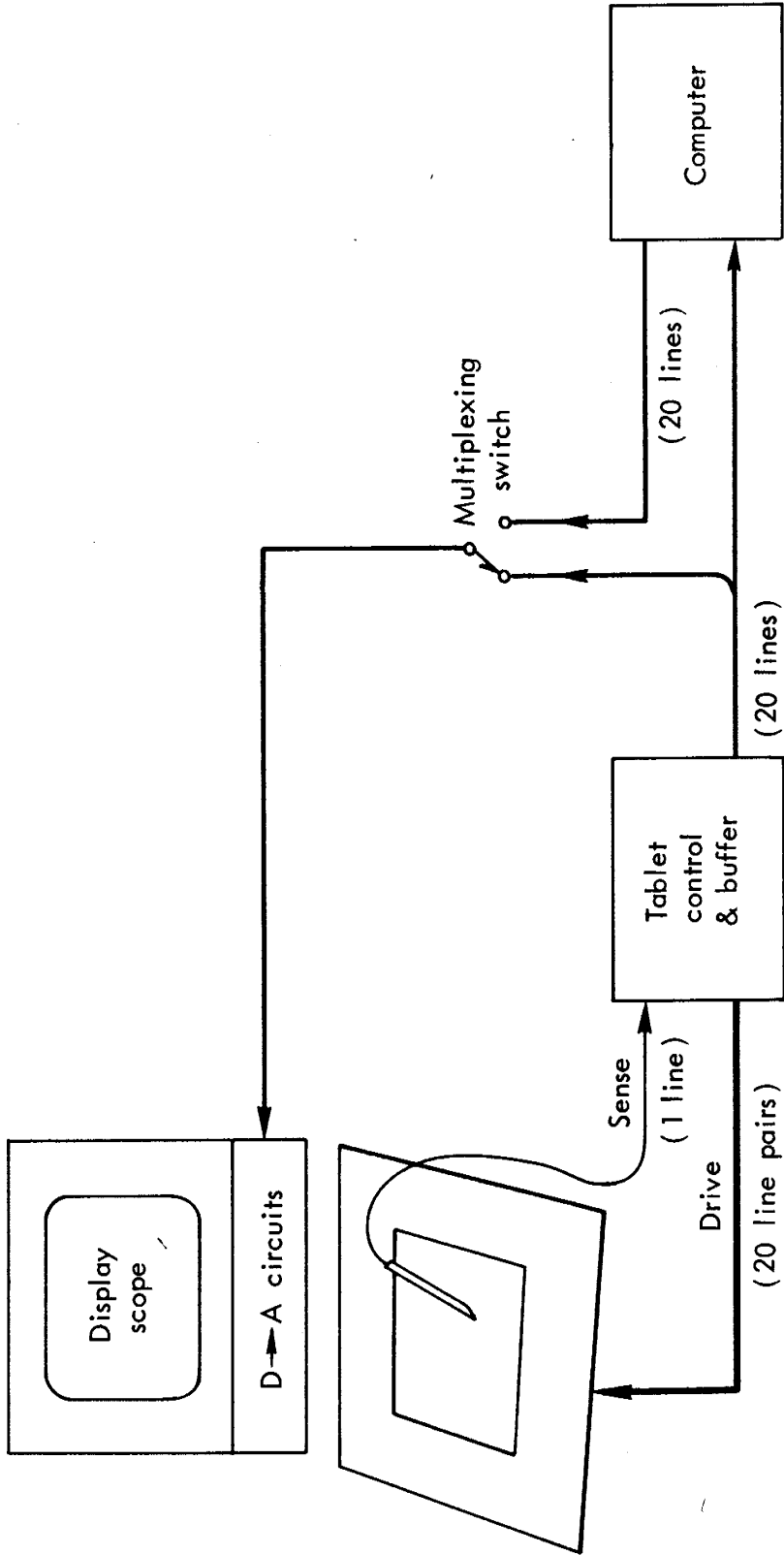

Fig. 10— Information paths in graphic I/O system

The tablet has been found to be particularly valuable in applications where excellent linearity and accuracy are important. Normal-thickness C.G.S. maps have been placed over the tablet to digitize contours by manual tracing with the pen.

Development of the stylus-tablet device has been carried to the point where, we feel, it represents a practical and economical tool for use in many applications. Additional application areas might be served by more development effort in directions such as providing for rear-projection of images onto the (translucent) tablet panel, provision for use of more than one sensing element, extension of the surface dimensions, etc.

BIBLIOGRAPHY

- Licklider, J.C.R., and W. E. Clark, "On-Line Man-Computer Communication," Proceedings 1962 Spring Joint Computer Conference, v. 21, The National Press, Palo Alto, California, 1962, pp. 113-128.
- Loomis, H. H., Jr., "Graphic Manipulation Techniques Using the Lincoln TX-2 Computer," Lincoln Laboratory, Massachusetts Institute of Technology, 516-0017 (U), November 11, 1960.
- Marrill, T., et al., "Cyclops-1: A Second-Generation Recognition System," AFIPS Conference Proceedings (1963 FJCC), v. 24, Spartan Books, Baltimore, Maryland, 1963, pp. 27-33.
- Stotz, R., "Man-Machine Console Facilities for Computer-Aided Design," AFIPS Conference Proceedings (1963 SJCC), v. 23, Spartan Books, Baltimore, Maryland, 1963, pp. 323-328.
- Sutherland, E. E., "Sketchpad: A Man-Machine Graphical Communication System," AFIPS Conference Proceedings (1963 SJCC), v. 23, Spartan Books, Baltimore, Maryland, 1963, pp. 329-346.
- Teager, H. R., Massachusetts Institute of Technology, Private Communication.