

UNCLASSIFIED

AD NUMBER

AD128000

CLASSIFICATION CHANGES

TO: unclassified

FROM: confidential

LIMITATION CHANGES

TO:  
Approved for public release, distribution unlimited

FROM:  
Distribution: Further dissemination only as directed by Naval Ordnance Test Station, NOTS, Attn: Code 7506, China Lake, CA, 01 JAN 1957, or higher DoD authority.

AUTHORITY

31 Jan 1969, DoDD 5200.10; NAWCWD ltr, 9 Jan 2008

THIS PAGE IS UNCLASSIFIED

UNCLASSIFIED

AD \_\_\_\_\_

DEFENSE DOCUMENTATION CENTER

FOR

SCIENTIFIC AND TECHNICAL INFORMATION

CAMERON STATION ALEXANDRIA, VIRGINIA

DOWNGRADED AT 3 YEAR INTERVALS:

DECLASSIFIED AFTER 12 YEARS

DOD DIR 5200.10



UNCLASSIFIED

**AD 28000**

# Armed Services Technical Information Agency

Reproduced by

**DOCUMENT SERVICE CENTER**

**KNOTT BUILDING, DAYTON, 2, OHIO**

This document is the property of the United States Government. It is furnished for the duration of the contract and shall be returned when no longer required, or upon recall by ASTIA to the following address: Armed Services Technical Information Agency, Document Service Center, Knott Building, Dayton 2, Ohio.

**NOTICE: WHEN GOVERNMENT OR OTHER DRAWINGS, SPECIFICATIONS OR OTHER DATA ARE USED FOR ANY PURPOSE OTHER THAN IN CONNECTION WITH A DEFINITELY RELATED GOVERNMENT PROCUREMENT OPERATION, THE U. S. GOVERNMENT THEREBY INCURS NO RESPONSIBILITY, NOR ANY OBLIGATION WHATSOEVER; AND THE FACT THAT THE GOVERNMENT MAY HAVE FORMULATED, FURNISHED, OR IN ANY WAY SUPPLIED THE SAID DRAWINGS, SPECIFICATIONS, OR OTHER DATA IS NOT TO BE REGARDED BY IMPLICATION OR OTHERWISE AS IN ANY MANNER LICENSING THE HOLDER OR ANY OTHER PERSON OR CORPORATION, OR CONVEYING ANY RIGHTS OR PERMISSION TO MANUFACTURE, USE OR SELL ANY PATENTED INVENTION THAT MAY IN ANY WAY BE RELATED THERETO.**

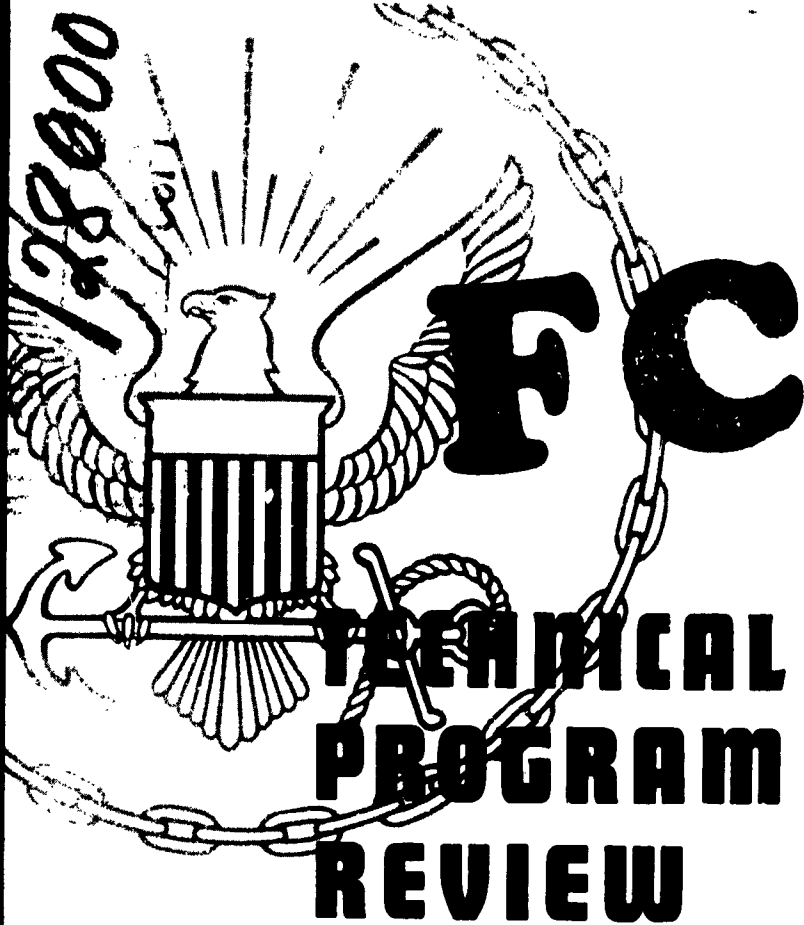

128000

# TECHNICAL PROGRAM REVIEW

# 1956

## CONFIDENTIAL

NOTS 1627

CHAPTER 6. COPY No. 322

This publication has been reviewed in accordance with ORNAVINST 5110.7. The classification shown in abstract is None. UNCLASSIFIED

11 Apr 57 *Sopraine Cash*  
(date)

Technical and Production Department  
U.S. Naval Ordnance Test Station

*Special Restrictions.  
None, beyond those imposed by  
Security Classification plus, need to  
know for subject of Chapter.*

### CHAPTER 6. Propellants and Propulsion for Missiles

## U. S. NAVAL ORDNANCE TEST STATION

China Lake, California

1 January 1957

APR 30 1957

57AA 20651

## CONFIDENTIAL

**NOTICE: THIS DOCUMENT CONTAINS INFORMATION AFFECTING THE  
NATIONAL DEFENSE OF THE UNITED STATES WITHIN THE MEANING  
OF THE ESPIONAGE LAWS, TITLE 18, U.S.C., SECTIONS 793 and 794.  
THE TRANSMISSION OR THE REVELATION OF ITS CONTENTS IN  
ANY MANNER TO AN UNAUTHORIZED PERSON IS PROHIBITED BY LAW.**

## Chapter 6. PROPELLANTS AND PROPULSION FOR MISSILES

### THE YEAR IN BRIEF

**Solid Propellants.** New and improved formulations and processing of propellants suitable for large-diameter missiles have been among the major developments. To meet the propulsion demands for larger missiles, a new double-base propellant, X-14, was evolved; it is high-energy, low-pressure, and fast-burning. Other new propellant formulations include X-13, designed primarily for gas generators and having burning-rate and storage characteristics superior to the original composition; and X-15, a high-energy composition that allows all ingredients to be added to the slurry.

Studies of N-5 propellant were continued, achieving tensile strengths as high as 4,000 psi, increasing super-rate burning through the use of certain polyhydroxybenzophenones, and varying the effect on specific impulse by adding reactive metallic powders such as aluminum. An extrudable ammonium nitrate-nitrocellulose composition, for use in torpedo propulsion systems and other gas generator applications, also was under development. Plastisol nitrocellulose shows promise as an ingredient for an elastomeric propellant.

Heat barrier materials for use with gas generators, long-burning rockets, and air-breathing systems were evaluated and methods for their application developed. The problems of thrust control and command thrust termination in solid-propellant rockets were investigated for the SIDEWINDER and ASROC programs.

In processing solid-propellant grains, particular emphasis was placed on the 12-inch-diameter shell for the ASROC motor. Two successful extrusion

methods were developed and new facilities to accommodate large grains were added. These grains were also built up from propellant segments. Burning rate was increased by extruding solid rods with embedded continuous longitudinal metal wires. Improvements in continuous extrusion-inhibiting methods and in the use of propellant screw-extruders were made. Evaluation processes were refined and new methods developed for more accurate and efficient determination of propellant properties and performance characteristics.

**Liquid Propellants.** Work on the 5.0-inch liquid-propellant aircraft rocket LAR continued, using this unit as a test vehicle for proving out propellants and components for rugged, high-performance systems for rockets and guided missiles. Because of the importance of variable thrust control in liquid-propulsion systems for advanced missiles, particular attention was devoted to possible designs of variable-area injectors and modulating flow control valves. A scaling study was undertaken to provide engineering information on the feasibility of applying the LAR-type motor to larger rockets and guided missiles. A thrust level of 20,000 pounds was attained for 3 seconds at 1,000-psi chamber pressure.

New applications were found for gas generators using liquid propellants, which offered the advantages of permitting long burning time, providing high secondary gas volumes for allowable space and weight, and providing high missile-design flexibility. Design proposals also were prepared for incorporation of liquid-propellant

propulsion systems into new weapons, such as THUNDERBIRD, DIAMONDBACK, and MARLIN.

Studies in liquid propellants and combustion were directed toward ignition delay, thrust variation, and specific-volume impulse. Qualitative comparisons of ignition delays of various propellant systems indicated that ignition delay is not the determinant of relative combustion smoothness. Tetramethyltetrazene and 1, 3-bis(dimethylamino) propane were evaluated as fuels. The latter material proved to be very stable and gave performance equal to dimethylhydrazine in a test motor. Current studies indicate that LAR propellant components may be stored at 165°F almost indefinitely. Thrust variation studies indicated that detailed design of the injector and injector-pressure drop were the critical variables. Under conditions allowing for differences in design factors, tests on liquid and

solid propellants gave comparable results for specific-volume impulse.

**Air-Breathing Propulsion Systems.** Investigations of air-breathing propulsion systems for small air-to-air missiles combining a solid-fuel ramjet with rocket propulsion demonstrated the feasibility of the basic concept. Accelerated launchings of a test vehicle showed smooth transition from the rocket boost to ramjet sustainer phase. Efforts were continued to find a fuel formulation to give improved ramjet performance in the test vehicle; equipment for the necessary burner test facility was designed and procured. Designs for a two-stage nozzle suitable for both booster and sustainer were prepared and tested statically. A tentative design for a ramjet diffuser capable of accommodating a missile seeker system in the central body was being tested.

## SOLID PROPELLANTS

### NEW AND MODIFIED COMPOSITIONS

**High-Strength Propellant N-5.** Composition, nature of the plasticizer, method of formulating, and processing all play a part in determining the strength of the propellant. Currently, modifications of propellant N-5 with tensile strengths as high as 4,000 psi (normal N-5 has a tensile strength of about 700 psi) can be prepared so that the formulation can be reproduced on a small scale. This is accomplished as follows: the diethyl phthalate is replaced with adiponitrile (which exerts a pronounced effect on the tensile strength), the nitrocellulose (NC) content is increased to 55%, the proportion of nitroglycerin is reduced correspondingly, and the formulation is either mixed in an acetone-ethanol-diethyl ether solvent (weight ratio, 2:1:1) and extruded at ambient temperature or mixed in acetone-ethanol (2:1 ratio), partially

dried, and extruded at 140–145°F. Comparable processing of N-5 containing diethyl phthalate and 55% NC gives a tensile strength of about 1,500 psi.

In other investigations, an increase in NC content and a corresponding decrease in plasticizer increased the tensile strength of N-5 propellant except at lower temperatures. At all temperatures the shear strength increased and the elongation decreased.

**Compositions for Super-Rate Burning.** Some factors in the production and development of super-rate burning in mesa propellants have been elucidated. The structure of the high-energy plasticizer has an important effect on the development of mesa ballistics (Fig. 6-1). Compounds with vicinal nitroxy groups are more effective in producing super-rate burning than those separated by three or more atoms; this behavior correlates with

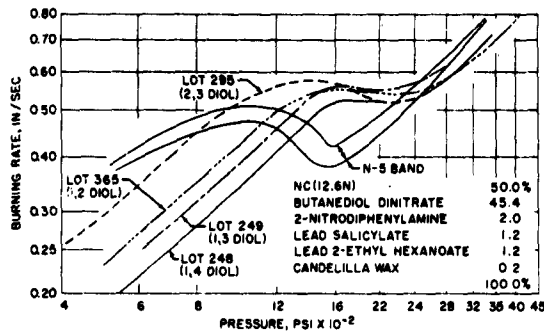

FIG. 6-1. Effect of Substituting Butanediol Dinitrates for Nitroglycerin in the N-5 Formulation.

the relative ease of photochemical or thermal decomposition of such nitrate esters. The differences in reactivity between primary and secondary nitroxy groups can be detected.

Super-rate burning is initiated in the precombustion zone of the propellant by the absorption of radiant energy, and additives have been found that will effectively regulate this absorption. Spectacular and beneficial increases in the mesa-burning rate of N-5 can be accomplished through the use of certain polyhydroxybenzophenones, particularly those with hydroxy groups in the 2,2' positions. The compound 2,2',4,4'-tetrahydroxybenzophenone (related to the organic portion of the ballistic modifier lead  $\beta$ -resorcyate) is typical and is the most effective material so far tested. Treating lead salicylate with eosin (a photosensitizer) also increases super-rate burning.

The hypothesis which was developed to correlate the ballistic performance of substituted lead salicylates with their structure and chemical behavior during attack by  $\text{NO}^+$  or  $\text{NO}_2^+$  has been further tested and confirmed with additional examples. There appears to be a correlation between the relative rate of this electrophilic attack and the kind of propellant in which the catalyst will produce useful mesa ballistics. Thus, compounds which react slowly will be effective only in slower-burning formulations, whereas those which react rapidly will be useful in faster-burning propellants. This generalization also seems to be applicable to modifiers not derived from salicylic acid.

**New Composition for Gas Generators.** A new double-base propellant, X-13, has been designed primarily for gas generators. It utilizes lead oxide and copper oxide as the ballistic modifiers and 2-nitrodiphenylamine and ethyl centralite as the stabilizers and replaces the original X-13 propellant, which contained lead cuprous oxychloride as the ballistic modifier. The strand-burning-rate characteristics are at least equal to those of the original X-13 and far superior to those of X-9 propellant. Preliminary data indicate that this propellant's storage characteristics are far superior to those of the original X-13 formulation.

**X-14 Prototype Propellant.** Search for a high-energy, low-pressure, fast-burning propellant for possible use in large-diameter missiles resulted in the development of a new double-base propellant designated X-14. This propellant contains basic cupric salicylate and basic lead  $\beta$ -resorcyate as the ballistic modifiers. It has an experimental heat of explosion of 1,150 cal/g, a temperature coefficient of 0.2%/°F or less from approximately 600 to 2,000 psi, and a maximum burning rate in the plateau region of 1.18 in/sec at 70°F (Fig. 6-2).

**X-15 Propellant.** A formulation, X-15, has been developed which allows all propellant ingredients to be added to the slurry. It contains basic cupric  $\beta$ -resorcyate and basic lead salicylate as the ballistic modifiers and approximates the strand-burning-rate characteristics of high-energy X-12.

**Aluminized Propellants.** Theoretical calculations on the effect of reactive metallic powders added to double-base propellants gave sufficiently

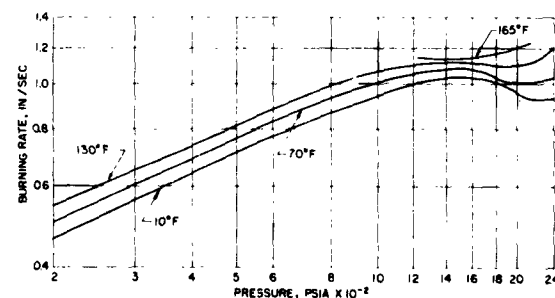

FIG. 6-2. Strand-Burning-Rate Data for X-14 Prototype Propellant.



encouraging results to justify an experimental program to evaluate the specific impulses of high-energy X-12 propellants containing 5 and 15% aluminum powder. The 5% aluminized composition produced an increase in specific impulse of nearly 10% at 1,500 psia, but the increase became almost insignificant at 3,500 psia (Fig. 6-3). Severe nozzle erosion due to the presence of solid metal-oxide particles in the gas stream and higher flame temperature is a potential problem.

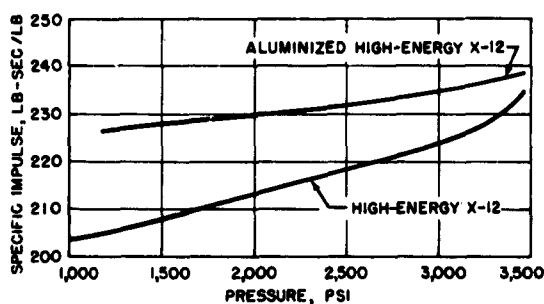

FIG. 6-3. Effect of Addition of 5% Aluminum on Specific Impulse of High-Energy X-12 Propellant.

**Ammonium Nitrate-Nitrocellulose Propellant.** An extrudable ammonium nitrate-nitrocellulose slow-burning propellant for various gas-generator and torpedo applications is under development. Various burning-rate depressors and a polymerizable solvent are being studied to overcome some of the processing difficulties in this system. Nitrocellulose in the binder appears practical and may help to overcome some of the inherent ignition and combustion difficulties.

**Plastisol Nitrocellulose.** Plastisol nitrocellulose, which is nitrocellulose in the form of small (1-100  $\mu$  diameter), dense spheres, is being studied as a key ingredient for an elastomeric propellant. Other ingredients are pentaerythritol trinitrate (PETriN) and a diisocyanate. Results from a sample of plastisol nitrocellulose prepared from a lacquer-grade stock proved sufficiently encouraging to warrant attempts to prepare plastisol nitrocellulose of 12.6% nitrogen content.

Atlantic Research Corp. (Ref. 6-1 and 6-2) has prepared an oil-in-water emulsion of a nitrocellulose lacquer by the use of a dispersing agent and a high-speed stirrer; the lacquer solvent is removed either by low-pressure distillation or by solvent extraction with water.

Difficulty in obtaining a satisfactory shaft seal for the high-speed stirrer prevented success in a number of preparative attempts at NOTS. Solvent extraction by drowning the emulsion in water produced satisfactory particles of 5-40  $\mu$ . Smaller, more regular particles were formed by use of a colloid mill for emulsion formation. These smaller particles tend to form plastisols with reduced pot life.

*Source of Funds. Task Assignments NOTS-W3-2d-16-1-56, NO-101866-63026-01054, NO-101966-63026-02054, NO-101966-63026-04054.*

## APPLICATIONS AND COMPONENTS

**Salt-Coated Ballistic Rods.** Ballistic rods with a plastic-bonded potassium sulfate coating are efficient in suppressing secondary flash of various rocket motors, but they sometimes present serious corrosion problems. Preliminary data indicate that potassium acid phthalate and potassium acid tartrate are as effective as potassium sulfate in suppressing secondary flash and lowering the rocket-flame temperature. The products of decomposition of these salts in exhausts are less corrosive to typical aircraft metals.

**Large-Missile Study.** The increasing emphasis on long-range missiles prompted a study of the effect of design variables on the performance of a two-stage ballistic missile. The variables considered include payload weight and—for each stage—maximum allowable acceleration, propellant specific impulse and density, properties of construction materials, operating pressure, length-to-diameter ratio, cross-sectional loading density, and the relative sizes of the two stages.

**Heat Barriers.** Long-burning double-base propellants and long-burning air-breathing systems require a heat barrier to protect the motor tube. A



FIG. 6-4. Asbestos-Phenolic Heat Barrier After 1.25-Second Static Firing. Note the thickness of the laminate.

liner consisting of long-fiber asbestos impregnated with phenolic resin was applied to the Ram-Air Rocket Engine (RARE). Tube fragments recovered from a major test of the vehicle showed no evidences of burn-through.

A NOTS Model 16A SIDEWINDER gas-generator canister, lined with a glass-epoxy laminate, was successfully fired for an 80-second period. The liner showed only minor deterioration.

A procedure and an apparatus were devised for determining the effect of high-temperature, high-velocity flames on small panels of various asbestos-reinforced plastic combinations.

Special methods were developed for applying the barriers. Motor tubes are lined by first wrapping the phenolic-impregnated asbestos felt around an inflatable rubber mold, which is itself mounted around a pipe. The motor tube is slid over the wrapped mold and the whole assembly rotated to unwind the felt from the mold onto the tube. The rubber is slightly pressurized and the contact tightened. Radiant heaters then cure the liner at 330°F for 30 minutes.

A new method was developed for laminating the SIDEWINDER canister. The resin-impregnated glass cloth is cut to length, inserted

in the canister, and unrolled against its wall. Then a flexible polyvinyl chloride casting of diameter slightly less than that of the canister is wrapped in a sheet of Mylar, inserted in the lined canister, and placed under compression. When the whole assembly is baked for one hour at 300°F the casting expands and firms the glass cloth against the canister wall.

**Thrust Control.** Two methods were studied for command control of the burning of end-burning solid-propellant charges: (1) control of the axial propagation of burning by the rate of withdrawal of liquid inhibitor from longitudinal holes in the charge; (2) subsurface ignition of the propellant by a cascade of wire filaments embedded along the axis of the charge and connected to an electrical power source so that the switching rate in the circuit determined the rate of propagation of the charge.

An analysis was made of the effect of propellant-burning characteristics (particularly pressure exponent) on the performance of command thrust control with solid propellant.<sup>1</sup>

<sup>1</sup> U. S. Naval Ordnance Test Station. *Effect of Propellant Burning Characteristics on Command Thrust Control of Solid Propellant Rocket Motors*, by E. W. Price. China Lake, Calif., NOTS, 10 September 1956. (TECH NOTE 5014-8.)

**Variable-Thrust Solid-Propellant Motor.**

Work was begun to determine the feasibility of varying the thrust of a solid-propellant motor by means of varying the throat area of the nozzle. The greatest thrust variation is obtainable with a propellant that has a high-pressure exponent,  $n$ , in the equation  $r = Cp^n$ . Calculations indicate that with an exponent of 0.85, a thrust variation of approximately 10:1 is possible.

**Thrust Termination.** Range control of a ballistic missile depends upon a method of thrust termination upon command from the inertial guidance system. Two schemes for extinguishing the propellant grain have been tested experimentally with favorable results: blowing off the motor nozzle as is commonly done in studies of partial burning, and introducing rapidly an inert liquid which will cool the propellant gases below the combustion limit.

**Ignition Studies.** Black powder-magnesium, magnesium-Teflon, and potassium nitrate-magnesium gave the best performance characteristics in test firings at 65°F with N-5, X-9, and X-11 propellant grains. Initial tests have been conducted with the 2.0-inch experimental rocket motor. Since the rocket motor and the ignition test bomb use the same igniter assembly, extremely good correlation should be possible between rocket-tube and closed-bomb data.

Test firings to correlate igniter shock with propellant-grain fracture were completed. A steel 2.75-inch static-firing rocket-motor tube was modified to accept the controllable igniter assembly in addition to the standard (Mk 43) production grain.

The study of the basic properties of igniter pyrotechnic materials includes investigation of linear burning rate, energy output, pressure output, rate of energy output, flame temperature, and combustion-product compositions. To study linear burning rates, two strand dies were designed and fabricated to press igniter pyrotechnic mixtures into solid strands similar to those used in determining burning rates of propellants: one to press igniter materials into miniature strands and the

other to form strands with wires running crosswise through them.

Squibs containing black powder were found to be unsatisfactory in igniting solid pellets and strands of metal-oxidant material because of their short flame duration and high brisance. A number of metal-oxidant compositions were substituted to develop an initiator material with low brisance and long-duration output. The pyrotechnic composition which gave the best results contained lead dioxide, magnesium, and zirconium. The majority of the metal-oxidant compositions greatly surpassed the black powder in flame volume, duration, and flame temperature.

*Source of Funds.* Task Assignments NOTS-S3-3e-544-1-56, NOTS-W3-3e-565-1-56, NO-520226-61006-02054, NO-000283-31001-01054, NO-101866-63026-01054, NO-101966-63026-05054, NO-101966-63029-01054; Local Project 701.

## PROCESSING METHODS AND FACILITIES

### Production Machinery

**Machining Tapered Grains.** The practicality of using production-type techniques to machine tapered grains was successfully demonstrated on the prototype production machine.

**Production-Type Spiral-Wrap Inhibiting Machine.** The production-type spiral-wrapping machine will now inhibit propellant grains up to 5 inches in diameter at the rate of 75 grains per hour.

**Production-Type End-Trimming Machine.** After extensive modifications, mechanical operation of the production-type end-trimming machine for cutting propellant grains to length was satisfactory. The GIMLET propellant grain was used as a test vehicle. An intensive study of cutter designs, feed-speed ratios, and cutter action was conducted to obtain a satisfactory obturating surface on the plastic end-inhibitor.

The machine was modified to permit the handling of 5.0-inch propellant grains. Preliminary tests to determine end-surface-finish acceptability were made. It was found that the Varidrive units

powering the cutter heads had to be converted to a lower rpm to obtain satisfactory finishes on the end inhibitors of these large-diameter grains.

**Tooling for Machining ASROC Grains.** A 16-inch-swing Monarch lathe was adapted for machining ASROC propellant grains. Development work is essentially complete on a boring head carrying a number of cutting tools that will reduce interior machining time by a factor of 12.

### Extrusion Equipment and Facilities

**Extrusion of Large-Diameter Grains.** Two methods were developed for extruding a propellant grain blank having an outside diameter of approximately 12 inches and an inside diameter of  $7\frac{3}{4}$  inches. In the first method, a die assembly was used to form an 8-inch-diameter grain containing a 3-inch round perforation. The assembly then expanded it to the desired diameter by use of an enlarged section in both stake and die. The resulting grains were of excellent consolidation, but it was difficult to maintain a sufficiently straight product because the extremely long stake was too flexible to resist the uneven flow of the propellant.

In the second approach, a breaker plate together with a short stake and a die with a slightly expanded section to provide additional working of the powder improved the consolidation. (The breaker plate is 6 inches thick and contains 13 holes of 2-inch diameter.) The stake was suspended directly from the breaker plate. There were only minor difficulties in extruding usable N-5 propellant grain blanks with 12-inch outside diameters.

**Extrusion of Wires in Propellant.** Static firing of one grain containing a single 0.006-inch diameter copper wire and one containing silver wire showed a material increase in consumption rate. A device was developed that permitted the extrusion of a 1.750-inch-outside-diameter solid rod containing either one centrally located wire or up to seven equally spaced wires.

**Extrusion-Coat Inhibiting of Tapered Grains.** A production method was developed for extrusion-coating tapered propellant grains with

ethylcellulose at a rate of 90 grains per hour on a  $2\frac{1}{2}$ -inch plastic extruder. In order to extrude more plastic onto the tapered portion at the nozzle end of the grain, thus maintaining a constant outside diameter over the entire grain length, a special mandrel and a double-land die were designed. The mandrel design provided a reservoir for extra plastic required at the tapered end of the grain.

**Balanced-Flow Crosshead Extrusion Inhibiting.** A balanced-flow crosshead in which the forming die is not adjusted was designed to eliminate the frequent adjustments required on the standard crosshead to assure an even inhibitor coat. Close tolerances of the mandrel and forming die ensure concentricity of the inhibitor with the grain within tolerances typical of machined parts.

**1.0-Inch Propellant Screw-Extruder.** Studies of the versatility of screw-extruders for the production of propellant grain blanks were directed toward determining grain-size limits from an extruder of given bore, and toward determining the extrudability of various propellant-powder types.

In the extrusion of relatively large-size grains, solid rods with a 1.5-inch outside diameter and perforated grains with a 2.5-inch outside diameter and 1.75-inch inside diameter were produced (Fig. 6-5). Several 2.0-inch grains produced and

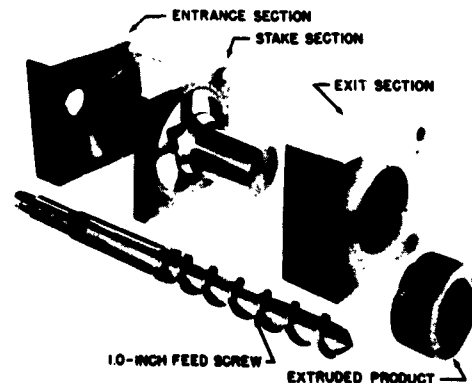

FIG. 6-5. Extrusion Die Used To Produce the Large Perforated Grain and a Sample of the Product. A 1-inch-diameter feed screw is shown for comparison.

tested compared favorably with ram-press-extruded grains. N-4 and N-5 propellants, and X-6, X-8, X-9, X-10, and X-12 formulations have been extruded successfully.

The ability to extrude grains to a desired size within close tolerances has been demonstrated. The relatively simple die designs required for screw-extruders may allow the continuous extrusion to size of special shapes (segmented grains). Die designs are being prepared.

**4.5-Inch Propellant Screw-Extruder.** Development work during the past year has been primarily directed toward the extrusion of acceptable Mk 43 grains. Two possible adverse effects are ripple and twist in the internal perforation of the grain (Fig. 6-6). Through refinements in die design, twist was reduced in the Mk 43 grain to less than 6 degrees per grain length, and ripple was reduced to less than 0.0005 inch. Mk 43 grains having twist of approximately 30 degrees per grain length and ripple of 0.010 inch were static-fired at 70°F with normal results.

**Reactivation of the 18-Inch Vertical Ram Press.** The trend towards larger grains made advisable reactivation of the 18-inch vertical ram press as a backup tool for the 12-inch press and as a

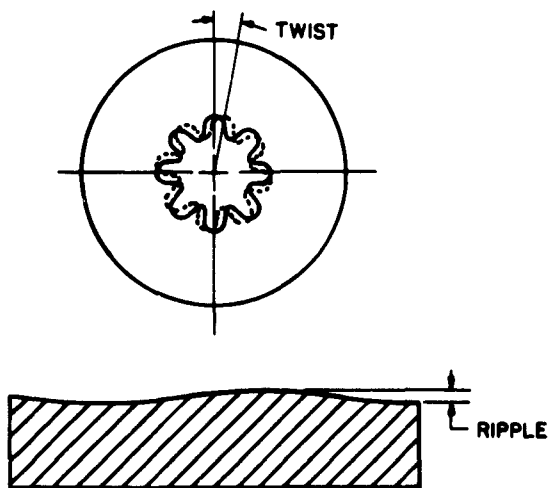

FIG. 6-6. Pictorial Representation of Twist and Ripple in the Screw-Extruded Mk 43 Grain.

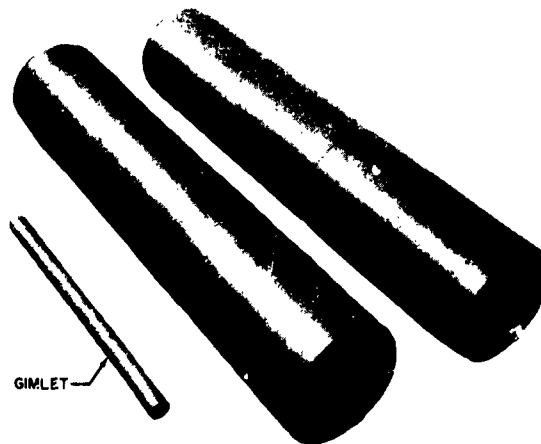

FIG. 6-7. ASROC Grain Extruded From the 12-Inch Ram Press. A 2-inch GIMLET grain is shown at the left for comparison.

stand-by for jobs too large for equipment now in operation at NOTS. A refined vacuum system and an improved grain receptor were incorporated. Extrusion dies were fabricated to produce the ASROC shell in the event that the 12-inch ram press should prove inadequate for this job.

**Composite-Propellant-Preparation Facility.** This facility, capable of producing batches of 15 to 20 pounds of propellant, is being designed to handle several composite types.

*Source of Funds. Task Assignments NOTS-W 3-2d-5-3-56 and NO-101966-63026-03054.*

## TEST AND EVALUATION

**Viscoelastic Properties of Nitrocellulose.\*** The creep behavior of nitrocellulose at small stress is exactly like that of metals. Behavior like that of the more amorphous polymers such as polyisobutylene had been anticipated.

**Propellant Stability Studies.** A study of the kinetics of propellant decomposition was initiated to obtain a simple and workable method of attacking the problem of propellant stability from a more quantitative standpoint. Modified Warburg apparatus was used to obtain data for the study.

\* The material under this heading is UNCLASSIFIED.

N-5 propellant was tested at a variety of temperatures. An apparent activation energy of 47 kcal/mole calculated from the data agreed closely with literature values for nitrocellulose and nitroglycerin. Other studies, using uncatalyzed propellant and mixtures of the standard N-5 propellant, and materials known either to increase or decrease propellant stability, determined that the test method could distinguish between propellants of various degrees of stability.

**Micromotor Propellant Evaluation.** The micromotor is a small test chamber developed for evaluating the ballistic properties of propellants through static firing. It uses a rod-and-shell configuration (see p. 174) for the propellant grain instead of an internal-external burning grain so that the hot gases from the burning grain are not in direct contact with the tube walls until the grain

is consumed. This results in a minimum loss of energy from heat radiation and a more accurate determination of the specific impulse. The propellant used in the micromotor weighs about 85 grams.

**Closed-Bomb Propellant Evaluation.** Investigation of an experimental method for determining the approximate specific impulse of propellants indicated good correlation with actual motor-firing determinations of specific impulse (Ref. 6-3). In this method, finely ground propellant is placed in a constant-volume bomb and ignited with a hot wire. The maximum pressure produced is used to calculate the specific impulse. A propellant sample size of 3 to 5 grams is required.

**Fluoroscopic Inspection of Rocket Motors.** To reduce the large X-ray film budget for radiography, a fluoroscopic method was introduced for

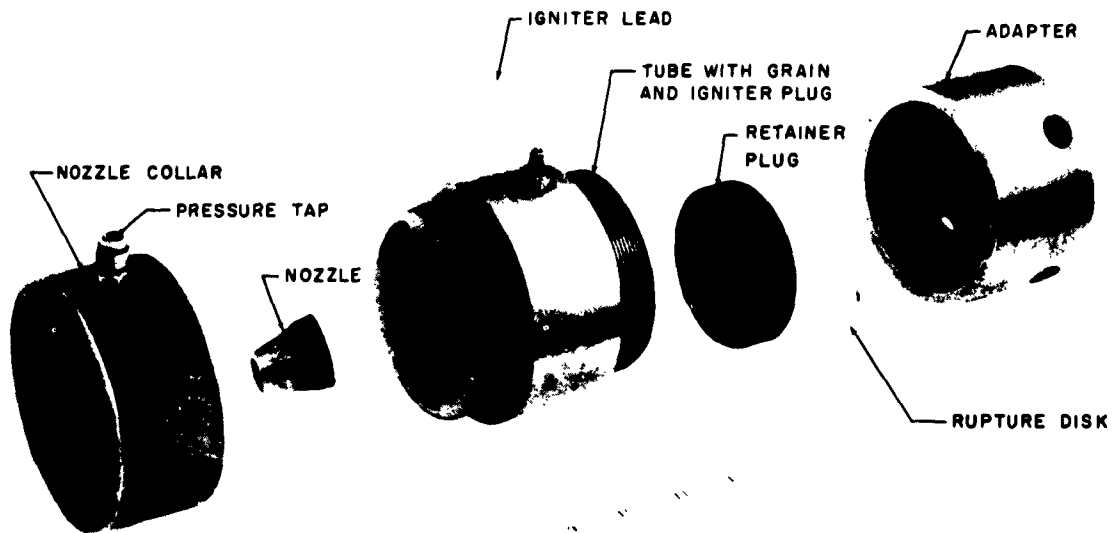

FIG. 6-8. Unassembled Micromotor Parts. The micromotor, weighing 85 grams, is used for ballistic-property evaluation.

internal inspection of end closures of 5-inch rocket motors such as SIDEWINDER propulsion unit (SPU) and the 5.0-inch general-purpose folding-fin aircraft rocket (ZUNI).

A filmless method applying X-rays as radiation source and cadmium selenide crystals as detectors was developed for the detection of O-rings on igniters of 2-inch rocket motors and for the inspection of fuzes for armed or safe condition.

**Flash Detector.** A phototransistor unit was devised to replace an existing photoelectric-cell detector for use in observing more accurately the intensity and duration of the visible flash produced by a static-fired rocket motor. The advantages of this device are lower voltage requirements (1½ volts); higher output; and reduced size, which makes it suitable for use on aircraft launchers.

**Gaging for Propellant Grains.** Numerous gages must be developed for solid-propellant grains produced by mass-production techniques and equipment.

*Two-Spot End-Angularity Gage.* This system incorporates a fixed reference foot, two gaging feet that contact the end face of the cylindrical object to be gaged, and a means of aligning the gage with the longitudinal axis of the object. It is particularly useful for the gaging of large bulky objects that cannot readily be moved.

*SPU Length-and-Angularity Gage.* Variations from a standard length and angularity are indicated on a dial as the SPU grains are rolled off the dowel-rod machine apron. This gage has a parallel-bar head and end stop.

*SIDEWINDER Gas Generator Unit (SGU) Length-and-Angularity Gage.* A gage with dial indicator, V-block jig with right-angled fixed stop, and right-angled movable stop has been developed for these measurements on the SGU NOTS Model 7E grain. Firing tests of 20 grains showed that end angularities are not an important defect.

*Contour-Gaging for Shaped Charges.* Accurate determination can be made of contour radius as a function of height or vice versa. A circular mounting disk permits precise location with respect to a

V-base; vertical and horizontal rectangular reference members with feeler bars are rigidly positioned on the base; and a special gage foot makes contact with the contour.

*Gaging for ASROC.* Special designs or modifications of existing gages are required for both the shell and cruciform grains. The end-angularity gages use the two-spot dial indicator system. A radius gage has been designed and fabricated that shows indirectly the location of the hole in the cruciform in relationship to the ribs, and directly the radius of each rib. Designs have been completed for dial-indicator bore gages.

*Kneecap Gage Foot.* A new foot developed for use on soft or porous curved surfaces has two advantages: the large radius curve on the almost flat foot distributes the contact force over a relatively large area, minimizing deformation, and accurately locates a well-defined point without the need for computing correction factors.

**Digital Internal-Ballistics Analyzer.** The Digital Internal-Ballistics Analyzer (DIBA) has been used to provide and record ballistic data on 6,000 individual tests. The DIBA system is used on nearly every rocket motor undergoing a static test firing—accurate and quickly available data were obtained for GIMLET, MIGHTY MOUSE, ZUNI, SIDEWINDER, and ASROC, as well as for several research projects. Electronic service and maintenance of the DIBA have proved to be minor problems.

A new facility was set up for testing small ordnance items such as squibs, igniters, and gas generators. Photocell pickups and timers, test stands allowing photographic coverage, pressure and vacuum cycling vessels, and oscillograph recorders were installed.

**New Test Equipment.** Designs were completed and contracts let for the procurement of a force-pressure ratio instrument that will provide computed ratios in digital form as a test motor is fired, and for an integral computer that will provide a triggering signal on the basis of an integration of either thrust or pressure.

**T-Range Instrumentation.** A Doppler digital data-recording system to be integrated with the AN/TPS-5 radar at T-range has been designed and a contract let for procurement. In addition to velocity-time curves recorded on oscillograph paper (which now require further hand assessment), data will be recorded in printed digital form.

**Vibration Testing.** To improve the physical and environmental test facilities, alterations of the vibration-testing building were continued. A humidity-controlled oven to accommodate the larger grains has been added. The oven, 7 by 8 by 14 feet and operating at  $-100$  to  $+200^{\circ}\text{F}$ , contains a 2,000-cps,  $\frac{1}{2}$ -inch displacement electromagnetic vibration table with 3,500-force-pound capacity. It is currently undergoing operation checks. A Hycon Vari-g unit for controlled acceleration firing tests on small ordnance such as SIDE-WINDER gas-generator units has been procured.

**Surveillance of Rocket Motors.** Studies of aging in ethylcellulose inhibitors of internal-burning grains and of scaled-down models of the grains have yielded temperature-dependence data of plasticizer migration between propellant and inhibitor. The information was applied to accelerated aging techniques for grains now being used in weapons under development at NOTS.

The ultimate level of plasticizer exchange to be expected in magazine storage was investigated. The saturation value at  $95^{\circ}\text{F}$  was selected as maximum value, representative of plasticizer migration under field conditions. Plasticizer migration in grains enclosed in motor tubes and exposed to summer sun while resting on desert sand did not significantly exceed the selected maximum value.

Excessive plasticizer migration developed after storage at  $130^{\circ}\text{F}$  or above, beyond the equivalent time for  $95^{\circ}\text{F}$  saturation. The grains stored at higher temperatures were found to crack during temperature cycling; those with no more than the normal  $95^{\circ}\text{F}$  level of exchange could withstand the cycling treatment.

Small-scale migration studies showed that both the migration time and the migration equilibrium could be approximated at temperatures between 70

and  $165^{\circ}\text{F}$  by the Arrhenius relationship. The highly volatile solvent, which is known to accelerate migration, was omitted in the model because frequent sampling made it unfeasible to introduce and maintain the exact quantities used in the spiral-wrapping process of the full-size grain. Therefore, the direct application of the small-scale data to the rocket grain, using a dimensional factor, was not successful.

Gas-generator grains were tested in canisters at  $130^{\circ}\text{F}$  for 90 days without failure, but after 30 days' storage at  $165^{\circ}\text{F}$  internal gassing caused the grains to crack. This treatment is more severe than required for service use but points toward certain limitations for end-burning grains of this type.

To test resistance to cook-off, N-5, N-4, X-8, and X-9 propellant grains have been held at  $240^{\circ}\text{F}$  for periods as long as 40 hours without deflagration.

*Source of Funds. Task Assignments NOTS-W3-2d-5-1-56, NOTS-W3-2d-16-1-56, NO-101966-63026-03054, NO-101966-63026-04054; Local Projects 854, 943, 991.*

## GRAIN DESIGN AND PREPARATION

**Support Tube for ASROC Grain.** The ASROC propulsion unit consists of a cruciform grain centered in a tubular shell grain. An axial metal rod or tube was cemented in the grain by potting with the polyester inhibiting formulation used as a peripheral inhibitor on gas-generator grains. Calcium carbonate was substituted for potassium sulfate as the inert filler in the potting mixture. Experimental equipment was designed to produce 12 grains a day.

**18-Inch Diameter Grain Cluster.** Preliminary studies showed that a 19-grain cluster of internal-external-burning tubular grains, 22.4 inches long, would be suitable for a proposed 18-inch-diameter propulsion system requiring a total 45,000-lb/sec impulse and a maximum 1.7-second burning time. A relatively large surface area and a thin web allows the use of slow-burning propellants and low operating pressures.



**Segmented Charge.** The ASROC tubular shell grain was selected as a test vehicle to determine the feasibility of building up large-diameter charges from double-base propellant segments. Twenty-four segments were machined from extruded solid billets of N-5 propellant (Fig. 6-9). The segments were bonded together with ELBA solvent. Static firing at 70°F showed smooth thrust and pressure lines.

**Case Bonding.** Two successful techniques were developed for case bonding propellant grains in motor tubes: (1) Coat the outside of the grain with a silicone elastomer and brush on a light silicone oil to destroy temporarily the adhesiveness of the elastomer and to act as a lubricant. The silicone oil is absorbed into the elastomer, leaving the surface oil-free and normally adhesive. (2) Cool the elastomer-coated grain by placing it in

dry ice. The grain shrinks and the elastomer loses its adhesiveness so that the grain can be inserted into the tube. At normal temperature the grain expands and the elastomer regains its adhesiveness.

Tests have proved that case-bonded rockets can be fired successfully at initial temperatures from 70 to 165°F. Work is continuing at subzero temperatures where difficulty was encountered because of grain shrinkage.

**Rod-and-Shell Grain.** This neutral-burning grain can have a very high loading density and negligible sliver loss if secondary effects, such as erosive burning, are ignored. In a modified grain designed for use in a sequence-charge sustainer, a propellant rod and shell were connected at the head end of the grain to a propellant disk equal in thickness to the shell. This disk was added to prevent premature ignition of the adjoining grain and igniter. The grains are separated by thin plastic disks.

**Annular-Shaped Grain for Gas Generators.** Static-firing tests of circumferentially burning annular X-9 propellant grains have shown that the burning surface assumes a stable shape. Because considerable difficulty has been experienced with heat transfer back to the propellant grain from the heated metal chamber, new grain-chamber design was developed to provide more heat insulation and a simplified gas-flow path so that less heat is transferred to the metal parts.

*Source of Funds. Task Assignments NOTS-W3-2d-5-3-56, NO-101866-63026-01054, NO-101966-63026-03054, NO-101966-63026-04054.*

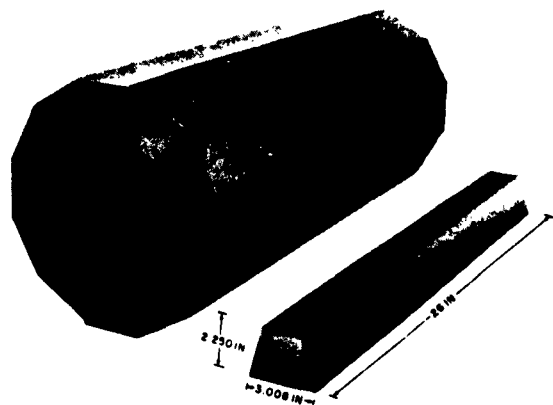

FIG. 6-9. Half-Length Segmented Tubular Shell Grain (left) and Single Segment (right). The full grain consists of twenty-four segments.

**LIQUID PROPELLANTS**

The objective of the liquid-propellant program is to develop the technology of liquid propellants and liquid-propellant propulsion systems for rockets

and guided missiles. The work is oriented to rugged, practical, high-performance systems. Throughout the course of this program, the approach has

been taken that the only practical means of evaluating the results of scientific and engineering studies in this field is to develop and test a flight vehicle of potential suitability as a service weapon. In keeping with this philosophy, work was started in 1950 on the 5.0-inch LAR. Technical progress on the LAR is reported, along with the results of supporting and supplementary investigations in the areas of propellant evaluation and combustion, components for liquid-propellant propulsion systems, and design studies of systems for proposed new weapons.

### LIQUID-PROPELLANT PROPULSION TEST VEHICLE (5.0-INCH LAR)

The LAR design differs radically in many ways from liquid-propellant propulsion units currently recognized as conventional. It involves no pumps, valves, or plumbing in the usual sense. Its tank closures and opening mechanisms, though not mechanically complex, allow the loaded motor to more than meet stringent service requirements for resistance to damage from transportation and handling. The motor can be loaded with liquid propellants at the assembly plant by automatic machines and then stored ready for use. Preparing a round for action requires no more than attaching the warhead and fuze to the motor. These characteristics of the LAR, together with its performance as a short-burning-time aircraft rocket for use with VT fuzes against short-range targets, demonstrate the practicality of liquid-propellant propulsion for small service rockets. The LAR concept promises to extend successfully to larger rockets and to guided-missile propulsion systems.

During 1956, the LAR program had three major goals: completing the fabrication and testing of Model 502A (Lot 8) motor; completing most of the fabrication and testing of the Model 502B (Lot 9) motor; and incorporating the necessary production changes to insure uniform performance and reliability.

**Experimental Production.** Six hundred of the motors scheduled for manufacture were completed

by 1 December 1956: 340 Lot 8 motors (with low-freezing hydrazine-ammonium thiocyanate solution, HT-32, for fuel and inhibited red fuming nitric acid); and 260 Lot 9 motors (with dimethylhydrazine, DMH, for fuel and inhibited red fuming nitric acid). Of the 340 Lot 8 motors, 122 were delivered in 1955 and 218 during the first four months of 1956. These motors were produced in comparatively small groups of no more than 100 rounds each, to permit thorough study and allow for changes in injector-hole size, propellant-loading ratio, and other adjustments that require data from flight tests.

Tests of Lot 8 motors led to several changes in the Lot 9 motor. The design of several mating parts was modified to improve the quality and ease of making welds; two expensive threading operations were eliminated; variation in oxidizer preflow was prevented by redesigning the oxidizer-tank rupture groove; the grain-tube stop spring, which controls the opening of the oxidizer tank, was improved; and the aluminum grain tube was protected by lining its interior with a thin-walled steel tube.

Testing also showed that the graphite exhaust-nozzle insert and the stud-welded fin pins used in early units were not satisfactory. When efforts to make these parts acceptable proved unsuccessful, new methods and materials were found. Sections of compression-molded fiber-glass-reinforced phenolic-base plastic held up well in the throat of a static-firing version of the LAR. The Lee Deane Products Co. contracted to mold this plastic as an integral nozzle and liner that would be machined to exact dimensions and then inserted in the combustion chamber. Molding the plastic directly into the combustion chamber proved more practical, however, because a molding eliminated costly machining and covered and held the press-fitted fin pins (serving the purpose of the previous stud welds). The mandrel that molds the nozzle and liner into the chamber proved difficult to retract once the molded parts were made. The Western Radiation Laboratory has contracted to make and test vibration equipment that will induce the mandrel to retract easily. The equipment will

employ frequencies of 500 and 20,000 cps and will have two transducers, each drawing 1 kilowatt. Figure 6-10 shows the sectioned chambers in interim use, with the nozzle insert molded to an asbestos-phenolic liner.

**Test Program.** The program of static and flight tests started in December 1955 continued. Preliminary tests of Lot 8 motors demonstrated that unsymmetrical-dimethylhydrazine (DMH) could be used successfully in the Lot 9 LAR's. This

planned change in fuel made it advantageous to use the Lot 8 LAR's to obtain basic information on internal ballistics. Tests showed that the operation of a number of components needed further study because motor functioning varied with minor changes in them. These problems were solved, and rounds ground-fired (2,250-foot altitude) at  $-65$  and  $165^{\circ}\text{F}$  gave average velocities of 2,280 and 2,300 fps, respectively. The average burning times for these rounds were 0.737 second at  $-65^{\circ}\text{F}$  and

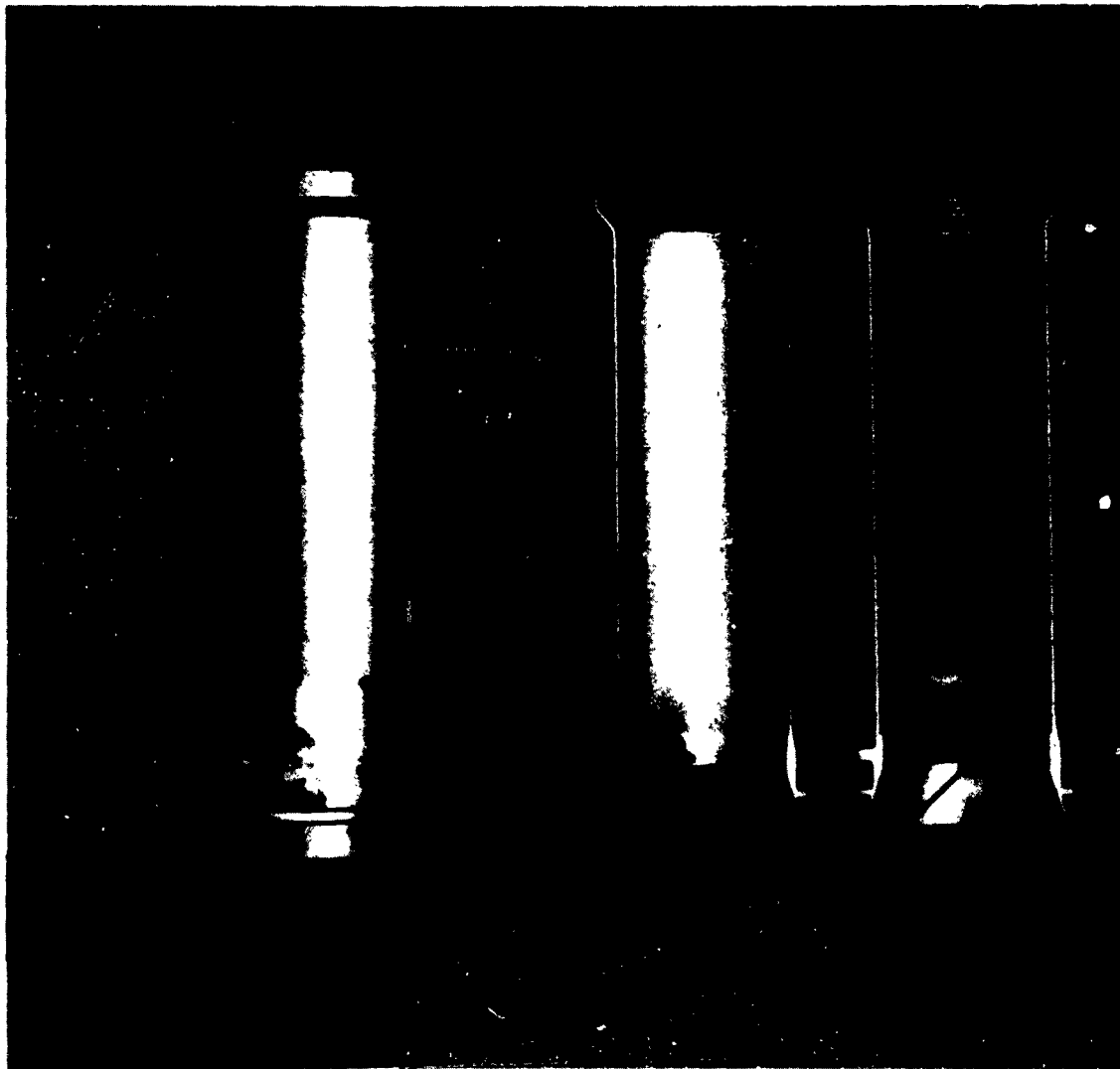

FIG. 6-10. Sectioned Liquid-Propellant Propulsion Test Vehicle (LAR) Combustion Chambers With the Nozzle Insert Molded to an Asbestos-Phenolic Liner.

0.676 second at 165°F. Subsequently, the burning time has been reduced. Ten rounds stored for 30 days at 130°F operated normally when field-fired at this initial temperature, with no apparent degradation of operation or performance.

Delivery of Lot 9 motors was stopped after 260 had been delivered, because motors were failing in field tests. In a number of the first motors flight-tested, the fuze housing failed at the radius of the thread relief. These failures were traced to machining error. Other motors failed due to hard starts, and methods are being studied to overcome this problem. New chamber-lining materials are also being investigated to prevent failure of the liner from the temperature and pressure shock during ignition. After testing of the latest sub-lot in process of manufacture, production on the balance of 900 rounds should proceed normally. Although the Lot 9 LAR contains 2 pounds less propellant than the Lot 8 LAR, both achieved the same burnt velocity of almost 2,300 fps when ground-fired at 2,250-foot altitude.

Table 6-1 shows the progress made in the development of the LAR.

TABLE 6-1. WEIGHTS AND MEASURED PERFORMANCE OF LIQUID-PROPELLANT PROPULSION TEST VEHICLE (LAR)

Initial motor temperature, 70°F; round length, 109 inches.

Item	Lot 4	Lot 7	Lot 9
Total wt., lb	137	137	121
Propellant wt., lb	42.8	39.4	30.4
Burning time, sec	0.5	0.55	0.6
Burnt velocity*, fps	2,000	2,400	2,300
Specific impulse, lb-sec/lb	175	232	243
Motor performance index	84	103	108

\* Ground-fired at 2,300-foot-altitude (m.s.l.).

**Igniter.** A new igniter for the LAR consists of pelleted boron-potassium nitrate ignition mix enclosed in a 0.060-inch-thick case made of either ethylcellulose or high-impact polystyrene, with the lid solvent-sealed to the case. This new igniter pro-

duced very satisfactory pressure traces when test-fired at -65°F in a LAR grain-test unit with a 2.0-inch grain of X-11 propellant.

*Source of Funds, Task Assignments* NOTS-W3-2d-33-1-56, NOTS-W3-3e-541-1-56, NO-101966-63027-01054; Local Project 866.

## PROPULSION STUDIES

### Thrust Control

Liquid propellants are especially suited to the programming and control of thrust because changes can be effected through changes in flow rate rather than burning rate. A program of applied and engineering research was begun to provide a fund of background information for the design of systems for the control of thrust. Attention is being given to both pressure-actuated flow-control valves and pressure-actuated variable-area injectors. Because the technology of flow-control valves is relatively advanced, engineering studies of these devices are being conducted in order to incorporate them into test-motor systems at an early date. Variable-area injectors, on the other hand, are considered to be more remote with respect to application, and require considerable applied research to advance them to the engineering-study stage.

**Thrust-Control Valves.** Thrust control can be obtained in a liquid-propellant rocket motor by means of a valve that modulates the propellant flow to the injector. This valve (Fig. 6-11) was designed to meet specifications of the proposed DIAMONDBACK system. It not only modulates flow to give continuous thrust variation, but provides a very large boost-propellant flow before switching, upon command, to the modulated sustain flow. Control of all valve operations is obtained by means of variable pressure acting against a control piston.

**Variable-Area Injectors.** Two experimental models of variable-area injectors have been fabricated (Fig. 6-12 and 6-13). Motors are being modified to incorporate them, so that concurrent studies of the mixing patterns and combustion characteristics peculiar to each type of injector can be made.

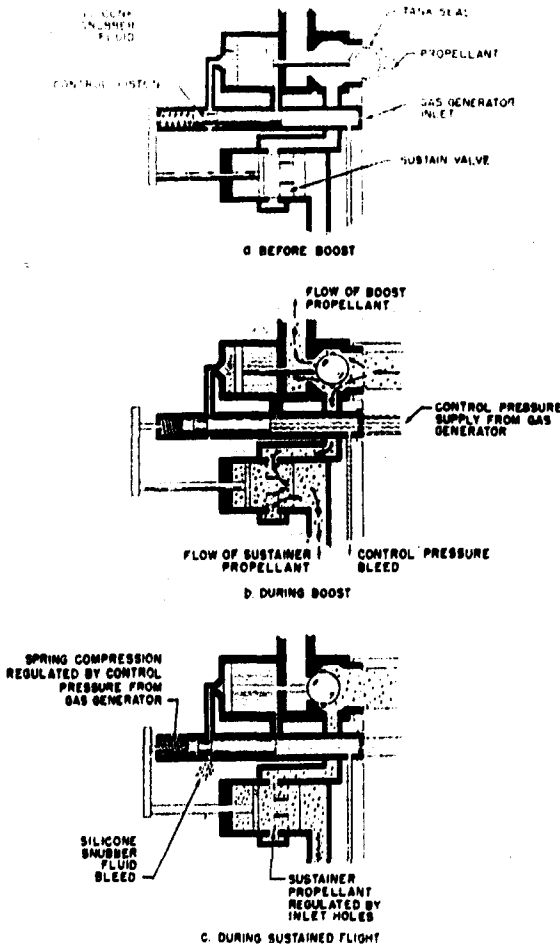

FIG. 6-11. Operation Sequence of a Liquid-Propellant Rocket-Motor Valve. This valve modulates flow to give continuous thrust variation.

**Scaling Study**

With demonstration of the practicality of the LAR as a propulsion system for small aircraft rockets, a study of scaling factors was undertaken to determine the feasibility of applying the LAR-type motor to larger rockets and guided missiles. The basic concept and principles of operation of the LAR were incorporated into this program, utilizing the specifications of a proposed missile, THUNDERBIRD, as intermediate goals.

A static motor composed of chamber, injector, and accessory equipment was designed and con-

structed, several test firings were completed. This motor was designed to deliver 20,000 pounds of thrust for 5 seconds at a chamber pressure of 1,000 psi. A thrust level of 20,000 pounds was attained for 3 seconds at 1,000-psi chamber pressure. The instantaneous specific impulse of this system has been shown to be 245 lb-sec/lb. The burning time has not been increased beyond 3 seconds because the erosion of the injector and grain orifice plate at the forward end of the chamber has been very severe. However, it is anticipated that this problem can be overcome by slight design and material modifications. Future static firings will be aimed at increasing the burning time and testing new materials and heat-resistant coatings to decrease weight.

**Gas Generators**

The liquid-propellant gas generator permits long burning time, provides high secondary gas volumes for allowable space and weight, and provides high missile-design flexibility.

New applications were found for gas generators in which the chamber pressure is not controlled by flow of gas through a nozzle as in conventional applications. A generator was designed to expel liquid propellants from tanks in the DIAMONDBACK missile by collapsing a metal diaphragm. A design proposal was prepared for a liquid-propellant gas generator to operate the engine and accessories powering a torpedo. By utilizing all of the available space, the range of the torpedo could be nearly doubled as compared with that obtainable with a solid-propellant gas generator. Variable speed could also be obtained in the torpedo with a liquid-propellant gas generator.

**New Design Proposals**

Several design studies and proposals for liquid-propellant propulsion systems were prepared to meet the requirements of proposed new weapon systems.

**THUNDERBIRD.** The specifications for this missile could easily be met with a propulsion pack-

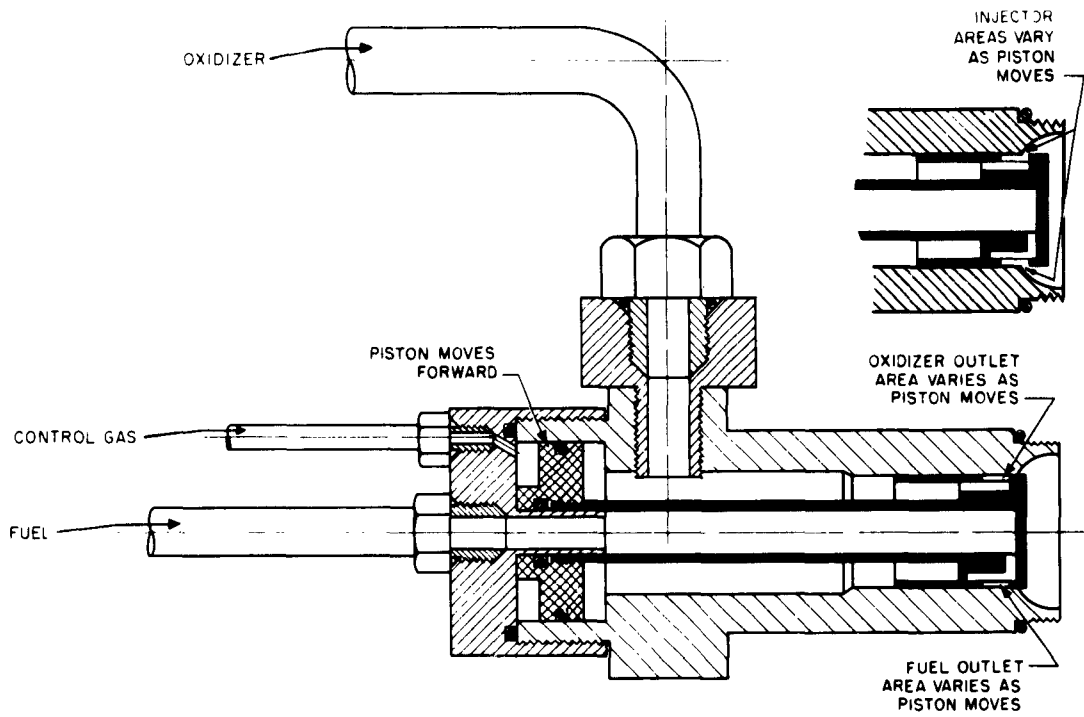

FIG. 6-12. Annular-Stream Variable-Area Injector for Use in Liquid-Propellant Rocket Motors.

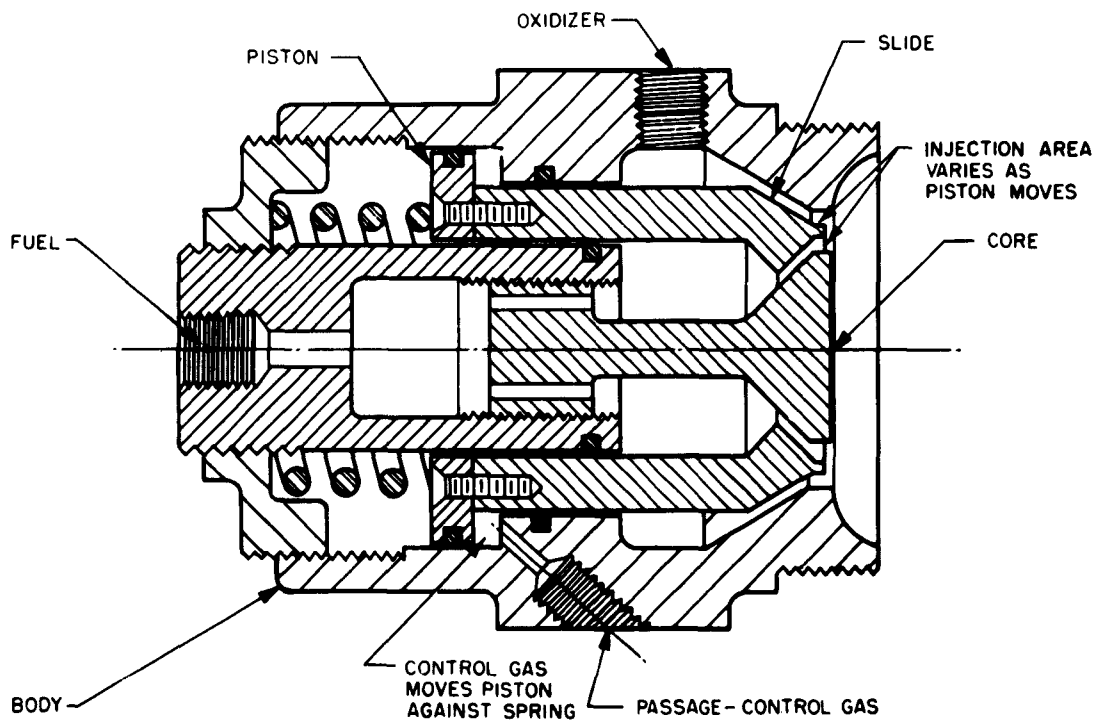

FIG. 6-13. Jet-Type Variable-Area Injector for Use in Liquid-Propellant Rocket Motors.

age 20 inches in diameter, 64 inches in length, and weighing 640 pounds.

**DING DONG.** Since the motor package was specified to accommodate a particular solid-propellant grain, the optimum liquid propulsion system could not be proposed. However, a liquid motor could be made within the specifications, and would exceed only the weight requirement with 556 pounds instead of the specified 520 pounds.

**MARLIN.** Basic comparisons were made between liquid- and solid-propellant systems for a submarine-launched ballistic missile with range of 100 to 200 nautical miles.

**Fleet Ballistic Missile.** A three-stage missile with the first two stages propulsive and the third stage (payload section) nonpropulsive was indicated as the optimum for a submarine-launched 1,500-nautical-mile liquid-propellant missile.

**DIAMONDBACK.** A thrust-control valve has been designed for this demand-controlled-thrust liquid-propellant motor. A static test motor is being installed for full-scale performance studies, and other studies are being made of welding techniques, grain and igniter design, and heat-resistant chamber-lining materials.

*Source of Funds. Task Assignments NOTS-W3-2d-33-1-56, NOTS-W2-10b-3-301-56, NO-000283-31001-01054, NO-101966-63027-01054; Local Project 701.*

## PROPELLANTS AND COMBUSTION

The studies in liquid propellants and combustion have included ignition delay and its effect on combustion in the motor; evaluation of propellants in a static rocket motor; studies of the impulse available from liquid propellants on a volumetric basis with the purpose of estimating readily attainable increases; and studies of thrust variation by means of control of flow in the static motor.

**Ignition Delay.** To determine the effect of ignition delay on rocket-motor performance where performance may be directly affected by combustion, low concentrations of catalysts were used in

the red fuming nitric acid oxidizer, thus permitting comparison of systems closely similar in other respects. DMH (as reference fuel) was compared to HT-32 with uncatalyzed acid and with acid containing three additives. Qualitative results indicated that ignition delay is not the primary determinant of relative combustion smoothness.

**Propellant Evaluation.** Tetramethyltetrazene is similar to unsymmetrical dimethylhydrazine in structure; however, the melting point is too high for present fuel specifications. Preliminary static firings indicated a specific impulse of 254 seconds at 1,500-psi chamber pressure, as compared with an optimum specific impulse of 269 seconds at 1,485-psi chamber pressure for DMH.

Thermal studies in glass at 50°C of 1,3-bis(dimethylamino)propane show that the material is very stable—no change in pressure has been observed in the sealed system for over 1 year. The propane derivative gave performance equally as good as that of DMH in the same chamber-injector assembly.

**Storability.** The surveillance of DMH and inhibited red fuming nitric acid in LAR rounds has continued. The fuel has been stored at 165°F, and after 22 months pressures less than 50 psi have developed. The oxidizer with an inhibitor concentration of 0.5% hydrofluoric acid exhibits less than 100-psi pressure after 45 months' storage in a LAR under desert ambient conditions (10–130°F). At higher temperatures, however, this liquid causes marked corrosion in minute crevices found in the tank construction of the LAR. Increase of the concentration of inhibitor to 1% is sufficient to protect against this corrosion. A round containing oxidizer with 1% inhibitor has been stored at 165°F for 5 months with pressures below 80 psi in a continuing test. Current studies indicate that both oxidizer and fuel may be stored in rounds at 165°F almost indefinitely without appreciable deterioration, either of propellant or of container.

**Propellant Impulse.** Effective impulse available with liquid propellants in existing rocket vehicles of all sizes was compared with that available from solid propellants. Design factors that

may differ for the two types were considered, for example, in limiting the quantity of propellant in a vehicle of given size. For several existing and proposed missiles, liquid and solid propellants were very nearly equal in effective impulse over the entire range of size. Only the propellants in use in each specific vehicle were considered. For example, the hydrazine fuel HT-32 gave approximately 5% higher specific-volume impulse than did X-8 double-base propellant, and DMH approximately the same specific-volume impulse as N-5 propellant, in comparisons between the LAR and comparable solid-propellant rockets.

**Thrust Variation.** Studies of dimethylhydrazine and red fuming nitric acid have been made in the PEMPLAR static rocket motor, which resembles the LAR without the central gas jet in the injector. Performance is measured in terms of the characteristic exhaust velocity,  $c^*$ /(ft/sec), determined by pressure in the chamber and flow rates. Variation in thrust was obtained by changing the gas pressure applied to the propellant tanks.

Preliminary tests were carried out using a 2-inch-diameter combustion chamber equipped with

an injector that gave optimum performance at 1,500-psi chamber pressures. Measurements were made at combustion chamber pressures from 1,485 to 705 psi. At the 1,485-psi pressure  $c^*$  was 98% of theoretical, and at 705 psi 89% of theoretical; thus a variation of 9% occurs in performance as the thrust varies over a range of 2:1.

Studies were continued with the same injector in a 4-inch-diameter combustion chamber. In these tests the combustion-chamber pressure varied from 569 to 35 psi. Smooth combustion was obtained, but efficiency as reflected in  $c^*$  or specific impulse decreased markedly at the lower chamber pressures. The motor is sensitive to minor instabilities; these are readily observable if present. The total thrust variation available under these conditions appears to be approximately 17:1.

The critical variables indicated in these tests are pressure drop in the injector and the detailed design of the particular injector used.

*Source of Funds. Task Assignments NOTS-W3-2d-33-1-56, and NO-101966-63027-01054.*

## RAMJET PROPULSION

**Ram-Air Rocket Engine (RARE).** The RARE project is an attempt to achieve comparatively long range in small air-to-air missiles by combining ramjet with rocket propulsion and employing only solid propellants and fuels. Feasibility of the basic concept was proved. Sled launchings of RARE Test Vehicle 1 (RARE TV-1) showed that it is stable in flight, passing smoothly through boost, transition, and ramjet stages (Fig. 6-14).

Theoretical studies and calculations resulted in various improvements in RARE TV-1; conception of a 6.5-inch-diameter test vehicle in which the SIDEWINDER guidance and warhead units are included; definition of the area in which the com-

bination of rocket and ramjet is superior to the rocket alone; and demonstration of the usefulness of applying the RARE principle to SIDEWINDER, MARLIN, and ASROC.

Components of RARE TV-1 are being improved. This missile, aiming merely at investigating the ramjet principle with a solid fuel, contained only essentials and employed only the most accessible and least expensive materials. The high-energy X-12 booster grain was square and burned both internally and externally. An improved N-5 booster grain with the shape of the SIDEWINDER 1B grain has 30% more propellant weight and burns internally only, causing minimal heating of



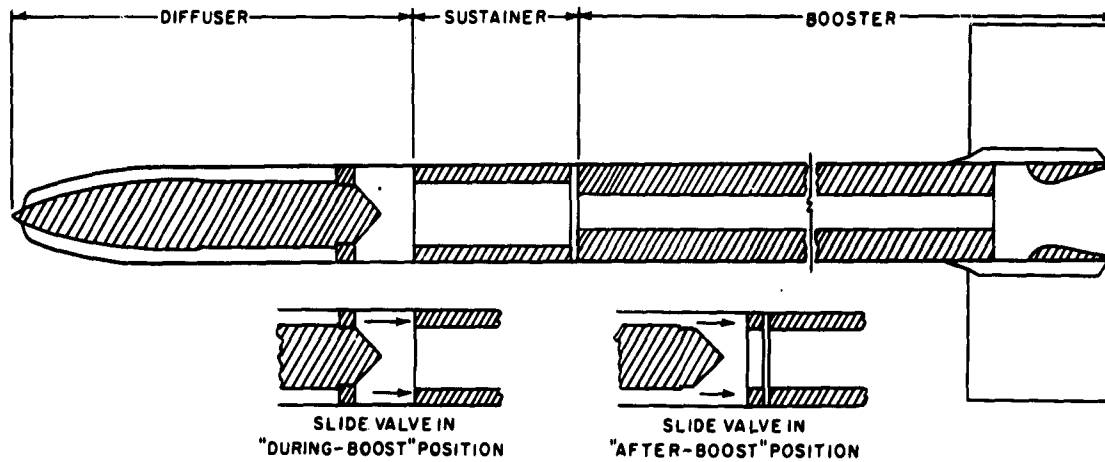

FIG. 6-14. Ram-Air Rocket Engine (RARE) Test Vehicle 1.

the motor wall. A search is under way for a booster grain providing greater impulse. Attempts to find a fuel formulation that will give improved ramjet action are continuing. Elemental boron shows most promise.

The throat diameter of the RARE TV-1 nozzle was a compromise—too large for the booster and too small for the sustainer. A two-stage nozzle has been devised in which an explosive bolt, electrically detonated, releases the booster nozzle at booster burnout. Two static-firing tests, in which the action taking place in flight tests of RARE vehicles was closely simulated, have shown the nozzle to be satisfactory.

Tests of a tentative design for a ramjet diffuser capable of taking an infrared-seeker system are in progress. Plans are being completed for equipment to be assembled at NOTS for small-scale testing of ramjet burners, fuels, and heat barriers. Ducted blowdown combustion tests of the RARE sustainer burner are in progress in the newly installed blowdown burner assembly at the Naval Air Missile Test Center. Formulations of the sustainer charges, variables associated with the air supplied to the burner, and tailpipe heat-barrier materials are being evaluated.

**Ramjet Propellants.** Light-metal-fluorocarbon systems look promising as solid fuels for ramjet engines. Although the magnesium-polytetrafluoro-

ethylene system is incapable of delivering a high specific impulse, it is a source of high energy (experimental heat-of-explosion of 2,000 cal/g). For this system, small amounts of inorganic fluorides and dichromates are the most effective catalysts for producing an experimental heat-of-explosion that closely approaches the theoretical value.

*Source of Funds. Task Assignments NOTS-S3-3e-544-1-56, NOTS-W3-3e-565-1-56, NO-000283-31001-01054, NO-101966-63026-05054; Local Project 701.*

#### REFERENCES

- 6-1. Atlantic Research Corp. *Research and Development Programs in Fields of Solid Propellants and Interior Ballistics, Quarterly Progress Report No. 17, April-June 1954*, by K. E. Rumbel and others. Alexandria, Va., ARC, October 1954. (ATRC QPR-10721-17). CONFIDENTIAL.
- 6-2. ———. *Research and Development Programs in Fields of Solid Propellants and Interior Ballistics, Quarterly Progress Report No. 18, July-September 1954*, by K. E. Rumbel and others. Alexandria, Va., ARC, January 1955. (ATRC QPR-10721-18). CONFIDENTIAL.
- 6-3. Rohm & Haas Co., Redstone Arsenal Research Division. *Quarterly Progress Report on Propellant Chemistry (U), February 1-April 30, 1955*. Huntsville, Ala., May 25, 1955. (Report No. P-55-8). CONFIDENTIAL.

## INITIAL DISTRIBUTION

Distribution of Chapter 6, "Propellants and Propulsion for Missiles," is in addition to that of the complete volume, which is distributed as listed at the end of that volume.

- 18 Chief, Bureau of Ordnance
- |           |              |
|-----------|--------------|
| Ad3 (1)   | ReS6-a-1 (1) |
| Ma3-a (1) | ReS6-b (1)   |
| Rex2 (1)  | ReS6-c (1)   |
| Re0 (1)   | ReW (1)      |
| Re04 (1)  | ReW-b (1)    |
| Re06 (1)  | ReW1 (1)     |
| Rem (1)   | ReW3 (1)     |
| ReS (1)   | SP27 (2)     |
| ReS1 (1)  |              |
- 4 Chief of Naval Operations (Operations Evaluation Group)
- 1 Commanding Officer, Naval Air Material Center, Philadelphia
- 1 Commander, Naval Air Test Center, Patuxent River (Aeronautical Publications Library)
- 1 Commanding Officer, Naval Aviation Ordnance Test Station, Chincoteague (Technical Development Department)
- 1 Commanding Officer, Naval Avionics Facility, Indianapolis (Library)
- 1 Commander, Naval Ordnance Laboratory, White Oak (WC)
- 3 Commanding Officer, Naval Powder Factory, Indian Head
- Dr. S. Skolnik (2)
- F. C. Thames (1)
- 2 Commanding Officer, Naval Underwater Ordnance Station, Newport
- 1 Commander, Operational Development Force, Atlantic Fleet, Norfolk
- 1 Naval Liaison Officer, Air Proving Ground, Eglin Air Force Base
- 1 Chief of Ordnance (ORDTU)
- 2 Commanding General, Aberdeen Proving Ground, Md. (Technical Library)
- 1 Commanding General, Frankford Arsenal, Philadelphia (M. S. Silverstein, Pitman-Dunn Laboratories)
- 1 Commanding General, Ordnance Ammunition Command, Joliet, Ill. (ORDLY-RDC)
- 2 Commanding General, Picatinny Arsenal, Dover, N. J. (Library)
- 2 Commanding General, Redstone Arsenal, Huntsville (Technical Library)
- 1 Commanding Officer, Sunflower Ordnance Works, Lawrence, Kans.
- 1 Commanding General, White Sands Proving Ground, N. Mex. (Technical Librarian)
- 1 Army Ordnance Representative, NOTS, Pasadena
- 7 Chief of Staff, U. S. Air Force, DCS/D
- AFDRD-AC-3, Col. Paul F. Nay (1)
- AFDRD-AR (1)
- Assistant for Development Programming (5)
- 1 Commander, Air Force Armament Center, Eglin Air Force Base (ACTRL)
- 1 Commander, Air Research and Development Command, Baltimore
- 5 Commander, Wright Air Development Center, Wright-Patterson Air Force Base, Ohio (WCOSI)
- 10 Armed Services Technical Information Agency
- 1 Bureau of Mines, Pittsburgh (Division of Explosives Technology)

- 4 British Joint Services Mission, Ministry of Supply Staff (Reports Officer), via BuOrd (Ad8)
- 4 Defense Research Member, Canadian Joint Staff (W), via BuOrd (Ad8)
- 1 Aerojet-General Corporation, Azusa, Calif. (Librarian), via BAR
- 1 Aerojet-General Corporation, Sacramento, Calif., via BAR Azusa
- 1 Allegany Ballistics Laboratory, Cumberland, Md., via AInsMat
- 1 Armour Research Foundation, Illinois Institute of Technology, Chicago  
(Propulsion and Structural Research, Department M), via ONR Branch Office
- 1 Arthur D. Little, Inc., Cambridge (W. A. Sawyer),  
via HQ First Army Industrial Security Division, New York
- 1 Atlantic Research Corporation, Alexandria, Va., via InsOrd, Silver Spring, Md.
- 1 California Institute of Technology, Pasadena (Dr. B. H. Sage), via ONR Branch Office
- 1 E. I. du Pont de Nemours and Company, Inc., Wilmington (W. F. Jackson),  
via HQ Second Army
- 1 Hercules Powder Company, Explosives Department, Wilmington (Dr. Lyman Bonner),  
via HQ Second Army
- 1 Hercules Powder Company, Sunflower Ordnance Works, Lawrence, Kans., via HQ Fifth Army
- 1 Jet Propulsion Laboratory, CIT, Pasadena (Dr. W. H. Pickering), via LAOD
- 1 Minnesota Mining & Manufacturing Company, St. Paul (G. E. Chutka), via R. W. McElroy,  
Security Administrator
- 1 Naval Ordnance Research School of Chemistry, University of Minnesota, Minneapolis  
(B. L. Crawford, Jr.), via Central Industrial Security Regional Office, ARDC, WADC,  
Wright-Patterson Air Force Base, Ohio
- 1 New York University, Department of Chemical Engineering, New York  
(C. J. Marsel), via Security Officer
- 1 Olin Mathieson Chemical Corporation, East Alton, Ill. (Everett Hord, Security Officer),  
via Fifth Army Regional Industrial Security Office, St. Louis
- 2 Phillips Petroleum Company, McGregor, Tex. (R. C. Terry, Management Service Branch),  
via SAAMA
- 1 Rocketdyne, Division of North American Aviation, Inc., Canoga Park, Calif.  
(Librarian, Dept. 596-3), via AAFPR
- 1 Rohm and Haas Company, Redstone Arsenal Research Division, Huntsville (Librarian),  
via HQ Third Army
- 10 Solid Propellant Information Agency, Applied Physics Laboratory, JHU, Silver Spring  
(K. G. Britton), via InsOrd
- 1 Southwest Research Institute, Department of Chemistry and Chemical Engineering, San Antonio  
(F. A. Warren), via Southern Industrial Security Regional Office, Baltimore
- 1 Standard Oil Company, Research Department, Whiting, Ind. (B. H. Shoemaker), via OCAMA
- 1 Thiokol Chemical Corporation, Redstone Division, Redstone Arsenal, Huntsville  
(Technical Director), via InsMat, Atlanta
- 1 University of Denver, Denver Research Institute (A. Krill),  
via Fifth Army Regional Industrial Security Office, St. Louis



## Naval Air Warfare Center Weapons Division

<b>Fax Transmittal</b>	
To: L. Ramserran DTIC	Date: 09 Jan 08
	Page 1 of 3
Phone:	Fax: 703-767-9244

From	C. O'Connell, Technical Communication Office
Phone: 760-939-7659	Fax: 760-939-7958
Subject:	Request for Public Release of AD0128000
<p>Laurence, Per our email conversations, I am enclosing the NAWCWD form authorizing public release of the document (AD0128000), initialed by the classification manager (Code 741000D) and the public affairs department (Code 750000D/E). In addition, page 2 was signed by J. Trowbridge; our Classification Manager. If you need additional information, please contact me at 760-939-7659. Thank you for your assistance.</p>	

*C. O'Connell*

JUN 20 2007

**REQUEST FOR PUBLIC RELEASE OF UNCLASSIFIED INFORMATION**

**INSTRUCTIONS**

1. Use this form for Statement A (Distribution Unlimited). Use NAWCWPNS 5510/2 for release of limited distribution unclassified papers and presentations. Use NAWCWPNS CL 5510/3 for release of a classified paper or presentation.

FROM	CODE	TELEPHONE NUMBER	DATE NEEDED
ANTONELLA THOMPSON	470000D	760-939-7144	07 Jun 2007

1. Release is required for the attached material. This paper is related to NAWCWD project

2. The sponsor has consented to this release.

SPONSOR (Printed name and signature required)	ORGANIZATION	TELEPHONE NUMBER
STUART R. BLASHILL <i>su-rmbl</i>	CODE 470000D	760-939-7991

TITLE (Paper, presentation/speech, contractor release, patent, etc.)

Naval Ordnance Test Station's "Technical Program Review 1956 Chapter 6 Propellants and Propulsion for Missiles" of 1/1/57

TYPE
<input checked="" type="checkbox"/> PAPER <input type="checkbox"/> PRESENTATION/SPEECH <input type="checkbox"/> CONTRACTOR RELEASE <input type="checkbox"/> PATENT <input type="checkbox"/> OTHER

MEETING OR PUBLICATION	PLACE/DATE OF MEETING OR RELEASE DATE	INITIALS
		AUTH    SPVSR

3. It is my opinion that the subject matter in this material has no information or military application requiring classification.

4. To the best of my knowledge, this material does not disclose any trade secrets or suggestions of outside individuals or concerns that were communicated to NAWCWD in confidence.

5. I reviewed the appropriate sections of the Military Critical Technology List (MCTL) and judge that the information does not contain military critical technology.

6. Part and Section of MCTL Reviewed:    PART    SECTION

AUTHOR'S COMMENTS

AUTHOR'S SIGNATURE REQUESTER	DATE
<i>Antonella Thompson</i>	6/19/07

ROUTING	APPROVED	DISAP-PROVED	DATE	COMMENTS
DEPARTMENT HEAD CODE: 470000D	<i>ATC</i>	<input type="checkbox"/>	6-19-07	
CHAIRMAN, PUBLIC TECHNICAL INFORMATION RELEASE PANEL CODE: 4TB000D	<i>for CSM</i>	<input type="checkbox"/>	6/21/07	MCTL
CODE: 741100D	<input checked="" type="checkbox"/>	<input type="checkbox"/>	6/27/07	John Trowbridge, Information Security, Classification Manager 1 Administration Circle, Bldg 8, NAWC-WD Code 741000D China Lake, CA 93555-6100, 760-939-0987
CODE: 750000D/E	<input checked="" type="checkbox"/> <i>(SR)</i>	<input type="checkbox"/>	7/2/07	Susan Read Public Affairs Department China Lake, CA 93555-6100 760-939-4587