

# **SOLAR THERMAL POWER AND ENERGY STORAGE HISTORICAL PERSPECTIVE**

© M. Ragheb  
8/11/2011

“One thing I feel sure of and that is that the human race must finally utilize direct sun power or revert to barbarism. I would recommend all far-sighted engineers and inventors to work in this direction to their own profit, and the eternal welfare of the human race.”  
Frank Shuman, Scientific American, 1914

“Sun power is now a fact and no longer in the ‘beautiful possibility stage.’ We have proved the commercial profit of sun power and ... that after our stores of oil and coal are exhausted the human race can receive unlimited power from the rays of the sun.”  
Frank Schuman, New York Times, 1916

## **INTRODUCTION**

The historical evolution of Solar Thermal Power and the associated methods of energy storage into a high-tech green technology are described. The origins of the operational experience of modern plants and the areas of research and development in enhancing the characteristics of the different components and the energy storage options are reviewed. The early developed technology is being reengineered and is advancing using modern available knowledge, materials choices, surface treatments, energy storage methods and controls.

A fear about the availability of coal arose in the Victorian 18<sup>th</sup> century, much like the worry about peak oil production in the 20-21<sup>st</sup> centuries. Both created interest in replacement sources of energy. These events induced technological shifts to replacement sources such as wind, solar, geothermal, biofuel and nuclear energies.

From a different perspective, the competition for the control of recoverable coal resources among the industrialized nations, in addition to nationalism, colonialism and imperialism, was a cause of World War I much like the control of the depleting petroleum resources is shaping the 21<sup>st</sup> century’s social and economical landscape. Historians suggest that the periods of punctuated equilibrium in human history eventually reach a tipping point, such as the industrial revolution, the communication revolution, and the shift to renewable and green sources of energy, at which sudden bursts of above-trend growth occur, associated with raising prospects of a rise in the standard of living as well as global conflict.

## **PIONEERING POWER DEVELOPMENTS**

### **SOLAR ENGINE ONE POWER PLANT, 1913**

The first documented Concentrated Solar Power (CSP) plant “Solar Engine One,” operated at Al Meadi, then a small farming community, and later a vibrant suburb of Cairo, Egypt, in 1913. Construction started in the fall of 1912 of the parabolic trough

solar collector irrigation pumping station. Al Meadi lies on the Nile River 15 miles (20 km) south of Cairo on the road to Helwan, a hot springs and mineral water resort town.

Solar Engine One was installed at the Al Meadi water works and had a capacity of 100 brake HP which were used to pump Nile River water for irrigation [1, 2]. Al Meadi in Arabic means “The Ferry-Boats.” The name originates from the fact that it was a crossing point across the Nile River on a caravan route connecting the Arabic Peninsula to the Nile’s West Bank and to the Cairo’s suburb of Giza from which the long trek to Upper Egypt started.

Al Meadi was the site at which the USA transferred \$3 million from a special fund to the group of Free Officers organizing the July 23<sup>rd</sup> 1952 Revolution which deposed King Farouk I. The funds transfer was by way of Al Meadi resident and special operative in Iran and Egypt, Miles Copeland who describes the event in his book: “The Game of Nations: The Amoralty of Power Politics,” [9]. The title of his book was adopted from that of a lecture delivered by the intellectual figure among the Free Officers, Zakaria Mohie El Din, at the Egyptian Army Chiefs of Staff College in Cairo on the Theory of Games entitled: “The Game of Nations.”

Solar Engine One was developed by the Philadelphia, USA inventor, entrepreneur, and solar visionary Frank Shuman. Five trench parabolic concentrating reflectorss were constructed using local labor and materials. Each collector was 204 feet (62 m) in length, 13 feet (4 m) in width, with a spacing of 7.6 m, oriented in a north-south direction and fitted with a mechanical tracker mechanism which kept them automatically tilted to face the sun from east to west.

The steam engine was shipped from the USA. The steam collected by the reflectors was used to power a water pump for the first time on July 11, 1913. They initially produced the equivalent power of 55 HP and were capable of pumping 6,000 gallons of water per minute (gpm) or 27,260 liters/ min, bringing irrigation water to arid desert land. A public demonstration was postponed due to a technical glitch where the zinc material used in the boiler tubes did not withstand the operational temperature and had to be replaced with cast iron tubing. The solar engine achieved an efficiency of 4 percent compared with the 10 percent efficiency of a steam engine.

Lord Kitchener supported the project and offered the Sun Power Company 12,000 hectares (ha) of land as a cotton plantation in the Sudan. On the other hand, Winston Churchill had decided to upgrade the British naval fleet with oil-fired boilers for steam production as a more convenient way than using coal-fired steam boilers. The oil interests led by the Standard Oil Rockefeller Company in the USA and the 1909 Anglo-Persian Oil Company, or British Petroleum Company, BP as of 1954 in the UK, also favored the petroleum option.

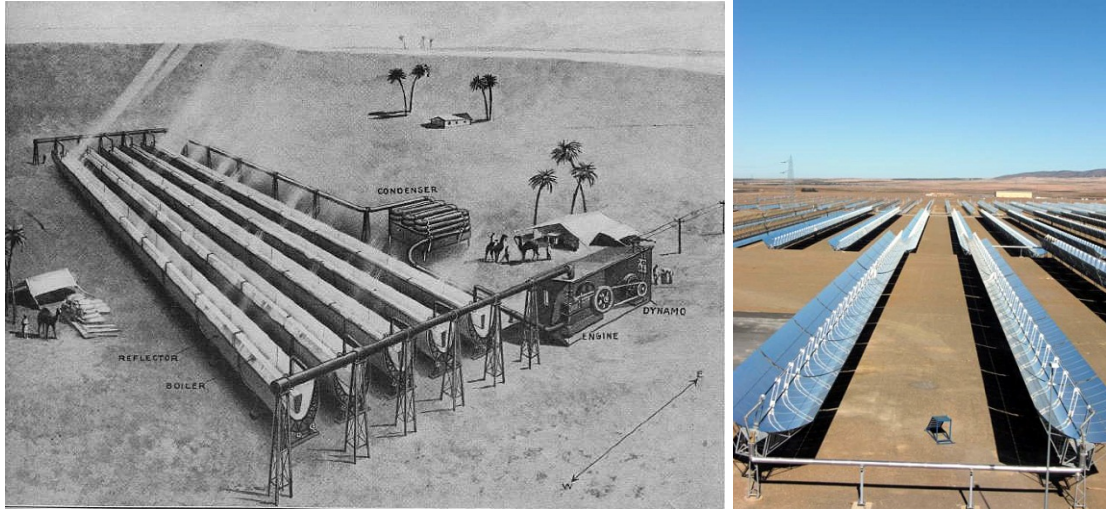

Figure 1. Schematic of 100 HP Solar Engine One, first Concentrated Solar Power, CSP plant at Al Meadi, Cairo, Egypt, appeared in the *Electrical Experimenter Magazine* in March 1916. It was initially intended for producing electrical power as shown in the diagram, but was used for pumping irrigation water instead [1, 2] (left). Contemporary realization at the solar island of the Al Kuraymat, Egypt (60 MW (24 MW solar) steam turbine, 74 MW gas turbine) Integrated Solar Combined Cycle (ISCC) solar station, 87 km south of Cairo, 3 km east of the Nile River, 2010 [18, 19] (right).

The Solar Engine One plant was the culmination of earlier pioneering efforts that met with different levels of success and failure, leading to the contemporary promising Concentrated Solar Power (CSP) technology [6].

### **AUGUSTIN BERNARD MOUCHOT (1825-1912) TRUNCATED CONE SOLAR ENGINE**

Augustin Mouchot is considered to have built the first solar engine based on a truncated cone dish. He was a mathematics instructor at the Lycée de Tours, France. He believed that coal, the main industrial fuel at the time, would eventually run out: “It would be prudent and wise not to fall asleep regarding this quasi security. Eventually industry will no longer find in Europe the resources to satisfy its prodigious expansion. Coal will undoubtedly be used up. What will industry do?”

He was inspired by the work of the Swiss physicist Horace-Bénédict de Saussur, and of Claude Pouillet the French physicist who was one of the first to attempt a calculation of the sun’s total energy falling on the Earth.

He performed his first solar energy experiments in 1860 with solar cooking devices. Between 1860 and 1880 he worked on developing solar powered steam engines. In 1861 he was granted the first patent for a solar engine and continued his work until 1880. He initially used an iron cauldron enclosed in glass through which solar radiation passed and boiled water in the cauldron. The amounts and pressure of steam were disappointing. He discovered that by adding a reflector to concentrate solar radiation, he could produce much more steam that he used in 1865 to operate a steam engine.

In the summer of 1866, he had completed his first sun-powered engine which was presented to the French Emperor Napoleon III in Paris who provided him with financial support to develop an industrial solar engine. He continued development and increased the capacity of his solar experiments refining the reflector to the form of a truncated cone.

He devised a two degrees of freedom tracking mechanism allowing the whole device to follow the sun's altitude and azimuth in the sky. In 1872, after 6 years of work, he showed to the public at the French city of Tours' library courtyard a device which was characterized by a truncated cone reflector described as: "an inverted lamp shade coated on the inside with very thin silver leaf," and its boiler as: "an enormous thimble made of blackened copper and covered with a glass bell." He connected the device to a steam engine powering a water pump and produced a power of ½ HP on a sunny day. He reported his work to the French Academy of Sciences.

After the war, using a local government grant, he installed a solar concentrator at the Lycée de Tours school where he was a teacher. During testing, the heat was so intense that the boiler appeared that it might explode.

The French government considered the use of the engine in its tropical colonies where the use of coal was costly. It supplied Augustin Mouchot with sufficient funding to build a larger 70 liters of water and 30 liters of steam boiler in the city of Constantine, Algeria. He improved the design by using a multi-tube boiler as a replacement to the original single cauldron allowing for a larger heat transfer area to the water resulting in higher steam pressure and improved performance.

In 1869 he published a book on solar energy: "La Chaleur Solaire et ses Applications Industrielles" or: "The Solar Heat and its Industrial Applications." His largest solar engine was displayed in Paris in 1869 until the city was invaded by Prussia. His solar machine disappeared and was never located.

He installed another machine at the Paris Exhibition of 1878 with a reflecting mirror of 4 m in diameter and an 80-liter boiler. He used the steam to drive an ice maker and produced ice from the sun: "In spite of the seeming paradox of the statement, it was possible to utilize the rays of the sun to make ice." This earned him a Gold Medal at the exhibition.



Figure 2. Augustin Bernard Mouchot, solar energy pioneer (1825-1912).

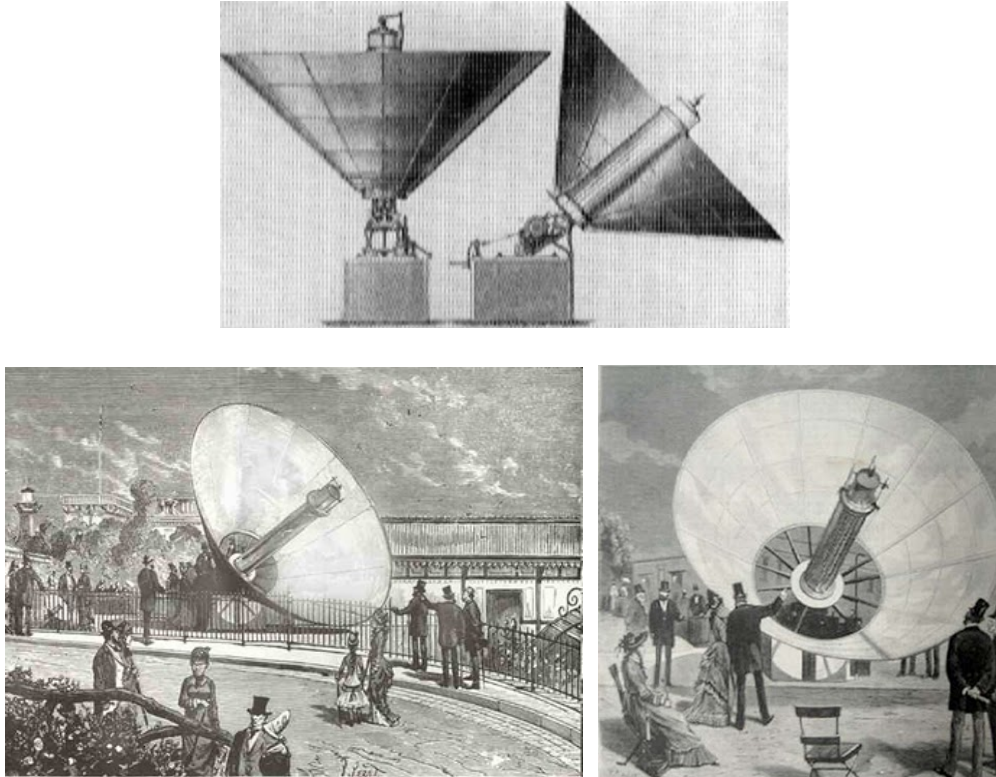

Figure 3. Truncated cone (inverted lamp shade) dish engine developed by Augustin Mouchot exhibited at the Lycée de Tours (left) and the Paris exhibition where it was used to operate an ice-maker in 1878 (right) and earned a Gold Medal.

In 1881, the French Ministry of Public Works appointed two commissions to evaluate the invention with 900 tests carried out at Montpellier, France and Constantine, Algeria that reached a conclusion that considered the device as “a technical success but a practical failure.” At that juncture in time France has secured ample supplies of cheap coal from England.

#### **ABEL PIFRE (1852-1928) PRINTING PRESS SOLAR ENGINE, 1882**

Abel Pifre, a French engineer, worked as an assistant to Augustin Mouchot. He built several solar engines of his own, but he is best known for its use to power a printing press. At the Jardin (Garden) des Tuilleries during the festival of the L’Union Française de La Jeunesse (French Youth Union) on August 6, 1882, Abel Pifre, editor of “La Chaleur Solaire” (The Solar Heat) publication, conceptualized for the occasion a parabolic dish solar concentrator that powered a steam engine to produce 500 copies per hour of “Le Journal du Soleil” (The Sun Journal), conceptualized for the event, on a Marioni type printing press.

He used a parabolic dish of 3.5 m (11.5 ft) diameter which focused the sun onto a cylindrical steam boiler producing 2.5 HP in a steam engine. The mirror surface was 100 ft<sup>2</sup>. He claimed that he utilized in the boiler more than 80 percent of the heat falling on the mirror to the tune of 12 calories/m<sup>2</sup>, as an improvement over the Augustin Mouchot’s

engine which utilized 50 percent of the heat. With a receiver of 9-25 m<sup>2</sup> in a clear sky he was able to boil 50 liters of water within 40 minutes and obtains a pressure of one atmosphere every 7-8 minutes.

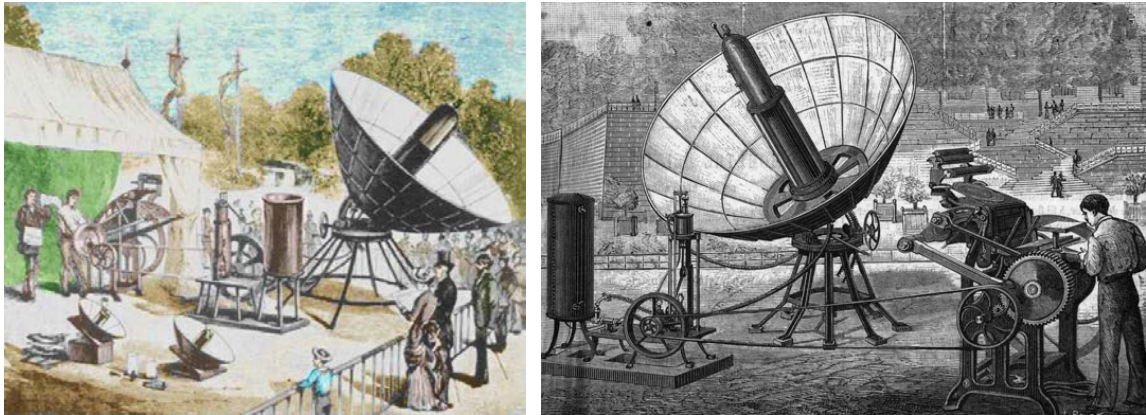

Figure 4. Parabolic dish solar concentrator built by Abel Pifre (1852-1928) on August 6, 1882, was used to power a Marioni printing press [15].

### **ROBERT STIRLING (1790-1878)**

The trail had been blazed earlier when the Scottish Pastor Robert Stirling (1790-1878) filed a patent for “a hot air engine” in 1816. In the Sterling cycle engine, the air contained in a cylinder underwent four cycles: heating, expansion, cooling and compression with the energy provided by an external heat source to produce rotational motion. In spite of numerous applications, the Stirling cycle engine was overcome by the economical competitiveness of the steam engine and the internal combustion engine. The Stirling cycle engine, as an external heat source engine is being revived as the ideal engine for CSE generators. It also offers silent running, a high efficiency, and reliability; requiring little maintenance and no exhaust products when solar energy is used as an external heat source.

### **JOHN ERICSSON PARABOLIC TROUGH, 1883**

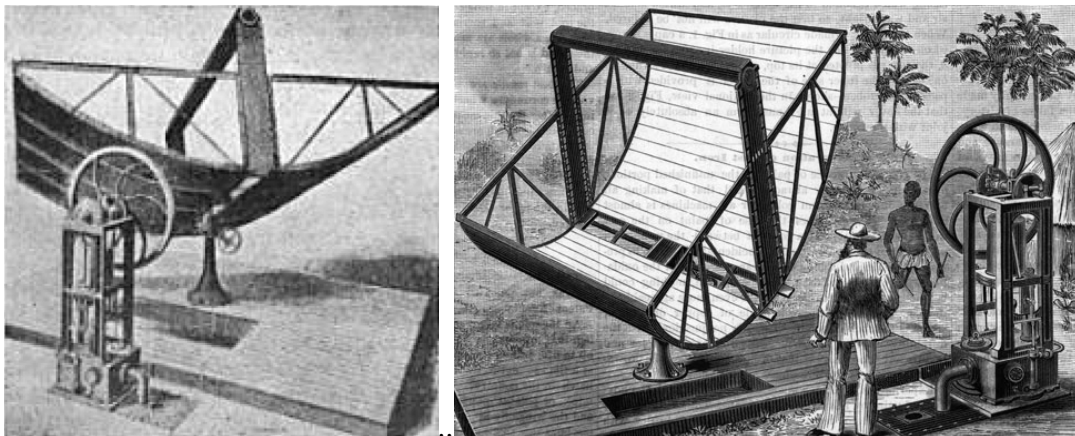



Figure 5. Captain John Ericsson longitudinal trough parabolic concentrator with a steam engine using a flywheel for energy storage, 1883 [15] (top), and its modern realization (bottom).

Around 1883, Captain John Ericsson used a longitudinal parabolic concentrator to operate a steam engine for pumping water. An engineer of Swedish heritage, he designed the ironclad steam-powered battleship “The Monitor,” that was credited for tipping the scale in the American Civil War to the North Union’s side. John Ericsson in 1868 believed that the industrial revolution would soon founder for lack of easily accessible coal reserves, and considered solar power as a more sustainable alternative: “A couple thousand years dropped in the ocean of time will completely exhaust the coal fields of Europe, unless, in the meantime, the heat of the sun be employed.”

Although John Ericsson’s experiments with solar motors powered by both steam and hot air never advanced beyond the prototype stage, his efforts sparked the imaginations of other inventors and pioneers including Augustin Mouchot, Aubrey G. Eneas, Abel Pifre, Henry E. Willsee, John Boyle and Nikola Tesla.

John Ericsson invested \$100,000 and the last twenty years of his life in an effort which was mildly successful since a steam engine has only a 10 percent efficiency compared with a 38 percent efficiency of a Diesel engine [15]. He initially used the Augustin Mouchot’s design with a conical reflector. He later introduced the parabolic trough concept which concentrates solar radiation on a line passing through the parabola’s focal point. The approach is simple in construction and needs only to track the sun in an east to west direction if lying horizontally in a north to south direction. The disadvantage is that lower steam temperatures and pressure can be achieved since the radiation is focused along a line rather than a point in the parabolic dish concept. He perfected the design trying lighter reflector materials but died in 1889 before commercializing it. This configuration is the one most favored in modern solar thermal power plants.

### **WILLIAM ADAMS, CENTRAL RECEIVER, SOLAR TOWER CONCEPT, 1878**

William Adams was the deputy registrar for the British Crown in Bombay, India, at the time of Augustin Mouchot work in France. He wrote a book: "Solar Heat: A Substitute for Fuel in Tropical Countries."

He read an account of the Augustin Mouchot demonstrations at Tours, France, and observed that the invention was impractical, as: "it would be impossible to construct a dish shaped reflector of much greater dimensions" for a greater capacity than Mouchot's 1/2 HP. He reasoned that the silver metal reflector would tarnish, and would be too costly to build and too unwieldy to efficiently track the sun.

As a remedy to the size scaling issue, he suggested that a reflector of flat silvered mirrors arranged in a semi-circle would be cheaper to construct and easier to maintain. He planned to build a large rack of multiple small mirrors that are each adjusted to reflect solar radiation in a specific direction. As a tracking mechanism, the entire rack could be rolled around a semicircular track, reflecting the solar radiation onto a stationary boiler. With cheap labor available he envisioned that the rack could be attended by a worker and would be moved only "three or four times during the day," with a larger number to frequently improve the performance.

William Adams started in 1878 by gradually adding 17x10 inch flat mirrors and measuring the resulting rising temperatures. He estimated that to reach the 1,200 °F needed to produce the high pressure steam needed to operate off the shelf steam engines, the reflector would be composed of 72 mirrors.

By placing a piece of wood at the focal point of the arranged flat panes it ignited instantly. He arranged the collectors around a boiler, retaining Augustin Mouchot's enclosed cauldron configuration, and connected it to a 2.5 HP steam engine that operated during daylight hours "for a fortnight in the compound of his bungalow" in Bombay, India. He displayed his device to newspaper reporters, the Army's commander in chief, a colonel from the Royal Engineers, the secretary of public works, various justices, and a principal mill owner, who were impressed.

Having proved the concept, William Adams did not pursue it further, turning his attention to other interests. Yet his idea persists today as the "Central Receiver" or the "Power Tower" concept. It is considered as the best configuration for large scale centralized solar plants. Modern central receiver solar plants follow the basic configuration of flat or slightly curved mirrors that remain stationary or travel on a semicircular track. They could reflect light upward to a boiler in a receiver tower or be reflected downward to a boiler at the ground level.



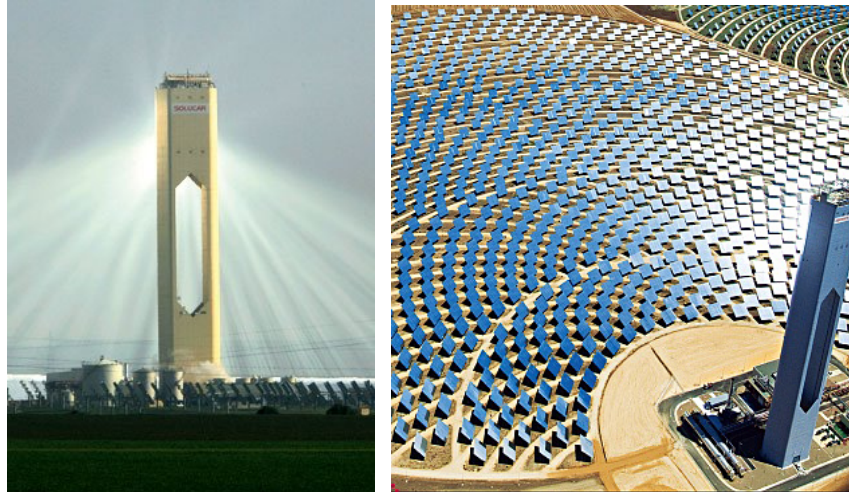

Figure 6. PS20 Andalusia, Spain Central Receiver or Solar Tower concentrated solar power plant.



Figure 7. Central Receiver or Solar Tower plant.

### **CHARLES TELLIER FLAT COLLECTORS**

French engineer Charles Tellier is known as the father of refrigeration systems, but he began his work trying to improve on the Augustin Mouchot and William Adams designs. He designed the first non-concentrating, or non-reflecting, flat panel solar engine.

Charles Tellier installed in 1885 a solar collector on the roof of his house similar in all respects to the flat panel collectors placed atop many south facing roofs today for heating domestic water or for swimming pools. His collector consisted of ten plates, each consisting of two iron sheets riveted together to form a watertight seal, and connected by tubes to form a single unit.

As a working medium, he used ammonia,  $\text{NH}_3$  as a working medium because of its lower boiling point than steam. Enough pressurized ammonia gas was produced to run a turbine driving a water pump drawing 300 gallons per hour during daylight from his well. Charles Tellier thought that by adding more plates industrial applications would be possible.

He enhanced the efficiency of his collectors by 1889 by enclosing the top in a glass enclosure and insulating its bottom. He documented his work in the publication: “The Elevation of Water with the Solar Atmosphere,” in which he included details on his thoughts on using the sun to produce ice.

In “The Peaceful Conquest of West Africa,” Charles Tellier argued that a consistent and readily available supply of energy would be required to power the machinery of industry before the French colonies in Africa could be developed. He suggested that the construction costs of his low-temperature, non-concentrating solar engine were low enough to justify its wide usage.

Charles Tellier work with ammonia as a cooling medium drew his focus to the more lucrative refrigeration field. A demand developed for the new technology to ship frozen meat to Europe from North and South America.

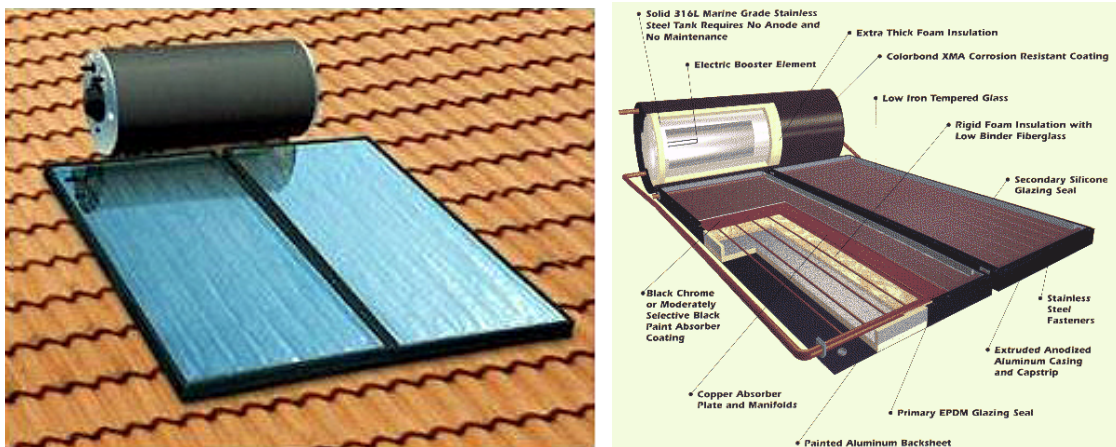

Figure 8. Roof-top flat panel thermal solar collector for domestic water heating.

### **AUBREY ENEAS SOLAR MOTOR AT THE CAWSTON OSTRICH FARM, 1901**

The baton in solar experimentation was passed from Europe to the USA as a solar-driven water pump was developed by Aubrey Eneas at the Cawston Ostrich Farm in South Pasadena, California, USA around 1916. It consisted of a parabolic dish mirror made of a large number of single glass panes set together. It had a diameter of 12 yards. Solar radiation was focused on a large cylindrical water tank, 2 ½ yards long as its axis. When empty of water on a sunny day its walls would glow red-hot within an hour. Its volume accommodated 400 quarts of water that were brought to the boiling point within 15 minutes. The steam drove a turbine of a 10 HP power, which operated through a pulley and belt a pump capable of pumping 5,600 quarts of water per hour [1].

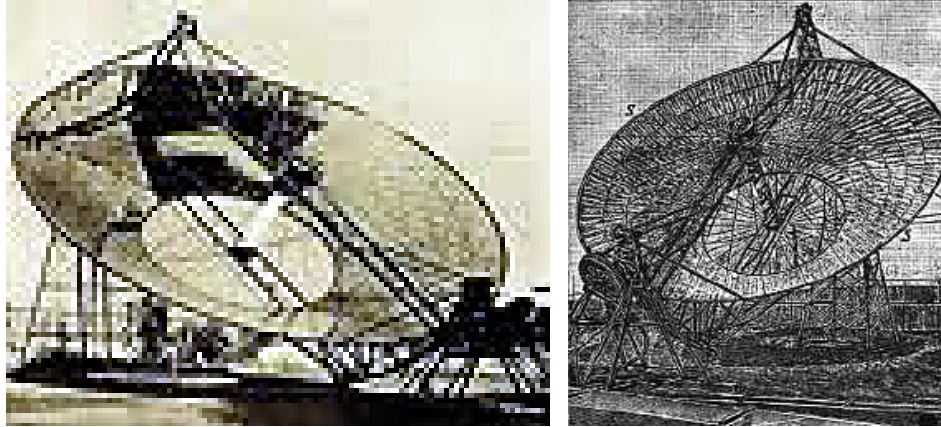

Figure 9. Aubrey Eneas' Solar Motor using 1,700 mirrors on a parabolic dish concentrator and a central boiler [1].

The mirrored parabolic dish had more than 700 feet of surface area and measured 35 feet across at its wide end. The device was hitched to a track running the length of a vertical lightweight steel tower that allowed a clock tracking mechanism to keep the device angled toward the sun throughout the day. It pumped 1,400 gallons of water per minute (gpm).

The Solar Motor was the inception of Aubrey Eneas, of British heritage. He was an engineer based in Boston, Massachusetts and was inspired by John Ericsson's work. He founded the "Solar Motor Company" of Boston in 1892.

After experimenting with an John Ericsson-like device using a parabolic trough-shaped reflector that had the detriment of heating only one side of the boiler, Aubrey Eneas adopted Augustin Mouchot's parabolic dish reflector design to heat the boiler more evenly, producing a larger volume of steam. By cutting off the bottom end of the parabolic dish and making the side more upright, Aubrey Eneas increased the amount of sun radiation heating the boiler, generating an average temperature of 1,000 °F. In 1903, Aubrey Eneas relocated the Solar Motor Company from Boston to Los Angeles, California.

Another customer of Aubrey Eneas was Arizona rancher Dr. Alexander Chandler, a prosperous veterinarian from Detroit, Michigan. Since a young age, growing up in Québec, Canada, Alexander Chandler had dreamed of cattle ranching in the American West. In 1887, a post for a veterinary surgeon opened in Arizona, and Alexander J. Chandler grabbed the opportunity, buying hundreds of acres of land to establish the Chandler Ranch south of Phoenix, Arizona. Irrigating his land would have cost him a fortune importing coal to pump the water up from the low-lying Salt River. He opted instead for Aubrey Eneas' solar motor. The capital cost of \$2,160 was steep at the time, but the fuel cost was zero. In 1903, the solar engine began to pay off, pumping thousands of gallons onto Alexander Chandler's new land.

Within a week, the large reflective surface area that made Aubrey Eneas's machine so powerful was also its greatest weakness. The massive but delicate device was structurally weak making it vulnerable to high winds and other inclement weather. During a wind storm, the part holding the boiler erect gave way, sending the heavy tube crashing down onto the mirrored parabolic dish, damaging it. Alexander Chandler,

unfazed, rebuilt the solar motor. Unfortunately, the other machines that Aubrey Eneas constructed were structurally weak, could not withstand the elements, and met similar fates. Another one was destroyed by a “dust devil,” a mini tornado common in desert areas and plains of the world, and another was shattered by a hail storm.

### **HENRY E. WILLSIE THERMAL ENERGY STORAGE PIONEER, 1904**

Henry E. Willsie identified the major weakness of all the previously built solar engines in their inability to overcome the intermittency problem of solar radiation. He was convinced that the lessons of the earlier pioneers Augustin Mouchout, Abel Pifre, William Adams, John Ericsson, and Aubrey Eneas proved the cost inefficiency of high-temperature, concentrating machines.

He thought that a non-reflective, lower-temperature collection system similar to Charles Tellier's design was the best method for directly utilizing solar heat, as long as it is coupled to some form of energy storage system that would make a solar engine operate at a high capacity factor, day and night and on cloudy or clear days. As low temperature operation lends itself to thermal energy storage, this is where he concentrated his effort.

As energy storage medium, he used large flat-plate collectors that heated water, which he kept warm all night in a large insulated basin. He submerged a bank of tubes inside the basin to extract the heat in sulfur dioxide (SO<sub>2</sub>) which he preferred to Charles Tellier's choice of ammonia (NH<sub>3</sub>). The high-pressure SO<sub>2</sub> vapor operated a turbine and exhausted into a condenser, where it cooled, returned to a liquid state, and continued the cycle.

He constructed in 1904 two plants, a 6 HP one in Saint Louis, Missouri, and a 15 HP horsepower one in Needles, California. He tested the energy storage capability of the 15 HP system. At night, he opened a valve that “allowed the solar heated water to flow over the exchanger pipes and thus start up the engine.”

Henry Willsie had succeeded in building the first ever solar device that could operate at night using part of the heat extracted during the day, overcoming the intermittence problem of solar as well as wind energy. The 15 HP engine was the most powerful device built up to that time. He provided detailed cost comparisons to justify his efforts. He claimed that the solar plant had a two years payback period. Henry Willsie initially intended his solar engine for desert land irrigation. However, in later patents applications he recognized that the invention was “designed for furnishing power for electric light and power, refrigerating and ice making, for milling and pumping at mines, and for other purposes where large amounts of power are required.”

However, potential customers were suspicious of the machine's durability, deterred by the high ratio of machine weight to power output, and fearful of the initial capital cost. Coal remained king and solar energy was bound to wait for more favorable economic and political circumstances.

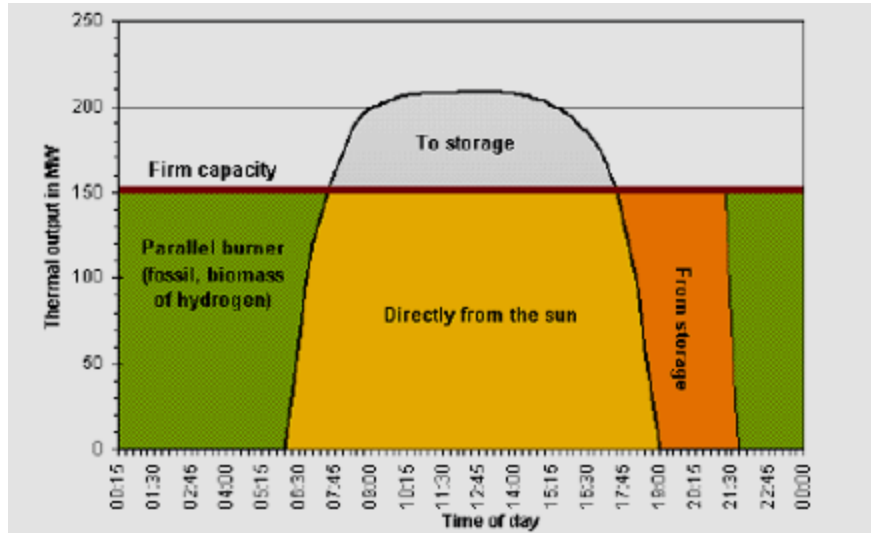

Figure 10. Energy storage scheme for continuous solar energy generation using Integrated Solar Combined Cycle (ISCC) plant.



Figure 11. Molten Salt Thermal Energy Storage Tank for electrical power generation, Andasol 1 plant, Spain. Source: Solar Millenium.

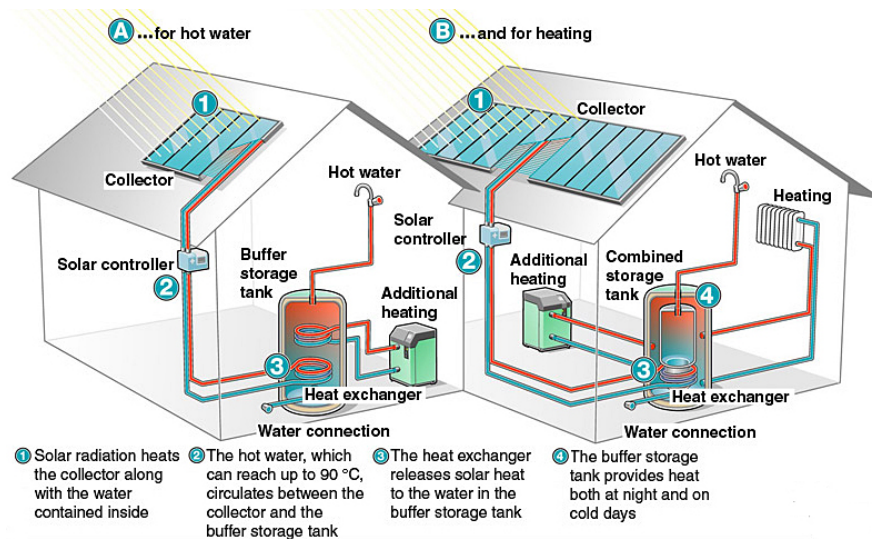

Figure 12. Thermal energy for hot water and heating for residential use. A similar configuration can be used for cooling and refrigeration.

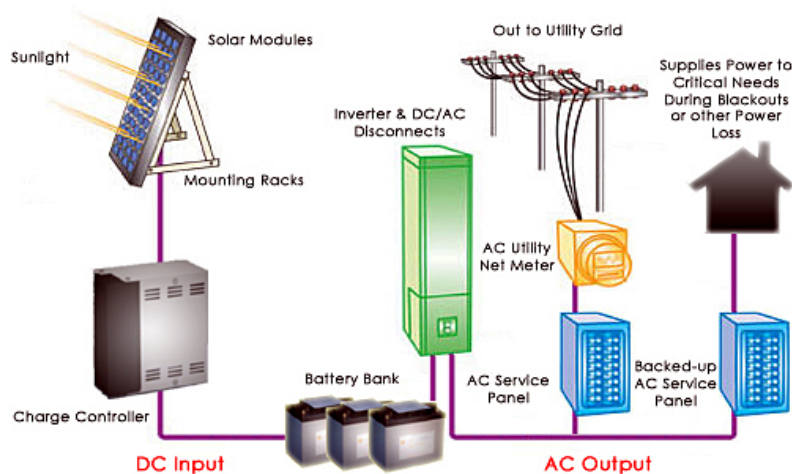

Figure 13. Electrical battery energy storage for residential use.

## SOLAR ENGINE ONE, SHUMAN-BOYS SOLAR PUMPING STATION AT AL MEADI, EGYPT, 1913

**FRANK SHUMAN (1862, 1918)**

In 1911, in a *Scientific American* article, Frank Shuman stated: “In Egypt, agriculture is totally dependent on the water from the Nile and the river’s yearly floodings. The irrigation of the fields is done by hundreds of thousands of ‘fellaheen,’ workers that pump water with archaic methods. A single solar engine would do the work of a thousand of these workers.” In 1914 he asserted that: “Using solar power you would only need 20,250 square miles in the Sahara in order to supply the whole world with

energy. One thing I know for sure. If mankind does not learn how to harness the power of the sun she will ultimately fall back into Barbary.”



Figure 14. Frank Shuman, Solar Engine One pioneer [12].

A period of national, colonial fervor and imperial rivalry and competition in controlling sources of coal energy as well as agricultural raw materials, particularly wool, cotton and sugar-cane existed as a prelude to World War I. The British, under Lord Kitchener as a Consul General and British Agent, later made “Earl of Khartoum and Broome,” considered the construction of a solar-powered irrigation pumping station in the Sudan in competition with Imperial Germany in its colonies and protectorates, Schutzgebiete. These colonies were being eyed up by the Allies who seized them for themselves as the victors in World War I and II. Just in Africa, these included German East Africa encompassing Tanganyika (with Zanzibar as present day Tanzania), Ruanda-Urundi (Rwanda and Burundi), Wituland (in Kenya), Kionmga Triangle (in Mozambique). They also encompassed German South West Africa including present day Namibia and part of Botswana, German West Africa including Kamerun (today Cameroon), Togoland (presently Ghana, Togo).

Earlier, in 1907, Frank Shuman, an American of German heritage, from Tacony, Philadelphia had filed a patent on using hot boxes 1 m by 1m consisting of two mirrors on each side, as collectors of solar energy for low-pressure steam production; which he demonstrated for the public in his backyard. As a youth, he would travel days from his chemical engineering job in West Virginia to collaborate on cutting-edge projects at his uncle Francis Schuman’s Tacony Iron and Metal Company. Shuman dropped the “c” in the family name following a practice in the USA to appear less Germanic.

He became intrigued on how glass can cause a greenhouse effect trapping the infrared portion of the solar radiation spectrum. Frank Shuman experimented with wire and “Safetee Glass,” and developed a low pressure steam engine for his solar energy plant. He also developed a method for producing cement pilings for buildings. He established the American Wire Glass Manufacturing Company and was the president of a safety glass firm. He established the Simplex Concrete Piling Company, which specialized in foundations for buildings.

Frank Schuman stayed at the still-existing historic Shepherd's Hotel in Cairo, where he conducted an interview in which he compared his activities with the development of aviation technology: "There are striking similarities between solar energy and aviation technology. Just a couple of years ago anyone investing good money in aviation would have been regarded as a lunatic. But now, when everyone knows that it really is possible to fly, there is no end to the willingness to invest. Big achievements are made every month in aviation. Solar technology will be the same success story."

He became a wealthy person and his activities made the city of Tacony, Philadelphia, the target of curious visitors when it became the site of the first successful use of solar energy in conjunction of a steam engine. Two solar steam power plants were built near Frank Shuman's Tacony home and later sold to Egypt where they were used to irrigate the desert near the Nile River. These solar energy plants brought Frank Shuman world-fame. He died in 1918 in his house on Disston Street at his home-town of Tacony.

### **OPERATIONAL DESIGN OF SOLAR ENGINE ONE**

The Solar Engine One plant was built on the West Bank of Nile River. It consisted of a series of reflectors and absorbers, a low pressure steam engine, a condenser and a pump. It was based on the Steam Turbine or the Joule Thermodynamic cycle, with ether that was earlier considered as a working fluid, avoided because of its toxicity.

It consisted of five trough parabolic reflectors of 204 feet (61 m) in length and 13 ft in width at the top which were placed about 25 ft apart so that they do not shade each other when the sun is low on the horizon in the morning and afternoon. The reflectors consisted of glass mirrors each of 1/8 in thickness. The reflectors presented 13,500 ft<sup>2</sup> of reflecting surface, but just 10,000 ft<sup>2</sup> were used. The boiler is 15 inches high and hung on light rods in such a manner that the expansion and contraction will not interfere with it. The reflectors were mounted on steel frames that are connected to each other and were geared to the engine by a central rack and cog wheels system.

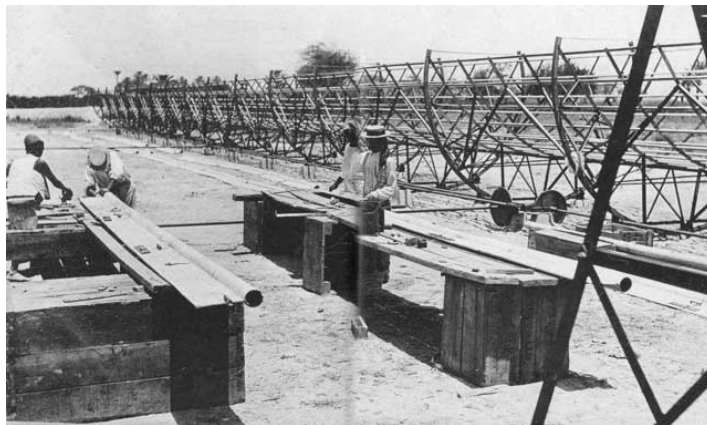

Figure 15. Solar Engine One plant under construction at Al Meadi, Egypt using local labor and materials [12].



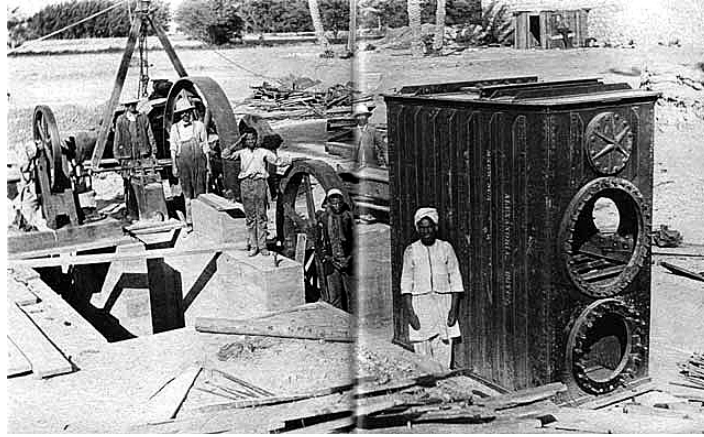

Figure 16. Solar Engine One steam water pump installation used belts, pulleys and flywheels for energy storage [12].

The tracking control system consisted of a thermostat which rotated the reflectors around a north south axis to face the sun throughout the day. They are reset at night to an east facing direction for the next day's operation.

In the middle of each reflector run the absorber or boiler consisting of a hollow box 3/8 of an inch in thickness connected to an upper cast iron tube. By means of an automatic feed system, the boiler box was always kept half full of water. The produced steam is conveyed by the upper tube to a branch steam pipe at the end of each boiler and then to the main steam pipe, then to the 100 HP low pressure steam engine operating at atmospheric pressure. The exhaust steam is sent to a condenser operating at 28 inches of vacuum created by the engine. The condensed water is returned to the absorbers to close the cycle. The engine is geared to a reciprocating suction pump by a belt and pulley drive with a delivery capacity of 6,000 gpm at a pressure head of 30 feet.

In 1913, the construction of "The No. 1 Sun Engine" was completed using low skilled local labor. After showing his prior proven experiments to English investors, construction began on the first utility scale solar thermal pumping station at Al Meadi, Egypt. The system was a parabolic trough system with centralized receivers and a single axis tracking. The system design changed during the development from Frank Shuman's 1911 flat plate concentrator design to the John Ericsson designed parabolic trough at the urging of C. V. Boys.

The plant was built by Frank Shuman and Boys in collaboration with several engineers and scientists, including A. S. E. Ackerman, A. G. Worrall, Lambert and Ralli [7, 8]. It used a 100 HP Shuman engine. Five concentrating parabolic trays oriented North-South were used. Each tray measured 15 feet in width by 206 feet in length. They were automatically heeled over, by being placed on wheels, from an easterly aspect in the morning to a westerly one in the evening, so as to actually follow the sun with an even absorption of the solar rays all day.

The total area of sunshine collected was 13,269 square feet. Cast iron receiving tubes boilers were placed at the focal point of the parabolic reflectors. They were covered with a single layer of glass which enclosed an air space around the boilers proper. The concentration value of this arrangement was 4 1/2 to 1. The

maximum amount of steam generated was 12 pounds per 100 square feet of sunshine, or the equivalent to 183 square feet per brake HP. The best hours' run developed, at atmospheric pressure, 1,442 pounds of steam. Allowing for 22 pounds of steam per brake HP, the maximum output for an hour was 55.5 HP. This was ten times better than any previous results generating a power output of 63 brake HP per acre of land occupied by the plant.

No marked reduction in the horsepower produced was noticeable in the early hours of the morning or in the late hours of the afternoon. The involved engineers recommended that such solar plants were feasible and practical and that they were useful in such arid regions for irrigation purposes.

Dust settling on the reflector mirrors became a nuisance, resulting in a loss of power according to the thickness of the deposited layer of dust. However labor is cheap in the tropical areas to keep the mirrors relatively clean. In more advanced designs, a water washing system is used whenever water is available.

An argument brought against them concerned their intermittency in cloudy weather and at night. The counterargument was simply that irrigation would not then be needed [1]. There were significant cost overruns and the Return On Investment (ROI) assumptions that Frank Schuman had shared with English investors were not realized.

World War I erupted in 1914. All system engineers left Al Meadi being summoned to join in the war effort. A British army contingent suddenly showed up and dismantled the No. 1 Solar Engine and left with the essential system parts "in the name of raw materials for the war effort." Skeptics suggest that it was a punishment of Frank Shuman for his business deals with Germany.

As a result of fighting in World War I, the majority of coal shipments from England; the world's largest exporter of coal at the time, had stopped. With a lack of fuel supplies, any discussion of renewable forms of energy was welcomed by the industrialized countries. Based on a rough estimation of the world's power needs, Frank Schuman did some rough power consumption needs at the time and found that: "Using solar power you would only need 20,250 square miles (about one tenth of the area of Sweden) in the Sahara in order to supply the whole world with energy. One thing I know for sure. If mankind does not learn how to harness the power of the sun she will ultimately fall back into Barbary."

The use of solar and wind energy from the Sahara Desert and its conveyance across the Mediterranean Sea to Europe is pursued as the "Desertec" Initiative jointly pursued by the European Union (EU) and North African countries.

## **ENERGY STORAGE**

Energy storage is crucial for any successful intermittent energy source be it solar or wind. At Solar Engine 1 a well-trying and simple method was used. During the day, large quantities of water were heated to the boiling point and stored in large tanks properly insulated from the atmosphere. From this boiling water low pressure steam was drawn during the night or a rainy day by generating a vacuum. The steam engine was designed to operate economically at 4 lbs absolute of steam pressure.

## **EARLIER EXPERIMENTATION**

Frank Shuman was inspired by the American engineers Henry E. Willsie and John Boyle who expanded the work of late 19<sup>th</sup> Century French engineer Charles Tellier, the inventor of commercial refrigeration. They were experimenting with low temperature solar motors using liquids with low boiling points, such as ammonia, to generate steam [14]. Frank Shuman experimented with lenses and mirrors as reflectors and with ether and reportedly sulfurous acid, H<sub>2</sub>SO<sub>3</sub> as working fluids.

## HOT BOX DESIGN

Initially, a series of hot boxes with vaporizing ether were used to run a toy train at his residence. The first experiments consisted of wooden boxes covered with two layers of glass with a small air space between them as an insulating layer. Hot boxes consisted of flat tin pan painted dull black on the inside then packed with cotton around the bottom and sides to prevent heat leakage. A small quantity of ether or water was poured in, covered with a pane of window glass, and exposed to the sun. The tropical sun, without any concentration would boil the water and generate steam. The sun shining into the black-body absorber pan produces a temperature of 250 °F with a power flux generation of about 4 BTU/(ft<sup>2</sup>.min) of heat. Concentrating the solar radiation using a mirror leads to the attainment of higher temperatures in addition to more energy proportional to the area affected.

In the box, a miniature ether boiler was placed. The second set of experiments consisted of a 2-inch steam pipe 16 feet in length insulated at the bottom and enclosed in a box covered by a double layer of glass. Ether was here again vaporized. The third set of trials consisted of a bed of water pipes 18 by 16 ft, insulated against heat loss with an ether engine generating 3 ½ HP.

Frank Shuman added better insulation to his hot boxes to increase the overall thermal efficiency and surrounded them with reflectors to focus solar radiation. Despite his aversion to the expensive, breakable reflectors used by Augustin Mouchot and Aubrey Eneas, Frank Shuman added concentrating mirrors to the design as one square yard angled reflectors at the top and bottom end of each hot box [14]. He further placed them on swivels to track the sun's movement.

Using low pressure steam, he introduced it into a partial vacuum vessel. At Standard Temperature and Pressure (STP), water boils at 212 °F. The partial vacuum caused a lower saturation pressure and consequently a lower boiling point for water causing it to "flash" into steam at 102 °F. The water heated by the collectors and flashed into steam drove a steam engine equipped with flywheels as a storage energy device.

He was able to generate his 3 ½ HP by using 200 square feet of surface area of the hot boxes. The pipes containing the ether exposed 900 square feet of surface to the solar radiation. The water also became heated and carried the heat to the underside of the pipes, thus realizing a greater efficiency. The ether boiled and its vapor drove a small vertical, single cylinder engine. The exhaust ether vapor passed into an air surface condenser and the liquid ether from this was pumped back into the tubes of the sun boiler. The plant worked well even with snow on the ground, which can be explained on the basis that the permeability of the atmosphere is 20 per cent larger in the winter than in the summer.

## IMPROVED STEAM ENGINE DESIGN

In 1911, Frank Schuman was able to build an engine and boiler which used 245 square feet of solar insolation per attainable one brake HP. The absorbing pipes constituting the sun boilers had to be blackened for low temperatures with lamp black. For high temperature operation they needed platinum black as an absorber.

He sought the expertize of an engineer E. P. Haines who used precise milling methods, closer tolerances and lighter weights in the moving parts of the steam engine. His breakthrough was achieved when he started evaporating water into steam in a partial vacuum and coupled a low pressure steam engine to his hot boxes array. He convinced investors that he developed a solar device that competes with coal as a source of energy. He held public demonstrations at his compound, invited school children and prospective venture capitalists to observe his 33 HP solar engine pump 3,000 gallons of water per minute to an elevation of 33 feet in the air.

Frank Shuman realized that he could produce 25 percent more steam in a tropical climate. He sought capital for a commercial scale solar plant in the UK which had trouble shipping coal to its colonies. He obtained the financial backing he needed to set up a solar powered irrigation plant in Egypt in 1913.

In 1911 he built 572 collectors in a 950 m<sup>2</sup> area at the Vogt playground at Tacomy, Philadelphia. To commercialize his patent, he raised funds from investors in the USA and the UK in 1912 through two establishments: the “Sun Power Company, Eastern Hemisphere,” and the “Shuman Engine Syndication, Limited.”



Figure 17. Shares in “The Sun Power Company” signed by Frank Shuman [11]

## CHARLES VERNON BOYS (1855-1944) CONTRIBUTION

The UK shareholders of The Sun Power Company requested a review of the project by Professor Charles Vernon Boys in London. His review of the Frank Shuman design came out negative about the use of a line of simple hot boxes, and he suggested the use of trough parabolic concentrators instead.

Born on March 15 1855; died on March 30, 1944, Sir Charles Vernon Boys was an English physicist and inventor of sensitive instruments. He graduated in mining and metallurgy and self-taught himself a wide knowledge of geometrical methods. In 1881, he invented the integrator which is a device for drawing the integral of a function. He used the torsion of quartz fibers in the measurement of very small forces, enabling him to elaborate in 1895 on Henry Cavendish's experiment to improve the values obtained for Isaac Newton's gravitational constant. He invented an improved automatic recording calorimeter for testing manufactured gas in 1905 and high-speed cameras to photograph rapidly moving objects, such as bullets and lightning strikes. Upon retirement in 1939, he grew weeds, attempting to unleash their food production possibilities. He authored a book on "Soap Bubbles and the Forces Which Mould Them."



Figure 18. Sir Charles Vernon Boys making a presentation on the properties of soap bubbles.

Sir Charles Vernon Boys filed a patent for a tracking mechanism using a thermostat associated with a cylindrical trough parabolic solar collector in 1912. He suggested that 5 reflectors, 60 m in length and 4 m in aperture each, could provide 55 hp and pump about 2,000 liters / min of water.

Charles Vernon Boys criticized the details of Frank Shuman's original design. In response, Frank Shuman was forced by his financial backers to hire Charles Vernon Boys as a technical consultant. Charles Vernon Boys used his knowledge in geometry and replaced the original hot boxes collectors in the Frank Shuman design by parabolic mirror concentrators, which concentrate the solar radiation at the focus of the parabolic surface. He also improved the design by adding his tracking mechanism invention so that the collectors would follow the sun from east to west during the day.

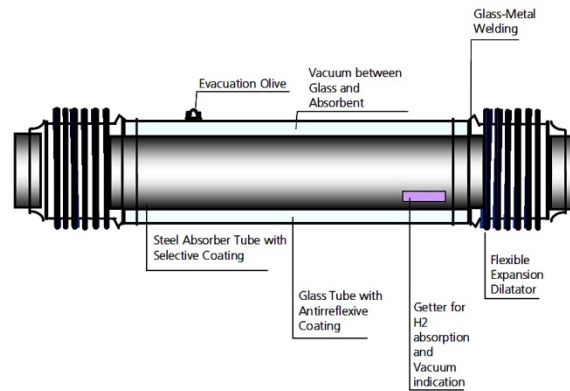

Figure 19. Solar Engine One Shuman-Boys parabolic collector system built at Al Meadi, Egypt, 1913. North view [1]. Schott PT 70 collector tube system used at Al Kuraymat, Egypt, 2010 [16].

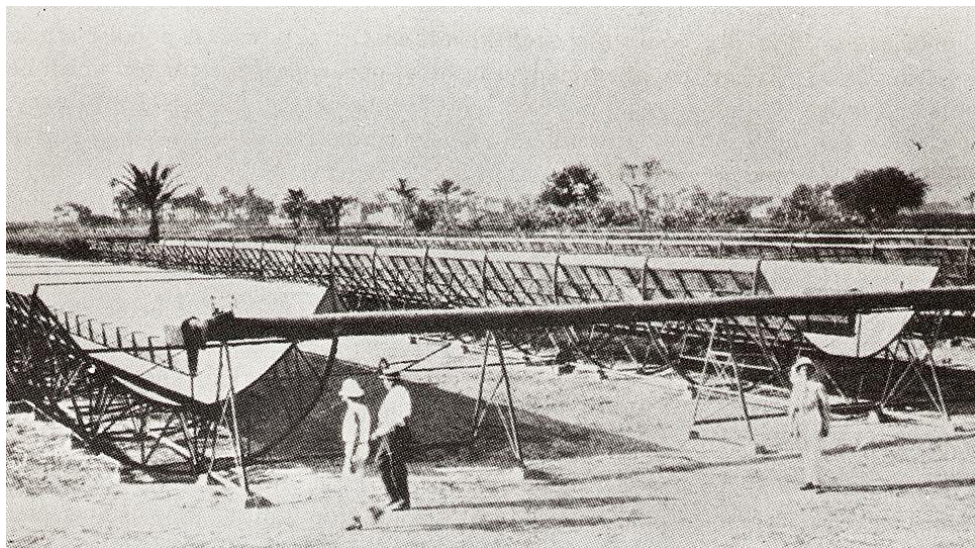

Figure 20. Solar Engine One. Shuman-Boys solar Nile water irrigation pumping station at Al Meadi, Egypt, 1913. The mirrors were tilted around the hoops to track the sun. South view [15].

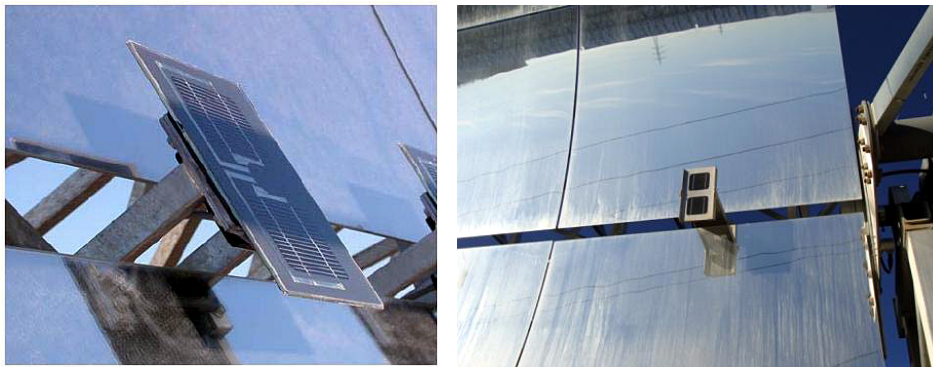
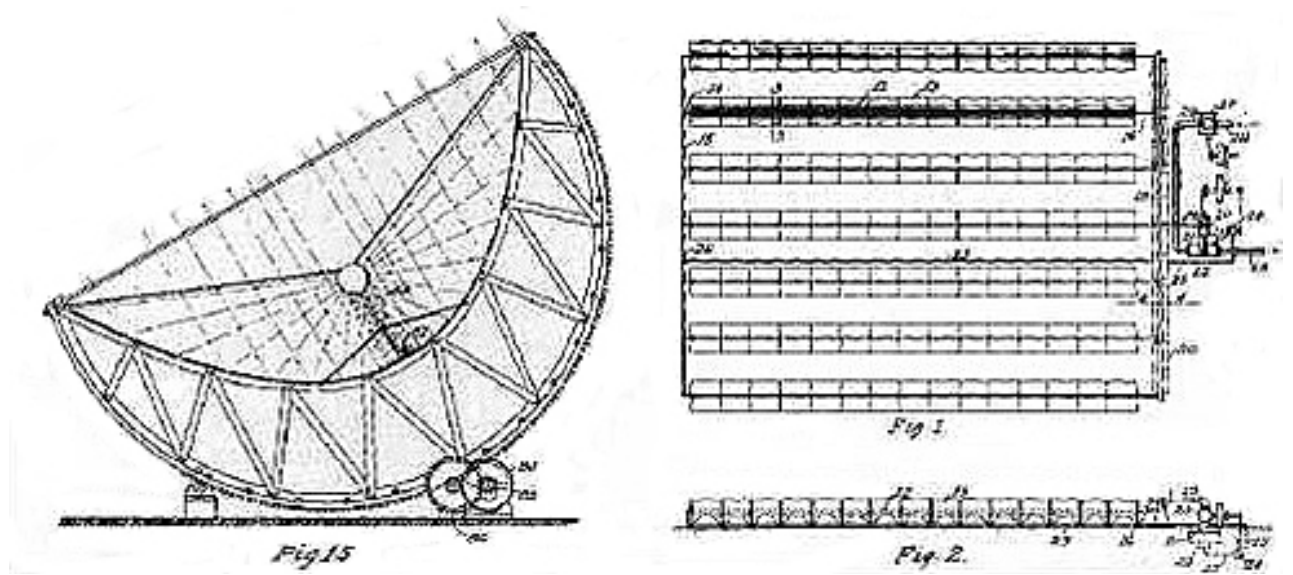

Figure 21. Patent application for the tracking system using a thermostat, and the plant layout of the Solar Engine One Shuman-Boys collector. Modern photovoltaic two-signal compensating systems at Al Kuraymat, Egypt, 2000 [16].

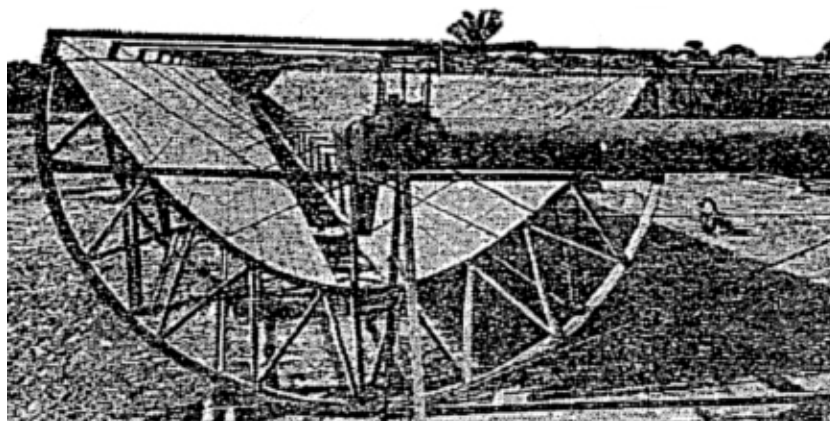

Figure 22. End view of parabolic trough showing boiler and steam conveyance tube at the Solar Engine One solar plant [10].

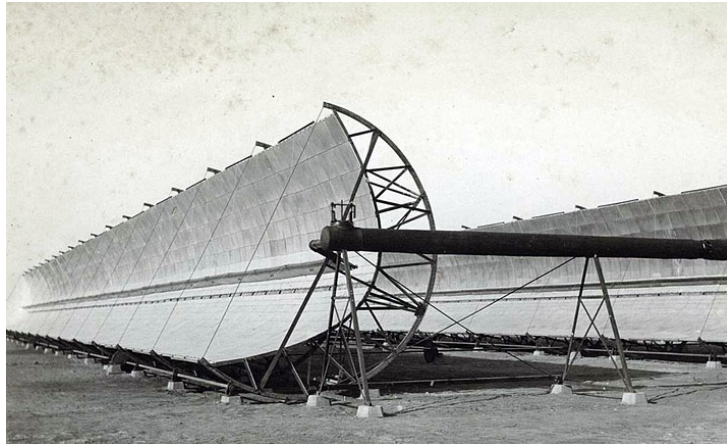

Figure 23. Front view of the steam collection system of the Solar Engine One Shuman-Boys parabolic collector at Al Meadi, Egypt [4].

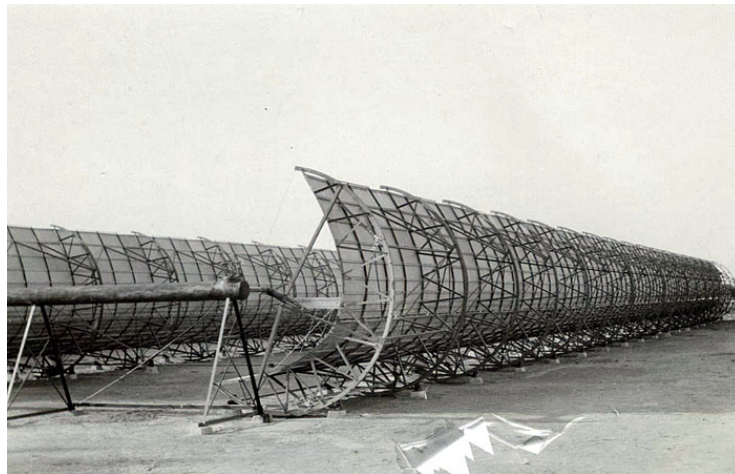

Figure 24. Back view of the steam collection system of the Solar Engine One Shuman-Boys parabolic collector at Al Meadi, Egypt [4].

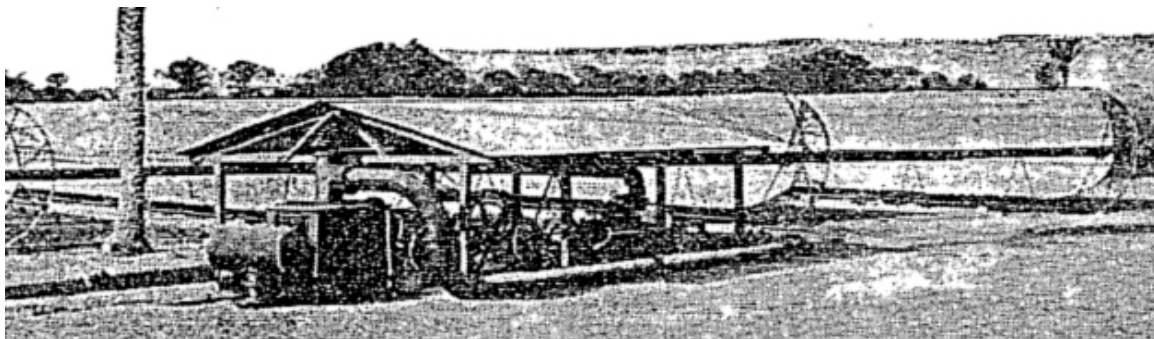



Figure 25. Pumping station of the Solar Engine One power plant [10].

## **ECONOMICS**

The improved design enhanced the efficiency of the device but also increased its capital costs. The result is that the project has to be scaled down to fit the available budget. Frank Shuman never liked the modifications to his original design and laments it: “From 1,000 horsepower and a simple construction we now have to settle for 100 horsepower and a lot of fancy fuzz.”

As a first of its kind, the initial capital cost of the plant was twice as much as that of a similar coal plant delivering the same power capacity. However, once installed, the operating cost is decreased by the fact that the cost of the coal fuel would be eliminated. A large economy in the operating staff was also achieved. Its niche application was the use of areas of high cost of the coal fuel then.

As a demonstration, the plant pumped out water from the Nile River and discharged it back. It apparently did not last long enough for use in irrigation as it succumbed to the colonial and imperial powers rivalries and the advent of World War I.

## **GREAT POWERS COMPETITION AND RIVALRIES**

At the inauguration of the Solar Engine One plant, the German Consul General in Cairo and his assistants took photographs and notes and on the spot invite Frank Shuman to visit Berlin for a presentation to the German Reichstag. In good faith, Frank Shuman accepts the invitation and in September 1913 he leaves Egypt on a ship to Hamburg, where a special train takes him to Berlin. Being of German heritage, Frank Shuman is greeted like a returning lost son. Solar power was also needed as an energy source in the German colonies in Africa and the rest of the world.

The well-meaning and unsuspecting Frank Shuman did not expect that this would upset his shareholders and financial backers in the UK and the USA. Tensions between Germany and the Austro-Hungarian Empire and between France and England escalated during the winter and spring and reached a breaking point on Sunday, June 28, 1914 at Sarajevo, capital of the province of Bosnia and Herzegovina. The driver of the procession of the Archduke Franz Ferdinand of Austria, a member of the Habsburg ruling dynasty, takes a wrong turn into a side street, exposing him and his wife Sophie to assassination by Gavrilo Princip, a Serbian nationalist.

The couple had previously been subject to an attack by a grenade that was thrown at their car. Archduke Franz Ferdinand deflected the grenade and it detonated far behind them. They insisted on seeing all those injured at the local hospital. On their way back to the palace their driver mistakenly turned onto the side street.

Austria-Hungary declared war on Serbia. Germany and Austria-Hungary and countries allied with Serbia declared war against each other, succumbing to a toxic brew of nationalism, militarism and imperialism, spreading the scourge of World War I over the whole European continent, with the USA eventually joining its European allies in the conflict.

## **DISMANTLEMENT OF SOLAR ENGINE ONE**

Frank Shuman raised the ire of the UK and USA financial and political interests when he tried to sell his ideas to Germany in the only address ever given to the German Parliament (Reichstag) by an inventor, which offered him 200,000 Deutsche Reichmarks to build a similar plant at the German East Africa colony. A proposition was also made for a plant in Chile [10].

Frank Shuman planned to build more of these solar reflector plants, conditional on the availability of enough Nile River water, in a 20,250 square miles expanse of the Sahara Desert. His vision was to provide the world “in perpetuity the 270 million horsepower per year required to equal all the fuel (in the form of coal) mined in 1909.”

He was forced by the colonial powers politics to shelve the idea at the outbreak of World War I. The engineers involved in Al Meadi plant were summoned to join the war effort work in their respective countries. A British Army contingent was ordered to dismantle the plant to use as scrap metal to supply its munitions industry [13].

The British government, to maintain the superiority of its naval fleet with oil-fired boilers partly nationalizes the Anglo-Persian oil company which had earlier discovered oil in Iran around 1908. Large oil fields were discovered in South California, Iraq and Venezuela. Germany lost its African colonies to the victors and the Deutschmark currency became worthless because of currency inflation, and the German government did not honor its contract with him.

After the war, as the world discovered the vast oil fields in Iraq, Iran, and Venezuela, the allure of limitless solar energy was diminished and Shuman returned to his hometown of Tacony, Pennsylvania. He tried unsuccessfully to get the USA Navy interested in liquid oxygen for submarines. In 1919 he died of a heart attack, with his dreams and visions to be realized in future generations.

## LATITUDE CONSIDERATION

Solar power was almost forgotten until its latest revival. The vision of using the Sahara Desert’s solar potential for the benefit of its surrounding countries and Europe is being revived through the “Desertec Project.”

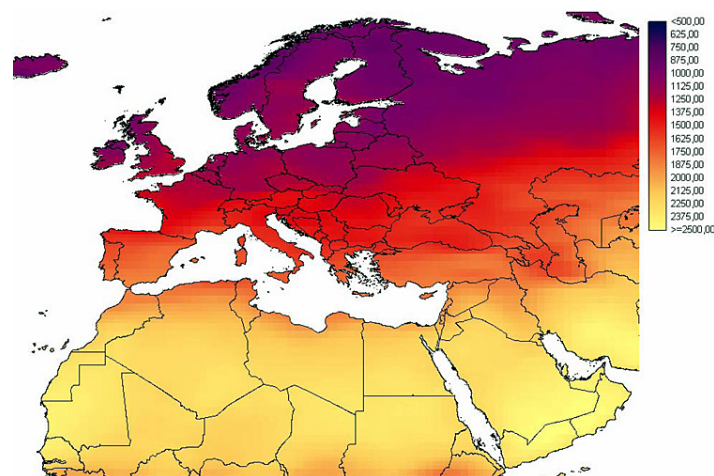

Figure 26. Europe has large energy needs that exist south of the Mediterranean Sea in North Africa suggesting the “Desertec” initiative.

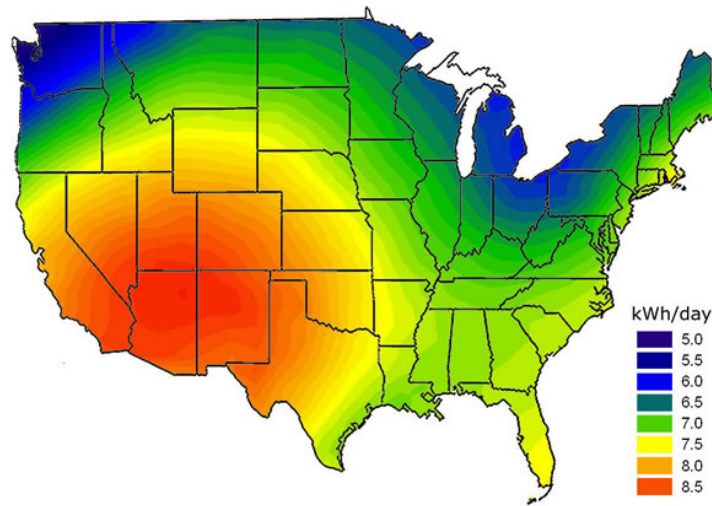

Figure 27. Solar Heat distribution in the USA.

Sun power generation is not practical in the higher altitudes, but is most promising in the equatorial latitudes. The reason is not just that the solar flux is lower. The reason is primarily that the percentage of hours of sunshine throughout the year is too low for economical applications at the higher latitudes.

For instance, in Philadelphia, USA the sun shines only 23 percent of the total daytime. Tropical regions have the sun shine 90 percent of the day and over. In addition, 20 percent of the cultivable area of the Earth where solar energy could be used, for instance for pumping water, lies in the tropical regions. Solar plants nevertheless, once constructed and placed into operation with an adequate energy storage system, dispense totally with any fuel needs.

Cairo is at 30 degrees in latitude, but it was easily accessible for for a demonstration plant.

## **PARABOLIC SOLAR TROUGH TECHNOLOGY**

Parabolic solar trough technology is the most proven solar thermal electric technology. It encompasses nine large commercial-scale solar power plants, the first of which has been operating in the California Mojave Desert since 1984. These plants, range in size from 14 to 80 MW in capacity.

Historically, parabolic trough plants have been designed to use solar energy as the primary energy source to produce electricity. The plants can operate at full rated power using solar energy alone given sufficient solar input. During the summer months, the plants typically operate for 10-12 hours a day at full-rated electric output.

Most solar plants in the USA have been hybrid solar/fossil plants; in the sense that they have a backup fossil-fired capability that can be used to supplement the solar output during periods of low solar radiation. Usually, an optional natural-gas-fired HTF heater is

situated in parallel with the solar field, or an optional gas steam boiler / reheater is located in parallel with the solar heat exchangers.

The fossil backup can be used to produce rated electric output during overcast or nighttime periods. Thermal storage is a potential option that can be added to provide improved dispatchability.

## DEVELOPMENT OF SOLAR THERMAL TECHNOLOGY

Development of solar collector technology began in the USA in the mid 1970s under the Energy Research and Development Administration (ERDA) and continued with the establishment of the USA Department of Energy (DOE) in 1978.

Parabolic trough collectors capable of generating temperatures larger than 500 °C or 932 °F were initially developed for Industrial Process Heat (IPH) applications. The early development was conducted by Sandia National Laboratory in Albuquerque, New Mexico.

Process heat applications, ranging in size from a few hundred to about 5,000 m<sup>2</sup> of collector area, were put into service. Acurex, SunTec, and Solar Kinetics were the key parabolic trough manufacturers in the USA during this period.

Table 1. Thermal Solar Collectors Assemblies, SCAs characteristics.

Collector	Acurex 3001	MAN M480	Luz LS-1	Luz LS-2		Luz LS-3
Year	1981	1984	1984	1985	1988	1989
Area [m <sup>2</sup> ]	34	80	128	235		545
Aperture [m]	1.8	2.4	2.5	5		5.7
Length [m]	20	38	50	48		99
Receiver Diameter [m]	0.051	0.058	0.042	0.07		0.07
Concentration Ratio	36:1	41:1	61:1	71:1		82:1
Optical Efficiency	0.77	0.77	0.734	0.737	0.764	0.8
Receiver Absorptivity	0.96	0.96	0.94	0.94	0.99	0.96
Mirror Reflectivity	0.93	0.93	0.94	0.94	0.94	0.94
Receiver Emittance	0.27	0.17	0.3	0.24	0.19	0.19
at temperature (°C/°F)			300/572	300/572	350/662	350/662
Operating Temp. (°C/°F)	295/563	307/585	307/585	349/660	390/734	390/734

Parabolic trough development was also taking place in Europe and culminated with the construction of the IEA Small Solar Power Systems Project/Distributed Collector System (SSPS/DCS) in Tabernas, Spain, in 1981. It consisted of two parabolic trough solar fields with a total mirror aperture area of 7,602 m<sup>2</sup>. The fields used the single-axis tracking Acurex collectors and the double-axis tracking parabolic trough collectors developed by the MAN company of Munich, Germany.

In 1982, Luz International Limited (Luz) developed a parabolic trough collector for IPH applications that was based largely on the experience that had been gained by DOE/Sandia and the SSPS projects.

Although several parabolic trough developers sold IPH systems in the 1970s and 1980s, they encountered two barriers to successful marketing of their technologies:

1. There was a relatively high marketing and engineering effort required for even small projects.
2. Most potential industrial customers had cumbersome decision-making processes which often resulted in a negative decision after considerable effort had already been expended.

In 1983, the Southern California Edison, SCE utility company signed an agreement with Acurex Corporation to purchase power from a solar electric parabolic trough power plant. Acurex was unable to raise financing for the project. The Luz Company negotiated similar power purchase agreements with SCE for the Solar Electric Generating System (SEGS) I and II plants.

## **PUBLIC UTILITY REGULATORY POLICIES ACT, PURPA**

With the advent of the California Standard Offer (SO) power purchase contracts for qualifying facilities under the Public Utility Regulatory Policies Act (PURPA), the Luz Company signed a number of SO contracts with SCE that led to the development of the SEGS III through SEGS IX projects.

Initially, the plants were limited by PURPA to 30 MW of power in capacity. This limit was raised to 80 MW. In 1991, Luz filed for bankruptcy when it was unable to secure construction financing for its tenth plant (SEGS X). Though many factors contributed to the demise of Luz, the basic problem was that the cost of the technology was too high to compete in the power market.

All of the SEGS plants were sold to investor groups as independent power projects and continue to operate.

## **THERMAL SOLAR COLLECTOR TECHNOLOGY**

The basic component of the solar field is the Solar Collector Assembly (SCA). Each SCA is an independently tracking parabolic trough solar collector made up of parabolic reflectors or mirrors, the metal support structure, the receiver tubes, and the tracking system that includes the drive, sensors, and controls.

The general trend is to build larger collectors with higher concentration ratios CR, where:

$$\text{Concentration Ratio CR} = \frac{\text{Collector Aperture}}{\text{Receiver Diameter}} = \frac{A}{D} \quad (1)$$

to maintain collector thermal efficiency at higher fluid outlet temperatures.

## **THE LUZ SYSTEM-3 SOLAR COLLECTOR ASSEMBLY, LS-3 SCA**

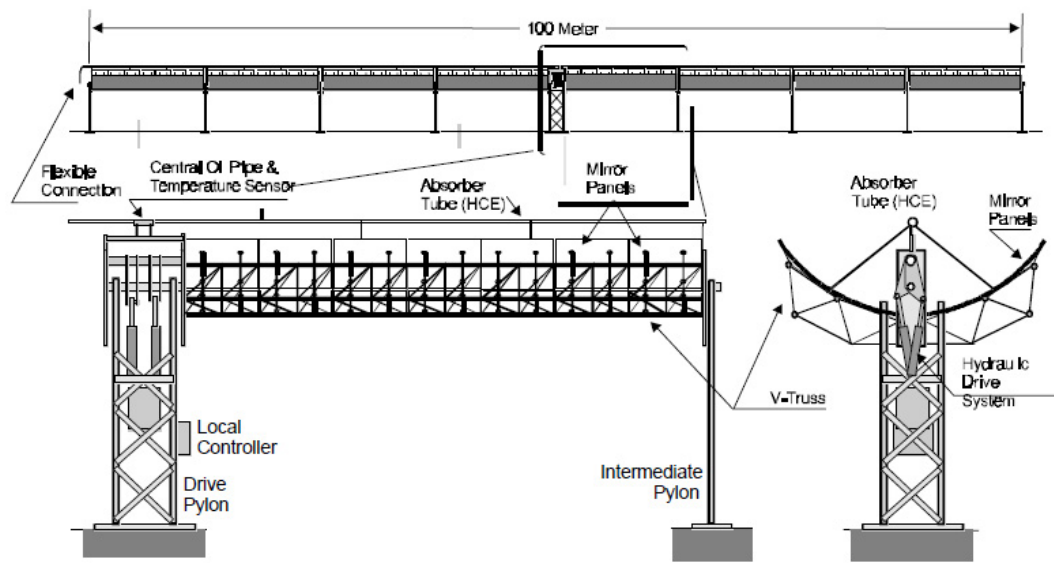

Figure 28. Luz System-3 Solar Collector Assembly, LS-3 SCA [1].

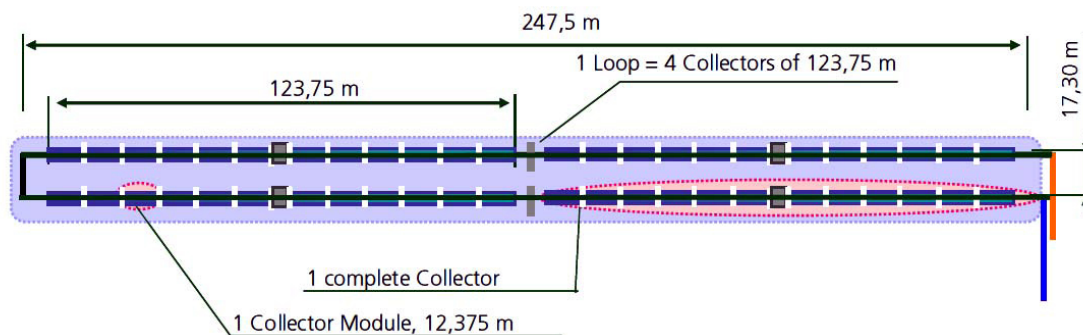

Figure 29. Front and back views of parabolic trough Skal-Et 150 at Al Kuraymat, Egypt, 2010. Peak optical efficiency: 80 percent. Geometric concentration: 82. Length: 123.75 m / SCA. Aperture area:  $817.5 \text{ m}^2/\text{SCA}$  [16].

The LS-3 collector was the last collector design produced by Luz and was used primarily at the larger 80 MW plants. The LS-3 collector represents the current state-of-the-art in parabolic trough collector design and is the favored collector in parabolic trough plants.

The LS-3 reflectors are made from hot-formed mirrored glass panels, supported by the truss system that gives the Solar Collector Assembly, SCA its structural integrity. The aperture or width of the parabolic reflectors is 5.76 m and the overall SCA length is 95.2 m of net glass.

The mirrors are made from a low iron float glass with a transmissivity of 98 percent that is silvered on the back and then covered with several protective coatings. The mirrors are heated on accurate parabolic molds in special ovens to obtain the parabolic shape. Ceramic pads used for mounting the mirrors to the collector structure are attached with a special adhesive. The high mirror quality allows 97 percent of the reflected rays to be incident on the linear receiver.

The linear receiver, also referred to as a Heat Collection Element (HCE), is one of the primary reasons for the high efficiency of the Luz parabolic trough collector design. The HCE consists of a 70 mm steel tube with a cermet selective surface, surrounded by an evacuated glass tube. The HCE incorporates glass-to-metal seals and metal bellows to achieve a vacuum-tight enclosure. The vacuum enclosure serves primarily to protect the selective surface and to reduce heat losses at the high operating temperatures. The vacuum in the HCE is maintained at about 0.0001 mm Hg or 0.013 Pa.

The cermet coating is sputtered onto the steel tube to give it excellent selective heat transfer properties with an absorptivity of 0.96 for direct beam solar radiation, and a design emissivity of 0.19 at 350 °C or 662 °F. The outer glass cylinder has anti-reflective coating on both surfaces to reduce reflective losses off the glass tube.

Getters, metallic substances that are designed to absorb gas molecules, are installed in the vacuum space to absorb hydrogen and other gases that permeate into the vacuum annulus over time.

The SCAs rotate around a horizontal north / south axis to track the sun as it moves through the sky during the day. The axis of rotation is located at the collector center of mass to minimize the required tracking power. The drive system uses hydraulic rams to position the collector. A closed loop tracking system relies on a sun sensor for the precise alignment required to focus the sun on the HCE during operation to within +/- 0.1 degrees. The tracking is controlled by a local controller on each SCA. The local controller also monitors the HTF temperature and reports operational status, alarms, and diagnostics to the main solar field control computer in the control room. The SCA is designed for normal operation in winds speeds up to 25 mph or 40 km/hr and somewhat reduced accuracy in winds up to 35 mph or 56 km/h. The SCAs are designed to withstand a maximum of 70 mph or 113 km/h winds in their stowed position with the collector aimed 30 degrees below the eastern horizon.

The SCA structure on earlier generations of Luz collectors was designed to high tolerances and erected in place in order to obtain the required optical performance. The LS-3 structure is a central truss that is built up in a jig and aligned precisely before being lifted into place for final assembly. The result is a structure that is both stronger and lighter. The truss is a pair of V-trusses connected by an end plate. Mirror support arms are attached to the V-trusses.

The mirrors were provided by Pilkington Solar International (PilkSolar) and are manufactured on the original SEGS mirror production line. The Luz HCE receiver tube manufacturing facility and technology rights were sold to SOLEL Solar Systems Ltd. of Jerusalem, Israel. SOLEL supplies HCEs as spare parts for the existing SEGS plants.

## **SEGS PLANTS OPERATING EXPERIENCE**

The nine operating SEGS plants have demonstrated the commercial nature of the Luz parabolic trough collector technology and have validated many of the SEGS plant design concepts. Additionally, many important lessons have been learned related to the design, manufacture, construction, operation, and maintenance of large-scale parabolic trough plants.

A simple problem with a single component, such as an HCE, can affect many thousands of components in a large solar field. Thus it is essential that each of the SCA components is designed for the 30-year design life of the plant and that a sufficient Quality Assurance, QA program is in place to ensure that manufacture and installation adhere to the design specifications.

The Luz Company used three generations of collector during the development of the nine SEGS plants. Each time a new generation of collectors was used, some form of component failure was experienced. However, one of the major achievements of Luz was the speed with which they were able to respond to new problems as they were identified. Problems with components were due to design or installation flaws. An important lesson learned from the plants has been the recognition that the Operation and Maintenance, O&M requirements need to be fully integrated into the original design.

### **Heat Collection Elements (HCEs)**

A number of HCE failure mechanisms have been identified at the SEGS plants, with all of these issues resolved through the development of improved installation practices and operation procedures, or through a design modification.







Figure 30. Receiver tube attachment configurations in parabolic trough collectors.



Figure 31. Heat Collection Element (HCE) receiver detail. Central receiver tube is coated with a dark paint, and surrounded by a vacuum-tight transparent insulating tube that is filled with a getter.

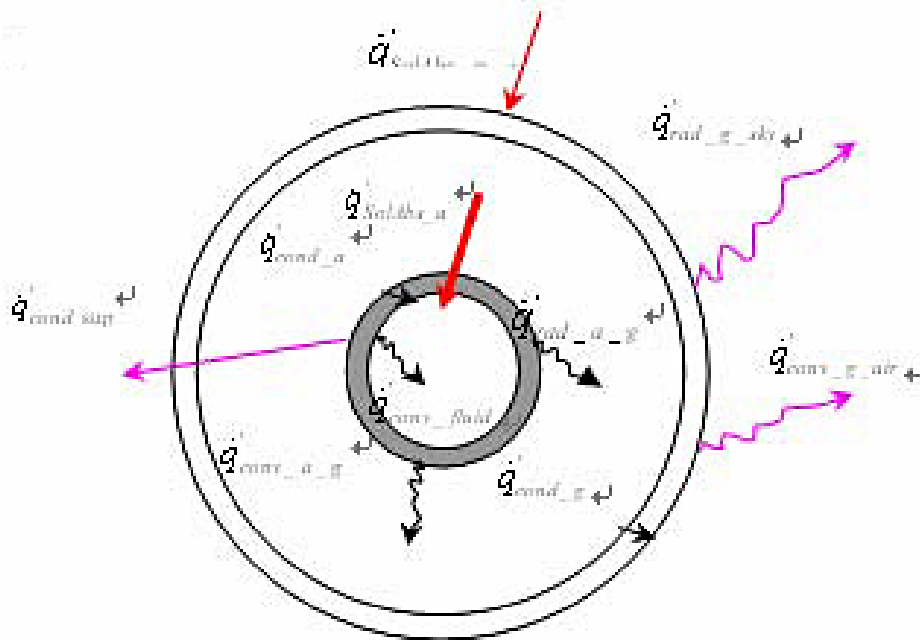

Figure 32. Receiver tube energy balances.

The receiver tube is located at the focus line of the parabolic reflective surface, as a means of transferring the absorbed solar energy to a working fluid. The inside of the receiver tube is the absorber tube coated with selective blackened nickel. This coating has high absorption of short wave length solar radiation and low emissivity for long wave (IR) energy radiation to reduce thermal radiation losses.

The absorber tube is contained within a glass envelope, which maintains good strength and transmittance under high temperatures. The outside glass envelope is transparent to solar radiation over the solar absorber surface. It reduces convection and radiation losses to the atmosphere,

The annulus gap between absorber tube and glass envelope of is kept in a vacuum in order to reduce conduction and convection losses between the absorber and glass envelope. Loss of vacuum, breakage of the glass envelope, deterioration of the selective surface, and bowing of the stainless steel tube, which eventually can lead to glass breakage, have been the primary HCE failures, all of which affect the overall thermal efficiency.

## RESEARCH AND DEVELOPMENT DIRECTIONS

Several of the existing SEGS plants have experienced unacceptably high HCE glass envelope breakage rates. The subsequent exposure to air accelerates degradation of the selective surface. Design improvements have been identified to improve durability and performance, and these have been introduced into replacement parts manufactured for the existing plants. In addition, better installation and operational procedures have significantly reduced HCE failures.

It is advised that future HCE designs would include:

1. The use of new tube materials to minimize bowing problems;
2. Allow broken glass to be replaced in-situ in the field;
3. Continue to improve the selective coating absorptance, emittance, and long-term stability in air.

## **Mirrors**

The current low iron glass mirrors are one of the most reliable components in the Luz collectors. Separation of the mirror mounting pads from the mirrors was an early problem caused by differential thermal expansion between the mirror and the pad. This problem was resolved by using ceramic pads, a more pliable adhesive, and thermal shielding. Methods have been developed that allow the O&M crew to retrofit the older mirror pad design and strengthen them to greatly reduce failures.

Mirror breakage due to high winds has been observed near the edges of the solar field where wind forces can be high. Strengthened glass mirrors or thin plastic silvered film reflectors have been designed to circumvent this problem.

There has been no long-term degradation in the reflective quality of the mirrors. Ten-year old mirrors can be cleaned and brought back to like-new reflectivity.

The glass mirrors are expensive and for the cost of the collector to be reduced, alternative mirrors are necessary. Any new mirror must be able to be washed without damaging the optical quality of the mirror. Front surface mirrors hold potential to have higher reflectivity, if the long-term performance and washability can be demonstrated.

## **Flexible hoses**

The flexible hoses or flexhoses that connect the SCAs to the headers and SCAs to each other have experienced high failure rates at the early SEGS plants. Later plants used an improved design with a substantially increased life that significantly reduced failures. In addition, a new design that replaces the flexhoses with a hard piped assembly with ball joints is used at the SEGS III-VII plants located at Kramer Junction.

The new ball joint assembly has a number of advantages over the flexhoses including lower cost, a significant reduction in pressure drop, and reduced heat losses. If ball joint assemblies can be proven to have a life comparable to the new longer-life flexhoses, then they will be included in all future trough designs.

## **Mirror Washing and Reflectivity Monitoring**

Development of an efficient and cost-effective program for monitoring mirror reflectivity and washing mirrors, particularly in dusty desert environments, is critical. Differing seasonal soiling rates require flexible procedures. For example, high soiling rates of 0.5 percent/day have been experienced during the summer period.

After considerable experience, O&M procedures have settled on several methods, including deluge washing, and direct and pulsating high-pressure sprays.

All methods use demineralized water to enhance the washing effectiveness. The periodic monitoring of mirror reflectivity can provide a valuable quality control tool for

mirror washing and help optimize wash labor. As a general rule, the reflectivity of glass mirrors can be returned to design levels with good washing.

### **Maintenance Tracking**

Computerized Maintenance Management Software, CMMS has found wide acceptance for use in conventional fossil power plant facilities. CMMS systems can greatly enhance the planning and efficiency with which maintenance activities are carried out, reduce maintenance costs, and often result in improved availability of the power plant.

CMMS programs have been implemented at trough power plants as well, but the software is not ideally suited for the solar field portion of the plant. CMMS systems excel in applications that have a thousand unique pieces of equipment, but are not suited to handle systems with a thousand of the same kind of equipment like SCAs in a solar field.

Custom database programs have been developed to track problems and schedule maintenance in the solar plant. These programs have proven to be an essential tool for tracking and planning solar field maintenance activities and should be considered to be essential for any new project.

### **Collector Alignment**

Operational experience has shown that it is important to be able to periodically check collector alignment and to be able to correct alignment problems when necessary.

Collector designs should allow field alignment checks and easy alignment corrections.

### **Project Start-up Support**

Operation of a solar power plant differs from a conventional fossil-fuel power plant operation in several ways, primarily due to the solar field equipment and operations requirements, integration of the solar field with the power block, and the effects of cyclic operation.

Knowledge has been gained from the existing SEGS plants that is applicable to the development of procedures, training of personnel, and the establishment of an effective O&M organization.

### **Thermal Cycling and Daily Startup, Need for energy Storage**

Typically, parabolic trough plants are operated whenever sufficient solar radiation exists, and the backup fossil is only used to fill in during the highest value non-solar periods.

As a result, the plants are typically shut down during the night and restarted each morning. The plants must be designed to not only be started on a daily basis, but also to start up as quickly as possible.

Since most of the current SEGS plant design does not include thermal storage, the solar field and power block are directly coupled. The use of thermal storage can significantly mitigate these problems. In general, equipment/system design specifications and operating procedures must be developed with these requirements in mind.

Both normal engineering considerations and the experience from the SEGS plants provide important inputs into these needs. Mundane design features such as valves, gaskets, seals and bolts selection can be an expensive problem unless properly specified.



Figure 33. Solar 3 parabolic trough collector plant.



Figure 34. Solar Millennium solar plant, Nevada, USA.



Figure 35. Kramer Junction solar plant, USA.



Figure 36. Andasol 1 plant, Solar Millenium, Spain.



Figure 37. Plataforma Solar Fresnel concentrating plant, Almeria, Spain.



Figure 38. Plataforma Solar single dish associated with a Sterling engine system, Almeria, Spain.



Figure 39. Stirling Engine multiple dishes solar energy collector. Source SAIC.

## **NIKOLA TESLA CONCEPTUALIZATION OF A SOLAR ENGINE**

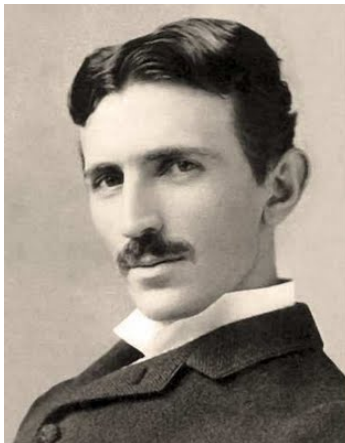

Figure 40. Nikola Tesla



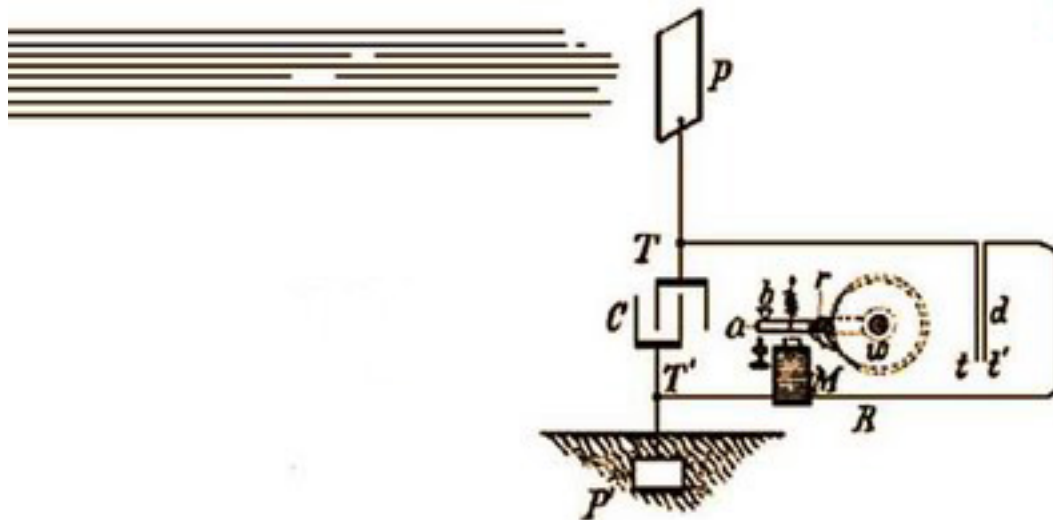
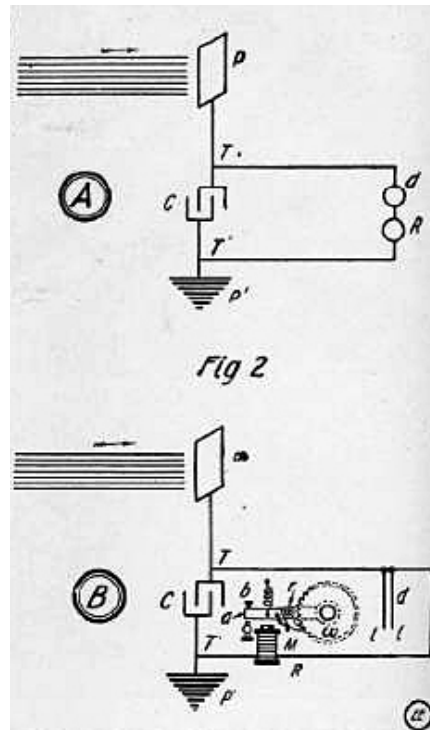

Figure 41. Nikola Tesla patent of an “Apparatus for the Utilization of Radiant Energy” [1].

Nikola Tesla filed patents on an “Apparatus for the Utilization of Radiant Energy” with the numbers 685,957 and 685,958. Nikola Tesla thought that radiative sources were capable of charging an electrical conductor, or discharging an electrified conductor by releasing its charge. His patents alleged a discovery by him that when such radiations are permitted to fall upon or impinge against an insulated conducting body  $p$  connected to one terminal of a condenser, such as  $C$ , while the other terminal of the condenser is made by independent means to receive or carry away electricity, a current flows into the

condenser so long as the insulated body p is exposed to such rays; so that an indefinite, yet measurable, accumulation of electrical energy in the condenser takes place. This energy, after a suitable time interval, during which the rays are allowed to act may manifest itself in a powerful discharge, which may be utilized for the operation or control of a mechanical or electrical device consisting of an instrument R, to be operated and a circuit-controlling device d.

Nikola Tesla bases his theory on his assumption that the Earth is negatively charged with electricity and he considers it to act as a vast reservoir of such static electricity. By the action of the sun's rays on the plate P there is an accumulation of charge in the condenser C. A weak current is supposed to flow continuously into the condenser and in a short time it is expected to become charged to a relatively high potential, even to the point of rupturing the dielectric. This stored charge can then be used to actuate any other device. The device d could be composed of two very thin conducting plates, t and t', placed in close proximity and very mobile such as in a vacuum. The plates t and t' would be connected in series with a corking circuit, including a suitable receiver, which in this case is shown as consisting of an electromagnet M, a movable armature a, a retractable spring B and a ratchet-wheel w, provided with a spring pawl r, which is pivoted to armature a. When the radiations of the sun or other radiant energy source fall upon plate p a current flows into the condenser, until the potential rises sufficiently to attract and bring into contact the two plates t and t', thereby closing the circuit connected to the two condenser terminals. This permits a flow of the stored energy in the electrical field in the condenser as a current which energizes the magnet M, causing it to draw down the armature a and impart a partial rotation to the ratchet wheel w. As the current ceases, the armature is retracted by the spring b, without, however, moving the wheel w. With the stoppage of the current the plates t and t' cease to be attracted and separate, thus restoring the circuit to its original condition.

While not practical, the Nikola Tesla patent emphasizes the crucial process of energy storage. In this case electrostatic energy storage in the form of the electrical field created in the condenser. It is also a harbinger of the later-discovered process of Photo-Voltaics, PV. Nikola Tesla stands corrected in that electromagnetic radiation in the range of solar radiation frequencies causes the emission of electrons through the photoelectric electric process. Only shorter wave lengths and higher energy photons in the x-rays and gamma rays regions interact through other processes such as Compton Scattering and electron-positron pair production. Tesla's vision is being realized in the development of energy scavenging devices.

## **ENERGY SCAVENGING DEVICES**

A research group from Georgia-Tech School of Electrical and Computer Engineering under Manos Tentzeris developed an approach of using industrial type inkjet printers to print antennas and energy-scavenging devices on paper or plastic sheets. Tests at at TV transmission frequencies were shown to give some fractions of one milli-Watt (mW). This was sufficient to operate a temperature sensor using the radio waves from a television station half a kilometer away.

To print electrical components and circuits, the Georgia Tech researchers use a standard inkjet printer with added silver nanoparticles and/or other nanoparticles in an

emulsion to the ink as conductors. This approach enables the printing on paper or flexible polymers not only Radio Frequency (RF) components such as antennas and circuits, but also sensing devices based on such nanomaterials as carbon nanotubes. A backup system can be envisioned when a battery or a solar-collector/battery failed completely, scavenged energy could allow the system to transmit a wireless distress signal while also potentially maintaining critical functionality. The goal is the production of paper-based wireless sensors that are self-powered, low-cost and able to function independently almost anywhere.

The goal is a microprocessor-based microcontroller that would be activated by holding it in the air. More advanced systems can suck up a broad spectrum of transmissions. This small amount of power is sufficient to run many small electronic devices, sensors and microprocessors.

By adding energy storage in the form of high quality capacitors to the micro antenna and energy circuits, one would be able to power devices requiring over 50 mW. Energy would build up in a battery-like super-capacitor and is utilized when the required power level is reached.

The energy gathering technology can use frequencies from FM radio to radar, a range spanning 100 megahertz (MHz) to 15 gigahertz (GHz). A practical use of these little energy sucking devices will be to power remote sensors such as security devices and monitoring sensors, reducing the use of conventional electrical batteries.

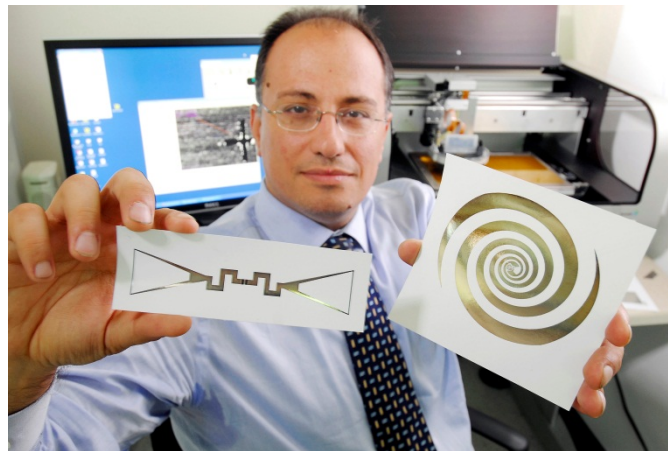

Figure 42. Inkjet technology used to print energy scavenging antenna (left) and ultra-broadband antenna (right) by Manos Tentzeris at Georgia Tech School of Electrical and Computer Engineering [16].

The scavenging devices could be used by themselves or in tandem with other generating technologies. For instance, the scavenged energy could assist a solar element to charge a battery during the day. At night, when solar cells cannot provide power, scavenged energy would continue to increase the battery charge or would prevent its discharge.

Potential fields of application include:

1. Airport security for detecting potential threats such as explosives or nuclear radiative materials.

2. Energy saving devices in a home could provide continuous monitoring of temperature and humidity conditions, leading to highly significant savings on heating and air conditioning costs. Paper-based sensors would degrade quickly in landfills.
3. Structural integrity monitoring by emplacement throughout various types of structures such as bridges and airplane wings to monitor stress and provide warning when an unusual condition is detected.
4. Scanning for chemicals associated with spoilage in stored food and perishable material
5. Wearable bio-monitoring devices for the autonomous observation of patient medical conditions.

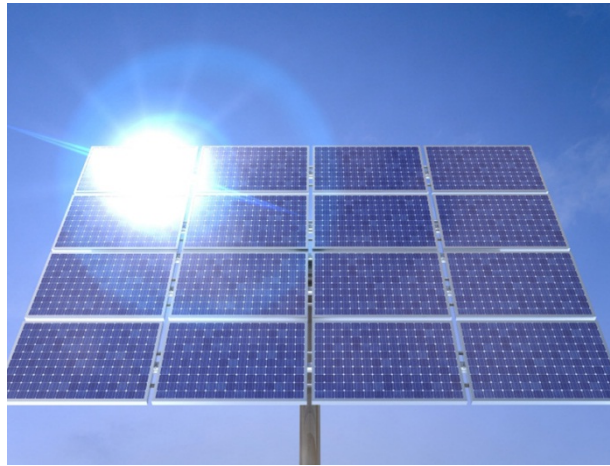

Figure 43. Photovoltaic, PV solar collector.

### COMMEMORATIVE ART WORK

As a historical event of interest, the Solar engine One plant was commemorated as an art exhibit by Christina Hemauer and Roman Keller at the 11<sup>th</sup> International Cairo Biennale at the Palace of Arts, Opera, Cairo [3].



Figure 44. Art exhibit “Sun of 1913” representation of the Solar Engine One plant parabolic trough collector by Christina Hemauer and Roman Keller at the 11<sup>th</sup>

International Cairo Biennale at the Palace of Arts, Opera, Cairo. Photo: Kaianders Sempler [4, 12].

## DISCUSSION

Solar thermal power generation offers advantages over solar-photovoltaic electricity. They are built on a much larger scale, and their costs have been much lower. Compared with other renewable sources of energy, they are probably best able to match a utility's electrical load. They function best when it is warmest and demand is greatest.

A major advantage is that the thermal energy that they generate can be stored, so the output of a solar-thermal plant does not fluctuate as wildly as that of a photovoltaic system which can store energy in batteries on a small scale. Since they use a turbine to generate electricity from heat, most solar-thermal plants can be easily and inexpensively supplemented with natural-gas boilers, enabling them to perform as reliably as a fossil-fuel power plant.

The central receiver tower concept was tried in several facilities such as the Edison's 10 MW Daggett plant in California and the 30 MW plant built in Jordan providing energy storage means to overcome the intermittency issue as well as providing supplementary sources such as in the Integrated Solar Combined Cycle (ISCC) approach. Emphasis is turning Renewable energy sources will continually compete while gaining market in the intense conventional energy market.

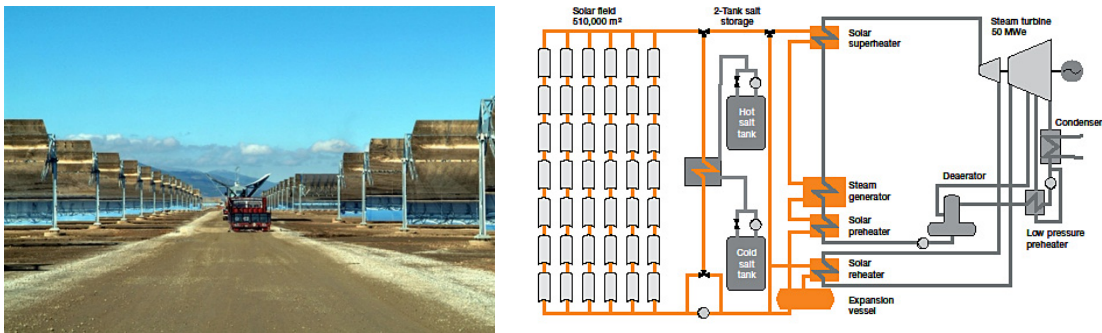

Figure 45. Energy storage power cycle for the Andasol 1 plant. Source: Solar Millenium.

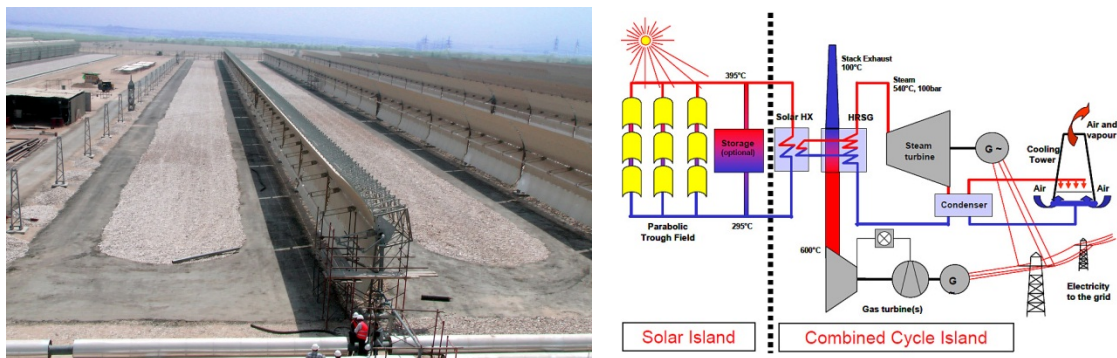

Figure 46. Integrated Solar Combined Cycle power diagram, Al Kuraymat, Egypt.

The basic principles outlined by Frank Shuman at the inauguration ceremony of the Solar one, Shams one, on July 11, 1913, for a successful solar engine still apply:

1. High efficiency, with the conduction, convection and radiative losses minimized by judicious insulation,
2. Low installation, capital and operation and maintenance costs. “They must not, for instance, cost so much to construct that the interest on the cost over and above that of a coal-burning plant of equal capacity will annul too much of the profit made by the saving of cost of the fuel.”
3. Well defined length of service. “They must be constructed of such material and in such manner that few repairs are needed, and so that they will last many years. They must be constructed strong enough to stand the heaviest gales that may occur in the localities where they are erected.”
4. The possibility of operation with local labor without the need for specially trained mechanics. “And they must be sufficiently simple, so that any one capable of running an ordinary coal-burning plant can operate them.”

The vision of using wind, solar and hydroelectric power within a collaborative effort between Europe and North Africa and the Middle Eastern nations is being realized within the context of the Desertec Project. Applications involve electrical power production and conveyance through long distances using High Voltage Direct Current, HVDC, as well as irrigation and fertilizers manufacture from the nitrogen in the air. The tropical regions of the world would help replace its depleting hydrocarbon reserves.

Table 2. Concentrated Solar Power (CSP) projects under development.

Concept	Name Location	Total capacity [MWe]	Solar Capacity [MWe]	Thermodynamic cycle	Companies, Agencies
Parabolic Trough	Kuraymat, Egypt	127	29	ISCC*	GEF Grant
	Algeria	140	35	ISCC	New Energy, Algeria
	Stanwell Power Station, Queensland, Australia	1,440	35	Compact Linear Fresnel Reflector	Austa Energy and Stanwell Corp, Australian Government Grant
	THESEUS, Crete, Greece	50	50	Steam Cycle	Solar Millenium, Fichtner Solar, OADYK, EU FP5 Grant
	Mathania, India	140	35	ISCC	GEF Grant, KfW loan
	Israel	100	100	Steam cycle, hybrid fossil firing	Solel, Israel Ministry of National Infrastructure

	Italy	40	40	Steam Cycle	ENEA
	Baja California Norte, Mexico	300	29	ISCC	GEF Grant
	Ain Beni Mathar, Morocco	230	26	ISCC	GEF Grant
	ANDASOL1, 2 Granada, Spain	2x50	2x50	Steam cycle 6 hours storage for solar only operation	Solar Millenium Group, Spanish premium EU FP5 grant
	Navarra, Spain	15	15	SEGS**	EHN and Duke Solar Spanish premium Navarra Government's fiscal allowances
	Nevada, USA	50	50	SEGS	Solargenix (former Duke Solar), Solar Portfolio, Nevada
Central Receiver, Power Tower	Planta Solar, PS10 Seville, Spain	10	10	Volumetric air receiver, small energy storage	Abengoa Group Spain, EU/Spanish premium grants/subsidy
	Solar Tres, Cordoba, Spain	15	15	Molten salt, direct steam cycle with 12-16 hours storage for solar only	Ghera Spain, Bechtel/Boeing USA, Spanish premium grant/subsidy
Parabolic dish	SunCal 2000, Huntingdon Beach, California	0.4	0.4	Stirling cycle, 8-dish	Stirling Energy Systems

\* ISCC: Integrated Solar Combined Cycle.

\*\* SEGS: Solar Electric Generating System

## REFERENCES

1. H. Gernsback and H. W. Secor eds., "The Utilization of the Sun's Energy," The Electrical Experimenter, Vol. III, Whole No. 35, Number 11, March 1916. [http://peswiki.com/index.php/Reprint:Tesla's\\_Solar\\_Ideas](http://peswiki.com/index.php/Reprint:Tesla's_Solar_Ideas).
2. John A. Duffie and William A. Beckman, "Solar Energy Thermal Processes," Wiley-Interscience, 1974.
3. "Status Report on Solar Thermal Power Plants," Pilkington Solar International, Report ISBN 3-9804901-0-6, 1996.
4. Christina Hemauer and Roman Keller, "No1 Sun Engine," Art Project, 11<sup>th</sup> Cairo International Biennale, Palace of Arts, Opera, Cairo, Egypt, <http://www.sun1913.info>, December 20 – February 20, 2008.
5. Ken Butti and John Perlin, "A Golden Thread: 2500 Years of Solar Architecture and Technology, Cheshire Books, 1980.

6. Magdi Ragheb. "Energy Storage Systems," <https://netfiles.uiuc.edu/mragheb/www/>, 2011.
7. Samir Rafaat, "Maadi 1904-1962, Society and History in a Cairo Suburb," "Using the Sun's Force," Al Ahram Newspaper, July 9, 1913, Maadi Introduces Solar Energy to the World in 1913, <http://www.egy.com/maadi/>
8. Samir Rafaat, "Maadi 1904-1962, Society and History in a Cairo Suburb," "Harnessing Phoebus. Sun Works machinery. Yesterday's Demonstration. The Modern Substitute for Old Sun-Worship," Egyptian Gazette Newspaper, July 12, 1913. <http://www.egy.com/maadi/>.
9. Miles Copeland, "The Game of Nations: The Amorality of Power Politics," Simon and Schuster, May 15, 1970.
10. "American Inventor Uses Egypt's Sun for Power, Appliance Concentrates the Heat Rays and Produces Steam, Which Can Be Used to Drive Irrigation Pumps in Hot Climates," The New York Times, July 2<sup>nd</sup>, 1916, <http://query.nytimes.com/mem/archive-free/pdf?res=990CE7DF1E3FE233A25751C0A9619C946796D6CF>
11. Kaianders Sempler, "Inget Nytt Under Solen," NyTeknik, February 18, 2009. [http://www.nyteknik.se/popular\\_teknik/kaianders/article518080.ece](http://www.nyteknik.se/popular_teknik/kaianders/article518080.ece)
12. Alison Fay Binney, "Nothing New Under the Sun," July 23, 2009. [http://www.newsciencejournalism.net/index.php?news\\_articles/view/nothing\\_new\\_under\\_the\\_sun/](http://www.newsciencejournalism.net/index.php?news_articles/view/nothing_new_under_the_sun/)
13. Jonathan Gornall, "The Promise of Solar Power, Made a Century Ago," The National Beta, January 2011. <http://www.thenational.ae/news/uae-news/technology/the-promise-of-solar-power-made-a-century-ago>
14. Jeremy Sheer, "Frank Shuman's Solar Arabian Dream," Renewable: A Reporter's Quest to Make Sense of the Coming Revolution in Alternative Energy, St. Martin's Press, 2011. <http://renewablebook.com/chapter-excerpts/350-2/>
15. Edwin E. Slosson, "This Changing World, V-Harnessing the Sun," The Independent, May 14, 1921. [http://books.google.com/books?id=MvflAAAAMAAJ&pg=PA511&lpg=PA511&dq=shuman+boys+sun+engine&source=bl&ots=x20Kj9FiKR&sig=hyPWluoLYtJAoLGDWvDIqB034UA&hl=en&ei=FoXeTcC5MoiugQfo\\_p3QCg&sa=X&oi=book\\_result&ct=result&resnum=10&sqi=2&ved=0CFkQ6AEwCQ#v=onepage&q=shuman%20boys%20sun%20engine&f=false](http://books.google.com/books?id=MvflAAAAMAAJ&pg=PA511&lpg=PA511&dq=shuman+boys+sun+engine&source=bl&ots=x20Kj9FiKR&sig=hyPWluoLYtJAoLGDWvDIqB034UA&hl=en&ei=FoXeTcC5MoiugQfo_p3QCg&sa=X&oi=book_result&ct=result&resnum=10&sqi=2&ved=0CFkQ6AEwCQ#v=onepage&q=shuman%20boys%20sun%20engine&f=false).
16. Rick Robinson, "Air Power: New Device Captures Ambient Electromagnetic Energy to Drive Small Electronic Devices," Research News, Georgia Tech, July 7, 2011.
17. Charles Smith, "Revisiting Solar Power's Past," Solar Power, Technology Review, July 1995.
18. Georg Brackmann, "Solar Power for Egypt – ISCC Kuraymat," Arabian Power and Water Summit, Abu Dhabi, March 29-31, 2010.
19. Georg Brackman, Khaled Fekry, and Ayman M. Fayek, "ISCC Kuraymat Integrated Solar Combined Cycle Power Plant in Egypt," 13<sup>th</sup> International Symposium on Concentrating Solar Power and Chemical Energy technologies, SolarPaces, Seville, Spain, June 20-23, 2006.