

The background of the cover is a photograph of a severely damaged building structure. The steel framework is exposed, with many columns and beams missing or broken. A construction worker wearing a red hard hat is visible on the right side of the structure. The sky is overcast and hazy. The text is overlaid on this image.

MCEER Special Report Series

**Engineering and Organizational Issues Related to
the World Trade Center Terrorist Attack**

Volume 1

**Overview of Damage to Buildings
Near Ground Zero**

By Michel Bruneau, Andrew Whittaker and Andrei Reinhorn

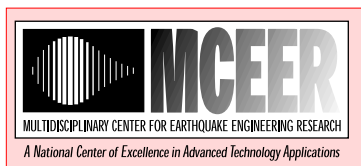

▲ ***The Multidisciplinary Center for Earthquake Engineering Research***

The Multidisciplinary Center for Earthquake Engineering Research (MCEER) is a national center of excellence in advanced technology applications that is dedicated to the reduction of earthquake losses nationwide. Headquartered at the University at Buffalo, State University of New York, the Center was originally established by the National Science Foundation (NSF) in 1986, as the National Center for Earthquake Engineering Research (NCEER).

Comprising a consortium of researchers from numerous disciplines and institutions throughout the United States, the Center's mission is to reduce earthquake losses through research and the application of advanced technologies that improve engineering, pre-earthquake planning and post-earthquake recovery strategies. Toward this end, the Center coordinates a nationwide program of multidisciplinary team research, education and outreach activities.

Funded principally by NSF, the State of New York and the Federal Highway Administration (FHWA), the Center derives additional support from the Federal Emergency Management Agency (FEMA), other state governments, academic institutions, foreign governments and private industry.

MCEER Special Report Series

**Engineering and Organizational Issues Related to
The World Trade Center Terrorist Attack**

**Volume 1:
Overview of Damage to Buildings near Ground Zero**

By Michel Bruneau, Andrew Whittaker and Andrei Reinhorn
Department of Civil, Structural, and Engineering
University at Buffalo
Buffalo, NY 14260

and the

Multidisciplinary Center for Earthquake Engineering Research
Red Jacket Quadrangle
University at Buffalo
Buffalo, NY 14261

March 2002

MCEER-02-SP02
Red Jacket Quadrangle
Tel: (716) 645-3391; Fax: (716) 645-3399; Email: mceer@acsu.buffalo.edu
World Wide Web: <http://mceer.buffalo.edu>

Foreword

The terrorist attack that took place on September 11, 2001 in New York City resulted in thousands of lives lost, the collapse of the twin towers of the World Trade Center as well as damage to adjacent buildings, and extensive disruption of transportation and other lifeline systems, economic activity, and other social activities within the city and the surrounding area. When the final accounting takes place, this attack will almost certainly constitute one of the most deadly and costly disasters in U. S. history.

In a very real sense, the September 11 tragedy, the nature of the damage that occurred, the challenges that the city's emergency response community faced, and the actions that were undertaken to meet those demands can be seen as a "proxy" – albeit a geographically concentrated one – for what a major earthquake can do in a complex, densely-populated modern urban environment. Like an earthquake, the terrorist attack occurred with virtually no warning. As would be expected in an earthquake, fires broke out and multiple structural collapses occurred. As has been observed in major urban earthquakes and in other disasters (e.g., Hurricane Andrew), structures housing facilities that perform critical emergency functions were destroyed, heavily damaged, or evacuated for life-safety reasons. Additionally, because the majority of the damage occurred to relatively new and well-engineered structures and because the emergency response system in New York City was considered very well prepared for all types of emergencies, particularly terrorist attacks, the attack and its aftermath provide a useful laboratory for exploring a variety of engineering and emergency management issues.

In this perspective, the Multidisciplinary Center for Earthquake Engineering Research initiated a research project (funded by the National Science Foundation) to collect perishable data in the aftermath of the attack for later study to gain a better understanding of how resilience is achieved in both physical, engineered systems and in organizational systems. The project is divided into two major components, focusing on the impact of the disaster on engineering and organizational systems:

- (a) Damage to Buildings in the Vicinity of Ground Zero – The objective of this effort is to collect perishable information on the various types of damage suffered by buildings at Ground Zero, including, most importantly, those that suffered moderate damage from the impact of large debris but that did not collapse, and to investigate whether state-

of-practice analytical methods used in earthquake engineering can be used to explain the observed structural behavior.

- (b) Organizational and Community Resilience in the World Trade Center Disaster – The objective of this effort is to collect information on the response activities of the City’s Emergency Operations Center and on other critical emergency response facilities. Of particular interest is to identify the plans that were in place at the time of the disaster, as well as how decision systems were used and coordinated with engineering decisions. Efforts will also include identifying the technologies and tools that were most useful or failed (or did not meet expectations) during the emergency period, the types of adaptations that had to be made by these organizations, how well intra-organizational communication and coordination functioned, and whether any emerging technologies were used during the emergency period.

The MCEER special report series “Engineering and Organizational Issues Related to The World Trade Center Terrorist Attack” was initiated to present the findings from this work. The decision to publish a number of brief individual reports focusing on different topics was prompted by the desire to provide timely access to this information. As such, each report in the series focuses on a narrow aspect of the disaster as studied by MCEER researchers. A compendium of these short reports is planned at a later time. It is hoped that this work will provide a useful contribution that can lead to a better understanding of how to cost-effectively enhance the resilience of buildings against catastrophic events.

Acknowledgment

This work was supported primarily by the Earthquake Engineering Research Centers Program of the National Science Foundation (NSF) under a Supplement to Award Number ECC-9701471 to the Multidisciplinary Center for Earthquake Engineering Research. The authors thank Dr. Priscilla Nelson and Dr. Joy Pauschke of NSF for their initiative and support of this project.

The authors also thank Messrs. Dan Cuoco, Edward Swierz, Kurt J. Goodfriend and Emmanuel Velivasakis of LZA Technology/Thornton-Tomasetti Engineers for their valuable assistance and Jane Stoye, MCEER, for her editorial assistance in the preparation of this report.

Contents

1.0	Introduction	1
2.0	Background Information	3
3.0	Damage at Ground Zero	7
3.1	World Trade Center Towers 1 and 2	8
3.2	World Trade Center 3 and 4	14
3.3	World Trade Center 5 and 6	17
3.4	World Trade Center 7	18
3.5	Verizon Building, 140 West Street	22
3.6	Winter Garden and 3 World Financial Center, 200 Vesey Street	24
3.7	90 West Street Building	28
3.8	Banker's Trust Building, 130 Liberty Street	29
3.9	Examples of Architectural Damage	32
4.0	Conclusions – Anticipated Progress, Findings, and Benefits of the Research	35
5.0	References	37

1.0 Introduction

This report contributes to one of the objectives of the Multidisciplinary Center for Earthquake Engineering Research's (MCEER) investigations undertaken following the September 11, 2001, attacks on the twin 110-story towers of the World Trade Center, in lower Manhattan, New York. That objective is to collect preliminary information on the various types of damage suffered by buildings at and around the seven-building complex of the World Trade Center (WTC), including those that suffered moderate damage from the impact of large falling debris but that remained standing, and to investigate whether analytical methods used in earthquake engineering at this time can be used to explain the observed structural behavior. This important work could lead to a better understanding of how to cost-effectively enhance the resilience of buildings against terrorist attacks.

This report is the first in MCEER's special series summarizing research conducted following the attacks. Therefore, it focuses on describing damage to buildings in the immediate vicinity of what has been commonly referred to as "Ground Zero" (roughly defined as the center of the WTC complex).

Only initial observations are presented here. The purpose of this report is not to describe the causes of collapse of the World Trade Center towers, but rather to describe the general damage that was observed at Ground Zero.

2.0 Background Information

Although the attacks on the towers of the World Trade Center have been reported exhaustively by news media (e.g., Time, Newsweek, Lipton and Glanz, 2002 and Powell, 2001), a brief summary of the events is provided below.

At 8:45 a.m. on September 11, 2001, hijacked American Airlines Boeing 767, flight 11, was purposely steered into Tower 1 of the World Trade Center, one of the twin 110-story high-rise buildings that stood in lower Manhattan. The plane, flying southward, impacted the North side of the tower head-on, penetrating the building at mid-width of the façade, cutting 33 of the 59 columns along that façade of the building from the 94th to the 99th floors. Eighteen minutes later, another hijacked Boeing 767, United Airlines flight 175, flying northward, hit Tower 2 of the World Trade Center, impacting the eastern third of the South façade of the tower, badly damaging the building shell from the 78th to the 84th floors. The extent of the damage inside the towers produced by the impact of the planes is unknown. However, the towers withstood the forces of the impacts, and remained standing in spite of the gross damage caused by the penetrating planes.

In both cases, jet fuel ignited at impact. Debris from the planes and the buildings were ejected into the adjacent space and buildings, principally in the directions of impact. Some of these debris were ablaze (see Figure 2.1). The fuel-fed fires raged at the stories where the collisions occurred, and propagated to the stories above. The extent of the spread and intensity of the fires are unknown.

At 9:50 a.m. the South Tower (WTC 2) collapsed. The segment of the tower above the impact area started to tilt eastward and then, nearly as a rigid body, penetrated the stories below, pushing the building façade outward leading to a progressive collapse that demolished all the stories below to the bottom. The collapse took between 9 to 15 seconds according to later reports. However, it took 53 minutes after the impact before the progressive collapse started. At 10:28 a.m., the North Tower (WTC 1) also collapsed, triggered by a different mechanism. Based on videos (shown by the media in the aftermath of the collapse), the stories above the impact areas started falling straight down on the stories below, while pushing the façade outward, similar to the fall of Tower 2 (see Figure 2.2). It took one hour and forty-three minutes (103 minutes) after the impact before the progressive collapse of the North Tower started.



AP/Wide World Photos

Figure 2.1. Explosion following the plane impact into the South Tower



AP/Wide World Photos

Figure 2.2. Large segments of the World Trade Center perimeter frame fell on adjacent buildings during the collapse of the towers

3.0 Damage at Ground Zero

On September 21 and 23, 2001, visits to Ground Zero were conducted by the authors of this report to view the structural damage to buildings. At that time, work underway at the site was focused on the task of debris removal.

The arrows in Fig. 3.1 indicate the route followed by the MCEER reconnaissance team on September 21, 2001. This route follows the edge of the debris pile at Ground Zero. Fig. 3.1 also provides an overview of damage as reported by a team from the Structural Engineers' Association of New York (SEAoNY), who conducted a rapid evaluation of buildings near Ground Zero. This rapid inspection was conducted for the New York City Department of Design and Construction/Department of Buildings (DDC/DoB) by members of SEAoNY and coordinated by LZA/Thornton-Tomasetti to establish which buildings were safe to reoccupy. For those buildings rated as having suffered damage, no distinction was made between structural and architectural damage in the figure.

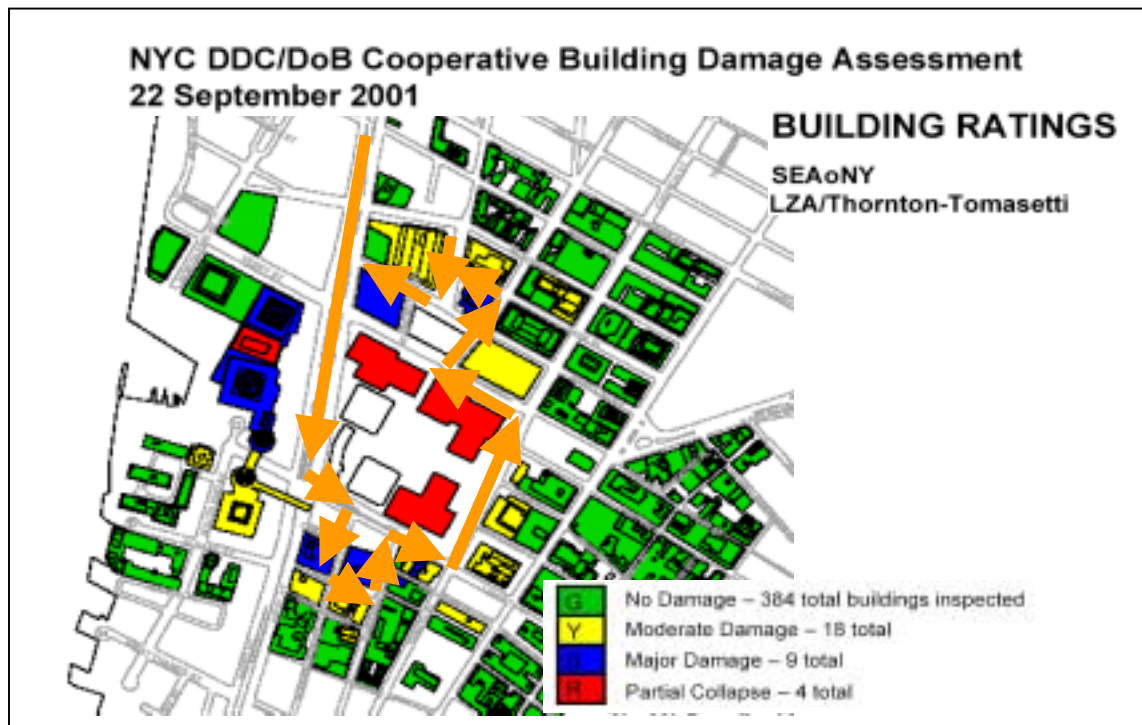
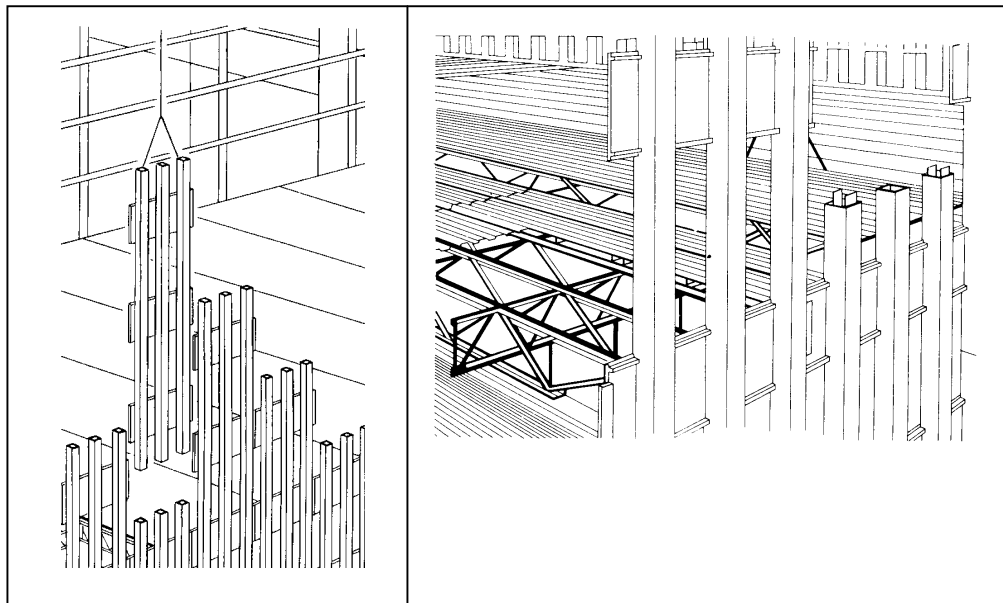

Figure 3.1. Arrows indicate the route followed by the MCEER reconnaissance team, superimposed on top of a map of the street layout by SEAoNY, LZA/Thornton-Tomasetti

3.1 World Trade Center Towers 1 and 2

The World Trade Center complex consisted of seven buildings, including the twin 110-story buildings. These towers were designated as the North Tower or WTC 1, and the South Tower or WTC 2. These were the target of the terrorist attacks.

The innovative structural framing system that was developed in the 1960s and used in the construction of these towers, was widely described in the literature at the time of their construction (e.g., Hart et al., 1978). In brief, the lateral loads (primarily wind) on these towers were resisted by an exterior steel tube that consisted of 59 box-section columns on each face, spaced 32” on center (Figure 3.2). Each of these columns was a rectangular hollow section built-up from plates of varying thicknesses and steel grades. The exterior tube was also constructed in a modular fashion, with each module consisting of three columns spanning over three stories assembled with short deep-spandrel beams. Modules were connected together using bolted splices to transfer shear in beams. They were connected vertically using bolts in the bearing plates, primarily for alignment. Figure 3.2 shows how the three-story three column perimeter frame modules were installed.



After Hart et al., 1978

Figure 3.2. Perimeter framing of the tower

Steel frames surrounded the central utility cores (elevators, stairways, and other services). Gravity loads on each floor were resisted by light joist

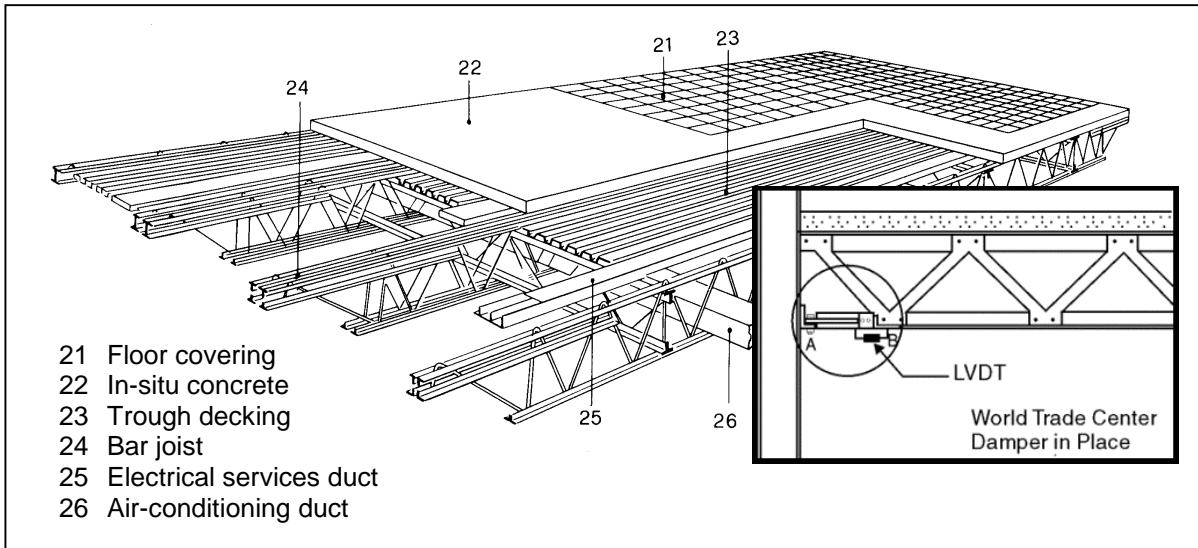

After Hart et al., 1978

Figure 3.3. Joist floor system of the World Trade Center towers

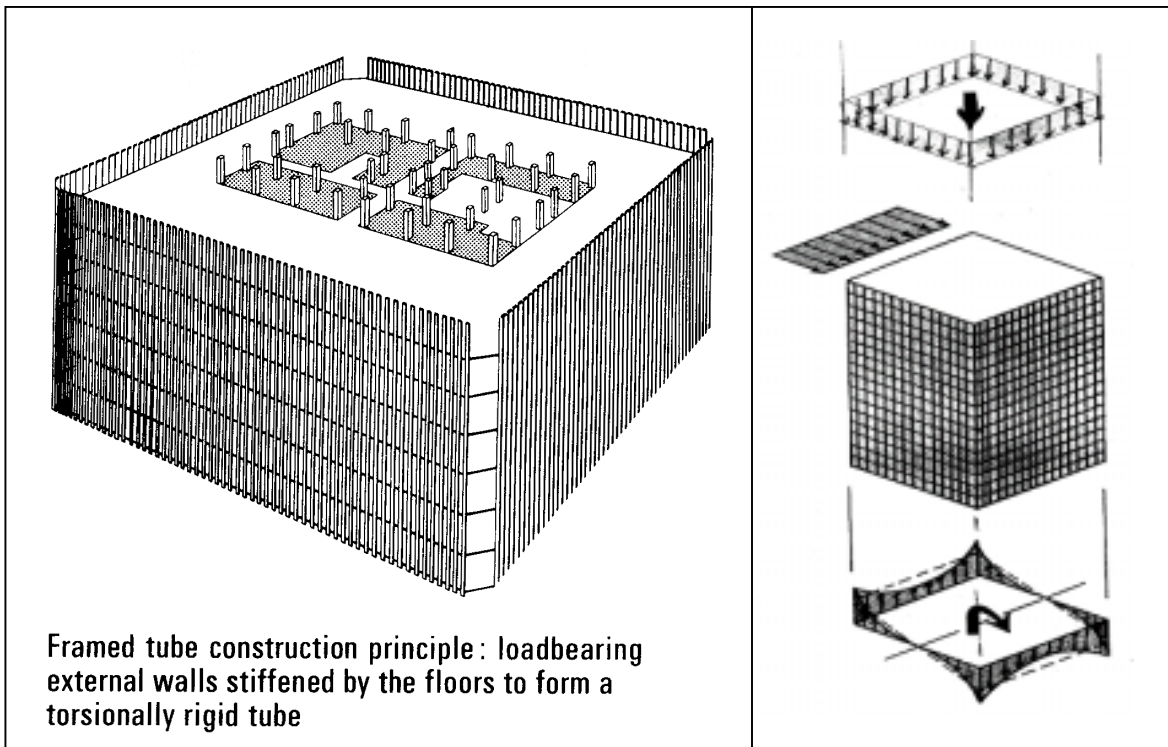

After Hart et al., 1978

Figure 3.4. Vertical structural elements and superposed axial stresses due to gravity and lateral loads

framing (Fig. 3.3) that enabled large column-free spans, and that transmitted the floor loads to both the central core and the exterior tube system (Fig. 3.4). Gravity loads on the exterior tube columns were sufficiently large to maintain compression in the columns, even during the design windstorm. The joists were simply connected (pinned) to the exterior tube column using seat-angle connections.

The only recognizable portions of WTC 1 and 2 on September 21, 2001, were parts of the exterior tube described above that remained standing in the debris pile (Figure 3.5). Some evidence of the building modular construction described in the previous paragraph could be observed from these parts of the building structural shell (Figure 3.6). The typical four-bolt column splices could be also observed (Figure 3.7), along with the hole on the side of each hollow rectangular column that provided access for erection of the frames (Figure 3.7, bottom photograph). As will be seen in the subsequent sections, some of these three-column modules became multi-ton projectiles that impacted and damaged adjacent buildings as the towers collapsed. The interior of the building shell (see Figure 3.6, top photographs) shows some evidence of where the supporting seats were located for the floor joists.

It is not the purpose of this report to describe the causes of collapse of WTC 1 and 2. That each tower absorbed the impact of a large plane and remained standing despite gross damage and intense fire, permitting occupants below the point of impact to evacuate, is a testimony to the skills of the engineer of record.



Figure 3.5. Portions of the perimeter tubes of WTC 1 and 2 remained standing in the debris pile (as of September 21, 2001)



*Figure 3.5. (continued).
Portions of the perimeter
tubes of WTC 1 and 2 that
remained standing in the
debris pile (as of September
21, 2001)*

Figure 3.6. Modular construction of the towers

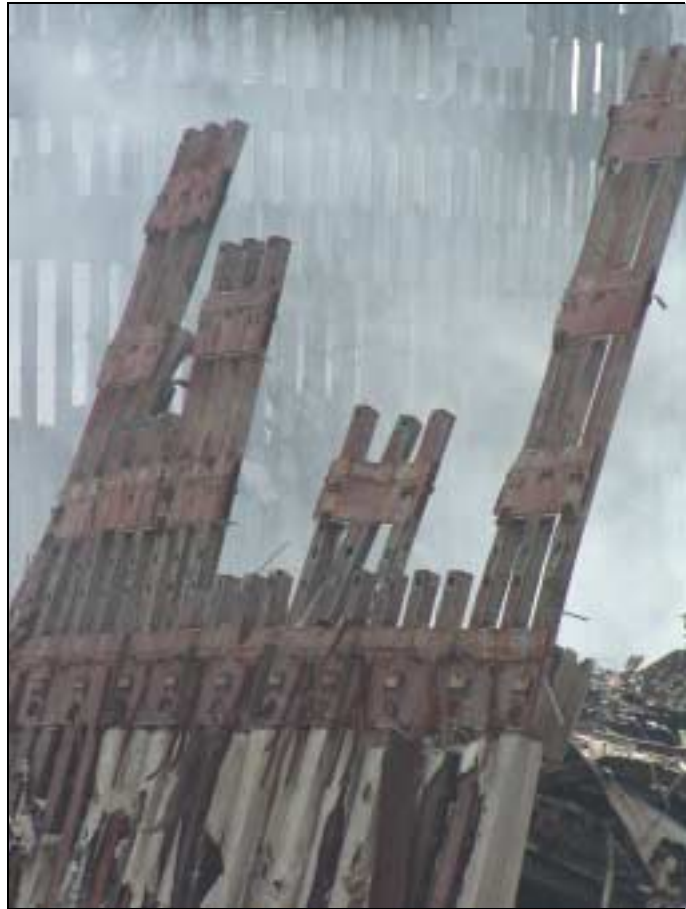



Figure 3.7. Typical four-bolt column splices and access holes on the side of hollow rectangular columns



3.2 World Trade Center 3 and 4

World Trade Center 3 (WTC 3) served as the Vista Hotel (formerly the Marriott hotel), and was located at the base of the two twin towers, immediately adjacent to and to the west of WTC 2 and to the south of WTC 1. It was effectively destroyed by falling debris from the collapse of the towers (see Figure 3.8). Although the building was a total loss, the fact that stories remain standing, albeit in a state of extreme damage, instead of being totally destroyed, could be partly due to the fact that the falling debris from the collapsing towers, for the most part, remained within their plan footprints.



*Figure 3.8.
Debris falling
destroyed WTC 3*

World Trade Center 4 (WTC 4) was similarly impacted by falling debris. The large permanent deformations (sagging) of many beams in that building (Figure 3.9) can be attributed to a combination of impact forces from falling debris and extensive fire damage.

*Figure 3.9.
Falling and
burning debris
destroyed
WTC 4*





*Figure 3.9. (continued).
Falling and burning debris
destroyed WTC 4*



3.3 World Trade Center 5 and 6

World Trade Center 5 (WTC 5) was located somewhat further from the towers than WTC 3 and 4, and was likely not showered by as much falling debris as these buildings were. However, parts of the building were still severely impacted. World Trade Center 6 (WTC 6) was immediately adjacent to WTC 1, and suffered tremendous damage. Both buildings were apparently hit by burning debris following the plane impact, and extensive fire-related damage was observed. Large heat distortion of structural members was observed in WTC 5 (Figure 3.10). Similar damage was also observed in WTC 6 (Figure 3.11).



Figure 3.10. Fire related damage to WTC 5



Figure 3.11. Impact and fire-related damage to WTC 6

3.4 World Trade Center 7

The 47-story World Trade Center 7 (WTC 7) was the third tallest building in the World Trade Center complex. The New York City Emergency Operations Center was housed in the building, with state-of-the-art emergency response facilities. The building was evacuated after the planes impacted the twin towers, and before the towers collapsed.

At 5:25 p.m. on September 11, 2001, WTC 7 collapsed as a consequence of damage and uncontrolled fire. The resulting debris pile was approximately seven stories high (Figure 3.12). Little reliable information on the collapse sequence can be surmised from the debris. Portions of conventional steel moment-resisting frames were observed in the debris pile (Figure 3.13), as well as distorted segments of beam stubs welded to columns with bolted splices a few feet away from the columns (Figure 3.14).



Figure 3.12. WTC 7 collapsed as a consequence of damage and uncontrolled fire



Figure 3.13. Portions of conventional steel moment-resisting frames were observed in the debris pile



Figure 3.14 Distorted segments of beam stubs welded to the columns

As WTC 7 collapsed, it fell partly on an adjacent building at 30 West Broadway, causing significant damage (Figure 3.15, south face and Figure 3.16, west face). Beams were permanently distorted by the impact (Figure 3.17).



Figure 3.15. Damage to the south face of a building at 30 West Broadway due to impact from the collapse of WTC 7



Figure 3.16 Damage to the west face of a building at 30 West Broadway due to impact from the collapse of WTC 7



Figure 3.17. Beams in the building at 30 West Broadway were permanently distorted by the impact of falling debris

3.5 Verizon Building, 140 West Street

The collapse of World Trade Center 7 damaged the adjacent Verizon building. Damage to the west façade of that building is shown in Figure 3.18. Large segments of the WTC 7 braced framing were lodged against the Verizon building, which also suffered notable perforations in its framing and cladding. In particular, a steel column was severely distorted, presumably by debris impact (Figure 3.18, bottom right photo).

Limited relatively minor damage was also observed to the south façade, possibly produced by debris from the collapse of WTC 1 (Figure 3.19).



Figure 3.18. Damage to the west façade of the Verizon Building



Figure 3.19. Minor damage to south façade of the Verizon building

3.6 Winter Garden and 3 World Financial Center, 200 Vesey Street

A number of the perimeter column modules (see Figure 3.2) from the collapsing towers penetrated the façade of 3 World Financial Center, significantly damaging the building's outer shell (see Figure 3.20). Parts of perimeter-column modules from one of the towers were still protruding from the façade of the World Financial Center tower during the two site visits. These pieces of debris had been secured to the building at the time of the first visit on September 21, awaiting a solution to remove them without jeopardizing the integrity of the gravity-load-resisting system.

The Winter Garden, located between the two towers of World Financial Center, was severely damaged as numerous pieces of debris penetrated the glass-ceiling of this steel-framed building (see Figure 3.21).

Figure 3.20. Damage to the façade of 3 World Financial Center





Figure 3.20. (continued) Damage to the façade of 3 World Financial Center

*Figure 3.21.
Severe damage to
the east side of the
Winter Garden*



3.7 90 West Street Building

The 90 West Street building was hit by burning debris from the collapse of World Trade Center 2, which started a number of small fires as evinced by damage to the façade (Figure 3.22). A large multi-ton segment of the façade of WTC 2 lodged at the base of the building, but caused only modest damage to the building (Figure 3.23).



Figure 3.22. 90 West Street building



Figure 3.23. Large multi-ton segment of the façade of the WTC 2 lodged at base of the 90 West Street building

3.8 Banker's Trust Building, 130 Liberty Street

The Banker's Trust Building at 130 Liberty Street was badly damaged by falling debris from the collapse of World Trade Center 2 (Figure 3.24). A large piece of debris, a perimeter column module from WTC 2, that was still lodged in the 6th story of the building at the time of the site visits, ripped a twenty story gash in the north façade of the building, from the 26th to the 6th story (see Figure 3.25), obliterating a column from the perimeter frame at that location, with much interior damage (see Figure 3.26).

Volume 2 in this MCEER special report series will present a detailed description of the damage to, and structural performance of this building, using information from the September 23, 2001, reconnaissance visit.



Figure 3.24. Banker's Trust Building, 130 Liberty Street



Figure 3.25. Twenty story gash in the north façade of the building, from the 26th to the 6th story



Figure 3.26. Exterior and interior damage to the Banker's Trust Building

3.9 Examples of Architectural Damage

In some instances, extensive nonstructural damage was observed in the absence of visible structural damage. For example, all the windows were broken in a building immediately located across from the collapsed World Trade Center 7. Two World Financial Center exhibited similar damage (Figure 3.27). However, in some instances, many of these windows were also broken by the fire-fighting crews. The Millennium Hilton, across Church Street from WTC 5, suffered major cladding damage, but appeared to be otherwise structurally sound (Figure 3.28).



Figure 3.27. Broken windows in 2 World Financial Center

Finally, although the miscellaneous debris were removed from the street by the time of the reconnaissance visit, some assessment of the quantity of dust and miscellaneous debris that probably littered the entire site on September 11 was provided by the amount of such debris still present at less accessible locations, such as in the emergency stairs of a small building adjacent to Ground Zero (Figure 3.29). Among the debris from the towers was a substantial amount of paper, which accumulated on the outside windows of buildings in the area.

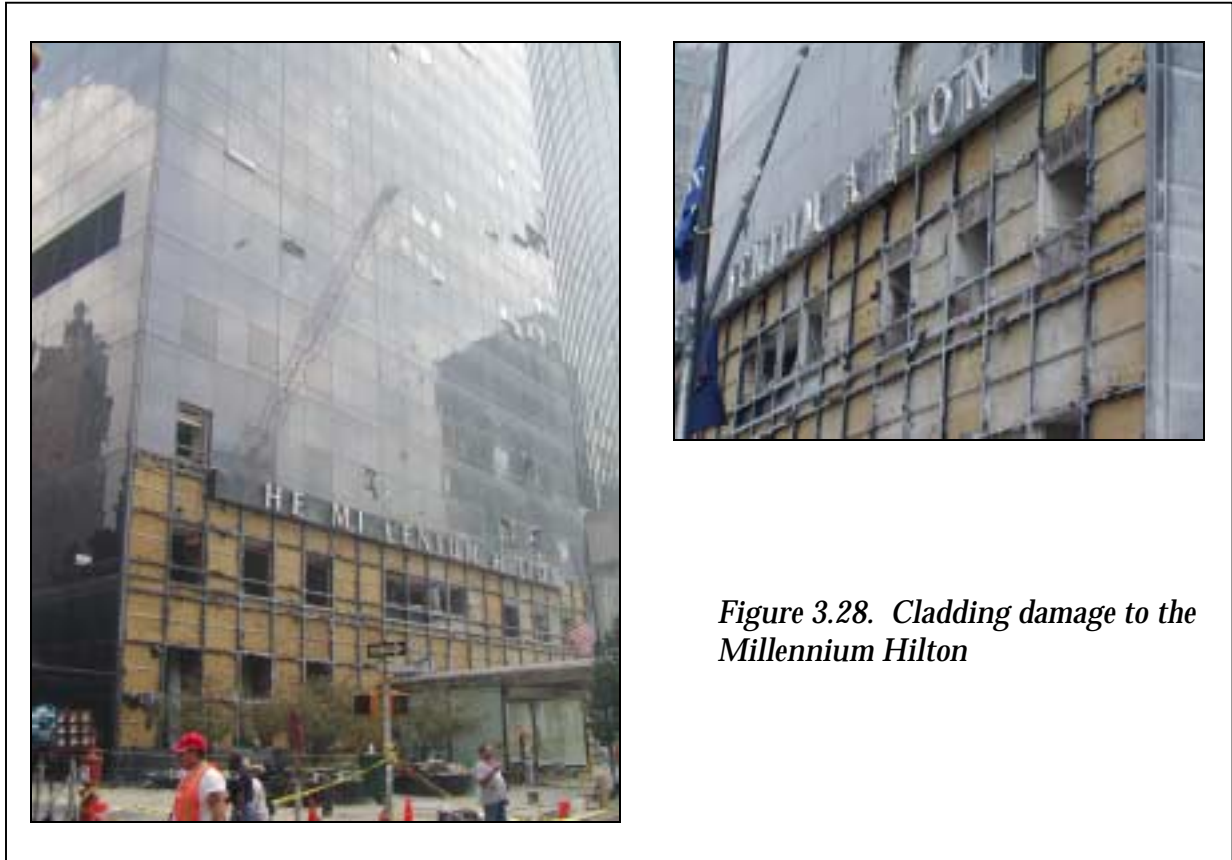

Figure 3.28. Cladding damage to the Millennium Hilton



Figure 3.29. Debris in the emergency stairs of a small building near Ground Zero

4.0 Conclusions - Anticipated Progress, Findings, and Benefits of the Research

The mission of MCEER is to help make communities, organizations, and other social units more resilient in the event of earthquakes and other disasters, including those caused by human actions. In that perspective, the information and damage overview presented in this report will be used in subsequent research activities to contribute to MCEER's mission by using earthquake engineering tools to assess the resilience of buildings to terrorist-induced blasts as well as impacts from collapsing buildings. This research will provide an unprecedented opportunity to develop a deeper understanding of the blast-resilience of structural systems, which can in turn lead to the development of effective measures to significantly enhance this resilience nationwide.

The data collected from these efforts could also have a long-term positive impact on research activities on the protection of critical buildings with respect to (1) understanding dynamic loading conditions (including shockwave and temperature) on buildings, (2) collapse mechanisms (including the changes of material properties due to fire), (3) post-event debris hazards and removal, and (4) development of retrofit strategies for buildings with multiple objectives (e.g., resistance to earthquake, blast, fire, and possibly other hazards).

5.0 References

Hart, F., Henn, W. and Sontag, H., 1978, *Multistory Buildings in Steel*, Granada Publishing Limited, English translation, ISBN 0-258-969761.

Lipton, E. and Glanz, J., 2002, *First Tower to Fall Was Hit at Higher Speed, Study Finds*, February 23, NYTimes.com.

Newsweek Extra Edition, 2001, Volume CXXXVIII, No. 12-A, 66 pages, September.

Powell, A.E., 2001, "September Eleventh: The Days After, The Days Ahead," *Civil Engineering*, November.

Time Magazine, September 23, 2001 issue.

▲ ***Acknowledgements***

This report was prepared by the Multidisciplinary Center for Earthquake Engineering Research through a grant from the Earthquake Engineering Research Centers Program of the National Science Foundation (supplement to award number EEC-9701471), funding from New York State, and other sponsors.

The material herein is based upon work supported in whole or in part by the National Science Foundation, New York State and other sponsors. Opinions, findings, conclusions or recommendations expressed in this publication do not necessarily reflect the views of these sponsors or the Research Foundation of the State University of New York.



MCEER

MULTIDISCIPLINARY CENTER FOR EARTHQUAKE ENGINEERING RESEARCH

A National Center of Excellence in Advanced Technology Applications

University at Buffalo, State University of New York
Red Jacket Quadrangle ■ Buffalo, New York 14261-0025
Phone: 716/645-3391 ■ Fax: 716/645-3399
E-mail: mceer@acsu.buffalo.edu ■ WWW Site: <http://mceer.buffalo.edu>



University at Buffalo *The State University of New York*