

**OFFICIAL
REPORT**

Competition Summary and Results

Volume 2

Report

Games of the XXIVth Olympiad Seoul 1988



화합과 전진

AFG AHO ALB ALG AND ANG ANT ARG ARU AUS AUT BAH BAN BAR BEL BEN BER BHR BHU BIR BIZ BOL BOT BRA
BRN BRU BUL BUR CAF CAN CAY CGO CHA CHI CHN CIV CMR COK COL CRC CUB CYP DEN DJI DOM ECU EGY ESA
ESP ETH FIJ FIN FRA FRG GAB GAM GBR GDR GEQ GHA GRE GRN GUA GUI GUM GUY HAI HKG HOL HON HUN INA
IND IRL IRN IRQ ISL ISR ISV ITA IVB JAM JOR JPN KEN KOR KSA KUW LAO LBA LBR LES LIB LIE LUX MAD MAL MAR
MAW MDV MEX MGL MLI MLT MON MOZ MRI MTN NCA NEP NGR NGU NIG NOR NZL OMA PAK PAN PAR PER PHI POL
POR PRK PUR QAR ROM RWA SAM ASA SEN SEY SIN SLE SMR SOL SOM SRI SUD SUI SUR SWE SWZ SYR TAN TCH
THA TOG TGA TPE TRI TUN TUR UAE UGA URS URU USA VAN VEN VIE VIN YAR YMD YUG ZAI ZAM ZIM

Harmony and progress

Harmonie et Progrès

Armonia y Progreso

和諧與前進

Harmonie und Fortschritt

توافق موسيقي و تقدم

Гармония и Прогресс

Armonia e Progresso

Uyum ve ilerleme

和合と前進

Keselarasan dan Kemajuan

**OFFICIAL
REPORT**

Competition Summary and Results

Volume 2

Report

1	Photographic Essay/ Album photographique		7
2	Seoul '88 Facts and Figures/ Les faits et les chiffres	A Highlight of Events, Games of the XXIVth Olympiad _____ September 17 — October 2, 1988/ Synthèse de la XXIV ^{ème} Olympiade de Séoul 17 Septembre — 2 Octobre 1988	146
		NOC Participation/ _____ Participation des C.N.O.	150
		Medalists/Médailles _____	162
		World and Olympic Records / _____ Records du monde et records olympiques	169
		Medal Tally by Country/ _____ Nombre des médailles remportées par pays.	174
		Listing of the Competitors/Listes des concurrents _____	176
3	Results of the Games of the XXIVth Olympiad/ Résultats de la XXIV^{ème} Olympiade	Archery/Tir à l'arc _____ Athletics/Athlétisme _____ Basketball/Basket-ball _____ Boxing/Boxe _____ Canoeing/Canoë _____ Cycling/Cyclisme _____ Equestrian Sports/Sports Equestres _____ Fencing/Escime _____ Football/Football _____ Gymnastics/Gymnastique _____ Handball/Handball _____ Hockey/Hockey _____ Judo/Judo _____ Women's Judo/Judo féminin _____ Modern Pentathlon/Pentathlon Moderne _____ Rowing/Aviron _____ Shooting/Tir _____ Swimming/Natation _____ Table Tennis/Table de tennis _____ Tennis/Tennis _____ Volleyball/Volley-ball _____ Weightlifting/Haltérophilie _____ Wrestling/Lutte _____ Yachting/Yachting _____ Baseball/Base-ball _____ Taekwondo/Taekwondo _____	205 215 271 291 333 351 361 369 407 423 437 461 479 498 505 513 535 545 605 617 625 639 647 679 709 715
		Staff of the Official Report/ _____ Redaction du Rapport officiel	727

화 보
Photographic Essay
Album photographique



1

































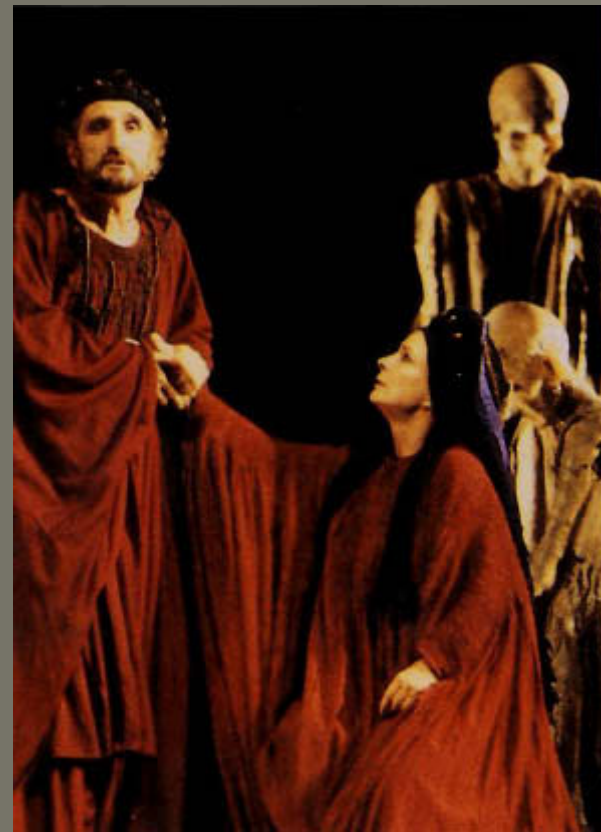





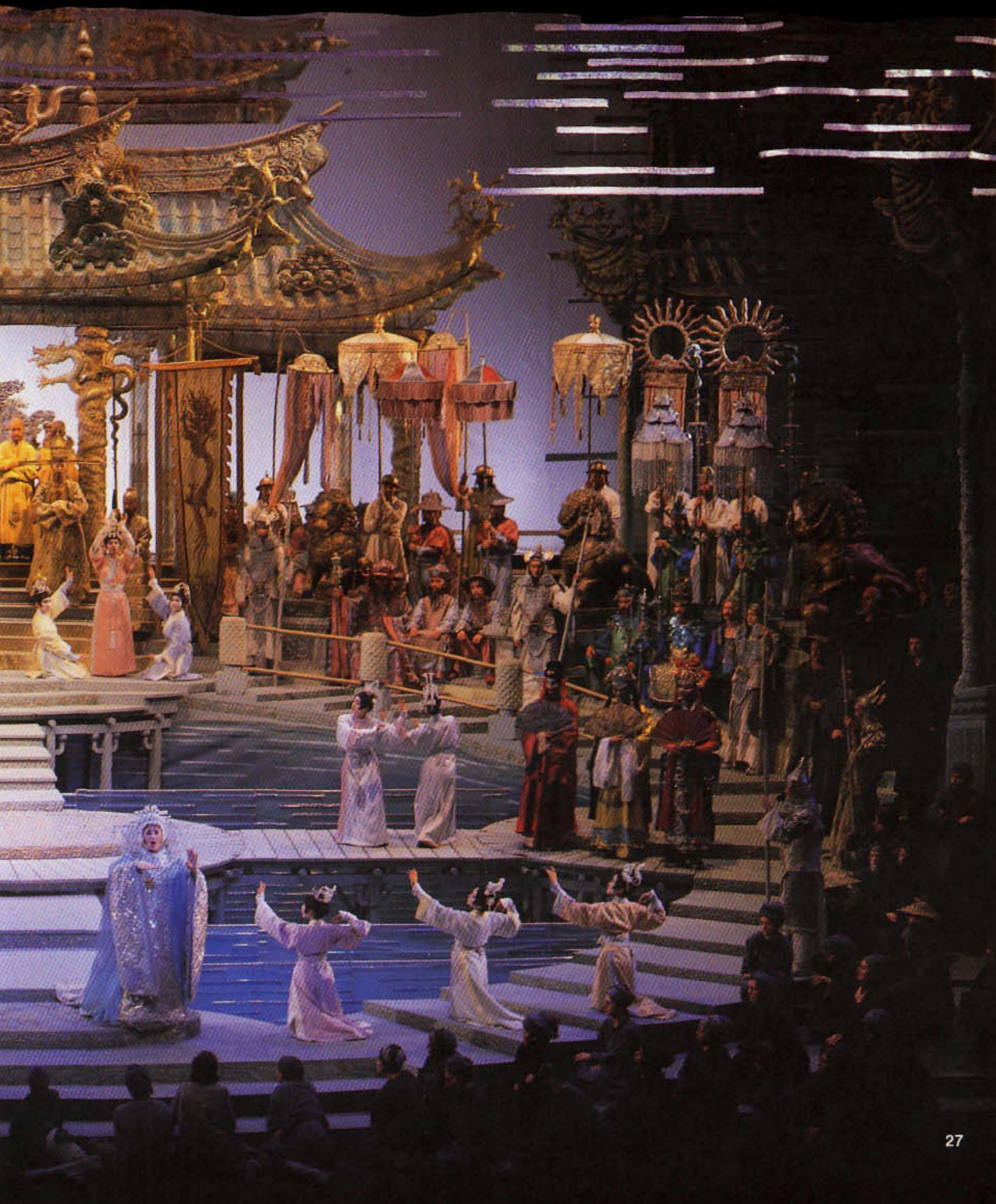



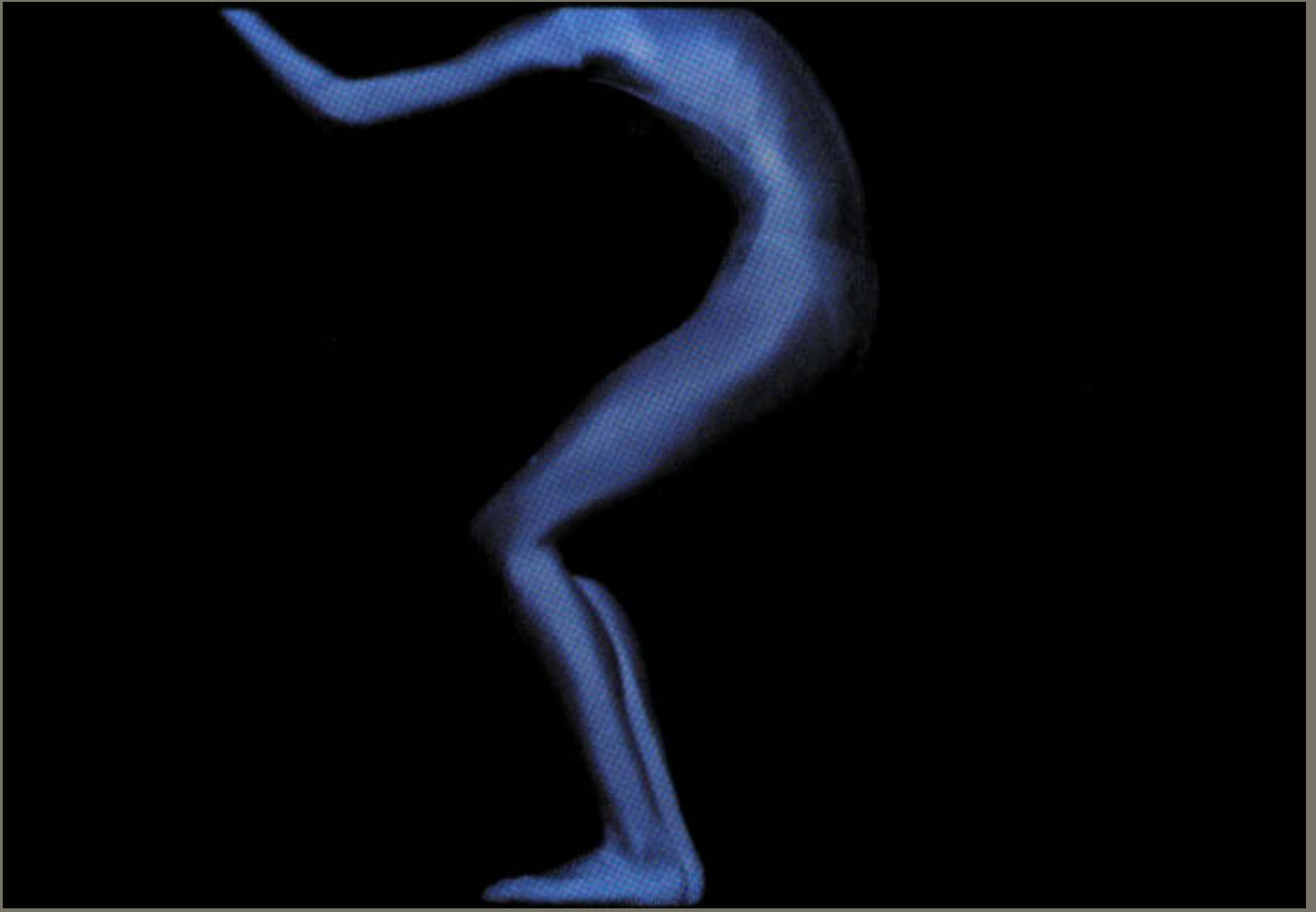













올림픽대회 OOOO GAMES OF THE XXIVTH OLYMPIAD SEOUL 1988

























한미당
ONE WORLD
LE MONDE UNI





























SEOUL 1988
3
ALG
Games of the XXIV Olympiad

582
ITA

551
IRL



346



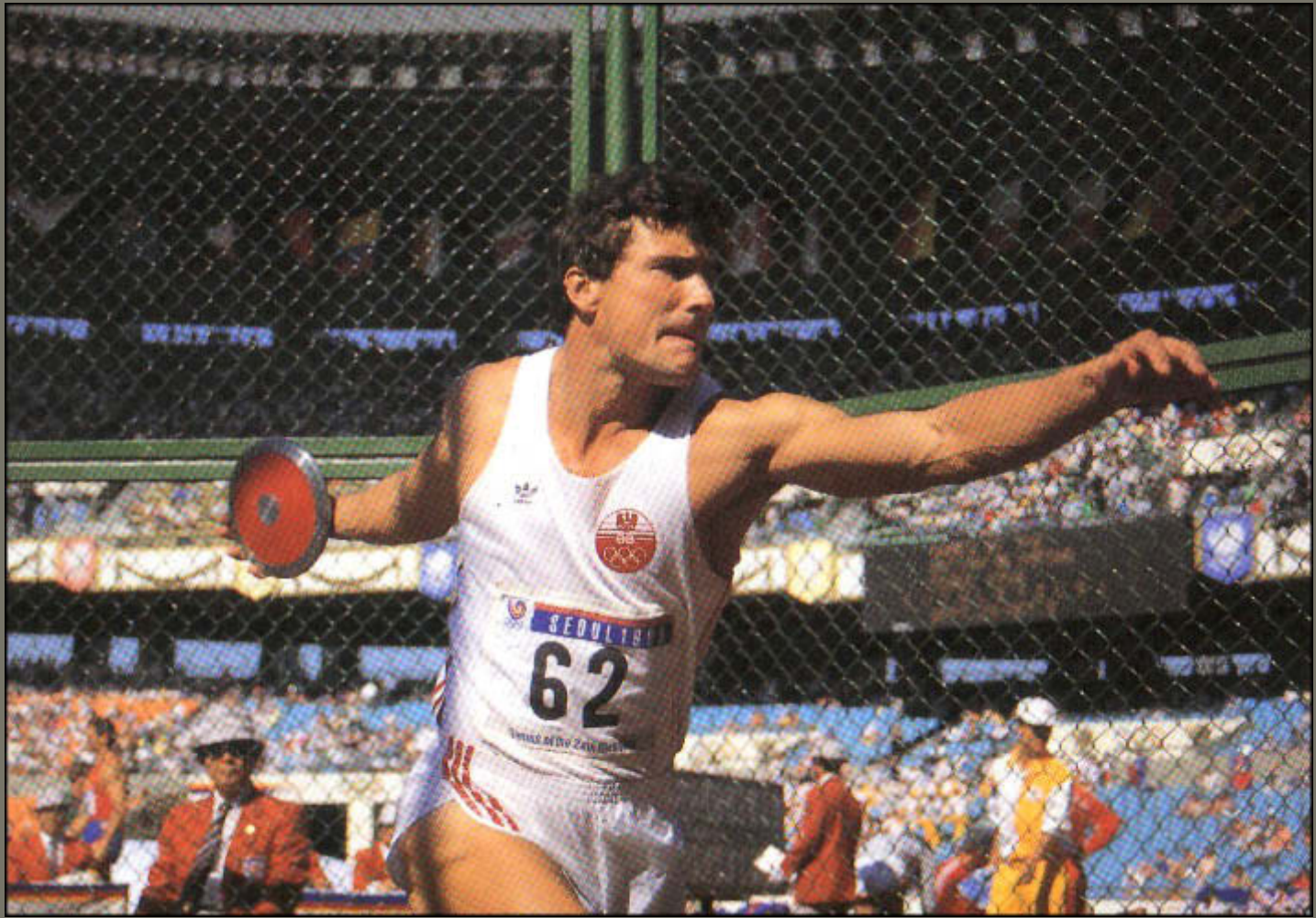































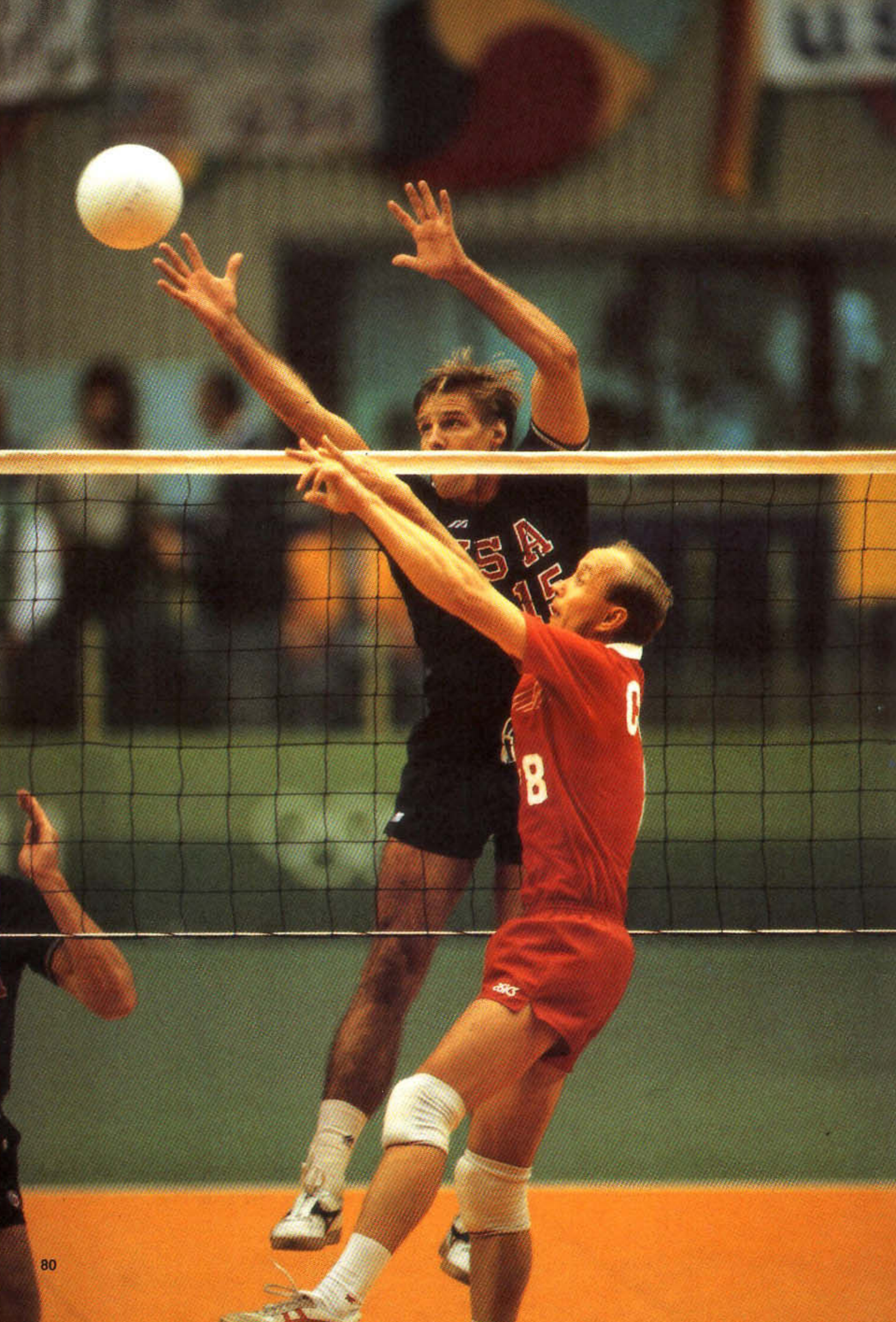

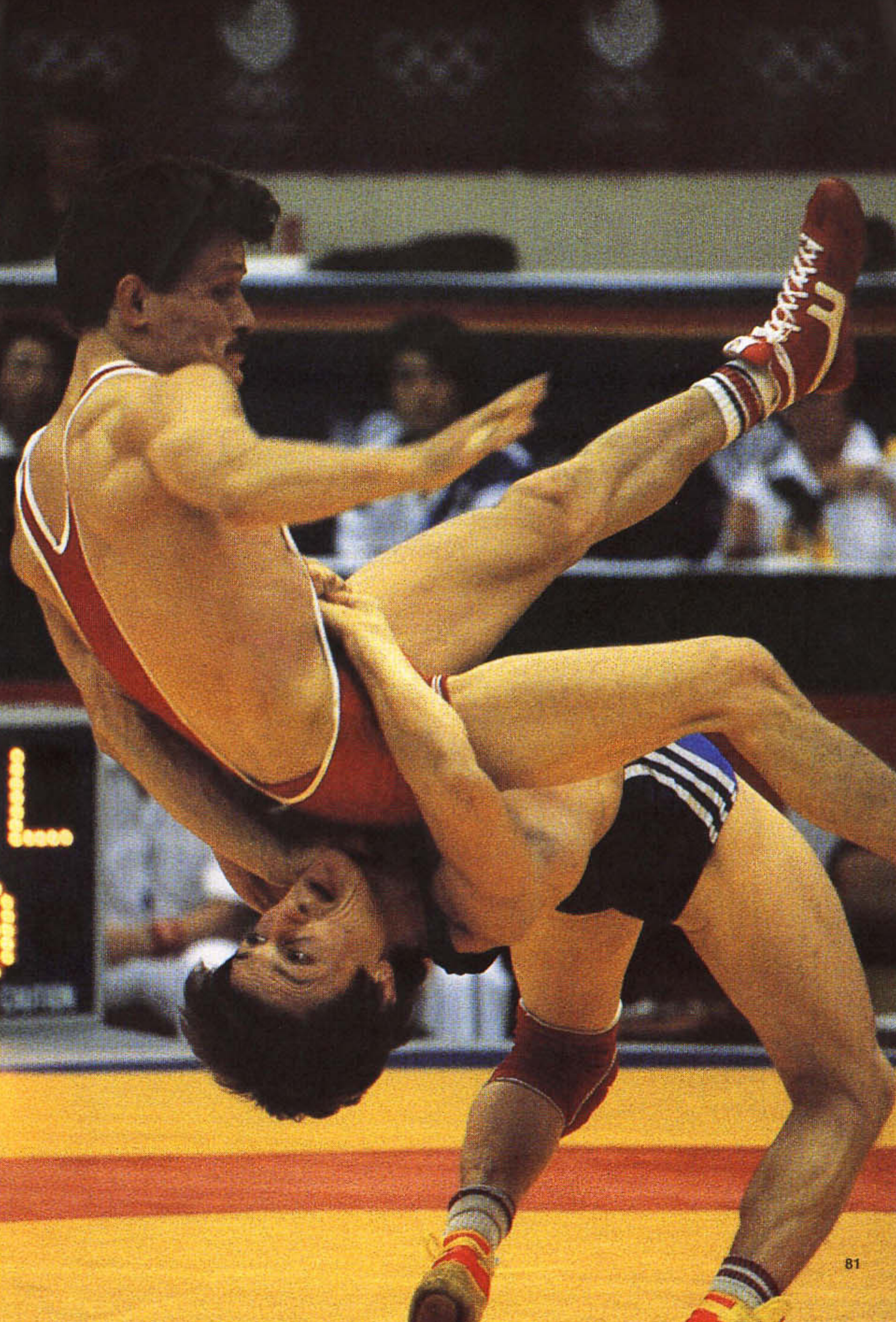





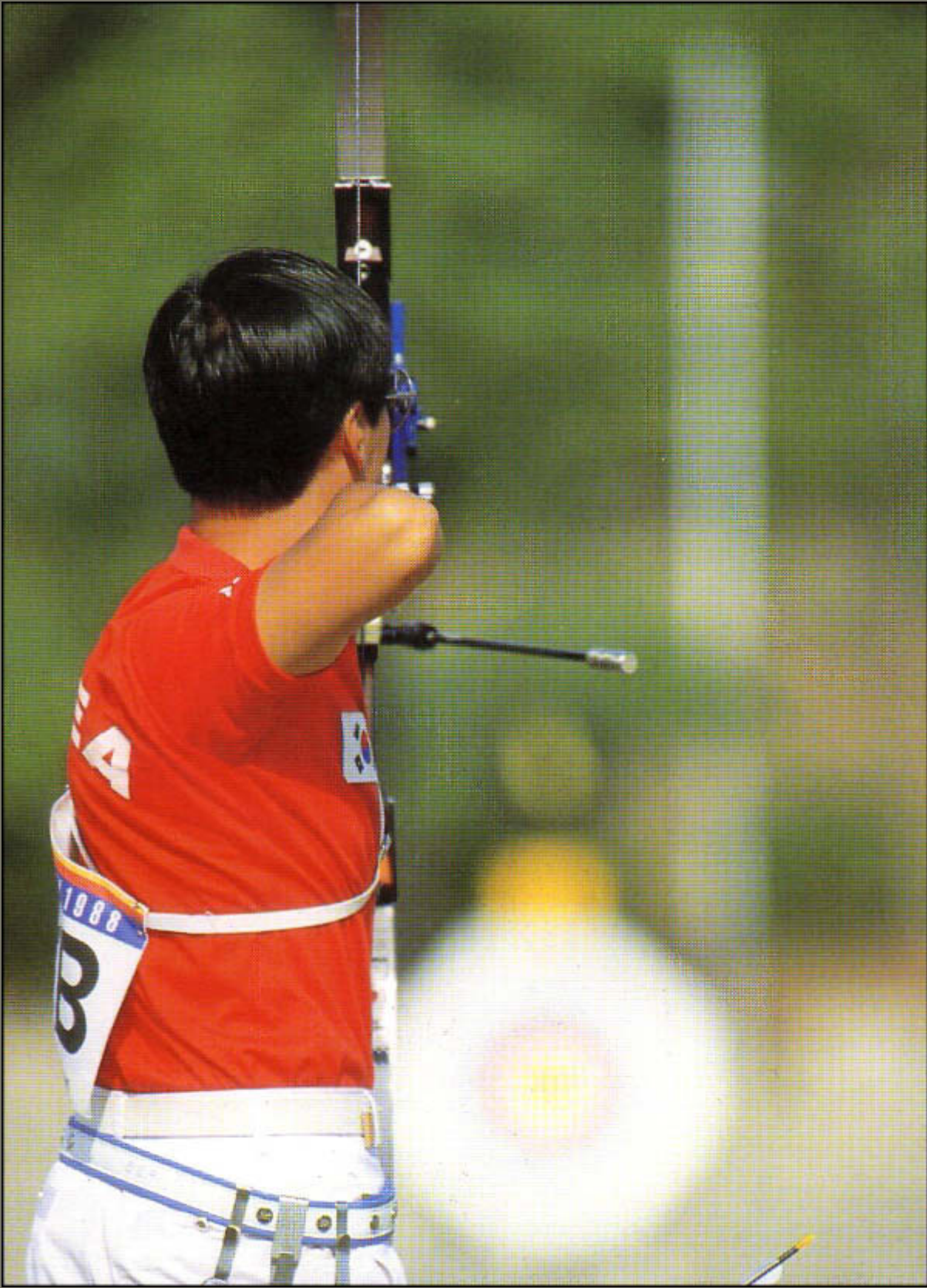





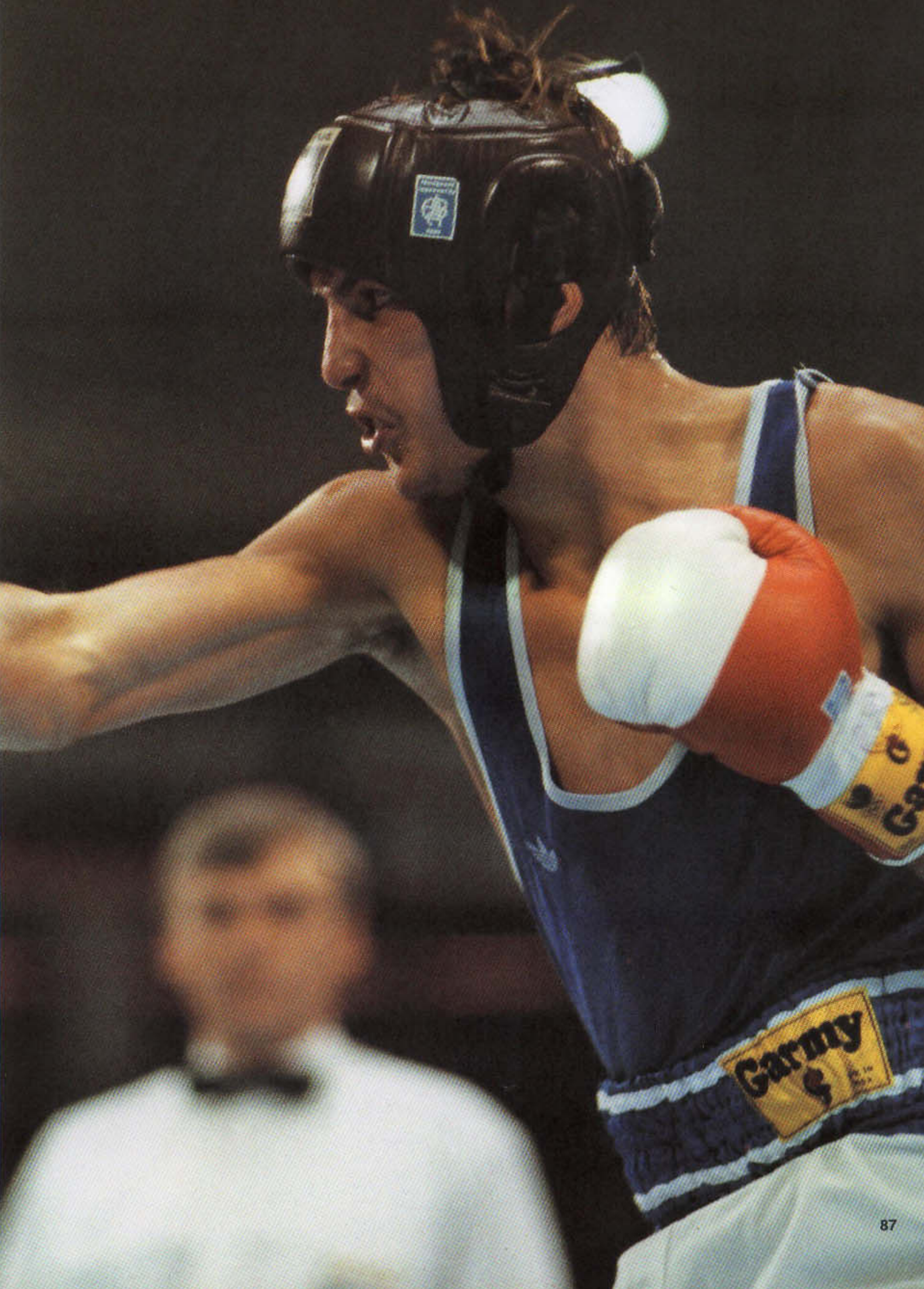









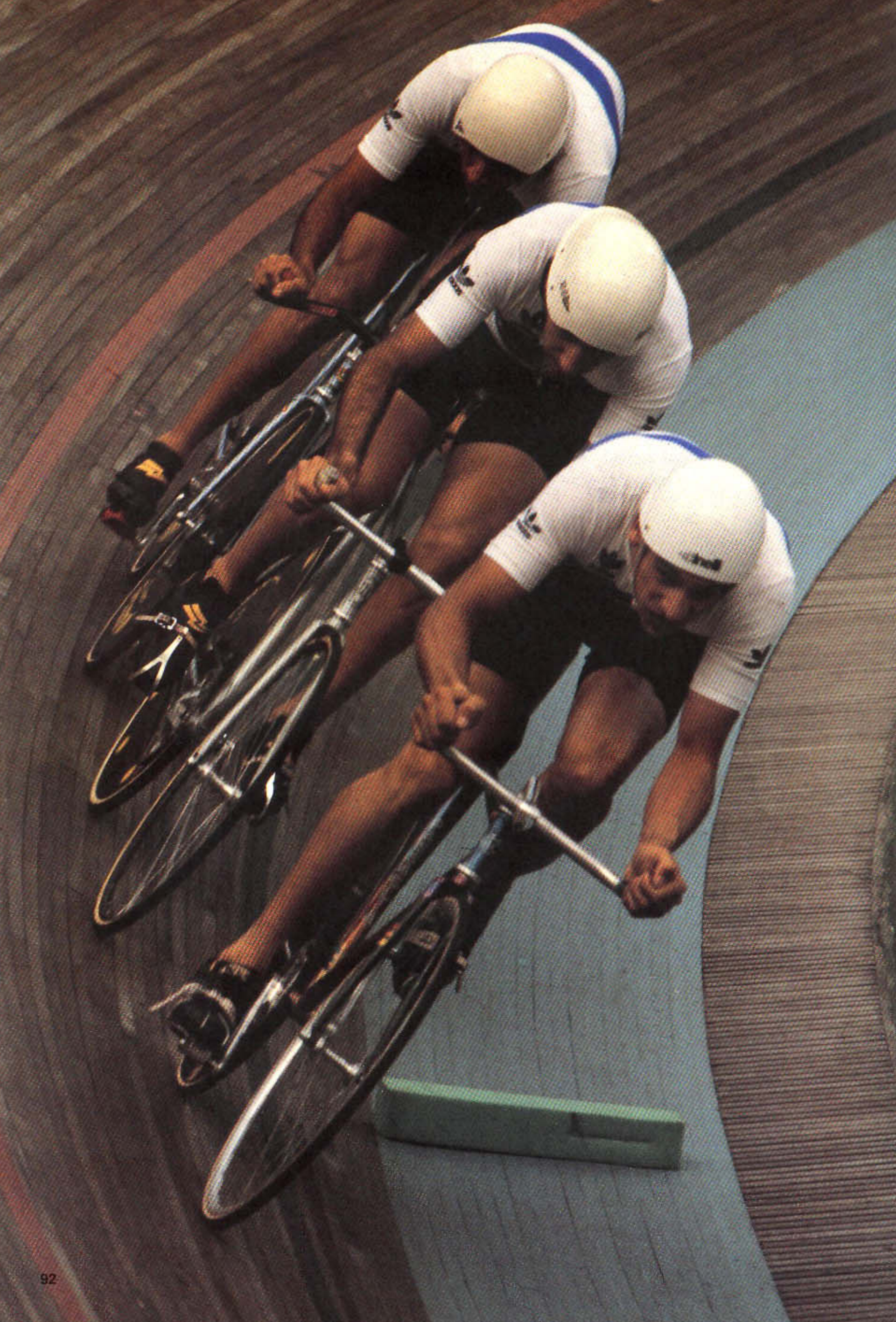

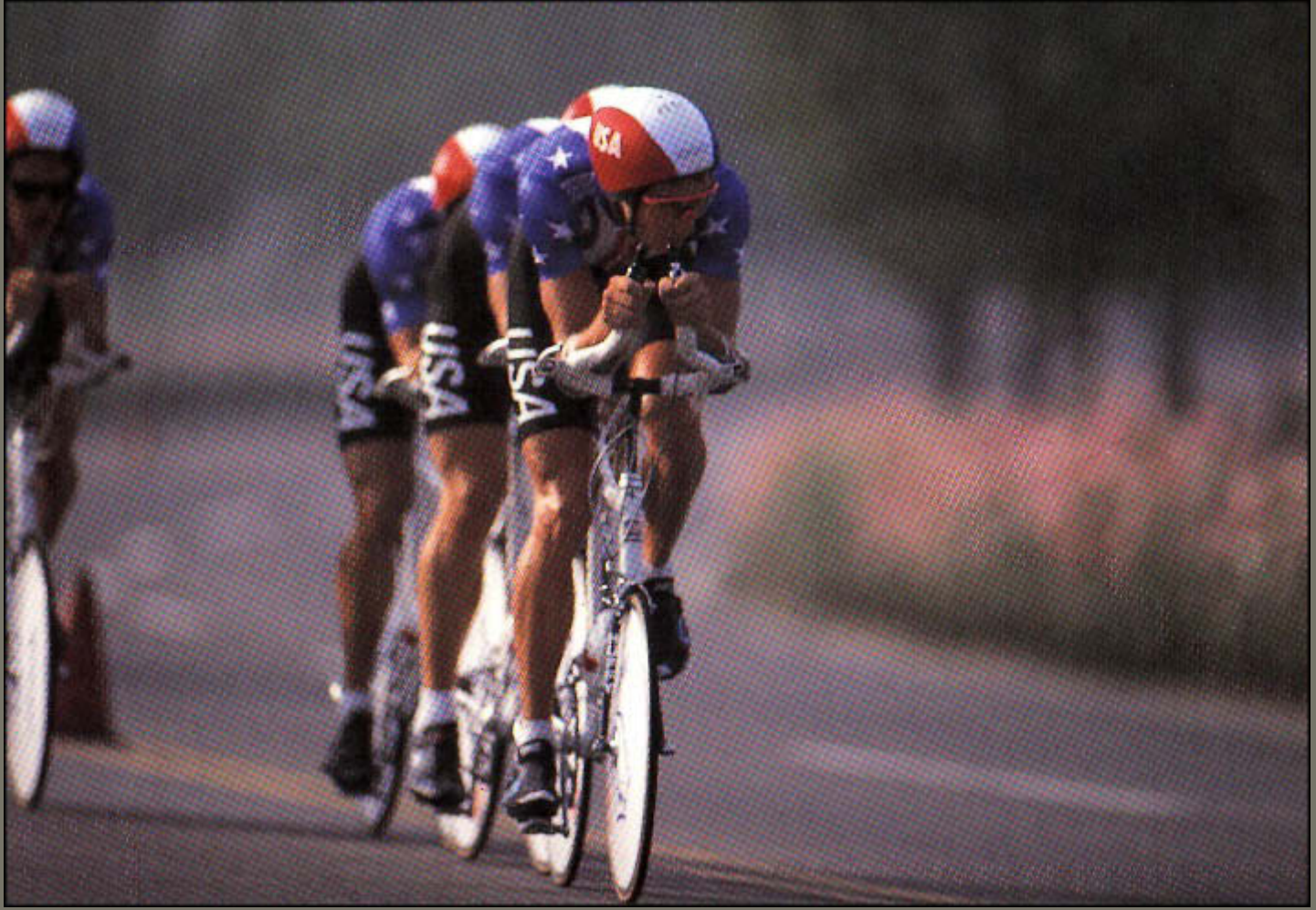



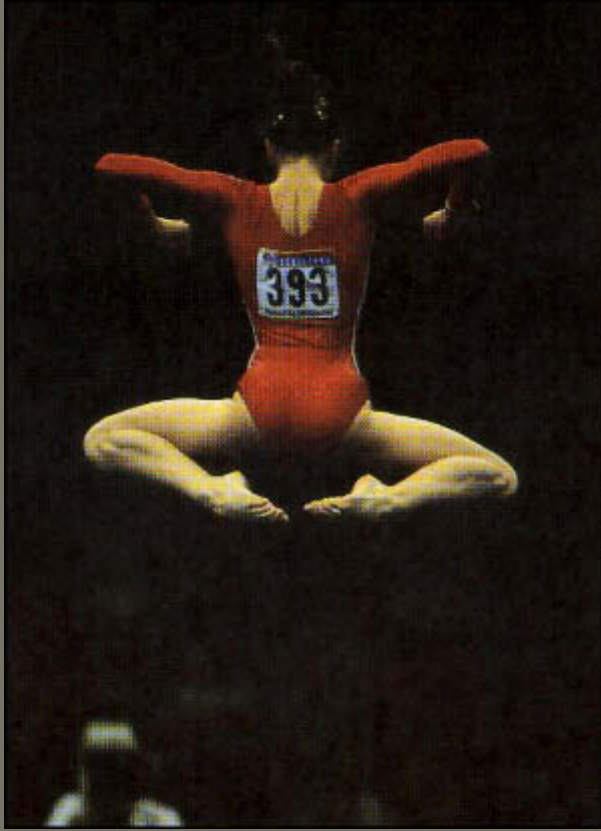







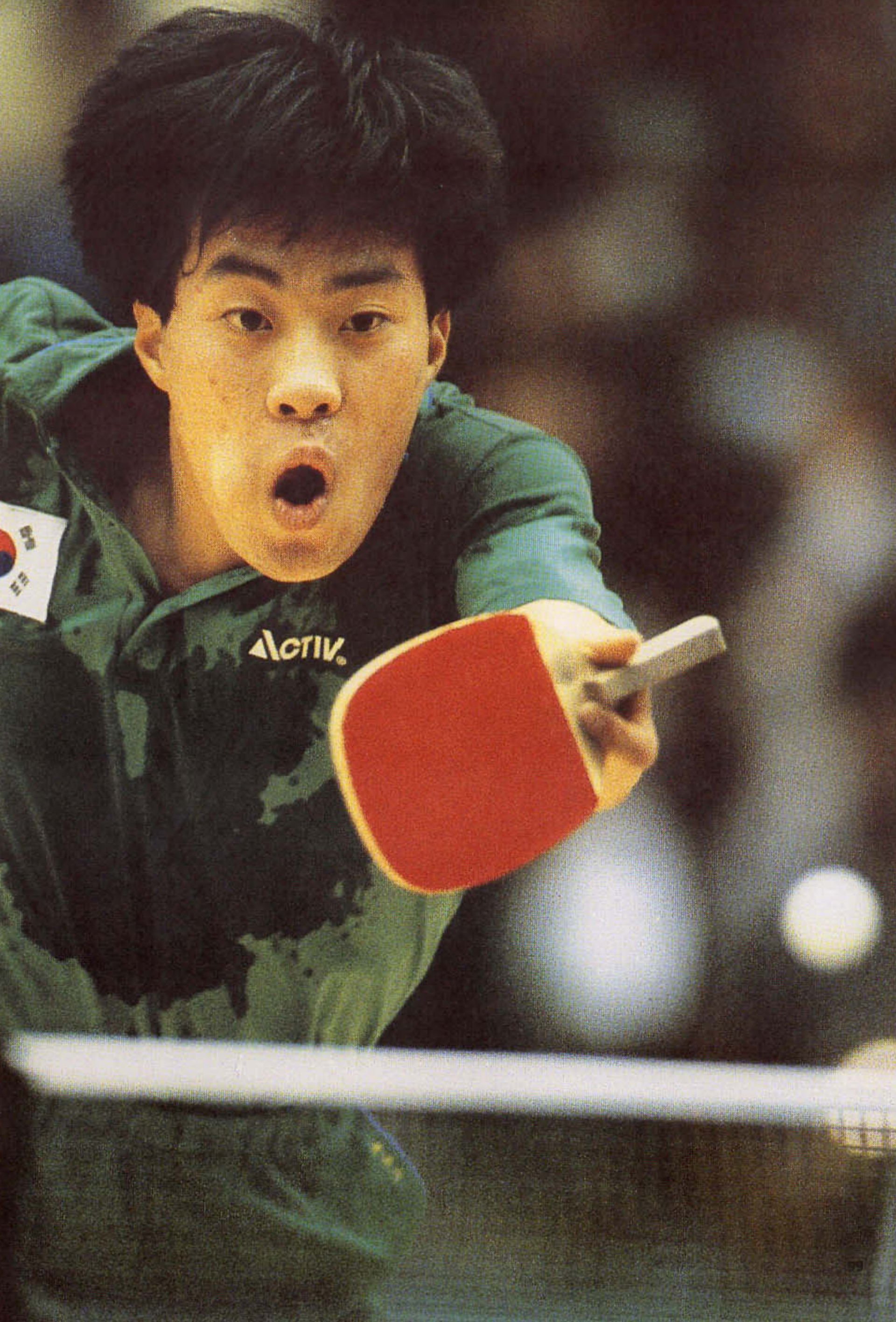



SEOUL 1988











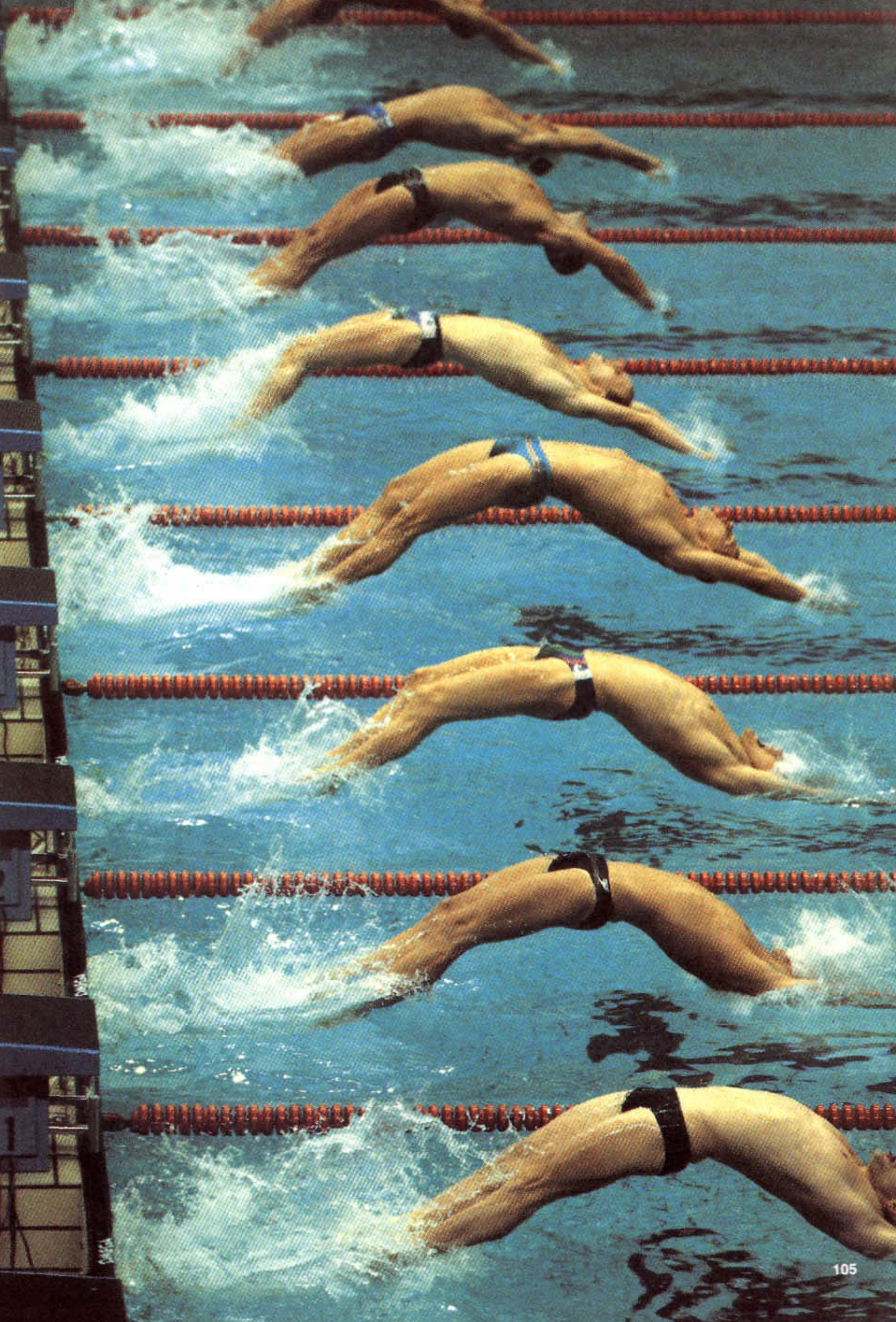













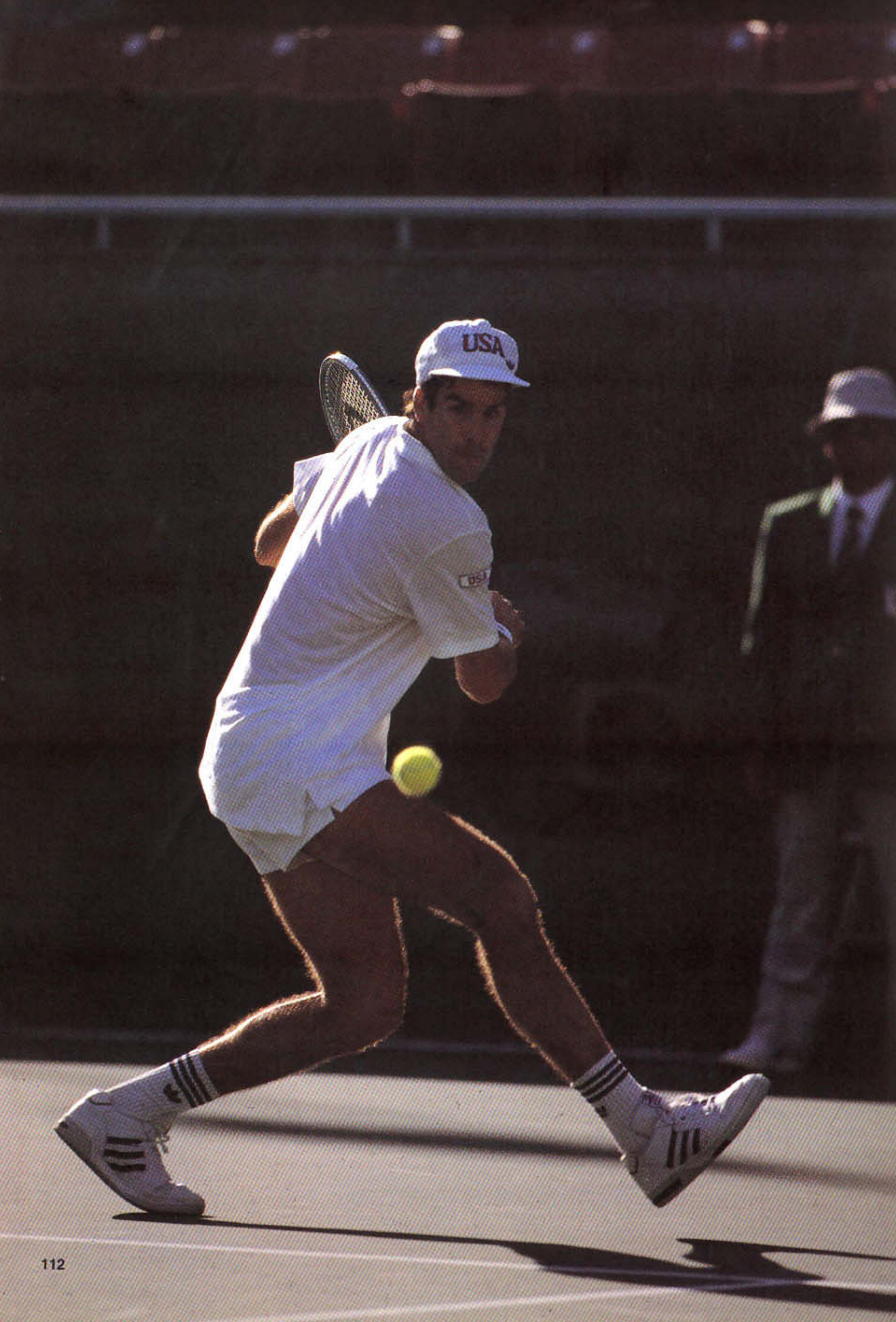







































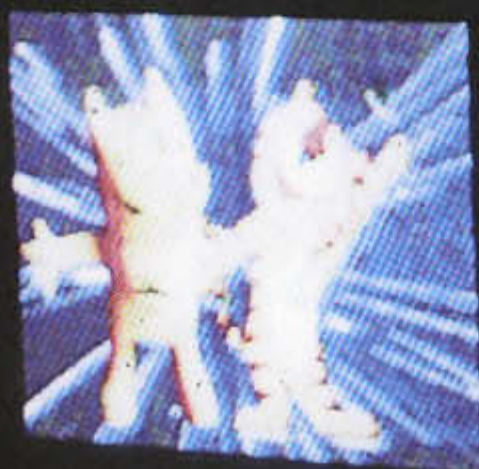

SEE YOU IN
BARCELONA
1992





SEE YOU IN
BARCELONA
1992









SEE YOU IN
BRISTOL
1992

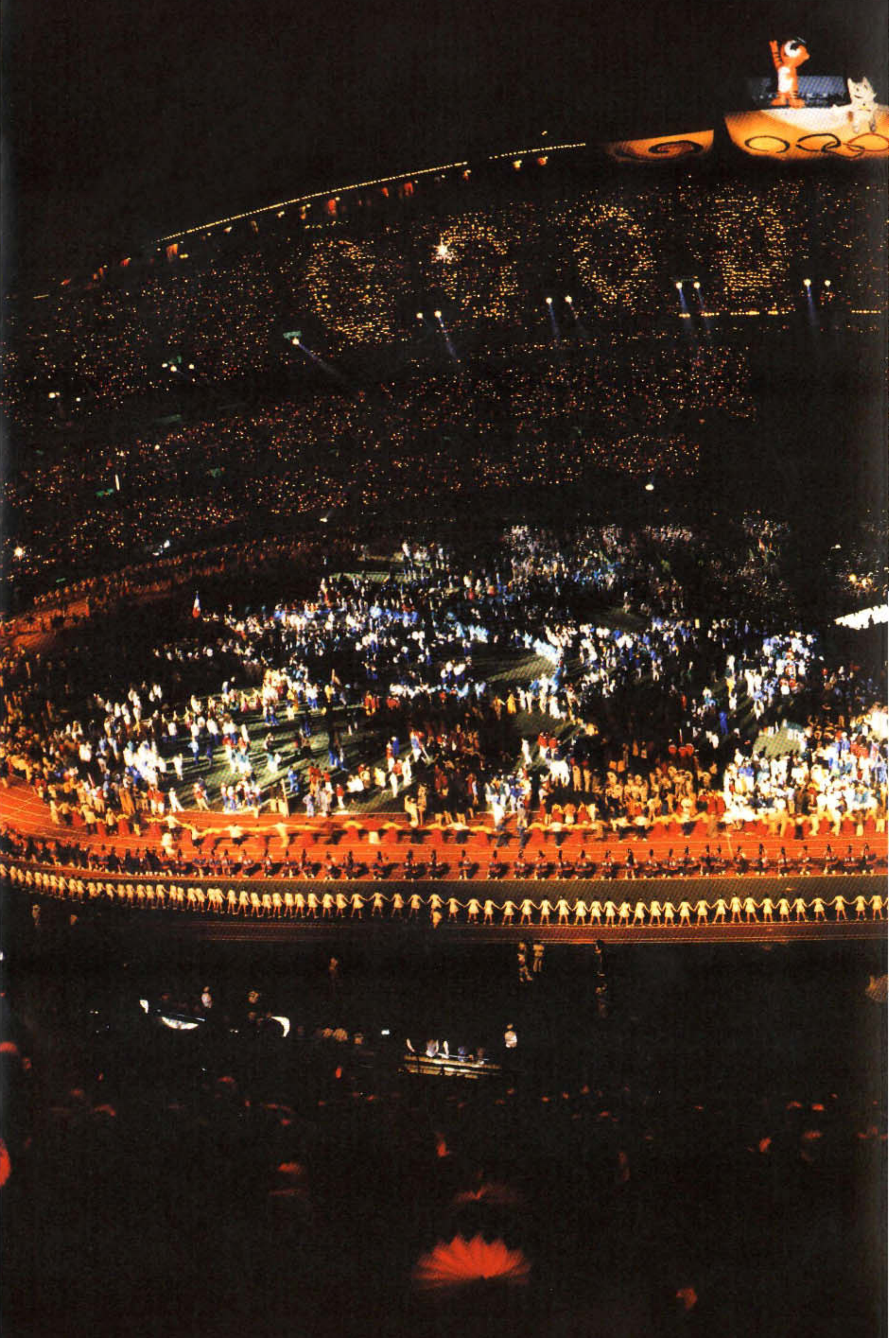



- 8 High Priestess Didaskalou lighting the sacred flame that will burn throughout the Seoul Olympic Games, using a reflected ray of sunlight at the temple of Hera, Olympia, Greece, at 11 a.m. August 23, 1988.
- 10 Thanassis Kaloyannia, Greek 400-meter hurdler, begins the first leg of the relay in Greece, where the torch was carried 352 kilometers overland and 22 kilometers by sea in two days.
- 11 Torch relay run along the Greek coast.
- 12 The torch relay in Korea covered 4,167 kilometers (1,596 sections) in 22 days; these runners are in the central area.
- 14 Miss Korea, Chang Yoon-jung, takes part in the torch relay.
- 15 Confucian followers relayed the torch to Ojukhon in Kangnung.
- 16 Royal ancestral shrine music was performed with the utmost fidelity at Seoul's Chongmyo shrine for the first time since national liberation in 1945 nine government-designated masters of the art were accompanied by 316 Korean national musicians (including many from the National Classical Music Institute Orchestra).
- 18 "Palgok Pyongpung" performed by the National Theatre as part of the Seoul International Theatre Festival.
- 19 Open-air stage folk plays were performed every day from September 15 to October 5.
- 20 "Story of Shim Chong" performed by MBC Madangnori at Munwha Gymnasium during the Seoul International Theatre Festival.
- 22 "Radical Lights" performed by Toronto Dance Theatre at Munye Theater August 28 and 29 as part of Seoul International Dance Festival.
- 24 (1) Hungary's Ballet Company of Gyor performs "The Lovers of the Sun" at Munye Theatre.
(2) Bolshoi Ballet of the U.S.S.R. on stage at Sejong Cultural Center.
(3) "Kanadehon Cushingura" performed by Grand Kabuki Troupe (Japan).
(4) "Oedipus Rex" performed by Greek National Theatre.
- 25 "Whakwanmu" delighted the audience at Seoul Nori Madang.
- 26 Puccini's opera "Turandot" by the Teatro del la Scala of Italy was the most expensive and ambitious production of the Seoul Olympic Arts Festival.
- 28 The International Open-air Sculpture Symposium and World Invitational Open-air Exhibition drew 191 entries.
- 29 A Toronto Dance Theatre performance during the Seoul International Dance Festival.
- 30 In a prayer for a successful Seoul Olympics, more than 200,000 Buddhist monks and believers set 70,000 lotus-shaped lanterns afloat on the Han River.
- 32 People pack Olympic Park on 'Chusok'; the national harvest moon holiday took place during the Games.
- 34 The Dragon Drum Procession at Olympic Stadium (10:45 a.m. September 17, 1988).
- 36 Beating traditional Korean drums, 1,200 Ducksoo Commercial High School students and 1,252 from Chongui Girls Commercial High School perform "Road at Dawn" to pave the way for the Seoul Olympics.
- 37 "Heaven, Earth and Man," symbolizing the Korean concept of the universe, is performed by 44 Korean women and 44 Greek women.
- 38 During the Opening Ceremony, 1,000 dancers form the Olympic emblem.
- 39 The World Tree, symbolizing civilization, is surrounded by balloons.
- 40 Kim Won-tak, Chong Son-min and Sohn Mi-jong kindle the Olympic flame in Main Stadium.
- 41 About 300 banner-bearing athletes lead a procession of competitors from 160 countries.
- 42 National flag bearers gather around the podium as athletes take the Olympic oath.
- 44 Huh Jae and Sohn Mi-na representing all the athletes as they take the oath.
- 45 "Chaos," performed with 838 masks of 160 kinds collected from 60 countries.
- 46 Spectators are captivated by the vibrant Opening Ceremony.
- 47 "One World," symbolizing harmony and compassion is performed by 6,000 participants, including dancers from 12 countries.
- 52 Hodori, Seoul Olympic mascot, entertains spectators.
- 53 Oral Selkridge of Antigua just before the start in men's 400-meter hurdle heat. Andre Phillips of the United States won the event with an Olympic record of 47.19.
- 54 Carl Lewis off the blocks in a heat of the men's 100-meter race. In the final, Lewis finished second (with an Olympic record of 9.92) to Ben Jonson, but the gold went to Lewis when Johnson showed positive in a doping test.
- 56 American Roger Kingdom won the men's 110-meter hurdle race with a time of 12.98, the Olympic best.
- 58 Florence Griffith Joyner becomes a triple gold medalist by winning the women's 100-meter, 200-meter and 400-meter medley.
- 59 Steven Lewis of the United States wins a men's 400-meter heat.
- 60 Marathoners crossing the Han River bridge during the men's marathon. Italy's Gelindo Bordin won the competition with a time of two hours, 10 minutes and 32 seconds, followed by Kenya's Douglas Wakiihuri and Djibouti's Houssein Saleh Ahmed.
- 61 In the men's 20-kilometer walk, Jozef Pribilinec won with an Olympic record.

- 62 Christian Plaziat of France placed first in the men's decathlon long jump.
- 63 Andre Phillips of the United States who won the men's 400-meter hurdles.
- 64 Georg Werthner of Austria throws the discus in the decathlon. Christian Schenk of the German Democratic Republic won the decathlon competition.
- 65 Valter Kioulivet of the U.S.S.R. in shot put during the decathlon.
- 66 Seppo Raty of Finland placed third in men's javelin, and Tapio Korjus of Finland placed first
- 67 American Carl Lewis placed first in men's long jump to become a double gold medalist (following his win in the men's 100-meter race).
- 68 Jane Flemming of Australia in long jump during the women's heptathlon. Jackie Joyner-Kersey of the United States captured the gold in the women's heptathlon.
- 70 Sabine Everts of the Federal Republic of Germany high jumping in the women's heptathlon.
- 72 Simon Poelman of New Zealand in pole vault (decathlon).
- 73 Semifinal between Brazil and the Federal Republic of Germany: after an extended match failed to decide the winner, Brazil won the competition in a Shootout, 3:2, advancing to the final.
- 74 Football final between the U.S.S.R. and Brazil: the match ended in a 1:1 draw, but the U.S.S.R. scored one goal in the extended match to capture the gold.
- 76 The French pair of Karine Schuler and Anne Capron in a duet (synchronized swimming).
- 77 Canadians Michelle Cameron and Carolyn Waldo placed first in duet synchronized swimming.
- 78 Water polo semifinal between Yugoslavia and the Federal Republic of Germany: Yugoslavia won the semifinal, 14:10, to reach the final against the U.S. (which Yugoslavia won, 9:7).
- 80 Men's volleyball final between the U.S. and U.S.S.R.: the U.S. won the final, 3:1.
- 81 In 52-kilogram Greco-Roman wrestling, Jon Ronningen of Norway placed first.
- 82 Lee Hyung-kun of Korea took the bronze medal in the 82.5-kilogram class in weightlifting. In the weight division, Israil Arsamakov of the U.S.S.R. placed first and Istvan Messzi of Hungary placed second.
- 83 Judo 60-kilogram final between Kim Jae-yup of Korea and Kevin Asano of the United States: Kim Jae-yup wins the contest, giving Korea the first gold medal in judo.
- 84 Korean archers Chon In-soo, Park Sung-soo and Lee Han-sup placed first in men's archery team competition.
- 85 Kim Soo-nyung becomes a double gold medalist by placing first in women's archery singles and team competition.
- 86 In a 60-kilogram lightweight boxing match, Andreas Zuelow of the German Democratic Republic defeated by decision Sweden's George Cramne to capture the gold.
- 88 Final match of the 81-kilogram light heavyweight class in boxing: Andrew Maynard of the United States decisioned Nourmagomed Chanavazov of the U.S.S.R. to capture the gold.
- 89 Dmitri Monakov of the U.S.S.R. wins trap shooting.
- 90 Hockey final between Korea and Australia: Australia wins the finals of the women's hockey competition, and Korea captures the silver.
- 92 Men's 4,000-meter cycling team pursuit: the U.S.S.R. wins the competition.
- 93 The U.S. team rolls down the road in the men's 100-kilometer race at Tongilro road race course; the German Democratic Republic won the competition.
- 94 Daniela Silivas of Rumania becomes a triple gold medalist by placing first in floor exercise, uneven bars and balance beam.
- 95 (1) Svetlana Boguinskaia of the U.S.S.R., who captured the silver in floor exercise, brought home the gold in the horse vault (2) Vladimir Artemov of the U.S.S.R. was a quadruple gold medalist, placing first in men's team, individual all-around, parallel bars and horizontal bar. (3) Valeri Lioukine of the U.S.S.R. wins the men's team competition.
- 96 Marina Lobatch of the U.S.S.R., who scored perfects in all events of rhythmic gymnastics, performs with clubs.
- 97 In rhythmic gymnastics, ranking is determined by totalling scores earned with rope, hoop, club and ribbon.
- 98 For the first time in Olympic history, table tennis was an official sport. There were 131 men and women from 41 countries competing for four goldmedals.
- 99 Korea's Yoo Nam-kyu placed first in men's table tennis singles.
- 100 Vincent Berthet of France in the endurance test of dressage.
- 101 Three-day event in dressage, jumping and endurance test: ranking are determined by adding the points earned in separate competitions.
- 102 Zita Funkenhauser of the Federal Republic of Germany, who won the women's foil in fencing, attacks Hungary's Zsuzsanna Janosi in the elimination round.

- 103 *Men's basketball final between the U.S.S.R. and Yugoslavia: the U.S.S.R. wins the final, 76:63.*
- 104 *Americans Allison Jolly and Lynne Jewell won the women's 470 class race.*
- 105 *Daichi Suzuki of Japan won the men's 100-meter backstroke; Igor Polianski of the U.S.S.R. won the 200-meter.*
- 106 *In men's diving (platform and springboard), Los Angeles Olympic gold medalist Gregory Louganis of the United States again became a double gold medalist.*
- 107 *Divers from the People's Republic of China swept the women's platform and springboard events.*
- 108 *The Danish pair paddles mightily, but the Soviet team won the 1,000-meter race.*
- 110 *(1) Janet Evans of the United States beams after becoming a triple medalist (in women's 400-meter freestyle, 400-meter individual medley, and 800-meter freestyle). (2) Men's freestyle: U.S. swimmers made a strong showing.*
- 111 *Kristin Otto of the German Democratic Republic becomes a six-time winner: in women's 50-meter freestyle, 100-meter freestyle, 100-meter backstroke, 100-meter butterfly, 400-meter medley and 400-meter medley relay. She set a world record in the 400-meter freestyle relay.*
- 112 *Tim Mayotte of the United States placed second in men's tennis singles.*
- 113 *In This women's handball round, Norway defeated Yugoslavia, 20:15. Korea won the gold in women's handball.*
- 114 *Men's coxed four: the German Democratic Republic crew won the competition.*
- 115 *Hungary's Janos Martinek wins the pentathlon cross-country.*
- 116 *The British men's field hockey team savors a 3:1 victory over France in the final.*
- 117 *A French competitor finishing first in the wheelchair race (an exhibition event).*
- 118 *Women's welterweight final between Korea's Kim Ji-sook and Arlene Limas of the United States: the U.S. captured the gold.*
- 120 *U.S. baseball players romp after winning that demonstration competition.*
- 122 *Victory ceremony personnel, clad in traditional Korean women's costumes, manage medal presentations.*
- 123 *Debra Flintoff-King of Australia, winner of the women's 400-meter hurdles, with her gold medal, bouquet and first-place smile.*
- 124 *Flagbearers lead the way during closing events.*
- 125 *Closing Ceremony: Greek athletes and officials wave to spectators while marching in.*
- 126 *Seoul Mayor Kim Yong-nae hands the Olympic Flag over to the mayor of Barcelona, host city for the 1992 Games.*
- 128 *In the "Ojakkyo" program for the Closing Ceremony, 320 women stage a fan dance.*
- 130 *The Olympic Flag is lowered while the Olympic song is played; soon the Olympic flame is extinguished, marking the end of the 16-day festival.*
- 132 *The Olympic Flag is carried from the stadium. The flag, made in Korea, was donated to the IOC. It will be the official Olympic Flag hoisted at future games.*
- 133 *Korean dancers perform a handing-over dance before the Olympic Flag is transferred.*
- 134 *Fireworks decorate the sky over the Olympic Stadium, marking the grand end to the Closing Ceremony.*
- 135 *Hodori and Cobi soar into the sky as card-carrying spectators spell "GOOD BYE" to the Olympic Games.*
- 140 *"See in Barcelona in 1992." The festival in Seoul ended and... As the 1988 Olympics came to a close, Seoul's message to the world was: "See You in Barcelona 1992."*

서울올림픽대회 총괄
Seoul '88 Facts and Figures
Les faits et les chiffres



2

The Games of the XXIVth Olympiad began September 17, 1988 with gala Opening Ceremonies at Seoul's Olympic Stadium. They were the result of seven years and five months of preparations.

Staged amidst some 100,000 spectators - and with billions of people watching by broadcast worldwide - the Opening Ceremonies were packed with touching moments.

After parading by boat on the Han River, the Dragon Drum Procession came into view at 10:30 a.m. Dancers performed rhythmic dance harmonizing ancient times and global solidarity, while a mass game enhanced the festived mood.

The official events of the Opening Ceremonies started when 13,304 athletes and officials from 160 countries marched in.

The SLOOC President Park Seh-jik spoke to the crowd, and IOC President Juan Antonio Samaranch delivered a welcoming address.

President Roh Tae Woo then declared the Seoul Olympic Games to be open. The sacred flame, carried from the Temple of Hera in Olympia, Greece, ignited the torch in the Main Stadium's huge cauldron.

The spectators were treated to seven programs: "A Great Day," "Chaos," "Beyond All Barriers," "Silence," "New Sprouts," "Harmony" and "One World." The vocal group Koreana sang the Olympic song "Hand in Hand" to bring down the curtain on the Opening Ceremonies.

Perfect facilities, fine weather and dedicated service by volunteer workers combined to produce a very successful 24th Games; during 16 days of heated competition, athletes shattered 33 world and 227 Olympic records.

9/17

Five official sports and taekwondo (a demonstration sport) were staged on the first day of the Games. With 12 gold medals at stake, 441 boxers from 106 countries entered into competition at Chamshil Students' Gymnasium. Byun Jong-il of Korea won the first round in bantamweight on points. In the women's platform diving preliminary, 12 divers, including Chen Xiaodan of the People's Republic of China, qualified for the finals.

In basketball at Chamshil Gymnasium, the People's Republic of China outpointed Egypt, 98:84, while Brazil easily defeated Canada.

In the Group A preliminary of men's volleyball at Hanyang University Gymnasium, Korea lost to Sweden 2:3 after a fierce battle of three hours and 10 minutes. In the men's Group B preliminary, the Netherlands defeated France.

Football preliminaries were held at Kwangju, Pusan, Taejon and Taegu, spreading the Olympic festival atmosphere all across the country. In Pusan, the Federal Republic of Germany defeated the People's Republic of China, 3:0, while in Kwangju, Italy outclassed Guatemala, 5:2. In Taegu, Sweden and Tunisia fought to a 2:2 draw, as did Iraq and Zambia in Taejon.

In the taekwondo demonstration competition, Korea captured three golds and one silver in four weight classes. Gold medalists included Choo Nan-yool in the women's flyweight division, Ha Tae-kyung in the men's flyweight division, and Chung Kook-hyun in the men's welterweight division. In the women's welterweight class, American Arlene Limas won the gold and Kim Ji-sook of Korea brought home the silver.

9/18

The first official gold medal of the Seoul Olympic Games came in shooting. In women's air rifle, Irina Chilova, an unheralded competitor from the U.S.S.R. captured the gold; her victory ceremony was televised. In men's free pistol, Sorin Babii of Rumania caught the world by surprise when he earned a gold medal by outpointing world record holder Igor Bassinski of the U.S.S.R.

Chun Byung-kwan of Korea established an Olympic record in 52-kilogram weightlifting, giving Korea the first Olympic silver of the Games. Sevdalin Marinov of Bulgaria captured the gold, setting a world record in that division.

In the 100-kilometer team road race at the Tongil-ro cycling circuit, the German Democratic Republic pedaled for gold in one hour, 57 minutes and 47 seconds.

In women's platform diving, Xu Yanmei of the People's Republic of China dove for a gold medal.

The football preliminary between Korea and the U.S.S.R. at Pusan Stadium ended in a scoreless tie; in Kwangju, Australia defeated Yugoslavia, 1:0; and in Taegu, the U.S.A. and Argentina fought to a 1:1 draw. In Taejon, Brazil defeated Nigeria, 4:0.

In men's basketball, underdog Yugoslavia defeated the U.S.S.R. The U.S.A. outpointed Spain, Australia trounced Puerto Rico, and Korea lost to Central Africa.

In gymnastics, Vladimir Artemov of the U.S.S.R. scored a perfect 10 on parallel bars.

The competitions on the second day comprised 12 sports. Five gold medals were awarded.

9/19

In the men's 200-meter freestyle final, unheralded Australian swimmer Duncan Armstrong stroked his way to a world record of 1:47.25, winning a gold medal coveted by world-class stars Michael Gross of the Federal Republic of Germany and Matthew Biondi of the United States.

Kristin Otto of the German Democratic Republic brought home the gold in the women's 100-meter freestyle to begin her medal collection. Janet Evans gave the United States its first gold in swimming by winning the women's 400-meter individual medley.

In springboard diving, Gregory Louganis of the United States sustained a frightening but minor injury when he hit the springboard. Cha Young-chul of Korea captured the silver in men's free rifle, prone.

In a basketball preliminary, Korea defeated Australia, 91:55; in volleyball, Korea defeated Brazil, 3:2.

Wrestlers competed in five events. In taekwondo demonstration matches, Chinese Taipei took the gold in the women's fin class final. In women's lightweight, the United States placed first and Denmark second.

In the football preliminary, Zambia achieved a 4:0 upset victory over Italy. Third-day events comprised 12 sports and produced seven gold medals.

9/20

Competition on the fourth day involved 18 sports, and athletes took part in nine finals.

Despite the head injury he suffered while diving from the springboard, Los Angeles double gold medalist Gregory Louganis managed to claim two golds again.

Naim Suleymanoglu, a Bulgarian who lives in Turkey, rewrote the record book six times (in snatch, clean and jerk, and total) in the 60-kilogram weight category of the weightlifting competition.

In the final of the men's gymnastics team competition, the U.S.S.R. earned the gold with an incredible seven perfect 10s. The U.S.S.R. also captured golds in shooting, wrestling and cycling, bounding into the early lead in the medal race with six golds.

In wrestling, An Dae-hyun of Korea secured the bronze in 62-kilogram Greco-Roman, while Kim Young-nam advanced to the September 21 finals with four straight wins and one draw in the 74-kilogram division.

In men's Group B handball competition at Suwon Gymnasium, Korea outlasted Hungary, 22:20.

In boxing, bantamweight Song Kyung-sop of Korea scored an RSC win in the first round.

In men's coxed pair rowing, the Abbagnales brothers of Italy finished first at the Han River Regatta Course. Korean women volleyball players defeated the German Democratic Republic, 3:1, in a preliminary at Hanyang University Gymnasium.

9/21

Korea captured its first gold of the Seoul Olympics. In 74-kilogram Greco-Roman wrestling, Kim Young-nam defeated heavy favorite Daoulet Tourlykhanov of the U.S.S.R. to give the host country its initial touch of gold. In 52-kilogram Greco-Roman, compatriot Lee Jae-suk won the bronze.

Weightlifter Angel Guanchev of Bulgaria established a world record in the 67.5-kilogram category. In the men's 100-meter butterfly, Anthony Nesty of Surinam captured the gold; in the 400-meter individual medley, Tamas Darnyi of Hungary, despite blindness in one eye, set a world record to win a gold medal. The United States earned its third swimming gold by winning the men's 4x200 meters relay.

In women's gymnastics team competition, Elena Chouchounova powered the U.S.S.R. to victory. The Soviets swept the team competition for both men and women.

The last match of the Group A football competition was held in Taegu; Sweden defeated the Federal Republic of Germany.

In women's handball at Suwon Gymnasium, Korea topped Czechoslovakia, 33:27.

Korea trounced the Federal Republic of Germany, 4:1, in women's hockey at Songnam Stadium.

Korean boxer Kim Kwang-sun scored an RSC win in the flyweight second round, but teammates Oh Kwang-soo and Park Byung-jin were eliminated.

9/22

Kristin Otto of the German Democratic Republic became a triple gold medalist by earning golds in the women's 100-meter backstroke and 4x100 meters freestyle relay. Janet Evans of the United States won the women's 400-meter freestyle with a world record, and compatriot Matthew Biondi finished first in the men's 100-meter freestyle, both to take their second gold medal.

Wrestler Kim Sung-moon of Korea captured the silver in the Greco-Roman 68-kilogram class; Kim Sang-kyu, also of Korea, won a bronze in the Greco-Roman 82-kilogram class.

The bantamweight boxing contest between Byun Jong-il of Korea and Alexandar. Hristov of Bulgaria was controversial. Disagreement over the decision sparked a protest and unruly behavior by the Korean coach and workers.

Korea's 2:1 football loss to Argentina excluded the host team from the eight-squad play off lineup. But the Korean men's handball team thrilled spectators at Suwon Gymnasium with a dramatic come-from-behind win over the German Democratic Republic.

Mitko Grablev of Bulgaria was stripped of his 56-kilogram class weightlifting gold medal after he tested positive for drugs.

9/23

The seventh day featured 16 sports, with a dozen gold medals to be decided in five sports. Athletics competition with a total of 42 medals at stake, started with seven events.

The first gold medal in athletics came in the women's marathon. Rosa Mota of Portugal finished first in the relatively slow race, followed by Australian Lisa Martin and Kathrin Doerre of the German Democratic Republic.

In the men's 20-kilometer walk, Czechoslovakia captured the gold; the silver went to the German Democratic Republic and the bronze to Italy.

In men's shot put, the German Democratic Republic won the gold, the United States finished second and Switzerland was third.

The French fencers finished first in men's sabre. In shooting, the U.S.S.R. won the gold in men's rapid fire pistol.

In men's running game target, Norway finished first, followed by the People's Republic of China and the U.S.S.R.

The German Democratic Republic swimmers earned gold medals both in the men's 400-meter freestyle and women's 100-meter butterfly, while first place in the men's 200-meter breaststroke went to Hungary (Great Britain was second and Spain third). Bulgaria won the gold in the women's 100-meter breaststroke, and U.S. swimmers won the men's 4x100 meters freestyle relay.

The day's spotlight was focused on the individual all around contest between gymnastics superstars Elena Chouchounova of the U.S.S.R. and Daniela Silivas of Rumania. The contest was close until the final event, the horse vault, in which Silivas scored 9.95, but Chouchounova a perfect 10.

9/24

Athletes competed in 16 sports, eight of which had finals with a total of 30 golds.

The day saw two world records and the emergence of a five-time gold medalist.

In the men's 100 meters final, the focus of worldwide attention, Ben Johnson of Canada finished first in 9.79, and Carl Lewis of the United States came in second at 9.92.

Jackie Joyner-Kersey of the United States won the women's heptathlon, finishing first in the 800 meters and establishing a world record of 7,291 points.

In gymnastics, Park Jong-hoon made the day bright for Korea when he won a bronze in the horse vault, scoring a perfect 10 on his second try.

Vladimir Artemov of the U.S.S.R. won two golds in parallel bars and horizontal bar; with golds in team competition and individual all around, Artemov emerged as a quadruple gold medalist.

Swimmer Kristin Otto of the German Democratic Republic finished first in the women's 4x100 meters medley relay and became a five-time medalist.

Angel Guanchev of Bulgaria tested positive for drugs, which cost him the gold medal in the 67.5-kilogram weightlifting. Earlier, Mitko Grablev, also a Bulgarian lifter, was stripped of his gold medal in the 56-kilogram class for doping.

9/25

On *Chusok*, Korea's most celebrated national holiday (equivalent to Thanksgiving Day), a total of 25 gold medals, including five in athletics and seven in rowing, were awarded.

In judo competition, Kim Jae-yup of Korea defeated Kevin Asano of the United States for a gold medal in the extra lightweight class. Kristin Otto of the German Democratic Republic continued her spectacular feats of swimming; she tallied her sixth gold medal in the women's 50-meter freestyle, defeating world record holder Yang Wenyi of the People's Republic of China with a finish of 25.49.

Matthew Biondi of the United States won the gold in the men's 400-meter medley relay, emerging as a five-time medalist.

In athletics competition, Florence Griffith Joyner of the United States won the women's 100 meters in 10.54. In the men's 400-meter hurdles, an event dominated by Edwin Moses of the United States for the past 12 years, Andre Phillips, also of the United States, earned the gold.

9/26

Athletes competed for 12 golds, including eight in athletics. In judo, Lee Kyung-keun of Korea attained a gold medal in the half lightweight class. Paul Ereng of Kenya captured the gold in the men's 800 meters with a time of 1:43.45, outrunning Joaquim Cruz of Brazil. In the men's long jump, Carl Lewis of the United States retained the title he won during the Los Angeles Games. In the men's 110-meter hurdles, Roger Kingdom of the United States won with a time of 12.98 to hold onto his Olympic title. Officials needed photo-finish to determine the results of the 82-kilometer women's individual road race after 45 cyclists reached the finish line almost simultaneously. Eventually, the gold went to Monique Knol of the Netherlands, the silver to Jutta Niehaus of the Federal Republic of Germany and the bronze to Laima Zilporitee of the U.S.S.R.

9/27

The day sent waves of shock and disillusionment to billions of television viewers around the world. Ben Johnson, who set a world record of 9.79 seconds in the men's 100 meters final September 24, failed a dope test; the IOC stripped him of his gold medal. In the first drug examination, conducted shortly after the sprint, Johnson tested positive. The second test showed the same result. At about 10 a.m. he left Seoul through Kimpo International Airport. Gregory Louganis of the United States repeated as gold medalist in the men's springboard diving. Shortly after the gold medal was hung around his neck, Louganis announced his retirement. Gold medals were also earned in equestrian, fencing, judo, swimming and weightlifting. The day saw athletes competing in 17 sports.

9/28

Eighteen sports were featured, offering 15 gold medals. Kim Soo-nyung of Korea smashed the world record in the women's 50-meter single round archery by scoring 336 points. In athletics, the United States swept the men's 400 meters; Steven Lewis finished first in 43.87, Harry Butch Reynolds came in second at 43.93 and Danny Everett crossed the line third in 44.09. In the men's 200 meters, Joe DeLoach of the United States established an Olympic record with a time of 19.75 to earn a gold medal that Carl Lewis had hoped to claim.

In the women's 400-meter hurdles, Debra Flintoff-King of Australia came in first at 53.17, a scant 0.01 second ahead of Tatiana Ledovskaia of the U.S.S.R. Only after looking at the electronic scoreboard was Flintoff-King certain she had finished first. In the pole vault finals, Sergey Bubka of the U.S.S.R. won the gold with an Olympic record of 5.90 meters; Soviets swept the medals in this event. Since 1983, Bubka has bettered his own world records nine times.

Powered by Anja Fichtel, the Federal Republic of Germany took the women's fencing foil team title. Six days earlier, Fichtel also won a gold in individual foil.

In the team jumping finals held at the Seoul Equestrian Park, the Federal Republic of Germany won the title with 17.25; the medal represented the nation's sixth gold in Seoul. It was the first team jumping gold finish for the Federal Republic since the 1972 Munich Games.

The Federal Republic of Germany earned four of the six golds at stake for equestrians in Seoul.

In connection with another doping scandal, Hungary sent 10 lifters home; the action followed the announcement by the IOC Medical Commission that Andor Szanyi, silver medalist in the 100-kilogram class, tested positive for anabolic steroids.

9/29

Athletes competed in 16 sports for 14 gold medals.

The Korean women's handball team defeated the U.S.S.R., 21:19, to win a gold for the first time in an Olympic ball game. At the Los Angeles Games, the Korean team finished second.

In the women's volleyball final, Peru took lead in the first two sets but lost the third, fourth and fifth sets to the U.S.S.R.

In the women's basketball final, the United States outpointed Yugoslavia, 77:70, to bring home the gold.

Florence Griffith Joyner of the United States finished first in the women's 200 meters final with a world record time of 21.34. Responding to cheers from spectators, Joyner circled the track in a victory lap.

In the women's long jump, Jackie Joyner-Kersey turned in an Olympic record of 7.40 to add a gold to the title she won in the women's heptathlon.

In the women's discus throw finals, Martina Hellmann of the German Democratic Republic broke an Olympic record with a throw of 72.30 meters: the silver went to teammate Diana Gansky.

Hungary won the gold, the U.S.S.R. the silver, and Italy the bronze medal in the men's fencing sabre team competition.

In the finals of the over 110-kilogram weightlifting competition, Alexandre Kourlovitch of the U.S.S.R. lifted 212.5 kilograms in snatch and 250 kilograms in clean and jerk for an Olympic record total of 462.5 kilograms. The previous record was 440 kilograms. Wrestling yielded three golds. In the 48-kilogram freestyle final, Japan's Takashi Kobayashi defeated Bulgaria's Ivan Tzonov to win the gold. In the 62-kilogram freestyle, John Smith of the United States defeated Stepan Sarkissian of the U.S.S.R. for a gold. In the 90-kilogram freestyle, Makharbek Khadartsev of the U.S.S.R. earned a gold by scoring a fall over Japan's Akira Ota.

9/30

The 14th day was packed with action in 16 sports, and victorious athletes claimed 24 gold medals.

Korea won golds in women's archery and table tennis. The hosts swept medals in the women's individual archery; Kim Soo-nyung scored 344 points for gold, Wang Hee-kyung won the silver with 332, and Yun Young-sook took the bronze with 327. The trio were all high school students.

In the men's individual archery competition, Jay Barrs of the United States took home the gold and Park Sung-soo of Korea won the silver.

In the finals of women's table tennis doubles-its first appearance as an official Olympic event-Koreans Hyun Jung-hwa and Yang Young-ja outpointed a heavily-favored Chinese pair, Chen Jing and Jiao Zhimin, 21:19, 16:21, and 21:10.

Korea lost the final women's hockey match to Australia, 0:2, but the team's silver medal was treasured because it came during the Korean squad's Olympic debut.

The Soviet men's basketball team, losers in a preliminary game with Yugoslavia, won revenge against the Yugoslavians in the final 76:63, to earn the gold medal.

Miloslav Mecir of Czechoslovakia defeated Tim Mayotte of the United States, 3:1, to capture the gold in men's singles tennis-a sport returned during the Seoul Games after a 64-year absence.

In rhythmic gymnastics competition, Marina Lobatch of the U.S.S.R. scored a perfect 60.00 to collect the gold medal.

Canada's Carolyn Waldo scored 200.150 to capture the gold for solo synchronized swimming, and Trade Ruiz-Conforto of the United States placed second with 197.633.

In the 52-kilogram freestyle wrestling final, Japan's Mitsuru Sato defeated Yugoslavia's Saban Trstena to earn a gold medal. Kenneth Monday of the United States defeated Adlan Varaev of the U.S.S.R. for the 74-kilogram title. Vasile Puscasu of Rumania won over Leri Khabelov of the U.S.S.R. in class the 100-kilogram division. During the day, six gold medals were awarded for canoeing. In the finals of men's 500-meter kayak singles, Hungary's Zsolt Gyulay finished first in 1:44.82. Olaf Heukrodt of the German Democratic Republic won the men's 500-meter Canadian singles with a time of 1:56.42.

In the finals of women's men's 500-meter kayak singles, Vania Guecheva of Bulgaria was the winner with a time of 1:55.19. New Zealand won the 500-meter kayak pairs, while the U.S.S.R. brought home top honors in the men's 500-meter Canadian pairs. The German Democratic Republic won the women's 500-meter kayak pairs.

Olga Bondarenko of the U.S.S.R. won the gold in the inaugural running of the women's 10,000 meters finishing in 31:05.21.

In the men's 3,000-meter steeple-chase, Kenya finished first and second; Julius Kariuki, the gold medalist, established an Olympic record of 8:05.51, only 0.1 second behind the world record established by a Kenyan 10 years ago.

Louise Ritter of the United States set an Olympic record of 2.03 meters in the women's high jump. In the women's 100-meter hurdles, Jordanka Donkova of Bulgaria captured the gold with an Olympic record of 12.38. In the men's 50-kilometer walk, Viacheslav Ivanenko of the U.S.S.R. finished first with an Olympic record of three hours, 38 minutes and 29 seconds.

10/1

With the Games swiftly drawing to a close, athletes battled for 39 gold medals on the second-last day of the competition. It was a fruitful day for the host country's entrants.

Korea swept the golds in archery team competitions for both men and women. Kim Soo-nyung, Wang Hee-kyung and Yun Young-sook, who finished 1-2-3 in women's individual competition, struck gold as a team with 982 points – a 30-point margin over second-place Indonesia.

Chun In-soo, Lee Han-sup and Park Sung-soo accumulated 986 points to win the men's team archery competition.

The final of men's table tennis singles was a contest between Koreans Yoo Nam-kyu and Kim Ki-taik. Yoo was the winner, 3:1.

Korea's Han Myung-woo defeated Turkey's Necmi Gencalp for a freestyle wrestling gold medal in the 82-kilogram class.

Soviet women streaked to a world record finish in 3:15.18 to win the 4x400 meter relay, while in the men's 4x400 meters, U.S. runners tied the world record of 2:56.16.

In the women's 400-meter relay, Florence Griffith Joyner of the United States won another gold to become a triple medalist.

Kenya finished first in the men's 1,500 meters and 5,000 meters; in the 1,500 meters, Peter Rono won with a time of 3:35.96, and in the 5,000 meters, John Ngugi clocked a winning 13:11.70.

Rumania's Paula Ivan took the women's 1,500-meter gold medal with an Olympic record time of 3:53.96.

For the first time since the Melbourne Games of 1956, the U.S.S.R. won the football title, defeating Brazil, 2:1.

In the men's handball final, Korea lost to the U.S.S.R., 32:25. The Great Britain beat the Federal Republic of Germany in men's hockey, 3:1.

In the women's tennis singles final, Steffi Graf of the Federal Republic of Germany defeated Gabriela Sabatini of Argentina, 2:0, to win the gold medal. In the men's tennis doubles final, Ken Flach and Robert Seguso of the United States defeated Spain's Emilio Sanchez and Sergio Casal, 3:2, after close games.

Six canoeing golds were determined as follows:

In the men's 1,000-meter kayak singles, Greg Barton of the United States finished first in 3:55.27; Barton also won the gold in the men's 1,000-meter kayak doubles with a time of 3:32.42.

Birgit Schmidt of the German Democratic Republic won the gold in women's 500-meter kayak fours. One day earlier, Schmidt took the gold in women's kayak pairs.

In men's 1,000-meter Canadian singles, Ivan Klementiev of the U.S.S.R. finished first; the Soviet men also won the 1,000-meter Canadian pairs.

Yugoslavia retained its Olympic water polo title by defeating the United States, 9:7. The gold medal for synchronized duet went to Canadians Michelle Cameron and Carolyn Waldo. In the judo heavyweight final, Hitoshi Saito of Japan defeated Henry Stoehr of the German Democratic Republic to garner his second Olympic gold.

10/2

Nine finals were conducted on the final day of the Seoul Games. Italy's unheralded marathon runner, Gelindo Bordin, finished first in a hotly contested race. The 42.195-kilometer marathon featured several world-class marathoners including Douglas Wakiihuri, Japan's Takeyuki Nakayama, and Houssein Ahmed Saleh of Djibouti. From the 39-kilometer mark on, Bordin displayed amazing speed, finally overtaking Saleh just two kilometers from the finish line and entering the Olympic Stadium to the cheers of spectators.

In the individual jumping final of the equestrian competition, Pierre Durand of France defeated Karsten Huck of the Federal Republic of Germany for a gold-his fourth win since the Tokyo Games of 1964.

The U.S. men's volleyball team suppressed the Soviets, 3:1, to win its fourth consecutive victory in major world competition since 1984. They had won the previous Olympics, World Cup and World Championship. In boxing finals, Korea's Kim Kwang-sun won the gold in flyweight and Park Sihun captured the gold in the light middleweight class. However, Association Internationale de Boxe Amateur (AIBA) named Park's opponent, Roy Jones of the United States, the best player.

The two golds Korea won on the final day brought the host country's medal count to 12, fourth among all the competing nations.

The 16 days of the Olympic competition drew to a close, leaving behind memories of the countless human dramas which grew from the interaction of some 9,700 athletes from all parts of the world.

As the sacred flame was extinguished, the story of the Seoul Games became matter for the history books.

NOC Participation



GRE

Greece

Officials/Officiels M:31 F:3
Athletes/Athlètes M:46 F:12



GHA

Ghana

Officials/Officiels M:12 F:1
Athletes/Athlètes M:11 F:7



GAB

Gabon

Officials/Officiels M:2 F:-
Athletes/Athlètes M:2 F:1



GUY

Guyana

Officials/Officiels M:3 F:-
Athletes/Athlètes M:7 F:1



GAM

Gambia

Officials/Officiels M:4 F:-
Athletes/Athlètes M:6 F:1



GUA

Guatemala

Officials/Officiels M:18 F:2
Athletes/Athlètes M:27 F:3



GUM

Guam

Officials/Officiels M:12 F:4
Athletes/Athlètes M:15 F:5

Participation des C.N.O.



GRN

Grenada

Officials/Officiels M:2 F:0
Athletes/Athlètes M:4 F:2



GUI

Guinea

Officials/Officiels M:4 F:0
Athletes/Athlètes M:8 F:0



GEQ

Equatorial Guinea

Officials/Officiels M:3 F:0
Athletes/Athlètes M:4 F:2



NGR

Nigeria

Officials/Officiels M:28 F:4
Athletes/Athlètes M:67 F:9



HOL

Netherlands

Officials/Officiels M:71 F:8
Athletes/Athlètes M:130 F:62



NEP

Nepal

Officials/Officiels M:12 F:1
Athletes/Athlètes M:15 F:3



NOR

Norway

Officials/Officiels M:35 F:5
Athletes/Athlètes M:53 F:26



NGU

Papua-New Guinea

Officials/Officiels M:9 F:-
Athletes/Athlètes M:10 F:2



LAO

Laos

Officials/Officiels M:1 F:-
Athletes/Athlètes M:5 F:1



NZL

New Zealand

Officials/Officiels M:42 F:13
Athletes/Athlètes M:70 F:23



LBR

Liberia

Officials/Officiels M:15 F:-
Athletes/Athlètes M:19 F:2



NIG

Niger

Officials/Officiels M:6 F:-
Athletes/Athlètes M:8 F:-



LIB

Lebanon

Officials/Officiels M:6 F:1
Athletes/Athlètes M:7 F:1



DEN

Denmark

Officials/Officiels M:44 F:8
Athletes/Athlètes M:62 F:30



LES

Lesotho

Officials/Officiels M:3 F:-
Athletes/Athlètes M:6 F:-



DOM

Dominican Republic

Officials/Officiels M:6 F:-
Athletes/Athlètes M:15 F:1



ROM

Rumania

Officials/Officiels M:17 F:4
Athletes/Athlètes M:31 F:33



GDR

German Democratic Republic

Officials/Officiels M:87 F:3
Athletes/Athlètes M:179 F:112



LUX

Luxembourg

Officials/Officiels M:6 F:-
Athletes/Athlètes M:5 F:3



FRG

Federal Republic of Germany

Officials/Officiels M:112 F:20
Athletes/Athlètes M:287 F:117



RWA

Rwanda

Officials/Officiels M:1 F:-
Athletes/Athlètes M:3 F:3

NOC Participation



LBA

Libya

Officials/Officiels M:9 F:-
Athletes/Athlètes M:6 F:-



LIE

Liechtenstein

Officials/Officiels M:5 F:4
Athletes/Athlètes M:9 F:3



MAW

Malawi

Officials/Officiels M:6 F:-
Athletes/Athlètes M:17 F:-



MAL

Malaysia

Officials/Officiels M:9 F:2
Athletes/Athlètes M:5 F:8



MLI

Mali

Officials/Officiels M:5 F:-
Athletes/Athlètes M:5 F:1



MEX

Mexico

Officials/Officiels M:46 F:3
Athletes/Athlètes M:72 F:19



MON

Monaco

Officials/Officiels M:7 F:1
Athletes/Athlètes M:8 F:1

Participation des C.N.O.



MAR

Morocco

Officials/Officiels M:20 F:1
Athletes/Athlètes M:24 F:3



MRI

Mauritius

Officials/Officiels M:5 F:-
Athletes/Athlètes M:6 F:2



MTN

Mauritania

Officials/Officiels M:3 F:-
Athletes/Athlètes M:6 F:-



MOZ

Mozambique

Officials/Officiels M:5 F:-
Athletes/Athlètes M:6 F:-



MDV

Maldives

Officials/Officiels M:2 F:-
Athletes/Athlètes M:7 F:-



MLT

Malta

Officials/Officiels M:4 F:-
Athletes/Athlètes M:8 F:1



MGL

Mongolia

Officials/Officiels M:12 F:-
Athletes/Athlètes M:24 F:4



USA

United States of America
Officials/Officiels M:124 F:40
Athletes/Athlètes M:388 F:227



BER

Bermuda
Officials/Officiels M:9 F:3
Athletes/Athlètes M:12 F:1



VAN

Vanuatu
Officials/Officiels M:1 F:-
Athletes/Athlètes M:5 F:1



ISV

Virgin Islands
Officials/Officiels M:14 F:7
Athletes/Athlètes M:20 F:6



BRN

Bahrain
Officials/Officiels M:10 F:-
Athletes/Athlètes M:11 F:-



IVB

British Virgin Islands
Officials/Officiels M:2 F:1
Athletes/Athlètes M:3 F:-



BAR

Barbados
Officials/Officiels M:11 F:2
Athletes/Athlètes M:16 F:1



BEN

Benin
Officials/Officiels M:2 F:-
Athletes/Athlètes M:6 F:1



BAH

Bahamas
Officials/Officiels M:8 F:2
Athletes/Athlètes M:13 F:4



VEN

Venezuela
Officials/Officiels M:11 F:4
Athletes/Athlètes M:16 F:2



BAN

Bangladesh
Officials/Officiels M:1 R:-
Athletes/Athlètes M:6 F:-



VIE

Vietnam
Officials/Officiels M:3 F:-
Athletes/Athlètes M:9 F:1



BIR

Burma
Officials/Officiels M:2 F:1
Athletes/Athlètes M:- F:2



BEL

Belgium
Officials/Officiels M:34 F:5
Athletes/Athlètes M:39 F:26

NOC Participation



BIZ

Belize
Officials/Officiels M:4 F:0
Athletes/Athlètes M:10 F:-



BOT

Botswana
Officials/Officiels M:2 F:-
Athletes/Athlètes M:8 F:-



BOL

Bolivia
Officials/Officiels M:4 F:1
Athletes/Athlètes M:6 F:-



BUR

Burkina Faso
Officials/Officiels M:2 F:-
Athletes/Athlètes M:5 F:1



BHU

Bhutan
Officials/Officiels M:3 F:-
Athletes/Athlètes M:3 F:-



BUL

Bulgaria
Officials/Officiels M:56 F:7
Athletes/Athlètes M:116 F:70



BRA

Brazil
Officials/Officiels M:62 F:3
Athletes/Athlètes M:136 F:35

Participation des C.N.O.



BRU

Brunei
Officials/Officiels M:1 F:-
Athletes/Athlètes M:- F:-



ASA

American Samoa
Officials/Officiels M:6 F:-
Athletes/Athlètes M:6 F:-



SAM

Western Samoa
Officials/Officiels M:5 F:1
Athletes/Athlètes M:11 F:-

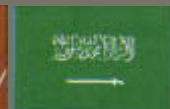

KSA

Saudi Arabia
Officials/Officiels M:9 F:-
Athletes/Athlètes M:14 F:-



CYP

Cyprus
Officials/Officiels M:5 F:-
Athletes/Athlètes M:7 F:2



SMR

San Marino
Officials/Officiels M:7 F:1
Athletes/Athlètes M:11 F:-



ESA

El Salvador
Officials/Officiels M:5 F:0
Athletes/Athlètes M:5 F:1



SEN

Senegal

Officials/Officiels M:15 F:1
Athletes/Athlètes M:22 F:-



SRI

Sri Lanka

Officials/Officiels M:0 F:1
Athletes/Athlètes M:4 F:2



VIN

St. Vincent & Grenadines

Officials/Officiels M:2 F:0
Athletes/Athlètes M:6 F:1



SWZ

Swaziland

Officials/Officiels M:8 F:-
Athletes/Athlètes M:11 F:-



URS

U.R.S.S.

Officials/Officiels M:129 F:12
Athletes/Athlètes M:348 F:166



SWE

Sweden

Officials/Officiels M:67 F:10
Athletes/Athlètes M:165 F:40



SOM

Somalia

Officials/Officiels M:6 F:0
Athletes/Athlètes M:7 F:0



SUI

Switzerland

Officials/Officiels M:49 F:10
Athletes/Athlètes M:82 F:27



SOL

Solomon Islands

Officials/Officiels M:2 F:-
Athletes/Athlètes M:7 F:-



SYR

Syria

Officials/Officiels M:8 F:-
Athletes/Athlètes M:16 F:-



SUD

Sudan

Officials/Officiels M:2 F:-
Athletes/Athlètes M:8 F:-



SLE

Sierra Leone

Officials/Officiels M:3 F:1
Athletes/Athlètes M:14 F:1



SUR

Surinam

Officials/Officiels M:5 F:1
Athletes/Athlètes M:4 F:2



SIN

Singapore

Officials/Officiels M:7 F:1
Athletes/Athlètes M:7 F:1

NOC Participation



UAE

United Arab Emirates
Officials/Officiels M:6 F:0
Athletes/Athlètes M:12 F:-



ARU

Aruba
Officials/Officiels M:5 F:2
Athletes/Athlètes M:4 F:4



ARG

Argentina
Officials/Officiels M:49 F:3
Athletes/Athlètes M:99 F:26



ISL

Iceland
Officials/Officiels M:18 F:-
Athletes/Athlètes M:28 F:4



HAI

Haiti
Officials/Officiels M:1 F:-
Athletes/Athlètes M:3 F:1



IRL

Ireland
Officials/Officiels M:29 F:9
Athletes/Athlètes M:55 F:10



AFG

Afghanistan
Officials/Officiels M:2 F:-
Athletes/Athlètes M:5 F:-

Participation des C.N.O.



AND

Andorra
Officials/Officiels M:2 F:-
Athletes/Athlètes M:3 F:-



ANT

Antigua
Officials/Officiels M:13 F:2
Athletes/Athlètes M:13 F:3



AHO

Netherlands Antilles
Officials/Officiels M:4 F:0
Athletes/Athlètes M:2 F:1



ALG

Algeria
Officials/Officiels M:22 F:-
Athletes/Athlètes M:42 F:4



ANG

Angola
Officials/Officiels M:14 F:1
Athletes/Athlètes M:22 F:7



ESP

Spain
Officials/Officiels M:86 F:8
Athletes/Athlètes M:226 F:43



ECU

Ecuador
Officials/Officiels M:14 F:2
Athletes/Athlètes M:13 F:13



GBR

Great Britain

Officials/Officiels M:104 F:31
Athletes/Athlètes M:237 F:132



JOR

Jordan

Officials/Officiels M:4 F:-
Athletes/Athlètes M:7 F:2



YMD

Yemen Democratic Republic

Officials/Officiels M:2 F:-
Athletes/Athlètes M:6 F:2



UGA

Uganda

Officials/Officiels M:7 F:2
Athletes/Athlètes M:20 F:5



YAR

Yemen Arabian Republic

Officials/Officiels M:7 F:-
Athletes/Athlètes M:11 F:-



URU

Uruguay

Officials/Officiels M:12 F:3
Athletes/Athlètes M:13 F:1



OMA

Oman

Officials/Officiels M:10 F:-
Athletes/Athlètes M:13 F:-



YUG

Yugoslavia

Officials/Officiels M:64 F:3
Athletes/Athlètes M:119 F:38



AUS

Australia

Officials/Officiels M:83 F:21
Athletes/Athlètes M:216 F:79



IRQ

Iraq

Officials/Officiels M:17 F:-
Athletes/Athlètes M:31 F:-



AUT

Austria

Officials/Officiels M:43 F:6
Athletes/Athlètes M:75 F:13



EGY

Arab Republic of Egypt

Officials/Officiels M:29 F:2
Athletes/Athlètes M:52 F:2



HON

Honduras

Officials/Officiels M:4 F:-
Athletes/Athlètes M:7 F:-



ITA

Italy

Officials/Officiels M:90 F:5
Athletes/Athlètes M:237 F:49

NOC Participation



IND

India

Officials/Officiels M:27 F:-
Athletes/Athlètes M:38 F:8



IRN

Iran

Officials/Officiels M:14 F:-
Athletes/Athlètes M:27 F:-



INA

Indonesia

Officials/Officiels M:22 F:3
Athletes/Athlètes M:23 F:8



JPN

Japan

Officials/Officiels M:91 F:10
Athletes/Athlètes M:214 F:75



ISR

Israel

Officials/Officiels M:16 F:2
Athletes/Athlètes M:15 F:4



JAM

Jamaica

Officials/Officiels M:14 F:2
Athletes/Athlètes M:24 F:11



ZAI

Zaire

Officials/Officiels M:8 F:1
Athletes/Athlètes M:16 F:2

Participation des C.N.O.



ZAM

Zambia

Officials/Officiels M:12 F:-
Athletes/Athlètes M:31 F:-



CAF

Central Africa

Officials/Officiels M:10 F:-
Athletes/Athlètes M:16 F:-



CHN

People's Republic of China

Officials/Officiels M:74 F:13
Athletes/Athlètes M:157 F:136



DJI

Djibouti

Officials/Officiels M:5 F:-
Athletes/Athlètes M:7 F:-



ZIM

Zimbabwe

Officials/Officiels M:8 F:1
Athletes/Athlètes M:24 F:7



CHA

Chad

Officials/Officiels M:2 F:-
Athletes/Athlètes M:6 F:-



TCH

Czechoslovakia

Officials/Officiels M:48 F:6
Athletes/Athlètes M:116 F:55



CHI

Chile

Officials/Officiels M:10 F:-
Athletes/Athlètes M:17 F:1



CIV

Ivory Coast

Officials/Officiels M:20 F:-
Athletes/Athlètes M:14 F:18



CMR

Cameroon

Officials/Officiels M:8 F:-
Athletes/Athlètes M:13 F:2



COL

Colombia

Officials/Officiels M:25 F:5
Athletes/Athlètes M:37 F:6



QAT

Qatar

Officials/Officiels M:9 F:-
Athletes/Athlètes M:12 F:-



CGO

People's Republic of Congo

Officials/Officiels M:2 F:-
Athletes/Athlètes M:7 F:2



CAN

Canada

Officials/Officiels M:93 F:29
Athletes/Athlètes M:262 F:117



KUW

Kuwait

Officials/Officiels M:18 F:-
Athletes/Athlètes M:31 F:-



KEN

Kenya

Officials/Officiels M:24 F:3
Athletes/Athlètes M:71 F:5



COK

Cook Islands

Officials/Officiels M:4 F:-
Athletes/Athlètes M:6 F:-



CAY

Cayman Islands

Officials/Officiels M:3 F:2
Athletes/Athlètes M:7 F:1



TPE

Chinese Taipei

Officials/Officiels M:37 F:4
Athletes/Athlètes M:66 F:24



CRC

Costa Rica

Officials/Officiels M:13 F:1
Athletes/Athlètes M:9 F:7



THA

Thailand

Officials/Officiels M:15 F:1
Athletes/Athlètes M:14 F:2

NOC Participation



TAN

Tanzania
 Officials/Officiels M:6 F:-
 Athletes/Athlètes M:10 F:-



TUR

Turkey
 Officials/Officiels M:24 F:1
 Athletes/Athlètes M:44 F:6



TOG

Togo
 Officials/Officiels M:3 F:-
 Athletes/Athlètes M:6 F:-



TGA

Tonga
 Officials/Officiels M:1 F:-
 Athletes/Athlètes M:5 F:1



TUN

Tunisia
 Officials/Officiels M:22 F:1
 Athletes/Athlètes M:39 F:2



TRI

Trinidad and Tobago
 Officials/Officiels M:6 F:-
 Athletes/Athlètes M:4 F:2



PAN

Panama
 Officials/Officiels M:3 F:-
 Athletes/Athlètes M:6 F:-

Participation des C.N.O.



PAR

Paraguay
 Officials/Officiels M:7 F:-
 Athletes/Athlètes M:1 F:-



PAK

Pakistan
 Officials/Officiels M:15 F:-
 Athletes/Athlètes M:31 F:-



PER

Peru
 Officials/Officiels M:14 F:2
 Athletes/Athlètes M:8 F:14



POR

Portugal
 Officials/Officiels M:28 F:3
 Athletes/Athlètes M:57 F:11



POL

Poland
 Officials/Officiels M:50 F:4
 Athletes/Athlètes M:118 F:34



PUR

Puerto Rico
 Officials/Officiels M:33 F:3
 Athletes/Athlètes M:66 F:4



FRA

France
 Officials/Officiels M:93 F:16
 Athletes/Athlètes M:227 F:82



FIJ

Fiji (Islands)

Officials/Officiels M:9 F:1
Athletes/Athlètes M:20 F:4



FIN

Finland

Officials/Officiels M:44 F:5
Athletes/Athlètes M:60 F:19



PHI

Philippines

Officials/Officiels M:22 F:6
Athletes/Athlètes M:28 F:5



HUN

Hungary

Officials/Officiels M:66 F:5
Athletes/Athlètes M:162 F:41



HKG

Hong Kong

Officials/Officiels M:22 F:2
Athletes/Athlètes M:39 F:10



KOR

Korea

Officials/Officiels M:164 F:9
Athletes/Athlètes M:314 F:153

Medalists/Médailles

Archery/Tir à l'Arc



Event Epreuve	Rank Rang	Results Resultats	Ctry Pays	Name Nom
Men/Hommes Indiv./Indiv.	1	338	USA	Barrs, Jay
	2	336	KOR	Park, Sung-Soo
	3	335	URS	Echeev, Vladimir
Team/Equipe	1	986	KOR	
	2	972	USA	
	3	968	GBR	
Women/Indiv./ Femmes/Indiv.	1	344	KOR	Kim, Soo-Nyung
	2	332	KOR	Wang, Hee-Kyung
	3	327	KOR	Yun, Young-Sook
Women/Team/ Femmes/Equipe	1	982	KOR	
	2	952	INA	
	3	952	USA	



Event Epreuve	Rank Rang	Results Resultats	Ctry Pays	Name Nom
Triple Jump/triple saut-	1	17.61M	BUL	Markov, Hristo
	2	17.52M	URS	Lapchine, Igor
	3	17.42M	URS	Kovalenko, Alexandre
Shot Put/lancer du poids	1	22.47M	GDR	Timmermann, Ulf
	2	22.39M	USA	Barnes, Randy
	3	21.99M	SUI	Guenthoer, Werner
Discus/lancer du disque	1	68.82M	GDR	Schult, Jurgen
	2	67.48M	URS	Oubartas, Romas
	3	67.38M	FRG	Danneberg, Rolf
Hammer Throw/ lancer du marteau	1	84.80M	URS	Litvinov, Serguei
	2	83.76M	URS	Sedykh, Yuriy
	3	81.16M	URS	Tamm, Iouri
Javelin/lancer du javelot	1	84.28M	FIN	Korjus, Tapio
	2	84.12M	TCH	Zelezny, Jan
	3	83.26M	FIN	Raty, Seppo
Decathlon/decathlon	1	8488	GDR	Schenk, Christian
	2	8399	GDR	Voss, Torsten
	3	8328	CAN	Steen, Dave

Athletics/Athlétisme



Event Epreuve	Rank Rang	Results Resultats	Ctry Pays	Name Nom
Men/Hommes 100M	1	9.92	USA	Lewis, Carl
	2	9.97	GBR	Christie, Linford
	3	9.99	USA	Smith, Calvin
200M	1	19.75	USA	DeLoach, Joe
	2	19.79	USA	Lewis, Carl
	3	20.04	BRA	Silva, Robson
400M	1	43.87	USA	Lewis, Steven
	2	43.93	USA	Reynolds, Harry Butch
	3	44.09	USA	Everett, Danny
800M	1	1:43.45	KEN	Ereng, Paul
	2	1:43.90	BRA	Cruz, Joaquim
	3	1:44.06	MAR	Aouita, Said
1500M	1	3:35.96	KEN	Rono, Peter
	2	3:36.15	GBR	Elliott, Peter
	3	3:36.21	GDR	Herold, Jens-Peter
5000M	1	13:11.70	KEN	Ngugi, John
	2	13:15.52	FRG	Baumann, Dieter
	3	13:15.73	GDR	Kunze, Hansjoerg
10000M	1	27:21.46	MAR	Boutaib, Mly. Brahim
	2	27:23.55	ITA	Antibo, Salvatore
	3	27:25.16	KEN	Kimeli, Kipkemboi
3000M Steeplechase/ steeplechase	1	8:05.51	KEN	Kariuki, Julius
	2	8:06.79	KEN	Koech, Peter
	3	8:07.96	GBR	Rowland, Mark
110M Hurdles/haies	1	12.98	USA	Kingdom, Roger
	2	13.28	GBR	Jackson, colin
	3	13.38	USA	Cambell, Anthony
400M Hurdles/haies	1	47.19	USA	Phillips, Andre
	2	47.23	SEN	Ba, El Hadj Dia
	3	47.56	USA	Moses, Edwin
20Km Walk/marche	1	1'19:57	TCH	Pribilinec, Jozef
	2	1'20:00	GDR	Weigel, Ronald
	3	1'20:14	ITA	Damilano, Maurizio
50Km Walk/marche	1	3'38:29	URS	Ivanenko, Viacheslav
	2	3'38:56	GDR	Weigel, Ronald
	3	3'30:45	GDR	Gauder, Hartwig
4x100M	1	38.19	URS	
	2	38.28	GBR	
	3	38.40	FRA	
4x400M	1	2:56:16	USA	
	2	3:00:30	JAM	
	3	3:00:56	FRG	
Marathon/matathon	1	2'10:32	ITA	Bordin, Gelindo
	2	2'10:47	KEN	Wakihuri, Douglas
	3	2'10:59	DJI	Ahmed Saleh, Houssein
High Jump/ saut en hauteur	1	2.38M	URS	Avdeenko, Guennadi
	2	2.36M	USA	Conway, Hollis
	3	2.36M	URS	Povarnitsyne, Roudolf
Pole Vault/ saut à la perche	1	5.90M	URS	Bubka, Sergey
	2	5.85M	URS	Gataouline, Radion
	3	5.80M	URS	Egorov, Grigori
Long Jump/ Saut en longueur	1	8.72M	USA	Lewis, Carl
	2	8.49M	USA	Powell, Mike
	3	8.27M	USA	Myricks, Larry

Event Epreuve	Rank Rang	Results Resultats	Ctry Pays	Name Nom
Women/femmes 100M	1	10.54	USA	Griffith Joyner, Florence
	2	10.83	USA	Ashford, Evelyn
	3	10.85	GDR	Drechsler, Heike
200M	1	21.34	USA	Griffith Joyner, Florence
	2	21.72	JAM	Jackson, Grace
	3	21.95	GDR	Drechsler, Heike
400M	1	48.65	URS	Bryzguina, Olga
	2	49.45	GDR	Mueller, Petra
	3	49.90	URS	Nazarova, Olga
800M	1	1:56.10	GDR	Wodars, Sigrun
	2	1:56.64	GDR	Wachtel, Christine
	3	1:56.91	USA	Gallagher, Kim
1500M	1	3:53.96	ROM	Ivan, Paula
	2	4:00.24	URS	Baikauskaite, Lailoute
	3	4:00.30	URS	Samolenko, Tatiana
3000M	1	8:26.53	URS	Samolenko, Tatiana
	2	8:27.15	ROM	Ivan, Paula
	3	8:29.02	GBR	Murray, Yvonne
10000M	1	31:05.21	URS	Bondarenko, Olga
	2	31:08.44	GBR	Mccolgan, Elizabeth
	3	31:19.82	URS	Joupieva, Elena
100M Hurdles/haies	1	12.38	BUL	Donkova, Jordanka
	2	12.61	GDR	Siebert, Gloria
	3	12.75	FRG	Zackiewicz, Claudia
400M Hurdles/haies	1	53.17	AUS	Flintoff-King, Debra
	2	53.18	URS	Ledovskaia, Tatiana
	3	53.63	GDR	Fiedler, Ellen
4x100M	1	41.98	USA	
	2	42.09	GDR	
	3	42.75	URS	
4x400M	1	3:15.18	URS	
	2	3:15.51	USA	
	3	3:18.29	GDR	
Marathon/marathon	1	2'25:40	POR	Mota, Rosa
	2	2'25:53	AUS	Martin, Lisa
	3	2'26:21	GDR	Doerre, Kathrin
High Jump/saut en hauteur	1	2.03M	USA	Ritter, Louise
	2	2.01M	BUL	Kostadinova, Stefka
	3	1.99M	URS	Bykova, Tamara
Long Jump/ saut en longueur	1	7.40M	USA	Joyner-Kersee, Jackie
	2	7.22M	GDR	Drechsler, Heike
	3	7.11M	URS	Tchistiakova, Galina
Shot Put/lancer du poids	1	22.24M	URS	Lisovskaya, Natalya
	2	21.07M	GDR	Neimke, Kathrin
	3	21.06M	CHN	Li, Meisu
Discus/lancer du disque	1	72.30M	GDR	Hellmann, Martina
	2	71.88M	GDR	Gansky, Diana
	3	69.74M	BUL	Hristova, Tzvetanka
Javelin/lancer du javelot	1	74.68M	GDR	Felke, Petra
	2	70.32M	GBR	Whitbread, Fatima
	3	67.30M	GDR	Koch, Beate
Heptathlon/heptathlon	1	7291	USA	Joyner-kersee, Jackie
	2	6897	GDR	John, Sabine
	3	6858	GDR	Behmer, Anke

Basketball/Basket-ball



Event Epreuve	Rank Rang	Results Resultats	Ctry Pays	Name Nom
Men/Hommes	1		URS	
	2		YUG	
	3		USA	
Women/Femmes	1		USA	
	2		YUG	
	3		URS	

Boxing/Boxe



Event Epreuve	Rank Rang	Results Resultats	Ctry Pays	Name Nom
Light Fly/mi-mouche -48Kg	1		BUL	Hristov, Ivailo
	2		USA	Carbajal, Michael
	3		PHI	Serantes, Leopoldo
	3		HUN	Isaszegi, Robert
Fly/mouche -51 Kg	1		KOR	Kim, Kwang-Sun
	2		GDR	Tews, Andreas
	3		MEX	Gonzalez, Mario
	3		URS	Skriabin, Timofei
Bantam/coq -54Kg	1		USA	Mckinney, Kennedy
	2		BUL	Hristove, Alexandar
	3		COL	Julio Rocha, Jorge E
	3		THA	Moolsan, Phajol
Feather/plume -57Kg	1		ITA	Parisi, Giovanni
	2		ROM	Dumitrescu, Daniel
	3		KOR	Lee, Jae-Hyuk
	3		MAR	Achik, Abdelhak
Light/leger -60Kg	1		GDR	Zuelow, Andreas
	2		SWE	Cramne, George
	3		MGL	Enkhbat, Nerguy
	3		USA	Ellis, Romallis
Light Welter/ mi-welter -63.5Kg	1		URS	Janovski, Viatcheslav
	2		AUS	Cheney, Grahame
	3		FRG	Gies, Reiner
	3		SWE	Myrberg, Lars
Welter/welter -67Kg	1		KEN	Wangila, Robert
	2		FRA	Boudouani, Laurent
	3		USA	Gould, Kenneth
	3		POL	Dydak, Jan
Light Middle/ Super-welter-71 Kg	1		KOR	Park, Si-Hun
	2		USA	Jones, Roy
	3		GBR	Woodhall, Richard
	3		CAN	Downey, Raymond
Middle/Moyen -75Kg	1		GDR	Maske, Henry
	2		CAN	Marcus, Egerton
	3		KEN	Sande, Chris
	3		PAK	Syed, Hussain Shan
Light Heavy/mi-lourd -81 Kg	1		USA	Maynard, Andrew
	2		URS	Channyvazov, Nourmagomed
	3		YUG	Skaro, Damir
	3		POL	Petrich, Henryk
Heavy/lourd-91 Kg	1		USA	Mercer, Ray
	2		KOR	Baik, Hyun-Man
	3		HOL	Vanderlijde, Arnold
	3		POL	Golota, Andrzej
Super Heavy/ Super-lourd +91 Kg	1		CAN	Lewis, Lennox
	2		USA	Bowe, Riddick
	3		URS	Mirochnitchenko, Alexandre
	3		POL	Zarehkwicz, Janusz

Canoeing/Canoe



Event Epreuve	Rank Rang	Results Resultats	Ctry Pays	Name Nom
Men/Hommes Kayak-1/kayak-1 500M	1	1:44.82	HUN	Gyulay, Zsolt
	2	1:46.38	GDR	Staehle, Andreas
	3	1:46.46	NZL	Mac Donald, Paul
Kayak-1/kayak-1 1000M	1	3:55.27	USA	Barton, Greg
	2	3:55.28	AUS	Davies, Grant
	3	3:55.55	GDR	Wohlbebe, Andre
Kayak-2/kayak-2 500M	1	1:33.98	NZL	
	2	1:34.15	URS	
	3	1:34.32	HUN	
Kayak-2/kayak-2 1000M	1	3:32.42	USA	
	2	3:32.71	NZL	
	3	3:33.76	AUS	



Event Epreuve	Rank Rang	Results Resultats	Ctry Pays	Name Nom
Kayak-4/kayak-4 1000M	1	3:00.20	HUN	
	2	3:01.40	URS	
	3	3:02.37	GDR	
Canadian-1/ canadien-1 500M	1	1:56.42	GDR	Heukrodt, Olaf
	2	1:57.26	URS	Slivinskil, Mikhail
	3	1:57.27	BUL	Marinov, Martin
Canadian-1/ canadien-1 1000M	1	4:12.78	URS	Klementiev, Ivan
	2	4:15.83	GDR	Schmidt, Joerg
	3	4:18.94	BUL	Boukhalov, Nikolai
Canadian-2/ canadien-2 500M	1	1:41.77	URS	
	2	1:43.61	POL	
	3	1:43.81	FRA	
Canadian-2/ canadien-2 1000M	1	3:48.36	URS	
	2	3:51.44	GDR	
	3	3:54.33	POL	
Women/Femmes Kayak-1/kayak-1 500M	1	1:55.19	BUL	Guecheva, Vania
	2	1:55.31	GDR	Schmidt, Birgit
	3	1:57.38	POL	Dylewska, Izabela
Kayak-2/kayak-2 500M	1	1:43.46	GDR	
	2	1:44.06	BUL	
	3	1:46.00	HOL	
Kayak-4/kayak-4 500M	1	1:40.78	GDR	
	2	1:41.88	HUN	
	3	1:42.63	BUL	

Cycling/Cyclisme



Event Epreuve	Rank Rang	Results Resultats	Ctry Pays	Name Nom
Men/Hommes Sprint/vitesse	1		GDR	Hesslich, Lutz
	2		URS	Kovche, Nikolai
	3		AUS	Neiwand, Gary
Time Trial/1Km contre	1	1:04.499	URS	Kiritchenko, Alexandre
	2	1:04.784	AUS	Vinnicombe, Martin
	3	1:05.114	FRG	Lechner, Robert
Indiv. Pursuit/ 4000M poursuite, indiv.	1	4:32.00	URS	Umaras, Gintaoutas
	2	4:35.00	AUS	Woods, Dean
	3	4:34.17	GDR	Dittert, Bernd
Team Pursuit/ 4000M poursuite, equipes	1	4:13.31	URS	
	2	4:14.09	GDR	
	3	4:16.02	AUS	
Indiv. Road Race/ 196.8Km course	1	4'32:22.	GDR	Ludwig, Olaf
	2	4'32:25.	FRG	Groene, Bernd
	3	4'32:46.	FRG	Henn, Christian
Team Time Trial/ 100Km contre, equipes	1	1'57:47.7	GDR	
	2	1'57:54.2	POL	
	3	1'59:47.3	SWE	
Points Race/ 50Km course aux points	1	038	DEN	Frost, Dan
	2	026	HOL	Peelen, Leo
	3	046	URS	Ganeev, Marat
Women/Femmes Sprint/vitesse	1		URS	Saloumiaie, Erika
	2		GDR	Luding, Rothenburg, Christa
	3		USA	Paraskevina-Young, Connie
Indiv. Road Race/ 82Km course sur route	1	2'00:52.	HOL	Knol, Monique
	2	G	FRG	Niehaus, Jutta
	3	G	URS	Zilporitee, Laima

Medalists/Médailles

Equestrian Sports/Sports equestres



Event Epreuve	Rank Rang	Results Resultats	Ctry Pays	Name Nom
Team Jumping/ sauts d'obstacles-équipes	1	17.25	FRG	
	2	20.50	USA	
	3	27.50	FRA	
Indiv. Jumping/ sauts d'obstacles-indiv.	1	1.25	FRA	Durand, Pierre
	2	4.00	USA	Best, Greg
	3	4.00	FRG	Huck, Karsten
Team Dressage/ dressage-équipe	1	4302	FRG	
	2	4164	SUI	
	3	3969	CAN	
Indiv. Dressage/ dressage-individuel	1	1521	FRG	Uphoff, Nicole
	2	1462	FRA	Otto-Crepin, Margitt
	3	1417	SUI	Stueckelberger, Christine
Three-day Event: Team/ concours complet: équipes	1	225.95	FRG	
	2	256.80	GBR	
	3	271.20	NZL	
Three-day Event: Indiv./ concours complet: indiv.	1	42.60	NZL	Todd, Mark
	2	52.80	GBR	Stark, Ian
	3	62.00	GBR	Leng, Virginia

Fencing/Escrime



Event Epreuve	Rank Rang	Results Resultats	Ctry Pays	Name Nom
Men/Hommes				
Foil-Team/fleuret-équipes	1		URS	
	2		FRG	
	3		HUN	
Epee-Team/epee-équipes	1		FRA	
	2		FRG	
	3		URS	
Sabre-Team/sabre-équipes	1		HUN	
	2		URS	
	3		ITA	
Foil-Indiv./fleuret-individuel	1		ITA	Cerioni, Stefano
	2		GDR	Wagner, Udo
	3		URS	Romankov, Alexandre
Epee-Indiv./epee-individuel	1		FRG	Schmitt, Arnd
	2		FRA	Riboud, Philippe
	3		URS	Chouvalov, Andrei
Sabre-Indiv./sabre-individuel	1		FRA	Lamour, Jeanfrancois
	2		POL	Olech, Janusz
	3		ITA	Scalzo, Giovanni
Women/Femmes				
Foil-Team/fleuret-équipes	1		FRG	
	2		ITA	
	3		HUN	
Foil-Indiv./fleuret-individuel	1		FRG	Fichtel, Anja
	2		FRG	Bau, Sabine
	3		FRG	Funkenhauser, Zita

Football/Football



Event Epreuve	Rank Rang	Results Resultats	Ctry Pays	Name Nom
	1		URS	
	2		BRA	
	3		FRG	

Gymnastics/Gymnastique



Event Epreuve	Rank Rang	Results Resultats	Ctry Pays	Name Nom
Men/Hommes				
Competition 1a & 1b/ concours 1a & 1b	1	593.350	URS	
	2	588.450	GDR	
	3	585.600	JPN	
2-Indiv. All Around/ 2-multiple individuel	1	119.125	URS	Artemov, Vladimir
	2	119.025	URS	Lioukine, Valeri
	3	118.975	URS	Bilozertchev, Dmitri
3-Floor Exercises/ 3-exercices au sol	1	19.925	URS	Kharikov, Serguei
	2	19.900	URS	Artemov, Vladimir
	3	19.850	CHN	Lou, Yun
3-Pommel Horse/ 3-cheval d'arçons	1	19.950	BUL	Gueraskov, Lyubomir
	1	19.950	HUN	Borkai, Zsolt
	1	19.950	URS	Bilozertchev, Dmitri
3-Rings/3-anneaux	1	19.925	GDR	Behrendt, Holger
	1	19.925	URS	Bilozertchev, Dmitri
	3	19.875	GDR	Tippelt, Sven
3-Horse Vault/ 3-saut de cheval	1	19.875	CHN	Lou, Yun
	2	19.862	GDR	Kroll, Sylvio
	3	19.775	KOR	Park, Jong-Hoon
3-Par, Bars/ 3-barres paralleles	1	19.925	URS	Artemov, Vladimir
	2	19.900	URS	Lioukine, Valeri
	3	19.750	GDR	Tippelt, Sven
3-Hor. Bar/3-barre fixe	1	19.900	URS	Artemov, Vladimir
	1	19.900	URS	Lioukine, Valeri
	3	19.800	GDR	Behrendt, Holger
	3	19.800	ROM	Gherman, Marius
Women/Femmes				
Competition 1a & 1b/ concours 1a & 1b	1	395.475	URS	
	2	394.125	ROM	
	3	390.875	GDR	
2-Indiv. All Around/ 2-multiple individuel	1	79.662	URS	Chouchounova, Elena
	2	79.637	ROM	Silivas, Daniela
	3	79.400	URS	Boguinskaia, Svetlana
3-Horse Vault/ 3-saut de cheval	1	19.905	URS	Boguinskaia, Svetlana
	2	19.830	ROM	Potorac, Gabriela
	3	19.818	ROM	Silivas, Daniela
3-Un. Bars/ 3-barres asymetriques	1	20.000	ROM	Silivas, Daniela
	2	19.987	GDR	Kersten, Dagmar
	3	19.962	URS	Chouchounova, Elena
3-B. Beam/3-poutre	1	19.924	ROM	Silivas, Daniela
	2	19.875	URS	Chouchounova, Elena
	3	19.837	ROM	Potorac, Gabriela
	3	19.837	USA	Mills, Phoebe
3-Floor Exercises/ 3-exercices au sol	1	19.937	ROM	Silivas, Daniela
	2	19.887	URS	Boguinskaia, Svetlana
	3	19.850	BUL	Doudeva, Diana
Rhythmic Competition/ concours rythmique	1	60.000	URS	Lobatch, Marina
	2	59.950	BUL	Dounavska, Adriana
	3	59.875	URS	Timochenko, Alexandra

Handball/Handball



Event Epreuve	Rank Rang	Results Resultats	Ctry Pays	Name Nom
Men/hommes	1		URS	
	2		KOR	
	3		YUG	
Women/femmes	1		KOR	
	2		NOR	
	3		URS	

Hockey/Hockey



Event Epreuve	Rank Rang	Results Resultats	Ctry Pays	Name Nom
Men/hommes	1		GBR	
	2		FRG	
	3		HOL	
Women/femmes	1		AUS	
	2		KOR	
	3		HOL	

Judo/Judo



Event Epreuve	Rank Rang	Results Resultats	Ctry Pays	Name Nom
Men/Hommes Extra-Light/ super leger -60Kg	1		KOR	Kim, Jae-Yup
	2		USA	Asano, Kevin
	3		JPN	Hosokawa, Shinji
	3		URS	Totikachvili, Amiran
Half-Light/mi-leger -65Kg	1		KOR	Lee, Kyung-Keun
	2		POL	Pawlowski, Janusz
	3		FRA	Carbetta, Bruno
	3		JPN	Yamamoto, Yosuke
Light/leger-71Kg	1		FRA	Alexandre, Marc
	2		GDR	Loll, Sven
	3		USA	Swain, Michael
	3		URS	Tenadze, Gueorgui
Half-Middle/mi-moyen -78Kg	1		POL	Legien, Waldemar
	2		FRG	Wieneke, Frank
	3		GDR	Brecht, Torsten
	3		URS	Varaev, Bachir
Middle/moyen -86Kg	1		AUT	Seisenbacher, Peter
	2		URS	Chestakov, Vladimir
	3		HOL	Spijkers, Ben
	3		JPN	Osako, Akinobu
Half-Heavy/mi-lourd -95Kg	1		BRA	Miguel, Aurelio
	2		FRG	Meiling, Marc
	3		BEL	Van De Walle, Robert
	3		GBR	Stewart, Dennis
Heavy/lourd +95Kg	1		JPN	Saito, Hitoshi
	2		GDR	Stoehr, Henry
	3		KOR	Cho, Yong-Chul
	3		URS	Veritchev, Grigori

Modern Pentathlon/Pentathlon Moderne



Event Epreuve	Rank Rang	Results Resultats	Ctry Pays	Name Nom
Team Competition/ competition par equipes	1	15886	HUN	
	2	15571	ITA	
	3	15276	GBR	
Indiv. Competition/ competition individuelle	1	5404	HUN	Martinek, Janos
	2	5379	ITA	Massullo, Carlo
	3	5367	URS	Iagorachvili, Vakhtang

Rowing/Aviron



Event Epreuve	Rank Rang	Results Results	Ctry Pays	Name Nom
Men Hommes Single Sculls/un rameur	1	06:49.86	GDR	Lange, Thomas
	2	06:54.77	FRG	Kolbe, Petermichael
	3	06:58.66	NZL	Verdonk, Eric
Double Sculls/ deux rameurs en couple	1	06:21.13	HOL	
	2	06:22.59	SUI	
	3	06:22.87	URS	
Coxless Pair/ deux, sans barreur	1	06:36.84	GBR	
	2	06:38.06	ROM	
	3	06:41.01	YUG	
Coxed Pair/ deux, avec barreur	1	06:58.79	ITA	
	2	07:00.63	GDR	
	3	07:01.95	GBR	
Quadruple Sculls/ quatre en couple	1	05:53.37	ITA	
	2	05:55.08	NOR	
	3	05:56.13	GDR	
Coxless Four/ quatre, sans barreur	1	06:03.11	GDR	
	2	06:05.53	USA	
	3	06:06.22	FRG	
Coxed Four/ quatre, avec barreu	1	06:10.74	GDR	
	2	06:13.58	ROM	
	3	06:15.78	NZL	
Eight-Oars/ huit, avec barreur	1	05:46.05	FRG	
	2	05:48.01	URS	
	3	05:48.26	USA	
Women/femmes Single Sculls/une rameuse	1	07:47.19	GDR	Behrendt, Jutta
	2	07:50.28	USA	Marden, Anne
	3	07:53.65	BUL	Gueorguieva, Magdalena
Double Sculls/ deux rameuses en couple	1	07:00.48	GDR	
	2	07:04.36	ROM	
	3	07:06.03	BUL	



Event Epreuve	Rank Rang	Results Resultats	Ctry Pays	Name Nom
Coxless Pair/ deux, sans barreuse	1	07:28.13	ROM	
	2	07:31.95	BUL	
	3	07:35.68	NZL	
Quadruple Sculls/ quatre en couple	1	06:21.06	GDR	
	2	06:23.47	URS	
	3	06:23.81	ROM	
Coxed Four/ quatre, avec barreuse	1	06:56.00	GDR	
	2	06:58.78	CHN	
	3	07:01.13	ROM	
Eight-Oars/ huit, avec barreuse	1	06:15.17	GDR	
	2	06:17.44	ROM	
	3	06:21.83	CHN	

Shooting/Tir



Event Epreuve	Rank Rang	Results Resultats	Ctry Pays	Name Nom
Men/Hommes Olympic Trap/ Fosse Olympique	1	222	URS	Monakov, Dmitri
	2	222	TCH	Bednarik, Miloslav
	3	219	BEL	Peeters, Frans
Olympic Skeet/ skeet olympique	1	222	GDR	Wegner, Axel
	2	221	CHI	De Iruarrizaga, Alfonso
	3	220	ESP	Guardiola, Jorge
Men/Hommes Air Rifle/cara. air comprime	1	695.6	YUG	Maksimovic, Goran
	2	694.2	FRA	Berthelot, Nicolas
	3	694.0	FRG	Riederer, Johann
SB. Rifle, 3 Positions/ cara. petit calibre 3 P.	1	1279.3	GBR	Cooper, Malcolm
	2	1275.6	GBR	Allan, Alistair
	3	1275.0	URS	Ivanov, Kirill
SB. Free Rifle, Prone/ cara. petit cal. couche	1	703.9	TCH	Varga, Miroslav
	2	702.8	KOR	Cha, Young-Chul
	3	701.9	HUN	Zahonyi, Attila
Air Pistol/ pistolet a air comprime	1	687.9	BUL	Kiriakov, Taniou
	2	687.9	USA	Buljung, Erich
	3	684.5	CHN	Xu, Haifeng
Free Pistol/pistolet libre	1	660.0	ROM	Babii, Sorin
	2	657.0	SWE	Skanaker, Ragnar
	3	657.0	URS	Bassinski, Igor
Rapid Fire Pistol/ pistolet de tir rapide	1	698.0	URS	Kouzmine, Afanasi
	2	696.0	GDR	Schumann, Ralf
	3	693.0	HUN	Kovacs, Zoltan
Running Game Target/ cible courante	1	689.0	NOR	Heiestad, Tor
	2	687.0	CHN	Huang, Shiping
	3	686.0	URS	Avramenko, Guennadi
Women/Femmes Air Rifle/cara. air comprime	1	498.5	URS	Chilova, Irina
	2	497.5	FRG	Sperber, Silvia
	3	495.8	URS	Maloukhina, Anna
SB. Stand. Rifle 3 Pos./ cara. stand, trois p.	1	685.6	FRG	Sperber, Silvia
	2	683.2	BUL	Letcheva, Vessela
	3	681.4	URS	Tcherka Ssova, Valentina
Air Pistol/ pistolet a air comprime	1	489.5	YUG	Sekaric, Jasna
	2	487.9	URS	Saloukvadze, Nino
	3	485.2	URS	Dobrantcheva, Marina
Sport Pistol/pistolet de sport	1	690.0	URS	Saloukvadze, Nino
	2	686.0	JPN	Hasegawa, Tomoko
	3	686.0	YUG	Sekaric, Jasna

Medalists/Médailles

Swimming/Natation



Event Epreuve	Rank Rang	Results Resultats	Ctry Pays	Name Nom
Men/Hommes				
50M Freestyle/nage libre	1	22.14	USA	Biondi, Matthew
	2	22.36	USA	Jager, Thomas
	3	22.71	URS	Prigoda, Gennadi
100M Freestyle/nage libre	1	48.63	USA	Biondi, Matthew
	2	49.08	USA	Jacobs, Christopher
	3	49.62	FRA	Caron, Stephan
200M Freestyle/nage libre	1	1:47.25	AUS	Armstrong, Duncan
	2	1:47.89	SWE	Holmertz, Anders
	3	1:47.99	USA	Biondi, Matthew
400M Freestyle/nage libre	1	3:46.95	GDR	Dassler, Uwe
	2	3:47.15	AUS	Armstrong, Duncan
	3	3:47.34	POL	Wojdat, Artur
1500M Freestyle/nage libre	1	15:00.40	URS	Salnikov, Vladimir
	2	15:02.69	FRG	Pfeiffer, Stefan
	3	15:06.15	GDR	Dassler, Uwe
100M Backstroke/dos	1	55.05	JPN	Suzuki, Daichi
	2	55.18	USA	Berkoff, David
	3	55.20	URS	Polianski, Igor
200M Backstroke/dos	1	1:59.37	URS	Polianski, Igor
	2	1:59.60	GDR	Baltrusch, Frank
	3	2:00.48	NZL	Kingsman, Paul
100M Breaststroke/brasse	1	1:02.04	GBR	Moorhouse, Adrian
	2	1:02.05	HUN	Guttler, Karoly
	3	1:02.20	URS	Volkov, Dmitri
200M Breaststroke/brasse	1	2:13.52	HUN	Szabo, Jozsef
	2	2:14.12	GBR	Gillingham, Nick
	3	2:15.21	ESP	Lopez, Sergio
100M Butterfly/papillon	1	53.00	SUR	Nesty, Anthony
	2	53.01	USA	Biondi, Matthew
	3	53.30	GBR	Jameson, Andy
200M Butterfly/papillon	1	1:56.94	FRG	Gross, Michael
	2	1:58.24	DEN	Nielsen, Benny
	3	1:58.28	NZL	Mosse, Anthony
200M Indiv. Medley/ 4 nages	1	2:00.17	HUN	Darnyi, Tamas
	2	2:01.61	GDR	Kuehl, Patrick
	3	2:02.40	URS	Iarochtschouk, Vadim
400M Indiv. Medley/ 4 nages	1	4:14.75	HUN	Darnyi, Tamas
	2	4:17.36	USA	Wharton, David
	3	4:18.01	ITA	Battistelli, Stefano
4x100M Medley Relay/ relais 4 nages	1	3:36.93	USA	
	2	3:39.28	CAN	
	3	3:39.96	URS	
4x100M Freestyle Relay/ relais nage libre	1	3:16.53	USA	
	2	3:18.33	URS	
	3	3:19.82	GDR	
4x200M Freestyle Relay/ relais nage libre	1	7:12.51	USA	
	2	7:13.68	GDR	
	3	7:14.35	FRG	
Springboard Diving / plongeon du tremplin	1	730.80	USA	Louganis, Gregory
	2	704.88	CHN	Tan, Liangde
	3	665.28	CHN	Li, Deliang
Platform Diving / plongeon de haut-vol	1	638.61	USA	Louganis, Gregory
	2	637.47	CHN	Xiong, Ni
	3	594.39	MEX	Mena, Jesus
Waterpolo/waterpolo	1		YUG	
	2		USA	
	3		URS	
Women/femmes				
50M Freestyle/libre	1	25.49	GDR	Otto, Kristin
	2	25.64	CHN	Yang, Wenyi
	3	25.71	GDR	Meissner, Katrin
	3	25.71	USA	Sterkel, Jill
100M Freestyle/libre	1	54.93	GDR	Otto, Kristin
	2	55.47	CHN	Zhuang, Yong
	3	55.49	FRA	Plewinski, Catherine
200M Freestyle/libre	1	1:57.65	GDR	Friedrich, Heike
	2	1:58.67	CRC	Poll, Silvia
	3	1:59.01	GDR	Stellmach, Manuela
400M Freestyle/libre	1	4:03.85	USA	Evans, Janet
	2	4:05.94	GDR	Friedrich, Heike
	3	4:06.62	GDR	Moehring, Anke
800M Freestyle/libre	1	8:20.20	USA	Evans, Janet
	2	8:20.09	GDR	Strauss, Astrid
	3	8:22.93	AUS	Mcdonald, Julie



Event Epreuve	Rank Rang	Results Resultats	Ctry Pays	Name Nom
100M Backstroke/dos	1	1:00.89	GDR	Otto, Kristin
	2	1:01.56	HUN	Egerszegi, Krisztina
	3	1:01.57	GDR	Sirch, Cornelia
200M Backstroke/dos	1	2:09.29	HUN	Egerszegi, Krisztina
	2	2:10.61	GDR	Zimmermann, Kathrin
	3	2:11.45	GDR	Sirch, Cornelia
100M Breaststroke/brasse	1	1:07.95	BUL	Dangalakova, Tania
	2	1:08.74	BUL	Frenkeva, Antoaneta
	3	1:08.83	GDR	Hoerner, Silke
200M Breaststroke/brasse	1	2:26.71	GDR	Hoerner, Silke
	2	2:27.49	CHN	Huang, Xiaomin
	3	2:28.34	BUL	Frenkeva, Antoaneta
100M Butterfly/papillon	1	59.00	GDR	Otto, Kristin
	2	59.45	GDR	Weigang, Birte
	3	59.52	CHN	Qian, Hong
200M Butterfly/papillon	1	2:09.51	GDR	Nord, Kathleen
	2	2:09.91	GDR	Weigang, Birte
	3	2:10.80	USA	Meagher, Mary T
200M Indiv. Medley/ 4 nages	1	2:12.59	GDR	Hunger, Daniela
	2	2:13.31	URS	Dendeberova, Elena
	3	2:14.85	ROM	Lung, Noemi Ildiko
400M Indiv. Medley/ 4 nages	1	4:37.76	USA	Evans, Janet
	2	4:39.46	ROM	Lung, Noemi Ildiko
	3	4:39.76	GDR	Hunger, Daniela
4x100M Medley Relay/ relais 4 nages	1	4:03.74	GDR	
	2	4:07.90	USA	
	3	4:10.49	CAN	
4x100M Freestyle Relay/ relais nage libre	1	3:40.63	GDR	
	2	3:43.39	HOL	
	3	3:44.25	USA	
Springboard Diving / plongeon du tremplin	1	580.23	CHN	Gao, Min
	2	534.33	CHN	Li, Qing
	3	533.19	USA	McCormick, Kelly Anne
Platform Diving / plongeon de haut-vol	1	445.20	CHN	Xu, Yanmei
	2	436.95	USA	Mitchell, Michele
	3	400.44	USA	Williams, Wendy Lian
Synchro, Solo/Synchro, solo	1	200.150	CAN	Waldo, Carolyn
	2	197.633	USA	Ruiz-Conforto, Tracie
	3	191.850	JPN	Kotani, Mikako
Synchro, Duet/synchro duo	1	197.717	CAN	
	2	197.284	USA	
	3	190.159	JPN	

Table Tennis/Tennis de Table



Event Epreuve	Rank Rang	Results Resultats	Ctry Pays	Name Nom
Men's Singles / simples hommes	1		KOR	Yoo, Nam-Kyu
	2		KOR	Kim, Ki-Taik
	3		SWE	Lindh, Erik
Men's Doubles / doubles hommes	1		CHN	
	2		YUG	
	3		KOR	
Women's Singles / simples dames	1		CHN	Chen, Jing
	2		CHN	Li, Huifen
	3		CHN	Jiao, Zhimin
Women's Doubles / doubles dames	1		KOR	
	2		CHN	
	3		YUG	

Volleyball/Volleyball



Event Epreuve	Rank Rang	Results Resultats	Ctry Pays	Name Nom
Men/hommes	1		USA	
	2		URS	
	3		ARG	
Women/femmes	1		URS	
	2		PER	
	3		CHN	

Tennis/Tennis



Event Epreuve	Rank Rang	Results Resultats	Ctry Pays	Name Nom
Men's Singles/ simples messieurs	1		TCH	Mecir, Miloslav
	2		USA	Mayotte, Tim
	3		SWE	Edberg, Stefan
	3		USA	Gilbert, Brad
Men's Doubles/ doubles messieurs	1		USA	
	2		ESP	
	3		TCH	
	3		SWE	
Women's Singles/ simples dames	1		FRG	Graf, Steffi
	2		ARG	Sabatini, Gabriela
	3		USA	Garrison, Zina
	3		BUL	Maleeva, Manuela
Women's Doubles/ doubles dames	1		USA	
	2		TCH	
	3		AUS	
	3		FRG	

Weightlifting/Halterophilie



Event Epreuve	Rank Rang	Results Resultats	Ctry Pays	Name Nom
52Kg (Total)	1	270.0Kg	BUL	Marinov, Sevdalin
	2	260.0Kg	KOR	Chun, Byung-Kwan
	3	257.5Kg	CHN	He, Zhouqiang
56Kg (Total)	1	292.5Kg	URS	Mirzolian, Oxen
	2	287.5Kg	CHN	He, Yingqiang
	3	267.5Kg	CHN	Liu, Shoubin
60Kg (Total)	1	342.5Kg	TUR	Suleymanoglu, Naim
	2	312.5Kg	BUL	Topourov, Stefan
	3	287.5Kg	CHN	Ye, Huanming
67.5Kg (Total)	1	340.0Kg	GDR	Kunz, Joachim
	2	337.5Kg	URS	Militossian, Israel
	3	325.0Kg	CHN	Li, Jinhe
75Kg (Total)	1	375.0Kg	BUL	Guidikov, Borislav
	2	360.0Kg	GDR	Steinboefel, Ingo
	3	357.5Kg	BUL	Varbanov, Alexander
82.5Kg (Total)	1	377.5Kg	URS	Arsamakov, Israil
	2	370.0Kg	HUN	Messzi, Istvan
	3	367.5Kg	KOR	Lee, Hyung-Kun
90Kg (Total)	1	412.5Kg	URS	Khrapatyi, Anatoli
	2	400.0Kg	URS	Moukhamediarov, Nail
	3	400.0Kg	POL	Zawada, Slawomir
100Kg (Total)	1	425.0Kg	URS	Kouznetsov, Pavel
	2	402.5Kg	ROM	Vlad, Nicu
	3	395.0Kg	FRG	Immesberger, Peter
110Kg (Total)	1	455.0Kg	URS	Zakharevitch, Yuri
	2	427.5Kg	HUN	Jacso, Jozsef
	3	425.0Kg	GDR	Weller, Ronny
Over 110Kg (Total)	1	462.5Kg	URS	Kourlovitch, Alexandre
Plus de 110Kg (Total)	2	430.0Kg	FRG	Nerlinger, Manfred
	3	415.0Kg	FRG	Zawieja, Martin

Wrestling/Lutte



Event Epreuve	Rank Rang	Results Resultats	Ctry Pays	Name Nom
Greco-Roman/ greco-romain 48Kg	1		ITA	Maenza, Vincenzo
	2		POL	Glab, Andrzej
	3		BUL	Tzenov, Bratan
Greco-Roman/ greco-romain 52Kg	1		NOR	Ronningen, Jon
	2		JPN	Miyahara, Atsuji
	3		KOR	Lee, Jae-Suk
Greco-Roman/ greco-romain 57Kg	1		HUN	Sike, Andras
	2		BUL	Balov, Stoyan
	3		GRE	Holidis, Charalambos
Greco-Roman/ greco-romain 62Kg	1		URS	Madjidov, Kamandar
	2		BUL	Vanguelov, Jivko
	3		KOR	An, Dae-Hyun
Greco-Roman/ greco-romain 68Kg	1		URS	Djoufalakian, Levon
	2		KOR	Kim, Sung-Moon
	3		FIN	Sipila, Tapio
Greco-roman/ greco-romain 74Kg	1		KOR	Kim, Young-Nam
	2		URS	Tourlykhanov, Daoulet
	3		POL	Tracz, Jozef



Event Epreuve	Rank Rang	Results Resultats	Ctry Pays	Name Nom
Greco-Roman/ greco-romain 82Kg	1		URS	Mamiachivili, Mikhail
	2		HUN	Komaromi, Tibor
	3		KOR	Kim, Sang-Kyu
Greco-Roman/ greco-romain 90Kg	1		BUL	Komchev, Atanas
	2		FIN	Koskela, Harri
	3		URS	Popov, Vladimir
Greco-Roman/ greco-romain 100Kg	1		POL	Wranski, Andrzej
	2		FRG	Himmel, Gerhard
	3		USA	Koslowski, Dennis
Greco-Roman/ greco-romain 130Kg	1		URS	Karelina, Alexandre
	2		BUL	Gueroski, Ranguel
	3		SWE	Johansson, Tomas
Free/libre 48Kg	1		JPN	Kobayashi, Takashi
	2		BUL	Tzonov, Ivan
	3		URS	Karamtchakov, Serguei
Free/libre 52Kg	1		JPN	Sato, Mitsuru
	2		YUG	Trstena, Saban
	3		URS	Togouzov, Vladimir
Free/libre 57Kg	1		URS	Beloglazov, Serguei
	2		IRN	Mohammadian, Askari
	3		KOR	Noh, Kyung-Sun
Free/libre 62Kg	1		USA	Smith, John
	2		URS	Sarkissian, Stepan
	3		BUL	Chterev, Simeon
Free/libre 68Kg	1		URS	Fadzaev, Arsen
	2		KOR	Park, Jang-Soon
	3		USA	Carr, Nate
Free/libre 72Kg	1		USA	Monday, Kenneth
	2		URS	Varaev, Adlan
	3		BUL	Sofiadi, Rakhmad
Free/libre 82Kg	1		KOR	Han, Myung-Woo
	2		TUR	Gencalp, Necmi
	3		TCH	Lohyna, Josef
Free/libre 90Kg	1		URS	Khadartsev, Makhbarbek
	2		JPN	Ota, Akira
	3		KOR	Kim, Tae-Woo
Free/libre 100Kg	1		ROM	Puscasu, Vasile
	2		URS	Khabelov, Leri
	3		USA	Scherr, William
Free/libre 130Kg	1		URS	Gobedjichvili, David
	2		USA	Baumgartner, Bruce
	3		GDR	Schroeder, Andreas

Yachting/Voile

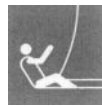

Event Epreuve	Rank Rang	Results Resultats	Ctry Pays	Name Nom
Men/Hommes Soling Class/classe soling	1	11.70	GDR	
	2	14.00	USA	
	3	52.70	DEN	
Star Class/classe star	1	45.70	GBR	
	2	48.00	USA	
	3	50.00	BRA	
FD Class/classe FD	1	31.40	DEN	
	2	37.40	NOR	
	3	48.40	CAN	
Finn Class/classe finn	1	38.10	ESP	Doreste, Jose Luis
	2	40.40	ISV	Holmberg, Peter
	3	45.00	NZL	Cutler, John
Tornado Class/ classe tornado	1	16.00	FRA	
	2	35.40	NZL	
	3	40.10	BRA	
Division II Class/ classe division II	1	35.40	NZL	Kendall, Bruce
	2	42.70	AHO	Boersma, Jan D.
	3	48.00	USA	Gebhardt, Michael
470 Class/classe 470	1	34.70	FRA	
	2	46.00	URS	
	3	51.00	USA	
Women/Femmes 470 Class/classe 470	1	26.70	USA	
	2	40.00	SWE	
	3	45.40	URS	

Medalists/Médailles

Baseball/Baseball



Event Epreuve	Rank Rang	Results Resultats	Ctry Pays	Name Nom
	1		USA	
	2		JPN	
	3		PUR	

Taekwondo/Taekwondo



Event Epreuve	Rank Rang	Results Resultats	Ctry Pays	Name Nom
Men/Hommes				
Fin/mi-mouche -50Kg	1		KOR	Kwon, Tae-Ho
	2		USA	Moreno, Juan
	3		MEX	Torroella, Enrique
	3		NEP	Lama, Bidhan
Fly/mouche 50Kg-54Kg	1		KOR	Ha, Tae-Kyung
	2		ESP	Garcia, Gabriel
	3		BRN	Darraj, Adel
	3		JOR	Abushekha, Ihsan
Bantam/coq 54Kg-58Kg	1		KOR	Ji, Yong-Suk
	2		ESP	Sanabria, Jose
	3		IRN	Danesh, Feisal
	3		USA	Lee, Han-Won
Feather/plume 58Kg-64Kg	1		KOR	Chang, Myung-Sam
	2		TUR	Yagiz, Cengiz
	3		JOR	Kamal, Samer
	3		KSA	Al Gafar, Ibrahim
Light/leger 64Kg-70Kg	1		KOR	Park, Bong-Kwon
	2		ESP	Sanchez, Jose Maria
	3		MEX	Jurado, Manuel
	3		USA	Baker, Greg
Welter/welter 70Kg-76Kg	1		KOR	Chung, Kook-Hyun
	2		ITA	D'Oriano, Luigi
	3		TPE	Wu, Tsung-Che
	3		USA	Warwick, Jay
Middle/moyen 76Kg-83Kg	1		KOR	Lee, Kye-Haeng
	2		EGY	Hussein, Amr
	3		FRG	Woznicki, Markus
	3		TUR	Sahin, Metin
Heavy/lourd +83Kg	1		USA	Kim, Jimmy
	2		KOR	Kim, Jong-Suk
	3		ESP	Alvarez, Jose Luis
	3		FRG	Arndt, Michael
Women Femmes				
Fin/mi-mouche -43Kg	1		TPE	Chin, Yu-Fang
	2		KOR	Lee, Hwa-Jin
	3		MAL	Marathamuthu, Vasugi
	3		MEX	Torres, Monica
Fly/mouche 43Kg-47Kg	1		KOR	Choo, Nan-Yool
	2		ESP	Naranjo, Maria Angela
	3		TPE	Pai, Yun-Yao
	3		USA	Pejo, Mayumi
Bantam/coq 47Kg-51Kg	1		TPE	Chen, Yi-An
	2		USA	Holloway, Debra
	3		ESP	Lopez, Josefina
	3		KOR	Park, Sun-Young
Feather/plume 51Kg-55Kg	1		DEN	Christensen, Annemette
	2		TUR	Tan, Zuleyha
	3		ESP	Dolls, Amparo
	3		KOR	Kim, So-Young
Light/leger 55Kg-60Kg	1		USA	Hee, Dana
	2		DEN	Schwartz, Karin
	3		HOL	Van Duren, Jolanda
	3		TPE	Chen, Jiun-Feng
Welter/welter 60Kg-65Kg	1		USA	Limas, Arlene
	2		KOR	Kim, Ji-Sook
	3		ESP	Bistuer, Coral
	3		FRG	Seidel, Sonny
Middle/moyen 65Kg-70Kg	1		KOR	Kim, Hyun-Hee
	2		HOL	De Jongh, Margaretha
	3		ESP	Navaz, Elena
	3		USA	Jewell, Sharon
Heavy/lourd +70Kg	1		USA	Love, Lynnette
	2		KOR	Jang, Yoon-Jung
	3		CAN	Franssen, Yvonne
	3		FRG	Guester, Ute

Women's Judo/Judo Féminin



Event Epreuve	Rank Rang	Results Resultats	Ctry Pays	Name Nom
Women/Femmes				
Extra-Light/ super leger -48Kg	1		CHN	Li, Zhongyun
	2		JPN	Esaki, Fumiko
	3		AUS	Reardon, Julie
	3		KOR	Cho, Min-Sun
Half-Light/mi-leger -52Kg	1		GBR	Rendle, Sharon
	2		FRA	Brun, Dominique
	3		ITA	Giungi, Alessandra
	3		JPN	Yamaguchi, Kaori
Light/leger -56Kg	1		AUS	Williams, Suzanne
	2		CHN	Liu, Guizhu
	3		FRA	Arnaud, Catherine
	3		FRG	Philips, Regina
Half/Middle/mi-moyen -61 Kg	1		GBR	Bell, Diane
	2		USA	Roethke, Lynn
	3		JPN	Mochida, Noriko
	3		POL	Olechnowicz, Boguslawa
Middle/moyen -66Kg	1		JPN	Sasaki, Hikari
	2		FRA	Deydier, Brigitte
	3		AUT	Hartl, Roswitha
	3		KOR	Park, Ji-Young
Half-Heavy/mi-lourd -72Kg	1		BEL	Berghmans, Ingrid
	2		KOR	Bae, Mi-jung
	3		FRG	Classen, Barbara
	3		JPN	Tanabe, Yoko
Heavy/Lourd +72Kg	1		HOL	Seriese, Angelique
	2		CHN	Gao, Fenglian
	3		FRG	Sigmund, Regina
	3		USA	Castro-Gomez, Margaret

World and Olympic Records/Records du monde et records Olympiques

World Records/Records du monde

Archery/Tir a l'Arc



Event Epreuve	Mark Marques	Competitor Competiteur	Previous record Ancien record
Women Ind./Femmes Ind.	1352	Kim, Soo-Nyung (KOR)	1338
Women Ind. 50m/ Femmes Ind.	336	Kim, Soo-Nyung (KOR)	335

Athletics/Athletisme



Event Epreuve	Mark Marques	Competitor Competiteur	Previous record Ancien record
Men 4x400m/Hommes	2:56.16 =	(USA) Everett, Danny Lewis, Steven Robinzine, Kevin Reynolds, Harry Butch	2:56.16
Women 200m/Femmes	21.56	Griffith Joyner, Florence (USA)	21.71
Women 200m/Femmes	21.34	Griffith Joyner, Florence (USA)	21.71
Women 4x400m/Femmes	3:15.18	(URS) Ledovskaia, Tatiana Nazarova, Olga Pinguina, Maria Bryzguina, Olga	3:15.92
Women Heptathlon/Femmes Heptathlon	7291	Joyner-Kersey, Jackie (USA)	7215

Cycling/Cyclisme



Event Epreuve	Mark Marques	Competitor Competiteur	Previous record Ancien record
Men Team Pursuit/Hommes 4000m poursuite, equipes	4:16.32	(AUS) Dutton, Brett McCarney, Wayne McGlede, Stephen Woods, Dean	4:17.710
Men Team Pursuit/Hommes 4000m poursuite, equipes	4:16.10	(URS) Ekimov, Viatcheslav Kaspoutis, Artouras Nelubine, Dmitri Umaras, Gintaoutas	4:16.32

Shooting/Tir



Event Epreuve	Mark Marques	Competitor Competiteur	Previous record Ancien record
Men Rapid Fire Pistol/ Hommes Pistolet de Tir Rapide	698.0	Kouzmine, Afanasi (URS)	697
Men SB. Free Rifle, Prone/ Hommes Cara. Petit cal. couché	600 =	Varga, Miroslav (TCH)	600
Men Air Pistol/Hommes Pistolet Air comprimé	590 =	Buljung, Erich (USA)	590
Women Air Pistol/Femmes Pistolet a Air comprimé	390	Saloukvadze, Nino (URS)	389
Women Air Pistol/Femmes Pistolet a Air comprimé	489.5	Sekaric, Jasna (YUG)	489.0
Women Air Pistol/Femmes Pistolet a Air comprimé	389 =	Sekaric, Jasna (YUG)	389

Swimming/Natation



Event Epreuve	Mark Marques	Competitor Competiteur	Previous record Ancien record
Men 50m Free-style/Hommes nage libre	22.14	Biondi, Matthew (USA)	22.23
Men 200m Free-style/Hommes nage libre	1:47.25	Armstrong, Duncan (AUS)	1:47.44
Men 400m Free-style/Hommes nage libre	3:46.95	Dassler, Uwe (GDR)	3:47.38
Men 100m Backstroke/ Hommes dos	54.51	Berkoff, David (USA)	54.91
Men 200m Ind. Medley/ Hommes 4 nage	2:00.17	Darnyi, Tamas (HUN)	2:00.56
Men 400m Ind. Medley/ Hommes 4 nage	4:14.75	Darnyi, Tamas (HUN)	4:15.42
Men 4x400m Medley Relay/ Hommes Relais 4 nages	3:36.93	(USA) Berkoff, David Schroeder, Richard Biondi, Matthew Jacobs, Christopher	3:38.28
Men 4 x400m Free-style Relay/Hommes n. libre	3:16.53	(USA) Jacobs, Christopher Dalbey, Troy Jager, Thomas Biondi, Matthew	3:17.08
Men 4x200m Freestyle Relay/ Hommes Relais n. libre	7:12.51	(USA) Dalbey, Troy Cetlinski, Matthew Gjertsen, Douglas Biondi, Matthew	7:13.10
Women 400m Freestyle/ Femmes libre	4:03.85	Evans, Janet (USA)	4:05.45
Women 200m Breaststroke/ Femmes brasse	2:26.71	Hoerner, Silke (GDR)	2:27.27

Weightlifting/Halterophilie/



Event Epreuve	Mark Marques	Competitor Competiteur	Previous record Ancien record
52kg (Total)	270.0kg	Marinov, Sevdalin (BUL)	267.5kg
52kg (Total)	267.5kg =	Marinov, Sevdalin (BUL)	267.5kg
60kg (Total)	341.0kg	Suleymanoglu, Naim (TUR)	335.0kg
60kg (Total)	342.5kg	Suleymanoglu, Naim (TUR)	335.0kg
110kg (Total)	455.0kg	Zakharevitch, Yuri (URS)	452.5kg
52kg (Snatch)/(Arrache)	120.0kg	Marinov, Sevdalin (BUL)	119.5kg
60kg (Snatch)/(Arrache)	150.5kg	Suleymanoglu, Naim (TUR)	150.0kg
60kg (Snatch)/(Arrache)	152.5kg	Suleymanoglu, Naim (TUR)	150.0kg
110kg (Snatch)/(Arrache)	205.0kg	Zakharevitch, Yuri (URS)	203.5kg
110kg (Snatch)/(Arrache)	210.0kg	Zakharevitch, Yuri (URS)	203.5kg
60kg (Cln&Jrk)/(Ep&Jete)	188.5kg	Suleymanoglu, Naim (TUR)	188.0kg
60kg (Cln & Jrk)/(Ep & Jete)	190.0kg	Suleymanoglu, Naim (TUR)	188.0kg

World and Olympic Records/Records du monde et records Olympiques

Olympic Records/Records Olympiques

Archery/Tir a l'Arc



Event Epreuve	Mark Marques	Competitor Competiteur	Previous record Ancien record
Men Ind. 90m/Hommes Ind.	618	Barrs, Jay (USA)	601
Men Ind. 90m/Hommes Ind.	603	Park, Sung-Soo (KOR)	601
Men Ind. 90m/Hommes Ind.	604	Echeev, Vladimir (URS)	601
Men Ind. 90m/Hommes Ind.	607	Chun, In-Soo (KOR)	601
Men Ind. 50m/Hommes Ind.	661	Reniers, martinus (HOL)	660
Men Ind. 50m/Hommes Ind.	664	Echeev, Vladimir (URS)	660
Men Ind. 30m/Hommes Ind.	704	Park, Sung-Soo (KOR)	702
Men Ind. 30m/Hommes Ind.	705	Chun, In-Soo (KOR)	702
Men Ind. 30m/Hommes Ind.	707	Reniers, Martinus (HOL)	702
Women Ind./Femmes Ind.	2683	Kim, Soo-Nyung (KOR)	2568
Women Ind./Femmes Ind.	2612	Wang, Hee-Kyung (KOR)	2568
Women Ind./Femmes Ind.	2603	Yun, Young-Sook (KOR)	2568
Women Ind./Femmes Ind.	2593	Arjannikova, Lioudmila (URS)	2568
Women Ind./Femmes Ind.	2581	Sjowall, Jenny (SWE)	2568
Women Ind. 70m/ Femmes Ind	646	Kim, Soo-Nyung (KOR)	611
Women Ind. 70m/ Femmes Ind.	640	Wang, Hee-Kyung (KOR)	611
Women Ind. 70m/ Femmes Ind.	624	Yun, Young-Sook (KOR)	611
Women Ind. 70m/ Femmes Ind.	629	Arjannikova, Lioudmila (URS)	611
Women Ind. 70m/ Femmes Ind.	650	Sjowall, Jenny (SWE)	611
Women Ind. 70m/ Femmes Ind.	627	Franks, Joanne (GBR)	611
Women Ind. 70m/ Femmes Ind.	615	Mountian, Tatiana (URS)	611
Women Ind. 60m/ Femmes Ind.	667	Kim, Soo-Nyung (KOR)	648
Women Ind. 60m/ Femmes Ind.	652	Wang, Hee-Kyung (KOR)	648
Women Ind. 60m/ Femmes Ind.	652	Yun, Young-Sook (KOR)	648
Women Ind. 50m/ Femmes Ind.	668	Kim, Soo-Nyung (KOR)	631
Women Ind. 50m/ Femmes Ind.	632	Mountian, Tatiana (URS)	631
Women Ind. 50m/ Femmes Ind.	635	Yun, Young-Sook (KOR)	631
Women Ind. 30m/ Femmes Ind.	702	Kim, Soo-Nyung (KOR)	694
Women Ind. 30m/ Femmes Ind.	698	Arjannikova, Lioudmila (URS)	694

Athletics/Athletisme



Event Epreuve	Mark Marques	Competitor Competiteur	Previous record Ancien record
Men 100m/Hommes	9.92	Lewis, Carl (USA)	9.95
Men 200m/Hommes	19.75	DeLoach, Joe (USA)	19.80
Men 1000m/Hommes	27:21.46	Boutaib, Mly. Brahim (MAR)	27:38.34
Men 3000m Steeplechase/ Hommes steeplechase	8:05.51	Kariuki, Julius (KEN)	8:08.02
Men 110m Hurdles/ Hommes Haies	13.17	Kingdom, Roger (USA)	13.20
Men 110m Hurdles/ Hommes Haies	12.98	Kingdom, Roger (USA)	13.17
Men 400m Hurdles/ Hommes Haies	47.19	Phillips, Andre (USA)	47.63
Men 20km Walk/ Hommes Marche	1'19:57	Pribilinec, Jozef (TCH)	1'23:13
Men 50km Walk/ Hommes Marche	3'38:29	Ivanenko, Viacheslav (URS)	3'47:26



Event Epreuve	Mark Marques	Competitor Competiteur	Previous record Ancien record
Men High Jump/ Hommes saut en Hauteur	2.38m	Avdeenko, Guennadi (URS)	2.36m
Men High Jump/ Hommes saut en Hauteur	2.36m =	Conway, Hollis (USA)	2.36m
Men High Jump/ Hommes saut en Hauteur	2.36m =	Povarnitsyne, Roudolf (URS)	2.36m
Men High Jump/ Hommes saut en Hauteur	2.36m =	Sjoberg, Patrik (SWE)	2.36m
Men Pole Vault/ Saut a la perche	5.90m	Bubka, Sergey (URS)	5.78m
Men Pole Vault/ Saut a la perche	5.85m	Gataouline, Radion (URS)	5.78m
Men Pole vault/ saut a la perche	5.80m	Egorov, Grigori (URS)	5.78m
Men Triple Jump/ Hommes Triple saut	17.61m	Markov, Hristo (BUL)	17.39m
Men Triple Jump/ Hommes Triple saut	17.42m	Kovalenko, Alexandre (URS)	17.39m
Men Shot Put/ Hommes Lancer du poids	21.45m	Guenthoer, Werner (GDR)	21.35m
Men Shot put/ Hommes Lancer du poids	22.39m	Barnes, Randy (USA)	21.35m
Men Shot Put/ Hommes Lancer du Poids	22.47m	Timmermann, Ulf (SUI)	21.35m
Men Discus/ Hommes Lancer du disque	68.82m	Schult, Jurgen (GDR)	68.28m
Men Hammer Throw/ Hommes Lancer du marteau	84.80m	Litvinov, Serguei (URS)	81.80m
Men Javelin/ Hommes Lancer du javelot	85.90m	Zelezny, Jan (TCH)	81.80m
Men Javelin/ Hommes Lancer du javelot	76.76m	Raty, Seppo (FIN)	81.80m
Men Javelin/ Hommes Lancer du javelot	78.66m	Borglund, Peter (SWE)	81.80m
Men Javelin/ Hommes Lancer du javelot	77.44m	Mizoguchi, Kazuhiro (JPN)	81.80m
Women 100m/Femmes	10.88	Griffith Joyner, Florence (USA)	10.97
Women 100m/Femmes	10.62	Griffith Joyner, Florence (USA)	10.88
Women 100m/Femmes	10.88 =	Ashford, Evelyn (USA)	10.88
Women 200m/Femmes	21.76	Griffith Joyner, Florence (USA)	21.81
Women 400m/Femmes	48.65	Bryzguina, Olga (URS)	48.83
Women 1500m/Femmes	3:53.96	Ivan, Paula (ROM)	3:56.56
Women 3000m/Femmes	8:26.53	Samolenko, Tatiana (URS)	8:35.96
Women 10000m/Femmes	31:44.69	Kristiansen, Ingrid (NOR)	31:44.96
Women 10000m/Femmes	31:05.21	Bondarenko, Olga (URS)	31:44.69
Women 100m Hurdle/ Femmes haies	12.47	Donkova, Jordanka (BUL)	12.56
Women 100m Hurdle/ Femmes haies	12.38	Donkova, Jordanka (BUL)	12.47
Women 400m Hurdle/ Femmes haies	54.58	Fiedler, Ellen (GDR)	54.61
Women 400m Hurdle/ Femmes haies	54.00	Flintoff-King, Debra (AUS)	54.58
Women 400m Hurdle/ Femmes haies	53.17	Flintoff-King, Debra (AUS)	54.00
Women High Jump/ Femmes saut en hauteur	2.03m	Ritter, Louise (USA)	2.02m
Women Long Jump/ Femmes saut en longueur	7.40m	Joyner-Kersey, Jackie (USA)	7.27m
Women Discus/ Femmes Lancer du disque	72.30m	Hellmann, Martina (GDR)	69.96m
Women Javelin/ Femmes Lancer du javelot	74.68m	Felke, Petra (GDR)	69.56m
Women Hepta-Long Jump/ Femmes Hepta-saut en longueur	7.27m	Joyner-Kersey, Jackie (USA)	7.06m

Shooting/Tir



Event Epreuve	Mark Marques	Competitor Competiteur	Previous record Ancien record
Men Air Rifle/ Hommes cara. Air Comprime	594	Maksimovic, Goran (YUG)	589
Men Air Rifle/ Hommes cara. Air comprime	593	Berthlot, Nicolas (FRA)	589
Men Air Rifle/ Hommes cara. Air comprime	592	Riederer, Johann (FRG)	589
Men Air Rifle/ Hommes cara. Air comprime	591	Stenvaag, Harald (NOR)	589
Men Air Rifle/ Hommes cara. Air comprime	591	Foth, Robert (USA)	589
Men Air Rifle/ Hommes cara. Air comprime	591	Wolfram, Andrea's (GDR)	589
Men Air Rifle/ Hommes cara. Air comprime	591	Zahonyi, Attila(HUN)	589
Men Air Rifle/ Hommes cara. Air comprime	590	An, Byung-Kyun (KOR)	589
Men Air Rifle/ Hommes cara. Air comprime	590	Gaspar, Oliver (HUN)	589
Men Air Rifle/ Hommes cara. Air comprime	590	Badiou, Franck (FRA)	589
Men Air Rifle/ Hommes cara. Air comprime	590	Kurka, Petr (TCH)	589
Men Air Rifle/ Hommes cara. Air comprime	589 =	Koba, Ryohei (JPN)	589
Men Air Rifle/ Hommes cara. Air comprime	589 =	Lee, Eun-Chul (KOR)	589
Men SB, Rifle, 3 Positions/ Hommes cara. petit calibre 3 p.	1181	Allan, Alister (GBR)	1173
Men SB, Rifle, 3 Positions/ Hommes cara. petit calibre 3 p.	1180	Cooper, Malcolm (GBR)	1173
Men SB, Rifle, 3 Positions/ Hommes cara. petit calibre 3 p.	1177	Christensen, Klavs Jorn (DEN)	1173
Men SB, Rifle, 3 Positions/ Hommes cara. petit calibre 3 p.	1174	Dubis, Glenn (USA)	1173
Men SB, Rifle, 3 Positions/ Hommes cara. petit calibre 3 p.	1173 =	Ivanov, Kirill (URS)	1173
Men SB, Rifle, 3 Positions/ Hommes cara. petit calibre 3 p.	1173 =	Stenvaag, Harald (NOR)	1173
Men SB, Rifle, 3 Positions/ Hommes cara. petit calibre 3 p.	1173 =	Petikiane, Gratchia (URS)	1173
Men SB, Rifle, 3 Positions/ Hommes cara. petit calibre 3 p.	1173 =	Maksimovic, Goran (YUG)	1173
Men Rapid Fire Pistol/ Hommes Pistolet de Tir Rapide	598	Kouzmine, Afanasi (URS)	597
Men Rapid Fire Pistol/ Hommes Pistolet de Tir Rapide	597 =	Mcnally, John (USA)	597
Men Rapid Fire Pistol/ Hommes Pistolet de Tir Rapide	597 =	Schumann, Ralf (GDR)	597
Men Running Game Target/ Hommes cible courante	591	Avramenko, Guennadi (URS)	589
Men Running Game Target/ Hommes cible courante	591	Heiestad, Tor(NOR)	589
Men Running Game Target/ Hommes cible courante	589 =	Huang, Shiping (CHN)	589
Women Air Rifle/ Femmes cara. Air comprime	395	Meili, Launi (USA)	393
Women Air Rifle/ Femmes cara. Air comprime	395	Chilova, Irina (URS)	393
Women Air Rifle/ Femmes cara. Air comprime	395	Zhang, Qiuping (CHN)	393
Women Air Rifle/ Femmes cara. Air comprime	394	Maloukhina, Anna (URS)	393
Women Air Rifle/ Femmes cara. Air comprime	394	Bowes, Sharon (CAN)	393



Event Epreuve	Mark Marques	Competitor Competiteur	Previous record Ancien record
Women Air Rifle/ Femmes cara. Air comprime	394	Buehlmann, Gabriele (SUI)	393
Women Air Rifle/ Femmes cara. Air comprime	393 =	Sperber, Silvia (FRG)	393
Women Air Rifle/ Femmes cara. Air comprime	393 =	Peltola, Pirjo (FIN)	393
Women Air Rifle/ Femmes cara. Air comprime	393 =	Baldessarini, Sylvia (AUT)	393
Women SB. Stand. Rifle 3 Pos./Femmes cara. Stand. Trois P.	590	Sperber, Silvia (FRG)	581
Women SB. Stand. Rifle 3 Pos./Femmes cara. Stand. Trois P.	586	Tcherka Ssova, Valentina (URS)	581
Women SB. Stand. Rifle 3 Pos./Femmes cara. Stand. Trois P.	585	Maloukhina, Anna (URS)	581
Women SB. Stand. Rifle 3 Pos./Femmes cara. Stand. Trois P.	584	Klepp, Katja (GDR)	581
Women SB. Stand. Rifle 3 Pos./Femmes cara. Stand. Trois P.	584	Bowes, Sharon (CAN)	581
Women SB. Stand. Rifle 3 Pos./Femmes cara. Stand. Trois P.	583	Letcheva, Vessela (BUL)	581
Women SB. Stand. Rifle 3 Pos./Femmes cara. Stand. Trois P.	583	Karlsson, Anita (SWE)	581
Women SB. Stand. Rifle 3 Pos./Femmes cara. Stand. Trois P.	582	Meili, Launi (USA)	581
Women SB. Stand. Rifle 3 Pos./Femmes cara. Stand. Trois P.	581 =	Dufaux, Irene (SUI)	581
Women Sport Pistol/ Femmes Pistolet de Sport	591	Sekaric, Jasna (YUG)	585
Women Sport Pistol/ Femmes Pistolet de Sport	591	Saloukvadze, Nino (URS)	585
Women Sport Pistol/ Femmes Pistolet de Sport	587	Hasegawa, Tomoko (JPN)	585
Women Sport Pistol/ Femmes Pistolet de Sport	586	Manchon, evelyne (FRA)	585
Women Sport Pistol/ Femmes Pistolet de Sport	586	Fries, Kristina (SWE)	585
Women Sport Pistol/ Femmes Pistolet de Sport	585 =	Breker, Lieselotte (FRG)	585
Women Sport Pistol/ Femmes Pistolet de Sport	585 =	Ferencz, Agnes (HUN)	585
Women Sport Pistol/ Femmes Pistolet de Sport	585 =	Dobranchicheva, Marina (URS)	585
Olympic Skeet/ Skeet Olympique	198 =	Wegner, Axel (GDR)	198
Olympic Skeet/ Skeet Olympique	198 =	De Iruarizaga, Alfonso (CHI)	198

World and Olympic Records/Records du monde et records Olympiques

Swimming/Natation



Event Epreuve	Mark Marques	Competitor Competiteur	Previous record Ancien record
Men 50m Freestyle/ Hommes nage libre	24.25 =	Ferguson, Garvin (BAH)	24.25
Men 50m Freestyle/ Hommes nage libre	23.44	Andrews, Mark (CAN)	24.25
Men 50m Freestyle/ Hommes nage libre	22.61	Hallsall, Dano (SUI)	23.44
Men 50m Freestyle/ Hommes nage libre	22.39	Biondi, Matthew (USA)	22.61
Men 100m Freestyle/ Hommes nage libre	49.20	Jacobs, Christopher (USA)	49.80
Men 100m Freestyle/ Hommes nage libre	49.04	Biondi, Matthew (USA)	49.20
Men 100m Freestyle/ Hommes nage libre	48.63	Biondi, Matthew (USA)	49.04
Men 400m Freestyle/ Hommes nage libre	3:49.51	Podkosielnny, Mariusz (POL)	3:50.91
Men 100m Backstroke/ Hommes dos	55.04	Polianski, Igor (URS)	55.49
Men 100m Butterfly/ Hommes Papillon	53.00	Nesty, Anthony (SUR)	53.08
Men 200m Butterfly/ Hommes Papillon	1:56.94	Gross, Michael (FRG)	1:57.04
Men 400m Ind. Medley/ Hommes 4 nages	4:16.55	Darnyi, Tamas (HUN)	4:17.41
Women 50m Freestyle/ Femmes libre	29.64 =	Araujo, Carolina (MOZ)	29.64
Women 50m Freestyle/ Femmes libre	27.96	Mauri, Carolina (CRC)	29.64
Women 50m Freestyle/ Femmes libre	27.44	Rezemde, Monica (BRA)	27.96
Women 50m Freestyle/ Femmes libre	26.49	Van Der Plaats, Diana (HOL)	27.44
Women 50m Freestyle/ Femmes libre	25.91	Fetter, Leigh (USA)	26.49
Women 50m Freestyle/ Femmes libre	25.85	Otto, Kristin (GDR)	25.91
Women 50m Freestyle/ Femmes libre	25.67	Yang, Wenyi (CHN)	25.85
Women 50m Freestyle/ Femmes libre	25.49	Otto, Kristin (GDR)	25.67
Women 200m Freestyle/ Femmes libre	1:57.65	Friedrich, Heike (GDR)	1:58.33
Women 800m Freestyle/ Femmes libre	8:20.20	Evans, Janet (USA)	8:24.95
Women 200m Backstroke/ Femmes dos	2:11.01	Egerszegi, Krisztina (HUN)	2:11.77
Women 200m Backstroke/ Femmes dos	2:10.46	Sirch, Cornelia (GDR)	2:11.01
Women 200m Backstroke/ Femmes dos	2:09.29	Egerszegi, Krisztina (HUN)	2:10.46
Women 100m Breaststroke/ Femmes brasse	1:08.35	Dangalakova, Tania (BUL)	1:09.88
Women 100m Breaststroke/ Femmes brasse	1:08.35 =	Hoerner, Silke (GDR)	1:08.35
Women 100m Breaststroke/ Femmes brasse	1:07.95	Dangalakova, Tania (BUL)	1:08.35
Women 200m Breaststroke/ Femmes brasse	2:28.94	Bogatcheva, Ioulia (URS)	2:29.54
Women 200m Breaststroke/ Femmes brasse	2:27.63	Hoerner, Silke (GDR)	2:28.94
Women 100m Butterfly/ Femmes Papillon	59.00	Otto, Kristin (GDR)	59.26
Women 200m Ind Medley/ Femmes 4 nages	2:12.59	Hunger, Daniela (GDR)	2:12.64
Women 4x100m Medley Relay/Femmes Relais 4nages	4:03.74	Otto, Kristin (GDR) Hoerner, Silke Weigang, Birte Meissner, Katrin	4:06.67
Women 4x100m Freestyle Relay/Femmes Relais n. libre	3:40.63	Otto, Kristin (GDR) Meissner, Katrin Hunger, Daniela Stellmach, Manuela	3:42.71

Weightlifting/Halterophilie



Event Epreuve	Mark Marques	Competitor Competiteur	Previous record Ancien record
52kg (Total)	262.5kg	Marinov, Sevdalin (BUL)	245.0kg
52kg (Total)	252.5kg	Chun, Byung-Kwan (KOR)	245.0kg
52kg (Total)	260.0kg	Chun, Byung-Kwan (KOR)	245.0kg
52kg (Total)	257.5kg	He, Zhuoqiang (CHN)	245.0kg
52kg (Total)	252.5kg	Zhang, Shoulie (CHN)	245.0kg
52kg (Total)	257.5kg	Zhang, Shoulie (CHN)	245.0kg
52kg (Total)	247.5kg	Gutowski, Jacek (POL)	245.0kg
56kg (Total)	287.5kg	Mirzozian, Oxen (URS)	275.0kg
56kg (Total)	292.5kg	Mirzozian, Oxen (URS)	275.0kg
56kg (Total)	287.5kg	He, Yingqiang (CHA)	275.0kg
56kg (Total)	275.0kg=	He, Yingqiang (CHN)	275.0kg
60kg (Total)	327.5kg	Suleymanoglu, Naim (TUR)	290.0kg
60kg (Total)	302.5kg	Topourov, Stefan (BUL)	290.0kg
60kg (Total)	312.5kg	Torourov, Stefan (BUL)	290.0kg
75kg (Total)	367.5kg	Guidikov, Borislav (BUL)	360.0kg
75kg (Total)	372.5kg	Guidikov, Borislav (BUL)	360.0kg
75kg (Total)	375.0kg	Guidikov, Borislav (BUL)	360.0kg
75kg (Total)	360.0kg=	Steinboefel, Ingo (GDR)	360.0kg
90kg (Total)	412.5kg	Khrapatyi, Anatoli (URS)	392.5kg
90kg (Total)	400.0kg	Moukhamediarov, Nail (URS)	392.5kg
90kg (Total)	400.0kg	Zawada, Slawomir (POL)	392.5kg
100kg (Total)	420.0kg	Kouznetsov, Pavel (URS)	395.0kg
100kg (Total)	425.0kg	Kouznetsov, Pavel (URS)	395.0kg
100kg (Total)	397.5kg	Vlad, Nicu (ROM)	395.0kg
100kg (Total)	402.0kg	Vlad, Nicu (ROM)	395.0kg
100kg (Total)	395.0kg=	Immesberger, Peter (FRG)	395.0kg
110kg (Total)	427.5kg	Jacso, Jozsef (HUN)	422.5kg
110kg (Total)	425.0kg	Weller, Ronny (GOR)	422.5kg
110kg (Total)	425.0kg	Schubert, Michael (GDR)	422.5kg
Over 110kg (Total)/Plus de	457.5kg	Kourlovitch, Alexandre (URS)	440.0kg
Over 110kg (Total)/Plus de	462.5kg	Kourlovitch, Alexandre (URS)	440.0kg
52kg (snatch)/(Arrache)	112.5kg	Marinov, Sevdalin (BUL)	110.0kg
52kg (snatch)/(Arrache)	117.5kg	Marinov, Sevdalin (BUL)	110.0kg
52kg (snatch)/(Arrache)	115.0kg	Zhang, Shoulie (CHN)	110.0kg
52kg (snatch)/(Arrache)	112.5kg	Gutowski, Jacek (POL)	110.0kg
52kg (snatch)/(Arrache)	112.5kg	He, Zhuoqiang (CHN)	110.0kg
52kg (snatch)/(Arrache)	112.5kg	Chun, Byung-Kwan (KOR)	110.0kg
52kg (snatch)/(Arrache)	110.0kg=	Zhang, Shoulie (CHN)	110.0kg
52kg (snatch)/(Arrache)	110.0kg=	Ciharean, Traian Ioach (ROM)	110.0kg
56kg (snatch)/(Arrache)	127.5kg	Liu, Shoubin (CHN)	125.0kg
56kg (snatch)/(Arrache)	127.5kg	Mirzozian, Oxen (URS)	125.0kg
56kg (snatch)/(Arrache)	125.0kg=	He, Yingqiang (CHN)	125.0kg
60kg (snatch)/(Arrache)	145.0kg	Suleymanoglu, Naim (TUR)	130.0kg
60kg (snatch)/(Arrache)	137.5kg	Topourov, Stefan (BUL)	130.0kg
67.5kg (snatch)/(Arrache)	155.0kg	Militossian, Israel (URS)	147.5kg
67.5kg (snatch)/(Arrache)	150.0kg	Kunz, Joachim (GDR)	147.5kg
67.5kg (snatch)/(Arrache)	147.5kg=	Kunz, Joachim (GDR)	147.5kg
67.5kg (snatch)/(Arrache)	147.5kg=	Li, Jinhe (CHN)	147.5kg
75kg (snatch)/(Arrache)	165.0kg	Guidikov, Borislav (BUL)	160.0kg
75kg (snatch)/(Arrache)	167.5kg	Guidikov, Borislav (BUL)	160.0kg
75kg (snatch)/(Arrache)	165.0kg	Steinboefel, Ingo (GDR)	160.0kg
75kg (snatch)/(Arrache)	160.0kg=	Guidikov, Borislav (BUL)	160.0kg
75kg (snatch)/(Arrache)	160.0kg=	Steinboefel, Ingo (GDR)	160.0kg
90kg (Snatch)/(Arrache)	180.0kg	Khrapatyi, Anatoli (URS)	172.5kg



Event Epreuve	Mark Marques	Competitor Competiteur	Previous record Ancien record
90kg (Snatch)/(Arrache)	185.0kg	Khrapatyi, Anatoli (URS)	172.5kg
90kg (Snatch)/(Arrache)	187.5kg	Khrapatyi, Anatoli (URS)	172.5kg
90kg (Snatch)/(Arrache)	180.0kg	Zawada, Slawomir (POL)	172.5kg
90kg (Snatch)/(Arrache)	177.5kg	Moukhamediarov, Nail (URS)	172.5kg
90kg (Snatch)/(Arrache)	175.0kg	Buda, Attila (HUN)	172.5kg
90kg (Snatch)/(Arrache)	172.5kg	Moukhamediarov, Nail (URS)	172.5kg
100kg (Snatch)/(Arrache)	185.0kg	Kouznetsov, Pavel (URS)	180.0kg
100kg (Snatch)/(Arrache)	190.0kg	Kouznetsov, Pavel (URS)	180.0kg
100kg (Snatch)/(Arrache)	185.0kg	Vlad, Nicu (ROM)	180.0kg
100kg (Snatch)/(Arrache)	180.0kg =	Vlad, Nicu (ROM)	180.0kg
100kg (Snatch)/(Arrache)	180.0kg =	Bokfi, Janos(HUN)	180.0kg
110kg (Snatch)/(Arrache)	195.0kg	Zakharevitch, Yuri (URS)	185.0kg
110kg (Snatch)/(Arrache)	190.0kg	Jacso, Jozsef (HUN)	185.0kg
110kg (Snatch)/(Arrache)	190.0kg	Weller, Ronny (GDR)	185.0kg
110kg (Snatch)/(Arrache)	187.5kg	Schubert, Michael (GDR)	185.0kg
110kg (Snatch)/(Arrache)	190.0kg	Schubert, Michael (GDR)	185.0kg
110kg (Snatch)/(Arrache)	187.5kg	Popov, Alexandre (URS)	185.0kg
110kg (Snatch)/(Arrache)	187.5kg	Oberburger, Norberto (ITA)	185.0kg
Over 110kg (Snatch)/ Plus de (Arrache)	202.5kg	Kourlovitch, Alexandre (URS)	195.0kg
Over 110kg (Snatch)/ Plus de (Arrache)	207.0kg	Kourlovitch, Alexandre (URS)	195.0kg
Over 110kg (Snatch)/ Plus de (Arrache)	212.5kg	Kourlovitch, Alexandre (URS)	195.0kg
52kg (Cln & Jrk)/(Ep & Jete)	142.5kg	Mariniov, Sevdalin (BUL)	137.5kg
52kg (Cln & Jrk)/(Ep & Jete)	147.5kg	Marinov, Sevdalin (BUL)	137.5kg
52kg (Cln & Jrk)/(Ep & Jete)	150.0kg	Marinov, Sevdalin (BUL)	137.5kg
52kg (Cln & Jrk)/(Ep & Jete)	140.0kg	Chun, Byung-Kwan (KOR)	137.5kg
52kg (Cln & Jrk)/(Ep & Jete)	147.5kg	Chun, Byung-Kwan (KOR)	137.5kg
52kg (Cln & Jrk)/(Ep & Jete)	145.0kg	He, Zhuoqiang (CHN)	137.5kg
52kg (Cln & Jrk)/(Ep & Jete)	142.0kg	Zhang, Shoulie (CHN)	137.5kg
52kg (Cln & Jrk)/(Ep & Jete)	137.5kg	Zhang, Shoulie (CHN)	137.5kg
56kg (Cln & Jrk)/(Ep & Jete)	160.0kg	Mirzoian, Oxen (URS)	157.5kg
56kg (Cln & Jrk)/(Ep & Jete)	165.0kg	Mirzoian, Oxen (URS)	157.5kg
56kg (Cln & Jrk)/(Ep & Jete)	162.5kg	He, Yingqiang (CHN)	157.5kg
60kg (Cln & Jrk)/(Ep & Jete)	175.0kg	Suleymanoglu, Naim (TUR)	160.0kg
60kg (Cln & Jrk)/(Ep & Jete)	165.0kg	Topourov, Stefan (BUL)	160.0kg
60kg (Cln & Jrk)/(Ep & Jete)	175.0kg	Topourov, Stefan (BUL)	160.0kg
60kg (Cln & Jrk)/(Ep & Jete)	160.0kg =	Ye, Huanming (CHN)	160.0kg
75kg (Cln & Jrk)/(Ep & Jete)	205.0kg	Guidikov, Borislav (BUL)	200.0kg
75kg (Cln & Jrk)/(Ep & Jete)	207.5kg	Guidikov, Borislav (BUL)	200.0kg
75kg (Cln & Jrk)/(Ep & Jete)	200.0kg =	Guidikov, Borislav (BUL)	200.0kg
75kg (Cln & Jrk)/(Ep & Jete)	200.0kg =	Varbanov, Alexander (BUL)	200.0kg
90kg (Cln & Jrk)/(Ep & Jete)	225.0kg	Khrapatyi, Anatoli (URS)	220.0kg
90kg (Cln & Jrk)/(Ep & Jete)	222.5kg	Moukhamediarov, Nail (URS)	220.0kg
90kg (Cln & Jrk)/(Ep & Jete)	220.0kg =	Zawada, Slawomir (POL)	220.0kg
100kg (Cln & Jrk)/(Ep & Jete)	230.0kg	Kouznetsov, Pavel (URS)	217.5kg
100kg (Cln & Jrk)/(Ep & Jete)	235.0kg	Kouznetsov, Pavel (URS)	217.5kg
100kg (Cln & Jrk)/(Ep & Jete)	220kg	Immesberger, Peter	217.5kg
100kg (Cln & Jrk)/(Ep & Jete)	222.5kg	Garon, Denis (CAN)	217.5kg
100kg (Cln & Jrk)/(Ep & Jete)	220.0kg	Hwang, Woo-Won (KOR)	217.5kg
100kg (Cln & Jrk)/(Ep & Jete)	217.5kg =	Vlad, Nicu (ROM)	217.5kg
100kg (Cln & Jrk)/(Ep & Jete)	217.5kg =	Garon, Denis (CAN)	217.5kg
110kg (Cln & Jrk)/(Ep & Jete)	245.0kg	Zakharevitch, Yuri (URS)	240.0kg

Seoul '88 Facts and Figures

Les faits et les chiffres

Medal Tally by Country/Nombre des médailles remportées par pays.

NOC		AR	AT	DB	BO	CA	CY	EQ	FE	FB	GY	HB	HO	JU	MP	RO	SH	SW	TT	TE	VB	WE	WR	YA	TOT	
1	URS	G		10	1	1	3	4	1	1	12	1				2	4	2			1	6	8	1	55	
		S	1	6	1	1	3	1	1	3		5	1		1	1	1	1	2			1	2	4	1	31
2	GDR	G		6	2	3	3				1		2			8	1	11				1	1		1	37
		S		11	1	2	2	1	1		3	4			1	1	1	8	9			1	1	1		35
3	USA	G	1	13	1	3	2									2	1	10		2	1		2	1	36	
		S	1	7	1	3			2			1			1	1	1	10		1	2		1	2	31	
4	KOR	G	3			2						1	1	2					2				2		12	
		S	2			1							1	1	1				1				1	2	10	
5	FRG	G						4	3				1			1	1	1							11	
		S		1				2	3				1	2		1	1	1			1		1	1	14	
6	HUN	G				2			1		1				2			4						1	11	
		S				1	1			2								2	2				2	1	6	
7	BUL	G		2	1	1					1						1	1				2	1		10	
		S		1	1	1					1						2	1	1		1	1	3	4	12	
8	ROM	G		1							3					1	1							1	7	
		S		1		1					3					4	2	1				1			11	
9	FRA	G						1	2					1										2	6	
		S		1		1		1	1					1				1							4	
10	ITA	G		1					1							2								1	6	
		S		1		1			1						2										1	4
11	CHN	G									1						1	2	2						5	
		S		1							1						1	6	2	2		1	1		11	
12	GBR	G						2					1			1	1	1						1	5	
		S	1	6		1			1						1	1	1	1							10	
13	KEN	G		4																					5	
		S		2		1																				2
14	JPN	G												1				1						2	4	
		S									2			3				2							2	3
15	AUS	G		1		1	2						1					1							3	
		S		1		1	1	2										1	1		1				6	
16	YUG	G			2												2	1							3	
		S			1							1					1	1		1			1		4	
17	TCH	G		1											1					1					3	
		S		1												1					1			1	3	
18	NZL	G				1		1																1	3	
		S				1	1		1								3	2						1	2	
19	CAN	G			1		1		1					1				2							3	
		S			4	1	1			1					1			1				1	1		5	
20	POL	G			4	1	1		1					1											2	
		S			4	2	1			1					1			1					1	1	5	
21	NOR	G															1							1	2	
		S									1													1	3	
22	HOL	G					1																		2	
		S				1	1						2	1				1							2	
23	DEN	G				1																		1	2	
		S																1						1	2	
24	BRA	G												1											1	
		S		1						1															2	
25	FIN	G		1																					1	
		S		1																				1	1	
25	ESP	G																			1			1	1	
		S																1	1						2	
27	TUR	G																				1			1	
		S																					1		1	

NOC	AR	AT	DB	BO	CA	CY	EQ	FE	FB	GY	HB	HO	JU	MP	RO	SH	SW	TT	TE	VB	WE	WR	YA	TOT	
28 MAR	G	1																						1	
	S	1		1																				2	
	B																							1	
29 POR	G	1																						1	
	S																								
	B																								
29 AUT	G												1											1	
	S																								
	B																								
29 SUR	G																1							1	
	S																								
	B																								
32 SWE	G			1												1	1						1	4	
	S	1		1		1												1	2			1	1	7	
	B																								
33 SUI	G																							2	
	S	1						1							1									2	
	B							1																	
34 JAM	G																							2	
	S	2																							
	B																								
35 ARG	G																							1	
	S																		1					1	
	B																			1					
36 SEN	G																							1	
	S	1																							
	B																								
36 AHO	G																						1	1	
	S																								
	B																								
36 CHI	G																							1	
	S																								
	B																								
36 ISV	G																						1	1	
	S																								
	B																								
36 PER	G																							1	
	S																								
	B																								
36 CRC	G																							1	
	S																								
	B																								
36 INA	G																							1	
	S	1																							
	B																								
36 IRN	G																						1	1	
	S																								
	B																								
44 BEL	G																							2	
	S												1												
	B																								
44 MEX	G																							2	
	S																								
	B			1																					
46 THA	G																							1	
	S																								
	B			1																					
46 MGL	G																							1	
	S																								
	B			1																					
46 PAK	G																							1	
	S																								
	B			1																					
46 GRE	G																						1	1	
	S																								
	B																								
46 PHI	G																							1	
	S																								
	B			1																					
46 COL	G																							1	
	S																								
	B			1																					
46 DJI	G																							1	
	S																								
	B																								
TOTAL	G	4	42	2	12	13	8	6	8	19	2	2	2	7	2	15	12	38	4	4	4	10	20	8	241
	S	43	2	12	12	9	6	8	1	13	1	2	7	2	15	12	38	4	4	2	10	20	8	234	
	B	4	43	2	24	12	9	6	8	1	17	2	2	14	2	14	13	39	4	4	2	10	20	8	264

Seoul '88 Facts and Figures

Les faits et les chiffres

Listing of the Competitors/Listes dies concurrents

Name Nom	Country Pays	Sport	Name Nom	Country Pays	Sport	Name Nom	Country Pays	Sport	Name Nom	Country Pays	Sport
A			Aebi, Regula	SUI	AT	Albaluchi, Ali	KUW	BO	Alvarez, Jose	MEX	SH
Aaltonen, Paivi	FIN	AR	Afghan, Ahmad	IRN	WR	Albentosa, Jose Manuel	ESP	AT	Alvarez, Jose Luis	ESP	TA
Aamir-Zafar	PAK	HO	Afzal, Muhammad	PAK	AT	Albert, Rick	CAN	HO	Alvarez, Rafael	ESP	SW
Aardenburg, Willemien	HOL	HO	Agada, Jude	NGR	FB	Albuquerque, Mabilio	POR	SW	Alves, Aloisio	BRA	FB
Abadjiev, Borislav	BUL	BO	Agenor, Ronald	HAI	TE	Alburez-Suarez, Eddy-Rolando	GUA	FB	Alvics, Gyula	HUN	BO
Abascal, Jose Manuel	ESP	AT	Agh, Norbert	HUN	SW	Alcaide, Osvaldo	PUR	YA	Alvis, Norm	USA	CY
Abbagnale, Agostino	ITA	RO	Agius, Joanna Jane	MLT	AR	Alcala, Maria	MEX	SW	Alvizuri, Alejandro	PER	SW
Abbagnale, Carmine	ITA	RO	Agostino, Pedro	POR	AT	Alcalde, Manuel	ESP	AT	Alwabran, Mohamed	KSA	TA
Abbagnale, Giuseppe	ITA	RO	Agosto, Andy	PUR	BO	Alchan, Andrei	URS	FE	Alwi, Rosman	MAL	CY
Abbas, Maher	LIB	AT	Agrikola, Georg	FRG	RO	Aldag, Peter	FRG	YA	Aly, Ramadan	EGY	WE
Abbot, James	USA	BA	Aguero, Roben Jose	ARG	FB	Aldaihani, Fayez	KUW	TA	Alyahiouh, Jamal	KUW	AT
Abdalla, Ahmed	EGY	SW	Aguiar, Anoumou	TOG	BO	Aldanondo, Javier	ESP	CY	Alyouhah, Marsouq	KUW	AT
Abdelhalim, Ashref	EGY	TT	Aguiar, Gonzalo	ESP	CY	Aldowaila, Jasem	KUW	AT	Amadi, Ferdinand	CAF	AT
Abdelhamed, Elhadi	LBA	CY	Aguila, Claudio S	ARG	RO	Alfardge, Peter	JAM	CY	Amado, Anthony	USA	WR
Abdellatif, Abdellatif	EGY	WR	Aguilar, Andreas	FRG	GY	Alegada, Samuel	PHI	WE	Amara, Henmedeh	MGL	WR
Abdenouz, Reda	ALG	AT	Aguilar, Domingo Omar	CHI	AT	Alejo, Blanca	DOM	TT	Amaral, Maria	BRA	SH
Abdi Doudoub, Guessod	DJI	AT	Aguilar, Natasha	CRC	SW	Aleksic, Miroslav	YUG	CA	Amarillas, Martin	MEX	BO
Abdo Sheikh, Saeedfaiz	YMD	AT	Aguirre, Jose Luis	ESP	RO	Alemany, Ivan	ESP	CY	Amarjargal, Tserendorj	MGL	BO
Abdouljaparov, Djamoludin	URS	CY	Ahmad, Bashir	PAK	AT	Alessandri, Fiona	AUS	SW	Amat, Jean-Pierre	FRA	SH
Abdoun, Alaaeldin	EGY	BB	Ahmed Saeed, Farook	YMD	AT	Alevizou, Maria	GRE	GY	Amaya, Marcos	COL	CY
Abduelkhir, Amr	EGY	BB	Ahmed, Abdalla	LBA	AT	Alexander, Edward	GBR	CY	Ambowode, Adolphe	CAF	AT
Abdul Hadi, Abdullatheef	MDV	AT	Ahmed, Hassan Kamal	IRQ	FB	Alexandersson, Camilla	SWE	YA	Ambrosione, Bartolo	ITA	ES
Abdul Majid	PAK	WR	Ahn, Byung-Keun	KOR	JU	Alexandre, Marc	FRA	JU	Ambrozic, Roman	YUG	RO
Abdul Wahab, Fahmi Ahmed	YAR	AT	Ahn, Jae-Hyung	KOR	TT	Alexandre, Marcelo	ARG	CY	Amer, Amin	EGY	SW
Abdul-Karim, Abdul-Karim	IRQ	FB	Ahokas, Juha	FIN	WR	Alexeev, Vadim	URS	SW	Amer, Mostafa	EGY	SW
Abdulla, Mohamed	UAE	SW	Airapetian, Sos	URS	HO	Alexiev, Roumen	BUL	RO	Amike, Henry	NGR	AT
Abdullah, Sadiq	NGR	TE	Aires, Mauro Gabriel	ARG	FB	Aleman, Ivan	SYR	WR	Amir, Eldad	ISR	YA
Abe, Tadashi	JPN	RO	Ait hocine, Makhlof	ALG	HB	Alfaro Moreno, Carlos-Alejandr	ARG	FB	Amir-Akhor, Iraj	IRN	CY
Abed, Benaissa	ALG	BO	Aizpors, Marion	FRG	SW	Alfredo, Frederio	BRA	JU	Amish, Ahmed Radhi	IRQ	FB
Abellan, Alfonso	ESP	AT	Ajilo, Jane	UGA	AT	Alger, Percival	PHI	FE	Amisi, Mobange	ZAI	CY
Aberg, Helena	SWE	SW	Ak, Ahmet	TUR	WR	Alger, Stephen	BER	TE	Amores, Juan	CRC	AT
Abicht, Silke	GDR	SW	Akabusi, Kriss	GBR	AT	Algrbi, Abdullah	YAR	WR	Amorim, Patricia	BRA	SW
Abio, Haythem	TUN	FB	Akaishi, Kosei	JPN	WR	Alhamar, Mohammad	KUW	FE	Amoros, Marta	ESP	SW
Abo-Awn, Natik H.	IRQ	FB	Akanmu, Iyabo	NGR	TT	Alhammad, Yousef	KUW	JU	Ampler, Uwe	GDR	CY
Aboobakur, Abdul razzak	MDV	AT	Akatsa, Peter	KEN	HO	Alharazi, Anwar	YAR	AT	Amritraj, Anand	IND	TE
Aboub, Sadoon M	IRQ	BO	Akerberg, Peter	SWE	FE	Alharshani, Faisal	KUW	FE	Amritraj, Vijay	IND	TE
Aboubacar, Inni	NIG	AT	Akerberg, Thomas	SWE	FE	Alhussein, Hafez	SYR	AT	Amundsen, Harald	NOR	CA
Aboud, Fathi	LBA	AT	Akhasamba, Joseph	KEN	BO	Ali, Abdul-Wahab	IRQ	TT	Amur, Hamad	OMA	AT
Abouelouad, Mohamed	EGY	MP	Akhremenko, Natalia	URS	AT	Ali, Yusuf	NGR	AT	An, Byung-Kyun	KOR	SH
Abraham, Attila	HUN	CA	Akhtar, Ayub	PAK	WR	Ali, Zeeshan	IND	TE	An, Dae-Hyun	KOR	WR
Abramova, Inna	URS	SW	Akiihuri, Douglas	KEN	AT	Alidad	AFG	WR	An,Woo-Hyok	KOR	CY
Abramovz, Natalia	URS	RO	Akiyama, Erika	JPN	GY	Alimondo, Thierry	FRA	SW	Anchondo, Jose	MEX	AR
Abrams, Colin	GUY	CY	Akogyiram, Eric	GHA	AT	Alizani, Abdallah	YAR	WR	Andersen, Anne-Marie	CAN	SW
Abrantes, Antonio	POR	AT	Akdmatsri, Ayewoubo	TOG	BO	Aljabrin, Adel	KSA	AR	Andersen, Erling	NOR	AT
Abrantes, Arnaldo	POR	AT	Akonay, Boay	TAN	AT	Alkemade, Guido	HOL	YA	Andersen, Georg	NOR	AT
Abrial, Franck	FRA	WR	Aksu, Semra	TUR	AT	Alkhudhur, Zeyad	KUW	AT	Andersen, Kjerstin	NOR	HB
Abshire, Brian	USA	AT	Akutsu, Kozo	JPN	AT	Alkindi, Alkindi	INA	FE	Andersen, Kunt	NOR	CA
Abt, Gudrun	FRG	AT	Al Alawiyat, Abdul Azeem	KSA	AT	Allakhverdiev, Maguiatdine	URS	WR	Anderson, Clovis	BRA	CY
Abu, Anthony	SLE	AT	Al Bishi, Mohamed	KSA	AT	Allan, Alistier	GBR	SH	Anderson, David	GBR	BO
Abudu, Juma	KEN	WE	Al Bulushi, Abdul Latif	OMA	SH	Allen, Monique	AUS	GY	Anderson, Derrick	GUM	JU
Abushekha, Ihsan	JOR	TA	Al Doseri, Abdullah	BRN	AT	Allievi, Vittorio	ITA	GY	Anderson, Gary	CAN	SW
Abuzamia, Ali	JOR	FE	Al Doseri, Ahmed	BRN	MP	Allison, Georse	GUY	BO	Anderson, Gary	NZL	CY
Acerenza, Claudia	URU	AT	Al Doseri, Ahmed	BRN	FE	Ally, Haji	TAN	BO	Anderson, Gordon	CAN	YA
Achik, Abdelhak	MAR	BO	Al Dossary, Yousef	KSA	AT	Almashmoum, Younes	KUW	FE	Anderson, Isaac	USA	WR
Achik, Mohamed	MAR	BO	Al Dousari, Hameed	KSA	AT	Almasri, Muneir	JOR	WR	Anderson, John	CAN	ES
Achouch, Mohamed	EGY	AT	Al Gafar, Ibrahim	KSA	TA	Almeida, Angelica	BRA	AT	Anderson, Katurah	CAN	AT
Achuo-bei, Assumpta	CMR	AT	Al Ghamdy, Abdalla	KSA	TA	Almeida, Paulo	BRA	BB	Anderson, Ross	NZL	SW
Acii, Oliver	UGA	AT	AlHashash, Waleed	BRN	TA	Almeland, Arne johan	NOR	CA	Anderson, Willie	USA	BB
Acioly, Ricardo	BRA	TE	Al Nagrany, Abdalla	KSA	TA	Almezzen, Yousef	KUW	AT	Andersson, Agneta	SWE	CA
Adam, Herman	MEX	AT	Al Zahrany, Salem	KSA	TA	Almohammad, Waleed	KUW	RO	Andersson, Allen	SWE	CY
Adam, Michael	AUT	SW	Al-Alawi, Mohamed Ali	OMA	AT	Almsouti, Mohamad	SYR	WR	Andersson, Bengt	SWE	CA
Adam, Mostafa	EGY	MP	Al-Barwani, Abdullah	OMA	BO	Almurdh, Nahedh	KUW	FE	Andersson, Joakim	SWE	SW
Adam, Shuaib	KEN	SH	Al-Bulushi, Khalfan Ali	OMA	AT	Almutairi, Husain	KUW	BO	Andersson, Lars	SWE	ES
Adama, Samba	MTN	WR	Al-Bulushi, Mansoor	OMA	AT	Almuwaiziri, Saud	KUW	BO	Andersson, Liselotte	SWE	AR
Adamczewski, Matthias	FRG	YA	Al-Habsi, Sulaiman	OMA	AT	Alnajadah, Adel	KUW	JU	Andersson, Michael	SWE	FB
Adamec, Lubos	TCH	SH	Al-Harithy, Handhal	OMA	BO	Alonco, Nilton	BRA	RO	Andersson, Sevn	SWE	FB
Adams, Lennox	VIM	AT	Al-Harhi, Matar	KSA	SH	Alonso, Ana Isabel	ESP	AT	Andonova, Lyudmila	BUL	AT
Adams, Neil	GBR	JU	Al-Kaab, Mohamed	QAT	YA	Alonso, Jose	ESP	AT	Andrade, Hernan	MEX	AT
Adams, Nelson	PUR	BO	Al-Khalidi, Abdullah	OMA	AT	Alotaibi, Nassar	KUW	TA	Andrade, Israel	BRA	BB
Adams, Phillip	AUS	SH	Al-Malki, Mohamed Amer	OMA	AT	Alotaibi, Sultan	KUW	SW	Andre, Soraia	BRA	JU
Adamson, Anthony	AUS	BA	Al-Owjan, Rashid	QAT	TA	Alqahtani, Hadi	KSA	AT	Andreae, Sally	GBR	RO
Adamson, Derek	JAM	AT	Al-Rawahi, Hamed Said	OMA	AT	Alrumaithi, Obaid	UAE	SW	Andreassen, Ole Andreas	NOR	RO
Adamu, Mamudu	NGR	JU	Al-Sameer, Awadh Shaban	OMA	AT	Alshammari, Hasan	KUW	SW	Andreev, Atanas	BUL	RO
Adan, Nenita	PHI	AT	Alabakov, Roumen	BUL	WR	Alshammari, Jadaan tarjam	QAT	SH	Andrei, Alessandro	ITA	AT
Adani, Abukar hasan	SOM	AT	Alabed, Ali	UAE	CY	Alshamsi, Abdullah	YAR	WR	Andrei, Vasile	ROM	WR
Addy, Mercy	GHA	AT	Alafrantti, Paivi	FIN	AT	Alshamy, Ahmad	SYR	WR	Andreu, Enrique	ESP	BB
Adegbusi, Adewale	NGR	BO	Alansari, Bassam	UAE	SW	Alsheeb, Abdullamohamed	QAT	AT	Andreu, Frankie	USA	CY
Aden, Jama Mohamud	SOM	AT	Alapurackal, Mercy Kuttan Math	IND	AT	Alsurrayei, Saqer	KUW	FE	Andrew, Skylet	GBR	TT
Adeniken, Olapade	NGR	AT	Alarcon, Agustin	ESP	RO	Altankhuyag, Nyamaa	MGL	BO	Andrews, Mark	CAN	SW
Adeshina, Ademola	NGR	FB	Alarcon, Bartolome	ESP	RO	Altansukh, Sodnomdar, Jaa	MGL	BO	Andric, Dragan	YUG	SW
Adeyanju, Isiaq	NGR	AT	Alarcon, Jorge	MEX	SW	Altantsetseg, Byambajav	MGL	SH	Andriev, Gheorghe	ROM	CA
Adeyemo, Fatai	NGR	TT	Alasmawi, Jarrah	KUW	SW	Altaqi, Majed	KUM	SW	Anduz, Reza	IRN	WR
Adilbish, Sanfidorj	MGL	SH	Alassane, Ousseni, Issa	BEN	AT	Altekruese, Charles	USA	RO	Ang, Peng siong	SIN	SW
Adler, Alan	BRA	YA	Alawadhi, Khaled	KUW	FE	Althoff, Ingeburg	ERG	RO	Angeles, Darwin	HON	BO
Adler, Daniel	BRA	YA	Alawi, karim M.	IRQ	FB	Altube, Miguel	ARG	HO	Angelucci, Monica	BRA	JU
Adlkofer, Katrin	FRG	YA	Alayon, Angel Noe	COL	CY	Altun, Ahmet	TUR	AT	Anger, Volker	GDR	WR
Adolfsson, Lars	SWE	JU	Alaywan, Mohamadamine	LIB	WE	Alubaha, Lucas	KEN	HO	Angers, Stephen	CAN	FE
Adou, Ali	DJI	YA	Albakheet, Waleed	KUW	AT	Alvarez Cervera, Luis	ESP	ES	Angotzi, Rita	ITA	AT
Adrian sofyana, Selvyana	INA	SH	Albalah, Mahmoud	SYR	WR	Alvarez Soto, Mario V	DOM	TT	Aniss Imova, Natalia	URS	HB
Adshead, Mark	GBR	JU	Albalah, Zouheir	SYR	WR	Alvarez, Javier	ESP	CA	Anitas, Herta	ROM	RO
Aduche, Gilbert Ojadi	NGR	WE									

Name Nom	Country Pays	Sport	Name Nom	Country Pays	Sport	Name Nom	Country Pays	Sport	Name Nom	Country Pays	Sport
Anjos, Henrique	POR	YA	Asinga, Tommy	SUR	AT	Bae, Mi-Jung	KOR	JU	Barrios, Arturo	MEX	AT
Ankamah, Alfred Addo	GHA	BO	Assuncao, Hugo	POR	JU	Baek, Jae-Woo	KOR	BA	Barros, Ana Lucia	USA	VB
Anohrieva, Galia	BUL	RO	Astafei, Galina	ROM	AT	Baer, Gottfried	AUT	TT	Barroso, Luis	POR	AT
Anok, Peter	SUD	BO	Astolfi, Luis	ESP	ES	Bagheri, Mansur	IRN	TA	Barroso, Manuel	POR	MP
Ansorena, Heber	URU	YA	Astwood, Glenn	BER	YA	Bagyula, Istvan	HUN	AT	Barrowman, Mike	USA	SW
Antakov, Vladimir	URS	HO	Atanassov, Atanas	BUL	WR	Bah, Alassane	GUI	AT	Barrs, Jay	USA	AR
Antibo, Salvatore	ITA	AT	Atanov, Igor	URS	HO	Bah, Doumbia-T	CIV	HB	Barsi, Laszlo	HUN	WE
Antman, Soren	SWE	BO	Atavin, Viatcheslav	URS	HB	Bahnert, Barrie	AUS	BA	Bartalfi, Krisztina	HUN	GY
Anton, Abel	ESP	AT	Ates, Harun	TUR	TA	Bahuau, Pascal	FRA	RO	Bartczak, Jolanta	POL	AT
Antonie, Peter	AUS	RO	Athanassiadis, Georgios	GRE	WR	Baik, Hyun-Man	KOR	BO	Bartek, Tomas	TCH	HB
Antonitsch, Alex	AUT	TE	Atiya, Fuad	YAR	WR	Baikauskaite, Lailoute	URS	AT	Bartels, Tineke	HOL	ES
Antonov, Iaroslav	URS	VB	Atiyeh, Dennis	SYR	WR	Balidon, Andrew	AUS	SW	Barth, Manfred	FRG	AR
Aoto, Shinji	JPN	AT	Atiyeh, Joseph	SYR	WR	Bailey, Angela	CAN	AT	Bartholomew, Jacinta	GRN	AT
Aouam, Fatima	MAR	AT	Atkin, Tracey	GBR	SW	Bailey, Shireen	GBR	AT	Bartlett, Anthony	GBR	FE
Aouita, Said	MAR	AT	Atkins, Gill	GBR	HO	Baitova, Svetlana	URS	GY	Bartlett, Terence	GBR	GY
Apaitchev, Alexandre	URS	AT	Atkins, Henriko	BAR	AT	Bajgar, Miroslav	TCH	HB	Bartolomeu Das, Abbao	ANG	JU
Apanasenko, Dmitri	URS	SW	Atkinson, Jeff	USA	AT	Bajkusa, Vesna	YUG	BB	Barton, Greg	USA	CA
Apanovitch, Alexandra	URS	CA	Atonio Inacio, Jose	ANG	JU	Bajool, Mohammedreza	IRN	CY	Basalusalu, Josateki	FIJ	JU
Apiafi, Grace	NGR	AT	Attallah, Alain	EGY	BB	Bakare, Airat	NGR	AT	Basbas, Azzedine	ALG	WE
Apostolov, Viktor	BUL	AT	Attolico, Cleonice	ITA	ES	Baker, Greg	USA	TA	Basic, Mirko	YUG	HB
Appel, Gaby	FRG	HO	Attye, Aly	SEN	JU	Baker, Nicholas	CAY	CY	Basik, Andrzej	POL	JU
Appelboom, Sidney	BEL	SW	Atwell, Shane	BAR	YA	Baker, Simon	AUS	AT	Baskin, Tracy	USA	AT
Appelgren, Mikael	SWE	TT	Au, Woon Yiu	HKG	JU	Baker, Victoria	USA	RO	Basnyat, Krisnaba Hadur	NEP	AT
Appiah, Martha	GHA	AT	Audain, Anne	NZL	AT	Baker, Wendy	CAN	HO	Bassett-Seguso, Carling	CAN	TE
Aptsiaouri, Vladimir	URS	FE	Auer, Georg-Josef	AUT	WR	Bakker, Robbert	HOL	RO	Bassinski, Igor	URS	SH
Aquino, Mariano	GUM	JU	Aufenanger, Winfried	FRG	AT	Bakker, Steven	HOL	YA	Basson, Beatrice	FRA	CA
Aquino-Sandoval, Oscar-Alfredo	GUA	CY	Augee, Myrtle	GBR	AT	Bakos, Gyorgy	HUN	AT	Bastet, Evert	CAN	YA
Aracil, Valentina	ARG	SW	Augmon, Stacey	USA	BB	Bakosi, Bela	HUN	AT	Bastos, Rodrigo	BRA	SH
Araki, Kumi	JPN	AT	Augustin, Jean Marc	FRA	BO	Baladadalaiah, Subramani	IND	HO	Basuki, Rahayu n	INA	TE
Aranda, Humberto	CRC	BO	Aupretre, Dominique	FRA	SH	Balan, Anisoara	ROM	RO	Batch, Colin	AUS	HO
Arango, Oscar	COL	FE	Austin, Lajabu	MAW	CY	Balan, Doina Iilian	ROM	RO	Batchelor, Stephen	GBR	HO
Arantes, Marcos	BRA	RO	Autonietti, Francine	SUI	SH	Balazsfi, Zoltan	HUN	WE	Bateman, Philip	GBR	CY
Arapovic, Franjo	YUG	BB	Autric, Natalia	ESP	SW	Balci, Erhan	TUR	WR	Baterdene, Badmaniambu	MGL	JU
Arason, Kristjan	ISL	HB	Auzeil, Nadine	FRA	AT	Bald, Kathy	CAN	SW	Bates, Jeremy	GBR	TE
Araujo, Carolina	MOZ	SW	Avaavau, Avaavau	SAM	BO	Baldacci, Antonio	ITA	RO	Batliner, Thomas	LIE	ES
Araujo, Jose	BRA	FB	Avci, Izzet	TUR	AR	Baldato, Fabio	ITA	CY	Batmaz, Ergun	TUR	WE
Arba, Rodica	ROM	RO	Avdeenko, Guennadi	URS	AT	Baldauf, Luke	ISV	YA	Batorfi, Csilla	HUN	TT
Arbo, Veronica	ARG	CA	Avdeenko, Liodmila	URS	AT	Baldessarini, Sylvia	AUT	SH	Batres-Morales, Jaime-Antonio	GUA	FB
Arbon, Jeffrey	GBR	SW	Avdeev, Anatoli	URS	MP	Baldisserrri, Pia Lucia	ITA	SH	Battaglia, Philippe	MON	YA
Arbutina, Andjelija	YUG	BB	Avek, Polonie D	NGU	AT	Baldus, Brita	GDR	SW	Batten, Malcolm	AUS	RO
Arcega, Fernando	ESP	BB	Avelar, Francisco	ESA	BO	Baljinniam, Odvog	MGL	JU	Battistelli, Stefano	ITA	SW
Arendt, Helga	FRG	AT	Averaimo, Gianni	ITA	SW	Balk, Wulfe	CAN	FE	Battul, Haltma	MGL	WR
Arendt, Nancy	LUX	SW	Averianova, Lidia	URS	RO	Ballantyne, Orde	VIN	AT	Batzill, Albert	FRG	YA
Arens, Frank	BEL	SH	Avila, Regis	BRA	FE	Ballantyne, Sara	CAN	HO	Bau, Sabine	FRG	FE
Arias, Juan Carlos	COL	CY	Avraam, Andri	CYP	AT	Ballard, Brian	USA	SH	Baudin, Belinda	USA	ES
Ariu, Likou	SAM	BO	Avramenko, Guennadi	URS	SH	Ballard, Robert	AUS	AT	Bauduin, Anne Marie	FRA	GY
Arjannikova, Lioudmila	URS	AR	Awa, Zomou	CIV	HB	Ballester, Jose luis	ESP	SW	Bauer, Hermann	AUT	RO
Arlt, Maike	GDR	VB	Awooda, Mansor	YAR	JU	Balogh, Laszlo	HUN	SH	Bauer, Seth	USA	RO
Armah, Grace	GHA	AT	Awosina, Olusola	NGR	WE	Balov, Stoyan	BUL	WR	Baumann, Dieter	FRG	AT
Armasescu, Mihaela	ROM	RO	Axpe, Rafael	ESP	SH	Balthasar, Ramona	GDR	RO	Baumann, Matthias	FRG	ES
Armengol, Jaime	ESP	HO	Ayala, Aldo	ARG	HO	Baltrusch, Frank	GDR	SW	Baumer, Susanne	AUS	SW
Armentero, Marie-Therese	SUI	SW	Ayala, Nuria	ESP	SW	Balwinder Singh	IND	HO	Baumgartner, Bruce	USA	WR
Armit, Leith	NZL	YA	Ayan, Alpaslan	TUR	JU	Bamber, Paul	ZIM	AR	Baumruk, Petr	TCH	HB
Armstrong, Desmond	USA	FB	Ayed, Lotfi	SWE	BO	Ban, Bernard	YUG	WR	Bauro, Tommy	SOL	BO
Armstrong, Duncan	AUS	SW	Ayesu, Peter	MAW	BO	Banco, Daniel	TCH	WE	Bausback, Kurt	USA	RO
Arnaud, Catherine	FRA	JU	Ayokouin, Grah	CIV	CA	Bandach, Leszek	POL	FE	Bausch, Ralf	GDR	HB
Arnberg, Goran	SWE	FB	Ayres, Robin	GBR	CA	Bandeira, Jose	POR	FE	Bautista, Ana	ESP	GY
Arndt, Bernardo	BRA	YA	Azarachvili, Maia	URS	AT	Bang, Hyun-Joo	KOR	SH	Bavelas, Anastassios	GRE	TE
Arndt, Michael	FRG	TA	Azcarraga, Jaime	MEX	ES	Bang, Sin-Hye	KOR	AT	Bawuah, Veronica	GHA	AT
Arneborg, Matthew	IVB	YA	Azevedo, Jorge	BRA	AR	Banian, Washington	NGU	BO	Bayes, Sharon	CAN	HO
Arneborg, Michael	IVB	YA	Azevedo, Luiz	BRA	BB	Banjanac, Vladimir	YUG	RO	Baylis, William	USA	YA
Arnold, Graham	AUS	FB	Azevedo, Wanderley	BRA	CY	Bank, Jesper	DEN	YA	Baylon, John	PHI	JU
Arnou, Pascal	FRA	WE	Azofra, Emilio	ESP	TA	Bankaitis Davis, Bunki	USA	CY	Bazanov, Alexandre	URS	SW
Arnould, Isabelle	BEL	SW	Azuma, Koichi	JPN	CY	Banko, Wabanko	ZAI	BO	Bazanov, Marina	URS	HB
Arnould, Jean-Marie	BEL	SW	Azuma, Matsuo	JPN	FE	Bankole, Yom	NGR	TT	Bazin, Marie Jose	FRA	AR
Aronis, Andonios	GRE	SW	Azzeb, Omar	ALG	HB	Bankovski, Dmitri	URS	CA	Bazon, Adriana	ROM	RO
Arop, Justin	UGA	AT	Azzizi, Yasmina	ALG	AT	Banks, Graeme	AUS	SW	Bazynski, Michael	FRG	JU
Arpin, Paul	FRA	AT				Banks, Kelcie	USA	BO	Beard, Elizabeth	USA	RO
Arques, Javier	ESP	AT				Banks, Wendy	GBR	HO	Beashel, Colin	AUS	YA
Arredondo, Rojelio	USA	SH				Banks, Willie	USA	AT	Beatson, Maurice	NZL	ES
Arroyo, Angel	PUR	WE	Ba, El Hadj Dia	SEN	AT	Banos, Jean-Marie	CAN	FE	Beauchamp, Glenn	CAN	JU
Arroyo, Harold	PUR	BO	Baar, Roland	FRG	RO	Banos, Jean-Paul	CAN	FE	Beaugeant, Chantal	FRA	AT
Arroyo, Hector A.	PUR	BO	Babacan, Halit Haluk	TUR	YA	Baouab, Modher	TUN	FB	Beaugendre, Madely	FRA	AT
Arsamakov, Israil	URS	WE	Babapur, Naser	IRN	AT	Barabino, Anna	ITA	YA	Beaumier, Carl	CAN	CA
Artemiev, Alexandre	URS	BO	Babii, Sorin	ROM	SH	Barahona, Pablo	HON	SW	Beaumont, Peter	GBR	RO
Artemov, Vladimir	URS	GY	Bablova, Marina	URS	SW	Baraniak, Anton	TCH	WE	Beca, Ramon	ESP	ES
Artemova, Matalia	URS	AT	Bacchiaga, Anna	ITA	YA	Barbach, Ahmed	MAR	JU	Becanovic, Dragomir	YUG	JU
Asada, Masako	JPN	SW	Baccouche, Fathi	TUN	AT	Barbaric, Ivica	YUG	FB	Becerra, Bailon	BOL	CY
Asai, Eriko	JPN	AT	Bachkatov, Iouri	URS	SW	Barber, Paul	GBR	HO	Bechara, Khodr	LIB	WR
Asano, Kevin	USA	JU	Bachmayer, Werner	AUT	CA	Barberie-Bert	USA	BA	Becker, Felix	FRG	FE
Asano, Ryo	JPN	YA	Backer, Harold	CAN	RO	Barbosa, Jose	BRA	AT	Beckford, Pat	GBR	AT
Asconegui, Jose	URU	CY	Bacska, Imre	HUN	BO	Barcia, Francisco	ESP	WR	Beckmann, Mike	FRG	GY
Ashby, David	FIJ	YA	Bada, Marie Felicite	BEN	AT	Barda, Michal	TCH	HB	Becue, Brigitte	BEL	SW
Ashcroft, Michael	CAN	SH	Bade, Jonas	NGU	BO	Bardgett, Edward	BER	YA	Bedard, David	CAN	SW
Ashcroft, Schulze, Christina	CAN	SH	Bader, Curt	USA	CA	Barel, Olessia	URS	BB	Bednarek, Jacek	POL	AT
Asher, Simon	AUS	SW	Badinelli, Dario	ITA	AT	Barnes, Jennifer Kirsten	CAN	RO	Bednarik, Miloslav	TCH	SH
Ashford, Evelyn	USA	AT	Badiou, Franck	FRA	SH	Barnes, Randy	USA	AT	Beerbaum, Ludger	FRG	ES
Ashok kumar	IND	HO	Badow, Rashed	BRN	TA	Barr, Beth	USA	SW	Begeo, Hector	PHI	AT
Ashurst, Andrew	GBR	AT	Badri, Abdalla	LBA	CY	Barr, Oslen	GUY	AT	Beghouache, Benali	ALG	HB
Asif, Ismail	MDV	AT	Bae, Eun-Mi	KOR	GY	Barreto, Marcos	MEX	AT	Beglin, Elizabeth	USA	HO

Seoul '88 Facts and Figures

Les faits et les chiffres

Listing of the Competitors/Listes dies concurrents

Name Nom	Country Pays	Sport	Name Nom	Country Pays	Sport	Name Nom	Country Pays	Sport	Name Nom	Country Pays	Sport
Behl, Peter	FRG	WR	Bermond Des Ambrois, Andrea	ITA	FE	Blas, Ricardo	GUM	JU	Borgmann, Ingo	FRG	SW
Behling, Guido	GDR	CA	Bermudez, Jose Manuel	ESP	RO	Blaszak, Genowefa	POL	AT	Borislavski, Alexei	URS	SW
Behm, Andreas	GDR	WE	Bermudez, Martin	MEX	AT	Blaszka, Henryk	POL	YA	Borkai, Zsolt	HUN	GY
Behmer, Anke	GDR	AT	Bernal, Maria-Paula	COL	ES	Blazek, Pavol	TCH	AT	Borner, Raymond	AUS	BB
Behr, Matthias	FRG	FE	Bernardi, Lorenzo	ITA	VB	Ble, Clementinea	CIV	HB	Borodinov, Serguei	URS	YA
Behrendt, Holger	GDR	GY	Berndt, Jens-Peter	FRG	SW	Bleyer, Pedro Rodolfo	BOL	FE	Borodiouk, Alexandre	URS	FB
Behrendt, Jutta	GDR	RO	Bernstein, Evan	ISR	WR	Bliesener, Hans-Joerg	GDR	CA	Borrmann, Elmar	FRG	FE
Behrendt, Kerstin	GDR	AT	Berrisford, Simon	GBR	RO	Bliss, Brian	USA	FB	Bortnitski, Igor	URS	RO
Beinhauer, Radek	TCH	SW	Berry, Earl	NZL	YA	Blochwitz, Steffen	GDR	CY	Bortolami, Gianluca	ITA	CY
Bejenaru, Nicolae	ROM	GY	Bertenyi, Erika	HUN	RO	Bloecher, Stefan	FRG	HO	Bortolozzi, Francesca	ITA	FE
Beks, Anthony	NZL	SW	Berthelot, Nicolas	FRA	SH	Bloeker, Herbert	FRG	ES	Bos, Frank	HOL	BA
Bel, Laurent	FRA	FE	Berthet, Vincent	FRA	ES	Blondel, Alain	FRA	AT	Boscarino, Lisa	PUR	JU
Belanger, Renee	CAN	AT	Berti, Gian Nicola	SMR	SH	Bloom, Gilad	ISR	TE	Boscatto, Alicia Maria	ARG	SW
Belben, Jason	GBR	YA	Bertimon, Charlus	FRA	AT	Blower, Maria	GBR	CY	Boskamp, Andre	HOL	CY
Belbin, Tracey	AUS	HO	Bertone, Oscar	ITA	SW	Bluhm, Kay	GDR	CA	Boss, Edith	SUI	SW
Belchi, Nuria	ESP	GY	Berube, Michelle	USA	GY	Blumenbeg, Bettina	FRG	HO	Botev, Pavel	BUL	JU
Belcourt, Michel	CAN	CY	Besselink, Paul	HOL	FE	Boardman, Christopher	GBR	CY	Botev, Stefan	BUL	WE
Belevskaia, Elena	URS	AT	Bessi, Eric-louis	MON	JU	Boarin, Silvio	ITA	CY	Botowamungu, Biko	AUT	BO
Belisle, Polin	BIZ	AT	Bessi, Gilbert	MON	AT	Boateng, Nelson	GHA	AT	Bott, Markus	FRG	BO
Belizaire, Marcos	PAN	AT	Bessy, Pascal	FRA	SH	Bobkin, Lome	CAN	GY	Bottini, Alberto	SUI	SW
Belkessam, Ahmed	ALG	AT	Best, Greg	USA	ES	Boccaro, Philippe	FRA	CA	Bouallouche, Kacem	MAR	WR
Bell, Diane	GBR	JU	Best, Greg	USA	ES	Bodenmann, Ueli	SUI	RO	Bouanik, Mahmoud	ALG	HB
Bell, Earl	USA	AT	Bestall, John	AUS	HO	Bodenmuller, Klaus	AUT	AT	Bouchabou, Oarda	ALG	TE
Bella, Richard-Felicite	CAF	BB	Bettin, Joel	FRA	CA	Bodi, Jeno	HUN	WR	Bouchekriou, Salah	ALG	HB
Belle, Maik	GDR	GY	Beu, Monika	GDR	VB	Bodin, Kerstin	SWE	SH	Boucher, Karine	FRA	GY
Bellingham, Norman	USA	CA	Beudet, Bruno	FRA	WR	Bodo, Zoltan	HUN	SH	Boucher, Renaud	FRA	SW
Bellini, Eduardo	ESP	YA	Beumer, Marcel	HOL	CY	Bodor, Mihly-Richard	HUN	SW	Boucherit, Pascal	FRA	CA
Bello, Angel	ARG	AR	Beurskens, Carolina	HOL	AT	Body, Pascal	FRA	RO	Bouchonneau-Oppliger, Martine	SUI	AT
Bellone, Stefano	ITA	FE	Beutler, Jacek	POL	JU	Bodyk, Jacek	POL	CY	Boudantsev, Victor	URS	YA
Bellucci, Sandro	ITA	AT	Beutler, Rolf	SUI	SH	Boegman, Nicole	AUS	AT	Boudouani, Laurent	FRA	BO
Belly, Toby	SUD	BO	Bewley, Helen	GBR	SW	Boehm, Georg	FRG	TT	Boudrie, Ronald	HOL	VB
Belmonte, Ricardo	BOL	JU	Beyer, Udo	GDR	AT	Boehm, Thomas	AUT	SW	Bouemba, Serge	GAB	BO
Beloglazov, Serguei	URS	WR	Beyermann, Ina	FRG	SW	Boernike, Susanne	GDR	SW	Bouet, Arnaud	FRA	SW
Belostennyi, Alexandre	URS	BB	Bezault, Laurent	FRA	CY	Boersma, Jan D.	AHO	YA	Bouhalissa, Abdelhak	ALG	HB
Beltrami, Ivan	ITA	CY	Bezci, Sakir	TUR	TA	Bogaerts, Jean	BEL	SH	Bouhalla, Mohamed	ALG	AT
Beltre Herrera, Jesus	DOM	BO	Bezmalinovic, Mislav	YUG	SW	Bogaerts, Karina	BEL	TT	Boukaka, Gustave	CGO	AT
Bemou, Jerd-Didace	CGO	AT	Bhatta, Dambardut, Ta	NEP	BO	Bogarín Arzamendia, Alfredo Ba	PAR	FE	Boukatine, Mikhail	URS	HO
Ben Abdallah, Abdalaziz	TUN	VB	Bhaura, Dulbir	GBR	HO	Bogason, Eggert	ISL	AT	Boukhalov, Nikolai	BUL	CA
Ben Alssa, Feiza	TUN	TT	Bhujel, Jhapatsingh	NEP	BO	Bogatcheva, Ioulia	URS	SW	Boukrouh, Mounir	FRA	TA
Ben Amara, Faycal	TUN	VB	Bhushan, Insook	USA	TT	Bogate, Teeka	NEP	AT	Boulatova, Flioura	URS	TT
Ben Amira, Hichem	TUN	VB	Bialkowska, Eliza	POL	GY	Boggio, Alberto-Osvaldo	ARG	FB	Boulmerka, Hassiba	ALG	AT
Ben Messaoud, Abderrazak	TUN	VB	Bickford, Bruce	USA	AT	Bogie, John	KEN	JU	Boundouris, Anastassios	GRE	YA
Ben Neji, Ali	TUN	FB	Bidei, Jackson	NGR	WR	Bogs, Steffen	GDR	RO	Boundouris, Andonios	GRE	YA
Ben Slimane, Lotfi	TUN	VB	Bidolach, Dorota	POL	SH	Boguinskaia, Svetlana	URS	GY	Bouraga, Svetlana	URS	AT
Ben Taiof, Sofiane	TUN	TT	Bigelow, Steve	USA	SW	Bohac, Jan	TCH	CA	Bourdin, Thierry	FRA	WR
Ben Yahia, Khaled	TUN	FB	Bilkova, Dagmar	TCH	SH	Bohay, Gary	CAN	WR	Bourdraili, Brahim	ALG	HB
Ben-Haim, Yehuda	ISR	BO	Billimoria, Cawas	IND	JU	Bohrer, Thomas	USA	RO	Bourdy, Hubert	FRA	ES
Benedict Thompson, Inga	USA	CY	Billingham, Robert	USA	YA	Boileau, Arthur	CAN	AT	Bouriakina, Olga	URS	BB
Benelli, Andrea	ITA	SH	Bilodeau, Caitlin	USA	FE	Bojaryn, Virginie	FRA	SW	Bourne, Grayson	GBR	CA
Benes, Andrew	USA	BA	Bilozertchev, Dmitri	URS	GY	Bojilov, Petar	BUL	CA	Boutsev, Mikhail	URS	FE
Bengochea, Veronica	ARG	HO	Bily, Laurence	FRA	AT	Bojsen-Moller, Jorgen	DEN	YA	Bourumeau, Martine	FRA	RO
Bengtsson, Birgitta	SWE	YA	Binabid, Mohammed	UAE	SW	Bokfi, Janos	HUN	WE	Bousarsar, Hedi	TUN	VB
Bengtsson, Per-Inge	SWE	CA	Bindels, Hubert	BEL	WR	Bolang, Virna, Shinta	INA	TA	Bousarsar, Rachid	TUN	VB
Bengtsson, Ulf	SWE	RO	Binder, Christian	AUT	YA	Bolduc, David	CAN	WE	Bousnina, Noureddine	TUN	FB
Benitez, Elena	ESP	TA	Binfield, Gary	GBR	SW	Bole, Maloni	FIJ	AT	Bousquet, Laurent	FRA	ES
Benmeghsbula, Abdeslam	ALG	HB	Biniakounou, Armand	CGO	AT	Bolhuis, Marjolein	HOL	HO	Boussebt, Mourad	ALG	HB
Benne, Edwin	HOL	VB	Binns, Steve	GBR	AT	Bolivar, Marcelino	VEN	BO	Bout, Venea Mine	URS	RO
Bennett, Brian	USA	HB	Biondi, Matthew	USA	SW	Boiling, Julian	SRI	SW	Boutaib, Mly. Ibrahim	MAR	AT
Bennett, Todd	GBR	AT	Birajdar, Shahuraj	IND	BO	Bommer, Rudi	FRG	FB	Boutouzova, Natalia	URS	AR
Bennie Fafale, Benjamin	SOL	WE	Birch, Angela	FIJ	SW	Bomprezzi, Roberto	ITA	MP	Bouvier, Eric	FRA	VB
Bennie, Andrew	NZL	ES	Birch, Samuel	CGO	AT	Bonanomi, Roberta	ITA	CY	Bouzou, Joel	FRA	MP
Benninga, Carina	HOL	HO	Bird, Andrew	NZL	RO	Bonapart, Ivette	SUR	AT	Bove lander, Floris Jan	HOL	HO
Benninga, Marc	HOL	HO	Bird, Robert Ian	CAN	HO	Bonatou, Jean-Paul	CMR	BO	Bowe, Riddick	USA	BO
Bensley, Todd	USA	SH	Biriukov, Jose	ESP	BB	Bonca, Valter	YUG	CY	Bower, Carol	USA	RO
Benzine, Sebti	ALG	CY	Birmingham, Warren	AUS	HO	Bondarenko, Olga	URS	AT	Bowes, Sharon	CAN	SH
Bera, Richard Sam	INA	SW	Birnbaum, Axel	AUT	FE	Bondev, Emil	BUL	RO	Bowker, Deborah	CAN	AT
Berberova, Lalka	BUL	RO	Biro, Imre	HUN	HB	Bonev, Deyan	BUL	CA	Bowman, Deborah	AUS	HO
Berezcky, Sandor	HUN	SH	Biro, Laszlo	HUN	WR	Bonfim, Jailto	BRA	AT	Boxell, Keith	GBR	WE
Berendiouga, Victor	URS	SW	Birocheau, Patrick	FRA	TT	Bonga, Daniel	SUI	YA	Boyadjian, Bruno	FRA	SW
Berenstein, Guno	HOL	JU	Bishop, Naomi	GBR	SW	Bonga, Jan	SUI	YA	Boyce, Trudy	NZL	ES
Beres, Laszlo	USA	MP	Bisiach, Nadia	AUS	TT	Bonilla, Pedro Nel	COL	CY	Boyd, Kevin	GBR	SW
Bergdahl, Johan	SWE	FE	Bistuer, Coral	ESP	TA	Bonneau, Bernard	FRA	YA	Boye, Cheikh H T	SEN	AT
Berge, Sophie	FRA	YA	Biva, Karin	BEL	SH	Bonner, Alison	GBR	RO	Boyer, Gregory V.	USA	SW
Berger, Andreas	AUT	AT	Bizioli, Antonella	ITA	AT	Bonnet, Françoise	FRA	AT	Boyle, Janet	GBR	AT
Berger, Ilana	ISR	TE	Bjerrendal, Gert	SWE	AR	Bonnet, Jorge	PUR	JU	Boza, Francisco	PER	SH
Bergeson, James H.	USA	SW	Bjerrendal, Goran	SWE	AR	Bonomi, Beniamino	ITA	CA	Bozinoski, Vlado	AUS	FB
Berghmans, Ingrid	BEL	JU	Bjonness, Lars	NOR	RO	Bontempi, Fabrizio	ITA	CY	Bracalente, Diane	USA	HO
Berglund, Marianne	SWE	CY	Bjorkum, Erik	NOR	YA	Bontje, Ellen	HOL	ES	Bracci, Marco	ITA	VB
Bergman, Christoph	BRA	YA	Bjorne, Hakan	SWE	VB	Boo, Sun-Hee	KOR	SH	Bracero, Albert	PUR	BA
Bergman, John	USA	WE	Blach, Wieslaw	POL	JU	Boonrat, Seksarn	THA	AT	Bracero, Jorge	PUR	SH
Bergmann, Elisabeth	AUT	GY	Black, Lisa	GBR	GY	Boor, Boris	AUT	ES	Bradley, Elizabeth	USA	RO
Bergmann, Sigurdur	ISL	JU	Blacuman, Carol	BER	ES	Borabota Epacua, Secundino	GEQ	AT	Bradshaw, Mark Daniel	USA	SW
Bergmann, Wolfgang	FRG	AT	Blad, Grazyna	POL	RO	Borchardt, Ruediger	GDR	HB	Bradstock, Roald	GBR	AT
Bergstrom, Jerri	SWE	FE	Bladas, Jose	ESP	SH	Borchert, Katrin	GDR	CA	Bradtke, Mark	AUS	BB
Berkeley, Mary	GBR	AT	Blagg, Paul	GBR	AT	Bordas, Jozsef	HUN	HB	Braghini, Luigi	FRA	CA
Berkhout, Darcel	CAN	RO	Blain, Philippe	FRA	VB	Bordeau, Christophe	FRA	SW	Brahm, Terry	USA	AT
Berkoff, David	USA	SW	Blake, Arthur	USA	AT	Bordin, Gelindo	ITA	AT	Brahmi, Azzeddine	ALG	AT
Berkova, Eva	TCH	BB	Blake, Christopher	AUS	AR	Borella, Andrea	ITA	FE	Braimoh, Liasu	NGR	BO
Berland, Bob	USA	JU	Blake, Kevin	NZL	WE	Borges, Rui	POR	SW	Brain, Stewart	AUS	JU
Bermel, Peter	FRG	SW	Blange, Peter	HOL	VB	Borglund, Peter	SWE	AT	Bramall, Ian	CAN	FE

Seoul '88 Facts and Figures

Les faits et les chiffres

Listing of the Competitors/Listes dies concurrents

Name Nom	Country Pays	Sport	Name Nom	Country Pays	Sport	Name Nom	Country Pays	Sport	Name Nom	Country Pays	Sport
Chalmers, Christopher	CAN	sw	Chiang, Tai-Chuan	TPE	BA	Chtchennikov, Mikhail	URS	AT	Colombo, Angelo	ITA	FB
Chalupa, Vaclav	TCH	RO	Chiaparro, Luis	URU	YA	Chterev, Simeon	BUL	WR	Colombo, Cecilia	ARG	HO
Chambeshi, Beston	ZAM	FB	Chiappa, Imelda	ITA	CY	Chuang, Tang fa	TPE	MP	Colonia, Gregorio	PHI	WE
Chambordon, Luc	SUI	YA	Chibani, Riad	ALG	JU	Chubaty, Jack	CAN	CA	Colorado, Rosa	ESP	AT
Chan, Chi Ming	HKG	TT	Chichirina, Elena	URS	SH	Chukanov, Viatcheslav	URS	ES	Colovic, Slobodanka	YUG	AT
Chan, Joseph	SIN	YA	Chichkine, Vladimir	URS	AT	Chun, Byung-Kook	KOR	WE	Coly, Lansana	SEN	JU
Chan, Kai Sang	HKG	FE	Chih, Chin-Long	TPE	TT	Chun, Byung-Kwan	KOR	WE	Comas, Jorge Alberto	ARG	FB
Chan, Siu Yuk	HKG	AR	Chih, Chin-Shui	TPE	TT	Chun, In-Sik	KOR	CA	Compaan, Jos	HOL	RO
Chanavazov, Nourmagomed	URS	BO	Chihara, Seiji	JPN	RO	Chun, In-Soo	KOR	AR	Con Cepcion, Lee Patrick	PHI	SW
Chanderasekaran, Raghavan	IND	WE	Chikabala, Webster	ZAM	FB	Chun, Jin-Chul	KOR	BO	Con Cepcion, Rene	PHI	SW
Chang, Chao-Chun	TPE	GY	Chikusa, Hisayo	JPN	SH	Chung, Boo-Jin	KOR	HO	Conde, Marcelo	BRA	YA
Chang, Eun-Jung	KOR	HO	Chikwanda, Justin	ZAM	BO	Chung, Boo-Young	KOR	RO	Cong, Xuedi	CHN	BB
Chang, Fen-Hwa	TPE	AT	Childerley, Stuart	GBR	YA	Chung, Eun-Kyung	KOR	HO	Cong, Yuzhen	CHN	AT
Chang, Ho-Ick	KOR	BA	Chillida, Miguel	ESP	SW	Chung, Hae-Won	KOR	FB	Conn, Michelle	CAN	HO
Chang, Hsiu-Yu	TPE	TT	Chilova, Irina	URS	SH	Chung, In-Kyo	KOR	RO	Connell, Craig	NZL	CY
Chang, Hui-Chien	TPE	SW	Chimwaza, Dyton	MAW	CY	Chung, Jae-Won	KOR	RO	Connell, Grant	CAN	TE
Chang, Jae-Keun	KOR	AT	Chin, Chee Min	MAL	SH	Chung, Jum-Sik	KOR	CY	Connor, David	AUS	YA
Chang, Jin-Young	KOR	GY	Chin, Chiu-Yueh	TPE	AR	Chung, Kook-Hyun	KOR	TA	Connor, Peter	IRL	CA
Chang, Myung-Hee	KOR	RO	Chin, Yu-Fang	TPE	TA	Chung, Kwang-Soo	KOR	RO	Conover, Mark	USA	AT
Chang, Myung-Sam	KOR	TA	Chinyadza, Duke	ZIM	BO	Chung, Kye-Suk	KOR	HO	Conover, Sheila	USA	CA
Chang, Qing	CHN	SW	Chipalo, Jonathan	ZAM	AT	Chung, Lae-Jin	KOR	CY	Consiglio, Douglas	CAN	AT
Chang, Shun-Chien	TPE	WE	Chisala, Dimus	ZAM	BO	Chung, Mi	KOR	CA	Constantinidis, Christos	GRE	WE
Chang, Si-Young	KOR	SW	Chisenga, Thomas	ZAM	BO	Chung, Mi-Ja	KOR	AT	Conte, Hugo Nestor	ARG	VB
Chang, Young-Chul	KOR	CA	Chitalu, James	ZAM	FB	Chung, Mi-Kyung	KOR	BB	Conti, Giovanni	SMR	YA
Chang, Yun-Chang	KOR	VB	Chitty, Zal	SRI	SH	Chung, Pii-Hwa	KOR	AT	Convery, Aileen	IRL	SW
Chanmugam, Dipika	SRI	SW	Chiu, Heng-An	TPE	JU	Chung, Sang-Hyun	KOR	HO	Conway, Hollis	USA	AT
Chansa, Wisdom mumba	ZAM	FB	Chiu, Ping-Kun	TPE	AR	Chung, Sun-Young	KOR	JU	Cook, Julie	GBR	HO
Chantanuhong, Sasithon	THA	AT	Chiu, Yuh-Chuan	TPE	WE	Chung, Yong-Hwan	KOR	FB	Cooke, Alan	GBR	TT
Chanthavanich, Somchai	THA	SH	Chkourikhine, Vladimir	URS	VB	Chung, Yung-Chi	TPE	WE	Cooman, Nelli	HOL	AT
Chapacu, Hugor	PAR	TE	Chkournova, Olga	URS	VB	Chute, Jason	FIJ	SW	Cooper, Andrew	AUS	RO
Chaparro, Fernando J	ARG	CA	Chmara, Miroslaw	POL	AT	Chwialkowski, Robert	POL	CA	Cooper, Bradley	BAH	AT
Chaplin, Andrea	AUS	FE	Chmielewski, Wieslaw	POL	MP	Chylak, Dorota	POL	SW	Cooper, Brent	NZL	JU
Chaplin, Ricky	GBR	WE	Cho, Byung-Deuk	KOR	FB	Cianchini, Elliot	PUR	BA	Cooper, Cynthia	USA	BB
Charadia, Andres	ARG	AT	Cho, Duk-Haeng	KOR	GY	Ciernik, Milos	TCH	WE	Cooper, Malcolm	GBR	SH
Charlesworth, Richard	AUS	HO	Cho, Hee-Jae	KOR	FE	Ciesielczyk, Waldemar	POL	FE	Cooper, Penney	CAN	HO
Charlton, Nancy	CAN	HO	Cho, Hyun-Wook	KOR	AT	Cieslakowski, Slawomir	POL	RO	Cooper, Sarah	GBR	SH
Charonov, Evgueni	URS	SW	Cho, Jin-Saeng	KOR	AT	Ciharean, Traian loach	ROM	WE	Cooper, Stephen	GBR	WR
Charovarov, Konstantine	URS	HB	Cho, Ki-Hyang	KOR	HO	Cioni, Daniele	ITA	SH	Copeland, James	USA	CY
Chartrand, Celine	CAN	AT	Cho, Kye-Yun	KOR	BA	Cipressa, Andrea	ITA	FE	Corbet, Jennifer	USA	RO
Chartrand, Philippe	CAN	GY	Cho, Min-Kook	KOR	FB	Cirillo, Gustavo G.	ARG	CA	Cordero, Domingo	PUR	AT
Chase, Roderick	BAR	CY	Cho, Min-Sun	KOR	JU	Cittar, Franco	ITA	YA	Cordes, Tom	HOL	CY
Chauque, Gorgina	MOZ	SW	Cho, Mun-Joo	KOR	BB	Ciucanu, Doina	ROM	RO	Cordwell, Belinda	NZL	TE
Chechi, Juri	ITA	GY	Cho, Yong-Chul	KOR	JU	Claesson, Per-Olof	SWE	RO	Corgos, Antonio	ESP	AT
Cheesman, Jennifer	AUS	BB	Chohan, Satinder	CAN	HO	Claesson, Soren	SWE	WR	Cormier, Marie-Huguette	CAN	FE
Cheesman, Maxwell	TRI	CY	Choi, Chan-Ok	FRG	TA	Clark, Darren	AUS	AT	Cormier, Rheel	CAN	BA
Cheikh, Yacine	ALG	BO	Choi, Chung-Hwan	KOR	CA	Clark, Geoffrey	AUS	SW	Cornet Rodas, Pedrol	PAR	FE
Cheminade, Denis	FRA	CA	Choi, Chon-Sik	KOR	VB	Clark, Joetta	USA	AT	Cornet, Cayetano	ESP	AT
Chen, Chin-Mou	TPE	BA	Choi, Choon-Ok	KOR	HO	Clarke, Heather	CAN	RO	Corre, Jean-Claude	FRA	AT
Chen, Cuiting	CHN	GY	Choi, Chul-Kwon	KOR	BB	Clarke, Kim	USA	HB	Cortes, Gerardo	CHI	MP
Chen, Huiling	CHN	SW	Choi, Hae-Myoung	KOR	BA	Clarke, Lorna	GBR	ES	Cortez, Hernan	BOL	WE
Chen, Jianhong	CHN	SW	Choi, Hoo, -Jae	KOR	BA	Clarke, Norman	CAN	BB	Costa, Artur	POR	SW
Chen, Jing	CHN	TT	Choi, Jang-Do	KOR	RO	Clarkson, David	AUS	BA	Costa, Eliani	USA	VB
Chen, Jiun-Feng	TPE	TA	Choi, Jung-Yoon	KOR	SW	Classen, Barbara	FRG	JU	Costache, Tamara Lirgi	ROM	SW
Chen, Longcan	CHN	TT	Choi, Kang-Hee	KOR	FB	Clatworthy, Jodie	AUS	SW	Costantini, Dino	ITA	ES
Chen, Qingmei	CHN	AT	Choi, Kyung-Hee	KOR	BB	Claus, Christian	AUT	YA	Costantini, Massimo	ITA	TT
Chen, Ruili	CHN	YA	Choi, Mi-Sun	KOR	AT	Clausen, Peter	DEN	CY	Costas, Juan	ESP	YA
Chen, Weixiu	CHN	CY	Choi, Myung-Jin	KOR	ES	Clauss, Yves	LUX	SW	Costigan, Sandra	USA	HO
Chen, Wen-Ing	TPE	AT	Choi, Sang-Kook	KOR	FB	Clayton-Greene, Campbell	NZL	RO	Costrau, Andreas	GDR	RO
Chen, Xiaodan	CHN	SW	Choi, Se-Beom	KOR	AT	Clement, Elspeth	AUS	HO	Cote, Alain	CAN	FE
Chen, Xiumei	CHN	YA	Choi, Soon-Ho	KOR	FB	Clerveaux, Ferrere	CAN	TA	Cote, Langis	CAN	WE
Chen, Y.f. Kim Berly	TPE	SW	Choi, Suk-Jae	KOR	HB	Cleveland, Jonathan	CAN	SW	Cottel, Stephanie	FRA	GY
Chen, Ya-Li	TPE	AT	Choi, Sun-Hyung	KOR	CA	Cleveland, William	ISV	SW	Cotter, Alicia	ESP	SW
Chen, Yanping	CHN	AT	Choi, Sun-Young	KOR	SW	Clift, Adam	GBR	RO	Cotter, Geoffrey	NZL	RO
Chen, Yi-An	TPE	TA	Choi, Yun-Kyum	KOR	FB	Clift, Robert	GBR	HO	Cottier, Frederic	FRA	ES
Chen, Yi-Hsin	TPE	BA	Choley, Luc	FRA	YA	Cliement, Fernando	ESP	RO	Cottingham, Robert	USA	FE
Chen, Yongliang	CHN	WR	Chomba, Samuel	ZAM	FB	Clinton, Glenn	BER	YA	Cottle, John	NZL	ES
Chen, Zhen	CHN	HB	Chong, Siao Chin	HKG	JU	Clode, Brent	NZL	CA	Coull, Joanna	GBR	SW
Chen, Zunrong	CHN	AT	Chongo, Joseph	ZAM	BO	Clouthier, Guylaine	CAN	SW	Coull, Robert	GBR	CY
Cheney, Grahame	AUS	BO	Choo choy, Alain	MRI	TT	Cochran, Neil	GBR	SW	Coupat, Monique	FRA	RO
Cheng, Chia-Tso	TPE	WE	Choo, Nan-Yool	KOR	TA	Cochrane, Nigel	CAN	YA	Court, Jeanfrancois	FRA	WR
Cheng, Hsin-Fu	TPE	AT	Chou, Yu-Ping	TPE	JU	Cockcroft, Mona-Jean	CAN	AT	Couto, Fernando	POR	AT
Chenoufi, Raouf	TUN	VB	Choubenkova, Natalia	URS	AT	Cocuzza, Maria	ITA	GY	Cova, Alberto	ITA	AT
Chepkurui, Francisca	KEN	AT	Chouchane, Mohamed Naceur	TUN	FB	Coeck, Inge	BEL	CA	Covacci, Monica	CAN	GY
Cherednik, Alexie	USA	FB	Chouchounova, Elena	URS	GY	Coenen, Laura	USA	HB	Coventry, William	NZL	RO
Cheris, Elaine	USA	FE	Chouinard, Jean-Marc	CAN	FE	Cogeanu, Veronica	ROM	RO	Covey, Deb	CAN	HO
Cherkasov, Andrei	URS	TE	Choukhrai, Serguei	URS	CA	Coghlan, Eamon	IRL	AT	Cox, Annemarie	HOL	CA
Chertow, Kenneth	USA	WR	Chouvalov, Andrei	URS	FE	Cohen, Steve	USA	JU	Cox, Charles Douglas	CAN	WR
Cheruiyot, Charles	KEN	AT	Chow, Tat-Ming	HKG	CY	Cola, Philippe	FRA	SH	Cox, Tracy Linda	ZIM	SW
Cheruiyot, Kipkoech	KEN	AT	Choy, Kam Shing	HKG	FE	Colas, Fabrice	FRA	CY	Crabb, Steve	GBR	AT
Cheshire, Joseph	KEN	AT	Christensen, Annemette	DEN	TA	Coles, Vernell	USA	BB	Cram, Steve	GBR	AT
Chesnokov, Andrei	URS	TE	Christensen, Claus	DEN	SW	Colla, Daniel M	ARG	VB	Cramne, George	SWE	BO
Chestakov, Alexandre	URS	WR	Christensen, John	SWE	WE	Colle, Florence	FRA	AT	Crass, Derrick	USA	WE
Chestakov, Vladimir	URS	JU	Christensen, Klavs Jorn	DEN	SH	Collet, Philippe	FRA	AT	Cravero, Roberto	ITA	FB
Cheung, Suet Yee	HKG	AT	Christensen, Mor	DEN	TE	Collier, Adrian	GBR	CA	Creelman, Sharon	CAN	HO
Chevalier, Christian	FRA	GY	Christie, Linford	GBR	AT	Collier, Raymond	CAN	RO	Crehan, Susan	GBR	AT
Chevtchenko, Elena	URS	GY	Christl, Ernst	FRG	CY	Colling, Wilfried	FRG	WR	Cresco, Milton L.	PUR	AR
Chevtsov, Youri	URS	HB	Christoforidis, Nikolaos	GRE	SW	Collins, Christopher	GRN	BO	Cresto, Gilles	MON	AR
Chi, Man-Hsien	TPE	WR	Christomanos, Christos	GRE	RO	Collins, Deitre	USA	VB	Cribaillet, Franck	FRA	TA
Chiang, Chi-Li	TPE	SW	Chritoforou, Christos	CYP	YA	Collins, Eoin	IRL	TE	Crichlow, Renn	CAN	CA
Chiang, Ming-Hsiung	TPE	WE	Chronowski, Ludomir	POL	FE	Colman, Roger	AUS	YA	Crino, Oscar	AUS	FB

Name Nom	Country Pays	Sport	Name Nom	Country Pays	Sport	Name Nom	Country Pays	Sport	Name Nom	Country Pays	Sport
Crippa, Massimo	ITA	FB	Debevec, Rajmond	YUG	SH	Diaz, Jacqueline	CHI	TT	Donnianni, Valerio	ITA	SH
Cripps, Annabelle	GBR	SW	Deblcqkvankuffeler, Ester	HOL	YA	Diaz, Jose	PAN	WE	Donovan, Anne	USA	BB
Cristovao, Pedro	POR	JU	Debnar, Tamas	HUN	SW	Diaz, Joseph	SEN	AT	Dopierala, Marek	POL	CA
Croft, June	GBR	SW	Debois, Nadine	FRA	AT	Diaz, Juan antonio	ARG	BO	Dopp, Heiner	FRG	HO
Crois, Dirk	BEL	RO	Deeble, Jon	AUS	BA	Diba, Dikanda	ZAI	AT	Doreste, Jose luis	ESP	YA
Cronin, Cornelius	IRL	RO	Defauw, Rita	BEL	RO	Dickerson, Wendell	ISV	AT	Doreste, Luis	ESP	YA
Crooks, Charmaine	CAN	AT	Degaspari, Fabio	ITA	AT	Dickson, Don	CAN	RO	Doreste, Manuel	ESP	YA
Crosby, Andrew	CAN	RO	Deguchi, Kazuya	JPN	WR	Didouk, Victor	URS	RO	Dorjderem, Jamsran	MGL	JU
Cross, Martin	GBR	RO	Dei Rossi, Riccardo	ITA	RO	Dieffenthaler, Karen	TRI	SW	Dorji, Thinley	BHU	AR
Crouser, Brian	USA	AT	Dejonckheere, Godfried	BEL	AT	Diemer, Brian	USA	AT	Dorland, Jason	CAN	RO
Crousillat, Marc	FRA	SW	Dejose, Dominique	BEL	CY	Diepeveen, Cees Jan	HOL	HO	Dorman, Loretta	AUS	HO
Crousillat, Michel	FRA	SW	Dekker, Geraldine	AUS	JU	Dietrich, Frank	FRG	RO	Dornic, Polona	YUG	BB
Crow, Kevin	USA	FB	Dekker, Rene	HOL	SW	Dietsche, Hugo	SUI	WR	Dorochenko, Leonid	URS	HB
Crucg, Maurits	HOL	HO	Dekker, Ronald	HOL	SW	Dietz, Helmut	FRG	JU	Dossenkeno, Valeri	URS	RO
Cruz, Andre	BRA	FB	Del Rosario, Manuel Iii	PHI	TA	Digre, Berit	NOR	HB	Dotson, Kim	USA	TA
Cruz, Angel	PUR	BB	Dela Cruz, Agripina	PHI	AT	Dijkstra, Herbert	HOL	CY	Douamba, Alimata	CIV	HB
Cruz, Guilhermina	ANG	AT	Delage, Laurent	FRA	YA	Dikanda, Theodore	SWE	WR	Doudeva, Diana	BUL	GY
Cruz, Joaquim	BRA	AT	Delapena, Eduardo	GUM	BO	Dillon, Terence	GBR	RO	Douglas, Desmond	GBR	TT
Cruz, Nadia	ANG	SW	Deldaele, Geert	BEL	CA	Dimitrov, Valentin	BUL	WR	Douglas, Troy	BER	AT
Csabai, Judit	HUN	SW	Deleon, Meluin	DOM	BO	Dimitrova, Svetla	BUL	AT	Douma, Paul	CAN	RO
Csak, Jozsef	HUN	JU	Deleze, Pierre	SUI	AT	Dine, Ahmed	ALG	BO	Doumtchev, Alexandre	URS	RO
Csengeri, Kalman	HUN	WE	Delgado Cerquera, William Javi	COL	WR	Ding, Yi	AUT	TT	Doumtchev, Iouri	URS	AT
Csepe, Gabriella	HUN	SW	Delice, Patrick	TRI	AT	Dino, Jerry	PHI	JU	Doumtcheva, Antonina	URS	RO
Cserey, Ildiko	HUN	RO	Deligiannis, Dimitrios	GRE	YA	Dione, Abacabar	SEN	JU	Dounavska, Adriana	BUL	GY
Csicsay, Otto	HUN	HB	Delissen, Marc	HOL	HO	Diop, Mouhamedou	SEN	SW	Dove-edwin, Horace	SLE	AT
Csipes, Ferenc	HUN	CA	Delia Chiesa, Luigi	ITA	RO	Diouf, Djib	SEN	WR	Dover, Robert	USA	ES
Csiszto, Zsuzsa	HUN	GY	Deloach, Joe	USA	AT	Ditsios, Constandinos	GRE	RO	Downey, Raymond	CAN	BO
Csongradi, Laszlo	HUN	FE	Deloof, Pierre-Marie	BEL	RO	Dittert, Bernd	GDR	CY	Doyle, Jack	IRL	ES
Ctvrlik, Robert J	USA	VB	Delord, Jacqueline	FRA	SW	Ditz, Nancy	USA	AT	Doyle, John	USA	FB
Cubric, Rajko	YUG	CY	Delpla, Frederic	FRA	FE	Divac, Vlade	YUG	BB	Doyle, Mark	AUS	RO
Cuentas, Alfredo	MEX	SH	Delrieu, Philippe	FRA	FE	Dixon, Diane	USA	AT	Doyle, Martin	GBR	WR
Cuesta, Marcela	CRC	SW	Delva-Noriega, Norman	GUA	FB	Dixon, Terry	JAM	BO	Dozsa, Ferenc	HUN	RO
Cui, Shiping	CHN	SW	Demanser, Kirsten	NZL	TA	Dixon, Vickey	GBR	HO	Dr. Hoffmann, Laszlo	HUN	HB
Cui, Yongmei	CHN	VB	Dembrel, Ochir	MGL	BO	Diz, Alejandro	ARG	VB	Dragomirova, Sonia	BUL	BB
Cukovic, Milan	GUM	WE	Demers, Jacques	CAN	WE	Djandjgava, Tatiana	URS	HB	Draguiev, Petyo	BUL	VB
Culbert, David	AUS	AT	Demina, Svetlana	URS	SH	Djedjemel, Rene	CIV	AT	Drakenberg, Otto	SWE	FE
Cullen, Stephen	IRL	SW	Demireva, Valia	BUL	AT	Djefal, Ahcene	ALG	HB	Draouci, Abousofiane	ALG	HB
Cuminetti, Juan Carlos	ARG	VB	Demongeot, Isabelle	FRA	TE	Djetnan, Kouadio	CIV	AT	Drechsler, Heike	GDR	AT
Cuming, Brenda	CAN	AR	Demoulin, Michel	BEL	SH	Djigalova, Lioudmila	URS	AT	Dreossi, Bruno	ITA	CA
Cumming, Daniel	AUS	WR	Demsitz, Lene S	DEN	AT	Djoman, Emilie	CIV	HB	Drevjana, Alena	TCH	GY
Cummings, Veronica	GUM	SW	Den Bakker, Maarten	HOL	CY	Djoulfalakian, Levon	URS	WR	Drews, Annett	GDR	RO
Cunha, Aurora	POR	AT	Dendeberova, Elena	URS	SW	Djuho, Veselin	YUG	SW	Driessen, Michiel	HOL	FE
Cunha, Luis	POR	AT	Dendy, Terri	USA	AT	Djukic, Slavica	YUG	HB	Driggers, Scott	USA	HB
Cunha, Marcia	USA	VB	Denissov, Victor	URS	CA	Djukic, Vladislav	YUG	FB	Dripaux, Stanislas	FRA	YA
Cuomo, Sandro	ITA	FE	Deno, Harunobu	JPN	FE	Djuric, Dragica	YUG	HB	Drontmann, Mark	HOL	YA
Curatolo, Maria	ITA	AT	Depoutatov, Victor	URS	HO	Djurica, Mirjana	YUG	HB	Drontmann, Robert	HOL	YA
Curran, Paul	GBR	CY	Deprez, Bround	FRA	SH	Dlamini, Thomas	SWZ	AT	Drost, Frank	HOL	SW
Curran, Randy	CAN	BA	Derckx, Annemiek	HOL	CA	Dmiyroussenko, Oleg	URS	AT	Drumm, Diego	GDR	BO
Curuchet, Gabriel Ovidio	ARG	CY	Derlin, Bruce	NZL	TE	Do Tien, Tuan	VIE	BO	Druppers, Rob	HOL	AT
Curuchet, Juan Esteban	ARG	CY	Dermendjjeva, Vania	BUL	BB	Do, Eun-Chul	KOR	CY	Dryke, Mathew	USA	SH
Curvelo, Paulo	POR	AT	Dery Batlik, Shirley	USA	CA	Dobbertin, Ana Maria	ESP	SW	Du Pont, Yul Mark	SWZ	SW
Curvelo, Pedro	POR	AT	Desavoye, Philippe	FRA	BO	Dobeleit, Norbert	FRG	AT	Du, Juan	CHN	AT
Cuthbert, Juliet	JAM	AT	Deschenes, Bruno	CAN	FE	Doberschuetz, Gerlinde	GDR	RO	Du, Zhencheng	CHN	FE
Cutler, John	NZL	YA	Desideri, Stefano	ITA	FB	Dobi, Lajos	HUN	MP	Duan, Ju	CHN	FB
Cutura, Zoran	YUG	BB	Deskoulidis, Irakiis	GRE	WR	Dobrantcheva, Marina	URS	SH	Duan, Xiuquan	CHN	AT
Cuvilly, Sylvie	FRA	CA	Deslauriers, Mario	CAN	ES	Dobrasinovic, Vukasin	YUG	BO	Duarte, Paulo	POR	WE
Cuyppers, Alain	BEL	AT	Desnoyers, Daniel	CAN	AR	Dobre, Aurelia	ROM	GY	Duback, Jeffrey	USA	FB
Cvjeticanin, Danko	YUG	BB	Dessureault, Michel	CAN	FE	Dobre, Danut	ROM	RO	Dube, Ajay	CAN	HO
Czanka, Attila	ROM	WE	Detant, Thierry	HOL	CY	Dobrescu, Luminita Lil	ROM	SW	Dube, Gailly	ZIM	AT
Czenczek, Liz	CAN	HO	Dethier, Sylvia	BEL	AT	Dobrev, Nenke	BUL	RO	Dube, Ndaba	ZIM	BO
Czyzowicz, Maciej	POL	MP	Deuring, Albert	AUT	SH	Dobrovicova, Erika	TCH	BB	Dubosquelle, Christine	FRA	RO
			Deuring, Dorothee	AUT	SH	Dobrovolski, Igor	URS	FB	Dubovszky, Istvan	HUN	JU
			Deutsch, Tamas	HUN	SW	Dodds, Richard	GBR	HO	Dubrawska, Agnieszka	POL	FE
			Deveney, Michael	GBR	BO	Dodoo, Francis	GHA	AT	Ducceschi, Raffaello	ITA	AT
			Devers-Roberts, Gail	USA	AT	Dodson, Thomas	NZL	YA	Duce, Gregory	CAN	BA
			Dewarder, Marlyn	GUY	AT	Doehring, Jim	USA	AT	Ducheix, Franck	FRA	FE
De Borbon, Cristina	ESP	YA	Deydier, Brigitte	FRA	JU	Doerre, Kathrin	GDR	AT	Dudas, Juraj	TCH	WE
De Bruin, Erik	HOL	AT	Dhiab, Tarek	TUN	FB	Doegbami, Wole	NGR	FB	Duerst, Thomas	FRG	CY
De Carvalho Inac, Helder Jose	ANG	JU	Di Buo, Ilario	ITA	AR	Doherty, Alejandro	ARG	HO	Dufaux, Irene	SUI	SH
De Castella, Robert	AUS	AT	Di Capua, Giuseppe	ITA	RO	Doherty, John	IRL	AT	Dufaux, Pierre Alain	SUI	SH
De Ceuster, Koen	BEL	AT									
De Giorgi, Ferdinando	ITA	VB									
De Iruarrizaga, Alfonso	CHI	SH	Di Costanzo, Geremia	ITA	TA	Doherty, Kevin	CAN	JU	Duflos, Patric	FRA	VB
De Jongh, Margaretha	HOL	TA	Di Donna, Roberto	ITA	SH	Doherty, Percy S	SLE	WE	Duggan, Keltie	CAN	SW
De koning, Patrick	BEL	AR	Di Napoli, Gennaro	ITA	AT	Dohou, Dossou Daniel	BEN	JU	Dukic, Darko	YUG	BO
De La Guerra, Alejandro	PER	VB	Di Palo, Giuseppe	ITA	RO	Doje, Qiying	CHN	AR	Dumitrescu, Daniel	ROM	BO
			Di Tella, Rafael M	ARG	FE	Dolecek, Milan	TCH	RO	Dumont, Mario	PUR	RO
De La Parte, Santiago	ESP	AT	Diabone, Ankiling	SEN	JU	Doleschall, Andras	HUN	SH	Duncan, Tricia	ISV	SW
De La Puente, Juan Antonio	ESP	HB	Diakov, Lyubtcho	BUL	SH	Dollente, Orlando	PHI	BO	Dunlop, Colin	FIJ	YA
De La Riva, Sandra	USA	HB	Diallo, Mamadoudiaw	GUI	WR	Dolls, Amparo	ESP	TA	Dunn, Paula	GBR	AT
De La Rocha, Santiago	ESP	ES	Diallo, Oushane	GUI	WR	Domachev, Alexandre	URS	HO	Dunn, Robert	AUS	FB
De Lima, Johnny	DEN	BO	Diallo, Sambajacob	GUI	BO	Domgoergen, Ruth	FRG	CA	Duplanty, Christopher D.	USA	SW
De Palma, Esteban	ARG	VB									
De Paz, Miguel	ESP	HO	Diankolela-Missengui, Judith-P	CGO	AT	Domian, Thomas	FRG	RO	Dupnai, A Aaron	NGU	AT
De Pra Filho, Lenoidio	BRA	VB	Diarra, Aminata	MLI	AT	Domingues, Adauto	BRA	AT	Duqom, Jaklein	JOR	TT
De Rimas, Kim	ARG	TT	Diarra, Ousmane	MLI	AT	Domonkos, Mariann	CAN	TT	Duque, Jose	VEN	YA
De Rover, Jolanda	HOL	SW	Diarra, Ousmane	SEN	AT	Dompeling, Hendrikus	HOL	SH	Durand, Pierre	FRA	ES
			Dias, Albertina	POR	AT	Dong, Yuping	CHN	AT	Durao, Roberto	POR	FE
De Souza, Brice Jose Maurice	BEN	AT	Dias, Jose Augusto	BRA	YA	Donkova, Jordanka	BUL	AT	Durben, Daniel	USA	SH
De Vega, Lydia	PHI	AT	Dias, Jose Paulo	BRA	YA	Donnelly, Linda	GBR	SW	Durisinova, Maria	TCH	HB
De Vries, Gerrit	HOL	CY	Diato, Fabienne	MON	SH	Donnelly, Megan	USA	HO	Duros, Marie Pierre	FRA	AT
De Vries, Tjark	HOL	RO	Diaz, Domingo	AUS	SH	Donnelly, Nigel	NZL	CY	Duroy, Marie-Christine	FRA	ES
De Wit, Robert	HOL	AT	Diaz, Hernan Edgardo	ARG	FB	Donnet, Jennifer	AUS	SW	Duroy, Marie-Christine	FRA	ES
De, Jesus, Madeline	PUR	AT									
Deady, Mark	USA	AT									
Deal, Lance	USA	AT									
Dean, Mark	USA	SW									
Deane, Andrew	AUS	HO									

Seoul '88 Facts and Figures

Les faits et les chiffres

Listing of the Competitors/Listes dies concurrents

Name Nom	Country Pays	Sport	Name Nom	Country Pays	Sport	Name Nom	Country Pays	Sport	Name Nom	Country Pays	Sport
Durtchova, Svetla	BUL	RO	Elimu, Lamachi	KEN	WR	Evans, Michaels.	USA	SW	Febriana. Sari, Ina	INA	TA
Dusabe, Telesphore	RWA	AT	Elizee, Marie-Clavde	FRA	AT	Evans, Peter	NZL	YA	Fedderson, Jan	DEN	YA
Dusart, Agnes	BEL	CY	Elizondo, Miguel	MEX	AT	Evans, Stephen	AUS	RO	Fediouchina, Valentina	URS	AT
Dutta, Soma	IND	SH	Elizondo, Rafael	CRC	WE	Evcioukov, Viktor	URS	AT	Fedorenko, Natalia	URS	RO
Dutton, Brett	AUS	CY	Elkordy, Ashraf	EGY	BB	Eve, Laverne	BAH	AT	Fehringner, Hermann	AUT	AT
Duvchin, Zeveg	MGL	WR	Elkoumy, Gamleldin	EGY	BO	Everett, Danny	USA	AT	Fejeran, Pete	GUM	WE
Dvorak, Laszlo	HUN	WR	Elkuch, Yvonne	LIE	CY	Everett, Mark	USA	AT	Fekete, Nicholas	CAN	MP
Dybiona, Patrick	HOL	SW	Elleingand, Koko-P.	CIV	HB	Evernden, Kelly	NZL	TE	Feldhoffer, Roland	FRG	WE
Dydak, Jan	POL	BO	Elliott, Mark	GBR	BO	Evert, Chris	USA	TE	Feliciano, Jesus I.	PUR	BA
Dyer, Kimberly	USA	SH	Elliott, Norbert	BAH	AT	Everts, Sabine	FRG	AT	Felix, Garth	GRN	BO
Dylewska, Izabela	POL	CA	Elliott, Peter	GBR	AT	Evkova, Olga	URS	BB	Felix, Juan	PUR	RO
Dyulguerov, Yuri	BUL	RO	Ellis, Britt-Marie	SWE	SH	Evoniuk, Marco	USA	AT	Felke, Petra	GDR	AT
Dzekedzeke, Kenneth	MAW	AT	Ellis, Romallis	USA	BO	Evpak, Valentina	URS	CY	Fell, Graeme	CAN	AT
E			Elloyzy, Mostafa	EGY	WE	Evseev, Nikolai	URS	SW	Fellner, Robert	ISV	TA
Elkhodary, Essam	EGY	WR	Ellwanger, Niels	FRG	CA	Evseeva, Inna	URS	AT	Felotti, Roberta	ITA	SW
Easter, Paul	GBR	SW	Elmagrisi, Ahmed	LBA	WE	Ewanje-epee, Maryse	FRA	AT	Feng, Qiangbiao	CHN	SW
Ebanks, Alfred	CAY	CY	Elmamoun, Driss	MAR	JU	Ewanje-epee, Monique	FRA	AT	Feraday, Stephen	CAN	AT
Ebeling, Rolf	FRG	RO	Elnagar, Ahmed	EGY	BO	Eyestone, Ed	USA	AT	Ferencz, Agnes	HUN	SH
Eberle, Pierre-Yves	SUI	SW	Elonga molico, Bernardo	GEQ	AT	Ezeogu, Emeka	NGR	FB	Ferguene, Abdelouahab	ALG	AT
Ebong-Salle, Frederic	CMR	AT	Elsaket, Sherif	EGY	TT	Ezinwa, Davison	NGR	AT	Ferguson, Garvin	BAH	SW
Ebrahim Warsama, Ahmed	QAT	AT	Elsayed, Emadelkin	EGY	BB	Eziuka, Tony	NGR	AT	Ferguson, Ian	NZL	CA
Echeev, Vladimir	URS	AR	Elsayed, Khalil	EGY	WE				Ferguson, Shonel	BAH	AT
Echeverri, Alcides	URU	CY	Elishakeri, Mohamed	EGY	BB	F			Ferland, Patrick	SUI	SW
Echols, Sheila	USA	AT	Elisharaf, Hisham	KUW	JU	Faagu, Lopesi	ASA	WE	Fermin Martinez, Raymundo	DOM	TT
Eckard, Jeff	CAN	YA	Eltang, Bjarne	DEN	RO	Faamaoni, Tiui	SAM	BO	Fernandez Duran, Alfredo	ESP	ES
Eckersley, Neil	GBR	JU	Eluaiza, Carlos Mario	ARG	BO	Fabbri, Nestor-Ariel	ARG	FB	Fernandez, Armando	FRG	SW
Eckert, Cynthia	USA	RO	Elvstrom, Ann Christine	DEN	YA	Fabry, Nestor-Ariel	ARG	FB	Fernandes Torres, Moises Marti	ANG	JU
Edberg, Stefan	SWE	TE	Elvstrom, Myralf, Inge Trine	DEN	YA	Faber, Patrick	HOL	HO	Fernandes, Carla	ANG	SW
Edeh, Rosey	CAN	AT	Elvstrom, Paul	DEN	YA	Fabian, Imre	HUN	HO	Fernandes, Gaspar	ANG	AT
Edenhauser, Fred	AUT	TA	Emilio, Renato	BRA	AR	Fabian, Ira	HUN	CY	Fernandes, Jorge	BRA	SW
Eder, Gernot	GDR	SH	Emmelmann, Kirsten	GDR	AT	Fabian, Laszlo	ANT	CY	Fernandes, Vivaldo	ANG	SW
Edet, Victor	NGR	AT	Emmiane, Robert	URS	AT	Fabian, Laszlo	HUN	MP	Fernandez, Angel	ESP	FE
Edge, David	CAN	AT	Emura, Koji	JPN	FE	Fabiani, Alain	HUN	FE	Fernandez, Carlos	ESP	WR
Edvardsson, Edvard	ISL	SW	Enciso, Jaime	ESP	AT	Fabregas, Eduardo	ESP	HO	Fernandez, Jesus	ESP	HB
Edwards, Diane	GBR	AT	Endo, Tsukasa	JPN	AT	Faccini, Andrea	ITA	CY	Fernandez, Joaquin	ESP	SW
Edwards, Jonathan	GBR	AT	Endres, Thomas	FRG	FE	Fach, Holger	ITA	CY	Fernandez, Marcelo g	ARG	RO
Edwards, Paul	GBR	AT	Enebayar, Tserenbatar	MGL	WR	Faderbauer, Harald	FRG	FB	Fernandez, Miguel Angel	ESP	CA
Edwards, Pauline	GBR	AR	Engelking, Bettina	FRG	TA	Fadzaev, Arsen	AUT	RO	Fernandez, Oscar	ESP	FE
Edwards, Teresa	USA	BB	English, Graeme	FRG	TA	Faehn, Rhonda	URS	WR	Fernandez, Sergio abel	ARG	RO
Eenhoorn, Robert	HOL	BA	Engqvist, Leif	GDR	WR	Faehrich, Gabriele	USA	GY	Fernandez, Stephen	PHI	TA
Eepickere, Ludovic	FRA	SW	Enhbayar, Lodoy	MGL	WR	Fahline, Sergio	GDR	GY	Fernandez, Maria Luisa	ESP	SW
Efemgil, Haldun	TUR	JU	Enhe, Avirmed	MGL	WR	Fahlin, Roul	MOZ	SW	Ferneck, Christine	FRG	HO
Eftekhari, Jalil	IRN	CY	Enkelmann, Aris	GDR	FE	Fahrner, Thomas	SWE	CY	Fernholm, Stefan	FRG	HO
Egbunike, Innocent	NGR	AT	Enkhbat, Nerguy	GDR	FE	Fairless, Stephen	FRG	SW	Fernholm, Stefan	SWE	AT
Egerszegi, Krisztina	HUN	SW	Envela Mahua, Gustavo	MGL	BO	Fairweather, Simon	FRG	SW	Ferrara, Ciro	ITA	FB
Egger, Kaspar	SUI	AT	Enweani, Cyprian	GEQ	AT	Faisal, Abdul Malik	AUS	AR	Ferrara, Fernando	ARG	HO
Egnot, Leslie	NZL	YA	Epton, Mark	CAN	AT	Faireweather, Simon	INA	YA	Ferrari, Giancarlo	ITA	AR
Egorov, Grigori	URS	AT	Erbay, Vedat	GBR	BO	Faisal, Abdul Malik	INA	YA	Ferre, Daniel	FRA	YA
Eguabor, Monday	NGR	WR	Erdogan, Levent	TUR	AR	Faivre Pierret, Didier	FRA	CY	Ferreira, Andre	BRA	VB
Eguavon, Augustine	NGR	FB	Erechtchenko, Vladimir	MGL	AR	Fajardo, Demisse	PER	VB	Ferreira, Conoico	POR	AT
Ehrenbrink, Ralf	FRG	ES	Ereng, Paul	TUR	WE	Fajkus, Csaba	HUN	GY	Ferreira, Jose	BRA	FB
Ehrens, Robertus	HOL	ES	Eroglu, Ali	URS	BO	Falassinidi, Christina	HUN	GY			
Ehrl, Andreas	FRG	SW	Eros, Lajos	KEN	AT	Falcao, Nelson	URS	SW			
Ehrle, Klaus	AUT	AT	Ersek, Zsolt	HUN	AT	Falck, Ismo	BRA	YA	Ferreira, Rolando	BRA	BB
Eichenmann, Genoveva	SUI	AT	Erfalvy, Nora	HUN	GY	Falconi, Ricardo	FIN	AR	Ferreiro, Alejandro	URU	YA
Eichholz, Armin	FRG	RO	Erhembayar, Sodnom	HUN	GY	Fale, Tualau	CHI	MP	Ferrero, Pedro	ARG	YA
Eichmann, Eric	USA	FB	Erhorn, Claus	MGL	JU	Falise, Didier	TGS	BO	Ferretti, Ivo	ITA	SW
Eichwurzel, Bernd	GDR	RO	Eriksson, Agneta	FRG	ES	Fall, Moussa	BEL	AT	Ferretti, Massimiliano	ITA	SW
Eicke, Ulrich	FRG	CA	Eriksson, Jennifer	SWE	SW	Fall, Samba	SEN	AT	Ferrian, Daniela	ITA	AT
Einarsson, Sigurdur	ISL	AT	Eriksson, Peter	FIN	ES	Fall, Serigne	SEN	AT	Fesselier, Martial	FRA	AT
Eisenhofer, Doris	FRG	SW	Ermolovitch, Natalia	SWE	FB	Fallah, Akbar	MTN	AT	Fessi, Slaheddine	TUN	FB
Eisenkrammer, Karoly	HUN	CY	Eroglu, Ali	SWE	YA	Fan, Di	GUI	BO	Fetter, Gyorgy	HUN	AT
Ekblom, Tommy	FIN	AT	Eros, Lajos	URS	AT	Fanelli, Gary	IRN	WR	Fetter, Leigh	USA	SW
Ekimov, Viatcheslav	URS	CY	Ersek, Zsolt	HUN	BO	Faneyte, Rikkert	CHN	GY			
Eklund, Henrik	FIN	YA	Ersu, Kerem	TUR	WE	Fantoni, Daria Camilla	ASA	AT	Fetzner, Steffen	FRG	TT
Eklund, Johan	SWE	HB	Ertel, Carl	HUN	BO	Fantoni, Fernando	HOL	BA	Fiala, Zbynek	TCH	CY
Eksi, Elif	TUR	AR	Esaki, Fumiko	HUN	FE	Farago, Jozsef	ITA	CY	Fiaz, Muhammad	PAK	AT
Eksi, Huriye	TUR	AR	Escalante, Olga	TUR	AR	Faraj, Ahmad	ITA	CY	Fibbens, Mike	GBR	SW
El-domyati, Amine	LIB	SW	Escamilla, Ignacio	GDR	RO	Farhan, Saleh	ITA	ES	Fibigr, Waldemar	TCH	CA
El-kaissi, Hassan	LIB	WE	Escobedo, Xochitl	GDR	RO	Farhan, Saleh	ITA	ES	Ficher, Fabienne	FRA	AT
El-khoury, Zahi	LIB	FE	Escude, Ignacio	GDR	RO	Fargis, Joe	ITA	ES	Fichtel, Anja	FRG	FE
El-masri, Ahmad	LIB	BO	Esmail, Ahmed Mohamed	GDR	RO	Farhan, Saleh	ITA	ES	Fidel, Laszlo	HUN	CA
El-masri, Bilal	LIB	BO	Esmaili, Abas	GDR	RO	Farhan, Saleh	ITA	ES	Fiedler, Ellen	GDR	AT
Elabrak, Moustafa	EGY	TA	Esnault, Dominique	GDR	RO	Farhan, Saleh	ITA	ES	Fiedler, Jens	GDR	HB
Elazoul, Mohamed	EGY	SW	Esperanza, Jesus	GDR	RO	Farias, Romario	ITA	ES	Fierro, Eliane	MEX	YA
Elbatoly, Reda	EGY	WE	Espeseth, Robert	GDR	RO	Farias, Romario	ITA	ES	Fierro, Tania	MEX	YA
Elbkh, Ebraheem	EGY	WE	Esser, Heike	GDR	RO	Farina, Frank	ITA	ES	Figueiredo, Maria	BRA	AT
Elenary, Farag	EGY	TA	Esteves, Sergio	GDR	RO	Farina, Frank	ITA	ES	Figueroa, Enrique	PUR	YA
Elford, Janelle	AUS	SW	Estiarte, Manuel	GDR	RO	Farina, Gianluca	ITA	ES	Figueroa, James C.	PUR	BA
Elgafy, Rehab	EGY	JU	Estrada, Blanca	GDR	RO	Farris, Gustavo-A	ITA	ES	Fiiev, Hristo	BUL	WR
Elhadad, Hassan	EGY	WR	Ethridge, Mary	GDR	RO	Farrell, Evelyn	ITA	ES	Filipe Fortunato, Luis Carlos	ANG	JU
Elhusseiny, Abdelmonem	EGY	FE	Etropolski, Hristo	GDR	RO	Farrell, John	ITA	ES	Finell, Sonja	FIN	AT
Eliasson, Marte	NOR	HB	Etropolski, Vassil	GDR	RO	Farrugia, Paul	ITA	ES	Fink, Cristina	MEX	AT
Elien, Evocyne	FRA	AT	Evangelisti, Giovanni	GDR	RO	Farrugia, Stephen	ITA	ES	Fiore, Mitchell	USA	BA
			Evani, Alberigo	GDR	RO	Fassoni, Tanta	ITA	ES			
			Evans, Janet	GDR	RO	Fastrich, Hanns-Henning	ITA	ES			
				GDR	RO	Faudet, Ali	ITA	ES			
				GDR	RO	Faulkner, David	ITA	ES			
				GDR	RO	Faulkner, Stewart	ITA	ES			
				GDR	RO	Faulkner, Christopher	ITA	ES			
				GDR	RO	Faure, Karyn	ITA	ES			
				GDR	RO	Faust, Hartmut	ITA	ES			
				GDR	RO	Faust, Wolfram	ITA	ES			
				GDR	RO	Fausto, Archer	ITA	ES			
				GDR	RO	Fayad, Mohamad	ITA	ES			
				GDR	RO	Fazekas, Erika	ITA	ES			
				GDR	RO	Fazi, Juri	ITA	ES			
				GDR	RO	Fazlic, Jasna	ITA	ES			
				GDR	RO	Feast, Alison	ITA	ES			

Name Nom	Country Pays	Sport	Name Nom	Country Pays	Sport	Name Nom	Country Pays	Sport	Name Nom	Country Pays	Sport
Fitz-randolph, Roderick	USA	SH	Fraser, David	GBR	TA	Gammelgaard Nielsen, Ole	DEN	AR	Genard, Bruno	FRA	MP
Fitzgerald, John	AUS	TE	Fraser, Wendy	GBR	HO	Ganbold, Jambal	MGL	JU	Gencalp, Necmi	TUR	WR
Fitzgerald, Paul	IRL	BO	Frederiksen, Christian	DEN	CA	Gandarias, Manuel	ESP	SW	Genes, Liliana	ROM	RO
Flach, Ken	USA	TE	Fredriksson, Magnus	SWE	WR	Gandolfi, Annapia	ITA	FE	Geneyro, Carlos	ARG	HO
Flach, Thomas	GDR	YA	Freimut, Maciej	POL	CA	Ganeev, Marat	URS	CY	Gengler, Sarah	USA	RO
Flament, Dominique	FRA	ES	Freimuth, Uwe	GDR	AT	Ganeff, Stephane	HOL	FE	Geoffroy, Remi	FRA	AT
Flax, Kenneth	USA	AT	Freire, Elsa	ANG	SW	Ganev, Ljubomir	BUL	VB	Georgosopoulos, Stelios	GRE	YA
Fleissner, Tomas	TCH	MP	Freitas, Cassio	BRA	CY	Gansky, Diana	GDR	AT	Gerdsmeyer, Fritz	FRG	WR
Flemming, Jane	AUS	AT	Freitas, Clinio	BRA	YA	Gantulga, Khaidav	MGL	BO	Geremias, Conceicao	BRA	AT
Flemming, Jimmy	ISV	AT	Freitas, Daniel	URU	BO	Ganz, Barbara	SUI	CY	Geriz, Arturo	ESP	CY
Flemming, Thomas	GDR	SW	Frenkeva, Antoaneta	BUL	SW	Gao, E	CHN	SH	Gerlach, Agnes	HUN	SW
Fieri Soler, Jean-Paul	MLT	YA	Frey, Andreas	SUI	YA	Gao, Fenglian	CHN	JU	Germanus, Adrian	GDR	FE
Flewelling, Larry	CAN	SW	Fria Reynoso, Pedro	DOM	BO	Gao, Min	CHN	SW	Gernharot, Torsten	FRG	TA
Flinn, Robert Stuart	CAN	YA	Frick, Arnold	LIE	JU	Gao, Sheng	CHN	FB	Gerull, Thomas	FRG	FE
Flintoff-King, Debra	AUS	AT	Fridriksson, Bjarni	ISL	JU	Garay, Ritajejan	PUR	SW	Gey, Mathias	FRG	FE
Flobeck, John	USA	RO	Fridriksson, Isleifur	ISL	YA	Garba, Sami	NIG	TA	Gha Kotey, Alfred Amon	GHA	BO
Floreal, Edrick	CAN	AT	Fried, Volker	FRG	HO	Garbayo, Amaia	ESP	SW	Ghadimi, Masoud	IRN	WR
Flores, Esteban	PUR	BO	Friedberg, Paul	USA	FE	Garcia De Soto, Francisco	ESP	YA	Ghanem, Ahmed	EGY	AT
Flores-Wurmser, Maria-Ines	GUA	GY	Friedrich, Heike	GDR	SW	Garcia Guevara, Fernando	ARG	YA	Ghansah, Ebenezer	GBR	TA
Florijn, Ronald	HOL	RO	Friedrich, Heike	FRG	SW	Garcia Pina, Gilberto	DOM	JU	Gharbi, Senda	TUN	SW
Florio, Glen	USA	RO	Fries, Kristina	SWE	SH	Garcia Trevijano, Juan Diego	ESP	ES	Ghariani, Fethi	TUN	VB
Floris, Sandro	ITA	AT	Frinta, Pavel	TCH	WR	Garcia Velazco, Jorge Ruben	ARG	YA	Gheel, Richard	IRL	SW
Florov, Tzvetan	BUL	VB	Froberg, Birgitte L	DEN	CA	Garcia, Andres	ESP	FE	Gheorghe, Gabriela	ROM	GY
Floyd, Delisa	USA	AT	Frolova, Inna	URS	RO	Garcia, Anthony	PUR	BA	Gheorghe, Marin	ROM	RO
Focque, Lucia	BEL	RO	Frost, Dan	DEN	CY	Garcia, Antonio	ESP	FE	Gherman, Marius	ROM	GY
Fodor, Janos	HUN	HB	Frost, David	CAN	CA	Garcia, Bonifacio	ESP	BO	Ghorpade, Sujayyashwant	IND	TT
Foerster, Hans	ISV	SW	Frost, Ken	DEN	CY	Garcia, Dario O G	ARG	JU	Giambalvo, Valerio	ITA	SW
Foerster, Kerstin	GDR	RO	Frostad, Knut	NOR	YA	Garcia, Efrain	PUR	BA	Giancespro, Caterina	CAN	GY
Foerster, Olaf	GDR	RO	Fuad Ahmed Nagi, Ehab	YMD	AT	Garcia, Gabriel	ESP	TA	Giani, Andrea	ITA	VB
Foerster, Paul	USA	YA	Fuchs, Markus	SUI	ES	Garcia, Javier	ESP	AT	Giannopoulos, Kyriakos	GRE	SW
Fofana, Bakary	CIV	BO	Fuchs, Thomas	SUI	ES	Garcia, Joe	ECU	WE	Giardini, Celso	ITA	SH
Fofana, Lancine	CIV	AT	Fuchs, Tracey	USA	HO	Garcia, Jose	POR	CA	Giasson, Benoit	CAN	FE
Fofana, Siaka	CIV	CA	Fuentes, Fernando	ESP	CA	Garcia, Jose	MEX	BO	Gibson, Michael	AUS	FB
Fogarty, Catherine Helen	ZIM	SW	Fuentes, Humberto	VEN	WE	Garcia, Jose	VEN	BO	Gibson, Neil	NZL	RO
Fogli, Laura	ITA	AT	Fuentes, Julio	CHI	MP	Garcia, Juan	ESP	HO	Gibson, Sharon	GBR	AT
Foidl, Hubert	DEN	SH	Fuhrig, Mike	GDR	HB	Garcia, Juan Carlos	COL	ES	Gies, Reiner	FRG	BO
Fok, Ming Shan	HKG	AR	Fujii, Izumi	JPN	HB	Garcia, Kricia	ESA	AT	Giese, Carmen	FRG	SH
Fokianos, Nikolaos	GRE	SW	Fujimoto, Takahiro	JPN	SW	Garcia, Luis	MEX	RO	Gifford, Christopher	CAN	HO
Fokine, Seguei	URS	FB	Fujita, Sashiko	JPN	VB	Garcia, Nuria	ESP	GY	Giha, Juan Jorge	PER	SH
Fokke, Annemieke	HOL	HO	Fukube, Masahiko	JPN	WR	Garcia, Pedro	ESP	SW	Gil, Jose Miguel	ESP	SW
Folga, Teresa	POL	GY	Fulco, Bettina	ARG	TE	Garcia, Rosa	PER	VB	Gilbert, Brad	USA	TE
Folkes, Carl	CAN	AT	Fuller, Debbie	CAN	SW	Garcia, Russell	GBR	HO	Gilbert, Glenroy	CAN	AT
Folta, Milan	TCH	HB	Fuller, Mark	USA	WR	Gardiner Walton, David-Enrique	GUA	FB	Gilbert, Lachlan	AUS	YA
Fombertasse, Laurent	FRA	WE	Fuller, Wendy	CAN	SW	Gardiner, Tricia	GBR	ES	Gilfillan, Ruth	GBR	SW
Fonseca, Douglas	BRA	FE	Funes-Hernandez, Juan Manuel	GUA	FB	Gardini, Andrea	ITA	VB	Gill, Alison	GBR	RO
Fonseca, Pedro	BRA	YA	Funkel, Wolfgang	FRG	FB	Gariba, Salaam	GHA	AT	Gill, Paramjit	CAN	WE
Fonseca, Santiago	HON	AT	Funkenhauser, Zita	FRG	FE	Garner, Mark	AUS	AT	Gillingham, Nick	GBR	SW
Foot, Caroline	GBR	SW	Furo, Yasumasa	JPN	SH	Garon, Denis	CAN	WE	Gillom, Jennifer	USA	BB
Ford, Burce	CAN	RO	Furuhashi, Terushi	JPN	AR	Garraffo, Marcelo	ARG	HO	Gilman, David	USA	CA
Forde, Elvis	BAR	AT	Furuhed, Karin	SWE	SW	Garrett, John	GBR	RO	Gilmour, Paul	AUS	CA
Forget, Guy	FRA	TE	Furuta, Atsuya	JPN	BA	Garrido, Luis	PUR	SH	Giordmaina, Jesmond	MLT	WR
Forian, Eva	HUN	SH	Fusaro, Roberto	ITA	RO	Garrison, Zina	USA	TE	Giorgadze, Mikhail	URS	SW
Forshaw, Sheila	CAN	HO	Fuzesi, Mary	CAN	GY	Garrison-Steves, Kelly	USA	GY	Giovannetti, Luciano	ITA	SH
Forster, Kevin	GBR	AT	Fuzesy, Zoltan	HUN	BO	Garsau, Pierre	FRA	SW	Girard, Patricia	FRA	AT
Forsythe, Mark	GBR	AT	Fvller, Eli	ANT	YA	Garzarella, Charles	AUS	WE	Girardi, Francesco	ITA	ES
Fort, Jaime	ESP	HB				Gasch, Uwe	GDR	RO	Giri, Rambahadur	NEP	BO
Fortin, Ana Joselina	HON	SW				Gascon, Florencio	ESP	AT	Giroldi, Ron	HOL	BA
Fortune, Scott T	USA	VB				Gaseitsiwe, Kebapetse	BOT	AT	Girr, Fritz	FRG	YA
Foster, David	IRL	ES				Gaspar, Armenio	ANG	AT	Giisason, Alfred	ISL	HB
Foster, John	ISV	YA	Gaal, Karoly	HUN	WR	Gaspar, Oliver	HUN	SH	Giuliani, Giuliano	ITA	FB
Foster, John Jr.	ISV	YA	Gabarra, James	USA	FB						
Foster, Mark	GBR	SW	Gabathuler, Walter	SUI	ES	Gaspar, Tamas	HUN	WR	Giungi, Alessandra	ITA	JU
Foster, Peter	AUS	CA	Gaday, Jorge-Alberto	ARG	CY	Gaspar, Teresa	POR	JU	Giusti, Maria	VEN	SW
Foster, Todd	USA	BO	Gaddi, Carlo	ITA	RO	Gatai, Robert	HUN	FE	Gjertsen, Douglas	USA	SW
Foth, Robert	USA	SH	Gadomski, Witold	POL	FE	Gataouline, Radion	URS	AT	Glab, Andrzej	POL	WR
Fotou, Georgios	GRE	RO	Gaebler, Roland	FRG	YA	Gatien, Jeanphilippe	FRA	TT	Gleria, Roberto	ITA	SW
Fougeroud, Olivier	FRA	SW	Gaehwiler, Beat	SUI	AT	Gatos, Spyridon	GRE	RO	Glesby, Tom	CAN	BO
Fountaine, Claire	FRA	YA	Gaeta, Renato	ITA	RO	Gatt, Sim	MLT	YA	Glikina, Elena	URS	FE
Fournigov, Hristo	BUL	BO	Gaille, Patrice	SUI	FE	Gauder, Hartwig	GDR	AT	Gloden, Justin	LUX	AT
Fowler, Brian	NZL	CY	Gal, Jessica	HOL	JU	Gaudiano, Luigi	ITA	BO	Gnalo, Akossi	TOG	AT
Fox, John	AUS	SW	Galaktopoulos, Petros	GRE	WR	Gaudin, Brigitte	FRA	FE	Gniewkowski, Marek	POL	FE
Fox, Ruby	USA	SH	Galandi, Christoph	FRG	RO	Gault, Thierry	FRA	CY	Gobedjichvili, David	URS	WR
Foy, Michial	USA	WR	Gale, Peter	AUS	YA	Gause, Raymond	PUR	BB	Goborov, Valeri	URS	BB
Frackelton, John	USA	RO	Galia, Roberto	ITA	FB	Gautheron, Isabelle	FRA	CY	Gocanin, Igor	YUG	SW
Fragata, Gaspar	ANG	SW	Galic, Zita	YUG	HB	Gautreau, Lise	CAN	GY	Godev, Petar	BUL	CA
Fraine, Gregory	NZL	CY	Galkov, Serguei	URS	CA	Gautschi, Nadia	SUI	AR	Goehy, Marlies	GDR	AT
Frana, Javier	ARG	TE	Gallagher, Kim	USA	AT	Gavenciak, Rudolf	TCH	BO	Goertz, Armin	FRG	FB
Francini, Alberto	SMR	JU	Gallagher, Margaret	USA	HB	Gavrilenko, Oleg	URS	SW	Goessner, Roger	FRG	WR
Francis, John William	IND	BO	Gallardo, Miriam	PER	VB	Gayaple, Seid	CHA	AT	Goffin, Anne	BEL	SH
Francis, Lornel	ANT	BO	Galli, Claudio	ITA	VB	Gayle, Barbara	GUM	SW	Gogoladze, Vladimir	URS	GY
Francken, Frank	BEL	CY	Galloway, James	AUS	RO	Gaze, Andrew	AUS	BB	Goksor, Susann	NOR	HB
Francllet, Claude	FRA	AR	Galloway, Janet	NZL	YA	Gbay, Tommy	LBR	BO	Goldman, Andrew	USA	YA
Francois, Andre	VIN	AT	Galovic, Zoran	YUG	WR	Ge, Jianqing	CHN	SW	Goldstein, Shulamit	ISR	GY
Franeek, Michal	TCH	BO	Gamba, Ezio	ITA	JU	Gebhardt, Michael	USA	YA	Golea, Eugenia	ROM	GY
Frank, Helen	GBR	SW	Gambelli, Annalisa	ITA	AT	Gecsek, Tibor	HUN	AT	Goles, Sabrina	YUG	TE
Frank, Tobias	FRG	HO	Gamble, Amy	USA	HB	Geczi, Erika	HUN	CA	Golic, Sladjana	YUG	BB
Franks, Joanne	GBR	AR	Gambra, Jorge	CHI	TT	Gedoevari, Imre	HUN	FE	Golomeev, Tzvetan	BUL	SW
Franssen, Yvonne	CAN	TA	Gamerding, Didier	MON	YA	Gee, Diana	USA	TT	Golomingi, Ndjibu	ZAI	CY
Fransson, Mats	SWE	HB	Gamme, Kamilla	NOR	SW	Geert-Jensen, Anders	DEN	YA	Golota, Andrzej	POL	BO
Franzen, Malene	DEN	GY				Gehrmann, Heike	FRG	HO	Goma, Khalid	BRN	AT
						Geller, Mauricette	BEL	GY	Gombe, Christian	CAF	BB

Seoul '88 Facts and Figures

Les faits et les chiffres

Listing of the Competitors/Listes dies concurrents

Name Nom	Country Pays	Sport	Name Nom	Country Pays	Sport	Name Nom	Country Pays	Sport	Name Nom	Country Pays	Sport
Gombedza, James	ZIM	AT	Grant, Cameron	CAN	SW	Guerra, Patricia	ESP	YA	Hafemeister, Dirk	FRG	ES
Gomer, Sara	GBR	TE	Grant, Dalton	GBR	AT	Guesgen, Stephan	FRG	SW	Hafsteinsson, Vestein	ISL	AT
Gomes, Eduardo	POR	CA	Grant, Howard	CAN	BO	Guester, Ute	FRG	TA	Hagara, Andreas	AUT	YA
Gomes, Jorge	ANG	SW	Grapenthin, Ina	GDR	RO	Guevara-cruz, Ottoniel	GUA	FB	Hagara, Roman	AUT	YA
Gomes, Manuel	ANG	BO	Grate, Pablo	SWE	CA	Gueye, Moustapha	SEN	WR	Hage, Heleen	HOL	CY
Gomez, Alejandro	ESP	AT	Graue, Santiago	ESP	HO	Gufler, Johannes	AUT	SH	Hagemann, Juergen	USA	CA
Gomez, Andres	ESP	HO	Graudyn, Vladimir	URS	AT	Gugler, Christian	SUI	AT	Hagen, Alexander	FRG	YA
Gomez, Federico	MEX	TA	Gravare, Magnus	SWE	YA	Guichot, Pierre	FRA	FE	Hager, Mark	AUS	HO
Gomez, Jesus	ESP	HB	Gray, Ian	BIZ	AT	Guidikov, Borislav	BUL	WE	Haggbom, Jonas	SWE	YA
Gomez, Joaquin	MEX	RO	Gray, Johnny	USA	AT	Guigui, Brigitte	CIV	HB	Hagger, Kim	GBR	AT
Gomez, Salvador	ESP	SW	Gray, Lendon	USA	ES	Guilbe, Edgardo	PUR	AT	Hahmann, Andrea	GDR	AT
Goncz, Anna	HUN	SH	Gray, Peter	BER	ES	Guillou, Laurence	FRA	SW	Hahn, Matthias	GDR	HB
Gondran, Lionel	FRA	WE	Grayer, Jeffrey	USA	BB	Guimaraes, Agberto	BRA	AT	Hahnenkamp, Josef	AUT	SH
Gong, Guohua	CHN	AT	Greaves, Sandra	CAN	JU	Guimaraes, Richardo	BRA	BB	Hajas, Erik	SWE	HB
Gong, Luming	CHN	BB	Greavette, Guy	CAN	WE	Guindon, Claudio Luis	ARG	RO	Hajek, Andreas	GDR	RO
Gontcharov, Valeri	URS	SW	Green, David	AUS	ES	Gul, Ramazan	TUR	BO	Hajkova, Zuzana	TCH	BB
Gonza lez Gauto, Miguel Amadeo	PAR	BO	Green, Michael	GBR	SW	Guldberg, Mogens D	DEN	AT	Hajtos, Bertalan	HUN	JU
Gonzalez Alvarez, Luis Arturo	COL	TE	Green, Michael	BAR	YA	Gullden, Christer	SWE	WR	Hakansson, Ulla	SWE	ES
Gonzalez, Adelina	ESP	YA	Green, Nicola	AUS	YA	Gundeeep Kumar	IND	HO	Halbouni, Hamed	SYR	BO
Gonzalez, Adolfo	MEX	AR	Greene Pereira, Hazel	IRL	AR	Gundersrud, Jan	NOR	SH	Halderman, Gerlach	HOL	BA
Gonzalez, Alexandre	FRA	AT	Greenwood, Eric	CRC	SW	Gunnarsson, Sigurdur	ISL	HB	Hale, Ian	AUS	SH
Gonzalez, Alfredo	COL	SH	Gregg, Malcolm	AUS	BA	Gunnell, Sally	GBR	AT	Haleem, Hussain	MDV	AT
Gonzalez, Bernardo	ESP	CY	Greiner, Cindy	USA	AT	Gunthardt, Heinz	SUI	TE	Halford, Brett	ZIM	SW
Gonzalez, Jorge	ESP	SH	Greiner, Thomas	GDR	RO	Guntner, Bernhard	FRG	TA	Hall, Loreen	GBR	AT
Gonzalez, Mannel	CHI	YA	Greszkiewicz, Jerzy	POL	SH	Guo, Daen	CHN	CA	Hallard, Steven	GBR	AR
Gonzalez, Marco Antonio	ESP	SW	Grichina, Elena	URS	FE	Guo, Jijun	CHN	FB	Halldorsdottir, Helga	ISL	AT
Gonzalez, Mario	MEX	BO	Grichine, Evgeni	URS	SW	Guo, Linxian	CHN	GY	Hallmen, Martina	FRG	HO
Gonzalez, Mauricio	MEX	AT	Griffin, Gary	GUM	YA	Guo, Longchen	CHN	CY	Halsall, Dan	SUI	SW
Gonzalez, Miguel	MEX	BO	Griffin, Mark	CAN	BA	Guo, Mei	CHN	RO	Haltvik, Trine	NOR	HB
Gonzalez, Rodrigo	MEX	SW	Griffin, Tyrome	USA	BA	Gurdenli, Arif	TUR	YA	Halupczok, Joachim	POL	CY
Gonzalez, Victorino	ESP	JU	Griffith Joyner, Florence	USA	AT	Gurina, Lioubov	URS	AT	Halvorsen, John	NOR	AT
Gonzalez, William	COL	FE	Griffith, Agnes	GRN	AT	Gurr, Mark	ZIM	TE	Ham, Duk-Won	KOR	WR
Gonzalez, Jose Luis	ESP	AT	Griffith, Charles	VEN	JU	Gusek, Jens	GDR	FE	Hamada, Ahmed	BRN	AT
Goodwin, Ken	CAN	HO	Griffith, Gregory	BAR	BO	Gustafson, Bengt	SWE	VB	Hamalainen, Mika	FIN	CY
Goodwin, Lian	GBR	SW	Griffiths, Barry	NZL	TT	Gustafsson, Bo	SWE	AT	Hambly, Barbara	GBR	HO
Goodwin, Tom	USA	BA	Grigorakis, Aristidis	GRE	WR	Gustafsson, Carina	SWE	RO	Hamidou, Abdoukerim	TOG	BO
Goody, Simon	GBR	YA	Grigorias, Ion	ROM	WR	Gustafsson, Lars	SWE	WR	Hamilton, Douglas	CAN	RO
Gopin, Valeri	URS	HB	Grigorieva, Natalia	URS	AT	Gustafsson, Tore	SWE	AT	Hamilton, Mark	USA	CA
Goporo, Aubin-Thierry	CAF	BB	Griman, David	VEN	BO	Gutierrez, Guillermo	MEX	CY	Hamilton, Richard	JAM	BO
Goporo, Frederique-Rufin	CAF	BB	Grimley, Martyn	GBR	HO	Gutierrez, Manuel	PAN	SW	Hamilton-Fleming, Sally	AUS	AT
Gorb, Tatiana	URS	HB	Grimmer, Wayne	CAN	HO	Gutowski, Jacek	POL	WE	Hammad, Mohamed	SUD	BO
Gordon, Bridgette	USA	BB	Griniakakis, Theodoros	GRE	SW	Guttler, Karoly	HUN	SW	Hammond, Barbara	GBR	ES
Gordon, Elvis	GBR	JU	Grisandi, Gianpaolo	ITA	CY	Gutzzeit, Bruno	FRA	SW	Hampstead, Curt	GUY	AT
Gordon, Tessa	CAN	TA	Grivel, Philippe	SUI	CY	Guy, Donna	NZL	JU	Han Kyung-Im	KOR	GY
Gorla, Giorgio	ITA	YA	Grobermann, Dov	ISR	WR	Guyomarch, Jean-Pierre	FRA	MP	Han, Hye-Soon	KOR	RO
Gorloukovitch, Serguei	URS	FB	Groc, Patrick	FRA	FE	Guzman Reynoso, Francisco	DOM	WE	Han, Hyun-Sook	KOR	HB
Gorman, Shelley	AUS	BB	Groeben Von Der, Alexander	FRG	JU	Guzman Reynoso, Jose Miguel	DOM	WE	Han, Jang-Sok	KOR	VB
Gornall, Mark	GBR	CY	Groene, Bernd	FRG	CY	Guzman, Manuel	PUR	SW	Han, Jin-Soo	KOR	HO
Gorostegui, Antonio	ESP	YA	Groitsov, Emil	BUL	RO	Gyani, Janos	HUN	JU	Han, Jung-Mi	KOR	YA
Gosbee, William	GBR	FE	Gronborg, Christian	DEN	YA	Gyongyosi, Andras	HUN	SW	Han, Jung-Tae	KOR	ES
Gospodinova, Bistra	BUL	SW	Gronfeldt, Iris	ISL	AT	Gyr, Brigitte	SUI	CY	Han, Keum-Sil	KOR	HO
Goss, Donald Alexander	CAN	SW	Gronlund, Timo	FIN	CA	Gysling, Eva	SUI	SW	Han, Ki-Bum	KOR	BB
Goss, Steven	USA	HB	Gronman, Jouni	FIN	WE	Gyulay, Katalin	HUN	CA	Han, Min-Soo	KOR	AT
Gosse, Christine	FRA	RO	Groos, Margaret	USA	AT	Gyulay, Zsolt	HUN	CA	Han, Myung-Woo	KOR	WR
Gostigan, Michael	USA	MP	Groot, Bill	HOL	BA	Gyurka, Janos	HUN	HB	Han, Ok-Kyung	KOR	HO
Gotchev, Stoytcho	BUL	GY	Grose, Katherine	GBR	RO				Han, Qingling	CHN	BB
Goudehounaite, Aouchra	URS	RO	Gross, Michael	FRG	SW				Han, Yaqin	CHN	RO
Gough, Joanne	GBR	RO	Grottenberg, Sissel	NOR	AT				Han, Young-Hee	KOR	SW
Gould, Donna	AUS	CY	Grover, Alan	AUS	RO				Hanaoka, Kazuo	JPN	YA
Gould, Kenneth	USA	BO	Grubba, Andrzej	POL	TT				Handayani, Lilies	INA	AR
Goulet, Brent	USA	FB	Gruener, Oliver	FRG	RO	Ha, Hyung-Ju	KOR	JU			
Gourine, Iouri	URS	CA	Grzywinski, Dariusz	POL	WR	Ha, Jin-Sik	KOR	RO			
Gourkovsky, Pavel	URS	RO	Gstoetner, Hans	GDR	WR	Ha, Jong-Ho	KOR	BO	Hanika, Sylvia	FRG	TE
Gouszeva, Eliina	URS	HB	Gu, Guohong	CHN	WR	Ha, Soo-Kyung	KOR	SW	Hanim, Mohamed	MDV	AT
Goutnik, Aelita	URS	AT	Guardiola, Jorge	ESP	SH	Ha, Tae-Kyung	KOR	TA	Hanna, Basil G.	IRQ	FB
Gouveia, Antonio	BRA	VB	Guczoghy, Gyorgy	HUN	GY	Haacker, Kathrin	GDR	RO	Hanna, Stephen	BAH	AT
Gouws, Pierre	ZIM	CY	Gudmundsson, Gudmundur	ISL	HB	Haage, Steffen	GDR	SW	Hannecker, Alois	FRG	AT
Goville, John	UGA	AT	Gudmundsson, Petur	ISL	AT	Haagensen, Nils	DEN	ES	Hannemann, Raik	GDR	SW
Gow, Philip	CAN	YA	Gudmundsson, Ragnar	ISL	SW	Haas Ili, George	USA	SH	Hannen, Lynley	NZL	RO
Goyal, Sanjiwan	KEN	HO	Guecheva, Vania	BUL	CA	Haas, Christian	FRG	AT	Hansen, Alf John	NOR	RO
Grabarczyk, Andrzej	POL	AT	Guedekhour, Couram	URS	WR	Haas, Doris	FRG	AR	Hansen, Aran	NZL	YA
Grabert, Karl	HOL	VB	Guehi, Wandou-R.	CIV	HB	Haas, Gerda	AUT	AT	Hansen, Erika	USA	SW
Grablev, Mitko	BUL	WE	Guelov, Ivo	BUL	RO	Haasz, Katalin	HUN	SW	Hansen, Ove	NOR	ES
Grabow, Guido	FRG	RO	Guelpa, Christophe	FRA	SH	Haber, Ralf	GDR	AT	Hansen-Nortey, Yvonne	GBR	AT
Grabow, Volker	FRG	RO	Guenchev, Angel	BUL	WE	Haberl, Gary	AUS	TT	Hansson, Mats	SWE	YA
Grael, Lars	BRA	YA	Guenthoer, Werner	SUI	AT	Habermann, Heiko	GDR	RO	Hansson, Per G.	SWE	SH
Grael, Torben	BRA	YA	Gueorguiev, Dimitar	BUL	RO	Habib, Abdul Naser	BRN	AT	Haouati, Khadija	MAR	JU
Graells, Josep	AND	AT	Gueorguiev, Gueorgui	BUL	AT	Hachemi, Samia	ALG	JU	Hara, Hideharu	JPN	VB
Graf, Steffi	FRG	TE	Gueorguiev, Iliia	BUL	WR	Hackney, Roger	GBR	AT	Hara, Toru	JPN	WE
Graham, Anthony	NZL	CY	Gueorguiev, Petar	BUL	GY	Hacksteiner, Markus	SUI	AT	Hara, Yoshihiko	JPN	WR
Graham, John	CAN	AT	Gueorguieva, Greta	BUL	RO	Haddad, Mohamad	SYR	BO	Harada, Hiroyo	JPN	SW
Graham, Kelvin	AUS	CA	Gueorguieva, Magdalena	BUL	RO	Haddow, Donald	CAN	SW	Harang, Remy	FRA	SH
Graham, Susan	NZL	TA	Gueorguieva, Nadejda	BUL	AT	Hadjiandreou marios	CYP	AT	Harbar, Shaun	AUS	BA
Graham, Trevor	JAM	AT	Guepin, Martine	FRA	SH	Hadjipavlis, Helias	GRE	YA	Harbold, Michael	USA	CA
Graham, Winthrop	JAM	AT	Gueraskov, Lyubomir	BUL	GY	Hadler-Olsen, Audun	NOR	RO	Harczi, Zsolt	HUN	TT
Grahammer, Ronald	FRG	FB	Guerdat, Philippe	SUI	ES	Haendle, Christian	FRG	RO	Hargate, Karen	GBR	GY
Grahl, Viola	FRG	HO	Guerqueltcheva, Daniela	BUL	TT	Haenel, Hal	USA	YA	Harkes, Jhon	USA	FB
Granger, Catherine	AUS	JU	Guerlits, Irina	URS	BB	Haenel, Ulrich	FRG	HO	Harksen, Rudiger	FRG	AT
Granger Veyron, Herve	FRA	FE	Guerovski, Ranguel	BUL	WR	Haesebrouck, Ann	BEL	RO	Harman, Ken	GBR	SH
Grant, Benjamin	SLE	AT	Guerra, Jorge	BRA	BB	Haessler, Thomas	FRG	FB	Harmeling, Lodewijk	HOL	CY
									Harmon, David	IRL	WR
									Harmsworth, Paul	GBR	AT

Name Nom	Country Pays	Sport	Name Nom	Country Pays	Sport	Name Nom	Country Pays	Sport	Name Nom	Country Pays	Sport
Harnett, Curtis	CAN	CY	Heppele, Elizabeth	AUS	CY	Holderbach, David	FRA	SW	Hsu, Jui-Te	TPE	CY
Harper, Neil	GBR	SW	Heppner, Uwe	GDR	RO	Holgado, Juan Carlos	ESP	AR	Hu, Pei-Wen	TPE	AR
Harper, Pierre	GBR	FE	Herbert, John	GBR	AT	Holidis, Charalambos	GRE	WR	Hu, Yadong	CHN	RO
Harries, Philip	GBR	AT	Herbert, Michael	USA	CA	Holjer, Marie	SWE	CY	Huang, Chien-Lung	TPE	WR
Harris, Douglas	CAN	HO	Herberth, Christian	FRG	TA	Hollaender, Meike	ERG	RO	Huang, Chiung-Lung	TPE	BA
Harris, Madonna	NZL	CY	Heredia, Isabel	PER	VB	Hollamby, Brent	NZL	WR	Huang, Guoxiong	CHN	SW
Harrison, Christopher	AUS	SW	Herlufsen, Jorgen Just	DEN	SH	Holland, Maree	AUS	AT	Huang, Huei-Chieh	TPE	TT
Harrison, Paul	AUS	WE	Hermann, Peter	LIE	CY	Holloway, Debra	USA	TA	Huang, Long	CHN	SW
Hart, Peter	GBR	MP	Hermine, Muriel	FRA	SW	Holmann, Knut	NOR	CA	Huang, Ping-Yang	TPE	BA
Hartai, Katalin	HUN	AT	Hernandez, Claudia	MEX	TE	Holmberg, Peter	ISV	YA	Huang, Qijiang	CHN	SW
Hartl, Roswitha	AUT	JU	Hernandez, Daniel Anibal	ARG	FB	Holmertz, Anders	SWE	SW	Huang, Shiping	CHN	SH
Hartmann, Gerhard	AUT	AT	Hernandez, Gregorio	ESP	CA	Holmes, Andrew	GBR	RO	Huang, Xiaomin	CHN	SW
Hartmann, Totto	NOR	YA	Hernandez, Honorato	ESP	AT	Holmes, Gary	CAN	WR	Huang, Yunlong	CHN	BB
Hartwig, Heike	GDR	AT	Hernandez, Mauricio	MEX	AT	Holmes, Lawrence	CAN	WR	Huang, Zhihong	CHN	AT
Harvey, Gregory	AUS	BA	Hernandez, Salvador	MEX	JU	Holmes, Patrick	IRL	CA	Huart, Helene	FRA	AT
Haryono, Yon	INA	WE	Hernando, Jose	ESP	SW	Holmes-Smith, Nicholas	CAN	ES	Huber, Jeffrey	HOL	TA
Hasan, Na Im	USA	TA	Herold, Jens-Peter	GDR	AT	Holmquist, Joakim	SWE	SW	Huber, Michaela	AUT	TA
Hasegawa, Tomoko	JPN	SH	Herrera, Jesus	MEX	AT	Holpert, Jozef	YUG	HB	Huber, Thomas	FRG	SW
Hashimoto, Seiko	JPN	CY	Herrmann, Joerg	GDR	YA	Holsboer, Noor	HOL	HO	Huber, Vicki	USA	AT
Hashimoto, Yukihiko	JPN	HB	Herrmann, Martin	FRG	SW	Holtmeyer, Ralf	FRG	RO	Huck, Karsten	FRG	ES
						Homeghi, Olga	ROM	RO			
Hasler, Yvonne	LIE	AT	Herrmann, Mike	GDR	SH				Hudec, Jiri	TCH	AT
Hassan, Emadeldin	EGY	JU	Herron, Angie	USA	RO	Homela, Melford	ZIM	AT	Hudecek, Petr	TCH	WE
Hassan, Mohamed	EGY	SW	Hervas, Manuela	ESP	GY	Hompoth, Ferenc	HUN	RO	Huebner, Michael	GDR	CY
Hassan, Moustafa	EGY	BO	Herve, Philippe	FRA	SW	Honda, Morimasa	JPN	GY	Hughes, Ann	GBR	JU
Hassan, Salih	GBR	RO	Hess, Olaf	GDR	SH	Honda, Tamon	JPN	WR	Huh, Byung-Ho	KOR	WR
Hatch, John	CAN	BB	Hesslich, Lutz	GDR	CY	Honegger, Martin	SUI	RO	Huhtala, Harri	FIN	AT
Hatch, Reginald	AUS	CA	Hetherington, Jill	CAN	TE	Honein, Georges	LIB	CY	Hui, Chak-Bor	HKG	CY
Hattin, Heather	CAN	RO	Heugabel, Reiner	FRG	WR	Honey, Christopher	BAR	SW	Hui, So Hung	HKG	TT
Hatton, Hollis	USA	RO	Heukrodt, Olaf	GDR	CA	Honey, Gary	AUS	AT	Hukkanen, Esa	FIN	BO
Hauck, Stephan	GDR	HB	Heulot, Eric	FRA	CY	Hong, Cha-Ok	KOR	TT	Hulten, Fredrik	SWE	RO
						Hong, Cheng-Chin	TPE	BA			
Hauer, Dietmar	AUT	CY	Heydeck, Maik	GDR	BO				Humber, Lome Franklin	CAN	BA
Haught, Teresa	USA	CA	Hibbert, Curtis	CAN	GY	Hong, Chul-Ho	KOR	BO	Hume, Sylvia	NZL	SW
Hautenaue, Jacqueline	BEL	AT	Hibon, Nathalie	FRA	AR	Hong, I-Chung	TPE	BA	Humphrey, Jacqueline	USA	AT
Havas, Endre	HUN	AT	Hidalgo, Herminio	PAN	WR	Hong, Ji-Hee	KOR	SW	Hung, Cee Kay	HKG	SW
Havelka, Monica	USA	RO	Hidalgo, Montserrat	CRC	SW	Hong, Seung-Pyo	KOR	SH	Hung, Chung-Yam	HKG	CY
Havelka, Pavel	TCH	CA	Hidding, Jantien	HOL	AT	Hong, Soon-Bo	KOR	SW	Hunger, Daniela	GDR	SW
Hawgood, Neil	AUS	HO	Hierzer, Hans	AUT	SH	Hong, Sung-Hee	KOR	GY	Hunger, Joachim	FRG	YA
Hawkes, Rechelle	AUS	HO	Higashi, Satoru	JPN	BO	Hong, Young-Mi	KOR	CY	Hunger, Wolfgang	FRG	YA
Hawkins, Hersey	USA	BB	Hightower, Yolanda	USA	HO	Hong, Young-Ok	KOR	SH	Hunter, Alan	AUS	FB
Hay, Susan	GBR	YA	Higson, Allison	CAN	SW	Hong, Young-Seung	KOR	FE	Hunter, Jill	GBR	AT
						Hongram, Phat	THA	BO			
Hayes, Andrea	USA	SW	Hiles, Darrell	AUS	BO				Hunter, Linda Elizabeth	ZIM	AT
Hayman, Gregory	AUS	WE	Hilgers, Michael	FRG	HO	Hoogewerf, Simon	CAN	AT	Hunter, Martin	AUS	CA
Hayner, Christian	SUI	YA	Hill, Jean	GBR	SW	Hooveld, Lara	AUS	SW	Huntington, Christopher	USA	RO
Hayyaz, Ali	UAE	CY	Hill, Michael	GBR	AT	Hooper, Dick	IRL	AT	Huo, Jianting	CHN	FB
He, Jianping	CHN	HB	Hillas, Lorraine	AUS	HO	Hopkins, Josie	AUS	SW	Hur, Jae	KOR	BB
He, Xiaomin	CHN	GY	Hillenbrand, Kurt	FRG	SH	Hora, Carols	PER	SH	Hur, Sang-Young	KOR	HO
He, Yanwen	CHN	RO	Hillery, Robert	USA	HB	Hormillosa, Michael	PHI	BO	Huricha, Carlos	CHN	WR
He, Yingqiang	CHN	WE	Hillman, Stewart	CAN	BA	Hornig, Carola	GDR	RO	Hurlston, Paul	CAY	AT
He, Zhuoqiang	CHN	WE	Hilmarsson, Atli	ISL	HB	Horning, Karen	PER	SW	Hussain, Amir J	IRQ	BO
Heberle, Isabelle	FRA	SH	Himmel, Gerhard	FRG	WR	Horny, Kayherine	PER	VB	Hussain, Imad H.	IRQ	FB
						Horrio, Eddie	PUR	BA			
Hecht, Heimo	AUT	YA	Hingsen, Jurgen	FRG	AT				Hussein, Amr	EGY	TA
Heck, Olivier	FRA	AR	Hinneburg, Lars	GDR	SW	Horvath, Attila	HUN	AT	Hussein, Ibrahim	KEN	AT
Hedengard, Jan	SWE	VB	Hirata, Akihisa	JPN	RO	Horvath, Zsolt	HUN	GY	Hussein, Moustafa	EGY	WR
Hedgepeth, Whitney	USA	SW	Hiriv, Juha	FIN	SH	Hory, Zouheir	SYR	WR	Hussein, Walid	EGY	JU
Hee, Dana	USA	TA	Hiro, Norie	JPN	VB	Hoshino, Mika	JPN	TT	Hussey, Marcela	ARG	HO
Heer, Fritz	FRG	AT	Hirst, Jeffrey	CAN	SW	Hosnany, Gilany	MRI	TT	Huttich, Carlos	MEX	JU
Hegazy, Mohamed	EGY	BO	Hjeltnes, Knut	NOR	AT	Hosoda, Tomomi	JPN	SW	Huynh, Chau	VIE	CY
Hegedus, Ferenc	HUN	FE	Hjortnes, Lasse	DEN	YA	Hosokawa, Shinji	JPN	JU	Hwang, Dae-Yeon	KOR	BA
Hegener, Eva	FRG	HO	Hlasek, Jakob	SUI	TE	Hospers, Hendrick	HOL	RO	Hwang, Hong-Chul	KOR	AT
Hegewisch, Everardo	MEX	ES	Hlavacek, Leos	TCH	SH	Hoszek, Tomas	SWE	VB	Hwang, In-Dong	KOR	WE
						Hotz, Marcel	SUI	RO			
Heggli, Rita	SUI	AT	Hlawe, Samuel	SWZ	AT				Hwang, Keum-Sook	KOR	HO
Hegh, Hanne	NOR	HB	Hlidek, Petr	TCH	RO	Hou john	NGU	AT	Hwang, Woo-Won	KOR	WE
Heiestad, Tor	NOR	SH	Hmed Saleh, Houssein	DJI	AT	Hou, Xuemei	CHN	AT	Hwang, Yao-Han	TPE	TA
Heiner, Roy	HOL	YA	Ho, Barry Takhung	HKG	YA	Hou, Yuzhu	CHN	VB	Hyde, Devon	BIZ	AT
Heinonen, Minna	FIN	AR	Hoban, Neil	GBR	CY	Houlding, John	CAN	RO	Hyde, James	USA	WE
Heinrich, Lothar	AUT	SH	Hobisgaltu,	CHN	WR	Hour, Jiunn-Yih	TPE	WR	Hylova, Irena	TCH	GY
Heinrichs, Elke	FRG	SW	Hochstatter, Ruth	AUT	SW	Howard, Denean	USA	AT	Hyun, Jung-Hwa	KOR	TT
Heiring, Jim	USA	AT	Hochstein, Erik	FRG	SW	Howard, Jim	USA	AT	Hyun, Sung-In	KOR	RO
Heisler, Randy	USA	AT	Hochwald, Bernhard	GDR	SH	Howard, Sherri	USA	AT			
Hejdusek, Oldrich	TCH	RO	Hocine, Youssef	FRA	FE	Howe, Jens	GDR	FE			
						Howe, Paul	GBR	SW			
Hejtmanikova, Monika	TCH	HB	Hodge, Lindel	IVB	AT						
Helbin, Joanna	POL	AR	Hodge, Neville	ISV	AT	Howkins, Mark	CAN	SH	laanson, Iouri	URS	RO
Hellgren, Claes	SWE	HB	Hodge, Sally	GBR	CY	Howlett, David	GBR	YA	Iachini, Giuseppe	ITA	FB
Hellmann, Martina	GDR	AT	Hodgson, Nick	GBR	SW	Hoy, Andrew	AUS	ES	Iacono, Franck	FRA	SW
Hellstern, Tue	DEN	MP	Hodosi, Sandor	HUN	CA	Hoy, Peter	CAN	BA	Iagorachvili, Vakhtang	URS	MP
Hellstrom, Jan	SWE	FB	Hoerner, Silke	GDR	SW	Hoyer, Didier	FRA	CA	Iahuat, James	VAN	BO
Helmdach, Joerg	FRG	WR	Hoerster, Thomas	FRG	FB	Hoyo, Marcelo	MEX	MP	Iakoucha, Vassily	URS	RO
Helyi, Tibor	HUN	CA	Hofer, Otto	SUI	ES	Hraban, Roman	TCH	AT	Iakovleva, Alia	URS	CY
Hembrick, Anthony	USA	BO	Hoffman, Paul	SWZ	WE	Hrachova, Marie	TCH	TT	Iakovleva, Olga	URS	BB
Hemmings, Andrew	GBR	YA	Hoffmann, Carola	FRG	HO	Hradaska, Anna	TCH	HB	Iannotti, Antonio	ITA	RO
						Hrafnelsson, Gudmundur	ISL	HB	Iapatu, Isaac	VAN	BO
Hempel, Jan	GDR	SW	Hoffmann, Joerg	GDR	SW						
Henard, Nicolas	FRA	YA	Hoffmann, Ulf	GDR	GY	Hristov, Alexander	BUL	BO	Iarochchouk, Vadim	URS	SW
Henkel, Rainer	FRG	SW	Hoffmeister, Frank	FRG	SW	Hristov, Ivailo	BUL	BO	Iarovenko, Evgueni	URS	FB
Henn, Christian	FRG	CY	Hofmann, Peter	GDR	HB	Hristov, Plamen	BUL	VB	Ibanez, Jose Andres	ESP	WE
Hennig, Roland	GDR	CY	Hofs, Ekkehard	FRG	RO	Hristova, Natacha	BUL	SW	Ibragimov, Anvar	URS	FE
Henrich, Mark	FRG	AT	Hogholm, Vagn	DEN	SW	Hristova, Pavlina	BUL	RO	Ibrahim, Kamal	EGY	WR
Henriksson, Seppo	FIN	RO	Hogness, Hanne	NOR	HB	Hristova, Tzvetanka	BUL	AT	Ibrahim, Khaled	EGY	TA
Henry, Gordon	CAN	RO	Hohmann, Margaret	GBR	SW	Hristozov, Kalofer	BUL	GY	Ichiba, Takashi	JPN	WE
Henry, Jean michel	FRA	FE	Hohsuwan, Anan	THA	YA	Hrivnak, Peter	TCH	BO	Ichillumpa, Edmundo	PER	WR
Henter, Frank	FRG	SW	Hoketsu, Hiroshi	JPN	ES	Hruza, Vladimir	TCH	CY	Idem, Josefa	FRG	CA
						Hsu, Hui-Ing	TPE	AT	Idir, Ali	ALG	JU

Name Nom	Country Pays	Sport	Name Nom	Country Pays	Sport	Name Nom	Country Pays	Sport	Name Nom	Country Pays	Sport
Kalfayan, Christophe	FRA	SW	Kazarian, Mikhak	URS	BO	Ki, Mi-Sook	KOR	HB	Kim, Sung-Hea	KOR	JU
Kalimbet, Irina	URS	RO	Kaziiski, Ilian	BUL	VB	Kidakas, Vatslovas	URS	AT	Kim, Sung-Ko	KOR	MP
Kalinic, Zoran	YUG	TT	Ke, Hua	CHN	CA	Kiejda, Ireneusz	POL	JU	Kim, Sung-Hwan	KOR	ES
Kalinowski, Anetta	FRG	SH	Keach, Scott	AUS	ES	Kielpikowski, Piotr	POL	FE	Kim, Sung-Jung	KOR	ES
Kalmazidis, Jannis	SWE	VB	Kearing, Jocelyn	USA	RO	Kierpacz, Roman	POL	WR	Kim, Sung-Moon	KOR	WR
Kalovelonis, George	GRE	TE	Kearns, Thomas	IRL	AT	Kihara, James	KEN	JU	Kim, Tae-Hyung	KOR	BA
Kaluzakova, Eva	TCH	BB	Keech, Bruce	AUS	CY	Kiiskila, Reijo	FIN	WE	Kim, Tae-Woo	KOR	WR
Kamal, Samer	JOR	TA	Keenan-Buckley, Anne	IRL	AT	Kikuchi, Satoshi	JPN	BA	Kim, Wan	KOR	TT
Kamarachki, Stanislav	BUL	RO	Kefalogiannis, Aris	GRE	SW	Killat, Albin	FRG	SW	Kim, Won-Tak	KOR	AT
Kamau, David	KEN	BO	Keggi, Mara	USA	RO	Killingbeck, Molly	CAN	AT	Kim, Yong-Kook	KOR	FE
Kamburski, Dimitar	BUL	RO	Keita, Francis	SLE	AT	Kim, Bock-Sup	KOR	AT	Kim, Yong-Kyu	KOR	CY
Kamela, Paul	CMR	BO	Keita, Mamadou	MLI	JU	Kim, Bong-Soo	KOR	TE	Kim, Yong-Se	KOR	FB
Kamis, Bengt	SWE	SH	Keita, Suma	SLE	AT	Kim, Byung-Chan	KOR	WE	Kim, Yoo-Hyun	KOR	BO
Kampf, Bettina	FRG	RO	Kelderman, Hans	HOL	RO	Kim, Chong-Kon	KOR	FB	Kim, Yoon-Ho	KOR	BB
Kamps, Uwe	FRG	FB	Kelemen, Ildiko	HUN	SW	Kim, Choon-Rye	KOR	HB	Kim, Yoon-Hye	KOR	VB
Kanada, Yasunobu	JPN	CA	Kelési, Helen	CAN	TE	Kim, Chul-Kyun	KOR	AT	Kim, You-Taek	KOR	BB
Kanatsu, Yoshihiko	JPN	FE	Keller, Andreas	FRG	HO	Kim, Chun-Hee	KOR	AT	Kim, Young-Gil	KOR	AT
Kane, Charles	GBR	BO	Keller, Cordula	FRG	RO	Kim, Dong-Soo	KOR	CA	Kim, Young-Joon	KOR	HO
Kanehama, Ryo	JPN	WR	Keller, Uwe	GDR	RO	Kim, Dong-Soo	KOR	BA	Kim, Young-Mi	KOR	SH
Kaneto, Keita	JPN	SW	Kelly, Jon	CAN	SW	Kim, Eun-Hee	KOR	SW	Kim, Young-Nam	KOR	WR
Kang, Hye-Ja	KOR	SH	Kelly, Steven	BAH	YA	Kim, Eun-Jung	KOR	SW	Kim, Young-Sook	KOR	HO
Kang, Jae-Won	KOR	HB	Kemah, Erol	TUR	WR	Kim, Eun-Mi	KOR	GY	Kim, Young-Sook	KOR	HB
Kang, Ki-Woong	KOR	BA	Kemner, Caren	USA	VB	Kim, Eun-Sok	KOR	VB	Kim, Yun-Man	KOR	WR
Kang, Kyung-Hyo	KOR	MP	Kemp, Troy	BAH	AT	Kim, Gap-Sik	KOR	RO	Kimani, Waruingi	KEN	WR
Kang, Man-Koo	KOR	RO	Kempenich, Joerg	FRG	FE	Kim, Ha-Yun	KOR	SH	Kimbell, Douglas D.	USA	SW
Kang, Min-Heung	KOR	RO	Kendall, Bruce	NZL	YA	Kim, Hee-Sun	KOR	AT	Kimeli, Kipkemboi	KEN	AT
Kang, Young-Soo	KOR	BA	Kennedy, Barry	CAN	MP	Kim, Ho-Chul	KOR	VB	Kinch, Beverly	GBR	AT
Kanika, Rund	ZAI	BO	Kennedy, Karen	ZAI	GY	Kim, Hwa-Soon	KOR	BB	Kinder, Gary	USA	AT
Kankovsky, Martin	TCH	CY	Kennedy, Mark	JAM	BO	Kim, Hye-Sook	KOR	YA	King, Emmitt	USA	AT
Kano, Claudio	BRA	TT	Kennedy, Peter	IRL	YA	Kim, Hye-Youn	KOR	BB	King, John	GBR	AT
Kansakangas, Anne	FIN	AT	Kennelly Jr, Richard	USA	RO	Kim, Hyun-Hee	KOR	TA	King, Marcie	CAN	TA
Kantari, Rami	LIB	SW	Kenny, Grant	AUS	CA	Kim, Hyun-Jun	KOR	BB	King, Patricia	USA	AT
Kantchev, Ventzislav	BUL	RO	Kent, Julie	AUS	SW	Kim, Hyun-Mee	KOR	HB	Kingdom, Roger	USA	AT
Kantor, Waldo Ariel	ARG	VB	Kent, Olney	USA	CA	Kim, Hyung-Chil	KOR	ES	Kingsman, Paul	NZL	SW
Kapocs, Aniko	HUN	RO	Keogh, Damian	AUS	BB	Kim, Il-Soon	KOR	TE	Kiniakine, Serguei	URS	RO
Karacsony, Gyula	HUN	SH	Keough, Linda	GBR	AT	Kim, In-Wha	KOR	GY	Kinnunen, Kimmo	FIN	AT
Karadouchev, Gueorgui	BUL	WR	Kerek, Istvan	HUN	WE	Kim, Jae-Chun	KOR	HO	Kinoshita, Kyoko	JPN	SH
Karaffa, Laszlo	HUN	AT	Kerho, Stephen	CAN	AT	Kim, Jae-Hwan	KOR	HB	Kinst, Vladimir	TCH	CY
Karamanliev, Gueorgui	BUL	WR	Kerly, Sean	GBR	HO	Kim, Jae-Yun	KOR	SW	Kinzel, Gisela	FRG	AT
Karamtchakov, Serguei	URS	WR	Kermarec, Michel	FRA	YA	Kim, Jae-Yup	KOR	JU	Kioulvet, Valter	URS	AT
Karapatakis, Andreas	CYP	YA	Kermiet, Jan	TCH	SH	Kim, Ji-Sook	KOR	TA	Kipkemboi, Simon	KEN	AT
Karaulic, Branislav	YUG	AT	Kern, Ralph	FRG	GY	Kim, Jimmy	USA	TA	Kiprotich, Nixon	KEN	AT
Karchakevish, Alexandre	URS	HB	Kernohan, Hugh	GBR	FE	Kim, Jin-Soon	KOR	FE	Kipsang, Joseph	KEN	AT
Karczag, Tibor	HUN	WE	Kerr, Andrew	AUS	SW	Kim, Jin-Tae	KOR	AT	Kiraly, Charles K	USA	VB
Karczmarek, Agata	POL	AT	Kerr, Jane	CAN	SW	Kim, Jin-Tae	KOR	SW	Kirch, Barbara	USA	RO
Kardolus, Arwin	HOL	FE	Kersten, Dagmar	GDR	GY	Kim, Jin-Young	KOR	CY	Kirchhoff, Dettlef	GDR	RO
Kardolus, Olaf	HOL	FE	Keskitalo, Petri	FIN	AT	Kim, Jong-Il	KOR	AT	Kiriakov, Taniou	BUL	SH
Karelina, Alexandre	URS	WR	Keskitalo, Sinikka	FIN	AT	Kim, Jong-Kap	KOR	HO	Kirilov, Deian	BUL	BO
Karinou, Hassane	NIG	AT	Keso, Vesa	FIN	RO	Kim, Jong-Oh	KOR	WR	Kiritani, Nona	JPN	FE
Kariuki, Julius	KEN	AT	Kessel, Laurel	USA	VB	Kim, Jong-Suk	KOR	TA	Kiritchenko, Alexandre	URS	CY
Karkusiewicz, Wojciech	POL	SH	Kessler, Norbert	FRG	RO	Kim, Joo-Seok	KOR	CY	Kirk, Stephen	USA	HB
Karlava, Larissa	URS	HB	Kessler, William	USA	HB	Kim, Joo-Sung	KOR	FB	Kirkorov, Kirkor	BUL	BO
Karlsson, Anita	SWE	SH	Keszthelyi, Tibor	HUN	SW	Kim, Ki-Bum	KOR	BA	Kirkwood, James	GBR	HO
Karlsson, Jan	SWE	CY	Ketachvili, Guela	URS	FB	Kim, Ki-Choon	KOR	SW	Kirsanov, Sergei	URS	CA
Karlsson, Mats	SWE	VB	Keys, George	NZL	RO	Kim, Ki-Han	KOR	YA	Kitahara, Kyoko	JPN	AR
Kama, Jarmo	FIN	AT	Keyte, Lawrence	CAN	MP	Kim, Ki-Jung	KOR	WR	Kitano, Takayo	JPN	SW
Karppinen, Pertti	FIN	RO	Kezel, Christian	FRA	SH	Kim, Ki-Taik	KOR	TT	Kitel, Martin	SWE	BO
Karppinen, Reima	FIN	RO	Kgarametso, Benny	BOT	AT	Kim, Ki-Woong	KOR	WE	Kitur, Simon	KEN	AT
Kartachov, Evgueni	URS	CA	Khabelov, Leri	URS	WR	Kim, Kil-Hwan	KOR	SW	Klaassen, Rene	HOL	HO
Kartalova, Maria	BUL	GY	Khadartsev, Makharbek	URS	WR	Kim, Kon-Il	KOR	SH	Kladiva, Petr	TCH	SW
Kasahara, Takahiro	JPN	AT	Khadem, Amir-Reza	IRN	WR	Kim, Kui-Soon	KOR	VB	Klaic, Ivica	YUG	TA
Kasalova, Renata	TCH	TT	Khadjiyankova, Nina	BUL	BB	Kim, Kwang-Sun	KOR	BO	Klampar, Tibor	HUN	TT
Kasama, Yuji	JPN	VB	Khadpo, Vichai	THA	BO	Kim, Kwi-Shik	KOR	WE	Klapheck, Wolfgang	FRG	RO
Kasongo, Mwana Bute	ZAI	AT	Khalaf, Nancy	LIB	SW	Kim, Kyung-Hee	KOR	VB	Klass, Edward Craig	USA	SW
Kasova, Alena	TCH	BB	Khalid Bashir	PAK	HO	Kim, Kyung-Ki	KOR	BA	Klauz, Laszlo	HUN	WR
Kaspar, Arndt	FRG	SH	Khalid Hamid	PAK	HO	Kim, Kyung-Sook	KOR	CY	Klawonn, Frank	GDR	RO
Kaspereit, Thies	FRG	ES	Khalid, Abdul Rahman	BRN	MP	Kim, Kyung-Soon	KOR	HB	Klein, Manfred	FRG	RO
Kaspoutis, Artouras	URS	CY	Khalid, Abdul Rahman	BRN	FE	Kim, Mal-Lyun	KOR	BB	Klein, Peter	FRG	AT
Kasprzyk, Ewa	POL	AT	Khalifa, Khalifa Omer	SUD	AT	Kim, Man-Ho	KOR	HB	Kleindl, Ulrike	AUT	AT
Kassouf, Mirwan	LIB	BO	Khalifa, Sultan	UAE	CY	Kim, Man-Whe	KOR	HO	Klementiev, Ivan	URS	CA
Kassoumi, Agathi	GRE	SH	Khalil, Hesham	EGY	BB	Kim, Mi-Ja	KOR	CA	Klepp, Katja	GDR	SH
Kasum, Goran	YUG	WR	Khamis, Khalifa	BRN	FE	Kim, Mi-Kyong	KOR	AT	Klepp, Mart	CAN	SH
Kaswanga, Danieljeremia	MAW	CY	Khamis, Khalifa	BRN	MP	Kim, Mi-Sook	KOR	CA	Kleppinger, Gerhard	FRG	FB
Katanec, Srecko	YUG	FB	Khammanipheth, Chansavang	LAO	AT	Kim, Mi-Sun	KOR	HO	Kleven, Stig Arild	NOR	WR
Katewicz, Renata	POL	AT	Khan, Moses	FIJ	AT	Kim, Mijinsu	KOR	SW	Klimke Dr, Reiner	FRG	ES
Kato, Masashi	JPN	SW	Khanji, Ahmadmayez	SYR	BO	Kim, Myung-Gon	KOR	MP	Klimko, Olga	URS	ES
Katombi, Eugenio	ANG	AT	Kharikov, Serguei	URS	GY	Kim, Myung-Soon	KOR	HB	Klimov, Victor	URS	CY
Katsuragi, Hiroki	JPN	BA	Kharine, Dmitri	URS	FB	Kim, Nam-Ok	KOR	GY	Klinsmann, Juergen	FRG	FB
Katz, Kerrye	AUS	JU	Kharitse, Mothobi	LES	AT	Kim, Pan-Keun	KOR	FB	Klitzkie, Lourdes	GUM	AT
Kaufmann, Klaus	FRG	CY	Khawam, Roni	LIB	JU	Kim, Pung-Joo	KOR	FB	Klopas, Frank	USA	FB
Kauvai, Joseph	COK	WE	Khellil, Allaoua	ALG	AT	Kim, Sang-Kyu	KOR	WR	Kloppenbourg, Mirjam	HOL	TT
Kavuma, Ali	UGA	WE	Khinkhintwe	BIR	AT	Kim, Sang-Wook	KOR	FE	Klotz, Ulrike	GDR	GY
Kawai, Carlos	BRA	TT	Khmelevskaia, Irina	URS	CA	Kim, Seung-Kyu	KOR	JU	Klug, Annette	FRG	FE
Kawai, Shunichi	JPN	VB	Khokhlova, Valentina	URS	RO	Kim, Seung-Pyo	KOR	FE	Kluge, Anja	GDR	RO
Kawamoto, Shunsuke	JPN	RO	Khomitchious, Valdemaras	URS	BB	Kim, So-Young	KOR	TA	Knabe, Kerstin	GDR	AT
Kawase, Yukari	JPN	VB	Khoperski, Oleg	URS	YA	Kim, Soo-Jin	KOR	SW	Knabe, Stefan	FRG	YA
Kawasumi, Hiromi	JPN	AT	Khorshed, Mohamed	EGY	SH	Kim, Soo-Nyung	KOR	AR	Knapp, Danforth	USA	YA
Kaygusuz, Selman	TUR	WR	Khoudachova, Elena	URS	BB	Kim, Soon-Duk	KOR	HO	Knappheide, Dirk	FRG	MP
Kazanowski, Geraldfrancois	CAN	BB	Khrabrova, Khrabrina	BUL	GY	Kim, Soon-Ja	KOR	AT	Knight, Sean	BAR	BO
Kazantsev, Roman	URS	RO	Khrapatyi, Anatoli	URS	WE	Kim, Sung-Eun	KOR	SW	Knighton, Marges	NZL	ES

Seoul '88 Facts and Figures

Les faits et les chiffres

Listing of the Competitors/Listes dies concurrents

Name Norn	Country Pays	Sport	Name Nom	Country Pays	Sport	Name Nom	Country Pays	Sport	Name Nom	Country Pays	Sport
Knol, Monique	HOL	CY	Koscielniakowski, Robert	POL	FE	Kroes, Hans	HOL	SW	Lachtchenova, Natalia	URS	GY
Knol, Robert	HOL	BA	Kosinski, Waldemar	POL	WE	Krogner, Karsten	DEN	SH	Lachtilina, Manuela	BUL	RO
Knoll, Silke	FRG	AT	Koskela, Harri	FIN	WR	Kroh, Matthias	GDR	YA	Lack, Portia	USA	HB
Knonth, Cinthia	BRA	YA	Koskull Von, Johan	FIN	YA	Krolikowska, Jolanta	POL	FE	Ladanyi, Andrea	HUN	GY
Knowles, Durward	BAH	YA	Koskull Von, Peter	FIN	YA	Kroll, Sylvio	GDR	GY	Ladanyi, Zsigmond	HUN	AT
Knowles, George	BAH	AT	Koslowski, Dennis	USA	WR	Kroupko, Pavel	URS	RO	Laffillee, J.Rfancois	FRA	CY
Knowles, Gregory	NZL	YA	Koslowski, Duane	USA	WR	Krstic, Mirjana	YUG	HB	Lafis, Michel	SWE	CY
Knudsen, Jeanette	DEN	CA	Kosmina, John	AUS	FB	Kruger, Alex	GBR	AT	Lafon, Chantal	FRA	RO
Knudsen, Yvonne b	DEN	CA	Kosolofski, Brent	CAN	BO	Kruize, Jan hidde	HOL	HO	Laforme, Mel	CAN	RO
Knuppel, Bernd	URU	YA	Kostadinov, Ivo	BUL	JU	Krukowski, Piotr	POL	WE	Lafranchi, Bruno	SUI	AT
Ko, Nak-Choon	KOR	FE	Kostadinova, Stefka	BUL	AT	Krumpe, Paul	USA	FB	Lagerborg, Lars	SWE	WR
Koba, Ryohei	JPN	SH	Kostecki, John	USA	YA	Kruyt, Marcel	HOL	BA	Lahbi, Fauzi	MAR	AT
Koban, Rita	HUN	CA	Kostel, Norbert	AUT	CY	Krylov, Vladimir	URS	AT	Lahcinia, Abderrahim	MAR	JU
Kobayashi, Maki	JPN	RO	Koster, Happy	HOL	BA	Krzepinski, Andrzej	POL	RO	Lahde, Jari	FIN	CY
Kobayashi, Miyuki	JPN	CA	Kostioutchenkova, Irina	URS	AT	Krzyzanski, Kazimierz	POL	CA	Lahia, Ilham.B.	INA	BO
Kobayashi, Takashi	JPN	WR	Kostoff, Jeff	USA	SW	Ksiazek, Bozena	POL	CA	Lahl, Sylvia	GDR	RO
Koberstein, Chris	CAN	CY	Kostrzewa, Andrzej	POL	FE	Ku, Sang-Bum	KOR	FB	Lahmar, Msaddak	TUN	VB
Koboldt, Mary	USA	HO	Kosz, Zoltan	HUN	SW	Kubiak, Andrzej	POL	WR	Lahme, Susanne	GDR	VB
Kocak, Sumer	TUR	WR	Kotani, Mikako	JPN	SW	Kubista, Jan	TCH	AT	Lahoud, Emile	LIB	SW
Koch, Anne	DEN	ES	Kotenko, Serguei	URS	SW	Kubuitsile, L.Shakes	BOT	BO	Lahoz, Esther	ESP	AT
Koch, Anne	DEN	ES	Kotkas, James	CAN	BA	Kucej, Jozef	TCH	AT	Lai, Chi Hung	HKG	AR
Koch, Beate	GDR	AT	Kotrc, Jiri	TCH	HB	Kucharczyk, Krzysztof	POL	SH	Lai, Fang-Mei	TPE	AR
Koch, Carolyn	USA	SH	Kotta, Jean-Pierre	CAF	BB	Kucharski, Leszek	POL	TT	Laidlow, Simone	GBR	AT
Koczka, Andrew	AUS	FB	Kouassi, Elisabeth	CIV	HB	Kuechler, Anton Albert	SUI	SH	Laine, Timo	FIN	RO
Koczorski, Eugenius	POL	ES	Kouassi, Kouassi A	CIV	BO	Kuehl, Patrick	GDR	SW	Lajbnerova, Zuzana	TCH	AT
Kodei, Victor	NGR	WR	Koudela, Filip	TCH	RO	Kuehn, Monika	FRG	SW	Lakes, Charles	USA	GY
Kodjeikov, Todor	BUL	RO	Koumych, Marina	URS	VB	Kuehnemund, Torsten	GDR	FE	Lakhal, Habib	TUN	WR
Koech, Peter	KEN	AT	Kouriaev, Serguei	URS	SW	Kueng, Ludwig	SUI	WR	Lakic, Mara	YUG	BB
Koehler, Dirk	FRG	SH	Kourlovitch, Alexandre	URS	WE	Kuenzler, Alexander	FRG	BO	Lam, Lap hing	HKG	JU
Koeleman, Hans	HOL	AT	Kourotchkina, Tatiana	URS	AT	Kuhn, Andre	SUI	FE	Lama, Bidhan	NEP	TA
Koenig, Walter	AUS	WR	Kourtinaitis, Rimas	URS	BB	Kuhn, Bodo	FRG	AT	Lamai, David	KEN	AT
Koenigshofer, Roland	AUT	CY	Koutchinkas, Siguitas	URS	RO	Kukoc, Toni	YUG	BB	Lamaro, Gianluca	ITA	YA
Koeppen, Jens	GDR	RO	Koutepov, Vloimir	URS	CY	Kulker, Han	HOL	AT	Lamberti, Giorgio	ITA	SW
Koeppen, Kerstin	GDR	RO	Kouyate, Alain	CIV	TA	Kulmiye, Mohiddin moh	SOM	AT	Lambruschini, Alessandro	ITA	AT
Koerner, Hildegard	GDR	AT	Kouzensov, Andrie	URS	VB	Kumada, Yasunori	JPN	VB	Lame, Garba	NGR	WR
Koeswandi, Silvia.k	INA	FE	Kouzmina, Svetlana	URS	SW	Kumar, Naresh	IND	WR	Lammer, Peter	AUT	CY
Koeses, Gabor	HUN	TE	Kouzmine, Afanasi	URS	SH	Kumar, Rajesh	IND	WR	Lamothé, Dieudonne	HAI	AT
Koffa, Aikaterini	GRE	AT	Kouznetsov, Alexei	URS	SW	Kumar, Vinod	IND	WR	Lamour, Jeanfrancois	FRA	FE
Koga, Toshihiko	JPN	JU	Kouznetsov, Evgueni	URS	FB	Kummer, Mario	GDR	CY	Lampariello Neto, Domingo	BRA	VB
Koh, Desmond	SIN	SW	Kouznetsov, Pavel	URS	WE	Kuna, Peter	HUN	SW	Lance, Pascal	FRA	CY
Koh, Kwang-Sun	KOR	RO	Kovacs, Attila	HUN		Kungu, Bakombo	ZAI	AT	Landa, Luis Miguel	ESP	AT
Koh, Suk-Chang	KOR	HB	Kovacs, Edit	HUN	FE	Kunwar, Dambar	NEP	AT	Landa-Zury, Eduardo	COL	JU
Kohde-Kilsch, Claudia	FRG	TE	Kovacs, Mihaly	HUN	HB	Kunz, Joachim	GDR	WE	Landsem, Siri	NOR	SH
Kohlmann, Patricia	MEX	SW	Kovacs, Peter	HUN	HB	Kunze, Hansjoerg	GDR	AT	Landsmann, Maik	GDR	CY
Kohsrof, Mohd	YAR	JU	Kovacs, Zoltan	HUN	CA	Kuo Cheng-Cherng	TPE	BA	Lanfranchi, Jacques	FRA	SH
Koike, Hirofumi	JPN	AT	Kovacs, Zoltan	HUN	SH	Kuo Lee, Chien-Fu	TPE	BA	Lang, Brent	USA	SW
Koji, Kamana	ZAI	AT	Kovalenko, Alexandre	URS	AT	Kurhajcova, Lubica	TCH	RO	Lang, Peter	FRG	YA
Kokorev, Boris	URS	SH	Kovalevitch, Nadejda	URS	CA	Kurihara, Koji	JPN	AT	Lange, Ingrid	GDR	AT
Kolasa, Marian	POL	AT	Kovatchev, Sava	BUL	VB	Kurisingal Abraham, Shiny	IND	AT	Lange, Matthias	FRG	CY
Kolbe, Petermichael	FRG	RO	Kovcha, Nikolai	URS	CY	Kurka, Petr	TCH	SH	Lange, Santiago r	ARG	YA
Kolczonay, Erno	HUN	FE	Kovchov, Yuri	URS	ES	Kuroiwa, Mamoru	JPN	BO	Lange, Thomas	GDR	RO
Kolecianova, Julia	TCH	HB	Kovtoun, Elena	URS	TT	Kurpiewski, Wojciech	POL	CA	Langenau, Ute	GDR	VB
Kolega, Natasa	YUG	HB	Kowalski, Wojciech	POL	TA	Kursinski, Anne	USA	ES	Langer, Reinhard	FRG	TA
Kolehmainen, Mikko	FIN	CA	Kowalski, Wojciech	POL	TE	Kuruvoli, Simione	FIJ	JU	Langon, David	USA	WE
Kolehmainen, Olli	FIN	CA	Kozelj, Matjaz	YUG	SW	Kusmuk, Dragomir	YUG	JU	Langschwager, Kathrin	GDR	VB
Kolev, Dian	BUL	GY	Kpidi, Akissi	CIV	AT	Kuster, Oswald	BRA	RO	Langthaler, Franz	AUT	WE
Kolman, Alojz	YUG	GY	Krabbe, Katrin	GDR	AT	Kuya, Zongo	CIV	AT	Lansink, Jos	HOL	ES
Kolobkov, Pavel	URS	FE	Krainova, Tatiana	URS	VB	Kuzmanovski, Slobodan	YUG	HB	Lanzoni, Ronald	CRC	AT
Kolouskova, Lenka	TCH	SH	Kram, Rachid	ALG	AT	Kvacha, Natalia	URS	RO	Lao, Shaopei	CHN	FE
Komaromi, Tibor	HUN	WR	Kramo, Mahoula-D	CIV	HB	Kvaran, Brynjar	ISL	HB	Lapchine, Igor	URS	AT
Komarov, Nikolai	URS	RO	Krasilnikov, Evgueny	URS	VB	Kvernmo, Geir	NOR	AT	Lapham, Vernon Wright	ZIM	YA
Komatsu, Kazunori	JPN	YA	Krasser, Horst	AUT	SH	Kvesic, Kornelija	YUG	BB	Lapierre, Odette	CAN	AT
Komchev, Atanas	BUL	WR	Krastev, Antonio	BUL	WE	Kwak, Jung-hoon	KOR	SH	Lapitskaia, Natalia	URS	HB
Konan, Hortense	CIV	HB	Kratschmer, Guido	FRG	AT	Kwasna, Joanna	POL	AR	Lapointe, Francois	CAN	AT
Kondratieva, Lioudmila	URS	AT	Kravetz, Inessa	URS	AT	Kwasnycia, Bohdan john	CAN	SH	Laporte, Stephane	FRA	AT
Kong, Guoxian	CHN	FB	Kravtchenko, Nkolai	URS	YA	Kwon, Duk-Yong	KOR	WR	Lapre, Johannes	HOL	TA
Kong, Jeong-Bae	KOR	RO	Kravtsov, Serguei	URS	YA	Kwon, Sang-Won	KOR	SW	Lara, Mariano	CRC	SH
Kongaouin, Bruno-Nazaire	CAF	BB	Krawcow, Grzegorz	POL	CA	Kwon, Seong-Lak	KOR	AT	Larrieu-Smith, Francie	USA	AT
Kongshaug, PeerAlbert	NOR	YA	Krawczyk, Krzysztof	POL	AT	Kwon, Soon-Kun	KOR	SW	Larsen, Jan patvel	DEN	SW
Koning, Henry	HOL	YA	Krdzalic, Sejad	YUG	AT	Kwon, Soon-Pil	KOR	HO	Larsen, Karin	CAN	SW
Konishi, Hiroyuki	JPN	GY	Kreher, Detlef	FRG	MP	Kwon, Tae-Ho	KOR	TA	Larsen, Lisbeth	DEN	TA
Konovalov, Iouri	URS	YA	Kreil, Nicole	AUT	SW	Kwon, Taek-Jae	KOR	BA	Larsen, Per	DEN	WE
Konta, Rita	HUN	AT	Krejцова, Hana	TCH	RO	Kwon, Taek-Yul	KOR	SH	Larsen, Unni Sigrid	NOR	CY
Konyegwachie, Anthony	NGR	BO	Kremer, Jean-Claude	LUX	SH	Kyakutema, Farida	UGA	AT	Larsson, Anders	SWE	RO
Kooijman, Hendrik Jan	HOL	HO	Kremer, Mitzi	USA	SW	Kyalisiima, Ruth	UGA	AT	Larsson, Annelie	SWE	RO
Kook, In-Sook	KOR	RO	Kren, Milan	TCH	CY	Kyossef, Borislay	BUL	VB	Larsson, Johanna	SWE	SW
Koot, Frank	HOL	BA	Krentz, Torsten	GDR	CA	Kyrklund, Kyra	FIN	ES	Lasak, Olivier	FRA	CA
Kopanski, Jerzy	POL	WR	Krieger, Helmut	POL	AT	Kysilkova, Svatava	TCH	BB	Lash, Peter	USA	HB
Kopitar, Rok	YUG	AT	Krioutchkine, Guennadi	URS	RO	Kytola, Ragne	FIN	AT	Lasurtregui, Luis Maria	ESP	RO
Koptchikova, Svetlana	URS	SW	Kristiansen, Arve	NOR	AT				Latendresse, Claude	CAN	GY
Kordhanke, Monika	FRG	RO	Kristiansen, Ingrid	NOR	AT				Lath, Melagne A	CIV	CA
Koretskii, Boris	URS	FE	Kristmanson, Alan	CAN	BB				Latterner, Maureen	USA	HB
Koriajkine, Serguei	URS	FE	Kriston, Zsolt	HUN	TT	Laaksalo, Tuula	FIN	AT	Latu, Sanitesi	TGA	AT
Korikov, Andre	URS	RO	Kritsky, Arn	USA	WE	Laarakkers, Wiljan	HOL	ES	Lau, Wai Cheng	MAL	TT
Korjus, Tapio	FIN	AT	Krivaneck, Tomas	TCH	CA	Laats, Johan	BEL	JU	Laumann, Silken	CAN	RO
Kort, Britta	FRG	RO	Krivocheeva, Olga	URS	VB	Laats, Philip	BEL	JU	Launa, Iammogapi	NGU	AT
Korte, Christoph	FRG	RO	Kriz, Claudia	FRG	AR	Labandeira, Julio A	ARG	YA	Laurendeau, Martin	CAN	TE
Korytova, Svetlana	URS	VB	Krizova, Eva	TCH	BB	Lacabra, Blanca	ESP	AT	Laurentet, Jennifer	AUS	AT
Kosaka, Tadahiro	JPN	AT	Krmelova, Ivona	TCH	GY	Lacasa, Lavrent	FRA	RO	Laurent, Thierry	FRA	CY
Koschnitzke, Olaf	GDR	WR	Krmpotich, David	USA	RO	Lachal, Mostafa	MAR	AT	Lauret, Thierry	FRA	AT
						Lacheheb, Fethnour	ALG	HB			
						Lachko, Irina	URS	SW			

Name Nom	Country Pays	Sport	Name Nom	Country Pays	Sport	Name Nom	Country Pays	Sport	Name Nom	Country Pays	Sport
Lavalle, Leonardo	MEX	TE	Lee, Myung-Hak	KOR	VB	Lhotellier, Patrice	FRA	FE	Lioityi, Vladimir	URS	FB
Laventure, Cyril	FRA	AT	Lee, Pil-Sung	KOR	YA	Li, Arthur	HKG	SW	Liou, Yuh	TPE	SH
Lavodrama, Anicet-Richard	CAF	BB	Lee, Roland	GBR	SW	Li, Baojin	CHN	AT	Lioukine, Valeri	URS	GY
Lavrinenko, Alexanre	URS	SH	Lee, Sang-Ho	KOR	WR	Li, Baolian	CHN	AT	Lipa, Elisabeta	ROM	RO
Lavrov, Andrei	URS	HB	Lee, Sang-Hyo	KOR	HB	Li, Chuanfen	CHN	HB	Lipski, Andre	URS	RO
Lawler, Ivan	GBR	CA	Lee, Sang-Keun	KOR	AT	Li, Chunyang	CHN	GY	Lisovskaya, Natalia	URS	AT
Lawler, Janine	GBR	CA	Lee, Sang-Ki	KOR	FE	Li, Deliang	CHN	SW	Littell, David	USA	FE
Lawlor, Joseph	IRL	BO	Lee, Sang-Yong	KOR	CA	Li, Feng	CHN	AT	Litvinov, Serguei	URS	AT
Lawrence, Christopher	AUS	YA	Lee, Sang-Yul	KOR	VB	Li, Ge	CHN	GY	Liu, Anpai	CHN	JU
Lawrence, Esmie	CAN	AT	Lee, Shiunn-Long	TPE	AT	Li, Guojun	CHN	VB	Liu, Dong	CHN	BO
Lawson, Boeviyoulou	TOG	AT	Lee, Suk-Jae	KOR	BA	Li, Huahua	CHN	FE	Liu, Fuk Man	HKG	TT
Laycock, Ronald	AUS	WE	Lee, Sun-Gee	KOR	SW	Li, Hui	CHN	FB	Liu, Guizhu	CHN	JU
Lazar, Reka Zsofia	ROM	FE	Lee, Sung-Hee	KOR	VB	Li, Huifen	CHN	TT	Liu, Haiguang	CHN	FB
Lazare, Alain	FRA	AT	Lee, Susan	CAN	AT	Li, Jianxiang	CHN	SW	Liu, Haiying	CHN	SH
Lazzera, Michele	ITA	AT	Lee, Tae-Jo	KOR	FB	Li, Jie	CHN	HB	Liu, Hong	CHN	CY
Lazdins, Ray	CAN	AT	Lee, Tae-Hwa	KOR	RO	Li, Jinhe	CHN	WE	Liu, Hsin-Hung	TPE	BO
Lazzarini, Roberto	BRA	FE	Lee, Taek-Won	KOR	SW	Li, Juan	CHN	AT	Liu, Huajin	CHN	AT
Lazzeroni, Alessandro	ITA	VB	Lee, Won-Woo	KOR	BB	Li, Khai Kam	HKG	SW	Liu, Junlin	CHN	JU
Lbik, Marek	POL	CA	Lee, Wook-Jae	KOR	FE	Li, King-Ho	TPE	MP	Liu, Peili	CHN	HB
Le Brun, Florence	FRA	YA	Lee, Wook-Jong	KOR	AT	Li, Kongzheng	CHN	SW	Liu, Pi-Yu	TPE	AR
Le Deroff, Jean-Yves	FRA	YA	Lee, Yong-Chul	KOR	CA	Li, Lianrong	CHN	CY	Liu, Qing	CHN	BB
Le Stum, Bruno	FRA	AT	Lee, Young-Rok	KOR	FE	Li, Lirong	CHN	HB	Liu, Shaomei	CHN	AT
Leal, Francisco	ESP	CA	Lee, Young-Sook	KOR	AT	Li, Meisu	CHN	AT	Liu, Shoubin	CHN	WE
Leary, George	CAN	SH	Leeuw De, Alfred	HOL	BA	Li, Ning	CHN	GY	Liu, Shuhua	CHN	TE
Leask, Edward	GBR	YA	Leeuwerink, Pieter-Jan	HOL	VB	Li, Qing	CHN	SW	Liu, Shuzhen	CHN	AT
Leatherdae, Paul	GBR	SH	Lefevre, Pascal	FRA	AT	Li, Ronghua	CHN	RO	Liu, Yunhong	CHN	FE
Leatherwood, Lillie	USA	AT	Lefou, Judex	MRI	AT	Li, Serguei	URS	WE	Livingston, Bobby	USA	CY
Leblanc, David	FRA	SW	Legaspi, Emmanuel	PHI	BO	Li, Tao	CHN	AT	Livingstone, Nicole	AUS	SW
Leblanc, Guillaume	CAN	AT	Legien, Waldemar	POL	JU	Li, Tao	CHN	SW	Liyau, Monica	PER	TT
Lechner, Robert	FRG	CY	Legras, Daniel	FRA	CA	Li, Xianjin	CHN	WR	Liz, Gabriela	ARG	HO
Lechuga-Reyecs, Victor B.	GUA	CY	Lehmann, Ulf	GDR	YA	Li, Xiaoqin	CHN	BB	Ljubek, Matija	YUG	CA
Lecointe, Dominique	FRA	RO	Lehnert, Rajmund	FRG	CY	Li, Yaguang	CHN	BB	Ljung, Roger	SWE	FB
Lecointe, Henri	FRA	TE	Lehtela, Jorma	FIN	RO	Li, Yeuming	CHN	VB	Ljungbeck, Benni	SWE	WR
Ledbetter, Brian	USA	YA	Lehto, Mika	FIN	WR	Li, Zhongqi	CHN	SH	Llamazares, Sergio-Alberto	ARG	CY
Ledingham, John	IRL	ES	Leikep, Gusztav	HUN	CA	Li, Zhongyun	CHN	JU	Llewellyn, John	GBR	FE
Ledovskaia, Tatiana	URS	AT	Leipold, Alexander	FRG	WR	Li, dan	CHN	SH	Llg, Patriz	FRG	AT
Lee, Bong-Soo	KOR	RO	Leistra, Prank	HOL	HO	Liang, Dejin	CHN	WR	Llopart, Jorge	ESP	AT
Lee, Byung-In	KOR	RO	Leitao, Jose	POR	AT	Liang, Qiuzhong	CHN	AR	Llorente, Jose Luis	ESP	BB
Lee, Byung-Nam	KOR	FE	Leitao, Roberto	BRA	WR	Liao, Chin-Ming	TPE	WE	Lloret, Maria Isabel	ESP	GY
Lee, Chae-On	KOR	VB	Leitch, Paul	NZL	CY	Liao, Hsing-Chou	TPE	WE	Lloyd, Andrea	USA	BB
Lee, Choong-Hee	KOR	BB	Leitner, Reinhold	AUT	SW	Liao, Wenfen	CHN	AT	Lloyd, Andrew	AUS	AT
Lee, Chu-Ming	TPE	BA	Leiva-Buhler, Max-Eduardo	GUA	CY	Lienhart, Hans	AUT	CY	Lloyd, Neil	ANT	CY
Lee, Chung Man	HKG	FE	Lejeune, Lisanne	HOL	HO	Ljeschke, Lisa	AUS	SW	Lo, Chao-Cheng	TPE	WR
Lee, David	CAN	SH	Lekovic, Dragoje	YUG	FB	Lhanda, Patrick	UGA	BA	Lo, Chen-Jung	TPE	BA
Lee, Do-Hee	KOR	CA	Leias, Zana	YUG	BB	Liljeblad, Anders	SWE	YO	Lo, Chuen Tsung	HKG	TT
Lee, Donna	USA	HO	Lelievre, Gerard	FRA	AT	Lillak, Kristiina	FIN	AT	Lo, Kuo-Chong	TPE	BA
Lee, Eun-Chul	KOR	SH	Lelut, Maria	FRA	AT	Lillistone, Simon	GBR	CY	Loban, Noel	GBR	WR
Lee, Eun-Young	KOR	TA	Lemaire, Tom	BEL	SW	Lim, Chun-Ae	KOR	AT	Lobatch, Marina	URS	GY
Lee, Fu-An	TPE	AT	Leman, Richard	GBR	HO	Lim, David	SIN	SW	Lockyear, Eric	HKG	YA
Lee, Fu-Hsiang	TPE	CY	Lemercier, Alain	FRA	AT	Lim, Eun-Joo	KOR	AT	Lockhart, Richard	NZL	SW
Lee, Han-Lim	KOR	YA	Lemieux, Lawrence	CAN	YA	Lim, Hye-Jin	KOR	GY	Lodge, Harry	GBR	CY
Lee, Han-Sup	KOR	AR	Lempereur, Ingrid	BEL	SW	Lim, Hye-Sook	KOR	VB	Lodziewski, Sven	GDR	SW
Lee, Han-Won	USA	TA	Lemstrom, Annika	FIN	YA	Lim, Jae-Man	KOR	RO	Loemker, Carsten	FRG	CA
Lee, Heung-Pyo	KOR	HO	Lemstrom, Bettina	FIN	YA	Lim, Jang-Soo	KOR	SH	Loennechen, Lars	NOR	YA
Lee, Hong-Keun	KOR	RO	Lena, Raul Ariel	ARG	YA	Lim, Jin-Suk	KOR	HB	Loft, Joudi	TUN	TT
Lee, Hong-Mi	KOR	SW	Lende, Karen	USA	ES	Lim, Kye-Sook	KOR	HO	Lofton, Michael	USA	FE
Lee, Hwa-Jin	KOR	TA	Leng, Virginia	GBR	ES	Lim, Kyung-Suk	KOR	RO	Logan, Jud	USA	AT
Lee, Hye-Kyung	KOR	SH	Lenglet, Olivier	FRA	FE	Lim, Mi-Kyung	KOR	HB	Lohberg-Schulz, Birgit	FRG	SW
Lee, Hyo-Kun	KOR	FE	Lennartsson, Urban	SWE	VB	Lima, Joao	POR	AT	Lohnisky, Alan	TCH	CA
Lee, Hyun-Soo	KOR	FE	Leon, Edgar	PUR	BB	Lima, Mauricio	BRA	VB	Lohyna, Josef	TCH	WR
Lee, Hyung-Ki	KOR	RO	Leon, Feranado	ESP	YA	Lima, Pedro	ANG	SW	Loikas, Jukka	FIN	WR
Lee, Hyung-Kun	KOR	WE	Leon, Francisco	PUR	BB	Liman, Jameleldoine	TUN	FB	Loksairi, Brahim	MAR	WR
Lee, Hyung-Sook	KOR	BB	Leonard, Cynthia	CAN	CA	Limas, Arlene	USA	TA	Loll, Sven	GDR	JU
Lee, Il-Hee	KOR	FE	Leong, Mee Wan	MAL	TT	Limba, Ram	IND	AR	Lom, Lubos	TCH	CY
Lee, Jae Hoon	CAN	TA	Leonova, Alexandra	URS	BB	Limousin, Philippe	FRA	ES	Lomba, Filipe	POR	AT
Lee, Jae-Bok	KOR	AT	Leontiev, Iouri	URS	AR	Limpar, Anders	SWE	FB	Lombardi, Giovanni	ITA	CY
Lee, Jae-Hyuk	KOR	BO	Leroux, Claudine	FRA	CA	Lin, Bo	CHN	YA	Lombardo, Patrizia	ITA	AT
Lee, Jae-Soo	KOR	SW	Leroux, Francoise	FRA	AT	Lin, I-Tseng	TPE	BA	Lombckco, Hygien-Nicaise	CGO	AT
Lee, Jae-Suk	KOR	WR	Leroy, Muriel	FRA	AT	Lin, Kuang-Liang	TPE	AT	Long, Dave	GBR	AT
Lee, Jeong-Myung	KOR	TE	Lescak, Filip	YUG	JU	Lin, Laiju	CHN	SW	Long, Zara	GBR	SW
Lee, Jin-Ok	KOR	CY	Lesch, Caby	FRG	AT	Lin, Li	CHN	SW	Longiross, Benjamin	UGA	AT
Lee, Jong-Kyung	KOR	VB	Lesiva, Viliamu	SAM	BO	Lin, Li-Ku	TPE	TT	Longley, Lucien	AUS	BB
Lee, Joo-Hyong	KOR	AT	Lesivakarua, Isimeli	FIJ	BO	Lin, Tzung-Chiu	TPE	BA	Longo, Jeannie	FRA	CY
Lee, Jung-Suk	KOR	SW	Lesniewski, Marek	POL	CY	Lind, Ulrich	FRG	SH	Longuepee, Frederic	FRA	GY
Lee, Kan	HKG	JU	Letcheva, Vessela	BUL	SH	Lindgren, Ola	SWE	HB	Lonn, Peter	SWE	FB
Lee, Kang-Chul	KOR	BA	Letriz, William	PUR	WE	Lindh, Erik	SWE	TT	Lopes, Carlos	POR	AT
Lee, Kang-Suk	KOR	BO	Lettieri, Dave	USA	CY	Lindman, Hakan	SWE	FB	Lopes, Jeanne Y.	AHO	SH
Lee, Keum-Jin	KOR	BB	Leung, Hung-Tak	HKG	CY	Lindner, Johann	AUT	AT	Lopez menseses, Luis Rodolfo	GUA	FB
Lee, Ki-Soon	KOR	HB	Leung, Wing Kwong	HKG	AT	Lindner, Rainer	FRG	GY	Lopez, Carlos	COL	ES
Lee, Kwang-Ik	KOR	AT	Leutscher, Johannes	HOL	RO	Lindqvist, Caterina	SWE	TE	Lopez, Eva	ESP	SW
Lee, Kwang-Soon	KOR	RO	Levy, Sandra	CAN	HO	Lindqvist, Mats	SWE	WE	Lopez, Fabiana	MEX	FE
Lee, Kwang-Woo	KOR	BA	Lewis, Carl	USA	AT	Lindroos, Aarne	FIN	RO	Lopez, Federico	PUR	BB
Lee, Kye-Haeng	KOR	TA	Lewis, Carol	USA	AT	Lindroos, Kari	FIN	RO	Lopez, Francisco	ESP	CA
Lee, Kyung-Hwa	KOR	RO	Lewis, Charles	BIZ	CY	Lindsay, Howard	ANT	AT	Lopez, Francisco	VEN	TT
Lee, Kyung-Keun	KOR	JU	Lewis, Lennox	CAN	BO	Lindsten, Eva	SWE	ES	Lopez, Jorge oscar	ARG	BO
Lee, Kyung-Mo	KOR	HB	Lewis, Michael	BIZ	CY	Ling, Guang	CHN	BB	Lopez, Josefina	ESP	TA
Lee, Mi-Kyung	KOR	SH	Lewis, Steven	USA	AT	Linley, Eversley	VIN	AT	Lopez, Julio	BRA	SW
Lee, Mi-Ok	KOR	AT	Lewis, Timothy	USA	AT	Lino, Pascal	FRA	CY	Lopez, Luis	CRC	AT
Lee, Mi-Young	KOR	HB	Lewison, Peter	USA	FE	Lins, Edwin	AUT	WR	Lopez, Luis	ESP	YA
Lee, Moon-Kyu	KOR	BB	Lewuillon, Alain	BEL	RO	Linsenhoff, Annkathrin	FRG	ES	Lopez, Marisa	ARG	HO

Seoul '88 Facts and Figures

Les faits et les chiffres

Listing of the Competitors/Listes dies concurrents

Name Norn	Country Pays	Sport	Name Nom	Country Pays	Sport	Name Nom	Country Pays	Sport	Name Nom	Country Pays	Sport
Lopez, Ramon	PAR	AT	Ma, Yongfeng	CHN	AT	Mallery, Margaret	USA	RO	Marsal, Catherine	FRA	CY
Lopez, Roswitha	ARU	SW	Ma, Zhi	CHN	FE	Malmstrom, Robert	SWE	FE	Marsh, Henry	USA	AT
Lopez, Sandro Luis	ARG	JU	Maach, Abdelhak	MAR	JU	Malone, Joseph	IRL	AR	Marsh, Michael	USA	AT
Lopez, Sergio	ESP	SW	Maachou, Mohamed	ALG	HB	Malone, Maicel	USA	AT	Marshall, Brian	CAN	AT
Lopez-Zubero, Martin	ESP	SW	Maaloul, Nabil	TUN	FB	Maloukhina, Anna	URS	SH	Marshall, Jeannie	USA	RO
Lord, Karen	AUS	SW	Mabrouk, Ghanem	KUW	AT	Malovecz, Zsuzsa	HUN	AT	Marshall, Pamela	USA	AT
Lorenz, Elwira	POL	RO	Mabuza, Dumsane	SWZ	BO	Malta Da Costa, Manuel	POR	ES	Marshall, Steve	CAN	WR
Lorenzana, Jose	PUR	BA	Mac Aleavey, Cathy	IRL	YA	Maltchougina, Galina	URS	AT	Marsollek, Marcus	FRG	MP
Lorenzo, Nestor Gabriel	ARG	FB	Mac Donald, Paul	NZL	CA	Malysa, Stanislaw	POL	WE	Marstrom, Goran	SWE	YA
Loriston-Clarke, Jenn	GBR	ES	Mac Nally, Maeve	IRL	YA	Mambosasa, George	MAW	AT	Martchenko, Alexandre	URS	RO
Lorton, Guy	CAN	SH	Mac, Donald, John	NZL	CA	Mamedov, Ilgar	URS	FE	Martchioulenis, Raimondas-Char	URS	BB
Losch, Claudia	FRG	AT	Macarencu, Aurel	ROM	CA	Mamiachvili, Mikhail	URS	WR	Martiarena, Jose Antonio	ESP	CY
Losch, Susanne	GDR	AT	Macdonald, David Ross	CAN	YA	Maminski, Boguslaw	POL	AT	Martigne, Jean Jacqjei	FRA	RO
Lospichl Von, Isabella	FRG	GY	Macdonald, Donald Bruce	CAN	YA	Mamoudou, Djingarey	NIG	BO	Martin Garcia, Corina	ARG	CA
Lossev, Valeri	URS	VB	Macev, Ismail	YUG	AT	Manabe, Kazushito	JPN	WE	Martin, Andrea	FRG	CA
Lossev, Victor	URS	FB	Machacek, Dusan	TCH	RO	Manabe, Masayoshi	JPN	VB	Martin, Ann	USA	RO
Lou, Yaping	CHN	SW	Machado, Albertina	POR	AT	Manandhar, Baikuntha	NEP	AT	Martin, Antonio	ESP	BB
Lou, Yun	CHN	GY	Machado, Antonio	BRA	FE	Manca, Dario	ITA	TA	Martin, Eamonn	GBR	AT
Loua, Robert	GUI	AT	Machaze, Alberto	MOZ	BO	Manchon, Evelyne	FRA	SH	Martin, Geoffrey	AUS	BA
Louganis, Gregory	USA	SW	Machura, Remigius	TCH	AT	Mandebele, Stanley	ZIM	AT	Martin, Lavonna	USA	AT
Louis, Richard	BAR	AT	Maciel, Francisc	MEX	TE	Mander, Simon	NZL	YA	Martin, Linda	GBR	FE
Loukianov, Alexandre	URS	RO	Macioce, Franco	ITA	SW	Manderson, Floyd	GBR	AT	Martin, Lisa	AUS	AT
Loukotova, Michaela	TCH	RO	Macleod, Moira	GBR	HO	Mandragona, Francesco	ITA	CA	Martin, Maria	ESP	GY
Loukov, Mariano	BUL	TT	Madaras, Zsolt	SUI	FE	Mandy, Gary	ZIM	CY	Martin, Roderick	SWE	MP
Louzenaite, Biroute	URS	RO	Maddocks, Chris	GBR	AT	Maneypandemuttana, Somaya	IND	HO	Martin, Roy	USA	AT
Louro, Fernando	BRA	CY	Madeira, Diogo	POR	SW	Manga, Jean	CMR	WR	Martin, Stephen	GBR	HO
Louvrier, Pascaline	FRA	SW	Madhar, Mohamedshies	SUR	JU	Manibog, Dean Carlo	PHI	WR	Martinek, Janos	HUN	MP
Lovbom, Stefan	SWE	SH	Madina, Stefka	BUL	RO	Manik, Ibrahim	MDV	AT	Martinez, Eduardo e	ARG	VB
Love, Lynnette	USA	TA	Madjidov, Kamandar	URS	WR	Mankova, Svetlana	URS	HB	Martinez, Ferran	ESP	BB
Lovrenski, Ladislau	ROM	RO	Madonia, Ezio	ITA	AT	Mannai, Andrea	ITA	BO	Martinez, Henry	ESA	BO
Lowey, John	IRL	BO	Madsen, Jimmi	DEN	CY	Manning, Danny	USA	BB	Martinez, Javier	ESP	BO
Lowing, Larissa	CAN	GY	Madsen, Niels H	DEN	BO	Mannironi, Angelo	ITA	WE	Martinez, Jose Luis	ESP	WE
Lozik, Valeri	URS	SW	Maduro, Victor	ARU	JU	Manrique, Domingo	ESP	YA	Martinez, Jose Luis	ESP	AT
Lu, Chih-Hsiung	TPE	BO	Maea, Terepai	COK	BO	Manrique, Eduardo	ESP	CY	Martinez, Luis Felipe	PUR	JU
Lu, Guanghong	CHN	HB	Maeda, Makoto	JPN	BA	Mansaray, Aboul	SLE	AT	Martinez, Mario	USA	WE
Lu, Suyan	CHN	CY	Maedicke, Stefan	GDR	YA	Mansdorf, Amos	ISR	TE	Martinez, Roberto	HON	BO
Luan, Juijie	CHN	FE	Maeguchi, Hideaki	JPN	RO	Mansoor Ahmed	PAK	HO	Martinez, Tino	USA	BA
Lubac, Pierre	FRA	CA	Maeke, John	SOL	AT	Mansoor B.K., Talal	QAT	AT	Martinez, Victor L.	PUR	BA
Lubensky, Zdenek	TCH	AT	Maelagi, Basil	SOL	BO	Manthos, Constandinos	GRE	YA	Martini, Olivier	MON	FE
Luberda, Miroslav	TCH	WR	Maennig Dr., Wolfgang	FRG	RO	Manzur, Gustavo	ESA	WR	Martino, Elena	ITA	AT
Lubke, Raif	FRG	AT	Maenza, Vincenzo	ITA	WR	Mar Mar Min	BIR	AT	Martins, Ana	ANG	SW
Lubulwa, Charles	UGA	BO	Maerina, Edgardo	PHI	RO	Marathamuthu, Vasugi	MAL	TA	Martion, Marco	ITA	AT
Lucca, Mario Bruno	ARG	FB	Maggioni, Roberto	ITA	CY	Marcek, Alexander	TCH	SW	Marttinen, Auli	FIN	AT
Lucchetta, Andrea	ITA	VB	Maghamis, Salam H.	IRQ	FB	Marchal, Joe	USA	JU	Martynov, Sergei	URS	SH
Lucchetta, Dino	ITA	RO	Magi, Andrea	ITA	BO	Marchand, Christopher	FRA	SW	Marusic, Sead	YUG	RO
Lucchetta, Pierpaolo	ITA	VB	Magne, Frederic	FRA	CY	Marchinares, Rolando	PER	WE	Maruyama, Shigemori	JPN	SW
Lucero, Wendy	USA	SW	Magnier, Christine	FRA	SW	Marcuno, Alfredo	ESP	WR	Maruyama, Yumi	JPN	VB
Luciani, Sabina	DEN	TA	Magrini, Fabio	ITA	WE	Marcus, Egerton	CAN	BO	Marwa, Joseph	TAN	BO
Luckwell, Ben	GBR	CY	Maher, Peter	CAN	AT	Marden, Anne	USA	RO	Marx, Michael	USA	FE
Luconi, Patrizia	ITA	GY	Maher, Robyn	AUS	BB	Mardi, Mardi	INA	AT	Marx, Robert	USA	FE
Luding, Rothenburg, Christa	GDR	CY	Mahgoub, Mahmoud	EGY	WE	Mardle, Paul	GBR	AT	Marxer, Manuela	LIE	AT
Ludwig, Olaf	GDR	CY	Mahjoubi, Mohamed	TUN	FB	Maree, Sydney	USA	AT	Marzouq S.M.Al-Abdulla, Rashid	QAT	AT
Luebbert, Petra	GDR	RO	Mahlalela, Charles	SWZ	BO	Marello, Jose Luis	ARG	CA	Marzouqs. Abdulla, Faraj	QAT	AT
Luetkefels, Andreas	FRG	RO	Mahmood, Samir Shakir	IRQ	FB	Margall, Jose Maria	ESP	BB	Masakayan, Elizabeth	USA	VB
Lugar, Judy	CAN	YA	Mahmoud, Ayman	EGY	MP	Margraff, Ines	ECU	SH	Masala, Daniele	ITA	MP
Luiz, Sergio	BRA	FB	Mahmoud, Kamal	KUW	AT	Mariaca, Fernando	ESP	WE	Masar, Dusan	TCH	WR
Luk, Kwok sun	HKG	CA	Mahony, Dominic	GBR	MP	Marie-Rose, Bruno	FRA	AT	Mascheroni, Marcelo	ARG	HO
Lukaszewicz, Jolanta	POL	CA	Mahorn, Atlee Anthony	CAN	AT	Mariethoz, Alessandra	SUI	FE	Maske, Henry	GDR	BO
Lukowski, Bodo	FRG	WR	Mahoulikponto, Patrice	BEN	AT	Marigliano, Pasquale	ITA	RO	Masoe, Francis	ASA	BO
Lum, Sabrina	TPE	SW	Mahovlich, Mike	CAN	AT	Marilovic, Srdjan	YUG	CA	Masoe, Mikaele	ASA	BO
Lundblad, Henrik	SWE	MP	Mai, Chao	CHN	FB	Marin, Jose	ESP	AT	Mason, Diana	GBR	ES
Lundmark, Anders	SWE	VB	Main, Gerald Grant	CAN	RO	Marin, Marco	ITA	FE	Massa, Leonardo	ITA	RO
Lung, Noemi Ildiko	ROM	SW	Maina, David	KEN	WE	Marin, Ricardo	ESP	HB	Massad, Abd Elrahman	SUD	AT
Luo, Xi	CHN	SW	Maina, Maurice	KEN	BO	Marinechechki, Nikolai	BUL	FE	Masse, William	USA	BA
Lupacova, Petra	TCH	HB	Mair, John	JAM	AT	Marinho, Denis	BRA	RO	Massialas, Gregory	USA	FE
Lupulesku, Ilija	YUG	TT	Maisetti, Georges	FRA	AT	Marini, Carlo	ITA	WR	Massullo, Carlo	ITA	MP
Luschan, Michael	AUT	YA	Majcen, Igor	YUG	SW	Marino Geers, Cathy	USA	CA	Mastrodonato, Michele	ITA	BO
Lusic, Deni	YUG	SW	Majerle, Daniel	USA	BB	Marinov, Ivan	BUL	CA	Masullo, Marisa	ITA	AT
Luyies, Ricci J	USA	VB	Major, Sandor	HUN	WR	Marinov, Martin	BUL	CA	Masur, Wally	AUS	TE
Luzek, Pavel	TCH	RO	Majoulis, Raimondas	URS	SW	Marinov, Sevdalin	BUL	WE	Mata, Edwin	ECU	WE
Lvov, Vladimir	URS	SH	Makalamba, Mtendere	MAW	BO	Marinova, Tzvetanka	BUL	CA	Matangi, Patrick	ZIM	JU
Lykomitros, Vassilios	GRE	RO	Makama, Mpuucuko	SWZ	BO	Marischael, Nicolas	FRA	SW	Matanu, Mayamona	ZAI	CY
Lyn, Lisa	CAN	HO	Makhmoutov, Alexandre	URS	BO	Maritim, Joseph	KEN	AT	Mateev, Nikolai	BUL	FE
Lynch, Noel	IRL	AR	Makinka, Derby	ZAM	FB	Marizluff, Jean-Baptiste	FRA	VB	Matei, Anisoara	ROM	SH
Lynch, Vincent	BAR	CY	Makok, Kazanga	ZAI	AT	Marjouane, Kamal	MAR	BO	Matei, Sorin	ROM	AT
Lyon, John	GBR	BO	Maksimovic, Goran	YUG	SH	Mark, Russell	AUS	SH	Mateo, Roberto	PUR	BA
Lyons, Daniel	USA	RO	Malaga, Natalia	PER	VB	Markine, Alexandre	URS	AT	Matete, Samuel	ZAM	AT
M			Malaibi, Pinye	NGU	WE	Markotch, Serguei	URS	SW	Matharu, Inderjit	KEN	HO
M'bongo, Guy	CAF	BB	Malamas, Helias	GRE	SW	Markov, Hristo	BUL	AT	Mathiasen, Jan dupont	DEN	YA
M'jirih, Mahjoub	MAR	BO	Malchow, Maic	GDR	CY	Markovic, Ljiljana	YUG	HB	Mathibeli, Teboho	LES	BO
MUrtoaro, Esa	FIN	WR	Maleeva, Katerina	BUL	TE	Markovics, Laszlo	HUN	TE	Mathiesen, Porgilsottar	ISL	HB
Ma, Fuliang	CHN	CA	Maleeva, Manuela	BUL	TE	Markphilip, Patterson	IND	HO	Mathys, Peter	SUI	AT
Ma, Keqin	CHN	TE	Malek, Petr	TCH	SH	Markwort, Elke	ERG	RO	Matlapeng, Bigboy Josie	BOT	AT
Ma, Lin	CHN	FB	Malekwa, Zakayo	TAN	AT	Marland, Robert	CAN	RO	Matoussiavitchene, Dalia	URS	AT
Ma, Shaorong	CHN	AR	Malenga, Evance	MAW	BO	Marlowe, Melissa	USA	GY	Matova, Nonka	BUL	SH
Ma, Wenzhu	CHN	WE	Malenica, Mladenka	YUG	SH	Marois, Barbara	USA	HO	Matsubara, Kaoru	JPN	AT
Ma, Xiangjun	CHN	AR	Malet, Valerie	FRA	SH	Marosi, Laszlo	HUN	HB	Matsui, Emi	JPN	AT
Ma, Ying	CHN	GY	Malgosa, Joaquin	ESP	HO	Maroto, Raul	ESP	FE	Matsumoto, Yasushi	JPN	BA
			Malgosa, Juan	ESP	HO	Marques, Jose	POR	WR	Matsuno, Akemi	JPN	AT
			Malina, Andrzej	POL	WR	Marquez, Baltasar	ESP	RO	Matsuo, Kaoru	JPN	SH

Name Nom	Country Pays	Sport	Name Nom	Country Pays	Sport	Name Nom	Country Pays	Sport	Name Nom	Country Pays	Sport
Matsuoka, Shuzo	JPN	TE	Mckean, Tom	GBR	AT	Mercado, Laurensio	ECU	BO	Minamoto, Yoko	JPN	SH
Matsushima, Katsuyuki	JPN	BO	Mckenzie, Donald	GBR	FE	Mercado, Oscar	PUR	YA	Minati, Fayadh L	IRQ	WR
Matsushita, Takayoshi	JPN	AR	Mckenzie, M	AUS	SW	Mercenario, Carlos	MEX	AT	Mincy, Jerome	PUR	BB
Matt, Patrick	LIE	CY	Mckerlich, Ian	CAN	RO	Mercer, David	GBR	WE	Mindirgassov, Serguei	URS	FE
Mattar, Luiz	BRA	TE	Mckernan, Jacqueline	GBR	AT	Mercer, Ray	USA	BO	Mine, Keiko	JPN	FE
Matthes, Sven	GDR	AT	Mckibbon, Tom	USA	RO	Meredith, Bruce	ISV	SH	Minea, Anisoara	ROM	RO
Mattheus, Jan	BEL	CY	Mckinley, Scott	USA	CY	Meredith, Kenneth	AUS	GY	Minervini, Gianni	ITA	SW
Mattioli, Carlo	ITA	AT	Mckinney, Kennedy	USA	BO	Mergenthaler, Eric	MEX	YA	Minev, Plamen	BUL	AT
Mattioni, Patrick	FRA	GY	Mckinney, Richard	USA	AR	Meridja, Mohamed	ALG	JU	Minicucci, Dominick	USA	GY
Matumla, Rashid Ally	TAN	BO	Mcknight, Stephanie	ISV	CY	Meringgi, Tonny, Z.	INA	TT	Minkh, Irina	URS	BB
Matute, Juan	ESP	ES	Mckoy, Mark	CAN	AT	Merren, Craig	CAY	CY	Minott, Ralph	GBR	TA
Matveev, Alexei	URS	SW	Mclachlan, Hamish	AUS	RO	Merren, Perry	CAY	CY	Minter, Anne	AUS	TE
Matveeva, Lioudmila	URS	AT	Mclain, Rodney	USA	CA	Merritt, Bruce	USA	CA	Minyemack, Jeannenicole	CMR	AT
Maude, Ado	NGR	AT	Mclaughlin, Elaine	GBR	AT	Merto, Rowel	PHI	AR	Mionske, Robert	USA	CY
Mauri, Carolina	CRC	SW	Mclaughlin, Frank	CAN	YA	Mervyn Ernadis, Mervyn	IND	HO	Mir, Mohamed	ALG	CY
Mauro, Massimo	ITA	FB	Mclaughlin, Jeff	USA	RO	Meshki, Leila	URS	TE	Miranda, Tania	BRA	AT
Maugroiovanni, Antonio	ITA	RO	Mcleod, Michael	GBR	AT	Meshref, Nihal	EGY	TT	Mirjanic, Saso	YUG	RO
Mauthe, Alan	CAN	BA	Mcmahon, Robert Brian	CAN	RO	Mesiarik, Peter	TCH	HB	Miro, Gisele	BRA	TE
Mavrotas, Georgios	GRE	SW	Mcmahon, Ronald	IRL	RO	Messerschmidt, Uwe	FRG	CY	Mirochina, Elena	URS	SW
Mavrovic, Zeljko	YUG	BO	Mcmanus, Eugene	IRL	JU	Messerschmitt, Alfons	FRG	SH	Mirochnitchenko, Alexandre	URS	BO
Maweni, Sunday	BOT	AT	Mcmiken, Christine	NZL	AT	Messzi, Istvan	HUN	WE	Miron, Oleg	URS	YA
Mawi, Syafrudin	INA	AR	Mcmurray, Benjamin	PHI	JU	Meszaros, Erika	HUN	CA	Mirona, John	SUD	BO
Maxey, John	GBR	RO	Mcnally, John	USA	SH	Metais, Sophie	FRA	RO	Mirzoian, Oxen	URS	WE
Maxie, Leslie	USA	AT	Mcneill, Lee	USA	AT	Metsola, Jukka-Pekka	FIN	JU	Misaggi, Alfio	ITA	SW
Maxwell, John	AUS	SH	Mcquaid, John	IRL	CY	Metz, Michael	FRG	HO	Mischler, Martial	FRA	WR
Maxwell, Stephanie	USA	RO	Mcvean, Jeffrey	AUS	ES	Metzke, Bernd	GDR	HB	Misko, Agnes	HUN	GY
May, Fiona	GBR	AT	Mcvein, Joe	USA	HB	Meyer, Dirk	FRG	YA	Misko, Zsuzsanna	HUN	GY
May, Peter	GBR	WE	Md Abdus Salam, Salam	BAN	SW	Meyer, Hendrik	HOL	TA	Missioulia, Evgueni	URS	AT
Mayanja, Jimmy	SWE	BO	Md Bazlur Rahman, Bazlur	BAN	SW	Meyer, Susanne	FRG	YA	Mitchell, Betsy	USA	SW
Mayer, Alexander	FRG	SW	Md Milzerhossain, Milzer	BAN	AT	Meyer, Willi	FRG	SW	Mitchell, David	AUS	FB
Mayers, Raymond	AUS	SW	Md Shah Alam, Alam	BAN	AT	Meygret, Gisele	FRA	FE	Mitchell, Dennis	USA	AT
Mayhew, Donna	USA	AT	Md Shah Jalal, Md Shah Jalal	BAN	AT	Meziane, Nouredidine	ALG	BO	Mitchell, Michele	USA	SW
Maynard, Andrew	USA	BO	Mdluli, Sizwe	SWZ	AT	Mheddhebi, Taoufik	TUN	FB	Mitchell, Parris	AUS	BA
Mayo, Francois	CMR	BO	Meagher, Mary T	USA	SW	Miakakem, Ronodji	CHA	AT	Mitev, Kostadin	BUL	VB
Mayor, Carlos Alberto	ARG	FB	Mecir, Miloslav	TCH	TE	Miang, Kampompo	ZAI	BO	Miteva, Neviana	BUL	SW
Mayotte, Tim	USA	TE	Meder, Remi	FRA	WR	Miasnikov, Alexandre	URS	HO	Mitkova, Svetla	BUL	AT
Mazariegos Bitron, Rocael	GUA	FB	Medina, William	COL	JU	Miccoli, Giovanni	ITA	RO	Mitring, Gabor	HUN	RO
Mazgutova, Bozena	TCH	HB	Meena, Shyam Lal	IND	AR	Michallek, Vera	FRG	AT	Mitruik, Natalia	URS	HB
Maziya, Frank	SWZ	AT	Meesaq Rizvi, Syed	PAK	AR	Michel, Detlef	GDR	AT	Mitsuhashi, Eizaburo	JPN	VB
Mazounov, Andrei	URS	TT	Meghoo, Gregory	JAM	AT	Michelena, Alejandro	URU	MP	Miura, Hiroshi	JPN	SW
Mazyi, Svetlana	URS	RO	Meglio, Ferdinando	ITA	FE	Michelena, Cristiano	BRA	SW	Miura, Kunihiko	JPN	BO
Mazzaron, Marcos	BRA	CY	Mehl, Gabriele	ERG	RO	Michelotti, Leonardo	ITA	SW	Miura, Kyoshi	JPN	CY
Mazzon, Herve	FRA	VB	Mehner, Siegfried	GDR	BO	Michels, Jeff	USA	WE	Miwa, Hideaki	JPN	CY
Mazzoni, Angelo	ITA	FE	Mehta, Kamlesh	IND	TT	Miwa, Tadafumi	CAN	TE	Miyahara, Atsuji	JPN	MP
Mbao, Lameck	ZAM	BO	Mei, Stefano	ITA	AT	Micic, Svetlana	YUG	HB	Miyahara, Miesko	JPN	WR
Mbaye, A.Mbagnick	SEN	AT	Meier, Dirk	GDR	CY	Mickan, Patricia	AUS	BB	Miyahara, Miesko	JPN	FE
Mbaye, Hamidou	SEN	AT	Meier, Joerg	FRG	RO	Midthun, Kristin	NOR	HB	Miyahara, Misako	JPN	AT
Mbenza, Pasi	ZAI	CY	Meier, Willi	FRG	AT	Mierzejewski, Andrzej	POL	CY	Miyamoto, Fumiharu	JPN	CY
Mbuamangongo, Rosa	GEQ	AT	Meijer, Theo	HOL	JU	Migliuex, Igor	URS	BB	Miyashita, Kazuhiro	JPN	HB
Mc Cormick, Kelly Anne	USA	SW	Meili, Launi	USA	SH	Miguel, Aurelio	BRA	JU	Miyazaki, Eiki	JPN	ES
Mc Donald, Larry	USA	BA	Meiling, Marc	FRG	JU	Miguens, Diego f	ARG	YA	Miyazaki, Yoshihito	JPN	TT
Mc Hugh, Jayne	USA	VB	Meisch, Dietmar	GDR	AT	Miguez, Enrique	ESP	CA	Miyoshi, Satoru	JPN	RO
Mc Intosh, Colin	NZL	ES	Meissner, Katrin	GDR	SW	Mihaleva, Miglena	BUL	RO	Mizoguchi, Kazuhiro	JPN	AT
Mc Kee, Charlie	USA	YA	Mejia, Alvaro	COL	CY	Mihic, Mirko	YUG	FB	Mizouri, Imad	TUN	FB
Mc Linden, Melissa	USA	VB	Melchiorri, Manuela	ITA	SW	Mijnders, Rene	HOL	RO	Mizser, Attila	HUN	MP
Mcadam, Ian	AUS	SW	Meldrum, Michael	CAN	SW	Mikhailitchenko, Alexei	URS	FB	Mizumoto, Yoshiyuki	JPN	SW
Mcbride, Violet	GBR	HO	Melendez, Jose V.	PUR	BA	Mikhalev, Gueorgui	BUL	SW	Mizushima, Koichi	JPN	GY
Mccann, Cormac	IRL	CY	Melentiev, Alexandre	URS	SH	Mikhaltchenko, Larissa	URS	AT	Mkangala, John Elson	MAW	BO
Mccarney, Wayne	AUS	CY	Meli, Joseph	CAN	JU	Mikulas, Milan	TCH	AT	Mmoh, Tony	NGR	TE
McCarthy, Michael	USA	CY	Melicherova, Ludmila	TCH	AT	Mikyskova, Blanka	TCH	RO	Mnyampanda, Juma	TAN	AT
Mccain, Katrina	USA	BB	Melien, Lori	CAN	SW	Milanov, Miltcho	BUL	VB	Mo, Ji-Young	KOR	HO
Mccloy, Paul	CAN	AT	Melinte, Doina Ofelia	ROM	AT	Milanic, Igor	YUG	SW	Mo, Wanlan	CHN	SW
Mccolgan, Elizabeth	GBR	AT	Melis, Cornelia	ARU	AT	Milchinn, Michale	USA	BA	Moberg, Lars-Erik	SWE	CA
Mccombie, Ian	GBR	AT	Mellaard, Emiel	HOL	AT	Miles, Helen	GBR	AT	Moberg, Per	SWE	CY
Mcconnell, Suzanne	USA	BB	Mellado, Santiago	ESA	AT	Miles, Jearl	USA	AT	Mochida, Noriko	JPN	JU
Mccormack, Paul	IRL	CY	Mellinghaus, Matthias	FRG	RO	Milinkovic, Dusko	YUG	FB	Moadine, Lavrence	FRA	FE
Mccullagh, Conor	IRL	AT	Mellor, Karen	GBR	SW	Militossian, Israel	URS	WE	Moe, Bente	NOR	AT
Mccullough, Wayne	IRL	BO	Melo, Flavio	BRA	RO	Milkovich, Peter	CAN	HO	Moehring, Anke	GDR	SW
Mcdavid, Erika	BRA	SW	Melu, Ashols J.	ZAM	FB	Mill, Frank	FRG	FB	Moellenkamp, Thomas	FRG	RO
Mcdermott, Gregory	AUS	ES	Melvin, James	USA	YA	Millan, Migual Angel	ESP	AT	Moeller, Frank	GDR	AT
Mcdonagh, Patrick	IRL	RO	Melzer, Hager	GDR	AT	Millar, Ian	CAN	ES	Moeller, Silke	GDR	AT
Mcdonald, Christina	CAN	GY	Memic, Muhamed	YUG	HB	Millauro, Maria D.L.A.	ARG	CA	Moes, Linda	HOL	SW
Mcdonald, Jimmy (James)	IRL	AT	Mena, Jesus	MEX	SW	Milleham, Matt	GBR	AT	Moffa, Marina	AUS	BB
Mcdonald, John	CAN	AR	Mena, Ramon	PAN	WR	Millen, John	CAN	YA	Mogenburg, Dietmar	FRG	AT
Mcdonald, Julie	AUS	SW	Mendes, Domingos	MOZ	AT	Miller, Albert	FIJ	AT	Mogulnyi, Valentin	URS	GY
Mcdonald, Neal	GBR	YA	Mendez, Alexis	VEN	CY	Miller, Graeme	NZL	CY	Mohamed, Adham	EGY	WE
Mcfarlane, Michael	GBR	AT	Mendez, Norberto E	ARG	CA	Miller, Larry	ANT	AT	Mohamed, Ahmed	EGY	FE
Mcfarlane, Tracey	USA	SW	Mendez, Porfirio	PAR	AT	Miller, Leigh	AUS	AT	Mohamed, Ali, Abdi	SOM	AT
Mcginnis, Donna	CAN	SW	Mendygaliyev, Nourlan	URS	SW	Millonig, Dietmar	AUT	AT	Mohamed, Anwar	BRN	TA
Mcglashan, Hamish	AUS	RO	Meneau, Christophe	FRA	VB	Mills, Phoebe	USA	GY	Mohamed, Elsayed	EGY	BB
Mcglede, Stephen	AUS	CY	Menendez De Cox, Maria Pilar	GUA	AT	Mills, Robert	CAN	RO	Mohamed, Issa	UAE	CY
Mcgrory, Scott	AUS	CY	Menezes, Sergio	BRA	AT	Milosevic, Bojana	YUG	BB	Mohamed, Mohamed Y	IRQ	WE
Mchugh, Terry	IRL	AT	Meng, Gang	CHN	SH	Milosevic, Cvijan	YUG	FB	Mohamed, Naglaa	EGY	JU
Mchenvieradze, Georgui	URS	SW	Menge, Sahin	TUR	WE	Milosevic, Roland	VEN	YA	Mohamed-Seghir, Zine-Eddine	ALG	HB
Mcilquham, Gordon	CAN	YA	Menkova, Nina	URS	ES	Miloudi, Boualem	ALG	JU	Mohammad Shahid	IND	HO
Mcintosh, Fiona	GBR	FE	Mennea, Pietro	ITA	AT	Milton, Richard	SWE	SW	Mohammad, Fiarhan J	IRQ	WR
Mcintyre, Michael	GBR	YA	Mera, Akitiro	JPN	SH	Min, Joon-Ki	KOR	WE	Mohammad, Salman	KUW	FE
Mckay, Antonio	USA	AT	Mera, Elia	COL	AT	Min, Se-Hoon	KOR	AT	Mohammadian, Askari	IRN	WR
Mckay, David	CAN	WR	Merande, Boniface	KEN	AT	Min, Young-Sam	KOR	SH	Mohammed, Abbas	NGR	AT
Mckay, Michael	AUS	RO	Mercado, Gilberto	COL	WE	Minadeo, Gabriel	ARG	HO	Mohammed, Ahmed J.	IRQ	FB

Seoul '88 Facts and Figures

Les faits et les chiffres

Listing of the Competitors/Listes dies concurrents

Name Nom	Country Pays	Sport	Name Nom	Country Pays	Sport	Name Nom	Country Pays	Sport	Name Nom	Country Pays	Sport
Mohammed, Hussain Said	IRQ	FB	Moriyama, Yasutoshi	JPN	WR	Murillo, Tolentino	COL	WE	Nardiello, Vincenzo	ITA	BO
Mohammed, Sabo	NGR	BO	Mormando, George	USA	FE	Murphy, Cornelius	IRL	YA	Nargiso, Diego	ITA	TE
Mohd Anwar	PAK	WR	Morris, Alwyn	CAN	CA	Murphy, Miles	AUS	AT	Narmontas, Ionas	URS	RO
Mohd Azeem	PAK	WR	Morris, Andrew	GBR	GY	Murphy, Sean	CAN	SW	Narojilenko, Lioudmila	URS	AT
Mohd Jadi, Nordin	MAL	AT	Morris, Anthony Paul	GBR	WR	Murphy-Rollins, Marie	IRL	AT	Nascimento, Emanuel	BRA	SW
Mohi, Zoltan	HUN	SW	Morris, Devon	JAM	AT	Murray, Bruce	USA	FB	Nascimento, Iomar	BRA	FB
Mohinderpalsingh	IND	HO	Morris, Graham	GBR	SW	Murray, Yvonne	GBR	AT	Nasir Ali	PAK	HO
Mohinga, Fidele	CAF	BO	Morris, Ian	TRI	AT	Murugayan, Kumaresan	MAL	CY	Nasirahmad	AFG	WR
Mohloli, Mohala	LES	AT	Morris, Jason	USA	JU	Musa, Atanda	NGR	TT	Nathhorst, Louise	SWE	ES
Mohsin, Najl.G.	IRQ	AT	Morris, Ruth	ISV	AT	Musaddiz Hussain	PAK	HO	Natorp, Hans	DEN	YA
Moir, Jose	MRI	WE	Morrisson, Brian	CAN	AT	Muslar, Eugene	BIZ	AT	Natorp, Paul	DEN	YA
Mojela, Sello	LES	BO	Morskova, Natalia	URS	HB	Musonda, Charles	ZAM	FB	Nattrass, Susan	CAN	SH
Mok, Ka Sha	HKG	TT	Mortensen, Eva	DEN	SW	Musonda, Enock	ZAM	AT	Nava, Eduardo	MEX	AT
Moldovan, Oleg	URS	SH	Mortensen, Franz	DEN	SW	Musonge, Moses	UGA	AT	Navarrete, Daniel A	ARG	WR
Molea, Valter	ITA	RO	Mortensen, Tommy Jorgen	DEN	JU	Mussa, Abdalla	LBA	WE	Navaz, Elena	ESP	TA
Molenda, Piotr	POL	TT	Mortenson, Jay	USA	SW	Musson, Sharon	NZL	SW	Naveko, Charles	MAW	AT
Moli, Yesky	CHA	AT	Morton, Leslie	GBR	AT	Musyl, Thomas	AUT	RO	Naydenov, Nayden	BUL	VB
Molina M., Jorge E.	COL	SH	Morvillers, Pascal	FRA	ES	Muteweta, Fred	UGA	BO	Naydenova, Mariana	BUL	BB
Molinari, Manlio	SMR	AT	Mosengo, Kimpale	ZAI	CY	Muthuswamy, Gurunathan	IND	WE	Nayeja, George Whiteson	MAW	CY
Mollandin, Andreas	FRG	HO	Moser, Ana Beatriz	USA	VB	Mutoke, Kaleka	ZAI	AT	Nazarova, Olga	URS	AT
Moller, Lorraine	NZL	AT	Moser, Severin	SUI	AT	Mutola, Maria	MOZ	AT	Ncala, Trevor	SWZ	SW
Molnar, Tamas	HUN	AT	Moses, Edwin	USA	AT	Mutua, Julius	KEN	HO	Ndagijimana, Eulucane	RWA	AT
Molnar, Zoltan	HUN	RO	Moskalenko, Larissa	URS	YA	Muyaba, Fabian	ZIM	AT	Ndiaye, Bruno	SEN	SW
Molokova, Marina	URS	AT	Moslih, Mohd.	YAR	JU	Mwamba, Antony	ZAM	BO	Ndinga, Henri	CGO	AT
Monakov, Dmitri	URS	SH	Mossa, Vera	USA	VB	Mwamba, Patrick	ZAM	BO	Ndinga, Pierre	CGO	AT
Moncif, Abdelmajide	MAR	AT	Mosse, Anthony	NZL	SW	Mwangata, Benjamin	TAN	BO	Ndiwa, Juma	KEN	AT
Monday, Kenneth	USA	WR	Mostaza, Miguel Angel	ESP	AT	Mwansa, Simon	ZAM	FB	Ndombasi, Lotuala	ANG	JU
Mondragon, Jorge	MEX	SW	Mota, Rosa	POR	AT	Mwanza, Pearson	ZAM	FB	Ndongo-Ebanga, Martin	CMR	BO
Mondragon, Martin	MEX	AT	Motar, Adnan Dirjal	IRQ	FB	Mwanza, Peter	ZAM	FB	Ndouba, Kouame	CIV	CA
Moneghetti, Stephen	AUS	AT	Motobuchi, Yuki	JPN	SW	Mwanza, Richard	ZAM	FB	Ndri, Adjoua-D	CIV	HB
Monico, Nives	ITA	AR	Motouzenko, Alexandre	URS	CA	Mwathiwa, John	MAW	AT	Ndrin, Celestine	CIV	AT
Monico, Nives	ITA	YA	Motta, Carlos Vinicius	BRA	ES	Mwema, Stephen	KEN	BO	Nduita, Ibibongo	ZAI	BO
Monjo, Jaime	ESP	YA	Motta, Maria Teresa	ITA	JU	Myers, Sandra	ESP	AT	Neagu, Drago	ROM	RO
Monnard, Jean-Marc	SUI	YA	Mouchawar, Alan E.	USA	SW	Myerscough, Richard	CAN	YA	Nebald, Gyorgy	HUN	FE
Monontsi, Ncholu	LES	BO	Moukhamediarov, Nail	URS	WE	Myles-Mills, John	GHA	AT	Nechchadi, Elmostafa	MAR	AT
Monot, Claude	FRA	AT	Moukrim, Aissa	MAR	BO	Myrberg, Lars	SWE	BO	Necula, Veronica	ROM	RO
Monplaisir, Sharon	USA	FE	Mountian, Tatiana	URS	AR	Myricks, Larry	USA	AT	Nedd, Jeffrey	ARU	BO
Montalvao, Suzete	BRA	AT	Moura, Sonia	POR	GY	Myszkowski, Grzegorz	POL	YA	Neff, Jean-Marie	FRA	AT
Montanaro Junior, Fose	BRA	VB	Mourachova, Galina	URS	AT				Negron, Carlos R.	PUR	WR
Montefusco, Paolo	ITA	YA	Mouraviev, Vladimir	URS	AT				Neil, Sara	CAN	CY
Montefusco, Sandro	ITA	YA	Mourier, Patrice	FRA	WR						
Montero, Jose Antonio	ESP	BB	Mousa, Hany	EGY	BB	N'da, Lucienne	CIV	AT	Neilson, Javis	GBR	AT
Montesdeoca, Jesus	ESP	WR	Moutarazak, Mustapha	HOL	TA	N'gapeth, Eric	FRA	VB	Neimke, Kathrin	GDR	AT
Montesi, Greg	USA	RO	Mowatt, Andrew	CAN	AT	N'goran, Clement	CIV	TE	Neira, Jorge	ESP	SW
Montesinos, Alvaro	ESP	GY	Moya, Mariano	ESP	SW	N'jie, Momodov Bello	GAM	AT	Neisse, Eric	FRA	AT
Monti, Rossana	ITA	AR	Mozdzen, Andrzej	POL	BO	N'tyamba, Joao	ANG	AT	Neitzel, Andreas	GDR	HB
Montiel, Juan	URU	BO	Mpaka, Masivi	ZAI	CY	Naanaa, Abderrahmane	MAR	WR	Neuward, Gary	AUS	CY
Monzo, Abdou	NIG	AT	Mphande, Lyton Levison	MAW	BO	Nabunone, A.H.Edward	INA	AT	Nelis, Juergen	HOL	RO
Monzon Perez, Victor Hugo	GUA	FB	Mrazek, Roman	TCH	AT	Nachappa, Ashwini	IND	AT	Nelson, Carey	CAN	AT
Monzon, Pedro Damian	ARG	FB	Mruk, Miroslaw	POL	RO	Nacinovic, Alvard	YUG	HB	Nelson, Lynn	USA	AT
						Naea, Asomua	SAM	BO	Nelson, Thomas	CAN	BA
Moolsan, Phajol	THA	BO	Msiska, Lucky	ZAM	FB				Nelubine, Dmitri	URS	CY
Moon Eun-Jin	KOR	ES	Mthembu, Gideon	SWZ	AT	Naeem Akhtar	PAK	HO	Nemachkalo, Elena	URS	HB
Moon, Hyun-Jin	KOR	ES	Muange, Samson	KEN	HO	Naeem Amjad	PAK	HO	Nemedi, Karoly	HUN	SW
Moon, Ji-Yoon	KOR	JU	Muavesi, Lui	FIJ	AT	Naessens, Peter	BEL	CY	Nemes, Olga	FRG	TT
Moon, Sun-Hee	KOR	VB	Muehbauer, Anke	FRG	SW	Nagaev, Igor	URS	CA	Nemeth, Karoly	HUN	JU
Moore, Colin	GUY	BO	Mueller, Ines	GDR	AT	Nagahata, Hironobu	JPN	SW	Nemeth, Robert	AUT	AT
Moore, Francis	IRL	RO	Mueller, Petra	GDR	AT	Nagasaki, Hiroko	JPN	SW	Nenadal, Zdenek	TCH	AT
Moorhouse, Adrian	GBR	SW	Mueller, Ronald	GDR	SH	Nagele, Johannes	AUT	FE	Nepp, Uwe	FRG	CY
Moracho, Javier	ESP	AT	Mueller, Rosmarie	SUI	AT	Nagy, Bela	HUN	WR	Nerlinger, Manfred	FRG	WE
Moradi-Ganjeh, Mehdi	IRN	WR	Muench, Uwe	GDR	CA	Nagy, Charles	USA	BA	Nesterov, Yuri	URS	HB
						Nagy, Istvan	HUN	AT			
Morales Mejia, Simon I.	COL	BO	Muftahmubarak, Saad	QAT	AT				Nesty, Anthony	SUR	SW
Morales, Mario	PUR	BB	Muglia, Patrick	USA	YA	Nagy, Janos	HUN	WR	Netchaev, Evgueni	URS	HO
Morales-Massella, Blanca J.	GUA	SW	Mugosa, Ljiljana	YUG	HB	Nagy, Robert	FRA	YA	Neto, Luis	ANG	AT
Morandini, Mickey	USA	BA	Mugosa, Svetlana	YUG	HB	Nai, Hui-Fang	TPE	AT	Neubauer, Dagmar	GDR	AT
Morase, Angel A.	PUR	BA	Muir, Julia	ZIM	TE	Najem, Sayed	CAN	TA	Neufeld, Kevin	CAN	RO
Moreau, John	USA	FE	Muis, Marianne	HOL	SW	Nakada, Kumi	JPN	VB	Neumuller, Alexander	AUT	WR
Moreira, Federico	URU	CY	Muis, Mildred	HOL	SW	Nakadome, Shunji	JPN	WR	Neunast, Daniela	GDR	RO
Moreira, Jose	BRA	SW	Mujanovic, Razija	YUG	BB	Nakagomi, Keiko	JPN	AR	Neupert, Uwe	GDR	WR
Moreno, Augustin	MEX	TE	Mujkic, Sadik	YUG	RO	Nakajima, Terushi	JPN	BA	Neuville, Laurent	FRA	SW
Moreno, Carlos	CHI	AT	Mukai, Takahiro	JPN	WR	Nakamori, Chikako	JPN	SW	Neves, Sandra	POR	SW
						Nakamura, Kenji	JPN	YA			
Moreno, Hector	COL	AT	Mukamurenzi, Marcianne	RWA	AT				Nevill, Mary	GBR	HO
Moreno, Jose Manel	ESP	CY	Mulenga, Eston	ZAM	FB	Nakano, Ayako	JPN	SW	Newman, Jeremy	GBR	YA
Moreno, Juan	USA	TA	Mulhall, Laura	ARG	HO	Nakano, Yoshihiro	JPN	ES	Newman, Pat	CAN	RO
Moreno, Katerine	BOL	SW	Mulkerrins, Peter	GBR	RO	Nakayama, Takeyuki	JPN	AT	Neyer, Rene	SUI	WR
Moreno, Querubin	COL	AT	Muller, Michael	CAN	HO	Nakazato, Harumi	JPN	CA	Neyer, Urs Roman	SUI	WR
Moreno, Rosa	ESP	TA	Mulliner, Joanne	GBR	AT	Nakic, Danira	YUG	BB	Ng, Chi Fan	HKG	JU
Moretti, Riccardo	ITA	RO	Mullins, Gerry	IRL	ES	Nakouze, Michel	LIB	JU	Ng, Fenella	HKG	JU
Morgan, Christy	USA	HO	Mumba, Edmon	ZAM	FB	Nalliod, Jerome	FRA	SW	Ng, Gideno Joe	CAN	TT
Morgan, David	GBR	WE	Munch, Cina	FIJ	SW	Nam, Ki-Young	KOR	FB	Ng, Ka Yi	HKG	AT
Morgan, Gary	USA	AT	Munch, Mette	DEN	YA	Nam, Kwan-Woo	KOR	ES	Ng, Yue Meng	SIN	SW
						Nam, Sang-Lan	KOR	RO			
Morgan, John	USA	WR	Mund, Uwe	GDR	RO				Ngadjadoum, Paul	CHA	AT
Morgan, Robert	GBR	SW	Mundt, Kristina	GDR	RO	Nam-Soon-Ok	KOR	VB	Ngodigha, David	NGR	FB
Morgan, Wayne	NZL	CY	Munerotto, Rosanna	ITA	AT	Namiki, Yoshinori	JPN	WE	Ngom, Oumar	SEN	WR
Mori, Mieko	JPN	GY	Mungar, Barry	CAN	BB	Nanahara, Yuriko	JPN	GY	Ngoyo, Sam	KEN	HO
Morikawa, Akemi	JPN	FE	Munk, Annemarie	HKG	SW	Nandor, Sabo	YUG	WR	Ngugi, John	KEN	AT
Morimura, Sachiko	JPN	GY	Munoz Echeverry, Oscar Bairon	COL	WR	Nanev, Alexander	BUL	WR	Nguyen Dinh, Minh	VIE	AT
Morin, Rachel	FRA	SH	Munoz, Dionisio	ESP	WE	Nanton, Hudson	VIN	BO	Nguyen Dinh, Quang	VIE	CY
Moriniere, Max	FRA	AT	Munoz, Juan F.	ESP	HB	Naoueyama, Francois	CAF	BB	Nguyen Kieu, Oanh	VIE	SW
Morio, Maiko	JPN	GY	Munoz, Laura	ESP	GY	Naoumou, Serge	URS	SW	Nguyen Kim, Huong	VIE	WR
Morishita, Satoko	JPN	SW	Muraki, Yosuke	JPN	WE	Naranjo, Maria Angela	ESP	TA	Nguyen Quoc, Cuong	VIE	SH
						Narbekovas, Arminas	URS	FB			

Name Nom	Country Pays	Sport	Name Nom	Country Pays	Sport	Name Nom	Country Pays	Sport	Name Nom	Country Pays	Sport
Nguyen Van, Thuyet	VIE	AT	Nsang Obiang, Juliana	GEQ	AT	Ogouchi, Fortune	BEN	AT	Omotara, Titus	NGR	TT
Nharimue, Jaime	MOZ	AT	Nsubuga, Emmanuel	UGA	BO	Oguienko, Valentina	URS	VB	Ondiek, Kennedy	KEN	AT
Ni, Shiwei	CHN	SW	Ntawulikura, Mathias	RWA	AT	Oguk, Charles	KEN	HO	Ondieki, Yobes	KEN	AT
Niamjav, Badrah	MGL	JU	Nteso, Nqheku	LES	AT	Ogunkoya, Falilat	NGR	AT	Oneill, Sean	USA	TT
Niang, Babacar	SEN	AT	Nto, Barthelemy D	CMR	WR	Ogura, Terumi	JPN	CY	Ong, Bee Eng	MAL	TA
Nicola, Franco	ARG	HO	Nugent, Andrea	CAN	SW	Oguri, Kazushige	JPN	WE	Ong, Kuan Seng Jeffrey	MAL	SW
Nicoll, Ashley	CAN	ES	Numa, Graham	NGU	YA	Ogwang, Jackson Fred	UGA	AT	Ongollo, Gisele	GAB	AT
Niec, Jerzy	POL	WR	Numa, Mauro	ITA	FE	Oh, Jong-Yul	KOR	YA	Onmura, Luiz	BRA	JU
Niehaus, Horst	CRC	SW	Nummela, Arimatti	FIN	SH	Oh, Kwang-Soo	KOR	BO	Ono, Seiji	JPN	TT
Niehaus, Jutta	FRG	CY	Nunez, Henry	CRC	JU	Oh, Seh-Woong	KOR	BB	Onogi, Tomoko	JPN	SW
Niehaus, Sigrid	CRC	SW	Nunez, Juan	DOM	AT	Oh, Young-Ki	KOR	HB	Onoko, Blessing	NGR	BO
Niehues, Dieter	FRG	CY	Nunez, Marcos	CHI	TT	Ohlinger, Eduard	FRG	WE	Onyali, Mary	NGR	AT
Nielsen, Benny	DEN	SW	Nurul, Huda Abdullah	MAL	SW	Ohlsen, Anders	SWE	CA	Oon, Jin Gee	SIN	SW
Nielsen, Claus Borge	DEN	BO	Nutz, Ricardo	ESP	RO	Ohr, Martine	HOL	HO	Opala, Krzysztof	POL	CY
Nielsen, Petermeiner	DEN	CY	Nwanu, Chidi	NGR	FB	Ojalehto, Arvo	FIN	WE	Opatril, Markus	AUT	SW
Nielsen, Tommy	DEN	CY	Nwosu, Henry	NGR	FB	Ojo, Amos	NGR	WR	Opatril, Stefan	AUT	SW
Nielsson, Arne	DEN	CA	Nyachwaya, Tiberius	KEN	JU	Ok, Kyung-Sook	KOR	JU	Operto, Stephanie	MON	CY
Nieman, Robert	USA	MP	Nyang'au, Elkana	KEN	AT	Oka, Tomoko	JPN	FE	Oporta, Arturo	PAN	WR
Niemi, Timo	FIN	WR	Nyari, Gyula	HUN	YA	Oka, Zeynep	TUR	SH	Oppel, Craig	USA	SW
Nieminen, Timo	FIN	SH	Nyari, Zoltan	HUN	YA	Okada, Hirotaka	JPN	JU	Orban, Jozsef	HUN	WR
Nieroba, Norbert	FRG	BO	Nyberg, Eva	SWE	SW	Okal, Hibeab Jafer	IRQ	FB	Oriso, Samson	KEN	HO
Niesecke, Bernd	GDR	RO	Nyberg, Mats	SWE	YA	Okamoto, Kumiko	JPN	TE	Ormaechea, Laura	ARG	HO
Nieuwenhuizen, Anneloes	HOL	HO	Nyberg, Thomas	SWE	AT	Okano, Tomoyuki	JPN	RO	Oronova, Daniela	BUL	RO
Nieves, Felipe	PUR	BO	Nyerges, Sandor	USA	CA	Okbi, Mourad	TUN	FB	Oross, Tibor	HUN	HB
Nijboer, Gerard	HOL	AT	Nygord, Donald	USA	SH	Oki, Katsuhiko	JPN	TA	Orozco, Alejandro	MEX	ES
Nikawadori, Yoshihiro	JPN	HB	Nyinawabera, Apollinarie	RWA	AT	Oki, Toyoko	JPN	AR	Ortega, Jose	ESP	BO
Nikolovski, Cedo	YUG	WR	Nyiramutuzo, Daphrose	RWA	AT	Okosieme, Ndubuisi	NGR	FB	Ortega, Josue	MEX	MP
Nikoulina, Marina	URS	VB	Nyirenda, Stone	ZAM	FB	Okot, Mike	UGA	AT	Ortego, Miguel	ESP	HO
Niil, Maik	FRG	WE	Nykiel, Julie	AUS	BB	Okotako, Omokheghele	NGR	AT	Ortiz Obergon, Alejandro	GUA	FB
Nielsen, Per Arne	NOR	YA	Nylander, Sven	SWE	AT	Okoth, John Eliud	KEN	HO	Ortiz Rijos, Jose	PUR	BB
Nilsson, Bengt	SWE	FB	Nyman, Joni	FIN	BO	Okpala, Sylvanus	NGR	FB	Ortiz, Arturo	ESP	AT
Nilsson, Joakim	SWE	FB	Nystrom, Hans	SWE	YA	Okubo, Yasuhiro	JPN	WR	Ortiz, Evaristo	DOM	AT
Nilsson, Lars	SWE	VB	Nzuzi, Adao	ANG	BO	Okuda, Shinji	JPN	HB	Ortiz, Jorge L.	PUR	AT
Nilsson, Rickard	SWE	WE				Okuno, Ryuzo	JPN	ES	Ortiz, Jose Lionel	PUR	BO
Nilsson, Ronald	SWE	FB				Okwaraji, Samuel	NGR	FB	Ortiz, Nuria	MEX	SH
Nilsson, Suzanne	SWE	SW				Olafsson, Magnus	ISL	SW	Ortiz, Pedro	COL	AT
Nind, Michael	AUS	BA				Olafsson, Pall	ISL	HB	Ortolano, Armando	GRE	YA
Ninova, Violeta	BUL	RO	O'Brien, Cathy	USA	AT	Olah, Bela	HUN	WE	Ortwig, Stephanie	FRG	SW
Nishi, Masafumi	JPN	BA	O'Connell, Carlos	IRL	AT	Olander, Mikael	SWE	AT	Orungi, Mohamad	KEN	BO
Nishiguchi, Shigeki	JPN	WR	O'halloran, Gregory	CAN	BA	Olayanwan, Khodr	LIB	WE	Osako, Akinobu	JPN	JU
			O'hara, William	IRL	YA						
Nishikawa, Daisuke	JPN	GY	O'hare, Turlough	CAN	SW	Oleary, Elizabeth	USA	RO	Osawa, Tomohiro	JPN	AT
Nishioka, Yoshie	JPN	SW	O'Neill, Mary	USA	FE	Olech, Janusz	POL	FE	Oschkenat, Cornelia	GDR	AT
Nishiyama, Kiyoshi	JPN	HB	O'Reilly, Gerry	IRL	AT	Olechnowicz, Boguslawa	POL	JU	Osenberg, Fred	FRG	AT
Nisiro, Annalisa	ITA	SW	O'Sullivan, Marcus	IRL	AT	Olive, Jorge	ESP	HO	Oshita, Rod	USA	HB
Nisovic, Mirko	YUG	CA	O'toole, Gary	IRL	SW	Oliveira, Helder	POR	AT	Osland, Paul	CAN	AT
Nissen-Lie, Hakon M.	NOR	YA	O'bartas, Romas	URS	AT	Oliveira, Jose	BRA	FB	Osselmann, Rainer	FRG	SW
Nitchepourenko, Mikhail	URS	HO				Oliveira, Wanderley	BRA	BO	Ossowski, John	CAN	RO
Nitz, Leonard	USA	CY	Oakes, Judy	GBR	AT	Olizarenko, Nadejda	URS	AT	Ostlund, Benny	SWE	SH
Nkala, Elijah	ZIM	AT	Oancia, Ecaterina	ROM	RO	Olkhovsky, Andrei	URS	TE	Ostrowski, Ryszard	POL	AT
Nkouka, Lasnet-Lelisse	CGO	AT	Obah, Darren	AUS	BO	Ollafsdottir, Bryndis	ISL	SW	Ota, Akira	JPN	WR
			Obata, Hiroyuki	JPN	WR						
Nkounkou, Theophile-Clorico	CGO	AT	Obatashi, Motoko	JPN	VB	Ollershaw, Scott	AUS	FB	Ota, Toshinori	JPN	MP
Nkwayed, Theodore	CMR	WE	Oberburger, Norberto	ITA	WE	Ollo, Desire	GBA	BO	Otake, Atsuyoshi	JPN	BA
Noack, Axel	GDR	AT	Oberg, Eje	SWE	YA	Olmsted, Barbara	CAN	CA	Otambo, Christopher	KEN	HO
Noall, Patricia	CAN	SW	Obewa, Edward	UGA	BO	Olmsted, Nancy	CAN	CA	Otchkan, Vladimir	URS	AT
Noaman, Saas Kies	IRQ	FB	Obholzer, Anton	GBR	RO	Olobia, Olatunji	NGR	AT	Otsuka, Hiroko	JPN	GY
Nobre, Delival	BRA	SH	Obi, Christian	NGR	FB	Olsen, Jan Erick	NOR	SW	Ottey, Merlene	JAM	AT
Noel, Peter	AUS	HO				Olsen, Lars	DEN	CY	Ottey, Milton	CAN	AT
Noel, Tami	ISV	TA	Obiku, Mike	NGR	FB	Olsen, May-Irene	NOR	SH	Ottke, Sven	FRG	BO
Nogami, Keiko	JPN	YA	Obobaifo, Osaro	NGR	FB	Olson, Billy	USA	AT	Ottley, David	GBR	AT
Noguer, Miguel	ESP	YA	Obradovic, Zelimir	YUG	BB	Olson, Robert Scott	CAN	BO	Otto, Andreas	GDR	BO
			Obreja, Grigore	ROM	CA						
Noh, Hea-Soon	KOR	AT	Obschernikat, Werner	FRG	SW	Olsson, Anna	SWE	CA	Otto, Frank	FRG	SW
Noh, Kyung-Sun	KOR	WR	Obucina, Svetlana	YUG	HB	Olsson, Gunnar	SWE	CA	Otto, Kristin	GDR	SW
Noh, Soo-Jin	KOR	FB	Obunga, Harold	KEN	BO	Olsson, Hans	SWE	CA	Otto-Crepin, Margitt	FRA	ES
Noh, Yum-Joo	KOR	CY	Obwoege, Maisiba	KEN	WR	Olsson, Liselotte	SWE	CA	Ouachi, Hachemi	TUN	FB
Nolan, Liam	IRL	RO	Ochieng, Pius	KEN	WE	Olsson, Mats	SWE	HB	Ouagon, Joseph Dieudonne	CAF	BB
Nolet, Alan	CAN	GY	Ochoa, Luis eduardo	COL	JU	Olsson, Staffan	SWE	HB	Ouchia, Kamel	ALG	HB
Nolte, Juergen	FRG	FE				Olukoju, Adewale	NGR	AT	Quiminga, Mariama	BUR	AT
Nolten, Katja	FRG	TT	Ochs, Debra	USA	AR	Olver, Jeffrey	AUS	FB	Ould houibib, Salem	MTN	WR
Nomo, Hideo	JPN	BA	Oconer, Noberto	PHI	CY	Olvera, Bernardo	MEX	WR	Ould khalifa, Mohamed	MTN	AT
Nomura, Masahiko	JPN	RO	Oden, Kimberly	USA	VB	Olvera, Jorge	MEX	WR	Ould khayar, Mohamed El M	MTN	AT
			Odera, Crispine	KEN	BO						
Nomurakenjiro	JPN	BA	Odhiambo, Joyce	KEN	AT	Olweny, Sunday	UGA	AT	Oulehlova, Lenka	TCH	GY
Nonaka, Hideo	JPN	SH	Odhier, Roy	KEN	HO	Olyslager, Marjan	HOL	AT	Oumarou Sanda Bouba	CAF	BB
Nonella, Luigi	SUI	AT	Odin, Cecile	FRA	CY	Omagbaluwaje, Majemite	NGR	JU	Oumezdi, Marian	MAR	AT
Nonomura, George	USA	FE	Odindo, Dan	UGA	BO	Omar, Khalifa	UAE	CY	Ovary, Eszter	HUN	GY
Nord, Kathleen	GDR	SW	Odizor, Nduka	NGR	TE	Omany, Paul sewe	KEN	HO	Ovaskainen, Juha	FIN	SW
Nordell, Peter	USA	RO	Odusanya, Muiyiwa	NGR	WE	Omar abdillahi, Talan	DJI	AT	Ovnteni, Badie	NIG	BO
Nordhagen, Finn-Vegard	NOR	CY				Omar moussa,	DJI	AT	Ovrebø, Tore	NOR	RO
Nordlander, Mats	SWE	AR	Oeckl, Christa	FRG	AR	Omar, Ibrahim Okash	SOM	AT	Ovtchinnikov, Vladimir	URS	AT
Noronha, Paulo	MOZ	AT	Oesterheld, Claudia	FRG	CA	Omara, Frank	IRL	AT	Ovtchinnikova, Elena	URS	VB
Norrish, Alison	GBR	RO	Offei, Patricia	GHA	TT	Ombito, Nelson	KEN	JU	Owairan, Ibrahim	KSA	AT
			Ofisa, Taveuni	SAM	WE						
Norstad, Knut Arthur Mosness	NOR	RO	Ogata, Shigeo	JPN	SW	Omelianovitch, Maria	URS	RO	Owino, Victor	KEN	HO
Notenboom, Francis	BEL	AR	Ogawa, Hirofumi	JPN	BA	Omelianovitch, Victor	URS	RO	Owolabi, Kuburat	NGR	TT
Nothnagel, Anke	GDR	CA	Ogawa, Naoyuki	JPN	YA	Omeliantschik, Oxana	URS	GY	Oyazabal, Jose Ramon	ESP	RO
Nouvikov, Vladimir	URS	GY	Ogborn, Julie	GUM	AT	Omer, Mohmaed	EGY	AT	Oyuntssetseg, Sambuu	MGL	AR
Novak, Jan	TCH	HB	Ogden, David	GBR	WR	Omiecki, Ireneusz	POL	RO	Ozib, Nilo	MEX	YA
Novakova, Ivana	TCH	BB	Ogilvie, Sarah Ann	CAN	RO	Omnes, Philippe	FRA	FE	Ozsoy, Osman Senel	TUR	TA
Novitski, Valdemar	URS	HB				Omokaro, Bright	NGR	FB	Ozturk, Zeki	TUR	AT
Novotna, Jana	TCH	TE				Omona, Kasmiro	UGA	BO			
Nowak, Tomasz	POL	BO				Omondi, Michael	KEN	HO			
Nowosielski, Dan	CAN	FE				Omori, Takeshi	JPN	BA			

Seoul '88 Facts and Figures

Les faits et les chiffres

Listing of the Competitors/Listes dies concurrents

Name Nom	Country Pays	Sport	Name Nom	Country Pays	Sport	Name Nom	Country Pays	Sport	Name Nom	Country Pays	Sport
P			Park, Ji-Sook	KOR	GY	Peelen, Leo	HOL	CY	Petricevic, Anamarija	YUG	SW
			Park, Ji-Young	KOR	JU	Peet, Peter	HOL	YA	Petrich, Henryk	POL	BO
			Park, Jong-Chun	KOR	BB	Peeters, Frans	BEL	SH	Petrikov, Pavel	TCH	JU
Panev, Marian	BUL	GY	Park, Jong-Hoon	KOR	GY	Peeva, Guerguana	BUL	GY	Petronijevic, Djordje	YUG	BO
Paasonen, Sakari	FIN	SH	Park, Jong-Sin	KOR	SH	Pehkonen, Keijo	FIN	WR	Petrov, Gueorgui	BUL	JU
Pace, Darrell	USA	AR	Park, Joo-Li	KOR	SW	Pehoua-Pelema, Eugene	CAF	BB	Petrov, Konstantine	URS	SW
Pacheco, Pascual	ECU	TA	Park, Jung-Hee	KOR	SH	Pejo, Mayumi	USA	TA	Petrov, Nikolai	BUL	AT
Padilla, Doug	USA	AT	Park, Ki-Chul	KOR	YA	Pejovic, Srecko	YUG	SH	Petrovic, Biljana	YUG	AT
Padvaiskas, Kenneth	CAN	CA	Park, Kil-Chul	KOR	YA	Pelgas, Jacques	FRA	AT	Petrovic, Drazen	YUG	BB
Pafundi, Claudio	ARG	AR	Park, Kyung-Chul	KOR	CA	Pellegrini, Luca	ITA	SW	Petrovic, Drazen	YUG	TA
Page, Sharon	GBR	SW									
Pagel, Ramona	USA	AT	Park, Kyung-Hoon	KOR	FB	Pellegrini, Luca	ITA	FB	Petrovics, Bela	HUN	CA
Pagendam, Jamie	CAN	BO	Park, Mi-Hee	KOR	VB	Pellen, Catherine	FRA	AR	Petrovics, Kalman	HUN	CA
			Park, Mi-Jung	KOR	RO	Pellicano, Marcia	BRA	YA	Petschel, Norbert	AUT	YA
Pages, Gilles	MON	JU	Park, Mi-Sun	KOR	AT	Pelliconi, Roberto	ITA	CY	Pettersen, Karin	NOR	HB
Pagliuca, Gianluca	ITA	FB	Park, Min-Soo	KOR	CY	Peltier, David	BAR	AT	Petterson, Stephen	NZL	SH
Pahlsson, Johnny	SWE	SH	Park, Sam-Yong	KOR	VB	Peltola, Pirjo	FIN	SH	Pettersson, Jan	SWE	SH
Pai, Yun-Yao	TPE	TA	Park, Sang-Won	KOR	SW	Peltoniemi, Asko	FIN	AT	Pfeffer, Thomas	GDR	SH
Pailos, Edgardo	ARG	HO	Park, Si-Hun	KOR	BO	Pena, Enrique	COL	AT	Pfefferle, Gerald	SUI	FE
Pain, Angela	GBR	AT	Park, So-Woon	KOR	ES	Pena, Fernando	ESP	FE	Pfeiffer, Stefan	FRG	SW
Pais, Peter	HUN	CY	Park, Sook-Ja	KOR	AT	Pena, Jose	POR	SH	Pfizinger, Christine	NZL	AT
Pakarinen, Marita	FIN	AT									
Pakkala, Tiina	FIN	AT	Park, Soon-Ja	KOR	HO	Penagos, Oscar	COL	WE	Pfizinger, Peter	USA	AT
Pakline, Igor	URS	AT	Park, Sun-Young	KOR	TA	Penaloza, Andres	COL	ES	Pfohe, Hans-Juergen	FRG	YA
			Park, Sung-Lae	KOR	RO	Penalver, Antonio	ESP	AT	Pfrang, Thomas	FRG	CA
Palazzani, Dario	ITA	SH	Park, Sung-Soo	KOR	AR	Peng, Ping	CHN	BB	Pham, Loung	USA	TA
Pale, Harouna	BUR	AT	Park, Sung-Soo	KOR	MP	Pengelle, Richard	AUS	SW	Phelipon, Xavier	FRA	YA
Pales, Peter	TCH	CA	Park, Sung-Won	KOR	SW	Penicaud, Cedric	FRA	SW	Phelps, Richard	GBR	MP
Palgut, Karyn	USA	HB	Park, Tae-Min	KOR	WE	Pentenga, Marjan	HOL	RO	Phiatheb, Phetsay	LAO	AT
Paliiska, Diana	BUL	CA	Park, Young-Chul	KOR	SW	Peon, Juan Carlos	ESP	HO	Phillion, Madeleine	CAN	FE
Paliije, Helman	MAW	BO	Park, Young-Dae	KOR	HB	Peponnet, Thierry	FRA	YA	Philipp, Luzius	SUI	CA
Pallet, Nathalie	FRA	FE	Park, Young-Jun	KOR	AT	Pera, Albano	ITA	SH	Philips, Regina	FRG	JU
Palm, Evy	SWE	AT									
Palm, Kerstin	SWE	FE	Parker, Andrew	JAM	AT	Peraboni, Alfio	ITA	YA	Philipsson, Anette	SWE	SW
Palma, Alejandra	ARG	HO	Parker, Denise	USA	AR	Perahia, Alex	FRA	RO	Phillips, Andre	USA	AT
			Parker, Kate	GBR	HO	Perchine, Alexei	URS	AT	Phillips, Mark	GBR	ES
Palma, Marcelo	BRA	AT	Parkhomtchouk, Irina	URS	VB	Percy, Matthew	AUS	YA	Phillips, Traci	USA	CA
Palmer, Anders	SWE	FB	Parlevliet, Erik	HOL	HO	Perec, Marie-Josée	FRA	AT	Philp, Anthony C.	FIJ	YA
Palmer, Howard	BAR	YA	Parra, Ali	VEN	CY	Pereira, Adriana	BRA	SW	Philp, Anthony S.	FIJ	YA
Palmer, Tony	USA	CY	Parrack, James	GBR	SW	Pereira, Jacqueline	AUS	HO	Philp, Colin	FIJ	YA
Palola, Harri	FIN	AT	Parrala, Esko	FIN	AT	Pereira, Manuel	ESP	FE	Phipps, Angela	CAN	AT
Pambudi, Kresno.Eko	INA	AT	Parsons, Geoff	GBR	AT	Pereverzev, Victor	URS	RO	Phipps, Prikeba	USA	VB
Panageas, Konstantions	GRE	SH	Parsons, Timothy	HKG	YA	Perez cepeda, Frank Alexis	DOM	WE	Piasecki, Piotr	POL	ES
Pandey, Rajkumari	NEP	AT									
Pandurang Shanbagh, Vandana	IND	AT	Partie, Robert d	USA	VB	Perez Del Solar, Gabriela	PER	VB	Piccinini A., Ricardo A.	GUA	FB
Panetta, Francesco	ITA	AT	Partridge, Kathleen	AUS	HO	Perez, Cristina	ESP	AT	Pickard, Ronald	ISV	SW
			Partyka, Artur	POL	AT	Perez, Emil	AND	CY	Pickering, Sharon	FIJ	SW
Panfil, Marianna	POL	AT	Pascal, Richard	CAY	CY	Perez, Eric	FRA	TA	Pielke, Christiane	FRG	SW
Pang, Qiong	CHN	GY	Pascal, Robin	GBR	YA	Perez, Erick-giovnni	GUA	BO	Pieri, Alessandro	ITA	CA
Pang, Yan	CHN	AT	Pasgrimaud, Didier	FRA	CY	Perez, Francisco	CHI	YA	Pierre, Frederic	FRA	SW
Paniagua G., Adan Onelio	GUA	FB	Paskvalin, Tomislav	YUG	SW	Perez, Hector	MEX	CY	Pietrzak, Jerzy	POL	SH
Pankrachkine, Victor	URS	BB	Paspalji, Zarko	YUG	BB	Perez, Hugo Leonardo	ARG	FB	Piggford, Angela	GBR	AT
Pankratz, Marcia	USA	HO	Pasquale, Ilario Enrico	CAN	BB	Perez, Jose	VEN	BO	Piguereau, Anne	FRA	AT
Pannier, Raymond	FRA	AT	Pasquali, Sergio	ITA	SW	Perez, Jose	ESP	YA	Pigula, Tadeusz	POL	FE
Panova, Bianka	BUL	GY									
Pansky, Jindrich	TCH	TT	Passarelli, Claudio	FRG	WR	Perez, Miguel	ESP	SW	Pikilidis, Georgios	GRE	WR
Pantano, Stefano	ITA	FE	Pastoriza, Fernando J	ARG	AT	Perez, Victor	PUR	BO	Pilavulakandi, Usha	IND	AT
			Pastusinski, Jacek	POL	AT	Perez, Xavier	AND	CY	Pilhatsch, Alexander	AUT	SW
Pantchnko, Iouri	URS	VB	Pasztor, Szabolcs	HUN	FE	Perez-Solozano, Byron	GUA	FB	Pillot, Luc	FRA	YA
Papanastassiou, Anastassios	GRE	SW	Pateros, Evangelos	GRE	SW	Peridakis, Eliana	JOR	AR	Pils, Erich	AUT	SW
Papanikolaou, Charalambos	GRE	SW	Patmore, Sharon	AUS	HO	Perkins, Jacqueline	AUS	AT	Pimenov, Iouri	URS	RO
Papanitz, Zoltan	HUN	SH	Patoucidou, Paraskevi	GRE	AT	Perkiss, Shahar	ISR	TE	Pimenov, Nikolai	URS	RO
Papaterpos, Pandelis	GRE	RO	Patras, Evangelos	GRE	SW	Perkovac, Goran	YUG	HB	Pinczura, Jan	POL	CA
Papez, Sandi	YUG	CY	Patrascioiu, Aneta	ROM	SW	Perkuciu, Gordana	YUG	TT	Pineda, Telesforo	MEX	GY
Papirov, Eduard	ISR	SH	Patrunky, Lutz	FRG	YA	Perot, Pascal	FRA	SW	Pingale, Manoj	IND	BO
Papke, Ulrich	GDR	CA									
Pappin, Veryan	GBR	HO	Patten, Samuel	AUS	RO	Perrett, Susie	GBR	CA	Pinheiro, Helder	POR	GY
Paprika, Jenő	HUN	GY	Patton, Ted	USA	RO	Perricelli, Giovanni	ITA	AT	Piniguina, Maria	URS	AT
			Paul, Terrence	CAN	RO	Perrone Capano, Roberto	ITA	YA	Pinnow, Christine	GDR	YA
Parada, Guillermo P	ARG	YA	Paulin, Andy	USA	CY	Persi, Silvia	ITA	SW	Pintea, Horatio	CHI	TT
Paraguassu, Ezequiel	BRA	JU	Paulitz, Viola	FRG	CY	Persson, Annakarín	SWE	SW	Pintea, Valentin	ROM	GY
Paraskevini-Young, Connie	USA	CY	Paululul, Edouard	VAN	BO	Persson, Jorgen	SWE	TT	Pinter, Istvan	HUN	SW
Pardaens, Agnes	BEL	AT	Paulus, Barbara	AUT	TE	Persson, Lennart	SWE	YA	Pinto, Antonio	POR	AT
Pardi, Tibor	HUN	SW	Pavoni, Pierfrancesco	ITA	AT	Persson, Stefan	SWE	SW	Pinto, Guilherme	BRA	GY
Parente Ribeiro, Luisa	BRA	GY	Pawlak, Wojciech	POL	CY	Pescatore, John	USA	RO	Pinto, Joaquin	COL	FE
Parenti, Andrea	ITA	AR	Pawlowski, Janusz	POL	JU	Pesic, Dragana	YUG	HB	Pinto, Jose	POR	AT
Parera, Silvia	ESP	SW									
Pargat Singh	IND	HO	Paya, Jorge	ESP	SW	Pessoa, Sergio	BRA	JU	Pinto, Oscar	POR	FE
Parisella, Roberta	ITA	TA	Payne Wiggins, Marita	CAN	AT	Peter, Birgit	GDR	RO	Piotrowski, Andrzej	POL	WE
			Payne, Daniel	CAN	WR	Peter, Joerg	GDR	AT	Pirkkio, Jaarli	FIN	WE
Parisi, Giovanni	ITA	BO	Payne, Nicola	NZL	RO	Peterka, Carol	USA	HB	Piros, Andrea	SUI	FE
Parisotts, Barry	CAN	BA	Paynter, Quinn	BER	BO	Peters, Beate	FRG	AT	Pisani, Sandra	AUS	HO
Park, Bok-Rye	KOR	VB	Paz, Juan Miguel	COL	FE	Peters, Brad	CAN	GY	Pisano, Andrea	ITA	SW
Park, Bong-Kwon	KOR	TA	Paz, Mercedes	ARG	TE	Peters, Kerstin	ARG	TE	Pisiewicz, Ewa	POL	AT
Park, Byung-Jin	KOR	BO	Paz, Richard	PHI	YA	Petersen, Mike	AUS	FB	Pitschmann, Franz	AUT	WR
Park, Byung-Ki	KOR	YA	Pazach, Ahad	IRN	WR	Petersen, Susanne	DEN	CA	Pittman, Richard	COK	BO
Park, Cha-Keun	KOR	CA	Pazos, Gabriela	ARG	HO	Petersmann, Cerstin	ERG	RO	Pittner, Markus	AUT	WR
Park, Chan-Mi	KOR	BB									
Park, Chan-Sook	KOR	BB	Pearce, Darryl	AUS	BB	Petersmann, Katrin	ERG	RO	Piva, Filippo	SMR	SW
Park, Chul-Sung	KOR	SH	Pecher, Doris	FRG	SW	Peterson, Kristin	USA	SH	Piva, Michele	SMR	SW
			Peck, Abigail	USA	RO	Petibout, Christophe	FRA	CA	Pivac, Lazo	YUG	RO
Park, Chung-Hee	KOR	JU	Pecqueur, Thierry	FRA	GY	Petikiane, Gratchia	URS	SH	Pizzolato, Orlando	ITA	AT
Park, Do-Hun	KOR	HB	Peczinka, Claudia	SUI	SW	Petkov, Petko	BUL	VB	Placheta, Alesander	AUT	SW
Park, Dong-Hee	KOR	BA	Pedersen, Atle	NOR	CY	Petkov, Plamen	BUL	CA	Plasencia, Steve	USA	AT
Park, Dong-Joo	KOR	ES	Pedraza, Miguel	PUR	AR	Petkova, Ogniana	BUL	CA	Plaza, Daniel	ESP	AT
Park, Dong-Pil	KOR	SW	Pedro, Lucas	ANG	AT	Petovary, Zsolt	HUN	SW	Plaziat, Christian	FRA	AT
Park, Eun-Hee	KOR	FE	Peel, Ian	GBR	SH	Petranoff, Tom	USA	AT	Plechakov, Serguei	URS	HO
Park, Hyun-Kon	KOR	CY	Peel, Stephen	GBR	RO	Petric, Darjan	YUG	SW	Plechakov, Vladimir	URS	HO
Park, Hyun-Sook	KOR	HB									
Park, Jae-Sik	KOR	HO									
Park, Jang-Soon	KOR	WR									

Name Nom	Country Pays	Sport	Name Nom	Country Pays	Sport	Name Nom	Country Pays	Sport	Name Nom	Country Pays	Sport
Pleskacova, Hana	TCH	CA	Prainsson, Karl	ISL	HB	Radjenovic, Goran	YUG	SW	Reinke, Andreas	FRG	RO
Plewinski, Catherine	FRA	SW	Prasad, Bineshwar	FIJ	AT	Radke, Piotr	POL	TA	Reino, Javier	ESP	HB
Ploj, Bojan	YUG	AR	Pratsi, Katerina	CYP	AT	Radke, Trina	USA	SW	Reinsch, Gabriele	GDR	AT
Plosila, Juha	FIN	AT	Pratt, Christopher	AUS	YA	Radkova, Kostadinka	BUL	BB	Reinsfield, Steven	NZL	WR
Plotitzka, Lris	FRG	AT	Prean, Carl	GBR	TT	Radomski, Andrzej	POL	WR	Reis, Carlos	POR	AR
Plourde, Tony	CAN	FE	Preissler, Uwe	GDR	CY	Radulovic, Zdravko	YUG	BB	Reis, Fernanda	ANG	SW
Plumer, Pattisue	USA	AT	Prekas, Georgios	GRE	YA	Raevski, Vitali	URS	RO	Reiter, Hans	ISV	YA
Plummer, Jason	AUS	SW	Presern, Bojan	YUG	RO	Rafalak, Krzysztof	POL	ES	Reiter, Josef	AUT	JU
Poddpubnyi, Victor	URS	JU	Pressler, Kerstin	FRG	AT	Raffin, Romel	CAN	BB	Reiter, Peter	AUT	JU
Podkoscilny, Mariusz	POL	SW	Preti, Boris	ITA	GY	Ragnarsson, Arnthor	ISL	SW	Reiterer, Werner	AUS	AT
Podlesek, Franc	YUG	WR	Preuss, Silke	GDR	YA	Rago, Tibor	HUN	CY	Reljin, Milena	YUG	GY
Podolszki, Attila	HUN	WR	Prevosto, Andre	FRA	CA	Rahilou, Khalid	MAR	BO	Remark, Patrick	CIV	TA
Poelman, Simon	NZL	AT	Prianon, Jean-Louis	FRA	AT	Rai, Ranjeet	CAN	HO	Remigolsky, Rakefet	ISR	GY
Poffet, Michel	SUI	FE	Priaux, Marcus	AUS	BO	Raikova, Ivelina	BUL	GY	Renaud, Philippe	FRA	CA
Pogossov, Gueorgui	URS	FE	Pribilinec, Jozef	TCH	AT	Raimundo, Ricardo	BRA	AT	Reinders, Marleen	BEL	AT
Poikolainen, Minna	FIN	AR	Price, Connie	USA	AT	Raiskio, Maarit	FIN	ES	Rendle, Sharon	GBR	JU
Poikolainen, Tomi	FIN	AR	Pridham, Chris	CAN	TE	Rajasinghe, Daya	SRI	SH	Reneasamy, Seelan	GBR	TA
Poirier, Marie-Jacynthe	CAN	FE	Priede, Rvben Darid	ARG	CY	Rajchrtova, Regina	TCH	TE	Reneau, Paul	BIZ	CY
Pokotilo, Boris	URS	RO	Priestman, Richard	GBR	AR	Rajcoomar, Teekaram	MRI	BO	Reneiski, Victor	URS	CA
Poli, Eduardo	BRA	SW	Prieto, Antonio	ESP	AT	Rajinder Singh, Rawat	IND	HO	Reniers, Martinus	HOL	AR
Poli, Eros	ITA	CY	Prigoda, Gennadi	URS	SW	Rajna, Andras	HUN	CA	Renk, Silke	GDR	AT
Poli, Piergiovanni	ITA	AT	Primorac, Zoran	YUG	TT	Rakusz, Eva	HUN	CA	Rensch, Rene	GDR	RO
Poli, Piero	ITA	RO	Primrose, John	CAN	SH	Ramadan, Abdalla	SUD	BO	Renselaar Van, Hans	HOL	BA
Poliakov, Nikolai	URS	YA	Prochazka, Petr	TCH	CA	Ramalho, Renato	BRA	SW	Repka, Attila	HUN	WR
Poliakov, Ueorgui	BUL	SH	Procter, Donna	AUS	SW	Ramseier, Duban	COL	CY	Restrepo, Pablo	COL	SW
Polianski, Igor	URS	SW	Proidnikov, Alexei	URS	FB	Ramos, Ana Claudia	USA	VB	Restrepo, Ximena	COL	AT
Poljak, Eszter	YUG	SH	Prokopius, Jiri	TCH	MP	Ramos, Luis	MEX	CY	Rex, Annett	GDR	SW
Polky, Karsten	GDR	WR	Prokske, Uwe	GDR	FE	Ramos, Luis	PUR	BA	Reynolds, Harry Butch	USA	AT
Poll, Silvia	CRC	SW	Prost, Regis	FRA	AT	Ramos, Ramon	PUR	BB	Reynolds, Mark	USA	YA
Pollen, Olepetter	NOR	YA	Proto, Ludovic	FRA	BO	Ramotshabi, Joseph	BOT	AT	Rezemde, Monica	BRA	SW
Polokova, Iveta	TCH	GY	Protsenko, Oleg	URS	AT	Rampazzo, Fabrizio	ITA	SW	Reznitchenko, Vladimir	URS	FE
Polovinskaia, Tatiana	URS	AT	Protti, Anita	SUI	AT	Ramsaran, Navind	MRI	WR	Ribeiro, Amauri	BRA	VB
Polti, Giuseppe	ITA	RO	Pruma, Tibor	HUN	GY	Ramsay, Alison	GBR	HO	Ribeiro, Angela	BRA	SW
Pomochtnikova, Natalia	URS	AT	Prunier, Cecile	FRA	SW	Ransein, Daniel	SUI	ES	Ribeiro, Fernanda	POR	AT
Ponce, Adrian	MEX	WR	Prusakowska, Hanna	POL	FE	Ranamagar, Dalbahadur	NEP	BO	Ribeiro, Wladimir	BRA	SW
Ponce, Jorge Fidel	HON	AT	Ptak, Jiri	TCH	RO	Ranft, Angela	GDR	CY	Ribinskaite, Reda	URS	RO
Pongsri, Wanchai	THA	BO	Puc, Iztok	YUG	HB	Rankin, Janine	CAN	GY	Ribot, Veronica G	ARG	SW
Ponomarev, Igor	URS	FB	Pueyo, Ricardo	ESP	AT	Rannene, Morad	TUN	FB	Riboud, Philippe	FRA	FE
Pons, Mario	ECU	CY	Puica, Maricica	ROM	AT	Ransehousen, Jessica	USA	ES	Ricchezza, Fabiana	ARG	HO
Pons, Olivier	FRA	RO	Puig, Jaime	ESP	HB	Rao, Kelly	IND	YA	Rich, Michael	FRG	CY
Ponting, Thomas	CAN	SW	Puiia, Pietro	ITA	WE	Rao, Vandana	IND	AT	Richa, Ana Maria	USA	VB
Popa, Celestina	ROM	GY	Pujol, Montserrat	ESP	AT	Rapoport, Andrei	URS	WE	Richard, Thierry	FRA	CY
Popa, Ion	AUS	RO	Pulai, Imre	HUN	CA	Rapp, Markus	SUI	AT	Richards, Greg	GBR	AT
Popescu, Dimitrie	ROM	RO	Punja, Ranjoy	IND	SW	Rapp, Susan	USA	SW	Richards, Jeremy	GBR	YA
Popesou, Marioara	ROM	RO	Punk, Edit	HUN	RO	Rashwan, Mohamed	EGY	JU	Richards, Sandie	JAM	AT
Popov, Alexandre	URS	WE	Pura, Stela Marian	ROM	SW	Rasmuson, Svante	SWE	MP	Richards, Stephen	NZL	CA
Popov, Stefan	BUL	RO	Puscasu, Vasile	ROM	WR	Rasmussen, Einar	NOR	CA	Richardson, Jillian	CAN	AT
Popov, Vladimir	URS	WR	Pusch, Alexander	FRG	FE	Rasmussen, Ole Riber	DEN	SH	Richmond, Mitchell	USA	BB
Popova, Valenina	URS	TT	Pusnik, Rolando	YUG	HB	Rasmussen, Per H S	DEN	RO	Richter, Anatol	AUT	FE
Popovic, Slobodan	YUG	AT	Putna, Bretislav	TCH	SH	Rasool, Javed	PAK	YA	Richter, Dirk	GDR	SW
Popovitch, Vitali	URS	AT	Puttini, Felice	SUI	CY	Rasovan, Romica	ROM	WR	Richter, Sabine	FRG	AT
Popper, Elizabeth	VEN	TT	Puttlitz, Jorg	FRG	RO	Ratia, Emilio	ESP	SW	Ricina, Hana	TCH	GY
Porritt, Trevor	CAN	HO	Puxkandl, Stephan	AUT	YA	Ratray-Williams, Cathy	JAM	AT	Rico, Lorenzo	ESP	HB
Pors, Inger	DEN	RO	Pyrah, Malcolm	GBR	ES	Raty, Seppo	FIN	AT	Ridgeon, Jonathan	GBR	AT
Portelli, Luis Jorge	ARG	JU	Pysall, Peter	GDR	HB	Raudaschl, Hubert	AUT	YA	Riederer, Johann	FRG	SH
Porter, Pat	USA	AT	Pyy, Juha	FIN	AT	Rauhala, Jukka	FIN	WR	Riedle, Karlheinz	FRG	FB
Portner, Zlatko	YUG	HB				Rauhala, Pekka	FIN	WR	Rienks, Nicolaas	HOL	RO
Portnov, Alexandre	URS	SW				Raumala, Sari	FIN	AT	Riera, Eva	BRA	SW
Portwich, Ramona	GDR	CA				Rawat, Menuka	NEP	AT	Ries-hotz, Ilse Martha	LUX	AR
Porvardarson, Einar	ISL	HB				Rawya, Ahmed	YAR	AT	Riffel, Gerhard	FRG	CA
Porzio, Francesco	ITA	SW	Qamar ibrahim	PAK	HO				Ribaldi, Domenico	ITA	SW
Posinkovic, Renco	YUG	SW	Qazi Mohib-Ur-Rehman	PAK	HO	Raynor, Angie	USA	HB	Rilaldi, Domenico	ITA	SW
Posova, Marta	TCH	HB	Qi, Chunxia	CHN	SH	Razigul	AFG	WR	Riley, John	USA	RO
Pospisilova, Lenka	TCH	HB	Qian, Hong	CHN	SW	Razzino, Andre	URS	AT	Rimarim, Bernardo	PHI	CY
Posse, Jesus	URU	RO	Qin, Qizhi	CHN	GY	Razzino, Ernesto	ITA	WR	Rincic, Slavica	YUG	HB
Posthuma, Jan-Marcus	HOL	VB	Quach Hoai, Nam	VIE	SW	Read, Glenn	AUS	YA	Rincon, Javier Eberto	COL	WR
Postiglione, Giovanni	ITA	RO	Quartey, Issifu Quartelai	GHA	BO	Read, Katharine	GBR	SW	Ringnald, Lance	USA	GY
Postiglione, Stefano	ITA	SW	Quaye, Emmanuel	GHA	BO	Reardon, Julie	AUS	JU	Rink, Michaela	FRG	SH
Postigo, Antonio	ESP	AT	Quelmalz, Udo	GDR	JU	Rebel, Juergen	FRG	TT	Rinke, Christopher	CAN	WR
Poswiat, Christian	GDR	SW	Queneherve, Gilles	FRA	AT	Rebello, George	BRA	YA	Rioos, Roberto	PUR	BB
Potachev, Alexandre	URS	AT	Querneq, Yvon	FRA	YA	Rebello, Joao	POR	SH	Rioux, Gervais	CAN	CY
Potie, Pascal	FRA	CY	Quesada, Eduardo	ESP	MP	Rebollo, Sonia	ESP	GY	Risher, John	USA	RO
Potorac, Gabriela	ROM	GY	Quesada, Jorge	ESP	MP	Rechardt, Lauri	FIN	YA	Risi, Bruno	SUI	CY
Potteck, Jens	GDR	SH	Quinaliza, Jose	ECU	AT	Reck, Oliver	FRG	FB	Ritter, Louise	USA	AT
Potteck, Uwe	GDR	SH	Quinn, Brendan	IRL	AT	Reck, Thomas	FRG	HO	Rivas, Mauricio	COL	FE
Potter, Jon	GBR	HO	Quinones, Mariano	PUR	BA	Redetzky, Heike	FRG	AT	Rivas, Ramon	PUR	BB
Pottinger, Tinks	NZL	ES	Quinones, Ray J.	PUR	AT	Redgrave, Steven	GBR	RO	Rivera Gomez, Cristian	DOM	WE
Pou, Michel	FRA	SW	Quintin, Michel	FRA	YA	Redmond, Derek	GBR	AT	Rivera, Alberto	MEX	ES
Poukhaeva, Elena	URS	RO	Quiroga, Raul Nicoras	ARG	VB	Reedy, Paul	AUS	RO	Rivera, Maria	MEX	SW
Poulsen, Annette	DEN	SW				Regalo, Jose	POR	AT	Rivera, Rey	PUR	BO
Poupart, Benedicto	PUR	BA				Regec, Jozef	TCH	CY	Rivera, Victor A.	PUR	JU
Poussev, Victor	URS	CA				Reggi, Rafaella	ITA	TE	Rizan, Marian	ROM	GY
Pouye, Babacar	SEN	AT	Retiz, Carlos	MEX	AT	Regis, John	GBR	AT	Rizwan Munir	PAK	HO
Povarnitsyne, Roudolf	URS	AT	Raab, Uwe	GDR	CY	Rehaa, Gabi	FRG	SW	Rizzitelli, Ruggiero	ITA	FB
Powell, Mike	USA	AT	Raabe, Juergen	GDR	SH	Rehders, Kerstin	ERG	RO	Rnic, Momir	YUG	HB
Powell, Richard	AUS	RO	Rabe, Bahne	FRG	RO	Rehn, Stefan	SWE	FB	Robbers, Rob	HOL	RO
Powell, Sharon	JAM	AT	Rabee, Tareq	KUW	RO	Reid, Graham	AUS	HO	Robbins, Douglas	USA	BA
Pracht, Eva Maria	CAN	ES	Racansky, Lubos	TCH	SH	Reid, Herman	USA	BB	Robert, Jose	ESP	RO
Pradhan, Rishiram	NEP	JU	Raciborski, Jan	GBR	CA	Reiher, Hendrik	GDR	RO	Robert, Michel	FRA	ES
Prado, Ricardo	BRA	SW	Radev, Vassil	BUL	RO	Reimann, Rene	FRG	SW	Robert, Pere	ESP	SW
			Radfan, Ariane	GDR	VB	Reineck, Thomas	FRG	CA	Robert, Serge	FRA	WR
			Radja, Dino	YUG	BB						

Seoul '88 Facts and Figures

Les faits et les chiffres

Listing of the Competitors/Listes dies concurrents

Name Nom	Country Pays	Sport	Name Nom	Country Pays	Sport	Name Nom	Country Pays	Sport	Name Nom	Country Pays	Sport
Roberti, Firmo Emilio	ARG	SH	Rossner, Petra	GDR	CY	Said, Azzedine	ALG	BO	Sangouma, Daniel	FRA	AT
Roberts, Lori	BAH	SW	Rosswess, Michael	GBR	AT	Saif, Farjad	PAK	TT	Sankovets, Nikolai	URS	HO
Roberts, Martin	AUS	SW	Roth, Greg	CAN	BA	Saikali, Fadi	LIB	JU	Sanna, George	AUS	ES
Robertson, Bruce	CAN	RO	Rothaar, Marion	FRG	GY	Saile, Bruno	SUI	RO	Sanneh, Bakary	GAM	WR
Robertson, Esther	ITA	AR	Roudjenis, Rimantas	URS	RO	Sailer, Hermann	AUT	SH	Sans, Jorge	ESP	SW
Robertson, Kevin	USA	SW	Rouillard, Carole	CAN	AT	Saiman, Nurfitriyana	INA	AR	Santana, Joilson	BRA	BO
Robertson, Max	GBR	AT	Rouissi, Lotfi	TUN	FB	Saina, Joseph	KEN	AT	Santana, Roberto	PUR	BA
Robinson, Albert	USA	AT	Roumain, Claudeg.	HAI	AT	Saini, Parminder	KEN	HO	Santana, Yolanda	ESP	TA
Robinson, David	USA	BB	Rounov, Igor	URS	VB	Saint-Phard, Deborah	HAI	AT	Santella, Luca	ITA	YA
Robinzine, Kevin	USA	AT	Rousnatchenko, Natalia	URS	HB	Saito, Aiko	JPN	YA	Santiago, Kimberly	USA	RO
Robles, Jorge	PUR	BA	Rousseau, Vincent	BEL	AT	Saito, Hirokatsu	JPN	TA	Santoro, Gerard	FRA	WR
Robotka, Istvan	HUN	WR	Roussinov, Svilen	BUL	BO	Saito, Hiroshi	JPN	MP	Santos, Antonio	ANG	AT
Robu, Valentin	ROM	RO	Roux, Patrick	FRA	JU	Saito, Hitoshi	JPN	JU	Santos, Diamantino	BRA	AT
Rocandio, Valentin	ESP	AT	Rovira, Miguel	ESP	HP	Saito, Ikuzo	JPN	WR	Santos, Edmar	BRA	FB
Rocha, Wagner	BRA	VB	Rowland, Mark	GBR	AT	Saito, Kiyoshi	JPN	TT	Santos, Edwaldo	BRA	WE
Rochefort, Ellen	CAN	AT	Roy, Kevin	CAN	WE	Saitov, Assiat	URS	CY	Santos, Joao	POR	SW
Rocheleau, Julie	CAN	AT	Roy, Niyati	IND	TT	Saive, Jean-Michle	BEL	TT	Santos, Joao	BRA	FB
Rocheleau, Luc	CAN	FE	Roycroft, Barry	AUS	ES	Saizozema	DOM	BO	Santos, Keray	USA	VB
Rock, Angela	USA	VB	Roycroft, Vicki	AUS	ES	Sakae, Kazuhito	JPN	WR	Santos, Renato	POR	JU
Rodan, Joseph	FIJ	AT	Rozier, Philippe	FRA	ES	Sakai, Hirofumi	JPN	AT	Santos, Rui	POR	AR
Rodas-Hurtarte, Julio-Alberto	GUA	FB	Rozon, James	CAN	GY	Sakakini, Andre-Saleh	EGY	ES	Sapega, Iouri	URS	VB
Rodehau, Gunther	GDR	AT	Ru, Guang	CHN	AR	Sakamoto, Toshisuke	JPN	CA	Saputera, Surya	INA	WR
Rodrigues, Abelvio	BRA	AT	Rubio, Miguel Angel	ESP	GY	Sakata, Masahiro	JPN	RO	Sar, Babacar	MTN	WR
Rodrigues, Ivo	BRA	AT	Ruddins, Kimberly	USA	VB	Sakonninohm, Mala	LAO	AT	Saracevic, Zlatko	YUG	HB
Rodriguez, Angelines	ESP	AT	Rudery, Victor	BER	SW	Sakovich, Jonathan	GUM	SW	Saratcheva, Milena	BUL	AT
Rodriguez, Ernesto	MEX	TA	Ruecker, Bernd	FRG	SH	Sakurai, Naoko	JPN	ES	Sardouk, May	LIB	AT
Rodriguez, Hector	COL	ES	Rueda, Eva	ESP	GY	Sala, Carlos	ESP	AT	Sarkissian, Stepan	URS	WR
Rodriguez, Humberto	MEX	BO	Ruer, Christophe	FRA	MP	Sala, Gabriele	ITA	GY	Sarlos, Katalin	HUN	RO
Rodriguez, Jose	ESP	CY	Ruffini, Robert	TCH	AT	Salah, Alimohamed	QAT	TA	Sarr, Ambroise	SEN	WR
Rodriguez, Jose Antonio	ESP	SW	Ruguga, Vincent	UGA	AT	Salah, Ghazi F	IRQ	WR	Sarr, Momodou	GAM	AT
Rodriguez, Jose Reyes	ESP	CA	Ruidiaz, Alejandro	ARG	FB	Salame, Jihad	LIB	AT	Sarsar, Mohamed	TUN	VB
Rodriguez, Julio Cesar	COL	CY	Ruiz, Angelo	PUR	JU	Salameh, Moh. Marwan	SYR	WR	Sarti, Leo Marino	SMR	JU
Rodriguez, Nelson	COL	CY	Ruiz, Antonio	MEX	AT	Salan, Philippe	FRA	VB	Sarusi Kis, Janos	HUN	CA
Rodriguez, Raoul	USA	RO	Ruiz, Joaquin	ESP	JU	Salas, Edward	AUS	CY	Sarvari, Ulrike	FRG	AT
Rodriguez, Tomas	PAN	WE	Ruiz, Julian	ESP	HB	Salazar, John	COL	WE	Sasaki, Hikari	JPN	JU
Rodriguez, Ubaldo J.	PUR	WR	Ruiz, Tomas	ESP	BO	Saibe, Kiptoo	KEN	WR	Sasaki, Kaori	JPN	SW
Rodriguez-Sadia, Alfonso	ESP	GY	Ruiz-Conforto, Tracie	USA	SW	Saleh Mehdi, Sahim	YMD	AT	Sasaki, Kazuaki	JPN	CY
Roehle, Peter	FRG	SW	Rumeon, Vicky	HOL	TA	Saleh, Awad	YAR	AT	Sasaki, Yasushige	JPN	WE
Roelts, Udo	FRG	CY	Runnolfsdottir, Ragneidur	ISL	SW	Saleh, Mustafa M	IRQ	BO	Sasakul, Chatchai	THA	BO
Roose, Hansmartin	FRG	CA	Ruotsalainen, Satu	FIN	AT	Saleh, Sherif	EGY	SH	Satersdal, Per Albert	NOR	RO
Roose, Paulo	BRA	VB	Ruppel, Martin	FRG	RO	Salem Obeib, Wallid	YMD	BO	Sato, Eric A	USA	VB
Roethke, Lynn	USA	JU	Russ, Alexandra	FRG	SW	Salihu, Aziz	YUG	BO	Sato, Ichiko	JPN	VB
Roethlisberger, Edgar	SUI	YA	Russo, Alejandro Marcelo	ARG	FB	Salim, Josef	DEN	TA	Sato, Liane	USA	VB
Rogerson, Craig	AUS	SW	Rutherford, Frank	BAH	AT	Salnikov, Vladimir	URS	SW	Sato, Megumi	JPN	AT
Roggero, Emanuel	ARG	HO	Rutledge, Michael Ross	CAN	HO	Salom, Ikaji	TAN	AT	Sato, Mitsuru	JPN	WR
Rogowski, Krzysztof	POL	ES	Ruzicka, Miroslav	TCH	SH	Salomaki, Jouko	FIN	WR	Sato, Saburo	JPN	YA
Roh, Chan-Yup	KOR	BA	Ryan, Matthew	AUS	ES	Salomykova, Irina	URS	CA	Sato, Toshiharu	JPN	GY
Roh, Hyun-Suk	KOR	HB	Rycroft, Leanne	AUS	GY	Salonen, Juha	FIN	JU	Satyanan	IND	WR
Rohde, Peter	DEN	SW	Ryffel, Markus	SUI	AT	Salonen, Reima	FIN	AT	Sauer, Gunnar	FRG	FB
Rohloff, Semon	AUS	SW	Rymanov, Alexandre	URS	HB	Salou, Jean-Pierre	FRA	YA	Saunders, Clarence	BER	AT
Rojas, Alejandro	CHI	RO	Rypien, David	CAN	BA	Saloukqvadze, Nino	URS	SH	Saunders, David P	USA	VB
Rojas, Marcelo	CHI	RO	Ryter, Jean-Philippe	SUI	YA	Saloumiaie, Erika	URS	CY	Saunderson, Brian	CAN	RO
Rokaya, Haribahadur	NEP	AT	Ryu, Tae-Keong	KOR	AT	Saltsidis, Pavlos	GRE	WE	Savchenko, Larisa	URS	TE
Rollan, Jesus	ESP	SW				Salvador, Antonio	ESP	CY	Savenko, Galina	URS	CA
Rollins, Marie	IRL	AT				Salzmann, Ralf	FRG	AT	Savevski, Toni	YUG	FB
Rolon, Luis	PUR	BO				Samarasinghe, Vithanakande Lek	SRI	AT	Savine, Vitali	URS	AT
Roman, Juan Jose	ESP	CA				Samartzidis, Epaminondas	GRE	SW	Savitchev, Iouri	URS	FB
Romanishine, Vladimir	URS	RO	Saaf, Per-Anders	SWE	VB	Samolenko, Tatiana	URS	AT	Savitskaia, Galina	URS	BB
Romankov, Alexandre	URS	FE	Saaliste, Ourmas	URS	SH	Samuel, Gene	TRI	CY	Sawad, Bharat	NEP	WE
Romano, Catherine	FRA	GY	Sabadosova, Gabriela	TCH	HB	Samuel-Kaya, Nchinda	CMR	AT	Sawai, Takao	JPN	ES
Romano, Valerio	ITA	YA	Sabali, Kamil	LIB	JU						
Romanova, Elena	URS	AT	Sabanadzovic, Refik	YUG	FB	Samuels, Vernon	GBR	AT	Sawe, Tito	KEN	AT
Romero, Hugo	ECU	SH	Sabatini, Gabriela	ARG	TE	San Epifanio, Juan Antonio	ESP	BB	Sawe, William	KEN	AT
Romero, Rogerio	BRA	SW	Sabia, Donato	ITA	AT	Sanabria, Jose	ESP	TA	Sawkiw, Wareen	CAN	BA
Romo, Carlos	MEX	SW	Sabjan, Ivan	YUG	CA	Sanada, Makiko	JPN	GY	Sawyer, David	SLE	AT
Romos, Tabare	USA	FB	Sabloskaite, Remiguiia	URS	AT	Sanchez Aleman, Pedro	ESP	ES	Sawyer, Christopher	GBR	TA
Rondo roku, Manuel	GEQ	AT	Sabonis, Arvidas-Romas	URS	BB	Sanchez, Alberto	ESP	CA	Saxton, Andrew	GBR	WE
Ronkainen, Janne	FIN	AT				Sanchez, Antonio	ESP	AT	Saya, Susan	LAO	SH
Ronningen, Jon	NOR	WR	Sacchi, Luca	ITA	SW	Sanchez, Arantxa	ESP	TE	Saynevirta, Tapio	FIN	SH
Ronningen, Lars	NOR	WR	Sadaqat, Muhammad	PAK	AT	Sanchez, Emilio	ESP	TE	Scaglia, Corrado	ITA	GY
			Sadiq, Mamoon	PAK	YA	Sanchez, Gabriela	ARG	HO	Scalzo, Giovanni	ITA	FE
			Sadkhan, Younis A.	IRQ	FB						
Rono, Peter	KEN	AT	Sadovskaia, Tatiana	URS	FE	Sanchez, Javier	ESP	TE	Scammell, Patrick	AUS	AT
Root, Jon E	USA	VB	Saebo, Erik Johan	NOR	CY	Sanchez, Joel	MEX	AT	Scanavino, Carlos	URU	SW
Ropke, Kurt Kenneth	DEN	CY	Saeed, Naji	UAE	CY	Sanchez, Jose Maria	ESP	TA	Scanlon, Peter	AUS	TA
Ropo, Ringa	FIN	AT	Safar, Hussei	KUW	JU	Sanchez, Juan Manuel	ESP	CA	Scarantino, Giovanni	ITA	WE
Roque, Monica	ANG	SW	Safarova, Alena	TCH	TT	Sanchez, Luna Francisco	ESP	YA	Scarpa, Daniele	ITA	CA
Rosa, Gloria M.	PUR	AR	Safarzadeh, Mehrdad	IRN	CY	Sanchez, Oscar	ESP	WR	Schabinger, Michaela	FRG	AT
Rosario, Abimael	PUR	BA				Sande, Chris	KEN	BO	Schacht, German	CHI	YA
Roscoe, Carolyn	GBR	SW	Safarzadeh, Syamak	IRN	CY	Sandegren, Ulf	SWE	FE	Schaefer, Anja	FRG	RO
Rose, Chmpbell	AUS	YA	Sagales, Juan	ESP	HB	Sanders-Keyzer, Annemarie	HOL	ES	Schaefer, Anja	ERG	RO
Rose, Sylvia	GDR	RO	Sagisi, Patrick	GUM	SW	Sanderson, Tessa	GBR	AT	Schaefer, Jorg	FRG	AT
			Sagnon, Sounaila	BUR	BO						
Rosenberg, Boris	URS	TT	Sahere, Abdelaziz	MAR	AT	Sandhu, Hargurnek	CAN	HO	Schafer, Gertrud	FRG	AT
Roso, Angelo	BRA	RO	Sahin, Ali	TUR	TA	Sandoval, Kevin	GUA	FB	Schaffer, Jamie	CAN	RO
Ross, Dave	CAN	RO	Sahin, Metin	TUR	TA	Sands, Jack	BAN	YA	Schafferius, Bradley	AUS	YA
Ross, Jacqueline	VIN	AT	Sahin, Zeki	TUR	WR	Sands, Jack	BAH	YA	Schaffter, Olivier	SUI	JU
Rossa, Tomasz	POL	SW	Sahli, Luzia	SUI	AT	Sandstrom, Bengt	AUS	SH	Schapers, Michiel	HOL	TE
Rossard, Olivier	FRA	VB	Sahner, Christoph	FRG	AT	Sandu, Adrian	ROM	GY	Scharwz, Ralph	HOL	RO
Rosser, Warren	AUS	JU				Sandurski, Adam	POL	WR	Schatzmann, Samuel	SUI	ES
Rossi, Marco	ITA	AT				Sandy, Felix	SLE	AT	Scheibe, Juergen	FRG	WR
Rossing, Anita	SWE	SW				Sang, Lucas	KEN	AT	Scheller, Gerlind	FRG	SW
Roszkopf, Joerg	FRG	TT				Sang, Patrick	KEN	AT	Schelling, Johannes	HOL	YA

Name Nom	Country Pays	Sport	Name Nom	Country Pays	Sport	Name Nom	Country Pays	Sport	Name Nom	Country Pays	Sport
Schenk, Christian	GDR	AT	Schwendtner, Josef	TCH	WR	Shaw, Colin	CAN	CA	Sin, Young-Suk	KOR	HB
Schenk, Hans	FRG	AT	Schwerzmann, Beat	SUI	RO	Shea, Patricia	USA	HO	Singarayar, Josephine	MAL	AT
Scherer, Markus	FRG	WR	Scirea, Mario	ITA	CY	Shearer, Janet	NZL	YA	Singer, Heike	GDR	CA
Scherr, James	USA	WR	Scott, Steve	USA	AT	Shearn, Nicola	GBR	SW	Singer, Karin	SUI	SW
Scherr, William	USA	WR	Scribani Rossi, Luca	ITA	SH	Sheffield, Latanya	USA	AT	Singer, Regina	AUT	TA
Schersing, Mathias	GDR	AT	Scuri, Daniel Pablo	ARG	RO	Sheldon, Shawn	USA	WR	Singh Tutt, Ravinder	GBR	WR
Scheur-Larsen, Tine	DEN	TE	Seack, Oliver	FRG	CA	Sheldon-Collins, Matthew	AUS	BA	Singh, Bishnubahadur	NEP	BO
Schieferdecker, Bettina	GDR	GY	Seaton, Anna	USA	RO	Shelley, Lee	USA	FE	Singh, Davendra	FIJ	AT
Schier, Birgit	AUT	GY	Sebastia, Agustin	ESP	CY	Shen, Jianqiang	CHN	SW	Singh, Iqbal	IND	AT
Schillaci, Giovanni	ITA	WR	Sebenik, Robert	YUG	CY	Sheppard, Alison	GBR	SW	Singh, Kartar	IND	WR
Schimmer, Michael	GDR	AT	Sebiev, Ramzan	URS	BO	Sherriff, Andrew	GBR	CA	Singh, Kuldeep	IND	WR
Schimrock, Gunar	GDR	HB	Secher, Steen	DEN	YA	Sherwani, Imran	GBR	HO	Singh, Sanjeeva	IND	AR
Schlatmann, Gerrit Jan	HOL	HO	Seck, Charles Louis	SEN	AT	Sheu, Tsay-Chwan	TPE	JU	Singleton, Kraig	ISV	SW
Schleppe, Shona	CAN	HO	Sedivak, Petr	TCH	JU	Shi, Wei	CHN	HB	Singleton, Kristan	ISV	SW
Schlesinger, Thomas	USA	GY	Sedykh, Yuriy	URS	AT	Shibata, Hiroyuki	JPN	AT	Singtao, Karin	NOR	HB
Schlicht, Svenja	FRG	SW	Seebaluck, Sheila	MRI	AT	Shields, Jane	GBR	AT	Sinisalo, Veikko	FIN	RO
Schliemann, Christian	FRG	HO	Seeberger, Herbert	FRG	SH	Shim, Duk-Sup	KOR	AT	Sinko, Andrea	HUN	GY
Schmeling, Karsten	GDR	RO	Seeburg, Joanne	GBR	SW	Shim, Jae-Hong	KOR	HB	Sinzinger, Karl	AUT	RO
Schmid, Harald	FRG	AT	Segato, Luca	CAN	CY	Shim, Kyu-Hae	KOR	YA	Sione, Alesana	ASA	WR
Schmid, Susanne	FRG	HO	Segawa, Setsuo	JPN	BO	Shin, Chang-Moo	KOR	ES	Sipila, Tapio	FIN	WR
Schmid, Thomas	FRG	YA	Segui, Juan	ESP	SH	Shin, Dae-Chul	KOR	CY	Sirch, Cornelia	GDR	SW
Schmidt, Birgit	GDR	CA	Segurola, Jose Maria	ESP	RO	Shin, Kwang-Soo	KOR	YA	Siri, Alejandro	ARG	HO
Schmidt, Holger	FRG	AT	Seguso, Robert	USA	TE	Shin, Suk-Kyun	KOR	HO	Siriphon, Bounhom	LAO	AT
Schmidt, Joerg	GDR	CA	Seick, Karin	FRG	SW	Shin, Sung-Ja	KOR	FE	Sirma, Susan	KEN	AT
Schmidt, Oscar	BRA	BB	Seidel, Sonny	FRG	TA	Shinoda, Miho	JPN	GY	Sisa, Csaba	HUN	RO
Schmidt, Steffi	GDR	VB	Seier, Jesper	DEN	YA	Shintaku, Hisatoshi	JPN	AT	Siska, Xenia	HUN	AT
Schmidt, Wieland	GDR	HB	Seipelt, Frank	FRG	WE	Shiokawa, Hirokazu	JPN	TA	Sisniaga, Ivar	MEX	MP
Schmidt-Opper, Ekkhard	FRG	HO	Seisenbacher, Peter	AUT	JU	Shiozaki, Tetsuya	JPN	BA	Sitt, Peter	FRG	SW
Schmied, Kurt	AUT	CY	Sejdi, Saban	YUG	WR	Shirley, Simon	AUS	AT	Siuley, Moumouni	NIG	BO
Schmiedt, Gabor	HUN	SW	Sekaric, Jasna	YUG	SH	Shirmohammed	AFG	WR	Siviski, Dario Andres	ARG	FB
Schmiemann, Diana	FRG	GY	Seker, Fevzi	TUR	WR	Shmuel, Jacov	ISR	BO	Siwek, Agnieszka	POL	AT
Schmitt, Arnd	FRG	FE	Seki, Natsue	JPN	CY	Short, Sallyanne	GBR	AT	Six, Christine	AUT	TA
Schmitt, Otto	ARG	HO	Sekky, Ashraf	EGY	BB	Shriver, Pam	USA	TE	Six, Veronika	AUT	TA
Schmitz, Torsten	GDR	BO	Seko, Toshihiko	JPN	AT	Shtigman, Eyal	ISR	SW	Sixsmith, Jane	GBR	HO
Schneider, Corinne	SUI	AT	Sela, Yoel	ISR	YA	Shudo, Shinichi	JPN	HB	Sjoberg, Patrik	SWE	AT
Schneider, Dieter	FRG	FE	Selenska, Antoaneta	BUL	AT	Shurrock, Ann	NZL	AR	Sjogren, Sten	SWE	HB
Schneider, Gilbert	FRG	CA	Seletopoulos, Dimitrios	GRE	SW	Siasia, Samson	NGR	FB	Sjowall, Jenny	SWE	AR
Schneider, Guenter	SUI	RO	Selinger, Avital	HOL	VB	Sibalin, Jakab	HUN	HB	Skanaker, Ragnar	SWE	SH
Schneider, Hans Rudolf	SUI	SH	Selkridge, Barbara	ANT	AT	Sibenge, James	ZIM	JU	Skandik, Josef	TCH	HB
Schneider, Holger	GDR	HB	Selkridge, Oral	ANT	AT	Sibley, Robert	AUS	BB	Skaro, Damir	YUG	BO
Schnieders, Andreas	FRG	BO	Sellers, Rex	NZL	YA	Sichel, John	ECU	WE	Skeete, Lesley-Ann	GBR	AT
Schober, Matthias	GDR	AT	Selmi, Mostefa-Kamel	ALG	AT	Sidiropoulos, Giannis	GRE	WE	Skelton, Nicholas	GBR	ES
Schoefs, Erik	BEL	CY	Semenova, Olga	URS	HB	Sidorenko, Tatiana	URS	VB	Skeritt, Anton	CAN	AT
Schoenenberger, Edith	SUI	CY	Semeraro, Paolo	ITA	YA	Sieben, Jonathan	AUS	SW	Skibby, Karina	DEN	CY
Schoenlebe, Thomas	GDR	AT	Semetka, Donald	TCH	MP	Siebert, Gloria	GDR	AT	Skillman, Melanie	USA	AR
Scholl, Reiner	FRG	CA	Semizuki, Fumihisa	JPN	SH	Siech, Birte	GDR	RO	Skirbekk, Geir	NOR	SH
Schommer, Craig	USA	CY	Sendker, Jacqueline	FRG	CA	Siemion, Krzysztof	POL	WE	Skliarov, Ivar	URS	FB
Schott, Franck	FRA	SW	Sene, Pierre yves	SEN	JU	Sierra, Leonardo	VEN	CY	Skoff, Horst	AUT	TE
Schowe, Gabriela	FRG	HO	Senecal, Jean-Francois	CAN	SH	Siess, Cezary	POL	FE	Skopek, Milan	TCH	RO
Schraider, Alessandro	ITA	RO	Sengstock, Larry	AUS	BB	Sievers, Ralf	FRG	FB	Skordi, Marina	GRE	AT
Schramm, Beate	GDR	RO	Seo, Hyo-Sun	KOR	HO	Siew, Shaw her	SIN	YA	Skottvoll, Annette	NOR	HB
Schreck, Ulrich	FRG	FE	Sigde, Kwang-Mi	KOR	HO	Sigdm, WRN	NOR	WR	Skouroumouni, Michalakis	CYP	JU
Schreiber, Alexandra	FRG	JU	Seo, Kyoko	JPN	GY	Sigmund, Regina	FRG	JU	Skriabin, Timofei	URS	BO
Schreier, Christian	FRG	FB	Serantes, Leopoldo	PHI	BO	Sigurdsson, Bjarki	ISL	HB	Skrzypaszek, Arkadiusz	POL	MP
Schroeder, Andreas	GDR	WR	Seras, Andrew	USA	WR	Sigurdsson, Jakob	ISL	HB	Skubacz, Marian	POL	WR
Schroeder, Katrin	GDR	RO	Sergent, Annette	FRA	AT	Siguria, John	NGU	AT	Slade, Mark	GBR	FE
Schroeder, Richard	USA	SW	Seriese, Angeliq	HOL	JU	Sike, Andras	HUN	WR	Slade, Melanie	CAN	HO
Schroeder, Roland	GDR	RO	Sermisiri, Anuwat	THA	AT	Sikorski, Andrzej	POL	CY	Slanar, Ivan	TCH	AT
Schroeder, Terry A.	USA	SW	Serna, Eusebio	ESP	WR	Silhava, Zdenka	TCH	AT	Slaney, Mary	USA	AT
Schroer, Beatrix	GDR	RO	Serneels, Patricia	BEL	SW	Silivas, Daniela	ROM	GY	Slater, Robert	AUS	FB
Schroeter, Martina	GDR	RO	Serra, Daniel	ESP	SW	Silva, Alvaro	POR	AT	Slatter, Helen	GBR	SW
Schroff, Alexander	SUI	YA	Serrani, Lucio	ITA	AT	Silva, Arnaldo	BRA	AT	Sleeper, Jane	USA	ES
Schroff, Daniel	SUI	YA	Serrano, Antonio	ESP	AT	Silva, Geovani	BRA	FB	Siegers, Lieve	BEL	AT
Schubert, Michael	GDR	WE	Serrano, Eugenio	ESP	HB	Silva, Joaquim	POR	AT	Sletsjoe, Arne bernard	NOR	CA
Schuck, Alexander	GDR	CA	Servais, David	USA	BA	Silva, Jorge	BRA	AT	Slimmon, Debra	AUS	BB
Schueler, Carl	USA	AT	Seto, Carwai	TPE	SW	Silva, Jorge	BRA	FB	Slivinskii, Mikhail	URS	CA
Schuemann, Jochen	GDR	YA	Sevieri, Alberto	ITA	SH	Silva, Mariano	ARG	HO	Sloothaak, Franke	FRG	ES
Schuler, Karine	FRA	SW	Seweryn, Marek	POL	WE	Silva, Mario	POR	AT	Slusarski, Joseph	USA	BA
Schulkowski, Bernhard	FRG	AR	Seyba, Yaya	MLI	AT	Silva, Paulo	BRA	BB	Sly, Wendy	GBR	AT
Schult, Jurgen	GDR	AT	Seyhanli, Aslan	TUR	WR	Silva, Peter	BRA	BO	Smajlagic, Irfan	YUG	HB
Schult, Mario	GDR	WE	Seymour, Eugene	BAH	BO	Silva, Robson	BRA	AT	Small, Kim	AUS	HO
Schultz, Eckhardt	FRG	RO	Seynou, Cheickak	BUR	AT	Silva-Mo Nterroso, Carlos-Rene	GUA	SH	Smart, William James	CAN	ES
Schultz, Mark	USA	WR	Sezgin, Hayri	TUR	WR	Silveira, Apolinario	ANG	BO	Smekhnova, Raissa	URS	AT
Schulz, Ekkehard	GDR	YA	Sfakianakis, Charalambos	GRE	WE	Silvestre, Antonio	BRA	CY	Smidova, Marie	TCH	HB
Schulz, Ines	GDR	AT	Sgrulletti, Enrico	ITA	AT	Silvestri, Russell	USA	YA	Smikle, Gary	JAM	BO
Schulz, Michael	FRG	FB	Sha, Guoli	CHN	BB	Silvestri, Scott	USA	BA	Smirani, Adel	TUN	FB
Schulze, Sabina	GDR	SW	Shabab, Abidnasir	JOR	BO	Silweya, Odia	MAW	AT	Smirnov, Nikolai	URS	SW
Schumacher, Guido	FRG	JU	Shabangu, Absalom	SWZ	WE	Simbeye, Boston	MAW	BO	Smirnov, Serguei	URS	RO
Schumann, Fred	GUM	AT	Shadden, John	USA	YA	Simbo, Samuel	SLE	BO	Smirnov, Serguei	URS	AT
Schumann, Ralf	GDR	SH	Shageef, Ahmed	MDV	AT	Simenc, Dubravko	YUG	SW	Smirnova, Irina	URS	VB
Schur, Jan	GDR	CY	Shah, Haider Ali	PAK	AT	Simic, Ljubisa	YUG	BO	Smirnova, Svetlana	URS	SH
Schutz, Rich	USA	WE	Shahanuddinchowdhury, Shahanud	BAN	AT	Simkhah, Majid	IRN	WR	Smith, Alan	AUS	SH
Schutz, Stephan	FRG	AT	Shahbaz Ahmed	PAK	HO	Simklina, Toti	TOG	AT	Smith, Andre	CAN	AT
Schuwalow, Carolyn	AUS	AT	Shahib, Laith M.	IRQ	FB	Simmelbauer, Bernhard	FRG	GY	Smith, Andrew	JAM	AT
Schwab Mag, Andreas	AUT	AT	Shannon, Kathleen	AUS	CY	Simon, Hugo	AUT	ES	Smith, Calvin	USA	AT
Schwarthoff, Florian	FRG	AT	Sharef, Isamael M.	IRQ	FB	Simon, Nathalie	FRA	AT	Smith, Charles D.	USA	BB
Schwartz, Karin	DEN	TA	Sharif, Jihad	JOR	WR	Simpkins, Charlie	USA	AT	Smith, Charles E.	USA	BB
Schwarz, Sven	HOL	RO	Sharman, Elizabeth	GBR	CA	Simpson, Conrad	IRL	YA	Smith, David	GBR	AT
Schweisfurth, Dirk	FRG	AT	Sharon, Revital	ISR	GY	Simpson, Diane	USA	GY	Smith, Eric	CAN	CA
Schweizer, Thomas	SUI	YA	Shatta, Ahmed	EGY	AT	Simpson, Judy	GBR	AT	Smith, Gary	AUS	YA

Seoul '88 Facts and Figures

Les faits et les chiffres

Listing of the Competitors/Listes dies concurrents

Name Nom	Country Pays	Sport	Name Nom	Country Pays	Sport	Name Nom	Country Pays	Sport	Name Nom	Country Pays	Sport
Smith, Gina	CAN	ES	Soumagne, Thierry	BEL	FE	Steinfeld, Hans	USA	YA	Sturny, Norbert	SUI	SH
Smith, Henry	SAM	AT	Soumnikov, Igor	URS	CY	Steinhofel, Ingo	GDR	WE	Styks, Ludek	TCH	CY
Smith, Janet	GBR	AT	Soumnikova, Irina	URS	BB	Steinmann, Peter	SUI	MP	Su, Chun-Yueh	TPE	AT
Smith, John	USA	WR	Sououn, Rikho	URS	CY	Steinmayr, Teddy	AUT	AT	Su, Huijuan	CHN	VB
Smith, John	USA	RO	Souprun, Marina	URS	RO	Stellmach, Manuela	GDR	SW	Suarez, Abraham	ECU	SW
Smith, Karin	USA	AT	Sousa, Ana	POR	AR	Stenvaag, Harand	NOR	SH	Suarez, Eduardo	USA	SH
Smith, Kevin	GBR	CA	Sousa, Vasco	POR	SW	Stephan, Birgit	GDR	AT	Suarez, Eva	ESP	SH
Smith, Kevin	CAN	YA	Southwick, Bruce	FIJ	YA	Stephens, David	USA	AT	Suarez, Giovanni	ITA	RO
Smith, Lawrie	GBR	YA	Souvanni	LAO	SH	Stephens, Thomas	LBR	BO	Suarez, Narciso	ESP	CA
Smith, Michael	CAN	AT	Souza, Francisco	BRA	WE	Steppin, Ute	GDR	VB	Subrt, Michal	TCH	RO
Smith, Michele	CAY	CY	Souza, Gerson	BRA	AT	Sterkel, Jill	USA	SW	Sudarma, I.Nyoman	INA	WE
Smith, Michelle	IRL	SW	Souza, Hamilton	BRA	FB	Sterzik, Uwe	FRG	SW	Sudduth, Andrew	USA	RO
Smith, Richard	USA	SH	Souza, Marcel	BRA	BB	Stevens, Gavin	NZL	CY	Suetovius, Rene	GDR	BO
Smith, Roger	AUS	HO	Souza, Maury	BRA	BB	Stevens, Patrick	BEL	AT	Sugai, Hitoshi	JPN	JU
Smith, Susan	GBR	RO	Souza, Milton	BRA	FB	Stevenson, Clayton	AUS	CY	Sugezky, Lisanoro D	ARG	SH
Smith, Tracy Lee	CAN	AT	Sovadina, Libor	TCH	HB	Steward, Gregory	USA	CA	Sugimoto, Kimio	JPN	VB
Smith, Tricia	CAN	RO	Sowa, Marc	LUX	AT	Steward, Scott	AUS	CY	Sugiyama, Akemi	JPN	VB
Smith, Vaughan Andren	ZIM	SW	Sowunmi, Sarat	NGR	AT	Stewart, Dennis	GBR	JU	Sugiyama, Kayoko	JPN	VB
Smits, Adriana	HOL	AR	Spannagl, Helmut	AUT	MP	Stewart, Gavin	GBR	RO	Sugriat, Wirmandi	INA	SW
Smolarek, Joanna	POL	AT	Spasic, Predrag	YUG	FB	Stewart, Maureen	CRC	AT	Suh, Jung-Kyun	KOR	ES
Smole, Joze	YUG	CY	Spassova, Larissa	BUL	BB	Stewart, Melvin	USA	SW	Suh, Kyung-Suk	KOR	CA
Smorodina, Marina	URS	RO	Spears, David	CAN	CY	Stewart, Paulo	BRA	ES	Suharyadi, Suharyadi	INA	TE
Smylie, Elizabeth	AUS	TE	Specer Jones, Jonathan	GBR	RO	Stewart, Raymond	JAM	AT	Subhat, Puntsag	MGL	WR
Smyth, Ailish	IRL	AT	Spedding, Charlie	GBR	AT	Stewart, Samuel	LBR	BO	Suhbatar, Tumendemberel	MGL	WR
Smyth, Philip	AUS	BB	Speight, Julie	AUS	CY	Stich, Matthias	FRG	SH	Suhonen, Ari	FIN	AT
Smythe, Albert	CAN	TA	Spelly, Ingo	GDR	CA	Stika, Frantisek	TCH	HB	Suire, Catherine	FRA	TE
Snep, Ioan	ROM	RO	Spence, Vivienne	JAM	AT	Still, Kevin	USA	RO	Sujit Kumar	IND	HO
Snowden, Neil	AUS	HO	Spencer, David	GBR	CY	Stinger, Cindy	USA	HB	Suk, Min-Hee	KOR	HB
Sobczak, Anna	POL	FE	Spennato, Isabelle	FRA	FE	Stjernberg, Peter	SWE	WR	Suker, Davor	YUG	FB
Sobhi, Nouredine	MAR	AT	Sperber, Silvia	FRG	SH	Stocher, Franz	AUT	CY	Sukova, Helena	TCH	TE
Soboleva, Marina	URS	FE	Sperl, Rudolf	AUT	YA	Stockwell, Troy	AUS	SW	Sukruoglu, Ilyas	TUR	WR
Sobral, Manuel	CAN	BO	Spieß, Floriano	BRA	WR	Stoehr, Henry	GDR	JU	Suleymanoglu, Naim	TUR	WE
Socaci, Andrei	ROM	WE	Spijkers, Ben	HOL	JU	Stoian, Daniel	ROM	CA	Suli, Peauope	TGA	AT
Soderholm, Tom	SWE	WE	Spittler, Kerstin	GDR	RO	Stoimenov, Peter	BUL	BO	Sulinan, Mohd	QAT	AT
Soderlund, Michael	SWE	SW	Spitzauer, Hans	AUT	YA	Stoitchkova, Olia	BUL	RO	Sullivan, Michael	USA	HB
Soderstrom, Marit	SWE	YA	Spivey, Theresa	USA	GY	Stojanovic, Deanka	YUG	HB	Sullivan, Molly	USA	FE
Sodikin, Sodikin	INA	WE	Sprague, Edward	USA	BA	Stojanovic, Stevan	YUG	FB	Sun, Fengwu	CHN	BB
Sofiadi, Rakhmad	BUL	WR	Spratt, Stephen	IRL	CY	Stojkovic, Dragan	YUG	FB	Sun, Hongyun	CHN	FE
Sohlberg, Tutu	FIN	ES	Sprauve, Phillicia	ISV	TA	Stollmeyer, John	USA	FB	Sun, Mi-Sook	KOR	VB
Sokk, Tiit	URS	BB	Springer, Gerg	USA	RO	Stone, Penelope	USA	HB	Sun, Sumei	CHN	AT
Sokolov, Andrei	URS	AT	Spyrou, Spyros	CYP	AT	Stone, Robert	AUS	AT	Sun, Xiulan	CHN	HB
Sokolov, Iouri	URS	JU	Squilla, Pablo	CHI	AT	Stone, Sarmite	URS	RO	Sundal, Heidi	NOR	HB
Sokolovska, Denisa	TCH	GY	Srecki, Eric	FRA	FE	Stoovelaar, Ronald	HOL	BA	Sundkvist, Karl	SWE	CA
Solari, David	ITA	CY	Srejber, Milan	TCH	TE	Storcer, Beata	HUN	GY	Sundquist, Carl	USA	CY
Solberg, Trine	NOR	AT	Sripet, Rajjai	THA	AT	Stork, Jeffery M	USA	VB	Sung, Jung-A	KOR	BB
Soleyne, St Clair	ANT	AT	Ssali, Joseph	UGA	AT	Storm, Simone	USA	VB	Sung, Kyung-Hwa	KOR	HB
Soliman, Ahmed	EGY	BB	Sta, Mourad	TUN	TT	Stormberg, Mark	USA	RO	Sung, Nak-Kun	KOR	AT
Solis, Ramon	PHI	WE	Staaf, Jan	SWE	AT	Stormorken, Anne Grethe	HOL	SH	Suominen, Petri	FIN	SW
Solorzano, Fidel	ECU	AT	Staccioli, Giulia	ITA	GY	Story, Joseph	USA	HB	Suropot, Claire	FRA	SW
Solovi, Fred	SAM	WR	Stachewicz, Thomas	AUS	SW	Stoute, Jennifer	GBR	AT	Suplis, Luc	BEL	JU
Soloviev, Viktor	URS	YA	Stack, Chelle	USA	GY	Stoyanov, Anguel	BUL	BO	Suprpto, Eddy.S	INA	YA
Solozabal, Ignacio	ESP	BB	Stackle, Kirk	USA	SW	Stoyanov, Blagovest	BUL	CA	Surattee, S.Khattjah	SIN	SH
Solti, Attila	HUN	SH	Stacy, Jay	AUS	HO	Stoyanova, Boriana	BUL	GY	Surin, Bruny	CAN	AT
Solvang, Svein Egil	NOR	CA	Staehele, Andreas	GDR	CA	Stoyanova, Mariana	BUL	RO	Suruagy, Sandra	USA	VB
Sommariva, Agostino	ITA	YA	Staeuble, Marcel	SUI	CY	Stoyanova, Radka	BUL	RO	Suryadi, Suryadi	INA	WR
Sommer, Coleen	USA	AT	Staines, Gary	GBR	AT	Stoyanova, Yordanka	BUL	AT	Sustr, Vratslav	TCH	CY
Somogyi, Miklos	HUN	CY	Stairs, Matthew	CAN	BA	Stoykov, Anguel	BUL	WR	Suter, Kenneth	USA	GY
Son, Mi-Na	KOR	HB	Stajkovic, Niki	AUT	SW	Stoykov, Stefan	BUL	RO	Sutfin, Lynda	USA	AT
Sondergaard, Soren	DEN	BO	Stakor, Robert	YUG	RO	Strachan, Linda	GBR	FE	Sutton, Ann	USA	ES
Song, Dong-Wook	KOR	TE	Stamenova, Rossitza	BUL	AT	Strahalm, Christine	AUT	SH	Sutton, Cheryl	GBR	AR
Song, Gu-Hong	KOR	BA	Stamm, Hagen	FRG	SW	Strajeva, Olga	URS	GY	Suwansichit, Pravitt	THA	BO
Song, Ji-Hyun	KOR	HB	Stamp, Calvin	JAM	WE	Straker, Karen	GBR	ES	Suzuki, Daichi	JPN	SW
Song, Jin-Woo	KOR	BA	Stanev, Ivan	BUL	RO	Strand, Eric	SWE	FE	Suzuki, Mitsuhiro	JPN	CY
Song, Kwang-Sun	KOR	SW	Staneva, Madlen	BUL	BB	Strandman, Karl	SWE	YA	Suzuki, Tetsuya	JPN	BA
Song, Kyung-Sup	KOR	BO	Stange, Uta	GDR	RO	Stranz, Steffen	FRG	JU	Svajlen, Lubomir	TCH	HB
Song, Ligang	CHN	BB	Stanhope, Richard	GBR	RO	Strauch, Annegret	GDR	RO	Sveinsson, Geir	ISL	HB
Song, Seung-Ho	KOR	SW	Stanojkovic, Vujadin	YUG	FB	Straughn, Seibert	BAR	AT	Sveinsson, Sigurdur	ISL	HB
Song, Suk-Chan	KOR	HO	Stanton, Brian	USA	AT	Straughn, Yolande	BAR	AT	Svensden, Cathrine	NOR	HB
Song, Yoo-Jin	KOR	GY	Stanton, Christine	AUS	AT	Strauss, Astrid	GDR	SW	Svensson, David	SWE	RO
Sonnavanh, Phetsmone	LAO	BO	Stapleton, Bill	USA	SW	Strayer, Ann	USA	RO	Svensson, Ola	SWE	FB
Sonnet, Selma	FRG	SH	Stark, Ian	GBR	ES	Streich, Jacek	POL	RO	Sviridenko, Guerogui	URS	HB
Sorby, Warren	FIJ	SW	Stasova, Jana	TCH	HB	Streif, Georg	FRG	TA	Svorada, Jan	TCH	CY
Sordelli, Martin	ARG	HO	Stassioulevitch, Anjela	URS	SW	Streit, Mario	GDR	RO	Swadi, Radhi S.	IRQ	FB
Sorensen, Lars	DEN	SW	Stawicka, Kornelia	POL	SW	Strnisko, Julius	TCH	WR	Swain, Michael	USA	JU
Sorensen, Lone	DEN	YA	Steardo, Antonello	ITA	SW	Stroeme, Lars-Ove	NOR	AT	Sweeney, David	CAN	YA
Sorensen, Pia	DEN	SW	Stecyk, Wladyslaw	POL	WR	Strohmeier, Arno	AUT	FE	Sweeney, Patrick	GBR	RO
Sorensen, Tonny	DEN	TA	Steeb, Carl-Uwe	FRG	TE	Strombo, Frank Juul	DEN	WE	Swiatek, Tomasz	POL	RO
Sorgers, Jana	GDR	RO	Steele, Paul	CAN	RO	Strong, Lori	CAN	GY	Swinford, Ted	USA	RO
Soriano, Nestor	PHI	YA	Steen, Dave	CAN	AT	Strotbeck, John	USA	RO	Swinkels, Eric	HOL	SH
Sorokolet, Alexandre	URS	VB	Steen, Ingrid	NOR	HB	Strumenlieva, Antoaneta	BUL	SW	Swinney, Scott	USA	SH
Sorov, Zoran	YUG	WR	Steens, Tim	HOL	HO	Stuart, Louise	GBR	AT	Sword, Glen	GBR	CY
Sosna, Jiri	TCH	JU	Stefanek, Gertrud	HUN	FE	Stubblefield, Simeon	LBR	BO	Sy, Oumar Samba	MTN	WR
Sostar, Aleksandar	YUG	SW	Stefanova, Evladia	BUL	BB	Studemann, Doerte	GDR	VB	Syed, Abrar-Hussain	PAK	BO
Sotillo, Carlos	ESP	JU	Steffny, Herbert	FRG	AT	Studi, Catur Mei	INA	WE	Syed, Hussain Shah	PAK	BO
Souaken, Said	MAR	WR	Steiger, Daniel	SUI	CY	Stueckelberger, Christine	SUI	ES	Sylvoz, Pascal	FRA	CA
Soucek, Miroslav	TCH	CA	Stein, Margit	FRG	SH	Stuetzinger, Christian	FRG	SH	Sypniewski, Marian	POL	FE
Sougako, Nadejda	URS	RO	Steinbach, Andreas	FRG	WR	Stull, Robert	USA	FE	Sypytowski, Andrzej	POL	CY
Soukenik, Pavel	TCH	SH	Steiner, Andreas	AUT	AT	Stull, Robert	USA	MP	Szabo, Attila	TCH	CA
Soukup, Pavel	TCH	CY	Steiner, Rudolf	SUI	AT	Stumpf, Remig	FRG	CY	Szabo, Attila	HUN	CA
Soukupova, Irena	TCH	RO	Steiner, Shelley	CAN	FE	Sturgess, Colin	GBR	CY	Szabo, Bence	HUN	FE

Name Nom	Country Pays	Sport	Name Nom	Country Pays	Sport	Name Nom	Country Pays	Sport	Name Nom	Country Pays	Sport
Szabo, Dezso	HUN	AT	Tanner, Troy R	USA	VB	Thee, Mbiganyi	BOT	AT	Tocchini, Ilaria	ITA	SW
Szabo, Jozsef	HUN	SW	Tanui, Moses	KEN	AT	Theel, Susanne	GDR	YA	Tocheva, Krassimira	BUL	RO
Szabo, Karolina	HUN	AT	Taouane, Abdellah	MAR	BO	Theismann, Dirk	FRG	SW	Todd, Mark	NZL	ES
Szabo, Laszlo	HUN	HB	Tarakanov, Serguei	URS	BB	Thelen, Henrik	FIN	YA	Todman, Willis	IVB	AT
Szabo, Lorant	HUN	BO	Taramai, William	COK	AT	Thelen, Kenneth	FIN	YA	Todorov, Gueorgui	BUL	AT
Szabo, Peter	HUN	SW	Taramov, Rouslan	URS	BO	Theodorescu, Monica	FRG	ES	Todorov, Ivan	YUG	JU
Szalma, Laszlo	HUN	AT	Taranenko, Leonid	URS	WE	Thephavong, Bounmy	LAO	BO	Todorov, Serafim	BUL	BO
Szanyi, Andor	HUN	WE	Tarapore, Farokh	IND	YA	Thern, Jonas	SWE	FB	Todorova, Rita	BUL	RO
Szaraz, Laszlo	HUN	WE	Tarev, Atanas	BUL	AT	Theus, Earl	BIZ	CY	Toft, Christian	DEN	SW
Szczepinska, Czeslawa	POL	RO	Tariq Sheikh	PAK	HO	Thiebaut, Pascal	FRA	AT	Toft, Henrik	DEN	AR
Szekely, Antal	HUN	YA	Tarnovetski, Pavel	URS	AT	Thiemard, Denise	SUI	AT	Togouzov, Vladimiv	URS	WR
Szekely, Zoltan	HUN	FE	Tarolo, Rossella	ITA	AT	Thienel, Ralf	FRG	RO	Tokas, Khazansingh	IND	SW
Szekeres, Pal	HUN	FE	Taroreh, Adrianus.j.	INA	BO	Thijs, Reuben	HOL	TA	Token, Roger	NGU	WE
Szekula, Paul	CAN	SW	Tarpenning, Kory	USA	AT	Thimm, Ute	FRG	AT	Toki, Shuichi	JPN	ES
Szelei, Istvan	HUN	FE	Tarr, Merrellyn	ZIM	AR	Thoennesen, Stephan	FRG	FE	Tokovoi, Iouri	URS	YA
Szikora, Pavol	TCH	AT	Tarr, Wrex	ZIM	AR	Thoiba Singh	IND	HO	Toltchev, Krassimir	BUL	AT
Szilagyi, Zoltan	HUN	SW	Tartas, Peter	AUS	BA	Tholse, Peter	SWE	VB	Tomas, Alberto J	ARG	RO
Szitas, Imre	HUN	AT	Taskov, Dimitar	BUL	GY	Thomas, Andrea	FRG	AT	Tomas, Juan Carlos	ESP	CY
Szlapkin, Zdzislaw	POL	AT	Tassotti, Mauro	ITA	FB	Thomas, Andrea	JAM	AT	Tomasevic, Robert	YUG	TA
Szocs, Zsuz Sanna	HUN	FE	Tata-Muya, Rose	KEN	AT	Thomas, Austin	ARU	FE	Tomashino, Kenji	JPN	BA
Szoke, Laszlo	HUN	BO	Tatar, Istvan	HUN	AT	Thomas, Bryan	AUS	CA	Tomasovicova, Irena	TCH	HB
Szukala, Rafal	POL	SW	Tatar, Kibar	TUR	BO	Thomas, Kibar	GBR	RO	Tomatsu, Nobutaka	JPN	WE
Tabor, Beth	CAN	CY	Tatartchenko, Vadim	URS	FB	Thomas, Margaret	GBR	SH	Tomkins, James	AUS	RO
Tacconi, Stefano	ITA	FB	Tate, Ethlyn	JAM	AT	Thomas, Mark	GBR	WE	Tomioaga, Vasile	ROM	RO
Tachiki, Koji	JPN	HB	Tate, Marcia	JAM	AT	Thomas, Raymond	JAM	CY	Tomov, Toma	BUL	AT
Tadjine, Nourreddine	ALG	AT	Tautama, Ulaipalota	SAM	BO	Thomas, Vaughan	GBR	RO	Tondo, Vincenzo	ITA	SH
Taeckenstroem, Per	SWE	FE	Taufek, Mudhafar J.	IRQ	FB	Thompson, Alan	NZL	CA	Tonev, Dimo	BUL	VB
Tafelmeier, Klaus	FRG	AT	Tauson, Michael	DEN	TE	Thompson, Daley	GBR	AT	Tong, King King	HKG	FE
Taffarel, Claudio	BRA	FB	Tauziat, Natmalie	FRA	TE	Thompson, Graham Lewis	ZIM	SW	Tontchev, Dimitar	BUL	RO
Tafalis, Gregg	USA	AT	Tavares, Sandra	MEX	AT	Thompson, Juliet	USA	RO	Tooby, Angela	GBR	AT
Taguchi, Takashi	JPN	HB	Taviwor, Jimothy	GBR	YA	Thompson, Lesley	CAN	RO	Tooby, Susan	GBR	AT
Tahir Zaman	PAK	HO	Taylor, Andrew	AUS	SW	Thompson, Rachel	SLE	AT	Tooth, Liane	AUS	HO
Tahir, Abdelaziz	MAR	WR	Taylor, Bryan	GBR	YA	Thoms, Christiane	GDR	GY	Topham, Kristin	CAN	SW
Tahir, Murat	TUR	SW	Taylor, Erica	AUS	ES	Thomsen, Morten	DEN	ES	Topourov, Stefan	BUL	WE
Taira, Choji	JPN	WE	Taylor, Harry	CAN	SW	Thomson, Akiko	PHI	SW	Tops, Johannes	HOL	ES
Taitano, Ricardo	GUM	AT	Taylor, Ian	GBR	HO	Thomson, Robert Paul	CAN	YA	Torell, Magnus	SWE	YA
Taiwo, Joseph	NGR	AT	Taylor, Sheila	CAN	CA	Thomson, Tony	AUS	BA	Torkan, Majid	IRN	WR
Tajmohammed	AFG	WR	Tayot, Pascal	FRA	JU	Thorsen, Rolf Bernt	NOR	RO	Tornblad, Anne Grethe	DEN	ES
Tak, Jung-Im	KOR	FE	Tazzer, Gerardo	MEX	ES	Thorsness, Kristine	USA	RO	Torpil, Mehmetbulent	TUR	SH
Takacs, Gabor	HUN	CA	Tchakarov, Ivan	BUL	WE	Thorsson, Pierre	SWE	HB	Torpy, Gregory	AUS	YA
Takacs, Janos	HUN	WR	Tche Noubossie, Ernest	CMR	AT	Thorwaldson, Bjorn	SWE	SH	Torrealva, Gina	PER	VB
Takahashi, Kiyomi	JPN	SW	Tcherendnik, Iouri	URS	VB	Thuemmler, Doerte	GDR	GY	Torrence, Gwen	USA	AT
Takahashi, Masayuki	JPN	YA	Tcherka Ssova, Valentina	URS	SH	Thuis, Yvette	ARU	SW	Torres, Abraham	VEN	BO
Takahashi, Phil	CAN	JU	Tcherkassov, Alexandre	URS	SH	Thune, Kurt	FIN	SH	Torres, Andres	GUA	CY
Takahashi, Shigehiro	JPN	SW	Tchetchenov, Viatcheslav	URS	HO	Thurley, Elizabeth	GBR	FE	Torres, Dara	USA	SW
Takahashi, Yoshiaki	JPN	BO	Tchistiakova, Galina	URS	AT	Thyssen, Ingrid	FRG	AT	Torres, Ernesto	PUR	AT
Takahashi, Yukiko	JPN	VB	Tchobanova, Mariana	BUL	BB	Tiacoh, Gabriel	CIV	AT	Torres, Fredy	ESA	JU
Takamura, Seiichi	JPN	HB	Tchogovadze, Gueorgui	URS	SW	Tiainen, Juha	FIN	AT	Torres, Manuel	COL	ES
Takano, Susumu	JPN	AT	Tchomakov, Gueorgui	BUL	FE	Tian, Yumei	CHN	AT	Torres, Monica	MEX	TA
Takasawa, Takayoshi	JPN	BO	Tchounikhovskaia, Irina	URS	YA	Tiberti, Gianluca	ITA	MP	Torres, Victor	GUM	YA
Takayawa, Viliame	FIJ	JU	Tchuprenski, Emil	BUL	BO	Tichko, Mikhail	URS	FE	Torroella, Enrique	MEX	TA
Takeda, Satoshi	JPN	SW	Tcooumak, Igor	URS	HB	Tichtchenko, Vadim	USA	FB	Torteli, Cicero	BRA	SW
Takikawa, Kazuo	JPN	CY	Tebourski, Mourad	TUN	VB	Tichy, Martin	TCH	RO	Torten, Dan-Noam	ISR	YA
Takizawa, Reiko	JPN	VB	Teffer, Martin	HOL	VB	Tidball-Balisky, Laura	CAN	ES	Torten, Ram-Jacob	ISR	YA
Takou, Dieudonne	CMR	WE	Teixeira, Vitor	BRA	ES	Tieanu, Livia	ROM	RO	Tortosa, Jesus	ESP	TA
Talavera, Enrique	ESP	AT	Tejero, Jose Daniel	ESP	WE	Tierney, Erin	COK	AT	Tosi, Fausto	ITA	WE
Taliauli, Sione Vaveni	TGA	BO	Telfer, Don	CAN	RO	Tiit, Cecilia	PER	VB	Toso, Luca	ITA	AT
Tallroth, Roger	SWE	WR	Telles, Soraya	BRA	AT	Tikhonov, Vassili	URS	RO	Toth, Balazs	HUN	GY
Talma, Brian	BAR	YA	Tellier, Peter Paul	HOL	YA	Tikhomirov, Igor	URS	FE	Toth, Gabor	HUN	WR
Talybov, Vladimir	URS	AT	Teloni, Maroula	CYP	AT	Tikhonenko, Valeri	URS	BB	Toth, Geza	HUN	HB
Tamaduianu, Claudiu	ROM	WR	Temke, Marcus	BRA	YA	Tikkanen, Paivi	FIN	AT	Toth, Imre	HUN	SW
Tamamura, Kenji	JPN	HB	Temo, Apete	FIJ	BO	Tillemann, Karl	CAN	BB	Toth, Laszlo	HUN	SW
Tamang, Manbahadur	NEP	TA	Tempestini, Riccardo	ITA	SW	Tilli, Stefano	ITA	AT	Toth, Tamas	HUN	SH
Tamba, Ibrahim	SEN	AT	Ten Kate, Marti	HOL	AT	Tillie, Laurent	FRA	VB	Totikachvili, Miran	URS	JU
Tambouvtsev, Alexandre	URS	WR	Tenadze, Gueorgui	URS	JU	Tillmann, Yvonne	FRG	TA	Toumi, Hakim	ALG	AT
Tamez, Guillermo	MEX	BO	Tennai, Derrick	SOL	AR	Timchenko, Anatoli	URS	ES	Toumaite, Vitalia	URS	BB
Tamm, Iouri	URS	AT	Tenn, Arthur	JAM	CY	Timmermann, Scott	CAN	CY	Tourlykhanov, Daoulet	URS	WR
Tamura, Takashi	JPN	YA	Teodosiev, Roumen	BUL	WE	Timmermann, Ulf	GDR	AT	Tourmefier, Francis	FRA	WE
Tan, Liangde	CHN	SW	Tepper, Kerri	AUS	TT	Timmons, Stephen D	USA	VB	Touret, Philippe	FRA	AT
Tan, Min	CHN	SW	Tererui, Michael	COK	WE	Timms, Christopher	NZL	YA	Tourtchak, Olga	URS	AT
Tan, Zuleyha	TUR	TA	Teresa, Tomas	ESP	AT	Timms, Michele	AUS	BB	Tourtchina, Zinaida	URS	HB
Tanabe, Yoko	JPN	JU	Tereshina, Elena	URS	RO	Timochenko, Alexandra	URS	GY	Toutain, Thierry	FRA	AT
Tanaka, Miyako	JPN	SW	Terrell, Brenton	AUS	RO	Timochinine, Vladimir	URS	SW	Toutchkine, Alexandre	URS	HB
Tanaka, Yukinori	JPN	SW	Terrell, James	USA	CA	Timokhine, Valeri	URS	SH	Tovar, Bernardo	COL	SH
Tandian, Aissatou	SEN	AT	Tertei, Jozef	YUG	WR	Timoti, Tauama	ASA	WE	Tovstogan, Evguenia	URS	HB
Tanev, Ivan	BUL	AT	Terwilliger, John	USA	RO	Tinari, Nancy	CAN	AT	Townley, Alison	USA	RO
Tang, Kei Shan	HKG	SW	Terzi, Mehmet	TUR	AT	Tioumentsev, Andrei	URS	HB	Townsend, Glenn	AUS	SW
Tang, Kwok Cheung	HKG	CA	Terzic, Dara	YUG	GY	Tippelt, Sven	GDR	GY	Toyama, Katsuya	JPN	CA
Tang, Wing Keung	HKG	FE	Terziiski, Neno	BUL	WE	Tippett, Cathy	USA	RO	Toyooka, Hiroshi	JPN	CY
Tang, Xuezhong	CHN	CY	Tesar, Pavel	TCH	CY	Tiprod, Supas	THA	AT	Tozdzian, German	URU	WE
Tang, Yaodong	CHN	FB	Teske, Charlotte	FRG	AT	Tirante, Florentino	PHI	WR	Trabado, Coloman	ESP	AT
Tankov, Anatoli	URS	ES	Tesselko, Margarita	URS	RO	Tissier, Franck	FRA	AT	Tracy, Max	CAN	CA
			Tetengi, Abdullahi	NGR	AT	Titov, Serguei	URS	RO	Tracz, Jozef	POL	WR
			Teterina, Irina	URS	RO	Titova, Tatiana	URS	SW	Tracz, Mieczyslaw	POL	WR
			Teti, Mike	USA	RO	Titus, Goran	SWE	SW	Trade, Maria	USA	VB
			Teulere, Jean	FRA	ES	Tizzano, Davide	ITA	RO	Train, Andrew	GBR	CA
			Tewksbury, Mark	CAN	SW	Tkashenko, Vladimir	URS	SW	Train, Steven	GBR	CA
			Tews, Andreas	GDR	BO	Toba, Marius Eugen	ROM	GY	Traineau, Stephane	FRA	JU
			Thapa, Parbati	NEP	SH	Tobin, Alexander	AUS	FB	Trandzikova, Daniela	TCH	HB
			Theas, Jean philipp	FRA	TA	Tobin, John	GRN	BO	Tranhardt, Carlo	FRG	AT

Seoul '88 Facts and Figures

Les faits et les chiffres

Listing of the Competitors/Listes dies concurrents

Name Nom	Country Pays	Sport	Name Nom	Country Pays	Sport	Name Nom	Country Pays	Sport	Name Nom	Country Pays	Sport
Traore, Kassim	MLI	BO	Tyniste, Tynou	URS	YA	Van Belleghem, Wim	BEL	RO	Verebelyi, Lajos	HUN	CY
Trapanese, Paolo	ITA	SW	Tyssier, Stephane	FRA	SH	Van Bentum, Cornelia	HOL	SW	Verga, Alejandro	ARG	HO
Trapella, Riccardo	ITA	GY	Tzekova, Polina	BUL	BB	Van Lladel, Cees	HOL	YA	Vergara, Alina	ARG	HO
Trasca, Marioara	ROM	RO	Tzenov, Bratan	BUL	WR	Van Bladel, Wil	HOL	YA	Veritchev, Grigori	URS	JU
Trautwein, Wolfgang	FRG	SH	Tzonov, Ivan	BUL	WR	Van De Vondel, Luc	BEL	SW	Verma, Subhash	IND	WR
Travella, Rocco	SUI	CY	Tzvetkov, Borislav	BUL	CA	Van De Walle, Robert	BEL	JU	Vermeiren, Paul	BEL	AR
Traversa, Lucia	ITA	FE				Van Den Honert, Taco	HOL	HO	Vermes, Peter	USA	FB
Traxl, Mario	AUT	CY				Van Der Ben, Helen	HOL	HO	Verouli, Anna	GRE	AT
Trcka, Ales	TCH	CY				Van Der Kwast, Henk	HOL	RO	Verschoor, Bart	HOL	YA
Treacy, John	IRL	AT				Van Der Mast, Martina	HOL	SW	Vervoom, Cornelis	HOL	SW
			U								
Treflova, Natalia	URS	SW	U, G. King Hung	HKG	SH	Van Der Plaats, Diana	HOL	SW	Verweij, Leendert	HOL	TA
Tregunno, E.Jane	CAN	RO	Uba, Owigibo	NGR	BO	Van Der Schans, Wout-Jan	HOL	ES	Vetchernikova, Anelia	BUL	AT
Tremblay, Thalie	CAN	FE	Ucan, Turgut	TUR	TA	Van Dijk, William	BEL	AT	Viale, Camille	FRA	AT
Trevisan, Jason	MLT	JU	Uccheddu, Valentina	ITA	AT	Van Doorn, Marieke	HOL	HO	Viali, Tonino	ITA	AT
Trevisan, Massimo	ITA	SW	Uchino, Tsunehisa	JPN	CA	Van Dorp, Yvonne	HOL	AT	Vianna, Joao	BRA	BB
Trevor, Stephen	USA	FE	Uchiyama, Kyoko	JPN	TT	Van Duren, Jolanda	HOL	TA	Vicevic, Mirko	YUG	SW
Trezzi, Fabrizio	ITA	CY	Udrakis, Rajmoundas	URS	ES	Van Egmond, Gary	AUS	FB	Victalino, Gerson	BRA	BB
Triano, James	CAN	BB	Ugbisie, Moses	NGR	AT	Van Etekovon, Harriet	HOL	RO	Vida, Jozsef	HUN	AT
Tricoire, Jean-Luc	FRA	SH	Uhlenbruck, Gabriele	FRG	HO	Van Grunsven, Anky	HOL	ES	Vidal, Philippe	FRA	WR
Trik, Reiner	FRG	WR	Uillegas S, Emilio A.	DOM	BO	Van Helden, Robin	HOL	AT	Vieira, Isabelle	BRA	SW
			U								
Trindade, Paulo	POR	SW	Ulaszewski, Dirk	FRG	CA	Van Hulst, Elisa	HOL	AT	Vigarani, Lorenza	ITA	SW
Trittshuh, Stephen	USA	FB	Ulberg, Pua	SAM	BO	Van Kuren, Cheryl	USA	HO	Vignaduzzi, Gianni	CAN	CY
Trivella, Eve	USA	JU	Ullo, Antonio	ITA	AT	Van Landeghem, Ria	BEL	AT	Vigneron, Thierry	FRA	AT
Troger, Barbara	AUT	SH	Ullrich, Kathrin	CHI	AT	Van Limbeek, Bean	HOL	SH	Vignissy, Dossou germain m.	BEN	AT
Trojer, Irmgard	ITA	AT	Ullrich, Stefan	GDR	RO	Van Manen, Aletta	HOL	HO	Vikstedt-Nyman, Tea	FIN	CY
Trombetta, Waldemar	BRA	RO	Ulmala, Risto	FIN	AT	Van Roozendaal, Jacqueline	HOL	AR	Vikstrom, Pentti	FIN	AR
Tromp, Gretha	HOL	AT	Um, Jin-Han	KOR	WR	Van Wirdum, Karen	AUS	SW	Vilde, Raimond	URS	VB
Tropin, Andrei	URS	MP	Um, Young-Sup	KOR	CY	Vandamme, Virginie	FRA	CA	Vilhjalmsson, Einal	ISL	AT
Trott, William O	BER	AT	Umaras, Gintaoutas	URS	CY	Vandenberg, Jacobus	HOL	YA	Villacampa, Jordi	ESP	BB
Trouabal, Jean-Charles	FRA	AT				Vander-Heyden, Sandra	USA	HO	Villalon, Jose maria	ESP	AT
			U								
Trstena, Saban	YUG	WR	Umaras, Mindaogas	URS	CY	Vanderherten, Dirk	BEL	AT	Villanueva, Domingo	PHI	CY
Trushakova, Marina	URS	RO	Umezawa, Kenichi	JPN	FE	Vanderlijde, Arnold	HOL	BO	Villaret, Henriette	POR	SW
Tsai, Hsin-Yen	TPE	SW	Undralbat, Lkhagvaa	MGL	SH	Vandermeulen, Gary	CAN	SW	Villeteon, Jocelyne	FRA	AT
Tsai, Pai-Sheng	TPE	SH	Unsal, Selda	TUR	AR	Vandermeulen, Stephen	CAN	SW	Vincent Mark, Arlene	GRN	AT
Tsai, Wen-Yee	TPE	WE	Uphoff, Nicole	FRG	ES	Vandermeulere, Marie-anne	BEL	RO	Vincent, William	NZL	JU
Tsang, Wing Sze	HKG	SW	Upton, Simon	AUS	SW	Vanek, Zdenek	TCH	HB	Vincze, Balazs	HUN	SW
Tsang, Yi Ming	HKG	SW	Urban, Edit	HUN	TT	Vangeenberghe, Jean-Claude	BEL	ES	Vindis, Miroslav	YUG	AT
Tsarbopoulou, Olga	GRE	TE	Urbanczyk, Elzbieta	POL	CA	Vangelovska, Stojna	YUG	BB	Vine, Natthew	GBR	WE
Tsay, Yow-Tyan	TPE	JU	Urbanik, Sandor	HUN	AT	Vangelov, Jivko	BUL	WR	Vinje, Vette	NOR	RO
Tscherniaeva, Mariia	URS	SW	Urbano, Jose	POR	AT	Vanky, Peter	SWE	FE	Vinnicombe, Martin	AUS	CY
			U								
Tseng, Chi-Chen	TPE	BA	Urbieto, Ibon	ESP	RO	Vanni, Tim	USA	WR	Vinolas, Xabier	ESP	RO
Tserennyam, Tyeyen-Oidov	MGL	BO	Urfaq, Muhammad	PAK	AT	Vanole, David	USA	FB	Viola, Emanuela	ITA	SW
Tshabangu, Nokuthula	ZIM	BO	Uria, Juan jose	ESP	HB	Vanzella, Flavio	ITA	CY	Viridis, Antonio	ITA	FB
Tshekiso, Magare	BOT	BO	Uriarte, Jon Emili	ARG	VB	Varadi, Janos	HUN	BO	Vivek Singh	IND	HO
Tshering, Jigme	BHU	AR	Uribe, Cenaida	PER	VB	Varaev, Adlan	URS	WR	Vizcarra, Federico	MEX	JU
Tshering, Pema	BHU	AR	Urick, Ronald	USA	CA	Varaev, Bachir	URS	JU	Vlad, Nicu	ROM	WE
Tsikaris, Anastassios	GRE	SW	Urrutia, Isabel	COL	AT	Varbanov, Alexander	BUL	WE	Vlahov, Andrew	AUS	SB
Tsintsaris, Giannis	GRE	WE	Urrutia, Roberto	USA	WE	Varenkamp, Ines	FRG	CY	Vlassov, Victor	URS	SH
Tsitsela, Panagiota	GRE	GY	Urtebise, Fernand	FRA	AT	Varga, Dario	YUG	RO	Vochchakina, Olga	URS	FE
Tsoni, Maria	GRE	AT	Usher, Carlton	BIZ	AT	Varga, Istvan	HUN	JU	Vodenitcharova, Deliana	BUL	GY
			U								
Tsuchihashi, Toshihisa	JPN	TE	Usieto, Gemma	ESP	SH	Varga, Mirislav	TCH	SH	Vodoungbo, Euphrasie	CIV	HB
Tsukinoki, Eiichi	JPN	RO	Usifo, Maria	NGR	AT	Varvariotos, Fotini	GRE	GY	Vodoungbo, Julienne	CIV	HB
Tsumuraya, Yoshihiro	JPN	CY	Ustorf, Michaela	FRG	GY	Vasickova, Sona	TCH	AT	Voelker, Anke	GDR	SH
Tsutsui, Daisuke	JPN	BA	Usui, Junichi	JPN	AT	Vaskuti, Istvan	HUN	CA	Vogler, Peter	AUS	BA
Tsziou, Konstantine	URS	BO	Uti, Sunday	NGR	AT	Vasquez, Atilio Cesar	ARG	CA	Voigt, Hartmut	FRG	YA
Tu, Hung-Chin	TPE	BA	Uwe, Andrew	NGR	FB	Vasquez, Edvin-Eduardo	GUA	WR	Voinea, Camelia	ROM	GY
Tu, Tai-Hsing	TPE	SH				Vassallo, Salvador	PUR	SW	Vokhmianine, Vladimir	URS	SH
Tucat, Alejandra	ARG	HO				Vassileva, Radmila	BUL	BB	Vokoun, Pavel	TCH	SW
Tuce, Semir	YUG	FB				Vassileva, Todorka	BUL	RO	Volery, Stefan	SUI	SW
Tucker, Reuben	GUM	WR	V.d.Eerenbeemt, Hermanus	HOL	RO	Vassiliev, Andrei	URS	RO	Volkerijk, Bart	HOL	BA
			V								
Tucker, Richard E.H.	SLE	WE	Vaattovaara, Sulo	SWE	FB	Vassiliev, Mikhail	URS	HB	Volkmann, Jens	FRG	AT
Tuckniss, James Philip	ZIM	TE	Vaccaroni, Dorina	ITA	FE	Vassiltchenko, Serguei	URS	RO	Volkov, Alexander	URS	TE
Tudor, Mary Jo-Anne	CAN	ES	Vachon, Roger	FRA	JU	Vastag, Francisc	ROM	BO	Volkov, Alexandre	URS	BB
Tudor-Cole Rodney	ZIM	SH	Vadasz, Csaba	HUN	WR	Vaughan, Kehinde	NGR	AT	Volkov, Dmitri	URS	SW
Tufan, Elisabeta	ROM	FE	Vader, Els	ZIM	AT	Vavasseur, Didier	FRA	CA	Volkova, Elena	URS	SW
Tuffuor, Emmanuel	GHA	AT	Vago, Bela	HUN	AT	Vayssilova, Tzonka	BUL	BB	Volkova, Elena	URS	VB
Tujunen, Jyrki	FIN	CY	Vagozari, Ayatollah	IRN	WR	Vazquez, Antonio	ESP	AR	Voll, Kjell Sverre	NOR	RO
Tukana, Sainiana	FIJ	AT	Vaihinger, Jorg	FRG	AT	Veatch, Daniel	USA	SW	Volochine, Leonid	URS	AT
Tuna, Takale	NGU	AT	Vainio, Jouni	FIN	SH	Vechko, Valeri	URS	CA	Volochchouk, Oleg	URS	RO
Tung, Ya-Ling	TPE	TA	Vaka, Filipopalako	TGA	BO	Veg, Julianna	HUN	AT	Volpi, Christian	FRA	SW
			V								
Tupchi, Mohammadreza	IRN	WR	Val, Luis	AUS	JU	Vegter, Henny	HOL	YA	Volpi, Giulia	ITA	GY
Turcotte, David	CAN	BB	Valades, Jose Manuel	ESP	YA	Vejrkova, Jana	TCH	GY	Von Schottenstein, Marcella	USA	HO
Turi, Joseph	GBR	ES	Valdes, Maria Teresa	ESP	AR	Vela, Ernesto	MEX	SW	Von Weiler, Sophie	HOL	HO
Turiace, Sergio r	ARG	FE	Valent, Gejza	TCH	AT	Velea, Angelin	ROM	CA	Vong, lu Veng	HKG	TT
Turkaya, Mehmet	TUR	WR	Valenta, Veroslav	TCH	AT	Velez, Wilfredo	PUR	BA	Vonstein, Winfried	FRG	AT
Turnbull, Wendy	AUS	TE	Valentini, Alfredo	SMR	SH	Velic, Ermin	YUG	HB	Voss, Torsten	GDR	AT
Turner, Stephen	GBR	RO	Valev, Marko	BUL	JU	Velinova, Iskra	BUL	RO	Vousif, Owf.A.	IRQ	AT
Turowski, Marian	POL	CY	Valguarnera, Fabio	ITA	WR	Veliskova, Martina	TCH	GY	Vozzone, Jorge	POR	YA
Turro, Carlos	ESP	AT	Valie, Pmilip Bryn	GBR	YA	Velitchkov, Borislav	BUL	WR	Vrabel, Martin	TCH	AT
Turu, Istvan	HUN	BO	Valiente, Ricardo	PER	AT	Venant, Thierry	FRA	AR	Vrankovic, Stojan	YUG	BB
			V								
Tuschak, Katalin	HUN	FE	Valladares Lopez, Rafael	HON	AT	Venetopoulos, Nikolaos	GRE	SW	Vries De, Eric	HOL	BA
Tutsch, Herbert	FRG	WR	Vallduvi, Eladio	ESP	SH	Venier, Annibale	ITA	RO	Vries De, Haitze	HOL	BA
Tutuk, Vedat	TUR	BO	Valle, Joaquin	ESP	WE	Ventura, Robin	USA	BA	Vriesde, Letitia	SUR	AT
Tuul, Suvd	MGL	AR	Valmon, Andrew	USA	AT	Venturelli, Stefano	ITA	JU	Vriesekoop, Bettine	HOL	TT
Tuur, Regilio	HOL	BO	Valova, Irma	TCH	BB	Venturini, Fernanda	USA	VB	Vuithier, Jean-Claude	SUI	YA
Tuzzi, Carar	ITA	AT	Valvik, Svein-Inge	NOR	AT	Vera Espenola, Sixto	PAR	BO	Vujovic, Veselin	YUG	HB
Twegbe, Nimely	LBR	AT	Vamplaw, Patrick	CAN	SH	Vera, Manuel	ESP	RO	Vyrvitch, Yaleri	URS	RO
Twittmann, Michael	FRG	RO	Van Baarle, Mario	HOL	CY	Vera, Rolando	ECU	AT	Vyssotski, Ivan	URS	RO
Tymvios, Michael	CYP	SH	Van Bekhoven, Jack	HOL	SH	Verboom, Marinus	HOL	CY			
Tyniste, Toomas	URS	YA				Verdonk, Eric	NZL	RO			

Name Nom	Country Pays	Sport	Name Nom	Country Pays	Sport	Name Nom	Country Pays	Sport	Name Nom	Country Pays	Sport		
W			Watson, Leroy	GBR	AR	Williams, Liam	IRL	RO	X				
			Watson, Michael	BER	AT	Williams, Lynn	CAN	AT					
			Watt, Kam Sing	HKG	SW	Williams, Marlon	ISV	AT					
	Wachtel, Christine	GDR	AT	Wattar, Amar	SYR	WR	Williams, Michael	VIN		AT	Xia, Fujie	CHN	SW
	Waddell, Yvan	CAN	CY	Wattebosi, Elieser	INA	AT	Williams, Paul	CAN		AT	Xiao, Aihua	CHN	FE
	Wade, Kirsty	GBR	AT	Watters, Daniel	USA	SW	Williams, Robin	GBR		CA	Xiao, Minglin	CHN	WE
	Wade, Paul	AUS	FB	Waweru, Patrick	KEN	BO	Williams, Schowonda	USA		AT	Xie, Jun	CHN	SW
	Wagner, Rodney	AUS	AR	Way, Kelly-Ann	CAN	CY	Williams, Stuart	NZL		CY	Xie, Litua	CHN	AT
	Wagner, Udo	GDR	FE	Wayte, Mary	USA	SW	Williams, Suzanne	AUS		JU	Xie, Yuxin	CHN	FB
	Wahl, Frank-Michael	GDR	HB	Waziri, Yohanna	NGR	AT	Williams, Wallace	ISV		AT	Xie, Zhiling	CHN	AT
	Waigo, John Bosco	UGA	BO								Xing, Ailan	CHN	AT
	Wainhouse, David	CAN	BA	Weatherspoon, Teresa	USA	BB	Williams, Wendy Lian	USA		SW	Xiong, Fengshan	CHN	JU
Waithe, James	BAR	JU	Webb, Tammy	USA	VB	Williams, Zekaria	COK	BO	Xiong, Ni	CHN	SW		
			Weber, Carlos J	ARG	VB	Wilmot, Robert	AUS	YA					
Waitz, Grete	NOR	AT	Weber, Christiane	FRG	FE	Wilson, Bronwyn	NZL	TA	Xiong, Qiyang	CHN	AT		
Waitz, Jack	NOR	AT	Weber, Frank	FRG	CY	Wilson, Bryan	AUS	SH	Xu, Chunmei	CHN	BB		
Wakahara, Hisashi	JPN	ES	Wecker, Andreas	GDR	GY	Wilson, Carl	AUS	SW	Xu, Guoqing	CHN	JU		
Wakinaga, Tatsuya	JPN	YA	Wedderburn, Eddie	GBR	AT	Wilson, Craig M.	USA	SW	Xu, Haifeng	CHN	SH		
Wala, Wojciech	POL	WR	Wedekind, Hartmut	FRG	SW	Wilson, David	AUS	SW	Xu, Jihua	CHN	WR		
Walalangi, Donald.W	INA	TE	Wegner, Axel	GDR	SH	Wilson, Harvey	NZL	ES	Xu, Xiaoguang	CHN	SH		
Waldner, Jan-Ove	SWE	TT	Wehrmeister, Silke	FRG	HO	Wilson, Lynne	GBR	SW	Xu, Xiaoliang	CHN	BB		
Waldo, Carolyn	CAN	SW							Xu, Yanmei	CHN	SW		
Walinga, Jennifer	CAN	RO	Wei, Qingguang	CHN	TT	Wilson, Rosemary	NZL	TA	Xu, Zengcai	CHN	TT		
Walker, Angela	NZL	GY	Wei, Qingkun	CHN	WR	Wilson, Thomas B.	PUR	ES	Xu, Zhiqiang	CHN	GY		
			Weidner, Thorsten	FRG	FE	Winck, Luiz	BRA	FB					
Walker, Fitzloyd	GBR	WR	Weigang, Birte	GDR	SW	Windischmann, Michael	USA	FB	Xue, Bing	CHN	CA		
Walker, James	GUM	AT	Weigel, Ronald	GDR	AT	Winkler, Daniel	FRG	GY	Xue, Cuilan	CHN	BB		
Walker, Laura	USA	SW	Weil, Gert	CHI	AT	Winkler, Heike	GDR	RO	Xue, Jinhua	CHN	HB		
Wallace, John	CAN	RO	Weir, Grant	AUS	BA	Winn, Sherry	USA	HB					
Wallin, Christer	SWE	SW	Weis, Heinz	FRG	AT	Winselmann, Holger	GDR	HB	Y				
Wallin, Tony	SWE	YA	Weiss, Gerald	GDR	AT	Winster, Valerie	AUS	SH					
Wallner, Thomas	AUT	YA	Weiss, Katarzyna	POL	CA	Winter, Lars	FIN	FE					
Walsh, James	IRL	ES								Yafuso, Claudio g	ARG	JU	
Walsh, William	IRL	BO	Weitnauer, Joerg	SUI	RO	Wirz, Francesco	ITA	YA		Yagiz, Cengiz	TUR	TA	
Walter, Fritz	FRG	FB	Wekesa, Peter	KEN	AT	Wirz, Peter	SUI	AT		Yakoubi, Kais	TUN	FB	
			Welch, Darren	AUS	BA	Wislander, Magnus	SWE	HB		Yamada, Takahiro	JPN	GY	
Walter, Patrick	CAN	RO	Weldon, Craig	CAN	JU	Wittmeier, Lynette	CAN	GY		Yamada, Wataru	JPN	BO	
Walters, John	USA	RO	Weller, Ronny	GDR	WE	Wodars, Sigrun	GDR	AT		Yamagishi, Isao	JPN	SW	
Walther, Martina	GDR	RO	Wellman, Allan Keny	GUA	FB	Wohllebe, Andre	GDR	CA		Yamaguchi, Kaori	JPN	JU	
Walton, Brian	CAN	CY	Wellman, Brian	BER	AT	Wohlwend, Johannes	LIE	JU		Yamamoto, Hiroshi	JPN	AR	
Walton, Dwight	CAN	BB	Wen, Fan	CHN	SW	Wojdat, Artur	POL	SW		Yamamoto, Kodo	JPN	HB	
Wanderley, Carlos	BRA	YA	Wen, Zhifang	CHN	SH	Wolf, Carsten	GDR	CY	Yamamoto, Yosuke	JPN	JU		
Wang, Baoshan	CHN	FB	Wendt, Joachim	AUT	FE	Wolf, Gabriela	FRG	AT					
Wang, Bolin	CHN	SW							Yamamura, Toshiyuki	JPN	HB		
Wang, Caixi	CHN	WE	Weng, Tak Fung	HKG	FE	Wolf, Robert	TCH	SW	Yamashita, Miyako	JPN	VB		
Wang, Chi	TPE	SW	Wennlund, Dag	SWE	AT	Wolff, Ingrid	HOL	HO	Yamashita, Norifumi	JPN	AT		
			Wentz, Siegfried	FRG	AT	Wolfram, Andreas	GDR	SH	Yamashita, Tomoya	JPN	SH		
Wang, Chongsheng	CHN	GY	Werckx, Kristell	BEL	CY	Wolls Chlager, Susi	FRG	HO	Yamauchi, Kenji	JPN	AT		
Wang, Dali	CHN	SW	Werner, Tommy	SWE	SW	Wolny, Ryszard	POL	WR	Yamfang, Rumpai	THA	SH		
Wang, Fei	CHN	BB	Werremeier, Stefanie	FRG	RO	Womplou, Marie	CIV	AT	Yan, Ming	CHN	SW		
Wang, Hee-Kyung	KOR	AR	Werthner, Georg	AUT	AT	Wong, Kin Chung	HKG	SW	Yan, Yinhua	CHN	CY		
Wang, Huiying	CHN	GY	Wessel, Nicolette	HOL	RO	Wong, Sam Tak Sum	HKG	YA	Yanai, Hiroshi	JPN	HB		
Wang, Jun	CHN	FB	Wessling, Ansgar	FRG	RO	Woo, Eun-Kyung	KOR	BB	Yang, Changling	CHN	WR		
Wang, Kuang-Huei	TPE	BA	West, Jeremy	GBR	CA	Woo, Yang-Ja	KOR	AT					
Wang, Libin	CHN	BB							Yang, Chieh-Jen	TPE	BA		
Wang, Mingxing	CHN	HB	Westbrook, Peter	USA	FE	Wood, Clare	GBR	TE	Yang, Chung-Yul	KOR	SH		
Wang, Minhui	CHN	SW	Westendorf, Uwe	GDR	WR	Wood, Edward	USA	BA	Yang, Dal-Sik	KOR	FE		
			Wester, Hubert	ARU	BO	Wood, Peter	AUS	BA	Yang, Guang	CHN	AT		
Wang, Qinghuan	CHN	AT	Wester, Paula	SWE	CY	Wood, Steven	AUS	CA	Yang, Hsiu-Chen	TPE	CY		
Wang, Ruiji	CHN	FE	Westergaard, Stig	DEN	YA	Woodcroft, Christopher	CAN	WR	Yang, Kwang-Jae	KOR	RO		
Wang, San-Tsai	TPE	FE	Westland, Cora	HOL	CY	Woodhall, Richard	GBR	BO	Yang, Kyoung-Hee	KOR	AT		
Wang, Shu-Hwa	TPE	AT	Wharton, David	USA	SW	Woodhouse, Robert	AUS	SW	Yang, Shanfeng	CHN	YA		
Wang, Tao	CHN	HB	Whitaker, Michael	GBR	ES	Woods, Dean	AUS	CY	Yang, Shenyi	CHN	SW		
Wang, Weiping	CHN	BO	Whitbread, Fatima	GBR	AT	Woods, Hilton	AHO	SW	Yang, Wook	KOR	SW		
Wang, Wenjing	CHN	GY	White, Carl	USA	CA	Woods, John	IRL	AT					
Wang, Xiaohong	CHN	SW							Yang, Xiao	CHN	RO		
Wang, Xiaoyan	CHN	GY	White, Christopher	NZL	RO	Woolley, John	NZL	SH	Yang, Xiaojun	CHN	VB		
Wang, Xiuting	CHN	AT	White, Curt	USA	WE	Worthington, Kay	CAN	RO	Yang, Xilan	CHN	VB		
			White, Densign	GBR	JU	Woznicki, Markus	FRG	TA	Yang, Yong	CHN	SW		
Wang, Yajun	CHN	VB	White, Maree	AUS	BB	Wrede, Jens-Peter	FRG	YA	Yang, Young-Ja	KOR	TT		
Wang, Yifu	CHN	SH	White, Robert	GBR	YA	Wright, Clive	JAM	AT	Yang, Zhizhong	CHN	WR		
Wang, Zhiming	CHN	FE	Whitford, Andrew	NZL	CY	Wright, George	CAN	AT	Yankey, Dinah	GHA	AT		
Wang, Zhong Nian	CHN	MP	Whittle, Brian	GBR	AT	Wright, Ian	NZL	RO	Yankos, Charlie	AUS	FB		
Wang, Zhonghua	CHN	SH	Whymms, Fabian	BAH	AT	Wright, John	ESP	TA	Yankoulova, Mariana	BUL	RO		
Wangganont, Chainarong	THA	AT	Wiawindi, Moussa	CAF	BO	Wright, Michael	HKG	SW	Yao, Yawen	CHN	AR		
Wangila, Robert	KEN	BO	Wiberg, Susanne	SWE	CA	Wright, Webster	USA	SH					
Wangui, Pascaline	KEN	AT							Yassenov, Anguel	BUL	WR		
Wanjau, John	KEN	BO	Wicki, Jodok	SUI	YA	Wroclawski, Romai	POL	WR	Yates, David	AUS	RO		
Wansbrough, David	AUS	HO	Widemann, Birt	GDR	VB	Wrona, Zdzislaw	POL	CY	Yaya, Ismael	CHA	AT		
			Wiegel, Torsten	FRG	SW	Wronski, Andrzej	POL	WR	Yaye Adien, Hoche	DJI	AT		
Wanyama, Franco	UGA	BO	Wieneke, Frank	FRG	JU	Wu, Chin-Jing	TPE	AT	Ye, Chong	CHN	FE		
Ward, Darren	CAN	SW	Wigger, Deena	USA	SH	Wu, Dan	CHN	VB	Ye, Huanming	CHN	WE		
Wardhani, Kusuma	INA	AR	Wightman, Andrew	AUS	SW	Wu, Fu-Lien	TPE	BA	Yearwood, Wayne	CAN	BB		
Wark, Ken	AUS	HO	Wihardja, Dirdja	INA	WE	Wu, Lanying	CHN	SH	Yeats, Douglas	CAN	WR		
Warming, Lars	DEN	AT	Wijnsma, Marjon	HOL	AT	Wu, Ming-Hsun	TPE	SW	Yego, Gideon	KEN	AT		
Warnecke, Mark	FRG	SW	Wild, Eleonora	YUG	BB	Wu, Po-Chen	TPE	JU	Yekini, Rachidi	NGR	FB		
Warren, Debra Anne	ZIM	JU	Wild, Ute	GDR	RO	Wu, Shih-Hsin	TPE	BA					
Warsoenke, Silvio	GDR	AT							Yelavich, Gregory	NZL	SH		
Warwick, Jay	USA	TA	Wilding-Davies, David	CAN	ES	Wu, Tsung-Che	TPE	TA	Yelle, Paul	BAR	SW		
Washington, Deborah	ISV	TA	Wilkins, David	IRL	YA	Wu, Weipei	CHN	CY	Yen, Man-Sung	TPE	AR		
			Wilkins, Mac	USA	AT	Wu, Wen-Chia	TPE	TT	Yendork, Juliana	GHA	AT		
Wastlund, Malin	SWE	AT	Willemse, Laurion	HOL	HO	Wulah, Melvina	LBR	AT	Yeo, Bum-Kyu	KOR	FB		
Wataanbe, Tomio	JPN	BA	Willey, Dean	GBR	WE	Wurzburger, Debra Joanne	CAN	SW	Yeo, Jung-Hoon	KOR	CY		
Watanabe, Hiroshi	JPN	ES	Williams, Angela	TRI	AT	Wuttke, Wolfram	FRG	FB	Yeoman, Roger	GBR	YA		
Watanabe, Kazumi	JPN	SH	Williams, Barrington	GBR	AT	Wybrow, Christopher	AUS	SW	Ygnalaga, Basilisa	PHI	AR		
Watanabe, Kenji	JPN	SW	Williams, Desai	CAN	AT	Wynn, Christine	CAN	AT	Yildiz, Rifat	FRG	WR		
Watanabe, Takehiro	JPN	TT	Williams, Desmond	SLE	BO	Wynter, Desi	ISV	AT	Yinga, Francois	CMR	WR		
Watanasin, Visut	THA	AT	Williams, Frank Noel	SLE	CY								
Watcharakupt, Pongsak	THA	AT											
Watson, Alexander	AUS	MP											
Watson, John	IRL	ES											

Seoul '88 Facts and Figures

Les faits et les chiffres

Listing of the Competitors/Listes dies concurrents

Name Nom	Country Pays	Sport	Name Nom	Country Pays	Sport	Name Nom	Country Pays	Sport	Name Nom	Country Pays	Sport
Yip, Hor Man	HKG	SW	Z			Zhang, Bin	CHN	BB	Zorko, Branko	YUG	AT
Ylonen, Sirpa	FIN	SH		Zhang, Bing	CHN	SH	Zorzi, Andrea	ITA	VB		
Ylostalo, Mikael	FIN	AT		Zhang, Caihua	CHN	AT	Zotov, Igor	URS	RO		
Yokochi, Alexandre	POR	SW		Zhang, Guojun	CHN	JU	Zotto, Renan Dal	BRA	VB		
Yolci, Yavuz	TUR	JU		Zhang, Guowei	CHN	AT	Zoubkov, Mikhail	URS	SW		
Yonassi, Itzhak	ISR	SH		Zhang, Hong	CHN	HB	Zouganeli, Georgia	GRE	AT		
Yoneshige, Shuichi	JPN	AT		Zhang, Kuikang	CHN	FB	Zuborenko, Igor	URS	RO		
Yoneyama, Kazutomo	JPN	VB		Zhang, Qiuping	CHN	SH	Zubricky, Jiri	TCH	WE		
Yonezaki, Kunji	JPN	BA		Zhang, Shoulie	CHN	WE	Zucchi, Franco	ITA	RO		
Yong, Po Po	MAL	TA		Zhang, Taohua	CHN	BB	Zucchi, Franco	ITA	RO		
Yoo, Byung-Hun	KOR	CY		Zaitsev, Evgueni	URS	BO	Zuccoli, Giorgio	ITA	YA		
Yoo, Chun-Ok	KOR	AT		Zaitsev, Viatcheslav	URS	VB	Zuehlke, Steffen	GDR	RO		
Yoo, Jae-Hak	KOR	BB		Zakharevitch, Yuri	URS	WE	Zuelow, Andreas	GDR	BO		
Yoo, Jae-Sung	KOR	AT		Zakirova, Saria	URS	RO	Zulianello, Claudio F	ARG	VB		
Yoo, Jin-Sun	KOR	TE		Zalaffi, Margherita	ITA	FE	Zuniga, Miguel A.	ESP	HB		
Yoo, Nam-Kyu	KOR	TT		Zaller, Erich	AUT	TA	Zuniga, Teresa	ESP	AT		
Yoo, Seung-Hoon	KOR	SW		Zanetti, Alberto E A	ARG	YA	Zurera, Jose	ESP	WE		
Yoo, Seung-Jin	KOR	HO		Zanfra, Flavia	ITA	SH	Zvazola, Rodrigo	CHI	YA		
Yoo, Young-Mi	KOR	VB		Zankawi, Muhammad	KUW	AT	Zvereva, Ellina	URS	AT		
Yoo, Young-Tai	KOR	WR		Zanolli, Michel	HOL	CY	Zvereva, Natalia	URS	TE		
				Zaprianov, Dimitar	BUL	JU					
Yoon, Chung-Hye	KOR	VB	Zaprianov, Petar	BUL	SH	Zhang, Zhicheng	CHN	FE	Zweir, Antonia	GRE	RO
Yoon, Joo-Il	KOR	SW	Zarenkiewicz, Janusz	POL	BO	Zhao, Bilong	CHN	SW	Zwerver, Ronald	HOL	VB
Yoon, Jung-Sook	KOR	FE				Zhao, Dianwen	CHN	CY	Zwicki, Rolf	SUI	YA
Yoon, Ki-Soo	KOR	CA	Zareva, Teodora	BUL	RO	Zhao, Hong	CHN	VB	Zwiener, Sabine	FRG	AT
Yoon, Kyung-Jae	KOR	WR	Zareva, Violeta	BUL	RO	Zhao, Jianqiang	CHN	WR	Zwolle, Henk Jan	HOL	RO
Yoon, Mi-Kyong	KOR	AT	Zarevucka, Hana	TCH	BB	Zhao, Wei	CHN	BB	Zybine, Alexandre	URS	YA
Yoon, Nam-Han	KOR	AT	Zarif, Jorge	BRA	YA	Zhao, Youfeng	CHN	AT	Zych, Boguslaw	POL	FE
Yoon, Nam-Ho	KOR	RO	Zaskalko, Alexandre	URS	RO	Zheng, Chen	CHN	AT			
Yoon, Nam-Jin	KOR	FE	Zassoulskaia, Natalia	URS	BB	Zheng, Haixia	CHN	BB			
Yoon, Tai-Il	KOR	HB	Zathonyi, Attila	HUN	SH	Zheng, Jian	CHN	SW			
			Zawada, Slawomir	POL	WE						
Yoon, Yong-Ho	KOR	RO	Zawieja, Martin	FRG	WE	Zheng, Meizhu	CHN	VB			
Yoon, Young-Dae	KOR	CA	Zayar, Mohamad	SYR	WR	Zheng, Qing	CHN	SW			
Yordanov, Danail	BUL	RO				Zheng, Zhaokang	CHN	FE			
Yordanov, Nikolai	BUL	CA	Zdonek, Mariusz	POL	TA	Zhong, Huandi	CHN	AT			
York, Michael	AUS	HO	Zdovc, Jurij	YUG	BB	Zhou, Danhong	CHN	SH			
Yoshida, Masami	JPN	AT	Zdravkova, Dolore	BUL	RO	Zhou, Ming	CHN	SW			
Yoshida, Ryoichi	JPN	AT	Zea, Urbano	MEX	SW	Zhou, Shouying	CHN	RO			
Yoshida, Shuji	JPN	BA	Zeekant, Marijke	HOL	RO	Zhou, Suying	CHN	CY			
Youcharoen, Somchai	THA	AT	Zeidler, Judith	GDR	RO	Zhou, Xiuhua	CHN	RO			
Youbare, Alexandre	BUR	AT	Zeinalnia, Naser	IRN	WR	Zhou, Yuanxiang	CHN	AT			
			Zelezny, Jan	TCH	AT						
Youmbi, Jean-B-L	CMR	WR	Zelfani, Mourad	TUN	WR	Zhu, Bo	CHN	FB			
Youmousse, Bathily	CIV	TA	Zelikovitch, Iouri	URS	RO	Zhu, Jianhua	CHN	AT			
Young, Dannelle	USA	AT				Zhu, Ping	CHN	FB			
Young, Darius	USA	SH	Zellweger, Josef	SUI	GY	Zhu, Qingyuan	CHN	FE			
Young, Kevin	USA	AT	Zeman, Jaroslav	TCH	WR	Zhuang, Yong	CHN	SW			
Young, Richard	CAN	CY	Zembsch, Mark	USA	RO	Ziegelmayr, Sebastian	FRG	YA			
Yousfi, Omar	ALG	WE	Zemina, Paige	USA	SW	Ziermann, Christoph	AUT	CY			
Youshimatz, Jose	MEX	CY	Zengli, Slimane	ALG	BO	Zikarsky, Bjoern	FRG	SW			
Youssef, Michel	LIB	FE	Zereske, Thomas	GDR	CA	Ziliox, Katja	FRG	SW			
Yousuf, Esmael	QAT	AT	Zesner, Steffen	GDR	SW	Zilporitee, Laima	URS	CY			
			Zhan, Jiang	CHN	SW						
Yrizar, Alejandro	MEX	MP	Zhan, Shuping	CHN	BB	Zimmermann, Kathrin	GDR	SW			
Ysrael, Mariana	GUM	AT	Zhang, Bin	CHN	MP	Zimmermann, Michael	FRG	MP			
Yu, Hourun	CHN	AT				Zinke, Heiko	GDR	CA			
Yu, Kau-Wai	HKG	CY				Zioerjen, Hanspeter	SUI	SH			
Yu, Xiang	CHN	SW				Zito, Alfonso	ITA	WR			
Yu, Zhicheng	CHN	AT				Zivojinovic, Slobodom	YUG	TE			
Yun, Young-Sook	KOR	AR				Zlatanov, Nikola	BUL	RO			
Yung, Yim King	HKG	FE				Zlatev, Assen	BUL	WE			
Yusuf, Moch. Yusuf	INA	AT				Znak, Marina	URS	RO			
Yusufu, Amadu	MAW	CY				Zoodsma, Ronald	HOL	VB			

제 24 회 서울올림픽대회 경기기록
Results of the Games of the XXIVth Olympiad
Résultats de la XXIV^{ème} Olympiade



3



양궁
Archery/Tir à l'arc



Archery/Tir à l'arc

Officials/Officiels

Fédération Internationale de Tir à l'Arc (F.I.T.A.)

President/président	Francesco Gnechi-Ruscione
Secretary General/secrétaire général	Giuseppe Cinnirella
Technical Delegates/délégués techniques	Knud Andreson

SLOOC Administrative Staff/Personnel Administratif du SLOOC

Commissioner/Directeur	Chung Mong Koo
Secretary General/secrétaire général	Ohm Byong Yun
Deputy Secretary General/secrétaire général adjoint	Chang Ho Ick
Competition Manager/chef de division des compétitions	Kim Ki Chan

Competitors/Concurrents

Men
Hommes

Competitors
Compétiteurs
85

Countries
Pays
35

Women
Femmes

Competitors
Compétiteurs
62

Countries
Pays
30

Legend/Notation

NWR	New World Record/Nouveau Record Mondial
NOR	New Olympic Record/Nouveau Record Olympique
SF	Shoot Off/Essai de tirage



Archery

Tir à l'arc

Men Individual Open Round/Sept. 27-28													Hommes/Individuel Tournoi Ouvert/27-28 Sept																			
Rank	Name	Ctry	90	RK	70	RK	50	RK	30	RK	Total	Hits	10	9	Rem.	Rank	Name	Ctry	90	RK	70	RK	50	RK	30	RK	Total	Hits	10	9	Rem.	
Rang	Nom	Pays														Rang	Nom	Pays														
1	Echeev, Vladimir	URS	298	9	321	1	338	1	347	15	1304	144	52	62		1	Echeev, Vladimir	URS	298	9	321	1	338	1	347	15	1304	144	52	62		
2	Park, Sung-Soo	KOR	310	1	320	2	322	13	351	3	1303	144	53	60		2	Park, Sung-Soo	KOR	310	1	320	2	322	13	351	3	1303	144	53	60		
3	Barrs, Jay	USA	303	5	320	3	321	16	350	6	1294	144	48	62		3	Barrs, Jay	USA	303	5	320	3	321	16	350	6	1294	144	48	62		
4	Mckinney, R	USA	288	22	317	6	334	2	349	8	1288	144	58	45		4	Mckinney, R	USA	288	22	317	6	334	2	349	8	1288	144	58	45		
5	Reniers, M	HOL	287	24	313	12	332	3	354	1	1286	144	59	47		5	Reniers, M	HOL	287	24	313	12	332	3	354	1	1286	144	59	47		
6	Chun, In-Soo	KOR	299	7	315	9	320	18	350	5	284	144	48	52		6	Chun, In-Soo	KOR	299	7	315	9	320	18	350	5	284	144	48	52		
7	Hallard, Steven	GBR	303	4	313	13	321	15	346	18	1283	144	46	56		7	Hallard, Steven	GBR	303	4	313	13	321	15	346	18	1283	144	46	56		
8	Bjerendal, Goran	SWE	287	25	317	5	325	9	351	3	1280	144	48	58		8	Bjerendal, Goran	SWE	287	25	317	5	325	9	351	3	1280	144	48	58		
9	Poikolainen, T	FIN	292	14	315	8	328	7	343	33	1278	144	44	58		9	Poikolainen, T	FIN	292	14	315	8	328	7	343	33	1278	144	44	58		
10	Heck, Olivier	FRA	308	2	304	32	317	26	348	11	1277	144	45	54		10	Heck, Olivier	FRA	308	2	304	32	317	26	348	11	1277	144	45	54		
11	Fairweather, S	AUS	295	11	314	11	318	24	349	9	1276	144	41	58		11	Fairweather, S	AUS	295	11	314	11	318	24	349	9	1276	144	41	58		
12	Lee, Han-Sup	KOR	308	3	308	23	314	33	345	20	1275	144	47	49		12	Lee, Han-Sup	KOR	308	3	308	23	314	33	345	20	1275	144	47	49		
13	Vikstrom, Pentti	FIN	291	17	315	7	323	11	344	27	1273	144	50	49		13	Vikstrom, Pentti	FIN	291	17	315	7	323	11	344	27	1273	144	50	49		
14	Yamamoto, H	JPN	302	6	312	16	316	29	341	43	1271	144	44	57		14	Yamamoto, H	JPN	302	6	312	16	316	29	341	43	1271	144	44	57		
15	Matsushita, T	JPN	289	18	307	24	329	5	341	42	1266	144	49	47		15	Matsushita, T	JPN	289	18	307	24	329	5	341	42	1266	144	49	47		
16	Mcdonald, John	CAN	295	10	313	14	308	48	347	13	1263	144	48	52		16	Mcdonald, John	CAN	295	10	313	14	308	48	347	13	1263	144	48	52		
17	Toft, Henrik	DEN	294	12	314	10	312	42	343	36	1263	144	38	58		17	Toft, Henrik	DEN	294	12	314	10	312	42	343	36	1263	144	38	58		
18	Erbay, Vedat	TUR	268	54	309	21	328	6	352	2	1257	144	44	54		18	Erbay, Vedat	TUR	268	54	309	21	328	6	352	2	1257	144	44	54		
19	Pace, Darrell	USA	289	19	305	28	315	30	348	10	1257	144	44	50		19	Pace, Darrell	USA	289	19	305	28	315	30	348	10	1257	144	44	50		
20	Kahlert, Detlef	FRG	289	20	302	35	324	10	339	48	1254	144	37	62		20	Kahlert, Detlef	FRG	289	20	302	35	324	10	339	48	1254	144	37	62		
21	Di Buo, Ilario	ITA	267	55	309	20	329	4	346	18	1251	144	50	49		21	Di Buo, Ilario	ITA	267	55	309	20	329	4	346	18	1251	144	50	49		
22	Vermeiren, Paul	BEL	279	37	306	25	321	14	344	24	1250	144	48	44		22	Vermeiren, Paul	BEL	279	37	306	25	321	14	344	24	1250	144	48	44		
23	Chkolny, K	URS	286	26	319	4	299	64	346	17	1250	144	44	49		23	Chkolny, K	URS	286	26	319	4	299	64	346	17	1250	144	44	49		
24	Watson, Leroy	GBR	293	13	299	38	313	38	343	33	1248	144	39	56		24	Watson, Leroy	GBR	293	13	299	38	313	38	343	33	1248	144	39	56		
25	Jacobsen, Jan	DEN	286	28	305	30	312	43	345	21	1248	144	39	48		25	Jacobsen, Jan	DEN	286	28	305	30	312	43	345	21	1248	144	39	48		
26	Anchondo, Jose	MEX	298	8	305	29	303	60	342	41	1248	144	38	51		26	Anchondo, Jose	MEX	298	8	305	29	303	60	342	41	1248	144	38	51		
27	Falck, Ismo	FIN	281	32	298	42	319	19	348	11	1246	144	41	48		27	Falck, Ismo	FIN	281	32	298	42	319	19	348	11	1246	144	41	48		
28	Parenti, Andrea	ITA	287	23	298	39	318	22	342	37	1245	144	48	40		28	Parenti, Andrea	ITA	287	23	298	39	318	22	342	37	1245	144	48	40		
29	Leontiev, Iouri	URS	292	15	296	47	323	12	334	64	1245	143	34	63		29	Leontiev, Iouri	URS	292	15	296	47	323	12	334	64	1245	143	34	63		
30	Nordlander, Mats	SWE	271	45	303	34	319	20	350	6	1243	144	42	53		30	Nordlander, Mats	SWE	271	45	303	34	319	20	350	6	1243	144	42	53		
31	Hu, Pei-Wentpe	TPE	281	31	300	37	315	32	347	13	1243	144	39	47		31	Hu, Pei-Wentpe	TPE	281	31	300	37	315	32	347	13	1243	144	39	47		
32	Vazquez, Antonio	ESP	279	38	308	22	314	35	338	52	1239	144	35	52		32	Vazquez, Antonio	ESP	279	38	308	22	314	35	338	52	1239	144	35	52		
33	Ferrari, G	ITA	270	47	298	41	326	8	343	35	1237	144	42	53		33	Ferrari, G	ITA	270	47	298	41	326	8	343	35	1237	144	42	53		
34	Ersu, Kerem	TUR	288	21	292	56	314	36	343	32	1237	144	40	51		34	Ersu, Kerem	TUR	288	21	292	56	314	36	343	32	1237	144	40	51		
35	Bjerendal, Gert	SWE	266	56	312	15	316	28	342	39	1236	144	44	44		35	Bjerendal, Gert	SWE	266	56	312	15	316	28	342	39	1236	144	44	44		
36	Singh, Sanjeeva	IND	285	29	290	59	311	44	347	15	1233	144	36	54		36	Singh, Sanjeeva	IND	285	29	290	59	311	44	347	15	1233	144	36	54		
37	Venant, Thierry	FRA	283	30	302	36	308	51	340	46	1233	144	32	53		37	Venant, Thierry	FRA	283	30	302	36	308	51	340	46	1233	144	32	53		
38	Bustani, Omar	MEX	276	40	296	48	318	23	342	39	1232	144	34	52		38	Bustani, Omar	MEX	276	40	296	48	318	23	342	39	1232	144	34	52		
39	Limba, Ram	IND	270	48	311	17	307	53	344	25	1232	143	41	48		39	Limba, Ram	IND	270	48	311	17	307	53	344	25	1232	143	41	48		
40	Furuhashi, T	JPN	286	27	297	43	308	49	338	55	1229	144	37	50		40	Furuhashi, T	JPN	286	27	297	43	308	49	338	55	1229	144	37	50		
41	Blake, C	AUS	269	49	311	18	304	57	344	27	1228	144	41	46		41	Blake, C	AUS	269	49	311	18	304	57	344	27	1228	144	41	46		
42	Yen, Man-Sung	TPE	280	33	306	26	313	37	328	73	1227	144	34	52		42	Yen, Man-Sung	TPE	280	33	306	26	313	37	328	73	1227	144	34	52		
43	Emilio, Renatobra	BRA	291	16	292	55	303	59	339	47	1225	144	39	45		43	Emilio, Renatobra	BRA	291	16	292	55	303	59	339	47	1225	144	39	45		
44	De Koning, P	BEL	268	53	305	27	318	21	334	65	1225	144	38	48		44	De Koning, P	BEL	268	53	305	27	318	21	334	65	1225	144	38	48		
45	Chiu, Ping-Kun	TPE	280	34	285	66	314	34	344	27	1223	143	42	50		45	Chiu, Ping-Kun	TPE	280	34	285	66	314	34	344	27	1223	143	42	50		
46	Doje, Qoiying	CHN	276	39	297	46	308	50	339	48	1220	144	33	50		46	Doje, Qoiying	CHN	276	39	297	46	308	50	339	48	1220	144	33	50		
47	Liang, Qiuzhong	CHN	274	42	304	33	309	46	333	67	1220	144	29	56		47	Liang, Qiuzhong	CHN	274	42	304	33	309	46	333	67	1220	144	29	56		
48	Mawi, Syafrudin	INA	275	41	287	64	312	40	345	21	1219	144	43	43		48	Mawi, Syafrudin	INA	275	41	287	64	312	40	345	21	1219	144	43	43		
49	Gonzalez, Adolfo	MEX	272	44	291	57	307	52	345	21	1215	144	41	46		49	Gonzalez, Adolfo	MEX	272	44	291	57	307	52	345	21	1215	144	41	46		
50	Jimenez-Tar Avi	ESP	269	52	293	52	317	25	336	58	1215	143	39	47		5																

Archery

Tir à l'arc

Men Team Open Round/Sept. 27-28			Hommes Equipe Tournoi Ouvert/27-28 Sept											
Rank	Ctry	Name	90	RK	70	RK	50	RK	30	RK	Total	Grand Total	Hits	10
Rang	Pays	Nom												
1	KOR	Chun, In-Soo	299	7	315	9	320	18	350	5	1284	3862	432	148
		Lee, Han-Sup	308	3	308	23	314	33	345	20	1275			
		Park, Sung-Soo	310	1	320	2	322	13	351	3	1303			
2	USA	Barrs, Jay	303	5	320	3	321	16	350	6	1294	3839	432	150
		Mckinney, R	288	22	317	6	334	2	349	8	1288			
		Pace, Darrell	289	19	305	28	315	30	348	10	1257			
3	URS	Chkolny, K	286	26	319	4	299	64	346	17	1250	3799	431	130
		Echeev, Vladimir	298	9	321	1	338	1	347	15	1304			
		Leontiev, Iouri	292	15	296	47	323	12	334	64	1245			
4	FIN	Falck, Ismo	281	32	298	42	319	19	348	11	1246	3797	432	135
		Poikolainen, T	292	14	315	8	328	7	343	33	1278			
		Vikstrom, Pentti	291	17	315	7	323	11	344	27	1273			
5	JPN	Furuhashi, T	286	27	297	43	308	49	338	55	1229	3766	432	130
		Matsushita, T	289	18	307	24	329	5	341	42	1266			
		Yamamoto, H	302	6	312	16	316	29	341	43	1271			
6	SWE	Bjerendal, Gert	266	56	312	15	316	28	342	39	1236	3759	432	134
		Bjerendal, Goran	287	25	317	5	325	9	351	3	1280			
		Nordlander, Mats	271	45	303	34	319	20	350	6	1243			
7	ITA	Di Buo, Ilario	267	55	309	20	329	4	346	18	1251	3733	432	140
		Ferrari, G	270	47	298	41	326	8	343	35	1237			
		Parenti, Andrea	287	23	298	39	318	22	342	37	1245			
8	GBR	Hallard, Steven	303	4	313	13	321	15	346	18	1283	3733	432	118
		Priestman, R	253	69	293	54	320	17	336	58	1202			
		Watson, Leroy	293	13	299	38	313	38	343	33	1248			
9	DEN	Gammelgaard Nie	269	50	297	45	295	68	342	38	1203	3714	432	107
		Jacobsen, Jan	286	28	305	30	312	43	345	21	1248			
		Toft, Henrik	294	12	314	10	312	42	343	36	1263			
10	MEX	Anchondo, Jose	298	8	305	29	303	60	342	41	1248	3695	432	113
		Bustani, Omar	276	40	296	48	318	23	342	39	1232			
		Gonzalez, Adolfo	272	44	291	57	307	52	345	21	1215			
11	TPE	Chiu, Ping-Kun	280	34	285	66	314	34	344	27	1223	3693	431	115
		Hu, Pei-Wen	281	31	300	37	315	32	347	13	1243			
		Yen, Man-Sung	280	33	306	26	313	37	328	73	1227			
12	FRA	Francllet, Claude	262	60	278	72	301	63	340	45	1181	3691	432	103
		Heck, Olivier	308	2	304	32	317	26	348	11	1277			
		Venant, Thierry	283	30	302	36	308	51	340	46	1233			
13	AUS	Blake, C	269	49	311	18	304	57	344	27	1228	3688	432	105
		Fairweather, S	295	11	314	11	318	24	349	9	1276			
		Wagner, Rodney	260	62	297	44	305	56	322	76	1184			
14	TUR	Avci, Izzet	279	35	288	62	296	66	329	71	1192	3686	432	114
		Erbay, Vedat	268	54	309	21	328	6	352	2	1257			
		Ersu, Kerem	288	21	292	56	314	36	343	32	1237			
15	BEL	De Koning, P	268	53	305	27	318	21	334	65	1225	3684	432	119
		Notenboom, F	256	66	304	31	316	27	333	68	1209			
		Vermeiren, Paul	279	37	306	25	321	14	344	24	1250			
16	CAN	Canuel, Denis	270	46	298	40	296	67	337	56	1201	3679	431	113
		Desnoyers, D	269	51	291	58	315	31	340	44	1215			
		Mcdonald, John	295	10	313	14	308	48	347	13	1263			
17	ESP	Holgado, J	255	67	310	19	309	47	336	57	1210	3664	431	107
		Jimenez-Tar Avi	269	52	293	52	317	25	336	58	1215			
		Vazquez, Antonio	279	38	308	22	314	35	338	52	123			
18	FRG	Barth, Manfred	273	43	294	51	304	58	335	61	1206	3659	432	110
		Kahler, Detlef	289	20	302	35	324	10	339	48	1254			
		Schulkowski, B	260	61	295	49	309	45	335	62	1199			
19	CHN	Doie, Qiying	276	39	297	46	308	50	339	48	1220	3644	432	96
		Liang, Qiuzhong	274	42	304	33	309	46	333	67	1220			
		Ru, Guang	279	36	295	50	291	74	339	50	1204			
20	IND	Limba, Ram	270	48	311	17	307	53	344	25	1232	3615	429	108
		Meena, Shyam Lal	239	71	275	75	292	73	344	25	1150			
		Singh, Sanjeeva	285	29	290	59	311	44	347	15	1233			
21	ZIM	Bamber, Paul	264	57	293	53	306	54	334	63	1197	3438	432	79
		Bryant, Alan	253	68	276	73	292	72	328	74	1149			
		Tarr, Wrex	224	77	265	78	286	76	317	80	1092			
22	BHU	Dorji, Thinley	230	75	284	69	286	78	344	27	1144	3338	429	82
		Tshering, Jigme	193	82	257	81	292	71	328	72	1070			
		Tshering, Pema	224	76	272	76	301	62	327	75	1124			

Men Team Semi-final/Oct. 1			Hommes/Equipe Demi-finale/1 Oct												
Rank	Ctry	Name	90	RK	70	RK	50	RK	30	RK	Total	Hits	10	9	Rem.
Rang	Pays	Nom													
1	USA	Barrs, Jay	231	1	252	2	244	1	265	1	992	108	45	44	
		Mckinney, R													
		Pace, Darrell													
2	URS	Chkolny, K	228	2	242	4	243	2	263	3	976	108	42	38	
		Echeev, Vladimir													
		Leontiev, Iouri													
3	TPE	Chiu, Ping-Kun	227	4	236	10	240	6	265	1	968	108	44	37	
		Hu, Pei-Wen													
		Yen, Man-Sung													
4	GBR	Hallard, Steven	228	2	238	8	240	3	259	7	965	108	45	29	
		Priestman, R													
		Watson, Leroy													
5	SWE	Bjerendal, Gert	224	6	239	7	238	8	263	3	964	108	39	40	
		Bjerendal, Goran													
		Nordlander, Mats													
6	KOR	Chun, In-Soo	217	9	245	3	237	9	261	5	960	108	42	32	
		Lee, Han-Sup													
		Park, Sung-Soo													
7	FIN	Falck, Ismo	218	8	241	5	240	4	261	6	960	108	41	37	
		Poikolainen, T													
		Vikstrom, Pentti													
8	JPN	Furuhashi, T	212	10	254	1	239	7	253	12	958	108	44	33	
		Matsushita, T													
		Yamamoto, H													
9	ITA	Di Buo, Ilario	224	5	240	6	235	11	258	8	957	108	36	41	
		Ferrari, G													
		Parenti, Andrea													
10	FRA	Francllet, Claude	223	7	230	11	237	10	258	9	948	108	31	42	
		Heck, Olivier													
		Venant, Thierry													
11	DEN	Gammelgaard Nie	212	11	237	9	234	12	255	11	938	108	29	38	



Men Team Oct. 1				Hommes/Equipe 1 Oct				Women Individual Open Round/Sept. 27-28										Femmes/Individuel Tournoi Ouvert/27-28 Sept					
Ctry Pays	Name Nom	Open	RK	Finals				Rank Rang	Name Nom	Ctry Pays	70	RK	60	RK	50	RK	30	RK	Total	Hits	10	9	Rem.
				Semi	RK	Grand	RK																
KOR	Chun, In-Soo Lee, Han-Sup Park, Sung-Soo	3862	1	960	6	986	1	1	Kim, Soo-Nyung	KOR	322	1	326	1	336	1	347	2	1331	144	63	59	
USA	Barrs, Jay Mckinney, R Pace, Darrell	3839	2	992	1	972	2	2	Wang, Hee-Kyung	KOR	314	4	318	3	319	6	347	2	1298	144	49	63	
GBR	Hallard, Steven Priestman, R Watson, Leroy	3733	8	965	4	968	3	3	Yun, Young-Sook	KOR	309	8	317	4	323	3	347	2	1296	144	50	54	
FIN	Falck, Ismo Poikolainen, T Vikstrom, Pentti	3797	4	960	7	956	4	4	Sjowall, Jenny	SWE	321	2	315	7	317	8	341	13	1294	143	53	56	
URS	Chkolny, K Echeev, Vladimir Leontiev, Iouri	3799	3	976	2	949	5	5	Franks, Joanne	GBR	318	3	324	2	296	30	343	8	1281	144	45	60	
JPN	Furuhashi, T Matsushita, T Yamamoto, H	3766	5	958	8	948	6	6	Arjannikova, L	URS	309	7	315	5	306	20	349	1	1279	144	50	47	
TPE	Chiu, Ping-Kun Hu, Pei-Wen Yen, Man-Sung	3693	11	968	3	937	7	7	Mountian, T	URS	309	5	307	16	321	5	335	34	1272	144	44	54	
SWE	Bjerendal, Gert Bjerendal, Goran Nordlander, Mats	3759	6	964	5	925	8	8	Boutouzova, N	URS	309	6	312	10	306	21	340	18	1267	143	44	57	
ITA	Di Buo, Ilario Ferrari, G Parenti, Andrea	3733	7	957	9			9	Aaltonen, Paivi	FIN	308	9	305	23	315	9	338	23	1266	144	48	47	
FRA	Francllet, Claude Heck, Olivier Venant, Thierry	3691	12	948	10			10	Liu, Pi-Yu	TPE	297	20	315	6	311	11	343	9	1266	144	37	63	
DEN	Gammelgaard Nie Jacobsen, Jan Toft, Henrik	3714	9	938	11			11	Parker, Denise	USA	305	10	310	14	313	10	335	37	1263	144	36	60	
MEX	Anchondo, Jose Bustani, Omar Gonzalez, Adolfo	3695	10	917	12			12	Saiman, N	INA	289	31	307	17	323	2	339	21	1258	143	45	50	
AUS	Blake, C Fairweather, S Wagner, Rodney	3688	13						Lai, Fang-Mei	TPE	292	26	314	8	304	22	347	2	1257	144	45	44	
TUR	Avci, Izzet Erbay, Vedat Ersu, Kerem	3686	14						Andersson, L	SWE	300	13	307	18	308	16	342	10	1257	143	40	53	
BEL	De Koning, P Notenboom, F Vermeiren, Paul	3684	15						Skillman, M	USA	287	36	305	21	322	4	338	24	1252	144	44	57	
CAN	Canuel, Denis Desnoyers, D Mcdonald, John	3679	16						Kwasna, Joanna	POL	284	42	311	11	318	7	339	20	1252	144	39	57	
ESP	Holgado, J Jimenez-Tar Avi Vazquez, Antonio	3664	17						Kriz, Claudia	FRG	289	30	313	9	307	17	341	16	1250	144	39	55	
FRG	Barth, Manfred Kahlert, Detlef Schulkowski, B	3659	18						Van Roozendaal	HOL	292	27	310	13	307	18	337	29	1246	144	35	53	
CHN	Doje, Qoiying Liang, Qiuzhong Ru, Guang	3644	19						Pellen, C	FRA	298	16	299	35	304	23	340	17	1241	143	41	48	
IND	Limba, Ram Meena, Shyam Lal Singh, Sanjeeva	3615	20						Wardhani, Kusuma	INA	285	37	306	20	311	12	337	28	1239	144	38	43	
ZIM	Bamber, Paul Bryant, Alan Tarr, Wrex	3438	21						Ma, Xiangjun	CHN	297	19	309	15	293	38	334	38	1233	144	42	42	
BHU	Dorji, Thinley Tshering, Jigme Tshering, Pema	3338	22						Ma, Shaorong	CHN	287	35	300	33	309	15	337	26	1233	144	34	48	
									Edwards, Pauline	GBR	284	41	299	36	310	13	339	22	1232	144	33	49	
									Tuul, Suvd	MGL	298	14	302	32	291	43	340	18	1231	144	36	48	
									Oeckl, Christa	FRG	298	18	303	29	297	28	332	43	1230	144	24	64	
									Ochs, Debra	USA	300	12	303	27	286	47	338	24	1227	144	36	46	
									Chin, Chiu-Yueh	TPE	288	32	287	50	309	14	342	10	1226	143	41	45	
									Hibon, Nathalie	FRA	289	29	298	39	303	24	334	39	1224	143	41	39	
									Breton, Aurora	MEX	298	17	294	44	299	27	333	41	1224	143	33	48	
									Handayani, L	INA	294	24	305	22	281	52	343	7	1223	144	42	44	
									Oki, Toyoko	JPN	278	49	303	25	307	19	335	33	1223	144	36	47	
									Haas, Doris	FRG	288	33	303	26	294	34	337	29	1222	144	33	52	
									Iwanek, Beata	POL	294	25	303	28	294	36	331	44	1222	144	31	56	
									Cuming, Brenda	CAN	300	11	281	53	294	35	342	10	1217	144	42	34	
									Yao, Yawen	CHN	291	28	296	42	299	26	331	45	1217	144	36	43	
									Shurrock, Ann	NZL	298	15	302	31	293	37	324	53	1217	144	30	49	
									Sousa, Ana	POR	283	44	303	30	295	31	332	42	1213	144	29	54	
									Greene Pereira	IRL	294	22	297	41	290	44	327	49	1208	144	34	45	
									Burger, Vreny	SUI	294	23	299	37	291	42	324	54	1208	144	23	56	
									Helbin, Joanna	POL	273	50	291	45	302	25	341	14	1207	144	32	50	
									Eksi, Huriye	TUR	284	39	288	49	292	41	341	15	1205	144	34	44	
									Eksi, Elif	TUR	278	48	306	19	296	296	324	52	1204	144	28	57	
									Smits, Adriana	HOL	284	43	289	47	286	48	344	6	1203	144	28	48	
									Oyuntsetseg, S	MGL	288	34	311	12	269	59	334	39	1202	144	24	51	
									Gautschi, Nadia	SUI	281	45	297	40	280	53	336	32	1194	143	39	35	
									Erdenechimeg, D	MGL	271	52	304	24	283	51	335	36	1193	141	30	53	
									Bazin, M	FRA	284	40	300	34	285	49	319	57	1188	144	21	52	
									Ries-Hotz, I	LUX	269	53	288	48	293	40	337	26	1187	144	30	45	
									Ygnalaga, B	PHI	281	47	290	46	283	50	328	47	1182	144	31	40	
									Unsal, Selda	TUR	281	46	280	54	295	32	325	51	1181	144	28	39	
									Sutton, Cheryl	GBR	295	21	273	56	288	46	323	56	1179	143	26	40	
									Nakagomi, Keiko	JPN	285	38	267	58	294	33	327	50	1173	144	24	37	
									Kitahara, Kyoko	JPN	272	51	295	43	276	55	328	48	1171	144	19	50	
									Rosa, Gloria M.	PUR	263	56	276	55	293	39	336	31	1168	143	30	38	
									Poikolainen, J	FIN	262	57	284	51	288	45	330	46	1164	144	26	35	
									Heinonen, Minna	FIN	269	54	298	38	273	57	323	55	1163	144	32	32	
									Valdes, M	ESP	246	60	270	57	274	56	335	35	1125	144	22	43	
									Agius, J	MLT	260	58	283	52	266	61	312	59	1121	142	15	52	
									Jonsson, Carina	SWE	264	55	258	60	279	54	310	61	1111	141	20	41	
									Chan, Siu Yuk	HKG	255	59	259	59	266	60	318	58	1098	143	18	36	
									Peridakis, E	JOR	243	61	253	61	253	62	306	62	1055	144	10	34	
									Tarr, Merrellyn	ZIM	194	62	240	62	270	58	311	60	1015	140	18	30	

Archery

Tir à l'arc

Women Individual Eighth-final/Sept. 29			Femmes/Individuel 1/8 de Finale/29 Sept											
Rank Rang	Name Nom	Ctry Pays	70	RK 60	RK 50	RK 30	RK Total	Hits	10	9	Rem.			
1	Arjannikova, L	URS	83	1	80	6	82	1	87	4	332	36	16	13
2	Kim, Soo-Nyung	KOR	80	7	84	2	79	3	88	1	331	36	14	16
3	Yun, Young-Sook	KOR	80	5	87	1	77	6	84	11	328	36	15	12
4	Ma, Xiangjun	CHN	78	9	81	3	78	4	85	7	322	36	8	19
5	Wang, Hee-Kyung	KOR	80	5	81	3	73	15	86	5	320	36	11	15
6	Mountian, T	URS	83	2	78	8	74	10	84	11	319	36	14	11
7	Andersson, L	SWE	81	4	72	20	77	6	87	3	317	36	10	15
8	Boutouzova, N	URS	76	14	76	14	80	2	82	19	314	36	9	14
9	Saiman, N	INA	77	11	78	9	75	9	84	11	314	36	8	15
10	Lai, Fang-Mei	TPE	76	13	80	5	73	14	83	17	312 ^o	36	10	12
11	Kriz, Claudia	FRG	76	12	77	10	73	12	85	9	311	36	11	12
12	Edwards, Pauline	GBR	75	15	76	13	77	5	83	16	311	36	10	12
13	Pellen, C	FRA	77	10	70	22	76	8	86	5	309	36	9	13
14	Skillman, M	USA	79	8	79	7	65	22	84	10	307	36	14	7
15	Liu, Pi-Yu	TPE	75	17	76	15	70	18	85	7	306	36	8	14
16	Sjowall, Jenny	SWE	82	3	70	24	73	13	80	23	305	36	7	12
17	Kwasna, Joanna	POL	75	16	74	18	72	17	83	15	304	36	8	9
18	Franks, Joanne	GBR	70	24	77	11	66	21	88	1	301	35	9	12
19	Wardhani, Kusuma	INA	73	20	75	16	72	16	80	22	300	36	7	10
20	Aaltonen, Paivi	FIN	73	22	74	17	69	19	83	17	299	36	6	14
21	Parker, Denise	USA	73	21	77	11	64	24	84	11	298	36	6	10
22	Ma, Shaorong	CHN	71	23	71	21	74	11	82	20	298	36	5	16
23	Van Roozendaal	HOL	74	19	74	19	66	20	79	24	293	36	1	18
24	Tuul, Suvd	MGL	75	18	70	23	64	23	81	21	290	36	7	9

Women Individual Quarter-final/Sept. 29			Femmes/Individuel Quart de Finale/29 Sept											
Rank Rang	Name Nom	Ctry Pays	30	RK 50	RK 60	RK 70	RK Total	Hits	10	9	Rem.			
1	Kim, Soo-Nyung	KOR	88	4	83	2	86	1	80	5	337	36	19	14
2	Wang, Hee-Kyung	KOR	86	12	79	4	84	4	81	3	330	36	16	11
3	Franks, Joanne	GBR	84	15	82	3	79	11	82	1	327	36	17	9
4	Sjowall, Jenny	SWE	89	1	76	10	83	5	79	6	327	36	14	12
5	Yun, Young-Sook	KOR	88	4	79	5	81	7	78	9	326	36	13	14
6	Arjannikova, L	URS	86	13	76	8	82	6	82	2	326	36	12	17
7	Saiman, N	INA	88	4	78	6	79	12	79	7	324	36	13	13
8	Kriz, Claudia	FRG	89	1	73	11	85	2	75	13	322	36	18	5
9	Skillman, M	USA	87	8	76	9	79	13	76	12	318	36	12	10
10	Ma, Xiangjun	CHN	81	18	86	1	78	14	73	16	318	36	11	14
11	Lai, Fang-Mei	TPE	88	4	71	15	80	10	78	8	317	36	12	13
12	Mountian, T	URS	85	14	76	7	78	15	77	10	316	36	10	14
13	Andersson, L	SWE	87	8	71	14	80	8	77	11	315	36	10	13
14	Pellen, C	FRA	89	1	73	12	77	16	74	15	313	36	14	8
15	Liu, Pi-Yu	TPE	87	8	71	13	80	8	72	17	310	36	9	13
16	Kwasna, Joanna	POL	84	16	69	16	75	17	75	14	303	36	8	13
17	Edwards, Pauline	GBR	83	17	63	17	75	18	80	4	301	36	7	12
18	Boutouzova, N	URS	87	8	62	18	85	3	66	18	300	36	11	13

Women Individual Semi-final/Sept. 30			Femmes/Individuel Demi-finale/30 Sept											
Rank Rang	Name Nom	Ctry Pays	30	RK 50	RK 60	RK 70	RK Total	Hits	10	9	Rem.			
1	Kim, Soo-Nyung	KOR	79	6	85	1	87	1	89	1	340	36	21	11
2	Wang, Hee-Kyung	KOR	81	4	84	5	80	5	87	4	332	36	14	18
3	Sjowall, Jenny	SWE	83	1	77	12	84	2	86	8	330	36	17	13
4	Franks, Joanne	GBR	81	2	78	10	83	3	88	3	330	36	14	16
5	Arjannikova, L	URS	78	7	84	3	78	9	89	1	329	36	16	12
6	Mountian, T	URS	76	10	85	2	80	6	87	4	328	36	14	13
7	Yun, Young-Sook	KOR	76	9	84	3	81	4	85	9	326	36	14	13
8	Kriz, Claudia	FRG	81	4	80	8	78	8	87	4	326	36	14	12
9	Saiman, N	INA	81	2	81	7	76	10	87	4	325	36	13	14
10	Skillman, M	USA	71	12	78	11	78	7	84	10	311	36	9	11
11	Ma, Xiangjun	CHN	76	8	78	9	71	11	84	11	309	36	9	16
12	Lai, Fang-Mei	TPE	74	11	82	6	69	12	81	12	306	36	8	12

Women Individual Grand-final/Sept. 30			Femmes/Individuel Finale/30 Sept											
Rank Rang	Name Nom	Ctry Pays	30	RK 50	RK 60	RK 70	RK Total	Hits	10	9	Rem.			
1	Kim, Soo-Nyung	KOR	90	1	83	1	86	1	85	1	344	36	25	8
	Finals Total		355		332		341		324		1352			NWR
	Open Total		347	2	336	1	326	1	322	1	1331			
	Open + Finals		702		668		667		646		2683			NOR
2	Wang, Hee-Kyung	KOR	86	5	77	5	85	2	84	3	332	36	17	13
	Finals Total		345		309		334		326		1314			
	Open Total		347	2	319	6	318	3	314	4	1298			
	Open + Finals		692		628		652		640		2612			NOR
3	Yun, Young-Sook	KOR	88	2	75	7	83	3	81	4	327	36	12	16
	Finals Total		345		312		335		315		1307			SF27
	Open Total		347	2	323	3	317	4	309	8	1296			
	Open + Finals		692		635		652		624		2603			NOR
4	Arjannikova, L	URS	87	3	81	2	82	5	77	5	327	36	15	10
	Finals Total		349		317		328		320		1314			SF25
	Open Total		349	1	306	20	315	5	309	7	1279			
	Open + Finals		698		623		643		629		2593			NOR
5	Sjowall, Jenny	SWE	85	7	74	8	81	6	85	1	325	36	15	12
	Finals Total		340		307		311		329		1287			
	Open Total		341	13	317	8	315	7	321	2	1294			
	Open + Finals		681		624		626		650		2581			NOR
6	Kriz, Claudia	FRG	87	3	75	6	82	4	74	7	318	36	15	8
	Finals Total		348		299		324		306		1277			S 26
	Open Total		341	16	307	17	313	9	289	30	1250			
	Open + Finals		689		606		637		595		2527			
7	Franks, Joanne	GBR	84	8	80	4	78	7	76	6	318	36	11	11
	Finals Total		344		311		312		309		1276			SF24
	Open Total		343	8	296	30	324	2	318	3	1281			
	Open + Finals		687		607		636		627		2557			NOR
8	Mountian, T	URS	86	5	81	3	77	8	70	8	314	36	11	12
	Finals Total		342		311		318		306		1277			
	Open Total		335	34	321	5	307	16	309	5	1272			
	Open + Finals		677		632		625		615		2549			NOR



**Women
Individual/Sept. 27-30**

**Femmes
Individuel/27-30 Sept**

Name Nom	Ctry Pays	Open	Finals										Grand Total
			RK	8th	RK	Qt.	RK	Semi	RK	Grand	RK	Total	
Kim, Soo-Nyung	KOR	1331	1	331	2	337	1	340	1	344	1	1352	2683
Wang, Hee-Kyung	KOR	1298	2	320	5	330	2	332	2	332	2	1314	2612
Yun, Young-Sook	KOR	1296	3	328	3	326	5	326	7	327	3	1307	2603
Arjannikova, L	URS	1279	6	332	1	326	6	329	5	327	4	1314	2593
Sjowall, Jenny	SWE	1294	4	305	16	327	4	330	3	325	5	1287	2581
Kriz, Claudia	FRG	1250	17	311	11	322	8	326	8	318	6	1277	2527
Franks, Joanne	GBR	1281	5	301	18	327	3	330	4	318	7	1276	2557
Mountian, T	URS	1272	7	319	6	316	12	328	6	314	8	1277	2549
Saiman, N	INA	1258	12	314	9	324	7	325	9				
Skillman, M	USA	1252	15	307	14	318	9	311	10				
Ma, Xiangjun	CHN	1233	21	322	4	318	10	309	11				
Lai, Fang-Mei	TPE	1257	13	312	10	317	11	306	12				
Andersson, L	SWE	1257	14	317	7	315	13						
Pellen, C	FRA	1241	19	309	13	313	14						
Liu, Pi-Yu	TPE	1266	10	306	15	310	15						
Kwasna, Joanna	POL	1252	16	304	17	303	16						
Edwards, Pauline	GBR	1232	23	311	12	301	17						
Boutouzova, N	URS	1267	8	314	8	300	18						
Wardhani, Kusuma	INA	1239	20	300	19								
Aaltonen, Paivi	FIN	1266	9	299	20								
Parker, Denise	USA	1263	11	298	21								
Ma, Shaorong	CHN	1233	22	298	22								
Van Roozendaal	HOL	1246	18	293	23								
Tuul, Suvd	MGL	1231	24	290	24								
Oeckl, Christa	FRG	1230	25										
Ochs, Debra	USA	1227	26										
Chin, Chiu-Yueh	TPE	1226	27										
Hibon, Nathalie	FRA	1224	28										
Breton, Aurora	MEX	1224	29										
Handayani, L	INA	1223	30										
Oki, Toyoko	JPN	1223	31										
Haas, Doris	FRG	1222	32										
Iwanek, Beata	POL	1222	33										
Cuming, Brenda	CAN	1217	34										
Yao, Yawen	CHN	1217	35										
Shurrock, Ann	NZL	1217	36										
Sousa, Ana	POR	1213	37										
Greene Pereira	IRL	1208	38										
Burger, Vreny	SUI	1208	39										
Helbin, Joanna	POL	1207	40										
Eksi, Huriye	TUR	1205	41										
Eksi, Elif	TUR	1204	42										
Smits, Adriana	HOL	1203	43										
Oyuntsetseg, S	MGL	1202	44										
Gautschi, Nadia	SUI	1194	45										
Erdenechimeg, D	MGL	1193	46										
Bazin, M	FRA	1188	47										
Ries-Hotz, I	LUX	1187	48										
Ygnalaga, B	PHI	1182	49										
Unsal, Selda	TUR	1181	50										
Sutton, Cheryl	GBR	1179	51										
Nakagomi, Keiko	JPN	1173	52										
Kitahara, Kyoko	JPN	1171	53										
Rosa, Gloria M.	PUR	1168	54										
Poikolainen, J	FIN	1164	55										
Heinonen, Minna	FIN	1163	56										
Valdes, M	ESP	1125	57										
Agius, J	MLT	1121	58										
Jonsson, Carina	SWE	1111	59										
Chan, Siu Yuk	HKG	1098	60										
Peridakis, E	JOR	1055	61										
Tarr, Merrellyn	ZIM	1015	62										

**Women Team
Open Round/Sept. 27-28**

**Femmes/Equipe
Tournoi Ouvert/27-28 Sept**

Rank Rang	Ctry Pays	Name Nom	70	RK	60	RK	50	RK	30	RK	Total	Grand Total	Hits	10	Rem.
1	KOR	Kim, Soo-Nyung	322	1	326	1	336	1	347	2	1331	3925	432	162	
		Wang, Hee-Kyung	314	4	318	3	319	6	347	2	1298				
		Yun, Young-Sook	309	8	317	4	323	3	347	2	1296				
2	URS	Arjannikova, L	309	7	315	5	306	20	349	1	1279	3818	431	138	
		Boutouzova, N	309	6	312	10	306	21	340	18	1267				
		Mountian, T	309	5	307	16	321	5	335	34	1272				
3	TPE	Chin, Chiu-Yueh	288	32	287	50	309	14	342	10	1226	3749	431	123	
		Lai, Fang-Mei	292	26	314	8	304	22	347	2	1257				
		Liu, Pi-Yu	297	20	315	6	311	11	343	9	1266				
4	USA	Ochs, Debra	300	12	303	27	286	47	338	24	1227	3742	432	116	
		Parker, Denise	305	10	310	14	313	10	335	37	1263				
		Skillman, M	287	36	305	21	322	4	338	24	1252				
5	INA	Handayani, L	294	24	305	22	281	52	343	7	1223	3720	431	125	
		Saiman, N	289	31	307	17	323	2	339	21	1258				
		Wardhani, Kusuma	285	37	306	20	311	12	337	28	1239				
6	FRG	Haas, Doris	288	33	303	26	294	34	337	29	1222	3702	432	96	
		Kriz, Claudia	289	30	313	9	307	17	341	16	1250				
		Oeckl, Christa	298	18	303	29	297	28	332	43	1230				
7	GBR	Edwards, Pauline	284	41	299	36	310	13	339	22	1232	3692	431	104	
		Franks, Joanne	318	3	324	2	296	30	343	8	1281				
		Sutton, Cheryl	295	21	273	56	288	46	323	56	1179				
8	CHN	Ma, Shaorong	287	35	300	33	309	15	337	26	1233	3683	432	112	
		Ma, Xiangjun	297	19	309	15	293	38	334	38	1233				
		Yao, Yawen	291	28	296	42	299	26	331	45	1217				
9	POL	Helbin, Joanna	273	50	291	45	302	25	341	14	1207	3681	432	102	
		Iwanek, Beata	294	25	303	28	294	36	331	44	1222				
		Kwasna, Joanna	284	42	311	11	318	7	339	20	1252				
10	SWE	Andersson, L	300	13	307	18	308	16	342	10	1257	3662	427	113	
		Jonsson, Carina	264	55	258	60	279	54	310	61	1111				
		Sjowall, Jenny	321	2	315	7	317	8	341	13	1294				
11	FRA	Bazin, M	284	40	300	34	285	49	319	57	1188	3653	430	103	
		Hibon, Nathalie	289	29	298	39	303	24	334	39	1224				
		Pellen, C	298	16	299	35	304	23	340	17	1241				
12	MGL	Erdenechimeg, D	271	52	304	24	283	51	335	36	1193	3626	429	90	
		Oyuntsetseg, S	288	34	311	12	269	59	334	39	1202				
		Tuul, Suvd	298	14	302	32	291	43	340	18	1231				
13	FIN	Aaltonen, Paivi	308	9	305	23	315	9	338	23	1266	3593	432	106	
		Heinonen, Minna	269	54	298	38	273	57	323	55	1163				
		Poikolainen, J	262	57	284	51	288	45	330	46	1164				
14	TUR	Eksi, Elif	278	48	306	19	296	29	324	52	1204	3590	432	90	
		Eksi, Huriye	284	39	288	49	292	41	341	15	1205				
		Unsal, Selda	281	46	280	54	295	32	325	51	1181				
15	JPN	Kitahara, Kyoko	272	51	295	43	276	55	328	48	1171	3567	432	79	
		Nakagomi, Keiko	285	38	267	58	294	33	327	50	1173				
		Oki, Toyoko	278	49	303	25	307	19	335	33	1223				

**Women Team
Semi-final/Oct. 1**

**Hommes/ Equipe
Demi-finale/1 Oct**

Rank Rang	Ctry Pays	Name Nom	70	RK	60	RK	50	RK	30	RK	Total	Hits	10	9	Rem.
1	KOR	Kim, Soo-Nyung	242	1	253	1	249	1	256	5	1000	108	49	42	
		Wang, Hee-Kyung													
		Yun, Young-Sook													
2	USA	Ochs, Debra	241	2	253	2	239	3	255	7	988	108	44	42	
		Parker, Denise													
		Skillman, M													
3	URS	Arjannikova, L	230	6	252	3	238	5	258	3	978	108	37	47	
		Boutouzova, N													
		Mountian, T													
4	INA	Handayani, L	225	10	246	5	243	2	261	1	975	108	45	37	
		Saiman, N													
		Wardhani, Kusuma													
5	GBR	Edwards, Pauline	2												

Archery

Women Team Grand-final/Oct. 1			Femmes/Equipe Finale/1 Oct												
Rank Rang	Ctry Pays	Name Nom	30	RK	50	RK	60	RK	70	RK	Total	Hits	10	9	Rem.
1	KOR	Kim, Soo-Nyung Wang, Hee-Kyung Yun, Young-Sook	258	2	240	1	241	1	243	1	982	108	43	39	
2	INA	Handayani, L Saiman, N Wardhani, Kusuma	259	1	237	3	235	3	221	7	952	108	34	39	SF 72
3	USA	Ochs, Debra Parker, Denise Skillman, M	253	3	237	2	234	4	228	6	952	108	30	47	SF 67
4	URS	Arjannikova, L Boutouzova, N Mountian, T	252	4	218	7	241	.2	240	2	951	108	27	47	
5	GBR	Edwards, Pauline Franks, Joanne Sutton, Cheryl	241	8	231	4	231	5	230	4	933	108	28	40	
6	FRG	Haas, Doris Kriz, Claudia Oeckl, Christa	249	6	226	5	228	7	228	5	931	108	22	48	
7	SWE	Andersson, L Jonsson, Carina Sjowall, Jenny	241	7	224	6	231	6	234	3	930	108	28	37	
8	FRA	Bazin, M Hibon, Nathalie Pellen, C	249	5	215	8	226	8	208	8	898	108	22	33	

Women Team Oct. 1		Femmes/Equipe 1 Oct					
Ctry Pays	Name Nom	Open	RK	Finals			
				Semi	RK	Grand	RK
KOR	Kim, Soo-Nyung Wang, Hee-Kyung Yun, Young-Sook	3925	1	1000	1	982	1
INA	Handayani, L Saiman, N Wardhani, Kusuma	3720	5	975	4	952	2
USA	Ochs, Debra Parker, Denise Skillman, M	3742	4	988	2	952	3
URS	Arjannikova, L Boutouzova, N Mountian, T	3818	2	978	3	951	4
GBR	Edwards, Pauline Franks, Joanne Sutton, Cheryl	3692	7	962	5	933	5
FRG	Haas, Doris Kriz, Claudia Oeckl, Christa	3702	6	953	6	931	6
SWE	Andersson, L Jonsson, Carina Sjowall, Jenny	3662	10	949	8	930	7
FRA	Bazin, M Hibon, Nathalie Pellen, C	3653	11	950	7	898	8
CHN	Ma, Shaorong Ma, Xiangjun Yao, Yawen	3683	8	948	9		
POL	Helbin, Joanna Iwanek, Beata Kwasna, Joanna	3681	9	945	10		
TPE	Chin, Chiu-Yueh Lai, Fang-Mei Liu, Pi-Yu	3749	3	939	11		
MGL	Erdenechimeg, D Oyuntsetseg, S Tuul, Suvd	3626	12	912	12		
FIN	Aaltonen, Paivi Heinonen, Minna Poikolainen, J	3593	13				
TUR	Eksi, Elif Eksi, Huriye Unsal, Selda	3590	14				
JPN	Kitahara, Kyoko Nakagomi, Keiko Oki, Toyoko	3567	15				



육 상

Athletics/Athlétisme



Athletics/Athlétisme

Officials/Officiels

International Amateur Athletic Federation (I.A.A.F.)

President/président	Primo Nebiolo
Secretary General/secrétaire général	John B. Holt
Technical Delegates/délégués techniques	Pierre Dasriaux Dapeng Lou Emanuel Rose

SLOOC Administrative Staff/Personnel Administratif du SLOOC

Commissioner/directeur	Park Jung Ki
Secretary General/secrétaire général	Kim Chang Keun
Deputy Secretary General/secrétaire général adjoint	Lee Dong Wook
Director of Competition Operation	Han Tae Bong
Competition Manager/chef de division des compétitions	Kim Hae Ryong

Competitors/Concurrents

Men Hommes	Competitors Competiteurs	Countries Pays
100 M	108	71
200 M	93	72
400 M	91	66
800 M	77	59
1500 M	68	53
3000 M Steeplechase	39	27
5000 M	70	48
10000 M	60	41
Marathon	133	69
110 M Hurdles/haies	44	34
400 M Hurdles/haies	43	33
20 KM Walk/marche	58	30
50 KM Walk/marche	49	24
4x100 M	180	34
4x400 M	142	28
High Jump/saut en hauteur	28	19
Pole Vault/saut a la perche	23	14
Long Jump/saut en longueur	48	35
Triple Jump/triple saut	46	34
Shot Put/poids	30	26
Discus/disque	34	25
Hammer/marteau	32	15
Javelin/javelot	41	23
Decathlon	42	26

Women Femmes	Competitors Competiteurs	Countries Pays
100 M	71	43
200 M	71	44
400 M	55	37
800 M	34	20
1500 M	35	22
3000 M	39	25
Marathon	77	39
100 M Hurdles/haies	40	25
400 M Hurdles/haies	37	25
4x100 M	110	19
4x400 M	100	18
High Jump/saut en hauteur	27	16
Long Jump/saut en longueur	38	23
Shot Put/poids	28	15
Discus/disque	25	15
Javelin/javelot	30	17
Heptathlon	32	24

Legend/Notation

NWR	New World Record/Nouveau Record Mondial
NOR	New Olympic Record/Nouveau Record Olympique
AB	Abandon/Abandon
Q	Qualified/Qualifié
NS	Did Not Start/N'a pas Participé
DQ	Disqualified/Disqualifié
—	Passed/Passe
O	Cleared/Reussi
X	Missed/Manque
N	Number of jumps at the height last cleared/Nombre de sauts tentés à la dernière hauteur Reussie
TF	Total failures up to and including the height last cleared/Total des essais manqués jus
EOR	Equals Olympic Record/Egale Record Olympique

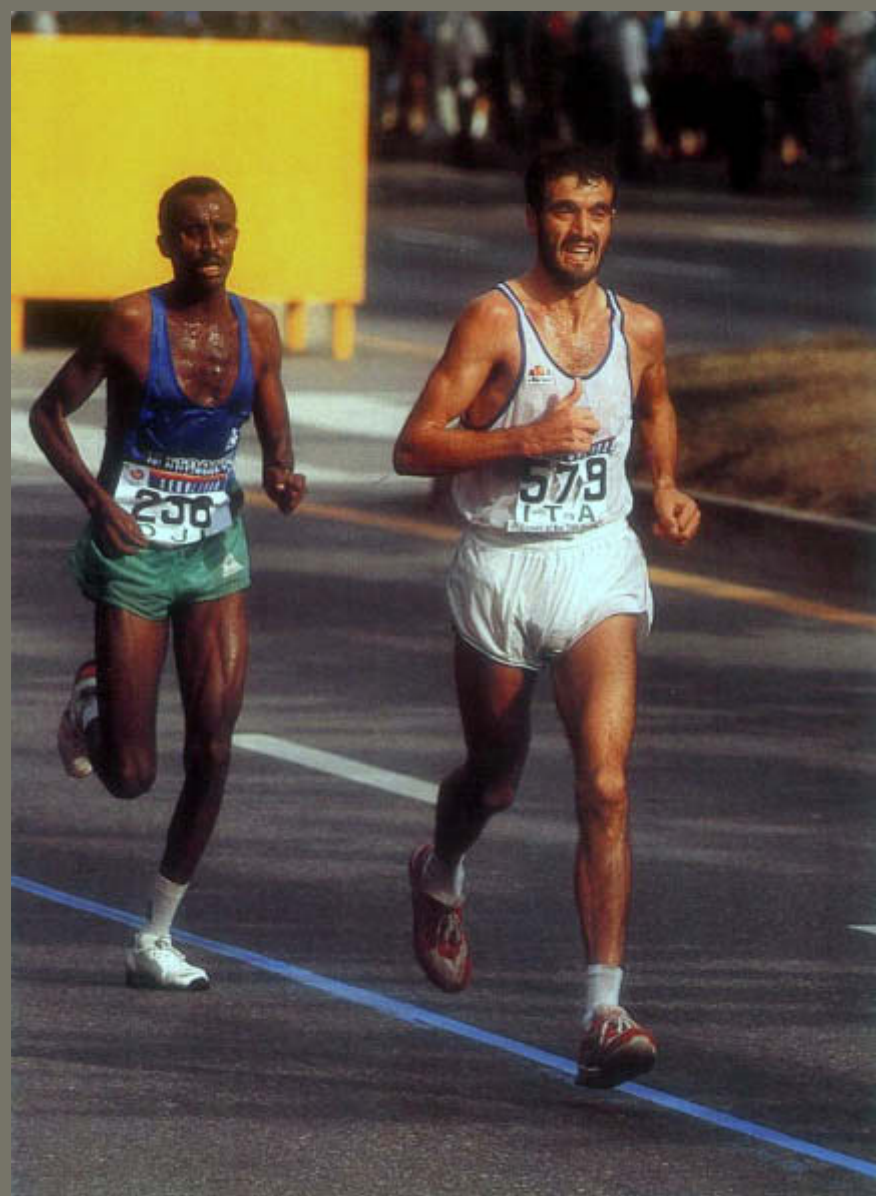

Athletics

Men 100m Round 1 Heat 1/Sept. 23				Hommes 100m Tour 1 Serie 1/23 Sept	
Rank Rang	Ctry Pays	Name Nom	Result Resultat		
1	BRA	Silva, Robson	10.37	Q	
2	ITA	Madonia, Ezio	10.40	Q	
3	TPE	Cheng, Hsin-Fu	10.48	Q	
4	FRA	Lauret, Thierry	10.56		
5	TOG	Lawson, Boeviyoulou	10.59		
6	HKG	Leung, Wing Kwong	10.82		
7	KSA	Al Bishi, Mohamed	10.85		
8	VAN	Jeremiah, Jerry	10.96		

Men 100m Round 1 Heat 2/Sept. 23				Hommes 100m Tour 1 Serie 2/23 Sept	
Rank Rang	Ctry Pays	Name Nom	Result Resultat		
1	USA	Smith, Calvin	10.28	Q	
2	HUN	Kovacs, Attila	10.39	Q	
3	INA	Mardi, Mardi	10.40	Q	
4	URS	Razine, Andre	10.58		
5	CGO	Ndinga, Henri	10.74		
6	ZIM	Muyaba, Fabian	10.75		
7	ALG	Selmi, Mostefa-Kamel	11.08		
8	LIE	Buchel, Markus	11.21		

Men 100m Round 1 Heat 3/Sept. 23				Hommes 100m Tour 1 Serie 3/23 Sept	
Rank Rang	Ctry Pays	Name Nom	Result Resultat		
1	QAT	Mansoor B.K., Talal	10.42	Q	
2	DOM	Nunez, Juan	10.47	Q	
3	SEN	Mbaye, A.Mbagnick	10.64	Q	
4	BAH	Whymms, Fabian	10.70		
5	ISV	Hodge, Neville	10.73		
6	SLE	Dove-Edwin, Horace	10.89		
7	BUR	Yougbare, Alexandre	10.90		
8	BAR	Atkins, Henriko	11.01		

Men 100m Round 1 Heat 4/Sept. 23				Hommes 100m Tour 1 Serie 4/23 Sept	
Rank Rang	Ctry Pays	Name Nom	Result Resultat		
1	GHA	Tuffuor, Emmanuel	10.31	Q	
2	JPN	Kurihara, Koji	10.46	Q	
3	JAM	Smith, Andrew	10.49	Q	
4	CHN	Zheng, Chen	10.51		
5	HUN	Tatar, Istvan	10.52		
6	FRG	Haas, Christian	10.54		
7	NGU	Hou John	10.96		
8	YMD	Fuad Ahmed Nagi, Ehab	11.53		

Men 100m Round 1 Heat 5/Sept. 23				Hommes 100m Tour 1 Serie 5/23 Sept	
Rank Rang	Ctry Pays	Name Nom	Result Resultat		
1	GBR	Christie, Linford	10.19	Q	
2	FRA	Moriniere, Max	10.34	Q	
3	GDR	Matthes, Sven	10.35	Q	
4	CHN	Li, Tao	10.47		
5	CMR	Samuel-Kaya, Nchinda	10.60		
6	TPE	Lee, Shiunn-Long	10.69		
7	BER	Trott, William O	10.69		
8	SWZ	Maziya, Frank	11.52		

Men 100m Round 1 Heat 6/Sept. 23				Hommes 100m Tour 1 Serie 6/23 Sept	
Rank Rang	Ctry Pays	Name Nom	Result Resultat		
1	NGR	Imo, Chidi	10.62	Q	
2	SEN	Seck, Charles Louis	10.64	Q	
3	BEN	Alassane, Ousseni, Issa	10.72	Q	
4	GBR	Regis, John	10.76		
5	LES	Kharitse, Mothobi	10.97		
6	GUI	Loua, Robert	11.20		
7	LBR	Birch, Samuel	11.68		
	POR	Agostinho, Pedro	AB		

Athlétisme

Men 100m Round 1 Heat 7/Sept. 23				Hommes 100m Tour 1 Serie 7/23 Sept	
Rank Rang	Ctry Pays	Name Nom	Result Resultat		
1	JAM	Stewart, Raymond	10.22	Q	
2	ITA	Pavoni, Pierfrancesco	10.36	Q	
3	URS	Savine, Vitali	10.52	Q	
4	HUN	Fetter, Gyorgy	10.54		
5	BRN	Goma, Khalid	10.80		
6	PAK	Afzal, Muhammad	10.91		
7	HAI	Roumain, Claudeg.	11.22		
	KOR	Chang, Jae-Keun	NS		

Men 100m Round 1 Heat 8/Sept. 23				Hommes 100m Tour 1 Serie 8/23 Sept	
Rank Rang	Ctry Pays	Name Nom	Result Resultat		
1	CAN	Johnson, Ben	10.37	Q	
2	CHN	Cai, Jianming	10.55	Q	
3	KOR	Shim, Duk-Sup	10.56	Q	
4	CHI	Moreno, Carlos	10.70		
5	OMA	Al-khalidi, Abdullah	10.90		
6	BAN	Md Shah Jalal, Md Shah Jalal	10.94		
7	UGA	Ssali, Joseph	10.95		
8	ANT	Soleyne, St Clair	11.17		

Men 100m Round 1 Heat 9/Sept. 23				Hommes 100m Tour 1 Serie 9/23 Sept	
Rank Rang	Ctry Pays	Name Nom	Result Resultat		
1	CAN	Williams, Desai	10.24	Q	
2	KEN	Wekesa, Peter	10.50	Q	
3	NGR	Adeniken, Olapade	10.56	Q	
4	MEX	Nava, Eduardo	10.68		
5	BRA	Bonfim, Jailto	10.75		
6	IVB	Hodge, Lindel	10.79		
7	THA	Watanasin, Visut	10.88		
8	ANG	Gaspar, Armenio	10.92		

Men 100m Round 1 Heat 10/Sept. 23				Hommes 100m Tour 1 Serie 10/23 Sept	
Rank Rang	Ctry Pays	Name Nom	Result Resultat		
1	URS	Krylov, Vladimir	10.34	Q	
2	BRA	Silva, Arnaldo	10.44	Q	
3	ITA	Lazazzera, Michele	10.47	Q	
4	KEN	Ondiek, Kennedy	10.51		
5	JPN	Kasahara, Takahiro	10.62		
6	ISV	Flemming, Jimmy	10.70		
7	LIB	Salame, Jihad	11.49		
8	MON	Bessi, Gilbert	11.55		

Men 100m Round 1 Heat 11/Sept. 23				Hommes 100m Tour 1 Serie 11/23 Sept	
Rank Rang	Ctry Pays	Name Nom	Result Resultat		
1	USA	Mitchell, Dennis	10.37	Q	
2	NGR	Adeyanju, Isiaq	10.45	Q	
3	MLI	Diarra, Ousmane	10.53	Q	
4	LBR	Daniels, Oliver	10.68		
5	POR	Cunha, Luis	10.80		
6	DOM	Ortiz, Evaristo	11.01		
7	VIE	Nguyen dinh, Minh	11.09		
8	GEO	Borabota Epacua, Secundino	11.52		

Men 100m Round 1 Heat 12/Sept. 23				Hommes 100m Tour 1 Serie 12/23 Sept	
Rank Rang	Ctry Pays	Name Nom	Result Resultat		
1	GHA	Myles-Mills, John	10.31	Q	
2	AUT	Berger, Andreas	10.40	Q	
3	GBR	Williams, Barrington	10.51	Q	
4	BEL	Stevens, Patrick	10.51		
5	ESP	Talavera, Enrique	10.61		
6	JPN	Osawa, Tomohiro	10.71		
7	SMR	Canti, Dominique f.	11.11		
8	MDV	Asif, Ismail	11.49		



Men 100m
Round 1 Heat 13/Sept. 23

Rank	Ctry	Name	Result	
Rang	Pays	Nom	Resultat	
1	USA	Lewis, Carl	10.14	Q
2	FRA	Trouabal, Jean-Charles	10.39	Q
3	ESP	Arques, Javier	10.44	Q
4	JAM	Mair, John	10.44	
5	BUR	Pale, Harouna	10.76	
6	TGA	Suli, Peauope	10.94	
7	FIJ	Bole, Maloni	11.19	

Hommes 100m
Tour 1 Serie 13/23 Sept

Rank	Ctry	Name	Result	
Rang	Pays	Nom	Resultat	
75	OMA	Al-khalidi, Abdullah	10.90	
75	BUR	Yougbare, Alexandre	10.90	
77	PAK	Afzal, Muhammad	10.91	
78	ANG	Gaspar, Armenio	10.92	
79	BAN	Md Shah Jalal, Md Shah Jalal	10.94	
79	TGA	Suli, Peauope	10.94	
81	UGA	Ssali, Joseph	10.95	
82	NGU	Hou John	10.96	
82	VAN	Jeremiah, Jerry	10.96	
84	LES	Kharitse, Mothobi	10.97	
85	BAR	Atkins, Henriko	11.01	
85	DOM	Ortiz, Evaristo	11.01	
87	ALG	Selmi, Mostefa-kamel	11.08	
88	VIE	Nguyen Dinh, Minh	11.09	
89	SMR	Canti, Dominique F.	11.11	
90	ANT	Soleyne, St Clair	11.17	
91	FIJ	Bole, Maloni	11.19	
92	GUI	Loua, Robert	11.20	
93	LIE	Buchel, Markus	11.21	
94	HAI	Roumain, Claudeg.	11.22	
95	LIB	Salame, Jihad	11.49	
95	MDV	Asif, Ismail	11.49	
97	GEQ	Borabota Epacua, Secundino	11.52	
98	SWZ	Maziya, Frank	11.52	
99	YMD	Fuad Ahmed Nagi, Ehab	11.53	
100	MON	Bessi, Gilbert	11.55	
101	LBR	Birch, Samuel	11.68	
	POR	Agostinho, Pedro	AB	
	KOR	Chang, Jae-Keun	NS	

Men 100m
Round 1/Sept. 23

Rank	Ctry	Name	Result	
Rang	Pays	Nom	Resultat	
1	USA	Lewis, Carl	10.14	Q
2	GBR	Christie, Linford	10.19	Q
3	JAM	Stewart, Raymond	10.22	Q
4	CAN	Williams, Desai	10.24	Q
5	USA	Smith, Calvin	10.28	Q
6	GHA	Myles-Mills, John	10.31	Q
6	GHA	Tuffuor, Emmanuel	10.31	Q
8	FRA	Moriniere, Max	10.34	Q
9	URS	Krylov, Vladimir	10.34	Q
10	GDR	Matthes, Sven	10.35	Q
11	ITA	Pavoni, Pierfrancesco	10.36	Q
12	BRA	Silva, Robson	10.37	Q
12	CAN	Johnson, Ben	10.37	Q
12	USA	Mitchell, Dennis	10.37	Q
15	FRA	Trouabal, Jean-Charles	10.39	Q
15	HUN	Kovacs, Attila	10.39	Q
17	AUT	Berger, Andreas	10.40	Q
17	INA	Mardi, Mardi	10.40	Q
17	ITA	Madonia, Ezio	10.40	Q
20	QAT	Mansoor B.K., Talal	10.42	Q
21	BRA	Silva, Arnaldo	10.44	Q
21	ESP	Arques, Javier	10.44	Q
21	JAM	Mair, John	10.44	Q
24	NGR	Adeyanju, Isiaq	10.45	Q
25	JPN	Kurihara, Koji	10.46	Q
26	CHN	Li, Tao	10.47	Q
26	DOM	Nunez, Juan	10.47	Q
26	ITA	Lazazzera, Michele	10.47	Q
29	TPE	Cheng, Hsin-Fu	10.48	Q
30	JAM	Smith, Andrew	10.49	Q
31	KEN	Wekesa, Peter	10.50	Q
32	BEL	Stevens, Patrick	10.51	Q
32	CHN	Zheng, Chen	10.51	Q
32	GBR	Williams, Barrington	10.51	Q
32	KEN	Ondiek, Kennedy	10.51	Q
36	HUN	Tatar, Istvan	10.52	Q
36	URS	Savine, Vitali	10.52	Q
38	MLI	Diarra, Ousmane	10.53	Q
39	FRG	Haas, Christian	10.54	Q
39	HUN	Fetter, Gyorgy	10.54	Q
41	CHN	Cai, Jianming	10.55	Q
42	FRA	Lauret, Thierry	10.56	Q
42	KOR	Shim, Duk-Sup	10.56	Q
42	NGR	Adeniken, Olapade	10.56	Q
45	URS	Razine, Andre	10.58	
46	TOG	Lawson, Boeviyoulou	10.59	
47	CMR	Samuel -Kaya, Nchinda	10.60	
48	ESP	Talavera, Enrique	10.61	
49	JPN	Kasahara, Takahiro	10.62	
49	NGR	Imo, Chidi	10.62	Q
51	SEN	Mbaye, A.Mbagnick	10.64	Q
51	SEN	Seck, Charles louis	10.64	Q
53	MEX	Nava, Eduardo	10.68	
53	LBR	Daniels, Oliver	10.68	
55	BER	Trott, William O	10.69	
55	TPE	Lee, Shiunn-Long	10.69	
57	BAH	Whymms, Fabian	10.70	
57	CHI	Moreno, Carlos	10.70	
57	ISV	Flemming, Jimmy	10.70	
60	JPN	Osawa, Tomohiro	10.71	
61	BEN	Alassane, Ousseni, Issa	10.72	Q
62	ISV	Hodge, Neville	10.73	
63	CGO	Ndinga, Henri	10.74	
64	BRA	Bonfim, Jailto	10.75	
64	ZIM	Muyaba, Fabian	10.75	
66	GBR	Regis, John	10.76	
66	BUR	Pale, Harouna	10.76	
68	IVB	Hodge, Lindel	10.79	
69	BRN	Goma, Khalid	10.80	
69	POR	Cunha, Luis	10.80	
71	HKG	Leung, Wing Kwong	10.82	
72	KSA	Al Bishi, Mohamed	10.85	
73	THA	Watanasin, Visut	10.88	
74	SLE	Dove-Edwin, Horace	10.89	

Hommes 100m
Tour 1/23 Sept

Men 100m
Semi-final Heat 1/Sept. 24

Rank	Ctry	Name	Result	
Rang	Pays	Nom	Resultat	
1	USA	Lewis, Carl	9.97	Q
2	USA	Smith, Calvin	10.15	Q
3	JAM	Stewart, Raymond	10.18	Q
4	CAN	Williams, Desai	10.24	Q
5	BRA	Silva, Arnaldo	10.32	
6	NGR	Adeniken, Olapade	10.33	
7	INA	Mardi, Mardi	10.39	
8	GHA	Myles-Mills, John	10.43	

Hommes 100m
Demi-finale Serie 1/24 Sept

Men 100m
Semi-final Heat 2/Sept. 24

Rank	Ctry	Name	Result	
Rang	Pays	Nom	Resultat	
1	CAN	Johnson, Ben	10.03	Q
2	GBR	Christie, Linford	10.11	Q
3	USA	Mitchell, Dennis	10.23	Q
4	BRA	Silva, Robson	10.24	Q
5	HUN	Kovacs, Attila	10.31	
6	DOM	Nunez, Juan	10.35	
7	NGR	Adeyanju, Isiaq	10.60	
	URS	Krylov, Vladimir	NS	

Hommes 100m
Demi-finale Serie 2/24 Sept

Men 100m
Final/Sept. 24

Rank	Ctry	Name	Result	
Rang	Pays	Nom	Resultat	
1	USA	Lewis, Carl	9.92	NOR
2	GBR	Christie, Linford	9.97	
3	USA	Smith, Calvin	9.99	
4	USA	Mitchell, Dennis	10.04	
5	BRA	Silva, Robson	10.11	
6	CAN	Williams, Desai	10.11	
7	JAM	Stewart, Raymond	12.26	
	CAN	Johnson, Ben	DQ	

Hommes 100m
Finale/24 Sept

Athletics

Men 200m Round 1 Heat1/Sept. 26				Hommes 200m Tour 1 Serie 1/26 Sept			
Rank Rang	Ctry Pays	Name Nom	Result Resultat				
1	USA	Martin, Roy	20.65				
2	GBR	Rosswess, Michael	20.95				
3	BUR	Pale, Harouna	21.33				
4	CMR	Samuel-Kaya, Nchinda	21.45				
5	CGO	Ndinga, Henri	21.66				
6	ZIM	Muyaba, Fabian	21.66				
7	LIE	Buchel, Markus	22.02				
8	BAN	Md Shah Alam, Alam	22.52				

Men 200m Round 1 Heat 2/Sept. 26				Hommes 200m Tour 1 Serie 2/26 Sept			
Rank Rang	Ctry Pays	Name Nom	Result Resultat				
1	FRA	Queneherve, Gilles	20.55				
2	JPN	Yamauchi, Kenji	20.98				
3	NGR	Adeyanju, Isiaq	21.10				
4	KOR	Chang, Jae-Keun	21.27				
5	TPE	Lee, Shiunn-Long	21.53				
6	IRQ	Vousif, Owf.A.	21.88				
7	NGU	Tuna, Takale	21.95				
8	YMD	Saleh Mehdi, Sahim	22.95				

Men 200m Round 1 Heat 3/Sept. 26				Hommes 200m Tour 1 Serie 3/26 Sept			
Rank Rang	Ctry Pays	Name Nom	Result Resultat				
1	CAN	Mahorn, Atlee Anthony	20.55				
2	FRG	Lubke, Raif	20.81				
3	LBR	Daniels, Oliver	21.59				
4	HKG	Leung, Wing kwong	21.69				
5	UGA	Olweny, Sunday	21.79				
6	PAK	Afzal, Muhammad	21.89				
7	KSA	Al bishi, Mohamed	22.09				

Men 200m Round 1 Heat 4/Sept. 26				Hommes 200m Tour 1 Serie 4/26 Sept			
Rank Rang	Ctry Pays	Name Nom	Result Resultat				
1	GBR	Regis, John	20.90				
2	JAM	Wright, Clive	20.94				
3	SEN	Tamba, Ibrahima	21.68				
4	BEN	Alassane, Oussemi, Issa	21.74				
5	FIJ	Bole, Maloni	22.44				
6	HAI	Roumain, Claudeg.	22.60				
	LBR	Birch, Samuel	NS				

Men 200m Round 1 Heat 5/Sept. 26				Hommes 200m Tour 1 Serie 5/26 Sept			
Rank Rang	Ctry Pays	Name Nom	Result Resultat				
1	USA	Deloach, Joe	20.98				
2	AUS	Gamer, Mark	21.09				
3	PUR	Guilbe, Edgardo	21.09				
4	AUT	Berger, Andreas	21.29				
5	BAR	Atkins, Henriko	21.98				
6	GUI	Loua, Robert	22.78				
	KEN	Kipkemboi, Simon	NS				

Men 200m Round 1 Heat 6/Sept. 26				Hommes 200m Tour 1 Serie 6/26 Sept			
Rank Rang	Ctry Pays	Name Nom	Result Resultat				
1	KEN	Ondiek, Kennedy	20.79				
2	BER	Douglas, Troy	20.91				
3	HUN	Kovacs, Attila	20.98				
4	ITA	Mennea, Pietro	21.10				
5	IVB	Hodge, Lindel	21.78				
6	OMA	Al-Khalidi, Abdullah	21.82				
7	VIN	Francois, Andre	21.88				
8	MDV	Asif, Ismail	23.17				

Athlétisme

Men 200m Round 1 Heat 7/Sept. 26				Hommes 200m Tour 1 Serie 7/26 Sept			
Rank Rang	Ctry Pays	Name Nom	Result Resultat				
1	GBR	Christie, Linford	21.05				
2	FRA	Marie-Rose, Bruno	21.11				
3	CAN	Brown, Courtney	21.45				
4	POR	Cunha, Luis	21.72				
5	CHI	Moreno, Carlos	22.13				
6	MAW	Silweya, Odia	22.24				
7	TGA	Suli, Peauope	22.49				
	TOG	Lawson, Boeviyoulou	NS				

Men 200m Round 1 Heat 8/Sept. 26				Hommes 200m Tour 1 Serie 8/26 Sept			
Rank Rang	Ctry Pays	Name Nom	Result Resultat				
1	CAN	Enweani, Cyprian	20.65				
2	FRA	Sangouma, Daniel	20.70				
3	BEL	Stevens, Patrick	20.84				
4	FRG	Dobeleit, Norbert	20.86				
5	CHN	Li, Feng	21.33				
6	MLI	Diarra, Ousmane	21.55				
7	LBA	Ahmed, Abdalla	22.11				
8	VIE	Nguyen Dinh, Minh	22.65				

Men 200m Round 1 Heat 9/Sept. 26				Hommes 200m Tour 1 Serie 9/26 Sept			
Rank Rang	Ctry Pays	Name Nom	Result Resultat				
1	BRA	Silva, Robson	21.12				
2	POR	Barroso, Luis	21.31				
3	ISV	Flemming, Jimmy	21.33				
4	BUR	Yougbare, Alexandre	22.14				
5	GEQ	Envela mahua, Gustavo	22.33				
6	BOT	Kgarametso, Benny	22.79				
	ANG	Fernandes, Gaspar	DQ				

Men 200m Round 1 Heat 10/Sept. 26				Hommes 200m Tour 1 Serie 10/26 Sept			
Rank Rang	Ctry Pays	Name Nom	Result Resultat				
1	ITA	Tilli, Stefano	20.68				
2	USA	Lewis, Carl	20.72				
3	NGR	Adeniken, Olapade	20.77				
4	GHA	Myles-Mills, John	21.04				
5	ALG	Selmi, Mostefa-Kamel	21.24				
6	ANT	Lindsay, Howard	21.78				
7	VAN	Jeremiah, Jerry	22.01				

Men 200m Round 1/Sept. 26				Hommes 200m Tour 1/26 Sept			
Rank Rang	Ctry Pays	Name Nom	Result Resultat				
1	CAN	Mahorn, Atlee Anthony	20.55			Q	
1	FRA	Queneherve, Gilles	20.55			Q	
3	CAN	Enweani, Cyprian	20.65			Q	
3	USA	Martin, Roy	20.65			Q	
5	ITA	Tilli, Stefano	20.68			Q	
6	FRA	Sangouma, Daniel	20.70			Q	
7	USA	Lewis, Carl	20.72			Q	
8	NGR	Adeniken, Olapade	20.77			Q	
9	KEN	Ondiek, Kennedy	20.79			Q	
10	FRG	Lubke, Raif	20.81			Q	
11	BEL	Stevens, Patrick	20.84			Q	
12	FRG	Dobeleit, Norbert	20.86			q	
13	GBR	Regis, John	20.90			Q	
14	BER	Douglas, Troy	20.91			Q	
15	JAM	Wright, Clive	20.94			Q	
16	GBR	Rosswess, Michael	20.95			Q	
17	HUN	Kovacs, Attila	20.98			Q	
17	JPN	Yamauchi, Kenji	20.98			Q	
17	USA	Deloach, Joe	20.98			Q	
20	GHA	Myles-Mills, John	21.04			q	
21	GBR	Christie, Linford	21.05			Q	
22	AUS	Garner, Mark	21.09			Q	
22	PUR	Guilbe, Edgardo	21.09			Q	
24	ITA	Mennea, Pietro	21.10			q	
24	NGR	Adeyanju, Isiaq	21.10			Q	
26	FRA	Marie-Rose, Bruno	21.11			Q	
27	BRA	Silva, Robson	21.12			Q	
28	ALG	Selmi, Mostefa-Kamel	21.24			q	
29	KOR	Chang, Jae-Keun	21.27			q	
30	AUT	Berger, Andreas	21.29			q	



Rank Rang	Ctry Pays	Name Nom	Result Resultat	
31	POR	Barroso, Luis	21.31	Q
32	CHN	Li, Feng	21.33	Q
32	ISV	Flemming, Jimmy	21.33	Q
32	BUR	Pale, Harouna	21.33	Q
35	CAN	Brown, Courtney	21.45	Q
35	CMR	Samuel-Kaya, Nchinda	21.45	Q
37	TPE	Lee, Shiunn-Long	21.53	Q
38	MLI	Diarra, Ousmane	21.55	Q
39	LBR	Daniels, Oliver	21.59	Q
40	ZIM	Muyaba, Fabian	21.66	
40	CGO	Ndinga, Henri	21.66	
42	SEN	Tamba, Ibrahima	21.68	Q
43	HKG	Leung, Wing kwong	21.69	
44	POR	Cunha, Luis	21.72	
45	BEN	Alassane, Oussemi, Issa	21.74	
46	ANT	Lindsay, Howard	21.78	
46	IVB	Hodge, Lindel	21.78	
48	UGA	Olweny, Sunday	21.79	
49	OMA	Al-Lhalidi, Abdullah	21.82	
50	IRQ	Vousif, Owf.a.	21.88	
50	VIN	Francois, Andre	21.88	
52	PAK	Afzal, Muhammad	21.89	
53	NGU	Tuna, Takale	21.95	
54	BAR	Atkins, Henrik	21.98	
55	VAN	Jeremiah, Jerry	22.01	
56	LIE	Buchel, Markus	22.02	
57	KSA	Al Bishi, Mohamed	22.09	
58	LBA	Ahmed, Abdalla	22.11	
59	CHI	Moreno, Carlos	22.13	
60	BUR	Youbare, Alexandre	22.14	
61	MAW	Silweya, Odia	22.24	
62	GEQ	Envela Mahua, Gustavo	22.33	
63	FIJ	Bole, Maloni	22.44	
64	TGA	Suli, Peauope	22.49	
65	BAN	Md Shah Alam, Alam	22.52	
66	HAI	Roumain, Claudeg.	22.60	
67	VIE	Nguyen Dinh, Minh	22.65	
68	GUI	Loua, Robert	22.78	
69	BOT	Kgarametso, Benny	22.79	
70	YMD	Saleh Mehdi, Sahim	22.95	
71	MDV	Asif, Ismail	23.17	
	ANG	Fernandes, Gaspar	DQ	
	KEN	Kipkemboi, Simon	NS	
	TOG	Lawson, Boeviyoulou	NS	
	LBR	Birch, Samuel	NS	

Men 200m Round 2 Heat 1/Sept. 26 **Hommes 200m** Tour 2 Serie 1/26 Sept

Rank Rang	Ctry Pays	Name Nom	Result Resultat	
1	USA	Lewis, Carl	20.57	Q
2	GBR	Regis, John	20.61	Q
3	CAN	Enweani, Cyprian	20.62	Q
4	PUR	Guilbe, Edgardo	20.73	
5	JPN	Yamauchi, Kenji	20.94	
6	ISV	Flemming, Jimmy	21.23	
7	ALG	Selmi, Mostefa-Kamel	21.26	
8	MLI	Diarra, Ousmane	21.46	

Men 200m Round 2 Heat 2/Sept. 28 **Hommes 200m** Tour 2 Serie 2/28 Sept

Rank Rang	Ctry Pays	Name Nom	Result Resultat	
1	FRA	Marie-Rose, Bruno	20.48	Q
2	USA	Martin, Roy	20.54	Q
3	BER	Douglas, Troy	20.70	Q
4	KEN	Ondiek, Kennedy	20.79	
5	HUN	Kovacs, Attila	21.19	
6	TPE	Lee, Shiunn-Long	21.34	
7	BUR	Pale, Harouna	21.35	
	ITA	Mennea, Pietro	NS	

Men 200m Round 2 Heat 3/Sept. 26 **Hommes 200m** Tour 2 Serie 3/26 Sept

Rank Rang	Ctry Pays	Name Nom	Result Resultat	
1	GBR	Christie, Linford	20.49	Q
2	CAN	Mahorn, Atlee Anthony	20.59	Q
3	FRG	Lubke, Raif	20.80	Q
4	POR	Barroso, Luis	20.81	
5	BEL	Stevens, Patrick	20.94	
6	GHA	Myles-Mills, John	20.95	
7	AUT	Berger, Andreas	21.40	
8	SEN	Tamba, Ibrahima	21.93	

Men 200m Round 2 Heat 4/Sept. 26 **Hommes 200m** Tour 2 Serie 4/26 Sept

Rank Rang	Ctry Pays	Name Nom	Result Resultat	
1	USA	Deloach, Joe	20.56	Q
2	FRA	Queneherve, Gilles	20.77	Q
3	NGR	Adeniken, Olapade	20.92	Q
4	FRG	Dobeleit, Norbert	20.98	
5	AUS	Garner, Mark	21.08	
6	KOR	Chang, Jae-Keun	21.35	
7	CHN	Li, Feng	21.38	
8	LBR	Daniels, Oliver	22.25	

Men 200m Round 2 Heat 5/Sept. 26 **Hommes 200m** Tour 2 Serie 5/26 Sept

Rank Rang	Ctry Pays	Name Nom	Result Resultat	
1	BRA	Silva, Robson	20.41	Q
2	ITA	Tilli, Stefano	20.67	Q
3	GBR	Rosswess, Michael	20.74	Q
4	FRA	Sangouma, Daniel	20.81	
5	JAM	Wright, Clive	20.87	
6	NGR	Adeyanju, Isiaq	21.01	
7	CAN	Brown, Courtney	21.18	
8	CMR	Samuel-Kaya, Nchinda	21.39	

Men 200m Round 2/Sept. 26 **Hommes 200m** Tour 2/26 Sept

Rank Rang	Ctry Pays	Name Nom	Result Resultat	
1	BRA	Silva, Robson	20.41	Q
2	FRA	Marie-Rose, Bruno	20.48	Q
3	GBR	Christie, Linford	20.49	Q
4	USA	Martin, Roy	20.54	Q
5	USA	Deloach, Joe	20.56	Q
6	USA	Lewis, Carl	20.57	Q
7	CAN	Mahorn, Atlee Anthony	20.59	Q
8	GBR	Regis, John	20.61	Q
9	CAN	Enweani, Cyprian	20.62	Q
10	ITA	Tilli, Stefano	20.67	Q
11	BER	Douglas, Troy	20.70	Q
12	PUR	Guilbe, Edgardo	20.73	Q
13	GBR	Rosswess, Michael	20.74	Q
14	FRA	Queneherve, Gilles	20.77	Q
15	KEN	Ondiek, Kennedy	20.79	
16	FRG	Lubke, Raif	20.80	Q
17	FRA	Sangouma, Daniel	20.81	
17	POR	Barroso, Luis	20.81	
19	JAM	Wright, Clive	20.87	
20	NGR	Adeniken, Olapade	20.92	Q
21	BEL	Stevens, Patrick	20.94	
21	JPN	Yamauchi, Kenji	20.94	
23	GHA	Myles-Mills, John	20.95	
24	FRG	Dobeleit, Norbert	20.98	
25	NGR	Adeyanju, Isiaq	21.01	
26	AUS	Garner, Mark	21.08	
27	CAN	Brown, Courtney	21.18	
28	HUN	Kovacs, Attila	21.19	
29	ISV	Flemming, Jimmy	21.23	
30	ALG	Selmi, Mostefa-Kamel	21.26	
31	TPE	Lee, Shiunn-Long	21.34	
32	KOR	Chang, Jae-Keun	21.35	
32	BUR	Pale, Harouna	21.35	
34	CHN	Li, Feng	21.38	
35	CMR	Samuel-Kaya, Nchinda	21.39	
36	AUT	Berger, Andreas	21.40	
37	MLI	Diarra, Ousmane	21.46	
38	SEN	Tamba, Ibrahima	21.93	
39	LBR	Daniels, Oliver	22.25	
	ITA	Mennea, Pietro	NS	

Men 200m Semi-final Heat 1/Sept. 28 **Hommes 200m** Demi-finale Serie 1/28 Sept

Rank Rang	Ctry Pays	Name Nom	Result Resultat	
1	USA	Lewis, Carl	20.23	Q
2	BRA	Silva, Robson	20.28	Q
3	CAN	Mahorn, Atlee Anthony	20.43	Q
4	FRA	Queneherve, Gilles	20.54	Q
5	ITA	Tilli, Stefano	20.59	
6	USA	Martin, Roy	20.62	
7	GBR	Regis, John	20.69	
8	FRG	Lubke, Raif	21.23	

Athletics

Men 200m Semi-final Heat 2/Sept. 28				Hommes 200m Demi-finale Serie 2/28 Sept	
Rank Rang	Ctry Pays	Name Nom	Result Resultat		
1	USA	Deloach, Joe	20.06	Q	
2	GBR	Christie, Linford	20.33	Q	
3	FRA	Marie-Rose, Bruno	20.50	Q	
4	GBR	Rosswess, Michael	20.51	Q	
5	CAN	Enweani, Cyprian	20.57		
6	NGR	Adeniken, Olapade	20.67		
7	PUR	Guilbe, Edgardo	20.77		
8	BER	Douglas, Troy	20.84		

Men 200m Final/Sept. 28				Hommes 200m Finale/28 Sept	
Rank Rang	Ctry Pays	Name Nom	Result Resultat		
1	USA	Deloach, Joe	19.75	NOR	
2	USA	Lewis, Carl	19.79		
3	BRA	Silva, Robson	20.04		
4	GBR	Christie, Linford	20.09		
5	CAN	Mahorn, Atee Anthony	20.39		
6	FRA	Queneherve, Gilles	20.40		
7	GBR	Rosswess, Michael	20.51		
8	FRA	Marie-Rose, Bruno	20.58		

Men 400m Round 1 Heat 1/Sept. 24				Hommes 400m Tour 1 Serie 1/24 Sept	
Rank Rang	Ctry Pays	Name Nom	Result Resultat		
1	GBR	Bennett, Todd	46.37	Q	
2	AUS	Murphy, Miles	46.38	Q	
3	CAN	Skerritt, Anton	46.64	Q	
4	BAR	Louis, Richard	46.80		
5	SLE	Sandy, Felix	46.82		
6	GEQ	Envela Mahua, Gustavo	48.11		
7	FJI	Rodan, Joseph	48.69		
8	MAW	Silweya, Odia	49.73		

Men 400m Round 1 Heat 2/Sept. 24				Hommes 400m Tour 1 Serie 2/24 Sept	
Rank Rang	Ctry Pays	Name Nom	Result Resultat		
1	GBR	Whittle, Brian	46.07	Q	
2	ESP	Cornet, Cayetano	46.16	Q	
3	USA	Reynolds, Harry Butch	46.28	Q	
4	BAR	Straughn, Seibert	47.37		
5	POR	Lomba, Filipe	47.57		
6	CHA	Faudet, Ali	48.69		
7	VAN	Firiam, Patis	51.77		

Men 400m Round 1 Heat 3/Sept. 24				Hommes 400m Tour 1 Serie 3/24 Sept	
Rank Rang	Ctry Pays	Name Nom	Result Resultat		
1	OMA	Al-Malki, Mohamed Amer	46.79	Q	
2	KEN	Sang, Lucas	46.85	Q	
3	SEN	Diarra, Ousmane	46.86	Q	
4	ZAM	Kalembo, Douglas	47.44		
5	BAN	Md milzerhossain, Milzer	48.76		
6	TOG	Gnalo, Akossi	51.46		
	COK	Taramai, William	NS		
	BRA	Menezes, Sergio	AB		

Men 400m Round 1 Heat 4/Sept. 24				Hommes 400m Tour 1 Serie 4/24 Sept	
Rank Rang	Ctry Pays	Name Nom	Result Resultat		
1	TRI	Morris, Ian	45.84	Q	
2	GDR	Schoenlebe, Thomas	47.07	Q	
3	NGR	Uti, Sunday	47.08	Q	
4	TPE	Lin, Kuang-Liang	48.18		
5	CMR	Tche noubossie, Ernest	48.31		
6	KSA	Alqahtani, Hadi	48.53		
7	ZAM	Musonda, Enock	49.21		
8	MDV	Shageef, Ahmed	50.61		

Athlétisme

Men 400m Round 1 Heat 5/Sept. 24				Hommes 400m Tour 1 Serie 5/24 Sept	
Rank Rang	Ctry Pays	Name Nom	Result Resultat		
1	USA	Lewis, Steven	45.31	Q	
2	GDR	Carlowitz, Jens	45.64	Q	
3	CIV	Tiacoh, Gabriel	47.19	Q	
4	CGO	Bemou, Jean-Didace	48.46		
5	LBA	Ahmed, Abdalla	48.89		
6	ZAM	Chipalo, Jonathan	48.97		
7	LIB	Abbas, Maher	51.29		
8	BIZ	Usher, Carlton	51.42		

Men 400m Round 1 Heat 6/Sept. 24				Hommes 400m Tour 1 Serie 6/24 Sept	
Rank Rang	Ctry Pays	Name Nom	Result Resultat		
1	BRA	Souza, Gerson	45.90	Q	
2	JAM	Davis, Howard	45.97	Q	
3	NGU	Tuna, Takale	47.87	Q	
4	BOT	Maweni, Sunday	47.97		
5	OMA	Al-Habsi, Sulaiman	48.30		
6	MAL	Mohd Jadi, Nordin	49.52		
7	VIN	Williams, Michael	51.22		
	GBR	Redmond, Derek	NS		

Men 400m Round 1 Heat 7/Sept. 24				Hommes 400m Tour 1 Serie 7/24 Sept	
Rank Rang	Ctry Pays	Name Nom	Result Resultat		
1	AUS	Clark, Darren	45.93	Q	
2	KEN	Kipkemboi, Simon	46.15	Q	
3	BAR	Forde, Elvis	46.47	Q	
4	ZIM	Nkala, Elijah	46.60		
5	ESP	Sanchez, Antonio	47.18		
6	MOZ	Nharimue, Jaime	47.33		
7	IRQ	Vousif, Owf. A.	47.45		
8	ISV	Wynter, Desi	48.39		

Men 400m Round 1 Heat 8/Sept. 24				Hommes 400m Tour 1 Serie 8/24 Sept	
Rank Rang	Ctry Pays	Name Nom	Result Resultat		
1	JAM	Cameron, Bertland	46.24	Q	
2	AUS	Stone, Robert	46.52	Q	
3	GAM	Jallow, Dawda	46.91	Q	
4	KOR	Yoon, Nam-Han	47.02		
5	UGA	Goville, John	47.11		
6	PAK	Fiaz, Muhammad	47.13		
7	MLI	Seyba, Yaya	48.83		
8	ANT	Browne, Alfred	48.92		

Men 400m Round 1 Heat 9/Sept. 24				Hommes 400m Tour 1 Serie 9/24 Sept	
Rank Rang	Ctry Pays	Name Nom	Result Resultat		
1	USA	Everett, Danny	45.63	Q	
2	JAM	Morris, Devon	45.95	Q	
3	POL	Jedrusik, Tomasz	46.12	Q	
4	TRI	Delice, Patrick	46.14		
5	YUG	Brankovic, Slobodan	46.59		
6	HON	Ponce, Jorge Fidel	51.11		
	ANG	Neto, Luis	NS		
	ZAI	Kasongo, Mwana Bute	DQ		

Men 400m Round 1 Heat 10/Sept. 24				Hommes 400m Tour 1 Serie 10/24 Sept	
Rank Rang	Ctry Pays	Name Nom	Result Resultat		
1	JPN	Takano, Susumu	45.42	Q	
2	BER	Douglas, Troy	45.69	Q	
3	NGR	Egbunike, Innocent	46.02	Q	
4	KEN	Nyang'au, Elkana	46.25		
5	YUG	Macev, Ismail	46.37		
6	INA	Wattebosi, Elieser	47.10		
7	IVB	Todman, Willis	50.11		
	PAR	Mendez, Porfirio	NS		



Men 400m Round 1/Sept. 24				Hommes 400m Tour 1/24 Sept	
Rank Rang	Ctry Pays	Name Nom	Result Resultat		
1	USA	Lewis, Steven	45.31	Q	
2	JPN	Takano, Susumu	45.42	Q	
3	USA	Everett, Danny	45.63	Q	
4	GDR	Carlowitz, Jens	45.64	Q	
5	BER	Douglas, Troy	45.69	Q	
6	TRI	Morris, Ian	45.84	Q	
7	BRA	Souza, Gerson	45.90	Q	
8	AUS	Clark, Darren	45.93	Q	
9	JAM	Morris, Devon	45.95	Q	
10	JAM	Davis, Howard	45.97	Q	
11	NGR	Egbunike, Innocent	46.02	Q	
12	GBR	Whittle, Brian	46.07	Q	
13	POL	Jedrusik, Tomasz	46.12	Q	
14	TRI	Delice, Patrick	46.14	Q	
15	KEN	Kipkemboi, Simon	46.15	Q	
16	ESP	Cornet, Cayetano	46.16	Q	
17	JAM	Cameron, Bertland	46.24	Q	
18	KEN	Nyang'au, Elkana	46.25	Q	
19	USA	Reynolds, Harry Butch	46.28	Q	
20	GBR	Bennett, Todd	46.37	Q	
20	YUG	Macev, Ismail	46.37		
22	AUS	Murphy, Miles	46.38	Q	
23	BAR	Forde, Elvis	46.47	Q	
24	AUS	Stone, Robert	46.52	Q	
25	YUG	Brankovic, Slobodan	46.59		
26	ZIM	Nkala, Elijah	46.60		
27	CAN	Skerritt, Anton	46.64	Q	
28	OMA	Al-Malki, Mohamed Amer	46.79	Q	
29	BAR	Louis, Richard	46.80		
30	SLE	Sandy, Felix	46.82		
31	KEN	Sang, Lucas	46.85	Q	
32	SEN	Diarra, Ousmane	46.86	Q	
33	GAM	Jallow, Dawda	46.91	Q	
34	KOR	Yoon, Nam-Han	47.02		
35	GDR	Schoenlebe, Thomas	47.07	Q	
36	NGR	Uti, Sunday	47.08	Q	
37	INA	Wattebosi, Elieser	47.10		
38	UGA	Goville, John	47.11		
39	PAK	Fiaz, Muhammad	47.13		
40	ESP	Sanchez, Antonio	47.18		
41	CIV	Tiacoh, Gabriel	47.19	Q	
42	MOZ	Nharimue, Jaime	47.33		
43	BAR	Straughn, Seibert	47.37		
44	ZAM	Kalembo, Douglas	47.44		
45	IRQ	Vousif, Owf.a.	47.45		
46	POR	Lomba, Filipe	47.57		
47	NGU	Tuna, Takale	47.87	Q	
48	BOT	Maweni, Sunday	47.97		
49	GEQ	Envela mahua, Gustavo	48.11		
50	TPE	Lin, Kuang-Liang	48.18		
51	OMA	Al-Habsi, Sulaiman	48.30		
52	CMR	Tche noubossie, Ernest	48.31		
53	ISV	Wynter, Desi	48.39		
54	CGO	Bemou, Jean-Didace	48.46		
55	KSA	Alqahtani, Hadi	48.53		
56	CHA	Faudet, Ali	48.69		
56	FIJ	Rodan, Joseph	48.69		
58	BAN	Md milzerhossain, Milzer	48.76		
59	MLI	Seyba, Yaya	48.83		
60	LBA	Ahmed, Abdalla	48.89		
61	ANT	Browne, Alfred	48.92		
62	ZAM	Chipalo, Jonathan	48.97		
63	ZAM	Musonda, Enock	49.21		
64	MAL	Mohd jadi, Nordin	49.52		
65	MAW	Silweya, Odia	49.73		
66	IVB	Todman, Willis	50.11		
67	MDV	Shageef, Ahmed	50.61		
68	HON	Ponce, Jorge fidel	51.11		
69	VIN	Williams, Michael	51.22		
70	LIB	Abbas, Maher	51.29		
71	BIZ	Usher, Carlton	51.42		
72	TOG	Gnalo, Akossi	51.46		
73	VAN	Firiam, Patis	51.77		
	BRA	Menezes, Sergio	AB		
	ZAI	Kasongo, Mwana Bute	DQ		
	ANG	Neto, Luis	NS		
	COK	Taramai, William	NS		
	GBR	Redmond, Derek	NS		
	PAR	Mendez, Porfirio	NS		

Men 400m Round 2 Heat 1/Sept. 25				Hommes 400m Tour 2 Serie 1/25 Sept	
Rank Rang	Ctry Pays	Name Nom	Result Resultat		
1	TRI	Morris, Ian	44.70	Q	
2	GDR	Carlowitz, Jens	45.09	Q	
3	GBR	Whittle, Brian	45.22	Q	
4	POL	Jedrusik, Tomasz	45.27	Q	
5	NGR	Uti, Sunday	45.33		
6	AUS	Murphy, Miles	45.93		
7	GAM	Jallow, Dawda	46.35		
8	BAR	Forde, Elvis	46.59		

Men 400m Round 2 Heat 2/Sept. 25				Hommes 400m Tour 2 Serie 2/25 Sept	
Rank Rang	Ctry Pays	Name Nom	Result Resultat		
1	USA	Everett, Danny	44.83	Q	
2	NGR	Egbunike, Innocent	45.02	Q	
3	GDR	Schoenlebe, Thomas	45.09	Q	
4	JAM	Cameron, Bertland	45.16	Q	
5	KEN	Kipkemboi, Simon	45.44		
6	GBR	Bennett, Todd	45.96		
7	SEN	Diarra, Ousmane	46.23		
8	BER	Douglas, Troy	46.28		

Men 400m Round 2 Heat 3/Sept. 25				Hommes 400m Tour 2 Serie 3/25 Sept	
Rank Rang	Ctry Pays	Name Nom	Result Resultat		
1	USA	Lewis, Steven	44.41	Q	
2	AUS	Clark, Darren	44.96	Q	
3	OMA	Al-Malki, Mohamed Amer	45.02	Q	
4	JAM	Morris, Devon	45.30	Q	
5	ESP	Cornet, Cayetano	45.39		
6	CAN	Skerritt, Anton	46.08		
7	KEN	Nyang'au, Elkana	46.09		
8	NGU	Tuna, Takale	47.48		

Men 400m Round 2 Heat 4/Sept. 25				Hommes 400m Tour 2 Serie 4/25 Sept	
Rank Rang	Ctry Pays	Name Nom	Result Resultat		
1	USA	Reynolds, Harry Butch	44.46	Q	
2	JPN	Takano, Susumu	45.00	Q	
3	BRA	Souza, Gerson	45.35	Q	
4	JAM	Davis, Howard	45.40	Q	
5	CIV	Tiacoh, Gabriel	45.49		
6	KEN	Sang, Lucas	45.72		
7	TRI	Delice, Patrick	45.75		
8	AUS	Stone, Robert	46.04		

Men 400m Round 2/Sept. 25				Hommes 400m Tour 2/25 Sept	
Rank Rang	Ctry Pays	Name Nom	Result Resultat		
1	USA	Lewis, Steven	44.41	Q	
2	USA	Reynolds, Harry Butch	44.46	Q	
3	TRI	Morris, Ian	44.70	Q	
4	USA	Everett, Danny	44.83	Q	
5	AUS	Clark, Darren	44.96	Q	
6	JPN	Takano, Susumu	45.00	Q	
7	NGR	Egbunike, Innocent	45.02	Q	
7	OMA	Al-Malki, Mohamed Amer	45.02	Q	
9	GDR	Carlowitz, Jens	45.09	Q	
9	GDR	Schoenlebe, Thomas	45.09	Q	
11	JAM	Cameron, Bertland	45.16	Q	
12	GBR	Whittle, Brian	45.22	Q	
13	POL	Jedrusik, Tomasz	45.27	Q	
14	JAM	Morris, Devon	45.30	Q	
15	NGR	Uti, Sunday	45.33		
16	BRA	Souza, Gerson	45.35	Q	
17	ESP	Cornet, Cayetano	45.39		
18	JAM	Davis, Howard	45.40	Q	
19	KEN	Kipkemboi, Simon	45.44		
20	CIV	Tiacoh, Gabriel	45.49		
21	KEN	Sang, Lucas	45.72		
22	TRI	Delice, Patrick	45.75		
23	AUS	Murphy, Miles	45.93		
24	GBR	Bennett, Todd	45.96		
25	AUS	Stone, Robert	46.04		
26	CAN	Skerritt, Anton	46.08		
27	KEN	Nyang'au, Elkana	46.09		
28	SEN	Diarra, Ousmane	46.23		
29	BER	Douglas, Troy	46.28		

Athletics

Rank	Ctry	Name	Result
Rang	Pays	Nom	Resultat
30	GAM	Jallow, Dawda	46.35
31	BAR	Forde, Elvis	46.59
32	NGU	Tuna, Takale	47.48

Men 400m				Hommes 400m			
Semi-final Heat 1/Sept. 26				Demi-finale Serie 1/26 Sept			
Rank	Ctry	Name	Result				
Rang	Pays	Nom	Resultat				

1	USA	Lewis, Steven	44.35	Q
2	USA	Everett, Danny	44.36	Q
3	AUS	Clark, Darren	44.38	Q
4	JAM	Cameron, Bertland	44.50	Q
5	JPN	Takano, Susumu	44.90	
6	GDR	Carlowitz, Jens	45.08	
7	BRA	Souza, Gerson	45.27	
8	POL	Jedrusik, Tomasz	46.17	

Men 400m				Hommes 400m			
Semi-final Heat 2/Sept. 26				Demi-finale Serie 2/26 Sept			
Rank	Ctry	Name	Result				
Rang	Pays	Nom	Resultat				

1	USA	Reynolds, Harry Butch	44.33	Q
2	TRI	Morris, Ian	44.60	Q
3	OMA	Al-Malki, Mohamed Amer	44.69	Q
4	NGR	Egbunike, Innocent	44.74	Q
5	GDR	Schoenlebe, Thomas	44.90	
6	JAM	Davis, Howard	45.48	
7	JAM	Morris, Devon	45.68	
8	GBR	Whittle, Brian	46.07	

Men 400m				Hommes 400m			
Final/Sept. 28				Finale/26 Sept			
Rank	Ctry	Name	Result				
Rang	Pays	Nom	Resultat				

1	USA	Lewis, Steven	43.87	
2	USA	Reynolds, Harry Butch	43.93	
3	USA	Everett, Danny	44.09	
4	AUS	Clark, Darren	44.55	
5	NGR	Egbunike, Innocent	44.72	
6	JAM	Cameron, Bertland	44.94	
7	TRI	Morris, Ian	44.95	
8	OMA	Al-Malki, Mohamed Amer	45.03	

Men 800m				Hommes 800m			
Round 1 Heat 1/Sept. 23				Tour 1 Serie 1/23 Sept			
Rank	Ctry	Name	Result				
Rang	Pays	Nom	Resultat				

1	MAR	Lahbi, Faouzi	1:47.82	Q
2	KEN	Kiprotich, Nixon	1:48.68	Q
3	POL	Ostrowski, Ryszard	1:49.04	Q
4	SEN	Fall, Moussa	1:49.14	
5	CYP	Spyrou, Spyros	1:49.84	
6	PAR	Mendez, Porfirio	1:50.72	
7	OMA	Al-Bulushi, Mansoor	1:51.03	
8	CHA	Moli, Yesky	1:57.97	

Men 800m				Hommes 800m			
Round 1 Heat 2/Sept. 23				Tour 1 Serie 2/23 Sept			
Rank	Ctry	Name	Result				
Rang	Pays	Nom	Resultat				

1	SEN	Niang, Babacar	1:47.65	Q
2	GBR	Cram, Steve	1:47.77	Q
3	ITA	Sabia, Donato	1:47.84	Q
4	OAT	Yousuf, Esmael	1:48.20	
5	KOR	Ryu, Tae-Keong	1:48.61	
6	VIN	Linley, Eversley	1:51.71	
7	FIJ	Muavesi, Lui	1:54.48	
	KSA	Alqahtani, Hadi	DQ	

Athlétisme

Men 800m				Hommes 800m			
Round 1 Heat 3/Sept. 23				Tour 1 Serie 3/23 Sept			
Rank	Ctry	Name	Result				
Rang	Pays	Nom	Resultat				

1	USA	Gray, Johnny	1:48.83	Q
2	FIN	Suhonen, Ari	1:48.90	Q
3	SOM	Omar, Ibrahim Okash	1:48.97	Q
4	POR	Abrantes, Antonio	1:49.01	
5	MEX	Hernandez, Mauricio	1:49.03	
6	MAW	Dzekedzeke, Kenneth	1:50.60	
7	TPE	Lin, Kuang-Liang	1:52.95	

Men 800m				Hommes 800m			
Round 1 Heat 4/Sept. 23				Tour 1 Serie 4/23 Sept			
Rank	Ctry	Name	Result				
Rang	Pays	Nom	Resultat				

1	URS	Graudyn, Vladimir	1:48.90	Q
2	CHI	Squella, Pablo	1:48.99	Q
3	POR	Silva, Alvaro	1:49.09	Q
4	USA	Everett, Mark	1:49.86	
5	BER	Watson, Michael	1:50.16	
6	PAK	Meesaq Rizvi, Syed	1:51.58	
7	SMR	Molinari, Manlio	1:52.35	
8	NGU	Siguria, Johnd	1:56.12	

Men 800m				Hommes 800m			
Round 1 Heat 5/Sept. 23				Tour 1 Serie 5/23 Sept			
Rank	Ctry	Name	Result				
Rang	Pays	Nom	Resultat				

1	MAR	Aouita, Said	1:49.67	Q
2	CAN	Hoogewerf, Simon	1:49.76	Q
3	SEN	Boye, Cheikh H T	1:49.89	Q
4	USA	Baskin, Tracy	1:50.38	
5	NGR	Maude, Ado	1:50.48	
6	RWA	Ndagijimana, Eulucane	1:52.08	
7	LIB	Abbas, Maher	1:53.76	
8	SLE	Sawyer, David	1:57.88	

Men 800m				Hommes 800m			
Round 1 Heat 6/Sept. 23				Tour 1 Serie 6/23 Sept			
Rank	Ctry	Name	Result				
Rang	Pays	Nom	Resultat				

1	FRG	Braun, Peter	1:47.32	Q
2	HOL	Druppers, Rob	1:47.48	Q
3	ITA	Viali, Tonino	1:47.74	Q
4	BOT	Gaseitsiwe, Kebapetse	1:48.08	
5	BRA	Guimaraes, Agberto	1:48.49	
6	YAR	Abdul Wahab, Fahmi Ahmed	1:55.24	
7	GAM	N'jie, Momodov Bello	1:55.57	
8	LBR	Twegbe, Nimely	1:58.43	

Men 800m				Hommes 800m			
Round 1 Heat 7/Sept. 23				Tour 1 Serie 7/23 Sept			
Rank	Ctry	Name	Result				
Rang	Pays	Nom	Resultat				

1	GBR	Elliott, Peter	1:46.83	Q
2	HOL	Van Helden, Robin	1:46.99	Q
3	KEN	Ndiwa, Juma	1:47.11	Q
4	ESP	Teresa, Tomas	1:47.32	
5	ALG	Belkessam, Ahmed	1:47.96	
6	CHN	Duan, Xiuquan	1:52.17	
	SUR	Asinga, Tommy	DQ	
	ZAI	Makok, Kazanga	DQ	

Men 800m				Hommes 800m			
Round 1 Heat 8/Sept. 23				Tour 1 Serie 8/23 Sept			
Rank	Ctry	Name	Result				
Rang	Pays	Nom	Resultat				

1	KEN	Ereng, Paul	1:46.14	Q
2	BRA	Barbosa, Jose	1:46.32	Q
3	YUG	Popovic, Slobodan	1:46.49	Q
4	ESP	Trabado, Coloman	1:46.76	
5	CAN	Osland, Paul	1:47.16	
6	BAN	Md Milzerhossain, Milzer	1:51.16	
7	AND	Graells, Josep	1:53.34	



Men 800m Round 1 Heat 9/Sept. 23				Hommes 800m Tour 1 Serie 9/23 Sept	
Rank Rang	Ctry Pays	Name Nom	Result Resultat		
1	BRA	Cruz, Joaquim	1:47.16	Q	
2	GBR	Mckean, Tom	1:47.24	Q	
3	ZIM	Homela, Melford	1:47.36	Q	
4	ALG	Abdenouz, Reda	1:47.67		
5	ANT	Jones, Dale	1:49.31		
6	ANG	N'tyamba, Joao	1:53.23		
7	GUY	Barr, Oslen	1:55.95		
8	COK	Taramai, William	1:58.80		

Men 800m Round 2 Heat 1/Sept. 24				Hommes 800m Tour 2 Serie 1/24 Sept	
Rank Rang	Ctry Pays	Name Nom	Result Resultat		
1	BRA	Cruz, Joaquim	1:46.10	Q	
2	KEN	Ereng, Paul	1:46.38	Q	
3	SEN	Boye, Cheikh H T	1:46.62	Q	
4	ALG	Abdenouz, Reda	1:46.97	Q	
5	URS	Graudyn, Vladimir	1:47.07		
6	CAN	Osland, Paul	1:48.02		
7	ITA	Viali, Tonino	1:50.85		
	FIN	Suhonen, Ari	AB		

Men 800m Round 1/Sept. 23				Hommes 800m Tour 1/23 Sept	
Rank Rang	Ctry Pays	Name Nom	Result Resultat		
1	KEN	Ereng, Paul	1:46.14	Q	
2	BRA	Barbosa, Jose	1:46.32	Q	
3	YUG	Popovic, Slobodan	1:46.49	Q	
4	ESP	Trabado, Coloman	1:46.76	Q	
5	GBR	Elliott, Peter	1:46.83	Q	
6	HOL	Van helden, Robin	1:46.99	Q	
7	KEN	Ndiwa, Juma	1:47.11	Q	
8	BRA	Cruz, Joaquim	1:47.16	Q	
8	CAN	Osland, Paul	1:47.16	Q	
10	GBR	Mckean, Tom	1:47.24	Q	
11	ESP	Teresa, Tomas	1:47.32	Q	
11	FRG	Braun, Peter	1:47.32	Q	
13	ZIM	Homela, Melford	1:47.36	Q	
14	HOL	Druppers, Rob	1:47.48	Q	
15	SEN	Niang, Babacar	1:47.65	Q	
16	ALG	Abdenouz, Reda	1:47.67	Q	
17	ITA	Viali, Tonino	1:47.74	Q	
18	GBR	Cram, Steve	1:47.77	Q	
19	MAR	Lahbi, Faouzi	1:47.82	Q	
20	ITA	Sabia, Donato	1:47.84	Q	
21	ALG	Belkessam, Ahmed	1:47.96	Q	
22	BOT	Gaseitsiwe, Kebapetse	1:48.08		
23	QAT	Yousuf, Esmael	1:48.20		
24	BRA	Guimaraes, Agberto	1:48.49		
25	KOR	Ryu, Tae-Keong	1:48.61		
26	KEN	Kiprotich, Nixon	1:48.68	Q	
27	USA	Gray, Johnny	1:48.83	Q	
28	FIN	Suhonen, Ari	1:48.90	Q	
28	URS	Graudyn, Vladimir	1:48.90	Q	
30	SOM	Omar, Ibrahim Okash	1:48.97	Q	
31	CHI	Squella, Pablo	1:48.99	Q	
32	POR	Abrantes, Antonio	1:49.01		
33	MEX	Hernandez, Mauricio	1:49.03		
34	POL	Ostrowski, Ryszard	1:49.04	Q	
35	POR	Silva, Alvaro	1:49.09	Q	
36	SEN	Fall, Moussa	1:49.14		
37	ANT	Jones, Dale	1:49.31		
38	MAR	Aouita, Said	1:49.67	Q	
39	CAN	Hoogewerf, Simon	1:49.76	Q	
40	CYP	Spyrou, Spyros	1:49.84		
41	USA	Everett, Mark	1:49.86		
42	SEN	Boye, Cheikh H T	1:49.89	Q	
43	BER	Watson, Michael	1:50.16		
44	USA	Baskin, Tracy	1:50.38		
45	NGR	Maude, Ado	1:50.48		
46	MAW	Dzekedzeke, Kenneth	1:50.60		
47	PAR	Mendez, Porfirio	1:50.72		
48	OMA	Al-Bulushi, Mansoor	1:51.03		
49	BAN	Md Milzerhossain, Milizer	1:51.16		
50	PAK	Meesaq Rizvi, Syed	1:51.58		
51	VIN	Linley, Eversley	1:51.71		
52	RWA	Ndagijimana, Eulucane	1:52.08		
53	CHN	Duan, Xiuquan	1:52.17		
54	SMR	Molinari, Manlio	1:52.35		
55	TPE	Lin, Kuang-Liang	1:52.95		
56	ANG	N'tyamba, Joao	1:53.23		
57	AND	Graells, Josep	1:53.34		
58	LIB	Abbas, Maher	1:53.76		
59	FIJ	Muavesi, Lui	1:54.48		
60	YAR	Saleh, Awad	1:55.24		
61	GAM	N'jie, Momodov Bello	1:55.57		
62	GUY	Barr, Oslen	1:55.95		
63	NGU	Siguria, Johnd	1:56.12		
64	SLE	Sawyer, David	1:57.88		
65	CHA	Moli, Yesky	1:57.97		
66	LBR	Twegbe, Nimely	1:58.43		
67	COK	Taramai, William	1:58.80		
	KSA	Alqahtani, Hadi	DQ		
	SUR	Asinga, Tommy	DQ		
	ZAI	Makok, Kazanga	DQ		

Men 800m Round 2 Heat 2/Sept. 24				Hommes 800m Tour 2 Serie 2/24 Sept	
Rank Rang	Ctry Pays	Name Nom	Result Resultat		
1	USA	Gray, Johnny	1:45.96	Q	
2	CAN	Hoogewerf, Simon	1:45.99	Q	
3	BRA	Barbosa, Jose	1:46.20	Q	
4	GBR	Mckean, Tom	1:46.40	Q	
5	SOM	Omar, Ibrahim Okash	1:46.55		
6	HOL	Druppers, Rob	1:46.91		
7	KEN	Ndiwa, Juma	1:47.27		
8	MAR	Lahbi, Faouzi	1:47.32		

Men 800m Round 2 Heat 3/Sept. 24				Hommes 800m Tour 2 Serie 3/24 Sept	
Rank Rang	Ctry Pays	Name Nom	Result Resultat		
1	MAR	Aouita, Said	1:45.24	Q	
2	YUG	Popovic, Slobodan	1:45.30	Q	
3	SEN	Niang, Babacar	1:45.38	Q	
4	KEN	Kiprotich, Nixon	1:45.68	Q	
5	CHI	Squella, Pablo	1:46.45		
6	GBR	Cram, Steve	1:46.47		
7	HOL	Van helden, Robin	1:46.61		
8	ESP	Teresa, Tomas	1:48.01		

Men 800m Round 2 Heat 4/Sept. 24				Hommes 800m Tour 2 Serie 4/24 Sept	
Rank Rang	Ctry Pays	Name Nom	Result Resultat		
1	ITA	Sabia, Donato	1:46.58	Q	
2	GBR	Elliott, Peter	1:46.61	Q	
3	POR	Silva, Alvaro	1:46.65	Q	
4	FRG	Braun, Peter	1:46.86	Q	
5	ALG	Belkessam, Ahmed	1:46.93		
6	POL	Ostrowski, Ryszard	1:47.72		
7	ESP	Trabado, Coloman	1:48.12		
8	ZIM	Homela, Melford	1:49.62		

Men 800m Round 2/Sept. 24				Hommes 800m Tour 2/24 Sept	
Rank Rang	Ctry Pays	Name Nom	Result Resultat		
1	MAR	Aouita, Said	1:45.24	Q	
2	YUG	Popovic, Slobodan	1:45.30	Q	
3	SEN	Niang, Babacar	1:45.38	Q	
4	KEN	Kiprotich, Nixon	1:45.68	Q	
5	USA	Gray, Johnny	1:45.96	Q	
6	CAN	Hoogewerf, Simon	1:45.99	Q	
7	BRA	Cruz, Joaquim	1:46.10	Q	
8	BRA	Barbosa, Jose	1:46.20	Q	
9	KEN	Ereng, Paul	1:46.38	Q	
10	GBR	Mckean, Tom	1:46.40	Q	
11	CHI	Squella, Pablo	1:46.45		
12	GBR	Cram, Steve	1:46.47		
13	SOM	Omar, Ibrahim Okash	1:46.55		
14	ITA	Sabia, Donato	1:46.58	Q	
15	GBR	Elliott, Peter	1:46.61	Q	
15	HOL	Van helden, Robin	1:46.61		
17	SEN	Boye, Cheikh H T	1:46.62	Q	

Athletics

Rank Rang	Ctry Pays	Name Nom	Result Resultat	
18	POR	Silva, Alvaro	1:46.65	Q
19	FRG	Braun, Peter	1:46.86	Q
20	HOL	Druppers, Rob	1:46.91	
21	ALG	Belkessam, Ahmed	1:46.93	
22	ALG	Abdenouz, Reda	1:46.97	Q
23	URS	Graudyn, Vladimir	1:47.07	
24	KEN	Ndiwa, Juma	1:47.27	
25	MAR	Lahbi, Faouzi	1:47.32	
26	POL	Ostrowski, Ryszard	1:47.72	
27	ESP	Teresa, Tomas	1:48.01	
28	CAN	Osland, Paul	1:48.02	
29	ESP	Trabado, Coloman	1:48.12	
30	ZIM	Homela, Melford	1:49.62	
31	ITA	Viali, Tonino	1:50.85	
	FIN	Suhonen, Ari	AB	

Men 800m Semi-final Heat 1/Sept. 25				Hommes 800m Demi-finale Serie 1/25 Sept			
Rank Rang	Ctry Pays	Name Nom	Result Resultat				
1	KEN	Ereng, Paul	1:44.55	Q			
2	BRA	Cruz, Joaquim	1:44.75	Q			
3	ITA	Sabia, Donato	1:44.90	Q			
4	GBR	Elliott, Peter	1:44.94	Q			
5	SEN	Niang, Babacar	1:45.09				
6	YUG	Popovic, Slobodan	1:45.11				
7	CAN	Hoogewerf, Simon	1:47.30				
8	FRG	Braun, Peter	1:47.43				

Men 800m Semi-final Heat 2/Sept. 25				Hommes 800m Demi-finale Serie 2/25 Sept			
Rank Rang	Ctry Pays	Name Nom	Result Resultat				
1	KEN	Kiprotich, Nixon	1:44.71	Q			
2	MAR	Aouita, Said	1:44.79	Q			
3	BRA	Barbosa, Jose	1:44.99	Q			
4	USA	Gray, Johnny	1:45.04	Q			
5	POR	Silva, Alvaro	1:45.12				
6	SEN	Boye, Cheikh H T	1:45.93				
7	ALG	Abdenouz, Reda	1:45.95				
8	SOM	Omar, Ibrahim Okash	1:46.62				

Men 800m Final/Sept. 26				Hommes 800m Finale/26 Sept			
Rank Rang	Ctry Pays	Name Nom	Result Resultat				
1	KEN	Ereng, Paul	1:43.45				
2	BRA	Cruz, Joaquim	1:43.90				
3	MAR	Aouita, Said	1:44.06				
4	GBR	Elliott, Peter	1:44.12				
5	USA	Gray, Johnny	1:44.80				
6	BRA	Barbosa, Jose	1:46.39				
7	ITA	Sabia, Donato	1:48.03				
8	KEN	Kiprotich, Nixon	1:49.55				

Men 1500m Round 1 Heat 1/Sept. 29				Hommes 1500m Tour 1 Serie 1/29 Sept			
Rank Rang	Ctry Pays	Name Nom	Result Resultat	400m	800m	1200m	1500m
1	GBR	Cram, Steve	3:40.89	1:01.00	2:02.00	3:02.00	3:40.89
2	USA	Scott, Steve	3:41.57	1:02.00	2:03.00	3:02.00	3:41.57
3	FRA	Geoffroy, Remi	3:41.68	1:02.00	2:02.00	3:02.00	3:41.68
4	KEN	Cheshire, Joseph	3:41.72	1:03.00	2:03.00	3:02.00	3:41.72
5	ITA	Di Napoli, Gennaro	3:41.85	1:02.00	2:02.00	3:02.00	3:41.85
6	IRL	O'sullivan, Marcus	3:42.01	1:03.00	2:02.00	3:02.00	3:42.01
7	FIN	Suhonen, Ari	3:43.61	1:03.00	2:03.00	3:02.00	3:43.61
8	BRA	Barbosa, Jose	3:44.46	1:03.00	2:03.00	3:02.00	3:44.46
9	YUG	Zorko, Branko	3:45.52	1:01.00	2:02.00	3:02.00	3:45.52
10	BEF	Watson, Michael	3:46.49	1:03.00	2:02.00	3:02.00	3:46.49
11	ZIM	Homela, Melford	3:47.38	1:04.00	2:03.00	3:06.00	3:47.38
12	DJI	Yaye Aden, Hoche	3:51.56	1:03.00	2:03.00	3:00.00	3:51.56
13	ANG	Katombi, Eugenio	3:54.25	1:04.00	2:04.00	3:10.00	3:54.25
14	SLE	Jonah, Modupe-D.A.	3:55.15	1:02.00	2:03.00	3:08.00	3:55.15
15	MTN	Ould Khayar, Mohamed EL M	4:12.18	1:04.00	2:08.00	3:28.00	4:12.18

Athlétisme

Men 1500m Round 1 Heat 2/Sept. 29				Hommes 1500m Tour 1 Serie 2/29 Sept			
Rank Rang	Ctry Pays	Name Nom	Result Resultat	400m	800m	1200m	1500m
1	KEN	Cheruiyot, Kipkoech	3:39.98	1:03.68	2:06.19	3:01.30	3:39.98
2	USA	Deady, Mark	3:41.91	1:03.10	2:05.35	3:02.19	3:41.91
3	DEN	Guldberg, Mogens D	3:42.01	1:02.88	2:05.21	3:01.71	3:42.01
4	MAR	Aouita, Said	3:42.18	1:03.90	2:06.03	3:02.86	3:42.18
5	POR	Silva, Mario	3:42.24	1:03.25	2:05.74	3:03.17	3:42.24
6	SUI	Rapp, Markus	3:42.64	1:03.05	2:05.45	3:02.62	3:42.64
7	CAN	Campbell, David	3:42.97	1:03.29	2:05.59	3:03.02	3:42.97
8	QAT	Sulinan, Mohd	3:44.43	1:03.52	2:05.09	3:02.99	3:44.43
9	CHN	Duan, Xiuquan	3:44.88	1:03.49	2:05.89	3:03.62	3:44.88
10	AUS	Scammell, Patrick	3:45.21	1:02.91	2:05.31	3:02.40	3:45.21
11	SOM	Aden, Jama Mohamud	3:49.84	1:03.68	2:05.43	3:02.62	3:49.84
12	PAR	Lopez, Ramon	3:53.31	1:03.36	2:06.51	3:08.20	3:53.31
13	MAW	Dzekedzeke, Kenneth	4:02.61	1:04.18	2:06.72	3:06.37	4:02.61
14	GEQ	Elonga molico, Bernardo	4:16.40	1:04.15	2:08.58	3:18.94	4:16.40
	LBR	Twegbe, Nimely	NS				

Men 1500m Round 1 Heat 3/Sept. 29				Hommes 1500m Tour 1 Serie 3/29 Sept			
Rank Rang	Ctry Pays	Name Nom	Result Resultat	400m	800m	1200m	1500m
1	KEN	Rono, Peter	3:37.65	59.05	1:58.82	2:55.90	3:37.65
2	USA	Atkinson, Jeff	3:38.33	59.77	1:59.82	2:56.19	3:38.33
3	GBR	Elliott, Peter	3:38.60	58.54	1:58.96	2:56.02	3:38.60
4	SUI	Hacksteiner, Markus	3:39.05	58.45	1:59.09	2:56.19	3:39.05
5	MAR	Lachal, Mostafa	3:39.20	59.08	1:59.40	2:57.18	3:39.20
6	ALG	Kram, Rachid	3:39.90	58.79	1:59.26	2:57.30	3:39.90
7	BRA	Cruz, Joaquim	3:40.92	59.27	1:59.41	2:56.94	3:40.92
8	BOT	Thee, Mbiganyi	3:41.97	59.50	1:59.58	2:57.96	3:41.97
9	CYP	Spyrou, Spyros	3:42.32	59.49	1:59.86	2:58.37	3:42.32
10	IRL	O'reilly, Gerry	3:43.23	58.82	1:59.20	2:57.19	3:43.23
11	KOR	Cho, Jin-Saeng	3:45.63	59.14	1:59.55	3:00.14	3:45.63
12	TCH	Kubista, Jan	3:46.41	58.22	1:59.00	2:58.25	3:46.41
13	FIJ	Khan, Moses	4:03.20	1:03.39	2:09.34	3:15.80	4:03.20
14	YAR	Saleh, Awad	4:03.86	1:03.00	2:08.89	3:16.02	4:03.86
15	NGU	Siguria, Johnd	4:07.04	1:02.55	2:09.60	3:17.33	4:07.04

Men 1500m Round 1 Heat 4/Sept. 29				Hommes 1500m Tour 1 Serie 4/29 Sept			
Rank Rang	Ctry Pays	Name Nom	Result Resultat	400m	800m	1200m	1500m
1	GDR	Herold, Jens-Peter	3:40.87	1:01.04	2:02.25	3:00.67	3:40.87
2	HOL	Kulker, Han	3:40.90	1:01.27	2:02.30	3:00.61	3:40.90
3	GBR	Crabb, Steve	3:41.12	1:01.04	2:02.03	3:00.42	3:41.12
4	SUI	Wirz, Peter	3:41.26	1:01.73	2:02.46	3:00.80	3:41.26
5	SUD	Khalifa, Khalifa Omer	3:41.46	1:01.15	2:02.11	3:00.51	3:41.46
6	MAR	Moncif, Abdelmajide	3:41.73	1:01.55	2:02.76	3:00.94	3:41.73
7	TUN	Kalbovssi, Mahmouvd	3:43.72	1:01.73	2:02.58	3:00.89	3:43.72
8	ANT	Jones, Dale	3:51.22	1:01.99	2:03.50	3:06.40	3:51.22
9	KSA	Al Dousari, Hameed	3:51.53	1:02.05	2:04.03	3:06.97	3:51.53
10	RWA	Ndagijimana, Eulucane	3:51.61	1:01.41	2:03.01	3:04.48	3:51.61
11	AND	Graells, Josep	3:52.68	1:01.47	2:03.30	3:06.33	3:52.68
12	TUR	Ozturk, Zeki	3:54.26	1:01.24	2:02.95	3:06.89	3:54.26
13	CAN	Consiglio, Douglas	3:55.31	1:01.89	2:03.72	3:07.14	3:55.31
14	CHA	Gayaple, Seid	3:58.46	1:02.14	2:04.82	3:09.68	3:58.46
15	NEP	Rokaya, Haribahadur	4:01.17	1:02.35	2:05.95	3:12.05	4:01.17

Men 1500m Round 1/Sept. 29				Hommes 1500m Tour 1/29 Sept			
Rank Rang	Ctry Pays	Name Nom	Result Resultat				
1	KEN	Rono, Peter	3:37.65	Q			
2	USA	Atkinson, Jeff	3:38.33	Q			
3	GBR	Elliott, Peter	3:38.60	Q			
4	SUI	Hacksteiner, Markus	3:39.05	Q			
5	MAR	Lachal, Mostafa	3:39.20	Q			
6	ALG	Kram, Rachid	3:39.90	Q			
7	KEN	Cheruiyot, Kipkoech	3:39.98	Q			
8	GDR	Herold, Jens-Peter	3:40.87	Q			
9	GBR	Cram, Steve	3:40.89	Q			
10	HOL	Kulker, Han	3:40.90	Q			
11	BRA	Cruz, Joaquim	3:40.92	Q			
12	GBR	Crabb, Steve	3:41.12	Q			
13	SUI	Wirz, Peter	3:41.26	Q			
14	SUD	Khalifa, Khalifa Omer	3:41.46	Q			
15	USA	Scott, Steve	3:41.57	Q			
16	FRA	Geoffroy, Remi	3:41.68	Q			
17	KEN	Cheshire, Joseph	3:41.72	Q			
18	MAR	Moncif, Abdelmajide	3:41.73	Q			
19	ITA	Di Napoli, Gennaro	3:41.85	Q			
20	USA	Deady, Mark	3:41.91	Q			
21	BOT	Thee, Mbiganyi	3:41.97	Q			
22	DEN	Guldberg, Mogens D	3:42.01	Q			



Rank Rang	Ctry Pays	Name Nom	Result Resultat	
22	IRL	O'sullivan, Marcus	3:42.01	Q
24	MAR	Aouita, Said	3:42.18	Q
25	POR	Silva, Mario	3:42.24	Q
26	CYP	Spyrou, Spyros	3:42.32	Q
27	SUI	Rapp, Markus	3:42.64	
28	CAN	Campbell, David	3:42.97	
29	IRL	O'reilly, Gerry	3:43.23	
30	FIN	Suhonen, Ari	3:43.61	
31	TUN	Kalbovssi, Mahmud	3:43.72	
32	QAT	Sulinan, Mohd	3:44.43	
33	BRA	Barbosa, Jose	3:44.46	
34	CHN	Duan, Xiuquan	3:44.88	
35	AUS	Scammell, Patrick	3:45.21	
36	YUG	Zorko, Branko	3:45.52	
37	KOR	Cho, Jin-Saeng	3:45.63	
38	TCH	Kubista, Jan	3:46.41	
39	BER	Watson, Michael	3:46.49	
40	ZIM	Homela, Melford	3:47.38	
41	SOM	Aden, Jama mohamud	3:49.84	
42	ANT	Jones, Dale	3:51.22	
43	KSA	Al Dousari, Hameed	3:51.53	
44	DJI	Yaye Aden, Hoche	3:51.56	
45	RWA	Ndagijimana, Eulucane	3:51.61	
46	AND	Graells, Josep	3:52.68	
47	PAR	Lopez, Ramon	3:53.31	
48	ANG	Katombi, Eugenio	3:54.25	
49	TUR	Ozturk, Zeki	3:54.26	
50	SLE	Jonah, Modupe-D.A.	3:55.15	
51	CAN	Consiglio, Douglas	3:55.31	
52	CHA	Gayaple, Seid	3:58.46	
53	NEP	Rokaya, Haribahadur	4:01.17	
54	MAW	Dzekedzeke, Kenneth	4:02.61	
55	FJ	Khan, Moses	4:03.20	
56	YAR	Saleh, Awad	4:03.86	
57	NGU	Siguria, Johnd	4:07.04	
58	MTN	Ould Khayar, Mohamed El M	4:12.18	
59	GEQ	Elonga Molico, Bernardo	4:16.40	
	LBR	Twegbe, Nimely	NS	

Men 1500m Semi-final Heat 1/Sept 30				Hommes 1500m Demi-finale Serie 1/30 Sept			
Rank Rang	Ctry Pays	Name Nom	400m	800m	1200m	1500m	
1	KEN	Cheruiyot, Kipkoech	1:03.83	2:02.37	2:57.94	3:38.09	Q
2	GBR	Cram, Steve	1:02.92	2:02.57	2:58.21	3:38.30	Q
3	GBR	Elliott, Peter	1:03.46	2:02.87	2:58.36	3:38.56	Q
4	HOL	Kulker, Han	1:03.34	2:03.04	2:58.44	3:39.06	Q
5	USA	Atkinson, Jeff	1:03.74	2:02.75	2:58.67	3:39.12	Q
6	KEN	Cheshire, Joseph	1:02.99	2:02.91	2:58.00	3:39.17	
7	DEN	Guldborg, Mogens D	1:02.75	2:02.72	2:58.80	3:39.86	
8	FRA	Geoffroy, Remi	1:03.21	2:03.14	2:58.79	3:40.96	
9	ALG	Kram, Rachid	1:03.10	2:03.14	2:59.13	3:41.39	
10	CYP	Spyrou, Spyros	1:03.39	2:03.38	2:59.71	3:43.49	
	MAR	Moncif, Abdelmajide	1:03.10	2:02.96	2:59.38	AB	
	BRA	Cruz, Joaquim				NS	
	SUI	Wirz, Peter	1:02.55	2:02.54		AB	

Men 1500m Semi-final Heat 2/Sept. 30				Hommes 1500m Demi-finale Serie 2/30 Sept			
Rank Rang	Ctry Pays	Name Nom	400m	800m	1200m	1500m	
1	USA	Scott, Steve	1:00.52	2:01.60	2:58.76	3:38.20	Q
2	KEN	Rono, Peter	1:00.36	2:00.83	2:58.19	3:38.25	Q
3	SUD	Khalifa, Khalifa Omer	1:00.01	2:01.07	2:58.45	3:38.40	Q
4	POR	Silva, Mario	1:00.60	2:01.88	2:58.99	3:38.56	Q
5	GDR	Herold, Jens-Peter	1:00.41	2:01.43	2:58.60	3:38.59	Q
6	IRL	O'sullivan, Marcus	1:00.20	2:01.07	2:58.68	3:38.84	
7	SUI	Hacksteiner, Markus	1:00.27	2:01.25	2:58.46	3:39.18	
8	USA	Deady, Mark	1:00.69	2:01.28	2:58.93	3:39.47	
9	GBR	Crabb, Steve	1:00.04	2:00.91	2:58.33	3:39.55	
10	BOT	Thee, Mbiganyi	1:00.87	2:01.13	2:59.95	3:42.62	
11	ITA	Di Napoli, Gennaro	1:00.37	2:01.70	2:59.41	3:43.58	
12	MAR	Lachal, Mostafa	1:00.42	2:01.47	2:59.75	3:45.65	
	MAR	Aouita, Said				NS	

Men 1500m Semi-final/Sept. 30				Hommes 1500m Demi-finale/30 Sept			
Rank Rang	Ctry Pays	Name Nom	Result Resultat				
1	KEN	Cheruiyot, Kipkoech	3:38.09	Q			
2	USA	Scott, Steve	3:38.20	Q			
3	KEN	Rono, Peter	3:38.25	Q			
4	GBR	Cram, Steve	3:38.30	Q			
5	SUD	Khalifa, Khalifa Omer	3:38.40	Q			
6	GBR	Elliott, Peter	3:38.56	Q			
6	POR	Silva, Mario	3:38.56	Q			
8	GDR	Herold, Jens-Peter	3:38.59	Q			
9	IRL	O'sullivan, Marcus	3:38.84	Q			
10	HOL	Kulker, Han	3:39.06	Q			
11	USA	Atkinson, Jeff	3:39.12	Q			
12	KEN	Cheshire, Joseph	3:39.17				
13	SUI	Hacksteiner, Markus	3:39.18				
14	USA	Deady, Mark	3:39.47				
15	GBR	Crabb, Steve	3:39.55				
16	DEN	Guldborg, Mogens D	3:39.86				
17	FRA	Geoffroy, Remi	3:40.96				
18	ALG	Kram, Rachid	3:41.39				
19	BOT	Thee, Mbiganyi	3:42.62				
20	CYP	Spyrou, Spyros	3:43.49				
21	ITA	Di Napoli, Gennaro	3:43.58				
22	MAR	Lachal, Mostafa	3:45.65				
	MAR	Moncif, Abdelmajide	AB				
	SUI	Wirz, Peter	AB				
	BRA	Cruz, Joaquim	NS				
	MAR	Aouita, Said	NS				

Men 1500m Final/Oct. 1				Hommes 1500m Finale/1 Oct			
Rank Rang	Ctry Pays	Name Nom	400m	800m	1200m	1500m	
1	KEN	Rono, Peter	1:00.71	2:00.31	2:56.69	3:35.96	
2	GBR	Elliott, Peter	59.86	2:00.39	2:56.82	3:36.15	
3	GDR	Herold, Jens-Peter	1:00.20	2:00.70	2:57.08	3:36.21	
4	GBR	Cram, Steve	59.86	2:00.61	2:57.05	3:36.24	
5	USA	Scott, Steve	1:00.08	2:00.97	2:57.13	3:36.99	
6	HOL	Kulker, Han	1:00.04	2:00.93	2:57.29	3:37.08	
7	KEN	Cheruiyot, Kipkoech	1:00.79	2:01.39	2:57.35	3:37.94	
8	IRL	O'sullivan, Marcus	59.65	2:00.77	2:57.65	3:38.39	
9	POR	Silva, Mario	1:00.28	2:01.03	2:57.93	3:38.77	
10	USA	Atkinson, Jeff	1:00.55	2:01.27	2:56.87	3:40.80	
11	KEN	Cheshire, Joseph	1:00.41	2:00.77	2:57.96	3:40.82	
12	SUD	Khalifa, Khalifa Omer	59.72	2:00.55	2:57.62	3:41.07	

Men 5000m Round 1 Heat 1/Sept. 28				Hommes 5000m Tour 1 Serie 1/28 Sept				
Rank Rang	Ctry Pays	Name Nom	1000m	2000m	3000m	4000m	5000m	
1	GBR	Staines, Gary	2:56.50	5:50.42	8:35.09	11:15.88	13:47.81	Q
2	USA	Maree, Sydney	2:57.45	5:51.05	8:36.10	11:16.45	13:47.85	Q
3	AUS	Lloyd, Andrew	2:55.78	5:49.80	8:35.18	11:16.13	13:47.87	Q
4	POR	Castro, Domingos	2:56.88	5:50.82	8:35.36	11:16.04	13:47.91	Q
5	KEN	Ngugi, John	2:57.26	5:51.01	8:35.65	11:16.18	13:47.93	Q
6	MEX	Gonzalez, Mauricio	2:56.01	5:50.04	8:35.36	11:16.35	13:47.98	Q
7	IRL	Doherty, John	2:56.25	5:50.27	8:34.87	11:15.71	13:47.99	Q
8	FRA	Arpin, Paul	2:57.50	5:50.65	8:35.89	11:16.56	13:48.03	
9	ESP	Gomez, Alejandro	2:57.07	5:51.14	8:36.02	11:16.22	13:51.60	
10	AUT	Millonig, Dietmar	2:56.91	5:50.77	8:35.82	11:16.74	14:01.92	
11	SUI	Deleze, Pierre	2:57.57	5:51.46	8:36.35	11:17.84	14:12.79	
12	CAN	Nelson, Carey	2:56.72	5:50.54	8:35.59	11:17.85	14:15.94	
13	SOM	Adani, Abukar Hasan	2:57.66	5:51.27	8:38.74	11:39.09	14:37.98	
14	DJI	Ismael, Hassan	2:57.85	5:51.50	8:44.04	11:44.92	14:45.40	
15	NEP	Rokaya, Haribahadur	2:57.88	5:53.31	8:54.13	11:58.76	14:53.75	
16	ZAI	Mutoke, Kaleka	2:57.74	5:52.15	8:53.00	11:54.93	14:56.33	
17	BIZ	Gray, Ian	2:57.90	5:52.18	8:52.96	12:01.28	15:33.24	
18	SUD	Massad, Abd Elrahman	2:57.25	5:53.71	9:01.32		15:50.91	
19	GEQ	Rondo Roku, Manuel	2:58.02	6:13.09	9:45.51	13:20.62	16:44.13	

Men 5000m Round 1 Heat 2/Sept. 28				Hommes 5000m Tour 1 Serie 2/28 Sept				
Rank Rang	Ctry Pays	Name Nom	1000m	2000m	3000m	4000m	5000m	
1	GBR	Martin, Eamonn	2:49.29	5:42.68	8:35.42	11:29.92	13:58.00	Q
2	ITA	Antibo, Salvatore	2:49.66	5:43.13	8:35.85	11:29.71	13:58.08	Q
3	FRA	Laventure, Cyril	2:49.48	5:42.92	8:35.42	11:29.90	13:58.19	Q
4	KEN	Ondieki, Yobes	2:49.70	5:43.34	8:35.65	11:29.87	13:58.24	Q
5	USA	Padilla, Doug	2:49.68	5:43.59	8:36.78	11:30.83	13:58.45	Q
6	FRG	Baumann, Dieter	2:49.79	5:42.60	8:36.22	11:30.45	13:58.46	Q
7	ESP	Anton, Abel	2:49.88	5:43.39	8:35.40	11:30.68	13:58.59	Q
8	POR	Couto, Fernando	2:49.93	5:43.18	8:35.83	11:30.26	13:58.72	
9	MEX	Barrios, Arturo	2:50.26	5:43.78	8:39.51	11:30.26	13:59.04	
10	IRL	Omara, Frank	2:49.30	5:43.79	8:35.65	11:31.02	13:59.46	

Athletics

Rank Rang	Ctry Pays	Name Nom	1000m	2000m	3000m	4000m	5000m
11	JPN	Yoneshige, Shuichi	2:50.36	5:44.00	8:36.06	11:30.42	13:59.68
12	ZIM	Mandebele, Stanley	2:50.11	5:43.63	8:35.97	11:30.06	14:03.97
13	KOR	Kim, Young-Gil	2:50.00	5:43.87	8:36.29	11:30.59	14:09.45
14	INA	Nabunone, A. H. Edward	2:48.09	5:42.38	8:35.19	11:30.52	14:19.40
15	MAW	Mambosasa, George	2:51.11	5:47.53	8:46.93	11:52.51	14:30.01
16	YAR	Alharazi, Anwar	2:50.88	5:49.56	8:57.19	12:06.36	14:49.25
17	MTN	Ould khalifa, Mohamed	2:48.80	5:42.92	8:51.21	12:10.39	15:18.64
	NOR	Stroeme, Lars-Ove	2:49.45	5:43.38	8:35.28	11:30.18	AB
	FIJ	Singh, Davendra					NS

Men 5000m Round 1 Heat 3/Sept. 28

Rank Rang	Ctry Pays	Name Nom	1000m	2000m	3000m	4000m	5000m
1	ITA	Mei, Stefano	2:44.83	5:31.97	8:19.88	11:09.34	13:42.96 Q
2	KEN	Cheruiyot, Charles	2:45.30	5:31.64	8:19.84	11:09.50	13:43.11 Q
3	FRA	Thiebaut, Pascal	2:45.75	5:32.58	8:20.73	11:10.14	13:43.28 Q
4	BEL	Rousseau, Vincent	2:44.45	5:32.06	8:20.04	11:08.89	13:43.38 Q
5	BUL	Ignatov, Evgueni	2:45.70	5:32.24	8:20.47	11:09.52	13:43.42 Q
6	CAN	Williams, Paul	2:46.21	5:32.86	8:20.26	11:02.14	13:43.43 Q
7	IRL	Coghlan, Eamon	2:46.00	5:32.98	8:21.22	11:09.48	13:43.48 Q
8	SWE	Danielsson, Jonny	2:45.78	5:31.82	8:20.32	11:09.94	13:43.54
9	POR	Regalo, Jose	2:45.06	5:32.16	8:21.02	11:09.69	13:43.59
10	GBR	Buckner, Jack	2:46.40	5:32.70	8:20.90	11:10.81	13:43.69
11	GDR	Kunze, Hansjoerg	2:45.24	5:32.39	8:20.60	11:09.78	13:44.34
12	URS	Dasko, Mikhail	2:45.49	5:32.31	8:20.84	11:09.67	13:45.25
13	USA	Brahm, Terry	2:45.98	5:33.27	8:20.53	11:09.92	13:45.28
14	MEX	Barreto, Marcos	2:45.33	5:31.87	8:20.13	11:09.34	13:45.82
15	TAN	Mnyampanda, Juma	2:45.41	5:31.68	8:19.91	11:10.37	14:05.09
16	QAT	Ebrahimm, Warsama, Ahmed	2:46.17	5:32.12	8:21.40	11:11.92	14:06.20
17	RWA	Ntawulikura, Mathias	2:45.53	5:32.12	8:20.67	11:12.14	14:08.84
18	YMD	Ahmed Saeed, Farook	2:47.39	5:42.90	8:52.43	12:06.71	15:11.20
19	CHA	Miakakem, Ronodji	2:46.76	5:50.80	9:06.73	12:30.97	15:42.73

Men 5000m Round 1/Sept. 28

Rank Rang	Ctry Pays	Name Nom	Result Resultat
1	ITA	Mei, Stefano	13:42.96 Q
2	KEN	Cheruiyot, Charles	13:43.11 Q
3	FRA	Thiebaut, Pascal	13:43.28 Q
4	BEL	Rousseau, Vincent	13:43.38 Q
5	BUL	Ignatov, Evgueni	13:43.42 Q
6	CAN	Williams, Paul	13:43.43 Q
7	IRL	Coghlan, Eamon	13:43.48 Q
8	SWE	Danielsson, Jonny	13:43.54 Q
9	POR	Regalo, Jose	13:43.59 Q
10	GBR	Buckner, Jack	13:43.69 Q
11	GDR	Kunze, Hansjoerg	13:44.34 Q
12	URS	Dasko, Mikhail	13:45.25 Q
13	USA	Brahm, Terry	13:45.28 Q
14	MEX	Barreto, Marcos	13:45.82 Q
15	GBR	Staines, Gary	13:47.81 Q
16	USA	Maree, Sydney	13:47.85 Q
17	AUS	Lloyd, Andrew	13:47.87 Q
18	POR	Castro, Domingos	13:47.91 Q
19	KEN	Ngugi, John	13:47.93 Q
20	MEX	Gonzalez, Mauricio	13:47.98 Q
21	IRL	Doherty, John	13:47.99 Q
22	FRA	Arpin, Paul	13:48.03 Q
23	ESP	Gomez, Alejandro	13:51.60 Q
24	GBR	Martin, Eamonn	13:58.00 Q
25	ITA	Antibo, Salvatore	13:58.08 Q
26	FRA	Laventure, Cyril	13:58.19 Q
27	KEN	Ondieki, Yobes	13:58.24 Q
28	USA	Padilla, Doug	13:58.45 Q
29	FRG	Baumann, Dieter	13:58.46 Q
30	ESP	Anton, Abel	13:58.59 Q
31	POR	Couto, Fernando	13:58.72
32	MEX	Barrios, Arturo	13:59.04
33	IRL	Omara, Frank	13:59.46
34	JPN	Yoneshige, Shuichi	13:59.68
35	AUT	Millonig, Dietmar	14:01.92
36	ZIM	Mandebele, Stanley	14:03.97
37	TAN	Mnyampanda, Juma	14:05.09
38	QAT	Ebrahimm, warsama, Ahmed	14:06.20
39	RWA	Ntawulikura, Mathias	14:08.84
40	KOR	Kim, Young-Gil	14:09.45
41	SUI	Deleze, Pierre	14:12.79
42	CAN	Nelson, Carey	14:15.94
43	INA	Nabunone, A. H. Edward	14:19.40
44	MAW	Mambosasa, George	14:30.01
45	SOM	Adani, Abukar Hasan	14:37.98

Athlétisme

Rank Rang	Ctry Pays	Name Nom	Result Resultat
46	DJI	Ismael, Hassan	14:45.40
47	YAR	Alharazi, Anwar	14:49.25
48	NEP	Rokaya, Haribahadur	14:53.75
49	ZAI	Mutoke, Kaleka	14:56.33
50	YMD	Ahmed Saeed, Farook	15:11.20
51	MTN	Ould Khalifa, Mohamed	15:18.64
52	BIZ	Gray, Ian	15:33.24
53	CHA	Miakakem, Ronodji	15:42.73
54	SUD	Massad, Abd Elrahman	15:50.91
55	GEQ	Rondo Roku, Manuel	16:44.13
	NOR	Stroeme, Lars-Ove	AB
	FIJ	Singh, Davendra	NS

Men 5000m Semi-final Heat 1/Sept. 29

Rank Rang	Ctry Pays	Name Nom	1000m	2000m	3000m	4000m	5000m
1	POR	Castro, Domingos	2:46.00	5:30.23	8:10.52	10:48.28	13:22.44 Q
2	USA	Maree, Sydney	2:47.00	5:30.82	8:11.23	10:48.78	13:22.61 Q
3	FRG	Baumann, Dieter	2:47.00	5:30.69	8:11.55	10:50.40	13:22.71 Q
4	FRA	Thiebaut, Pascal	2:47.00	5:30.53	8:11.60	10:51.21	13:22.71 Q
5	KEN	Ondieki, Yobes	2:47.00	5:30.26	8:11.25	10:48.50	13:22.85 Q
6	GDR	Kunze, Hansjoerg	2:46.00	5:30.10	8:11.46	10:50.64	13:23.04 Q
7	GBR	Buckner, Jack	2:47.00	5:30.67	8:10.69	10:48.08	13:23.17
8	ITA	Antibo, Salvatore	2:47.00	5:30.82	8:10.24	10:50.18	13:25.64
9	FRA	Laventure, Cyril	2:47.00	5:30.10	8:10.80	10:49.34	13:29.92
10	KEN	Cheruiyot, Charles	2:46.00	5:29.89	8:10.48	10:49.84	13:38.44
11	ESP	Gomez, Alejandro	2:47.00	5:30.37	8:10.98	10:51.77	13:41.73
12	AUS	Lloyd, Andrew	2:46.00	5:29.84	8:11.39	10:54.64	13:42.49
13	CAN	Williams, Paul	2:46.00	5:30.24	8:11.20	10:52.34	13:44.57
14	MEX	Barreto, Marcos	2:46.00	5:30.04	8:11.13	11:00.10	13:53.93
15	IRL	Coghlan, Eamon	2:46.00	5:30.40	8:13.99	11:07.21	14:02.16

Men 5000m Semi-final Heat 2/Sept. 29

Rank Rang	Ctry Pays	Name Nom	1000m	2000m	3000m	4000m	5000m
1	ITA	Mei, Stefano	2:46.18	5:29.26	8:11.24	10:53.46	13:24.20 Q
2	KEN	Ngugi, John	2:47.49	5:28.52	8:10.12	10:52.20	13:24.43 Q
3	POR	Regalo, Jose	2:46.27	5:28.66	8:10.39	10:52.65	13:24.48 Q
4	GBR	Staines, Gary	2:46.51	5:29.03	8:10.42	10:52.76	13:24.51 Q
5	IRL	Doherty, John	2:47.04	5:29.17	8:10.70	10:52.44	13:24.61 Q
6	BUL	Ignatov, Evgueni	2:46.43	5:28.93	8:10.87	10:52.93	13:24.76 Q
7	FRA	Arpin, Paul	2:46.83	5:28.80	8:10.76	10:53.10	13:24.82
8	SWE	Danielsson, Jonny	2:47.92	5:29.81	8:11.85	10:54.11	13:25.25
9	GBR	Martin, Eamonn	2:47.27	5:29.55	8:11.31	10:53.60	13:26.26
10	MEX	Gonzalez, Mauricio	2:46.65	5:29.03	8:10.99	10:53.30	13:32.52
11	USA	Padilla, Doug	2:47.45	5:30.25	8:12.14	10:54.83	13:37.11
12	ESP	Anton, Abel	2:46.97	5:29.36	8:11.16	10:53.78	13:39.13
13	URS	Dasko, Mikhail	2:47.19	5:29.53	8:11.56	10:58.42	13:43.65
14	BEL	Rousseau, Vincent	2:46.74	5:28.80	8:10.61	11:05.54	14:03.74
15	USA	Brahm, Terry	2:47.63	5:30.02	8:13.44	11:11.18	14:04.12

Men 5000m Semi-final/Sept. 29

Rank Rang	Ctry Pays	Name Nom	Result Resultat
1	POR	Castro, Domingos	13:22.44 Q
2	USA	Maree, Sydney	13:22.61 Q
3	FRA	Thiebaut, Pascal	13:22.71 Q
3	FRG	Baumann, Dieter	13:22.71 Q
5	KEN	Ondieki, Yobes	13:22.85 Q
6	GDR	Kunze, Hansjoerg	13:23.04 Q
7	GBR	Buckner, Jack	13:23.17 Q
8	ITA	Mei, Stefano	13:24.20 Q
9	KEN	Ngugi, John	13:24.43 Q
10	POR	Regalo, Jose	13:24.48 Q
11	GBR	Staines, Gary	13:24.51 Q
12	IRL	Doherty, John	13:24.61 Q
13	BUL	Ignatov, Evgueni	13:24.76 Q
14	FRA	Arpin, Paul	13:24.82 Q
15	SWE	Danielsson, Jonny	13:25.25 Q
16	ITA	Antibo, Salvatore	13:25.64
17	GBR	Martin, Eamonn	13:26.26
18	FRA	Laventure, Cyril	13:29.92
19	MEX	Gonzalez, Mauricio	13:32.52
20	USA	Padilla, Doug	13:37.11
21	KEN	Cheruiyot, Charles	13:38.44
22	ESP	Anton, Abel	13:39.13
23	ESP	Gomez, Alejandro	13:41.73
24	AUS	Lloyd, Andrew	13:42.49
25	URS	Dasko, Mikhail	13:43.65



Rank Rang	Ctry Pays	Name Nom	Result Resultat
26	CAN	Williams, Paul	13:44.57
27	MEX	Barreto, Marcos	13:53.93
28	IRL	Coghlan, Eamon	14:02.16
29	BEL	Rousseau, Vincent	14:03.74
30	USA	Brahm, Terry	14:04.12

Men 5000m Final/Oct. 1			Hommes 5000m Finale/1 Oct				
Rank Rang	Ctry Pays	Name Nom	1000m	2000m	3000m	4000m	5000m

1	KEN	Ngugi, John	2:42.75	5:14.96	7:56.12	10:36.20	13:11.70
2	FRG	Baumann, Dieter	2:44.54	5:21.37	8:03.34	10:44.74	13:15.52
3	GDR	Kunze, Hansjoerg	2:44.62	5:22.36	8:03.97	10:45.24	13:15.73
4	POR	Castro, Domingos	2:43.18	5:20.91	8:02.36	10:39.89	13:16.09
5	USA	Maree, Sydney	2:44.01	5:20.85	8:03.12	10:44.84	13:23.69
6	GBR	Buckner, Jack	2:44.79	5:21.60	8:03.52	10:45.08	13:23.85
7	ITA	Mei, Stefano	2:43.98	5:22.16	8:04.37	10:50.60	13:26.17
8	BUL	Ignatov, Evgueni	2:43.32	5:21.32	8:03.76	10:45.40	13:26.41
9	IRL	Doherty, John	2:44.40	5:20.61	8:02.61	10:44.55	13:27.71
10	SWE	Danielsson, Jonny	2:44.73	5:22.66	8:04.89	10:51.38	13:30.44
11	FRA	Thiebaut, Pascal	2:44.25	5:21.85	8:04.11	10:51.01	13:31.99
12	KEN	Ondieki, Yobes	2:44.11	5:21.13	8:02.87	10:51.22	13:52.01
13	GBR	Staines, Gary	2:43.60	5:20.69	8:03.67	10:51.64	13:55.00
14	FRA	Arpin, Paul	2:44.27	5:22.02	8:17.29	11:17.80	14:13.19
	POR	Regalo, Jose	2:43.01	5:21.08	8:07.94		AB

Men 10000m Round 1 Heat 1/Sept. 23			Hommes 10000m Tour 1 Serie 1/23 Sept				
Rank Rang	Ctry Pays	Name Nom	1000m 6000m	2000m 7000m	3000m 8000m	4000m 9000m	5000m 10000m

1	KEN	Kimeli, Kipkemboi	3:02.00 15:46.00	5:44.00 19:37.00	8:32.00 22:25.00	11:22.00 25:11.00	14:06.00 28:00.39	Q
2	FRA	Prianon, Jean-Louis	2:59.00 15:46.00	5:44.00 19:37.00	8:34.00 22:26.00	11:22.00 25:15.00	14:06.00 28:08.38	Q
3	MEX	Barrios, Arturo	2:59.00 15:46.00	5:44.00 19:37.00	8:32.00 22:26.00	11:22.00 25:15.00	14:06.00 28:08.63	Q
4	ITA	Antibo, Salvatore	2:59.00 15:46.00	5:43.00 19:37.00	8:32.00 22:26.00	11:22.00 25:15.00	14:06.00 28:09.35	Q
5	BUL	Ignatov, Evgueni	3:02.00 15:50.00	5:45.00 19:45.00	8:47.00 22:39.00	11:24.00 25:33.00	14:11.00 28:15.63	Q
6	POR	Pinto, Antonio	3:02.00 15:46.00	5:45.00 19:45.00	8:32.00 22:39.00	11:24.00 25:33.00	14:11.00 28:15.63	Q
7	USA	Bickford, Bruce	3:02.00 15:50.00	5:45.00 19:45.00	8:34.00 22:42.00	11:23.00 25:33.00	14:13.00 28:16.16	Q
8	JPN	Akutsu, Kozo	3:02.00 15:47.00	5:45.00 19:45.00	8:34.00 22:39.00	11:24.00 25:33.00	14:06.00 28:16.43	Q
9	ECU	Vera, Rolando	3:02.00 15:50.00	5:44.00 19:46.00	8:32.00 22:43.00	11:23.00 25:37.00	14:15.00 28:17.88	
10	KEN	Merande, Boniface	2:59.00 15:47.00	5:44.00 19:45.00	8:32.00 22:39.00	11:22.00 25:33.00	14:06.00 28:21.84	
11	NOR	Halvorsen, John	2:59.00 15:47.00	5:44.00 19:45.00	8:34.00 22:39.00	11:22.00 25:33.00	14:06.00 28:22.25	
12	HOL	Ten Kate, Marti	3:02.00 15:50.00	5:46.00 19:51.00	8:32.00 22:45.00	11:24.00 25:37.00	14:06.00 28:23.23	
13	GBR	Binns, Steve	3:02.00 15:51.00	5:44.00 19:59.00	8:32.00 22:54.00	11:23.00 25:38.00	14:06.00 28:52.88	
14	COL	Ortiz, Pedro	3:02.00 15:50.00	5:45.00 20:07.00	8:34.00 22:59.00	11:23.00 25:55.00	14:06.00 29:08.25	
15	TAN	Akonay, Boay	3:02.00 16:06.00	5:43.00 20:07.00	8:32.00 23:07.00	11:23.00 26:12.00	14:26.00 29:19.06	
16	QAT	Ebrahimm, Warsama, Ahmed	3:02.00 16:18.00	5:47.00 20:14.00	8:34.00 23:08.00	11:25.00 26:12.00	14:20.00 29:37.99	
17	INA	Nabunone, A. H. Edward	2:59.00 17:41.00	5:51.00 20:49.00	8:32.00 24:10.00	11:48.00 27:25.00	14:16.00 29:55.23	
18	BOL	Calizaya, Policarpio	3:02.00 17:35.00	5:46.00 19:54.00	8:34.00 22:54.00	11:35.00 25:38.00	14:26.00 30:35.01	
19	CHA	Yaya, Ismael	3:02.00 16:00.00	5:45.00 20:52.00	8:46.00 24:13.00	12:03.00 27:32.00	14:15.00 30:47.29	
20	MAW	Naveko, Charles	3:02.00 16:21.00	5:56.00 20:55.00	8:34.00 24:13.00	12:24.00 27:32.00	14:40.00 31:23.53	
21	YAR	Dawod, Abdulkarim	3:02.00 18:16.00	6:03.00 20:59.00	9:16.00 24:20.00	12:35.00 27:42.00	14:52.00 32:33.04	
	ESP	Albentosa, Jose Manuel	3:02.00 15:48.00	5:44.00 19:45.00	8:32.00 22:39.00	11:23.00 25:33.00	14:06.00 AB	

Rank Rang	Ctry Pays	Name Nom	1000m 6000m	2000m 7000m	3000m 8000m	4000m 9000m	5000m 10000m
	POR	Castro, Dionisio	3:02.00 15:55.00	5:44.00	8:34.00	11:23.00	14:06.00 AB
	CAN	Williams, Paul	3:02.00 15:50.00	5:44.00 20:42.00	8:34.00 24:10.00	11:24.00 27:25.00	14:06.00 AB
	AUS	Lloyd, Andrew	3:02.00 15:57.00	5:45.00	9:06.00	11:24.00	14:13.00 AB
	GBR	Mcleod, Michael	3:02.00 15:55.00	5:45.00 20:37.00	8:32.00 23:45.00	11:24.00 26:59.00	14:15.00 AB

Men 10000m Round 1 Heat 2/Sept. 23			Hommes 10000m Tour 1 Serie 2/23 Sept				
Rank Rang	Ctry Pays	Name Nom	1000m 6000m	2000m 7000m	3000m 8000m	4000m 9000m	5000m 10000m

1	MAR	Boutaib, Mly. Brahim	3:02.00 17:10.00	5:47.00 21:08.00	8:40.00 22:48.00	11:32.00 26:40.00	14:20.00 28:17.61	Q
2	KEN	Tanui, Moses	2:59.00 17:10.00	5:47.00 21:08.00	8:40.00 22:48.00	11:32.00 26:42.00	14:20.00 28:20.98	Q
3	GDR	Kunze, Hansjoerg	3:02.00 17:10.00	5:47.00 21:08.00	8:41.00 22:48.00	11:33.00 26:42.00	14:48.00 28:22.09	Q
4	ESP	Prieto, Antonio	2:59.00 17:10.00	5:47.00 21:58.00	8:41.00 22:48.00	11:33.00 26:42.00	14:22.00 28:22.52	Q
5	GBR	Martin, Eamonn	3:02.00 17:10.00	5:47.00 21:09.00	8:41.00 22:48.00	11:32.00 26:42.00	14:20.00 28:25.46	Q
6	FRA	Arpin, Paul	3:02.00 17:10.00	5:47.00 21:08.00	8:43.00 22:48.00	11:32.00 26:42.00	14:20.00 28:25.56	Q
7	JPN	Yoneshige, Shuichi	3:02.00 17:10.00	5:48.00 21:09.00	8:48.00 22:48.00	11:33.00 26:42.00	15:47.00 28:26.04	Q
8	MEX	Gonzalez, Mauricio	3:02.00 17:10.00	5:47.00 21:13.00	8:43.00 22:52.00	11:32.00 26:57.00	14:22.00 28:36.66	Q
9	POR	Canario, Ezequiel	2:59.00 17:12.00	5:47.00 21:13.00	8:41.00 22:52.00	11:33.00 26:54.00	14:22.00 28:43.02	
10	ITA	Cova, Alberto	2:59.00 17:10.00	5:47.00 21:08.00	8:40.00 22:48.00	11:32.00 27:13.00	14:20.00 28:43.84	
11	USA	Porter, Pat	3:02.00 17:10.00	5:47.00 21:09.00	8:40.00 22:50.00	11:34.00 27:02.00	14:20.00 28:45.04	
12	ESP	Serrano, Antonio	3:02.00 17:10.00	5:47.00 21:35.00	8:43.00 22:56.00	11:33.00 27:43.00	14:22.00 29:01.13	
13	SUD	Joda, Musa Ahmed	2:59.00 17:12.00	5:47.00 21:09.00	8:40.00 23:00.00	11:37.00 27:21.00	14:48.00 29:03.87	
14	MEX	Barreto, Marcos	2:59.00 17:20.00	5:47.00 21:09.00	8:40.00 23:26.00	11:37.00 27:44.00	14:22.00 29:18.14	
15	CAN	Mccloy, Paul	3:02.00 17:12.00	5:47.00 21:09.00	8:40.00 23:11.00	11:33.00 27:50.00	14:22.00 29:34.07	
16	KOR	Lee, Sang-Keun	3:02.00 17:20.00	5:47.00 21:09.00	8:50.00 23:36.00	11:40.00 27:45.00	15:47.00 29:37.14	
17	ZIM	Mandebale, Stanley	3:02.00 17:32.00	5:47.00 21:13.00	8:43.00 23:48.00	11:48.00 28:02.00	14:34.00 29:50.99	
18	DJI	Omar Abdillahi, Talan	3:02.00 17:43.00	5:48.00 21:31.00	8:40.00 25:19.00	11:37.00 28:06.00	14:34.00 30:08.53	
19	NEP	Rokaya, Haribahadur	3:02.00 18:15.00	5:57.00 22:00.00	8:41.00 24:07.00	12:01.00 28:12.00	14:48.00 30:48.16	
20	NGU	Dupnai, A Aaron	3:03.00 19:34.00	6:18.00 22:34.00	9:35.00 26:18.00	12:56.00 28:16.00	16:34.00 32:50.63	
21	FIJ	Prasad, Bineshwar	3:03.00 19:34.00	6:18.00 22:12.00	9:38.00 26:18.00	12:56.00 28:24.00	16:34.00 33:30.43	
22	SOL	Maeke, John	3:03.00 20:32.00	6:08.00	9:34.00 26:20.00	13:14.00 28:25.00	16:48.00 35:16.93	
	ZAI	Koji, Kamana	3:02.00 18:16.00	5:48.00 21:58.00	8:41.00 23:58.00	12:01.00	15:35.00 AB	
	JPN	Endo, Tsukasa	3:02.00	5:47.00	8:40.00	11:33.00	16:01.00 AB	
	USA	Plasencia, Steve	3:02.00	5:48.00	8:41.00		16:18.00 AB	
	TCH	Vrabel, Martin	3:02.00	5:48.00 21:56.00	8:52.00		16:26.00 AB	

Athletics

Athlétisme

Men 10000m				Hommes 10000m			
Round 1/Sept. 23				Tour 1/23 Sept			
Rank	Ctry	Name	Result	Rank	Ctry	Name	Result
Rang	Pays	Nom	Resultat	Rang	Pays	Nom	Resultat
1	KEN	Kimeli, Kipkemboi	28:00.39	Q			
2	FRA	Prianon, Jean-Louis	28:08.38	Q			
3	MEX	Barrios, Arturo	28:08.63	Q			
4	ITA	Antibo, Salvatore	28:09.35	Q			
5	BUL	Ignatov, Evgueni	28:15.63	Q			
5	POR	Pinto, Antonio	28:15.63	Q			
7	USA	Bickford, Bruce	28:16.16	Q			
8	JPN	Akutsu, Kozo	28:16.43	Q			
9	MAR	Boutaib, Mly. Brahim	28:17.61	Q			
10	ECU	Vera, Rolando	28:17.88	Q			
11	KEN	Tanui, Moses	28:20.98	Q			
12	KEN	Merande, Boniface	28:21.84	Q			
13	GDR	Kunze, Hansjoerg	28:22.09	Q			
14	NOR	Halvorsen, John	28:22.25	Q			
15	ESP	Prieto, Antonio	28:22.52	Q			
16	HOL	Ten Kate, Marti	28:23.23	Q			
17	GBR	Martin, Eamonn	28:25.46	Q			
18	FRA	Arpin, Paul	28:25.56	Q			
19	JPN	Yoneshige, Shuichi	28:26.04	Q			
20	MEX	Gonzalez, Mauricio	28:36.66	Q			
21	POR	Canario, Ezequiel	28:43.02				
22	ITA	Cova, Alberto	28:43.84				
23	USA	Porter, Pat	28:45.04				
24	GBR	Binns, Steve	28:52.88				
25	ESP	Serrano, Antonio	29:01.13				
26	SUD	Joda, Musa Ahmed	29:03.87				
27	COL	Ortiz, Pedro	29:08.25				
28	MEX	Barreto, Marcos	29:18.14				
29	TAN	Akonay, Boay	29:19.06				
30	CAN	Mccloy, Paul	29:34.07				
31	KOR	Lee, Sang-Keun	29:37.14				
32	QAT	Ebrahim, Warsama, Ahmed	29:37.99				
33	ZIM	Mandebale, Stanley	29:50.99				
34	INA	Nabunone, A. H. Edward	29:55.23				
35	DJI	Omar Abdillahi, Talan	30:08.53				
36	BOL	Calizaya, Policarpio	30:35.01				
37	CHA	Yaya, Ismael	30:47.29				
38	NEP	Rokaya, Haribahadur	30:48.16				
39	MAW	Naveko, Charles	31:23.53				
40	YAR	Dawod, Abdulkarim	32:33.04				
41	NGU	Dupnai, A Aaron	32:50.63				
42	FIJ	Prasad, Bineshwar	33:30.43				
43	SOL	Maeke, John	35:16.93				
	AUS	Lloyd, Andrew	AB				
	CAN	Williams, Paul	AB				
	ESP	Albentosa, Jose Manuel	AB				
	GBR	Mcleod, Michael	AB				
	JPN	Endo, Tsukasa	AB				
	POR	Castro, Dionisio	AB				
	TCH	Vrabel, Martin	AB				
	USA	Plasencia, Steve	AB				
	ZAI	Koji, Kamana	AB				

Men 10000m				Hommes 10000m				
Final/Sept. 26				Finale/26 Sept				
Rank	Ctry	Name	1000m	2000m	3000m	4000m	5000m	
Rang	Pays	Nom	6000m	7000m	8000m	9000m	10000m	
1	MAR	Boutaib, Mly. Brahim	2:42.69 16:20.07	5:30.21 19:04.56	8:08.00 21:50.17	10:50.27 24:35.79	13:35.52 27:21.46	NOR
2	ITA	Antibo, Salvatore	2:41.74 16:23.72	5:29.46 19:09.36	8:08.43 21:52.78	10:51.18 24:40.62	13:37.71 27:23.55	
3	KEN	Kimeli, Kipkemboi	2:42.43 16:20.98	5:29.37 19:05.61	8:07.78 21:53.11	10:50.05 24:39.24	13:35.32 27:25.16	
4	FRA	Prianon, Jean-Louis	2:43.14 16:34.18	5:30.66 19:22.12	8:13.71 22:04.68	10:58.02 24:53.35	13:45.58 27:36.43	
5	MEX	Barrios, Arturo	2:42.55 16:34.44	5:30.14 19:21.66	8:13.54 22:09.63	10:57.79 24:57.56	13:45.37 27:39.32	
6	GDR	Kunze, Hansjoerg	2:43.26 16:35.02	5:31.00 19:21.94	8:14.46 22:09.90	10:58.86 24:57.77	13:46.21 27:39.35	
7	FRA	Arpin, Paul	2:43.37 16:34.71	5:30.79 19:22.12	8:13.63 22:10.11	10:58.65 24:58.08	13:45.99 27:39.36	
8	KEN	Tanui, Moses	2:42.02 16:22.94	5:28.50 19:12.41	8:09.10 22:05.23	10:50.59 24:57.96	13:36.74 27:47.23	
9	HOL	Ten Kate, Marti	2:43.96 16:36.31	5:31.58 19:26.58	8:15.38 22:15.49	11:00.54 25:06.54	13:47.60 27:50.30	
10	ESP	Prieto, Antonio	2:43.64 16:35.91	5:31.38 19:26.27	8:14.91 22:16.54	10:59.40 25:09.28	13:47.40 27:52.78	
11	MEX	Gonzalez, Mauricio	2:42.77 16:36.11	5:30.07 19:26.47	8:13.42 22:16.74	10:58.44 25:10.08	13:47.04 27:59.90	
12	BUL	Ignatov, Evgueni	2:42.90 16:34.49	5:30.60 19:22.31	8:13.86 22:16.22	10:58.21 25:16.01	13:45.74 28:09.32	

Rank	Ctry	Name	1000m	2000m	3000m	4000m	5000m
Rang	Pays	Nom	6000m	7000m	8000m	9000m	10000m
13	POR	Pinto, Antonio	2:43.51 16:34.74	5:31.02 19:24.35	8:14.69 22:19.01	10:59.71 25:20.38	13:46.42 28:09.53
14	JPN	Akutsu, Kozo	2:42.63 16:40.71	5:30.32 19:35.34	8:14.06 22:31.93	11:00.26 25:26.42	13:47.91 28:09.70
15	ECU	Vera, Rolando	2:43.38 16:42.50	5:30.47 19:35.20	8:14.27 22:31.73	11:00.05 25:26.22	13:49.83 28:17.64
16	NOR	Halvorsen, John	2:44.25 16:50.46	5:32.01 19:45.80	8:18.31 22:39.68	11:06.38 25:33.49	13:56.79 28:29.21
17	JPN	Yoneshige, Shuichi	2:42.21 17:09.39	5:30.45 20:11.78	8:13.86 22:00.96	11:05.39 26:15.61	14:08.18 29:04.44
18	USA	Bickford, Bruce	2:43.73 17:00.39	5:31.27 20:03.13	8:15.65 23:05.13	11:05.15 26:05.86	14:01.09 29:09.74
	KEN	Merande, Boniface	2:42.39	5:29.98	8:16.61	11:11.80	AB
	GBR	Martin, Eamonn	2:43.04	5:30.74	8:14.26	10:59.07	13:46.66 AB

Men 3000m Steeplechase				Hommes 3000m Steeplechase			
Round 1 Heat 1/Sept. 26				Tour 1 Serie 1/26 Sept			
Rank	Ctry	Name	1000m	2000m	3000m		
Rang	Pays	Nom					
1	FRA	Pannier, Raymond	2:56.00	5:49.00	8:30.94	Q	
2	GBR	Rowland, Mark	2:56.00	5:49.00	8:31.40	Q	
3	KEN	Koech, Peter	2:57.00	5:49.00	8:31.66	Q	
4	ITA	Lambruschini, Alessandro	2:57.00	5:49.00	8:32.59	Q	
5	BRA	Domingues, Adauto	2:57.00	5:49.00	8:32.77	Q	
6	USA	Marsh, Henry	2:57.00	5:49.00	8:33.89	Q	
7	HOL	Koeleman, Hans	2:57.00	5:49.00	8:35.20	Q	
8	PHI	Begeo, Hector	2:58.00	5:52.00	8:46.60		
9	PAR	Lopez, Ramon	2:57.00	5:52.00	8:56.06		
10	FIJ	Singh, Davendra	2:59.00	6:09.00	9:23.50		
	MAR	Sahere, Abdelaziz	2:57.00	5:49.00	DQ		

Men 3000m Steeplechase				Hommes 3000m Steeplechase			
Round 1 Heat 2/Sept. 26				Tour 1 Serie 2/26 Sept			
Rank	Ctry	Name	1000m	2000m	3000m		
Rang	Pays	Nom					
1	ITA	Panetta, Francesco	2:48.00	5:37.00	8:29.75	Q	
2	KEN	Kariuki, Julius	2:50.00	5:39.00	8:33.42	Q	
3	ALG	Brahmi, Azzeddine	2:48.00	5:38.00	8:35.59	Q	
4	USA	Diemer, Brian	2:50.00	5:39.00	8:38.40	Q	
5	GBR	Wedderburn, Eddie	2:50.00	5:39.00	8:38.90	Q	
6	POL	Maminski, Boguslaw	2:52.00	5:39.00	8:45.72	Q	
7	CAN	Fell, Graeme	2:50.00	5:44.00	8:51.25	Q	
8	KOR	Cha, Han-Sik	2:52.00	5:52.00	8:59.82		
9	TAN	Salom, Ikaji	2:56.00	6:02.00	9:10.36		
	HUN	Vago, Bela			NS		
	CHI	Ulloa, Emilio	2:53.00		AB		

Men 3000m Steeplechase				Hommes 3000m Steeplechase			
Round 1 Heat 3/Sept. 26				Tour 1 Serie 3/26 Sept			
Rank	Ctry	Name	1000m	2000m	3000m		
Rang	Pays	Nom					
1	KEN	Sang, Patrick	2:52.00	5:47.00	8:36.11	Q	
2	FRG	Volkman, Jens	2:52.00	5:47.00	8:36.37	Q	
3	GDR	Melzer, Hager	2:52.00	5:47.00	8:36.45	Q	
4	USA	Abshire, Brian	2:53.00	5:47.00	8:36.56	Q	
5	BEL	Van Dijk, Willam	2:52.00	5:47.00	8:36.80	Q	
6	FRA	Le Stum, Bruno	2:53.00	5:47.00	8:36.95	Q	
7	TUN	Baccouche, Fathi	2:53.00	5:47.00	8:38.67	Q	
8	GBR	Hackney, Roger	2:53.00	5:47.00	8:39.30		
9	IRL	Quinn, Brendan	2:53.00	5:47.00	8:40.87		
10	KSA	Al Dousari, Hameed	2:54.00	5:49.00	8:45.25		
11	BRN	Al Doseri, Abdullah	2:54.00	5:59.00	9:10.85		

Men 3000m Steeplechase				Hommes 3000m Steeplechase			
Round 1/Sept. 26				Tour 1/26 Sept			
Rank	Ctry	Name	Result	Rank	Ctry	Name	Result
Rang	Pays	Nom	Resultat	Rang	Pays	Nom	Resultat
1	ITA	Panetta, Francesco	8:29.75	Q			
2	FRA	Pannier, Raymond	8:30.94	Q			
3	GBR	Rowland, Mark	8:31.40	Q			
4	KEN	Koech, Peter	8:31.66	Q			
5	ITA	Lambruschini, Alessandro	8:32.59	Q			
6	BRA	Domingues, Adauto	8:32.77	Q			
7	KEN	Kariuki, Julius	8:33.42	Q			
8	USA	Marsh, Henry	8:33.89	Q			



Rank Rang	Ctry Pays	Name Nom	Result Resultat	
9	HOL	Koeleman, Hans	8:35.20	Q
10	ALG	Brahmi, Azzeddine	8:35.59	Q
11	KEN	Sang, Patrick	8:36.11	Q
12	FRG	Volkman, Jens	8:36.37	Q
13	GDR	Melzer, Hager	8:36.45	Q
14	USA	Abshire, Brian	8:36.56	Q
15	BEL	Van Dijck, William	8:36.80	Q
16	FRA	Le Stum, Bruno	8:36.95	Q
17	USA	Diemer, Brian	8:38.40	Q
18	TUN	Baccouche, Fathi	8:38.67	Q
19	GBR	Wedderburn, Eddie	8:38.90	Q
20	GBR	Hackney, Roger	8:39.30	Q
21	IRL	Quinn, Brendan	8:40.87	Q
22	KSA	Al Dousari, Hameed	8:45.24	Q
23	POL	Maminski, Boguslaw	8:45.72	Q
24	PHI	Begeo, Hector	8:46.60	Q
25	CAN	Fell, Graeme	8:51.25	Q
26	PAR	Lopez, Ramon	8:56.06	Q
27	KOR	Cha, Han-Sik	8:59.82	
28	TAN	Salom, Ikaji	9:10.36	
29	BRN	Al Doseri, Abdullah	9:10.85	
30	FIJ	Singh, Davendra	9:23.50	
	CHI	Ulloa, Emilio	AB	
	MAR	Sahere, Abdelaziz	DQ	
	HUN	Vago, Bela	NS	

Men 3000m Steeplechase Semi-final/Sept. 28				Hommes 3000m Steeplechase Demi-finale/28 Sept			
Rank Rang	Ctry Pays	Name Nom	Result Resultat				
1	BEL	Van Dijck, William	8:15.63	Q			
2	KEN	Koech, Peter	8:15.68	Q			
3	GDR	Melzer, Hager	8:16.27	Q			
4	ALG	Brahmi, Azzeddine	8:16.54	Q			
5	KEN	Sang, Patrick	8:16.70	Q			
6	ITA	Lambruschini, Alessandro	8:16.92	Q			
7	ITA	Panetta, Francesco	8:17.23	Q			
8	POL	Maminski, Boguslaw	8:18.28	Q			
9	GBR	Rowland, Mark	8:18.31	Q			
10	KEN	Kariuki, Julius	8:18.53	Q			
11	USA	Marsh, Henry	8:18.94	Q			
12	FRA	Pannier, Raymond	8:19.39	Q			
13	CAN	Fell, Graeme	8:19.99	Q			
14	HOL	Koeleman, Hans	8:21.86				
15	USA	Diemer, Brian	8:23.89				
16	FRG	Volkman, Jens	8:25.19				
17	FRA	Le Stum, Bruno	8:26.69				
18	USA	Abshire, Brian	8:27.78				
19	GBR	Wedderburn, Eddie	8:28.62				
20	TUN	Baccouche, Fathi	8:31.36				
21	BRA	Domingues, Adauto	8:35.05				
22	PHI	Begeo, Hector	8:35.09				
23	IRL	Quinn, Brendan	8:43.34				
24	KSA	Al Dousari, Hameed	8:44.22				
25	PAR	Lopez, Ramon	8:52.62				
	GBR	Hackney, Roger	AB				

Men 3000m Steeplechase Semi-final Heat 1/Sept. 28			Hommes 3000m Steeplechase Demi-finale Serie 1/28 Sept			
Rank Rang	Ctry Pays	Name Nom	1000m	2000m	3000m	
1	BEL	Van Dijck, William	2:43.73	5:31.65	8:15.63	Q
2	KEN	Koech, Peter	2:44.64	5:32.23	8:15.68	Q
3	GDR	Melzer, Hager	2:44.03	5:31.89	8:16.27	Q
4	KEN	Sang, Patrick	2:45.39	5:32.51	8:16.70	Q
5	ITA	Panetta, Francesco	2:43.47	5:31.26	8:17.23	Q
6	POL	Maminski, Boguslaw	2:45.16	5:32.88	8:18.28	
7	USA	Marsh, Henry	2:46.47	5:33.88	8:18.94	
8	HOL	Koeleman, Hans	2:45.87	5:33.13	8:21.86	
9	FRA	Le Stum, Bruno	2:45.12	5:37.10	8:26.69	
10	GBR	Wedderburn, Eddie	2:44.91	5:33.80	8:28.62	
11	BRA	Domingues, Adauto	2:46.85	5:45.36	8:35.05	
12	PHI	Begeo, Hector	2:48.44	5:46.83	8:35.09	
	GBR	Hackney, Roger	2:45.63	5:40.47	AB	

Men 3000m Steeplechase Final/Sept. 30			Hommes 3000m Steeplechase Finale/30 Sept			
Rank Rang	Ctry Pays	Name Nom	1000m	2000m	3000m	
1	KEN	Kariuki, Julius	2:43.95	5:28.60	8:05.51	NOR
2	KEN	Koech, Peter	2:43.70	5:28.75	8:06.79	
3	GBR	Rowland, Mark	2:43.96	5:28.96	8:07.96	
4	ITA	Lambruschini, Alessandro	2:44.84	5:30.28	8:12.17	
5	BEL	Van Dijck, William	2:43.29	5:28.85	8:13.99	
6	USA	Marsh, Henry	2:45.33	5:31.57	8:14.39	
7	KEN	Sang, Patrick	2:44.63	5:29.88	8:15.22	
8	POL	Maminski, Boguslaw	2:44.32	5:29.17	8:15.97	
9	ITA	Panetta, Francesco	2:42.93	5:28.29	8:17.79	
10	GDR	Melzer, Hager	2:43.62	5:30.73	8:19.82	
11	CAN	Fell, Graeme	2:44.99	5:32.49	8:21.73	
12	FRA	Pannier, Raymond	2:44.05	5:31.01	8:23.80	
13	ALG	Brahmi, Azzeddine	2:44.56	5:32.74	8:26.68	

Men 3000m Steeplechase Semi-final Heat 2/Sept. 28			Hommes 3000m Steeplechase Demi-finale Serie 2/28 Sept			
Rank Rang	Ctry Pays	Name Nom	1000m	2000	3000m	
1	ALG	Brahmi, Azzeddine	2:49.66	5:37.29	8:16.54	Q
2	ITA	Lambruschini, Alessandro	2:49.51	5:37.51	8:16.92	Q
3	GBR	Rowland, Mark	2:48.08	5:36.67	8:18.31	Q
4	KEN	Kariuki, Julius	2:48.86	5:37.14	8:18.53	Q
5	FRA	Pannier, Raymond	2:47.74	5:36.56	8:19.39	Q
6	CAN	Fell, Graeme	2:48.67	5:37.75	8:19.99	
7	USA	Diemer, Brian	2:49.93	5:36.88	8:23.89	
8	FRG	Volkman, Jens	2:49.14	5:38.30	8:25.19	
9	USA	Abshire, Brian	2:50.38	5:37.71	8:27.78	
10	TUN	Baccouche, Fathi	2:48.43	5:37.20	8:31.36	
11	IRL	Quinn, Brendan	2:50.07	5:41.07	8:43.34	
12	KSA	Al Dousari, Hameed	2:50.75	5:46.12	8:44.22	
13	PAR	Lopez, Ramon	2:52.20	5:52.14	8:52.62	

Athletics

Men 110m Hurdles Round 1 Heat 1/Sept. 25				Hommes 110m Haies Tour 1 Serie 1/25 Sept	
Rank Rang	Ctry Pays	Name Nom	Result Resultat		
1	GBR	Jackson, Colin	13.50	Q	
2	FRA	Caristan, Stephane	13.96	Q	
3	JAM	Parker, Andrew	14.00	Q	
4	FRG	Schwarthoff, Florian	14.13	Q	
5	ALG	Tadjine, Nourreddine	14.36	Q	
6	QAT	Marzouq S. M. Al-Abdulla, Rashid	14.69		
7	BEN	De souza, Brice Jose Maurice	15.05		
	BRA	Campos, Lyndon	NS		

Men 110m Hurdles Round 1 Heat 2/Sept. 25				Hommes 110m Haies Tour 1 Serie 2/25 Sept	
Rank Rang	Ctry Pays	Name Nom	Result Resultat		
1	USA	Cambell, Anthony	13.45	Q	
2	CHN	Yu, Zhicheng	14.07	Q	
3	URS	Markine, Alexandre	14.17	Q	
4	IRL	Kearns, Thomas	14.17	Q	
5	DOM	Castillo, Modesto	14.40	Q	
6	MRI	Lefou, Judex	14.73		
	CAN	Kerho, Stephen	AB		

Men 110m Hurdles Round 1 Heat 3/Sept. 25				Hommes 110m Haies Tour 1 Serie 3/25 Sept	
Rank Rang	Ctry Pays	Name Nom	Result Resultat		
1	USA	Kingdom, Roger	13.40	Q	
2	GBR	Jarrett, Tony	13.45	Q	
3	CHN	Yang, Guang	14.01	Q	
4	BAH	Knowles, George	14.22	Q	
5	KUW	Alkhudhur, Zeyad	14.44	Q	
6	KSA	Al Dossary, Yousif	15.03		
	SLE	Grant, Benjamin	NS		

Men 110m Hurdles Round 1 Heat 4/Sept. 25				Hommes 110m Haies Tour 1 Serie 4/25 Sept	
Rank Rang	Ctry Pays	Name Nom	Result Resultat		
1	CAN	Mckoy, Mark	13.78	Q	
2	TCH	Hudec, Jiri	13.78	Q	
3	FRA	Tourret, Philippe	13.88	Q	
4	BEL	Cuypers, Alain	13.89	Q	
5	ESP	Moracho, Javier	13.96	Q	
6	TPE	Wu, Chin-Jing	14.11		
7	NEP	Kunwar, Dambar	16.51		

Men 110m Hurdles Round 1 Heat 5/Sept. 25				Hommes 110m Haies Tour 1 Serie 5/25 Sept	
Rank Rang	Ctry Pays	Name Nom	Result Resultat		
1	URS	Chichkine, Vladimir	13.75	Q	
2	FIN	Ylostalo, Mikael	13.87	Q	
3	DEN	Jensen, Erik S	13.91	Q	
4	ESP	Sala, Carlos	14.00	Q	
5	KOR	Kim, Jin-Tae	14.06	Q	
6	POR	Lima, Joao	14.73		
7	FIJ	Miller, Albert	14.86		

Men 110m Hurdles Round 1 Heat 6/Sept. 25				Hommes 110m Haies Tour 1 Serie 6/25 Sept	
Rank Rang	Ctry Pays	Name Nom	Result Resultat		
1	USA	Blake, Arthur	13.66	Q	
2	GBR	Ridgeon, Jonathan	13.75	Q	
3	JAM	Bucknor, Richard	13.89	Q	
4	HUN	Bakos, Gyorgy	13.94	Q	
5	IRQ	Mohsin, Najl. G.	14.46	Q	
6	GUY	Hampstead, Curt	14.88		
7	MEX	Carmona, Roberto	15.24		

Men 110m Hurdles Round 1/Sept. 25				Hommes 110m Haies Tour 1/25 Sept	
Rank Rang	Ctry Pays	Name Nom	Result Resultat		
1	USA	Kingdom, Roger	13.40	Q	
2	GBR	Jarrett, Tony	13.45	Q	
2	USA	Cambell, Anthony	13.45	Q	
4	GBR	Jackson, Colin	13.50	Q	
5	USA	Blake, Arthur	13.66	Q	

Athletics

Rank Rang	Ctry Pays	Name Nom	Result Resultat		
6	GBR	Ridgeon, Jonathan	13.75	Q	
6	URS	Chichkine, Vladimir	13.75	Q	
8	CAN	Mckoy, Mark	13.78	Q	
8	TCH	Hudec, Jiri	13.78	Q	
10	FIN	Ylostalo, Mikael	13.87	Q	
11	FRA	Tourret, Philippe	13.88	Q	
12	BEL	Cuypers, Alain	13.89	Q	
12	JAM	Bucknor, Richard	13.89	Q	
14	DEN	Jensen, Erik s	13.91	Q	
15	HUN	Bakos, Gyorgy	13.94	Q	
16	ESP	Moracho, Javier	13.96	Q	
16	FRA	Caristan, Stephane	13.96	Q	
18	ESP	Sala, Carlos	14.00	Q	
18	JAM	Parker, Andrew	14.00	Q	
20	CHN	Yang, Guang	14.01	Q	
21	KOR	Kim, Jin-Tae	14.06	Q	
22	CHN	Yu, Zhicheng	14.07	Q	
23	TPE	Wu, Chin-Jing	14.11	Q	
24	FRG	Schwarthoff, Florian	14.13	Q	
25	IRL	Kearns, Thomas	14.17	Q	
25	URS	Markine, Alexandre	14.17	Q	
27	BAH	Knowles, George	14.22	Q	
28	ALG	Tadjine, Nourreddine	14.36	Q	
29	DOM	Castillo, Modesto	14.40	Q	
30	KUW	Alkhudhur, Zeyad	14.44	Q	
31	IRQ	Mohsin, Najl. G.	14.46	Q	
32	QAT	Marzouq S. M. Al-Abdulla, Rashid	14.69	Q	
33	MRI	Lefou, Judex	14.73		
33	POR	Lima, Joao	14.73		
35	FIJ	Miller, Albert	14.86		
36	GUY	Hampstead, Curt	14.88		
37	KSA	Al Dossary, Yousif	15.03		
38	BEN	De Souza, Brice Jose Maurice	15.05		
39	MEX	Carmona, Roberto	15.24		
40	NEP	Kunwar, Dambar	16.51		
	CAN	Kerho, Stephen	AB		
	BRA	Campos, Lyndon	NS		
	SLE	Grant, Benjamin	NS		

Men 110m Hurdles Round 2 Heat 1/Sept. 25				Hommes 110m Haies Tour 2 Serie 1/25 Sept	
Rank Rang	Ctry Pays	Name Nom	Result Resultat		
1	USA	Kingdom, Roger	13.17	Q	NOR
2	CAN	Mckoy, Mark	13.56	Q	
3	FRA	Caristan, Stephane	13.61	Q	
4	TCH	Hudec, Jiri	13.65	Q	
5	FRG	Schwarthoff, Florian	13.67		
6	ESP	Moracho, Javier	13.88		
7	IRL	Kearns, Thomas	14.30		
8	QAT	Marzouq S. M. Al-Abdulla, Rashid	14.47		

Men 110m Hurdles Round 2 Heat 2/Sept. 25				Hommes 110m Haies Tour 2 Serie 2/25 Sept	
Rank Rang	Ctry Pays	Name Nom	Result Resultat		
1	USA	Cambell, Anthony	13.47	Q	
2	FRA	Tourret, Philippe	13.73	Q	
3	GBR	Ridgeon, Jonathan	13.74	Q	
4	CHN	Yu, Zhicheng	13.95	Q	
5	DEN	Jensen, Erik S	14.02		
6	JAM	Parker, Andrew	14.05		
7	URS	Markine, Alexandre	14.19		
8	KUW	Alkhudhur, Zeyad	14.56		

Men 110m Hurdles Round 2 Heat 3/Sept. 25				Hommes 110m Haies Tour 2 Serie 3/25 Sept	
Rank Rang	Ctry Pays	Name Nom	Result Resultat		
1	GBR	Jarrett, Tony	13.59	Q	
2	URS	Chichkine, Vladimir	13.60	Q	
3	FIN	Ylostalo, Mikael	13.70	Q	
4	ESP	Sala, Carlos	13.77	Q	
5	TPE	Wu, Chin-Jing	14.23		
6	BAH	Knowles, George	14.30		
7	IRQ	Mohsin, Najl. G.	14.47		
8	HUN	Bakos, Gyorgy	18.02		

**Men 110m Hurdles
Round 2 Heat 4/Sept. 25**

Rank Rang	Ctry Pays	Name Nom	Result Resultat	
1	GBR	Jackson, Colin	13.37	Q
2	USA	Blake, Arthur	13.65	Q
3	JAM	Bucknor, Richard	13.91	Q
4	BEL	Cuypers, Alain	13.97	Q
5	KOR	Kim, Jin-Tae	14.00	
6	DOM	Castillo, Modesto	14.21	
7	CHN	Yang, Guang	14.24	
8	ALG	Tadjine, Nourreddine	14.35	

**Hommes 110m Haies
Tour 2 Serie 4/25 Sept**

Rank Rang	Ctry Pays	Name Nom	Result Resultat	
6	GBR	Jackson, Colin	13.55	Q
7	GBR	Jarrett, Tony	13.56	Q
8	GBR	Ridgeon, Jonathan	13.68	Q
9	FRA	Caristan, Stephane	13.71	
10	TCH	Hudec, Jiri	13.73	
11	ESP	Sala, Carlos	13.85	
12	BEL	Cuypers, Alain	13.92	
13	CHN	Yu, Zhicheng	13.94	
14	FRA	Tourret, Philippe	13.96	
15	JAM	Bucknor, Richard	13.98	
16	FIN	Ylostalo, Mikael	14.09	

**Men 110m Hurdles
Round 2/Sept. 25**

Rank Rang	Ctry Pays	Name Nom	Result Resultat	
1	USA	Kingdom, Roger	13.17	Q NOR
2	GBR	Jackson, Colin	13.37	Q
3	USA	Cambell, Anthony	13.47	Q
4	CAN	Mckoy, Mark	13.56	Q
5	GBR	Jarrett, Tony	13.59	Q
6	URS	Chichkine, Vladimir	13.60	Q
7	FRA	Caristan, Stephane	13.61	Q
8	TCH	Hudec, Jiri	13.65	Q
8	USA	Blake, Arthur	13.65	Q
10	FRG	Schwarthoff, Florian	13.67	
11	FIN	Ylostalo, Mikael	13.70	Q
12	FRA	Tourret, Philippe	13.73	Q
13	GBR	Ridgeon, Jonathan	13.74	Q
14	ESP	Sala, Carlos	13.77	Q
15	ESP	Moracho, Javier	13.88	
16	JAM	Bucknor, Richard	13.91	Q
17	CHN	Yu, Zhicheng	13.95	Q
18	BEL	Cuypers, Alain	13.97	Q
19	KOR	Kim, Jin-Tae	14.00	
20	DEN	Jensen, Erik S	14.02	
21	JAM	Parker, Andrew	14.05	
22	URS	Markine, Alexandre	14.19	
23	DOM	Castillo, Modesto	14.21	
24	TPE	Wu, Chin-Jing	14.23	
25	CHN	Yang, Guang	14.24	
26	BAH	Knowles, George	14.30	
26	IRL	Keams, Thomas	14.30	
28	ALG	Tadjine, Nourreddine	14.35	
29	IRQ	Mohsin, Najl. G.	14.47	
29	QAT	Marzouq S. M. Al-Abdulla, Rashid	14.47	
31	KUW	Alkhudhur, Zeyad	14.56	
32	HUN	Bakos, Gyorgy	18.02	

**Men 110m Hurdles
Semi-final Heat 1/Sept. 26**

Rank Rang	Ctry Pays	Name Nom	Result Resultat	
1	URS	Chichkine, Vladimir	13.46	Q
2	USA	Cambell, Anthony	13.47	Q
3	GBR	Jackson, Colin	13.55	Q
4	GBR	Ridgeon, Jonathan	13.68	Q
5	FRA	Caristan, Stephane	13.71	
6	ESP	Sala, Carlos	13.85	
7	BEL	Cuypers, Alain	13.92	
8	JAM	Bucknor, Richard	13.98	

**Hommes 110m Haies
Demi-finale Serie 1/26 Sept**

Rank Rang	Ctry Pays	Name Nom	Result Resultat	
1	USA	Kingdom, Roger	13.37	Q
2	USA	Blake, Arthur	13.52	Q
3	CAN	Mckoy, Mark	13.54	Q
4	GBR	Jarrett, Tony	13.56	Q
5	TCH	Hudec, Jiri	13.73	
6	CHN	Yu, Zhicheng	13.94	
7	FRA	Tourret, Philippe	13.96	
8	FIN	Ylostalo, Mikael	14.09	

**Men 110m Hurdles
Semi-final Heat 2/Sept. 26**

Rank Rang	Ctry Pays	Name Nom	Result Resultat	
1	USA	Kingdom, Roger	13.37	Q
2	USA	Blake, Arthur	13.52	Q
3	CAN	Mckoy, Mark	13.54	Q
4	GBR	Jarrett, Tony	13.56	Q
5	TCH	Hudec, Jiri	13.73	
6	CHN	Yu, Zhicheng	13.94	
7	FRA	Tourret, Philippe	13.96	
8	FIN	Ylostalo, Mikael	14.09	

**Hommes 110m Haies
Demi-finale Serie 2/26 Sept**

Rank Rang	Ctry Pays	Name Nom	Result Resultat	
1	USA	Kingdom, Roger	13.37	Q
2	URS	Chichkine, Vladimir	13.46	Q
3	USA	Cambell, Anthony	13.47	Q
4	USA	Blake, Arthur	13.52	Q
5	CAN	Mckoy, Mark	13.54	Q

**Men 110m Hurdles
Semi-final/Sept. 26**

Rank Rang	Ctry Pays	Name Nom	Result Resultat	
1	USA	Kingdom, Roger	13.37	Q
2	URS	Chichkine, Vladimir	13.46	Q
3	USA	Cambell, Anthony	13.47	Q
4	USA	Blake, Arthur	13.52	Q
5	CAN	Mckoy, Mark	13.54	Q

**Hommes 110m Haies
Demi-finale/26 Sept**

Rank Rang	Ctry Pays	Name Nom	Result Resultat	
1	USA	Kingdom, Roger	13.37	Q
2	URS	Chichkine, Vladimir	13.46	Q
3	USA	Cambell, Anthony	13.47	Q
4	USA	Blake, Arthur	13.52	Q
5	CAN	Mckoy, Mark	13.54	Q

Rank Rang	Ctry Pays	Name Nom	Result Resultat	
6	GBR	Jackson, Colin	13.55	Q
7	GBR	Jarrett, Tony	13.56	Q
8	GBR	Ridgeon, Jonathan	13.68	Q
9	FRA	Caristan, Stephane	13.71	
10	TCH	Hudec, Jiri	13.73	
11	ESP	Sala, Carlos	13.85	
12	BEL	Cuypers, Alain	13.92	
13	CHN	Yu, Zhicheng	13.94	
14	FRA	Tourret, Philippe	13.96	
15	JAM	Bucknor, Richard	13.98	
16	FIN	Ylostalo, Mikael	14.09	

**Men 110m Hurdles
Final/Sept. 26**

Rank Rang	Ctry Pays	Name Nom	Result Resultat	
1	USA	Kingdom, Roger	12.98	NOR
2	GBR	Jackson, Colin	13.28	
3	USA	Cambell, Anthony	13.38	
4	URS	Chichkine, Vladimir	13.51	
5	GBR	Ridgeon, Jonathan	13.52	
6	GBR	Jarrett, Tony	13.54	
7	CAN	Mckoy, Mark	13.61	
8	USA	Blake, Arthur	13.96	

**Hommes 110m Haies
Finale/26 Sept**

Rank Rang	Ctry Pays	Name Nom	Result Resultat	
1	USA	Kingdom, Roger	12.98	NOR
2	GBR	Jackson, Colin	13.28	
3	USA	Cambell, Anthony	13.38	
4	URS	Chichkine, Vladimir	13.51	
5	GBR	Ridgeon, Jonathan	13.52	
6	GBR	Jarrett, Tony	13.54	
7	CAN	Mckoy, Mark	13.61	
8	USA	Blake, Arthur	13.96	

**Men 400m Hurdles
Round 1 Heat 1/Sept. 23**

Rank Rang	Ctry Pays	Name Nom	Result Resultat	
1	SEN	Ba, El Hadj Dia	49.41	Q
2	AUT	Ehrle, Klaus	50.10	Q
3	CAN	Graham, John	50.30	Q
4	KOR	Hwang, Hong-Chul	50.52	
5	GBR	Harries, Philip	50.81	
6	KUW	Aldowaila, Jasem	51.87	
7	NEP	Kunwar, Dambar	56.80	
	SWE	Nylander, Sven	NS	

**Hommes 400m Haies
Tour 1 Serie 1/23 Sept**

Rank Rang	Ctry Pays	Name Nom	Result Resultat	
1	SEN	Ba, El Hadj Dia	49.41	Q
2	AUT	Ehrle, Klaus	50.10	Q
3	CAN	Graham, John	50.30	Q
4	KOR	Hwang, Hong-Chul	50.52	
5	GBR	Harries, Philip	50.81	
6	KUW	Aldowaila, Jasem	51.87	
7	NEP	Kunwar, Dambar	56.80	
	SWE	Nylander, Sven	NS	

**Men 400m Hurdles
Round 1 Heat 2/Sept. 23**

Rank Rang	Ctry Pays	Name Nom	Result Resultat	
1	FRG	Schmid, Harald	49.77	Q
2	KEN	Kitur, Simon	49.88	Q
3	BEL	Cuypers, Alain	50.42	Q
4	EGY	Ghanem, Ahmed	50.44	
5	JPN	Yoshida, Ryoichi	50.49	
6	ZAM	Matete, Samuel	51.06	
7	PUR	Cordero, Domingo	51.26	
8	HON	Ponce, Jorge Fidel	55.38	

**Hommes 400m Haies
Tour 1 Serie 2/23 Sept**

Rank Rang	Ctry Pays	Name Nom	Result Resultat	
1	FRG	Schmid, Harald	49.77	Q
2	KEN	Kitur, Simon	49.88	Q
3	BEL	Cuypers, Alain	50.42	Q
4	EGY	Ghanem, Ahmed	50.44	
5	JPN	Yoshida, Ryoichi	50.49	
6	ZAM	Matete, Samuel	51.06	
7	PUR	Cordero, Domingo	51.26	
8	HON	Ponce, Jorge Fidel	55.38	

**Men 400m Hurdles
Round 1 Heat 3/Sept. 23**

Rank Rang	Ctry Pays	Name Nom	Result Resultat	
1	USA	Moses, Edwin	49.38	Q
2	FRG	Ilt, Edgar	50.10	Q
3	ESP	Alonso, Jose	50.21	Q
4	AUS	Miller, Leigh	50.53	
5	YUG	Karaulic, Branislav	51.32	
6	BAR	Ince, Allan	52.76	
7	ANT	Selkridge, Oral	53.44	

**Hommes 400m Haies
Tour 1 Serie 3/23 Sept**

Rank Rang	Ctry Pays	Name Nom	Result Resultat	
1	USA	Moses, Edwin	49.38	Q
2	FRG	Ilt, Edgar	50.10	Q
3	ESP	Alonso, Jose	50.21	Q
4	AUS	Miller, Leigh	50.53	
5	YUG	Karaulic, Branislav	51.32	
6	BAR	Ince, Allan	52.76	
7	ANT	Selkridge, Oral	53.44	

**Men 400m Hurdles
Round 1 Heat 4/Sept. 23**

Rank Rang	Ctry Pays	Name Nom	Result Resultat	
1	USA	Young, Kevin	49.35	Q
2	GBR	Akabusi, Kriss	49.62	Q
3	KEN	Yego, Gideon	49.80	Q
4	TCH	Kucej, Jozef	49.89	
5	YUG	Kopitar, Rok	50.54	
6	SEN	Mbaye, Hamidou	50.58	
7	SLE	Grant, Benjamin	51.73	
8	FIJ	Rodan, Joseph	53.66	

**Hommes 400m Haies
Tour 1 Serie 4/23 Sept**

Rank Rang	Ctry Pays	Name Nom	Result Resultat	
1	USA	Young, Kevin	49.35	Q
2	GBR	Akabusi, Kriss	49.62	Q
3	KEN	Yego, Gideon	49.80	Q
4	TCH	Kucej, Jozef	49.89	
5	YUG	Kopitar, Rok	50.54	
6	SEN	Mbaye, Hamidou	50.58	
7	SLE	Grant, Benjamin	51.73	
8	FIJ	Rodan, Joseph	53.66	

Athletics

Men 400m Hurdles Round 1 Heat 5/Sept. 23				Hommes 400m Haies Tour 1 Serie 5/23 Sept	
Rank Rang	Ctry Pays	Name Nom	Result Resultat		
1	USA	Phillips, Andre	49.34	Q	
2	JAM	Graham, Winthrop	49.40	Q	
3	KEN	Maritim, Joseph	49.64	Q	
4	BUL	Tomov, Toma	49.66		
5	GBR	Robertson, Max	50.67		
6	BRN	Hamada, Ahmed	51.34		
7	KSA	Al Dossary, Yousif	53.51		

Men 400m Hurdles Round 1/Sept. 23				Hommes 400m Haies Tour 1/23 Sept	
Rank Rang	Ctry Pays	Name Nom	Result Resultat		
1	USA	Phillips, Andre	49.34	Q	
2	USA	Young, Kevin	49.35	Q	
3	USA	Moses, Edwin	49.38	Q	
4	JAM	Graham, Winthrop	49.40	Q	
5	SEN	Ba, El Hadj Dia	49.41	Q	
6	GBR	Akabusi, Kriss	49.62	Q	
7	KEN	Maritim, Joseph	49.64	Q	
8	BUL	Tomov, Toma	49.66	Q	
9	FRG	Schmid, Harald	49.77	Q	
10	KEN	Yego, Gideon	49.80	Q	
11	KEN	Kitur, Simon	49.88	Q	
12	TCH	Kucej, Jozef	49.89		
13	AUT	Ehrle, Klaus	50.10	Q	
13	FRG	Itt, Edgar	50.10	Q	
15	ESP	Alonso, Jose	50.21	Q	
16	CAN	Graham, John	50.30	Q	
17	BEL	Cuypers, Alain	50.42	Q	
18	EGY	Ghanem, Ahmed	50.44		
19	JPN	Yoshida, Ryoichi	50.49		
20	KOR	Hwang, Hong-Chul	50.52		
21	AUS	Miller, Leigh	50.53		
22	YUG	Kopitar, Rok	50.54		
23	SEN	Mbaye, Hamidou	50.58		
24	GBR	Robertson, Max	50.67		
25	GBR	Harries, Philip	50.81		
26	ZAM	Matete, Samuel	51.06		
27	PUR	Cordero, Domingo	51.26		
28	YUG	Karaulic, Branislav	51.32		
29	BRN	Hamada, Ahmed	51.34		
30	SLE	Grant, Benjamin	51.73		
31	KUW	Aldowaila, Jasem	51.87		
32	BAR	Ince, Allan	52.76		
33	ANT	Selkridge, Oral	53.44		
34	KSA	Al Dossary, Yousif	53.51		
35	FIJ	Rodan, Joseph	53.66		
36	HON	Ponce, Jorge Fidel	55.38		
37	NEP	Kunwar, Dambar	56.80		
	SWE	Nylander, Sven	NS		

Men 400 Hurdles Semi-final Heat 1/Sept. 24				Hommes 400m Haies Demi-finale Serie 1/24 Sept	
Rank Rang	Ctry Pays	Name Nom	Result Resultat		
1	USA	Moses, Edwin	47.89	Q	
2	USA	Young, Kevin	48.56	Q	
3	FRG	Schmid, Harald	48.93	Q	
4	GBR	Akabusi, Kriss	49.22	Q	
5	KEN	Maritim, Joseph	49.50		
6	ESP	Alonso, Jose	49.57		
7	AUT	Ehrle, Klaus	51.04		
8	CAN	Graham, John	51.33		

Men 400m Hurdles Semi-final Heat 2/Sept. 24				Hommes 400m Haies Demi-finale Serie 2/24 Sept	
Rank Rang	Ctry Pays	Name Nom	Result Resultat		
1	USA	Phillips, Andre	48.19	Q	
2	JAM	Graham, Winthrop	48.37	Q	
3	SEN	Ba, El hadj Dia	48.48	Q	
4	FRG	Itt, Edgar	48.86	Q	
5	BUL	Tomov, Toma	48.90		
6	KEN	Kitur, Simon	49.74		
7	BEL	Cuypers, Alain	49.75		
	KEN	Yego, Gideon	DQ		

Athlétisme

Men 400m Hurdles semi-final/Sept. 24				Hommes 400m Haies Demi-final/24 Sept	
Rank Rang	Ctry Pays	Name Nom	Result Resultat		
1	USA	Moses, Edwin	47.89	Q	
2	USA	Phillips, Andre	48.19	Q	
3	JAM	Graham, Winthrop	48.37	Q	
4	SEN	Ba, El Hadj Dia	48.48	Q	
5	USA	Young, Kevin	48.56	Q	
6	FRG	Itt, Edgar	48.86	Q	
7	BUL	Tomov, Toma	48.90		
8	FRG	Schmid, Harald	48.93	Q	
9	GBR	Akabusi, Kriss	49.22	Q	
10	KEN	Maritim, Joseph	49.50		
11	ESP	Alonso, Jose	49.57		
12	KEN	Kitur, Simon	49.74		
13	BEL	Cuypers, Alain	49.75		
14	AUT	Ehrle, Klaus	51.04		
15	CAN	Graham, John	51.33		
	KEN	Yego, Gideon	DQ		

Men 400m Hurdles Final/Sept. 25				Hommes 400m Haies Finale/25 Sept	
Rank Rang	Ctry Pays	Name Nom	Result Resultat		
1	USA	Phillips, Andre	47.19	NOR	
2	SEN	Ba, El Hadj Dia	47.23		
3	USA	Moses, Edwin	47.56		
4	USA	Young, Kevin	47.94		
5	JAM	Graham, Winthrop	48.04		
6	GBR	Akabusi, Kriss	48.69		
7	FRG	Schmid, Harald	48.76		
8	FRG	Itt, Edgar	48.78		



Men 20km Walk Final/Sept. 23				Hommes 20km Marche Finale/23 Sept				Men 50km Walk Final/Sept. 30				Hommes 50km Marche Finale/30 Sept				
Rank	Ctry	Name		5km	10km	15km	20km	Rank	Ctry	Name	5km	10km	15km	20km	25km	
Rang	Pays	Nom						Rang	Pays	Nom	30km	35km	40km	45km	50km	
1	TCH	Pribilinec, Jozef		20:08	40:37	1'00:39	1'19:57 NBO	1	URS	Ivanenko, Viacheslav	22:43	45:36	1'08:12	1'30:33	1'52:59	
2	GDR	Weigel, Ronald		20:08	40:48	1'00:39	1'20:00				2'14:31	2'35:50	2'56:29	3'17:22	3'38:29 NBO	
3	ITA	Damilano, Maurizio		20:08	40:37	1'00:47	1'20:14	2	GDR	Weigel, Ronald	22:43	45:36	1'08:12	1'30:33	1'52:59	
4	ESP	Marin, Jose		20:08	40:37	1'00:50	1'20:34				2'14:31	2'35:50	2'56:32	3'17:40	3'38:56	
5	TCH	Mrazek, Roman		20:08	40:37	1'00:50	1'20:43	3	GDR	Gauder, Hartwig	22:43	45:36	1'08:12	1'30:33	1'52:59	
6	URS	Chtchennikov, Mikhail		20:49	40:51	1'00:47	1'20:47				2'14:31	2'35:50	2'56:32	3'17:43	3'39:45	
7	MEX	Mercenario, Carlos		21:23	40:37	1'00:54	1'20:53	4	URS	Potachev, Alexandre	22:43	45:36	1'08:12	1'30:33	1'52:59	
8	GDR	Noack, Axel		20:51	40:43	1'00:54	1'21:14				2'14:31	2'35:50	2'56:43	3'17:48	3'41:00	
9	ITA	De Benedictis, Giovanni		20:08	40:57	1'05:04	1'21:18	5	ESP	Marin, Jose	22:43	45:36	1'08:12	1'30:33	1'52:59	
10	CAN	Leblanc, Guillaume		20:08	40:48	1'01:13	1'21:29				2'14:31	2'35:50	2'56:43	3'18:43	3'43:03	
11	AUS	Baker, Simon		20:08	40:57	1'01:07	1'21:47	6	AUS	Baker, Simon	22:43	45:46	1'08:12	1'30:33	1'53:19	
12	ESP	Plaza, Daniel		20:49	40:43	1'01:13	1'21:53				2'15:12	2'36:46	2'58:22	3'20:40	3'44:07	
13	GBR	Mccombie, Ian		20:51	40:48	1'01:32	1'22:03	7	SWE	Gustafsson, Bo	22:43	45:36	1'08:12	1'30:33	1'52:59	
14	URS	Perchine, Alexei		20:08	40:37	1'01:42	1'22:32				2'14:31	2'36:09	2'58:08	3'21:34	3'44:49	
15	TCH	Blazek, Pavol		20:08	40:43	1'01:13	1'22:39	8	ITA	Ducceschi, Raffaello	22:43	45:36	1'08:12	1'30:33	1'52:59	
16	FRA	Fesselier, Martial		20:22	41:31	1'02:07	1'22:43				2'14:31	2'36:46	2'58:48	3'22:16	3'45:43	
17	IRL	Mcdonald, Jimmy (James)		20:08	40:48	1'02:07	1'22:45	9	GDR	Meisch, Dietmar	22:43	45:36	1'08:12	1'30:33	1'52:59	
18	FRA	Toutain, Thierry		20:25	41:31	1'01:50	1'22:55				2'14:31	2'36:46	2'58:48	3'22:16	3'45:43	
19	ITA	Mattioli, Carlo		20:51	40:43	1'01:42	1'22:58	10	TCH	Szikora, Pavol	22:43	45:36	1'08:12	1'30:33	1'52:59	
20	FRA	Corre, Jean-Claude		20:22	41:31	1'02:19	1'23:09				2'15:21	2'37:49	2'59:13	3'22:39	3'47:04	
21	HUN	Urbanik, Sandor		20:08	40:51	1'01:46	1'23:18	11	ITA	Perricelli, Giovanni	23:01	46:14	1'09:13	1'32:12	1'55:00	
22	NOR	Andersen, Erling		20:51	40:57	1'01:50	1'23:30				2'17:32	2'39:54	3'00:21	3'23:16	3'47:14	
23	ESP	Pueyo, Ricardo		20:08	41:22	1'02:07	1'23:40	12	TCH	Blazek, Pavol	22:43	45:36	1'08:12	1'30:33	1'52:59	
24	GBR	Maddocks, Chris		20:22	41:39	1'02:19	1'23:46				2'14:54	2'36:36	2'59:46	3'23:58	3'47:31	
25	SWE	Johansson, Stefan		20:49	41:25	1'02:19	1'23:51	13	ESP	Llopart, Jorge	22:43	45:36	1'08:12	1'30:33	1'52:59	
26	JPN	Sakai, Hirofumi		20:08	41:07	1'01:46	1'24:08				2'14:54	2'37:25	2'59:26	3'22:52	3'48:09	
27	URS	Missioulla, Evgueni		20:08	41:34	1'03:19	1'24:39	14	CAN	Lapointe, Francois	22:43	45:36	1'08:12	1'30:33	1'52:59	
28	AUS	Jachno, Andrew		20:22	41:28	1'02:56	1'24:52				2'16:08	2'37:49	3'00:53	3'24:11	3'48:15	
29	POR	Urbano, Jose		20:49	41:22	1'02:56	1'24:56	15	MEX	Bermudez, Martin	22:27	45:23	1'08:05	1'30:01	1'51:58	
30	SWE	Staaf, Jan		20:49	41:22	1'02:56	1'24:59				2'14:25	2'35:50	2'58:29	3'22:39	3'49:22	
31	POR	Pinto, Jose		20:49	42:39	1'03:37	1'26:33	16	FRA	Lemercier, Alain	22:43	45:36	1'08:12	1'30:33	1'52:59	
32	ALG	Ferguene, Abdelouahab		20:22	41:39	1'03:19	1'26:33				2'14:31	2'36:21	2'58:31	3'21:58	3'50:28	
33	COL	Moreno, Hector		20:08	42:34	1'03:24	1'27:06	17	TCH	Mrazek, Roman	23:03	46:56	1'09:58	1'33:01	1'56:13	
34	ALG	Bouhalla, Mohamed		20:25	42:34	1'03:37	1'27:10				2'19:35	2'42:29	3'04:53	3'24:16	3'50:46	
35	BEL	Dejonckheere, Godfried		21:23	42:53	1'04:51	1'27:14	18	FIN	Salonen, Reima	22:43	45:36	1'08:12	1'30:33	1'52:59	
36	POL	Szlapkin, Zdzislaw		20:22	42:34	1'03:24	1'27:23				2'16:15	2'39:27	3'02:11	3'25:58	3'51:36	
37	USA	Morgan, Gary		20:25	42:34	1'03:59	1'27:26	19	AUS	Jachno, Andrew	22:56	46:14	1'09:19	1'32:12	1'55:00	
38	USA	Heiring, Jim		20:25	40:51	1'04:12	1'27:30				2'17:34	2'39:54	3'01:56	3'24:28	3'53:23	
39	POR	Oliveira, Helder		20:25	42:39	1'04:00	1'27:39	20	SWE	Johansson, Stefan	23:20	47:09	1'10:37	1'33:52	1'57:18	
40	HON	Fonseca, Santiago		20:49	42:53	1'04:51	1'27:41				2'20:31	2'42:38	3'05:07	3'28:20	3'53:34	
41	CHN	Li, Baojin		21:23	42:39	1'05:12	1'27:57	21	POR	Pinto, Jose	23:01	46:41	1'10:37	1'34:20	1'57:54	
42	FIN	Salonen, Reima		20:08	41:28	1'03:37	1'28:25				2'21:45	2'43:37	3'08:48	3'32:56	3'55:57	
43	BUL	Ivanov, Lyubomir		20:22	41:34	1'03:24	1'28:43	22	USA	Evoniuk, Marco	22:43	45:36	1'08:12	1'30:33	1'52:59	
44	USA	Lewis, Timothy		20:22	42:34	1'05:27	1'31:00				2'15:06	2'39:13	3'03:50	3'25:41	3'56:55	
45	BRA	Palma, Marcelo		20:22	42:48	1'05:28	1'31:42	23	USA	Schueler, Carl	23:20	46:35	1'09:46	1'33:00	1'56:14	
46	KOR	Chung, Pil-Hwa		21:55	43:23	1'05:44	1'32:23				2'19:42	2'43:33	3'06:37	3'35:29	3'57:44	
47	JPN	Kosaka, Tadahiro		22:30	44:20	1'06:26	1'32:46	24	POL	Bednarek, Jacek	23:01	46:28	1'09:15	1'32:12	1'55:00	
48	HON	Valladares Lopez, Rafael		22:56	45:45	1'07:20	1'37:09				2'17:50	2'41:07	3'05:07	3'32:16	3'58:31	
49	KOR	Jung, Myong-Oh		24:54	46:59	1'09:01	1'40:09	25	ESP	Alcalde, Manuel	22:43	46:10	1'09:15	1'32:12	1'55:00	
	COL	Moreno, Querubin		20:49	41:25		AB				2'17:50	2'40:13	3'05:02	3'29:58	3'59:13	
	MEX	Canto, Ernesto		20:08	40:37	1'00:39	DQ	26	URS	Popovitch, Vitali	22:43	45:36	1'08:12	1'30:33	1'52:59	
	MEX	Sanchez, Joel		20:51	41:07		DO				2'14:56	2'37:30	3'00:13	3'26:45	3'59:23	
	LUX	Sowa, Marc		21:23	42:53	1'05:04	DQ	27	GBR	Morton, Leslie	23:20	47:51	1'10:23	1'35:14	1'59:04	
											2'22:43	2'46:26	3'14:01	3'38:07	3'59:30	
								28	GBR	Blagg, Paul	23:20	47:51	1'10:23	1'35:14	1'59:04	
											2'22:43	2'45:52	3'12:39	3'37:12	4'00:07	
								28	CHN	Li, Baojin	22:43	45:36	1'08:12	1'31:17	1'54:17	
											2'16:59	2'39:54	3'04:15	3'31:48	4'00:07	

Athletics

Athlétisme

Rank Rang	Ctry Pays	Name Nom	5km 30km	10km 35km	15km 40km	20km 45km	25km 50km
30	COL	Moreno, Hector	23:35 2'26:20	49:18 2'50:31	1'13:38 3'18:20	1'37:58 3'43:51	1'59:10 4'01:31
31	JPN	Kosaka, Tadahiro	23:20 2'22:43	47:34 2'46:26	1'10:23 3'10:12	1'35:14 3'37:32	1'59:04 4'03:12
32	ITA	Bellucci, Sandro	22:43 2'17:34	45:36 2'41:30	1'08:12 3'06:23	1'31:17 3'32:28	1'54:43 4'04:56
33	MEX	Bravo, Arturo	22:43 2'16:30	45:36 2'41:44	1'08:12 3'05:21	1'30:33 3'40:48	1'52:59 4'08:08
34	USA	Kaestner, Andrew	23:20 2'24:43	47:51 2'51:10	1'10:23 3'18:33	1'35:14 3'45:12	1'59:04 4'12:49
35	KEN	Sawe, William	23:55 2'29:35	49:18 2'56:26	1'14:23 3'24:27	1'39:24 3'55:17	2'02:02 4'25:24
	MEX	Andrade, Hernan	22:27	45:23	1'07:35	1'29:47	DQ
	NOR	Andersen, Erling	22:43 2'14:31	45:36 2'36:14	1'08:12 2'58:54	1'30:33	1'52:59 AB
	BEL	Dejonckheere, Godfried	22:43	45:36	1'08:12	1'30:33	AB
	FRA	Neff, Jean-Marie	22:56	45:36	1'08:12	1'30:33	1'54:03 DQ
	FRA	NEISSE,ERIC	22:43 2'14:56	45:36 2'37:45	1'08:12 3'02:52	1'30:33	1'52:59 DQ
	HUN	Urbanik, Sandor	22:43 2'14:31	45:36 2'35:50	1'08:12 2'57:40	1'30:33	1'52:59 AB
	SWE	Staaf, Jan	23:03 2'17:34	46:28 2'41:30	1'09:13	1'32:12	1'55:00 AB

Men 4x100m Round 1 Heat 1/Sept. 30			Hommes 4x100m Tour 1 Serie 1/30 Sept	
Rank Rang	Ctry Pays	Name Nom	Result Resultat	
1	FRA	Marie-Rose, Bruno Sangouma, Daniel Queneherve, Gilles Moriniere, Max	38.87	Q
2	NGR	Edet, Victor Ezinwa, Davison Tetengi, Abdullahi Olobia, Olatunji	39.15	Q
3	ITA	Madonia, Ezio Floris, Sandro Pavoni, Pierfrancesco Tilli, Stefano	39.20	Q
4	KOR	Sung, Nak-Kun Shim, Duk-Sup Kim, Bock-Sup Chang, Jae-Keun	39.61	
5	TPE	Cheng, Hsin-Fu Lee, Shiunn-Long Nai, Hui-Fang Wu, Chin-Jing	40.40	
6	UGA	Musonge, Moses Ssali, Joseph Goville, John Okot, Mike	41.39	
7	MDV	Asif, Ismail Manik, Ibrahim Aboobakur, Abdul Razzak Hanim, Mohamed	44.31	

Men 4x100m Round 1 Heat 2/Sept. 30			Hommes 4x100m Tour 1 Serie 2/30 Sept	
Rank Rang	Ctry Pays	Name Nom	Result Resultat	
1	URS	Krylov, Vladimir Mouraviev, Vladimir Bryzgine, Victor Savine, Vitali	38.82	Q
2	FRG	Haas, Christian Heer, Fritz Klein, Peter Schweisfurth, Dirk	39.01	Q
3	GHA	Akogyiram, Eric Gariba, Salaam Myles-Mills, John Tuffuor, Emmanuel	39.13	Q
4	CHN	Cai, Jianming Li, Feng Li, Tao Zheng, Chen	39.67	
5	QAT	Marzouqs. Abdulla, Rashid Marzouqs. Abdulla, Faraj Muftahmubarak, Saad Mansoor B.K., Talal	40.05	
6	CGO	Biniakounou, Armand Lombocko, Hygien-Nicaise Ndinga, Henri Ndinga, Pierre	41.26	
	SEN	Diaz, Joseph Mbaye, A. Mbagnick Pouye, Babacar Tamba, Ibrahima	DQ	
	INA	Mardi, Mardi Pambudi, Kresno. Eko Wattebosi, Elieser Yusuf, Moch. Yusuf	AB	

Men 4x100m Round 1 Heat 3/Sept. 30			Hommes 4x100m Tour 1 Serie 3/30 Sept	
Rank Rang	Ctry Pays	Name Nom	Result Resultat	
1	CAN	Mowatt, Andrew Mahorn, Atlee Anthony Williams, Desai Morrisson, Brian	39.41	Q
2	JAM	Faulknor, Christopher Meghoo, Gregory Mair, John Wright, Clive	39.53	Q
3	JPN	Matsubara, Kaoru Aoto, Shinji Kurihara, Koji Kasahara, Takahiro	39.70	Q
4	KEN	Nyang'au, Elkana Ondiek, Kennedy Kipkemboi, Simon Wekesa, Peter	40.30	



Rank Rang	Ctry Pays	Name Nom	Result Resultat
5	THA	Tiprod, Supas Watanasin, Visut Sermisiri, Anuwat Wangganont, Chainarong	40.57
6	ANT	Soleyne, St Clair Browne, Alfred Lindsay, Howard Miller, Larry	41.18
7	SLE	Keita, Francis Dove-Edwin, Horace Grant, Benjamin Sandy, Felix	41.19
	ESP	Gascon, Florencio Talavera, Enrique Rocandio, Valentin Arques, Javier	AB

Men 4x100m Round 1 Heat 4/Sept. 30				Hommes 4x100m Tour 1 Serie 4/30 Sept			
Rank Rang	Ctry Pays	Name Nom	Result Resultat				

1	HUN	Bakos, Gyorgy Karaffa, Laszlo Tatar, Istvan Kovacs, Attila	39.12	Q
2	GBR	Bunney, Elliot Regis, John I Mcfarlane, Michael Callender, Clarence	39.17	Q
3	POR	Abrantes, Arnaldo Curvelo, Pedro Agostinho, Pedro Barroso, Luis	39.61	Q
4	MEX	Adam, Herman Nava, Eduardo Ruiz, Antonio Elizondo, Miguel	40.31	
5	BEN	Ogouchi, Fortune Mahoulikponto, Patrice Vignissy, Dossou Germain M. Alassane, Ousseni, Issa	41.52	
6	BAN	Md Shah alam, Alam Shahanuddinchowdhury, Shahanud MD Milzerhossain, Milzer MD Shah Jalal, MD Shah Jalal	41.78	
	USA	Mitchell, Dennis Robinson, Albert Smith, Calvin Mcneill, Lee	DQ	

Men 4x100m Round 1/Sept. 30				Hommes 4x100m Tour 1/30 Sept			
Rank Rang	Ctry Pays	Name Nom	Result Resultat				

1	URS	Krylov, Vladimir Mouraviev, Vladimir Bryzgine, Victor Savine, Vitali	38.82	Q
2	FRA	Marie-Rose, Bruno Sangouma, Daniel Queneherve, Gilles Moriniere, Max	38.87	Q
3	FRG	Haas, Christian Heer, Fritz Klein, Peter Schweisfurth, Dirk	39.01	Q
4	HUN	Bakos, Gyorgy Karaffa, Laszlo Tatar, Istvan Kovacs, Attila	39.12	Q
5	GHA	Akogyiram, Eric Gariba, Salaam Myles-Mills, John Tuftuor, Emmanuel	39.13	Q
6	NGR	Edet, Victor Ezinwa, Davison Tetengi, Abdullahi Olobia, Olatunji	39.15	Q
7	GBR	Bunney, Elliot Regis, John Mcfarlane, Michael Callender, Clarence	39.17	Q
8	ITA	Madonia, Ezio Floris, Sandro Pavoni, Pierfrancesco Tilli, Stefano	39.20	Q

9	CAN	Mowatt, Andrew Mahorn, Atlee Anthony Williams, Desai Morrisson, Brian	39.41	Q
10	JAM	Faulknor, Christopher Meghoo, Gregory Mair, John Wright, Clive	39.53	Q
11	KOR	Sung, Nak-Kun Shim, Duk-Sup Kim, Bock-Sup Chang, Jae-Keun	39.61	Q
11	POR	Abrantes, Arnaldo Curvelo, Pedro Agostinho, Pedro Barroso, Luis	39.61	Q
13	CHN	Cai, Jianming Li, Feng Li, Tao Zheng, Chen	39.67	Q
14	JPN	Matsubara, Kaoru Aoto, Shinji Kurihara, Koji Kasahara, Takahiro	39.70	Q
15	QAT	Marzouqs, Abdulla, Rashid Marzouqs, Abdulla, Faraj Muftahmubarak, Saad Mansoor B.K., Talal	40.05	Q
16	KEN	Nyang'au, Elkana Ondiek, Kennedy Kipkemboi, Simon Wekesa, Peter	40.30	Q
17	MEX	Adam, Herman Nava, Eduardo Ruiz, Antonio Elizondo, Miguel	40.31	
18	TPE	Cheng, Hsin-Fu Lee, Shiunn-Long Nai, Hui-Fang Wu, Chin-Jing	40.40	
19	THA	Tiprod, Supas Watanasin, Visut Sermisiri, Anuwat Wangganont, Chainarong	40.57	
20	ANT	Soleyne, St Clair Browne, Alfred Lindsay, Howard Miller, Larry	41.18	
21	SLE	Keita, Francis Dove-Edwin, Horace Grant, Benjamin Sandy, Felix	41.19	
22	CGO	Biniakounou, Armand Lombocko, Hygien-nicaise Ndinga, Henri Ndinga, Pierre	41.26	
23	UGA	Musonge, Moses Ssali, Joseph Goville, John Okot, Mike	41.39	
24	BEN	Ogouchi, Fortune Mahoulikponto, Patrice Vignissy, Dossou Germain M. Alassane, Ousseni, Issa	41.52	
25	BAN	Md Shah Alam, Alam Shahanuddinchowdhury, Shahanud MD Milzerhossain, Milzer MD Shah Jalal, MD Shah Jalal	41.78	
26	MDV	Asif, Ismail Manik, Ibrahim Aboobakur, Abdul Razzak Hanim, Mohamed	44.31	
	ESP	Gascon, Florencio Talavera, Enrique Rocandio, Valentin Arques, Javier	AB	
	INA	Mardi, Mardi Pambudi, Kresno. Eko Wattebosi, Elieser Yusuf, Moch. Yusuf	AB	
	SEN	Diaz, Joseph Mbaye, A. Mbagnick Pouye, Babacar Tamba, Ibrahim	DQ	
	USA	Mitchell, Dennis Robinson, Albert Smith, Calvin Mcneill, Lee	DQ	

Athletics

Athlétisme

Men 4x100m Semi-final Heat 1/Oct. 1				Hommes 4x100m Demi-finale Serie 1/1 Oct	
Rank Rang	Ctry Pays	Name Nom	Result Resultat		
1	FRA	Marie-Rose, Bruno Sangouma, Daniel Queneherve, Gilles Moriniere, Max	38.49	Q	
2	GBR	Bunney, Elliot Regis, John Mcfarlane, Michael Christie, Linford	38.52	Q	
3	JAM	Faulknor, Christopher Meghoo, Gregory Wright, Clive Mair, John	38.75	Q	
4	FRG	Heer, Fritz Haas, Christian Klein, Peter Schweisfurth, Dirk	38.75	Q	
5	JPN	Aoto, Shinji Yamauchi, Kenji Kurihara, Koji Takano, Susumu	38.90		
6	NGR	Edet, Victor Adeniken, Olapade Adeyanju, Isiaq Olobia, Olatunji	39.05		
7	KOR	Sung, Nak-Kun Shim, Duk-Sup Kim, Bock-Sup Chang, Jae-Keun	39.43		
8	QAT	Marzouq S. M. Al-Abdulla, Rashid Marzouqs. Abdulla, Faraj Muftahmubarak, Saad Mansoor B. K., Talal	41.19		

Men 4x100m Semi-final Heat 2/Oct. 1				Hommes 4x100m Demi-finale Serie 2/1 Oct	
Rank Rang	Ctry Pays	Name Nom	Result Resultat		
1	URS	Bryzgine, Victor Krylov, Vladimir Mouraviev, Vladimir Savine, Vitali	38.55	Q	
2	ITA	Madonia, Ezio Floris, Sandro Pavoni, Pierfrancesco Tilli, Stefano	38.65	Q	
3	HUN	Bakos, Gyorgy Karaffa, Laszlo Tatar, Istvan Kovacs, Attila	38.84	Q	
4	CAN	Mowatt, Andrew Mahorn, Atlee Anthony Williams, Desai Morrisson, Brian	38.94	Q	
5	GHA	Myles-Mills, John Akogyiram, Eric Gariba, Salaam Boateng, Nelson	39.46		
6	KEN	Nyang'au, Elkana Ondiek, Kennedy Kipkemboi, Simon Wekesa, Peter	39.47		
	POR	Abrantes, Arnaldo Curvelo, Pedro Agostinho, Pedro Barroso, Luis	DQ		
	CHN	Li, Tao Cai, Jianming Li, Feng Zheng, Chen	AB		

Men 4x100m Final/Oct. 1				Hommes 4x100m Finale/1 Oct	
Rank Rang	Ctry Pays	Name Nom	Result Resultat		
1	URS	Bryzgine, Victor Krylov, Vladimir Mouraviev, Vladimir Savine, Vitali	38.19		
2	GBR	Bunney, Elliot Regis, John Mcfarlane, Michael Christie, Linford	38.28		
3	FRA	Marie-Rose, Bruno Sangouma, Daniel Queneherve, Gilles Moriniere, Max	38.40		

Rank Rang	Ctry Pays	Name Nom	Result Resultat		
4	JAM	Faulknor, Christopher Meghoo, Gregory Wright, Clive Mair, John	38.47		
5	ITA	Madonia, Ezio Floris, Sandro Pavoni, Pierfrancesco Tilli, Stefano	38.54		
6	FRG	Heer, Fritz Haas, Christian Klein, Peter Schweisfurth, Dirk	38.55		
7	CAN	Williams, Desai Mahorn, Atlee Anthony Enweani, Cyprian Morrisson, Brian	38.93		
8	HUN	Bakos, Gyorgy Karaffa, Laszlo Tatar, Istvan Kovacs, Attila	39.19		

Men 4x400m Round 1 Heat 1/Sept. 30				Hommes 4x400m Tour 1 Serie 1/30 Sept	
Rank Rang	Ctry Pays	Name Nom	Result Resultat		
1	FRG	Kuhn, Bodo Henrich, Mark Vaihinger, Jorg Lubke, Raif	3:03.90	Q	
2	GBR	Whittle, Brian Harmsworth, Paul Bennett, Todd Brown, Philip	3:04.18	Q	
3	JPN	Koike, Hirofumi Yamauchi, Kenji Kawasumi, Hiromi Takano, Susumu	3:05.63	Q	
4	AUS	Ballard, Robert Garner, Mark Miller, Leigh Murphy, Miles	3:05.93	Q	
5	BAR	Straughn, Seibert Louis, Richard Ince, Allan Forde, Elvis	3:06.03		
6	SLE	Dove-Edwin, Horace Sandy, Felix Grant, Benjamin Sawyer, David	3:10.47		
7	OMA	Al-Habsi, Sulaiman Al-Malki, Mohamed Amer Al-Khalidi, Abdullah Al-Bulushi, Mansoor	3:12.89		
8	KOR	Hwang, Hong-Chul Yoon, Nam-Han Ryu, Tae-Keong Cho, Jin-Saeng	3:14.71		

Men 4x400m Round 1 Heat 2/Sept. 30				Hommes 4x400m Tour 1 Serie 2/30 Sept	
Rank Rang	Ctry Pays	Name Nom	Result Resultat		
1	JAM	Burnett, Howard Morris, Devon Graham, Trevor Davis, Howard	3:04.00	Q	
2	YUG	Karaulic, Branislav Popovic, Slobodan Brankovic, Slobodan Macev, Ismail	3:05.62	Q	
3	POR	Curvelo, Paulo Lomba, Filipe Abrantes, Antonio Silva, Alvaro	3:07.75	Q	
4	GDR	Carlowitz, Jens Schimmer, Michael Schersing, Mathias Schoenlebe, Thomas	3:08.13	Q	
5	CAN	Graham, John Folkes, Carl Osland, Paul Skerritt, Anton	3:09.52		
6	ANT	Lindsay, Howard Browne, Alfred Selkridge, Oral Miller, Larry	3:11.04		



Rank Rang	Ctry Pays	Name Nom	Result Resultat
7	ZAM	Kalembo, Douglas Musonda, Enock Chipalo, Jonathan Matete, Samuel	3:11.35
	UGA	Goville, John Musonge, Moses Okot, Mike Olweny, Sunday	NS

Men 4x400m Round 1 Heat 3/Sept. 30 **Hommes 4x400m Tour 1 Serie 3/30 Sept**

Rank Rang	Ctry Pays	Name Nom	Result Resultat
1	USA	Valmon, Andrew Robinzine, Kevin Mckay, Antonio Lewis, Steven	3:02.16 Q
2	KEN	Sawe, Tito Sang, Lucas Ereng, Paul Kipkemboi, Simon	3:05.21 Q
3	NGR	Uti, Sunday Ugbisie, Moses Amike, Henry Egbunike, Innocent	3:06.59 Q
4	SEN	Diarra, Ousmane Niang, Babacar Fall, Moussa Ba, El hadj Dia	3:06.93 Q
5	CIV	Kpidi, Akissi Kuya, Zongo Fofana, Lancine Tiacoh, Gabriel	3:07.40
6	PAK	Ahmad, Bashir Sadaqat, Muhammad Afzal, Muhammad Fiaz, Muhammad	3:08.54
7	BOT	Ramotshabi, Joseph Gaseitsiwe, Kebapetse Kgarametso, Benny Maweni, Sunday	3:13.16

Men 4x400m Round 1/Sept. 30 **Hommes 4x400m Tour 1/30 Sept**

Rank Rang	Ctry Pays	Name Nom	Result Resultat
1	USA	Valmon, Andrew Robinzine, Kevin Mckay, Antonio Lewis, Steven	3:02.16 Q
2	FRG	Kuhn, Bodo Henrich, Mark Vaihinger, Jorg Lubke, Raif	3:03.90 Q
3	JAM	Burnett, Howard Morris, Devon Graham, Trevor Davis, Howard	3:04.00 Q
4	GBR	Whittle, Brian Harmsworth, Paul Bennett, Todd Brown, Philip	3:04.18 Q
5	KEN	Sawe, Tito Sang, Lucas Ereng, Paul Kipkemboi, Simon	3:05.21 Q
6	YUG	Karaulic, Branislav Popovic, Slobodan Brankovic, Slobodan Macev, Ismail	3:05.62 Q
7	JPN	Koike, Hirofumi Yamauchi, Kenji Kawasumi, Hiromi Takano, Susumu	3:05.63 Q
8	AUS	Ballard, Robert Garner, Mark Miller, Leigh Murphy, Miles	3:05.93 Q
9	BAR	Straughn, Seibert Louis, Richard Ince, Allan Forde, Elvis	3:06.03 Q
10	NGR	Uti, Sunday Ugbisie, Moses Amike, Henry Egbunike, Innocent	3:06.59 Q

Rank Rang	Ctry Pays	Name Nom	Result Resultat
11	SEN	Diarra, Ousmane Niang, Babacar Fall, Moussa Ba, El Hadj Dia	3:06.93 Q
12	CIV	Kpidi, Akissi Kuya, Zongo Fofana, Lancine Tiacoh, Gabriel	3:07.40 Q
13	POR	Curvelo, Paulo Lomba, Filipe Abrantes, Antonio Silva, Alvaro	3:07.75 Q
14	GDR	Carlowitz, Jens Schimmer, Michael Schersing, Mathias Schoenlebe, Thomas	3:08.13 Q
15	PAK	Ahmad, Bashir Sadaqat, Muhammad Afzal, Muhammad Fiaz, Muhammad	3:08.54 Q
16	CAN	Graham, John Folkes, Carl Osland, Paul Skerritt, Anton	3:09.52 Q
17	SLE	Dove-Edwin, Horace Sandy, Felix Grant, Benjamin Sawyer, David	3:10.47
18	ANT	Lindsay, Howard Browne, Alfred Seikridge, Oral Miller, Larry	3:11.04
19	ZAM	Kalembo, Douglas Musonda, Enock Chipalo, Jonathan Matete, Samuel	3:11.35
20	OMA	Al-Habsi, Sulaiman Al-Malki, Mohamed Amer Al-Khalidi, Abdullah Al-Bulushi, Mansoor	3:12.89
21	BOT	Ramotshabi, Joseph Gaseitsiwe, Kebapetse Kgarametso, Benny Maweni, Sunday	3:13.16
22	KOR	Hwang, Hong-Chul Yoon, Nam-Han Ryu, Tae-Keong Cho, Jin-Saeng	3:14.71
	UGA	Goville, John Musonge, Moses Okot, Mike Olweny, Sunday	NS

Men 4x400m Semi-final Heat 1/Sept. 30 **Hommes 4x400m Demi-finale Serie 1/30 Sept**

Rank Rang	Ctry Pays	Name Nom	Result Resultat
1	USA	Valmon, Andrew Robinzine, Kevin Mckay, Antonio Lewis, Steven	3:02.84 Q
2	KEN	Sawe, Tito Sang, Lucas Ereng, Paul Kipkemboi, Simon	3:03.24 Q
3	GBR	Whittle, Brian Akabusi, Kriss Bennett, Todd Brown, Philip	3:04.60 Q
4	AUS	Murphy, Miles Garner, Mark Ballard, Robert Clark, Darren	3:06.63 Q
5	BAR	Straughn, Seibert Louis, Richard Ince, Allan Forde, Elvis	3:06.93
6	CIV	Kpidi, Akissi Djedjemel, Rene Djetnan, Kouadio Tiacoh, Gabriel	3:07.15
7	POR	Curvelo, Paulo Lomba, Filipe Abrantes, Antonio Silva, Alvaro	3:07.75

Athletics

Athlétisme

Rank Rang	Ctry Pays	Name Nom	Result Resultat
8	CAN	Graham, John Folkes, Carl Osland, Paul Skerritt, Anton	3:09.48

Men 4 x 400m Semi-final Heat 2/Sept. 30				Hommes 4 x 400m Demi-finale Serie 2/30 Sept			
Rank Rang	Ctry Pays	Name Nom	Result Resultat				

1	GDR	Carlowitz, Jens Moeller, Frank Schersing, Mathias Schoenlebe, Thomas	3:00.60	Q			
2	FRG	Dobeleit, Norbert Henrich, Mark Vaihinger, Jorg Lubke, Raif	3:00.66	Q			
3	JAM	Graham, Trevor Morris, Devon Cameron, Bertland Davis, Howard	3:00.94	Q			
4	NGR	Uti, Sunday Ugbisie, Moses Amike, Henry Egbunike, Innocent	3:01.13	Q			
5	YUG	Karaulic, Branislav Popovic, Slobodan Brankovic, Slobodan Macev, Ismail	3:01.59				
6	JPN	Koike, Hirofumi Yamauchi, Kenji Kawasumi, Hiromi Takano, Susumu	3:03.80				
7	SEN	Diarra, Ousmane Niang, Babacar Fall, Moussa Ba, El hadj Dia	3:07.19				
8	PAK	Ahmad, Bashir Sadaqat, Muhammad Afzal, Muhammad Fiaz, Muhammad	3:09.50				

Men 4 x 400m Final/Oct. 1				Hommes 4x400m Finale/1 Oct			
Rank Rang	Ctry Pays	Name Nom	Result Resultat				

1	USA	Everett, Danny Lewis, Steven Robinzine, Kevin Reynolds, Harry Butch	2:56.16	EWR			
2	JAM	Davis, Howard Morris, Devon Graham, Winthrop Cameron, Bertland	3:00.30				
3	FRG	Dobeleit, Norbert Ilt, Edgar Vaihinger, Jorg Lubke, Raif	3:00.56				
4	GDR	Carlowitz, Jens Schersing, Mathias Moeller, Frank Schoenlebe, Thomas	3:01.13				
5	GBR	Whittle, Brian Akabusi, Kriss Bennett, Todd Brown, Philip	3:02.00				
6	AUS	Ballard, Robert Garner, Mark Murphy, Miles Clark, Darren	3:02.49				
7	NGR	Uti, Sunday Ugbisie, Moses Amike, Henry Egbunike, Innocent	3:02.50				
8	KEN	Sawe, Tito Sang, Lucas Ereng, Paul Kipkemboi, Simon	3:04.69				

Men Marathon Final/Oct. 2			Hommes Marathon Finale/2 Oct				
Rank Rang	Ctry Pays	Name Nom	5km 25km	10km 30km	15km 35km	20km 40km	Finish

1	ITA	Bordin, Gelindo	15:34 1'16:57	30:32 1'32:49	46:42 1'48:25	1'01:22 2'03:45	2'10:32
2	KEN	Wakiihuri, Douglas	15:29 1'16:57	30:32 1'32:49	45:57 1'48:25	1'01:21 2'03:43	2'10:47
3	DJI	Ahmed Saleh, Houssein	15:29 1'16:57	30:59 1'32:49	45:57 1'48:25	1'01:21 2'03:39	2'10:59
4	JPN	Nakayama, Takeyuki	15:29 1'16:57	30:59 1'32:49	45:57 1'48:25	1'01:21 2'04:02	2'11:05
5	AUS	Moneghetti, Stephen	15:47 1'16:57	30:32 1'32:54	45:57 1'48:47	1'01:21 2'04:49	2'11:49
6	GBR	Spedding, Charlie	15:37 1'16:57	30:32 1'32:49	45:57 1'48:25	1'01:22 2'04:59	2'12:19
7	TAN	Ikangaa, Juma	15:29 1'24:44	30:32 1'32:49	45:57 1'48:25	1'01:22 2'05:19	2'13:06
8	AUS	De Castella, Robert	15:39 1'16:57	30:32 1'32:51	45:57 1'48:53	1'01:21 2'05:44	2'13:07
9	JPN	Seko, Toshihiko	15:37 1'16:57	30:32 1'32:49	45:57 1'49:17	1'01:21 2'06:18	2'13:41
10	URS	Kachapov, Ravil	15:29 1'16:57	30:32 1'32:54	45:57 1'49:22	1'01:21 2'06:11	2'13:49
11	MEX	Herrera, Jesus	15:29 1'16:57	30:32 1'32:58	45:57 1'49:20	1'01:22 2'06:11	2'13:58
12	NZL	Campbell, John	16:10 1'19:15	31:43 1'34:51	47:15 1'50:42	1'02:56 2'06:52	2'14:08
13	HOL	Nijboer, Gerard	15:36 1'18:51	31:19 1'34:17	46:42 1'50:34	1'02:21 2'07:19	2'14:40
14	USA	Pfltzinger, Peter	16:03 1'19:00	31:38 1'34:32	47:15 1'50:51	1'02:49 2'07:34	2'14:44
15	HOL	Ten Kate, Marti	15:47 1'17:44	31:19 1'33:56	45:57 1'50:22	1'01:58 2'07:25	2'14:53
16	ITA	Pizzolato, Orlando	15:54 1'18:30	31:38 1'34:27	47:00 1'51:01	1'02:34 2'07:51	2'15:20
17	JPN	Shintaku, Hisatoshi	15:36 1'16:57	30:32 1'33:10	45:57 1'50:08	1'01:21 2'08:01	2'15:42
18	KOR	Kim, Won-Tak	15:30 1'18:05	30:40 1'34:34	46:42 1'51:23	1'01:28 2'08:27	2'15:44
19	ITA	Poli, Piergiovanni	15:36 1'17:04	30:37 1'33:40	45:57 1'50:51	1'01:22 2'08:23	2'16:07
20	HAI	Lamothe, Dieudonne	15:47 1'18:34	31:19 1'34:21	46:42 1'51:01	1'02:27 2'08:23	2'16:15
21	GBR	Long, Dave	15:34 1'19:13	31:38 1'34:58	47:00 1'51:52	1'02:34 2'08:52	2'16:18
22	DEN	Jorgensen, Henrik Hove	15:36 1'17:36	30:59 1'33:25	46:42 1'49:46	1'01:49 2'07:46	2'16:40
23	FRG	Salzmann, Ralf	15:36 1'18:01	31:11 1'34:27	45:57 1'51:24	1'01:58 2'08:55	2'16:54
24	IRL	Hooper, Dick	15:32 1'20:40	31:22 1'35:58	47:00 1'52:37	1'02:58 2'09:42	2'17:16
25	YUG	Vindis, Miroslav	15:29 1'18:17	30:40 1'34:52	45:57 1'52:00	1'01:58 2'09:45	2'17:47
26	CHN	Cai, Shangyan	15:34 1'18:14	30:40 1'34:51	45:57 1'51:52	1'01:34 2'09:58	2'17:54
27	POR	Silva, Joaquim	15:29 1'17:25	31:19 1'33:34	46:42 1'50:34	1'01:58 2'09:39	2'18:05
28	CAN	Boileau, Arthur	16:10 1'21:42	32:06 1'37:12	48:07 1'53:57	1'03:59 2'10:43	2'18:20
29	USA	Eyestone, Ed	15:30 1'17:35	30:32 1'34:29	45:57 1'52:08	1'01:21 2'10:54	2'19:09
30	MAR	Sobhi, Noureddine	15:29 1'22:38	31:24 1'38:07	47:48 1'54:26	1'04:03 2'12:02	2'19:56
31	KOR	Yoo, Jae-Sung	15:30 1'19:45	31:19 1'35:48	46:42 1'53:03	1'02:38 2'11:49	2'20:11
32	TUR	Terzi, Mehmet	16:10 1'21:24	31:48 1'37:40	47:54 1'54:44	1'03:59 2'12:26	2'20:12
33	GBR	Forster, Kevin	15:34 1'17:23	30:32 1'34:36	45:57 1'52:42	1'01:21 2'12:19	2'20:45
34	BOT	Matlapeng, Bigboy Josie	15:41 1'22:30	31:38 1'38:32	48:01 1'55:34	1'04:15 2'13:02	2'20:51
35	ALG	Khellil, Allaoua	15:44 1'20:46	30:37 1'37:27	46:42 1'55:51	1'02:27 2'13:24	2'21:12
36	LUX	Gloden, Justin	15:56 1'21:12	31:38 1'37:15	47:38 1'54:51	1'03:38 2'13:26	2'22:14



Rank Rang	Ctry Pays	Name Nom	5km 25km	10km 30km	15km 35km	20km 40km	Finish
37	ERA	Gonzalez, Alexandre	15:30 1'20:32	31:11 1'36:37	46:42 1'55:29	1'02:38 2'13:57	2'22:24
38	CHN	Zhang, Guowei	15:32 1'18:05	30:40 1'35:33	45:57 1'54:34	1'01:46 2'14:34	2'22:49
39	COL	Ortiz, Pedro	15:56 1'18:20	31:33 1'34:29	47:00 1'52:35	1'02:34 2'13:38	2'23:34
40	CRC	Lanzoni, Ronald	16:17 1'21:20	32:06 1'37:12	48:07 1'54:19	1'03:59 2'13:20	2'23:45
41	AUS	Camp, Bradley	15:30 1'17:18	31:10 1'34:40	45:57 1'54:56	1'01:21 2'15:25	2'23:49
42	CAF	Ambowode, Adolphe	15:29 1'22:52	31:38 1'38:40	47:54 1'57:09	1'04:09 2'15:37	2'23:52
43	TAN	Bura, John	15:29 1'17:40	30:36 1'35:32	45:57 1'54:44	1'01:22 2'15:23	2'24:17
44	SWZ	Hlawe, Samuel	15:41 25:06	32:29 1'40:22	48:59 1'56:41	1'05:41 2'15:56	2'24:42
45	CRC	Amores, Juan	16:28 1'25:17	33:12 1'42:26	50:13 1'59:55	1'07:16 2'17:21	2'24:49
46	CAN	Maher, Peter	16:13 1'24:32	32:15 1'39:23	48:59 1'57:11	1'05:05 2'17:09	2'24:49
47	NIG	Monzo, Abdou	16:17 1'25:13	32:24 1'40:56	49:03 1'58:59	1'05:41 2'17:09	2'25:05
48	BRA	Santos, Diamantino	15:30 1'17:04	31:38 1'34:38	45:57 1'54:28	1'01:22 2'16:08	2'25:13
49	DJI	Omar Moussa,	15:29 1'22:07	30:37 1'39:12	45:57 1'57:52	1'03:08 2'17:11	2'25:25
50	MEX	Retiz, Carlos	15:34 1'23:07	30:32 1'41:19	46:42 1'59:13	1'03:29 2'17:28	2'25:34
51	ASA	Fanelli, Gary	16:20 1'25:02	32:12 1'40:24	48:43 1'58:54	1'05:17 2'17:22	2'25:35
52	IRL	Woods, John	16:13 1'25:13	32:06 1'41:08	48:45 1'59:38	1'05:41 2'17:33	2'25:38
53	SWZ	Mthembu, Gideon	15:58 1'24:44	32:02 1'40:23	48:07 1'59:10	1'04:48 2'17:45	2'25:56
54	NEP	Manandhar, Baikuntha	16:31 1'25:17	33:12 1'42:02	50:24 2'01:02	1 07:16 2'18:07	2'25:57
55	TCH	David, Karel	15:56 1'22:14	31:38 1'42:34	47:30 2'01:04	1'03:31 2'18:42	2'26:12
56	BRA	Rodrigues, Ivo	15:47 1'19:28	30:59 1'36:16	47:00 1'56:24	1'02:34 2'17:02	2'26:27
57	MEX	Mondragon, Martin	15:29 1'17:28	30:32 1'35:27	45:57 1'57:37	1 01:22 2'18:18	2'27:10
58	SWZ	Dlamini, Thomas	15:47 1'23:07	32:06 1'38:44	48:07 1'58:25	1'04:27 2'19:00	2'28:06
59	NIG	Aboubacar, Inni	16:17 1'25:55	32:38 1'43:54	49:55 2'02:09	1'07:11 2'20:23	2'28:15
60	NGR	Waziri, Yohanna	16:18 1'25:55	32:38 1'44:02	50:01 2'03:30	1'07:11 2'21:21	2'29:14
61	LES	Nteso, Nqheku	16:10 1'25:51	32:29 1'42:29	49:55 2'01:38	1'07:11 2'21:01	2'29:44
62	UGA	Longiross, Benjamin	15:49 1'25:13	31:38 1'41:23	48:21 2'01:38	1'05:11 2'21:38	2'30:29
63	UGA	Ruguga, Vincent	16:38 1'26:48	33:33 1'44:50	50:57 2'04:22	1'08:04 2'22:28	2'31:04
64	ESP	Abellan, Alfonso	15:29 1'19:50	31:19 1'36:25	46:42 1'56:39	1'02:38 2'19:45	2'31:10
65	SRI	Samarasinghe, Vithanakande Lek	16:38 1'25:17	33:20 1'42:41	50:24 2'02:15	1'07:16 2'22:35	2'31:29
66	NEP	Bogate, Teeka	16:33 1'25:17	32:29 1'43:16	50:24 2'02:57	1 07:16 2'23:01	2'31:49
67	CAN	Edge, David	15:40 1'23:07	31:43 1'39:35	47:54 2'01:15	1'04:09 2'23:22	2'32:19
68	CRC	Lopez, Luis	16:42 1'26:12	33:20 1'45:06	50:24 2'04:45	1'07:33 2'23:53	2'32:43
69	BOL	Camacho, Juan Rodrigo	17:22 1'28:17	34:39 1'47:16	52:13 2'08:23	1'09:55 2'26:08	2'34:41
70	NGR	Mohammed, Abbas	16:10 1'27:39	33:04 1'46:30	50:44 2'04:26	1'08:36 2'25:11	2'35:26
71	TUR	Altun, Ahmet	16:01 1'21:04	31:38 1'37:06	47:24 1'56:40	1'03:16 2'27:18	2'37:44
72	ZIM	Gombedza, James	16:20 1'26:12	33:00 1'44:42	50:01 2'06:26	1'07:16 2'27:36	2'38:13

Rank Rang	Ctry Pays	Name Nom	5km 25km	10km 30km	15km 35km	20km 40km	Finish
73	ZAI	Koji, Kamana	15:29 1'25:55	31:43 1'44:15	49:26 2'06:18	1'06:48 2'28:36	2'38:34
74	ANG	Carvalho, Joao	17:55 1'34:25	36:59 1'54:27	55:43 2'13:17	1'14:48 2'32:35	2'40:45
75	NGU	Dupnai, A Aaron	16:51 1'27:33	34:05 1'45:06	51:36 2'04:46	1'08:59 2'28:43	2'41:47
76	FIJ	Prasad, Bineshwar	16:51 1'28:20	34:13 1'47:54	52:08 2'09:13	1'09:51 2'32:13	2'41:50
77	ISV	Dallas, Calvin	16:17 1'27:48	32:53 1'48:15	50:30 2'11:46	1'08:32 2'32:28	2'42:19
78	RWA	Dusabe, Telesphore	16:50 1'27:48	34:13 1'47:49	51:36 2'09:01	1'09:02 2'31:57	2'42:52
79	BIZ	Muslar, Eugene	17:30 1'28:11	34:28 1'47:49	52:08 2'09:41	1'09:42 2'32:22	2'43:29
80	NIG	Karinou, Hassane	16:12 1'26:48	32:34 1'47:03	49:55 2'09:15	1'07:33 2'33:13	2'43:51
81	ISV	Williams, Wallace	17:37 1'34:00	56:02 1'56:14	55:14 2'14:33	1'14:14 2'35:32	2'44:40
82	LES	Mohloli, Mohala	16:33 1'28:02	33:38 1'48:03	51:36 2'12:57	1'09:42 2'35:17	2'44:44
83	OMA	Al-Sameer, Awadh Shaban	17:15 1'30:41	35:20 1'53:17	53:31 2'13:17	1'11:36 2'36:25	2'46:59
84	JAM	Adamson, Derek	16:31 1'28:09	33:20 1'50:18	50:41 2'13:25	1'08:47 2'38:30	2'47:57
85	NEP	Basnyat, Krisnaba Hadur	16:18 1'25:17	33:20 1'44:28	49:42 2'08:28	1'06:48 2'36:21	2'47:57
86	GUM	Schumann, Fred	17:51 1'35:49	36:31 1'57:22	56:03 2'15:01	1'15:48 2'41:00	2'49:52
87	MAW	Mwathiwa, John	16:31 1'27:33	33:22 1'46:31	50:41 2'11:56	1'08:16 2'38:58	2'51:43
88	ISV	Williams, Marlon	16:51 1'29:37	34:38 1'51:11	52:54 2'13:18	1'10:46 2'39:42	2'52:06
89	ZAI	Mutoke, Kaleka	15:54 1'26:50	31:38 1'48:36	48:45 2'13:25	1'06:48 2'43:19	2'55:21
90	GUM	Walker, James	19:30 1'41:13	39:38 2'02:16	56:55 2'15:30	1'22:15 2'46:09	2'56:32
91	SOM	Kulmiye, Mohiddin Moh	15:47 1'22:59	32:06 1'39:28	48:07 2'06:21	1'04:27 2'43:25	2'58:10
92	UGA	Ogwang, Jackson Fred	16:31 1'27:39	33:29 1'47:18	50:41 2'12:57	1'08:15 2'46:09	2'59:35
93	IRN	Babapur, Naser	16:51 1'27:48	33:55 1'49:23	51:26 2'14:53	1'09:02 2'47:53	3'00:20
94	GUM	Taitano, Ricardo	20:04 1'43:20	40:43 2'05:51	1'01:38 2'24:48	1'23:27 2'53:01	3'03:19
95	SLE	Keita, Suma	17:35 1'35:21	35:59 1'58:08	55:14 2'18:03	1'15:02 2'51:15	3'04:00
96	GUI	Bah, Alassane	18:06 1'36:41	37:01 2'00:45	56:27 2'23:37	1'16:34 2'53:48	3'06:27
97	VIE	Nguyen Van, Thuyet	18:07 1'42:34	37:19 2'07:32	56:36 2'27:23	1'20:26 3'00:15	3'10:57
98	BIZ	Belisle, Polin	16:47 1'32:55	34:05 1'54:02	52:43 2'14:32	1'12:55 2'40:36	3'14:02

Athletics

Men High Jump Qualifying Group 1/Sept. 24				Hommes Saut en hauteur Qualification Groupe 1/24 Sept	
Rank Rang	Ctry Pays	Name Nom	Result Resultat		
1	FRG	Mogenburg, Dietmar	2.28	Q	
1	URS	Pakline, Igor	2.28	Q	
3	GBR	Parsons, Geoff	2.28	Q	
4	BER	Saunders, Clarence	2.28	Q	
5	GBR	Grant, Dalton	2.28	Q	
6	USA	Conway, Hollis	2.28	Q	
7	ESP	Ortiz, Arturo	2.28	Q	
8	TCH	Ruffini, Robert	2.25		
9	ITA	Toso, Luca	2.25		
10	ROM	Matei, Sorin	2.19		
11	BAH	Kemp, Troy	2.19		
12	GBR	Manderson, Floyd	2.19		
13	CHA	Ngadjadoun, Paul	2.15		

Men High Jump Qualifying Group 2/Sept. 24				Hommes Saut en hauteur Qualification Groupe 2/24 Sept	
Rank Rang	Ctry Pays	Name Nom	Result Resultat		
1	SWE	Sjoberg, Patrik	2.25		
2	URS	Povarnitsyne, Roudolf	2.25		
3	USA	Stanton, Brian	2.25		
4	URS	Avdeenko, Guennadi	2.25		
5	FRG	Tranhardt, Carlo	2.25		
6	USA	Howard, Jim	2.25		
7	POL	Krawczyk, Krzysztof	2.25		
8	CAN	Ottey, Milton	2.22		
9	KOR	Cho, Hyun-wook	2.22		
10	CAN	Marshall, Brian	2.22		
11	POL	Partyka, Artur	2.19		
12	CHN	Zhu, Jianhua	2.19		
13	ARG	Pastoriza, Fernando J.	2.10		
	BUR	Seynou, Cheickak	X		

Men High Jump Final/Sept. 25				Hommes/Saut en hauteur Finale/25 Sept	
Rank Rang	Ctry Pays	Name Nom	Result Resultat		
1	URS	Avdeenko, Guennadi	2.38	NOR	
2	USA	Conway, Hollis	2.36	EOR	
3	URS	Povarnitsyne, Roudolf	2.36	EOR	
3	SWE	Sjoberg, Patrik	2.36	EOR	
5	BER	Saunders, Clarence	2.34		
6	FRG	Mogenburg, Dietmar	2.34		
7	FRG	Tranhardt, Carlo	2.31		
7	URS	Pakline, Igor	2.31		
7	GBR	Grant, Dalton	2.31		
10	USA	Howard, Jim	2.31		
11	USA	Stanton, Brian	2.31		
12	POL	Krawczyk, Krzysztof	2.31		
13	ITA	Toso, Luca	2.25		
14	ESP	Ortiz, Arturo	2.25		
15	TCH	Ruffini, Robert	2.20		
16	GBR	Parsons, Geoff	2.15		

Men Pole Vault Qualifying Group 1/Sept. 26				Hommes Saut a la perche Qualification Groupe 1/26 Sept						
Rank Rang	Ctry Pays	Name Nom	Result Resultat							
				530	540	545	550	555	N	TF
1	URS	Gataouline, Radion	—	—	—	O	—	—	5.50	1 0
1	URS	Bubka, Sergey	—	—	—	O	—	—	5.50	1 0
3	URS	Egorov, Grigori	—	—	O	—	—	—	5.45	1 0
4	USA	Tarpenning, Kory	—	O	—	—	X-	—	5.40	1 0
4	USA	Bell, Earl	—	O	—	—	X-	—	5.40	1 0
4	POL	Chmara, Mirosław	—	O	—	—	—	—	5.40	1 0
7	USA	Olson, Billy	—	XO	—	—	—	—	5.40	2 1
7	FRA	Collet, Philippe	—	XO	—	—	—	—	5.40	2 1
9	AUT	Fehringer, Hermann	O	XO	—	—	X-	—	5.40	2 1
	BUL	Tarev, Atanas	—	XXX	—	—	—	X		

Men Pole Vault Qualifying Group 2/Sept. 26				Hommes Saut a la perche Qualification Groupe 2/26 Sept								
Rank Rang	Ctry Pays	Name Nom	Result Resultat									
				510	520	530	540	545	550	555	N	TF
1	POL	Kolasa, Marian	—	—	—	O	—	—	—	—	5.40	1 0
2	FIN	Peltoniemi, Asko	—	—	XXO	O	—	—	—	—	5.40	1 2
3	TCH	Lubensky, Zdenek	—	O	O	XO	—	—	—	—	5.40	2 1
3	FRA	D-Encausse, Philippe	—	O	—	XO	—	—	—	—	5.40	2 1
5	HUN	Bagyula, Istvan	O	O	O	XO	—	—	—	—	5.40	2 1
6	FRA	Vigneron, Thierry	O	O	XO	XO	—	—	—	—	5.40	2 2

Athlétisme

Rank Rang	Ctry Pays	Name Nom	Result Resultat							
7	KOR	Kim, Chul-Kyun	XO	XO	XO	XXX			5.30	2 4
8	CAN	Just, Paul	XO	O	XXO	XXX			5.30	3 3
	KOR	Lee, Jae-Bok	XXX						X	
	ESP	Garcia, Javier	XXX						X	
	GBR	Ashurst, Andrew	XXX						X	

Men Pole Vault Final/Sept. 28				Hommes Saut a la perche Finale/28 Sept									
Rank Rang	Ctry Pays	Name Nom	Result Resultat										
				510	525	540	550	560	565	570	575	N	TF
				580	585	590	595	610					
1	URS	Bubka, Sergey	—	—	—	—	—	—	—	XO	—	5.90	3 3 NOR
			—	—	XXO	—	—	—					
2	URS	Gataouline, Radion	—	—	—	—	—	—	—	O	—	5.85	3 2 NOR
			—	XXO	—	XXX							
3	URS	Egorov, Grigori	—	—	—	O	—	—	—	XO	—	5.80	1 1 NOR
			O	—	XXX								
4	USA	Bell, Earl	—	—	O	—	O	—	O	XXX		5.70	1 0
5	FRA	Vigneron, Thierry	—	XO	—	O	O	—	XO	X		5.70	2 2
5	FRA	Collet, Philippe	—	—	—	XO	—	—	XO	XXX		5.70	2 2
7	HUN	Bagyula, Istvan	O	O	O	O	O	XXX				5.60	1 0
8	FRA	D-Encausse, Philippe	—	—	O	X-	XO	—	XXX			5.60	2 2
9	FIN	Peltoniemi, Asko	—	—	O	—	XXO	—	XXX			5.60	3 2
10	USA	Tarpenning, Kory	—	—	—	O	—	XXX				5.50	1 0
11	TCH	Lubensky, Zdenek	—	XO	—	O	—	XXX				5.50	1 1
12	USA	Olson, Billy	—	—	—	XXO	—	XXX				5.50	3 2
13	AUT	Fehringer, Hermann	—	O	O	XXX						5.40	1 0
	POL	Chmara, Mirosław	—	—	—	—	XXX					X	
	POL	Kolasa, Marian	—	—	—	XXX						X	

Men Long Jump Qualifying Group 1/Sept. 25				Hommes Saut en longueur Qualification Groupe 1/25 Sept			
Rank Rang	Ctry Pays	Name Nom	1)	2)	3)	Result Resultat	
1	USA	Myricks, Larry	8.19 + 0.4	—	—	8.19	Q
2	FRA	Brige, Norbert	X	8.05	—	8.05	Q
					+0.8		
3	HOL	Mellaard, Emiel	7.84 -0.4	8.02 +1.8	—	8.02	Q
4	HUN	Szalma, Laszlo	7.92 + 1.0	7.89 -0.2	X	7.92	
5	ESP	Corgos, Antonio	7.91 + 1.2	7.88 -0.5	—	7.91	
6	GBR	Faulkner, Stewart	7.72 -0.7	7.74 + 0.8	7.74 -0.1	7.74	
7	CAN	Surin, Bruny	7.69 -0.2	7.73 + 0.5	7.39 -0.1	7.73	
8	ANT	Browne, James	7.06 + 1.7	7.67 -0.1	7.33 -0.5	7.67	
9	AUS	Culbert, David	X	X	7.64 + 0.3	7.64	
10	AUT	Steiner, Andreas	7.40 + 1.6	7.61 -0.1	7.48 -1.5	7.61	
11	CAN	Gilbert, Glenroy	7.46 + 1.2	7.61 + 1.8	7.27 -0.7	7.61	
12	GBR	King, John	7.57 + 1.0	X	X	7.57	
13	CAN	James, Ian	X	X	7.52 -0.0	7.52	
14	TPE	Nai, Hui-Fang	7.45 -0.7	X	7.16 + 1.6	7.45	
15	POR	Leitao, Jose	X	6.99 -0.0	6.81 + 0.4	6.99	
16	PER	Valiente, Ricardo	6.91 -0.5	X	6.92 -1.2	6.92	
	KEN	Lamai, David	X	X	X	X	



Rank Rang	Ctry Pays	Name Nom	1)	2)	3)	Result Resultat
	VIN	Ballantyne, Orde	X	X	—	X
	SWZ	Mdluh, Sizwe	X	X	X	X
	BAN	Shahanuddinchowdhury, Shahanud	X	X	X	X
	QAT	Alsheeb, Abdullamohamed	X	—	AB	AB
	AUS	Honey, Gary				NS

Men Long Jump Qualifying Group 2/Sept. 25 **Hommes Saut en longueur Qualification Groupe 2/25 Sept**

Rank Rang	Ctry Pays	Name Nom	1)	2)	3)	Result Resultat
1	USA	Powell, Mike	7.83 -0.4	X	8.34 + 2.3	8.34 Q
2	USA	Lewis, Carl	8.08 + 1.2	—	—	8.08 Q
3	FIN	Karna, Jarmo	7.71 -1.1	7.89 +0.2	7.90 +0.0	7.90
4	URS	Volochine, Leonid	X	X	7.89 -0.0	7.89
5	ITA	Evangelisti, Giovanni	X	7.81 -1.1	7.60 + 0.2	7.81
6	CHN	Pang, Yan	7.64 -0.9	X	7.79 -1.6	7.79
7	GBR	Forsythe, Mark	7.77 -1.9	7.77 -1.1	7.45 + 0.2	7.77
8	NGR	Ali, Yusuf	7.72 + 1.5	7.73 + 1.6	7.67 -0.6	7.73
9	KOR	Kim, Jong-Il	7.36 + 1.4	7.68 + 1.1	7.70 + 1.2	7.70
10	CHN	Chen, Zunrong	X	7.61 + 0.8	7.66 -0.9	7.66
11	CMR	Ebong-Salle, Frederic	7.34 + 0.9	7.65 -1.0	X	7.65
12	BAH	Hanna, Stephen	7.54 -1.1	X	X	7.54
13	JPN	Shibata, Hiroyuki	X	7.48 -1.2	X	7.48
14	AUT	Steinmayr, Teddy	X	7.31 + 1.1	7.36 + 1.8	7.36
15	ALG	Kaida, Lotfi	7.10 -0.7	X	X	7.10
16	PAK	Urfaq, Muhammad	X	X	7.09 -0.5	7.09
17	SLE	Keita, Francis	6.52 + 0.7	6.87 -0.3	6.14 + 0.9	6.87
	JPN	Usui, Junichi	X	X	X	X
	PUR	Quinones, Ray J.	X	X	X	X
	URS	Emmiane, Robert	AB			AB
	URS	Otchkan, Vladimir				NS

Men Long Jump Final/Sept. 26 **Hommes Saut en longueur Finale/26 Sept**

Rank Rang	Ctry Pays	Name Nom	1)	2)	3)	4)	5)	6)	Result Resultat
1	USA	Lewis, Carl	8.41 -0.1	8.56 + 2.2	8.52 + 1.5	8.72 -0.2	8.52 + 0.3	X	8.72
2	USA	Powell, Mike	8.23 + 1.6	8.11 -0.6	8.49 + 1.8	X	—	X	8.49
3	USA	Myricks, Larry	8.14 -2.2	8.27 + 1.2	X	8.17 + 0.1	X	X	8.27
4	ITA	Evangelisti, Giovanni	7.84 -0.2	8.08 + 2.2	7.63 + 1.5	—	—	—	8.08
5	ESP	Corgos, Antonio	8.03 + 0.5	X	X	7.86 + 1.0	X	7.99 -0.0	8.03
6	HUN	Szalma, Laszlo	X	X	8.00 + 1.8	X	X	X	8.00
7	FRA	Brige, Norbert	7.87 -0.6	X	X	7.97 + 0.4	X	X	7.97
8	URS	Volochine, Leonid	7.87 -0.0	7.78 -0.1	X	X	X	7.89 -0.2	7.89

Rank Rang	Ctry Pays	Name Nom	1)	2)	3)	4)	5)	6)	Result Resultat
9	CHN	Pang, Yan	X + 0.3	7.72 + 0.9	7.86				7.86
10	FIN	Karna, Jarmo	X + 1.2	7.81 + 0.2	7.82				7.82
11	HOL	Mellaard, Emiel	7.71 + 0.1	X	7.51 + 1.7				7.71
12	GBR	Forsythe, Mark	X	X	7.54 + 1.1				7.54

Men Triple Jump Qualifying Group 1/Sept. 23 **Hommes Triple saut Qualification Groupe 1/23 Sept**

Rank Rang	Ctry Pays	Name Nom	1)	2)	3)	Result Resultat
1	URS	Kovalenko, Alexandre	17.24 -0.1	—	—	17.24 Q
2	POL	Pastusinski, Jacek	16.66 + 0.0	—	—	16.66
3	TCH	Slanar, Ivan	16.59 -0.1	16.45 -0.9	—	16.59
4	USA	Banks, Willie	16.57 -0.3	X	—	16.57
5	NGR	Taiwo, Joseph	16.42 -0.2	16.24 -0.3	16.34 -0.9	16.42
6	JPN	Yamashita, Norifumi	16.27 -0.2	X	16.29 -0.7	16.29
7	GBR	Samuels, Vernon	15.85 + 1.7	16.28 -0.3	16.07 -0.1	16.28
8	CAN	Wright, George	15.26 + 0.5	X	16.09 -0.4	16.09
9	GBR	Edwards, Jonathan	13.66 -0.4	15.66 -0.6	15.88 + 0.0	15.88
10	ECU	Quinaliza, Jose	15.57 -0.0	15.86 -0.0	15.55 -0.5	15.86
11	BAH	Rutherford, Frank	X	15.42 -0.2	15.84 -0.4	15.84
12	TPE	Nai, Hui-Fang	15.74 -0.1	15.42 -0.0	15.49 -0.2	15.74
13	KUW	Alyouhah, Marsouq	15.62 -0.0	15.72 -0.4	15.60 -1.0	15.72
14	USA	Cannon, Robert	14.33 -0.0	15.69 -0.1	X	15.69
15	ALG	Kaida, Lotfi	15.40 -0.4	14.07 -0.0	15.68 + 0.7	15.68
16	POR	Leitao, Jose	15.51 -0.4	15.60 -0.1	15.47 -0.9	15.60
17	PUR	Torres, Ernesto	15.44 -0.0	15.35 -0.0	15.59 -0.4	15.59
18	BRA	Rodrigues, Abcelvio	15.13 + 0.8	14.77 -1.0	14.74 -0.1	15.13
19	VIN	Adams, Lennox	14.44 -0.4	14.73 -0.0	14.68 -0.3	14.73
20	MOZ	Noronha, Paulo	14.71 -0.6	14.35 -0.5	14.07 -1.3	14.71
21	BIZ	Hyde, Devon	13.59 -0.1	—	14.09 -0.2	
	HUN	Bakosi, Bela	NS			NS

Men Triple Jump Qualifying Group 2/Sept. 23 **Hommes Triple saut Qualification Groupe 2/23 Sept**

Rank Rang	Ctry Pays	Name Nom	1)	2)	3)	Result Resultat
1	URS	Lapchine, Igor	17.37 + 0.1	—	—	17.37 Q
2	URS	Protsenko, Oleg	17.00 -0.3	—	—	17.00 Q
3	BUL	Markov, Hristo	16.49 -0.2	16.91 -1.5	—	16.91 Q
4	BAH	Elliott, Norbert	16.43 + 0.0	16.33 -0.1	X	16.43
5	USA	Simpkins, Charlie	16.00 -0.4	16.27 -0.4	16.35 -0.2	16.35

Athletics

Rank Rang	Ctry Pays	Name Nom	1)	2)	3)	Result Resultat
6	BEL	Falise, Didier	16.19 -0.0	X	16.35 -0.1	16.35
7	CHN	Chen, Yanping	X	16.25 -0.5	X	16.25
8	POL	Grabarczyk, Andrzej	16.18 -0.0	16.24 -0.0	16.24 -1.2	16.24
9	GBR	Herbert, John	16.01 + 0.6	16.17 -0.3	16.18 -0.2	16.18
10	GHA	Dodoo, Francis	15.79 + 0.0	X	16.17 -0.2	16.17
11	CAN	Floreal, Edrick	16.11 -0.0	X	14.57 -0.6	16.11
12	BAH	Johnson, Patterson	15.85 + 0.2	16.03 -0.2	X	16.03
13	CYP	Hadjiandreou Marios	15.89 -0.8	15.95 -0.8	X	15.95
14	BRA	Silva, Jorge	15.95 -0.3	15.63 -0.4	15.87 -0.6	15.95
15	KOR	Park, Young-Jun	15.79 -0.2	15.79 -0.0	15.86 -0.2	15.86
16	PER	Valiente, Ricardo	X	15.54 -0.0	15.59 -1.6	15.59
17	BER	Wellman, Brian	15.07 -0.5	15.31 -0.5	15.47 -0.0	15.47
18	LBA	Aboud, Fathi	15.13 -0.6	—	AB	15.13
19	PAK	Shah, Haider Ali	14.88 -0.3	14.57 -0.2	X	14.88
20	TOG	Simklina, Toyi	X	13.92 -0.3	X	13.92
	ANG	Santos, Antonio	X	—	AB	AB
	TCH	Mikulas, Milan	X	AB		AB
	ANT	Browne, James	NS			NS

Men Triple Jump Final/Sept. 24			Hommes Triple saut Finale/24 Sept						Result Resultat
Rank Rang	Ctry Pays	Name Nom	1)	2)	3)	4)	5)	6)	Result Resultat
1	BUL	Markov, Hristo	17.61 + 0.7	X	15.71 -0.1	17.54 + 1.1	X	17.10 + 0.1	17.61 NOR
2	URS	Lapchine, Igor	16.75 -0.0	17.09 + 0.3	X	X	X	17.52 + 0.1	17.52
3	URS	Kovalenko, Alexandre	17.42 -0.8	17.40 -0.1	X	X	—	X	17.42 NOR
4	URS	Protsenko, Oleg	17.38 + 0.0	X	X	17.31 -0.5	X	16.61 -0.8	17.38
5	USA	Simpkins, Charlie	16.62 -1.2	X	X	—	X	17.29 + 0.2	17.29
6	USA	Banks, Willie	X	17.03 + 0.9	16.90 -0.1	—	16.86 -0.7	X	17.03
7	TCH	Slanar, Ivan	16.58 -1.1	16.75 + 0.0	16.59 + 1.2	X	X	16.24 -0.3	16.75
8	POL	Pastusinski, Jacek	16.72 -0.6	X	X	X	16.50 + 1.0	16.56 + 0.3	16.72
9	NGR	Taiwo, Joseph	X	16.46 + 0.8	16.27 -0.6				16.46
10	BAH	Elliott, Norbert	16.19 -0.2	X	16.08 -0.1				16.19
11	BEL	Falise, Didier	16.06 -0.0	X	16.17 + 0.2				16.17
12	JPN	Yamashita, Norifumi	15.62 -0.4	X	X				15.62

Men Shot Put Qualifying Group 1/Sept. 23			Hommes Lancer du poids Qualification Groupe 1/23 Sept				Result Resultat
Rank Rang	Ctry Pays	Name Nom	1)	2)	3)	Result Resultat	
1	GDR	Timmermann, Ulf	21.27	—	—	21.27 Q	
2	USA	Barnes, Randy	20.16	20.83	—	20.83 Q	
3	ITA	Andrei, Alessandro	19.72	20.18	19.93	20.18	
4	CHI	Weil, Gert	20.18	19.58	19.59	20.18	
5	USA	Doehring, Jim	16.89	17.66	19.73	19.73	

Athlétisme

Rank Rang	Ctry Pays	Name Nom	1)	2)	3)	Result Resultat
6	BUL	Todorov, Gueorgui	19.25	19.02	19.68	19.68
7	AUT	Bodenmuller, Klaus	18.89	17.54	—	18.89
8	CHN	Ma, Yongfeng	17.48	17.79	18.27	18.27
9	EGY	Shatta, Ahmed	16.94	17.61	17.37	17.61
10	GBR	Edwards, Paul	17.13	17.11	17.28	17.28
11	KOR	Han, Min-Soo	15.67	15.68	15.64	15.68

Men Shot Put Qualifying Group 2/Sept. 23			Hommes Lancer du poids Qualification Groupe 2/23 Sept				Result Resultat
Rank Rang	Ctry Pays	Name Nom	1)	2)	3)	Result Resultat	
1	GDR	Beyer, Udo	X	20.97	—	20.97 Q	
2	SUI	Guenthoer, Werner	20.70	—	—	20.70 Q	
3	URS	Smimov, Serguei	20.13	20.48	—	20.48 Q	
4	TCH	Machura, Remigius	19.88	20.16	X	20.16	
5	NOR	Andersen, Georg	X	19.95	20.05	20.05	
6	POL	Krieger, Helmut	19.42	X	19.75	19.75	
7	USA	Tafrales, Gregg	19.71	19.44	X	19.71	
8	ISL	Gudmundsson, Petur	19.21	X	X	19.21	
9	EGY	Achouch, Mohamed	18.19	18.94	18.50	18.94	
10	KUW	Zankawi, Muhammad	X	15.34	15.92	15.92	

Men Shot Put Final/Sept. 23			Hommes Lancer du poids Finale/23 Sept						Result Resultat
Rank Rang	Ctry Pays	Name Nom	1)	2)	3)	4)	5)	6)	Result Resultat
1	GDR	Timmermann, Ulf	22.02	21.31	22.16	21.90	22.29	22.47	22.47 NOR
2	USA	Barnes, Randy	20.17	20.72	X	21.31	21.01	22.39	22.39 NOR
3	SUI	Guenthoer, Werner	21.45	21.59	21.70	20.98	21.99	21.61	21.99 NOR
4	GDR	Beyer, Udo	X	21.40	20.84	20.82	21.30	21.31	21.40
5	TCH	Machura, Remigius	20.57	20.03	20.16	20.36	20.12	20.29	20.57
6	CHI	Weil, Gert	20.22	20.09	X	20.23	20.21	20.38	20.38
7	ITA	Andrei, Alessandro	19.71	20.17	20.06	19.93	20.36	20.26	20.36
8	URS	Smimov, Serguei	20.11	X	20.36	X	X	X	20.36
9	USA	Tafrales, Gregg	20.16	X	X				20.16
10	NOR	Andersen, Georg	X	X	19.91				19.91
11	USA	Doehring, Jim	19.27	X	19.89				19.89
12	POL	Krieger, Helmut	X	19.51	X				19.51

Men Discus Qualifying Group 1/Sept. 30			Hommes Lancer du disque Qualification Groupe 1/30 Sept				Result Resultat
Rank Rang	Ctry Pays	Name Nom	1)	2)	3)	Result Resultat	
1	USA	Wilkins, Mac	62.48	X	61.34	62.48	
2	URS	Doumtchev, Iouri	61.30	60.24	62.08	62.08	
3	TCH	Bugar, Imrich	61.94	61.48	61.00	61.94	
4	BUL	Gueorguiev, Gueorgui	59.78	61.34	X	61.34	
5	URS	Kidikas, Vatslovas	58.82	60.88	X	60.88	
6	NOR	Valvik, Svein-Inge	59.40	X	60.64	60.64	
7	AUS	Reiterer, Werner	X	57.58	59.78	59.78	
8	USA	Heisler, Randy	X	X	59.08	59.08	
9	FRA	Journoud, Patrick	58.94	57.62	55.82	58.94	
10	FRG	Brunner, Wulf	X	57.50	X	57.50	
11	NGR	Olukoju, Adewale	51.38	54.44	47.60	54.44	
12	SAM	Smith, Henry	47.96	49.40	48.98	49.40	
13	KOR	Min, Se-Hoon	X	46.52	47.84	47.84	
	ISL	Bogason, Eggert	X	X	X	X	
	KSA	Owairan, Ibrahim	X	X	X	X	

Men Discus Qualifying Group 2/Sept. 30			Hommes Lancer du disque Qualification Groupe 2/30 Sept				Result Resultat
Rank Rang	Ctry Pays	Name Nom	1)	2)	3)	Result Resultat	
1	FRG	Danneberg, Rolf	65.70	—	—	65.70 Q	
2	URS	Oubartas, Romas	65.58	—	—	65.58 Q	
3	GDR	Schult, Jurgen	64.70	—	—	64.70 Q	
4	NOR	Hjeltnes, Knut	63.50	62.66	X	63.50	
5	TCH	Valent, Gejza	61.88	62.84	63.46	63.46	
6	USA	Buncic, Mike	X	63.16	X	63.16	
7	HOL	De Bruin, Erik	58.56	60.72	61.66	61.66	
8	FRG	Hannecker, Alois	61.44	X	X	61.44	
9	BAH	Cooper, Bradley	59.74	56.88	56.44	59.74	
10	ISL	Hafsteinsson, Vesteyinn	58.94	57.10	55.70	58.94	
11	GBR	Mardle, Paul	57.18	56.06	58.28	58.28	
12	CAN	Lazdins, Ray	57.94	X	X	57.94	
13	PAR	Jimenez Gaona Arrellano, Ramon	50.18	48.80	50.90	50.90	
	EGY	Omer, Mohmaed	X	AB		AB	



Men Discus Final/Oct. 1			Hommes Lancer du disque Finale/1 Oct						
Rank Rang	Ctry Pays	Name Nom	1)	2)	3)	4)	5)	6)	Result Resultat
1	GDR	Schult, Jurgen	68.82	67.92	65.76	68.18	65.70	68.26	68.82 NOR
2	URS	Oubartas, Romas	66.86	66.20	66.24	64.40	63.74	67.48	67.48
3	FRG	Danneberg, Rolf	65.58	63.60	X	63.88	67.38	62.56	67.38
4	URS	Doumtchev, Iouri	64.00	63.74	63.54	63.66	62.86	66.42	66.42
5	USA	Wilkins, Mac	61.88	X	65.12	63.84	65.90	62.96	65.90
6	TCH	Valent, Gejza	X	63.36	62.46	62.80	64.28	65.80	65.80
7	NOR	Hjeltnes, Knut	63.30	X	64.10	64.94	63.22	X	64.94
8	FRG	Hannecker, Alois	60.28	62.50	63.28	60.94	61.54	X	63.28
9	HOL	De Bruin, Erik	63.06	X	X				63.06
10	USA	Buncic, Mike	62.46	X	X				62.46
11	BUL	Gueorguiev, Gueorgui	61.24	61.12	59.66				61.24
12	TCH	Bugar, Imrich	59.60	X	60.88				60.88

Rank Rang	Ctry Pays	Name Nom	1)	2)	3)	Result Resultat
8	ISL	Vilhjalmsson, Einar	78.46	75.64	78.92	78.92
9	USA	Petrantoff, Tom	71.42	75.04	77.48	77.48
10	JPN	Mizoguchi, Kazuhiro	77.44	X	77.46	77.46 NOR
11	SUI	Steiner, Rudolf	76.02	67.56	X	76.02
12	GBR	Bradstock, Roald	75.96	73.66	72.60	75.96
13	USA	Crouser, Brian	72.66	72.64	72.72	72.72
14	FRA	Bertimon, Charlus	70.84	70.58	70.48	70.84
15	CAN	Mahovlich, Mike	X	69.44	67.32	69.44
16	FRA	Laporte, Stephane	63.66	X	69.40	69.40
17	TAN	Malekwa, Zakayo	X	67.14	67.56	67.56
18	KUW	Mabrouk, Ghanem	62.88	63.50	65.84	65.84
19	CAY	Hurlston, Paul	X	62.34	61.78	62.34

Men Hammer Throw Qualifying Group 1/Sept. 25			Hommes Lancer du marteau Qualification Groupe 1/25 Sept			
Rank Rang	Ctry Pays	Name Nom	1)	2)	3)	Result Resultat
1	URS	Tamm, Iouri	79.68	—	—	79.68 Q
2	URS	Sedykh, Yuriy	78.48	—	—	78.48 Q
3	GDR	Haber, Ralf	75.64	78.16	—	78.16 Q
4	GDR	Rodehau, Gunther	X	78.12	—	78.12 Q
5	FIN	Huhtala, Harri	75.98	77.34	—	77.34 Q
6	HUN	Gecsek, Tibor	X	77.12	—	77.12 Q
7	HUN	Szitas, Imre	74.98	76.24	73.82	76.24
8	FIN	Tiainen, Juha	72.44	73.74	X	73.74
9	BUL	Apostolov, Viktor	X	X	71.10	71.10
10	GBR	Smith, David	X	X	69.12	69.12
11	ALG	Toumi, Hakim	65.78	65.72	X	65.78
12	GBR	Milleham, Matt	59.94	62.42	X	62.42
13	KOR	Lee, Joo-Hyong	X	X	55.98	55.98
	SWE	Bystedt, Kjell	X	X	X	X

Men Javelin Qualifying Group 2/Sept. 24			Hommes Lancer du javelot Qualification Groupe 2/24 Sept			
Rank Rang	Ctry Pays	Name Nom	1)	2)	3)	Result Resultat
1	FIN	Korjus, Tapio	76.42	78.26	81.42	81.42 Q
2	GBR	Ottley, David	80.98	—	—	80.98 Q
3	FRG	Tafelmeier, Klaus	77.98	75.08	80.52	80.52 Q
4	SWE	Wennlund, Dag	X	79.66	—	79.66 Q
5	URS	Evcoukov, Viktor	71.18	79.26	—	79.26 Q
6	USA	Stephens, David	78.42	76.80	70.86	78.42
7	GDR	Warsoenke, Silvio	75.88	75.78	78.22	78.22
8	KOR	Lee, Wook-Jong	X	67.96	78.10	78.10
9	GDR	Michel, Detlef	73.54	77.68	77.70	77.70
10	GBR	Hill, Michael	77.20	74.98	72.98	77.20
11	JPN	Yoshida, Masami	74.76	71.38	76.90	76.90
12	IRL	Mchugh, Terry	76.46	73.34	69.18	76.46
13	FRA	Lefevre, Pascal	76.42	74.56	72.90	76.42
14	TCH	Nenadal, Zdenek	75.56	69.78	75.34	75.56
15	ISL	Einarsson, Sigurdur	69.18	72.90	75.52	75.52
16	CAN	Feraday, Stephen	68.78	66.22	73.32	73.32
17	UGA	Arop, Justin	67.54	69.10	67.68	69.10
18	SYR	Alhoussein, Hafez	63.34	63.34	63.30	63.34
19	KSA	Al Alawayat, Abdul Azeem	56.32	53.32	49.48	56.32

Men Hammer Throw Qualifying Group 2/Sept. 25			Hommes Lancer du marteau Qualification Groupe 2/25 Sept			
Rank Rang	Ctry Pays	Name Nom	1)	2)	3)	Result Resultat
1	URS	Litvinov, Serguei	81.24	—	—	81.24 Q
2	FRG	Weis, Heinz	76.40	76.70	77.24	77.24 Q
3	BUL	Tanev, Ivan	76.84	X	X	76.84
4	AUT	Lindner, Johann	76.60	74.54	X	76.60
5	SWE	Gustafsson, Tore	72.90	73.14	76.44	76.44
6	FRG	Sahner, Christoph	75.84	72.42	72.46	75.84
7	BUL	Minev, Plamen	74.46	70.22	X	74.46
8	HUN	Vida, Jozsef	70.60	74.30	72.50	74.30
9	USA	Deal, Lance	X	71.72	73.66	73.66
10	USA	Flax, Kenneth	X	72.70	72.24	72.70
11	USA	Logan, Jud	69.46	72.46	72.64	72.64
12	ITA	Serrani, Lucio	70.50	X	70.00	70.50
13	GBR	Jones, Michael	70.38	X	68.94	70.38
14	IRL	Mccullagh, Conor	X	X	68.66	68.66
15	ARG	Charadia, Andres	66.86	66.02	68.26	68.26
16	KUW	Albakheet, Waleed	62.78	60.14	63.86	63.86

Men Javelin Final/Sept. 25			Hommes Lancer du javelot Finale/25 Sept						
Rank Rang	Ctry Pays	Name Nom	1)	2)	3)	4)	5)	6)	Result Resultat
1	FIN	Korjus, Tapio	82.74	76.26	—	—	X	84.28	84.28
2	TCH	Zelezny, Jan	X	82.32	81.60	83.46	77.88	84.12	84.12
3	FIN	Raty, Seppo	80.00	76.26	83.26	78.74	80.66	80.44	83.26
4	FRG	Tafelmeier, Klaus	80.14	78.72	78.28	X	77.76	82.72	82.72
5	URS	Evcoukov, Viktor	81.42	82.32	X	80.38	81.42	79.52	82.32
6	GDR	Weiss, Gerald	80.66	81.30	79.94	77.26	77.80	78.28	81.30
7	URS	Ovtchinnikov, Vladimir	76.48	76.58	79.12	X	77.32	74.64	79.12
8	SWE	Wennlund, Dag	76.88	75.62	78.30	X	76.60	X	78.30
9	SWE	Borglund, Peter	78.16	78.22	74.76				78.22
10	FIN	Kinnunen, Kimmo	75.62	77.78	78.04				78.04
11	GBR	Ottley, David	74.52	75.70	76.96				76.96
12	YUG	Krdzalic, Sejad	72.12	73.28	X				73.28

Men Hammer Throw Final/Sept. 26			Hommes Lancer du marteau Finale/26 Sept						
Rank Rang	Ctry Pays	Name Nom	1)	2)	3)	4)	5)	6)	Result Resultat
1	URS	Litvinov, Serguei	84.76	83.82	83.86	83.98	84.80	83.80	84.80 NOR
2	URS	Sedykh, Yuriy	80.96	83.62	83.44	83.44	X	83.76	83.76
3	URS	Tamm, Iouri	80.94	81.16	X	X	X	X	81.16
4	GDR	Haber, Ralf	78.92	78.72	79.18	X	78.88	80.44	80.44
5	FRG	Weis, Heinz	78.50	76.80	X	77.70	78.98	79.16	79.16
6	HUN	Gecsek, Tibor	78.18	76.52	74.36	77.82	X	78.36	78.36
7	HUN	Szitas, Imre	76.00	76.40	76.20	75.66	76.10	77.04	77.04
8	BUL	Tanev, Ivan	75.56	75.76	X	75.28	75.54	76.08	76.08
9	FIN	Huhtala, Harri	75.26	75.38	75.08				75.38
10	AUT	Lindner, Johann	75.36	75.14	75.28				75.36
11	SWE	Gustafsson, Tore	74.24	73.32	X				74.24
12	GDR	Rodehau, Gunther	X	X	72.36				72.36

Men Javelin Qualifying Group 1/Sept. 24			Hommes Lancer du javelot Qualification Groupe 1/24 Sept					
Rank Rang	Ctry Pays	Name Nom	1)	2)	3)	Result Resultat		
1	TCH	Zelezny, Jan	85.90	—	—	85.90 Q NOR		
2	FIN	Raty, Seppo	76.76	77.70	81.62	81.62 Q NOR		
3	URS	Ovtchinnikov, Vladimir	X	77.68	80.26	80.26 Q		
4	FIN	Kinnunen, Kimmo	77.22	80.24	—	80.24 Q		
5	GDR	Weiss, Gerald	78.20	74.80	80.22	80.22 Q		
6	SWE	Borglund, Peter	78.66	73.76	80.16	80.16 Q NOR		
7	YUG	Krdzalic, Sejad	72.40	78.06	79.90	79.90 Q		

Athletics

Men Decathlon — 100m Heat 1/Sept. 28

Rank Rang	Ctry Pays	Name Nom	Result Resultat	
1	NZL	Poelman, Simon	11.09	841
2	USA	Johnson, David	11.15	827
3	USA	Bright, Tim	11.18	821
4	URS	Tarnovetski, Pavel	11.23	810
5	USA	Kinder, Gary	11.31	793
6	TCH	Valenta, Veroslav	11.51	750
7	GDR	Freimuth, Uwe	11.57	738
	FRG	Hingsen, Jurgen	DQ	

Men Decathlon — 100m Heat 2/Sept. 28

Rank Rang	Ctry Pays	Name Nom	Result Resultat	
1	TPE	Lee, Fu-An	11.00	861
2	AUS	Shirley, Simon	11.03	854
3	SUI	Moser, Severin	11.10	838
4	GBR	Kruger, Alex	11.30	795
5	ESP	Penalver, Antonio	11.38	778
6	SUI	Gugler, Christian	11.49	755
7	GBR	Richards, Greg	11.50	753
8	AUT	Werthner, Georg	11.52	748

Men Decathlon — 100m Heat 3/Sept. 28

Rank Rang	Ctry Pays	Name Nom	Result Resultat	
1	ECU	Solorzano, Fidel	11.01	858
2	IRL	O'connell, Carlos	11.26	804
3	ESA	Mellado, Santiago	11.33	789
4	CHN	Gong, Guohua	11.43	767
5	FIJ	Miller, Albert	11.47	759
6	KOR	Lee, Kwang-Ik	11.57	738
7	NEP	Kunwar, Dambar	12.12	628

Men Decathlon — 100m Heat 4/Sept. 28

Rank Rang	Ctry Pays	Name Nom	Result Resultat	
1	GBR	Thompson, Daley	10.62	947
2	TCH	Hraban, Roman	10.89	885
3	FIN	Keskitalo, Petri	10.94	874
4	CAN	Smith, Michael	10.99	863
5	HUN	Szabo, Dezso	11.02	856
6	DEN	Warming, Lars	11.07	845
7	SUI	Gaehwiler, Beat	11.18	821
8	SWE	Olander, Mikael	11.46	761

Men Decathlon — Long Jump Group 1/Sept. 28

Rank Rang	Ctry Pays	Name Nom	1)	2)	3)	Result Resultat	
1	FRA	Plaziat, Christian	7.62 + 1.1	7.37 + 0.7	7.15 - 0.4	7.62	965
2	GDR	Voss, Torsten	7.36 + 0.4	X	7.45 + 1.1	7.45	922
3	CAN	Steen, Dave	7.44 + 0.5	7.33 + 0.1	7.38 + 0.0	7.44	920
4	FRA	Blondel, Alain	7.37 + 1.5	7.43 + 0.0	7.43 + 0.6	7.43	918
5	GDR	Schenk, Christian	X	7.43 - 0.7	X	7.43	918
6	GBR	Thompson, Daley	7.20 + 1.5	7.38 + 0.0	7.24 + 0.5	7.38	905
7	SUI	Gaehwiler, Beat	7.34 + 0.7	7.29 + 0.8	7.31 + 0.0	7.34	896
8	HUN	Szabo, Dezso	7.09 - 0.4	7.29 - 0.2	6.98 - 0.3	7.29	883
9	URS	Tarnovetski, Pavel	6.95 + 0.9	X	7.28 - 0.7	7.28	881
10	URS	Kioulvet, Valter	6.97 + 0.6	6.87 - 1.0	7.14 + 1.2	7.14	847
11	USA	Johnson, David	X	7.12 + 1.2	X	7.12	842
12	NZL	Poelman, Simon	6.84 + 0.6	6.97 + 1.0	7.08 - 0.9	7.08	833
13	TCH	Hraban, Roman	6.84 + 0.3	4.94 - 0.7	7.07 + 0.7	7.07	830

Athlétisme

Rank Rang	Ctry Pays	Name Nom	1)	2)	3)	Result Resultat	
14	USA	Bright, Tim	6.72 - 0.3	7.04 - 0.6	7.05 + 0.7	7.05	826
15	TCH	Valenta, Veroslav	6.97 - 0.3	6.99 + 0.3	7.01 + 0.3	7.01	816
16	GDR	Freimuth, Uwe	6.75 - 0.1	7.00 + 1.3	6.92 - 0.7	7.00	814
17	USA	Kinder, Gary	6.75 + 0.7	7.00 + 1.3	X	7.00	814
18	HOL	De Wit, Robert	6.84 + 0.7	6.95 - 0.2	6.90 - 1.2	6.95	802
	URS	Apaitchev, Alexandre	NS			NS	
	FRG	Hingsen, Jurgen	AB			AB	

Men Decathlon — Long Jump Group 2/Sept. 28

Rank Rang	Ctry Pays	Name Nom	1)	2)	3)	Result Resultat	
1	FIN	Keskitalo, Petri	X	7.56 + 1.1	7.49 + 0.8	7.56	950
2	AUS	Shirley, Simon	7.14 + 0.8	7.45 + 0.2	X	7.45	922
3	CAN	Smith, Michael	7.01 + 1.1	6.86 - 0.1	7.37 + 0.2	7.37	903
4	AUT	Werthner, Georg	X	7.36 + 0.3	7.21 + 1.0	7.36	900
5	TPE	Lee, Fu-An	7.17 - 0.4	7.12 - 0.1	7.23 + 0.4	7.23	869
6	KOR	Lee, Kwang-Ik	X	X	7.19 + 0.5	7.19	859
7	GBR	Richards, Greg	7.09 + 0.2	X	6.87 + 0.9	7.09	835
8	ESP	Penalver, Antonio	7.08 + 1.0	X	X	7.08	833
9	DEN	Warming, Lars	6.87 + 1.0	X	7.04 - 0.0	7.04	823
10	SUI	Gugler, Christian	7.02 + 1.4	6.98 + 0.4	X	7.02	818
11	SUI	Moser, Severin	6.98 + 2.0	X	X	6.98	809
12	GBR	Kruger, Alex	X	6.97 - 0.7	X	6.97	807
13	IRL	O'connell, Carlos	6.90 + 0.9	X	X	6.90	790
14	ESA	Mellado, Santiago	6.36 + 0.1	6.52 + 0.3	6.83 - 0.4	6.83	774
15	ECU	Solorzano, Fidel	6.79 + 0.7	6.63 + 0.2	6.63 - 0.4	6.79	764
16	SWE	Olander, Mikael	6.47 + 0.5	6.51 + 0.1	6.75 + 1.3	6.75	755
17	FIJ	Miller, Albert	6.37 + 0.5	X	6.43 - 0.1	6.43	682
18	CHN	Gong, Guohua	X	X	6.22 + 0.7	6.22	635
19	NEP	Kunwar, Dambar	5.11 + 1.2	5.60 - 0.1	5.83 + 0.7	5.83	550

Men Decathlon — Shot Put Group 1/Sept. 28

Rank Rang	Ctry Pays	Name Nom	1)	2)	3)	Result Resultat	
1	TCH	Hraban, Roman	15.56	15.84	X	15.84	841
2	GDR	Freimuth, Uwe	15.60	X	15.13	15.60	827
3	GDR	Schenk, Christian	15.48	15.11	15.22	15.48	819
4	HOL	De wit, Robert	15.34	13.45	14.67	15.34	811
5	URS	Kioulvet, Valter	14.90	15.29	X	15.29	808
6	URS	Tarnovetski, Pavel	15.25	15.23	15.25	15.25	805
7	GBR	Thompson, Daley	15.02	X	X	15.02	791
8	GDR	Voss, Torsten	14.38	14.97	X	14.97	788
9	USA	Kinder, Gary	14.89	X	X	14.89	783
10	USA	Johnson, David	14.35	13.87	14.52	14.52	760
11	NZL	Poelman, Simon	14.51	14.26	X	14.51	760
12	SUI	Gaehwiler, Beat	14.48	14.06	14.15	14.48	758
13	CAN	Steen, Dave	13.90	14.20	14.05	14.20	741
14	TCH	Valenta, Veroslav	13.57	14.17	13.64	14.17	739

Hommes Decathlon — Lancer du poids Groupe 1/28 Sept



Rank	Ctry	Name				Result	
Rang	Pays	Nom	1)	2)	3)	Resultat	Resultat
15	USA	Bright, Tim	13.56	13.63	14.12	14.12	736
16	FRA	Plaziat, Christian	13.19	13.53	13.58	13.58	703
17	FRA	Blondel, Alain	12.92	12.91	X	12.92	662
18	HUN	Szabo, Dezso	10.58	12.07	12.92	12.92	662
	FRG	Hingsen, Jurgen	NS			NS	
	URS	Apaitchev, Alexandre	NS			NS	

Men Decathlon — Shot Put **Group 2/Sept. 28** **Hommes Decathlon — Lancer du poids** **Groupe 2/28 Sept**

Rank	Ctry	Name				Result	
Rang	Pays	Nom	1)	2)	3)	Resultat	Resultat
1	SWE	Olander, Mikael	15.31	15.65	16.07	16.07	856
2	FIN	Keskitalo, Petri	14.51	15.34	X	15.34	811
3	ESP	Penalver, Antonio	13.99	13.38	14.31	14.31	747
4	AUS	Shirley, Simon	12.71	14.20	X	14.20	741
5	CHN	Gong, Guohua	13.98	13.21	13.71	13.98	727
6	AUT	Werthner, Georg	13.93	X	13.57	13.93	724
7	SUI	Gugler, Christian	13.80	12.89	13.32	13.80	716
8	CAN	Smith, Michael	12.97	13.33	13.61	13.61	704
9	DEN	Warming, Lars	12.65	13.41	13.10	13.41	692
10	GBR	Kruger, Alex	13.23	12.71	13.18	13.23	681
11	TPE	Lee, Fu-An	13.15	X	12.88	13.15	676
12	GBR	Richards, Greg	12.94	X	12.93	12.94	664
13	SUI	Moser, Severin	12.33	12.69	12.16	12.69	648
14	IRL	O'connell, Carlos	12.41	12.23	11.95	12.41	631
15	FIJ	Miller, Albert	12.33	12.17	12.17	12.33	626
16	ECU	Solorzano, Fidel	X	11.59	11.76	11.76	592
17	ESA	Mellado, Santiago	X	10.45	11.63	11.63	584
18	KOR	Lee, Kwang-ik	9.75	10.23	10.27	10.27	502
19	NEP	Kunwar, Dambar	9.38	9.42	9.71	9.71	468

Men Decathlon — High Jump **Group 1/Sept. 28** **Hommes Decathlon — Saut en hauteur** **Groupe 1/28 Sept**

Rank	Ctry	Name											Result	
Rang	Pays	Nom	185	188	191	194	197	200	203	206	N	TF	Resultat	Resultat
1	GDR	Schenk, Christian	—	—	—	—	—	O	—	—	2.27	2	1	1061
			O	—	O	O	O	O	XO	XXX				
2	GBR	Kruger, Alex	—	—	—	—	—	O	—	O	2.15	2	1	944
			O	O	X	XXX								
3	FRA	Plaziat, Christian	—	—	—	O	—	O	—	O	2.12	1	2	915
			XXO	O	XXX									
4	USA	Bright, Tim	—	—	O	—	O	O	O	XXO	2.06	3	2	859
			XXX											
4	HUN	Szabo, Dezso	O	—	O	O	O	O	O	XXO	2.06	3	2	859
			XXX											
6	SUI	Gugler, Christian	—	—	O	O	O	O	O	XXX	2.03	1	0	831
6	USA	Johnson, David	—	O	—	—	O	O	O	XXX	2.03	1	0	831
6	TPE	Lee, Fu-An	—	—	—	O	—	O	XXO	XXX	2.03	3	2	831
6	NZL	Poelman, Simon	—	O	—	O	O	O	XXO	XXX	2.03	3	2	831
10	HOL	De Wit, Robert	—	—	XO	XO	O	XXO	XXX		2.00	3	4	803
10	URS	Kioulvet, Valter	—	—	O	O	O	O	XXX		2.00	1	0	803
10	ESP	Penalver, Antonio	—	—	O	O	XO	XO	XXX		2.00	2	2	803
13	URS	Tarnovetski, Pavel	—	—	O	—	XXO	XXX			1.97	3	2	776
13	CAN	Steen, Dave	O	—	O	—	XO	XXX			1.97	2	1	776
13	USA	Kinder, Gary	—	—	O	—	O	XXX			1.97	1	0	776
13	GDR	Voss, Torsten	—	—	O	—	XXO	XXX			1.97	3	2	776
13	CAN	Smith, Michael	—	—	O	—	XXO	XXX			1.97	3	2	776
13	AUS	Shirley, Simon	—	O	—	XO	O	XXX			1.97	1	1	776
13	FRA	Blondel, Alain	—	O	—	O	XXO	XXX			1.97	3	2	776

Men Decathlon — High Jump **Group 2/Sept. 28** **Hommes Decathlon — Saut en hauteur** **Groupe 2/28 Sept**

Rank	Ctry	Name											Result	
Rang	Pays	Nom	170	173	176	179	182	185	188	191	N	TF	Resultat	Resultat
1	ESA	Mellado, Santiago	—	—	—	—	O	—	O	—	2.06	2	2	859
			O	—	O	XO	XO	XXX						
2	GBR	Thompson, Daley	—	—	—	—	O	—	O	—	2.03	1	0	831
			O	O	O	O	XXX							

Rank	Ctry	Name											Result			
Rang	Pays	Nom	1)	2)	3)	4)	5)	6)	7)	8)	9)	10)	Resultat	Resultat	Resultat	Resultat
3	SWE	Olander, Mikael	—	—	—	—	O	—	O	XO	O	XO	2.00	3	4	803
			XO	O	XXO	XXX										
4	FIN	Keskitalo, Petri	—	—	—	—	—	—	—	O	—	O	1.97	2	1	776
			O	XO	XXX											
5	TCH	Valenta, Veroslav	—	—	—	—	O	—	XO	O	O	O	1.94	2	2	749
			XO	XXX												
5	DEN	Warming, Lars	—	—	—	—	O	O	O	XO	O	O	1.94	1	1	749
			O	XXX												
5	FIJ	Miller, Albert	—	—	XO	O	—	O	XO	O	O	O	1.94	2	3	749
			XO	XXX												
5	AUT	Werthner, Georg	—	—	—	—	O	—	O	—	O	—	1.94	2	1	749
			XO	XXX												
5	GDR	Freimuth, Uwe	—	—	—	—	—	O	—	O	—	O	1.94	1	0	749
			O	XXX												
5	SUI	Gaehwiler, Beat	—	—	—	—	O	O	O	O	O	O	1.94	1	0	749
			O	XXX												
11	KOR	Lee, Kwang-ik	—	—	O	—	O	O	O	O	XO	O	1.91	2	1	723
			XXX													
11	CHN	Gong, Guohua	—	—	—	—	O	XO	O	O	O	O	1.91	1	1	723
			XXX													
13	ECU	Solorzano, Fidel	—	—	—	—	XO	—	XO	XXX			1.88	2	2	696
13	IRL	O'connell, Carlos	—	—	O	—	—	XO	XXO	XXX			1.88	3	3	696
15	SUI	Moser, Severin	—	—	—	O	O	XXO	XXX				1.85	3	2	670
16	GBR	Richards, Greg	—	—	—	—	O	XXX					1.82	1	0	644
17	TCH	Hraban, Roman	—	—	—	O	—	XXX					1.79	1	0	619
18	NEP	Kunwar, Dambar	XXO	XXX									1.70	3	2	544

Men Decathlon — 400m **Heat 1/Sept. 28** **Hommes Decathlon — 400m** **Serie 1/28 Sept**

Rank	Ctry	Name	Result	
Rang	Pays	Nom	Resultat	Resultat
1	IRL	O'connell, Carlos	48.24	898
2	ESA	Mellado, Santiago	48.37	891
3	FIJ	Miller, Albert	50.30	801
4	KOR	Lee, Kwang-ik	50.71	782
5	CHN	Gong, Guohua	51.25	758
6	NEP	Kunwar, Dambar	52.32	711
	ECU	Solorzano, Fidel	NS	

Men Decathlon — 400m **Heat 2/Sept. 28** **Hommes Decathlon — 400m** **Serie 2/28 Sept**

Rank	Ctry	Name	Result	
Rang	Pays	Nom	Resultat	Resultat
1	URS	Tarnovetski, Pavel	48.60	880
2	USA	Johnson, David	49.15	854
3	USA	Bright, Tim	49.34	845
4	GDR	Freimuth, Uwe	49.84	822
5	NZL	Poelman, Simon	49.89	820
6	TCH	Valenta, Veroslav	51.16	762
7	USA	Kinder, Gary	51.79	734
	FRG	Hingsen, Jurgen	NS	

Men Decathlon — 400m **Heat 3/Sept. 28** **Hommes Decathlon — 400m** **Serie 3/28 Sept**

Rank	Ctry	Name	Result	
Rang	Pays	Nom	Resultat	Resultat
1	FRA	Blondel, Alain	47.44	936
2	GDR	Voss, Torsten	47.71	923
3	HOL	De Wit, Robert	48.21	899
4	CAN	Steen, Dave	48.29	895
5	FRA	Plaziat, Christian	48.34	893
6	GDR	Schenk, Christian	48.90	866
7	URS	Kioulvet, Valter	50.62	786
	URS	Apaitchev, Alexandre	NS	

Athletics

Men Decathlon — 400m Heat 4/Sept. 28

Rank Rang	Ctry Pays	Name Nom	Result Resultat	
1	CAN	Smith, Michael	47.83	917
2	DEN	Warming, Lars	47.97	911
3	HUN	Szabo, Dezso	48.23	898
4	SUI	Gaehwiler, Beat	49.02	860
5	GBR	Thompson, Daley	49.06	858
6	TCH	Hraban, Roman	49.68	829
7	FIN	Keskitalo, Petri	49.94	817
8	SWE	Olander, Mikael	51.28	757

Hommes Decathlon — 400m Serie 4/28 Sept

Men Decathlon — 400m Heat 5/Sept. 28

Rank Rang	Ctry Pays	Name Nom	Result Resultat	
1	SUI	Moser, Severin	48.63	879
2	AUS	Shirley, Simon	48.84	869
3	GBR	Richards, Greg	49.27	849
4	TPE	Lee, Fu-An	49.73	827
5	GBR	Kruger, Alex	49.98	816
6	AUT	Werthner, Georg	49.99	815
7	ESP	Penalver, Antonio	50.24	804
8	SUI	Gugler, Christian	50.60	787

Hommes Decathlon — 400m Serie 5/28 Sept

Men Decathlon — 110m Hurdles Heat 1/Sept. 29

Rank Rang	Ctry Pays	Name Nom	Result Resultat	
1	FIN	Keskitalo, Petri	14.25	942
2	DEN	Warming, Lars	14.49	912
3	CAN	Smith, Michael	14.70	886
4	GBR	Thompson, Daley	14.72	884
5	TCH	Hraban, Roman	14.94	857
6	HUN	Szabo, Dezso	14.96	854
7	SUI	Gaehwiler, Beat	15.11	836
8	SWE	Olander, Mikael	16.06	726

Hommes Decathlon — 110m haies Serie 1/29 Sept

Men Decathlon — 110m Hurdles Heat 2/Sept. 29

Rank Rang	Ctry Pays	Name Nom	Result Resultat	
1	FRA	Plaziat, Christian	14.18	951
2	HOL	De Wit, Robert	14.36	929
3	FRA	Blondel, Alain	14.40	924
4	GDR	Voss, Torsten	14.46	916
5	CAN	Steen, Dave	14.81	873
6	GDR	Schenk, Christian	15.13	834
	URS	Kioulvet, Valter	AB	
	URS	Apaitchev, Alexandre	NS	

Hommes Decathlon — 110m haies Serie 2/29 Sept

Men Decathlon — 110m Hurdles Heat 3/Sept. 29

Rank Rang	Ctry Pays	Name Nom	Result Resultat	
1	TPE	Lee, Fu-An	14.96	854
2	ESP	Penalver, Antonio	14.97	853
3	SUI	Moser, Severin	15.13	834
4	SUI	Gugler, Christian	15.22	823
5	GBR	Kruger, Alex	15.38	804
6	AUS	Shirley, Simon	15.44	797
7	GBR	Richards, Greg	15.56	783
8	AUT	Werthner, Georg	15.64	774

Hommes Decathlon — 110m haies Serie 3/29 Sept

Men Decathlon — 110m Hurdles Heat 4/Sept. 29

Rank Rang	Ctry Pays	Name Nom	Result Resultat	
1	USA	Bright, Tim	14.39	925
2	USA	Johnson, David	14.66	891
3	URS	Tarnovetski, Pavel	14.76	879
4	NZL	Poelman, Simon	14.78	876
5	GDR	Freimuth, Uwe	15.04	845
6	TCH	Valenta, Veroslav	15.18	828
	FRG	Hingsen, Jurgen	NS	
	USA	Kinder, Gary	NS	

Hommes Decathlon — 110m haies Serie 4/29 Sept

Athlétisme

Men Decathlon — 110m Hurdles Heat 5/Sept. 29

Rank Rang	Ctry Pays	Name Nom	Result Resultat	
1	FIJ	Miller, Albert	15.00	850
2	ESA	Mellado, Santiago	15.39	803
3	IRL	O'connell, Carlos	15.61	777
4	CHN	Gong, Guohua	15.88	746
5	KOR	Lee, Kwang-ik	16.20	710
6	NEP	Kunwar, Dambar	17.05	619
	ECU	Solorzano, Fidel	NS	

Hommes Decathlon — 110m haies Serie 5/29 Sept

Men Decathlon — Discus Group 1/Sept. 29

Rank Rang	Ctry Pays	Name Nom	1)	2)	3)	Result Resultat	
1	GDR	Schenk, Christian	44.56	49.28	X	49.28	855
2	URS	Tarnovetski, Pavel	48.02	X	47.12	48.02	829
3	GDR	Freimuth, Uwe	43.64	46.66	X	46.66	801
4	TCH	Valenta, Veroslav	X	X	45.84	45.84	784
5	TCH	Hraban, Roman	43.98	X	45.32	45.32	773
6	GBR	Thompson, Daley	44.44	44.80	42.26	44.80	763
7	GDR	Voss, Torsten	44.36	X	43.16	44.36	754
8	CAN	Steen, Dave	43.66	X	42.02	43.66	739
9	NZL	Poelman, Simon	42.26	X	43.20	43.20	730
10	FRA	Plaziat, Christian	42.12	X	43.06	43.06	727
11	SUI	Gaehwiler, Beat	X	41.96	42.46	42.46	715
12	USA	Johnson, David	42.36	X	X	42.36	713
13	USA	Bright, Tim	40.42	41.68	X	41.68	699
14	HOL	De Wit, Robert	X	X	41.32	41.32	691
15	FRA	Blondel, Alain	X	40.64	41.20	41.20	689
16	HUN	Szabo, Dezso	38.20	39.54	38.24	39.54	655
	USA	Kinder, Gary	NS			NS	
	URS	Kioulvet, Valter	AB			AB	
	URS	Apaitchev, Alexandre	NS			NS	
	FRG	Hingsen, Jurgen	NS			NS	

Hommes Decathlon — Lancer du disque Groupe 1/29 Sept

Men Decathlon — Discus Group 2/Sept. 29

Rank Rang	Ctry Pays	Name Nom	1)	2)	3)	Result Resultat	
1	SWE	Olander, Mikael	49.00	46.72	50.66	50.66	884
2	ESP	Penalver, Antonio	41.24	45.50	46.34	46.34	794
3	CHN	Gong, Guohua	44.22	X	46.18	46.18	791
4	CAN	Smith, Michael	40.26	43.88	43.56	43.88	744
5	GBR	Richards, Greg	38.54	38.24	42.32	42.32	712
6	FIN	Keskitalo, Petri	39.94	41.86	X	41.86	702
7	AUS	Shirley, Simon	39.48	41.68	41.00	41.68	699
8	DEN	Warming, Lars	X	39.56	40.38	40.38	672
9	SUI	Gugler, Christian	39.08	38.46	X	39.08	646
10	AUT	Werthner, Georg	X	38.82	X	38.82	641
11	FIJ	Miller, Albert	X	38.68	38.72	38.72	639
12	GBR	Kruger, Alex	38.72	X	36.88	38.72	639
13	TPE	Lee, Fu-An	36.46	38.06	32.62	38.06	625
14	SUI	Moser, Severin	35.70	38.04	X	38.04	625
15	IRL	O'connell, Carlos	38.02	36.66	36.54	38.02	624
16	ESA	Mellado, Santiago	35.50	35.60	37.52	37.52	614
17	KOR	Lee, Kwang-ik	34.36	X	33.84	34.36	551
18	NEP	Kunwar, Dambar	24.16	25.96	27.10	27.10	408
	ECU	Solorzano, Fidel	NS			NS	

Hommes Decathlon — Lancer du disque Groupe 2/29 Sept

Men Decathlon — Pole Vault Group 1/Sept. 29

Rank Rang	Ctry Pays	Name Nom	430	440	450	460	470	480	490	500	Result Resultat	N	TF	
			510	520	530	540	550	560	570	580				
1	USA	Bright, Tim	—	—	—	—	—	—	—	—	5.70	3	5	1132
			—	O	—	O	XXO	XO	XXO	XXX				
2	URS	Tarnovetski, Pavel	—	—	—	XO	—	O	—	XO	5.20	2	4	972
			XO	XO	XXX									
2	CAN	Steen, Dave	—	—	—	—	—	O	—	O	5.20	3	2	972
			O	XXO	XXX									
2	FRA	Blondel, Alain	—	—	—	—	—	O	—	XO	5.20	3	4	972
			XO	XXO	XXX									
5	GDR	Voss, Torsten	—	—	—	—	XO	—	O	O	5.10	1	1	941
			O	XXX										
6	HUN	Szabo, Dezso	—	—	—	O	—	O	—	O	5.00	1	0	910
			—	XXX										
7	USA	Johnson, David	—	—	—	XXO	—	XXO	XXO	XXX	4.90	3	6	880
7	GDR	Freimuth, Uwe	—	O	—	XXO	—	O	XO	XXX	4.90	2	3	880
7	NZL	Poelman, Simon	—	—	—	O	—	XXO	O	XXX	4.90	1	2	880

Hommes Decathlon — Saut a la perche Groupe 1/29 Sept



Rank Rang	Ctry Pays	Name Nom											Result Resultat	
7	TCH	Hraban, Roman	—	XO	—	O	—	XXO	O	XXX	4.90	1	3	880
7	FRA	Plaziat, Christian	—	—	XO	—	XO	—	XO	XXX	4.90	2	3	880
7	GBR	Thompson, Daley	—	—	—	—	XO	—	XXO	XXX	4.90	3	3	880
13	FIN	Keskitalo, Petri	—	—	—	O	—	XXO	XXX		4.80	3	2	849
13	HOL	De Wit, Robert	—	—	—	O	—	XO	—	XXX	4.80	2	1	849
15	SUI	Gaehwiler, Beat	—	XO	O	XO	O	XXX			4.70	1	2	819
15	SUI	Moser, Severin	—	—	O	—	XXO	XXX			4.70	3	2	819
15	SUI	Gugler, Christian	—	O	O	O	XXO	X			4.70	3	2	819
	URS	Kioulvet, Valter									NS			

**Men Decathlon — Pole Vault
Group 2/Sept. 29**

Rank Rang	Ctry Pays	Name Nom											Result Resultat	
			280	290	370	390	400	410	420	430		N	TF	
			440	450	460	470	480	490						
1	DEN	Warming, Lars	—	—	—	—	—	—	—	—	4.80	1	2	849
			XO	—	O	XO	O	XXX						
1	SWE	Olander, Mikael	—	—	—	—	—	—	—	O	4.80	1	2	849
			—	XO	—	XO	O	XXX						
3	GDR	Schenk, Christian	—	—	—	—	—	—	—	O	4.70	3	4	819
			O	XXo	O	XXO	XXX							
3	AUS	Shirley, Simon	—	—	—	—	—	—	—	O	4.70	3	2	819
			—	O	O	XXO	XXX							
5	AUT	Werthner, Georg	—	—	—	—	O	—	—	—	4.60	1	0	790
			—	O	O	XXX								
5	ESA	Mellado, Santiago	—	—	—	—	—	XXO	—	O	4.60	1	2	790
			—	O	O	XXX								
5	TCH	Valenta, Veroslav	—	—	—	—	—	—	—	O	4.60	2	2	790
			—	XO	XO	XXX								
5	CHN	Gong, Guohua	—	—	—	—	—	—	—	—	4.60	1	1	790
			O	XO	O	XXX								
5	GBR	Kruger, Alex	—	—	—	—	XO	—	—	O	4.60	3	5	790
			XXO	O	XXO	XXX								
10	TPE	Lee, Fu-An	—	—	—	—	—	—	—	—	4.50	1	0	760
			—	O	—	XXX								
10	GBR	Richards, Greg	—	—	—	—	—	—	—	—	4.50	2	1	760
			O	XO	XXX									
12	IRL	O'Connell, Carlos	—	—	—	—	O	—	—	XO	4.40	3	3	731
			XXO	XXX										
12	ESP	Penalver, Antonio	—	—	—	—	O	—	O	—	4.40	2	1	731
			XO	XXX										
14	CAN	Smith, Michael	—	—	—	—	O	—	XO	XXO	4.30	3	3	702
			XXX											
15	KOR	Lee, Kwang-ik	—	—	O	XO	O	XO	XXX		4.10	2	2	645
16	FIJ	Miller, Albert	—	—	—	—	XO	XXX			4.00	2	1	617
17	NEP	Kunwar, Dambar	O	XXX							2.80	1	0	309
	ECU	Solorzano, Fidel									NS			

**Men Decathlon — Javelin
Group 1/Sept. 29**

Rank Rang	Ctry Pays	Name Nom	1)	2)	3)	Result Resultat
1	FIN	Keskitalo, Petri	57.76	66.64	59.28	66.64 838
2	CAN	Smith, Michael	59.38	65.46	66.54	66.54 837
3	SUI	Gaehwiler, Beat	63.90	65.84	X	65.84 826
4	SUI	Gugler, Christian	59.82	60.92	58.48	60.92 752
5	FIJ	Miller, Albert	55.54	57.26	56.38	57.26 697
6	ESP	Penalver, Antonio	48.66	48.32	55.68	55.68 673
7	KOR	Lee, Kwang-ik	52.96	54.88	54.94	54.94 662
8	IRL	O'Connell, Carlos	52.10	52.68	50.04	52.68 628
9	SUI	Moser, Severin	46.50	49.10	49.52	49.52 581
10	NEP	Kunwar, Dambar	34.10	39.10	32.48	39.10 429

**Men Decathlon — Javelin
Group 2/Sept. 29**

Rank Rang	Ctry Pays	Name Nom	1)	2)	3)	Result Resultat
1	AUT	Werthner, Georg	63.44	67.04	62.12	67.04 844
2	USA	Johnson, David	62.70	66.46	X	66.46 835
3	GBR	Thompson, Daley	59.06	60.62	64.04	64.04 799
4	HOL	De Wit, Robert	58.06	62.02	63.00	63.00 783
5	GDR	Voss, Torsten	61.76	58.04	59.14	61.76 764
6	TCH	Hraban, Roman	60.48	58.96	59.80	60.48 745
7	NZL	Poelman, Simon	55.60	53.48	57.18	57.18 696
8	HUN	Szabo, Dezso	56.80	49.84	56.12	56.80 690
9	GBR	Richards, Greg	52.44	53.50	X	53.50 641
10	FRA	Plaziat, Christian	51.20	52.18	X	52.18 621

**Hommes Decathlon — Lancer du javelot
Groupe 2/29 Sept**

**Men Decathlon — Javelin
Group 3/Sept. 29**

Rank Rang	Ctry Pays	Name Nom	1)	2)	3)	Result Resultat
1	SWE	Olander, Mikael	69.30	68.84	72.80	72.80 932
2	CAN	Steen, Dave	61.44	64.16	62.58	64.16 801
3	AUS	Shirley, Simon	58.56	64.00	54.22	64.00 798
4	USA	Bright, Tim	61.60	X	59.98	61.60 762
5	GDR	Schenk, Christian	59.50	61.32	56.00	61.32 758
6	GDR	Freimuth, Uwe	59.68	57.96	60.20	60.20 741
7	URS	Tarnovetski, Pavel	58.38	59.48	58.58	59.48 730
8	CHN	Gong, Guohua	57.26	56.10	57.84	57.84 705
9	FRA	Blondel, Alain	56.26	57.46	X	57.46 700
10	TCH	Valenta, Veroslav	52.86	55.68	56.28	56.28 682
11	ESA	Mellado, Santiago	51.76	55.28	55.42	55.42 669
12	GBR	Kruger, Alex	46.08	53.04	54.34	54.34 653
13	TPE	Lee, Fu-An	52.82	51.90	49.80	52.82 630
14	DEN	Warming, Lars	49.02	51.50	50.02	51.50 611

**Hommes Decathlon — Lancer du javelot
Groupe 3/29 Sept**

**Men Decathlon — 1500m
Heat 1/Sept. 29**

Rank Rang	Ctry Pays	Name Nom	Result Resultat
1	SUI	Moser, Severin	4:21.90 799
2	SUI	Gugler, Christian	4:21.93 798
3	DEN	Warming, Lars	4:22.41 795
4	AUT	Werthner, Georg	4:26.42 768
5	KOR	Lee, Kwang-ik	4:29.98 745
6	ESA	Mellado, Santiago	4:30.07 744
7	IRL	O'Connell, Carlos	4:32.06 731
8	ESP	Penalver, Antonio	4:32.68 727
9	GBR	Kruger, Alex	4:37.84 694
10	NEP	Kunwar, Dambar	4:41.24 673
11	TPE	Lee, Fu-An	4:45.57 646
12	GDR	Freimuth, Uwe	4:46.04 643
13	FIJ	Miller, Albert	4:53.72 596
14	GBR	Richards, Greg	4:53.85 596
15	CHN	Gong, Guohua	4:54.99 589
16	TCH	Valenta, Veroslav	5:03.17 542
17	TCH	Hraban, Roman	5:06.68 522

**Hommes Decathlon — 1500m
Serie 1/29 Sept**

**Men Decathlon — 1500m
Heat 2/Sept. 29**

Rank Rang	Ctry Pays	Name Nom	Result Resultat
1	FRA	Blondel, Alain	4:16.64 835
2	SUI	Gaehwiler, Beat	4:16.74 834
3	HUN	Szabo, Dezso	4:17.85 826
4	CAN	Steen, Dave	4:23.20 790
5	HOL	De Wit, Robert	4:25.86 772
6	AUS	Shirley, Simon	4:27.48 761
7	NZL	Poelman, Simon	4:28.54 754
8	GDR	Schenk, Christian	4:28.95 752
9	CAN	Smith, Michael	4:28.97 751
10	USA	Johnson, David	4:29.62 747
11	GDR	Voss, Torsten	4:33.02 725
12	FRA	Plaziat, Christian	4:34.07 718
13	GBR	Thompson, Daley	4:45.11 648
14	USA	Bright, Tim	4:51.20 611
15	URS	Tarnovetski, Pavel	4:52.24 605
16	FIN	Keskitalo, Petri	4:55.89 584
17	SWE	Olander, Mikael	5:02.42 546

**Hommes Decathlon — 1500m
Serie 2/29 Sept**

Athletics

Athlétisme

Men Decathlon Sept. 28-29									Hommes Decathlon 28-29 Sept								
Rank Rang	Ctry Pays	Name Nom	100m 110H	Long Discus	Shot Pole	High Javelin	400m 1500m	Result Resultat	Rank Rang	Ctry Pays	Name Nom	100m 110H	Long Discus	Shot Pole	High Javelin	400m 1500m	Result Resultat
1	GDR	Schenk, Christian	11.25 806 15.13 834	7.43 918 49.28 855	15.48 819 4.70 819	2.27 1061 61.32 758	48.90 866 4:28.95 752	8488	21	AUT	Werthner, Georg	11.52 748 15.64 774	7.36 900 38.82 641	13.93 724 4.60 790	1.94 749 67.04 844	49.99 815 4:26.42 768	7753
2	GDR	Voss, Torsten	10.87 890 14.46 916	7.45 922 44.36 754	14.97 788 5.10 941	1.97 776 61.76 764	47.71 923 4:33.02 725	8399	22	SUI	Gugler, Christian	11.49 755 15.22 823	7.02 818 39.08 646	13.80 716 4.70 819	2.03 831 60.92 752	50.60 787 4:21.93 798	7745
3	CAN	Steen, Dave	11.18 821 14.81 873	7.44 920 43.66 739	14.20 741 5.20 972	1.97 776 64.16 801	48.29 895 4:23.20 790	8328	23	ESP	Penalver, Antonio	11.38 778 14.97 853	7.08 883 46.34 794	14.31 747 4.40 731	2.00 803 55.68 673	50.24 804 4:32.68 727	7743
4	GBR	Thompson, Daley	10.62 947 14.72 884	7.38 905 44.80 763	15.02 791 4.90 880	2.03 831 64.04 799	49.06 858 4:45.11 648	8306	24	GBR	Kruger, Alex	11.30 795 15.38 804	6.97 807 38.72 639	13.23 681 4.60 790	2.15 944 54.34 653	49.98 816 4:37.84 694	7623
5	FRA	Plaziat, Christian	10.83 899 14.18 951	7.62 965 43.06 727	13.58 703 4.90 880	2.12 915 52.18 621	48.34 893 4:34.07 718	8272	25	TPE	Lee, Fu-An	11.00 861 14.96 854	7.23 869 38.06 625	13.15 676 4.50 760	2.03 831 52.82 630	49.73 827 4:45.57 646	7579
6	FRA	Blondel, Alain	11.02 856 14.40 924	7.43 918 41.20 689	12.92 662 5.20 972	1.97 776 57.46 700	47.44 936 4:16.64 835	8268	26	ESA	Mellado, Santiago	11.33 789 15.39 803	6.83 774 37.52 614	11.63 584 4.60 790	2.06 859 55.42 669	48.37 891 4:30.07 744	7517
7	USA	Bright, Tim	11.18 821 14.39 925	7.05 826 41.68 699	14.12 736 5.70 1132	2.06 859 61.60 762	49.34 845 4:51.20 611	8216	27	SUI	Moser, Severin	11.10 838 15.13 834	6.98 809 38.04 625	12.69 648 4.70 819	1.85 670 49.52 581	48.63 879 4:21.90 799	7502
8	HOL	De Wit, Robert	11.05 850 14.36 929	6.95 802 41.32 691	15.34 811 4.80 849	2.00 803 63.00 783	48.21 899 4:25.86 772	8189	28	TCH	Valenta, Veroslav	11.51 750 15.18 828	7.01 816 45.84 784	14.17 739 4.60 790	1.94 749 56.28 682	51.16 762 5:03.17 542	7442
9	USA	Johnson, David	11.15 827 14.66 891	7.12 842 42.36 713	14.52 760 4.90 880	2.03 831 66.46 835	49.15 854 4:29.62 747	8180	29	IRL	O'Connell, Carlos	11.26 804 15.61 777	6.90 790 38.02 624	12.41 631 4.40 731	1.88 696 52.68 628	48.24 898 4:32.06 731	7310
10	URS	Tarnovetski, Pavel	11.23 810 14.76 879	7.28 881 48.02 829	15.25 805 5.20 972	1.97 776 59.48 730	48.60 880 4:52.24 605	8167	30	GBR	Richards, Greg	11.50 753 15.56 783	7.09 835 42.32 712	12.94 664 4.50 760	1.82 644 53.50 641	49.27 849 4:53.85 596	7237
11	FIN	Keskitalo, Petri	10.94 874 14.25 942	7.56 950 41.86 702	15.34 811 4.80 849	1.97 776 66.64 838	49.94 817 4:55.89 584	8143	31	CHN	Gong, Guohua	11.43 767 15.88 746	6.22 635 46.18 791	13.98 727 4.60 790	1.91 723 57.84 705	51.25 758 4:54.99 589	7231
12	SUI	Gaehwiler, Beat	11.18 821 15.11 836	7.34 896 42.46 715	14.48 758 4.70 819	1.94 749 65.84 826	49.02 860 4:16.74 834	8114	32	FIJ	Miller, Albert	11.47 759 15.00 850	6.43 682 38.72 639	12.33 626 4.00 617	1.94 749 57.26 697	50.30 801 4:53.72 596	7016
13	HUN	Szabo, Dezso	11.02 856 14.96 854	7.29 883 39.54 655	12.92 662 5.00 910	2.06 859 56.80 690	48.23 898 4:17.85 826	8093	33	KOR	Lee, Kwang-ik	11.57 738 16.20 710	7.19 859 34.36 551	10.27 502 4.10 645	1.91 723 54.94 662	50.71 782 4:29.98 745	6917
14	CAN	Smith, Michael	10.99 863 14.70 886	7.37 903 43.88 744	13.61 704 4.30 702	1.97 776 66.54 837	47.83 917 4:28.97 751	8083	34	NEP	Kunwar, Dambar	12.12 628 17.05 619	5.83 550 27.10 408	09.71 468 2.80 309	1.71 544 39.10 429	52.32 711 4:41.24 673	5339
15	AUS	Shirley, Simon	11.03 854 15.44 797	7.45 922 41.68 699	14.20 741 4.70 819	1.97 776 64.00 798	48.84 869 4:27.48 761	8036		URS	Kioulvet, Valter	11.31 793 NS	7.14 847	15.29 808	2.00 803	50.62 786	
16	NZL	Poelman, Simon	11.09 841 14.78 876	7.08 833 43.20 730	14.51 760 4.90 880	2.03 831 57.18 696	49.89 820 4:28.54 754	8021		USA	Kinder, Gary	11.31 793 NS	7.00 814	14.89 783	1.97 776	51.79 734	
17	SWE	Olander, Mikael	11.46 761 16.06 726	6.75 755 50.66 884	16.07 856 4.80 849	2.00 803 72.80 932	51.28 757 5:02.42 546	7869		ECU	Solorzano, Fidel	11.01 858	6.79 764	11.76 592	1.88 696	NS	
18	GDR	Freimuth, Uwe	11.57 738 15.04 845	7.00 814 46.66 801	15.60 827 4.90 880	1.94 749 60.20 741	49.84 822 4:46.04 643	7860		URS	Apaitchev, Alexandre	AB					
19	Den	Warming, Lars	11.07 845 14.49 912	7.04 823 40.38 672	13.41 692 4.80 849	1.94 749 51.50 611	47.97 911 4:22.41 795	7859		FRG	Hingsen, Jurgen	DQ					
20	TCH	Hraban, Roman	10.89 885 14.94 857	7.07 830 45.32 773	15.84 841 4.90 880	1.79 619 60.48 745	49.68 829 5:06.68 522	7781									



Women 100m Round 1 Heat 1/Sept. 24				Femmes 100m Tour 1 Serie 1/24 Sept	
Rank Rang	Ctry Pays	Name Nom	Result Resultat		
1	BUL	Vetchernikova, Anelia	11.09	Q	
2	JAM	Jackson, Grace	11.18	Q	
3	GBR	Dunn, Paula	11.39	Q	
4	CHN	Tian, Yumei	11.56		
5	GRE	Patoucidou, Paraskevi	11.85		
6	LBR	Wulah, Melvina	12.16		
7	BEN	Bada, Marie felicite	12.27		
8	UGA	Kyakutema, Farida	12.32		

Women 100m Round 1 Heat 2/Sept. 24				Femmes 100m Tour 1 Serie 2/24 Sept	
Rank Rang	Ctry Pays	Name Nom	Result Resultat		
1	BAH	Davis, Pauline	11.20	Q	
2	HOL	Cooman, Nelli	11.22	Q	
3	GDR	Goehr, Marlies	11.22	Q	
4	POL	Janota, Jolanta	11.71		
5	ESP	Myers, Sandra	11.86		
6	MAR	Oumezdi, Marian	11.90		
7	SUR	Bonapart, Ivette	12.27		
8	MLI	Diarra, Aminata	12.87		

Women 100m Round 1 Heat 3/Sept. 24				Femmes 100m Tour 1 Serie 3/24 Sept	
Rank Rang	Ctry Pays	Name Nom	Result Resultat		
1	USA	Torrence, Gwen	11.12	Q	
2	URS	Kondratieva, Lioudmila	11.19	Q	
3	FRA	Bily, Laurence	11.34	Q	
4	COL	Caicedo, Amparo	11.59		
5	ITA	Masullo, Marisa	11.71		
6	POL	Pisiewicz, Ewa	11.84		
7	HKG	Ng, Ka Yi	12.18		
8	GAM	Jawo, Jabou	12.27		

Women 100m Round 1 Heat 4/Sept. 24				Femmes 100m Tour 1 Serie 4/24 Sept	
Rank Rang	Ctry Pays	Name Nom	Result Resultat		
1	JAM	Cuthbert, Juliet	11.14	Q	
2	GDR	Moeller, Silke	11.27	Q	
3	HOL	Vader, Els	11.38	Q	
4	FRG	Richter, Sabine	11.49		
5	FRA	Leroux, Francoise	11.58		
6	PHI	De Vega, Lydia	11.67		
7	ANG	Cruz, Guilhermina	12.47		
8	COK	Tierney, Erin	12.52		

Women 100m Round 1 Heat 5/Sept. 24				Femmes 100m Tour 1 Serie 5/24 Sept	
Rank Rang	Ctry Pays	Name Nom	Result Resultat		
1	USA	Ashford, Evelyn	11.10	Q	
2	URS	Jirova, Marina	11.22	Q	
3	POL	Smolarek, Joanna	11.43	Q	
4	FRG	Thomas, Andrea	11.46		
5	CAN	Rocheleau, Julie	11.60		
6	ZIM	Dube, Gaily	12.07		
7	URU	Acerenza, Claudia	12.11		
8	CGO	Diankolela-Missengui, Judith-P	12.14		

Women 100m Round 1 Heat 6/Sept. 24				Femmes 100m Tour 1 Serie 6/24 Sept	
Rank Rang	Ctry Pays	Name Nom	Result Resultat		
1	URS	Pomochtnikova, Natalia	11.11	Q	
2	GDR	Drechsler, Heike	11.15	Q	
3	GBR	Jacobs, Simmone	11.56	Q	
4	TRI	Williams, Angela	11.62		
5	CHN	Liu, Shaomei	11.66		
6	KOR	Lee, Young-Sook	11.74		
7	KEN	Odhiambo, Joyce	11.90		
8	BUR	Ouiminga, Mariama	12.62		

Women 100m Round 1 Heat 7/Sept. 24				Femmes 100m Tour 1 Serie 7/24 Sept	
Rank Rang	Ctry Pays	Name Nom	Result Resultat		
1	USA	Griffith Joyner, Florence	10.88	Q	NOR
2	AUS	Johnson, Kerry	11.44	Q	
3	CAN	Bailey, Angela	11.61	Q	
4	FRA	Girard, Patricia	11.65		
5	CHN	Zhang, Caihua	11.84		
6	GAB	Ongollo, Gisele	11.85		
7	TPE	Chen, Ya-Li	12.16		
8	ARU	Farrell, Evelyn	12.48		

Women 100m Round 1 Heat 8/Sept. 24				Femmes 100m Tour 1 Serie 8/24 Sept	
Rank Rang	Ctry Pays	Name Nom	Result Resultat		
1	JAM	Ottey, Merlene	11.03	Q	
2	FRG	Sarvari, Ulrike	11.26	Q	
3	CAN	Issajenko, Angela	11.42	Q	
4	GHA	Yankey, Dinah	11.64		
5	ITA	Tarolo, Rossella	11.86		
6	GBR	Miles, Helen	11.88		
7	VAN	Daruhi, Olivette	13.00		
8	LAO	Sakonninhom, Mala	15.12		

Women 100m Round 1/Sept. 2				Femmes 100m Tour 1/2 Sept	
Rank Rang	Ctry Pays	Name Nom	Result Resultat		
1	USA	Griffith Joyner, Florence	10.88	Q	NOR
2	JAM	Ottey, Merlene	11.03	Q	
3	BUL	Vetchernikova, Anelia	11.09	Q	
4	USA	Ashford, Evelyn	11.10	Q	
5	URS	Pomochtnikova, Natalia	11.11	Q	
6	USA	Torrence, Gwen	11.12	Q	
7	JAM	Cuthbert, Juliet	11.14	Q	
8	GDR	Drechsler, Heike	11.15	Q	
9	JAM	Jackson, Grace	11.18	Q	
10	URS	Kondratieva, Lioudmila	11.19	Q	
11	BAH	Davis, Pauline	11.20	Q	
12	GDR	Goehr, Marlies	11.22	Q	
12	HOL	Cooman, Nelli	11.22	Q	
12	URS	Jirova, Marina	11.22	Q	
15	FRG	Sarvari, Ulrike	11.26	Q	
16	GDR	Moeller, Silke	11.27	Q	
17	FRA	Bily, Laurence	11.34	Q	
18	HOL	Vader, Els	11.38	Q	
19	GBR	Dunn, Paula	11.39	Q	
20	CAN	Issajenko, Angela	11.42	Q	
21	POL	Smolarek, Joanna	11.43	Q	
22	AUS	Johnson, Kerry	11.44	Q	
23	FRG	Thomas, Andrea	11.46	Q	
24	FRG	Richter, Sabine	11.49	Q	
25	CHN	Tian, Yumei	11.56	Q	
25	GBR	Jacobs, Simmone	11.56	Q	
27	FRA	Leroux, Francoise	11.58	Q	
28	COL	Caicedo, Amparo	11.59	Q	
29	CAN	Rocheleau, Julie	11.60	Q	
30	CAN	Bailey, Angela	11.61	Q	
31	TRI	Williams, Angela	11.62	Q	
32	GHA	Yankey, Dinah	11.64	Q	
33	FRA	Girard, Patricia	11.65		
34	CHN	Liu, Shaomei	11.66		
35	PHI	De Vega, Lydia	11.67		
36	ITA	Masullo, Marisa	11.71		
36	POL	Janota, Jolanta	11.71		
38	KOR	Lee, Young-Sook	11.74		
39	CHN	Zhang, Caihua	11.84		
39	POL	Pisiewicz, Ewa	11.84		
41	GAB	Ongollo, Gisele	11.85		
41	GRE	Patoucidou, Paraskevi	11.85		
43	ESP	Myers, Sandra	11.86		
43	ITA	Tarolo, Rossella	11.86		
45	GBR	Miles, Helen	11.88		
46	KEN	Odhiambo, Joyce	11.90		
46	MAR	Oumezdi, Marian	11.90		
48	ZIM	Dube, Gaily	12.07		
49	URU	Acerenza, Claudia	12.11		
50	CGO	Diankolela-Missengui, Judith-P12.14			
51	TPE	Chen, Ya-Li	12.16		
51	LBR	Wulah, Melvina	12.16		
53	HKG	Ng, Ka Yi	12.18		
54	BEN	Bada, Marie Felicite	12.27		
54	GAM	Jawo, Jabou	12.27		
54	SUR	Bonapart, Ivette	12.27		
57	UGA	Kyakutema, Farida	12.32		

Athletics

Athlétisme

Rank Rang	Ctry Pays	Name Nom	Result Resultat
58	ANG	Cruz, Guilhermina	12.47
59	ARU	Farrell, Evelyn	12.48
60	COK	Tierney, Erin	12.52
61	BUR	Ouiminga, Mariama	12.62
62	MLI	Diarra, Aminata	12.87
63	VAN	Daruihi, Olivette	13.00
64	LAO	Sakoninhom, Mala	15.12

Women 100m Round 2 Heat 1/Sept. 24				Femmes 100m Tour 2 Serie 1/24 Sept	
Rank Rang	Ctry Pays	Name Nom	Result Resultat		
1	GDR	Drechsler, Heike	10.96	Q	
2	JAM	Ottey, Merlene	11.03	Q	
3	FRG	Sarvari, Ulrike	11.16	Q	
4	BAH	Davis, Pauline	11.21	Q	
5	CAN	Bailey, Angela	11.29		
6	HOL	Vader, Els	11.51		
7	CHN	Tian, Yumei	11.55		
8	FRA	Leroux, Francoise	11.75		

Women 100m Round 2 Heat 2/Sept. 24				Femmes/100m Tour 2 Serie 2/24 Sept	
Rank Rang	Ctry Pays	Name Nom	Result Resultat		
1	USA	Ashford, Evelyn	10.88	Q	EOR
2	URS	Pomochtnikova, Natalia	10.98	Q	
3	GDR	Goehr, Marlies	10.99	Q	
4	HOL	Cooman, Nelli	11.08	Q	
5	CAN	Issajenko, Angela	11.27		
6	POL	Smolarek, Joanna	11.35		
7	TRI	Williams, Angela	11.45		
8	COL	Caicedo, Amparo	11.65		

Women 100m Round 2 Heat 3/Sept. 24				Femmes 100m Tour 2 Serie 3/24 Sept	
Rank Rang	Ctry Pays	Name Nom	Result Resultat		
1	USA	Griffith Joyner, Florence	10.62	Q	NOR
2	JAM	Cuthbert, Juliet	11.03	Q	
3	URS	Kondratieva, Lioudmila	11.05	Q	
4	GDR	Moeller, Silke	11.10	Q	
5	GBR	Jacobs, Simone	11.31		
6	FRA	Bily, Laurence	11.35		
7	FRG	Thomas, Andrea	11.37		
8	GHA	Yankey, Dinah	11.63		

Women 100m Round 2 Heat 4/Sept. 24				Femmes 100m Tour 2 Serie 4/24 Sept	
Rank Rang	Ctry Pays	Name Nom	Result Resultat		
1	BUL	Vetchernikova, Anelia	10.96	Q	
2	USA	Torrence, Gwen	10.99	Q	
3	JAM	Jackson, Grace	11.13	Q	
4	URS	Jirova, Marina	11.14	Q	
5	GBR	Dunn, Paula	11.37		
6	AUS	Johnson, Kerry	11.42		
7	FRG	Richter, Sabine	11.59		
8	CAN	Rocheleau, Julie	11.75		

Women 100m Round 2/Sept. 24				Femmes 100m Tour 2/24 Sept	
Rank Rang	Ctry Pays	Name Nom	Result Resultat		
1	USA	Griffith Joyner, Florence	10.62	Q	NOR
2	USA	Ashford, Evelyn	10.88	Q	EOR
3	BUL	Vetchernikova, Anelia	10.96	Q	
3	GDR	Drechsler, Heike	10.96	Q	
5	URS	Pomochtnikova, Natalia	10.98	Q	
6	GDR	Goehr, Marlies	10.99	Q	
6	USA	Torrence, Gwen	10.99	Q	
8	JAM	Cuthbert, Juliet	11.03	Q	
8	JAM	Ottey, Merlene	11.03	Q	
10	URS	Kondratieva, Lioudmila	11.05	Q	
11	HOL	Cooman, Nelli	11.08	Q	
12	GDR	Moeller, Silke	11.10	Q	
13	JAM	Jackson, Grace	11.13	Q	
14	URS	Jirova, Marina	11.14	Q	
15	FRG	Sarvari, Ulrike	11.16	Q	

Rank Rang	Ctry Pays	Name Nom	Result Resultat
16	BAH	Davis, Pauline	11.21 Q
17	CAN	Issajenko, Angela	11.27
18	CAN	Bailey, Angela	11.29
19	GBR	Jacobs, Simone	11.31
20	FRA	Bily, Laurence	11.35
20	POL	Smolarek, Joanna	11.35
22	FRG	Thomas, Andrea	11.37
22	GBR	Dunn, Paula	11.37
24	AUS	Johnson, Kerry	11.42
25	TRI	Williams, Angela	11.45
26	HOL	Vader, Els	11.51
27	CHN	Tian, Yumei	11.55
28	FRG	Richter, Sabine	11.59
29	GHA	Yankey, Dinah	11.63
30	COL	Caicedo, Amparo	11.65
31	CAN	Rocheleau, Julie	11.75
31	FRA	Leroux, Francoise	11.75

Women 100m Semi-final Heat 1/Sept. 25				Femmes 100m Demi-finale Serie 1/25 Sept	
Rank Rang	Ctry Pays	Name Nom	Result Resultat		
1	USA	Ashford, Evelyn	10.99	Q	
2	BUL	Vetchernikova, Anelia	11.00	Q	
3	USA	Torrence, Gwen	11.02	Q	
4	JAM	Cuthbert, Juliet	11.10	Q	
5	GDR	Moeller, Silke	11.12		
6	GDR	Goehr, Marlies	11.13		
7	URS	Kondratieva, Lioudmila	11.21		
8	URS	Jirova, Marina	11.24		

Women 100m Semi-final Heat 2/Sept. 25				Femmes 100m Demi-finale Serie 2/25 Sept	
Rank Rang	Ctry Pays	Name Nom	Result Resultat		
1	USA	Griffith Joyner, Florence	10.70	Q	
2	GDR	Drechsler, Heike	10.91	Q	
3	URS	Pomochtnikova, Natalia	11.03	Q	
4	JAM	Jackson, Grace	11.06	Q	
5	FRG	Sarvari, Ulrike	11.12		
6	BAH	Davis, Pauline	11.12		
7	HOL	Cooman, Nelli	11.13		
	JAM	Ottey, Merlene	NS		

Women 100m Final/Sept. 25				Femmes 100m Finale/25 Sept	
Rank Rang	Ctry Pays	Name Nom	Result Resultat		
1	USA	Griffith Joyner, Florence	10.54		
2	USA	Ashford, Evelyn	10.83		
3	GDR	Drechsler, Heike	10.85		
4	JAM	Jackson, Grace	10.97		
5	USA	Torrence, Gwen	10.97		
6	URS	Pomochtnikova, Natalia	11.00		
7	JAM	Cuthbert, Juliet	11.26		
8	BUL	Vetchernikova, Anelia	11.49		

Women 200m Round 1 Heat 1/Sept. 28				Femmes 200m Tour 1 Serie 1/28 Sept	
Rank Rang	Ctry Pays	Name Nom	Result Resultat		
1	GDR	Drechsler, Heike	22.93	Q	
2	POL	Siwek, Agnieszka	23.10	Q	
3	NGR	Ogunkoya, Fallilat	23.12	Q	
4	TRI	Williams, Angela	23.76		
5	COL	Restrepo, Ximena	24.00		
6	BEN	Bada, Marie felicite	25.42		
7	BUR	Ouiminga, Mariama	26.08		



Women 200m Round 1 Heat 2/Sept. 28				Femmes 200m Tour 1 Serie 2/28 Sept	
Rank Rang	Ctry Pays	Name Nom	Result Resultat		
1	BUL	Gueorguieva, Nadejda	22.80	Q	
2	NGR	Onyali, Mary	22.82	Q	
3	FRG	Thomas, Andrea	22.92	Q	
4	ITA	Angotzi, Rita	23.59		
5	GRE	Skordi, Marina	24.06		
6	ISV	Morris, Ruth	24.51		
7	GRN	Griffith, Agnes	24.79		
8	HKG	Ng, Ka Yi	25.35		

Women 200m Round 1 Heat 3/Sept. 28				Femmes 200m Tour 1 Serie 3/28 Sept	
Rank Rang	Ctry Pays	Name Nom	Result Resultat		
1	URS	Maltchougina, Galina	22.85	Q	
2	GDR	Moeller, Silke	23.07	Q	
3	POL	Janota, Jolanta	23.40	Q	
4	ANT	Joseph, Joycelyn	23.57		
5	ITA	Masullo, Marisa	23.58		
6	KOR	Woo, Yang-Ja	24.94		
7	LBR	Wulah, Melvina	25.46		
8	COK	Tierney, Erin	26.16		

Women 200m Round 1 Heat 4/Sept. 28				Femmes 200m Tour 1 Serie 4/28 Sept	
Rank Rang	Ctry Pays	Name Nom	Result Resultat		
1	JAM	Ottey, Merlene	23.06	Q	
2	FRA	Perec, Marie-Josée	23.49	Q	
3	FRG	Knoll, Silke	23.51	Q	
4	GBR	Stuart, Louise	23.61		
5	KEN	Odhiambo, Joyce	24.26		
6	UGA	Acii, Oliver	24.39		
7	CGO	Diankolela-Missengui, Judith-P	25.20		
8	ARU	Farrell, Evelyn	25.74		

Women 200m Round 1 Heat 5/Sept. 28				Femmes 200m Tour 1 Serie 5/28 Sept	
Rank Rang	Ctry Pays	Name Nom	Result Resultat		
1	USA	Griffith Joyner, Florence	22.51	Q	
2	GDR	Krabbe, Katrin	23.14	Q	
3	FRA	Leroy, Muriel	23.19	Q	
4	SUI	Aebi, Regula	23.22		
5	CHN	Zhang, Xiaoqiong	24.08		
6	SUR	Bonapart, Ivette	24.95		
7	ANG	Cruz, Guilhermina	25.62		

Women 200m Round 1 Heat 6/Sept. 28				Femmes 200m Tour 1 Serie 6/28 Sept	
Rank Rang	Ctry Pays	Name Nom	Result Resultat		
1	JAM	Jackson, Grace	22.66	Q	
2	URS	Azrachvili, Maia	22.98	Q	
3	COL	Carabali, Norfalia	23.78	Q	
4	BAR	Straughn, Yolande	23.81		
5	ZIM	Dube, Gaily	24.42		
6	LIE	Hasler, Yvonne	24.91		
7	MLI	Diarra, Aminata	25.81		
	AUS	Holland, Maree	NS		

Women 200m Round 1 Heat 7/Sept. 28				Femmes 200m Tour 1 Serie 7/28 Sept	
Rank Rang	Ctry Pays	Name Nom	Result Resultat		
1	USA	Torrence, Gwen	22.87	Q	
2	BAH	Davis, Pauline	23.08	Q	
3	AUS	Johnson, Kerry	23.20	Q	
4	GBR	Jacobs, Simone	23.47		
5	FRA	Cazier-Ballo, Marie-Christine	23.50		
6	URU	Acerenza, Claudia	24.46		
7	TPE	Chen, Ya-Li	25.03		

Women 200m Round 1 Heat 8/Sept. 28				Femmes 200m Tour 1 Serie 8/28 Sept	
Rank Rang	Ctry Pays	Name Nom	Result Resultat		
1	GBR	Dunn, Paula	23.32	Q	
2	BRA	Figueiredo, Maria	23.71	Q	
3	FRG	Janke, Karin	23.83	Q	
4	CHN	Xie, Zhiling	24.01		
5	VAN	Daruhi, Olivette	26.88		
6	GEQ	Mbuamangongo, Rosa	31.12		
	USA	Marshall, Pamela	AB		

Women 200m Round 1/Sept. 28				Femmes 200m Tour 1/28 Sept	
Rank Rang	Ctry Pays	Name Nom	Result Resultat		
1	USA	Griffith Joyner, Florence	22.51	Q	
2	JAM	Jackson, Grace	22.66	Q	
3	BUL	Gueorguieva, Nadejda	22.80	Q	
4	NGR	Onyali, Mary	22.82	Q	
5	URS	Maltchougina, Galina	22.85	Q	
6	USA	Torrence, Gwen	22.87	Q	
7	FRG	Thomas, Andrea	22.92	Q	
8	GDR	Drechsler, Heike	22.93	Q	
9	URS	Azrachvili, Maia	22.98	Q	
10	JAM	Ottey, Merlene	23.06	Q	
11	GDR	Moeller, Silke	23.07	Q	
12	BAH	Davis, Pauline	23.08	Q	
13	POL	Siwek, Agnieszka	23.10	Q	
14	NGR	Ogunkoya, Falilat	23.12	Q	
15	GDR	Krabbe, Katrin	23.14	Q	
16	FRA	Leroy, Muriel	23.19	Q	
17	AUS	Johnson, Kerry	23.20	Q	
18	SUI	Aebi, Regula	23.22	Q	
19	GBR	Dunn, Paula	23.32	Q	
20	POL	Janota, Jolanta	23.40	Q	
21	GBR	Jacobs, Simone	23.47	Q	
22	FRA	Perec, Marie-Josée	23.49	Q	
23	FRA	Cazier-Ballo, Marie-Christine	23.50	Q	
24	FRG	Knoll, Silke	23.51	Q	
25	ANT	Joseph, Joycelyn	23.57	Q	
26	ITA	Masullo, Marisa	23.58	Q	
27	ITA	Angotzi, Rita	23.59	Q	
28	GBR	Stuart, Louise	23.61	Q	
29	BRA	Figueiredo, Maria	23.71	Q	
30	TRI	Williams, Angela	23.76	Q	
31	COL	Carabali, Norfalia	23.78	Q	
32	BAR	Straughn, Yolande	23.81		
33	FRG	Janke, Karin	23.83	Q	
34	COL	Restrepo, Ximena	24.00		
35	CHN	Xie, Zhiling	24.01		
36	GRE	Skordi, Marina	24.06		
37	CHN	Zhang, Xiaoqiong	24.08		
38	KEN	Odhiambo, Joyce	24.26		
39	UGA	Acii, Oliver	24.39		
40	ZIM	Dube, Gaily	24.42		
41	URU	Acerenza, Claudia	24.46		
42	ISV	Morris, Ruth	24.51		
43	GRN	Griffith, Agnes	24.79		
44	LIE	Hasler, Yvonne	24.91		
45	KOR	Woo, Yang-Ja	24.94		
46	SUR	Bonapart, Ivette	24.95		
47	TPE	Chen, Ya-Li	25.03		
48	CGO	Diankolela-Missengui, Judith-P	25.20		
49	HKG	Ng, Ka Yi	25.35		
50	BEN	Bada, Marie felicite	25.42		
51	LBR	Wulah, Melvina	25.46		
52	ANG	Cruz, Guilhermina	25.62		
53	ARU	Farrell, Evelyn	25.74		
54	MLI	Diarra, Aminata	25.81		
55	BUR	Ouiminga, Mariama	26.08		
56	COK	Tierney, Erin	26.16		
57	VAN	Daruhi, Olivette	26.88		
58	GEQ	Mbuamangongo, Rosa	31.12		
	USA	Marshall, Pamela	AB		
	AUS	Holland, Maree	NS		

Women 200m Round 2 Heat 1/Sept. 28				Femmes 200m Tour 2 Serie 1/28 Sept	
Rank Rang	Ctry Pays	Name Nom	Result Resultat		
1	USA	Griffith Joyner, Florence	21.76	Q	NOR
2	URS	Azrachvili, Maia	22.37	Q	
3	GDR	Drechsler, Heike	22.38	Q	
4	SUI	Aebi, Regula	22.88	Q	
5	AUS	Johnson, Kerry	23.01		
6	FRG	Knoll, Silke	23.15		
7	TRI	Williams, Angela	23.48		
8	FRA	Cazier-Ballo, Marie-Christine	23.63		

Athletics

Athlétisme

Women 200m Round 2 Heat 2/Sept. 28				Femmes 200m Tour 2 Serie 2/28 Sept			
Rank Rang	Ctry Pays	Name Nom	Result Resultat				
1	USA	Torrence, Gwen	22.25	Q			
2	JAM	Ottey, Merlene	22.30	Q			
3	BUL	Gueorguieva, Nadejda	22.60	Q			
4	GDR	Krabbe, Katrin	22.67	Q			
5	NGR	Ogunkoya, Falilat	22.88				
6	ITA	Angotzi, Rita	23.33				
7	POL	Janota, Jolanta	23.34				
8	GBR	Stuart, Louise	23.59				

Women 200m Semi-final Heat 1/Sept. 29				Femmes 200m Demi-finale Serie 1/29 Sept			
Rank Rang	Ctry Pays	Name Nom	Result Resultat				
1	USA	Griffith Joyner, Florence	21.56	Q	NWR		
2	JAM	Ottey, Merlene	22.07	Q			
3	GDR	Moeller, Silke	22.15	Q			
4	URS	Azarachvili, Maia	22.33	Q			
5	NGR	Onyali, Mary	22.43				
6	GDR	Krabbe, Katrin	22.59				
7	BAH	Davis, Pauline	22.67				
8	FRG	Thomas, Andrea	22.91				

Women 200m Round 2 Heat 3/Sept. 28				Femmes 200m Tour 2 Serie 3/28 Sept			
Rank Rang	Ctry Pays	Name Nom	Result Resultat				
1	JAM	Jackson, Grace	22.24	Q			
2	FRG	Thomas, Andrea	22.84	Q			
3	GDR	Moeller, Silke	22.86	Q			
4	GBR	Dunn, Paula	23.04	Q			
5	FRA	Leroy, Muriel	23.22				
6	ITA	Masullo, Marisa	23.52				
7	ANT	Joseph, Joycelyn	23.59				
8	COL	Carabali, Norfalia	23.96				

Women 200m Semi-final Heat 2/Sept. 29				Femmes 200m Demi-finale Serie 2/24 Sept			
Rank Rang	Ctry Pays	Name Nom	Result Resultat				
1	JAM	Jackson, Grace	22.13	Q			
2	GDR	Drechsler, Heike	22.27	Q			
3	USA	Torrence, Gwen	22.53	Q			
4	URS	Maltchougina, Galina	22.55	Q			
5	BUL	Gueorguieva, Nadejda	22.67				
6	GBR	Dunn, Paula	23.14				
7	POL	Siwek, Agnieszka	23.20				
8	SUI	Aebi, Regula	23.33				

Women 200m Round 2 Heat 4/Sept. 28				Femmes 200m Tour 2 Serie 4/28 Sept			
Rank Rang	Ctry Pays	Name Nom	Result Resultat				
1	URS	Maltchougina, Galina	22.77	Q			
2	NGR	Onyali, Mary	22.89	Q			
3	BAH	Davis, Pauline	22.92	Q			
4	POL	Siwek, Agnieszka	22.96	Q			
5	GBR	Jacobs, Simmone	23.38				
6	BRA	Figueiredo, Maria	23.67				
7	FRG	Janke, Karin	23.87				
8	FRA	Perec, Marie-Josée	24.22				

Women 200m Semi-final/Sept. 29				Femmes 200m Demi-finale/29 Sept			
Rank Rang	Ctry Pays	Name Nom	Result Resultat				
1	USA	Griffith Joyner, Florence	21.56	Q	NWR		
2	JAM	Ottey, Merlene	22.07	Q			
3	JAM	Jackson, Grace	22.13	Q			
4	GDR	Moeller, Silke	22.15	Q			
5	GDR	Drechsler, Heike	22.27	Q			
6	URS	Azarachvili, Maia	22.33	Q			
7	NGR	Onyali, Mary	22.43				
8	USA	Torrence, Gwen	22.53	Q			
9	URS	Maltchougina, Galina	22.55	Q			
10	GDR	Krabbe, Katrin	22.59				
11	BAH	Davis, Pauline	22.67				
11	BUL	Gueorguieva, Nadejda	22.67				
13	FRG	Thomas, Andrea	22.91				
14	GBR	Dunn, Paula	23.14				
15	POL	Siwek, Agnieszka	23.20				
16	SUI	Aebi, Regula	23.33				

Women 200m Round 2/Sept. 28				Femmes 200m Tour 2/28 Sept			
Rank Rang	Ctry Pays	Name Nom	Result Resultat				
1	USA	Griffith Joyner, Florence	21.76	Q	NOR		
2	JAM	Jackson, Grace	22.24	Q			
3	USA	Torrence, Gwen	22.25	Q			
4	JAM	Ottey, Merlene	22.30	Q			
5	URS	Azarachvili, Maia	22.37	Q			
6	GDR	Drechsler, Heike	22.38	Q			
7	BUL	Gueorguieva, Nadejda	22.60	Q			
8	GDR	Krabbe, Katrin	22.67	Q			
9	URS	Maltchougina, Galina	22.77	Q			
10	FRG	Thomas, Andrea	22.84	Q			
11	GDR	Moeller, Silke	22.86	Q			
12	NGR	Ogunkoya, Falilat	22.88				
12	SUI	Aebi, Regula	22.88	Q			
14	NGR	Onyali, Mary	22.89	Q			
15	BAH	Davis, Pauline	22.92	Q			
16	POL	Siwek, Agnieszka	22.96	Q			
17	AUS	Johnson, Kerry	23.01				
18	GBR	Dunn, Paula	23.04	Q			
19	FRG	Knoll, Silke	23.15				
20	FRA	Leroy, Muriel	23.22				
21	ITA	Angotzi, Rita	23.33				
22	POL	Janota, Jolanta	23.34				
23	GBR	Jacobs, Simmone	23.38				
24	TRI	Williams, Angela	23.48				
25	ITA	Masullo, Marisa	23.52				
26	ANT	Joseph, Joycelyn	23.59				
26	GBR	Stuart, Louise	23.59				
28	FRA	Cazier-Ballo, Marie-Christine	23.63				
29	BRA	Figueiredo, Maria	23.67				
30	FRG	Janke, Karin	23.87				
31	COL	Carabali, Norfalia	23.96				
32	FRA	Perec, Marie-Josée	24.22				

Women 200m Final/Sept. 29				Femmes 200m Finale/29 Sept			
Rank Rang	Ctry Pays	Name Nom	Result Resultat				
1	USA	Griffith Joyner, Florence	21.34	NWR			
2	JAM	Jackson, Grace	21.72				
3	GDR	Drechsler, Heike	21.95				
4	JAM	Ottey, Merlene	21.99				
5	GDR	Moeller, Silke	22.09				
6	USA	Torrence, Gwen	22.17				
7	URS	Azarachvili, Maia	22.33				
8	URS	Maltchougina, Galina	22.42				

Women 400m Round 1 Heat 1/Sept. 23				Femmes 400m Tour 1 Serie 1/23 Sept			
Rank Rang	Ctry Pays	Name Nom	Result Resultat				
1	URS	Nazarova, Olga	52.18	Q			
2	ESP	Lacambra, Blanca	53.04	Q			
3	CAN	Crooks, Charmaine	53.58	Q			
4	ECU	Chala, Liliana	53.74	Q			
5	GBR	Beckford, Pat	54.39				
6	KOR	Yang, Kyoung-Hee	58.18				
7	GEQ	Nsang Obiang, Juliana	67.58				

Women 400m Round 1 Heat 2/Sept. 23				Femmes 400m Tour 1 Serie 2/23 Sept			
Rank Rang	Ctry Pays	Name Nom	Result Resultat				
1	GDR	Neubauer, Dagmar	52.51	Q			
2	CAN	Payne Wiggins, Marita	52.70	Q			
3	NGR	Bakare, Airat	52.83	Q			
4	FRA	Ficher, Fabienne	53.42	Q			
5	UGA	Kyakutema, Farida	56.00				
6	ZAI	Kungu, Bakombo	57.85				



Women 400m				Femmes 400m	
Round 1 Heat 3/Sept. 23				Tour 1 Serie 3/23 Sept	
Rank	Ctry	Name	Result		
Rang	Pays	Nom	Resultat		
1	BRA	Figueiredo, Maria	51.74	Q	
2	GDR	Mueller, Petra	51.93	Q	
3	JAM	Richards, Sandie	52.19	Q	
4	GBR	Hall, Loreen	53.13	Q	
5	CHN	Sun, Sumei	53.46		
6	BAR	Straughn, Yolande	53.62		
	AUT	Haas, Gerda	NS		

Women 400m				Femmes 400m	
Round 1 Heat 4/Sept. 23				Tour 1 Serie 4/23 Sept	
Rank	Ctry	Name	Result		
Rang	Pays	Nom	Resultat		
1	USA	Dixon, Diane	52.45	Q	
2	FRG	Thimm, Ute	52.79	Q	
3	HOL	Van Dorp, Yvonne	52.84	Q	
4	FRA	Elien, Evecyne	52.90	Q	
5	GUY	Dewarder, Marilyn	54.76		
6	LIB	Sardouk, May	60.01		
	MRI	Seebaluck, Sheila	NS		

Women 400m				Femmes 400m	
Round 1 Heat 5/Sept. 23				Tour 1 Serie 5/23 Sept	
Rank	Ctry	Name	Result		
Rang	Pays	Nom	Resultat		
1	USA	Brisco, Valerie	51.96	Q	
2	AUS	Holland, Maree	52.29	Q	
3	COL	Carabali, Norfalia	53.27	Q	
4	GDR	Emmelmänn, Kirsten	54.02	Q	
5	CMR	Achuo-Bei, Assumpta	55.22		
6	MAL	Singarayar, Josephine	56.06		
7	CGO	Nkouka, Lasnet-Lelisse	57.19		

Women 400m				Femmes 400m	
Round 1 Heat 6/Sept. 23				Tour 1 Serie 6/23 Sept	
Rank	Ctry	Name	Result		
Rang	Pays	Nom	Resultat		
1	URS	Bryzguina, Olga	51.94	Q	
2	GBR	Keough, Linda	52.26	Q	
3	JAM	Rattray-Williams, Cathy	52.39	Q	
4	CIV	Ndrin, Celestine	52.48	Q	
5	IND	Alapurackal, Mercy Kuttan Math	53.41		
6	ISV	Morris, Ruth	55.60		
7	ANT	Selkridge, Barbara	55.96		

Women 400m				Femmes 400m	
Round 1 Heat 7/Sept. 23				Tour 1 Serie 7/23 Sept	
Rank	Ctry	Name	Result		
Rang	Pays	Nom	Resultat		
1	USA	Howard, Denean	52.26	Q	
2	FRG	Arendt, Helga	52.69	Q	
3	SEN	Tandian, Aissatou	52.95	Q	
4	CAN	Richardson, Jillian	53.06	Q	
5	FRA	Simon, Nathalie	53.30		
6	TPE	Chang, Fen-Hwa	56.10		
7	GRN	Griffith, Agnes	57.09		

Women 400m				Femmes 400m	
Round 1/Sept. 23				Tour 1/23 Sept	
Rank	Ctry	Name	Result		
Rang	Pays	Nom	Resultat		
1	BRA	Figueiredo, Maria	51.74	Q	
2	GDR	Mueller, Petra	51.93	Q	
3	URS	Bryzguina, Olga	51.94	Q	
4	USA	Brisco, Valerie	51.96	Q	
5	URS	Nazarova, Olga	52.18	Q	
6	JAM	Richards, Sandie	52.19	Q	
7	GBR	Keough, Linda	52.26	Q	
7	USA	Howard, Denean	52.26	Q	
9	AUS	Holland, Maree	52.29	Q	
10	JAM	Rattray-Williams, Cathy	52.39	Q	
11	USA	Dixon, Diane	52.45	Q	
12	CIV	Ndrin, Celestine	52.48	Q	
13	GDR	Neubauer, Dagmar	52.51	Q	
14	FRG	Arendt, Helga	52.69	Q	
15	CAN	Payne Wiggins, Marita	52.70	Q	
16	FRG	Thimm, Ute	52.79	Q	
17	NGR	Bakare, Airat	52.83	Q	
18	HOL	Van Dorp, Yvonne	52.84	Q	
19	FRA	Elien, Evecyne	52.90	Q	

Rank	Ctry	Name	Result		
Rang	Pays	Nom	Resultat		
20	SEN	Tandian, Aissatou	52.95	Q	
21	ESP	Lacambra, Blanca	53.04	Q	
22	CAN	Richardson, Jillian	53.06	Q	
23	GBR	Hall, Loreen	53.13	Q	
24	COL	Carabali, Norfalia	53.27	Q	
25	FRA	Simon, Nathalie	53.30	Q	
26	IND	Alapurackal, Mercy Kuttan Math	53.41	Q	
27	FRA	Ficher, Fabienne	53.42	Q	
28	CHN	Sun, Sumei	53.46	Q	
29	CAN	Crooks, Charmaine	53.58	Q	
30	BAR	Straughn, Yolande	53.62	Q	
31	ECU	Chala, Liliana	53.74	Q	
32	GDR	Emmelmänn, Kirsten	54.02	Q	
33	GBR	Beckford, Pat	54.39		
34	GUY	Dewarder, Marilyn	54.76		
35	CMR	Achuo-Bei, Assumpta	55.22		
36	ISV	Morris, Ruth	55.60		
37	ANT	Selkridge, Barbara	55.96		
38	UGA	Kyakutema, Farida	56.00		
39	MAL	Singarayar, Josephine	56.06		
40	TPE	Chang, Fen-Hwa	56.10		
41	GRN	Griffith, Agnes	57.09		
42	CGO	Nkouka, Lasnet-Lelisse	57.19		
43	ZAI	Kungu, Bakombo	57.85		
44	KOR	Yang, Kyoung-Hee	58.18		
45	LIB	Sardouk, May	60.01		
46	GEQ	Nsang Obiang, Juliana	67.58		
	AUT	Haas, Gerda	NS		
	MRI	Seebaluck, Sheila	NS		

Women 400m				Femmes 400m	
Round 2 Heat 1/Sept. 24				Tour 2 Serie 1/24 Sept	
Rank	Ctry	Name	Result		
Rang	Pays	Nom	Resultat		
1	AUS	Holland, Maree	50.90	Q	
2	GDR	Emmelmänn, Kirsten	51.02	Q	
3	USA	Howard, Denean	51.02	Q	
4	FRG	Thimm, Ute	51.18	Q	
5	BRA	Figueiredo, Maria	51.32		
6	NGR	Bakare, Airat	52.86		
7	GBR	Hall, Loreen	53.42		
	FRA	Simon, Nathalie	NS		

Women 400m				Femmes 400m	
Round 2 Heat 2/Sept. 24				Tour 2 Serie 2/24 Sept	
Rank	Ctry	Name	Result		
Rang	Pays	Nom	Resultat		
1	URS	Bryzguina, Olga	51.90	Q	
2	USA	Dixon, Diane	51.98	Q	
3	FRG	Arendt, Helga	52.08	Q	
4	CAN	Richardson, Jillian	52.33	Q	
5	JAM	Richards, Sandie	52.90		
6	FRA	Elien, Evecyne	53.36		
7	CHN	Sun, Sumei	53.58		
8	BAR	Straughn, Yolande	54.22		

Women 400m				Femmes 400m	
Round 2 Heat 3/Sept. 24				Tour 2 Serie 3/24 Sept	
Rank	Ctry	Name	Result		
Rang	Pays	Nom	Resultat		
1	GDR	Mueller, Petra	51.45	Q	
2	CAN	Payne Wiggins, Marita	51.73	Q	
3	COL	Carabali, Norfalia	51.76	Q	
4	JAM	Rattray-Williams, Cathy	51.81	Q	
5	GBR	Keough, Linda	51.91		
6	HOL	Van Dorp, Yvonne	53.50		
7	ECU	Chala, Liliana	53.83		
8	IND	Alapurackal, Mercy Kuttan Math	53.93		

Women 400m				Femmes 400m	
Round 2 Heat 4/Sept. 24				Tour 2 Serie 4/24 Sept	
Rank	Ctry	Name	Result		
Rang	Pays	Nom	Resultat		
1	URS	Nazarova, Olga	50.26	Q	
2	USA	Brisco, Valerie	51.24	Q	
3	GDR	Neubauer, Dagmar	51.48	Q	
4	CAN	Crooks, Charmaine	51.64	Q	
5	CIV	Ndrin, Celestine	52.04		
6	SEN	Tandian, Aissatou	52.33		
7	FRA	Ficher, Fabienne	52.95		
8	ESP	Lacambra, Blanca	53.76		

Athletics

Women 400m Round 2/Sept. 24				Femmes 400m Tour 2/24 Sept	
Rank Rang	Ctry Pays	Name Nom	Result Resultat		
1	URS	Nazarova, Olga	50.26	Q	
2	AUS	Holland, Maree	50.90	Q	
3	GDR	Emmelmann, Kirsten	51.02	Q	
3	USA	Howard, Denean	51.02	Q	
5	FRG	Thimm, Ute	51.18	Q	
6	USA	Brisco, Valerie	51.24	Q	
7	BRA	Figueiredo, Maria	51.32		
8	GDR	Mueller, Petra	51.45	Q	
9	GDR	Neubauer, Dagmar	51.48	Q	
10	CAN	Crooks, Charmaine	51.64	Q	
11	CAN	Payne Wiggins, Marita	51.73	Q	
12	COL	Carabali, Norfalia	51.76	Q	
13	JAM	Rattray-Williams, Cathy	51.81	Q	
14	URS	Bryzguina, Olga	51.90	Q	
15	GBR	Keough, Linda	51.91		
16	USA	Dixon, Diane	51.98	Q	
17	CIV	Ndrin, Celestine	52.04		
18	FRG	Arendt, Helga	52.08	Q	
19	CAN	Richardson, Jillian	52.33	Q	
19	SEN	Tandian, Aissatou	52.33		
21	NGR	Bakare, Airat	52.86		
22	JAM	Richards, Sandie	52.90		
23	FRA	Ficher, Fabienne	52.95		
24	FRA	Elien, Evecyne	53.36		
25	GBR	Hall, Loreen	53.42		
26	HOL	Van Dorp, Yvonne	53.50		
27	CHN	Sun, Sumei	53.58		
28	ESP	Lacambra, Blanca	53.76		
29	ECU	Chala, Liliana	53.83		
30	IND	Alapurackal, Mercy Kuttan Math	53.93		
31	BAR	Straughn, Yolande	54.22		
	FRA	Simon, Nathalie	NS		

Women 400m Semi-final Heat 1/Sept. 25				Femmes 400m Demi-finale Serie 1/25 Sept	
Rank Rang	Ctry Pays	Name Nom	Result Resultat		
1	URS	Nazarova, Olga	49.11	Q	
2	GDR	Mueller, Petra	49.50	Q	
3	USA	Dixon, Diane	49.84	Q	
4	USA	Howard, Denean	49.87	Q	
5	CAN	Richardson, Jillian	49.91		
6	FRG	Thimm, Ute	50.28		
7	CAN	Payne Wiggins, Marita	50.29		
8	GDR	Neubauer, Dagmar	50.92		

Women 400m Semi-final Heat 2/Sept. 25				Femmes 400m Demi-finale Serie 2/25 Sept	
Rank Rang	Ctry Pays	Name Nom	Result Resultat		
1	URS	Bryzguina, Olga	49.33	Q	
2	USA	Brisco, Valerie	49.90	Q	
3	AUS	Holland, Maree	50.24	Q	
4	FRG	Arendt, Helga	50.36	Q	
5	GDR	Emmelmann, Kirsten	50.39		
6	JAM	Rattray-Williams, Cathy	50.82		
7	CAN	Crooks, Charmaine	51.63		
8	COL	Carabali, Norfalia	52.65		

Women 400m Semi-final/Sept. 25				Femmes 400m Demi-finale/25 Sept	
Rank Rang	Ctry Pays	Name Nom	Result Resultat		
1	URS	Nazarova, Olga	49.11	Q	
2	URS	Bryzguina, Olga	49.33	Q	
3	GDR	Mueller, Petra	49.50	Q	
4	USA	Dixon, Diane	49.84	Q	
5	USA	Howard, Denean	49.87	Q	
6	USA	Brisco, Valerie	49.90	Q	
7	CAN	Richardson, Jillian	49.91		
8	AUS	Holland, Maree	50.24	Q	
9	FRG	Thimm, Ute	50.28		
10	CAN	Payne Wiggins, Marita	50.29		
11	FRG	Arendt, Helga	50.36	Q	
12	GDR	Emmelmann, Kirsten	50.39		
13	JAM	Rattray-Williams, Cathy	50.82		
14	GDR	Neubauer, Dagmar	50.92		
15	CAN	Crooks, Charmaine	51.63		
16	COL	Carabali, Norfalia	52.65		

Athlétisme

Women 400m Final/Sept. 26				Femmes 400m Finale/26 Sept	
Rank Rang	Ctry Pays	Name Nom	Result Resultat		
1	URS	Bryzguina, Olga	48.65	NOR	
2	GDR	Mueller, Petra	49.45		
3	URS	Nazarova, Olga	49.90		
4	USA	Brisco, Valerie	50.16		
5	USA	Dixon, Diane	50.72		
6	USA	Howard, Denean	51.12		
7	FRG	Arendt, Helga	51.17		
8	AUS	Holland, Maree	51.25		

Women 800m Round 1 Heat 1/Sept. 24				Femmes 800m Tour 1 Serie 1/24 Sept	
Rank Rang	Ctry Pays	Name Nom	Result Resultat		
1	URS	Evseeva, Inna	2:01.59	Q	
2	YUG	Colovic, Slobodanka	2:01.80	Q	
3	GBR	Bailey, Shireen	2:02.36	Q	
4	JAM	Powell, Sharon	2:03.49		
5	ESP	Pujol, Montserrat	2:03.73		
6	KOR	Choi, Se-Beom	2:06.65		
7	CMR	Achuo-Bei, Assumpta	2:07.10		
8	ZAI	Kungu, Bakombo	2:11.00		

Women 800m Round 1 Heat 2/Sept. 24				Femmes 800m Tour 1 Serie 2/24 Sept	
Rank Rang	Ctry Pays	Name Nom	Result Resultat		
1	GDR	Wachtel, Christine	2:00.62	Q	
2	USA	Clark, Joetta	2:00.83	Q	
3	FRG	Lesch, Caby	2:00.95	Q	
4	ESP	Zuniga, Teresa	2:00.98		
5	CAN	Burzminski, Mary	2:02.85		
6	IND	Kurisingal Abraham, Shiny	2:03.26		
7	MOZ	Mutola, Maria	2:04.36		
8	MRI	Seebaluck, Sheila	2:08.93		

Women 800m Round 1 Heat 3/Sept. 24				Femmes 800m Tour 1 Serie 3/24 Sept	
Rank Rang	Ctry Pays	Name Nom	Result Resultat		
1	GDR	Wodars, Sigrun	2:02.24	Q	
2	USA	Floyd, Delisa	2:02.37	Q	
3	BRA	Telles, Soraya	2:02.48	Q	
4	URS	Matoussiavitchene, Dalia	2:02.57		
5	GBR	Wade, Kirsty	2:02.75		
6	CRC	Stewart, Maureen	2:08.17		
7	ANT	Bryan, Laverne	2:12.18		
	CHN	Sun, Sumei	NS		

Women 800m Round 1 Heat 4/Sept. 24				Femmes 800m Tour 1 Serie 4/24 Sept	
Rank Rang	Ctry Pays	Name Nom	Result Resultat		
1	USA	Gallagher, Kim	2:01.70	Q	
2	GBR	Edwards, Diane	2:01.79	Q	
3	URS	Olizarenko, Nadejda	2:01.81	Q	
4	SUR	Vriesde, Letitia	2:01.83		
5	ALG	Boulmerka, Hassiba	2:03.33		
6	CAN	Belanger, Renee	2:04.74		
	ESP	Colorado, Rosa	NS		

Women 800m Round 1/Sept. 24				Femmes 800m Tour 1/24 Sept	
Rank Rang	Ctry Pays	Name Nom	Result Resultat		
1	GDR	Wachtel, Christine	2:00.62	Q	
2	USA	Clark, Joetta	2:00.83	Q	
3	FRG	Lesch, Caby	2:00.95	Q	
4	ESP	Zuniga, Teresa	2:00.98	Q	
5	URS	Evseeva, Inna	2:01.59	Q	
6	USA	Gallagher, Kim	2:01.70	Q	
7	GBR	Edwards, Diane	2:01.79	Q	
8	YUG	Colovic, Slobodanka	2:01.80	Q	
9	URS	Olizarenko, Nadejda	2:01.81	Q	
10	SUR	Vriesde, Letitia	2:01.83	Q	
11	GDR	Wodars, Sigrun	2:02.24	Q	
12	GBR	Bailey, Shireen	2:02.36	Q	
13	USA	Floyd, Delisa	2:02.37	Q	
14	BRA	Telles, Soraya	2:02.48	Q	
15	URS	Matoussiavitchene, Dalia	2:02.57	Q	



Rank	Ctry	Name	Result
Rang	Pays	Nom	Resultat
16	GBR	Wade, Kirsty	2:02.75 Q
17	CAN	Burzminski, Mary	2:02.85
18	IND	Kurisingal Abraham, Shiny	2:03.26
19	ALG	Boulmerka, Hassiba	2:03.33
20	JAM	Powell, Sharon	2:03.49
21	ESP	Pujol, Montserrat	2:03.73
22	MOZ	Mutola, Maria	2:04.36
23	CAN	Belanger, Renee	2:04.74
24	KOR	Choi, Se-Beom	2:06.65
25	CMR	Achuo-Bei, Assumpta	2:07.10
26	CRC	Stewart, Maureen	2:08.17
27	MRI	Seebaluck, Sheila	2:08.93
28	ZAI	Kungu, Bakombo	2:11.00
29	ANT	Bryan, Laverne	2:12.18
	CHN	Sun, Sumei	NS
	ESP	Colorado, Rosa	NS

Women 800m Semi-final Heat 1/Sept. 25				Femmes 800m Demi-finale Serie 1/25 Sept			
Rank	Ctry	Name	Result	Rank	Ctry	Name	Result
Rang	Pays	Nom	Resultat	Rang	Pays	Nom	Resultat
1	GDR	Wodars, Sigrun	1:57.21 Q				
2	USA	Gallagher, Kim	1:57.39 Q				
3	YUG	Colovic, Slobodanka	1:58.49 Q				
4	ESP	Zuniga, Teresa	1:58.85 Q				
5	GBR	Wade, Kirsty	2:00.86				
6	BRA	Telles, Soraya	2:01.86				
7	USA	Clark, Joetta	2:03.32				
8	URS	Olizarenko, Nadejda	2:05.27				

Women 800m Semi-final Heat 2/Sept. 25				Femmes 800m Demi-finale Serie 2/25 Sept			
Rank	Ctry	Name	Result	Rank	Ctry	Name	Result
Rang	Pays	Nom	Resultat	Rang	Pays	Nom	Resultat
1	GDR	Wachtel, Christine	1:58.44 Q				
2	USA	Floyd, Delisa	1:58.82 Q				
3	URS	Evseeva, Inna	1:59.10 Q				
4	GBR	Edwards, Diane	1:59.66 Q				
5	FRG	Lesch, Caby	1:59.85				
6	GBR	Bailey, Shireen	1:59.94				
7	URS	Matoussiavitchene, Dalia	2:00.15				
8	SUR	Vriesde, Letitia	2:02.34				

Women 800m Final/Sept. 26				Femmes 800m Finale/26 Sept			
Rank	Ctry	Name	Result	Rank	Ctry	Name	Result
Rang	Pays	Nom	Resultat	Rang	Pays	Nom	Resultat
1	GDR	Wodars, Sigrun	1:56.10				
2	GDR	Wachtel, Christine	1:56.64				
3	USA	Gallagher, Kim	1:56.91				
4	YUG	Colovic, Slobodanka	1:57.50				
5	USA	Floyd, Delisa	1:57.80				
6	URS	Evseeva, Inna	1:59.37				
7	ESP	Zuniga, Teresa	1:59.82				
8	GBR	Edwards, Diane	2:00.77				

Women 1500m Round 1 Heat 1/Sept. 29				Femmes 1500m Tour 1 Serie 1/29 Sept			
Rank	Ctry	Name	400m	800m	1200m	1500m	
Rang	Pays	Nom					
1	ROM	Melinte, Doina Ofelia	1:08.34	2:14.73	3:21.29	4:06.87	Q
2	CAN	Bowker, Deborah	1:08.69	2:15.25	3:21.69	4:07.06	Q
3	URS	Samolenko, Tatiana	1:08.76	2:15.05	3:21.48	4:07.11	Q
4	USA	Gallagher, Kim	1:08.61	2:15.02	3:21.62	4:07.22	Q
5	HOL	Van Hulst, Elisa	1:08.84	2:14.29	3:21.27	4:07.40	
6	GBR	Wade, Kirsty	1:08.87	2:15.27	3:21.74	4:08.37	
7	URS	Gurina, Lioubov	1:08.56	2:14.86	3:21.53	4:08.59	
8	CAN	Chalmers, Angela	1:08.95	2:15.30	3:21.80	4:08.64	
9	FRG	Michallek, Vera	1:08.08	2:14.70	3:21.45	4:10.05	
10	SUI	Buerki, Cornelia	1:08.99	2:14.98	3:22.02	4:10.89	
11	BIR	Khinkhintwe	1:09.28	2:17.82	3:28.04	4:20.92	
12	KOR	Noh, Hea-Soon	1:09.21	2:19.39	3:32.39	4:26.05	
13	RWA	Nyiramutuzo, Daphrose	1:08.45	2:18.62	3:34.89	4:32.31	
14	NGU	Avek, Polonie D	1:09.65	2:23.89	3:44.45	4:46.49	

Women 1500m Round 1 Heat 2/Sept. 29				Femmes 1500m Tour 1 Serie 2/29 Sept			
Rank	Ctry	Name	400m	800m	1200m	1500m	
Rang	Pays	Nom					
1	ROM	Ivan, Paula	1:06.16	2:12.00	3:16.82	4:03.33	Q
2	USA	Slaney, Mary	1:05.24	2:11.72	3:17.41	4:03.61	Q
3	GDR	Hahmann, Andrea	1:05.67	2:11.96	3:17.23	4:03.65	Q
4	CAN	Williams, Lynn	1:05.82	2:12.09	3:17.04	4:04.20	Q
5	GBR	Bailey, Shireen	1:06.71	2:12.62	3:17.60	4:04.65	
6	GBR	Cahill, Christina	1:05.41	2:11.81	3:16.88	4:05.33	
7	URS	Baikauskaite, Lailoute	1:06.41	2:12.38	3:17.01	4:05.74	
8	MAR	Aouam, Fatima	1:06.22	2:12.21	3:17.26	4:06.87	
9	ALG	Boulmerka, Hassiba	1:05.62	2:12.20	3:18.32	4:08.33	
10	KEN	Sirma, Susan	1:06.34	2:12.69	3:19.75	4:10.13	
11	USA	Jacobs, Regina	1:05.89	2:12.37	3:20.62	4:18.09	
12	SUR	Vriesde, Letitia	1:06.29	2:13.40	3:26.37	4:19.58	
13	ANT	Bryan, Laverne	1:06.81	2:19.15	3:40.63	4:39.73	
14	SLE	Thompson, Rachel	1:09.09	2:26.39	4:16.47	5:31.42	

Women 1500m Round 1/Sept. 29				Femmes 1500m Tour 1/29 Sept			
Rank	Ctry	Name	Result	Rank	Ctry	Name	Result
Rang	Pays	Nom	Resultat	Rang	Pays	Nom	Resultat
1	ROM	Ivan, Paula	4:03.33 Q				
2	USA	Slaney, Mary	4:03.61 Q				
3	GDR	Hahmann, Andrea	4:03.65 Q				
4	CAN	Williams, Lynn	4:04.20 Q				
5	GBR	Bailey, Shireen	4:04.65 Q				
6	GBR	Cahill, Christina	4:05.33 Q				
7	URS	Baikauskaite, Lailoute	4:05.74 Q				
8	MAR	Aouam, Fatima	4:06.87 Q				
8	ROM	Melinte, Doina Ofelia	4:06.87 Q				
10	CAN	Bowker, Deborah	4:07.06 Q				
11	URS	Samolenko, Tatiana	4:07.11 Q				
12	USA	Gallagher, Kim	4:07.22 Q				
13	HOL	Van hulst, Elisa	4:07.40				
14	ALG	Boulmerka, Hassiba	4:08.33				
15	GBR	Wade, Kirsty	4:08.37				
16	URS	Gurina, Lioubov	4:08.59				
17	CAN	Chalmers, Angela	4:08.64				
18	FRG	Michallek, Vera	4:10.05				
19	KEN	Sirma, Susan	4:10.13				
20	SUI	Buerki, Cornelia	4:10.89				
21	USA	Jacobs, Regina	4:18.09				
22	SUR	Vriesde, Letitia	4:19.58				
23	BIR	Khinkhintwe	4:20.92				
24	KOR	Noh, Hea-Soon	4:26.05				
25	RWA	Nyiramutuzo, Daphrose	4:32.31				
26	ANT	Bryan, Laverne	4:39.73				
27	NGU	Avek, Polonie D	4:46.49				
28	SLE	Thompson, Rachel	5:31.42				

Women 1500m Final/Oct. 1				Femmes 1500m Finale/1 Oct			
Rank	Ctry	Name	400m	800m	1200m	1500m	
Rang	Pays	Nom					
1	ROM	Ivan, Paula	1:02.52	2:05.76	3:08.25	3:53.96	NOR
2	URS	Baikauskaite, Lailoute	1:03.55	2:07.59	3:13.27	4:00.24	
3	URS	Samolenko, Tatiana	1:03.15	2:06.65	3:12.36	4:00.30	
4	GBR	Cahill, Christina	1:03.33	2:07.07	3:12.29	4:00.64	
5	CAN	Williams, Lynn	1:03.16	2:07.27	3:12.48	4:00.86	
6	GDR	Hahmann, Andrea	1:03.04	2:06.79	3:12.15	4:00.96	
7	GBR	Bailey, Shireen	1:03.88	2:08.47	3:13.41	4:02.32	
8	USA	Slaney, Mary	1:02.81	2:07.07	3:12.61	4:02.49	
9	ROM	Melinte, Doina Ofelia	1:02.94	2:06.55	3:12.07	4:02.89	
10	MAR	Aouam, Fatima	1:03.68	2:07.66	3:15.30	4:08.00	
11	USA	Gallagher, Kim	1:03.50	2:07.89	3:16.51	4:16.25	
12	CAN	Bowker, Deborah	1:04.02	2:10.27	3:23.04	4:17.95	

Women 3000m Round 1 Heat 1/Sept. 23				Femmes 3000m Tour 1 Serie 1/23 Sept			
Rank	Ctry	Name	1000m	2000m	3000m		
Rang	Pays	Nom					
1	URS	Romanova, Elena	3:02.48	6:01.77	8:48.47	Q	
2	HOL	Van Hulst, Elisa	3:01.55	6:01.18	8:48.54	Q	
3	CAN	Chalmers, Angela	3:01.98	6:01.83	8:48.60	Q	
4	CAN	Williams, Lynn	3:01.67	6:01.23	8:48.70	Q	
5	USA	Huber, Vicki	3:01.59	6:01.33	8:48.93	Q	
6	GBR	Sly, Wendy	3:02.15	6:01.19	8:49.71	Q	
7	CHN	Wang, Xiuting	3:02.22	6:01.92	8:54.19		
8	GBR	Hunter, Jill	3:02.07	6:01.39	8:57.28		
9	NZL	Pfritzing, Christine	3:01.78	6:02.31	9:01.30		
10	AUS	Perkins, Jacqueline	3:02.03	6:02.09	9:01.82		
11	CYP	Avraam, Andri	3:02.10	6:02.51	9:02.18		
12	ESP	Rodriguez, Angelines	3:02.22	6:01.94	9:03.39		
13	POF	Ribeiro, Fernanda	3:01.72	6:01.98	9:05.92		

Athletics

Athlétisme

Rank Rang	Ctry Pays	Name Nom	1000m	2000m	3000m
14	KEN	Sirma, Susan	3:01.50	6:01.55	9:06.90
15	KOR	Lim, Chun-Ae	3:02.27	6:03.78	9:21.18
	ROM	Puica, Maricica	3:01.73	6:01.34	AB
	FRA	Duros, Marie Pierre	3:01.93		AB

Women 3000m Round 1 Heat 2/Sept. 23			Femmes 3000m Tour 1 Serie 2/23 Sept		
Rank Rang	Ctry Pays	Name Nom	1000m	2000m	3000m

1	ROM	Ivan, Paula	2:55.80	5:57.32	8:43.10	Q
2	GBR	Murray, Yvonne	2:55.67	5:57.18	8:43.73	Q
3	CAN	Bowker, Deborah	2:55.87	5:57.38	8:43.81	Q
4	USA	Slaney, Mary	2:55.60	5:57.17	8:44.15	Q
5	URS	Samolenko, Tatiana	2:56.72	5:57.96	8:44.18	Q
6	URS	Artemova, Matalia	2:56.90	5:57.68	8:44.30	Q
7	USA	Plumer, Pattisue	2:56.13	5:57.50	8:45.21	
8	FRA	Sergent, Annette	2:56.33	5:57.54	8:45.94	
9	SUI	Buerki, Cornelia	2:56.64	5:57.74	8:48.37	
10	FRG	Michallek, Vera	2:56.14	5:57.85	8:51.34	
11	CHN	Chen, Qingmei	2:56.04	5:57.88	8:51.53	
12	ITA	Brunet, Roberta	2:56.29	5:57.74	8:53.04	
13	IRL	Keenan-Buckley, Anne	2:56.53	5:51.22	9:03.10	
14	BIR	Khinkhinhtwe	2:55.44	6:08.70	9:26.57	
15	RWA	Nyiramutuzo, Daphrose	2:57.71	6:18.38	9:47.98	
16	ZAI	Diba, Dikanda	3:08.34	6:50.38	10:32.88	
	MAR	Aouam, Fatima		5:57.63	AB	
	NGU	Avek, Polonie D	3:15.12		AB	

Women 3000m Round 1/Sept. 23			Femmes 3000m Tour 1/23 Sept		
Rank Rang	Ctry Pays	Name Nom	Result Resultat		

1	ROM	Ivan, Paula	8:43.10	Q
2	GBR	Murray, Yvonne	8:43.73	Q
3	CAN	Bowker, Deborah	8:43.81	Q
4	USA	Slaney, Mary	8:44.15	Q
5	URS	Samolenko, Tatiana	8:44.18	Q
6	URS	Artemova, Matalia	8:44.30	Q
7	USA	Plumer, Pattisue	8:45.21	Q
8	FRA	Sergent, Annette	8:45.94	Q
9	SUI	Buerki, Cornelia	8:48.37	Q
10	URS	Romanova, Elena	8:48.47	Q
11	HOL	Van hulst, Elisa	8:48.54	Q
12	CAN	Chalmers, Angela	8:48.60	Q
13	CAN	Williams, Lynn	8:48.70	Q
14	USA	Huber, Vicki	8:48.93	Q
15	GBR	Sly, Wendy	8:49.71	Q
16	FRG	Michallek, Vera	8:51.34	
17	CHN	Chen, Qingmei	8:51.53	
18	ITA	Brunet, Roberta	8:53.04	
19	CHN	Wang, Xiuting	8:54.19	
20	GBR	Hunter, Jill	8:57.28	
21	NZL	Pfzinger, Christine	9:01.30	
22	AUS	Perkins, Jacqueline	9:01.82	
23	CYP	Avraam, Andri	9:02.18	
24	IRL	Keenan-Buckley, Anne	9:03.10	
25	ESP	Rodriguez, Angelines	9:03.39	
26	POR	Ribeiro, Fernanda	9:05.92	
27	KEN	Sirma, Susan	9:06.90	
28	KOR	Lim, Chun-Ae	9:21.18	
29	BIR	Khinkhinhtwe	9:26.57	
30	RWA	Nyiramutuzo, Daphrose	9:47.98	
31	ZAI	Diba, Dikanda	10:32.88	
	FRA	Duros, Marie Pierre	AB	
	MAR	Aouam, Fatima	AB	
	NGU	Avek, Polonie D	AB	
	ROM	Puica, Maricica	AB	

Women 3000m Final/Sept. 25			Femmes 3000m Finale/25 Sept		
Rank Rang	Ctry Pays	Name Nom	1000m	2000m	3000m

1	URS	Samolenko, Tatiana	2:47.46	5:44.43	8:26.53	NOR
2	ROM	Ivan, Paula	2:46.95	5:44.24	8:27.15	
3	GBR	Murray, Yvonne	2:47.00	5:44.13	8:29.02	
4	URS	Romanova, Elena	2:47.75	5:44.67	8:30.45	
5	URS	Artemova, Matalia	2:48.08	5:44.71	8:31.67	
6	USA	Huber, Vicki	2:47.65	5:44.08	8:37.25	
7	GBR	Sly, Wendy	2:47.89	5:44.86	8:37.70	
8	CAN	Williams, Lynn	2:47.44	5:44.55	8:38.43	
9	HOL	Van hulst, Elisa	2:47.23	5:44.41	8:43.92	

Rank Rang	Ctry Pays	Name Nom	1000m	2000m	3000m
10	USA	Slaney, Mary	2:46.68	5:44.42	8:47.13
11	SUI	Buerki, Cornelia	2:50.00	5:49.36	8:48.32
12	FRA	Sergent, Annette	2:49.67	5:50.45	8:49.14
13	USA	Plumer, Pattisue	2:49.75	5:51.95	8:59.17
14	CAN	Chalmers, Angela	2:49.84	5:53.49	9:04.75
15	CAN	Bowker, Deborah	2:51.26	6:00.69	9:11.95

Women 10000m Round 1 Heat 1/Sept. 26			Femmes 10000m Tour 1 Serie 1/26 Sept				
Rank Rang	Ctry Pays	Name Nom	1000m 6000m	2000m 7000m	3000m 8000m	4000m 9000m	5000m 10000m

1	NOR	Kristiansen, Ingrid	3:19.00 19:19.00	6:35.00 22:27.00	9:48.00 25:33.00	13:01.00 28:39.00	16:15.00 31:44.69	Q	NOR
2	URS	Bondarenko, Olga	3:20.00 19:23.00	6:35.00 22:33.00	9:48.00 25:43.00	13:02.00 28:52.00	16:15.00 31:47.67	Q	
3	URS	Joupieva, Elena	3:19.00 19:21.00	6:35.00 22:29.00	9:48.00 25:38.00	13:01.00 28:48.00	16:15.00 31:47.99	Q	
4	GDR	Ullrich, Kathrin	3:20.00 19:23.00	6:35.00 22:33.00	9:48.00 25:43.00	13:02.00 28:52.00	16:15.00 31:51.40	Q	
5	CAN	Lee, Susan	3:19.00 19:24.00	6:36.00 22:33.00	9:48.00 25:43.00	13:03.00 28:52.00	16:15.00 31:51.42	Q	
6	USA	Larrieu-Smith, Francie	3:19.00 19:25.00	6:35.00 22:33.00	9:49.00 25:43.00	13:03.00 28:52.00	16:15.00 31:52.02	Q	
7	POR	Machado, Albertina	3:20.00 19:23.00	6:36.00 22:33.00	9:49.00 25:43.00	13:03.00 28:52.00	16:15.00 31:52.04	Q	
8	CHN	Wang, Qinghuan	3:19.00 19:23.00	6:35.00 22:33.00	9:48.00 25:44.00	13:02.00 28:52.00	16:15.00 32:04.52	Q	
9	ITA	Munerotto, Rosanna	3:19.00 19:25.00	6:35.00 22:33.00	9:48.00 25:44.00	13:02.00 28:56.00	16:15.00 32:06.76		
10	CAN	Rouillard, Carole	3:20.00 19:24.00	6:36.00 22:33.00	9:49.00 25:46.00	13:04.00 28:53.00	16:17.00 32:09.08		
11	AUS	Schuwalow, Carolyn	3:19.00 19:24.00	6:35.00 23:03.00	9:48.00 25:48.00	13:01.00 28:58.00	16:15.00 32:10.05		
12	NZL	Audain, Anne	3:19.00 19:23.00	6:35.00 22:33.00	9:48.00 25:48.00	13:01.00 28:58.00	16:15.00 32:10.73		
13	BEL	Renders, Marleen	3:19.00 19:25.00	6:35.00 22:33.00	9:48.00 25:48.00	13:02.00 28:58.00	16:15.00 32:11.49		
14	SUI	Bouchonneau-Oppliger, Martine	3:19.00 19:25.00	6:35.00 22:33.00	9:48.00 25:54.00	13:02.00 29:12.00	16:15.00 32:28.26		
15	ESP	Alonso, Ana Isabel	3:19.00 19:24.00	6:35.00 23:03.00	9:49.00 25:54.00	13:03.00 29:12.00	16:15.00 32:40.50		
16	GBR	Tooby, Angela	3:19.00 19:35.00	6:36.00 23:15.00	9:49.00 26:31.00	13:03.00 29:59.00	16:15.00 33:26.57		
17	CHN	Xie, Lihua	3:20.00 19:44.00	6:36.00 23:08.00	9:49.00 26:46.00	13:03.00 30:10.00	16:19.00 33:28.13		
18	KOR	Chung, Mi-Ja	3:19.00 20:03.00	6:35.00 23:34.00	9:48.00 27:01.00	13:04.00 30:31.00	16:34.00 33:48.96		
	POL	Panfil, Marianna						NS	
	MRI	Justin, Maryse						NS	
	FIN	Jousimaa, Tuija						NS	

Women 10000m Round 1 Heat 2/Sept. 26			Femmes 10000m Tour 1 Serie 2/26 Sept				
Rank Rang	Ctry Pays	Name Nom	1000m 6000m	2000m 7000m	3000m 8000m	4000m 9000m	5000m 10000m

1	GBR	Mccolgan, Elizabeth	3:22.00 19:37.00	6:45.00 22:48.00	9:59.00 26:04.00	13:14.00 29:14.00	16:25.00 32:11.95	Q
2	URS	Matveeva, Lioudmila	3:22.00 19:37.00	6:45.00 22:48.00	9:58.00 26:04.00	13:14.00 29:14.00	16:25.00 32:12.87	Q
3	CHN	Wang, Xiuting	3:22.00 19:36.00	6:44.00 22:48.00	9:58.00 26:04.00	13:13.00 29:14.00	16:24.00 32:13.00	Q
4	FRA	Sergent, Annette	3:22.00 19:38.00	6:43.00 22:48.00	9:58.00 26:04.00	13:13.00 29:14.00	16:25.00 32:13.45	Q
5	POR	Dias, Albertina	3:22.00 19:37.00	6:44.00 22:48.00	9:58.00 26:04.00	13:14.00 29:14.00	16:25.00 32:13.85	Q
6	USA	Nelson, Lynn	3:23.00 19:38.00	6:45.00 22:48.00	9:59.00 26:04.00	13:14.00 29:14.00	16:25.00 32:15.45	Q
7	CAN	Tinari, Nancy	3:22.00 19:36.00	6:43.00 22:48.00	9:58.00 26:04.00	13:13.00 29:14.00	16:25.00 32:16.27	Q
8	USA	Jennings, Lynn	3:23.00 19:36.00	6:45.00 22:48.00	9:59.00 26:04.00	13:14.00 29:14.00	16:25.00 32:18.44	Q



Rank	Ctry	Name	1000m	2000m	3000m	4000m	5000m
Rang	Pays	Nom	6000m	7000m	8000m	9000m	10000m
9	JPN	Matsuno, Akemi	3:22.00 19:37.00	6:44.00 22:48.00	9:58.00 26:04.00	13:13.00 29:14.00	16:25.00 32:19.57
10	NZL	Mcmiken, Christine	3:22.00 19:38.00	6:44.00 22:48.00	9:59.00 26:04.00	13:15.00 29:14.00	16:25.00 32:20.39
11	GBR	Shields, Jane	3:22.00 19:37.00	6:43.00 22:50.00	9:58.00 26:25.00	13:13.00 29:33.00	16:25.00 32:46.07
12	CYP	Avraam, Andri	3:22.00 19:44.00	6:44.00 23:02.00	9:59.00 26:35.00	13:15.00 29:48.00	16:25.00 32:59.30
13	MAR	Darami, Elhassania	3:23.00 19:44.00	6:44.00 23:02.00	9:58.00 26:25.00	13:15.00 29:48.00	16:26.00 33:01.52
14	AUS	Perkins, Jacqueline	3:22.00 19:45.00	6:44.00 23:13.00	9:58.00 26:46.00	13:14.00 30:22.00	16:25.00 33:45.22
15	BEL	Siegers, Lieve	3:23.00 19:38.00	6:44.00 23:01.00	9:58.00 26:10.00	13:13.00 30:12.00	16:25.00 33:51.36
	FIN	Tikkanen, Paivi					NS
	HUN	Fazekas, Erika	3:22.00	6:44.00	10:04.00		AB
	BIR	Mar Mar Min					NS
	LUX	Kaber, Daniele					NS
	FRG	Pressler, Kerstin					NS
	TCH	Melicherova, Ludmila					NS

Women 10000m Round 1/Sept. 26			Femmes 10000m Tour 1/26 Sept	
Rank	Ctry	Name	Result	
Rang	Pays	Nom	Resultat	
1	NOR	Kristiansen, Ingrid	31:44.69	NOR
2	URS	Bondarenko, Olga	31:47.67	Q
3	URS	Joupieva, Elena	31:47.99	Q
4	GDR	Ullrich, Kathrin	31:51.40	Q
5	CAN	Lee, Susan	31:51.42	Q
6	USA	Larrieu-Smith, Francie	31:52.02	Q
7	POR	Machado, Albertina	31:52.04	Q
8	CHN	Wang, Qinghuan	32:04.52	Q
9	ITA	Munerotto, Rosanna	32:06.76	Q
10	CAN	Rouillard, Carole	32:09.08	Q
11	AUS	Schuwalow, Carolyn	32:10.05	Q
12	NZL	Audain, Anne	32:10.73	Q
13	BEL	Renders, Marleen	32:11.49	
14	GBR	Mccolgan, Elizabeth	32:11.95	Q
15	URS	Matveeva, Lioudmila	32:12.87	Q
16	CHN	Wang, Xiuting	32:13.00	Q
17	FRA	Sergent, Annette	32:13.45	Q
18	POR	Dias, Albertina	32:13.85	Q
19	USA	Nelson, Lynn	32:15.45	Q
20	CAN	Tinari, Nancy	32:16.27	Q
21	USA	Jennings, Lynn	32:18.44	Q
22	JPN	Matsuno, Akemi	32:19.57	
23	NZL	Mcmiken, Christine	32:20.39	
24	SUI	Bouchonneau-Opliger, Martine	32:28.26	
25	ESP	Alonso, Ana isabel	32:40.50	
26	GBR	Shields, Jane	32:46.07	
27	CYP	Avraam, Andri	32:59.30	
28	MAR	Darami, Elhassania	33:01.52	
29	GBR	Tooby, Angela	33:26.57	
30	CHN	Xie, Lihua	33:28.13	
31	AUS	Perkins, Jacqueline	33:45.22	
32	KOR	Chung, Mi-Ja	33:48.96	
33	BEL	Siegers, Lieve	33:51.36	
	HUN	Fazekas, Erika	AB	
	BIR	Mar Mar Min	NS	
	FIN	Jousimaa, Tuija	NS	
	FIN	Tikkanen, Paivi	NS	
	FRG	Pressler, Kerstin	NS	
	LUX	Kaber, Danide	NS	
	MRI	Justin, Maryse	NS	
	POL	Pantil, Mariana	NS	
	TCH	Melicherova, Ludmila	NS	

Women 10000m Final/Sept. 30			Femmes 10000m Finale/30 Sept				
Rank	Ctry	Name	1000m	2000m	3000m	4000m	5000m
Rang	Pays	Nom	6000m	7000m	8000m	9000m	10000m
1	URS	Bondarenko, Olga	3:10.04 18:48.88	6:23.56 21:58.22	9:21.88 25:04.57	12:27.81 28:09.56	15:38.26 31:05.21
2	GBR	Mccolgan, Elizabeth	3:09.80 18:48.21	6:23.30 21:57.70	9:21.72 25:04.27	12:27.32 28:09.26	15:37.89 31:08.44
3	URS	Joupieva, Elena	3:10.13 18:48.70	6:23.47 21:58.44	9:21.65 25:04.78	12:27.55 28:10.30	15:38.17 31:19.82
4	GDR	Ullrich, Kathrin	3:09.83 18:48.44	6:23.38 21:57.97	9:19.64 25:07.02	12:24.13 28:24.10	15:37.99 31:29.27
5	USA	Larrieu-Smith, Francie	3:10.25 19:03.49	6:23.94 22:13.30	9:27.81 25:23.35	12:38.91 28:32.21	15:50.27 31:35.52
6	USA	Jennings, Lynn	3:10.66 19:03.73	6:24.18 22:13.56	9:26.72 25:23.67	12:39.16 28:35.94	15:50.54 31:39.93
7	CHN	Wang, Xiuting	3:10.22 19:03.27	6:24.03 22:13.79	9:26.93 25:24.03	12:37.90 28:35.96	15:49.48 31:40.23
8	CAN	Lee, Susan	3:10.84 19:03.66	6:24.70 22:14.26	9:27.99 25:29.63	12:38.68 28:45.00	15:49.73 31:50.51
9	POR	Machado, Albertina	3:10.55 19:03.88	6:23.79 22:15.50	9:27.76 25:29.44	12:38.24 28:45.46	15:49.22 32:02.13
10	POR	Dias, Albertina	3:10.48 19:13.74	6:24.29 22:26.69	9:31.72 25:42.73	12:42.55 28:58.47	15:55.75 32:07.13
11	NZL	Audain, Anne	3:11.22 19:09.16	6:24.55 22:22.78	9:31.94 25:38.50	12:42.35 28:57.44	15:55.58 32:10.47
12	URS	Matveeva, Lioudmila	3:09.79 19:04.14	6:23.73 22:22.98	9:27.60 25:41.60	12:38.48 28:58.39	15:50.03 32:12.27
13	CAN	Tinari, Nancy	3:11.52 19:16.48	6:25.06 22:32.39	9:35.43 25:48.40	12:48.58 29:05.27	16:02.59 32:14.05
14	ITA	Munerotto, Rosanna	3:10.96 19:16.92	6:24.29 22:32.50	9:32.79 25:49.87	12:45.03 29:10.80	16:01.82 32:29.84
15	USA	Nelson, Lynn	3:09.94 19:13.11	6:23.23 22:33.79	9:31.60 25:55.90	12:42.22 29:16.76	15:55.50 32:32.24
16	CAN	Rouillard, Carole	3:11.13 19:16.14	6:24.78 22:37.78	9:32.89 26:03.99	12:43.24 29:27.72	16:00.14 32:41.43
17	AUS	Schuwalow, Carolyn	3:11.70 19:17.17	6:24.44 22:37.87	9:33.02 26:02.30	12:45.26 29:28.11	16:02.06 32:45.07
18	CHN	Wang, Qinghuan	3:10.46 19:17.43	6:24.05 22:41.33	9:27.89 26:02.54	12:39.30 29:30.15	15:55.34 32:49.86
19	FRA	Sergent, Annette	3:10.33 19:17.31	6:23.79 22:43.16	9:27.38 26:11.86	12:39.86 29:46.36	15:57.70 33:17.38
	NOR	Kristiansen, Ingrid	3:10.04	6:23.42			AB

Women 100m Hurdles Round 1 Heat 1/Sept. 29			Femmes 100m haies Tour 1 Serie 1/29 Sept	
Rank	Ctry	Name	Result	
Rang	Pays	Nom	Resultat	
1	URS	Grigorieva, Natalia	12.96	Q
2	GDR	Knabe, Kerstin	13.13	Q
3	USA	Martin, Lavonna	13.20	Q
4	FRA	Colle, Florence	13.32	Q
5	AUS	Flemming, Jane	13.53	
6	MEX	Tavares, Sandra	13.81	
7	FIJ	Tukana, Sainiana	15.50	

Women 100m Hurdles Round 1 Heat 2/Sept. 29			Femmes 100m haies Tour 1 Serie 2/29 Sept	
Rank	Ctry	Name	Result	
Rang	Pays	Nom	Resultat	
1	GDR	Siebert, Gloria	12.65	Q
2	URS	Narojilenko, Lioudmila	12.76	Q
3	FRG	Zackiewicz, Claudia	13.00	Q
4	USA	Humphrey, Jacqueline	13.24	Q
5	NGR	Usifo, Maria	13.50	
6	GHA	Yankey, Dinah	13.64	
	BEL	Dethier, Sylvia	DQ	

Women 100m Hurdles Round 1 Heat 3/Sept. 29			Femmes 100m haies Tour 1 Serie 3/29 Sept	
Rank	Ctry	Name	Result	
Rang	Pays	Nom	Resultat	
1	HOL	Olyslager, Marjan	13.04	Q
2	CAN	Rocheleau, Julie	13.07	Q
3	GBR	Skeete, Lesley-Ann	13.38	Q
4	SUI	Heggli, Rita	13.72	Q
5	TPE	Chen, Wen-Ing	14.01	
6	PHI	Dela Cruz, Agripina	14.36	
	BUL	Zagorcheva, Ginka	AB	

Athletics

Women 100m Hurdles Round 1 Heat 4/Sept. 29

Rank Rang	Ctry Pays	Name Nom	Result Resultat
1	GDR	Oschkenat, Cornelia	12.72 Q
2	CHN	Liu, Huajin	13.02 Q
3	USA	Devers-Roberts, Gail	13.18 Q
4	FRA	Ewanje-Epee, Monique	13.18 Q
5	GBR	Jeal, Wendy	13.32
6	HOL	Tromp, Gretha	13.48
7	KOR	Bang, Sin-Hye	13.84
8	HKG	Cheung, Suet Yee	14.26

Femmes 100m haies Tour 1 Serie 4/29 Sept

Women 100m Hurdles Round 1 Heat 5/Sept. 29

Rank Rang	Ctry Pays	Name Nom	Result Resultat
1	BUL	Donkova, Jordanka	12.89 Q
2	GBR	Gunnell, Sally	13.26 Q
3	CHN	Du, Juan	13.51 Q
4	FRA	Piguereau, Anne	13.56 Q
5	ECU	Vallecilla, Nancy	13.97
6	LIE	Marxer, Manuela	14.38
	SRI	Jinadasa, Tilaka	DO
	VIN	Johnson, Michele	NS

Femmes 100m haies Tour 1 Serie 5/29 Sept

Women 100m Hurdles Round 1/Sept. 29

Rank Rang	Ctry Pays	Name Nom	Result Resultat
1	GDR	Siebert, Gloria	12.65 Q
2	GDR	Oschkenat, Cornelia	12.72 Q
3	URS	Narajilenko, Lioudmila	12.76 Q
4	BUL	Donkova, Jordanka	12.89 Q
5	URS	Grigorieva, Natalia	12.96 Q
6	FRG	Zackiewicz, Claudia	13.00 Q
7	CHN	Liu, Huajin	13.02 Q
8	HOL	Olyslager, Marjan	13.04 Q
9	CAN	Rocheleau, Julie	13.07 Q
10	GDR	Knabe, Kerstin	13.13 Q
11	FRA	Ewanje-Epee, Monique	13.18 Q
11	USA	Devers-Roberts, Gail	13.18 Q
13	USA	Martin, Lavonna	13.20 Q
14	USA	Humphrey, Jacqueline	13.24 Q
15	GBR	Gunnell, Sally	13.26 Q
16	FRA	Colle, Florence	13.32 Q
16	GBR	Jeal, Wendy	13.32 Q
18	GBR	Skeete, Lesley-Ann	13.38 Q
19	HOL	Tromp, Gretha	13.48 Q
20	NGR	Usifo, Maria	13.50 Q
21	CHN	Du, Juan	13.51 Q
22	AUS	Flemming, Jane	13.53 Q
23	FRA	Piguereau, Anne	13.56 Q
24	GHA	Yankey, Dinah	13.64
25	SUI	Heggli, Rita	13.72 Q
26	MEX	Tavares, Sandra	13.81
27	KOR	Bang, Sin-Hye	13.84
28	ECU	Vallecilla, Nancy	13.97
29	TPE	Chen, Wen-Ing	14.01
30	HKG	Cheung, Suet yee	14.26
31	PHI	Dela Cruz, Agripina	14.36
32	LIE	Marxer, Manuela	14.38
33	FIJ	Tukana, Sainiana	15.50
	BUL	Zagorcheva, Ginka	AB
	BEL	Dethier, Sylvia	DQ
	SRI	Jinadasa, Tilaka	DO
	VIN	Johnson, Michele	NS

Women 100m Hurdles Round 2 Heat 1/Sept. 29

Rank Rang	Ctry Pays	Name Nom	Result Resultat
1	BUL	Donkova, Jordanka	12.47 Q
2	URS	Narajilenko, Lioudmila	12.62 Q
3	GDR	Knabe, Kerstin	12.81 Q
4	CAN	Rocheleau, Julie	12.90 Q
5	FRA	Colle, Florence	13.00
6	USA	Humphrey, Jacqueline	13.25
7	GBR	Skeete, Lesley-Ann	13.27
	AUS	Flemming, Jane	NS

Femmes 100m haies Tour 2 Serie 1/29 Sept

Athlétisme

Women 100m Hurdles Round 2 Heat 2/Sept. 29

Rank Rang	Ctry Pays	Name Nom	Result Resultat
1	GDR	Oschkenat, Cornelia	12.69 Q
2	URS	Grigorieva, Natalia	12.89 Q
3	HOL	Olyslager, Marjan	13.02 Q
4	FRA	Ewanje-Epee, Monique	13.10 Q
5	USA	Martin, Lavonna	13.20
6	GBR	Jeal, Wendy	13.32
7	CHN	Du, Juan	13.58
8	SUI	Heggli, Rita	13.95

Femmes 100m haies Tour 2 Serie 2/29 Sept

Women 100m Hurdles Round 2 Heat 3/Sept. 29

Rank Rang	Ctry Pays	Name Nom	Result Resultat
1	GDR	Siebert, Gloria	12.74 Q
2	FRG	Zackiewicz, Claudia	12.87 Q
3	GBR	Gunnell, Sally	13.04 Q
4	USA	Devers-Roberts, Gail	13.22 Q
5	HOL	Tromp, Gretha	13.42
6	CHN	Liu, Huajin	14.37
	FRA	Piguereau, Anne	AB
	NGR	Usifo, Maria	AB

Femmes 100m haies Tour 2 Serie 3/29 Sept

Women 100m Hurdles Round 2/Sept. 29

Rank Rang	Ctry Pays	Name Nom	Result Resultat
1	BUL	Donkova, Jordanka	12.47 Q
2	URS	Narajilenko, Lioudmila	12.62 Q
3	GDR	Oschkenat, Cornelia	12.69 Q
4	GDR	Siebert, Gloria	12.74 Q
5	GDR	Knabe, Kerstin	12.81 Q
6	FRG	Zackiewicz, Claudia	12.87 Q
7	URS	Grigorieva, Natalia	12.89 Q
8	CAN	Rocheleau, Julie	12.90 Q
9	FRA	Colle, Florence	13.00 Q
10	HOL	Olyslager, Marjan	13.02 Q
11	GBR	Gunnell, Sally	13.04 Q
12	FRA	Ewanje-Epee, Monique	13.10 Q
13	USA	Martin, Lavonna	13.20 Q
14	USA	Devers-Roberts, Gail	13.22 Q
15	USA	Humphrey, Jacqueline	13.25 Q
16	GBR	Skeete, Lesley-Ann	13.27 Q
17	GBR	Jeal, Wendy	13.32
18	HOL	Tromp, Gretha	13.42
19	CHN	Du, Juan	13.58
20	SUI	Heggli, Rita	13.95
21	CHN	Liu, Huajin	14.37
	FRA	Piguereau, Anne	AB
	NGR	Usifo, Maria	AB
	AUS	Flemming, Jane	NS

Femmes 100m haies Tour 2/29 Sept

Women 100m Hurdles Semi-final Heat 1/Sept. 30

Rank Rang	Ctry Pays	Name Nom	Result Resultat
1	BUL	Donkova, Jordanka	12.58 Q
2	GDR	Siebert, Gloria	12.60 Q
3	CAN	Rocheleau, Julie	12.91 Q
4	FRA	Colle, Florence	12.92 Q
5	GDR	Knabe, Kerstin	12.93
6	GBR	Skeete, Lesley-Ann	13.23
7	USA	Martin, Lavonna	13.29
8	USA	Devers-Roberts, Gail	13.51

Femmes 100m haies Demi-finale Serie 1/30 Sept

Women 100m Hurdles Semi-final Heat 2/Sept. 30

Rank Rang	Ctry Pays	Name Nom	Result Resultat
1	GDR	Oschkenat, Cornelia	12.63 Q
2	FRG	Zackiewicz, Claudia	12.75 Q
3	URS	Grigorieva, Natalia	12.81 Q
4	FRA	Ewanje-Epee, Monique	12.95 Q
5	HOL	Olyslager, Marjan	13.08
6	GBR	Gunnell, Sally	13.13
7	USA	Humphrey, Jacqueline	13.59
	URS	Narajilenko, Lioudmila	AB

Femmes 100m haies Demi-finale Serie 2/30 Sept



Women 100m Hurdles Final/Sept. 30				Femmes 100m haies Finale/30 Sept	
Rank Rang	Ctry Pays	Name Nom	Result Resultat		
1	BUL	Donkova, Jordanka	12.38	NOR	
2	GDR	Siebert, Gloria	12.61		
3	FRG	Zackiewicz, Claudia	12.75		
4	URS	Grigorieva, Natalia	12.79		
5	FRA	Colle, Florence	12.98		
6	CAN	Rocheleau, Julie	12.99		
7	FRA	Ewanje-Epee, Monique	13.14		
8	GDR	Oschkenat, Cornelia	13.73		

Women 400m Hurdles Round 1 Heat 1/Sept. 25				Femmes 400m haies Tour 1 Serie 1/25 Sept	
Rank Rang	Ctry Pays	Name Nom	Result Resultat		
1	GDR	Losch, Susanne	55.90	Q	
2	URS	Ledovskaia, Tatiana	55.91	Q	
3	GBR	Mclaughlin, Elaine	56.11	Q	
4	KEN	Tata-Muya, Rose	56.18		
5	CIV	Womplou, Marie	57.35		
6	CAN	Wynn, Christine	58.00		
7	IND	Pilavulakandi, Usha	59.55		

Women 400m Hurdles Round 1 Heat 2/Sept. 25				Femmes 400m haies Tour 1 Serie 2/25 Sept	
Rank Rang	Ctry Pays	Name Nom	Result Resultat		
1	GDR	Busch, Sabine	55.96	Q	
2	HOL	Tromp, Gretha	56.11	Q	
3	POL	Blaszak, Genowefa	56.18	Q	
4	AUS	Laurendet, Jennifer	56.44		
5	CAN	Edeh, Rosey	56.59		
6	UGA	Kyalisiima, Ruth	59.62		
7	PHI	Adan, Nenita	61.92		

Women 400m Hurdles Round 1 Heat 3/Sept. 25				Femmes 400m haies Tour 1 Serie 3/25 Sept	
Rank Rang	Ctry Pays	Name Nom	Result Resultat		
1	GDR	Fiedler, Ellen	54.58	Q	NOR
2	SUI	Protti, Anita	54.81	Q	
3	URS	Kourotchkina, Tatiana	55.04	Q	
4	USA	Sheffield, Latanya	55.61		
5	NGR	Usifo, Maria	55.99		
6	ISL	Halldorsdottir, Helga	58.99		
7	KOR	Kim, Soon-Ja	59.78		

Women 400m Hurdles Round 1 Heat 4/Sept. 25				Femmes 400m haies Tour 1 Serie 4/25 Sept	
Rank Rang	Ctry Pays	Name Nom	Result Resultat		
1	AUS	Flintoff-King, Debra	54.99	Q	
2	ESP	Perez, Cristina	55.29	Q	
3	GBR	Gunnell, Sally	55.44	Q	
4	ITA	Trojer, Irmgard	55.74		
5	USA	Maxie, Leslie	57.60		
6	IRL	Johnson, Barbara	58.61		
7	TPE	Chang, Fen-Hwa	60.16		

Women 400m Hurdles Round 1 Heat 5/Sept. 25				Femmes 400m haies Tour 1 Serie 5/25 Sept	
Rank Rang	Ctry Pays	Name Nom	Result Resultat		
1	FRG	Abt, Gudrun	55.72	Q	
2	USA	Williams, Schowonda	55.98	Q	
3	FRA	Beaugeant, Chantal	56.03	Q	
4	AUS	Hamilton-Fleming, Sally	56.08		
5	ECU	Chala, Liliana	57.15		
6	TUR	Aksu, Semra	57.20		
7	GBR	Laidlow, Simone	59.28		

Women 400m Hurdles Round 1/Sept. 25				Femmes 400m haies Tour 1/25 Sept	
Rank Rang	Ctry Pays	Name Nom	Result Resultat		
1	GDR	Fiedler, Ellen	54.58	Q	NOR
2	SUI	Protti, Anita	54.81	Q	
3	AUS	Flintoff-King, Debra	54.99	Q	
4	URS	Kourotchkina, Tatiana	55.04	Q	
5	ESP	Perez, Cristina	55.29	Q	
6	GBR	Gunnell, Sally	55.44	Q	
7	USA	Sheffield, Latanya	55.61	Q	
8	FRG	Abt, Gudrun	55.72	Q	
9	ITA	Trojer, Irmgard	55.74		
10	GDR	Losch, Susanne	55.90	Q	
11	URS	Ledovskaia, Tatiana	55.91	Q	
12	GDR	Busch, Sabine	55.96	Q	
13	USA	Williams, Schowonda	55.98	Q	
14	NGR	Usifo, Maria	55.99		
15	FRA	Beaugeant, Chantal	56.03	Q	
16	AUS	Hamilton-Fleming, Sally	56.08		
17	GBR	Mclaughlin, Elaine	56.11	Q	
17	HOL	Tromp, Gretha	56.11	Q	
19	KEN	Tata-Muya, Rose	56.18		
19	POL	Blaszak, Genowefa	56.18	Q	
21	AUS	Laurendet, Jennifer	56.44		
22	CAN	Edeh, Rosey	56.59		
23	ECU	Chala, Liliana	57.15		
24	TUR	Aksu, Semra	57.20		
25	CIV	Womplou, Marie	57.35		
26	USA	Maxie, Leslie	57.60		
27	CAN	Wynn, Christine	58.00		
28	IRL	Johnson, Barbara	58.61		
29	ISL	Halldorsdottir, Helga	58.99		
30	GBR	Laidlow, Simone	59.28		
31	IND	Pilavulakandi, Usha	59.55		
32	UGA	Kyalisiima, Ruth	59.62		
33	KOR	Kim, Soon-Ja	59.78		
34	TPE	Chang, Fen-Hwa	60.16		
35	PHI	Adan, Nenita	61.92		

Women 400m Hurdles Semi-final Heat 1/Sept. 26				Femmes 400m haies Demi-finale Serie 1/26 Sept	
Rank Rang	Ctry Pays	Name Nom	Result Resultat		
1	AUS	Flintoff-King, Debra	54.00	Q	NOR
2	URS	Ledovskaia, Tatiana	54.01	Q	
3	USA	Sheffield, Latanya	54.36	Q	
4	GBR	Gunnell, Sally	54.48	Q	
5	SUI	Protti, Anita	54.56		
6	GDR	Losch, Susanne	55.56		
7	POL	Blaszak, Genowefa	56.76		
8	HOL	Tromp, Gretha	57.57		

Women 400m Hurdles Semi-final Heat 2/Sept. 26				Femmes 400m haies Demi-finale Serie 2/26 Sept	
Rank Rang	Ctry Pays	Name Nom	Result Resultat		
1	GDR	Fiedler, Ellen	54.28	Q	
2	URS	Kourotchkina, Tatiana	54.46	Q	
3	FRG	Abt, Gudrun	54.52	Q	
4	GDR	Busch, Sabine	54.71	Q	
5	ESP	Perez, Cristina	55.23		
6	GBR	Mclaughlin, Elaine	55.91		
7	USA	Williams, Schowonda	56.71		
8	FRA	Beaugeant, Chantal	56.94		

Women 400m Hurdles Final/Sept. 28				Femmes 400m haies Finale/28 Sept	
Rank Rang	Ctry Pays	Name Nom	Result Resultat		
1	AUS	Flintoff-King, Debra	53.17	NOR	
2	URS	Ledovskaia, Tatiana	53.18		
3	GDR	Fiedler, Ellen	53.63		
4	GDR	Busch, Sabine	53.69		
5	GBR	Gunnell, Sally	54.03		
6	FRG	Abt, Gudrun	54.04		
7	URS	Kourotchkina, Tatiana	54.39		
8	USA	Sheffield, Latanya	55.32		

Athletics

Athlétisme

Women 4x100m Round 1 Heat 1/Sept. 30				Femmes 4x100m Tour 1 Serie 1/30 Sept	
Rank Rang	Ctry Pays	Name Nom	Result Resultat		
1	URS	Jirova, Marina Kondratieva, Lioudmila Maltchougina, Galina Pomochtchnikova, Natalia	42.88	Q	
2	FRG	Richter, Sabine Sarvari, Ulrike Thimm, Ute Thomas, Andrea	42.99	Q	
3	FRA	Bily, Laurence Cazier-Ballo, Marie-Christine Leroux, Françoise Leroy, Muriel	43.43	Q	
4	BUL	Demireva, Valia Donkova, Jordanka Gueorguieva, Nadejda Ilieva, Tzvetanka	43.92	Q	
5	COL	Caicedo, Amparo Carabali, Norfalia Escalante, Olga Restrepo, Ximena	45.46		
6	TPE	Chang, Fen-Hwa Chen, Wen-Ing Chen, Ya-Li Wang, Shu-Hwa	46.21		

Women 4x100m Round 1 Heat 2/Sept. 30				Femmes 4x100m Tour 1 Serie 2/30 Sept	
Rank Rang	Ctry Pays	Name Nom	Result Resultat		
1	GDR	Behrendt, Kerstin Goehr, Marlies Lange, Ingrid Moeller, Silke	42.92	Q	
2	JAM	Tate, Ethlyn Jackson, Grace Spence, Vivienne Johnson, Laurel	43.50	Q	
3	CAN	Bailey, Angela Phipps, Angela Issajenko, Angela Anderson, Katurah	43.92	Q	
4	CHN	Zhang, Xiaoqiong Liu, Shaomei Xie, Zhiling Zhang, Caihua	44.29	Q	
5	ITA	Angotzi, Rita Ferrian, Daniela Masullo, Marisa Tarolo, Rossella	44.33		
6	GRE	Tsoni, Maria Patoucidou, Paraskevi Zouganeli, Georgia Skordi, Marina	45.44		
7	KOR	Yoon, Mi-Kyong Woo, Yang-Ja Park, Mi-Sun Lee, Young-Sook	45.83		

Women 4x100m Round 1 Heat 3/Sept. 30				Femmes 4x100m Tour 1 Serie 3/30 Sept	
Rank Rang	Ctry Pays	Name Nom	Result Resultat		
1	USA	Brown, Alice Echols, Sheila Young, Dannette Ashford, Evelyn	42.39	Q	
2	GBR	Short, Sallyanne Kinch, Beverly Jacobs, Simmone Dunn, Paula	43.91	Q	
3	HOL	Cooman, Nelli Tromp, Gretha Olyslager, Marjan Vader, Els	43.96	Q	
4	POL	Janota, Jolanta Pisiewicz, Ewa Siwek, Agnieszka Smolarek, Joanna	43.98	Q	
5	GHA	Bawuah, Veronica Yankey, Dinah Addy, Mercy Appiah, Martha	44.12		
6	UGA	Acii, Oliver Buzu, Grace Kyakutema, Farida Kyalisiima, Ruth	46.55		

Women 4x100m Round 1/Sept. 30				Femmes 4x100m Tour 1/30 Sept	
Rank Rang	Ctry Pays	Name Nom	Result Resultat		
1	USA	Brown, Alice Echols, Sheila Young, Dannette Ashford, Evelyn	42.39	Q	
2	URS	Jirova, Marina Kondratieva, Lioudmila Maltchougina, Galina Pomochtchnikova, Natalia	42.88	Q	
3	GDR	Moeller, Silke Behrendt, Kerstin Lange, Ingrid Goehr, Marlies	42.92	Q	
4	FRG	Richter, Sabine Sarvari, Ulrike Thimm, Ute Thomas, Andrea	42.99	Q	
5	FRA	Bily, Laurence Cazier-Ballo, Marie-Christine Leroux, Françoise Leroy, Muriel	43.43	Q	
6	JAM	Tate, Ethlyn Jackson, Grace Spence, Vivienne Johnson, Laurel	43.50	Q	
7	GBR	Short, Sallyanne Kinch, Beverly Jacobs, Simmone Dunn, Paula	43.91	Q	
8	BUL	Demireva, Valia Donkova, Jordanka Gueorguieva, Nadejda Ilieva, Tzvetanka	43.92	Q	
8	CAN	Bailey, Angela Phipps, Angela Issajenko, Angela Anderson, Katurah	43.92	Q	
10	HOL	Cooman, Nelli Tromp, Gretha Olyslager, Marjan Vader, Els	43.96	Q	
11	POL	Janota, Jolanta Pisiewicz, Ewa Siwek, Agnieszka Smolarek, Joanna	43.98	Q	
12	GHA	Bawuah, Veronica Yankey, Dinah Addy, Mercy Appiah, Martha	44.12	Q	
13	CHN	Zhang, Xiaoqiong Liu, Shaomei Xie, Zhiling Zhang, Caihua	44.29	Q	
14	ITA	Angotzi, Rita Tarolo, Rossella Ferrian, Daniela Masullo, Marisa	44.33	Q	
15	GRE	Tsoni, Maria Patoucidou, Paraskevi Zouganeli, Georgia Skordi, Marina	45.44	Q	
16	COL	Caicedo, Amparo Carabali, Norfalia Escalante, Olga Restrepo, Ximena	45.46	Q	
17	KOR	Yoon, Mi-Kyong Woo, Yang-Ja Park, Mi-Sun Lee, Young-Sook	45.83		
18	TPE	Chang, Fen-Hwa Chen, Wen-Ing Chen, Ya-Li Wang, Shu-Hwa	46.21		
19	UGA	Acii, Oliver Buzu, Grace Kyakutema, Farida Kyalisiima, Ruth	46.55		



Women 4x100m Semi-final Heat 1/Oct. 1				Femmes 4x100m Demi-finale Serie 1/1 Oct	
Rank Rang	Ctry Pays	Name Nom	Result Resultat		
1	URS	Kondratieva, Lioudmila Maltchougina, Galina Jirova, Marina Pomochtchnikova, Natalia	42.01	Q	
2	GDR	Moeller, Silke Behrendt, Kerstin Lange, Ingrid Goehr, Marlies	42.23	Q	
3	JAM	Tate, Ethlyn Jackson, Grace Cuthbert, Juliet Ottey, Merlene	43.30	Q	
4	POL	Smolarek, Joanna Janota, Jolanta Pisiewicz, Ewa Siwek, Agnieszka	43.44	Q	
5	HOL	Cooman, Nelli Tromp, Gretha Olyslager, Marjan Vader, Els	43.48		
6	GBR	Short, Sallyanne Kinch, Beverly Jacobs, Simmone Dunn, Paula	43.50		
7	ITA	Angotzi, Rita Tarolo, Rossella Ferrian, Daniela Masullo, Marisa	43.97		
8	GRE	Tsoni, Maria Patoucidou, Paraskevi Koffa, Aikaterini Skordi, Marina	45.74		

Women 4 x 100m Final/Oct. 1				Femmes 4x100m Finale/1 Oct	
Rank Rang	Ctry Pays	Name Nom	Result Resultat		
1	USA	Brown, Alice Echols, Sheila Griffith joyner, Florence Ashford, Evelyn	41.98		
2	GDR	Moeller, Silke Behrendt, Kerstin Lange, Ingrid Goehr, Marlies	42.09		
3	URS	Kondratieva, Lioudmila Maltchougina, Galina Jirova, Marina Pomochtchnikova, Natalia	42.75		
4	FRG	Richter, Sabine Sarvari, Ulrike Thomas, Andrea Thimm, Ute	42.76		
5	BUL	Ilieva, Tzvetanka Demireva, Valia Gueorguieva, Nadejda Donkova, Jordanka	43.02		
6	POL	Smolarek, Joanna Janota, Jolanta Pisiewicz, Ewa Siwek, Agnieszka	43.93		
7	FRA	Leroux, Françoise Leroy, Muriel Bily, Laurence Girard, Patricia	44.02		
	JAM	Tate, Ethlyn Jackson, Grace Cuthbert, Juliet Ottey, Merlene	NS		

Women 4 x 100m Semi-final Heat 2/Oct. 1				Femmes 4x100m Demi-finale Serie 2/1 Oct	
Rank Rang	Ctry Pays	Name Nom	Result Resultat		
1	USA	Brown, Alice Echols, Sheila Griffith joyner, Florence Ashford, Evelyn	42.12	Q	
2	FRG	Richter, Sabine Sarvari, Ulrike Thomas, Andrea Thimm, Ute	42.69	Q	
3	BUL	Ilieva, Tzvetanka Demireva, Valia Gueorguieva, Nadejda Donkova, Jordanka	43.07	Q	
4	FRA	Leroux, Françoise Leroy, Muriel Bily, Laurence Girard, Patricia	43.66	Q	
5	CAN	Bailey, Angela Phipps, Angela Issajenko, Angela Anderson, Katurah	43.82		
6	GHA	Bawuah, Veronica Yankey, Dinah Addy, Mercy Appiah, Martha	44.30		
7	CHN	Zhang, Xiaoqiong Liu, Shaomei Xie, Zhiling Zhang, Caihua	44.36		
	COL	Caicedo, Amparo Carabali, Norfalia Restrepo, Ximena Escalante, Olga	NS		

Women 4 x 400m Round 1 Heat 1/Sept. 30				Femmes 4x400m Tour 1 Serie 1/30 Sept	
Rank Rang	Ctry Pays	Name Nom	Result Resultat		
1	GDR	Breuer, Grit Neubauer, Dagmar Emmelmann, Kirsten Mueller, Petra	3:27.37	Q	
2	CAN	Crooks, Charmaine Lawrence, Esmie Payne Wiggins, Marita Richardson, Jillian	3:27.63	Q	
3	FRG	Arendt, Helga Schabinger, Michaela Kinzel, Gisela Abt, Gudrun	3:27.75	Q	
4	GBR	Keough, Linda Stoute, Jennifer Smith, Janet Gunnell, Sally	3:28.52		
5	FRA	Ficher, Fabienne Simon, Nathalie Elien, Evécyne Debois, Nadine	3:29.95		
6	NGR	Ogunkoya, Fallilat Vaughan, Kehinde Bakare, Airat Onyali, Mary	3:30.21		
7	IND	Alapurackal, Mercy Kuttan math Rao, Vandana Pandurang Shanbagh, Vandana Kurisingal Abraham, Shiny	3:33.46		
	AUS	Flintoff-King, Debra Holland, Maree Johnson, Kerry Laurendet, Jennifer	NS		

Athletics

Athlétisme

Women 4 x 400m Round 1 Heat 2/Sept. 30				Femmes 4 x 400m Tour 1 Serie 2/30 Sept	
Rank Rang	Ctry Pays	Name Nom	Result Resultat		
1	USA	Leatherwood, Lillie Howard, Sherri Howard, Denean Dixon, Diane	3:25.86	Q	
2	JAM	Tate, Marcia Thomas, Andrea Ratray-Williams, Cathy Powell, Sharon	3:26.83	Q	
3	URS	Djigalova, Lioudmila Nazarova, Olga Piniguina, Maria Bryzguina, Olga	3:27.14	Q	
4	BRA	Miranda, Tania Montalvao, Suzete Telles, Soraya Figueiredo, Maria	3:36.81		
5	KOR	Yang, Kyoung-Hee Choi, Se-Beom Lim, Chun-Ae Kim, Soon-Ja	3:51.09		
	COL	Escalante, Olga Carabali, Norfalia Caicedo, Amparo Restrepo, Ximena	DO		
	UGA	Ajilo, Jane Buzu, Grace Kyakutema, Farida Kyalisiima, Ruth	NS		
	ESP	Lacambra, Blanca Lahoz, Esther Perez, Cristina Zuniga, Teresa	NS		

Women 4 x 400m Final/Oct. 1				Femmes 4 x 400m Finale/1 Oct	
Rank Rang	Ctry Pays	Name Nom	Result Resultat		
1	URS	Ledovskaia, Tatiana Nazarova, Olga Piniguina, Maria Bryzguina, Olga	3:15.18	NWR	
2	USA	Howard, Denean Dixon, Diane Brisco, Valerie Griffith joyner, Florence	3:15.51		
3	GDR	Neubauer, Dagmar Emmelmann, Kirsten Busch, Sabine Mueller, Petra	3:18.29		
4	FRG	Thimm, Ute Arendt, Helga Thomas, Andrea Abt, Gudrun	3:22.49		
5	JAM	Richards, Sandie Thomas, Andrea Ratray-williams, Cathy Powell, Sharon	3:23.13		
6	GBR	Keough, Linda Stoute, Jennifer Piggford, Angela Gunnell, Sally	3:26.89		
7	FRA	Ficher, Fabienne Simon, Nathalie Debois, Nadine Elien, Evecyne	3:29.37		
	CAN	Crooks, Charmaine Killingbeck, Molly Payne wiggins, Marita Richardson, Jillian	AB		

Women Marathon Final/Sept. 23				Femmes Marathon Finale/23 Sept				
Rank Rang	Ctry Pays	Name Nom	5km 25km	10km 30km	15km 35km	20km 40km	Finish	
1	POR	Mota, Rosa	17:10 1'25:55	34:13 1'43:13	51:30 2'01:09	1'08:46 2'18:10	2'25:40	
2	AUS	Martin, Lisa	17:10 1'25:55	34:13 1'43:13	51:30 2'01:10	1'08:46 2'18:24	2'25:53	
3	GDR	Doerre, Kathrin	17:10 1'25:55	34:13 1'43:13	51:30 2'01:09	1'08:46 2'18:25	2'26:21	
4	URS	Polovinskaia, Tatiana	17:20 1'25:55	34:13 1'43:13	51:30 2'01:10	1'08:46 2'19:02	2'27:05	
5	CHN	Zhao, Youfeng	17:20 1'25:55	34:13 1'43:51	51:30 2'01:37	1'08:46 2'19:25	2'27:06	
6	ITA	Fogli, Laura	17:22 1'25:55	34:13 1'43:58	51:30 2'02:00	1'08:46 2'19:51	2'27:49	
7	LUX	Kaber, Daniele	17:49 1'26:50	34:13 1'44:45	51:43 2'03:06	1'09:05 2'21:25	2'29:23	
8	ITA	Curatolo, Maria	17:20 1'25:55	34:13 1'44:45	51:30 2'03:10	1'08:46 2'22:18	2'30:14	
9	URS	Ivanova, Zoia	17:20 1'25:55	34:13 1'43:53	51:30 2'02:45	1'08:46 2'22:16	2'30:25	
10	GBR	Pain, Angela	18:03 1'29:30	30:34 1'47:23	53:57 2'05:15	1'11:18 2'23:02	2'30:51	
11	CAN	Lapierre, Odette	18:24 1'29:30	35:11 1'47:30	53:26 2'05:14	1'11:18 2'23:14	2'30:56	
12	GBR	Tooby, Susan	17:25 1'28:09	34:13 1'46:27	52:09 2'05:00	1'09:55 2'23:10	2'31:33	
13	HUN	Szabo, Karolina	18:03 1'30:39	35:50 1'48:34	54:48 2'06:07	1'12:34 2'24:21	2'32:26	
14	FRA	Bonnet, Francoise	17:26 1'27:54	34:29 1'46:27	52:21 2'05:10	1'10:01 2'24:07	2'32:36	
15	KOR	Lee, Mi-Ok	17:20 1'28:09	34:13 1'46:27	51:46 2'05:10	1'09:36 2'29:42	2'32:51	
16	URS	Smekhnova, Raissa	17:10 1'25:55	34:13 1'44:12	51:30 2'03:49	1'08:46 2'24:15	2'33:19	
17	USA	Ditz, Nancy	17:23 1'27:40	34:29 1'46:17	52:21 2'05:25	1'09:55 2'25:23	2'33:42	
18	FRA	Lelut, Maria	17:29 1'28:09	34:29 1'46:27	52:21 2'05:10	1'10:01 2'24:53	2'33:47	
19	FRA	Villeton, Jocelyne	17:32 1'28:09	34:29 1'46:47	52:21 2'06:09	1'10:01 2'25:37	2'34:02	
20	POR	Ferreira, Conoeciao	18:03 1'29:46	34:40 1'48:13	53:26 2'07:03	1'11:18 2'26:07	2'34:23	
21	FRG	Pressler, Kerstin	17:32 1'28:09	34:29 1'46:48	52:38 2'06:01	1'10:01 2'26:00	2'34:26	
22	POL	Panfil, Marianna	17:20 1'27:12	34:13 1'46:08	51:30 2'05:29	1'08:46 2'25:42	2'34:35	
23	ITA	Bizioli, Antonella	18:03 1'30:17	35:50 1'48:48	54:07 2'07:35	1'11:59 2'26:35	2'34:38	
24	SWE	Palm, Evy	17:56 1'29:03	34:36 1'47:38	53:13 2'06:38	1'10:40 2'26:10	2'34:41	
25	JPN	Asai, Eriko	17:45 1'30:17	35:41 1'48:48	54:07 2'07:36	1'11:59 2'26:35	2'34:41	
26	CAN	Bussieres, Lizanne	18:14 1'29:30	35:11 1'48:03	53:26 2'07:00	1'11:18 2'26:30	2'35:03	
27	FRG	Wolf, Gabriela	17:25 1'29:03	34:29 1'48:07	52:21 2'07:46	1'10:19 2'26:53	2'35:11	
28	JPN	Araki, Kumi	17:25 1'30:39	35:41 1'49:02	54:17 2'08:07	1'12:26 2'27:28	2'35:15	
29	JPN	Miyahara, Misako	17:56 1'30:28	35:41 1'49:12	54:17 2'08:37	1'12:03 2'27:28	2'35:26	
30	CHN	Zhong, Huandi	17:20 1'25:55	34:13 1'44:34	51:30 2'04:09	1'08:46 2'25:58	2'36:02	
31	CAN	Rochefort, Ellen	18:46 1'29:30	35:11 1'48:21	53:34 2'07:56	1'11:18 2'28:11	2'36:44	
32	GBR	Crehan, Susan	18:09 1'30:17	35:50 1'49:30	54:07 2'09:35	1'11:59 2'28:36	2'36:57	
33	NZL	Moller, Lorraine	18:11 1'27:27	34:13 1'46:31	51:30 2'07:54	1'09:11 2'28:54	2'37:52	
34	HOL	Beurskens, Carolina	17:20 1'25:55	34:13 1'44:22	51:30 2'03:25	1'08:46 2'28:54	2'37:52	
35	BEL	Hands, Magda	18:03 1'31:05	35:28 1'50:17	54:07 2'09:37	1'12:13 2'29:26	2'38:02	
36	NOR	Grottenberg, Sissel	18:09 1'30:05	35:20 1'48:58	53:39 2'09:07	1'11:33 2'29:35	2'38:17	



Rank Rang	Ctry Pays	Name Nom	Result Resultat				
37	KOR	Lim, Eun-Joo	17:54 1'31:35	35:50 1'50:38	54:23 2'10:04	1'12:49 2'29:42	2'38:21
38	RWA	Mukamurenzi, Marcianne	17:39 V 28:09	34:29 1'47:23	52:21 2'08:15	1'10:01 2'30:14	2'40:12
39	USA	Groos, Margaret	17:22 1'27:53	34:13 1'47:18	52:09 2'08:36	1'09:33 2'31:59	2'40:59
40	USA	O'brien, Cathy	17:25 1'29:20	34:13 1'49:55	52:21 2'11:55	1'10:07 2'32:26	2'41:04
41	FIN	Jousimaa, Tuija	17:20 1'30:39	34:13 1'51:50	51:38 2'12:55	1'10:42 2'33:46	2'43:00
42	FIN	Keskitalo, Sinikka	17:56 1'31:05	34:38 1'52:02	53:19 2'12:56	1'11:38 2'33:46	2'43:00
43	MEX	Jaime, Blanca	17:56 1'33:17	35:50 1'53:05	54:52 2'13:18	1'13:44 2'34:03	2'43:00
44	BRA	Almeida, Angelica	18:03 1'32:40	36:06 1'52:35	55:15 2'13:32	1'13:28 2'34:19	2'43:40
45	TCH	Melicherova, Ludmila	18:09 1'33:39	36:25 1'53:21	55:26 2'13:31	1'14:14 2'34:20	2'43:56
46	IRL	Smyth, Ailish	18:12 1'34:36	36:45 1'54:20	56:27 2'14:16	1'15:03 2'35:10	2'44:17
47	SUI	Eichenmann, Genoveva	18:09 1'34:36	36:25 1'54:44	55:48 2'15:10	1'14:50 2'35:40	2'44:37
48	SUI	Mueller, Rosmarie	18:09 1'33:56	36:25 1'54:21	55:32 2'15:21	1'14:23 2'37:38	2'47:31
49	KEN	Wangui, Pascaline	18:09 1'36:18	36:25 1'56:45	56:02 2'17:48	1'16:02 2'38:37	2'47:42
50	RWA	Nyinawabera, Apollinarie	17:56 1'36:18	36:35 1'56:45	57:45 2'17:48	1'16:14 2'39:27	2'49:18
51	MRI	Justin, Maryse	17:56 1'35:05	36:14 1'55:36	56:02 2'17:28	1'15:20 2'40:00	2'50:00
52	CAY	Bush, Michelle	20:05 1'40:12	38:55 2'00:37	1'02:04 2'21:38	1'20:00 2'42:31	2'51:30
53	GUA	Menendez De Cox, Maria Pilar	21:23 1'38:16	36:54 1'59:31	58:45 2'20:00	1'17:53 2'42:27	2'51:33
54	CHN	Li, Juan	18:55 1'35:08	35:08 1'57:43	54:35 2'21:16	1'14:10 2'44:10	2'53:08
55	ZIM	Hunter, Linda elizabeth	20:05 1'40:12	38:24 2'01:08	59:53 2'22:26	1'19:29 2'44:13	2'53:17
56	ARU	Melis, Cornelia	19:16 1'40:04	37:12 2'00:38	59:13 2'21:38	1'19:07 2'43:54	2'53:24
57	IRL	Murphy-Rollins, Marie	18:11 1'36:03	36:30 1'57:21	55:57 2'21:05	1'15:19 2'44:54	2'54:37
58	ESA	Garcia, Kriscia	18:55 1'39:53	36:54 2'02:40	57:45 2'27:31	1'17:54 2'53:15	3'04:21
59	GUM	Ogborn, Julie	20:05 1'46:14	38:57 2'08:39	1'02:04 2'31:47	1'23:50 2'56:03	3'06:05
60	NEP	Pandey, Rajkumari	21:25 1'53:25	40:45 2'17:02	1'07:17 2'40:01	1'30:20 3'01:15	3'10:31
61	NEP	Rawat, Menuka	21:25 1'53:25	44:02 2'17:03	1'07:17 2'40:01	1'30:20 3'02:00	3'11:17
62	GRN	Vincent Mark, Arlene	23:32 1'53:25	40:07 2'17:03	1'07:17 2'41:53	1'30:20 3'02:45	3'23:56
63	GUM	Kiitzkie, Lourdes	23:39 2'05:28	48:18 2'27:38	1'12:59 2'52:04	1'37:40 3'15:42	3'25:32
64	GUM	Ysrael, Mariana	23:32 2'06:28	44:07 2'32:07	1'12:59 3'00:48	1'38:07 3'30:11	3'42:23
	GDR	Stephan, Birgit					NS
	NOR	Waitz, Grete					AB
	BEL	Pardaens, Agnes					AB
	KOR	Kim, Mi-Kyong					AB
	POR	Cunha, Aurora					NS
	NOR	Moe, Bente					AB
	CYP	Pratsi, Katerina					NS
	BIR	Mar mar min					AB

**Women High Jump
Qualifying Group 1/Sept. 29**

Rank Rang	Ctry Pays	Name Nom	Result Resultat										
1	KOR	Kim, Hee-Sun	170	175	180	184	187	190	192	N	TF		
2	URS	Ourtchak, Olga	—	—	—	—	—	—	—	—	—	1.92	1 0 Q
3	GBR	Oyle, Janet	—	—	—	—	—	—	—	—	—	1.92	1 1 Q
4	FRA	Wanje-Epee, Maryse	—	—	—	—	—	—	—	—	—	1.92	1 3 Q
5	BUL	Ostadinova, Stefka	—	—	—	—	—	—	—	—	—	1.92	2 1 Q
6	FRG	Edetzky, Heike	—	—	—	—	—	—	—	—	—	1.90	1 0
7	AUS	Rowne, Vanessa	—	—	—	—	—	—	—	—	—	1.90	2 4
8	CHN	In, Ling	—	—	—	—	—	—	—	—	—	1.90	3 2
9	USA	Ing, Patricia	—	—	—	—	—	—	—	—	—	1.84	1 0
10	MEX	Fink, Cristina	—	—	—	—	—	—	—	—	—	1.84	3 2
11	YUG	Petrovic, Biljana	—	—	—	—	—	—	—	—	—	1.80	1 1
12	CIV	N' Da, Lucienne	—	—	—	—	—	—	—	—	—	1.75	3 2

**Women High Jump
Qualifying Group 2/Sept. 29**

Rank Rang	Ctry Pays	Name Nom	Result Resultat										
1	JPN	Sato, Megumi	170	175	180	184	187	190	192	N	TF		
2	URS	Bykova, Tamara	—	—	—	—	—	—	—	—	—	1.92	1 0 Q
3	ROM	Astafei, Galina	—	—	—	—	—	—	—	—	—	1.92	1 1 Q
4	BUL	Ndonova, Lyudmila	—	—	—	—	—	—	—	—	—	1.92	2 1 Q
4	GBR	Davies, Diana	—	—	—	—	—	—	—	—	—	1.92	2 1 Q
6	USA	Ritter, Louise	—	—	—	—	—	—	—	—	—	1.92	3 3 Q
7	AUS	Tanton, Christine	—	—	—	—	—	—	—	—	—	1.92	3 3 Q
8	GBR	Jennings, Jo	—	—	—	—	—	—	—	—	—	1.90	3 4
9	URS	Avdeenko, Lidmila	—	—	—	—	—	—	—	—	—	1.87	1 0
10	USA	Sommer, Coleen	—	—	—	—	—	—	—	—	—	1.87	2 1
11	FRA	Beaugendre, Madely	—	—	—	—	—	—	—	—	—	1.84	1 1
12	TPE	Su, Chun-Yueh	—	—	—	—	—	—	—	—	—	1.80	2 1

**Women High Jump
Final/Sept. 30**

Rank Rang	Ctry Pays	Name Nom	Result Resultat										
1	USA	Ritter, Louise	175 203	180 203	185 207	190 209	193	196	199	201	N	TF	
2	BUL	Ostadinova, Stefka	—	—	—	—	—	—	—	—	—	2.03	1 3 NOR
3	URS	Bykova, Tamara	—	—	—	—	—	—	—	—	—	2.01	1 0
4	URS	Tourtchak, Olga	—	—	—	—	—	—	—	—	—	1.99	3 3
5	ROM	Astafei, Galina	—	—	—	—	—	—	—	—	—	1.96	1 1
5	BUL	Ndonova, Lyudmila	—	—	—	—	—	—	—	—	—	1.93	1 0
7	AUS	Tanton, Christine	—	—	—	—	—	—	—	—	—	1.93	2 1
8	GBR	Davies, Diana	—	—	—	—	—	—	—	—	—	1.90	1 0
8	KOR	Kim, Hee-Sun	—	—	—	—	—	—	—	—	—	1.90	1 0
10	FRA	Ewanje-Epee, Maryse	—	—	—	—	—	—	—	—	—	1.90	2 1
11	JPN	Sato, Megumi	—	—	—	—	—	—	—	—	—	1.90	3 2
12	GBR	Boyle, Janet	—	—	—	—	—	—	—	—	—	1.90	3 3

**Women Long Jump
Qualifying Group 1/Sept. 28**

Rank Rang	Ctry Pays	Name Nom	Result Resultat				
1	USA	Joyner-Kersey, Jackie	6.96 + 0.2	—	—	6.96	Q
2	GDR	John, Sabine	X	X	6.81 + 1.0	6.81	Q
3	URS	Kravetz, Inessa	6.50 -0.0	6.72 -0.0	—	6.72	Q
4	AUS	Boegman, Nicole	X	6.72 + 0.4	—	6.72	Q
5	GDR	Drechsler, Heike	6.72 + 0.0	—	—	6.72	Q
6	DEN	Demsitz, Lene s	X	6.59 + 0.5	X	6.59	
7	CHN	Liu, Shuzhen	6.35 + 0.1	6.48 + 0.6	6.48 -0.1	6.48	
8	USA	Echols, Sheila	6.37 + 1.2	6.29 + 0.0	X	6.37	
9	GBR	Hagger, Kim	X	6.33 + 0.7	6.34 -0.5	6.34	
10	ITA	Capriotti, Antonella	6.31 + 0.8	X	X	6.31	
11	POL	Bartczak, Jolanta	6.28 -0.5	X	6.30 -0.0	6.30	

Athletics

Rank Rang	Ctry Pays	Name Nom	1)	2)	3)	Result Resultat
12	CYP	Teloni, Maroula	6.29 + 0.0	X	5.98 + 0.0	6.29
13	KOR	Park, Sook-Ja	5.74 + 0.7	5.79 - 0.7	5.90 + 1.5	5.90
14	GHA	Yendork, Juliana	5.40 - 0.6	5.35 - 0.9	5.34 + 0.3	5.40
15	LBR	Wulah, Melvina	5.23 + 0.2	4.91 + 1.5	5.17 - 0.8	5.23
	CAN	Smith, Tracy lee	X	X	X	X

Women Long Jump Qualifying Group 2/Sept. 28

Rank Rang	Ctry Pays	Name Nom	1)	2)	3)	Result Resultat
1	URS	Belevskaia, Elena	7.06 - 0.5	—	—	7.06 Q
2	URS	Tchistiakova, Galina	6.97 - 0.1	—	—	6.97 Q
3	POL	Karczmarek, Agata	6.57 + 1.2	6.45 - 0.2	6.67 + 1.1	6.67 Q
4	GBR	May, Fiona	X	6.66 - 0.9	—	6.66 Q
5	CHN	Xiong, Qiyang	6.43 - 0.2	6.61 + 0.6	6.44 - 1.3	6.61
6	USA	Lewis, Carol	6.45 + 0.2	6.39 + 0.6	6.47 - 0.0	6.47
7	CHN	Liao, Wenfen	X	6.44 - 0.9	6.41 - 0.4	6.44
8	HOL	Wijnsma, Marjon	6.39 + 1.2	6.25 - 0.9	X	6.39
9	BAH	Ferguson, Shonel	6.21 + 1.4	6.34 + 0.0	6.16 + 2.5	6.34
10	AUT	Kleindl, Ulrike	6.13 - 0.3	X	X	6.13
11	PUR	De, Jesus, Madeline	6.08 + 0.9	X	5.95 + 1.6	6.08
12	TPE	Wang, Shu-Hwa	5.75 + 0.3	5.87 - 0.6	X	5.87
13	VIN	Ross, Jacqueline	X	X	5.50 + 0.7	5.50
14	GBR	Berkeley, Mary	X	X	5.04 + 0.6	5.04
	COK	Tierney, Erin	NS			NS
	GDR	Behmer, Anke	NS			NS

Women Long Jump Final/Sept. 29

Rank Rang	Ctry Pays	Name Nom	1)	2)	3)	4)	5)	6)	Result Resultat
1	USA	Joyner-Kersey, Jackie	7.00 - 0.7	X	7.16 - 0.7	X	7.40 + 0.9	X	7.40 NOR
2	GDR	Drechsler, Heike	6.92 + 1.0	7.06 - 0.6	7.18 + 0.0	7.22 + 0.5	7.16 + 0.1	7.17 + 0.0	7.22
3	URS	Tchistiakova, Galina	7.11 + 1.3	6.24 - 0.7	X	7.02 + 1.1	6.96 - 0.3	6.84 - 0.1	7.11
4	URS	Belevskaia, Elena	6.36 - 0.4	7.04 - 0.0	6.99 - 0.8	X	X	6.66 + 0.1	7.04
5	AUS	Boegman, Nicole	6.59 - 0.8	X	X	X	6.71 + 0.6	6.73 + 2.3	6.73
6	GBR	May, Fiona	X	X	6.53 + 0.7	6.62 - 0.7	6.52 + 1.2	X	6.62
7	POL	Karczmarek, Agata	X	6.40 - 0.9	6.60 - 0.9	X	6.48 + 0.1	6.23 - 0.0	6.60
8	GDR	John, Sabine	6.47 - 0.1	6.55 - 0.9	6.45 - 0.3	6.43 - 0.9	X	X	6.55
9	CHN	Xiong, Qiyang	6.49 - 0.5	6.50 - 0.3	6.46 - 0.8				6.50
10	URS	Kravetz, Inessa	6.36 + 0.1	6.46 - 0.8	6.37 - 0.1				6.46

Athlétisme

Rank Rang	Ctry Pays	Name Nom	1)	2)	3)	4)	5)	6)	Result Resultat
11	CHN	Liu, Shuzhen	6.30 - 0.3	6.40 - 0.5	X				6.40
12	DEN	Demsitz, Lene S	6.28 - 0.1	6.38 + 0.6	X				6.38

Women Shot Put Qualifying Group 1/Sept. 30

Rank Rang	Ctry Pays	Name Nom	1)	2)	3)	Result Resultat
1	FRG	Losch, Claudia	18.82	20.39	—	20.39 Q
2	CHN	Li, Meisu	20.30	—	—	20.30 Q
3	GDR	Neimke, Kathrin	20.18	—	—	20.18 Q
4	GDR	Hartwig, Heike	19.22	20.06	—	20.06 Q
5	TCH	Silhava, Zdenka	19.74	—	—	19.74 Q
6	CHN	Cong, Yuzhen	19.55	—	—	19.55 Q
7	BUL	Mitkova, Svetla	18.80	19.53	—	19.53 Q
8	USA	Dasse, Bonnie	19.29	19.45	18.94	19.45
9	URS	Fediouchina, Valentina	16.93	19.05	19.06	19.06
10	USA	Price, Connie	15.61	X	17.09	17.09
11	COL	Urrutia, Isabel	15.13	14.85	14.42	15.13
11	GBR	Hanson-Nortey, Yvonne	15.13	14.86	X	15.13
13	TGA	Ikavuka, Siulolo Vao	12.31	X	11.18	12.31

Femmes Lancer du poids Qualification Groupe 1/30 Sept

Women Shot Put Qualifying Group 2/Sept. 30

Rank Rang	Ctry Pays	Name Nom	1)	2)	3)	Result Resultat
1	GDR	Mueller, Ines	19.79	—	—	19.79 Q
2	URS	Lisovskaya, Natalia	19.78	—	—	19.78 Q
3	CHN	Huang, Zhihong	19.71	—	—	19.71 Q
4	URS	Akhremenko, Natalia	19.26	19.40	X	19.40
5	FRG	Plotzicka, Lris	18.79	19.06	X	19.06
6	USA	Pagel, Ramona	18.55	18.45	18.36	18.55
7	GBR	Oakes, Judy	17.76	18.34	18.02	18.34
8	GBR	Augee, Myrtle	16.85	16.44	17.31	17.31
9	HAI	Saint-Phard, Deborah	14.87	15.35	16.02	16.02
10	NGR	Apjafi, Grace	15.06	15.05	14.58	15.06
11	KOR	Choi, Mi-Sun	13.90	13.44	13.97	13.97
12	CMR	Minyemeck, Jeannenicole	11.84	12.73	12.61	12.73
	TCH	Vasickova, Sona	NS			NS

Femmes Lancer du poids Qualification Groupe 2/30 Sept

Women Shot Put Final/Oct. 1

Rank Rang	Ctry Pays	Name Nom	1)	2)	3)	4)	5)	6)	Result Resultat
1	URS	Lisovskaya, Natalia	21.69	21.49	21.24	21.74	21.11	22.24	22.24
2	GDR	Neimke, Kathrin	19.64	20.07	19.82	20.37	20.72	21.07	21.07
3	CHN	Li, Meisu	19.99	20.03	20.72	20.49	21.06	20.84	21.06
4	GDR	Mueller, Ines	20.37	19.34	X	X	19.55	20.34	20.37
5	FRG	Losch, Claudia	20.08	X	19.40	20.27	X	X	20.27
6	GDR	Hartwig, Heike	19.94	20.20	19.71	20.16	X	19.75	20.20
7	URS	Akhremenko, Natalia	19.37	19.86	19.18	X	19.60	20.13	20.13
8	CHN	Huang, Zhihong	18.26	19.15	19.82	19.79	19.73	19.56	19.82
9	CHN	Cong, Yuzhen	19.69	X	19.65				19.69
10	BUL	Mitkova, Svetla	18.29	18.79	19.09				19.09
11	TCH	Silhava, Zdenka	16.85	18.86	X				18.86
12	USA	Dasse, Bonnie	17.60	17.59	17.51				17.60

Femmes Lancer du poids Finale/1 Oct

Women Discus Qualifying Group 1/Sept. 28

Rank Rang	Ctry Pays	Name Nom	1)	2)	3)	Result Resultat
1	TCH	Silhava, Zdenka	66.52	—	—	66.52 Q
2	GDR	Gansky, Diana	65.40	—	—	65.40 Q
3	BUL	Mitkova, Svetla	64.68	—	—	64.68 Q
4	URS	Mikhailchenko, Larissa	X	X	64.32	64.32 Q
5	CHN	Yu, Hourun	61.22	62.86	—	62.86 Q
6	URS	Mourachova, Galina	57.28	61.46	62.54	62.54 Q
7	USA	Pagel, Ramona	57.50	55.86	53.12	57.50
8	USA	Price, Connie	51.78	53.36	57.04	57.04
9	GBR	Mckernan, Jacqueline	50.92	X	X	50.92
10	KOR	Kim, Chun-Hee	45.00	X	45.88	45.88
	CMR	Minyemeck, Jeannenicole	X	X	X	X

Femmes Lancer du disque Qualification Groupe 1/28 Sept

**Women Discus
Qualifying Group 2/Sept. 28**

Rank Rang	Ctry Pays	Name Nom	1)	2)	3)	Result Resultat
1	GDR	Hellmann, Martina	67.12	—	—	67.12 Q
2	GDR	Reinsch, Gabriele	X	59.18	66.88	66.88 Q
3	BUL	Hristova, Tzvetanka	65.92	—	—	65.92 Q
4	URS	Zvereva, Ellina	63.26	—	—	63.26 Q
5	USA	Cady, Carol	60.08	56.38	62.72	62.72 Q
6	CHN	Hou, Xuemei	62.64	—	—	62.64 Q
7	POL	Katewicz, Renata	58.60	57.20	60.34	60.34
8	CHN	Xing, Ailan	57.74	59.26	59.20	59.26
9	COL	Urrutia, Isabel	53.82	48.90	52.06	53.82
10	NGR	Apiafi, Grace	49.84	49.52	48.40	49.84
11	TGA	Ikavuka, Siulolo Vao	44.94	43.28	43.78	44.94

**Women Discus
Final/Sept. 29**

Rank Rang	Ctry Pays	Name Nom	1)	2)	3)	4)	5)	6)	Result Resultat
1	GDR	Hellmann, Martina	71.84	64.80	68.70	72.30	69.66	67.50	72.30 NOR
2	GDR	Gansky, Diana	65.58	66.14	X	65.82	71.88	68.08	71.88
3	BUL	Hristova, Tzvetanka	66.48	66.44	64.06	66.84	69.74	69.00	69.74
4	BUL	Mitkova, Svetla	63.62	65.74	65.56	67.24	X	69.14	69.14
5	URS	Zvereva, Ellina	X	65.74	66.86	X	X	68.94	68.94
6	TCH	Silhava, Zdenka	67.40	X	65.70	66.30	67.84	66.50	67.84
7	GDR	Reinsch, Gabriele	67.26	66.50	63.30	65.88	66.40	X	67.26
8	CHN	Hou, Xuemei	63.44	63.88	65.18	65.94	65.50	65.06	65.94
9	CHN	Yu, Hourun	62.94	X	64.08				64.08
10	URS	Mikhaltchenko, Larissa	X	64.08	X				64.08
11	USA	Cady, Carol	60.82	61.06	63.42				63.42
	URS	Mourachova, Galina	X	X	X				X

**Women Javelin
Qualifying Group 1/Sept. 25**

Rank Rang	Ctry Pays	Name Nom	1)	2)	3)	Result Resultat
1	GDR	Felke, Petra	67.06	—	—	67.06 Q
2	GDR	Koch, Beate	66.86	—	—	66.86 Q
3	URS	Ermolovitch, Natalia	X	64.44	—	64.44 Q
4	HUN	Malovecz, Zsuzsa	64.30	—	—	64.30 Q
5	SUI	Thiemard, Denise	55.18	61.74	55.60	61.74
6	FIN	Laaksalo, Tuula	57.34	60.64	54.66	60.64
7	FRG	Peters, Beate	X	X	60.20	60.20
8	BAH	Eve, Laverne	X	57.48	60.02	60.02
9	NOR	Solberg, Trine	57.76	56.90	58.82	58.82
10	GRE	Verouli, Anna	57.60	58.52	X	58.52
11	GBR	Sanderson, Tessa	54.18	56.70	56.26	56.70
12	CHN	Zhou, Yuanxiang	53.66	52.80	56.36	56.36
13	USA	Sutfin, Lynda	56.08	56.12	X	56.12
14	CAN	Chartrand, Celine	47.64	46.18	54.10	54.10
	FRA	Auzeil, Nadine	X	X	X	X

**Women Javelin
Qualifying Group 2/Sept. 25**

Rank Rang	Ctry Pays	Name Nom	1)	2)	3)	Result Resultat
1	GBR	Whitbread, Fatima	54.90	X	68.44	68.44 Q
2	BUL	Selenska, Antoaneta	50.84	61.62	64.60	64.60 Q
3	GDR	Renk, Silke	63.64	—	—	63.64 Q
4	FRG	Thyssen, Ingrid	63.32	—	—	63.32 Q
5	URS	Kostioutchenkova, Irina	58.56	X	63.24	63.24 Q
6	FIN	Alafranti, Paivi	62.82	58.54	59.82	62.82
7	USA	Mayhew, Donna	61.56	60.62	59.08	61.56
8	FIN	Lillak, Kristiina	60.06	X	55.52	60.06
9	CHN	Li, Baolian	56.64	58.92	56.62	58.92
10	USA	Smith, Karin	57.42	53.86	57.94	57.94
11	JPN	Matsui, Emi	50.70	X	56.26	56.26
12	GBR	Gibson, Sharon	56.00	50.74	53.20	56.00
13	ISL	Gronfeldt, Iris	X	54.28	50.84	54.28
14	KOR	Yoo, Chun-Ok	X	44.92	48.26	48.26

**Women Javelin
Final/Sept. 26**

Rank Rang	Ctry Pays	Name Nom	1)	2)	3)	4)	5)	6)	Result Resultat
1	GDR	Felke, Petra	72.62	74.68	66.12	66.76	71.12	68.38	74.68 NOR
2	GBR	Whitbread, Fatima	61.98	67.46	66.58	64.86	67.82	70.32	70.32
3	GDR	Koch, Beate	67.30	65.66	66.48	62.04	65.64	66.02	67.30
4	URS	Kostioutchenkova, Irina	64.34	67.00	63.12	63.42	63.10	X	67.00
5	GDR	Renk, Silke	60.86	58.74	63.98	64.60	64.74	66.38	66.38
6	URS	Ermolovitch, Natalia	64.84	X	X	X	X	—	64.84
7	USA	Mayhew, Donna	57.52	X	61.78	59.72	X	56.74	61.78
8	FRG	Thyssen, Ingrid	60.76	60.12	56.66	X	59.64	58.28	60.76
9	SUI	Thiemard, Denise	57.58	57.20	58.54				58.54
10	FIN	Alafranti, Paivi	58.20	55.86	56.46				58.20
11	BUL	Selenska, Antoaneta	56.78	X	X				56.78
12	HUN	Malovecz, Zsuzsa	X	54.58	X				54.58

**Women Heptathlon — 100m Hurdles
Heat 1/Sept. 23**

Rank Rang	Ctry Pays	Name Nom	Result Resultat
1	BEL	Hautenuave, Jacqueline	14.04 973
2	BRA	Geremias, Conceicao	14.23 946
3	KOR	Ji, Jeong-Mi	14.53 905
4	TPE	Hsu, Hui-Ing	14.85 862
5	FIJ	Tukana, Sainiana	15.60 764
6	NGU	Launa, Iammogapi	16.42 664
	ALG	Azzizi, Yasmina	NS
	LIE	Hasler, Yvonne	NS

**Women Heptathlon — 100m Hurdles
Heat 2/Sept. 23**

Rank Rang	Ctry Pays	Name Nom	Result Resultat
1	GBR	Hagger, Kim	13.47 1055
2	FRG	Everts, Sabine	13.74 1015
3	GBR	Simpson, Judy	13.78 1010
4	FIN	Ruotsalainen, Satu	13.79 1008
5	SUI	Schneider, Corinne	13.85 1000
6	USA	Brown, Wendy	14.07 968
7	FIN	Kytola, Ragne	14.31 935
8	GBR	Mulliner, Joanne	14.39 924

**Women Heptathlon — 100m Hurdles
Heat 3/Sept. 23**

Rank Rang	Ctry Pays	Name Nom	Result Resultat
1	USA	Joyner-Kersey, Jackie	12.69 1172
2	GDR	John, Sabine	12.85 1147
3	GDR	Behmer, Anke	13.20 1094
4	URS	Bouraga, Svetlana	13.25 1087
5	URS	Choubenkova, Natalia	13.51 1049
6	URS	Sablovskaitė, Remiguiia	13.61 1034
7	GDR	Schulz, Ines	13.75 1014
8	FRA	Beaugeant, Chantal	16.76 624

**Women Heptathlon — 100m Hurdles
Heat 4/Sept. 23**

Rank Rang	Ctry Pays	Name Nom	Result Resultat
1	BUL	Dimitrova, Svetla	13.24 1089
2	AUS	Flemming, Jane	13.38 1068
3	USA	Greiner, Cindy	13.55 1043
4	TCH	Lajbnerova, Zuzana	13.63 1031
5	FRG	Braun, Sabine	13.71 1020
6	HOL	Wijnsma, Marjon	13.75 1014
7	CHN	Dong, Yuping	13.93 988
	HOL	Hidding, Jantien	AB

Athletics

Women Heptathlon — High Jump Group 1/Sept. 23			Femmes Heptathlon — Saut en haies Groupe 1/23 Sept								Result		N TF	
Rank Rang	Ctry Pays	Name Nom	165 189	168 192	171 195	174	177	180	183	186				
1	USA	Joyner-Kersey, Jackie	— XXX	—	O	—	O	—	O	XO	1.86	2	1	1054
2	SUI	Schneider, Corinne	— XXX	O	O	O	O	O	O	XO	1.86	2	1	1054
3	HOL	Wijnsma, Marjon	— XXX	—	O	O	O	XO	O	XO	1.86	2	2	1054
4	CHN	Dong, Yuping	O XXX	O	O	O	O	O	XXO	XO	1.86	2	3	1054
5	GDR	Behmer, Anke	O	—	O	O	O	O	O	XXX	1.83	1	0	1016
6	GDR	Schulz, Ines	O	O	O	XO	O	O	O	XXX	1.83	1	1	1016
7	FRG	Braun, Sabine	—	O	O	O	O	XXO	O	XXX	1.83	1	2	1016
8	TCH	Lajbnerova, Zuzana	O	O	—	XO	O	O	XO	XXX	1.83	2	2	1016
9	USA	Brown, Wendy	—	O	O	XO	XO	XO	XXO	XXX	1.83	3	5	1016
10	FRA	Beaugeant, Chantal	—	—	O	O	O	O	XXX		1.80	1	0	978
11	USA	Greiner, Cindy	O	—	O	O	XXO	O	XXX		1.80	1	2	978
12	AUS	Flemming, Jane	O	—	O	XO	XO	O	XXX		1.80	1	2	978
13	FIN	Ruotsalainen, Satu	—	XO	XO	O	XO	O	XXX		1.80	1	3	978
14	GDR	John, Sabine	O	O	O	O	O	XXO	XXX		1.80	3	2	978
15	FIN	Kytola, Ragne	—	O	XO	XO	O	XXX			1.77	1	2	941
16	GBR	Simpson, Judy	O	O	O	O	XXO	XXX			1.77	3	2	941

Women Heptathlon — High Jump Group 2/Sept. 23			Femmes Heptathlon — Saut en Hauteur Groupe 2/23 Sept								Result		N TF	
Rank Rang	Ctry Pays	Name Nom	135 159 183	138 162 186	141 165	144 168	147 171	150 174	153 177	156 180				
1	GBR	Hagger, Kim	— XXX	—	—	—	—	—	—	—	1.80	2	1	978
2	URS	Sablovskaitė, Remiguiia	— XXX	O	—	O	O	O	O	XXO	1.80	3	2	978
3	DUL	Dimitrova, Svetla	— XXX	O	O	O	O	XXO	XO	O	1.80	3	5	978
4	URS	Bouraga, Svetlana	—	—	—	—	—	—	—	O	1.77	1	2	941
5	BEL	Hautenuave, Jacqueline	— XO	—	—	—	—	—	—	—	1.77	2	2	941
6	URS	Choubenkova, Natalia	— O	—	—	—	—	—	—	O	1.74	3	2	903
7	FRG	Everts, Sabine	—	—	—	—	—	—	—	—	1.71	1	0	867
8	BRA	Geremias, Conceicao	—	—	—	—	—	—	—	—	1.71	2	1	867
9	KOR	Ji, Jeong-Mi	—	—	—	—	—	—	—	—	1.71	2	4	867
10	GBR	Mulliner, Joanne	—	—	—	—	—	—	—	—	1.71	3	3	867
11	TPE	Hsu, Hui-Ing	— XO	—	—	—	—	—	—	—	1.68	2	2	830
12	NGU	Launa, Iammogapi	—	O	O	O	O	XO	XXX		1.50	2	1	621
	HOL	Hidding, Jantien									NS			
	FIJ	Tukana, Sainiana	—	—	—	—	—	—	—	XXX	X			
	ALG	Azzizi, Yasmina									NS			
	LIE	Hasler, Yvonne									NS			

Athlétisme

Women Heptathlon — Shot Put Group 1/Sept. 23			Femmes Heptathlon — Lancer du poids Groupe 1/23 Sept					Result	
Rank Rang	Ctry Pays	Name Nom	1)	2)	3)	Result Resultat			
1	GDR	John, Sabine	16.23	X	X	16.23	943		
2	USA	Joyner-Kersey, Jackie	15.80	15.12	14.86	15.80	915		
3	URS	Sablovskaitė, Remiguiia	15.14	15.12	15.23	15.23	876		
4	URS	Choubenkova, Natalia	13.75	14.66	14.76	14.76	845		
5	TCH	Lajbnerova, Zuzana	14.28	13.96	13.78	14.28	813		
6	CHN	Dong, Yuping	14.21	X	12.66	14.21	808		
7	GDR	Behmer, Anke	14.20	13.99	13.64	14.20	807		
8	USA	Greiner, Cindy	13.29	14.13	14.00	14.13	803		
9	GDR	Schulz, Ines	13.20	13.50	13.12	13.50	761		
10	FRG	Braun, Sabine	13.05	13.16	X	13.16	738		
11	HOL	Wijnsma, Marjon	12.81	12.57	13.01	13.01	728		
12	AUS	Flemming, Jane	X	12.88	12.54	12.88	719		
13	FRA	Beaugeant, Chantal	12.79	12.55	12.48	12.79	713		
14	URS	Bouraga, Svetlana	12.56	X	12.62	12.62	702		
15	BUL	Dimitrova, Svetla	11.95	11.78	12.02	12.02	662		
	HOL	Hidding, Jantien	NS			NS			

Women Heptathlon — Shot Put Group 2/Sept. 23			Femmes Heptathlon — Lancer du poids Groupe 2/23 Sept					Result	
Rank Rang	Ctry Pays	Name Nom	1)	2)	3)	Result Resultat			
1	BRA	Geremias, Conceicao	12.62	12.95	12.65	12.95	724		
2	GBR	Hagger, Kim	12.13	12.75	12.15	12.75	711		
3	USA	Brown, Wendy	12.69	X	12.41	12.69	707		
4	GBR	Mulliner, Joanne	12.34	12.68	12.63	12.68	706		
5	FIN	Ruotsalainen, Satu	11.71	12.32	12.28	12.32	682		
6	BEL	Hautenuave, Jacqueline	11.18	11.81	11.54	11.81	649		
7	NGU	Launa, Iammogapi	10.01	10.07	11.78	11.78	647		
8	FIN	Kytola, Ragne	11.23	11.45	11.66	11.66	639		
9	SUI	Schneider, Corinne	11.31	11.42	11.58	11.58	633		
10	FRG	Everts, Sabine	11.54	X	—	11.54	631		
11	KOR	Ji, Jeong-Mi	10.83	10.78	10.52	10.83	584		
12	TPE	Hsu, Hui-Ing	9.26	9.70	10.00	10.00	529		
13	FIJ	Tukana, Sainiana	7.59	8.61	7.61	8.61	439		
	LIE	Hasler, Yvonne	NS			NS			
	GBR	Simpson, Judy	NS			NS			
	ALG	Azzizi, Yasmina	NS			NS			

Women Heptathlon — 200m Heat 1/Sept. 23			Femmes Heptathlon — 200m Serie 1/23 Sept	
Rank Rang	Ctry Pays	Name Nom	Result Resultat	
1	BUL	Dimitrova, Svetla	23.49	1030
2	AUS	Flemming, Jane	23.59	1020
3	USA	Greiner, Cindy	24.48	935
4	FRG	Braun, Sabine	24.78	907
5	TCH	Lajbnerova, Zuzana	24.86	900
6	CHN	Dong, Yuping	25.00	887
7	HOL	Wijnsma, Marjon	25.03	884
	HOL	Hidding, Jantien	NS	

Women Heptathlon — 200m Heat 2/Sept. 23			Femmes Heptathlon — 200m Serie 2/23 Sept	
Rank Rang	Ctry Pays	Name Nom	Result Resultat	
1	TPE	Hsu, Hui-Ing	25.23	866
2	BRA	Geremias, Conceicao	25.50	841
3	BEL	Hautenuave, Jacqueline	25.61	832
4	NGU	Launa, Iammogapi	26.16	783
5	FIJ	Tukana, Sainiana	26.37	765
6	KOR	Ji, Jeong-Mi	26.61	745
	LIE	Hasler, Yvonne	NS	
	ALG	Azzizi, Yasmina	NS	

Women Heptathlon — 200m Heat 3/Sept. 23			Femmes Heptathlon — 200m Serie 3/23 Sept	
Rank Rang	Ctry Pays	Name Nom	Result Resultat	
1	USA	Joyner-Kersey, Jackie	22.56	1123
2	GDR	Behmer, Anke	23.10	1069
3	URS	Bouraga, Svetlana	23.59	1020
4	GDR	John, Sabine	23.65	1015
5	URS	Sablovskaitė, Remiguiia	23.92	988
6	URS	Choubenkova, Natalia	23.93	987
7	GDR	Schulz, Ines	24.65	919
	FRA	Beaugeant, Chantal	NS	

**Women Heptathlon — 200m
Heat 4/Sept. 23****Femmes Heptathlon — 200m
Serie 4/23 Sept**

Rank Rang	Ctry Pays	Name Nom	Result Resultat	
1	FIN	Ruotsalainen, Satu	24.61	923
2	USA	Brown, Wendy	24.83	902
3	SUI	Schneider, Corinne	24.87	899
4	GBR	Mulliner, Joanne	24.92	894
5	GBR	Hagger, Kim	25.47	844
6	FIN	Kytola, Ragne	25.69	824
	FRG	Everts, Sabine	NS	
	GBR	Simpson, Judy	NS	

**Women Heptathlon — Long Jump
Group 1/Sept. 24****Femmes Heptathlon — Saut en longueur
Groupe 1/24 Sept**

Rank Rang	Ctry Pays	Name Nom	1)	2)	3)	Result Resultat		
1	USA	Joyner-Kersey, Jackie	7.27 + 0.7	—	—	7.27	1264	NOR
2	GDR	John, Sabine	6.71 + 0.0	6.67 + 0.0	6.64 + 0.0	6.71	1076	
3	GDR	Behmer, Anke	6.68 + 0.1	6.36 + 0.1	X	6.68	1066	
4	USA	Greiner, Cindy	6.30 - 0.9	X	6.47 + 0.1	6.47	997	
5	CHN	Dong, Yuping	6.13 - 0.2	6.15 - 0.1	6.40 + 0.4	6.40	975	
6	AUS	Flemming, Jane	6.13 + 0.4	6.36 + 0.5	6.37 + 0.4	6.37	965	
7	HOL	Wijnsma, Marjon	6.10 + 0.7	6.34 + 1.0	6.16 + 0.1	6.34	956	
8	GDR	Schulz, Ines	X	6.22 + 0.5	6.33 + 0.6	6.33	953	
9	URS	Choubenkova, Natalia	6.10 + 0.0	6.32 - 0.3	X	6.32	949	
10	URS	Bouraga, Svetlana	6.16 - 0.2	6.16 + 0.0	6.28 + 0.6	6.28	937	
11	URS	Sablovskaite, Remiguiia	5.92 - 0.0	6.13 - 0.2	6.25 + 0.7	6.25	927	
12	BUL	Dimitrova, Svetla	6.18 + 0.2	6.19 - 0.5	X	6.19	908	
13	FRG	Braun, Sabine	X	5.89 + 0.0	6.12 + 0.3	6.12	887	
14	TCH	Lajbnerova, Zuzana	5.82 - 0.3	6.00 + 0.0	6.11 + 0.0	6.11	883	
	FRA	Beaugeant, Chantal	NS			NS		
	HOL	Hidding, Jantien	NS			NS		

**Women Heptathlon — Long Jump
Group 2/Sept. 24****Femmes Heptathlon — Saut en longueur
Groupe 2/24 Sept**

Rank Rang	Ctry Pays	Name Nom	1)	2)	3)	Result Resultat	
1	GBR	Hagger, Kim	6.10 - 0.0	X	6.34 - 0.0	6.34	956
2	USA	Brown, Wendy	6.09 - 0.3	6.13 - 0.3	X	6.13	890
3	GBR	Mulliner, Joanne	5.83 + 1.2	X	6.10 + 0.1	6.10	880
4	FIN	Ruotsalainen, Satu	X	X	6.08 - 0.0	6.08	874
5	SUI	Schneider, Corinne	5.50 + 0.0	5.91 + 0.8	6.05 + 0.0	6.05	865
6	BEL	Hautenaue, Jacqueline	5.67 + 0.2	5.99 - 0.5	5.95 - 0.4	5.99	846
7	FIN	Kytola, Ragne	5.75 - 0.5	5.49 - 0.0	5.40 + 1.1	5.75	774
8	BRA	Geremias, Conceicao	5.50 - 0.5	5.50 + 0.4	5.45 - 1.0	5.50	700
9	KOR	Ji, Jeong-Mi	4.36 - 0.4	5.50 + 0.5	X	5.50	700
10	TPE	Hsu, Hui-Ing	5.47 - 0.5	5.47 + 0.7	5.28 + 0.0	5.47	691
11	FIJ	Tukana, Sainiana	4.79 + 0.0	4.77 + 0.4	5.12 - 0.0	5.12	592

Rank Rang	Ctry Pays	Name Nom	1)	2)	3)	Result Resultat	
12	NGU	Launa, Iammogapi	X	4.52 + 0.0	4.88 + 0.0	4.88	527
	ALG	Azzizi, Yasmina	NS			NS	
	FRG	Everts, Sabine	NS			NS	
	GBR	Simpson, Judy	NS			NS	
	LIE	Hasler, Yvonne	NS			NS	

**Women Heptathlon — Javelin
Group 1/Sept. 24****Femmes Heptathlon — Lancer du javelot
Groupe 1/24 Sept**

Rank Rang	Ctry Pays	Name Nom	1)	2)	3)	Result Resultat	
1	SUI	Schneider, Corinne	46.52	47.50	X	47.50	812
2	NGU	Launa, Iammogapi	46.38	40.80	X	46.38	790
3	FIN	Ruotsalainen, Satu	43.58	45.44	X	45.44	772
4	USA	Brown, Wendy	X	41.24	44.34	44.34	751
5	BRA	Geremias, Conceicao	37.78	38.08	39.64	39.64	660
6	FIN	Kytola, Ragne	X	39.48	X	39.48	657
7	KOR	Ji, Jeong-Mi	39.26	37.34	36.12	39.26	653
8	TPE	Hsu, Hui-Ing	37.92	39.14	X	39.14	651
9	GBR	Mulliner, Joanne	X	34.48	37.76	37.76	624
10	GBR	Hagger, Kim	35.78	33.46	33.30	35.78	587
11	BEL	Hautenaue, Jacqueline	35.68	X	X	35.68	585
	FRG	Everts, Sabine	NS			NS	
	LIE	Hasler, Yvonne	NS			NS	
	GBR	Simpson, Judy	NS			NS	
	FIJ	Tukana, Sainiana	X	X	X	X	
	ALG	Azzizi, Yasmina	NS			NS	

**Women Heptathlon — Javelin
Group 2/Sept. 24****Femmes Heptathlon — Lancer du javelot
Groupe 2/24 Sept**

Rank Rang	Ctry Pays	Name Nom	1)	2)	3)	Result Resultat	
1	URS	Choubenkova, Natalia	47.46	44.14	X	47.46	811
2	USA	Joyner-Kersey, Jackie	44.34	45.66	X	45.66	776
3	FRG	Braun, Sabine	44.58	X	X	44.58	755
4	GDR	Behmer, Anke	44.54	—	—	44.54	755
5	TCH	Lajbnerova, Zuzana	39.82	37.60	43.30	43.30	731
6	GDR	Schulz, Ines	42.82	41.70	39.36	42.82	721
7	URS	Sablovskaite, Remiguiia	41.00	42.78	42.54	42.78	721
8	GDR	John, Sabine	41.60	41.52	42.56	42.56	716
9	AUS	Flemming, Jane	39.16	X	40.28	40.28	673
10	URS	Bouraga, Svetlana	39.06	X	38.18	39.06	649
11	CHN	Dong, Yuping	34.96	38.60	34.44	38.60	640
12	USA	Greiner, Cindy	37.70	38.00	37.22	38.00	629
13	HOL	Wijnsma, Marjon	X	37.86	X	37.86	626
14	BUL	Dimitrova, Svetla	37.62	35.14	33.90	37.62	622
	FRA	Beaugeant, Chantal	NS			NS	
	HOL	Hidding, Jantien	NS			NS	

**Women Heptathlon — 800m
Heat 1/Sept. 24****Femmes Heptathlon — 800m
Serie 1/24 Sept**

Rank Rang	Ctry Pays	Name Nom	Result Resultat	
1	FIN	Kytola, Ragne	2:13.35	916
2	BEL	Hautenaue, Jacqueline	2:13.90	908
3	TPE	Hsu, Hui-Ing	2:17.30	861
4	GBR	Mulliner, Joanne	2:18.02	851
5	GBR	Hagger, Kim	2:18.48	844
6	KOR	Ji, Jeong-Mi	2:19.17	835
7	BRA	Geremias, Conceicao	2:24.02	770
8	NGU	Launa, Iammogapi	2:43.43	534

**Women Heptathlon — 800m
Heat 2/Sept. 24****Femmes Heptathlon — 800m
Serie 2/24 Sept**

Rank Rang	Ctry Pays	Name Nom	Result Resultat	
1	HOL	Wijnsma, Marjon	2:11.49	943
2	URS	Bouraga, Svetlana	2:14.74	896
3	SUI	Schneider, Corinne	2:14.93	894
4	BUL	Dimitrova, Svetla	2:15.73	882
5	FIN	Ruotsalainen, Satu	2:17.06	864
6	FRG	Braun, Sabine	2:22.82	786
7	USA	Brown, Wendy	2:26.43	738
8	CHN	Dong, Yuping	2:26.67	735

Athletics

Athlétisme

Women Heptathlon — 800m Heat 3/Sept. 24

Rank Rang	Ctry Pays	Name Nom	Result Resultat	
1	GDR	Behmer, Anke	2:04.20	1051
2	GDR	Schulz, Ines	2:05.79	1027
3	GDR	John, Sabine	2:06.14	1022
4	URS	Choubenkova, Natalia	2:07.90	996
5	USA	Joyner-Kersey, Jackie	2:08.51	987
6	URS	Sablovskaite, Remiguiia	2:12.24	932
7	AUS	Flemming, Jane	2:12.54	928
8	USA	Greiner, Cindy	2:13.65	912
9	TCH	Lajbnerova, Zuzana	2:16.05	878

Women Heptathlon Sept. 23-24

Rank Rang	Ctry Pays	Name Nom	100H Long	High Javelin	Shot 800m	200m	Result Resultat	
1	USA	Joyner-Kersey, Jackie	12.69 1172 7.27 1264	1.86 1054 45.66 776	15.80 915 2:08.51 987	22.56 1123	7291	NWR
2	GDR	John, Sabine	12.85 1147 6.71 1076	1.80 978 42.56 716	16.23 943 2:06.14 1022	23.65 1015	6897	
3	GDR	Behmer, Anke	13.20 1094 6.68 1066	1.83 1016 44.54 755	14.20 807 2:04.20 1051	23.10 1069	6858	
4	URS	Choubenkova, Natalia	13.51 1049 6.32 949	1.74 903 47.46 811	14.76 845 2:07.90 996	23.93 987	6540	
5	URS	Sablovskaite, Remiguiia	13.61 1034 6.25 927	1.80 978 42.78 721	15.23 876 2:12.24 932	23.92 988	6456	
6	GDR	Schulz, Ines	13.75 1014 6.33 953	1.83 1016 42.82 721	13.50 761 2:05.79 1027	24.65 919	6411	
7	AUS	Flemming, Jane	13.38 1068 6.37 965	1.80 978 40.28 673	12.88 719 2:12.54 928	23.59 1020	6351	
8	USA	Greiner, Cindy	13.55 1043 6.47 997	1.80 978 38.00 629	14.13 803 2:13.65 912	24.48 935	6297	
9	TCH	Lajbnerova, Zuzana	13.63 1031 6.11 883	1.83 1016 43.30 731	14.28 813 2:16.05 878	24.86 900	6252	
10	URS	Bouraga, Svetlana	13.25 1087 6.28 937	1.77 941 39.06 649	12.62 702 2:14.74 896	23.59 1020	6232	
11	HOL	Wijnsma, Marjon	13.75 1014 6.34 956	1.86 1054 37.86 626	13.01 728 2:11.49 943	25.03 884	6205	
12	BUL	Dimitrova, Svetla	13.24 1089 6.19 908	1.80 978 37.62 622	12.02 662 2:15.73 882	23.49 1030	6171	
13	SUI	Schneider, Corinne	13.85 1000 6.05 865	1.86 1054 47.50 812	11.58 633 2:14.93 894	24.87 899	6157	
14	FRG	Braun, Sabine	13.71 1020 6.12 887	1.83 1016 44.58 755	13.16 738 2:22.82 786	24.78 907	6109	
15	FIN	Ruotsalainen, Satu	13.79 1008 6.08 874	1.80 978 45.44 772	12.32 682 2:17.06 864	24.61 923	6101	

Femmes Heptathlon — 800m Serie 3/24 Sept

Rank Rang	Ctry Pays	Name Nom	100H Long	High Javelin	Shot 800m	200m	Result Resultat
16	CHN	Dong, Yuping	13.93 988 6.40 975	1.86 1054 38.60 640	14.21 808 2:26.67 735	25.00 887	6087
17	GBR	Hagger, Kim	13.47 1055 6.34 956	1.80 978 35.78 587	12.75 711 2:18.48 844	25.47 844	5975
18	USA	Brown, Wendy	14.07 968 6.13 890	1.83 1016 44.34 751	12.69 707 2:26.43 738	24.83 902	5972
19	GBR	Mulliner, Joanne	14.39 924 6.10 880	1.71 867 37.76 624	12.68 706 2:18.02 851	24.92 894	5746
20	BEL	Hautenuave, Jacqueline	14.04 973 5.99 846	1.77 941 35.68 585	11.81 649 2:13.90 908	25.61 832	5734
21	FIN	Kytola, Ragne	14.31 935 5.75 774	1.77 941 39.48 657	11.66 639 2:13.35 916	25.69 824	5686
22	BRA	Geremias, Conceicao	14.23 946 5.50 700	1.71 867 39.64 660	12.95 724 2:24.02 770	25.50 841	5508
23	TPE	Hsu, Hui-Ing	14.85 862 5.47 691	1.68 830 39.14 651	10.00 529 2:17.30 861	25.23 866	5290
24	KOR	Ji, Jeong-Mi	14.53 905 5.50 700	1.71 867 39.26 653	10.83 584 2:19.17 835	26.61 745	5289
25	NGU	Launa, Iammogapi	16.42 664 4.88 527	1.50 621 46.38 790	11.78 647 2:43.43 534	26.16 783	4566
26	FIJ	Tukana, Sainiana	15.60 764 5.12 592		08.61 439	26.37 765	2560
27	FRG	Everts, Sabine	13.74 1015	1.71 867	11.54 631		2513
28	FRA	Beaugeant, Chantal	16.76 624	1.80 978	12.79 713		2315
29	GBR	Simpson, Judy	13.78 1010	1.77 941			1951
	ALG	Azzizi, Yasmina					NS
	HOL	Hidding, Jantien					NS
	LIE	Hasler, Yvonne					NS



농구

Basketball/Basket-ball



Basketball/Basket-ball

Officials/Officiels

Fédération Internationale de Basket-ball Amateur (F.I.B.A.)

President/président	Robert Busnel
Secretary General/secrétaire général	Borislav Stankovic
Technical Delegates/délégués techniques	David Turner

SLOOC Administrative Staff/Personnel Administratif du SLOOC

Commissioner/directeur	Kim Sang Ha
Secretary General/secrétaire général	Byun Seung Mok
Deputy Secretary General/secrétaire général adjoint	Park Shin Ja
Competition Manager/chef de division des compétitions	Kim In Keon

Competitors/Concurrents

Men Hommes	Competitors Competiteurs	Countries pays
	144	12
Women Femmes	Competitors Competiteurs	Countries Pays
	96	8

Legend/Notation

*	Starter/Partant
+	Substitution-In/Remplacant-Terrain
T.P.G.	Three Point goal/Panier a Trois Points
F.G.	Field Goal/Panier Reussi du Terrain
FT	Free Throw/Lancer Franc
M	Made/Reussite
A	Attempted/Tentative
PTS	Points
Foul	Foul/Faute
REBND	Rebound (O; Offense, D; Defense)
RECS	Recoveries (STL+x+GDD)
X	Recovery (Loose ball, Jump ball, etc)
AST	Assist
STL	Steal, Interception
FB	Fast Break/Contre-Attaques
VIO	Violation
LST	Lost Ball/Ballon Perdu
BLK	Block a Shot/Bloc un Tir
GDD	Good Defence/Bonne Defense
TIME	Played Time/Temps Joues
Turns	Turnovers (VIO+LST+Held Ball)



Basketball

Men Preliminary Pool Group A Match 1/Sept. 18											Hommes Poule Preliminaire Groupe A Match 1/18 Sept										
No.	Name	<T.P.G> MA	<F.G> MA	<F.T> MA	Pts	Foul	Rebnd O / D	X	AST	STL	VIO	LST	BLK	GDD	<Time> Min Sec						
AUS 81-77 PUR (50-36,31-41)																					
AUS																					
04	Pearce, Darryl	0/0	0/0	0/0	0	0	0	0	0	0	0	0	0	0	0:00						
05	Sibley, Robert	0/0	0/0	0/0	0	0	0	0	0	0	0	0	0	0	0:00						
06	Smyth, Philip	1/5	1/4	4/4	9	3	0	4	0	2	2	0	1	0	39:54						
07	Sengstock, Larry	1/1	3/4	0/0	9	5	1	3	0	3	1	0	3	0	23:39						
08	Keogh, Damian	0/0	0/0	0/0	0	1	0	0	0	1	0	0	1	0	8:41						
09	Carroll, Wayne	2/6	2/5	3/7	13	1	1	1	0	3	4	1	1	0	36:23						
10	Longley, Lucien	0/0	3/4	0/0	6	4	1	5	0	1	1	0	2	1	17:18						
11	Gaze, Andrew	5/9	7/14	4/9	33	1	1	1	1	1	4	1	0	0	35:02						
12	Bradtko, Mark	0/0	2/2	1/1	5	4	0	1	0	0	0	0	2	3	15:10						
13	Dalton, Bradley	0/0	0/0	0/0	0	0	0	0	0	0	0	0	0	0	0:00						
14	Vlahov, Andrew	0/0	0/0	0/0	0	0	0	0	0	0	0	0	0	0	0:00						
15	Borner, Raymond	0/0	3/6	0/2	6	3	3	1	2	0	4	1	2	0	23:53						
Total		9/21	21/39	12/23	81	22	7	16	3	11	16	3	12	4	200:00						

PUR															
No.	Name	<T.P.G> MA	<F.G> MA	<F.T> MA	Pts	Foul	Rebnd O / D	X	AST	STL	VIO	LST	BLK	GDD	<Time> Min Sec
04	Ortiz Rijos, J	0/0	8/13	2/4	18	4	1	1	3	2	0	0	4	0	28:10
05	Lopez, Federico	0/0	0/1	2/3	2	1	0	1	0	1	0	0	0	0	20:23
06	Gause, Raymond	0/0	0/2	0/0	0	2	0	0	0	0	0	0	1	0	5:52
07	Ithier, Vicente	0/0	2/4	0/0	4	2	1	1	2	1	1	0	1	1	22:22
08	Mincy, Jerome	0/0	7/10	3/4	17	3	2	6	0	0	2	1	2	0	22:37
09	Riocos, Roberto	0/0	0/0	0/0	0	0	0	0	0	0	0	0	0	0	2:14
10	Cruz, Angel	1/3	4/4	1/2	12	2	0	1	0	0	0	0	3	0	32:40
11	Rivas, Ramon	0/0	0/0	0/1	0	1	0	1	0	0	0	0	1	0	4:43
12	Morales, Mario	1/2	5/9	0/0	13	3	4	3	1	0	1	0	0	0	34:08
13	Leon, Edgar	0/0	0/1	0/0	0	0	0	1	0	0	0	0	0	0	5:00
14	Leon, Francisco	0/0	0/1	0/0	0	0	1	0	0	0	0	0	0	0	2:21
15	Ramos, Ramon	0/0	4/6	3/3	11	2	0	4	1	0	0	0	2	2	19:30
Total		2/5	30/51	11/17	77	20	9	19	7	4	4	1	14	3	200:00

<Team Statistics/Statistiques de l'Equipe>

Teams	T.P	Goals	FLD	Goals	FR.	Throws	Fouls	Rebs	Recs	Assts	Blks	Turns	FB	Efficiency	
AUS	9/21	43%	21/39	54%	12/23	52%	22	23	26	11	4	16	1/1		
PUR	2/5	40%	30/51	59%	11/17	65%	20	28	22	4	3	15	0/0		
Referee/Arbitre		GRE		DOUVIS, STAVROS											
Umpire/Arb. Adjoint		POL		ZYCH, WIESLAW											

Men Preliminary Pool Group A Match 2/Sept. 18																Hommes Poule Preliminaire Groupe A Match 2/18 Sept															
No.	Name	<T.P.G> MA	<F.G> MA	<F.T> MA	Pts	Foul	Rebnd O / D	X	AST	STL	VIO	LST	BLK	GDD	<Time> Min Sec																
CAF 73-70 KOR (47-30,26-40)																															
CAF																															
04	Oumarou Sanda B	2/3	1/2	1/3	9	0	0	1	0	0	1	1	0	0	23:14																
05	Goporo, A	0/0	0/0	0/0	0	0	0	0	0	0	0	0	0	0	2:04																
06	Ouagon, J	0/0	0/0	0/0	0	0	0	0	0	0	0	0	0	0	0:00																
07	Kongaouin, B	0/1	2/5	1/1	5	3	5	3	1	0	1	0	4	0	21:50																
08	Pehoua-Pelema, E	0/0	1/2	0/0	2	1	0	0	0	1	2	0	0	0	17:40																
09	Mbongo, Guy	0/0	0/0	0/0	0	0	0	0	0	0	0	0	0	0	0:00																
10	Goporo, F	2/4	2/5	5/7	15	4	1	1	0	1	3	0	1	1	37:56																
11	Kotta, J	1/4	1/5	4/4	9	1	0	2	0	0	1	0	0	0	20:38																
12	Gombe, Christian	0/0	2/4	0/0	4	0	1	1	1	1	0	0	0	0	7:46																
13	Lavodrama, A	0/1	8/15	5/8	21	3	4	7	2	3	0	1	4	2	40:00																
14	Bella, R	0/0	0/3	2/4	2	1	1	4	1	0	1	0	2	1	17:38																
15	Naoueyama, F	0/0	2/3	2/2	6	1	3	5	0	0	0	0	0	0	11:14																
Total		5/13	19/44	20/29	73	14	15	24	5	6	9	2	11	4	200:00																

KOR															
No.	Name	<T.P.G> MA	<F.G> MA	<F.T> MA	Pts	Foul	Rebnd O / D	X	AST	STL	VIO	LST	BLK	GDD	<Time> Min Sec
04	Lee, Won-Woo	1/3	0/0	2/2	5	1	1	0	0	0	0	0	0	0	7:55
05	Choi, Chul-Kwon	0/0	0/0	0/0	0	0	0	0	0	0	0	0	0	0	0:00
06	Lee, Choong-Hee	1/9	4/8	1/1	12	1	2	0	0	1	1	0	0	0	20:00
07	Oh, Seh-Woong	0/0	0/0	0/0	0	0	0	0	0	0	0	0	0	0	0:00
08	Yoo, Jae-Hak	0/0	0/1	0/0	0	2	0	0	0	0	0	0	0	0	4:00
09	Lee, Moon-Kyu	1/3	1/3	0/0	5	4	3	6	0	0	1	0	1	0	36:00
10	Kim, Hyun-Jun	6/13	6/12	0/0	30	3	0	0	1	2	1	0	0	0	36:20
11	Hur, Jae	2/8	1/6	1/4	9	4	3	3	2	0	3	1	0	0	35:45
12	Kim, Yoon-Ho	0/0	0/1	0/0	0	0	0	1	0	0	0	0	0	0	6:54
13	Park, Jong-Chun	0/0	0/0	0/0	0	0	0	0	0	0	0	0	0	0	3:33
14	Kim, You-Taek	0/1	2/3	0/0	4	5	1	2	2	1	2	0	1	0	22:29
15	Han, Ki-Bum	0/0	1/4	3/4	5	5	3	4	2	0	1	0	0	0	27:04
Total		11/37	15/38	7/11	70	25	13	16	7	4	9	1	2	0	200:00

<Team Statistics/Statistiques de l'Equipe>

Teams	T.P	Goals	FLD	Goals	FR.	Throws	Fouls	Rebs	Recs	Assts	Blks	Turns	FB	Efficiency	
CAF	5/13	38%	19/44	43%	20/29	69%	14	39	17	6	4	14	3/6		
KOR	11/37	30%	15/38	39%	7/11	64%	25	29	21	4	0	3	0/0		
Referee/Arbitre		TCH		KOTLEBA, LUBOMIR											
Umpire/Arb. Adjoint		ARG		RUBINSZTEIN, JORGE A.											

Basket-ball

Men Preliminary Pool Group A Match 3/Sept. 18																Hommes Poule Preliminaire Groupe A Match 3/18 Sept															
No.	Name	<T.P.G> MA	<F.G> MA	<F.T> MA	Pts	Foul	Rebnd O / D	X	AST	STL	VIO	LST	BLK	GDD	<Time> Min Sec																
URS 79-92 YUG (33-39,46-53)																															
URS																															
04	Volkov, A	0/0	1/3	0/2	2	5	0	0	1	0	0	1	0	0	12:31																
05	Sokk, Tiit	2/2	3/4	8/11	20	0	0	1	1	2	1	1	0	0	31:04																
06	Tarkanov, S	0/0	3/8	1/2	7	1	0	0	0	0	0	0	0	0	12:45																
07	Martchioulenis	0/2	8/11	4/5	20	4	1	2	1	1	0	0	1	0	35:38																
08	Migliniex, Igor	0/0	0/0	0/0	0	C	1	0	0	0	0	0	0	0	0:00																
09	Tikhonenko, V	0/0	1/3	0/0	2	2	0	2	0	0	0	0	1	0	11:32																
10	Kourtinaitis, R	0/2	1/6	2/3	4	3	1	3	2	1	0	1	0	1	21:47																
11	Saboris, A	0/0	4/9	3/5	11	3	1	3	1	2	1	0	2	1	25:46																
12	Pankrachkine, V	0/0	0/0	0/0	0	0	0	0	0	0	0	0	0	0	0:00																
13	Khomitchious, V	1/5	1/4	2/2	7	4	1	0	1	0	0	0	1	0	26:13																
14	Belostennyi, A	0/0	1/3	0/0	2	1	3	3	1	0	0	0	0	0	11:46																
15	Goborov, Valeri	0/0	2/2	0/0	4	2	1	1	1	0	0	0	0	1	10:58																
Total		3/11	25/53	20/30	79	25	9	15	9	6	2	2	6	3	200:00																

YUG															
No.	Name	<T.P.G> MA	<F.G> MA	<F.T> MA	Pts	Foul	Rebnd O / D	X	AST	STL	VIO	LST	BLK	GDD	<Time> Min Sec
04	Petrovic, Drazen	3/7	3/8	10/11	25	3	0	2	1	1	0	0	3	0	35:31
05	Radulovic, Z	0/1	0/1	0/0	0	1	0	0	1	0	0	0	0	0	8:27
06	Cutura, Zoran	0/0	0/2	0/0	0	0	0	2	0	0	0	0	1	0	4:38
07	Kukoc, Toni	2/3	3/6	1/2	13	3	2	7	0	0	1	0	1	1	28:24
08	Paspalj, Zarko	1/1	6/12	5/6	20	5	6	5	0	1	0	1	2	1	35:46
09	Obradovic, Z	2/2	4/4	0/0	14	2	0	1	1	1	0				



Men Preliminary Pool Group A Match 5/Sept. 20 **Hommes** Poule Preliminaire Groupe A Match 5/20 Sept

No.	Name	<T.P.G> <F.G> <F.T>			Pts	Foul	Rebnd			AST	STL	VIO	LST	BLK	GDD	<Time> Min Sec
		MA	MA	MA			O	D	X							
CAF 61-102 YUG (21-51,40-51)																
04	Oumarou Sanda B	1/2	0/5	1/5	4	1	0	1	0	2	0	0	1	0	1	17:35
05	Goporo, A	0/0	0/0	0/0	0	0	0	0	0	0	0	0	0	0	0	7:46
06	Quagon, J	0/0	0/0	0/0	0	0	0	0	0	0	0	0	0	0	0	0:00
07	Kongaouin, B	0/0	0/0	0/0	0	0	0	0	0	0	0	0	0	0	0	0:00
08	Pehoua-Pelema, E	0/0	0/2	0/0	0	1	0	0	0	0	0	0	0	0	0	7:06
09	M'bongo, Guy	0/0	0/2	0/0	0	0	0	2	2	0	0	0	1	0	0	15:50
10	Goporo, F	2/7	3/7	1/3	13	4	0	2	2	5	2	0	3	0	0	32:14
11	Kotta, J	0/2	0/1	0/0	0	1	0	0	0	0	0	1	1	0	0	9:43
12	Gombe, Christian	0/0	3/5	0/0	6	4	3	0	1	0	1	0	0	0	1	18:34
13	Lavodrama, A	0/2	11/21	8/20	30	2	7	6	2	2	1	0	4	4	1	40:00
14	Bella, R	0/0	3/8	0/0	6	4	2	1	4	0	0	0	1	1	1	33:37
15	Naoueyama, F	0/0	1/2	0/0	2	2	0	1	0	0	0	0	0	1	1	17:35
Total		3/13	21/53	10/28	61	19	12	13	11	9	4	1	11	6	5	200:00

No.	Name	<T.P.G> <F.G> <F.T>			Pts	Foul	Rebnd			AST	STL	VIO	LST	BLK	GDD	<Time> Min Sec
		MA	MA	MA			O	D	X							
YUG																
04	Petrovic, Drazen	1/2	6/10	2/2	17	1	0	1	0	4	1	0	1	1	0	20:00
05	Radulovic, Z	1/3	2/3	0/0	7	4	0	1	0	1	0	1	0	0	0	18:50
06	Cutura, Zoran	0/0	3/7	4/4	10	4	2	7	0	2	0	0	0	0	2	20:00
07	Kukoc, Toni	0/0	0/0	0/0	0	0	0	0	0	0	0	0	0	0	0	0:00
08	Paspalj, Zarko	0/0	3/4	6/7	12	3	3	2	0	2	0	2	1	0	0	13:58
09	Obradovic, Z	2/3	2/2	0/1	10	0	0	0	0	1	1	0	0	0	0	17:42
10	Zdovc, Jurij	2/2	2/2	0/0	10	1	1	0	0	0	2	0	0	1	1	20:00
11	Vrankovic, S	0/0	6/7	0/1	12	1	0	7	1	2	0	2	0	5	1	20:00
12	Divac, Vlade	0/0	3/7	4/4	10	1	0	4	1	0	1	0	0	0	0	14:19
13	Arapovic, Franjo	0/0	1/2	0/0	2	5	1	4	0	0	0	0	0	0	0	9:31
14	Radja, Dino	0/0	0/1	5/6	5	3	1	2	0	1	0	0	3	0	0	16:10
15	Cvjeticanin, D	1/2	1/8	2/2	7	0	1	2	0	2	1	0	0	0	0	29:30
Total		7/12	29/53	23/27	102	23	9	30	2	15	6	5	5	7	4	200:00

<Team Statistics/Statistiques de l'Equipe>

Teams	T.P	Goals	FLD	Goals	FR.	Throws	Fouls	Rebs	Recs	Assts	Blks	Turns	FB Efficiency
CAF	3/13	23%	21/53	40%	10/28	36%	19	25	20	9	6	12	1/1
YUG	7/12	58%	29/53	55%	23/27	85%	23	39	12	15	7	10	3/3

Referee/Arbitre BRA AFFINI, ANTONIO CARLOS
 Umpire/Arb. Adjoint CHN ZHU, JIA ZHONG

Men Preliminary Pool Group A Match 6/Sept. 20 **Hommes** Poule Preliminaire Groupe A Match 6/20 Sept

No.	Name	<T.P.G> <F.G> <F.T>			Pts	Foul	Rebnd			AST	STL	VIO	LST	BLK	GDD	<Time> Min Sec
		MA	MA	MA			O	D	X							
AUS 69-91 URS (35-53,34-38)																
04	Pearce, Darryl	0/3	0/2	0/0	0	2	0	1	0	0	1	0	1	0	2	11:49
05	Sibley, Robert	0/0	0/0	0/0	0	0	0	0	0	0	0	0	0	0	0	0:00
06	Smyth, Philip	1/3	1/4	0/0	5	2	0	2	0	1	1	0	2	0	1	27:39
07	Sengstock, Larry	0/0	2/3	1/3	5	0	3	4	0	0	0	0	1	0	0	18:28
08	Keogh, Damian	0/1	6/8	3/5	15	1	0	1	0	0	2	0	0	0	0	23:34
09	Carroll, Wayne	2/5	0/2	2/2	8	3	0	0	0	0	1	0	1	0	2	17:32
10	Longley, Lucien	0/0	3/6	2/3	8	5	1	2	0	3	1	0	1	0	1	14:00
11	Gaze, Andrew	0/1	4/6	1/2	9	4	2	3	1	1	0	1	3	0	0	23:32
12	Bradke, Mark	0/0	3/5	0/0	6	2	0	3	0	0	1	0	2	2	1	18:24
13	Dalton, Bradley	0/0	2/4	0/1	4	2	1	4	0	0	0	0	1	0	0	12:07
14	Vlahov, Andrew	1/2	0/3	2/2	5	3	0	2	0	0	0	0	1	0	2	13:04
15	Borner, Raymond	0/1	2/8	0/1	4	3	1	5	2	1	1	0	4	0	1	19:51
Total		4/16	23/51	11/19	69	27	8	27	3	6	8	1	17	2	10	200:00

No.	Name	<T.P.G> <F.G> <F.T>			Pts	Foul	Rebnd			AST	STL	VIO	LST	BLK	GDD	<Time> Min Sec
		MA	MA	MA			O	D	X							
URS																
04	Volkov, A	0/0	6/10	4/4	16	5	2	2	2	1	1	0	2	0	1	23:25
05	Sokk, Tiit	0/0	0/1	0/0	0	4	1	0	1	3	1	0	1	0	1	21:57
06	Tarakanov, S	0/0	0/1	2/2	2	1	0	0	1	1	0	0	3	0	0	11:13
07	Martchioulenis	0/0	3/5	2/3	8	3	0	0	1	1	1	0	1	0	0	20:31
08	Migliniex, Igor	0/0	0/1	0/1	0	1	0	2	1	2	0	1	2	0	0	11:52
09	Tikhonenko, V	2/2	4/5	0/0	14	1	1	4	1	0	2	0	1	0	0	15:51
10	Kourtinaitis, R	5/5	2/3	2/2	21	2	0	3	1	2	0	0	3	0	2	19:53
11	Sabonis, A	0/0	8/22	1/4	17	2	6	14	0	4	2	1	3	2	2	28:48
12	Pankrachkine, V	0/0	1/3	0/0	2	0	0	3	0	0	1	0	0	1	0	10:52
13	Khomitchious, V	1/2	1/3	6/2	0	0	3	1	0	0	0	0	0	1	0	18:43
14	Belostennyi, A	0/0	0/1	2/2	2	2	0	0	0	0	0	0	0	0	0	8:51
15	Goborov, Valeri	0/0	1/2	1/1	3	2	2	1	0	1	0	0	1	1	1	8:04
Total		8/9	26/56	15/22	91	25	12	32	9	15	8	2	17	5	7	200:00

<Team Statistics/Statistiques de l'Equipe>

Teams	T.P	Goals	FLD	Goals	FR.	Throws	Fouls	Rebs	Recs	Assts	Blks	Turns	FB Efficiency
AUS	4/16	25%	23/51	45%	11/19	58%	27	35	21	6	2	18	0/0
URS	8/9	89%	26/56	46%	15/22	68%	25	44	24	15	5	19	2/2

Referee/Arbitre CAN STEEVES, RICHARD
 Umpire/Arb. Adjoint ESP ROSIQUE, VICENTE SANCHIS

Men Preliminary Pool Group A Match 7/Sept. 21 **Hommes** Poule Preliminaire Groupe A Match 7/21 Sept

No.	Name	<T.P.G> <F.G> <F.T>			Pts	Foul	Rebnd			AST	STL	VIO	LST	BLK	GDD	<Time> Min Sec
		MA	MA	MA			O	D	X							
KOR 92-104 YUG (46-48,46-56)																
KOR																
04	Lee, Won-Woo	1/2	0/0	0/0	3	4	0	0	0	0	0	0	1	0	0	13:26
05	Choi, Chul-Kwon	0/0	0/0	0/0	0	0	0	0	0	0	0	0	0	0	0	0:00
06	Lee, Choong-Hee	4/8	12/19	2/2	38	2	0	1	0	2	0	0	0	0	0	40:00
07	Oh, Seh-Woong	0/0	0/0	0/0	0	0	0	0	0	0	0	0	0	0	0	0:00
08	Yoo, Jae-Hak	0/0	0/0	0/0	0	0	0	0	0	0	0	0	0	0	0	0:00
09	Lee, Moon-Kyu	0/1	2/6	0/0	4	5	4	1	1	1	1	0	0	0	1	31:18
10	Kim, Hyun-Jun	2/6	4/10	0/0	14	2	0	0	1	2	0	0	2	0	1	31:43
11	Hur, Jae	4/5	3/4	5/5	23	5	0	0	0	2	7	0	2	0	1	34:51
12	Kim, Yoon-Ho	0/0	0/0	0/0	0	0	0	0	1	0	0	0	0	0	1	8:42
13	Park, Jong-Chun	0/0	0/0	0/0	0	0	0	0	0	0	0	0	0	0	0	0:00
14	Kim, You-Taek	0/0	3/8	4/4	10	4	4	3	1	1	0	0	2	1	2	33:58
15	Han, Ki-Bum	0/0	0/1	0/0	0	0	0	0	1	0	0	0	1	0	1	6:02
Total		11/22	24/48	11/11	92	22	8	5	5	8	7	0	8	1	7	200:00

Basketball

Men		Hommes																
Preliminary Pool Group A Match 9/Sept. 21		Poile Preliminaire Groupe A Match 9/21 Sept																
No.	Name	<T.P.G>	<F.G>	<F.T>	Pts	Foul	Rebnd				<Time>							
		MA	MA	MA		O	D	X	AST	STL	VIO	LST	BLK	GDD	Min	Sec		
AUS		106-67	CAF	(57-35,49-32)														
04	Pearce, Darryl	1/2	0/1	3/4	6	1	0	1	0	2	0	0	0	0	0	6:45		
05	Sibley, Robert	0/0	0/0	0/0	0	0	0	0	0	0	0	0	0	0	0:00			
06	Smyth, Philip	6/8	3/4	0/0	24	2	1	1	1	0	1	0	1	0	31:50			
07	Sengstock, Larry	0/1	2/4	0/0	4	4	0	6	1	1	1	0	1	0	21:51			
08	Keogh, Damian	1/1	2/4	0/1	7	3	1	2	0	3	0	0	4	0	21:16			
09	Carroll, Wayne	0/3	5/8	0/0	10	0	1	2	0	1	1	0	2	0	20:09			
10	Longley, Lucien	0/0	2/4	5/6	9	1	2	6	0	0	0	0	0	4	13:40			
11	Gaze, Andrew	4/9	5/8	3/3	25	2	1	3	0	1	0	0	2	0	30:29			
12	Bradtke, Mark	0/0	4/5	0/0	8	1	2	2	0	0	1	0	3	0	9:36			
13	Dalton, Bradley	0/0	1/1	0/0	2	4	1	2	0	0	0	0	0	0	14:36			
14	Vlahov, Andrew	1/1	2/4	0/0	7	0	0	3	0	0	1	0	1	0	9:31			
15	Borner, Raymond	0/0	2/4	0/0	4	2	2	4	2	1	1	0	1	0	20:17			
Total		13/25	28/47	11/14	106	20	11	32	4	9	6	0	15	4	4	200:00		

Men		Hommes														
Preliminary Pool Group A Match 10/Sept. 23		Poile Preliminaire Groupe A Match 10/23 Sept														
No.	Name	<T.P.G>	<F.G>	<F.T>	Pts	Foul	Rebnd				<Time>					
		MA	MA	MA		O	D	X	AST	STL	VIO	LST	BLK	GDD	Min	Sec
CAF		18/49	16/27	67/79	67	19	11	18	8	5	5	1	12	5	8	200:00
04	Oumarou Sanda B	1/8	3/6	2/2	11	0	0	0	1	0	0	0	2	0	2	21:24
05	Goporo, A	0/0	0/0	0/0	0	2	0	0	0	0	0	0	2	0	0	2:40
06	Ouagon, J	0/0	0/0	0/0	0	0	0	0	0	0	0	0	0	0	0	3:35
07	Kongaouin, B	0/1	0/1	0/0	0	0	1	1	0	0	0	0	0	0	0	8:37
08	Pehoua-Pelema, E	0/0	0/0	0/0	0	1	0	0	1	0	0	1	1	0	0	3:30
09	M'bongo, Guy	0/0	0/0	0/0	0	0	0	0	0	0	0	0	0	0	0	2:36
10	Goporo, F	3/7	3/11	0/0	15	3	0	5	3	1	0	0	2	0	1	37:20
11	Kotta, J	1/3	0/2	0/0	3	2	0	0	1	1	1	0	0	1	1	13:34
12	Gombe, Christian	0/0	1/5	0/0	2	2	1	3	0	0	3	0	2	0	3	23:51
13	Lavodrama, A	0/0	8/12	14/23	30	3	3	6	0	3	1	0	2	3	1	40:00
14	Bella, R	0/0	1/3	0/2	2	2	4	3	2	0	0	0	0	0	0	28:31
15	Naoueyama, F	0/0	2/9	0/0	4	4	2	0	0	0	0	0	1	1	0	14:22
Total		5/19	18/49	16/27	67	19	11	18	8	5	5	1	12	5	8	200:00

<Team Statistics/Statistiques de l'Equipe>

Teams	T.P	Goals	FLD	Goals	FR.	Throws	Fouls	Rebs	Recs	Assts	Blks	Turns	FB Efficiency
AUS	13/25	52%	28/47	60%	11/14	79%	20	43	14	9	4	15	0/0
CAF	5/19	26%	18/49	37%	16/27	59%	19	29	21	5	5	13	0/0

Referee/Arbitre USA FORTE, JOSEPH PATRICK
 Umpire/Arb. Adjoint CHN FANG, LIJIAN

Men		Hommes																
Preliminary Pool Group A Match 10/Sept. 23		Poile Preliminaire Groupe A Match 10/23 Sept																
No.	Name	<T.P.G>	<F.G>	<F.T>	Pts	Foul	Rebnd				<Time>							
		MA	MA	MA		O	D	X	AST	STL	VIO	LST	BLK	GDD	Min	Sec		
CAF		67-71	PUR	(41-37,26-34)														
04	Oumarou Sanda B	1/5	0/2	1/2	4	2	2	2	1	2	0	1	3	0	1	27:19		
05	Goporo, A	1/1	0/2	0/0	3	3	0	0	2	0	0	0	1	0	2	10:06		
08	Pehoua-Pelema, E	0/0	0/0	0/0	0	4	0	1	0	2	3	0	2	0	0	10:24		
09	M'bongo, Guy	0/0	0/0	0/0	0	0	0	0	0	0	0	0	0	0	0	3:09		
10	Goporo, F	2/5	3/8	5/11	17	3	1	1	0	1	1	0	0	0	2	29:54		
11	Kotta, J	1/6	2/5	1/2	8	3	1	0	0	3	0	1	0	0	0	18:26		
12	Gombe, Christian	0/0	0/1	1/2	1	0	0	2	0	0	1	0	0	0	1	14:53		
13	Lavodrama, A	0/1	6/11	4/7	16	5	0	5	0	2	1	2	0	0	3	23:35		
14	Bella, R	0/0	3/6	1/2	7	4	3	5	2	0	0	0	2	1	1	35:37		
15	Naoueyama, F	0/0	4/11	3/6	11	5	4	5	0	0	1	2	0	0	2	24:56		
Total		5/18	18/48	16/32	67	30	11	21	6	7	10	5	9	1	12	200:00		

Men		Hommes																
Preliminary Pool Group A Match 12/Sept. 23		Poile Preliminaire Groupe A Match 12/23 Sept																
No.	Name	<T.P.G>	<F.G>	<F.T>	Pts	Foul	Rebnd				<Time>							
		MA	MA	MA		O	D	X	AST	STL	VIO	LST	BLK	GDD	Min	Sec		
AUS		78-98	YUG	(43-52,35-46)														
04	Pearce, Darryl	3/5	0/0	0/0	9	0	0	0	1	0	0	0	1	0	0	12:01		
05	Sibley, Robert	0/0	0/0	0/0	0	0	0	0	0	0	0	0	0	0	0	0:00		
08	Keogh, Damian	0/1	1/5	2/2	4	3	0	2	0	2	0	1	0	1	0	21:04		
09	Carroll, Wayne	0/1	3/4	2/2	8	1	0	0	1	0	0	0	1	0	1	18:56		
10	Longley, Lucien	0/0	1/1	0/0	2	3	1	2	1	0	0	0	4	1	0	12:49		
11	Gaze, Andrew	4/6	4/7	5/6	25	2	2	3	0	0	1	0	1	0	0	27:24		
12	Bradtke, Mark	0/0	2/3	0/0	4	1	0	1	0	0	1	0	0	1	1	18:01		
13	Dalton, Bradley	0/1	0/1	4/4	4	3	0	2	0	0	0	0	1	0	1	10:09		
14	Vlahov, Andrew	0/0	1/3	2/4	4	0	0	2	1	0	0	0	1	0	1	12:36		
15	Borner, Raymond	0/0	2/4	2/2	6	0	0	3	2	0	0	0	0	0	0	17:02		
Total		9/22	17/34	17/22	78	17	5	18	6	9	3	1	11	2	6	200:00		

<Team Statistics/Statistiques de l'Equipe>

Teams	T.P	Goals	FLD	Goals	FR.	Throws	Fouls	Rebs	Recs	Assts	Blks	Turns	FB Efficiency
CAF	5/18	28%	18/48	38%	16/32	50%	30	32	28	7	1	15	1/2
PUR	5/17	29%	16/35	46%	24/35	69%	28	27	27	16	5	23	1/1

Referee/Arbitre ITA DURANTI, BRUNO
 Umpire/Arb. Adjoint EGY SEOUD, YEHIAABOUEL

Basket-ball

Men		Hommes																
Preliminary Pool Group A Match 11/Sept. 23		Poile Preliminaire Groupe A Match 11/23 Sept																
No.	Name	<T.P.G>	<F.G>	<F.T>	Pts	Foul	Rebnd				<Time>							
		MA	MA	MA		O	D	X	AST	STL	VIO	LST	BLK	GDD	Min	Sec		
KOR		73-110	URS	(38-59,35-51)														
04	Lee, Won-Woo	0/0	0/1	0/0	0	1	0	0	0	0	0	0	0	0	1	7:47		
05	Choi, Chul-Kwon	0/0	0/0	0/0	0	0	0	0	0	0	0	0	0	0	0	0:00		
06	Lee, Choong-Hee	2/2	2/10	4/4	14	0	0	1	1	0	1	1	0	1	1	27:42		
07	Oh, Seh-Woong	1/3	1/3	2/2	7	1	1	0	0	0	2	0	3	0	1	18:56		
08	Yoo, Jae-Hak	2/4	1/1	0/0	8	2	0	0	0	0	1	0	1	0	0	10:45		
09	Lee, Moon-Kyu	0/0	2/2	0/0	4	3	2	3	0	0	1	2	0	0	3	25:39		
10	Kim, Hyun-Jun	2/8	6/9	0/0	18	0	0	0	0	2	0	0	0	0	0	22:29		
11	Hur, Jae	1/5	3/6	1/3	10	2	1	0	1	2	3	0	1	0	1	30:29		
12	Kim, Yoon-Ho	0/0	0/1	0/0	0	1	0	0	0	1	1	0	3	0	0	14:21		
13	Park, Jong-Chun	0/0	0/0	0/0	0	0	0	0	0	0	0	0	0	0	0	0:00		
14	Kim, You-Taek	0/0	2/4	2/2	6	4	3	7	1	0	1	2	3	0	0	22:43		
15	Han, Ki-Bum	0/0	3/5	0/0	6	5	0	3	2	0	0	0	1	0	0	17:17		
Total		8/22	20/42	9/11	73	19	7	14	5	5	10	5	13	0	6	200:00		

Men		Hommes														
Preliminary Pool Group A Match 11/Sept. 23		Poile Preliminaire Groupe A Match 11/23 Sept														
No.	Name	<T.P.G>	<F.G>	<F.T>	Pts	Foul	Rebnd				<Time>					
		MA	MA	MA		O	D	X	AST	STL	VIO	LST	BLK	GDD	Min	Sec
URS		40/60	15/18	110/122	110	12	15	26	9	17	10	1	14	4	7	200:00
04	Volkov, A	0/0	3/7	0/0	6	0										



Men		Hommes															
Preliminary Pool Group A Match 13/Sept. 24		Poule Preliminaire Groupe A Match 13/24 Sept															
No.	Name	<T.P.G>	<F.G>	<F.T>	Pts	Foul	Rebnd			AST	STL	VIO	LST	BLK	GDD	<Time>	
		MA	MA	MA			O	D	X							Min Sec	
		AUS	95-75	KOR	(51-39,44-36)												
AUS																	
04	Pearce, Darryl	1/1	0/0	0/0	3	0	0	0	0	0	0	0	0	0	0	3:10	
05	Sibley, Robert	0/0	0/0	0/0	0	0	0	0	0	0	0	0	0	0	0	0:00	
06	Smyth, Philip	2/5	2/5	0/0	10	2	0	2	3	1	0	0	0	0	0	38:36	
07	Sengstock, Larry	0/1	3/4	2/2	8	1	3	7	0	4	0	0	2	1	1	26:49	
08	Keogh, Damian	1/1	4/7	0/1	11	1	0	1	0	2	1	1	1	0	0	22:15	
09	Carroll, Wayne	0/1	3/5	0/0	6	1	2	1	0	2	1	0	2	0	1	19:09	
10	Longley, Lucien	0/0	0/0	0/0	0	0	0	0	0	0	0	0	0	0	0	0:00	
11	Gaze, Andrew	4/9	5/8	5/6	27	1	4	2	0	1	0	0	2	0	0	36:50	
12	Bradtko, Mark	0/0	1/2	0/0	2	1	1	1	0	0	1	0	1	0	0	8:36	
13	Dalton, Bradley	0/0	0/0	0/0	0	0	0	0	0	0	0	0	0	0	0	0:00	
14	Vlahov, Andrew	0/0	4/5	1/3	9	2	3	5	0	0	0	0	0	0	1	15:52	
15	Bomer, Raymond	0/0	8/11	3/3	19	1	4	2	2	1	1	0	1	0	0	28:43	
Total		8/18	30/47	11/15	95	10	17	21	5	11	4	1	9	1	3	200:00	

KOR																
04	Lee, Won-Woo	1/6	3/5	2/2	11	4	2	0	2	1	1	0	1	0	1	25:56
05	Choi, Chul-Kwon	0/0	0/0	0/0	0	0	0	0	0	0	0	0	0	0	0	0:00
06	Lee, Choong-Hee	0/3	10/13	2/2	22	2	0	0	1	1	0	0	1	0	0	33:23
07	Oh, Seh-Woong	0/0	0/1	0/0	0	0	0	0	0	0	0	0	0	0	0	2:41
08	Yoo, Jae-Hak	0/0	0/0	0/0	0	0	0	0	0	0	0	0	0	0	0	0:00
09	Lee, Moon-Kyu	0/2	1/1	0/0	2	2	0	4	0	1	0	0	1	0	2	27:41
10	Kim, Hyun-Jun	0/2	1/4	0/0	2	0	2	0	1	1	0	0	1	0	1	18:02
11	Hur, Jae	4/10	4/7	1/1	21	5	1	3	2	0	1	2	1	1	1	39:58
12	Kim, Yoon-Ho	0/0	1/2	0/0	2	1	0	0	0	0	0	0	0	0	1	7:21
13	Park, Jong-Chun	0/0	0/0	0/0	0	0	0	0	0	0	0	0	0	0	0	0:00
14	Kim, You-Taek	0/0	6/10	1/1	13	4	4	5	3	0	3	0	1	0	1	33:09
15	Han, Ki-Bum	0/0	1/3	0/0	2	3	1	0	0	0	0	0	0	0	0	11:49
Total		5/23	27/46	6/6	75	21	10	12	9	4	5	2	6	1	7	200:00

<Team Statistics/Statistiques de l'Equipe>

Teams	T.P	Goals	FLD	Goals	FR.	Throws	Fouls	Rebs	Recs	Assts	Blks	Turns	FB Efficiency
AUS	8/18	44%	30/47	64%	11/15	73%	10	38	12	11	1	11	0/0
KOR	5/23	22%	27/46	59%	6/6	100%	21	22	21	4	1	8	3/4

Referee/Arbitre FRA MAININI, YVAN
 Umpire/Arb. Adjoint JPN SUGIURA, ITSUO

Men		Hommes															
Preliminary Pool Group A Match 14/Sept. 24		Poule Preliminaire Groupe A Match 14/24 Sept															
No.	Name	<T.P.G>	<F.G>	<F.T>	Pts	Foul	Rebnd			AST	STL	VIO	LST	BLK	GDD	<Time>	
		MA	MA	MA			O	D	X							Min Sec	
		CAF	78-87	URS	(31-40,47-47)												
CAF																	
04	Oumarou Sanda B	0/2	2/8	4/4	8	2	1	1	2	2	3	0	1	0	1	20:10	
05	Goporo, A	0/0	0/0	0/0	0	0	0	0	0	1	0	0	1	0	0	4:55	
06	Ouagon, J	0/0	0/0	0/0	0	0	0	0	0	0	0	0	0	0	0	0:00	
07	Kongaouin, B	0/0	0/0	0/0	0	0	0	0	0	0	0	0	0	0	0	0:00	
08	Pehoua-Pelema, E	0/0	0/1	0/0	0	1	0	1	1	2	0	0	2	0	0	8:02	
09	M'bongo, Guy	0/0	0/1	0/0	0	1	1	0	0	0	0	0	0	0	0	5:53	
10	Goporo, F	3/4	2/5	3/4	16	3	1	0	2	5	1	1	5	0	1	36:40	
11	Kotta, J	0/1	0/1	0/0	0	0	0	0	0	2	1	0	1	0	0	12:26	
12	Gombe, Christian	0/0	2/7	0/2	4	3	4	1	0	1	1	0	0	0	0	18:22	
13	Lavodrama, A	0/0	8/17	11/14	27	3	2	8	0	6	0	0	1	0	2	40:00	
14	Bella, R	0/0	5/9	2/2	12	1	3	0	3	0	0	0	1	0	0	30:48	
15	Naoueyama, F	0/0	4/6	3/4	11	2	0	3	0	0	0	0	1	0	1	22:44	
Total		3/7	23/55	23/30	78	16	12	14	8	19	6	1	13	0	5	200:00	

URS																
04	Volkov, A	0/0	4/4	2/3	10	5	1	1	3	3	0	0	1	0	0	20:56
05	Sokk, Tiit	0/1	0/0	0/0	0	1	0	1	0	0	2	0	0	0	0	14:25
06	Tarakanov, S	0/1	6/9	0/0	12	1	5	1	0	1	1	0	0	0	0	16:57
07	Martchioulenis	1/2	3/7	8/8	17	2	0	0	1	1	0	0	3	0	0	17:08
08	Migliniex, Igor	1/2	1/1	2/3	7	2	0	0	0	1	2	0	0	0	1	13:41
09	Tikhonenko, V	2/5	2/4	0/0	10	1	1	1	1	0	3	0	2	0	0	19:34
10	Kourtinaitis, R	2/7	2/3	0/0	10	4	1	0	1	2	1	0	1	0	0	22:52
11	Sabonis, A	0/0	4/6	0/0	8	3	1	9	2	0	0	0	1	3	0	15:46
12	Pankrachkine, V	1/1	0/0	0/0	3	1	0	1	0	0	0	0	1	0	0	6:36
13	Khomitchious, V	2/6	1/2	0/0	8	1	0	0	1	0	2	1	2	0	0	25:35
14	Belostennyi, A	0/0	0/1	0/0	0	1	1	4	0	0	0	0	0	1	1	9:17
15	Goborov, Valeri	0/0	1/4	0/0	2	0	0	1	0	0	0	1	2	1	0	17:13
Total		9/25	24/41	12/14	87	22	10	19	9	8	11	2	13	5	2	200:00

<Team Statistics/Statistiques de l'Equipe>

Teams	T.P	Goals	FLD	Goals	FR.	Throws	Fouls	Rebs	Recs	Assts	Blks	Turns	FB Efficiency
CAF	3/7	43%	23/55	42%	23/30	77%	16	26	19	19	0	14	3/4
URS	9/25	36%	24/41	59%	12/14	86%	22	29	22	8	5	15	5/8

Referee/Arbitre TCH KOTLEBA, LUBOMIR
 Umpire/Arb. Adjoint CHN ZHU, JIA ZHONG

Men		Hommes															
Preliminary Pool Group A Match 15/Sept. 24		Poule Preliminaire Groupe A Match 15/24 Sept															
No.	Name	<T.P.G>	<F.G>	<F.T>	Pts	Foul	Rebnd			AST	STL	VIO	LST	BLK	GDD	<Time>	
		MA	MA	MA			O	D	X							Min Sec	
		PUR	74-72	YUG	(36-37,38-35)												
PUR																	
04	Ortiz Rijos, J	0/0	3/10	2/5	8	2	0	1	3	1	0	0	1	1	0	22:09	
05	Lopez, Federico	0/1	1/3	0/0	2	2	0	0	1	2	0	0	0	0	2	20:38	
06	Gause, Raymond	1/5	3/6	2/2	11	2	0	5	0	0	1	0	0	0	0	35:38	
07	Ithier, Vicente	0/0	0/0	0/0	0	0	0	0	0	0	0	0	0	0	0	0:00	
08	Mincy, Jerome	0/0	3/7	6/6	12	1	1	1	0	0	0	1	0	0	0	12:34	
09	Riios, Roberto	0/2	1/3	1/2	3	1	0	0	1	0	0	0	0	0	0	7:34	
10	Cruz, Angel	2/2	6/8	0/0	18	1	0	1	1	6	0	0	0	0	1	32:26	
11	Rivas, Ramon	0/0	1/5	0/0	2	1	1	8	0	1	0	0	0	0	1	20:38	
12	Morales, Mario	0/1	4/7	0/0	8	1	2	1	0	0	0	0	2	0	0	24:12	
13	Leon, Edgar	0/0	0/0	0/0	0	0	0	0	0	0	0	0	0	0	0	0:00	
14	Leon, Francisco	0/0	0/0	0/0	0	0	0	0	0	0	0	0	0	0	0	0:00	
15	Ramos, Ramon	0/0	3/5	4/4	10	2	3	1	0	0	1	0	2	1	1	24:11	
Total		3/11	25/54	15/19	74	13	7	18	6	9	4	0	5	2	5	200:00	

YUG																
04	Petrovic, Drazen	1/3	3/6	0/1	9	3	1	1	1	1	0	0	2	0	0	26:22
05	Radulovic, Z	0/0	0/0	0/0	0	0	0	0	0	0	0	0	0	0	0	0:00
06	Cutura, Zoran	0/0	4/6	2/2	10	2	0	0	0	0	0	0	0	0	1	17:04
07	Kukoc, Toni	0/4	2/3	0/0	4	0	1	1	1	1	1	0	1			

Basketball

Men		Hommes														
Preliminary Pool Group B Match 2/Sept. 17		Poule Preliminaire Groupe B Match 2/17 Sept														
No.	Name	<T.P.G> <F.G> <F.T>			Pts	Foul	Rebnd			AST	STL	VIO	LST	BLK	GDD	<Time> Min Sec
		MA	MA	MA			O	D	X							
BRA 125-109 CAN (56-45,69-64)																
BRA																
04	Almeida, Paulo	0/0	0/0	0/0	0	0	0	0	0	0	0	0	0	0	0	0:00
05	Guerra, Jorge	1/1	1/1	3/4	8	4	0	1	0	0	0	2	0	1	12:12	
06	Victalino, G	1/1	12/18	1/2	28	4	3	7	3	0	0	2	4	2	40:00	
07	Vianna, Joao	0/0	0/0	0/0	0	0	0	0	0	0	0	0	0	0	0:00	
08	Ferreira, R	0/0	2/3	0/0	4	3	1	3	0	0	0	1	0	0	16:01	
09	Guimaraes, R	0/0	0/0	0/0	0	0	0	0	0	0	0	0	0	0	0:00	
10	Souza, Maury	2/2	3/8	2/2	14	1	2	3	1	4	0	1	3	0	27:58	
11	Souza, Marcel	7/13	3/6	3/4	30	3	0	2	2	2	2	1	2	2	38:12	
12	Azevedo, Luiz	0/1	0/1	1/2	1	2	1	1	0	0	0	0	0	0	5:18	
13	Silva, Paulo	0/0	0/0	0/0	0	0	0	0	0	0	0	0	0	0	0:00	
14	Schmidt, Oscar	4/7	8/13	8/9	36	4	4	6	0	1	0	0	2	0	36:30	
15	Andrade, Israel	0/0	2/4	0/1	4	3	2	7	1	0	0	0	3	2	23:49	
Total		15/25	31/54	18/24	125	24	13	30	7	7	2	2	15	8	5	200:00

Men		Hommes														
Preliminary Pool Group B Match 3/Sept. 18		Poule Preliminaire Groupe B Match 3/18 Sept														
No.	Name	<T.P.G> <F.G> <F.T>			Pts	Foul	Rebnd			AST	STL	VIO	LST	BLK	GDD	<Time> Min Sec
		MA	MA	MA			O	D	X							
CAN																
04	Clarke, Norman	0/0	0/0	0/0	0	0	0	0	0	0	0	0	0	0	0	0:50
05	Turcotte, David	0/2	4/4	5/5	13	2	0	0	1	0	0	0	0	0	7:59	
06	Pasquale, I	2/2	0/1	0/2	6	1	0	2	2	4	2	0	1	0	30:09	
07	Tilleman, Karl	2/5	0/2	0/0	6	2	1	3	0	0	1	0	0	0	10:55	
08	Kristmanson, A	1/2	8/9	6/7	25	2	3	0	0	1	1	0	2	0	22:25	
09	Triano, James	0/5	7/10	0/0	14	1	1	1	0	3	3	0	0	0	29:09	
10	Walton, Dwight	0/0	1/2	0/0	2	1	0	1	0	0	0	0	0	0	7:13	
11	Hatch, John	0/0	2/8	2/3	6	4	1	2	0	0	0	1	0	1	13:24	
12	Mungar, Barry	0/0	5/10	0/0	10	2	1	2	2	1	1	0	1	0	21:11	
13	Raffin, Romel	0/0	1/2	0/0	2	1	2	1	0	0	1	0	0	0	12:32	
14	Yearwood, Wayne	0/0	10/24	1/1	21	5	6	1	1	1	0	0	1	0	27:55	
15	Kazanowski, G	0/1	2/2	0/1	4	2	1	1	0	1	1	0	0	0	16:18	
Total		5/17	40/74	14/19	109	23	16	14	6	11	10	0	6	0	6	200:00

<Team Statistics/Statistiques de l'Equipe>

Teams	T.P	Goals	FLD	Goals	FR.	Throws	Fouls	Rebs	Recs	Assts	Blks	Turns	FB	Efficiency
BRA	15/25	60%	31/54	57%	18/24	75%	24	43	14	7	8	18	1/1	
CAN	5/17	29%	40/74	54%	14/19	74%	23	30	22	11	0	6	0/0	
Referee/Arbitre		URS	DAWYDOV, MICHAEL											
Umpire/Arb. Adjoint		YUG	GIBAC, ZORAN											

Men		Hommes														
Preliminary Pool Group B Match 3/Sept. 18		Poule Preliminaire Groupe B Match 3/18 Sept														
No.	Name	<T.P.G> <F.G> <F.T>			Pts	Foul	Rebnd			AST	STL	VIO	LST	BLK	GDD	<Time> Min Sec
		MA	MA	MA			O	D	X							
ESP 53-97 USA (32-48,21-49)																
ESP																
04	Villacampa, J	0/0	0/3	0/0	0	0	2	0	0	0	1	0	1	0	8:14	
05	Llorente, J	0/0	0/0	0/0	0	0	0	0	0	0	0	0	1	0	7:40	
06	Biriukov, Jose	2/3	0/2	0/0	6	3	0	0	0	0	0	0	0	0	8:15	
07	Margall, J	0/1	2/4	0/0	4	1	0	0	0	2	0	0	1	0	17:00	
08	Jimenez, Andres	0/0	0/6	0/2	0	1	2	0	0	0	0	1	0	0	19:04	
09	Andreu, Enrique	0/0	0/1	0/0	0	0	2	0	0	0	0	0	0	0	4:44	
10	Montero, J	2/3	2/6	2/2	12	1	0	0	0	1	1	0	2	0	29:11	
11	Arcega, Fernando	0/0	1/3	8/14	10	2	3	1	0	0	0	0	0	0	23:40	
12	Solozabal, I	1/1	0/1	0/0	3	2	0	2	0	1	0	0	1	0	26:40	
13	Martinez, Ferran	0/0	1/3	3/4	5	5	0	3	0	1	0	1	2	0	11:41	
14	Martin, Antonio	0/0	1/4	0/0	2	3	1	4	2	0	0	0	2	0	20:51	
15	San Epifanio, J	1/5	4/6	0/0	11	1	1	2	0	3	1	0	0	0	23:00	
Total		6/13	11/39	13/22	53	19	11	12	2	8	3	2	10	0	8	20:00

Men		Hommes														
Preliminary Pool Group B Match 5/Sept. 20		Poule Preliminaire Groupe B Match 5/20 Sept														
No.	Name	<T.P.G> <F.G> <F.T>			Pts	Foul	Rebnd			AST	STL	VIO	LST	BLK	GDD	<Time> Min Sec
		MA	MA	MA			O	D	X							
CAN 70-76 USA (42-40,28-36)																
CAN																
04	Clarke, Norman	0/0	0/0	0/0	0	0	0	0	0	0	0	0	0	0	0	0:00
05	Turcotte, David	0/0	0/1	2/2	2	0	0	0	0	1	0	0	0	0	2:48	
06	Pasquale, I	2/4	1/4	9/13	17	2	1	2	1	5	2	0	5	0	37:12	
07	Tilleman, Karl	0/2	0/0	0/0	0	0	0	0	0	1	0	0	1	0	6:45	
08	Kristmanson, A	2/3	7/10	5/7	25	2	1	2	0	1	0	0	1	0	28:12	
09	Triano, James	3/7	2/12	2/2	15	2	0	1	1	1	0	0	1	0	33:15	
10	Walton, Dwight	0/0	0/0	0/0	0	0	0	0	0	0	0	0	0	0	0:00	
11	Hatch, John	0/0	0/1	0/1	0	2	1	5	0	1	0	0	0	0	11:48	
12	Mungar, Barry	0/0	1/1	1/1	3	2	0	1	0	0	0	0	0	0	9:27	
13	Raffin, Romel	0/0	1/2	0/0	2	2	1	1	0	1	0	0	1	0	16:12	
14	Yearwood, Wayne	0/0	1/4	0/0	2	4	4	7	2	0	0	0	0	0	26:25	
15	Kazanowski, G	0/0	2/5	0/0	4	2	1	1	1	1	0	1	2	0	27:56	
Total		7/16	15/40	19/26	70	18	9	20	6	11	2	1	12	0	5	200:00

<Team Statistics/Statistiques de l'Equipe>

Teams	T.P	Goals	FLD	Goals	FR.	Throws	Fouls	Rebs	Recs	Assts	Blks	Turns	FB	Efficiency
ESP	6/13	46%	11/39	28%	13/22	59%	19	23	13	8	0	12	1/2	
USA	14	25%	39/65	60%	16/20	80%	23	39	16	4	7	12	2/2	
Referee/Arbitre		GRE	RIGAS, CONSTANTIN											
Umpire/Arb. Adjoint		AUS	HUNT, RAYMOND JOHN											

Basket-ball

Men		Hommes														
Preliminary Pool Group B Match 4/Sept. 20		Poule Preliminaire Groupe B Match 4/20 Sept														
No.	Name	<T.P.G> <F.G> <F.T>			Pts	Foul	Rebnd			AST	STL	VIO	LST	BLK	GDD	<Time> Min Sec
		MA	MA	MA			O	D	X							
BRA 130-108 CHN (72-61,58-47)																
BRA																
04	Almeida, Paulo	0/1	8/11	1/2	17	4	3	1	0	2	0	0	0	0	1	18:08
05	Guerra, Jorge	0/0	0/0	0/0	0	1	0	0	1	1	0	1	2	0	10:15	
06	Victalino, G	0/1	6/15	0/0	12	2	3	5	3	2	3	0	3	0	24:39	
07	Vianna, Joao	0/0	2/4	0/0	4	5	2	3	1	0	1	1	1	0	13:38	
08	Ferreira, R	0/0	3/3	0/0	6	3	0	1	1	0	0	1	0	1	12:22	
09	Guimaraes, R	0/0	0/1	0/0	0	1	0	1	1	4	1	0	0	0	13:36	
10	Souza, Maury	0/1	1/4	1/2	3	1	1	1	2	6	0	0	2	0	16:09	
11	Souza, Marcel	3/7	2/6	8/10	21	2	2	0	1	3	1	1	1	0	24:54	
12	Azevedo, Luiz	0/0	1/1	0/0	2	1	0	0	0	1	0	0	0	0	6:24	
13	Silva, Paulo	0/0	2/2	0/2	4	2	1	1	0	0	0	0	2	1	4:20	
14	Schmidt, Oscar	3/7	12/19	11/12	44	3	5	5	3	1	0	0	1	0	30:34	
15	Andrade, Israel	0/0	6/10	5/6	17	1	2	6	0	2	2	1	2	0	25:01	
Total		6/17	43/76	26/34	130	26	19	24	13	22	10	5	14	2	8	200:00

Men		Hommes													
Preliminary Pool Group B Match 5/Sept. 20															



Men		Hommes															
Preliminary Pool Group B Match 6/Sept. 20		Poule Preliminaire Groupe B Match 6/20 Sept															
No.	Name	<T.P.G>	<F.G>	<F.T>	Pts	Foul	Rebnd				AST	STL	VIO	LST	BLK	GDD	<Time>
		MA	MA	MA			O	D	X								Min Sec
EGY		70-113	ESP (44-57,26-56)														
04	Abdoun, A	0/1	1/3	0/0	2	1	0	0	0	0	1	0	0	0	0	0	17:18
05	Mousa, Hany	0/0	4/8	1/2	9	3	0	3	1	0	0	0	3	0	0	17:49	
06	Sekky, Ashraf	1/2	0/2	0/0	3	1	0	0	0	0	0	0	0	0	0	8:57	
07	Ismail, Mohamed	1/2	2/4	0/0	7	1	0	1	0	0	1	0	1	0	0	16:47	
08	Attallah, Alain	3/4	1/4	2/2	13	2	0	0	0	0	0	0	0	0	0	20:49	
09	Abduelkhir, Amr	2/3	1/1	0/0	8	1	0	1	0	0	0	0	1	0	0	14:16	
10	Elkordy, Ashraf	0/0	2/6	1/2	5	2	2	2	0	1	1	0	0	0	2	22:11	
11	Elsayed, E	0/3	2/4	0/0	4	3	0	0	0	0	2	0	3	0	0	19:56	
12	Khalil, Hesham	1/2	2/5	0/0	7	3	2	1	1	1	0	0	2	0	0	19:19	
13	Elishakeri, M	0/0	0/0	0/0	0	3	0	0	0	0	0	0	0	0	0	6:59	
14	Mohamed, Elsayed	0/1	3/5	4/4	10	3	0	2	0	0	2	0	1	0	3	20:55	
15	Soliman, Ahmed	0/1	1/3	0/0	2	0	0	0	1	0	1	0	0	0	0	14:44	
Total		8/19	19/45	8/10	70	23	4	10	3	2	8	0	11	0	5	200:00	

ESP																
04	Villacampa, J	0/1	10/10	0/0	20	1	0	5	1	2	2	1	1	3	0	22:06
05	Llorente, J	0/0	0/0	3/4	3	0	0	1	0	1	2	0	0	0	0	10:18
06	Biriukov, Jose	2/4	1/3	2/2	10	1	2	0	0	1	0	0	0	0	0	17:54
07	Margall, J	2/3	1/6	0/1	8	2	0	3	1	1	0	0	0	0	1	20:32
08	Jimenez, Andres	0/0	6/7	3/3	15	3	0	0	0	0	0	0	2	0	0	15:23
09	Andreu, Enrique	0/0	2/2	0/0	4	0	1	3	0	0	0	0	0	0	0	5:41
10	Montero, J	0/0	0/0	0/0	0	0	0	0	0	0	0	0	0	0	0	0:00
11	Arcega, Fernando	0/0	4/6	5/6	13	1	2	6	1	0	0	0	2	0	0	18:56
12	Solozabal, I	1/1	3/6	5/5	14	2	0	4	3	2	2	1	0	0	0	29:42
13	Martinez, Ferran	0/0	7/9	3/4	17	2	7	4	3	0	1	0	0	2	1	30:03
14	Martin, Antonio	0/0	0/1	3/4	3	1	2	4	0	1	0	0	0	0	0	9:57
15	San Epifanio, J	0/1	3/6	0/0	6	0	0	0	0	3	0	1	2	0	1	19:28
Total		5/10	37/56	24/29	113	13	14	30	9	11	7	3	7	5	3	200:00

<Team Statistics/Statistiques de l'Equipe>

Teams	T.P	Goals	FLD	Goals	FR.	Throws	Fouls	Rebs	Recs	Assts	Blks	Turns	FB Efficiency
EGY	8/19	42%	19/45	42%	8/10	80%	23	14	16	2	0	12	1/1
ESP	5/10	50%	37/56	66%	24/29	83%	13	44	19	11	5	10	1/1
Referee/Arbitre		ARG		RUBINSZTEIN, JORGE A									
Umpire/Arb. Adjoint		KOR		JANG, CHANG-HWAN									

Men		Hommes															
Preliminary Pool Group B Match 8/Sept. 21		Poule Preliminaire Groupe B Match 8/21 Sept															
No.	Name	<T.P.G>	<F.G>	<F.T>	Pts	Foul	Rebnd				AST	STL	VIO	LST	BLK	GDD	<Time>
		MA	MA	MA			O	D	X								Min Sec
CAN		117-64	EGY (61-32,56-32)														
04	Clarke, Norman	0/0	0/0	0/0	0	1	1	0	0	2	1	0	0	0	0	0	9:24
05	Turcotte, David	1/1	0/0	3/6	6	1	0	1	0	2	0	0	1	0	1	16:02	
06	Pasquale, I	1/1	1/1	0/0	5	0	0	1	1	2	1	0	0	0	1	17:17	
07	Tilleman, Karl	7/11	3/5	2/3	29	1	1	3	1	3	3	0	0	0	1	23:08	
08	Kristmanson, A	0/1	1/2	3/4	5	0	0	2	0	1	0	0	0	0	0	14:44	
09	Triano, James	2/3	2/3	2/2	12	2	0	4	1	0	1	0	1	0	2	21:13	
10	Walton, Dwight	0/0	4/4	4/6	12	2	2	3	2	1	0	2	0	0	0	10:23	
11	Hatch, John	0/0	7/12	1/2	15	0	4	0	0	0	0	1	0	1	0	2	17:52
12	Mungar, Barry	0/0	6/13	3/5	15	3	2	1	2	0	2	0	2	0	2	15:07	
13	Raffin, Romel	0/0	3/5	1/1	7	0	2	3	1	3	0	0	0	0	0	19:30	
14	Yearwood, Wayne	0/0	3/6	0/2	6	3	1	3	2	2	1	0	3	1	1	19:30	
15	Kazanowski, G	0/0	2/7	1/2	5	1	1	3	0	2	0	0	1	1	1	15:50	
Total		11/17	32/58	20/33	117	14	14	24	10	18	10	2	9	2	11	200:00	

EGY																
04	Abdoun, A	0/2	0/0	0/0	0	1	0	1	0	0	0	0	2	0	0	10:52
05	Mousa, Hany	0/0	2/7	0/0	4	5	0	2	2	0	0	0	1	0	2	18:45
06	Sekky, Ashraf	0/1	0/0	0/0	0	0	0	1	0	0	1	1	3	0	0	9:08
07	Ismail, Mohamed	2/4	2/2	1/2	11	1	0	0	2	0	0	0	1	0	0	20:00
08	Attallah, Alain	2/5	2/3	0/0	10	0	0	2	0	1	0	0	3	1	1	27:20
09	Abduelkhir, Amr	0/3	5/7	2/2	12	2	0	1	2	3	2	0	1	0	0	20:00
10	Elkordy, Ashraf	0/0	2/4	0/0	4	4	1	1	0	0	0	0	1	0	1	12:44
11	Elsayed, E	0/0	1/8	1/2	3	3	0	2	0	1	0	0	4	0	0	21:49
12	Khalil, Hesham	0/1	2/3	6/6	10	5	1	1	1	0	1	0	1	0	1	17:55
13	Elishakeri, M	0/0	3/4	2/2	8	5	1	2	0	0	2	0	2	1	1	18:11
14	Mohamed, Elsayed	0/2	1/3	0/0	2	2	0	3	0	0	2	0	1	0	1	20:00
15	Soliman, Ahmed	0/0	0/0	0/0	0	1	0	0	0	0	0	0	0	0	0	3:16
Total		4/18	20/41	12/14	64	29	3	16	7	5	8	1	20	2	7	200:00

<Team Statistics/Statistiques de l'Equipe>

Teams	T.P	Goals	FLD	Goals	FR.	Throws	Fouls	Rebs	Recs	Assts	Blks	Turns	FB Efficiency
CAN(M)	11/17	65%	32/58	55%	20/33	61%	14	38	31	18	2	11	1/1
EGY(M)	4/18	22%	20/41	49%	12/14	86%	29	19	22	5	2	21	2/2
Referee/Arbitre		AUS		HUNT, RAYMOND JOHN									
Umpire/Arb. Adjoint		JPN		SUGIURA, ITSUO									

Men		Hommes															
Preliminary Pool Group B Match 7/Sept. 21		Poule Preliminaire Groupe B Match 7/21 Sept															
No.	Name	<T.P.G>	<F.G>	<F.T>	Pts	Foul	Rebnd				AST	STL	VIO	LST	BLK	GDD	<Time>
		MA	MA	MA			O	D	X								Min Sec
BRA		87-102	USA (55-63,32-39)														
04	Almeida, Paulo	0/1	0/3	1/1	1	0	0	0	0	1	0	0	0	0	0	7:58	
05	Guerra, Jorge	0/0	2/3	0/0	4	2	0	0	2	3	2	0	0	0	0	10:51	
06	Victalino, G	0/4	2/4	4/4	8	4	0	3	1	0	1	0	0	1	1	33:46	
07	Vianna, Joao	0/0	1/1	2/2	4	0	1	3	1	0	0	0	0	1	0	6:14	
08	Ferreira, R	0/0	3/5	0/0	6	2	0	1	0	0	0	0	0	1	1	14:30	
09	Guimaraes, R	0/0	0/0	0/1	0	0	0	1	0	1	0	0	3	0	0	4:14	
10	Souza, Maury	0/1	3/5	1/2	7	3	0	3	2	3	0	1	3	0	0	24:55	
11	Souza, Marcel	3/9	1/2	0/1	11	3	0	2	0	1	0	1	2	0	0	32:02	
12	Azevedo, Luiz	0/0	0/0	0/0	0	0	0	0	0	0	0	0	0	0	0	0:00	
13	Silva, Paulo	0/0	0/0	0/0	0	0	0	0	0	0	0	0	0	0	0	0:00	
14	Schmidt, Oscar	2/4	5/12	15/15	31	2	5	2	1	1	0	0	2	1	3	40:00	
15	Andrade, Israel	0/2	6/11	3/3	15	5	6	1	1	2	0	0	0	0	3	25:30	
Total		5/21	23/46	26/29	87	21	12	16	6	11	3	2	10	4	8	200:00	

USA																
04	Richmond, M	0/1	3/8	3/4	9	3	3	1	2	0	0	1	0	0	0	19:15
05	Smith, C	0/1	3/6	2/2	8	2	0	0	2	3	2	0	1	0	0	21:33
06	Coles, Vernell	0/0	2/7	3/3	7	1	2	1	2	0	2	0	0	0	2	18:27
07	Hawkins, Hersey															

Basketball

Men Preliminary Pool Group B Match 10/Sept. 23

No.	Name	<T.P.G> <F.G> <F.T>			Pts	Foul	Rebnd			AST	STL	VIO	LST	BLK	GDD	<Time> Min Sec
		MA	MA	MA			O	D	X							
CAN 84-94 ESP (51-45,33-49)																
CAN																
04	Clarke, Norman	0/0	0/0	0/0	0	0	0	0	0	0	0	0	0	0	0	0:00
05	Turcotte, David	0/0	0/0	0/0	0	2	0	0	0	0	0	0	0	0	1	3:16
06	Pasquale, I	4/8	2/6	3/4	19	2	1	1	2	1	2	1	2	0	1	37:50
07	Tillemann, Karl	10/16	3/3	1/2	37	3	0	2	0	0	0	0	1	0	0	25:22
08	Kristmanson, A	0/1	1/4	4/4	6	1	0	3	0	2	0	0	3	0	0	17:11
09	Triano, James	0/3	3/7	0/0	6	1	0	2	0	0	0	0	1	1	0	18:05
10	Walton, Dwight	0/0	0/0	0/0	0	1	0	0	0	0	0	0	0	0	0	0:32
11	Hatch, John	0/0	0/7	0/0	0	1	4	1	0	1	0	0	0	0	0	18:16
12	Mungar, Barry	0/0	2/2	4/5	8	2	1	4	0	0	2	0	0	0	1	26:08
13	Raffin, Romel	0/0	1/2	2/2	4	2	0	1	0	0	1	1	0	0	0	26:22
14	Yearwood, Wayne	0/0	1/3	0/0	2	3	1	5	2	0	0	0	0	0	0	16:17
15	Kazanowski, G	0/0	1/4	0/0	2	3	0	1	0	0	0	0	1	0	1	10:41
Total		14/28	14/38	14/17	84	21	7	20	4	4	5	2	8	1	4	200:00

<Team Statistics/Statistiques de l'Equipe>																
Teams	T.P	Goals	FLD	Goals	FR.	Throws	Fouls	Rebs	Recs	Assts	Blks	Turns	FB	Efficiency		
CAN	14/28	50%	14/38	37%	14/17	82%	21	27	13	4	1	10	0/0			
ESP	7/19	37%	31/50	62%	11/17	65%	18	36	15	15	4	11	6/6			
Referee/Arbitre		TCH		KOTLEBA, LUBOMIR												
Umpire/Arb. Adjoint		PUR		ARROYO, ANIBAL GARCIA												

Men Preliminary Pool Group B Match 11/Sept. 23

No.	Name	<T.P.G> <F.G> <F.T>			Pts	Foul	Rebnd			AST	STL	VIO	LST	BLK	GDD	<Time> Min Sec
		MA	MA	MA			O	D	X							
BRA 138-85 EGY (66-38,72-47)																
BRA																
04	Almeida, Paulo	0/0	6/9	5/6	17	3	4	0	0	2	0	0	0	0	0	18:38
05	Guerra, Jorge	0/0	0/0	0/0	0	3	0	1	0	2	0	0	0	0	0	9:48
06	Victalino, G	0/0	2/6	3/4	7	0	3	6	1	1	0	0	0	1	1	16:49
07	Vianna, Joao	0/0	2/3	0/1	4	3	1	4	2	0	1	1	0	0	2	18:30
08	Ferreira, R	0/0	5/6	0/0	10	0	2	3	0	1	0	0	1	1	1	14:57
09	Guimaraes, R	0/0	2/3	2/2	6	1	1	2	0	3	2	0	0	1	0	12:24
10	Souza, Maury	0/0	0/0	2/2	2	0	0	1	0	11	0	1	1	1	0	17:48
11	Souza, Marcel	3/8	6/10	1/1	22	0	1	2	0	1	0	0	0	0	0	22:41
12	Azevedo, Luiz	0/0	7/14	6/6	20	1	0	2	1	2	3	0	0	0	0	13:16
13	Silva, Paulo	0/0	0/0	0/0	0	0	3	0	0	0	0	0	0	0	0	4:41
14	Schmidt, Oscar	2/5	12/19	9/11	39	1	3	5	0	1	0	0	0	0	1	25:25
15	Andrade, Israel	0/0	3/11	5/7	11	0	4	4	1	2	2	0	0	1	0	25:03
Total		5/13	45/81	33/40	138	12	19	33	5	26	8	2	2	5	5	200:00

<Team Statistics/Statistiques de l'Equipe>																
Teams	T.P	Goals	FLD	Goals	FR.	Throws	Fouls	Rebs	Recs	Assts	Blks	Turns	FB	Efficiency		
BRA	5/13	38%	45/81	56%	33/40	83%	12	52	18	26	5	5	8/11			
EGY	7/15	47%	31/67	46%	2/3	67%	26	20	15	12	4	16	1/2			
Referee/Arbitre		BUL		TOCHEV, KAMEN												
Umpire/Arb. Adjoint		AUS		WEEKS, GEOFFREY ROBERT												

Basket-ball

Men Preliminary Pool Group B Match 12/Sept. 23

No.	Name	<T.P.G> <F.G> <F.T>			Pts	Foul	Rebnd			AST	STL	VIO	LST	BLK	GDD	<Time> Min Sec
		MA	MA	MA			O	D	X							
CHN 57-108 USA (26-59,31-49)																
CHN																
04	Gong, Luming	0/0	1/2	0/0	2	2	1	1	0	1	1	0	2	0	0	20:00
05	Wang, Fei	0/0	0/1	2/2	2	1	0	1	0	1	0	1	4	0	0	16:30
06	Huang, Yunlong	0/0	2/8	0/0	4	2	1	1	2	1	0	0	1	0	1	21:47
07	Sha, Guoli	0/0	0/3	0/0	0	0	0	0	0	0	0	0	0	0	0	4:45
08	Zhang, Xuelei	2/3	0/0	0/0	6	0	0	0	0	0	0	0	1	0	0	9:48
09	Song, Ligang	0/0	7/16	6/10	20	1	5	4	1	2	0	0	1	2	3	35:42
10	Li, Yaguang	0/4	2/6	0/1	4	2	2	1	1	1	1	0	3	0	4	21:36
11	Sun, Fengwu	0/1	1/4	0/0	2	1	0	0	1	2	0	0	0	0	1	20:00
12	Wang, Libin	0/0	6/10	0/1	12	4	0	1	1	0	0	0	2	0	0	22:31
13	Zhang, Yongjun	1/3	1/4	0/0	5	4	0	0	0	1	1	0	0	1	1	27:21
14	Xu, Xiaoliang	0/0	0/0	0/0	0	0	0	0	0	0	0	0	0	0	0	0:00
15	Zhang, Bin	0/0	0/0	0/0	0	0	0	0	0	0	0	0	0	0	0	0:00
Total		3/11	20/54	8/14	57	17	9	9	6	9	4	1	13	3	10	200:00

<Team Statistics/Statistiques de l'Equipe>																
Teams	T.P	Goals	FLD	Goals	FR.	Throws	Fouls	Rebs	Recs	Assts	Blks	Turns	FB	Efficiency		
CHN	3/11	27%	20/54	37%	8/14	57%	17	18	20	9	3	14	1/1			
USA	1/3	33%	48/75	64%	9/14	64%	18	54	22	13	6	18	1/1			
Referee/Arbitre		URS		GRIGORIEV, MICHAEL												
Umpire/Arb. Adjoint		KOR		JANG, CHANG-HWAN												

Men Preliminary Pool Group B Match 13/Sept. 24

No.	Name	<T.P.G> <F.G> <F.T>			Pts	Foul	Rebnd			AST	STL	VIO	LST	BLK	GDD	<Time> Min Sec
		MA	MA	MA			O	D	X							
CAN 99-96 CHN (56-52,43-44)																
CAN																
04	Clarke, Norman	0/0	0/0	0/0	0	0	0	0	0	0	0	0	0	0	0	0:00
05	Turcotte, David	3/4	2/4	1/2	14	1	0	1	0	0	1	0	0	0	0	32:38
06	Pasquale, I	2/3	0/1	0/0	6	3	0	1	3	6	0	0	3	0	1	37:25
07	Tillemann, Karl	0/1	2/2	0/1	4	2	0	0	0	0	0	0	0	0	0	10:50
08	Kristmanson, A	0/0	1/2	0/0	2	1	1	0	0	1	0	0	0	0	0	5:48
09	Triano, James	0/1	6/10	8/9	20	3	1	2	0	1	1	1	0	0	0	26:07
10	Walton, Dwight	0/0	4/7	5/6	13	4	2	5	1	1	2	0	3	0	1	21:44
11	Hatch, John	0/0	7/10	0/0	14	4	2	6	0	1	3	0	5	0	0	20:41
12	Mungar, Barry	0/0	2/5	4/4	8	3	2	2	0	0	0	0	2	0	1	16:53
13	Raffin, Romel	0/0	0/0	1/2	1	2	0	1	0	1	0	0	1	0	0	3:50
14	Yearwood, Wayne	0/0	6/9	3/3	15	4	2	1	1	0	0	0	2	0	2	20:17
15	Kazanowski, G	0/0	1/4	0/0	2	2	1	1	0	0	0	0	0	0	0	3:47
Total		5/9	31/54	22/27	99	29	11	20	5	11	7	1	16	0	5	200:00

<Team Statistics/Statistiques de l'Equipe>																
Teams	T.P	Goals	FLD	Goals	FR.	Throws	Fouls	Rebs	Recs	Assts	Blks	Turns	FB	Efficiency		
CAN	5/9	56%	31/54	57%	22/27	81%	29	31	17	11	0	18	0/0			
CHN	13/18	72%	20/39	51%	17/24	71%	27	18	25	6	1	14	2/2			
Referee/Arbitre		URS		DAVYDOV, MICHAEL												
Umpire/Arb. Adjoint		KOR		LEE, JAE-DUK												



Men
Quarter-final Match 3/Sept. 26

Hommes
Quart de Finale Match 3/26 Sept

No.	Name	<T.P.G> <F.G> <F.T>			Pts	Foul	Rebnd				AST	STL	VIO	LST	BLK	GDD	<Time> Min Sec	
		MA	MA	MA			O	D	X									
URS 110-105		BRA (53-58,57-47)																
04	Volkov, A	1/1	7/9	3/4	20	4	2	4	0	2	2	0	2	0	1	33:45		
05	Sokk, Tiit	3/3	2/2	0/0	13	4	0	0	3	1	0	0	1	0	1	31:28		
06	Tarakanov, S	1/3	3/6	4/5	13	2	1	2	0	2	1	0	1	0	0	14:08		
07	Martchioulenis	0/2	6/8	2/2	14	3	0	4	2	1	1	0	1	0	0	27:05		
08	Migliniex, Igor	0/0	0/0	0/0	0	0	0	0	0	0	0	0	0	0	0	0:00		
09	Tikhonenko, V	1/1	2/6	0/0	7	2	0	1	0	1	1	1	0	0	0	13:37		
10	Kourtinaitis, R	6/9	2/4	2/4	24	0	0	1	0	0	0	0	0	0	2	20:50		
11	Sabonis, A	0/0	4/13	4/4	12	4	4	5	2	2	1	0	1	1	1	29:29		
12	Pankrachkine, V	0/0	0/0	0/0	0	0	0	0	0	0	0	0	0	0	0	0:00		
13	Khomitchious, V	1/4	1/3	0/0	5	2	0	1	1	0	1	0	0	0	0	18:14		
14	Belostennyi, A	0/0	0/0	0/0	0	0	0	0	0	0	0	0	0	0	0	0:00		
15	Goborov, Valeri	0/0	1/1	0/0	2	0	1	0	0	0	0	0	1	1	0	11:24		
Total		13/23	28/52	15/19	110	21	8	18	8	9	7	1	7	2	5	200:00		

BRA

04	Almeida, Paulo	0/1	1/2	2/2	4	2	0	0	1	0	0	0	0	0	0	8:38
05	Guerra, Jorge	0/0	0/1	0/0	0	1	0	0	0	0	1	0	0	0	0	4:13
06	Victalino, G	0/1	4/6	0/0	8	2	1	5	2	0	0	0	1	2	2	34:46
07	Vianna, Joao	0/0	0/0	0/0	0	1	0	0	0	0	0	0	0	0	1	5:14
08	Ferreira, R	0/0	0/0	0/0	0	2	0	2	0	0	1	0	0	1	0	3:56
09	Guimaraes, R	0/0	0/0	0/0	0	1	0	0	0	0	0	0	0	0	0	4:18
10	Souza, Maury	1/1	3/5	0/0	9	3	0	3	0	5	0	0	3	0	1	31:29
11	Souza, Marcel	2/8	5/5	0/0	16	2	0	2	1	3	0	0	1	0	0	33:59
12	Azevedo, Luiz	0/0	0/0	0/0	0	0	0	0	0	0	0	0	0	0	0	0:00
13	Silva, Paulo	0/0	0/0	0/0	0	0	0	0	0	0	0	0	0	0	0	0:00
14	Schmidt, Oscar	5/8	7/15	17/18	46	4	1	4	2	2	2	2	1	0	0	37:23
15	Andrade, Israel	0/0	7/11	8/8	22	4	3	8	0	1	0	1	1	0	0	36:04
Total		8/19	27/45	27/28	105	22	5	24	6	11	4	3	7	3	4	200:00

<Team Statistics/Statistiques de l'Equipe>

Teams	T.P	Goals	FLD	Goals	FR.	Throws	Fouls	Rebs	Recs	Assts	Blks	Turns	FB Efficiency
URS	13/23	57%	28/52	54%	15/19	79%	21	26	20	9	2	9	1/1
BRA	8/19	42%	27/45	60%	27/28	96%	22	29	14	11	3	11	1/1

Referee/Arbitre CAN WEILAND, JOHN RUEBEN
Umpire/Arb. Adjoint TCH KOTLEBA, LUBOMIR

Men
Quarter-final Match 4/Sept. 26

Hommes
Quart de Finale Match 4/26 Sept

No.	Name	<T.P.G> <F.G> <F.T>			Pts	Foul	Rebnd				AST	STL	VIO	LST	BLK	GDD	<Time> Min Sec	
		MA	MA	MA			O	D	X									
ESP 74-77		AUS (40-41,34-36)																
04	Villacampa, J	0/0	2/2	2/2	6	2	0	0	0	0	0	0	1	0	0	5:00		
05	Llorente, J	0/0	0/0	0/0	0	0	0	0	0	0	0	0	0	0	0	0:00		
06	Biriukov, Jose	0/1	2/3	4/5	8	2	0	0	0	0	0	1	0	0	0	11:12		
07	Margall, J	1/3	1/2	0/1	5	1	2	3	1	0	2	0	3	0	1	21:16		
08	Jimenez, Andres	0/0	6/8	3/8	15	4	4	3	0	1	2	2	1	0	2	40:00		
09	Andreu, Enrique	0/0	0/0	0/0	0	0	0	0	0	0	0	0	0	0	0	0:00		
10	Montero, J	0/0	1/2	0/0	2	1	0	0	0	3	0	0	0	0	0	12:29		
11	Arcega, Fernando	0/0	3/3	0/0	6	2	0	1	1	1	2	0	0	0	0	9:31		
12	Solozabal, I	0/1	0/1	0/0	0	3	0	2	0	1	0	0	0	0	0	28:21		
13	Martinez, Ferran	0/0	0/3	2/2	2	1	3	4	0	0	0	1	0	0	0	9:40		
14	Martin, Antonio	0/0	5/11	3/3	13	3	2	4	3	0	0	1	3	0	1	30:20		
15	San Epifanio, J	0/1	8/10	1/2	17	1	0	1	0	0	0	0	0	0	1	32:11		
Total		1/6	28/45	15/23	74	20	11	18	5	6	6	5	8	0	5	200:00		

AUS

04	Pearce, Darryl	0/0	0/0	0/0	0	0	0	0	0	0	0	0	0	0	0	0:00
05	Sibley, Robert	0/0	0/0	0/0	0	0	0	0	0	0	0	0	0	0	0	0:00
06	Smyth, Philip	4/8	1/5	2/2	16	1	0	2	1	1	0	0	0	0	1	37:34
07	Sengstock, Larry	0/0	2/4	2/2	6	5	0	5	0	1	0	0	2	0	1	21:26
08	Keogh, Damian	1/3	1/1	0/0	5	0	1	1	1	0	0	0	0	0	0	12:13
09	Carroll, Wayne	2/3	5/8	0/0	16	1	0	0	2	1	0	1	0	1	0	34:13
10	Longley, Lucien	0/0	0/2	0/0	0	3	2	1	0	1	1	0	1	1	0	13:09
11	Gaze, Andrew	5/12	3/6	7/7	28	3	2	2	1	0	1	0	3	0	4	36:00
12	Bradtko, Mark	0/0	2/3	0/1	4	4	2	2	1	0	0	0	0	0	1	19:16
13	Dalton, Bradley	0/0	0/0	0/0	0	0	0	0	0	0	0	0	0	0	0	0:00
14	Vlahov, Andrew	0/0	0/1	0/0	0	2	1	0	0	0	0	0	0	0	0	3:58
15	Bomer, Raymond	0/1	0/2	2/2	2	5	2	2	2	0	1	1	1	0	2	22:11
Total		12/27	14/32	13/14	77	24	10	15	8	4	3	2	7	2	9	200:00

<Team Statistics/Statistiques de l'Equipe>

Teams	T.P	Goals	FLD	Goals	FR.	Throws	Fouls	Rebs	Recs	Assts	Blks	Turns	FB Efficiency
ESP	1/6	17%	28/45	62%	15/23	65%	20	29	16	6	0	14	0/0
AUS	12/27	44%	14/32	44%	13/14	93%	24	25	20	4	2	9	0/0

Referee/Arbitre PUR ARROYO, ANIBAL GARCIA
Umpire/Arb. Adjoint BRA AFFINI, ANTONIO CARLOS

Men
Classification (for 5th) Match 1/Sept. 28

Hommes
Classement (pour 5 ème Place) Match 1/28 Sept

No.	Name	<T.P.G> <F.G> <F.T>			Pts	Foul	Rebnd				AST	STL	VIO	LST	BLK	GDD	<Time> Min Sec	
		MA	MA	MA			O	D	X									
BRA 104-86		PUR (51-39,53-47)																
BRA																		
04	Almeida, Paulo	0/0	5/11	7/7	17	3	2	3	3	3	1	0	0	3	0	1	23:46	
05	Guerra, Jorge	0/0	1/2	0/0	2	2	0	2	1	7	1	0	1	0	2	23:46		
06	Victalino, G	0/0	4/6	0/2	8	2	0	4	3	1	0	0	1	1	1	27:10		
07	Vianna, Joao	0/0	0/2	3/4	3	0	3	3	0	1	0	0	1	0	1	12:50		
08	Ferreira, R	0/0	3/5	0/0	6	2	0	2	2	0	2	0	0	0	2	13:04		
09	Guimaraes, R	0/0	0/1	0/0	0	2	0	1	0	0	0	1	0	0	0	5:39		
10	Souza, Maury	0/0	1/2	0/0	2	1	0	1	0	2	0	0	4	0	1	11:37		
11	Souza, Marcel	2/5	0/1	0/0	6	1	0	3	0	0	0	0	1	0	1	10:35		
12	Azevedo, Luiz	0/0	2/4	0/0	4	0	0	0	0	0	0	0	0	0	0	5:39		
13	Silva, Paulo	0/0	1/2	0/0	2	1	0	0	0	0	0	0	0	1	0	2:03		
14	Schmidt, Oscar	8/12	8/18	6/8	46	2	6	3	0	1	0	0	3	0	0	38:58		
15	Andrade, Israel	1/1	1/4	3/4	8	4	1	7	1	1	1	0	0	1	1	24:53		
Total		11/18	26/58	19/25	104	20	12	29	10	14	3	1	16	2	9	200:00		

PUR

04	Ortiz Rijos, J	0/0	5/7	2/2	12	3	3	5	2	0	0	1	2	0	0	24:26
05	Lopez, Federico	1/2	4/6	0/0	11	2	0	0	0	1	1	0	0	0	1	22:57
06	Gause, Raymond	0/2	1/1	0/0	2	0	0	0	0	0	0	0	0	0	0	6:21
07	Ithier, Vicente	0/0	1/2	0/0	2	1	0	0	0	0	1	0	1	0	0	9:22
08																

Basketball

Men		Hommes															
Final (5-6 Places)/Sept. 30		Finale (5-6 Places)/30 Sept															
No.	Name	<T.P.G> <F.G> <F.T>			Pts	Foul	Rebnd			AST	STL	VIO	LST	BLK	GDD	<Time> Min Sec	
		MA	MA	MA			O	D	X								
BRA 106-90 CAN (43-39,63-51)																	
BRA																	
04	Almeida, Paulo	0/3	10/11	5/6	25	3	0	1	0	2	0	0	0	0	0	25:37	
05	Guerra, Jorge	0/1	0/2	0/0	0	2	1	2	0	0	0	0	0	0	0	8:53	
06	Victalino, G	0/0	0/3	0/0	0	3	0	1	1	0	0	0	0	0	1	7:18	
07	Vianna, Joao	0/0	7/7	9/10	23	5	8	9	1	0	2	0	1	2	0	31:24	
08	Ferreira, R	0/0	1/1	0/1	2	2	0	1	0	0	0	0	0	0	0	8:42	
09	Guimaraes, R	0/2	1/4	0/0	2	4	0	2	0	0	0	0	0	0	0	12:53	
10	Souza, Maury	0/0	1/3	0/0	2	1	0	1	0	1	1	0	1	0	0	18:14	
11	Souza, Marcel	0/4	0/3	0/0	0	1	0	1	0	0	0	0	0	0	0	14:17	
12	Azevedo, Luiz	1/1	0/2	0/0	3	0	0	0	0	0	0	0	0	0	0	1:18	
13	Silva, Paulo	0/0	0/0	0/0	0	1	0	1	0	0	0	0	0	0	0	1:18	
14	Schmidt, Oscar	5/9	9/12	8/8	41	0	2	6	1	2	0	0	2	1	0	39:24	
15	Andrade, Israel	0/1	2/7	4/5	8	2	2	5	2	1	1	1	2	1	0	30:42	
Total		6/21	31/55	26/30	106	24	13	30	5	6	4	1	6	4	1	200:00	
CAN																	
04	Clarke, Norman	0/0	0/0	0/0	0	0	0	0	1	0	0	0	0	0	0	1:45	
05	Turcotte, David	0/0	0/1	0/0	0	1	0	0	0	0	0	0	1	0	0	3:03	
06	Pasquale, I	1/6	3/5	2/2	11	3	0	4	3	2	1	0	0	0	2	36:03	
07	Tillemann, Karl	2/4	1/5	0/1	8	2	2	0	0	0	0	0	1	0	0	8:32	
08	Kristmanson, A	0/0	0/1	0/0	0	1	0	0	0	0	0	0	0	0	0	3:19	
09	Triano, James	3/8	7/10	6/6	29	2	0	2	4	1	0	0	1	0	0	36:12	
10	Walton, Dwight	0/0	0/2	0/0	0	3	1	0	1	0	1	0	1	0	1	10:26	
11	Hatch, John	1/2	8/14	6/7	25	5	3	7	2	2	0	0	1	0	1	34:39	
12	Mungar, Barry	0/0	0/4	0/2	0	1	1	0	0	0	0	0	0	0	0	5:29	
13	Raffin, Romel	0/0	1/5	0/0	2	2	2	5	0	0	1	0	1	0	0	28:22	
14	Yearwood, Wayne	0/0	6/14	3/6	15	4	3	4	2	3	0	0	1	1	0	30:21	
15	Kazanowski, G	0/0	0/1	0/0	0	0	0	0	0	0	0	0	0	0	0	1:49	
Total		7/20	26/62	17/24	90	24	12	22	13	8	3	0	7	1	4	200:00	

<Team Statistics/Statistiques de l'Equipe>

Teams	T.P	Goals	FLD	Goals	FR.	Throws	Fouls	Rebs	Recs	Assts	Blks	Turns	FB Efficiency
BRA	6/21	29%	31/55	56%	26/30	87%	24	43	10	6	4	7	1/1
CAN	7/20	35%	26/62	42%	17/24	71%	24	34	20	8	1	7	1/1

Referee/Arbitre YUG RADONJIC, ZORDAN
 Umpire/Arb. Adjont BUL TOCHEV, KAMEN

Men		Hommes															
Final (7-8 Places)/Sept. 29		Finale (7-8 Places)/29 Sept															
No.	Name	<T.P.G> <F.G> <F.T>			Pts	Foul	Rebnd			AST	STL	VIO	LST	BLK	GDD	<Time> Min Sec	
		MA	MA	MA			O	D	X								
ESP 92-93 PUR (45-47,47-46)																	
ESP																	
04	Villacampa, J	0/0	1/1	0/0	2	2	0	0	0	0	0	0	3	0	0	7:35	
05	Llorente, J	0/0	0/0	0/0	0	0	0	0	0	0	0	0	0	0	0	0:00	
06	Biriukov, Jose	0/1	1/3	5/6	7	4	0	1	0	0	2	0	0	0	1	17:38	
07	Margall, J	0/0	1/2	0/0	2	0	2	0	1	2	0	0	0	0	0	14:47	
08	Jimenez, Andres	0/0	11/13	9/12	31	5	2	6	0	0	0	2	0	1	0	31:15	
09	Andreu, Enrique	0/0	0/0	0/0	0	0	0	0	0	0	0	0	0	0	0	0:00	
10	Montero, J	0/0	0/0	0/0	0	0	0	0	0	0	0	0	0	0	0	0:00	
11	Aroega, Fernando	0/0	0/0	0/0	0	2	0	0	0	1	0	0	3	0	0	8:45	
12	Solozabal, I	0/4	1/2	0/0	2	2	0	1	1	6	1	0	2	0	1	40:00	
13	Martinez, Ferran	0/0	4/5	4/4	12	3	0	3	1	0	0	0	1	3	0	15:13	
14	Martin, Antonio	0/0	4/10	3/4	11	2	0	6	1	0	0	1	2	0	1	24:47	
15	San Epifanio, J	3/3	5/7	6/6	25	1	0	6	1	3	1	0	1	0	1	40:00	
Total		3/8	28/43	27/32	92	21	2	25	4	11	6	1	14	3	5	200:00	
PUR																	
04	Ortiz Rijos, J	0/0	5/11	5/8	15	3	1	7	3	4	1	0	1	3	1	26:33	
05	Lopez, Federico	0/1	0/2	0/0	0	2	0	0	1	2	1	0	1	0	2	24:43	
06	Gause, Raymond	0/2	3/9	3/3	9	3	1	1	0	0	1	0	2	0	0	18:55	
07	Ithier, Vicente	0/0	0/0	2/2	2	1	0	0	0	2	1	0	0	0	0	9:06	
08	Mincy, Jerome	0/0	6/6	3/3	15	3	3	5	0	0	0	1	1	0	1	19:55	
09	Ricoos, Roberto	0/0	1/2	3/4	5	0	0	0	0	0	1	0	0	0	0	6:24	
10	Cruz, Angel	1/2	3/10	0/0	9	2	0	0	4	3	0	0	2	0	0	28:23	
11	Rivas, Ramon	0/0	0/0	0/0	0	0	0	0	0	0	0	0	0	0	0	0:00	
12	Morales, Mario	4/8	5/10	3/4	25	4	4	0	0	2	0	1	0	0	0	32:29	
13	Leon, Edgar	0/0	3/7	0/0	6	4	2	3	1	1	1	0	1	0	0	13:31	
14	Leon, Francisco	0/0	0/0	0/0	0	0	0	0	0	0	0	0	0	0	0	0:00	
15	Ramos, Ramon	0/0	2/6	3/3	7	2	2	2	1	0	1	1	0	0	2	20:01	
Total		5/13	28/63	22/27	93	24	13	18	10	10	10	3	9	3	6	200:00	

<Team Statistics/Statistiques de l'Equipe>

Teams	T.P	Goals	FLD	Goals	FR.	Throws	Fouls	Rebs	Recs	Assts	Blks	Turns	FB Efficiency
ESP	3/8	38%	28/43	65%	27/32	84%	21	27	15	11	3	15	0/0
PUR	5/13	38%	28/63	44%	22/27	81%	24	31	26	10	3	12	0/2

Referee/Arbitre YUG GIBAC, ZORAN
 Umpire/Arb. Adjont CAN STEEVES, RICHARD

Basket-ball

Men		Hommes															
Semi-final Match 1/Sept. 28		Demi-finale Match 1/28 Sept															
No.	Name	<T.P.G> <F.G> <F.T>			Pts	Foul	Rebnd			AST	STL	VIO	LST	BLK	GDD	<Time> Min Sec	
		MA	MA	MA			O	D	X								
URS 82-76 USA (47-37, 35-39)																	
URS																	
04	Volkov, A	0/0	4/6	4/5	12	4	3	3	1	5	1	0	2	0	3	37:29	
05	Sokk, Tiit	0/2	1/2	3/4	5	4	0	2	0	4	3	0	3	0	2	36:34	
06	Tarakanov, S	0/0	0/1	0/0	0	0	0	0	0	0	0	0	0	0	0	6:18	
07	Marthioulenis	3/3	2/8	6/8	19	5	3	1	0	3	0	0	6	0	2	26:43	
08	Migliniex, Igor	0/0	0/0	0/0	0	0	0	0	0	0	0	0	0	0	0	0:15	
09	Tikhonenko, V	0/1	1/2	1/2	3	1	0	0	2	0	0	0	1	0	0	9:57	
10	Kourtinaitis, R	4/10	4/6	8/9	28	3	4	1	0	0	1	0	0	0	2	33:02	
11	Sabonis, A	0/0	6/12	1/2	13	4	3	10	2	2	1	0	1	1	0	35:20	
12	Pankrachkine, V	0/0	0/0	0/0	0	0	0	0	0	0	0	0	0	0	0	0:00	
13	Khomitchious, V	0/1	1/3	0/0	2	0	1	0	0	0	1	0	2	0	0	8:32	
14	Belostennyi, A	0/0	0/1	0/0	0	0	1	0	0	0	0	0	0	0	1	4:09	
15	Goborov, Valeri	0/0	0/1	0/0	0	0	0	0	0	0	0	0	0	0	0	1:41	
Total		7/17	19/42	23/30	82	21	15	17	5	14	7	0	15	1	10	200:00	
USA																	
04	Richmond, M	1/2	0/2	2/2	5	3	0	0	1	0	2	0	1	0	1	13:31	
05	Smith, C	1/1	4/8	0/1	11	2	0	1	1	1	0	0	2	0	0	33:57	
06	Coles, Vernell	0/0	2/4	2/3	6	5	0	1	1	2	1	0	2	0	1	17:33	
07	Hawkins, Hersey	0/0	0/0	0/0	0	0	0	0	0	0	0	0	0	0	0	0:00	
08	Grayer, Jeffrey	1/1	0/2	1/2	4	2	0	1	0	0	1	0	0	0	0	9:58	
09	Smith, C	0/0	0/2	2/2	2	1	1	1	0								



Men		Hommes													Rebnd	<Time>	
Final (1-2 Places)/Sept. 30		Finale (1-2 Places)/30 Sept															
No.	Name	<T.P.G>	<F.G>	<F.T>	Pts	Foul	O	D	X	AST	STL	VIO	LST	BLK	GDD	Min	Sec
URS 76-63 YUG (31-28,45-35)																	
URS																	
04	Volkov, A	0/1	3/5	1/1	7	5	1	2	0	3	0	0	0	1	1		26:10
05	Sokk, Tiit	0/2	1/1	3/4	5	0	0	3	1	0	0	0	1	0	0		34:50
06	Tarakanov, S	0/0	3/5	2/3	8	2	1	2	2	0	0	0	0	0	0		15:09
07	Martchioulenis	3/6	4/5	4/4	21	4	0	3	1	6	1	0	3	0	0		36:00
08	Miglinix, Igor	0/0	0/0	0/0	0	0	0	0	0	0	0	0	0	0	0		0:00
09	Tikhonenko, V	0/0	0/0	0/0	0	0	0	0	0	0	0	0	0	0	0		0:00
10	Kourtinaitis, R	1/3	0/2	4/4	7	4	0	2	0	1	1	1	0	0	0		20:01
11	Sabonis, A	0/0	8/14	4/5	20	4	4	11	4	1	0	0	5	3	2		37:08
12	Pankrachkine, V	0/0	0/0	0/0	0	0	0	0	0	0	0	0	0	0	0		0:00
13	Khomitchious, V	1/3	2/4	0/0	7	2	0	2	0	0	1	0	2	0	0		26:33
14	Belostennyi, A	0/0	0/1	1/2	1	0	0	0	0	0	0	0	0	0	0		4:09
15	Goborov, Valeri	0/0	0/0	0/0	0	0	0	0	0	0	0	0	0	0	0		0:00
Total		5/15	21/37	19/23	76	21	6	25	8	11	3	1	11	4	3		200:00

YUG																	
04	Petrovic, Drazen	2/6	6/11	6/9	24	2	0	3	0	4	2	0	1	0	1		38:02
05	Radulovic, Z	0/0	1/1	0/0	0	0	0	0	0	0	0	0	0	0	0		0:00
06	Cutura, Zoran	0/0	0/3	0/0	0	1	0	0	0	0	0	0	0	0	0		6:08
07	Kukoc, Toni	0/2	1/1	1/3	3	2	2	0	1	1	2	0	0	0	0		21:00
08	Paspalj, Zarko	0/0	2/6	4/4	8	2	1	0	0	1	0	0	0	0	0		27:46
09	Obradovic, Z	0/2	3/4	0/0	6	2	0	1	0	1	0	0	0	0	0		23:17
10	Zdovc, Jurij	0/0	0/0	0/0	0	0	0	0	0	0	0	0	0	0	0		0:00
11	Vrankovic, S	0/0	1/4	1/3	3	3	0	2	0	0	0	0	0	1	0		8:14
12	Divac, Vlade	0/1	3/10	5/8	11	4	2	5	2	0	5	0	2	0	1		31:08
13	Arapovic, Franjo	0/0	0/0	0/0	0	0	0	0	0	0	0	0	0	0	0		0:00
14	Radja, Dino	0/0	2/3	0/1	4	5	0	2	1	0	0	1	2	0	0		22:32
15	Cvijecanin, D	0/0	1/1	2/2	4	1	0	3	0	0	0	0	0	0	2		21:53
Total		2/11	19/43	19/30	63	22	5	16	4	7	9	1	5	1	4		200:00

<Team Statistics/Statistiques de l'Equipe>

Teams	T.P	Goals	FLD	Goals	FR.	Throws	Fouls	Rebs	Recs	Assts	Blks	Turns	FB Efficiency
URS	5/15	33%	21/37	57%	19/23	83%	21	31	14	11	4	12	0/0
YUG	2/11	18%	19/43	44%	19/30	63%	22	21	17	7	1	6	2/4

Referee/Arbitre USA FORTE, JOSEPH PATRICK
 Umpire/Arb. Adjoint BRA AFFINI, ANTONIO CARLOS

Women		Femmes													Rebnd	<Time>	
Preliminary Pool Group A Match 1/Sept. 19		Poule Preliminaire Groupe A Match 1/19 Sept															
No.	Name	<T.P.G>	<F.G>	<F.T>	Pts	Foul	O	D	X	AST	STL	VIO	LST	BLK	GDD	Min	Sec
BUL 62-91 URS (26-50,36-41)																	
BUL																	
04	Khadjiyankova, N	0/1	1/5	0/1	2	1	0	2	1	2	2	1	2	0	0		14:52
05	Spasova, L	0/2	1/1	0/0	2	2	1	0	1	2	1	0	2	0	2		25:08
06	Naydenova, M	0/0	1/2	2/2	4	0	0	0	0	1	0	0	1	0	0		5:13
07	Vayssilova, T	0/0	0/0	0/0	0	1	0	0	2	0	0	0	0	0	0		3:56
08	Dermendjieva, V	0/0	8/15	1/1	17	4	1	2	1	0	0	0	3	0	1		22:30
09	Dragomirova, S	0/0	0/1	0/0	0	0	0	0	1	0	0	0	0	0	0		5:34
10	Vassileva, R	0/0	0/2	2/2	2	2	0	0	0	1	0	0	1	0	0		10:16
11	Radkova, K	1/1	2/6	0/0	7	2	0	0	2	0	0	2	0	0	0		27:48
12	Stefanova, E	0/1	3/4	1/2	7	0	1	3	0	3	1	0	4	0	2		31:09
13	Staneva, Madlen	0/0	7/14	3/4	17	3	1	5	3	2	1	0	0	1	2		34:07
14	Tzekova, Polina	0/0	1/1	2/3	4	2	0	2	1	0	0	0	1	0	0		8:47
15	Tchobanova, M	0/0	0/3	0/0	0	5	1	1	0	0	0	0	1	0	1		10:40
Total		1/5	24/54	11/15	62	22	5	16	11	11	5	1	18	3	9		200:00

URS																	
04	Evkova, Olga	0/1	2/2	0/0	4	1	0	1	0	3	1	1	2	0	0		15:14
05	Guerlits, Irina	0/0	3/5	5/9	11	1	2	0	0	1	1	0	1	1	0		12:42
06	Barel, Olessia	0/0	4/7	0/0	8	3	1	1	0	0	0	0	0	1	0		15:33
07	Sournikova, I	0/0	2/3	0/1	4	3	0	2	0	1	2	0	0	0	0		19:10
08	Bouriakina, Olga	0/3	1/1	2/2	4	0	1	0	0	0	1	1	0	0	0		18:48
09	Iakovleva, Olga	0/4	0/2	0/0	0	3	3	7	0	1	0	0	0	0	2		21:26
10	Minkh, Irina	1/2	1/5	0/0	5	2	0	2	0	4	1	1	1	0	2		18:10
11	Leonova, A	2/2	0/0	0/0	6	1	0	0	0	0	0	1	2	0	0		8:38
12	Khoudachova, E	0/0	4/10	1/1	9	0	2	3	2	0	1	0	0	0	1		24:09
13	Touomaite, V	0/0	0/1	1/2	1	1	1	4	0	2	0	0	1	0	1		8:30
14	Zassoulskaia, N	0/0	8/13	7/9	23	0	5	5	0	2	1	0	1	1	0		19:06
15	Savitskaia, G	0/2	6/11	4/5	16	2	1	2	0	0	2	0	1	0	1		18:34
Total		3/14	31/60	20/29	91	17	16	27	2	14	10	4	9	3	7		200:00

<Team Statistics/Statistiques de l'Equipe >

Teams	T.P	Goals	FLD	Goals	FR.	Throws	Fouls	Rebs	Recs	Assts	Blks	Turns	FB Efficiency
BUL	1/5	20%	24/54	44%	11/15	73%	22	21	25	11	3	21	2/3
URS	3/14	21%	31/60	52%	20/29	69%	17	43	19	14	3	16	6/6

Referee/Arbitre YUG RADONJIC, ZORDAN
 Umpire/Arb. Adjoint USA BRODERICK, PATRICIA ANN

Men		Hommes													Rebnd	<Time>	
Final (3-4 Places)/Sept. 29		Finale (3-4 Places)/29 Sept															
No.	Name	<T.P.G>	<F.G>	<F.T>	Pts	Foul	O	D	X	AST	STL	VIO	LST	BLK	GDD	Min	Sec
AUS 49-78 USA (29-52, 20-26)																	
AUS																	
04	Pearce, Darryl	0/1	1/3	0/0	2	0	0	0	0	0	0	0	0	0	0		10:22
05	Sibley, Robert	0/0	0/0	0/0	0	0	0	0	0	0	0	0	0	0	0		0:00
06	Smyth, Philip	2/4	0/4	4/4	10	1	0	1	2	2	0	0	3	0	0		30:41
07	Sengstock, Larry	0/0	1/2	0/1	2	2	0	6	0	0	1	0	4	0	0		19:06
08	Keogh, Damian	1/1	0/6	1/2	4	3	2	0	1	1	2	1	2	0	1		20:39
09	Carroll, Wayne	0/2	0/1	0/0	0	1	0	1	0	0	0	0	2	0	0		14:39
10	Longley, Lucien	0/0	0/1	1/3	1	2	0	1	1	0	0	0	3	0	2		13:00
11	Gaze, Andrew	3/6	4/7	0/0	17	3	0	1	0	1	1	0	1	0	0		29:41
12	Bradtko, Mark	0/0	1/2	2/2	4	1	1	1	0	0	0	1	0	1	0		12:25
13	Dalton, Bradley	0/0	0/1	0/0	0	0	1	1	0	0	0	0	0	0	1		10:06
14	Vlahov, Andrew	0/0	1/3	0/2	2	3	1	4	0	1	1	0	1	0	1		13:58
15	Bomer, Raymond	0/0	3/5	1/1	7	3	3	1	1	1	1	1	2	1	2		25:23
Total		6/14	11/35	9/15	49	19	8	17	5	6	6	3	18	2	7		200:00

USA																	
04	Richmond, M	0/1	6/10	0/1	12	3	1	6	0	2	1	0	0	0	0		25:15
05	Smith, C	0/1	0/2	2/2	2	1	1	1	0	1	1	0	1	0	1		23:57
06	Coles, Vernell	0/0	2/4	1/1	5	2	0	0	1	1	0	0	1	0	0		16:03
07	Hawkins, Hersey	0/															

Basketball

Women Preliminary Pool Group A Match 3/Sept. 22

No.	Name	<T.P.G> <F.G> <F.T>			Pts	Rebnd										<Time> Min Sec
		MA	MA	MA		Foul	O	D	X	AST	STL	VIO	LST	BLK	GDD	
KOR 66-69 URS (35-33, 31-36)																
KOR																
04	Lee, Keun-Jin	5/6	0/2	2/2	17	2	0	1	0	0	0	0	0	0	0	28:03
05	Kim, Mal-Lyun	0/0	0/0	0/0	0	0	0	0	0	0	0	0	0	0	0	0:00
06	Choi, Kyong-Hee	4/9	3/4	2/3	20	3	0	3	1	0	0	0	0	0	1	36:46
07	Lee, Hyung-Sook	0/1	2/3	3/3	7	4	0	0	3	0	0	0	0	0	2	22:50
08	Park, Chan-Mi	0/0	0/0	0/0	0	0	0	0	0	0	0	0	0	0	0	0:00
09	Woo, Eun-Kyung	0/0	0/1	0/0	0	0	0	0	0	0	0	0	0	0	0	1:18
10	Chung, Mi-Kyung	0/0	3/5	2/3	8	4	0	0	0	0	0	1	0	0	0	22:42
11	Kim, Hwa-Soon	0/3	2/4	0/0	4	4	0	2	0	0	0	1	0	0	0	16:30
12	Kim, Hye-young	0/0	0/0	0/0	0	0	0	0	0	0	0	0	0	0	0	0:00
13	Park, Chan-Sook	0/0	0/2	0/0	0	0	0	0	2	0	0	0	0	0	0	13:33
14	Sung, Jung-A	0/0	3/5	2/4	8	3	3	11	0	0	2	1	3	2	0	40:00
15	Cho, Mun-Joo	0/0	0/1	2/3	2	3	0	2	0	0	1	0	3	1	0	18:18
Total		9/19	13/27	13/18	66	23	3	19	6	0	3	3	6	3	3	200:00

No.	Name	<T.P.G> <F.G> <F.T>			Pts	Rebnd										<Time> Min Sec
		MA	MA	MA		Foul	O	D	X	AST	STL	VIO	LST	BLK	GDD	
URS																
04	Evkova, Olga	0/0	1/2	0/0	2	2	0	1	1	1	0	0	0	0	0	16:30
05	Guerlits, Irina	0/0	0/1	0/0	0	1	0	1	1	0	0	0	0	0	0	2:12
06	Barel, Olessia	0/0	0/0	0/0	0	0	0	0	0	0	0	0	1	0	0	6:41
07	Soumnikova, I	1/3	2/3	1/1	8	3	0	2	1	2	0	0	0	2	1	24:12
08	Bouriakina, Olga	2/3	1/4	2/2	10	1	1	2	1	0	1	0	0	0	0	19:33
09	Iakovleva, Olga	1/5	0/1	0/0	3	1	1	2	1	1	1	0	0	0	1	29:54
10	Minkh, Irina	0/1	4/6	5/6	13	5	4	1	0	0	1	0	1	0	0	17:11
11	Leonova, A	0/1	0/0	0/0	0	0	0	0	1	0	0	0	0	0	0	4:49
12	Khoudachova, E	0/0	2/5	0/0	4	1	1	3	2	0	0	0	3	3	1	14:36
13	Touomaite, V	0/0	3/4	2/2	8	0	0	0	1	0	0	0	0	0	1	12:56
14	Zassoulskaia, N	0/0	1/4	1/2	3	3	0	2	2	0	0	0	1	0	0	16:06
15	Savitskaia, G	0/1	4/10	10/12	18	2	2	4	1	0	1	0	0	2	0	35:20
Total		4/14	18/40	21/25	69	19	9	18	12	4	4	0	6	7	4	200:00

<Team Statistics/Statistiques de l'Equipe>

Teams	T.P	Goals	FLD	Goals	FR.	Throws	Fouls	Rebs	Recs	Assts	Blks	Turns	F.B	Efficiency
KOR	9/19	47%	13/27	48%	13/18	72%	23	22	12	0	3	11	0/0	
URS	4/14	29%	18/40	45%	21/25	84%	19	27	20	4	7	6	1/1	
Referee/Arbitre	BRA AFFINI, ANTONIO CARLOS													
Umpire/Arb. Adjoint	ARG RUBINSZTEIN, JORGE A.													

Women Preliminary Pool Group A Match 4/Sept. 22

No.	Name	<T.P.G> <F.G> <F.T>			Pts	Rebnd										<Time> Min Sec
		MA	MA	MA		Foul	O	D	X	AST	STL	VIO	LST	BLK	GDD	
AUS 63-57 BUL (31-30, 32-27)																
AUS																
04	Maier, Robyn	0/0	6/19	8/10	20	1	3	6	2	2	0	0	1	0	0	36:52
05	Brondello, S	0/0	0/0	0/0	0	0	0	0	0	0	0	0	0	0	0	0:00
06	Cheesman, J	0/0	0/3	0/0	0	0	0	0	0	0	0	0	0	0	1	3:17
07	Timms, Michele	2/4	2/5	3/3	13	1	1	3	1	3	0	2	5	0	1	36:43
08	Brown, Donna	0/1	2/3	3/4	7	3	0	4	1	2	1	0	1	0	1	24:22
09	Mickan, Patricia	0/0	2/8	1/2	5	2	3	2	2	0	1	0	1	0	0	25:08
10	Nykiel, Julie	0/0	0/0	0/0	0	0	0	1	0	0	0	0	0	0	0	3:24
11	Slimmon, Debra	0/0	1/1	1/2	3	1	1	0	0	0	0	0	0	0	0	6:57
12	Moffa, Marina	0/1	3/5	0/0	6	1	3	1	1	0	0	0	3	0	2	13:46
13	Dalton, Karen	0/0	2/3	0/3	4	2	2	5	3	2	0	0	0	0	2	30:45
14	Gorman, Shelley	1/1	1/3	0/0	5	2	0	2	0	0	1	0	0	0	0	15:38
15	White, Maree	0/0	0/0	0/0	0	0	0	0	0	0	0	0	0	0	0	3:08
Total		3/7	19/50	16/24	63	13	13	24	10	9	3	2	11	0	7	200:00

No.	Name	<T.P.G> <F.G> <F.T>			Pts	Rebnd										<Time> Min Sec
		MA	MA	MA		Foul	O	D	X	AST	STL	VIO	LST	BLK	GDD	
BUL																
04	Khadjiyankova, N	1/2	3/8	0/0	9	3	0	2	0	1	2	0	3	0	0	25:56
05	Spassova, L	0/3	0/2	0/0	0	3	0	4	2	0	3	1	0	0	0	31:46
06	Naydenova, M	0/0	0/0	0/0	0	0	0	0	0	0	0	0	0	0	0	0:00
07	Vayssilova, T	0/0	0/0	0/0	0	0	0	0	0	0	0	0	0	0	0	0:00
08	Dermendjieva, V	0/0	4/10	3/5	11	2	0	2	0	0	0	0	2	2	1	23:22
09	Dragomirova, S	0/0	0/0	0/0	0	0	0	0	0	0	0	0	0	0	0	0:00
10	Vassileva, R	0/0	0/0	2/2	2	1	0	1	0	1	0	0	1	1	0	16:30
11	Radkova, K	0/0	2/2	0/0	4	3	0	2	0	1	0	0	1	2	0	11:20
12	Stefanova, E	3/4	3/6	0/0	15	4	0	6	2	2	2	0	1	0	2	34:28
13	Staneva, Madlen	0/0	2/6	2/2	6	3	1	3	2	0	0	1	1	1	2	31:09
14	Tzekova, Polina	0/0	0/0	0/0	0	0	0	0	0	0	0	0	0	1	0	0:00
15	Tchobanova, M	0/0	4/8	2/2	10	3	2	0	0	1	1	0	0	3	0	25:29
Total		4/9	18/42	9/11	57	22	3	20	6	6	8	2	9	10	5	200:00

<Team Statistics/Statistiques de l'Equipe>

Teams	T.P	Goals	FLD	Goals	FR.	Throws	Fouls	Rebs	Recs	Assts	Blks	Turns	F.B	Efficiency
AUS	3/7	43%	19/50	38%	16/24	67%	13	37	20	9	0	13	2/3	
BUL	4/9	44%	18/42	43%	9/11	82%	22	23	19	6	10	14	0/0	
Referee/Arbitre	GRE RIGAS, CONSTANTIN													
Umpire/Arb. Adjoint	USA BRODERICK, PATRICIA ANN													

Basket-ball

Women Preliminary Pool Group A Match 5/Sept. 25

No.	Name	<T.P.G> <F.G> <F.T>			Pts	Rebnd										<Time> Min Sec
		MA	MA	MA		Foul	O	D	X	AST	STL	VIO	LST	BLK	GDD	
BUL 98-87 KOR (48-51, 50-36)																
BUL																
04	Khadjiyankova, N	1/4	1/4	0/0	5	1	0	1	0	2	3	0	2	0	0	19:24
05	Spassova, L	3/4	2/4	4/4	17	4	0	2	1	0	3	1	1	0	0	33:42
06	Naydenova, M	0/0	0/0	0/0	0	0	0	0	0	0	0	0	0	0	0	0:00
07	Vayssilova, T	0/0	0/0	0/0	0	0	0	0	0	0	0	0	0	0	0	0:00
08	Dermendjieva, V	0/0	9/11	1/1	19	3	1	4	3	0	0	1	2	0	1	40:00
09	Dragomirova, S	3/4	0/1	0/0	9	3	0	2	0	0	1	0	0	1	0	26:54
10	Vassileva, R	0/0	0/0	0/0	0	0	0	0	0	0	0	0	0	0	0	0:00
11	Radkova, K	1/1	0/0	0/0	3	1	0	0	0	0	0	0	0	1	1	5:18
12	Stefanova, E	3/6	13/16	4/4	39	2	2	6	0	2	1	2	0	0	0	40:00
13	Staneva, Madlen	0/0	0/1	0/0	0	0	0	0	0	0	1	1	0	0	1	10:36
14	Tzekova, Polina	0/0	0/0	0/0	0	0	0	0	0	0	0	0	0	0	0	0:00
15	Tchobanova, M	2/5	0/2	0/0	6	0	0	2	2	3	0	0	0	0	2	24:06
Total		13/24	25/39	9/9	98	14	3	17	7	8	9	4	6	3	4	200:00

No.	Name	<T.P.G> <F.G> <F.T>			Pts	Rebnd										<Time> Min Sec
		MA	MA	MA		Foul	O	D	X	AST	STL	VIO	LST	BLK	GDD	
KOR																
04	Lee, Keun-Jin	3/7	0/3	0/0	9	1	0	1								



Women Preliminary Pool Group B Match 1/Sept. 19 **Femmes Poule Preliminaire Groupe B Match 1/19 Sept**

No.	Name	<T.P.G> <F.G> <F.T>			Pts	Rebnd					<Time>						
		MA	MA	MA		Foul	O	/	D	X	AST	STL	VIO	LST	BLK	GDD	Min
TCH 81-87 USA (39-37, 42-50)																	
TCH																	
04	Kysilkova, S	1/1	5/9	0/0	13	4	0	0	1	0	1	0	2	0	2		27:17
05	Kasova, Alena	0/0	0/2	0/0	0	1	0	0	0	0	0	0	0	0	0		7:43
06	Kaluzakova, Eva	2/4	1/4	3/4	11	2	0	2	1	2	1	0	4	0	0		32:17
07	Novakova, Ivana	0/0	10/17	1/2	21	4	4	4	3	2	5	0	3	0	1		38:37
08	Hajkova, Zuzana	0/0	0/0	0/0	0	0	0	0	0	0	0	0	0	0	0		0:00
09	Janostinova, A	0/0	1/4	0/0	2	5	2	2	0	0	0	0	0	0	0		19:26
10	Brziakova, Zora	0/0	5/6	1/2	11	1	0	0	0	0	0	0	1	0	0		14:06
11	Zarevucka, Hana	0/0	0/0	0/0	0	0	0	0	0	0	0	0	0	0	0		0:00
12	Dobrovicova, E	0/0	4/8	2/3	10	5	1	4	2	1	1	0	2	2	0		29:23
13	Krizova, Eva	0/0	1/1	3/6	5	1	0	1	0	0	0	0	1	0	0		10:50
14	Valova, Irma	0/0	4/4	0/0	8	1	1	3	0	0	0	0	2	2	0		16:44
15	Berkova, Eva	0/0	0/1	0/0	0	0	0	1	0	0	0	0	1	0	0		3:37
Total		3/5	31/56	10/17	81	24	8	17	7	5	8	0	16	4	3		200:00

USA																	
No.	Name	<T.P.G> <F.G> <F.T>			Pts	Rebnd					<Time>						
		MA	MA	MA	Foul	O	/	D	X	AST	STL	VIO	LST	BLK	GDD	Min	Sec
USA 101-74 YUG (55-40, 46-34)																	
USA																	
04	Edwards, Teresa	0/0	8/14	8/10	24	4	1	0	1	2	2	0	1	0	1		28:26
05	Ethridge, Mary	0/0	1/1	0/0	2	1	0	1	0	0	0	0	0	0	0		13:47
06	Brown, Cynthia	1/1	4/7	3/5	14	2	1	5	0	0	0	2	1	1	1		18:22
07	Donovan, Anne	0/0	1/4	1/2	3	0	2	1	2	0	2	0	4	1	0		17:28
08	Weatherspoon, T	0/0	0/2	0/0	0	2	1	0	2	1	1	1	1	0	0		16:37
09	Gordon, B	0/0	2/7	0/0	4	0	1	2	1	1	0	0	0	0	0		11:59
10	Bullett, V	0/0	2/4	2/2	6	1	2	2	0	0	1	0	1	0	0		12:01
11	Lloyd, Andrea	0/0	1/3	4/4	6	1	0	1	1	0	1	0	1	0	0		14:42
12	Mcclain, Katrina	0/0	8/18	3/5	19	3	4	4	1	1	3	0	0	0	0		28:48
13	Gillom, Jennifer	0/0	0/1	0/0	0	1	1	0	0	0	0	0	0	0	0		3:21
14	Cooper, Cynthia	0/0	1/3	0/0	2	4	1	2	0	1	1	0	1	0	0		16:25
15	Mcconnell, S	1/1	1/1	2/2	7	2	0	1	0	0	0	0	1	0	0		18:04
Total		2/2	29/65	23/30	87	21	14	19	8	6	11	3	11	2	2		200:00

<Team Statistics/Statistiques de l'Equipe>

Teams	T.P	Goals	FLD	Goals	FR.	Throws	Fouls	Rebs	Recs	Assts	Blks	Turns	FB Efficiency
TCH	3/5	60%	31/56	55%	10/17	59%	24	25	18	5	4	18	1/1
USA	2/2	100%	29/65	45%	23/30	77%	21	33	21	6	2	16	2/2

Referee/Arbitre AUS WEEKS, GEOFFREY ROBERT
 Umpire/Arb. Adjoint JPN SUGIURA, ITSUO

Women Preliminary Pool Group B Match 3/Sept. 22 **Femmes Poule Preliminaire Groupe B Match 3/22 Sept**

No.	Name	<T.P.G> <F.G> <F.T>			Pts	Rebnd					<Time>						
		MA	MA	MA		Foul	O	/	D	X	AST	STL	VIO	LST	BLK	GDD	Min
USA 101-74 YUG (55-40, 46-34)																	
USA																	
04	Edwards, Teresa	0/1	9/13	5/6	23	1	1	1	4	1	2	1	1	0	1		32:49
05	Ethridge, Mary	0/0	0/0	0/0	0	2	0	0	0	0	0	0	0	0	0		4:34
06	Brown, Cynthia	0/0	1/1	1/3	3	4	0	2	0	0	0	2	3	0	0		12:58
07	Donovan, Anne	0/0	0/3	0/0	0	1	0	0	3	0	0	1	3	0	1		10:31
08	Weatherspoon, T	0/0	1/1	4/5	6	2	0	2	2	2	2	0	2	0	1		23:52
09	Gordon, B	0/0	8/11	4/5	20	2	2	1	0	0	1	0	0	0	0		18:46
10	Bullett, V	0/0	3/8	4/4	10	2	4	1	1	1	0	0	0	1	0		14:03
11	Lloyd, Andrea	0/1	3/5	0/0	6	3	0	0	0	0	0	0	0	0	2		10:46
12	Mcclain, Katrina	0/0	2/5	4/4	8	3	2	7	0	0	1	0	0	1	0		27:43
13	Gillom, Jennifer	0/0	0/4	5/7	5	3	3	2	0	0	3	0	0	0	2		12:17
14	Cooper, Cynthia	3/3	2/2	4/4	17	1	0	2	0	0	0	0	1	0	3		17:39
15	Mcconnell, S	0/0	1/3	1/2	3	1	0	0	1	0	1	0	0	0	0		14:02
Total		3/5	30/56	32/40	101	25	12	18	11	4	10	4	12	2	10		200:00

YUG																	
No.	Name	<T.P.G> <F.G> <F.T>			Pts	Rebnd					<Time>						
		MA	MA	MA	Foul	O	/	D	X	AST	STL	VIO	LST	BLK	GDD	Min	Sec
YUG																	
04	Vangelovska, S	0/0	2/2	4/4	8	2	0	3	4	2	0	0	7	0	0		34:46
05	Lacic, Mara	0/1	0/0	0/0	0	0	1	0	0	0	0	1	1	0	0		5:14
06	Lelas, Zana	0/0	0/2	2/2	2	3	0	0	0	0	0	0	1	0	0		6:12
07	Wild, Eleonora	0/1	0/1	0/0	0	2	0	0	0	0	0	0	0	0	0		7:58
08	Kvesic, K	0/0	1/3	2/2	4	0	1	1	0	0	0	0	0	0	1		12:45
09	Nakic, Danira	0/0	4/8	7/9	15	5	0	2	0	0	0	3	4	1	1		22:04
10	Golic, Sladjana	0/0	8/10	0/0	16	5	3	0	0	1	2	0	2	0	2		33:30
11	Dornik, Polona	0/0	5/11	1/2	11	5	4	0	1	0	1	0	0	4	0		21:35
12	Mujanovic, R	0/0	1/3	2/2	4	0	0	1	1	1	0	0	0	0	1		12:13
13	Bajkusa, Vesna	0/0	1/1	0/1	2	3	0	1	0	2	0	0	2	0	1		9:01
14	Arbutina, A	2/4	0/1	0/0	6	5	0	2	0	1	0	0	2	0	0		20:31
15	Milosevic, B	0/0	2/3	2/4	6	4	1	2	0	1	0	1	1	0	1		14:11
Total		2/6	24/45	20/26	74	34	10	12	6	8	3	5	20	5	7		200:00

<Team Statistics/Statistiques de l'Equipe>

Teams	T.P	Goals	FLD	Goals	FR.	Throws	Fouls	Rebs	Recs	Assts	Blks	Turns	FB Efficiency
USA	3/5	60%	30/56	54%	32/40	80%	25	30	31	4	2	17	0/0
YUG	2/6	33%	24/45	53%	20/26	77%	34	22	16	8	5	28	1/1

Referee/Arbitre FRA MAININI, YVAN
 Umpire/Arb. Adjoint AUS HUNT, RAYMOND JOHN

Women Preliminary Pool Group B Match 2/Sept. 19 **Femmes Poule Preliminaire Groupe B Match 2/19 Sept**

No.	Name	<T.P.G> <F.G> <F.T>			Pts	Rebnd					<Time>						
		MA	MA	MA		Foul	O	/	D	X	AST	STL	VIO	LST	BLK	GDD	Min
CHN 53-56 YUG (32-35, 21-21)																	
CHN																	
04	Han, Qingling	0/0	2/4	2/3	6	4	1	2	3	2	1	0	2	0	2		29:32
05	Ling, Guang	0/0	2/4	1/1	5	0	0	0	0	0	0	0	2	0	1		11:57
06	Li, Xiaoqin	1/2	0/1	0/0	3	0	0	0	0	0	0	0	1	0	1		11:18
07	Zhao, Wei	0/0	0/0	0/0	0	0	0	0	0	0	0	0	0	0	0		0:00
08	Zhang, Taohua	0/0	0/0	0/0	0	0	0	0	0	0	0	0	0	0	0		0:00
09	Zhan, Shuping	0/0	0/0	0/0	0	0	0	0	0	0	0	0	0	0	0		0:00
10	Peng, Ping	0/0	4/6	1/2	9	3	0	4	0	2	0	0	0	0	2		21:30
11	Zheng, Haixia	0/0	6/12	1/2	13	2	0	7	2	2	0	1	4	3	1		40:00
12	Cong, Xuedi	1/3	1/1	0/0	5	3	0	3	0	0	0	0	3	0	1		29:02
13	Xue, Cuilan	1/1	3/4	2/2	11	2	1	2	5	3	0	2	2	0	1		38:11
14	Liu, Qing	0/0	0/3	1/2	1	2	0	2	0	0	0	1	1	0	0		18:30
15	Xu, Chunmei	0/0	0/0	0/0	0	0	0	0	0	0	0	0	0	0	0		0:00
Total		3/6	18/35	8/12	53	16	2	20	10	9							

Basketball

Women Preliminary Pool Group B Match 5/Sept. 25

		Femmes Poule Preliminaire Groupe B Match 5/25 Sept														
No.	Name	<T.P.G> MA	<F.G> MA	<F.T> MA	Pts	Foul	Rebnd O / D X	AST	STL	VIO	LST	BLK	GDD	<Time> Min Sec		
TCH 57-69 YUG (15-41,42-28)																
TCH																
04	Kysilkova, S	0/0	2/12	0/0	4	1	1 6	0	2	0	0	3	0	2	29:28	
05	Kasova, Alena	0/0	0/2	1/2	1	2	0 1	0	1	1	0	1	0	2	21:31	
06	Kaluzakova, Eva	1/1	0/2	0/0	3	0	1 1	0	3	0	0	1	0	0	18:29	
07	Novakova, Ivana	0/0	7/12	2/2	16	2	0 3	0	2	3	0	3	1	1	31:01	
08	Hajkova, Zuzana	0/0	0/0	0/0	0	1	0 0	0	0	0	0	0	0	1	3:34	
09	Janostinova, A	0/0	3/7	0/0	6	3	1 8	0	1	0	0	2	2	1	28:53	
10	Brziakova, Zora	0/0	1/4	1/2	3	3	1 0	0	0	1	0	2	0	1	13:34	
11	Zarevucka, Hana	0/1	0/0	0/0	0	0	0 0	0	0	0	0	0	0	0	2:23	
12	Dobrovicova, E	0/0	6/14	5/6	17	4	4 5	2	2	0	0	1	5	2	29:17	
13	Krizova, Eva	0/0	1/1	3/4	5	1	0 1	0	0	0	0	1	0	0	11:02	
14	Valova, Irma	0/0	1/3	0/0	2	1	0 1	0	0	1	0	0	0	0	6:17	
15	Berkova, Eva	0/0	0/0	0/0	0	0	0 0	0	0	0	0	0	0	0	4:31	
Total		1/2	21/57	12/16	57	18	8 26	2	11	6	0	14	8	10	200:00	

		Femmes Poule Preliminaire Groupe B Match 5/25 Sept														
No.	Name	<T.P.G> MA	<F.G> MA	<F.T> MA	Pts	Foul	Rebnd O / D X	AST	STL	VIO	LST	BLK	GDD	<Time> Min Sec		
YUG																
04	Vangelovska, S	2/3	1/2	0/0	8	2	0 3	1	7	0	0	6	0	1	38:03	
05	Lacic, Mara	0/0	0/1	0/0	0	0	0 0	1	0	0	0	0	0	0	1:57	
06	Lelas, Zana	0/0	0/0	0/0	0	0	0 0	0	0	0	0	0	0	0	0:00	
07	Wild, Eleonora	0/0	0/0	0/0	0	2	0 1	0	0	1	0	0	0	0	6:47	
08	Kvesic, K	0/0	0/0	0/0	0	0	0 0	0	0	0	0	0	0	0	0:54	
09	Nakic, Danira	0/0	8/16	8/10	24	3	0 3	1	1	0	2	2	0	0	40:00	
10	Golic, Sladjana	0/0	2/3	1/2	5	2	2 5	1	0	1	0	2	0	0	36:55	
11	Dornik, Polona	0/0	9/19	1/1	19	5	1 7	5	0	4	1	0	2	0	36:30	
12	Mujanovic, R	0/0	0/0	0/0	0	0	0 0	0	0	0	0	0	0	0	0:00	
13	Bajkusa, Vesna	0/0	0/0	0/0	0	1	0 0	0	0	0	0	0	0	0	1:38	
14	Arbutina, A	2/3	2/8	3/4	13	2	0 6	2	1	3	0	0	0	0	31:35	
15	Milosevic, B	0/0	0/0	0/0	0	1	0 0	0	0	0	0	1	0	0	5:41	
Total		4/6	22/49	13/17	69	18	3 25	11	9	9	3	11	2	1	200:00	

<Team Statistics/Statistiques de l'Equipe>

Teams	T.P	Goals	FLD	Goals	FR.	Throws	Fouls	Rebs	Recs	Assts	Blks	Turns	FB Efficiency
TCH	12	50%	21/57	37%	12/16	75%	18	34	18	11	8	14	3/4
YUG	4/6	67%	22/49	45%	13/17	76%	18	28	21	9	2	14	0/1

Referee/Arbitre	GRE	DOUVIS, STAVROS
Umpire/Arb. Adjoint	CAN	WEILAND, JOHN RUEBEN

Women Preliminary Pool Group B Match 6/Sept. 25

		Femmes Poule Preliminaire Groupe B Match 6/25 Sept														
No.	Name	<T.P.G> MA	<F.G> MA	<F.T> MA	Pts	Foul	Rebnd O / D X	AST	STL	VIO	LST	BLK	GDD	<Time> Min Sec		
CHN 79-94 USA (37-46, 42-48)																
CHN																
04	Han, Qingling	0/1	0/0	0/0	0	2	0 1	0	0	0	0	1	1	0	15:44	
05	Ling, Guang	0/2	0/0	0/0	0	0	1 2	1	2	3	0	4	0	0	21:25	
06	Li, Xiaoqin	0/1	0/0	0/0	0	0	1 0	0	0	0	0	0	0	1	3:56	
07	Zhao, Wei	0/0	0/0	0/0	0	0	0 0	0	0	0	0	0	0	0	0:00	
08	Zhang, Taohua	0/0	0/0	0/0	0	0	0 0	0	0	0	0	0	0	0	0:00	
09	Zhan, Shuping	0/0	0/0	0/0	0	0	0 0	0	0	0	0	0	0	0	0:00	
10	Peng, Ping	0/0	7/8	0/0	14	2	3 1	0	2	0	0	1	0	1	20:54	
11	Zheng, Haixia	0/0	15/20	2/3	32	1	2 6	0	0	1	2	0	1	0	30:53	
12	Cong, Xuedi	4/9	0/1	2/2	14	3	0 1	1	5	1	0	3	0	3	40:00	
13	Xue, Cuilan	0/1	1/7	3/4	5	2	1 1	0	2	0	0	3	0	1	38:55	
14	Liu, Qing	0/0	4/8	0/1	8	3	1 3	1	3	0	0	2	0	2	19:06	
15	Xu, Chunmei	0/0	3/7	0/0	6	1	0 1	1	0	0	0	1	0	0	9:07	
Total		4/14	30/51	7/10	79	14	9 16	4	14	4	1	17	1	9	200:00	

Women Preliminary Pool Group B Match 6/Sept. 25

		Femmes Poule Preliminaire Groupe B Match 6/25 Sept														
No.	Name	<T.P.G> MA	<F.G> MA	<F.T> MA	Pts	Foul	Rebnd O / D X	AST	STL	VIO	LST	BLK	GDD	<Time> Min Sec		
USA																
04	Edwards, Teresa	0/0	3/7	0/0	6	3	0 1	1	5	1	1	3	1	1	29:29	
05	Ethridge, Mary	0/0	0/0	0/0	0	0	0 0	0	0	0	0	0	0	0	0:00	
06	Brown, Cynthia	0/0	3/6	0/0	6	2	1 3	0	2	3	0	4	0	1	12:33	
07	Donovan, Anne	0/0	0/1	0/0	0	1	0 0	0	0	0	0	0	0	0	2:53	
08	Weatherspoon, T	0/0	0/1	0/1	0	2	0 4	0	0	1	0	3	1	0	19:14	
09	Gordon, B	0/0	3/8	0/0	6	1	3 0	0	0	0	0	0	0	0	20:46	
10	Bullett, V	0/0	1/2	0/0	2	0	3 0	1	1	1	0	0	0	1	9:59	
11	Lloyd, Andrea	0/0	5/9	2/2	12	2	4 1	0	2	3	0	1	0	0	19:18	
12	Mcclain, Katrina	0/0	11/13	5/6	27	0	3 10	2	2	0	0	0	0	1	31:21	
13	Gillom, Jennifer	0/0	1/2	1/2	3	0	1 1	0	0	0	0	0	0	0	3:56	
14	Cooper, Cynthia	0/1	6/9	2/2	14	2	0 1	1	2	0	0	0	0	1	29:45	
15	Mcconnell, S	2/3	4/8	4/4	18	3	0 1	1	4	4	0	2	0	0	20:46	
Total		2/4	37/66	14/17	94	16	15 22	6	18	13	1	13	2	5	200:00	

<Team Statistics/Statistiques de l'Equipe>

Teams	T.P	Goals	FLD	Goals	FR.	Throws	Fouls	Rebs	Recs	Assts	Blks	Turns	FB Efficiency
CHN	4/14	29%	30/51	59%	7/10	70%	14	25	17	14	1	19	1/1
USA	2/4	50%	37/66	56%	14/17	82%	16	37	24	18	2	15	2/3

Referee/Arbitre	ESP	ROSIQUE, VICENTE SANCHIS
Umpire/Arb. Adjoint	AUS	WEEKS, GEOFFREY ROBERT

Basket-ball

Women Classification (for 5th) Match 1/Sept. 27

		Femmes Classement (pour 5 ème Place) Match 1/27 Sept														
No.	Name	<T.P.G> MA	<F.G> MA	<F.T> MA	Pts	Foul	Rebnd O / D X	AST	STL	VIO	LST	BLK	GDD	<Time> Min Sec		
CHN 97-95 KOR (43-38, 42-47, 12-10)																
CHN																
04	Han, Qingling	0/0	4/4	2/3	10	4	1 0	0	1	1	0	1	0	1	21:15	
05	Ling, Guang	0/0	0/2	2/2	2	1	1 1	0	0	1	0	0	0	0	12:24	
06	Li, Xiaoqin	1/1	3/6	3/3	12	2	0 1	0	1	0	1	0	0	1	28:40	
07	Zhao, Wei	0/0	0/0	0/0	0	0	0 0	0	0	0	0	0	0	0	0:00	
08	Zhang, Taohua	0/0	0/0	0/0	0	0	0 0	0	0	0	0	0	0	0	0:00	
09	Zhan, Shuping	0/0	0/0	0/0	0	0	0 0	0	0	0	0	0	0	0	0:00	
10	Peng, Ping	0/0	2/4	0/0	4	2	1 2	0	1	0	0	1	0	1	16:08	
11	Zheng, Haixia	0/0	4/6	0/0	8	2	1 1	0	1	0	1	0	1	0	15:47	
12	Cong, Xuedi	3/3	2/2	0/0	13	5	0 3	0	2	2	0	2	0	0	30:42	
13	Xue, Cuilan	1/1	5/8	5/5	18	3	0 2	2	5	4	1	2	0	0	42:17	
14	Liu, Qing	0/0	8/13	8/10	24	2	2 4	2	4	0	1	2	0	1	42:03	
15	Xu, Chunmei	0/0	3/6	0/0	6	2	0 2	2	2	0	0	0	1	0	15:44	
Total		5/5	31/51	20/23	97	23	6 16	6	15	8	2	12	2	4	225:00	

		Femmes Classement (pour 5 ème Place) Match 1/27 Sept														
No.	Name	<T.P.G> MA	<F.G> MA	<F.T> MA	Pts	Foul	Rebnd O / D X	AST	STL	VIO	LST	BLK	GDD	<Time> Min Sec		
KOR																
04	Lee, Keum-Jin	4/6	2/3	2/2	18	4	0 0	0	0	1	0	0	0	0	29:16	
05	Kim, Mal-Lyun	0/0	0/0	0/0												



Women		Femmes														
Final (5-6 Places)/Sept. 29		Finale (5-6 Places)/29 Sept														
No.	Name	<T.P.G> <F.G> <F.T>			Pts	Foul	Rebnd			AST	STL	VIO	LST	BLK	GDD	<Time> Min Sec
		MA	MA	MA			O	D	X							
BUL 102-74 CHN (53-19, 49-55)																
BUL																
04	Khadjiyankova, N	0/0	1/3	0/0	2	1	0	1	0	0	0	0	1	0	0	8:26
05	Spassova, L	0/2	3/4	2/2	8	2	1	2	2	1	0	0	1	0	0	31:34
06	Naydenova, M	0/0	0/1	2/2	2	1	0	1	1	1	0	0	0	0	0	7:24
07	Vayssilova, T	0/0	1/1	1/1	3	0	0	0	0	0	0	0	0	0	1	4:46
08	Dermendjieva, V	0/0	2/4	2/2	6	0	1	1	1	1	0	0	0	0	0	5:45
09	Dragomirova, S	0/0	0/0	0/0	0	0	0	0	0	0	0	0	0	0	0	0:00
10	Vassileva, R	0/0	2/2	1/1	5	1	0	0	0	0	0	0	2	1	0	8:26
11	Radkova, K	1/1	5/7	0/0	13	1	0	5	0	2	1	0	2	1	2	32:36
12	Stefanova, E	0/1	10/12	2/2	22	0	2	3	0	1	0	0	0	0	1	31:34
13	Staneva, Madlen	0/0	8/13	4/4	20	1	2	6	2	1	0	0	0	0	3	35:14
14	Tzekova, Polina	0/0	0/0	0/0	0	0	0	0	0	0	0	0	0	0	0	0:00
15	Tchobanova, M	3/5	6/10	0/0	21	3	4	2	0	1	0	0	1	0	1	34:15
Total		4/9	38/57	14/14	102	10	10	21	6	8	1	0	7	2	8	200:00

Women		Femmes														
Final (5-6 Places)/Sept. 29		Finale (5-6 Places)/29 Sept														
No.	Name	<T.P.G> <F.G> <F.T>			Pts	Foul	Rebnd			AST	STL	VIO	LST	BLK	GDD	<Time> Min Sec
		MA	MA	MA			O	D	X							
CHN																
CHN																
04	Han, Qingling	0/0	1/1	0/0	2	0	0	0	1	0	0	0	0	0	0	7:13
05	Ling, Guang	0/1	0/0	0/0	0	0	0	0	1	0	0	0	1	0	0	5:08
06	Li, Xiaolin	3/12	0/1	0/0	9	0	0	1	1	0	2	0	1	0	0	19:21
07	Zhao, Wei	0/0	0/1	0/0	0	3	0	0	0	0	0	0	0	0	0	5:21
08	Zhang, Taohua	0/0	0/0	0/0	0	0	0	0	0	0	0	0	0	0	0	0:00
09	Zhan, Shuping	0/0	0/0	0/0	0	0	0	0	0	0	0	0	0	0	0	0:00
10	Peng, Ping	0/1	4/12	0/0	8	2	2	3	0	0	0	1	0	0	0	29:05
11	Zheng, Haixia	0/0	11/14	1/4	23	4	3	0	1	0	0	0	1	0	0	24:44
12	Cong, Xuedi	6/10	1/6	2/2	22	0	1	4	2	1	1	0	1	0	0	40:00
13	Xue, Cuilan	0/3	1/4	0/0	2	3	0	2	1	1	1	0	0	0	0	34:57
14	Liu, Qing	0/0	2/3	2/2	6	3	3	0	1	1	0	0	1	0	0	25:57
15	Xu, Chunmei	0/0	1/2	0/0	2	0	0	0	1	0	1	0	1	0	0	8:14
Total		9/27	21/44	5/8	74	15	9	10	9	3	5	1	7	0	0	200:00

<Team Statistics/Statistiques de l'Equipe>

Teams	T.P	Goals	FLD	Goals	FR.	Throws	Fouls	Rebs	Recs	Assts	Blks	Turns	FB Efficiency
BUL	4/9	44%	38/57	67%	14/14	100%	10	31	15	8	2	8	2/2
CHN	9/27	33%	21/44	48%	5/8	63%	15	19	14	3	0	9	2/2

Referee/Arbitre NGR MILLIGAN, ROBIN
 Umpire/Arb. Adjoint AUS HUNT, RAYMOND JOHN

Women		Femmes														
Semi-final Match 1/Sept. 27		Demi-finale Match 1/27 Sept														
No.	Name	<T.P.G> <F.G> <F.T>			Pts	Foul	Rebnd			AST	STL	VIO	LST	BLK	GDD	<Time> Min Sec
		MA	MA	MA			O	D	X							
AUS 56-57 YUG (30-32, 26-25)																
AUS																
04	Maher, Robyn	0/3	3/7	1/1	7	4	1	0	2	2	2	2	3	0	1	37:45
05	Brondello, S	0/0	0/0	0/0	0	0	0	0	0	0	0	0	0	0	0	0:00
06	Cheesman, J	0/0	0/0	0/0	0	1	0	0	0	1	0	0	0	0	0	2:37
07	Timms, Michele	5/9	2/3	0/0	19	3	2	5	0	0	0	0	1	0	2	37:23
08	Brown, Donna	0/0	0/3	0/0	0	1	2	1	0	0	0	0	0	0	0	19:36
09	Mickan, Patricia	0/0	2/4	4/5	8	3	0	0	0	0	0	0	2	0	0	20:19
10	Nykiel, Julie	0/0	0/0	0/0	0	0	0	0	0	0	0	0	0	0	0	0:00
11	Slimmon, Debra	0/0	0/3	0/0	0	1	1	0	0	0	0	0	0	0	2	13:07
12	Moffa, Marina	0/0	4/9	0/0	8	0	3	1	1	0	1	1	2	0	2	19:17
13	Dalton, Karen	0/0	4/6	2/2	10	3	3	5	2	2	2	0	0	0	2	27:17
14	Gorman, Shelley	0/3	1/3	2/2	4	1	2	1	0	0	0	1	1	0	1	22:39
15	White, Maree	0/0	0/0	0/0	0	0	0	0	0	0	0	0	0	0	0	0:00
Total		5/15	16/38	9/10	56	17	14	13	5	5	5	4	9	0	10	200:00

Women		Femmes														
Semi-final Match 1/Sept. 27		Demi-finale Match 1/27 Sept														
No.	Name	<T.P.G> <F.G> <F.T>			Pts	Foul	Rebnd			AST	STL	VIO	LST	BLK	GDD	<Time> Min Sec
		MA	MA	MA			O	D	X							
YUG																
YUG																
04	Vangelovska, S	0/1	0/0	2/3	2	3	0	1	4	2	0	0	3	0	1	40:00
05	Lakic, Mara	0/0	0/0	0/0	0	0	0	0	0	0	0	0	0	0	0	0:00
06	Lelas, Zana	0/0	0/0	0/0	0	0	0	0	0	0	0	0	0	0	0	0:00
07	Wild, Eleonora	0/0	0/0	0/0	0	0	0	0	0	0	0	0	0	0	0	0:00
08	Kvesic, K	0/0	0/0	0/0	0	0	0	0	0	0	0	0	0	0	0	0:00
09	Nakic, Danira	0/0	3/5	2/2	8	2	0	4	0	0	0	2	2	0	3	32:54
10	Golic, Sladjana	0/0	1/1	0/0	2	5	0	0	1	1	0	0	2	0	2	20:44
11	Domik, Polona	0/0	3/6	2/3	8	3	1	3	2	0	0	1	1	1	1	30:18
12	Mujanovic, R	0/0	10/16	0/3	20	2	0	4	0	0	1	2	3	0	1	28:58
13	Bajkusa, Vesna	0/0	0/0	0/0	0	0	0	0	0	0	0	0	0	0	0	0:00
14	Arbutina, A	2/2	4/8	1/1	15	3	2	1	0	0	3	0	1	0	0	40:00
15	Milosevic, B	0/0	1/1	0/0	2	1	0	0	0	0	0	0	0	0	0	7:06
Total		2/3	22/37	7/12	57	19	3	13	7	3	4	5	12	1	8	200:00

<Team Statistics/Statistiques de l'Equipe>

Teams	T.P	Goals	FLD	Goals	FR.	Throws	Fouls	Rebs	Recs	Assts	Blks	Turns	FB Efficiency
AUS	5/15	33%	16/38	42%	9/10	90%	17	27	20	5	0	15	0/0
YUG	2/3	67%	22/37	59%	7/12	58%	19	16	19	3	1	18	1/1

Referee/Arbitre ESP ROSIQUE, VICENTE SANCHIS
 Umpire/Arb. Adjoint BRA AFFINI, ANTONIO CARLOS

Women		Femmes														
Final (7-8 Places)/Sept. 28		Finale (7-8 Places)/28 Sept														
No.	Name	<T.P.G> <F.G> <F.T>			Pts	Foul	Rebnd			AST	STL	VIO	LST	BLK	GDD	<Time> Min Sec
		MA	MA	MA			O	D	X							
KOR 77-59 TCH (41-26, 36-33)																
KOR																
04	Lee, Keum-Jin	3/4	2/3	0/0	13	1	0	0	1	0	0	0	1	0	0	11:41
05	Kim, Mal-Lyun	0/1	0/0	0/0	0	0	0	0	2	0	0	0	1	0	0	5:55
06	Choi, Kyung-Hee	3/8	4/6	1/1	18	2	0	1	4	1	2	0	3	0	0	30:19
07	Lee, Hyung-Sook	0/0	2/5	0/0	4	3	0	1	1	0	0	1	0	0	1	14:08
08	Park, Chan-Mi	1/1	0/2	0/0	3	2	0	0	0	0	0	0	1	0	0	5:55
09	Woo, Eun-Kyung	0/0	0/1	2/2	2	1	0	1	0	0	1	0	0	0	0	6:34
10	Chung, Mi-Kyung	1/1	4/7	0/0	11	2	0	1	1	2	0	0	1	1	0	25:52
11	Kim, Hwa-Soon	1/4	4/7	3/3	14	2	0	1	1	3	1	0	2	1	2	25:12
12	Kim, Hye-Youn	0/0	0/2	0/0	0	0	0	0	0	0	0	0	0	0	0	3:46
13	Park, Chan-Sook	0/0	2/3	0/0	4	0	1	0	2	0	2	0	0	0	3	14:53
14	Sung, Jung-A	0/0	2/2	2/4	6	2	0	6	0	2	4	0	3	0	1	33:24
15	Cho, Mun-Joo	0/0	1/1	0/0	2	5	0	4	0	0	0	0	0	0	1	22:21
Total		9/19	21/39	8/10	77	20	1	15	12	8	10	1	12	2	8	200:00

Women		Femmes													
Final (7-8 Places)/Sept. 28		Finale (7-8													

Basketball

Basket-ball

Women											Femmes										
Final (1-2 Places)/Sept. 29											Finale (1-2 Places)/29 Sept										
No.	Name	<T.P.G> MA	<F.G> MA	<F.T> MA	Pts	Foul	Rebnd			AST	STL	VIO	LST	BLK	GDD	<Time> Min Sec					

USA 77-70 YUG (42-36, 35-34)																
USA																
04	Edwards, Teresa	0/2	8/14	2/2	18	4	3	0	2	3	2	1	4	0	1	34:25
05	Ethridge, Mary	0/0	0/0	0/0	0	0	0	0	0	0	0	0	0	0	0	0:31
06	Brown, Cynthia	0/0	6/12	0/0	12	2	1	7	0	0	0	0	0	2	0	23:26
07	Donovan, Anne	0/0	2/6	2/2	6	0	2	1	0	0	3	0	1	3	1	16:13
08	Weatherspoon, T	0/0	2/4	0/0	4	4	0	2	0	2	0	0	1	0	0	15:29
09	Gordon, B	0/0	3/4	0/3	6	2	1	0	0	0	0	0	1	0	2	14:38
10	Bullett, V	0/0	1/2	2/2	4	2	2	1	0	0	0	0	0	0	1	13:18
11	Lloyd, Andrea	0/0	1/4	0/0	2	0	0	2	0	0	0	0	0	0	0	7:16
12	Mcclain, Katrina	0/0	3/5	2/6	8	5	2	5	2	0	1	0	0	1	2	22:06
13	Gillom, Jennifer	0/0	0/0	0/0	0	0	0	0	0	0	0	0	0	0	0	0:00
14	Cooper, Cynthia	0/1	2/7	7/8	11	4	1	3	2	0	2	0	2	1	0	28:38
15	Mcconnell, S	0/0	1/5	4/4	6	0	0	2	2	3	0	0	0	0	1	24:00
Total		0/3	29/63	19/27	77	23	12	23	8	8	8	1	9	7	8	200:00

YUG																
04	Vangelovska, S	0/2	0/0	0/0	0	2	0	0	1	0	0	0	1	0	2	36:31
05	Lacic, Mara	0/1	0/0	2/2	2	0	0	0	0	0	0	0	0	0	0	5:48
06	Lelas, Zana	0/0	0/0	0/0	0	0	0	0	0	0	0	0	0	0	0	1:02
07	Wild, Eleonora	1/3	0/1	0/0	3	1	0	1	0	0	0	0	0	0	0	7:40
08	Kvesic, K	0/0	0/1	0/0	0	0	1	0	0	0	0	0	0	0	0	3:16
09	Nakic, Danira	0/0	5/17	13/14	23	2	3	3	1	3	1	1	2	0	0	34:56
10	Golic, Sladjana	0/0	4/9	5/8	13	3	5	5	0	0	2	2	2	0	0	35:42
11	Dornik, Polona	0/0	5/6	1/1	11	4	3	4	1	1	0	1	2	3	1	19:50
12	Mujanovic, R	0/0	4/9	3/4	11	3	3	4	1	0	1	0	1	2	0	20:10
13	Bajkusa, Vesna	0/0	0/0	0/0	0	1	0	0	0	0	1	0	0	0	0	3:37
14	Arbutina, A	1/4	1/8	0/0	5	3	0	3	2	0	0	0	3	0	1	23:28
15	Milosevic, B	0/0	1/2	0/0	2	2	0	2	0	0	1	1	0	0	0	8:00
Total		2/10	20/53	24/29	70	21	15	22	6	4	6	5	11	5	4	200:00

<Team Statistics/Statistiques de l'Equipe>

Teams	T.P	Goals	FLD	Goals	FR.	Throws	Fouls	Rebs	Recs	Assts	Blks	Turns	FB	Efficiency		
USA	0/3	0%	29/63	46%	19/27	70%	23	35	24	8	7	11	5/7			
YUG	2/10	20%	20/53	38%	24/29	83%	21	37	16	4	5	17	0/0			
Referee/Arbitre		URS		DAVYDOV, MICHAIL												
Umpire/Arb. Adjoint		TCH		KOTLEBA, LUBOMIR												

Women											Femmes										
Final (3-4 Places)/Sept. 28											Finale (3-4 Places)/28 Sept										
No.	Name	<T.P.G> MA	<F.G> MA	<F.T> MA	Pts	Foul	Rebnd			AST	STL	VIO	LST	BLK	GDD	<Time> Min Sec					

AUS 53-68 URS (21-32, 32-36)																
AUS																
04	Mahe, Robyn	1/1	7/12	5/8	22	4	1	2	1	4	2	1	0	0	0	32:38
05	Brondello, S	0/0	0/0	0/0	0	0	0	0	0	0	0	0	0	0	0	0:00
06	Cheesman, J	0/0	0/0	2/2	2	3	0	0	1	0	0	0	0	0	0	13:21
07	Timms, Michele	0/4	1/5	2/2	4	5	0	3	2	1	2	0	2	0	2	28:59
08	Brown, Donna	0/0	4/5	0/0	8	1	0	2	0	2	1	0	0	0	1	28:09
09	Mickan, Patricia	0/0	0/1	0/0	0	1	0	2	1	0	0	0	2	1	0	17:20
10	Nykiel, Julie	0/0	1/1	0/0	2	0	0	1	0	0	0	0	0	0	0	10:22
11	Slimmon, Debra	0/0	1/1	0/0	2	1	0	2	0	0	0	0	2	0	1	10:53
12	Moffa, Marina	0/1	2/6	0/1	4	1	2	0	0	0	0	0	0	0	0	17:15
13	Dalton, Karen	0/0	1/1	0/1	2	5	0	0	3	1	0	1	0	1	0	24:10
14	Gorman, Shelley	1/2	0/4	4/4	7	4	0	2	0	0	0	0	0	0	0	16:53
15	White, Maree	0/0	0/0	0/0	0	0	0	0	0	0	0	0	0	0	0	0:00
Total		2/8	17/36	13/18	53	25	3	14	8	8	5	2	6	2	4	200:00

URS																
04	Evkova, Olga	1/2	1/2	0/0	5	4	0	4	0	1	0	1	0	0	0	23:14
05	Guerlits, Irina	0/0	1/3	2/2	4	0	0	1	2	0	1	0	0	0	0	13:50
06	Barel, Olessia	0/0	0/1	0/0	0	1	0	0	0	0	0	0	0	0	0	2:15
07	Soumnikova, I	0/0	0/0	0/0	0	0	0	0	0	0	0	0	0	0	0	2:32
08	Bouriakina, Olga	3/6	0/1	0/0	9	4	0	5	3	2	0	1	0	1	1	35:44
09	Iakovleva, Olga	3/5	1/2	0/0	11	4	0	7	3	0	1	0	1	0	1	32:51
10	Minkh, Irina	0/3	4/7	5/8	13	4	1	0	2	0	2	0	4	0	0	32:48
11	Leonova, A	0/0	0/0	0/0	0	0	0	0	0	0	0	0	0	0	0	0:00
12	Khoudachova, E	0/0	0/0	0/0	0	0	0	0	0	0	0	0	0	0	0	0:00
13	Touomaite, V	0/0	3/8	4/4	10	2	0	2	5	0	0	0	2	0	0	26:07
14	Zassoulskaia, N	0/0	0/2	0/0	0	1	0	1	0	0	0	0	0	1	0	3:17
15	Savitskaia, G	1/2	6/9	1/3	16	3	1	2	0	1	1	0	1	0	1	27:22
Total		8/18	16/35	12/17	68	23	2	22	15	4	5	2	8	2	3	200:00

<Team Statistics/Statistiques de l'Equipe>

Teams	T.P	Goals	FLD	Goals	FR.	Throws	Fouls	Rebs	Recs	Assts	Blks	Turns	FB	Efficiency		
AUS	2/8	25%	17/36	47%	13/18	72%	25	17	17	8	2	17	0/1			
URS	8/18	44%	16/35	46%	12/17	71%	23	24	23	4	2	20	0/0			
Referee/Arbitre		JPN		SUGIURA, ITSUO												
Umpire/Arb. Adjoint		FIN		JUNGEBRAND, CARL												



복싱
Boxing/Boxe



Boxing/Boxe

Officials/Officiels

Association Internationale de Boxe Amateur (A.I.B.A)

President/président	Anwar Chowdhry
Secretary General/secrétaire général	Karl Heinz Wehr
Technical Delegates/délégués techniques	Arthur Tunstall K. Thiruganasothi

SLOOC Administrative Staff/Personnel Administratif du SLOOC

Commissioner/directeur	Kim Seung Youn
Secretary General/secrétaire général	Oh Soo In
Deputy Secretary General/secrétaire général adjoint	Lee Yum
Competition Manager/chef de division des compétitions	Yoo Hyun Joon

Competitors/Concurrents

Men Hommes	Competitors Competiteurs	Countries Pays
Light Flyweight/mi-mouche (-48 kg)	35	35
Flyweight/mouche (-51 kg)	44	44
Bantamweight/coq(-54 kg)	49	49
Featherweight/plume (-57 kg)	48	48
Lightweight/leger (-60 kg)	39	39
Light Welterweight/mi-welter (-63.5 kg)	49	49
Welterweight/welter (-67 kg)	44	44
Light Middleweight/super-welter (-71 kg)	37	37
Middleweight/moyen(-75kg)	34	34
Light Heavyweight/mi-lourd (-81kg)	28	28
Heavyweight/lourd (-91 kg)	18	18
Super Heavyweight/super-lourd (+91 kg)	17	17

Legend/Notation

PTS	Win on Points/Aux points
KOH	Knock-Out (Head)/Knock-Out a la tete
*	Winner/Gagnant
RSCH	Referee Stops Contest, Head Blow/Arret de l'arbitre, Coup a la Tete
DISQ	Disqualification/Disqualifie
WO	Walk Over/Forfait
RSCO	Referee Stops Contest, Out Class/Arret de l'arbitre, Domination manife
RSCI	Referee Stops Contest, Injury/Arret de l'arbitre, Blessure
KOB	Knock-out (Body)/Knock-Out au corps
DISQ	Disqualification/Disqualifie
RET	Win by Retirement/Victoire par Abandon
BYE	Bye/Exempt

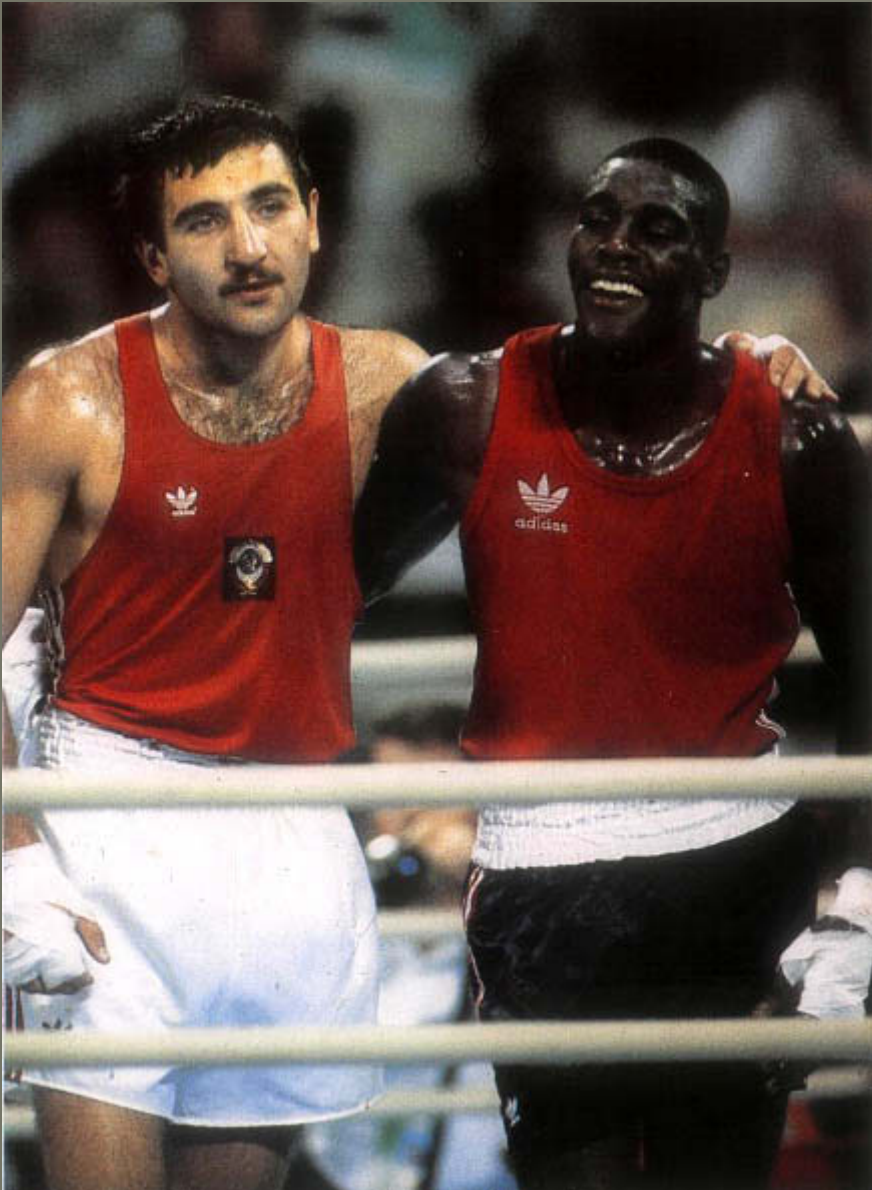

Boxing

Boxe

Light Fly -48Kg		Mi-mouche -48Kg	
1/32 Bout 30/Sept. 17		1/32 Combat 30/17 Sept	
Name	Ctry	Result	
Nom	Pays	Resultat	
* Epton, Mark	GBR	PTS	5:0
Bhatta, Dambardut, Ta	NEP		
Referee	GABY MANCINI	CAN	Total
Judge 1	ALBERTO DURAN	URU	60:57
2	STANLEY WACHANGA	KEN	59:57
3	MARIUS GUIRAMO LOUGBO	CIV	60:56
4	HONG-TSUNG YONG	TPE	60:56
5	OSVALDO BISBAL	ARG	60:56

Light Fly -48Kg		Mi-mouche -48Kg	
1/16 Bout 4/Sept. 21		1/16 Combat 4/21 Sept	
Name	Ctry	Result	
Nom	Pays	Resultat	
Banian, Washington	NGU		
* Olson, Robert Scott	CAN	KOH	1RD. 1:15
Referee	RODERICK ROBERTSON	GBR	
Judge 1	WERNER WEGSCHEIDER	AUT	
2	TAKUYA MOROOKA	JPN	
3	SOMPONG SUKAR	THA	
4	GUSTAV BAUMGARDT	GDR	
5	MUILI ADE OJO	NGR	

Light Fly -48Kg		Mi-mouche -48Kg	
1/16 Bout 10/Sept. 21		1/16 Combat 10/21 Sept	
Name	Ctry	Result	
Nom	Pays	Resultat	
Angeles, Darwin	HON		
* Stewart, Samuel	LBR	PTS	0:5
Referee	KISHEN M. NARSI	IND	TOTAL
Judge 1	PIETER GEDOAN	INA	58:59
2	SANDOR PAJAR	HUN	55:60
3	STIG RONGE	SWE	56:59
4	HONG-TSUNG YONG	TPE	57:59
5	OSVALDO BISBAL	ARG	55:60

Light Fly -48Kg		Mi-mouche -48Kg	
1/32 Bout 31/Sept. 17		1/32 Combat 31/17 Sept	
Name	Ctry	Result	
Nom	Pays	Resultat	
* Martinez, Henry	ESA	PTS	5:0
Cheikh, Yacine	ALG		
Referee	ALDO LEONI	ITA	Total
Judge 1	STIG RONGE	SWE	60:57
2	BOB D. KASULE	UGA	60:57
3	ABDUL HANI	IRQ	59:58
4	D. WEERAKOON	SRI	59:58
5	STOINO PARLAPANOV	BUL	

Light Fly -48Kg		Mi-mouche -48Kg	
1/16 Bout 5/Sept. 21		1/16 Combat 5/21 Sept	
Name	Ctry	Result	
Nom	Pays	Resultat	
Rolon, Luis	PUR		
* Sasakul, Chatchai	THA	PTS	2:3
Referee	MOHAMED	EGY	TOTAL
Judge 1	HIOUAD LARBI	MAR	58:59
2	ELMO ADOLPH	USA	58:59
3	LUISMINAMI	PER	60:56
4	RONALD MARK GREGOR	AUS	60:58
5	MUILI ADE OJO	NGR	58:59

Light Fly -48Kg		Mi-mouche -48Kg	
1/16 Bout 11/Sept. 21		1/16 Combat 11/21 Sept	
Name	Ctry	Result	
Nom	Pays	Resultat	
* Chisenga, Thomas	ZAM	PTS	4:1
Liu, Hsin-Hung	TPE		
Referee	ALDO LEONI	ITA	TOTAL
Judge 1	VIKTOR PLAVEC	YUG	59:58
2	ARTURO MORALES	DOM	58:59
3	ALBERTO DURAN	URU	60:57
4	KEITH WALKER	NZL	60:57
5	OSVALDO BISBAL	ARG	59:57

Light Fly -48Kg		Mi-mouche -48Kg	
1/32 Bout 32/Sept. 17		1/32 Combat 32/17 Sept	
Name	Ctry	Result	
Nom	Pays	Resultat	
* Dembrel, Ochir	MGL	KOH	3RD. 1:42
Kuroiwa, Mamoru	JPN		
Referee	MOULOUD KOURAD	ALG	
Judge 1	SANDOR PAJAR	HUN	
2	STOINO PARLAPANOV	BUL	
3	OSVALDO BISBAL	ARG	
4	STANLEY WACHANGA	KEN	
5	ABDUL HANI	IRQ	

Light Fly -48Kg		Mi-mouche -48Kg	
1/16 Bout 6/Sept. 21		1/16 Combat 6/21 Sept	
Name	Ctry	Result	
Nom	Pays	Resultat	
* Maina, Maurice	KEN	PTS	4:1
Haddad, Mohamad	SYR		
Referee	WILLI KELLERMANN	FRG	TOTAL
Judge 1	DIMITR DORU BANCUI	ROM	59:58
2	ELMO ADOLPH	USA	58:59
3	LUIS MINAMI	PER	59:58
4	RONALD MARK GREGOR	AUS	59:58
5	ZAUT GVADJAVA	URS	59:58

Light Fly -48Kg		Mi-mouche -48Kg	
1/16 Bout 12/Sept. 21		1/16 Combat 12/21 Sept	
Name	Ctry	Result	
Nom	Pays	Resultat	
* M'jirih, Mahjoub	MAR	PTS	3:2
Dembrel, Ochir	MGL		
Referee	VIKTOR PLAVEC	YUG	TOTAL
Judge 1	ALDO LEONI	ITA	58:59
2	ARTURO MORALES	DOM	58:59
3	GABY MANCINI	CAN	59:58
4	KEITH WALKER	NZL	60:57
5	STOINO PARLAPANOV	BUL	59:58

Light Fly -48Kg		Mi-mouche -48Kg	
1/16 Bout 1/Sept. 21		1/16 Combat 1/21 Sept	
Name	Ctry	Result	
Nom	Pays	Resultat	
* Carbajal, Michael	USA	PTS	3:2
Oh, Kwang-Soo	KOR		
Referee	THEODOROS VIDALIS	GRE	Total
Judge 1	ZAUT GVADJAVA	URS	59:60
2	MUILI ADE OJO	NGR	59:58
3	RONALD MARK GREGOR	AUS	59:58
4	LUIS MINAMI	PER	59:58
5	MOHAMED	EGY	58:60

Light Fly -48Kg		Mi-mouche -48Kg	
1/16 Bout 7/Sept. 21		1/16 Combat 7/21 Sept	
Name	Ctry	Result	
Nom	Pays	Resultat	
Moore, Colin	GUY		
* Isaszegi, Robert	HUN	PTS	0:5
Referee	MOHAMED GHAZNAVI	PAK	TOTAL
Judge 1	KIM, YOUNG BAE	BAE	57:60
2	MOHAMED	EGY	58:60
3	MUILI ADE OJO	NGR	57:60
4	ELMO ADOLPH	USA	57:60
5	RONALD MARK GREGOR	AUS	57:60

Light Fly -48Kg		Mi-mouche -48Kg	
1/16 Bout 13/Sept. 21		1/16 Combat 13/21 Sept	
Name	Ctry	Result	
Nom	Pays	Resultat	
* Beltre Herrera, Jesus	DOM	PTS	4:1
Bolivar, Marcelino	VEN		
Referee	RYSZARD REDO	POL	TOTAL
Judge 1	STOINO PARLAPANOV	BUL	59:58
2	PIETER GEDOAN	INA	59:59 +
3	HAN, DONG JIN	KOR	59:56
4	KEITH WALKER	NZL	60:57
5	STANLEY WACHANGA	KEN	60:57

Light Fly -48Kg		Mi-mouche -48Kg	
1/16 Bout 2/Sept. 21		1/16 Combat 2/21 Sept	
Name	Ctry	Result	
Nom	Pays	Resultat	
* Dang Hieu, Hien	VIE	RSCH	2RD. 2:28
Caballero, Antonio	ESP		
Referee	ELMO ADOLPH	USA	
Judge 1	HIOUAD LARBI	MAR	
2	MOHAMED	EGY	
3	LUIS MINAMI	PER	
4	RONALD MARK GREGOR	AUS	
5	MUILI ADE OJO	NGR	

Light Fly -48Kg		Mi-mouche -48Kg	
1/16 Bout 8/Sept. 21		1/16 Combat 8/21 Sept	
Name	Ctry	Result	
Nom	Pays	Resultat	
Thephavong, Bounmy	LAO		
* Aboub, Sadoon M	IRQ	RSCH	2RD. 2:47
Referee	MUILI ADE OJO	NGR	
Judge 1	HIOUAD LARBI	MAR	
2	WERNER WEGSCHEIDER	AUT	
3	RODERICK ROBERTSON	GBR	
4	ELMO ADOLPH	USA	
5	RONALD MARK GREGOR	AUS	

Light Fly -48Kg		Mi-mouche -48Kg	
1/16 Bout 14/Sept. 21		1/16 Combat 14/21 S	
Name	Ctry	Result	
Nom	Pays	Resultat	
Eluauza, Carlos Mario	ARG		
* Makhmoutov, Alexandre	URS	PTS	0:5
Referee	ABDUL HANI	IRQ	TOTAL
Judge 1	D. WEERAKOON	SRI	57:60
2	BOB D. KASULE	UGA	57:60
3	MARIUS GUIRAMO LOUGBO	CIV	58:59
4	GABY MANCINI	CAN	58:59
5	KEITH WALKER	NZL	57:59

Light Fly -48Kg		Mi-mouche -48Kg	
1/16 Bout 3/Sept. 21		1/16 Combat 3/21 Sept	
Name	Ctry	Result	
Nom	Pays	Resultat	
* Mccullough, Wayne	IRL	PTS	5:0
Muteweta, Fred	UGA		
Referee	CHO, SUK IN	KOR	TOTAL
Judge 1	MOHAMED GHAZNAVI	PAK	59:57
2	TAKUYA MOROOKA	JPN	58:57
3	RONALD MARK GREGOR	AUS	60:56
4	LUIS MINAMI	PER	59:58
5	ELMO ADOLPH	USA	58:55

Light Fly -48Kg		Mi-mouche -48Kg	
1/16 Bout 9/Sept. 21		1/16 Combat 9/21 Sept	
Name	Ctry	Result	
Nom	Pays	Resultat	
Hassan, Moustafa	EGY		
* Serantes, Leopoldo	PHI	RSCH	2RD. 0:59
Referee	STOINO PARLAPANOV	BUL	
Judge 1	RYSZARD REDO	POL	
2	ALBERTO DURAN	URU	
3	ARTURO MORALES	DOM	
4	KEITH WALKER	NZL	
5	GABY MANCINI	CAN	

Light Fly -48Kg		Mi-mouche -48Kg	
1/16 Bout 15/Sept. 21		1/16 Combat 15/21 Sept	
Name	Ctry	Result	
Nom	Pays	Resultat	
* Hristov, Ivailo	BUL	PTS	5:0
Epton, Mark	GBR		
Referee	HONG-TSUNG YOUNG	TPE	Total
Judge 1	ALBERTO DURAN	URU	60:57
2	OSVALDO BISBAL	ARG	60:56
3	D. WEERAKOON	SRI	60:57
4	MOULOUD KOURAD	ALG	60:57
5	ABDUL HANI	IRQ	60:56



Light Fly -48Kg **Mi-mouche -48Kg**
1/16 Bout 16/Sept. 21 1/16 Combat 16/21 Sept

Name Nom	Ctry Pays	Result Resultat
* Martinez, Henry	ESA	WO
Ben-Haim, Yehuda	ISR	

Referee	Judge 1	2	3	4	5

Light Fly -48Kg **Mi-mouche -48Kg**
1/8 Bout 1/Sept. 25 1/8 Combat 1/25 Sept

Name Nom	Ctry Pays	Result Resultat
* Carbajal, Michael	USA	RSCO 1RD. 1:54
Dang Hieu, Hien	VIE	

Referee	Judge 1	2	3	4	5
GUSTAV BAUMGARDT	BOUNAB HEDI	MUILI ADE OJO	THEODOROS VIDALIS	RONALD MARK GREGOR	WERNER WEGSCHEIDER
GDR	TUN	NGR	GRE	AUS	AUT

Light Fly -48Kg **Mi-mouche -48Kg**
1/8 Bout 2/Sept. 25 1/8 Combat 2/25 Sept

Name Nom	Ctry Pays	Result Resultat
Mccullough, Wayne	IRL	PTS 0:5
* Olson, Robert Scott	CAN	

Referee	Judge 1	2	3	4	5
ROMEO SOMODIO	TAKUYA MOROOKA	HIOUAD LARBI	MOHAMED	AMADOR BURGUILLOS	RONALD MARK GREGOR
PHI TOTAL	JPN 54:60	MAR 58:59	EGY 57:59	VEN 57:59	AUS 56:60

Light Fly -48Kg **Mi-mouche -48Kg**
1/8 Bout 3/Sept. 25 1/8 Combat 3/25 Sept

Name Nom	Ctry Pays	Result Resultat
* Sasakul, Chatchai	THA	PTS 5:0
Maina, Maurice	KEN	

Referee	Judge 1	2	3	4	5
ZAUT GVADJAVA	DIMITR DORU BANCUI	AUGUSTIN ZARAGOZA	LUIS MINAMI	RONALD MARK GREGOR	ELMO ADOLPH
URS TOTAL	ROM 60:55	MEX 60:57	PER 60:56	AUS 60:56	USA 60:56

Light Fly -48Kg **Mi-mouche -48Kg**
1/8 Bout 4/Sept. 25 1/8 Combat 4/25 Sept

Name Nom	Ctry Pays	Result Resultat
* Isaszegi, Robert	HUN	RSCO IRD. 2:29
Aboub, Sadoon M	IRQ	

Referee	Judge 1	2	3	4	5
ELMO ADOLPH	MOHAMED	BOUNAB HEDI	LUIS MINAMI	RONALD MARK GREGOR	AMADOR BURGUILLOS
USA	EGY	TUN	PER	AUS	VEN

Light Fly -48Kg **Mi-mouche -48Kg**
1/8 Bout 5/Sept. 25 1/8 Combat 5/25 Sept

Name Nom	Ctry Pays	Result Resultat
* Serantes, Leopoldo	PHI	PTS 5:0
Stewart, Samuel	LBR	

Referee	Judge 1	2	3	4	5
WILLI KELLERMANN	AMADOR BURGUILLOS	DIMITR DORU BANCUI	ELMO ADOLPH	LUIS MINAMI	GUSTAV BAUMGARDT
FRG TOTAL	VEN 59:57	ROM 59:57	USA 60:56	PER 60:56	GDR 58:57

Light Fly -48Kg **Mi-mouche -48Kg**
1/8 Bout 6/Sept. 25 1/8 Combat 6/25 Sept

Name Nom	Ctry Pays	Result Resultat
Chisenga, Thomas	ZAM	PTS 0:5
* M'Jirih, Mahjoub	MAR	

Referee	Judge 1	2	3	4	5
SOMPONG SUKAR	THEODOROS VIDALIS	CHO, SUK IN	RODERICK ROBERTSON	AUGUSTIN ZARAGOZA	RONALD MARK GREGOR
THA TOTAL	GRE 58:59	KOR 58:59	GBR 57:60	MEX 56:60	AUS 57:60

Light Fly -48Kg **Mi-mouche -48Kg**
1/8 Bout 7/Sept. 25 1/8 Combat 7/25 Sept

Name Nom	Ctry Pays	Result Resultat
Beltre Herrera, Jesus	DOM	PTS 1:4
* Makhmontor, Alexandre	URS	

Referee	Judge 1	2	3	4	5
HIOUAD LARBI	MUILI ADE OJO	MOHAMED GHAZNAVI	ROMEO SOMODIO	LUIS MINAMI	RONALD MARK GREGOR
MAR TOTAL	NGR 58:59	PAK 58:59	PHI 59:59 +	PER 59:58	AUS 57:59

Light Fly -48Kg **Mi-mouche -48Kg**
1/8 Bout 8/Sept. 25 1/8 Combat 8/25 Sept

Name Nom	Ctry Pays	Result Resultat
Hristov, Ivailo	BUL	PTS 5:0
Martinez, Henry	ESA	

Referee	Judge 1	2	3	4	5
CHO, SUK IN	TAKUYA MOROOKA	AMADOR BURGUILLOS	LUIS MINAMI	BOUNAB HEDI	HIOUAD LARBI
KOR TOTAL	JPN 60:57	VEN 60:56	PER 59:58	TUN 60:57	MAR 60:57

Light Fly -48Kg **Mi-mouche -48Kg**
Quarter-final Bout 1/Sept. 27 Quart de Finale Combat 1/27 Sept

Name Nom	Ctry Pays	Result Resultat
* Carbajal, Michael	USA	PTS 5:0
Olson, Robert Scott	CAN	

Referee	Judge 1	2	3	4	5
PIETER GEDOAN	WILLI KELLERMANN	VIKTOR PLAVED	OSVALDO BISBAL	MOHAMED GHAZNAVI	MUILI ADE OJO
INA TOTAL	FRG 60:57	YUG 60:57	ARG 60:57	PAK 59:57	NGR 60:58

Light Fly -48Kg **Mi-mouche -48Kg**
Quarter-final Bout 2/Sept. 27 Quart de Finale Combat 2/27 Sept

Name Nom	Ctry Pays	Result Resultat
Sasakul, Chatchai	THA	PTS 2:3
* Isaszegi, Robert	HUN	

Referee	Judge 1	2	3	4	5
ELMO ADOLPH	GUSTAV BAUMGARDT	GABY MANCINI	CHO, SUK IN	OSVALDO BISBAL	HONG-TSUNG YONG
USA TOTAL	GDR 57:60	CAN 57:60	KOR 59:58	ARG 58:59	TPE 60:58

Light Fly -48Kg **Mi-mouche -48Kg**
Quarter-final Bout 3/Sept. 27 Quart de Finale Combat 3/27 Sept

Name Nom	Ctry Pays	Result Resultat
* Serantes, Leopoldo	PHI	RSCH 3RD. 2:45
M' Jirih, Mahjoub	MAR	

Referee	Judge 1	2	3	4	5
OSVALDO BISBAL	ALDO LEONI	STOINO PARLAPANOV	GABY MANCINI	HONG-TSUNG YONG	ALBERTO DURAN
ARG	ITA	BUL	CAN	TPE	URU

Light Fly -48Kg **Mi-mouche -48Kg**
Quarter-final Bout 4/Sept. 27 Quart de Finale Combat 4/27 Sept

Name Nom	Ctry Pays	Result Resultat
Makhmoutov, Alexandre	URS	PTS 0:5
* Hristov, Ivailo	BUL	

Referee	Judge 1	2	3	4	5
ROMEO SOMODIO	CHO, SUK IN	ELMO ADOLPH	MOHAMED GHAZNAVI	ALBERTO DURAN	BOB D. KASULE
PHI TOTAL	KOR 57:60	USA 57:60	PAK 58:59	URU 58:59	UGA 57:60

Light Fly -48Kg **Mi-mouche -48Kg**
Semi-final Bout 1/Sept. 29 Demi-finale Combat 1/29 Sept

Name Nom	Ctry Pays	Result Resultat
* Carbajal, Michael	USA	PTS 4:1
Isaszegi, Robert	HUN	

Referee	Judge 1	2	3	4	5
MUILI ADE OJO	GUSTAV BAUMGARDT	KIM, YOUNG BAE	D. WEERAKOON	GABY MANCINI	MOULOUD KOURAD
NGR TOTAL	GDR 58:59	KOR 60:57	SRI 59:58	CAN 59:58	ALG 60:57

Light Fly -48Kg **Mi-mouche -48Kg**
Semi-final Bout 2/Sept. 29 Demi-finale Combat 2/29 Sept

Name Nom	Ctry Pays	Result Resultat
Serantes, Leopoldo	PHI	PTS 0:5
* Hristov, Ivailo	BUL	

Referee	Judge 1	2	3	4	5
HIOUAD LARBI	ABDUL HANI	ALDO LEONI	ELMO ADOLPH	GABY MANCINI	OSVALDO BISBAL
MAR TOTAL	IRQ 58:60	ITA 58:60	USA 58:59	CAN 57:60	ARG 58:59

Light Fly -48Kg **Mi-mouche -48Kg**
Final Bout /Oct.1 Finale /1 Oct

Name Nom	Ctry Pays	Result Resultat
Carbajal, Michael	USA	PTS 0:5
* Hristov, Ivailo	BUL	

Referee	Judge 1	2	3	4	5
KISHEN M. NARSI	MOHAMED GHAZNAVI	SOMPONG SUKAR	BOB D. KASULE	OSVALDO BISBAL	ALBERTO DURAN
IND TOTAL	PAK 58:59	THA 58:59	UGA 58:59	ARG 58:59	URU 58:59

Boxing

Boxe

Light Fly -48Kg
Competition Summary

Mi-mouche -48Kg
Tableau de la Competition

1/32	1/16	1/8	Quarter-final/Quart de Final e	Semi-final/Demi-final e	Final/Final e
Carbajal, M (USA) BYE	Carbajal, M	Carbajal, M PTS	Carbajal, M RSCO	Carbajal, M PTS	Carbajal, M PTS
Oh, Kwang-So (KOR) BYE	Oh, Kwang-So				
Dang Hieu, H (VIE) BYE	Dang Hieu, H	Dang Hieu, H RSCH			
Caballero, A (ESP) BYE	Caballero, A				
Mccullough, (IRL) BYE	Mccullough,	Mccullough, PTS	Olson, R PTS		
Muteweta, Fr (UGA) BYE	Muteweta, Fr				
Banian, W (NGU) BYE	Banian, W	Olson, R KOH			
Olson, R (CAN) BYE	Olson, R				
Rolon, Luis (PUR) BYE	Rolon, Luis	Sasakul, C PTS	Sasakul, C PTS	Isaszegi, Ro PTS	Hristov, Iva PTS
Sasakul, C (THA) BYE	Sasakul, C				
Mama, Mauri (KEN) BYE	Maina, Mauri	Maina, Mauri PTS			
Haddad, Moha (SYR) BYE	Haddad, Moha				
Moore, Colin (GUY) BYE	Moore, Colin	Isaszegi, Ro PTS	Isaszegi, Ro RSCO		
Isaszegi, Ro (HUN) BYE	Isaszegi, Ro				
Thephavong, (LAO) BYE	Thephavong,	Aboub, Sadoo RSCH			
Aboub, Sadoo (IRQ) BYE	Aboub, Sadoo				
Hassan, Mous (EGY) BYE	Hassan, Mous	Serantes, L RSCH	Serantes, L PTS	Serantes, L RSCH	Hristov, Iva PTS
Serantes, L (PHI) BYE	Serantes, L				
Angeles, Dar (HON) BYE	Angeles, Dar	Stewart, Sam PTS			
Stewart, Sam (LBR) BYE	Stewart, Sam				
Chisenga, Th (ZAM) BYE	Chisenga, Th	Chisenga, Th PTS	M'jirih, Mah PTS		
Liu, Hsin-Hu (TPE) BYE	Liu, Hsin-Hu				
M'jirih, Mah (MAR) BYE	M'jirih, Mah	M'jirih, Mah PTS			
Ben-Haim, Ye (ISR) BYE	Ben-Haim, Ye				
Beltre Herr (DOM) BYE	Beltre Herr	Beltre Herr PTS	Makhmoutov, PTS	Hristov, Iva PTS	Hristov, Iva PTS
Bolivar, M (VEN) BYE	Bolivar, M				
Eluaiza, C (ARG) BYE	Eluaiza, C	Makhmoutov, PTS			
Makhmoutov, (URS) BYE	Makhmoutov,				
Hristov, Iva (BUL) BYE	Hristov, Iva	Hristov, Iva PTS	Hristov, Iva PTS		
Epton, Mark (GBR) Bhatta, D (NEP)	Epton, Mark PTS				
Martinez, He (ESA) Cheikh, Yaci (ALG)	Martinez, He PTS	Martinez, He WO			
Dembrel, Och (MGL) Kuroiwa, Mam (JPN)	Dembrel, Och KOH				



Fly-51 Kg **Mouche-51 Kg**
1/32 Bout 21/Sept. 18 1/32 Combat 21/18 Sept

Name Nom	Ctry Pays	Result Resultat	
* Agosto, Andy Khadpo, Vichai	PUR THA	PTS	5:0

Referee			
Willi Kellermann	FRG	TOTAL	
Judge 1	Werner Wegscheider	AUT	59:58
2	Hiouad Larbi	MAR	60:57
3	Muili Ade Ojo	NGR	59:58
4	Amador Burguillos	VEN	59:58
5	Luis Minami	PER	59:58

Fly-51 Kg **Mouche-51 Kg**
1/32 Bout 22/Sept. 18 1/32 Combat 22/18 Sept

Name Nom	Ctry Pays	Result Resultat	
* Halbouni, Hamed Bredahl, Johnny	SYR DEN	RSCH	2RD. 2:39

Referee			
Mohamed	EGY		
Judge 1	Bounab Hedi	TUN	
2	Augustin Zaragoza	MEX	
3	Elmo Adolph	USA	
4	Ronald Mark Gregor	AUS	
5	Muili Ade Ojo	NGR	

Fly-51 Kg **Mouche-51 Kg**
1/32 Bout 23/Sept. 18 1/32 Combat 23/18 Sept

Name Nom	Ctry Pays	Result Resultat	
Williams, Zekaria * Skriabin, Timofei	COK URS	PTS	0:5

Referee			
Cho, Suk In	KOR	TOTAL	
Judge 1	Takuya Morooka	JPN	54:60
2	Mohamed	EGY	55:60
3	Bounab Hedi	TUN	55:60
4	Elmo Adolph	USA	52:60
5	Gaby Mancini	CAN	54:60

Fly-51 Kg **Mouche-51 Kg**
1/32 Bout 24/Sept. 18 1/32 Combat 24/18 Sept

Name Nom	Ctry Pays	Result Resultat	
* Lawlor, Joseph Fausto, Archer	IRL MOZ	KOH	2RD. 0:58

Referee			
Romeo Somodio	PHI		
Judge 1	Sompong Sukar	THA	
2	Ronald Mark Gregor	AUS	
3	Augustin Zaragoza	MEX	
4	Luis Minami	PER	
5	Mohamed Ghaznavi	PAK	

Fly-51 Kg **Mouche-51 Kg**
1/32 Bout 25/Sept. 18 1/32 Combat 25/18 Sept

Name Nom	Ctry Pays	Result Resultat	
Vera Espenola, Sixto * Singh, Bishnubhadur	PAR NEP	PTS	0:5

Referee			
Roderick Robertson	GBR	TOTAL	
Judge 1	Gustav Baumgardt	GDR	57:60
2	Luis Minami	PER	57:60
3	Elmo Adolph	USA	56:60
4	Ronald Mark Gregor	AUS	57:60
5	Zaut Gvadjava	URS	58:59

Fly-51 Kg **Mouche-51 Kg**
1/32 Bout 26/Sept. 18 1/32 Combat 26/18 Sept

Name Nom	Ctry Pays	Result Resultat	
Mannai, Andrea * Johnson, Arthur	ITA USA	PTS	0:5

Referee			
Muili Ade Ojo	NGR	TOTAL	
Judge 1	Hiouad Larbi	MAR	58:59
2	Amador Burguillos	VEN	58:59
3	Ronald Mark Gregor	AUS	57:60
4	Cho, Suk In	KOR	56:59
5	Romeo Somodio	PHI	58:60

Fly-51 Kg **Mouche-51 Kg**
1/32 Bout 27/Sept. 18 1/32 Combat 27/18 Sept

Name Nom	Ctry Pays	Result Resultat	
Garcia, Bonifacio * Tshabangu, Nokuthula	ESP ZIM	PTS	1:4

Referee			
Ronald Mark Gregor	AUS	TOTAL	
Judge 1	Mohamed Ghaznavi	PAK	59:58
2	Sompong Sukar	THA	58:59
3	Luis Minami	PER	57:60
4	Augustin Zaragoza	MEX	57:60
5	Romeo Somodio	PHI	58:59

Fly-51 Kg **Mouche-51 Kg**
1/32 Bout 28/Sept. 18 1/32 Combat 28/18 Sept

Name Nom	Ctry Pays	Result Resultat	
Tsereniyam, Tyeyen-Oidov * Kim, Kwang-Sun	MGL KOR	RSCH	2RD. 2:32

Referee			
Theodoros Vidalis	GRE		
Judge 1	Dimitr Doru Banciu	ROM	
2	Mohamed	EGY	
3	Hiouad Larbi	MAR	
4	Elmo Adolph	USA	
5	Willi Kellermann	FRG	

Fly-51 Kg **Mouche-51 Kg**
1/32 Bout 29/Sept. 18 1/32 Combat 29/18 Sept

Name Nom	Ctry Pays	Result Resultat	
* Segawa, Setsuo Morales Mejia, Simon I.	JPN COL	PTS	4:1

Referee			
Zaut Gvadjava	URS	TOTAL	
Judge 1	Roderick Robertson	GBR	59:57
2	Theodoros Vidalis	GRE	58:58 +
3	Muili Ade Ojo	NGR	59:58
4	Augustin Zaragoza	MEX	59:58
5	Ronald Mark Gregor	AUS	59:58

Fly-51 Kg **Mouche-51 Kg**
1/32 Bout 30/Sept. 18 1/32 Combat 30/18 Sept

Name Nom	Ctry Pays	Result Resultat	
* Todorov, Serafim Griman, David	BUL VEN	PTS	4:1

Referee			
Bounab Hedi	TUN	TOTAL	
Judge 1	Takuya Morooka	JPN	59:58
2	Cho, Suk In	KOR	60:58
3	Mohamed	EGY	59:58
4	Augustin Zaragoza	MEX	59:59 +
5	Elmo Adolph	USA	60:58

Fly-51 Kg **Mouche-51 Kg**
1/32 Bout 31/Sept. 18 1/32 Combat 31/18 Sept

Name Nom	Ctry Pays	Result Resultat	
* Gul, Ramazan Lyon, John	TUR GBR	PTS	4:1

Referee			
Amador Burguillos	VEN	TOTAL	
Judge 1	Mohamed Ghaznavi	PAK	59:58
2	Sompong Sukar	THA	+ 59:59
3	Bounab Hedi	TUN	59:58
4	Luis Minami	PER	57:60
5	Ronald Mark Gregor	AUS	59:58

Fly-51 Kg **Mouche-51 Kg**
1/32 Bout 32/Sept. 18 1/32 Combat 32/18 Sept

Name Nom	Ctry Pays	Result Resultat	
* Elkoumy, Gameldin Hussain, Amir J	EGY IRQ	PTS	4:1

Referee			
Gustav Baumgardt	GDR	TOTAL	
Judge 1	Werner Wegscheider	AUT	59:58
2	Elmo Adolph	USA	60:58
3	Augustin Zaragoza	MEX	58:59
4	Dimitr Doru Banciu	ROM	59:58
5	Luis Minami	PER	60:57

Fly-51 Kg **Mouche-51 Kg**
1/16 Bout 1/Sept. 21 1/16 Combat 1/21 Sept

Name Nom	Ctry Pays	Result Resultat	
* Pingale, Manoj Chongo, Joseph	IND ZAM	PTS	5:00

Referee			
Werner Wegscheider	AUT	TOTAL	
Judge 1	Willi Kellermann	FRG	59:58
2	Luis Minami	PER	59:57
3	Ronald Mark Gregor	AUS	59:57
4	Elmo Adolph	USA	58:57
5	Gustav Baumgardt	GDR	59:57

Fly-51 Kg **Mouche-51 Kg**
1/16 Bout 2/Sept. 21 1/16 Combat 2/21 Sept

Name Nom	Ctry Pays	Result Resultat	
Mathibeli, Teboho * Gonzalez, Mario	LES MEX	PTS	0:5

Referee			
Gustav Baumgardt	GDR	TOTAL	
Judge 1	Dimitr Doru Banciu	ROM	55:60
2	Theodoros Vidalis	GRE	56:60
3	Sompong Sukar	THA	55:60
4	Mohamed Ghaznavi	PAK	57:60
5	Ronald Mark Gregor	AUS	56:60

Fly-51 Kg **Mouche-51 Kg**
1/16 Bout 3/Sept. 21 1/16 Combat 3/21 Sept

Name Nom	Ctry Pays	Result Resultat	
Almutairi, Husain * Kotey, Alfred Amon	KUW GHA	RSCO	1RD. 2:43

Referee			
Luis Minami	PER		
Judge 1	Elmo Adolph	USA	
2	Ronald Mark Gregor	AUS	
3	Zaut Gvadjava	URS	
4	Roderick Robertson	GBR	
5	Theodoros Vidalis	GRE	

Fly-51 Kg **Mouche-51 Kg**
1/16 Bout 4/Sept. 21 1/16 Combat 4/21 Sept

Name Nom	Ctry Pays	Result Resultat	
* Mwangata, Benjamin Ayesu, Peter	TAN MAW	PTS	5:0

Referee			
Romeo Somodio	PHI	TOTAL	
Judge 1	Kim, Young Bae	KOR	60:57
2	Dimitr Doru Banciu	ROM	60:57
3	Werner Wegscheider	AUT	60:57
4	Luis Minami	PER	60:56
5	Mohamed Ghaznavi	PAK	60:56

Fly-51 Kg **Mouche-51 Kg**
1/16 Bout 5/Sept. 21 1/16 Combat 5/21 Sept

Name Nom	Ctry Pays	Result Resultat	
Salem Obeib, Wallid * Nsubuga, Emmanuel	YWD UGA	KOH	1RD. 2:32

Referee			
Dimitr Doru Banciu	ROM		
Judge 1	Willi Kellermann	FRG	
2	Zaut Gvadjava	URS	
3	Luis Minami	PER	
4	Elmo Adolph	USA	
5	Ronald Mark Gregor	AUS	

Fly-51 Kg **Mouche-51 Kg**
1/16 Bout 6/Sept. 21 1/16 Combat 6/21 Sept

Name Nom	Ctry Pays	Result Resultat	
Moukrim, Aissa * Abed, Benaissa	MAR ALG	PTS	2:3

Referee			
Kim, Young Bae	KOR	TOTAL	
Judge 1	Mohamed Ghaznavi	PAK	58:59
2	Werner Wegscheider	AUT	58:59
3	Roderick Robertson	GBR	59:58
4	Ronald Mark Gregor	AUS	59:58
5	Luis Minami	PER	57:60

Boxing

Boxe

Fly-51 Kg 1/16 Bout 7/Sept. 21			Mouche-51 Kg 1/16 Combat 7/21 Sept		
Name Nom	Ctry Pays	Result Resultat			
* Yaradi, Janos	HUN	PTS	4:1		
Jalnaiz, Roberto	PHI				
Referee	HIOUAD LARBI	MAR	TOTAL		
Judge 1	MUILI ADE OJO	NGR	57:60		
2	MOHAMED	EGY	60:58		
3	ELMO ADOLPH	USA	59:58		
4	LUIS MINAMI	PER	59:58		
5	RONALD MARK GREGOR	AUS	60:57		

Fly-51 Kg 1/16 Bout 13/Sept. 21			Mouche-51 Kg 1/16 Combat 13/21 Sept		
Name Nom	Ctry Pays	Result Resultat			
Singh, Bishnubahadur	NEP				
* Johnson, Arthur	USA	RSCH	2RD.	3:00	
Referee	SANDOR PAJAR	HUN			
Judge 1	VIKTOR PLAVEC	YUG			
2	STANLEY WACHANGA	KEN			
3	MARIUS GUIRAMO LOUGBO	CIV			
4	HONG-TSUNG YONG	TPE			
5	OSVALDO BISBAL	ARG			

Fly -51Kg 1/8 Bout 3/Sept. 25			Mouche-51 Kg 1/8 Combat 3/25 Sept		
Name Nom	Ctry Pays	Result Resultat			
Nsubuga, Emmanuel	UGA				
* Abed, Benaissa	ALG	PTS	2:3		
Referee	THEODOROS VIDALIS	GRE	TOTAL		
Judge 1	GUSTAV BAUMGARDT	GDR	58:59		
2	SOMPONG SUKAR	THA	59:58		
3	CHO, SUK IN	KOR	58:59		
4	RONALD MARK GREGOR	AUS	57:60		
5	AUGUSTIN ZARAGOZA	MEX	59:58		

Fly-51 Kg 1/16 Bout 8/Sept. 21			Mouche-51 Kg 1/16 Combat 8/21 Sept		
Name Nom	Ctry Pays	Result Resultat			
Wang, Weiping	CHN				
* Tews, Andreas	GDR	PTS	0:5		
Referee	MUILI ADE OJO	NGR	TOTAL		
Judge 1	HIOUAD LARBI	MAR	55:60		
2	MOHAMED	EGY	57:60		
3	ELMO ADOLPH	USA	54:60		
4	LUIS MINAMI	PER	55:60		
5	RONALD MARK GREGOR	AUS	54:60		

Fly-51 Kg 1/16 Bout 14/Sept. 21			Mouche-51 Kg 1/16 Combat 14/21 Sept		
Name Nom	Ctry Pays	Result Resultat			
Tshabangu, Nokuthula	ZIM				
* Kim, Kwang-Sun	KOR	RSCH	2RD.	0:59	
Referee	RYSZARD REDO	POL			
Judge 1	ALDO LEONI	ITA			
2	ALBERTO DURAN	URU			
3	OSVALDO BISBAL	ARG			
4	KEITH WALKER	NZL			
5	HONG-TSUNG YONG	TPE			

Fly -51 Kg 1/8 Bout 4/Sept. 25			Mouche-51 Kg 1/8 Combat 4/25 Sept		
Name Nom	Ctry Pays	Result Resultat			
Varadi, Janos	HUN				
* Tews, Andreas	GDR	PTS	0:5		
Referee	MUILI ADE OJO	NGR	TOTAL		
Judge 1	MOHAMED	EGY	56:60		
2	MOHAMED GHAZNAVI	PAK	56:60		
3	ROMEO SOMODIO	PHI	56:60		
4	LUIS MINAMI	PER	56:60		
5	AUGUSTIN ZARAGOZA	MEX	55:60		

Fly-51 Kg 1/16 Bout 9/Sept. 21			Mouche-51 Kg 1/16 Combat 9/21 Sept		
Name Nom	Ctry Pays	Result Resultat			
* Desavoie, Philippe	FRA	RSCH	2RD.	0:23	
Ikegu, Anthony	KEN				
Referee	ALBERTO DURAN	URU			
Judge 1	HAN, DONG-JIN	KOR			
2	PIETER GEDOAN	INA			
3	ARTURO MORALES	DOM			
4	GABY MANCINI	CAN			
5	HONG-TSUNG YONG	TPE			

Fly-51 Kg 1/16 Bout 15/Sept. 21			Mouche-51 Kg 1/16 Combat 15/21 Sept		
Name Nom	Ctry Pays	Result Resultat			
Segawa, Setsuo	JPN				
* Todorov, Serafim	BUL	PTS	0:5		
Referee	OSVALDO BISBAL	ARG	TOTAL		
Judge 1	ALBERTO DURAN	URU	54:60		
2	MOULOUD KOURAD	ALG	54:60		
3	GABY MANCINI	CAN	55:60		
4	ARTURO MORALES	DOM	53:60		
5	KEITH WALKER	NZL	53:60		

Fly-51 Kg 1/8 Bout 5/Sept. 25			Mouche-51 Kg 1/8 Combat 5/25 Sept		
Name Nom	Ctry Pays	Result Resultat			
Desavoie, Philippe	FRA				
* Deleon, Meluiv	DOM	PTS	0:59		
Referee	MOHAMED GHAZNAVI	PAK	TOTAL		
Judge 1	HIOUAD LARBI	MAR	57:60		
2	RONALD MARK GREGOR	AUS	54:60		
3	TAKUYA MOROOKA	JPN	55:60		
4	BOUNAB HEDI	TUN	57:59		
5	AMADOR BURGUILLOS	VEN	57:60		

Fly-51 Kg 1/16 Bout 10/Sept. 21			Mouche-51 Kg 1/16 Combat 10/21 Sept		
Name Nom	Ctry Pays	Result Resultat			
Ovnteni, Badie	NIG				
* Deleon, Meluin	DOM	RSCH	1RD.	1:33	
Referee	STIG RONGE	SWE			
Judge 1	STOINO PARLAPANOV	BUL			
2	STANLEY WACHANGA	KEN			
3	BOB D. KASULE	UGA			
4	KEITH WALKER	NZL			
5	HONG-TSUNG YONG	TPE			

Fly-51 Kg 1/16 Bout 16/Sept. 21			Mouche-51 Kg 1/16 Combat 16/21 Sept		
Name Nom	Ctry Pays	Result Resultat			
Gul, Ramazan	TUR				
* Elkoumy, Gamleldin	EGY	PTS	1:4		
Referee	PIETER GEDOAN	INA	TOTAL		
Judge 1	ABDUL HANI	IRQ	59:58		
2	ALBERTO DURAN	URU	58:59		
3	OSVALDO BISBAL	ARG	58:59		
4	HONG-TSUNG YONG	TPE	57:60		
5	ARTURO MORALES	DOM	58:59		

Fly-51 Kg 1/8 Bout 6/Sept. 25			Mouche-51 Kg 1/8 Combat 6/25 Sept		
Name Nom	Ctry Pays	Result Resultat			
Agosto, Andy	PUR				
* Skriabin, Timofei	URS	PTS	0:5		
Referee	ROMEO SOMODIO	PHI	TOTAL		
Judge 1	SOMPONG SUKAR	THA	58:59		
2	BOUNAB HEDI	TUN	58:59		
3	HIOUAD LARBI	MAR	57:60		
4	RONALD MARK GREGOR	AUS	58:60		
5	LUIS MINAMI	PER	58:59		

Fly-51 Kg 1/16 Bout 11/Sept. 21			Mouche-51 Kg 1/16 Combat 11/21 Sept		
Name Nom	Ctry Pays	Result Resultat			
* Agosto, Andy	PUR	PTS	5:0		
Halbouni, Hamed	SYR				
Referee	MOULOUD KOURAD	ALG	TOTAL		
Judge 1	MARIUS GUIRAMO LOUGBO	CIV	60:56		
2	STIG RONGE	SWE	60:57		
3	RYSZARD REDO	POL	60:57		
4	KEITH WALKER	NZL	60:57		
5	OSVALDO BISBAL	ARG	60:55		

Fly-51 Kg 1/8 Bout 1/Sept. 25			Mouche-51 Kg 1/8 Combat 1/25 Sept		
Name Nom	Ctry Pays	Result Resultat			
Pingale, Manoj	IND				
* Gonzalez, Mario	MEX	PTS	1:4		
Referee	RODERICK ROBERTSON	GBR	TOTAL		
Judge 1	ZAUT GVADJAVA	URS	+ 58:58		
2	WERNER WEGSCHEIDER	AUT	56:59		
3	BOUNAB HEDI	TUN	58:59		
4	AMADOR BURGUILLOS	VEN	58:59		
5	RONALD MARK GREGOR	AUS	56:60		

Fly-51 Kg 1/8 Bout 7/Sept. 25			Mouche-51 Kg 1/8 Combat 7/25 Sept		
Name Nom	Ctry Pays	Result Resultat			
Johnson, Arthur	USA				
* Kim, Kwang-Sun	KOR	PTS	0:5		
Referee	GUSTAV BAUMGARDT	GDR	TOTAL		
Judge 1	THEODOROS VIDALIS	GRE	58:59		
2	DIMITR DORU BANCUI	ROM	57:60		
3	MOHAMED	EGY	58:60		
4	BOUNAB HEDI	TUN	56:60		
5	LUIS MINAMI	PER	55:60		

Fly-51 Kg 1/16 Bout 12/Sept. 21			Mouche-51 Kg 1/16 Combat 12/21 Sept		
Name Nom	Ctry Pays	Result Resultat			
* Skriabin, Timofei	URS	PTS	5:0		
Lawlor, Joseph	IRL				
Referee	D. WEERAKOON	SRI	TOTAL		
Judge 1	ABDUL HANI	IRQ	60:57		
2	MOULOUD KOURAD	ALG	60:55		
3	BOB D. KASULE	UGA	60:57		
4	ALBERTO DURAN	URU	60:57		
5	HONG-TSUNG YONG	TPE	60:57		

Fly-51 Kg 1/8 Bout 2/Sept. 25			Mouche-51 Kg 1/8 Combat 2/25 Sept		
Name Nom	Ctry Pays	Result Resultat			
* Koley, Alfred Amon	GHA	PTS	5:0		
Mwangata, Benjamin	TAN				
Referee	AMADOR BURGUILLOS	VEN	TOTAL		
Judge 1	LUIS MINAMI	PER	60:57		
2	WILLI KELLERMANN	FRG	59:57		
3	DIMITR DORU BANCUI	ROM	60:55		
4	TAKUYA MOROOKA	JPN	60:56		
5	ELMO ADOLPH	USA	59:56		

Fly-51 Kg 1/8 Bout 8/Sept. 25			Mouche-51 Kg 1/8 Combat 8/25 Sept		
Name Nom	Ctry Pays	Result Resultat			
* Todorov, Serafim	BUL	WO			
Elkoury, Gamleldin	EGY				
Referee	SOMPONG SUKAR	THA			
Judge 1	MOHAMED GHAZNAVI	PAK			
2	CHO, SUK IN	KOR			
3	AMADOR BURGUILLOS	VEN			
4	ELMO ADOLPH	USA			
5	RONALD MARK GREGOR	AUS			



Fly-51 Kg		Mouche -51kg	
Quarter-final Bout 1/Sept. 27		Quart de finale Combat 1/27 Sept	
Name	Ctry	Result	
Nom	Pays	Resultat	
* Gonzalez, Mario	MEX	WO	
Kotey, Alfred Amon	GHA		

Referee	GUSTAV BAUMGARDT	GDR	
Judge 1	SOMPONG SUKAR	THA	
2	KISHEN M. NARSI	IND	
3	MULI ADE OJO	NGR	
4	GABY MANCINI	CAN	
5	WERNER WEGSCHEIDER	AUT	

Fly -51 Kg		Mouche -51 Kg	
Final/Oct. 2		Final/2 Oct	
Name	Ctry	Result	
Nom	Pays	Resultat	
Tews, Andreas	GDR		
* Kim, Kwang-Sun	KOR	PTS	1:4

Referee	GABY MANCINI	CAN	TOTAL
Judge 1	ALBERTO DURAN	URU	58:59
2	BOB D. KASULE	UGA	58:60
3	ELMO ADOLPH	USA	59:58
4	OSVALDO BISBAL	ARG	57:60
5	HIOUAD LARBI	MAR	58:59

Bantam -54Kg		Coq -54Kg	
1/32 Bout 16/Sept. 17		1/32 Combat 16/17 Sept	
Name	Ctry	Result	
Nom	Pays	Resultat	
Saleh, Mustafa M	IRQ		
* Lowey, John	IRL	PTS	1:4

Referee	HIOUAD LARBI	MAR	TOTAL
Judge 1	RONALD MARK GREGOR	AUS	55:60
2	ELMO ADOLPH	USA	57:60
3	MOHAMED	EGY	57:60
4	AMADOR BURGUILLOS	VEN	59:58
5	LUIS MINAMI	PER	57:60

Fly-51 Kg		Mouche -51kg	
Quarter-final Bout 2/Sept. 27		Quarts de Finale Combat 2/27 Sept	
Name	Ctry	Result	
Nom	Pays	Resultat	
Abed, Benaissa	ALG		
* Tews, Andreas	GDR	PTS	0:5

Referee	OSVALDO BISBAL	ARG	TOTAL
Judge 1	D. WEERAKOON	SRI	55:60
2	ABDUL HANI	IRQ	54:60
3	STANLEY WACHANGA	KEN	56:60
4	ZAUT GVADJAVA	URS	56:60
5	ELMO ADOLPH	USA	56:60

Bantam -54Kg		Coq -54Kg	
1/32 Bout 17/Sept. 17		1/32 Combat 17/17 Sept	
Name	Ctry	Result	
Nom	Pays	Resultat	
Obewa, Edward	UGA		
* Tutuk, Vedat	TUR	PTS	2:3

Referee	KIM, YOUNG BAE	KOR	TOTAL
Judge 1	ROMEO SOMODIO	PHI	58:57
2	AUGUSTIN ZARAGOZA	MEX	58:59
3	AMADOR BURGUILLOS	VEN	59:57
4	RONALD MARK GREGOR	AUS	58:59
5	LUIS MINAMI	PER	58:59

Fly-51 Kg		Mouche -51 Kg	
Quarter-final Bout 3/Sept. 27		Quart de Finale Combat 3/27 Sept	
Name	Ctry	Result	
Nom	Pays	Resultat	
Deleon, Meluin	DOM		
* Skriabin, Timofei	URS	PTS	2:3

Referee	KISHEN M. NARSI	IND	TOTAL
Judge 1	ROMEO SOMODIO	PHI	59:58
2	KIM, YOUNG BAE	KOR	58:59
3	MOULOUD KOURAD	ALG	58:59
4	ALDO LEONI	ITA	58:59
5	ELMO ADOLPH	USA	60:57

Bantam -54Kg		Coq -54Kg	
1/32 Bout 18/Sept. 17		1/32 Combat 18/17 Sept	
Name	Ctry	Result	
Nom	Pays	Resultat	
Tshekiso, Magare	BOT		
* Breitbarth, Rene	GDR	PTS	0:5

Referee	MOHAMED GHAZNAVI	PAK	TOTAL
Judge 1	TAKUYA MOROOKA	JPN	55:60
2	AUGUSTIN ZARAGOZA	MEX	56:60
3	LUIS MINAMI	PER	57:60
4	AMADOR BURGUILLOS	VEN	54:60
5	ELMO ADOLPH	USA	54:60

Fly-51 Kg		Mouche -51 Kg	
Quarter-final Bout 4/Sept. 27		Quart de finale Combat 4/27 Sept	
Name	Ctry	Result	
Nom	Pays	Resultat	
* Kim, Kwang-Sun	KOR	PTS	4:1
Todorov, Serafim	BUL		

Referee	HIOUAD LARBI	MAR	TOTAL
Judge 1	D. WEERAKOON	SRI	60:56
2	THEODOROS VIDALIS	GRE	60:56
3	GABY MANCINI	CAN	60:57
4	MULI ADE OJO	NGR	58:59
5	ALBERTO DURAN	URU	60:57

Bantam -54Kg		Coq -54Kg	
1/32 Bout 19/Sept. 17		1/32 Combat 19/17 Sept	
Name	Ctry	Result	
Nom	Pays	Resultat	
* Nieves, Felipe	PUR	PTS	5:0
Diallo, Sambajacob	GUI		

Referee	RONALD MARK GREGOR	AUS	TOTAL
Judge 1	WILLI KELLERMANN	FRG	60:56
2	THEODOROS VIDALIS	GRE	60:56
3	ROMEO SOMODIO	PHI	60:53
4	KIM, YOUNG BAE	KOR	60:55
5	LUIS MINAMI	PER	60:57

Fly-51 Kg		Mouche -51 Kg	
Semi-final Bout 1/Sept. 29		Demi-finale Combat 1/29 Sept	
Name	Ctry	Result	
Nom	Pays	Resultat	
Gonzalez, Mario	MEX		
* Tews, Andreas	GDR	PTS	0:5

Referee	HIOUAD LARBI	MAR	TOTAL
Judge 1	BOB D. KASULE	UGA	57:60
2	MOHAMED GHAZNAVI	PAK	56:60
3	SOMPONG SUKAR	THA	57:60
4	GABY MANCINI	CAN	57:60
5	DIMITR DORU BANCUI	ROM	56:60

Bantam -54Kg		Coq -54Kg	
1/32 Bout 20/Sept. 17		1/32 Combat 20/17 Sept	
Name	Ctry	Result	
Nom	Pays	Resultat	
* Julio Rocha, Jorge E	COL	RSCH	3RD. 2:06
Hormillosa, Michael	PHI		

Referee	DIMITR DORU BANCUI	ROM	
Judge 1	ZAUT GVADJAVA	URS	
2	AUGUSTIN ZARAGOZA	MEX	
3	BOUNAB HEDI	TUN	
4	MOHAMED	EGY	
5	RONALD MARK GREGOR	AUS	

Fly-51 Kg		Mouche -51 Kg	
Semi-final Bout 2/Sept. 29		Demi-finale Combat 2/29 Sept	
Name	Ctry	Result	
Nom	Pays	Resultat	
Skriabin, Timofei	URS		
* Kim, Kwang-Sun	KOR	PTS	0:5

Referee	ELMO ADOLPH	USA	TOTAL
Judge 1	STOINO PARLAPANOV	BUL	58:59
2	HIOUAD LARBI	MAR	58:59
3	D. WEERAKOON	SRI	57:60
4	GABY MANCINI	CAN	58:59
5	ALBERTO DURAN	URU	58:59

Batam -54Kg		Coq -54Kg	
1/32 Bout 21/Sept. 17		1/32 Combat 21/17 Sept	
Name	Ctry	Result	
Nom	Pays	Resultat	
Stephens, Thomas	LBR		
* Chikwanda, Justin	ZAM	RSCH	1RD. 2:56

Referee	SOMPONG SUKAR	THA	
Judge 1	GUSTAV BAUMGARDT	GDR	
2	RODERICK ROBERTSON	GBR	
3	ELMO ADOLPH	USA	
4	RONALD MARK GREGOR	AUS	
5	KIM, YOUNG BAE	KOR	



Bantam -54Kg		Coq -54Kg			
1/32 Bout 22/Sept. 27		1/32 Combat 22/27 Sept			
Name	Ctry	Result			
Nom	Pays	Resultat			
Faamaoni, Tiui	SAM				
* Stuley, Moumouni	NIG	RSCH	3RD	2:47	

Referee	WERNER WEGSCHEIDER	AUT			
Judge 1	RODERICK ROBERTSON	GBR			
2	SOMPONG SUKAR	THA			
3	MOHAMED GHAZNAVI	PAK			
4	AUGUSTIN ZARAGOZA	MEX			
5	AMADOR BURGUILLOS	VEN			

Bantam -54Kg		Coq -54Kg			
1/32 Bout 28/Sept. 17		1/32 Combat 28/17 Sept			
Name	Ctry	Result			
Nom	Pays	Resultat			
* Byun, Jong-Il	KOR	PTS	5:0		
Augustin, Jean Marc	FRA				

Referee	BOB D. KASULE	UGA	TOTAL		
Judge 1	MOULOUD KOURAD	ALG	60:57		
2	PIETER GEDOAN	INA	59:58		
3	RYSZARD REDO	POL	60:57		
4	HONG-TSUNG YONG	TPE	60:57		
5	OSVALDO BISBAL	ARG	60:57		

Bantam -54Kg		Coq -54Kg			
1/16 Bout 2/Sept. 22		1/16 Combat 2/22 Sept			
Name	Ctry	Result			
Nom	Pays	Resultat			
* Birajdar, Shahuraj	IND	PTS	5:0		
Akomatsri, Ayewoubo	TOG				

Referee	RODERICK ROBERTSON	GBR	TOTAL		
Judge 1	DIMITR DORU BANCUI	ROM	59:58		
2	AMADOR BURGUILLOS	VEN	59:58		
3	ELMO ADOLPH	USA	60:56		
4	LUIS MINAMI	PER	59:57		
5	RONALD MARK GREGOR	AUS	59:58		

Bantam -54Kg		Coq -54Kg			
1/32 Bout 23/Sept. 17		1/32 Combat 23/17 Sept			
Name	Ctry	Result			
Nom	Pays	Resultat			
Aly, Haji	TAN				
* Nduita, Ibibongo	ZAI	PTS	2:3		

Referee	AUGUSTIN ZARAGOZA	MEX	TOTAL		
Judge 1	TAKUYA MOROOKA	JPN	57:60		
2	DIMITR DORU BANCUI	ROM	59:58		
3	WERNER WEGSCHEIDER	AUT	58:59		
4	RONALD MARK GREGOR	AUS	57:60		
5	ELMO ADOLPH	USA	59:58		

Bantam -54Kg		Coq -54Kg			
1/32 Bout 29/Sept. 17		1/32 Combat 29/17 Sept			
Name	Ctry	Result			
Nom	Pays	Resultat			
* Santana, Joilson	BRA	PTS	5:0		
Sonnavanh, Phetsmone	LAO				

Referee	STOINO PARLANOV	BUL	TOTAL		
Judge 1	VIKTOR PLAVEC	YUG	59:57		
2	BOB D. KASULE	UGA	59:58		
3	HONG-TSUNG YONG	TPE	59:58		
4	OSVALDO BISBAL	ARG	58:57		
5	D. WEERAKOON	SRI	59:58		

Bantam -54Kg		Coq -54Kg			
1/16 Bout 3/Sept. 22		1/16 Combat 3/22 Sept			
Name	Ctry	Result			
Nom	Pays	Resultat			
* Mwema, Stephen	KEN	RSCH	2RD.	0:25	
Giri, Rambahadur	NEP				

Referee	ZAUT GVADJAVA	URS			
Judge 1	GUSTAV BAUMGARDT	GDR			
2	AMADOR BURGUILLOS	VEN			
3	LUIS MINAMI	PER			
4	RONALD MARK GREGOR	AUS			
5	ELMO ADOLPH	USA			

Bantam -54Kg		Coq -54Kg			
1/32 Bout 24/Sept. 17		1/32 Combat 24/17 Sept			
Name	Ctry	Result			
Nom	Pays	Resultat			
* Matsushima, Katsuyuki	JPN	RSCH	1RD.	2:20	
Almuwaizri, Saud	KUW				

Referee	GUSTAV BAUMGARDT	GDR			
Judge 1	WILLI KELLERMANN	FRG			
2	MULI ADE OJO	NGR			
3	HIOUAD LARBI	MAR			
4	AUGUSTIN ZARAGOZA	MEX			
5	AMADOR BURGUILLOS	VEN			

Bantam -54Kg		Coq -54Kg			
1/32 Bout 30/Sept. 17		1/32 Combat 30/17 Sept			
Name	Ctry	Result			
Nom	Pays	Resultat			
* Zengli, Slimane	ALG	PTS	5:0		
Gomes, Manuel	ANG				

Referee	HAN, DONG-JIN	KOR	TOTAL		
Judge 1	ALDO LEONI	ITA	60:55		
2	RYSZARD REDO	POL	60:56		
3	KISHEN M. NARSI	IND	60:55		
4	GABY MANCINI	CAN	60:55		
5	ALBERTO DURAN	URU	60:57		

Bantam -54Kg		Coq -54Kg			
1/16 Bout 4/Sept. 22		1/16 Combat 4/22 Sept			
Name	Ctry	Result			
Nom	Pays	Resultat			
Deveney, Michael	GBR				
* Machaze, Alberto	MOZ	PTS	0:5		

Referee	ELMO ADOLPH	USA	TOTAL		
Judge 1	KIM, YOUNG BAE	KOR	58:59		
2	ROMEO SOMODIO	PHI	56:58		
3	AMADOR BURGUILLOS	VEN	58:59		
4	LUIS MINAMI	PER	57:59		
5	RONALD MARK GREGOR	AUS	57:60		

Bantam -54Kg		Coq -54Kg			
1/32 Bout 25/Sept. 17		1/32 Combat 25/17 Sept			
Name	Ctry	Result			
Nom	Pays	Resultat			
Achik, Mohamed	MAR				
* Mayanja, Jimmy	SWE	PTS	1:4		

Referee	TAKUYA MOROOKA	JPN	TOTAL		
Judge 1	SOMPONG SUKAR	THA	58:59		
2	LUIS MINAMI	PER	57:60		
3	RONALD MARK GREGOR	AUS	57:59		
4	ELMO ADOLPH	USA	59:58		
5	AMADOR BURGUILLOS	VEN	58:59		

Bantam -54Kg		Coq -54Kg			
1/32 Bout 31/Sept. 17		1/32 Combat 31/17 Sept			
Name	Ctry	Result			
Nom	Pays	Resultat			
* Dube, Ndaba	ZIM	RSCO	2RD.	2:45	
Francis, Lomel	ANT				

Referee	KISHEN M. NARSI	IND			
Judge 1	PIETER GEDOAN	INA			
2	ALDO LEONI	ITA			
3	ALBERTO DURAN	URU			
4	KEITH WALKER	NZL			
5	MOULOUD KOURAD	ALG			

Bantam -54Kg		Coq -54Kg			
1/16 Bout 5/Sept. 22		1/16 Combat 5/22 Sept			
Name	Ctry	Result			
Nom	Pays	Resultat			
* Moolsan, Phajol	THA	PTS	5:0		
Priault, Marcus	AUS				

Referee	MOHAMED	EGY	TOTAL		
Judge 1	BOUNAB HEDI	TUN	60:54		
2	GUSTAV BAUMGARDT	GDR	60:53		
3	ZAUT GVADJAVA	URS	60:54		
4	AMADOR BURGUILLOS	VEN	60:56		
5	LUIS MINAMI	PER	60:54		

Bantam -54Kg		Coq -54Kg			
1/32 Bout 26/Sept. 17		1/32 Combat 26/17 Sept			
Name	Ctry	Result			
Nom	Pays	Resultat			
Joseph, Tad	GRN				
* Garcia, Jose	MEX	RSCH	1RD.	1:02	

Referee	LUIS MINAMI	PER			
Judge 1	BOUNAB HEDI	TUN			
2	MULI ADE OJO	NGR			
3	ZAUT GVADJAVA	URS			
4	THEODOROS VIDALIS	GRE			
5	MOHAMED GHAZNAVI	PAK			

Bantam -54Kg		Coq -54Kg			
1/32 Bout 32/Sept. 17		1/32 Combat 32/17 Sept			
Name	Ctry	Result			
Nom	Pays	Resultat			
* Artemiev, Alexandre	URS	WO			
Paululum, Edouard	VAN				

Referee					
Judge 1					
2					
3					
4					
5					

Bantam -54Kg		Coq -54Kg			
1/16 Bout 6/Sept. 22		1/16 Combat 6/22 Sept			
Name	Ctry	Result			
Nom	Pays	Resultat			
Rajcoomar, Teekaram	MRI				
* Torres, Abraham	VEN	PTS	0:5		

Referee	SOMPONG SUKAR	THA	TOTAL		
Judge 1	TAKUYA MOROOKA	JPN	55:60		
2	WILLI KELLERMANN	FRG	54:60		
3	THEODOROS VIDALIS	GRE	55:60		
4	RONALD MARK GREGOR	AUS	54:60		
5	CHO, SUK IN	KOR	55:60		

Bantam -54Kg		Coq -54Kg			
1/32 Bout 27/Sept. 17		1/32 Combat 27/17 Sept			
Name	Ctry	Result			
Nom	Pays	Resultat			
Anok, Peter	SUD				
* Hristov, Alexandar	BUL	PTS	1:4		

Referee	LEE, JAE IN	KOR	TOTAL		
Judge 1	D. WEERAKOON	SRI	56:60		
2	SANDOR PAJAR	HUN	56:60		
3	GABY MANCINI	CAN	57:60		
4	KEITH WALKER	NZL	56:60		
5	MARIUS GUIRAMO LOUGBO	CIV	59:58		

Bantam -54Kg		Coq -54Kg			
1/16 Bout 1/Sept. 22		1/16 Combat 1/22 Sept			
Name	Ctry	Result			
Nom	Pays	Resultat			
* Mckinney, Kennedy	USA	RSCH	1RD.	1:44	
Perez, Erick-Giovanni	GUA				

Referee	BOUNAB HEDI	TUN			
Judge 1	KIM, YOUNG BAE	KOR			
2	WERNER WEGSCHEIDER	AUT			
3	GUSTAV BAUMGARDT	GDR			
4	HIOUAD LARBI	MAR			
5	AMADOR BURGUILLOS	VEN			

Bantam -54Kg		Coq -54Kg			
1/16 Bout 7/Sept. 22		1/16 Combat 7/22 Sept			
Name	Ctry	Result			
Nom	Pays	Resultat			
* Altankhuyag, Nyamaa	MGL	PTS	3:2		
Jablonski, Grzegorz	POL				

Referee	AMADOR BURGUILLOS	VEN	TOTAL		
Judge 1	HIOUAD LARBI	MAR	58:59		
2	MULI ADE OJO	NGR	58:59		
3	RONALD MARK GREGOR	AUS	60:57		
4	ELMO ADOLPH	USA	60:57		
5	LUIS MINAMI	PER	59:58		

Boxing

Boxe

Bantam -54Kg 1/16 Bout 8/Sept. 22		Coq -54Kg 1/16 Combat 8/22 Sept	
Name Nom	Ctry Pays	Result Resultat	
Mohammed, Sabo	NGR	PTS	1:4
* Lowey, John	IRL		
Referee	MOHAMED GHAZNAVI	PAK	TOTAL
Judge 1	ROMEO SOMODIO	PHI	+ 59:59
2	AMADOR BURGUILLOS	VEN	57:60
3	LUIS MINAMI	PER	56:60
4	ELMO ADOLPH	USA	56:60
5	SOMPONG SUKAR	THA	58:59

Bantam -54Kg 1/16 Bout 14/Sept. 22		Coq -54Kg 1/16 Combat 14/22 Sept	
Name Nom	Ctry Pays	Result Resultat	
* Hristov, Alexandar	BUL	PTS	4:1
Byun, Jong-Il	KOR		
Referee	KEITH WALKER	NZL	TOTAL
Judge 1	HONG-TSUNG YONG	TPE	58:59
2	GABY MANCINI	CAN	59:58
3	MARIUS GUIRAMO LOUGBO	CIV	59:57
4	BOB D. KASULE	UGA	58:57
5	MOULOUD KOURAD	ALG	59:57

Bantam -54Kg 1/8 Bout 4/Sept. 26		Coq -54Kg 1/8 Combat 4/26 Sept	
Name Nom	Ctry Pays	Result Resultat	
* Altankhuyag, Nyamaa	MGL	PTS	3:2
Lowey, John	IRL		
Referee	MULI ADE OJO	NGR	Total
Judge 1	BOUNAB HEDI	TUN	59:58
2	ELMO ADOLPH	USA	58:60
3	MOHAMED	EGY	59:58
4	RONALD MARK GREGOR	AUS	57:60
5	AUGUSTIN ZARAGOZA	MEX	60:58

Bantam -54Kg 1/16 Bout 9/Sept. 22		Coq -54Kg 1/16 Combat 9/22 Sept	
Name Nom	Ctry Pays	Result Resultat	
Tutuk, Vedat	TUR	PTS	0:5
* Breitbarth, Rene	GDR		
Referee	MOULOUD KOURAD	ALG	TOTAL
Judge 1	BOB D. KASULE	UGA	56:60
2	ABDUL HANI	IRQ	57:60
3	LEE, JAE IN	KOR	56:59
4	OSVALDO BISBAL	ARG	57:60
5	GABY MANCINI	CAN	56:59

Bantam -54Kg 1/16 Bout 15/Sept. 22		Coq -54Kg 1/16 Combat 15/22 Sept	
Name Nom	Ctry Pays	Result Resultat	
Santana, Joilson	BRA	PTS	0:5
* Zengli, Slimane	ALG		
Referee	RYSZARD REDO	POL	TOTAL
Judge 1	ALDO LEONI	ITA	57:60
2	STIG RONGE	SWE	56:60
3	HONG-TSUNG YONG	TPE	56:60
4	KISHEN M. NARSI	IND	57:60
5	GABY MANCINI	CAN	57:60

Bantam -54Kg 1/8 Bout 5/Sept. 26		Coq -54Kg 1/8 Combat 5/26 Sept	
Name Nom	Ctry Pays	Result Resultat	
Breitbarth, Rene	GDR	PTS	1:4
* Julio Rocha, Jorge E	COL		
Referee	SOMPONG SUKAR	THA	TOTAL
Judge 1	MOHAMED GHAZNAVI	PAK	58:59
2	BOUNAB HEDI	TUN	59:58
3	MOHAMED	EGY	58:59
4	ELMO ADOLPH	USA	57:59
5	RONALD MARK GREGOR	AUS	57:59

Bantam -54Kg 1/16 Bout 10/Sept. 22		Coq -54Kg 1/16 Combat 10/22 Sept	
Name Nom	Ctry Pays	Result Resultat	
Nieves, Felipe	PUR	PTS	0:5
* Julio Rocha, Jorge	COL		
Referee	ALDO LEONI	ITA	TOTAL
Judge 1	RYSZARD REDO	POL	56:59
2	KISHEN M. NARSI	IND	58:59
3	PIETER GEDOAN	INA	58:59
4	STANLEY WACHANGA	KEN	55:59
5	MOULOUD KOURAD	ALG	57:59

Bantam -54Kg 1/16 Bout 16/Sept. 22		Coq -54Kg 1/16 Combat 16/22 Sept	
Name Nom	Ctry Pays	Result Resultat	
Dube, Ndaba	ZIM	RSCH	1RD. 1:00
* Artemiev, Alexandre	URS		
Referee	HONG-TSUNG YONG	TPE	
Judge 1	PIETER GEDOAN	INA	
2	LEE, JAE IN	KOR	
3	ALBERTO DURAN	URU	
4	OSVALDO BISBAL	ARG	
5	ARTURO MORALES	DOM	

Bantam -54Kg 1/8 Bout 6/Sept. 26		Coq -54Kg 1/8 Combat 6/26 Sept	
Name Nom	Ctry Pays	Result Resultat	
Chikwanda, Justin	ZAM	PTS	2:3
* Matsushima, Katsuyuki	JPN		
Referee	WILL KELLERMANN	FRG	TOTAL
Judge 1	THEODOROS VIDALIS	GRE	58:59
2	DIMITR DORU BANCUI	ROM	59:58
3	LUIS MINAMI	PER	58:59
4	AUGUSTIN ZARAGOZA	MEX	58:59
5	RONALD MARK GREGOR	AUS	60:57

Bantam -54Kg 1/16 Bout 11/Sept. 22		Coq -54Kg 1/16 Combat 11/22 Sept	
Name Nom	Ctry Pays	Result Resultat	
Chikwanda, Justin	ZAM	RSCH	1RD. 3:00
Siuley, Moumouni	NIG		
Referee	STOINO PARLAPANOV	BUL	
Judge 1	SANDOR PAJAR	HUN	
2	D. WEERAKOON	SRI	
3	KISHEN M. NARSI	IND	
4	GABY MANCINI	CAN	
5	KEITH WALKER	NZL	

Bantam -54Kg 1/8 Bout 1/Sept. 26		Coq -54Kg 1/8 Combat 1/26 Sept	
Name Nom	Ctry Pays	Result Resultat	
* Mckinney, Kennedy	USA	WO	
Birajdar, Shahuraj	IND		
Referee	WERNER WEGSCHEIDER	AUT	
Judge 1	GUSTAV BAUMGARDT	GDR	
2	MULI ADE OJO	NGR	
3	MOHAMED	EGY	
4	AMADOR BURGUILLOS	VEN	
5	RONALD MARK GREGOR	AUS	

Bantam -54Kg 1/8 Bout 7/Sept. 26		Coq -54Kg 1/8 Combat 7/26 Sept	
Name Nom	Ctry Pays	Result Resultat	
Mayanja, Jimmy	SWE	PTS	0:5
* Hristov, Alexandar	BUL		
Referee	MOHAMED	EGY	TOTAL
Judge 1	MULI ADE OJO	NGR	58:59
2	CHO, SUK IN	KOR	57:60
3	TAKUYA MOROOKA	JPN	56:60
4	AUGUSTIN ZARAGOZA	MEX	57:60
5	RONALD MARK GREGOR	AUS	56:60

Bantam -54Kg 1/16 Bout 12/Sept. 22		Coq -54Kg 1/16 Combat 12/22 Sept	
Name Nom	Ctry Pays	Result Resultat	
Nduita, Ibibongo	ZAI	PTS	0:5
* Matsushima, Katsuyuki	JPN		
Referee	VIKTOR PLAVEC	YUG	TOTAL
Judge 1	STIG RONGE	SWE	56:60
2	ALBERTO DURAN	URU	56:60
3	HONG-TSUNG YONG	TPE	56:60
4	ARTURO MORALES	DOM	56:59
5	KEITH WALKER	NZL	56:59

Bantam -54Kg 1/8 Bout 2/Sept. 26		Coq -54Kg 1/8 Combat 2/26 Sept	
Name Nom	Ctry Pays	Result Resultat	
* Mwema, Stephen	KEN	PTS	5:0
Machaze, Alberto	MOZ		
Referee	RODERICK ROVERTSON	GBR	TOTAL
Judge 1	WILLI KELLERMANN	FRG	59:56
2	TAKUYA MOROOKA	JPN	59:57
3	ROMEO SOMODIO	PHI	59:57
4	ELMO ADOLPH	USA	59:57
5	RONALD MARK GREGOR	AUS	59:57

Bantam -54Kg 1/8 Bout 8/Sept. 26		Coq -54Kg 1/8 Combat 8/26 Sept	
Name Nom	Ctry Pays	Result Resultat	
Zengli, Slimane	ALG	PTS	0:5
* Artemiev, Alexandre	URS		
Referee	ELMO ADOLPH	USA	TOTAL
Judge1	AUGUSTIN ZARAGOZA	MEX	54:60
2	SOMPONG SUKAR	THA	56:60
3	TAKUYA MOROOKA	JPN	55:60
4	LUIS MINAMI	PER	56:60
5	AMADOR BURGUILLOS	VEN	56:60

Bantam -54Kg 1/16 Bout 13/Sept. 22		Coq -54Kg 1/16 Combat 13/22 Sept	
Name Nom	Ctry Pays	Result Resultat	
* Mayanja, Jimmy	SWE	PTS	4:1
Garcia, Jose	MEX		
Referee	LEE, JAE IN	KOR	TOTAL
Judge 1	PIETER GEDOAN	INA	59:58
2	STANLEY WACHANGA	KEN	59:58
3	MOULOUD KOURAD	ALG	58:59
4	HONG-TSUNG YONG	TPE	59:56
5	D. WEERAKOON	SRI	60:56

Bantam -54Kg 1/8 Bout 3/Sept. 26		Coq -54Kg 1/8 Combat 3/26 Sept	
Name Nom	Ctry Pays	Result Resultat	
* Moolsan, Phajol	THA	PTS	3:2
Torres, Abraham	VEN		
Referee	WERNER WEGSCHEIDER	AUT	TOTAL
Judge 1	ZAUT GVADJAVA	URS	57:59
2	MOHAMED	EGY	+ 59:59
3	MULI ADE OJO	NGR	59:58
4	AUFUSTIN ZARAGOZA	MEX	59:58
5	RONALD MARK GREGOR	AUS	58:59

Bantam -54Kg Quarter-final Bout 1/Sept. 28		Coq -54Kg Quart de Finale Combat 1/28 Sept	
Name Nom	Ctry Pays	Result Resultat	
* Mckinney, Kennedy	USA	PTS	5:0
Mwema, Stephen	KEN		
Referee	LEE, JAE IN	KOR	TOTAL
Judge 1	ABDUL HANI	IRQ	59:57
2	SOMPONG SUKAR	THA	59:58
3	STIG RONGE	SWE	60:57
4	GUSTAV BAUMGARDT	GRD	60:56
5	ALBERTO DURAN	URU	59:58



Bantam -54Kg
Competition Summary

Coq -54Kg
Tableau de la Competition

1/32	1/16	1/8	Quarter-final/Quart de Finale	Semi-final/Demi-finale	Final/Finale
Mckinney, K (USA)	Mckinney, K	Mckinney, K	Mckinney, K	Mckinney, K	Mckinney, K
BYE					
Perez, E (GUA)	Perez, E	RSCH			
BYE					
Birajdar, S (IND)	Birajdar, S				
BYE					
Akomatsri, A (TOG)	Akomatsri, A	Birajdar, S			
BYE		PTS			
Mwema, Steph (KEN)	Mwema, Steph				
BYE					
Giri, Rambah (NEP)	Giri, Rambah	Mwema, Steph			
BYE		RSCH			
Deveney, Mic (GBR)	Deveney, Mic				
BYE					
Machaze, Alb (MOZ)	Machaze, Alb	Machaze, Alb			
BYE		PTS			
Moolsan, Pha(THA)	Moolsan, Pha				
BYE					
Priaulx, Mar (AUS)	Priaulx, Mar	Moolsan, Pha			
BYE		PTS			
Rajcoomar, T (MRI)	Rajcoomar, T				
BYE					
Torres, Abra (VEN)	Torres, Abra	Torres, Abra			
BYE		PTS			
Altankhuyag (MGL)	Altankhuyag				
BYE					
Jablonski, G (POL)	Jablonski, G	Altankhuyag			
BYE		PTS			
Mohammed, Sa (NGR)	Mohammed, Sa				
BYE					
Saleh, Musta (IRQ)	Lowey, John	Lowey, John			
BYE		PTS			
Lowey, John (IRL)	PTS				
Obewa, Edwar (UGA)	Tutuk, Vedat				
BYE					
Tutuk, Vedat (TUR)	PTS				
Tshekiso, Ma (BOT)	Breitbarth,	Breitbarth,			
BYE		PTS			
Breitbarth, (GDR)	PTS				
Nieves, Feli (PUR)	Nieves, Feli				
BYE					
Diallo, S (GUI)	PTS				
Julio Rocha (COL)	Julio Rocha	Julio Rocha			
BYE		PTS			
Hormillosa, (PHI)	RSCH				
Stephens, Th (LBR)	Chikwanda, J	Chikawanda, J			
BYE		RSCH			
Chikwanda, J (ZAM)	RSCH				
Faamaoni, Ti (SAM)	Siuley, Moun				
BYE					
Siuley, Moun (NIG)	RSCH				
Ally, Haji (TAN)	Nduita, Ibib				
BYE					
Nduita, Ibib (ZAI)	PTS				
Matsushima, (JPN)	Matsushima,	Matsushimay			
BYE		PTS			
Almuwaizri, (KUW)	PTS				
Achik, Moham (MAR)	Mayanja, Jim	Mayanja, Jim			
BYE		PTS			
Mayanja, Jim (SWE)	PTS				
Joseph, Tad (GRN)	Garcia, Jose				
BYE					
Garcia, Jose (MEX)	RSCH				
Anok, Peter (SUD)	Hristov, A	Hristov, A			
BYE		PTS			
Hristov, A (BUL)	PTS				
Byun, Jong-I (KOR)	Byun, Jong-I	Hristov, A			
BYE		PTS			
Augustin, J (FRA)	PTS				
Santana, Joi (BRA)	Santana, Joi				
BYE					
Sonnavanh, P (LAO)	PTS	Zengli, Slim			
Zengli, Slim (ALG)	Zengli, Slim	PTS			
Gomes, Manue (ANG)	PTS				
Dube, Ndaba (ZIM)	Dube, Ndaba				
BYE					
Francis, Lor (ANT)	RSCO	Artemiev, A			
Artemiev, A (URS)	Artemiev, A	RSCH			
BYE					
Paululum, E (VAN)	Wo				

Boxing

Boxe

Bantam -54Kg Quarter-final Bout 2/Sept. 28				Coq -54Kg Quart de Finale Combat 2/28 Sept				Feather -57Kg 1/32 Bout 17/Sept. 18				Plume -57Kg 1/32 Combat 17/18 Sept				Feather -57Kg 1/32 Bout 23/Sept. 18				Plume -57Kg 1/32 Combat 23/18 Sept			
Name Nom	Ctry Pays	Result Resultat		Name Nom	Ctry Pays	Result Resultat		Name Nom	Ctry Pays	Result Resultat		Name Nom	Ctry Pays	Result Resultat		Name Nom	Ctry Pays	Result Resultat					
* Moolsan, Phajol	THA	PTS	5:0	Altankhuyag, Nyamaa	MGL			Fofana, Bakary	CIV	RSCO	1RD.	1:06				Damigella, Domingo N	ARG	PTS	1:4	* Anderson, David	GBR		
Referee	STOINO PARLAPANOV	BUL	TOTAL	Referee	WERNER WEGSCHEIDER	AUT		Referee	TAKUYA MOROOKA	JPN	TOTAL	Referee	TAKUYA MOROOKA	JPN	TOTAL	Referee	TAKUYA MOROOKA	JPN	TOTAL	Referee	TAKUYA MOROOKA	JPN	TOTAL
Judge 1	MOHAMED	EGY	59:58	Judge 1	RONALD MARK GREGOR	AUS		Judge 1	ROMEO SOMODIO	PHI	57:60	Judge 1	ROMEO SOMODIO	PHI	57:60	Judge 1	ROMEO SOMODIO	PHI	57:60	Judge 1	ROMEO SOMODIO	PHI	57:60
2	MOULOU KOURAD	ALG	60:57	2	ELMO ADOLPH	USA		2	CHO, SUK IN	KOR	57:60	2	CHO, SUK IN	KOR	57:60	2	CHO, SUK IN	KOR	57:60	2	CHO, SUK IN	KOR	57:60
3	ALDO LEONI	ITA	60:56	3	AMADOR BURGUILLOS	VEN		3	MOHAMED	EGY	56:60	3	MOHAMED	EGY	56:60	3	MOHAMED	EGY	56:60	3	MOHAMED	EGY	56:60
4	GABY MANCINI	CAN	60:56	4	GUSTAV BAUMGARDT	GDR		4	MULI ADEOJO	NGR	57:60	4	MULI ADEOJO	NGR	57:60	4	MULI ADEOJO	NGR	57:60	4	MULI ADEOJO	NGR	57:60
5	OSVALDO BISBAL	ARG	59:57	5	WILLI KELLERMANN	FRG		5	AUGUSTIN ZARAGOZA	MEX	59:58	5	AUGUSTIN ZARAGOZA	MEX	59:58	5	AUGUSTIN ZARAGOZA	MEX	59:58	5	AUGUSTIN ZARAGOZA	MEX	59:58

Bantam -54Kg Quarter-final Bout 3/Sept. 28				Coq -54Kg Quart de Finale Combat 3/28 Sept				Feather -57Kg 1/32 Bout 18/Sept. 18				Plume -57Kg 1/32 Combat 18/18 Sept				Feather -57Kg 1/32 Bout 24/Sept. 18				Plume -57Kg 1/32 Combat 24/18 Sept			
Name Nom	Ctry Pays	Result Resultat		Name Nom	Ctry Pays	Result Resultat		Name Nom	Ctry Pays	Result Resultat		Name Nom	Ctry Pays	Result Resultat		Name Nom	Ctry Pays	Result Resultat					
* Julio Rocha, Jorge E	COL	PTS	5:0	Matsushima, Katsuyuki	JPN			Konyegwachie, Anthony	NGR	PTS	0:5	* Dumitrescu, Daniel	ROM	PTS	0:5	* Fitzgerald, Paul	IRL	PTS	4:1	Uillegas S, Emilio A	DOM		
Referee	BOB D. KASULE	UGA	TOTAL	Referee	ROMEO SOMODIO	PHI	TOTAL	Referee	ROMEO SOMODIO	PHI	TOTAL	Referee	HIOUAD LARBI	MAR	TOTAL	Referee	HIOUAD LARBI	MAR	TOTAL	Referee	HIOUAD LARBI	MAR	TOTAL
Judge 1	D. WEERAKOON	SRI	59:58	Judge 1	MOHAMED GHAZNAVI	PAK	55:60	Judge 1	MOHAMED GHAZNAVI	PAK	55:60	Judge 1	MULI ADE OJO	NGR	60:57	Judge 1	MULI ADE OJO	NGR	60:57	Judge 1	MULI ADE OJO	NGR	60:57
2	HIOUAD LARBI	MAR	59:58	2	AUGUSTIN ZARAGOZA	MEX	56:59	2	AUGUSTIN ZARAGOZA	MEX	56:59	2	ROMEO SOMODIO	PHI	59:58	2	ROMEO SOMODIO	PHI	59:58	2	ROMEO SOMODIO	PHI	59:58
3	THEODOROS VIDALIS	GRE	60:56	3	LUIS MINAMI	PER	55:60	3	LUIS MINAMI	PER	55:60	3	TAKUYA MOROOKA	JPN	59:58	3	TAKUYA MOROOKA	JPN	59:58	3	TAKUYA MOROOKA	JPN	59:58
4	SANDOR PAJAR	HUN	60:56	4	CHO, SUK IN	KOR	55:60	4	CHO, SUK IN	KOR	55:60	4	AMADOR BURGUILLOS	VEN	58:59	4	AMADOR BURGUILLOS	VEN	58:59	4	AMADOR BURGUILLOS	VEN	58:59
5	OSVALDO BISBAL	ARG	59:57	5	ELMO ADOLPH	USA	55:60	5	ELMO ADOLPH	USA	55:60	5	RONALD MARK GREGOR	AUS	60:58	5	RONALD MARK GREGOR	AUS	60:58	5	RONALD MARK GREGOR	AUS	60:58

Bantam -54Kg Quarter-final Bout 4/Sept. 28				Coq -54Kg Quart de Finale Combat 4/28 Sept				Feather -57Kg 1/32 Bout 19/Sept. 18				Plume -57Kg 1/32 Combat 19/18 Sept				Feather -57Kg 1/32 Bout 25/Sept. 18				Plume -57Kg 1/32 Combat 25/18 Sept			
Name Nom	Ctry Pays	Result Resultat		Name Nom	Ctry Pays	Result Resultat		Name Nom	Ctry Pays	Result Resultat		Name Nom	Ctry Pays	Result Resultat		Name Nom	Ctry Pays	Result Resultat					
* Hristov, Alexandarr	BUL	PTS	3:2	Artemiev, Alexandre	URS			* Flores, Esteban	PUR	PTS	4:1	Mwamba, Patrick	ZAM			Malenga, Evance	MAW	PTS	0:5	* Tauatama, Ulaipalota	SAM	PTS	0:5
Referee	CHO, SUK IN	KOR	TOTAL	Referee	DIMITR DORU BANCUI	ROM	TOTAL	Referee	DIMITR DORU BANCUI	ROM	TOTAL	Referee	SOMPONG SUKAR	THA	TOTAL	Referee	SOMPONG SUKAR	THA	TOTAL	Referee	SOMPONG SUKAR	THA	TOTAL
Judge 1	TAKUYA MOROOKA	JPN	57:60	Judge 1	ZAUT GYADJAVA	URS	60:57	Judge 1	ZAUT GYADJAVA	URS	60:57	Judge 1	MOHAMED GHAZNAVI	PAK	57:60	Judge 1	MOHAMED GHAZNAVI	PAK	57:60	Judge 1	MOHAMED GHAZNAVI	PAK	57:60
2	ABDUL HANI	IRQ	59:58	2	THEODOROS VIDALIS	GRE	59:58	2	THEODOROS VIDALIS	GRE	59:58	2	ELMO ADOLPH	USA	56:60	2	ELMO ADOLPH	USA	56:60	2	ELMO ADOLPH	USA	56:60
3	MULI ADE OJO	NGR	59:58	3	SOMPONG SUKAR	THA	60:58	3	SOMPONG SUKAR	THA	60:58	3	AUGUSTIN ZARAGOZA	MEX	58:59	3	AUGUSTIN ZARAGOZA	MEX	58:59	3	AUGUSTIN ZARAGOZA	MEX	58:59
4	ELMO ADOLPH	USA	58:60	4	TAKUYA MOROOKA	JPN	59:58	4	TAKUYA MOROOKA	JPN	59:58	4	LUIS MINAMI	PER	57:60	4	LUIS MINAMI	PER	57:60	4	LUIS MINAMI	PER	57:60
5	ALBERTO DURAN	URU	59:58	5	RONALD MARK GREGOR	AUS	57:60	5	RONALD MARK GREGOR	AUS	57:60	5	CHO, SUK IN	KOR	56:60	5	CHO, SUK IN	KOR	56:60	5	CHO, SUK IN	KOR	56:60

Bantam -54Kg Semi-final Bout 1/Sept. 29				Coq -54Kg Demi-finale Combat 1/29 Sept				Feather -57Kg 1/32 Bout 20/Sept. 18				Plume -57Kg 1/32 Combat 20/18 Sept				Feather -57Kg 1/32 Bout 26/Sept. 18				Plume -57Kg 1/32 Combat 26/18 Sept			
Name Nom	Ctry Pays	Result Resultat		Name Nom	Ctry Pays	Result Resultat		Name Nom	Ctry Pays	Result Resultat		Name Nom	Ctry Pays	Result Resultat		Name Nom	Ctry Pays	Result Resultat					
* Mckinney, Kennedy	USA	RSCH	1 RD.	2:32	Moolsan, Phajol	THA		* Pongsri, Wanchai	THA	RSCO	1RD.	2:13	Jaffer Ali Mohmed, Sanad	YMD		Mamoudou, Djingarey	NIG	PTS	0:5	* Nowak, Tomasz	POL	PTS	0:5
Referee	WILLI KELLERMANN	FRG		Referee	AUGUSTIN ZARAGOZA	MEX		Referee	AUGUSTIN ZARAGOZA	MEX		Referee	LUIS MINAMI	PER	TOTAL	Referee	LUIS MINAMI	PER	TOTAL	Referee	LUIS MINAMI	PER	TOTAL
Judge 1	STANLEY WACHANGA	KEN		Judge 1	RODERICK ROBERTSON	GBR		Judge 1	RODERICK ROBERTSON	GBR		Judge 1	CHO, SUK IN	KOR	57:60	Judge 1	CHO, SUK IN	KOR	57:60	Judge 1	CHO, SUK IN	KOR	57:60
2	ROMEO SOMODIO	PHI		2	ZAUT GYADJAVA	URS		2	ZAUT GYADJAVA	URS		2	MOHAMED GHAZNAVI	PAK	58:59	2	MOHAMED GHAZNAVI	PAK	58:59	2	MOHAMED GHAZNAVI	PAK	58:59
3	GABY MANCINI	CAN		3	AMADOR BURGUILLOS	VEN		3	AMADOR BURGUILLOS	VEN		3	RONALD MARK GREGOR	AUS	56:60	3	RONALD MARK GREGOR	AUS	56:60	3	RONALD MARK GREGOR	AUS	56:60
4	ALBERTO DURAN	URU		4	THEODOROS VIDALIS	GRE		4	THEODOROS VIDALIS	GRE		4	AUGUSTIN ZARAGOZA	MEX	56:60	4	AUGUSTIN ZARAGOZA	MEX	56:60	4	AUGUSTIN ZARAGOZA	MEX	56:60
5	STOINO PARLAPANOV	BUL		5	RONALD MARK GREGOR	AUS		5	RONALD MARK GREGOR	AUS		5	ELMO ADOLPH	USA	57:59	5	ELMO ADOLPH	USA	57:59	5	ELMO ADOLPH	USA	57:59

Bantam -54Kg Semi-final Bout 2/Sept. 29				Coq -54Kg Demi-finale Combat 2/29 Sept				Feather -57Kg 1/32 Bout 21/Sept. 18				Plume -57Kg 1/32 Combat 21/18 Sept				Feather -57Kg 1/32 Bout 27/Sept. 18				Plume -57Kg 1/32 Combat 27/18 Sept				
Name Nom	Ctry Pays	Result Resultat		Name Nom	Ctry Pays	Result Resultat		Name Nom	Ctry Pays	Result Resultat		Name Nom	Ctry Pays	Result Resultat		Name Nom	Ctry Pays	Result Resultat						
Julio Rocha, Jorge E	COL			* Hristov, Alexandar	BUL	PTS	2:3	Szoke, Laszlo	HUN			* Wanjau, John	KEN	PTS	2:3	* Seymour, Eugene	BAH	DISQ	2RD.	2:47	Dollente, Orlando	PHI		
Referee	HAN, DONG-JIN	KOR	TOTAL	Referee	CHO, SUK IN	KOR	TOTAL	Referee	CHO, SUK IN	KOR	TOTAL	Referee	SANDOR PAJAR	HUN		Referee	SANDOR PAJAR	HUN		Referee	SANDOR PAJAR	HUN		
Judge 1	KISHEN M. NARSI	IND	59:58	Judge 1	TAKUYA MOROOKA	JPN	60:58	Judge 1	TAKUYA MOROOKA	JPN	60:58	Judge 1	RYSZARD REDO	POL		Judge 1	RYSZARD REDO	POL		Judge 1	RYSZARD REDO	POL		
2	ELMO ADOLPH	USA	58:59	2	LUIS MINAMI	PER	59:58	2	LUIS MINAMI	PER	59:58	2	BOB D. KASULE	UGA		2	BOB D. KASULE	UGA		2	BOB D. KASULE	UGA		
3	RODERICK ROBERTSON	GBR	59:58	3	ROMEO SOMODIO	PHI	58:59	3	ROMEO SOMODIO	PHI	58:59	3	MOULOU KOURAD	ALG		3	MOULOU KOURAD	ALG		3	MOULOU KOURAD	ALG		
4	OSVALDO BISBAL	ARG	58:59	4	ELMO ADOLPH	USA	58:59	4	ELMO ADOLPH	USA	58:59	4	KEITH WALKER	NZL		4	KEITH WALKER	NZL		4	KEITH WALKER	NZL		
5	BOB D. KASULE	UGA	58:59	5	AMADOR BURGUILLOS	VEN	58:59	5	AMADOR BURGUILLOS	VEN	58:59	5	ALBERTO DURAN	URU		5	ALBERTO DURAN	URU		5	ALBERTO DURAN	URU		

Bantam -54Kg Final Bout/Oct. 1				Coq -54Kg Finale/1 Oct				Feather -57Kg 1/32 Bout 22/Sept. 18				Plume -57Kg 1/32 Combat 22/18 Sept				Feather -57Kg 1/32 Bout 28/Sept. 18				Plume -57Kg 1/32 Combat 28/18 Sept			
Name Nom	Ctry Pays	Result Resultat		Name Nom	Ctry Pays	Result Resultat		Name Nom	Ctry Pays	Result Resultat		Name Nom	Ctry Pays	Result Resultat		Name Nom	Ctry Pays	Result Resultat					
* Mckinney, Kennedy	USA	PTS	5:0	Hristov, Alexandar	BUL			* Tuur, Regilio	HOL	KOH	1 RD.	1:50	Banks, Keltie	USA		* Eskelinen, Jarmo	FIN	PTS	5:0	Fall, Serigne	GUI		
Referee	MOHAMED GHAZNAVI	PAK	TOTAL	Referee	MOHAMED GHAZNAVI	PAK		Referee	MOHAMED GHAZNAVI	PAK		Referee	ABDUL HANI	IRQ	TOTAL	Referee	ABDUL HANI	IRQ	TOTAL	Referee	ABDUL HANI	IRQ	TOTAL
Judge 1	OSVALDO BISBAL	ARG	59:58	Judge 1	SOMPONG SUKAR	THA		Judge 1	SOMPONG SUKAR	THA		Judge 1	LEE, JAE IN	KOR	60:53	Judge 1	LEE, JAE IN	KOR	60:53	Judge 1	LEE, JAE IN	KOR	60:53
2	HIOUAD LARBI	MAR	59:58	2	BOUNAB HEDI	TUN		2	BOUNAB HEDI	TUN		2	HONG-TSUNG YONG	TPE	60:55	2	HONG-TSUNG YONG	TPE	60:55	2	HONG-TSUNG YONG	TPE	60:55
3	SOMPONG SUKAR	THA	59:58	3	HIOUAD LARBI	MAR		3	HIOUAD LARBI	MAR		3	OSVALDO BISBAL	ARG	60:55	3	OSVALDO BISBAL	ARG	60:55	3	OSVALDO BISBAL	ARG	60:55
4	ALBERTO DURAN	URU	60:56	4	LUIS MINAMI	PER		4	LUIS MINAMI	PER		4	GABY MANCINI	CAN	60:56	4	GABY MANCINI	CAN	60:56	4	GABY MANCINI	CAN	60:56
5	ABDUL HANI	IRQ	59:58	5	RONALD MARK GREGOR	AUS		5	RONALD MARK GREGOR	AUS		5	ARTURO MORALES	DOM	60:55	5	ARTURO MORALES	DOM	60:55	5	ARTURO MORALES	DOM	60:55



Feather -57Kg **Plume -57Kg**
1/32 Bout 29/Sept. 18 1/32 Combat 29/18 Sept

Name Nom	Ctry Pays	Result Resultat		
* Pagendam, Jamie Amarjargal, Tserendorj	CAN MGL	RSCH	3RD.	0:46

Referee				
MARIUS GUIRAMO LOUGBO	CIV			
Judge 1 STANLEY WACHANGA	KEN			
2 VIKTOR PLAVEC	YUG			
3 STIG RONGE	SWE			
4 OSVALDO BISBAL	ARG			
5 KEITH WALKER	NZL			

Feather -57Kg **Plume -57Kg**
1/32 Bout 30/Sept. 18 1/32 Combat 30/18 Sept

Name Nom	Ctry Pays	Result Resultat		
Durmm, Diego * Kirkorov, Kirkor	GDR BUL	PTS		0:5

Referee				
PIETER GEDOAN	INA	TOTAL		
Judge 1 KISHEN M. NARSI	IND	58:59		
2 BOB D. KASULE	UGA	58:59		
3 MARIUS GUIRAMO LOUGBO	CIV	57:60		
4 KEITH WALKER	NZL	57:60		
5 GABY MANCINI	CAN	57:60		

Feather -57Kg **Plume -57Kg**
1/32 Bout 31/Sept. 18 1/32 Combat 31/18 Sept

Name Nom	Ctry Pays	Result Resultat		
* Hiles, Darrell Celikiz, Ali	AUS TUR	PTS		5:0

Referee				
D. WEERAKOON	SRI	TOTAL		
Judge 1 HAN, DONG-JIN	KOR	60:57		
2 STANLEY WACHANGA	KEN	60:57		
3 MOULOUD KOURAD	ALG	60:57		
4 OSVALDO BISBAL	ARG	60:57		
5 ALBERTO DURAN	URU	59:58		

Feather -57Kg **Plume -57Kg**
1/32 Bout 32/Sept. 18 1/32 Combat 32/18 Sept

Name Nom	Ctry Pays	Result Resultat		
Gonzalez, Miguel * Lee, Jae-Hyuk	MEX KOR	PTS		0:5

Referee				
OSVALDO BISBAL	ARG	TOTAL		
Judge 1 HONG-TSUNG YONG	TPE	57:60		
2 STOINO PARLAPANOV	BUL	58:59		
3 ALDO LEONI	ITA	57:59		
4 ALBERTO DURAN	URU	58:59		
5 STANLEY WACHANGA	KEN	57:60		

Feather -57Kg **Plume -57Kg**
1/16 Bout 1/Sept. 22 1/16 Combat 1/22 Sept

Name Nom	Ctry Pays	Result Resultat		
Avelar, Francisco * Achik, Abdelhak	ESA MAR	PTS		1:4

Referee				
RODERICK ROBERTSON	GBR	TOTAL		
Judge 1 DIMITR DORU BANCUI	ROM	58:59		
2 KIM, YOUNG BAE	KOR	58:59		
3 MOHAMED GHAZNAVI	PAK	58:59		
4 RONALD MARK GREGOR	AUS	57:60		
5 THEODOROS VIDALIS	GRE	59:58		

Feather -57Kg **Plume -57Kg**
1/16 Bout 2/Sept. 22 1/16 Combat 2/22 Sept

Name Nom	Ctry Pays	Result Resultat		
Kagambega, Moussa * Catari, Omar	BUR VEN	KOH	1RD.	2:05

Referee				
WERNER WEGSCHEIDER	AUT			
Judge 1 ZAUT GVADJAVA	URS			
2 CHO, SUK IN	KOR			
3 ROMEO SOMODIO	PHI			
4 GUSTAV BAUMGARDT	GDR			
5 ELMO ADOLPH	USA			

Feather -57Kg **Plume -57Kg**
1/16 Bout 3/Sept. 22 1/16 Combat 3/22 Sept

Name Nom	Ctry Pays	Result Resultat		
Francis, John William * Liu, Dong	IND CHN	PTS		2:3

Referee				
ZAUT GVADJAVA	URS	TOTAL		
Judge 1 WILLI KELLERMANN	FRG	58:59		
2 BOUNAB HEDI	TUN	59:58		
3 MOHAMED	EGY	58:59		
4 AMADOR BURGUILLOS	VEN	59:58		
5 THEODOROS VIDALIS	GRE	57:60		

Feather -57Kg **Plume -57Kg**
1/16 Bout 4/Sept. 22 1/16 Combat 4/22 Sept

Name Nom	Ctry Pays	Result Resultat		
Lahia, Ilham. B. * Bouemba, Serge	INA GAB	PTS		1:4

Referee				
WILLI KELLERMANN	FRG	TOTAL		
Judge 1 RODERICK ROBERTSON	GBR	59:57		
2 GUSTAV BAUMGARDT	GDR	58:59		
3 ELMO ADOLPH	USA	58:59		
4 RONALD MARK GREGOR	AUS	58:59		
5 AMADOR BURGUILLOS	VEN	58:59		

Feather -57Kg **Plume -57Kg**
1/16 Bout 5/Sept. 22 1/16 Combat 5/22 Sept

Name Nom	Ctry Pays	Result Resultat		
* Kazarian, Mikhak Simic, Ljubisa	URS YUG	PTS		5:0

Referee				
AMADOR BURGUILLOS	VEN	TOTAL		
Judge 1 TAKUYA MOROOKA	JPN	60:57		
2 MOHAMED GHAZNAVI	PAK	60:55		
3 MOHAMED	EGY	59:58		
4 BOUNAB HEDI	TUN	60:58		
5 LUIS MINAMI	PER	59:58		

Feather -57Kg **Plume -57Kg**
1/16 Bout 6/Sept. 22 1/16 Combat 6/22 Sept

Name Nom	Ctry Pays	Result Resultat		
* Parisi, Giovanni Lu, Chih-Hsiung	ITA TPE	PTS		5:0

Referee				
AMADOR BURGUILLOS	VEN	TOTAL		
Judge 1 TAKUYA MOROOKA	JPN	60:57		
2 MOHAMED GHAZNAVI	PAK	60:57		
3 MOHAMED	EGY	60:56		
4 BOUNAB HEDI	TUN	60:56		
5 LUIS MINAMI	PER	60:54		

Feather -57Kg **Plume -57Kg**
1/16 Bout 7/Sept. 22 1/16 Combat 7/22 Sept

Name Nom	Ctry Pays	Result Resultat		
* Shmuel, Jacov Mirona, John	ISR SUD	RSCH	1RD.	1:15

Referee				
ELMO ADOLPH	USA			
Judge 1 MUI LI ADE OJO	NGR			
2 AMADOR BURGUILLOS	VEN			
3 DIMITR DORU BANCUI	ROM			
4 LUIS MINAMI	PER			
5 KIM, YOUNG BAE	KOR			

Feather -57Kg **Plume -57Kg**
1/16 Bout 8/Sept. 22 1/16 Combat 8/22 Sept

Name Nom	Ctry Pays	Result Resultat		
* Pittman, Richard Mabuza, Dumsane	COK SWZ	PTS		4:1

Referee				
LUIS MINAMI	PER	TOTAL		
Judge 1 TAKUYA MOROOKA	JPN	59:58		
2 ROMEO SOMODIO	PHI	58:59		
3 WERNER WEGSCHEIDER	AUT	59:58		
4 DIMITR DORU BANCUI	ROM	60:57		
5 AMADOR BURGUILLOS	VEN	60:57		

Feather -57Kg **Plume -57Kg**
1/16 Bout 9/Sept. 22 1/16 Combat 9/22 Sept

Name Nom	Ctry Pays	Result Resultat		
Yamada, Wataru * Dumitrescu, Daniel	JPN ROM	PTS		0:5

Referee				
OSVALDO BISBAL	ARG	TOTAL		
Judge 1 ALBERTO DURAN	URU	55:60		
2 STANLEY WACHANGA	KEN	54:60		
3 MARIUS GUIRAMO LOUGBO	CIV	54:60		
4 GABY MANCINI	CAN	55:60		
5 ARTURO MORALES	DOM	56:60		

Feather -57Kg **Plume -57Kg**
1/16 Bout 10/Sept. 22 1/16 Combat 10/22 Sept

Name Nom	Ctry Pays	Result Resultat		
Flores, Esteban * Pongsri, Wanchai	PUR THA	PTS		0:5

Referee				
ALDO LENOI	ITA	TOTAL		
Judge 1 STOINO PARLAPANOV	BUL	58:59		
2 MOULOUD KOURAD	ALG	57:60		
3 BOB D. KASULE	UGA	58:59		
4 OSVALDO BISBAL	ARG	57:59		
5 VIKTOR PLAVEC	YUG	56:60		

Feather -57Kg **Plume -57Kg**
1/16 Bout 11/Sept. 22 1/16 Combat 11/22 Sept

Name Nom	Ctry Pays	Result Resultat		
Wanjau, John * Tuur, Regilio	KEN HOL	PTS		1:4

Referee				
LEE, JAE IN	KOR	TOTAL		
Judge 1 ABDUL HANI	IRQ	59:59 +		
2 D. WEERAKOON	SRI	60:58		
3 GABY MANCINI	CAN	58:59		
4 ALBERTO DURAN	URU	57:60		
5 HONG-TSUNG YONG	TPE	58:59		

Feather -57Kg **Plume -57Kg**
1/16 Bout 12/Sept. 22 1/16 Combat 12/22 Sept

Name Nom	Ctry Pays	Result Resultat		
* Anderson, David Fitzgerald, Paul	GBR IRL	PTS		5:0

Referee				
KISHEN M. NARSI	IND	TOTAL		
Judge 1 LEE, JAE IN	KOR	60:57		
2 D. WEERAKOON	SRI	59:58		
3 BOB D. KASULE	UGA	60:57		
4 MOULOUD KOURAD	ALG	60:57		
5 OSVALDO BISBAL	ARG	59:58		

Feather -57Kg **Plume -57Kg**
1/16 Bout 13/Sept. 22 1/16 Combat 13/22 Sept

Name Nom	Ctry Pays	Result Resultat		
Tauatama, Ulaipalota * Nowak, Tamasz	SAM POL	WO		

Referee				
ABDUL HANI	IRQ			
Judge 1 STANLEY WACHANGA	KEN			
2 MARIUS GUIRAMO LOUGBO	CIV			
3 PIETER GEDOAN	INA			
4 ALBERTO DURAN	URU			
5 OSVALDO BISBAL	ARG			

Feather -57Kg **Plume -57Kg**
1/16 Bout 14/Sept. 22 1/16 Combat 14/22 Sept

Name Nom	Ctry Pays	Result Resultat		
* Seymour, Eugene Eskelinen, Jarmo	BAH FIN	WO		

Referee				
Judge 1				
2				
3				
4				
5				

Boxing

Boxe

Feather -57Kg 1/16 Bout 15/Sept. 22		Plume -57Kg 1/16 Combat 15/22 Sept	
Name Nom	Ctry Pays	Result Resultat	
Pagendam, Jamie	CAN		
* Kirkorov, Kirkor	BUL	WO	
Referee	PIETER GEDOAN	INA	
Judge 1	D. WEERAKOON	SRI	
2	LEE, JAE IN	KOR	
3	OSVALDO BISBAL	ARG	
4	ALBERTO DURAN	URU	
5	MOULOU KOURAD	ALG	

Feather -57Kg 1/8 Bout 5/Sept. 26		Plume -57Kg 1/8 Combat 5/26 Sept	
Name Nom	Ctry Pays	Result Resultat	
* Dumitrescu, Daniel	ROM	PTS	3:2
Pongsri, Wanchai	THA		
Referee	HIQUAD LARBI	MAR	TOTAL
Judge 1	BOUNAB HEDI	TUN	58:59
2	MUILI ADE OJO	NGR	57:60
3	AMADOR BURGUILLOS	VEN	59:58
4	ELMO ADOLPH	USA	59:58
5	RONALD MARK GREGOR	AUS	60:54

Feather -57Kg Quarter-final Bout 3/Sept. 28		Plume -57Kg Quart de Finale Combat 3/28 Sept	
Name Nom	Ctry Pays	Result Resultat	
* Dumitrescu, Daniel	ROM	PTS	5:0
Tuur, Regilio	HOL		
Referee	THEODOROS VIDALIS	GRE	TOTAL
Judge 1	SANDOR PAJAR	HUN	60:56
2	MOULOU KOURAD	ALG	60:56
3	ROMEO SOMODIO	PHI	60:55
4	KIM, YOUNG BAE	KOR	60:56
5	OSVALDO, BISBAL	ARG	60:55

Feather -57Kg 1/16 Bout 16/Sept. 22		Plume -57Kg 1/16 Combat 16/22 Sept	
Name Nom	Ctry Pays	Result Resultat	
Hiles, Darrell	AUS		
* Lee, Jae-Hyuk	KOR	PTS	0:5
Referee	SANDOR PAJAR	HUN	TOTAL
Judge 1	STIG RONGE	SWE	57:60
2	RYSZARD REDO	POL	57:60
3	STANLEY WACHANGA	KEN	56:60
4	ARTURO MORALES	DOM	57:60
5	ALBERTO DURAN	URU	57:60

Feather -57Kg 1/8 Bout 6/Sept. 26		Plume -57Kg 1/8 Combat 6/26 Sept	
Name Nom	Ctry Pays	Result Resultat	
* Tuur, Regilio	HOL	RSCO	2RD. 1:02
Anderson, David	GBR		
Referee	ELMO ADOLPH	USA	
Judge 1	TAKUYA MOROOKA	JPN	
2	SOMPONG SUKAR	THA	
3	MOHAMED	EGY	
4	BOUNAB HEDI	TUN	
5	AMADOR BURGUILLOS	VEN	

Feather -57Kg Quarter-final Bout 4/Sept. 28		Plume -57Kg Quart de Finale Combat 4/28 Sept	
Name Nom	Ctry Pays	Result Resultat	
Nowak, Tomasz	POL		
* Lee, Jae-Hyuk	KORPTS		0:5
Referee	GABY MANCINI	CAN	TOTAL
Judge 1	WILLI KELLERMANN	FRG	58:59
2	STANLEY WACHANGA	KEN	58:59
3	MOULOU KOURAD	ALG	57:60
4	PIETER GEDOAN	INA	58:60
5	OSVALDO BISBAL	ARG	58:59

Feather -57Kg 1/8 Bout 1/Sept. 26		Plume -57Kg 1/8 Combat 1/26 Sept	
Name Nom	Ctry Pays	Result Resultat	
* Achik, Abdelhak	MAR	KOH	1RD. 3:00
Catari, Omar	VEN		
Referee	CHO, SUK IN	KOR	
Judge 1	TAKUYA MOROOKA	JPN	
2	WERNER WEGSCHEIDER	AUT	
3	DIMITR DORU BANCUI	ROM	
4	SOMPONG SUKAR	THA	
5	RONALD MARK GREGOR	AUS	

Feather -57Kg 1/8 Bout 7/Sept. 26		Plume -57Kg 1/8 Combat 7/26 Sept	
Name Nom	Ctry Pays	Result Resultat	
* Nowak, Tomasz	POL	PTS	5:0
Seymour, Eugene	BAH		
Referee	MOHAMED GHAZNAVI	PAK	TOTAL
Judge 1	KIM, YOUNG BAE	KOR	60:56
2	MOHAMED	EGY	59:58
3	HIQUAD LARBI	MAR	60:57
4	AMADOR BURGUILLOS	VEN	60:57
5	RONALD MARK GREGOR	AUS	60:57

Feather -57Kg Semi-final Bout 1/Sept. 29		Plume -57Kg Demi-finale Combat 1/29 Sept	
Name Nom	Ctry Pays	Result Resultat	
Achik, Abdelhak	MAR		
* Parisi, Giovanni	ITA	RSCO	1 RD. 1:55
Referee	ROMEO SOMODIO	PHI	
Judge 1	STIG RONGE	SWE	
2	BOB D. KASULE	UGA	
3	CHO, SUK IN	KOR	
4	ELMO ADOLPH	USA	
5	OSVALDO BISBAL	ARG	

Feather -57Kg 1/8 Bout 2/Sept. 26		Plume -57Kg 1/8 Combat 2/26 Sept	
Name Nom	Ctry Pays	Result Resultat	
* Liu, Dong	CHN	PTS	5:0
Bouemba, Serge	GAB		
Referee	THEODOROS VIDALIS	GRE	TOTAL
Judge 1	RODERICK ROBERTSON	GBR	60:56
2	ZAUT GVADJAVA	URS	59:58
3	AMADOR BURGUILLOS	VEN	59:58
4	ELMO ADOLPH	USA	60:57
5	DIMITR DORU BANCUI	ROM	59:58

Feather -57Kg 1/8 Bout 8/Sept. 26		Plume -57Kg 1/8 Combat 8/26 Sept	
Name Nom	Ctry Pays	Result Resultat	
Kirkorov, Kirkor	BUL		
* Lee, Jae-Hyuk	KOR	PTS	2:3
Refereed	MUILI ADE OJO	NGR	TOTAL
Judge 1	HIQUAD LARBI	MAR	58:59
2	AMADOR BURGUILLOS	VEN	58:59
3	RONALD MARK GREGOR	AUS	60:58
4	ELMO ADOLPH	USA	59:58
5	BOUNAB HEDI	TUN	58:59

Feather -57Kg Semi-final Bout 2/Sept. 29		Plume -57Kg Demi-finale Combat 2/29 Sept	
Name Nom	Ctry Pays	Result Resultat	
* Dumitrescu, Daniel	ROM	PTS	5:0
Lee, Jae-Hyuk	KOR		
Referee	ALDO LEONI	ITA	TOTAL
Judge 1	GABY MANCINI	CAN	60:57
2	ALBERTO DURAN	URU	59:58
3	RODERICK ROBERTSON	GBR	60:57
4	ABDUL LARBI	MAR	59:58
5	HIQUAD LARBI	MAR	59:58

Feather -57Kg 1/8 Bout 3/Sept. 26		Plume -57Kg 1/8 Combat 3/26 Sept	
Name Nom	Ctry Pays	Result Resultat	
Kazarian, Mikhak	URS		
* Parisi, Giovanni	ITA	RSCH	2RD. 2:27
Referee	ROMEO SOMODIO	PHI	
Judge 1	MOHAMED GHAZNAVI	PAK	
2	SOMPONG SUKAR	THA	
3	MOHAMED	EGY	
4	BOUNAB HEDI	TUN	
5	RONALD MARK GREGOR	AUS	

Feather -57Kg Quarter-final Bout 1/Sept. 28		Plume -57Kg Quart de Finale Combat 1/28 Sept	
Name Nom	Ctry Pays	Result Resultat	
* Achik, Abdelhad	MAR	KOH	1RD. 2:18
Liu, Dong	CHN		
Referee	RYSZARD REDO	POL	
Judge 1	ELMO ADOLPH	USA	
2	VIKTOR PLAVED	YUG	
3	WERNER WEGSCHEIDER	AUT	
4	BOB D. KASULE	UGA	
5	KISHEN M. NARSI	IND	

Feather -57Kg Final Bout/Oct. 2		Plume -57Kg Finale/2 Oct	
Name Nom	Ctry Pays	Result Resultat	
* Parisi, Giovanni	ITA	1RD.	1:41
Dumitrescu, Daniel	ROM		
Referee	WILLI KELLERMANN	FRG	
Judge 1	ABDUL HANI	IRQ	
2	RODERICK ROBERTSON	GBR	
3	BOB D. KASULE	UGA	
4	VIKTOR PLAVEC	YUG	
5	ELMO ADOLPH	USA	

Feather -57Kg 1/8 Bout 4/Sept. 26		Plume -57Kg 1/8 Combat 4/26 Sept	
Name Nom	Ctry Pays	Result Resultat	
* Shmuel, Jacov	ISR	PTS	5:0
Pittman, Richard	COK		
Referee	ZAUT GVADJAVA	URS	TOTAL
Judge 1	THEODOROS VIDALIS	GRE	60:56
2	GUSTAV BAUMGARDT	GDR	60:56
3	MUILI ADE OJO	NGR	60:57
4	AMADOR BURGUILLOS	VEN	60:56
5	ELMO ADOLPH	USA	60:56

Feather -57Kg Quarter-final Bout 2/Sept. 28		Plume -57Kg Quart de Finale Combat 2/28 Sept	
Name Nom	Ctry Pays	Result Resultat	
* Parisi, Giovanni	ITA	PTS	5:0
Shmuel, Jacov	ISR		
Referee	D. WEERAKOON	SRI	TOTAL
Judge 1	TAKUYA MOROOKA	JPN	60:57
2	STANLEY WACHANGA	KEN	60:57
3	DIMITR DORU BANCUI	ROM	60:57
4	GABY MANCINI	CAN	60:57
5	ALBERTO DURAN	URU	60:57



Feather -57Kg
Competition Summary

Plume -57Kg
Tableau de la Competition

1/32	1/16	1/8	Quarter-final/Quart de Finale	Semi-final/Demi-finale	Final/Finale
Avelar, F (ESA)	Avelar, F	Achik, Abdel	Achik, Abdel	Achik, Abdel	Parisi, Giov RSCO
BYE	Achik, Abdel	PTS	KOH	KOH	
Achik, Abdel (MAR)	Achik, Abdel	Achik, Abdel	Achik, Abdel	Achik, Abdel	Parisi, Giov RSCO
BYE	Achik, Abdel	PTS	KOH	KOH	
Kagambega, M (BUR)	Kagambega, M	Catari, Omar	Achik, Abdel	Achik, Abdel	Parisi, Giov RSCO
BYE	Kagambega, M	KOH	KOH	KOH	
Catari, Omar (VEN)	Catari, Omar	Catari, Omar	Achik, Abdel	Achik, Abdel	Parisi, Giov RSCO
BYE	Catari, Omar	KOH	KOH	KOH	
Francis, J (IND)	Francis, J	Liu, Dong	Liu, Dong	Liu, Dong	Parisi, Giov RSCO
BYE	Francis, J	PTS	PTS	PTS	
Liu, Dong (CHN)	Liu, Dong	Liu, Dong	Liu, Dong	Liu, Dong	Parisi, Giov RSCO
BYE	Liu, Dong	PTS	PTS	PTS	
Lahia, Ilham (INA)	Lahia, Ilham	Bouemba, Ser	Liu, Dong	Liu, Dong	Parisi, Giov RSCO
BYE	Lahia, Ilham	PTS	PTS	PTS	
Bouemba, Ser (GAB)	Bouemba, Ser	Bouemba, Ser	Liu, Dong	Liu, Dong	Parisi, Giov RSCO
BYE	Bouemba, Ser	PTS	PTS	PTS	
Kazarian, Mi (URS)	Kazarian, Mi	Kazarian, Mi	Parisi, Giov	Parisi, Giov	Parisi, Giov RSCO
BYE	Kazarian, Mi	PTS	RSCH	PTS	
Simic, Ljubi (YUG)	Simic, Ljubi	Kazarian, Mi	Parisi, Giov	Parisi, Giov	Parisi, Giov RSCO
BYE	Simic, Ljubi	PTS	RSCH	PTS	
Parisi, Giov (ITA)	Parisi, Giov	Parisi, Giov	Parisi, Giov	Parisi, Giov	Parisi, Giov RSCO
BYE	Parisi, Giov	PTS	RSCH	PTS	
Lu, Chih-Hsi (TPE)	Lu, Chih-Hsi	Parisi, Giov	Parisi, Giov	Parisi, Giov	Parisi, Giov RSCO
BYE	Lu, Chih-Hsi	PTS	RSCH	PTS	
Shmuel, Jaco (ISR)	Shmuel, Jaco	Shmuel, Jaco	Shmuel, Jaco	Shmuel, Jaco	Parisi, Giov RSCO
BYE	Shmuel, Jaco	RSCH	PTS	PTS	
Mirona, John (SUD)	Mirona, John	Shmuel, Jaco	Shmuel, Jaco	Shmuel, Jaco	Parisi, Giov RSCO
BYE	Mirona, John	RSCH	PTS	PTS	
Pittman, Ric (COK)	Pittman, Ric	Pittman, Ric	Shmuel, Jaco	Shmuel, Jaco	Parisi, Giov RSCO
BYE	Pittman, Ric	PTS	PTS	PTS	
Mabuza, Dums (SWZ)	Mabuza, Dums	Pittman, Ric	Shmuel, Jaco	Shmuel, Jaco	Parisi, Giov RSCO
BYE	Mabuza, Dums	PTS	PTS	PTS	
Fofana, Baka (CIV)	Yamada, Wata	Dumitrescu,	Dumitrescu,	Dumitrescu,	Parisi, Giov RSCO
Yamada, Wata (JPN)	RSCO	PTS	PTS	PTS	
Konyegwachi (NGR)	Dumitrescu,	Dumitrescu,	Dumitrescu,	Dumitrescu,	Parisi, Giov RSCO
Dumitrescu, (ROM)	PTS	PTS	PTS	PTS	
Flores, Este (PUR)	Flores, Este	Pongsri, Wan	Dumitrescu,	Dumitrescu,	Parisi, Giov RSCO
Mwamba, Patr (ZAM)	PTS	PTS	PTS	PTS	
Pongsri, Wan (THA)	Pongsri, Wan	Pongsri, Wan	Dumitrescu,	Dumitrescu,	Parisi, Giov RSCO
Jaffer Ali (YMD)	RSCO	PTS	PTS	PTS	
Szoke, Laszl (HUN)	Wanjau, John	Tuur, Regili	Dumitrescu,	Dumitrescu,	Parisi, Giov RSCO
Wanjau, John (KEN)	PTS	PTS	PTS	PTS	
Tuur, Regili (HOL)	Tuur, Regili	Tuur, Regili	Tuur, Regili	Tuur, Regili	Parisi, Giov RSCO
Banks, Kelci (USA)	KOH	PTS	RSCO	RSCO	
Damigella, D (ARG)	Anderson, Da	Anderson, Da	Tuur, Regili	Tuur, Regili	Parisi, Giov RSCO
Anderson, Da (GBR)	PTS	PTS	RSCO	RSCO	
Fitzgerald, (IRL)	Fitzgerald,	Anderson, Da	Tuur, Regili	Tuur, Regili	Parisi, Giov RSCO
Uillegas S, (DOM)	PTS	PTS	RSCO	RSCO	
Malenga, Eva (MAW)	Tauatama, U	Nowak, Tomas	Dumitrescu,	Dumitrescu,	Parisi, Giov RSCO
Tauatama, U (SAM)	PTS	WO	PTS	PTS	
Mamoudou, D (NIG)	Nowak, Tomas	Nowak, Tomas	Dumitrescu,	Dumitrescu,	Parisi, Giov RSCO
Nowak, Tomas (POL)	PTS	PTS	PTS	PTS	
Seymour, Eug (BAH)	Seymour, Eug	Seymour, Eug	Nowak, Tomas	Nowak, Tomas	Parisi, Giov RSCO
Dollente, O (PHI)	DISQ	WO	PTS	PTS	
Eskelinen, J (FIN)	Eskelinen, J	Seymour, Eug	Nowak, Tomas	Nowak, Tomas	Parisi, Giov RSCO
Fall, Serign (GUI)	PTS	WO	PTS	PTS	
Pagendam, Ja (CAN)	Pagendam, Ja	Seymour, Eug	Nowak, Tomas	Nowak, Tomas	Parisi, Giov RSCO
Amarjargal, (MGL)	RSCH	WO	PTS	PTS	
Drumm, Diego (GDR)	Kirkorov, Ki	Kirkorov, Ki	Nowak, Tomas	Nowak, Tomas	Parisi, Giov RSCO
Kirkorov, Ki (BUL)	PTS	WO	PTS	PTS	
Hiles, Darre (AUS)	Hiles, Darre	Kirkorov, Ki	Nowak, Tomas	Nowak, Tomas	Parisi, Giov RSCO
Celikiz, Ali (TUR)	PTS	PTS	PTS	PTS	
Gonzalez, Mi (MEX)	Lee, Jae-Hyu	Lee, Jae-Hyu	Lee, Jae-Hyu	Lee, Jae-Hyu	Parisi, Giov RSCO
Lee, Jae-Hyu (KOR)	PTS	PTS	PTS	PTS	

Boxing

Boxe

Light -60Kg 1/32 Bout 26/Sept. 19

Name Nom	Ctry Pays	Result Resultat
* Said, Azzedine	ALG	KOB 2RD. 2:36
Mbao, Lameck	ZAM	

Referee	Judge 1	Judge 2	Judge 3	Judge 4	Judge 5
RYSZARD REDO	KISHEN M. NARSI	ABDUL HANI	ALDO LEONI	ARTURO MORALES	KEITH WALKER
POL	IND	IRQ	ITA	DOM	NZL

Light -60Kg 1/32 Bout 32/Sept. 19

Name Nom	Ctry Pays	Result Resultat
* Knight, Sean	BAR	PTS 5:0
Tamez, Guillermo	MEX	

Referee	Judge 1	Judge 2	Judge 3	Judge 4	Judge 5
WILLI KELLERMANN	WERNER WEGSCHEIDER	DIMITR DORU BANCUI	SOMPONG SUKAR	MOHAMED GHAZNAVI	MOHAMED
FRG	AUT	ROM	THA	PAK	EGY

Light -60Kg 1/16 Bout 6/Sept. 23

Name Nom	Ctry Pays	Result Resultat
Perez, Jose	VEN	PTS 0:5
* Enkhbat, Nerguy	MGL	

Referee	Judge 1	Judge 2	Judge 3	Judge 4	Judge 5
ROMEO SOMODIO	TAKUYA MOROOKA	WERNER WEGSCHEIDER	GUSTAV BAUMGARDT	ELMO ADOLPH	RONALD MARK GREGOR
PHI	JPN	AUT	GDR	USA	AUS

Light -60Kg 1/32 Bout 27/Sept. 19

Name Nom	Ctry Pays	Result Resultat
* Hegazy, Mohamed	EGY	PTS 5:0
Ranamagar, Dalbahadur	NEP	

Referee	Judge 1	Judge 2	Judge 3	Judge 4	Judge 5
ALDO LEONI	GABY MANCINI	STOINO PARLAPANOV	OSVALDO BISBAL	ALBERTO DURAN	HONG-TSUNG YONG
ITA	CAN	BUL	ARG	URU	TPE

Light -60Kg 1/16 Bout 1/Sept. 23

Name Nom	Ctry Pays	Result Resultat
* Carruth, Michael	IRL	PTS 5:0
Higashi, Satoru	JPN	

Referee	Judge 1	Judge 2	Judge 3	Judge 4	Judge 5
BOUNAB HEDI	HIOUAD LARBI	LUIS MINAMI	AMADOR BURGUILLOS	ELMO ADOLPH	RONALD MARK GREGOR
TUN	MAR	PER	VEN	USA	AUS

Light -60Kg 1/16 Bout 7/Sept. 23

Name Nom	Ctry Pays	Result Resultat
* Arroyo, Hector A.	PUR	PTS 5:0
Tatar, Kibar	TUR	

Referee	Judge 1	Judge 2	Judge 3	Judge 4	Judge 5
RONALD MARK GREGOR	SOMPONG SUKAR	MOHAMED GHAZNAVI	BOUNAB HEDI	MULI ADE OJO	CHO, SUK IN
AUS	THA	PAK	TUN	NGR	KOR

Light -60Kg 1/32 Bout 28/Sept. 19

Name Nom	Ctry Pays	Result Resultat
Lubulwa, Charles	UGA	RSCH 3RD. 3:00
* Onoko, Blessing	NGR	

Referee	Judge 1	Judge 2	Judge 3	Judge 4	Judge 5
VIKTOR PLAVEC	STIG RONGE	D. WEERAKOON	LEE, JAE IN	OSVALDO BISBAL	GABY MANCINI
YUG	SWE	SRI	KOR	ARG	CAN

Light -60Kg 1/16 Bout 2/Sept. 23

Name Nom	Ctry Pays	Result Resultat
Mkangala, John Elson	MAW	PTS 0:5
* Cramne, George	SWE	

Referee	Judge 1	Judge 2	Judge 3	Judge 4	Judge 5
MOHAMED GHAZNAVI	ROMEO SOMODIO	AMADOR BURGUILLOS	LUIS MINAMI	RONALD MARK GREGOR	SOMPONG SUKAR
PAK	PHI	VEN	PER	AUS	THA

Light -60Kg 1/16 Bout 8/Sept. 23

Name Nom	Ctry Pays	Result Resultat
* Marjouane, Kamal	MAR	PTS 5:0
Gbay, Tommy	LBR	

Referee	Judge 1	Judge 2	Judge 3	Judge 4	Judge 5
RODERICK ROBERTSON	THEODOROS VIDALIS	ROMEO SOMODIO	SOMPONG SUKAR	AMADOR BURGUILLOS	ELMO ADOLPH
GBR	GRE	PHI	THA	VEN	USA

Light -60Kg 1/32 Bout 29/Sept. 19

Name Nom	Ctry Pays	Result Resultat
Freitas, Daniel	URU	RSCH 3RD. 1:54
* Campanella, Giorgio	ITA	

Referee	Judge 1	Judge 2	Judge 3	Judge 4	Judge 5
PIETER GEDOAN	HAN, DONG-JIN	BOB D. KASULE	MOULOUD KOURAD	HONG-TSUNG YONG	ARTURO MORALES
INA	KOR	UGA	ALG	TPE	DOM

Light -60Kg 1/16 Bout 3/Sept. 23

Name Nom	Ctry Pays	Result Resultat
Dar, Asif	CAN	RSCH 2RD. 0:46
* Hongram, Phat	THA	

Referee	Judge 1	Judge 2	Judge 3	Judge 4	Judge 5
WILLI KELLERMANN	THEODOROS VIDALIS	MOHAMED	MULI ADE OJO	DIMITR DORU BANCUI	LUIS MINAMI
FRG	GRE	EGY	NGR	ROM	PER

Light -60Kg 1/16 Bout 9/Sept. 23

Name Nom	Ctry Pays	Result Resultat
* Ellis, Romallis	USA	PTS 5:0
Lee, Kang-Suk	KOR	

Referee	Judge 1	Judge 2	Judge 3	Judge 4	Judge 5
LUIS MINAMI	DIMITR DORU BANCUI	ZAUT GVADJAVA	RONALD MARK GREGOR	BOUNAB HEDI	HIOUAD LARBI
PER	ROM	URS	AUS	TUN	MAR

Light -60Kg 1/32 Bout 30/Sept. 19

Name Nom	Ctry Pays	Result Resultat
Waweru, Patrick	KEN	PTS 0:5
* Zuelow, Andreas	GDR	

Referee	Judge 1	Judge 2	Judge 3	Judge 4	Judge 5
KISHEN M. NARSI	HAN, DONG-JIN	HONG-TSUNG YONG	ALBERTO DURAN	ARTURO MORALES	GABY MANCINI
IND	KOR	TPE	URU	DOM	CAN

Light -60Kg 1/16 Bout 4/Sept. 23

Name Nom	Ctry Pays	Result Resultat
Taroreh, Adrianus. J.	INA	PTS
* Kane, Charles	GBR	

Referee	Judge 1	Judge 2	Judge 3	Judge 4	Judge 5
ELMO ADOLPH	MOHAMED	HIOUAD LARBI	AMADOR BURGUILLOS	RONALD MARK GREGOR	MULI ADE OJO
USA	EGY	MAR	VEN	AUS	NGR

Light -60Kg 1/16 Bout 10/Sept. 23

Name Nom	Ctry Pays	Result Resultat
Belly, Toby	SUD	PTS 0:5
* Traore, Kassim	MLI	

Referee	Judge 1	Judge 2	Judge 3	Judge 4	Judge 5
WERNER WEGSCHEIDER	RODERICK ROBERTSON	CHO, SUK IN	MOHAMED GHAZNAVI	ELMO ADOLPH	ROMEO SOMODIO
AUT	GBR	KOR	PAK	USA	PHI

Light -60Kg 1/32 Bout 31/Sept. 19

Name Nom	Ctry Pays	Result Resultat
Cantancio, Leopoldo	PHI	KOH 1RD. 1:28
* Tsiou, Konstantine	URS	

Referee	Judge 1	Judge 2	Judge 3	Judge 4	Judge 5
BOUNAB HEDI	HIOUAD LARBI	RONALD MARK GREGOR	ELMO ADOLPH	LUIS MINAMI	MULI ADE OJO
TUN	MAR	AUS	USA	PER	NGR

Light -60Kg 1/16 Bout 5/Sept. 23

Name Nom	Ctry Pays	Result Resultat
Bonatou, Jean-Paul	CMR	PTS 0:5
* Turu, Istvan	HUN	

Referee	Judge 1	Judge 2	Judge 3	Judge 4	Judge 5
CHO, SUK IN	TAKUYA MOROOKA	LUIS MINAMI	AMADOR BURGUILLOS	RONALD MARK GREGOR	MOHAMED GHAZNAVI
KOR	JPN	PER	VEN	AUS	PAK

Light -60Kg 1/16 Bout 11/Sept. 23

Name Nom	Ctry Pays	Result Resultat
* Kennedy, Mark	JAM	RSCO 1RD. 3:00
Maea, Terepai	COK	

Referee	Judge 1	Judge 2	Judge 3	Judge 4	Judge 5
GUSTAV BAUMGARDT	WILLI KELLERMANN	ROMEO SOMODIO	SOMPONG SUKAR	LUIS MINAMI	ZAUT GVADJAVA
GDR	FRG	PHI	THA	PER	URS



Light -60Kg 1/16 Bout 12/Sept. 23		Leger-60Kg 1/16 Combat 12/23 Sept		
Name Nom	Ctry Pays	Result Resultat		
Delapena, Eduardo	GUM			
* Tchuprenski, Emil	BUL	RSCI	2RD.	2:52
Referee	SOMPONG SUKAR	THA		
Judge 1	MOHAMED GHAZNAVI	PAK		
2	CHO, SUK IN	KOR		
3	BQUNAB HEDI	TUN		
4	MOHAMED	EGY		
5	ELMO ADOLPH	USA		

Light -60Kg 1/8 Bout 2/Sept. 25		Leger -60Kg 1/8 Combat 2/25 Sept		
Name Nom	Ctry Pays	Result Resultat		
Hongram, Phat	THA			
* Kane, Charles	GBR	PTS	14	
Referee	MOULOU KOURAD	ALG	TOTAL	
Judge 1	MARIUS GUIRAMO LOUGBO	CIV	56:60	
2	ARTURO MORALES	DOM	56:60	
3	ALBERTO DURAN	URU	58:59	
4	HONG-TSUNG YONG	TPE	58:59	
5	STANLEY WACHANGA	KEN	59:58	

Light -60Kg 1/8 Bout 8/Sept. 25		Leger -60Kg 1/8 Combat 8/25 Sept		
Name Nom	Ctry Pays	Result Resultat		
* Zuelow, Andreas	GDR	PTS	3:2	
Tsziou, Konstantine	URS			
Referee	GABY MANCINI	CAN	TOTAL	
Judge 1	ALBERTO DURAN	URU	59:58	
2	ABDUL HANI	IRQ	+ 59:59	
3	LEE, JAE IN	KOR	58:59	
4	BOB, D. KASULE	UGA	58:59	
5	MOULOU KOURAD	ALG	59:58	

Light -60Kg 1/16 Bout 13/Sept. 23		Leger -60Kg 1/16 Combat 13/23 Sept		
Name Nom	Ctry Pays	Result Resultat		
Kubuitsile, L.Shakes	BOT			
* Said, Azzedine	ALG	RSCH	1RD.	2:28
Referee	KISHEN M. NARSI	IND		
Judge 1	D. WEERAKOON	SRI		
2	SANDOR PAJAR	HUN		
3	VIKTOR PLAVEC	YUG		
4	GABY MANCINI	CAN		
5	HONG-TSUNG YONG	TPE		

Light -60Kg 1/8 Bout 3/Sept. 25		Leger -60Kg 1/8 Combat 3/25 Sept		
Name Nom	Ctry Pays	Result Resultat		
Turu, Istvan	HUN			
* Enkhbat, Nerguy	MGL	RSCH	3RD.	2:54
Referee	BOB D. KASULE	UGA		
Judge 1	STANLEY WACHANGA	KEN		
2	ARTURO MORALES	DOM		
3	GABY MANCINI	CAN		
4	OSVALDO BISBAL	ARG		
5	MARIUS GUIRAMO LOUGBO	CIV		

Light -60Kg Quarter-final Bout 1/Sept. 27		Leger -60Kg Quart de Finale Combat 1/27 Sept		
Name Nom	Ctry Pays	Result Resultat		
* Cramne, George	SWE	PTS	4:1	
Kane, Charles	GBR			
Referee	TAKUYA MOROOKA	JPN	TOTAL	
Judge 1	STOINO PARLAPANOV	BUL	58:58+	
2	ELMO ADOLPH	USA	59:58	
3	D. WEERAKOON	SRI	59:58	
4	LEE, JAE IN	KOR	58:57	
5	MOHAMED	EGY	59:58	

Light -60Kg 1/16 Bout 14/Sept. 23		Leger -60Kg 1/16 Combat 14/23 Sept		
Name Nom	Ctry Pays	Result Resultat		
* Hegazy, Mohamed	EGY	PTS	5:0	
Onoko, Blessing	NGR			
Referee	PIETER GEDOAN	INA	TOTAL	
Judge 1	OSVALDO BISBAL	ARG	60:57	
2	ABDUL HANI	IRQ	60:55	
3	ALDO LEONI	ITA	60:57	
4	STIG RONGE	SWE	60:58	
5	ARTURO MORALES	DOM	59:58	

Light -60Kg 1/8 Bout 4/Sept. 25		Leger -60Kg 1/8 Combat 4/25 Sept		
Name Nom	Ctry Pays	Result Resultat		
Arroyo, Hector A.	PUR			
* Marjouane, Kamal	MAR	PTS	2:3	
Referee	VIKTOR PLAVEC	YUG	TOTAL	
Judge 1	STIG RONGE	SWE	58:59	
2	LEE, JAE IN	KOR	58:59	
3	KISHEN M. NARSI	IND	58:59	
4	ALBERTO DURAN	URU	59:58	
5	HONG-TSUNG YONG	TPE	59:58	

Light -60Kg Quarter-final Bout 2/Sept. 27		Leger -60Kg Quart de Finale Combat 2/27 Sept		
Name Nom	Ctry Pays	Result Resultat		
* Enkhbat, Nerguy	MGL	PTS	5:0	
Marjouane, Kamal	MAR			
Referee	GABY MANCINI	CAN	TOTAL	
Judge 1	DIMITR DORU BANCUI	ROM	59:57	
2	STIG RONGE	SWE	59:58	
3	TAKUYA MOROOKA	JPN	59:58	
4	ELMO ADOLPH	USA	59:58	
5	BOB D. KASULE	UGA	59:58	

Light -60Kg 1/16 Bout 15/Sept. 23		Leger -60Kg 1/16 Combat 15/23 Sept		
Name Nom	Ctry Pays	Result Resultat		
Campanella, Giorgio	ITA			
* Zuelow, Andreas	GDR	PTS	0:5	
Referee	GABY MANCINI	CAN	TOTAL	
Judge 1	MOULOU KOURAD	ALG	57:58	
2	BOB D. KASULE	UGA	58:59	
3	LEE, JAE IN	KOR	58:59	
4	KISHEN M. NARSI	IND	58:59	
5	ALBERTO DURAN	URU	58:59	

Light -60Kg 1/8 Bout 5/Sept. 25		Leger -60Kg 1/8 Combat 5/25 Sept		
Name Nom	Ctry Pays	Result Resultat		
* Ellis, Romallis	USA	RSCH	2RD.	1:44
Traore, Kassim	MLI			
Referee	ABDUL HANI	IRQ		
Judge 1	PIETER GEDOAN	INA		
2	ALDO LEONI	ITA		
3	SANDOR PAJAR	HUN		
4	OSVALDO BISBAL	ARG		
5	HONG-TSUNG YONG	TPE		

Light -60Kg Quarter-final Bout 3/Sept. 27		Leger -60Kg Quart de Finale Combat 3/27 Sept		
Name Nom	Ctry Pays	Result Resultat		
* Ellis, Romallis	USA	PTS	3:2	
Tchuprenski, Emil	BUL			
Referee	HIOUAD LARBI	MAR	TOTAL	
Judge 1	RODERICK ROBERTSON	GBR	59:57	
2	GABY MANCINI	CAN	59:58	
3	PIETER GEDOAN	INA	58:60	
4	MOHAMED GHAZNAVI	PAK	58:59	
5	STANLEY WACHANGA	KEN	59:58	

Light -60Kg 1/16 Bout 16/Sept. 23		Leger -60Kg 1/16 Combat 16/23 Sept		
Name Nom	Ctry Pays	Result Resultat		
* Tsziou, Konstantine	URS	RSCH	1RD.	2:30
Knight, Sean	BAR			
Refree	BOB D. KASULE	UGA		
Judge 1	STANLEY WACHANGA	KEN		
2	PIETER GEDOAN	INA		
3	HAN, DONG-JIN	KOR		
4	ARTURO MORALES	DOM		
5	HONG-TSUNG YONG	TPE		

Light -60Kg 1/8 Bout 6/Sept. 25		Leger -60Kg 1/8 Combat 6/25 Sept		
Name Nom	Ctry Pays	Result Resultat		
Kennedy, Mark	JAM			
* Tchuprenski, Emil	BUL	PTS	0:5	
Referee	PIETER GEDOAN	INA	TOTAL	
Judge 1	D. WEERAKOON	SRI	56:60	
2	STANLEY WACHANGA	KEN	55:60	
3	MARIUS GUIRAMO LOUGBO	CIV	56:60	
4	ALBERTO DURAN	URU	55:60	
5	KISHEN M. NARSI	IND	58:60	

Light -60Kg Quarter-final Bout 4/Sept. 27		Leger -60Kg Quart de Finale Combat 4/27 Sept		
Name Nom	Ctry Pays	Result Resultat		
Hegazy, Mohamed	EGY			
* Zuelow, Andreas	GDR	PTS	0:5	
Referee	OSVALDO BISBAL	ARG	TOTAL	
Judge 1	ALDO LEONI	ITA	56:60	
2	GABY MANCINI	CAN	57:60	
3	HAN, DONG-JIN	KOR	57:60	
4	ROMEO SOMODIO	PHI	58:60	
5	ALBERTO DURAN	URU	57:60	

Light -60Kg 1/8 Bout 1/Sept. 25		Leger -60Kg 1/8 Combat 1/25 Sept		
Name Nom	Ctry Pays	Result Resultat		
Carruth, Michael	IRL			
* Cramne, George	SWE	KOH	1RD.	2:59
Referee	D. WEERAKOON	SRI		
Judge 1	ABDUL HANI	IRQ		
2	MARIUS GUIRAMO LOUGBO	CIV		
3	MOULOU KOURAD	ALG		
4	GABY MANCINI	CAN		
5	ALBERTO DURAN	URU		

Light -60Kg 1/8 Bout 7/Sept. 25		Leger -60Kg 1/8 Combat 7/25 Sept		
Name Nom	Ctry Pays	Result Resultat		
Said, Azzedine	ALG			
* Hegazy, Mohamed	EGY	PTS	0:5	
Referee	OSVALDO BISBAL	ARG	TOTAL	
Judge 1	PIETER GEDOAN	INA	58:60	
2	D. WEERAKOON	SRI	58:59	
3	STOINO PARLAPANOV	BUL	58:59	
4	ALDO LEONI	ITA	58:59	
5	ARTURO MORALES	DOM	58:59	

Light -60Kg Semi-final Bout 1/Sept. 29		Leger -60Kg Demi-finale Combat 1/29 Sept		
Name Nom	Ctry Pays	Result Resultat		
* Cramne, George	SWE	PTS	3:2	
Enkhbat, Nerguy	MGL			
Referee	GABY MANCINI	CAN	TOTAL	
Judge 1	BOB D. KASULE	UGA	58:59	
2	DIMITR DORU BANCUI	ROM	59:58	
3	ELMO ADOLPH	USA	59:57	
4	ALBERTO DURAN	URU	59:58	
5	TAKUYA MOROOKA	JPN	58:59	

Boxing

Boxe

Light -60Kg
Competition Summary

Leger -60Kg
Tableau de la Competition

1/32	1/16	1/8	Quarter-final/Quart de Finale	Semi-final/Demi-finale	Final/Finale				
Carruth, Mic (IRL)	Carruth, Mic	Carruth, Mic	Cramne, Geor KOH	Cramne, Geor PTS	Cramne, Geor PTS				
BYE		PTS							
Higashi, Sat (JPN)	Higashi, Sat		Kane, Charle PTS	Enkhbat, Ner PTS		Zuelow, Andr PTS			
BYE									
Mkangala, J (MAW)	Mkangala, J	Cramne, Geor	Marjouan, K PTS	Ellis, Romal PTS			Zuelow, Andr PTS		
BYE		PTS							
Cramne, Geor (SWE)	Cramne, Geor		Arroyo, H PTS	Tchuprenski PTS				Zuelow, Andr PTS	
BYE									
Dar, Asif (CAN)	Dar, Asif	Hongram, Pha	Gbay, Tommy PTS	Hegazy, Moha PTS					Zuelow, Andr PTS
BYE		RSCH							
Hongram, Pha (THA)	Hongram, Pha		Ellis, Romal RSCH	Zuelow, Andr PTS	Zuelow, Andr PTS				
BYE									
Taroreh, A (INA)	Taroreh, A	Kane, Charle	Kubuitsile PTS	Said, Azzedi RSCH		Zuelow, Andr PTS			
BYE		PTS							
Kane, Charle (GBR)	Kane, Charle		Maaea, Terepa RSCO	Tchuprenski RSCI			Zuelow, Andr PTS		
BYE									
Bonatou, J (CMR)	Bonatou, J	Turu, Istvan	Maaea, Terepa RSCO	Tchuprenski RSCI				Zuelow, Andr PTS	
BYE		PTS							
Turu, Istvan (HUN)	Turu, Istvan		Delapena, E PTS	Tchuprenski RSCI					Zuelow, Andr PTS
BYE									
Perez, Jose (VEN)	Perez, Jose	Enkhbat, Ner	Kubuitsile PTS	Said, Azzedi RSCH	Zuelow, Andr PTS				
BYE		PTS							
Enkhbat, Ner (MGL)	Enkhbat, Ner		Kubuitsile PTS	Said, Azzedi RSCH		Zuelow, Andr PTS			
BYE									
Arroyo, H (PUR)	Arroyo, H	Arroyo, H	Kubuitsile PTS	Said, Azzedi RSCH			Zuelow, Andr PTS		
BYE		PTS							
Tatar, Kibar (TUR)	Tatar, Kibar		Kubuitsile PTS	Said, Azzedi RSCH				Zuelow, Andr PTS	
BYE									
Marjouane, K (MAR)	Marjouan, K	Marjouan, K	Kubuitsile PTS	Said, Azzedi RSCH					Zuelow, Andr PTS
BYE		PTS							
Gbay, Tommy (LBR)	Gbay, Tommy		Kubuitsile PTS	Said, Azzedi RSCH	Zuelow, Andr PTS				
BYE									
Ellis, Romal (USA)	Ellis, Romal	Ellis, Romal	Kubuitsile PTS	Said, Azzedi RSCH		Zuelow, Andr PTS			
BYE		PTS							
Lee, Kang-Su (KOR)	Lee, Kang-Su		Kubuitsile PTS	Said, Azzedi RSCH			Zuelow, Andr PTS		
BYE									
Belly, Toby (SUD)	Belly, Toby	Traore, Kass	Kubuitsile PTS	Said, Azzedi RSCH				Zuelow, Andr PTS	
BYE		PTS							
Traore, Kass (MLI)	Traore, Kass		Kubuitsile PTS	Said, Azzedi RSCH					Zuelow, Andr PTS
BYE									
Kennedy, Mar (JAM)	Kennedy, Mar	Kennedy, Mar	Kubuitsile PTS	Said, Azzedi RSCH	Zuelow, Andr PTS				
BYE		RSCO							
Maaea, Terepa (COK)	Maaea, Terepa		Kubuitsile PTS	Said, Azzedi RSCH		Zuelow, Andr PTS			
BYE									
Delapena, E (GUM)	Delapena, E	Tchuprenski	Kubuitsile PTS	Said, Azzedi RSCH			Zuelow, Andr PTS		
BYE		RSCI							
Tchuprenski (BUL)	Tchuprenski		Kubuitsile PTS	Said, Azzedi RSCH				Zuelow, Andr PTS	
BYE									
Kubuitsile (BOT)	Kubuitsile	Said, Azzedi	Kubuitsile PTS	Said, Azzedi RSCH					Zuelow, Andr PTS
BYE		RSCH							
Said, Azzedi (ALG)	Said, Azzedi		Kubuitsile PTS	Said, Azzedi RSCH	Zuelow, Andr PTS				
BYE									
Mbao, Lameck (ZAM)	Mbao, Lameck	Hegazy, Moha	Kubuitsile PTS	Said, Azzedi RSCH		Zuelow, Andr PTS			
BYE		PTS							
Hegazy, Moha (EGY)	Hegazy, Moha		Kubuitsile PTS	Said, Azzedi RSCH			Zuelow, Andr PTS		
BYE									
Ranamagar, D (NEP)	Ranamagar, D	Hegazy, Moha	Kubuitsile PTS	Said, Azzedi RSCH				Zuelow, Andr PTS	
BYE		PTS							
Lubulwa, Cha (UGA)	Lubulwa, Cha	Onoko, Bless	Kubuitsile PTS	Said, Azzedi RSCH					Zuelow, Andr PTS
BYE		RSCH							
Onoko, Bless (NGR)	Onoko, Bless		Kubuitsile PTS	Said, Azzedi RSCH	Zuelow, Andr PTS				
BYE									
Freitas, Dan (URU)	Freitas, Dan	Zuelow, Andr	Kubuitsile PTS	Said, Azzedi RSCH		Zuelow, Andr PTS			
BYE		PTS							
Campanella (ITA)	Campanella, RSCH		Kubuitsile PTS	Said, Azzedi RSCH			Zuelow, Andr PTS		
BYE									
Waweru, Patr (KEN)	Waweru, Patr	Zuelow, Andr	Kubuitsile PTS	Said, Azzedi RSCH				Zuelow, Andr PTS	
BYE		PTS							
Zuelow, Andr (GDR)	Zuelow, Andr		Kubuitsile PTS	Said, Azzedi RSCH					Zuelow, Andr PTS
BYE									
Cantancio, L (PHI)	Cantancio, L	Tsziou, K	Kubuitsile PTS	Said, Azzedi RSCH	Zuelow, Andr PTS				
BYE		KOH							
Tsziou, K (URS)	Tsziou, K		Kubuitsile PTS	Said, Azzedi RSCH		Zuelow, Andr PTS			
BYE									
Knight, Sean (BAR)	Knight, Sean	Tsziou, K	Kubuitsile PTS	Said, Azzedi RSCH			Zuelow, Andr PTS		
BYE		RSCH							
Tamez, Guill (MEX)	Tamez, Guill		Kubuitsile PTS	Said, Azzedi RSCH				Zuelow, Andr PTS	
BYE									



Light 60Kg
Semi-final Bout2/Sept. 29

Name Nom	Ctry Pays	Result Resultat	
Ellis, Romallis	USA		
* Zuelow, Andreas	GDR	PTS	0:5

Referee			
CHO, SUK IN	KOR	TOTAL	
Judge 1	MOHAMED GHAZNAVI	PAK	58:59
2	SOMPONG SUKAR	THA	58:60
3	HIOUAD LARBI	MAR	58:59
4	ALBERTO DURAN	URU	57:60
5	BOB D. KASULE	UGA	58:59

Leger 60Kg
Demi-finale Combat 2/29 Sept

Light Welter -63.5Kg
1/32 Bout 16/Sept. 19

Name Nom	Ctry Pays	Result Resultat	
Al-Harithy, Handhal	OMA		
* Myrberg, Lars	SWE	RSCH	1RD. 2:30

Referee			
BOB D. KASULE	UGA		
Judge 1	STANLEY WACHANGA	KEN	
2	OSVALDO BISBAL	ARG	
3	ALBERTO DURAN	URU	
4	HONG-TSUNG YONG	TPE	
5	KEITH WALKER	NZL	

Mi-welter -63.5Kg
1/32 Combat 16/19 Sept

Light Welter -63.5Kg
1/32 Bout 22/Sept. 19

Name Nom	Ctry Pays	Result Resultat	
Avaavau, Avaavau	SAM		
* Rahilou, Khalid	MAR	RSCO	3RD. 1:45

Referee			
HAN, DONG-JIN	KOR		
Judge 1	ABDUL HANI	IRQ	
2	STIG RONGE	SWE	
3	VIKTOR PLAVEC	YUG	
4	OSVALDO BISBAL	ARG	
5	ARTURO MORALES	DOM	

Mi-welter -63.5Kg
1/32 Combat 22/19 Sept

Light 60Kg
Final Bout /Oct. 1

Name Nom	Ctry Pays	Result Resultat	
Cramne, George	SWE		
* Zuelow, Andreas	GDR	PTS	0:5

Referee			
RYSZARD REDO	POL	TOTAL	
Judge 1	TAKUYA MOROOKA	JPN	55:60
2	BOB D. KASULE	UGA	57:60
3	ALDO LEONI	ITA	57:60
4	OSVALDO BISBAL	ARG	57:60
5	THEODOROS VIDALIS	GRE	57:60

Leger 60Kg
Finale/1 Oct

Light Welter -63.5Kg
1/32 Bout 17/Sept. 19

Name Nom	Ctry Pays	Result Resultat	
Makama, Mpucuko	SWZ		
* Proto, Ludovic	FRA	WO	

Referee			
ABDUL HANI	IRQ		
Judge 1	LEE, JAE IN	KOR	
2	ALBERTO DURAN	URU	
3	GABY MANCINI	CAN	
4	ARTURO MORALES	DOM	
5	HONG-TSUNG YONG	TPE	

Mi-welter -63.5Kg
1/32 Combat 17/19 Sept

Light Welter -63.5Kg
1/32 Bout 23/Sept. 19

Name Nom	Ctry Pays	Result Resultat	
* Mwamba, Antony	ZAM	PTS	5:0
Miura, Kunihiro	JPN		

Referee			
ALDO LEONI	ITA	TOTAL	
Judge 1	STIG RONGE	SWE	60:55
2	ARTURO MORALES	DOM	60:56
3	ALBERTO DURAN	URU	60:57
4	KEITH WALKER	NZL	60:56
5	GABY MANCINI	CAN	60:56

Mi-welter -63.5Kg
1/32 Combat 23/19 Sept

Light Welter -63.5Kg
1/32 Bout 18/Sept. 19

Name Nom	Ctry Pays	Result Resultat	
Ruiz, Tomas	ESP		
* Elliot, Mark	GBR	PTS	0:5

Referee			
OSVALDO BISBAL	ARG	TOTAL	
Judge 1	KISHEN M. NARSI	IND	55:60
2	HAN, DONG-JIN	KOR	56:60
3	MOULOUD KOURAD	ALG	55:60
4	STANLEY WACHANGA	KEN	56:60
5	KEITH WALKER	NZL	55:60

Mi-welter -63.5Kg
1/32 Combat 18/19 Sept

Light Welter -63.5Kg
1/32 Bout 24/Sept. 19

Name Nom	Ctry Pays	Result Resultat	
Bade, Jonas	NGU		
* Aguiar, Anoumou	TOG	DISQ	2RD. 1:30

Referee			
STIG RONGE	SWE		
Judge 1	VIKTOR PLAVEC	YUG	
2	KISHEN M. NARSI	IND	
3	HAN, DONG-JIN	KOR	
4	ARTURO MORALES	DOM	
5	ALBERTO DURAN	URU	

Mi-welter -63.5Kg
1/32 Combat 24/19 Sept

Light Welter -63.5Kg
1/32 Bout 19/Sept. 19

Name Nom	Ctry Pays	Result Resultat	
* Janovski, Viatcheslav	URS	RSCH	2RD. 3:00
Sondergaard, Soren	DEN		

Referee			
GABY MANCINI	CAN		
Judge 1	BOB D. KASULE	UGA	
2	D. WEERAKOON	SRI	
3	PIETER GEDOAN	INA	
4	ARTURO MORALES	DOM	
5	MOULOUD KOURAD	ALG	

Mi-welter -63.5Kg
1/32 Combat 19/19 Sept

Light Welter -63.5Kg
1/32 Bout 25/Sept. 19

Name Nom	Ctry Pays	Result Resultat	
* Dobrasinovic, Vukasin	YUG	PTS	3:2
Abadjiev, Borislav	BUL		

Referee			
LEE, JAE IN	KOR	TOTAL	
Judge 1	D. WEERAKOON	SRI	58:59
2	MOULOUD KOURAD	ALG	58:59
3	STANLEY WACHANGA	KEN	59:58
4	GABY MANCINI	CAN	60:58
5	OSVALDO BISBAL	ARG	60:57

Mi-welter -63.5Kg
1/32 Combat 25/19 Sept

Light Welter -63.5Kg
1/32 Bout 20 Sept. 19

Name Nom	Ctry Pays	Result Resultat	
* Matumla, Rashid Ally	TAN	RSCH	1RD. 2:51
Kouassi, Kouassi A	CIV		

Referee			
HONG-TSUNG YONG	TPE		
Judge 1	ABDUL HANI	IRQ	
2	PIETER GEDOAN	INA	
3	SANDOR PAJAR	HUN	
4	ALDO LEONI	ITA	
5	ALBERTO DURAN	URU	

Mi-welter -63.5Kg
1/32 Combat 20/19 Sept

Light Welter -63.5Kg
1/32 Bout 26/Sept. 19

Name Nom	Ctry Pays	Result Resultat	
El-Masri, Bilal	LIB		
* Carew, Adrian	GUY	PTS	0:5

Referee			
MOULOUD KOURAD	ALG	TOTAL	
Judge 1	BOB D. KASULE	UGA	57:60
2	SANDOR PAJAR	HUN	56:60
3	RYSZARD REDO	POL	55:60
4	HONG-TSUNG YONG	TPE	55:60
5	GABY MANCINI	CAN	57:60

Mi-welter -63.5Kg
1/32 Combat 26/19 Sept

Light Welter -63.5Kg
1/32 Bout 21/Sept. 19

Name Nom	Ctry Pays	Result Resultat	
Bhujel, Jhapatsingh	NEP		
* Mphande, Lyton Levison	MAW	PTS	0:5

Referee			
STOINO PARLAPANOV	BUL	TOTAL	
Judge 1	RYSZARD REDO	POL	57:60
2	GABY MANCINI	CAN	58:60
3	OSVALDO BISBAL	ARG	58:59
4	HONG-TSUNG YONG	TPE	56:60
5	KEITH WALKER	NZL	58:59

Mi-welter -63.5Kg
1/32 Combat 21/19 Sept

Light Welter -63.5Kg
1/32 Bout 27/Sept. 19

Name Nom	Ctry Pays	Result Resultat	
Perez, Victor	PUR		
* Szabo, Lorant	HUN	PTS	2:3

Referee			
MOHAMED	EGY	TOTAL	
Judge 1	MOHAMED GHAZNAVI	PAK	58:59
2	ROMEO SOMODIO	PHI	59:58
3	BOUNAB HEDI	TUN	59:58
4	AMDOR BURGUILLOS	VEN	58:59
5	LUIS MINAMI	PER	58:59

Mi-welter -63.5Kg
1/32 Combat 27/19 Sept

Boxing

Boxe

Light Welter -63.5Kg 1/32 Bout 28/Sept. 19			Mi-welter -63.5Kg 1/32 Combat 28/19 Sept		
Name Nom	Ctry Pays	Result Resultat			
* Gies, Reiner Maelagi, Basil	FRG SOL	WO			
Referee	SOMPONG SUKAR	THA			
Judge 1	TAKUYA MOROOKA	JPN			
2	MULI ADE OJO	NGR			
3	ELMO ADOLPH	USA			
4	KIM, YOUNG BAE	KOR			
5	AMADOR BURGUILLOS	VEN			

Light Welter 63.5Kg 1/16 Bout 2/Sept. 23			Mi-welter 63.5Kg 1/16 Combat 2/23 Sept		
Name Nom	Ctry Pays	Result Resultat			
Saizozema	DOM				
* Quarthey, Issifu Quartelaia	GHA	PTS	0:5		
Referee	THEODOROS VIDALIS	GRE	TOTAL		
Judge 1	RODERICK ROBERTSON	GBR	58:59		
2	WERNER WEGSCHEIDER	AUT	58:59		
3	AMADOR BURGUILLOS	VEN	57:59		
4	LUIS MINAMI	PER	57:59		
5	RONALD MARK GREGOR	AUS	58:59		

Light Welter -63.5Kg 1/16 Bout 8/Sept. 23			Mi-welter -63.5Kg 1/16 Combat 8/23 Sept		
Name Nom	Ctry Pays	Result Resultat			
Khanji, Ahmadmayez	SYR				
* Myrberg, Lars	SWE	PTS	1:4		
Referee	MOHAMED	EGY	TOTAL		
Judge 1	BOUNAB HEDI	TUN	58:59		
2	MULI ADE OJO	NGR	59:58		
3	AMADOR BURGUILLOS	VEN	57:60		
4	LUIS MINAMI	PER	57:60		
5	ELMO ADOLPH	USA	57:60		

Light Welter -63.5Kg 1/32 Bout 29/Sept. 19			Mi-welter -63.5Kg 1/32 Combat 29/19 Sept		
Name Nom	Ctry Pays	Result Resultat			
* Kamau, David Shabab, Abidnasir	KEN JOR	RSCH	1RD.	1:31	
Refereed	ZAUT GVADJAVA	URS			
Judge 1	THEODOROS VIDALIS	GRE			
2	RODERICK ROBERTSON	GBR			
3	RONALD MARK GREGOR	AUS			
4	ELMO ADOLPH	USA			
5	LUIS MINAMI	PER			

Light Welter 63.5Kg 1/16 Bout 3/Sept. 23			Mi-welter 63.5Kg 1/16 Combat 3/23 Sept		
Name Nom	Ctry Pays	Result Resultat			
* Foster, Todd Rahilou, Khalid	USA MAR	KOH	2RD.	2:19	
Referee	GUSTAV BAUMGARDT	GDR			
Judge 1	THEODOROS VIDALIS	GRE			
2	DIMITR DORU BANCUI	ROM			
3	SOMPONG SUKAR	THA			
4	TAKUYA MOROOKA	JPN			
5	AMADOR BURGUILLOS	VEN			

Light Welter -63.5Kg 1/16 Bout 9/Sept. 23			Mi-welter -63.5Kg 1/16 Combat 9/23 Sept		
Name Nom	Ctry Pays	Result Resultat			
* Proto, Ludovic Elliot, Mark	FRA GBR	RSCI	1RD.	0:52	
Referee	HIOUAD LARBI	MAR			
Judge 1	MOHAMED	EGY			
2	RONALD MARK GREGOR	AUS			
3	TAKUYA MOROOKA	JPN			
4	CHO, SUK IN	KOR			
5	ELMO ADOLPH	USA			

Light Welter -63.5Kg 1/32 Bout 30/Sept. 19			Mi-welter -63.5Kg 1/32 Combat 30/19 Sept		
Name Nom	Ctry Pays	Result Resultat			
* Ndongo-Ebanga, Martin Wester, Hubert	CMR ARU	RSCH	1RD.	2:03	
Referee	ROMEO SOMODIO	PHI			
Judge 1	KIM, YOUNG BAE	KOR			
2	SOMPONG SUKAR	THA			
3	WERNER WEGSCHEIDER	AUT			
4	WILLI KELLERMANN	FRG			
5	RONALD MARK GREGOR	AUS			

Ligh Welter -63.5Kg 1/16 Bout 4/Sept. 23			Mi-welter -63.5Kg 1/16 Combat 4/23 Sept		
Name Nom	Ctry Pays	Result Resultat			
* Chun, Jin-Chul Braumoh, Liasu	KOR NGR	RSCH	3RD.	2:02	
Referee	DIMITR DORU BANCUI	ROM			
Judge 1	ZAUT GVADJAVA	URS			
2	THEODOROS VIDALIS	GRE			
3	RONALD MARK GREGOR	AUS			
4	AMADOR BURGUILLOS	VEN			
5	LUIS MINAMI	PER			

Light Welter -63.5Kg 1/16 Bout 10/Sept. 23			Mi-welter -63.5Kg 1/16 Combat 10/23 Sept		
Name Nom	Ctry Pays	Result Resultat			
* Janovski, Viatcheslav Matumla, Rashid Ally	URS TAN	RSCO	3RD.	2:53	
Referee	ELMO ADOLTH	USA			
Judge 1	ROMEO SOMODIO	PHI			
2	MOHAMED GHAZNAVI	PAK			
3	LUIS MINAMI	PER			
4	AMADOR BURGUILLOS	VEN			
5	RONALD MARK GREGOR	AUS			

Light Welter -63.5Kg 1/32 Bout 31/Sept. 19			Mi-welter -63.5Kg 1/32 Combat 31/19 Sept		
Name Nom	Ctry Pays	Result Resultat			
Suwanwichit, Pravit	THA				
* Altansukh, Sodnomdar, Jaa	MGL	PTS	2:3		
Referee	GUSTAV BAUMGARDT	GDR	TOTAL		
Judge 1	DIMITR DORU BANCUI	ROM	59:58		
2	BOUNAB HEDI	TUN	58:59		
3	MOHAMED	EGY	57:59		
4	MULI ADE OJO	NGR	59:58		
5	ELMO ADOLPH	USA	58:59		

Light Welter -63.5Kg 1/16 Bout 5/Sept. 23			Mi-welter -63.5Kg 1/16 Combat 5/23 Sept		
Name Nom	Ctry Pays	Result Resultat			
* Chinyadza, Duke Mozdzen, Andrzej	ZIM POL	PTS	3:2		
Referee	TAKUYA MOROOKA	JPN	TOTAL		
Judge 1	CHO, SUK IN	KOR	58:59		
2	MOHAMED GHAZNAVI	PAK	59:58		
3	ELMO ADOLPH	USA	+ 58:58		
4	AMADOR BURGUILLOS	VEN	59:58		
5	RONALD MARK GREGOR	AUS	58:58 +		

Light Welter -63.5Kg 1/16 Bout 11/Sept. 23			Mi-welter -63.5Kg 1/16 Combat 11/23 Sept		
Name Nom	Ctry Pays	Result Resultat			
* Mphande, Lyton Levison Miango, Kampompo	MAW ZAI	WO			
Referee	WERNER WEGSCHEIDER	AUT			
Judge 1	DIMITR DORU BANCUI	ROM			
2	GUSTAV BAUMGARDT	GDR			
3	ELMO ADOLPH	USA			
4	SOMPONG SUKAR	THA			
5	ROMEO SOMODIO	PHI			

Light Welter -63.5Kg 1/32 Bout 32/Sept. 19			Mi-welter -63.5Kg 1/32 Combat 32/19 Sept		
Name Nom	Ctry Pays	Result Resultat			
* Odindo, Dan Olló, Desire	UGA GAB	WO			
Referee	AUGUSTIN ZARAGOZA	MEX			
Judge 1	DIMITR DORU BANCUI	ROM			
2	WILLI KELLERMANN	FRG			
3	TAKUYA MOROOKA	JPN			
4	ROMEO SOMODIO	PHI			
5	LUIS MINAMI	PER			

Light Welter -63.5Kg 1/16 Bout 6/Sept. 23			Mi-welter -63.5Kg 1/16 Combat 6/23 Sept		
Name Nom	Ctry Pays	Result Resultat			
Temo, Apete	FIJ				
* Rodriguez, Humberto	MEX	RSCH	2RD.	0:47	
Referee	ZAUT GVADJAVA	URS			
Judge 1	RODERICK ROBERTSON	GBR			
2	WILLI KELLERMANN	FRG			
3	HIOUAD LARBI	MAR			
4	MOHAMED	EGY			
5	ROMEO SOMODIO	PHI			

Light Welter -63.5Kg 1/16 Bout 12/Sept. 23			Mi-welter -63.5Kg 1/16 Combat 12/23 Sept		
Name Nom	Ctry Pays	Result Resultat			
* Mwamba, Antony Aguiar, Anoumou	ZAM TOG	RSCH	2RD.	1:44	
Referee	CHO, SUK IN	KOR			
Judge 1	TAKUYA MOROOKA	JPN			
2	MOHAMED GHAZNAVI	PAK			
3	ZAUT GVADJAVA	URS			
4	RODERICK ROBERTSON	GBR			
5	ELMO ADOLPH	USA			

Light Welter -63.5Kg 1/16 Bout 1/Sept. 23			Mi-welter -63.5Kg 1/16 Combat 1/23 Sept		
Name Nom	Ctry Pays	Result Resultat			
* Cheney, Grahame Gonza Lez Gauto, Miguel Amade	AUS PAR	RSCH	2RD.	2:33	
Referee	AUGUSTIN ZARAGOZA	MEX			
Judge 1	WILLI KELLERMANN	FRG			
2	GUSTAV BAUMGARDT	GDR			
3	MOHAMED GHAZNAVI	PAK			
4	SOMPONG SUKAR	THA			
5	MULI ADE OJO	NGR			

Light Welter -63.5Kg 1/16 Bout 7/Sept. 23			Mi-welter -63.5Kg 1/16 Combat 7/23 Sept		
Name Nom	Ctry Pays	Result Resultat			
* Grant, Howard Otto, Andreas	CAN GDR	RSCI	2RD.	0:59	
Referee	MULI ADE OJO	NGR			
Judge 1	BOUNAB HEDI	TUN			
2	RONALD MARK GREGOR	AUS			
3	LUIS MINAMI	PER			
4	MOHAMED	EGY			
5	HIOUAD LARBI	MAR			

Light Welter -63.5Kg 1/16 Bout 13/Sept. 23			Mi-welter -63.5Kg 1/16 Combat 13/23 Sept		
Name Nom	Ctry Pays	Result Resultat			
Dobrasinovic, Vukasin	YUG				
* Carew, Adrian	GUY	PTS	1:4		
Referee	MOULOUD KOURAD	ALG	TOTAL		
Judge 1	MARIUS GUIRAMO LOUGBO	CIV	58:59		
2	KISHEN M. NARSI	IND	58:59		
3	LEE, JAE IN	KOR	58:59		
4	GABY MANCINI	CAN	58:59		
5	HONG-TSUNG YONG	TPE	60:58		



Light Welter -63.5Kg 1/16 Bout 14/Sept. 23			Mi-welter -63.5Kg 1/16 Combat 14/23 Sept		
Name Nom	Ctry Pays	Result Resultat			
Szabo, Lorant	HUN				
* Gies, Reiner	FRG	PTS	0.5		
Referee	D. WEERAKOON	SRI	TOTAL		
Judge 1	ABDUL HANI	IRQ	58:59		
2	STANLEY WACHANGA	KEN	56:60		
3	BOB D. KASULE	UGA	57:60		
4	OSVALDO BISBAL	ARG	55:60		
5	ALBERTO DURAN	URU	57:60		

Light Welter -63.5Kg 1/8 Bout 4/Sept. 25			Mi-welter -63.5Kg 1/8 Combat 4/25 Sept		
Name Nom	Ctry Pays	Result Resultat			
Grant, Howard	CAN				
* Myrberg, Lars	SWE	PTS	1.4		
Referee	BOB D. KASULE	UGA	TOTAL		
Judge 1	STANLEY WACHANGA	KEN	57:60		
2	D. WEERAKOON	SRI	58:59		
3	LEE, JAE IN	KOR	58:59		
4	HONG-TSUNG YONG	TPE	58:59		
5	ALBERTO DURAN	URU	59:58		

Light Welter -63.5Kg Quarter-final Bout 2/Sept. 27			Mi-welter -63.5Kg Quart de Finale Combat 2/27 Sept		
Name Nom	Ctry Pays	Result Resultat			
Rodriguez, Humberto	MEX				
* Myrberg, Lars	SEW	KOH	1RD.	1:27	
Referee	SOMPONG SUKAR	THA			
Judge 1	ROMEO SOMODIO	PHI			
2	PIETER GEDOAN	INA			
3	MOHAMED	EGY			
4	BOB D. KASULE	UGA			
5	ALBERTO DURAN	URU			

Light Welter -63.5Kg 1/16 Bout 15/Sept. 23			Mi-welter -63.5Kg 1/16 Combat 15/23 Sept		
Name Nom	Ctry Pays	Result Resultat			
* Kamau, David	KEN	PTS	5:0		
Ndongo-Ebanga, Martin	CMR				
Referee	OSVALDO BISBAL	ARG	TOTAL		
Judge 1	STOINO PARLAPANOV	BUL	59:58		
2	RYSZARD REDO	POL	59:58		
3	PIETER GEDOAN	INA	60:57		
4	HAN, DONG-JIN	KOR	59:58		
5	ARTURO MORALES	DOM	60:56		

Light Welter -63.5Kg 1/8 Bout 5/Sept. 25			Mi-welter -63.5Kg 1/8 Combat 5/25 Sept		
Name Nom	Ctry Pays	Result Resultat			
Proto, Ludovic	FRA				
* Janovski, Viatcheslav	URS	PTS	0:5		
Referee	OSVALDO BISBAL	ARG	TOTAL		
Judge 1	ABDUL HANI	IRQ	57:60		
2	PIETER GEDOAN	INA	57:60		
3	GABY MANCINI	CAN	57:59		
4	HONG-TSUNG YONG	TPE	57:59		
5	ALBERTO DURAN	URU	56:60		

Light Welter -63.5Kg Quarter-finale Bout 3/Sept. 27			Mi-welter -63.5Kg Quart de Finale Combat 3/27 Sept		
Name Nom	Ctry Pays	Result Resultat			
* Janovski, Viatcheslav	URS	PTS	5:0		
Mwamba, Antony	ZAM				
Referee	D. WEERAKOON	SRI	TOTAL		
Judge 1	ABDUL HANI	IRQ	60:57		
2	STANLEY WACHANGA	KEN	60:57		
3	RYSZARD REDO	POL	60:56		
4	ELMO ADOLPH	USA	60:57		
5	OSVALDO BISBAL	ARG	60:57		

Light Welter -63.5Kg 1/16 Bout 16/Sept. 23			Mi-welter -63.5Kg 1/16 Combat 16/23 Sept		
Name Nom	Ctry Pays	Result Resultat			
* Altansukh, Sodnomdar, Jaa	MGL	RSCH	2RD.	2:59	
Odindo, Dan	UGA				
Referee	ALDO LEONI	ITA			
Judge 1	VIKTOR PLAVEC	YUG			
2	STIG RONGE	SWE			
3	GABY MANCINI	CAN			
4	ALBERTO DURAN	URU			
5	HONG-TSUNG YONG	TPE			

Light Welter -63.5Kg 1/8 Bout 6/Sept. 25			Mi-welter -63.5Kg 1/8 Combat 6/25 Sept		
Name Nom	Ctry Pays	Result Resultat			
Mphande, Lyton Levison	MAW				
* Mwamba, Antony	ZAM	KOH	2RD.	2:25	
Referee	LEE, JAE IN	KOR			
Judge 1	KISHEN M. NARSI	IND			
2	RYSZARD REDO	POL			
3	STIG RONGE	SWE			
4	GABY MANCINI	CAN			
5	ARTURO MORALES	DOM			

Light Welter -63.5Kg Quarter-finale Bout 4/Sept. 27			Mi-welter -63.5Kg Quart de Finale Combat 4/27 Sept		
Name Nom	Ctry Pays	Result Resultat			
* Gies, Reiner	FRG	PTS	4:1		
Altansukh, Sodnomdar, Jaa	MGL				
Referee	GABY MANCINI	CAN	TOTAL		
Judge 1	VIKTOR PLAVEC	YUG	60:57		
2	MOHAMED	EGY	58:59		
3	LEE, JAE IN	KOR	59:58		
4	ALBERTO DURAN	URU	60:57		
5	ELMO ADOLPH	USA	59:57		

Light Welter -63.5Kg 1/8 Bout 1/Sept. 25			Mi-welter -63.5Kg 1/8 Combat 1/25 Sept		
Name Nom	Ctry Pays	Result Resultat			
* Cheney, Grahame	AUS	PTS	5:0		
Quartey, Issifu Quartelai	GHA				
Referee	ALDO LEONI	ITA	TOTAL		
Judge 1	RYSZARD REDO	POL	60:57		
2	PIETER GEDOAN	INA	60:57		
3	KISHEN M. NARSI	IND	59:58		
4	OSVALDO BISBAL	ARG	59:58		
5	ARTURO MORALES	DOM	60:57		

Light Welter -63.5Kg 1/8 Bout 7/Sept. 25			Mi-welter -63.5Kg 1/8 Combat 7/25 Sept		
Name Nom	Ctry Pays	Result Resultat			
Carew, Adrian	GUY				
* Gies, Reiner	FRG	PTS	2:3		
Referee	GABY MANCINI	CAN	TOTAL		
Judge 1	MARIUS GUIRAMO LOUGBO	CIV	59:58		
2	MOULOU KOURAD	ALG	57:59		
3	D. WEERAKOON	SRI	59:58		
4	PIETER GEDOAN	INA	57:60		
5	ARTURO MORALES	DOM	58:59		

Light Welter -63.5Kg Semi-final Bout 1/Sept. 29			Mi-welter -63.5Kg Demi-finale Combat 1/29 Sept		
Name Nom	Ctry Pays	Result Resultat			
* Cheney, Grahame	AUS	PTS	5:0		
Myrberg, Lars	SWE				
Referee	KIM, YOUNG BAE	KOR	TOTAL		
Judge 1	MOHAMED	EGY	60:57		
2	TAKUYA MOROOKA	JPN	60:57		
3	ZAUT GVADJAVA	URS	59:58		
4	ELMO ADOLPH	USA	60:56		
5	OSVALDO BISBAL	ARG	60:57		

Light Welter -63.5Kg 1/8 Bout 2/Sept. 25			Mi-welter -63.5Kg 1/8 Combat 2/25 Sept		
Name Nom	Ctry Pays	Result Resultat			
* Foster, Todo	USA	KOH	2RD.	2:25	
Chun, Jin-Chul	KOR				
Referee	ALDO LEONI	ITA			
Judge 1	STIG RONGE	SWE			
2	BOB D. KASULE	UGA			
3	MOULOU KOURAD	ALG			
4	ALBERTO DURAN	URU			
5	HONG-TSUNG YONG	TPE			

Light Welter -63.5Kg 1/8 Bout 8/Sept. 25			Mi-welter -63.5Kg 1/8 Combat 8/25 Sept		
Name Nom	Ctry Pays	Result Resultat			
Kamau, David	KEN				
* Altansukh, Sodnomdar, Jaa	MGL	0:5			
Referee	HONG-TSUNG YONG	TPE	TOTAL		
Judge 1	ALBERTO DURAN	URU	57:60		
2	VIKTOR PLAVEC	YUG	57:60		
3	STIG RONGE	SWE	57:59		
4	OSVALDO BISBAL	ARG	57:59		
5	GABY MANCINI	CAN	56:60		

Light Welter -63.5Kg Semi-final Bout 2/Sept. 29			Mi-welter -63.5Kg Demi-finale Combat 2/29 Sept		
Name Nom	Ctry Pays	Result Resultat			
* Janovski, Viatcheslav	URS	KOH	1RD.	2:55	
Gies, Reiner	FRG				
Referee	ALDO LEONI	ITA			
Judge 1	HIOUAD LARBI	MAR			
2	BOB D. KASULE	UGA			
3	SOMPONG SUKAR	THA			
4	ROMEO SOMODIO	PHI			
5	ALBERTO DURAN	URU			

Light Welter -63.5Kg 1/8 Bout 3/Sept. 25			Mi-welter -63.5Kg 1/8 Combat 3/25 Sept		
Name Nom	Ctry Pays	Result Resultat			
Chinyadza, Duke	ZIM				
* Rodriguez, Humberto	MEX	KOH	1RD.	0:57	
Referee	RYSZARD REDO	POL			
Judge 1	VIKTOR PLAVEC	YUG			
2	HAN, DONGJIN	KOR			
3	ABDUL HANI	IRQ			
4	OSVALDO BISBAL	ARG			
5	HONG-TSUNG YONG	TPE			

Light Welter -63.5Kg Quarter-final Bout 1/Sept. 27			Mi-welter -63.5Kg Quart de Finale Combat 1/27 Sept		
Name Nom	Ctry Pays	Result Resultat			
* Cheney, Grahame	AUS	PTS	3:2		
Foster, Todo	UAS				
Referee	RODERICK ROBERTSON	GBR	TOTAL		
Judge 1	MOHAMED GHAZNAVI	PAK	60:56		
2	TAKUYA MOROOKA	JPN	57:59		
3	MOULOU KOURAD	ALG	59:58		
4	HIOUAD LARBI	MAR	58:59		
5	STOINO PARLAPANOV	BUL	59:58		

Light Welter -63.5Kg Final Bout /Oct. 2			Mi-welter -63.5Kg Finale/2 Oct		
Name Nom	Ctry Pays	Result Resultat			
Cheney, Grahame	AUS				
* Janovski, Viatcheslav	URS	PTS	0:5		
Referee	ELMO ADOLPH	USA	TOTAL		
Judge 1	TAKUYA MOROOKA	JPN	57:59		
2	HIOUAD LARBI	MAR	58:59		
3	GABY MANCINI	CAN	58:59		
4	ROMEO SOMODIO	PHI	58:59		
5	OSVALDO BISBAL	ARG	58:59		

Boxing

Boxe

Light welter -63.5Kg
Competition Summary

Mi-welter -63.5Kg
Tableau de la Competition

1/32	1/16	1/8	Quarter-final/Quart de Finale	Semi-final/Demi-finale	Final/Finale
Cheney, Grah (AUS)	Cheney, Grah	Cheney, Grah RSCH	Cheney, Grah PTS	Cheney, Grah PTS	Cheney, Grah PTS
BYE					
Gonza Lez G (PAR)	Gonza Lez G	Quartey, I PTS	Foster, Todd KOH	Cheney, Grah PTS	Cheney, Grah PTS
BYE					
Saizozema (DOM)	Saizozema	Quartey, I PTS	Foster, Todd KOH	Cheney, Grah PTS	Cheney, Grah PTS
BYE					
Quartey, I (GHA)	Quartey, I	Chun, Jin-Ch RSCH	Foster, Todd KOH	Cheney, Grah PTS	Cheney, Grah PTS
BYE					
Foster, Todd (USA)	Foster, Todd	Chun, Jin-Ch RSCH	Foster, Todd KOH	Cheney, Grah PTS	Cheney, Grah PTS
BYE					
Miango, Kamp (ZAI)	Miango, Kamp	Chun, Jin-Ch RSCH	Foster, Todd KOH	Cheney, Grah PTS	Cheney, Grah PTS
BYE					
Chun, Jin-Ch (KOR)	Chun, Jin-Ch	Chinyadza, D PTS	Rodriguez, H KOH	Cheney, Grah PTS	Cheney, Grah PTS
BYE					
Braimoh, Lia (NGR)	Braimoh, Lia	Chinyadza, D PTS	Rodriguez, H KOH	Cheney, Grah PTS	Cheney, Grah PTS
BYE					
Chinyadza, D (ZIM)	Chinyadza, D	Rodriguez, H RSCH	Rodriguez, H KOH	Cheney, Grah PTS	Cheney, Grah PTS
BYE					
Mozdzen, And (POL)	Mozdzen, And	Rodriguez, H RSCH	Rodriguez, H KOH	Cheney, Grah PTS	Cheney, Grah PTS
BYE					
Temo, Apete (FIJ)	Temo, Apete	Rodriguez, H RSCH	Rodriguez, H KOH	Cheney, Grah PTS	Cheney, Grah PTS
BYE					
Rodriguez, H (MEX)	Rodriguez, H	Grant, Howar RSCI	Myrberg, Lar PTS	Cheney, Grah PTS	Cheney, Grah PTS
BYE					
Grant, Howar (CAN)	Grant, Howar	Grant, Howar RSCI	Myrberg, Lar PTS	Cheney, Grah PTS	Cheney, Grah PTS
BYE					
Otto, Andrea (GDR)	Otto, Andrea	Myrberg, Lar PTS	Myrberg, Lar PTS	Cheney, Grah PTS	Cheney, Grah PTS
BYE					
Khanji, A (SYR)	Khanji, A	Myrberg, Lar PTS	Myrberg, Lar PTS	Cheney, Grah PTS	Cheney, Grah PTS
BYE					
Al-Harithy, (OMA)	Myrberg, Lar RSCH	Proto, Ludov RSCI	Myrberg, Lar PTS	Cheney, Grah PTS	Cheney, Grah PTS
Myrberg, Lar (SWE)					
Makama, Mpuc (SWZ)	Proto, Ludov WO	Proto, Ludov RSCI	Myrberg, Lar PTS	Cheney, Grah PTS	Cheney, Grah PTS
Proto, Ludov (FRA)					
Ruiz, Tomas (ESP)	Elliot, Mark PTS	Proto, Ludov RSCI	Myrberg, Lar PTS	Cheney, Grah PTS	Cheney, Grah PTS
Elliot, Mark (GBR)					
Janovski, V(URS)	Janovski, V RSCH	Janovski, V RSCO	Janovski, V PTS	Cheney, Grah PTS	Cheney, Grah PTS
Sondergaard (DEN)					
Matumla, R (TAN)	Matumla, R RSCH	Mphande, L WO	Mwamba, Anto KOH	Cheney, Grah PTS	Cheney, Grah PTS
Kouassi, K (CIV)					
Bhujel, J(NEP)	Mphande, L PTS	Mphande, L WO	Mwamba, Anto KOH	Cheney, Grah PTS	Cheney, Grah PTS
Mphande, L (MAW)					
Avaavau, Ava (SAM)	Rahilou, Kha RSCO	Mphande, L WO	Mwamba, Anto KOH	Cheney, Grah PTS	Cheney, Grah PTS
Rahilou, Kha(MAR)					
Mwamba, Anto (ZAM)	Mwamba, Anto PTS	Mwamba, Anto RSCH	Mwamba, Anto KOH	Cheney, Grah PTS	Cheney, Grah PTS
Miura, Kunih (JPN)					
Bade, Jonas (NGU)	Aguiar, Anou DISQ	Gies, Reiner PTS	Gies, Reiner PTS	Cheney, Grah PTS	Cheney, Grah PTS
Aguiar, Anou (TOG)					
Dobrasinovi (YUG)	Dobrasinovi PTS	Carew, Adria PTS	Gies, Reiner PTS	Cheney, Grah PTS	Cheney, Grah PTS
Abadjiev, B (BUL)					
El-Masri, Bi (LIB)	Carew, Adria PTS	Carew, Adria PTS	Gies, Reiner PTS	Cheney, Grah PTS	Cheney, Grah PTS
Carew, Adria (GUY)					
Perez, Victo (PUR)	Szabo, Loran PTS	Gies, Reiner PTS	Gies, Reiner PTS	Cheney, Grah PTS	Cheney, Grah PTS
Szabo, Loran (HUN)					
Gies, Reiner (FRG)	Gies, Reiner PTS	Kamau, David PTS	Altansukh, S PTS	Cheney, Grah PTS	Cheney, Grah PTS
Maelagi, Bas (SOL)					
Kamau, David (KEN)	Kamau, David RSCH	Kamau, David PTS	Altansukh, S PTS	Cheney, Grah PTS	Cheney, Grah PTS
Shabab, A (JOR)					
Ndongo-Eban (CMR)	Ndongo-Eban RSCH	Kamau, David PTS	Altansukh, S PTS	Cheney, Grah PTS	Cheney, Grah PTS
Wester, Hube (ARU)					
Suwanwichit (THA)	Altansukh, S PTS	Altansukh, S RSCH	Altansukh, S PTS	Cheney, Grah PTS	Cheney, Grah PTS
Altansukh, S (MGL)					
Odindo, Dan (UGA)	Odindo, Dan Wo	Altansukh, S RSCH	Altansukh, S PTS	Cheney, Grah PTS	Cheney, Grah PTS
Ollo, Desire (GAB)					



Welter -67Kg 1/32 Bout 21/Sept. 20			Welter -67Kg 1/32 Combat 21/20 Sept		
Name Nom	Ctry Pays	Result Resultat			
Omona, Kasmiro	UGA				
* Kuenzler, Alexander	FRG	PTS	0:5		
Referee	PIETER GEDOAN	INA	TOTAL		
Judge 1	D. WEERAKOON	SRI	55:60		
2	GABY MANCINI	CAN	56:60		
3	ALBERTO DURAN	URU	58:59		
4	HONG-TSUNG YONG	TPE	56:60		
5	ARTURO MORALES	DOM	56:60		

Welter -67Kg 1/32 Bout 27/Sept. 20			Welter -67Kg 1/32 Combat 27/20 Sept		
Name Nom	Ctry Pays	Result Resultat			
Simbeye, Boston	MAW				
* Ankamah, Alfred Addo	GHA	KOH	1RD.	1:15	
Referee	VIKTOR PLAVEC	YUG			
Judge 1	ALDO LEONI	ITA			
2	KISHEN M. NARSI	IND			
3	LEE, JAE IN	KOR			
4	GABY MANCINI	CAN			
5	OSVALDO BISBAL	ARG			

Welter -67Kg 1/16 Bout 1/Sept. 24			Welter -67Kg 1/16 Combat 1/24 Sept		
Name Nom	Ctry Pays	Result Resultat			
* Adegbusi, Adewale	NGR	KOB	1RD.	0:49	
Josedh, Daryc	ANT				
Referee	AMADOR BURGUILLOS	VEN			
Judge 1	LUIS MINAMI	PER			
2	KIM, YOUNG BAE	KOR			
3	SOMPONG SUKAR	THA			
4	RODERICK ROBERTSON	GBR			
5	ZAUT GVADJAVA	URS			

Welter -67Kg 1/32 Bout 22/Sept. 20			Welter -67Kg 1/32 Combat 22/20 Sept		
Name Nom	Ctry Pays	Result Resultat			
Walsh, William	IRL				
* Song, Kyung-Sup	KOR	RSCO	2RD.	2:59	
Referee	KEITH WALKER	NZL			
Judge 1	MOULOU KOURAD	ALG			
2	STANLEY WACHANGA	KEN			
3	ARTURO MORALES	DOM			
4	GABY MANCINI	CAN			
5	OSUALDO BISBAL	ARG			

Welter -67Kg 1/32 Bout 28/Sept. 20			Welter -67Kg 1/32 Combat 28/20 Sept		
Name Nom	Ctry Pays	Result Resultat			
Marwa, Joseph	TAN				
* Gould, Kenneth	USA	PTS	1:4		
Referee	ALDO LEONI	ITA	TOTAL		
Judge 1	STOINO PARLAPANOV	BUL	59:58		
2	ABDUL HANI	IRQ	58:59		
3	KISHEN M. NARSI	IND	57:60		
4	KEITH WALKER	NZL	58:59		
5	OSVALDO BISBAL	ARG	57:58		

Welter -67Kg 1/16 Bout 2/Sept. 24			Welter -67Kg 1/16 Combat 2/24 Sept		
Name Nom	Ctry Pays	Result Resultat			
* Martinez, Javier	ESP	PTS	5:0		
Januario, Lucas	MOZ				
Referee	ROMEO SOMODIO	PHI	TOTAL		
Judge 1	TAKUYA MOROOKA	JPN	60:56		
2	RONALD MARK GREGOR	AUS	60:56		
3	ELMO ADOLPH	USA	+ 58:58		
4	LUIS MINAMI	PER	59:57		
5	SOMPONG SUKAR	THA	59:58		

Welter -67Kg 1/32 Bout 23/Sept. 20			Welter -67Kg 1/32 Combat 23/20 Sept		
Name Nom	Ctry Pays	Result Resultat			
Do Tien, Tuan	VIE				
* Taouane, Abdellah	MAR	PTS	0:5		
Referee	ALBERTO DURAN	URU	TOTAL		
Judge 1	STIG RONGE	SWE	55:60		
2	SANDOR PAJAR	HUN	56:60		
3	KEITH WALKER	NZL	53:60		
4	HONG-TSUNG YONG	TPE	55:60		
5	ARTURO MORALES	DOM	55:60		

Welter -67Kg 1/32 Bout 29/Sept. 20			Welter -67Kg 1/32 Combat 29/20 Sept		
Name Nom	Ctry Pays	Result Resultat			
* Antman, Soren	SWE	RSCH	2RD.	2:59	
Lesivakarua, Isimeli	FIJ				
Referee	BOB D. KASULE	UGA			
Judge 1	MOULOU KOURAD	ALG			
2	ABDUL HANI	IRQ			
3	KISHEN M. NARSI	IND			
4	GABY MANCINI	CAN			
5	ALBERTO DURAN	URU			

Welter -67Kg 1/16 Bout 3/Sept. 24			Welter -67Kg 1/16 Combat 3/24 Sept		
Name Nom	Ctry Pays	Result Resultat			
* Dydak, Jan	POL	PTS	4:1		
Garcia, Jose	VEN				
Referee	KIM, YOUNG BAE	KOR	TOTAL		
Judge 1	ROMEO SOMODIO	PHI	60:57		
2	TAKUYA MOROOKA	JPN	59:57		
3	MUJLI ADE OJO	NGR	58:59		
4	BOUNAB HEDI	TUN	59:58		
5	ELMO ADOLPH	USA	60:55		

Welter -67Kg 1/32 Bout 24/Sept. 20			Welter -67Kg 1/32 Combat 24/20 Sept		
Name Nom	Ctry Pays	Result Resultat			
* Mehnert, Siegfried	GDR	PTS	5:0		
Ortiz, Jose Lionel	PUR				
Referee	D. WEERAKOON	SRI	TOTAL		
Judge 1	ABDUL HANI	IRQ	60:54		
2	BOB D. KASULE	UGA	60:57		
3	STANLEY WACHANGA	KEN	60:55		
4	OSVALDO BISBAL	ARG	60:55		
5	KEITH WALKER	NZL	60:50		

Welter -67Kg 1/32 Bout 30/Sept. 20			Welter -67Kg 1/32 Combat 30/20 Sept		
Name Nom	Ctry Pays	Result Resultat			
Sobral, Manuel	CAN				
* Nyman, Joni	FIN	PTS	1:4		
Referee	HAN, DONG-JIN	KOR	TOTAL		
Judge 1	D. WEERAKOON	SRI	58:59		
2	STANLEY WACHANGA	KEN	57:59		
3	MARIUS GUIRAMO LOUGBO	CIV	58:59		
4	HONG-TSUNG YONG	TPE	58:59		
5	ALBERTO DURAN	URU	59:58		

Welter -67Kg 1/16 Bout 4/Sept. 24			Welter -67Kg 1/16 Combat 4/24 Sept		
Name Nom	Ctry Pays	Result Resultat			
Naea, Asomua	SAM				
* Aranda, Humberto	CRC	RSCH	2RD.	2:34	
Referee	THEODOROS VIDALIS	GRE			
Judge 1	GUSTAV BAUMGARDT	GDR			
2	WILLI KELLERMANN	FRG			
3	ROMEO SOMODIO	PHI			
4	HIOUAD LARBI	MAR			
5	MOHAMED	EGY			

Welter -67Kg 1/32 Bout 25/Sept. 20			Welter -67Kg 1/32 Combat 25/20 Sept		
Name Nom	Ctry Pays	Result Resultat			
* Mohinga, Fidele	CAF	PTS	5:0		
Nzuzi, Adao	ANG				
Referee	SANDOR PAJAR	HUN	TOTAL		
Judge 1	STOINO PARLAPANOV	BUL	60:56		
2	KISHEN M. NARSI	IND	59:58		
3	HAN, DONG-JIN	KOR	59:57		
4	ALBERTO DURAN	URU	60:57		
5	HONG-TSUNG YONG	TPE	60:56		

Welter -67Kg 1/32 Bout 31/Sept. 20			Welter -67Kg 1/32 Combat 31/20 Sept		
Name Nom	Ctry Pays	Result Resultat			
Takahashi, Yoshiaki	JPN				
* Erechchenko, Vladimir	URS	PTS	0:5		
Referee	HIOUAD LARBI	MAR	TOTAL		
Judge 1	MOHAMED	EGY	55:60		
2	MUJLI ADE OJO	NGR	56:60		
3	RONALD MARK GREGOR	AUS	53:60		
4	AMADOR BURGUILLOS	VEN	55:60		
5	LUIS MINAMI	PER	54:60		

Welter -67Kg 1/16 Bout 5/Sept. 24			Welter -67Kg 1/16 Combat 5/24 Sept		
Name Nom	Ctry Pays	Result Resultat			
* Hamidou, Abdoukerim	TOG	DISQ	3RD.	2:23	
Vastag, Francisc	ROM				
Referee	SOMPONG SUKAR	THA			
Judge 1	TAKUYA MOROOKA	JPN			
2	AMADOR BURGUILLOS	VEN			
3	ELMO ADOLPH	USA			
4	RONALD MARK GREGOR	AUS			
5	KIM, YOUNG BAE	KOR			

Welter -67Kg 1/32 Bout 26/Sept. 20			Welter -67Kg 1/32 Combat 26/20 Sept		
Name Nom	Ctry Pays	Result Resultat			
Fria Reynoso, Pedro	DOM				
* Masoe, Francis	ASA	RSCH	1RD.	3:00	
Referee	RYSZARD REDO	POL			
Judge 1	VIKTOR PLAVEC	YUG			
2	BOB D. KASULE	UGA			
3	MOULOU KOURAD	ALG			
4	LEE, JAE IN	KOR			
5	PIETER GEDOAN	INA			

Welter -67Kg 1/32 Bout 32/Sept. 20			Welter -67Kg 1/32 Combat 32/20 Sept		
Name Nom	Ctry Pays	Result Resultat			
Oliveira, Wanderley	BRA				
* Chisala, Dimus	ZAM	RSCH	1RD.	2:04	
Referee	ELMO ADOLPH	USA			
Judge 1	RONALD MARK GREGOR	AUS			
2	THEODOROS VIDALIS	GRE			
3	DIMITR DORU BANCUI	ROM			
4	SOMPONG SUKAR	THA			
5	TAKUYA MOROOKA	JPN			

Welter -67Kg 1/16 Bout 6/Sept. 24			Welter -67Kg 1/16 Combat 6/24 Sept		
Name Nom	Ctry Pays	Result Resultat			
* Fournigov, Hristo	BUL	KOH	1RD.	2:25	
Griffith, Gregory	BAR				
Referee	BOUNAB HEDI	TUN			
Judge 1	MUJLI ADE OJO	NGR			
2	SOMPONG SUKAR	THA			
3	KIM, YOUNG BAE	KOR			
4	ELMO ADOLPH	USA			
5	RONALD MARK GREGOR	AUS			

Boxing

Boxe

Welter -67Kg 1/16 Bout 7/Sept. 24			Welter -67Kg 1/16 Combat 7/24 Sept		
Name Nom	Ctry Pays	Result Resultat			
Petronijevic, Djordje	YUG				
* Wangila, Robert	KEN	RSCH	2RD.	2:31	
Referee	LUIS MINAMI	PER			
Judge 1	AMADOR BURGUILLLOS	VEN			
2	TAKUYA MOROOKA	JPN			
3	ROMEO SOMODIO	PHI			
4	RONALD MARK GREGOR	AUS			
5	ELMO ADOLPH	USA			

Welter -67Kg 1/16 Bout 13/Sept. 24			Welter -67Kg 1/16 Combat 13/24 Sept		
Name Nom	Ctry Pays	Result Resultat			
Mohinga, Fidele	CAF				
* Masoe, Francis	ASA	RSCH	2RD.	2:31	
Referee	STIG RONGE	SWE			
Judge 1	STOINO PARLAPANOV	BUL			
2	D. WEERAKOON	SRI			
3	ABDUL HANI	IRQ			
4	ALBERTO DURAN	URU			
5	ARTURO MORALES	DOM			

Welter -67Kg 1/8 Bout 3/Sept. 26			Welter -67Kg 1/8 Combat 3/26 Sept		
Name Nom	Ctry Pays	Result Resultat			
Hamidou, Abdoukerim	TOG				
* Fournigov, Hristo	BUL	PTS	0:5		
Referee	D. WEERAKOON	SRI	TOTAL		
Judge 1	KISHEN M. NARSI	IND	58:59		
2	OSVALDO BISBAL	ARG	58:59		
3	ALBERTO DURAN	URU	58:59		
4	ARTURO MORALES	DOM	56:60		
5	HONG-TSUNG YONG	TPE	57:60		

Welter -67Kg 1/16 Bout 8/Sept. 24			Welter -67Kg 1/16 Combat 8/24 Sept		
Name Nom	Ctry Pays	Result Resultat			
* Gantulga, Khaidav	MGL	RSCH	2RD.	2:22	
Hamilton, Richard	JAM				
Referee	WILLI KELLERMANN	FRG			
Judge 1	WERNER WEGSCHEIDER	AUT			
2	HIOUAD LARBI	MAR			
3	MUILI ADE OJO	NGR			
4	AMADOR BURGUILLLOS	VEN			
5	DIMITR DORU BANCUI	ROM			

Welter -67Kg 1/16 Bout 14/Sept. 24			Welter -67Kg 1/16 Combat 14/24 Sept		
Name Nom	Ctry Pays	Result Resultat			
Ankamah, Alfred Addo	GHA				
* Gould, Kenneth	USA	PTS	0:5		
Referee	RYSZARD REDO	POL	TOTAL		
Judge 1	ALDO LEONI	ITA	55:60		
2	KISHEN M. NARSI	IND	57:60		
3	LEE, JAE IN	KOR	57:60		
4	OSVALDO BISBAL	ARG	56:60		
5	HONG-TSUNG YONG	TPE	56:60		

Welter -67Kg 1/8 Bout 4/Sept. 26			Welter -67Kg 1/8 Combat 4/26 Sept		
Name Nom	Ctry Pays	Result Resultat			
* Wangila, Robert	KEN	RET	2RD.	0:03	
Gantulga, Khaidav	MGL				
Referee	ALDO LEONI	ITA			
Judge 1	STOINO PARLAPANOV	BUL			
2	OSVALDO BISBAL	ARG			
3	ALBERTO DURAN	URU			
4	GABY MANCINI	CAN			
5	VIKTOR PLAVEC	YUG			

Welter -67Kg 1/16 Bout 9/Sept. 24			Welter -67Kg 1/16 Combat 9/24 Sept		
Name Nom	Ctry Pays	Result Resultat			
Bacskai, Imre	HUN				
* Boudouani, Laurent	FRA	PTS	1:4		
Referee	MOHAMED	EGY	TOTAL		
Judge 1	SOMPONG SUKAR	THA	58:59		
2	KIM, YOUNG BAE	KOR	58:59		
3	LUIS MINAMI	PER	59:58		
4	ELMO ADOLPH	USA	58:59		
5	HIOUAD LARBI	MAR	58:59		

Welter -67Kg 1/16 Bout 15/Sept. 24			Welter -67Kg 1/16 Combat 15/24 Sept		
Name Nom	Ctry Pays	Result Resultat			
Antman, Soren	SWE				
* Nyman, Joni	FIN	PTS	0:5		
Referee	ABDUL HANI	IRQ	TOTAL		
Judge 1	PIETER GEDOAN	INA	58:60		
2	MARIUS GUIRAMO LOUGBO	CIV	56:60		
3	MOULOUD KOURAD	ALG	57:60		
4	GABY MANCINI	CAN	58:59		
5	ALBERTO DURAN	URU	57:60		

Welter -67Kg 1/8 Bout 5/Sept. 26			Welter -67Kg 1/8 Combat 5/26 Sept		
Name Nom	Ctry Pays	Result Resultat			
* Boudouani, Laurent	FRA	PTS	5:0		
Obah, Darren	AUS				
Referee	BOB D. KASULE	UGA	TOTAL		
Judge 1	STANLEY WACHANGA	KEN	60:55		
2	PIETER GEDOAN	INA	60:56		
3	D. WEERAKOON	SRI	60:53		
4	OSVALDO BISBAL	ARG	60:54		
5	GABY MANCINI	CAN	60:55		

Welter -67Kg 1/16 Bout 10/Sept. 24			Welter -67Kg 1/16 Combat 10/24 Sept		
Name Nom	Ctry Pays	Result Resultat			
* Obah, Darren	AUS	RSCO	3RD.	1:28	
Al-Barwani, Abdullah	OMA				
Referee	RODERICK ROBERTSON	GBR			
Judge 1	ZAUT GVADJAVA	URS			
2	WILLI KELLERMANN	FRG			
3	BOUNAB HEDI	TUN			
4	MUILI ADE OJO	NGR			
5	AMADOR BURGUILLLOS	VEN			

Welter -67Kg 1/16 Bout 16/Sept. 24			Welter -67Kg 1/16 Combat 16/24 Sept		
Name Nom	Ctry Pays	Result Resultat			
Erechtchenko, Vladimir	URS				
* Chisala, Dimus	ZAM	RSCI	3RD.	0:41	
Referee	ALBERTO DURAN	URU			
Judge 1	HONG-TSUNG YONG	TPE			
2	OSVALDO BISBAL	ARG			
3	GABY MANCINI	CAN			
4	HAN, DONG-JIN	KOR			
5	D. WEERAKOON	SRI			

Welter -67Kg 1/8 Bout 6/Sept. 26			Welter -67Kg 1/8 Combat 6/26 Sept		
Name Nom	Ctry Pays	Result Resultat			
* Song, Kyung-Sup	KOR	PTS	3:2		
Mehnert, Siegfried	GDR				
Referee	GABY MANCINI	CAN	TOTAL		
Judge 1	ARTURO MORALES	DOM	+ 58:58		
2	ALBERTO DURAN	URU	58:59		
3	HONG-TSUNG YONG	TPE	59:58		
4	BOB D. KASULE	UGA	58:59		
5	MARIUS GUIRAMO LOUGBO	CIV	+ 58:58		

Welter -67Kg 1/16 Bout 11/Sept. 24			Welter -67Kg 1/16 Combat 11/24 Sept		
Name Nom	Ctry Pays	Result Resultat			
Kuenzler, Alexander	FRG				
* Song, Kyung-Sup	KOR	PTS	0:5		
Referee	AUGUSTIN ZARAGOZA	MEX	TOTAL		
Judge 1	BOUNAB HEDI	TUN	58:59		
2	HIOUAD LARBI	MAR	58:59		
3	LUIS MINAMI	PER	58:60		
4	RONALD MARK GREGOR	AUS	58:59		
5	MOHAMED	EGY	58:60		

Welter -67Kg 1/8 Bout 1/Sept. 26			Welter -67Kg 1/8 Combat 1/26 Sept		
Name Nom	Ctry Pays	Result Resultat			
* Adegbusi, Adewale	NGR	PTS	5:0		
Martinez, Javier	ESP				
Referee	PIETER GEDOAN	INA	TOTAL		
Judge 1	HAN, DONG-JIN	KOR	59:57		
2	HONG-TSUNG YONG	TPE	58:57		
3	ALBERTO DURAN	URU	59:58		
4	GABY MANCINI	CAN	+ 58:58		
5	ARTURO MORALES	DOM	58:57		

Welter -67Kg 1/8 Bout 7/Sept. 26			Welter -67Kg 1/8 Combat 7/26 Sept		
Name Nom	Ctry Pays	Result Resultat			
Masoe, Francis	ASA				
* Gould, Kenneth	USA	PTS	0:5		
Referee	STIG RONGE	SWE	TOTAL		
Judge 1	SANDOR PAJAR	HUN	55:60		
2	HAN, DONG-JIN	KOR	57:59		
3	ABDUL HANI	IRQ	57:60		
4	MOULOUD KOURAD	ALG	56:60		
5	STANLEY WACHANGA	KEN	53:60		

Welter -67Kg 1/16 Bout 12/Sept. 24			Welter -67Kg 1/16 Combat 12/24 Sept		
Name Nom	Ctry Pays	Result Resultat			
Taouane, Abdellah	MAR				
* Mehnert, Siegfried	GDR	PTS	0:5		
Referee	RONALD MARK GREGOR	AUS	TOTAL		
Judge 1	ROMEO SOMODIO	PHI	55:60		
2	TAKUYA MOROOKA	JPN	54:60		
3	AMADOR BURGUILLLOS	VEN	55:60		
4	LUIS MINAMI	PER	55:60		
5	ELMO ADOLPH	USA	56:60		

Welter -67Kg 1/8 Bout 2/Sept. 26			Welter -67Kg 1/8 Combat 2/26 Sept		
Name Nom	Ctry Pays	Result Resultat			
* Dydak, Jan	POL	PTS	4:1		
Aranda, Humberto	CRC				
Referee	MOULOUD KOURAD	ALG	TOTAL		
Judge 1	MARIUS GUIRAMO LOUGBO	CIV	58:59		
2	KISHEN M. NARSI	IND	59:58		
3	ABDUL HANI	IRQ	59:58		
4	HONG-TSUNG YONG	TPE	60:57		
5	OSVALDO BISBAL	ARG	59:58		

Welter -67Kg 1/8 Bout 8/Sept. 26			Welter -67Kg 1/8 Combat 8/26 Sept		
Name Nom	Ctry Pays	Result Resultat			
* Nyman, Joni	FIN	PTS	5:0		
Chisala, Dimus	ZAM				
Referee	KISHEN M. NARSI	IND	TOTAL		
Judge 1	PIETER GEDOAN	INA	60:57		
2	HONG-TSUNG YONG	TPE	60:58		
3	OSVALDO BISBAL	ARG	60:57		
4	ALBERTO DURAN	URU	60:57		
5	ARTURO MORALES	DOM	60:58		



Welter -67Kg Quarter-final Bout 1/Sept. 28

Name Nom	Ctry Pays	Result Resultat
Adegbusi, Adewale	NGR	PTS
* Dydak, Jan	POL	1:4

Referee	INA	TOTAL
Judge 1	KIM, YOUNG BAE	KOR 58:59
2	KISHEN M. NARSI	IND 57:59
3	STANLEY WACHANGA	KEN 57:59
4	VIKTOR PLAVEC	YUG 58:59
5	ALBERTO DURAN	URU 59:58

Welter -67Kg Quart de Finale Combat 1/28 Sept

Name Nom	Ctry Pays	Result Resultat
* Wangila, Robert	KEN	PTS
Boudouani, Laurent	FRA	0:5

Referee	KOR	TOTAL
Judge 1	CHO, SUK IN	KOR 58:59
2	OSVALDO BISBAL	PHI 58:59
3	D. WEERAKOON	ARG 56:60
4	GABY MANCINI	CAN 56:60
5	SOMPONG SUKAR	THA 58:59

Welter -67Kg Final/Oct. 1

Name Nom	Ctry Pays	Result Resultat
* Wangila, Robert	KEN	KOH 2RD. 0:44
Boudouani, Laurent	FRA	

Referee	KOR	TOTAL
Judge 1	ALBERTO DURAN	URU 58:59
2	OSVALDO BISBAL	ARG 56:60
3	D. WEERAKOON	SRI 56:60
4	GABY MANCINI	CAN 56:60
5	SOMPONG SUKAR	THA 58:59

Welter -67Kg Finale/1 Oct

Name Nom	Ctry Pays	Result Resultat
* Wangila, Robert	KEN	KOH 2RD. 0:44
Boudouani, Laurent	FRA	

Referee	KOR	TOTAL
Judge 1	CHO, SUK IN	KOR 58:59
2	OSVALDO BISBAL	PHI 58:59
3	D. WEERAKOON	ARG 56:60
4	GABY MANCINI	CAN 56:60
5	SOMPONG SUKAR	THA 58:59

Light Middle -71Kg 1/32 Bout 28/Sept. 20

Name Nom	Ctry Pays	Result Resultat
* Mercado, Laurensio	ECU	KOB 3 RD 1:49
Quaye, Emmanuel	GHA	

Referee	SWE	TOTAL
Judge 1	STIG RONG	SWE 55:60
2	STOINO PARLAPANOV	BUL 53:60
3	D. WEERAKOON	SRI 56:60
4	KISHEN M. NARSI	IND 56:60
5	ARTURO MORALES	DOM 56:60

Super-welter -71Kg 1/32 Combat 28/20 Sept

Name Nom	Ctry Pays	Result Resultat
* Mercado, Laurensio	ECU	KOB 3 RD 1:49
Quaye, Emmanuel	GHA	

Referee	SWE	TOTAL
Judge 1	STIG RONG	SWE 55:60
2	STOINO PARLAPANOV	BUL 53:60
3	D. WEERAKOON	SRI 56:60
4	KISHEN M. NARSI	IND 56:60
5	ARTURO MORALES	DOM 56:60

Welter -67Kg Quarter-final Bout 2/Sept. 28

Name Nom	Ctry Pays	Result Resultat
Fournigov, Hristo	BUL	PTS
* Wangila, Robert	KEN	0:5

Referee	ARG	TOTAL
Judge 1	OSVALDO BISBAL	ARG 58:59
2	ROMEO SOMODIO	PHI 58:59
3	MOHAMED GHAZNAVI	PAK 58:59
4	MOULOUD KOURAD	ALG 56:60
5	DIMITR DORU BANCIU	ROM 56:60

Welter -67Kg Quart de Finale Combat 2/28 Sept

Name Nom	Ctry Pays	Result Resultat
* Wangila, Robert	KEN	PTS
Fournigov, Hristo	BUL	0:5

Referee	ARG	TOTAL
Judge 1	OSVALDO BISBAL	ARG 58:59
2	ROMEO SOMODIO	PHI 58:59
3	MOHAMED GHAZNAVI	PAK 58:59
4	MOULOUD KOURAD	ALG 56:60
5	DIMITR DORU BANCIU	ROM 56:60

Light Middle -71Kg 1/32 Bout 29/Sept. 20

Name Nom	Ctry Pays	Result Resultat
Lopez, Jorge Oscar	ARG	PTS
* Downey, Raymond	CAN	0:5

Referee	POL	TOTAL
Judge 1	RYSZARD REDO	POL 55:60
2	VIKTOR PLAVEC	YUG 53:60
3	ABDUL HANI	IRQ 56:60
4	PIETER GEDOAN	INA 56:60
5	STANLEY WACHANGA	KEN 56:60

Super-welter-71Kg 1/32 Combat 29/20 Sept

Name Nom	Ctry Pays	Result Resultat
Lopez, Jorge Oscar	ARG	PTS
* Downey, Raymond	CAN	0:5

Referee	POL	TOTAL
Judge 1	RYSZARD REDO	POL 55:60
2	VIKTOR PLAVEC	YUG 53:60
3	ABDUL HANI	IRQ 56:60
4	PIETER GEDOAN	INA 56:60
5	STANLEY WACHANGA	KEN 56:60

Welter -67Kg Quarter-final Bout 3/Sept. 28

Name Nom	Ctry Pays	Result Resultat
* Boudouani, Laurent	FRA	PTS
Song, Kyung-Sup	KOR	3:2

Referee	USA	TOTAL
Judge 1	ELMO ADOLPH	USA 59:59 +
2	SOMPONG SUKAR	THA 60:57
3	STANLEY WACHANGA	KEN 58:59
4	MOHAMED	EGY 59:58
5	WILLI KELLERMANN	FRG 59:58

Welter -67Kg Quart de Finale Combat 3/28 Sept

Name Nom	Ctry Pays	Result Resultat
* Boudouani, Laurent	FRA	PTS
Song, Kyung-Sup	KOR	3:2

Referee	USA	TOTAL
Judge 1	ELMO ADOLPH	USA 59:59 +
2	SOMPONG SUKAR	THA 60:57
3	STANLEY WACHANGA	KEN 58:59
4	MOHAMED	EGY 59:58
5	WILLI KELLERMANN	FRG 59:58

Light Middle -71Kg 1/32 Bout 30/Sept. 20

Name Nom	Ctry Pays	Result Resultat
Felix, Garth	GRN	PTS
* Nieroba, Norbert	FRG	KOH 1 RD 2:27

Referee	IND	TOTAL
Judge 1	KISHEN M. NARSI	IND 55:60
2	PIETER GEDOAN	INA 53:60
3	MOULOUD KOURAD	ALG 56:60
4	BOB D. KASULE	UGA 56:60
5	HONG-TSUNG YONG	TPE 56:60

Super-welter -71Kg 1/32 Combat 30/20 Sept

Name Nom	Ctry Pays	Result Resultat
Felix, Garth	GRN	PTS
* Nieroba, Norbert	FRG	KOH 1 RD 2:27

Referee	IND	TOTAL
Judge 1	KISHEN M. NARSI	IND 55:60
2	PIETER GEDOAN	INA 53:60
3	MOULOUD KOURAD	ALG 56:60
4	BOB D. KASULE	UGA 56:60
5	HONG-TSUNG YONG	TPE 56:60

Welter -67Kg Quarter-final Bout 4/Sept. 28

Name Nom	Ctry Pays	Result Resultat
* Gould, Kenneth	USA	PTS
Nyman, Joni	FIN	5:0

Referee	MAR	TOTAL
Judge 1	HIOUAD LARBI	MAR 59:58
2	TAKUYA MOROOKA	JPN 60:57
3	MULI ADE OJO	NGR 60:56
4	WERNER WEGSCHEIDER	AUT 60:57
5	GABY MANCINI	CAN 60:57

Welter -67Kg Quart de Finale Combat 4/28 Sept

Name Nom	Ctry Pays	Result Resultat
* Gould, Kenneth	USA	PTS
Nyman, Joni	FIN	5:0

Referee	MAR	TOTAL
Judge 1	HIOUAD LARBI	MAR 59:58
2	TAKUYA MOROOKA	JPN 60:57
3	MULI ADE OJO	NGR 60:56
4	WERNER WEGSCHEIDER	AUT 60:57
5	GABY MANCINI	CAN 60:57

Light Middle -71Kg 1/32 Bout 31/Sept. 20

Name Nom	Ctry Pays	Result Resultat
* Syed, Abrar-Hussain	PAK	KOH 2 RD. 1:47
Meziane, Nouredine	ALG	

Referee	YUG	TOTAL
Judge 1	VIKTOR PLAVEC	YUG 55:60
2	STOINO PARLAPANOV	BUL 53:60
3	HONG-TSUNG YONG	TPE 56:60
4	OSVALDO BISBAL	ARG 56:60
5	GABY MANCINI	CAN 56:60

Super-welter-71Kg 1/32 Combat 31/20 Sept

Name Nom	Ctry Pays	Result Resultat
* Syed, Abrar-Hussain	PAK	KOH 2 RD. 1:47
Meziane, Nouredine	ALG	

Referee	YUG	TOTAL
Judge 1	VIKTOR PLAVEC	YUG 55:60
2	STOINO PARLAPANOV	BUL 53:60
3	HONG-TSUNG YONG	TPE 56:60
4	OSVALDO BISBAL	ARG 56:60
5	GABY MANCINI	CAN 56:60

Welter -67Kg Semi-final Bout 1/Sept. 29

Name Nom	Ctry Pays	Result Resultat
Dydak, Jan	POL	PTS
* Wangila, Robert	KEN	WO

Referee	JPN	TOTAL
Judge 1	TAKUYA MOROOKA	JPN 59:58
2	D. WEERAKOON	SRI 60:57
3	GUSTAV BAUMGARDT	GDR 60:57
4	GABY MANCINI	CAN 60:57
5	OSVALDO BISBAL	ARG 60:57

Welter -67Kg Demi-finale Combat 1/29 Sept

Name Nom	Ctry Pays	Result Resultat
Dydak, Jan	POL	PTS
* Wangila, Robert	KEN	WO

Referee	JPN	TOTAL
Judge 1	TAKUYA MOROOKA	JPN 59:58
2	D. WEERAKOON	SRI 60:57
3	GUSTAV BAUMGARDT	GDR 60:57
4	GABY MANCINI	CAN 60:57
5	OSVALDO BISBAL	ARG 60:57

Light Middle -71Kg 1/32 Bout 32/Sept. 20

Name Nom	Ctry Pays	Result Resultat
* Mayo, Francois	CMR	RSCH 1 RD. 1:56
Wiawindi, Moussa	CAF	

Referee	SRI	TOTAL
Judge 1	D. WEERAKOON	SRI 55:60
2	PIETER GEDOAN	INA 53:60
3	RYSZARD REDO	POL 56:60
4	ALDO LEONI	ITA 56:60
5	KEITH WALKER	NZL 56:60

Super-welter -71Kg 1/32 Combat 32/20 Sept

Name Nom	Ctry Pays	Result Resultat
* Mayo, Francois	CMR	RSCH 1 RD. 1:56
Wiawindi, Moussa	CAF	

Referee	SRI	TOTAL
Judge 1	D. WEERAKOON	SRI 55:60
2	PIETER GEDOAN	INA 53:60
3	RYSZARD REDO	POL 56:60
4	ALDO LEONI	ITA 56:60
5	KEITH WALKER	NZL 56:60

Welter -67Kg Semi-final Bout 2/Sept. 29

Name Nom	Ctry Pays	Result Resultat
* Boudouani, Laurent	FRA	PTS
Gould, Kenneth	USA	4:1

Referee	ARG	TOTAL
Judge 1	OSVALDO BISBAL	ARG 60:57
2	KIM, YOUNG BAE	KOR 59:58
3	KISHEN M. NARSI	IND 59:58
4	ALBERTO DURAN	URU 59:58
5	HIOUAD LARBI	MAR 59:58

Welter -67Kg Demi-finale Combat 2/29 Sept

Name Nom	Ctry Pays	Result Resultat
* Boudouani, Laurent	FRA	PTS
Gould, Kenneth	USA	4:1

Referee	ARG	TOTAL
Judge 1	OSVALDO BISBAL	ARG 60:57
2	KIM, YOUNG BAE	KOR 59:58
3	KISHEN M. NARSI	IND 59:58
4	ALBERTO DURAN	URU 59:58
5	HIOUAD LARBI	MAR 59:58

Light Middle -71Kg 1/16 Bout 1/Sept. 24

Name Nom	Ctry Pays	Result Resultat
Mahlalala, Charles	SWZ	PTS
* Silva, Peter	BRA	0:5

Boxing

Boxe

Welter -67Kg
Competition Summary

Welter -67Kg
Tableau de la Competition

1/32	1/16	1/8	Quarter-final/Quart de Finale	Semi-final/Demi-finale	Final/Finale
Adegbusi, A (NGR)	Adegbusi, A	Adegbusi, A	Adegbusi, A	Dydak, Jan	WO
BYE		KOB	PTS	PTS	
Josedh, Dary (ANT)	Josedh, Dary	Martinez, Ja			
BYE		PTS			
Martinez, Ja (ESP)	Martinez, Ja	Aranda, Humb			
BYE		RSCH			
Januario, Lu (MOZ)	Januario, Lu	Mamidou, A			
BYE		DISQ			
Dydak, Jan (POL)	Dydak, Jan	Fournigov, H			
BYE		PTS			
Garcia, Jose (VEN)	Garcia, Jose	Fournigov, H			
BYE		KOH			
Naea, Asomua (SAM)	Naea, Asomua	Wangila, Rob			
Aranda, Humb (CRC)	Aranda, Humb	RSCH			
BYE					
Hamidou, A (TOG)	Mamidou, A	Wangila, Rob			
BYE		RSCH			
Vastag, Fran (ROM)	Vastag, Fran	Gantulga, K			
BYE		RSCH			
Fournigov, H (BUL)	Fournigov, H	Boudouani, L			
BYE		PTS			
Griffith, G (BAR)	Griffith, G	Obah, Darren			
BYE		RSCO			
Petronijevi (YUG)	Petronijevi	Al-Barwani			
BYE					
Wangila, Rob(KEN)	Wangila, Rob	Boudouani, L			
BYE		PTS			
Gantulga, K (MGL)	Gantulga, K	Song, Kyung			
BYE		PTS			
Hamilton, R (JAM)	Hamilton, R	RSCO			
BYE					
Bacskai, Imr(HUN)	Bacskai, Imr	Mehnert, S			
BYE		PTS			
Boudouani, L (FRA)	Boudouani, L	PTS			
BYE					
Obah, Darren (AUS)	Obah, Darren	Mohinga, Fid			
BYE		PTS			
Al-Barwani, (OMA)	Al-Barwani	Nzuzi, Adao (ANG)			
BYE		PTS			
Omona, Kasmi (UGA)	Kuenzler, A	Fria Reynos (DOM)			
BYE	PTS	RSCH			
Kuenzler, A (FRG)	PTS	Masoe, Franc (ASA)			
Walsh, Willi (IRL)	Song, Kyung	RSCH			
Song, Kyung (KOR)	RSCO				
Do Tien, Tua (VIE)	Taouane, A	Simbeye, Bos (MAW)			
Taouane, A (MAR)	PTS	Ankamah, A			
Mehnert, S (GDR)	Mehnert, S	KOH			
Oritiz, J (PUR)	PTS	Gould, Kenne			
Mohinga, Fid (CAF)	Mohinga, Fid	PTS			
Nzuzi, Adao (ANG)	PTS				
Fria Reynos (DOM)	Masoe, Franc	Antman, Sore (SWE)			
Masoe, Franc (ASA)	RSCH	RSCH			
Simbeye, Bos (MAW)	Ankamah, A	Lesivakarua (FIJ)			
Ankamah, A(GHA)	KOH	RSCH			
Marwa, Josep (TAN)	Gould, Kenne	Sobral, Mann (CAN)			
Gould, Kenne (USA)	PTS	Nyman, Joni			
Antman, Sore (SWE)	Antman, Sore	PTS			
Lesivakarua (FIJ)	RSCH				
Sobral, Mann (CAN)	Nyman, Joni	Takahashi, Y (JPN)			
Nyman, Joni (FIN)	PTS	Erechtchenk(URS)			
Takahashi, Y (JPN)	PTS	PTS			
Erechtchenk(URS)	PTS	Chisala, Dim			
Oliveira, W (BRA)	Chisala, Dim	RSCI			
Chisala, Dim (ZAM)	RSCH				



Light Middle -71Kg 1/16 Bout 2/Sept. 24		Super-welter-71Kg 1/16 Combat 2/24 Sept	
Name Nom	Ctry Pays	Result Resultat	
* Rivera, Rye Allison, Georse	PUR GUY	PTS	5:0
Referee	MOHAMED	PAK	TOTAL
Judge 1	WILLI KELLERMANN	FRG	60:56
2	KIM, YOUNG BAE	KOR	60:55
3	ZUAT GVADJAVA	URS	60:56
4	RONALD MARK GREGOR	AUS	60:54
5	MOHAMED	EGY	60:57

Light Middle-71Kg 1/16 Bout 8/Sept. 24		Super-welter-71Kg 1/16 Combat 8/24 Sept	
Name Nom	Ctry Pays	Result Resultat	
Waigo, John Bosco * Sagnon, Sounaila	UGA BUR	RSCH	1 RD. 1:51
Referee	ELMO ADOLPH	USA	
Judge 1	WILLI KELLERMANN	FRG	
2	RODERICK ROBERTSON	GBR	
3	SOMPONG SUKAR	THA	
4	RONALD MARK GREGOR	AUS	
5	TAKUYA MOROOKA	JPN	

Light Middle -71Kg 1/16 Bout 14/Sept. 24		Super-welter-71Kg 1/16 Combat 14/24 Sept	
Name Nom	Ctry Pays	Result Resultat	
Banko, Wabanko * Mercado, Laurensio	ZAI ECU	PTS	0:5
Referee	SANDOR PAJAR	HUN	TOTAL
Judge 1	STOINO PARLAPANOV	BUL	58:59
2	KISHEN M. NARSI	IND	57:58
3	PIETER GEDOAN	INA	57:60
4	GABY MANCINI	CAN	57:60
5	HONG-TSUNG YONG	TPE	57:59

Light Middle-71Kg 1/16 Bout 3/Sept. 24		Super-welter-71Kg 1/16 Combat 3/24 Sept	
Name Nom	Ctry Pays	Result Resultat	
* Woodhall, Richard Williams, Desmond	GBR SLE	PTS	5:0
Referee	AMADOR BURGUILLOS	VEN	TOTAL
Judge 1	SOMPONG SUKAR	THA	60:53
2	MOHAMED GHAZNAVI	PAK	60:54
3	LUIS MINAMI	PER	60:52
4	ELMO ADOLPH	USA	60:51
5	RONALD MARK GREGOR	AUS	60:51

Light Middle -71Kg 1/16 Bout 9/Sept. 24		Super-welter-71Kg 1/16 Combat 9/24 Sept	
Name Nom	Ctry Pays	Result Resultat	
Ramadan, Abdalla * Park, Si-Hun	SUD KOR	RSCO	2 RD. 2:15
Referee	RONALD MARK GREGOR	AUS	
Judge 1	DIMITR DORU BANCUI	ROM	
2	WILLI KELLERMANN	FRG	
3	LUIS MINAMI	PER	
4	AMADOR BURGUILLOS	VEN	
5	ELMO ADOLPH	USA	

Light Middle -71Kg 1/16 Bout 15/Sept. 24		Super-welter-71Kg 1/16 Combat 15/24 Sept	
Name Nom	Ctry Pays	Result Resultat	
* Downey, Raymond Nieroba, Norbert	CAN FRG	PTS	3:2
Referee	D. WEERAKOON	SRI	TOTAL
Judge 1	BOBD, KASULE	UGA	59:58
2	HAN, DONG-JIN	KOR	59:58
3	MOULOU KOURAD	ALG	60:56
4	HONG-TSUNG YONG	TPE	58:59
5	ALBERTO DURAN	URU	59:57

Light Middle -71Kg 1/16 Bout 4/Sept. 24		Super-welter-71Kg 1/16 Combat 4/24 Sept	
Name Nom	Ctry Pays	Result Resultat	
Orungi, Mohamad * Silveira, Apolinario	KEN ANG	RSCH	2 RD 1:33
Referee	DIMITR DORU BANCUI	ROM	
Judge 1	THEODOROS VIDALIS	GRE	
2	KIM, YOUNG BAE	KOR	
3	TAKUYA MOROOKA	JPN	
4	AMADOR BURGUILLOS	VEN	
5	LUIS MINAMI	PER	

Light Middle -71Kg 1/16 Bout 10/Sept. 24		Super-welter-71Kg 1/16 Combat 10/24 Sept	
Name Nom	Ctry Pays	Result Resultat	
* Schmitz, Torsten Stoyanov, Anguel	GDR BUL	PTS	3:2
Referee	KIM, YOUNG BAE	KOR	TOTAL
Judge 1	SOMPONG SUKAR	THA	59:58
2	MOHAMED	EGY	59:58
3	HIOUAD LARBI	MAR	59:58
4	LUIS MINAMI	PER	59:59 +
5	AMADOR BURGUILLOS	VEN	58:59

Light Middle -71Kg 1/16 Bout 16/Sept. 24		Super-welter-71Kg 1/16 Combat 16/24 Sept	
Name Nom	Ctry Pays	Result Resultat	
* Franek, Michal Mayo, Francois	TCH CMR	RSCH	2 RD. 1:46
Referee	HONG-TSUNG YONG	TPE	
Judge 1	PIETER GEDOAN	INA	
2	HAN, DONG-JIN	KOR	
3	GABY MANCINI	CAN	
4	ALBERTO DURAN	URU	
4	OSVALDO BISBAL	ARG	

Light Middle -71Kg 1/16 Bout 5/Sept. 24		Super-welter-71Kg 1/16 Combat 5/24 Sept	
Name Nom	Ctry Pays	Result Resultat	
* Syed, Abrar-Hussain lapatu, Isaac	PAK VAN	WO	
Referee	ZAUT GVADJVA	URS	
Judge 1	WERNER WEGSCHEIDER	AUT	
2	AMADOR BURGUILLOS	VEN	
3	ELMO ADOLPH	USA	
4	MULI ADE OJO	NGR	
5	MOHAMED	EGY	

Light Middle-71Kg 1/16 Bout 11/Sept. 24		Super-welter-71Kg 1/16 Combat 11/24 Sept	
Name Nom	Ctry Pays	Result Resultat	
De Lima, Johnny * Paynter, Quinn	DEN BER	RSCI	3 RD. 1:31
Referee	AUGUSTIN ZARAGOZA	MEX	
Judge 1	TAKUYA MOROOKA	JPN	
2	MOHAMED GHAZNAVI	PAK	
3	BOUNAB HEDI	TUN	
4	HIOUAD LARBI	MAR	
5	LUIS MINAMI	PER	

Light Middle -71Kg 1/8 Bout 1/Sept. 26		Super-welter-71Kg 1/8 Combat 1/26 Sept	
Name Nom	Ctry Pays	Result Resultat	
Silva, Peter * Rivera, Rey	BRA PUR	KOH	1 RD. 0:20
Referee	RYSZARD REDO	POL	
Judge 1	STIG RONGE	SWE	
2	ABDUL HANI	IRQ	
3	LEE, JAE IN	KOR	
4	BOB D. KASULE	UGA	
5	MOULOU KOURAD	ALG	

Light Middle -71Kg 1/16 Bout 6/Sept. 24		Super-welter-71Kg 1/16 Combat 6/24 Sept	
Name Nom	Ctry Pays	Result Resultat	
Makalamba, Mtenere * Jones, Roy	MAW USA	KOH	1 RD 1:44
Referee	THEODOROS VIDALIS	GRE	
Judge 1	GUSTAV BAUMGARDT	GDR	
2	MOHAMED GHAZNAVI	PAK	
3	SOMPONG SUKAR	THA	
4	LUIS MINAMI	PER	
5	RONALD MARK GREGOR	AUS	

Light Middle -71Kg 1/16 Bout 12/Sept. 24		Super-welter-71Kg 1/16 Combat 12/24 Sept	
Name Nom	Ctry Pays	Result Resultat	
* Nardiello, Vincenzo Ariu, Likou	ITA SAM	KOH	3 RD. 1:37
Referee	SOMPONG SUKAR	THA	
Judge 1	KIM, YOUNG BAE	KOR	
2	MOHAMED	EGY	
3	BOUNAB HEDI	TUN	
4	ELMO ADOLPH	USA	
5	AMADOR BURGUILLOS	VEN	

Light Middle -71Kg 1/8 Bout 2/Sept. 26		Super-welter-71Kg 1/8 Combat 2/26 Sept	
Name Nom	Ctry Pays	Result Resultat	
* Woodhall, Richard Silveira, Apolinario	GBR ANG	PTS	5:0
Referee	HONG-TSUNG YONG	TPE	TOTAL
Judge 1	D. WEERAKOON	SRI	60:53
2	KISHEN M. NARSI	IND	60:53
3	OSVALDO BISBAL	ARG	60:54
4	ALBERTO DURAN	URU	60:56
5	GABY MANCINI	CAN	60:52

Light Middle -71Kg 1/16 Bout 7/Sept. 24		Super-welter-71Kg 1/16 Combat 7/24 Sept	
Name Nom	Ctry Pays	Result Resultat	
* Zaitsev, Evgueni Smikle, Gary	URS JAM	PTS	5:0
Referee	MULI ADE OJO	NGR	TOTAL
Judge 1	BOUNAB HEDI	TUN	59:58
2	MOHAMED GHAZNAVI	PAK	60:55
3	KIM, YOUNG BAE	KOR	60:56
4	AMADOR BURGUILLOS	VEN	59:56
5	RONALD MARK GREGOR	AUS	59:56

Light Middle-71Kg 1/16 Bout 13/Sept. 24		Super-welter -71Kg 1/16 Combat 13/24 Sept	
Name Nom	Ctry Pays	Result Resultat	
Monontsi, Ncholu * Kitel, Martin	LES SWE	PTS	0:5
Referee	LEE, JAE IN	KOR	TOTAL
Judge 1	ABDUL HANI	IRQ	56:60
2	ARTURO MORALES	DOM	54:60
3	OSVALDO BISBAL	ARG	55:60
4	GABY MANCINI	CAN	54:60
5	ALBERTO DURAN	URU	55:60

Light Middle -71Kg 1/8 Bout 3/Sept. 26		Super-welter-71Kg 1/8 Combat 3/26 Sept	
Name Nom	Ctry Pays	Result Resultat	
Franek, Michal * Jones, Roy	TCH USA	PTS	0:5
Referee	LEE, JAE IN	KOR	TOTAL
Judge 1	STANLEY WACHANGA	KEN	56:60
2	MARIUS GUIRAMO LOUGBO	CIV	56:60
3	PIETER GEDOAN	INA	56:60
4	ABDUL HANI	IRQ	55:60
5	ALBERTO DURAN	URU	57:59

Boxing

Boxe

Light Middle -71Kg 1/8 Bout 4/Sept. 26		Super-welter-71Kg 1/8 Combat 4/26 Sept		
Name Nom	Ctry Pays	Result Resultat		
* Zaitsev, Evgueni Sagnon, Sounaila	URS BUR	RSCH	2 RD.	1:05
Referee	D. WEERAKOON	SRI		
Judge 1	ARTURO MORALES	DOM		
2	KISHEN M. NARSI	IND		
3	LEE, JAE IN	KOR		
4	HONG-TSUNG YONG	TPE		
5	OSVALDO BISBAL	ARG		

Light Middle -71Kg Quarter-final Bout 2/Sept. 28		Super-welter-71Kg Quart de Finale Combat 2/28 Sept		
Name Nom	Ctry Pays	Result Resultat		
* Jones, Roy Zaitsev, Evgueni	USA URS	PTS		5:0
Referee	MOHAMED	EGY	TOTAL	
Judge 1	GABY MANCINI	CAN	60:57	
2	RODERICK ROBERTSON	GBR	59:58	
3	BOB D. KASULE	UGA	60:57	
4	D. WEERAKOON	SRI	60:57	
5	ROMEO SOMODIO	PHI	60:55	

Middle -75Kg 1/32 Bout 31/Sept. 19		Moyen -75Kg 1/32 Combat 31/19 Sept		
Name Nom	Ctry Pays	Result Resultat		
* Ottke, Sven Jacobashvili, Aharon	FRG ISR	PTS		5:0
Referee	ALBERTO DURAN	URU	TOTAL	
Judge 1	STANLEY WACHANGA	KEN	60:56	
2	BOB D. KASULE	UGA	60:57	
3	OSVALDO BISBAL	ARG	60:56	
4	ARTURO MORALES	DOM	60:56	
5	HONG-TSUNG YONG	TPE	59:57	

Light Middle -71Kg 1/8 Bout 5/Sept. 26		Super-welter-71Kg 1/8 Combat 5/26 Sept		
Name Nom	Ctry Pays	Result Resultat		
* Park, Si-Hun Schmitz, Torsten	KOR GDR	PTS		5:0
Referee	GABY MANCINI	CAN	TOTAL	
Judge 1	MOULOUD KOURAD	ALG	59:58	
2	STANLEY WACHANGA	KEN	59:58	
3	OSVALDO BISBAL	ARG	59:58	
4	ALBERTO DURAN	URU	59:58	
5	ARTURO MORALES	DOM	59:57	

Light Middle-71Kg Quarter-final Bout 3/Sept. 28		Super-welter-71Kg Quart de Finale Combat 3/28 Sept		
Name Nom	Ctry Pays	Result Resultat		
* Park, Si-Hun Nardiello, Vincenzo	KOR ITA	PTS		3:2
Referee	ELMO ADOLPH	USA	TOTAL	
Judge 1	GUSTAV BAUMGARDT	GDR	57:60	
2	STANLEY WACHANGA	KEN	59:58	
3	MOULOUD KOURAD	ALG	+ 59:59	
4	PIETER GEDOAN	INA	+ 59:59	
5	ALBERTO DURAN	URU	58:60	

Middle -75Kg 1/32 Bout 32/Sept. 19		Moyen -75Kg 1/32 Combat 32/19 Sept		
Name Nom	Ctry Pays	Result Resultat		
Kassouf, Mirwan * Mastrodonato, Michele	LIB ITA	RSCH	1RD.	2:40
Referee	KEITH WALKER	NZL		
Judge 1	MOULOUD KOURAD	ALG		
2	BOB D. KASULE	UGA		
3	GABY MANCINI	CAN		
4	ALBERTO DURAN	URU		
5	OSVALDO BISBAL	ARG		

Light Middle-71Kg 1/8 Bout 6/Sept. 26		Super-welter-71Kg 1/8 Combat 6/26 Sept		
Name Nom	Ctry Pays	Result Resultat		
Paynter, Quinn * Nardiello, Vincenzo	BER ITA	KOH	2 RD.	2:08
Referee	PIETER GEDOAN	INA		
Judge 1	D. WEERAKOON	SRI		
2	HONG-TSUNG YONG	TPE		
3	ALBERTO DURAN	URU		
4	BOB D. KASULE	UGA		
5	MARIUS GUIRAMO LOUGBO	CIV		

Light Middle-71Kg Quarter-final Bout 4/Sept. 28		Super-welter-71Kg Quart de Finale Combat 4/28 Sept.		
Name Nom	Ctry Pays	Result Resultat		
Kitel, Martin * Downey, Raymond	SWE CAN	PTS		0:5
Referee	OSVALDO BISBAL	ARG	TOTAL	
Judge 1	ELMO ADOLPH	USA	57:60	
2	ZAUT GVADJAVA	URS	58:59	
3	MOHAMED	EGY	58:59	
4	SOMPONG SUKAR	THA	58:60	
5	ABDUL HANI	IRQ	58:50	

Middle -75Kg 1/16 Bout 1/Sept. 19		Moyen -75Kg 1/16 Combat 1/19 Sept		
Name Nom	Ctry Pays	Result Resultat		
* Sande, Chris Montiel, Juan	KEN URU	KOH	3RD.	0:27
Referee	LEE, JAE IN	KOR		
Judge 1	PIETER GEDOAN	INA		
2	SANDOR PAJAR	HUN		
3	RYSZARD REDO	POL		
4	ARTURO MORALES	DOM		
5	KEITH WALKER	NZL		

Light Middle -71Kg 1/8 Bout 7/Sept. 26		Super-welter -71Kg 1/8 Combat 7/26 Sept		
Name Nom	Ctry Pays	Result Resultat		
* Kitel, Martin Mercado, Laurensio	SWE ECU	PTS		3:2
Referee	KISHEN M. NARSI	IND	TOTAL	
Judge 1	LEE, JAE IN	KOR	58:59	
2	MOULOUD KOURAD	ALG	59:58	
3	STANLEY WACHANGA	KEN	60:57	
4	ARTURO MORALES	DOM	58:59	
5	ABDUL HANI	IRQ	59:58	

Light Middle -71Kg Semi-final Bout 1/Sept. 29		Super-welter-71Kg Demi-finale Combat 1/29 Sept		
Name Nom	Ctry Pays	Result Resultat		
Woodhall, Richard * Jones, Roy	GBR USA	PTS		0:5
Referee	MUJIL ADE OJO	NGR	TOTAL	
Judge 1	MOHAMED	EGY	55:60	
2	MOHAMED GHAZNAVI	PAK	57:60	
3	SAMDOR PAJAR	HUN	57:60	
4	GABY MANCINI	CAN	58:59	
5	ALBERTO DURAN	URU	57:60	

Middle -75Kg 1/16 Bout 2/Sept. 19		Moyen -75Kg 1/16 Combat 2/19 Sept		
Name Nom	Ctry Pays	Result Resultat		
* Kanela, Paul Ioannidis, Georgios	CMR GRE	PTS		3:2
Referee	HAN, DONG-JIN	KOR	TOTAL	
Judge 1	ABDUL HANI	IRQ	58:59	
2	GABY MANCINI	CAN	60:57	
3	KEITH WALKER	NZL	59:58	
4	OSVALDO BISBAL	ARG	59:58	
5	ARTURO MORALES	DOM	58:59	

Light Middle -71Kg 1/8 Bout 8/Sept. 26		Super-welter -71Kg 1/8 Combat 8/26 Sept		
Name Nom	Ctry Pays	Result Resultat		
* Downey, Raymond Syed, Abrar-Hussain	CAN PAK	PTS		5:0
Referee	VIKTOR PLAVEC	YUG	TOTAL	
Judge 1	ALDO LEONI	ITA	60:54	
2	BOB D. KASULE	UGA	60:57	
3	STANLEY WACHANGA	KEN	60:56	
4	HONG-TSUNG YONG	TPE	60:55	
5	OSVALDO BISBAL	ARG	60:54	

Light Middle -71Kg Semi-final Bout 2/Sept. 29		Super-welter-71Kg Demi-finale Combat 2/29 Sept		
Name Nom	Ctry Pays	Result Resultat		
* Park, Si-Hun Downey, Raymond	KOR CAN	PTS		5:0
Referee	DIMITR DORU BANCUI	ROM	TOTAL	
Judge 1	VIKTOR PLAVEC	YUG	59:58	
2	HIOUAD LARBI	MAR	59:58	
3	BOB D. KASULE	UGA	59:58	
4	D. WEERAKOON	SRI	59:58	
5	OSVALDO BISBAL	ARG	59:57	

Middle -75Kg 1/16 Bout 3/Sept. 19		Moyen 75Kg 1/16 Combat 3/19 Sept		
Name Nom	Ctry Pays	Result Resultat		
Vaka, Filipopalako * Joyce, Kieran	TGA IRL	RSCO	1RD.	2:13
Referee	GABY MANCINI	CAN		
Judge 1	STANLEY WACHANGA	KEN		
2	KISHEN M. NARSI	IND		
3	D. WEERAKOON	SRI		
4	MOULOUD KOURAD	ALG		
5	ALBERTO DURAN	URU		

Light Middle-71Kg Quarter-final Bout 1/Sept. 28		Super-welter -71Kg Quart de Finale Combat 1/28 Sept		
Name Nom	Ctry Pays	Result Resultat		
Rivera, Rey * Woodhall, Richard	PUR GBR	PTS		0:5
Referee	HAN, DONG-JIN	KOR	TOTAL	
Judge 1	ELMO ADOLPH	USA	57:59	
2	ALDO LEONI	ITA	54:60	
3	HIOUAD LARBI	MAR	55:60	
4	SOMPONG SUKAR	THA	56:59	
5	KISHEN M. NARSI	IND	57:59	

Light Middle-71Kg Final Bout/Oct. 2		Super-welter-71Kg Finale/2 Oct		
Name Nom	Ctry Pays	Result Resultat		
Jones, Roy * Park, Si-Hun	USA KOR	PTS		2:3
Referee	ALDO LEONI	ITA	TOTAL	
Judge 1	BOB D. KASULE	UGA	59:59 +	
2	ZAUT GVADJAVA	URS	60:56	
3	ALBERTO DURAN	URU	58:59	
4	HIOUAD LARBI	MAR	58:59	
5	SANDOR PAJAR	HUN	60:56	

Middle -75Kg 1/16 Bout 4/Sept. 19		Moyen -75Kg 1/16 Combat 4/19 Sept		
Name Nom	Ctry Pays	Result Resultat		
* Wanyama, Franco Dabai, Omar	UGA JOR	PTS		5:0
Referee	SANDOR PAJAR	HUN	TOTAL	
Judge 1	ALDO LEONI	ITA	60:54	
2	GABY MANCINI	CAN	60:55	
3	ARTURO MORALES	DOM	60:55	
4	OSVALDO BISBAL	ARG	60:55	
5	HONG-TSUNG YONG	TPE	60:55	



Light Middle -71Kg
Competition Summary

Supe-welter-71Kg
Tableau de la Competition

1/32	1/16	1/8	Quarter-final/Quart de Finale	Semi-final/Demi-finale	Final/Finale
Mahlalela, C (SWZ)	Mahlalela, C	Silva, Peter	Rivera, Rey	Woodhall, R	Jones, Roy
BYE		PTS	KOH	PTS	PTS
Silva, Peter (BRA)	Silva, Peter	Rivera, Rey	Woodhall, R	Jones, Roy	
BYE		PTS	PTS	PTS	
Rivera, Rey (PUR)	Rivera, Rey	Silveira, A	Jones, Roy		
BYE		RSCH	PTS		
Allison, Geo (GUY)	Allison, Geo	Franeck, Mich	Zaitsev, Evg		
BYE		PTS	RSCH		
Woodhall, R (GBR)	Woodhall, R	lapatu, Isaa	Sagnon, Soun		
BYE		WO	RSCH		
Williams, D (SLE)	Williams, D	Makalamba, M	Ramadan, Abd		
BYE		PTS	PTS		
Orungi, Moha (KEN)	Orungi, Moha	Jones, Roy	Park, Si-Hun		
BYE		KOH	PTS		
Silveira, A (ANG)	Silveria, A	Schmitz, Tor	Schmitz, Tor		
BYE		RSCH	PTS		
Franeck, Mich (TCH)	Franeck, Mich	Stoyanov, An	De Lima, Joh		
BYE		PTS	PTS		
lapatu, Isaa (VAN)	lapatu, Isaa	Paynter, Qui	Paynter, Qui		
BYE		WO	RSCI		
Makalamba, M (MAW)	Makalamba, M	Nardiello, V	Nardiello, V		
BYE		PTS	KOH		
Jones, Roy (USA)	Jones, Roy	Ariu, Likou	Ariu, Likou		
BYE		KOH	KOH		
Zaitsev, Evg (URS)	Zaitsev, Evg	Monontsi, Nc	Monontsi, Nc		
BYE		PTS	PTS		
Smikle, Gary (JAM)	Smikle, Gary	Kitel, Marti	Kitel, Marti		
BYE		PTS	PTS		
Waigo, J (UGA)	Waigo, J	Mercado, L	Mercado, L		
BYE		RSCH	PTS		
Sagnon, Soun (BUR)	Sagnon, Soun	Quaye, Emman	Quaye, Emman		
BYE		RSCH	KOB		
Ramadan, Abd (SUD)	Ramadan, Abd	Lopez, J	Lopez, J		
BYE		PTS	PTS		
Park, Si-Hun (KOR)	Park, Si-Hun	Downey, Raym	Downey, Raym		
BYE		RSCO	PTS		
Schmitz, Tor (GDR)	Schmitz, Tor	Felix, Garth	Felix, Garth		
BYE		PTS	PTS		
Stoyanov, An (BUL)	Stoyanov, An	Nieroba, Nor	Nieroba, Nor		
BYE		PTS	KOH		
De Lima, Joh (DEN)	De Lima, Joh	Syed, A	Syed, A		
BYE		PTS	KOH		
Paynter, Qui (BER)	Paynter, Qui	Meziane, N	Meziane, N		
BYE		RSCI	KOH		
Nardiello, V (ITA)	Nardiello, V	Mayo, Franco	Mayo, Franco		
BYE		KOH	RSCH		
Ariu, Likou (SAM)	Ariu, Likou	Wiawindi, Mo	Wiawindi, Mo		
BYE		KOH	RSCH		
Monontsi, Nc (LES)	Monontsi, Nc				
BYE					
Kitel, Marti (SWE)	Kitel, Marti				
BYE					
Banko, Waban (ZAI)	Banko, Waban				
BYE					
Mercado, L (ECU)	Mercado, L				
Quaye, Emman (GHA)	Mercado, L				
Lopez, J (ARG)	Downey, Raym				
Downey, Raym (CAN)	PTS				
Felix, Garth (GRN)	Nieroba, Nor				
Nieroba, Nor (FRG)	KOH				
Syed, A (PAK)	Syed, A				
Meziane, N (ALG)	KOH				
Mayo, Franco (CMR)	Mayo, Franco				
Wiawindi, Mo (CAF)	RSCH				

Boxing

Boxe

Middle -75Kg 1/16 Bout 5/Sept. 20

Name Nom	Ctry Pays	Result Resultat	
* Mojela, Sello	LES	PTS	5:0
Stubblefield, Simeon	LBR		

Referee			
WERNER WEGSCHEIDER	AUT	TOTAL	
Judge 1 ZAUT GVADJAVA	URS	60:55	
2 WILLI KELLERMANN	FRG	60:55	
3 ELMO ADOLPH	USA	60:55	
4 TAKUYA MOROOKA	JPN	60:54	
5 ROMEO SOMODIO	PHI	60:56	

Moyen -75Kg 1/16 Combat 5/20 Sept

Name Nom	Ctry Pays	Result Resultat	
* Mojela, Sello	LES	PTS	5:0
Stubblefield, Simeon	LBR		

Referee			
WERNER WEGSCHEIDER	AUT	TOTAL	
Judge 1 ZAUT GVADJAVA	URS	60:55	
2 WILLI KELLERMANN	FRG	60:55	
3 ELMO ADOLPH	USA	60:55	
4 TAKUYA MOROOKA	JPN	60:54	
5 ROMEO SOMODIO	PHI	60:56	

Middle -75Kg 1/16 Bout 11/Sept. 20

Name Nom	Ctry Pays	Result Resultat	
Dine, Ahmed	ALG	PTS	0:5
* Fuzesy, Zoltan	HUN		

Referee			
LEE, JAE IN	KOR	TOTAL	
Judge 1 ABDUL HANI	IRQ	58:59	
2 HONG-TSUNG YONG	TPE	57:59	
3 KEITH WALKER	NZL	58:59	
4 ARTURO MORALES	DOM	58:59	
5 OSVALDO BISBAL	ARG	57:59	

Middle -75Kg 1/8 Bout 1/Sept. 25

Name Nom	Ctry Pays	Result Resultat	
* Sande, Chris	KEN	PTS	5:0
Kamela, Paul	CMR		

Referee			
WERNER WEGSCHEIDER	AUT	TOTAL	
Judge 1 ZAUT GVADJAVA	URS	60:56	
2 SOMPONG SUKAR	THA	60:58	
3 AMADOR BURGUILLOS	VEN	60:57	
4 CHO, SUK IN	KOR	60:57	
5 AUGUSTIN ZARAGOZA	MEX	60:57	

Middle -75Kg 1/16 Bout 6/Sept. 19

Name Nom	Ctry Pays	Result Resultat	
* Maske, Henry	GDR	PTS	5:0
Palije, Helman	MAW		

Referee			
KIM, YOUNG BAE	KOR	TOTAL	
Judge 1 TAKUYA MOROOKA	JPN	60:53	
2 SOMPONG SUKAR	THA	60:55	
3 RONALD MARK GREGOR	AUS	60:54	
4 AMADOR BURGUILLOS	VEN	60:55	
5 ELMO ADOLPH	USA	60:53	

Moyen -75Kg 1/16 Combat 6/19 Sept

Name Nom	Ctry Pays	Result Resultat	
* Maske, Henry	GDR	PTS	5:0
Palije, Helman	MAW		

Referee			
KIM, YOUNG BAE	KOR	TOTAL	
Judge 1 TAKUYA MOROOKA	JPN	60:53	
2 SOMPONG SUKAR	THA	60:55	
3 RONALD MARK GREGOR	AUS	60:54	
4 AMADOR BURGUILLOS	VEN	60:55	
5 ELMO ADOLPH	USA	60:53	

Middle -75Kg 1/16 Bout 12/Sept. 20

Name Nom	Ctry Pays	Result Resultat	
Martinez, Roberto	HON	PTS	0:5
* Hukkanen, Esa	FIN		

Referee			
OSVALDO BISBAL	ARG	TOTAL	
Judge 1 MARIUS GUIRAMO LOUGBO	CIV	56:60	
2 PIETER GEDOAN	INA	54:60	
3 ABDUL HANI	IRQ	54:60	
4 ALBERTO DURAN	URU	54:60	
5 KEITH WALKER	NZL	55:60	

Middle -75Kg 1/8 Bout 2/Sept. 25

Name Nom	Ctry Pays	Result Resultat	
Joyce, Kieran	IRL	PTS	2:3
* Wanyama, Franco	UGA		

Referee			
LUIS MINAMI	PER	TOTAL	
Judge 1 TAKUYA MOROOKA	JPN	58:59	
2 ROMEO SOMODIO	PHI	58:59	
3 RONALD MARK GREGOR	AUS	59:58	
4 ELMO ADOLPH	USA	58:59	
5 AUGUSTIN ZARAGOZA	MEX	60:58	

Middle -75Kg 1/16 Bout 7/Sept. 19

Name Nom	Ctry Pays	Result Resultat	
Hembrick, Anthony	USA		
* Mastrodonato, Michele	ITA	WO	

Referee			
THEODOROS VIDALIS	GRE		
Judge 1 RODERICK ROBERTSON	GBR		
2 WILLI KELLERMANN	FRG		
3 MUILI ADE OJO	NGR		
4 RONALD MARK GREGOR	AUS		
5 BOUNAB HEDI	TUN		

Moyen -75Kg 1/16 Combat 7/19 Sept

Name Nom	Ctry Pays	Result Resultat	
Hembrick, Anthony	USA		
* Mastrodonato, Michele	ITA	WO	

Referee			
THEODOROS VIDALIS	GRE		
Judge 1 RODERICK ROBERTSON	GBR		
2 WILLI KELLERMANN	FRG		
3 MUILI ADE OJO	NGR		
4 RONALD MARK GREGOR	AUS		
5 BOUNAB HEDI	TUN		

Middle -75Kg 1/16 Bout 13/Sept. 20

Name Nom	Ctry Pays	Result Resultat	
* Dukic, Darko	YUG	RSCO	2RD. 2:03
Lesiva, Viliamu	SAM		

Referee			
CHO, SUK IN	KOR		
Judge 1 SOMPONG SUKAR	THA		
2 MOHAMED GHAZNAVI	PAK		
3 RONALD MARK GREGOR	AUS		
4 LUIS MINAMI	PER		
5 ELMO ADOLPH	USA		

Middle -75Kg 1/8 Bout 3/Sept. 25

Name Nom	Ctry Pays	Result Resultat	
Mojela, Sello	LES		
* Maske, Henry	GDR	WO	

Referee			
MOHAMED GHAZNAVI	PAK		
Judge 1 SOMPONG SUKAR	THA		
2 AMADOR BURGUILLOS	VEN		
3 AUGUSTIN ZARAGOZA	MEX		
4 RONALD MARK GREGOR	AUS		
5 ELMO ADOLPH	USA		

Middle -75Kg 1/16 Bout 8/Sept. 19

Name Nom	Ctry Pays	Result Resultat	
Tobin, John	GRN		
* Ayed, Lotfi	SWE	PTS	0:5

Referee			
MUILI ADE OJO	NGR	TOTAL	
Judge 1 TAKUYA MOROOKA	JPN	56:59	
2 MOHAMED GHAZNAVI	PAK	58:59	
3 HIOUAD LARBI	MAR	56:60	
4 ROMEO SOMODIO	PHI	57:60	
5 AMADOR BURGUILLOS	VEN	56:60	

Moyen -75Kg 1/16 Combat 8/19 Sept

Name Nom	Ctry Pays	Result Resultat	
Tobin, John	GRN		
* Ayed, Lotfi	SWE	PTS	0:5

Referee			
MUILI ADE OJO	NGR	TOTAL	
Judge 1 TAKUYA MOROOKA	JPN	56:59	
2 MOHAMED GHAZNAVI	PAK	58:59	
3 HIOUAD LARBI	MAR	56:60	
4 ROMEO SOMODIO	PHI	57:60	
5 AMADOR BURGUILLOS	VEN	56:60	

Middle -75Kg 1/16 Bout 14/Sept. 20

Name Nom	Ctry Pays	Result Resultat	
* Marcus, Egerton	CAN	KOH	1RD. 1:36
Legaspi, Emmanuel	PHI		

Referee			
RODERICK ROBERTSON	GBR		
Judge 1 MUILI ADE OJO	NGR		
2 HIOUAD LARBI	MAR		
3 AMADOR BURGUILLOS	VEN		
4 WERNER WEGSCHEIDER	AUT		
5 ZAUT GVADJAVA	URS		

Middle -75Kg 1/8 Bout 4/Sept. 25

Name Nom	Ctry Pays	Result Resultat	
* Mastrodonato, Michele	ITA	PTS	5:0
Ayed, Lotfi	SWE		

Referee			
TAKUYA MOROOKA	JPN	TOTAL	
Judge 1 ROMEO SOMODIO	PHI	59:58	
2 MUILI ADE OJO	NGR	59:57	
3 MOHAMED	EGY	59:58	
4 LUIS MINAMI	PER	59:58	
5 ELMO ADOLPH	USA	60:57	

Middle -75Kg 1/16 Bout 9/Sept. 20

Name Nom	Ctry Pays	Result Resultat	
* Syed, Hussain Shah	PAK	PTS	3:2
Amarillas, Martin	MEX		

Referee			
STOINO PARLAPANOV	BUL	TOTAL	
Judge 1 SANDOR PAJAR	HUN	58:59	
2 BOB D. KASULE	UGA	58:59	
3 MOULOUD KOURAD	ALG	60:57	
4 ALBERTO DURAN	URU	59:58	
5 OSVALDO BISBAL	ARG	59:58	

Moyen -75Kg 1/16 Combat 9/20 Sept

Name Nom	Ctry Pays	Result Resultat	
* Syed, Hussain Shah	PAK	PTS	3:2
Amarillas, Martin	MEX		

Referee			
STOINO PARLAPANOV	BUL	TOTAL	
Judge 1 SANDOR PAJAR	HUN	58:59	
2 BOB D. KASULE	UGA	58:59	
3 MOULOUD KOURAD	ALG	60:57	
4 ALBERTO DURAN	URU	59:58	
5 OSVALDO BISBAL	ARG	59:58	

Middle -75Kg 1/16 Bout 15/Sept. 20

Name Nom	Ctry Pays	Result Resultat	
* Taramov, Rouslan	URS	KOH	1RD. 1:01
Simbo, Samuel	SLE		

Referee			
MOHAMED GHAZNAVI	PAK		
Judge 1 ROMEO SOMODIO	PHI		
2 TAKUYA MOROOKA	JPN		
3 RONALD MARK GREGOR	AUS		
4 ELMO ADOLPH	USA		
5 LUIS MINAMI	PER		

Middle -75Kg 1/8 Bout 5/Sept. 25

Name Nom	Ctry Pays	Result Resultat	
* Syed, Hussain Shah	PAK	PTS	5:0
Kabongo, Musungay	ZAI		

Referee			
STOINO PARLAPANOV	BUL	TOTAL	
Judge 1 VIKTOR PLAVEC	YUG	60:57	
2 OSVALDO BISBAL	ARG	60:56	
3 HONG-TSUNG YONG	TPE	60:57	
4 ARTURO MORALES	DOM	60:56	
5 ALBERTO DURAN	URU	60:55	

Middle -75Kg 1/16 Bout 10/Sept. 20

Name Nom	Ctry Pays	Result Resultat	
* Kabongo, Musungay	ZAI	RSCH	1RD. 1:13
lahuat, James	VAN		

Referee			
STIG RONGE	SWE		
Judge 1 SANDOR PAJAR	HUN		
2 HAN, DONG-JIN	KOR		
3 D. WEERAKOON	SRI		
4 GABY MANCINI	CAN		
5 ALBERTO DURAN	URU		

Moyen -75Kg 1/16 Combat 10/20 Sept

Name Nom	Ctry Pays	Result Resultat	
* Kabongo, Musungay	ZAI	RSCH	1RD. 1:13
lahuat, James	VAN		

Referee			
STIG RONGE	SWE		
Judge 1 SANDOR PAJAR	HUN		
2 HAN, DONG-JIN	KOR		



Middle -75Kg 1/8 Bout 7/Sept. 25			Moyen -75Kg 1/8 Combat 7/25 Sept		
Name Nom	Ctry Pays	Result Resultat			
Dukic, Darko	YUG				
* Marcus, Egerton	CAN	KOH	2RD.	0:32	
Referee	ALBERTO DURAN		URU		
Judge 1	HAN, DONG-JIN		KOR		
2	PIETER GEDOAN		INA		
3	HONG-TSUNG YONG		TPE		
4	MARIUS GUIRAMO LOUGBO		CIV		
5	STANLEY WACHANGA		KEN		

Middle -75Kg Semi-final Bout 1/Sept. 29			Moyen -75Kg Demi-finale Combat 1/29 Sept		
Name Nom	Ctry Pays	Result Resultat			
Sande, Chris	KEN				
* Maske, Henry	GDR	PTS		0:5	
Referee	ELMO ADOLPH		USA	TOTAL	
Judge 1	BOB D. KASULE		UGA	57:60	
2	SOMPONG SUKAR		THA	57:60	
3	STIG RONGE		SWE	57:59	
4	GABY MANCINI		CAN	57:60	
5	OSVALDO BISBAL		ARG	56:60	

Light Heavy -81Kg 1/16 Bout 6/Sept. 21			Mi-lourd -81Kg 1/16 Combat 6/21 Sept		
Name Nom	Ctry Pays	Result Resultat			
Nanton, Hudson	VIN				
* Elnagar, Ahmed	EGY	WO			
Referee	DIMITR DORU BANCUI		ROM		
Judge 1	THEODOROS VIDALIS		GRE		
2	MOHAMED GHAZNAVI		PAK		
3	ROMEO SOMODIO		PHI		
4	CHO, SUK IN		KOR		
5	WILLI KELLERMANN		FRG		

Middle -75Kg 1/8 Bout 8/Sept. 25			Moyen -75Kg 1/8 Combat 8/25 Sept		
Name Nom	Ctry Pays	Result Resultat			
Taramov, Rouslan	URS				
* Ottke, Sven	FRG	PTS		0:5	
Referee	HONG-TSUNG YONG		TPE	TOTAL	
Judge 1	LEE, JAE IN		KOR	57:59	
2	D. WEERAKOON		SRI	58:60	
3	BOB D. KASULE		UGA	57:60	
4	MOULOUD KOURAD		ALG	56:59	
5	GABY MANCINI		CAN	56:60	

Middle -75Kg Semi-final Bout 2/Sept. 29			Moyen -75Kg Demi-finale Combat 2/29 Sept		
Name Nom	Ctry Pays	Result Resultat			
Syed, Hussain Shah	PAK				
* Marcus, Egerton	CAN	PTS		1:4	
Referee	VIKTOR PLAVEC		YUG	TOTAL	
Judge 1	ROMEO SOMODIO		PHI	+ 59:59	
2	ZAUT GVADJAVA		URS	57:60	
3	ELMO ADOLPH		USA	57:60	
4	ALBERTO DURAN		URU	58:59	
5	HIOUAD LARBI		MAR	56:60	

Light Heavy -81Kg 1/16 Bout 7/Sept. 21			Mi-lourd -81Kg 1/16 Combat 7/21 Sept		
Name Nom	Ctry Pays	Result Resultat			
Dixon, Terry	JAM				
* Madsen, Niels H	DEN	RSCH	2RD.	2:50	
Referee	TAKUYA MOROOKA		JPN		
Judge 1	SOMPONG SUKAR		THA		
2	MULI ADE OJO		NGR		
3	HIOUAD LARBI		MAR		
4	LUIS MINAMI		PER		
5	RONALD MARK GREGOR		AUS		

Middle -75Kg Quarter-final Bout 1/Sept. 27			Moyen -75Kg Quart de Finale Combat 1/27 Sept		
Name Nom	Ctry Pays	Result Resultat			
Sande, Chris	KEN	PTS		5:0	
Wanyama, Franco	UGA				
Referee	GUSTAV BAUMGARDT		GDR	TOTAL	
Judge 1	WILLI KELLERMANN		FRG	60:57	
2	ALDO LEONI		ITA	60:56	
3	TAKUYA MOROOKA		JPN	60:56	
4	ABDUL HANI		IRQ	59:57	
5	MOULOUD KOURAD		ALG	60:56	

Middle -75Kg Final/Oct. 1			Moyen -75Kg Finale/1 Oct		
Name Nom	Ctry Pays	Result Resultat			
Maske, Henry	GDR	PTS		5:0	
Marcus, Egerton	CAN				
Referee	OSVALDO BISBAL		ARG	TOTAL	
Judge 1	BOB D. KASULE		UGA	59:58	
2	ALBERTO DURAN		URU	59:58	
3	MOHAMED GHAZNAVI		PAK	60:56	
4	HIOUAD LARBI		MAR	60:56	
5	SOMPONG SUKAR		THA	60:57	

Light Heavy -81Kg 1/16 Bout 8/Sept. 21			Mi-lourd -81Kg 1/16 Combat 8/21 Sept		
Name Nom	Ctry Pays	Result Resultat			
Park, Byung-Jin	KOR				
* Petrich, Henryk	POL	RSCH	2RD.	2:50	
Referee	HIOUAD LARBI		MAR		
Judge 1	MULI ADE OJO		NGR		
2	ELMO ADOLPH		USA		
3	LUIS MINAMI		PER		
4	RONALD MARK GREGOR		AUS		
5	MOHAMED		EGY		

Middle -75Kg Quarter-final Bout 2/Sept. 27			Moyen -75Kg Quart de Finale Combat 2/27 Sept		
Name Nom	Ctry Pays	Result Resultat			
Maske, Henry	GDR	PTS		5:0	
Mastrodonato, Michele	ITA				
Referee	MOHAMED GHAZNAVI		PAK	TOTAL	
Judge 1	HIOUAD LARBI		MAR	60:56	
2	KISHEN M. NARSI		IND	60:55	
3	LEE, JAE IN		KOR	60:56	
4	MULI ADE OJO		NGR	60:54	
5	ELMO ADOLPH		USA	60:55	

Light Heavy-81Kg 1/16 Bout 9/Sept. 21			Mi-lourd -81Kg 1/16 Combat 9/21 Sept		
Name Nom	Ctry Pays	Result Resultat			
Imadiyi, Osmond	NGR	KOH	1RD.	2:23	
Kanika, Rund	ZAI				
Referee	OSVALDO BISBAL		ARG		
Judge 1	ALBERTO DURAN		URU		
2	STIG RONGE		SWE		
3	RYSZARD REDO		POL		
4	ABDUL HANI		IRQ		
5	GABY MANCINI		CAN		

Middle -75Kg Quarter-final Bout 3/Sept. 27			Moyen -75Kg Quart de Finale Combat 3/27 Sept		
Name Nom	Ctry Pays	Result Resultat			
Syed, Hussain Shah	PAK	PTS		3:2	
Fuzesy, Zoltan	HUN				
Referee	GABY MANCINI		CAN	TOTAL	
Judge 1	RYSZARD REDO		POL	58:59	
2	ELMO ADOLPH		USA	58:60	
3	ABDUL HANI		IRQ	+ 59:59	
4	HAN, DONG-JIN		KOR	59:58	
5	STANLEY WACHANGA		KEN	59:58	

Light Heavy -81Kg 1/16 Bout 10/Sept. 21			Mi-lourd -81Kg 1/16 Combat 10/21 Sept		
Name Nom	Ctry Pays	Result Resultat			
Kirilov, Deian	BUL				
* Skaro, Damir	YUG	PTS		2:3	
Referee	KEITH WALKER		NZL	TOTAL	
Judge 1	HONG-TSUNG YONG		TPE	59:58	
2	STANLEY WACHANGA		KEN	58:59	
3	MOULOUD KOURAD		ALG	59:58	
4	ARTURO MORALES		DOM	57:60	
5	KISHEN M. NARSI		IND	58:60	

Middle -75Kg Quarter-final Bout 4/Sept. 27			Moyen -75Kg Quart de Finale Combat 4/27 Sept		
Name Nom	Ctry Pays	Result Resultat			
Marcus, Egerton	CAN	PTS		5:0	
Ottke, Sven	FRG				
Referee	PIETER GEDOAN		INA	TOTAL	
Judge 1	ZAUT GVADJAVA		URS	59:58	
2	ELMO ADOLPH		USA	60:55	
3	D. WEERAKOON		SRI	59:58	
4	TAKUYA MOROOKA		JPN	60:56	
5	HIOUAD LARBI		MAR	59:58	

Light Heavy -81Kg 1/16 Bout 11/Sept. 21			Mi-lourd -81Kg 1/16 Combat 11/21 Sept		
Name Nom	Ctry Pays	Result Resultat			
Taliauli, Sione Vaveni	TGA	KOH	1RD.	2:20	
Bauro, Tommy	SOL				
Referee	SANDOR PAJAR		HUN		
Judge 1	RYSZARD REDO		POL		
2	ABDUL HANI		IRQ		
3	D. WEERAKOON		SRI		
4	BOB D. KASULE		UGA		
5	HONG-TSUNG YONG		TPE		

Boxing

Boxe

Middle -75Kg
Competition Summary

Moyen -75Kg
Tableau de la Competition

1/32	1/16	1/8	Quarter-final/Quart de Finale	Semi-final/Demi-finale	Final/Finale
Sande, Chris (KEN)	Sande, Chris	Sande, Chris KOH	Sande, Chris PTS	Sande, Chris PTS	Maske, Henry PTS
BYE					
Montiel, Jua (URU)	Montiel, Jua	Kamela, Paul PTS	Wanyama, Fra PTS	Maske, Henry PTS	
BYE					
Kamela, Paul (CMR)	Kamela, Paul	Joyce, Kiera RSCO	Maske, Henry WO	Maske, Henry PTS	
BYE					
Ioannidis, G (GRE)	Ioannidis, G	Wanyama, Fra PTS	Ha, Jong-Ho PTS	Syed, H PTS	
BYE					
Vaka, F (TGA)	Vaka, F	Mojela, Sell PTS	Maske, Henry PTS	Maske, Henry PTS	
BYE					
Joyce, Kiera (IRL)	Joyce, Kiera	Maske, Henry PTS	Ha, Jong-Ho PTS	Syed, H PTS	
BYE					
Wanyama, Fra (UGA)	Wanyama, Fra	Maske, Henry PTS	Syed, H PTS	Syed, H PTS	
BYE					
Dabaj, Omar (JOR)	Dabaj, Omar	Maske, Henry PTS	Syed, H PTS	Syed, H PTS	
BYE					
Mojela, Sell (LES)	Mojela, Sell	Maske, Henry PTS	Syed, H PTS	Syed, H PTS	
BYE					
Stubblefiel (LBR)	Stubblefiel	Maske, Henry PTS	Syed, H PTS	Syed, H PTS	
BYE					
Maske, Henry (GDR)	Maske, Henry	Maske, Henry PTS	Syed, H PTS	Syed, H PTS	
BYE					
Palijs, Helm (MAW)	Palijs, Helm	Maske, Henry PTS	Syed, H PTS	Syed, H PTS	
BYE					
Hembrick, A (USA)	Hembrick, A	Maske, Henry PTS	Syed, H PTS	Syed, H PTS	
BYE					
Ha, Jong-Ho (KOR)	Ha, Jong-Ho	Maske, Henry PTS	Syed, H PTS	Syed, H PTS	
BYE					
Tobin, John (GRN)	Tobin, John	Maske, Henry PTS	Syed, H PTS	Syed, H PTS	
BYE					
Ayed, Lotfi (SWE)	Ayed, Lotfi	Maske, Henry PTS	Syed, H PTS	Syed, H PTS	
BYE					
Syed, H (PAK)	Syed, H	Maske, Henry PTS	Syed, H PTS	Syed, H PTS	
BYE					
Amarillas, M (MEX)	Amarillas, M	Maske, Henry PTS	Syed, H PTS	Syed, H PTS	
BYE					
Kabongo, M (ZAI)	Kabongo, M	Maske, Henry PTS	Syed, H PTS	Syed, H PTS	
BYE					
Iahuat, Jame (VAN)	Iahuat, Jame	Maske, Henry PTS	Syed, H PTS	Syed, H PTS	
BYE					
Dine, Ahmed (ALG)	Dine, Ahmed	Maske, Henry PTS	Syed, H PTS	Syed, H PTS	
BYE					
Fuzesy, Zolt (HUN)	Fuzesy, Zolt	Maske, Henry PTS	Syed, H PTS	Syed, H PTS	
BYE					
Martinez, R (HON)	Martinez, R	Maske, Henry PTS	Syed, H PTS	Syed, H PTS	
BYE					
Hukkanen, Es (FIN)	Hukkanen, Es	Maske, Henry PTS	Syed, H PTS	Syed, H PTS	
BYE					
Dukic, Darko (YUG)	Dukic, Darko	Maske, Henry PTS	Syed, H PTS	Syed, H PTS	
BYE					
Lesiva, Vili (SAM)	Lesiva, Vili	Maske, Henry PTS	Syed, H PTS	Syed, H PTS	
BYE					
Marcus, Eger (CAN)	Marcus, Eger	Maske, Henry PTS	Syed, H PTS	Syed, H PTS	
BYE					
Legaspi, E (PHI)	Legaspi, E	Maske, Henry PTS	Syed, H PTS	Syed, H PTS	
BYE					
Taramov, Rou (URS)	Taramov, Rou	Maske, Henry PTS	Syed, H PTS	Syed, H PTS	
BYE					
Simbo, Samue (SLE)	Simbo, Samue	Maske, Henry PTS	Syed, H PTS	Syed, H PTS	
BYE					
Ottke, Sven (FRG)	Ottke, Sven	Maske, Henry PTS	Syed, H PTS	Syed, H PTS	
BYE					
Jacobashvil (ISR)	PTS	Maske, Henry PTS	Syed, H PTS	Syed, H PTS	
BYE					
Kassouf, Mir (LIB)	Mastrodonat	Maske, Henry PTS	Syed, H PTS	Syed, H PTS	
BYE					
Mastrodonat (ITA)	RSCH	Maske, Henry PTS	Syed, H PTS	Syed, H PTS	
BYE					



Light Heavy -81Kg 1/16 Bout 12/Sept. 21		Mi-lourd -81Kg 1/16 Combat 12/21 Sept		
Name Nom	Ctry Pays	Result Resultat		
* Akhasamba, Joseph Nedd, Jeffrey	KEN ARU	RSCH	2RD.	0:53
Referee	HAN, DONG-JIN	KOR		
Judge 1	SANDOR PAJAR	HUN		
2	ALDO LEONI	ITA		
3	PIETER GEDOAN	INA		
4	ALBERTO DURAN	URU		
5	OSVALDO BISBAL	ARG		

Light Heavy-81Kg 1/8 Bout 2/Sept. 25		Mi-lourd -81Kg 1/8 Combat 2/25 Sept		
Name Nom	Ctry Pays	Result Resultat		
* Maynard, Andrew Masoe, Mikaele	USA ASA	RSCO	2RD.	2:34
Referee	BOUNAB HEDI	TUN		
Judge 1	MUJLI ADE OJO	NGR		
2	ZAUT GVADJAVA	URS		
3	WILLI KELLERMANN	FRG		
4	TAKUYA MOROOKA	JPN		
5	SOMPONG SUKAR	THA		

Light Heavy -81Kg 1/8 Bout 8/Sept. 25		Mi-lourd -81Kg 1/8 Combat 8/25 Sept		
Name Nom	Ctry Pays	Result Resultat		
Bott, Markus * Chanavazov, Nourmagomed	FRG URS	PTS		0:5
Referee	KISHEN M. NARSI	IND	TOTAL	
Judge 1	PIETER GEDOAN	INA	57:60	
2	STANLEY WACHANGA	KEN	56:60	
3	MARIUS GUIRAMO LOUGBO	CIV	57:60	
4	GABY MANCINI	CAN	58:59	
5	OSVALDO BISBAL	ARG	58:59	

Light Heavy -81Kg 1/16 Bout 13/Sept. 21		Mi-lourd -81Kg 1/16 Combat 13/21 Sept		
Name Nom	Ctry Pays	Result Resultat		
* Magi, Andrea Ulberg, Pua	ITA SAM	PTS		5:0
Referee	ELMO ADOLPH	USA	TOTAL	
Judge 1	ROMEO SOMODIO	PHI	59:58	
2	TAKUYA MOROOKA	JPN	60:56	
3	MUJLI ADE OJO	NGR	60:55	
4	HIOUAD LARBI	MAR	60:56	
5	LUIS MINAMI	PER	60:56	

Light Heavy -81Kg 1/8 Bout 3/Sept. 25		Mi-lourd -81Kg 1/8 Combat 3/25 Sept		
Name Nom	Ctry Pays	Result Resultat		
Collins, Christopher * Elnagar, Ahmed	GRN EGY	PTS		0:5
Referee	CHO, SUK IN	KOR	TOTAL	
Judge 1	MOHAMED GHAZNAVI	PAK	57:60	
2	ROMEO SOMODIO	PHI	58:59	
3	RODERICK ROBERTSON	GBR	55:60	
4	WERNER WEGSCHEIDER	AUT	56:60	
5	RONALD MARK GREGOR	AUS	58:59	

Light Heavy -81Kg Quarter-final Bout 1/Sept. 27		Mi-lourd -81Kg Quart de Finale Combat 1/27 Sept		
Name Nom	Ctry Pays	Result Resultat		
Eros, Lajos * Maynard, Andrew	HUN USA	PTS		0:5
Referee	LEE, JAE IN	KOR	TOTAL	
Judge 1	KISHEN M. NARSI	IND	56:60	
2	D. WEERAKOON	SRI	53:60	
3	BOB D. KASULE	UGA	57:60	
4	WILLI KELLERMANN	FRG	55:60	
5	GABY MANCINI	CAN	55:60	

Light Heavy -81Kg 1/16 Bout 14/Sept. 21		Mi-lourd -81Kg 1/16 Combat 14/21 Sept		
Name Nom	Ctry Pays	Result Resultat		
* Kosolofski, Brent El-Masri, Ahmad	CAN LIB	RSCH	3RD.	1:57
Referee	RONALD MARK GREGOR	AUS		
Judge 1	WILLI KELLERMANN	FRG		
2	ZAUT GVADJAVA	URS		
3	MUJLI ADE OJO	NGR		
4	HIOUAD LARBI	MAR		
5	LUIS MINAMI	PER		

Light Heavy -81Kg 1/8 Bout 4/Sept. 25		Mi-lourd -81Kg 1/8 Combat 4/25 Sept		
Name Nom	Ctry Pays	Result Resultat		
Madsen, Niels H * Petrich, Henryk	DEN POL	PTS		0:5
Referee	HIOUAD LARBI	MAR	TOTAL	
Judge 1	BOUNAB HEDI	TUN	57:60	
2	MOHAMED	EGY	57:60	
3	CHO, SUK IN	KOR	58:60	
4	AUGUSTIN ZARAGOZA	MEX	57:60	
5	LUIS MINAMI	PER	57:60	

Light Heavy-81Kg Quarter-final Bout 2/Sept. 27		Mi-lourd -81Kg Quart de Finale Combat 2/27 Sept		
Name Nom	Ctry Pays	Result Resultat		
Elnagar, Ahmed * Petrich, Henryk	EGY POL	PTS		0:5
Referee	ROMEO SOMODIO	PHI	TOTAL	
Judge 1	PIETER GEDOAN	INA	58:60	
2	DIMITR DORU BANCUI	ROM	57:60	
3	MOULOUD KOURAD	ALG	57:60	
4	GABY MANCINI	CAN	57:60	
5	OSVALDO BISBAL	ARG	57:60	

Light Heavy-81Kg 1/16 Bout 15/Sept. 21		Mi-lourd -81Kg 1/16 Combat 15/21 Sept		
Name Nom	Ctry Pays	Result Resultat		
* Bott, Markus Suetovius, Rene	FRG GDR	RSCH	3RD.	2:43
Referee	KEITH WALKER	NZL		
Judge 1	HAN, DONG-JIN	KOR		
2	D. WEERAKOON	SRI		
3	BOB D. KASULE	UGA		
4	MOULOUD KOURAD	ALG		
5	GABY MANCINI	CAN		

Light Heavy -81Kg 1/8 Bout 5/Sept. 25		Mi-lourd-81Kg 1/8 Combat 5/25 Sept		
Name Nom	Ctry Pays	Result Resultat		
Imadiji, Osmond * Skaro, Damir	NGR YUG	PTS		0:5
Referee	ABDUL HANI	IRQ	TOTAL	
Judge 1	D. WEERAKOON	SRI	56:60	
2	GABY MANCINI	CAN	56:60	
3	PIETER GEDOAN	INA	56:60	
4	ARTURO MORALES	DOM	55:60	
5	ALBERTO DURAN	URU	57:60	

Light Heavy -81Kg Quarter-final Bout 3/Sept. 27		Mi-lourd -81Kg Quart de Finale Combat 3/27 Sept		
Name Nom	Ctry Pays	Result Resultat		
* Skaro, Damir Akhasamba, Joseph	YUG KEN	PTS		5:0
Referee	OSVALDO BISBAL	ARG	TOTAL	
Judge 1	ALBERTO DURAN	URU	60:57	
2	TAKUYA MOROOKA	JPN	60:57	
3	SANDOR PAJAR	HUN	60:57	
4	BOB D. KASULE	UGA	60:58	
5	GABY MANCINI	CAN	60:57	

Light Heavy -81Kg 1/16 Bout 16/Sept. 21		Mi-lourd -81Kg 1/16 Combat 16/21 Sept		
Name Nom	Ctry Pays	Result Resultat		
Lihanda, Patrick * Chanavazov, Nourmagomed	UGA URS	PTS		2:3
Referee	GABY MANCINI	CAN	TOTAL	
Judge 1	PIETER GEDOAN	INA	58:60	
2	ABDUL HANI	IRQ	59:58	
3	ARTURO MORALES	DOM	57:60	
4	HAN, DONG-JIN	KOR	+ 58:58	
5	KEITH WALKER	NZL	58:59	

Light Heavy -81Kg 1/8 Bout 6/Sept. 25		Mi-lourd -81Kg 1/8 Combat 6/25 Sept		
Name Nom	Ctry Pays	Result Resultat		
Taliauli, Sione Vaveni * Akhasamba, Joseph	TGA KEN	PTS		0:5
Referee	STOINO PARLAPANOV	BUL	TOTAL	
Judge 1	ALDO LEONI	ITA	53:60	
2	LEE, JAE IN	KOR	55:60	
3	KISHEN M. NARSI	IND	56:60	
4	ARTURO MORALES	DOM	55:60	
5	ALBERTO DURAN	URU	56:60	

Light Heavy -81Kg Quarter-final Bout 4/Sept. 27		Mi-lourd-81Kg Quart de Finale Combat 4/27 Sept		
Name Nom	Ctry Pays	Result Resultat		
Magi, Andrea * Chanavazov, Nourmagomed	ITA URS	PTS		0:5
Referee	MOHAMED	EGY	TOTAL	
Judge 1	KIM, YOUNG BAE	KOR	56:60	
2	MOHAMED GHAZNVI	PAK	57:60	
3	MUJLI ADE OJO	NGR	57:60	
4	MOULOUD KOURAD	ALG	57:60	
5	ALBERTO DURAN	URU	57:60	

Light Heavy -81Kg 1/8 Bout 1/Sept. 25		Mi-lourd -81Kg 1/8 Combat 1/25 Sept		
Name Nom	Ctry Pays	Result Resultat		
* Eros, Lajos Adams, Nelson	HUN PUR	PTS		4:1
Referee	MOHAMED	EGY	TOTAL	
Judge 1	HIOUAD LARBI	MAR	59:58	
2	TAKUYA MOROOKA	JPN	58:59	
3	CHO, SUK IN	KOR	59:58	
4	AMADOR BURGUILLOS	VEN	59:58	
5	RONALD MARK GREGOR	AUS	60:56	

Light Heavy -81Kg 1/8 Bout 7/Sept. 25		Mi-lourd -81Kg 1/8 Combat 7/25 Sept		
Name Nom	Ctry Pays	Result Resultat		
* Magi, Andrea Kosolofski, Brent	ITA CAN	PTS		4:1
Referee	PIETER GEDOAN	INA	TOTAL	
Judge 1	D. WEERAKOON	SRI	60:58	
2	BOB D. KASULE	UGA	58:59	
3	MOULOUD KOURAD	ALG	60:57	
4	ALBERTO DURAN	URU	59:58	
5	HONG-TSUNG YONG	TPE	59:58	

Light Heavy -81Kg Semi-final Bout 1/Sept. 29		Mi-lourd-81Kg Demi-finale Combat 1/29 Sept		
Name Nom	Ctry Pays	Result Resultat		
* Maynard, Andrew Petrich, Henryk	USA POL	RET	3RD.	0:01
Referee	OSVALDO BISBAL	ARG		
Judge 1	WERNER WEGSCHEIDER	AUT		
2	MOHAMED	EGY		
3	TAKUYA MOROOKA	JPN		
4	ALBERTO DURAN	URU		
5	GABY MANCINI	CAN		

Boxing

Boxe

Light Heavy-81Kg
Competition Summary

Mi-lourd -81Kg
Tableau de la Competition





Light Heavy -81Kg Semi-final Bout 2/Sept. 29		Mi-lourd -81Kg Demi-finale Combat 2/29 Sept	
Name Nom	Ctry Pays	Result Resultat	
Skaro, Damir	YUG		
* Chanavazov, Nourmagomed	URS	WO	
Referee	THEODOROS VIDALIS	GRE	
Judge 1	BOB D. KASULE	UGA	
2	ABDUL HANI	IQR	
3	KISHEN M. NARSI	IND	
4	ELMO ADOLPH	USA	
5	ALBERTO DURAN	URU	

Heavy -91Kg 1/16 Bout 15/Sept. 22		Lourd -91Kg 1/16 Combat 15/22 Sept	
Name Nom	Ctry Pays	Result Resultat	
Nielsen, Claus Borge	DEN		
* Glesby, Tom	CAN	RSCH 3RD. 2:17	
Referee	MUILI ADE OJO	NGR	
Judge 1	MOHAMED	EGY	
2	CHO, SUK IN	KOR	
3	MOHAMED GHAZNAVI	PAK	
4	RONALD MARK GREGOR	AUS	
5	AMADOR BURGUILLOS	VEN	

Heavy -91Kg 1/8 Bout 5/Sept. 26		Lourd -91Kg 1/8 Combat 5/26 Sept	
Name Nom	Ctry Pays	Result Resultat	
Sebiev, Ramzan	URS		
* Gaudiano, Luigi	ITA	PTS 2:3	
Referee	OSVALDO BISBAL	ARG	TOTAL
Judge 1	STANLEY WACHANGA	KEN	58:59
2	ABDUL HANI	IRQ	59:58
3	HAN, DONG-JIN	KOR	59:58
4	GABY MANCINI	CAN	58:59
5	ALBERTO DURAN	URU	58:59

Light Heavy-81Kg Final Bout/Oct.2		Mi-lourd-81Kg Finale/2 Oct	
Name Nom	Ctry Pays	Result Resultat	
* Maynard, Andrew	USA	PTS 5:0	
Chanavazov, Nourmagomed	URS		
Referee	SOMPONG SUKAR	THA	TOTAL
Judge 1	KISHEN M. NARSI	IND	59:58
2	OSVALDO BISBAL	ARG	59:58
3	BOB D. KASULE	UGA	59:58
4	D. WEERAKOON	SRI	60:58
5	HIOUAD LARBI	MAR	59:58

Heavy -91Kg 1/16 Bout 16/Sept. 22		Lourd -91Kg 1/16 Combat 16/22 Sept	
Name Nom	Ctry Pays	Result Resultat	
Ortega, Jose	ESP		
* Alvics, Gyula	HUN	PTS 0:5	
Referee	HIOUAD LARBI	MAR	TOTAL
Judge 1	BOUNAB HEDI	TUN	58:59
2	ROMEO SOMODIO	PHI	57:59
3	TAKUYA MOROOKA	JPN	58:59
4	LUIS MINAMI	PER	58:59
5	ELMO ADOLPH	USA	58:59

Heavy-91Kg 1/8 Bout 6/Sept. 26		Lourd -91Kg 1/8 Combat 6/26 Sept	
Name Nom	Ctry Pays	Result Resultat	
Gavenciak, Rudolf	TCH		
* Mercer, Ray	USA	RSCH 3 RD. 0:35	
Referee	HAN, DONG-JIN	KOR	
Judge 1	D. WEERAKOON	SRI	
2	PIETER GEDOAN	INA	
3	BOB D. KASULE	UGA	
4	MOULOU KOURAD	ALG	
5	OSVALDO BISBAL	ARG	

Heavy-91Kg 1/8 Bout 1/Sept. 26		Lourd-91Kg 1/8 Combat 1/26 Sept	
Name Nom	Ctry Pays	Result Resultat	
* Heydeck, Maik	GDR	PTS 5:0	
Diaz, Juan Antonio	ARG		
Referee	TAKUYA MOROOKA	JPN	TOTAL
Judge 1	ROMEO SOMODIO	PHI	60:57
2	MOHAMED	EGY	60:57
3	MUILI ADE OJO	NGR	60:56
4	ELMO ADOLPH	USA	60:56
5	RONALD MARK GREGOR	AUS	60:55

Heavy -91Kg 1/8 Bout 7/Sept. 26		Lourd -91Kg 1/8 Combat 7/26 Sept	
Name Nom	Ctry Pays	Result Resultat	
* Vanderlijde, Arnold	HOL	PTS 3:2	
Akinwande, Henry	GBR		
Referee	ALBERTO DURAN	URU	TOTAL
Judge 1	GABY MANCINI	CAN	59:58
2	MARIUS GUIRAMO LOUGBO	CIV	59:58
3	STANLEY WACHANGA	KEN	56:60
4	ABDUL HANI	IRQ	59:59 +
5	KISHEN M. NARSI	IND	59:58

Heavy -91Kg 1/8 Bout 2/Sept. 26		Lourd -91Kg 1/8 Combat 2/26 Sept	
Name Nom	Ctry Pays	Result Resultat	
Mavrovic, Zeljko	YUG		
* Baik, Hyun-Man	KOR	PTS 0:5	
Referee	MOHAMED	EGY	TOTAL
Judge 1	BOUNAB HEDI	TUN	58:58 +
2	AMADOR BURGUILLOS	VEN	58:59
3	AUGUSTIN ZARAGOZA	MEX	57:59
4	RONALD MARK GREGOR	AUS	58:58 +
5	LUIS MINAMI	PER	56:60

Heavy -91Kg 1/8 Bout 8/Sept. 26		Lourd -91Kg 1/8 Combat 8/26 Sept	
Name Nom	Ctry Pays	Result Resultat	
Glesby, Tom	CAN		
* Alvics, Gyula	HUN	RSCH 2RD. 1:42	
Referee	ABDUL HANI	IRQ	
Judge 1	KISHEN M. NARSI	IND	
2	HAN, DONG-JIN	KOR	
3	HONG-TSUNG YONG	TPE	
4	BOB D. KASULE	UGA	
5	OSVALDO BISBAL	ARG	

Heavy -91Kg 1/8 Bout 3/Sept. 26		Lourd -91Kg 1/8 Combat 3/26 Sept	
Name Nom	Ctry Pays	Result Resultat	
* Golota, Andrzej	POL	PTS 0:5	
Roussinov, Svilen	BUL		
Referee	BOUNAB HEDI	TUN	TOTAL
Judge 1	AUGUSTIN ZARAGOZA	MEX	60:56
2	MUILI ADE OJO	NGR	60:57
3	ELMO ADOLPH	USA	60:56
4	TAKUYA MOROOKA	JPN	60:57
5	KIM, YOUNG BAE	KOR	59:58

Heavy -91Kg Quarter-final Bout 1/Sept. 28		Lourd -91Kg Quart de Finale Combat 1/28 Sept	
Name Nom	Ctry Pays	Result Resultat	
Heydeck, Maik	GDR		
* Baik, Hyun-Man	KOR	RSCO 1 RD. 3:00	
Referee	GABY MANCINI	CAN	
Judge 1	D. WEERAKOON	SRI	
2	BOB D. KASULE	UGA	
3	ZAUT GVADJAVA	URS	
4	ELMO ADOLPH	USA	
5	ALBERTO DURAN	URU	

Heavy -91Kg 1/8 Bout 4/Sept. 26		Lourd-91Kg 1/8 Combat 4/26 Sept	
Name Nom	Ctry Pays	Result Resultat	
* Obunga, Harold	KEN	RSCH 1 RD. 2:39	
Fale, Tualau	TGA		
Referee	MOHAMED GHAZNAVI	PAK	
Judge 1	ROMEO SOMODIO	PHI	
2	DIMITR DORU BANCIU	ROM	
3	GUSTAV BAUMGARDT	GDR	
4	LUIS MINAMI	PER	
5	ELMO ADOLPH	USA	

Heavy-91Kg Quarter-final Bout 2/Sept. 28		Lourd-91 Kg Quart de Finale Combat 2/28 Sept	
Name Nom	Ctry Pays	Result Resultat	
* Golota, Andrzej	POL	PTS 5:0	
Obunga, Harold	KEN		
Referee	KISHEN M. NARSI	IND	TOTAL
Judge 1	ROMEO SOMODIO	PHI	60:57
2	MUILI ADE OJO	NGR	60:56
3	RODERICK ROBERTSON	GBR	60:56
4	ELMO ADOLPH	USA	60:56
5	OSVALDO BISBAL	ARG	60:55

Boxing

Boxe

Heavy-91 Kg
Competition Summary

Lourd -91Kg
Tableau de la Competition





Heavy -91Kg Quarter-final Bout 3/Sept. 28
Lourd -91Kg Quart de Finale Combat 3/28 Sept.

Name Nom	Ctry Pays	Result Resultat
Gaudiano, Luigi	ITA	
* Mercer, Ray	USA	KOH 1 RD. 3:00

Referee	Judge 1	Judge 2	Judge 3	Judge 4	Judge 5
MOHAMED	ABDUL HANI	PIETER GEDOAN	MOULOUD KOURAD	RYSZRD REDO	GABY MANCINI
EGY	IRQ	INA	ALG	POL	CAN

Super Heavy +91Kg 1/16 Bout 16/Sept. 22
Super-lourd +91Kg 1/16 Combat 16/22 Sept

Name Nom	Ctry Pays	Result Resultat
Kadima, Tshibalabala	ZAI	
* Schnieders, Andreas	FRG	RSCH 2 RD. 2:09

Referee	Judge 1	Judge 2	Judge 3	Judge 4	Judge 5
RONALD MARK GREGOR	KIM, YOUNG BAE	SOMPONG SUKAR	ELMO ADOLPH	AMADOR BURGUILLOS	LUIS MINAMI
AUS	KOR	THA	USA	VEN	PER

Super Heavy +91Kg 1/8 Bout 6/Sept. 26
Super-lourd +91Kg 1/8 Combat 6/26 Sept

Name Nom	Ctry Pays	Result Resultat
Saliyu, Aziz	YUG	
* Kaden, Ulli	GDR	PTS 0:5

Referee	Judge 1	Judge 2	Judge 3	Judge 4	Judge 5
MOULOUD KOURAD	D. WEERAKOON	PIETER GEDOAN	MARIUS GUIRAMO LOUGBO	HONG-TSUNG YONG	ALBERTO DURAN
ALQ	SRI	INA	CIV	TPE	URU
TOTAL	57:60	58:60	58:59	58:60	57:60

Heavy -91Kg Quarter-final Bout 4/Sept. 28
Lourd -91Kg Quart de Finale Combat 4/28 Sept

Name Nom	Ctry Pays	Result Resultat
* Vanderlijde, Arnold	HOL	PTS 5:0
Alvics, Gyula	HUN	

Referee	Judge 1	Judge 2	Judge 3	Judge 4	Judge 5
OSVALDO BISBAL	MOHAMED GHAZNAVI	HIOUAD LARBI	RYSARD REDO	ELMO ADOLPH	ALBERTO DURAN
ARG	PAK	MAR	POL	USA	URU
TOTAL	59:58	60:56	60:56	60:55	60:55

Super Heavy +91Kg 1/8 Bout 1/Sept. 26
Super-lourd +91Kg 1/8 Combat 1/26 Sept

Name Nom	Ctry Pays	Result Resultat
* Mirochnitchenko, Alexandre	URS	PTS 5:0
Albaluchi, Ali	KUW	

Referee	Judge 1	Judge 2	Judge 3	Judge 4	Judge 5
MOHAMED	AMADOR BURGUILLOS	ELMO ADOLPH	BOUNAB HEDI	MUILI ADE OJO	RONALD MARK GREGOR
EGY	VEN	USA	TUN	NGR	AUS
TOTAL	60:51	60:55	60:54	60:53	60:54

Super Heavy +91Kg 1/8 Bout 7/Sept. 26
Super-lourd +91Kg 1/8 Combat 7/26 Sept

Name Nom	Ctry Pays	Result Resultat
* Zarenkiewicz, Janusz	POL	PTS 5:0
Arroyo, Harold	PUR	

Referee	Judge 1	Judge 2	Judge 3	Judge 4	Judge 5
OSVALDO BISBAL	D. WEERAKOON	ABDUL HANI	STANLEY WACHANGA	MARIUS GUIRAMO LOUGBO	ALBERTO DURAN
ARG	SRI	IRQ	KEN	CIV	URU
TOTAL	60:55	60:55	60:54	60:55	60:57

Heavy -91Kg Semi-final Bout 1/Sept. 29
Lourd -91Kg Demi-final Combat 1/29 Sept

Name Nom	Ctry Pays	Result Resultat
* Baik, Hyun-Man	KOR	RSCI 2RD. 1:43
Golota, Andrzej	POL	

Referee	Judge 1	Judge 2	Judge 3	Judge 4	Judge 5
ELMO ADOLPH	MOHAMED GHAZNAVI	WERNER WEGSCHEIDER	GABY MANCINI	OSVALDO BISBAL	HIOUAD LARBI
USA	PAK	AUT	CAN	ARG	MAR

Super Heavy +91Kg 1/8 Bout 2/Sept. 26
Super-lourd +91Kg 1/8 Combat 2/26 Sept

Name Nom	Ctry Pays	Result Resultat
* Kim, Yoo-Hyun	KOR	RET
Hammad, Mohamed	SUD	

Referee	Judge 1	Judge 2	Judge 3	Judge 4	Judge 5
DIMITR DORU BANCUI	THEODOROS VIDALIS	WILLI KELLERMANN	ELMO ADOLPH	MOHAMED	SOMPONG SUKAR
ROM	GRE	FRG	USA	EGY	THA

Super Heavy +91Kg Quarter-final Bout 1/Sept. 28
Super-lourd +91Kg Quart de Finale Combat 1/28 Sept

Name Nom	Ctry Pays	Result Resultat
* Mirochnitchenko, Alexandre	URS	PTS 5:0
Kim, Yoo-Hyun	KOR	

Referee	Judge 1	Judge 2	Judge 3	Judge 4	Judge 5
HIOUAD LARBI	ELMO ADOLPH	STOINO PARLAPANOV	MOULOUD KOURAD	TAKUYA MOROOKA	ALBERTO DURAN
MAR	USA	BUL	ALG	JPN	URU
TOTAL	60:56	60:56	60:57	60:56	60:57

Heavy -91Kg Semi-final Bout 2/Sept. 29
Lourd -91Kg Demi-finale Combat 2/29 Sept

Name Nom	Ctry Pays	Result Resultat
* Mercer, Ray	USA	RSCH 2RD. 2:15
Vanderlijde, Arnold	HOL	

Referee	Judge 1	Judge 2	Judge 3	Judge 4	Judge 5
ABDUL HANI	TAKUTY MOROOKA	SANDOR PAJAR	GABY MANCINI	ALBERTO DURAN	HIOUAD LARBI
IRQ	JPN	HUN	CAN	URU	MAR

Super Heavy +91Kg 1/8 Bout 3/Sept. 26
Super-lourd +91Kg 1/8 Combat 3/26 Sept

Name Nom	Ctry Pays	Result Resultat
* Hrivnak, Peter	TCH	RSCI 2 RD. 0:42
Stoimenov, Petar	BUL	

Referee	Judge 1	Judge 2	Judge 3	Judge 4	Judge 5
KIM, YOUNG BAE	MOHAMED GHAZNAVI	RONALD MARK GREGOR	ELMO ADOLPH	AMADOR BURGUILLOS	HIOUAD LARBI
KOR	PAK	AUS	USA	VEN	MAR

Super Heavy +91Kg Quarter-final Bout 2/Sept. 28
Super-lourd +91Kg Quart de Finale Combat 2/28 Sept

Name Nom	Ctry Pays	Result Resultat
Hrivnak, Peter	TCH	
* Bowe, Riddick	USA	RSCH 1 RD. 2:34

Referee	Judge 1	Judge 2	Judge 3	Judge 4	Judge 5
MOHAMED	GABY MANCINI	GUSTAV BAUMGARDT	STANLEY WACHANGA	TAKUYA MOROOKA	KISHEN M. NARSI
EGY	CAN	GDR	KEN	JPN	IND

Heavy -91Kg Final Bout/Oct.1
Lourd -91Kg Finale/1 Oct

Name Nom	Ctry Pays	Result Resultat
Baik, Hyun-Man	KOR	
* Mercer, Ray	USA	KOH 1 RD. 2:16

Referee	Judge 1	Judge 2	Judge 3	Judge 4	Judge 5
HIOUAD LARBI	DIMITR DORU BANCUI	ZAUT GVADJAVA	OSVALDO BISBAL	MUILI ADE OJO	BOB D. KASULE
MAR	ROM	URS	ARG	NGR	UGA

Super Heavy +91Kg 1/8 Bout 4/Sept. 26
Super-lourd +91Kg 1/8 Combat 4/26 Sept

Name Nom	Ctry Pays	Result Resultat
Botowamungu, Biko	AUT	
* Bowe, Riddick	USA	KOH 2 RD. 2:53

Referee	Judge 1	Judge 2	Judge 3	Judge 4	Judge 5
MUILI ADE OJO	HIOUAD LARBI	SOMPONG SUKAR	TAKUYA MOROOKA	BOUNAB HEDI	AMADOR BURGUILLOS
NGR	MAR	THA	JPN	TUN	VEN

Super Heavy +91Kg Quarter-final Bout 3/Sept. 28
Super-lourd +91Kg Quart de Finale Combat 3/28 Sept

Name Nom	Ctry Pays	Result Resultat
* Lewis, Lennox	CAN	RSCH 1 RD. 0:34
Kaden, Ulli	GDR	

Referee	Judge 1	Judge 2	Judge 3	Judge 4	Judge 5
D. WEERAKOON	ELMO ADOLPH	ALDO LEONI	BOB D. KASULE	MOULOUD KOURAD	KIM, YOUNG BAE
SRI	USA	ITA	UGA	ALG	KOR

Super Heavy +91Kg 1/8 Bout 5/Sept. 26
Super-lourd +91Kg 1/8 Combat 5/26 Sept

Name Nom	Ctry Pays	Result Resultat
* Lewis, Lennox	CAN	RSCH 2 RD. 2:59
Odera, Crispine	KEN	

Referee	Judge 1	Judge 2	Judge 3	Judge 4	Judge 5
STOINO PARLAPANOV	SANDOR PAJAR	KISHEN M. NARSI	LEE, JAE IN	OSVALDO BISBAL	HONG-TSUNG YONG
BUL	HUN	IND	KOR	ARG	TPE

Super Heavy +91Kg Quarter-final Bout 4/Sept. 28
Super-lourd +91Kg Quart de Finale Combat 4/28 Sept

Name Nom	Ctry Pays	Result Resultat
* Zarenkiewicz, Janusz	POL	PTS 3:2
Schnieders, Andreas	FRG	

Referee	Judge 1	Judge 2	Judge 3	Judge 4	Judge 5
DIMITR DORU BANCUI	HAN, DONG-JIN	RODERICK ROBERTSON	HIOUAD LARBI	OSVALDO BISBAL	ELMO ADOLPH
ROM	KOR	GBR	MAR	ARG	USA
TOTAL	59:58	60:57	57:59	59:58	58:60

Boxing

Boxe

Super Heavy +91Kg
Competition Summary

Super-lourd +91Kg
Tableau de la Competition





Super Heavy +91Kg **Super-lourd +91Kg**
Semi-final Bout 1/Sept. 29 **Demi-final Combat 1/29 Sept**

Name	Ctry	Result
Nom	Pays	Resultat
Mirochnitchenko Alexandre	URS	
* Bowe, Riddick	USA	PTS 0:5

Referee	OSVALDO BISBAL	ARG	TOTAL
Judge 1	MOHAMED	EGY	57:59
2	BOB D. KASULE	UGA	58:59
3	TAKUYA MOROOKA	JPN	57:59
4	KISHEN M. NARSI	IND	57:58
5	ALBERTO DURAN	URU	57:58

Super Heavy +91Kg **Super-lourd +91Kg**
Semi-final Bout 2/Sept. 29 **Demi-finale Combat 2/29 Sept**

Name	Ctry	Result
Nom	Pays	Resultat
* Lewis, Lennox	CAN	WO
Zarenkiewicz, Janusz	POL	

Referee	OSVALDO BISBAL	ARG
Judge 1	MOHAMED	EGY
2	BOB D. KASULE	UGA
3	TAKUYA MOROOKA	JPN
4	KISHEN M. NARSI	IND
5	ALBERTO DURAN	URU

Super Heavy +91Kg **Super-lourd +91Kg**
Final Bout/Oct.2 **Finale/2 Oct**

Name	Ctry	Result
Nom	Pays	Resultat
Bowe, Riddick	USA	
* Lewis, Lennox	CAN	RSCO 2RD. 0:43

Referee	GUSTAV BAUMGAROT	GDR
Judge 1	ALBERTO DURAN	URU
2	D. WEERAKOON	SRI
3	WERNER WEGSCHEIDER	AUT
4	BOB D. KASULE	UGA
5	STOINO PARLAPANOV	BUL



카누
Canoeing/Canoë



Canoeing/Canoë

Officials/Officiels

Federation Internationale de Canoë (F.I.C.)

President/président	Sergio Orsi
Secretary General/secrétaire général	Caslav Veljic
Technical Delegates/délégués techniques	Sergio Orsi Bonn Otto

SLOOC Administrative Staff/Personnel Administratif du SLOOC

Commissioner/directeur	Moon Bak
Secretary General/secrétaire général	Lee Man Yong
Deputy Secretary General/secrétaire général adjoint	Lee Chul Nam
Competition Manager/chef de division des compétitions	Peter Ahn

Competitors/Concurrents

Men Hommes	Competitors Competiteurs	Countries Pays
Kayak 1 500 M	22	22
Kayak 2 500 M	48	24
Canadian 1 500 M/canadien 1 500 M	19	19
Canadian 2 500 M/canadien 2 500 M	36	18
Kayak 1 1000 M	21	21
Kayak 2 1000 M	50	25
Kayak 4 1000 M	72	18
Canadian 1 1000M/canadien 1 1000M	17	17
Canadian 2 1000 M/canadien 2 1000 M	36	18

Women Femmes	Competitors Competiteurs	Countries Pays
Kayak 1 500 M	18	18
Kayak 2 500 M	30	15
Kayak 4 500 M	52	13

Legend/Notation

(R)	(Intermediaterankateachpoint/Rangintermediaire
DQL	Disqualified/Disqualifie
WDR	Withdrawn/Abandonne
DNF	Did not finish/N'a pas fini



Canoeing

Canoë

Men Kayak-1 500m Preliminary Heat 1/Sept. 26			Hommes Kayak-1 500m Eliminatoire 1/26 Sept	
Rank Rang	Ctry Pays	Name Nom	250m (R)	500m
1	HUN	Gyulay, Zsolt	0:48.43 (2)	1:41.24 + 0:52.81
2	NZL	Mac Donald, Paul	0:47.76(1)	1:41.65 + 0:53.89
3	URS	Poussev, Victor	0:53.88 (7)	1:42.30 + 0:48.42
4	USA	Herbert, Michael	0:49.01 (3)	1:43.41 + 0:54.40
5	AUS	Hunter, Martin	0:49.81 (4)	1:46.35 + 0:56.54
6	CAN	Crichlow, Renn	0:50.61 (5)	1:47.53 + 0:56.92
7	GBR	West, Jeremy	0:51.20(6)	1:58.29 + 1:07.09
Weather/Temps			: sunny	
Wind/Vent			: Velocity/Vitesse = 2.1 m/s Direction = WNW	
Temperature			: Air = 10.3 C Water/Eau = 21.7 C	
Air Pressure/Pression Atm.			: 761 mmHg	

Men Kayak-1 500m Preliminary Heat 2/Sept. 26			Hommes Kayak-1 500m Eliminatoire 2/26 Sept	
Rank Rang	Ctry Pays	Name Nom	250m (R)	500m
1	GDR	Staehle, Andreas	0:50.89(1)	1:44.26 + 0:53.37
2	NOR	Rasmussen, Einar	0:52.36 (4)	1:44.50 + 0:52.14
3	TCH	Szabo, Attila	0:51.33 (2)	1:45.06 + 0:53.73
4	SWE	Sundkvist, Karl	0:51.76 (3)	1:46.32 + 0:54.56
5	KOR	Chun, In-sik	0:54.13(6)	1:49.86 + 0:55.73
6	POR	Garcia, Jose	0:53.18(5)	1:57.83 + 1:04.65
Weather/Temps			: sunny	
Wind/Vent			: Velocity/Vitesse = 1.5 m/s Direction = WNW	
Temperature			: Air = 9.7 C Water/Eau = 21.7 C	
Air Pressure/Pression Atm.			: 761 mmHg	

Men Kayak-1 500m Preliminary Heat 3/Sept. 26			Hommes Kayak-1 500m Eliminatoire 3/26 Sept	
Rank Rang	Ctry Pays	Name Nom	250m (R)	500m
1	FRG	Joestel, Dirk	0:52.26 (2)	1:45.64 + 0:53.38
2	BEL	Deldaele, Geert	0:51.53(1)	1:46.71 + 0:55.18
3	ESP	Leal, Francisco	0:53.16(3)	1:47.71 + 0:54.55
4	SUI	Philipp, Luzius	0:53.82 (4)	1:49.08 + 0:55.26
5	HKG	Tang, Kwok Cheung	0:58.10(5)	2:01.92 + 1:03.82
Weather/Temps			: sunny	
Wind/Vent			: Velocity/Vitesse = 2.6 m/s Direction = NW	
Temperature			: Air = 9.8 C Water/Eau = 21.7 C	
Air Pressure/Pression Atm.			: 761 mmHg	

Men Kayak-1 500m Repechage 2/Sept. 26			Hommes Kayak-1 500m Repechage 2/26 Sept	
Rank Rang	Ctry Pays	Name Nom	250m (R)	500m
1	AUS	Hunter, Martin	0:50.18(1)	1:45.10 + 0:54.92
2	SWE	Sundkvist, Karl	0:50.91 (2)	1:46.77 + 0:55.86
3	GBR	West, Jeremy	0:53.78 (3)	2:01.16 + 1:07.38
4	HKG	Tang, Kwok Cheung	1:06.96(4)	2:12.91 + 1:05.95
	POR	Garcia, Jose		DQL
Weather/Temps			: cloudy	
Wind/Vent			: Velocity/Vitesse = 2.4 m/s Direction = ESE	
Temperature			: Air = 13.9 C Water/Eau = 20.5 C	
Air Pressure/Pression Atm.			: 760 mmHg	

Men Kayak-1 500m Semi-final 1/Sept. 28			Hommes Kayak-1 500m Demi-finale 1/28 Sept	
Rank Rang	Ctry Pays	Name Nom	250m (R)	500m
1	HUN	Gyulay, Zsolt	0:48.82(1)	1:41.52 + 0:52.70
2	USA	Herbert, Michael	0:49.51 (2)	1:43.40 + 0:53.89
3	TCH	Szabo, Attila	0:50.21 (3)	1:43.89 + 0:53.68
4	CAN	Crichlow, Renn	0:50.59 (4)	1:46.51 + 0:55.92
5	GBR	West, Jeremy	0:52.18(6)	1:46.65 + 0:54.47
6	BEL	Deldaele, Geert	0:51.49(5)	1:47.21 + 0:55.72
Weather/Temps			: sunny	
Wind/Vent			: Velocity/Vitesse = 1.6 m/s Direction = WNW	
Temperature			: Air = 9.0 C Water/Eau = 20.5 C	
Air Pressure/Pression Atm.			: 766 mmHg	

Men Kayak-1 500m Semi-final 2/Sept. 28			Hommes Kayak-1 500m Demi-finale 2/28 Sept	
Rank Rang	Ctry Pays	Name Nom	250m (R)	500m
1	NZL	Mac Donald, Paul	0:49.14(1)	1:43.33 + 0:54.19
2	SWE	Sundkvist, Karl	0:51.08(3)	1:44.45 + 0:53.37
3	GDR	Staehle, Andreas	0:50.44 (2)	1:45.51 + 0:55.07
4	ESP	Leal, Francisco	0:52.74 (4)	1:46.93 + 0:54.19
5	HKG	Tang, Kwok Cheung	0:55.84 (5)	2:03.22 + 1:07.38
	SUI	Philipp, Luzius		WDR
Weather/Temps			: sunny	
Wind/Vent			: Velocity/Vitesse = 2.8 m/s Direction = NW	
Temperature			: Air = 11.0 C Water/Eau = 20.5 C	
Air Pressure/Pression Atm.			: 766 mmHg	

Men Kayak-1 500m Semi-final 3/Sept. 28			Hommes Kayak-1 500m Demi-finale 3/28 Sept	
Rank Rang	Ctry Pays	Name Nom	250m (R)	500m
1	URS	Poussev, Victor	0:57.81 (2)	1:42.90 + 0:45.09
2	AUS	Hunter, Martin	0:57.44(1)	1:43.36 + 0:45.92
3	FRG	Joestel, Dirk	0:58.22 (3)	1:43.97 + 0:45.75
4	NOR	Rasmussen, Einar	0:58.79 (4)	1:45.15 + 0:46.36
5	KOR	Chun, In-sik	0:59.52 (5)	1:51.17 + 0:51.65
Weather/Temps			: sunny	
Wind/Vent			: Velocity/Vitesse=3.2 m/s Direction=NW	
Temperature			: Air=12.0 C Water/Eau=20.5 C	
Air Pressure/Pression Atm.			: 766 mmHg	

Men Kayak-1 500m Final/Sept. 30			Hommes Kayak-1 500m Finale/30 Sept	
Rank Rang	Ctry Pays	Name Nom	250m (R)	500m
1	HUN	Gyulay, Zsolt	0:49.63(1)	1:44.82 + 0:55.19
2	GDR	Staehle, Andreas	0:52.78 (7)	1:46.38 + 0:53.60
3	NZL	Mac Donald, Paul	0:50.07 (2)	1:46.46 + 0:56.39
4	USA	Herbert, Michael	0:51.26(4)	1:46.73 + 0:55.47
5	SWE	Sundkvist, Karl	0:53.38 (8)	1:46.76 + 0:53.38
6	TCH	Szabo, Attila	0:52.26 (6)	1:47.38 + 0:55.12
7	AUS	Hunter, Martin	0:50.60 (3)	1:47.66 + 0:57.06



Rank	Ctry	Name	250m (R)	500m
Rang	Pays	Nom		
8	FRG	Joestel, Dirk	0:53.94 (9)	1:47.91 + 0:53.97
9	URS	Poussev, Victor	0:51.77(5)	1:48.83 + 0:57.06

Weather/Temps : sunny
Wind/Vent : Velocity/Vitesse = 1.8 m/s Direction = SE
Temperature : Air = 9.7 C Water/Eau = 20.7 C
Air Pressure/Pression Atm. : 770 mmHg

Men Kayak-1 1000m Preliminary Heat 1/Sept. 27			Hommes Kayak-1 1000m Eliminatoire 1/27 Sept			
Rank	Ctry	Name	250m (R)	500m (R)	750m (R)	1000m
Rang	Pays	Nom				
1	USA	Barton, Greg	0:52.43(1)	1:48.22(1) + 0:55.79	2:45.63(1) + 0:57.41	3:42.26 + 0:56.63
2	URS	Bankovski, Dmitri	0:52.93 (2)	1:50.23 (2) + 0:57.30	2:47.10(3) + 0:56.87	3:43.32 + 0:56.22
3	FRA	Boccara, Philippe	0:54.75 (5)	1:50.73 (3) + 0:55.98	2:46.62 (2) + 0:55.89	3:44.37 + 0:57.75
4	POR	Garcia, Jose	0:55.34 (6)	1:52.13(5) + 0:56.79	2:48.05 (4) + 0:55.92	3:44.53 + 0:56.48
5	FRG	Ulaszewski, Dirk	0:54.32 (4)	1:52.70(6) + 0:58.38	2:48.93 (5) + 0:56.23	3:45.10 + 0:56.17
6	ESP	Rodriguez, Jose Reyes	0:53.64 (3)	1:51.40(4) + 0:57.76	2:52.50 (6) + 1:01.10	3:57.92 + 1:05.42

Weather/Temps : sunny
Wind/Vent : Velocity/Vitesse = 0.7 m/s Direction = SW
Temperature : Air = 8.6 C Water/Eau = 20.7 C
Air Pressure/Pression Atm. : 767 mmHg

Men Kayak-1 1000m Preliminary Heat 2/Sept. 27			Hommes Kayak-1 1000m Eliminatoire 2/27 Sept			
Rank	Ctry	Name	250m (R)	500m (R)	750m (R)	1000m
Rang	Pays	Nom				
1	HUN	Csipes, Ferenc	0:54.39 (4)	1:49.97(3) + 0:55.58	2:46.16(2) + 0:56.19	3:41.87 + 0:55.71
2	NOR	Ivarsen, Morten	0:52.60(1)	1:48.84(1) + 0:56.24	2:45.67(1) + 0:56.83	3:43.10 + 0:57.43
3	AUS	Davies, Grant	0:53.69 (3)	1:49.39 (2) + 0:55.70	2:46.75 (3) + 0:57.36	3:43.52 + 0:56.77
4	IRL	Holmes, Patrick	0:53.18(2)	1:50.53(4) + 0:57.35	2:50.81 (4) + 1:00.28	3:52.67 + 1:01.86
5	GBR	Lawler, Ivan	0:56.37 (5)	1:54.44(5) + 0:58.07	2:52.90 (5) + 0:58.46	3:54.85 + 1:01.95
6	HKG	Luk, Kwok Sun	1:02.41 (6)	2:06.28 (6) + 1:03.87	3:15.69(6) + 1:09.41	4:27.84 + 1:12.15

Weather/Temps : sunny
Wind/Vent : Velocity/Vitesse = 0.9 m/s Direction = WSW
Temperature : Air = 9.1 C Water/Eau = 20.7 C
Air Pressure/Pression Atm. : 763 mmHg

Men Kayak-1 1000m Preliminary Heat 3/Sept. 27			Hommes Kayak-1 1000m Eliminatoire 3/27 Sept			
Rank	Ctry	Name	250m (R)	500m (R)	750m (R)	1000m
Rang	Pays	Nom				
1	SWE	Olsson, Gunnar	0:54.64 (5)	1:50.31 (4) + 0:55.67	2:45.55 (2) + 0:55.24	3:41.60 + 0:56.05
2	GDR	Wohlbebe, Andre	0:52.36(1)	1:48.42(1) + 0:56.06	2:44.07(1) + 0:55.65	3:42.07 + 0:58.00
3	TCH	Szabo, Attila	0:53.46 (3)	1:49.60(3) + 0:56.14	2:45.94 (3) + 0:56.34	3:46.70 + 1:00.76
4	NZL	Thompson, Alan	0:52.92 (2)	1:49.05 (2) + 0:56.13	2:46.99 (4) + 0:57.94	3:48.10 + 1:01.11
5	CAN	Beaumier, Carl	0:54.03 (4)	1:52.88(5) + 0:58.85	2:57.11 (5) + 1:04.23	4:00.63 + 1:03.52
6	ARG	Vasquez, Atilio Cesar	0:57.35 (7)	1:56.34 (6) + 0:58.99	3:00.19(6) + 1:05.85	4:01.35 + 1:01.16
7	KOR	Kim, Dong-Soo	0:56.56 (6)	1:58.81 (7) + 1:02.25	3:03.73 (7) + 1:04.92	4:10.42 + 1:06.69

Weather/Temps : sunny
Wind/Vent : Velocity/Vitesse = 0.9 m/s Direction = W
Temperature : Air = 9.5 C Water/Eau = 20.7 C
Air Pressure/Pression Atm. : 763 mmHg

Men Kayak-1 1000m Repechage 1/Sept. 27			Hommes Kayak-1 1000m Repechage 1/27 Sept			
Rank	Ctry	Name	250m (R)	500m (R)	750m (R)	1000m
Rang	Pays	Nom				
1	POR	Garcia, Jose		1:53.88 (2)	2:53.78(2) + 0:59.90	3:51.14 + 0:57.36
2	ESP	Rodriguez, Jose Reyes		1:55.18(4)	2:53.34(1) + 0:58.16	3:53.39 + 1:00.05
3	CAN	Beaumier, Carl		1:52.98(1)	2:54.26 (3) + 1:01.28	3:55.27 + 1:01.01
4	ARG	Vasquez, Atilio Cesar		1:58.42(5)	2:56.64 (5) + 0:58.22	3:58.03 + 1:01.39
5	GBR	Lawler, Ivan		1:54.50 (3)	2:55.18(4) + 1:00.68	3:59.69 + 1:04.51

Weather/Temps : sunny
Wind/Vent : Velocity/Vitesse = 2.4 m/s Direction = ENE
Temperature : Air = 16.7 C Water/Eau = 20.7 C
Air Pressure/Pression Atm. : 763 mmHg

Men Kayak-1 1000m Repechage 2/Sept. 27			Hommes Kayak-1 1000m Repechage 2/27 Sept			
Rank	Ctry	Name	250m (R)	500m (R)	750m (R)	1000m
Rang	Pays	Nom				
1	NZL	Thompson, Alan	0:55.32(1)	1:51.96(2) + 0:56.64	2:48.21 (2) + 0:56.25	3:46.20 + 0:57.99
2	FRG	Ulaszewski, Dirk	0:56.57 (3)	1:52.54 (3) + 0:55.97	2:46.84(1) + 0:54.30	3:46.46 + 0:59.62
3	IRL	Holmes, Patrick	0:55.91 (2)	1:51.92(1) + 0:56.01	2:49.29 (3) + 0:57.37	3:46.92 + 0:57.63
4	KOR	Kim, Dong-Soo	0:57.32 (4)	2:00.38 (4) + 1:03.06	2:52.16(4) + 0:51.78	4:05.51 + 1:13.35
5	HKG	Luk, Kwok Sun	1:12.77(5)	2:18.41 (5) + 1:05.64	2:54.13(5) + 0:35.72	4:30.20 + 1:36.07

Weather/Temps : sunny
Wind/Vent : Velocity/Vitesse = 3.7 m/s Direction = NNE
Temperature : Air = 18.1 C Water/Eau = 21.4 C
Air Pressure/Pression Atm. : 763 mmHg

Men Kayak-1 1000m Semi-final 1/Sept. 29			Hommes Kayak-1 1000m Demi-finale 1/29 Sept			
Rank	Ctry	Name	250m (R)	500m (R)	750m (R)	1000m
Rang	Pays	Nom				
1	USA	Barton, Greg	0:53.05(1)	1:48.52(1) + 0:55.47	2:49.09(1) + 1:00.57	3:40.96 + 0:51.87
2	NOR	Ivarsen, Morten	0:53.82 (2)	1:49.04 (2) + 0:55.22	2:49.58 (2) + 1:00.54	3:41.86 + 0:52.28
3	TCH	Szabo, Attila	0:54.46 (3)	1:50.86 (3) + 0:56.40	2:50.12(3) + 0:59.26	3:43.44 + 0:53.32
4	POR	Garcia, Jose	0:55.86 (5)	1:51.31 (4) + 0:55.45	2:50.78 (4) + 0:59.47	3:44.00 + 0:53.22
5	IRL	Holmes, Patrick	0:55.10(4)	1:51.36(5) + 0:56.26	2:51.37(5) + 1:00.01	3:49.26 + 0:57.89

Weather/Temps : sunny
Wind/Vent : Velocity/Vitesse = 1.4 m/s Direction = N
Temperature : Air = 13.2 C Water/Eau = 20.7 C
Air Pressure/Pression Atm. : 770 mmHg

Men Kayak-1 1000m Semi-final 2/Sept. 29			Hommes Kayak-1 1000m Demi-finale 2/29 Sept			
Rank	Ctry	Name	250m (R)	500m (R)	750m (R)	1000m
Rang	Pays	Nom				
1	GDR	Wohlbebe, Andre	0:52.15(1)	1:47.02(1) + 0:54.87	2:42.96(1) + 0:55.94	3:39.98 + 0:57.02
2	HUN	Csipes, Ferenc	0:53.90 (3)	1:49.15(3) + 0:55.25	2:43.76 (2) + 0:54.61	3:40.17 + 0:56.41
3	FRA	Boccara, Philippe	0:55.36 (5)	1:49.83(4) + 0:54.47	2:44.50(3) + 0:54.67	3:41.01 + 0:56.51
4	NZL	Thompson, Alan	0:52.87 (2)	1:48.29(2) + 0:55.42	2:51.18(4) + 1:02.89	3:45.30 + 0:54.12
5	CAN	Beaumier, Carl	0:54.62 (4)	1:50.24(5) + 0:55.62	2:54.91 (5) + 1:04.67	3:55.86 + 1:00.95

Weather/Temps : sunny
Wind/Vent : Velocity/Vitesse = 1.2 m/s Direction = N
Temperature : Air = 13.9 C Water/Eau = 20.7 C
Air Pressure/Pression Atm. : 770 mmHg

Canoeing

Canoe

Men Kayak-1 1000m Semi-final 3/Sept. 29			Hommes Kayak-1 1000m Demi-finale 3/29 Sept			
Rank Rang	Ctry Pays	Name Nom	250m (R)	500m (R)	750m (R)	1000m
1	SWE	Olsson, Gunnar	0:54.35 (2)	1:49.55(1) + 0:55.20	2:44.31 (1) + 0:54.76	3:38.82 + 0:54.51
2	URS	Bankovski, Dmitri	0:53.86(1)	1:49.99(2) + 0:56.13	2:46.12(2) + 0:56.13	3:42.14 + 0:56.02
3	AUS	Davies, Grant	0:55.65 (4)	1:51.58(4) + 0:55.93	2:47.46 (3) + 0:55.88	3:42.66 + 0:55.20
4	FRG	Ulaszewski, Dirk	0:55.01 (3)	1:50.46(3) + 0:55.45	2:48.07 (4) + 0:57.61	3:44.17 + 0:56.10
5	ESP	Rodriguez, Jose reyes	0:56.27 (5)	1:53.21 (5) + 0:56.94	2:48.85 (5) + 0:55.64	3:48.35 + 0:59.50

Weather/Temps : sunny
 Wind/Vent : Velocity/Vitesse = 2.4 m/s Direction = NW
 Temperature : Air = 14.1 C Water/Eau = 20.7 C
 Air Pressure/Pression Atm. : 770 mmHg

Men Kayak-1 1000m Final/Oct. 1			Hommes/Kayak-1 1000m Finale/1 Oct			
Rank Rang	Ctry Pays	Name Nom	250m (R)	500m	750m (R)	1000m
1	USA	Barton, Greg	0:58.83 (7)	1:55.03(2) + 0:56.20	2:54.84 (2) + 0:59.81	3:55.27 + 1:00.43
2	AUS	Davies, Grant	0:55.89(1)	1:55.89(4) + 1:00.00	2:56.62 (5) + 1:00.73	3:55.28 + 0:58.66
3	GDR	Wohlebe, Andre	0:56.47 (2)	1:58.07(8) + 1:01.60	2:56.06 (4) + 0:57.99	3:55.55 + 0:59.49
4	URS	Bankovski, Dmitri	0:59.28 (8)	1:55.48(3) + 0:56.20	2:55.49 (3) + 1:00.01	3:56.49 + 1:01.00
5	SWE	Olsson, Gunnar	0:57.34 (4)	1:57.67(7) + 1:00.33	2:58.85 (9) + 1:01.18	3:56.84 + 0:57.99
6	NZL	Thompson, Alan	0:56.92 (3)	1:57.12(6) + 1:00.20	2:57.67 (7) + 1:00.55	3:56.91 + 0:59.24
7	TCH	Szabo, Attila	0:58.32 (6)	1:58.54(9) + 1:00.22	2:57.11 (6) + 0:58.57	3:57.52 + 1:00.41
8	NOR	Ivansen, Morten	0:57.82 (5)	1:56.38(5) + 0:58.56	2:58.20 (8) + 1:01.82	3:59.18 + 1:00.98
9	HUN	Csipes, Ferenc	0:59.68 (9)	1:54.47(1) + 0:54.79	2:54.23(1) + 0:59.76	4:00.30 + 1:06.07

Weather/Temps : sunny
 Wind/Vent : Velocity/Vitesse = 2.2 m/s Direction = SE
 Temperature : Air = 7.4 C Water/Eau = 20.5 C
 Air Pressure/Pression Atm. : 767 mmHg

Men Kayak-2 500m Preliminary Heat 1/Sept. 26			Hommes Kayak-2 500m Eliminatoire 1/26 Sept	
Rank Rang	Ctry Pays	Name Nom	250m (R)	500m
1	URS	Nagaev, Igor Denissov, Victor	0:45.75 (2)	1:33.20 0:47.45
2	GDR	Bluhm, Kay Wohlebe, Andre	0:45.12(1)	1:33.66 0:48.54
3	FIN	Kolehmainen, Mikko Kolehmainen, Olli	0:46.21 (3)	1:35.50 0:49.29
4	ESP	Sanchez, Juan manuel Fuentes, Fernando	0:47.01 (4)	1:36.17 0:49.16
5	FRA	Bregeon, Bernard Lasak, Olivier	0:47.45 (5)	1:38.05 0:50.60
6	CAN	Morris, Alwyn Fisher, Hugh	0:48.02 (6)	1:39.39 0:51.37
7	CHN	Xue, Bing Ma, Fuliang	0:49.24 (8)	1:41.10 0:51.86
8	IRL	Carey, Alan Holmes, Patrick	0:48.59 (7)	1:42.11 0:53.52

Weather/Temps : sunny
 Wind/Vent : Velocity/Vitesse = 3.8 m/s Direction = NW
 Temperature : Air = 11.2 C Water/Eau = 21.7 C
 Air Pressure/Pression Atm. : 761 mmHg

Men Kayak-2 500m Preliminary Heat 2/Sept. 26			Hommes Kayak-2 500m Eliminatoire 2/26 Sept	
Rank Rang	Ctry Pays	Name Nom	250m (R)	500m
1	HUN	Abraham, Attila Csipes, Ferenc	0:45.12(1)	1:32.83 0:47.71
2	ROM	Stoian, Daniel Velea, Angelin	0:45.51 (2)	1:34.09 0:48.58
3	ITA	Bonomi, Beniamino Scarpa, Daniele	0:46.63 (3)	1:35.00 0:48.37
4	TCH	Havelka, Pavel Bohac, Jan	0:47.18(4)	1:38.72 0:51.54
5	KOR	Byun, Sang-Soo Yoon, Ki-Soo	0:48.82 (5)	1:41.80 0:52.98
6	CIV	Lath, Melagne A Ndouba, Kouame	0:49.36 (6)	1:47.88 0:58.52

Weather/Temps : sunny
 Wind/Vent : Velocity/Vitesse = 2.4 m/s Direction = NW
 Temperature : Air = 11.8 C Water/Eau = 21.7 C
 Air Pressure/Pression Atm. : 761 mmHg

Men Kayak-2 500m Preliminary Heat 3/Sept. 26			Hommes Kayak-2 500m Eliminatoire 3/26 Sept	
Rank Rang	Ctry Pays	Name Nom	250m (R)	500m
1	NZL	Ferguson, Ian Mac Donald, Paul	0:44.98(1)	1:32.32 0:47.34
2	FRG	Scholl, Reiner Pfrang, Thomas	0:45.40 (2)	1:33.29 0:47.89
3	USA	Kent, Olney White, Carl	0:47.02 (5)	1:34.69 0:47.67
4	POL	Freimut, Maciej Kurpiewski, Wojciech	0:45.81 (3)	1:34.72 0:48.91
5	AUS	Foster, Peter Graham, Kelvin	0:46.51 (4)	1:34.73 0:48.22
6	GBR	Lawler, Ivan Bourne, Grayson	0:48.72 (6)	1:40.08 0:51.36
7	ARG	Cirillo, Gustavo G. Marello, Jose Luis	0:52.21 (7)	1:52.42 1:00.21
	SWE	Bengtsson, Per-Inge Sundkvist, Karl		DQL

Weather/Temps : sunny
 Wind/Vent : Velocity/Vitesse = 2.6 m/s Direction = WNW
 Temperature : Air = 12.6 C Water/Eau = 21.7 C
 Air Pressure/Pression Atm. : 761 mmHg

Men Kayak-2 500m Repechage 1/Sept. 26			Hommes Kayak-2 500m Repechage 1/26 Sept	
Rank Rang	Ctry Pays	Name Nom	250m (R)	500m
1	ESP	Sanchez, Juan Manuel Fuentes, Fernando	0:49.15(2)	1:40.09 0:50.94
2	IRL	Carey, Alan Holmes, Patrick	0:48.44(1)	1:41.12 0:52.68
3	POL	Freimut, Maciej Kurpiewski, Wojciech	0:49.75 (3)	1:41.99 0:52.24
4	CAN	Morris, Alwyn Fisher, Hugh	0:50.58 (4)	1:43.03 0:52.45
5	KOR	Byun, Sang-Soo Yoon, Ki-soo	0:51.63(5)	1:44.64 0:53.01
6	ARG	Cirillo, Gustavo G. Marello, Jose Luis	0:52.56 (6)	1:46.98 0:54.42

Weather/Temps : cloudy
 Wind/Vent : Velocity/Vitesse = 4.4 m/s Direction = ESE
 Temperature : Air = 15.0 C Water/Eau = 21.7 C
 Air Pressure/Pression Atm. : 760 mmHg

**Men Kayak-2 500m
Repechage 2/Sept. 26****Hommes Kayak-2 500m
Repechage 2/26 Sept**

Rank Rang	Ctry Pays	Name Nom	250m (R)	500m
1	AUS	Foster, Peter Graham, Kelvin	0:49.38(1)	1:37.28 0:47.90
2	FRA	Bregeon, Bernard Lasak, Olivier	0:50.53 (4)	1:38.71 0:48.18
3	GBR	Lawler, Ivan Bourne, Grayson	0:49.75 (2)	1:39.72 0:49.97
4	TCH	Havelka, Pavel Bohac, Jan	0:50.13(3)	1:40.78 0:50.65
5	CHN	Xue, Bing Ma, Fuliang	0:50.89(5)	1:43.17 0:52.28
6	CIV	Lath, Melagne a Ndouba, Kouame	0:52.59 (6)	1:55.65 1:03.06

Weather/Temps : sunny
Wind/Vent : Velocity/Vitesse = 3.5 m/s Direction = E
Temperature : Air = 15.0C Water/Eau = 21.7C
Air Pressure/Pression Atm. : 760 mmHg

**Men Kayak-2 500m
Semi-final 3/Sept. 28****Hommes Kayak-2 500m
Demi-finale 3/28 Sept**

Rank Rang	Ctry Pays	Name Nom	250m (R)	500m
1	NZL	Ferguson, Ian Mac Donald, Paul	0:45.51 (1)	1:33.81 0:48.30
2	ROM	Stoian, Daniel Velea, Angelin	0:46.64 (3)	1:35.04 0:48.40
3	POL	Freimut, Maciej Kurpiewski, Wojciech	0:46.06 (2)	1:35.33 0:49.27
4	AUS	Foster, Peter Graham, Kelvin	0:47.40 (4)	1:35.97 0:48.57
5	FIN	Kolehmainen, Mikko Kolehmainen, Olli	0:48.37 (5)	1:37.76 0:49.39

Weather/Temps : sunny
Wind/Vent : Velocity/Vitesse = 1.5 m/s Direction = W
Temperature : Air = 15.7 C Water/Eau = 20.5 C
Air Pressure/Pression Atm. : 766 mmHg

**Men Kayak-2 500m
Semi-final 1/Sept. 28****Hommes Kayak-2 500m
Demi-finale 1/28 Sept**

Rank Rang	Ctry Pays	Name Nom	250m (R)	500m
1	FRG	Scholl, Reiner Pfrang, Thomas	0:45.11 (2)	1:32.73 0:47.62
2	URS	Nagaev, Igor Denissov, Victor	0:44.38(1)	1:34.46 0:50.08
3	ITA	Bonomi, Beniamino Scarpa, Daniele	0:47.91 (3)	1:34.50 0:46.59
4	CAN	Morris, Alwyn Fisher, Hugh	0:48.86 (5)	1:36.00 0:47.14
5	ESP	Sanchez, Juan manuel Fuentes, Fernando	0:48.31 (4)	1:36.22 0:47.91
6	GBR	Lawler, Ivan Bourne, Grayson	0:49.98 (6)	1:37.75 0:47.77

Weather/Temps : sunny
Wind/Vent : Velocity/Vitesse = 2.4 m/s Direction = WNW
Temperature : Air = 15.9 C Water/Eau = 20.5 C
Air Pressure/Pression Atm. : 766 mmHg

**Men Kayak-2 500m
Final/Sept. 30****Hommes Kayak-2 500m
Finale/30 Sept**

Rank Rang	Ctry Pays	Name Nom	250m (R)	500m
1	NZL	Ferguson, Ian Mac Donald, Paul	0:44.58(1)	1:33.98 0:49.40
2	URS	Nagaev, Igor Denissov, Victor	0:47.43 (5)	1:34.15 0:46.72
3	HUN	Abraham, Attila Csipes, Ferenc	0:49.63 (9)	1:34.32 0:44.69
4	FRG	Scholl, Reiner Pfrang, Thomas	0:46.91 (4)	1:34.40 0:47.49
5	ROM	Stoian, Daniel Velea, Angelin	0:46.22 (3)	1:35.96 0:49.74
6	POL	Freimut, Maciej Kurpiewski, Wojciech	0:45.44 (2)	1:36.22 0:50.78
7	GDR	Bluhm, Kay Wohllebe, Andre	0:48.34 (7)	1:36.49 0:48.15
8	USA	Kent, Olney White, Carl	0:47.90 (6)	1:36.62 0:48.72
9	ITA	Bonomi, Beniamino Scarpa, Daniele	0:48.75 (8)	1:37.30 0:48.55

Weather/Temps : sunny
Wind/Vent : Velocity/Vitesse = 0.5 m/s Direction = ESE
Temperature : Air = 14.3 C Water/Eau = 20.7 C
Air Pressure/Pression Atm. : 770 mmHg

**Men Kayak-2 500m
Semi-final 2/Sept. 28****Hommes Kayak-2 500m
Demi-finale 2/28 Sept**

Rank Rang	Ctry Pays	Name Nom	250m (R)	500m
1	HUN	Abraham, Attila Csipes, Ferenc	0:44.49(1)	1:34.00 0:49.51
2	GDR	Bluhm, Kay Wohllebe, Andre	0:46.04 (2)	1:35.67 0:49.63
3	USA	Kent, Olney White, Carl	0:46.63 (3)	1:36.33 0:49.70
4	FRA	Bregeon, Bernard Lasak, Olivier	0:47.87 (4)	1:38.31 0:50.44
5	TCH	Havelka, Pavel Bohac, Jan	0:49.50 (6)	1:39.48 0:49.98
6	IRL	Carey, Alan Holmes, Patrick	0:48.44 (5)	1:39.94 0:51.50

Weather/Temps : sunny
Wind/Vent : Velocity/Vitesse = 1.0 m/s Direction = SW
Temperature : Air = 15.7 C Water/Eau = 20.5 C
Air Pressure/Pression Atm. : 766 mmHg

**Men Kayak-2 1000m
Preliminary Heat 1/Sept. 27****Hommes Kayak-2 1000m
Eliminatoire 1/27 Sept**

Rank Rang	Ctry Pays	Name Nom	250m (R)	500m (R)	750m (R)	1000m
1	ITA	Dreossi, Bruno Pieri, Alessandro	0:49.23 (3)	1:41.38(3) + 0:52.15	2:32.88(1) + 0:51.50	3:25.76 + 0:52.88
2	URS	Kalesnik, Sergei Galkov, Serguei	0:48.11 (1)	1:39.82(1) + 0:51.71	2:34.62 (3) + 0:54.80	3:27.06 + 0:52.44
3	FIN	Kolehmainen, Mikko Kolehmainen, Olli	0:48.69(2)	1:40.72(2) + 0:52.03	2:33.28 (2) + 0:52.56	3:27.52 + 0:54.24
4	POR	Brinco, Antonio Gomes, Eduardo	0:51.14(6)	1:44.11 (6) + 0:52.97	2:37.96 (6) + 0:53.85	3:31.95 + 0:53.99
5	ESP	Sanchez, Alberto Hernandez, Gregorio	0:49.68 (4)	1:43.18(5) + 0:53.50	2:36.50 (5) + 0:53.32	3:32.97 + 0:56.47
6	CAN	Brien, Donald Shaw, Colin	0:50.49 (5)	1:44.85(7) + 0:54.36	2:38.62 (7) + 0:53.77	3:35.30 + 0:56.68
7	NOR	Solvang, Svein Egil Amundsen, Harald	0:52.11 (7)	1:42.51 (4) + 0:50.40	2:35.38 (4) + 0:52.87	3:36.85 + 1:01.47

Weather/Temps : sunny
Wind/Vent : Velocity/Vitesse = 0.5 m/s Direction = E
Temperature : Air = 12.1 C Water/Eau = 20.7 C
Air Pressure/Pression Atm. : 763 mmHg

Canoeing

Canoë

Men Kayak-2 1000m Preliminary Heat 2/Sept. 27			Hommes Kayak-2 1000m Eliminatoire 2/27 Sept			
Rank Rang	Ctry Pays	Name Nom	250m (R)	500m (R)	750m (R)	1000m
1	NZL	Ferguson, Ian Mac Donald, Paul	0:46.01 (1)	1:37.37(1) + 0:51.36	2:29.01 (1) + 0:51.64	3:20.44 + 0:51.43
2	USA	Barton, Greg Bellingham, Norman	0:47.47 (3)	1:38.82(3) + 0:51.35	2:30.11 (3) + 0:51.29	3:20.50 + 0:50.39
3	FRA	Boccara, Philippe Boucherit, Pascal	0:49.97 (6)	1:40.95(5) + 0:50.98	2:29.51 (2) + 0:48.56	3:23.00 + 0:53.49
4	SWE	Ohlsen, Anders Olsson, Hans	0:48.66 (4)	1:40.23(4) + 0:51.57	2:31.88(5) + 0:51.65	3:26.43 + 0:54.55
5	ROM	Stoian, Daniel Velea, Angelin	0:46.78 (2)	1:38.22(2) + 0:51.44	2:30.71 (4) + 0:52.49	3:28.42 + 0:57.71
6	FRG	Ellwanger, Niels Loemker, Carsten	0:49.36 (5)	1:41.73(6) + 0:52.37	2:35.13(6) + 0:53.40	3:37.82 + 1:02.69
7	IRL	Burns, Declan Connor, Peter	0:50.91 (7)	1:45.91 (7) + 0:55.00	2:37.57 (7) + 0:51.66	3:41.18 + 1:03.61
Weather/Temps			: sunny			
Wind/Vent			: Velocity/Vitesse = 0.4 m/s Direction = W			
Temperature			: Air = 12.8 C Water/Eau = 20.7 C			
Air Pressure/Pression Atm.			: 763 mmHg			

Men Kayak-2 1000m Preliminary Heat 3/Sept. 27			Hommes Kayak-2 1000m Eliminatoire 3/27 Sept			
Rank Rang	Ctry Pays	Name Nom	250m (R)	500m (R)	750m (R)	1000m
1	GDR	Behling, Guido Krentz, Torsten	0:47.57 (2)	1:38.31 (1) + 0:50.74	2:31.18(1) + 0:52.87	3:24.45 + 0:53.27
2	AUS	Foster, Peter Graham, Kelvin	0:48.26 (3)	1:40.07(3) + 0:51.81	2:32.11 (2) + 0:52.04	3:25.66 + 0:53.55
3	HUN	Helyi, Tibor Rajna, Andras	0:46.83(1)	1:39.13(2) + 0:52.30	2:32.76 (3) + 0:53.63	3:26.00 + 0:53.24
4	CHN	Xue, Bing Ma, Fuliang	0:50.85 (5)	1:42.56(5) + 0:51.71	2:36.05 (5) + 0:53.49	3:31.24 + 0:55.19
5	GBR	Sherriff, Andrew Smith, Kevin	0:50.27 (4)	1:41.81 (4) + 0:51.54	2:34.16(4) + 0:52.35	3:33.16 + 0:59.00
6	KOR	Park, Cha-Keun Chun, In-Sik	0:51.39(6)	1:45.36(6) + 0:53.97	2:37.38 (6) + 0:52.02	3:47.21 + 1:09.83
Weather/Temps			: sunny			
Wind/Vent			: Velocity/Vitesse = 1.4 m/s Direction = E			
Temperature			: Air = 13.4 C Water/Eau = 20.7 C			
Air Pressure/Pression Atm.			: 763 mmHg			

Men Kayak-2 1000m Repechage 1/Sept. 27			Hommes Kayak-2 1000m Repechage 1/27 Sept			
Rank Rang	Ctry Pays	Name Nom	250m (R)	500m (R)	750m (R)	1000m
1	ROM	Stoian, Daniel Velea, Angelin	0:48.40(1)	1:40.45(1) + 0:52.05	2:35.35(1) + 0:54.90	3:31.51 + 0:56.16
2	CAN	Brien, Donald Shaw, Colin	0:51.91 (4)	1:45.20(3) + 0:53.29	2:41.75 (3) + 0:56.55	3:38.74 + 0:56.99
3	CHN	Xue, Bing Ma, Fuliang	0:50.40 (2)	1:43.89(2) + 0:53.49	2:41.03(2) + 0:57.14	3:39.56 + 0:58.53
4	IRL	Burns, Declan Connor, Peter	0:51.23(3)	1:46.10(4) + 0:54.87	2:43.11 (4) + 0:57.01	3:43.02 + 0:59.91
5	POR	Brinco, Antonio Gomes, Eduardo	0:52.95 (5)	1:46.95(5) + 0:54.00	2:44.88 (5) + 0:57.93	3:47.99 + 1:03.11
Weather/Temps			: sunny			
Wind/Vent			: Velocity/Vitesse = 3.7 m/s Direction = NW			
Temperature			: Air = 18.7 C Water/Eau = 21.4 C			
Air Pressure/Pression Atm.			: 763 mmHg			

Men Kayak-2 1000m Repechage 2/Sept. 27			Hommes Kayak-2 1000m Repechage 2/27 Sept			
Rank Rang	Ctry Pays	Name Nom	250m (R)	500m (R)	750m (R)	1000m
1	SWE	Ohlsen, Anders Olsson, Hans	0:49.09 (3)	1:40.74(3) + 0:51.65	2:31.89(1) + 0:51.15	3:26.75 + 0:54.86
2	GBR	Sherriff, Andrew Smith, Kevin	0:49.83 (4)	1:42.62(5) + 0:52.79	2:35.00 (4) + 0:52.38	3:31.78 + 0:56.78
3	FRG	Ellwanger, Niels Loemker, Carsten	0:47.96(1)	1:38.89(1) + 0:50.93	2:32.52 (2) + 0:53.63	3:31.95 + 0:59.43
4	NOR	Solvang, Svein Egil Amundsen, Harald	0:48.56 (2)	1:39.89(2) + 0:51.33	2:34.06 (3) + 0:54.17	3:32.07 + 0:58.01
5	ESP	Sanchez, Alberto Hernandez, Gregorio	0:51.30(6)	1:42.06(4) + 0:50.76	2:36.21 (5) + 0:54.15	3:32.92 + 0:56.71
6	KOR	Park, Cha-Keun Chun, In-Sik	0:50.59 (5)	1:43.17(6) + 0:52.58	2:38.46 (6) + 0:55.29	3:36.70 + 0:58.24
Weather/Temps			: sunny			
Wind/Vent			: Velocity/Vitesse = 3.2 m/s Direction = ESE			
Temperature			: Air = 19.2 C Water/Eau = 21.4 C			
Air Pressure/Pression Atm.			: 763 mmHg			

Men Kayak-2 1000m Semi-final 1/Sept. 29			Hommes Kayak-2 1000m Demi-finale 1/29 Sept			
Rank Rang	Ctry Pays	Name Nom	250m (R)	500m (R)	750m (R)	1000m
1	ROM	Stoian, Daniel Velea, Angelin	0:48.05(1)	1:38.91 (1) + 0:50.86	2:31.84(1) + 0:52.93	3:25.91 + 0:54.07
2	AUS	Foster, Peter Graham, Kelvin	0:48.42 (2)	1:39.22 (2) + 0:50.80	2:32.83 (2) + 0:53.61	3:26.87 + 0:54.04
3	FRG	Ellwanger, Niels Loemker, Carsten	0:51.51 (4)	1:41.13(3) + 0:49.62	2:33.95 (3) + 0:52.82	3:28.91 + 0:54.96
4	IRL	Burns, Declan Connor, Peter	0:52.17(5)	1:47.56 (5) + 0:55.39	2:43.35 (4) + 0:55.79	3:38.92 + 0:55.57
5	ITA	Dreossi, Bruno Pieri, Alessandro	0:50.87 (3)	1:47.27(4) + 0:56.40	2:49.48 (5) + 1:02.21	4:11.90 + 1:22.42
	FRA	Boccara, Philippe Boucherit, Pascal				DQL
Weather/Temps			: sunny			
Wind/Vent			: Velocity/Vitesse = 2.1 m/s Direction = E			
Temperature			: Air = 15.2 C Water/Eau = 20.7 C			
Air Pressure/Pression Atm.			: 770 mmHg			

Men Kayak-2 1000m Semi-final 2/Sept. 29			Hommes Kayak-2 1000m Demi-finale 2/29 Sept			
Rank Rang	Ctry Pays	Name Nom	250m (R)	500m (R)	750m (R)	1000m
1	NZL	Ferguson, Ian Mac Donald, Paul	0:46.28(1)	1:37.20(1) + 0:50.92	2:30.89(1) + 0:53.69	3:23.13 + 0:52.24
2	HUN	Helyi, Tibor Rajna, Andras	0:48.21 (3)	1:39.76(3) + 0:51.55	2:32.90 (3) + 0:53.14	3:24.24 + 0:51.34
3	NOR	Solvang, Svein Egil Amundsen, Harald	0:49.91 (5)	1:41.43(5) + 0:51.52	2:34.51 (4) + 0:53.08	3:25.00 + 0:50.49
4	URS	Kalesnik, Sergei Galkov, Serguei	0:47.57 (2)	1:39.35 (2) + 0:51.78	2:32.16(2) + 0:52.81	3:27.03 + 0:54.87
5	CAN	Brien, Donald Shaw, Colin	0:50.66 (6)	1:43.50 (6) + 0:52.84	2:37.95 (6) + 0:54.45	3:30.29 + 0:52.34
6	GBR	Sherriff, Andrew Smith, Kevin	0:49.08 (4)	1:40.83 (4) + 0:51.75	2:35.29 (5) + 0:54.46	3:31.65 + 0:56.36
Weather/Temps			: sunny			
Wind/Vent			: Velocity/Vitesse = 2.7 m/s Direction = NNE			
Temperature			: Air = 15.7 C Water/Eau = 20.7 C			
Air Pressure/Pression Atm.			: 770 mmHg			



Men Kayak-2 1000m Semi-final 3/Sept. 29			Hommes Kayak-2 1000m Demi-finale 3/29 Sept			
Rank Rang	Ctry Pays	Name Nom	250m (R)	500m (R)	750m (R)	1000m
1	USA	Barton, Greg Bellingham, Norman	0:48.52 (2)	1:39.88(1) + 0:51.36	2:32.93(1) + 0:53.05	3:25.36 + 0:52.43
2	GDR	Behling, Guido Krentz, Torsten	0:48.10(1)	1:40.40 (2) + 0:52.30	2:34.02 (2) + 0:53.62	3:27.19 + 0:53.17
3	SWE	Ohlsen, Anders Olsson, Hans	0:49.80 (4)	1:42.93 (4) + 53.13	2:34.90 (3) + 0:51.97	3:28.31 + 0:53.41
4	FIN	Kolehmainen, Mikko Kolehmainen, Olli	0:49.16(3)	1:42.10(3) + 0:52.94	2:35.56 (4) + 0:53.46	3:30.98 + 0:55.42
5	CHN	Xue, Bing Ma, Fuliang	0:51.59(5)	1:45.82(5) + 0:54.23	2:42.71 (5) + 0:56.89	3:42.91 + 1:00.20
Weather/Temps			: sunny			
Wind/Vent			: Velocity/Vitesse = 1.9 m/s Direction = NE			
Temperature			: Air = 15.8 C Water/Eau = 20.7 C			
Air Pressure/Pression Atm.			: 770 mmHg			

Men Kayak-2 1000m Final/Oct. 1			Hommes Kayak-2 1000m Finale/1 Oct			
Rank Rang	Ctry Pays	Name Nom	250m (R)	500m (R)	750m (R)	1000m
1	USA	Barton, Greg Bellingham, Norman	0:49.76 (3)	1:43.40 (3) + 0:53.64	2:38.86 (3) + 0:55.46	3:32.42 + 0:53.56
2	NZL	Ferguson, Ian Mac Donald, Paul	0:53.34 (9)	1:42.26(1) + 0:48.92	2:38.23 (2) + 0:55.97	3:32.71 + 0:54.48
3	AUS	Foster, Peter Graham, Kelvin	0:48.44(1)	1:42.81 (2) + 0:54.37	2:36.66(1) + 0:53.85	3:33.76 + 0:57.10
4	FRG	Ellwanger, Niels Loemker, Carsten	0:52.78 (8)	1:46.66(9) + 0:53.88	2:41.94(7) + 0:55.28	3:34.63 + 0:52.69
5	GDR	Behling, Guido Krentz, Torsten	0:49.07 (2)	1:45.82(7) + 0:56.75	2:40.76 (5) + 0:54.94	3:35.44 + 0:54.68
6	ROM	Stoian, Daniel Velea, Angelin	0:50.42 (4)	1:43.97 (4) + 0:53.55	2:39.69 (4) + 0:55.72	3:35.75 + 0:56.06
7	SWE	Ohlsen, Anders Olsson, Hans	0:51.69(6)	1:44.78(5) + 0:53.09	2:41.44 (6) + 0:56.66	3:36.13 + 0:54.69
8	NOR	Solvang, Svein Egil Amundsen, Harald	0:52.24 (7)	1:46.20(8) + 0:53.96	2:42.58 (8) + 0:56.38	3:38.16 + 0:55.58
9	HUN	Helyi, Tibor Rajna, Andras	0:51.16(5)	1:45.33(6) + 0:54.17	2:43.09 (9) + 0:57.76	3:43.43 + 1:00.34
Weather/Temps			: sunny			
Wind/Vent			: Velocity/Vitesse = 2.1 m/s Direction = ESE			
Temperature			: Air = 10.4 C Water/Eau = 20.5 C			
Air Pressure/Pression Atm.			: 767 mmHg			

Men Kayak-4 1000m Preliminary Heat 1/Sept. 27			Hommes Kayak-4 1000m Eliminatoire 1/27 Sept			
Rank Rang	Ctry Pays	Name Nom	250m (R)	500m (R)	750m (R)	1000m
1	HUN	Gyulay, Zsolt Csipes, Ferenc Hodosi, Sandor Abraham, Attila	0:43.45(1)	1:30.61 (2) + 0:47.16	2:14.45(1) + 0:43.84	2:58.54 + 0:44.09
2	FRG	Schneider, Gilbert Scholl, Reiner Joestel, Dirk Reineck, Thomas	0:43.96 (2)	1:28.64(1) + 0:44.68	2:14.93(2) + 0:46.29	3:01.07 + 0:46.14
3	NOR	Holmann, Knut Iverson, Morten Sletsjoe, Arne Bernard Almeland, Arne Johan	0:45.40 (3)	1:33.98(5) + 0:48.58	2:16.06(3) + 0:42.08	3:01.54 + 0:45.48
4	ITA	Bonomi, Beniamino Scarpa, Daniele Pieri, Alessandro Mandragona, Francesco	0:46.55 (4)	1:33.32 (4) + 0:46.77	2:16.98(4) + 0:43.66	3:04.38 + 0:47.40
5	FRA	Vavasseur, Didier Petibout, Christophe Lubac, Pierre Legras, Daniel	0:47.12(5)	1:31.54(3) + 0:44.42	2:18.83(5) + 0:47.29	3:16.54 + 0:57.71
6	KOR	Suh, Kyung-Suk Yoon, Young-Dae Lee, Yong-Chul Kim, Dong-Soo	0:49.50 (6)	1:39.67(6) + 0:50.17	2:22.54 (6) + 0:42.87	3:23.32 + 1:00.78
Weather/Temps			: sunny			
Wind/Vent			: Velocity/Vitesse = 0.7 m/s Direction = SSW			
Temperature			: Air = 15.8 C Water/Eau = 20.7 C			
Air Pressure/Pression Atm.			: 763 mmHg			

Men Kayak-4 1000m Preliminary Heat 2/Sept. 27			Hommes Kayak-4 1000m Eliminatoire 2/27 Sept			
Rank Rang	Ctry Pays	Name Nom	250m (R)	500m (R)	750m (R)	1000m
1	POL	Freimut, Maciej Kurpiewski, Wojciech Krawcow, Grzegorz Krzyzanski, Kazimierz	0:42.94(1)	1:29.04(1) + 0:46.10	2:15.10(1) + 0:46.06	3:06.52 + 0:51.42
2	USA	Harbold, Michael White, Carl Bader, Curt Kent, Olney	0:46.47 (4)	1:31.12(3) + 0:44.65	2:20.84 (3) + 0:49.72	3:07.70 + 0:46.86
3	AUS	Thomas, Bryan Wood, Steven Kenny, Grant Gilmour, Paul	0:43.85 (2)	1:30.46(2) + 0:46.61	2:19.06(2) + 0:48.60	3:10.32 + 0:51.26
4	GBR	Burgess, Rueben Ayres, Robin Raciborski, Jan Collier, Adrian	0:45.56(3)	1:33.10(4) + 0:47.54	2:24.21 (4) + 0:51.11	3:16.71 + 0:52.50
5	ARG	Cirillo, Gustavo G. Marello, Jose Luis Chaparro, Fernando J Mendez, Norberto E	0:47.71 (5)	1:38.37(5) + 0:50.66	2:25.63 (5) + 0:47.26	3:23.33 + 0:57.70
6	CAN	Brien, Donald Shaw, Colin Padvaikas, Kenneth Crichlow, Renn	0:48.43 (6)	1:38.85 (6) + 0:50.42	2:27.59 (6) + 0:48.74	3:31.62 + 1:04.03
Weather/Temps			: sunny			
Wind/Vent			: Velocity/Vitesse = 3.2 m/s Direction = E			
Temperature			: Air = 16.5 C Water/Eau = 20.7 C			
Air Pressure/Pression Atm.			: 763 mmHg			

Men Kayak-4 1000m Preliminary Heat 3/Sept. 27			Hommes Kayak-4 1000m Eliminatoire 3/27 Sept			
Rank Rang	Ctry Pays	Name Nom	250m (R)	500m (R)	750m (R)	1000m
1	GDR	Bluhm, Kay Wohllebe, Andre Staehle, Andreas Bliesener, Hans-Joerg	0:44.33 (3)	1:28.52(2) + 0:44.19	2:15.49(2) + 0:46.97	3:02.72 + 0:47.23
2	URS	Motouzenko, Alexandre Kirsanov, Sergei Nagaev, Igor Denissov, Victor	0:43.36(1)	1:27.63(1) + 0:44.27	2:14.95(1) + 0:47.32	3:03.30 + 0:48.35
3	SWE	Bengtsson, Per-Inge Moberg, Lars-Erik Sundkvist, Karl Andersson, Bengt	0:45.44 (4)	1:31.39(4) + 0:45.95	2:17.34(4) + 0:45.95	3:04.98 + 0:47.64
4	ESP	Sanchez, Juan manuel Fuentes, Fernando Alvarez, Javier Roman, Juan jose	0:47.54 (6)	1:29.24(3) + 0:41.70	2:18.00(5) + 0:48.76	3:06.96 + 0:48.96
5	NZL	Bramwell, Grant Clode, Brent Mac, Donald, John Richards, Stephen	0:46.68 (5)	1:34.02 (6) + 0:47.34	2:18.67(6) + 0:44.65	3:10.27 + 0:51.60
6	BUL	Yordanov, Nikolai Godev, Petar Tzvetkov, Borislav Marinov, Ivan	0:43.80 (2)	1:33.05(5) + 0:49.25	2:16.56(3) + 0:43.51	3:15.00 + 0:58.44
Weather/Temps			: sunny			
Wind/Vent			: Velocity/Vitesse = 3.9 m/s Direction = NE			
Temperature			: Air = 16.0 C Water/Eau = 20.7 C			
Air Pressure/Pression Atm.			: 763 mmHg			

Canoeing

Canoë

Men Kayak-4 1000m Repechage 1/Sept. 27			Hommes Kayak-4 1000m Repechage 1/27 Sept			
Rank Rang	Ctry Pays	Name Nom	250m (R)	500m (R)	750m (R)	1000m
1	ITA	Bonomi, Beniamino Scarpa, Daniele Pieri, Alessandro Mandragona, Francesco	0:46.64 (3)	1:33.06(2) + 0:46.42	2:20.46 (2) + 0:47.40	3:06.90 + 0:46.44
2	BUL	Yordanov, Nikolai Godev, Petar Tzvetkov, Borislav Marinov, Ivan	0:45.72 (2)	1:33.59(3) + 0:47.87	2:21.58(3) + 0:47.99	3:09.30 + 0:47.72
3	NZL	Bramwell, Grant Clode, Brent Mac, Donald, John Richards, Stephen	0:44.39(1)	1:31.46(1) + 0:47.07	2:19.27(1) + 0:47.81	3:11.27 + 0:52.00
4	ARG	Cirillo, GustavoG. Marello, Jose Luis Chaparro, Fernando J Mendez, Norberto E	0:48.42 (4)	1:39.71 (4) + 0:51.29	2:30.91 (4) + 0:51.20	3:24.16 + 0:53.25
5	KOR	Suh, Kyung-Suk Yoon, Young-Dae Lee, Yong-Chul Kim, Dong-Soo	0:50.85 (5)	1:41.53(5) + 0:50.68	2:32.38 (5) + 0:50.85	3:26.79 + 0:54.41
Weather/Temps			: sunny			
Wind/Vent			: Velocity/Vitesse = 1.5 m/s Direction = ESE			
Temperature			: Air = 18.4 C Water/Eau = 21.4 C			
Air Pressure/Pression Atm.			: 763 mmHg			

Men Kayak-4 1000m Semi-final 2/Sept. 29			Hommes Kayak-4 1000m Demi-finale 2/29 Sept			
Rank Rang	Ctry Pays	Name Nom	250m (R)	500m (R)	750m (R)	1000m
1	URS	Motouzenko, Alexandre Kirsanov, Sergei Nagaev, Igor Denissov, Victor	0:43.84(1)	1:30.58(1) + 0:46.74	2:20.02(1) + 0:49.44	3:09.07 + 0:49.05
2	POL	Freimut, Maciej Kurpiewski, Wojciech Krawcow, Grzegorz Krzyszanski, Kazimierz	0:45.29 (2)	1:33.15(3) + 0:47.86	2:22.82 (3) + 0:49.67	3:10.87 + 0:48.05
3	FRA	Vavasseur, Didier Petibout, Christophe Lubac, Pierre Legras, Daniel	0:46.68 (4)	1:32.69(2) + 0:46.01	2:21.70(2) + 0:49.01	3:11.11 + 0:49.41
4	NZL	Bramwell, Grant Clode, Brent Mac, Donald, John Richards, Stephen	0:45.92 (3)	1:34.67 (4) + 0:48.75	2:24.79 (4) + 0:50.12	3:15.90 + 0:51.11
	NOR	Holmann, Knut Ivarsen, Morten Sletsjoe, Arne bernard Almeland, Arne johan				DNF
Weather/Temps			: sunny			
Wind/Vent			: Velocity/Vitesse = 2.8 m/s Direction = ESE			
Temperature			: Air = 17.4 C Water/Eau = 20.7 C			
Air Pressure/Pression Atm.			: 770 mmHg			

Men Kayak-4 1000m Repechage 2/Sept. 27			Hommes Kayak-4 1000m Repechage 2/27 Sept			
Rank Rang	Ctry Pays	Name Nom	250m (R)	500m (R)	750m (R)	1000m
1	FRA	Vavasseur, Didier Petibout, Christophe Lubac, Pierre Legras, Daniel	0:45.82(1)	1:34.39(1) + 0:48.57		3:16.68
2	ESP	Sanchez, Juan manuel Fuentes, Fernando Alvarez, Javier Roman, Juan Jose	0:47.27 (3)	1:36.15(3) + 0:48.88		3:16.79
3	CAN	Brien, Donald Shaw, Colin Padvaiskas, Kenneth Crichlow, Renn	0:48.02 (4)	1:37.64(4) + 0:49.62		3:16.80
4	GBR	Burgess, Rueben Ayres, Robin Raciborski, Jan Collier, Adrian	0:46.58 (2)	1:35.62(2) + 0:49.04		3:17.54
Weather/Temps			: sunny			
Wind/Vent			: Velocity/Vitesse = 1.9 m/s Direction = E			
Temperature			: Air = 18.8 C Water/Eau = 21.4 C			
Air Pressure/Pression Atm.			: 763 mmHg			

Men Kayak-4 1000m Semi-final 3/Sept. 29			Hommes Kayak-4 1000m Demi-finale 3/29 Sept			
Rank Rang	Ctry Pays	Name Nom	250m (R)	500m (R)	750m (R)	1000m
1	GDR	Bluhm, Kay Wohllebe, Andre Staehele, Andreas Bliesener, Hans-Joerg	0:43.54(1)	1:29.59(1) + 0:46.05	2:16.88(1) + 0:47.29	3:06.80 + 0:49.92
2	AUS	Thomas, Bryan Wood, Steven Kenny, Grant Gilmour, Paul	0:44.83 (2)	1:31.94(2) + 0:47.11	2:18.75(2) + 0:46.81	3:08.52 + 0:49.77
3	FRG	Schneider, Gilbert Scholl, Reiner Joestel, Dirk Reineck, Thomas	0:47.63 (5)	1:32.51 (3) + 0:44.88	2:19.30(3) + 0:46.79	3:09.67 + 0:50.37
4	BUL	Yordanov, Nikolai Godev, Petar Tzvetkov, Borislav Marinov, Ivan	0:45.87 (4)	1:33.44(4) + 0:47.57	2:20.55 (4) + 0:47.11	3:11.56 + 0:51.01
5	ESP	Sanchez, Juan manuel Fuentes, Fernando Alvarez, Javier Roman, Juan Jose	0:45.38 (3)	1:35.13(5) + 0:49.75	2:21.82(5) + 0:46.69	3:13.88 + 0:52.06
Weather/Temps			: sunny			
Wind/Vent			: Velocity/Vitesse = 3.0 m/s Direction = ENE			
Temperature			: Air = 17.7 C Water/Eau = 20.7 C			
Air Pressure/Pression Atm.			: 770 mmHg			

Men Kayak-4 1000m Semi-final 1/Sept. 29			Hommes Kayak-4 1000m Demi-finale 1/29 Sept			
Rank Rang	Ctry Pays	Name Nom	250m (R)	500m	750m (R)	1000m
1	HUN	Gyulay, Zsolt Csipes, Ferenc Hodosi, Sandor Abraham, Attila	0:44.42(1)	1:31.70(1) + 0:47.28	2:18.39(1) + 0:46.69	3:07.16 + 0:48.77
2	SWE	Bengtsson, Per-Inge Moberg, Lars-Erik Sundkvist, Karl Andersson, Bengt	0:45.01 (2)	1:32.28(2) + 0:47.27	2:20.74 (2) + 0:48.46	3:10.11 + 0:49.37
3	ITA	Bonomi, Beniamino Scarpa, Daniele Pieri, Alessandro Mandragona, Francesco	0:46.11 (3)	1:33.92(3) + 0:47.81	2:22.51 (3) + 0:48.59	3:12.44 + 0:49.93
4	CAN	Brien, Donald Shaw, Colin Padvaiskas, Kenneth Crichlow, Renn	0:47.64 (5)	1:36.85(5) + 0:49.21	2:25.76 (5) + 0:48.91	3:15.03 + 0:49.27
5	USA	Harbold, Michael White, Carl Bader, Curt Kent, Olney	0:46.90 (4)	1:34.44 (4) + 0:47.54	2:23.82 (4) + 0:49.38	3:15.60 + 0:51.78
Weather/Temps			: sunny			
Wind/Vent			: Velocity/Vitesse = 1.8 m/s Direction = ENE			
Temperature			: Air = 16.9 C Water/Eau = 20.7 C			
Air Pressure/Pression Atm.			: 770 mmHg			

Men Kayak-4 1000m Final/Oct. 1			Hommes Kayak-4 1000m Finale/1 Oct			
Rank Rang	Ctry Pays	Name Nom	250m (R)	500m (R)	750m (R)	1000m
1	HUN	Gyulay, Zsolt Csipes, Ferenc Hodosi, Sandor Abraham, Attila	0:43.52 (2)	1:30.95(7) + 0:47.43	2:13.59(1) + 0:42.64	3:00.20 + 0:46.61
2	URS	Motouzenko, Alexandre Kirsanov, Sergei Nagaev, Igor Denissov, Victor	0:43.97 (3)	1:28.55(2) + 0:44.58	2:14.95(2) + 0:46.40	3:01.40 + 0:46.45
3	GDR	Bluhm, Kay Wohllebe, Andre Staehele, Andreas Bliesener, Hans-Joerg	0:43.14(1)	1:28.14(1) + 0:45.00	2:15.54(3) + 0:47.40	3:02.37 + 0:46.83
4	AUS	Thomas, Bryan Wood, Steven Kenny, Grant Gilmour, Paul	0:44.90 (5)	1:30.55(6) + 0:45.65	2:17.17(4) + 0:46.62	3:03.70 + 0:46.53
5	POL	Freimut, Maciej Kurpiewski, Wojciech Krawcow, Grzegorz Krzyszanski, Kazimierz	0:44.43 (4)	1:28.98(3) + 0:44.55	2:18.16(6) + 0:49.18	3:04.73 + 0:46.57
6	FRG	Schneider, Gilbert Scholl, Reiner Joestel, Dirk Reineck, Thomas	0:47.01 (9)	1:29.46 (4) + 0:42.45	2:19.63(8) + 0:50.17	3:05.43 + 0:45.80



Rank Rang	Ctry Pays	Name Nom	250m (R)	500m (R)	750m (R)	1000m
7	ITA	Bonomi, Beniamino Scarpa, Daniele Pieri, Alessandro Mandragona, Francesco	0:45.90 (7)	1:31.36(8) + 0:45.46	2:17.68(5) + 0:46.32	3:05.97 + 0:48.29
8	SWE	Bengtsson, Per-Inge Moberg, Lars-Erik Sundkvist, Karl Andersson, Bengt	0:46.43 (8)	1:30.05 (5) + 0:43.62	2:18.88(7) + 0:48.83	3:06.03 + 0:47.15
9	FRA	Vasseur, Didier Petibout, Christophe Lubac, Pierre Legras, Daniel	0:45.41 (6)	1:31.79(9) + 0:46.38	2:20.41 (9) + 0:48.62	3:08.71 + 0:48.30

Weather/Temps : sunny
Wind/Vent : Velocity/Vitesse = 12 m/s Direction = ESE
Temperature : Air = 12.4 C Water/Eau = 20.5 C
Air Pressure/Pression Atm. : 767 mmHg

Men Canadian-1 500m Preliminary Heat 1/Sept. 26			Hommes Canadien-1 500m Eliminatoire 1/26 Sept	
Rank Rang	Ctry Pays	Name Nom	250m (R)	500m
1	URS	Slivinskii, Mikhail	0:55.48 (3)	1:51.90 + 0:56.42
2	BUL	Marinov, Martin	0:54.72 (2)	1:52.74 + 0:58.02
3	GDR	Heukrodt, Olaf	0:54.32(1)	1:53.73 + 0:59.41
4	TCH	Prochazka, Petr	0:56.65 (5)	1:58.09 + 1:01.44
5	POL	Pinczura, Jan	0:56.07 (4)	2:00.20 + 1:04.13
6	KOR	Chang, Young-Chul	0:59.66 (6)	2:11.96 + 1:12.30

Weather/Temps : sunny
Wind/Vent : Velocity/Vitesse = 2.9 m/s Direction = WNW
Temperature : Air = 11.4 C Water/Eau = 21.7 C
Air Pressure/Pression Atm. : 761 mmHg

Men Canadian-1 500m Preliminary Heat 3/Sept. 26			Hommes Canadien-1 500m Eliminatoire 3/26 Sept	
Rank Rang	Ctry Pays	Name Nom	250m (R)	500m
1	HUN	Szabo, Attila	0:56.53 (2)	1:54.83 + 0:58.30
2	ROM	Macarencu, Aurel	0:57.01 (3)	1:54.95 + 0:57.94
3	GBR	Jamieson, Eric	0:55.43(1)	1:55.66 + 1:00.23
4	YUG	Sabjan, Ivan	0:57.61 (4)	2:00.55 + 1:04.94
5	FIN	Gronlund, Timo	0:58.73 (5)	2:01.60 + 1:02.87
6	JPN	Kanada, Yasunobu	0:59.53 (6)	2:10.20 + 1:10.67

Weather/Temps : sunny
Wind/Vent : Velocity/Vitesse = 4.7 m/s Direction = WNW
Temperature : Air = 10.6 C Water/Eau = 21.7 C
Air Pressure/Pression Atm. : 761 mmHg

Men Canadian-1 500m Repechage 1/Sept. 26			Hommes Canadien-1 500m Repechage 1/26 Sept	
Rank Rang	Ctry Pays	Name Nom	250m (R)	500m
1	TCH	Prochazka, Petr	0:58.43(1)	2:00.64 + 1:02.21
2	FIN	Gronlund, Timo	0:59.18(2)	2:01.48 + 1:02.30
3	KOR	Chang, Young-Chul	1:01.01 (4)	2:05.85 +1:04.84
4	JPN	Kanada, Yasunobu	0:59.89 (3)	2:06.31 + 1:06.42

Weather/Temps : cloudy
Wind/Vent : Velocity/Vitesse = 3.8 m/s Direction = N
Temperature : Air = 13.6 C Water/Eau = 21.7 C
Air Pressure/Pression Atm. : 760 mmHg

Men Canadian-1 500m Semi-final 1/Sept. 28			Hommes Canadien-1 500m Demi-finale 1/28 Sept	
Rank Rang	Ctry Pays	Name Nom	250m (R)	500m
1	URS	Slivinskii, Mikhail	0:55.76 (2)	1:52.86 + 0:57.10
2	GBR	Jamieson, Eric	0:55.07(1)	1:54.30 + 0:59.23
3	TCH	Prochazka, Petr	0:56.46 (3)	1:55.62 + 0:59.16
4	CAN	Cain, Larry	0:57.21 (4)	1:56.24 + 0:59.03

Weather/Temps : sunny
Wind/Vent : Velocity/Vitesse = 2.5 m/s Direction = WNW
Temperature : Air = 12.8 C Water/Eau = 20.5 C
Air Pressure/Pression Atm. : 766 mmHg

Men Canadian-1 500m Semi-final 2/Sept. 28			Hommes Canadien-1 500m Demi-finale 2/28 Sept	
Rank Rang	Ctry Pays	Name Nom	250m (R)	500m
1	GDR	Heukrodt, Olaf	0:55.86(1)	1:55.50 + 0:59.64
2	POL	Pinczura, Jan	0:56.96 (2)	1:57.61 + 1:00.65
3	ROM	Macarencu, Aurel	0:57.76 (3)	1:57.81 + 1:00.05
4	USA	Terrell, James	0:58.34 (4)	2:00.13 + 1:03.79
5	KOR	Chang, Young-Chul	1:00.16(5)	2:05.04 +1:04.88

Weather/Temps : sunny
Wind/Vent : Velocity/Vitesse = 2.0 m/s Direction = NW
Temperature : Air = 13.4 C Water/Eau = 20.5 C
Air Pressure/Pression Atm. : 766 mmHg

Men Canadian-1 500m Semi-final 3/Sept. 28			Hommes Canadien-1 500m Demi-finale 3/28 Sept	
Rank Rang	Ctry Pays	Name Nom	250m (R)	500m
1	BUL	Marinov, Martin	0:56.18(1)	1:55.61 + 0:59.43
2	HUN	Szabo, Attila	0:56.60 (2)	1:55.72 + 0:59.12
3	ESP	Suarez, Narciso	0:57.14(3)	1:55.98 + 0:58.84
4	YUG	Sabjan, Ivan	0:57.76 (4)	1:55.99 + 0:58.23
5	FIN	Gronlund, Timo	0:59.39 (5)	2:04.82 + 1:05.43

Weather/Temps : sunny
Wind/Vent : Velocity/Vitesse = 2.2 m/s Direction = WNW
Temperature : Air = 14.0 C Water/Eau = 20.5 C
Air Pressure/Pression Atm. : 766 mmHg

Canoeing

Canoë

Men Canadian-1 500m Final/Sept. 30			Hommes Canadien-1 500m Finale/30 Sept	
Rank Rang	Ctry Pays	Name Nom	250m (R)	500m
1	GDR	Heukrodt, Olaf	1:01.11 (9)	1:56.42 + 0:55.31
2	URS	Slivinskii, Mikhail	0:57.58 (3)	1:57.26 + 0:59.68
3	BUL	Marinov, Martin	0:59.93 (7)	1:57.27 + 0:57.34
4	HUN	Szabo, Attila	0:59.34 (6)	1:59.87 + 1:00.53
5	POL	Pinczura, Jan	1:00.50 (8)	1:59.90 + 0:59.40
6	ROM	Macarencu, Aurel	0:56.98 (2)	2:00.98 + 1:04.00
7	ESP	Suarez, Narciso	0:58.73 (5)	2:01.33 + 1:02.60
8	TCH	Prochazka, Petr	0:56.41 (1)	2:01.36 + 1:04.95
9	GBR	Jamieson, Eric	0:58.16(4)	2:02.27 + 1:04.11

Weather/Temps : sunny
Wind/Vent : Velocity/Vitesse = 1.4 m/s Direction = E
Temperature : Air = 10.8 C Water/Eau = 20.7 C
Air Pressure/Pression Atm. : 770 mmHg

Men Canadian-1 1000m Preliminary Heat 1/Sept. 27			Hommes Canadien-1 1000m Eliminatoire 1/27 Sept			
Rank Rang	Ctry Pays	Name Nom	250m (R)	500m (R)	750m (R)	1000m
1	GDR	Schmidt, Joerg	0:58.53 (2)	2:00.18(2) + 1:03.65	3:03.31 (2) + 1:03.13	4:06.18 + 1:02.87
2	GBR	Jamieson, Eric	0:57.75(1)	1:59.56(1) + 1:01.81	3:02.68(1) + 1:03.12	4:06.88 + 1:04.20
3	BUL	Boukhalov, Nikolai	0:59.18(3)	2:02.38 (4) + 1:03.20	3:04.57 (3) + 1:02.19	4:09.57 + 1:05.00
4	TCH	Pales, Peter	0:59.83 (4)	2:01.73(3) + 1:01.90	3:05.11 (4) + 1:03.38	4:11.88 + 1:06.77
5	POL	Pinczura, Jan	1:01.05(6)	2:04.60 (6) + 1:03.55	3:07.10(5) + 1:02.50	4:14.10 + 1:07.00
6	USA	Merritt, Bruce	1:00.48(5)	2:04.08 (5) + 1:03.60	3:08.93 (6) + 1:04.85	4:17.73 + 1:08.80
7	FIN	Gronlund, Timo	1:01.71 (7)	2:06.08 (7) + 1:04.37	3:13.35(7) + 1:07.27	4:24.69 + 1:11.34

Weather/Temps : sunny
Wind/Vent : Velocity/Vitesse = 1.3 m/s Direction = WNW
Temperature : Air = 10.0 C Water/Eau = 20.7 C
Air Pressure/Pression Atm. : 763 mmHg

Men Canadian-1 1000m Preliminary Heat 2/Sept. 27			Hommes Canadien-1 1000m Eliminatoire 2/27 Sept			
Rank Rang	Ctry Pays	Name Nom	250m (R)	500m (R)	750m (R)	1000m
1	URS	Klementiev, Ivan	0:57.28(1)	1:58.95(1) + 1:01.67	3:01.87(1) + 1:02.92	4:05.12 + 1:03.25
2	CAN	Cain, Larry	0:59.24 (4)	2:00.14(2) + 1:02.90	3:03.52 (2) + 1:03.38	4:09.50 + 1:05.98
3	ROM	Macarencu, Aurel	0:58.68 (3)	2:00.71 (3) + 1:02.03	3:04.64 (3) + 1:03.93	4:09.71 + 1:05.07
4	YUG	Sabjan, Ivan	1:01.77(7)	2:04.26 (6) + 1:02.49	3:09.04 (6) + 1:04.78	4:11.54 + 1:02.50
5	HUN	Pulai, Imre	1:00.75 (6)	2:01.92(4) + 1:01.17	3:06.75 (4) + 1:04.83	4:12.18 + 1:05.43
6	ESP	Lopez, Francisco	1:00.00(5)	2:03.06 (5) + 1:03.06	3:07.69 (5) + 1:04.63	4:16.02 + 1:08.33
7	JPN	Izumi, Hiroyuki	1:03.87(8)	2:12.88(7) + 1:09.01	3:21.28(7) + 1:08.40	4:40.34 + 1:19.06
8	KOR	Chang, Young-Chul	0:58.13(2)	2:17.64(8) + 1:19.51	3:25.79 (8) + 1:08.15	4:47.95 + 1:22.16

Weather/Temps : sunny
Wind/Vent : Velocity/Vitesse = 1.0 m/s Direction = NW
Temperature : Air = 10.0 C Water/Eau = 20.7 C
Air Pressure/Pression Atm. : 763 mmHg

Men Canadian-1 1000m Repechage 1/Sept. 27			Hommes Canadien-1 1000m Repechage 1/27 Sept			
Rank Rang	Ctry Pays	Name Nom	250m (R)	500m (R)	750m (R)	1000m
1	TCH	Pales, Peter	0:59.37(1)	2:03.35(1) + 1:03.98	3:10.31 (1) + 1:06.96	4:17.83 + 1:07.52
2	HUN	Pulai, Imre	0:59.96 (2)	2:03.88 (2) + 1:03.92	3:12.57(2) + 1:08.69	4:20.50 + 1:07.93
3	USA	Merritt, Bruce	1:00.81 (3)	2:08.12(3) + 1:07.31	3:21.27(3) + 1:13.15	4:41.75 + 1:20.48
4	JPN	Izumi, Hiroyuki	1:03.22 (4)	2:15.05(4) + 1:11.83	3:22.63 (4) + 1:07.58	5:00.96 + 1:38.33

Weather/Temps : sunny
Wind/Vent : Velocity/Vitesse = 3.4 m/s Direction = ENE
Temperature : Air = 18.5 C Water/Eau = 21.4 C
Air Pressure/Pression Atm. : 763 mmHg

Men Canadian-1 1000m Repechage 2/Sept. 27			Hommes Canadien-1 1000m Repechage 2/27 Sept			
Rank Rang	Ctry Pays	Name Nom	250m (R)	500m (R)	750m (R)	1000m
1	YUG	Sabjan, Ivan	1:01.74(1)	2:07.42(1) + 1:05.68	3:14.60(1) + 1:07.18	4:20.82 + 1:06.22
2	ESP	Lopez, Francisco	1:02.73 (2)	2:08.50 (2) + 1:05.77	3:15.81 (2) + 1:07.31	4:22.34 + 1:06.53
3	POL	Pinczura, Jan	1:03.59(3)	2:09.53 (3) + 1:05.94	3:16.75(3) + 1:07.22	4:24.10 + 1:07.35
4	FIN	Gronlund, Timo	1:05.34(5)	2:10.71 (4) + 1:05.37	3:18.77(4) + 1:08.06	4:26.80 + 1:08.03
5	KOR	Chang, Young-chul	1:04.39(4)	2:14.59(5) + 1:10.20	3:24.15(5) + 1:09.56	4:43.95 + 1:19.80

Weather/Temps : sunny
Wind/Vent : Velocity/Vitesse = 2.1 m/s Direction = NE
Temperature : Air = 18.2 C Water/Eau = 21.4 C
Air Pressure/Pression Atm. : 763 mmHg

Men Canadian-1 1000m Semi-final 1/Sept. 29			Hommes Canadien-1 1000m Demi-finale/29 Sept			
Rank Rang	Ctry Pays	Name Nom	250m (R)	500m (R)	750m (R)	1000m
1	ROM	Macarencu, Aurel	0:58.73(1)	1:59.78(1) + 1:01.05	3:03.80(1) + 1:04.02	4:07.69 + 1:03.89
2	GDR	Schmidt, Joerg	0:59.32 (2)	2:00.07 (2) + 1:02.75	3:04.62 (2) + 1:04.55	4:08.17 + 1:03.55
3	YUG	Sabjan, Ivan	1:00.03 (3)	2:02.26 (3) + 1:02.23	3:06.39 (3) + 1:04.13	4:08.75 + 1:02.36
4	USA	Merritt, Bruce	1:01.69(4)	2:05.56 (4) + 1:03.87	3:11.61 (4) + 1:06.05	4:16.51 + 1:04.90

Weather/Temps : sunny
Wind/Vent : Velocity/Vitesse = 1.2 m/s Direction = N
Temperature : Air = 14.6 C Water/Eau = 20.7 C
Air Pressure/Pression Atm. : 770 mmHg

Men Canadian-1 1000m Semi-final 2/Sept. 29			Hommes Canadien-1 1000m Demi-finale 2/29 Sept			
Rank Rang	Ctry Pays	Name Nom	250m (R)	500m (R)	750m (R)	1000m
1	URS	Klementiev, Ivan	0:58.23(1)	1:59.81 (1) + 1:01.58	3:02.59(1) + 1:02.78	4:05.06 + 1:02.47
2	BUL	Boukhalov, Nikolai	0:59.52 (3)	2:00.38 (2) + 1:02.86	3:03.61 (2) + 1:03.23	4:07.23 + 1:03.62
3	HUN	Pulai, Imre	0:59.00 (2)	2:00.69 (3) + 1:01.69	3:04.40 (3) + 1:03.71	4:10.79 + 1:06.39
4	ESP	Lopez, Francisco	1:00.30(4)	2:03.57 (4) + 1:03.27	3:09.51 (4) + 1:05.94	4:16.90 + 1:07.39

Weather/Temps : sunny
Wind/Vent : Velocity/Vitesse = 1.9 m/s Direction = NW
Temperature : Air = 14.7 C Water/Eau = 20.7 C
Air Pressure/Pression Atm. : 770 mmHg



Men Canadian-1 1000m
Semi-final 3/Sept. 29

Hommes Canadien-1 1000m
Demi-finale 3/29 Sept

Rank Rang	Ctry Pays	Name Nom	250m (R)	500m (R)	750m (R)	1000m
1	CAN	Cain, Larry	0:57.69(1)	1:58.86(1) + 1:01.17	3:02.84(1) + 1:03.98	4:07.47 + 1:04.63
2	TCH	Pales, Peter	0:58.99(3)	2:01.31 (3) + 1:02.32	3:04.93 (2) + 1:03.62	4:08.84 + 1:03.91
3	GBR	Jamieson, Eric	0:58.05 (2)	2:00.00 (2) + 1:03.95	3:05.38 (3) + 1:05.38	4:13.44 + 1:08.06
	POL	Pinczura, Jan				DQL

Weather/Temps : sunny
Wind/Vent : Velocity/Vitesse = 2.3 m/s Direction = NW
Temperature : Air = 15.0 C Water/Eau = 20.7 C
Air Pressure/Pression Atm. : 770 mmHg

Men Canadian-1 1000m
Final/Oct. 1

Hommes Canadien-1 1000m
Finale/1 Oct

Rank Rang	Ctry Pays	Name Nom	250m (R)	500m (R)	750m (R)	1000m
1	URS	Klementiev, Ivan	1:00.28(1)	2:02.95(1) + 1:02.67	3:07.68(1) + 1:04.73	4:12.78 + 1:05.10
2	GDR	Schmidt, Joerg	1:01.15(3)	2:04.19(2) + 1:03.04	3:09.68 (2) + 1:05.49	4:15.83 + 1:06.15
3	BUL	Boukhalov, Nikolai	1:02.57(6)	2:06.73 (4) + 1:04.16	3:11.99(3) + 1:05.26	4:18.94 + 1:06.95
4	CAN	Cain, Larry	1:00.69(2)	2:05.81 (3) + 1:05.12	3:13.17(4) + 1:07.36	4:20.70 + 1:07.53
5	ROM	Macarencu, Aurel	1:03.46 (8)	2:09.60 (7) + 1:06.14	3:17.13(6) + 1:07.53	4:21.72 + 1:04.59
6	HUN	Pulai, Imre	1:02.10(5)	2:07.75 (5) + 1:05.65	3:16.60(5) + 1:08.85	4:21.86 + 1:05.26
7	TCH	Pales, Peter	1:03.03(7)	2:08.96 (6) + 1:05.93	3:17.76(7) + 1:08.80	4:22.14 + 1:04.38
8	YUG	Sabjan, Ivan	1:03.98(9)		3:18.68(8)	4:24.67 + 1:05.99
9	GBR	Jamieson, Eric	1:01.62(4)	2:10.46(8) + 1:08.84	3:21.93(9) + 1:11.47	4:39.60 + 1:17.67

Weather/Temps : sunny
Wind/Vent : Velocity/Vitesse = 1.6 m/s Direction = E
Temperature : Air = 8.8 C Water/Eau = 20.5 C
Air Pressure/Pression Atm. : 767 mmHg

Men Canadian-2 500m
Preliminary Heat 1/Sept. 26

Hommes Canadien-2 500m
Eliminatoire 1/26 Sept

Rank Rang	Ctry Pays	Name Nom	250m (R)	500m
1	BUL	Bonev, Deyan Bojilov, Petar	0:50.48(1)	1:44.53 0:54.05
2	FRG	Faust, Hartmut Faust, Wolfram	0:51.93(2)	1:46.52 0:54.59
3	ESP	Suarez, Narciso Miguez, Enrique	0:52.29 (3)	1:48.75 0:56.46
4	CHN	Guo, Daen Ke, Hua	0:52.92 (4)	1:56.02 1:03.10
5	KOR	Choi, Chang-hwan Park, Kyung-chul	0:56.99 (5)	2:01.08 1:04.09

Weather/Temps : sunny
Wind/Vent : Velocity/Vitesse = 4.0 m/s Direction = W
Temperature : Air = 13.5 C Water/Eau = 21.7 C
Air Pressure/Pression Atm. : 761 mmHg

Men Canadian-2 500m
Preliminary Heat 2/Sept. 26

Hommes Canadien-2 500m
Eliminatoire 2/26 Sept

Rank Rang	Ctry Pays	Name Nom	250m (R)	500m
1	POL	Dopierala, Marek Lbik, Marek	0:49.54(1)	1:43.09 0:53.55
2	FRA	Renaud, Philippe Bettin, Joel	0:50.10(2)	1:43.83 0:53.73
3	DEN	Frederiksen, Christian Nielsen, Arne	0:50.77 (3)	1:43.92 0:53.15
4	TCH	Prochazka, Petr Lohnisky, Alan	0:51.41(4)	1:46.30 0:54.89
5	GBR	Train, Andrew Train, Steven	0:52.79 (6)	1:46.95 0:54.16
6	JPN	Uchino, Tsunehisa Inoue, Kiyoto	0:52.36 (5)	1:48.70 0:56.34

Weather/Temps : sunny
Wind/Vent : Velocity/Vitesse = 4.6 m/s Direction = NW
Temperature : Air = 13.2 C Water/Eau = 21.7 C
Air Pressure/Pression Atm. : 761 mmHg

Men Canadian-2 500m
Preliminary Heat 3/Sept. 26

Hommes Canadien-2 500m
Eliminatoire 3/26 Sept

Rank Rang	Ctry Pays	Name Nom	250m (R)	500m
1	GDR	Schuck, Alexander Zereske, Thomas	0:48.64(1)	1:42.67 0:54.03
2	URS	Reneiski, Victor Jouravski, Nikolai	0:49.18(2)	1:42.80 0:53.62
3	HUN	Sarusi kis, Janos Vaskuti, Istvan	0:49.95 (3)	1:43.16 0:53.21
4	ROM	Obreja, Grigore Andriev, Gheorghe	0:50.67 (4)	1:44.91 0:54.24
5	CAN	Frost, David Smith, Eric	0:51.51 (5)	1:46.93 0:55.42
6	USA	Mclain, Rodney Merritt, Bruce	0:53.36 (6)	1:51.48 0:58.12

Weather/Temps : sunny
Wind/Vent : Velocity/Vitesse = 3.2 m/s Direction = NW
Temperature : Air = 13.1 C Water/Eau = 21.7 C
Air Pressure/Pression Atm. : 761 mmHg

Men Canadian-2 500m
Repechage 1/Sept. 26

Hommes Canadien-2 500m
Repechage 1/26 Sept

Rank Rang	Ctry Pays	Name Nom	250m (R)	500m
1	GBR	Train, Andrew Train, Steven	0:56.01 (2)	1:52.63 0:56.62
2	CAN	Frost, David Smith, Eric	0:56.42 (3)	1:53.07 0:56.65
3	USA	Mclain, Rodney Merritt, Bruce	0:55.64(1)	1:53.36 0:57.72
4	CHN	Guo, Daen Ke, Hua	0:57.44 (4)	1:53.69 0:56.25

Weather/Temps : sunny
Wind/Vent : Velocity/Vitesse = 4.1 m/s Direction = E
Temperature : Air = 15.1 C Water/Eau = 21.7 C
Air Pressure/Pression Atm. : 760 mmHg

Men Canadian-2 500m
Repechage 2/Sept. 26

Hommes Canadien-2 500m
Repechage 2/26 Sept.

Rank Rang	Ctry Pays	Name Nom	250m (R)	500m
1	TCH	Prochazka, Petr Lohnisky, Alan	0:53.72(1)	1:50.23 0:56.51
2	ROM	Obreja, Grigore Andriev, Gheorghe	0:54.17(2)	1:50.44 0:56.27
3	JPN	Uchino, Tsunehisa Inoue, Kiyoto	0:54.89 (3)	1:55.13 1:00.24
4	KOR	Choi, Chang-Hwan Park, Kyung-Chul	0:58.33 (4)	2:05.58 1:07.25

Weather/Temps : sunny
Wind/Vent : Velocity/Vitesse = 5.9 m/s Direction = NNE
Temperature : Air = 15.3 C Water/Eau = 21.7 C
Air Pressure/Pression Atm. : 760 mmHg

Canoeing

Canoë

Men Canadian-2 500m Semi-final 1/Sept. 28			Hommes Canadien-2 500m Demi-finale 1/28 Sept	
Rank Rang	Ctry Pays	Name Nom	250m (R)	500m
1	HUN	Sarusi kis, Janos Vaskuti, Istvan	0:50.70(1)	1:45.91 0:55.21
2	FRA	Renaud, Philippe Bettin, Joel	0:51.23 (2)	1:45.99 0:54.76
3	BUL	Bonev, Deyan Bojilov, Petar	0:52.24 (3)	1:48.60 0:56.36
4	GBR	Train, Andrew Train, Steven	0:54.20 (5)	1:50.31 0:56.11
5	JPN	Uchino, Tsunehisa Inoue, Kiyoto	0:53.23 (4)	1:50.89 0:57.66
Weather/Temps : sunny Wind/Vent : Velocity/Vitesse = 0.7 m/s Direction = W Temperature : Air = 15.8C Water/Eau = 20.5 C Air Pressure/Pression Atm. : 766 mmHg				

Men Canadian-2 500m Semi-final 2/Sept. 28			Hommes Canadien-2 500m Demi-finale 2/28 Sept	
Rank Rang	Ctry Pays	Name Nom	250m (R)	500m
1	URS	Reneiski, Victor Jouravski, Nikolai	0:50.09(1)	1:45.16 0:55.07
2	POL	Dopierala, Marek Lbik, Marek	0:50.71 (2)	1:49.06 0:58.35
3	TCH	Prochazka, Petr Lohnisky, Alan	0:53.30 (3)	1:50.14 0:56.84
4	ESP	Suarez, Narciso Miguez, Enrique	0:54.19(4)	1:50.63 0:56.44
5	USA	Mclain, Rodney Merritt, Bruce	0:55.03 (5)	1:53.32 0:58.29
Weather/Temps : sunny Wind/Vent : Velocity/Vitesse = 0.6 m/s Direction = SW Temperature : Air = 17.1 C Water/Eau = 20.5 C Air Pressure/Pression Atm. : 766 mmHg				

Men Canadian-2 500m Semi-final 3/Sept. 28			Hommes Canadien-2 500m Demi-finale 3/28 Sept	
Rank Rang	Ctry Pays	Name Nom	250m (R)	500m
1	GDR	Schuck, Alexander Zereske, Thomas	0:42.03(1)	1:46.07 1:04.04
2	ROM	Obreja, Grigore Andriev, Gheorghe	0:42.46 (2)	1:46.25 1:03.79
3	DEN	Frederiksen, Christian Nielsen, Arne	0:43.11 (3)	1:47.24 1:04.13
4	FRG	Faust, Hartmut Faust, Wolfram	0:50.74 (5)	1:47.70 0:56.96
5	CAN	Frost, David Smith, Eric	0:43.53 (4)	1:49.92 1:06.39
Weather/Temps : sunny Wind/Vent : Velocity/Vitesse = 1.3 m/s Direction = ESE Temperature : Air = 17.1 C Water/Eau = 20.5 C Air Pressure/Pression Atm. : 766 mmHg				

Men Canadian-2 500m Final/Sept. 30			Hommes Canadien-2 500m Finale/30 Sept	
Rank Rang	Ctry Pays	Name Nom	250m (R)	500m
1	URS	Reneiski, Victor Jouravski, Nikolai	0:49.48 (2)	1:41.77 0:52.29
2	POL	Dopierala, Marek Lbik, Marek	0:49.99 (3)	1:43.61 0:53.62
3	FRA	Renaud, Philippe Bettin, Joel	0:50.56 (4)	1:43.81 0:53.25
4	BUL	Bonev, Deyan Bojilov, Petar	0:51.03(5)	1:44.32 0:53.29
5	GDR	Schuck, Alexander Zereske, Thomas	0:48.81 (1)	1:44.36 0:55.55
6	HUN	Sarusi kis, Janos Vaskuti, Istvan	0:51.55 (6)	1:44.85 0:53.30
7	ROM	Obreja, Grigore Andriev, Gheorghe	0:52.02 (7)	1:45.84 0:53.82
8	DEN	Frederiksen, Christian Nielsen, Arne	0:52.54 (8)	1:45.90 0:53.36
9	TCH	Prochazka, Petr Lohnisky, Alan	0:53.24 (9)	1:51.00 0:57.76
Weather/Temps : sunny Wind/Vent : Velocity/Vitesse = 2.1 m/s Direction = WNW Temperature : Air = 15.3 C Water/Eau = 20.7 C Air Pressure/Pression Atm. : 770 mmHg				

Men Canadian-2 1000m Preliminary Heat 1/Sept. 27			Hommes Canadien-2 1000m Eliminatoire 1/27 Sept			
Rank Rang	Ctry Pays	Name Nom	250m (R)	500m (R)	750m (R)	1000m
1	URS	Reneiski, Victor Jouravski, Nikolai	0:51.49(1)	1:49.10(1) + 0:57.61	2:49.16(1) + 1:00.06	3:48.27 + 0:59.11
2	DEN	Frederiksen, Christian Nielsen, Arne	0:53.77 (2)	1:50.88 (2) + 0:57.11	2:50.72 (2) + 0:59.84	3:50.58 + 0:59.86
3	GBR	Train, Andrew Train, Steven	0:55.25 (4)	1:55.14(4) + 0:59.89	2:54.66 (3) + 0:59.52	3:55.90 + 1:01.24
4	CAN	Frost, David Smith, Eric	0:54.66 (3)	1:54.59 (3) + 0:59.93	2:56.17(4) + 1:01.58	3:58.14 + 1:01.97
5	YUG	Nisovic, Mirko Ljubek, Matija	0:57.13(5)	1:57.34 (5) + 1:00.21	2:57.77 (5) + 1:00.43	4:02.10 + 1:04.33
6	USA	Steward, Gregory Urlick, Ronald	0:59.89 (6)	2:05.24 (6) + 1:05.35	3:01.68(6) + 0:56.44	4:26.56 + 1:24.88
Weather/Temps : sunny Wind/Vent : Velocity/Vitesse = 0.7 m/s Direction = SE Temperature : Air = 12.9 C Water/Eau = 20.7 C Air Pressure/Pression Atm. : 763 mmHg						

Men Canadian-2 1000m Preliminary Heat 2/Sept. 27			Hommes Canadien-2 1000m Eliminatoire 2/27 Sept			
Rank Rang	Ctry Pays	Name Nom	250m (R)	500m (R)	750m (R)	1000m
1	ROM	Obreja, Grigore Andriev, Gheorghe	0:53.74(1)	1:51.28(1) + 0:57.54	2:50.32(1) + 0:59.04	3:48.41 + 0:58.09
2	FRA	Sylvoz, Pascal Hoyer, Didier	0:54.26 (2)	1:52.07 (2) + 0:57.81	2:50.84 (2) + 0:58.77	3:48.47 + 0:57.63
3	TCH	Krivanek, Tomas Fibigr, Waldemar	0:54.89 (3)	1:52.85 (3) + 0:57.96	2:52.36 (3) + 0:59.51	3:54.38 + 1:02.02
4	JPN	Sakamoto, Toshisuke Toyama, Katsuya	0:57.90 (4)	2:02.09 (4) + 1:04.19	2:58.26 (4) + 0:56.17	4:09.29 + 1:11.03
5	KOR	Choi, Chang-hwan Park, Kyung-Chul	1:00.46(5)	2:06.59 (5) + 1:06.13	2:59.08 (5) + 0:52.49	4:23.51 + 1:24.43
Weather/Temps : sunny Wind/Vent : Velocity/Vitesse = 0.6 m/s Direction = ESE Temperature : Air = 13.2 C Water/Eau = 20.7 C Air Pressure/Pression Atm. : 763 mmHg						



Men Canadian-2 1000m Preliminary Heat 3/Sept. 27			Hommes Canadien-2 1000m Eliminatoire 3/27 Sept			
Rank Rang	Ctry Pays	Name Nom	250m (R)	500m (R)	750m (R)	1000m
1	GDR	Heukrodt, Olaf Spelly, Ingo	0:50.86(1)	1:45.73(1) + 0:54.87	2:41.94(1) + 0:56.21	3:40.82 + 0:58.88
2	POL	Dopierala, Marek Lbik, Marek	0:51.66(2)	1:46.77 (2) + 0:55.11	2:44.20 (3) + 0:57.43	3:44.24 +1:00.04
3	HUN	Takacs, Gabor Leikep, Gusztav	0:52.67 (3)	1:47.92 (3) + 0:55.25	2:42.96 (2) + 0:55.04	3:45.50 + 1:02.54
4	FRG	Faust, Hartmut Faust, Wolfram	0:53.96 (5)	1:48.94 (4) + 0:54.98	2:45.80 (4) + 0:56.86	3:52.43 + 1:06.63
5	BUL	Bonev, Deyan Bojilov, Petar	0:53.29 (4)	1:49.99 (5) + 0:56.70	2:47.20 (5) + 0:57.21	4:01.42 + 1:14.22
6	CHN	Guo, Daen Ke, Hua				4:15.50
Weather/Temps : sunny						
Wind/Vent : Velocity/Vitesse = 0.9 m/s Direction = W						
Temperature : Air = 14.3 C Water/Eau = 20.7 C						
Air Pressure/Pression Atm. : 763 mmHg						

Men Canadian-2 1000m Repechage 1/Sept. 27			Hommes Canadien-2 1000m Repechage 1/27 Sept			
Rank Rang	Ctry Pays	Name Nom	250m (R)	500m (R)	750m (R)	1000m
1	CHN	Guo, Daen Ke, Hua	0:57.11 (1)	1:58.35(1) + 1:01.24	3:01.75(1) + 1:03.40	4:06.86 + 1:05.11
2	BUL	Bonev, Deyan Bojilov, Petar	0:58.74 (3)	2:00.42 (3) + 1:03.68	3:02.27 (2) + 1:01.85	4:06.91 + 1:04.64
3	CAN	Frost, David Smith, Eric	0:57.83 (2)	1:59.83 (2) + 1:02.00	3:02.80 (3) + 1:02.97	4:06.93 + 1:04.13
4	USA	Steward, Gregory Urlick, Ronald	1:00.75 (5)	2:05.67 (4) + 1:04.92	3:11.71 (4) + 1:06.04	4:17.77 + 1:06.06
5	KOR	Choi, Chang-Hwan Park, Kyung-Chul	0:59.84 (4)	2:06.04 (5) + 1:06.20	3:12.30(5) + 1:06.26	4:18.23 + 1:05.93
Weather/Temps : sunny						
Wind/Vent : Velocity/Vitesse = 1.1 m/s Direction = ENE						
Temperature : Air = 19.3 C Water/Eau = 21.4 C						
Air Pressure/Pression Atm. : 763 mmHg						

Men Canadian-2 1000m Semi-final 1/Sept. 29			Hommes Canadien-2 1000m Demi-finale 1/29 Sept			
Rank Rang	Ctry Pays	Name Nom	250m (R)	500m (R)	750m (R)	1000m
1	URS	Reneiski, Victor Jouravski, Nikolai	0:51.34(1)	1:48.73(1) + 0:57.39	2:47.82(1) + 0:59.09	3:46.85 + 0:59.03
2	FRA	Sylvoz, Pascal Hoyer, Didier	0:53.21 (2)	1:52.30(2) + 0:59.09	2:52.12(2) + 0:59.82	3:55.25 + 1:03.13
3	HUN	Takacs, Gabor Leikep, Gusztav	0:54.32 (3)	1:53.14(3) + 0:58.82	2:52.81 (3) + 0:59.67	3:59.08 + 1:06.27
4	CHN	Guo, Daen Ke, Hua	0:55.58 (4)	1:55.90(4) + 1:00.32	3:00.18(4) + 1:06.28	4:06.49 + 1:06.31
5	JPN	Sakamoto, Toshisuke Toyama, Katsuya	0:56.83 (5)	1:58.89 (5) + 1:02.06	3:03.39 (5) + 1:04.50	4:09.20 + 1:05.81
Weather/Temps : sunny						
Wind/Vent : Velocity/Vitesse = 2.2 m/s Direction = E						
Temperature : Air = 16.0 C Water/Eau = 20.7 C						
Air Pressure/Pression Atm. : 770 mmHg						

Men Canadian-2 1000m Semi-final 2/Sept. 29			Hommes Canadien-2 1000m Demi-finale 2/29 Sept			
Rank Rang	Ctry Pays	Name Nom	250m (R)	500m (R)	750m (R)	1000m
1	POL	Dopierala, Marek Lbik, Marek	0:54.00 (2)	1:50.56(1) + 0:56.56	2:49.68(1) + 0:59.12	3:50.45 + 1:00.77
2	FRG	Faust, Hartmut Faust, Wolfram	0:56.13(5)	1:51.93(3) + 0:55.80	2:51.47(3) + 0:59.54	3:52.03 + 1:00.56
3	ROM	Obreja, Grigore Andriev, Gheorghe	0:53.37(1)	1:50.87(2) + 0:57.50	2:50.70 (2) + 0:59.83	3:53.76 +1:03.06
4	CAN	Frost, David Smith, Eric	0:54.94 (3)	1:52.44 (4) + 0:57.50	2:52.90 (4) + 1:00.46	3:57.34 + 1:04.44
5	GBR	Train, Andrew Train, Steven	0:55.54 (4)	1:54.04(5) + 0:58.50	2:54.11 (5) + 1:00.07	3:59.22 + 1:05.11
Weather/Temps : sunny						
Wind/Vent : Velocity/Vitesse = 3.1 m/s Direction = E						
Temperature : Air = 16.0 C Water/Eau = 20.7 C						
Air Pressure/Pression Atm. : 770 mmHg						

Men Canadian-2 1000m Semi-final 3/Sept. 29			Hommes Canadien-2 1000m Demi-finale 3/29 Sept			
Rank Rang	Ctry Pays	Name Nom	250m (R)	500m (R)	750m (R)	1000m
1	GDR	Heukrodt, Olaf Spelly, Ingo	0:55.77 (4)	1:52.28(1) + 0:56.51	2:50.02(1) + 0:57.74	3:50.10 +1:00.08
2	DEN	Frederiksen, Christian Nielsen, Arne	0:55.00 (3)	1:52.76(2) + 0:57.76	2:50.91 (2) + 0:58.15	3:51.62 + 1:00.71
3	BUL	Bonev, Deyan Bojilov, Petar	0:54.57 (2)	1:53.90(4) + 0:59.33	2:54.40 (4) + 1:00.50	3:54.98 +1:00.58
4	TCH	Krivanek, Tomas Fibigr, Waldemar	0:53.35(1)	1:53.46(3) + 1:00.11	2:53.39 (3) + 0:59.93	3:56.15 +1:02.76
5	YUG	Nisovic, Mirko Ljubek, Matija	0:56.77 (5)	1:57.73 (5) + 1:00.96	2:57.92 (5) +1:00.19	3:59.04 +1:01.12
Weather/Temps : sunny						
Wind/Vent : Velocity/Vitesse = 2.8 m/s Direction = ESE						
Temperature : Air = 17.0 C Water/Eau = 20.7 C						
Air Pressure/Pression Atm. : 770 mmHg						

Men Canadian-2 1000m Final/Oct. 1			Hommes Canadien-2 1000m Finale/1 Oct			
Rank Rang	Ctry Pays	Name Nom	250m (R)	500m (R)	750m (R)	1000m
1	URS	Reneiski, Victor Jouravski, Nikolai	0:53.48(1)	1:50.74(1) + 0:57.26	2:49.93(1) + 0:59.19	3:48.36 + 0:58.43
2	GDR	Heukrodt, Olaf Spelly, Ingo	0:55.71 (2)	1:53.99(2) + 0:58.28	2:53.29 (2) + 0:59.30	3:51.44 + 0:58.15
3	POL	Dopierala, Marek Lbik, Marek	0:58.46 (7)	1:56.59(8) + 0:58.13	2:56.69 (6) + 1:00.10	3:54.33 + 0:57.64
4	DEN	Frederiksen, Christian Nielsen, Arne	0:56.87 (4)	1:54.87 (4) + 0:58.00	2:55.71 (5) + 1:00.84	3:54.94 +0:59.23
5	FRG	Faust, Hartmut Faust, Wolfram	0:57.43 (5)	1:55.30(5) + 0:57.87	2:53.97 (3) + 1:58.67	3:55.62 + 1:01.65
6	ROM	Obreja, Grigore Andriev, Gheorghe	0:56.31 (3)	1:54.42(3) + 0:58.11	2:54.92 (4) + 1:00.50	3:56.56 + 1:01.64
7	HUN	Takacs, Gabor Leikep, Gusztav	0:58.95 (8)	1:56.15(7) + 0:57.20	2:57.70 (7) + 1:01.55	4:04.18 +1:06.48
8	FRA	Sylvoz, Pascal Hoyer, Didier	1:08.99 (9)	1:57.06 (9) + 0:48.07	2:58.51 (8) + 1:01.45	4:04.75 + 1:06.24
9	BUL	Bonev, Deyan Bojilov, Petar	0:57.96 (6)	1:55.66(6) + 0:57.70	2:59.79 (9) + 1:04.13	4:11.42 + 1:11.63
Weather/Temps : sunny						
Wind/Vent : Velocity/Vitesse = 1.9 m/s Direction = ESE						
Temperature : Air = 12.2 C Water/Eau = 20.5 C						
Air Pressure/Pression Atm. : 767 mmHg						

Women Kayak-1 500m Preliminary Heat 1/Sept. 26			Femmes Kayak-1 500m Eliminatoire 1/26 Sept	
Rank Rang	Ctry Pays	Name Nom	250m (R)	500m
1	BUL	Guecheva, Vania	0:55.49(1)	1:55.44 + 0:59.95
2	POL	Dylewska, Izabela	0:56.50 (2)	1:57.42 + 1:00.92
3	SWE	Andersson, Agneta	0:58.63 (3)	2:00.27 + 1:03.64
4	GBR	Perrett, Susie	1:00.06(4)	2:01.97 + 1:01.91
5	KOR	Kim, Mi-Ja	1:04.42(6)	2:11.76 + 1:07.34
6	ARG	Millauro, Maria D.L.A.	1:03.57(5)	2:12.32 + 1:08.75
Weather/Temps : sunny				
Wind/Vent : Velocity/Vitesse = 3.3 m/s Direction = NW				
Temperature : Air = 11.6 C Water/Eau = 21.7 C				
Air Pressure/Pression Atm. : 761 mmHg				

Canoeing

Canoë

Women Kayak-1 500m Preliminary Heat 2/Sept. 26			Femmes Kayak-1 500m Eliminatoire 2/26 Sept	
Rank Rang	Ctry Pays	Name Nom	250m (R)	500m
1	DEN	Knudsen, Yvonne B	0:56.21 (2)	1:54.96 + 0:58.75
2	GDR	Schmidt, Birgit	0:55.77(1)	1:56.24 + 1:00.47
3	URS	Savenko, Galina	0:56.86 (3)	1:57.69 + 1:00.83
4	USA	Phillips, Traci	0:57.46 (4)	1:59.53 + 1:02.07
5	CAN	Brunet, Caroline	0:57.98 (5)	2:00.82 + 1:04.84
	JPN	Kobayashi, Miyuki		WDR
Weather/Temps : sunny Wind/Vent : Velocity/Vitesse = 3.3 m/s Direction = NW Temperature : Air = 10.9 C Water/Eau = 21.7 C Air Pressure/Pression Atm. : 761 mmHg				

Women Kayak-1 500m Preliminary Heat 3/Sept. 26			Femmes Kayak-1 500m Eliminatoire 3/26 Sept	
Rank Rang	Ctry Pays	Name Nom	250m (R)	500m
1	HUN	Koban, Rita	0:57.13(1)	1:57.04 + 0:59.91
2	TCH	Pleskacova, Hana	0:57.55 (2)	1:59.28 + 1:01.73
3	FRG	Idem, Josefa	0:58.67 (4)	2:00.42 + 1:03.75
4	BEL	Coeck, Inge	0:58.26 (3)	2:01.69 + 1:03.43
Weather/Temps : sunny Wind/Vent : Velocity/Vitesse = 2.9 m/s Direction = NW Temperature : Air = 11.1 C Water/Eau = 21.7 C Air Pressure/Pression Atm. : 761 mmHg				

Women Kayak-1 500m Semi-final 1/Sept. 28			Femmes Kayak-1 500m Demi-finale 1/28 Sept	
Rank Rang	Ctry Pays	Name Nom	250m (R)	500m
1	GDR	Schmidt, Birgit	0:55.56(1)	1:55.94 + 1:00.38
2	BUL	Guecheva, Vania	0:56.11 (2)	1:56.26 + 1:00.15
3	FRG	Idem, Josefa	0:57.76 (3)	1:59.04 + 1:01.28
4	BEL	Coeck, Inge	0:59.41 (4)	2:02.74 + 1:03.33
5	CAN	Brunet, Caroline	1:00.20(5)	2:08.34 + 1:08.14
Weather/Temps : sunny Wind/Vent : Velocity/Vitesse = 0.6 m/s Direction = SE Temperature : Air = 15.0 C Water/Eau = 20.5 C Air Pressure/Pression Atm. : 766 mmHg				

Women Kayak-1 500m Semi-final 2/Sept. 28			Femmes Kayak-1 500m Demi-finale 2/28 Sept	
Rank Rang	Ctry Pays	Name Nom	250m (R)	500m
1	DEN	Knudsen, Yvonne B	0:57.30(1)	1:57.83 + 1:00.53
2	SWE	Andersson, Agneta	0:58.00 (2)	1:59.30 + 1:01.30
3	USA	Phillips, Traci	0:58.98 (3)	1:59.48 + 1:00.50
4	TCH	Pleskacova, Hanax	0:59.74 (4)	1:59.95 + 1:00.21
5	GBR	Perrett, Susie	1:01.07(5)	2:04.95 + 1:03.88
Weather/Temps : sunny Wind/Vent : Velocity/Vitesse = 1.0 m/s Direction = ESE Temperature : Air = 16.2 C Water/Eau = 20.5 C Air Pressure/Pression Atm. : 766 mmHg				

Women Kayak-1 500m Semi-final 3/Sept. 28			Femmes Kayak-1 500m Demi-finale 3/28 Sept	
Rank Rang	Ctry Pays	Name Nom	250m (R)	500m
1	POL	Dylewska, Izabela	0:56.52 (2)	1:56.47 + 0:59.95
2	HUN	Koban, Rita	0:55.86(1)	1:57.03 + 1:01.17
3	URS	Savenko, Galina	0:57.89 (3)	2:01.56 + 1:03.67
4	ARG	Millauro, Maria D.L.A.	1:01.10(4)	2:11.07 + 1:09.97
5	KOR	Kim, Mi-Ja	1:02.85(5)	2:11.99 + 1:09.14
Weather/Temps : sunny Wind/Vent : Velocity/Vitesse = 12 m/s Direction = WSW Temperature : Air = 16.0 C Water/Eau = 20.5 C Air Pressure/Pression Atm. : 766 mmHg				

Women Kayak-1 500m Final/Sept. 30			Femmes Kayak-1 500m Finale/30 Sept	
Rank Rang	Ctry Pays	Name Nom	250m (R)	500m
1	BUL	Guecheva, Vania	0:55.43 (2)	1:55.19 + 0:59.76
2	GDR	Schmidt, Birgit	0:54.78(1)	1:55.31 + 1:00.53
3	POL	Dylewska, Izabela	0:56.97 (4)	1:57.38 + 1:00.41
4	HUN	Koban, Rita	0:56.12(3)	1:57.58 + 1:01.46
5	DEN	Knudsen, Yvonne B	0:58.45 (6)	1:58.80 + 1:00.35
6	USA	Phillips, Traci	0:58.96 (7)	2:00.81 + 1:03.85
7	URS	Savenko, Galina	0:57.69 (5)	2:00.88 + 1:03.19
8	SWE	Andersson, Agneta	0:59.53 (8)	2:01.00 + 1:01.47
9	FRG	Idem, Josefa	1:00.19(9)	2:01.80 + 1:01.61
Weather/Temps : sunny Wind/Vent : Velocity/Vitesse = 1.0 m/s Direction = NE Temperature : Air = 12.1 C Water/Eau = 20.7 C Air Pressure/Pression Atm. : 770 mmHg				

Women Kayak-2 500m Preliminary Heat 1/Sept. 26			Femmes Kayak-2 500m Eliminatoire 1/26 Sept	
Rank Rang	Ctry Pays	Name Nom	250m (R)	500m
1	BUL	Guecheva, Vania Paliiska, Diana	0:50.38(1)	1:44.52 0:54.14
2	GDR	Schmidt, Birgit Nothnagel, Anke	0:51.20(2)	1:45.53 0:54.33
3	HUN	Meszaros, Erika Rakusz, Eva	0:52.13(3)	1:46.54 0:54.41
4	URS	Salomykova, Irina Khmelevskaia, Irina	0:52.79 (4)	1:47.30 0:54.51
5	SWE	Olsson, Anna Andersson, Agneta	0:53.61 (5)	1:52.82 0:59.21
6	FRG	Oosterheld, Claudia Martin, Andrea	0:54.44 (6)	1:55.25 1:00.81
7	GBR	Lawler, Janine Sharman, Elizabeth	0:56.79 (7)	1:58.90 1:02.11
8	ARG	Martin garcia, Corina Arbo, Veronica	0:59.39 (8)	1:59.38 0:59.99
Weather/Temps : sunny Wind/Vent : Velocity/Vitesse = 3.2 m/s Direction = SSE Temperature : Air = 13.4 C Water/Eau = 21.7 C Air Pressure/Pression Atm. : 761 mmHg				



Women Kayak-2 500m Preliminary Heat 2/Sept. 26				Femmes Kayak-2 500m Eliminatoire 2/26 Sept	
Rank Rang	Ctry Pays	Name Nom	250m (R)	500m	
1	HOL	Derckx, Annemiek Cox, Annemarie	0:53.16(2)	1:48.65 0:55.49	
2	USA	Conover, Sheila Marino geers, Cathy	0:54.06 (3)	1:50.54 0:56.48	
3	POL	Ksiazek, Bozena Lukaszewicz, Jolanta	0:54.62 (4)	1:51.55 0:56.93	
4	CAN	Olmsted, Barbara Taylor, Sheila	0:52.66(1)	1:52.45 0:59.79	
5	DEN	Knudsen, Jeanette B Froberg, Birgitte L	0:55.16(5)	1:55.33 1:00.17	
6	KOR	Lee, Do-Hee Choi, Sun-Hyung	0:57.25 (7)	1:57.10 0:59.85	
7	JPN	Nakazato, Harumi Kobayashi, Miyuki	0:56.14(6)	1:57.34 1:01.20	
Weather/Temps			: sunny		
Wind/Vent			: Velocity/Vitesse = 3.4 m/s Direction = S		
Temperature			: Air = 13.6 C Water/Eau = 21.7 C		
Air Pressure/Pression Atm.			: 761 mmHg		

Women Kayak-2 500m Repechage 1/Sept. 26				Femmes Kayak-2 500m Repechage 1/26 Sept	
Rank Rang	Ctry Pays	Name Nom	250m (R)	500m	
1	URS	Salomykova, Irina Khmelevskaia, Irina	0:54.46(1)	1:49.81 0:55.35	
2	DEN	Knudsen, Jeanette B Froberg, Birgitte L	0:55.98 (2)	1:53.30 0:57.32	
3	FRG	Oesterheld, Claudia Martin, Andrea	0:56.67 (3)	1:56.02 0:59.35	
4	JPN	Nakazato, Harumi Kobayashi, Miyuki	0:58.05 (4)	1:58.99 1:00.94	
5	ARG	Martin garcia, Corina Arbo, Veronica	1:01.31(5)	2:04.72 1:03.41	
Weather/Temps			: sunny		
Wind/Vent			: Velocity/Vitesse = 4.1 m/s Direction = NNE		
Temperature			: Air = 14.7 C Water/Eau = 21.7 C		
Air Pressure/Pression Atm.			: 760 mmHg		

Women Kayak-2 500m Repechage 2/Sept. 26				Femmes Kayak-2 500m Repechage 2/26 Sept	
Rank Rang	Ctry Pays	Name Nom	250m (R)	500m	
1	SWE	Olsson, Anna Andersson, Agneta	0:55.08 (2)	1:53.17 0:58.09	
2	CAN	Olmsted, Barbara Taylor, Sheila	0:54.55(1)	1:54.56 1:00.01	
3	GBR	Lawler, Janine Sharman, Elizabeth	0:57.37 (3)	1:57.82 1:00.45	
4	KOR	Lee, Do-Hee Choi, Sun-Hyung	0:59.88 (4)	2:00.34 1:02.46	
Weather/Temps			: sunny		
Wind/Vent			: Velocity/Vitesse = 4.7 m/s Direction = NE		
Temperature			: Air = 13.8 C Water/Eau = 21.7 C		
Air Pressure/Pression Atm.			: 760 mmHg		

Women Kayak-2 500m Semi-final 1/Sept. 28				Femmes Kayak-2 500m Demi-finale 1/28 Sept	
Rank Rang	Ctry Pays	Name Nom	250m (R)	500m	
1	SWE	Olsson, Anna Andersson, Agneta	0:55.02 (2)	1:51.41 0:56.39	
2	BUL	Guecheva, Vania Paliiska, Diana	0:54.07(1)	1:52.48 0:58.41	
3	POL	Ksiazek, Bozena Lukaszewicz, Jolanta	0:55.62 (3)	1:54.30 0:58.68	
4	FRG	Oesterheld, Claudia Martin, Andrea	0:56.63 (4)	1:55.37 0:58.74	
Weather/Temps			: sunny		
Wind/Vent			: Velocity/Vitesse = 0.2 m/s Direction = SSE		
Temperature			: Air = 17.5 C Water/Eau = 20.5 C		
Air Pressure/Pression Atm.			: 766 mmHg		

Women Kayak-2 500m Semi-final 2/Sept. 28				Femmes Kayak-2 500m Demi-finale 2/28 Sept	
Rank Rang	Ctry Pays	Name Nom	250m (R)	500m	
1	HUN	Meszaros, Erika Rakusz, Eva	0:53.33(1)	1:48.94 0:55.61	
2	HOL	Derckx, Annemiek Cox, Annemarie	0:54.20 (2)	1:50.24 0:56.04	
3	CAN	Olmsted, Barbara Taylor, Sheila	0:54.94 (3)	1:52.62 0:57.68	
4	DEN	Knudsen, Jeanette B Froberg, Birgitte L	0:55.92 (4)	1:53.37 0:57.45	
Weather/Temps			: sunny		
Wind/Vent			: Velocity/Vitesse = 1.3 m/s Direction = SW		
Temperature			: Air = 16.6 C Water/Eau = 20.5 C		
Air Pressure/Pression Atm.			: 766 mmHg		

Women Kayak-2 500m Semi-final 3/Sept. 28				Femmes Kayak-2 500m Demi-finale 3/28 Sept	
Rank Rang	Ctry Pays	Name Nom	250m (R)	500m	
1	GDR	Schmidt, Birgit Nothnagel, Anke	0:51.92(1)	1:46.62 0:54.70	
2	URS	Salomykova, Irina Khmelevskaia, Irina	0:53.72 (2)	1:49.55 0:55.83	
3	USA	Conover, Sheila Marino Geers, Cathy	0:55.30 (3)	1:54.16 0:58.86	
4	GBR	Lawler, Janine Sharman, Elizabeth	0:56.14(4)	1:58.70 1:02.56	
Weather/Temps			: sunny		
Wind/Vent			: Velocity/Vitesse = 0.9 m/s Direction = SE		
Temperature			: Air = 16.6 C Water/Eau = 20.5 C		
Air Pressure/Pression Atm.			: 766 mmHg		

Women Kayak-2 500m Final/Sept. 30				Femmes Kayak-2 500m Finale/30 Sept	
Rank Rang	Ctry Pays	Name Nom	250m (R)	500m	
1	GDR	Schmidt, Birgit Nothnagel, Anke	0:51.04(2)	1:43.46 0:52.42	
2	BUL	Guecheva, Vania Paliiska, Diana	0:50.54(1)	1:44.06 0:53.52	
3	HOL	Derckx, Annemiek Cox, Annemarie	0:54.05 (8)	1:46.00 0:51.95	
4	HUN	Meszaros, Erika Rakusz, Eva	0:52.09 (4)	1:46.58 0:54.49	
5	URS	Salomykova, Irina Khmelevskaia, Irina	0:51.53(3)	1:47.68 0:56.15	
6	SWE	Olsson, Anna Andersson, Agneta	0:52.56 (5)	1:48.39 0:55.83	
7	USA	Conover, Sheila Marino geers, Cathy	0:53.10(6)	1:50.33 0:57.23	
8	CAN	Olmsted, Barbara Taylor, Sheila	0:53.61 (7)	1:51.03 0:57.42	
9	POL	Ksiazek, Bozena Lukaszewicz, Jolanta	0:54.82 (9)	1:51.13 0:56.31	
Weather/Temps			: sunny		
Wind/Vent			: Velocity/Vitesse = 0.9 m/s Direction = NNE		
Temperature			: Air = 14.8 C Water/Eau = 20.7 C		
Air Pressure/Pression Atm.			: 769 mmHg		

Canoeing

Canoë

Women Kayak-4 500m Preliminary Heat 1/Sept. 27			Femmes Kayak-4 500m Eliminatoire 1/27 Sept	
Rank Rang	Ctry Pays	Name Nom	250m (R)	500m
1	GDR	Schmidt, Birgit Nothnagel, Anke Portwich, Ramona Singer, Heike	0:47.75 (1)	1:36.84 + 0:49.09
2	URS	Salomykova, Irina Khmelevskaia, Irina Apanovitch, Alexandra Kovalevitch, Nadejda	0:48.35 (2)	1:37.78 + 0:49.43
3	SWE	Olsson, Anna Andersson, Agneta Wiberg, Susanne Olsson, Liselotte	0:51.56(5)	1:41.40 + 0:49.84
4	USA	Phillips, Traci Conover, Sheila Marino Geers, Cathy Dery Batlik, Shirley	0:50.68 (4)	1:41.77 + 0:51.09
5	CAN	Olmsted, Nancy Olmsted, Barbara Brunet, Caroline Taylor, Sheila	0:50.28 (3)	1:43.52 + 0:53.24
6	FRA	Cuvilly, Sylvie Leroux, Claudine Vandamme, Virginie Basson, Beatrice	0:52.42 (6)	1:45.41 + 0:52.99
7	KOR	Lee, Do-Hee Chung, Mi Kim, Mi-Ja Choi, Sun-Hyung	0:54.66 (7)	1:49.97 + 0:55.31

Weather/Temps : sunny
 Wind/Vent : Velocity/Vitesse = 1.3 m/s Direction = WNW
 Temperature : Air = 10.3 C Water/Eau = 20.7 C
 Air Pressure/Pression Atm. : 763 mmHg

Women Kayak-4 500m Semi-final 1/Sept. 29			Femmes Kayak-4 500m Demi-finale 1/29 Sept	
Rank Rang	Ctry Pays	Name Nom	250m (R)	500m
1	FRG	Idem, Josefa Oesterheld, Claudia Martin, Andrea Domgoergen, Ruth	0:50.36 (2)	1:42.09 + 0:51.73
2	POL	Ksiazek, Bozena Lukaszewicz, Jolanta Urbanczyk, Elzbieta Weiss, Katarzyna	0:49.77(1)	1:42.55 + 0:52.78
3	USA	Phillips, Traci Conover, Sheila Marino Geers, Cathy Dery Batlik, Shirley	0:51.71 (4)	1:43.17 + 0:51.46
4	CAN	Olmsted, Nancy Olmsted, Barbara Brunet, Caroline Taylor, Sheila	0:50.92(3)	1:43.63 + 0:52.71
5	GBR	Dawson, Angela Lawler, Janine Dallaway, Andrea Perrett, Susie	0:52.72 (5)	1:46.18 + 0:53.46
6	FRA	Cuvilly, Sylvie Leroux, Claudine Vandamme, Virginie Basson, Beatrice	0:53.80 (6)	1:47.71 + 0:53.91
7	KOR	Lee, Do-Hee Chung, Mi Kim, Mi-Ja Choi, Sun-Hyung		1:51.16

Weather/Temps : sunny
 Wind/Vent : Velocity/Vitesse = 1.6 m/s Direction = ESE
 Temperature : Air = 15.9 C Water/Eau = 20.7 C
 Air Pressure/Pression Atm. : 770 mmHg

Women Kayak-4 500m Preliminary Heat 2/Sept. 27			Femmes Kayak-4 500m Eliminatoire 2/27 Sept	
Rank Rang	Ctry Pays	Name Nom	250m (R)	500m
1	HUN	Geczi, Erika Meszaros, Erika Rakusz, Eva Koban, Rita	0:47.66(1)	1:36.48 + 0:48.82
2	BUL	Guecheva, Vania Paliiska, Diana Petkova, Ogniana Ivanova, Borislava	0:48.17(2)	1:39.40 + 0:51.23
3	DEN	Knudsen, Yvonne B Petersen, Susanne Knudsen, Jeanette B Froberg, Birgitte L	0:52.35 (6)	1:40.87 + 0:48.52
4	POL	Ksiazek, Bozena Lukaszewicz, Jolanta Urbanczyk, Elzbieta Weiss, Katarzyna	0:50.03 (4)	1:41.07 + 0:51.04
5	FRG	Idem, Josefa Oesterheld, Claudia Martin, Andrea Domgoergen, Ruth	0:51.18(5)	1:43.43 + 0:52.25
6	GBR	Dawson, Angela Lawler, Janine Dallaway, Andrea Perrett, Susie	0:49.49 (3)	1:46.68 + 0:57.19

Weather/Temps : sunny
 Wind/Vent : Velocity/Vitesse = 0.8 m/s Direction = W
 Temperature : Air = 10.5 C Water/Eau = 20.7 C
 Air Pressure/Pression Atm. : 763 mmHg

Women Kayak-4 500m Final/Oct. 1			Femmes Kayak-4 500m Finale/1 Oct	
Rank Rang	Ctry Pays	Name Nom	250m (R)	500m
1	GDR	Schmidt, Birgit Nothnagel, Anke Portwich, Ramona Singer, Heike	0:48.64(1)	1:40.78 + 0:52.14
2	HUN	Geczi, Erika Meszaros, Erika Rakusz, Eva Koban, Rita	0:49.93 (3)	1:41.88 + 0:51.95
3	BUL	Guecheva, Vania Paliiska, Diana Petkova, Ogniana Ivanova, Borislava	0:49.40 (2)	1:42.63 + 0:53.23
4	URS	Salomykova, Irina Khmelevskaia, Irina Apanovitch, Alexandra Kovalevitch, Nadejda	0:51.10(4)	1:44.26 + 0:53.16
5	FRG	Idem, Josefa Oesterheld, Claudia Martin, Andrea Domgoergen, Ruth	0:54.52 (9)	1:45.62 + 0:51.10
6	SWE	Olsson, Anna Andersson, Agneta Wiberg, Susanne Olsson, Liselotte	0:53.23 (7)	1:45.67 + 0:52.44
7	DEN	Knudsen, Yvonne B Petersen, Susanne Knudsen, Jeanette B Froberg, Birgitte L	0:53.89 (8)	1:47.10 + 0:53.21
8	POL	Ksiazek, Bozena Lukaszewicz, Jolanta Urbanczyk, Elzbieta Weiss, Katarzyna	0:52.57 (6)	1:47.40 + 0:54.83
9	USA	Phillips, Traci Conover, Sheila Marino Geers, Cathy Dery Batlik, Shirley	0:51.89(5)	1:47.94 + 0:56.05

Weather/Temps : sunny
 Wind/Vent : Velocity/Vitesse = 2.2 m/s Direction = ESE
 Temperature : Air = 9.4 C Water/Eau = 20.5 C
 Air Pressure/Pression Atm. : 767 mmHg



사이클
Cycling/Cyclisme



Cycling/Cyclisme

Officials/Officiels

Fédération Internationale Amateur de Cyclisme (F.I.A.C.)

President/président	Valery Syssoev
Secretary General/secrétaire général	Carla Giuliani
Technical Delegates/délégués techniques	Jean Pitallier Miron Baramia

SLOOC Administrative Staff/Personnel Administratif du SLOOC

Commissioner/directeur	Min Kyung Jung
Secretary General/secrétaire général	Choi Ho Kwang
Deputy Secretary General/secrétaire général adjoint	Chung Ik Rai Song Wan Shik
Competition Manager/chef de division des compétitions	Yim Sang Cho Park Jung Chul

Competitors/Concurrents

Men Hommes	Competitors Competiteurs	Countries Pays
1000 M Time Trial/contre la montre	30	30
Sprint/vitesse	25	25
4000 M Individual Pursuit/poursuite individuelle	23	23
Points Race/course aux points	35	35
4000 M Team Pursuit/poursuite equipe	76	19
Individual Road Race/epreuve sur route	143	56
100 km Team Trial/epreuve par equipe	124	31

Women Femmes	Competitors Competiteurs	Countries Pays
Individual Road Race/epreuve sur route	53	23
Sprint/vitesse	12	12

Legend/Notation

DNP	Did not participate/N'a pas participe
09	Overtaken at the 9th Lap/Rejoint au 9eme Tour
010	Overtaken at the 10th Lap/Rejoint au 10eme Tour
011	Overtaken at the 11th Lap/Rejoint au 11eme Tour
O	Winner/Gagnant
X	Loser/Perdant
NWR	New World Record/Nouveau Record Mondial
DNF	Did not finish/N'a pas termine
DNS	Did not start/N'a pas participe
AB	Abandon/Abandon
G	Group/Groupe
DQ	Disqualified/Disqualifie



Cycling

Cyclisme

Men 100km Team Time Trial Finals/Sept. 18				Hommes/100km Contre la Montre par Equipes Finales/18 Sept			
Rank Rang	Order Ordre	Ctry Pays	Name Nom	Results Resultats			
				25 km	50 km	75 km	100 km
1	26	GDR	Ampler, Uwe Kummer, Mario Landsmann, Maik Schur, Jan	29:16.5	57:55.4	1'27:56.1	1'57:47.7
2	20	POL	Halupczok, Joachim Jaskula, Zenon Lesniewski, Marek Sypytkowski, Andrzej	29:36.0	58:06.9	1'28:27.7	1'57:54.2
3	12	SWE	Johansson, Bjorn Karlsson, Jan Lafis, Michel Jarl, Anders	29:45.0	59:00.0	1'30:03.6	1'59:47.3
4	28	FRA	Bezault, Laurent Heulot, Eric Lance, Pascal Laurent, Thierry	30:04.7	58:58.7	1'29:07.0	1'59:49.8
5	31	ITA	Maggioni, Roberto Poli, Eros Scirea, Mario Vanzella, Flavio	29:50.3	59:11.3	1'29:00.1	1'59:58.3
6	27	FRG	Christl, Ernst Groene, Bernd Lehnert, Rajmund Stumpf, Remig	29:55.3	58:59.7	1'29:18.5	2'00:06.3
7	30	URS	Jdanov, Vasili Klimov, Victor Saitov, Assiat Soumnikov, Igor	30:12.3	59:27.1	1'29:45.4	2'00:27.0
8	23	TCH	Hruza, Vladimir Kinst, Vladimir Kren, Milan Regeg, Jozef	29:59.6	59:04.2	1'29:53.3	2'00:57.1
9	21	AUS	Fairless, Stephen Keech, Bruce Stevenson, Clayton Steward, Scott	30:31.1	1'00:19.8	1'31:47.2	2'02:24.6
10	6	USA	Alvis, Norm Copeland, James Palmer, Tony Paulin, Andy	30:13.4	1'00:00.3	1'31:51.3	2'02:35.7
11	14	HOL	Cordes, Tom De Vries, Gerrit Den Bakker, Maarten Zanoli, Michel	30:12.1	1'00:05.0	1'31:54.7	2'03:28.4
12	18	NZL	Fowler, Brian Fraire, Gregory Leitch, Paul Stevens, Gavin	30:53.9	1'00:26.9	1'32:17.8	2'03:48.7
13	19	CAN	Koberstein, Chris Spears, David Waddell, Yvan Walton, Brian	30:32.3	1'00:10.4	1'31:25.8	2'04:09.0
14	16	ESP	Aldanondo, Javier Carbayeda, Javier Geriz, Arturo Rodriguez, Jose	31:09.4	1'01:24.3	1'33:27.8	2'05:11.4
15	24	YUG	Bonca, Valter Papez, Sandi Sebenik, Robert Smole, Joze	30:54.6	1'00:59.3	1'32:35.9	2'05:35.1
16	29	AUT	Hauer, Dietmar Kostel, Norbert Lienhart, Hans Traxl, Mario	30:44.0	1'00:47.0	1'32:10.8	2'06:14.5
17	17	CHN	Guo, Longchen Liu, Hong Tang, Xuezhong Wu, Weipei	32:11.4	1'02:28.7	1'34:16.6	2'06:22.5
18	15	BRA	Azevedo, Wanderley Daneliczen, Cesar Freitas, Cassio Mazzaron, Marcos	31:45.2	1'02:25.1	1'35:30.0	2'07:11.7
19	25	IRL	Cassidy, Philip McCann, Cormac Mcquaid, John Spratt, Stephen	31:41.2	1'02:24.6	1'34:49.7	2'07:59.7
20	8	GBR	Bateman, Philip Lodge, Harry Luckwell, Ben Spencer, David	32:03.9	1'02:52.9	1'36:06.9	2'08:07.8
21	1	COL	Alayon, Angel Noe Bonilla, Pedro Nel Castillo, Orlando Rodriguez, Julio Cesa	32:43.1	1'04:17.9	1'37:28.3	2'10:34.3

Rank Rang	Order Ordre	Ctry Pays	Name Nom	Results Resultats			
				25 km	50 km	75 km	100 km
22	10	MEX	Cano, Edgar Gutierrez, Guillermo Perez, Hector Ramos, Luis	33:31.2	1'05:47.0	1'40:01.1	2'12:46.4
23	11	IRN	Chaichi-Raghimi, Most Esmaili, Abas Safarzadeh, Mehرداد Safarzadeh, Syamak	33:32.3	1'06:20.8	1'41:42.6	2'15:29.5
24	22	KOR	Cho, Duk-Haeng Lee, Jin-Ok Park, Hyun-Kon Yoo, Byung-Hun	33:04.6	1'05:17.5	1'39:59.7	2'16:16.9
25	4	HKG	Hui, Chak-Bor Hung, Chung-Yam Leung, Hung-Tak Yu, Kau-Wai	33:44.9	1'06:45.0	1'42:28.3	2'16:43.6
26	7	GUA	Aquino-Sandoval, Oscala Illescas, Julio Lechuga-Reyes, Victor Torres, Andres	34:21.1	1'08:16.0	1'44:25.5	2'18:58.7
27	2	CAY	Baker, Nicholas Ebanks, Alfred Merren, Craig Pascal, Richard	35:23.9	1'09:28.7	1'45:22.3	2'19:08.0
28	13	ZAI	Amisi, Mobange Golomingi, Ndjibu Mbenza, Pasi Mosengo, Kimpale	34:56.7	1'08:54.8	1'46:11.8	2'21:37.3
29	9	UAE	Alabed, Ali Hayyaz, Ali Khalifa, Sultan Saeed, Najj	36:04.6	1'11:08.1	1'49:37.7	2'26:11.3
30	5	MAW	Chimwaza, Dyton Kaswanga, Danieljerem Nayeja, George Whites Yusufu, Amadu	37:39.7	1'14:22.6	1'54:00.1	2'32:37.6
	3	BIZ	Joseph, Fitzgerald Lewis, Charles Lewis, Michael Theus, Earl	36:46.0	1'13:11.8	1'52:46.9	DQ

Men 1km Time Trial Finals/Sept. 20			Hommes/1km Contre la Montre Finales/20 Sept				
Rank Rang	Order Ordre	Name Nom	Ctry Pays	1 Lap 1 Tour	2 Lap 2 Tour	1000m 1000m	Km/h Km/h
1	16	Kiritchenko, Alexandre	URS	22.903	42.568	1:04.499	55.814
2	30	Vinnicombe, Martin	AUS	23.388	43.037	1:04.784	55.569
3	26	Lechner, Robert	FRG	23.195	43.296	1:05.114	55.287
4	9	Ropke, Kurt Kenneth	DEN	24.075	43.772	1:05.168	55.241
5	17	Gonzalez, Bernardo	ESP	24.163	43.690	1:05.281	55.146
6	29	Malchow, Maic	GDR	23.919	43.790	1:05.393	55.051
7	6	Graham, Anthony	NZL	24.726	44.512	1:05.744	54.757
8	24	Magne, Frederic	FRA	23.701	44.332	1:06.142	54.428
9	11	Travella, Rocco	SUI	23.562	43.668	1:06.209	54.373
10	3	Anderson, Clovis	BRA	23.796	44.380	1:06.282	54.313
11	27	Harnett, Curtis	CAN	23.486	44.042	1:06.291	54.306
12	28	Samuel, Gene	TRI	23.256	43.615	1:06.560	54.086
13	18	Alexandre, Marcelo	ARG	24.211	44.521	1:06.925	53.791
14	7	Livingston, Bobby	USA	23.763	44.299	1:06.926	53.790
15	12	Um, Young-Sup	KOR	23.624	44.079	1:07.000	53.731
16	15	Toyooka, Hiroshi	JPN	24.605	44.844	1:07.240	53.539
17	10	Hamalainen, Mika	FIN	24.630	45.039	1:07.384	53.425
18	25	Detant, Thierry	HOL	24.208	44.772	1:07.555	53.289
19	21	Pons, Mario	ECU	23.415	44.636	1:08.351	52.669
20	19	Mandy, Gary	ZIM	24.087	45.116	1:08.474	52.574
21	8	Hermann, Peter	LIE	25.542	46.716	1:08.999	52.174
22	1	Lee, Fu-Hsiang	TPE	24.591	45.557	1:09.024	52.155
23	2	Leiva-Buhler, Max-Eduardo	GUA	24.874	46.062	1:09.214	52.012
24	22	Chase, Roderick	BAR	24.168	45.709	1:09.994	51.432
25	4	Alwi, Rosman	MAL	25.249	46.972	1:10.446	51.102
26	14	Rimarim, Bernardo	PHI	26.303	48.111	1:11.647	50.246
27	5	Etekhari, Jalil	IRN	25.169	47.302	1:11.683	50.221
28	23	Smith, Michele	CAY	25.775	47.730	1:11.820	50.125
29	20	Becerra, Bailon	BOL	25.087	47.967	1:13.513	48.970
30	13	Lloyd, Neil	ANT	26.999	50.995	1:18.324	45.962

**Men 4000m Individual Pursuit
Qualification/Sept. 20****Hommes/4000m Poursuite Individuelle
Qualification/20 Sept**

Rank Rang	Name Nom	Ctry Pays	Results Resultats				Km/h Km/h
			1000m	2000m	3000m	4000m	
1	Dittert, Bernd	GDR	1:10.02	2:17.37	3:25.90	4:34.45	52.468
2	Umaras, Gintaoutas	URS	1:10.85	2:18.19	3:26.18	4:35.03	52.357
3	Sturgess, Colin	GBR	1:10.28	2:19.16	3:28.62	4:35.42	52.283
4	Woods, Dean	AUS	1:09.43	2:17.40	3:26.61	4:35.89	52.194
5	Dawidowicz, Ryszard	POL	1:11.55	2:18.25	3:27.27	4:36.21	52.134
6	Clausen, Peter	DEN	1:13.67	2:22.41	3:30.16	4:38.88	51.635
7	Beltrami, Ivan	ITA	1:12.75	2:21.21	3:30.48	4:40.94	51.256
8	Anderson, Gary	NZL	1:13.09	2:21.99	3:32.85	4:41.83	51.094
9	Risi, Bruno	SUI	1:10.63	2:20.11	3:31.22	4:43.41	50.809
10	Duerst, Thomas	FRG	1:10.46	2:21.38	3:33.31	4:45.59	50.421
11	Tujunen, Jyrki	FIN	1:14.13	2:24.92	3:36.52	4:47.05	50.165
12	Curuchet, Gabriel Ovidio	ARG	1:13.04	2:23.66	3:35.32	4:47.18	50.142
13	Cermak, Roman	TCH	1:13.98	2:24.23	3:35.43	4:47.63	50.064
14	Brinton, David	USA	1:12.29	2:22.78	3:35.62	4:48.93	49.839
15	Somogyi, Miklos	HUN	1:14.75	2:24.32	3:35.03	4:49.38	49.761
16	Cent, Erik	HOL	1:11.22	2:24.77	3:39.66	4:54.16	48.952
17	Martarena, Jose Antonio	ESP	1:10.76	2:22.01	3:37.13	4:54.39	48.914
18	Matt, Patrick	LIE	1:13.99	2:29.26	3:44.16	4:57.47	48.408
19	Park, Min-Soo	KOR	1:15.06	2:28.16	3:43.10	4:58.57	48.229
20	Silvestre, Antonio	BRA	1:14.24	2:28.21	3:44.19	5:02.07	47.671
	Jessurun, Realdo	SUR	1:14.45	2:33.04	3:55.51	09	
	Chaichi-Raghimi, Mostafa	IRN	1:15.61	3:03.93		010	
	Fabian, Ira	ANT				DNP	

**Men 4000m Individual Pursuit
Semi-finals/Sept. 22****Hommes/4000m Poursuite Individuelle
Demi-finales/22 Sept**

Heat Serie	Name Nom	Ctry Pays	Results Resultats				Km/h Km/h
			1000m	2000m	3000m	4000m	
1	Dittert, Bernd	GDR	1:10.33	2:19.29	3:28.81	4:39.06	51.601 X
	Woods, Dean	AUS	1:10.64	2:18.53	3:26.89	4:35.02	52.359 O
2	Umaras, Gintaoutas	URS	1:12.09	2:18.05	3:26.10	4:40.24	51.384 O
	Sturgess, Colin	GBR	1:10.74	2:20.48	3:32.65	4:46.25	50.305 X

O: Winner/Gagnant
X: Loser/Perdant**Men 4000m Individual Pursuit
Finals/Sept. 22****Hommes 4000m Poursuite Individuelle
Finales/22 Sept**

Rank Rang	Name Nom	Ctry Pays	Results Resultats				Km/h Km/h
			1000m	2000m	3000m	4000m	
1	Umaras, Gintaoutas	URS	1:11.53	2:16.95	3:23.01	4:32.00	52.941
2	Woods, Dean	AUS	1:09.33	2:16.12	3:24.86	4:35.00	52.363
3	Dittert, Bernd	GDR	1:10.16	2:18.20	3:26.64	4:34.17	52.522
4	Sturgess, Colin	GBR	1:11.67	2:20.28	3:29.21	4:34.90	52.382
5	Dawidowicz, Ryszard	POL	1:13.36	2:20.17	3:29.13	4:39.44	51.531
6	Clausen, Peter	DEN	1:14.05	2:23.59	3:32.92	4:42.62	50.951
7	Anderson, Gary	NZL	1:13.12	2:23.25	3:33.40	4:42.82	50.915
8	Beltrami, Ivan	ITA	1:13.58	2:24.65	3:36.24	010	

010: Overtaken at the 10th Lap/Rejoint au 10eme Tour

**Men 4000m Individual Pursuit
1/8 Finals/Sept. 21****Hommes/4000m Poursuite Individuelle
Huitiemes de Finale/21 Sept**

Heat Serie	Name Nom	Ctry Pays	Results Resultats				Km/h Km/h
			1000m	2000m	3000m	4000m	
1	Anderson, Gary	NZL	1:12.09	2:21.74	3:32.11	4:41.25	51.200 O
	Risi, Bruno	SUI	1:11.81	2:21.90	3:33.01	4:44.38	50.636 X
2	Beltrami, Ivan	ITA	1:13.46	2:23.98	3:34.55	4:44.33	50.645 O
	Duerst, Thomas	FRG	1:11.71	2:22.67	3:34.08	4:45.20	50.490 X
3	Clausen, Peter	DEN	1:13.02	2:22.25	3:32.38	4:43.71	50.756 O
	Tujunen, Jyrki	FIN	1:14.27	2:24.99	3:36.01	4:46.65	50.235 X
4	Dawidowicz, Ryszard	POL	1:10.12	2:19.12	3:30.32	4:42.03	51.058 O
	Curuchet, Gabriel Ovidio	ARG	1:11.78	2:22.98	3:35.68	4:50.75	49.527 X
5	Woods, Dean	AUS	1:10.62	2:19.12	3:28.28	4:36.49	52.081 O
	Cermak, Roman	TCH	1:12.04	2:23.48	3:36.34	011	X
6	Sturgess, Colin	GBR	1:11.14	2:20.60	3:30.07	4:37.17	51.953 O
	Brinton, David	USA	1:12.71	2:22.24	3:34.18	4:47.27	50.127 X
7	Umaras, Gintaoutas	URS	1:11.77	2:19.13	3:26.93	4:35.32	52.302 O
	Somogyi, Miklos	HUN	1:13.96	2:24.92		09	X
8	Dittert, Bernd	GDR	1:10.14	2:18.75	3:28.29	4:36.01	52.172 O
	Cent, Erik	HOL	1:11.71	2:24.00	3:36.98	011	X

O: Winner/Gagnant
X: Loser/Perdant09: Overtaken at the 9th Lap/Rejoint au 9eme Tour
011: Overtaken at the 11th Lap/Rejoint au 11eme Tour**Men 4000m Individual Pursuit
1/4 Finals/Sept. 21****Hommes/4000m Poursuite Individuelle
Quarts de Finale/21 Sept**

Heat Serie	Name Nom	Ctry Pays	Results Resultats				Km/h Km/h
			1000m	2000m	3000m	4000m	
1	Sturgess, Colin	GBR	1:12.04	2:22.18	3:31.83	4:39.39	51.540 O
	Anderson, Gary	NZL	1:13.12	2:23.25	3:33.40	4:42.82	50.915 X
2	Woods, Dean	AUS	1:10.47	2:18.46	3:26.93	4:35.11	52.342 O
	Dawidowicz, Ryszard	POL	1:13.36	2:20.17	3:29.13	4:39.44	51.531 X
3	Dittert, Bernd	GDR	1:10.91	2:18.94	3:27.05	4:33.70	52.612 O
	Clausen, Peter	DEN	1:14.05	2:23.59	3:32.92	4:42.62	50.951 X
4	Umaras, Gintaoutas	URS	1:11.48	2:18.28	3:25.58	4:32.83	52.780 O
	Beltrami, Ivan	ITA	1:13.58	2:24.65	3:36.24	010	

O: Winner/Gagnant
X: Loser/Perdant

010: Overtaken at the 10th Lap/Rejoint au 10eme Tour

**Men 4000m Team Pursuit
Qualification/Sept. 23****Hommes/4000m Poursuite par Equipes
Qualification/23 Sept**

Rank Rang	Ctry Pays	Name Nom	Results Resultats				Km/h Km/h	
			1000m	2000m	3000m	4000m		
1		Ekimov, Viatcheslav Kaspoutis, Artouras Nelubine, Dmitri Umaras, Gintaoutas	URS	1:06.65	2:09.04	3:12.33	4:16.10	56.228 NWR
2		Dutton, Brett Mccarney, Wayne Moglede, Stephen Woods, Dean	AUS	1:06.72	2:09.79	3:13.21	4:16.32	56.179 NWR
3		Dagorne, Herve Lino, Pascal Pasgrimaud, Didier Potie, Pascal	FRA	1:08.16	2:10.97	3:13.96	4:17.19	55.989
4		Blochitz, Steffen Meier, Dirk Preissler, Uwe Wolf, Carsten	GDR	1:05.67	2:09.12	3:13.32	4:17.61	55.898
5		Buchta, Svatopluk Soukup, Pavel Tesar, Pavel Treka, Ales	TCH	1:06.56	2:10.84	3:15.13	4:20.55	55.267
6		Dawidowicz, Ryszard Halupczok, Joachim Sikorski, Andrzej Turowski, Marian	POL	1:08.29	2:12.19	3:16.37	4:21.30	55.109
7		Madsen, Jimmi Frost, Dan Frost, Ken Olsen, Lars	DEN	1:09.64	2:13.67	3:18.40	4:22.37	54.884
8		Baldato, Fabio Grisandi, Gianpaolo Solari, David Trezzi, Fabrizio	ITA	1:09.41	2:13.18	3:18.07	4:22.64	54.827
9		Lettieri, Dave McCarthy, Michael Nitz, Leonard Sundquist, Carl	USA	1:11.05	2:16.38	3:19.96	4:22.96	54.761
10		Duerst, Thomas Lange, Matthias Nepp, Uwe Rich, Michael	FRG	1:06.91	2:11.02	3:16.40	4:23.10	54.732
11		Gonzalez, Bernardo Isasa, Xabier Martarena, Jose Antonio Sebastia, Agustin	ESP	1:07.50	2:12.01	3:18.06	4:24.90	54.360
12		Beumer, Marcel Cent, Erik Peelen, Leo Van Baarle, Mario	HOL	1:08.09	2:13.10	3:19.03	4:25.67	54.202
13		Boardman, Christopher Coull, Robert Lillistone, Simon Sword, Glen	GBR	1:10.06	2:15.16	3:20.64	4:25.87	54.161

Cycling

Rank Rang	Name Nom	Ctry Pays	Results Resultats				Km/h Km/h
			1000m	2000m	3000m	4000m	
14	Connell, Craig Donnelly, Nigel Whitford, Andrew Williams, Stuart	NZL	1:09.67	2:14.93	3:20.49	4:26.13	54.108
15	Azuma, Koichi Miyamoto, Fumiharu Sasaki, Kazuaki Takikawa, Kazuo	JPN	1:08.45	2:14.09	3:21.47	4:28.50	53.631
16	Koenigshofer, Roland Lienhart, Hans Schmied, Kurt Stocher, Franz	AUT	1:09.38	2:15.71	3:22.80	4:28.64	53.603
17	Curuchet, Gabriel Ovidio Gaday, Jorge-Alberto Llamazares, Sergio-Alberto Priede, Rvben Darid	ARG	1:09.94	2:15.70	3:22.17	4:29.90	53.353
18	An, Woo-Hyok Chung, Jum-Sik Kim, Yong-Kyu Park, Min-Soo	KOR	1:12.02	2:19.34	3:26.87	4:34.55	52.449
19	Anderson, Clovis Jamur, Paulo Louro, Fernando Silvestre, Antonio	BRA	1:10.27	2:18.29	3:27.11	4:38.21	51.759

Men 4000m Team Pursuit 14 Finals/Sept. 23			Hommes/4000m Poursuite par Equipes Quarts de Finale/23 Sept				
Heat Serie	Name Nom	Ctry Pays	Results Resultats				Km/h Km/h
			1000m	2000m	3000m	4000m	
1	Blochwitz, Steffen Hennig, Roland Meier, Dirk Wolf, Carsten	GDR	1:05.93	2:07.92	3:10.78	4:14.45	56.592 O
	Buchta, Svatopluk Fiala, Zbynek Soukup, Pavel Trcka, Ales	TCH	1:07.29	2:10.34	3:14.08	4:19.05	55.587 X
2	Dagorne, Herve Lino, Pascal Pasgrimaud, Didier Potie, Pascal	FRA	1:08.30	2:10.48	3:13.70	4:17.70	55.878 O
	Dawidowicz, Ryszard Halupczok, Joachim Sikorski, Andrzej Turowski, Marian	POL	1:07.15	2:10.61	3:15.90	4:22.50	54.857 X
3	Dutton, Brett Mcglede, Stephen Mcgrory, Scott Woods, Dean	AUS	1:06.71	2:09.98	3:13.65	4:17.14	56.000 O
	Clausen, Peter Frost, Dan Madsen, Jimmi Olsen, Lars	DEN	1:08.18	2:11.25	3:16.23	4:25.30	54.278 X
4	Ekimov, Viatcheslav Kaspoutis, Artouras Nelubine, Dmitri Umaras, Mindaougas	URS	1:06.50	2:07.99	3:10.94	4:14.22	56.643 O
	Beltrami, Ivan Grisandi, Gianpaolo Solari, David Trezzi, Fabrizio	ITA	1:09.35	2:13.48	3:17.29	4:20.90	55.193 X

O: Winner/Gagnant
X: Loser/Perdant

Cyclisme

Men 4000m Team Pursuit Semi-finals/Sept. 24			Hommes/4000m Poursuite par Equipes Demi-finales/24 Sept				
Heat Serie	Name Nom	Ctry Pays	Results Resultats				Km/h Km/h
			1000m	2000m	3000m	4000m	
1	Blochwitz, Steffen Hennig, Roland Meier, Dirk Wolf, Carsten	GDR	1:06.82	2:10.14	3:15.17	4:20.65	55.246 O
	Dutton, Brett Mcglede, Stephen Mcgrory, Scott Woods, Dean	AUS	1:10.98	2:16.26	3:21.83	4:27.57	53.817 X
2	Ekimov, Viatcheslav Kaspoutis, Artouras Nelubine, Dmitri Umaras, Gintaoutas	URS	1:06.79	2:09.23	3:14.88	4:20.17	55.348 O
	Dagorne, Herve Lino, Pascal Pasgrimaud, Didier Potie, Pascal	FRA	1:10.20	2:17.06	3:24.71	4:29.49	53.434 X

O: Winner/Gagnant
X: Loser/Perdant

Men 4000m Team Pursuit Finals/Sept. 24			Hommes/4000m Poursuite par Equipes Finales/24 Sept				
Rank Rang	Name Nom	Ctry Pays	Results Resultats				Km/h Km/h
			1000m	2000m	3000m	4000m	
1	Ekimov, Viatcheslav Kaspoutis, Artouras Nelubine, Dmitri Umaras, Gintaoutas	URS	1:06.29	2:07.85	3:10.34	4:13.31	56.847
2	Blochwitz, Steffen Hennig, Roland Meier, Dirk Wolf, Carsten	GDR	1:06.66	2:08.72	3:11.99	4:14.09	56.672
3	Dutton, Brett McCarney, Wayne Mcglede, Stephen Woods, Dean	AUS	1:06.95	2:08.89	3:12.17	4:16.02	56.245
4	Dagorne, Herve Lino, Pascal Pasgrimaud, Didier Potie, Pascal	FRA	1:08.08	2:10.31	3:15.30	4:22.23	54.913
5	Buchta, Svatopluk Fiala, Zbynek Soukup, Pavel Trcka, Ales	TCH	1:07.29	2:10.34	3:14.08	4:19.05	55.587
6	Beltrami, Ivan Grisandi, Gianpaolo Solari, David Trezzi, Fabrizio	ITA	1:09.35	2:13.48	3:17.29	4:20.90	55.193
7	Dawidowicz, Ryszard Halupczok, Joachim Sikorski, Andrzej Turowski, Marian	POL	1:07.15	2:10.61	3:15.90	4:22.50	54.857
8	Clausen, Peter Frost, Dan Madsen, Jimmi Olsen, Lars	DEN	1:08.18	2:11.25	3:16.23	4:25.30	54.278

Men 30km Points Race Qualification Heat 1/Sept. 21			Hommes/30km course aux points Qualification Serie 1/21 Sept	
Rank Rang	Name Nom	Ctry Pays	Laps Down	Points
			Tours en Retard	Points
1	Do, Eun-Chul	KOR	00	029
2	Frost, Dan	DEN	00	027
3	Mendez, Alexis	VEN	00	021
4	Somogyi, Miklos	HUN	00	012
5	Koenigshofer, Roland	AUT	00	005
6	Burns, Robert	AUS	01	024
7	Ludwig, Olaf	GDR	01	021
8	Ganeev, Marat	URS	01	017
9	Salvador, Antonio	ESP	01	015
10	Pawlak, Wojciech	POL	01	011
11	Andreu, Frankie	USA	01	011
12	Louro, Fernando	BRA	01	010
13	Hermann, Peter	LIE	01	009
14	Tsumuraya, Yoshihiro	JPN	01	007
15	Smith, Michele	CAY	01	001
	Chase, Roderick	BAR		AB
	Rimarim, Bernardo	PHI		AB

NOTE:
The first 12 riders are qualified for the final.
Les premiers 12 coureurs sont qualifiés pour la finale.



Men 30km Points Race
Qualification Heat 2/Sept. 22

Hommes/30km course aux points
Qualification Serie 2/22 Sept

Rank Rang	Name Nom	Ctry Pays	Laps Down Tours en Retard	Points Points
1	Youshimatz, Jose	MEX	00	032
2	Lom, Lubos	TCH	00	020
3	Samuel, Gene	TRI	00	016
4	Peelen, Leo	HOL	00	013
5	Curuchet, Juan Esteban	ARG	00	011
6	Lino, Pascal	FRA	01	028
7	Messerschmidt, Uwe	FRG	01	022
8	Grivel, Philippe	SUI	01	019
9	Aldridge, Peter	JAM	01	015
10	Hsu, Jui-Te	TPE	01	014
11	Lombardi, Giovanni	ITA	01	013
12	Vignaduzzi, Gianni	CAN	01	003
13	Murugayan, Kumaresan	MAL	01	001
14	Eftekhari, Jalil	IRN	02	013
	Lloyd, Neil	ANT		AB
	Becerra, Bailon	BOL		AB
	Moreira, Federico	URU		AB
	Pons, Mario	ECU		DNP

Men 50km Points Race
Finals/Sept. 24

Hommes/50km course aux points
Finales/24 Sept

Rank Rang	Name Nom	Ctry Pays	Laps Down Tours en Retard	Points Points
1	Frost, Dan	DEN	00	038
2	Peelen, Leo	HOL	00	026
3	Ganeev, Marat	URS	01	046
4	Burns, Robert	AUS	01	020
5	Curuchet, Juan Esteban	ARG	01	018
6	Messerschmidt, Uwe	FRG	02	028
7	Lino, Pascal	FRA	02	021
8	Andreu, Frankie	USA	02	021
9	Youshimatz, Jose	MEX	02	021
10	Somogyi, Miklos	HUN	02	013
11	Lombardi, Giovanni	ITA	02	013
12	Koenigshofer, Roland	AUT	02	011
13	Mendez, Alexis	VEN	02	008
14	Ludwig, Olaf	GDR	03	019
15	Samuel, Gene	TRI	03	010
16	Pawlak, Wojciech	POL	03	008
17	Vignaduzzi, Gianni	CAN	03	007
18	Salvador, Antonio	ESP	03	005
19	Do, Eun-Chul	KOR	03	004
20	Grivel, Philippe	SUI	03	004
21	Hsu, Jui-Te	TPE	03	004
22	Aldridge, Peter	JAM	03	004
23	Lom, Lubos	TCH	03	003
24	Louro, Fernando	BRA	03	000

TIME: 59:58.26

Men Sprint
Qualification/Sept. 21

Hommes/Vitesse
Qualification/21 Sept

Rank Rang	Name Nom	Ctry Pays	Result Resultat
1	Hesslich, Lutz	GDR	10.395
2	Neiwand, Gary	AUS	10.563
3	Kovche, Nikolai	URS	10.595
4	Sustr, Vratislav	TCH	10.704
5	Carpenter, Ken	USA	10.792
6	Colas, Fabrice	FRA	10.857
7	Weber, Frank	FRG	10.919
8	Alexander, Edward	GBR	10.930
9	Moreno, Jose Manuel	ESP	10.931
10	Schoefs, Erik	BEL	11.032
11	Miwa, Hideki	JPN	11.063
12	Faccini, Andrea	ITA	11.073
13	Harnett, Curtis	CAN	11.144
14	Cheesman, Maxwell	TRI	11.171
15	Faris, Gustavo-A	ARG	11.187
16	Alwi, Rosman	MAL	11.204
17	Um, Young-Sup	KOR	11.222
18	Pons, Mario	ECU	11.339
19	Lee, Fu-Hsiang	TPE	11.475
20	Reneau, Paul	BIZ	11.732
21	Abrams, Colin	GUY	11.815
22	Lynch, Vincent	BAR	11.845
23	Smith, Michele	CAY	12.055
24	Becerra, Bailon	BOL	12.216
25	Fabian, Ira	ANT	12.817

Men Sprint
1/16 Finals/Sept. 21

Hommes/Vitesse
Seizieme de Finales/21 Sept

Heat Serie	Name Nom	Ctry Pays	Result Resultat	Rank Rang
1	Hesslich, Lutz	GDR	11.25	1
	Alwi, Rosman	MAL		3
	Um, Young-Sup	KOR		2
2	Neiwand, Gary	AUS	11.19	1
	Faris, Gustavo-A	ARG		3
	Pons, Mario	ECU		2
3	Kovche, Nikolai	URS	11.26	1
	Cheesman, Maxwell	TRI		3
	Lee, Fu-Hsiang	TPE		2
4	Sustr, Vratislav	TCH	11.21	1
	Harnett, Curtis	CAN		2
	Reneau, Paul	BIZ		3
5	Carpenter, Ken	USA		2
	Faccini, Andrea	ITA	11.74	1
	Abrams, Colin	GUY		3
6	Colas, Fabrice	FRA	10.77	1
	Miwa, Hideki	JPN		2
	Lynch, Vincent	BAR		3
7	Weber, Frank	FRG		2
	Schoefs, Erik	BEL	11.34	1
	Smith, Michele	CAY		3
8	Alexander, Edward	GBR	11.40	1
	Moreno, Jose Manuel	ESP		2
	Becerra, Bailon	BOL		3

Men Sprint
1/16 Finals-repechage/Sept. 21

Hommes/Vitesse
Seizieme de Finale Repechage/21 Sept

Heat Serie	Name Nom	Ctry Pays	Result Resultat	Rank Rang
1	Um, Young-Sup	KOR		3
	Moreno, Jose Manuel	ESP		4
	Faris, Gustavo-A	ARG		2
	Cheesman, Maxwell	TRI	12.11	1
2	Pons, Mario	ECU		2
	Weber, Frank	FRG	11.55	1
	Becerra, Bailon	BOL		3
	Abrams, Colin	GUY		4
3	Lee, Fu-Hsiang	TPE		2
	Miwa, Hideki	JPN	11.56	1
	Reneau, Paul	BIZ		3
	Smith, Michele	CAY		4
4	Harnett, Curtis	CAN	11.26	1
	Carpenter, Ken	USA		2
	Lynch, Vincent	BAR		4
	Alwi, Rosman	MAL		3

Men Sprint
1/8 Finals/Sept. 22

Hommes/Vitesse
Huitiemes de Finale/22 Sept

Heat Serie	Name Nom	Ctry Pays	Result Resultat	Rank Rang
1	Hesslich, Lutz	GDR	11.04	1
	Alexander, Edward	GBR		2
	Miwa, Hideki	JPN		3
2	Neiwand, Gary	AUS		3
	Schoefs, Erik	BEL	11.27	1
	Harnett, Curtis	CAN		2
3	Kovche, Nikolai	URS	11.10	1
	Colas, Fabrice	FRA		2
	Weber, Frank	FRG		3
4	Sustr, Vratislav	TCH	11.13	1
	Faccini, Andrea	ITA		3
	Cheesman, Maxwell	TRI		2

Men Sprint
1/8 Final Repechage/Sept. 22

Hommes/Vitesse
Huitiemes de Finale Repechage/22 Sept

Heat Serie	Name Nom	Ctry Pays	Result Resultat	Rank Rang
1	Alexander, Edward	GBR	11.32	1
	Faccini, Andrea	ITA		2
2	Harnett, Curtis	CAN		2
	Weber, Frank	FRG	11.39	1
3	Colas, Fabrice	FRA		2
	Neiwand, Gary	AUS	11.57	1
4	Cheesman, Maxwell	TRI	11.31	1
	Miwa, Hideki	JPN		2

Cycling

Cyclisme

Men Sprint 1/4 Finals/Sept. 22

Hommes/Vitesse Quarts de Finale/22 Sept

Heat Serie	Name Nom	Ctry Pays	Results Resultats		
			1 rd	2 rd	3 rd
1	Hesslich, Lutz	GDR	10.60	11.50	O
	Weber, Frank	FRG			X
2	Schoefs, Erik	BEL	10.96		X
	Alexander, Edward	GBR		11.81 10.79	O
3	Kovche, Nikolai	URS	11.77	11.05	O
	Cheesman, Maxwell	TRI			X
4	Sustr, Vratislav	TCH			X
	Neiwand, Gary	AUS	10.92	11.37	O

O: Winner/Gagnant
X: Loser/Perdant

Men Sprint Semi-finals/Sept. 23

Hommes/Vitesse Demi-finales/23 Sept

Heat Serie	Name Nom	Ctry Pays	Results Resultats		
			1 rd	2 rd	3 rd
1	Hesslich, Lutz	GDR	11.12	10.64	O
	Neiwand, Gary	AUS			X
2	Alexander, Edward	GBR			X
	Kovche, Nikolai	URS	11.09	11.90	O

O: Winner/Gagnant
X: Loser/Perdant

Men Sprin Final (5-8 Places)/Sept. 23

Hommes/Vitesse Finale (5-8 Places)/23 Sept

Rank Rang	Name Nom	Ctry Pays	Result Resultat
5	Sustr, Vratislav	TCH	11.34
6	Schoefs, Erik	BEL	
7	Weber, Frank	FRG	
8	Cheesman, Maxwell	TRI	

Men Sprint Finals/Sept. 24

Hommes/Vitesse Finales/24 Sept

Rank Rang	Name Nom	Ctry Pays	Results Resultats		
			1 rd	2 rd	3 rd
1	Hesslich, Lutz	GDR	13.98	11.82	
2	Kovche, Nikolai	URS			
3	Neiwand, Gary	AUS	10.97	10.88	
4	Alexander, Edward	GBR			
5	Sustr, Vratislav	TCH	11.34		
6	Schoefs, Erik	BEL			
7	Weber, Frank	FRG			
8	Cheesman, Maxwell	TRI			

Men 196.8Km Individual Road Race Finals/Sept. 27

Hommes/196.8km Course Ind. sur Route Finales/27 Sept

Rank Rang	Name Nom	Ctry Pays	Results Resultats	Km/h Km/h
1	Ludwig, Olaf	GDR	4'32:22	43.353
2	Groene, Bernd	FRG	4'32:25	43.345
3	Henn, Christian	FRG	4'32:46	43.289
4	Mionske, Robert	USA	G	
5	Abdoudjaparov, Djamoludin	URS	G	
6	Salas, Edward	AUS	G	
7	Pelliconi, Roberto	ITA	G	
8	Miller, Graeme	NZL	G	
9	Perez, Emili	AND	G	
10	Regec, Jozef	TCH	G	
11	Mattheus, Jan	BEL	G	
12	Hung, Chung-Yam	HKG	G	
13	Pedersen, Atle	NOR	G	
14	Stumpf, Remig	FRG	4'32:56	43.263
15	Zanoli, Michel	HOL	G	
16	Bontempi, Fabrizio	ITA	G	
17	Wrona, Zdzislaw	POL	G	
18	Hoban, Neil	GBR	G	
19	Dauwe, Johnny	BEL	G	
20	Freitas, Cassio	BRA	G	
21	Park, Hyun-Kon	KOR	G	
22	Traxl, Mario	AUT	G	
23	Raab, Uwe	GDR	G	
24	Laffillee, J. Rfancois	FRA	G	
25	Suzuki, Mitsuhiro	JPN	G	

Rank Rang	Name Nom	Ctry Pays	Results Resultats	Km/h Km/h
26	Staeuble, Marcel	SUI	G	
27	Saebo, Erik Johan	NOR	G	
28	Bodyk, Jacek	POL	G	
29	Waddell, Yvan	CAN	G	
30	Cubric, Rajko	YUG	G	
31	Arias, Juan Carlos	COL	G	
32	Brkovic, Mico	YUG	G	
33	Walton, Brian	CAN	G	
34	Lienhart, Hans	AUT	G	
35	Steiger, Daniel	SUI	G	
36	Curran, Paul	GBR	G	
37	Lahde, Jari	FIN	G	
38	Harmeling, Lodewijk	HOL	G	
39	Mir, Mohamed	ALG	G	
40	Bortolami, Gianluca	ITA	G	
41	Hauer, Dietmar	AUT	G	
42	Cordes, Tom	HOL	G	
43	Lafis, Michel	SWE	G	
44	Tang, Xuezhong	CHN	G	
45	Mccann, Cormac	IRL	G	
46	Asconegui, Jose	URU	G	
47	Styks, Ludek	TCH	G	
48	Rodriguez, Nelson	COL	G	
49	Mcquaid, John	IRL	G	
50	Leung, Hung-Tak	HKG	G	
51	Saitov, Assiat	URS	G	
52	Manrique, Eduardo	ESP	G	
53	Liu, Hong	CHN	G	
54	Hermann, Peter	LIE	G	
55	Chow, Tat-Ming	HKG	G	
56	Amir-Akhori, Iraj	IRN	G	
57	Jarl, Anders	SWE	G	
58	Merren, Perry	CAY	G	
59	Perez, Xavier	AND	G	
60	Sououn, Rikho	URS	G	
61	Lom, Lubos	TCH	G	
62	Gornall, Mark	GBR	G	
63	Azevedo, Wanderley	BRA	G	
64	Jessurun, Realdo	SUR	G	
65	Mckinley, Scott	USA	G	
66	Mazzaron, Marcos	BRA	G	
67	Ramirez, Duban	COL	G	
68	Dahlen, Geir	NOR	G	
69	Schommer, Craig	USA	G	
70	Carlin, Claude	FRA	G	
71	Nielsen, Tommy	DEN	G	
72	Miura, Kyoshi	JPN	G	
73	Rioux, Gervais	CAN	G	
74	Nielsen, Petermeiner	DEN	G	
75	Fowler, Brian	NZL	G	
76	Echeverri, Alcides	URU	G	
77	Ramos, Luis	MEX	G	
78	Bonca, Valter	YUG	G	
79	Puttini, Felice	SUI	G	
80	Aguiar, Gonzalo	ESP	G	
81	Mccormack, Paul	IRL	G	
82	Ampler, Uwe	GDR	G	
83	Sierra, Leonardo	VEN	G	
84	Torres, Andres	GUA	G	
85	Lee, Jin-Ok	KOR	G	
86	Aquino-Sandoval, Oscar-Alf	GUA	G	
87	Fahlin, Roul	SWE	G	
88	Francken, Frank	BEL	G	
89	Aleman, Ivan	ESP	G	
90	Shin, Dae-Chul	KOR	4'34:13	43.060
91	Bezault, Laurent	FRA	4'35:19	42.888
92	Murugayan, Kumaresan	MAL	4'35:45	42.821
93	Safarzadeh, Syamak	IRN	4'42:47	41.756
94	Perez, Hector	MEX	G	
95	Tsumuraya, Yoshihiro	JPN	G	
96	Benzine, Sebti	ALG	4'43:15	41.687
97	Thomas, Raymond	JAM	G	
98	Amisi, Mobange	ZAI	G	
99	Gouws, Pierre	ZIM	4'43:28	41.655
100	Lechuga-Reyes, Victor B.	GUA	4'44:37	41.487
101	Khalifa, Sultan	UAE	4'44:37	41.487
102	Pascal, Richard	CAY	4'44:56	41.441
103	Villanueva, Domingo	PHI	4'45:20	41.383
104	Mosengo, Kimpale	ZAI	4'45:20	41.383
105	Mandy, Gary	ZIM	4'45:50	41.310
106	Operto, Stephane	MON	4'46:42	41.186
107	Tenn, Arthur	JAM	4'48:06	40.986
108	Mierzejewski, Andrzej	POL	4'48:06	40.986
109	Chimwaza, Dyton	MAW	4'52:43	40.340
	Huynh, Chau	VIE	AB	
	Fairless, Stephen	AUS	DNF	



Rank Rang	Name Nom	Ctry Pays	Results Resultats	Km/h Km/h
	Steward, Scott	AUS	DNF	
	Joseph, Fitzgerald	BIZ	DNF	
	Lewis, Michael	BIZ	DNF	
	Theus, Earl	BIZ	DNF	
	Smith, Michele	CAY	DNF	
	Cai, Yingquan	CHN	DNF	
	James, Byron	GUY	DNF	
	Bajool, Mohammadreza	IRN	DNF	
	Abdelhamed, Elhadi	LBA	DNF	
	Badri, Abdalla	LBA	DNF	
	Honein, Georges	LIB	DNF	
	Zadorian, Hratch	LIB	DNF	
	Matt, Patrick	LIE	DNF	
	Nayeja, George Whiteson	MAW	DNF	
	Yusufu, Amadu	MAW	DNF	
	Cano, Edgar	MEX	DNF	
	Morgan, Wayne	NZL	DNF	
	Oconer, Noberto	PHI	DNF	
	Williams, Frank Noel	SLE	DNF	
	Hsu, Jui-Te	TPE	DNF	
	Mohamed, Issa	UAE	DNF	
	Omair, Khalifa	UAE	DNF	
	Campos, Enrique	VEN	DNF	
	Parra, Ali	VEN	DNF	
	Golomingi, Ndjibu	ZAI	DNF	
	Fabian, Ira	ANT	DNS	
	Lloyd, Neil	ANT	DNS	
	Curuchet, Gabriel Ovidio	ARG	DNS	
	Curuchet, Juan Esteban	ARG	DNS	
	Llamazares, Sergio-Alberto	ARG	DNS	
	Moreira, Federico	URU	DNS	
	Nguyen Dinh, Quang	VIE	DNS	

Women Sprint Qualification/Sept. 21		Femmes/Vitesse Qualification/21 Sept	
Rank Rang	Name Nom	Ctry Pays	Results Resultats
1	Saloumia, Erika	URS	11.527
2	Gautheron, Isabelle	FRA	11.611
3	Luding, Rothenburg, Christa	GDR	11.692
4	Paraskevin-Young, Connie	USA	11.845
5	Speight, Julie	AUS	11.955
6	Jones, Louise	GBR	12.287
7	Fanton, Elisabetta	ITA	12.303
8	Yang, Hsiu-Chen	TPE	12.374
9	Kim, Jin-Young	KOR	12.416
10	Hashimoto, Seiko	JPN	12.425
11	Zhou, Suying	CHN	12.477
12	Tabor, Beth	CAN	12.588

Women Sprint 1/8 Finals/Sept. 21		Femmes/Vitesse Huitiemes de Finale/21 Sept		
Heat Serie	Name Nom	Ctry Pays	Results Resultat	Rank Rang
1	Saloumia, Erika	URS	12.83	1
	Yang, Hsiu-Chen	TPE		2
	Kim, Jin-Young	KOR		3
2	Gautheron, Isabelle	FRA	12.22	1
	Fanton, Elisabetta	ITA		3
	Hashimoto, Seiko	JPN		2
3	Luding, Rothenburg, Christa	GDR	12.24	1
	Jones, Louise	GBR		3
	Zhou, Suying	CHN		2
4	Paraskevin-Young, Connie	USA	12.11	1
	Speight, Julie	AUS		2
	Tabor, Beth	CAN		3

Women Sprint 1/8 Final Repechage/Sept. 21		Femmes/Vitesse Huitiemes de Finale Repechage/21 Sept		
Heat Serie	Name Nom	Ctry Pays	Results Resultat	Rank Rang
1	Yang, Hsiu-Chen	TPE	12.80	1
	Tabor, Beth	CAN		2
2	Hashimoto, Seiko	JPN		2
	Jones, Louise	GBR	12.36	1
3	Zhou, Suying	CHN	12.65	1
	Fanton, Elisabetta	ITA		2
4	Speight, Julie	AUS	13.04	1
	Kim, Jin-Young	KOR		2

Women Sprint 1/4 Finals/Sept. 22		Femmes/Vitesse Quarts de Finale/22 Sept			
Heat Serie	Name Nom	Ctry Pays	Results Resultats		
			1rd	2rd	3rd
1	Saloumia, Erika	URS	12.34	11.81	O
	Jones, Louise	GBR			X
2	Gautheron, Isabelle	FRA	12.13	11.90	O
	Yang, Hsiu-Chen	TPE			X
3	Luding, Rothenburg, Christa	GDR	11.80	11.63	O
	Speight, Julie	AUS			X
4	Paraskevin-Young, Connie	USA	12.85	12.94	O
	Zhou, Suying	CHN			X

O: Winner/Gagnant
X: Loser/Perdant

Women Sprint Semi-finals/Sept. 23		Femmes/Vitesse Demi-finales/23 Sept			
Heat Serie	Name Nom	Ctry Pays	Results Resultats		
			1rd	2rd	3rd
1	Saloumia, Erika	URS	12.38	12.22	O
	Paraskevin-Young, Connie	USA			X
2	Gautheron, Isabelle	FRA		11.79	X
	Luding, Rothenburg, Christa	GDR	11.92		O

Women Sprint Final (5-8 Places)/Sept. 23		Femmes/Vitesse Finale (5-8 Places)/23 Sept	
Rank Rang	Name Nom	Ctry Pays	Results Resultats
5	Speight, Julie	AUS	12.56
6	Zhou, Suying	CHN	
7	Jones, Louise	GBR	
8	Yang, Hsiu-Chen	TPE	

Women Sprint Finals/Sept. 24		Femmes/Vitesse Finales/24 Sept			
Rank Rang	Name Nom	Ctry Pays	Results Resultats		
			1rd	2rd	3rd
1	Saloumia, Erika	URS		12.00	12.58
2	Luding, Rothenburg, Christa	GDR	11.68		
3	Paraskevin-Young, Connie	USA	14.07	12.41	
4	Gautheron, Isabelle	FRA			
5	Speight, Julie	AUS	12.56		
6	Zhou, Suying	CHN			
7	Jones, Louise	GBR			
8	Yang, Hsiu-Chen	TPE			

Women 82Km Individual Road Race Finals/Sept. 26		Femmes/82Km Course Ind. sur Route Finales/26 Sept		
Rank Rang	Name Nom	Ctry Pays	Results Resultats	Km/h Km/h
1	Knol, Monique	HOL	2'00:52	40.706
2	Niehaus, Jutta	FRG	G	
3	Zilporitee, Laima	URS	G	
4	Brunet, Genevieve	CAN	G	
5	Evpak, Valentina	URS	G	
6	Blower, Maria	GBR	G	
7	Holjer, Marie	SWE	G	
8	Benedict, Thompson, Inga	USA	G	
9	Hodge, Sally	GBR	G	
10	Marsal, Catherine	FRA	G	
11	Brambani, Lisa	GBR	G	
12	Varenkamp, Ines	FRG	G	
13	Paulitz, Viola	FRG	G	
14	Bankaitis Davis, Bunki	USA	G	
15	Chiappa, Imelda	ITA	G	
16	Zack, Sally	USA	G	
17	Elkuch, Yvonne	LIE	G	
18	Schoenenberger, Edith	SUI	G	
19	Hage, Heleen	HOL	G	
20	Larsen, Unni Sigrid	NOR	G	
21	Longo, Jeannie	FRA	G	
22	Hepple, Elizabeth	AUS	G	
23	Werckx, Kristell	BEL	G	
24	Lu, Suyan	CHN	G	
25	Ranft, Angela	GDR	G	

Rank	Name	Ctry	Results	Km/h
Rang	Nom	Pays	Resultats	Km/h
26	Wester, Paula	SWE	G	
27	Gould, Donna	AUS	G	
28	Odin, Cecile	FRA	G	
29	Shannon, Kathleen	AUS	G	
30	Ogura, Terumi	JPN	G	
31	Kim, Kyung-Sook	KOR	G	
32	Canins, Maria	ITA	G	
33	Yan, Yinhua	CHN	G	
34	Iakovleva, Alla	URS	G	
35	Danielsen, Astrid	NOR	G	
36	Dusart, Agnes	BEL	G	
37	Noh, Yum-Joo	KOR	G	
38	Way, Kelly-Ann	CAN	G	
39	Neil, Sara	CAN	G	
40	Ganz, Barbara	SUI	G	
41	Gyr, Brigitte	SUI	G	
42	Skibby, Karina	DEN	G	
43	Vikstedt-Nyman, Tea	FIN	G	
44	Berglund, Marianne	SWE	G	
45	Bonanomi, Roberta	ITA	G	
46	Westland, Cora	HOL	2'01:50	40.383
47	Chen, Weixiu	CHN	G	
48	Mcknight, Stephanie	ISV	G	
49	Hong, Young-Mi	KOR	2'03:24	39.870
50	Seki, Natsue	JPN	2'14:32	36.570
	Rossner, Petra	GDR	AB	
	Harris, Madonna	NZL	AB	
	Yang, Hsiu-Chen	TPE	AB	



승 마

Equestrian Sports/Sports Equestres



Equestrian Sports/Sports Equestres

Officials/Officiels

Fédération Equestre Internationale (F.E.I.)

President/président	Princesse Anne, M ^{me} Mark Philips
Secretary General/secrétaire général	Fritz Widmer
Technical Delegates/délégués techniques	E.B. Graham Pamela Carruthers

SLOOC Administrative Staff/Personnel Administratif du SLOOC

Commissioner/Directeur	Lee Kun Young
Secretary General/secrétaire général	Choi Sang Won
Deputy Secretary General/secrétaire général adjoint	Eun Hee Shin
Competition Manager/chef de division des compétitions	Lee Byung Kyu

Competitors/Concurrents

	Competitors Competiteurs	Countries Pays
Three-Day Event: Individual Classification/ Concours complet: Classement individuel	136	16
Three-Day Event: Team Classification/ Concours complet: Classement équipes	120	10
Individual Jumping Competition/Sauts d'obstacles: competition de qualification individuelle	74	24
Team Jumping Competition/Sauts d'obstacles: competition par équipes	64	16
Individual Dressage Competition/ Dressage: competition individuelle	19	11
Team Dressage Competition/ Dressage: competition par équipes	54	18

Legend/Notation

*	Indicates not counted in team score./Pas mis en compte dans le score de l'équipe.
Q1 (Q2)	First (Second) Qualifying Competition./Première (Seconde) compétition de qualification.
F1 (F2)	Final round 1 (2)/1er (2e) Tour de finale.
E, H, C, M, B	Judges' position/Positions des juges



Equestrian Sports

Sports Equestres

Three-day Event: Individual Class. Dressage Test/Sept. 19-20				Concours Complet: Individuel Epreuve de Dressage/19-20 Sept				
Rank	Ctry	Name	Horse	Judges	Errors	Penalties		
Rank	Pays	Nom	Cheval	H	C	M	Erreurs	
							Penalites	
1	NZL	Todd, Mark	Charisma	193.0	173.0	166.0	0.00	37.60
2	FRG	Erhorn, Claus	Justyn Thyme	182.0	181.0	159.0	0.00	39.60
3	GBR	Leng, Virginia	Master Craftsma	167.0	177.0	160.0	0.00	43.20
4	FRG	Kaspereit, Thies	Sherry 42	167.0	167.0	152.0	0.00	46.80
5	GBR	Stark, Ian	Sir Wattie	154.0	166.0	150.0	0.00	50.00
6	USA	Davidson, Bruce	Dr. Peaches	158.0	153.0	157.0	0.00	50.40
7	FRG	Baummann, Matthias	Shamrock 11	149.0	159.0	159.0	0.00	50.60
8	NZL	Bennie, Andrew	Grayshott	140.0	168.0	151.0	0.00	52.20
9	GBR	Straker, Karen	Get Smart	149.0	157.0	148.0	0.00	53.20
10	USA	Dawson, Phyllis	Albany II	152.0	168.0	127.0	0.00	54.60
11	AUS	Green, David	Shannagh	165.0	156.0	119.0	0.00	56.00
12	POL	Jarecki, Boguslaw	Niewiaza	151.0	154.0	132.0	0.00	56.60
13	AUS	Hoy, Andrew	Kiwi	145.0	147.0	143.0	0.00	57.00
14	USA	Sutton, Ann	Tarzan	137.0	149.0	148.0	0.00	57.20
15	FRA	Teulere, Jean	Mohican V	138.0	149.0	145.0	0.00	57.60
16	ITA	Campello, Ranieri	Cotton End	149.0	172.0	110.0	0.00	57.80
17	ITA	Ambrosione, Bartolo	Phoenix	133.0	161.0	132.0	0.00	58.80
18	PUR	Wilson, Thomas B.	Personal Touch	149.0	165.0	120.0	2.00	59.20
19	FRA	Berthet, Vincent	Jet Crub	135.0	155.0	133.0	0.00	59.40
20	FRA	Duroy, Marie-Christin	Harley	143.0	131.0	146.0	0.00	60.00
21	USA	Lende, Karen	The Optimist	136.0	149.0	114.0	0.00	64.20
22	FRA	Morvillers, Pascal	Frangin III	132.0	133.0	132.0	0.00	64.60
23	NZL	Pottinger, Judith	Volunteer	134.0	144.0	113.0	0.00	65.80
24	FRG	Ehrenbrink, Ralf	Uncle Todd	145.0	140.0	104.0	0.00	66.20
25	JPN	Watanabe, Hiroshi	Yakumo Masanori	130.0	142.0	112.0	0.00	67.20
26	AUS	Keach, Scott	Trade Commissio	140.0	133.0	109.0	0.00	67.60
27	ITA	Costantini, Dino	Boardmans Beaut	128.0	126.0	127.0	0.00	67.80
28	KOR	Choi, Myung-Jin	Snuffler	121.0	139.0	113.0	0.00	69.40
29	ESP	De La Rocha, Santiago	Kinvarra	112.0	140.0	120.0	0.00	69.60
30	ITA	Girardi, Francesco	Moreado	115.0	140.0	111.0	0.00	70.80
31	CAN	Holmes-Smith, Nichola	Espionage	128.0	117.0	116.0	0.00	71.80
32	POL	Rafalak, Krzysztof	Dzwinograd	130.0	124.0	104.0	0.00	72.40
32	KOR	Kim, Hyung-Chil	Casson Road	123.0	127.0	108.0	0.00	72.40
34	IRL	Foster, David	Killiney Bay	119.0	116.0	121.0	0.00	72.80
35	ISV	Brodax, Eric	Marcellus	95.0	138.0	116.0	0.00	74.20
36	NZL	Knighon, Margaret	Enterprise	123.0	125.0	99.0	0.00	74.60
37	CAN	Tudor, Mary Jo-Anne	Sparrow Hawk II	128.0	131.0	83.0	0.00	75.60
37	BER	Gray, Peter	Somers	119.0	119.0	104.0	0.00	75.60
39	GBR	Phillips, Mark	Cartier	117.0	107.0	105.0	0.00	78.20
40	JPN	Iwatani, Kazuhiro	Copen Hagen V	109.0	123.0	93.0	0.00	79.00
41	POL	Rogowski, Krzysztof	Alkierz	113.0	112.0	94.0	0.00	80.20
42	AUS	Roycroft, Barry	Last Tango	106.0	105.0	82.0	0.00	85.40
42	IRL	Watson, John	Tullineaskey	105.0	112.0	76.0	0.00	85.40
44	ESP	Beca, Ramon	Count De Bolebe	94.0	110.0	88.0	0.00	85.60
45	KOR	Park, So-Woon	Misson Davril	104.0	87.0	96.0	0.00	86.60
46	POL	Koczorski, Eugeniusz	Idrys	90.0	97.0	83.0	0.00	90.00
47	BER	Blacuman, Carol	Sneak Preview	81.0	91.0	85.0	0.00	92.60
48	JPN	Wakahara, Hisashi	Lord Waterford	85.0	84.0	69.0	0.00	96.40
49	JPN	Miyazaki, Eiki	Scrooge	76.0	90.0	68.0	0.00	97.20
50	KOR	Park, Dong-Joo	Aqaba Legend A	77.0	83.0	61.0	0.00	99.80

Three-day Event: Individual Class. Jumping Test/Sept. 22				Concours Complet: Individuel Epreuve de Sauts d'Obstacles/22 Sept					
Rank	Ctry	Name	Horse	Dress	Endur	Jumping	Jumping	Total	Total
Rank	Pays	Nom	Cheval	Dress	Fond	Jump	Time	Total	Grand
1	NZL	Todd, Mark	Charisma	37.60	0.00	5	0.00	5.00	42.60
2	GBR	Stark, Ian	Sir Wattie	50.00	2.80	0	0.00	0.00	52.80
3	GBR	Leng, Virginia	Master Craftsman	43.20	8.80	10	0.00	10.00	62.00
4	FRG	Erhorn, Claus	Justyn Thyme	39.60	16.00	5	1.75	6.75	62.35
5	NZL	Pottinger, Tinks	Volunteer	65.80	0.00	0	0.00	0.00	65.80
6	FRG	Baummann, Matthias	Shamrock 11	50.60	13.20	5	0.00	5.00	68.80
7	FRA	Teulere, Jean	Mohican V	57.60	6.40	5	0.00	5.00	69.00
8	AUS	Hoy, Andrew	Kiwi	57.00	32.00	0	0.00	0.00	89.00
9	FRG	Kaspereit, Thies	Sherry 42	46.80	38.00	10	0.00	10.00	94.80
10	USA	Dawson, Phyllis	Albany II	54.60	40.00	5	0.00	5.00	99.60
11	ITA	Ambrosione, Bartolo	Phoenix	58.80	47.60	0	1.50	1.50	107.90
12	POL	Jarecki, Boguslaw	Niewiaza	56.60	44.80	10	0.00	10.00	111.40
13	POL	Rogowski, Krzysztof	Alkierz	80.20	29.60	5	0.00	5.00	114.80
14	CAN	Holmes-Smith, Nichola	Espionage	71.80	45.60	0	0.00	0.00	117.40
15	ESP	De La Rocha, Santiago	Kinvarra	69.60	44.40	5	2.00	7.00	121.00
16	IRL	Foster, David	Killiney Bay	72.80	34.40	15	0.50	15.50	122.70
17	KOR	Choi, Myung-Jin	Snuffler	69.40	60.40	0	0.75	0.75	130.55
18	USA	Davidson, Bruce	Dr. Peaches	50.40	76.40	15	0.00	15.00	141.80
19	GBR	Straker, Karen	Get Smart	53.20	88.80	0	0.00	0.00	142.00
20	NZL	Bennie, Andrew	Grayshott	52.20	85.60	25	0.00	25.00	162.80
21	POL	Rafalak, Krzysztof	Dzwinograd	72.40	86.00	5	0.00	5.00	163.40
22	ITA	Girardi, Francesco	Moreado	70.80	94.80	0	0.75	0.75	166.35
23	AUS	Keach, Scott	Trade Commissioner	67.60	104.00	5	0.00	5.00	176.60
24	AUS	Green, David	Shannagh	56.00	136.00	0	0.00	0.00	192.00
25	AUS	Roycroft, Barry	Last Tango	85.40	100.40	10	0.00	10.00	195.80
26	JPN	Miyazaki, Eiki	Scrooge	97.20	94.40	10	0.00	10.00	201.60
27	FRA	Berthet, Vincent	Jet Crub	59.40	142.80	0	0.00	0.00	202.20
28	KOR	Park, Dong-Joo	Aqaba Legend A	99.80	117.20	10	0.00	10.00	227.00
29	FRA	Morvillers, Pascal	Frangin III	64.60	158.00	5	0.00	5.00	227.60
30	FRA	Duroy, Marie-Christin	Harley	60.00	168.80	5	0.00	5.00	233.80
31	BER	Gray, Peter	Somers	75.60	149.60	10	5.50	15.50	240.70
32	ESP	Beca, Ramon	Count De Bolebec	85.60	167.20	20	0.00	20.00	272.80
33	POL	Koczorski, Eugeniusz	Idrys	90.00	170.80	15	1.50	16.50	277.30
34	KOR	Park, So-Woon	Moisson d'Avril	86.60	250.00	35	11.00	46.00	382.60
35	ISV	Brodax, Eric	Marcellus	74.20	333.60	10	0.00	10.00	417.80
36	JPN	Iwatani, Kazuhiro	Copen Hagen V	79.00	382.00	50	6.25	56.25	517.25

Three-day Event: Team Classific. Jumping Test/Sept. 22				Concours Complet: Equipes Epreuve de Sauts d'Obstacles/22 Sept				
Rank	Ctry	Name	Horse	Dress	Endur	Jumping	Total	Total
Rank	Pays	Nom	Cheval	Dress	Fond	Sauts	Indiv	Team
1	FRG	Erhorn, Claus	Justyn Thyme	39.60	16.00	6.75	62.35	225.95
		Baummann, Matthias	Shamrock 11	50.60	13.20	5.00	68.80	
		Kaspereit, Thies	Sherry 42	46.80	38.00	10.00	94.80	
		Ehrenbrink, Ralf	Uncle Todd	66.20	39.60	Disqualified	*	
2	GBR	Phillips, Mark	Cartier	78.20	Withdrawn		*	256.80
		Straker, Karen	Get Smart	53.20	88.80	0.00	142.00	
		Leng, Virginia	Master Craftsman	43.20	8.80	10.00	62.00	
		Stark, Ian	Sir Wattie	50.00	2.80	0.00	52.80	
3	NZL	Todd, Mark	Charisma	37.60	0.00	5.00	42.60	271.20
		Knighon, Marges	Enterprise	74.60	90.00	Disqualified	*	
		Bennie, Andrew	Grayshott	52.20	85.60	25.00	162.80	
		Pottinger, Tinks	Volunteer	65.80	0.00	0.00	65.80	
4	POL	Rogowski, Krzysztof	Alkierz	80.20	29.60	5.00	114.80	389.60
		Rafalak, Krzysztof	Dzwinograd	72.40	86.00	5.00	163.40	
		Koczorski, Eugeniusz	Idrys	90.00	170.80	16.50	277.30*	
		Jarecki, Boguslaw	Niewiaza	56.60	44.80	10.00	111.40	
5	AUS	Hoy, Andrew	Kiwi	57.00	32.00	0.00	89.00	457.60
		Roycroft, Barry	Last Tango	85.40	100.40	10.00	195.80*	
		Green, David	Shannagh	56.00	136.00	0.00	192.00	
		Keach, Scott	Trade Commissioner	67.60	104.00	5.00	176.60	
6	FRA	Morvillers, Pascal	Frangin III	64.60	158.00	5.00	227.60	498.80
		Duroy, Marie-Christin	Harley	60.00	168.80	5.00	233.80*	
		Berthet, Vincent	Jet Crub	59.40	142.80	0.00	202.20	
		Teulere, Jean	Mohican V	57.60	6.40	5.00	69.00	
7	KOR	Park, Dong-Joo	Aqaba Legend A	99.80	117.20	10.00	227.00	740.15
		Kim, Hyung-Chil	Casson Road	72.40	Withdrawn		*	
		Park, So-Woon	Moisson d'Avril	86.60	250.00	46.00	382.60	
		Choi, Myung-Jin	Snuffler	69.40	60.40	0.75	130.55	
	ITA	Costantini, Dino	Boardmans Beauty	67.80	62.00	Disqualified		WIT
		Campello, Ranieri	Cotton End	57.80	Withdrawn			
		Girardi, Francesco	Moreado	70.80	94.80	0.75	166.35	
		Ambrosione, Bartolo	Phoenix	58.80	47.60	1.50	107.90	
	JPN	Iwatani, Kazuhiro	Copen Hagen V	79.00	382.00	56.25	517.25	
		Wakahara, Hisashi	Lord Waterford	96.40	Retired			
		Miyazaki, Eiki	Scrooge	97.20	94.40	10.00	201.60	
		Watanabe, Hiroshi	Yakumo Masonori	67.20	Eliminated			
	USA	Dawson, Phyllis	Albany II	54.60	40.00	5.00	99.60	
		Davidson, Bruce	Dr. Peaches	50.40	76.40	15.00	141.80	
		Sutton, Ann	Tarzan	57.20	Withdrawn			
		Lende, Karen	The Optimist	64.20	Eliminated			

Three-day Event: Individual Class. Endurance Test/Sept. 21				Concours Complet: Individuel Epreuve de Fond/21 Sept						
Rank	Ctry	Name	Horse	Dress	A	B	C	D	Total	Total
Rank	Pays	Nom	Cheval	Dress	Jump Time			Jump Time	Endur	Total
1	NZL	Todd, Mark	Charisma	37.60	0	0	0.0	0	0.0	37.60
2	GBR	Leng, Virginia	Master Craftsma	43.20	0	0	0.0	0	8.8	52.00
3	GBR	Stark, Ian	Sir Wattie	50.00	0	0	0.0	0	2.8	52.80
4	FRG	Erhorn, Claus	Justyn Thyme	39.60	0	0	0.0	0	16.0	55.60
5	FRG	Baummann, Matthias	Shamrock 11	50.60	0	0	0.0	0	13.2	63.80
6	FRA	Teulere, Jean	Mohican V	57.60	0	0	0.0	0	6.4	64.00
7	NZL	Pottinger, Tinks	Volunteer	65.80	0	0	0.0	0	0.0	65.80
8	FRG	Kaspereit, Thies	Sherry 42	46.80	0	0	0.0	0	38.0	84.80
9										

Team Dressage Competition
Final/Sept. 24-25
Dressage-Competition par Equipe
Finale/24-25 Sept

Rank Rang	Ctry Pays	Name Nom	Horse Cheval	Judges					Total Indiv	Total Team
				E	H	C	M	B		
1	FRG	Klimke Dr, Reiner Linsenhoff, Annkathri Theodorescu, Monica Uphoff, Nicole	Ahlerich 2 Courage 10 Ganymedes Rembrandt 24	275	284	285	281	277	1402*	4302
				276	293	276	293	273	1411	
				289	285	290	286	283	1433	
				284	283	286	307	298	1458	
2	SUI	Hofer, Otto Stueckelberger, Chris Ramseier, Daniel Schatzmann, Samuel	Andiamo Gauguin De Lully Ch Random Rochus	293	274	293	263	269	1392	4164
				271	280	297	296	286	1430	
				270	266	277	271	258	1342	
				239	245	247	251	243	1225*	
3	CAN	Ishoy, Cynthia Pracht, Eva Maria Smith, Gina Nicoll, Ashley	Dynasty Emirage Malte Reipo	276	265	279	264	279	1363	3969
				249	257	250	246	253	1255*	
				262	267	254	255	260	1298	
				272	255	265	248	268	1308	
4	URS	Kovchov, Yuri Klimko, Olga Menkova, Nina Tankov, Anatoli	Barin Buket Dixon Izharsk	248	255	247	237	272	1259	3926
				235	263	264	270	240	1272	
				279	283	281	287	265	1395	
				251	240	245	257	256	1249*	
5	HOL	Sanders-Keyzer, Annem Bartels, Tineke Bontje, Ellen Van Grunsven, Anky	Amon 5 Olympic Petit Prince Prisco	257	263	255	260	268	1303	3903
				259	259	247	260	263	1288	
				266	268	261	255	262	1312	
				258	255	232	247	247	1239*	
6	USA	Baudin, Belinda Dover, Robert Gray, Lendon Ransehousen, Jessica	Christopher Federleicht Later On Orpheus	240	255	255	244	254	1248	3883
				263	258	270	259	277	1327	
				241	239	242	245	245	1212*	
				263	269	258	265	253	1308	
6	FIN	Kyrklund, Kyra Eriksson, Jennifer Raiskio, Maarit Sohlberg, Tutu	Matador My Way Nor Pakistan	290	279	287	284	276	1416	3883
				237	246	231	257	254	1225	
				235	230	235	229	232	1161*	
				242	253	247	245	255	1242	
8	FRA	Otto-Crepin, Margitt Desme, Dominique Limousin, Philippe	Corlandus Hopal Fleuri Hn Iris De La Fosse	303	295	297	287	273	1455	3832
				254	242	229	257	237	1219	
				234	229	222	235	238	1158	
				256	265	259	254	259	1293	
9	DEN	Haagensen, Nils Thomsen, Morten Koch, Anne Tornblad, Anne	Cantat Diplomat Le Fiere Grethe Ravel	257	259	251	255	247	1269	3825
				243	247	238	240	249	1217*	
				259	246	250	251	257	1263	
				262	255	263	261	252	1293	
10	GBR	Loriston-Clarke, Jenn Hammond, Barbara Mason, Diana Gardiner, Tricia	Dutch Gold Krist Prince Consort Wily Imp	234	228	236	236	240	1174*	3797
				231	243	253	252	251	1230	
				258	256	250	256	254	1274	
				240	232	233	235	227	1167*	
11	SWE	Lindsten, Eva Hakansson, Ulla Nathorst, Louise Andersson, Lars	Cello Cesam Cirac Herkules	248	249	258	255	261	1271	3771
				249	244	246	252	260	1251	
				245	245	243	263	253	1249	
				211	217	220	210	223	1081	
JPN	Hoketsu, Hiroshi Sakurai, Naoko Inoue, Kikuko	Medina Ravello 6 Teldor	Withdrawn	247	216	231	235	240	1169	3771
				258	245	235	249	258	1245	
				199	191	201	172	215	978	
				250	234	246	245	254	1229	
ESP	Matute, Juan	Rex The Blacky	242	236	243	241	243	1205	1205	
				223	214	204	224	231		1096
				261	254	254	251	264		1284
				224	207	216	226	228		1101
KOR	Shin, Chang-Moo Suh, Jung-Kyun	Lugana Pascal	269	258	266	264	267	1324	1324	
				269	258	266	264	267		1324

Individual Dressage Competition
Final/Sept. 27
Dressage-Competition Individuel
Finale/27 Sept

Rank Rang	Ctry Pays	Name Nom	Horse Cheval	Judges					Total
				E	H	C	M	B	
1	FRG	Uphoff, Nicole	Rembrandt 24	290	293	307	318	313	1521
2	FRA	Otto-Crepin, Margitt	Corlandus	296	279	304	294	289	1462
3	SUI	Stueckelberger, Chris	Gauguin De Lully Ch	284	292	296	270	275	1417
4	CAN	Ishoy, Cynthia	Dynasty	275	276	284	287	279	1401
5	FIN	Kyrklund, Kyra	Matador	283	275	293	273	269	1393
6	FRG	Theodorescu, Monica	Ganymedes	277	270	282	281	275	1385
7	SUI	Hofer, Otto	Andiamo	270	279	279	288	267	1383
8	FRG	Linsenhoff, Annkathri	Courage 10	275	269	282	271	277	1374
9	URS	Menkova, Nina	Dixon	275	263	278	271	267	1354
10	KOR	Suh, Jung-Kyun	Pascal	269	267	283	268	262	1349
11	SUI	Ramseier, Daniel	Random	267	266	274	266	257	1330
12	CAN	Smith, Gina	Malte	261	259	264	275	267	1326
13	USA	Dover, Robert	Federleicht	267	271	263	265	254	1320
14	GBR	Loriston-Clarke, Jenn	Dutch Gold	264	263	257	249	271	1304
15	HOL	Bontje, Ellen	Petit Prince	260	258	257	261	261	1297
16	CAN	Nicoll, Ashley	Reipo	245	263	262	258	268	1296
17	USA	Ransehousen, Jessica	Orpheus	254	260	256	249	263	1282
18	DEN	Haagensen, Nils	Cantat	254	261	253	259	253	1280
19	HOL	Sanders-Keyzer, Annem	Amon 5	250	265	250	257	245	1267

Team Jumping Competition
Round 1/Sept. 28
Sauts d'Obstacles-Equipes
1er Tour/28 Sept

Rank Rang	Ctry Pays	Name Nom	Horse Cheval	Penalties Penalites	Time Temps	Time Penal. Temps	Total Rnd1	Total Team
2	USA	Best, Greg Jacquin, Lisa Kursinski, Anne Fargis, Joe	Gem Twist For the Moment Starman Mill Pearl	4 4 8 4	109.31 116.68 110.25 106.55	0.00 0.25 0.00 0.00	4.00 4.25 8.00* 4.00	12.25
3	CAN	Deslauriers, Mario Tidball-Balisky, Laur Carlsen, Lisa Millar, Ian	Box Car Willie Lavendel 48 Kahlua Big ben	4 15 4 8	112.60 127.86 113.51 110.70	0.00 3.00 0.00 0.00	4.00 18.00* 4.00 8.00	16.00
3	SUI	Guerdat, Phillippe Fuchs, Markus Gabathuler, Walter Fuchs, Thomas	Lanciano II Shandor II Jogger Dollar Girl	4 0 20 12	111.91 113.85 116.61 113.21	0.00 0.00 0.25 0.00	4.00 0.00 20.25* 12.00	16.00
3	GBR	Skelton, Nicholas Turi, Joseph Pyrah, Malcolm Broome, David	Apollo Vital Anglezarke Countryman	8 4 8 4	109.67 111.06 111.49 115.58	0.00 0.00 0.00 0.00	8.00* 4.00 8.00 4.00	16.00
6	HOL	Tops, Johannes Ehrens, Robbertus Van Der Schans, Wout- Lansink, Jos	Doreen Sunrise Van Der Schans, Wout- Lansink, Jos	4 8 4 12	113.24 111.05 116.88 110.04	0.00 0.00 0.25 0.00	4.00 8.00 4.25 12.00*	16.25
7	FRA	Bourdy, Hubert Cottier, Frederic Robert, Michel Durand, Pierre	Morgat Flambeauc La Fayette Jappeloup	8 12 4 4	117.17 115.42 120.14 119.76	0.50 0.00 1.25 1.00	8.50 12.00* 5.25 5.00	18.75
8	ESP	Fernandez Duran, Alfr Garcia Trevijano, Jua Sanchez Aleman, Pedro Alvarez Cervera, Luis	Kaoua Tirol Nuit Des Tourelles Mirage Mexicain	12 12 4 28	119.92 116.01 116.89 113.04	1.00 0.25 0.25 0.00	13.00 12.25 4.25 28.00*	29.50
9	IRL	Darragh, Paul Kilcoltrim, John Doyle, Jack Mullins, Gerry	For Sure Kilcoltrim Hardly Glendalough	16 36 8 8	117.06 121.62 117.50 114.50	0.50 1.50 0.50 0.00	16.50 37.50* 8.50 8.00	33.00
10	BRA	Johannpeter, Andre' Johannpeter, Christin Stewart, Paulo Teixeira, Vitor	Heartbreaker Societe Platon Going	16 12 28 8	127.60 117.78 117.54 117.06	3.00 0.50 0.50 0.50	19.00 12.50 28.50* 8.50	40.00
11	AUS	Mcvean, Jeffrey Brown, Rodney Roycroft, Vicki Sanna, George	Whisper grey Slinky Mickey Mouse Schnaps	20 20 12 12	112.02 111.77 116.28 114.90	0.00 0.00 0.25 0.00	20.00 20.00* 12.25 12.00	44.25
12	NZL	Beatson, Maurice Mc Intosh, Colin Wilson, Harvev Todd, Mark	Jeferson Junior Gigolo Crosby Bago	20 32 20 12	112.67 114.62 113.82 116.87	0.00 0.00 0.00 0.25	20.00 32.00* 20.00 12.25	52.25
13	JPN	Sawai, Takao Okuno, Ryuzo Toki, Shuichi Nakano, Yoshihiro	Milkyway Step-By-Step Purplex El Lute	28 12 24 24	112.03 120.99 123.49 109.95	0.00 1.25 2.00 0.00	28.00* 13.25 26.00 24.00	63.25
14	MEX	Hegewisch, Everardo Azcarraaga, Jaime Rivera, Alberto Tazzer, Gerardo	Pepito Chin chin Rey A Peregrine	43 12 Retired 12	140.32 123.40 Retired 120.49	6.25 2.00 Retired 1.25	49.25 14.00 Retired 13.25	76.50
15	URS	Timchenko, Anatoli Udrakis, Rajmoundas Chukanov, Viatcheslav Chakourov, Serguei	Pinguin Dekoratsia Zritel Final	8 40 Eliminated 28	121.28 113.25 Eliminated 126.82	1.50 0.00 Eliminated 2.75	9.50 40.00 70.75* 30.75	80.25
16	KOR	Moon Eun-Jin Moon, Hyun-Jin Nam, Kwan-Woo Kim, Sung-Hwan	Makmillion Out This World Opal Forever	39 Eliminated Eliminated 20	162.58 Eliminated Eliminated 120.35	11.75 Eliminated Eliminated 1.25	50.75 70.75 70.75* 21.25	142.75

Team Jumping Competition
Round 2/Sept. 28
Sauts d'Obstacles-Equipes
2er Tour/28 Sept

Rank Rang	Ctry Pays	Name Nom	Horse Cheval	Round 1	Penal Penal	Time Temps	Time Penal. 2	Round 2	Total Indiv	Total Team
1	FRG	Beerbaum, Ludger Brinkmann, Wolf gang Hafemeister, Dirk Sloothaak, Franke	The Freak Pedro Orchidee 76 Walzerkonig 19	0.25 9.00* 4.00 0.00	4 0 8 Withdrawn	113.01 119.50 114.07 Withdrawn	0.00 1.00 0.00 0.00	4.00 1.00 8.00 13.00	4.25 10.00 12.00 17.25	
2	USA	Best, Greg Jacquin, Lisa Kursinski, Anne Fargis, Joe	Gem Twist For the Moment Starman Mill Pearl	4.00 4.25 8.00* 4.00	4 4 8 0	112.17 112.85 113.84 116.84	0.00 0.00 0.00 0.25	4.00 4.00 8.00* 8.25	8.00 8.25 16.00 4.25	
3	FRA	Bourdy, Hubert Cottier, Frederic Robert, Michel Durand, Pierre	Morgat Flambeauc La Fayette Jappeloup	8.50 12.00* 5.25 5.00	8 4 4 0	111.33 115.47 118.60 114.57	0.00 0.00 0.75 0.00	8.00* 4.00 4.75 0.00	16.50 16.00 10.00 5.00	
				*Team Results		18.75		8.75	27.50	

Equestrian Sports

Sports Equestres

Rank	Ctry	Name	Horse	Round 1	Penal	Time	Time Penal.	Round 2	Total	Total
Rang	Pays	Nom	Cheval	Tour 1	Penal	Temps	Penal. Temps	Tour 2	Indiv	Team
4	CAN	Deslauriers, Mario Tidball-Balisky, Laur Carlsen, Lisa Millar, Ian	Box Car Willie Lavendel 48 Kahlua Big Ben	4.00 18.00* 4.00 8.00	8 4 12 0	113.67 118.65 113.83 114.83	0.00 0.75 0.00 0.00	8.00 4.75 12.00* 0.00	12.00 22.75 16.00 8.00	
			*Team Results	16.00				12.75		28.75
5	HOL	Tops, Johannes Ehrens, Robbertus Van Der Schans, Wout- Lansink, Jos	Doreen Sunrise Treffer Felix	4.00 8.00 4.25 12.00*	12 4 4 8	114.80 110.56 111.36 111.76	0.00 0.00 0.00 0.00	12.00* 4.00 4.00 8.00	16.00 12.00 8.25 20.00	
			*Team Results	16.25				16.00		32.25
6	GBR	Skelton, Nicholas Turi, Joseph Pyrah, Malcolm Broome, David	Apollo Vital Anglezarke Countryman	8.00* 4.00 8.00 4.00	4 16 8 12	114.24 108.67 115.93 113.87	0.00 0.00 0.00 0.00	4.00 16.00* 8.00 12.00	12.00 20.00 16.00 16.00	
			*Team Results	16.00				24.00		40.00
7	SUI	Guerdat, Phillippe Fuchs, Markus Gabathuler, Walter Fuchs, Thomas	Lanciano II Shandor II Jogger Dollar Girl	4.00 0.00 20.25* 12.00	16 12 16 0	115.24 112.70 114.10 116.33	0.00 0.00 0.00 0.25	16.00* 12.00 16.00 0.25	20.00 12.00 36.25 12.25	
			*Team Results	16.00				28.25		44.25
8	BRA	Johannpeter, Andre' Johannpeter, Christin Stewart, Paulo Teixeira, Vitor	Heartbreaker Societe Platon Going	19.00 12.50 28.50* 8.50	8 12 12 20	117.96 119.05 121.61 123.02	0.50 1.00 1.50 2.00	8.50 13.00 13.50 22.00*	27.50 25.50 42.00 30.50	
			*Team Results	40.00				35.00		75.00
8	ESP	Fernandez Duran, Alfr Garcia Trevijano, Jua Sanchez Aleman, Pedro Alvarez Cervera, Luis	Kaoua Tirol Nuit Des Tourell Mirage Mexicain	13.00 12.25 4.25 28.00*	8 20 24 16	112.84 117.75 111.79 119.98	0.00 0.50 0.00 1.00	8.00 20.50 24.00* 17.00	21.00 32.75 28.25 45.00	
			*Team Results	29.50				45.50		75.00
10	AUS	Mcvean, Jeffrey Brown, Rodney Roycroft, Vicki Sanna, George	Whisper Grey Slinky Mickey mouse Schnaps	20.00 20.00* 12.25 12.00	8 12 20 12	111.13 117.87 111.02 118.59	0.00 0.50 0.00 0.75	8.00 12.50 20.00* 12.75	28.00 32.50 32.25 24.75	
			*Team Results	44.25				33.25		77.50
11	IRL	Darragh, Paul Ledingham, John Doyle, Jack Mullins, Gerry	For Sure Kilcoltrim Hardly Glendalough	16.50 37.50* 8.50 8.00	20 40 24 4	110.70 118.87 117.68 113.62	0.00 0.75 0.50 0.00	20.00 40.75* 24.50 4.00	36.50 78.25 33.00 12.00	
			*Team Results	33.00				48.50		81.50
12	NZL	Beatson, Maurice Mc Intosh, Colin Wilson, Harvey Todd, Mark	Jeferson Junior Gigolo Crosby Bago	20.00 32.00* 20.00 12.25	28 20 16 8	111.06 111.47 117.51 116.63	0.00 0.00 0.50 0.25	28.00* 20.00 16.50 8.25	48.00 52.00 36.50 20.50	
			*Team Results	52.25				44.75		97.00

Individual Jumping Competition				Sauts d'Obstacles-Individuel				
Qualifying Round 1/Sept. 26				1er Tour de Qualification/26 Sept				
Rank	Ctry	Name	Horse	Penalties	Time	Time Penal.	Total	Points
Rang	Pays	Nom	Cheval	Penalites	Temps	Penal. Temps		
1	CAN	Millar, Ian	Big Ben	0	105.17	0.00	0.00	69.50
1	HOL	Ehrens, Robbertus	Sunrise	0	103.12	0.00	0.00	69.50
1	USA	Kursinski, Anne	Starman	0	106.52	0.00	0.00	69.50
1	USA	Fargis, Joe	Mill Pearl	0	106.29	0.00	0.00	69.50
1	POR	Malta Da Costa, Manue	Talisco B	0	107.44	0.00	0.00	69.50
1	FRA	Bourdy, Hubert	Morgat	0	107.90	0.00	0.00	69.50
1	BEL	Vangeenberghe, Jean-C	Piquet	0	102.98	0.00	0.00	69.50
1	USA	Best, Greg	Gem Twist	0	101.94	0.00	0.00	69.50
1	CAN	Carlsen, Lisa	Kahlua	0	106.98	0.00	0.00	69.50
1	FRG	Hafemeister, Dirk	Orchidee 76	0	104.43	0.00	0.00	69.50
11	SUI	Fuchs, Thomas	Dollar Girl	0	108.62	0.25	0.25	63.50
11	FRA	Robert, Michel	La Fayette	0	108.78	0.25	0.25	63.50
13	ESP	Garcia Trevijano, Jua	Tirol	0	109.98	0.50	0.50	61.50
13	CAN	Deslauriers, Mario	Box Car Willie	0	109.18	0.50	0.50	61.50
15	ESP	Sanchez Aleman, Pedro	Nuit Des Tourelles	0	112.46	1.25	1.25	59.50
15	FRA	Durand, Pierre	Jappeloup	0	112.86	1.25	1.25	59.50
17	MEX	Azcarraga, Jaime	Chin Chin	0	116.30	2.25	2.25	58.00
18	AUS	Mcdermott, Gregory	Mr. Shrimpton	4	104.23	0.00	4.00	55.00
18	AUS	Brown, Rodney	Slinky	4	100.19	0.00	4.00	55.00
18	NZL	Todd, Mark	Bago	4	107.35	0.00	4.00	55.00
18	HOL	Tops, Johannes	Doreen La Silla	4	101.91	0.00	4.00	55.00
18	IRL	Mullins, Gerry	Glendalough	4	107.53	0.00	4.00	55.00
23	GBR	Pyrah, Malcolm	Anglezarke	4	108.22	0.25	4.25	52.00
24	HOL	Van Der Schans, Wout	Treffer	3	114.76	1.75	4.75	51.00
25	FRA	Cottier, Frederic	Flambeauc	4	111.46	1.00	5.00	50.00
26	FRG	Sloothaak, Franke	Walzerkonig 19	4	112.95	1.25	5.25	48.00
26	GBR	Broome, David	Countryman	4	112.82	1.25	5.25	48.00
26	FRG	Huck, Karsten	Nepomuk 8	4	113.00	1.25	5.25	48.00
29	BRA	Teixeira, Vitor	Going	4	113.16	1.50	5.50	46.00
30	LIE	Batliner, Thomas	Foxstone	4	114.83	1.75	5.75	45.00
31	NZL	Beatson, Maurice	Jeferson Junior	8	99.52	0.00	8.00	43.50
31	HOL	Lansink, Jos	Felix	8	105.46	0.00	8.00	43.50
33	GBR	Skelton, Nicholas	Apollo	8	108.02	0.25	8.25	41.50
33	AUT	Boor, Boris	Monaco F	8	108.92	0.25	8.25	41.50
35	ESP	Alvarez Cervera, Luis	Mirage Mexicain	8	110.20	0.75	8.75	40.00
36	FRG	Brinkmann, Wolf Gang	Pedro	8	111.53	1.00	9.00	39.00
37	NOR	Hansen, Ove	Sancerre	8	112.98	1.25	9.25	38.00
38	AUS	Sanna, George	Schnaps	8	118.66	2.75	10.75	37.00
39	GBR	Turi, Joseph	Vital	12	104.88	0.00	12.00	34.50
39	AUT	Simon, Hugo	Gipsy Lady	12	107.14	0.00	12.00	34.50

Rank	Ctry	Name	Horse	Penalties	Time	Time Penal.	Total	Points
Rang	Pays	Nom	Cheval	Penalites	Temps	Penal. Temps		
39	JPN	Nakano, Yoshihiro	El Lute	12	104.98	0.00	12.00	34.50
39	MEX	Rivera, Alberto	Rey A	12	99.54	0.00	12.00	34.50
43	COL	Torres, Manuel	Zalme	12	108.84	0.25	12.25	32.00
44	KOR	Kim, Sung-Hwan	Forever	7	129.96	5.50	12.50	30.50
44	IRL	Doyle, Jack	Hardly	12	109.49	0.50	12.50	30.50
46	BRA	Johannpeter, Andre'	Heartbreaker	12	110.73	0.75	12.75	29.00
47	CAN	Anderson, John	Goby	12	111.97	1.00	13.00	27.50
47	BRA	Stewart, Paulo	Platon	12	111.81	1.00	13.00	27.50
49	JPN	Toki, Shuichi	Purplex	12	121.34	3.50	15.50	25.50
49	SUI	Guerdat, Phillippe	Lanciano II	11	125.63	4.50	15.50	25.50
51	MEX	Tazzer, Gerardo	Peregrine	16	104.00	0.00	16.00	22.50
51	NZL	Wilson, Harvey	Crosby	16	107.61	0.00	16.00	22.50
51	SUI	Fuchs, Markus	Shandor II	11	127.96	5.00	16.00	22.50
51	SUI	Gabathuler, Walter	Jogger	16	107.22	0.00	16.00	22.50
55	IRL	Darragh, Paul	For Sure	16	108.30	0.25	16.25	19.50
55	IRL	Ledingham, John	Kilcoltrim	16	108.87	0.25	16.25	19.50
57	URS	Timchenko, Anatoli	Pinguin	16	114.20	1.75	17.75	18.00
58	ESP	Astolfi, Luis	Coreven Steepers	20	107.72	0.00	20.00	17.00
59	USA	Jacquini, Lisa	For The Moment	11	147.35	10.00	21.00	16.00
60	MEX	Orozco, Alejandro	Eros	20	112.53	1.25	21.25	15.00
61	NZL	Cottle, John	Ups & Downs	24	106.41	0.00	24.00	13.50
61	AUS	Mcvean, Jeffrey	Furst	24	107.76	0.00	24.00	13.50
63	COL	Garcia, Juan Carlos	Buenos Aires	24	110.51	0.75	24.75	12.00
64	VEN	Carmona, Alberto	The Dubliner	24	114.79	1.75	25.75	11.00
65	JPN	Okuno, Ryuzo	Challenger No.1	28	114.49	1.75	29.75	10.00
66	KOR	Moon Eun-Jin	Makmillion	25	142.85	8.75	33.75	9.00
67	JPN	Sawai, Takao	Milkyway	36	115.26	2.00	38.00	8.00
68	URS	Udrakis, Rajmoundas	Dekoratsia	31	140.04	8.25	39.25	7.00
69	BRA	Johannpeter, Christin	Societe	25	169.33	15.50	40.50	6.00
70	URS	Chukanov, Viatcheslav	Zritel	28	161.70	13.50	41.50	5.00
71	URS	Chakourov, Serguei	Final	40	119.87	3.00	43.00	4.00
72	KOR	Nam, Kwan-Woo	Opal	39	141.18	8.50	47.50	3.00
	EGY	Sakakini, Andre-Saleh	Tric Trac 2	Eliminated				0.00
	KOR	Moon, Hyun-Jin	Out This World	Eliminated				0.00

Individual Jumping Competition				Sauts d'Obstacles-Individuel					
Qualifying Round 2/Sept. 30				2e Tour de Qualification/30 Sept					
Rank	Ctry	Name	Horse	Penalties	Time	Time Penal.	Total	Points	
Rang	Pays	Nom	Cheval	Penalites	Temps	Penal. Temps			
1	CAN	Carlsen, Lisa	Kahlua	Q1) Q2) Q1+Q2)	0 0 0	106.98 91.95 0.00	0.00 0.00 0.00	0.00 0.00 0.00	69.50 73.50 143.00
2	FRG	Hafemeister, Dirk	Orchidee 76	Q1) Q2) Q1+Q2)	0 0 0	104.43 96.57 0.50	0.00 0.50 0.50	0.00 0.50 0.50	69.50 70.00 139.50
3	FRA	Robert, Michel	La Fayette	Q1) Q2) Q1+Q2)	0 0 0	108.78 92.63 0.25	0.25 0.00 0.25	0.25 0.00 0.25	63.50 73.50 137.00
4	SUI	Fuchs, Thomas	Dollar Girl	Q1) Q2) Q1+Q2)	0 0 0	108.62 96.65 0.75	0.25 0.50 0.75	0.25 0.50 0.75	63.50 70.00 133.50
5	BEL	Vangeenberghe, Jean-C	Piquet	Q1) Q2) Q1+Q2)	0 4 4	102.98 94.50 0.00	0.00 0.00 0.00	0.00 4.00 4.00	69.50 63.50 133.00
5	USA	Best, Greg	Gem Twist	Q1) Q2) Q1+Q2)	0 4 4	101.94 92.85 0.00	0.00 0.00 0.00	0.00 4.00 4.00	69.50 63.50 133.00
5	USA	Fargis, Joe	Mill Pearl	Q1) Q2) Q1+Q2)	0 4 4	106.29 91.01 0.00	0.00 0.00 0.00	0.00 4.00 4.00	69.50 63.50 133.00
8	CAN	Millar, Ian	Big Ben	Q1) Q2) Q1+Q2)	0 8 8	105.17 94.56 0.00	0.00 0.00 0.00	0.00 8.00 8.00	69.50 56.00 125.50
8	FRA	Bourdy, Hubert	Morgat	Q1) Q2) Q1+Q2)	0 8 8				



Rank	Ctry	Name	Horse	Penalties	Time	Time Penal.	Total	Points
Rang	Pays	Nom	Cheval	Penalites	Temps	Penal.Temps		
17	FRA	Cottier, Frederic	Flambeauc	Q1) 4 Q2) 4 Q1+Q2) 8	111.46 95.11	1.00 0.25 1.25	5.00 4.25 9.25	50.00 61.00 111.00
18	FRA	Durand, Pierre	Jappeloup	Q1) 0 Q2) 8 Q1+Q2) 8	112.86 98.98	1.25 1.00 2.25	1.25 9.00 10.25	59.50 50.50 110.00
19	FRG	Brinkmann, Wolf Gang	Pedro	Q1) 8 Q2) 0 Q1+Q2) 8	111.53 98.14	1.00 1.00 2.00	9.00 1.00 10.00	39.00 67.50 106.50
20	FRG	Sloothaak, Franke	Walzerkonig 19	Q1) 4 Q2) 8 Q1+Q2) 12	112.95 94.86	1.25 0.00 1.25	5.25 8.00 13.25	48.00 56.00 104.00
21	AUT	Simon, Hugo	Gipsy Lady	Q1) 12 Q2) 0 Q1+Q2) 12	107.14 99.60	0.00 1.25 1.25	12.00 1.25 13.25	34.50 66.00 100.50
22	HOL	Tops, Johannes	Doreen	Q1) 4 Q2) 12 Q1+Q2) 16	101.91 93.85	0.00 0.00 0.00	4.00 12.00 16.00	55.00 45.00 100.00
23	GBR	Turi, Joseph	Vital	Q1) 12 Q2) 4 Q1+Q2) 16	104.88 92.08	0.00 0.00 0.00	12.00 4.00 16.00	34.50 63.50 98.00
24	GBR	Skelton, Nicholas	Apollo	Q1) 8 Q2) 8 Q1+Q2) 16	108.02 90.73	0.25 0.00 0.25	8.25 8.00 16.25	41.50 56.00 97.50
25	AUS	Brown, Rodney	Slinky	Q1) 4 Q2) 12 Q1+Q2) 16	100.19 98.46	0.00 1.00 1.00	4.00 13.00 17.00	55.00 40.00 95.00
26	POR	Malta Da Costa, Manue	Jalisco B	Q1) 0 Q2) 20 Q1+Q2) 20	107.44 98.05	0.00 1.00 1.00	0.00 21.00 21.00	69.50 25.00 94.50
27	ESP	Garcia Trevijano, Jua	Tirol	Q1) 0 Q2) 20 Q1+Q2) 20	109.98 92.54	0.50 0.00 0.50	0.50 20.00 20.50	61.50 29.00 90.50
28	GBR	Broome, David	Countryman	Q1) 4 Q2) 12 Q1+Q2) 16	112.82 97.49	1.25 0.75 2.00	5.25 12.75 18.00	48.00 41.00 89.00
29	ESP	Sanchez Aleman, Pedro	Nuit Des Tourelle	Q1) 0 Q2) 20 Q1+Q2) 20	112.46 91.02	1.25 0.00 1.25	1.25 20.00 21.25	59.50 29.00 88.50
30	NZL	Todd, Mark	Bago	Q1) 4 Q2) 16 Q1+Q2) 20	107.35 96.63	0.00 0.50 0.50	4.00 16.50 20.50	55.00 33.00 88.00
31	AUT	Boor, Boris	Monaco F	Q1) 8 Q2) 12 Q1+Q2) 20	108.92 94.22	0.25 0.00 0.25	8.25 12.00 20.25	41.50 45.00 86.50
32	AUS	Sanna, George	Schnaps	Q1) 8 Q2) 8 Q1+Q2) 16	118.66 99.22	2.75 1.25 4.00	10.75 9.25 20.00	37.00 49.00 86.00
33	IRL	Mullins, Gerry	Glendalough	Q1) 4 Q2) 20 Q1+Q2) 24	107.53 96.09	0.00 0.50 0.50	4.00 20.50 24.50	55.00 27.00 82.00
34	IRL	Doyle, Jack	Hardly	Q1) 12 Q2) 8 Q1+Q2) 20	109.49 98.63	0.50 1.00 1.50	12.50 9.00 21.50	30.50 50.50 81.00
35	GBR	Pyrah, Malcolm	Anglezarke	Q1) 4 Q2) 20 Q1+Q2) 24	108.22 97.61	0.25 0.75 1.00	4.25 20.75 25.00	52.00 26.00 78.00
36	SUI	Guerdat, Phillippe	Lanciano II	Q1) 11 Q2) 8 Q1+Q2) 19	125.63 103.72	4.50 2.25 6.75	15.50 10.25 25.75	25.50 48.00 73.50
37	ESP	Alvarez Cervera, Luis	Mirage Mexicain	Q1) 8 Q2) 16 Q1+Q2) 24	110.20 96.22	0.75 0.50 1.25	8.75 16.50 25.25	40.00 33.00 73.00
38	BRA	Johannpeter, Andre'	Heartbreaker	Q1) 12 Q2) 12 Q1+Q2) 24	110.73 101.16	0.75 1.75 2.50	12.75 13.75 26.50	29.00 39.00 68.00
39	SUI	Fuchs, Markus	Shandor II	Q1) 11 Q2) 12 Q1+Q2) 23	127.96 93.78	5.00 0.00 5.00	16.00 12.00 28.00	22.50 45.00 67.50
39	COL	Torres, Manuel	Zalme	Q1) 12 Q2) 16 Q1+Q2) 28	108.84 95.46	0.25 0.25 0.50	12.25 16.25 28.50	32.00 35.50 67.50
41	HOL	Van Der Schans, Wout	Treffer	Q1) 3 Q2) 29 Q1+Q2) 32	114.76 131.81	1.75 9.25 11.00	4.75 38.25 43.00	51.00 15.00 66.00
42	JPN	Nakano, Yoshihiro	Ei Lute	Q1) 12 Q2) 20 Q1+Q2) 32	104.98 91.31	0.00 0.00 0.00	12.00 20.00 32.00	34.50 29.00 63.50
43	ESP	Astolfi, Luis	Coreven Steepers	Q1) 20 Q2) 12 Q1+Q2) 32	107.72 91.75	0.00 0.00 0.00	20.00 12.00 32.00	17.00 45.00 62.00

Rank	Ctry	Name	Horse	Penalties	Time	Time Penal.	Total	Points
Rang	Pays	Nom	Cheval	Penalites	Temps	Penal. Temps		
43	LIE	Batliner, Thomas	Foxstone	Q1) 4 Q2) 24 Q1+Q2) 28	114.83 105.57	1.75 2.75 4.50	5.75 26.75 32.50	45.00 17.00 62.00
45	KOR	Kim, Sung-Hwan	Forever	Q1) 7 Q2) 16 Q1+Q2) 23	129.96 104.81	5.50 2.50 8.00	12.50 18.50 31.00	30.50 31.00 61.50
46	URS	Timchenko, Anatoli	Pinguin	Q1) 16 Q2) 12 Q1+Q2) 28	114.20 95.53	1.75 0.25 2.00	17.75 12.25 30.00	18.00 42.00 60.00
46	NOR	Hansen, Ove	Sancerre	Q1) 8 Q2) 19 Q1+Q2) 27	112.98 108.94	1.25 3.50 4.75	9.25 22.50 31.75	38.00 22.00 60.00
48	NZL	Beatson, Maurice	Jeferson Junior	Q1) 8 Q2) 32 Q1+Q2) 40	99.52 88.10	0.00 0.00 0.00	8.00 32.00 40.00	43.50 16.00 59.50
49	CAN	Anderson, John	Farmer	Q1) 8 Q2) 12 Q1+Q2) 20	90.54	0.00	8.00	56.00 56.00
50	COL	Garcia, Juan Carlos	Buenos Aires	Q1) 24 Q2) 11 Q1+Q2) 35	110.51 106.48	0.75 3.00 3.75	24.75 14.00 38.75	12.00 38.00 50.00
51	JPN	Toki, Shuichi	Purplex	Q1) 12 Q2) 20 Q1+Q2) 32	121.34 103.01	3.50 2.25 5.75	15.50 22.25 37.75	25.50 23.00 48.50
52	JPN	Okuno, Ryuzo	Challenger No.1	Q1) 28 Q2) 12 Q1+Q2) 40	114.49 104.44	1.75 2.50 4.25	29.75 14.50 44.25	10.00 37.00 47.00
53	AUS	Mcvean, Jeffrey	Whisper Grey	Q1) 12 Q2) 12 Q1+Q2) 24	94.24	0.00	12.00	0.00 45.00 45.00
54	MEX	Tazzer, Gerardo	Peregrine	Q1) 16 Q2) 17 Q1+Q2) 33	104.00 119.78	0.00 6.25 6.25	16.00 23.25 39.25	22.50 21.00 43.50
55	NZL	Wilson, Harvey	Crosby	Q1) 16 Q2) 24 Q1+Q2) 40	107.61 94.62	0.00 0.00 0.00	16.00 24.00 40.00	22.50 19.50 42.00
56	USA	Jacquín, Lisa	For The Moment	Q1) 11 Q2) 13 Q1+Q2) 24	147.35 129.60	10.00 8.75 18.75	21.00 21.75 42.75	16.00 24.00 40.00
57	KOR	Nam, Kwan-Woo	Opal	Q1) 39 Q2) 16 Q1+Q2) 55	141.18 95.94	8.50 0.25 8.75	47.50 16.25 63.75	3.00 35.50 38.50
58	EGY	Sakakini, Andre-Saleh	Tric Trac 2	Q1) Eliminated Q2) 16 Q1+Q2) 16	96.16	0.50	16.50	0.00 33.00 33.00
59	VEN	Carmona, Alberto	The Dubliner	Q1) 24 Q2) 24 Q1+Q2) 48	114.79 98.73	1.75 1.00 2.75	25.75 25.00 50.75	11.00 18.00 29.00
60	JPN	Sawai, Takao	Milkyway	Q1) 36 Q2) 24 Q1+Q2) 60	115.26 90.40	2.00 0.00 2.00	38.00 24.00 62.00	8.00 19.50 27.50
61	MEX	Orozco, Alejandro	Eros	Q1) 20 Q2) Withdrawn Q1+Q2) 20	112.53	1.25	21.25	15.00 0.00 15.00
62	KOR	Moon, Hyun-Jin	Amadeus	Q1) Eliminated Q2) 39 Q1+Q2) 39	132.79	9.50	48.50	0.00 14.00 14.00
63	KOR	Moon Eun-Jin	Makmillion	Q1) 25 Q2) Eliminated Q1+Q2) 25	142.85	8.75	33.75	9.00 0.00 9.00

Individual Jumping Competition				Sautes d'Obstacles-Individuel			
Final Round 1/Oct. 2				1er Tour de Finale/2 Oct			
Rank	Ctry	Name	Horse	Penalties	Time	Time Penal.	Total
Rang	Pays	Nom	Cheval	Penalites	Temps	Penal. Temps	
1	FRG	Huck, Karsten	Nepomuk 8	0	104.35	0.00	0.00
2	FRA	Durand, Pierre	Jappeloup	0	107.15	0.25	0.25
3	CAN	Millar, Ian	Big Ben	0	109.43	0.75	0.75
4	SUI	Fuchs, Thomas	Dollar Girl	4	103.44	0.00	4.00
4	HOL	Lansink, Jos	Felix	4	102.18	0.00	4.00
4	FRG	Sloothaak, Franke	Walzerkonig 19	4	102.89	0.00	4.00
4	FRA	Robert, Michel	La Fayette	4	102.36	0.00	4.00
4	CAN	Carlsen, Lisa	Kahlua	4	105.88	0.00	4.00
4	GBR	Skelton, Nicholas	Apollo	4	103.22	0.00	4.00
4	USA	Fargis, Joe	Mill Pearl	4	99.71	0.00	4.00
4	GBR	Broome, David	Countryman	4	103.79	0.00	4.00
4	SUI	Fuchs, Markus	Shandor II	4	102.77	0.00	4.00
4	USA	Kursinski, Anne	Starman	4	104.82	0.00	4.00
4	USA	Best, Greg	Gem Twist	4	98.89	0.00	4.00
4	FRG	Hafemeister, Dirk	Orchidee 76	4	103.36	0.00	4.00
4	MEX	Azcarraga, Jaime	Chin Chin	4	105.47	0.00	4.00
17	GBR	Turi, Joseph	Vital	4	107.20	0.25	4.25
18	ESP	Garcia Trevijano, Jua	Tirol	8	103.95	0.00	8.00
18	IRL	Doyle, Jack	Hardly	8	104.90	0.00	8.00
18	HOL	Tops, Johannes	Doreen	8	99.34	0.00	8.00

Rank	Ctry	Name	Horse	Penalties	Time	Time Penal.	Total
Rang	Pays	Nom	Cheval	Penalites	Temps	Penal. Temps	
18	HOL	Ehrens, Robbertus	Sunrise	8	99.89	0.00	8.00
22	IRL	Mullins, Gerry	Glendalough	8	108.53	0.50	8.50
22	ESP	Sanchez Aleman, Pedro	Nuit Des Tourelle	8	108.56	0.50	8.50
24	BRA	Teixeira, Vitor	Going	8	109.18	0.75	8.75
25	BRA	Johannpeter, Andre'	Heartbreaker	8	112.41	1.50	9.50
26	BEL	Vangeenberghe, Jean-C	Piquet	12	102.59	0.00	12.00
26	NZL	Todd, Mark	Bago	12	104.33	0.00	12.00
28	AUS	Sanna, George	Schnaps	12	111.47	1.25	13.25
29	AUS	Brown, Rodney	Slinky	12	112.49	1.50	13.50
30	CAN	Deslauriers, Mario	Box Car Willie	11	125.38	4.75	15.75
31	FRA	Cottier, Frederic	Flambeauc	16	102.09	0.00	16.00
32	SUI	Guerdat, Phillippe	Lanciano II	19	125.98	4.75	23.75
33	POR	Alta Da Costa, Manue	Jalisco B	24	106.24	0.00	24.00
33	ESP	Alvarez Cervera, Luis	Mirage Mexicain	24	106.14	0.00	24.00
35	AUT	Boor, Boris	Monaco F	24	109.93	0.75	24.75
36	COL	Torres, Manuel	Zalme	31	125.54	4.75	35.75
	AUT	Simon, Hugo	Gipsy Lady	Retired			

Individual Jumping Competition				Sauts d'Obstacles-Individuel					
Final Round 2/Oct. 2				2e Tour de Finale/2 Oct					
Rank	Ctry	Name	Horse	Penalties	Time	Time Penal.	Total	Total	
Rang	Pays	Nom	Cheval	Penalites	Temps	Penal. Temps	Round		
1	FRA	Durand, Pierre	Jappeloup	F1) F2)	0 0	107.15 89.69	0.25 1.00	0.25 1.00	1.25
2	USA	Best, Greg	Gem Twist	F1) F2)	4 0	98.89 79.73	0.00 0.00	4.00 0.00	4.00
2	FRG	Huck, Karsten	Nepomuk 8	F1) F2)	0 4	104.35 84.05	0.00 0.00	0.00 4.00	4.00
4	USA	Kursinski, Anne	Starman	F1) F2)	4 4	104.82 84.15	0.00 0.00	4.00 4.00	8.00
4	GBR	Broome, David	Countryman	F1) F2)	4 4	103.79 83.88	0.00 0.00	4.00 4.00	8.00
6	MEX	Azcarraga, Jaime	Chin Chin	F1) F2)	4 4	105.47 86.94	0.00 0.25	4.00 4.25	8.25
7	HOL	Tops, Johannes	Doreen	F1) F2)	8 4	99.34 81.77	0.00 0.00	8.00 4.00	12.00
7	GBR	Skelton, Nicholas	Apollo	F1) F2)	4 8	103.22 83.87	0.00 0.00	4.00 8.00	12.00
7	USA	Fargis, Joe	Mill Pearl	F1) F2)	4 8	99.71 83.57	0.00 0.00	4.00 8.00	12.00
7	FRG	Sloothaak, Franke	Walzerkonig 19	F1) F2)	4 8	102.89 80.98	0.00 0.00	4.00 8.00	12.00
7	SUI	Fuchs, Markus	Shandor II	F1) F2)	4 8	102.77 85.09	0.00 0.00	4.00 8.00	12.00
7	SUI	Fuchs, Thomas	Dollar Girl	F1) F2)	4 8	103.44 84.01	0.00 0.00	4.00 8.00	12.00
7	HOL	Lansink, Jos	Felix	F1) F2)	4 8	102.18 85.06	0.00 0.00	4.00 8.00	12.00
14	GBR	Turi, Joseph	Vital	F1) F2)	4 8	107.20 83.41	0.25 0.00	4.25 8.00	12.25
15	CAN	Millar, Ian	Big Ben	F1) F2)	0 12	109.43 86.62	0.75 0.25	0.75 12.25	13.00
16	HOL	Ehrens, Robbertus	Sunrise	F1) F2)	8 8	99.89 76.62	0.00 0.00	8.00 8.00	16.00
16	FRA	Robert, Michel	La Fayette	F1) F2)	4 12	102.36 82.61	0.00 0.00	4.00 12.00	16.00
18	ESP	Garcia Trevijano, Jua	Tirol	F1) F2)	8 8	103.95 86.85	0.00 0.25	8.00 8.25	16.25
19	FRG	Hafemeister, Dirk	Orchidee 76	F1) F2)	4 11	103.36 97.55	0.00 3.00	4.00 14.00	18.00
20	IRL	Doyle, Jack	Hardly	F1) F2)	8 24	104.90 89.00	0.00 0.75	8.00 24.75	32.75
	CAN	Carlsen, Lisa	Kahlua	F1) F2)	4 Eliminated	105.88	0.00	4.00	

Individual Jumping Competition				Sauts d'Obstacles-Individuel					
Jump-off 1/Oct. 2				1er Barrage/2 Oct					
Rank	Ctry	Name	Horse	Total	Penal.	Time	Time Penal.	Total	
Rang	Pays	Nom	Cheval	Final	Penal.	Temps	Penal. Temp	J-off	
2	USA	Best, Greg	Gem Twist	4.00	4	45.70	0.00	4.00	
3	FRG	Huck, Karsten	Nepomuk 8	4.00	4	54.75	0.00	4.00	



펜싱

Fencing/Escrim



Fencing/Escrime

Officials/Officiels

Fédération Internationale d' Escrime (F.I.E.)

President/président	Rolland Boitelle
Secretary General/secrétaire général	Emmanuel Rodocanachi
Technical Delegates/délégués techniques	Sidney Romeo Wolf Dieffenbach

SLOOC Administrative Staff/Personnel Administratif du SLOOC

Commissioner/directeur	Cho Nai Byok
Secretary General/secrétaire général	Kim Jong Kyu
Deputy Secretary General/secrétaire général adjoint	Kang Sang Hae
Competition Manager/chef de division des compétitions	Lee Keun Bae

Competitors/Concurrents

Men	Competitors	Countries
Hommes	Competiteurs	Pays
Foil Individual/fleuret individuelle	70	28
Sabre Individual/sabre-individuel	43	21
Epee Individual/epee-individuel	81	34
Foil Team/fleuret-equipe	77	16
Sabre Team/sabre-equipe	55	11
Epee Team/epee-equipe	88	18
Women	Competitors	Countries
Femmes	Competiteurs	Pays
Foil Individual/fleuret individuelle	48	19
Foil Team/fleuret-equipe	60	12

Legend/Notation

V/M	Number of Victories vs Number of Matches/Nombre de Victoires sur Nombre de Maichs
TD	Hits Scored/Touches Donnees
TR	Hits Received/Touches Recues
PL	Place within Pool/Place a l'Interieur de la Poule
Q	Qualification/Qualifie
E	Elimination/Elimine
V	Victories/Victoires
M	Matches/Matches

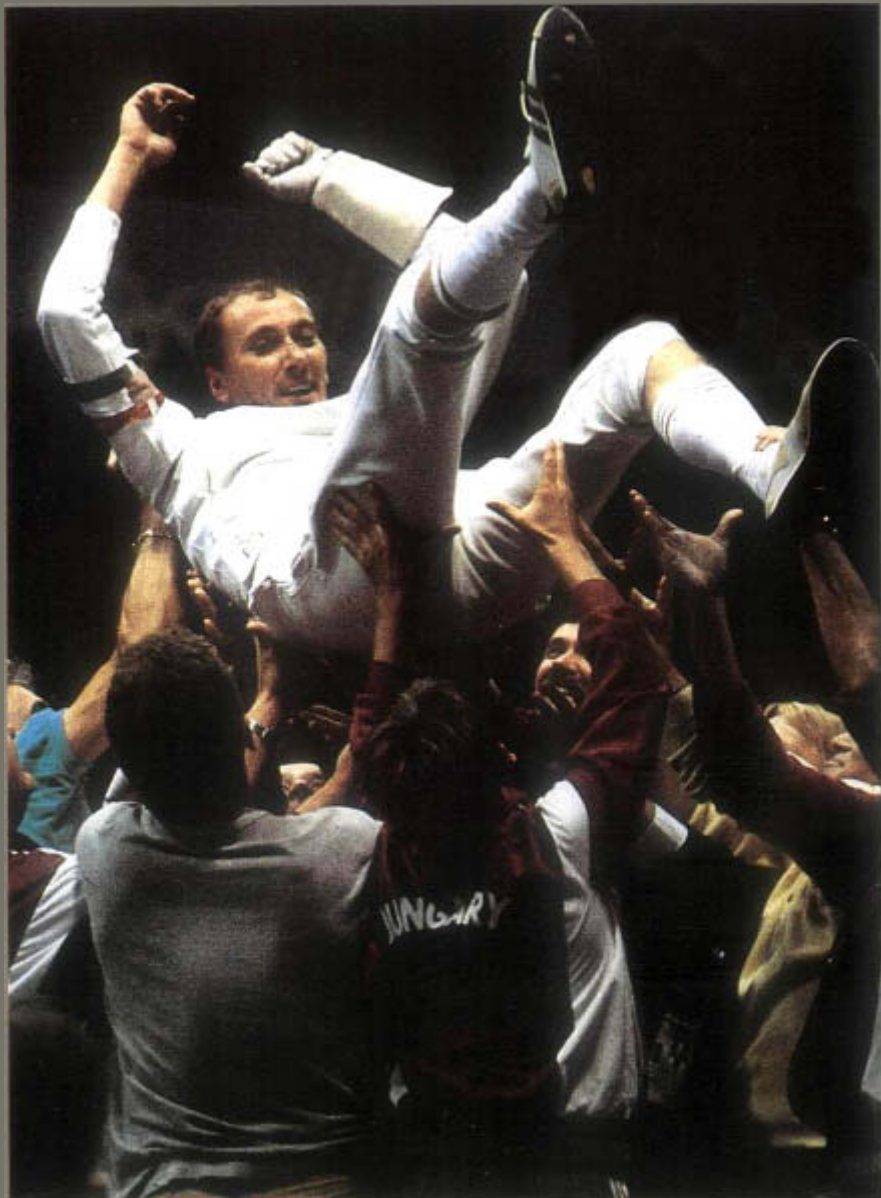

Fencing

Men Foil-Individual			Hommes/Fleuret-Individuel											
Preliminary Round 1 Pool 1/Sept. 20			Preliminaires Tour 1 Poule 1/20 Sept											
Name	Ctry	Order	1	2	3	4	5	6	7	V/M	TD	TR	TD-TR	PL
Turiace, Sergio R	ARG	1	*	1	3	V	0			0.250	9	19	-10	4 Q
Gey, Mathias	FRG	2	V	*	V	V	4			0.750	19	10	9	1 Q
Elhousseiny, Abdelmonem	EGY	3	V	3	*	V	V			0.750	18	11	7	2 Q
Fonseca, Douglas	BRA	4	4	1	2	*	4			0.000	11	20	-9	5 E
Strand, Eric	SWE	5	V	V	1	V	*			0.750	16	13	3	3 Q

Men Foil-Individual			Hommes/Fleuret-Individuel											
Preliminary Round 1 Pool 2/Sept. 20			Preliminaires Tour 1 Poule 2/20 Sept											
Name	Ctry	Order	1	2	3	4	5	6	7	V/M	TD	TR	TD-TR	PL
Behr, Matthias	FRG	1	*	V	4	V	V			0.750	19	9	10	1 Q
Mamedov, Ilgar	URS	2	0	*	V	V	V			0.750	15	7	8	2 Q
Kajbjerg, Ola	SWE	3	V	1	*	V	V			0.750	16	14	2	3 Q
Enkelmann, Aris	GDR	4	1	0	4	*	V			0.250	10	15	-5	4 Q
Alawadhi, Khaled	KUW	5	3	1	1	0	*			0.000	5	20	-15	5 E

Men Foil-Individual			Hommes/Fleuret-Individuel											
Preliminary Round 1 Pool 3/Sept. 20			Preliminaires Tour 1 Poule 3/20 Sept											
Name	Ctry	Order	1	2	3	4	5	6	7	V/M	TD	TR	TD-TR	PL
Cerioni, Stefano	ITA	1	*	V	V	V	V			1.000	20	12	8	1 Q
Harper, Pierre	GBR	2	4	*	V	V	3			0.500	17	13	4	3 Q
Alsurrayei, Saqer	KUW	3	2	1	*	1	2			0.000	6	20	-14	5 E
Bandach, Leszek	POL	4	3	2	V	*	4			0.250	14	16	-2	4 Q
Ko, Nak-Choon	KOR	5	3	V	V	V	*			0.750	18	14	4	2 Q

Men Foil-Individual			Hommes/Fleuret-Individuel											
Preliminary Round 1 Pool 4/Sept. 20			Preliminaires Tour 1 Poule 4/20 Sept											
Name	Ctry	Order	1	2	3	4	5	6	7	V/M	TD	TR	TD-TR	PL
Schreck, Ulrich	FRG	1	*	V	V	V	V			1.000	20	10	10	1 Q
Akerberg, Thomas	SWE	2	2	*	4	1	4			0.000	11	20	-9	5 E
Lewison, Peter	USA	3	1	V	*	1	V			0.500	12	17	-5	3 Q
Ersek, Zsolt	HUN	4	3	V	V	*	V			0.750	18	9	9	2 Q
Umezawa, Kenichi	JPN	5	4	V	3	2	*			0.250	14	19	-5	4 Q

Men Foil-Individual			Hommes/Fleuret-Individuel											
Preliminary Round 1 Pool 5/Sept. 20			Preliminaires Tour 1 Poule 5/20 Sept											
Name	Ctry	Order	1	2	3	4	5	6	7	V/M	TD	TR	TD-TR	PL
Cornet Rodas, Pedro L	PAR	1	*	0	4	0	1	0		0.000	5	25	-20	6 E
Numa, Mauro	ITA	2	V	*	V	V	V	4		0.800	24	14	10	1 Q
Howe, Jens	GDR	3	V	3	*	V	V	V		0.800	23	15	8	2 Q
Mohamed, Ahmed	EGY	4	V	3	2	*	4	V		0.400	19	16	3	4 Q
Kim, Yong-Kook	KOR	5	V	3	1	V	*	3		0.400	17	20	-3	5 E
Marx, Michael	USA	6	V	V	3	1	V	*		0.600	19	17	2	3 Q

Men Foil-Individual			Hommes/Fleuret-Individuel											
Preliminary Round 1 Pool 6/Sept. 20			Preliminaires Tour 1 Poule 6/20 Sept											
Name	Ctry	Order	1	2	3	4	5	6	7	V/M	TD	TR	TD-TR	PL
Thomas, Austin	ARU	1	*	0	V	1	0	3		0.200	9	22	-13	6 E
Zych, Boguslaw	POL	2	V	*	4	V	V	V		0.800	24	10	14	1 Q
Wendt, Joachim	AUT	3	2	V	*	V	3	V		0.600	20	16	4	2 Q
Choy, Kam Shing	HKG	4	V	1	0	*	2	4		0.200	12	21	-9	5 E
Liu, Yunhong	CHN	5	V	2	2	V	*	V		0.600	19	16	3	3 Q
Davidson, Robert	AUS	6	V	2	V	V	4	*		0.600	21	20	1	4 Q

Men Foil-Individual			Hommes/Fleuret-Individuel											
Preliminary Round 1 Pool 7/Sept. 20			Preliminaires Tour 1 Poule 7/20 Sept											
Name	Ctry	Order	1	2	3	4	5	6	7	V/M	TD	TR	TD-TR	PL
Lazzarini, Roberto	BRA	1	*	2	0	3	1	V		0.200	11	21	-10	5 E
Esperanza, Jesus	ESP	2	V	*	V	3	3	V		0.600	21	17	4	3 Q
Littell, David	USA	3	V	3	*	2	2	V		0.400	17	16	1	4 Q
Romankov, Alexandre	URS	4	V	V	V	*	V	V		1.000	25	10	15	1 Q
Gosbee, William	GBR	5	V	V	V	2	*	V		0.800	22	11	11	2 Q
Alkindi, Alkindi	INA	6	1	2	1	0	0	*		0.000	4	25	-21	6 E

Men Foil-Individual			Hommes/Fleuret-Individuel											
Preliminary Round 1 Pool 8/Sept. 20			Preliminaires Tour 1 Poule 8/20 Sept											
Name	Ctry	Order	1	2	3	4	5	6	7	V/M	TD	TR	TD-TR	PL
Garcia, Andres	ESP	1	*	1	V	V	4	V		0.600	20	16	4	3 Q
Omnes, Philippe	FRA	2	V	*	V	V	2	V		0.800	22	10	12	1 Q
Mohammad, Salman	KUW	3	0	3	*	2	1	2		0.000	8	25	-17	6 E
Kanatsu, Yoshihiko	JPN	4	2	0	V	*	V	V		0.600	17	17	0	4 Q
Gatai, Robert	HUN	5	V	V	V	4	*	V		0.800	24	12	12	2 Q
Richter, Anatol	AUT	6	4	1	V	1	0	*		0.200	11	22	-11	5 E

Escrime

Men Foil-Individual			Hommes/Fleuret-Individuel											
Preliminary Round 1 Pool 9/Sept. 20			Preliminaires Tour 1 Poule 9/20 Sept											
Name	Ctry	Order	1	2	3	4	5	6	7	V/M	TD	TR	TD-TR	PL
Kim, Seung-Pyo	KOR	1	*	0	V	3	2	V		0.400	15	18	-3	4 Q
Koretskii, Boris	URS	2	V	*	V	3	V	V		0.800	23	10	13	1 Q
Machado, Antonio	BRA	3	1	1	*	V	2	V		0.400	14	23	-9	5 E
Szekeres, Pal	HUN	4	V	V	4	*	2	V		0.600	21	17	4	3 Q
Mckenzie, Donald	GBR	5	V	2	V	V	*	V		0.800	22	11	11	2 Q
Jan, Ming-Shean	TPE	6	2	2	4	1	0	*		0.000	9	25	-16	6 E

Men Foil-Individual			Hommes/Fleuret-Individuel											
Preliminary Round 1 Pool 10/Sept. 20			Preliminaires Tour 1 Poule 10/20 Sept											
Name	Ctry	Order	1	2	3	4	5	6	7	V/M	TD	TR	TD-TR	PL
Youssef, Michel	LIB	1	*	1	1	V	4	2		0.200	13	21	-8	5 E
Bel, Laurent	FRA	2	V	*	V	V	V	V		0.800	24	12	12	1 Q
Wagner, Udo	GDR	3	V	4	*	V	2	4		0.400	20	17	3	4 Q
Weng, Tak Fung	HKG	4	1	1	1	*	3	2		0.000	8	25	-17	6 E
Giasson, Benoit	CAN	5	V	V	V	V	*	0		0.800	20	18	2	3 Q
Zhang, Zhicheng	CHN	6	V	1	V	V	V	*		0.800	21	13	8	2 Q

Men Foil-Individual			Hommes/Fleuret-Individuel											
Preliminary Round 1 Pool 11/Sept. 20			Preliminaires Tour 1 Poule 11/20 Sept											
Name	Ctry	Order	1	2	3	4	5	6	7	V/M	TD	TR	TD-TR	PL
El-Khoury, Zahi	LIB	1	*	0	0	1	1	0		0.000	2	25	-23	6 E
Groc, Patrick	FRA	2	V	*	1	V	V	V		0.800	21	11	10	1 Q
Sypniewski, Marian	POL	3	V	V	*	V	3	3		0.600	21	11	10	2 Q
Wang, San-Tsai	TPE	4	V	2	0	*	1	V		0.400	13	19	-6	5 E
Rocheleau, Luc	CAN	5	V	1	V	V	*	3		0.600	19	15	4	4 Q
Emura, Koji	JPN	6	V	3	V	3	V	*		0.600	21	16	5	3 Q

Men Foil-Individual			Hommes/Fleuret-Individuel											
Preliminary Round 1 Pool 12/Sept. 20			Preliminaires Tour 1 Poule 12/20 Sept											
Name	Ctry	Order	1	2	3	4	5	6	7	V/M	TD	TR	TD-TR	PL
Bandeira, Jose	POR	1	*	2	2	V	1	1		0.200	11	22	-11	5 E
Borella, Andrea	ITA	2	V	*	V	V	V	V		1.000	25	12	13	1 Q
Lao, Shaopei	CHN	3	V	3	*	V	V	V		0.800	23	11	12	2 Q
Lee, Chung Man	HKG	4	2	1	3	*	0	V		0.200	11	23	-12	6 E
Soumagne, Thierry	BEL	5	V	3	1	V	*	V		0.600	19	15	4	3 Q
Angers, Stephen	CAN	6	V	3	0	3	4	*		0.200	15	21	-6	4 Q

Men		Hommes												
Foil-Individual		Fleuret-Individuel												
Preliminary Round 1/Sept. 20		Preliminaires Tour 1/20 Sept												
Class	Name	Ctry	V	M	V/M	TD	TR	TD-TR	PL					
1	Romankov, Alexandre	URS	5	5	1.000	25	10	15						
2	Borella, Andrea	ITA	5	5	1.000	25	12	13						
3	Schreck, Ulrich	FRG	4	4	1.000	20	10	10						
4	Cerioni, Stefano	ITA	4	4	1.000	20	12	8						
5	Zych, Boguslaw	POL	4	5	0.800	24	10	14						
6	Koretskii, Boris	URS	4	5	0.800	23	10	13						
7	Omnes, Philippe	FRA	4	5	0.800	22	10	12						
8	Lao, Shaopei	CHN	4	5	0.800	23	11	12						
9	Gatai, Robert	HUN	4	5	0.800	24	12	12						
10	Bel, Laurent	FRA	4	5	0.800	24	12	12						
11	Gosbee, William	GBR	4</											



Class	Name	Ctry	V	M	V/M	TD	TR	TD-TR
45	Enkelmann, Aris	GDR	1	4	0.250	10	15	-5
46	Umezawa, Kenichi	JPN	1	4	0.250	14	19	-5
47	Turiace, Sergio R	ARG	1	4	0.250	9	19	-10
48	Angers, Stephen	CAN	1	5	0.200	15	21	-6

The above athletes are qualified/Les athletes ci-haut se qualifient

The following athletes are eliminated/Les athletes suivants sont elimines

49	Kim, Yong-Kook	KOR	2	5	0.400	17	20	-3
50	Wang, San-Tsai	TPE	2	5	0.400	13	19	-6
51	Machado, Antonio	BRA	2	5	0.400	14	23	-9
52	Youssef, Michel	LIB	1	5	0.200	13	21	-8
53	Choy, Kam Shing	HKG	1	5	0.200	12	21	-9
54	Lazzarini, Roberto	BRA	1	5	0.200	11	21	-10
55	Richter, Anatol	AUT	1	5	0.200	11	22	-11
55	Bandeira, Jose	POR	1	5	0.200	11	22	-11
57	Lee, Chung Man	HKG	1	5	0.200	11	23	-12
58	Thomas, Austin	ARU	1	5	0.200	9	22	-13
59	Fonseca, Douglas	BRA	0	4	0.000	11	20	-9
59	Akerberg, Thomas	SWE	0	4	0.000	11	20	-9
61	Aisurayei, Saqer	KUW	0	4	0.000	6	20	-14
62	Alawadhi, Khaled	KUW	0	4	0.000	5	20	-15
63	Jan, Ming-Shean	TPE	0	5	0.000	9	25	-16
64	Mohammad, Salman	KUW	0	5	0.000	8	25	-17
64	Weng, Tak Fung	HKG	0	5	0.000	8	25	-17
66	Cornet Rodas, Pedro L	PAR	0	5	0.000	5	25	-20
67	Alkindi, Alkindi	INA	0	5	0.000	4	25	-21
68	El-Khoury, Zahi	LIB	0	5	0.000	2	25	-23

Men Foil-Individual Preliminary Round 2 Pool 1/Sept. 20 **Hommes/Fleuret- Individuel Preliminaires Tour 2 Poule 1/20 Sept**

Name	Ctry	Order	1	2	3	4	5	6	7	V/M	TD	TR	TD-TR	PL
Giasson, Benoit	CAN	1	*	V	3	V	4	1		0.400	18	22	-4	5 Q
Angers, Stephen	CAN	2	4	*	0	3	0	3		0.000	10	25	-15	6 E
Romankov, Alexandre	URS	3	V	V	*	V	0	V		0.800	20	16	4	1 Q
Howe, Jens	GDR	4	3	V	4	*	V	V		0.600	22	17	5	3 Q
Esperanza, Jesus	ESP	5	V	V	V	0	*	3		0.600	18	14	4	4 Q
Szekeres, Pal	HUN	6	V	V	4	4	V	*		0.600	23	17	6	2 Q

Men Foil-Individual Preliminary Round 2 Pool 2/Sept. 20 **Hommes/Fleuret-Individuel Preliminaires Tour 2 Poule 2/20 Sept**

Name	Ctry	Order	1	2	3	4	5	6	7	V/M	TD	TR	TD-TR	PL
Mark, Michael	USA	1	*	V	V	2	V	2		0.600	19	16	3	2 Q
Garcia, Andres	ESP	2	1	*	3	3	V	V		0.400	17	19	-2	4 Q
Behr, Matthias	FRG	3	3	V	*	4	1	V		0.400	18	21	-3	5 Q
Zhang, Zhicheng	CHN	4	V	V	V	*	0	V		0.800	20	16	4	1 Q
Turiace, Sergio R	ARG	5	2	4	V	V	*	2		0.400	18	16	2	3 Q
Borella, Andrea	ITA	6	V	0	3	2	V	*		0.400	15	19	-4	6 E

Men Foil-Individual Preliminary Round 2 Pool 3/Sept. 20 **Hommes/Fleuret-Individuel Preliminaires Tour 2 Poule 3/20 Sept**

Name	Ctry	Order	1	2	3	4	5	6	7	V/M	TD	TR	TD-TR	PL
Schreck, Ulrich	FRG	1	*	V	3	3	V	V		0.600	21	15	6	2 Q
Ersek, Zsolt	HUN	2	3	*	V	V	V	V		0.800	23	18	5	1 Q
Wendt, Joachim	AUT	3	V	3	*	3	V	V		0.600	21	20	1	4 Q
Numa, Mauro	ITA	4	V	3	V	*	2	V		0.600	20	18	2	3 Q
Liu, Yunhong	CHN	5	1	3	4	V	*	V		0.400	18	18	0	5 Q
Umezawa, Kenichi	JPN	6	1	4	3	2	1	*		0.000	11	25	-14	6 E

Men Foil-Individual Preliminary Round 2 Pool 4/Sept. 20 **Hommes/Fleuret-Individuel Preliminaires Tour 2 Poule 4/20 Sept**

Name	Ctry	Order	1	2	3	4	5	6	7	V/M	TD	TR	TD-TR	PL
Enkelmann, Aris	GDR	1	*	3	1	V	4	V		0.400	18	20	-2	4 Q
Soumagne, Thierry	BEL	2	V	*	V	4	3	3		0.400	20	22	-2	5 Q
Cerioni, Stefano	ITA	3	V	4	*	V	V	V		0.800	24	11	13	1 Q
Gey, Mathias	FRG	4	4	V	2	*	V	V		0.600	21	19	2	2 Q
Groc, Patrick	FRA	5	V	V	2	3	*	V		0.600	20	19	1	3 Q
Davidson, Robert	AUS	6	1	V	1	2	2	*		0.200	11	23	-12	6 E

Men Foil-Individual Preliminary Round 2 Pool 5/Sept. 20 **Hommes/Fleuret-Individuel Preliminaires Tour 2 Poule 5/20 Sept**

Name	Ctry	Order	1	2	3	4	5	6	7	V/M	TD	TR	TD-TR	PL
Mckenzie, Donald	GBR	1	*	4	V	4	V	3		0.400	21	19	2	3 Q
Mamedov, Ilgar	URS	2	V	*	V	V	V	4		0.800	24	17	7	2 Q
Kanatsu, Yoshihiko	JPN	3	3	3	*	1	0	4		0.000	11	25	-14	6 E
Rocheleau, Luc	CAN	4	V	4	V	*	4	4		0.400	22	20	2	4 Q
Kim, Seung-Pyo	KOR	5	1	1	V	V	*	1		0.400	13	19	-6	5 Q
Zych, Boguslaw	POL	6	V	V	V	V	V	*		1.000	25	16	9	1 Q

Men Foil-Individual Preliminary Round 2 Pool 6/Sept. 20 **Hommes/Fleuret-Individuel Preliminaires Tour 2 Poule 6/20 Sept**

Name	Ctry	Order	1	2	3	4	5	6	7	V/M	TD	TR	TD-TR	PL
Emura, Koji	JPN	1	*	4	V	3	2	V		0.400	19	19	0	3 Q
Koretskii, Boris	URS	2	V	*	V	4	V	V		0.800	17	7	2	2 Q
Littell, David	USA	3	2	4	*	2	V	1		0.200	14	23	-9	6 E
Bel, Laurent	FRA	4	V	V	V	*	V	V		1.000	25	12	13	1 Q
Harper, Pierre	GBR	5	V	1	3	1	*	4		0.200	14	22	-8	5 Q
Elhusseiny, Abdelmonem	EGY	6	2	3	V	2	V	*		0.400	17	20	-3	4 Q

Men Foil-Individual Preliminary Round 2 Pool 7/Sept. 20 **Hommes/Fleuret-Individuel Preliminaires Tour 2 Poule 7/20 Sept**

Name	Ctry	Order	1	2	3	4	5	6	7	V/M	TD	TR	TD-TR	PL
Bandach, Leszek	POL	1	*	V	V	4	2	V		0.600	21	15	6	1 Q
Ko, Nak-Choon	KOR	2	2	*	3	V	V	2		0.400	17	21	-4	6 E
Omnes, Philippe	FRA	3	1	V	*	V	1	V		0.600	17	17	0	2 Q
Gosbee, William	GBR	4	V	3	2	*	V	V		0.600	20	21	-1	3 Q
Kajbjerg, Ola	SWE	5	V	3	V	3	*	2		0.400	18	18	0	4 Q
Lewisson, Peter	USA	6	2	V	2	4	V	*		0.400	18	19	-1	5 Q

Men Foil-Individual Preliminary Round 2 Pool 8/Sept. 20 **Hommes/Fleuret-Individuel Preliminaires Tour 2 Poule 8/20 Sept**

Name	Ctry	Order	1	2	3	4	5	6	7	V/M	TD	TR	TD-TR	PL
Wagner, Udo	GDR	1	*	3	V	V	4	4		0.400	21	21	0	4 Q
Gatai, Robert	HUN	2	V	*	2	V	V	V		0.800	22	15	7	1 Q
Sypniewski, Marian	POL	3	3	V	*	V	V	2		0.600	20	18	2	3 Q
Mohamed, Ahmed	EGY	4	3	2	2	*	4	3		0.000	14	25	-11	6 E
Lao, Shaopei	CHN	5	V	1	4	V	*	3		0.400	18	23	-5	5 Q
Strand, Eric	SWE	6	V	4	V	V	V	*		0.800	24	17	7	2 Q

Men Foil-Individual Preliminary Round 2/Sept. 20 **Hommes/Fleuret-Individuel Preliminaires Tour 2/20 Sept**

Class	Name	Ctry	V	M	V/M	TD	TR	TD-TR
1	Bel, Laurent	FRA	5	5	1.000	25	12	13
2	Zych, Boguslaw	POL	5	5	1.000	25	16	9
3	Cerioni, Stefano	ITA	4	5	0.800	24	11	13
4	Gatai, Robert	HUN	4	5	0.800	22	15	7
5	Mamedov, Ilgar	URS	4	5	0.800	24	17	7
6	Strand, Eric	SWE	4	5	0.800	24	17	7
7	Koretskii, Boris	URS	4	5	0.800	24	17	7
8	Ersek, Zsolt	HUN	4	5	0.800	23	18	5
9	Zhang, Zhicheng	CHN	4	5	0.800	20	16	4
10	Romankov, Alexandre	URS	4	5	0.800	20	16	4
11	Bandach, Leszek	POL	3	5	0.600	21	15	6
12	Schreck, Ulrich	FRG	3	5	0.600	21	15	6
13	Szekeres, Pal	HUN	3	5	0.600	23	17	6
14	Howe, Jens	GDR	3	5	0.600	22	17	5
15	Esperanza, Jesus	ESP	3	5	0.600	18	14	4
16	Marx, Michael	USA	3	5	0.600	19	16	3
17	Sypniewski, Marian	POL	3	5	0.600	20	18	2
18	Numa, Mauro	ITA	3	5	0.600	20	18	2
19	Gey, Mathias	FRG	3	5	0.600	21	19	2
20	Groc, Patrick	FRA	3	5	0.600	20	19	1
21	Wendt, Joachim	AUT	3	5	0.600	21	20	1
22	Omnes, Philippe	FRA	3	5	0.600	17	17	0
23	Gosbee, William	GBR	3	5	0.600	20	21	-1
24	Turiace, Sergio R	ARG	2	5	0.400	18	16	2
25	Mckenzie, Donald	GBR	2	5	0.400	21	19	2
26	Rocheleau, Luc	CAN	2	5	0.400	22	20	2
27	Kajbjerg, Ola	SWE	2	5	0.400	18	18	0
28	Liu, Yunhong	CHN	2	5	0.400	18	18	0
29	Emura, Koji	JPN	2	5	0.400	19	19	0
30	Wagner, Udo	GDR	2	5	0.400	21	21	0
31	Lewisson, Peter	USA	2	5	0.400	18	19	-1
32	Garcia, Andres	ESP	2	5	0.400	17	19	-2
33	Enkelmann, Aris	GDR	2	5	0.400	18	20	-2
34	Soumagne, Thierry	BEL	2	5	0.400	20	22	-2
35	Elhusseiny, Abdelmonem	EGY	2	5	0.400	17	20	-3
36	Behr, Matthias	FRG	2	5	0.400	18	21	-3
37	Giasson, Benoit	CAN	2	5	0.400	18	22	-4
38	Lao, Shaopei	CHN	2	5	0.400	18	23	-5
39	Kim, Seung-Pyo	KOR	2	5	0.400	13	19	-6
40	Harper, Pierre	GBR	1	5	0.200	14	22	-8

The above athletes are qualified/Les athletes ci-haut se qualifient

The following athletes are eliminated/Les athletes suivants sont elimines

41	Borella, Andrea	ITA	2	5	0.400	15	19	-4
42	Ko, Nak-Choon	KOR	2	5	0.400	17	21	-4
43	Littell, David	USA	1	5	0.200	14	23	-9
44	Davidson, Robert	AUS	1	5	0.200	11	23	-12
45	Mohamed, Ahmed	EGY	0	5	0.000	14	25	-11
46	Umezawa, Kenichi							

Fencing

Men Foil-Individual Preliminary Round 3 Pool 1/Sept. 20			Hommes/Fleuret-Individuel Preliminaires Tour 3 Poule 1/20 Sept											
Name Nom	Ctry Pays	Order Ordre	1	2	3	4	5	6	7	V/M	TD	TR	TD-TR	PL
Sypniewski, Marian	POL	1	*	V	V	2	V			0.750	17	13	4	2 Q
Bel, Laurent	FRA	2	2	*	V	3	V			0.500	15	16	-1	3 Q
Garcia, Andres	ESP	3	2	2	*	1	V			0.250	10	16	-6	4 Q
Enkelmann, Aris	GDR	4	V	V	V	*	V			1.000	20	10	10	1 Q
Mark, Michael	USA	5	4	4	1	4	*			0.000	13	20	-7	5 E

Men Foil-Individual Preliminary Round 3 Pool 2/Sept. 20			Hommes/Fleuret-Individuel Preliminaires Tour 3 Poule 2/20 Sept											
Name Nom	Ctry Pays	Order Ordre	1	2	3	4	5	6	7	V/M	TD	TR	TD-TR	PL
Esperanza, Jesus	ESP	1	*	0	V	2	0			0.250	7	18	-11	5 E
Lewison, Peter	USA	2	V	*	V	V	3			0.750	18	10	8	1 Q
Soumagne, Thierry	BEL	3	3	1	*	3	V			0.250	12	19	-7	4 Q
Zych, Boguslaw	POL	4	V	4	V	*	4			0.500	18	15	3	3 Q
Numa, Mauro	ITA	5	V	V	4	V	*			0.750	19	12	7	2 Q

Men Foil-Individual Preliminary Round 3 Pool 3/Sept. 20			Hommes/Fleuret-Individuel Preliminaires Tour 3 Poule 3/20 Sept											
Name Nom	Ctry Pays	Order Ordre	1	2	3	4	5	6	7	V/M	TD	TR	TD-TR	PL
Cerioni, Stefano	ITA	1	*	V	4	V	V			0.750	19	13	6	1 Q
Szekeres, Pal	HUN	2	1	*	V	3	V			0.500	14	11	3	3 Q
Elhusseiny, Abdelmonem	EGY	3	V	0	*	0	3			0.250	8	19	-11	5 E
Wagner, Udo	GDR	4	4	V	V	*	3			0.500	17	13	4	2 Q
Gey, Mathias	FRG	5	3	1	V	V	*			0.500	14	16	-2	4 Q

Men Foil-Individual Preliminary Round 3 Pool 4/Sept. 20			Hommes/Fleuret-Individuel Preliminaires Tour 3 Poule 4/20 Sept											
Name Nom	Ctry Pays	Order Ordre	1	2	3	4	5	6	7	V/M	TD	TR	TD-TR	PL
Howe, Jens	GDR	1	*	V	V	1	2			0.500	13	13	0	4 Q
Groc, Patrick	FRA	2	0	*	3	1	2			0.000	6	20	-14	5 E
Gatai, Robert	HUN	3	3	V	*	V	V			0.750	18	13	5	1 Q
Behr, Matthias	FRG	4	V	V	3	*	4			0.500	17	12	5	3 Q
Emura, Koji	JPN	5	V	V	2	V	*			0.750	17	13	4	2 Q

Men Foil-Individual Preliminary Round 3 Pool 5/Sept. 20			Hommes/Fleuret-Individuel Preliminaires Tour 3 Poule 5/20 Sept											
Name Nom	Ctry Pays	Order Ordre	1	2	3	4	5	6	7	V/M	TD	TR	TD-TR	PL
Kajbjer, Ola	SWE	1	*	1	2	V	2			0.250	10	19	-9	5 E
Wendt, Joachim	AUT	2	V	*	4	V	4			0.500	18	15	3	3 Q
Mamedov, Ilgar	URS	3	V	V	*	3	V			0.750	18	13	5	1 Q
Giasson, Benoit	CAN	4	4	4	V	*	2			0.250	15	18	-3	4 Q
Schreck, Ulrich	FRG	5	V	V	2	V	*			0.750	17	13	4	2 Q

Men Foil-Individual Preliminary Round 3 Pool 6/Sept. 20			Hommes/Fleuret-Individuel Preliminaires Tour 3 Poule 6/20 Sept											
Name Nom	Ctry Pays	Order Ordre	1	2	3	4	5	6	7	V/M	TD	TR	TD-TR	PL
Omnes, Philippe	FRA	1	*	V	V	V	V			1.000	20	2	18	1 Q
Romankov, Alexandre	URS	2	1	*	V	V	V			0.750	16	17	-1	2 Q
Strand, Eric	SWE	3	0	4	*	3	2			0.000	9	20	-11	5 E
Kim, Seung-Pyo	KOR	4	1	4	V	*	1			0.250	11	18	-7	4 Q
Liu, Yunhong	CHN	5	0	4	V	V	*			0.500	14	13	1	3 Q

Men Foil-Individual Preliminary Round 3 Pool 7/Sept. 20			Hommes/Fleuret-Individuel Preliminaires Tour 3 Poule 7/20 Sept											
Name Nom	Ctry Pays	Order Ordre	1	2	3	4	5	6	7	V/M	TD	TR	TD-TR	PL
Koretskii, Boris	URS	1	*	V	V	2	V			0.750	17	15	2	2 Q
Lao, Shaopei	CHN	2	3	*	1	3	4			0.000	11	20	-9	5 E
Bandach, Leszek	POL	3	3	V	*	2	V			0.500	15	15	0	3 Q
Gosbee, William	GBR	4	V	V	V	*	V			1.000	20	11	9	1 Q
Rocheleau, Luc	CAN	5	4	V	4	4	*			0.250	17	19	-2	4 Q

Men Foil-Individual Preliminary Round 3 Pool 8/Sept. 20			Hommes/Fleuret-Individuel Preliminaires Tour 3 Poule 8/20 Sept											
Name Nom	Ctry Pays	Order Ordre	1	2	3	4	5	6	7	V/M	TD	TR	TD-TR	PL
Mckenzie, Donald	GBR	1	*	3	3	2	V			0.250	13	18	-5	4 Q
Harper, Pierre	GBR	2	V	*	0	0	V			0.500	10	14	-4	3 Q
Ersek, Zsolt	HUN	3	V	V	*	V	V			1.000	20	6	14	1 Q
Zhang, Zhicheng	CHN	4	V	V	0	*	V			0.750	15	8	7	2 Q
Turiace, Sergio R	ARG	5	3	1	3	1	*			0.000	8	20	-12	5 E

Escrime

Men Foil-Individual Preliminary Round 3/Sept. 20		Hommes Fleuret-Individuel Preliminaires Tour 3/20 Sept						
Class	Name Nom	Ctry Pays	V	M	V/M	TD	TR	TD-TR
1	Omnes, Philippe	FRA	4	4	1.000	20	2	18
2	Ersek, Zsolt	HUN	4	4	1.000	20	6	14
3	Enkelmann, Aris	GDR	4	4	1.000	20	10	10
4	Gosbee, William	GBR	4	4	1.000	20	11	9
5	Lewison, Peter	USA	3	4	0.750	18	10	8
6	Zhang, Zhicheng	CHN	3	4	0.750	15	8	7
7	Numa, Mauro	ITA	3	4	0.750	19	12	7
8	Cerioni, Stefano	ITA	3	4	0.750	19	13	6
9	Gatai, Robert	HUN	3	4	0.750	18	13	5
10	Mamedov, Ilgar	URS	3	4	0.750	18	13	5
11	Emura, Koji	JPN	3	4	0.750	17	13	4
12	Sypniewski, Marian	POL	3	4	0.750	17	13	4
13	Schreck, Ulrich	FRG	3	4	0.750	17	13	4
14	Koretskii, Boris	URS	3	4	0.750	17	15	2
15	Romankov, Alexandre	URS	3	4	0.750	16	17	-1
16	Behr, Matthias	FRG	2	4	0.500	17	12	5
17	Wagner, Udo	GDR	2	4	0.500	17	13	4
18	Szekeres, Pal	HUN	2	4	0.500	14	11	3
19	Zych, Boguslaw	POL	2	4	0.500	18	15	3
20	Wendt, Joachim	AUT	2	4	0.500	18	15	3
21	Liu, Yunhong	CHN	2	4	0.500	14	13	1
22	Howe, Jens	GDR	2	4	0.500	13	13	0
23	Bandach, Leszek	POL	2	4	0.500	15	15	0
24	Bel, Laurent	FRA	2	4	0.500	15	16	-1
25	Gey, Mathias	FRG	2	4	0.500	14	16	-2
26	Harper, Pierre	GBR	2	4	0.500	10	14	-4
27	Rocheleau, Luc	CAN	1	4	0.250	17	19	-2
28	Giasson, Benoit	CAN	1	4	0.250	15	18	-3
29	Mckenzie, Donald	GBR	1	4	0.250	13	18	-5
30	Garcia, Andres	ESP	1	4	0.250	10	16	-6
31	Kim, Seung-Pyo	KOR	1	4	0.250	11	18	-7
32	Soumagne, Thierry	BEL	1	4	0.250	12	19	-7

The above athletes are qualified/Les athletes ci-haut se qualifient

The following athletes are eliminated/Les athletes suivants sont elimines

33	Kajbjer, Ola	SWE	1	4	0.250	10	19	-9
34	Esperanza, Jesus	ESP	1	4	0.250	7	18	-11
35	Elhusseiny, Abdelmonem	EGY	1	4	0.250	8	19	-11
36	Marx, Michael	USA	0	4	0.000	13	20	-7
37	Lao, Shaopei	CHN	0	4	0.000	11	20	-9
38	Strand, Eric	SWE	0	4	0.000	9	20	-11
39	Turiace, Sergio r	ARG	0	4	0.000	8	20	-12
40	Groc, Patrick	FRA	0	4	0.000	6	20	-14



Men
Foil-Individual/Sept. 20-21

Hombres
Fleuret-Individuel/20-21 Sept

Rank Rang	Ctry Pays	Name Nom
1	ITA	Cerioni, Stefano
2	GDR	Wagner, Udo
3	URS	Romankov, Alexandre
4	FRG	Schreck, Ulrich
5	HUN	Ersek, Zsolt
6	ITA	Numa, Mauro
7	GDR	Howe, Jens
8	FRG	Gey, Mathias
9	FRA	Omnès, Philippe
10	URS	Mamedov, Ilgar
11	GDR	Enkelmann, Aris
12	USA	Lewison, Peter
13	FRA	Bel, Laurent
14	HUN	Gatai, Robert
15	POL	Zych, Boguslaw
16	URS	Koretskii, Boris
17	JPN	Emura, Koji
18	AUT	Wendt, Joachim
19	FRG	Behr, Matthias
20	CHN	Liu, Yunhong
21	CAN	Rocheleau, Luc
22	BEL	Soumagne, Thierry
23	GBR	Harper, Pierre
24	KOR	Kim, Seung-Pyo
25	CHN	Zhang, Zhicheng
26	GBR	Gosbee, William
27	POL	Sypniewski, Marian
28	HUN	Szekeres, Pal
29	POL	Bandach, Leszek
30	GBR	Mckenzie, Donald
31	CAN	Giasson, Benoit
32	ESP	Garcia, Andres
33	SWE	Kajbjerg, Ola
34	ESP	Esperanza, Jesus
35	EGY	Elhusseiny, Abdelmonem
36	USA	Marx, Michael
37	CHN	Lao, Shaopei
38	SWE	Strand, Eric
39	ARG	Turiace, Sergio R
40	FRA	Groc, Patrick
41	ITA	Borella, Andrea
42	KOR	Ko, Nak-Choon
43	USA	Littell, David
44	AUS	Davidson, Robert
45	EGY	Mohamed, Ahmed
46	JPN	Umezawa, Kenichi
46	JPN	Kanatsu, Yoshihiko
48	CAN	Angers, Stephen
49	KOR	Kim, Yong-Kook
50	TPE	Wang, San-Tsai
51	BRA	Machado, Antonio
52	LIB	Youssef, Michel
53	HKG	Choy, Kam Shing
54	BRA	Lazzarini, Roberto
55	AUT	Richter, Anatol
55	POR	Bandeira, Jose
57	HKG	Lee, Chung Man
58	ARU	Thomas, Austin
59	BRA	Fonseca, Douglas
59	SWE	Akerberg, Thomas
61	KUW	Alsurayei, Saqer
62	KUW	Alawadhi, Khaled
63	TPE	Jan, Ming-Shean
64	KUW	Mohammad, Salman
64	HKG	Weng, Tak Fung
66	PAR	Cornet Rodas, Pedro L
67	INA	Alkindi, Alkindi
68	LIB	El-Khoury, Zahi

Fencing

Escrime

Men Foil-Individual Direct Elimination W/R. Table A
Competition Summary

Hommes/Fleuret-Individuel Elimination Directe A/R. Tableau A
Tableau de la Competition





Men Foil-Individual Direct Elimination W/R. Table E
Competition Summary

Hommes/Fleuret-Individuel Elimination Directe A/R. Tableau E
Tableau de la Competition

Table/Tableau E

Table/Tableau F

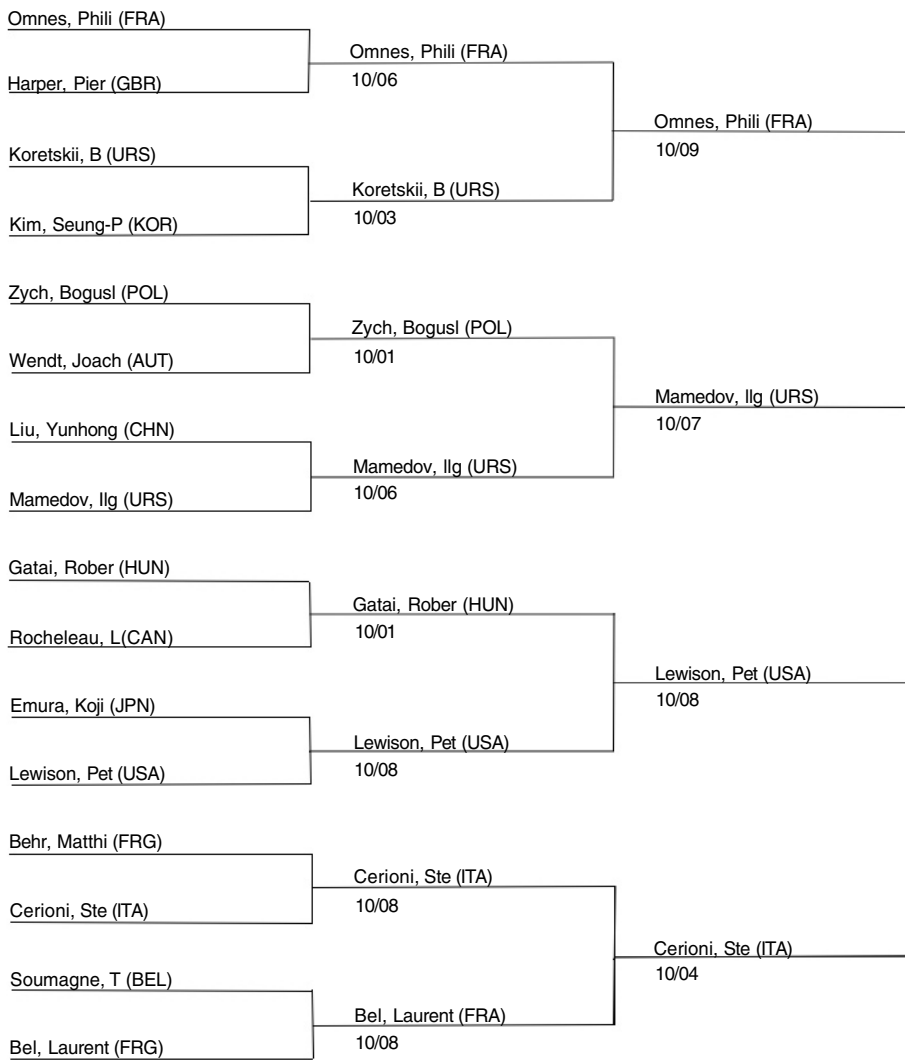

Men Foil-Individual Direct Elimination W/R. Table G
Competition Summary

Hommes/Fleuret-Individuel Elimination Directe A/R. Tableau G
Tableau de la Competition

Table/Tableau G

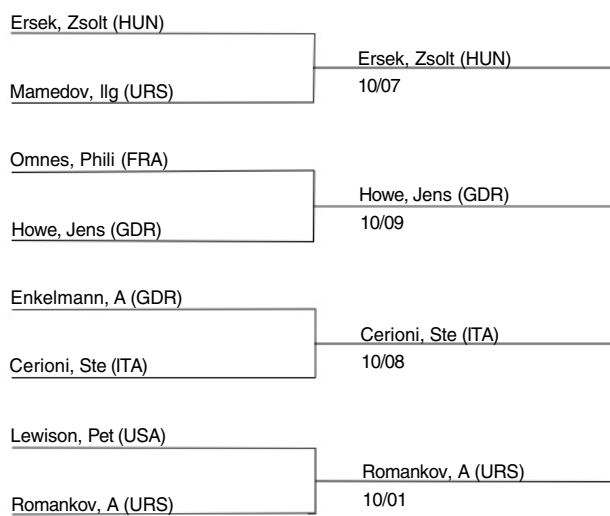

Changement de decision de l'order des matchs

Fencing

Escrime

Men Foil-Individual Final Table
Competition Summary

Hommes/Fleuret-Individuel Tableau Final
Tableau de la Competition

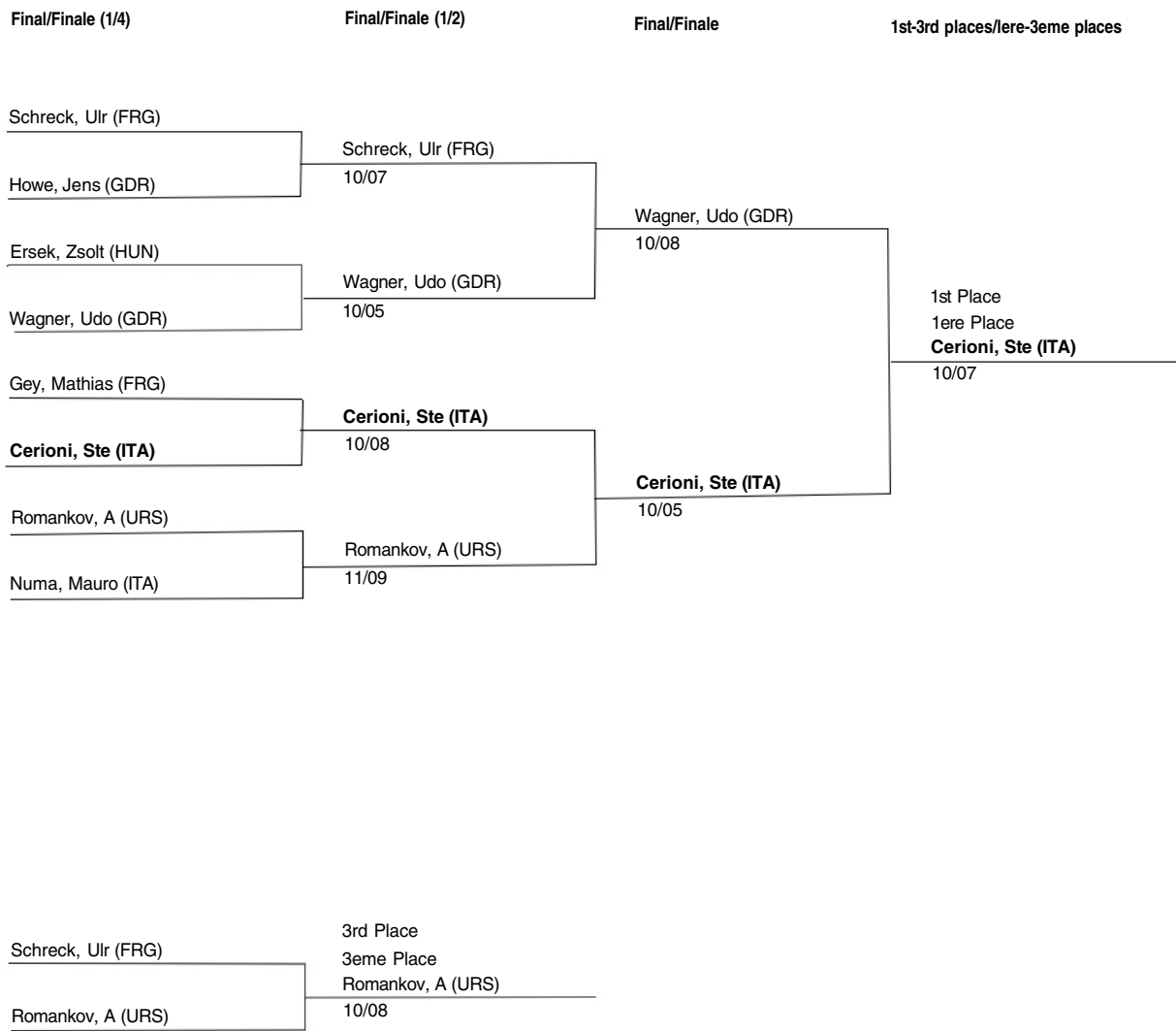



**Men Sabre-Individual
Preliminary Round 1 Pool 1/Sept. 22**

Name Nom	Ctry Pays	Order Ordre	1	2	3	4	5	6	7	V/M	TD	TR	TD-TR	PL
Jan, Ming-Shean	TPE	1	*	0	0	1	3	2	0	0.000	6	30	-24	7 E
Marin, Marco	ITA	2	V	*	V	4	V	2	V	0.666	26	17	9	2 Q
Marinechechki, Nikolai	BUL	3	V	1	*	2	V	1	1	0.333	15	22	-7	6 E
Wang, Zhiming	CHN	4	V	V	V	*	1	4	2	0.500	22	22	0	4 Q
Thoennessen, Stephan	FRG	5	V	2	2	V	*	2	V	0.500	21	22	-1	5 Q
Bujdoso, Imre	HUN	6	V	V	V	V	V	*	V	1.000	30	13	17	1 Q
Mormando, George	USA	7	V	4	V	V	3	2	*	0.500	24	18	6	3 Q

**Men Sabre-Individual
Preliminary Round 1 Pool 2/Sept. 22**

Name Nom	Ctry Pays	Order Ordre	1	2	3	4	5	6	7	V/M	TD	TR	TD-TR	PL
Zheng, Zhaokang	CHN	1	*	V	3	1	V	4	V	0.500	23	22	1	4 Q
Avila, Regis	BRA	2	1	*	0	3	0	0	0	0.000	4	30	-26	7 E
Pogossov, Gueorgui	URS	3	V	V	*	3	V	V	V	0.833	28	17	11	2 Q
Guichot, Pierre	FRA	4	V	V	V	*	V	1	V	0.833	26	18	8	3 Q
Lofton, Michael	USA	5	2	V	4	2	*	3	4	0.166	20	25	-5	6 E
Etropolski, Hristo	BUL	6	V	V	3	V	V	*	V	0.833	28	13	15	1 Q
Banos, Jean-Marie	CAN	7	4	V	2	4	V	0	*	0.333	20	24	-4	5 Q

**Men Sabre-Individual
Preliminary Round 1 Pool 3/Sept. 22**

Name Nom	Ctry Pays	Order Ordre	1	2	3	4	5	6	7	V/M	TD	TR	TD-TR	PL
Alger, Percival	PHI	1	*	0	4	1	3	2	0	0.000	10	30	-20	7 E
Gedoevari, Imre	HUN	2	V	*	V	V	V	V	1	0.833	26	11	15	2 Q
Slade, Mark	GBR	3	V	0	*	2	4	3	0	0.166	14	29	-15	6 E
Banos, Jean-Paul	CAN	4	V	2	V	*	V	1	1	0.500	19	19	0	4 Q
Jia, Guihua	CHN	5	V	1	V	1	*	1	2	0.333	15	27	-12	5 Q
Delrieu, Philippe	FRA	6	V	3	V	V	V	*	4	0.666	27	17	10	3 Q
Etropolski, Vassil	BUL	7	V	V	V	V	V	V	*	1.000	30	8	22	1 Q

**Men Sabre-Individual
Preliminary Round 1 Pool 4/Sept. 22**

Name Nom	Ctry Pays	Order Ordre	1	2	3	4	5	6	7	V/M	TD	TR	TD-TR	PL	
Bleyer, Pedro Rodolfo	BOL	1	*	0	1	2	1	2	3	0.000	9	30	-21	7 E	
Garcia, Antonio	ESP	2	V	*	1	V	2	2	3	0.333	18	23	-5	5 Q	
Olech, Janusz	POL	3	V	V	*	V	V	4	1	0.666	25	18	7	3 Q	
Kim, Sang-Wook	KOR	4	V	3	2	*	4	2	1	0.166	17	27	-10	6 E	
Westbrook, Peter	USA	5	V	V	4	V	V	*	4	3	0.500	26	22	4	4 Q
Alchan, Andrei	URS	6	V	V	V	V	V	*	V	1.000	30	16	14	1 Q	
Nebald, Gyorgy	HUN	7	V	V	V	V	V	2	*	0.833	27	16	11	2 Q	

**Men Sabre-Individual
Preliminary Round 1 Pool 5/Sept. 22**

Name Nom	Ctry Pays	Order Ordre	1	2	3	4	5	6	7	V/M	TD	TR	TD-TR	PL
Martini, Olivier	MON	1	*	4	2	1	1	2		0.000	10	25	-15	6 E
Lee, Byung-Nam	KOR	2	V	*	4	3	2	2		0.200	16	24	-8	5 Q
Scalzo, Giovanni	ITA	3	V	V	*	V	3	2		0.600	20	20	0	3 Q
Pigula, Tadeusz	POL	4	V	V	4	*	3	4		0.400	21	19	2	4 Q
Nolte, Juergen	FRG	5	V	V	V	V	*	1		0.800	21	14	7	2 Q
Lamour, Jeanfrancois	FRA	6	V	V	V	V	V	*		1.000	25	11	14	1 Q

**Men Sabre-Individual
Preliminary Round 1 Pool 6/Sept. 22**

Name Nom	Ctry Pays	Order Ordre	1	2	3	4	5	6	7	V/M	TD	TR	TD-TR	PL
Lee, Woo-Jae	KOR	1	*	2	3	1	1	0		0.000	7	25	-18	6 E
Koscielniakowski, Robert	POL	2	V	*	1	1	V	V		0.600	17	15	2	4 Q
Mindrigassov, Serguei	URS	3	V	V	*	V	4	V		0.800	24	9	15	1 Q
Dalla Barba, Gianfranco	ITA	4	V	V	0	*	V	V		0.800	20	12	8	2 Q
Becker, Felix	FRG	5	V	1	V	4	*	V		0.600	20	15	5	3 Q
Balk, Wulfe	CAN	6	V	2	0	1	0	*		0.200	8	20	-12	5 Q

**Men Sabre-Individual
Preliminary Round 1/Sept. 22**

Class Nom	Name	Ctry Pays	V	M	V/M	TD	TR	TD-TR
1	Etropolski, Vassil	BUL	6	6	1.000	30	8	22
2	Bujdoso, Imre	HUN	6	6	1.000	30	13	17
3	Lamour, Jeanfrancois	FRA	5	5	1.000	25	11	14
4	Alchan, Andrei	URS	6	6	1.000	30	16	14
5	Gedoevari, Imre	HUN	5	6	0.833	26	11	15
6	Etropolski, Hristo	BUL	5	6	0.833	28	13	15
7	Nebald, Gyorgy	HUN	5	6	0.833	27	16	11
8	Pogossov, Gueorgui	URS	5	6	0.833	28	17	11
9	Guichot, Pierre	FRA	5	6	0.833	26	18	8
10	Mindrigassov, Serguei	URS	4	5	0.800	24	9	15
11	Dalla Barba, Gianfranco	ITA	4	5	0.800	20	12	8
12	Nolte, Juergen	FRG	4	5	0.800	21	14	7
13	Delrieu, Philippe	FRA	4	6	0.666	27	17	10
14	Marin, Marco	ITA	4	6	0.666	26	17	9
15	Olech, Janusz	POL	4	6	0.666	25	18	7
16	Becker, Felix	FRG	3	5	0.600	20	15	5
17	Koscielniakowski, Robert	POL	3	5	0.600	17	15	2
18	Scalzo, Giovanni	ITA	3	5	0.600	20	20	0
19	Mormando, George	USA	3	6	0.500	24	18	6
20	Westbrook, Peter	USA	3	6	0.500	26	22	4
21	Zheng, Zhaokang	CHN	3	6	0.500	23	22	1
22	Banos, Jean-Paul	CAN	3	6	0.500	19	19	0
23	Wang, Zhiming	CHN	3	6	0.500	22	22	0
24	Thoennessen, Stephan	FRG	3	6	0.500	21	22	-1
25	Pigula, Tadeusz	POL	2	5	0.400	21	19	2
26	Banos, Jean-Marie	CAN	2	6	0.333	20	24	-4
27	Garcia, Antonio	ESP	2	6	0.333	18	23	-5
28	Jia, Guihua	CHN	6	3	0.333	15	27	-12
29	Lee, Byung-Nam	KOR	1	5	0.200	16	24	-8
30	Balk, Wulfe	CAN	1	5	0.200	8	20	-12

The above athletes are qualified/Les athletes ci-haut se qualifient

The following athletes are eliminated/Les athletes suivants sont elimines

31	Marinechechki, Nikolai	BUL	2	6	0.333	15	22	-7
32	Lofton, Michael	USA	1	6	0.166	20	25	-5
33	Kim, Sang-Wook	KOR	1	6	0.166	17	27	-10
34	Slade, Mark	GBR	1	6	0.166	14	29	-15
35	Martini, Olivier	MON	0	5	0.000	10	25	-15
36	Lee, Wook-Jae	KOR	0	5	0.000	7	25	-18
37	Alger, Percival	PHI	0	6	0.000	10	30	-20
38	Bleyer, Pedro Rodolfo	BOL	0	6	0.000	9	30	-21
39	Jan, Ming-Shean	TPE	0	6	0.000	6	30	-24
40	Avila, Regis	BRA	0	6	0.000	4	30	-26

**Men Sabre-Individual
Preliminary Round 2 Pool 1/Sept. 22**

Name Nom.	Ctry Pays	Order Ordre	1	2	3	4	5	6	7	V/M	TD	TR	TD-TR	PL
Etropolski, Vassil	BUL	1	*	V	V	V	V			1.000	20	10	10	1 Q
Banos, Jean-Marie	CAN	2	4	*	1	1	V			0.250	11	17	-6	5 E
Nolte, Juergen	FRG	3	1	V	*	1	V			0.500	12	14	-2	3 Q
Delrieu, Philippe	FRA	4	2	V	V	*	1			0.500	13	12	1	2 Q
Pigula, Tadeusz	POL	5	3	2	3	V	*			0.250	13	16	-3	4 Q

**Men Sabre-Individual
Preliminary Round 2 Pool 2/Sept. 22**

Name Nom.	Ctry Pays	Order Ordre	1	2	3	4	5	6	7	V/M	TD	TR	TD-TR	PL
Bujdoso, Imre	HUN	1	*	3	V	V	V			0.750	18	13	5	3 Q
Dalla barba, Gianfranco	ITA	2	V	*	V	4	V			0.750	19	12	7	2 Q
Thoennessen, Stephan	FRG	3	2	2	*	1	V			0.250	10	15	-5	4 Q
Olech, Janusz	POL	4	4	V	V	*	V			0.750	19	10	9	1 Q
Wang, Zhiming	CHN	5	2	2	0	0	*			0.000	4	20	-16	5 E

**Men Sabre-Individual
Preliminary Round 2 Pool 3/Sept. 22**

Name Nom.	Ctry Pays	Order Ordre	1	2	3	4	5	6	7	V/M	TD	TR	TD-TR	PL
Garcia, Antonio	ESP	1	*	3	4	4	1			0.000	12	20	-8	5 E
Lamour, Jeanfrancois	FRA	2	V	*	V	3	V			0.750	18	15	3	2 Q
Banos, Jean-Paul	CAN	3	V	3	*	4	0			0.250	12	19	-7	4 Q
Mindrigassov, Serguei	URS	4	V	V	V	*	3			0.750	18	16	2	3 Q
Marin, Marco	ITA	5	V	4	V	V	*			0.750	19	9	10	1 Q

**Men Sabre-Individual
Preliminary Round 2 Pool 4/Sept. 22**

Name Nom.	Ctry Pays	Order Ordre	1	2	3	4	5	6	7	V/M	TD	TR	TD-TR	PL
Guichot, Pierre	FRA	1	*	1	4	V	V			0.500	15	16	-1	3 Q
Alchan, Andrei	URS	2	V	*	V	V	V			1.000	20	9	11	1 Q
Becker, Felix	FRG	3	V	4	*	V	V			0.750	19	12	7	2 Q
Lee Byung-Nam	KOR	4	3	2	3	*	1			0.000	9	20	-11	5 E
Zheng, Zhaokang	CHN	5	3	2	0	V	*			0.250	10	16	-6	4 Q

**Men Sabre-Individual
Preliminary Round 2 Pool 5/Sept. 22**

Name Nom.	Ctry Pays	Order Ordre	1	2	3	4	5	6	7	V/M	TD	TR	TD-TR	PL
Pogossov, Gueorgui	URS	1	*	V	V	V	V			1.000	20	12	8	1 Q
Gedoevari, Imre	HUN	2	3	*	3	V	V			0.500	16	13	3	2 Q
Koscielniakowski, Robert	POL	3	4	V	*	V	3			0.500	17	17	0	3 Q
Jia, Guihua	CHN	4	2	1	4	*	4			0.000	11	20	-9	5 E
Westbrook, Peter	USA	5	3	2	V	V	*			0.500	15	17		

Fencing

Men Sabre-Individual Preliminary Round 2 Pool 6/Sept. 22				Hommes/Sabre-Individuel Preliminaires Tour 2 Poule 6/22 Sept											
Name Nom.	Ctry Pays	Order Ordre		1	2	3	4	5	6	7	V/M	TD	TR	TD-TR	PL
Scalzo, Giovanni	ITA	1	*	1	V	4	V				0.500	15	15	0	3 Q
Etropolski, Hristo	BUL	2		V	*	4	3	V			0.500	17	15	2	2 Q
Mormando, George	USA	3		2	V	*	3	V			0.500	15	16	-1	4 Q
Nebald, Gyorgy	HUN	4		V	V	V	*	V			1.000	20	10	10	1 Q
Balk, Wulfe	CAN	5		3	4	2	0	*			0.000	9	20	-11	5 E

Men Sabre-Individual Preliminary Round 2/Sept. 22				Hommes Sabre-Individuel Preliminaires Tour 2/22 Sept											
Class	Name Nom	Ctry Pays		V	M	V/M	TD	TR	TD-TR						
1	Alchan, Andrei	URS	4	4	1.000	20	9	11							
2	Etropolski, Vassil	BUL	4	4	1.000	20	10	10							
3	Nebald, Gyorgy	HUN	4	4	1.000	20	10	10							
4	Pogossov, Gueorgui	URS	4	4	1.000	20	12	8							
5	Marin, Marco	ITA	3	4	0.750	19	9	10							
6	Olech, Janusz	POL	3	4	0.750	19	10	9							
7	Dalla Barba, Gianfranco	ITA	3	4	0.750	19	12	7							
8	Becker, Felix	FRG	3	4	0.750	19	12	7							
9	Bujdoso, Imre	HUN	3	4	0.750	18	13	5							
10	Lamour, Jeanfrancois	FRA	3	4	0.750	18	15	3							
11	Mindirgassov, Serguei	URS	3	4	0.750	18	16	2							
12	Gedoevari, Imre	HUN	2	4	0.500	16	13	3							
13	Etropolski, Hristo	BUL	2	4	0.500	17	15	2							
14	Delrieu, Philippe	FRA	2	4	0.500	13	12	1							
15	Scalzo, Giovanni	ITA	2	4	0.500	15	15	0							
16	Koscielniakowski, Robert	POL	2	4	0.500	17	17	0							
17	Guichot, Pierre	FRA	2	4	0.500	15	16	-1							
18	Mormando, George	USA	2	4	0.500	15	16	-1							
19	Nolte, Juergen	FRG	2	4	0.500	12	14	-2							
20	Westbrook, Peter	USA	2	4	0.500	15	17	-2							
21	Pigula, Tadeusz	POL	1	4	0.250	13	16	-3							
22	Thoennessen, Stephan	FRG	1	4	0.250	10	15	-5							
23	Zheng, Zhaokang	CHN	1	4	0.250	10	16	-6							
24	Banos, Jean-Paul	CAN	1	4	0.250	12	19	-7							

The above athletes are qualified/Les athletes ci-haut se qualifient

The following athletes are eliminated/Les athletes suivants sont elimines

25	Banos, Jean-Marie	CAN	1	4	0.250	11	17	-6							
26	Garcia, Antonio	ESP	0	4	0.000	12	20	-8							
27	Jia, Guihua	CHN	0	4	0.000	11	20	-9							
28	Lee, Byung-Nam	KOR	0	4	0.000	9	20	-11							
28	Balk, Wulfe	CAN	0	4	0.000	9	20	-11							
30	Wang, Zhiming	CHN	0	4	0.000	4	20	-16							

Men Sabre-Individual Preliminary Round 3 Pool 1/Sept. 22				Hommes/Sabre-Individuel Preliminaires Tour 3 Poule 1/22 Sept											
Name Nom.	Ctry Pays	Order Ordre		1	2	3	4	5	6	7	V/M	TD	TR	TD-TR	PL
Guichot, Pierre	FRA	1	*	V	V	3	V	V			0.800	23	15	8	1 Q
Banos, Jean-Paul	CAN	2		1	*	4	4	3	3		0.000	15	25	-10	6 E
Scalzo, Giovanni	ITA	3		1	V	*	V	V	2		0.600	18	20	-2	4 Q
Becker, Felix	FRG	4		V	V	3	*	V	4		0.600	22	20	2	3 Q
Bujdoso, Imre	HUN	5		4	V	3	3	*	V		0.400	20	21	-1	5 E
Alchan, Andrei	URS	6		4	V	V	V	3	*		0.600	22	19	3	2 Q

Men Sabre-Individual Preliminary Round 3 Pool 2/Sept. 22				Hommes/Sabre-Individuel Preliminaires Tour 3 Poule 2/22 Sept											
Name Nom.	Ctry Pays	Order Ordre		1	2	3	4	5	6	7	V/M	TD	TR	TD-TR	PL
Etropolski, Vassil	BUL	1	*	V	V	3	4	V			0.600	22	18	4	2 Q
Koscielniakowski, Robert	POL	2		4	*	V	4	V	2		0.400	20	19	1	5 E
Thoennessen, Stephan	FRG	3		2	2	*	4	4	2		0.000	14	25	-11	6 E
Dalla barba, Gianfranco	ITA	4		V	V	V	*	V	4		0.800	24	20	4	1 Q
Lamour, Jeanfrancois	FRA	5		V	2	V	4	*	V		0.600	21	22	-1	4 Q
Mormando, George	USA	6		2	V	V	V	4	*		0.600	21	18	3	3 Q

Men Sabre-Individual Preliminary Round 3 Pool 3/Sept. 22				Hommes/Sabre-Individuel Preliminaires Tour 3 Poule 3/22 Sept											
Name Nom.	Ctry Pays	Order Ordre		1	2	3	4	5	6	7	V/M	TD	TR	TD-TR	PL
Nebald, Gyorgy	HUN	1	*	V	V	2	V	3			0.600	20	15	5	2 Q
Delrieu, Philippe	FRA	2		1	*	V	3	V	V		0.600	19	17	2	3 Q
Zheng, Zhaokang	CHN	3		1	1	*	1	0	1		0.000	4	25	-21	6 E
Olech, Janusz	POL	4		V	V	V	*	V	4		0.800	24	14	10	1 Q
Mindirgassov, Serguei	URS	5		3	3	V	3	*	V		0.400	19	16	3	5 E
Nolte, Juergen	FRG	6		V	3	V	V	1	*		0.600	19	18	1	4 Q

Men Sabre-Individual Preliminary Round 3 Pool 4/Sept. 22				Hommes/Sabre-Individuel Preliminaires Tour 3 Poule 4/22 Sept											
Name Nom.	Ctry Pays	Order Ordre		1	2	3	4	5	6	7	V/M	TD	TR	TD-TR	PL
Pigula, Tadeusz	POL	1	*	V	2	3	V	V			0.600	20	20	0	4 Q
Etropolski, Hristo	BUL	2		2	*	3	V	4	3		0.200	17	23	-6	6 E
Pogossov, Gueorgui	URS	3		V	V	*	2	2	V		0.600	19	19	0	3 Q
Gedoevari, Imre	HUN	4		V	3	V	*	V	V		0.800	23	18	5	1 Q
Marin, Marco	ITA	5		4	V	V	4	*	V		0.600	23	19	4	2 Q
Westbrook, Peter	USA	6		4	V	4	4	3	*		0.200	20	23	-3	5 E

Escrime

Men Sabre-Individual Preliminary Round 3/Sept. 22				Hommes Sabre-Individuel Preliminaires Tour 3/20 Sept						
Class	Name Nom	Ctry Pays		V	M	V/M	TD	TR	TD-TR	
1	Olech, Janusz	POL	4	5	0.800	24	14	10		
2	Guichot, Pierre	FRA	4	5	0.800	23	15	8		
3	Gedoevari, Imre	HUN	4	5	0.800	23	18	5		
4	Dalla barba, Gianfranco	ITA	4	5	0.800	24	20	4		
5	Nebald, Gyorgy	HUN	3	5	0.600	20	15	5		
6	Etropolski, Vassil	BUL	3	5	0.600	22	18	4		
7	Marin, Marco	ITA	3	5	0.600	23	19	4		
8	Mormando, George	USA	3	5	0.600	21	18	3		
9	Alchan, Andrei	URS	3	5	0.600	22	19	3		
10	Delrieu, Philippe	FRA	3	5	0.600	19	17	2		
11	Becker, Felix	FRG	3	5	0.600	22	20	2		
12	Nolte, Juergen	FRG	3	5	0.600	19	18	1		
13	Pogossov, Gueorgui	URS	3	5	0.600	19	19	0		
14	Pigula, Tadeusz	POL	3	5	0.600	20	20	0		
15	Lamour, Jeanfrancois	FRA	3	5	0.600	21	22	-1		
16	Scalzo, Giovanni	ITA	3	5	0.600	18	20	-2		

The above athletes are qualified/Les athletes co-haut se qualifient

The following athletes are eliminated/Les athletes suivants sont elimines

17	Mindirgassov, Serguei	URS	2	5	0.400	19	16	3	
18	Koscielniakowski, Robert	POL	2	5	0.400	20	19	1	
19	Bujdoso, Imre	HUN	2	5	0.400	20	21	-1	
20	Westbrook, Peter	USA	1	5	0.200	20	23	-3	
21	Etropolski, Hristo	BUL	1	5	0.200	17	23	-6	
22	Banos, Jean-Paul	CAN	0	5	0.000	15	25	-10	
23	Thoennessen, Stephan	FRG	0	5	0.000	14	25	-11	
24	Zheng, Zhaokang	CHN	0	5	0.000	4	25	-21	

Men Sabre-Individual/Sept. 22-23			Hommes Sabre-Individuel/22-23 Sept						
Rank Rang	Ctry Pays	Name Nom							
1	FRA	Lamour, Jeanfrancois							
2	POL	Olech, Janusz							
3	ITA	Scalzo, Giovanni							
4	FRA	Delrieu, Philippe							
5	HUN	Nebald, Gyorgy							
6	URS	Pogossov, Gueorgui							
7	FRG	Becker, Felix							
8	FRG	Nolte, Juergen							
9	URS	Alchan, Andrei							
10	ITA	Dalla barba, Gianfranco							
11	FRA	Guichot, Pierre							
12	POL	Pigula, Tadeusz							
13	BUL	Etropolski, Vassil							
14	ITA	Marin, Marco							
15	HUN	Gedoevari, Imre							
16	USA	Mormando, George							
17	URS	Mindirgassov, Serguei							
18	POL	Koscielniakowski, Robert							
19	HUN	Bujdoso, Imre							
20	USA	Westbrook, Peter							
21	BUL	Etropolski, Hristo							
22	CAN	Banos, Jean-Paul							
23	FRG	Thoennessen, Stephan							
24	CHN	Zheng, Zhaokang							
25	CAN	Banos, Jean-Marie							
26	ESP	Garcia, Antonio							
27	CHN	Jia, Guihua							
28	KOR	Lee, Byung-Nam							
28	CAN	Balk, Wulfe							
30	CHN	Wang, Zhiming							
31	BUL	Marinechechki, Nikolai							
32	USA	Lofton, Michael							
33	KOR	Kim, Sang-Wook							
34	GBR	Slade, Mark							
35	MON	Martini, Olivier							
36</									



Fencing

Escrime

Men Sabre-Individual Direct Elimination W/R. Table G
Competition Summary

Hommes/Sabre-Individuel Directe A/R. Tableau G
Tableau de la Competition

Tableau G

Olech, Janus (POL)	
Pigula, Tade(POL)	Olech, Janus (POL) 10/06
Lamour, J (FRA)	
Guichot, Pie (FRA)	Lamour, J (FRA) 10/04
Pogossov, G (URS)	
Dalla Barba (ITA)	Pogossov, G (URS) 10/07
Scalzo, Giov (ITA)	
Alchan, Andr (URS)	Scalzo, Giov (ITA) 10/08

Men Sabre-Individual Final
Competition Summary

Hommes/Sabre-Individuel Tableau Finale
Tableau de la Competition

Final/Finale (1/4)	Final/Finale (1/2)	Final/Finale	
Nebald, Gyor(HUN)	Scalzo, Giov (ITA) 10/08	Olech, Janus (POL) 10/09	1st Place 1ere Place Lamour, J (FRA) 10/04
Scalzo, Giov (ITA)	Olech, Janus (POL) 10/07	Lamour, J (FRA) 10/07	
Olech, Janus (POL)			
Nolte, Juerg (FRG)			
Delrieu, P (FRA)	Delrieu, P (FRA) 10/09		
Pogossov, G (URS)	Lamour, J (FRA) 10/06		
Lamour, J (FRA)			
Becker, Feli (FRG)			
Scalzo, Giov (ITA)	3rd Place 3eme Place Scalzo, Giov (ITA) 10/02		
Delrieu, P (FRA)			



Men Epee-Individual Preliminary Round 1 Pool 1 Sept./23			Hommes/Epee-Individuel Preliminaires Tour 1 Poule 1/23 Sept											
Name Nom	Ctry Pays	Order Ordre	1	2	3	4	5	6	7	V/M	TD	TR	TD-TR	PL
Trevor, Stephen	USA	1	*	4	4	V	V			0.500	18	16	2	3 Q
Szekely, Zoltan	HUN	2	V	*	4	V	V			0.750	19	14	5	2 Q
Mazzoni, Angelo	ITA	3	V	V	*	V	V			1.000	20	12	8	1 Q
El-Khoury, Zahi	LIB	4	4	2	0	*	0			0.000	6	20	-14	5 E
Almashmoum, Younes	KUW	5	2	3	4	V	*			0.250	14	15	-1	4 Q

Men Epee-Individual Preliminary Round 1 Pool 9/Sept. 23			Hommes/Epee-Individuel Preliminaires Tour 1 Poule 9/23 Sept											
Name Nom	Ctry Pays	Order Ordre	1	2	3	4	5	6	7	V/M	TD	TR	TD-TR	PL
Reznichenko, Vladimir	URS	1	*	V	V	V	V			1.000	20	9	11	1 Q
Abuzamia, Ali	JOR	2	2	*	0	0	4			0.000	6	20	-14	5 E
Joos, Stefan	BEL	3	1	V	*	V	4			0.500	15	14	1	3 Q
Lee, Sang-Ki	KOR	4	4	V	4	*	V			0.500	18	11	7	2 Q
Strohmeier, Arno	AUT	5	2	V	V	1	*			0.500	13	18	-5	4 Q

Men Epee-Individual Preliminary Round 1 Pool 2/Sept. 23			Hommes/Epee-Individuel Preliminaires Tour 1 Poule 2/23 Sept											
Name Nom	Ctry Pays	Order Ordre	1	2	3	4	5	6	7	V/M	TD	TR	TD-TR	PL
Kuhn, Andre	SUI	1	*	1	V	V	2			0.500	13	17	-4	3 Q
Lazzarini, Roberto	BRA	2	V	*	V	V	3			0.750	18	9	9	2 Q
Ganeff, Stephane	HOL	3	4	1	*	V	2			0.250	12	16	-4	4 Q
Pinto, Oscar	POR	4	3	2	1	*	0			0.000	6	20	-14	5 E
Cuomo, Sandro	ITA	5	V	V	V	V	*			1.000	20	7	13	1 Q

Men Epee-Individual Preliminary Round 1 Pool 10/Sept. 23			Hommes/Epee-Individuel Preliminaires Tour 1 Poule 10/23 Sept											
Name Nom	Ctry Pays	Order Ordre	1	2	3	4	5	6	7	V/M	TD	TR	TD-TR	PL
Gaille, Patrice	SUI	1	*	3	2	V	3			0.250	13	15	-2	4 Q
Llewellyn, John	GBR	2	V	*	3	V	3			0.500	16	16	0	2 Q
Gadomski, Witold	POL	3	V	V	*	1	0			0.500	11	15	-4	3 Q
Tong, King King	HKG	4	0	3	V	*	2			0.250	10	16	-6	5 E
Riboud, Philippe	FRA	5	V	V	V	V	*			1.000	20	8	12	1 Q

Men Epee-Individual Preliminary Round 1 Pool 3/Sept. 23			Hommes/Epee-Individuel Preliminaires Tour 1 Poule 3/23 Sept											
Name Nom	Ctry Pays	Order Ordre	1	2	3	4	5	6	7	V/M	TD	TR	TD-TR	PL
Henry, Jean Michel	FRA	1	*	V	V	V	V			1.000	20	8	12	1 Q
Marx, Robert	USA	2	4	*	5	3	4			0.000	16	20	-4	5 E
Durao, Roberto	POR	3	1	V	*	3	2			0.250	11	20	-9	4 Q
Lee, Il-Hee	KOR	4	2	V	V	*	V			0.750	17	13	4	2 Q
Pena, Fernando	ESP	5	1	V	V	2	*			0.500	13	16	-3	3 Q

Men Epee-Individual Preliminary Round 1 Pool 11/Sept. 23			Hommes/Epee-Individuel Preliminaires Tour 1 Poule 11/23 Sept											
Name Nom	Ctry Pays	Order Ordre	1	2	3	4	5	6	7	V/M	TD	TR	TD-TR	PL
Brill, Martin	NZL	1	*	V	V	V	0	4		0.600	19	13	6	3 Q
Thomas, Austin	ARU	2	0	*	2	V	3	0		0.200	10	24	-14	5 E
Birnbaum, Axel	AUT	3	1	V	*	V	3	V		0.600	19	20	-1	4 Q
Tang, Wing Keung	HKG	4	2	4	4	*	1	0		0.000	11	25	-14	6 E
Tichko, Mikhail	URS	5	V	V	V	V	*	1		0.800	21	12	9	2 Q
Winter, Lars	FIN	6	V	V	4	V	V	*		0.800	24	10	14	1 Q

Men Epee-Individual Preliminary Round 1 Pool 4/Sept. 23			Hommes/Epee-Individuel Preliminaires Tour 1 Poule 4/23 Sept											
Name Nom	Ctry Pays	Order Ordre	1	2	3	4	5	6	7	V/M	TD	TR	TD-TR	PL
Davidson, Robert	AUS	1	*	V	2	2	V			0.500	14	15	-1	4 Q
Wang, San-Tsai	TPE	2	2	*	3	3	0			0.000	8	20	-12	5 E
Drakenberg, Otto	SWE	3	V	V	*	V	2			0.750	17	12	5	1 Q
Chouvalov, Andrei	URS	4	V	V	2	*	V			0.750	17	13	4	2 Q
Machado, Antonio	BRA	5	3	V	V	3	*			0.500	16	12	4	3 Q

Men Epee-Individual Preliminary Round 1 Pool 12/Sept. 23			Hommes/Epee-Individuel Preliminaires Tour 1 Poule 12/23 Sept											
Name Nom	Ctry Pays	Order Ordre	1	2	3	4	5	6	7	V/M	TD	TR	TD-TR	PL
Soumagne, Thierry	BEL	1	*	V	V	1	2			0.500	13	14	-1	3 Q
Khalid, Abdul Rahman	BRN	2	0	*	1	V	1			0.250	6	17	-11	5 E
Chan, Kai Sang	HKG	3	4	V	*	0	1			0.250	10	16	-6	4 Q
Proske, Uwe	GDR	4	V	2	V	*	2			0.500	14	11	3	2 Q
Poffet, Michel	SUI	5	V	V	V	V	*			1.000	20	5	15	1 Q

Men Epee-Individual Preliminary Round 1 Pool 5/Sept. 23			Hommes/Epee-Individuel Preliminaires Tour 1 Poule 5/23 Sept											
Name Nom	Ctry Pays	Order Ordre	1	2	3	4	5	6	7	V/M	TD	TR	TD-TR	PL
Driessen, Michiel	HOL	1	*	4	3	3	3			0.000	13	20	-7	5 E
Sreck, Eric	FRA	2	V	*	V	V	V			1.000	20	12	8	1 Q
Turiace, Sergio R	ARG	3	V	1	*	0	V			0.500	11	17	-6	3 Q
Rivas, Mauricio	COL	4	V	4	V	*	V			0.750	19	9	10	2 Q
Alhamar, Mohammad	KUW	5	V	3	4	1	*			0.250	13	18	-5	4 Q

Men Epee-Individual Preliminary Round 1 Pool 13/Sept. 23			Hommes/Epee-Individuel Preliminaires Tour 1 Poule 13/23 Sept											
Name Nom	Ctry Pays	Order Ordre	1	2	3	4	5	6	7	V/M	TD	TR	TD-TR	PL
Dessureault, Michel	CAN	1	*	3	1	V	4	V		0.400	18	20	-2	3 Q
Farhan, Saleh	BRN	2	V	*	0	3	4	4		0.200	16	23	-7	6 E
Pantano, Stefano	ITA	3	V	V	*	4	V	V		0.800	24	11	13	1 Q
Jahrami, Khaled	KUW	4	2	V	V	*	2	3		0.400	17	22	-5	5 E
Nagele, Johannes	AUT	5	V	V	2	V	*	V		0.800	22	17	5	2 Q
Kernohan, Hugh	GBR	6	3	V	3	V	2	*		0.400	18	22	-4	4 Q

Men Epee-Individual Preliminary Round 1 Pool 6/Sept. 23			Hommes/Epee-Individuel Preliminaires Tour 1 Poule 6/23 Sept											
Name Nom	Ctry Pays	Order Ordre	1	2	3	4	5	6	7	V/M	TD	TR	TD-TR	PL
Chronowski, Ludomir	POL	1	*	V	3	V	1			0.500	14	12	2	3 Q
Youssef, Michel	LIB	2	1	*	1	2	1			0.000	5	20	-15	5 E
Yoon, Nam-Jin	KOR	3	V	V	*	5	3			0.500	18	14	4	2 Q
Stull, Robert	USA	4	1	V	5	*	1			0.250	12	17	-5	4 Q
Pusch, Alexander	FRG	5	V	V	V	V	*			1.000	20	6	14	1 Q

Men Epee-Individual Preliminary Round 1 Pool 14/Sept. 23			Hommes/Epee-Individuel Preliminaires Tour 1 Poule 14/23 Sept											
Name Nom	Ctry Pays	Order Ordre	1	2	3	4	5	6	7	V/M	TD	TR	TD-TR	PL
Cote, Alain	CAN	1	*	V	V	4	5	2		0.400	21	22	-1	5 E
Kuehnemund, Torsten	GDR	2	3	*	V	V	V	3		0.600	21	17	4	1 Q
Fonseca, Douglas	BRA	3	4	4	*	V	V	V		0.600	23	21	2	3 Q
Al Doseri, Ahmed	BRN	4	V	2	3	*	1	4		0.200	15	24	-9	6 E
Fernandez, Angel	ESP	5	5	1	3	V	*	V		0.400	19	18	1	4 Q
Ma, Zhi	CHN	6	V	V	5	V	2	*		0.600	22	19	3	2 Q

Men Epee-Individual Preliminary Round 1 Pool 7/Sept. 23			Hommes/Epee-Individuel Preliminaires Tour 1 Poule 7/23 Sept											
Name Nom	Ctry Pays	Order Ordre	1	2	3	4	5	6	7	V/M	TD	TR	TD-TR	PL
Bergstrom, Jerri	SWE	1	*	V	3	V	5			0.500	18	15	3	2 Q
Pinto, Joaquin	COL	2	3	*	4	4	V			0.250	16	19	-3	4 Q
Gerull, Thomas	FRG	3	V	V	*	V	4			0.750	19	14	5	1 Q
Pereira, Manuel	ESP	4	2	V	2	*	4			0.250	13	19	-6	5 E
Kolczonay, Erno	HUN	5	5	4	V	V	*			0.500	19	18	1	3 Q

Men Epee-Individual Preliminary Round 1 Pool 15/Sept. 23			Hommes/Epee-Individuel Preliminaires Tour 1 Poule 15/23 Sept											
Name Nom	Ctry Pays	Order Ordre	1	2	3	4	5	6	7	V/M	TD	TR	TD-TR	PL
Siess, Cezary	POL	1	*	3	V	V	1	V		0.600	19	19	0	4 Q
Di Tella, Rafael M	ARG	2	V	*	5	0	V	V		0.600	20	17	3	3 Q
Bandeira, Jose	POR	3	3	5	*	3	1	V		0.200	17	23	-6	5 E
Kardolus, Arwin	HOL	4	3	V	V	*	5	V		0.600	23	15	8	2 Q
Schmitt, Arnd	FRG	5	V	3	V	5	*	V		0.600	23	12	11	1 Q
Bogarín Arzamendia, Alfredo Ba	PAR	6	3	1	3	2	0	*		0.000	9	25	-16	6 E

Men Epee-Individual Preliminary Round 1 Pool 8/Sept. 23			Hommes/Epee-Individuel Preliminaires Tour 1 Poule 8/23 Sept											
Name Nom	Ctry Pays	Order Ordre	1	2	3	4	5	6	7	V/M	TD	TR	TD-TR	PL
Du, Zhencheng	CHN</													

Fencing

Escrime

Men Epee-Individual Preliminary Round 1/Sept. 23			Hommes Epee-Individuel Preliminares Tour 1/23 Sept					
Class	Name	Ctry Pays	V	M	V/M	TD	TR	TD-TR
1	Poffet, Michel	SUI	4	4	1.000	20	5	15
2	Pusch, Alexander	FRG	4	4	1.000	20	6	14
3	Cuomo, Sandro	ITA	4	4	1.000	20	7	13
4	Henry, Jean Michel	FRA	4	4	1.000	20	8	12
5	Riboud, Philippe	FRA	4	4	1.000	20	8	12
6	Reznitchenko, Vladimir	URS	4	4	1.000	20	9	11
7	Srecki, Eric	FRA	4	4	1.000	20	12	8
8	Mazzoni, Angelo	ITA	4	4	1.000	20	12	8
9	Winter, Lars	FIN	4	5	0.800	24	10	14
10	Pantano, Stefano	ITA	4	5	0.800	24	11	13
11	Tichko, Mikhail	URS	4	5	0.800	21	12	9
12	Nagele, Johannes	AUT	4	5	0.800	22	17	5
13	Rivas, Mauricio	COL	3	4	0.750	19	9	10
14	Lazzarini, Roberto	BRA	3	4	0.750	18	9	9
15	Drakenberg, Otto	SWE	3	4	0.750	17	12	5
16	Szekely, Zoltan	HUN	3	4	0.750	19	14	5
17	Gerull, Thomas	FRG	3	4	0.750	19	14	5
18	Pasztor, Szabolcs	HUN	3	4	0.750	19	14	5
19	Lee, Il-Hee	KOR	3	4	0.750	17	13	4
20	Chouvalov, Andrei	URS	3	4	0.750	17	13	4
21	Schmitt, Arnd	FRG	3	5	0.600	23	12	11
22	Kardolus, Arwin	HOL	3	5	0.600	23	15	8
23	Brill, Martin	NZL	3	5	0.600	19	13	6
24	Kuehnemund, Torsten	GDR	3	5	0.600	21	17	4
25	Di Tella, Rafael M	ARG	3	5	0.600	20	17	3
26	Ma, Zhi	CHN	3	5	0.600	22	19	3
27	Fonseca, Douglas	BRA	3	5	0.600	23	21	2
28	Siess, Cezary	POL	3	5	0.600	19	19	0
29	Birnbaum, Axel	AUT	3	5	0.600	19	20	-1
30	Lee, Sang-Ki	KOR	2	4	0.500	18	11	7
31	Machado, Antonio	BRA	2	4	0.500	16	12	4
32	Yoon, Nam-Jin	KOR	2	4	0.500	18	14	4
33	Proske, Uwe	GDR	2	4	0.500	14	11	3
34	Bergstrom, Jerri	SWE	2	4	0.500	18	15	3
35	Chronowski, Ludomir	POL	2	4	0.500	14	12	2
36	Trevor, Stephen	USA	2	4	0.500	18	16	2
37	Joos, Stefan	BEL	2	4	0.500	15	14	1
38	Kolczonay, Erno	HUN	2	4	0.500	19	18	1
39	Vanky, Peter	SWE	2	4	0.500	16	16	0
40	Llewellyn, John	GBR	2	4	0.500	16	16	0
41	Soumagne, Thierry	BEL	2	4	0.500	13	14	-1
42	Davidson, Robert	AUS	2	4	0.500	14	15	-1
43	Paz, Juan Miguel	COL	2	4	0.500	17	19	-2
44	Pena, Fernando	ESP	2	4	0.500	13	16	-3
45	Gadomski, Witold	POL	2	4	0.500	11	15	-4
46	Kuhn, Andre	SUI	2	4	0.500	13	17	-4
47	Strohmeyer, Arno	AUT	2	4	0.500	13	18	-5
48	Turiace, Sergio R	ARG	2	4	0.500	11	17	-6
49	Fernandez, Angel	ESP	2	5	0.400	19	18	1
50	Dessureault, Michel	CAN	2	5	0.400	18	20	-2
51	Kernohan, Hugh	GBR	2	5	0.400	18	22	-4
52	Almashmoum, Younes	KUW	1	4	0.250	14	15	-1
53	Du, Zhencheng	CHN	1	4	0.250	18	19	-1
54	Gaille, Patrice	SUI	1	4	0.250	13	15	-2
55	Pinto, Joaquin	COL	1	4	0.250	16	19	-3
56	Ganef, Stephane	HOL	1	4	0.250	12	16	-4
57	Stull, Robert	USA	1	4	0.250	12	17	-5
58	Alhamar, Mohammad	KUW	1	4	0.250	13	18	-5
59	Chan, Kai Sang	HKG	1	4	0.250	10	16	-6
60	Durao, Roberto	POR	1	4	0.250	11	20	-9

The above athletes are qualified/Les athletes ci-haut se qualifient

The following athletes are eliminated/Les athletes suivants sont elimines

61	Cote, Alain	CAN	2	5	0.400	21	22	-1
62	Jahrami, Khaled	KUW	2	5	0.400	17	22	-5
63	Chouinard, Jean-Marc	CAN	1	4	0.250	17	19	-2
64	Tong, King King	HKG	1	4	0.250	10	16	-6
65	Pereira, Manuel	ESP	1	4	0.250	13	19	-6
66	Khalid, Abdul Rahman	BRN	1	4	0.250	6	17	-11
67	Bandeira, Jose	POR	1	5	0.200	17	23	-6
68	Farhan, Saleh	BRN	1	5	0.200	16	23	-7
69	Al Doseri, Ahmed	BRN	1	5	0.200	15	24	-9
70	Thomas, Austin	ARU	1	5	0.200	10	24	-14
71	Marx, Robert	USA	0	4	0.000	16	20	-4
72	Driessen, Michiel	HOL	0	4	0.000	13	20	-7
73	Wang, San-Tsai	TPE	0	4	0.000	8	20	-12
74	El-Khoury, Zahi	LIB	0	4	0.000	6	20	-14
74	Pinto, Oscar	POR	0	4	0.000	6	20	-14
74	Abuzamia, Ali	JOR	0	4	0.000	6	20	-14
77	Tang, Wing Keung	HKG	0	5	0.000	11	25	-14
78	Youssef, Michel	LIB	0	4	0.000	5	20	-15
79	Bogarín Arzamendia, Alfredo Ba	PAR	0	5	0.000	9	25	-16

Men Epee-Individual Preliminary Round 2 Pool 1/Sept. 23			Hommes/Epee-Individuel Preliminares Tour 2 Poule 1/23 Sept											
Name	Ctry Pays	Order	1	2	3	4	5	6	7	V/M	TD	TR	TD-TR	PL
Fernandez, Angel	ESP	1	*	3	V	2	3			0.250	13	20	-7	5 E
Di Tella, Rafael M	ARG	2	V	*	2	2	4			0.250	13	18	-5	4 Q
Dessureault, Michel	CAN	3	5	V	*	1	3			0.250	14	17	-3	3 Q
Kuehnemund, Torsten	GDR	4	V	V	V	*	V			1.000	20	8	12	1 Q
Poffet, Michel	SUI	5	V	V	V	3	*			0.750	18	15	3	2 Q

Men Epee-Individual Preliminary Round 2 Pool 2/Sept. 23			Hommes/Epee-Individuel Preliminares Tour 2 Poule 2/23 Sept											
Name	Ctry Pays	Order	1	2	3	4	5	6	7	V/M	TD	TR	TD-TR	PL
Strohmeyer, Arno	AUT	1	*	V	V	1	4			0.500	15	15	0	4 Q
Ma, Zhi	CHN	2	4	*	V	V	2			0.500	16	13	3	3 Q
Turiace, Sergio R	ARG	3	1	2	*	2	4			0.000	9	20	-11	5 E
Pusch, Alexander	FRG	4	V	1	V	*	V			0.750	16	10	6	1 Q
Brill, Martin	NZL	5	V	V	V	2	*			0.750	17	15	2	2 Q

Men Epee-Individual Preliminary Round 2 Pool 3/Sept. 23			Hommes/Epee-Individuel Preliminares Tour 2 Poule 3/23 Sept											
Name	Ctry Pays	Order	1	2	3	4	5	6	7	V/M	TD	TR	TD-TR	PL
Gadomski, Witold	POL	1	*	V	V	V	3			0.750	18	13	5	1 Q
Fonseca, Douglas	BRA	2	4	*	V	2	2			0.250	13	18	-5	4 Q
Kernohan, Hugh	GBR	3	0	3	*	1	V			0.250	9	15	-6	5 E
Cuomo, Sandro	ITA	4	4	V	V	*	4			0.500	18	13	5	3 Q
Kardolus, Arwin	HOL	5	V	V	0	V	*			0.750	15	14	1	2 Q

Men Epee-Individual Preliminary Round 2 Pool 4/Sept. 23			Hommes/Epee-Individuel Preliminares Tour 2 Poule 4/23 Sept											
Name	Ctry Pays	Order	1	2	3	4	5	6	7	V/M	TD	TR	TD-TR	PL
Schmitt, Arnd	FRG	1	*	V	V	V	V			1.000	20	14	6	1 Q
Siess, Cezary	POL	2	4	*	2	1	V			0.250	12	19	-7	4 Q
Henry, Jean Michel	FRA	3	4	V	*	V	V			0.750	19	12	7	2 Q
Kuhn, Andre	SUI	4	2	V	4	*	V			0.500	16	15	1	3 Q
Almashmoum, Younes	KUW	5	4	4	1	4	*			0.000	13	20	-7	5 E

Men Epee-Individual Preliminary Round 2 Pool 5/Sept. 23			Hommes/Epee-Individuel Preliminares Tour 2 Poule 5/23 Sept											
Name	Ctry Pays	Order	1	2	3	4	5	6	7	V/M	TD	TR	TD-TR	PL
Chouvalov, Andrei	URS	1	*	V	V	V	V			1.000	20	11	9	1 Q
Birnbaum, Axel	AUT	2	1	*	1	V	V			0.500	12	15	-3	3 Q
Riboud, Philippe	FRA	3	3	V	*	V	V			0.750	18	10	8	2 Q
Pena, Fernando	ESP	4	4	2	2	*	3			0.000	11	20	-9	5 E
Du, Zhencheng	CHN	5	3	3	2	V	*			0.250	13	18	-5	4 Q

Men Epee-Individual Preliminary Round 2 Pool 6/Sept. 23			Hommes/Epee-Individuel Preliminares Tour 2 Poule 6/23 Sept											
Name	Ctry Pays	Order	1	2	3	4	5	6	7	V/M	TD	TR	TD-TR	PL
Lee, Il-Hee	KOR	1	*	3	3	V	2			0.250	13	19	-6	5 E
Reznitchenko, Vladimir	URS	2	V	*	V	2	V			0.750	17	14	3	2 Q
Machado, Antonio	BRA	3	V	4	*	2	V			0.500	16	16	0	3 Q
Gaille, Patrice	SUI	4	4	V	V	*	V			0.750	19	12	7	1 Q
Paz, Juan miguel	COL	5	V	2	3	3	*			0.250	13	17	-4	4 Q

Men Epee-Individual Preliminary Round 2 Pool 7/Sept. 23			Hommes/Epee-Individuel Preliminares Tour 2 Poule 7/23 Sept											
Name	Ctry Pays	Order	1	2	3	4	5	6	7	V/M	TD	TR	TD-TR	PL
Pasztor, Szabolcs	HUN	1	*	2	V	V	V			0.750	17	14	3	2 Q
Srecki, Eric	FRA	2	V	*	V	V	V			1.000	20	10	10	1 Q
Lee, Sang-Ki	KOR	3	4	4	*	V	V			0.500	18	15	3	3 Q
Pinto, Joaquin	COL	4	1	4	1	*	V			0.250	11	19	-8	4 Q
Davidson, Robert	AUS	5	4	0	4	4	*			0.000	12	20	-8	5 E

Men Epee-Individual Preliminary Round 2 Pool 8/Sept. 23			Hommes/Epee-Individuel Preliminares Tour 2 Poule 8/23 Sept											
Name	Ctry Pays	Order	1	2	3	4	5	6	7	V/M	TD	TR	TD-TR	PL
Soumagne, Thierry	BEL	1	*	1	2	0	V			0.250	8	19	-11	5 E
Yoon, Nam-Jin	KOR	2	V	*	2	2	V			0.500	14	13	1	2 Q
Gerull, Thomas	FRG	3	V	V	*	2	1			0.500	13	14	-1	4 Q
Mazzoni, Angelo	ITA	4	V	V	V	*	4			0.750	19	9	10	1 Q
Ganef, Stephane	HOL	5	4	2	V	V	*			0.500	16	15	1	3 Q

Men Epee-Individual Preliminary Round 2 Pool 9/Sept. 23			Hommes/Epee-Individuel Preliminares Tour 2 Poule 9/23 Sept											
Name	Ctry Pays	Order	1	2	3	4	5	6	7	V/M	TD	TR	TD-TR	PL
Proske, Uwe	GDR	1	*	4	V	2	V			0.500	16	16	0	4 Q
Vanky, Peter	SWE	2	V	*	2	4	V			0.500	16	15	1	3 Q
Szekely, Zoltan	HUN	3	4	V	*	V	V			0.750	19	12	7	1 Q
Stull, Robert	USA	4	V	V	2	*	V			0.750	17	14	3	2 Q
Winter, Lars	FIN	5	2	1										



Men Epee-Individual Preliminary Round 2 Pool 10/Sept. 23				Hommes/Epee-Individuel Preliminaires Tour 2 Poule 10/23 Sept											
Name Nom	Ctry Pays	Order Ordre		1	2	3	4	5	6	7	V/M	TD	TR	TD-TR	PL
Chronowski, Ludomir	POL	1	*	V	V	V	V				1.000	20	13	7	1 Q
Llewellyn, John	GBR	2	4	*	V	V	V				0.750	19	13	6	2 Q
Drakenberg, Otto	SWE	3	3	3	*	1	5				0.000	12	20	-8	5 E
Alhamar, Mohammad	KUW	4	2	1	V	*	4				0.250	12	16	-4	4 Q
Pantano, Stefano	ITA	5	4	4	V	V	*				0.500	18	19	-1	3 Q

Men Epee-Individual Preliminary Round 2 Pool 11/Sept. 23				Hommes/Epee-Individuel Preliminaires Tour 2 Poule 11/23 Sept											
Name Nom	Ctry Pays	Order Ordre		1	2	3	4	5	6	7	V/M	TD	TR	TD-TR	PL
Bergstrom, Jerri	SWE	1	*	0	V	V	V				0.750	15	10	5	2 Q
Kolczonay, Erno	HUN	2	V	*	V	V	4				0.750	19	10	9	1 Q
Lazzarini, Roberto	BRA	3	2	1	*	V	2				0.250	10	17	-7	4 Q
Chan, Kai Sang	HKG	4	0	4	2	*	2				0.000	8	20	-12	5 E
Tichko, Mikhail	URS	5	3	V	V	V	*				0.750	18	13	5	3 Q

Men Epee-Individual Preliminary Round 2 Pool 12/Sept. 23				Hommes/Epee-Individuel Preliminaires Tour 2 Poule 12/23 Sept											
Name Nom	Ctry Pays	Order Ordre		1	2	3	4	5	6	7	V/M	TD	TR	TD-TR	PL
Trevor, Stephen	USA	1	*	V	V	V	V				1.000	20	6	14	1 Q
Durao, Roberto	POR	2	2	*	2	2	1				0.000	7	20	-13	5 E
Rivas, Mauricio	COL	3	0	V	*	V	2				0.500	12	12	0	3 Q
Nagele, Johannes	AUT	4	2	V	0	*	3				0.250	10	17	-7	4 Q
Joos, Stefan	BEL	5	2	V	V	V	*				0.750	17	11	6	2 Q

Men Epee-Individual Preliminary Round 2/Sept. 23			Hommes/Epee-Individuel Preliminaires Tour 2/23 Sept					
Class	Name	Ctry	V	M	V/M	TD	TR	TD-TR
1	Trevor, Stephen	USA	4	4	1.000	20	6	14
2	Kuehnemund, Torsten	GDR	4	4	1.000	20	8	12
3	Srecki, Eric	FRA	4	4	1.000	20	10	10
4	Chouvalov, Andrei	URS	4	4	1.000	20	11	9
5	Chronowski, Ludomir	POL	4	4	1.000	20	13	7
6	Schmitt, Arnd	FRG	4	4	1.000	20	14	6
7	Mazzoni, Angelo	ITA	3	4	0.750	19	9	10
8	Kolczonay, Erno	HUN	3	4	0.750	19	10	9
9	Riboud, Philippe	FRA	3	4	0.750	18	10	8
10	Gaille, Patrice	SUI	3	4	0.750	19	12	7
11	Szekely, Zoltan	HUN	3	4	0.750	19	12	7
12	Henry, Jean Michel	FRA	3	4	0.750	19	12	7
13	Pusch, Alexander	FRG	3	4	0.750	16	10	6
14	Joos, Stefan	BEL	3	4	0.750	17	11	6
15	Llewellyn, John	GBR	3	4	0.750	19	13	6
16	Bergstrom, Jerri	SWE	3	4	0.750	15	10	5
17	Tichko, Mikhail	URS	3	4	0.750	18	13	5
18	Gadomski, Witold	POL	3	4	0.750	18	13	5
19	Reznitchenko, Vladimir	URS	3	4	0.750	17	14	3
20	Pasztor, Szabolcs	HUN	3	4	0.750	17	14	3
21	Stull, Robert	USA	3	4	0.750	17	14	3
22	Poffet, Michel	SUI	3	4	0.750	18	15	3
23	Brill, Martin	NZL	3	4	0.750	17	15	2
24	Kardolus, Arwin	HOL	3	4	0.750	15	14	1
25	Cuomo, Sandro	ITA	2	4	0.500	18	13	5
26	Ma, Zhi	CHN	2	4	0.500	16	13	3
27	Lee, Sang-Ki	KOR	2	4	0.500	18	15	3
28	Yoon, Nam-Jin	KOR	2	4	0.500	14	13	1
29	Kuhn, Andre	SUI	2	4	0.500	16	15	1
30	Vanky, Peter	SWE	2	4	0.500	16	15	1
31	Ganeff, Stephane	HOL	2	4	0.500	16	15	1
32	Rivas, Mauricio	COL	2	4	0.500	12	12	0
33	Strohmeier, Arno	AUT	2	4	0.500	15	15	0
34	Proske, Uwe	GDR	2	4	0.500	16	16	0
35	Machado, Antonio	BRA	2	4	0.500	16	16	0
36	Gerull, Thomas	FRG	2	4	0.500	13	14	-1
37	Pantano, Stefano	ITA	2	4	0.500	18	19	-1
38	Birnbaum, Axel	AUT	2	4	0.500	12	15	-3
39	Dessureault, Michel	CAN	1	4	0.250	14	17	-3
40	Alhamar, Mohammad	KUW	1	4	0.250	12	16	-4
41	Paz, Juan Miguel	COL	1	4	0.250	13	17	-4
42	Fonseca, Douglas	BRA	1	4	0.250	13	18	-5
43	Di tella, Rafael M	ARG	1	4	0.250	13	18	-5
44	Du, Zhencheng	CHN	1	4	0.250	13	18	-5
45	Nagele, Johannes	AUT	1	4	0.250	10	17	-7
46	Lazzarini, Roberto	BRA	1	4	0.250	10	17	-7
47	Siess, Cezary	POL	1	4	0.250	12	19	-7
48	Pinto, Joaquin	COL	1	4	0.250	11	19	-8

The above athletes are qualified/Les athletes ci-haut se qualifient

The following athletes are eliminated/Les athletes suivants sont elimines

49	Kernohan, Hugh	GBR	1	4	0.250	9	15	-6
50	Lee, Il-Hee	KOR	1	4	0.250	13	19	-6
51	Fernandez, Angel	ESP	1	4	0.250	13	20	-7
52	Soumagne, Thierry	BEL	1	4	0.250	8	19	-11
53	Almashmoum, Younes	KUW	0	4	0.000	13	20	-7
54	Davidson, Robert	AUS	0	4	0.000	12	20	-8
54	Drakenberg, Otto	SWE	0	4	0.000	12	20	-8
56	Pena, Fernando	ESP	0	4	0.000	11	20	-9
57	Turiace, Sergio R	ARG	0	4	0.000	9	20	-11
57	Winter, Lars	FIN	0	4	0.000	9	20	-11
59	Chan, Kai Sang	HKG	0	4	0.000	8	20	-12
60	Durao, Roberto	POR	0	4	0.000	7	20	-13

Men Epee-Individual Preliminary Round 3 Pool 1/Sept. 23				Hommes/Epee-Individuel Preliminaires Tour 3 Poule 1/23 Sept											
Name Nom	Ctry Pays	Order Ordre		1	2	3	4	5	6	7	V/M	TD	TR	TD-TR	PL
Strohmeier, Arno	AUT	1	*	V	3	V	V	4			0.600	22	20	2	3 Q
Rivas, Mauricio	COL	2	3	*	2	V	4	V			0.400	19	22	-3	4 Q
Bergstrom, Jerri	SWE	3	V	V	*	V	V	V			1.000	25	11	14	1 Q
Trevor, Stephen	USA	4	3	4	2	*	V	1			0.200	15	21	-6	5 E
Siess, Cezary	POL	5	4	V	0	1	*	3			0.200	13	24	-11	6 E
Tichko, Mikhail	URS	6	V	3	4	V	V	*			0.600	22	18	4	2 Q

Men Epee-Individual Preliminary Round 3 Pool 2/Sept. 23				Hommes/Epee-Individuel Preliminaires Tour 3 Poule 2/23 Sept											
Name Nom	Ctry Pays	Order Ordre		1	2	3	4	5	6	7	V/M	TD	TR	TD-TR	PL
Pinto, Joaquin	COL	1	*	2	4	1	V	0			0.200	12	24	-12	6 E
Machado, Antonio	BRA	2	V	*	4	V	3	2			0.400	19	19	0	3 Q
Gadomski, Witold	POL	3	V	V	*	V	5	4			0.600	24	21	3	2 Q
Ganeff, Stephane	HOL	4	V	2	3	*	V	2			0.400	17	19	-2	4 Q
Llewellyn, John	GBR	5	4	V	5	3	*	0			0.200	17	23	-6	5 E
Kuehnemund, Torsten	GDR	6	V	V	V	V	V	*			1.000	25	8	17	1 Q

Men Epee-Individual Preliminary Round 3 Pool 3/Sept. 23				Hommes/Epee-Individuel Preliminaires Tour 3 Poule 3/23 Sept											
Name Nom	Ctry Pays	Order Ordre		1	2	3	4	5	6	7	V/M	TD	TR	TD-TR	PL
Srecki, Eric	FRA	1	*	V	V	V	V	V			1.000	25	17	8	1 Q
Proske, Uwe	GDR	2	4	*	2	V	1	V			0.400	17	21	-4	5 E
Vanky, Peter	SWE	3	4	V	*	V	V	4			0.600	23	20	3	2 Q
Joos, Stefan	BEL	4	3	2	4	*	V	V			0.400	19	17	2	3 Q
Reznitchenko, Vladimir	URS	5	4	V	4	1	*	V			0.400	19	18	1	4 Q
Lazzarini, Roberto	BRA	6	2	4	V	1	2	*			0.200	14	24	-10	6 E

Men Epee-Individual Preliminary Round 3 Pool 4/Sept. 23				Hommes/Epee-Individuel Preliminaires Tour 3 Poule 4/23 Sept											
Name Nom	Ctry Pays	Order Ordre		1	2	3	4	5	6	7	V/M	TD	TR	TD-TR	PL
Kuhn, Andre	SUI	1	*	2	3	4	2	4			0.000	15	25	-10	6 E
Chouvalov, Andrei	URS	2	V	*	V	V	V	V			1.000	25	14	11	1 Q
Pasztor, Szabolcs	HUN	3	V	4	*	4	5	5			0.200	23	23	0	5 E
Pusch, Alexander	FRG	4	V	2	V	*	4	V			0.600	21	18	3	3 Q
Pantano, Stefano	ITA	5	V	4	V	V	*	V			0.800	24	19	5	2 Q
Nagele, Johannes	AUT	6	V	2	V	0	3	*			0.400	15	24	-9	4 Q

Men Epee-Individual Preliminary Round 3 Pool 5/Sept. 23				Hommes/Epee-Individuel Preliminaires Tour 3 Poule 5/23 Sept											
Name Nom	Ctry Pays	Order Ordre		1	2	3	4	5	6	7	V/M	TD	TR	TD-TR	PL
Henry, Jean Michel	FRA	1	*	V	V	V	V	1			0.800	21	14	7	1 Q
Du, Zhencheng	CHN	2	4	*	V	3	V	4			0.400	21	18	3	4 Q
Chronowski, Ludomir	POL	3	2	1	*	3	V	V			0.400	16	18	-2	5 E
Gerull, Thomas	FRG	4	2	V	V	*	V	4			0.600	21	20	1	3 Q
Stull, Robert	USA	5	1	2	2	4	*	5			0.000	14	25	-11	6 E
Yoon, Nam-Jin	KOR	6	V	V	1	V	V	*			0.800	21	19	2	2 Q

Men Epee-Individual Preliminary Round 3 Pool 6/Sept. 23				Hommes/Epee-Individuel Preliminaires Tour 3 Poule 6/23 Sept											
Name Nom	Ctry Pays	Order Ordre		1	2	3	4	5	6	7	V/M	TD	TR	TD-TR	PL
Lee, Sang-Ki	KOR	1	*	V	5	V	V	V			0				

Fencing

Men Epee-Individual Preliminary Round 3/Sept. 23			Hommes Epee-Individuel Preliminaires Tour 3/23 Sept					
Class	Name	Ctry Pays	V	M	V/M	TD	TR	TD-TR
1	Kuehnemund, Torsten	GDR	5	5	1.000	25	8	17
2	Bergstrom, Jerri	SWE	5	5	1.000	25	11	14
3	Riboud, Philippe	FRA	5	5	1.000	25	11	14
4	Chouvalov, Andrei	URS	5	5	1.000	25	14	11
5	Srecki, Eric	FRA	5	5	1.000	25	17	8
6	Schmitt, Arnd	FRG	4	5	0.800	22	10	12
7	Lee, Sang-Ki	KOR	4	5	0.800	25	13	12
8	Henry, Jean Michel	FRA	4	5	0.800	21	14	7
9	Pantano, Stefano	ITA	4	5	0.800	24	19	5
10	Yoon, Nam-Jin	KOR	4	5	0.800	21	19	2
11	Brill, Martin	NZL	3	5	0.600	23	18	5
12	Tichko, Mikhail	URS	3	5	0.600	22	18	4
13	Kardolus, Arwin	HOL	3	5	0.600	19	16	3
14	Mazzoni, Angelo	ITA	3	5	0.600	20	17	3
15	Cuomo, Sandro	ITA	3	5	0.600	20	17	3
16	Pusch, Alexander	FRG	3	5	0.600	21	18	3
17	Vanky, Peter	SWE	3	5	0.600	23	20	3
18	Gadomski, Witold	POL	3	5	0.600	24	21	3
19	Szekely, Zoltan	HUN	3	5	0.600	21	19	2
20	Dessureault, Michel	CAN	3	5	0.600	21	19	2
21	Strohmeier, Arno	AUT	3	5	0.600	22	20	2
22	Gaille, Patrice	SUI	3	5	0.600	23	21	2
23	Gerull, Thomas	FRG	3	5	0.600	21	20	1
24	Du, Zhencheng	CHN	2	5	0.400	21	18	3
25	Joos, Stefan	BEL	2	5	0.400	19	17	2
26	Reznitchenko, Vladimir	URS	2	5	0.400	19	18	1
27	Machado, Antonio	BRA	2	5	0.400	19	19	0
28	Ganef, Stephane	HOL	2	5	0.400	17	19	-2
29	Kolczonay, Emo	HUN	2	5	0.400	18	20	-2
30	Rivas, Mauricio	COL	2	5	0.400	19	22	-3
31	Poffet, Michel	SUI	2	5	0.400	16	20	-4
32	Nagele, Johannes	AUT	2	5	0.400	15	24	-9

The above athletes are qualified/Les athletes ci-haut se qualifient

The following athletes are eliminated/Les athletes suivants sont elimines

33	Chronowski, Ludomir	POL	2	5	0.400	16	18	-2
34	Proske, Uwe	GDR	2	5	0.400	17	21	-4
35	Fonseca, Douglas	BRA	2	5	0.400	15	23	-8
36	Pasztor, Szabolcs	HUN	1	5	0.200	23	23	0
37	Ma, Zhi	CHN	1	5	0.200	18	22	-4
38	Trevor, Stephen	USA	1	5	0.200	15	21	-6
38	Paz, Juan Miguel	COL	1	5	0.200	15	21	-6
40	Llewellyn, John	GBR	1	5	0.200	17	23	-6
41	Di Tella, Rafael M	ARG	1	5	0.200	18	24	-6
42	Lazzarini, Roberto	BRA	1	5	0.200	14	24	-10
43	Siess, Cezary	POL	1	5	0.200	13	24	-11
44	Alhamar, Mohammad	KUW	1	5	0.200	11	23	-12
45	Pinto, Joaquin	COL	1	5	0.200	12	24	-12
46	Kuhn, Andre	SUI	0	5	0.000	15	25	-10
47	Stull, Robert	USA	0	5	0.000	14	25	-11
48	Birnbaum, Axel	AUT	0	5	0.000	9	25	-16

Escrime

Men Epee-Individual/Sept. 23-24			Hommes Epee-Individuel/23-24 Sept		
Rank Rang	Ctry Pays	Name Nom			
1	FRG	Schmitt, Arnd			
2	FRA	Riboud, Philippe			
3	URS	Chouvalov, Andrei			
4	ITA	Cuomo, Sandro			
5	GDR	Kuehnemund, Torsten			
6	SWE	Bergstrom, Jerri			
7	NZL	Brill, Martin			
8	URS	Reznitchenko, Vladimir			
9	FRG	Pusch, Alexander			
10	HUN	Kolczonay, Erno			
11	AUT	Strohmeier, Arno			
12	COL	Rivas, Mauricio			
13	SUI	Gaille, Patrice			
14	ITA	Pantano, Stefano			
15	SUI	Poffet, Michel			
16	HOL	Ganef, Stephane			
17	FRA	Srecki, Eric			
18	FRA	Henry, Jean Michel			
19	KOR	Lee, Sang-Ki			
20	HUN	Szekely, Zoltan			
21	POL	Gadomski, Witold			
22	BEL	Joos, Stefan			
23	FRG	Gerull, Thomas			
24	AUT	Nagele, Johannes			
25	ITA	Mazzoni, Angelo			
26	URS	Tichko, Mikhail			
27	HOL	Kardolus, Arwin			
28	KOR	Yoon, Nam-Jin			
29	SWE	Vanky, Peter			
30	BRA	Machado, Antonio			
31	CAN	Dessureault, Michel			
32	CHN	Du, Zhencheng			
33	POL	Chronowski, Ludomir			
34	GDR	Proske, Uwe			
35	BRA	Fonseca, Douglas			
36	HUN	Pasztor, Szabolcs			
37	CHN	Ma, Zhi			
38	USA	Trevor, Stephen			
38	COL	Paz, Juan Miguel			
40	GBR	Llewellyn, John			
41	ARG	Di Tella, Rafael M			
42	BRA	Lazzarini, Roberto			
43	POL	Siess, Cezary			
44	KUW	Alhamar, Mohammad			
45	COL	Pinto, Joaquin			
46	SUI	Kuhn, Andre			
47	USA	Stull, Robert			
48	AUT	Birnbaum, Axel			
49	GBR	Kernohan, Hugh			
50	KOR	Lee, Il-Hee			
51	ESP	Fernandez, Angel			
52	BEL	Soumagne, Thierry			
53	KUW	Almashmoum, Younes			
54	AUS	Davidson, Robert			
54	SWE	Drakenberg, Otto			
56	ESP	Pena, Fernando			
57	ARG	Turiace, Sergio R			
57	FIN	Winter, Lars			
59	HKG	Chan, Kai Sang			
60	POR	Durao, Roberto			
61	CAN	Cote, Alain			
62	KUW	Jahrami, Khaled			
63	CAN	Chouinard, Jean-Marc			
64	HKG	Tong, King King			
65	ESP	Pereira, Manuel			
66	BRN	Khalid, Abdul Rahman			
67	POR	Bandeira, Jose			
68	BRN	Farhan, Saleh			
69	BRN	Al Doseri, Ahmed			
70	ARU	Thomas, Austin			
71	USA	Marx, Robert			
72	HOL	Driessen, Michiel			
73	TPE	Wang, San-Tsai			
74	LIB	El-khouy, Zahi			
74	POR	Pinto, Oscar			
74	JOR	Abuzamia, Ali			
77	HKG	Tang, Wing Keung			
78	LIB	Youssef, Michel			
79	PAR	Bogarin Arzamendia, Alfredo Ba			



Men Epee-Individual Direct Elimination W/R. Table A
Competition Summary

Hommes/Epee-Individuel Elimination Directe A/R. Tableau A
Tableau de la Competition



Fencing

Escrime

Men Epee-Individual Direct Elimination W/R. Table E
Competition Summary

Hommes/Epee-Individuel Elimination Directe A/R. Tableau E
Tableau de la Competition

Table/Tableau E

Tableau F

Schmitt, Arn (FRG)	Schmitt, Arn (FRG)	Schmitt, Arn (FRG) 10/08
Nagele, Joha (AUT)	10/02	
Srecki, Eric (FRA)	Poffet, Mich (SUI)	Schmitt, Arn (FRG) 10/08
Poffet, Mich (SUI)	10/05	
Joos, Stefan (BEL)	Gaille, Patr (SUI)	Brill, Marti (NZL) 10/05
Gaille, Patr (SUI)	10/05	
Gerull, Thom (FRG)	Brill, Marti (NZL)	Brill, Marti (NZL) 10/05
Brill, Marti (NZL)	10/07	
Gadomski, Wi (POL)	Pantano, Ste (ITA)	Cuomo, Sandr (ITA) 10/05
Pantano, Ste (ITA)	10/05	
Szekely, Zol (HUN)	Cuomo, Sandr (ITA)	Cuomo, Sandr (ITA) 10/05
Cuomo, Sandr (ITA)	10/09	
Kolczonay, E (HUN)	Kolczonay, E (HUN)	Kolczonay, E (HUN) 10/09
Henry, J (FRA)	10/08	
Ganeff, Step (HOL)	Ganeff, Step (HOL)	Kolczonay, E (HUN) 10/09
Lee, Sang-Ki (KOR)	10/04	

Men Epee-Individual Direct Elimination W/R. Table G
Competition Summary

Hommes/Epee-Individuel Elimination Directe A/R. Tableau G
Tableau de la Competition

Table/Tableau G

Riboud, Phil (FRA)	Riboud, Phil (FRA)
Kolczonay, E (HUN)	10/06
Schmitt, Arn (FRG)	Schmitt, Arn (FRG)
Rivas, Maurc (COL)	10/02
Strohmeier, (AUT)	Brill, Marti (NZL)
Brill, Marti (NZL)	10/07
Cuomo, Sandr (ITA)	Cuomo, Sandr (ITA)
Pusch, Alexa (FRG)	10/04



Women Epee-Individual Final Table
Competition Summary

Hommes/ Epee-Individuel Tableau Finale
Tableau de la Competition

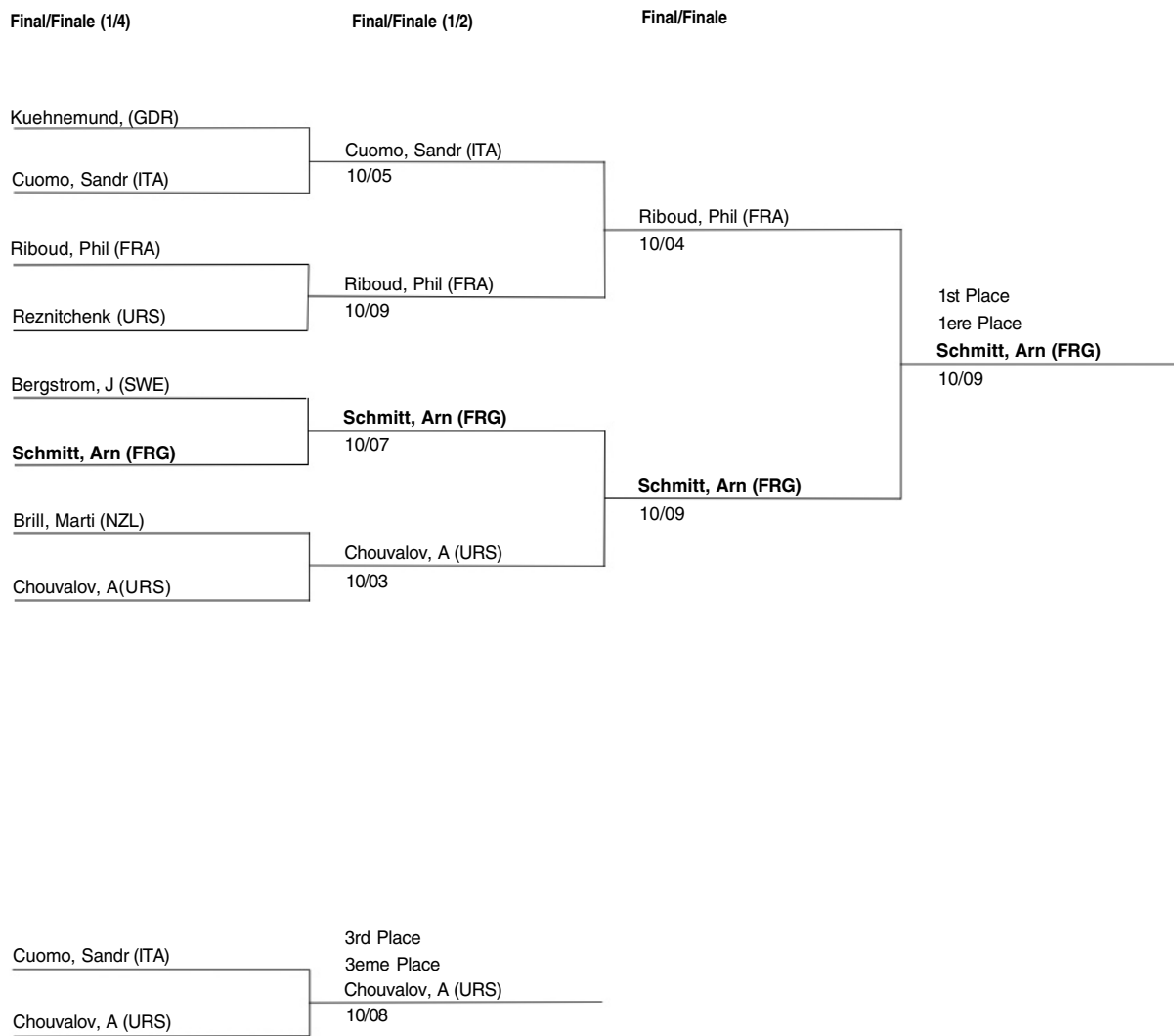

Fencing

Escrime

Men Foil-Team			Hommes/Fleuret-Equipes													
Prelim. Round 1 Pool 1 Match 1/Sept. 26			Prelim. Tour 1 Poule 1 Match 1/26 Sept													
Ctry Pays	Name Nom	Order Ordre	1	2	3	4	*	5	6	7	8	*	V	TD	TR	
			Total:											0	18	45
KUW	Alawadhi, Khaled	1												0	4	15
	Mohammad, Salman	2												4	4	10
	Alsurayei, Saqer	3												2	0	10
	Alharshani, Faisal	4												1	2	10
	Jahrami, Khaled	*												0	0	0
			Total:											9	45	18
GDR	Gusek, Jens	5		V	V									2	10	5
	Germanus, Adrian	6		V	V	V								3	15	4
	Enkelmann, Aris	7		V	V									2	10	8
	Howe, Jens	8		V	V									2	10	1
	Wagner, Udo	*												0	0	0

Men Foil-Team			Hommes/Fleuret-Equipes													
Prelim. Round 1 Pool 1 Match 6/Sept. 26			Prelim. Tour 1 Poule 1 Match 6/26 Sept													
Ctry Pays	Name Nom	Order Ordre	1	2	3	4	*	5	6	7	8	*	V	TD	TR	
			Total:											9	59	46
GDR	Wagner, Udo	1												V	V	4
	Gusek, Jens	2												4	V	2
	Howe, Jens	3												2	V	V
	Germanus, Adrian	4												V	V	V
	Enkelmann, Aris	*												3	15	6
			Total:											0	0	0
			Total:											5	46	59
CHN	Liu, Yunhong	5		4	V	V	1							2	15	16
	Zhang, Zhicheng	6		0	1	4	2							0	7	20
	Lao, Shaopei	7		4	V	3								1	12	12
	Ye, Chong	8		V	V	2								2	12	11
		*												0	0	0

Men Foil-Team			Hommes/Fleuret-Equipes													
Prelim. Round 1 Pool 1 Match 2/Sept. 26			Prelim. Tour 1 Poule 1 Match 2/26 Sept													
Ctry Pays	Name Nom	Order Ordre	1	2	3	4	*	5	6	7	8	*	V	TD	TR	
			Total:											7	60	65
GBR	Gosbee, William	1												*	V	V
	Mckenzie, Donald	2												1	4	V
	Davis, Jonathan	3												V	4	3
	Bartlett, Anthony	4												0	V	4
	Harper, Pierre	*												4		5
			Total:											9	65	60
CHN	Liu, Yunhong	5		*	V	3	V	V						3	18	10
	Zhang, Zhicheng	6		2	V	V	3							2	15	18
	Lao, Shaopei	7		2	3	V	V							2	15	17
	Ye, Chong	8		V	3	4	V							2	17	15
		0												0	0	0

Men Foil-Team			Hommes/Fleuret-Equipes													
Prelim. Round 1 Pool 2 Match 1/Sept. 26			Prelim. Tour 1 Poule 2 Match 1/26 Sept													
Ctry Pays	Name Nom	Order Ordre	1	2	3	4	*	5	6	7	8	*	V	TD	TR	
			Total:											0	10	45
HKG	Lee, Chung Man	1													2	1
	Weng, Tak Fung	2												2		1
	Choy, Kam Shing	3												1		0
	Tong, King King	4												1	2	
	Tang, Wing Keung	*												0	3	10
			Total:											0	0	0
			Total:											9	45	10
URS	Koretskii, Boris	5			V	V	V							2	10	3
	Mamedov, Ilgar	6			V	V	V							3	15	5
	Ibragimov, Anvar	7			V	V	V							2	10	2
	Aptsiaouri, Vladimir	8			V	V	V							2	10	0
	Romankov, Alexandre	*												0	0	0

Men Foil-Team			Hommes/Fleuret-Equipes													
Prelim. Round 1 Pool 1 Match 3/Sept. 26			Prelim. Tour 1 Poule 1 Match 3/26 Sept													
Ctry Pays	Name Nom	Order Ordre	1	2	3	4	*	5	6	7	8	*	V	TD	TR	
			Total:											9	56	33
CHN	Liu, Yunhong	1													V	V
	Zhang, Zhicheng	2												3	V	V
	Ye, Chong	3												V	4	V
	Lao, Shaopei	4												4	V	V
		*												2	14	10
			Total:											0	0	0
			Total:											3	33	56
KUW	Mohammad, Salman	5			V	1	V							2	11	12
	Alawadhi, Khaled	6			3	V	2							1	10	14
	Alsurayei, Saqer	7			3	1	3							0	7	15
	Alharshani, Faisal	8			1	2	2							0	5	15
	Jahrami, Khaled	*												0	0	0

Men Foil-Team			Hommes/Fleuret-Equipes													
Prelim. Round 1 Pool 2 Match 2/Sept. 26			Prelim. Tour 1 Poule 2 Match 1/26 Sept													
Ctry Pays	Name Nom	Order Ordre	1	2	3	4	*	5	6	7	8	*	V	TD	TR	
			Total:											9	50	31
POL	Bandach, Leszek	1													4	V
	Sypniewski, Marian	2												V	1	V
	Kielpikowski, Piotr	3												V	V	V
	Ciesielczyk, Waldemar	4												V	V	V
	Zych, Boguslaw	*												2	10	4
			Total:											0	0	0
			Total:											2	31	50
CAN	Rocheleau, Luc	5			3	3	0							0	6	15
	Giasson, Benoit	6			V	3	4							1	12	14
	Angers, Stephen	7			2	V								1	7	6
	Nowosielski, Dan	8			0	2	4							0	6	15
	Dessureault, Michel	*												0	0	0

Men Foil-Team			Hommes/Fleuret-Equipes													
Prelim. Round 1 Pool 1 Match 4/Sept. 26			Prelim. Tour 1 Poule 1 Match 4/26 Sept													
Ctry Pays	Name Nom	Order Ordre	1	2	3	4	*	5	6	7	8	*	V	TD	TR	
			Total:											9	53	29
GDR	Wagner, Udo	1													V	V
	Germanus, Adrian	2												V	V	4
	Howe, Jens	3												V	V	4
	Gusek, Jens	4												*	V	
	Enkelmann, Aris	*												V		3
			Total:											2	29	53
GBR	Gosbee, William	5			2	0	*	3						0	5	15
	Harper, Pierre	6			3	1	2							0	6	15
	Mckenzie, Donald	7			4	V								1	9	9
	Davis, Jonathan	8			3	1	V							1	9	14
	Bartlett, Anthony	*												0	0	0

Men Foil-Team			Hommes/Fleuret-Equipes													
Prelim. Round 1 Pool 2 Match 3/Sept. 26			Prelim. Tour 1 Poule 2 Match 3/26 Sept													
Ctry Pays	Name Nom	Order Ordre	1	2	3	4	*	5	6	7	8	*	V	TD	TR	
			Total:											9	49	26
URS	Ibragimov, Anvar	1													V	V
	Romankov, Alexandre	2												V	V	V
	Aptsiaouri, Vladimir	3												V	V	V
	Koretskii, Boris	4												4	V	
	Mamedov, Ilgar	*												0	0	0
			Total:											1	26	49
CAN	Rocheleau, Luc	5			1	3	V							1	9	14
	Giasson, Benoit	6			3	1	4							0	8	15
	Angers, Stephen	7			2	2								0	4	10
	Nowosielski, Dan	8			2	3								0	5	10
	Dessureault, Michel	*												0	0	0

Men Foil-Team			Hommes/Fleuret-Equipes													
Prelim. Round 1 Pool 1 Match 5/Sept. 26			Prelim. Tour 1 Poule 1 Match 5/26 Sept													
Ctry Pays	Name Nom	Order Ordre	1	2	3	4	*	5	6	7	8	*	V	TD	TR	
			Total:											9	53	49
GBR	Harper, Pierre	1													V	0
	Mckenzie, Donald	2												1	V	V
	Davis, Jonathan	3														

Fencing

Men Foil-Team Prelim. Round 1 Pool 4 Match 3/Sept. 26			Hommes/Fleuret-Equipes Prelim. Tour 1 Poule 4 Match 3/26 Sept													
Ctry Pays	Name Nom	Order Order	1	2	3	4	*	5	6	7	8	*	V	TD	TR	
													Total:	9	57	38
ITA	Borella, Andrea	1						V	V	V	1		3	16	8	
	Numa, Mauro	2						V	V	2	V		3	17	9	
	Cipressa, Andrea	3						V	3		V		2	13	10	
	Cervi, Federico	4						4	2	*			0	6	10	
	Cerioni, Stefano	*									V		1	5	1	
													Total:	5	38	57
KOR	Kim, Yong-Kook	5	0	3	2	V							1	10	19	
	Hong, Young-Seung	6	1	0	V	V							2	11	15	
	Ko, Nak-Choon	7	2	V		*	1						1	8	12	
	Lee, Young-Rok	8	V	1	3								1	9	11	
	Kim, Seung-Pyo	*											0	0	0	

Men Foil-Team Prelim. Round 1 Pool 4 Match 4/Sept. 26			Hommes/Fleuret-Equipes Prelim. Tour 1 Poule 4 Match 4/26 Sept													
Ctry Pays	Name Nom	Order Order	1	2	3	4	*	5	6	7	8	*	V	TD	TR	
													Total:	9	57	46
HUN	Ersek, Zsolt	1						*	V	V	V		3	15	8	
	Szekeres, Pal	2						V	V	1	V		3	16	13	
	Szelei, Istvan	3						V	V		4		2	14	9	
	Gatai, Robert	4						3	3	*			0	6	10	
	Busa, Istvan	*						V		1			1	6	6	
													Total:	5	46	57
JPN	Deno, Harunobu	5	*	4	3	V	1						1	13	18	
	Umezawa, Kenichi	6	2	3	1	V							1	11	18	
	Emura, Koji	7	3	V		*	V						2	13	7	
	Kanatsu, Yoshihiko	8	3	1	V								1	9	14	
	Azuma, Matsuo	*											0	0	0	

Men Foil-Team Prelim. Round 1 Pool 4 Match 5/Sept. 26			Hommes/Fleuret-Equipes Prelim. Tour 1 Poule 4 Match 5/26 Sept													
Ctry Pays	Name Nom	Order Order	1	2	3	4	*	5	6	7	8	*	V	TD	TR	
													Total:	4	45	58
JPN	Azuma, Matsuo	1						3	V	4	4		1	16	19	
	Emura, Koji	2						1		V	2		1	8	14	
	Umezawa, Kenichi	3						1	2	*	4		0	7	15	
	Kanatsu, Yoshihiko	4						V	V	4			2	14	10	
	Deno, Harunobu	*											0	0	0	
													Total:	9	58	45
KOR	Ko, Nak-Choon	5	V	V	V	2							3	17	10	
	Hong, Young-Seung	6	4		V	3							1	12	12	
	Kim, Seung-Pyo	7	V	4		V							2	14	13	
	Kim, Yong-Kook	8	V	V	V								3	15	10	
	Lee, Young-Rok	*											0	0	0	

Men Foil-Team Prelim. Round 1 Pool 4 Match 6/Sept. 26			Hommes/Fleuret-Equipes Prelim. Tour 1 Poule 4 Match 6/26 Sept													
Ctry Pays	Name Nom	Order Order	1	2	3	4	*	5	6	7	8	*	V	TD	TR	
													Total:	9	59	53
ITA	Cerioni, Stefano	1						V	4	V	V		3	19	14	
	Numa, Mauro	2						3	0	V	V		2	13	12	
	Borella, Andrea	3						V	2	*	V		3	17	15	
	Cipressa, Andrea	4						1	4	V		V	1	10	12	
	Cervi, Federico	*											0	0	0	
													Total:	6	53	59
HUN	Ersek, Zsolt	5	2	V	4	V							2	16	14	
	Szekeres, Pal	6	V	V	V	V							4	20	10	
	Gatai, Robert	7	3	1	*	2							0	6	15	
	Szelei, Istvan	8	4	1	2								0	7	15	
	Busa, Istvan	*			4								0	4	5	

Men Foil-Team Rank of Eliminated Ath./Sept. 26-27			Hommes/Fleuret-Equipes Place des Elimines/26-27 Sept			
Rank Rang	Ctry Pays	PTS PTS	V-D	TD-TR	TR	

The following teams are 3rd class in the pool/
Les equipes suivantes sont classees 3emes dans les poules

9	KOR	2	-2	-16	158
10	GBR	2	-5	-25	167
11	CAN	2	-7	-15	119
12	SWE	2	-8	-25	132

The following teams are 4th class in the pool/
Les equipes suivantes sont classees 4emes dans les poules

13	JPN	0	-16	-43	168
14	USA	0	-18	-48	156
15	KUW	0	-19	-54	154
16	HKG	0	-26	-88	137

Escrime

Men Foil-Team/Sept. 26-27		Hommes Fleuret-Equipes/26-27 Sept	
Rank Rang	Ctry Pays	Name Nom	
1	URS	Aptsiaouri, Vladimir Ibraguimov, Anvar Koretskii, Boris Mamedov, Ilgar Romankov, Alexandre	
2	FRG	Behr, Matthias Endres, Thomas Gey, Mathias Schreck, Ulrich Weidner, Thorsten	
3	HUN	Busa, Istvan Ersek, Zsolt Gatai, Robert Szekeres, Pal Szelei, Istvan	
4	GDR	Enkelmann, Aris Germanus, Adrian Gusek, Jens Howe, Jens Wagner, Udo	
5	POL	Bandach, Leszek Ciesielczyk, Waldemar Kielpikowski, Piotr Sypniewski, Marian Zych, Boguslaw	
6	FRA	Bel, Laurent Groc, Patrick Hocine, Youssef Lhotellier, Patrice Omnes, Philippe	
7	ITA	Borella, Andrea Cerioni, Stefano Cervi, Federico Cipressa, Andrea Numa, Mauro	
8	CHN	Lao, Shaopei Liu, Yunhong Ye, Chong Zhang, Zhicheng	
9	KOR	Hong, Young-Seung Kim, Seung-Pyo Kim, Yong-Kook Ko, Nak-Choon Lee, Young-Rok	
10	GBR	Bartlett, Anthony Davis, Jonathan Gosbee, William Harper, Pierre Mckenzie, Donald	
11	CAN	Angers, Stephen Dessureault, Michel Giasson, Benoit Nowosielski, Dan Rocheleau, Luc	
12	SWE	Akerberg, Peter Akerberg, Thomas Kajbjer, Ola Strand, Eric Taeckenstroem, Per	
13	JPN	Azuma, Matsuo Deno, Harunobu Emura, Koji Kanatsu, Yoshihiko Umezawa, Kenichi	
14	USA	Lewis, Peter Littell, David Marx, Michael Massialas, Gregory Nonomura, George	
15	KUW	Alawadhi, Khaled Alharshani, Faisal Alsurayei, Saqer Jahrami, Khaled Mohammad, Salman	
16	HKG	Choy, Kam Shing Lee, Chung Man Tang, Wing Keung Tong, King King Weng, Tak Fung	



Men Foil-Team Final Table
Competition Summary

Hommes/Fleuret-Equipes Tableau Final
Tableau de la Competition

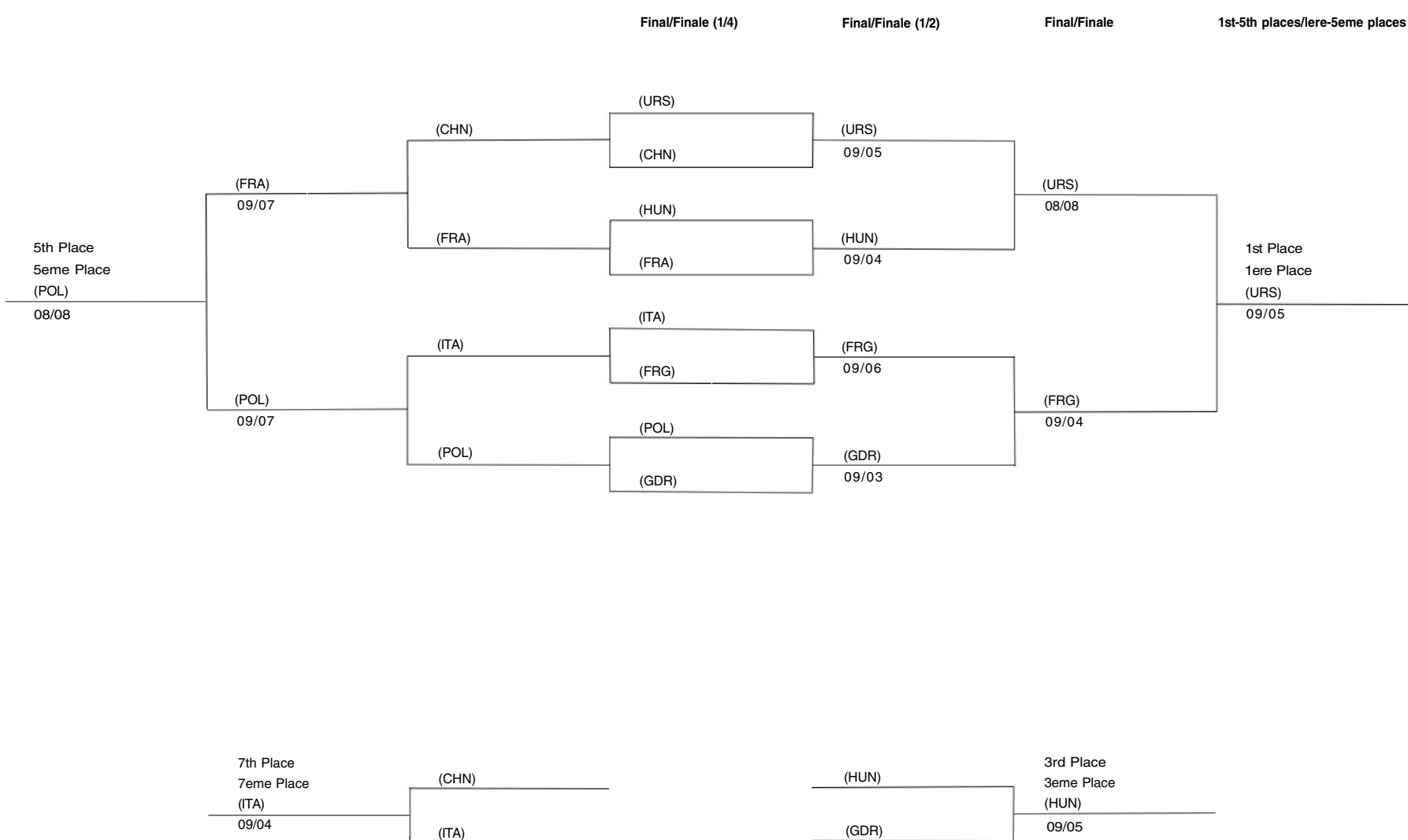

Fencing

Esgrime

Men Sabre-Team			Hommes/Sabre-Equipes														
Prelim. Round 1 Pool 1 Match 1/Sept. 28			Prelim. Tour 1 Poule 1 Match 1/28 Sept														
Ctry Pays	Name Nom	Order Order	1	2	3	4	*	5	6	7	8	*	V	TD	TR		
HUN	Nebald, Gyorgy	1							V	2	V			9	47	38	
	Szabo, Bence	2						V		V	V			2	12	11	
	Bujdosó, Imre	3						V	V		V			3	15	9	
	Gedoevari, Imre	4						V	0					3	15	10	
	Csongradi, Laszlo	*												1	5	8	
													0	0	0		
														Total:	2	38	47
BUL	Marinechechki, Nikolai	5		2	3	3								0	8	15	
	Etropolski, Hristo	6	2		4	V								1	11	10	
	Etropolski, Vassil	7	V	4										1	9	7	
	Tchomakov, Gueorgui	8	4	3	3									0	10	15	
	Mateev, Nikolai	*												0	0	0	

Men Sabre-Team			Hommes/Sabre-Equipes														
Prelim. Round 1 Pool 1 Match 2/Sept. 28			Prelim. Tour 1 Poule 1 Match 2/28 Sept														
Ctry Pays	Name Nom	Order Order	1	2	3	4	*	5	6	7	8	*	V	TD	TR		
FRA	Lamour, Jeanfrancois	1							V	V	V			9	54	36	
	Ducheix, Franck	2						V		4	4			3	15	9	
	Delrieu, Philippe	3						V	1		V			2	11	7	
	Guichot, Pierre	4						V	V	V				3	15	7	
	Granger Veyron, Herve	*												0	0	0	
														Total:	3	36	54
BUL	Mateev, Nikolai	5		3	2	1								0	6	15	
	Etropolski, Hristo	6	2		V	4								1	11	11	
	Etropolski, Vassil	7	4	V		2								1	11	14	
	Tchomakov, Gueorgui	8	3	V	0									1	8	14	
	Marinechechki, Nikolai	*												0	0	0	

Men Sabre-Team			Hommes/Sabre-Equipes														
Prelim. Round 1 Pool 1 Match 3/Sept. 28			Prelim. Tour 1 Poule 1 Match 3/28 Sept														
Ctry Pays	Name Nom	Order Order	1	2	3	4	*	5	6	7	8	*	V	TD	TR		
FRA	Lamour, Jeanfrancois	1						1	V	2	4			4	37	60	
	Ducheix, Franck	2						1		2	1			1	12	19	
	Delrieu, Philippe	3						2	V		0			0	4	15	
	Guichot, Pierre	4						2	V					1	7	14	
	Granger Veyron, Herve	*						4	V	V				2	14	12	
														0	0	0	
														Total:	9	60	37
HUN	Nebald, Gyorgy	5	V	V	V	V								4	20	8	
	Szabo, Bence	6	4		4	4								0	12	15	
	Gedoevari, Imre	7	V	V		3								2	13	9	
	Bujdosó, Imre	8	V	V	V									3	15	5	
	Csongradi, Laszlo	*												0	0	0	

Men Sabre-Team			Hommes/Sabre-Equipes														
Prelim. Round 1 Pool 2 Match 1/Sept. 28			Prelim. Tour 1 Poule 2 Match 1/28 Sept														
Ctry Pays	Name Nom	Order Order	1	2	3	4	*	5	6	7	8	*	V	TD	TR		
ITA	Marin, Marco	1							V	4	V			9	50	30	
	Dalla barba, Gianfranco	2						V		V	*	V		2	14	11	
	Cavaliere, Massimo	3						V	V		V			3	15	7	
	Meglio, Ferdinando	4						1	V					1	6	5	
	Scalzo, Giovanni	*												0	0	0	
														Total:	2	30	50
KOR	Lee, Hyo-Kun	5		3	1	V								1	9	11	
	Kim, Sang-Wook	6	3		3	0								0	6	15	
	Lee, Wook-Jae	7	V	2										1	7	9	
	Lee, Byung-Nam	8	3	*	3									0	6	10	
	Lee, Hyun-Soo	*		2										0	2	5	

Men Sabre-Team			Hommes/Sabre-Equipes														
Prelim. Round 1 Pool 2 Match 2/Sept. 28			Prelim. Tour 1 Poule 2 Match 2/28 Sept														
Ctry Pays	Name Nom	Order Order	1	2	3	4	*	5	6	7	8	*	V	TD	TR		
FRG	Nolte, Juergen	1							V	V	V			9	48	35	
	Kempenich, Joerg	2						V		V	V			3	15	6	
	Thoennessen, Stephan	3						1	V		1			1	7	13	
	Becker, Felix	4						V	1	*		V		2	11	9	
	Schneider, Dieter	*												0	0	0	
														Total:	3	35	48
USA	Westbrook, Peter	5		3	V	1								1	9	11	
	Lofton, Michael	6	1		3	V								1	9	11	
	Friedberg, Paul	7	2	2		*								0	4	10	
	Mormando, George	8	3	2	V									1	10	11	
	Cottingham, Robert	*				3								0	3	5	

Men Sabre-Team			Hommes/Sabre-Equipes														
Prelim. Round 1 Pool 2 Match 3/Sept. 28			Prelim. Tour 1 Poule 2 Match 3/28 Sept														
Ctry Pays	Name Nom	Order Order	1	2	3	4	*	5	6	7	8	*	V	TD	TR		
FRG	Becker, Felix	1								4	V			9	49	29	
	Nolte, Juergen	2						V		V			2	14	9		
	Schneider, Dieter	3						V	V		V		2	10	8		
	Kempenich, Joerg	4						V	V				3	15	4		
	Thoennessen, Stephan	*											2	10	8		
													0	0	0		
														Total:	1	29	49
KOR	Lee, Wook-Jae	5		4	3	4								0	11	15	
	Lee, Hyun-Soo	6	V		0	4								1	9	14	
	Lee, Hyo-Kun	7	2	4										0	6	10	
	Kim, Sang-Wook	8	2		1									0	3	10	
	Lee, Byung-Nam	*												0	0	0	

Men Sabre-Team			Hommes/Sabre-Equipes														
Prelim. Round 1 Pool 2 Match 4/Sept. 28			Prelim. Tour 1 Poule 2 Match 4/28 Sept														
Ctry Pays	Name Nom	Order Order	1	2	3	4	*	5	6	7	8	*	V	TD	TR		
ITA	Scalzo, Giovanni	1							V	4	V	2		9	56	37	
	Marin, Marco	2						2		V	V		2	12	8		
	Dalla Barba, Gianfranco	3						3	V		V		2	13	7		
	Meglio, Ferdinando	4						V	V	V			3	15	6		
	Cavaliere, Massimo	*											0	0	0		
														Total:	4	37	56
USA	Westbrook, Peter	5	4	V	V	2								2	16	15	
	Lofton, Michael	6	V		1	3								1	9	14	
	Cottingham, Robert	7	2	2		1								0	5	15	
	Mormando, George	8	V	1	1									1	7	12	
	Friedberg, Paul	*												0	0	0	

Men Sabre-Team			Hommes/Sabre-Equipes														
Prelim. Round 1 Pool 2 Match 5/Sept. 28			Prelim. Tour 1 Poule 2 Match 5/28 Sept														
Ctry Pays	Name Nom	Order Order	1	2	3	4	*	5	6	7	8	*	V	TD	TR		
KOR	Lee, Hyun-Soo	1							*	2	3	2	V	5	46	53	
	Lee, Wook-Jae	2						V	4	3	2		1	12	16		
	Lee, Hyo-Kun	3						*	V		0	V	2	10	9		
	Lee, Byung-Nam	4						*	4	1		V	1	10	12		
	Kim, Sang-Wook	*											0	0	0		
														Total:	9	53	46
USA	Westbrook, Peter	5	*	1	*	*								0	1	5	
	Lofton, Michael	6	V	V	4	V								3	19	15	
	Cottingham, Robert	7	V	V		V								3	15	7	
	Mormando, George	8	V	V	V									3	15	4	
	Friedberg, Paul	*	1		0	2								0	3	15	

Men Sabre-Team			Hommes/Sabre-Equipes													
Prelim. Round 1 Pool 2 Match 6/Sept. 28			Prelim. Tour 1 Poule 2 Match 6/28 Sept													
Ctry Pays	Name Nom	Order Order	1	2	3	4	*	5	6	7	8	*	V	TD	TR	
ITA	Scalzo, Giovanni	1							V	V	V	4		9	63	51
	Marin, Marco	2														



Men Sabre-Team			Hommes/Sabre-Equipes												
Prelim. Round 1 Pool 3 Match 2/Sept. 28			Prelim. Tour 1 Poule 3 Match 2/28 Sept												
Ctry	Name	Order	1	2	3	4	*	5	6	7	8	*	V	TD	TR
CAN	Banos, Jean-Paul	1													
	Banos, Jean-Marie	2							V	3	3		1	11	13
	Balk, Wulfe	3							3	3		3	0	9	15
	Plourde, Tony	4							4	3			0	7	10
	Deschenes, Bruno	*											0	0	0
Total:													1	34	48
URS	Korjajkine, Serguei	5		V	V	V							3	15	10
	Pogossov, Gueorgui	6	3		V	V							2	13	11
	Bourtsev, Mikhail	7	V	V									2	10	7
	Mindirgassov, Serguei	8	V		V								2	10	6
	Alchan, Andrei	*											0	0	0
Total:													9	48	34

Men Sabre-Team			Hommes/Sabre-Equipes												
Prelim. Round 1 Pool 3 Match 3/Sept. 28			Prelim. Tour 1 Poule 3 Match 3/28 Sept												
Ctry	Name	Order	1	2	3	4	*	5	6	7	8	*	V	TD	TR
CHN	Wang, Zhiming	1								0	1	2	0	3	15
	Zheng, Zhaokang	2							4		2		0	6	10
	Jia, Guihua	3							0	1		1	0	2	15
	Wang, Ruiji	4							V	3			1	8	9
	*												0	0	0
Total:													9	49	19
URS	Korjajkine, Serguei	5		V	V	4							2	14	9
	Alchan, Andrei	6	V		V	V							3	15	4
	Mindirgassov, Serguei	7	V	V									2	10	3
	Pogossov, Gueorgui	8	V		V								2	10	3
	Bourtsev, Mikhail	*											0	0	0
Total:													9	49	19

Men Sabre-Team			Hommes/Sabre-Equipes												
Prelim. Round 1 Pool 3 Match 4/Sept. 28			Prelim. Tour 1 Poule 3 Match 4/28 Sept												
Ctry	Name	Order	1	2	3	4	*	5	6	7	8	*	V	TD	TR
POL	Olech, Janusz	1								4	V	4	1	13	10
	Koscielniakowski, Robert	2							V		V	V	3	15	8
	Kostrzewa, Andrzej	3							V	V		V	3	15	5
	Pigula, Tadeusz	4							V	4	V		2	14	12
	Gniewkowski, Marek	*											0	0	0
Total:													3	35	57
CAN	Banos, Jean-Marie	5		2	1	3							0	6	15
	Banos, Jean-Paul	6	V		2	V							2	12	13
	Deschenes, Bruno	7	0	4		4							0	8	15
	Balk, Wulfe	8	V	2	2								1	9	14
	Plourde, Tony	*											0	0	0
Total:													9	48	34

Men Sabre-Team			Hommes/Sabre-Equipes												
Prelim. Round 1 Pool 3 Match 5/Sept. 28			Prelim. Tour 1 Poule 3 Match 5/28 Sept												
Ctry	Name	Order	1	2	3	4	*	5	6	7	8	*	V	TD	TR
CHN	Wang, Zhiming	1								V	V	1	V	3	16
	Zheng, Zhaokang	2							4	3	V	4	1	16	16
	Jia, Guihua	3							1	4	*	V	V	2	15
	Wang, Ruiji	4							0	4	V	4	1	13	19
	*												0	0	0
Total:													7	60	62
CAN	Banos, Jean-Marie	5	4	V	V	V							3	19	10
	Banos, Jean-Paul	6	1	V	V	V							3	16	16
	Plourde, Tony	7	V	1	*	4							1	10	11
	Balk, Wulfe	8	2	V	4	V							2	16	18
	Deschenes, Bruno	*				1							0	1	5
Total:													9	62	60

Men Sabre-Team			Hommes/Sabre-Equipes												
Prelim. Round 1 Pool 3 Match 6/Sept. 28			Prelim. Tour 1 Poule 3 Match 6/28 Sept												
Ctry	Name	Order	1	2	3	4	*	5	6	7	8	*	V	TD	TR
POL	Olech, Janusz	1								V	V	V	V	4	20
	Koscielniakowski, Robert	2								V	V	3	4	2	17
	Kostrzewa, Andrzej	3								3	4	3	0	0	10
	Pigula, Tadeusz	4								4	V	3	3	1	15
	Gniewkowski, Marek	*												0	0
Total:													7	62	67
URS	Alchan, Andrei	5	2	4	V	V							2	16	17
	Bourtsev, Mikhail	6	4	2	V	4							1	15	19
	Mindirgassov, Serguei	7	3	V	V	V							3	18	14
	Pogossov, Gueorgui	8	3	V	V	V							3	18	12
	Korjajkine, Serguei	*											0	0	0
Total:													9	67	62

Men Sabre-Team			Hommes/Sabre-Equipes					
Rank of Eliminated Ath./Sept. 28-29			Place des Elimines/28-29 Sept					
Rank	Ctry	PTS	V-D	TD-TR	TR			
The following teams are 3rd class in the pool/ Les equipes suivantes sont classees 3emes dans les poules								
7	USA	0	-11	-32	104			
8	BUL	0	-13	-27	101			
9	CAN	0	-14	-36	105			
The following teams are 4th class in the pool/Les equipes suivantes sont classees 4emes dans les poules								
10	CHN	0	-18	-49	160			
11	KOR	0	-19	-47	152			

Men Sabre-Team/Sept. 28-29			Hommes Sabre-Equipes/28-29 Sept			
Rank	Ctry	Name				
1	HUN	Bujdoso, Imre Csongradi, Laszlo Gedoevari, Imre Nebald, Gyorgy Szabo, Bence				
2	URS	Alchan, Andrei Bourtsev, Mikhail Korjajkine, Serguei Mindirgassov, Serguei Pogossov, Gueorgui				
3	ITA	Cavaliere, Massimo Dalla Barba, Gianfranco Marin, Marco Meglio, Ferdinando Scalzo, Giovanni				
4	FRA	Delrieu, Philippe Ducheix, Franck Granger Veyron, Herve Guichot, Pierre Lamour, Jeanfrancois				
5	POL	Gniewkowski, Marek Koscielniakowski, Robert Kostrzewa, Andrzej Olech, Janusz Pigula, Tadeusz				
6	FRG	Becker, Felix Kempenich, Joerg Nolte, Juergen Schneider, Dieter Thoennessen, Stephan				
7	USA	Cottingham, Robert Friedberg, Paul Lofton, Michael Mormando, George Westbrook, Peter				
8	BUL	Etropolski, Hristo Etropolski, Vassil Marinechechki, Nikolai Mateev, Nikolai Tchomakov, Gueorgui				
9	CAN	Balk, Wulfe Banos, Jean-Marie Banos, Jean-Paul Deschenes, Bruno Plourde, Tony				
10	CHN	Jia, Guihua Wang, Ruiji Wang, Zhiming Zheng, Zhaokang				
11	KOR	Kim, Sang-Wook Lee, Byung-Nam Lee, Hyo-Kun Lee, Hyun-Soo Lee, Wook-Jae				



Men Epee-Team			Hommes/Epee-Equipes															
Prelim. Round 1 Pool 1 Match 1/Sept. 29			Prelim. Tour 1 Poule 1 Match 1/29 Sept															
Ctry Pays	Name Nom	Order Order	1	2	3	4	*	5	6	7	8	*	V	TD	TR			
			Total:													9	48	24
USA	Trevor, Stephen	1							V	V	V			3	15	8		
	Stull, Robert	2						V		3			1	8	7			
	Marx, Robert	3						V	V		V		3	15	6			
	Shelley, Lee	4						V	V				2	10	3			
	Moreau, John	*											0	0	0			
			Total:													1	24	48
BRA	Avila, Regis	5		2	1	1							0	4	15			
	Machado, Antonio	6		3		1	2						0	6	15			
	Lazzarini, Roberto	7		2	V								1	7	8			
	Fonseca, Douglas	8		3		4							0	7	10			
		*											0	0	0			

Men Epee-Team			Hommes/Epee-Equipes															
Prelim. Round 1 Pool 2 Match 3/Sept. 29			Prelim. Tour 1 Poule 2 Match 3/29 Sept															
Ctry Pays	Name Nom	Order Order	1	2	3	4	*	5	6	7	8	*	V	TD	TR			
			Total:													9	55	39
URS	Tikhomirov, Igor	1								2	4	V		1	11	11		
	Chouvalov, Andrei	2						V		V	*	V	3	15	8			
	Kolobkov, Pavel	3						V	V		V		3	15	8			
	Reznitchenko, Vladimir	4						V	4	V			2	14	12			
	Tichko, Mikhail	*											0	0	0			
			Total:													3	39	55
CAN	Chouinard, Jean-Marc	5			2	3	4						0	9	15			
	Bramall, Ian	6		V		4	V						2	14	11			
	Nowosielski, Dan	7		V	2		3						1	10	14			
	Cote, Alain	8		1	*	1							0	2	10			
	Dessureault, Michel	*			4								0	4	5			

Men Epee-Team			Hommes/Epee-Equipes															
Prelim. Round 1 Pool 1 Match 2/Sept. 29			Prelim. Tour 1 Poule 1 Match 2/29 Sept															
Ctry Pays	Name Nom	Order Order	1	2	3	4	*	5	6	7	8	*	V	TD	TR			
			Total:													9	52	26
FRG	Pusch, Alexander	1							V	V	V			3	15	4		
	Schmitt, Arnd	2						V		V	V		3	15	2			
	Fischer, Volker	3						4	2		1		0	7	15			
	Gerull, Thomas	4						V	V	V			3	15	5			
	Borrmann, Elmar	*											0	0	0			
			Total:													3	26	52
BRA	Avila, Regis	5			0	V	3						1	8	14			
	Machado, Antonio	6		2		V	2						1	9	12			
	Lazzarini, Roberto	7		0	2		0						0	2	15			
	Fonseca, Douglas	8		2	0	V							1	7	11			
		*											0	0	0			

Men Epee-Team			Hommes/Epee-Equipes															
Prelim. Round 1 Pool 3 Match 1/Sept. 29			Prelim. Tour 1 Poule 3 Match 1/29 Sept															
Ctry Pays	Name Nom	Order Order	1	2	3	4	*	5	6	7	8	*	V	TD	TR			
			Total:													1	26	48
KUW	Alhamar, Mohammad	1								5	1	4		0	10	15		
	Jahrami, Khaled	2						1		1			0	2	10			
	Almurdh, Nahedh	3						4	1		2		0	7	15			
	Almashmoum, Younes	4						2	V				1	7	8			
		*											0	0	0			
			Total:													9	48	26
POL	Chronowski, Ludomir	5			V	V	V						3	15	7			
	Gadomski, Witold	6		V		V	3						2	13	11			
	Kielpikowski, Piotr	7		V	V								2	10	2			
	Siess, Cezary	8		V		V							2	10	6			
	Zych, Boguslaw	*											0	0	0			

Men Epee-Team			Hommes/Epee-Equipes															
Prelim. Round 1 Pool 1 Match 3/Sept. 29			Prelim. Tour 1 Poule 1 Match 3/29 Sept															
Ctry Pays	Name Nom	Order Order	1	2	3	4	*	5	6	7	8	*	V	TD	TR			
			Total:													9	53	26
FRG	Pusch, Alexander	1							V	V	V			3	15	5		
	Schmitt, Arnd	2						V		4	V		2	14	7			
	Fischer, Volker	3						V	V		V		3	15	7			
	Borrmann, Elmar	4						4	V				1	9	7			
	Gerull, Thomas	*											0	0	0			
			Total:													2	26	53
USA	Trevor, Stephen	5			1	4	V						1	10	14			
	Stull, Robert	6		1		1	2						0	4	15			
	Shelley, Lee	7		2	V								1	7	9			
	Marx, Robert	8		2	1	2							0	5	15			
	Moreau, John	*											0	0	0			

Men Foil-Team			Hommes/Epee-Equipes															
Prelim. Round 1 Pool 3 Match 2/Sept. 29			Prelim. Tour 1 Poule 3 Match 2/29 Sept															
Ctry Pays	Name Nom	Order Order	1	2	3	4	*	5	6	7	8	*	V	TD	TR			
			Total:													0	16	45
KUW	Alhamar, Mohammad	1								2	0	3		0	5	15		
	Almashmoum, Younes	2						3		3			0	6	10			
	Jahrami, Khaled	3								0	3		0	3	10			
	Almurdh, Nahedh	4						1	1				0	2	10			
		*											0	0	0			
			Total:													9	45	16
FRA	Srecki, Eric	5			V	V	V						2	10	4			
	Henry, Jean Michel	6		V		V	V						3	15	3			
	Lenglet, Olivier	7		V	V								2	10	3			
	Delpla, Frederic	8		V		V							2	10	6			
	Riboud, Philippe	*											0	0	0			

Men Epee-Team			Hommes/Epee-Equipes															
Prelim. Round 1 Pool 2 Match 1/Sept. 29			Prelim. Tour 1 Poule 2 Match 1/29 Sept															
Ctry Pays	Name Nom	Order Order	1	2	3	4	*	5	6	7	8	*	V	TD	TR			
			Total:													8	62	62
CAN	Chouinard, Jean-Marc	1							V	V	2	V		3	17	15		
	Nowosielski, Dan	2						V	2	3	V		2	15	17			
	Cote, Alain	3						2	4	5	V		1	16	17			
	Dessureault, Michel	4						2	V	2	*		1	9	12			
	Bramall, Ian	*									V		1	5	1			
			Total:													7	62	62
HOL	Besselink, Paul	5		4	4	V	V						2	18	14			
	Ganeff, Stephane	6		4	V	V	2						2	16	16			
	Kardolus, Arwin	7		V	V	5	V						3	20	12			
	Driessen, Michiel	8		2	3	2	*	1					0	8	20			
	Kardolus, Olaf	*											0	0	0			

Men Epee-Team			Hommes/Epee-Equipes															
Prelim. Round 1 Pool 3 Match 3/Sept. 29			Prelim. Tour 1 Poule 3 Match 3/29 Sept															
Ctry Pays	Name Nom	Order Order	1	2	3	4	*	5	6	7	8	*	V	TD	TR			
			Total:													9	56	32
FRA	Srecki, Eric	1							V	V	V	V		4	20	6		
	Henry, Jean Michel	2						V	3	V	2		2	13	6			
	Lenglet, Olivier	3						V	4	V			2	14	8			
	Delpla, Frederic	4						3	1	*			0	4	10			
	Riboud, Philippe	*								V			1	5	2			
			Total:													4	32	56
POL	Chronowski, Ludomir	5		0	1	2	V						1	8	18			
	Gadomski, Witold	6		1	V	V							2	11	10			
	Kielpikowski, Piotr	7		2	V	*	2						1	9	13			
	Siess, Cezary	8		3	0	1							0	4	15			
	Zych, Boguslaw	*											0	0	0			

Men Epee-Team			Hommes/Epee-Equipes															
Prelim. Round 1 Pool 2 Match 2/Sept. 29			Prelim. Tour 1 Poule 2 Match 2/29 Sept															
Ctry Pays	Name Nom	Order Order	1	2	3	4	*	5	6	7	8	*	V	TD	TR			
			Total:													8	49	35
URS	Chouvalov, Andrei	1							V	V	V			3	15	6		
	Tikhomirov, Igor	2						5		V			1	10	9			
	Kolobkov, Pavel	3						V	V		4		2	14	11			
	Tichko, Mikhail	4					</											

Fencing

Men Epee-Team			Hommes/Epee-Equipes																	
Prelim. Round 1 Pool 4 Match 2/Sept. 29			Prelim. Tour 1 Poule 4 Match 2/29 Sept																	
Ctry	Name	Order	1	2	3	4	*	5	6	7	8	*	V	TD	TR					
Pays	Nom	Order																		
ITA	Mazzoni, Angelo	1											3	*	V	0	V	2	13	15
	Cuomo, Sandro	2											V		V	5		2	15	9
	Pantano, Stefano	3											V	V		5		2	15	8
	Bellone, Stefano	4											V	V	5			2	15	9
	Bermond Des Ambrois, Andrea	*																0	0	0
Total:													8	58	41					
ESP	Fernandez, Oscar	5	V	4	2	1												1	12	18
	Pena, Fernando	6	*		1	3												0	4	10
	Fernandez, Angel	7	1	0		V												1	6	15
	Pereira, Manuel	8	V	V	V													3	15	10
	Maroto, Raul	*	4															0	4	5
	Total:													5	41	58				

Men Epee-Team			Hommes/Fleuret-Equipes																	
Prelim. Round 1 Pool 4 Match 3/Sept. 29			Prelim. Tour 1 Poule 4 Match 3/29 Sept																	
Ctry	Name	Order	1	2	3	4	*	5	6	7	8	*	V	TD	TR					
Pays	Nom	Order																		
ITA	Mazzoni, Angelo	1											V	2	V	V	3	17	9	
	Cuomo, Sandro	2											V	4	3	V	2	17	14	
	Pantano, Stefano	3											V	V		4	2	14	13	
	Bermond Des Ambrois, Andrea	4											4	V	4		1	13	14	
	Bellone, Stefano	*																0	0	0
Total:													6	50	61					
KOR	Lee, Sang-Ki	5	1	2	4	V												1	12	19
	Lee, Il-Hee	6	V	V	4	4												2	18	16
	Cho, Hee-Jae	7	3	V		V												2	13	12
	Yang, Dal-Sik	8	0	2	V													1	7	14
	Yoon, Nam-Jin	*																0	0	0

Men Epee-Team			Hommes/Epee-Equipes																	
Prelim. Round 1 Pool 5 Match 1/Sept. 29			Prelim. Tour 1 Poule 5 Match 1/29 Sept																	
Ctry	Name	Order	1	2	3	4	5	6	7	8	*	V	TD	TR						
Pays	Nom	Order																		
HKG	Chan, Kai Sang	1																		
	Tang, Wing Keung	2		1	1	2														
	Tong, King King	3		4	3	0														
	Choy, Kam Shing	4		1	1															
	Lee, Chung Man	*																		
Total:													2	26	51					
COL	Rivas, Mauricio	5	V	V	V													3	15	6
	Paz, Juan Miguel	6	V	V	V													3	15	7
	Pinto, Joaquin	7	2	V														1	7	6
	Arango, Oscar	8	4	V	V													2	14	7
	Gonzalez, William	*																0	0	0
Total:													9	51	26					

Men Epee-Team			Hommes/Epee-Equipes																	
Prelim. Round 1 Pool 5 Match 2/Sept. 29			Prelim. Tour 1 Poule 5 Match 2/29 Sept																	
Ctry	Name	Order	1	2	3	4	*	5	6	7	8	*	V	TD	TR					
Pays	Nom	Order																		
SUI	Pfefferle, Gerald	1											V	V	V	3	15	6		
	Poffet, Michel	2											V		V	2	10	5		
	Kuhn, Andre	3											*	V	V	2	10	5		
	Gaille, Patrice	4											V	4		1	9	8		
	Madarasz, Zsolt	*											V			1	5	4		
Total:													1	28	49					
HKG	Tong, King King	5	1	*	3	4												0	8	15
	Chan, Kai Sang	6	1	2	V													1	8	14
	Tang, Wing Keung	7	1	4														0	5	10
	Choy, Kam Shing	8	4	3														0	7	10
	Lee, Chung Man	*																0	0	0

Men Epee-Team			Hommes/Epee-Equipes																	
Prelim. Round 1 Pool 5 Match 3/Sept. 29			Prelim. Tour 1 Poule 5 Match 3/29 Sept																	
Ctry	Name	Order	1	2	3	4	*	5	6	7	8	*	V	TD	TR					
Pays	Nom	Order																		
SUI	Pfefferle, Gerald	1											3	V	V	V	3	18	13	
	Poffet, Michel	2											4	*	4	*	0	8	10	
	Kuhn, Andre	3											4	3	V	V	2	17	13	
	Gaille, Patrice	4											V	4	5		1	14	14	
	Madarasz, Zsolt	*											V				2	10	6	
Total:													8	67	56					
COL	Rivas, Mauricio	5	V	V	V	4												3	19	16
	Paz, Juan miguel	6	5	*	V	V	4											2	19	17
	Pinto, Joaquin	7	2	V	1	V												2	1	19
	Arango, Oscar	8	1	*	2		2											0	5	15
	Gonzalez, William	*																0	0	0
Total:													7	56	67					

Esgrime

Men Epee-Team			Hommes/Epee-Equipes																	
Prelim. Round 1 Pool 6 Match 1/Sept. 29			Prelim. Tour 1 Poule 6 Match 1/29 Sept																	
Ctry	Name	Order	1	2	3	4	*	5	6	7	8	*	V	TD	TR					
Pays	Nom	Order																		
SWE	Vanky, Peter	1																		
	Bergdahl, Johan	2											V		V	3	2	13	9	
	Sandegren, Ulf	3											4	V		5	1	14	11	
	Drakenberg, Otto	4											V	V	V		3	15	5	
	Bergstrom, Jerri	*																0	0	0
Total:													9	57	30					
BRN	Al doseri, Ahmed	5																1	10	14
	Khalid, Abdul Rahman	6	1															0	2	15
	Khamis, Khalifa	7	1	1		3												0	5	15
	Farhan, Saleh	8	3	V	V													2	13	13
		*																0	0	0
Total:													3	30	57					

Men Epee-Team			Hommes/Epee-Equipes																	
Prelim. Round 1 Pool 6 Match 2/Sept. 29			Prelim. Tour 1 Poule 6 Match 2/29 Sept																	
Ctry	Name	Order	1	2	3	4	*	5	6	7	8	*	V	TD	TR					
Pays	Nom	Order																		
HUN	Kolczonay, Erno	1																		
	Pasztor, Szabolcs	2											V		V	V	3	15	3	
	Hegedus, Ferenc	3											V	V	V	V	3	15	6	
	Fabian, Laszlo	4											4	V			1	9	6	
	Szekely, Zoltan	*																0	0	0
Total:													1	20	49					
BRN	Aldoseri, Ahmed	5																1	10	14
	Khalid, Abdul Rahman	6	2			3	1											0	6	15
	Khamis, Khalifa	7	0	1														0	1	10
	Farhan, Saleh	8	1		2													0	3	10
		*																0	0	0
Total:													4	1	49					

Men Epee-Team			Hommes/Epee-Equipes																	
Prelim. Round 1 Pool 6 Match 3/Sept. 29			Prelim. Tour 1 Poule 6 Match 3/29 Sept																	
Ctry	Name	Order	1	2	3	4	*	5	6	7	8	*	V	TD	TR					
Pays	Nom	Order																		
HUN	Kolczonay, Erno	1																		
	Pasztor, Szabolcs	2																		



Men
Epee-Team/Sept. 29-30

Hommes
Epee-Equipes/29-30 Sept

Rank Rang	Ctry Pays	Name Nom
1	FRA	Delpla, Frederic Henry, Jean Michel Lenglet, Olivier Riboud, Philippe Srecki, Eric
2	FRG	Borrmann, Elmar Fischer, Volker Gerull, Thomas Pusch, Alexander Schmitt, Arnd
3	URS	Chouvalov, Andrei Kolobkov, Pavel Reznitchenko, Vladimir Tichko, Mikhail Tikhomirov, Igor
4	ITA	Bellone, Stefano Bermond Das Ambrois, Andrea Cuomo, Sandro Mazzoni, Angelo Pantano, Stefano
5	SUI	Gaille, Patrice Kuhn, Andre Madarasz, Zsolt Pfefferle, Gerald Poffet, Michel
6	HUN	Fabian, Laszlo Hegedus, Ferenc Kolczonay, Emo Pasztor, Szabolcs Szekely, Zoltan
7	KOR	Cho, Hee-Jae Lee, Il-Hee Lee, Sang-Ki Yang, Dal-Sik Yoon, Nam-Jin
8	SWE	Bergdahl, Johan Bergstrom, Jerri Drakenberg, Otto Sandegren, Ulf Vanky, Peter
9	COL	Arango, Oscar Gonzalez, William Paz, Juan Miguel Pinto, Joaquin Rivas, Mauricio
10	POL	Chronowski, Ludomir Gadomski, Witold Kielpikowski, Piotr Siess, Cezary Zych, Boguslaw
11	USA	Marx, Robert Moreau, John Shelley, Lee Stull, Robert Trevor, Stephen
12	CAN	Bramall, Ian Chouinard, Jean-Marc Cote, Alain Dessureault, Michel Nowosielski, Dan
13	ESP	Fernandez, Angel Fernandez, Oscar Maroto, Raul Pena, Fernando Pereira, Manuel
14	HOL	Besselink, Paul Driessen, Michiel Ganeff, Stephane Kardolus, Arwin Kardolus, Olaf
15	BRA	Avila, Regis Fonseca, Douglas Lazzarini, Roberto Machado, Antonio
16	BRN	Al Doseri, Ahmed Farhan, Saleh Khalid, Abdul Rahman Khamis, Khalifa
17	HKG	Chan, Kai Sang Choy, Kam Shing Lee, Chung Man Tang, Wing Keung Tong, King King
18	KUW	Alhamar, Mohammad Almashmour, Younes Almurdh, Nahedh Jahrami, Khaled

Fencing

Escrime

Men Epee-Team Final Table
Competition Summary

Hommes/Epee-Equipes Tableau Final
Tableau de la Competition

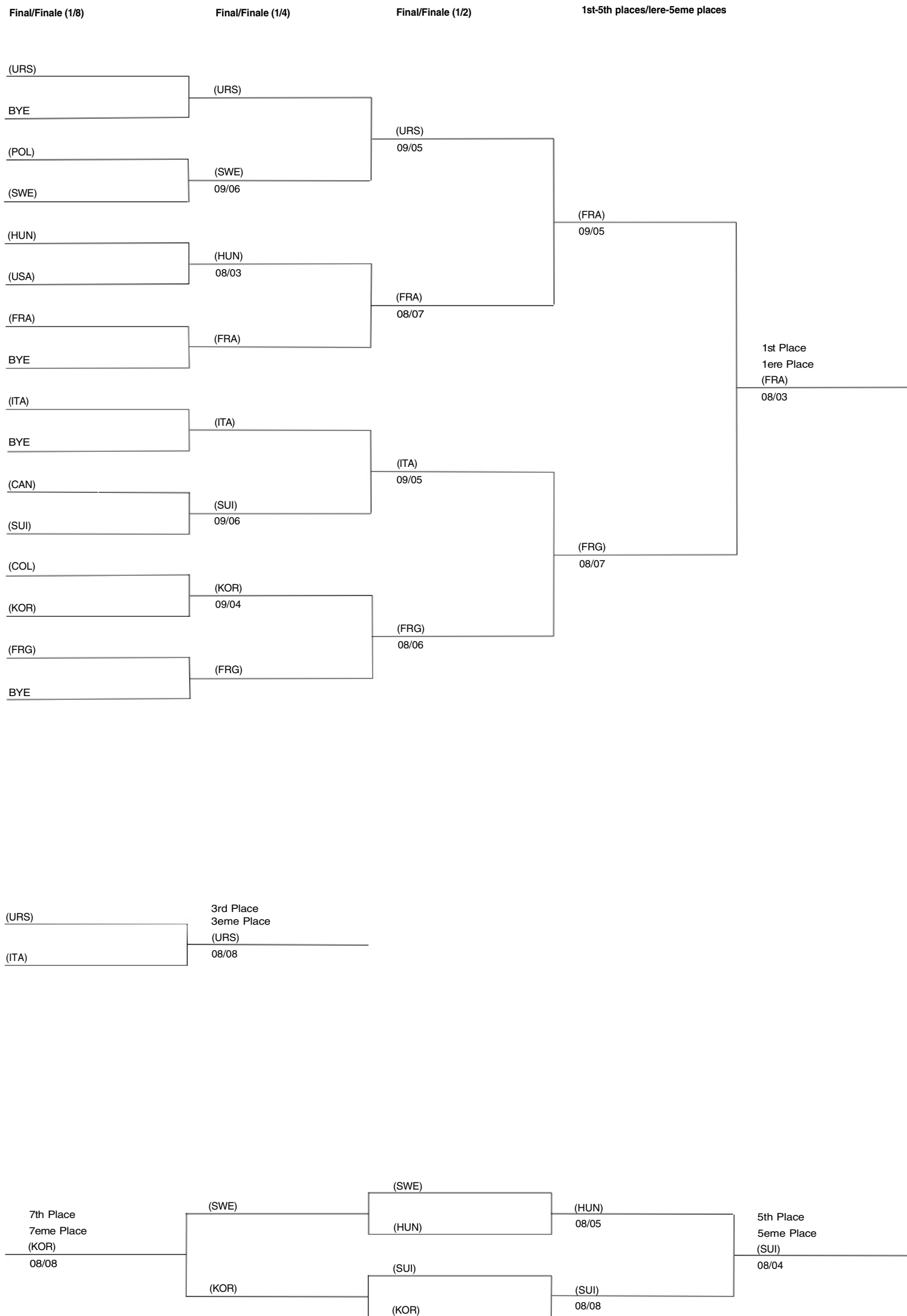



Women Foil-Individual Preliminary Round 1 Pool 1/Sept. 21			Femmes/Fleuret-Individuel Preliminaires Tour 1 Poule 1/21 Sept											
Name Nom	Ctry Pays	Order Ordre	1	2	3	4	5	6	7	V/M	TD	TR	TD-TR	PL
Oka, Tomoko	JPN	1	*	1	V	2	V			0.500	13	13	0	3 Q
Funkenhauser, Zita	FRG	2	V	*	V	V	V			1.000	20	6	14	1 Q
Kovacs, Edit	HUN	3	2	0	*	V	V			0.500	12	14	-2	4 Q
Gaudin, Brigitte	FRA	4	V	1	4	*	V			0.500	15	12	3	2 Q
Koeswandi, Silvia. K	INA	5	1	4	0	0	*			0.000	5	20	-15	5 E

Women Foil-Individual Preliminary Round 1 Pool 2/Sept. 21			Femmes/Fleuret-Individuel Preliminaires Tour 1 Poule 2/21 Sept											
Name Nom	Ctry Pays	Order Ordre	1	2	3	4	5	6	7	V/M	TD	TR	TD-TR	PL
Chaplin, Andrea	AUS	1	*	1	2	4	1			0.000	8	20	-12	5 E
Janosi, Zsuzsanna	HUN	2	V	*	V	4	V			0.750	19	11	8	2 Q
Martin, Linda	GBR	3	V	2	*	4	4			0.250	15	17	-2	4 Q
Modaine, Lavrence	FRA	4	V	V	V	*	V			1.000	20	16	4	1 Q
Monplaisir, Sharon	USA	5	V	3	V	4	*			0.500	17	15	2	3 Q

Women Foil-Individual Preliminary Round 1 Pool 3/Sept. 21			Femmes/Fleuret-Individuel Preliminaires Tour 1 Poule 3/21 Sept											
Name Nom	Ctry Pays	Order Ordre	1	2	3	4	5	6	7	V/M	TD	TR	TD-TR	PL
Luan, Jujie	CHN	1	*	4	2	V	V			0.500	16	13	3	3 Q
Shin, Sung-Ja	KOR	2	V	*	4	V	2			0.500	16	16	0	4 Q
Sobczak, Anna	POL	3	V	V	*	V	3			0.750	18	11	7	2 Q
Yung, Yim King	HKG	4	0	2	0	*	0			0.000	2	20	-18	5 E
Bilodeau, Caitlin	USA	5	3	V	V	V	*			0.750	18	10	8	1 Q

Women Foil-Individual Preliminary Round 1 Pool 4/Sept. 21			Femmes/Fleuret-Individuel Preliminaires Tour 1 Poule 4/21 Sept											
Name Nom	Ctry Pays	Order Ordre	1	2	3	4	5	6	7	V/M	TD	TR	TD-TR	PL
O'Neill, Mary	USA	1	*	4	V	0	1			0.250	10	18	-8	4 Q
Sadovskaia, Tatiana	URS	2	V	*	V	3	V			0.750	18	14	4	2 Q
Miyahara, Mieko	JPN	3	3	3	*	4	3			0.000	13	20	-7	5 E
Vaccaroni, Dorina	ITA	4	V	V	V	*	V			1.000	20	11	9	1 Q
Zhu, Qingyuan	CHN	5	V	2	V	4	*			0.500	16	14	2	3 Q

Women Foil-Individual Preliminary Round 1 Pool 5/Sept. 21			Femmes/Fleuret-Individuel Preliminaires Tour 1 Poule 5/21 Sept											
Name Nom	Ctry Pays	Order Ordre	1	2	3	4	5	6	7	V/M	TD	TR	TD-TR	PL
Park, Eun-Hee	KOR	1	*	1	1	3	0			0.000	5	20	-15	5 E
Fichtel, Anja	FRG	2	V	*	V	V	V			1.000	20	6	14	1 Q
Dubrawska, Agnieszka	POL	3	V	4	*	V	4			0.500	18	15	3	3 Q
Mcintosh, Fiona	GBR	4	V	1	4	*	1			0.250	11	18	-7	4 Q
Sun, Hongyun	CHN	5	V	0	V	V	*			0.750	15	10	5	2 Q

Women Foil-Individual Preliminary Round 1 Pool 6/Sept. 21			Femmes/Fleuret-Individuel Preliminaires Tour 1 Poule 6/21 Sept											
Name Nom	Ctry Pays	Order Ordre	1	2	3	4	5	6	7	V/M	TD	TR	TD-TR	PL
Tremblay, Thalie	CAN	1	*	0	4	V	3			0.250	12	18	-6	4 Q
Tufan, Elisabeta	ROM	2	V	*	4	V	V			0.750	19	9	10	2 Q
Thurley, Elizabeth	GBR	3	V	V	*	V	V			1.000	20	13	7	1 Q
Piros, Andrea	SUI	4	3	1	4	*	1			0.000	9	20	-11	5 E
Spennato, Isabelle	FRA	5	V	3	1	V	*			0.500	14	14	0	3 Q

Women Foil-Individual Preliminary Round 1 Pool 7/Sept. 21			Femmes/Fleuret-Individuel Preliminaires Tour 1 Poule 7/21 Sept											
Name Nom	Ctry Pays	Order Ordre	1	2	3	4	5	6	7	V/M	TD	TR	TD-TR	PL
Zalaffi, Margherita	ITA	1	*	V	V	2	V			0.750	17	8	9	1 Q
Phillion, Madeleine	CAN	2	1	*	1	V	V			0.500	12	16	-4	3 Q
Morikawa, Akemi	JPN	3	1	V	*	2	3			0.250	11	16	-5	5 E
Stefanek, Gertrud	HUN	4	V	4	V	*	4			0.500	18	14	4	2 Q
Krolikowska, Jolanta	POL	5	1	2	V	V	*			0.500	13	17	-4	4 Q

Women Foil-Individual Preliminary Round 1 Pool 8/Sept. 21			Femmes/Fleuret-Individuel Preliminaires Tour 1 Poule 8/21 Sept											
Name Nom	Ctry Pays	Order Ordre	1	2	3	4	5	6	7	V/M	TD	TR	TD-TR	PL
Bau, Sabine	FRG	1	*	V	V	V	V			1.000	20	14	6	1 Q
Palm, Kerstin	SWE	2	4	*	V	V	2			0.500	16	15	1	3 Q
Lazar, Reka zsofia	ROM	3	4	1	*	V	3			0.250	13	15	-2	4 Q
Lopez, Fabiana	MEX	4	4	4	0	*	1			0.000	9	20	-11	5 E
Glikina, Elena	URS	5	2	V	V	V	*			0.750	17	11	6	2 Q

Women Foil-Individual Preliminary Round 1 Pool 9/Sept. 21			Femmes/Fleuret-Individuel Preliminaires Tour 1 Poule 9/21 Sept											
Name Nom	Ctry Pays	Order Ordre	1	2	3	4	5	6	7	V/M	TD	TR	TD-TR	PL
Gandolfi, Annapia	ITA	1	*	V	3	3	V			0.500	16	14	2	3 Q
Poirier, Marie-Jacynthe	CAN	2	1	*	V	V	0			0.500	11	15	-4	4 Q
Vochtchakina, Olga	URS	3	V	3	*	4	V			0.500	17	14	3	2 Q
Tak, Jung-Im	KOR	4	V	2	V	*	V			0.750	17	13	4	1 Q
Mariethoz, Alessandra	SUI	5	3	V	1	1	*			0.250	10	15	-5	5 E

Women Foil-Individual Preliminary Round 1/Sept. 21			Femmes/Fleuret-Individuel Preliminaires Tour 1/21 Sept										
Class	Name Nom	Ctry Pays	V	M	V/M	TD	TR	TD-TR	PL				
1	Funkenhauser, Zita	FRG	4	4	1.000	20	6	14					
2	Fichtel, Anja	FRG	4	4	1.000	20	6	14					
3	Vaccaroni, Dorina	ITA	4	4	1.000	20	11	9					
4	Thurley, Elizabeth	GBR	4	4	1.000	20	13	7					
5	Bau, Sabine	FRG	4	4	1.000	20	14	6					
6	Modaine, Lavrence	FRA	4	4	1.000	20	16	4					
7	Tufan, Elisabeta	ROM	3	4	0.750	19	9	10					
8	Zalaffi, Margherita	ITA	3	4	0.750	17	8	9					
9	Bilodeau, Caitlin	USA	3	4	0.750	18	10	8					
10	Janosi, Zsuzsanna	HUN	3	4	0.750	19	11	8					
11	Sobczak, Anna	POL	3	4	0.750	18	11	7					
12	Glikina, Elena	URS	3	4	0.750	17	11	6					
13	Sun, Hongyun	CHN	3	4	0.750	15	10	5					
14	Tak, Jung-Im	KOR	3	4	0.750	17	13	4					
15	Sadovskaia, Tatiana	URS	3	4	0.750	18	14	4					
16	Stefanek, Gertrud	HUN	2	4	0.500	18	14	4					
17	Gaudin, Brigitte	FRA	2	4	0.500	15	12	3					
18	Luan, Jujie	CHN	2	4	0.500	16	13	3					
19	Vochtchakina, Olga	URS	2	4	0.500	17	14	3					
20	Dubrawska, Agnieszka	POL	2	4	0.500	18	15	3					
21	Zhu, Qingyuan	CHN	2	4	0.500	16	14	2					
22	Gandolfi, Annapia	ITA	2	4	0.500	16	14	2					
23	Monplaisir, Sharon	USA	2	4	0.500	17	15	2					
24	Palm, Kerstin	SWE	2	4	0.500	16	15	1					
25	Oka, Tomoko	JPN	2	4	0.500	13	13	0					
26	Spennato, Isabelle	FRA	2	4	0.500	14	14	0					
27	Shin, Sung-Ja	KOR	2	4	0.500	16	16	0					
28	Kovacs, Edit	HUN	2	4	0.500	12	14	-2					
29	Poirier, Marie-Jacynthe	CAN	2	4	0.500	11	15	-4					
30	Phillion, Madeleine	CAN	2	4	0.500	12	16	-4					
31	Krolikowska, Jolanta	POL	2	4	0.500	13	17	-4					
32	Lazar, Reka zsofia	ROM	1	4	0.250	13	15	-2					
33	Martin, Linda	GBR	1	4	0.250	15	17	-2					
34	Tremblay, Thalie	CAN	1	4	0.250	12	18	-6					
35	Mcintosh, Fiona	GBR	1	4	0.250	11	18	-7					
36	O'Neill, Mary	USA	1	4	0.250	10	18	-8					

The above athletes are qualified/Les athletes ci-haut se qualifient

The following athletes are eliminated/Les athletes suivants sont elimines

37	Mariethoz, Alessandra	SUI	1	4	0.250	10	15	-5	
38	Morikawa, Akemi	JPN	1	4	0.250	11	16	-5	
39	Miyahara, Mieko	JPN	0	4	0.000	13	20	-7	
40	Piros, Andrea	SUI	0	4	0.000	9	20	-11	
40	Lopez, Fabiana	MEX	0	4	0.000	9	20	-11	
42	Chaplin, Andrea	AUS	0	4	0.000	8	20	-12	
43	Koeswandi, Silvia.k	INA	0	4	0.000	5	20	-15	
43	Park, Eun-Hee	KOR	0	4	0.000	5	20	-15	
45	Yung, Yim King	HKG	0	4	0.000	2	20	-18	

Women Foil-Individual Preliminary Round 2 Pool 1/Sept. 21			Femmes/Fleuret-Individuel Preliminaires Tour 2 Poule 1/21 Sept											
Name Nom	Ctry Pays	Order Ordre	1	2	3	4	5	6	7	V/M	TD	TR	TD-TR	PL
Sun, Hongyun	CHN	1	*	V	V	V	0	V		0.800	20	19	1	2 Q
O'Neill, Mary	USA	2	4	*	3	1	0	2		0.000	10	25	-15	6 E
Oka, Tomoko	JPN	3	3	V	*	V	0	0		0.600	18	17	1	4 Q
Palm, Kerstin	SWE	4	3	V	2	*	3	2		0.200	15	21	-6	5 E
Funkenhauser, Zita	FRG	5	V	V	2	V	*	2		0.600	19	13	6	3 Q
Glikina, Elena	URS	6	4	V	V	V	V	*		0.800	24	11	13	1 Q

Women Foil-Individual Preliminary Round 2 Pool 2/Sept. 21			Femmes/Fleuret-Individuel Preliminaires Tour 2 Poule 2/21 Sept										
Name Nom	Ctry Pays	Order Ordre	1	2	3	4	5	6	7	V/M			

Fencing

Women Foil-Individual Preliminary Round 2 Pool 5/Sept. 21				Femmes/Fleuret-Individuel Preliminaires Tour 2 Poule 5/21 Sept											
Name Nom	Ctry Pays	Order Ordre		1	2	3	4	5	6	7	V/M	TD	TR	TD-TR	PL
Zalaffi, Margherita	ITA	1	*	2	V	V	V	V			0.800	22	16	6	1 Q
Bau, Sabine	FRG	2		V	*	V	V	V	0		0.800	20	15	5	2 Q
Dubrawska, Agnieszka	POL	3		2	4	*	4	V	1		0.200	16	22	-6	6 E
Kovacs, Edit	HUN	4		4	1	V	*	4	V		0.400	19	21	-2	4 Q
Gaudin, Brigitte	FRA	5		2	3	2	V	*	V		0.400	17	20	-3	5 E
Lazar, Reka zsofia	ROM	6		3	V	V	2	1	*		0.400	16	16	0	3 Q

Women Foil-Individual Preliminary Round 2 Pool 6/Sept. 21				Femmes/Fleuret-Individuel Preliminaires Tour 2 Poule 6/21 Sept											
Name Nom	Ctry Pays	Order Ordre		1	2	3	4	5	6	7	V/M	TD	TR	TD-TR	PL
Krolikowska, Jolanta	POL	1	*	V	2	3	V	3			0.400	18	18	0	4 Q
Modaine, Lavrence	FRA	2		2	*	V	2	3	4		0.200	16	23	-7	6 E
Luan, Jujie	CHN	3		V	3	*	4	4	V		0.400	21	21	0	5 E
Vochtchakina, Olga	URS	4		V	V	V	*	2	4		0.600	21	19	2	2 Q
Tufan, Elisabeta	ROM	5		1	V	V	V	*	V		0.800	21	18	3	1 Q
Philion, Madeleine	CAN	6		V	V	4	V	4	*		0.600	23	21	2	3 Q

Women Foil-Individual Preliminary Round 2/Sept. 21			Femmes Fleuret-Individuel Preliminaires Tour 2/21 Sept					
Class	Name	Ctry	V	M	V/M	TD	TR	TD-TR
Class	Nom	Pays						
1	Tak, Jung-Im	KOR	5	5	1.000	25	17	8
2	Glikina, Elena	URS	4	5	0.800	24	11	13
3	Sadovskaia, Tatiana	URS	4	5	0.800	22	12	10
4	Bilodeau, Caitlin	USA	4	5	0.800	22	14	8
5	Stefanek, Gertrud	HUN	4	5	0.800	20	14	6
6	Zalaffi, Margherita	ITA	4	5	0.800	22	16	6
7	Bau, Sabine	FRG	4	5	0.800	20	15	5
8	Tufan, Elisabeta	ROM	4	5	0.800	21	18	3
9	Sun, Hongyun	CHN	4	5	0.800	20	19	1
10	Fichtel, Anja	FRG	3	5	0.600	22	14	8
11	Funkenhauser, Zita	FRG	3	5	0.600	19	13	6
12	Vaccaroni, Dorina	ITA	3	5	0.600	20	15	5
13	Janosi, Zsuzsanna	HUN	3	5	0.600	22	18	4
14	Thurley, Elizabeth	GBR	3	5	0.600	19	17	2
15	Vochtchakina, Olga	URS	3	5	0.600	21	19	2
16	Philion, Madeleine	CAN	3	5	0.600	23	21	2
17	Oka, Tomoko	JPN	3	5	0.600	18	17	1
18	Shin, Sung-Ja	KOR	3	5	0.600	20	21	-1
19	Lazar, Reka Zsofia	ROM	2	5	0.400	16	16	0
20	Krolikowska, Jolanta	POL	2	5	0.400	18	18	0
21	Spennato, Isabelle	FRA	2	5	0.400	19	19	0
22	Sobczak, Anna	POL	2	5	0.400	20	20	0
23	Mcintosh, Fiona	GBR	2	5	0.400	18	20	-2
24	Kovacs, Edit	HUN	2	5	0.400	19	21	-2

The above athletes are qualified/Les athletes ci-haut se qualifient

The following athletes are eliminated/Les athletes suivants sont elimines

25	Luan, Jujie	CHN	2	5	0.400	21	21	0
26	Gaudin, Brigitte	FRA	2	5	0.400	17	20	-3
27	Gandolfi, Annapia	ITA	2	5	0.400	15	23	-8
28	Martin, Linda	GBR	1	5	0.200	17	22	-5
29	Palm, Kerstin	SWE	1	5	0.200	15	21	-6
30	Dubrawska, Agnieszka	POL	1	5	0.200	16	22	-6
31	Poirier, Marie-Jacynthe	CAN	1	5	0.200	15	22	-7
32	Zhu, Qingyuan	CHN	1	5	0.200	16	23	-7
32	Modaine, Lavrence	FRA	1	5	0.200	16	23	-7
34	Tremblay, Thalie	CAN	1	5	0.200	14	22	-8
35	Monplaisir, Sharon	USA	1	5	0.200	11	24	-13
36	O'Neill, Mary	USA	0	5	0.000	10	25	-15

Women Foil-Individual Preliminary Round 3 Pool 1/Sept. 21				Femmes/Fleuret-Individuel Preliminaires Tour 3 Poule 1/21 Sept											
Name Nom	Ctry Pays	Order Ordre		1	2	3	4	5	6	7	V/M	TD	TR	TD-TR	PL
Tak, Jung-Im	KOR	1	*	3	V	0	3	V			0.400	16	17	-1	4 Q
Tufan, Elisabeta	ROM	2		V	*	V	3	3	4		0.400	20	22	-2	5 E
Vochtchakina, Olga	URS	3		1	4	*	V	V	V		0.600	20	17	3	2 Q
Sun, Hongyun	CHN	4		V	V	3	*	V	V		0.800	23	16	7	1 Q
Kovacs, Edit	HUN	5		V	V	4	4	*	3		0.400	21	21	0	3 Q
Oka, Tomoko	JPN	6		1	V	0	4	V	*		0.400	15	22	-7	6 E

Women Foil-Individual Preliminary Round 3 Pool 2/Sept. 21				Femmes/Fleuret-Individuel Preliminaires Tour 3 Poule 2/21 Sept											
Name Nom	Ctry Pays	Order Ordre		1	2	3	4	5	6	7	V/M	TD	TR	TD-TR	PL
Glikina, Elena	URS	1	*	2	V	0	V	4			0.400	16	16	0	3 Q
Bau, Sabine	FRG	2		V	*	3	4	V	2		0.400	19	20	-1	4 Q
Philion, Madeleine	CAN	3		1	V	*	4	V	1		0.400	16	21	-5	5 E
Vaccaroni, Dorina	ITA	4		V	V	V	*	V	2		0.800	22	15	7	2 Q
Mcintosh, Fiona	GBR	5		0	3	3	2	*	1		0.000	9	25	-16	6 E
Shin, Sung-Ja	KOR	6		V	V	V	V	V	*		1.000	25	10	15	1 Q

Women Foil-Individual Preliminary Round 3 Pool 3/Sept. 21				Femmes/Fleuret-Individuel Preliminaires Tour 3 Poule 3/21 Sept											
Name Nom	Ctry Pays	Order Ordre		1	2	3	4	5	6	7	V/M	TD	TR	TD-TR	PL
Zalaffi, Margherita	ITA	1	*	4	V	V	V	V			0.800	24	10	14	1 Q
Sadovskaia, Tatiana	URS	2		V	*	2	V	V	V		0.800	22	18	4	2 Q
Janosi, Zsuzsanna	HUN	3		1	V	*	1	V	V		0.600	17	17	0	4 Q
Fichtel, Anja	FRG	4		1	3	V	*	V	V		0.600	19	17	2	3 Q
Sobczak, Anna	POL	5		1	2	4	3	*	2		0.000	12	25	-13	6 E
Lazar, Reka zsofia	ROM	6		2	4	1	3	V	*		0.200	15	22	-7	5 E

Escrime

Women Foil-Individual Preliminary Round 3 Pool 4/Sept. 21				Femmes/Fleuret-Individuel Preliminaires Tour 3 Poule 4/21 Sept											
Name Nom	Ctry Pays	Order Ordre		1	2	3	4	5	6	7	V/M	TD	TR	TD-TR	PL
Bilodeau, Caitlin	USA	1	*	V	V	1	4	V			0.600	20	17	3	2 Q
Funkenhauser, Zita	FRG	2		1	*	V	V	3	V		0.600	19	18	1	3 Q
Thurley, Elizabeth	GBR	3		4	3	*	V	V	1		0.400	18	20	-2	5 E
Krolikowska, Jolanta	POL	4		V	4	2	*	4	V		0.400	20	17	3	4 Q
Stefanek, Gertrud	HUN	5		V	V	3	V	*	V		0.800	23	19	4	1 Q
Spennato, Isabelle	FRA	6		2	1	V	1	3	*		0.200	12	21	-9	6 E

Women Foil-Individual/Sept. 21-22			Femmes Fleuret-Individuel/21-22 Sept			
Rank Rang	Ctry Pays	Name Nom				
1	FRG	Fichtel, Anja				
2	FRG	Bau, Sabine				
3	FRG	Funkenhauser, Zita				
4	HUN	Janosi, Zsuzsanna				
5	URS	Sadovskaia, Tatiana				
6	HUN	Stefanek, Gertrud				
7	CHN	Sun, Hongyun				
8	URS	Glikina, Elena				
9	ITA	Zalaffi, Margherita				
10	ITA	Vaccaroni, Dorina				
11	USA	Bilodeau, Caitlin				
12	KOR	Tak, Jung-Im				
13	KOR	Shin, Sung-Ja				
14	URS	Vochtchakina, Olga				
15	POL	Krolikowska, Jolanta				
16	HUN	Kovacs, Edit				
17	GBR	Thurley, Elizabeth				
18	ROM	Tufan, Elisabeta				
19	CAN	Philion, Madeleine				
20	JPN	Oka, Tomoko				
21	ROM	Lazar, Reka Zsofia				
22	FRA	Spennato, Isabelle				
23	POL	Sobczak, Anna				
24	GBR	Mcintosh, Fiona				
25	CHN	Luan, Jujie				
26	FRA	Gaudin, Brigitte				
27	ITA	Gandolfi, Annapia				
28	GBR	Martin, Linda				
29	SWE	Palm, Kerstin				
30	POL	Dubrawska, Agnieszka				
31	CAN	Poirier, Marie-Jacynthe				
32	CHN	Zhu, Qingyuan				
32	FRA	Modaine, Lavrence				
34	CAN	Tremblay, Thalie				
35	USA	Monplaisir, Sharon				
36	USA	O'Neill, Mary				
37	SUI	Mariethoz, Alessandra				
38	JPN	Morikawa, Akemi				
39	JPN	Miyahara, Mieko				
40	SUI	Piros, Andrea				
40	MEX	Lopez, Fabiana				
42	AUS	Chaplin, Andrea				
43	INA	Koeswandi, Silvia.k				
43	KOR	Park, Eun-Hee				
45	HKG	Yung, Yim King				



Women Foil-Individual Direct Elimination W/R. Table A
Competition Summary

Femmes/Fleuret-Individuel Elimination Directe A/R. Tableau A
Tableau de la Competition

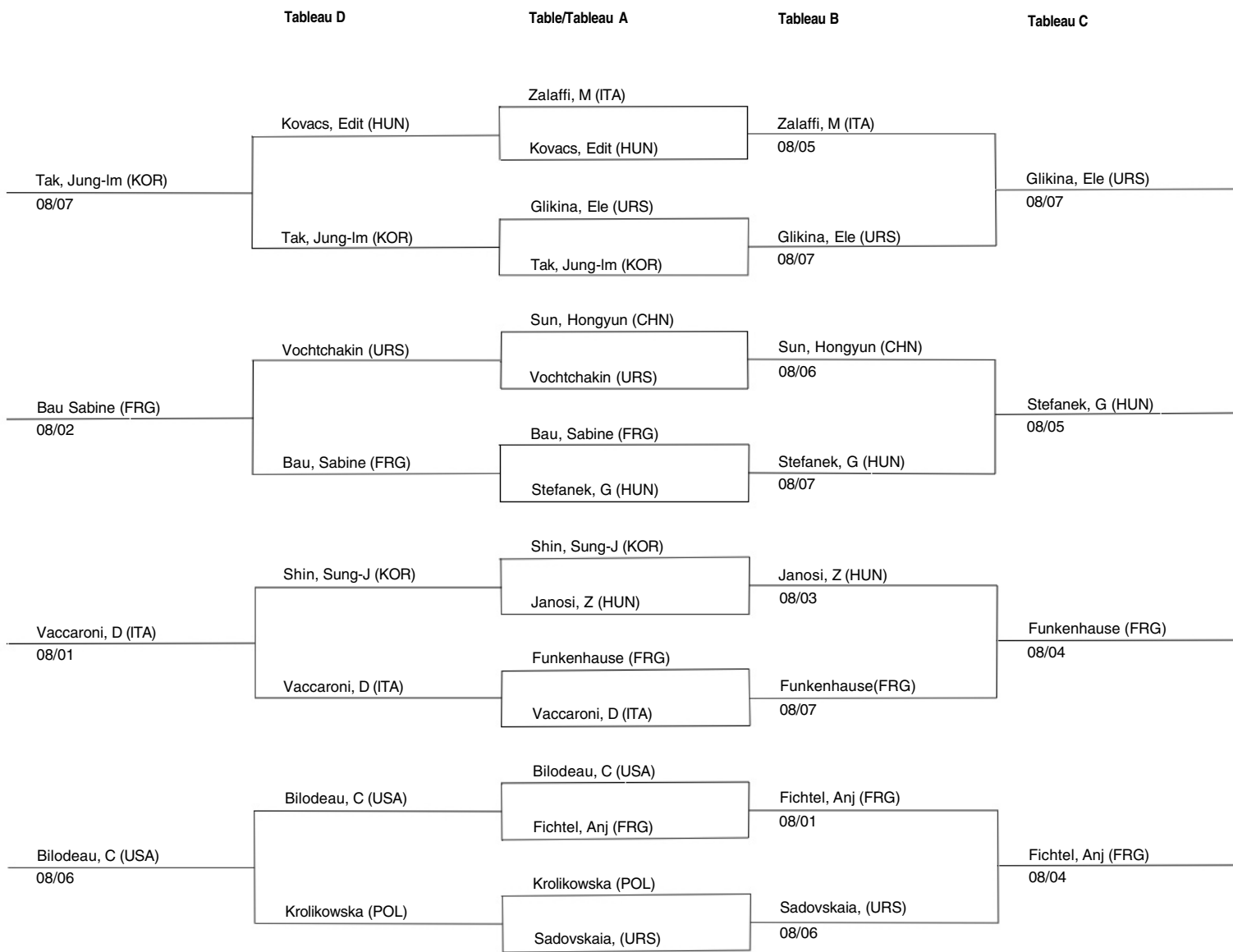

Fencing

Escrime

Women Foil-Individual Direct Elimination W/R. Table G Competition Summary

Femmes/Fleuret-Individuel Elimination Directe A/R. Tableau G Tableau de la Competition

Table/Tableau G

Zalaffi, M (ITA)	Bau, Sabine (FRG)	08/07
Bau, Sabine (FRG)	Janosi, Z (HUN)	08/03
Vaccaroni, D (ITA)	Sun, Hongyun (CHN)	08/05
Janosi, Z (HUN)	Sun, Hongyun (CHN)	08/05
Sun, Hongyun (CHN)	Sadovskaia, (URS)	08/04
Bilodeau, C (USA)	Sadovskaia, (URS)	08/04
Tak, Jung-Im (KOR)		
Sadovskaia, (URS)		

Women Foil-Individual Final Table Competition Summary

Women Foil-Individual Tableau Finale Tableau de la Competition

Final/Finale (1/4)	Final/Finale (1/2)	Final/Finale	
Stefanek, G (HUN)	Bau, Sabine (FRG)	Bau, Sabine (FRG)	1st Place 1ere Place Fichtel, Anj (FRG)
Bau, Sabine (FRG)	08/06	08/03	
Sadovskaia, (URS)	Funkenhause (FRG)		
Funkenhause (FRG)	08/05		
Fichtel, Anj (FRG)	Fichtel, Anj (FRG)	Fichtel, Anj (FRG)	08/05
Sun, Hongyun (CHN)	08/04	08/05	
Janosi, Z (HUN)	Janosi, Z (HUN)		
Glikina, Ele (URS)	08/04		
Funkenhause (FRG)	3rd Place 3eme Place Funkenhause (FRG)		
Janosi, Z (HUN)	08/07		

Fencing

Escrime

Women Foil-Team Prelim. Round 1 Pool 4 Match 3/Sept. 27			Femmes/Fleuret-Equipes Prelim. Tour 1 Poule 4 Match 3/27 Sept												
Ctry Pays	Name Nom	Order Order	1	2	3	4	*	5	6	7	8	*	V	TD	TR
CHN	Luan, Jujie	1						4	4	3	3		Total: 6	56	56
	Xiao, Aihua	2						V	2	V	V		3	17	10
	Li, Huahua	3						V	1	4	1		1	11	16
	Sun, Hongyun	4						4	V	V			2	14	10
	Zhu, Qingyuan	*											0	0	0
													Total: 9	56	56
ITA	Zalaffi, Margherita	5	V	3	1	V							2	14	18
	Vaccaroni, Dorina	6	V	V	V	2							3	17	12
	Gandolfi, Annapia	7	V	1	V	3							2	14	17
	Bortolozzi, Francesca	8	V	1	V								2	11	9
	Traversa, Lucia	*											0	0	0

Rank Rang	Ctry Pays	Name Nom
6	USA	Bilodeau, Caitlin Cheris, Elaine Monplaisir, Sharon O'Neill, Mary Sullivan, Molly
7	FRA	Gaudin, Brigitte Meygret, Gisele Modaine, Lavrence Pallet, Nathalie Spennato, Isabelle
8	KOR	Kim, Jin-Soon Park, Eun-Hee Shin, Sung-Ja Tak, Jung-Im Yoon, Jung-Sook
9	CAN	Cormier, Marie-Huguette Phillion, Madeleine Poirier, Marie-Jacynthe Steiner, Shelley Tremblay, Thalie
10	POL	Bres, Malgorzata Dubrawska, Agnieszka Krolikowska, Jolanta Prusakowska, Hanna Sobczak, Anna
11	GBR	Brannon, Ann Martin, Linda Mcintosh, Fiona Strachan, Linda Thurley, Elizabeth
12	JPN	Kiritani, Nona Mine, Keiko Miyahara, Mieko Morikawa, Akemi Oka, Tomoko

Women Foil-Team/Sept. 27-28			Femmes Fleuret-Equipes/27-28 Sept		
Rank Rang	Ctry Pays	Name Nom			
1	FRG	Bau, Sabine Fichtel, Anja Funkenhauser, Zita Klug, Annette Weber, Christiane			
2	ITA	Bortolozzi, Francesca Gandolfi, Annapia Traversa, Lucia Vaccaroni, Dorina Zalaffi, Margherita			
3	HUN	Janosi, Zsuzsanna Kovacs, Edit Stefanek, Gertrud Szocs, Zsuz Sanna Tuschak, Katalin			
4	URS	Glikina, Elena Grichina, Elena Sadovskaia, Tatiana Soboleva, Marina Vochtchakina, Olga			
5	CHN	Li, Huahua Luan, Jujie Sun, Hongyun Xiao, Aihua Zhu, Qingyuan			

Women Foil-Team Final Table
Competition Summary

Femmes/Fleuret-Equipes Tableau Final
Tableau de la Competition

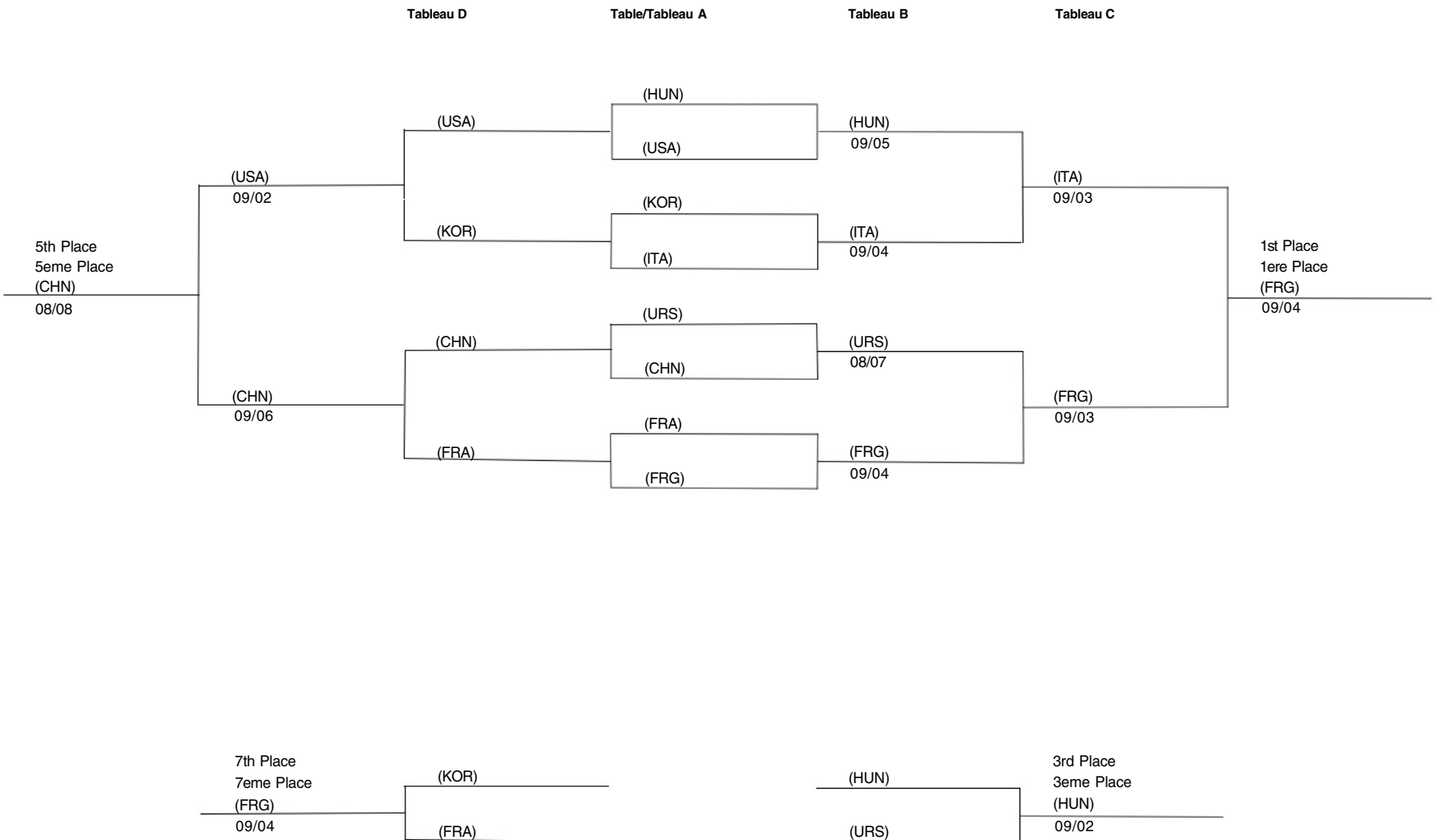



축 구

Football/Football



Football/Football

Officials/Officiels

Federation Internationale de Football Association (F.I.F.A.)

President/président	João Havelange
Secretary General/secrétaire général	Joseph S. Blatter
Technical Delegates/délégués techniques	

SLOOC Administrative Staff/Personnel Administratif du SLOOC

Commissioner/directeur	Kim Woo Jung
Secretary General/secrétaire général	Oh Wan Gun
Deputy Secretary General/secrétaire général adjoint	Ryu Young Woo
Competition Manager/chef de division de compétitions	Ryu Hyun Chol

Competitors/Concurrents

Men
Hommes

Competitors
Competiteurs

Countries
Pays

314

16

Legend/Notation

*	Initial Line-up/Formation initiale
R	Reserve/En reserve
N	Did not play/N'a pas joué
—	Substitution-out/A été remplacé
+	Substitution-in/A remplacé



Football

First Round Group A, Match 1 Sept. 17

Premier Tour Groupe A, Match 1 17 Sept

No	Pos	Name Nom	Goals Buts	No	Pos	Name Nom	Goals Buts
CHN-FRG 0-3 (0-1)							
CHN				FRG			
1	GK	Kong, Guoxian	0 R	1	GK	Reck, Oliver	0 R
2	FB	Zhu, Bo	0 *	2	FB	Schulz, Michael	0 *
3	FB	Gao, Sheng	0 *	3	LK	Goertz, Armin	0 *
4	FB	Guo, Jijun	0 *	4	FB	Funkel, Wolfgang	0 *
5	FB	Jia, Xiuquan	0 *	5	FB	Hoerster, Thomas	0 *
7	FW	Xie, Yuxin	0 -	6	LK	Janssen, Olaf	0 N
8	FW	Tang, Yaodong	0 *	7	LK	Bommer, Rudi	0 R
9	FW	Liu, Haiguang	0 *	8	LK	Fach, Holger	0 -
10	FW	Ma, Lin	0 -	9	FW	Klinsmann, Juergen	0 *
11	FW	Zhu, Ping	0 N	10	LK	Wuttke, Wolfram	1 -
12	FW	Wang, Baoshan	0 +	11	FW	Mill, Frank	2 *
14	FW	Huo, Jianting	0 N	12	GK	Kamps, Uwe	0 *
15	FB	Zhang, Xiaowen	0 R	13	FB	Grahammer, Roland	0 *
16	LK	Li, Hui	0 +	14	LK	Haessler, Thomas	0 *
17	FB	Mai, Chao	0 *	15	LK	Schreier, Christian	0 +
18	LK	Duan, Ju	0 *	16	FW	Walter, Fritz	0 N
19	FW	Wang, Jun	0 R	17	FB	Sievers, Ralf	0 N
20	GK	Zhang, Kuikang	0 *	18	LK	Kleppinger, Gerhard	0 +
Coach	CHN	Gao, Fengwen		19	FW	Riedle, Karlheinz	0 R
				20	FB	Sauer, Gunnar	0 N
				Coach	FRG	Loehr, Hannes	

Referee/Arbitre

URU J. CARDELLING DE S.VINCENTE

Linesman/Juges de Touche

MAR B. LAOUISSI
TRI LENNOX SIRJUESINGH

Reserved Referee/Arbitre Suppleant

KOR NA, YOON-SHIK

Total	Goals Buts	Defense	Keeper Gardien	Missed Manques	Posts Poteaux
CHN-FRG 0-3 (0-1)					

First Round Group A, Match 2 Sept. 17

Premier Tour Groupe A, Match 2 17 Sept

No	Pos	Name Nom	Goals Buts	No	Pos	Name Nom	Goals Buts
SWE-TUN 2-2 (2-2)							
SWE				TUN			
1	GK	Andersson, Sven	0 *	1	GK	Chouchane, Mohamed Naceur	0 *
2	DF	Vaattovaara, Sulo	0 *	2	FB	Ouachi, Hachemi	0 *
3	DF	Lonn, Peter	0 *	3	FB	Chahat, Abderrzek	0 N
4	DF	Arnberg, Goran	0 *	4	FB	Mizouri, Imad	0 *
5	DF	Nilsson, Roland	0 *	5	FB	Ben Neji, Ali	0 R
6	MF	Them, Jonas	1 -	6	LN	Smirani, Adel	0 *
7	MF	Engqvist, Leif	0 N	7	FW	Limam, Jameleddine	0 -
8	MF	Andersson, Michael	0 *	8	LN	Abid, Haythem	0 R
9	MF	Nilsson, Joakim	0 *	9	FW	Yakoubi, Kais	0 R
10	MF	Limpar, Anders	0 +	10	LN	Dhiab, Tarek	1 *
11	FW	Lindman, Hakan	0 N	11	LN	Rouissi, Lotfi	0 *
12	GK	Nilsson, Bengt	0 R	12	LN	Maaloul, Nabil	1 *
13	FW	Dahlin, Martin	0 +	13	FB	Mheddhebi, Taoufik	0 N
14	FW	Eskilsson, Hans	0 -	14	FB	Mahjoubi, Mohamed	0 *
15	FW	Hellstrom, Jan	1 -	15	FB	Ben Yahia, Khaled	0 *
16	DF	Ljung, Roger	0 R	16	FW	Rannene, Morad	0 N
17	GK	Eriksson, Lars	0 N	17	FB	Bousnina, Noureddine	0 R
18	DF	Svensson, Ola	0 R	18	FB	Okbi, Mourad	0 N
19	MF	Palmer, Anders	0 N	19	LN	Baouab, Modher	0 *
20	MF	Rehn, Stefan	0 *	20	GK	Fessi, Slaheddine	0 R
Coach	SWE	Lennartsson, Benny		Coach	TUN	Ben Miled, Baccar	

Referee/Arbitre

MEX E. CODESAL

Linesman/Juges de Touche

SYR AL-SHRIF JAMAL.
BRA A.D.C. COELHO

Reserved Referee/Arbitre Suppleant

KOR PARK, KYUNG-WHA

Football

Total	Goals Buts	Defense	Keeper Gardien	Missed Manques	Posts Poteaux
SWE-TUN 2-2 (2-2)					
Goal Attempts/Tirs au But					
Penalty 11M	0-1	0-1	0-0	0-0	0-0
On Free Kick/Sur Coup Franc	0-0	0-0	0-0	0-0	0-0
In Phase of Play/En Jeu	15-9	2-1	4-1	5-2	4-5
Total	15-10	2-2	4-1	5-2	4-5
Assist/Assistance	1-1		Into Own Goal/But C.S.C.		0-0
Caution/Avertissement	0-3		Off-side/Hors-jeu		2-0
Corner Kicks/Corners	5-0		Sent off/Expulsions		1-1
Fouls/Fautes	19-21		Substitutions		2-0

First Round Group A, Match 9 Sept. 19

Premier Tour Groupe A, Match 9 19 Sept

No	Pos	Name Nom	Goals Buts	No	Pos	Name Nom	Goals Buts
TUN-FRG 1-4 (1-1)							
TUN				FRG			
1	GK	Chouchane, Mohamed Naceur	0 *	1	GK	Reck, Oliver	0 R
2	FB	Ouachi, Hachemi	0 *	2	FB	Schulz, Michael	0 *
3	FB	Chahat, Abderrzek	0 N	3	LK	Goertz, Armin	0 -
4	FB	Mizouri, Imad	0 *	4	FB	Funkel, Wolfgang	0 *
5	FB	Ben Neji, Ali	0 R	5	FB	Hoerster, Thomas	0 *
6	LN	Smirani, Adel	0 -	6	LK	Janssen, Olaf	0 N
7	FW	Limam, Jameleddine	0 N	7	LK	Bommer, Rudi	0 N
8	LN	Abid, Haythem	0 +	8	LK	Fach, Holger	1 *
9	FW	Yakoubi, Kais	0 N	9	FW	Klinsmann, Juergen	0 *
10	LN	Dhiab, Tarek	0 *	10	LK	Wuttke, Wolfram	1 -
11	LN	Rouissi, Lotfi	0 *	11	FW	Mill, Frank	1 *
12	LN	Maaloul, Nabil	1 *	12	GK	Kamps, Uwe	0 *
13	FB	Mheddhebi, Taoufik	0 N	13	FB	Grahammer, Roland	1 *
14	FB	Mahjoubi, Mohamed	0 *	14	LK	Haessler, Thomas	0 *
15	FB	Ben Yahia, Khaled	0 *	15	LK	Schreier, Christian	0 +
16	FW	Rannene, Morad	0 *	16	FW	Walter, Fritz	0 R
17	FB	Bousnina, Noureddine	0 R	17	FB	Sievers, Ralf	0 N
18	FB	Okbi, Mourad	0 R	18	LK	Kleppinger, Gerhard	0 +
19	LN	Baouab, Modher	0 *	19	FW	Riedle, Karlheinz	0 R
20	GK	Fessi, Slaheddine	0 R	20	FB	Sauer, Gunnar	0 N
Coach	TUN	Ben Miled, Baccar		Coach	FRG	Loehr, Hannes	

Referee/Arbitre

GBR K. HOPE

Linesman/Juges de Touche

AUS CH. BAMBRIDGE
URU J. CARDELLINO DE S.VINCENTE

Reserved Referee/Arbitre Suppleant

KOR NA, YOON-SHIK

Total	Goals Buts	Defense	Keeper Gardien	Missed Manques	Posts Poteaux
TUN-FRG 1-4 (1-1)					

Goal Attempts/Tirs au But

Penalty 11M	1-2	1-1	0-0	0-0	0-1	0-0
On Free Kick/Sur Coup Franc	0-0	0-0	0-0	0-0	0-0	0-0
In Phase of Play/En Jeu	6-10	0-3	1-0	3-1	2-6	0-0
Total	7-12	1-4	1-0	3-1	2-7	0-0

Assist/Assistance	0-3		Into Own Goal/But C.S.C.		0-0
Caution/Avertissement	2-1		Off-side/Hors-jeu		1-2
Corner Kicks/Corners	2-3		Sent off/Expulsions		0-0
Fouls/Fautes	15-6		Substitutions		1-2



**First Round Group A, Match 10
Sept. 19**

**Premier Tour Groupe A, Match 10
19 Sept**

No	Pos	Name Nom	Goals Buts	No	Pos	Name Nom	Goals Buts
SWE-CHN 2-0 (2-0)							
SWE				CHN			
1	GK	Andersson, Sven	0 *	1	GK	Kong, Guoxian	0 R
2	DF	Vaattovaara, Sulo	0 N	2	FB	Zhu, Bo	0 *
3	DF	Lonn, Peter	1 *	3	FB	Gao, Sheng	0 *
4	DF	Arnberg, Goran	0 *	4	FB	Guo, Jijun	0 *
5	DF	Nilsson, Roland	0 *	5	FB	Jia, Xiuquan	0 *
6	MF	Thern, Jonas	0 N	7	FW	Xie, Yuxin	0 *
7	MF	Engqvist, Leif	0 *	8	FW	Tang, Yaodong	0 *
8	MF	Andersson, Michael	0 *	9	FW	Liu, Haiguang	0 -
9	MF	Nilsson, Joakim	0 -	10	FW	Ma, Lin	0 *
10	MF	Limpar, Anders	0 *	11	FW	Zhu, Ping	0 N
11	FW	Lindman, Hakan	0 +	12	FW	Wang, Baoshan	0 +
12	GK	Nilsson, Bengt	0 N	14	FW	Huo, Jianting	0 N
13	FW	Dahlin, Martin	0 -	15	FB	Zhang, Xiaowen	0 R
14	FW	Eskilsson, Hans	0 N	16	LK	Li, Hui	0 R
15	FW	Hellstrom, Jan	1 *	17	FB	Mai, Chao	0 *
16	DF	Ljung, Roger	0 *	18	LK	Duan, Ju	0 *
17	GK	Eriksson, Lars	0 R	19	FW	Wang, Jun	0 R
18	DF	Svensson, Ola	0 R	20	GK	Zhang, Kuikang	0 *
19	MF	Palmer, Anders	0 +	Coach	CHN	Gao, Fengwen	
20	MF	Rehn, Stefan	0 R				
Coach	SWE	Lennartsson, Benny					

Referee/Arbitre
SEN B. SENE

Linesman/Juges de Touche
FRA G. BIGUET
SUI ROETHLISBERGER
Reserved Referee/Arbitre Suppleant
KOR PARK, KYUNG-WHA

	Total	Goals Buts	Defense	Keeper Gardien	Missed Manques	Posts Poteaux
SWE-CHN 2-0 (2-0)						
Goal Attempts/Tirs au But						
Penalty 11M	0-0	0-0	0-0	0-0	0-0	0-0
On Free Kick/Sur Coup Franc	0-2	0-0	0-0	0-1	0-1	0-0
In Phase of Play/En Jeu	10-9	2-0	0-1	7-1	1-6	0-1
Total	10-11	2-0	0-1	7-2	1-7	0-1
Assist/Assistance	1-0			Into Own Goal/But C.S.C.		0-0
Caution/Avertissement	0-1			Off-side/Hors-jeu		5-7
Corner Kicks/Corners	3-4			Sent off/Expulsions		0-0
Fouls/Fautes	8-11			Substitutions		2-1

**First Round Group A, Match 17
Sept. 21**

**Premier Tour Groupe A, Match 17
21 Sept**

No	Pos	Name Nom	Goals Buts	No	Pos	Name Nom	Goals Buts
TUN-CHN 0-0 (0-0)							
TUN				CHN			
1	GK	Chouchane, Mohamed Naceur	0 R	1	GK	Kong, Guoxian	0 R
2	FB	Ouachi, Hachemi	0 N	2	FB	Zhu, Bo	0 *
3	FB	Chahat, Abderrzek	0 *	3	FB	Gao, Sheng	0 *
4	FB	Mizouri, Imad	0 R	4	FB	Guo, Jijun	0 *
5	FB	Ben Neji, Ali	0 *	5	FB	Jia, Xiuquan	0 *
6	LN	Smirani, Adel	0 N	7	FW	Xie, Yuxin	0 *
7	FW	Limam, Jameleddine	0 N	8	FW	Tang, Yaodong	0 *
8	LN	Abid, Haythem	0 +	9	FW	Liu, Haiguang	0 -
9	FW	Yakoubi, Kais	0 +	10	FW	Ma, Lin	0 N
10	LN	Dhiab, Tarek	0 *	11	FW	Zhu, Ping	0 R
11	LN	Rouissi, Lotfi	0 N	12	FW	Wang, Baoshan	0 +
12	LN	Maaloul, Nabil	0 *	14	FW	Huo, Jianting	0 R
13	FB	Mhaddhebi, Taoufik	0 -	15	FB	Zhang, Xiaowen	0 *
14	FB	Mahjoubi, Mohamed	0 *	16	LK	Li, Hui	0 *
15	FB	Ben Yahia, Khaled	0 *	17	FB	Mai, Chao	0 N
16	FW	Rannene, Morad	0 -	18	LK	Duan, Ju	0 *
17	FB	Bousnina, Nouredine	0 *	19	FW	Wang, Jun	0 R
18	FB	Okbi, Mourad	0 R	20	GK	Zhang, Kuikang	0 *
19	LN	Baouab, Modher	0 *	Coach	CHN	Gao, Fengwen	
20	GK	Fessi, Slaheddine	0 *				
Coach	TUN	Ben Miled, Baccar					

Referee/Arbitre
TRI LENNOX SIRJUESINGH

Linesman/Juges de Touche
ITA T. LANESE
MAR B. LAOUISSI
Reserved Referee/Arbitre Suppleant
KOR NA, YOON-SHIK

	Total	Goals Buts	Defense	Keeper Gardien	Missed Manques	Posts Poteaux
TUN-CHN 0-0 (0-0)						
Goal Attempts/Tirs au But						
Penalty 11M	0-0	0-0	0-0	0-0	0-0	0-0
On Free Kick/Sur Coup Franc	0-2	0-0	0-1	0-0	0-1	0-0
In Phase of Play/En Jeu	4-5	0-0	1-0	0-3	3-2	0-0
Total	4-7	0-0	1-1	0-3	3-3	0-0
Assist/Assistance	0-0			Into Own Goal/But C.S.C.		0-0
Caution/Avertissement	1-0			Off-side/Hors-jeu		4-4
Corner Kicks/Corners	1-11			Sent off/Expulsions		0-0
Fouls/Fautes	26-8			Substitutions		2-1

**First Round Group A, Match 18
Sept. 21**

**Premier Tour Groupe A, Match 18
21 Sept**

No	Pos	Name Nom	Goals Buts	No	Pos	Name Nom	Goals Buts
SWE-FRG 2-1 (0-0)							
SWE				FRG			
1	GK	Andersson, Sven	0 *	1	GK	Reck, Oliber	0 R
2	DF	Vaattovaara, Sulo	0 R	2	FB	Schulz, Michael	0 *
3	DF	Lonn, Peter	1 *	3	LK	Goertz, Armin	0 *
4	DF	Arnberg, Goran	0 *	4	FB	Funkel, Wolfgang	0 N
5	DF	Nilsson, Roland	0 *	5	FB	Hoerster, Thomas	0 *
6	MF	Thern, Jonas	0 N	6	LK	Janssen, Olaf	0 N
7	MF	Engqvist, Leif	1 *	7	LK	Bommer, Rudi	0 R
8	MF	Andersson, Michael	0 *	8	LK	Fach, Holger	0 *
9	MF	Nilsson, Joakim	0 *	9	FW	Klinsmann, Juergen	0 *
10	MF	Limpar, Anders	0 *	10	LK	Wuttke, Wolfram	0 -
11	FW	Lindman, Hakan	0 N	11	FW	Mill, Frank	0 -
12	GK	Nilsson, Bengt	0 R	12	GK	Kamps, Uwe	0 *
13	FW	Dahlin, Martin	0 -	13	FB	Grahammer, Roland	0 *
14	FW	Eskilsson, Hans	0 N	14	LK	Haessler, Thomas	0 *
15	FW	Hellstrom, Jan	0 *	15	LK	Schreier, Christian	0 +
16	DF	Ljung, Roger	0 *	16	FW	Walter, Fritz	1 +
17	GK	Eriksson, Lars	0 N	17	FB	Sievers, Ralf	0 R
18	DF	Svensson, Ola	0 R	18	LK	Kleppinger, Gerhard	0 *
19	MF	Palmer, Anders	0 R	19	FW	Riedle, Karlheinz	0 N
20	MF	Rehn, Stefan	0 +	20	FB	Sauer, Gunnar	0 N
Coach	SWE	Lennartsson, Benny		Coach	FRG	Loehr, Hannes	

Referee/Arbitre
SUI ROETHLISBERGER

Linesman/Juges de Touche
SEN B. SENE
FRA G. BIGUET
Reserved Referee/Arbitre Suppleant
KOR PARK, KYUNG-WHA

	Total	Goals Buts	Defense	Keeper Gardien	Missed Manques	Posts Poteaux
SWE-FRG 2-1 (0-0)						
Goal Attempts/Tirs au But						
Penalty 11M	0-0	0-0	0-0	0-0	0-0	0-0
On Free Kick/Sur Coup Franc	0-2	0-0	0-0	0-1	0-1	0-0
In Phase of Play/En Jeu	12-13	2-1	2-0	6-1	2-11	0-0
Total	12-15	2-1	2-0	6-2	2-12	0-0
Assist/Assistance	2-0			Into Own Goal/But C.S.C.		0-0
Caution/Avertissement	1-1			Off-side/Hors-jeu		1-5
Corner Kicks/Corners	5-2			Sent off/Expulsions		0-0
Fouls/Fautes	17-9			Substitutions		1-2

Football

First Round Group B, Match 3 Sept. 17

No	Pos	Name Nom	Goals Buts	No	Pos	Name Nom	Goals Buts
ZAM-IRQ 2-2 (1-1)				Premier Tour Groupe B, Match 3 17 Sept			
ZAM				IRQ			
1	GK	Chabala, David	0 -	1	GK	Mohammed, Ahmed J.	0 *
2	FB	Mwanza, Peter	0 N	2	FB	Motar, Adnan Dirjal	0 *
3	FB	Mumba, Edmon	0 *	3	FB	Ahmed, Hassan Kamal	0 *
4	FB	Chomba, Samuel	0 *	4	FB	Jasim, Ghaeim A.	0 *
5	FB	Chitalu, James	0 *	5	FB	Mahmood, Samir Shakir	0 R
6	LK	Makinka, Derby	0 *	6	LK	Okal, Hibeab Jafer	0 *
7	FW	Bwalya, Johnson	0 *	7	FW	Sadkhan, Younis A.	0 R
8	LK	Musonda, Charles	0 *	8	FW	Amish, Ahmed Radhi	1 *
9	FW	Chambeshi, Beston	0 R	9	LK	Sharef, Ismael M.	0 +
10	FW	Chikabala, Webster	0 R	10	FW	Mohammed, Hussaim Said	0 *
11	FW	Msiska, Lucky	0 N	11	LK	Noaman, Saad Kies	0 *
12	FW	Bwalya, Kalusha	1 *	12	FB	Abdul-Karim, Abdul-Karim	0 N
13	LK	Mwansa, Simon	0 N	13	FB	Alawi, Karim M.	1 *
14	FB	Chabinga, Manfred	0 N	14	LK	Hanna, Basil G.	0 -
15	FB	Melu, Ashols J.	0 *	15	LK	Abo-Awn, Natik H.	0 *
16	GK	Mwanza, Richard	0 +	16	FB	Taufek, Mudhafar J.	0 R
17	FW	Mwanza, Pearson	0 R	17	LK	Shahib, Laith M.	0 N
18	FW	Chansa, Wisdom Mumba	0 *	18	LK	Swadi, Radhi S.	0 N
19	FW	Nyirenda, Stone	1 *	19	FB	Maghamis, Salam H.	0 N
20	FB	Mulenga, Eston	0 R	20	GK	Hussain, Imad H.	0 R
Coach	ZAM	Ndhlovu, Samuel		Coach	IRQ	Dawood Ammanuel B.	

Referee/Arbitre
COL JESUS DIAZ

Linesman/Juges de Touche
USA V. MAURO
URS A. SPIRIN

Reserved Referee/Arbitre Suppleant
KOR KIM, IN-SOO

Total	Goals Buts	Defense	Keeper Gardien	Missed Manques	Posts Poteaux
ZAM-IRQ 2-2 (1-1)					

Goal Attempts/Tirs au But					
Penalty 11M	0-1	0-1	0-0	0-0	0-0
On Free Kick/Sur Coup Franc	1-2	0-0	0-0	0-1	1-0
In Phase of Play/En Jeu	13-13	2-1	1-0	2-2	8-8
Total	14-16	2-2	1-0	2-3	8-9

Assist/Assistance	1-0	Into Own Goal/But C.S.C.	0-0
Caution/Avertissement	1-0	Off-side/Hors-jeu	4-7
Corner Kicks/Corners	3-6	Sent off/Expulsions	0-0
Fouls/Fautes	14-11	Substitutions	1-1

First Round Group B, Match 4 Sept. 17

No	Pos	Name Nom	Goals Buts	No	Pos	Name Nom	Goals Buts
ITA-GUA 5-2 (4-1)				Premier Tour Groupe B, Match 4 17 Sept			
ITA				GUA			
1	GK	Tacconi, Stefano	0 *	1	GK	Jerez-Hidalgo, Edgar-Ricardo	0 *
2	FB	Cravero, Roberto	0 *	2	FB	Davila, Lopez, Juan Manuel	0 *
3	FW	Camevale, Andrea	1 *	3	FB	Wellman, Allan Keny	0 *
4	FB	De Agostini, Luigi	0 *	4	FB	Mazariegos Bitron, Rocacl	0 -
5	FB	Ferrara, Ciro	1 *	5	FB	Monzon Perez, Victor Hugo	0 *
6	FB	Tassotti, Mauro	0 *	6	FB	Batres-Morales, Jaime-Antonio	0 *
7	LK	Colombo, Angelo	0 *	7	FW	Castaneda-Mendez, Carlos E.	1 *
8	FB	Pellegrini, Luca	0 R	8	LK	Funes-Hernandez, Juan Manuel	0 *
9	FB	Brambati, Massimo	0 R	9	FW	Paniagua G., Adan Onelio	1 *
10	FB	Carobbi, Stefano	0 N	10	FW	Perez-Solorzano, Byron	0 *
11	LK	Crippa, Massimo	0 N	11	FW	Delva-Noriega, Norman	0 R
12	GK	Giuliani, Giuliano	0 R	12	LK	Sandoval, Kevin	0 R
13	FW	Virdis, Antonio	1 *	13	LK	Lopez Meneses, Luis Rodolfo	0 R
14	FW	Rizzitelli, Ruggiero	0 N	14	FB	Guevara-Cruz, Ottoniel	0 N
15	LK	Galia, Roberto	0 +	15	FB	Ortiz Obergon, Alejandro	0 +
16	LK	Iachini, Giuseppe	0 -	16	LK	Gardiner Walton, David-Enrique	0 N
17	LK	Desideri, Stefano	1 +	17	LK	Rodas-Hurtarte, Julio-Alberto	0 *
18	LK	Mauro, Massimo	0 *	18	GK	Piccinini A., Ricardo A.	0 R
19	LK	Evani, Alberigo	1 -	19	LK	Alburez-Suarez, Eddy-Rolando	0 N
20	GK	Pagliuca, Gianluca	0 N	Coach	GUA	Roldan Popol, Jorge	
Coach	ITA	Rocca, Francesco					

Referee/Arbitre
JPN TAKADA SHIZUO

Linesman/Juges de Touche
BRN MANDI ABDUL RAHMAN JASSIM
KOR KIL, KI-CHUL

Reserved Referee/Arbitre Suppleant
GBR K. HACKETT

Football

Total	Goals Buts	Defense	Keeper Gardien	Missed Manques	Posts Poteaux
-------	---------------	---------	-------------------	-------------------	------------------

ITA-GUA 5-2 (4-1)

Goal Attempts/Tirs au But					
Penalty 11M	0-0	0-0	0-0	0-0	0-0
On Free Kick/Sur Coup Franc	1-1	1-1	0-0	0-0	0-0
In Phase of Play/En Jeu	14-7	4-1	2-1	1-1	7-4
Total	15-8	5-2	2-1	1-1	7-4

Assist/Assistance	1-2	into Own Goal/But C.S.C.	0-0
Caution/Avertissement	1-1	Off-side/Hors-jeu	3-4
Corner Kicks/Corners	3-1	Sent off/Expulsions	0-0
Fouls/Fautes	14-5	Substitutions	2-1

First Round Group B, Match 11 Sept. 19

No	Pos	Name Nom	Goals Buts	No	Pos	Name Nom	Goals Buts
----	-----	-------------	---------------	----	-----	-------------	---------------

IRQ-GUA 3-0 (0-0)

IRQ

GUA

1	GK	Mohammed, Ahmed J.	0 *	1	GK	Jerez-Hidalgo, Edgar-Ricardo	0 R
2	FB	Motar, Adnan Dirjal	0 *	2	FB	Davila Lopez, Juan Manuel	0 *
3	FB	Ahmed, Hassan Kamal	0 *	3	FB	Wellman, Allan Keny	0 *
4	FB	Jasim, Ghaeim A.	0 *	4	FB	Mazariegos Bitron, Rocacl	0 *
5	FB	Mahmood, Samir Shakir	0 R	5	FB	Monzon Perez, Victor Hugo	0 *
6	LK	Okal, Hibeab Jafer	0 *	6	FB	Batres-Morales, Jaime-Antonio (1)	0 -
7	FW	Sadkhan, Younis A.	0 +	7	FW	Castaneda-Mendez, Carlos E.	0 *
8	FW	Amish, Ahmed Radhi	1 *	8	LK	Funes-Hernandez, Juan Manuel	0 *
9	LK	Sharef, Ismael M.	0 *	9	FW	Paniagua G., Adan Onelio	0 *
10	FW	Mohammed, Hussain Said	0 -	10	FW	Perez-Solorzano, Byron	0 *
11	LK	Noaman, Saad Kies	0 *	11	FW	Delva-Noriega, Norman	0 +
12	FB	Abdul-Karim, Abdul-Karim	0 N	12	LK	Sandoval, Kevin	0 +
13	FB	Alawi, Karim M.	0 R	13	LK	Lopez Meneses, Luis Rodolfo	0 R
14	LK	Hanna, Basil G.	0 -	14	FB	Guevara-Cruz, Ottoniel	0 N
15	LK	Abo-Awn, Natik H.	0 N	15	FB	Ortiz Obergon, Alejandro	0 N
16	FB	Taufek, Mudhafar J.	1 *	16	LK	Gardiner Walton, David-Enrique	0 R
17	LK	Shahib, Laith M.	0 +	17	LK	Rodas-Hurtarte, Julio-Alberto	0 -
18	LK	Swadi, Radhi S.	0 N	18	GK	Piccinini A., Ricardo A.	0 *
19	FB	Maghamis, Salam H.	0 N	19	LK	Alburez-Suarez, Eddy-Rolando	0 N
20	GK	Hussain, Imad H.	0 R	Coach	GUA	Roldan Popol, Jorge	
Coach	IRQ	Dawood Ammanuel B.					

Referee/Arbitre
GAB J.F. DIRAMBA

Linesman/Juges de Touche
KOR CHOI, GIL-SOO
KOR KIM, IN-SOO

Reserved Referee/Arbitre Suppleant
URS A. SPIRIN

Total	Goals Buts	Defense	Keeper Gardien	Missed Manques	Posts Poteaux
-------	---------------	---------	-------------------	-------------------	------------------

IRQ-GUA 3-0 (0-0)

Goal Attempts/Tirs au But					
Penalty 11M	0-0	0-0	0-0	0-0	0-0
On Free Kick/Sur Coup Franc	1-0	0-0	0-0	0-0	1-0
In Phase of Play/En Jeu	27-8	2-0	7-2	6-1	12-5
Total	28-8	2-0	7-2	6-1	13-5

Assist/Assistance	1-0	Into Own Goal/But C.S.C.	0-1
Caution/Avertissement	1-0	Off-side/Hors-jeu	4-4
Corner Kicks/Corners	6-3	Sent off/Expulsions	0-0
Fouls/Fautes	17-10	Substitutions	2-2



**First Round Group B, Match 12
Sept. 19**

**Premier Tour Groupe B, Match 12
19 Sept**

No	Pos	Name Nom	Goals Buts	No	Pos	Name Nom	Goals Buts
ZAM-ITA 4-0 (1-0)				ITA			
ZAM				ITA			
1	GK	Chabala, David	0 *	1	GK	Tacconi, Stefano	0 *
2	FB	Mwanza, Peter	0 R	2	FB	Cravero, Roberto	0 -
3	FB	Mumba, Edmon	0 *	3	FW	Carnevale, Andrea	0 *
4	FB	Chomba, Samuel	0 *	4	FB	De Agostini, Luigi	0 *
5	FB	Chitalu, James	0 N	5	FB	Ferrara, Ciro	0 *
6	LK	Makinka, Derby	0 *	6	FB	Tassotti, Mauro	0 *
7	FW	Bwalya, Johnson	1 *	7	LK	Colombo, Angelo	0 -
8	LK	Musonda, Charles	0 *	8	FB	Pellegrini, Luca	0 +
9	FW	Chambeshi, Beston	0 N	9	FB	Brambati, Massimo	0 R
10	FW	Chikabala, Webster	0 +	10	FB	Carobbi, Stefano	0 N
11	FW	Msiska, Lucky	0 R	11	LK	Crippa, Massimo	0 +
12	FW	Bwalya, Kalusha	3 *	12	GK	Giuliani, Giuliano	0 R
13	LK	Mwansa, Simon	0 N	13	FW	Viridis, Antonio	0 *
14	FB	Chabinga, Manfred	0 *	14	FW	Rizzitelli, Ruggiero	0 N
15	FB	Melu, Ashols J.	0 *	15	LK	Galia, Roberto	0 *
16	GK	Mwanza, Richard	0 R	16	LK	Iachini, Giuseppe	0 *
17	FW	Mwanza, Pearson	0 N	17	LK	Desideri, Stefano	0 R
18	FW	Chansa, Wisdom Mumba	0 *	18	LK	Mauro, Massimo	0 *
19	FW	Nyirenda, Stone	0 -	19	LK	Evani, Alberigo	0 N
20	FB	Mulenga, Eston	0 R	20	GK	Pagliuca, Gianluca	0 N
Coach	ZAM	Ndhlovu, Samuel		Coach	ITA	Rocca, Francesco	

Referee/Arbitre

GBR K. HACKETT

Linesman/Juges de Touche

JPN TAKADA SHIZUO

ARG J. LOUSTAU

Reserved Referee/Arbitre Suppleant

KOR KIL, KI-CHUL

Total	Goals Buts	Defense	Keeper Gardien	Missed Manques	Posts Poteaux
ZAM-ITA 4-0 (1-0)					

Goal Attempts/Tirs au But

Penalty 11M	0-0	0-0	0-0	0-0	0-0	0-0
On Free Kick/Sur Coup Franc	3-1	1-0	1-0	0-1	1-0	0-0
In Phase of Play/En Jeu	11-9	3-0	2-0	4-2	2-7	0-0
Total	14-10	4-0	3-0	4-3	3-7	0-0

Assist/Assistance

Assist/Assistance	0-0	Into Own Goal/But C.S.C.	0-0
Caution/Avertissement	3-2	Off-side/Hors-jeu	6-7
Corner Kicks/Corners	8-5	Sent off/Expulsions	0-0
Fouls/Fautes	22-13	Substitutions	1-2

**First Round Group B, Match 19
Sept. 21**

**Premier Tour Groupe B, Match 19
21 Sept**

No	Pos	Name Nom	Goals Buts	No	Pos	Name Nom	Goals Buts
ZAM-GUA 4-0 (0-0)				GUA			
ZAM				GUA			
1	GK	Chabala, David	0 *	1	GK	Jerez-Hidalgo, Edgar-Ricardo	0 *
2	FB	Mwanza, Peter	0 R	2	FB	Davila, Lopez, Juan Manuel	0 *
3	FB	Mumba, Edmon	0 *	3	FB	Wellman, Allan Keny	0 N
4	FB	Chomba, Samuel	0 N	4	FB	Mazariegos Bitron, Rocael	0 *
5	FB	Chitalu, James	0 R	5	FB	Monzon Perez, Victor Hugo	0 -
6	LK	Makinka, Derby	2 *	6	FB	Batres-Morales, Jaime-Antonio	0 +
7	FW	Bwalya, Johnson	0 N	7	FW	Castaneda-Mendez, Carlos E.	0 *
8	LK	Musonda, Charles	0 *	8	LK	Funes-Hernandez, Juan Manuel	0 N
9	FW	Chambeshi, Beston	0 *	9	FW	Paniagua G., Adan Onelio	0 N
10	FW	Chikabala, Webster	0 N	10	FW	Perez-Solorzano, Byron	0 *
11	FW	Msiska, Lucky	0 R	11	FW	Delva-Noriega, Norman	0 *
12	FW	Bwalya, Kalusha	2 *	12	LK	Sandoval, Kevin	0 -
13	LK	Mwansa, Simon	0 N	13	LK	Lopez Meneses, Luis Rodolfo	0 *
14	FB	Chabinga, Manfred	0 *	14	FB	Guevara-Cruz, Ottoniel	0 R
15	FB	Melu, Ashols J.	0 *	15	FB	Ortiz Obergon, Alejandro	0 *
16	GK	Mwanza, Richard	0 R	16	LK	Gardiner Walton, David-Enrique	0 +
17	FW	Mwanza, Pearson	0 +	17	LK	Rodas-Hurtarte, Julio-Alberto	0 *
18	FW	Chansa, Wisdom Mumba	0 *	18	GK	Piccinini A., Ricardo A.	0 R
19	FW	Nyirenda, Stone	0 -	19	LK	Alburez-Suarez, Eddy-Rolando	0 R
20	FB	Mulenga, Eston	0 *	Coach	GUA	Roldan Popol, Jorge	
Coach	ZAM	Ndhlovu, Samuel					

Referee/Arbitre

BRN MANDI ABDUL RAHMAN JASSIM

Linesman/Juges de Touche

ARG J. LOUSTAU

KOR KIL, KI-CHUL

Reserved Referee/Arbitre Suppleant

JPN TAKADA SHIZUO

Total	Goals Buts	Defense	Keeper Gardien	Missed Manques	Posts Poteaux
ZAM-GUA 4-0 (0-0)					

Goal Attempts/Tirs au But

Penalty 11M	1-0	1-0	0-0	0-0	0-0	0-0
On Free Kick/Sur Coup Franc	1-3	0-0	0-0	1-1	0-2	0-0
In Phase of Play/En Jeu	18-4	3-0	5-0	3-0	6-4	1-0
Total	20-7	4-0	5-0	4-1	6-6	1-0

Assist/Assistance

Assist/Assistance	1-0	Into Own Goal/But C.S.C.	0-0
Caution/Avertissement	1-1	Off-side/Hors-Jeu	2-4
Corner Kicks/Corners	9-4	Sent off/Expulsions	0-0
Fouls/Fautes	15-8	Substitutions	1-2

**First Round Group B, Match 20
Sept. 21**

**Premier Tour Groupe B, Match 20
21 Sept**

No	Pos	Name Nom	Goals Buts	No	Pos	Name Nom	Goals Buts
IRQ-ITA 0-2 (0-0)				ITA			
IRQ				ITA			
1	GK	Mohammed, Ahmed J. Motar, Adnan Dirjal	0 *	1	GK	Tacconi, Stefano	0 *
2	FB	Ahmed, Hassan Kamal	0 *	2	FB	Cravero, Roberto	0 R
3	FB	Jasim, Ghaeim A.	0 *	3	FW	Carnevale, Andrea	0 +
4	FB	Mahmood, Samir Shakir	0 *	4	FB	De Agostini, Luigi	0 *
5	LK	Okal, Hibeab Jafer	0 +	5	FB	Ferrara, Ciro	0 *
6	FW	Sadkhan, Younis A.	0 R	6	FB	Tassotti, Mauro	0 *
7	FW	Amish, Ahmed Radhi	0 *	7	LK	Colombo, Angelo	0 +
8	LK	Sharef, Ismael M.	0 *	8	FB	Pellegrini, Luca	0 N
9	FW	Mohammed, Hussain Said	0 -	9	FB	Brambati, Massimo	0 *
10	LK	Noaman, Saad Kies	0 -	10	FB	Carobbi, Stefano	0 R
11	FB	Abdul-Karim, Abdul-Karim	0 N	11	LK	Crippa, Massimo	0 *
12	FB	Alawi, Karim M.	0 +	12	GK	Giuliani, Giuliano	0 R
13	LK	Hanna, Basil G.	0 N	13	FW	Viridis, Antonio	0 *
14	LK	Abo-Awn, Natik H.	0 N	14	FW	Rizzitelli, Ruggiero	1 -
15	FB	Taufek, Mudhafar J.	0 *	15	LK	Galia, Roberto	0 N
16	LK	Shahib, Laith M.	0 *	16	LK	Iachini, Giuseppe	0 *
17	LK	Swadi, Radhi S.	0 R	17	LK	Desideri, Stefano	0 N
18	FW	Maghamis, Salam H.	0 N	18	LK	Mauro, Massimo	1 -
19	GK	Hussain, Imad H.	0 R	19	LK	Evani, Alberigo	0 *
20	GK	Dawood Ammanuel B.	0 R	20	GK	Pagliuca, Gianluca	0 N
Coach	IRQ			Coach	ITA	Rocca, Francesco	

Referee/Arbitre

CHI M.SILVA ARCE

Linesman/Juges de Touche

POL M. LISTKIEWICZ

FRG K.H.TRITSCHLER

Reserved Referee/Arbitre Suppleant

KOR YOO, KUN-HO

Total	Goals Buts	Defense	Keeper Gardien	Missed Manques	Posts Poteaux
IRQ-ITA 0-2 (0-0)					

Goal Attempts/Tirs au But

Penalty 11M	0-0	0-0	0-0	0-0	0-0	0-0
On Free Kick/Sur Coup Franc	1-2	0-0	0-0	1-0	0-2	0-0
In Phase of Play/En Jeu	6-13	0-2	0-1	3-5	2-4	1-1
Total	7-15	0-2	0-1	4-5	2-6	1-1

Assist/Assistance

Assist/Assistance	0-0	Into Own Goal/But C.S.C.	0-0
Caution/Avertissement	3-2	Off-side/Hors-jeu	2-3
Corner Kicks/Corners	2-6	Sent off/Expulsions	0-0
Fouls/Fautes	32-17	Substitutions	2-2

Football

First Round Group C, Match 5 Sept. 18

No	Pos	Name Nom	Goals Buts	No	Pos	Name Nom	Goals Buts
KOR-URS 0-0 (0-0)							
KOR				URS			
1	GK	Cho, Byung-Deuk	0 *	1	GK	Kharine, Dmitri	0 *
2	FB	Park, Kyung-Hoon	0 *	2	FB	Ketachvili, Guela	0 *
3	FB	Choi, Kang-Hee	0 *	3	FB	Skliarov, Igor	0 N
4	FB	Cho, Min-Kook	0 *	4	FB	Cherednik, Alexei	0 *
5	FB	Chung, Yong-Hwan	0 *	5	FB	Ianonis, Arvidas	0 R
6	FW	Lee, Tae-Ho	0 N	6	LK	Tichtchenko, Vadim	0 N
7	LK	Noh, Soo-Jin	0 R	7	LK	Kouznetsov, Evgueni	0 N
8	FW	Chung, Hae-Won	0 -	8	LK	Ponomarev, Igor	0 *
9	FW	Kim, Yong-Se	0 R	9	FW	Borodiouk, Alexandre	0 -
10	FW	Choi, Sang-Kook	0 +	10	LK	Dobrovolski, Igor	0 *
11	FW	Byun, Byung-Joo	0 *	11	FW	Lioutyi, Vladimir	0 +
12	FB	Kim, Pan-Keun	0 N	12	FB	Iarovenko, Evgueni	0 R
13	FB	Nam, Ki-Young	0 N	13	FB	Fokine, Serguei	0 N
14	FW	Choi, Soon-Ho	0 *	14	FW	Tatartchouk, Vladimir	0 +
15	LK	Kim, Chong-Kon	0 N	15	FW	Mikhailitchenko, Alexei	0 *
16	LK	Kim, Joo-Sung	0 *	16	GK	Proudnikov, Alexei	0 R
17	FB	Ku, Sang-Bum	0 *	17	FB	Lossev, Victor	0 *
18	FB	Choi, Yun-Kyum	0 +	18	FB	Gorloukovitch, Serguei	0 *
19	LK	Yeo, Bum-Kyu	0 -	19	LK	Savitchev, Iouri	0 -
20	GK	Kim, Pung-Joo	0 R	20	LK	Narbekovas, Arminas	0 *
Coach	KOR	Kim, Chung-Nam		Coach	URS	Bychovets, Anatoli	

Referee/Arbitre
ITA T. LANESE

Linesman/Juges de Touche
GBR K.HOPE
AUS CH. BAMBRIDGE

Reserved Referee/Arbitre Suppleant
URU J. CARDELLINO DE S. VINCENTE

	Total	Goals Buts	Defense	Keeper Gardien	Missed Manques	Posts Poteaux
KOR-URS 0-0 (0-0)						
Goal Attempts/Tirs au But						
Penalty 11M	0-0	0-0	0-0	0-0	0-0	0-0
On Free Kick/Sur Coup Franc	0-0	0-0	0-0	0-0	0-0	0-0
In Phase of Play/En Jeu	7-9	0-0	1-2	3-2	3-4	0-1
Total	7-9	0-0	1-2	3-2	3-4	0-1
Assist/Assistance	0-0		Into Own Goal/But C.S.C.			0-0
Caution/Avertissement	1-0		Off-side/Hors-jeu			0-0
Corner Kicks/Corners	4-6		Sent off/Expulsions			0-0
Fouls/Fautes	21-18		Substitutions			2-2

First Round Group C, Match 6 Sept. 18

No	Pos	Name Nom	Goals Buts	No	Pos	Name Nom	Goals Buts
USA-ARG 1-1 (0-0)							
USA				ARG			
1	GK	Vanole, David	0 *	1	GK	Islas, Luis Alberto	0 *
2	FB	Trittschuh, Stephen	0 N	2	FB	Aguero, Ruben Jose	0 *
3	FB	Doyle, John	0 N	3	FW	Aires, Mauro Gabriel	0 +
4	FB	Crow, Kevin	0 *	4	FW	Alfaro Moreno, Carlos-Alejandro	1 *
5	FB	Windischmann, Michael	1 +	5	FB	Boggio, Alberto-Osvaldo	0 N
6	FW	Klopas, Frank	0 R	6	LK	Cabrera, Claudio-Martin	0 N
7	LK	Gabarra, James	0 N	7	FW	Comas, Jorge Alberto	0 -
8	LK	Davis, Richard	0 *	8	LK	Diaz, Hernan Edgardo	0 *
9	FW	Goulet, Brent	0 -	9	FB	Fabbri, Nestor-Ariel	0 *
10	FW	Vermes, Peter	0 *	10	FW	Hernandez, Daniel Anibal	0 R
11		Eichmann, Eric	0 N	11	LK	Lorenzo, Nestor Gabriel	0 *
12	FB	Krumpe, Paul	0 *	12	GK	Cancelarich, Fabian Oscar	0 R
13	LK	Harkes, John	0 +	13	LK	Lucca, Mario Bruno	0 +
14	LK	Stollmeyer, John	0 R	14	LK	Mayor, Carlos Alberto	0 -
15	LK	Ramos, Tabare	0 -	15	LK	Monzon, Pedr Damian	0 R
16	LK	Murray, Bruce	0 *	16	LK	Perez, Hugo Leonardo	0 *
17	FB	Armstrong, Desmond	0 *	17	FW	Ruidiaz, Alejandro	0 *
18	GK	Duback, Jeffrey	0 R	18	FW	Russo, Alejandro Marcelo	0 N
19	FB	Bliss, Brian	0 *	19	LK	Siviski, Dario Andres	0 *
20	FB	Caligiuri, Paul	0 *	Coach	ARG	C. Pachame	
Coach	USA	Oslander, Lothar					

Referee/Arbitre
SYR AL-SHRIFJAMAL

Linesman/Juges de Touche
BRA A.D.C. COELHO
MEX E. CODESAL

Reserved Referee/Arbitre Suppleant
SUI ROETHLISBERGER

Football

	Total	Goals Buts	Defense	Keeper Gardien	Missed Manques	Posts Poteaux
USA-ARG 1-1 (0-0)						
Goal Attempts/Tirs au But						
Penalty 11M	0-1	0-1	0-0	0-0	0-0	0-0
On Free Kick/Sur Coup Franc	0-0	0-0	0-0	0-0	0-0	0-0
In Phase of Play/En Jeu	10-8	1-0	0-0	2-4	6-4	1-0
Total	10-9	1-1	0-0	2-4	6-4	1-0
Assist/Assistance	0-0		Into Own Goal/But C.S.C.			0-0
Caution/Avertissement	2-2		Off-side/Hors-jeu			4-1
Corner Kicks/Corners	5-3		Sent off/Expulsions			0-0
Fouls/Fautes	14-14		Substitutions			2-2

First Round Group C, Match 13 Sept. 20

No	Pos	Name Nom	Goals Buts	No	Pos	Name Nom	Goals Buts
KOR-USA 0-0 (0-0)							
KOR				USA			
1	GK	Cho, Byung-Deuk	0 *	1	GK	Vanole, David	0 *
2	FB	Park, Kyung-Hoon	0 *	2	FB	Trittschuh, Stephen	0 N
3	FB	Choi, Kang-Hee	0 -	3	FB	Doyle, John	0 +
4	FB	Cho, Min-Kook	0 *	4	FB	Crow, Kevin	0 *
5	FB	Chung, Yong-Hwan	0 *	5	FB	Windischmann, Michael	0 N
6	FW	Lee, Tae-Ho	0 -	6	FW	Klopas, Frank	0 *
7	LK	Noh, Soo-Jin	0 R	7	LK	Gabarra, James	0 R
8	FW	Chung, Hae-Won	0 N	8	LK	Davis, Richard	0 *
9	FW	Kim, Yong-Se	0 +	9	FW	Goulet, Brent	0 *
10	FW	Choi, Sang-Kook	0 *	10	FW	Vermes, Peter	0 N
11	FW	Byun, Byung-Joo	0 *	11		Eichmann, Eric	0 R
12	FB	Kim, Pan-Keun	0 N	12	FB	Krumpe, Paul	0 *
13	FB	Nam, Ki-Young	0 N	13	LK	Harkes, John	0 -
14	FW	Choi, Soon-Ho	0 *	14	LK	Stollmeyer, John	0 +
15	LK	Kim, Chong-Kon	0 N	15	LK	Ramos, Tabare	0 -
16	LK	Kim, Joo-Sung	0 *	16	LK	Murray, Bruce	0 N
17	FB	Ku, Sang-Bum	0 *	17	FB	Armstrong, Desmond	0 *
18	FB	Choi, Yun-Kyum	0 *	18	GK	Duback, Jeffrey	0 R
19	LK	Yeo, Bum-Kyu	0 R	19	FB	Bliss, Brian	0 *
20	GK	Kim, Pung-Joo	0 R	20	FB	Caligiuri, Paul	0 *
Coach	KOR	Kim, Chung-Nam		Coach	USA	Oslander, Lothar	

Referee/Arbitre
MAR B. LAOUISSI

Linesman/Juges de Touche
TRI LENNOX SIRJUESINGH
ITA T. LANESE

Reserved Referee/Arbitre Suppleant
AUS CH. BAMBRIDGE

	Total	Goals Buts	Defense	Keeper Gardien	Missed Manques	Posts Poteaux
KOR-USA 0-0 (0-0)						
Goal Attempts/Tirs au But						
Penalty 11M	0-0	0-0	0-0	0-0	0-0	0-0
On Free Kick/Sur Coup Franc	0-0	0-0	0-0	0-0	0-0	0-0
In Phase of Play/En Jeu	14-4	0-0	2-1	3-0	8-3	1-0
Total	14-4	0-0	2-1	3-0	8-3	1-0
Assist/Assistance	0-0		Into Own Goal/But C.S.C.			0-0
Caution/Avertissement	1-0		Off-side/Hors-jeu			1-1
Corner Kicks/Corners	9-2		Sent off/Expulsions			0-0
Fouls/Fautes	14-7		Substitutions			2-2



First Round Group C, Match 14
Sept. 20

Premier Tour Groupe C, Match 14
20 Sept

No	Pos	Name Nom	Goals Buts	No	Pos	Name Nom	Goals Buts
URS-ARG 2-1 (2-0)				URS			
1	GK	Kharine, Dmitri	0 *	1	GK	Islas, Luis Alberto	0 *
2	FB	Ketachvili, Guela	0 *	2	FB	Aguero, Ruben Jose	0 *
3	FB	Skliarov, Igor	0 N	3	FW	Aires, Mauro Gabriel	0 +
4	FB	Cherednik, Alexei	0 *	4	FW	Alfaro Moreno, Carlos-Alejandro	1 *
5	FB	Ilanonis, Arvidas	0 R	5	FB	Boggio, Alberto-Osvaldo	0 N
6	LK	Tichtchenko, Vadim	0 N	6	LK	Cabrera, Claudio-Martin	0 -
7	LK	Kouznetsov, Evgueni	0 *	7	FW	Comas, Jorge Alberto	0 *
8	LK	Ponomarev, Igor	0 N	8	LK	Diaz, Hernan Edgardo	0 *
9	FW	Borodiouk, Alexandre	0 R	9	FB	Fabbri, Nestor-Ariel	0 *
10	LK	Dobrovolski, Igor	1 *	10	FW	Hernandez, Daniel Anibal	0 R
11	FW	Lioutyi, Vladimir	0 *	11	LK	Lorenzo, Nestor Gabriel	0 *
12	FB	Iarovenko, Evguent	0 +	12	GK	Cancelarich, Fabian Oscar	0 R
13	FB	Fokine, Serguei	0 N	13	LK	Lucca, Mario Bruno	0 *
14	FW	Tatarchouk, Vladimir	0 -	14	LK	Mayor, Carlos Alberto	0 N
15	FW	Mikhailitchenko, Alexei	1 *	15	LK	Monzon, Pedrd Damian	0 R
16	GK	Proudnikov, Alexei	0 R	16	LK	Perez, Hugo Leonardo	0 *
17	FB	Lossev, Victor	0 *	17	FW	Ruidiaz, Alejandro	0 N
18	FB	Gorloukovitch, Serguei	0 *	18	FW	Russo, Alejandro Marcelo	0 R
19	LK	Savitchev, Iouri	0 +	19	LK	Siviski, Dario Andres	0 *
20	LK	Narbekovas, Arminas	0 -	Coach	ARG	C. Pachame	
Coach	URS	Bychovets, Anatoli					

Referee/Arbitre

FRA G. BIGUET

Linesman/Juges de Touche

SUI ROETHLISBERGER
SEN B. SENE

Reserved Referee/Arbitre Suppleant

SYR AL-SHRIF JAMAL

Total	Goals Buts	Defense	Keeper Gardien	Missed Manques	Posts Poteaux
URS-ARG 2-1 (2-0)					

Goal Attempts/Tirs au But	Penalty 11M	On Free Kick/Sur Coup Franc	In Phase of Play/En Jeu	Total	Assist/Assistance	Caution/Avertissement	Corner Kicks/Corner	Fouls/Fautes
0-1	0-1	0-0	0-0	0-0	0-0	3-1	7-2	23-18
0-0	0-0	0-0	6-2	8-4	0-0	3-0	0-0	2-1
2-0	2-1	1-0	6-2	9-4	0-0			
0-0					0-0			

First Round Group C, Match 21
Sept. 22

Premier Tour Groupe C, Match 21
22 Sept

No	Pos	Name Nom	Goals Buts	No	Pos	Name Nom	Goals Buts
KOR-ARG 1-2 (1-1)				KOR			
1	GK	Cho, Byung-Deuk	0 *	1	GK	Islas, Luis Alberto	0 *
2	FB	Park, Kyung-Hoon	0 *	2	FB	Aguero, Ruben Jose	0 R
3	FB	Choi, Kang-Hee	0 -	3	FW	Aires, Mauro Gabriel	0 *
4	FB	Cho, Min-Kook	0 *	4	FW	Alfaro Moreno, Carlos-Alejandro	1 *
5	FB	Chung, Yong-Hwan	0 *	5	FB	Boggio, Alberto-Osvaldo	0 N
6	FW	Lee, Tae-Ho	0 R	6	LK	Cabrera, Claudio-Martin	0 +
7	LK	No, Soo-Jin	1 -	7	FW	Comas, Jorge Alberto	0 *
8	FW	Chung, Hae-Won	0 N	8	LK	Diaz, Hernan Edgardo	0 *
9	FW	Kim, Yong-Se	0 +	9	FB	Fabbri, Nestor-Ariel	1 *
10	FW	Choi, Sang-Kook	0 *	10	FW	Hernandez, Daniel Anibal	0 N
11	FW	Byun, Byung-Joo	0 *	11	LK	Lorenzo, Nestor Gabriel	0 -
12	FB	Kim, Pan-Keun	0 N	12	GK	Cancelarich, Fabian Oscar	0 R
13	FB	Nam, Ki-Young	0 N	13	LK	Lucca, Mario Bruno	0 *
14	FW	Choi, Soon-Ho	0 *	14	LK	Mayor, Carlos Alberto	0 N
15	LK	Kim, Chong-Kon	0 N	15	LK	Monzon, Pedrd Damian	0 *
16	LK	Kim, Joo-Sung	0 *	16	LK	Perez, Hugo Leonardo	0 -
17	FB	Ku, Sang-Bum	0 *	17	FW	Ruidiaz, Alejandro	0 R
18	FB	Choi, Yun-Kyun	0 R	18	FW	Russo, Alejandro Marcelo	0 +
19	LK	Yeo, Bum-Kyu	0 +	19	LK	Siviski, Dario Andres	0 *
20	GK	Kim, Pung-Joo	0 R	Coach	ARG	C. Pachame	
Coach	KOR	Kim, Chung-Nam					

Referee/Arbitre

AUS CH. BAMBRIDGE

Linesman/Judge de Touche

URU J. CARDELLINO DE S. VINCENTE
GBR K. HOPE

Reserved Referee/Arbitre Suppleant

ITA T. LANESE

Total	Goals Buts	Defense	Keeper Gardien	Missed Manques	Posts Poteaux
KOR-ARG 1-2 (1-1)					

Goal Attempts/Tirs au But	Penalty 11M	On Free Kick	In Phase of Play/En Jeu	Total	Assist/Assistance	Caution/Avertissement	Corner Kicks/Corner	Fouls/Fautes
1-0	0-0	0-0	12-16	13-18	3-2	0-1	5-6	22-9
0-0	0-0	0-1	2-3	4-2	0-0	0-1	0-0	0-0
0-0			2-5	2-4	0-0	1-0	0-0	
0-0			5-6	2-5	0-0			
0-0			5-7	2-5	0-0			

Total	Goals Buts	Defense	Keeper Gardien	Missed Manques	Posts Poteaux
KOR-ARG 1-2 (1-1)					

Goal Attempts/Tirs and But	Penalty 11M	On Free Kick/Sur Coup Franc	In Phase of Play/En Jeu	Total	Assist/Assistance	Caution/Avertissement	Corner Kicks/Corner	Fouls/Fautes
0-0	0-0	0-0	13-7	13-7	1-2	1-0	6-6	15-15
0-0	0-0	0-0	1-0	1-0	0-0	0-0	0-0	
0-0			4-1	4-1	0-0	3-1	0-0	
0-0			7-4	7-4	0-0		2-2	
0-0			1-0	1-0	0-0			
0-0			4-1	4-1	0-0			
0-0			7-4	7-4	0-0			

First Round Group C, Match 22
Sept. 22

Premier Tour Groupe C, Match 22
22 Sept

No	Pos	Name Nom	Goals Buts	No	Pos	Name Nom	Goals Buts
URS-USA 4-2 (3-0)				URS			
1	GK	Kharine, Dmitri	0 *	1	GK	Vanole, David	0 *
2	FB	Ketachvili, Guela	0 *	2	FB	Tritschuh, Stephen	0 R
3	FB	Skliarov, Igor	0 N	3	FB	Doyle, John	1 *
4	FB	Cherendik, Alexei	0 N	4	FB	Crow, Kevin	0 *
5	FB	Ilanonis, Arvidas	0 +	5	FB	Windischmann, Michael	0 N
6	LK	Tichtchenko, Vadim	0 N	6	FW	Klopas, Frank	0 *
7	LK	Kouznetsov, Evgueni	0 *	7	LK	Gabarra, James	0 R
8	LK	Ponomarev, Igor	0 R	8	LK	Davis, Richard	0 *
9	FW	Borodiouk, Alexandre	0 +	9	FW	Goulet, Brent	1 +
10	LK	Dobrovolski, Igor	1 -	10	FW	Vermes, Peter	0 *
11	FW	Lioutyi, Vladimir	0 *	11	FW	Eichmann, Eric	0 N
12	FB	Iarovenko, Evgueni	0 *	12	FB	Krumpe, Paul	0 -
13	FB	Fokine, Seerguei	0 N	13	LK	Harkes, John	0 N
14	FW	Tatarchouk, Vladimir	0 R	14	LK	Stollmeyer, John	0 -
15	FW	Mikhailitchenko, Alexei	2 -	15	LK	Ramos, Tabare	0 N
16	GK	Proudnikov, Alexei	0 R	16	LK	Murray, Bruce	0 *
17	FB	Lossev, Victor	0 *	17	FB	Armstrong, Desmond	0 +
18	FB	Gorloukovitch, Serguei	0 *	18	GK	Duback, Jeffrey	0 R
19	LK	Savitchev, Iouri	0 *	19	FB	Bliss, Brian	0 *
20	LK	Narbekovas, Arminas	1 *	20	FB	Caligiuri, Paul	0 *
Coach	URS	Bychovets, Anatoli		Coach	USA	Oslander, Lothar	

Referee/Arbitre

BRA A.D.C. Coelho

Linesman/Juges de Touche

MEX E. Codesal
SYR Al-Shrif Jamal

Reserved Referee/Arbitre Suppleant

SEN B. SENE

Total	Goals Buts	Defense	Keeper Gardien	Missed Manques	Posts Poteaux
URS-USA 4-2 (3-0)					

Goal Attempts/Tirs au But	Penalty 11M	On Free Kick	In Phase of Play/En Jeu	Total	Assist/Assistance	Caution/Avertissement	Corner Kicks/Corner	Fouls/Fautes
1-0	0-0	0-0	12-16	13-18	3-2	0-1	5-6	22-9
0-0	0-0	0-1	2-3	4-2	0-0	0-1	0-0	0-0
0-0			2-5	2-4	0-0	1-0	0-0	
0-0			5-6	2-5	0-0			
0-0			5-7	2-5	0-0			

Football

First Round Group D, Match 7 Sept. 18

No	Pos	Name Nom	Goals Buts	No	Pos	Name Nom	Goals Buts
BRA-NGR 4-0 (0-0)							
BRA				NGR			
1	GK	Taffarel, Claudio	0 *	1	GK	Ngodigha, David	0 *
2	FB	Campos, Jorge	0 *	2	FB	Ezeogu, Emeka	0 -
3	f b	Santos, Joad	0 R	3	FB	Uwe, Andrew	0 *
4	FB	Raimundo, Ricardo	0 N	4	FB	Adeshina, Ademola	0 *
5	LK	Kaefler, Ademir	0 *	5	FB	Nwanu, Chidi	0 *
6	FB	Kerchner, Nelson	0 N	6	LK	Dairu, Saidi	0 *
7	FW	Candido, Valdo	0 N	7	LK	Eguavon, Augustine	0 *
8	LK	Silva, Geovani	0 *	8	LK	Okpala, Sylvanus	0 *
9	FW	Santos, Edmar	1 -	9	FW	Jorfa, Dominic	0 -
10	LK	Souza, Hamilton	0 -	10	LK	Okwaraji, Samuel	0 *
11	FW	Farias, Romario	2 *	11	FW	Yekini, Rachidi	0 *
12	GK	Araujo, Jose	0 R	12	GK	Obi, Christian	0 R
13	FB	Cruz, Andre	0 *	13	FW	Obiku, Mike	0 R
14	FB	Winck, Luiz	0 *	14	LK	Omokaro, Bright	0 +
15	FB	Alves, Aloisio	0 *	15	FW	Siasia, Samson	0 R
16	LK	Souza, Milton	0 *	16	LK	Obobaifo, Osaro	0 +
17	LK	Ferreira, Jose	0 +	17	FW	Dofgbami, Wole	0 N
18	LK	Luiz, Sergio	0 R	18	LK	Okosieme, Ndubuisi	0 N
19	FW	Silva, Jorge	0 N	19	FB	Agada, Jude	0 N
20	FW	Oliveira, Jose	1 +	20	LK	Nwosu, Henry	0 N
Coach	BRA	Silva, Carlos		Coach	NGR	Hoener, Manfred	

Referee/Arbitre

USA V.MAURO

Linesman/Juges de Touche

URS A. SPIRIN
COL JESUS DIAZ

Reserved Referee/Arbitre Suppleant

KOR CHOI, GIL-SOO

Total	Goals Buts	Defense	Keeper Gardien	Missed Manques	Posts Poteaux
BRA-NGR 4-0 (0-0)					

BRA-NGR 4-0 (0-0)

Goal Attempts/Tirs au But

Penalty 11m	0-0	0-0	0-0	0-0	0-0	0-0
On Free Kick/Sur Coup Franc	2-1	0-0	1-0	1-0	0-1	0-0
In Phase of Play/En Jeu	23-7	4-0	2-0	8-2	9-3	0-2
Total	25-8	4-0	3-0	9-2	9-4	0-2

Assist/Assistance	4-0	Into Own Goal/But C.S.C.	0-0
Caution/Avertissement	0-2	Off-side/Hors-jeu	4-5
Corner Kicks/Corner	10-2	Sent off/Expulsions	0-0
Fouls/Fautes	11-20	Substitutions	2-2

First Round Group D, Match 8 Sept. 18

Premier Tour Groupe D, Match 8 18 Sept

No	Pos	Name Nom	Goals Buts	No	Pos	Name Nom	Goals Buts
AUS-YUG 1-0 (0-0)							
AUS				YUG			
1	GK	Olver, Jeferev	0 *	1	GK	Lekovic, Dragoje	0 -
2	FB	Van Egmond, Gary	0 R	2	FB	Stanojkovic, Vujadin	0 *
3	FB	Jennings, Graham	0 *	3	FB	Spasic, Predrag	0 *
4	FB	Yankos, Charlie	0 *	4	FB	Katanec, Srecko	0 *
5	FB	Dunn, Robert	0 *	5	FB	Jozic, Davor	0 N
6	LK	Wade, Paul	0 *	6	LK	Branovic, Dragoljub	0 *
7	FW	Farina, Frank	1 *	7	LK	Sabanadzovic, Refik	0 *
8	LK	Petersen, Mike	0 *	8	LK	Savevski, Toni	0 R
9	FW	Arnold, Graham	0 -	9	FB	Barbaric, Ivica	0 *
10	FW	Kosmina, John	0 R	10	LK	Stojkovic, Dragan	0 *
11	LK	Crino, Oscar	0 *	11	LK	Milosevic, Cvijan	0 R
12	LK	Davidson, Alan	0 *	12	LK	Stojanovic, Stevan	0 +
13	FB	Tobin, Alexander	0 N	13	FW	Milinkovic, Dusko	0 -
14	FB	Hunter, Alan	0 N	14	FW	Suker, Davor	0 R
15	FB	Koczka, Andrew	0 N	15	FW	Tuce, Semir	0 *
16	LK	Bozinoski, Vlado	0 +	16	FW	Djukic, Vladislav	0 *
17	FW	Slater, Robert	0 +	17	FW	Mihic, Mirko	0 +
18	FW	Mitchell, David	0 -	18	LK	Jaksic, Nenad	0 N
19	FW	Ollerenshaw, Scott	0 N	Coach	YUG	Cabrinovic, Ivan	
20	GK	Gibson, Michael	0 R				
Coach	AUS	Arok, Frank					

Referee/Arbitre

ARG J. LOUSTAU

Linesman/Juges de Touche

GBR K. HACKETT
JPN TAKADA SHIZUO

Reserved Referee/Arbitre Suppleant

BRN MANDI ABDUL RAHMAN JASSIM

Football

Total	Goals Buts	Defense	Keeper Gardien	Missed Manques	Posts Poteaux
AUS-YUG 1-0 (0-0)					
Goal Attempts/Tirs au But					
Penalty 11M	1-0	0-0	0-0	1-0	0-0
On Free Kick/Sur Corp Franc	3-3	0-0	0-2	2-0	1-1
In Phase of Play/En Jeu	7-6	1-0	1-1	1-3	3-2
Total	11-9	1-0	1-3	3-3	5-3
Assist/Assistance	1-0	Into Own Goal/But C.S.C.			0-0
Caution/Avertissement	4-1	Off-side/Hors-jeu			4-2
Corner Kicks/Corners	4-4	Sent off/Expulsions			0-0
Fouls/Fautes	14-13	Substitutions			2-2

First Round Group D, Match 15 Sept. 20

Premier Tour Groupe D, Match 15 20 Sept

No	Pos	Name Nom	Goals Buts	No	Pos	Name Nom	Goals Buts
YUG-NGR 3-1 (1-0)							
YUG				NGR			
1	GK	Lekovic, Dragoje	0 R	1	GK	Ngodigha, David	0 R
2	FB	Stanojkovic, Vujadin	0 *	2	FB	Ezeogu, Emeka	0 R
3	LB	Spasic, Predrag	0 *	3	FB	Uwe, Andrew	0 *
4	FB	Katanec, Srecko	0 *	4	FB	Adeshina, Ademola	0 *
5	MF	Jozic, Davor	0 *	5	FB	Nwanu, Chidi	0 *
6	LK	Branovic, Dragoljub	0 +	6	LK	Dairu, Saidi	0 *
7	MF	Sabanadzovic, Refik	1 -	7	LK	Eguavon, Augustine	0 *
8	LK	Savevski, Toni	0 *	8	LK	Okpala, Sylvanus	0 *
9	FB	Barbaric, Ivica	0 *	9	FW	Jorfa, Dominic	0 R
10	MF	Stojkovic, Dragan	2 *	10	LK	Okwaraji, Samule	0 -
11	LK	Milosevic, Dragan	0 +	11	FW	Yekini, Rachidi	1 *
12	GK	Stojanovic, Stevan	0 *	12	GK	Obi, Christian	0 *
13	FW	Milinkovic, Dusko	0 R	13	FW	Obiku, Mike	0 +
14	FW	Suker, Davor	0 -	14	LK	Omokard, Bright	0 -
15	FW	Tuce, Semir	0 N	15	FW	Siasia, Samson	0 *
16	FW	Djukic, Vladislav	0 N	16	LK	Obobaifo, Osaro	0 N
17	FW	Mihic, Mirko	0 *	17	FW	Dofgbami, Wole	0 +
18	LK	Jakstc, Nenad	0 R	18	LK	Okosieme, Ndubuisi	0 N
Coach	YUG	Cabrinovic, Ivan		19	FB	Agada, Jude	0 N
				20	LK	Nwosu, Henry	0 N
				Coach	NGR	Hoener, Manfred	

Referee/Arbitre

KOR Choi, Gil-Soo

Linesman/Juges Diaz

COL JESUS DIAZ
USA V. MAURO

Reserved Referee/Arbitre Suppleant

GAB J. F. DIRAMBA

Total	Goals Buts	Defense	Keeper Gardien	Missed Manques	Posts Poteaux
YUG-NGR 3-1 (1-0)					

YUG-NGR 3-1 (1-0)

Goal Attempts/Tirs au But

Penalty 11M	1-0	1-0	0-0	0-0	0-0	0-0
On Free Kick/Sur Coup Franc	1-1	0-0	0-0	0-0	1-1	0-0
In Phase of Play/En Jeu	24-10	2-1	4-0	8-4	9-5	1-0
Total	26-11	3-1	4-0	8-4	10-6	1-0

Assist/Assistance	2-1	Into Own Goal/But C.S.C.			0-0
Caution/Avertissement	1-1	Off-side			3-1
Corner Kicks/Corners	10-5	Sent off/Expulsions			0-0
Fouls/Fautes	12-12	Substitutions			2-2



**First Round Group D, Match 16
Sept. 20**

**Premier Tour Groupe D, Match 16
20 Sept**

No	Pos	Name Nom	Goals Buts	No	Pos	Name Nom	Goals Buts
AUS-BRA 0-3 (0-1)							
AUS				BRA			
1	GK	Olver, Jeferey	0 *	1	GK	Taffarel, Claudio	0 *
2		Van Egmond, Gary	0 *	2	FB	Campos, Jorge	0 N
3	FB	Jennings, Graham	0 *	3	FB	Santos, Joao	0 *
4	FB	Yankos, Charlie	0 *	4	FB	Raimundo, Ricardo	0 N
5	FB	Dunn, Robert	0 -	5	LK	Kaefer, Ademir	0 *
6	LK	Wade, Paul	0 *	6	FB	Kerchner, Nelson	0 N
7	FW	Farina, Frank	0 -	7	FW	Candido, Valdo	0 N
8	LK	Petersen, Mike	0 *	8	LK	Silva, Geovani	0 *
9	FW	Arnold, Graham	0 *	9	FW	Santos, Edmar	0 *
10	FW	Kosmina, John	0 R	10	LK	Souza, Hamilton	0 -
11	LK	Crino, Oscar	0 *	11	FW	Farias, Romario	3 *
12	LK	Davidson, Alan	0 *	12	GK	Araujo, Jose	0 R
13	FB	Tobin, Alexander	0 N	13	FB	Cruz, Andre	0 *
14	FB	Hunter, Alan	0 N	14	FB	Winck, Luiz	0 *
15	FB	Koczk, Andrew	0 N	15	FB	Alves, Aloisio	0 *
16	LK	Bozinovski, Vlado	0 R	16	LK	Souza, Milton	0 -
17	FW	Slater, Robert	0 +	17	LK	Ferreira, Jose	0 R
18	FW	Mitchell, David	0 *	18	LK	Luiz, Sergio	0 +
19	FW	Ollerenshaw, Scott	0 N	19	FW	Silva, Jorge	0 R
20	GK	Gibson, Michael	0 R	20	FW	Oliveira, Jose	0 +
Coach	AUS	Arok, Frank		Coach	BRA	Silva, Carlos	

Referee/Arbitre
FRG K. H. TRITSCHLER
Linesman/Juges de Touche
CHI M. SILVA ARCE
POL M. LISTKIEWICZ
Reserved Referee/Arbitre Suppleant
KOR PARK, HEE-CHA-RANG

	Total	Goals Buts	Defense	Keeper Gardien	Missed Manques	Posts Poteaux
AUS-BRA 0-3 (0-1)						
Goal Attempts/Tirs au But						
Penalty 11M	0-1	0-0	0-0	0-1	0-0	0-0
On Free Kick/Sur Coup Franc	0-0	0-0	0-0	0-0	0-0	0-0
In Phase of Play/En Jeu	9-11	0-3	0-3	4-4	5-1	0-0
Total	9-12	0-3	0-3	4-5	5-1	0-0
Assist/Assistance	0-2		Into Own Goal/But C.S.C			0-0
Caution/Avertissement	1-2		Off-side/Hors-jeu			1-0
Corner Kicks/Corners	9-2		Sent off/Expulsions			0-0
Fouls/Fautes	21-17		Substitutions			2-2

**First Round Group D, Match 23
Sept. 22**

**Premier Tour Groupe D, Match 23
22 Sept**

No	Pos	Name Nom	Goals Buts	No	Pos	Name Nom	Goals Buts
YUG-BRA 1-2 (0-1)							
YUG				BRA			
1	GK	Lekovic, Dragoje	0 R	1	GK	Taffarel, Claudio	0 *
2	FB	Stanojkovic, Vujadin	0 *	2	FB	Campos, Jorge	0 N
3	LB	Spasic, Predrag	0 *	3	FB	Santos, Joao	0 *
4	FB	Katanec, Srecko	0 *	4	FB	Raimundo, Ricardo	0 N
5	MF	Jozic, Davor	0 *	5	LK	Kaefer, Ademir	0 *
6	LK	Brnovic, Dragoljub	0 -	6	FB	Kerchner, Nelson	0 N
7	MF	Sabanadzovic, Refik	1 *	7	FW	Candido, Valdo	0 N
8	LK	Savevski, Toni	0 N	8	LK	Silva, Geovani	0 *
9	FB	Barbaric, Ivica	0 *	9	FW	Santos, Edmar	0 -
10	MF	Stojkovic, Dragan	0 *	10	LK	Souza, Hamilton	0 -
11	LK	Milosevic, Cvijan	0 +	11	FW	Farias, Romario	0 *
12	GK	Stojanovic, Stevan	0 *	12	GK	Araujo, Jose	0 R
13	FW	Milinkovic, Dusko	0 R	13	FB	Cruz, Andre	1 *
14	FW	Suker, Davor	0 +	14	FB	Winck, Luiz	0 *
15	FW	Tuce, Semir	0 *	15	FB	Alves, Aloisio	0 *
16	FW	Djukic, Vladislav	0 R	16	LK	Souza, Milton	0 *
17	FW	Mihic, Mirko	0 -	17	LK	Ferreira, Jose	0 R
18	LK	Jaksic, Nenad	0 N	18	LK	Luiz, Sergio	0 R
Coach	YUG	Cabrinovic, Ivan		19	FW	Silva, Jorge	0 +
				20	FW	Oliveira, Jose	1 +
				Coach	BRA	Silva, Carlos	

Referee/Arbitre
URS A. SPIRIN
Linesman/Juges de Touche
GAB J.F. DIRAMBA
KOR CHOI, GIL-SOO
Reserved Referee/Arbitre Suppleant
KOR KIM, IN-SOO

	Total	Goals Buts	Defense	Keeper Gardien	Missed Manques	Posts Poteaux
YUG-BRA 1-2 (0-1)						
Goal Attempts/Tirs au But						
Penalty 11M	0-0	0-0	0-0	0-0	0-0	0-0
On Free Kick/Sur Coup Franc	3-0	0-0	1-0	1-0	1-0	0-0
In Phase of Play/En Jeu	12-13	1-0	1-1	6-3	3-9	1-0
Total	15-13	1-0	2-1	7-3	4-9	1-0
Assist/Assistance	0-0		Into Own Goal/But C.S.C			0-0
Caution/Avertissement	0-1		Off-side/Hors-jeu			3-3
Corner Kicks/Corners	6-5		Sent off/Expulsions			0-0
Fouls/Fautes	8-17		Substitutions			2-2

	Total	Goals Buts	Defense	Keeper Gardien	Missed Manques	Posts Poteaux
YUG-BRA 1-2 (0-1)						
Goal Attempts/Tirs au But						
Penalty 11M	0-0	0-0	0-0	0-0	0-0	0-0
On Free Kick/Sur Coup Franc	1-3	0-1	0-1	1-0	0-1	0-0
In Phase of Play/En Jeu	13-11	1-1	0-0	3-5	9-4	0-1
Total	14-14	1-2	0-1	4-5	9-5	0-1
Assist/Assistance	1-0		Into Own Goal/But C.S.C			0-0
Caution/Avertissement	1-0		Off-side/Hors-jeu			5-2
Corner Kicks/Corners	11-5		Sent off/Expulsions			0-0
Fouls/Fautes	12-22		Substitutions			2-2

**First Round Group D, Match 24
Sept. 22**

**Premier Tour Groupe D, Match 24
22 Sept**

No	Pos	Name Nom	Goals Buts	No	Pos	Name Nom	Goals Buts
AUS-NGR 1-0 (0-0)							
AUS				NGR			
1	GK	Olver, Jeffrey	0 *	1	GK	Ngodigha, David	0 R
2		Van Egmond, Gary	0 *	2	FB	Ezeogu, Emeke	0 +
3	FB	Jennings, Graham	0 *	3	FB	Uwe, Andrew	0 *
4	FB	Yankos, Charlie	0 *	4	FB	Adeshina, Ademola	0 *
5	FB	Dunn, Robert	0 -	5	FB	Nwanu, Chidi	0 N
6	LK	Wade, Paul	0 *	6	LK	Dairu, Saidi	0 *
7	FW	Farina, Frank	0 N	7	LK	Eguavon, Augustine	0 *
8	LK	Petersen, Mike	0 N	8	LK	Okpala, Sylvanus	0 *
9	FW	Arnold, Graham	0 *	9	FW	Jorja, Dominic	0 -
10	FW	Kosmina, John	1 -	10	LK	Okwaraji, Samuel	0 *
11	LK	Crino, Oscar	0 *	11	FW	Yekini, Rachidi	0 *
12	LK	Davidson, Alan	0 *	12	GK	Obi, Christian	0 *
13	FB	Tobin, Alexander	0 N	13	LK	Omokaro, Bright	0 R
14	FB	Hunter, Alan	0 N	14	LK	Obobaifo, Osaro	0 R
15	FB	Koczk, Andrew	0 +	15	FW	Obiku, Mike	0 -
16	LK	Bozinovski, Vlado	0 R	16	FW	Siasia, Samson	0 *
17	FW	Slater, Robert	0 R	17	FW	Dofgbami, Wole	0 +
18	FW	Mitchell, David	0 *	18	LK	Okosieme, Ndubuissi	0 N
19	FW	Ollerenshaw, Scott	0 +	19	FB	Agada, Jude	0 N
20	GK	Gibson, Michael	0 R	20	LK	Nwosu, Henry	0 N
Coach	AUS	Arok, Frank		Coach	NGR	Hoener, Manfred	

Referee/Arbitre
POL M. LISTKIEWICZ
Linesman/Juges de Touche
KOR PARK, HEE-CHA-RANG
KOR YOO, KUN-HO
Reserved Referee/Arbitre Suppleant
FRG K.H. TRITSCHLER

	Total	Goals Buts	Defense	Keeper Gardien	Missed Manques	Posts Poteaux
AUS-NGR 1-0 (0-0)						
Goal Attempts/Tirs au But						
Penalty 11M	0-0	0-0	0-0	0-0	0-0	0-0
On Free Kick/Sur Coup Franc	3-0	0-0	1-0	1-0	1-0	0-0
In Phase of Play/En Jeu	12-13	1-0	1-1	6-3	3-9	1-0
Total	15-13	1-0	2-1	7-3	4-9	1-0
Assist/Assistance	0-0		Into Own Goal/But C.S.C			0-0
Caution/Avertissement	0-1		Off-side/Hors-jeu			3-3
Corner Kicks/Corners	6-5		Sent off/Expulsions			0-0
Fouls/Fautes	8-17		Substitutions			2-2

	Total	Goals Buts	Defense	Keeper Gardien	Missed Manques	Posts Poteaux
AUS-NGR 1-0 (0-0)						
Goal Attempts/Tirs au But						
Penalty 11M	0-0	0-0	0-0	0-0	0-0	0-0
On Free Kick/Sur Coup Franc	3-0	0-0	1-0	1-0	1-0	0-0
In Phase of Play/En Jeu	12-13	1-0	1-1	6-3	3-9	1-0
Total	15-13	1-0	2-1	7-3	4-9	1-0
Assist/Assistance	0-0		Into Own Goal/But C.S.C			0-0
Caution/Avertissement	0-1		Off-side/Hors-jeu			3-3
Corner Kicks/Corners	6-5		Sent off/Expulsions			0-0
Fouls/Fautes	8-17		Substitutions			2-2

Football

Quarter-final, Match 25 Sept. 25

No	Pos	Name Nom	Goals Buts	No	Pos	Name Nom	Goals Buts
SWE-ITA 1-1 (0-0) (EXT. 0-1)							
SWE				ITA			
1	GK	Andersson, Sven	0 *	1	GK	Tacconi, Stefano	0 *
2	DF	Vattovaara, Sulo	0 R	2	FB	Cravero, Roberto	0 R
3	DF	Lonn, Peter	0 *	3	FW	Carnevale, Andrea	0 +
4	DF	Arnberg, Goran	0 *	4	FB	De Agostini, Luigi	0 *
5	DF	Nilsson, Roland	0 *	5	FB	Ferrara, Ciro	0 *
6	MF	Them, Jonas	0 *	6	FB	Tassolti, Mauro	0 *
7	MF	Engqvist, Leif	0 *	7	LK	Colombo, Angelo	0 +
8	MF	Andersson, Michael	0 *	8	FB	Pellegrini, Luca	0 N
9	MF	Nilsson, Joakim	0 -	9	FB	Brambati, Massimo	0 *
10	MF	Limpar, Anders	0 -	10	FB	Carobbi, Stefano	0 R
11	FW	Lindman, Hakan	0 N	11	LK	Crippa, Massimo	1 *
12	GK	Nilsson, Bengt	0 N	12	GK	Giuliani, Giuliano	0 R
13	FW	Dahlin, Martin	0 +	13	FW	Viridis, Antonio	1 *
14	FW	Eskilsson, Hans	0 +	14	FW	Rizzitelli, Ruggiero	0 -
15	FW	Hellstrom, Jan	1 *	15	LK	Galia, Roberto	0 N
16	DF	Ljung, Roger	0 *	16	LK	Iachini, Giuseppe	0 *
17	GK	Eriksson, Lars	0 R	17	LK	Desideri, Stefano	0 N
18	DF	Svensson, Ola	0 N	18	LK	Mauro, Massimo	0 *
19	MF	Palmer, Anders	0 N	19	LK	Evani, Alberigo	0 -
20	MF	Rehn, Stefan	0 R	20	GK	Pagliuca, Gianluca	0 N
Coach	SWE	Lennartsson, Benny		Coach	ITA	Rocca, Francesco	

Referee/Arbitre

FRA G. BIGUET

Linesman/Juges de Touche

POL M. LISTKIEWICZ
GAB J.F. DIRAMBA

Reserved Referee/Arbitre Suppleant

ARG J. LOUSTAU

Total	Goals Buts	Defense	Keeper Gardien	Missed Manques	Posts Poteaux
SWE-ITA 1-1 (0-0) (EXT. 0-1)					

Goal Attempts/Tirs au But

Penalty 11M	1-0	0-0	0-0	0-0	1-0	0-0
On Free Kick/Sur Coup Franc	0-0	0-0	0-0	0-0	0-0	0-0
In Phase of Play/En Jeu	9-13	1-2	1-3	3-3	4-4	0-1
Total	10-13	1-2	1-3	3-3	5-4	0-1

Assist/Assistance	1-2	Into Own Goal/But C.S.C	0-0
Caution/Avertissement	1-4	Off-side/Hors-jeu	3-12
Corner Kicks/Corners	11-7	Sent off/Expulsions	0-0
Fouls/Fautes	25-17	Substitutions	2-2

Quarter-final, Match 26 Sept. 25

Quart de Finale, Match 26 25 Sept

No	Pos	Name Nom	Goals Buts	No	Pos	Name Nom	Goals Buts
ZAM-FRG 0-4 (0-3)							
ZAM				FRG			
1	GK	Chabala, David	0 *	1	GK	Reck, Oliver	0 R
2	FB	Mwanza, Peter	0 R	2	FB	Schulz, Michael	0 *
3	FB	Mumba, Edmon	0 *	3	LK	Goertz, Armin	0 *
4	FB	Chomba, Samuel	0 *	4	FB	Funkel, Wolfgang	1 *
5	FB	Chitalu, James	0 N	5	FB	Hoerster, Thomas	0 *
6	LK	Makinka, Derby	0 *	6	LK	Janssen, Olaf	0 +
7	FW	Bwalya, Johnson	0 -	7	LK	Bommer, Rudi	0 N
8	LK	Musonda, Charles	0 *	8	LK	FAch, Holger	0 *
9	FW	Chambeshi, Beston	0 N	9	FW	Klinsmann, Juergen	3 *
10	FW	Chikabala, Webster	0 N	10	LK	Wuttke, Wolfram	0 *
11	FW	Msiska, Lucky	0 +	11	FW	Mill, Frank	0 N
12	FW	Bwalya, Kalusha	0 *	12	GK	Kamps, Uwe	0 *
13	LK	Mwansa, Simon	0 N	13	FB	Grahammer, Roland	0 *
14	FB	Chabinga, Manfred	0 *	14	LK	Haessler, Thomas	0 -
15	FB	Melu, Ashols J.	0 *	15	LK	Schreier, Christian	0 N
16	GK	Mwanza, Richard	0 R	16	FW	Walter, Fritz	0 R
17	FW	Mwanza, Pearson	0 +	17	FB	Sievers, Ralf	0 R
18	FW	Chansa, Wisdom Mumba	0 *	18	LK	Kleppinger, Gerhard	0 +
19	FW	Nyirenda, Stone	0 -	19	FW	Riedle, Karlheinz	0 -
20	FB	Mulenga, Eston	0 R	20	FB	Sauer, Gunnar	0 N
Coach	ZAM	Ndhlovu, Samuel		Coach	FRG	Loehr, Hannes	

Referee/Arbitre

COL JESUS DIAZ

Linesman/Juges de Touche

SYR AL-SHRIF JAMAL
BRN MANDI ABDUL RAHMAN JASSIM

Reserved Referee/Arbitre Suppleant

AUS CH. BAMBRIDGE

Football

Total	Goals Buts	Defense	Keeper Gardien	Missed Manques	Posts. Poteaux
ZAM-FRG 0-4 (0-3)					
Goal Attempts/Tirs au But					
Penalty 11M	0-1	0-1	0-0	0-0	0-0
On Free Kick/Sur Coup Franc	3-0	0-0	3-0	0-0	0-0
In Phase of Play/En Jeu	12-13	0-3	1-1	4-1	7-8
Total	15-14	0-4	4-1	4-1	7-8
Assist/Assistance					
0-1		Into Own Goal/But C.S.C			0-0
Caution/Avertissement					
1-0		Off-side/Hors-jeu			3-4
Corner Kicks/Corners					
10-5		Sent off/Expulsions			0-0
Fouls/Fautes					
6-14		Substitutions			2-2

Quarter-final, Match 27 Sept. 25

Quart de Finale, Match 27 25 Sept

No	Pos	Name Nom	Goals Buts	No	Pos	Name Nom	Goals Buts
URS-AUS 3-0 (0-0)							
URS				AUS			
1	GK	Kharine, Dmitri	0 *	1	GK	Olver, Jeffrey	0 *
2	FB	Ketachvili, Guela	0 *	2		Van Egmond, Gary	0 *
3	FB	Skliarov, Igor	0 +	3	FB	Jennings, Graham	0 *
4	FB	Cherednik, Alexei	0 -	4	FB	Yankos, Charlie	0 *
5	FB	Ianonis, Arvidas	0 N	5	FB	Dunn, Robert	0 *
6	LK	Tichtchenko, Vadim	0 N	6	LK	Wade, Paul	0 *
7	LK	Kouznetsov, Evgueni	0 *	7	FW	Farina, Frank	0 *
8	LK	Ponomarev, Igor	0 N	8	LK	Petersen, Mike	0 R
9	FW	Borodiouk, Alexandre	0 N	9	FW	Arnold, Graham	0 *
10	LK	Dobrovolski, Igor	2 *	10	FW	Kosmina, John	0 R
11	FW	Lioutyi, Vladimir	0 *	11	LK	Crino, Oscar	0 *
12	FB	Iarovenko, Evgueni	0 R	12	LK	Davidson, Alan	0 *
13	FB	Fokine, Serguei	0 +	13	FB	Tobin, Alexander	0 N
14	FW	Tatartchouk, Vladimir	0 -	14	FB	Hunter, Alan	0 N
15	FW	Mikhailitchenko, Alexei	1 *	15	FB	Koczka, Andrew	0 R
16	HK	Proudnikov, Alexei	0 R	16	LK	Bozinoski, Vlado	0 R
17	FB	Lossev, Victor	0 *	17	FW	Slater, Robert	0 N
18	FB	Gorloukovitch, Serguei	0 *	18	FW	Mitchell, David	0 -
19	LK	Savitchev, Iouri	0 R	19	FW	Ollershaw, Scott	0 N
20	LK	Narbekovas, Arminas	0 *	20	GK	Gibson, Michael	0 R
Coach	URS	Bychovets, Anatoli		Coach	AUS	Arok, Frank	

Referee/Arbitre

URU J.CARDELLINO DE S.VINCENTE

Linesman/Juges de Touche

USA V. MAURO
MEX E. CODESAL

Reserved Referee/Arbitre Suppleant

ITA T. LANESE

Total	Goals Buts	Defense	Keeper Gardien	Missed Manques	Posts Poteaux
URS-AUS 3-0 (0-0)					

Goal Attempts/Tirs au But

Penalty 11M	2-0	2-0	0-0	0-0	0-0
On Free Kick/Sur Coup Franc	1-2	1-0	0-0	0-1	0-1
In Phase of Play/En Jeu	10-4	0-0	1-1	7-1	2-2
Total	13-6	3-0	1-1	7-2	2-3

Assist/Assistance	1-0	Into Own Goal/But C.S.C	0-0
Caution/Avertissement	1-1	Off-side/Hors-jeu	1-1
Corner Kicks/Corners	6-1	Sent off/Expulsions	0-1
Fouls/Fautes	11-17	Substitutions	2-0



Quarter-final, Match 28
Sept. 25

Quart de Finale, Match 28
25 Sept

No	Pos	Name Nom	Goals Buts	No	Pos	Name Nom	Goals Buts
BRA-ARG 1-0 (0-0)							
BRA				ARG			
1	GK	Taffarel, Claudio	0 *	1	GK	Isias, Luis Alberto	0 *
2	FB	Campos, Jorge	0 *	2	FB	Aguero, Ruben Jose	0 N
3	FB	Santos, Joao	0 R	3	FW	Aires, Mauro Gabriel	0 *
4	FB	Raimundo, Ricardo	0 N	4	FW	Alfaro Moreno, Carlos-Alejan	0 *
5	LK	Kaefer, Ademir	0 *	5	FB	Boggio, Alberto-Osvaldo	0 N
6	FB	Nascimento, Iomar	0 N	6	LK	Cabrera, Claudio-Martin	0 R
7	FW	Candido, Valdo	0 N	7	FW	Comas, Jorge Alberto	0 *
8	LK	Silva, Geovani	1 *	8	LK	Diaz, Hernan Edgardo	0 *
9	FW	Santos, Edmar	0 R	9	FB	Fabbri, Nestor-Ariel	0 -
10	LK	Souza, Hamilton	0 +	10	FW	Hernandez, Daniel Anibal	0 N
11	FW	Farias, Romario	0 *	11	LK	Lorenzo, Nestor Gabriel	0 *
12	GK	Araujo, Jose	0 R	12	GK	Candelarich, Fabian Oscar	0 R
13	FB	Cruz, Andre	0 *	13	LK	Lucca, Mario Bruno	0 *
14	FB	Winck, Luiz	0 *	14	LK	Mayor, Carlos Alberto	0 +
15	FB	Alves, Aloisio	0 *	15	LK	Monzon, Pedro Damian	0 *
16	LK	Souza, Milton	0 -	16	LK	Perez, Hugo Leonardo	0 -
17	LK	Ferreira, Jose	0 R	17	FW	Ruidiaz, Alejandro	0 R
18	LK	Luiz, Sergio	0 N	18	FW	Russo, Alejandro Marcelo	0 +
19	FW	Silva, Jorge	0 *	19	LK	Siviski, Dario Andres	0 *
20	FW	Oliveira, Jose	0 *	Coach	ARG	C. Pachame	0 *
Coach	BRA	Silva, Carlos					

Referee/Arbitre
SUI ROETHLISBERGER

Linesman/Juges de Touche
GBR K. HACKETT
JPN TAKADA SHIZUO

Reserved Referee/Arbitre Suppleant
FRG K.H. TRITSCHLER

	Total	Goals Buts	Defense	Keeper Gardien	Missed Manques	Posts Poteaux
BRA-ARG 1-0 (0-0)						
Goal Attempts/Tirs au But						
Penalty 11M	0-0	0-0	0-0	0-0	0-0	0-0
On Free Kick/Sur Coup Franc	7-1	0-0	0-0	6-1	1-0	0-0
In Phase of Play/En Jeu	15-3	1-0	1-0	6-3	6-0	1-0
Total	22-4	1-0	1-0	12-4	7-0	1-0
Assist/Assistance	0-0		Into Own Goal/But C.S.C.			0-0
Caution/Avertissement	2-0		Off-side/Hors-jeu			5-1
Corner Kicks/Corners	9-4		Sent off/Expulsions			0-0
Fouls/Fautes	16-29		Substitutions			1-2

Semi-final, Match 29
Sept. 27

Demi-finale, Match 29
27 Sept

No	Pos	Name Nom	Goals Buts	No	Pos	Name Nom	Goals Buts
ITA-URS 1-1 (0-0) (EXT. 1-2)							
ITA				URS			
1	GK	Tacconi, Stefano	0 *	1	GK	Kharine, Dmitri	0 *
2	FB	Cravero, Roberto	0 R	2	FB	Ketachvili, Guela	0 *
3	FW	Carnevale, Andrea	1 +	3	FB	Skliarov, Igor	0 R
4	FB	De Agostini, Luigi	0 N	4	FB	Cherednik, Alexei	0 -
5	FB	Ferrara, Ciro	0 -	5	FB	Ianonis, Arvidas	0 N
6	FB	Tassotti, Mauro	0 *	6	LK	Tichtchenko, Vadim	0 N
7	LK	Colombo, Angelo	0 N	7	LK	Kouznetsov, Evgueni	0 *
8	FB	Pellegrini, Luca	0 N	8	LK	Ponomarev, Igor	0 N
9	FB	Brambati, Massimo	0 *	9	FW	Borodiouk, Alexandre	0 R
10	FB	Carobbi, Stefano	0 *	10	LK	Dobrovolski, Igor	1 *
11	LK	Crippa, Massimo	0 *	11	FW	Lioutyi, Vladimir	0 *
12	GK	Giuliani, Giuliano	0 R	12	FB	Iarovenko, Evgueni	0 +
13	FW	Virdis, Antonio	1 *	13	FB	Forkine, Serguei	0 N
14	FW	Rizzitelli, Ruggiero	0 -	14	FW	Tatartchouk, Vladimir	0 -
15	LK	Galia, Roberto	0 R	15	FW	Mikhailitchenko, Alexei	1 *
16	LK	Iachini, Giuseppe	0 *	16	GK	Proudnikov, Alexei	0 R
17	LK	Desideri, Stefano	0 +	17	FB	Lossev, Victor	0 *
18	LK	Mauro, Massimo	0 *	18	FB	Gorloukovitch, Serguei	0 *
19	LK	Evani, Alberigo	0 -	19	LK	Savitchev, Iouri	0 +
20	GK	Pagliuca, Gianluca	0 N	20	LK	Narbekovas, Arminas	1 *
Coach	ITA	Rocca, Francesco		Coach	URS	Bychovets, Anatoli	

Referee/Arbitre
SYR AL-SHRIF JAMAL

Linesman/Juges de Touche
FRA G. BIGUET
POL M. LISTKIEWICZ

Reserved Referee/Arbitre Suppleant
USA V. MAURO

	Total	Goals Buts	Defense	Keeper Gardien	Missed Manques	Posts Poteaux
ITA-URS 1-1 (0-0) (EXT. 1-2)						
Goal Attempts/Tirs au But						
Penalty 11M	0-0	0-0	0-0	0-0	0-0	0-0
On Free Kick/Sur Coup Franc	4-3	0-0	1-1	0-1	3-1	0-0
In Phase of Play/En Jeu	9-14	2-3	0-0	3-3	4-7	0-1
Total	13-17	2-3	1-1	3-4	7-8	0-1
Assist/Assistance	2-3		Into Own Goal/But C.S.C.			0-0
Caution/Avertissement	2-4		Off-side/Hors-jeu			1-3
Corner Kicks/Corners	3-9		Sent off/Expulsions			1-0
Fouls/Fautes	11-31		Substitutions			2-2

Semi-final, Match 30
Sept. 27

Demi-finale, Match 30
27 Sept

No	Pos	Name Nom	Goals Buts	No	Pos	Name Nom	Goals Buts
FRG-BRA 1-1 (0-0) (EXT. 0-0) (P.K 2-3)							
FRG				BRA			
1	GK	Reck, Oliver	0 R	1	GK	Taffarel, Claudio	0 *
2	FB	Schulz, Michael	0 *	2	FB	Campos, Jorge	0 *
3	LK	Goertz, Armin	0 -	3	FB	Santos, Joao	0 N
4	FB	Funkel, Wolfgang	0 *	4	FB	Raimundo, Ricardo	0 N
5	FB	Hoerster, Thomas	0 *	5	LK	Kaefer, Ademir	0 -
6	LK	Janssen, Olaf	0 +	6	FB	Nascimento, Iomar	0 R
7	LK	Bommer, Rudi	0 N	7	FW	Candido, Valdo	0 N
8	LK	Fach, Holger	1 *	8	LK	Silva, Geovani	0 *
9	FW	Klinsmann, Juergen	0 *	9	FW	Santos, Edmar	0 R
10	LK	Wuttke, Wolfram	0 *	10	LK	Souza, Hamilton	0 *
11	FW	Mill, Frank	0 -	11	FW	Farias, Romario	1 *
12	GK	Kamps, Uwe	0 *	12	GK	Araujo, Jose	0 R
13	FB	Grahammer, Roland	0 *	13	FB	Cruz, Andre	0 *
14	LK	Haessler, Thomas	0 *	14	FB	Winck, Luiz	0 *
15	LK	Schreier, Christian	0 N	15	FB	Alves, Aloisid	0 *
16	FW	Walter, Fritz	0 N	16	LK	Souza, Milton	0 +
17	FB	Sievers, Ralf	0 R	17	LK	Ferreira, Jose	0 N
18	LK	Kleppinger, Gerhard	0 +	18	LK	Luiz, Sergio	0 +
19	FW	Riedle, Karlheinz	0 R	19	FW	Silva, Jorge	0 *
20	FB	Sauer, Gunnar	0 N	20	FW	Oliveira, Jose	0 -
Coach	FRG	Loehr, Hannes		Coach	BRA	Silva, Carlos	

Referee/Arbitre
GBR K. HACKETT

Linesman/Juges de Touche
AUS CH. BAMBRIDGE
ARG J. LOUSTAU

Reserved Referee/Arbitre Suppleant
GAB J.F. DIRAMBA

	Total	Goals Buts	Defense	Keeper Gardien	Missed Manques	Posts Poteaux
FRG-BRA 1-1 (0-0) (EXT. 0-0) (P.K 2-3)						
Goal Attempts/Tirs au But						
Penalty 11M	1-0	0-0	0-0	0-0	1-0	0-0
On Free Kick/Sur Coup Franc	2-7	1-0	0-0	0-3	1-4	0-0
In Phase of Play/En Jeu	9-10	0-1	1-1	2-4	6-4	0-0
Total	12-17	1-1	1-1	2-7	8-8	0-0
Assist/Assistance	1-1		Into Own Goal/But C.S.C.			0-0
Caution/Avertissement	1-4		Off-side/Hors-jeu			2-1
Corner Kicks/Corners	9-18		Sent off/Expulsions			0-0
Fouls/Fautes	29-25		Substitutions			2-2

Football

Football

Final (3-4 Places), Match 31 Sept. 30				Finale (3-4 Places), Match 31 30 Sept			
No	Pos	Name Nom	Goals Buts	No	Pos	Name Nom	Goals Buts
ITA-FRG 0-3 (0-2)							
ITA				FRG			
1	GK	Tacconi, Stefano	0 *	1	GK	Reck, Oliver	0 R
2	FB	Cravero, Roberto	0 R	2	FB	Schulz, Michael	0 *
3	FW	Carnevale, Andrea	0 *	3	LK	Goertz, Armin	0 N
4	FB	De Agostini, Luigi	0 *	4	FB	Funkel, Wolfgang	0 *
5	FB	Ferrara, Ciro	0 N	5	FB	Hoerster, Thomas	0 *
6	FB	Tassotti, Mauro	0 *	6	LK	Janssen, Olaf	0 N
7	LK	Colombo, Angelo	0 *	7	LK	Bommer, Rudi	0 +
8	FB	Pellegrini, Luca	0 N	8	LK	Fach, Holger	0 N
9	FB	Brambati, Massimo	0 *	9	FW	Klinsmann, Juergen	1 *
10	FB	Carobbi, Stefano	0 *	10	LK	Wuttke, Wolfram	0 -
11	LK	Crippa, Massimo	0 *	11	FW	Mill, Frank	0 *
12	GK	Giuliani, Giuliano	0 R	12	GK	Kamps, Uwe	0 *
13	FW	Viridis, Antonio	0 -	13	FB	Grahammer, Roland	0 *
14	FW	Rizzitelli, Ruggiero	0 +	14	LK	Haessler, Thomas	0 *
15	LK	Galia, Roberto	0 *	15	LK	Schreier, Christian	1 +
16	LK	Iachini, Giuseppe	0 N	16	FW	Walter, Fritz	0 R
17	LK	Desideri, Stefano	0 R	17	FB	Sievers, Ralf	0 -
18	LK	Mauro, Massimo	0 *	18	LK	Kleppinger, Gerhard	1 *
19	LK	Evani, Alberigo	0 R	19	FW	Riedle, Karlheinz	0 R
20	GK	Pagliuca, Gianluca	0 N	20	FB	Sauer, Gunnar	0 N
Coach	ITA	Rocca, Francesco		Coach	FRG	Loehr, Hannes	
Referee/Arbitre							
ARG J. LOUSTAU							
Linesman/Juges de Touche							
SUI ROETHLISBERGER							
GAB J.F. DIRAMBA							
Reserved Referee/Arbitre Suppleant							
POL M. LISTKIEWICZ							

Total	Goals Buts	Defense	Keeper Gardien	Missed Manques	Posts Poteaux
ITA-FRG 0-3 (0-2)					
Goal Attempts/Tirs au But					
Penalty 11M	0-0	0-0	0-0	0-0	0-0
On Free Kick/Sur Coup Franc	2-0	0-0	2-0	0-0	0-0
In Phase of Play/En Jeu	8-9	0-3	0-1	3-1	4-4
Total	10-9	0-3	2-1	3-1	4-4
Assist/Assistance	0-3	Into Own Goal/But C.S.C.			0-0
Caution/Avertissement	2-1	Off-side/Hors-jeu			3-6
Corner Kicks/Corners	8-4	Sent off/Expulsions			0-0
Fouls/Fautes	13-18	Substitutions			1-2

Final (1-2 Places), Match 32 Oct. 1				Finale (1-2 Places), Match 32 1 Oct			
No	Pos	Name Nom	Goals Buts	No	Pos	Name Nom	Goals Buts
URS-BRA 1-1 (0-1) (EXT. 1-0)							
URS				BRA			
1	GK	Kharine, Dmitri	0 *	1	GK	Taffarel, Claudio	0 *
2	FB	Ketachvili, Guela	0 *	2	FB	Campos, Jorge	0 *
3	FB	Skliarov, Igor	0 +	3	FB	Santos, Joao	0 R
4	FB	Cherednik, Alexei	0 N	4	FB	Raimundo, Ricardo	0 N
5	FB	Ilanonis, Arvidas	0 N	5	LK	Kaefer, Ademir	0 N
6	LK	Tichtchenko, Vadim	0 N	6	FB	Nascimento, Iomar	0 R
7	LK	Kouznetsov, Evgueni	0 *	7	FW	Candido, Valdo	0 N
8	LK	Ponomarev, Igor	0 N	8	LK	Silva, Geovani	0 N
9	FW	Borodiouk, Alexandre	0 R	9	FW	Santos, Edmar	0 -
10	LK	Dobrovolski, Igor	1 *	10	LK	Souza, Hamilton	0 *
11	FW	Lioutyi, Vladimir	0 -	11	FW	Farias, Romario	1 *
12	FB	Iarovenko, Evgueni	0 *	12	GK	Araujo, Jose	0 R
13	FB	Forkine, Serguei	0 R	13	FB	Cruz, Andre	0 *
14	FW	Tatartchouk, Vladimir	0 -	14	FB	Winck, Luiz	0 *
15	FW	Mikhailitchenko, Alexei	0 *	15	FB	Alves, Aloisio	0 *
16	GK	Proudnikov, Alexei	0 R	16	LK	Souza, Milton	0 *
17	FB	Lossev, Victor	0 *	17	LK	Ferreira, Jose	0 -
18	FB	Gorloukovitch, Serguei	0 *	18	LK	Luiz, Sergio	0 +
19	LK	Savitchev, Iouri	1 +	19	FW	Silva, Jorge	0 *
20	LK	Narbekovas, Arminas	0 -	20	FW	Oliveira, Jose	0 -
Coach	URS	Bychovets, Anatoli		Coach	BRA	Silva, Carlos	
Referee/Arbitre							
FRA G. BIGUET							
Linesman/Juges de Touche							
COL JESUS DIAZ							
BRN MANDI ABDUL RAHMAN JASSIM							
Reserved Referee/Arbitre Suppleant							
USA V. MAURO							

Time Temps	Event Evenement	Result Resultat	Ctry Pays	No.	Pos.	Name Nom
00:00	Kick-off	0-0	URS	14	FW	Tatartchouk, Vladimir
03:00	Shot (Stopped by Defense)	-	BRA	20	FW	Oliveira, Jose
03:30	Corner Kick	-	BRA	17	LK	Ferreira, Jose
05:00	Corner Kick	-	URS	10	LK	Dobrovolski, Igor
09:00	Shot (Missed)	-	URS	15	FW	Mikhailitchenko, Alexei
16:00	Free Kick (Missed)	-	BRA	13	FB	Cruz, Andre
17:00	Free Kick (Stopped by Keeper)	-	URS	10	LK	Dobrovolski, Igor
25:00	Shot (Stopped by Keeper)	-	URS	11	FW	Lioutyi, Vladimir
29:00	Corner Kick	-	BRA	17	LK	Ferreira, Jose
29:10	Goal	0-1	BRA	11	FW	Farias, Romario
	Assist	-	BRA	17	LK	Ferreira, Jose
30:00	Corner Kick	-	BRA	17	LK	Ferreira, Jose
31:00	Corner Kick	-	BRA	17	LK	Ferreira, Jose
35:00	Free Kick (Missed)	-	BRA	20	FW	Oliveira, Jose
40:00	Corner Kick	-	BRA	17	LK	Ferreira, Jose
42:00	Caution	-	URS	2	FB	Ketachvili, Guela
42:00	Caution	-	BRA	10	LK	Souza, Hamilton
44:00	Free Kick (Stopped by Keeper)	-	BRA	15	FB	Alves, Aloisio
44:40	Corner Kick	-	BRA	17	LK	Ferreira, Jose
45:00	Half-time	0-1				
00:00	Substitution out	-	URS	20	LK	Narbekovas, Arminas
	Substitution in	-	URS	19	LK	Savitchev, Iouri
02:00	Shot (Stopped by Keeper)	-	URS	19	LK	Savitchev, Iouri
02:36	Corner Kick	-	URS	10	LK	Dobrovolski, Igor
03:00	Corner Kick	-	URS	10	LK	Dobrovolski, Igor
04:00	Corner Kick	-	URS	10	LK	Dobrovolski, Igor
12:00	Shot (Stopped by Defense)	-	BRA	17	LK	Ferreira, Jose
12:50	Shot (Missed)	-	BRA	2	FB	Campos, Jorge
16:00	Goal (Penalty Kick)	1-1	URS	10	LK	Dobrovolski, Igor
17:00	Caution	-	BRA	13	FB	Cruz, Andre
20:00	Free Kick (Stopped by Keeper)	-	URS	10	LK	Dobrovolski, Igor
25:00	Shot (Stopped by Keeper)	-	BRA	17	LK	Ferreira, Jose
27:00	Caution	-	BRA	14	FB	Winck, Luiz
27:00	Substitution out	-	BRA	17	LK	Ferreira, Jose
	Substitution in	-	BRA	9	FW	Santos, Edmar
28:00	Free Kick (Missed)	-	URS	2	FB	Ketachvili, Guela
29:00	Substitution out	-	BRA	20	FW	Oliveira, Jose
	Substitution in	-	BRA	18	LK	Luiz, Sergio
30:50	Corner Kick	-	URS	14	FW	Tatartchouk, Vladimir
33:00	Shot (Stopped by Keeper)	-	BRA	11	FW	Farias, Romario
33:36	Shot (Stopped by Defense)	-	BRA	9	FW	Santos, Edmar
34:00	Caution	-	URS	14	FW	Tatartchouk, Vladimir
35:00	Shot (Stopped by Keeper)	-	BRA	19	FW	Silva, Jorge
36:00	Shot (Stopped by Keeper)	-	BRA	14	FB	Winck, Luiz
41:00	Free Kick (Stopped by Keeper)	-	BRA	18	LK	Luiz, Sergio
43:00	Free Kick (Stopped by Defense)	-	BRA	18	LK	Luiz, Sergio
44:00	Free Kick (Stopped by Keeper)	-	URS	2	FB	Ketachvili, Guela
45:00	End of regulation	1-1				
00:00	Extra time Kick-off	-				
01:00	Caution	-	URS	18	FB	Gorloukovitch, Serguei
03:00	Free Kick (Missed)	-	URS	14	FW	Tatartchouk, Vladimir
05:00	Corner Kick	-	URS	10	LK	Dobrovolski, Igor
06:00	Shot (Stopped by Keeper)	-	BRA	18	LK	Luiz, Sergio
06:50	Corner Kick	-	BRA	18	LK	Luiz, Sergio
08:00	Corner Kick	-	BRA	18	LK	Luiz, Sergio
09:00	Shot (Stopped by Keeper)	-	BRA	9	FW	Santos, Edmar
09:18	Corner Kick	-	BRA	18	LK	Luiz, Sergio
13:00	Goal	2-1	URS	19	LK	Savitchev, Iouri
15:00	Extra time Half-time	2-1				
02:00	Off-side	-	BRA	11	FW	Farias, Romario
04:00	Sent off	-	URS	14	FW	Tatartchouk, Vladimir
05:00	Shot (Stopped by Keeper)	-	URS	15	FW	Mikhailitchenko, Alexei
07:00	Shot (Stopped by Keeper)	-	BRA	13	FB	Cruz, Andre
07:56	Corner Kick	-	BRA	18	LK	Luiz, Sergio
09:00	Shot (Missed)	-	BRA	10	LK	Souza, Hamilton
10:00	Caution	-	BRA	15	FB	Alves, Aloisio
10:35	Substitution out	-	URS	11	FW	Lioutyi, Vladimir
	Substitution in	-	URS	3	FB	Skliarov, Igor
12:00	Sent off	-	BRA	9	FW	Santos, Edmar
15:00	Shot (Missed)	-	URS	19	LK	Savitchev, Iouri
15:00	End of match	2-1				

Total	Goals Buts	Defense	Keeper Gardien	Missed Manques	Posts Poteaux
URS-BRA 1-1 (0-1) (EXT. 1-0)					
Goal Attempts/Tirs au But					
Penalty 11M	1-0	1-0	0-0	0-0	0-0
On Free Kick/Sur Coup Franc	5-5	0-0	0-1	3-2	2-2
In Phase of Play/En Jeu	6-13	1-1	0-3	3-7	2-2
Total	12-18	2-1	0-4	6-9	4-4
Assist/Assistance	0-1	Into Own Goal/But C.S.C.			0-0
Caution/Avertissement	3-4	Off-side/Hors-jeu			0-1
Corner Kicks/Corners	6-10	Sent off/Expulsions			1-1
Fouls/Fautes	29-23	Substitutions			2-2



Final Standing **Classement Final**
Sept. 17-Oct. 1 17 Sept-1 Oct

< League system/Système championnat >

Group A					Group B				
Rank	Ctry	No.	Pos.	Name	Goals	Assist	Played		
1.	SWE	*	2-2	2-0	2-1				
3.	TUN	2-2	*	0-0	1-4				
4.	CHN	0-2	0-0	*	0-3				
2.	FRG	1-2	4-1	3-0	*				

Group C					Group D				
Rank	Ctry	No.	Pos.	Name	Goals	Assist	Played		
3.	KOR	*	0-0	0-0	1-2				
1.	URS	0-0	*	4-2	2-1				
4.	USA	0-0	2-4	*	1-1				
2.	ARG	2-1	1-2	1-1	*				

< Cup system/System coupe >

Quarter-finals/Quarts de Finale

B1-A2	ZAM-FRG	0-4 (0-3)
C1-D2	URS-AUS	3-0 (0-0)
A1-B2	SWE-ITA	1-1 (0-0) (EXT. 0-1)
D1-C2	BRA-ARG	1-0 (0-0)

Semi-finals/Demi-finales

ITA-URS	1-1 (0-0) (EXT. 1-2)
FRG-BRA	1-1 (0-0) (EXT. 0-0) (P.K 2-3)

Final/Finale (3-4 Places)

ITA-FRG	0-3 (0-2)
---------	-----------

Final/Finale (1-2 Places)

URS-BRA	1-1 (0-1) (EXT. 1-0)
---------	----------------------

< Final Standing/Classement Final >

Rank	Country
1	URS : U.S.S.R.
2	BRA : Brazil
3	FRG : Federal Republic of Germany
4	ITA : Italy

Score Standing **Classement des Buteurs**
Sept. 17-Oct. 1 17 Sept-1 Oct

Rank	Ctry	No.	Pos.	Name	Goals	Assist	Played
Rank	Pays			Nom	Buts	Joues	Joues
1	BRA	11	FW	Farias, Romario	7	2	6
2	URS	10	LK	Dobrovolski, Igor	6	5	6
2	ZAM	12	FW	Bwalya, Kalusha	6	0	4
4	URS	15	FW	Mikhailitchenko, Alexei	5	0	6
5	FRG	9	FW	Klinsmann, Juergen	4	2	6
6	SWE	15	FW	Hellstrom, Jan	3	1	4
6	FRG	11	FW	Mill, Frank	3	2	5
6	ITA	13	FW	Virdis, Antonio	3	0	6
6	ARG	4	FW	Alfaro Moreno, Carlos-Alejandr	3	0	4
10	FRG	8	LK	Fach, Holger	2	0	5
10	BRA	20	FW	Oliveira, Jose	2	1	6
10	IRQ	8	FW	Amish, Ahmed Radhi	2	0	3
10	TUN	12	LN	Maaloul, Nabil	2	0	3
10	YUG	7	MF	Sabanadzovic, Refik	2	0	3
10	ZAM	6	LK	Makinka, Derby	2	0	4
10	SWE	3	DF	Lonn, Peter	2	0	4
10	FRG	10	LK	Wuttke, Wolfram	2	0	6
10	YUG	10	MF	Stojkovic, Dragan	2	1	3
10	URS	20	LK	Narbekovas, Arminas	2	0	6
10	ITA	3	FW	Carnevale, Andrea	2	0	6
21	AUS	10	FW	Kosmina, John	1	0	1
21	GUA	7	FW	Castaneda-Mendez, Carlos E.	1	0	3
21	AUS	7	FW	Farina, Frank	1	0	3
21	GUA	9	FW	Paniagua G., Adan Onelio	1	0	2
21	FRG	13	FB	Grahammer, Roland	1	1	6
21	ITA	17	LK	Desideri, Stefano	1	0	2
21	BRA	9	FW	Santos, Edmar	1	0	4
21	ARG	9	FB	Fabbri, Nestor-Ariel	1	0	4
21	FRG	16	FW	Walter, Fritz	1	0	1
21	ITA	14	FW	Rizzitelli, Ruggiero	1	0	4
21	BRA	13	FB	Cruz, Andre	1	0	6
21	KOR	7	LK	Noh, Soo-Jin	1	0	1
21	NGR	11	FW	Yekini, Rachidi	1	0	3
21	SWE	7	MF	Engqvist, Leif	1	0	3
21	ITA	18	LK	Mauro, Massimo	1	3	6
21	IRQ	16	FB	Taufek, Mudhafar J.	1	0	2
21	FRG	4	FB	Funkel, Wolfgang	1	1	5
21	TUN	10	LN	Dhiab, Tarek	1	0	3
21	FRG	18	LK	Kleppinger, Gerhard	1	0	6
21	ITA	19	LK	Evani, Alberigo	1	1	4
21	ITA	5	FB	Ferrara, Ciro	1	0	5
21	FRG	15	LK	Schreier, Christian	1	0	4
21	URS	19	LK	Savitchev, Iouri	1	3	5
21	USA	3	FB	Doyle, John	1	0	2
21	USA	9	FW	Goulet, Brent	1	0	3
21	USA	5	FB	Windischmann, Michael	1	0	1
21	IRQ	13	FB	Alawi, Karim M.	1	0	2
21	BRA	8	LK	Silva, Geovani	1	0	5
21	ZAM	7	FW	Bwalya, Johnson	1	0	3
21	SWE	6	MF	Thery, Jonas	1	0	2
21	ITA	11	LK	Crippa, Massimo	1	0	5
21	ZAM	19	FW	Nyirenda, Stone	1	0	4

Assister Standing **Classement des Passeurs**
Sept. 17-Oct. 1 17 Sept-1 Oct

Rank	Ctry	No.	Pos.	Name	Assist	Goals	Played
Rank	Pays		Nom		Buts	Joues	Joues
1	URS	10	LK	Dobrovolski, Igor	5	6	6
2	URS	19	LK	Savitchev, Iouri	3	1	5
2	ITA	18	LK	Mauro, Massimo	3	1	6
2	FRG	14	LK	Haessler, Thomas	3	0	6
5	BRA	11	FW	Farias, Romario	2	7	6
5	FRG	11	FW	Mill, Frank	2	3	5
5	SWE	9	MF	Nilsson, Joakim	2	0	4
5	GUA	10	FW	Perez-Solorzano, Byron	2	0	3
5	FRG	2	FB	Schulz, Michael	2	0	6
5	FRG	9	FW	Klinsmann, Juergen	2	4	6
5	YUG	14	FW	Suker, Davor	2	0	2
12	ARG	3	FW	Aires, Manuro Gabriel	1	0	4
12	BRA	2	FB	Campos, Jorge	1	0	4
12	BRA	14	FB	Winck, Luiz	1	0	6
12	BRA	17	LK	Ferreira, Jose	1	0	2
12	AUS	12	LK	Davidson, Alan	1	0	4
12	BRA	10	LK	Souza, Hamilton	1	0	6
12	IRQ	3	FB	Ahmed, Hassan Kamal	1	0	3
12	ITA	19	LK	Evani, Alberigo	1	1	4
12	ARG	7	FW	Comas, Jorge Alberto	1	0	4
12	ITA	6	FB	Tassotti, Mauro	1	0	6
12	KOR	10	FW	Choi, Sang-Kook	1	0	3
12	NGR	17	FW	Dofgbami, Wole	1	0	2
12	SWE	8	MF	Andersson, Michael	1	0	4
12	BRA	20	FW	Oliveira, Jose	1	2	6
12	SWE	16	DF	Ljung, Roger	1	0	3
12	BRA	16	LK	Souza, Milton	1	0	6
12	TUN	7	FW	Limam, Jameleddine	1	0	1
12	FRG	4	FB	Funkel, Wolfgang	1	1	5
12	FRG	13	FB	Grahammer, Roland	1	1	6
12	USA	8	LK	Davis, Richard	1	0	3
12	USA	6	FW	Klopas, Frank	1	0	2
12	YUG	10	MF	Stojkovic, Dragan	1	2	3
12	SWE	15	FW	Hellstrom, Jan	1	3	4
12	ZAM	18	FW	Chansa, Wisdom Mumba	1	0	4
12	ZAM	17	FW	Mwanza, Pearson	1	0	2

First Round **Premier Tour**
Sept. 17-22 17-22 Sept

Rank	Ctry	Played	Won	Tied	Lost	For	Against	Diff	Points
Rank	Pays	Joues	Gagnes	Nuls	Perdus	Pour	Contre		

< Team standing/Classement des equipes >

Group A					Group B				
1	SWE	3	2	1	0	6	3	3	5
2	FRG	3	2	0	1	8	3	5	4
3	TUN	3	0	2	1	3	6	-3	2
4	CHN	3	0	1	2	0	5	-5	1

Group B					Group C				
1	ZAM	3	2	1	0	10	2	8	5
2	ITA	3	2	0	1	7	6	1	4
3	IRQ	3	1	1	1	5	4	1	3
4	GUA	3	0	0	3	2	12	-10	0

Group C					Group D				
1	URS	3	2	1	0	6	3	3	5
2	ARG	3	1	1	1	4	4	0	3
3	KOR	3	0	2	1	1	2	-1	2
4	USA	3	0	2	1	3	5	-2	2

Group D					Group E				
1	BRA	3	3	0	0	9	1	8	6
2	AUS	3	2	0	1	2	3	-1	4
3	YUG	3	1	0	2	4	4	0	2
4	NGR	3	0	0	3	1	8	-7	0

< Round progress/Deroulement du tour >

Group A					Group B				
SWE	*	2-2	2-0	2-1	ZAM	*	2-2	4-0	4-0
TUN	2-2	*	0-0	1-4	IRQ	2-2	*	0-2	3-0
CHN	0-2	0-0	*	0-3	ITA	0-4	2-0	*	5-2
FRG	1-2	4-1	3-0	*	GUA	0-4	0-3	2-5	*

Group C					Group D				
KOR	*	0-0	0-0	1-2	AUS	*	1-0	0-3	1-0
URS	0-0	*	4-2	2-1	YUG	0-1	*	1-2	3-1
USA	0-0	2-4	*	1-1	BRA	3-0	2-1	*	4-0
ARG	2-1	1-2	1-1	*	NGR	0-1	1-3	0-4	*



체 조
Gymnastics/Gymnastique



Gymnastics/Gymnastique

Officials/Officiels

Fédération Internationale de Gymnastique (F.I.G.)

President/président	Yuri Titov
Secretary General/secrétaire général	Max Bangerter
Technical Delegates/délégués techniques	Karl-Heinz Zschocke Ellen Berger Jeannine Rinaldi

SLOOC Administrative Staff/Personnel Administratif du SLOOC

Commissioner/directeur	Chun g Myun g Sik
Secretary General/secrétaire général	Kim Kyun g Soo
Deputy Secretary General/secrétaire général adjoint	Hwang In Soo
Competition Manager/chef de division de compétitions	Lee Bo Sun Kim Jin Soo Kim Sook Ja

Competitors/Concurrents

Men Hommes	Competitors Competiteurs	Countries Pays
Team Competition/par équipe	99	23
Women Femmes	Competitors Competiteurs	Countries Pays
Team Competition/concours par équipe	102	23
Rhythmic Competition/concours rythmique	40	23

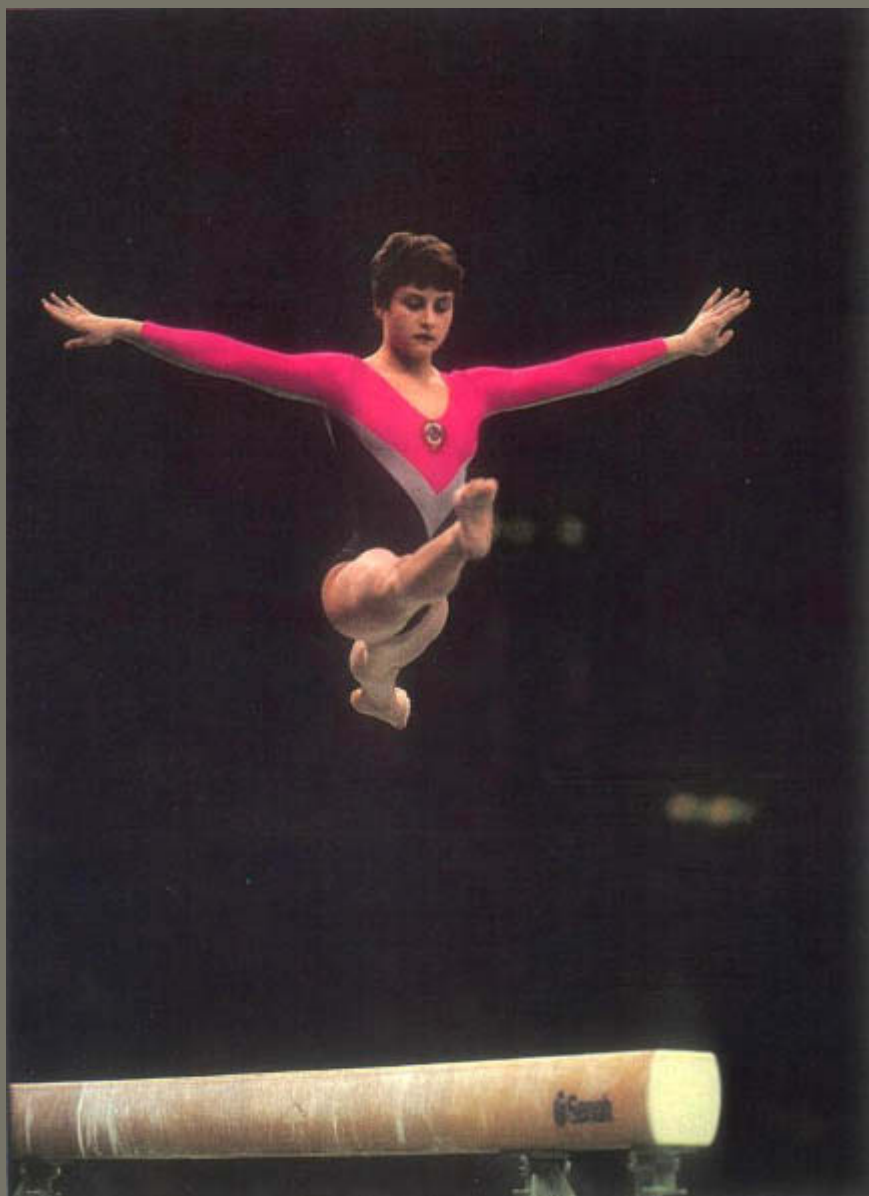
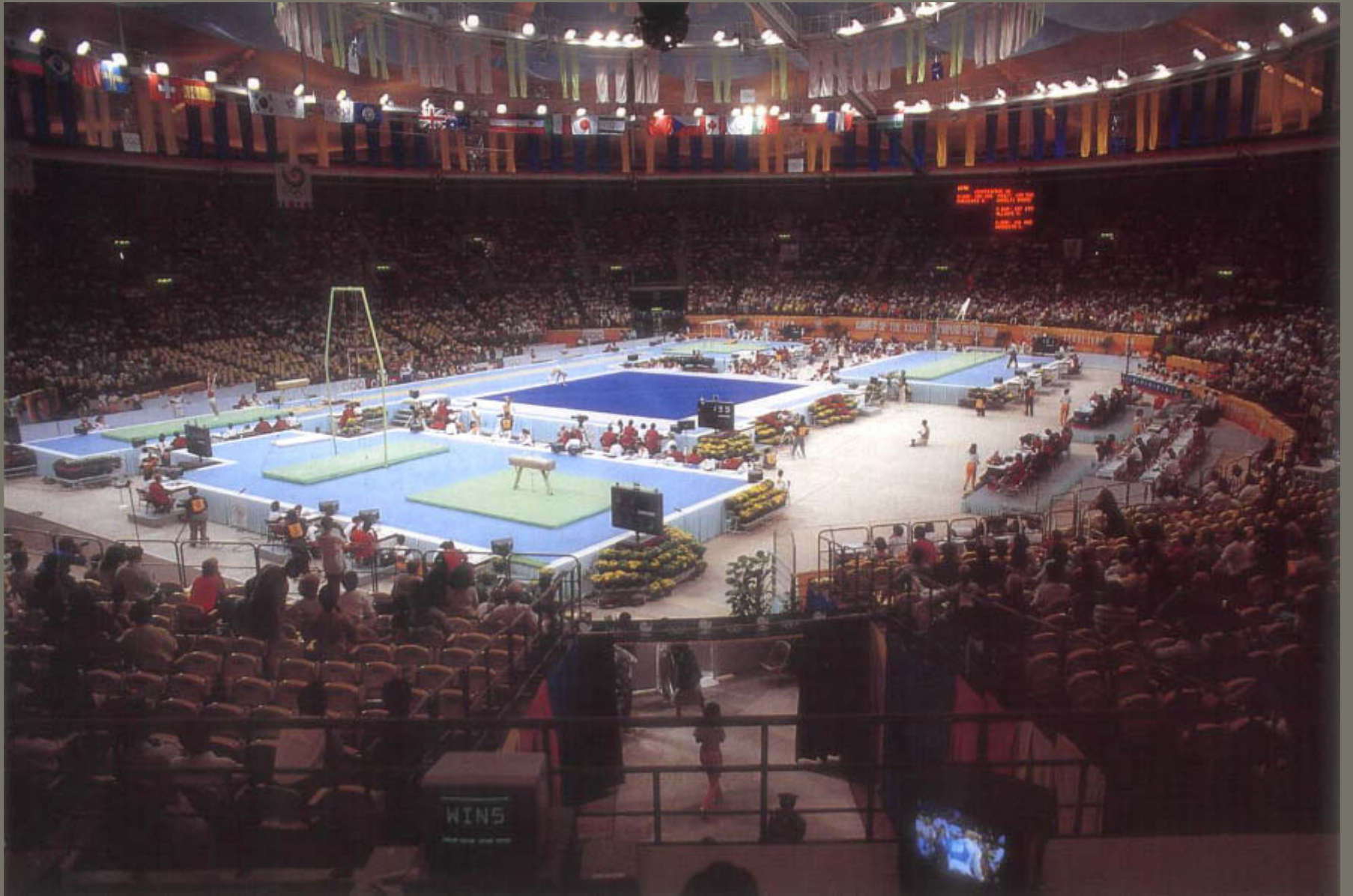

Gymnastics

Gymnastique

Men Competition Ia & Ib Subdivision 1/Sept. 18-20

Gr	Ctry	Name	Floor	Pomm	Rings	Vault	P Bar	H Bar	Total	la+Ib
Pays	Nom	Sol	Arcon	Ann	Saut	Bar P	Bar F			
Group 1/Groupe 1										
SUI	Cavelti, Bruno	la	9.550	9.300	9.350	9.500	9.400	9.600	56.700	
		lb	9.100	9.500	9.600	9.250	9.400	9.550	56.400	113.100
SUI	Zellweger, Josef	la	9.700	9.400	9.700	9.300	9.650	9.500	57.250	
		lb	9.450	9.750	9.750	9.500	9.800	9.100	57.350	114.600
GBR	Bartlett, Terence	la	9.550	9.350	9.500	9.800	9.500	9.300	57.000	
		lb	9.350	8.600	9.150	9.600	9.550	9.700	55.950	112.950
GBR	Morris, Andrew	la	9.400	9.200	9.500	9.350	9.450	8.800	55.700	
		lb	9.450	9.550	9.500	9.450	9.600	8.800	56.350	112.050
TPE	Chang, Chao-Chun	la	9.400	8.750	9.200	9.150	9.050	9.000	54.550	
		lb	9.300	9.300	8.950	9.700	9.550	8.950	55.750	110.300

Group 2/Groupe 2

ESP	Montesinos, Alvaro	la	9.650	9.300	9.550	9.550	9.300	9.350	56.700	
		lb	9.450	8.950	9.300	9.550	9.400	9.300	55.950	112.650
ESP	Rubio, Miguel angel	la	9.150	9.450	9.600	9.600	9.550	8.800	56.150	
		lb	9.500	9.000	9.650	9.150	9.600	9.800	56.700	112.850
ESP	Rodriguez-Sadia, Alto	la	9.650	9.050	9.700	9.800	9.650	9.500	57.350	
		lb	9.700	9.550	9.750	9.600	9.700	9.800	58.100	115.450
KOR	Song, Yoo-Jin	la	9.600	8.550	9.650	9.850	9.450	9.500	56.600	
		lb	9.600	9.000	9.750	9.500	9.650	9.500	57.000	113.600
KOR	Park, Jong-Hoon	la	9.750	9.450	9.650	9.850	9.700	9.650	58.050	
		lb	9.700	9.150	9.550	9.750	9.700	9.700	57.550	115.600
KOR	Joo, Young-Sam	la	9.750	9.650	9.750	9.750	9.600	9.600	58.100	
		lb	9.400	8.800	9.300	9.300	9.700	9.650	56.150	114.250

Group 3/Groupe 3

SWE	Jonasson, Johan	la	9.650	9.550	9.400	9.500	9.400	9.550	57.050	
		lb	9.600	9.700	9.650	9.500	9.400	9.700	57.550	114.600
BRA	Pinto, Guilherme	la	9.400	8.450	8.800	9.400	8.300	9.350	53.700	
		lb	9.600	9.100	9.300	9.300	9.500	9.400	56.200	109.900
AUS	Meredith, Kenneth	la	9.500	9.150	9.300	9.400	9.150	8.750	55.250	
		lb	9.550	9.550	9.500	9.500	9.600	9.150	56.850	112.100

Group 4/Groupe 4

MEX	Pineda, Telesforo	la	9.550	8.750	8.600	9.050	9.650	9.500	55.100	
		lb	8.700	8.300	9.400	9.250	9.650	2.000	47.300	102.400
POR	Pinheiro, Helder	la	9.300	9.450	8.700	8.800	9.200	9.200	54.650	
		lb	9.200	9.600	9.250	9.150	9.400	8.350	54.950	109.600
YUG	Kolman, Alojz	la	9.000	9.300	9.100	9.500	9.050	8.250	54.200	
		lb	9.250	9.200	9.300	9.400	9.500	9.600	56.250	110.450

Men Competition Ia & Ib Subdivision 2/Sept. 18-20

Gr	Ctry	Name	Floor	Pomm	Rings	Vault	P Bar	H Bar	Total	la+Ib
Pays	Nom	Sol	Arcon	Ann	Saut	Bar P	Bar F			
Group 1/Groupe 1										
		la	49.100	48.500	48.350	48.100	48.400	48.050	290,500	
		lb	48,350	48,800	48,450	47,700	49,150	48,750	291,200	581,700
ROM	Rizan, Marian	la	9.600	9.800	9.550	9.400	8.900	9.500	56.750	
		lb	9.550	9.900	9.650	9.350	9.900	9.750	58.100	114.850
ROM	Sandu, Adrian	la	9.750	9.700	9.550	9.700	9.800	9.600	58.100	
		lb	9.550	9.250	9.450	9.400	9.700	9.700	57.050	115.150
ROM	Bejenaru, Nicolae	la	9.800	9.600	9.550	9.350	9.600	9.500	57.400	
		lb	9.650	9.750	9.550	9.500	9.850	9.600	57.900	115.300
ROM	Gherman, Marius	la	9.900	9.800	9.650	9.700	9.800	9.800	58.650	
		lb	9.800	9.800	9.700	9.800	9.900	9.900	58.900	117.550
ROM	Toba, Marius eugen	la	9.900	9.600	9.850	9.700	9.550	9.650	58.250	
		lb	9.800	9.700	9.800	9.600	9.800	9.800	58.500	116.750
ROM	Pintea, Valentin	la	9.750	9.500	9.750	9.600	9.650	9.350	57.600	
		lb	0.000	9.650	9.750	9.400	9.600	9.550	47.950	105.550

Group 2/Groupe 2

		la	48.700	47.600	48.150	48.050	48.450	48.700	289.650	
		lb	48.150	48.050	47.600	48.100	48.650	48.600	289.150	578.800
CAN	Nolet, Alan	la	9.550	9.550	9.550	9.450	9.500	9.600	57.200	
		lb	9.500	9.550	9.400	9.600	9.200	9.650	56.900	114.100
CAN	Rozon, James	la	9.600	9.350	9.500	9.600	9.600	9.650	57.300	
		lb	9.300	9.500	9.300	9.600	9.550	9.550	56.800	114.100
CAN	Peters, Brad	la	9.700	9.700	9.700	9.600	9.700	9.750	58.150	
		lb	9.700	9.750	9.550	9.500	9.700	9.700	57.900	116.050
CAN	Bobkin, Lome	la	9.700	9.400	9.450	9.700	9.600	9.750	57.600	
		lb	9.800	9.650	9.150	9.650	9.700	9.050	57.000	114.600
CAN	Chartrand, Philippe	la	9.800	9.350	9.700	9.450	9.750	9.750	57.800	
		lb	0.000	9.600	9.650	9.150	9.800	9.800	48.000	105.800
CAN	Hibbert, Curtis	la	9.900	9.600	9.700	9.700	9.800	9.800	58.500	
		lb	9.850	9.150	9.700	9.750	9.900	9.900	58.250	116.750

Group 3/Groupe 3

		la	48.800	47.550	47.900	48.000	48.450	48.100	288.800	
		lb	48.350	49.300	48.700	47.750	49.050	47.050	290.200	579.000
ITA	Sala, Gabriele	la	9.600	9.350	9.450	9.500	9.700	9.600	57.200	
		lb	9.450	9.700	9.200	9.600	9.700	9.400	57.050	114.250
ITA	Allievi, Vittorio	la	9.600	9.000	9.150	9.450	9.350	9.550	56.100	
		lb	9.200	9.800	9.400	9.450	9.550	9.150	56.550	112.650
ITA	Bucci, Paolo	la	9.700	9.500	9.550	9.600	9.700	9.650	57.700	
		lb	9.500	9.900	9.800	9.500	9.850	9.450	58.000	115.700
ITA	Trapella, Riccardo	la	9.800	9.400	9.400	9.300	9.500	9.500	56.900	
		lb	9.700	9.800	9.700	9.600	9.750	9.300	57.850	114.750
ITA	Chechi, Juri	la	9.800	9.600	9.800	9.700	9.750	9.200	57.850	
		lb	9.800	9.900	9.900	9.600	9.850	9.650	58.700	116.550
ITA	Preti, Boris	la	9.900	9.700	9.700	9.750	9.800	9.800	58.650	
		lb	9.900	9.900	9.900	9.400	9.900	9.250	58.250	116.900

Gr	Ctry	Name	Floor	Pomm	Rings	Vault	P Bar	H Bar	Total	la+Ib
Pays	Nom	Sol	Arcon	Ann	Saut	Bar P	Bar F			
Group 4/Groupe 4										
		la	48.350	47.400	47.350	48.150	48.650	47.800	287.700	
		lb	48.400	48.900	48.350	47.450	48.250	48.400	289.750	577.450
FRA	Longuepee, Frederic	la	9.450	9.300	9.150	9.700	9.500	9.250	56.350	
		lb	9.450	9.250	9.550	9.200	9.600	9.500	56.550	112.900
FRA	Carmona, Claude	la	9.600	9.600	9.700	9.500	9.800	9.450	57.650	
		lb	9.600	9.700	9.600	9.500	9.800	9.200	57.400	115.050
FRA	Cauterman, Stephane	la	9.500	9.500	9.250	9.350	9.700	8.900	56.200	
		lb	9.750	9.900	9.400	9.500	9.400	9.600	57.550	113.750
FRA	Pecqueux, Thierry	la	9.700	9.400	9.400	9.500	9.650	9.700	57.350	
		lb	9.750	9.700	9.750	9.500	9.100	9.700	57.500	114.850
FRA	Mattioni, Patrick	la	9.750	9.300	9.550	9.750	9.700	9.750	57.800	
		lb	9.650	9.800	9.650	9.650	9.650	9.800	58.200	116.000
FRA	Chevalier, Christian	la	9.800	9.600	9.450	9.700	9.800	9.650	58.000	
		lb	9.650	9.800	9.800	9.300	9.800	9.800	58.150	116.150

Group 5/Groupe 5

		la	47.900	47.350	48.050	48.450	48.050	46.950	286.750	
		lb	47.700	48.050	47.700	47.900	48.550	47.450	287.350	574.100
FRG	Simmelbauer, Bernhard	la	9.350	9.200	9.450	9.650	9.500	9.050	56.200	
		lb	9.450	9.600	9.500	9.500	9.750	9.600	57.400	113.600
FRG	Aguilar, Andreas	la	8.750	9.500	9.800					



										Men Competition Ia & Ib/Sept. 18-20			Hommes Concours Ia & Ib/18-20 Sept			
Gr	Ctry	Name	Floor	Pomm	Rings	Vault	P Bar	H Bar	Total	la+Ib	Rank	Name	Ctry	Ia	Ib	Ia+Ib
	Pays	Nom	Sol	Arcon	Ann	Saut	Bar P	Bar F			Rang	Nom	Pays			
Group 4/Groupe 4										1	Artemov, Vladimir	URS	59.400	59.550	118.950	
			la	48.900	48.050	48.750	48.500	48.150	49.050	291.400	2	Lioukine, Valeri	URS	59.150	59.700	118.850
			lb	49.400	48.600	49.350	48.800	49.000	48.700	293.850	3	Bilozertchev, Dmitri	URS	59.350	59.100	118.450
CHN	Guo, Linxian		la	9.600	9.100	9.700	9.650	9.700	9.650	57.400	4	Kharkov, Serguei	URS	58.850	59.550	118.400
			lb	9.700	9.750	9.800	9.700	9.900	9.100	57.950	5	Kroll, Sylvio	GDR	58.350	59.500	117.850
CHN	Wang, Chongsheng		la	9.700	9.750	9.750	9.650	9.650	9.900	58.400	6	Hristozov, Kalofer	BUL	58.600	59.100	117.700
			lb	9.800	9.850	9.800	9.850	9.650	9.850	58.800	6	Gogoladze, Vladimir	URS	58.600	59.100	117.700
CHN	Xu, Zhiqiang		la	9.750	9.700	9.800	9.800	9.700	9.900	58.650	8	Iketani, Yukio	JPN	58.900	58.750	117.650
			lb	9.800	9.300	9.900	9.700	9.850	9.800	58.350	9	Tippelt, Sven	GDR	59.050	58.550	117.600
CHN	Li, Chunyang		la	9.450	9.600	9.700	9.500	9.700	9.650	57.600	10	Gherman, Marius	ROM	58.650	58.900	117.550
			lb	9.900	9.800	9.800	9.600	9.750	9.700	58.550	11	Nouvikov, Vladimir	URS	58.750	58.750	117.500
CHN	Li, Ning		la	9.900	9.800	9.400	9.250	9.000	9.800	57.150	12	Mizushima, Koichi	JPN	58.600	58.850	117.450
			lb	9.950	9.350	9.950	9.150	9.600	9.800	57.800	13	Guczoghy, Gyorgy	HUN	58.400	58.850	117.250
CHN	Lou, Yun		la	9.950	9.200	9.800	9.900	9.400	9.800	58.050	13	Nishikawa, Daisuke	JPN	58.550	58.700	117.250
			lb	9.950	9.850	9.900	9.950	9.850	9.550	59.050	15	Wang, Chongsheng	CHN	58.400	58.800	117.200
Group 5/Groupe 5										15	Buechner, Ralf	GDR	58.500	58.700	117.200	
			la	48.650	48.550	48.850	48.300	48.500	48.400	291.250	17	Lou, Yun	CHN	58.050	59.050	117.100
			lb	48.800	49.350	49.300	48.600	49.350	48.450	293.850	18	Xu, Zhiqiang	CHN	58.650	58.350	117.000
BUL	Gueorguiev, Petar		la	9.350	9.750	9.650	9.600	9.700	9.500	57.550	19	Behrendt, Holger	GDR	58.650	58.300	116.950
			lb	9.600	9.800	9.700	9.700	9.800	9.450	58.050	20	Preti, Boris	ITA	58.650	58.250	116.900
BUL	Gotchev, Stoytcho		la	9.500	9.350	9.700	9.300	9.800	9.750	57.400	21	Gueraskov, Lyubomir	BUL	58.400	58.350	116.750
			lb	9.700	9.750	9.850	9.600	9.850	9.800	58.550	21	Taskov, Dimitar	BUL	57.700	59.050	116.750
BUL	Taskov, Dimitar		la	9.700	9.750	9.650	9.650	9.300	9.650	57.700	21	Hibbert, Curtis	CAN	58.500	58.250	116.750
			lb	9.800	9.900	9.800	9.800	9.950	9.800	59.050	21	Fajkuscz, Csaba	HUN	57.950	58.800	116.750
BUL	Gueraskov, Lyubomir		la	9.800	9.900	9.800	9.600	9.600	9.700	58.400	21	Toba, Marius eugen	ROM	58.250	58.500	116.750
			lb	9.700	10.000	9.900	9.550	9.800	9.400	58.350	26	Sato, Toshiharu	JPN	58.500	58.150	116.650
BUL	Kolev, Dian		la	9.750	9.500	9.800	9.800	9.600	9.600	58.050	27	Chechi, Juri	ITA	57.850	58.700	116.550
			lb	9.700	9.500	9.850	9.850	9.750	9.600	58.250	28	Lakes, Charles	USA	57.900	58.550	116.450
BUL	Hristozov, Kalofer		la	9.900	9.650	9.900	9.650	9.800	9.700	58.600	29	Hoffmann, Ulf	GDR	58.050	58.350	116.400
			lb	9.900	9.900	9.900	9.650	9.950	9.800	59.100	30	Kolev, Dian	BUL	58.050	58.250	116.300
Group 6/Groupe 6										30	Wecker, Andreas	GDR	57.850	58.450	116.300	
			la	48.300	48.600	48.600	48.550	48.400	48.550	291.000	30	Li, Chunyang	CHN	57.600	58.550	116.150
			lb	48.050	48.650	48.650	48.250	49.050	48.650	291.300	32	Chevalier, Christian	FRA	58.000	58.150	116.150
HUN	Paprika, Jeno		la	9.450	9.550	9.500	9.650	9.150	9.600	56.900	34	Peters, Brad	CAN	58.150	57.900	116.050
			lb	9.650	9.700	9.650	9.600	9.700	9.500	57.800	35	Mattioni, Patrick	FRA	57.800	58.200	116.000
HUN	Toth, Balazs		la	9.600	9.700	9.650	9.700	9.700	9.800	58.150	36	Gotchev, Stoytcho	BUL	57.400	58.550	115.950
			lb	9.150	0.000	0.000	0.000	9.750	18.900	77.050	37	Konishi, Hiroyuki	JPN	57.800	58.000	115.800
HUN	Horvath, Zsolt		la	9.600	9.550	9.600	9.650	9.550	9.500	57.550	38	Bucci, Paolo	ITA	57.700	58.000	115.700
			lb	9.700	9.300	9.800	9.700	9.800	9.650	57.950	39	Gueorguiev, Petar	BUL	57.550	58.050	115.600
HUN	Fajkuscz, Csaba		la	9.650	9.750	9.700	9.500	9.600	9.750	57.950	39	Park, Jong-Hoon	KOR	58.050	57.550	115.600
			lb	9.800	9.750	9.850	9.700	9.900	9.800	58.800	41	Horvath, Zsolt	HUN	57.550	57.950	115.500
HUN	Borkai, Zsolt		la	9.650	9.900	9.800	9.800	9.800	9.800	58.750	42	Rodriguez-Sadia, Alfonso	ESP	57.350	58.100	115.450
			lb	8.150	10.000	9.450	9.550	9.850	9.650	56.650	43	Borkai, Zsolt	HUN	58.750	56.650	115.400
HUN	Guczoghy, Gyorgy		la	9.800	9.700	9.850	9.750	9.750	9.550	58.400	43	Yamada, Takahiro	JPN	57.700	57.700	115.400
			lb	9.750	9.900	9.900	9.700	9.900	9.700	58.850	45	Guo, Linxian	CHN	57.400	57.950	115.350
Men Competition Ia & Ib Final/Sept. 18-20										46	Bejenaru, Nicolae	ROM	57.400	57.900	115.300	
Hommes/Concours Ia & Ib Finale/18-20 Sept										47	Ringnald, Lance	USA	56.950	58.300	115.250	
Rank	Ctry		Floor	Pomm	Rings	Vault	P Bar	H Bar	Total	la+Ib	48	Sandu, Adrian	ROM	58.100	57.050	115.150
Rang	Pays		Sol	Arcons	Ann	Saut	Bar P	Bar F			49	Carmona, Claude	FRA	57.650	57.400	115.050
1	URS	la	49.500	49.100	49.450	49.200	49.400	49.050	295.700	593.350	50	Li, Ning	CHN	57.150	57.800	114.950
		lb	49.550	49.750	49.650	49.300	49.750	49.650	297.650		51	Pecqueux, Thierry	FRA	57.350	57.500	114.850
2	GDR	la	49.100	48.600	49.100	48.900	49.150	48.600	293.450	588.450	51	Rizan, Marian	ROM	56.750	58.100	114.850
		lb	48.750	49.200	49.350	49.200	49.250	49.250	295.000		53	Trapella, Riccardo	ITA	56.900	57.850	114.750
3	JPN	la	48.800	48.800	48.700	48.600	48.700	49.050	292.650	585.600	53	Davis, Kevin	USA	57.050	57.700	114.750
		lb	48.750	49.600	48.700	48.300	49.000	48.600	292.950		55	Paprika, Jeno	HUN	56.900	57.800	114.700
4	CHN	la	48.900	48.050	48.750	48.500	48.150	49.050	291.400	585.250	56	Bobkin, Lome	CAN	57.600	57.000	114.600
		lb	49.400	48.600	49.350	48.800	49.000	48.700	293.850		56	Zellweger, Josef	SUI	57.250	57.350	114.600
5	BUL	la	48.650	48.550	48.850	48.300	48.500	48.400	291.250	585.100	56	Jonasson, Johan	SWE	57.050	57.550	114.600
		lb	48.800	49.350	49.300	48.600	49.350	48.450	293.850		59	Winkler, Daniel	FRG	57.150	57.350	114.500
6	HUN	la	48.300	48.600	48.600	48.550	48.400	48.550	291.000	582.300	60	Beckmann, Mike	FRG	57.450	57.000	114.450
		lb	48.050	48.650	48.650	48.250	49.050	48.650	291.300		61	Sala, Gabriele	ITA	57.200	57.050	114.250
7	ROM	la	49.100	48.500	48.350	48.100	48.400	48.050	290.500	581.700	61	Joo, Young-Sam	KOR	58.100	56.150	114.250
		lb	48.350	48.800	48.450	47.700	49.150	48.750	291.200		63	Johnson, Scott	USA	55.800	58.400	114.200
8	ITA	la	48.800	47.550	47.900	48.000	48.450	48.100	288.800	579.000	64	Bruemmer, Jurgen	FRG	56.650	57.500	114.150
		lb	48.350	49.300	48.700	47.750	49.050	47.050	290.200		65	Nolet, Alan	CAN	57.200	56.900	114.100
9	CAN	la	48.700	47.600	48.150	48.050	48.450	48.700	289.650	578.800	65	Rozen, James	CAN	57.300	56.800	114.100
		lb	48.150	48.050	47.600	48.100	48.650	48.600	289.150		67	Kern, Ralph	FRG	57.550	56.350	113.900
10	FRA	la	48.350	47.400	47.350	48.150	48.650	47.800	287.700	577.450	67	Minicucci, Dominick	USA	56.750	57.150	113.900
		lb	48.400	48.900	48.350	47.450	48.250	48.400	289.750		69	Suter, Kenneth	USA	56.250	57.600	113.850
11	USA	la	47.900	47.450	47.250	47.500	47.900	47.900	285.900	576.850	70	Cauterman, Stephane	FRA	56.200	57.550	113.750
		lb														

Gymnastics

Men Competition Ia & Ib-Floor Ex./Sept. 18-20			Hommes Concours Ia & Ib-Ex. Sol/18-20 Sept		
Rank Rang	Name Nom	Ctry Pays	Ia	Ib	Ia+Ib
1	Lou, Yun	CHN	9.950	9.950	19.900
1	Artemov, Vladimir	URS	9.950	9.950	19.900
1	Kharikov, Serguei	URS	9.900	10.000	19.900
4	Li, Ning	CHN	9.900	9.950	19.850
5	Hristozov, Kalofer	BUL	9.900	9.900	19.800
5	Preti, Boris	ITA	9.900	9.900	19.800
5	Iketani, Yukio	JPN	9.900	9.900	19.800
5	Lioukine, Valeri	URS	9.900	9.900	19.800
9	Hibbert, Curtis	CAN	9.900	9.850	19.750
9	Bilozertchev, Dmitri	URS	9.900	9.850	19.750
11	Kroll, Sylvio	GDR	9.800	9.900	19.700
11	Gherman, Marius	ROM	9.900	9.800	19.700
11	Toba, Marius eugen	ROM	9.900	9.800	19.700
14	Gogoladze, Vladimir	URS	9.800	9.850	19.650
15	Buechner, Ralf	GDR	9.800	9.800	19.600
15	Tippelt, Sven	GDR	9.900	9.700	19.600
15	Chechi, Juri	ITA	9.800	9.800	19.600
15	Lakes, Charles	USA	9.700	9.900	19.600
19	Xu, Zhiqiang	CHN	9.750	9.800	19.550
19	Wecker, Andreas	GDR	9.850	9.700	19.550
19	Guczoghy, Gyorgy	HUN	9.800	9.750	19.550
19	Mizushima, Koichi	JPN	9.800	9.750	19.550
19	Nouvikov, Vladimir	URS	9.850	9.700	19.550
19	Johnson, Scott	USA	9.700	9.850	19.550
25	Gueraskov, Lyubomir	BUL	9.800	9.700	19.500
25	Taskov, Dimitar	BUL	9.700	9.800	19.500
25	Bobkin, Lome	CAN	9.700	9.800	19.500
25	Wang, Chongsheng	CHN	9.700	9.800	19.500
25	Trapella, Riccardo	ITA	9.800	9.700	19.500
30	Kolev, Dian	BUL	9.750	9.700	19.450
30	Chevalier, Christian	FRA	9.800	9.650	19.450
30	Pecqueux, Thierry	FRA	9.700	9.750	19.450
30	Fajkus, Csaba	HUN	9.650	9.800	19.450
30	Nishikawa, Daisuke	JPN	9.700	9.750	19.450
30	Sato, Toshiharu	JPN	9.700	9.750	19.450
30	Park, Jong-Hoon	KOR	9.750	9.700	19.450
30	Bejenaru, Nicolae	ROM	9.800	9.650	19.450
30	Ringnald, Lance	USA	9.650	9.800	19.450
39	Peters, Brad	CAN	9.700	9.700	19.400
39	Mattioni, Patrick	FRA	9.750	9.650	19.400
39	Hoffmann, Ulf	GDR	9.750	9.650	19.400
42	Li, Chunyang	CHN	9.450	9.900	19.350
42	Rodriguez-Sadia, Alfonso	ESP	9.650	9.700	19.350
42	Bruemmer, Jurgen	FRG	9.750	9.600	19.350
45	Guo, Linxian	CHN	9.600	9.700	19.300
45	Horvath, Zsolt	HUN	9.600	9.700	19.300
45	Sandu, Adrian	ROM	9.750	9.550	19.300
48	Cauterman, Stephane	FRA	9.500	9.750	19.250
48	Beckmann, Mike	FRG	9.650	9.600	19.250
48	Jonasson, Johan	SWE	9.650	9.600	19.250
51	Gotchev, Stoytcho	BUL	9.500	9.700	19.200
51	Carmona, Claude	FRA	9.600	9.600	19.200
51	Bucci, Paolo	ITA	9.700	9.500	19.200
51	Konishi, Hiroyuki	JPN	9.600	9.600	19.200
51	Song, Yoo-Jin	KOR	9.600	9.600	19.200
51	Davis, Kevin	USA	9.450	9.750	19.200
57	Kern, Ralph	FRG	9.600	9.550	19.150
57	Joo, Young-Sam	KOR	9.750	9.400	19.150
57	Rizan, Marian	ROM	9.600	9.550	19.150
57	Zellweger, Josef	SUI	9.700	9.450	19.150
61	Montesinos, Alvaro	ESP	9.650	9.450	19.100
61	Paprika, Jenő	HUN	9.450	9.650	19.100
61	Suter, Kenneth	USA	9.400	9.700	19.100
64	Meredith, Kenneth	AUS	9.500	9.550	19.050
64	Nolet, Alan	CAN	9.550	9.500	19.050
64	Winkler, Daniel	FRG	9.550	9.500	19.050
64	Sala, Gabriele	ITA	9.600	9.450	19.050
68	Pinto, Guilherme	BRA	9.400	9.600	19.000
68	Behrendt, Holger	GDR	9.700	9.300	19.000
68	Yamada, Takahiro	JPN	9.700	9.300	19.000
71	Gueorguiev, Petar	BUL	9.350	9.600	18.950
72	Rozon, James	CAN	9.600	9.300	18.900
72	Longuepee, Frederic	FRA	9.450	9.450	18.900
72	Bartlett, Terence	GBR	9.550	9.350	18.900
72	Minicucci, Dominick	USA	9.350	9.550	18.900
76	Morris, Andrew	GBR	9.400	9.450	18.850
77	Simmelbauer, Bernhard	FRG	9.350	9.450	18.800
77	Allievi, Vittorio	ITA	9.600	9.200	18.800
79	Toth, Balazs	HUN	9.600	9.150	18.750
80	Chang, Chao-Chun	TPE	9.400	9.300	18.700
81	Rubio, Miguel Angel	ESP	9.150	9.500	18.650
81	Cavelti, Bruno	SUI	9.550	9.100	18.650
83	Pinheiro, Helder	POR	9.300	9.200	18.500
84	Pineda, Telesforo	MEX	9.550	8.700	18.250
84	Kolman, Alojz	YUG	9.000	9.250	18.250
86	Aguilar, Andreas	FRG	8.750	9.300	18.050
87	Borkai, Zsolt	HUN	9.650	8.150	17.800
88	Chartrand, Philippe	CAN	9.800	0.000	9.800
89	Pintea, Valentin	ROM	9.750	0.000	9.750

Gymnastique

Men Competition Ia & Ib-Pommel Horse/Sept. 18-20			Hommes Concours Ia & Ib-Cheval d'Arcons/18-20 Sept		
Rank Rang	Name Nom	Ctry Pays	Ia	Ib	Ia+Ib
1	Gueraskov, Lyubomir	BUL	9.900	10.000	19.900
1	Borkai, Zsolt	HUN	9.900	10.000	19.900
1	Mizushima, Koichi	JPN	9.900	10.000	19.900
1	Bilozertchev, Dmitri	URS	9.900	10.000	19.900
5	Lioukine, Valeri	URS	9.850	10.000	19.850
6	Nishikawa, Daisuke	JPN	9.800	10.000	19.800
7	Kroll, Sylvio	GDR	9.800	9.950	19.750
7	Artemov, Vladimir	URS	9.800	9.950	19.750
9	Tippelt, Sven	GDR	9.800	9.900	19.700
9	Rizan, Marian	ROM	9.800	9.900	19.700
9	Nouvikov, Vladimir	URS	9.800	9.900	19.700
12	Taskov, Dimitar	BUL	9.750	9.900	19.650
12	Sato, Toshiharu	JPN	9.750	9.900	19.650
12	Kharikov, Serguei	URS	9.750	9.900	19.650
15	Wang, Chongsheng	CHN	9.750	9.850	19.600
15	Guczoghy, Gyorgy	HUN	9.700	9.900	19.600
15	Preti, Boris	ITA	9.700	9.900	19.600
15	Gherman, Marius	ROM	9.800	9.800	19.600
19	Gueorguiev, Petar	BUL	9.750	9.800	19.550
19	Hristozov, Kalofer	BUL	9.650	9.900	19.550
19	Konishi, Hiroyuki	JPN	9.650	9.900	19.550
22	Buechner, Ralf	GDR	9.700	9.800	19.500
22	Fajkus, Csaba	HUN	9.750	9.750	19.500
22	Chechi, Juri	ITA	9.600	9.900	19.500
22	Iketani, Yukio	JPN	9.700	9.800	19.500
22	Gogoladze, Vladimir	URS	9.700	9.800	19.500
22	Davis, Kevin	USA	9.700	9.800	19.500
28	Peters, Brad	CAN	9.700	9.750	19.450
28	Beckmann, Mike	FRG	9.700	9.750	19.450
30	Li, Chunyang	CHN	9.600	9.800	19.400
30	Cauterman, Stephane	FRA	9.500	9.900	19.400
30	Chevalier, Christian	FRA	9.600	9.800	19.400
30	Bucci, Paolo	ITA	9.500	9.900	19.400
30	Lakes, Charles	USA	9.600	9.800	19.400
35	Bejenaru, Nicolae	ROM	9.600	9.750	19.350
36	Carmona, Claude	FRA	9.600	9.700	19.300
36	Hoffmann, Ulf	GDR	9.600	9.700	19.300
36	Yamada, Takahiro	JPN	9.550	9.750	19.300
36	Toba, Marius eugen	ROM	9.600	9.700	19.300
40	Paprika, Jenő	HUN	9.550	9.700	19.250
40	Jonasson, Johan	SWE	9.550	9.700	19.250
42	Trapella, Riccardo	ITA	9.400	9.800	19.200
43	Li, Ning	CHN	9.800	9.350	19.150
43	Pintea, Valentin	ROM	9.500	9.650	19.150
43	Zellweger, Josef	SUI	9.400	9.750	19.150
46	Gotchev, Stoytcho	BUL	9.350	9.750	19.100
46	Nolet, Alan	CAN	9.550	9.550	19.100
46	Mattioni, Patrick	FRA	9.300	9.800	19.100
46	Pecqueux, Thierry	FRA	9.400	9.700	19.100
46	Ringnald, Lance	USA	9.400	9.700	19.100
51	Bobkin, Lome	CAN	9.400	9.650	19.050
51	Lou, Yun	CHN	9.200	9.850	19.050
51	Sala, Gabriele	ITA	9.350	9.700	19.050
51	Pinheiro, Helder	POR	9.450	9.600	19.050
51	Suter, Kenneth	USA	9.450	9.600	19.050
56	Kolev, Dian	BUL	9.500	9.500	19.000
56	Xu, Zhiqiang	CHN	9.700	9.300	19.000
56	Kern, Ralph	FRG	9.400	9.600	19.000
59	Chartrand, Philippe	CAN	9.350	9.600	18.950
59	Bruemmer, Jurgen	FRG	9.350	9.600	18.950
59	Behrendt, Holger	GDR	9.700	9.250	18.950
59	Sandu, Adrian	ROM	9.700	9.250	18.950
63	Winkler, Daniel	FRG	9.400	9.500	18.900
63	Wecker, Andreas	GDR	9.050	9.850	18.900
63	Minicucci, Dominick	USA	9.300	9.600	18.900
66	Rozon, James	CAN	9.350	9.500	18.850
66	Guo, Linxian	CHN	9.100	9.750	18.850
66	Horvath, Zsolt	HUN	9.550	9.300	18.850
69	Simmelbauer, Bernhard	FRG	9.200	9.600	18.800
69	Allievi, Vittorio	ITA	9.000	9.800	18.800
69	Cavelti, Bruno	SUI	9.300	9.500	18.800
72	Hibbert, Curtis	CAN	9.600	9.150	18.750
72	Morris, Andrew	GBR	9.200	9.550	18.750
74	Meredith, Kenneth	AUS	9.150	9.550	18.700
75	Rodriguez-Sadia, Alfonso	ESP	9.050	9.550	18.600
75	Aguilar, Andreas	FRG	9.500	9.100	18.600
75	Park, Jong-Hoon	KOR	9.450	9.150	18.600
78	Longuepee, Frederic	FRA	9.300	9.250	18.550
79	Johnson, Scott	USA	8.850	9.650	18.500
79	Kolman, Alojz	YUG	9.300	9.200	18.500
81	Rubio, Miguel Angel	ESP	9.450	9.000	18.450
81	Joo, Young-Sam	KOR	9.650	8.800	18.450
83	Montesinos, Alvaro	ESP	9.300	8.950	18.250
84	Chang, Chao-Chun	TPE	8.750	9.300	18.050
85	Bartlett, Terence	GBR	9.350	8.600	17.950
86	Pinto, Guilherme	BRA	8.450	9.100	17.550
86	Song, Yoo-Jin	KOR	8.550	9.000	17.550
88	Pineda, Telesforo	MEX	8.750	8.300	17.050
89	Toth, Balazs	HUN	9.700	0.000	9.700

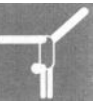

Men Competition Ia & Ib-Rings/Sept. 18-20			Hommes Concours Ia & Ib-Anneaux/18-20 Sept		
Rank Rang	Name Nom	Ctry Pays	Ia	Ib	Ia+Ib
1	Bilozertchev, Dmitri	URS	9.950	10.000	19.950
2	Behrendt, Holger	GDR	9.900	10.000	19.900
3	Tippelt, Sven	GDR	9.900	9.950	19.850
3	Lioukine, Valeri	URS	9.900	9.950	19.850
5	Hristozov, Kalofar	BUL	9.900	9.900	19.800
5	Artemov, Vladimir	URS	9.900	9.900	19.800
5	Kharikoy, Serguei	URS	9.900	9.900	19.800
8	Guczoghy, Gyorgy	HUN	9.850	9.900	19.750
9	Gueraskov, Lyubomir	BUL	9.800	9.900	19.700
9	Lou, Yun	CHN	9.800	9.900	19.700
9	Xu, Zhiqiang	CHN	9.800	9.900	19.700
9	Aguilar, Andreas	FRG	9.800	9.900	19.700
9	Kroll, Sylvio	GDR	9.800	9.900	19.700
9	Chechi, Juri	ITA	9.800	9.900	19.700
9	Nouvikov, Vladimir	URS	9.800	9.900	19.700
16	Kolev, Dian	BUL	9.800	9.850	19.650
16	Toba, Marius eugen	ROM	9.850	9.800	19.650
18	Wecker, Andreas	GDR	9.800	9.800	19.600
18	Preti, Boris	ITA	9.700	9.900	19.600
18	Gogoladze, Vladimir	URS	9.800	9.800	19.600
21	Gotchev, Stoytcho	BUL	9.700	9.850	19.550
21	Wang, Chongsheng	CHN	9.750	9.800	19.550
21	Fajkus, Csaba	HUN	9.700	9.850	19.550
21	Iketani, Yukio	JPN	9.800	9.750	19.550
21	Sato, Toshiharu	JPN	9.750	9.800	19.550
26	Guo, Linxian	CHN	9.700	9.800	19.500
26	Li, Chunyang	CHN	9.700	9.800	19.500
26	Pintea, Valentin	ROM	9.750	9.750	19.500
29	Taskov, Dimitar	BUL	9.650	9.800	19.450
29	Rodriguez-Sadia, Alfonso	ESP	9.700	9.750	19.450
29	Mizushima, Koichi	JPN	9.650	9.800	19.450
29	Nishikawa, Daisuke	JPN	9.750	9.700	19.450
29	Zellweger, Josef	SUI	9.700	9.750	19.450
34	Hibbert, Curtis	CAN	9.700	9.700	19.400
34	Bruemmer, Jurgen	FRG	9.700	9.700	19.400
34	Buechner, Ralf	GDR	9.700	9.700	19.400
34	Horvath, Zsolt	HUN	9.600	9.800	19.400
34	Song, Yoo-jin	KOR	9.650	9.750	19.400
39	Gueorguiev, Petar	BUL	9.650	9.700	19.350
39	Chartrand, Philippe	CAN	9.700	9.650	19.350
39	Li, Ning	CHN	9.400	9.950	19.350
39	Hoffmann, Ulf	GDR	9.650	9.700	19.350
39	Bucci, Paolo	ITA	9.550	9.800	19.350
39	Yamada, Takahiro	JPN	9.700	9.650	19.350
39	Gherman, Marius	ROM	9.650	9.700	19.350
46	Carmona, Claude	FRA	9.700	9.600	19.300
46	Konishi, Hiroyuki	JPN	9.700	9.600	19.300
48	Peters, Brad	CAN	9.700	9.550	19.250
48	Rubio, Miguel angel	ESP	9.600	9.650	19.250
48	Chevalier, Christian	FRA	9.450	9.800	19.250
48	Borkai, Zsolt	HUN	9.800	9.450	19.250
52	Mattioni, Patrick	FRA	9.550	9.650	19.200
52	Park, Jong-hoon	KOR	9.650	9.550	19.200
52	Rizan, Marian	ROM	9.550	9.650	19.200
52	Lakes, Charles	USA	9.600	9.600	19.200
56	Pecqueux, Thierry	FRA	9.400	9.750	19.150
56	Paprika, Jenő	HUN	9.500	9.650	19.150
58	Trapella, Riccardo	ITA	9.400	9.700	19.100
58	Bejenaru, Nicolae	ROM	9.550	9.550	19.100
58	Davis, Kevin	USA	9.500	9.600	19.100
58	Johnson, Scott	USA	9.300	9.800	19.100
62	Joo, Young-Sam	KOR	9.750	9.300	19.050
62	Jonasson, Johan	SWE	9.400	9.650	19.050
62	Minicucci, Dominick	USA	9.550	9.500	19.050
65	Morris, Andrew	GBR	9.500	9.500	19.000
65	Sandu, Adrian	ROM	9.550	9.450	19.000
67	Nolet, Alan	CAN	9.550	9.400	18.950
67	Simmelbauer, Bernhard	FRG	9.450	9.500	18.950
67	Cavelti, Bruno	SUI	9.350	9.600	18.950
70	Winkler, Daniel	FRG	9.500	9.400	18.900
71	Montesinos, Alvaro	ESP	9.550	9.300	18.850
71	Ringnald, Lance	USA	9.300	9.550	18.850
73	Meredith, Kenneth	AUS	9.300	9.500	18.800
73	Rozon, James	CAN	9.500	9.300	18.800
75	Longuepee, Frederic	FRA	9.150	9.550	18.700
76	Cauterman, Stephane	FRA	9.250	9.400	18.650
76	Bartlett, Terence	GBR	9.500	9.150	18.650
76	Sala, Gabriele	ITA	9.450	9.200	18.650
79	Bobkin, Lome	CAN	9.450	9.150	18.600
79	Beckmann, Mike	FRG	9.400	9.200	18.600
81	Allievi, Vittorio	ITA	9.150	9.400	18.550
82	Suter, Kenneth	USA	9.150	9.350	18.500
83	Kern, Ralph	FRG	9.600	8.800	18.400
83	Kolman, Alojz	YUG	9.100	9.300	18.400
85	Chang, Chao-Chun	TPE	9.200	8.950	18.150
86	Pinto, Guilherme	BRA	8.800	9.300	18.100
87	Pineda, Telesforo	MEX	8.600	9.400	18.000
88	Pinheiro, Helder	POR	8.700	9.250	17.950
89	Toth, Balazs	HUN	9.650	0.000	9.650

Men Competition Ia & Ib-Horse Vault/Sept. 18-20			Hommes Concours Ia & Ib-Saut de Cheval/18-20 Sept		
Rank Rang	Name Nom	Ctry Pays	Ia	Ib	Ia+Ib
1	Lou, Yun	CHN	9.900	9.950	19.850
2	Kroll, Sylvio	GDR	9.850	9.950	19.800
2	Kharikov, Serguei	URS	9.850	9.950	19.800
4	Gogoladze, Vladimir	URS	9.900	9.850	19.750
5	Behreadt, Holger	GDR	9.800	9.900	19.700
6	Kolev, Dian	BUL	9.800	9.850	19.650
6	Iketani, Yukio	JPN	9.900	9.750	19.650
6	Artemov, Vladimir	URS	9.850	9.800	19.650
9	Buechner, Ralf	GDR	9.800	9.800	19.600
9	Park, Jong-Hoon	KOR	9.850	9.750	19.600
9	Bilozertchev, Dmitri	URS	9.800	9.800	19.600
9	Lioukine, Valeri	URS	9.700	9.900	19.600
13	Bruemmer, Jurgen	FRG	9.850	9.700	19.550
13	Tippelt, Sven	GDR	9.750	9.800	19.550
15	Wang, Chongsheng	CHN	9.650	9.850	19.500
15	Xu, Zhiqiang	CHN	9.800	9.700	19.500
15	Gherman, Marius	ROM	9.700	9.800	19.500
18	Taskov, Dimitar	BUL	9.650	9.800	19.450
18	Hibbert, Curtis	CAN	9.700	9.750	19.450
18	Hoffmann, Ulf	GDR	9.700	9.750	19.450
18	Guczoghy, Gyorgy	HUN	9.750	9.700	19.450
22	Rodriguez-Sadia, Alfonso	ESP	9.800	9.600	19.400
22	Mattioni, Patrick	FRA	9.750	9.650	19.400
22	Bartlett, Terence	GBR	9.800	9.600	19.400
22	Nishikawa, Daisuke	JPN	9.750	9.650	19.400
26	Bobkin, Lome	CAN	9.700	9.650	19.350
26	Guo, Linxian	CHN	9.650	9.700	19.350
26	Borkai, Zsolt	HUN	9.800	9.550	19.350
26	Horvath, Zsolt	HUN	9.650	9.700	19.350
26	Mizushima, Koichi	JPN	9.700	9.650	19.350
26	Sato, Toshiharu	JPN	9.700	9.650	19.350
26	Song, Yoo-Jin	KOR	9.850	9.500	19.350
33	Gueorguiev, Petar	BUL	9.600	9.700	19.300
33	Hristozov, Kalofar	BUL	9.650	9.650	19.300
33	Kern, Ralph	FRG	9.800	9.500	19.300
33	Wecker, Andreas	GDR	9.650	9.650	19.300
33	Chechi, Juri	ITA	9.700	9.600	19.300
33	Toba, Marius eugen	ROM	9.700	9.600	19.300
39	Beckmann, Mike	FRG	9.650	9.600	19.250
39	Paprika, Jenő	HUN	9.650	9.600	19.250
39	Nouvikov, Vladimir	URS	9.800	9.450	19.250
42	Rozon, James	CAN	9.600	9.600	19.200
42	Fajkus, Csaba	HUN	9.500	9.700	19.200
42	Johnson, Scott	USA	9.500	9.700	19.200
42	Lakes, Charles	USA	9.600	9.600	19.200
46	Gueraskov, Lyubomir	BUL	9.600	9.550	19.150
46	Simmelbauer, Bernhard	FRG	9.650	9.500	19.150
46	Preti, Boris	ITA	9.750	9.400	19.150
46	Konishi, Hiroyuki	JPN	9.550	9.600	19.150
50	Peters, Brad	CAN	9.600	9.500	19.100
50	Li, Chunyang	CHN	9.500	9.600	19.100
50	Montesinos, Alvaro	ESP	9.550	9.550	19.100
50	Winkler, Daniel	FRG	9.500	9.600	19.100
50	Bucci, Paolo	ITA	9.600	9.500	19.100
50	Sala, Gabriele	ITA	9.500	9.600	19.100
50	Sandu, Adrian	ROM	9.700	9.400	19.100
50	Ringnald, Lance	USA	9.400	9.700	19.100
58	Nolet, Alan	CAN	9.450	9.600	19.050
58	Joo, Young-Sam	KOR	9.750	9.300	19.050
60	Carmona, Claude	FRA	9.500	9.500	19.000
60	Chevalier, Christian	FRA	9.700	9.300	19.000
60	Pecqueux, Thierry	FRA	9.500	9.500	19.000
60	Yamada, Takahiro	JPN	9.400	9.600	19.000
60	Pintea, Valentin	ROM	9.600	9.400	19.000
60	Jonasson, Johan	SWE	9.500	9.500	19.000
60	Suter, Kenneth	USA	9.500	9.500	19.000
67	Meredith, Kenneth	AUS	9.400	9.500	18.900
67	Gotchev, Stoytcho	BUL	9.300	9.600	18.900
67	Longuepee, Frederic	FRA	9.700	9.200	18.900
67	Allievi, Vittorio	ITA	9.450	9.450	18.900
67	Trapella, Riccardo	ITA	9.300	9.600	18.900
67	Kolman, Alojz	YUG	9.500	9.400	18.900
73	Cauterman, Stephane	FRA	9.350	9.500	18.850
73	Bejenaru, Nicolae	ROM	9.350	9.500	18.850
73	Chang, Chao-Chun	TPE	9.150	9.700	18.850
73	Minicucci, Dominick	USA	9.500	9.350	18.850
71	Morris, Andrew	GBR	9.350	9.450	18.800
77	Zellweger, Josef	SUI	9.300	9.500	18.800
79	Rubio, Miguel Angel	ESP	9.600	9.150	18.750
79	Rizan, Marian	ROM	9.400	9.350	18.750
79	Cavelti, Bruno	SUI	9.500	9.250	18.750
79	Davis, Kevin	USA	9.300	9.450	18.750
83	Pinto, Guilherme	BRA	9.400	9.300	18.700
84	Chartrand, Philippe	CAN	9.450	9.150	18.600
85	Aguilar, Andreas	FRG	9.350	9.200	18.550
86	Li, Ning	CHN	9.250	9.150	18.400
87	Pineda, Telesforo	MEX	9.050	9.250	18.300
88	Pinheiro, Helder	POR	8.800	9.150	17.950
89	Toth, Balazs	HUN	9.700	0.000	9.700

Gymnastics

Gymnastique

Men Competition Ia & Ib-Paralle Bars/Sept. 18-20			Hommes Concours Ia & Ib-Barres Paralle/18-20 Sept		
Rank Rang	Name Nom	Ctry Pays	Ia	Ib	Ia+Ib
1	Artemov, Vladimir	URS	10.000	9.950	19.950
2	Bilozertchev, Dmitri	URS	9.900	10.000	19.900
2	Lioukine, Valeri	URS	9.900	10.000	19.900
4	Hristozov, Kalofer	BUL	9.800	9.950	19.750
4	Kroll, Sylvio	GDR	9.850	9.900	19.750
6	Hibbert, Curtis	CAN	9.800	9.900	19.700
6	Behrendt, Holger	GDR	9.800	9.900	19.700
6	Tippelt, Sven	GDR	9.900	9.800	19.700
6	Preti, Boris	ITA	9.800	9.900	19.700
6	Gherman, Marius	ROM	9.800	9.900	19.700
6	Kharikov, Serguei	URS	9.800	9.900	19.700
6	Nouvikov, Vladimir	URS	9.800	9.900	19.700
13	Gotchev, Stoytcho	BUL	9.800	9.850	19.650
13	Hoffmann, Ulf	GDR	9.800	9.850	19.650
13	Borkai, Zsolt	HUN	9.800	9.850	19.650
13	Guczoghy, Gyorgy	HUN	9.750	9.900	19.650
13	Gogoladze, Vladimir	URS	9.750	9.900	19.650
18	Guo, Linxian	CHN	9.700	9.900	19.600
18	Carmona, Claude	FRA	9.800	9.800	19.600
18	Chevalier, Christian	FRA	9.800	9.800	19.600
18	Buechner, Ralf	GDR	9.800	9.800	19.600
18	Chechi, Juri	ITA	9.750	9.850	19.600
18	Mizushima, Koichi	JPN	9.700	9.900	19.600
18	Sato, Toshiharu	JPN	9.800	9.800	19.600
25	Chartrand, Philippe	CAN	9.750	9.800	19.550
25	Xu, Zhiqiang	CHN	9.700	9.850	19.550
25	Bucci, Paolo	ITA	9.700	9.850	19.550
25	Lakes, Charles	USA	9.600	9.950	19.550
29	Gueorguiev, Petar	BUL	9.700	9.800	19.500
29	Iketani, Yukio	JPN	9.700	9.800	19.500
29	Nishikawa, Daisuke	JPN	9.750	9.750	19.500
29	Yamada, Takahiro	JPN	9.750	9.750	19.500
29	Sandu, Adrian	ROM	9.800	9.700	19.500
29	Johnson, Scott	USA	9.700	9.800	19.500
35	Li, Chunyang	CHN	9.700	9.750	19.450
35	Aguilar, Andreas	FRG	9.650	9.800	19.450
35	Bejenaru, Nicolae	ROM	9.600	9.850	19.450
35	Zellweger, Josef	SUI	9.650	9.800	19.450
39	Gueraskov, Lyubomir	BUL	9.600	9.800	19.400
39	Peters, Brad	CAN	9.700	9.700	19.400
39	Fajkus, Csaba	HUN	9.600	9.800	19.400
39	Sala, Gabriele	ITA	9.700	9.700	19.400
39	Park, Jong-Hoon	KOR	9.700	9.700	19.400
44	Kolev, Dian	BUL	9.600	9.750	19.350
44	Rodriguez-Sadia, Alfonso	ESP	9.650	9.700	19.350
44	Mattioni, Patrick	FRA	9.700	9.650	19.350
44	Horvath, Zsolt	HUN	9.550	9.800	19.350
44	Toba, Marius eugen	ROM	9.550	9.800	19.350
44	Davis, Kevin	USA	9.500	9.850	19.350
50	Bobkin, Lome	CAN	9.600	9.700	19.300
50	Wang, Chongsheng	CHN	9.650	9.650	19.300
50	Beckmann, Mike	FRG	9.600	9.700	19.300
50	Kern, Ralph	FRG	9.700	9.600	19.300
50	Winkler, Daniel	FRG	9.600	9.700	19.300
50	Konishi, Hiroyuki	JPN	9.600	9.700	19.300
50	Joo, Young-Sam	KOR	9.600	9.700	19.300
50	Pineda, Telesforo	MEX	9.650	9.650	19.300
50	Ringnald, Lance	USA	9.500	9.800	19.300
59	Taskov, Dimitar	BUL	9.300	9.950	19.250
59	Lou, Yun	CHN	9.400	9.850	19.250
59	Simmelbauer, Bernhard	FRG	9.500	9.750	19.250
59	Wecker, Andreas	GDR	9.700	9.550	19.250
59	Tapella, Riccardo	ITA	9.500	9.750	19.250
59	Pintea, Valentin	ROM	9.650	9.600	19.250
59	Minicucci, Dominick	USA	9.600	9.650	19.250
66	Suter, Kenneth	USA	9.400	9.800	19.200
67	Rozon, James	CAN	9.600	9.550	19.150
67	Rubio, Miguel Angel	ESP	9.550	9.600	19.150
69	Cauterman, Stephane	FRA	9.700	9.400	19.100
69	Longuepee, Frederic	FRA	9.500	9.600	19.100
69	Song, Yoo-Jin	KOR	9.450	9.650	19.100
72	Bruemmer, Jurgen	FRG	9.450	9.600	19.050
72	Bartlett, Terence	GBR	9.500	9.550	19.050
72	Morris, Andrew	GBR	9.450	9.600	19.050
75	Allievi, Vittorio	ITA	9.350	9.550	18.900
76	Paprika, Jenő	HUN	9.150	9.700	18.800
77	Rizhan, Marian	ROM	8.900	9.900	18.800
77	Cavelti, Bruno	SUI	9.400	9.400	18.800
77	Jonasson, Johan	SWE	9.400	9.400	18.800
80	Meredith, Kenneth	AUS	9.150	9.600	18.750
80	Pecqueux, Thierry	FRA	9.650	9.100	18.750
82	Nolet, Alan	CAN	9.500	9.200	18.700
82	Montesinos, Alvaro	ESP	9.300	9.400	18.700
84	Li, Ning	CHN	9.000	9.600	18.600
84	Pinheiro, Helder	POR	9.200	9.400	18.600
84	Chang, Chao-Chun	TPE	9.050	9.550	18.600
87	Kolman, Alojz	YUG	9.050	9.500	18.550
88	Pinto, Guilherme	BRA	8.300	9.500	17.800
89	Toth, Balazs	HUN	9.700	9.700	19.400

Men Competition Ia & Ib-Horizontal Bar/Sept. 18-20			Hommes Concours Ia & Ib-Barre Fixe/18-20 Sept		
Rank Rang	Name Nom	Ctry Pays	Ia	Ib	Ia+Ib
1	Artemov, Vladimir	URS	9.900	10.000	19.900
2	Lioukine, Valeri	URS	9.900	9.950	19.850
3	Wang, Chongsheng	CHN	9.900	9.850	19.750
4	Hibbert, Curtis	CAN	9.800	9.900	19.700
4	Xu, Zhiqiang	CHN	9.900	9.800	19.700
4	Behrendt, Holger	GDR	9.750	9.950	19.700
4	Wecker, Andreas	GDR	9.800	9.900	19.700
4	Gherman, Marius	ROM	9.800	9.900	19.700
9	Fajkus, Csaba	HUN	9.750	9.900	19.650
9	Iketani, Yukio	JPN	9.900	9.750	19.650
9	Nishikawa, Daisuke	JPN	9.800	9.850	19.650
12	Li, Ning	CHN	9.800	9.800	19.600
12	Mizushima, Koichi	JPN	9.850	9.750	19.600
12	Nouvikov, Vladimir	URS	9.700	9.900	19.600
15	Gotchev, Stoytcho	BUL	9.750	9.800	19.550
15	Chartrand, Philippe	CAN	9.750	9.800	19.550
15	Mattioni, Patrick	FRA	9.750	9.800	19.550
15	Toth, Balazs	HUN	9.800	9.750	19.550
15	Gogoladze, Vladimir	URS	9.650	9.900	19.550
15	Kharikov, Serguei	URS	9.650	9.900	19.550
21	Hristozov, Kalofer	BUL	9.700	9.800	19.500
21	Buechner, Ralf	GDR	9.700	9.800	19.500
21	Lakes, Charles	USA	9.800	9.700	19.500
24	Taskov, Dimitar	BUL	9.650	9.800	19.450
24	Peters, Brad	CAN	9.750	9.700	19.450
24	Chevalier, Christian	FRA	9.650	9.800	19.450
24	Borkai, Zsolt	HUN	9.800	9.650	19.450
24	Toba, Marius Eugen	ROM	9.650	9.800	19.450
24	Ringnald, Lance	USA	9.700	9.750	19.450
30	Pecqueux, Thierry	FRA	9.700	9.700	19.400
31	Li, Chunyang	CHN	9.650	9.700	19.350
31	Lou, Yun	CHN	9.800	9.550	19.350
31	Park, Jong-Hoon	KOR	9.650	9.700	19.350
31	Bilozertchev, Dmitri	URS	9.900	9.450	19.350
35	Rodriguez-Sadia, Alfonso	ESP	9.500	9.800	19.300
35	Konishi, Hiroyuki	JPN	9.700	9.600	19.300
35	Sandu, Adrian	ROM	9.600	9.700	19.300
38	Nolet, Alan	CAN	9.600	9.650	19.250
38	Winkler, Daniel	FRG	9.600	9.650	19.250
38	Hoffmann, Ulf	GDR	9.550	9.700	19.250
38	Guczoghy, Gyorgy	HUN	9.550	9.700	19.250
38	Horvath, Zsolt	HUN	9.600	9.650	19.250
38	Yamada, Takahiro	JPN	9.600	9.650	19.250
38	Joo, Young-Sam	KOR	9.600	9.650	19.250
38	Rizhan, Marian	ROM	9.500	9.750	19.250
38	Jonasson, Johan	SWE	9.550	9.700	19.250
47	Kolev, Dian	BUL	9.600	9.600	19.200
47	Rozon, James	CAN	9.650	9.550	19.200
47	Tippelt, Sven	GDR	9.800	9.400	19.200
50	Kroll, Sylvio	GDR	9.250	9.900	19.150
50	Cavelti, Bruno	SUI	9.600	9.550	19.150
52	Gueraskov, Lyubomir	BUL	9.700	9.400	19.100
52	Paprika, Jenő	HUN	9.600	9.500	19.100
52	Bucci, Paolo	ITA	9.650	9.450	19.100
52	Bejenaru, Nicolae	ROM	9.500	9.600	19.100
56	Preti, Boris	ITA	9.800	9.250	19.050
56	Sato, Toshiharu	JPN	9.800	9.250	19.050
58	Aguilar, Andreas	FRG	9.400	9.600	19.000
58	Bartlett, Terence	GBR	9.300	9.700	19.000
58	Sala, Gabriele	ITA	9.600	9.400	19.000
58	Song, Yoo-Jin	KOR	9.500	9.500	19.000
58	Suter, Kenneth	USA	9.350	9.650	19.000
63	Gueorguiev, Petar	BUL	9.500	9.450	18.950
63	Minicucci, Dominick	USA	9.450	9.500	18.950
65	Pintea, Valentin	ROM	9.350	9.550	18.900
66	Chechi, Juri	ITA	9.200	9.650	18.850
66	Davis, Kevin	USA	9.600	9.250	18.850
68	Bobkin, Lome	CAN	9.750	9.050	18.800
68	Trapella, Riccardo	ITA	9.500	9.300	18.800
70	Pinto, Guilherme	BRA	9.350	9.400	18.750
70	Guo, Linxian	CHN	9.650	9.100	18.750
70	Longuepee, Frederic	FRA	9.250	9.500	18.750
70	Kern, Ralph	FRG	9.450	9.300	18.750
74	Allievi, Vittorio	ITA	9.550	9.150	18.700
75	Montesinos, Alvaro	ESP	9.350	9.300	18.650
75	Carmona, Claude	FRA	9.450	9.200	18.650
75	Simmelbauer, Bernhard	FRG	9.050	9.600	18.650
78	Rubio, Miguel Angel	ESP	8.800	9.800	18.600
78	Beckmann, Mike	FRG	9.450	9.150	18.600
78	Zellweger, Josef	SUI	9.500	9.100	18.600
81	Cauterman, Stephane	FRA	8.900	9.600	18.500
82	Johnson, Scott	USA	8.750	9.600	18.350
83	Chang, Chao-Chun	TPE	9.000	8.950	17.950
84	Meredith, Kenneth	AUS	8.750	9.150	17.900
85	Bruemmer, Jurgen	FRG	8.550	9.300	17.850
85	Kolman, Alojz	YUG	8.250	9.600	17.850
87	Morris, Andrew	GBR	8.800	8.800	17.600
88	Pinheiro, Helder	POR	9.200	8.350	17.550
89	Pineda, Telesforo	MEX	9.500	2.000	11.500

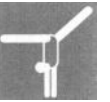
**Men Competition II-Indiv. All Around
Final/Sept. 22**
**Hommes/Concours II-Multiple Individuel
Finale/22 Sept**

Rank Rang	Name Nom	Floor Sol	Pomm Arcons	Rings Ann	Vault Saut	P Bar Bar P	H Bar Bar F	Final Finale	Prelim	Total
1	Artemov, Vladimir	9.900	9.900	URS 9.900	9.950	10.000	10.000	59.650	59.475	119.125
2	Lioukine, Valeri	9.900	9.950	URS 9.950	9.900	9.900	10.000	59.600	59.425	119.025
3	Bilozertchev, Dmitri	9.900	10.000	URS 10.000	10.000	9.950	9.900	59.750	59.225	118.975
4	Tippelt, Sven	9.800	9.950	GDR 9.950	9.900	9.800	9.800	59.200	58.800	118.000
5	Gherman, Marius	9.800	9.900	ROM 9.850	9.800	9.800	9.900	59.050	58.775	117.825
6	Hristozov, Kalofer	9.800	9.900	BUL 9.900	9.650	9.850	9.800	58.900	58.850	117.750
6	Wang, Chongsheng	9.750	9.900	CHN 9.850	9.900	9.850	9.900	59.150	58.600	117.750
8	Guczoghy, Gyorgy	9.750	10.000	HUN 9.900	9.800	9.800	9.800	59.050	58.625	117.675
8	Iketani, Yukio	9.950	9.800	JPN 9.750	9.650	9.900	9.800	58.850	58.825	117.675
10	Kroll, Sylvio	9.900	10.000	GDR 9.850	9.650	9.900	9.400	58.700	58.925	117.625
10	Mizushima, Koichi	9.800	9.800	JPN 9.900	9.650	9.850	9.900	58.900	58.725	117.625
12	Lou, Yun	9.900	9.900	CHN 9.900	9.700	9.900	9.750	59.050	58.550	117.600
13	Nishikawa, Daisuke	9.850	9.900	JPN 9.800	9.450	9.900	9.900	58.800	58.625	117.425
14	Fajkus, Csaba	9.750	9.900	HUN 9.800	9.750	9.750	10.000	58.950	58.375	117.325
15	Xu, Zhiqiang	9.900	9.850	CHN 9.900	9.800	9.900	9.450	58.800	58.500	117.300
15	Preti, Boris	9.850	9.900	ITA 9.900	9.800	9.750	9.650	58.850	58.450	117.300
17	Chechi, Jur	9.800	9.900	ITA 9.950	9.800	9.800	9.750	59.000	58.275	117.275
18	Buechner, Ralf	9.750	9.800	GDR 9.800	9.650	9.750	9.850	58.600	58.600	117.200
19	Lakes, Charles	9.900	9.750	USA 9.800	9.850	9.700	9.950	58.950	58.225	117.175
20	Taskov, Dimitar	9.550	9.800	BUL 9.750	9.850	9.900	9.900	58.750	58.375	117.125
21	Toba, Marius eugen	9.800	9.850	ROM 9.900	9.700	9.500	9.800	58.550	58.375	116.925
22	Hibbert, Curtis	9.800	9.600	CAN 9.700	9.600	9.850	9.900	58.450	58.375	116.825
23	Gueraskov, Lyubomir	9.550	9.900	BUL 9.800	9.500	9.700	9.800	58.250	58.375	116.625
24	Bucci, Paolo	9.750	9.900	ITA 9.850	9.800	9.750	9.700	58.750	57.850	116.600
25	Park, Jong-Hoon	9.750	9.600	KOR 9.800	9.850	9.850	9.850	58.700	57.800	116.500
26	Peters, Brad	9.800	9.900	CAN 9.750	9.500	9.800	9.700	58.450	58.025	116.475
27	Rodriguez-Sadia, A	9.800	9.900	ESP 9.800	9.600	9.700	9.900	58.700	57.725	116.425
28	Horvath, Zsolt	9.800	9.950	HUN 9.600	9.900	9.700	9.700	58.650	57.750	116.400
29	Chevalier, Christian	9.700	9.600	FRA 9.500	9.600	9.700	9.800	57.900	58.075	115.975
30	Jonasson, Johan	9.700	9.850	SWE 9.850	9.800	9.650	9.800	58.650	57.300	115.950
31	Mattioni, Patrick	9.650	9.800	FRA 9.750	9.550	9.750	8.950	57.450	58.000	115.450
31	Zellweger, Josef	9.650	9.800	SUI 9.800	9.500	9.800	9.600	58.150	57.300	115.450
33	Bejenaru, Nicolae	9.700	9.800	ROM 9.750	9.600	9.900	9.000	57.750	57.650	115.400
34	Davis, Kevin	9.650	9.800	USA 9.650	9.500	9.650	9.700	57.950	57.375	115.325
35	Ringnald, Lance	9.500	9.800	USA 9.650	9.550	9.850	9.100	57.450	57.625	115.075
36	Carmona, Claude	9.600	9.800	FRA 9.650	9.600	9.800	8.950	57.400	57.525	114.925

**Men Competition III-Floor Exercises
Final/Sept. 24**
**Hommes/Concours III-Exercices au Sol
Finale/24 Sept**

Rank Rang	Name Nom	Ctry Pays	Final Finale	la	lb	la+lb	Prelim	Total
1	Kharikov, Serguei	URS	9.975	9.900	10.000	19.900	9.950	19.925
2	Artemov, Vladimir	URS	9.950	9.950	9.950	19.900	9.950	19.900
3	Lou, Yun	CHN	9.900	9.950	9.950	19.900	9.950	19.850
3	Iketani, Yukio	JPN	9.950	9.900	9.900	19.800	9.900	19.850
5	Li, Ning	CHN	9.875	9.900	9.950	19.850	9.925	19.800
6	Preti, Boris	ITA	9.875	9.900	9.900	19.800	9.900	19.775
7	Hristozov, Kalofer	BUL	9.850	9.900	9.900	19.800	9.900	19.750
8	Hibbert, Curtis	CAN	9.650	9.900	9.850	19.750	9.875	19.525

**Men Competition III-Pommel Horse
Final/Sept. 24**
**Hommes/Concours III-Cheval d'Arcons
Finale/24 Sept**

Rank Rang	Name Nom	Ctry Pays	Final Finale	la	lb	la+lb	Prelim	Total
1	Gueraskov, Lyubomir	BUL	10.000	9.900	10.000	19.900	9.950	19.950
1	Borkai, Zsolt	HUN	10.000	9.900	10.000	19.900	9.950	19.950
1	Bilozertchev, Dmitri	URS	10.000	9.900	10.000	19.900	9.950	19.950
4	Mizushima, Koichi	JPN	9.950	9.900	10.000	19.900	9.950	19.900
5	Lioukine, Valeri	URS	9.950	9.850	10.000	19.850	9.925	19.875
6	Nishikawa, Daisuke	JPN	9.950	9.800	10.000	19.800	9.900	19.850
7	Tippelt, Sven	GDR	9.950	9.800	9.900	19.700	9.850	19.800
8	Kroll, Sylvio	GDR	9.900	9.800	9.950	19.750	9.875	19.775

**Men Competition III-Rings
Final/Sept. 24**
**Hommes/Concours III-Anneaux
Finale/24 Sept**

Rank Rang	Name Nom	Ctry Pays	Final Finale	la	lb	la+lb	Prelim	Total
1	Behrendt, Holger	GDR	9.975	9.900	10.000	19.900	9.950	19.925
1	Bilozertchev, Dmitri	URS	9.950	9.950	10.000	19.950	9.975	19.925
3	Tippelt, Sven	GDR	9.950	9.900	9.950	19.850	9.925	19.875
4	Hristozov, Kalofer	BUL	9.925	9.900	9.900	19.800	9.900	19.825
4	Lioukine, Valeri	URS	9.900	9.900	9.950	19.850	9.925	19.825
6	Lou, Yun	CHN	9.950	9.800	9.900	19.700	9.850	19.800
6	Chechi, Juri	ITA	9.950	9.800	9.900	19.700	9.850	19.800
8	Guczoghy, Gyorgy	HUN	9.825	9.850	9.900	19.750	9.875	19.700

The results of player No. 0143 (GDR) and No. 0148 (GDR) have been changed by T.D.
The results are the same as the original result — Competition III (Ring).
Les resultats des athletes No. 0143 (RDA) et No. 0148 (GDR) ont ete revises par T.D.

**Men Competition III-Horse Vault
Final/Sept. 24**
**Hommes/Concours III-Saut de Cheval
Finale/24 Sept**

Rank Rang	Name Nom	Ctry Pays	Final Finale	la	lb	la+lb	Prelim	Total
1	Lou, Yun	CHN	9.950	9.900	9.950	19.850	9.925	19.875
2	Kroll, Sylvio	GDR	9.962	9.850	9.950	19.800	9.900	19.862
3	Park, Jong-Hoon	KOR	9.975	9.850	9.750	19.600	9.800	19.775
4	Kolev, Dian	BUL	9.912	9.800	9.850	19.650	9.825	19.737
5	Behrendt, Holger	GDR	9.800	9.800	9.900	19.700	9.850	19.650
6	Kharikov, Serquei	URS	9.700	9.850	9.950	19.800	9.900	19.600
7	Iketani, Yukio	JPN	9.700	9.900	9.750	19.650	9.825	19.525
8	Gogoladze, Vladimir	URS	9.637	9.900	9.850	19.750	9.875	19.512

**Men Competition III-Parallel Bars
Final/Sept. 24**
**Hommes/Concours III-Barres Paralleles
Finale/24 Sept**

Rank Rang	Name Nom	Ctry Pays	Final Finale	la	lb	la+lb	Prelim	Total
1	Artemov, Vladimir	URS	9.950	10.000	9.950	19.950	9.975	19.925
2	Lioukine, Valeri	URS	9.950	9.900	10.000	19.900	9.950	19.900
3	Tippelt, Sven	GDR	9.900	9.900	9.800	19.700	9.850	19.750
4	Hristozov, Kalofer	BUL	9.850	9.800	9.950	19.750	9.875	19.725
5	Gherman, Marius	ROM	9.850	9.800	9.900	19.700	9.850	19.700
6	Hibbert, Curtis	CAN	9.825	9.800	9.900	19.700	9.850	19.675
7	Kroll, Sylvio	GDR	9.750	9.850	9.900	19.750	9.875	19.625
8	Preti, Boris	ITA	9.750	9.800	9.900	19.700	9.850	19.600

**Men Competition III-Horizontal Bar
Final/Sept. 24**
**Hommes/Concours III-Barre Fixe
Finale/24 Sept**

Rank Rang	Name Nom	Ctry Pays	Final Finale	la	lb	la+lb	Prelim	Total
1	Artemov, Vladimir	URS	9.950	9.900	10.000	19.900	9.950	19.900
1	Lioukine, Valeri	URS	9.975	9.900	9.950	19.850	9.925	19.900
3	Behrendt, Holger	GDR	9.950	9.750	9.950	19.700	9.850	19.800
3	Gherman, Marius	ROM	9.950	9.800	9.900	19.700	9.850	19.800
5	Wang, Chongsheng	CHN	9.900	9.900	9.850	19.750	9.875	19.775
6	Xu, Zhiqiang	CHN	9.850	9.900	9.800	19.700	9.850	19.700
7	Hibbert, Curtis	CAN	9.825	9.800	9.900	19.700	9.850	19.675
8	Wecker, Andreas	GDR	9.650	9.800	9.900	19.700	9.850	19.500

Gymnastics

Women Competition Ia & Ib Subdivision 1/Sept. 19-21

Gr	Ctry Pays	Name Nom	Femmes/Concours Ia & Ib Subdivision 1/19-21 Sept					Total	Ia + Ib
			Vault Saut	U Bar B Asy	B Beam Poutre	Floor Sol			
Group 1/Groupe 1									
FRG		Lospichl Von, Isabell	la	9.550	9.700	9.375	9.450	38.075	55.050
			lb	8.675	8.300	0.000		16.975	
ITA		Cocuzza, Maria	la	9.575	9.450	9.550	9.525	38.100	75.875
			lb	9.375	9.450	9.475	9.475	37.775	
ITA		Luconi, Patrizia	la	9.450	9.700	9.500	9.500	38.150	76.450
			lb	9.625	9.750	9.450	9.475	38.300	
BRA		Parente ribeiro, Luis	la	9.525	9.675	9.600	9.550	38.350	76.650
			lb	9.550	9.650	9.600	9.500	38.300	
FRA		Boucher, Karine	la	9.525	9.525	9.550	9.775	38.375	76.775
			lb	9.550	9.750	9.500	9.600	38.400	
ITA		Volpi, Giulia	la	9.600	9.575	9.725	9.775	38.675	76.925
			lb	9.675	9.775	9.050	9.750	38.250	

Group 2/Groupe 2

FRG		Ustorf, Michaela	la	9.550	9.500	9.450	9.425	37.925	74.875
			lb	9.100	8.750	9.575	9.525	36.950	
AUS		Allen, Monique	la	9.450	9.625	9.425	9.500	38.000	75.900
			lb	9.650	9.125	9.550	9.575	37.900	
FRA		Bauduin, Anne marie	la	9.275	9.425	9.600	9.700	38.000	74.500
			lb	9.400	9.100	9.225	8.775	36.500	
GUA		Flores-Wurmsers, Maria	la	9.400	9.350	9.375	9.325	37.450	75.325
			lb	9.650	9.300	9.425	9.500	37.875	
ISR		Sharon, Revital	la	9.525	9.000	9.500	9.575	37.600	37.600
			lb		0.000	0.000		0.000	
FRA		Romano, Catherine	la	9.300	9.575	9.300	9.525	37.700	75.500
			lb	9.425	9.450	9.575	9.350	37.800	

Group 3/Groupe 3

GBR		Kennedy, Karen	la	9.200	9.350	9.000	9.225	36.775	36.775
			lb			0.000		0.000	
GBR		Hargate, Karen	la	9.400	9.425	9.175	9.275	37.275	74.400
			lb	9.600	9.500	8.750	9.275	37.125	
GRE		Varvartoy, Fotini	la	9.250	9.475	9.275	9.425	37.425	75.700
			lb	9.700	9.700	9.425	9.450	38.275	
AUS		Rycroft, Leanne	la	9.275	9.500	9.275	9.375	37.425	75.350
			lb	9.450	9.675	9.475	9.325	37.925	
BEL		Geller, Mauricette	la	9.225	8.750	8.825	8.975	35.775	35.775
			lb			0.000		0.000	
POR		Moura, Sonia	la	9.300	9.375	8.775	9.175	36.625	73.025
			lb	9.575	9.275	8.400	9.150	36.400	

Women Competition Ia & Ib Subdivision 2/Sept. 19-21

Gr	Ctry Pays	Name Nom	Femmes/Concours Ia & Ib Subdivision 2/19-21 Sept					Total	Ia+Ib
			Vault Saut	U Bar B Asy	B Beam Poutre	Floor Sol			
Group 1/Groupe 1									
KOR		Kim, Eun-Mi	la	47.850	48.275	48.200	48.325	192.650	383.825
			lb	47.925	48.050	47.650	47.550	191.175	
KOR		Bae, Eun-Mi	la	9.425	9.325	9.650	9.675	38.075	72.950
			lb	9.450	8.500	7.800	9.125	34.875	
KOR		Lim, Hye-Jin	la	9.500	9.650	9.625	9.700	38.475	76.500
			lb	9.550	9.725	9.575	9.275	38.125	
KOR		Han kyung-lm	la	9.425	9.725	9.750	9.525	38.425	77.100
			lb	9.600	9.800	9.725	9.550	38.675	
KOR		Kim, Nam-Ok	la	9.650	9.525	9.375	9.575	38.125	76.150
			lb	9.625	9.600	9.125	9.675	38.025	
KOR		Park, Ji-Sook	la	9.675	9.725	9.650	9.775	38.825	77.500
			lb	9.600	9.750	9.600	9.725	38.675	

Group 2/Groupe 2

ESP		Belchi, Nuria	la	47.525	48.375	47.525	47.950	191.375	383.975
			lb	48.450	48.650	47.150	48.350	192.600	
ESP		Hervas, Manuela	la	9.400	9.500	9.300	9.300	37.500	75.650
			lb	9.700	9.575	9.300	9.575	38.150	
ESP		Castillejo, Lidia	la	9.300	9.625	9.425	9.500	37.850	76.050
			lb	9.600	9.700	9.400	9.500	38.200	
ESP		Garcia, Nuria	la	9.500	9.675	9.475	9.400	38.050	75.925
			lb	9.575	9.675	9.400	9.225	37.875	
ESP		Rueda, Eva	la	9.425	9.675	9.475	9.550	38.125	77.475
			lb	9.550	9.675	8.875	9.625	37.725	
ESP		Munoz, Laura	la	9.675	9.700	9.550	9.700	38.625	77.650
			lb	9.800	9.775	9.450	9.825	38.850	

Group 3/Groupe 3

CAN		Mcdonald, Christina	la	47.425	47.750	47.625	48.175	190.975	383.750
			lb	48.650	48.900	47.200	48.025	192.775	
CAN		Giancaspro, Caterina	la	8.675	9.650	9.150	9.425	36.900	75.075
			lb	9.650	9.600	9.425	9.500	38.175	
CAN		Covacci, Monica	la	9.300	9.200	9.500	9.600	37.600	76.700
			lb	9.700	9.650	8.900	9.600	37.850	
CAN		Loving, Larissa	la	9.500	9.125	9.650	9.700	37.975	76.225
			lb	9.800	9.750	9.475	9.700	38.725	
CAN		Rankin, Janine	la	9.425	9.575	9.350	9.475	37.825	77.025
			lb	9.675	9.800	9.425	9.500	38.400	
CAN		Strong, Lori	la	9.600	9.675	9.525	9.700	38.500	77.175
			lb	9.675	9.800	9.325	9.725	38.525	

Gymnastique

Gr	Ctry Pays	Name Nom	Femmes/Concours Ia & Ib Subdivision 1/19-21 Sept					Total	Ia+Ib
			Vault Saut	U Bar B Asy	B Beam Poutre	Floor Sol			
Group 4/Groupe 4			la	46.900	47.450	47.550	47.350	189.250	380.200
			lb	47.600	48.375	47.300	47.675	190.950	
JPN		Morio, Maiko	la	9.250	9.550	9.525	9.550	37.875	75.875
			lb	9.425	9.650	9.500	9.425	38.000	
JPN		Nanahara, Yuriko	la	9.350	9.525	9.500	9.400	37.775	75.625
			lb	9.475	9.500	9.225	9.650	37.850	
JPN		Mori, Mieko	la	9.400	9.475	9.500	9.575	37.950	75.975
			lb	9.375	9.700	9.475	9.475	38.025	
JPN		Morimura, Sachiko	la	9.375	9.325	9.450	9.275	37.425	75.575
			lb	9.500	9.650	9.425	9.575	38.150	
JPN		Shinoda, Miho	la	9.350	9.550	9.575	9.325	37.800	76.450
			lb	9.675	9.750	9.675	9.550	38.650	
JPN		Sanada, Makiko	la	9.425	9.350	9.450	9.500	37.725	74.825
			lb	9.525	9.625	8.700	9.250	37.100	

Women Competition Ia & Ib Subdivision 3/Sept. 19-21

Gr	Ctry Pays	Name Nom	Femmes/Concours Ia & Ib Subdivision 3/19-21 Sept					Total	Ia+Ib
			Vault Saut	U Bar B Asy	B Beam Poutre	Floor Sol			
Group 1/Groupe 1									
BUL		Kartalova, Maria	la	48.975	48.150	48.175	49.075	194.375	390.550
			lb	49.225	48.975	48.950	49.025	196.175	
BUL		Raikova, Ivelina	la	9.625	9.550	9.475	9.750	38.400	77.250
			lb	9.725	9.700	9.675	9.750	38.850	
BUL		Vodenitcharova, Delia	la	9.750	9.600	9.600	9.700	38.650	77.850
			lb	9.800	9.800	9.725	9.875	39.200	
BUL		Khrabrova, Khrabrina	la	9.800	9.700	9.650	9.850	39.000	78.325
			lb	9.800	9.800	9.825	9.900	39.325	
BUL		Doudeva, Diana	la	9.750	9.550	9.500	9.625	38.425	76.025
			lb	9.850	8.925	9.225	9.600	37.600	
BUL		Stoyanova, Boriana	la	9.825	9.750	9.725	9.900	39.200	78.650
			lb	9.800	9.850	9.900	9.900	39.450	

Group 2/Groupe 2

CHN		Wang, Wenjing	la	47.900	48.425	48.400	48.425	193.150	388.400
			lb	49.275	48.850	48.175	48.950	195.250	
CHN		Fan, Di	la	9.425	9.750	9.725	9.675	38.575	77.400
			lb	9.625	9.825	9.675	9.700	38.825	
CHN		Ma, Ying	la	9.450	9.750	9.675	9.525	38.400	77.475
			lb	9.775	9.900	9.575	9.825	39.075	
CHN		Chen, Cuiting	la	9.500	9.675	9.500	9.525	38.200	77.025
			lb	9.900	9.650	9.575	9.700	38.825	
CHN		Wang, Xiaoyan	la	9.525	9.600	9.675	9.825	38.625	77.875
			lb	9.900	9.825	9.625	9.900	39.250	
CHN		Wang, Huiying	la	9.775	9.250	9.500	9.650	38.175	76.925
			lb	9.900	9.650	9.475	9.725	38.750	

Group 3/Groupe 3

TCH		Krmelova, Ivona	la	47.450	48.725	48.550	48.350	193.075	386.150
			lb	48.075	48.900	47.825	48.275	193.075	
TCH		Vejrkova, Jana	la	9.500	9.750				



**Women Competition la & lb
Subdivision 4/Sept. 19-21**

**Femmes/Concours la & lb
Subdivision 4/19-21 Sept**

Gr	Ctry	Name	Vault	U Bar	B Beam	Floor	Total	la+lb	
	Pays	Nom	Saut	B Asy	Poutre	Sol			
Group 1/Groupe 1			la	49.475	49.350	49.250	49.250	197.325	395.475
			lb	49.675	49.575	49.500	49.400	198.150	
URS	URS	Baitova, Svetlana	la	9.800	9.800	9.800	9.700	39.100	78.425
			lb	9.825	9.875	9.900	9.725	39.325	
URS	URS	Chevtchenko, Elena	la	9.800	9.675	9.750	9.775	39.000	78.350
			lb	9.900	9.800	9.800	9.850	39.350	
URS	URS	Strajeva, Olga	la	9.875	9.900	9.900	9.775	39.450	68.175
			lb	9.900	9.925	8.900		28.725	
URS	URS	Lachtchenova, Natalia	la	9.900	9.800	9.750	9.900	39.350	78.900
			lb	9.900	9.875	9.875	9.900	39.550	
URS	URS	Boguinskaia, Svetlana	la	9.900	9.925	9.900	9.900	39.625	79.400
			lb	9.975	9.900	9.975	9.925	39.775	
URS	URS	Chouchounova, Elena	la	10.000	9.925	9.900	9.900	39.725	79.675
			lb	10.000	10.000	9.950	10.000	39.950	
Group 2/Groupe 2			la	48.900	49.000	49.175	49.350	196.425	394.125
			lb	49.625	49.350	49.550	49.175	197.700	
ROM	ROM	Popa, Celestina	la	9.800	9.725	9.800	9.850	39.175	78.575
			lb	9.875	9.825	9.900	9.800	39.400	
ROM	ROM	Voinea, Camelia	la	9.700	9.675	9.750	9.800	38.925	77.775
			lb	9.900	9.275	9.800	9.875	38.850	
ROM	ROM	Golea, Eugenia	la	9.700	9.525	9.750	9.725	38.700	77.875
			lb	9.900	9.725	9.850	9.700	39.175	
ROM	ROM	Potorac, Gabriela	la	9.800	9.775	9.875	9.800	39.250	78.925
			lb	9.975	9.900	9.900	9.900	39.675	
ROM	ROM	Dobre, Aurelia	la	9.625	9.825	9.875	9.900	39.225	78.675
			lb	9.950	9.900	9.900	9.700	39.450	
ROM	ROM	Silivas, Daniela	la	9.900	10.000	9.875	10.000	39.775	79.575
			lb	9.900	10.000	10.000	9.900	39.800	
Group 3/Groupe 3			la	48.525	49.200	48.700	49.000	195.425	390.875
			lb	49.250	49.325	47.900	48.975	195.450	
GDR	GDR	Jentsch, Martina	la	9.500	9.700	9.500	9.550	38.250	38.250
			lb	0.000	0.000	0.000	0.000	0.000	
GDR	GDR	Faehrich, Gabriele	la	9.600	9.750	9.675	9.625	38.650	77.625
			lb	9.725	9.875	9.750	9.625	38.975	
GDR	GDR	Klotz, Ulrike	la	9.650	9.800	9.750	9.775	38.975	78.275
			lb	9.800	9.800	9.850	9.850	39.300	
GDR	GDR	Schieferdecker, Betti	la	9.775	9.375	9.675	9.800	38.625	77.450
			lb	9.875	9.725	9.500	9.725	38.825	
GDR	GDR	Thuemmler, Doerte	la	9.700	9.950	9.800	9.900	39.350	78.550
			lb	9.900	9.950	9.400	9.950	39.200	
GDR	GDR	Kersten, Dagmar	la	9.800	10.000	9.800	9.900	39.500	78.650
			lb	9.950	9.975	9.400	9.825	39.150	
Group 4/Groupe 4			la	48.600	48.125	48.650	49.075	194.450	390.575
			lb	49.025	49.225	48.900	48.975	196.125	
USA	USA	Marlowe, Melissa	la	9.600	9.750	8.975	9.625	37.950	76.850
			lb	9.750	9.775	9.725	9.650	38.900	
USA	USA	Garrison-steves, Kell	la	9.700	9.700	9.775	9.800	38.975	77.825
			lb	9.750	9.750	9.800	9.550	38.850	
USA	USA	Stack, Chelle	la	9.675	9.225	9.625	9.700	38.225	77.400
			lb	9.825	9.875	9.675	9.800	39.175	
USA	USA	Spivey, Theresa	la	9.725	9.650	9.675	9.800	38.850	77.450
			lb	9.850	9.275	9.675	9.800	38.600	
USA	USA	Mills, Phoebe	la	9.650	9.750	9.850	9.900	39.150	78.675
			lb	9.800	9.925	9.900	9.900	39.525	
USA	USA	Johnson, Brandy	la	9.850	9.775	9.725	9.875	39.225	78.550
			lb	9.800	9.900	9.800	9.825	39.325	

Rank	Ctry	Name	Vault	U Bar	B Beam	Floor	Total	la+lb
Rang	Pays	Nom	Saut	B Asy	Poutre	Sol		
9	ESP	la	47.525	48.375	47.525	47.950	191.375	383.975
		lb	48.450	48.650	47.150	48.350	192.600	
10	KOR	la	47.850	48.275	48.200	48.325	192.650	383.825
		lb	47.925	48.050	47.650	47.550	191.175	
11	CAN	la	47.425	47.750	47.625	48.175	190.975	383.750
		lb	48.650	48.900	47.200	48.025	192.775	
12	JPN	la	46.900	47.450	47.550	47.350	189.250	380.200
		lb	47.600	48.375	47.300	47.675	190.950	

Women Competition la & lb/Sept. 19-21

Femmes Concours la & lb/19-21 Sept

Rank	Name	Ctry	la	lb	la+lb
Rang	Nom	Pays			
1	Chouchounova, Elena	URS	39.725	39.950	79.675
2	Silivas, Daniela	ROM	39.775	39.800	79.575
3	Boguinskaia, Svetlana	URS	39.625	39.775	79.400
4	Potorac, Gabriela	ROM	39.250	39.675	78.925
5	Lachtchenova, Natalia	URS	39.350	39.550	78.900
6	Dobre, Aurelia	ROM	39.225	39.450	78.675
6	Mills, Phoebe	USA	39.150	39.525	78.675
8	Doudeva, Diana	BUL	39.200	39.450	78.650
8	Kersten, Dagmar	GDR	39.500	39.150	78.650
10	Popa, Celestina	ROM	39.175	39.400	78.575
11	Thuemmler, Doerte	GDR	39.350	39.200	78.550
11	Johnson, Brandy	USA	39.225	39.325	78.550
13	Baitova, Svetlana	URS	39.100	39.325	78.425
14	Chevtchenko, Elena	URS	39.000	39.350	78.350
15	Vodenitcharova, Deliana	BUL	39.000	39.325	78.325
16	Klotz, Ulrike	GDR	38.975	39.300	78.275
17	Stoyanova, Boriana	BUL	38.900	39.050	77.950
18	Chen, Cuiting	CHN	38.625	39.250	77.875
18	Golea, Eugenia	ROM	38.700	39.175	77.875
20	Raikova, Ivelina	BUL	38.650	39.200	77.850
21	Garrison-Steves, Kelly	USA	38.975	38.850	77.825
22	Voinea, Camelia	ROM	38.925	38.850	77.775
23	Munoz, Laura	ESP	38.625	39.025	77.650
23	Polokova, Iveta	TCH	39.150	38.500	77.650
25	Faehrich, Gabriele	GDR	38.650	38.975	77.625
26	Ovary, Eszter	HUN	38.550	38.950	77.500
26	Park, Ji-Sook	KOR	38.825	38.675	77.500
28	Fan, Di	CHN	38.400	39.075	77.475
28	Rueda, Eva	ESP	38.625	38.850	77.475
30	Schieferdecker, Bettina	GDR	38.625	38.825	77.450
30	Spivey, Theresa	USA	38.850	38.600	77.450
32	Wang, Wenjing	CHN	38.575	38.825	77.400
32	Stack, Chelle	USA	38.225	39.175	77.400
34	Wang, Huiying	CHN	38.875	38.475	77.350
35	Kartalova, Maria	BUL	38.400	38.850	77.250
35	Ladanvi, Andrea	HUN	38.900	38.350	77.250
35	Storz, Beata	HUN	38.450	38.800	77.250
38	Strong, Lori	CAN	38.550	38.625	77.175
38	Ricna, Hana	TCH	38.525	38.650	77.175
40	Han kyung-Im	KOR	38.425	38.675	77.100
41	Rankin, Janine	CAN	38.500	38.525	77.025
41	Ma, Ying	CHN	38.200	38.825	77.025
43	Drevjana, Alena	TCH	38.475	38.500	76.975
44	Wang, Xiaoyan	CHN	38.175	38.750	76.925
44	Volpi, Giulia	ITA	38.675	38.250	76.925
46	Marlowe, Melissa	USA	37.950	38.900	76.850
47	Boucher, Karine	FRA	38.375	38.400	76.775
47	Csiszto, Zsuzsa	HUN	38.375	38.400	76.775
49	Krmelova, Ivona	TCH	38.375	38.350	76.725
50	Covacci, Monica	CAN	37.975	38.725	76.700
51	Parente Ribeiro, Luisa	BRA	38.350	38.300	76.650
52	Veliskova, Martina	TCH	38.325	38.275	76.600
53	Bae, Eun-Mi	KOR	38.375	38.125	76.500
54	Luconi, Patrizia	ITA	38.150	38.300	76.450
54	Shinoda, Miho	JPN	37.800	38.650	76.450
56	Misko, Zsuzsanna	HUN	38.050	38.225	76.275
57	Lowing, Larissa	CAN	37.825	38.400	76.225
58	Vejrkova, Jana	TCH	38.125	38.050	76.175
59	Kim, Nam-Ok	KOR	38.125	38.025	76.150
59	Lim, Hye-Jin	KOR	38.475	37.675	76.150
61	Hervas, Manuela	ESP	37.850	38.200	76.050
62	Khrabrova, Khrabrina	BUL	38.425	37.600	76.025
63	Mori, Mieko	JPN	37.950	38.025	75.975
64	Castillejo, Lidia	ESP	38.050	37.875	75.925
65	Allen, Monique	AUS	38.000	37.900	75.900
66	Cocuzza, Maria	ITA	38.100	37.775	75.875
66	Morio, Maiko	JPN	37.875	38.000	75.875
68	Garcia, Nuria	ESP	38.125	37.725	75.850
69	Varvarioly, Fotini	GRE	37.425	38.275	75.700
70	Belchi, Nuria	ESP	37.500	38.150	75.650
71	Nanahara, Yuriko	JPN	37.775	37.850	75.625
72	Morimura, Sachiko	JPN	37.425	38.150	75.575
73	Romano, Catherine	FRA	37.700	37.800	75.500
74	Giancaspro, Caterina	CAN	37.600	37.850	75.450
75	Rycroft, Leanne	AUS	37.425	37.925	75.350
76	Flores-Wurmser, Maria-Ines	GUA	37.450	37.875	75.325
77	Sharon, Revital	ISR	37.600	37.650	75.250
78	Mcdonald, Christina	CAN	36.900	38.175	75.075
79	Ustorf, Michaela	FRG	37.925	36.950	74.875
80	Sanada, Makiko	JPN	37.725	37.100	74.825
81	Bauduin, Anne marie	FRA	38.000	36.500	74.500
82	Hargate, Karen	GBR	37.275	37.125	74.400
83	Moura, Sonia	POR	36.625	36.400	73.025
84	Kim, Eun-Mi	KOR	38.075	34.875	72.950

**Women Competition la & lb
Final/Sept. 19-21**

**Femmes/Concours la & lb
Finale/19-21 Sept**

Rank	Ctry	Name	Vault	U Bar	B Beam	Floor	Total	la+lb
Rang	Pays	Nom	Saut	B Asy	Poutre	Sol		

Gymnastics

Rank Rang	Name Nom	Ctry Pays	la	lb	la+lb
85	Strajeva, Olga	URS	39.450	28.725	68.175
86	Lospichl von, Isabella	FRG	38.075	16.975	55.050
87	Jentsch, Martina	GDR	38.250	0.000	38.250
88	Misko, Agnes	HUN	38.150		38.150
89	Kennedy, Karen	GBR	36.775	0.000	36.775
90	Geller, Mauricette Schier, Birgit	BEL AUT	35.775	0.000	35.775

Women Competition la & lb-Horse Vault/Sept. 19-21			Femmes Concours la & lb-Saut de Cheval/19-21 Sept		
Rank Rang	Name Nom	Ctry Pays	la	lb	la+lb

1	Chouchounova, Elena	URS	10.000	10.000	20.000
2	Boguinskaia, Svetlana	URS	9.900	9.975	19.875
3	Stoyanova, Boriana	BUL	9.850	9.975	19.825
4	Silivas, Daniela	ROM	9.900	9.900	19.800
4	Lachtchenova, Natalia	URS	9.900	9.900	19.800
6	Potorac, Gabriela	ROM	9.800	9.975	19.775
6	Strajeva, Olga	URS	9.875	9.900	19.775
8	Kersten, Dagmar	GDR	9.800	9.950	19.750
9	Chevtchenko, Elena	URS	9.800	9.900	19.700
10	Wang, Xiaoyan	CHN	9.775	9.900	19.675
10	Popa, Celestina	ROM	9.800	9.875	19.675
12	Schieferdecker, Bettina	GDR	9.775	9.875	19.650
12	Johnson, Brandy	USA	9.850	9.800	19.650
14	Doudeva, Diana	BUL	9.825	9.800	19.625
14	Ovary, Eszter	HUN	9.750	9.875	19.625
14	Baitova, Svetlana	URS	9.800	9.825	19.625
17	Khrabrova, Khrabrina	BUL	9.750	9.850	19.600
17	Vodenitcharova, Deliana	BUL	9.800	9.800	19.600
17	Thuemmler, Doerte	GDR	9.700	9.900	19.600
17	Golea, Eugenia	ROM	9.700	9.900	19.600
17	Voinea, Camelia	ROM	9.700	9.900	19.600
22	Dobre, Aurelia	ROM	9.625	9.950	19.575
22	Spivey, Theresa	USA	9.725	9.850	19.575
24	Raikova, Ivelina	BUL	9.750	9.800	19.550
25	Stack, Chelle	USA	9.675	9.825	19.500
26	Rueda, Eva	ESP	9.675	9.800	19.475
27	Wang, Huiying	CHN	9.650	9.800	19.450
27	Klotz, Ulrike	GDR	9.650	9.800	19.450
27	Storcz, Beata	HUN	9.750	9.700	19.450
27	Garrison-Steves, Kelly	USA	9.700	9.750	19.450
27	Mills, Phoebe	USA	9.650	9.800	19.450
32	Chen, Cuiting	CHN	9.525	9.900	19.425
33	Strong, Lori	CAN	9.600	9.800	19.400
33	Ma, Ying	CHN	9.500	9.900	19.400
35	Kartalova, Maria	BUL	9.625	9.725	19.350
35	Ladanyi, Andrea	HUN	9.650	9.700	19.350
35	Marlowe, Melissa	USA	9.600	9.750	19.350
38	Faehnrich, Gabriele	GDR	9.600	9.725	19.325
38	Csiszto, Zsuzsa	HUN	9.625	9.700	19.325
38	Polokova, Iveta	TCH	9.625	9.700	19.325
41	Covacci, Monica	CAN	9.500	9.800	19.300
41	Munoz, Laura	ESP	9.525	9.775	19.300
43	Rankin, Janine	CAN	9.600	9.675	19.275
43	Volpi, Giulia	ITA	9.600	9.675	19.275
43	Kim, Nam-Ok	KOR	9.650	9.625	19.275
43	Park, Ji-Sook	KOR	9.675	9.600	19.275
47	Fan, Di	CHN	9.450	9.775	19.225
48	Sharon, Revital	ISR	9.525	9.625	19.150
48	Bae, Eun-Mi	KOR	9.600	9.550	19.150
50	Misko, Zsuzsanna	HUN	9.475	9.650	19.125
50	Krmelova, Ivona	TCH	9.500	9.625	19.125
52	Allen, Monique	AUS	9.450	9.650	19.100
52	Lowing, Larissa	CAN	9.425	9.675	19.100
52	Belchi, Nuria	ESP	9.400	9.700	19.100
52	Vejkova, Jana	TCH	9.450	9.650	19.100
56	Parente ribeiro, Luisa	BRA	9.525	9.550	19.075
56	Castillejo, Lidia	ESP	9.500	9.575	19.075
56	Boucher, Karine	FRA	9.525	9.550	19.075
56	Luconi, Patrizia	ITA	9.450	9.625	19.075
56	Drevjana, Alena	TCH	9.475	9.600	19.075
61	Wang, Wenjing	CHN	9.425	9.625	19.050
61	Flores-Wurmser, Maria-ines	GUA	9.400	9.650	19.050
61	Lim, Hye-jin	KOR	9.500	9.550	19.050
64	Shinoda, Miho	JPN	9.350	9.675	19.025
64	Han kyung-im	KOR	9.425	9.600	19.025
66	Giancaspro, Caterina	CAN	9.300	9.700	19.000
66	Hargate, Karen	GBR	9.400	9.600	19.000
68	Garcia, Nuria	ESP	9.425	9.550	18.975
69	Varvariotoy, Fotini	GRE	9.250	9.700	18.950
69	Cocuzza, Maria	ITA	9.575	9.375	18.950
69	Sanada, Makiko	JPN	9.425	9.525	18.950
72	Hervas, Manuela	ESP	9.300	9.600	18.900
72	Veliskova, Martina	TCH	9.400	9.500	18.900
74	Morimura, Sachiko	JPN	9.375	9.500	18.875
74	Kim, Eun-mi	KOR	9.425	9.450	18.875
74	Moura, Sonia	POR	9.300	9.575	18.875
77	Nanahara, Yuriko	JPN	9.350	9.475	18.825
78	Ricna, Hana	TCH	9.350	9.450	18.800
79	Mori, Mieko	JPN	9.400	9.375	18.775
80	Rycroft, Leanne	AUS	9.275	9.450	18.725
80	Romano, Catherine	FRA	9.300	9.425	18.725
82	Bauduin, Anne marie	FRA	9.275	9.400	18.675
82	Morio, Maiko	JPN	9.250	9.425	18.675
84	Ustorf, Michaela	FRG	9.550	9.100	18.650
85	Mcdonald, Christina	CAN	8.675	9.650	18.325
86	Lospichl Von, Isabella	FRG	9.550	8.675	18.225
87	Jentsch, Martina	GDR	9.500	0.000	9.500
88	Misko, Agnes	HUN	9.450		9.450
89	Geller, Mauricette	BEL	9.225		9.225
90	Kennedy, Karen Schier, Birgit	GBR AUT	9.200		9.200

Gymnastique

Women Competition la & lb-Uneven Bars/Sept. 19-21			Femmes Concours la & lb-Bar. Asymetriques/19-21 Sept		
Rank Rang	Name Nom	Ctry Pays	la	lb	la+lb

1	Silivas, Daniela	ROM	10.000	10.000	20.000
2	Kersten, Dagmar	GDR	10.000	9.975	19.975
3	Chouchounova, Elena	URS	9.925	10.000	19.925
4	Thuemmler, Doerte	GDR	9.950	9.950	19.900
5	Boguinskaia, Svetlana	URS	9.925	9.900	19.825
5	Strajeva, Olga	URS	9.900	9.925	19.825
7	Dobre, Aurelia	ROM	9.825	9.900	19.725
7	Polokova, Iveta	TCH	9.825	9.900	19.725
9	Potorac, Gabriela	ROM	9.775	9.900	19.675
9	Baitova, Svetlana	URS	9.800	9.875	19.675
9	Lachtchenova, Natalia	URS	9.800	9.875	19.675
9	Johnson, Brandy	USA	9.775	9.900	19.675
9	Mills, Phoebe	USA	9.750	9.925	19.675
14	Fan, Di	CHN	9.750	9.900	19.650
15	Faehnrich, Gabriele	GDR	9.750	9.875	19.625
16	Doudeva, Diana	BUL	9.750	9.850	19.600
16	Klotz, Ulrike	GDR	9.800	9.800	19.600
18	Wang, Wenjing	CHN	9.750	9.825	19.575
19	Strong, Lori	CAN	9.650	9.900	19.550
19	Ladanyi, Andrea	HUN	9.750	9.800	19.550
19	Popa, Celestina	ROM	9.725	9.825	19.550
19	Krmelova, Ivona	TCH	9.750	9.800	19.550
19	Ricna, Hana	TCH	9.750	9.800	19.550
24	Munoz, Laura	ESP	9.700	9.825	19.525
24	Han Kyung-Im	KOR	9.725	9.800	19.525
24	Marlowe, Melissa	USA	9.750	9.775	19.525
27	Vodenitcharova, Deliana	BUL	9.700	9.800	19.500
28	Rankin, Janine	CAN	9.675	9.800	19.475
28	Rueda, Eva	ESP	9.700	9.775	19.475
28	Park, Ji-Sook	KOR	9.725	9.750	19.475
28	Chevtchenko, Elena	URS	9.675	9.800	19.475
32	Luconi, Patrizia	ITA	9.700	9.750	19.450
32	Garrison-Steves, Kelly	USA	9.700	9.750	19.450
34	Chen, Cuiting	CHN	9.600	9.825	19.425
34	Drevjana, Alena	TCH	9.700	9.725	19.425
36	Raikova, Ivelina	BUL	9.600	9.800	19.400
36	Csiszto, Zsuzsa	HUN	9.625	9.775	19.400
38	Lowing, Larissa	CAN	9.575	9.800	19.375
38	Bae, Eun-Mi	KOR	9.650	9.725	19.375
38	Veliskova, Martina	TCH	9.700	9.675	19.375
41	Castillejo, Lidia	ESP	9.675	9.675	19.350
41	Garcia, Nuria	ESP	9.675	9.675	19.350
41	Volpi, Giulia	ITA	9.575	9.775	19.350
44	Parente Ribeiro, Luisa	BRA	9.675	9.650	19.325
44	Ma, Ying	CHN	9.675	9.650	19.325
44	Hervas, Manuela	ESP	9.625	9.700	19.325
47	Stoyanova, Boriana	BUL	9.475	9.825	19.300
47	Shinoda, Miho	JPN	9.550	9.750	19.300
49	Boucher, Karine	FRA	9.525	9.750	19.275
49	Ovary, Eszter	HUN	9.625	9.650	19.275
51	Kartalova, Maria	BUL	9.550	9.700	19.250
51	Mcdonald, Christina	CAN	9.650	9.600	19.250
51	Golea, Eugenia	ROM	9.525	9.725	19.250
54	Morio, Maiko	JPN	9.550	9.650	19.200
55	Rycroft, Leanne	AUS	9.500	9.675	19.175
55	Varvariotoy, Fotini	GRE	9.475	9.700	19.175
55	Misko, Zsuzsanna	HUN	9.550	9.625	19.175
55	Mori, Mieko	JPN	9.475	9.700	19.175
59	Kim, Nam-Ok	KOR	9.525	9.600	19.125
60	Schieferdecker, Bettina	GDR	9.375	9.725	19.100
60	Stack, Chelle	USA	9.225	9.875	19.100
62	Belchi, Nuria	ESP	9.500	9.575	19.075
63	Romano, Catherine	FRA	9.575	9.450	19.025
63	Nanahara, Yuriko	JPN	9.525	9.500	19.025
65	Morimura, Sachiko	JPN	9.325	9.650	18.975
65	Sanada, Makiko	JPN	9.350	9.625	18.975
67	Voinea, Camelia	ROM	9.675	9.275	18.950
68	Hargate, Karen	GBR	9.425	9.500	18.925
68	Spivey, Theresa	USA	9.650	9.275	18.925
70	Wang, Xiaoyan	CHN	9.250	9.650	18.900
70	Cocuzza, Maria	ITA	9.450	9.450	18.900
72	Covacci, Monica	CAN	9.125	9.750	18.875
73	Giancaspro, Caterina	CAN	9.200	9.650	18.850
74	Lim, Hye-Jin	KOR	9.650	9.175	18.825
75	Wang, Huiying	CHN	9.650	9.150	18.800
75	Vejkova, Jana	TCH	9.575	9.225	18.800
77	Allen, Monique	AUS	9.625	9.125	18.750
77	Storcz, Beata	HUN	9.200	9.550	18.750
79	Flores-Wurmser, Maria-ines	GUA	9.350	9.300	18.650
79	Moura, Sonia	POR	9.375	9.275	18.650
81	Sharon, Revital	ISR	9.000	9.550	18.550
82	Bauduin, Anne Marie	FRA	9.425	9.100	18.525
83	Khrabrova, Khrabrina	BUL	9.550	8.925	18.475
84	Ustorf, Michaela	FRG	9.500	8.750	18.250
85	Lospichl Von, Isabella	FRG	9.700	8.300	18.000
86	Kim, Eun-Mi	KOR	9.325	8.500	17.825
87	Jentsch, Martina	GDR	9.700	0.000	9.700
88	Misko, Agnes	HUN	9.600		9.600
89	Kennedy, Karen	GBR	9.350		9.350
90	Geller, Mauricette Schier, Birgit	BEL AUT	8.750		8.750

**Women
Competition Ia & Ib-Balance Beam/Sept. 19-21****Femmes
Concours Ia & Ib-Poutre/19-21 Sept**

Rank Rang	Name Nom	Ctry Pays	Ia	Ib	Ia+Ib
1	Silivas, Daniela	ROM	9.875	10.000	19.875
1	Boguinskaia, Svetlana	URS	9.900	9.975	19.875
3	Chouchounova, Elena	URS	9.900	9.950	19.850
4	Dobre, Aurelia	ROM	9.875	9.900	19.775
4	Potorac, Gabriela	ROM	9.875	9.900	19.775
6	Mills, Phoebe	USA	9.850	9.900	19.750
7	Popa, Celestina	ROM	9.800	9.900	19.700
7	Baitova, Svetlana	URS	9.800	9.900	19.700
9	Doudeva, Diana	BUL	9.725	9.900	19.625
9	Lachtchenova, Natalia	URS	9.750	9.875	19.625
11	Klotz, Ulrike	GDR	9.750	9.850	19.600
11	Golea, Eugenia	ROM	9.750	9.850	19.600
13	Garrison-steves, Kelly	USA	9.775	9.800	19.575
14	Wang, Huiying	CHN	9.825	9.725	19.550
14	Voinea, Camelia	ROM	9.750	9.800	19.550
14	Chevtchenko, Elena	URS	9.750	9.800	19.550
17	Stoyanova, Boriana	BUL	9.700	9.825	19.525
17	Ricna, Hana	TCH	9.800	9.725	19.525
17	Johnson, Brandy	USA	9.725	9.800	19.525
20	Vodenitcharova, Deliana	BUL	9.650	9.825	19.475
20	Han Kyung-lm	KOR	9.750	9.725	19.475
22	Faehrich, Gabriele	GDR	9.675	9.750	19.425
23	Wang, Wenjing	CHN	9.725	9.675	19.400
23	Drevjana, Alena	TCH	9.725	9.675	19.400
25	Spivey, Theresa	USA	9.675	9.675	19.350
26	Raikova, Ivelina	BUL	9.600	9.725	19.325
27	Chen, Cuiting	CHN	9.675	9.625	19.300
27	Storczer, Beata	HUN	9.650	9.650	19.300
27	Stack, Chelle	USA	9.625	9.675	19.300
30	Fan, Di	CHN	9.675	9.575	19.250
30	Shinoda, Miho	JPN	9.575	9.675	19.250
30	Lim, Hye-Jin	KOR	9.625	9.625	19.250
30	Park, Ji-Sook	KOR	9.650	9.600	19.250
34	Parente Ribeiro, Luisa	BRA	9.600	9.600	19.200
34	Munoz, Laura	ESP	9.600	9.600	19.200
34	Kersten, Dagmar	GDR	9.800	9.400	19.200
34	Thuemmler, Doerte	GDR	9.800	9.400	19.200
34	Vejrkova, Jana	TCH	9.575	9.625	19.200
34	Veliskova, Martina	TCH	9.600	9.600	19.200
40	Schieferdecker, Bettina	GDR	9.675	9.500	19.175
41	Kartalova, Maria	BUL	9.475	9.675	19.150
41	Strong, Lori	CAN	9.600	9.550	19.150
43	Covacci, Monica	CAN	9.650	9.475	19.125
44	Csiszto, Zsuzsa	HUN	9.525	9.575	19.100
44	Ovary, Eszter	HUN	9.500	9.600	19.100
44	Bae, Eun-Mi	KOR	9.525	9.575	19.100
47	Ma, Ying	CHN	9.500	9.575	19.075
48	Boucher, Karine	FRA	9.550	9.500	19.050
49	Ustorf, Michaela	FRG	9.450	9.575	19.025
49	Ladanyi, Andrea	HUN	9.750	9.275	19.025
49	Misko, Zsuzsanna	HUN	9.550	9.475	19.025
49	Cocuzza, Maria	ITA	9.550	9.475	19.025
49	Morio, Maiko	JPN	9.525	9.500	19.025
54	Rueda, Eva	ESP	9.550	9.450	19.000
55	Allen, Monique	AUS	9.425	9.550	18.975
55	Wang, Xiaoyan	CHN	9.500	9.475	18.975
55	Mori, Mieko	JPN	9.500	9.475	18.975
58	Luconi, Patrizia	ITA	9.500	9.450	18.950
59	Polokova, Iveta	TCH	9.850	9.075	18.925
60	Castillejo, Lidia	ESP	9.475	9.400	18.875
60	Romano, Catherine	FRA	9.300	9.575	18.875
60	Morimura, Sachiko	JPN	9.450	9.425	18.875
63	Rankin, Janine	CAN	9.525	9.325	18.850
64	Hervas, Manuela	ESP	9.425	9.400	18.825
64	Bauduin, Anne marie	FRA	9.600	9.225	18.825
66	Flores-Wurmser, Maria-Ines	GUA	9.375	9.425	18.800
66	Strajeva, Olga	URS	9.900	8.900	18.800
68	Lowing, Larissa	CAN	9.350	9.425	18.775
68	Volpi, Giulia	ITA	9.725	9.050	18.775
70	Rycroft, Leanne	AUS	9.275	9.475	18.750
71	Khrabrova, Khrabrina	BUL	9.500	9.225	18.725
71	Nanahara, Yuriko	JPN	9.500	9.225	18.725
73	Varvariotoy, Fotini	GRE	9.275	9.425	18.700
73	Marlowe, Melissa	USA	8.975	9.725	18.700
75	Krmelova, Ivona	TCH	9.450	9.200	18.650
76	Belchi, Nuria	ESP	9.300	9.300	18.600
77	Mcdonald, Christina	CAN	9.150	9.425	18.575
78	Sharon, Revital	ISR	9.500	9.050	18.550
79	Kim, Nam-Ok	KOR	9.375	9.125	18.500
80	Giancaspro, Caterina	CAN	9.500	8.900	18.400
81	Garcia, Nuria	ESP	9.475	8.875	18.350
82	Sanada, Makiko	JPN	9.450	8.700	18.150
83	Hargate, Karen	GBR	9.175	8.750	17.925
84	Kim, Eun-Mi	KOR	9.650	7.800	17.450
85	Moura, Sonia	POR	8.775	8.400	17.175
86	Jentsch, Martina	GDR	9.500	0.000	9.500
87	Misko, Agnes	HUN	9.450		9.450
88	Lospichl Von, Isabella	FRG	9.375	0.000	9.375
89	Kennedy, Karen	GBR	9.000	0.000	9.000
90	Geller, Mauricette	BEL	8.825	0.000	8.825
	Schier, Birgit	AUT			

**Women
Competition Ia & Ib-Floor Ex./Sept. 19-21****Femmes
Concours Ia & Ib-Ex. Sol/19-21 Sept**

Rank Rang	Name Nom	Ctry Pays	Ia	Ib	Ia+Ib
1	Silivas, Daniela	ROM	10.000	9.900	19.900
1	Chouchounova, Elena	URS	9.900	10.000	19.900
3	Thuemmler, Doerte	GDR	9.900	9.950	19.850
4	Boguinskaia, Svetlana	URS	9.900	9.925	19.825
5	Doudeva, Diana	BUL	9.900	9.900	19.800
5	Lachtchenova, Natalia	URS	9.900	9.900	19.800
5	Mills, Phoebe	USA	9.900	9.900	19.800
8	Vodenitcharova, Deliana	BUL	9.850	9.900	19.750
8	Storczer, Beata	HUN	9.850	9.900	19.750
10	Chen, Cuiting	CHN	9.825	9.900	19.725
10	Kersten, Dagmar	GDR	9.900	9.825	19.725
12	Potorac, Gabriela	ROM	9.800	9.900	19.700
12	Johnson, Brandy	USA	9.875	9.825	19.700
14	Voinea, Camelia	ROM	9.800	9.875	19.675
14	Polokova, Iveta	TCH	9.850	9.825	19.675
16	Popa, Celestina	ROM	9.850	9.800	19.650
17	Munoz, Laura	ESP	9.800	9.825	19.625
17	Klotz, Ulrike	GDR	9.775	9.850	19.625
17	Chevtchenko, Elena	URS	9.775	9.850	19.625
20	Dobre, Aurelia	ROM	9.900	9.700	19.600
20	Spivey, Theresa	USA	9.800	9.800	19.600
22	Raikova, Ivelina	BUL	9.700	9.875	19.575
23	Wang, Huiying	CHN	9.750	9.800	19.550
24	Rueda, Eva	ESP	9.700	9.825	19.525
24	Schieferdecker, Bettina	GDR	9.800	9.725	19.525
24	Volpi, Giulia	ITA	9.775	9.750	19.525
27	Kartalova, Maria	BUL	9.750	9.750	19.500
27	Ovary, Eszter	HUN	9.675	9.825	19.500
27	Park, Ji-Sook	KOR	9.775	9.725	19.500
27	Stack, Chelle	USA	9.700	9.800	19.500
31	Rankin, Janine	CAN	9.700	9.725	19.425
31	Golea, Eugenia	ROM	9.725	9.700	19.425
31	Baitova, Svetlana	URS	9.700	9.725	19.425
34	Covacci, Monica	CAN	9.700	9.700	19.400
34	Krmelova, Ivona	TCH	9.675	9.725	19.400
36	Wang, Wenjing	CHN	9.675	9.700	19.375
36	Wang, Xiaoyan	CHN	9.650	9.725	19.375
36	Boucher, Karine	FRA	9.775	9.600	19.375
39	Fan, Di	CHN	9.525	9.825	19.350
39	Garrison-Steves, Kelly	USA	9.800	9.550	19.350
41	Ladanyi, Andrea	HUN	9.750	9.575	19.325
42	Stoyanova, Boriana	BUL	9.875	9.425	19.300
42	Ricna, Hana	TCH	9.625	9.675	19.300
44	Marlowe, Melissa	USA	9.625	9.650	19.275
45	Faehrich, Gabriele	GDR	9.625	9.625	19.250
45	Kim, Nam-Ok	KOR	9.575	9.675	19.250
47	Khrabrova, Khrabrina	BUL	9.625	9.600	19.225
47	Ma, Ying	CHN	9.525	9.700	19.225
49	Giancaspro, Caterina	CAN	9.600	9.600	19.200
50	Garcia, Nuria	ESP	9.550	9.625	19.175
51	Veliskova, Martina	TCH	9.625	9.500	19.125
52	Allen, Monique	AUS	9.500	9.575	19.075
52	Strong, Lori	CAN	9.700	9.375	19.075
52	Han Kyung-lm	KOR	9.525	9.550	19.075
52	Drevjana, Alena	TCH	9.575	9.500	19.075
52	Vejrkova, Jana	TCH	9.525	9.550	19.075
57	Parente Ribeiro, Luisa	BRA	9.550	9.500	19.050
57	Mori, Mieko	JPN	9.575	9.475	19.050
57	Nanahara, Yuriko	JPN	9.400	9.650	19.050
60	Lim, Hye-Jin	KOR	9.700	9.325	19.025
61	Hervas, Manuela	ESP	9.500	9.500	19.000
61	Sharon, Revital	ISR	9.575	9.425	19.000
61	Cocuzza, Maria	ITA	9.525	9.475	19.000
64	Lowing, Larissa	CAN	9.475	9.500	18.975
64	Luconi, Patrizia	ITA	9.500	9.475	18.975
64	Morio, Maiko	JPN	9.550	9.425	18.975
67	Ustorf, Michaela	FRG	9.425	9.525	18.950
67	Csiszto, Zsuzsa	HUN	9.600	9.350	18.950
67	Misko, Zsuzsanna	HUN	9.475	9.475	18.950
70	Mcdonald, Christina	CAN	9.425	9.500	18.925
71	Belchi, Nuria	ESP	9.300	9.575	18.875
71	Romano, Catherine	FRA	9.525	9.350	18.875
71	Varvariotoy, Fotini	GRE	9.425	9.450	18.875
71	Shinoda, Miho	JPN	9.325	9.550	18.875
71	Bae, Eun-Mi	KOR	9.600	9.275	18.875
76	Morimura, Sachiko	JPN	9.275	9.575	18.850
77	Flores-Wurmser, Maria-Ines	GUA	9.325	9.500	18.825
78	Kim, Eun-Mi	KOR	9.675	9.125	18.800
79	Sanada, Makiko	JPN	9.500	9.250	18.750
80	Rycroft, Leanne	AUS	9.375	9.325	18.700
81	Castillejo, Lidia	ESP	9.400	9.225	18.625
82	Hargate, Karen	GBR	9.275	9.275	18.550
83	Bauduin, Anne Marie	FRA	9.700	8.775	18.475
84	Moura, Sonia	POR	9.175	9.150	18.325
85	Strajeva, Olga	URS	9.775		9.775
86	Misko, Agnes	HUN	9.650		9.650
87	Jentsch, Martina	GDR	9.550	0.000	9.550
88	Lospichl Von, Isabella	FRG	9.450		9.450
89	Kennedy, Karen	GBR	9.225		9.225
90	Geller, Mauricette	BEL	8.975		8.975
	Schier, Birgit	AUT			

Gymnastics

Gymnastique

Women Competition II-Indiv. All Around Final/Sept. 23			Femmes/Concours II-Multiple Individuel Finale/23 Sept					
Rank Rang	Name Nom	Vault Saut	U Bar B Asy	B Beam Poutre	Floor Sol	Final Finale	Prelim	Total
1	Chouchounova, Elena	URS 10.000	9.900	9.925	10.000	39.825	39.837	79.662
2	Silivas, Daniela	ROM 9.950	10.000	9.900	10.000	39.850	39.787	79.637
3	Boguinskaia, Svetlana	URS 9.950	9.950	9.900	9.900	39.700	39.700	79.400
4	Potorac, Gabriela	ROM 9.800	9.900	9.950	9.925	39.575	39.462	79.037
5	Lachtchenova, Natalia	URS 9.825	9.825	9.875	9.900	39.425	39.450	78.875
6	Dobre, Aurelia	ROM 9.825	9.900	9.900	9.850	39.475	39.337	78.812
7	Thuemmler, Doerte	GDR 9.900	9.975	9.725	9.925	39.525	39.275	78.800
8	Kersten, Dagmar	GDR 9.925	9.900	9.725	9.900	39.450	39.325	78.775
9	Doudeva, Diana	BUL 9.800	9.875	9.825	9.900	39.400	39.325	78.725
10	Johnson, Brandy	USA 9.825	9.875	9.825	9.725	39.250	39.275	78.525
11	Klotz, Ulrike	GDR 9.800	9.875	9.775	9.900	39.350	39.137	78.487
12	Vodenitcharova, Deliana	BUL 9.700	9.800	9.775	9.900	39.175	39.162	78.337
13	Stoyanova, Boritana	BUL 9.775	9.875	9.725	9.850	39.225	38.975	78.200
14	Chen, Cuiting	CHN 9.825	9.775	9.700	9.900	39.200	38.937	78.137
15	Mills, Phoebe	USA 9.800	9.850	9.275	9.775	38.700	39.337	78.037
16	Garrison-Steves, Kelly	USA 9.825	9.750	9.675	9.775	39.025	38.912	77.937
17	Polokova, Iveta	TCH 9.700	9.825	9.700	9.800	39.025	38.825	77.850
18	Rueda, Eva	ESP 9.750	9.750	9.600	9.850	38.950	38.737	77.687
19	Ovary, Eszter	HUN 9.825	9.675	9.600	9.825	38.925	38.750	77.675
20	Fan, Di	CHN 9.675	9.900	9.725	9.600	38.900	38.737	77.637
21	Park, Ji-Sook	KOR 9.700	9.700	9.600	9.850	38.850	38.750	77.600
22	Covacci, Monica	CAN 9.800	9.800	9.725	9.750	39.075	38.350	77.425
23	Munoz, Laura	ESP 9.875	9.750	9.150	9.800	38.575	38.825	77.400
23	Storcer, Beata	HUN 9.725	9.600	9.650	9.800	38.775	38.625	77.400
25	Boucher, Karine	FRA 9.725	9.800	9.637	9.825	38.987	38.387	77.374
26	Drevjana, Alena	TCH 9.700	9.825	9.675	9.600	38.800	38.487	77.287
27	Ladanyi, Andrea	HUN 9.675	9.825	9.150	9.700	38.350	38.625	76.975
28	Volpi, Giulia	ITA 9.775	9.800	9.125	9.800	38.500	38.462	76.962
29	Ricna, Hana	TCH 9.125	9.825	9.625	9.700	38.275	38.587	76.862
30	Han Kyung-lm	KOR 9.725	9.700	9.725	9.150	38.300	38.550	76.850
31	Rankin, Janine	CAN 9.775	9.675	9.125	9.700	38.275	38.512	76.787
32	Wang, Wenjing	CHN 9.525	9.225	9.675	9.575	38.000	38.700	76.700
33	Bae, Eun-Mi	KOR 9.625	9.775	9.625	9.275	38.300	38.250	76.550
34	Shinoda, Miho	JPN 9.750	9.625	9.125	9.750	38.250	38.225	76.475
35	Parente Ribeiro, Luisa	BRA 9.700	9.700	9.175	8.850	37.425	38.325	75.750
36	Strong, Lori	CAN 9.225	9.750	9.150	28.125	38.587		66.712

Women Competition III-Horse Vault Final/Sept. 25			Femmes/Concours III-Saut de Cheval Finale/25 Sept					
Rank Rang	Name Nom	Ctry Pays	Final Finale	la	lb	la+lb	Prelim	Total
1	Boguinskaia, Svetlana	URS	9.968	9.900	9.975	19.875	9.937	19.905
2	Potorac, Gabriela	ROM	9.943	9.800	9.975	19.775	9.887	19.830
3	Silivas, Daniela	ROM	9.918	9.900	9.900	19.800	9.900	19.818
4	Stoyanova, Boriana	BUL	9.868	9.850	9.975	19.825	9.912	19.780
5	Johnson, Brandy	USA	9.949	9.850	9.800	19.650	9.825	19.774
6	Kersten, Dagmar	GDR	9.881	9.800	9.950	19.750	9.875	19.756
7	Wang, Xiaoyan	CHN	9.893	9.775	9.900	19.675	9.837	19.730
8	Chouchounova, Elena	URS	9.712	10.000	10.000	20.000	10.000	19.712

Women Competition III-Uneven Bars Final/Sept. 25			Femmes/Concours III-Barres Asymetriques Finale/25 Sept					
Rank Rang	Name Nom	Ctry Pays	Final Finale	la	lb	la+lb	Prelim	Total
1	Silivas, Daniela	ROM	10.000	10.000	10.000	20.000	10.000	20.000
2	Kersten, Dagmar	GDR	10.000	10.000	9.975	19.975	9.987	19.987
3	Chouchounova, Elena	URS	10.000	9.925	10.000	19.925	9.962	19.962
4	Thuemmler, Doerte	GDR	9.950	9.950	9.950	19.900	9.950	19.900
5	Boguinskaia, Svetlana	URS	9.987	9.925	9.900	19.825	9.912	19.899
6	Polokova, Iveta	TCH	9.975	9.825	9.900	19.725	9.862	19.837
7	Dobre, Aurelia	ROM	9.962	9.825	9.900	19.725	9.862	19.824
8	Mills, Phoebe	USA	9.950	9.750	9.925	19.675	9.837	19.787

Women Competition III-Balance Beam Final/Sept. 25				Femmes/Concours III-Poutre Finale/25 Sept				
Rank Rang	Name Nom	Ctry Pays	Final Finale	la	lb	la+lb	Prelim	Total
1	Silivas, Daniela	ROM	9.987	9.875	10.000	19.875	9.937	19.924
2	Chouchounova, Elena	URS	9.950	9.900	9.950	19.850	9.925	19.875
3	Potorac, Gabriela	ROM	9.950	9.875	9.900	19.775	9.887	19.837
3	Mills, Phoebe	USA	9.962	9.850	9.900	19.750	9.875	19.837
5	Boguinskaia, Svetlana	URS	9.850	9.900	9.975	19.875	9.937	19.787
6	Doudeva, Diana	BUL	9.912	9.725	9.900	19.625	9.812	19.724
7	Garrison-Steves, Kelly	USA	9.862	9.775	9.800	19.575	9.787	19.649
8	Klotz, Ulrike	GDR	8.325	9.750	9.850	19.600	9.800	18.125

Women Competition III-Floor Exercises Final/Sept. 25				Femmes/Concours III-Exercices au Sol Finale/25 Sept				
Rank Rang	Name Nom	Ctry Pays	Final Finale	la	lb	la+lb	Prelim	Total
1	Silivas, Daniela	ROM	9.987	10.000	9.900	19.900	9.950	19.937
2	Boguinskaia, Svetlana	URS	9.975	9.900	9.925	19.825	9.912	19.887
3	Doudeva, Diana	BUL	9.950	9.900	9.900	19.800	9.900	19.850
4	Vodenitcharova, Deliana	BUL	9.962	9.850	9.900	19.750	9.875	19.837
5	Storcer, Beata	HUN	9.800	9.850	9.900	19.750	9.875	19.675
6	Mills, Phoebe	USA	9.762	9.900	9.900	19.800	9.900	19.662
7	Chouchounova, Elena	URS	9.625	9.900	10.000	19.900	9.950	19.575
8	Thuemmler, Doerte	GDR	9.600	9.900	9.950	19.850	9.925	19.525

Women Rhythmic Competition-Preliminary /Sept. 28-29				Femmes Concours Rythmique-Preliminaire/28-29 Sept			
Rank Rang	Name Nom	Ctry Pays	Rope Corde	Hoop Cerceau	Clubs Massues	Ribbon Ruban	Total
1	Lobatch, Marina	URS	10.000	10.000	10.000	10.000	40.000
2	Dounavska, Adriana	BUL	10.000	10.000	9.900	10.000	39.900
3	Timochenko, Alexandra	URS	10.000	10.000	9.750	10.000	39.750
4	Panova, Bianka	BUL	10.000	10.000	9.550	9.900	39.450
5	Sinko, Andrea	HUN	9.800	9.700	9.850	9.700	39.050
6	Lloret, Maria Isabel	ESP	9.800	9.750	9.700	9.750	39.000
6	Staccioli, Giulia	ITA	9.800	9.600	9.800	9.800	39.000
6	Reljin, Milena	YUG	9.800	9.650	9.800	9.750	39.000
9	Folga, Teresa	POL	9.750	9.500	9.800	9.800	38.850
10	Schmiemann, Diana	FRG	9.700	9.600	9.800	9.700	38.800
10	Bialkowska, Eliza	POL	9.750	9.750	9.650	9.650	38.800
12	Fuzesi, Mary	CAN	9.700	9.600	9.800	9.600	38.700
12	Imperator, Micaela	ITA	9.700	9.600	9.700	9.700	38.700
14	Pang, Qiong	CHN	9.650	9.550	9.700	9.700	38.600
14	Sokolovska, Denisa	TCH	9.650	9.600	9.800	9.550	38.600
16	Martin, Maria	ESP	9.750	9.500	9.700	9.600	38.550
17	He, Xiaomin	CHN	9.500	9.600	9.700	9.700	38.500
17	Rothaar, Marion	FRG	9.600	9.600	9.700	9.600	38.500
17	Akiyama, Erika	JPN	9.700	9.450	9.700	9.650	38.500
20	Erfalvy, Nora	HUN	9.500	9.600	9.700	9.650	38.450
21	Alevizou, Maria	GRE	9.600	9.500	9.500	9.600	38.200
22	Oulehlova, Lenka	TCH	9.700	9.600	9.300	9.500	38.100
22	Berube, Michelle	USA	9.550	9.500	9.550	9.500	38.100
24	Cottel, Stephanie	FRA	9.600	9.400	9.450	9.600	38.050
25	Bergmann, Elisabeth	AUT	9.400	9.400	9.600	9.500	37.900
26	Simpson, Diane	USA	9.450	9.450	9.500	9.400	37.800
27	Brihay, Laurence	BEL	9.350	9.400	9.500	9.350	37.600
27	Otsuka, Hiroko	JPN	9.100	9.400	9.600	9.500	37.600
29	Hong, Sung-Hee	KOR	9.350	9.400	9.050	9.550	37.350
30	Jorge, Patricia	POR	9.350	9.100	9.200	9.400	37.050
31	Kim, In-Wha	KOR	9.200	9.100	9.300	9.400	37.000
32	Gautreau, Lise	CAN	9.000	9.150	9.400	9.400	36.950
32	Walker, Angela	NZL	9.300	9.200	9.100	9.350	36.950
34	Franzen, Malene	DEN	9.200	9.250	9.200	9.200	36.850
35	Tsitsela, Panagiota	GRE	9.300	8.800	9.400	9.000	36.500

Women Rhythmic Competition Final/Sept. 30				Femmes/Concours Rythmique Finale/30 Sept					
Rank Rang	Name Nom	Ctry Pays	Role Corde	Hoop Cerceau	Clubs Massues	Ribbon Ruban	Final Finale	Prelim	Total
1	Lobatch, Marina	URS	10.000	10.000	10.000	10.000	40.000	20.000	60.000
2	Dounavska, Adriana	BUL	10.000	10.000	10.000	10.000	40.000	19.950	59.950
3	Timochenko, Alexandra	URS	10.000	10.000	10.000	10.000	40.000	19.875	59.875
4	Panova, Bianka	BUL	10.000	10.000	10.000	10.000	40.000	19.725	59.725
5	Lloret, Maria Isabel	ESP	9.850	9.850	9.850	9.850	39.400	19.500	58.900
6	Sinko, Andrea	HUN	9.850	9.800	9.800	9.800	39.250	19.525	58.775
7	Folga, Teresa	POL	9.800	9.800	9.700	9.900	39.200	19.425	58.625
8	Schmiemann, Diana	FRG	9.800	9.800	9.800	9.800	39.200	19.400	58.600
9	Reljin, Milena	YUG	9.800	9.700	9.800	9.700	39.000	19.500	58.500
10	Fuzesi, Mary	CAN	9.800	9.700	9.800	9.800	39.100	19.350	58.450
11	Pang, Qiong	CHN	9.750	9.700	9.750	9.800	39.000	19.300	58.300
12	Imperator, Micaela	ITA	9.700	9.800	9.800	9.600	38.900	19.350	58.250
13	Sokolovska, Denisa	TCH	9.800	9.700	9.650	9.800	38.950	19.300	58.250
14	Bialkowska, Eliza	POL	9.700	9.800	9.650	9.650	38.800	19.400	58.200
15	Akiyama, Erika	JPN	9.700	9.600	9.800	9.700	38.800	19.250	58.050
16	He, Xiaomin	CHN	9.700	9.650	9.700	9.700	38.750	19.250	58.000
17	Erfalvy, Nora	HUN	9.750	9.550	9.700	9.700	38.		



핸드볼

Handball/Handball



Handball/Handball

Officials/Officiels

Fédération Internationale de Hand-ball (I.H.F.)

President/président	Erwin Lanc
Secretary General/secrétaire général	Max Rinkenburger
Technical Delegates/délégués techniques	Max Rinkenburger Curt Wadmark

SLOOC Administrative Staff/Personnel Administratif du SLOOC

Commissioner/directeur	Suh Ryp Kyu
Secretary General/secrétaire général	Kim Chin Ha
Deputy Secretary General/secrétaire général adjoint	Park Sung Woo
Competition Manager/chef de division de compétition	Lee Bong Il

Competitors/Concurrents

Men
Hommes

Competitors
Competiteurs

Countries
Pays

180

12

Women
Femmes

Competitors
Competiteurs

Countries
Pays

120

8

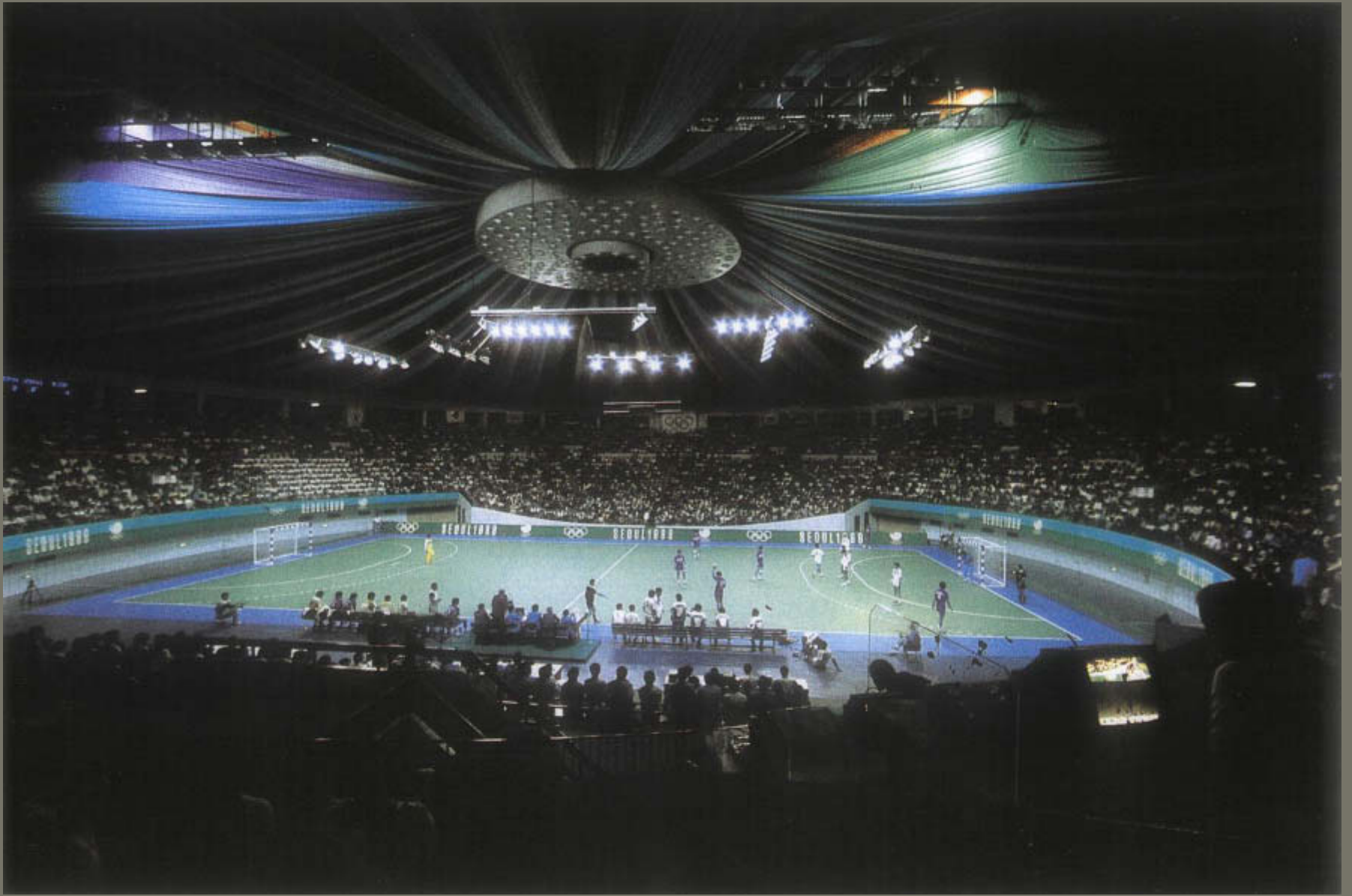

Handball

Men Prelim. Round Group A Match 1/Sept. 20			Hommes Series Prelim. Groupe A Match 1/20 Sept		
No.	Name Nom	Goals Buts	No.	Name Nom	Goals Buts
YUG 18-24 URS (7-10, 11-14)					
YUG	Yugoslavia		URS	U.S.S.R.	
01	Pusnik, Rolando	0	01	Lavrov, Andrei	0
02	Rnic, Momir	2	02	Toutchkine, Alexandre	3
04	Saracevic, Zlatko	1	03	Rymanov, Alexandre	3
05	Puc, Iztok	3	05	Karchakevish, Alexandre	3
07	Smajlagic, Irfan	0	06	Nesterov, Youri	0
08	Portner, Zlatko	2	07	Sviridenko, Guerogui	0
09	Vujovic, Veselin	8	09	Tioumentsev, Andrei	6
10	Holpert, Jozef	0	10	Vassiliev, Mikhail	0
11	Jarak, Boris	0	11	Chevtsov, Youri	5
12	Basic, Mirko	0	13	Atavin, Viatcheslav	4
13	Nacinovic, Alvaro	0	15	Novitski, Valdemar	0
14	Kuzmanovski, Slobodan	2	16	Tcooumak, Igor	0
Coach/Entraîneur;			Coach/Entraîneur;		
Arslanagic, Abbas			Evtouchenko, Anatoli Latyshkevitch, Leonid		
Referees/Arbitres;					
1. FRG Hofmann, Erhard					
2. FRG Prause, Manfred					

	Goals Buts	Saved Arrets	Missed Rates	G.Post Poteaux	Blocked Contres	Total
Line Shots /Lancer de la Ligne	2-11	2-2	1-0	2-1	0-0	7-14
Field Shots /Lancer du Terrain	10-3	9-3	4-0	2-0	3-0	28-6
Side Shots(R) /Lancer de Cote(D)	1-1	0-1	0-0	0-0	0-0	1-2
Side Shots(L) /Lancer de Cote(G)	1-2	1-1	0-0	0-0	0-0	2-3
Penalty Throws /Jet de 7 Metres	2-3	1-0	0-0	0-0	0-0	3-3
Free Throws /Jet Franc	1-0	0-0	0-0	0-0	0-0	1-0
Fast Breaks /Contre Attaques	1-4	0-0	0-0	0-1	0-0	1-5
** Total **	18-24	13-7	5-0	4-2	3-0	43-33
Assist	6-15		Suspension 2 Min.			4-5
Error/Erreur	5-8		Disqualification			0-0
Warning/Avertissement	3-2		Expulsion			0-0

Men Prelim. Round Group A Match 2/Sept. 20			Hommes Series Prelim. Groupe A Match 2/20 Sept		
No.	Name Nom	Goals Buts	No.	Name Nom	Goals Buts
SWE 21-18 ALG (14-9, 7-9)					
SWE	Sweden		ALG	Algeria	
01	Olsson, Mats	0	02	Bourdrali, Brahim	3
02	Jarphag, Peder	4	05	Azzeb, Omar	1
03	Wislander, Magnus	2	06	Beghouache, Benali	2
04	Eklund, Johan	0	07	Ait Hocine, Makhlof	2
05	Lindgren, Ola	2	08	Bouchecriou, Salah	1
06	Carlen, Per	3	09	Djefal, Ahcene	1
07	Hajas, Erik	4	10	Bouanik, Mahmoud	2
09	Jilsen, Bjorn	2	11	Lacheheb, Fethnour	0
10	Jilsen, Par	0	12	Ouchia, Kamel	0
11	Sjogren, Sten	1	13	Benmeghsoula, Abdeslam	1
13	Olsson, Staffan	3	14	Mohamed-Seghir, Zine-Eddin	5
16	Hellgren, Claes	0	16	Boussebt, Mourad	0
Coach/Entraîneur;			Coach/Entraîneur;		
Carlsson, Roger			Derouaz, Mohamed Lamine Az Hassen-Khodja, Mohamed Elf Melhani, Farid		
Referees/Arbitres;					
1. FRA Lelong, Jean					
2. FRA Tancrez, Gerard					

Handball

	Goals Buts	Saved Arrets	Missed Rates	G.Post Poteaux	Blocked Contres	Total
Line Shots /Lancer de la Ligne	9-4	2-1	1-0	2-0	0-0	14-5
Field Shots /Lancer du Terrain	3-6	0-6	3-3	0-0	0-0	6-15
Side Shots(R) /Lancer de Cote(D)	1-1	3-1	1-0	1-0	0-0	6-2
Side Shots(L) /Lancer de Cote(G)	2-1	1-0	0-1	0-0	0-0	3-2
Penalty Throws /Jet de 7 Metres	2-5	0-0	0-0	1-0	0-0	3-5
Free Throws /Jet Franc	0-0	1-0	0-0	0-0	0-0	1-0
Fast Breaks /Contre Attaques	4-1	0-1	0-0	0-0	0-0	4-2
** Total **	21-18	7-9	5-4	4-0	0-0	37-31
Assist	11-7		Suspension 2 Min.			4-6
Error/Erreur	11-16		Disqualification			0-0
Warning/Avertissement	2-3		Expulsion			0-0

Men Prelim. Round Group A Match 3/Sept. 20			Hommes Series Prelim. Groupe A Match 3/20 Sept		
No.	Name Nom	Goals Buts	No.	Name Nom	Goals Buts
ISL 22-15 USA (8-8, 14-7)					
ISL	Iceland		USA	United States of America	
01	Porvardarson, Einar	0	02	Story, Joseph	2
02	Mathiesen, Porgilsottar	7	03	Janny, Boyd	2
03	Sigurdsson, Jakob	0	04	Johnson, Bryant	0
04	Sigurdsson, Bjarki	1	05	Sullivan, Michael	2
06	Gunnarsson, Sigurdur	1	08	Goss, Steven	3
07	Gislason, Alfred	1	09	Buehning, James	0
09	Gudmundsson, Gudmundur	4	10	Driggers, Scott	0
10	Arason, Kristjan	8	11	Lash, Peter	4
11	Sveinsson, Geir	0	12	Oshita, Rod	0
13	Sveinsson, Sigurdur	0	14	Hillery, Robert	2
14	Hilmarsson, Atli	0	15	Kirk, Stephen	0
16	Hrafnelsson, Gudmundur	0	16	Kessler, William	0
Coach/Entraîneur;			Coach/Entraîneur;		
Kowalczyk, Bogdan Gudmundsson, Gudjon			Pokrajac, Branislau		
Referees/Arbitres;					
1. GDR Rauchfuss, Peter					
2. GDR Buchda, Rudolf					

	Goals Buts	Saved Arrets	Missed Rates	G.Post Poteaux	Blocked Contres	Total
Line Shots /Lancer de la Ligne	7-4	1-3	0-0	1-0	0-0	9-7
Field Shots /Lancer du Terrain	4-5	6-7	2-3	2-0	2-4	16-19
Side Shots(R) /Lancer de Cote(D)	1-1	0-3	1-0	0-0	0-0	2-4
Side Shots(L) /Lancer de Cote (G)	2-1	0-0	0-0	0-0	0-0	2-1
Penalty Throws /Jet de 7 Metres	4-2	0-0	0-0	0-0	0-0	4-2
Free Throws /Jet Franc	0-0	0-0	0-0	0-0	0-0	0-0
Fast Breaks /Contre Attaques	4-2	2-0	0-0	0-0	0-0	6-2
** Total **	22-15	9-13	3-3	3-0	2-4	39-35
Assist	14-9		Suspension 2 Min.			2-5
Error/Erreur	7-11		Disqualification			0-0
Warning/Avertissement	3-3		Expulsion			0-0



Men
Prelim. Round Group A Match 4/Sept. 22

Hommes
Series Prelim. Groupe A Match 4/22 Sept

No.	Name Nom	Goals Buts	No.	Name Nom	Goals Buts
YUG 31-23 USA (17-11, 14-12)					
YUG Yugoslavia			USA United States of America		
02	Rnic, Momir	6	02	Story, Joseph	2
03	Memic, Muhamed	1	03	Janny, Boyd	1
04	Saracevic, Zlatko	4	04	Johnson, Bryant	3
05	Puc, Iztok	4	05	Sullivan, Michael	3
06	Perkovac, Goran	0	06	Mcvein, Joe	1
08	Portner, Zlatko	6	08	Goss, Steven	7
09	Vujovic, Veselin	7	09	Buehning, James	0
10	Holpert, Jozef	3	10	Driggers, Scott	1
11	Jarak, Boris	0	11	Lash, Peter	3
12	Basic, Mirko	0	12	Oshita, Rod	0
13	Nacinovic, Alvaro	0	14	Hillery, Robert	2
16	Velic, Ermin	0	16	Kessler, William	0

Coach/Entraîneur;

Arslanagic, Abbas

Coach/Entraîneur;

Pokrajac, Branislau

Referees/Arbitres;

- KOR Lee, Moon-Sik
- KOR Park, Chun-Jo

	Goals Buts	Saved Arrets	Missed Rates	G.Post Poteaux	Blocked Contres	Total
Line Shots /Lancer de la Ligne	8-7	2-1	1-0	0-1	0-0	11-9
Field Shots /Lancer du Terrain	12-7	3-3	0-0	0-2	3-0	18-12
Side Shots(R) /Lancer de Cote(D)	3-1	1-0	0-0	0-0	0-0	4-1
Side Shots(L) /Lancer de Cote(G)	3-2	1-2	0-0	0-0	0-0	4-4
Penalty Throws /Jet de 7 Metres	4-3	0-0	0-0	0-0	0-0	4-3
Free Throws /Jet Franc	0-0	0-1	0-0	0-0	0-0	0-1
Fast Breaks /Contre Attaques	1-3	0-4	0-0	0-0	0-0	1-7
** Total **	31-23	7-11	1-0	0-3	3-0	42-37
Assist	17-11		Suspension 2 Min.			3-5
Error/Erreur	10-16		Disqualification			0-0
Warning/Avertissement	2-1		Expulsion			0-0

Men
Prelim. Round Group A Match 5/Sept. 22

Hommes
Series Prelim. Groupe A Match 5/22 Sept

No.	Name Nom	Goals Buts	No.	Name Nom	Goals Buts
SWE 18-22 URS (7-11, 11-11)					
SWE Sweden			URS U.S.S.R.		
01	Olsson, Mats	0	01	Lavrov, Andrei	0
02	Jarphag, Peder	0	02	Toutchkine, Alexandre	4
03	Wislander, Magnus	1	03	Rymanov, Alexandre	2
04	Eklund, Johan	0	05	Karchakevish, Alexandre	9
05	Lindgren, Ola	0	06	Nesterov, Youri	1
06	Carlen, Per	3	07	Sviridenko, Guerogui	0
07	Hajas, Erik	6	09	Tioumentsev, Andrei	1
08	Carlsson, Per	2	10	Vassiliev, Mikhail	0
09	Jiilsen, Bjorn	3	11	Chevtsov, Youri	3
11	Sjogren, Sten	0	13	Atavin, Viatcheslav	2
13	Olsson, Staffan	3	15	Novitski, Valdemar	0
16	Hellgren, Claes	0	16	Tcooumak, Igor	0

Coach/Entraîneur;

Carlsson, Roger

Coach/Entraîneur;

Evtouchenko, Anatoli
Latyshkevitch, Leonid

Referees/Arbitres;

- ROM Marin, Marin
- ROM Serban, Stefan

	Goals Buts	Saved Arrets	Missed Rates	G.Post Poteaux	Blocked Contres	Total
Line Shots /Lancer de la Ligne	4-10	0-9	0-0	0-0	0-0	4-19
Field Shots /Lancer du Terrain	6-3	3-5	3-4	3-1	3-0	18-13
Side Shots(R) /Lancer de Cote(D)	0-0	3-1	0-0	1-0	0-0	4-1
Side Shots(L) /Lancer de Cote(G)	3-4	3-1	0-0	0-0	0-0	6-5
Penalty Throws /Jet de 7 Metres	1-1	0-1	1-0	1-0	0-0	3-2
Free Throws /Jet Franc	0-0	0-0	1-0	0-0	0-0	1-0
Fast Breaks /Contre Attaques	4-4	1-0	0-0	0-0	0-0	5-4
** Total **	18-22	10-15	5-4	5-1	3-0	41-44
Assist	11-15		Suspension 2 Min.			3-7
Error/Erreur	13-11		Disqualification			0-0
Warning/Avertissement	3-2		Expulsion			0-0

Men
Prelim. Round Group A Match 6/Sept. 22

Hommes
Series Prelim. Groupe A Match 6/22 Sept

No.	Name Nom	Goals Buts	No.	Name Nom	Goals Buts
ISL 22-16 ALG (11-8, 11-8)					
ISL Iceland			ALG Algeria		
01	Porvardarson, Einar	0	02	Bourdrali, Brahim	2
02	Mathiesen, Porgilsottar	3	03	Bouhalissa, Abdelhak	2
03	Sigurdsson, Jakob	0	05	Azzeb, Omar	0
04	Sigurdsson, Bjarki	3	06	Beghouache, Benali	0
06	Gunnarsson, Sigurdur	5	07	Ait Hocine, Makhlof	2
07	Gislason, Alfred	0	08	Bouhekriou, Salah	1
08	Olafsson, Pall	0	10	Bouanik, Mahmoud	2
09	Gudmundsson, Gudmundur	0	11	Lacheheb, Fethnour	0
10	Arason, Kristjan	8	12	Ouchia, Kamel	0
11	Sveinsson, Geir	0	13	Benmeghsoula, Abdeslam	3
14	Hilmarrson, Atli	3	14	Mohamed-Seghir, Zine-Eddin	4
16	Hrafnkelsson, Gudmundur	0	16	Boussebt, Mourad	0

Coach/Entraîneur;

Kowalczyk, Bogdan
Gudmundsson, Gudjon

Coach/Entraîneur;

Derouaz, Mohamed Lamine Az
Hassen-Khodja, Mohamed Elf
Melhani, Farid

Referees/Arbitres;

- ARG Zaworotny, Miguel Angel
- ARG Brosio, Eduardo

	Goals Buts	Saved Arrets	Missed Rates	G.Post Poteaux	Blocked Contres	Total
Line Shots /Lancer de la Ligne	6-2	2-0	0-0	0-0	0-0	8-2
Field Shots /Lancer du Terrain	7-3	3-1	3-3	1-3	1-3	15-13
Side Shots(R) /Lancer de Cote(D)	2-2	1-0	0-0	0-0	0-0	3-2
Side Shots(L) /Lancer de Cote(G)	1-3	0-2	0-0	0-0	0-0	1-5
Penalty Throws /Jet de 7 Metres	5-4	0-0	0-0	0-1	0-0	5-5
Free Throws /Jet Franc	1-0	0-1	0-0	0-0	0-0	1-1
Fast Breaks /Contre Attaques	0-2	0-2	0-0	0-0	0-0	0-4
** Total **	22-16	6-6	3-3	1-4	1-3	33-32
Assist	12-11		Suspension 2 Min.			6-6
Error/Erreur	8-9		Disqualification			2-0
Warning/Avertissement	2-2		Expulsion			0-0

Handball

Men Prelim. Round Group A Match 7/Sept. 24			Hommes Series Prelim. Groupe A Match 7/24 Sept		
No.	Name Nom	Goals Buts	No.	Name Nom	Goals Buts
YUG 23-22 ALG (10-11, 13-11)					
YUG	Yugoslavia		ALG	Algeria	
01	Pusnik, Rolando	0	02	Bourdrali, Brahim	4
02	Rnic, Momir	3	06	Beghouache, Benali	3
03	Memic, Muhamed	0	07	Ait Hocine, Makhlof	4
04	Saracevic, Zlatko	0	08	Bouhekriou, Salah	1
05	Puc, Iztok	1	09	Djefal, Ahcene	4
06	Perkovac, Goran	1	10	Bouanik, Mahmoud	1
07	Smajlagic, Irfan	7	11	Lacheheb, Fethnour	0
08	Portner, Zlatko	6	12	Ouchia, Kamel	0
09	Vujovic, Veselin	1	13	Benmeghsoula, Abdeslam	2
10	Holpert, Jozef	4	14	Mohamed-Seghir, Zine-Eddin	2
13	Nacinovic, Alvaro	0	15	Draouci, Abousofiane	0
16	Velic, Ermin	0	16	Boussebt, Mourad	1
Coach/Entraîneur;			Coach/Entraîneur;		
Arslanagic, Abbas			Derouaz, Mohamed Lamine Az Hassen-Khodja, Mohamed Elf Melhani, Farid		
Referees/Arbitres;					
1. GDR Rauchfuss, Peter					
2. GDR Buchda, Rudolf					

	Goals Buts	Saved Arrets	Missed Rates	G.Post Poteaux	Blocked Contres	Total
Line Shots /Lancer de la Ligne	9-4	3-0	0-0	0-1	0-0	12-5
Field Shots /Lancer du Terrain	2-2	3-5	2-2	3-1	0-2	10-12
Side Shots(R) /Lancer de Cote(D)	1-4	0-0	0-0	0-0	0-0	1-4
Side Shots(L) /Lancer de Cote(G)	2-2	1-0	0-0	0-0	0-0	3-2
Penalty Throws /Jet de 7 Metres	2-1	0-0	0-0	3-0	0-0	5-1
Free Throws /Jet Franc	0-0	0-0	0-0	0-0	0-0	0-0
Fast Breaks /Contre Attaques	7-9	2-3	0-0	1-0	0-0	10-12
** Total **	23-22	9-8	2-2	7-2	0-2	41-36
Assist	17-10	Suspension 2 Min.		7-3		
Error/Erreur	15-17	Disqualification		0-0		
Warning/Avertissement	3-3	Expulsion		0-0		

Men Prelim. Round Group A Match 8/Sept. 24			Hommes Series Prelim. Groupe A Match 8/24 Sept		
No.	Name Nom	Goals Buts	No.	Name Nom	Goals Buts
SWE 20-14 ISL (12-6, 8-8)					
SWE	Sweden		ISL	Iceland	
01	Olsson, Mats	0	01	Porvardarson, Einar	0
02	Jarphag, Peder	0	02	Mathiesen, Porgilsottar	1
03	Wislander, Magnus	1	03	Sigurdsson, Jakob	0
04	Eklund, Johan	0	04	Sigurdsson, Bjarki	0
05	Lindgren, Ola	1	06	Gunnarsson, Sigurdur	2
06	Carlen, Per	5	07	Gislason, Alfred	3
07	Hajas, Erik	5	09	Gudmundsson, Gudmundur	0
08	Carlsson, Per	3	10	Arason, Kristjan	3
09	Jilsen, Bjorn	1	11	Sveinsson, Geir	2
10	Jilsen, Par	2	12	Kvaran, Brynjar	0
13	Olsson, Staffan	2	13	Sveinsson, Sigurdur	0
16	Hellgren, Claes	0	14	Hilmarsson, Atli	3
Coach/Entraîneur;			Coach/Entraîneur;		
Carlsson, Roger			Kowalczyk, Bogdan Gudmudsson, Gudjon		
Referees/Arbitres;					
1. NOR Sjong, Per Erik					
2. NOR Ludvigsen, Jan Rolf					

Handball

	Goals Buts	Saved Arrets	Missed Rates	G.Post Poteaux	Blocked Contres	Total
Line Shots /Lancer de la Ligne	6-4	1-3	0-1	0-0	0-0	7-8
Field Shots /Lancer du Terrain	3-7	4-13	6-5	2-0	2-11	17-36
Side Shots(R) /Lancer de Cote(D)	2-0	0-1	1-0	0-0	0-0	3-1
Side Shots(L) /Lancer de Cote(G)	2-0	1-2	0-0	0-0	0-0	3-2
Penalty Throws /Jet de 7 Metres	1-2	0-1	0-0	0-0	0-0	1-3
Free Throws /Jet Franc	0-0	0-0	1-0	1-0	0-0	2-0
Fast Breaks /Contre Attaques	6-1	1-0	0-0	0-0	0-0	7-1
** Total **	20-14	7-20	8-6	3-0	2-11	40-51
Assist	14-5	Suspension 2 Min.		3-4		
Error/Erreur	13-12	Disqualification		0-0		
Warning/Avertissement	2-2	Expulsion		0-0		

Men Prelim. Round Group A Match 9/Sept. 24			Hommes Series Prelim. Groupe A Match 9/24 Sept		
No.	Name Nom	Goals Buts	No.	Name Nom	Goals Buts
URS 26-14 USA (10-5, 16-9)					
URS	U.S.S.R.		USA	United States of America	
01	Lavrov, Andrei	0	02	Story, Joseph	0
02	Toutchkine, Alexandre	3	03	Janny, Boyd	2
03	Rymanov, Alexandre	2	04	Johnson, Bryant	1
05	Karchakevish, Alexandre	2	05	Sullivan, Michael	1
06	Nesterov, Youri	2	06	Mcvein, Joe	0
07	Sviridenko, Guerogui	4	08	Goss, Steven	5
09	Tiountsev, Andrei	6	10	Driggers, Scott	0
10	Vassiliev, Mikhail	1	11	Lash, Peter	3
13	Atavin, Viatcheslav	5	12	Oshita, Rod	0
15	Novitski, Valdemar	0	14	Hillery, Robert	1
16	Tcooumak, Igor	0	15	Kirk, Stephen	1
19	Charovarov, Konstantine	1	16	Kessler, William	0
Coach/Entraîneur;			Coach/Entraîneur;		
Evtouchenko, Anatoli Latyshkevitch, Leonid			Pokrajac, Branislav		
Referees/Arbitres;					
1. HOL Haak, Peter					
2. HOL Koppe, Henry					

	Goals Buts	Saved Arrets	Missed Rates	G.Post Poteaux	Blocked Contres	Total
Line Shots /Lancer de la Ligne	7-5	4-1	0-0	2-0	0-0	13-6
Field Shots /Lancer du Terrain	3-6	3-7	1-2	0-1	1-1	8-17
Side Shots(R) /Lancer de Cote(D)	0-0	0-0	0-0	0-0	0-0	0-0
Side Shots(L) /Lancer de Cote(G)	2-0	0-1	0-0	1-0	0-0	3-1
Penalty Throws /Jet de 7 Metres	5-2	2-1	1-0	0-0	0-0	8-3
Free Throws /Jet Franc	0-0	0-0	0-0	0-0	0-0	0-0
Fast Breaks /Contre Attaques	9-1	2-2	0-0	0-0	0-1	11-4
** Total **	26-14	11-12	2-2	3-1	1-2	43-31
Assist	18-5	Suspension 2 Min.		3-3		
Error/Erreur	10-20	Disqualification		1-0		
Warning/Avertissement	2-3	Expulsion		0-0		



Men
Prelim. Round Group A Match 10/Sept. 26

No.	Name Nom	Goals Buts
-----	-------------	---------------

YUG 19-19 ISL (8-10, 11-9)

No.	Name Nom	Goals Buts
02	Rnic, Momir	2
04	Saracevic, Zlatko	3
05	Puc, Iztok	0
06	Perkovic, Goran	0
07	Smajlagic, Irfan	0
08	Portner, Zlatko	6
09	Vujovic, Veselin	4
10	Holpert, Jozef	3
12	Basic, Mirko	0
13	Nacinovic, Alvaro	0
14	Kuzmanovski, Slobodan	1
16	Velic, Ermin	0

Coach/Entraîneur;
Arslanagic, Abbas

Referees/Arbitres;
1. HOL Haak, Peter
2. HOL Koppe, Henry

	Goals Buts	Saved Arrets	Missed Rates	G.Post Poteaux	Blocked Contres	Total
--	---------------	-----------------	-----------------	-------------------	--------------------	-------

Line Shots /Lancer de la Ligne	4-4	2-1	0-0	0-0	0-0	6-5
Field Shots /Lancer du Terrain	7-4	9-9	3-1	0-4	0-3	19-21
Side Shots(R) /Lancer de Cote(D)	0-3	0-1	0-0	0-0	0-0	0-4
Side Shots(L) /Lancer de Cote(G)	2-1	2-0	0-0	0-0	0-0	4-1
Penalty Throws /Jet de 7 Metres	3-2	1-1	0-0	0-0	0-0	4-3
Free Throws /Jet Franc	0-1	0-0	0-0	0-0	0-0	0-1
Fast Breaks /Contre Attaques	3-4	0-0	0-0	1-0	0-0	4-4
** Total **	19-19	14-12	3-1	1-4	0-3	37-39
Assist	8-11		Suspension 2 Min.			11-8
Error/Erreur	7-9		Disqualification			0-0
Warning/Avertissement	2-3		Expulsion			0-0

Men
Prelim. Round Group A Match 11/Sept. 26

No.	Name Nom	Goals Buts
-----	-------------	---------------

SWE 26-12 USA (11-6, 15-6)

No.	Name Nom	Goals Buts
01	Olsson, Mats	0
02	Jarphag, Peder	2
03	Wislander, Magnus	2
04	Eklund, Johan	1
05	Lindgren, Ola	5
06	Carlen, Per	4
07	Hajas, Erik	1
09	Jilsen, Bjorn	6
10	Jilsen, Par	1
11	Sjogren, Sten	3
13	Olsson, Staffan	1
16	Hellgren, Claes	0

Coach/Entraîneur;
Carlsson, Roger

Referees/Arbitres;
1. ARG Brosio, Eduardo
2. ARG Zaworotny, Miguel Angel

Hommes
Series Prelim. Groupe A Match 10/26 Sept

No.	Name Nom	Goals Buts
-----	-------------	---------------

No.	Name Nom	Goals Buts
01	Porvaldason, Einar	0
02	Mathiesen, Porgilsottar	2
03	Sigurdsson, Jakob	1
05	Prainsson, Karl	5
06	Gunnarsson, Sigurdur	0
07	Gislason, Alfred	5
08	Olafsson, Pall	0
09	Gudmundsson, Gudmundur	1
10	Arason, Kristjan	3
11	Sveinsson, Geir	0
14	Hilmarsson, Atli	2
16	Hrafnelsson, Gudmundur	0

Coach/Entraîneur;
Kowalczyk, Bogdan
Gudmundsson, Gudjon

	Goals Buts	Saved Arrets	Missed Rates	G.Post Poteaux	Blocked Contres	Total
--	---------------	-----------------	-----------------	-------------------	--------------------	-------

Line Shots /Lancer de la Ligne	9-5	2-2	0-0	0-0	0-0	11-7
Field Shots /Lancer du Terrain	5-4	1-7	0-1	4-3	2-2	12-17
Side Shots(R) /Lancer de Cote(D)	1-0	1-0	0-0	0-0	0-0	2-0
Side Shots(L) /Lancer de Cote(G)	2-0	3-1	0-0	0-0	0-0	5-1
Penalty Throws /Jet de 7 Metres	6-2	1-0	0-0	1-0	0-0	8-2
Free Throws /Jet Franc	0-0	0-0	0-0	0-0	0-0	0-0
Fast Breaks /Contre Attaques	3-1	0-0	0-0	0-0	0-0	3-1
** Total **	26-12	8-10	0-1	5-3	2-2	41-28
Assist	19-6		Suspension 2 Min.			1-5
Error/Erreur	10-19		Disqualification			0-0
Warning/Avertissement	2-2		Expulsion			0-0

Men
Prelim. Round Group A Match 12/Sept. 26

No.	Name Nom	Goals Buts
-----	-------------	---------------

URS 26-13 ALG (13-5, 13-8)

No.	Name Nom	Goals Buts
01	Lavrov, Andrei	0
02	Toutchkine, Alexandre	3
03	Rymanov, Alexandre	3
06	Nesterov, Youri	4
07	Sviridenko, Guerogui	3
08	Gopin, Valeri	4
09	Tioumentsev, Andrei	2
10	Vassiliev, Mikhail	2
11	Chevtsov, Youri	1
13	Atavin, Viatcheslav	3
16	Tooumak, Igor	0
19	Charovarov, Konstantine	1

Coach/Entraîneur;
Evtouchenko, Anatoli
Latyshkevitch, Leonid

Referees/Arbitres;
1. KOR Lee, Moon-Sik
2. KOR Park, Chun-Jo

	Goals Buts	Saved Arrets	Missed Rates	G.Post Poteaux	Blocked Contres	Total
--	---------------	-----------------	-----------------	-------------------	--------------------	-------

Line Shots /Lancer de la Ligne	13-4	2-2	0-0	1-0	0-0	16-6
Field Shots /Lancer du Terrain	5-6	3-6	1-2	0-0	0-2	9-16
Side Shots(R) /Lancer de Cote(D)	0-1	0-0	1-0	0-0	0-0	1-1
Side Shots(L) /Lancer de Cote(G)	2-1	1-0	0-0	0-0	0-0	3-1
Penalty Throws /Jet de 7 Metres	2-1	0-0	0-0	0-0	0-0	2-1
Free Throws /Jet Franc	0-0	1-0	0-0	0-0	0-0	1-0
Fast Breaks /Contre Attaques	4-0	1-0	0-0	0-0	0-0	5-0
** Total **	26-13	8-8	2-2	1-0	0-2	37-25
Assist	17-4		Suspension 2 Min.			2-4
Error/Erreur	8-19		Disqualification			0-0
Warning/Avertissement	2-1		Expulsion			0-0

Handball

Men Prelim. Round Group A Match 13/Sept. 28			Hommes Series Prelim. Groupe A Match 13/28 Sept		
No.	Name Nom	Goals Buts	No.	Name Nom	Goals Buts
USA 17-20 ALG (8-10,9-10)					
USA United States of America			ALG Algeria		
02	Story, Joseph	2	02	Bourdrali, Brahim	2
03	Janny, Boyd	1	03	Bouhalissa, Abdelhak	1
05	Sullivan, Michael	0	06	Beghouache, Benali	1
07	Fitschen, Craig	0	07	Ait Hocine, Makhlouf	3
08	Goss, Steven	3	08	Bouchekriou, Salah	1
09	Buehning, James	0	09	Djefal, Ahcene	2
10	Driggers, Scott	1	10	Bouanik, Mahmoud	2
11	Lash, Peter	5	11	Lacheheb, Fethnour	2
12	Oshita, Rod	0	12	Ouchia, Kamel	0
14	Hillery, Robert	5	13	Benmeghsoula, Abdeslam	3
15	Kirk, Stephen	0	14	Mohamed-Seghir, Zine-Eddin	3
16	Kessler, William	0	16	Boussebt, Mourad	0
Coach/Entraîneur; Pokrajac, Branislau			Coach/Entraîneur; Derouaz, Mohamed Lamine Az Hassen-Khocja, Mohamed Elf Melhani, Farid		
Referees/Arbitres; 1. FRA Lelong, Jean 2. FRA Tancrez, Gerard					

	Goals Buts	Saved Arrets	Missed Rates	G.Post Poteaux	Blocked Contres	Total
Line Shots /Lancer de la Ligne	9-8	1-3	1-0	0-0	0-0	11-11
Field Shots /Lancer du Terrain	5-3	4-4	0-1	0-1	3-4	12-13
Side Shots(R) /Lancer de Cote(D)	0-4	1-1	0-1	0-0	0-0	1-6
Side Shots(L) /Lancer de Cote(G)	1-3	1-2	0-0	0-1	0-0	2-6
Penalty Throws /Jet de 7 Metres	0-2	0-0	0-0	1-0	0-0	1-2
Free Throws /Jet Franc	0-0	0-0	0-0	0-0	0-1	0-1
Fast Breaks /Contre Attaques	2-0	0-0	0-1	0-0	0-0	2-1
** Total **	17-20	7-10	1-3	1-2	3-5	29-40
Assist	4-11					4-2
Error/Erreur	16-9					0-0
Warning/Avertissement	3-3					0-0

Men Prelim. Round Group A Match 14/Sept. 28			Hommes Series Prelim. Groupe A Match 14/28 Sept		
No.	Name Nom	Goals Buts	No.	Name Nom	Goals Buts
ISL 19-32 URS (8-5, 11-17)					
ISL Iceland			URS U.S.S.R.		
01	Porvardarson, Einar	0	01	Lavrov, Andrei	0
02	Mathiesen, Porgilsottar	1	02	Toutchkine, Alexandre	11
05	Prainsson, Karl	0	03	Rymanov, Alexandre	1
06	Gunnarsson, Sigurdur	2	05	Karchakevish, Alexandre	2
07	Gislason, Alfred	6	06	Nesterov, Youri	2
08	Olafsson, Pall	0	07	Sviridenko, Guerogui	4
09	Gudmundsson, Gudmundur	2	09	Tioumentsev, Andrei	2
10	Arason, Kristjan	2	10	Vassiliev, Mikhail	2
11	Sveinsson, Geir	3	11	Chevtsov, Youri	5
13	Sveinsson, Sigurdur	2	13	Atavin, Viatcheslav	3
14	Hilmarsson, Atli	1	15	Novitski, Valdemar	0
16	Hrafnelsson, Gudmundur	0	16	Tcooumak, Igor	0
Coach/Entraîneur; Kowalczyk, Bogdan Gudmundsson, Gudjon			Coach/Entraîneur; Evtouchenko, Anatoli Latyshkevitch, Leonid		
Referees/Arbitres; 1. GDR Rauchfuss, Peter 2. GDR Buchda, Rudolf					

Handball

	Goals Buts	Saved Arrets	Missed Rates	G.Post Poteaux	Blocked Contres	Total
Line Shots /Lancer de la Ligne	5-9	1-1	0-0	0-1	0-0	6-11
Field Shots /Lancer du Terrain	6-8	9-1	5-2	0-1	4-0	24-12
Side Shots(R) /Lancer de Cote(D)	0-4	3-0	0-0	0-0	0-0	3-4
Side Shots(L) /Lancer de Cote(G)	1-1	0-3	0-0	1-0	0-0	2-4
Penalty Throws /Jet de 7 Metres	7-5	2-0	1-0	0-0	0-0	10-5
Free Throws /Jet Franc	0-0	0-0	0-0	0-0	0-0	0-0
Fast Breaks /Contre Attaques	0-5	0-3	0-0	0-0	0-0	0-8
** Total **	19-32	15-8	6-2	1-2	4-0	45-44
Assist	10-15					2-7
Error/Erreur	14-7					0-0
Warning/Avertissement	3-3					0-0

Men Prelim. Round Group A Match 15/Sept. 28			Hommes Series Prelim. Groupe A Match 15/28 Sept		
No.	Name Nom	Goals Buts	No.	Name Nom	Goals Buts
YUG 25-21 SWE (14-10, 11-11)					
YUG Yugoslavia			SWE Sweden		
01	Pusnik, Rolando	0	01	Olsson, Mats	0
02	Rnic, Momir	3	02	Jarphag, Peder	0
04	Saracevic, Zlatko	0	03	Wislander, Magnus	2
05	Puc, Iztok	5	04	Eklund, Johan	0
06	Perkovac, Goran	2	05	Lindgren, Ola	0
07	Smajljagic, Irfan	3	06	Carlén, Per	5
08	Portner, Zlatko	4	07	Hajas, Erik	4
09	Vujovic, Veselin	2	08	Carlsson, Per	0
10	Holpert, Jozef	3	09	Jilsen, Bjorn	5
12	Basic, Mirko	0	11	Sjogren, Sten	2
13	Nacinovic, Alvaro	0	13	Olsson, Staffan	3
14	Kuzmanovski, Slobodan	3	16	Hellgren, Claes	0
Coach/Entraîneur; Arslanagic, Abbas			Coach/Entraîneur; Carlsson, Roger		
Referees/Arbitres; 1. ROM Marin, Marin 2. ROM Serban, Stefan					

	Goals Buts	Saved Arrets	Missed Rates	G.Post Poteaux	Blocked Contres	Total
Line Shots /Lancer de la Ligne	7-5	2-1	1-0	0-0	0-0	10-6
Field Shots /Lancer du Terrain	10-5	3-6	2-0	5-2	7-5	27-18
Side Shots(R) /Lancer de Cote(D)	2-0	1-3	0-1	0-0	0-0	3-4
Side Shots(L) /Lancer de Cote(G)	1-2	0-1	0-0	0-0	0-0	1-3
Penalty Throws /Jet de 7 Metres	3-5	0-1	1-0	0-0	0-0	4-6
Free Throws /Jet Franc	0-0	0-0	0-0	0-0	0-0	0-0
Fast Breaks /Contre Attaques	2-4	2-2	0-0	0-1	0-0	4-7
** Total **	25-21	8-14	4-1	5-3	7-5	49-44
Assist	9-10					1-2
Error/Erreur	10-13					0-0
Warning/Avertissement	2-3					0-0



Men Prelim. Round Group B Match 1/Sept. 20			Hommes Series Prelim. Groupe B Match 1/20 Sept		
No.	Name Nom	Goals Buts	No.	Name Nom	Goals Buts
HUN 20-22 KOR (9-11, 11-11)					
HUN Hungary			KOR Korea		
01	Dr.hoffmann, Laszlo	0	01	Yoon, Tae-Il	0
02	Bordas, Jozsef	0	02	Kim, Jae-Hwan	4
03	Kovacs, Peter	10	03	Sin, Young-Suk	3
04	Kovacs, Mihaly	1	04	Park, Do-Hun	5
05	Fodor, Janos	1	05	Park, Young-Dae	0
06	Marosi, Laszlo	2	06	Koh, Suk-Chang	0
07	Ivancsik, Mihaly	2	11	Oh, Young-Ki	0
08	Sibalin, Jakab	0	12	Choi, Suk-Jae	0
10	Toth, Geza	0	13	Kang, Jae-Won	7
11	Csicsay, Otto	2	14	Lee, Sang-Hyo	3
13	Gyurka, Janos	2	15	Shim, Jae-Hong	0
16	Oross, Tibor	0	17	Lim, Jin-Suk	0
Coach/Entraîneur; Adorjan, Janos Mocsai, Lajos			Coach/Entraîneur; Yoo, Jae-Choong Lee, Keum-Ku		
Referees/Arbitres; 1. DEN Christensen, Ole 2. DEN Jorgensen, Per Godsk					

	Goals Buts	Saved Arrets	Missed Rates	G.Post Poteaux	Blocked Contres	Total
Line Shots /Lancer de la Ligne	4-4	0-5	1-0	0-0	0-0	5-9
Field Shots /Lancer du Terrain	6-8	12-6	1-1	0-2	0-6	19-23
Side Shots(R) /Lancer de Cote(D)	2-0	3-1	0-0	1-0	0-0	6-1
Side Shots(L) /Lancer de Cote(G)	2-1	1-0	0-1	0-0	0-0	3-2
Penalty Throws /Jet de 7 Metres	4-5	0-0	0-0	0-1	0-0	4-6
Free Throws /Jet Franc	1-2	0-0	1-0	0-0	0-0	2-2
Fast Breaks /Contre Attaques	1-2	2-3	0-0	1-0	0-0	4-5
** Total **	20-22	18-15	3-2	2-3	0-6	43-48
Assist	7-7					5-4
Error/Erreur	12-11					0-1
Warning/Avertissement	2-3					0-0

Men Prelim. Round Group B Match 2/Sept. 20			Hommes Series Prelim. Groupe B Match 2/20 Sept		
No.	Name Nom	Goals Buts	No.	Name Nom	Goals Buts
GDR 25-18 JPN (14-10, 11-8)					
GDR GermanDemocraticRepublic			JPN Japan		
01	Hofmann, Peter	0	01	Ito, Hidetada	0
02	Hauck, Stephan	1	02	Nishiyama, Kiyoshi	1
03	Pysall, Peter	0	03	Yamamoto, Kodo	3
04	Wahl, Frank-Michael	6	04	Tamamura, Kenji	3
05	Winselmann, Holger	1	06	Shudo, Shinichi	0
06	Neitzel, Andreas	1	07	Fujii, Izumi	0
08	Borchardt, Ruediger	6	08	Takamura, Seiichi	2
09	Fiedler, Jens	0	09	Tachiki, Koji	1
10	Fuhrig, Mike	0	10	Taguchi, Takashi	0
11	Hahn, Matthias	5	11	Miyashita, Kazuhiro	6
12	Schmidt, Wieland	0	12	Yanai, Hiroshi	0
14	Schneider, Holger	5	14	Yamamura, Toshiyuki	2
Coach/Entraîneur; Tiedemann, Paul			Coach/Entraîneur; Tsugawa, Akira		
Referees/Arbitres; 1. HOL Haak, Peter 2. HOL Koppe, Henry					

	Goals Buts	Saved Arrets	Missed Rates	G.Post Poteaux	Blocked Contres	Total
Line Shots /Lancer de la Ligne	9-2	1-1	0-0	0-0	0-0	10-3
Field Shots /Lancer du Terrain	4-8	2-9	1-2	2-1	0-9	9-29
Side Shots(R) /Lancer de Cote(D)	2-2	1-0	0-0	1-0	0-0	4-2
Side Shots(L) /Lancer de Cote(G)	3-1	0-1	0-0	0-0	0-0	3-2
Penalty Throws /Jet de 7 Metres	3-4	0-1	0-0	1-0	0-0	4-5
Free Throws /Jet Franc	0-0	1-0	0-0	0-0	0-1	1-1
Fast Breaks /Contre Attaques	4-1	0-0	0-0	0-1	0-0	4-2
** Total **	25-18	5-12	1-2	4-2	0-10	35-44
Assist	12-7					4-4
Error/Erreur	11-11					0-0
Warning/Avertissement	2-3					0-0

Men Prelim. Round Group B Match 3/Sept. 20			Hommes Series Prelim. Groupe B Match 3/20 Sept		
No.	Name Nom	Goals Buts	No.	Name Nom	Goals Buts
ESP 17-20 TCH (5-10, 12-10)					
ESP Spain			TCH Czechoslovakia		
01	Zuniga, Miguel A.	0	01	Barda, Michal	0
02	Cabanas, Javier	2	02	Skandik, Josef	0
03	Munoz, Juan F.	2	03	Bajgar, Miroslav	2
04	Reino, Javier	0	04	Sovadina, Libor	3
05	De La Puente, Juan Antonio	1	05	Kotrc, Jiri	3
07	Marin, Ricardo	1	06	Brestovansky, Milan	0
08	Uria, Juan Jose	0	07	Folta, Milan	0
09	Gomez, Jesus	1	09	Bartek, Tomas	6
10	Ruiz, Julian	3	10	Vanek, Zdenek	0
11	Serrano, Eugenio	7	11	Baumruk, Petr	4
12	Rico, Lorenzo	0	14	Novak, Jan	2
13	Puig, Jaime	0	16	Mesiarik, Peter	0
Coach/Entraîneur; Roman Seco, Juan De Dios			Coach/Entraîneur; Mares, Vojtech		
Referees/Arbitres; 1. SWE Wester, Axel 2. SWE Blademo, Kent					

	Goals Buts	Saved Arrets	Missed Rates	G.Post Poteaux	Blocked Contres	Total
Line Shots /Lancer de la Ligne	0-4	0-0	0-0	0-0	0-0	0-4
Field Shots /Lancer du Terrain	3-8	11-2	1-3	1-1	0-2	16-16
Side Shots(R) /Lancer de Cote(D)	2-3	1-1	0-0	0-0	0-0	3-4
Side Shots(L) /Lancer de Cote(G)	3-1	1-0	0-0	0-0	0-0	4-1
Penalty Throws /Jet de 7 Metres	6-3	0-2	1-0	1-0	0-0	8-5
Free Throws /Jet Franc	0-1	0-0	0-0	0-0	1-0	1-1
Fast Breaks /Contre Attaques	3-0	0-0	0-0	0-0	0-1	3-1
** Total **	17-20	13-5	2-3	2-1	1-3	35-32
Assist	9-9					4-7
Error/Erreur	8-10					0-2
Warning/Avertissement	2-2					0-0

Handball

Men Prelim. Round Group B Match 4/Sept. 22			Hommes Series Prelim. Groupe B Match 4/22 Sept		
No.	Name Nom	Goals Buts	No.	Name Nom	Goals Buts
HUN 16-19 TCH (6-12, 10-7)					
HUN Hungary			TCH Czechoslovakia		
01	Dr. Hoffmann, Laszlo	0	01	Barda, Michal	0
02	Bordas, Jozsef	0	02	Skandik, Josef	0
03	Kovacs, Peter	1	03	Bajgar, Miroslav	2
04	Kovacs, Mihaly	3	04	Sovadina, Libor	1
05	Fodor, Janos	0	05	Kotrc, Jiri	7
06	Marosi, Laszlo	2	06	Brestovansky, Milan	1
07	Ivancsik, Mihaly	6	07	Folta, Milan	0
08	Sibalin, Jakab	1	09	Bartek, Tomas	3
10	Toth, Geza	0	10	Vanek, Zdenek	0
11	Csicsay, Otto	0	11	Baumruk, Petr	5
12	Biro, Imre	0	14	Novak, Jan	0
13	Gyurka, Janos	3	16	Mesiarik, Peter	0
Coach/Entraîneur; Adorjan, Janos Mocsai, Lajos			Coach/Entraîneur; Mares, Vojtech		
Referees/Arbitres; 1. URS Guterman, Grigorij 2. URS Taranuhin, Juri					

	Goals Buts	Saved Arrets	Missed Rates	G Post Poteaux	Blocked Contres	Total
Line Shots /Lancer de la Ligne	3-8	0-3	1-1	0-0	0-0	4-12
Field Shots /Lancer du Terrain	6-7	6-5	2-2	0-0	3-4	17-18
Side Shots (R) /Lancer de Cote(D)	4-0	0-0	0-0	0-0	0-0	4-0
Side Shots(L) /Lancer de Cote(G)	0-1	3-1	0-0	0-0	0-0	3-2
Penalty Throws /Jet de 7 Metres	0-2	1-0	0-0	0-0	0-0	1-2
Free Throws /Jet Franc	0-0	0-0	0-0	0-0	0-0	0-0
Fast Breaks /Contre Attaques	3-1	1-0	0-0	0-0	0-0	4-1
** Total **	16-19	11-9	3-3	0-0	3-4	33-35
Assist	8-10					3-4
Error/Erreur	14-16					0-0
Warning/Avertissement	3-2					0-0

Men Prelim. Round Group B Match 5/Sept. 22			Hommes Series Prelim. Groupe B Match 5/22 Sept		
No.	Name Nom	Goals Buts	No.	Name Nom	Goals Buts
GDR 22-23 KOR (13-9, 9-14)					
GDR German Democratic Republic			KOR Korea		
01	Hofmann, Peter	0	01	Yoon, Tae-Il	0
02	Hauck, Stephan	1	02	Kim, Jae-Hwan	5
03	Pysall, Peter	0	03	Sin, Young-Suk	1
04	Wahl, Frank-Michael	5	04	Park, Do-Hun	2
05	Winselmann, Holger	1	05	Park, Young-Dae	0
07	Metzke, Bernd	1	06	Koh, Suk-Chang	2
08	Borchardt, Ruediger	8	11	Oh, Young-Ki	0
09	Fiedler, Jens	1	12	Choi, Suk-Jae	0
10	Fuhrig, Mike	0	13	Kang, Jae-Wofi	9
11	Hahn, Matthias	5	14	Lee, Sang-Hyo	4
12	Schmidt, Wieland	0	15	Shim, Jae-Hong	0
14	Schneider, Holger	0	17	Lim, Jin-Suk	0
Coach/Entraîneur; Tiedemann, Paul			Coach/Entraîneur; Yoo, Jae-Choong Lee, Keum-Ku		
Referees/Arbitres; 1. YUG Jug, Stefan 2. YUG Jeglic, Herbert					

Handball

	Goals Buts	Saved Arrets	Missed Rates	G.Post Poteaux	Blocked Contres	Total
Line Shots /Lancer de la Ligne	8-6	2-2	0-0	0-0	0-0	10-8
Field Shots /Lancer du Terrain	3-7	10-13	5-0	0-1	0-1	18-22
Side Shots(R) /Lancer de Cote(D)	1-2	1-0	0-0	0-0	0-0	2-2
Side Shots(L) /Lancer de Cote(G)	0-0	2-1	1-1	1-0	0-0	4-2
Penalty Throws /Jet de 7 Metres	5-7	0-5	0-0	0-0	0-0	5-12
Free Throws /Jet Franc	1-0	0-0	0-0	0-0	0-0	1-0
Fast Breaks /Contre Attaques	4-1	0-0	0-1	0-0	0-0	4-2
** Total **	22-23	15-21	6-2	1-1	0-1	44-48
Assist	13-13					4-3
Error/Erreur	6-7					0-0
Warning/Avertissement	3-1					0-0

Men Prelim. Round Group B Match 6/Sept. 22			Hommes Series Prelim. Groupe B Match 6/22 Sept		
No.	Name Nom	Goals Buts	No.	Name Nom	Goals Buts
ESP 25-19 JPN (13-5, 12-14)					
ESP Spain			JPN Japan		
01	Zuniga, Miguel A.	0	01	Ito, Hidetada	0
02	Cabanas, Javier	6	02	Nishiyama, Kiyoshi	2
03	Munoz, Juan F.	8	03	Yamamoto, Kodo	1
04	Reino, Javier	1	04	Tamamura, Kenji	1
05	De La Puente, Juan Antonio	1	06	Shudo, Shinichi	1
06	Fernandez, Jesus	2	08	Takamura, Seiichi	0
07	Marin, Ricardo	1	09	Tachiki, Koji	4
08	Uria, Juan Jose	2	10	Taguchi, Takashi	0
10	Ruiz, Julian	2	11	Miyashita, Kazuhiro	4
11	Serrano, Eugenio	0	13	Okuda, Shinji	0
12	Rico, Lorenzo	0	14	Yamamura, Toshiyuki	6
13	Puig, Jaime	2	16	Hashimoto, Yukihiro	0
Coach/Entraîneur; Roman Seco, Juan De Dios			Coach/Entraîneur; Tsugawa, Akira		
Referees/Arbitres; 1. NOR Sjong, Per Erik 2. NOR Ludvigsen, Jan Rolf					

	Goals Buts	Saved Arrets	Missed Rates	G.Post Poteaux	Blocked Contres	Total
Line Shots /Lancer de la Ligne	7-6	2-0	0-0	0-0	0-0	9-6
Field Shots /Lancer du Terrain	9-4	5-10	1-2	0-1	2-5	17-22
Side Shots(R) /Lancer de Cote(D)	3-1	0-0	1-0	0-0	0-0	4-1
Side Shots(L) /Lancer de Cote(G)	1-3	1-1	1-1	0-0	0-0	3-5
Penalty Throws /Jet de 7 Metres	4-2	1-2	0-0	1-0	0-0	6-4
Free Throws /Jet Franc	0-0	0-0	0-0	0-0	0-0	0-0
Fast Breaks /Contre Attaques	1-3	0-0	0-0	0-0	0-0	1-3
** Total **	25-19	9-13	3-3	1-1	2-5	40-41
Assist	12-14					5-6
Error/Erreur	10-11					0-1
Warning/Avertissement	2-2					0-0



Men
Prelim. Round Group B Match 7/Sept. 24

No.	Name Nom	Goals Buts
-----	-------------	---------------

HUN 22-19 JPN (10-11, 12-8)

HUN Hungary

02	Bordas, Jozsef	0
03	Kovacs, Peter	0
04	Kovacs, Mihaly	1
05	Fodor, Janos	0
06	Marosi, Laszlo	11
07	Ivancsik, Mihaly	3
09	Szabo, Laszlo	1
10	Toth, Geza	1
11	Csicsay, Otto	1
12	Biro, Imre	0
13	Gyurka, Janos	4
16	Oross, Tibor	0

Coach/Entraîneur;

Adorjan, Janos
Mocsai, Lajos

Referees/Arbitres;

1. SWE Wester, Axel
2. SWE Blademo, Kent

	Goals Buts	Saved Arrets	Missed Rates	G.Post Poteaux	Blocked Contres	Total
--	---------------	-----------------	-----------------	-------------------	--------------------	-------

Line Shots /Lancer de la Ligne 2-3 3-0 0-0 0-0 0-0 5-3

Field Shots /Lancer du Terrain 11-10 6-7 2-3 1-2 0-6 20-28

Side Shots(R) /Lancer de Cote(D) 1-1 2-2 0-0 1-0 0-0 4-3

Side Shots(L) /Lancer de Cote(G) 2-1 0-0 0-0 0-2 0-0 2-3

Penalty Throws /Jet de 7 Metres 3-3 0-0 0-1 0-0 0-0 3-4

Free Throws /Jet Franc 0-0 0-0 0-0 0-0 0-0 0-0

Fast Breaks /Contre Attaques 3-1 2-0 0-0 1-0 0-0 6-1

**** Total **** 22-19 13-9 2-4 3-4 0-6 40-42

Assist 9-5 Suspension 2 Min. 6-9
Error/Erreur 15-18 Disqualification 0-1
Warning/Avertissement 2-1 Expulsion 0-0

Men
Prelim. Round Group B Match 8/Sept. 24

No.	Name Nom	Goals Buts
-----	-------------	---------------

GDR 21-20 ESP (11-8, 10-12)

GDR German Democratic Republic

01	Hofmann, Peter	0
02	Hauck, Stephan	4
03	Pysall, Peter	0
04	Wahl, Frank-Michael	3
05	Winselmann, Holger	0
06	Neitzel, Andreas	0
07	Metzke, Bernd	0
08	Borchardt, Ruediger	8
09	Fiedler, Jens	0
11	Hahn, Matthias	3
12	Schmidt, Wieland	0
14	Schneider, Holger	3

Coach/Entraîneur;

Tiedemann, Paul

Referees/Arbitres;

1. DEN Christensen, Ole
2. DEN Jorgensen, Per Godsk

Hombres
Series Prelim. Groupe B Match 7/24 Sept

No.	Name Nom	Goals Buts
-----	-------------	---------------

JPN Japan

01	Ito, Hidetada	0
03	Yamamoto, Kodo	0
04	Tamamura, Kenji	13
05	Nikawadori, Yoshihiro	0
06	Shudo, Shinichi	1
07	Fujii, Izumi	0
08	Takamura, Seiichi	0
09	Tachiki, Koji	0
10	Taguchi, Takashi	0
11	Miyashita, Kazuhiro	2
12	Yanai, Hiroshi	0
14	Yamamura, Toshiyuki	3

Coach/Entraîneur;

Tsugawa, Akira

	Goals Buts	Saved Arrets	Missed Rates	G.Post Poteaux	Blocked Contres	Total
--	---------------	-----------------	-----------------	-------------------	--------------------	-------

Line Shots /Lancer de la Ligne 2-3 0-1 0-0 0-0 0-0 2-4

Field Shots /Lancer du Terrain 10-6 7-11 0-0 0-1 4-4 21-22

Side Shots(R) /Lancer de Cote(D) 0-2 0-0 0-0 0-0 0-0 0-2

Side Shots(L) /Lancer de Cote(G) 2-2 1-0 1-0 1-0 0-0 5-2

Penalty Throws /Jet de 7 Metres 4-4 0-1 0-0 0-0 0-0 4-5

Free Throws /Jet Franc 0-0 1-0 0-0 0-0 1-0 2-0

Fast Breaks /Contre Attaques 3-3 1-1 0-0 0-0 0-0 4-4

**** Total **** 21-20 10-14 1-0 1-1 5-4 38-39

Assist 7-13 Suspension 2 Min. 4-5
Error/Erreur 14-14 Disqualification 0-1
Warning/Avertissement 2-2 Expulsion 0-0

Men
Prelim. Round Group B Match 9/Sept. 24

No.	Name Nom	Goals Buts
-----	-------------	---------------

KOR 29-28 TCH (15-12, 14-16)

KOR Korea

01	Yoon, Tae-Il	0
02	Kim, Jae-Hwan	5
03	Sin, Young-Suk	1
04	Park, Do-Hun	4
05	Park, Young-Dae	1
06	Koh, Suk-Chang	1
11	Oh, Young-Ki	0
12	Choi, Suk-Jae	0
13	Kang, Jae-Won	8
14	Lee, Sang-Hyo	9
15	Shim, Jae-Hong	0
17	Lim, Jin-Suk	0

Coach/Entraîneur;

Yoo, Jae-Choong

Referees/Arbitres;

1. FRG Hofmann, Erhard
2. FRG Prause, Manfred

	Goals Buts	Saved Arrets	Missed Rates	G.Post Poteaux	Blocked Contres	Total
--	---------------	-----------------	-----------------	-------------------	--------------------	-------

Line Shots /Lancer de la Ligne 7-7 2-0 0-0 1-0 0-0 10-7

Field Shots /Lancer du Terrain 9-7 5-4 0-1 0-0 2-1 16-13

Side Shots(R) /Lancer de Cote(D) 2-3 4-2 0-0 0-0 0-0 6-5

Side Shots(L) /Lancer de Cote(G) 3-4 1-0 1-0 0-0 0-0 5-4

Penalty Throws /Jet de 7 Metres 6-1 1-1 0-0 0-0 0-0 7-2

Free Throws /Jet Franc 0-0 0-0 0-0 0-0 0-0 0-0

Fast Breaks /Contre Attaques 2-6 3-2 0-0 0-0 0-0 5-8

**** Total **** 29-28 16-9 1-1 1-0 2-1 49-39

Assist 15-11 Suspension 2 Min. 5-7
Error/Erreur 11-13 Disqualification 0-0
Warning/Avertissement 3-3 Expulsion 0-0

Handball

Men Prelim. Round Group B Match 10/Sept. 26			Hommes Series Prelim. Groupe B Match 10/26 Sept		
No.	Name Nom	Goals Buts	No.	Name Nom	Goals Buts
HUN 26-16 ESP (14-8, 12-8)					
HUN Hungary			ESP Spain		
01	Dr. Hoffmann, Laszlo	0	01	Zuniga, Miguel A.	0
02	Bordas, Jozsef	0	02	Cabanas, Javier	1
03	Kovacs, Peter	6	03	Munoz, Juan F.	5
04	Kovacs, Mihaly	0	04	Reino, Javier	2
05	Fodor, Janos	1	07	Marin, Ricardo	0
06	Marosi, Laszlo	8	08	Uria, Juan Jose	0
07	Ivancsik, Mihaly	6	09	Gomez, Jesus	0
09	Szabo, Laszlo	2	10	Ruiz, Julian	1
10	Toth, Geza	0	11	Serrano, Eugenio	4
11	Csicsay, Otto	0	12	Rico, Lorenzo	0
13	Gyurka, Janos	3	13	Puig, Jaime	2
16	Oross, Tibor	0	14	Sagales, Juan	1
Coach/Entraîneur; Adorjan, Janos Mocsai, Lajos			Coach/Entraîneur; Roman Seco, Juan De Dios Argiles, Cesar		
Referees/Arbitres; 1. YUG Jug, Stefan 2. YUG Jeglic, Herbert					

	Goals Buts	Saved Arrets	Missed Rates	G.Post Poteaux	Blocked Contres	Total
Line Shots /Lancer de la Ligne	4-4	0-1	0-0	0-0	0-0	4-5
Field Shots /Lancer du Terrain	5-7	6-10	1-1	2-1	2-4	16-23
Side Shots(R) /Lancer de Cote(D)	3-1	0-1	0-0	0-0	0-0	3-2
Side Shots(L) /Lancer de Cote(G)	4-1	0-0	0-0	0-0	1-0	5-1
Penalty Throws /Jet de 7 Metres	2-3	0-2	0-0	0-0	0-0	2-5
Free Throws /Jet Franc	2-0	0-0	0-0	0-0	0-0	2-0
Fast Breaks /Contre Attaques	6-0	0-1	0-1	0-0	0-0	6-2
** Total **	26-16	6-15	1-2	2-1	3-4	38-38
Assist	15-5					5-5
Error/Erreur	14-18					0-0
Warning/Avertissement	2-2					0-0

Men Prelim. Round Group B Match 11/Sept. 26			Hommes Series Prelim. Groupe B Match 11/26 Sept		
No.	Name Nom	Goals Buts	No.	Name Nom	Goals Buts
GDR 24-21 TCH (11-9, 13-12)					
GDR German Democratic Republic			TCH Czechoslovakia		
01	Hofmann, Peter	0	01	Barda, Michal	0
02	Hauck, Stephan	1	02	Skandik, Josef	0
03	Pysall, Peter	0	03	Bajgar, Miroslav	5
04	Wahl, Frank-Michael	3	04	Sovadina, Libor	4
05	Winselmann, Holger	2	05	Kotrc, Jiri	3
07	Metzke, Bernd	0	07	Folta, Milan	0
08	Borchardt, Ruediger	9	09	Bartek, Tomas	5
09	Fiedler, Jens	0	10	Vanek, Zdenek	0
10	Fuhrig, Mike	0	11	Baumruk, Petr	0
11	Hahn, Matthias	3	13	Jindrichovsky, Karel	3
12	Schmidt, Wieland	0	14	Novak, Jan	1
14	Schneider, Holger	6	16	Mesiarik, Peter	0
Coach/Entraîneur; Tiedemann, Paul			Coach/Entraîneur; Mares, Vojtech		
Referees/Arbitres; 1. ROM Marin, Marin 2. ROM Serban, Stefan					

Handball

	Goals Buts	Saved Arrets	Missed Rates	G.Post Poteaux	Blocked Contres	Total
Line Shots /Lancer de la Ligne	6-5	1-2	0-1	0-1	0-0	7-9
Field Shots /Lancer du Terrain	3-8	0-5	1-1	0-0	0-3	4-17
Side Shots(R) /Lancer de Cote(D)	2-3	3-0	0-0	0-0	0-0	5-3
Side Shots(L) /Lancer de Cote(G)	6-1	3-1	0-0	0-0	0-0	9-2
Penalty Throws /Jet de 7 Metres	5-4	0-2	0-0	0-0	0-0	5-6
Free Throws /Jet Franc	1-0	0-0	0-0	0-0	0-0	1-0
Fast Breaks /Contre Attaques	1-0	1-1	0-0	0-0	0-0	2-1
** Total **	24-21	8-11	1-2	0-1	0-3	33-38
Assist	15-9					8-6
Error/Erreur	8-10					0-1
Warning/Avertissement	3-2					0-0

Men Prelim. Round Group B Match 12/Sept. 26			Hommes Series Prelim. Groupe B Match 12/26 Sept		
No.	Name Nom	Goals Buts	No.	Name Nom	Goals Buts
KOR 33-24 JPN (18-11, 15-13)					
KOR Korea			JPN Japan		
01	Yoon, Tae-Il	0	01	Ito, Hidetada	0
02	Kim, Jae-Hwan	5	02	Nishiyama, Kiyoshi	1
03	Sin, Young-Suk	2	03	Yamamoto, Kodo	0
04	Park, Do-Hun	5	04	Tamamura, Kenji	2
05	Park, Young-Dae	0	06	Shudo, Shinichi	3
06	Koh, Suk-Chang	3	07	Fujii, Izumi	3
11	Oh, Young-Ki	1	08	Takamura, Seiichi	3
12	Choi, Suk-Jae	0	09	Tachiki, Koji	0
13	Kang, Jae-Won	10	10	Taguchi, Takashi	1
14	Lee, Sang-Hyo	3	11	Miyashita, Kazuhiro	4
15	Shim, Jae-Hong	4	12	Yanai, Hiroshi	0
17	Lim, Jin-Suk	0	14	Yamamura, Toshiyuki	7
Coach/Entraîneur; Yoo, Jae-Choong Lee, Keum-Ku			Coach/Entraîneur; Tsugawa, Akira		
Referees/Arbitres; 1. URS Guterman, Grigorij 2. URS Taranuhin, Juri					

	Goals Buts	Saved Arrets	Missed Rates	G.Post Poteaux	Blocked Contres	Total
Line Shots /Lancer de la Ligne	8-8	0-1	0-0	0-0	0-0	8-9
Field Shots /Lancer du terrain	9-8	5-5	4-1	2-1	2-2	22-17
Side Shots (R) /Lancer de Cote (D)	4-3	0-3	0-0	0-0	0-0	4-6
Side Shots (D) /Lancer de Cote (G)	1-3	1-2	0-0	0-0	0-0	2-5
Penalty Throws /Jet de 7 Metres	4-0	1-1	0-1	1-0	0-0	6-2
Free Throws /Jet Franc	0-0	0-0	0-0	0-0	1-0	1-0
Fast Breaks /Contre Attaques	7-2	4-2	0-0	0-0	0-0	11-4
Total	33-24	11-14	4-2	3-1	3-2	54-43
Assist	18-11					6-6
Error/Erreur	13-25					0-0
Warning/Avertissement	0-2					0-0



Men Prelim. Round Group B Match 13/Sept. 28
Hommes Series prelim. Groupe B Match 13/28 Sept

No	Name Nom	Goals Buts	No.	Name Nom	Goals Buts
TCH 21-17 JPN (13-7, 8-10)					
TCH	Czechoslovakia		JPN	Japan	
01	Barda, Michal	0	01	Ito, Hidetada	0
02	Skandik, Josef	2	04	Tamamura, Kenji	5
03	Bajgar, Miroslav	2	05	Nikawadori, Yoshihiro	0
04	Sovadina, Libor	6	06	Shudo, Shinichi	2
05	Kotrc, Jiri	1	07	Fujii, Izumi	2
07	Folta, Milan	0	08	Takamura, Seiichi	1
08	Stika, Frantisek	4	09	Tachiki, Koji	2
09	Bartek, Tomas	1	10	Taguchi, Takashi	0
10	Vanek, Zdenek	1	11	Miyashita, Kazuhiro	0
13	Jindrichovsky, Karel	1	13	Okuda, Shinji	0
14	Novak, Jan	3	14	Yamamura, Toshiyuki	5
16	Mesiarik, Peter	0	16	Hashimoto, Yukihiko	0
Coach/Entraîneur;			Coach/Entraîneur;		
Mares, Vojtech			Tsugawa, Akira		
Referees/Arbitres;					
1. YUG Jug, Stefan					
2. YUG Jeglic, Herbert					

	Goals Buts	Saved Arrets	Missed Rates	G.Post Poteaux	Blocked Contres	Total
Line Shots /Lancer de la Ligne	7-5	0-1	0-0	0-1	0-0	7-7
Field Shots /Lancer du Terrain	7-3	4-9	0-0	0-2	1-4	12-18
Side Shots(R) /Lancer de Cote(D)	2-1	1-2	1-0	0-0	0-0	4-3
Side Shots(L) /Lancer de Cote(G)	2-1	1-0	0-0	0-0	0-0	3-1
Penalty Throws /Jet de 7 Metres	0-4	2-0	0-0	0-2	0-0	2-6
Free Throws /Jet Franc	0-0	0-0	0-0	0-0	0-0	0-0
Fast Breaks /Contre Attaques	3-3	1-2	0-0	0-0	0-0	4-5
** Total **	21-17	9-14	1-0	0-5	1-4	32-40
Assist	12-9		Suspension 2 Min.			5-2
Error/Erreur	18-13		Disqualification			0-0
Warning/Avertissement	2-2		Expulsion			0-0

Men Prelim. Round Group B Match 14/Sept. 28
Hommes Series Prelim. Groupe B Match 14/28 Sept

No.	Name Nom	Goals Buts	No.	Name Nom	Goals Buts
ESP 23-20 KOR (10-9, 13-11)					
ESP	Spain		KOR	Korea	
02	Cabanas, Javier	2	01	Yoon, Tae-Il	0
03	Munoz, Juan F.	2	02	Kim, Jae-Hwan	3
05	De La Puente, Juan Antonio	1	03	Sin, Young-Suk	1
06	Fernandez, Jesus	0	04	Park, Do-Hun	1
07	Marin, Ricardo	3	05	Park, Young-Dae	0
08	Uria, Juan Jose	1	06	Koh, Suk-Chang	1
10	Ruiz, Julian	0	11	Oh, Young-Ki	1
11	Serrano, Eugenio	8	12	Choi, Suk-Jae	0
12	Rico, Lorenzo	0	13	Kang, Jae-Won	5
13	Puig, Jaime	4	14	Lee, Sang-Hyo	8
14	Sagales, Juan	2	15	Shim, Jae-Hong	0
16	Fort, Jaime	0	17	Lim, Jin-Suk	0
Coach/Entraîneur;			Coach/Entraîneur;		
Roman Seco, Juan De Dios Argiles, Cesar			Yoo, Jae-Choong Lee, Keum-Ku		
Referees/Arbitres;					
1. SWE Blademo, Kent					
2. SWE Wester, Axel					

	Goals Buts	Saved Arrets	Missed Rates	G.Post Poteaux	Blocked Contres	Total
Line Shots /Lancer de la Ligne	7-3	1-2	0-1	0-0	0-0	8-6
Field Shots /Lancer du Terrain	5-8	6-9	2-3	0-5	0-5	13-30
Side Shots (R) /Lancer de Cote (D)	2-2	2-1	1-2	1-0	0-0	6-5
Side Shots (L) /Lancer de Cote (G)	2-1	1-2	1-0	0-0	1-0	5-3
Penalty Throws /Jet de 7 Metres	3-4	0-0	1-0	0-0	0-0	4-4
Free Throws /Jet Franc	0-0	0-0	0-0	0-0	0-0	0-0
Fast Breaks /Contre Attaques	4-2	2-0	0-0	0-0	0-0	6-2
** Total **	23-20	12-14	5-6	1-5	1-5	42-50
Assist	12-10		Suspension 2 Min.			2-1
Error/Erreur	12-8		Disqualification			0-0
Warning/Avertissement	2-2		Expulsion			0-0

Men Prelim. Round Group B Match 15/Sept. 28
Hommes Series Prelim. Groupe B Match 15/28 Sept

No.	Name Nom	Goals Buts	No.	Name Nom	Goals Buts
HUN 18-17 GDR (7-9, 11-8)					
HUN	Hungary		GDR	German Democratic Republic	
01	Dr. Hoffmann, Laszlo	0	01	Hofmann, Peter	0
02	Bordas, Jozsef	0	02	Hauck, Stephan	3
03	Kovacs, Peter	0	03	Pysall, Peter	0
04	Kovacs, Mihaly	1	04	Wahl, Frank-Michael	2
05	Fodor, Janos	0	05	Winselmann, Holger	1
06	Marosi, Laszlo	4	07	Metzke, Bernd	0
07	Ivancsik, Mihaly	8	08	Borchardt, Ruediger	3
09	Szabo, Laszlo	3	09	Fiedler, Jens	0
10	Toth, Geza	0	10	Fuhrig, Mike	0
11	Csicsay, Otto	0	11	Hahn, Matthias	4
12	Biro, Imre	0	12	Schmidt, Wieland	0
13	Gyurka, Janos	2	14	Schneider, Holger	4
Coach/Entraîneur;			Coach/Entraîneur;		
Adorjan, Janos Mocsa, Lajos			Tiedemann, Paul		
Referees/Arbitres;					
1. URS Guterman, Grigorij					
2. URS Taranuhin, Juri					

	Goals Buts	Saved Arrets	Missed Rates	G. Post Poteaux	Blocked Contres	Total
Line Shots /Lancer de la Ligne	4-3	1-1	0-0	0-0	0-0	5-4
Field Shots /Lancer du Terrain	3-5	7-6	0-0	0-0	4-7	14-18
Side Shots(R) /Lancer de Cote(D)	0-1	0-1	0-0	0-0	0-0	0-2
Side Shots(L) /Lancer de Cote(G)	2-1	0-1	0-0	0-0	0-0	2-2
Penalty Throws /Jet de 7 Metres	6-3	3-0	0-0	1-0	0-0	10-3
Free Throws /Jet Franc	0-0	0-0	0-0	0-0	0-0	0-0
Fast Breaks /Contre Attaques	3-4	0-0	0-6	0-0	0-0	3-4
** Total **	18-17	11-9	0-0	1-0	4-7	34-33
Assist	12-6		Suspension 2 Min.			6-6
Error/Erreur	8-11		Disqualification			0-0
Warning/Avertissement	3-2		Expulsion			0-0

Handball

Men Preliminary Round/Sept. 20-28					Hommes Series Preliminaires/20-28 Sept				
Rank Rang	Ctry Pays	Points	Played Joues	Won Gagnes	Tied Nuls	Lost Perdus	For Pour	Against Contre	Diff
* Group A/ Groupe A									
1	URS	10	5	5	0	0	130	82	48
2	YUG	7	5	3	1	1	116	109	7
3	SWE	6	5	3	0	2	106	91	15
4	ISL	5	5	2	1	2	96	102	-6
5	ALG	2	5	1	0	4	89	109	-20
6	USA	0	5	0	0	5	81	125	-44
YUG	SWE	ISL	URS	USA	ALG				
YUG	*	25-21	19-19	18-24	31-23	23-22			
SWE	21-25	*	20-14	18-22	26-12	21-18			
ISL	19-19	14-20	*	19-32	22-15	22-16			
URS	24-18	22-18	32-19	*	26-14	26-13			
USA	23-31	12-26	15-22	14-26	*	17-20			
ALG	22-23	18-21	16-22	13-26	20-17	*			

* Group B/Groupe B									
Rank Rang	Ctry Pays	Points	Played Joues	Won Gagnes	Tied Nuls	Lost Perdus	For Pour	Against Contre	Diff
1	KOR	8	5	4	0	1	127	117	10
2	HUN	6	5	3	0	2	102	93	9
3	TCH	6	5	3	0	2	109	103	6
4	GDR	6	5	3	0	2	109	100	9
5	ESP	4	5	2	0	3	101	106	-5
6	JPN	0	5	0	0	5	97	126	-29
HUN	GDR	ESP	KOR	TCH	JPN				
HUN	*	18-17	26-16	20-22	16-19	22-19			
GDR	17-18	*	21-20	22-23	24-21	25-18			
ESP	16-26	20-21	*	23-20	17-20	25-19			
KOR	22-20	23-22	20-23	*	29-28	33-24			
TCH	19-16	21-24	20-17	28-29	*	21-17			
JPN	19-22	18-25	19-25	24-33	17-21	*			

The classification of group B is decided as stated above due to the adoption of the 25% rule.

Après l'adoption de 'principe de 25%', le classement du groupe B a été modifié comme ci-dessus.

Men Final (11-12 Places)/Sept. 30			Hommes Finale (11-12 Places)/30 Sept		
No.	Name Nom	Goals Buts	No.	Name Nom	Goals Buts
USA 21-24 JPN (11-8, 10-16)					
USA	United States of America		JPN	Japan	
02	Story, Joseph	1	01	Ito, Hidetada	0
03	Janny, Boyd	4	02	Nishiyama, Kiyoshi	0
04	Johnson, Bryant	1	03	Yamamoto, Kodo	0
05	Sullivan, Michael	0	04	Tamamura, Kenji	10
07	Fitschen, Craig	0	06	Shudo, Shinichi	2
08	Goss, Steven	8	07	Fujii, Izumi	1
09	Buehning, James	0	08	Takamura, Seiichi	4
10	Driggers, Scott	0	09	Tachiki, Koji	2
11	Lash, Peter	3	10	Taguchi, Takashi	0
12	Oshita, Rod	0	11	Miyashita, Kazuhiro	0
14	Hillery, Robert	4	12	Yanai, Hiroshi	0
16	Kessler, William	0	14	Yamamura, Toshiyuki	5

Coach/Entraîneur; Pokrajac, Branislau Coach/Entraîneur; Tsugawa, Akira

Referees/Arbitres; 1. ARG Brosio, Eduardo 2. ARG Zaworotny, Miguel Angel

Handball

	Goals Buts	Saved Arrets	Missed Rates	G.Post Poteaux	Blocked Contres	Total
Line Shots /Lancer de la Ligne	5-6	1-3	0-0	1-0	0-0	7-9
Field Shots /Lancer du Terrain	8-8	4-6	1-1	1-5	0-3	14-23
Side Shots (R) /Lancer de Cote (D)	1-1	1-0	0-0	0-0	0-0	2-1
Side Shots (L) /Lancer de Cote (G)	0-3	0-3	2-0	0-0	0-0	2-6
Penalty Throws /Jet de 7 Metres	5-5	0-0	0-0	0-0	0-0	5-5
Free Throws /Jet Franc	0-0	0-0	0-0	0-0	0-0	0-0
Fast Breaks /Contre Attaques	2-1	2-0	0-0	0-0	0-0	4-1
** Total **	21-24	8-12	3-1	2-5	0-3	34-45
Assist	5-11			Suspension 2 Min.		4-3
Error/Erreur	14-9			Disqualification		0-0
Warning/Avertissement	2-2			Expulsion		0-0

Men Final (9-10 Places)/Sept. 30			Hommes Finale (9-10 Places)/30 Sept		
No.	Name Nom	Goals Buts	No.	Name Nom	Goals Buts
ALG 15-21 ESP (6-11, 9-10)					
ALG	Algeria		ESP	Spain	
02	Bourdrail, Brahim	1	01	Zuniga, Miguel A.	0
05	Azzeb, Omar	0	02	Cabanas, Javier	3
06	Beghouache, Benali	0	03	Munoz, Juan F.	1
07	Ait Hocine, Makhlof	4	05	De La Puente, Juan Antonio	3
08	Bouchecriou, Salah	3	06	Fernandez, Jesus	0
09	Djefal, Ahcene	0	07	Marin, Ricardo	4
10	Bouanik, Mahmoud	1	08	Uria, Juan Jose	3
11	Lacheheb, Fethnour	0	10	Ruiz, Julian	3
12	Ouchia, Kamel	0	11	Serrano, Eugenio	3
13	Benmeghsoula, Abdeslam	1	12	Rico, Lorenzo	0
14	Mohamed-Seghir, Zine-Eddin	5	13	Puig, Jaime	0
16	Boussebt, Mourad	0	14	Sagales, Juan	1

Coach/Entraîneur; Derouaz, Mohamed Lamine Az Hassen-Khodia, Mohamed Elf Coach/Entraîneur; Roman Seco, Juan De Dios Argiles, Cesar

Referees/Arbitres; 1. NOR Ludvigsen, Jan Rolf 2. NOR Sjong, Per Erik

	Goals Buts	Saved Arrets	Missed Rates	G. Post Poteaux	Blocked Contres	Total
Line Shots /Lancer de la Ligne	3-7	0-2	0-2	0-0	0-0	3-11
Field Shots /Lancer du Terrain	2-4	6-4	2-1	1-1	2-1	13-11
Side Shots (R) /Lancer de Cote (D)	2-4	1-0	1-0	1-0	0-0	5-4
Side Shots (L) /Lancer de Cote (G)	2-2	1-0	1-0	0-0	0-0	4-2
Penalty Throws /Jet de 7 Metres	4-2	3-0	0-0	0-0	0-0	7-2
Free Throws /Jet Franc	0-0	0-0	0-0	0-0	0-0	0-0
Fast Breaks /Contre Attaques	2-2	0-1	0-0	0-0	0-0	2-3
** Total **	15-21	11-7	4-3	2-1	2-1	34-33
Assist	7-9			Suspension 2 Min.		0-3
Error/Erreur	8-8			Disqualification		0-0
Warning/Avertissement	0-2			Expulsion		0-0



Men Final (7-8 Places)/Sept. 30 **Hommes Finale (7-8 Places)/30 Sept**

No.	Name Nom	Goals Buts	No.	Name Nom	Goals Buts
-----	-------------	---------------	-----	-------------	---------------

ISL 29-31 GDR (13-12, 10-11, 2-2, 3-3, 1-3)

ISL	Iceland		GDR	German Democratic Republic	
01	Porvardarson, Einar	0	01	Hofmann, Peter	0
02	Mathiesen, Porgilsottar	8	02	Hauck, Stephan	1
03	Sigurdsson, Jakob	0	03	Pysall, Peter	2
04	Sigurdsson, Bjarki	0	04	Wahl, Frank-Michael	5
05	Prainsson, Karl	0	05	Winselmann, Holger	3
06	Gunnarsson, Sigurdur	2	06	Neitzel, Andreas	3
07	Gislason, Alfred	1	08	Borchardt, Ruediger	8
09	Gudmundsson, Gudmundur	4	09	Fiedler, Jens	1
10	Arason, Kristjan	9	10	Fuhrig, Mike	1
11	Sveinsson, Geir	1	11	Hahn, Matthias	0
12	Kvaran, Brynjar	0	12	Schmidt, Wieland	0
14	Hilmarrson, Atli	4	14	Schneider, Holger	7

Coach/Entraîneur; Kowalczyk, Bogdan Gudmundsson, Gudjon
Coach/Entraîneur; Tiedemann, Paul

Referees/Arbitres;
1. DEN Christensen, Ole
2. DEN Jorgensen, Per Godsk

	Goals Buts	Saved Arrets	Missed Rates	G.Post Poteaux	Blocked Contres	Total
--	---------------	-----------------	-----------------	-------------------	--------------------	-------

Line Shots /Lancer de la Ligne	12-5	4-2	0-0	0-0	0-0	16-7
Field Shots /Lancer du Terrain	8-6	6-10	3-0	1-0	2-5	20-21
Side Shots (R) /Lancer de Cote (D)	0-4	2-2	0-0	0-0	0-0	2-6
Side Shots (L) /Lancer de Cote (G)	1-5	1-1	0-0	0-0	0-0	2-6
Penalty Throws /Jet de 7 Metres	5-7	3-4	0-0	1-0	0-0	9-11
Free Throws /Jet Franc	0-0	1-0	0-0	0-0	1-0	2-0
Fast Breaks /Contre Attaques	3-4	1-0	0-0	0-0	0-0	4-4
Total	29-31	18-19	3-0	2-0	3-5	55-55

Assist 16-13
Error/Erreur 12-13
Warning/Avertissement 2-2
Suspension 2 Min. Disqualification 0-0
Expulsion 0-0

Men Final (5-6 Places)/Sept. 30 **Hommes Finale (5-6 Places)/30 Sept**

No.	Name Nom	Goals Buts	No.	Name Nom	Goals Buts
-----	-------------	---------------	-----	-------------	---------------

SWE 27-18 TCH (14-8, 13-10)

SWE	Sweden		TCH	Czechoslovakia	
01	Olsson, Mats	0	01	Barda, Michal	0
02	Jarphag, Peder	8	02	Skandik, Josef	0
03	Wislander, Magnus	3	03	Bajgar, Miroslav	2
04	Eklund, Johan	0	04	Sovadina, Libor	1
05	Lindgren, Ola	2	05	Kotrc, Jiri	2
06	Carlen, Per	3	07	Folta, Milan	1
07	Hajas, Erik	1	09	Bartek, Tomas	5
08	Carlsson, Per	3	10	Vanek, Zdenek	1
09	Jilsen, Bjorn	2	11	Baumruk, Petr	0
10	Jilsen, Par	1	13	Jindrichovsky, Karel	3
12	Fransson, Mats	0	14	Novak, Jan	3
13	Olsson, Staffan	4	16	Mesiarik, Peter	0

Coach/Entraîneur; Carlsson, Roger
Coach/Entraîneur; Mares, Vojtech

Referees/Arbitres;
1. FRA Lelong, Jean
2. FRA Tancrez, Gerard

	Goals Buts	Saved Arrets	Missed Rates	G.Post Poteaux	Blocked Contres	Total
--	---------------	-----------------	-----------------	-------------------	--------------------	-------

Line Shots /Lancer de la Ligne	9-7	1-2	0-1	0-0	0-0	10-10
Field Shots /Lancer du Terrain	6-8	2-7	1-1	0-1	2-4	11-21
Side Shots (R) /Lancer de Cote (D)	3-0	0-0	0-0	0-0	0-0	3-0
Side Shots (L) /Lancer de Cote (G)	1-0	2-1	0-0	0-0	0-0	3-1
Penalty Throws /Jet de 7 Metres	4-1	1-1	0-0	1-1	0-0	6-3
Free Throws /Jet Franc	0-0	0-0	0-0	0-0	0-0	0-0
Fast Breaks /Contre Attaques	4-2	1-0	0-0	0-0	0-0	5-2
** Total **	27-18	7-11	1-2	1-2	2-4	38-37

Assist 15-8
Error/Erreur 7-14
Warning/Avertissement 2-2
Suspension 2 Min. Disqualification 4-4
Expulsion 0-1
0-0

Men Final (3-4 Places)/Oct. 1 **Hommes Finale (3-4 Places)/1 Oct**

No.	Name Nom	Goals Buts	No.	Name Nom	Goals Buts
-----	-------------	---------------	-----	-------------	---------------

YUG 27-23 HUN (12-13, 15-10)

YUG	Yugoslavia		HUN	Hungary	
02	Rnic, Momir	1	01	Dr. Hoffmann, Laszlo	0
04	Saracevic, Zlatko	1	02	Bordas, Jozsef	0
05	Puc, Iztok	3	03	Kovacs, Peter	6
06	Perkovac, Goran	1	04	Kovacs, Mihaly	0
07	Smajljagic, Irfan	4	05	Fodor, Janos	1
08	Portner, Zlatko	7	06	Marosi, Laszlo	3
09	Vujovic, Veselin	7	07	Ivancsik, Mihaly	6
10	Holpert, Jozef	2	09	Szabo, Laszlo	3
12	Basic, Mirko	0	10	Toth, Geza	0
13	Nacinovic, Alvaro	0	11	Csicsay, Otto	0
14	Kuzmanovski, Slobodan	1	13	Gyurka, Janos	4
16	Velic, Ermin	0	16	Oross, Tibor	0

Coach/Entraîneur; Arslanagic, Abbas
Coach/Entraîneur; Adorjan, Janos Mocsai, Lajos

Referees/Arbitres;
1. DEN Christensen, Ole
2. DEN Jorgensen, Per Godsk

	Goals Buts	Saved Arrets	Missed Rates	G.Post Poteaux	Blocked Contres	Total
--	---------------	-----------------	-----------------	-------------------	--------------------	-------

Line Shots /Lancer de la Ligne	6-7	2-2	0-1	1-0	0-0	9-10
Field Shots /Lancer du Terrain	13-8	8-7	1-2	2-1	1-5	25-23
Side Shots(R) /Lancer de Cote(D)	0-0	1-1	0-0	0-0	0-0	1-1
Side Shots(L) /Lancer de Cote(G)	1-3	0-0	0-0	0-1	0-0	1-4
Penalty Throws /Jet de 7 Metres	4-3	0-1	0-0	0-0	0-0	4-4
Free Throws /Jet Franc	0-1	0-0	0-0	0-0	0-0	0-1
Fast Breaks /Contre Attaques	3-1	0-1	0-0	0-1	0-0	3-3
** Total **	27-23	11-12	1-3	3-3	1-5	43-46

Assist 13-9
Error/Erreur 10-9
Warning/Avertissement 2-2
Suspension 2 Min. Disqualification 6-4
Expulsion 1-0
0-0

Handball

Men Final (1-2 Places)/Oct. 1			Hommes Finale (1-2 Places)/1 Oct		
No.	Name Nom	Goals Buts	No.	Name Nom	Goals Buts
URS 32-25 KOR (17-11, 15-14)					
URS	U.S.S.R.		KOR	Korea	
01	Lavrov, Andrei	0	01	Yoon, Tae-Il	0
02	Toutchkine, Alexandre	5	02	Kim, Jae-Hwan	5
03	Rymanov, Alexandre	7	03	Sin, Young-Suk	1
05	Karchakevish, Alexandre	4	04	Park, Do-hun	4
06	Nesterov, Youri	1	05	Park, Young-Dae	0
07	Sviridenko, Guerogui	1	06	Koh, Suk-Chang	1
09	Tioumentsev, Andrei	4	07	Roh, Hyun-Suk	0
10	Vassiliev, Mikhail	0	11	Oh, Young-Ki	0
11	Chevtsov, Youri	4	12	Choi, Suk-Jae	0
13	Atavin, Viatcheslav	6	13	Kang, Jae-Won	10
15	Novitski, Valdemar	0	14	Lee, Sang-Hyo	4
16	Tcooumak, Igor	0	17	Lim, Jin-Suk	0
Coach/Entraîneur;			Coach/Entraîneur;		
Evtouchenko, Anatoli Latyshkevitch, Leonid			Yoo, Jae-Choong Lee, Keum-Ku		
Referees/Arbitres;					
1. FRG Hofmann, Erhard					
2. FRG Prause, Manfred					

	Goals Buts	Saved Arrets	Missed Rates	G. Post Poteaux	Blocked Contres	Total
Line Shots /Lancer de la Ligne	15-5	4-2	0-0	1-0	0-0	20-7
Field Shots /Lancer du Terrain	5-7	3-10	2-1	1-2	2-6	13-26
Side Shots (R) /Lancer de Cote (D)	1-1	1-1	0-0	0-0	0-0	2-2
Side Shots (L) /Lancer de Cote(G)	1-3	1-3	0-0	0-0	0-0	2-6
Penalty Throws /Jet de 7 Metres	3-6	2-2	0-0	1-0	0-0	6-8
Free Throws /Jet Franc	1-0	0-1	0-0	0-0	0-0	1-1
Fast Breaks /Contre Attaques	6-3	2-1	0-0	0-0	0-0	8-4
** Total **	32-25	13-20	2-1	3-2	2-6	52-54
Assist	19-11			Suspension 2 Min.		3-1
Error/Erreur	6-12			Disqualification		0-0
Warning/Avertissement	3-2			Expulsion		0-0

Handball

No.	Name Nom	Line Shot Lancer Ligne	Field Shot Lancer Terrain	Side Shot Lancer Cote	Penalty Throw Jets de 7m	Free Throw Jets Franc	Fast Break Contre Attaque	Total	Rate	Asst	Error
URS U.S.S.R.											
<Court Players>		G/S	G/S	G/S	G/S	G/S	G/S	G/S			
2	Toutchkine, Alexandre	0/1	3/6	0/0	1/2	0/0	1/2	5/11	45.4	1	1
3	Rymanov, Alexandre	6/8	0/0	0/0	0/0	0/0	1/1	7/9	77.7	2	0
5	Karchakevish, Alexandre	2/2	0/0	1/1	0/0	0/0	1/1	4/4	100.0	8	0
6	Nesterov, Youri	0/0	0/0	0/0	0/0	0/0	1/1	1/1	100.0	0	1
7	Sviridenko, Guerogui	1/2	0/0	0/1	0/0	0/0	0/0	1/3	33.3	0	2
9	Tioumentsev, Andrei	4/5	0/0	0/1	0/0	0/0	0/0	4/6	66.6	5	1
10	Vassiliev, Mikhail	0/0	0/0	0/0	0/0	0/0	0/0	0/0	0.0	0	0
11	Chevtsov, Youri	1/1	0/0	1/1	0/0	0/0	2/3	4/5	80.0	0	0
13	Atavin, Viatcheslav	1/1	2/7	0/0	2/4	1/1	0/0	6/13	46.1	2	1
15	Novitski, Valdemar	0/0	0/0	0/0	0/0	0/0	0/0	0/0	0.0	1	0
** Total **		15/20	5/13	2/4	3/6	1/1	6/8	32/52	61.5	19	6
< Goal Keepers >		S/A	S/A	S/A	S/A	S/A	S/A	S/A			
1	Lavrov, Andrei	1/6	7/12	2/6	2/4	0/0	1/3	13/31	41.9	0	0
16	Tcooumak, Igor	1/1	3/5	2/2	0/4	1/1	0/1	7/14	50.0	0	0
** Total **		2/7	10/17	4/8	2/8	1/1	1/4	20/45	44.4	0	0

KOR Korea											
< Court Players >		G/S	G/S	G/S	G/S	G/S	G/S	G/S			
2	Kim, Jae-Hwan	0/1	1/1	2/5	1/2	0/0	1/1	5/10	50.0	3	2
3	Sin, Young-Suk	0/0	1/3	0/0	0/0	0/0	0/0	1/3	33.3	1	1
4	Park, Do-Hun	4/5	0/0	0/0	0/0	0/1	0/0	4/6	66.6	1	3
5	Park, Young-Dae	0/0	0/0	0/0	0/0	0/0	0/0	0/0	0.0	1	0
6	Koh, Suk-Chang	0/0	0/0	1/2	0/0	0/0	0/0	1/2	50.0	0	1
7	Roh, Hyun-Suk	0/0	0/0	0/0	0/0	0/0	0/0	0/0	0.0	0	0
11	Oh, Young-Ki	0/0	0/2	0/0	0/0	0/0	0/0	0/2	0.0	0	0
13	Kang, Jae-Won	1/1	3/9	0/0	4/4	0/0	2/3	10/17	58.8	4	3
14	Lee, Sang-Hyo	0/0	2/10	1/1	1/2	0/0	0/0	4/13	30.7	1	1
17	Lim, Jin-Suk	0/0	0/1	0/0	0/0	0/0	0/0	0/1	0.0	0	0
** Total **		5/7	7/26	4/8	6/8	0/1	3/4	25/54	46.2	11	11
< Goal Keepers >		S/A	S/A	S/A	S/A	S/A	S/A	S/A			
1	Yoon, Tae-Il	4/19	3/8	2/4	2/5	0/1	2/8	13/45	28.8	0	1
12	Choi, Suk-Jae	0/0	0/0	0/0	0/0	0/0	0/0	0/0	0.0	0	0
** Total **		4/19	3/8	2/4	2/5	0/1	2/8	13/45	28.8	0	1

Men Final /Sept. 20-Oct. 1				Hommes/Finale /20 Sept-1 Oct			
< Final Round/Series Finales >							
Final (1-2 Places)							
A1 -B1	URS-KOR	32-25	Olympic Gymnastics Hall				
Final (3-4 Places)							
A2-B2	YUG-HUN	27-23	Olympic Gymnastics Hall				
Final (5-6 Places)							
A3-B3	SWE-TCH	27-18	Suwon Gymnasium				
Final (7-8 Places)							
A4-B4	ISL-GDR	29-31	Suwon Gymnasium				
Final (9-10 Places)							
A5-B5	ALG - ESP	15-21	Suwon Gymnasium				
Final (11-12 Places)							
A6-B6	USA-JPN	21 -24	Suwon Gymnasium				
< Final Standing / Classement Final >							
1	URS	U.S.S.R.					
2	KOR	Korea					
3	YUG	Yugoslavia					
4	HUN	Hungary					
5	SWE	Sweden					
6	TCH	Czechoslovakia					
7	GDR	German Democratic Republic					
8	ISL	Iceland					
9	ESP	Spain					
10	ALG	Algeria					
11	JPN	Japan					
12	USA	United States of America					



Women Prelim. Round Group A Match 1/Sept. 21			Femmes Series Prelim. Groupe A Match 1/21 Sept		
No.	Name Nom	Goals Buts	No.	Name Nom	Goals Buts
TCH 27-33 KOR (9-15, 18-18)					
TCH	Czechoslovakia		KOR	Korea	
01	Hradska, Anna	0	01	Song, Ji-Hyun	0
03	Trandzikova, Daniela	4	04	Han, Hyun-Sook	0
04	Smidova, Marie	1	05	Kim, Choon-Rye	6
05	Sabadosova, Gabriela	1	06	Kim, Myung-Soon	4
07	Budayova, Zuzana	1	07	Lee, Ki-Soon	0
08	Damitsova, Alena	2	09	Kim, Hyun-Mee	8
09	Lupacova, Petra	6	10	Ki, Mi-Sook	5
10	Durisinova, Maria	2	11	Suk, Min-Hee	4
11	Hejtmanikova, Monika	6	12	Son, Mi-Na	0
12	Pospisilova, Lenka	0	13	Lim, Mi-Kyung	1
13	Stasova, Jana	3	14	Kim, Kyung-Soon	0
14	Mazgutova, Bozena	1	15	Sung, Kyung-Hwa	5
Coach/Entraîneur;			Coach/Entraîneur;		
Zerzan, Jiri			Koh, Byung-Hoon Park, Jae-Soo		
Referees/Arbitres:					
1. FRA Lelong, Jean					
2. FRA Tancrez, Gerard					

	Goals Buts	Saved Arrets	Missed Rates	G. Post Poteaux	Blocked Contres	Total
Line Shots /Lancer de la Ligne	8-7	4-0	0-0	0-1	0-0	12-8
Field Shots /Lancer du Terrain	7-11	5-4	1-2	1-2	1-1	15-20
Side Shots (R) /Lancer de Cote (D)	6-1	1-1	1-1	0-0	0-0	8-3
Side Shots (L) /Lancer de Cote (G)	1-0	1-0	0-0	0-0	0-0	2-0
Penalty Throws /Jet de 7 Metres	3-5	2-0	0-0	1-0	0-0	6-5
Free Throws /Jet Franc	0-1	0-0	0-0	0-0	0-0	0-1
Fast Breaks /Contre Attaques	2-8	0-1	1-0	0-0	0-0	3-9
** Total **	27-33	13-6	3-3	2-3	1-1	46-46
Assist	14-12		Suspension 2 Min.			5-3
Error/Erreur	12-13		Disqualification			1-0
Warning/Avertissement	2- 2		Expulsion			0-0

Women Prelim. Round Group A Match 2/Sept. 21			Femmes Series Prelim. Groupe A Match 2/21 Sept		
No.	Name Nom	Goals Buts	No.	Name Nom	Goals Buts
YUG 19-18 USA (10-8,9-10)					
YUG	Yugoslavia		USA	United States of America	
02	Krstic, Mirjana	0	02	Gamble, Amy	2
04	Pesic, Dragana	1	03	Gallagher, Margaret	0
06	Galic, Zita	5	04	Winn, Sherry	0
07	Jankovic, Ljubinka	2	05	Palgut, Karyn	1
09	Markovic, Ljiljana	0	06	Lack, Portia	0
10	Djurica, Mirjana	1	07	De La Riva, Sandra	0
11	Kolega, Natasa	0	08	Clarke, Kim	1
12	Djukic, Slavica	0	10	Stinger, Cindy	2
13	Mugosa, Ljiljana	3	12	Raynor, Angie	0
14	Mugosa, Svetlana	5	13	Jones, Leora	9
15	Stojanovic, Deanka	2	14	Peterka, Carol	3
16	Djuric, Dragica	0	16	Coenen, Laura	0
Coach/Entraîneur;			Coach/Entraîneur;		
Nisevic, Dragan			Faludi, Mihaly		
Referees/Arbitres;					
1. ROM Marin, Marin					
2. ROM Serban, Stefan					

	Goals Buts	Saved Arrets	Missed Rates	G.Post Poteaux	Blocked Contres	Total
Line Shots /Lancer de la Ligne	12-4	2-0	0-0	0-1	0-0	14-5
Field Shots /Lancer du Terrain	4-6	4-7	1-3	0-2	0-6	9-24
Side Shots(R) /Lancer de Cote(D)	1-0	2-0	1-0	1-2	0-0	5-2
Side Shots(L) /Lancer de Cote(G)	0-0	0-1	0-0	0-1	0-0	0-2
Penalty Throws /Jet de 7 Metres	2-2	0-1	0-0	0-0	0-0	2-3
Free Throws /Jet Franc	0-2	0-0	0-0	0-1	0-0	0-3
Fast Breaks /Contre Attaques	0-4	0-1	0-0	0-0	0-0	0-5
** Total **	19-18	8-10	2-3	1-7	0-6	30-44
Assist	10-7		Suspension 2 Min.			3-3
Error/Erreur	19-11		Disqualification			0-0
Warning/Avertissement	2-2		Expulsion			0-0

Women Prelim. Round Group A Match 3/Sept. 23			Femmes Series Prelim. Groupe A Match 3/23 Sept		
No.	Name Nom	Goals Buts	No.	Name Nom	Goals Buts
TCH 33-19 USA (13-11, 20-8)					
TCH	Czechoslovakia		USA	United States of America	
01	Hradska, Anna	0	02	Gamble, Amy	1
03	Trandzikova, Daniela	3	03	Gallagher, Margaret	0
05	Sabadosova, Gabriela	0	04	Winn, Sherry	2
06	Kolecianiova, Julia	2	05	Palgut, Karyn	1
07	Budayova, Zuzana	1	06	Lack, Portia	1
08	Damitsova, Alena	8	08	Clarke, Kim	2
09	Lupacova, Petra	2	10	Stinger, Cindy	0
10	Durisinova, Maria	7	12	Raynor, Angie	0
11	Hejtmanikova, Monika	2	13	Jones, Leora	10
13	Stasova, Jana	3	14	Peterka, Carol	1
14	Mazgutova, Bozena	5	15	Stone, Penelope	1
16	Posova, Marta	0	16	Coenen, Laura	0
Coach/Entraîneur;			Coach/Entraîneur;		
Zerzan, Jiri			Faludi, Mihaly		
Referees/Arbitres;					
1. DEN Christensen, Ole					
2. DEN Jorgensen, Per Godsk					

	Goals Buts	Saved Arrets	Missed Rates	G.Post Poteaux	Blocked Contres	Total
Line Shots /Lancer de la Ligne	11-2	1-3	1-0	0-0	0-0	13-5
Field Shots /Lancer du Terrain	7-9	3-12	0-3	2-5	2-0	14-29
Side Shots(R) /Lancer de Cote(D)	2-1	1-1	0-0	0-0	0-0	3-2
Side Shots(L) /Lancer de Cote(G)	5-1	1-0	2-0	0-0	0-0	8-1
Penalty Throws /Jet de 7 Metres	4-1	1-1	0-0	0-0	0-0	5-2
Free Throws /Jet Franc	0-2	0-1	0-0	0-0	0-0	0-3
Fast Breaks /Contre Attaques	4-3	1-1	0-0	0-0	0-0	5-4
** Total **	33-19	8-19	3-3	2-5	2-0	48-46
Assist	16-6		Suspension 2 Min.			3-6
Error/Erreur	7-11		Disqualification			0-0
Warning/Avertissement	1-1		Expulsion			0-0

Handball

Women Prelim. Round Group A Match 4/Sept. 23			Femmes Series Prelim. Groupe A Match 4/23 Sept		
No.	Name Nom	Goals Buts	No.	Name Nom	Goals Buts
YUG 22-19 KOR (10-13, 12-6)					
YUG Yugoslavia			KOR Korea		
02	Krstic, Mirjana	0	01	Song, Ji-Hyun	0
03	Rincic, Slavica	0	04	Han, Hyun-Sook	2
04	Pesic, Dragana	3	05	Kim, Choon-Rye	6
06	Galic, Zita	5	06	Kim, Myung-Soon	2
07	Jankovic, Ljubinka	4	07	Lee, Ki-Soon	0
10	Djurica, Mirjana	0	09	Kim, Hyun-Mee	2
11	Kolega, Natasa	6	10	Ki, Mi-Sook	1
12	Djukic, Slavica	0	11	Suk, Min-Hee	3
13	Mugosa, Ljiljana	0	12	Son, Mi-Na	0
14	Mugosa, Svetlana	4	13	Lim, Mi-Kyung	2
15	Stojanovic, Deanka	0	14	Kim, Kyung-Soon	0
16	Djuric, Dragica	0	15	Sung, Kyung-Hwa	1
Coach/Entraîneur; Nisevic, Dragan			Coach/Entraîneur; Koh, Byung-Hoon Park, Jae-Soo		
Referees/Arbitres; 1. URS Guterman, Grigorij 2. URS Taranuhin, Juri					

	Goals Buts	Saved Arrets	Missed Rates	G.Post Poteaux	Blocked Contres	Total
Line Shots /Lancer de la Ligne	7-5	3-1	0-0	0-1	0-0	10-7
Field Shots /Lancer du Terrain	8-5	4-4	4-1	4-0	0-10	20-20
Side Shots (R) /Lancer de Cote (D)	2-0	0-0	0-1	0-0	0-0	2-1
Side Shots (L) /Lancer de Cote (G)	0-3	0-0	0-0	0-0	0-0	0-3
Penalty Throws /Jet de 7 Metres	1-4	2-2	0-0	0-0	0-0	3-6
Free Throws /Jet Franc	0-0	0-0	0-0	0-0	0-0	0-0
Fast Breaks /Contre Attaques	4-2	2-2	0-0	0-0	0-0	6-4
** Total **	22-19	11-9	4-2	4-1	0-10	41-41
Assist	10-11	Suspension 2 Min.				3-2
Error/Erreur	18-17	Disqualification				0-0
Warning/Avertissement	1-0	Expulsion				0-0

Women Prelim. Round Group A Match 5/Sept. 25			Femmes Series Prelim. Groupe A Match 5/25 Sept		
No.	Name Nom	Goals Buts	No.	Name Nom	Goals Buts
KOR 24-18 USA (11-10, 13-8)					
KOR Korea			USA United States of America		
01	Song, Ji-Hyun	0	02	Gamble, Amy	2
04	Han, Hyun-Sook	1	03	Gallagher, Margaret	0
05	Kim, Choon-Rye	7	04	Winn, Sherry	5
06	Kim, Myung-Soon	1	05	Palgut, Karyn	1
07	Lee, Ki-Soon	0	06	Lack, Portia	1
09	Kim, Hyun-Mee	1	08	Clarke, Kim	3
10	Ki, Mi-Sook	3	10	Stinger, Cindy	0
11	Suk, Min-Hee	3	12	Raynor, Angie	0
12	Son, Mi-Na	0	13	Jones, Leora	6
13	Lim, Mi-Kyung	4	14	Peterka, Carol	0
14	Kim, Kyung-Soon	0	15	Stone, Penelope	0
15	Sung, Kyung-Hwa	4	16	Coenen, Laura	0
Coach/Entraîneur; Koh, Byung-Hoon Park, Jae-Soo			Coach/Entraîneur; Faludi, Mihaly		
Referees/Arbitres; 1. SWE Blademo, Kent 2. SWE Wester, Axel					

Handball

	Goals Buts	Saved Arrets	Missed Rates	G.Post Poteaux	Blocked Contres	Total
Line Shots /Lancer de la Ligne	6-9	1-0	0-0	1-0	0-0	8-9
Field Shots /Lancer du Terrain	4-4	3-9	1-3	2-1	3-2	13-19
Side Shots (R) /Lancer de Cote (D)	1-0	0-1	1-1	0-0	0-0	2-2
Side Shots (L) /Lancer de Cote (G)	5-1	1-0	0-0	0-0	0-0	6-1
Penalty Throws /Jet de 7 Metres	5-3	1-1	0-1	0-0	0-0	6-5
Free Throws /Jet Franc	0-1	0-0	0-0	0-0	0-0	0-1
Fast Breaks /Contre Attaques	3-0	0-2	0-0	0-1	0-0	3-3
** Total **	24-18	6-13	2-5	3-2	3-2	38-40
Assist	13-10	Suspension 2 Min.				4-3
Error/Erreur	13-14	Disqualification				0-0
Warning/Avertissement	2-2	Expulsion				0-0

Women Prelim. Round Group A Match 6/Sept. 25			Femmes Series Prelim. Groupe A Match 6/25 Sept		
No.	Name Nom	Goals Buts	No.	Name Nom	Goals Buts
TCH 21-17 YUG (8-7, 13-10)					
TCH Czechoslovakia			YUG Yugoslavia		
01	Hradska, Anna	0	02	Krstic, Mirjana	0
03	Trandzikova, Daniela	1	03	Rincic, Slavica	0
05	Sabadosova, Gabriela	0	04	Pesic, Dragana	3
06	Kolecaniova, Julia	0	06	Galic, Zita	4
07	Budayova, Zuzana	1	07	Jankovic, Ljubinka	3
08	Damitsova, Alena	3	10	Djurica, Mirjana	0
09	Lupacova, Petra	4	11	Kolega, Natasa	3
10	Durisinova, Maria	9	12	Djukic, Slavica	0
11	Hejtmankova, Monika	1	13	Mugosa, Ljiljana	0
13	Stasova, Jana	1	14	Mugosa, Svetlana	1
14	Mazgutova, Bozena	1	15	Stojanovic, Deanka	3
16	Posova, Marta	0	16	Djuric, Dragica	0
Coach/Entraîneur; Zerzan, Jiri			Coach/Entraîneur; Nisevic, Dragan		
Referees/Arbitres; 1. NOR Ludvigsen, Jan Rolf 2. NOR Sjong, Per Erik					

	Goals Buts	Saved Arrets	Missed Rates	G.Post Poteaux	Blocked Contres	Total
Line Shots /Lancer de la Ligne	2-7	3-4	0-0	0-0	0-0	5-11
Field Shots /Lancer du Terrain	5-6	6-6	0-0	3-1	5-1	19-14
Side Shots (R) /Lancer de Cote (D)	4-1	4-1	1-0	1-0	0-0	10-2
Side Shots (L) /Lancer de Cote (G)	0-2	1-0	0-0	1-0	0-0	2-2
Penalty Throws /Jet de 7 Metres	6-1	1-0	0-0	0-0	0-0	7-1
Free Throws /Jet Franc	0-0	0-0	0-0	0-0	0-0	0-0
Fast Breaks /Contre Attaques	4-0	1-0	0-0	0-0	0-0	5-0
** Total **	21-17	16-11	1-0	5-1	5-1	48-30
Assist	10-8	Suspension 2 Min.				6-7
Error/Erreur	9-15	Disqualification				0-1
Warning/Avertissement	2-1	Expulsion				0-0



Women
Prelim. Round Group B Match 1/Sept. 21

Femmes
Series Prelim. Groupe B Match 1/21 Sept

No.	Name Nom	Goals Buts	No.	Name Nom	Goals Buts
-----	-------------	---------------	-----	-------------	---------------

URS 24-19 CHN (12-9, 12-10)

URS	U.S.S.R.		CHN	People's Republic of China	
01	Mitriuk, Natalia	0	02	Zhang, Hong	1
02	Karlova, Larissa	3	03	He, Jianping	5
04	Tourtchina, Zinaida	1	05	Zhang, Weihong	2
05	Semenova, Olga	0	06	Wang, Mingxing	0
07	Bazanov, Marina	4	07	Chen, Zhen	2
08	Morskova, Natalia	1	08	Li, Lirong	0
09	Gorb, Tatiana	4	10	Li, Jie	0
10	Tovstogan, Evguenia	5	11	Sun, Xiulan	8
13	Nemachkalo, Elena	3	12	Xue, Jinhua	0
16	Djandigava, Tatiana	0	13	Dai, Jianfen	1
17	Aniss Imova, Natalia	1	16	Wang, Tao	0
19	Lapitskaia, Natalia	2	18	Lu, Guanghong	0

Coach/Entraîneur; Tourtchine, Igor
Loutsenko, Mikhail

Coach/Entraîneur; Zhang, Yulin

Referees/Arbitres;
1. YUG Jug, Stefan
2. YUG Jeglic, Herbert

	Goals Buts	Saved Arrets	Missed Rates	G.Post Poteaux	Blocked Contres	Total
--	---------------	-----------------	-----------------	-------------------	--------------------	-------

Line Shots /Lancer de la Ligne	9-4	1-3	1-1	1-0	0-0	12-8
Field Shots /Lancer du Terrain	10-5	5-10	0-0	1-2	1-5	17-22
Side Shots (R) /Lancer de Cote (D)	1-0	0-1	0-0	0-0	0-0	1-1
Side Shots (L) /Lancer de Cote (G)	0-2	0-0	1-0	0-0	0-0	1-2
Penalty Throws /Jet de 7 Metres	1-7	0-0	0-0	1-0	0-0	2-7
Free Throws /Jet Franc	0-0	0-0	1-0	0-0	0-0	1-0
Fast Breaks /Contre Attaques	3-1	1-0	0-0	0-0	0-0	4-1
** Total **	24-19	7-14	3-1	3-2	1-5	38-41
Assist	8-11		Suspension 2 Min.			4-1
Error/Erreur	13-15		Disqualification			0-0
Warning/Avertissement	3-3		Expulsion			0-0

Women
Prelim. Round Group B Match 2/Sept. 21

Femmes
Series Prelim. Groupe B Match 2/21 Sept

No.	Name Nom	Goals Buts	No.	Name Nom	Goals Buts
-----	-------------	---------------	-----	-------------	---------------

NOR 34-14 CIV (15-8, 19-6)

NOR	Norway		CIV	Ivory Coast	
02	Svendsen, Cathrine	6	01	Kouassi, Elisabeth	0
03	Sundal, Heidi	3	03	Elleingand, Koko-P.	0
04	Hegh, Hanne	3	04	Djoman, Emilie	3
06	Hogness, Hanne	6	06	Awa, Zomou	0
07	Singstao, Karin	1	07	Douamba, Alimata	1
08	Haltvik, Trine	3	08	Kramo, Mahoula-D	5
10	Steen, Ingrid	3	09	Ble, Clementinea	1
11	Pettersen, Karin	2	10	Ndri, Adjoua-D	2
12	Skottvoll, Annette	0	11	Bah, Doumbia-T	0
13	Midthun, Kristin	7	12	Vodoungbo, Julienne	0
14	Eliasson, Marte	0	14	Irie, Gouna	0
16	Andersen, Kjerstin	0	15	Guigui, Brigitte	2

Coach/Entraîneur; Jacobsen, Sven Tore
Borgesen, Arne
Johnsen, Roy

Coach/Entraîneur; Bleou, Tokou J.L.
Tape, Kalou Julien

Referees/Arbitres;
1. KOR Lee, Moon-Sik
2. KOR Park, Chun-Jo

	Goals Buts	Saved Arrets	Missed Rates	G.Post Poteaux	Blocked Contres	Total
--	---------------	-----------------	-----------------	-------------------	--------------------	-------

Line Shots /Lancer de la Ligne	8-3	0-1	0-0	0-0	0-0	8-4
Field Shots /Lancer du Terrain	6-8	5-7	1-4	2-2	0-5	14-26
Side Shots (R) /Lancer de Cote (D)	2-2	0-0	0-1	0-0	0-0	2-3
Side Shots (L) /Lancer de Cote (G)	3-1	2-1	0-0	0-0	0-0	5-2
Penalty Throws /Jet de 7 Metres	8-0	2-1	0-0	0-0	0-0	10-1
Free Throws /Jet Franc	0-0	0-0	0-0	0-0	0-0	0-0
Fast Breaks /Contre Attaques	7-0	1-0	0-0	1-0	0-0	9-0
** Total **	34-14	10-10	1-5	3-2	0-5	48-36
Assist	22-1		Suspension 2 Min.			1-7
Error/Erreur	8-23		Disqualification			0-0
Warning/Avertissement	3-2		Expulsion			0-0

Women
Prelim. Round Group B Match 3/Sept. 23

Femmes
Series Prelim. Groupe B Match 3/23 Sept

No.	Name Nom	Goals Buts	No.	Name Nom	Goals Buts
-----	-------------	---------------	-----	-------------	---------------

URS 32-11 CIV (14-7, 18-4)

URS	U.S.S.R.		CIV	Ivory coast	
02	Karlova, Larissa	2	01	Kouassi, Elisabeth	0
03	Mankova, Svetlana	1	02	Guehi, Wandou-R.	0
05	Semenova, Olga	6	03	Elleingand, Koko-P.	0
07	Bazanov, Marina	3	04	Djoman, Emilie	0
08	Morskova, Natalia	8	06	Awa, Zomou	1
09	Gorb, Tatiana	2	07	Douamba, Alimata	1
12	Rousnatchenko, Natalia	0	08	Kramo, Mahoula-D	4
13	Nemachkalo, Elena	0	10	Ndri, Adjoua-D	3
16	Djandigava, Tatiana	0	11	Bah, Doumbia-T	0
17	Aniss Imova, Natalia	5	12	Vodoungbo, Julienne	0
18	Gouszeva, Elina	1	13	Konan, Hortense	0
19	Lapitskaia, Natalia	4	15	Guigui, Brigitte	2

Coach/Entraîneur; Tourtchine, Igor
Loutsenko, Mikhail

Coach/Entraîneur; Bleou, Tokou J. L.
Tape, Kalou Julien

Referees/Arbitres;
1. ARG Zaworotny, Miguel Angel
2. ARG Brosio, Eduardo

	Goals Buts	Saved Arrets	Missed Rates	G. Post Poteaux	Blocked Contres	Total
--	---------------	-----------------	-----------------	--------------------	--------------------	-------

Line Shots /Lancer de la Ligne	9-2	0-1	0-0	0-0	0-0	9-3
Field Shots /Lancer du Terrain	5-7	2-4	5-3	2-0	0-12	14-26
Side Shots (R) /Lancer de Cote (D)	2-0	0-0	0-0	0-0	0-0	2-0
Side Shots (L) /Lancer de Cote (G)	0-1	2-2	0-0	0-0	0-0	2-3
Penalty Throws /Jet de 7 Metres	8-1	1-2	0-0	1-0	0-0	10-3
Free throws /Jet Franc	0-0	0-0	0-0	0-0	0-0	0-0
Fast Breaks /Contre Attaques	8-0	1-0	0-0	1-0	0-0	10-0
** Total **	32-11	6-9	5-3	4-0	0-12	47-35
Assist	18-2		Suspension 2 Min.			2-7
Error/Erreur	6-15		Disqualification			0-0
Warning/Avertissement	1-2		Expulsion			0-0

Handball

Women Prelim. Round Group B Match 4/Sept. 23			Femmes Series Prelim. Groupe B Match 4/23 Sept		
No.	Name Nom	Goals Buts	No.	Name Nom	Goals Buts
NOR 22-20 CHN (12-10, 10-10)					
NOR Norway			CHN People's Republic of China		
01	Johnsen, Vibeke	0	02	Zhang, Hong	0
02	Svendsen, Cathrine	2	03	He, Jianping	3
03	Sundal, Heidi	3	05	Zhang, Weihong	3
04	Hegh, Hanne	0	06	Wang, Mingxing	0
06	Hogness, Hanne	2	07	Chen, Zhen	4
07	Singstao, Karin	0	08	Li, Lirong	3
08	Haltvik, Trine	2	10	Li, Jie	0
09	Digre, Berit	0	11	Sun, Xiulan	4
10	Steen, Ingrid	6	12	Xue, Jinhua	0
11	Pettersen, Karin	4	13	Dai, Jianfen	3
13	Midthun, Kristin	3	16	Wang, Tao	0
16	Andersen, Kjerstin	0	18	Lu, Guanghong	0
Coach/Entraîneur; Jacobsen, Sven Tore Borgesen, Arne Johnsen, Roy			Coach/Entraîneur; Zhang, Yulin		
Referees/Arbitres; 1. FRG Hofmann, Erhard 2. FRG Prause, Manfred					

	Goals Buts	Saved Arrets	Missed Rates	G.Post Poteaux	Blocked Contres	Total
Line Shots /Lancer de la Ligne	7-6	2-2	0-0	0-0	0-0	9-8
Field Shots /Lancer du Terrain	10-4	4-1	1-1	1-2	4-2	20-10
Side Shots (R) /Lancer de Cote (D)	0-1	1-0	0-1	0-0	0-0	1-2
Side Shots (L) /Lancer de Cote (G)	0-0	0-0	0-0	0-0	0-0	0-0
Penalty Throws /Jet de 7 Metres	3-3	1-1	0-0	0-1	0-0	4-5
Free Throws /Jet Franc	0-0	0-0	0-0	0-0	0-0	0-0
Fast Breaks /Contre Attaques	2-6	0-0	0-0	1-0	0-0	3-6
** Total **	22-20	8-4	1-2	2-3	4-2	37-31
Assist	11-10		Suspension 2 Min.			2-2
Error/Erreur	17-22		Disqualification			0-0
Warning/Avertissement	2-1		Expulsion			0-0

Women Prelim. Round Group B Match 5/Sept. 25			Femmes Series Prelim. Groupe B Match 5/25 Sept		
No.	Name Nom	Goals Buts	No.	Name Nom	Goals Buts
CHN 37-12 CIV (20-4, 17-8)					
CHN People's Republic of China			CIV Ivory Coast		
02	Zhang, Hong	1	01	Kouassi, Elisabeth	0
03	He, Jianping	9	03	Elleingand, Koko-R	0
05	Zhang, Weihong	0	04	Djoman, Emilie	3
06	Wang, Mingxing	2	06	Awa, Zomou	2
07	Chen, Zhen	4	07	Douamba, Alimata	0
08	Li, Lirong	4	08	Kramo, Mahoula-D	2
10	Li, Jie	1	09	Ble, Clementinea	2
11	Sun, Xiulan	10	10	Ndri, Adjoua-D	0
12	Xue, Jinhua	0	11	Bah, Doumbia-T	0
13	Dai, Jianfen	2	12	Vodoungbo, Julienne	0
16	Wang, Tao	0	14	Irie, Gouna	2
18	Lu, Guanghong	4	15	Guigui, Brigitte	1
Coach/Entraîneur; Zhang, Yulin			Coach/Entraîneur; Bleou, Tokou J. L. Tape, Kalou Julien		
Referees/Arbitres; 1. FRA Lelong, Jean 2. FRA Tancrez, Gerard					

Handball

	Goals Buts	Saved Arrets	Missed Rates	G.Post Poteaux	Blocked Contres	Total
Line Shots /Lancer de la Ligne	11-6	3-0	0-1	0-0	0-0	14-7
Field Shots /Lancer du Terrain	6-4	1-8	1-5	1-1	0-4	9-22
Side Shots (R) /Lancer de cote (D)	3-1	2-2	0-1	0-0	0-0	5-4
Side Shots (L) /Lancer de Cote (G)	4-0	1-0	0-0	0-0	0-0	5-0
Penalty Throws /Jet de 7 Metres	4-0	0-2	0-0	1-0	0-0	5-2
Free Throws /Jet Franc	0-0	0-0	0-0	0-0	0-0	0-0
Fast Breaks /Contre Attaques	9-1	2-0	0-0	0-0	0-0	11-1
** Total **	37-12	9-12	1-7	2-1	0-4	49-36
Assist	21-5		Suspension 2 Min.			0-0
Error/Erreur	12-24		Disqualification			0-0
Warning/Avertissement	2-3		Expulsion			0-0

Women Prelim. Round Group B Match 6/Sept. 25			Femmes Series Prelim. Groupe B Match 6/25 Sept		
No.	Name Nom	Goals Buts	No.	Name Nom	Goals Buts
URS 19-19 NOR (13-10,6-9)					
URS U.S.S.R.			NOR Norway		
01	Mitruik, Natalia	0	02	Svendsen, Cathrine	5
02	Karlova, Larissa	0	03	Sundal, Heidi	2
04	Tourtchina, Zinaida	0	04	Hegh, Hanne	0
05	Semenova, Olga	0	06	Hogness, Hanne	1
07	Bazanava, Marina	4	07	Singstao, Karin	0
08	Morskova, Natalia	3	08	Haltvik, Trine	4
09	Gorb, Tatiana	2	09	Digre, Berit	0
10	Tovstogan, Evguenia	1	10	Steen, Ingrid	1
13	Nemachkalo, Elena	4	11	Pettersen, Karin	3
16	Djandjgava, Tatiana	0	12	Skottvoll, Annette	0
17	Aniss Imova, Natalia	0	13	Midthun, Kristin	3
19	Lapitskaia, Natalia	5	16	Andersen, Kjerstin	0
Coach/Entraîneur; Tourchine, Igor Loutsenko, Mikhail			Coach/Entraîneur; Jacobsen, Sven Tore Borgesen, Arne Johnsen, Roy		
Referees/Arbitres; 1. GDR Rauchfuss, Peter 2. GDR Buchda, Rudolf					

	Goals Buts	Saved Arrets	Missed Rates	G.Post Poteaux	Blocked Contres	Total
Line Shots /Lancer de la Ligne	4-7	0-1	0-0	0-0	0-0	4-8
Field Shots /Lancer du Terrain	7-5	9-8	1-3	2-2	4-1	23-19
Side Shots (R) /Lancer de Cote (D)	3-0	0-1	0-0	0-0	0-0	3-1
Side Shots (L) /Lancer de Cote (G)	1-2	0-2	1-0	0-0	0-0	2-4
Penalty Throws /Jet de 7 Metres	1-3	0-0	0-0	0-0	0-0	1-3
Free Throws /Jet Franc	0-0	0-0	0-2	0-0	0-0	0-2
Fast Breaks /Contre Attaques	3-2	0-0	0-0	0-0	0-0	3-2
** Total **	19-19	9-12	2-5	2-2	4-1	36-39
Assist	10-9		Suspension 2 Min.			4-2
Error/Erreur	19-12		Disqualification			1-0
Warning/Avertissement	3-3		Expulsion			0-0



Women		Femmes								
Preliminary Round/Sept. 21-25		Series Preliminaires/21-25 Sept								
Rank	Ctry	Points	Played	Won	Tied	Lost	For	Against	Diff	
Rang	Pays		Joues	Gagnes	Nuls	Perdus	Pour	Contre		
* Group A/Groupe A										
1	KOR	4	3	2	0	1	76	67	9	
2	YUG	4	3	2	0	1	58	58	0	
3	TCH	4	3	2	0	1	81	69	12	
4	USA	0	3	0	0	3	55	76	-21	
	TCH	YUG	KOR	USA						
TCH	*	21-17	27-33	33-19						
YUG	17-21	*	22-19	19-18						
KOR	33-27	19-22	*	24-18						
USA	19-33	18-19	18-24	*						

* Group B/Groupe B										
Rank	Ctry	Points	Played	Won	Tied	Lost	For	Against	Diff	
Rang	Pays		Joues	Gagnes	Nuls	Perdus	Pour	Contre		
1	URS	5	3	2	1	0	75	49	26	
2	NOR	5	3	2	1	0	75	53	22	
3	CHN	2	3	1	0	2	76	58	18	
4	CIV	0	3	0	0	3	37	103	-66	
	URS	NOR	CHN	CIV						
URS	*	19-19	24-19	32-11						
NOR	19-19	*	22-20	34-14						
CHN	19-24	20-22	*	37-12						
CIV	11-32	14-34	12-37	*						

The classification of group B is decided as stated above due to the adoption of the 25% rule.

Après l'adoption de 'principe de 25%', le classement du groupe B a été modifié comme ci-dessus.

Women			Femmes		
Final Round (5-8 Places) Match 1/Sept. 27			Series Finales (5-8 Places) Match 1/27 Sept		
No.	Name	Goals	No.	Name	Goals
	Nom	Buts		Nom	Buts
CHN	31-22	USA	(12-13, 19-9)		
CHN	People's Republic of China		USA	United States of America	
02	Zhang, Hong	0	01	Callaghan, Kathy	0
03	He, Jianping	5	02	Gamble, Amy	0
05	Zhang, Weihong	3	03	Gallagher, Margaret	4
06	Wang, Mingxing	0	04	Winn, Sherry	2
07	Chen, Zhen	4	05	Paigut, Karyn	2
08	Li, Lirong	3	06	Lack, Portia	0
10	Li, Jie	0	07	De la riva, Sandra	2
11	Sun, Xiulan	10	08	Clarke, Kim	2
12	Xue, Jinhua	1	13	Jones, Leora	6
13	Dai, Jianfen	1	14	Peterka, Carol	4
16	Wang, Tao	0	15	Stone, Penelope	0
18	Lu, Guanghong	4	16	Coenen, Laura	0
Coach/Entraîneur;			Coach/Entraîneur;		
Zhang, Yulin			Faludi, Mihaly		
Referees/Arbitres;					
1. HOL	Haak, Peter				
2. HOL	Koppe, Henry				

	Goals	Saved	Missed	G.Post	Blocked	Total
	Buts	Arrets	Rates	Poteaux	Contres	
Line Shots	9-5	1-2	0-0	0-0	0-0	10-7
/Lancer de la Ligne						
Field Shots	6-3	5-6	4-3	3-3	1-1	19-16
/Lancer du Terrain						
Side Shots (R)	4-4	1-0	0-0	0-0	0-0	5-4
/Lancer de Cote (D)						
Side Shots (L)	1-2	0-1	0-0	1-0	0-0	2-3
/Lancer de Cote (G)						
Penalty Throws	4-5	0-1	0-0	0-1	0-0	4-7
/Jet de 7 Metres						
Free Throws	0-0	0-0	0-0	0-0	0-0	0-0
/Jet Fran						
Fast Breaks	7-3	2-0	0-0	0-0	0-0	9-3
/Contre Attaques						
** Total **	31-22	9-10	4-3	4-4	1-1	49-40
Assist	19-16			Suspension 2 Min.		3-2
Error/Erreur	11-23			Disqualification		0-0
Warning/Avertissement	3-3			Expulsion		0-0

Women			Femmes		
Final Round (5-8 Places) Match 2/Sept. 27			Series Finales (5-8 Places) Match 2/27 Sept		
No.	Name	Goals	No.	Name	Goals
	Nom	Buts		Nom	Buts
CIV	12-34	TCH	(5-16,7-18)		
CIV	Ivory coast		TCH	Czechoslovakia	
01	Kouassi, Elisabeth	0	02	Tomasovicova, Irena	2
02	Guehi, Wandou-R.	1	03	Trandzikova, Daniela	4
03	Elleingand, Koko-P	1	04	Smidova, Marie	2
04	Djoman, Emilie	2	05	Sabadosova, Gabriela	6
06	Awa, Zomou	1	06	Kolecianiova, Julia	5
07	Douamba, Alimata	0	07	Budayova, Zuzana	5
08	Kramo, Mahoula-D	5	08	Damitsova, Alena	0
09	Ble, Clementinea	0	09	Lupacova, Petra	3
12	Vodoungbo, Julienne	0	11	Hejtmankova, Monika	7
13	Konan, Hortense	0	12	Pospisilova, Lenka	0
14	Irie, Gouna	0	13	Stasova, Jana	0
15	Guigui, Brigitte	2	16	Posova, Marta	0
Coach/Entraîneur;			Coach/Entraîneur;		
Bleou, Tokou J. L. Tape, Kalou Julien			Zerzan, Jiri		
Referees/Arbitres;					
1. KOR	Kim, Chang Hoon				
2. KOR	Park, Jong Kap				

	Goals	Saved	Missed	G. Post	Blocked	Total
	Buts	Arrets	Rates	Poteaux	Contres	
Line Shots	3-2	2-0	0-0	0-1	0-0	5-3
/Lancer de la Ligne						
Field Shots	5-3	7-5	4-1	3-3	3-0	22-12
/Lancer du Terrain						
Side Shots (R)	1-4	6-0	2-0	0-1	0-1	9-6
/Lancer de Cote (D)						
Side Shots (L)	0-2	1-3	0-0	1-1	0-0	2-6
/Lancer de Cote (G)						
Penalty Throws	2-7	1-1	0-0	0-0	0-0	3-8
/Jet de 7 Metres						
Free Throws	0-0	0-0	0-0	0-0	0-0	0-0
/Jet Franc						
Fast Breaks	1-16	2-3	0-0	0-0	0-0	3-19
/Contre Attaques						
** Total **	12-34	19-12	6-1	4-6	3-1	44-54
Assist	4-28			Suspension 2 Min.		3-2
Error/Erreur	23-13			Disqualification		0-0
Warning/Avertissement	3-3			Expulsion		0-0

Handball

Women Final Round (5-8 Places) Match 3/Sept. 29			Femmes Series Finales (5-8 Places) Match 3/29 Sept		
No.	Name Nom	Goals Buts	No.	Name Nom	Goals Buts
CIV 16-27 USA (6-14, 10-13)					
CIV	Ivory coast		USA	United States of America	
01	Kouassi, Elisabeth	0	01	Callaghan, Kathy	0
02	Guehi, Wandou-R.	0	02	Gamble, Amy	3
04	Djoman, Emilie	3	03	Gallagher, Margaret	3
06	Awa, Zomou	0	04	Winn, Sherry	0
07	Douamba, Alimata	0	05	Palgut, Karyn	3
08	Kramo, Mahoula-D	5	06	Lack, Portia	1
09	Ble, Clementinea	0	07	De La Riva, Sandra	2
10	Ndri, Adjoua-D	1	08	Clarke, Kim	4
11	Bah, Doumbia-T	5	13	Jones, Leora	4
12	Vodoungbo, Julienne	0	14	Peterka, Carol	4
13	Konan, Hortense	0	15	Stone, Penelope	3
14	Irie, Gouna	2	16	Coenen, Laura	0
Coach/Entraîneur; Bleou, Tokou J.L. Tape, Kalou Julien			Coach/Entraîneur; Faludi, Mihaly		
Referees/Arbitres; 1. KOR Lee, Moon Sik 2. KOR Park, Chun Jo					

	Goals Buts	Saved Arrets	Missed Rates	G.Post Poteaux	Blocked Contres	Total
Line Shots /Lancer de la Ligne	2-9	3-1	0-1	0-0	0-0	5-11
Field Shots /Lancer du Terrain	5-2	14-4	4-3	1-3	8-0	32-12
Side Shots(R) /Lancer de Cote(D)	4-1	1-1	1-0	0-0	0-0	6-2
Side Shots(L) /Lancer de Cote(G)	0-1	0-1	0-0	0-0	0-0	0-2
Penalty Throws /Jet de 7 Metres	4-3	1-1	0-0	1-0	0-0	6-4
Free Throws /Jet Franc	0-1	0-0	0-1	0-0	0-0	0-2
Fast Breaks /Contre Attaques	1-10	1-1	0-1	0-1	0-0	2-13
** Total **	16-27	20-9	5-6	2-4	8-0	51-46
Assist Error/Erreur	10-17 13-15		Suspension 2 Min. Disqualification			4-2 0-0
Warning/Avertissement	2-1		Expulsion			0-0

Women Final Round (5-8 Places) Match 4/Sept. 29			Femmes Series Finales (5-8 Places) Match 4/29 Sept		
No.	Name Nom	Goals Buts	No.	Name Nom	Goals Buts
CHN 21-26 TCH (10-9, 11-17)					
CHN	People's Republic of China		TCH	Czechoslovakia	
02	Zhang, Hong	2	01	Hradska, Anna	0
03	He, Jianping	4	02	Tomasovicova, Irena	0
05	Zhang, Weihong	2	03	Trandzikova, Daniela	2
06	Wang, Mingxing	1	06	Kolecianiova, Julia	1
07	Chen, Zhen	7	07	Budayova, Zuzana	6
08	Li, Lirong	0	08	Damitsova, Alena	2
10	Li, Jie	0	09	Lupacova, Petra	3
11	Sun, Xiulan	4	10	Durisinova, Maria	6
12	Xue, Jinhua	0	11	Hejtmankova, Monika	0
13	Dai, Jianfen	0	12	Pospisilova, Lenka	0
16	Wang, Tao	0	13	Stasova, Jana	2
18	Lu, Guanghong	1	14	Mazgutova, Bozena	4
Coach/Entraîneur; Zhang, Yulin			Coach/Entraîneur; Zerzan, Jiri		
Referees/Arbitres; 1. SWE Blademo, Kent 2. SWE Wester, Axel					

Handball

	Goals Buts	Saved Arrets	Missed Rates	G.Post Poteaux	Blocked Contres	Total
Line Shots /Lancer de la Ligne	6-7	2-2	0-1	0-0	0-0	8-10
Field Shots /Lancer du Terrain	7-9	5-3	1-3	5-0	1-2	19-17
Side Shots (R) /Lancer de Cote (D)	2-2	3-3	0-0	0-0	1-0	6-5
Side Shots (L) /Lancer de Cote (G)	3-1	0-4	1-0	0-0	0-0	4-5
Penalty Throws /Jet de 7 Metres	0-3	1-0	0-0	0-0	0-0	1-3
Free Throws /Jet Franc	0-0	0-0	0-0	0-0	0-0	0-0
Fast Breaks /Contre Attaques	3-4	1-0	0-0	1-0	0-0	5-4
** Total **	21-26	12-12	2-4	6-0	2-2	43-44
Assist Error/Erreur	8-15 16-20		Suspension 2 Min. Disqualification			3-3 0-0
Warning/Avertissement	2-2		Expulsion			0-0

Women Final Round (1-4 Places) Match 1/Sept. 27			Femmes Series Finales (1-4 Places) Match 1/27 Sept		
No.	Name Nom	Goals Buts	No.	Name Nom	Goals Buts
YUG 15-18 URS (8-9,7-9)					
YUG	Yugoslavia		URS	U.S.S.R.	
03	Rincic, Slavica	1	01	Mitruik, Natalia	0
04	Pesic, Dragana	3	02	Karlova, Larissa	2
06	Galic, Zita	5	03	Mankova, Svetlana	0
07	Jankovic, Ljubinka	0	04	Tourtchina, Zinaida	0
08	Micic, Svetlana	0	07	Bazanava, Marina	1
10	Djurica, Mirjana	1	08	Morskova, Natalia	6
11	Kolega, Natasa	3	09	Gorb, Tatiana	1
12	Djukic, Slavica	0	10	Tovstogan, Evguenia	2
13	Mugosa, Ljiljana	0	13	Nemachkalo, Elena	1
14	Mugosa, Svetlana	2	16	Djandjgava, Tatiana	0
15	Stojanovic, Deanka	0	17	Aniss Imova, Natalia	2
16	Djuric, Dragica	0	19	Lapitskaia, Natalia	3
Coach/Entraîneur; Nisevic, Dragan			Coach/Entraîneur; Tourchine, Igor Loutsenko, Mikhail		
1. DEN Christensen, Ole 2. DEN Jorgensen, Per Godsk					

	Goals Buts	Saved Arrets	Missed Rates	G.Post Poteaux	Blocked Contres	Total
Line Shots /Lancer de la Ligne	5-5	3-3	0-0	0-0	0-0	8-8
Field Shots /Lancer du Terrain	8-8	7-5	3-3	2-2	2-6	22-24
Side Shots (R) /Lancer de Cote (D)	0-0	2-2	0-0	0-0	0-0	2-2
Side Shots (L) /Lancer de Cote (G)	0-2	0-1	1-0	0-0	0-0	1-3
Penalty Throws /Jet de 7 Metres	0-3	0-0	0-0	0-0	0-0	0-3
Free Throws /Jet Franc	0-0	0-0	0-0	0-1	0-0	0-1
Fast Breaks /Contre Attaques	2-0	0-0	0-0	0-0	0-0	2-0
** Total **	15-18	12-11	4-3	2-3	2-6	35-41
Assist Error/Erreur	7-6 19-16		Suspension 2 Min. Disqualification			5-4 0-0
Warning/Avertissement	2-1		Expulsion			0-0



Women
Final Round (1-4 Places) Match 2/Sept. 27

Femmes
Series Finales (1-4 Places) Match 2/27 Sept

No.	Name Nom	Goals Buts	No.	Name Nom	Goals Buts
KOR 23-20 NOR (10-9, 13-11)					
KOR	Korea		NOR	Norway	
01	Song, Ji-Hyun	0	02	Svendsen, Cathrine	3
04	Han, Hyun-Sook	0	03	Sundal, Heidi	6
05	Kim, Choon-Rye	4	04	Hegh, Hanne	1
06	Kim, Myung-Soon	5	06	Hogness, Hanne	1
07	Lee, Ki-Soon	0	07	Singtao, Karin	0
09	Kim, Hyun-Mee	5	08	Haltvik, Trine	0
10	Ki, Mi-Sook	0	09	Digre, Berit	1
11	Suk, Min-Hee	2	10	Steen, Ingrid	3
12	Son, Mi-Na	0	11	Pettersen, Karin	1
13	Lim, Mi-Kyung	3	12	Skottvoll, Annette	0
14	Kim, Kyung-Soon	0	13	Midthun, Kristin	4
15	Sung, Kyung-Hwa	4	16	Andersen, Kjerstin	0
Coach/Entraîneur;			Coach/Entraîneur;		
Koh, Byung-Hoon Park, Jae-Soo			Jacobsen, Sven Tore Borgesen, Arne Johnsen, Roy		
Referees/Arbitres;					
1. FRG Hofmann, Erhard 2. FRG Prause, Manfred					

	Goals Buts	Saved Arrets	Missed Rates	G. Post Poteaux	Blocked Contres	Total
Line Shots /Lancer de la Ligne	10-7	2-2	1-0	0-0	0-0	13-9
Field Shots /Lancer du Terrain	5-3	4-5	2-2	0-0	5-2	16-12
Side Shots (R) /Lancer de Cote (D)	0-1	3-2	0-0	0-0	0-0	3-3
Side Shots (L) /Lancer de Cote (G)	1-2	0-2	0-0	0-1	0-0	1-5
Penalty Throws /Jet de 7 Metres	4-5	1-0	0-0	0-0	0-0	5-5
Free Throws /Jet Franc	0-0	0-0	0-0	0-0	0-0	0-0
Fast Breaks /Contre Attaques	3-2	2-1	0-0	0-0	0-0	5-3
** Total **	23-20	12-12	3-2	0-1	5-2	43-37
Assist	12-14		Suspension 2 Min.			3-2
Error/Erreur	15-18		Disqualification			0-0
Warning/Avertissement	2-2		Expulsion			0-0

Women
Final Round (1-4 Places) Match 3/Sept. 29

Femmes
Series Finales (1-4 Places) Match 3/29 Sept

No.	Name Nom	Goals Buts	No.	Name Nom	Goals Buts
YUG 15-20 NOR (10-9,5-11)					
YUG	Yugoslavia		NOR	Norway	
02	Krstic, Mirjana	0	02	Svendsen, Cathrine	0
04	Pesic, Dragana	2	03	Sundal, Heidi	2
05	Obucina, Svetlana	0	04	Hegh, Hanne	1
06	Galic, Zita	3	05	Goksor, Susann	0
07	Jankovic, Ljubinka	1	06	Hogness, Hanne	4
10	Djurica, Mirjana	0	07	Singtao, Karin	0
11	Kolega, Natasa	2	08	Haltvik, Trine	1
12	Djukic, Slavica	0	10	Steen, Ingrid	5
13	Mugosa, Ljiljana	2	11	Pettersen, Karin	3
14	Mugosa, Svetlana	3	12	Skottvoll, Annette	0
15	Stojanovic, Deanka	2	13	Midthun, Kristin	4
16	Djuric, Dragica	0	16	Andersen, Kjerstin	0
Coach/Entraîneur;			Coach/Entraîneur;		
Nisevic, Dragan			Jacobsen, Sven Tore Borgesen, Arne Johnsen, Roy		
Referees/Arbitres;					
1. ROM Marin, Marin 2. ROM Serban, Stefan					

	Goals Buts	Saved Arrets	Missed Rates	G.Post Poteaux	Blocked Contres	Total
Line Shots /Lancer de la Ligne	5-2	1-1	1-0	1-1	0-0	8-4
Field Shots /Lancer du Terrain	6-5	2-3	2-1	2-2	3-1	15-12
Side Shots (R) /Lancer de Cote (D)	1-4	1-0	0-0	0-1	0-0	2-5
Side Shots (L) /Lancer de Cote (G)	0-2	2-1	0-0	0-1	0-0	2-4
Penalty Throws /Jet de 7 Metres	3-5	2-1	0-0	0-0	0-0	5-6
Free Throws /Jet Franc	0-0	0-0	0-1	0-0	0-0	0-1
Fast Breaks /Contre Attaques	0-2	0-2	0-0	0-0	0-0	0-4
** Total **	15-20	8-8	3-2	3-5	3-1	32-36
Assist	6-13		Suspension 2 Min.			5-6
Error/Erreur	14-11		Disqualification			0-0
Warning/Avertissement	3-2		Expulsion			0-0

Women
Final Round (1-4 Places) Match 4/Sept. 29

Femmes
Series Finales (1-4 Places) Match 4/29 Sept

No.	Name Nom	Goals Buts	No.	Name Nom	Goals Buts
KOR 21-19 URS (13-11,8-8)					
KOR	Korea		URS	U.S.S.R.	
01	Song, Ji-Hyun	0	01	Mitruik, Natalia	0
04	Han, Hyun-Sook	0	02	Karlova, Larissa	0
05	Kim, Choon-Rye	1	03	Mankova, Svetlana	0
06	Kim, Myung-Soon	1	04	Tourtchina, Zinaida	0
07	Lee, Ki-Soon	0	07	Bazanava, Marina	1
09	Kim, Hyun-Mee	4	08	Morskova, Natalia	7
10	Ki, Mi-Sook	2	09	Gorb, Tatiana	1
11	Suk, Min-Hee	3	10	Tovstogan, Evguenia	2
12	Son, Mi-Na	0	13	Nemachkalo, Elena	0
13	Lim, Mi-Kyung	6	16	Djandjgava, Tatiana	0
14	Kim, Kyung-Soon	0	17	Aniss imova, Natalia	5
15	Sung, Kyung-Hwa	4	19	Lapitskaia, Natalia	3
Coach/Entraîneur;			Coach/Entraîneur;		
Koh, Byung-Hoon Park, Jae-Soo			Tourchina, Igor Loutsenko, Mikhail		
Referees/Arbitres;					
1. GDR Rauchfuss, Peter 2. GDR Buchda, Rudolf					

	Goals Buts	Saved Arrets	Missed Rates	G.Post Poteaux	Blocked Contres	Total
Line Shots /Lancer de la Ligne	1-5	0-2	0-0	0-0	0-0	1-7
Field Shots /Lancer du Terrain	11-9	12-8	4-2	4-2	6-2	37-23
Side Shots (R) /Lancer de Cote (D)	1-1	2-1	0-0	0-0	0-0	3-2
Side Shots (L) /Lancer de Cote (G)	0-0	1-0	0-0	0-0	0-0	1-0
Penalty Throws /Jet de 7 Metres	3-2	1-1	0-0	0-1	0-0	4-4
Free Throws /Jet Franc	0-0	0-1	0-0	0-0	0-1	0-2
Fast Breaks /Contre Attaques	5-2	0-0	0-0	0-0	0-0	5-2
** Total **	21-19	16-13	4-2	4-3	6-3	51-40
Assist	6-5		Suspension 2 Min.			2-3
Error/Erreur	12-27		Disqualification			0-0
Warning/Avertissement	2-1		Expulsion			0-0

Handball

Women Final /Sept. 21-29

Femmes/Finale /21-29 Sept

< Final Round/Series Finales >

* Group (1-4 Places)/Groupe (1-4 Places)

	KOR	NOR	URS	YUG	Won	Tied	Lost	Pts
1 KOR	*	23-20	21-19	19-22	2	0	1	4
2 NOR	20-23	*	19-19	20-15	1	1	1	3
3 URS	19-21	19-19	*	18-15	1	1	1	3
4 YUG	22-19	15-20	15-18	*	1	0	2	2

* Group (5-8 Places)/Groupe (5-8 Places)

	TCH	CHN	USA	CIV	Won	Tied	Lost	Pts
1 TCH	*	26-21	33-19	34-12	3	0	0	6
2 CHN	21-26	*	31-22	37-12	2	0	1	4
3 USA	19-33	22-31	*	27-16	1	0	2	2
4 CIV	12-34	12-37	16-27	*	0	0	3	0

< Final Standing/Classement Final >

1	KOR	Korea
2	NOR	Norway
3	URS	U.S.S.R.
4	YUG	Yugoslavia
5	TCH	Czechoslovakia
6	CHN	People's Republic of China
7	USA	United States of America
8	CIV	Ivory coast



하 키
Hockey/Hockey



Hockey/Hockey

Officials/Officiels

Fédération Internationale de Hockey (F.I.H.)

President/président
Secretary General/secrétaire général
Technical Delegates/délégués techniques

Etienne Glichitch
Juan Angel Calzado de Castro
Etienne Glichitch
Juan Angel Calzado de Castro

SLOOC Administrative Staff/Personnel Administratif du SLOOC

Commissioner/directeur
Secretary General/secrétaire général
Deputy Secretary General/secrétaire général adjoint
Competition Manager/chef de division de compétitions

Jung Tae Soo
An Dae Won
Kim Youg Sup
Kim Dong Han
Chun Yeoug Sun

Competitors/Concurrents

Men
Hommes

Competitors
Competiteurs

Countries
Pays

192

12

Women
Femmes

Competitors
Competiteurs

Countries
Pays

128

8

Legend/Notation

* Starter/Partant
+ Substitute In/Remplacant (Terrain)
— Substitute Out/Remplacant (Touche)



Hockey

Men Prelim. Round Group A Match 1/Sept. 18				Hommes Series Prelim. Groupe A Match 1/18 Sept			
Ctry	No.	Name	Goals	Ctry	No.	Name	Goals
Pays	Doss	Nom	Buts	Pays	Doss	Nom	Buts
PAK	5-1	ESP (0-1,5-0)		*ESP*	01	Rovira, Miguel	0*
	01	Mansoor Ahmed	0*		02	Escude, Ignacio	0*
	02	Nasir Ali	0*		03	Malgosa, Joaquin	0*
	03	Qazi Mohib-Ur-Rehman	0*		04	Gomez, Andres	0+
	04	Aamir-Zafar	0*		05	Garcia, Juan	0*
	05	Ishtiaq Ahmed	0		06	Armengol, Jaime	0-
	06	Naeem Akhtar	0*		07	Peon, Juan Carlos	1-
	07	Qamar Ibrahim	2*		08	Malgosa, Juan	0*
	08	Shahbaz Ahmed	0*		09	Escude, Jaime	0+
	09	Tariq Sheikh	1*		10	Escude, Javier	0*
	10	Zahid Sharif	2*		11	Oliva, Jorge	0+
	11	Khalid Hamid	0+		12	Ortego, Miguel	0
	12	Rizwan Munir	0		13	De Paz, Miguel	0*
	13	Khalid Bashir	0*		14	Fabregas, Eduardo	0-
	14	Naeem Amjad	0		15	Iglesias, Jose Antonio	0*
	15	Tahir Zaman	0		16	Grau, Santiago	0
	16	Musaddiz Hussain	0-				

Coach/Entraîneur: Manzoor-UI-Hassan, Manzoor
Asst. Coach/Entraîneur Adj.:
Manager/Chef d'Equipe: Ahsan Alam

Coach/Entraîneur: Cortes Villa, Santiago
Asst. Coach/Entraîneur Adj.:
Manager/Chef d'Equipe: Aurell, Pep

Event	Total	1st	Half	2nd	Half	Extra Period
Evenement	Total	1ere	Mi-temps	2eme	Mi-temps	Prolongation
Shot on Goal / Lancer au But	10-8	2-3		8-5		0-0
Field Goal/But de Champ	5-1	0-1		5-0		0-0
P-Stroke Goal / But de Coup Penalty	0-0	0-0		0-0		0-0
P-Corner Goal / But de Penalty Coin	0-0	0-0		0-0		0-0
Cor-Hit Goal/But de Coup Coin	0-0	0-0		0-0		0-0
Assist / Assistance	0-0	0-0		0-0		0-0
Off-Side/Hors Jeu	5-2	2-0		3-2		0-0
Warning / Avertissement	2-2	1-1		1-1		0-0

Men Prelim. Round Group A Match 2/Sept. 18				Hommes Series Prelim. Groupe A Match 2/18 Sept			
Ctry	No.	Name	Goals	Ctry	No.	Name	Goals
Pays	Doss	Nom	Buts	Pays	Doss	Nom	Buts
HOL	5-1	ARG (2-1,3-0)		*ARG*	01	Schmitt, Otto	0-
	01	Leistra, Prank	0*		02	Siri, Alejandro	0-
	02	Benninga, Marc	0+		03	Altube, Miguel	0*
	03	Diepeveen, Cees Jan	0*		04	Mascheroni, Marcelo	0*
	04	Cruug, Maurits	0-		05	Garraffo, Marcelo	0*
	05	Klaassen, Rene	0*		06	Pailos, Edgardo	0*
	06	Kooijman, Hendrik Jan	0*		07	Doherty, Alejandro	0*
	07	Delissen, Marc	1*		08	Ayala, Aldo	0*
	08	Brinkman, Jacques	0*		09	Geneyro, Carlos	1-
	09	Schlatmann, Gerrit Jan	0+		10	Minadeo, Gabriel	0+
	10	Steens, Tim	0		11	Verga, Alejandro	0*
	11	Bove Lander, Floris Jan	2*		12	Ferrara, Fernando	0*
	12	Faber, Patrick	0		13	Roggero, Emanuel	0+
	13	Jansen, Ronald	0		14	Nicola, Franco	0
	14	Kruize, Jan Hidde	0-		15	Sordelli, Martin	0+
	15	Parlevliet, Erik	1*		16	Silva, Mariano	0
	16	Van Den Honert, Taco	1*				

Coach/Entraîneur: Jorritsma, Hans
Asst. Coach/Entraîneur Adj.:
Manager/Chef d'Equipe: Spits, Nico

Coach/Entraîneur:
Asst. Coach/Entraîneur Adj.:
Manager/Chef d'Equipe:

Event	Total	1st	Half	2nd	Half	Extra Period
Evenement	Total	1ere	Mi-temps	2eme	Mi-temps	Prolongation
Shot on Goal/Lancer au But	9-9	5-4		4-5		0-0
Field Goal/But de Champ	3-0	0-0		3-0		0-0
P-Stroke Goal / But de Coup Penalty	0-0	0-0		0-0		0-0
P-Corner Goal/But de Penalty Coin	2-1	2-1		0-0		0-0
Cor-Hit Goal/But de Coup Coin	0-0	0-0		0-0		0-0
Assist/Assistance	0-0	0-0		0-0		0-0
Off-Side/Hors Jeu	4-2	3-1		1-1		0-0
Warning/Avertissement	2-0	0-0		2-0		0-0

Men Prelim. Round Group A Match 3/Sept. 18				Hommes Series Prelim. Groupe A Match 3/18 Sept			
Ctry	No.	Name	Goals	Ctry	No.	Name	Goals
Pays	Doss	Nom	Buts	Pays	Doss	Nom	Buts
AUS	7-1	KEN (3-0, 4-1)		*KEN*	01	Omany, Paul Sewe	0*
	01	Davies, Craig	0*		02	Saini, Parminder	0*
	02	Batch, Colin	1*		03	Odhier, Roy	0*
	03	Bestall, John	0+		04	Oguk, Charles	0*
	04	Birmingham, Warren	2*		05	Okoth, John Eliud	0*
	05	Charlesworth, Richard	0+		06	Omondi, Michael	0*
	06	Deane, Andrew	0-		07	Ngoyo, Sam	0+
	07	York, Michael	0		08	Akatsa, Peter	0*
	08	Hager, Mark	3*		09	Goyal, Sanjivan	1*
	09	Stacy, Jay	0+		10	Otambo, Christopher	0*
	10	Hawgood, Neil	0*		11	Alubaha, Lucas	0
	11	Noel, Peter	0		12	Owino, Victor	0-
	12	Reid, Graham	0*		13	Oriso, Samson	0
	13	Smith, Roger	0*		14	Matharu, Inderjit	0*
	14	Snowden, Niel	0*		15	Muange, Samson	0
	15	Wansbrough, David	1-		16	Mutua, Julius	0
	16	Wark, Ken	0-				

Coach/Entraîneur: Aggiss, Richard
Asst. Coach/Entraîneur Adj.: Piper, Desmond
Manager/Chef d'Equipe: Berry, A.T.

Coach/Entraîneur:
Asst. Coach/Entraîneur Adj.:
Manager/Chef d'Equipe:

Hockey

Event	Total	1st	Half	2nd	Half	Extra Period
Evenement	Total	1ere	Mi-temps	2eme	Mi-temps	Prolongation
Shot on Goal / Lancer au But	23-5	11-2		12-3		0-0
Field Goal/But de Champ	5-1	1-0		4-1		0-0
P-Stroke Goal / But de Coup Penalty	2-0	2-0		0-0		0-0
P-Corner Goal/But de Penalty Coin	0-0	0-0		0-0		0-0
Cor-Hit Goal/But de Coup Coin	0-0	0-0		0-0		0-0
Assist / Assistance	0-0	0-0		0-0		0-0
Off-Side/Hors Jeu	2-0	1-0		1-0		0-0
Warning / Avertissement	1-0	0-0		1-0		0-0

Men Prelim. Round Group A Match 4/Sept. 20				Hommes Series Prelim. Groupe A Match 4/20 Sept			
Ctry	No.	Name	Goals	Ctry	No.	Name	Goals
Pays	Doss	Nom	Buts	Pays	Doss	Nom	Buts
AUS	4-0	ARG (2-0, 2-0)		*AUS*	01	Davies, Craig	0*
	01	Davies, Craig	0*		02	Siri, Alejandro	0*
	02	Batch, Colin	0-		03	Altube, Miguel	0-
	03	Bestall, John	0		04	Mascheroni, Marcelo	0*
	04	Birmingham, Warren	1*		05	Garraffo, Marcelo	0*
	05	Charlesworth, Richard	0*		06	Pailos, Edgardo	0*
	06	Deane, Andrew	0+		07	Doherty, Alejandro	0-
	07	York, Michael	0+		08	Ayala, Aldo	0-
	08	Hager, Mark	2*		09	Geneyro, Carlos	0*
	09	Stacy, Jay	0		10	Minadeo, Gabriel	0+
	10	Hawgood, Neil	1*		11	Verga, Alejandro	0*
	11	Noel, Peter	0+		12	Ferrara, Fernando	0*
	12	Reid, Graham	0*		13	Roggero, Emanuel	0*
	13	Smith, Roger	0-		14	Nicola, Franco	0+
	14	Snowden, Neil	0-		15	Sordelli, Martin	0+
	15	Wansbrough, David	0*		16	Silva, Mariano	0
	16	Wark, Ken	0*				

Coach/Entraîneur: Aggiss, Richard
Asst. Coach/Entraîneur Adj.: Piper, Desmond
Manager/Chef d'Equipe: Berry, A.T.

Coach/Entraîneur:
Asst. Coach/Entraîneur Adj.:
Manager/Chef d'Equipe:

Event	Total	1st	Half	2nd	Half	Extra Period
Evenement	Total	1ere	Mi-temps	2eme	Mi-temps	Prolongation
Shot on Goal / Lancer au But	16-4	6-1		10-3		0-0
Field Goal/But de Champ	3-0	1-0		2-0		0-0
P-Stroke Goal / But de Coup Penalty	0-0	0-0		0-0		0-0
P-Corner Goal / But de Penalty Coin	0-0	0-0		0-0		0-0
Cor-Hit Goal/But de Coup Coin	1-0	1-0		0-0		0-0
Assist / Assistance	0-0	0-0		0-0		0-0
Off-Side/Hors Jeu	7-2	3-0		4-2		0-0
Warning / Avertissement	2-3	1-1		1-2		0-0

Men Prelim. Round Group A Match 5/Sept. 20				Hommes Series Prelim. Groupe A Match 5/20 Sept			
Ctry	No.	Name	Goals	Ctry	No.	Name	Goals
Pays	Doss	Nom	Buts	Pays	Doss	Nom	Buts
HOL	1-1	ESP (0-0, 1-1)		*HOL*	01	Leistra, Prank	0*
	01	Leistra, Prank	0*		02	Escude, Ignacio	1*
	02	Benninga, Marc	0+		03	Malgosa, Joaquin	0*
	03	Diepeveen, Cees Jan	0*		04	Gomez, Andres	0+
	04	Cruug, Maurits	0-		05	Garcia, Juan	0*
	05	Klaassen, Rene	0*		06	Armengol, Jaime	0-
	06	Kooijman, Hendrik Jan	1*		07	Peon, Juan Carlos	0-
	07	Delissen, Marc	0*		08	Malgosa, Juan	0*
	08	Brinkman, Jacques	0*		09	Escude, Jaime	0+
	09	Schlatmann, Gerrit Jan	0+		10	Escude, Javier	0*
	10	Steens, Tim	0		11	Oliva, Jorge	0*
	11	Bove lander, Floris Jan	0*		12	Ortego, Miguel	0
	12	Faber, Patrick	0		13	De paz, Miguel	0*
	13	Jansen, Ronald	0		14	Fabregas, Eduardo	0
	14	Kruize, Jan Hidde	0*		15	Iglesias, Jose Antonio	0*
	15	Parlevliet, Erik	0-		16	Grau, Santiago	0*
	16	Van den honert, Taco	0*				

Coach/Entraîneur: Jorritsma, Hans
Asst. Coach/Entraîneur Adj.:
Manager/Chef d'Equipe: Spits, Nico

Coach/Entraîneur: Cortes Villa, Santiago
Asst. Coach/Entraîneur Adj.:
Manager/Chef d'Equipe: Aurell, Pep

Event	Total	1st	Half	2nd	Half	Extra Period
Evenement	Total	1ere	Mi-temps	2eme	Mi-temps	Prolongation
Shot on Goal/Lancer au But	4-7	3-3		1-4		0-0
Field Goal/But de Champ	0-0	0-0		0-0		0-0
P-Stroke Goal / But de Coup Penalty	1-0	0-0		1-0		0-0
P-Corner Goal/But de Penalty Coin	0-1	0-0		0-1		0-0
Cor-Hit Goal/But de Coup Coin	0-0	0-0		0-0		0-0
Assist/Assistance	0-0	0-0		0-0		0-0
Off-Side/Hors Jeu	5-1	1-1		4-0		0-0
Warning / Avertissement	2-0	0-0		2-0		0-0



Men Prelim. Round Group A Match 6/Sept. 20				Hommes Series Prelim. Groupe A Match 6/20 Sept			
Ctry Pays	No. Doss	Name Nom	Goals Buts	Ctry Pays	No. Doss	Name Nom	Goals Buts
PAK	8-0	KEN (4-0, 4-0)					
PAK	01	Mansoor Ahmed	0*	*KEN*	01	Omany, Paul Sewe	0-
	02	Nasir Ali	0*		02	Saini, Parminder	0*
	03	Qazi Mohib-Ur-Rehman	1*		03	Odhier, Roy	0
	04	Aamir-Zafar	0		04	Oguk, Charles	0*
	05	Ishtiaq Ahmed	0		05	Okoth, John Eliud	0*
	06	Naeem Akhtar	0*		06	Omondi, Michael	0-
	07	Qamar Ibrahim	0*		07	Ngoyo, Sam	0+
	08	Shahbaz Ahmed	2*		08	Akatsa, Peter	0+
	09	Tariq Sheikh	4*		09	Goyal, Sanjiwan	0*
	10	Zahid Sharif	1*		10	Otambo, Christopher	0*
	11	Khalid Hamid	0-		11	Alubaha, Lucas	0*
	12	Rizwan Munir	0		12	Owino, Victor	0
	13	Khalid Bashir	0*		13	Oriso, Samson	0-
	14	Naeem Amjad	0*		14	Matharu, Inderjit	0*
	15	Tahir Zaman	0		15	Muange, Samson	0*
	16	Musaddiz Hussain	0+		16	Mutua, Julius	0+

Coach/Entraîneur: Manzoor-Ul-Hassan, Manzoor
Asst. Coach/Entraîneur Adj.:
Manager/Chef d'Equipe: Siddiqui, Islahuddin

Coach/Entraîneur:
Asst. Coach/Entraîneur Adj.:
Manager/Chef d'Equipe

Event Evenement	Total Total	1st 1ere	Half Mi-temps	2nd 2eme	Half Mi-temps	Extra Period Prolongation
Shot on Goal/Lancer au But	21-11	11-8		10-3		0-0
Field Goal/But de Champ	7-0	3-0		4-0		0-0
P-Stroke Goal/But de Coup Penalty	1-0	1-0		0-0		0-0
P-Corner Goal/But de Penalty Coin	0-0	0-0		0-0		0-0
Cor-Hit Goal/But de Coup Coin	0-0	0-0		0-0		0-0
Assist/Assistance	0-0	0-0		0-0		0-0
Off-Side/Hors Jeu	2-1	0-0		2-1		0-0
Warning / Avertissement	0-2	0-1		0-1		0-0

Men Prelim. Round Group A Match 7/Sept. 22				Hommes Series Prelim. Groupe A Match 7/22 Sept			
Ctry Pays	No. Doss	Name Nom	Goals Buts	Ctry Pays	No. Doss	Name Nom	Goals Buts
PAK	2-1	ARG (1-0/1-1)					
	01	Mansoor Ahmed	0*	*ARG*	01	Schmitt, Otto	0
	02	Nasir Ali	0*		02	Siri, Alejandro	0-
	03	Qazi Mohib-Ur-Rehman	0*		03	Altube, Miguel	0*
	04	Aamir-Zafar	0		04	Mascheroni, Marcelo	1*
	05	Ishtiaq Ahmed	0		05	Garraffo, Marcelo	0*
	06	Naeem Akhtar	0*		06	Pailos, Edgardo	0*
	07	Qamar Ibrahim	0*		07	Doherty, Alejandro	0-
	08	Shahbaz Ahmed	1*		08	Ayala, Aldo	0*
	09	Tariq Sheikh	0*		09	Genevro, Carlos	0*
	10	Zahid Sharif	1-		10	Minadeo, Gabriel	0+
	11	Khalid Hamid	0*		11	Verga, Alejandro	0-
	12	Rizwan Munir	0		12	Ferrara, Fernando	0+
	13	Khalid Bashir	0*		13	Roggero, Emanuel	0*
	14	Naeem Amjad	0*		14	Nicola, Franco	0*
	15	Tahir Zaman	0+		15	Sordelli, Martin	0+
	16	Musaddiz Hussain	0		16	Silva, Mariano	0

Coach/Entraîneur: Manzoor-Ul-Hassan, Manzoor
Asst. Coach/Entraîneur Adj.:
Manager/Chef d'Equipe: Siddiqui, Islahuddin

Coach/Entraîneur:
Asst. Coach/Entraîneur Adj.:
Manager/Chef d'Equipe:

Event Evenement	Total Total	1st 1ere	Half Mi-temps	2nd 2eme	Half Mi-temps	Extra Period Prolongation
Shot on Goal/Lancer au But	10-3	4-1		6-2		0-0
Field Goal/But de Champ	2-0	1-0		1-0		0-0
P-Stroke Goal/But de Coup Penalty	0-0	0-0		0-0		0-0
P-Corner Goal/But de Penalty Coin	0-1	0-0		0-1		0-0
Cor-Hit Goal/But de Coup Coin	0-0	0-0		0-0		0-0
Assist / Assistance	0-0	0-0		0-0		0-0
Off-Side/Hors Jeu	8-1	3-0		5-1		0-0
Warning / Avertissement	1-3	1-1		0-2		0-0

Men Prelim. Round Group A Match 8/Sept. 22				Hommes Series Prelim. Groupe A Match 8/22 Sept			
Ctry Pays	No. Doss	Name Nom	Goals Buts	Ctry Pays	No. Doss	Name Nom	Goals Buts
KEN	2-4	ESP (1-3, 1-1)					
KEN	01	Omany, Paul Sewe	0-	*ESP*	01	Rovira, Miguel	0*
	02	Saini, Parminder	0*		02	Escude, Ignacio	1*
	03	Odhier, Roy	0+		03	Malgosa, Joaquin	0*
	04	Oguk, Charles	0*		04	Gomez, Andres	0+
	05	Okoth, John Eliud	1*		05	Garcia, Juan	0*
	06	Omondi, Michael	0		06	Armengol, Jaime	0+
	07	Ngoyo, Sam	0*		07	Peon, Juan Carlos	0-
	08	Akatsa, Peter	0*		08	Malgosa, Juan	0*
	09	Goyal, Sanjiwan	0*		09	Escude, Jaime	0-
	10	Otambo, Christopher	0*		10	Escude, Javier	1*
	11	Alubaha, Lucas	0*		11	Oliva, Jorge	1+
	12	Owino, Victor	0		12	Ortego, Miguel	0
	13	Oriso, Samson	0		13	De paz, Miguel	1*
	14	Matharu, Inderjit	1*		14	Fabregas, Eduardo	0-
	15	Muange, Samson	0-		15	Iglesias, Jose Antonio	0*
	16	Mutua, Julius	0+		16	Grau, Santiago	0

Coach/Entraîneur: Lall, Gursharam Singh
Asst. Coach/Entraîneur Adj.:
Manager/Chef d'Equipe: Hardev, Singh

Coach/Entraîneur: Cortes Villa, Santiago
Asst. Coach/Entraîneur Adj.:
Manager/Chef d'Equipe: Aurell, Pep

Event Evenement	Total Total	1st 1ere	Half Mi-temps	2nd 2eme	Half Mi-temps	Extra Period Prolongation
Shot on Goal/Lancer au But	9-14	6-9		3-5		0-0
Field Goal/But de Champ	2-3	1-3		1-0		0-0
P-Stroke Goal/But de Coup Penalty	0-0	0-0		0-0		0-0
P-Corner Goal/But de Penalty Coin	0-1	0-0		0-1		0-0
Cor-Hit Goal/But de Coup Coin	0-0	0-0		0-0		0-0
Assist/Assistance	0-0	0-0		0-0		0-0
Off-Side/Hors Jeu	4-1	1-0		3-1		0-0
Warning/Avertissement	3-4	0-1		3-3		0-0

Men Prelim. Round Group A Match 9/Sept. 22				Hommes Series Prelim. Groupe A Match 9/22 Sept			
Ctry Pays	No. Doss	Name Nom	Goals Buts	Ctry Pays	No. Doss	Name Nom	Goals Buts
AUS	3-2	HOL (2-0, 1-2)					
AUS	01	Davies, Craig	0*	*HOL*	01	Leistra, Frank	0
	02	Batch, Colin	1*		02	Benninga, Marc	0+
	03	Bestall, John	0*		03	Diepeveen, Cees Jan	0*
	04	Birmingham, Warren	0*		04	Crucg, Maurits	0+
	05	Charlesworth, Richard	0*		05	Klaassen, Rene	0-
	06	Deane, Andrew	0+		06	Kooijman, Hendrik Jan	0*
	07	York, Michael	0		07	Delissen, Marc	0*
	08	Hager, Mark	1*		08	Brinkman, Jacques	0-
	09	Stacy, Jay	0		09	Schlatmann, Gerrit Jan	0+
	10	Hawgood, Neil	1-		10	Steens, Tim	0-
	11	Noel, Peter	0		11	Bove Lander, Floris Jan	2*
	12	Reid, Graham	0*		12	Faber, Patrick	0
	13	Smith, Roger	0*		13	Jansen, Ronald	0*
	14	Snowden, Neil	0*		14	Kruize, Jan Hidde	0*
	15	Wansbrough, David	0*		15	Parlevliet, Erik	0*
	16	Wark, Ken	0		16	Van Den Honert, Taco	0*

Coach/Entraîneur: Aggiss, Richard
Asst. Coach/Entraîneur Adj.: Piper, Desmond
Manager/Chef d'Equipe: Berry, A.T.

Coach/Entraîneur: Jorritsma, Hans
Asst. Coach/Entraîneur Adj.:
Manager/Chef d'Equipe: Spits, Nico

Event Evenement	Total Total	1st 1ere	Half Mi-temps	2nd 2eme	Half Mi-temps	Extra Period Prolongation
Shot on Goal / Lancer au But	12-9	4-2		8-7		0-0
Field Goal / But de Champ	3-0	2-0		1-0		0-0
P-Stroke Goal / But de Coup Penalty	0-0	0-0		0-0		0-0
P-Corner Goal/But de Penalty Coin	0-2	0-0		0-2		0-0
Cor-Hit Goal/ But de Coup Coin	0-0	0-0		0-0		0-0
Assist/Assistance	0-0	0-0		0-0		0-0
Off-Side /Hors Jeu	2-0	0-0		2-0		0-0
Warning / Avertissement	3-4	1-3		2-1		0-0

Men Prelim. Round Group A Match 10/Sept. 24				Hommes Series Prelim. Groupe A Match 10/24 Sept			
Ctry Pays	No. Doss	Name Nom	Goals Buts	Ctry Pays	No. Doss	Name Nom	Goals Buts
HOL	2-1	KEN (1-0, 1-1)					
HOL	01	Leistra, Frank	0	*KEN*	01	Omany, Paul Sewe	0*
	02	Benninga, Marc	0-		02	Saini, Parminder	0-
	03	Diepeveen, Cees Jan	0*		03	Odhier, Roy	0*
	04	Crucg, Maurits	0*		04	Oguk, Charles	0*
	05	Klaassen, Rene	0+		05	Okoth, John Eliud	0*
	06	Kooijman, Hendrik Jan	0*		06	Omondi, Michael	0+
	07	Delissen, Marc	0*		07	Ngoyo, Sam	0*
	08	Brinkman, Jacques	0-		08	Akatsa, Peter	0*
	09	Schlatmann, Gerrit Jan	0*		09	Goyal, Sanjiwan	0*
	10	Steens, Tim	0		10	Otambo, Christopher	0-
	11	Bove Lander, Floris Jan	1*		11	Alubaha, Lucas	0*
	12	Faber, Patrick	0*		12	Owino, Victor	0
	13	Jansen, Ronald	0*		13	Oriso, Samson	0
	14	Kruize, Jan Hidde	0*		14	Matharu, Inderjit	1*
	15	Parlevliet, Erik	0+		15	Muange, Samson	0+
	16	Van Den Honert, Taco	1*		16	Mutua, Julius	0

Coach/Entraîneur: Jorritsma, Hans
Asst. Coach/Entraîneur Adj.:
Manager/Chef d'Equipe: Spits, Nico

Coach/Entraîneur: Lall, Gursharam Singh
Asst. Coach/Entraîneur Adj.:
Manager/Chef d'Equipe: Hardev, Singh

Event Evenement	Total Total	1st 1ere	Half Mi-temps	2nd 2eme	Half Mi-temps	Extra Period Prolongation
Shot on Goal/Lancer au But	18-7	7-0		11-7		0-0
Field Goal/But de Champ	1-0	0-0		1-0		0-0
P-Stroke Goal/But de Coup Penalty	0-1	0-0		0-1		0-0
P-Corner Goal/But de Penalty Coin	1-0	1-0		0-0		0-0
Cor-Hit Goal/But de Coup Coin	0-0	0-0		0-0		0-0
Assist/Assistance	0-0	0-0		0-0		0-0
Off-Side/Hors Jeu	2-0	1-0		1-0		0-0
Warning/Advertissement	4-3	2-1		2-2		0-0

Hockey

Men Prelim. Round Group A Match 11/Sept. 24				Hommes Series Prelim. Groupe A Match 11/24 Sept			
Ctry Pays	No. Doss	Name Nom	Goals Buts	Ctry Pays	No. Doss	Name Nom	Goals Buts
AUS	4-0	PAK	(4-0, 0-0)				
AUS	01	Davies, Craig	0-	*PAK*	01	Mansoor Ahmed	0*
	02	Batch, Colin	0-		02	Nasir Ali	0*
	03	Bestall, John	1*		03	Qazi Mohib-Ur-Rehman	0*
	04	Birmingham, Warren	0*		04	Aamir-Zafar	0+
	05	Charlesworth, Richard	0*		05	Ishtiaq Ahmed	0-
	06	Deane, Andrew	0+		06	Naeem Akhtar	0-
	07	York, Michael	0		07	Qamar Ibrahim	0*
	08	Hager, Mark	1-		08	Shahbaz Ahmed	0*
	09	Stacy, Jay	0+		09	Tariq Sheikh	0*
	10	Hawgood, Neil	2*		10	Zahid Sharif	0*
	11	Noel, Peter	0		11	Khalid Hamid	0-
	12	Reid, Graham	0*		12	Rizwan Munir	0
	13	Smith, Roger	0*		13	Khalid Bashir	0*
	14	Snowden, Neil	0*		14	Naeem Amjad	0+
	15	Wansbrough, David	0*		15	Tahir Zaman	0
	16	Wark, Ken	0+		16	Musaddiz Hussain	0+

Coach/Entraîneur: Aggiss, Richard
Asst. Coach/Entraîneur Adj.: Piper, Desmond
Manager/Chef d'Equipe: Berry, A.T.

Coach/Entraîneur: Manzoor Ul Hassan
Asst. Coach/Entraîneur Adj.:
Manager/Chef d'Equipe: Siddiqui, Islahuddin

Event Evenement	Total Total	1st 1ere	Half Mi-temps	2nd 2eme	Half Mi-temps	Extra Period Prolongation
Shot on Goal / Lancer au But	16-4	12-1		4-3		0-0
Field Goal/But de Champ	3-0	3-0		0-0		0-0
P-Stroke Goal / But de Coup Penalty	0-0	0-0		0-0		0-0
P-Corner Goal/But de Penalty Coin	1-0	1-0		0-0		0-0
Cor-Hit Goal/But de Coup Coin	0-0	0-0		0-0		0-0
Assist / Assistance	0-0	0-0		0-0		0-0
Off-Side/HorsJeu	3-0	1-0		2-0		0-0
Warning / Avertissement	0-4	0-2		0-2		0-0

Men Prelim. Round Group A Match 12/Sept. 24				Hommes Series Prelim. Groupe A Match 12/24 Sept			
Ctry Pays	No. Doss	Name Nom	Goals Buts	Ctry Pays	No. Doss	Name Nom	Goals Buts
ARG	1-0	ESP	(0-0, 1-0)				
ARG	01	Schmitt, Otto	0	*ESP*	01	Rovira, Miguel	0
	02	Siri, Alejandro	0*		02	Escude, Ignacio	0*
	03	Altube, Miguel	0*		03	Malgosa, Joaquin	0*
	04	Mascheroni, Marcelo	0*		04	Gomez, Andres	0+
	05	Garraffo, Marcelo	0*		05	Garcia, Juan	0*
	06	Pailos, Edgardo	0*		06	Armengol, Jaime	0*
	07	Doherty, Alejandro	0+		07	Peon, Juan Carlos	0-
	08	Ayala, Aldo	0-		08	Malgosa, Juan	0*
	09	Geneyro, Carlos	0*		09	Escude, Jaime	0
	10	Minadeo, Gabriel	0-		10	Escude, Javier	0*
	11	Verga, Alejandro	0-		11	Oliva, Jorge	0*
	12	Ferrara, Fernando	1*		12	Ortego, Miguel	0
	13	Roggero, Emanuel	0*		13	De Paz, Miguel	0*
	14	Nicola, Franco	0+		14	Fabregas, Eduardo	0
	15	Sordelli, Martin	0+		15	Iglesias, Jose Antonio	0*
	16	Silva, Mariano	0		16	Grau, Santiago	0*

Coach/Entraîneur: Luis, Ciancia
Asst. Coach/Entraîneur Adj.:
Manager/Chef d'Equipe: Eduardo, Guelfand

Coach/Entraîneur: Cortes Villa, Santiago
Asst. Coach/Entraîneur Adj.:
Manager/Chef d'Equipe: Aurell, Pep

Event Evenement	Total Total	1st 1ere	Half Mi-temps	2nd 2eme	Half Mi-temps	Extra Period Prolongation
Shot on Goal / Lancer au But	5-11	2-4		3-7		0-0
Field Goal/But de Champ	1-0	0-0		1-0		0-0
P-Stroke Goal / But de Coup Penalty	0-0	0-0		0-0		0-0
P-Corner Goal / But de Penalty Coin	0-0	0-0		0-0		0-0
Cor-Hit Goal/But de Coup Coin	0-0	0-0		0-0		0-0
Assist / Assistance	0-0	0-0		0-0		0-0
Off-Side/Hors Jeu	3-2	1-1		2-1		0-0
Warning / Avertissement	1-0	0-0		1-0		0-0

Men Prelim. Round Group A Match 13/Sept. 26				Hommes Series Prelim. Groupe A Match 13/26 Sept			
Ctry Pays	No. Doss	Name Nom	Goals Buts	Ctry Pays	No. Doss	Name Nom	Goals Buts
AUS	1-0	ESP	(0-0,1-0)				
AUS	01	Davies, Craig	0*	*ESP*	01	Rovira, Miguel	0
	02	Batch, Colin	0		02	Escude, Ignacio	0*
	03	Bestall, John	0*		03	Malgosa, Joaquin	0*
	04	Birmingham, Warren	0-		04	Gomez, Andres	0+
	05	Charlesworth, Richard	0-		05	Garcia, Juan	0*
	06	Deane, Andrew	0*		06	Armengol, Jaime	0*
	07	York, Michael	0*		07	Peon, Juan Carlos	0-
	08	Hager, Mark	0*		08	Malgosa, Juan	0*
	09	Stacy, Jay	1+		09	Escude, Jaime	0+
	10	Hawgood, Neil	0*		10	Escude, Javier	0*
	11	Noel, Peter	0*		11	Oliva, Jorge	0-
	12	Reid, Graham	0*		12	Ortego, Miguel	0
	13	Smith, Roger	0		13	De paz, Miguel	0*
	14	Snowden, Neil	0		14	Fabregas, Eduardo	0
	15	Wansbrough, David	0*		15	Iglesias, Jose Antonio	0*
	16	Wark, Ken	0+		16	Grau, Santiago	0*

Coach/Entraîneur: Aggiss, Richard
Asst. Coach/Entraîneur Adj.: Piper, Desmond
Manager/Chef d'Equipe: Berry, A.T.

Coach/Entraîneur: Cortes Villa, Santiago
Asst. Coach/Entraîneur Adj.:
Manager/Chef d'Equipe: Aurell, Pep

Hockey

Event Evenement	Total Total	1st 1ere	Half Mi-temps	2nd 2eme	Half Mi-temps	Extra Period Prolongation
Shot on Goal/Lancer au But	6-5	0-1		6-4		0-0
Field Goal/But de Champ	0-0	0-0		0-0		0-0
P-Stroke Goal / But de Coup Penalty	0-0	0-0		0-0		0-0
P-Corner Goal / But de Penalty Coin	1-0	0-0		1-0		0-0
Cor-Hit Goal / But de Coup Coin	0-0	0-0		0-0		0-0
Assist / Assistance	0-0	0-0		0-0		0-0
Off-Side /Hors Jeu	5-3	4-2		1-1		0-0
Warning / Avertissement	4-5	1-3		3-2		0-0

Men Prelim. Round Group A Match 14/Sept. 26				Hommes Series Prelim. Groupe A Match 14/26 Sept			
Ctry Pays	No. Doss	Name Nom	Goals Buts	Ctry Pays	No. Doss	Name Nom	Goals Buts
ARG	5-1	KEN	(1-1,4-0)				
ARG	01	Schmitt, Otto	0*	*KEN*	01	Omany, Paul Sewe	0*
	02	Siri, Alejandro	0-		02	Saini, Parminder	0+
	03	Altube, Miguel	0*		03	Odhier, Roy	0*
	04	Mascheroni, Marcelo	1*		04	Oguk, Charles	0*
	05	Garraffo, Marcelo	0*		05	Okoth, John Eliud	0-
	06	Pailos, Edgardo	1-		06	Omondi, Michael	0*
	07	Doherty, Alejandro	0		07	Ngoyo, Sam	0*
	08	Ayala, Aldo	0*		08	Akatsa, Peter	0*
	09	Geneyro, Carlos	0-		09	Goyal, Sanjiwan	0*
	10	Minadeo, Gabriel	1*		10	Otambo, Christopher	0*
	11	Verga, Alejandro	1*		11	Alubaha, Lucas	1*
	12	Ferrara, Fernando	1*		12	Owino, Victor	0
	13	Roggero, Emanuel	0		13	Oriso, Samson	0
	14	Nicola, Franco	0+		14	Matharu, Inderjit	0*
	15	Sordelli, Martin	0+		15	Muange, Samson	0
	16	Silva, Mariano	0+		16	Mutua, Julius	0

Coach/Entraîneur: Luis, Ciancia
Asst. Coach/Entraîneur Adj.:
Manager/Chef d'Equipe: Eduardo, Guelfand

Coach/Entraîneur: Lall, Gursharam Singh
Asst. Coach/Entraîneur Adj.:
Manager/Chef d'Equipe: Hardev, Singh

Event Evenement	Total Total	1st 1ere	Half Mi-temps	2nd 2eme	Half Mi-temps	Extra Period Prolongation
Shot on Goal / Lancer au But	11-4	6-3		5-1		0-0
Field Goal/But de Champ	3-0	0-0		3-0		0-0
P-Stroke Goal / But de Coup Penalty	0-0	0-0		0-0		0-0
P-Corner Goal / But de Penalty Coin	2-1	1-1		1-0		0-0
Cor-Hit Goal/But de Coup Coin	0-0	0-0		0-0		0-0
Assist / Assistance	0-0	0-0		0-0		0-0
Off-Side/Hors Jeu	0-3	0-2		0-1		0-0
Warning / Avertissement	1-1	0-0		1-1		0-0

Men Prelim. Round Group A Match 15/Sept. 26				Hommes Series Prelim. Groupe A Match 15/26 Sept			
Ctry Pays	No. Doss	Name Nom	Goals Buts	Ctry Pays	No. Doss	Name Nom	Goals Buts
HOL	2-0	PAK	(2-0, 0-0)				
HOL	01	Leistra, Frank	0*	*PAK*	01	Mansoor Ahmed	0*
	02	Benninga, Marc	0		02	Nasir Ali	0*
	03	Diepeveen, Cees Jan	0*		03	Qazi Mohib-Ur-Rehman	0-
	04	Crucg, Maurits	0*		04	Aamir-Zafar	0-
	05	Klaassen, Rene	0*		05	Ishtiaq Ahmed	0*
	06	Kooijman, Hendrik Jan	0*		06	Naeem Akhtar	0
	07	Delissen, Marc	0*		07	Qamar Ibrahim	0*
	08	Brinkman, Jacques	0*		08	Shahbaz Ahmed	0*
	09	Schlatmann, Gerrit Jan	0		09	Tariq Sheikh	0*
	10	Steens, Tim	0		10	Zahid Sharif	0*
	11	Bove Lander, Floris Jan	2*		11	Khalid Hamid	0
	12	Faber, Patrick	0		12	Rizwan Munir	0
	13	Jansen, Ronald	0		13	Khalid Bashir	0*
	14	Kruize, Jan Hidde	0*		14	Naeem Amjad	0*
	15	Parlevliet, Erik	0*		15	Tahir Zaman	0+
	16	Van Den Honert, Taco	0*		16	Musaddiz Hussain	0+

Coach/Entraîneur: Jorritsma, Hans
Asst. Coach/Entraîneur Adj.:
Manager/Chef d'Equipe: Spits, Nico

Coach/Entraîneur: Manzoor Ul Hassan
Asst. Coach/Entraîneur Adj.:
Manager/Chef d'Equipe: Siddiqui, Islahuddin

Event Evenement	Total Total	1st 1ere	Half Mi-temps	2nd 2eme	Half Mi-temps	Extra Period Prolongation
Shot on Goal / Lancer au But	8-3	5-1		3-2		0-0
Field Goal/But de Champ	0-0	0-0		0-0		0-0
P-Stroke Goal / But de Coup Penalty	0-0	0-0		0-0		0-0
P-Corner Goal / But de Penalty Coin	2-0	2-0		0-0		0-0
Cor-Hit Goal/But de Coup Coin	0-0	0-0		0-0		0-0
Assist / Assistance	0-0	0-0		0-0		0-0
Off-Side/Hors Jeu	3-2	1-1		2-1		0-0
Warning / Avertissement	1-1	0-0		1-1		0-0



Men
Prelim. Round Group B Match 1/Sept. 28

Hommes
Series Prelim. Groupe B Match 1/28 Sept

Ctry Pays	No Doss	Name Nom	Goals Buts	Ctry Pays	No Doss	Name Nom	Goals Buts
URS	10	IND (1-0, 0-0)					
URS	01	Plechakov, Vladimir	0*	*IND*	01	Rajinder Singh, Rawat	0*
	02	Depoutatov, Viotor	0*		02	Pargat Singh	0*
	03	Ioultchiev, Igor	0*		03	Ashok Kumar	0
	04	Airapetian, Sos	0*		04	MohinderPalSingh	0*
	05	Sankovets, Nikolai	0		05	Maneypandemuttana, Somaya	0*
	06	Antakov, Vladimir	0*		06	Vivek Singh	0-
	07	Tchetchenov, Viatcheslav	0*		07	Sujit Kumar	0*
	08	Atanov, Igor	0-		08	Baladadalaiaash, Subramani	0+
	09	Chakhvorostov, Serguei	0+		09	Mohammad Shahid	0+
	10	Plechakov, Serguei	0-		10	Jude Felix Sebastian	0*
	11	Nitchevrourenko, Mikhail	0		11	Balwinder Singh	0-
	12	Domachev, Alexandre	0		12	Mervyn Ernadis, Mervyn	0*
	13	Davydov, Igor	1*		13	Thoiba Singh	0*
	14	Miasnikov, Alexandre	0*		14	Gundeep Kumar	0-
	15	Netchaev, Evgueni	0+		15	Jagbir Singh	0+
	16	Boukatme, Mikhail	0*		16	Markphiliip, Patterson	0

Coach/Entraîneur: Pavlovski, Leonid
Asst. Coach/Entraîneur Adj.: Ossintsev, Mikhail
Manager/Chef d'Equipe:

Coach/Entraîneur: Bilimoggaputtaswamy, Govin
Asst. Coach/Entraîneur Adj.:
Manager/Chef d'Equipe: Sharma, Jamanlal

Event Evenement	Total Total	1st 1ere	Half Mi-temps	2nd 2eme	Half Mi-temps	Extra Period Prolongation
Shot on Goal/Lancer au But	8-5	2-4		6-1		0-0
Field Goal/But de Champ	1-0	1-0		0-0		0-0
P-Stroke Goal/But de Coup Penalty	0-0	0-0		0-0		0-0
P-Corner Goal / But de Penalty Coin	0-0	0-0		0-0		0-0
Cor-Hit Goal/But de Coup Coin	0-0	0-0		0-0		0-0
Assist/Assistance	0-0	0-0		0-0		0-0
Off-Side/Hors Jeu	3-5	1-4		2-1		0-0
Warning / Avertissement	1-0	0-0		1-0		0-0

Men
Prelim. Round Group B Match 2/Sept. 18

Hommes
Series Prelim. Groupe B Match 2/18 Sept

Ctry Pays	No. Doss	Name Nom	Goals Buts	Ctry Pays	No. Doss	Name Nom	Goals Buts
FRG	3-1	CAN (2-1, 1-0)					
FRG	01	Schliemann, Christian	0	*CAN*	01	Rutledge, Michael Ross	0*
	02	Frank, Tobias	0*		02	Sandhu, Hargurnek	0*
	03	Haenel, Ulrich	0*		03	Albert, Rick	0*
	04	Fischer, Carsten	1*		04	Burrows, Patrick	0*
	05	Mollandin, Andreas	0		05	Chohan, Satinder	0*
	06	Schmidt-Opper, Ekkhard	0*		06	Gifford, Christopher	1 -
	07	Brinkmann, Dirk	0*		07	Grimmer, Wayne	0 -
	08	Dopp, Heiner	0-		08	Rai, Ranjeet	0 +
	09	Bloecher, Stefan	1-		09	Milkovich, Peter	0 +
	10	Keller, Andreas	0*		10	Porritt, Trevor	0*
	11	Reck, Thomas	1*		11	Bird, Robert Ian	0*
	12	Brinkmann, Thomas	0 +		12	Harris, Douglas	0
	13	Fastrich, Hanns-Henning	0		13	Muller, Michael	0
	14	Hilgers, Michael	0 +		14	Caruso, Pasouale	0*
	15	Fried, Volker	0*		15	Dube, Ajay	0
	16	Metz, Michael	0*		16	Goodwin, Ken	0*

Coach/Entraîneur: Kleiter, Klaus
Asst. Coach/Entraîneur Adj.:
Manager/Chef d'Equipe: Schneider, Kurt

Coach/Entraîneur: Clarke, Trevor
Asst. Coach/Entraîneur Adj.:
Manager/Chef d'Equipe: Crooks, Dennis

Event Evenement	Total Total	1st 1ere	Half Mi-temps	2nd 2eme	Half Mi-temps	Extra Period Prolongation
Shot on Goal / Lancer au But	18-11	13-4		5-7		0-0
Field Goal/But de Champ	2-0	1-0		1-0		0-0
P-Stroke Goal/But de Coup Penalty	0-0	0-0		0-0		0-0
P-Corner Goal / But de Penalty Coin	1-1	1-1		0-0		0-0
Cor-Hit Goal/But de Coup Coin	0-0	0-0		0-0		0-0
Assist/Assistance	0-0	0-0		0-0		0-0
Off-Side/ Hors Jeu	5-0	4-0		1-0		0-0
Warning / Avertissement	0-1	0-1		0-0		0-0

Men
Prelim. Round Group B Match 3/Sept. 18

Hommes
Series Prelim. Groupe B Match 3/18 Sept

Ctry Pays	No. Doss	Name Nom	Goals Buts	Ctry Pays	No. Doss	Name Nom	Goals Buts
GBR	2-2	KOR (1-0, 1-2)					
GBR	01	Taylor, Ian	0*	*KOR*	01	Song, Suk-Chan	0*
	02	Pappin, Vervan	0		02	Kim, Young-Joon	0*
	03	Faulkner, David	0*		03	Kim, Jong-Kap	1*
	04	Barber, Paul	1*		04	Chung, Boo-Jin	0*
	05	Martin, Stephen	0		05	Chung, Kye-Suk	0*
	06	Potter, Jon	0*		06	Kim, Jae-Chun	0
	07	Dodds, Richard	0*		07	Kwon, Soon-Pil	0 +
	08	Grimley, Martyn	0*		08	Mo, Ji-Young	0*
	09	Batchelor, Stephen	0 +		09	Ji, Jae-Kwan	0*
	10	Leman, Richard	0-		10	Kim, Man-Whe	1*
	11	Kirkwood, James	0 +		11	Han, Jin-Soo	0-
	12	Bhaura, Dulbir	0-		12	Lee, Heung-Pyo	0
	13	Kerly, Sean	1*		13	Hur, Sang-Young	0 +
	14	Clift, Robert	0*		14	Park, Jae-Sik	0-
	15	Sherwani, Imran	0*		15	Yoo, Seung-Jin	0*
	16	Garcia, Russell	0		16	Shin, Suk-Kyun	0

Coach/Entraîneur: Whitaker, David
Asst. Coach/Entraîneur Adj.:
Manager/Chef d'Equipe: Cotton, Bernard

Coach/Entraîneur: Yoo, Min-Seung
Asst. Coach/Entraîneur Adj.:
Manager/Chef d'Equipe:

Event Evenement	Total Total	1st 1ere	Half Mi-temps	2nd 2eme	Half Mi-temps	Extra Period Prolongation
Shot on Goal/Lancer au But	10-10	3-7		7-3		0-0
Field Goal/But de Champ	2-1	1-0		1-1		0-0
P-Stroke Goal / But de Coup Penalty	0-0	0-0		0-0		0-0
P-Corner Goal/But de Penalty Coin	0-1	0-0		0-1		0-0
Cor-Hit Goal/But de Coup Coin	0-0	0-0		0-0		0-0
Assist / Assistance	0-0	0-0		0-0		0-0
Off-Side/Hors Jeu	2-0	1-0		1-0		0-0
Warning / Avertissement	1-2	1-2		0-0		0-0

Men
Prelim. Round Group B Match 4/Sept. 20

Hommes
Series Prelim. Groupe B Match 4/20 Sept

Ctry Pays	No. Doss	Name Nom	Goals Buts	Ctry Pays	No. Doss	Name Nom	Goals Buts
GBR	3-0	CAN (1-0, 2-0)					
GBR	01	Taylor, Ian	0*	*CAN*	01	Rutledge, Michael Ross	0*
	02	Pappin, Vervan	0		02	Sandhu, Hargurnek	0*
	03	Faulkner, David	0*		03	Albert, Rick	0-
	04	Barber, Paul	1*		04	Burrows, Patrick	0*
	05	Martin, Stephen	0		05	Chohan, Satinder	0*
	06	Potter, Jon	0*		06	Gifford, Christopher	0*
	07	Dodds, Richard	1*		07	Grimmer, Wayne	0 +
	08	Grimley, Martyn	0*		08	Rai, Ranjeet	0 +
	09	Batchelor, Stephen	0 +		09	Milkovich, Peter	0-
	10	Leman, Richard	0-		10	Porritt, Trevor	0*
	11	Kirkwood, James	0		11	Bird, Robert Ian	0*
	12	Bhaura, Dulbir	0-		12	Harris, Douglas	0
	13	Kerly, Sean	0*		13	Muller, Michael	0
	14	Clift, Robert	0*		14	Caruso, Pasouale	0*
	15	Sherwani, Imran	1*		15	Dube, Ajay	0
	16	Garcia, Russell	0 +		16	Goodwin, Ken	0*

Coach/Entraîneur: Whitaker, David
Asst. Coach/Entraîneur Adj.:
Manager/Chef d'Equipe: Cotton, Bernard

Coach/Entraîneur: Clarke, Trevor
Asst. Coach/Entraîneur Adj.:
Manager/Chef d'Equipe: Crooks, Dennis

Event Evenement	Total Total	1st 1ere	Half Mi-temps	2nd 2eme	Half Mi-temps	Extra Period Prolongation
Shot on Goal / Lancer au But	17-2	7-2		10-0		0-0
Field Goal/But de Champ	2-0	1-0		1-0		0-0
P-Stroke Goal / But de Coup Penalty	0-0	0-0		0-0		0-0
P-Corner Goal/But de Penalty Coin	1-0	0-0		1-0		0-0
Cor-Hit Goal/But de Coup Coin	0-0	0-0		0-0		0-0
Assist / Assistance	0-0	0-0		0-0		0-0
Off-Side/Hors Jeu	3-0	2-0		1-0		0-0
Warning/Avertissement	1-1	1-0		0-1		0-0

Men
Prelim. Round Group B Match 5/Sept. 20

Hommes
Series Prelim. Groupe B Match 5/20 Sept

Ctry Pays	No. Doss	Name Nom	Goals Buts	Ctry Pays	No. Doss	Name Nom	Goals Buts
FRG	1-1	IND (1-1, 0-0)					
FRG	01	Schliemann, Christian	0*	*IND*	01	Rajinder Singh, Rawat	0*
	02	Frank, Tobias	0		02	Pargat Singh	0*
	03	Haenel, Ulrich	0*		03	Ashok Kumar	0*
	04	Fischer, Carsten	0*		04	MohinderPalSingh	0 +
	05	Mollandin, Andreas	0		05	Maneypandemuttana, Somaya	0*
	06	Schmidt-Opper, Ekkhard	0*		06	Vivek Singh	0-
	07	Brinkmann, Dirk	0*		07	Sujit Kumar	0-
	08	Dopp, Heiner	0-		08	Baladadalaiaash, Subramani	0 +
	09	Bloecher, Stefan	0		09	Mohammad Shahid	0
	10	Keller, Andreas	0*		10	Jude Felix Sebastian	1*
	11	Reck, Thomas	0*		11	Balwinder Singh	0*
	12	Brinkmann, Thomas	0 +		12	Mervyn Ernadis, Mervyn	0-
	13	Fastrich, Hanns-Henning	0		13	Thoiba Singh	0*
	14	Hilgers, Michael	1*		14	Gundeep Kumar	0*
	15	Fried, Volker	0*		15	Jagbir Singh	0 +
	16	Metz, Michael	0*		16	Mark Philiip, Patterson	0

Coach/Entraîneur: Kleiter, Klaus
Asst. Coach/Entraîneur Adj.:
Manager/Chef d'Equipe: Schneider, Kurt

Coach/Entraîneur: Bilimoggaputtaswamy, Govin
Asst. Coach/Entraîneur Adj.:
Manager/Chef d'Equipe: Jaman Lal Sharma

Event Evenement	Total Total	1st 1ere	Half Mi-temps	2nd 2eme	Half Mi-temps	Extra Period Prolongation
Shot on Goal / Lancer au But	14-8	7-6		7-2		0-0
Field Goal/But de Champ	1-1	1-1		0-0		0-0
P-Stroke Goal / But de Coup Penalty	0-0	0-0		0-0		0-0
P-Corner Goal/But de Penalty Coin	0-0	0-0		0-0		0-0
Cor-Hit Goal/But de Coup Coin	0-0	0-0		0-0		0-0
Assist / Assistance	0-0	0-0		0-0		0-0
Off-Side/Hors Jeu	2-3	1-2		1-1		0-0
Warning / Avertissement	1-2	1-1		0-1		0-0

Hockey

Men Prelim. Round Group B Match 6/Sept. 20				Hommes Series Prelim. Groupe B Match 6/20 Sept			
Ctry Pays	No. Doss	Name Nom	Goals Buts	Ctry Pays	No. Doss	Name Nom	Goals Buts
URS	3-1	KOR	(1-1, 2-0)				
URS	01	Plechakov, Vladimir	0*	*KOR*	01	Song, Suk-Chan	0*
	02	Depoutatov, Viotor	1*		02	Kim, Young-Joon	0*
	03	Ioultchiev, Igor	0*		03	Kim, Jong-Kap	0*
	04	Airapetian, Sos	0*		04	Chung, Boo-Jin	0*
	05	Sankovets, Nikolai	0		05	Chung, Kye-Suk	0*
	06	Antakov, Vladimir	0*		06	Kim, Jae-Chun	0
	07	Tchetchenov, Viatcheslav	0*		07	Kwon, Soon-Pil	0-
	08	Atanov, Igor	0-		08	Mo, Ji-Young	0*
	09	Chakhvorostov, Serguei	0+		09	Ji, Jae-Kwan	0*
	10	Plechakov, Serguei	0-		10	Kim, Man-Whe	0*
	11	Nitchevorenko, Mikhail	0+		11	Han, Jin-Soo	0
	12	Domachev, Alexandre	0		12	Lee, Heung-Pyo	0
	13	Davydov, Igor	1*		13	Hur, Sang-Young	0+
	14	Miasnikov, Alexandre	0*		14	Park, Jae-Sik	0*
	15	Netchaev, Evgueni	0		15	Yoo, Seung-Jin	1*
	16	Boukatine, Mikhail	1*		16	Shin, Suk-Kyun	0

Coach/Entraîneur: Pavlovski, Leonid
Asst. Coach/Entraîneur Adj.: Ossintsev, Mikhail
Manager/Chef d'Equipe:

Coach/Entraîneur: Yoo, Min-Seung
Asst. Coach/Entraîneur Adj.:
Manager/Chef d'Equipe:

Event Evenement	Total Total	1st 1ere	Half Mi-temps	2nd 2eme	Half Mi-temps	Extra Period Prolongation
Shot on Goal/Lancer au But	5-7	2-4		3-3		0-0
Field Goal/But de Champ	2-0	1-0		1-0		0-0
P-Stroke Goal / But de Coup Penalty	0-0	0-0		0-0		0-0
P-Corner Goal/But de Penalty Coin	1-1	0-1		1-0		0-0
Cor-Hit Goal/But de Coup Coin	0-0	0-0		0-0		0-0
Assist/Assistance	0-0	0-0		0-0		0-0
Off-Side/Hors Jeu	2-2	2-1		0-1		0-0
Warning /Avertissement	0-0	0-0		0-0		0-0

Men Prelim. Round Group B Match 7/Sept. 22				Hommes Series Prelim. Groupe B Match 7/22 Sept			
Ctry Pays	No. Doss	Name Nom	Goals Buts	Ctry Pays	No. Doss	Name Nom	Goals Buts
KOR	1-3	IND	(1-0, 0-3)				
KOR	01	Song, Suk-Chan	0	*IND*	01	Rajinder Singh, Rawat	0*
	02	Kim, Young-Joon	1*		02	Pargat Singh	0*
	03	Kim, Jong-Kap	0*		03	Ashok Kumar	0*
	04	Chung, Boo-Jin	0*		04	MohinderPal Singh	0*
	05	Chung, Kye-Suk	0*		05	Maneypandemuttana, Somaya	0*
	06	Kim, Jae-Chun	0		06	Vivek Singh	0-
	07	Kwon, Soon-Pil	0+		07	Sujit Kumar	0
	08	Mo, Ji-Young	0-		08	Baladadalaiah, Subramani	0+
	09	Ji, Jae-Kwan	0-		09	Mohammad Shahid	0+
	10	Kim, Man-Whe	0*		10	Jude Felix, Sebastian	1*
	11	Han, Jin-Soo	0*		11	Balwinder Singh	0
	12	Lee, Heung-Pyo	0+		12	Mervyn Eradis, Mervyn	0*
	13	Hur, Sang-Young	0		13	Thoiba Singh	2*
	14	Park, Jae-Sik	0*		14	Gundeep Kumar	0-
	15	Yoo, Seung-Jin	0*		15	Jagbir Singh	0*
	16	Shin, Suk-Kyun	0*		16	Markphilip, Patterson	0

Coach/Entraîneur: Yoo, Min-Seung
Asst. Coach/Entraîneur Adj.:
Manager/Chef d'Equipe:

Coach/Entraîneur: Bilimoggaputtaswamy, Govin
Asst. Coach/Entraîneur Adj.:
Manager/Chef d'Equipe: Jaman Lal Sharma

Event Evenement	Total Total	1st 1ere	Half Mi-temps	2nd 2eme	Half Mi-temps	Extra Period Prolongation
Shot on Goal/Lancer au But	5-15	2-9		3-6		0-0
Field Goal/But de Champ	0-3	0-0		0-3		0-0
P-Stroke Goal / But de Coup Penalty	0-0	0-0		0-0		0-0
P-Corner Goal/But de Penalty Coin	1-0	1-0		0-0		0-0
Cor-Hit Goal/But de Coup Coin	0-0	0-0		0-0		0-0
Assist/Assistance	0-0	0-0		0-0		0-0
Off-Side/Hors Jeu	1-2	1-2		0-0		0-0
Warning/Avertissement	2-1	2-0		0-1		0-0

Men Prelim. Round Group B Match 8/Sept. 22				Hommes Series Prelim. Groupe B Match 8/22 Sept			
Ctry Pays	No. Doss	Name Nom	Goals Buts	Ctry Pays	No. Doss	Name Nom	Goals Buts
URS	0-0	CAN	(0-0, 0-0)				
URS	01	Plechakov, Vladimir	0*	*CAN*	01	Rutledge, Michael Ross	0*
	02	Depoutatov, Viotor	0-		02	Sandhu, Hargurnek	0*
	03	Ioultchiev, Igor	0*		03	Albert, Rick	0*
	04	Airapetian, Sos	0*		04	Burrows, Patrick	0*
	05	Sankovets, Nikolai	0		05	Chohan, Satinder	0*
	06	Antakov, Vladimir	0*		06	Gifford, Christopher	0+
	07	Tchetchenov, Viatcheslav	0*		07	Grimmer, Wayne	0
	08	Atanov, Igor	0		08	Rai, Ranjeet	0+
	09	Chakhvorostov, Serguei	0*		09	Milkovich, Peter	0-
	10	Plechakov, Serguei	0*		10	Porritt, Trevor	0-
	11	Nitchevorenko, Mikhail	0+		11	Bird, Robert Ian	0*
	12	Domachev, Alexandre	0		12	Harris, Douglas	0
	13	Davydov, Igor	0*		13	Muller, Michael	0*
	14	Miasnikov, Alexandre	0*		14	Caruso, Pasouale	0*
	15	Netchaev, Evgueni	0		15	Dube, Ajay	0
	16	Boukatine, Mikhail	0*		16	Goodwin, Ken	0*

Coach/Entraîneur: Pavlovski, Leonid
Asst. Coach/Entraîneur Adj.: Ossintsev, Mikhail
Manager/Chef d'Equipe:

Coach/Entraîneur: Clarke, Trevor
Asst. Coach/Entraîneur Adj.:
Manager/Chef d'Equipe: Crooks, Dennis

Hockey

Event Evenement	Total Total	1st 1ere	Half Mi-temps	2nd 2eme	Half Mi-temps	Extra Period Prolongation
Shot on Goal/Lancer au But	4-4	2-2		2-2		0-0
Field Goal/But de Champ	0-0	0-0		0-0		0-0
P-Stroke Goal/But de Coup Penalty	0-0	0-0		0-0		0-0
P-Corner Goal/But de Penalty Coin	0-0	0-0		0-0		0-0
Cor-Hit Goal/But de Coup Coin	0-0	0-0		0-0		0-0
Assist/Assistance	0-0	0-0		0-0		0-0
Off-Side/ Hors Jeu	3-0	3-0		0-0		0-0
Warning / Avertissement	1-3	1-1		0-2		0-0

Men Prelim. Round Group B Match 9/Sept. 22				Hommes Series Prelim. Groupe B Match 9/22 Sept			
Ctry Pays	No. Doss	Name Nom	Goals Buts	Ctry Pays	No. Doss	Name Nom	Goals Buts
GBR	1-2	FRG	(1-0, 0-2)				
GBR	01	Taylor, Ian	0*	*FRG*	01	Schliemann, Christian	0
	02	Pappin, Vervan	0		02	Frank, Tobias	0*
	03	Faulkner, David	0*		03	Haenel, Ulrich	0*
	04	Barber, Paul	1*		04	Fischer, Carsten	1*
	05	Martin, Stephen	0		05	Mollandin, Andreas	0
	06	Potter, Jon	0*		06	Schmidt-Opper, Ekkhard	0*
	07	Dodds, Richard	0*		07	Brinkmann, Dirk	0*
	08	Grimley, Martyn	0*		08	Dopp, Heiner	0*
	09	Batchelor, Stephen	0*		09	Bloecher, Stefan	1*
	10	Leman, Richard	0-		10	Keller, Andreas	0*
	11	Kirkwood, James	0		11	Reck, Thomas	0-
	12	Bhaura, Dulbir	0+		12	Brinkmann, Thomas	0+
	13	Kerly, Sean	0*		13	Fastrich, Hanns-Henning	0
	14	Clift, Robert	0-		14	Hilgers, Michael	0+
	15	Sherwani, Imran	0*		15	Fried, Volker	0*
	16	Garcia, Russell	0+		16	Metz, Michael	0-

Coach/Entraîneur: Whitaker, David
Asst. Coach/Entraîneur Adj.:
Manager/Chef d'Equipe: Cotton, Bernard

Coach/Entraîneur: Kleiter, Klaus
Asst. Coach/Entraîneur Adj.:
Manager/Chef d'Equipe: Schneider, Kurt

Event Evenement	Total Total	1st 1ere	Half Mi-temps	2nd 2eme	Half Mi-temps	Extra Period Prolongation
Shot on Goal/Lancer au But	3-16	2-11		1-5		0-0
Field Goal / But de Champ	0-0	0-0		0-0		0-0
P-Stroke Goal / But de Coup Penalty	0-1	0-0		0-1		0-0
P-Corner Goal/But de Penalty Coin	1-1	1-0		0-1		0-0
Cor-Hit Goal/But de Coup Coin	0-0	0-0		0-0		0-0
Assist/Assistance	0-0	0-0		0-0		0-0
Off-Side/ Hors Jeu	0-1	0-0		0-1		0-0
Warning/Avertissement	2-0	1-0		1-0		0-0

Men Prelim. Round Group B Match 10/Sept. 24				Hommes Series Prelim. Groupe B Match 10/24 Sept			
Ctry Pays	No. Doss	Name Nom	Goals Buts	Ctry Pays	No. Doss	Name Nom	Goals Buts
FRG	1-0	KOR	(0-0, 1-0)				
FRG	01	Schliemann, Christian	0*	*KOR*	01	Song, Suk-Chan	0*
	02	Frank, Tobias	0		02	Kim, Young-Joon	0*
	03	Haenel, Ulrich	0*		03	Kim, Jong-Kap	0*
	04	Fischer, Carsten	1*		04	Chung, Boo-Jin	0*
	05	Mollandin, Andreas	0		05	Chung, Kye-Suk	0
	06	Schmidt-Opper, Ekkhard	0*		06	Kim, Jae-Chun	0*
	07	Brinkmann, Dirk	0*		07	Kwon, Soon-Pil	0
	08	Dopp, Heiner	0-		08	Mo, Ji-Young	0
	09	Bloecher, Stefan	0*		09	Ji, Jae-Kwan	0
	10	Keller, Andreas	0*		10	Kim, Man-Whe	0*
	11	Reck, Thomas	0*		11	Han, Jin-Soo	0*
	12	Brinkmann, Thomas	0		12	Lee, Heung-Pyo	0*
	13	Fastrich, Hanns-Henning	0*		13	Hur, Sang-Young	0*
	14	Hilgers, Michael	0+		14	Park, Jae-Sik	0*
	15	Fried, Volker	0*		15	Yoo, Seung-Jin	0*
	16	Metz, Michael	0		16	Shin, Suk-Kyun	0

Coach/Entraîneur: Kleiter, Klaus
Asst. Coach/Entraîneur Adj.:
Manager/Chef d'Equipe: Schneider, Kurt

Coach/Entraîneur: Yoo, Seung-In
Asst. Coach/Entraîneur Adj.:
Manager/Chef d'Equipe: Yoo, Min-Seung

Event Evenement	Total Total	1st 1ere	Half Mi-temps	2nd 2eme	Half Mi-temps	Extra Period Prolongation
Shot on Goal/Lancer au But	8-6	4-1		4-5		0-0
Field Goal/But de Champ	0-0	0-0		0-0		0-0
P-Stroke Goal / But de Coup Penalty	0-0	0-0		0-0		0-0
P-Corner Goal/But de Penalty Coin	1-0	0-0		1-0		0-0
Cor-Hit Goal/But de Coup Coin	0-0	0-0		0-0		0-0
Assist/Assistance	0-0	0-0		0-0		0-0
Off-Side/Hors Jeu	1-1	1-1		0-0		0-0
Warning / Avertissement	4-3	1-0		3-3		0-0



Men
Prelim. Round Group B Match 11/Sept. 24

Ctry Pays	No. Doss	Name Nom	Goals Buts	Ctry Pays	No. Doss	Name Nom	Goals Buts
GBR	3-1	URS (0-0, 3-1)					
GBR	01	Taylor, Ian	0*	*URS*	01	Plechakov, Vladimir	0*
	02	Pappin, Veryan	0		02	Depoutatov, Viotor	0*
	03	Faulkner, David	0*		03	Ioulthchiev, Igor	0*
	04	Barber, Paul	1*		04	Airapetian, Sos	0*
	05	Martin, Stephen	0		05	Sankovets, Nikolai	0
	06	Potter, Jon	0*		06	Antakov, Vladimir	0*
	07	Dodds, Richard	0*		07	Tchetchenov, Viatcheslav	0*
	08	Grimley, Martyn	0*		08	Atanov, Igor	0*
	09	Batchelor, Stephen	0+		09	Chakhvorostov, Serguei	0-
	10	Leman, Richard	0*		10	Plechakov, Serguei	0*
	11	Kirkwood, James	0		11	Nitchevourenko, Mikhail	0+
	12	Bhaura, Dulbir	0-		12	Domachev, Alexandre	0
	13	Kerly, Sean	2*		13	Davydov, Igor	0-
	14	Clift, Robert	0*		14	Miasnikov, Alexandre	0*
	15	Sherwani, Imran	0*		15	Netchaev, Evgueni	0
	16	Garcia, Russell	0		16	Boukatine, Mikhail	1+

Coach/Entraîneur: Whitaker, David
Asst. Coach/Entraîneur Adj.:
Manager/Chef d'Equipe: Self, Roger

Coach/Entraîneur: Pavlovski, Leonid
Asst. Coach/Entraîneur Adj.: Ossintsev, Mikhail
Manager/Chef d'Equipe:

Event Evenement	Total Total	1st 1ere	Half Mi-temps	2nd 2eme	Half Mi-temps	Extra Period Prolongation
Shot on Goal/Lancer au But	11-3	4-1		7-2		0-0
Field Goal/But de Champ	1-1	0-0		1-1		0-0
P-Stroke Goal/But de Coup Penalty	0-0	0-0		0-0		0-0
P-Corner Goal/But de Penalty Coin	2-0	0-0		2-0		0-0
Cor-Hit Goal/But de Coup Coin	0-0	0-0		0-0		0-0
Assist/Assistance	0-0	0-0		0-0		0-0
Off-Side/Hors Jeu	1-0	1-0		0-0		0-0
Warning / Avertissement	1-3	1-0		0-3		0-0

Men
Prelim. Round Group B Match 12/Sept. 24

Ctry Pays	No. Doss	Name Nom	Goals Buts	Ctry Pays	No. Doss	Name Nom	Goals Buts
CAN	1-5	IND (1-3, 0-2)					
CAN	01	Rutledge, Michael ross	1*	*IND*	01	Rajinder Singh, Rawat	0*
	02	Sandhu, Hargurnek	0*		02	Pargat Singh	0*
	03	Albert, Rick	0*		03	Ashok Kumar	0*
	04	Burrows, Patrick	0-		04	MohinderPalSingh	2*
	05	Chohan, Satinder	0*		05	Maneypandemuttana, Somaya	0*
	06	Gifford, Christopher	0-		06	Vivek Singh	0-
	07	Grimmer, Wayne	0+		07	Sujit Kumar	0
	08	Rai, Ranjeet	0		08	Baladadalaiah, Subramani	1+
	09	Milkovich, Peter	0		09	Mohammad Shahid	0+
	10	Porritt, Trevor	0*		10	Jude Felix, Sebastian	1*
	11	Bird, Robert Ian	0*		11	Balwinder Singh	0+
	12	Harris, Douglas	0+		12	Mervyn Ernadis, Mervyn	1-
	13	Muller, Michael	0*		13	Thoiba Singh	0*
	14	Caruso, Pasouale	0*		14	Gundeep Kumar	0-
	15	Dube, Ajay	0		15	Jagbir Singh	0*
	16	Goodwin, Ken	0*		16	Markphilip, Patterson	0

Coach/Entraîneur: Clarke, Trevor
Asst. Coach/Entraîneur Adj.:
Manager/Chef d'Equipe: Crooks, Dennis

Coach/Entraîneur: Mollera Poovaiah, Ganbsh
Asst. Coach/Entraîneur Adj.:
Manager/Chef d'Equipe: Jaman Lal Sharma

Event Evenement	Total Total	1st 1ere	Half Mi-temps	2nd 2eme	Half Mi-temps	Extra Period Prolongation
Shot on Goal/Lancer au But	9-12	3-7		6-5		0-0
Field Goal/But de Champ	0-3	0-1		0-2		0-0
P-Stroke Goal/But de Coup Penalty	0-0	0-0		0-0		0-0
P-Corner Goal/But de Penalty Coin	0-2	0-2		0-0		0-0
Cor-Hit Goal/But de Coup Coin	1-0	1-0		0-0		0-0
Assist/Assistance	0-0	0-0		0-0		0-0
Off-Side/Hors Jeu	0-7	0-3		0-4		0-0
Warning / Avertissement	2-0	1-0		1-0		0-0

Men
Prelim. Round Group B Match 13/Sept. 26

Ctry Pays	No. Doss	Name Nom	Goals Buts	Ctry Pays	No. Doss	Name Nom	Goals Buts
FRG	6-0	URS (2-0, 4-0)					
FRG	01	Schliemann, Christian	0	*URS*	01	Plechakov, Vladimir	0*
	02	Frank, Tobias	0		02	Depoutatov, Viotor	0*
	03	Haenel, Ulrich	0*		03	Ioulthchiev, Igor	0*
	04	Fischer, Carsten	1*		04	Airapetian, Sos	0*
	05	Mollandin, Andreas	1*		05	Sankovets, Nikolai	0*
	06	Schmidt-Opper, Ekhard	0-		06	Antakov, Vladimir	0*
	07	Brinkmann, Dirk	0-		07	Tchetchenov, Viatcheslav	0*
	08	Dopp, Heiner	1*		08	Atanov, Igor	0+
	09	Bloecher, Stefan	1*		09	Chakhvorostov, Serguei	0
	10	Keller, Andreas	1*		10	Plechakov, Serguei	0*
	11	Reck, Thomas	0-		11	Nitchevourenko, Mikhail	0+
	12	Brinkmann, Thomas	0+		12	Domachev, Alexandre	0
	13	Fastrich, Hanns-Henning	0+		13	Davydov, Igor	0*
	14	Hilgers, Michael	1+		14	Miasnikov, Alexandre	0*
	15	Fried, Volker	0*		15	Netchaev, Evgueni	0-
	16	Metz, Michael	0*		16	Boukatine, Mikhail	0-

Coach/Entraîneur: Kleiter, Klaus
Asst. Coach/Entraîneur Adj.:
Manager/Chef d'Equipe: Schneider, Kurt

Coach/Entraîneur: Pavlovski, Leonid
Asst. Coach/Entraîneur Adj.:
Manager/Chef d'Equipe: Mikhail Ossintsev

Event Evenement	Total Total	1st 1ere	Half Mi-temps	2nd 2eme	Half Mi-temps	Extra Period Prolongation
Shot on Goal/Lancer au But	12-6	6-1		6-5		0-0
Field Goal/But de Champ	4-0	2-0		2-0		0-0
P-Stroke Goal/But de Coup Penalty	0-0	0-0		0-0		0-0
P-Corner Goal/But de Penalty Coin	2-0	0-0		2-0		0-0
Cor-Hit Goal/But de Coup Coin	0-0	0-0		0-0		0-0
Assist/Assistance	0-0	0-0		0-0		0-0
Off-Side/Hors Jeu	5-3	3-0		2-3		0-0
Warning / Avertissement	0-1	0-0		0-1		0-0

Men
Prelim. Round Group B Match 14/Sept. 26

Ctry Pays	No. Doss	Name Nom	Goals Buts	Ctry Pays	No. Doss	Name Nom	Goals Buts
GBR	3-0	IND (0-0, 3-0)					
GBR	01	Taylor, Ian	0*	*IND*	01	Rajinder Singh, Rawat	0*
	02	Pappin, Veryan	0		02	Pargat Singh	0*
	03	Faulkner, David	0*		03	Ashok Kumar	0*
	04	Barber, Paul	1*		04	MohinderPalSingh	0*
	05	Martin, Stephen	0		05	Maneypandemuttana, Somaya	0*
	06	Potter, Jon	1*		06	Vivek Singh	0-
	07	Dodds, Richard	0*		07	Sujit Kumar	0
	08	Grimley, Martyn	0*		08	Baladadalaiah, Subramani	0+
	09	Batchelor, Stephen	0*		09	Mohammad Shahid	0+
	10	Leman, Richard	0-		10	Jude Felix, Sebastian	0*
	11	Kirkwood, James	0+		11	Balwinder Singh	0+
	12	Bhaura, Dulbir	0		12	Mervyn Ernadis, Mervyn	0-
	13	Kerly, Sean	1*		13	Thoiba Singh	0*
	14	Clift, Robert	0-		14	Gundeep Kumar	0-
	15	Sherwani, Imran	0*		15	Jagbir Singh	0*
	16	Garcia, Russell	0+		16	Markphilip, Patterson	0

Coach/Entraîneur: Whitaker, David
Asst. Coach/Entraîneur Adj.:
Manager/Chef d'Equipe: Self, Roger

Coach/Entraîneur: Mollera Poovaiah, Ganbsh
Asst. Coach/Entraîneur Adj.:
Manager/Chef d'Equipe: Jaman Lal Sharma

Men
Prelim. Round Group B Match 15/Sept. 26

Ctry Pays	No. Doss	Name Nom	Goals Buts	Ctry Pays	No. Doss	Name Nom	Goals Buts
CAN	1-1	KOR (1-1, 0-0)					
CAN	01	Rutledge, Michael Ross	0*	*KOR*	01	Song, Suk-Chan	0
	02	Sandhu, Hargurnek	1*		02	Kim, Young-Joon	0*
	03	Albert, Rick	0+		03	Kim, Jong-Kap	0*
	04	Burrows, Patrick	0		04	Chung, Boo-Jin	0*
	05	Chohan, Satinder	0*		05	Chung, Kye-Suk	1*
	06	Gifford, Christopher	0+		06	Kim, Jae-Chun	0+
	07	Grimmer, Wayne	0+		07	Kwon, Soon-Pil	0+
	08	Rai, Ranjeet	0-		08	Mo, Ji-Young	0-
	09	Milkovich, Peter	0-		09	Ji, Jae-Kwan	0
	10	Porritt, Trevor	0*		10	Kim, Man-Whe	0-
	11	Bird, Robert Ian	0*		11	Han, Jin-Soo	0*
	12	Harris, Douglas	0-		12	Lee, Heung-Pyo	0*
	13	Muller, Michael	0*		13	Hur, Sang-Young	0+
	14	Caruso, Pasouale	0*		14	Park, Jae-Sik	0-
	15	Dube, Ajay	0		15	Yoo, Seung-Jin	0*
	16	Goodwin, Ken	0*		16	Shin, Suk-Kyun	0*

Coach/Entraîneur: Clarke, Trevor
Asst. Coach/Entraîneur Adj.:
Manager/Chef d'Equipe: Crooks, Dennis

Coach/Entraîneur: Yoo, Seung-In
Asst. Coach/Entraîneur Adj.:
Manager/Chef d'Equipe: Yoo, Min-Seung

Event Evenement	Total Total	1st 1ere	Half Mi-temps	2nd 2eme	Half Mi-temps	Extra Period Prolongation
Shot on Goal/Lancer au But	9-2	5-2		4-0		0-0
Field Goal/But de Champ	0-0	0-0		0-0		0-0
P-Stroke Goal/But de Coup Penalty	0-0	0-0		0-0		0-0
P-Corner Goal/But de Penalty Coin	1-1	1-1		0-0		0-0
Cor-Hit Goal/But de Coup Coin	0-0	0-0		0-0		0-0
Assist/Assistance	0-0	0-0		0-0		0-0
Off-Side/Hors Jeu	2-1	1-1		1-0		0-0
Warning / Avertissement	2-0	2-0		0-0		0-0

Hockey

Men Preliminary Round/Sept. 18-Oct. 1									
Rank Rang	Ctry Pays	Points Joues	Played Joutes	Won Gagnes	Tied Nuls	Lost Perdus	For Pour	Against Contre	Diff
* Group A/Groupe A									
1	AUS	10	5	5	0	0	19	3	16
2	HOL	7	5	3	1	1	12	6	6
3	PAK	6	5	3	0	2	15	8	7
4	ARG	4	5	2	0	3	8	12	-4
5	ESP	3	5	1	1	3	6	10	-4
6	KEN	0	5	0	0	5	5	26	-21
* Group B/Groupe B									
1	FRG	9	5	4	1	0	13	3	10
2	GBR	7	5	3	1	1	12	5	7
3	IND	5	5	2	1	2	9	7	2
4	URS	5	5	2	1	2	5	10	-5
5	KOR	2	5	0	2	3	5	10	-5
6	CAN	2	5	0	2	3	3	12	-9
* Group C/Groupe C									
* Group D/Groupe D									
* Group E/Groupe E									
* Group F/Groupe F									
* Group G/Groupe G									
* Group H/Groupe H									
* Group I/Groupe I									
* Group J/Groupe J									
* Group K/Groupe K									
* Group L/Groupe L									
* Group M/Groupe M									
* Group N/Groupe N									
* Group O/Groupe O									
* Group P/Groupe P									
* Group Q/Groupe Q									
* Group R/Groupe R									
* Group S/Groupe S									
* Group T/Groupe T									
* Group U/Groupe U									
* Group V/Groupe V									
* Group W/Groupe W									
* Group X/Groupe X									
* Group Y/Groupe Y									
* Group Z/Groupe Z									

Men Semi-final Match 1 (A1-B2)/Sept. 28				Hommes Demi-finale Match 1 (A1-B2)/28 Sept			
Ctry Pays	No. Doss	Name Nom	Goals Buts	Ctry Pays	No. Doss	Name Nom	Goals Buts
AUS	2-3	GBR	(0-1,2-2)				
AUS	01	Davies, Craig	0*	*GBR*	01	Taylor, Ian	0*
	02	Batch, Colin	0*		02	Pappin, Veryan	0
	03	Bestall, John	0*		03	Faulkner, David	0*
	04	Birmingham, Warren	0*		04	Barber, Paul	0*
	05	Charlesworth, Richard	0-		05	Martin, Stephen	0
	06	Deane, Andrew	0+		06	Potter, Jon	0*
	07	York, Michael	0		07	Dodds, Richard	0*
	08	Hager, Mark	1*		08	Grimley, Martyn	0*
	09	Stacy, Jay	0		09	Batchelor, Stephen	0-
	10	Hawgood, Neil	1*		10	Leman, Richard	0*
	11	Noel, Peter	0		11	Kirkwood, James	0
	12	Reid, Graham	0*		12	Bhaura, Dulbir	0+
	13	Smith, Roger	0*		13	Kerly, Sean	3*
	14	Snowden, Neil	0*		14	Clift, Robert	0*
	15	Wansbrough, David	0*		15	Sherwani, Imran	0*
	16	Wark, Ken	0		16	Garcia, Russell	0
Coach/Entraîneur: Aggiss, Richard Asst. Coach/Entraîneur Adj.: Piper, Desmond Manager/Chef d'Equipe: Berry, A.T.				Coach/Entraîneur: Whitaker, David Asst. Coach/Entraîneur Adj.: Manager/Chef d'Equipe: Self, Roger			

Event Evenement	Total Total	1st 1ere	Half Mi-temps	2nd 2eme	Half Mi-temps	Extra Period Prolongation
Shot on Goal / Lancer au But	7-8	3-4		4-4		0-0
Field Goal / But de Champ	2-2	0-0		2-2		0-0
P-Stroke Goal / But de Coup Penalty	0-0	0-0		0-0		0-0
P-Corner Goal / But de Penalty Coin	0-1	0-1		0-0		0-0
Cor-Hit Goal / But de Coup Coin	0-0	0-0		0-0		0-0
Assist / Assistance	0-0	0-0		0-0		0-0
Off-Side/Hors Jeu	0-1	0-0		0-1		0-0
Warning / Avertissement	2-2	0-1		2-1		0-0

Hockey

Men Semi-final Match 2 (B1-A2)/Sept. 28				Hommes Demi-finale Match 2 (B1-A2)/28 Sept			
Ctry Pays	No. Doss	Name Nom	Goals Buts	Ctry Pays	No. Doss	Name Nom	Goals Buts
FRG	2-1	HOL	(0-1,2-0)				
FRG	01	Schliemann, Christian	0	*HOL*	01	Leistra, Prank	0*
	02	Frank, Tobias	0*		02	Benninga, Marc	0
	03	Haenel, Ulrich	0*		03	Diepeveen, Cees Jan	0*
	04	Fischer, Carsten	0*		04	Crucg, Maurits	1*
	05	Mollandin, Andreas	0		05	Klaassen, Rene	0*
	06	Schmidt-Opper, Ekkhard	0*		06	Kooijman, Hendrik Jan	0*
	07	Brinkmann, Dirk	0*		07	Delissen, Marc	0*
	08	Dopp, Heiner	1*		08	Brinkman, Jacques	0*
	09	Bloecher, Stefan	0-		09	Schlatmann, Gerrit Jan	0+
	10	Keller, Andreas	0*		10	Steens, Tim	0
	11	Reck, Thomas	1*		11	Bove Lander, Floris Jan	0*
	12	Brinkmann, Thomas	0		12	Faber, Patrick	0
	13	Fastrich, Hanns-Henning	0		13	Jansen, Ronald	0
	14	Hilgers, Michael	0+		14	Kruize, Jan Hidde	0*
	15	Fried, Volker	0*		15	Parvliet, Erik	0-
	16	Metz, Michael	0*		16	Van Den Honert, Taco	0*
Coach/Entraîneur: Kleiter, Klaus Asst. Coach/Entraîneur Adj.: Manager/Chef d'Equipe: Schneider, Kurt				Coach/Entraîneur: Jorritsma, Hans Asst. Coach/Entraîneur Adj.: Manager/Chef d'Equipe: Spits, Nico			

Event Evenement	Total Total	1st 1ere	Half Mi-temps	2nd 2eme	Half Mi-temps	Extra Period Prolongation
Shot on Goal / Lancer au But	16-8	6-4		10-4		0-0
Field Goal / But de Champ	2-1	0-1		2-0		0-0
P-Stroke Goal / But de Coup Penalty	0-0	0-0		0-0		0-0
P-Corner Goal / But de Penalty Coin	0-0	0-0		0-0		0-0
Cor-Hit Goal / But de Coup Coin	0-0	0-0		0-0		0-0
Assist / Assistance	0-0	0-0		0-0		0-0
Off-side/Hors Jeu	0-0	0-0		0-0		0-0
Warning / Avertissement	0-1	0-0		0-1		0-0

Men Semi-final Match 3 (A3-B4)/Sept. 28				Hommes Demi-finale Match 3 (A3-B4)/28 Sept			
Ctry Pays	No. Doss	Name Nom	Goals Buts	Ctry Pays	No. Doss	Name Nom	Goals Buts
PAK	10	URS	(0-0, 1-0)				
PAK	01	Mansoor Ahmed	0*	*URS*	01	Plechakov, Vladimir	0
	02	Nasir Ali	0		02	Depoutatov, Viotor	0*
	03	Qazi Mohib-Ur-Rehman	1*		03	loutchiev, Igor	0*
	04	Aamir-Zafar	0*		04	Airapetian, Sos	0*
	05	Ishtiaq Ahmed	0*		05	Sankovets, Nikolai	0
	06	Naeem Akhtar	0+		06	Antakov, Vladimir	0*
	07	Qamar Ibrahim	0*		07	Tchetchenov, Viatcheslav	0*
	08	Shahbaz Ahmed	0*		08	Atanov, Igor	0*
	09	Tariq Sheikh	0*		09	Chakhvorostov, Serguei	0-
	10	Zahid Sharif	0*		10	Plechakov, Serguei	0+
	11	Khalid Hamid	0-		11	Nitchevorenko, Mikhail	0+
	12	Rizwan Munir	0		12	Domachev, Alexandre	0*
	13	Khalid Bashir	0*		13	Davydov, Igor	0-
	14	Naeem Amjad	0-		14	Miasnikov, Alexandre	0*
	15	Tahir Zaman	0+		15	Netchaev, Evgueni	0
	16	Musaddiz Hussain	0		16	Boukatine, Mikhail	0*
Coach/Entraîneur: Manzoor Ul Hassan Asst. Coach/Entraîneur Adj.: Manager/Chef d'Equipe: Siddiqui, Islahuddin				Coach/Entraîneur: Pavlovski, Leonid Asst. Coach/Entraîneur Adj.: Manager/Chef d'Equipe: Mikhail Ossintsev			

Event Evenement	Total Total	1st 1ere	Half Mi-temps	2nd 2eme	Half Mi-temps	Extra Period Prolongation
Shot on Goal / Lancer au But	5-3	3-1		2-2		0-0
Field Goal / But de Champ	0-0	0-0		0-0		0-0
P-Stroke Goal / But de Coup Penalty	0-0	0-0		0-0		0-0
P-Corner Goal / But de Penalty Coin	1-0	0-0		1-0		0-0
Cor-Hit Goal / But de Coup Coin	0-0	0-0		0-0		0-0
Assist / Assistance	0-0	0-0		0-0		0-0
Off-side / Hors Jeu	1-3	0-2		1-1		0-0
Warning / Avertissement	1-0	1-0		0-0		0-0



Men
Semi-final Match 4 (B3-A4)/Sept. 28

Hommes
Demi-finale Match 4 (B3-A4)/28 Sept

Ctry Pays	No. Doss	Name Nom	Goals Buts	Ctry Pays	No. Doss	Name Nom	Goals Buts
IND	6-6	ARG (4-2,1-3,1-0,0-1)	*P.S.C. *(4-3)				
IND	01	Rajinder Singh, Rawat	0*	*ARG*	01	Schmitt, Otto	0+
	02	Pargat Singh	0*		02	Siri, Alejandro	0*
	03	Ashok Kumar	0*		03	Altube, Miguel	0*
	04	MohinderPalSingh	2*		04	Mascheroni, Marcelo	1*
	05	Maneypandemuttana, Somaya	0*		05	Garraffo, Marcelo	1*
	06	Vivek Singh	0+		06	Pailos, Edgardo	0*
	07	Sujit Kumar	0		07	Doherty, Alejandro	0+
	08	Baladadalaiaash, Subramani	0*		08	Ayala, Aldo	0*
	09	Mohammad Shahid	1+		09	Geneyro, Carlos	3*
	10	Jude Felix, Sebastian	0*		10	Minadeo, Gabriel	0-
	11	Balwinder Singh	1+		11	Verga, Alejandro	0*
	12	Mervyn Ernadis, Mervyn	2-		12	Ferrara, Fernando	1*
	13	Thoiba Singh	0*		13	Roggero, Emanuel	0-
	14	Gundeep Kumar	0-		14	Nicola, Franco	0
	15	Jagbir Singh	0-		15	Sordelli, Martin	0
	16	Markphilip, Patterson	0		16	Silva, Mariano	0

Coach/Entraîneur: Mollera Poovaiyah, Ganbsh
Asst. Coach/Entraîneur Adj.:
Manager/Chef d'Equipe: Jaman Lal Sharma

Coach/Entraîneur: Luis, Ciancia
Asst. Coach/Entraîneur Adj.:
Manager/Chef d'Equipe: Eduardo, Guelfand

Event Evenement	Total Total	1st 1ere	Half Mi-temps	2nd 2eme	Half Mi-temps	Extra Period Prolongation
Shot on Goal / Lancer au But	22-21	6-5		9-12		7-4
Field Goal / But de Champ	3-1	1-1		1-0		1-0
P-Stroke Goal / But de Coup Penalty	1-1	1-0		0-1		0-0
P-Corner Goal / But de Penalty Coin	2-4	2-1		0-2		0-1
Cor-Hit Goal / But de Coup Coin	0-0	0-0		0-0		0-0
Assist/Assistance	0-0	0-0		0-0		0-0
Off-Side/Hors Jeu	7-2	4-2		1-0		2-0
Warning / Avertissement	0-4	0-2		0-1		0-1

Men
Semi-final Match 5 (A5-B6)/Sept. 28

Hommes
Demi-finale Match 5 (A5-B6)/28 Sept

Ctry Pays	No. Doss	Name Nom	Goals Buts	Ctry Pays	No. Doss	Name Nom	Goals Buts
ESP	2-0	CAN (1-0, 1-0)					
ESP	01	Rovira, Miguel	0*	*CAN*	01	Rutledge, Michael Ross	0*
	02	Escude, Ignacio	1*		02	Sandhu, Hargurnek	0*
	03	Malgosa, Joaquin	0*		03	Albert, Rick	0+
	04	Gomez, Andres	0*		04	Burrows, Patrick	0*
	05	Garcia, Juan	0-		05	Chohan, Satinder	0*
	06	Armengol, Jaime	0+		06	Gifford, Christopher	0+
	07	Peon, Juan Carlos	0+		07	Grimmer, Wayne	0+
	08	Malgosa, Juan	0*		08	Rai, Ranjeet	0-
	09	Escude, Jaime	1*		09	Milkovich, Peter	0-
	10	Escude, Javier	0*		10	Porritt, Trevor	0*
	11	Oliva, Jorge	0-		11	Bird, Robert Ian	0-
	12	Ortego, Miguel	0+		12	Harris, Douglas	0
	13	De paz, Miguel	0-		13	Muller, Michael	0*
	14	Fabregas, Eduardo	0		14	Caruso, Pasouale	0*
	15	Iglesias, Jose Antonio	0*		15	Dube, Ajay	0
	16	Grau, Santiago	0		16	Goodwin, Ken	0*

Coach/Entraîneur: Cortes Villa, Santiago
Asst. Coach/Entraîneur Adj.:
Manager/Chef d'Equipe: Aurell, Pep

Coach/Entraîneur: Clarke, Trevor
Asst. Coach/Entraîneur Adj.:
Manager/Chef d'Equipe: Crooks, Dennis

Event Evenement	Total Total	1st 1ere	Half Mi-temps	2nd 2eme	Half Mi-temps	Extra Period Prolongation
Shot on Goal / Lancer au But	11-5	4-1		7-4		0-0
Field Goal/But de Champ	0-0	0-0		0-0		0-0
P-Stroke Goal / But de Coup Penalty	1-0	0-0		1-0		0-0
P-Corner Goal/But de Penalty Coin	1-0	1-0		0-0		0-0
Cor-Hit Goal / But de Coup Coin	0-0	0-0		0-0		0-0
Assist/Assistance	0-0	0-0		0-0		0-0
Off-Side/Hors Jeu	3-4	0-3		3-1		0-0
Warning / Avertissement	1-4	1-2		0-2		0-0

Men
Semi-final Match 6 (B5-A6)/Sept. 28

Hommes
Demi-finale Match 6 (B5-A6)/28 Sept

Ctry Pays	No. Doss	Name Nom	Goals Buts	Ctry Pays	No. Doss	Name Nom	Goals Buts
KOR	5-2	KEN (2-1,0-1,3-0,0-0)					
KOR	01	Song, Suk-Chan	0	*KEN*	01	Omany, Paul Sewe	0*
	02	Kim, Young-Joon	0*		02	Saini, Parminder	0*
	03	Kim, Jong-Kap	0+		03	Odhier, Roy	0+
	04	Chung, Boo-Jin	0*		04	Oguk, Charles	0*
	05	Chung, Kye-Suk	0*		05	Okoth, John Eliud	0*
	06	Kim, Jae-Chun	0*		06	Omondi, Michael	0-
	07	Kwon, Soon-Pil	0+		07	Ngoyo, Sam	0*
	08	Mo, Ji-Young	0-		08	Akatsa, Peter	0*
	09	Ji, Jae-Kwan	0		09	Goyal, Sanjiwan	0+
	10	Kim, Man-Whe	0-		10	Otambo, Christopher	0-
	11	Han, Jin-Soo	3*		11	Alubaha, Lucas	1*
	12	Lee, Heung-Pyo	0+		12	Owino, Victor	0+
	13	Hur, Sang-Young	0-		13	Oriso, Samson	0
	14	Park, Jae-Sik	0*		14	Matharu, Inderjit	1*
	15	Yoo, Seung-Jin	2*		15	Muange, Samson	0-
	16	Shin, Suk-Kyun	0*		16	Mutua, Julius	0

Coach/Entraîneur: Yoo, Seung-In
Asst. Coach/Entraîneur Adj.:
Manager/Chef d'Equipe: Yoo, Min-Seung

Coach/Entraîneur: Lall, Gursharam Singh
Asst. Coach/Entraîneur Adj.:
Manager/Chef d'Equipe: Hardev, Singh

Event Evenement	Total Total	1st 1ere	Half Mi-temps	2nd 2eme	Half Mi-temps	Extra Period Prolongation
Shot on Goal / Lancer au But	12-13	3-7		5-5		4-1
Field Goal / But de Champ	5-1	2-0		0-1		3-0
P-Stroke Goal / But de Coup Penalty	0-0	0-0		0-0		0-0
P-Corner Goal / But de Penalty Coin	0-1	0-1		0-0		0-0
Cor-Hit Goal / But de Coup Coin	0-0	0-0		0-0		0-0
Assist / Assistance	0-0	0-0		0-0		0-0
Off-Side/ Hors Jeu	2-4	0-2		0-2		2-0
Warning / Avertissement	5-3	3-1		1-2		1-0

Men
Final (1-2 Places)/Oct. 1

Hommes
Finale (1-2 Places)/1 Oct

Ctry Pays	No. Doss	Name Nom	Goals Buts	Ctry Pays	No. Doss	Name Nom	Goals Buts
FRG	1-3	GBR (0-1, 1-2)					
FRG	01	Schliemann, Christian	0	*GBR*	01	Taylor, Ian	0-
	02	Frank, Tobias	0*		02	Pappin, Veryan	0+
	03	Haenel, Ulrich	0-		03	Faulkner, David	0*
	04	Fischer, Carsten	0*		04	Barber, Paul	0*
	05	Mollandin, Andreas	0+		05	Martin, Stephen	0+
	06	Schmidt-Opper, Ekkhard	0*		06	Potter, Jon	0+
	07	Brinkmann, Dirk	0*		07	Dodds, Richard	0*
	08	Dopp, Heiner	1*		08	Grimley, Martyn	0*
	09	Blocher, Stefan	0		09	Batchelor, Stephen	0-
	10	Keller, Andreas	0*		10	Leman, Richard	0-
	11	Reck, Thomas	0*		11	Kirkwood, James	0
	12	Brinkmann, Thomas	0+		12	Bhaura, Dulbir	0+
	13	Fastrich, Hanns-Henning	0		13	Kerly, Sean	1*
	14	Hilgers, Michael	0-		14	Clift, Robert	0*
	15	Friedl, Volker	0*		15	Sherwani, Imran	2*
	16	Metz, Michael	0*		16	Garcia, Russell	0

Coach/Entraîneur: Kleiter, Klaus
Asst. Coach/Entraîneur Adj.:
Manager/Chef d'Equipe: Schneider, Kurt

Coach/Entraîneur: Whitaker, David
Asst. Coach/Entraîneur Adj.:
Manager/Chef d'Equipe: Self, Roger

Event Evenement	Total Total	1st 1ere	Half Mi-temps	2nd 2eme	Half Mi-temps	Extra Period Prolongation
Shot on Goal / Lancer au But	11-4	5-2		6-2		0-0
Field Goal / But de Champ	1-2	0-1		1-1		0-0
P-Stroke Goal / But de Coup Penalty	0-0	0-0		0-0		0-0
P-Corner Goal / But de Penalty Coin	0-1	0-0		0-1		0-0
Cor-Hit Goal / But de Coup Coin	0-0	0-0		0-0		0-0
Assist/Assistance	0-3	0-1		0-2		0-0
Off-Side/ Hors Jeu	0-4	0-2		0-2		0-0
Warning / Avertissement	1-2	1-1		0-1		0-0

Men
Final (3-4 Places)/Oct. 1

Hommes
Finale (3-4 Places)/1 Oct

Ctry Pays	No. Doss	Name Nom	Goals Buts	Ctry Pays	No. Doss	Name Nom	Goals Buts
AUS	1-2	HOL (0-1, 1-1)					
AUS	01	Davies, Craig	0*	*HOL*	01	Leistra, Prank	0*
	02	Batch, Colin	0*		02	Benninga, Marc	0
	03	Bestall, John	0-		03	Dieveveen, Cees Jan	0*
	04	Birmingham, Warren	0*		04	Crugg, Maurits	0*
	05	Charlesworth, Richard	0-		05	Klaassen, Rene	0*
	06	Deane, Andrew	0+		06	Kooijman, Hendrik Jan	0*
	07	York, Michael	0		07	Delissen, Marc	0*
	08	Hager, Mark	0*		08	Brinkman, Jacques	0*
	09	Stacy, Jay	0+		09	Schlatmann, Gerrit Jan	0
	10	Hawgood, Neil	0-		10	Steens, Tim	0
	11	Noel, Peter	0*		11	Bove Lander, Floris Jan	2*
	12	Reid, Graham	1*		12	Faber, Patrick	0+
	13	Smith, Roger	0*		13	Jansen, Ronald	0
	14	Snowden, Neil	0		14	Kruize, Jan Hidde	0-
	15	Wansbrough, David	0*		15	Parlevliet, Erik	0*
	16	Wark, Ken	0+		16	Van Den Honert, Taco	0*

Coach/Entraîneur: Aggiss, Richard
Asst. Coach/Entraîneur Adj.: Piper, Desmond
Manager/Chef d'Equipe: Berry, A.T.

Coach/Entraîneur: Jorritsma, Hans
Asst. Coach/Entraîneur Adj.:
Manager/Chef d'Equipe: Spits, Nico

Event Evenement	Total Total	1st 1ere	Half Mi-temps	2nd 2eme	Half Mi-temps	Extra Period Prolongation
Shot on Goal/Lancer au But	19-7	11-4		8-3		0-0
Field Goal / But de Champ	1-0	0-0		1-0		0-0
P-Stroke Goal / But de Coup Penalty	0-0	0-0		0-0		0-0
P-Corner Goal/But de Penalty Coin	0-2	0-1		0-1		0-0
Cor-Hit Goal / But de Coup Coin	0-0	0-0		0-0		0-0
Assist / Assistance	0-0	0-0		0-0		0-0
Off-Side/Hors Jeu	2-3	2-1		0-2		0-0
Warning / Avertissement	3-2	3-1		0-1		0-0

Hockey

Men Final (5-6 Places)/Sept. 30				Hommes Finale (5-6 Places)/30 Sept			
Ctry	No.	Name	Goals	Ctry	No.	Name	Goals
Pays	Doss	Nom	Buts	Pays	Doss	Nom	Buts
IND	1-2	PAK	(0-1, 1-1)				
IND	01	Rajinder Singh, Rawat	0	*PAK*	01	Mansoor Ahmed	0*
	02	Pargat Singh	0-		02	Nasir Ali	0
	03	Ashok Kumar	0 +		03	Qazi Mohib-Ur-Rehman	1*
	04	MohinderPalSingh	1*		04	Aamir-Zafar	0*
	05	Maneypandemuttana, Somaya	0*		05	Ishtiaq Ahmed	0*
	06	Vivek Singh	0-		06	Naeem Akhtar	0
	07	Sujit Kumar	0*		07	Qamar Ibrahim	0*
	08	Baladadalaiaash, Subramani	0 +		08	Shahbaz Ahmed	0*
	09	Mohammad Shahid	0 +		09	Tariq Sheikh	0
	10	Jude Felix, Sebastian	0*		10	Zahid Sharif	0*
	11	Balwinder Singh	0*		11	Khalid Hamid	0
	12	Mervyn Ernadis, Mervyn	0*		12	Rizwan Munir	0
	13	Thoiba Singh	0*		13	Khalid Bashir	0*
	14	Gundeep Kumar	0-		14	Naeem Amjad	0*
	15	Jagbir Singh	0		15	Tahir Zaman	0*
	16	Markphilip, Patterson	0*		16	Musaddiz Hussain	1*

Event	Total	1st	Half	2nd	Half	Extra Period
Evenement	Total	1ere	Mi-temps	2eme	Mi-temps	Prolongation
Shot on Goal / Lancer au But	13-11	6-5		7-6		0-0
Field Goal / But de Champ	0-1	0-1		0-0		0-0
P-Stroke Goal / But de Coup Penalty	0-1	0-0		0-1		0-0
P-Corner Goal / But de Penalty Coin	1-0	0-0		1-0		0-0
Cor-Hit Goal / But de Coup Coin	0-0	0-0		0-0		0-0
Assist/Assistance	0-0	0-0		0-0		0-0
Off-Side/Hors Jeu	1-1	0-0		1-1		0-6
Warning/Avertissement	0-3	0-0		0-3		0-0

Men Final (7-8 Places)/Sept. 30				Hommes Finale (7-8 Places)/30 Sept			
Ctry	No.	Name	Goals	Ctry	No.	Name	Goals
Pays	Doss	Nom	Buts	Pays	Doss	Nom	Buts
URS	4-1	ARG	(2-1,2-0)				
URS	01	Plechakov, Vladimir	0*	*ARG*	01	Schmitt, Otto	0*
	02	Depoutatov, Viotor	0*		02	Siri, Alejandro	0*
	03	Ioulthchiev, Igor	0*		03	Altube, Miguel	0*
	04	Airapetian, Sos	0*		04	Mascheroni, Marcelo	0*
	05	Sankovets, Nikolai	0		05	Garraffo, Marcelo	0*
	06	Antakov, Vladimir	0*		06	Pailos, Edgardo	0*
	07	Tchetchenov, Viatcheslav	1*		07	Doherty, Alejandro	0 +
	08	Atanov, Igor	0*		08	Ayala, Aldo	0*
	09	Chakhvorostov, Serguei	0-		09	Geneyro, Carlos	0-
	10	Plechakov, Serguei	2*		10	Minadeo, Gabriel	0-
	11	Nitcheppureenko, Mikhail	0 +		11	Verga, Alejandro	1*
	12	Domachev, Alexandre	0		12	Ferrara, Fernando	0-
	13	Davydov, Igor	0		13	Roggero, Emanuel	0
	14	Miasnikov, Alexandre	1*		14	Nicola, Franco	0 +
	15	Netchaev, Evgueni	0		15	Sordelli, Martin	0 +
	16	Boukatine, Mikhail	0*		16	Silva, Mariano	0

Event	Total	1st	Half	2nd	Half	Extra Period
Evenement	Total	1ere	Mi-temps	2eme	Mi-temps	Prolongation
Shot on Goal / Lancer au But	9-13	4-6		5-7		0-0
Field Goal / But de Champ	3-1	1-1		2-0		0-0
P-Stroke Goal / But de Coup Penalty	1-0	1-0		0-0		0-0
P-Corner Goal / But de Penalty Coin	0-0	0-0		0-0		0-0
Cor-Hit Goal / But de Coup Coin	0-0	0-0		0-0		0-0
Assist / Assistance	0-0	0-0		0-0		0-0
Off-Side /Hors Jeu	2-0	1-0		1-0		0-0
Warning /Avertissement	0-2	0-2		0-0		0-0

Men Final (9-10 Places)/Sept. 29				Hommes Finale (9-10 Places)/29 Sept			
Ctry	No.	Name	Goals	Ctry	No.	Name	Goals
Pays	Doss	Nom	Buts	Pays	Doss	Nom	Buts
ESP	2-0	KOR	(1-0, 1-0)				
ESP	01	Rovira, Miguel	0	*KOR*	01	Song, Suk-Chan	0 +
	02	Escuda, Ignacio	1*		02	Kim, Young-Joon	0*
	03	Malgosa, Joaquin	0*		03	Kim, Jong-Kap	0-
	04	Gomez, Andres	0 +		04	Chung, Boo-Jin	0*
	05	Garcia, Juan	0*		05	Chung, Kye-Suk	0*
	06	Armengol, Jaime	0*		06	Kim, Jae-Chun	0-
	07	Peon, Juan Carlos	1*		07	Kwon, Soon-Pil	0 +
	08	Malgosa, Juan	0*		08	Mo, Ji-Young	0
	09	Escude, Jaime	0*		09	Ji, Jae-Kwan	0
	10	Escude, Javier	0*		10	Kim, Man-Whe	0*
	11	Oliva, Jorge	0-		11	Han, Jin-Soo	0*
	12	Ortego, Miguel	0		12	Lee, Heung-Pyo	0*
	13	De paz, Miguel	0		13	Hur, Sang-Young	0 +
	14	Fabregas, Eduardo	0		14	Park, Jae-Sik	0*
	15	Iglesias, Jose Antonio	0*		15	Yoo, Seung-Jin	0*
	16	Grau, Santiago	0*		16	Shin, Suk-Kyun	0-

Coach/Entraîneur: Cortes Villa, Santiago
 Asst. Coach/Entraîneur Adj.:
 Manager/Chef d'Equipe: Aurell, Pep

Coach/Entraîneur: Yoo, Seung-In
 Asst. Coach/Entraîneur Adj.:
 Manager/Chef d'Equipe: Yoo, Min-Seung

Hockey

Event	Total	1st	Half	2nd	Half	Extra Period
Evenement	Total	1ere	Mi-temps	2eme	Mi-temps	Prolongation
Shot on Goal / Lancer au But	8-4	4-3		4-1		0-0
Field Goal / But de Champ	2-0	1-0		1-0		0-0
P-Stroke Goal / But de Coup Penalty	0-0	0-0		0-0		0-0
P-Corner Goal / But de Penalty Coin	0-0	0-0		0-0		0-0
Cor-Hit Goal / But de Coup Coin	0-0	0-0		0-0		0-0
Assist/Assistance	0-0	0-0		0-0		0-0
Off-Side /Hors Jeu	0-1	0-1		0-0		0-0
Warning /Avertissement	4-1	2-1		2-0		0-0

Men Final (11-12 Places)/Sept. 29				Hommes Finale (11-12 Places)/29 Sept			
Ctry	No.	Name	Goals	Ctry	No.	Name	Goals
Pays	Doss	Nom	Buts	Pays	Doss	Nom	Buts
CAN	3-1	KEN	(3-0, 0-1)				
CAN	01	Rutledge, Michael Ross	1*	*KEN*	01	Omany, Paul Sewe	0
	02	Sandhu, Hargurnek	1*		02	Saini, Parminder	0*
	03	Albert, Rick	0*		03	Odhier, Roy	0-
	04	Burrows, Patrick	0*		04	Oguk, Charles	0*
	05	Chohan, Satinder	0*		05	Okoth, John Eliud	0*
	06	Gifford, Christopher	0 +		06	Omondi, Michael	0 +
	07	Grimmer, Wayne	0		07	Ngoyo, Sam	0*
	08	Rai, Ranjeet	0 +		08	Akatsa, Peter	1*
	09	Milkovich, Peter	0-		09	Goyal, Sanjiwan	0 +
	10	Porritt, Trevor	1*		10	Otambo, Christopher	0 +
	11	Bird, Robert Ian	0*		11	Alubaha, Lucas	0*
	12	Harris, Douglas	0		12	Owino, Victor	0-
	13	Muller, Michael	0-		13	Oriso, Samson	0
	14	Caruso, Pasouale	0*		14	Matharu, Inderjit	0*
	15	Dube, Ajay	0 +		15	Muange, Samson	0-
	16	Goodwin, Ken	0-		16	Mutua, Julius	0*

Coach/Entraîneur: Clarke, Trevor
 Asst. Coach/Entraîneur Adj.:
 Manager/Chef d'Equipe: Crooks, Dennis

Coach/Entraîneur: Lall, Gursharam Singh
 Asst. Coach/Entraîneur Adj.:
 Manager/Chef d'Equipe: Hardev, Singh

Event	Total	1st	Half	2nd	Half	Extra Period
Evenement	Total	1ere	Mi-temps	2eme	Mi-temps	Prolongation
Shot on Goal / Lancer au But	16-7	7-3		9-4		0-0
Field Goal / But de Champ	2-1	2-0		0-1		0-0
P-Stroke Goal / But de Coup Penalty	0-0	0-0		0-0		0-0
P-Corner Goal / But de Penalty Coin	1-0	1-0		0-0		0-0
Cor-Hit Goal / But de Coup Coin	0-0	0-0		0-0		0-0
Assist/Assistance	0-0	0-0		0-0		0-0
Off-Side/Hors Jeu	2-0	2-0		0-0		0-0
Warning /Avertissement	4-4	2-3		2-1		0-0

Men Warning Statistics/Sept. 18-Oct. 1					Hommes Stat. des Avertissements/18 Sept-1 Oct				
Rank	Ctry	Red	Yellow	Green	Rank	Ctry	Red	Yellow	Green
Rang	Pays	Rouge	Jaune	Vert	Rang	Pays	Rouge	Jaune	Vert
1	IND	0	1	2					
2	FRG	0	0	6					
2	URS	0	3	3					
4	GBR	0	0	10					
5	PAK	0	3	9					
6	KOR	0	2	11					
7	ARG	0	2	12					
8	AUS	0	4	11					
9	ESP	0	5	11					
9	HOL	0	3	13					
9	KEN	0	6	10					
12	CAN	0	4	13					

Men Scorer Standing/Sept. 18-Oct. 1				Hommes Classement des Marqueurs/18 Sept-1 Oct					
Rank	No.	Ctry	Name	Total	Field	Pty	Pty	Corner	Matches
Rang	Doss	Pays	Nom	Total	Goals	St.	Cn.	Corner	Matches
1	11	HOL	Bove Lander, Floris Jan	9	0	0	9	0	7
2	08	AUS	Hager, Mark	8	7	0	0	1	7
2	13	GBR	Kerly, Sean	8	5	0	3	0	7
4	10	AUS	Hawgood, Neil	5	5	0	0	0	7
4	04	GBR	Barber, Paul	5	1	0	4	0	7
4	04	IND	MohinderPalSingh	5	0	0	5	0	7
4	09	PAK	Tariq Sheikh	5	5	0	0	0	7
8	09	ARG	Geneyro, Carlos	4	0	1	3	0	7
8	02	ESP	Escude, Ignacio	4	1	0	3	0	7
8	04	FRG	Fischer, Carsten	4	0	0	4	0	7
8	10	PAK	Zahid Sharif	4	4	0	0	0	7
12	04	ARG	Mascheroni, Marcelo	3	0	0	3	0	7
12	12	ARG	Ferrara, Fernando	3	2	0	1	0	7
12	04	AUS	Birmingham, Warren	3	1	2	0	0	7
12	08	FRG	Dopp, Heiner	3	3	0	0	0	7
12	09	FRG	Bloecher, Stefan	3	2	1	0	0	7
12	15	GBR	Sherwani, Imran	3	3	0	0	0	7
12	10	IND	Jude Felix, Sebastian	3	3	0	0	0	7
12	12	IND	Mervyn Ernadis, Mervyn	3	2	1	0	0	7
12	14	KEN	Matharu, Inderjit	3	2	1	0	0	7
12	11	KOR	Han, Jin-Soo	3	3	0	0	0	7
12	15	KOR	Yoo, Seung-Jin	3	2	0	1	0	7
12	03	PAK	Qazi Mohib-Ur-Rehman	3	0	2	1	0	7
12	08	PAK	Shahbaz Ahmed	3	3	0	0	0	7
25	11	ARG	Verga, Alejandro	2	2	0	0	0	7
25	02	AUS	Batch, Colin	2	2	0	0	0	7
25	01	CAN	Rutledge, Michael Ross	2	1	0	0	1	7



Rank Rang	No. Doss	Ctry Pays	Name Nom	Total Total	Field Goals	Pty St.	Pty Cn.	Corner	Matches
25	02	CAN	Sandhu, Hargumek	2	0	0	2	0	7
25	07	ESP	Peon, Juan Carlos	2	2	0	0	0	7
25	11	FRG	Reck, Thomas	2	2	0	0	0	7
25	14	FRG	Hilgers, Michael	2	2	0	0	0	7
25	16	HOL	Van Den Honert, Taco	2	2	0	0	0	7
25	13	IND	Thoiba Singh	2	2	0	0	0	7
25	11	KEN	Alubaha, Lucas	2	0	0	2	0	7
25	07	PAK	Qamar Ibrahim	2	2	0	0	0	7
25	10	URS	Plechakov, Serguei	2	2	0	0	0	7
25	13	URS	Davydov, Igor	2	2	0	0	0	7
25	16	URS	Boukatine, Mikhail	2	1	0	1	0	7
39	05	ARG	Garraffo, Marcelo	1	0	0	1	0	7
39	06	ARG	Pailos, Edgardo	1	1	0	0	0	7
39	10	ARG	Minadeo, Gabriel	1	1	0	0	0	7
39	03	AUS	Bestall, John	1	0	0	1	0	7
39	09	AUS	Stacy, Jay	1	0	0	1	0	7
39	12	AUS	Reid, Graham	1	1	0	0	0	7
39	15	AUS	Wansbrough, David	1	1	0	0	0	7
39	06	CAN	Gifford, Christopher	1	0	0	1	0	7
39	10	CAN	Porritt, Trevor	1	1	0	0	0	7
39	09	ESP	Escude, Jaime	1	0	1	0	0	7
39	10	ESP	Escude, Javier	1	1	0	0	0	7
39	11	ESP	Oliva, Jorge	1	1	0	0	0	7
39	13	ESP	De Paz, Miguel	1	1	0	0	0	7
39	05	FRG	Mollandin, Andreas	1	1	0	0	0	7
39	10	FRG	Keller, Andreas	1	0	0	1	0	7
39	06	GBR	Potter, Jon	1	0	1	0	0	7
39	07	GBR	Dodds, Richard	1	1	0	0	0	7
39	04	HOL	Crucg, Maurits	1	1	0	0	0	7
39	06	HOL	Kooijman, Hendrik Jan	1	0	1	0	0	7
39	07	HOL	Delissen, Marc	1	1	0	0	0	7
39	15	HOL	Parlevliet, Erik	1	1	0	0	0	7
39	08	IND	Baladadalaish, Subramani	1	1	0	0	0	7
39	09	IND	Mohammad Shahid	1	1	0	0	0	7
39	11	IND	Balwinder Singh	1	1	0	0	0	7
39	05	KEN	Okoth, John Eliud	1	1	0	0	0	7
39	08	KEN	Akatsa, Peter	1	1	0	0	0	7
39	09	KEN	Goyal, Sanjiwan	1	1	0	0	0	7
39	02	KOR	Kim, Young-Joon	1	0	0	1	0	7
39	03	KOR	Kim, Jong-Kap	1	0	0	1	0	7
39	05	KOR	Chung, Kye-Suk	1	0	0	1	0	7
39	10	KOR	Kim, Man-Whe	1	1	0	0	0	7
39	16	PAK	Musaddiz Hussain	1	1	0	0	0	7
39	02	URS	Depoutatov, Viotor	1	1	0	0	0	7
39	07	URS	Tchetchenov, Viatcheslav	1	0	1	0	0	7
39	14	URS	Miasnikov, Alexandre	1	1	0	0	0	7

Men Hommes
Final Standing/Sept. 18-Oct. 1 Classement Final/18 Sept-1 Oct

< Semi-final/Demi-finale >		
Semi-final Match 1 (A1-B2)	AUS-GBR	2-3
Semi-final Match 2 (B1-A2)	FRG-HOL	2-1
Semi-final Match 3 (A3-B4)	PAK-URS	1-0
Semi-final Match 4 (B3-A4)	IND-ARG	6-6 * P.S.C. *(4-3)
Semi-final Match 5 (A5-B6)	ESP-CAN	2-0
Semi-final Match 6 (B5-A6)	KOR-KEN	5-2

< Final/Finale >		
Final (1-2 Places)	FRG-GBR	1-3
Final (3-4 Places)	AUS-HOL	1-2
Final (5-6 Places)	IND-PAK	1-2
Final (7-8 Places)	URS-ARG	4-1
Final (9-10 Places)	ESP-KOR	2-0
Final (11-12 Places)	CAN-KEN	3-1

< Final Standing/Classement Final >		
1 —GBR	Great Britain	
2 —FRG	Federal Republic of Germany	
3 —HOL	Netherlands	
4 —AUS	Australia	
5 —PAK	Pakistan	
6 —IND	India	
7 —URS	U.S.S.R.	
8 —ARG	Argentina	
9 —ESP	Spain	
10 —KOR	Korea	
11 —CAN	Canada	
12 —KEN	Kenya	

Women Femmes
Prelim. Round Group A Match 1/Sept. 21 Series Prelim. Groupe A Match 1/21 Sept

Ctry Pays	No. Doss	Name Nom	Goals Buts	Ctry Pays	No. Doss	Name Nom	Goals Buts
ARG	0-1	GBR	(0-1, 0-0)				
ARG	01	Mulhall, Laura	0*	*GBR*	01	Atkins, Gill	0*
	02	Colombo, Cecilia	0*		02	Banks, Wendy	0
	03	Lopez, Marisa	0*		03	Brown, Gill	0-
	04	Tucat, Alejandra	0*		04	Brown, Karen	0*
	05	Carbo, Victoria	0*		05	Nevill, Mary	0*
	06	Ricchezza, Fabiana	0*		06	Cook, Julie	0*
	07	Liz, Gabriela	0*		07	Dixon, Vickey	0*
	08	Sanchez, Gabriela	0*		08	Fraser, Wendy	0+
	09	Brinnand, Moira	0*		09	Hambly, Barbara	0*
	10	Hussey, Marcela	0*		10	Jordan, Caroline	0+
	11	Palma, Alejandra	0-		11	Mcbride, Violet	0*
	12	Ormaechea, Laura	0		12	Macleod, Moira	1*
	13	Bengochea, Veronica	0+		13	Brewer, Caroline	0
	14	Vergara, Alina	0		14	Sixsmith, Jane	0
	15	Pazos, Gabriela	0		15	Parker, Kate	0-
	16	Fioroni, Andrea	0		16	Ramsay, Alison	0*

Coach/Entraîneur: Asst. Coach/Entraîneur Adj.: Manager/Chef d'Equipe: Hay, Dennis
Asst. Coach/Entraîneur Adj.: Manager/Chef d'Equipe: Batterham, Diane

Event Evenement	Total Total	1st 1ere	Half Mi-temps	2nd 2eme	Half Mi-temps	Extra Period Prolongation
Shot on Goal / Lancer au But	2-10	2-5		0-5		0-0
Field Goal / But de Champ	0-0	0-0		0-0		0-0
P-Stroke Goal / But de Coup Penalty	0-0	0-0		0-0		0-0
P-Corner Goal / But de Penalty Coin	0-1	0-1		0-0		0-0
Cor-Hit Goal/But de Coup Coin	0-0	0-0		0-0		0-0
Assist/Assistance	0-0	0-0		0-0		0-0
Off-Side/Hors Jeu	1-3	0-1		1-2		0-0
Warning / Avertissement	0-1	0-0		0-1		0-0

Women Femmes
Prelim. Round Group A Match 2/Sept. 21 Series Prelim. Groupe A Match 2/21 Sept

Ctry Pays	No. Doss	Name Nom	Goals Buts	Ctry Pays	No. Doss	Name Nom	Goals Buts
HOL	3-1	USA	(2-0, 1-1)				
HOL	01	De Beus, Bernadette	0*	*USA*	01	Shea, Patricia	0
	02	Buter, Yvonne	0		02	Hightower, Yolanda	0*
	03	Aardenburg, Willemien	0		03	Koboldt, Mary	0*
	04	Willemse, Laurien	0*		04	Pankratz, Marcia	0-
	05	Bolhuis, Marjolein	0*		05	Van kuren, Cheryl	0
	06	Lejeune, Lisanne	1*		06	Bracalente, Diane	0
	07	Benninga, Carina	0*		07	Beglin, Elizabeth	0*
	08	Fokke, Annemieke	0		08	Von Schottenstein, Marcell	0*
	09	Wolff, Ingrid	0-		09	Vander-Heyden, Sandra	0*
	10	Van Doom, Marieke	0		10	Fuchs, Tracey	0+
	11	Von Weiler, Sophie	1*		11	Johnson, Sheryl	1*
	12	Van Manen, Aletta	0*		12	Costigan, Sandra	0
	13	Holsboer, Noor	0*		13	Morgan, Christy	0*
	14	Van Der Ben, Helen	1*		14	Marois, Barbara	0*
	15	Ohr, Martine	0+		15	Donnelly, Megan	0*
	16	Nieuwenhuizen, Anneloes	0*		16	Lee, Donna	0*

Coach/Entraîneur: Van Heumen, Gys Asst. Coach/Entraîneur Adj.: Manager/Chef d'Equipe: Tolentino, Roberto
Coach/Entraîneur: Castellijn, Boud Asst. Coach/Entraîneur Adj.: Didio, Marisa Manager/Chef d'Equipe: Madison, Michele

Event Evenement	Total Total	1st 1ere	Half Mi-temps	2nd 2eme	Half Mi-temps	Extra Period Prolongation
Shot on Goal / Lancer au But	18-2	11-0		7-2		0-0
Field Goal / But de Champ	1-1	1-0		0-1		0-0
P-Stroke Goal / But de Coup Penalty	0-0	0-0		0-0		0-0
P-Corner Goal / But de Penalty Coin	2-0	1-0		1-0		0-0
Cor-Hit Goal / But de Coup Coin	0-0	0-0		0-0		0-0
Assist/Assistance	0-0	0-0		0-0		0-0
Off-Side/Hors Jeu	1-1	0-0		1-1		0-0
Warning / Avertissement	1-1	0-0		1-1		0-0

Women Femmes
Prelim. Round Group A Match 3/Sept. 23 Series Prelim. Groupe A Match 3/23 Sept

Ctry Pays	No. Doss	Name Nom	Goals Buts	Ctry Pays	No. Doss	Name Nom	Goals Buts
HOL	5-1	GBR	(3-1, 2-0)				
HOL	01	De Beus, Bernadette	0*	*GBR*	01	Atkins, Gill	0+
	02	Buter, Yvonne	0		02	Banks, Wendy	0
	03	Aardenburg, Willemien	0+		03	Brown, Gill	0*
	04	Willemse, Laurien	0*		04	Brown, Karen	0*
	05	Bolhuis, Marjolein	0-		05	Nevill, Mary	0*
	06	Lejeune, Lisanne	4*		06	Cook, Julie	0*
	07	Benninga, Carina	0*		07	Dixon, Vickey	1-
	08	Fokke, Annemieke	0		08	Fraser, Wendy	0+
	09	Wolff, Ingrid	0-		09	Hambly, Barbara	0*
	10	Van Doom, Marieke	0+		10	Jordan, Caroline	0
	11	Von Weiler, Sophie	1*		11	Mcbride, Violet	0*
	12	Van Manen, Aletta	0*		12	Macleod, Moira	0*
	13	Holsboer, Noor	0-		13	Brewer, Caroline	0-
	14	Van Der Ben, Helen	0*		14	Sixsmith, Jane	0+
	15	Ohr, Martine	0+		15	Parker, Kate	0-
	16	Nieuwenhuizen, Anneloes	0*		16	Ramsay, Alison	0*

Coach/Entraîneur: Van Heumen, Gys Asst. Coach/Entraîneur Adj.: Manager/Chef d'Equipe: Cora De Wilde
Coach/Entraîneur: Hay, Dennis Asst. Coach/Entraîneur Adj.: Manager/Chef d'Equipe: Batterham, Diane

Hockey

Event	Total	1st	Half	2nd	Half	Extra Period
Evenement	Total	1ere	Mi-temps	2eme	Mi-temps	Prolongation
Shot on Goal / Lancer au But	15-5	6-3		9-2		0-0
Field Goal / But de Champ	1-0	0-0		1-0		0-0
P-Stroke Goal / But de Coup Penalty	1-1	0-1		1-0		0-0
P-Corner Goal / But de Penalty Coin	3-0	3-0		0-0		0-0
Cor-Hit Goal / But de Coup Coin	0-0	0-0		0-0		0-0
Assist/Assistance	0-0	0-0		0-0		0-0
Off-Side/Hors Jeu	1-5	1-3		0-2		0-0
Warning /Avertissement	1-0	1-0		0-0		0-0

Women				Femmes			
Prelim. Round Group A Match 4/Sept. 23				Series Prelim. Groupe A Match 4/23 Sept			
Ctry	No.	Name	Goals	Ctry	No.	Name	Goals
Pays	Doss	Nom	Buts	Pays	Doss	Nom	Buts

ARG	2-1	USA	(1-0,1-1)				
ARG	01	Mulhall, Laura	0*	*USA*	01	Shea, Patricia	0
	02	Colombo, Cecilia	1*		02	Hightower, Yolanda	0-
	03	Lopez, Marisa	0*		03	Koboldt, Mary	0*
	04	Tucat, Alejandra	0*		04	Pankratz, Marcia	0-
	05	Carbo, Victoria	1*		05	Van Kuren, Cheryl	0
	06	Ricchezza, Fabiana	0-		06	Bracalente, Diane	0 +
	07	Liz, Gabriela	0*		07	Beglin, Elizabeth	0*
	08	Sanchez, Gabriela	0*		08	Von Schottenstein, Marcell	0*
	09	Brinnand, Moira	0-		09	Vander-Heyden, Sandra	0*
	10	Hussey, Marcela	0*		10	Fuchs, Tracey	0 +
	11	Palma, Alejandra	0-		11	Johnson, Sheryl	0*
	12	Ormaechea, Laura	0		12	Costigan, Sandra	0 +
	13	Bengochea, Veronica	0 +		13	Morgan, Christy	1*
	14	Vergara, Alina	0		14	Marois, Barbara	0-
	15	Pazos, Gabriela	0 +		15	Donnelly, Megan	0*
	16	Fioroni, Andrea	0 +		16	Lee, Donna	0*

Coach/Entraîneur: Maccormik, Miguel
 Asst. Coach/Entraîneur Adj.:
 Manager/Chef d'Equipe: Medici, Claudia

Coach/Entraîneur: Castelijn, Boud
 Asst. Coach/Entraîneur Adj.: Didio, Marisa
 Manager/Chef d'Equipe: Madison, Michele

Event	Total	1st	Half	2nd	Half	Extra Period
Evenement	Total	1ere	Mi-temps	2eme	Mi-temps	Prolongation
Shot on Goal / Lancer au But	4-13	3-4		1-9		0-0
Field Goal/But de Champ	0-0	0-0		0-0		0-0
P-Stroke Goal/But de Coup Penalty	0-0	0-0		0-0		0-0
P-Corner Goal / But de Penalty Coin	2-1	1-0		1-1		0-0
Cor-Hit Goal / But de Coup Coin	0-0	0-0		0-0		0-0
Assist /Assistance	0-0	0-0		0-0		0-0
Off-Side/Hors Jeu	1-0	0-0		1-0		0-0
Warning / Avertissement	1-0	1-0		0-0		0-0

Women				Femmes			
Prelim. Round Group A Match 5/Sept. 25				Series Prelim. Groupe A Match 5/25 Sept			
Ctry	No.	Name	Goals	Ctry	No.	Name	Goals
Pays	Doss	Nom	Buts	Pays	Doss	Nom	Buts

USA	2-2	GBR	(0-1,2-1)				
USA	01	Shea, Patricia	0*	*GBR*	01	Atkins, Gill	0-
	02	Hightower, Yolanda	0*		02	Banks, Wendy	0
	03	Koboldt, Mary	0*		03	Brown, Gill	0*
	04	Pankratz, Marcia	0 +		04	Brown, Karen	0*
	05	Van Kuren, Cheryl	0		05	Nevill, Mary	0*
	06	Bracalente, Diane	0 +		06	Cook, Julie	0*
	07	Beglin, Elizabeth	0*		07	Dixon, Vickey	1*
	08	Von Schottenstein, Marcell	0*		08	Fraser, Wendy	0 +
	09	Vander-Heyden, Sandra	0*		09	Hambly, Barbara	0*
	10	Fuchs, Tracey	0-		10	Jordan, Caroline	0 +
	11	Johnson, Sheryl	1*		11	Mcbride, Violet	0*
	12	Costigan, Sandra	0		12	Macleod, Moira	0*
	13	Morgan, Christy	1*		13	Brewer, Caroline	0
	14	Marois, Barbara	0-		14	Sixsmith, Jane	0
	15	Donnelly, Megan	0*		15	Parker, Kate	1-
	16	Lee, Donna	0		16	Ramsay, Alison	0*

Coach/Entraîneur: Castelijn, Boud
 Asst. Coach/Entraîneur Adj.: Didio, Marisa
 Manager/Chef d'Equipe: Madison, Michele

Coach/Entraîneur: Hay, Dennis
 Asst. Coach/Entraîneur Adj.:
 Manager/Chef d'Equipe: Batterham, Diane

Event	Total	1st	Half	2nd	Half	Extra Period
Evenement	Total	1ere	Mi-temps	2eme	Mi-temps	Prolongation
Shot on Goal/Lancer au But	7-12	2-8		5-4		0-0
Field Goal / But de Champ	0-1	0-0		0-1		0-0
P-Stroke Goal / But de Coup Penalty	0-1	0-1		0-0		0-0
P-Corner Goal / But de Penalty Coin	2-0	0-0		2-0		0-0
Cor-Hit Goal / But de Coup Coin	0-0	0-0		0-0		0-0
Assist /Assistance	0-0	0-0		0-0		0-0
Off-Side /Hors Jeu	1-0	0-0		1-0		0-0
Warning / Avertissement	3-3	2-3		1-0		0-0

Hockey

Women				Femmes			
Prelim. Round Group A Match 6/Sept. 25				Series Prelim. Groupe A Match 6/25 Sept			
Ctry	No.	Name	Goals	Ctry	No.	Name	Goals
Pays	Doss	Nom	Buts	Pays	Doss	Nom	Buts

HOL	1-0	ARG	(1-0,0-0)				
HOL	01	De Beus, Bernadette	0	*ARG*	01	Mulhall, Laura	0*
	02	Buter, Yvonne	0*		02	Colombo, Cecilia	0*
	03	Aardenburg, Willemien	0*		03	Lopez, Marisa	0*
	04	Willemse, Laurien	0-		04	Tucat, Alejandra	0*
	05	Bolhuis, Marjolein	0-		05	Carbo, Victoria	0*
	06	Lejeune, Lisanne	0		06	Ricchezza, Fabiana	0*
	07	Benninga, Carina	0*		07	Liz, Gabriela	0*
	08	Fokke, Annemieke	0 +		08	Sanchez, Gabriela	0*
	09	Wolff, Ingrid	0*		09	Brinnand, Moira	0*
	10	Van Doorn, Marieke	0-		10	Hussey, Marcela	0*
	11	Von Weiler, Sophie	0 +		11	Palma, Alejandra	0*
	12	Van Manen, Aletta	0*		12	Ormaechea, Laura	0
	13	Holsboer, Noor	0 +		13	Bengochea, Veronica	0
	14	Van Der Ben, Helen	1*		14	Vergara, Alina	0
	15	Ohr, Martine	0*		15	Pazos, Gabriela	0
	16	Nieuwenhuizen, Anneloes	0*		16	Fioroni, Andrea	0

Coach/Entraîneur: Van Heumen, Gys
 Asst. Coach/Entraîneur Adj.:
 Manager/Chef d'Equipe: Cora De Wilde

Coach/Entraîneur: Maccormik, Miguel
 Asst. Coach/Entraîneur Adj.:
 Manager/Chef d'Equipe: Medici, Claudia

Event	Total	1st	Half	2nd	Half	Extra Period
Evenement	Total	1ere	Mi-temps	2eme	Mi-temps	Prolongation
Shot on Goal/Lancer au But	6-5	3-2		3-3		0-0
Field Goal / But de Champ	0-0	0-0		0-0		0-0
P-Stroke Goal / But de Coup Penalty	0-0	0-0		0-0		0-0
P-Corner Goal / But de Penalty Coin	1-0	1-0		0-0		0-0
Cor-Hit Goal / But de Coup Coin	0-0	0-0		0-0		0-0
Assist /Assistance	0-0	0-0		0-0		0-0
Off-Side/Hors Jeu	0-3	0-2		0-1		0-0
Warning / Avertissement	0-0	0-0		0-0		0-0

Women				Femmes			
Prelim. Round Group B Match 1/Sept. 21				Series Prelim. Groupe B Match 1/21 Sept			
Ctry	No.	Name	Goals	Ctry	No.	Name	Goals
Pays	Doss	Nom	Buts	Pays	Doss	Nom	Buts

KOR	4-1	FRG	(2-1,2-0)				
KOR	01	Kim, Mi-Sun	0	*FRG*	01	Buechel, Pia	0
	02	Han, Ok-Kyung	0*		02	Schmid, Susanne	0*
	03	Chang, Eun-Jung	0*		03	Hoffmann, Carola	0*
	04	Han, Keum-Sil	0*		04	Gehrmann, Heike	1*
	05	Choi, Choon-Ok	0*		05	Bremer, Dagmar	0*
	06	Kim, Soon-Duk	0*		06	Uhlenbruck, Gabriele	0
	07	Chung, Sang-Hyun	1*		07	Grahl, Viola	0 +
	08	Jin, Won-Sim	0 +		08	Blumenbeg, Bettina	0 +
	09	Hwang, Keum-Sook	0-		09	Appel, Gaby	0*
	10	Cho, Ki-Hyang	0		10	Hallmen, Martina	0-
	11	Seo, Kwang-Mi	1 +		11	Ferneck, Christine	0*
	12	Park, Soon-Ja	0-		12	Wehrmeister, Silke	0-
	13	Kim, Young-Sook	0		13	Jungjohann, Caren	0*
	14	Seo, Hyo-Sun	0*		14	Hegener, Eva	0
	15	Lim, Kye-Sook	2*		15	Wolls Chlager, Susi	0*
	16	Chung, Eun-Kyung	0*		16	Schowe, Gabriela	0*

Coach/Entraîneur: Park, Young-Jo
 Asst. Coach/Entraîneur Adj.:
 Manager/Chef d'Equipe:

Coach/Entraîneur: Strodtter, Wolfgang
 Asst. Coach/Entraîneur Adj.:
 Manager/Chef d'Equipe: Rommel, Wolfgang

Event	Total	1st	Half	2nd	Half	Extra Period
Evenement	Total	1ere	Mi-temps	2eme	Mi-temps	Prolongation
Shot on Goal / Lancer au But	15-8	6-4		9-4		0-0
Field Goal/But de Champ	4-1	2-1		2-0		0-0
P-Stroke Goal/But de Coup Penalty	0-0	0-0		0-0		0-0
P-Corner Goal / But de Penalty Coin	0-0	0-0		0-0		0-0
Cor-Hit Goal / But de Coup Coin	0-0	0-0		0-0		0-0
Assist / Assistance	0-0	0-0		0-0		0-0
Off-Side / Hors Jeu	2-1	2-0		0-1		0-0
Warning / Avertissement	1-2	0-1		1-1		0-0

Women				Femmes			
Prelim. Round Group B Match 2/Sept. 21				Series Prelim. Groupe B Match 2/21 Sept			
Ctry	No.	Name	Goals	Ctry	No.	Name	Goals
Pays	Doss	Nom	Buts	Pays	Doss	Nom	Buts

AUS	1-1	CAN	(0-1,1-0)				
AUS	01	Partridge, Kathleen	0*	*CAN*	01	Bayes, Sharon	0*
	02	Clement, Elspeth	0*		02	Baker, Wendy	0
	03	Tooth, Liane	0*		03	Covey, Deb	0*
	04	Dorman, Loretta	0*		04	Lyn, Lisa	0
	05	Hillas, Lorraine	0		05	Branchaud, Laura	0*
	06	Capes, Michelle	0*		06	Levy, Sandra	0*
	07	Pisani, Sandra	0*		07	Johnson, Kathryn	0*
	08	Bowman, Deborah	1*		08	Slade, Melanie	0
	09	Capes, Lee	0-		09	Cooper, Penney	0
	10	Small, Kim	0-		10	Schleppe, Shona	0*
	11	Carbon, Sally	0 +		11	Conn, Michelle	0*
	12	Pereira, Jacqueline	0*		12	Czenczek, Liz	0*
	13	Belbin, Tracey	0		13	Forshaw, Sheila	1*
	14	Hawkes, Rechele	0 +		14	Charlton, Nancy	0
	15	Patmore, Sharon	0*		15	Ballantyne, Sara	0*
	16	Fish, Maree	0		16	Creelman, Sharon	0*

Coach/Entraîneur:
 Asst. Coach/Entraîneur Adj.: Freitag, Peter
 Manager/Chef d'Equipe:

Coach/Entraîneur: Broderick, Kathleen
 Asst. Coach/Entraîneur Adj.:
 Manager/Chef d'Equipe: Cicinelli, Mary



Event	Total	1st	Half	2nd	Half	Extra Period
Evenement	Total	1ere	Mi-temps	2eme	Mi-temps	Prolongation
Shot on Goal / Lancer au But	14-3	8-2		6-1		0-0
Field Goal / But de Champ	0-1	0-1		0-0		0-0
P-Stroke Goal / But de Coup Penalty	1-0	0-0		1-0		0-0
P-Corner Goal/But de Penalty Coin	0-0	0-0		0-0		0-0
Cor-Hit Goal / But de Coup Coin	0-0	0-0		0-0		0-0
Assist/Assistance	0-0	0-0		0-0		0-0
Off-Side/ Hors Jeu	1-3	0-1		1-2		0-0
Warning / Avertissement	0-0	0-0		0-0		0-0

Women Prelim. Round Group B Match 3/Sept. 23 **Femmes Series Prelim. Groupe B Match 3/23 Sept**

Ctry	No.	Name	Goals	Ctry	No.	Name	Goals
Pays	Doss	Nom	Buts	Pays	Doss	Nom	Buts
AUS	1-0	FRG (0-0,1-0)					
AUS	01	Partridge, Kathleen	0*	*FRG*	01	Buechel, Pia	0
	02	Clement, Elspeth	0*		02	Schmid, Susanne	0*
	03	Tooth, Liane	0*		03	Hoffmann, Carola	0*
	04	Dorman, Loretta	0*		04	Gehrmann, Heike	0*
	05	Hillas, Lorraine	0		05	Bremer, Dagmar	0*
	06	Capes, Michelle	0*		06	Uhlenbruck, Gabriele	0
	07	Pisani, Sandra	0		07	Grahl, Viola	0*
	08	Bowman, Deborah	1 +		08	Blumenbeg, Bettina	0-
	09	Capes, Lee	0*		09	Appel, Gaby	0*
	10	Small, Kim	0-		10	Hallmen, Martina	0
	11	Carbon, Sally	0 +		11	Ferneck, Christine	0 +
	12	Pereira, Jacqueline	0*		12	Wehrmeister, Silke	0*
	13	Belbin, Tracey	0*		13	Jungjohann, Caren	0*
	14	Hawkes, Rechelle	0-		14	Hegener, Eva	0
	15	Patmore, Sharon	0*		15	Wolls Chjager, Susi	0*
	16	Fish, Maree	0		16	Schowe, Gabriela	0*

Coach/Entraîneur: Brian Glencross
 Asst. Coach/Entraîneur Adj.: Freitag, Peter
 Manager/Chef d'Equipe: Yvonne Parsons

Coach/Entraîneur: Strodtter, Wolfgang
 Asst. Coach/Entraîneur Adj.:
 Manager/Chef d'Equipe: Dorte Wulf

Event	Total	1st	Half	2nd	Half	Extra Period
Evenement	Total	1ere	Mi-temps	2eme	Mi-temps	Prolongation
Shot on Goal / Lancer au But	13-8	5-1		8-7		0-0
Field Goal / But de Champ	1-0	0-0		1-0		0-0
P-Stroke Goal / But de Coup Penalty	0-0	0-0		0-0		0-0
P-Corner Goal/ But de Penalty Coin	0-0	0-0		0-0		0-0
Cor-Hit Goal / But de Coup Coin	0-0	0-0		0-0		0-0
Assist/ Assistance	0-0	0-0		0-0		0-0
Off-Side/ Hors Jeu	3-0	1-0		2-0		0-0
Warning / Avertissement	0-4	0-0		0-4		0-0

Women Prelim. Round Group B Match 4/Sept. 23 **Femmes Series Prelim. Groupe B Match 4/23 Sept**

Ctry	No.	Name	Goals	Ctry	No.	Name	Goals
Pays	Doss	Nom	Buts	Pays	Doss	Nom	Buts
KOR	3-1	CAN (2-1,1-0)					
KOR	01	Kim, Mi-Sun	0	*CAN*	01	Bayes, Sharon	0*
	02	Han, Ok-Kyung	0*		02	Baker, Wendy	0
	03	Chang, Eun-Jung	0*		03	Covey, Deb	0*
	04	Han, Keum-Sil	0*		04	Lyn, Lisa	0
	05	Choi, Choon-Ok	0*		05	Branchaud, Laura	0*
	06	Kim, Soon-Duk	0*		06	Levy, Sandra	0*
	07	Chung, Sang-Hyun	0*		07	Johnson, Kathryn	1*
	08	Jin, Won-Sim	0 +		08	Slade, Melanie	0
	09	Hwang, Keum-Sook	0-		09	Cooper, Penney	0
	10	Cho, Ki-Hyang	0		10	Schleppe, Shona	0 +
	11	Seo, Kwang-Mi	0		11	Conn, Michelle.	0*
	12	Park, Soon-Ja	2-		12	Czenczek, Liz	0*
	13	Kim, Young-Sook	0 +		13	Forshaw, Sheila	0*
	14	Seo, Hyo-Sun	1*		14	Charlton, Nancy	0-
	15	Lim, Kye-Sook	0*		15	Ballantyne, Sara	0*
	16	Chung, Eun-Kyung	0*		16	Creelman, Sharon	0*

Coach/Entraîneur: Yoo, Young-Chae
 Asst. Coach/Entraîneur Adj.:
 Manager/Chef d'Equipe: Park, Young-Jo

Coach/Entraîneur: Marina Van Der Merwe
 Asst. Coach/Entraîneur Adj.:
 Manager/Chef d'Equipe: Cicinelli, Mary

Event	Total	1st	Half	2nd	Half	Extra Period
Evenement	Total	1ere	Mi-temps	2eme	Mi-temps	Prolongation
Shot on Goal / Lancer au But	19-4	7-2		12-2		0-0
Field Goal / But de Champ	3-0	2-0		1-0		0-0
P-Stroke Goal / But de Coup Penalty	0-0	0-0		0-0		0-0
P-Corner Goal / But de Penalty Coin	0-1	0-1		0-0		0-0
Cor-Hit Goal / But de Coup Coin	0-0	0-0		0-0		0-0
Assist/Assistance	0-0	0-0		0-0		0-0
Off-Side/ Hors Jeu	0-1	0-1		0-0		0-0
Warning / Avertissement	3-1	3-0		0-1		0-0

Women Prelim. Round Group B Match 5/Sept. 25 **Femmes Series Prelim. Groupe B Match 5/25 Sept**

Ctry	No.	Name	Goals	Ctry	No.	Name	Goals
Pays	Doss	Nom	Buts	Pays	Doss	Nom	Buts
CAN	1-2	FRG (0-1,1-1)					
CAN	01	Bayes, Sharon	0*	*FRG*	01	Buechel, Pia	0
	02	Baker, Wendy	0		02	Schmid, Susanne	0*
	03	Covey, Deb	0*		03	Hoffmann, Carola	0*
	04	Lyn, Lisa	1*		04	Gehrmann, Heike	0*
	05	Branchaud, Laura	0*		05	Bremer, Dagmar	0*
	06	Levy, Sandra	0*		06	Uhlenbruck, Gabriele	0
	07	Johnson, Kathryn	0*		07	Grahl, Viola	0-
	08	Slade, Melanie	0		08	Blumenbeg, Bettina	1-
	09	Cooper, Penney	0		09	Appel, Gaby	0*
	10	Schleppe, Shona	0 +		10	Hallmen, Martina	0
	11	Conn, Michelle	0-		11	Ferneck, Christine	0 +
	12	Czenczek, Liz	0*		12	Wehrmeister, Silke	0*
	13	Forshaw, Sheila	0*		13	Jungjohann, Caren	1*
	14	Charlton, Nancy	0 +		14	Hegener, Eva	0 +
	15	Ballantyne, Sara	0-		15	Wolls Chlager, Susi	0*
	16	Creelman, Sharon	0*		16	Schowe, Gabriela	0*

Coach/Entraîneur: Marina Van Der Merwe
 Asst. Coach/Entraîneur Adj.:
 Manager/Chef d'Equipe: Cicinelli, Mary

Coach/Entraîneur: Strodtter, Wolfgang
 Asst. Coach/Entraîneur Adj.:
 Manager/Chef d'Equipe: Dorte Wulf

Event	Total	1st	Half	2nd	Half	Extra Period
Evenement	Total	1ere	Mi-temps	2eme	Mi-temps	Prolongation
Shot on Goal / Lancer au But	13-6	3-2		10-4		0-0
Field Goal / But de Champ	0-1	0-1		0-0		0-0
P-Stroke Goal / But de Coup Penalty	1-0	0-0		1-0		0-0
P-Corner Goal/ But de Penalty Coin	0-1	0-0		0-1		0-0
Cor-Hit Goal / But de Coup Coin	0-0	0-0		0-0		0-0
Assist/ Assistance	0-0	0-0		0-0		0-0
Off-Side/ Hors Jeu	1-1	0-1		1-0		0-0
Warning / Avertissement	0-1	0-0		0-1		0-0

Women Prelim. Round Group B Match 6/Sept. 25 **Femmes Series Prelim. Groupe B Match 6/25 Sept**

Ctry	No.	Name	Goals	Ctry	No.	Name	Goals
Pays	Doss	Nom	Buts	Pays	Doss	Nom	Buts
AUS	5-5	KOR (4-3,1-2)					
AUS	01	Partridge, Kathleen	0*	*KOR*	01	Kim, Mi-Sun	0
	02	Clement, Elspeth	1*		02	Han, Ok-Kyung	0-
	03	Tooth, Liane	0*		03	Chang, Eun-Jung	0*
	04	Dorman, Loretta	0-		04	Han, Keum-Sil	0*
	05	Hillas, Lorraine	0		05	Choi, Choon-Ok	0*
	06	Capes, Michelle	0*		06	Kim, Soon-Duk	0 +
	07	Pisani, Sandra	0 +		07	Chung, Sang-Hyun	1*
	08	Bowman, Deborah	1*		08	Jin, Won-Sim	0*
	09	Capes, Lee	0-		09	Hwang, Keum-Sook	0 +
	10	Small, Kim	0-		10	Cho, Ki-Hyang	0
	11	Carbon, Sally	0 +		11	Seo, Kwang-Mi	0-
	12	Pereira, Jacqueline	3*		12	Park, Soon-Ja	0 +
	13	Belbin, Tracey	0*		13	Kim, Young-Sook	1-
	14	Hawkes, Rechelle	0 +		14	Seo, Hyo-Sun	0*
	15	Patmore, Sharon	0*		15	Lim, Kye-Sook	3*
	16	Fish, Maree	0		16	Chung, Eun-Kyung	0*

Coach/Entraîneur: Brian Glencross
 Asst. Coach/Entraîneur Adj.: Freitag, Peter
 Manager/Chef d'Equipe: Yvonne Parsons

Coach/Entraîneur: Yoo, Young-Chae
 Asst. Coach/Entraîneur Adj.:
 Manager/Chef d'Equipe: Park, Young-Jo

Event	Total	1st	Half	2nd	Half	Extra Period
Evenement	Total	1ere	Mi-temps	2eme	Mi-temps	Prolongation
Shot on Goal / Lancer au But	18-19	13-5		5-14		0-0
Field Goal / But de Champ	4-3	4-2		0-1		0-0
P-Stroke Goal / But de Coup Penalty	1-1	0-0		1-1		0-0
P-Corner Goal / But de Penalty Coin	0-1	0-1		0-0		0-0
Cor-Hit Goal / But de Coup Coin	0-0	0-0		0-0		0-0
Assist / Assistance	0-0	0-0		0-0		0-0
Off-Side/ Hors Jeu	1-0	0-0		1-0		0-0
Warning / Avertissement	1-1	1-1		0-0		0-0

Women Preliminary Round /Sept. 21-25 **Femmes Series Preliminaires/21-25 Sept**

* Group A/Groupe A *

	HOL	GBR	ARG	USA
1 HOL	*	5-1	1-0	3-1
2 GBR	1-5	*	1-0	2-2
3 ARG	0-1	0-1	*	2-1
4 USA	1-3	2-2	1-2	*

* Group B/Groupe B *

	KOR	AUS	FRG	CAN
1 KOR	*	5-5	4-1	3-1
2 AUS	5-5	*	1-0	1-1
3 FRG	1-4	0-1	*	2-1
4 CAN	1-3	1-1	1-2	*

Hockey

Women Semi-final Match 1 (A1-B2)/Sept. 27				Femmes Demi-finale Match 1 (A1-B2)/27 Sept			
Ctry Pays	No. Doss	Name Nom	Goals Buts	Ctry Pays	No. Doss	Name Nom	Goals Buts
HOL	2-3	AUS	(1-1,1-2)				
HOL	01	De Beus, Bernadette	0*	*AUS*	01	Partridge, Kathleen	0*
	02	Buter, Yvonne	0		02	Clement, Elspeth	0*
	03	Aardenburg, Willemien	0		03	Tooth, Liane	1*
	04	Willemse, Laurien	0*		04	Dorman, Loretta	0*
	05	Bolhuis, Marjolein	1*		05	Hillas, Lorraine	0
	06	Lejeune, Lisanne	1*		06	Capes, Michelle	0*
	07	Benninga, Carina	0*		07	Pisani, Sandra	0
	08	Fokke, Annemieke	0		08	Bowman, Deborah	0*
	09	Wolff, Ingrid	0-		09	Capes, Lee	0*
	10	Van Doorn, Marieke	0		10	Small, Kim	0*
	11	Von Weiler, Sophie	0*		11	Carbon, Sally	0
	12	Van Manen, Aletta	0*		12	Pereira, Jacqueline	0*
	13	Holsboer, Noor	0*		13	Belbin, Tracey	0*
	14	Van Der Ben, Helen	0*		14	Hawkes, Rechelle	0
	15	Ohr, Martine	0+		15	Patmore, Sharon	2*
	16	Nieuwenhuizen, Anneloes	0*		16	Fish, Maree	0

Coach/Entraîneur: Van Heumen, Gys
Asst. Coach/Entraîneur Adj.:
Manager/Chef d'Equipe: Cora De Wilde

Coach/Entraîneur: Brian Glencross
Asst. Coach/Entraîneur Adj.: Freitag, Peter
Manager/Chef d'Equipe: Yvonne Parsons

Event Evenement	Total Total	1st 1ere	Half Mi-temps	2nd 2eme	Half Mi-temps	Extra Period Prolongation
Shot on Goal / Lancer au But	9-21	4-9		5-12		0-0
Field Goal / But de Champ	0-2	0-0		0-2		0-0
P-Stroke Goal / But de Coup Penalty	0-0	0-0		0-0		0-0
P-Corner Goal / But de Penalty Coin	2-1	1-1		1-0		0-0
Cor-Hit Goal / But de Coup Coin	0-0	0-0		0-0		0-0
Assist / Assistance	0-0	0-0		0-0		0-0
Off-Side/ Hors Jeu	0-2	0-0		0-2		0-0
Warning / Avertissement	2-0	1-0		1-0		0-0

Women Semi-final Match 2 (B1-A2)/Sept. 27				Femmes Demi-finale Match 2 (B1-A2)/27 Sept			
Ctry Pays	No. Doss	Name Nom	Goals Buts	Ctry Pays	No. Doss	Name Nom	Goals Buts
KOR	1-0	GBR	(1-0,0-0)				
KOR	01	Kim, Mi-Sun	0	*GBR*	01	Atkins, Gill	0*
	02	Han, Ok-Kyung	0-		02	Banks, Wendy	0*
	03	Chang, Eun-Jung	0*		03	Brown, Gill	0*
	04	Han, Keum-Sil	0*		04	Brown, Karen	0-
	05	Choi, Choon-Ok	0*		05	Nevill, Mary	0*
	06	Kim, Soon-Duk	0*		06	Cook, Julie	0
	07	Chung, Sang-Hyun	0*		07	Dixon, Vicky	0*
	08	Jin, Won-Sim	0+		08	Fraser, Wendy	0+
	09	Hwang, Keum-Sook	0-		09	Hambly, Barbara	0*
	10	Cho, Ki-Hyang	0		10	Jordan, Caroline	0
	11	Seo, Kwang-Mi	0		11	Mcbride, Violet	0*
	12	Park, Soon-Ja	0*		12	Macleod, Moira	0*
	13	Kim, Young-Sook	0+		13	Brewer, Caroline	0
	14	Seo, Hyo-Sun	1*		14	Sixsmith, Jane	0+
	15	Lim, Kye-Sook	0*		15	Parker, Kate	0-
	16	Chung, Eun-Kyung	0*		16	Ramsay, Alison	0*

Coach/Entraîneur: Yoo, Young-Chae
Asst. Coach/Entraîneur Adj.:
Manager/Chef d'Equipe: Park, Young-Jo

Coach/Entraîneur: Hay, Dennis
Asst. Coach/Entraîneur Adj.:
Manager/Chef d'Equipe: Batterham, Diane

Event Evenement	Total Total	1st 1ere	Half Mi-temps	2nd 2eme	Half Mi-temps	Extra Period Prolongation
Shot on Goal / Lancer au But	11-8	7-8		4-0		0-0
Field Goal / But de Champ	1-0	1-0		0-0		0-0
P-Stroke Goal / But de Coup Penalty	0-0	0-0		0-0		0-0
P-Corner Goal / But de Penalty Coin	0-0	0-0		0-0		0-0
Cor-Hit Goal / But de Coup Coin	0-0	0-0		0-0		0-0
Assist / Assistance	0-0	0-0		0-0		0-0
Off-Side/ Hors Jeu	1-3	0-2		1-1		0-0
Warning / Avertissement	1-0	1-0		0-0		0-0

Women Semi-final Match 3 (A3-B4)/Sept. 27				Femmes Demi-finale Match 3 (A3-B4)/27 Sept			
Ctry Pays	No. Doss	Name Nom	Goals Buts	Ctry Pays	No. Doss	Name Nom	Goals Buts
ARG	1-3	CAN	(0-1, 1-0,0-1,0-1)				
ARG	01	Mulhall, Laura	0*	*CAN*	01	Bayes, Sharon	0*
	02	Colombo, Cecilia	0*		02	Baker, Wendy	0
	03	Lopez, Marisa	0*		03	Covey, Deb	0*
	04	Tucat, Alejandra	0*		04	Lyn, Lisa	0*
	05	Carbo, Victoria	0-		05	Branchaud, Laura	0*
	06	Ricchezza, Fabiana	0-		06	Levy, Sandra	0*
	07	Liz, Gabriela	0*		07	Johnson, Kathryn	0*
	08	Sanchez, Gabriela	0*		08	Slade, Melanie	0
	09	Brinnand, Moira	0-		09	Cooper, Pennney	0
	10	Hussey, Marcela	0*		10	Schleppe, Shona	0
	11	Palma, Alejandra	1*		11	Conn, Michelle	0*
	12	Ormaechea, Laura	0		12	Czenczek, Liz	0*
	13	Bengochea, Veronica	0+		13	Forshaw, Sheila	1*
	14	Vergara, Alina	0+		14	Charlton, Nancy	0
	15	Pazos, Gabriela	0+		15	Ballantyne, Sara	0*
	16	Fioroni, Andrea	0		16	Creelman, Sharon	2*

Coach/Entraîneur: Maccormik, Miguel
Asst. Coach/Entraîneur Adj.:
Manager/Chef d'Equipe: Medici, Claudia

Coach/Entraîneur: Marina Van Der Merwe
Asst. Coach/Entraîneur Adj.:
Manager/Chef d'Equipe: Cicinelli, Mary

Hockey

Event Evenement	Total Total	1st 1ere	Half Mi-temps	2nd 2eme	Half Mi-temps	Extra Period Prolongation
Shot on Goal / Lancer au But	10-15	2-7		6-5		2-3
Field Goal / But de Champ	0-1	0-1		0-0		0-0
P-Stroke Goal / But de Coup Penalty	1-0	0-0		1-0		0-0
P-Corner Goal / But de Penalty Coin	0-2	0-0		0-0		0-2
Cor-Hit Goal / But de Coup Coin	0-0	0-0		0-0		0-0
Assist / Assistance	0-0	0-0		0-0		0-0
Off-Side/ Hors Jeu	2-1	2-0		0-0		0-1
Warning / Avertissement	0-0	0-0		0-0		0-0

Women Semi-final Match 4 (B3-A4)/Sept. 27				Femmes Demi-finale Match 4 (B3-A4)/27 Sept			
Ctry Pays	No. Doss	Name Nom	Goals Buts	Ctry Pays	No. Doss	Name Nom	Goals Buts
FRG	2-1	USA	(0-1, 2-0)				
FRG	01	Buechel, Pia	0	*USA*	01	Shea, Patricia	0*
	02	Schmid, Susanne	0*		02	Hightower, Yolanda	0-
	03	Hoffmann, Carola	0-		03	Koboldt, Mary	0-
	04	Gehrmann, Heike	0-		04	Pankratz, Marcia	0*
	05	Bremer, Dagmar	0*		05	Van Kuren, Cheryl	0+
	06	Uhlenbruck, Gabriele	0+		06	Bracalente, Diane	0+
	07	Grahl, Viola	0		07	Beglin, Elizabeth	0*
	08	Blumenbeg, Bettina	1*		08	Von Schottenstein, Marcell	0*
	09	Appel, Gaby	0*		09	Vander-Heyden, Sandra	0-
	10	Hallmen, Martina	0+		10	Fuchs, Tracey	0
	11	Ferneck, Christine	0-		11	Johnson, Sheryl	0*
	12	Wehrmeister, Silke	0*		12	Costigan, Sandra	0+
	13	Jungjohann, Caren	0*		13	Morgan, Christy	0*
	14	Hegener, Eva	0+		14	Marois, Barbara	0*
	15	Wolls Chlager, Susi	1*		15	Donnelly, Megan	1*
	16	Schowe, Gabriela	0*		16	Lee, Donna	0

Coach/Entraîneur: Strodtter, Wolfgang
Asst. Coach/Entraîneur Adj.:
Manager/Chef d'Equipe: Dorte Wulf

Coach/Entraîneur: Castelijin, Boud
Asst. Coach/Entraîneur Adj.: Didio, Marisa
Manager/Chef d'Equipe: Madison, Michele

Event Evenement	Total Total	1st 1ere	Half Mi-temps	2nd 2eme	Half Mi-temps	Extra Period Prolongation
Shot on Goal / Lancer au But	19-3	6-2		13-1		0-0
Field Goal / But de Champ	1-0	0-0		1-0		0-0
P-Stroke Goal / But de Coup Penalty	1-0	0-0		1-0		0-0
P-Corner Goal / But de Penalty Coin	0-1	0-1		0-0		0-0
Cor-Hit Goal / But de Coup Coin	0-0	0-0		0-0		0-0
Assist / Assistance	0-0	0-0		0-0		0-0
Off-Side/ Hors Jeu	1-1	1-1		0-0		0-0
Warning / Avertissement	2-3	2-3		0-0		0-0

Women Final (1-2 Places)/Sept. 30				Femmes Finale (1-2 Places)/30 Sept			
Ctry Pays	No. Doss	Name Nom	Goals Buts	Ctry Pays	No. Doss	Name Nom	Goals Buts
AUS	2-0	KOR	(0-0, 2-0)				
AUS	01	Partridge, Kathleen	0-	*KOR*	01	Kim, Mi-Sun	0+
	02	Clement, Elspeth	0*		02	Han, Ok-Kyung	0
	03	Tooth, Liane	0*		03	Chang, Eun-Jung	0-
	04	Dorman, Loretta	0*		04	Han, Keum-Sil	0*
	05	Hillas, Lorraine	0+		05	Choi, Choon-Ok	0*
	06	Capes, Michelle	0*		06	Kim, Soon-Duk	0*
	07	Pisani, Sandra	0		07	Chung, Sang-Hyun	0*
	08	Bowman, Deborah	1*		08	Jin, Won-Sim	0+
	09	Capes, Lee	1*		09	Hwang, Keum-Sook	0+
	10	Small, Kim	0-		10	Cho, Ki-Hyang	0*
	11	Carbon, Sally	0		11	Seo, Kwang-Mi	0
	12	Pereira, Jacqueline	0*		12	Park, Soon-Ja	0*
	13	Belbin, Tracey	0*		13	Kim, Young-Sook	0-
	14	Hawkes, Rechelle	0		14	Seo, Hyo-Sun	0*
	15	Patmore, Sharon	0*		15	Lim, Kye-Sook	0*
	16	Fish, Maree	0+		16	Chung, Eun-Kyung	0-

Coach/Entraîneur: Brian Glencross
Asst. Coach/Entraîneur Adj.: Freitag, Peter
Manager/Chef d'Equipe: Yvonne Parsons

Coach/Entraîneur: Yoo, Young-Chae
Asst. Coach/Entraîneur Adj.:
Manager/Chef d'Equipe: Park, Young-Jo

Event Evenement	Total Total	1st 1ere	Half Mi-temps	2nd 2eme	Half Mi-temps	Extra Period Prolongation
Shot on Goal / Lancer au But	12-7	5-1		7-6		0-0
Field Goal / But de Champ	1-0	0-0		1-0		0-0
P-Stroke Goal / But de Coup Penalty	1-0	0-0		1-0		0-0
P-Corner Goal / But de Penalty Coin	0-0	0-0		0-0		0-0
Cor-Hit Goal / But de Coup Coin	0-0	0-0		0-0		0-0
Assist / Assistance	0-0	0-0		0-0		0-0
Off-Side/ Hors Jeu	2-1	1-0		1-1		0-0
Warning / Avertissement	0-2	0-2		0-0		0-0



Women
Final (3-4 Places)/Sept. 30

Ctry Pays	No. Doss	Name Nom	Goals Buts	Ctry Pays	No. Doss	Name Nom	Goals Buts
HOL	3-1	GBR	(3-1,0-0)				
HOL	01	De Beus, Bernadette	0*	*GBR*	01	Atkins, Gill	0*
	02	Buter, Yvonne	0		02	Banks, Wendy	0*
	03	Aardenburg, Willemien	0		03	Brown, Gill	0-
	04	Willemse, Laurien	0*		04	Brown, Karen	0*
	05	Bolhuis, Marjolein	1*		05	Nevill, Mary	1*
	06	Lejeune, Lisanne	2*		06	Cook, Julie	0
	07	Benninga, Carina	0*		07	Dixon, Vickey	0*
	08	Fokke, Annemieke	0		08	Fraser, Wendy	0*
	09	Wolff, Ingrid	0*		09	Hambly, Barbara	0
	10	Van Doorn, Marieke	0*		10	Jordan, Caroline	0+
	11	Von Weiler, Sophie	0-		11	Mcbride, Violet	0*
	12	Van Manen, Aletta	0-		12	Macleod, Moira	0*
	13	Holsboer, Noor	0*		13	Brewer, Caroline	0
	14	Van Der Ben, Helen	0+		14	Sixsmith, Jane	0+
	15	Ohr, Martine	0+		15	Parker, Kate	0-
	16	Nieuwenhuizen, Anneloes	0*		16	Ramsay, Alison	0*

Coach/Entraîneur: Van Heumen, Gys
Asst. Coach/Entraîneur Adj.:
Manager/Chef d'Equipe: Cora De Wilde

Coach/Entraîneur: Hay, Dennis
Asst. Coach/Entraîneur Adj.:
Manager/Chef d'Equipe: Batterham, Diane

Event Evenement	Total Total	1st 1ere	Half Mi-temps	2nd 2eme	Half Mi-temps	Extra Period Prolongation
Shot on Goal / Lancer au But	7-9	7-4		0-5		0-0
Field Goal / But de Champ	1-0	1-0		0-0		0-0
P-Stroke Goal / But de Coup Penalty	0-0	0-0		0-0		0-0
P-Corner Goal / But de Penalty Coin	2-1	2-1		0-0		0-0
Cor-Hit Goal / But de Coup Coin	0-0	0-0		0-0		0-0
Assist / Assistance	0-0	0-0		0-0		0-0
Off-Side / Hors Jeu	0-0	0-0		0-0		0-0
Warning / Avertissement	0-0	0-0		0-0		0-0

Women
Final (5-6 Places)/Sept. 29

Ctry Pays	No. Doss	Name Nom	Goals Buts	Ctry Pays	No. Doss	Name Nom	Goals Buts
FRG	4-2	CAN	(1-1,3-1)				
FRG	01	Buechel, Pia	0	*CAN*	01	Bayes, Sharon	0-
	02	Schmid, Susanne	1-		02	Baker, Wendy	0+
	03	Hoffmann, Carola	0-		03	Covey, Deb	0*
	04	Gehrmann, Heike	0+		04	Lyn, Lisa	0*
	05	Bremer, Dagmar	0*		05	Branchaud, Laura	0*
	06	Uhlenbruck, Gabriele	0+		06	Levy, Sandra	0-
	07	Grahl, Viola	0		07	Johnson, Kathryn	0*
	08	Blumenbeg, Bettina	3*		08	Slade, Melanie	0
	09	Appel, Gaby	0*		09	Cooper, Penney	0
	10	Hallmen, Martina	0-		10	Schleppe, Shona	0-
	11	Ferneck, Christine	0*		11	Conn, Michelle	0+
	12	Wehrmeister, Silke	0*		12	Czenczek, Liz	0*
	13	Jungjohann, Caren	0*		13	Forshaw, Sheila	2*
	14	Hegener, Eva	0+		14	Charlton, Nancy	0+
	15	Wolls Chlager, Susi	0*		15	Ballantyne, Sara	0*
	16	Schowe, Gabriela	0*		16	Creelman, Sharon	0*

Coach/Entraîneur: Strodter, Wolfgang
Asst. Coach/Entraîneur Adj.:
Manager/Chef d'Equipe: Dorte Wulf

Coach/Entraîneur: Marina Van Der Merwe
Asst. Coach/Entraîneur Adj.:
Manager/Chef d'Equipe: Cicinelli, Mary

Event Evenement	Total Total	1st 1ere	Half Mi-temps	2nd 2eme	Half Mi-temps	Extra Period Prolongation
Shot on Goal / Lancer au But	11-8	5-7		6-1		0-0
Field Goal / But de Champ	3-1	1-1		2-0		0-0
P-Stroke Goal / But de Coup Penalty	0-0	0-0		0-0		0-0
P-Corner Goal / But de Penalty Coin	1-1	0-0		1-1		0-0
Cor-Hit Goal / But de Coup Coin	0-0	0-0		0-0		0-0
Assist / Assistance	0-1	0-0		0-1		0-0
Off-Side / Hors Jeu	0-3	0-1		0-2		0-0
Warning / Avertissement	0-1	0-0		0-1		0-0

Women
Final (7-8 Places)/Sept. 29

Ctry Pays	No. Doss	Name Nom	Goals Buts	Ctry Pays	No. Doss	Name Nom	Goals Buts
USA	1-3	ARG	(0-0,1-1,0-2,0-0)				
USA	01	Shea, Patricia	0*	*ARG*	01	Mulhall, Laura	0*
	02	Hightower, Yolanda	0*		02	Colombo, Cecilia	0*
	03	Koboldt, Mary	0-		03	Lopez, Marisa	0*
	04	Pankratz, Marcia	0*		04	Tucat, Alejandra	0*
	05	Van Kuren, Cheryl	0*		05	Carbo, Victoria	0*
	06	Bracalente, Diane	0*		06	Ricchezza, Fabiana	0-
	07	Beglin, Elizabeth	0*		07	Liz, Gabriela	0*
	08	Von Schottenstein, Marcell	0-		08	Sanchez, Gabriela	0*
	09	Vander-Heyden, Sandra	0		09	Brinnand, Moira	1-
	10	Fuchs, Tracey	0*		10	Hussey, Marcela	1*
	11	Johnson, Sheryl	0*		11	Palma, Alejandra	1*
	12	Costigan, Sandra	0+		12	Ormaechea, Laura	0
	13	Morgan, Christy	1+		13	Bengochea, Veronica	0+
	14	Marois, Barbara	0-		14	Vergara, Alina	0
	15	Donnelly, Megan	0+		15	Pazos, Gabriela	0+
	16	Lee, Donna	0		16	Fioroni, Andrea	0

Coach/Entraîneur: Castelijn, Boud
Asst. Coach/Entraîneur Adj.: Didio, Marisa
Manager/Chef d'Equipe: Madison, Michele

Coach/Entraîneur: McCormik, Miguel
Asst. Coach/Entraîneur Adj.:
Manager/Chef d'Equipe: Medici, Claudia

Event Evenement	Total Total	1st Half 1ere	2nd Half 2eme	Extra Period Prolongation
Shot on Goal/Lancer au But	7-17	0-5	6-6	1-6
Field Goal/But de Champ	1-3	0-0	1-1	0-2
P-Stroke Goal/But de Coup Penalty	0-0	0-0	0-0	0-0
P-Corner Goal/But de Penalty Coin	0-0	0-0	0-0	0-0
Cor-Hit Goal/But de Coup Coin	0-0	0-0	0-0	0-0
Assist/Assistance	1-2	0-0	1-1	0-1
Off-Side/Hors Jeu	0-2	0-0	0-2	0-0
Warning/Advertissement	3-2	2-2	1-0	0-0

Women
Warning Statistics/Sept. 21-30

Rank Rang	Ctry Pays	Red Rouge	Yellow Jaune	Green Vert
1	AUS	0	0	1
2	CAN	0	1	1
3	ARG	0	0	3
4	GBR	0	0	4
4	HOL	0	0	4
6	KOR	0	1	7
7	FRG	0	1	8
8	USA	0	4	6

Femmes
Stat. des Avertissements.21 -30 Sept

Women
Scorer Standing/Sept. 21-30

Rank Rang	No. Doss	Ctry Pays	Name Nom	Total Total	Field Goals	Pty St.	Pty Cn.	Corner	Matches
1	06	HOL	Lejeune, Lisanne	8	0	1	7	0	5
2	08	FRG	Blumenbeg, Bettina	5	4	0	1	0	5
2	15	KOR	Lim, Kye-Sook	5	3	1	1	0	5
4	08	AUS	Bowman, Deborah	4	2	2	0	0	5
4	13	CAN	Forshaw, Sheila	4	3	0	1	0	5
6	12	AUS	Pereira, Jacqueline	3	3	0	0	0	5
7	11	ARG	Palma, Alejandra	2	1	1	0	0	5
7	15	AUS	Patmore, Sharon	2	2	0	0	0	5
7	16	CAN	Creelman, Sharon	2	0	0	2	0	5
7	07	GBR	Dixon, Vickey	2	0	2	0	0	5
7	05	HOL	Bolhuis, Marjolein	2	1	0	1	0	5
7	11	HOL	Von Weiler, Sophie	2	2	0	0	0	5
7	14	HOL	Van Der Ben, Helen	2	0	0	2	0	5
7	07	KOR	Chung, Sang-Hyun	2	2	0	0	0	5
7	12	KOR	Park, Soon-Ja	2	2	0	0	0	5
7	14	KOR	Seo, Hyo-Sun	2	2	0	0	0	5
7	11	USA	Johnson, Sheryl	2	1	0	1	0	5
7	13	USA	Morgan, Christy	2	1	0	1	0	5
7	15	USA	Donnelly, Megan	2	0	0	2	0	5
20	02	ARG	Colombo, Cecilia	1	0	0	1	0	5
20	05	ARG	Carbo, Victoria	1	0	0	1	0	5
20	09	ARG	Brinnand, Moira	1	1	0	0	0	5
20	10	ARG	Hussey, Marcela	1	1	0	0	0	5
20	02	AUS	Clement, Elspeth	1	0	1	0	0	5
20	03	AUS	Tooth, Liane	1	0	0	1	0	5
20	09	AUS	Capes, Lee	1	1	0	0	0	5
20	04	CAN	Lyn, Lisa	1	0	1	0	0	5
20	07	CAN	Johnson, Kathryn	1	0	0	1	0	5
20	02	FRG	Schmid, Susanne	1	1	0	0	0	5
20	04	FRG	Gehrmann, Heike	1	1	0	0	0	5
20	13	FRG	Jungjohann, Caren	1	0	0	1	0	5
20	15	FRG	Wolls Chlager, Susi	1	0	1	0	0	5
20	05	GBR	Nevill, Mary	1	0	0	1	0	5
20	12	GBR	Macleod, Moira	1	0	0	1	0	5
20	15	GBR	Parker, Kate	1	1	0	0	0	5
20	11	KOR	Seo, Kwang-Mi	1	1	0	0	0	5
20	13	KOR	Kim, Young-Sook	1	1	0	0	0	5

Women
Final Standing/Sept. 21-30

< Semi-final/Demi-finale >		
Semi-final Match 1 (A1-B2)	HOL-AUS	2-3
Semi-final Match 2 (B1-A2)	KOR-GBR	1-0
Semi-final Match 3 (A3-B4)	ARG-CAN	1-3
Semi-final Match 4 (B3-A4)	FRG-USA	2-1
< Final/Finale >		
Final (1-2 Places)	AUS-KOR	2-0
Final (3-4 Places)	HOL-GBR	3-1
Final (5-6 Places)	FRG-CAN	4-2
Final (7-8 Places)	USA-ARG	1-3

< Final Standing/Classement Final >

- 1—AUS Australia
- 2—KOR Korea
- 3—HOL Netherlands
- 4—GBR Great Britain
- 5—FRG Federal Republic of Germany
- 6—CAN Canada
- 7—ARG Argentina
- 8—USA United States of America



유 도
Judo/Judo







Judo/Judo

Officials/Officiels

International Judo Federation (I.J.F.)

President/président	Sarkis Kaloghlian
Secretary General/secrétaire général	Heinz Kempa
Technical Delegates/délégués techniques	Isao Inokuma Henri Courtine

SLOOC Administrative Staff/Personnel Administratif du SLOOC

Commissioner/directeur	Park Youg Sung
Secretary General/secrétaire général	Kim Dong Kyu
Deputy Secretary General/secrétaire général adjoint	Cho Jea Ki
Competition Manager/chef de division des compétitions	Kim Jong Haeng

Competitors/Concurrents

Men Hommes	Competitors Compétiteurs	Countries Pays
Extra Lightweight/super-leger (-60 kg)	38	38
Half Lightweight/mi-leger (-65 kg)	44	44
Lightweight/leger (-71 kg)	41	41
Half Middleweight/mi-moyen (-78 kg)	41	41
Middleweight/moyen (-86 kg)	36	36
Half Heavyweight/mi-lourd (-95 kg)	23	23
Heavyweight/lourd (+95 kg)	27	27

Women Femmes	Competitors Compétiteurs	Countries Pays
Extra Lightweight/Super-leger (-48 kg)	8	8
Half-Lightweight/Mi-leger (-52 kg)	8	8
Lightweight/Leger (-56 kg)	8	8
Half-Middleweight/Mi-moyen (-61 kg)	8	8
Middleweight/Moyen (-66 kg)	8	8
Half-Heavyweight/Mi-lourd (-72 kg)	7	7
Heavyweight/Lourd (+72 kg)	7	7

Legend/Notation

*	Winner/Gagnant
W-L	Win-Loss/Gagnes — Perdus
IPO	Ippon/Full point/Ippon
YUS	Yusei-gachi/Win by decision/Victoire par décision
WAZ	Waza-ari/Almost Ippon/Presque ippou
WIP	Waza-ari awasete ippou/Win due to waza-ari/Victoire sur waza-ari
KOK	Koka/Almost yuko/Presque yuko
YUK	Yuko/Almost waza-ari/Presque waza-ari
SHI	Shido/
SOG	Sogo-gachi/Compound win/Victoire composée
BYE	Bye/Exempt



Men Extra-Lightweight -60Kg 1/32 Preliminaries/Sept. 25			Hommes/Super leger -60Kg 1/32 preliminaires/25 Sept		
Pool Poule	Name Nom	Ctry Pays	Scores Points		Time Temps
			IWYK	HECS	
A	* Kim, Jae-Yup Madhar, Mohamedshies	KOR SUR	1111 0000	0000 0000	2:28
	Won By: Ippon				
A	* Francini, Alberto Kohsrof, Mohd	SMR YAR	0200 0000	0000 0000	1:40
	Won By: Waza-ari-awaset-ippou				
A	* Csak, Jozsef Cattedra, Marino	HUN ITA	0110 0010	0000 0000	5:00
	Won By: Waza-ari				
B	Dino, Jerry * Zhang, Guojun	PHI CHN	0000 1000	0000 0000	0:29
	Won By: Ippon				
B	Martinez, Luis Felipe * Eckersley, Neil	PUR GBR	0000 1000	0000 0000	2:19
	Won By: Ippon				

Men Extra-Lightweight -60Kg 1/16 Preliminaries/Sept. 25			Hommes Super leger -60kg 1/16 Preliminats 25 Sept		
Pool Poule	Name Nom	Ctry Pays	Scores Points		Time Temps
			IWYK	HECS	
A	* Kim, Jae-Yup Totikachvili, Amiran	KOR URS	0001 0000	0000 0000	5:00
	Won By: Koka				
A	* Pessoa, Sergio Pages, Gilles	BRA MON	1020 0000	0000 0000	2:34
	Won By: Ippon				
A	Francini, Alberto * Berenstein, Guno	SMR HOL	0000 1010	0000 0000	0:19
	Won By: Ippon				
A	Kiejda, Ireneusz * Dietz, Helmut	POL FRG	0001 0000	0110 0000	5:00
	Won By: Keikoku				
A	* Csak, Jozsef Efemgil, Haldun	HUN TUR	0001 0000	0000 0000	5:00
	Won By: Koka				
A	Takahashi, Phil * Idir, Ali	CAN ALG	0000 1010	0000 0000	1:33
	Won By: Ippon				
A	* Botev, Pavel Skouroumouni, Michalakis	BUL CYP	1001 0000	0000 0000	2:45
	Won By: Ippon				
A	Hassan, Emadeldin * Roux, Patrick	EGY FRA	0000 0000	0000 0000	5:00
	Won By: Yusei-Gachi				
B	* Zhang, Guojun Niamjav, Badrah	CHN MGL	0000 0000	0000 0000	5:00
	Won By: Yusei-Gachi				
B	* Santos, Renato Sotillo, Carlos	POR ESP	0000 0000	0010 0000	0:40
	Won By: Kiken-Gachi				
B	* Hosokawa, Shinji Bartolomeu Dias, Abbao	JPN ANG	1000 0000	0000 0000	0:35
	Won By: Ippon				
B	* Eckersley, Neil Brunhart, Daniel	GBR LIE	1000 0000	0000 0000	1:39
	Won By: Ippon				
B	* Sheu, Tsay-Chwan Belmonte, Ricardo	TPE BOL	1012 0000	0000 0000	1:43
	Won By: Ippon				
B	Garcia Pina, Gilberto * Lee, Kan	DOM HKG	0000 1000	0000 0000	1:13
	Won By: Ippon				
B	* Asano, Kevin Sedivak, Petr	USA TCH	0001 0000	0000 0000	5:00
	Won By: Koka				

Men Extra-Lightweight -60Kg 1/8 Preliminaries/Sept. 25			Hommes/Super leger -60Kg 1/8 Preliminaires/25 Sept		
Pool Poule	Name Nom	Ctry Pays	Scores Points		Time Temps
			IWYK	HECS	
A	* Kim, Jae-Yup Pessoa, Sergio	KOR BRA	0000 0000	0000 0000	5:00
	Won By: Yusei-Gachi				
A	Berenstein, Guno * Dietz, Helmut	HOL FRG	0001 0000	0100 0000	5:00
	Won By: Keikoku				
A	* Csak, Jozsef Idir, Ali	HUN ALG	0004 0000	0000 0000	5:00
	Won By: Koka				
A	Botev, Pavel * Roux, Patrick	BUL FRA	0000 0001	0000 0000	5:00
	Won By: Koka				
B	* Zhang, Guojun Santos, Renato	CHN POR	0000 0000	0000 0000	5:00
	Won By: Yusei-Gachi				
B	Hernandez, Salvador * Hosokawa, Shinji	MEX JPN	0000 1000	0010 0000	1:23
	Won By: Ippon				
B	Eckersley, Neil * Sheu, Tsay-Chwan	GBR TPE	0000 1001	0000 0000	2:43
	Won By: Ippon				
B	Lee, Kan * Asano, Kevin	HKG USA	0000 1010	0000 0000	0:24
	Won By: Ippon				

Men Extra-Lightweight -60Kg Quarter-finals/Sept. 25			Hommes/Super leger -60Kg Quarts de Finale/25 Sept		
Pool Poule	Name Nom	Ctry Pays	Scores Points		Time Temps
			IWYK	HECS	
A	* Kim, Jae-Yup Dietz, Helmut	KOR FRG	1000 0000	0000 0000	3:27
	Won By: Ippon				
A	Csak, Jozsef * Roux, Patrick	HUN FRA	0000 1001	0000 0000	2:59
	Won By: Ippon				
B	Zhang, Guojun Hosokawa, Shinji	CHN JPN	0000 1000	0010 0000	0:42
	Won By: Ippon				
B	Sheu, Tsay-Chwan Asano, Kevin	TPE USA	0000 1010	0000 0000	2:57
	Won By: Ippon				

Men Extra-Lightweight -60Kg Semi-finals/Sept. 25			Hommes/Super leger -60Kg Demi-finales/25 Sept		
Pool Poule	Name Nom	Ctry Pays	Scores Points		Time Temps
			IWYK	HECS	
A	* Kim, Jae-Yup Roux, Patrick	KOR FRA	0002 0000	0000 0000	5:00
	Won By: Koka				
B	Hosokawa, Shinji * Asano, Kevin	JPN USA	0000 0000	0000 0000	5:00
	Won By: Yusei-Gachi				

Judo

Men Extra-Lightweight -60Kg Final/Sept. 25

Pool Poule	Name Nom	Ctry Pays	Scores Points		Time Temps
			IWYK	HECS	
REP. A	Madhar, Mohamedhies Totikachvili, Amiran	SUR URS	0000 1000	0000 0000	0:17
	Won By: Ippon				
REP. A	* Totikachvili, Amiran Pessoa, Sergio	URS BRA	1000 0000	0000 0000	1:57
	Won By: Ippon				
REP. A	* Totikachvili, Amiran Dietz, Helmut	URS FRG	0021 0000	0000 0001	5:00
	Won By: Yuko				
REP. A	* Totikachvili, Amiran Roux, Patrick	URS FRA	0011 0000	0000 0000	5:00
	Won By: Yuko				
REP. B	* Sedivak, Petr Lee, Kan	TCH HKG	1000 0000	0000 0100	2:27
	Won By: Ippon				
REP. B	Sedivak, Petr * Sheu, Tsay-Chwan	TCH TPE	0000 0100	0000 0111	5:00
	Won By: Yusei-Gachi				
REP. B	Sheu, Tsay-Chwan * Hosokawa, Shinji	TPE JPN	0000 1000	0000 0000	1:08
	Won By: Ippon				
Final	* Kim, Jae-Yup Asano, Kevin	KOR USA	0000 0000	0000 0001	5:00
	Won By: Shido				

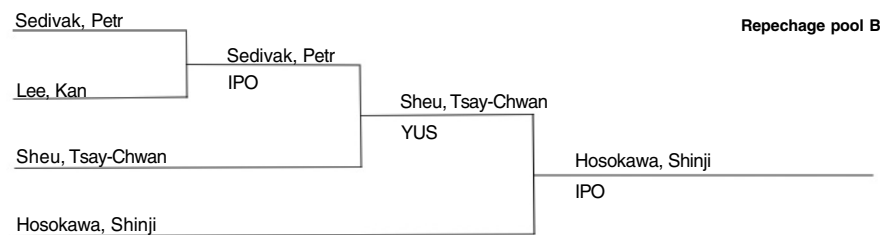
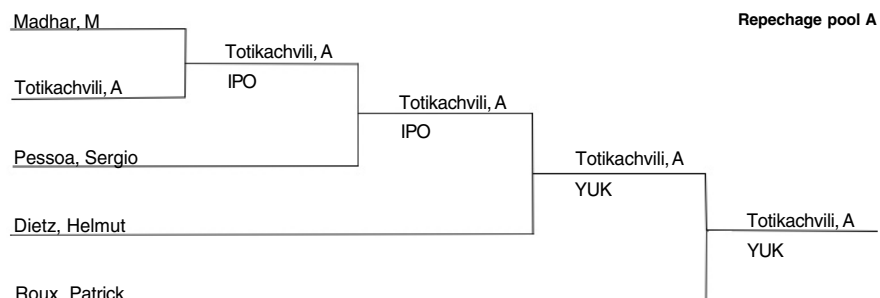

Men Half-Lightweight -65Kg 1/32 Preliminaries/Sept. 26

Pool Poule	Name Nom	Ctry Pays	Scores Points		Time Temps
			IWYK	HECS	
A	Adsheed, Mark * Kostadinov, Ivo	GBR BUL	0000 0011	0000 0000	5:00
	Won By: Yuko				
A	* Pawlowski, Janusz Laats, Philip	POL BEL	0020 0000	0000 0000	5:00
	Won By: Yuko				
A	Sabali, Kamil * Elmamoun, Driss	LIB MAR	0000 1101	0000 0000	3:05
	Won By: Ippon				
A	Weldon, Carig * Quellmalz, Udo	CAN GDR	0000 0010	0001 0000	5:00
	Won By: Yuko				
A	Bogje, John * Cespedes Olmedo, Vicente	KEN PAR	0000 0014	1111 0000	4:22
	Won By: Hansoku-Gachi				
B	* Yafuso, Claudio G Anderson, Derrick	ARG GUM	1000 0000	0000 0000	0:13
	Won By: Ippon				
B	* Becanovic, Dragomir Dahmani, Meziane	YUG ALG	0000 0000	0000 0000	5:00
	Won By: Yusei-Gachi				

Judo

Pool Poule	Name Nom	Ctyr Pays	Scores Points		Time Temps
			IWYK	HECS	
B	* Carabetta, Bruno Sokolov, Iouri	FRA URS	0120 0000	0000 0000	5:00
	Won By: Waza-Ari				
B	Rivera, Victor A. * Bujko, Tamas	PUR HUN	0010 0010	0001 0000	5:00
	Won By: Shido				
B	* Petrikov, Pavel Pradhan, Rishiram	TCH NEP	0200 0000	0000 0000	2:30
	Won By: Waza-Air-Awasete-Ippon				

Men Half-Lightweight -65kg 1/6 Preliminaries/Sept. 26

Pool Poule	Name Nom	Ctry Pays	Scores Points		Time Temps
			IWYK	HECS	
A	* Kostadinov, Ivo Schumacher, Guido	BUL FRG	1000 0000	0000 0000	0:52
	Won By: Ippon				
A	* Pawlowski, Janusz Mortensen, Tommy Jorgen	POL DEN	0110 0000	0000 0000	5:00
	Won By: Waza-Ari				
A	* Elmamoun, Driss Safar, Hussei	MAR KUW	0010 0000	0000 0001	5:00
	Won By: Yuko				
A	* Cooper, Brent Sene, Pierre Yves	NZL SEN	1000 0000	0000 0000	0:10
	Won By: Ippon				
A	* Quellmalz, Udo Yamamoto, Yosuke	GDR JPN	0000 0101	0000 0000	5:00
	Won By: Waza-Ari				
A	* Marchal, Joe Wu, Po-Chen	USA TPE	1000 0000	0000 0000	2:21
	Won By: Ippon				
A	* Cespedes Olmedo, Vicente Sarti, Leo Marino	PAR SMR	0211 0001	0000 0000	3:39
	Won By: Waza-Ari-Awasete-Ippon				
A	* Reiter, Josef Farrugia, Stephen	AUT MLT	1100 0000	0000 0000	0:44
	Won By: Ippon				
B	* Yafuso, Claudio G Yolci, Yavuz	ARG TUR	0001 0000	0000 0000	5:00
	Won By: Koka				
B	Becanovic, Dragomir * Lee, Kyung-Keun	YUG KOR	0000 1000	0000 0000	0:37
	Won By: Ippon				
B	* Carabetta, Bruno Filipe Fortunato, Luis Carlos	FRA ANG	0201 0000	0000 0001	4:34
	Won By: Waza-Ari-Awasete-Ippon				
B	Ioannou, Elias * Omagbaluwaje, Majemite	CYP NGR	0000 0120	0000 0001	5:00
	Won By: Waza-Ari				
B	* Bujko, Tamas Keita, Mamadou	HUN MLI	1000 0100	0000 0000	0:45
	Won By: Ippon				
B	Au, Woon Yiu * Landa-Zury, Eduardo	HKG COL	0000 0010	0000 0000	5:00
	Won By: Yuko				
B	* Petrikov, Pavel Cardoso, Ricardo	TCH BRA	0002 0000	0000 0000	5:00
	Won By: Koka				
B	* Dorjderem, Jamsran Rosser, Warren	MGL AUS	1000 0000	0000 0000	0:59
	Won By: Ippon				

Judo

Men Extra-Lightweight -65Kg 1/8 Preliminaries/Sept. 26			Hommes/Super leger -65Kg 1/8 preliminaires/26 Sept		
Pool Poule	Name Nom	Ctry Pays	Scores Points		Time Temps
			IWYK	HECS	
A	Kostadinov, Ivo * Pawlowski, Janusz	BUL POL	0000 1001	0000 0000	2:30
Won By: Ippon					
A	Elmamoun, Driss * Cooper, Brent	MAR NZL	0000 1000	0000 0000	1:18
Won By: Ippon					
A	* Yamamoto, Yosuke Marchal, Joe	JPN USA	1000 0000	0000 0000	1:12
Won By: Ippon					
A	Cespedes Olmedo, Vicente * Reiter, Josef	PAR AUT	0000 1000	0000 0000	0:54
Won By: Ippon					
B	Yafuso, Claudio G * Lee, Kyung-Keun	ARG KOR	0000 0210	0000 0000	1:15
Won By: Waza-Ari-Awasete-Ippon					
B	* Carabetta, Bruno Omagbaluwaje, Majemite	FRA NGR	0000 0010	0000 0011	5:00
Won By: Yusei-Gachi					
B	* Bujko, Tamas Landa-zury, Eduardo	HUN COL	1101 0000	0000 0000	1:49
Won By: Ippon					
B	* Petrikov, Pavel Dorjderem, Jamsran	TCH MGL	0000 0000	0001 0001	5:00
Won By: Yusei-Gachi					

Men Extra-Lightweight -65Kg Quarter-finals/Sept. 26			Hommes/Mi-leger -65Kg Quarts de Finale/26 Sept		
Pool Poule	Name Nom	Ctry Pays	Scores Points		Time Temps
			IWYK	HECS	
A	* Pawlowski, Janusz Cooper, Brent	POL NZL	0001 0000	0000 0000	5:00
Won By: Koka					
A	* Yamamoto, Yosuke Reiter, Josef	JPN AUT	0201 0000	0000 0000	4:52
Won By: Waza-Ari-Awasete-Ippon					
B	* Lee, Kyung-Keun Carabetta, Bruno	KOR FRA	0000 0000	0000 0000	5:00
Won By: Yusei-Gachi					
B	* Bujko, Tamas Petrikov, Pavel	HUN TCH	1000 0000	0001 0000	4:08
Won By: Ippon					

Men Half-Lightweight -65kg Semi-finals/Sept 26			Hommes Mi-leger -65kg Demi-finales/26 Sept		
Pool Poule	Name Nom	Ctry Pays	Scores Points		Time Temps
			IWYK	HECS	
A	* Pawlowski, Janusz Yamamoto, Yosuke	POL JPN	1000 0000	0000 0000	4:23
Won By: Ippon					
B	* Lee, Kyung-Keun Bujko, Tamas	KOR HUN	1111 0000	0000 0000	3:33
Won By: Ippon					

Judo

Men Half-Lightweight -65Kg Final/Sept 26			Hommes Mi-leger -65Kg Finales/26 Sept		
Pool Poule	Name Nom	Ctry Pays	Scores Points		Time Temps
			IWYK	HECS	
REP. A	* Laats, Philip Mortensen, Tommy Jorgen	BEL DEN	1010 0000	0000 0000	1:56
Won By: Ippon					
REP. A	* Laats, Philip Kostadinov, Ivo	BEL BUL	0001 0000	0000 0000	5:00
Won By: Koka					
REP. A	Laats, Philip * Cooper, Brent	BEL NZL	0000 0001	0000 0000	5:00
Won By: Koka					
REP. A	Cooper, Brent * Yamamoto, Yosuke	NZL JPN	0000 1000	0000 0000	1:40
Won By: Ippon					
REP. B	Becanovic, Dragomir * Yafuso, Claudio G	YUG ARG	0021 0100	0000 0001	5:00
Won By: Waza-ari					
REP. B	Yafuso, Claudio G * Carabetta, Bruno	ARG FRA	0000 1000	0000 0000	3:21
Won By: Ippon					
REP. B	* Carabetta, Bruno Bujko, Tamas	FRA HUN	0000 0000	0000 0000	5:00
Won By: Yusei-Gachi					
FINAL	Pawlowski, Janusz * Lee, Kyung-Keun	POL KOR	0000 0000	0000 0000	5:00
Won By: Yusei-Gachi					

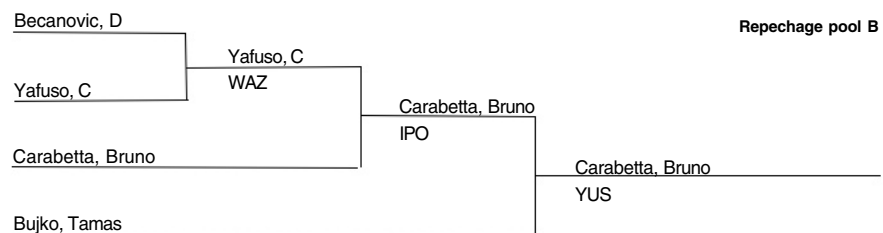
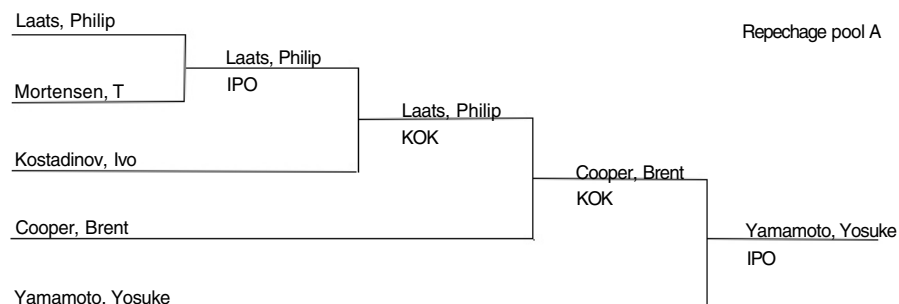

Men Lightweight -71kg 1/32 Preliminaries/Sept 27			Hommes Leger -71kg 1/32 Preliminaires/27 Sept		
Pool Poule	Name Nom	Ctry Pays	Scores Points		Time Temps
			IWYK	HECS	
A	* Blach, Wieslaw Chong, Siao Chin	POL HKG	1010 0000	0000 0000	2:13
Won By: Ippon					
A	Khawam, Roni * Brown, Kerrith	LIB GBR	0000 1001	0000 0000	1:40
Won By: Ippon					
A	Sibenge, James * Assuncao, Hugo	ZIM POR	0000 1000	0000 0000	0:50
Won By: Ippon					
A	Ndombasi, Lotuala * Loll, Sven	ANG GDR	0000 1100	0000 0000	1:20
Won By: Ippon					
A	Alnajadah, Adel * Beauchamp, Glenn	KUW CAN	0000 1001	0001 0000	4:24
Won By: Ippon					
B	Dione, Babacar * Hajtos, Bertalan	SEN HUN	0000 1010	0011 0000	3:13
Won By: Ippon					
B	Ganbold, Jambal * Ayan, Alpaslan	MGL TUR	0000 1000	0000 0000	3:33
Won By: Ippon					
B	Torres, Fredy * Tenadze, Gueorgui	ESA URS	0000 1000	0010 0000	1:17
Won By: Ippon					
B	* Xiong, Fengshan Trevisan, Jason	CHN MLT	1010 0000	0000 0010	1:37
Won By: Ippon					



**Men Half-Lightweight -65Kg
Competition Summary**

**Hommes/Mi-leger -65Kg
Tableau de la Competition**

Round/Tour 1	Round/Tour 2	Round/Tour 3	Round/Tour 4	Final/Finale
Adshead, Mark (GBR)	Kostadinov, Ivo	Kostadinov, Ivo	Pawlowski, J	Pawlowski, J KOK
Kostadinov, Ivo (BUL)	YUK	IPO	IPO	
Schumacher, G (FRG)	Schumacher, G	Pawlowski, J	Cooper, Brent IPO	Pawlowski, J KOK
BYE	BYE	WAZ		
Pawlowski, J (POL)	Pawlowski, J	Elmamoun, Driss	Yamamoto, Yosuke IPO	Yamamoto, Yosuke WIP
Laats, Philip (BEL)	YUK	YUK		
Mortensen, T (DEN)	Mortensen, T	Elmamoun, Driss	Reiter, Josef IPO	Lee, Kyung-Keun YUS
BYE	BYE	YUK		
Sabali, Kamil (LIB)	Elmamoun, Driss	Yamamoto, Yosuke	Lee, Kyung-Keun WIP	Lee, Kyung-Keun YUS
Elmamoun, Driss (MAR)	IPO	WAZ		
Safar, Hussei (KUW)	Safar, Hussei	Marchal, Joe	Carabetta, Bruno YUS	Lee, Kyung-Keun YUS
BYE	BYE	IPO		
Cooper, Brent (NZL)	Cooper, Brent	Reiter, Josef	Bujko, Tamas IPO	Bujko, Tamas IPO
BYE	BYE	IPO		
Sene, P (SEN)	Sene, P	Reiter, Josef	Petrikov, Pavel KOK	Petrikov, Pavel YUS
BYE	BYE	IPO		
Weldon, Craig (CAN)	Quellmale, Udo	Reiter, Josef	Dorjderem, J YUS	Dorjderem, J YUS
Quellmalz, Udo (GDR)	YUK	IPO		
Yamamoto, Yosuke (JPN)	Yamamoto, Yosuke	Reiter, Josef	Rosser, Warren IPO	Rosser, Warren
BYE	BYE	IPO		
Marchal, Joe (USA)	Marchal, Joe	Reiter, Josef	Rosser, Warren IPO	Rosser, Warren
Byala, Sandeep (IND)	BYE	IPO		
Wu, Po-Chen (TPE)	Wu, Po-Chen	Reiter, Josef	Rosser, Warren IPO	Rosser, Warren
BYE	BYE	IPO		
Bogie, John (KEN)	Cespedes Olmedo	Reiter, Josef	Rosser, Warren IPO	Rosser, Warren
Cespedes Olmedo (PAR)	HAN	IPO		
Sarti, L (SMR)	Sarti, L	Reiter, Josef	Rosser, Warren IPO	Rosser, Warren
BYE	BYE	IPO		
Reiter, Josef (AUT)	Reiter, Josef	Reiter, Josef	Rosser, Warren IPO	Rosser, Warren
BYE	BYE	IPO		
Farrugia, S (MLT)	Farrugia, S	Reiter, Josef	Rosser, Warren IPO	Rosser, Warren
BYE	BYE	IPO		
Yafuso, C (ARG)	Yafuso, C	Reiter, Josef	Rosser, Warren IPO	Rosser, Warren
Anderson, D (GUM)	IPO	IPO		
Yolci, Yavuz (TUR)	Yolci, Yavuz	Reiter, Josef	Rosser, Warren IPO	Rosser, Warren
BYE	BYE	IPO		
Becanovic, D (YUG)	Becanovic, D	Reiter, Josef	Rosser, Warren IPO	Rosser, Warren
Dahmani, Meziane (ALG)	YUS	IPO		
Lee, Kyung-Keun (KOR)	Lee, Kyung-Keun	Lee, Kyung-Keun	Rosser, Warren IPO	Rosser, Warren
BYE	BYE	IPO		
Carabetta, Bruno (FRA)	Carabetta, Bruno	Reiter, Josef	Rosser, Warren IPO	Rosser, Warren
Sokolov, Iouri (URS)	WAZ	IPO		
Filipe Fortunat (ANG)	Filipe Fortunat	Reiter, Josef	Rosser, Warren IPO	Rosser, Warren
BYE	BYE	IPO		
Ioannou, Elias (CYP)	Ioannou, Elias	Reiter, Josef	Rosser, Warren IPO	Rosser, Warren
BYE	BYE	IPO		
Omagbaluwaje, M (NGR)	Omagbaluwaje, M	Reiter, Josef	Rosser, Warren IPO	Rosser, Warren
BYE	BYE	IPO		
Rivera, V (PUR)	Bujko, Tamas	Reiter, Josef	Rosser, Warren IPO	Rosser, Warren
Bujko, Tamas (HUN)	SHI	IPO		
Keita, Mamadou (MLI)	Keita, Mamadou	Reiter, Josef	Rosser, Warren IPO	Rosser, Warren
BYE	BYE	IPO		
Awooda, Mansor (YAR)	Au, Woon Yiu	Reiter, Josef	Rosser, Warren IPO	Rosser, Warren
AU, Woon Yiu (HKG)	BYE	IPO		
Landa-Zury, E (COL)	Landa-Zury, E	Reiter, Josef	Rosser, Warren IPO	Rosser, Warren
BYE	BYE	IPO		
Petrikov, Pavel (TCH)	Petrikov, Pavel	Reiter, Josef	Rosser, Warren IPO	Rosser, Warren
Pradhan, R (NEP)	WIP	IPO		
Cardoso, Ricardo (BRA)	Cardoso, Ricardo	Reiter, Josef	Rosser, Warren IPO	Rosser, Warren
BYE	BYE	IPO		
Dorjderem, J (MGL)	Dorjderem, J	Reiter, Josef	Rosser, Warren IPO	Rosser, Warren
BYE	BYE	IPO		
Rosser, Warren (AUS)	Rosser, Warren	Reiter, Josef	Rosser, Warren IPO	Rosser, Warren
BYE	BYE	IPO		

Judo

Men Lightweight -71 Kg 1/16 Preliminaries/Sept. 27			Hommes Leger -71 Kg 1/16 Preliminaires/27 Sept		
Pool Poule	Name Nom	Ctry Pays	Scores Points		Time Temps
			IWYK	HECS	
A	Blach, Wieslaw * Onmura, Luiz	POL BRA	0000 0010	0000 0000	5:00
Won By: Yuko					
A	* Brown, Kerrith Maach, Abdelhak	GBR MAR	0001 0000	0000 0000	5:00
Won By: Koka					
A	* Assuncao, Hugo Mcmamus, Eugene	POR IRL	0000 0000	0000 0000	5:00
Won By: Yusei-Gachi					
A	Nunez, Henry * Dahlin, Anders	CRC SWE	0000 0001	0000 0000	5:00
Won By: Koka					
A	* Loll, Sven Wohlwend, Johannes	GDR LIE	1020 0000	0000 0000	4:23
Won By: Ippon					
A	* Stranz, Steffen Dohou, Dossou Daniel	FRG BEN	1000 0001	0000 0000	0:54
Won By: Ippon					
A	* Beauchamp, Glenn Moslih, Mohd.	CAN YAR	1010 0000	0000 0000	1:27
Won By: Ippon					
A	* Swain, Michael Ombito, Nelson	USA KEN	0200 0000	0000 0000	1:45
Won By: Waza-Ari-Awasete-Ippon					
B	* Hajtos, Bertalan Ju, Hsiang-Hung	HUN TPE	0001 0000	0001 0000	5:00
Won By: Yusei-Gachi					
B	* Alexandre, Marc Camara, Ousmane	FRA MLI	1012 0000	0000 0001	3:52
Won By: Ippon					
B	Ayan, Alpaslan * Gamba, Ezio	TUR ITA	0010 0010	0000 0000	5:00
Won By: Yusei-Gachi					
B	* Ruiz, Joaquin Meridja, Mohamed	ESP ALG	0011 0000	0000 0001	5:00
Won By: Yuko					
B	* Tenadze, Gueorgui Dangol, Gangabhadur	URS NEP	0100 0000	0000 0100	0:57
Won By: Sogo-Gachi					
B	* Koga, Toshihiko Park, Chung-Hee	JPN KOR	0001 0000	0000 0000	5:00
Won By: Koka					
B	Xiong, Fengshan * Brain, Stewart	CHN AUS	0020 0110	0000 0001	5:00
Won By: Waza-Ari					
B	* Vizcarra, Federico Ruiz, Angelo	MEX PUR	0000 0000	0000 0001	5:00
Won By: Shido					

Men Lightweight-71 Kg 1/8 Preliminaries/Sept. 27			Hommes Leger -71 Kg 1/8 Preliminaires/27 Sept		
Pool Poule	Name Nom	Ctry Pays	Scores Points		Time Temps
			IWYK	HECS	
A	Onmura, Luiz * Brown, Kerrith	BRA GBR	0000 0000	0001 0000	5:00
Won By: Shido					
A	Assuncao, Hugo * Dahlin, Anders	POR SWE	0000 0001	0000 0000	5:00
Won By: Koka					
A	* Loll, Sven Stranz, Steffen	GDR FRG	0001 0000	0000 0000	5:00
Won By: Koka					
A	Beauchamp, Glenn * Swain, Michael	CAN USA	0000 0000	0000 0000	5:00
Won By: Yusei-Gachi					
B	Hajtos, Bertalan * Alexandre, Marc	HUN FRA	0000 0000	0000 0000	5:00
Won By: Yusei-Gachi					
B	Gamba, Ezio * Ruiz, Joaquin	ITA ESP	0000 0000	0001 0000	5:00
Won By: Shido					
B	* Tenadze, Gueorgui Koga, Toshihiko	URS JPN	0011 0000	0000 0001	5:00
Won By: Yuko					
B	* Brain, Stewart Vizcarra, Federico	AUS MEX	0010 0000	0000 0000	5:00
Won By: Yuko					

Judo

Men Lightweight -71 Kg Quarter-finals/Sept. 27			Hommes Leger -71 Kg Quarts de finale/27 Sept		
Pool Poule	Name Nom	Ctry Pays	Scores Points		Time Temps
			IWYK	HECS	
A	* Brown, Kerrith Dahlin, Anders	GBR SWE	0000 0000	0000 0000	5:00
Won By: Yusei-Gachi					
A	* Loll, Sven Swain, Michael	GDR USA	0010 0001	0000 0000	5:00
Won By: Yuko					
B	* Alexandre, Marc Ruiz, Joaquin	FRA ESP	0010 0010	0000 0011	5:00
Won By: Yuko					
B	* Tenadze, Gueorgui Brain, Stewart	URS AUS	1000 0000	0000 0000	1:44
Won By: Ippon					

Men Light Weight-71 Kg Semi-finals/Sept. 27			Hommes Leger -71 Kg Demi-finals/27 Sept		
Pool Poule	Name Nom	Ctry Pays	Scores Points		Time Temps
			IWYK	HECS	
A	Brown, Kerrith * Loll, Sven	GBR GDR	0000 1010	0000 0000	1:09
Won By: Ippon					
B	* Alexandre, Marc Tenadze, Gueorgui	FRA URS	0001 0000	0000 0000	5:00
Won By: Koka					

Men Lightweight -71 Kg Final/Sept. 27			Hommes Leger -71 Kg Finale/27 Sept		
Pool Poule	Name Nom	Ctry Pays	Scores Points		Time Temps
			IWYK	HECS	
REP. A	Ndombasi, Lotuala * Wohlwend, Johannes	ANG LIE	0010 0020	0011 0000	5:00
Won By: Yuko					
REP. A	Wohlwend, Johannes * Stranz, Steffen	LIE FRG	0000 1000	0000 0000	1:33
Won By: Ippon					
REP. A	Stranz, Steffen * Swain, Michael	FRG USA	0000 0000	0000 0000	5:00
Won By: Yusei-Gachi					
REP. A	Swain, Michael * Brown, Kerrith	USA GBR	0000 0001	0000 0000	5:00
Won By: Koka					
REP. B	Camara, Ousmane * Hajtos, Bertalan	MLI HUN	0000 1000	0000 0000	1:07
Won By: Ippon					
REP. B	* Hajtos, Bertalan Ruiz, Joaquin	HUN ESP	0002 0001	0001 0000	5:00
Won By: Yusei-Gachi					
REP. B	Hajtos, Bertalan * Tenadze, Gueorgui	HUN URS	0000 1000	0000 0000	1:44
Won By: Ippon					
FINAL	Loll, Sven * Alexandre, Marc	GDR FRA	0000 0001	0000 0000	5:00
Won By: Koka					

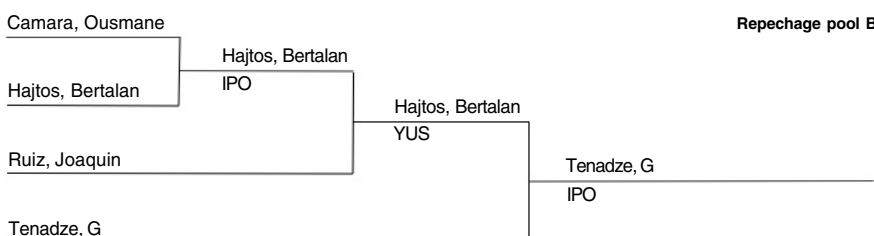
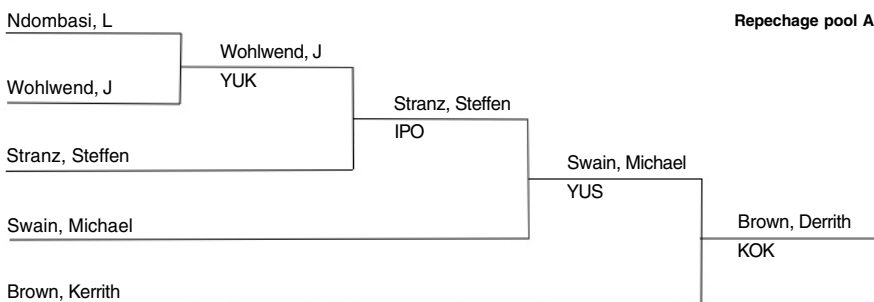



Men Lightweight-71 Kg
Competition Summary

Hommes/Lager-71 Kg
Tableau de la Competition

Round/Tour 1	Round/Tour 2	Round/Tour 3	Round/Tour 4	Final/Finale
Blach, Wieslaw (POL)	Blach, Wieslaw	Onmura, Luiz	Brown, Kerrith	Brown, Kerrith YUS
Chong, Siao Chin (HKG)	IPO	YUK	SHI	
Onmura, Luiz (BRA)	Onmura, Luiz	Brown, Kerrith	Dahlin, Anders KOK	Loll, Sven IPO
BYE		KOK		
Khawam, Roni (LIB)	Brown, Kerrith	Assuncao, Hugo	Loll, Sven KOK	Alexandre, Marc KOK
Brown, Kerrith (GBR)	IPO	YUS		
Maach, Abdelhak (MAR)	Maach, Abdelhak	Dahlin, Anders	Swain, Michael YUS	Alexandre, Marc KOK
BYE		KOK		
Sibenge, James (ZIM)	Assuncao, Hugo	Dahlin, Anders	Swain, Michael YUS	Alexandre, Marc KOK
Assuncao, Hugo (POR)	IPO	KOK		
Mcmanus, Eugene (IRL)	Mcmanus, Eugene	Loll, Sven	Ruiz, Joaquin SHI	Alexandre, Marc KOK
BYE		IPO		
Nunez, Henry (CRC)	Nunez, Henry	Stranz, Steffen	Ruiz, Joaquin SHI	Alexandre, Marc KOK
BYE		IPO		
Dahlin, Anders (SWE)	Dahlin, Anders	Dohou, D	Ruiz, Joaquin SHI	Alexandre, Marc KOK
BYE		IPO		
Ndombasi, L (ANG)	Loll, Sven	Beauchamp, Glenn	Ruiz, Joaquin SHI	Alexandre, Marc KOK
Loll, Sven (GDR)	IPO	IPO		
Wohlwend, J (LIE)	Wohlwend, J	Beauchamp, Glenn	Ruiz, Joaquin SHI	Alexandre, Marc KOK
BYE		IPO		
Stranz, Steffen (FRG)	Stranz Steffen	Moslih, Mohd	Ruiz, Joaquin SHI	Alexandre, Marc KOK
BYE		IPO		
Dohou, D (BEN)	Dohou, D	Swain, Michael	Ruiz, Joaquin SHI	Alexandre, Marc KOK
BYE		IPO		
Alnajadah, Adel (KUW)	Beauchamp, Glenn	Ombito, Nelson	Ruiz, Joaquin SHI	Alexandre, Marc KOK
Beauchamp, Glenn (CAN)	IPO	WIP		
Moslih, Mohd. (YAR)	Moslih, Mohd	Hajtos, Bertalan	Ruiz, Joaquin SHI	Alexandre, Marc KOK
BYE		YUS		
Swain, Michael (USA)	Swain, Michael	Ju, Hsiang-Hung	Ruiz, Joaquin SHI	Alexandre, Marc KOK
BYE		YUS		
Ombito, Nelson (KEN)	Ombito, Nelson	Alexandre, Marc	Ruiz, Joaquin SHI	Alexandre, Marc KOK
BYE		YUS		
Dione, Babacar (SEN)	Hajtos, Bertalan	Alexandre, Marc	Ruiz, Joaquin SHI	Alexandre, Marc KOK
Hajtos, Bertalan (HUN)	IPO	IPO		
Ju, Hsiang-Hung (TPE)	Ju, Hsiang-Hung	Camara, Ousmane	Ruiz, Joaquin SHI	Alexandre, Marc KOK
BYE		IPO		
Alexandre, Marc (FRA)	Alexandre, Marc	Gamba, Ezio	Ruiz, Joaquin SHI	Alexandre, Marc KOK
BYE		YUS		
Camara, Ousmane (MLI)	Camara, Ousmane	Gamba, Ezio	Ruiz, Joaquin SHI	Alexandre, Marc KOK
BYE		YUS		
Ganbold, Jambal (MGL)	Ayan, Alpaslan	Ruiz, Joaquin	Ruiz, Joaquin SHI	Alexandre, Marc KOK
Ayan, Alpaslan (TUR)	IPO	YUK		
Gamba, Ezio (ITA)	Gamba Ezio	Meridja, Mohamed	Ruiz, Joaquin SHI	Alexandre, Marc KOK
BYE		YUK		
Ruiz, Joaquin (ESP)	Ruiz, Joaquin	Tenadze, G	Ruiz, Joaquin SHI	Alexandre, Marc KOK
BYE		YUK		
Meridja, Mohamed (ALG)	Meridja, Mohamed	Dangol, G	Ruiz, Joaquin SHI	Alexandre, Marc KOK
BYE		YUK		
Torres, Fredy (ESA)	Tenadze, G	Koga, Toshihiko	Ruiz, Joaquin SHI	Alexandre, Marc KOK
Tenadze, G (URS)	IPO	KOK		
Dangol, G (NEP)	Dangol, G	Park, Chung-Hee	Ruiz, Joaquin SHI	Alexandre, Marc KOK
BYE		KOK		
Koga, Toshihiko (JPN)	Koga, Toshihiko	Xiong, Fengshan	Ruiz, Joaquin SHI	Alexandre, Marc KOK
BYE		IPO		
Park, Chung-Hee (KOR)	Park, Chung-Hee	Trevisan, Jason	Ruiz, Joaquin SHI	Alexandre, Marc KOK
BYE		IPO		
Xiong, Fengshan (CHN)	Xiong, Fengshan	Brain, Stewart	Ruiz, Joaquin SHI	Alexandre, Marc KOK
Trevisan, Jason (MLT)	IPO	WAZ		
Brain, Stewart (AUS)	Brain, Stewart	Vizcarra, F	Ruiz, Joaquin SHI	Alexandre, Marc KOK
BYE		YUK		
Vizcarra, F (MEX)	Vizcarra, F	Ruiz, Angelo	Ruiz, Joaquin SHI	Alexandre, Marc KOK
BYE		SHI		
Ruiz, Angelo (PUR)	Ruiz, Angelo			
BYE				

Judo

Men Half-Middleweight -78Kg 1/32 Preliminaries/Sept. 28		Hommes/Mi-moyen -78Kg 1/32 Preliminaires/28 Sept			
Pool Poule	Name Nom	Ctry Pays	Scores Points		Time Temps
			IWYK	HECS	
A	Reiter, Peter * Wieneke, Frank	AUT FRG	0000 1000	0001 0000	4:46
Won By: Ippon					
A	* Gonzalez, Victorino Kihara, James	ESP KEN	1000 0000	0001 0001	1:48
Won By: Ippon					
A	* Tayot, Pascal Saikali, Fadi	FRA LIB	0200 0000	0000 0000	0:59
Won By: Waza-Ari-Awasete-Ippon					
A	* Brechot, Torsten Paraguassu, Ezequiel	GDR BRA	1001 0003	0000 0000	4:53
Won By: Ippon					
A	* Erhembayar, Sodnom Kuruvoli, Simone	MGL FIJ	1000 0000	0000 0000	1:45
Won By: Ippon					
B	Schaffter, Olivier * Morris, Jason	SUI USA	0000 0000	0111 0000	5:00
Won By: Keikoku					
B	* Metsola, Jukka-Pekka Adamu, Mamudu	FIN NGR	0000 0000	0000 0010	5:00
Won By: Chui					
B	Nemeth, Karoly * Hussein, Walid	HUN EGY	0000 0001	0001 0000	5:00
Won By: Koka					
B	* Ahn, Byung-Keun Laats, Johan	KOR BEL	1001 0100	0000 0000	3:09
Won By: Ippon					

Men Half-Middleweight -78Kg 1/16 Preliminaries/Sept. 28		Hommes/Mi-moyen -78Kg 1/16 Preliminaires/28 Sept			
Pool Poule	Name Nom	Ctry Pays	Scores Points		Time Temps
			IWYK	HECS	
A	* Wieneke, Frank Adolfsson, Lars	FRG SWE	0011 0000	0000 0010	5:00
Won By: Yuko					
A	* Gonzalez, Victorino Ochoa, Luis Eduardo	ESP COL	0201 0000	0000 0000	3:49
Won By: Waza-Ari-Awasete-Ippon					
A	* Tayot, Pascal Jose Boy, Ricardo	FRA ANG	1000 0000	0000 0000	1:08
Won By: Ippon					
A	Lescak, Filip * Okada, Hirotaka	YUG JPN	0000 0020	0111 0000	5:00
Won By: Yuko					
A	* Brechot, Torsten Baylon, John	GDR PHI	1000 0000	0000 0000	0:58
Won By: Ippon					
A	Cristovao, Pedro * Adams, Neil	POR GBR	0000 1000	0001 0000	3:08
Won By: Ippon					
A	* Erhembayar, Sodnom Huttich, Carlos	MGL MEX	0102 0000	0000 0000	5:00
Won By: Waza-Ari					
A	Aquino, Mariano * Elsharaf, Hisham	GUM KUW	0000 1011	0000 0000	3:54
Won By: Ippon					
B	Morris, Jason * Varaev, Bachir	USA URS	0000 0000	0001 0001	5:00
Won By: Yusei-gachi					
B	* Cakiroglu, Temel Val, Luis	TUR AUS	0000 0000	0000 0000	5:00
Won By: Yusei-Gachi					
B	* Metsola, Jukka-Pekka Campos, Kilmar	FIN VEN	1100 0000	0000 0000	2:45
Won By: Ippon					
B	* Matangi, Patrick Tsay, Yow-Tayn	ZIM TPE	1010 0000	0001 0000	5:23
Won By: Ippon					
B	Hussein, Walid * Legien, Waldemar	EGY POL	0000 0200	0000 0000	1:09
Won By: Waza-Ari-Awasete-Ippon					
B	Attye, Aly * Garcia, Dario O G	SEN ARG	0000 1000	0001 0000	4:39
Won By: Ippon					
B	Ahn, Byung-Keun * Doherty, Kevin	KOR CAN	0000 0000	0111 0011	5:00
Won By: Keikoku					
B	* Lam, Lap Hing Buchel, Magnus	HKG LIE	1001 0000	0000 0000	2:42
Won By: Ippon					

Judo

Men Half-Middleweight -78kg 1/8 Preliminaries/Sept. 28		Hommes/Mi-moyen -78kg 1/8 Preliminaires/28 Sept			
Pool Poule	Name Nom	Ctry Pays	Scores Points		Time Temps
			IWYK	HECS	
A	* Wieneke, Frank Gonzalez, Victorino	FRG ESP	1100 0000	0001 0010	3:13
Won By: Ippon					
A	* Tayot, Pascal Okada, Hirotaka	FRA JPN	1001 0000	0000 0011	4:53
Won By: Ippon					
A	* Brechot, Torsten Adams, Neil	GDR GBR	0001 0000	0000 0000	5:00
Won By: Koka					
A	* Erhembayar, Sodnom Elsharaf, Hisham	MGL KUW	0000 0000	0000 0001	5:00
Won By: Shido					
B	* Varaev, Bachir Cakiroglu, Temel	URS TUR	0110 0000	0000 0111	4:28
Won By: Sogo-Gachi					
B	* Metsola, Jukka-Pekka Matangi, Patrick	FIN ZIM	1010 0000	0000 0000	1:10
Won By: Ippon					
B	* Legien, Waldemar Garcia, Dario O G	POL ARG	1000 0000	0000 0000	1:54
Won By: Ippon					
B	* Doherty, Kevin Lam, Lap Hing	CAN HKG	1000 0000	0000 0001	0:43
Won By: Ippon					

Men Half-Middleweight -78Kg Quarter-finals/Sept. 28		Hommes/Mi-moyen -78Kg Quarts de Final/28 Sept			
Pool Poule	Name Nom	Ctry Pays	Scores Points		Time Temps
			IWYK	HECS	
A	* Wieneke, Frank Tayot, Pascal	FRG FRA	0001 0000	0000 0000	5:00
Won By: Koka					
A	* Brechot, Torsten Erhembayar, Sodnom	GDR MGL	0200 0000	0000 0000	1:30
Won By: Waza-Ari-Awasete-Ippon					
B	* Varaev, Bachir Metsola, Jukka-Pekka	URS FIN	1000 0100	0000 0000	1:56
Won By: Ippon					
B	* Legien, Waldemar Doherty, Kevin	POL CAN	0101 0000	0000 0000	5:00
Won By: Waza-Ari					

Men Half-Middleweight -78Kg Semi-finals/Sept. 28		Hommes/Mi-moyen -78Kg Demi-finales/28 Sept			
Pool Poule	Name Nom	Ctry Pays	Scores Points		Time Temps
			IWYK	HECS	
A	* Wieneke, Frank Brechot, Torsten	FRG GDR	0001 0000	0000 0000	5:00
Won By: Koka					
B	Varaev, Bachir * Legien, Waldemar	URS POL	0000 0000	0000 0000	5:00
Won By: Yusei-Gachi					

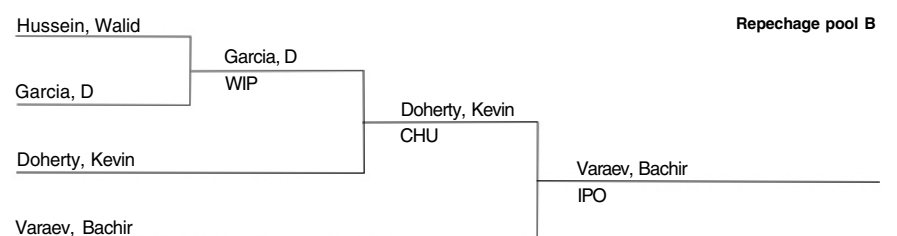
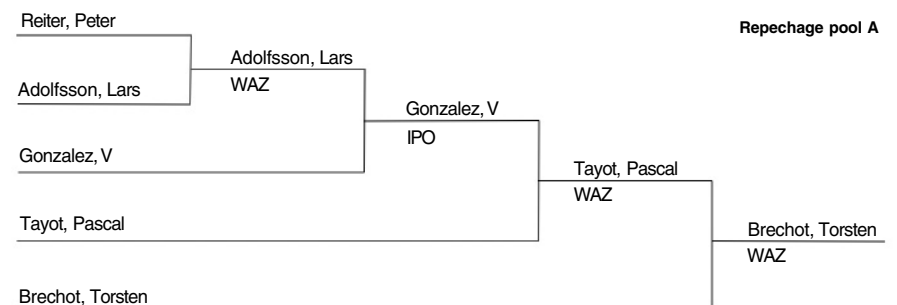



**Men Half-Middleweight -78Kg
Competition Summary**

**Hommes/Mi-moyen -78Kg
Tableau de la Competition**

Round/Tour 1	Round/Tour 2	Round/Tour 3	Round/Tour 4	Final/Finale
Reiter, Peter (AUT)	Wieneke, Frank	Wieneke, Frank	Wieneke, Frank	Wieneke, Frank KOK
Wieneke, Frank (FRG)	IPO	YUK	IPO	
Adolfsson, Lars (SWE)	Adolfsson, Lars	Gonzalez, V	Tayot, Pascal	
BYE		WIP		
Gonzalez, V (ESP)	Gonzalez, V	Okada, Hirotaka	Brechot, Torsten	
Kihara, James (KEN)	IPO	YUK		
Ochoa, L (COL)	Ochoa, L	Brechot, Torsten	KOK	
BYE		IPO		
Tayot, Pascal (FRA)	Tayot, Pascal	Adams, Neil	Erhembayar, S	
Saikali, Fadi (LIB)	WIP	IPO		
Jose Boy, R (ANG)	Jose Boy, R	Erhembayar, S	SHI	
BYE		WAZ		
Lescak, Filip (YUG)	Lescak, Filip	Elsharaf, Hisham	IPO	
BYE		IPO		
Okada, Hirotaka (JPN)	Okada, Hirotaka	Legien, Waldemar	WIP	
BYE		WIP		
Brechot, Torsten (GDR)	Brechot, Torsten	Legien, Waldemar	IPO	
Paraguassu, E (BRA)	IPO	WIP		
Baylon, John (PHI)	Baylon, John	Legien, Waldemar	IPO	
BYE		WIP		
Cristovao, Pedro (POR)	Cristovao, Pedro	Legien, Waldemar	IPO	
BYE		WIP		
Adams, Neil (GBR)	Adams, Neil	Legien, Waldemar	IPO	
BYE		WIP		
Erhembayar, S (MGL)	Erhembayar, S	Legien, Waldemar	IPO	
Kuruvoli, S (FIJ)	IPO	WIP		
Huttich, Carlos (MEX)	Huttich, Carlos	Legien, Waldemar	IPO	
BYE		WIP		
Aquino, Mariano (GUM)	Aquino, Mariano	Legien, Waldemar	IPO	
BYE		WIP		
Elsharaf, Hisham (KUW)	Aquino, Mariano	Legien, Waldemar	IPO	
BYE		WIP		
Schaffter, O (SUI)	Morris, Jason	Legien, Waldemar	IPO	
Morris, Jason (USA)	KEI	WIP		
Varaev, Bachir (URS)	Varaev, Bachir	Legien, Waldemar	IPO	
BYE		WIP		
Cakiroglu, Temel (TUR)	Cakiroglu, Temel	Legien, Waldemar	IPO	
BYE		WIP		
Val, Luis(AUS)	Val, Luis	Legien, Waldemar	IPO	
BYE		WIP		
Metsola, J (FIN)	Metsola, J	Legien, Waldemar	IPO	
Adamu, Mamudu (NGR)	CHU	WIP		
Campos, Kilmar (VEN)	Campos, Kilmar	Legien, Waldemar	IPO	
BYE		WIP		
Matangi, Patrick (ZIM)	Matangi, Patrick	Legien, Waldemar	IPO	
BYE		WIP		
Tsay, Yow-Tayn (TPE)	Tsay, Yow-Tayn	Legien, Waldemar	IPO	
BYE		WIP		
Nemeth, Karoly(HUN)	Hussein, Walid	Legien, Waldemar	IPO	
Hussein, Walid (EGY)	KOK	WIP		
Legien, Waldemar (POL)	Legien, Waldemar	Legien, Waldemar	IPO	
BYE		WIP		
Attye, Aly (SEN)	Attye, Aly	Legien, Waldemar	IPO	
BYE		WIP		
Garcia, D (ARG)	Garcia, D	Legien, Waldemar	IPO	
BYE		WIP		
Ahn, Byung-Keun (KOR)	Ahn, Byung-Keun	Legien, Waldemar	IPO	
Laats, Johan (BEL)	IPO	WIP		
Doherty, Kevin (CAN)	Doherty, Kevin	Legien, Waldemar	IPO	
BYE		WIP		
Lam, Lap Hing (HKG)	Lam, Lap Hing	Legien, Waldemar	IPO	
BYE		WIP		
Buchel, Magnus (LIE)	Buchel, Magnus	Legien, Waldemar	IPO	
BYE		WIP		

Judo

Men Half-Middleweight -78Kg Final/Sept. 28

Hommes Mi-moyen -78Kg Finale/28 Sept

Pool Poule	Name Nom	Ctry Pays	Scores Points		Time Temps
			IWYK	HECS	
REP.A	Reiter, Peter	AUT	0000	0011	5:00
	* Adolfsson, Lars	SWE	0100	0010	
Won By: Waza-Ari					
REP.A	Adolfsson, Lars	SWE	0000	0000	3:23
	* Gonzalez, Victorino	ESP	1000	0000	
Won By: Ippon					
REP.A	Gonzalez, Victorino	ESP	0001	0010	5:00
	* Tayot, Pascal	FRA	0100	0001	
Won By: Waza-Ari					
REP.A	Tayot, Pascal	FRA	0000	0000	5:00
	* Brechot, Torsten	GDR	0100	0001	
Won By: Waza-ari					
REP.B	Hussein, Walid	EGY	0000	0000	2:32
	* Garcia, Dario O G	ARG	0200	0000	
Won By: Waza-ari-awasete-ippou					
REP.B	Garcia, Dario O G	ARG	0000	0011	5:00
	* Doherty, Kevin	CAN	0000	0001	
Won By: Chui					
REP.B	Doherty, Kevin	CAN	0000	0000	1:23
	* Varaev, Bachir	URS	1000	0000	
Won By: Ippon					
Final	Wieneke, Frank	FRG	0000	0000	4:44
	* Legien, Waldemar	POL	1000	0000	
Won By: Ippon					

Men Middleweight -86Kg 1/32 Preliminaries/Sept. 29

Hommes Moyen -86Kg 1/32 Preliminaires/29 Sept

Pool Poule	Name Nom	Ctry Pays	Scores Points		Time Temps
			IWYK	HECS	
A	* White, Densign	GBR	0000	0000	5:00
	Suplis, Luc	BEL	0000	0000	
Won By: Yusei-Gachi					
A	Bazynski, Michael	FRG	0000	0000	5:00
	* Spijkers, Ben	HOL	0020	0001	
Won By: Yuko					
B	Bessi, Eric-Louis	MON	0000	0001	4:53
	* Medina, William	COL	1010	0001	
Won By: Ippon					
B	Frick, Arnold	LIE	0000	0000	3:39
	* Diabone, Ankiling	SEN	1120	0000	
Won By: Ippon					

Men Middleweight -86Kg 1/16 Preliminaries/Sept. 29

Hommes/Moyen -86Kg 1/16 Preliminaires/29 Sept

Pool Poule	Name Nom	Ctry Pays	Scores Points		Time Temps
			IWYK	HECS	
A	* White, Densign	GBR	0010	0000	5:00
	Lopez, Sandro Luis	ARG	0001	0000	
Won By: Yuko					
A	* Vincent, William	NZL	1000	0000	0:32
	Jani, Louis	CAN	0000	0000	
Won By: Ippon					
A	* Chiu, Heng-An	TPE	0141	0000	5:00
	Maduro, Victor	ARU	0000	0000	
Won By: Waza-Ari					
A	* Chestakov, Vladimir	URS	1011	0000	5:02
	Basalusalu, Josateki	FUJ	0010	0011	
Won By: Ippon					
A	* Spijkers, Ben	HOL	0020	0000	5:00
	Capo, Rene	USA	0000	0000	
Won By: Yuko					
A	Todorov, Ivan	YUG	0000	0000	2:57
	* Baljinniam, Odvog	MGL	1000	0000	
Won By: Ippon					
A	Casadei, Franch	SMR	0000	0010	2:42
	* Gyani, Janos	HUN	0200	0000	
Won By: Waza-Ari-Awasete-Ippon					
A	Ng, Chiu Fan	HKG	0000	0000	0:50
	* Petrov, Gueorgui	BUL	1000	0000	
Won By: Ippon					
B	Medina, William	COL	0000	0001	5:00
	* Chibani, Riad	ALG	0110	0000	
Won By: Waza-Ari					
B	Alhammad, Yousef	KUW	0000	0000	5:00
	* Canu, Fabien	FRA	0200	0000	
Won By: Waza-Ari-Awasete-Ippon					

Judo

Pool Poule	Name Nom	Ctry Pays	Scorest Points		Time Temps
			IWYK	HECS	
B	Bonnet, Jorge	PUR	0000	0000	0:21
	* Seisenbacher, Peter	AUT	1000	0000	
Won By: Ippon					
B	Nyachwaya, Tiberius	KEN	0000	0010	5:00
	* Kim, Seung-Kyu	KOR	0201	0000	
Won By: Waza-Ari-Awasete-Ippon					
B	Diabone, Ankiling	SEN	0000	0001	5:00
	* Griffith, Charles	VEN	0100	0000	
Won By: Waza-Ari					
B	Waithe, James	BAR	0000	0000	0:56
	* Liu, Junlin	CHN	1001	0000	
Won By: Ippon					
B	* Osako, Akinobu	JPN	0210	0000	1:42
	Atonio Inacio, Jose	ANG	0000	0000	
Won By: Waza-Ari-Awasete-Ippon					
B	Iqiebor, West	NGR	0000	1110	2:42
	* Carmona, Walter	BRA	0000	0000	
Won By: Hansoku-Gachi					

Men Middle weight-86kg 1/8 Preliminaries/Sept. 29

Hommes Moyen-86kg 1/8 Preliminaires/29 Sept

Pool Poule	Name Nom	Ctry Pays	Scores Points		Time Temps
			IWYK	HECS	
A	* White, Densign	GBR	1000	0000	1:32
	Vincent, William	NZL	0000	0000	
Won By: Ippon					
A	Chiu, Heng-An	TPE	0000	0000	1:49
	* Chestakov, Vladimir	URS	1010	0000	
Won By: Ippon					
A	* Spijkers, Ben	HOL	1000	0000	1:19
	Baljinniam, Odvog	MGL	0000	0000	
Won By: Ippon					
A	* Gyani, Janos	HUN	1000	0000	2:08
	Petrov, Gueorgui	BUL	0000	0000	
Won By: Ippon					
B	Chibani, Riad	ALG	0000	0000	5:00
	* Canu, Fabien	FRA	0002	0000	
Won By: Koka					
B	* Seisenbacher, Peter	AUT	1000	0000	1:12
	Kim, Seung-Kyu	KOR	0000	0000	
Won By: Ippon					
B	Griffith, Charles	VEN	0000	0000	1:22
	* Liu, Junlin	CHN	0000	0000	
Won By: Kiken-Gachi					
B	* Osako, Akinobu	JPN	0000	0000	5:00
	Carmona, Walter	BRA	0000	0000	
Won By: Yusei-Gachi					

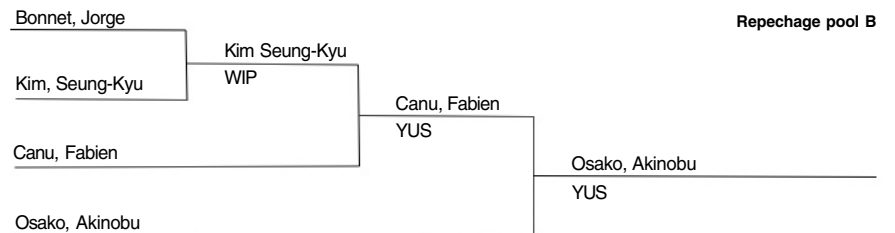
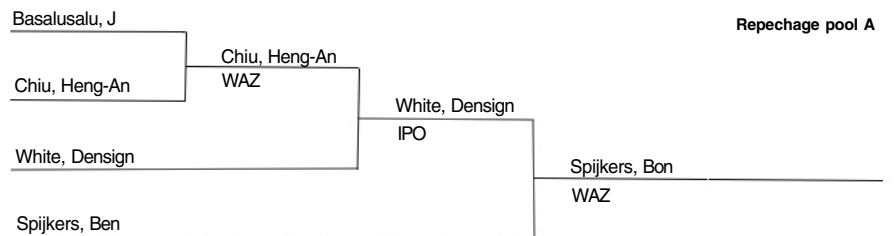



**Men Middleweight -86Kg
Competition Summary**

**Hommes/Moyen -86Kg
Tableau de la Competition**



Judo

Men Middleweight -86Kg Quarter-finals/Sept. 29			Hommes Moyen -86Kg Quarter de finals/29 Sept		
Pool Poule	Name Nom	Ctry Pays	Scores Points		Time Temps
			IWYK	HECS	
A	White, Densign	GBR	0000	0001	5:00
	* Chestakov, Vladimir	URS	0000	0001	
Won By: Yusei-Gachi					
A	* Spijkers, Ben	HOL	0000	0000	5:00
	Gyani Janos	HUN	0000	0000	
Won By: Yusei-Gachi					
B	Canu, Fabien	FRA	0000	0000	5:00
	* Seisenbacher Peter	AUT	0010	0000	
Won By: Yuko					
B	Liu, Junlin	CHN	0000	0000	2:26
	* Osako, Akinobu	JPN	1101	0000	
Won By: Ippon					

Men Middleweight -86kg Semi-finals/Sept. 29			Hommes Moyen -86kg Demi-finales/29 Sept		
Pool Poule	Name Nom	Ctry Pays	Scores Points		Time Temps
			IWYK	HECS	
A	* Chestakov, Vladimir	URS	0001	0000	5:00
	Spijkers, Ben	HOL	0000	0000	
Won By: Koka					
B	* Seisenbacher, Peter	AUT	0010	0001	5:00
	Osako, Akinobu	JPN	0000	0000	
Won By: Yuko					

Men Middleweight -86Kg Final/Sept. 29			Hommes Moyen -86Kg Final/29 Sept		
Pool Poule	Name Nom	Ctry Pays	Scores Points		Time Temps
			IWYK	HECS	
REP. A	* Basalusalu, Josateki	FIJ	0000	0001	5:00
	* Chiu, Heng-An	TPE	0122	0000	
Won By: Waza-Ari					
REP. A	Chiu, Heng-An	TPE	0000	0000	3:58
	* White, Densign	GBR	1000	0000	
Won By: Ippon					
REP. A	White, Densign	GBR	0000	0000	5:00
	* Spijkers, Ben	HOL	0110	0000	
Won By: Waza-Ari					
REP. B	Bonnet, Jorge	PUR	0000	0001	4:05
	* Kim, Seung-Kyu	KOR	0212	0001	
Won By: Waza-Ari-Awasete-Ippon					
REP. B	Kim, Seung-Kyu	KOR	0000	0000	5:00
	* Canu, Fabien	FRA	0000	0000	
Won By: Yusei-Gachi					
REP. B	Canu, Fabien	FRA	0000	0000	5:00
	* Osako, Akinobu	JPN	0000	0000	
Won By: Yusei-Gachi					
FINAL	Chestakov, Vladimir	URS	0000	0000	5:00
	* Seisenbacher, Peter	AUT	0000	0000	
Won By: Yusei-Gachi					

Men Half-Heavyweight -95Kg 1/16 Preliminaries/Sept. 30			Hommes Mi-lourd -95Kg 1/16 Preliminaires/30 Sept		
Pool Poule	Name Nom	Ctry Pays	Scores Points		Time Temps
			IWYK	HECS	
A	* Meijer, Theo	HOL	1010	0000	4:06
	Liu, Anpai	CHN	0000	0000	
Won By: Ippon					
A	Ha, Hyung-Ju	KOR	0000	0000	1:59
	* Van De Walle, Robert	BEL	1001	0000	
Won By: Ippon					
B	Valev, Marko	BUL	0000	0000	5:00
	* Fazi, Juri	ITA	0100	0011	
Won By: Waza-Ari					
B	* Miguel, Aurelio	BRA	0000	0000	5:00
	Stewart, Dennis	GBR	0000	0000	
Won By: Yusei-Gachi					
B	* Traineau, Stephane	FRA	1000	0000	0:35
	Takayawa, Viliame	FIJ	0000	0000	
Won By: Ippon					

Judo

Men Half-Heavyweight -95Kg 1/8 Preliminaries/Sept. 30			Hommes Mi-lourd -95Kg 1/8 Preliminaires/30 Sept		
Pool Poule	Name Nom	Ctry Pays	Scores Points		Time Temps
			IWYK	HECS	
A	* Meijer, Theo	HOL	1000	0000	0:52
	Fernandes Torres, Moises Marti	ANG	0000	0000	
Won By: Ippon					
A	* Beutler, Jacek	POL	0100	0001	5:00
	Barbach, Ahmed	MAR	0000	0011	
Won By: Waza-Ari					
A	* Van De Walle, Robert	BEL	1000	0000	4:05
	Poddoubnyi, Victor	URS	0002	0001	
Won By: Ippon					
A	* Meiling, Marc	FRG	0000	0001	5:00
	Berland, Bob	USA	0000	0010	
Won By: Chui					
B	* Fazi, Juri	ITA	0001	0000	5:00
	Meli, Joseph	CAN	0000	0000	
Won By: Koka					
B	* Miguel, Aurelio	BRA	0000	0000	5:00
	Fridriksson, Bjarni	ISL	0000	0000	
Won By: Yusei-Gachi					
B	* Traineau, Stephane	FRA	0010	0001	5:00
	Sugai, Hitoshi	JPN	0000	0000	
Won By: Yuko					
B	* Sosna, Jiri	TCH	1000	0000	3:06
	Varga, Istvan	HUN	0000	0000	
Won By: Ippon					

Men Half-Heavyweight -95Kg Quarter-finals/Sept. 30			Hommes Mi-lourd -95Kg Quarts de Finale/30 Sept		
Pool Poule	Name Nom	Ctry Pays	Scores Points		Time Temps
			IWYK	HECS	
A	Meijer, Theo	HOL	0000	0000	0:17
	* Beutler, Jacek	POL	1000	0000	
Won By: Ippon					
A	Van De Walle, Robert	BEL	0000	0000	1:46
	* Meiling, Marc	FRG	1000	0000	
Won By: Ippon					
B	Fazi, Juri	ITA	0000	0011	5:00
	* Miguel, Aurelio	BRA	0000	0000	
Won By: Chui					
B	Traineau, Stephane	FRA	0000	0000	5:00
	* Sosna, Jiri	TCH	0000	0000	
Won By: Yusei-Gachi					

Men Half-Heavyweight -95Kg Semi-finals/Sept. 30			Hommes Mi-lourd -95Kg Demi-finales/30 Sept		
Pool Poule	Name Nom	Ctry Pays	Scores Points		Time Temps
			IWYK	HECS	
A	Beutler, Jacek	POL	0000	0010	5:00
	* Meiling, Marc	FRG	0003	0001	
Won By: Chui					
B	* Miguel, Aurelio	BRA	0000	0000	5:00
	Sosna, Jiri	TCH	0000	0011	
Won By: Chui					

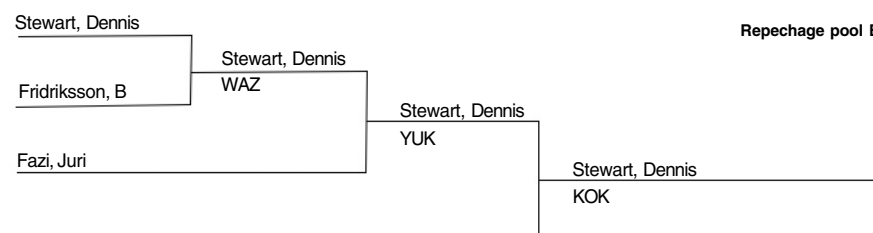
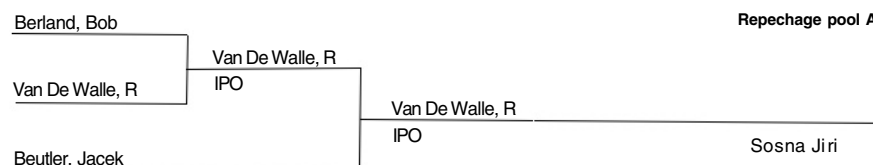



**Men Half-Heavyweight -95Kg
Competition Summary**

**Hommes/Mi-lourd -95Kg
Tableau de la Competition**



Judo

Men Half-Heavyweight -95kg Final/Sept. 30			Hommes Mi-lourd -95kg Finale/30 Sept		
Pool Poule	Name Nom	Ctry Pays	Scores Points		Time Temps
			IWYK	HECS	
REP. A	Berland, Bob	USA	0000	0001	2:40
	* Van De Walle, Robert	BEL	1000	0000	
Won By: Ippon					
REP. A	* Van De Walle, Robert	BEL	1000	0000	0:19
	Beutler, Jacek	POL	0000	0000	
Won By: Ippon					
REP. B	* Stewart, Dennis	GBR	0101	0000	5:00
	Fridriksson, Bjarni	ISL	0000	0000	
Won By: Waza-Ari					
REP. B	* Stewart, Dennis	GBR	0011	0000	5:00
	Fazi, Juri	ITA	0000	0000	
Won By: Yuko					
REP. B	* Stewart, Dennis	GBR	0011	0011	5:00
	Sosna, Jiri	TCH	0000	0000	
Won By: Koka					
FINAL	Meiling, Marc	FRG	0000	0011	5:00
	* Miguel, Aurelio	BRA	0000	0001	
Won By: Chui					

Men Heavyweight +95Kg 1/16 Preliminaries/Oct. 1			Hommes Lourd +95Kg 1/16 Preliminaires/1 Oct		
Pool Poule	Name Nom	Ctry Pays	Scores Points		Time Temps
			IWYK	HECS	
A	* Zaprianov, Dimitar	BUL	0001	0001	5:00
	Vachon, Roger	FRA	0000	0001	
Won By: Koka					
A	* Saito, Hitoshi	JPN	1000	0000	1:47
	Coly, Lansana	SEN	0000	0000	
Won By: Ippon					
A	Groeben Von Der, Alexander	FRG	0000	0000	2:20
	* Cho, Yong-Chul	KOR	1010	0000	
Won By: Ippon					
A	* Venturelli, Stefano	ITA	1000	0001	2:04
	Miloudi, Boualem	ALG	0000	0000	
Won By: Ippon					
A	* Basik, Andrzej	POL	0001	0000	5:00
	Jehle, Clemens	SUI	0000	0000	
Won By: Koka					
B	* Salonen, Juha	FIN	0010	0000	5:00
	Xu, Guoqing	CHN	0001	0000	
Won By: Yuko					
B	* Cohen, Steve	USA	0101	0000	5:00
	Bias, Ricardo	GUM	0000	0011	
Won By: Waza-Ari					
B	* Stoehr, Henry	GDR	1000	0010	2:14
	Mcmurray, Benjamin	PHI	0000	0001	
Won By: Ippon					
B	* Veritchev, Grigori	URS	0101	0001	5:00
	Kusmuk, Dragomir	YUG	0000	0010	
Won By: Waza-Ari					
B	Lahcinia, Abderrahim	MAR	0000	0110	3:45
	* Alfredo, Frederico	BRA	1001	0000	
Won By: Ippon					

Men Heavyweight +95kg 1/8 Preliminaries/Oct. 1			Hommes Lourd +95kg 1/8 Preliminaire/1 Oct		
Pool Poule	Name Nom	Ctry Pays	Scores Points		Time Temps
			IWYK	HECS	
A	Zaprianov, Dimitar	BUL	0000	0110	4:58
	* Saito, Hitoshi	JPN	1001	0001	
Won By: Ippon					
A	* Rashwan, Mohamed	EGY	1100	0000	1:54
	Bergmann, Sigurdur	ISL	0000	0000	
Won By: Ippon					
A	* Cho, Yong-Chul	KOR	0100	0000	5:00
	Venturelli, Stefano	ITA	0000	0000	
Won By: Waza-Ari					
A	* Basik, Andrzej	POL	0200	0000	1:41
	De Carvalho Inac, Helder Jose	ANG	0000	0000	
Won By: Waza-Ari-Awasete-Ippon					
B	* Salonen, Juha	FIN	0000	0111	5:00
	Cohen, Steve	USA	0000	0111	
Won By: Yusei-Gachi					
B	* Stoehr, Henry	GDR	1000	0000	0:48
	Dubovszky, Istvan	HUN	0000	0000	
Won By: Ippon					
B	* Veritchev, Grigori	URS	0200	0000	3:52
	Baterdene, Badmaniambu	MGL	0000	0000	
Won By: Waza-Ari-Awasete-Ippon					

Judo

Pool Poule	Name Nom	Ctry Pays	Scorest Points		Time Temps
			IWYK	HECS	
B	* Alfredo, Frederico	BRA	1000	0000	2:42
	Gordon, Elvis	GBR	0000	0000	
Won By: Ippon					

Men Heavyweight +95Kg Quarter-finals/Oct. 1			Men Lourd +95Kg Quarts de Finale/1 Oct		
Pool Poule	Name Nom	Ctry Pays	Scores Points		Time Temps
			IWYK	HECS	
A	* Saito, Hitoshi	JPN	1000	0000	3:05
	Rashwan, Mohamed	EGY	0000	0000	
Won By: Ippon					
A	* Cho, Yong-Chul	KOR	0010	0000	5:00
	Basik, Andrzej	POL	0000	0000	
Won By: Yuko					
B	Salonen, Juha	FIN	0000	0000	0:42
	* Stoehr, Henry	GDR	1000	0000	
Won By: Ippon					
B	* Veritchev, Grigori	URS	0000	0000	5:00
	Alfredo, Frederico	BRA	0000	0000	
Won By: Yusei-Gachi					

Men Heavyweight +95Kg Semi-finals/Oct. 1			Men Lourd +95Kg Demi-finales/1 Oct		
Pool Poule	Name Nom	Ctry Pays	Scores Points		Time Temps
			IWYK	HECS	
A	* Saito, Hitoshi	JPN	0000	0000	5:00
	Cho, Yong-Chul	KOR	0000	0011	
Won By: Chui					
B	* Stoehr, Henry	GDR	0000	0000	5:00
	Veritchev, Grigori	URS	0000	0000	
Won By: Yusei-Gachi					

Men Heavyweight +95Kg Final/Oct. 1			Hommes Lourd +95Kg Final/1 Oct		
Pool Poule	Name Nom	Ctry Pays	Scores Points		Time Temps
			IWYK	HECS	
REP. A	* Coly, Lansana	SEN	0000	0000	2:14
	* Zaprianov, Dimitar	BUL	1000	0000	
Won By: Ippon					
REP. A	* Zaprianov, Dimitar	BUL	0000	0011	5:00
	Rashwan, Mohamed	EGY	0000	0011	
Won By: Yusei-Gachi					
REP. A	Zaprianov, Dimitar	BUL	0000	0001	5:00
	* Cho, Yong-Chul	KOR	0000	0000	
Won By: Shido					
REP. B	Mcmurray, Benjamin	PHI	0000	0001	1:41
	* Dubovszky, Istvan	HUN	1000	0000	
Won By: Ippon					
REP. B	* Dubovszky, Istvan	HUN	0000	0001	5:00
	Salonen, Juha	FIN	0000	0011	
Won By: Chui					
REP. B	Dubovszky, Istvan	HUN	0000	0011	5:00
	* Veritchev, Grigori	URS	0010	0011	
Won By: Yuko					
FINAL	* Saito, Hitoshi	JPN	0000	0011	5:00
	Stoehr, Henry	GDR	0000	0111	
Won By: Keikoku					

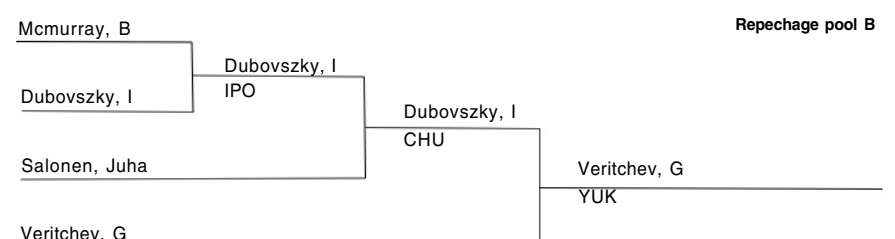
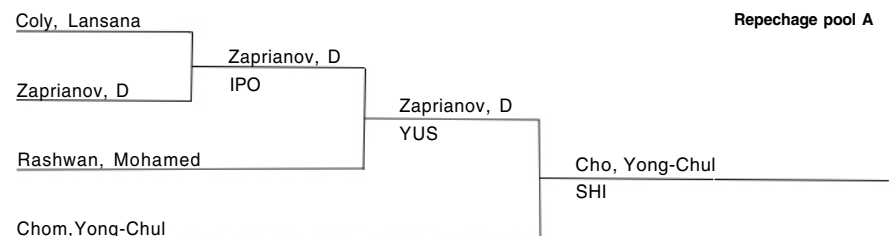



Men Heavyweight +95kg
Competition Summary

Hommes/Lourd +95kg
Tableau de la Competition



Women Extra-Lightweight -48Kg
Competition summary

Femmes/Super leger -48Kg
Tableau de la Competition

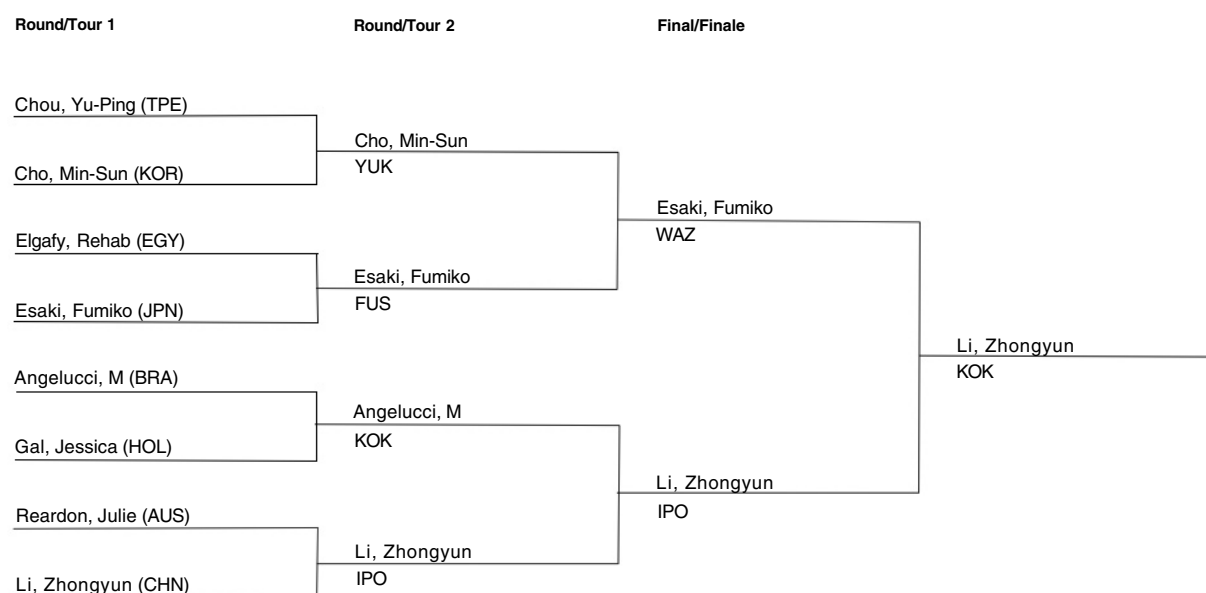

Women Extra-Lightweight -48Kg Quarter-finals/Sept. 25			Femmes Super leger -48Kg Quarts de Finale/25 Sept		
Pool Poule	Name Nom	Ctry Pays	Scores Points		Time Temps
			IWYK	HECS	
A	Chou, Yu-Ping * Cho, Min-Sun	TPE KOR	0002 0011	0000 0000	4:00
Won By: Yuko					
A	Elgafy, Rehab * Esaki, Fumiko	EGY JPN	0000 0000	0000 0000	0:00
Won By: Fusen-Gachi					
B	* Angelucci, Monica Gal, Jessica	BRA HOL	0001 0000	0000 0000	4:00
Won By: Koka					
B	Reardon, Julie * Li, Zhongyun	AUS CHN	0000 1001	0000 0000	1:40
Won By: Ippon					

Cho, Min-Sun Repechage pool A

Reardon, Julie Repechage pool B

Angelucci, M Reardon, Julie
IPO

Women Extra-Lightweight -48Kg Semi-finals/Sept. 25			Femmes Super leger -48Kg Demi-finale/25 Sept		
Pool Poule	Name Nom	Ctry Pays	Scores Points		Time Temps
			IWYK	HECS	
A	Cho, Min-Sun * Esaki, Fumiko	KOR JPN	0000 0100	0000 0000	4:00
Won By: Waza-Ari					
B	Angelucci, Monica * Li, Zhongyun	BRA CHN	0000 1000	0000 0000	3:54
Won By: Ippon					

Women Extra-Lightweight -48Kg Final/Sept. 25			Femmes Super Leger -48Kg Finale/25 Sept		
Pool Poule	Name Nom	Ctry Pays	Scores Points		Time Temps
			IWYK	HECS	
REP. B	* Reardon, Julie Angelucci, Monica	AUS BRA	1000 0000	0000 0000	3:40
Won By: Ippon					
FINAL	Esaki, Fumiko * Li, Zhongyun	JPN CHN	0000 0001	0000 0000	4:00
Won By: Koka					



Women Half-Lightweight -52Kg
Competition Summary

Femmes/Mi-leger -52Kg
Tableau de la Competition

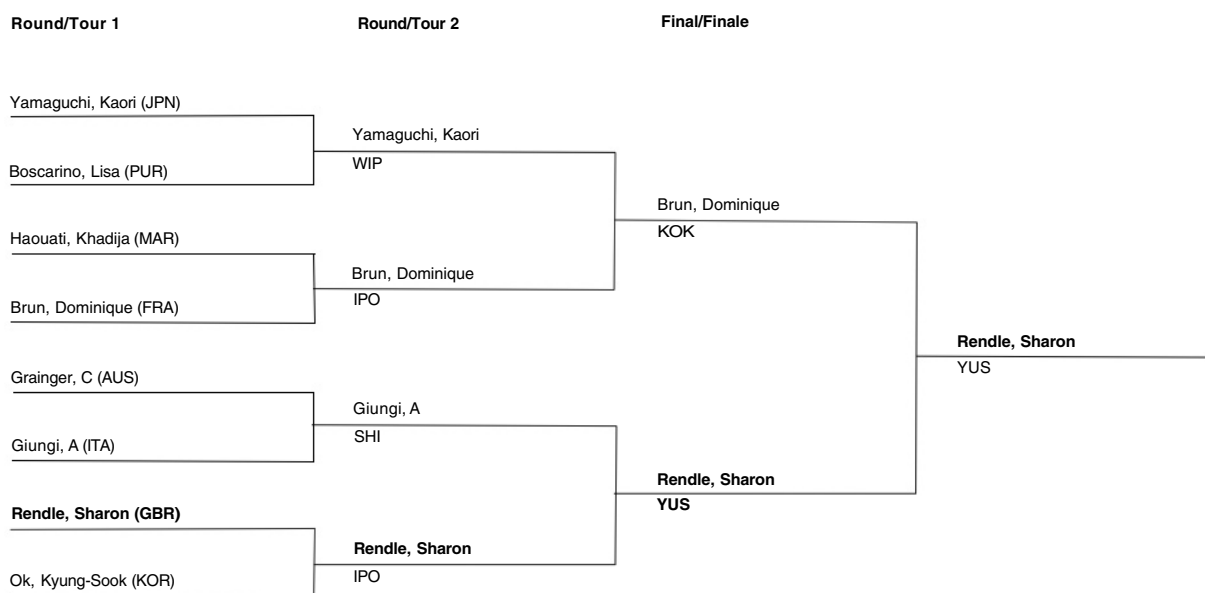

Women Half-Lightweight -52Kg Quarter-finals/Sept. 26			Femmes Mi-Leger -52Kg Quarts de Finale/26 Sept		
Pool Poule	Name Nom	Ctry Pays	Scores Points		Time Temps
			IWYK	HECS	
A	* Yamaguchi, Kaori	JPN	0210	0000	3:16
	Boscarino, Lisa	PUR	0000	0000	
Won By: Waza-Ari-Awasete-Ippon					
A	Haouati, Khadija	MAR	0000	0000	1:01
	* Brun, Dominique	FRA	1001	0000	
Won By: Ippon					
B	Grainger, Catherine	AUS	0000	0001	4:00
	* Giungi, Alessandra	ITA	0000	0000	
Won By: Shido					
B	* Rendle, Sharon	GBR	1001	0000	0:44
	Ok, Kyung-Sook	KOR	0000	0000	
Won By: Ippon					

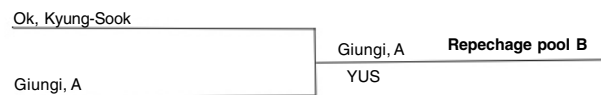
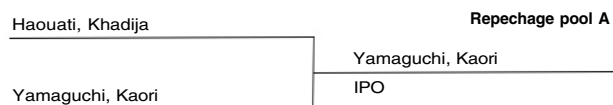

Women Half-Lightweight -52Kg Semi-finals/Sept. 26			Femmes Mi-Leger -52Kg Demi-finale/26 Sept		
Pool Poule	Name Nom	Ctry Pays	Scores Points		Time Temps
			IWYK	HECS	
A	Yamaguchi, Kaori	JPN	0000	0000	4:00
	* Brun, Dominique	FRA	0001	0000	
Won By: Koka					
B	Giungi, Alessandra	ITA	0000	0000	4:00
	* Rendle, Sharon	GBR	0000	0000	
Won By: Yusei-Gachi					

Women Half-Lightweight -52Kg Final/Sept. 26			Femmes Mi-Leger -52Kg Finale/25 Sept		
Pool Poule	Name Nom	Ctry Pays	Scores Points		Time Temps
			IWYK	HECS	
REP. A	Haouati, Khadija	MAR	0000	0000	0:19
	* Yamaguchi, Kaori	JPN	1100	0000	
Won By: Ippon					
REP. B	Ok, Kyung-Sook	KOR	0000	0000	4:00
	* Giungi, Alessandra	ITA	0000	0000	
Won By: Yusei-Gachi					
FINAL	Brun, Dominique	FRA	0000	0000	4:00
	* Rendle, Sharon	GBR	0000	0000	
Won By: Yusei-Gachi					

Women Lightweight -56Kg
Competition Summary

Femmes/Leger -56Kg
Tableau de la Competition

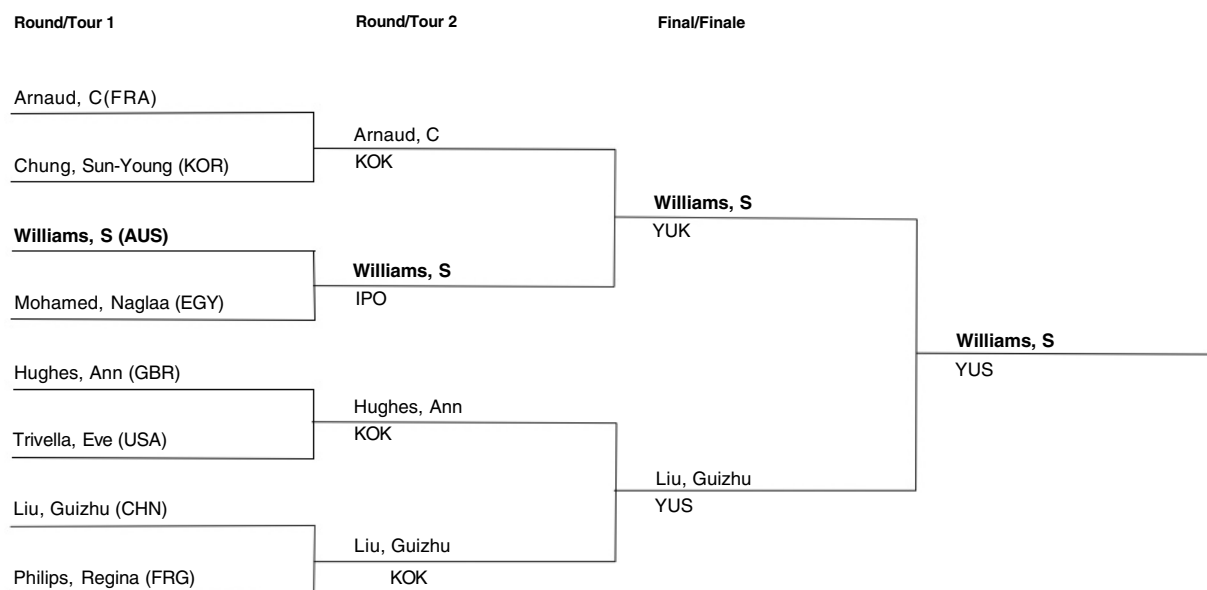

Women Lightweight -56Kg Quarter-finals/Sept. 27			Femmes Leger -56Kg Quarts de Finale/27 Sept		
Pool Poule	Name Nom	Ctry Pays	Scores Points		Time Temps
			IWYK	HECS	
A	* Arnaud, Catherine Chung, Sun-Young	FRA KOR	0001 0000	0000 0000	4:00
Won By: Koka					
A	* Williams, Suzanne Mohamed, Naglaa	AUS EGY	1002 0000	0000 0000	3:10
Won By: Ippon					
B	* Hughes, Ann Trivella, Eve	GBR USA	0001 0000	0000 0000	4:00
Won By: Koka					
B	* Liu, Guizhu Philips, Regina	CHN FRG	0001 0000	0000 0000	4:00
Won By: Koka					

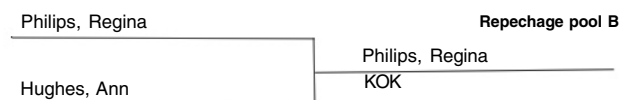
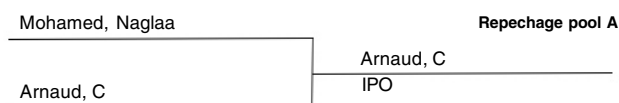

Women Lightweight -56Kg Semi-finals/Sept. 27			Femmes Leger -56Kg Demi-Finale/27 Sept		
Pool Poule	Name Nom	Ctry Pays	Scores Points		Time Temps
			IWYK	HECS	
A	Arnaud, Catherine * Williams, Suzanne	FRA AUS	0000 0010	0000 0000	4:00
Won By: Yuko					
B	Hughes, Ann * Liu, Guizhu	GBR CHN	0000 0000	0000 0000	4:00
Won By: Yusei-Gachi					

Women Lightweight -56Kg Final/Sept. 27			Femmes Leger -56Kg Finale 27 Sept		
Pool Poule	Name Nom	Ctry Pays	Scores Points		Time Temps
			IWYK	HECS	
REP. A	Mohamed, Naglaa * Arnaud, Catherine	EGY FRA	0000 1011	0000 0000	3:33
Won By: Ippon					
REP. B	* Philips, Regina Hughes, Ann	FRG GBR	0001 0000	0000 0000	4:00
Won By: Koka					
FINAL	* Williams, Suzanne Liu, Guizhu	AUS CHN	0000 0000	0000 0000	4:00
Won By: Yusei-Gachi					



Women Half-Middleweight -61 Kg
Competition Summary

Femmes/Mi-moyen-61 Kg
Tableau de la Competition

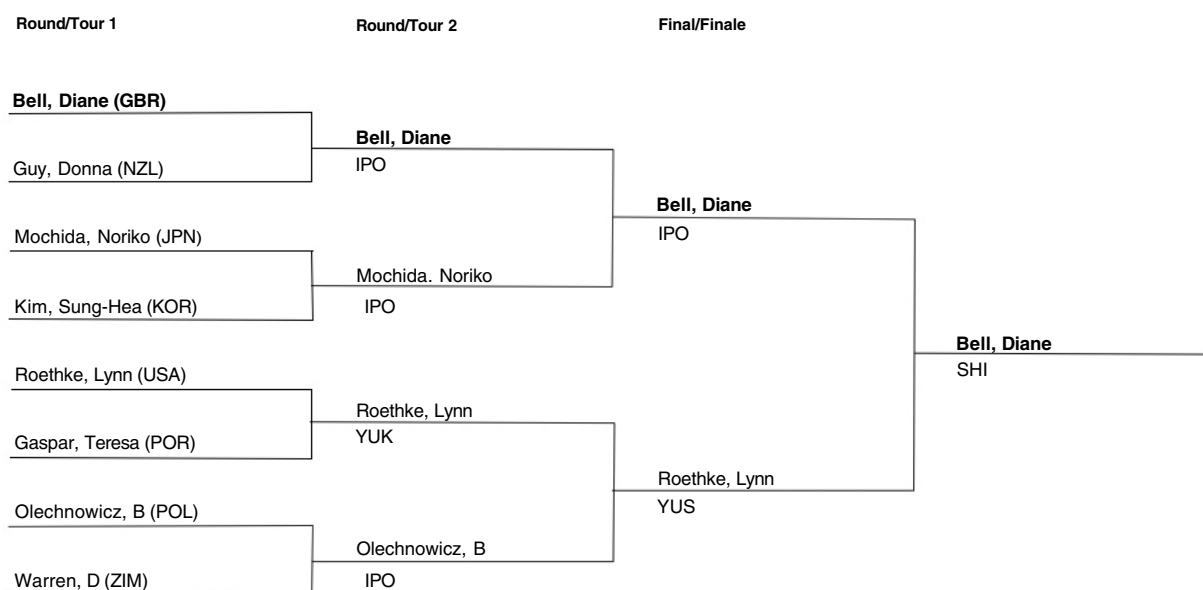

Women Half-lightweight -61 Kg
Quarter-finals/Sept. 28

Femmes Mi-Moyen -61 Kg
Quarts de Finale/28 Sept

Pool Poule	Name Nom	Ctry Pays	Scores Points		Time Temps
			IWYK	HECS	
A	* Bell, Diane Guy, Donna	GBR NZL	1000 0000	0000 0000	2:40
Won By: Ippon					
A	* Mochida, Noriko Kim, Sung-Hea	JPN KOR	1000 0110	0001 0001	4:25
Won By: Ippon					
B	* Roethke, Lynn Gaspar, Teresa	USA POR	0011 0000	0000 0000	4:00
Won By: Yuko					
B	* Olechnowicz, Boguslawa Warren, Debra Anne	POL ZIM	1020 0000	0000 0000	3:49
Won By: Ippon					

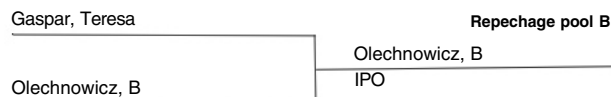

Women Half Middle Weight -61 Kg
Semi-finals/Sept. 28

Femmes Poids Mi-Moyen -61 Kg
Demi-finales/28 Sept

Pool Poule	Name Nom	Ctry Pays	Scores Points		Time Temps
			IWYK	HECS	
A	* Bell, Diane Mochida, Noriko	GBR JPN	1000 0002	0000 0000	1:37
Won By: Ippon					
B	* Roethke, Lynn Olechnowicz, Boguslawa	USA POL	0000 0010	0000 0011	4:00
Won By: Yusei-Gachi					

Women Half-Middle Weight -61 Kg
Final/Sept. 28

Femmes Mi-Moyen -61 Kg
Finale/28 Sept

Pool Poule	Name Nom	Ctry Pays	Scores Points		Time Temps
			IWYK	HECS	
REP. A	Guy, Donna * Mochida, Noriko	NZL JPN	0000 0100	0000 0000	4:00
Won By: Waza-Ari					
REP. B	Gaspar, Teresa * Olechnowicz, Boguslawa	POR POL	0000 1000	0000 0000	0:15
Won By: Ippon					
FINAL	* Bell, Diane Roethke, Lynn	GBR USA	0000 0000	0000 0001	4:00
Won By: Shido					

Judo

Judo

Women Middleweight -66Kg
Competition Summary

Femmes/Moyen -66Kg
Tableau de la Competition

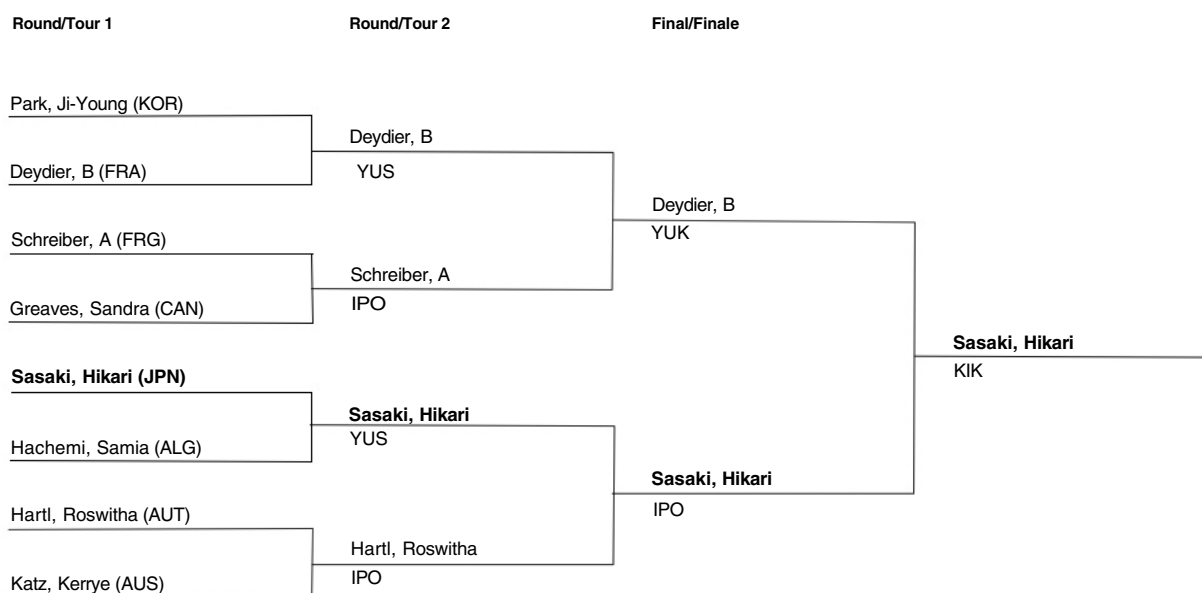

Women Middle Weight -66Kg Quarter-finals/Sept. 29			Femmes Moyen -48Kg Quarts de finale/25 Sept		
Pool Poule	Name Nom	Ctry Pays	Scores Points		Time Temps
			IWYK	HECS	
A	* Park, Ji-Young * Deydier, Brigitte	KOR FRA	0000 0000	0000 0000	4:00
Won By: Yusei-Gachi					
A	* Schreiber, Alexandra Greaves, Sandra	FRG CAN	1020 0000	0000 0000	2:44
Won By: Ippon					
B	* Sasaki, Hikari Hachemi, Samia	JPN ALG	0000 0000	0000 0000	4:00
Won By: Yusei-Gachi					
B	* Hartl, Roswitha Katz, Kerrye	AUT AUS	1001 0010	0000 0011	3:56
Won By: Ippon					

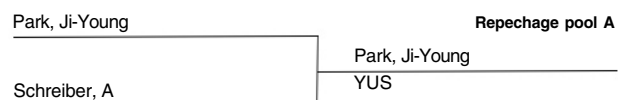

Women Middle Weight -66Kg Semi-finals/Sept. 29			Femmes Moyen -66Kg Demi-finales/29 Sept		
Pool Poule	Name Nom	Ctry Pays	Scores Points		Time Temps
			IWYK	HECS	
A	* Deydier, Brigitte Schreiber, Alexandra	FRA FRG	0010 0000	0001 0000	4:00
Won By: Yuko					
B	* Sasaki, Hikari Hartl, Roswitha	JPN AUT	1000 0000	0000 0000	3:48
Won By: Ippon					

Women Middle Weight -66Kg Final/Sept. 29			Femmes Moyen -66Kg Final/29 Sept		
Pool Poule	Name Nom	Ctry Pays	Scores Points		Time Temps
			IWYK	HECS	
REP. A	* Park, Ji-young Schreiber, Alexandra	KOR FRG	0010 0010	0000 0000	4:00
Won By: Yusei-gachi					
REP. B	Hachemi, Samia * Hartl, Roswitha	ALG AUT	0000 1000	0000 0001	2:02
Won By: Ippon					
FINAL	Deydier, Brigitte * Sasaki, Hikari	FRA JPN	0000 0000	0000 0000	2:27
Won By: Kiken-gachi					



Women Half-Heavyweight -72Kg
Competition Summary

Femmes/Mi-lourd -72Kg
Tableau de la Competition

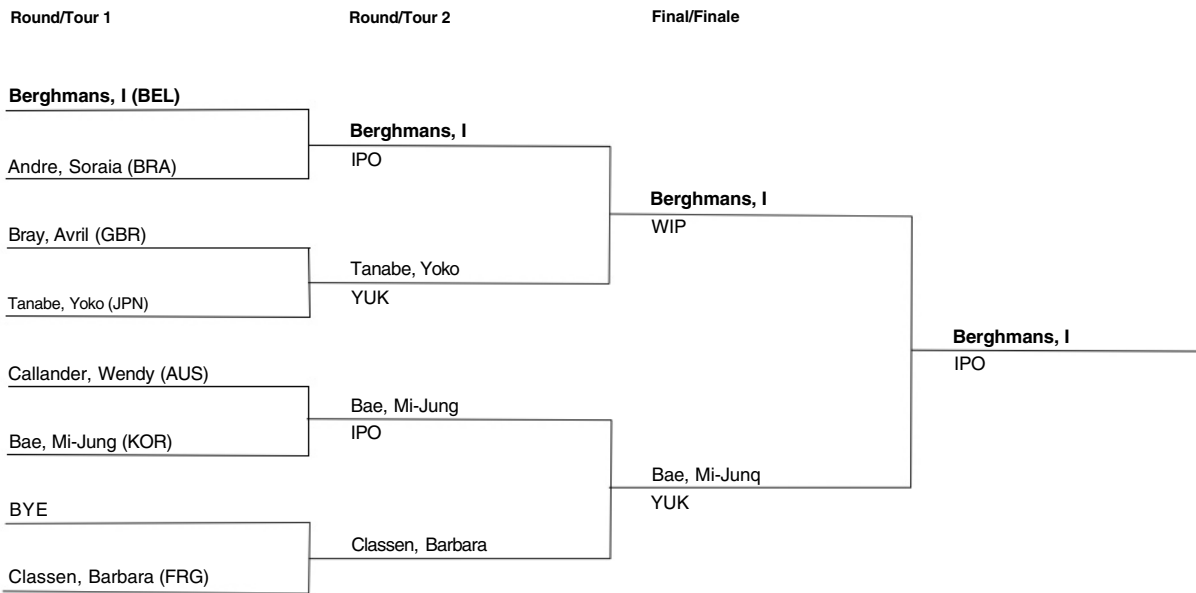

Women Half Heavy Weight -72Kg Quarter-finals/Sept. 30			Femmes Mi-Lourd -72Kg Quarts de Finale/30 Sept		
Pool Poule	Name Nom	Ctry Pays	Scores Points		Time Temps
			IWYK	HECS	
A	* Berghmans, Ingrid Andre, Soraia	BEL BRA	1000 0000	0000 0000	1:30
Won By: Ippon					
A	Bray, Avril * Tanabe, Yoko	GBR JPN	0000 0010	0000 0000	4:00
Won By: Yuko					
B	Callander, Wendy * Bae, Mi-Jung	AUS KOR	0000 1000	0000 0000	0:28
Won By: Ippon					



Women Half Heavy Weight -72Kg Semi-finals/Sept. 30			Femmes Mi-Lourd -72Kg Demi-finales/30 Sept		
Pool Poule	Name Nom	Ctry Pays	Scores Points		Time Temps
			IWYK	HECS	
A	* Berghmans, Ingrid Tanabe, Yoko	BEL JPN	0200 0000	0000 0000	3:01
Won By: Waza-Ari-Awasete-Ippon					
B	* Bae, Mi-Jung Classen, Barbara	KOR FRG	0011 0000	0001 0000	4:00
Won By: Yuko					

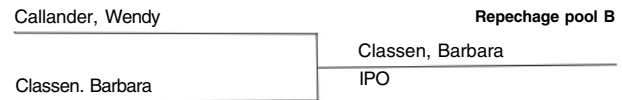

Women Half Heavy Weight -72Kg Final/Sept. 30			Femmes Mi-Lourd -72Kg Final/30 Sept		
Pool Poule	Name Nom	Ctry Pays	Scores Points		Time Temps
			IWYK	HECS	
REP. A	Andre, Soraia * Tanabe, Yoko	BRA JPN	0000 0010	0000 0001	4:00
Won By: Yuko					
REP. B	Callander, Wendy * Classen, Barbara	AUS FRG	0000 1011	0000 0000	2:11
Won By: Ippon					
FINAL	* Berghmans, Ingrid Bae, Mi-Jung	BEL KOR	1000 0000	0000 0000	2:31
Won By: Ippon					

Women Heavyweight +72Kg
Competition Summary

Femmes/Lourd +72Kg
Tableau de la Competition

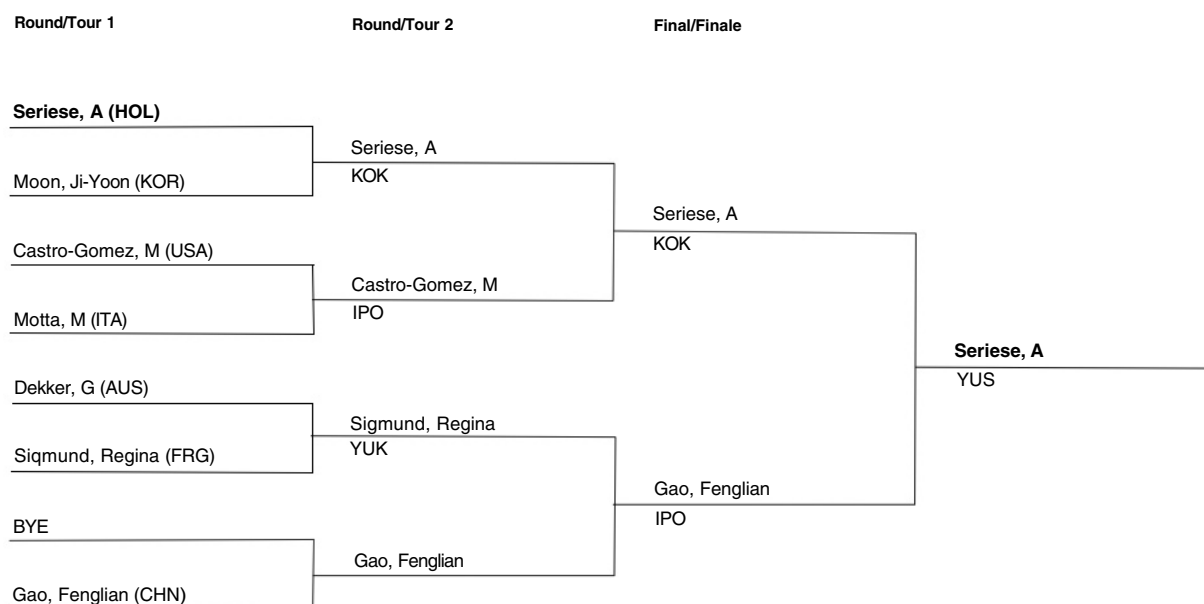

Women Heavy Weight +72Kg Quarter-finals/Oct. 1			Femmes Lourd +72Kg Quarts de Finale/1 Oct		
Pool	Name	Ctry	Scores		Time
Poule	Nom	Pays	IWYK	HECS	Temps
A	* Serie, Angelique Moon, Ji-Yoon	HOL KOR	0001 0000	0000 0000	4:00
Won By: Koka					
A	* Castro-Gomez, Margaret Motta, Maria Teresa	USA ITA	1010 0000	0000 0000	3:20
Won By: Ippon					
B	Dekker, Geraldine * Sigmund, Regina	AUS FRG	0000 0010	0000 0000	4:00
Won By: Yuko					



Women Heavy Weight +72Kg Semi-finals/Oct. 1			Femmes Lourd -72Kg Demi-finales/1 Oct		
Pool	Name	Ctry	Scores		Time
Poule	Nom	Pays	IWYK	HECS	Temps
A	* Serie, Angelique Castro-Gomez, Margaret	HOL USA	0001 0000	0000 0000	4:00
Won By: Koka					
B	Sigmund, Regina * Gao, Fenglian	FRG CHN	0000 1000	0000 0000	1:29
Won By: Ippon					

Women Heavy Weight +72Kg Final/Oct. 1			Femmes Lourd +72Kg Finale/1 Oct		
Pool	Name	Ctry	Scores		Time
Poule	Nom	Pays	IWYK	HECS	Temps
REP. A	Moon, Ji-Yoon * Castro-Gomez, Margaret	KOR USA	0000 0100	0001 0011	4:00
Won By: Waza-Ari					
FINAL	* Serie, Angelique Gao, Fenglian	HOL CHN	0000 0000	0000 0000	4:00
Won By: Yusei-Gachi					



근대 5종

Modern Pentathlon/Pentathlon Moderne



Modern Pentathlon/Pentathlon Moderne

Officials/Officiels

Union Internationale de Pentathlon Moderne et Biathlon (U.I.P.M.B.)

President/président	Sven Thofelt
Secretary General/secrétaire général	W. Thor Henning
Technical Delegates/délégués techniques	Col. Ioan Muresanu Dieter Krickow

SLOOC Administrative Staff/Personnel Administratif du SLOOC

Commissioner/directeur	Kwon Yong Gack
Secretary General/secrétaire général	Choi Kui Sung
Deputy Secretary General/secrétaire général adjoint	Yu Dong Ok
Competition Manager/chef de division des compétitions	Han Ki Moon

Competitors/Concurrents

Men
Hommes

Competitors
Competiteurs

Countries
Pays

79

27

Legend/Notation

EL	Eliminated/Éliminé
NP	Did not Participate/N'a pas Participé
DQ	Disqualified/Disqualifié



Modern Pentathlon

Pentathlon Moderne

Individual Competition Riding/Sept. 18			Competition individuelle Equitation/18 Sept			
Rank Rang	Name Nom	Ctry Pays	Horse Cheval	Time Temps	Penalty Time/Obs. Temps/Obs.	Points
1	Watson, Alexander	AUS	Print	1:36.22		1100
2	Abouelsouad, Mohamed	EGY	Knok li	1:39.62		1100
3	Saito, Hiroshi	JPN	Isonia	1:44.63	4	1096
4	Kang, Kyung-Hyo	KOR	Gin Fiss	1:37.00	30	1070
5	Li, King-Ho	TPE	Isonia	1:43.94	2 30	1068
6	Martinek, Janos	HUN	Moonshine	1:44.91	4 30	1066
7	Kadlec, Milan	TCH	Vincents Pride	1:45.59	6 30	1064
8	Hellstern, Tue	DEN	Hansi	1:47.25	10 30	1060
9	Kim, Myung-Gon	KOR	Print	1:30.43	60	1040
10	Tiberti, Gianluca	ITA	Gold Rose	1:34.44	60	1040
11	Skrzypaszek, Arkadiusz	POL	Polar	1:42.53	60	1040
12	Mahony, Dominic	GBR	Quasanova	1:44.52	4 60	1036
13	Knappheide, Dirk	FRG	Miserto	1:45.12	6 60	1034
14	Keyte, Lawrence	CAN	Walter	1:46.84	8 60	1032
15	Spannagl, Helmut	AUT	Fresco	1:50.58	16 60	1024
16	Fekete, Nicholas	CAN	Vicky	1:50.62	16 60	1024
17	Adam, Mostafa	EGY	Vincents Pride	1:56.38	28 60	1012
18	Quesada, Eduardo	ESP	Moonshine	1:37.03	90	1010
19	Massullo, Carlo	ITA	Jokaster	1:37.59	90	1010
20	Mizser, Attila	HUN	El Real	1:37.62	90	1010
21	Fleissner, Tomas	TCH	Vicky	1:44.43	4 90	1006
22	Bouzou, Joel	FRA	Delitant	1:45.43	6 90	1004
23	Brookhouse, Graham	GBR	Miuro	1:49.92	14 100	986
24	Iagorachvili, Vakhtang	URS	Mandia	1:27.59	120	980
25	Falconi, Ricardo	CHI	Ginger	1:33.96	120	980
26	Prokopius, Jiri	TCH	Gold Rose	1:41.13	120	980
27	Jung, Andy	SUI	Knok li	2:05.73	46 80	974
28	Ruer, Christophe	FRA	Fernanda	1:48.22	12 120	968
29	Phelps, Richard	GBR	Jokaster	1:45.60	6 130	964
30	Quesada, Jorge	ESP	Simona	1:50.42	16 120	964
31	Miwa, Tadafumi	JPN	Ginger	1:51.55	18 120	962
32	Sisniega, Ivar	MEX	Ronja	1:30.15	150	950
33	Cortes, Gerardo	CHI	Blue Boy	1:40.11	150	950
34	Zimmermann, Michael	FRG	Quasanova	1:42.46	150	950
35	Masala, Daniele	ITA	Renardo	1:43.42	2 150	948
36	Mahmoud, Ayman	EGY	Miserto	2:14.51	64 90	946
37	Nieman, Robert	USA	Fresco	2:10.35	56 100	944
38	Burger, Peter	SUI	Almansor	1:48.35	12 150	938
39	Hoyo, Marcelo	MEX	Fernanda	1:49.55	14 160	926
40	Chuang, Tang-Fa	TPE	Walter	1:30.37	180	920
41	Steinmann, Peter	SUI	Tristan	1:42.72	180	920
42	Rasmuson, Svante	SWE	Gilbert	1:44.59	4 180	916
43	Michelena, Alejandro	URU	Renardo	1:56.39	28 160	912
44	Genard, Bruno	FRA	Hansi	2:06.16	48 140	912
45	Barroso, Manuel	POR	Gin Fiss	1:40.49	190	910
46	Danielsson, Jan-Erik	SWE	Magia	1:40.34	210	890
47	Fabian, Laszlo	HUN	Waidfee	1:49.71	14 210	876
48	Marsollek, Marcus	FRG	Tristan	2:03.53	42 200	858
49	Yrizar, Alejandro	MEX	Ronja	2:35.33	106 140	854
50	Farhan, Saleh	BRN	El Real	1:45.21	6 270	824
51	Al Doseri, Ahmed	BRN	Delitant	1:59.09	34 250	816
52	Centeno, Leopoldo	ESP	Simona	2:16.42	68 235	797
53	Fuentes, Julio	CHI	Magia	2:01.41	38 280	782
54	Kennedy, Barry	CAN	Get Ready	1:39.93	330	770
55	Czyzowicz, Maciej	POL	Waidfee	2:42.18	120 210	770
56	Iouferov, Guerman	URS	Get Ready	1:49.78	14 370	716
57	Zhang, Bin	CHN	Almansor	3:19.71	194 200	706
58	Avdeev, Anatoli	URS	Theo	3:12.49	180 240	680
59	Khalid, Abdul Rahman	BRN	Matador	2:48.65	132 340	628
60	Chmielewski, Wieslaw	POL	Polar	3:04.17	164 360	576
61	Stull, Robert	USA	Miuro	3:07.13	170 460	470
62	Izumikawa, Hiroaki	JPN	Mandia	EL		0
62	Kim, Sung-Ho	KOR	Matador	EL		0
62	Martin, Roderick	SWE	Theo	EL		0
62	Gostigan, Michael	USA	Gilbert	EL		0

Rank Rang	Name Nom	Ctry Pays	Vict.	Def.	Penalty Penalite.	Points
31	Hoyo, Marcelo	MEX	31	33		762
31	Fleissner, Tomas	TCH	31	33		762
37	Sisniega, Ivar	MEX	31	33	10	752
38	Hellstern, Tue	DEN	30	34		745
39	Al Doseri, Ahmed	BRN	30	34	10	735
40	Kennedy, Barry	CAN	29	35		728
40	Adam, Mostafa	EGY	29	35		728
40	Li, King-Ho	TPE	29	35		728
43	Saito, Hiroshi	JPN	29	35	10	718
44	Watson, Alexander	AUS	28	36		711
44	Fekete, Nicholas	CAN	28	36		711
44	Genard, Bruno	FRA	28	36		711
47	Abouelsouad, Mohamed	EGY	27	37		694
47	Izumikawa, Hiroaki	JPN	27	37		694
47	Burger, Peter	SUI	27	37		694
47	Prokopius, Jiri	TCH	27	37		694
47	Chuang, Tang-Fa	TPE	27	37		694
52	Knappheide, Dirk	FRG	26	38		677
52	Barroso, Manuel	POR	26	38		677
54	Tiberti, Gianluca	ITA	27	37	20	674
55	Skrzypaszek, Arkadiusz	POL	25	39		660
56	Khalid, Abdul Rahman	BRN	25	39	10	650
57	Centeno, Leopoldo	ESP	24	40		643
57	Brookhouse, Graham	GBR	24	40		643
59	Keyte, Lawrence	CAN	22	42		609
59	Mahmoud, Ayman	EGY	22	42		609
59	Kim, Sung-Ho	KOR	22	42		609
62	Miwa, Tadafumi	JPN	21	43	10	582
63	Falconi, Ricardo	CHI	20	44		575
64	Fuentes, Julio	CHI	19	45	10	548
65	Michelena, Alejandro	URU	12	52	10	429

Individual Competition Fencing/Sept. 19			Competition individuelle Escrime/19 Sept			
Rank Rang	Name Nom	Ctry Pays	Vict.	Def.	Penalty Penalite.	Points
1	Fabian, Laszlo	HUN	48	16		1051
2	Martinek, Janos	HUN	45	19	10	990
3	Bouzou, Joel	FRA	44	20		983
3	Steinmann, Peter	SUI	44	20		983
3	Stull, Robert	USA	44	20		983
6	Iouferov, Guerman	URS	42	22		949
7	Nieman, Robert	USA	41	23		932
8	Martin, Roderick	SWE	40	24		915
8	Iagorachvili, Vakhtang	URS	40	24		915
10	Kadlec, Milan	TCH	40	24	10	905
11	Mahony, Dominic	GBR	39	25		898
11	Phelps, Richard	GBR	39	25		898
13	Massullo, Carlo	ITA	38	26		881
14	Avdeev, Anatoli	URS	38	26	10	871
15	Quesada, Jorge	ESP	37	27		864
15	Jung, Andy	SUI	37	27		864
15	Danielsson, Jan-Erik	SWE	37	27		864
18	Farhan, Saleh	BRN	36	28		847
18	Marsollek, Marcus	FRG	36	28		847
18	Mizser, Attila	HUN	36	28		847
18	Yrizar, Alejandro	MEX	36	28		847
18	Chmielewski, Wieslaw	POL	36	28		847
18	Czyzowicz, Maciej	POL	36	28		847
24	Masala, Daniele	ITA	36	28	10	837
25	Kang, Kyung-Hyo	KOR	35	29		830
25	Rasmuson, Svante	SWE	35	29		830
27	Gostigan, Michael	USA	35	29	10	820
28	Zimmermann, Michael	FRG	34	30		813
29	Spannagl, Helmut	AUT	33	31		796
30	Ruer, Christophe	FRA	32	32		779
31	Cortes, Gerardo	CHI	31	33		762
31	Zhang, Bin	CHN	31	33		762
31	Quesada, Eduardo	ESP	31	33		762
31	Kim, Myung-Gon	KOR	31	33		762

Individual Competition Swimming/Sept. 20			Competition individuelle Natation/20 Sept				
Rank Rang	Name Nom	Ctry Pays	Heat Serie	Lane Couloir	Time Temps	Penalty Penalite Min: Sec	Points
1	Ruer, Christophe	FRA	6	2	3:10.580		1348
2	Iagorachvili, Vakhtang	URS	9	1	3:11.230		1344
3	Avdeev, Anatoli	URS	2	4	3:13.750		1324
4	Iouferov, Guerman	URS	4	2	3:13.820		1324
5	Skrzypaszek, Arkadiusz	POL	5	7	3:15.110		1312
6	Brookhouse, Graham	GBR	4	7	3:15.220		1312
7	Czyzowicz, Maciej	POL	3	3	3:15.650		1308
8	Phelps, Richard	GBR	8	6	3:16.350		1304
9	Fabian, Laszlo	HUN	9	7	3:16.350		1304
10	Tiberti, Gianluca	ITA	5	4	3:17.100		1296
11	Martin, Roderick	SWE	1	2	3:19.970		1276
12	Knappheide, Dirk	FRG	5	5	3:20.340		1272
13	Kang, Kyung-Hyo	KOR	9	8	3:21.160		1264
14	Gostigan, Michael	USA	1	6	3:21.240		1264
15	Martinek, Janos	HUN	9	5	3:21.470		1264
16	Sisniega, Ivar	MEX	5	6	3:21.510		1260
17	Genard, Bruno	FRA	3	4	3:21.720		1260
18	Quesada, Eduardo	ESP	7	7	3:22.060		1256
19	Centeno, Leopoldo	ESP	2	1	3:22.360		1256
20	Kim, Myung-Gon	KOR	7	5	3:22.770		1252
21	Steinmann, Peter	SUI	9	2	3:22.900		1252
22	Nieman, Robert	USA	8	4	3:23.090		1248
23	Kim, Sung-Ho	KOR	1	7	3:23.440		1248
24	Yrizar, Alejandro	MEX	5	1	3:23.470		1248
25	Prokopius, Jiri	TCH	4	3	3:23.730		1244
26	Zimmermann, Michael	FRG	6	3	3:24.230		1240
27	Stull, Robert	USA	2	6	3:24.250		1240
28	Barroso, Manuel	POR	3	2	3:24.980		1236
29	Rasmuson, Svante	SWE	6	6	3:25.000		1232
30	Masala, Daniele	ITA	7	1	3:25.190		1232
31	Chmielewski, Wieslaw	POL	2	7	3:26.390		1224
32	Massullo, Carlo	ITA	8	5	3:28.740		1204
33	Mizser, Attila	HUN	8	3	3:29.860		1196
34	Jung, Andy	SUI	8	7	3:30.040		1192
35	Mahmoud, Ayman	EGY	3	1	3:32.320		1176
36	Quesada, Jorge	ESP	8	2	3:32.490		1176
37	Bouzou, Joel	FRA	9	4	3:32.510		1172
38	Fleissner, Tomas	TCH	6	4	3:32.610		1172
39	Burger, Peter	SUI	4	1	3:32.740		1172
40	Fekete, Nicholas	CAN	6	7	3:34.370		1160
41	Spannagl, Helmut	AUT	8	8	3:34.480		1160
42	Fuentes, Julio	CHI	1	3	3:34.520		1156
43	Hellstern, Tue	DEN	7	3	3:35.290		1152
44	Mahony, Dominic	GBR	9	3	3:35.990		1148
45	Adam, Mostafa	EGY	6	1	3:36.670		1140
46	Marsollek, Marcus	FRG	5	2	3:36.880		1140
47	Danielsson, Jan-Erik	SWE	6	5	3:36.900		1140
48	Hoyo, Marcelo	MEX	4	4	3:36.970		1140
49	Kennedy, Barry	CAN	2	5	3:38.230		1128
50	Falconi, Ricardo	CHI	3	6	3:40.460		1112
51	Farhan, Saleh	BRN	4	5	3:40.470		1112
52	Cortes, Gerardo	CHI	5	3	3:41.340		1104
53	Chuang, Tang-Fa	TPE	3	5	3:41.850		1100
54	Li, King-Ho	TPE	7	2	3:42.630		1092
55	Kadlec, Milan	TCH	9	6	3:42.790		1092
56	Keyte, Lawrence	CAN	4	6	3:42.900		1092
57	Khalid, Abdul Rahman	BRN	1	5	3:43.040		1088
58	Miwa, Tadafumi	JPN	2	3	3:44.090		1080
59	Zhang, Bin	CHN	2	2	3:44.140		1080
60	Abouelsouad, Mohamed						



**Individual Competition
Shooting/Sept. 21**

**Competition individuelle
Tir/21 Sept**

Rank Rang	Name Nom	Ctry Pays	1	2	3	4	= Result Resultat	Penalty Penalite	Points
1	Khalid, Abdul Rahman	BRN	50	50	49	49	198		1088
2	Kim, Myung-Gon	KOR	49	49	49	50	197		1066
3	Masala, Daniele	ITA	50	49	50	48	197		1066
4	Danielsson, Jan-Erik	SWE	50	48	48	50	196		1044
5	Martin, Roderick	SWE	50	50	47	49	196		1044
6	Marsollek, Marcus	FRG	49	49	50	48	196		1044
7	Abouelsouad, Mohamed	EGY	50	48	50	48	196		1044
8	Massullo, Carlo	ITA	49	50	49	48	196		1044
9	Gostigan, Michael	USA	50	49	49	48	196		1044
10	Fleissner, Tomas	TCH	49	50	48	48	195		1022
11	Kennedy, Barry	CAN	46	48	50	50	194		1000
12	Czyzowicz, Maciej	POL	49	47	49	49	194		1000
13	Kim, Sung-Ho	KOR	48	48	50	48	194		1000
14	Tiberti, Gianluca	ITA	49	48	49	48	194		1000
15	Nieman, Robert	USA	48	50	48	48	194		1000
16	Iagorachvili, Vakhtang	URS	48	49	48	48	193		978
17	Fekete, Nicholas	CAN	47	48	47	50	192		956
18	Miwa, Tadafumi	JPN	48	47	47	50	192		956
19	Centeno, Leopoldo	ESP	50	45	47	50	192		956
20	Saito, Hiroshi	JPN	48	47	48	49	192		956
21	Fuentes, Julio	CHI	48	48	49	47	192		956
22	Knappheide, Dirk	FRG	49	48	44	50	191		934
23	Iouferov, Guerman	URS	47	47	48	49	191		934
24	Skrzypaszek, Arkadiusz	POL	48	46	49	48	191		934
25	Prokopius, Jiri	TCH	46	49	48	48	191		934
26	Mizser, Attila	HUN	49	48	46	48	191		934
27	Keyte, Lawrence	CAN	50	47	47	47	191		934
28	Rasmuson, Svante	SWE	49	49	46	47	191		934
29	Ruer, Christophe	FRA	50	48	46	47	191		934
30	Michelena, Alejandro	URU	48	48	49	46	191		934
31	Genard, Bruno	FRA	49	45	47	49	190		912
32	Jung, Andy	SUI	47	49	47	47	190		912
33	Adam, Mostafa	EGY	49	47	48	46	190		912
34	Hellstern, Tue	DEN	45	45	50	49	189		890
35	Avdeev, Anatoli	URS	43	49	48	49	189		890
36	Li, King-Ho	TPE	47	46	47	49	189		890
37	Zhang, Bin	CHN	45	49	46	49	189		890
38	Sisniega, Ivar	MEX	47	47	46	49	189		890
39	Mahmoud, Ayman	EGY	45	48	48	48	189		890
40	Al Doseri, Ahmed	BRN	47	48	46	48	189		890
41	Yrizar, Alejandro	MEX	47	47	48	47	189		890
42	Mahony, Dominic	GBR	47	48	48	46	189		890
43	Stull, Robert	USA	47	49	44	48	188		868
44	Spannagl, Helmut	AUT	45	46	50	47	188		868
45	Martinek, Janos	HUN	46	49	46	47	188		868
46	Bouzou, Joel	FRA	46	48	48	46	188		868
47	Phelps, Richard	GBR	47	48	47	46	188		868
48	Kang, Kyung-Hyo	KOR	47	48	47	46	188		868
49	Chuang, Tang-Fa	TPE	47	49	47	45	188		868
50	Izumikawa, Hiroaki	JPN	45	47	46	49	187		846
51	Brookhouse, Graham	GBR	48	48	45	46	187		846
52	Zimmermann, Michael	FRG	48	45	46	47	186		824
53	Fabian, Laszlo	HUN	46	46	44	49	185		802
54	Barroso, Manuel	POR	47	44	47	47	185		802
55	Kadlec, Milan	TCH	47	48	44	46	185		802
56	Burger, Peter	SUI	45	46	45	48	184		780
57	Hoyo, Marcelo	MEX	46	46	44	48	184		780
58	Steinmann, Peter	SUI	45	45	49	45	184		780
59	Quesada, Jorge	ESP	45	47	48	44	184		780
60	Chmielewski, Wieslaw	POL	46	44	46	47	183		758
61	Falconi, Ricardo	CHI	41	46	46	49	182		736
62	Farhan, Saleh	BRN	46	47	42	47	182		736
63	Quesada, Eduardo	ESP	45	42	49	41	177		626
64	Cortes, Gerardo	CHI	35	44	46	42	167		406
65	Watson, Alexander	AUS					DQ		0

Results have been changed due to the failure of player No. 3 (AUS) in doping control test.
Changement des resultats du a la disqualification de l'athlete No. 3 (AUS) apres le control anti-dopage.

**Individual Competition
Cross Country/Sept. 22**

**Competition individuelle
Course a Pied/22 Sept**

Rank Rang	Name Nom	Ctry Pays	Time Temps	Points
1	Mizser, Attila	HUN	12:37.88	1294
2	Kadlec, Milan	TCH	12:46.85	1267
3	Steinmann, Peter	SUI	12:53.05	1246
4	Massullo, Carlo	ITA	12:55.86	1240
5	Barroso, Manuel	POR	13:02.54	1219
6	Martinek, Janos	HUN	13:03.19	1216
7	Ruer, Christophe	FRA	13:04.47	1213
8	Sisniega, Ivar	MEX	13:04.47	1213
9	Brookhouse, Graham	GBR	13:04.53	1213
10	Quesada, Eduardo	ESP	13:09.18	1198
11	Phelps, Richard	GBR	13:10.96	1195
12	Hoyo, Marcelo	MEX	13:11.76	1192
13	Keyte, Lawrence	CAN	13:15.28	1180
14	Al Doseri, Ahmed	BRN	13:15.38	1180
15	Izumikawa, Hiroaki	JPN	13:17.42	1174
16	Bouzou, Joel	FRA	13:18.51	1171
17	Fabian, Laszlo	HUN	13:19.24	1168
18	Centeno, Leopoldo	ESP	13:21.88	1162
19	Iagorachvili, Vakhtang	URS	13:25.91	1150
20	Burger, Peter	SUI	13:26.21	1147
21	Saito, Hiroshi	JPN	13:30.40	1135
22	Czyzowicz, Maciej	POL	13:34.22	1123
23	Chmielewski, Wieslaw	POL	13:43.75	1096
24	Hellstern, Tue	DEN	13:44.58	1093
25	Iouferov, Guerman	URS	13:47.16	1084
26	Yrizar, Alejandro	MEX	13:48.31	1081
27	Farhan, Saleh	BRN	13:48.65	1081
28	Rasmuson, Svante	SWE	13:50.41	1075
29	Mahony, Dominic	GBR	13:50.52	1075
30	Marsollek, Marcus	FRG	13:50.91	1075

Rank Rang	Name Nom	Ctry Pays	Time Temps	Points
31	Avdeev, Anatoli	URS	13:50.92	1075
32	Masala, Daniele	ITA	13:52.11	1069
33	Mahmoud, Ayman	EGY	13:57.17	1054
34	Kennedy, Barry	CAN	13:58.52	1051
35	Prokopius, Jiri	TCH	13:58.84	1041
36	Fleissner, Tomas	TCH	13:59.18	1048
37	Khalid, Abdul Rahman	BRN	13:59.75	1048
38	Kang, Kyung-Hyo	KOR	14:01.34	1042
39	Skrzypaszek, Arkadiusz	POL	14:03.19	1036
40	Genard, Bruno	FRA	14:04.45	1033
41	Tiberti, Gianluca	ITA	14:05.16	1030
42	Stull, Robert	USA	14:06.02	1027
43	Martin, Roderick	SWE	14:06.94	1027
44	Danielsson, Jan-Erik	SWE	14:09.16	1018
45	Jung, Andy	SUI	14:12.91	1009
46	Kim, Sung-Ho	KOR	14:16.86	997
47	Spannagl, Helmut	AUT	14:20.82	985
48	Kim, Myung-Gon	KOR	14:22.69	979
49	Zimmermann, Michael	FRG	14:30.23	955
50	Abouelsouad, Mohamed	EGY	14:34.05	943
51	Miwa, Tadafumi	JPN	14:36.06	937
52	Cortes, Gerardo	CHI	14:37.63	934
53	Fekete, Nicholas	CAN	14:37.88	934
54	Falconi, Ricardo	CHI	14:44.71	913
55	Nieman, Robert	USA	14:45.89	910
56	Li, King-Ho	TPE	14:47.60	904
57	Gostigan, Michael	USA	14:50.75	895
58	Fuentes, Julio	CHI	14:54.52	883
59	Chuang, Tang-Fa	TPE	15:04.21	853
60	Knappheide, Dirk	FRG	13:59.10	848
61	Adam, Mostafa	EGY	15:24.42	793
62	Michelena, Alejandro	URU	15:54.48	703
63	Zhang, Bin	CHN	16:14.29	643
64	Watson, Alexander	AUS	DQ	0
64	Quesada, Jorge	ESP	DQ	0

Player ranking has changed due to the correction of competition result of Player No. 30 (FRG). (Penalty points 200)
Changement du classement du a la modification des resultats de competition de l'athlete No. 30 (FRG).
(Points de penalisation 200)

**Individual Competition
Summary/Sept. 18-22**

**Competition individuelle
Synthese/18-22 Sept**

Rank Rang	Name Nom	Ctry Pays	Total	Rid. Equ.	Fenc. Esc.	Swimm. Nat.	Shoot. Tir	Run'ng Course
1	Martinek, Janos	HUN	5404	1066	990	1264	868	1216
2	Massullo, Carlo	ITA	5379	1010	881	1204	1044	1240
3	Iagorachvili, Vakhtang	URS	5367	980	915	1344	978	1150
4	Mizser, Attila	HUN	5281	1010	847	1196	934	1294
5	Ruer, Christophe	FRA	5242	968	779	1348	934	1213
6	Phelps, Richard	GBR	5229	964	898	1304	868	1195
7	Fabian, Laszlo	HUN	5201	876	1051	1304	802	1168
8	Bouzou, Joel	FRA	5198	1004	983	1172	868	1171
9	Steinmann, Peter	SUI	5181	920	983	1252	780	1246
10	Masala, Daniele	ITA	5152	948	837	1232	1066	1069
11	Kadlec, Milan	TCH	5130	1064	905	1092	802	1267
12	Kim, Myung-Gon	KOR	5099	1040	762	1252	1066	979
13	Kang, Kyung-Hyo	KOR	5074	1070	830	1264	868	1042
14	Sisniega, Ivar	MEX	5065	950	752	1260	890	1213
15	Czyzowicz, Maciej	POL	5048	770	847	1308	1000	1123
16	Mahony, Dominic	GBR	5047	1036	898	1148	890	1075
17	Tiberti, Gianluca	ITA	5040	1040	674	1296	1000	1030
18	Nieman, Robert	USA	5034	944	932	1248	1000	910
19	Fleissner, Tomas	TCH	5010	1006	762	1172	1022	1048
20	Iouferov, Guerman	URS	1007	716	949	1324	934	1084
21	Brookhouse, Graham	GBR	5000	986	643	1312	846	1213
22	Rasmuson, Svante	SWE	4987	916	830	1232	934	1075
23	Skrzypaszek, Arkadiusz	POL	4982	1040	660	1312	934	1036
24	Marsollek, Marcus	FRG	4964	858	847	1140	1044	1075
25	Danielsson, Jan-Erik	SWE	4956	890	864	1140	1044	1018
26	Jung, Andy	SUI	4951	974	864	1192	912	1009
27	Hellstern, Tue	DEN	4940	1060	745	1152	890	1093
28	Yrizar, Alejandro	MEX	4920	854	847	1248	890	1081
29	Prokopius, Jiri	TCH	4903	980	694	1244	934	1051
30	Saito, Hiroshi	JPN	4881	1096	718	976	956	1135
31	Abouelsouad, Mohamed	EGY	4853	1100	694	1072	1044	943
32	Quesada, Eduardo	ESP	4852	1010	762	1256	626	1198
33	Keyte, Lawrence	CAN	4847	1032	609	1092	934	1180
34	Barroso, Manuel	POR	4844	910	677	1236	802	1219
35	Avdeev, Anatoli	URS	4840	680	871	1324	890	1075
36	Spannagl, Helmut	AUT	4833	1024	796	1160	868	985
37	Genard, Bruno	FRA	4828	912	711	1260	912	1033
38	Centeno, Leopoldo	ESP	4814	797	643	1256	956	1162
39	Hoyo, Marcelo	MEX	4800	926	762	1140	780	1192
40	Fekete, Nicholas	CAN						

Modern Pentathlon

Rank Rang	Name Nom	Ctry Pays	Total	Rid. Equ.	Fenc. Esc.	Swimm. Nat.	Shoot. Tir	Run'ng Course
61	Kim, Sung-Ho	KOR	3854	0	609	1248	1000	997
62	Michelena, Alejandro	URU	3790	912	429	812	934	703
63	Izumikawa, Hiroaki	JPN	3722	0	694	1008	846	1174
64	Watson, Alexander	AUS	0	0	0	0	0	0
64	Quesada, Jorge	ESP	0	0	0	0	0	0

Player ranking has changed due to the correction of competition result of player 30, KNAPPHEIDE, DIRK (FRG).
 Changement du classement du a la modification des resultats de competition de l'athlete No. 30, KNAPPHEIDE, DIRK (FRG.)

Team Competition Riding/Sept. 18

Team Competition Riding/Sept. 18			Competition par equipes Equitation/18 Sept				
Rank Rang	Ctry Pays	Name Nom	Horse Cheval	Total	Penalty Time/Obs. Temps/Obs.	Points	
1	EGY	Abouelsouad, Mohamed	Knok li	3058		1100	
		Adam, Mostafa	Vincents Pride		28 60	1012	
		Mahmoud, Ayman	Miserto		64 90	946	
2	TCH	Kadlec, Milan	Vincents Pride	3050	6 30	1064	
		Fleissner, Tomas	Vicky		4 90	1006	
		Prokopius, Jiri	Gold Rose		120	980	
3	ITA	Tiberti, Gianluca	Gold Rose	2998	60	1040	
		Massullo, Carlo	Jokaster		90	1010	
		Masala, Daniele	Renardo		2 150	948	
4	GBR	Mahony, Dominic	Quasanova	2986	4 60	1036	
		Brookhouse, Graham	Miuro		14 100	986	
		Phelps, Richard	Jokaster		6 130	964	
5	HUN	Martinek, Janos	Moonshine	2952	4 30	1066	
		Mizser, Attila	El Real		90	1010	
		Fabian, Laszlo	Waidfee		14 210	876	
6	FRA	Bouzou, Joel	Delitant	2884	6 90	1004	
		Ruer, Christophe	Fernanda		12 120	968	
		Genard, Bruno	Hansi		48 140	912	
7	FRG	Knappheide, Dirk	Miserto	2842	6 60	1034	
		Zimmermann, Michael	Quasanova		150	950	
		Marsollek, Marcus	Tristan		42 200	858	
8	SUI	Jung, Andy	Knok li	2832	46 80	974	
		Burger, Peter	Almansor		12 150	938	
		Steinmann, Peter	Tristan		180	920	
9	CAN	Keyte, Lawrence	Walter	2826	8 60	1032	
		Fekete, Nicholas	Vicky		16 60	1024	
		Kennedy, Barry	Get Ready		330	770	
10	ESP	Quesada, Eduardo	Moonshine	2771	90	1010	
		Quesada, Jorge	Simona		16 120	964	
		Centeno, Leopoldo	Simona		68 235	797	
11	MEX	Sisniega, Ivar	Ronja	2730	150	950	
		Hoyo, Marcelo	Fernanda		14 160	926	
		Yrizar, Alejandro	Ronja		106 140	854	
12	CHI	Falconi, Ricardo	Ginger	2712	120	980	
		Cortes, Gerardo	Blue Boy		150	950	
		Fuentes, Julio	Magia		38 280	782	
13	POL	Skrzypaszek, Arkadiusz	Polar	2386	60	1040	
		Czyzowicz, Maciej	Waidfee		120 210	770	
		Chmielewski, Wieslaw	Polar		164 360	576	
14	URS	Iagorachvili, Vakhtang	Mandia	2376	120	980	
		Iouferov, Guerman	Get Ready		14 370	716	
		Avdeev, Anatoli	Theo		180 240	680	
15	BRN	Farhan, Saleh	El Real	2268	6 270	824	
		Al Doseri, Ahmed	Delitant		34 250	816	
		Khalid, Abdul Rahman	Matador		132 340	628	
16	KOR	Kang, Kyung-Hyo	Gin Fiss	2110	30	1070	
		Kim, Myung-Gon	Print		60	1040	
		Kim, Sung-Ho	Matador			0	
17	JPN	Saito, Hiroshi	Isonia	2058	4	1096	
		Miwa, Tadafumi	Ginger		18 120	962	
		Izumikawa, Hiroaki	Mandia			0	
18	TPE	Li, King-Ho	Isonia	1988	2 30	1068	
		Chuang, Tang-Fa	Walter		180	920	
19	SWE	Rasmuson, Svante	Gilbert	1806	4 180	916	
		Danielsson, Jan-Erik	Magia		210	890	
		Martin, Roderick	Theo			0	
20	USA	Nieman, Robert	Fresco	1414	56 100	944	
		Stull, Robert	Miuro		170 460	470	
		Gostigan, Michael	Gilbert			0	
21	AUS	Watson, Alexander	Print	1100		1100	
22	DEN	Hellstern, Tue	Hansi	1060	10 30	1060	
23	AUT	Spannagl, Helmut	Fresco	1024	16 60	1024	
24	URU	Michelena, Alejandro	Renardo	912	28 160	912	
25	POR	Barroso, Manuel	Gin Fiss	910	190	910	
26	CHN	Zhang, Bin	Almansor	706	194 200	706	

Team Competition Fencing/Sept. 19

Team Competition Fencing/Sept. 19			Competition par equipes Escrime/19Sept				
Rank Rang	Ctry Pays	Name Nom	Total	Vict.	Def.	Penalty Penalite	Points
1	HUN	Fabian, Laszlo	2888	48	16		1051
		Martinek, Janos		45	19	10	990
		Mizser, Attila		36	28		847
2	URS	Iouferov, Guerman	2735	42	22		949
		Iagorachvili, Vakhtang		40	24		915
		Avdeev, Anatoli		38	26	10	871
2	USA	Stull, Robert	2735	44	20		983
		Nieman, Robert		41	23		932
		Gostigan, Michael		35	29	10	820
4	SWE	Martin, Roderick	2609	40	24		915
		Danielsson, Jan-Erik		37	27		864
		Rasmuson, Svante		35	29		830
5	SUI	Steinmann, Peter	2541	44	20		983
		Jung, Andy		37	27		864
		Burger, Peter		27	37		694

Pentathlon Moderne

Rank Rang	Ctry Pays	Name Nom	Total	Vict.	Def.	Penalty Penalite	Points
6	FRA	Bouzou, Joel	2473	44	20		983
		Ruer, Christophe		32	32		779
		Genard, Bruno		28	36		711
7	GBR	Mahony, Dominic	2439	39	25		898
		Phelps, Richard		39	25		898
		Brookhouse, Graham		24	40		643
8	ITA	Massullo, Carlo	2392	38	26		881
		Masala, Daniele		36	28	10	837
		Tiberti, Gianluca		27	37	20	674
9	MEX	Yrizar, Alejandro	2361	36	28		847
		Hoyo, Marcelo		31	33		762
		Sisniega, Ivar		31	33	10	752
9	TCH	Kadlec, Milan	2361	40	24	10	905
		Fleissner, Tomas		31	33		762
		Prokopius, Jiri		27	37		694
11	POL	Chmielewski, Wieslaw	2354	36	28		847
		Czyzowicz, Maciej		36	28		847
		Skrzypaszek, Arkadiusz		25	39		660
12	FRG	Marsollek, Marcus	2337	36	28		847
		Zimmermann, Michael		34	30		813
		Knappheide, Dirk		26	38		677
13	ESP	Quesada, Jorge	2269	37	27		864
		Quesada, Eduardo		31	33		762
		Centeno, Leopoldo		24	40		643
14	BRN	Farhan, Saleh	2232	36	28		847
		Al Doseri, Ahmed		30	34	10	735
		Khalid, Abdul Rahman		25	39	10	650
15	KOR	Kang, Kyung-Hyo	2201	35	29		830
		Kim, Myung-Gon		31	33		762
		Kim, Sung-Ho		22	42		609
16	CAN	Kennedy, Barry	2048	29	35		728
		Fekete, Nicholas		28	36		711
		Keyte, Lawrence		22	42		609
17	EGY	Adam, Mostafa	2031	29	35		728
		Abouelsouad, Mohamed		27	37		694
		Mahmoud, Ayman		22	42		609
18	JPN	Saito, Hiroshi	1994	29	35	10	718
		Izumikawa, Hiroaki		27	37		694
		Miwa, Tadafumi		21	43	10	582
19	CHI	Cortes, Gerardo	1885	31	33		762
		Falconi, Ricardo		20	44		575
		Fuentes, Julio		19	45	10	548
20	TPE	Li, King-Ho	1422	29	35		728
		Chuang, Tang-Fa		27	37		694
21	AUT	Spannagl, Helmut	796	33	31		796
22	CHN	Zhang, Bin	762	31	33		762
23	DEN	Hellstern, Tue	745	30	34		745
24	AUS	Watson, Alexander	711	28	36		711
25	POR	Barroso, Manuel	677	26	38		677
26	URU	Michelena, Alejandro	429	12	52	10	429

Team Competition Swimming/Sept. 20

Team Competition Swimming/Sept. 20			Competition par equipes Natation/20 Sept					
Rank Rang	Ctry Pays	Name Nom	Total	Heat Serie	Lane Couloir	Time Temps	Penalty Penalite Min: Sec	Points
1	URS	Iagorachvili, Vakhtang	3992	9	1	3:11.230		1344
		Avdeev, Anatoli		2	4	3:13.750		1324
		Iouferov, Guerman		4	2	3:13.820		1324
2	POL	Skrzypaszek, Arkadiusz	3844	5	7	3:15.110		1312
		Czyzowicz, Maciej		3	3	3:15.650		1308
		Chmielewski, Wieslaw		2	7	3:26.390		1224
3	FRA	Ruer, Christophe	3780	6	2	3:10.580		1348
		Genard, Bruno		3	4	3:21.720		1260
		Bouzou, Joel		9	4	3:32.510		1172
4	GBR	Brookhouse, Graham	3764	4	7	3:15.220		1312
		Phelps, Richard		8	6	3:16.350		1304
		Mahony, Dominic		9	3	3:35.990		1148
4	HUN	Fabian, Laszlo	3764	9	7	3:16.350		1304
		Martinek, Janos		9	5	3:21.470		1264
		Mizser, Attila		8	3	3:29.860		1196
4	KOR	Kang, Kyung-Hyo	3764	9	8	3:21.160		1264
		Kim, Myung-Gon		7	5	3:22.770		1252
		Kim, Sung-Ho		1	7	3:23.440		1248
7	USA	Gostigan, Michael	3752	1	6	3:21.240		1264
		Nieman, Robert		8	4	3:23.090		1248
		Stull, Robert		2	6	3:24.250		1240
8	ITA	Tiberti, Gianluca	3732	5	4	3:17.100		1296
		Masala, Daniele		7	1	3:25.190		1232
		Massullo, Carlo		8	5	3:28.740		1204
9	ESP	Quesada, Eduardo	3688	7	7	3:22.060		1256
		Centeno, Leopoldo		2	1	3:22.360		1256
		Quesada, Jorge		8	2	3:32.490		1176
10	FRG	Knappheide, Dirk	3652	5	5	3:20.340		1



Rank Rang	Ctry Pays	Name Nom	Total	Heat Serie	Lane Couloir	Time Temps	Penalty Penalite Min: Sec	Points
17	CHI	Fuentes, Julio	3372	1	3	3:34.520		1156
		Falconi, Ricardo		3	6	3:40.460		1112
		Cortes, Gerardo		5	3	3:41.340		1104
18	BRN	Farhan, Saleh	3220	4	5	3:40.470		1112
		Khalid, Abdul Rahman		1	5	3:43.040		1088
		Al Doseri, Ahmed		3	7	3:51.740		1020
19	JPN	Miwa, Tadafumi	3064	2	3	3:44.090		1080
		Izumikawa, Hiroaki		1	1	3:53.470		1008
		Saito, Hiroshi		8	1	3:57.340		976
20	TPE	Chuang, Tang-Fa	2192	3	5	3:41.850		1100
		Li, King-Ho		7	2	3:42.630		1092
21	POR	Barroso, Manuel	1236	3	2	3:24.980		1236
22	AUT	Spannagl, Helmut	1160	8	8	3:34.480		1160
23	DEN	Hellstern, Tue	1152	7	3	3:35.290		1152
24	CHN	Zhang, Bin	1080	2	2	3:44.140		1080
25	URU	Michelena, Alejandro	812	1	4	4:17.840		812
26	AUS	Watson, Alexander	0	7	4	0:00.000		0

Results have been changed due to the failure of player No. 3 (AUS) in doping control test.
Changement des resultats du a la disqualification de l'athlete No. 3 (AUS) apres le control anti-dopage.

Team Competition Shooting/Sept. 21			Competition par equipes Tir/21 Sept							Points		
Rank Rang	Ctry Pays	Name Nom	Total	1	+	2	+	3	+		4	= Result Resultat
1	ITA	Masala, Daniele	3110	50	49	50	48	197			1066	
		Massullo, Carlo		49	50	49	48	196			1044	
		Tiberti, Gianluca		49	48	49	48	194			1000	
2	SWE	Danielsson, Jan-Erik	3022	50	48	48	50	196			1044	
		Martin, Roderick		50	50	47	49	196			1044	
		Rasmuson, Svante		49	49	46	47	191			934	
3	KOR	Kim, Myung-Gon	2934	49	49	49	50	197			1066	
		Kim, Sung-Ho		48	48	50	48	194			1000	
		Kang, Kyung-Hyo		47	48	47	46	188			868	
4	USA	Gostigan, Michael	2912	50	49	49	48	196			1044	
		Nieman, Robert		48	50	48	48	194			1000	
		Stull, Robert		47	49	44	48	188			868	
5	CAN	Kennedy, Barry	2890	46	48	50	50	194			1000	
		Fekete, Nicholas		47	48	47	50	192			956	
		Keyte, Lawrence		50	47	47	47	191			934	
6	EGY	Abouelsouad, Mohamed	2846	50	48	50	48	196			1044	
		Adam, Mostafa		49	47	48	46	190			912	
		Mahmoud, Ayman		45	48	48	48	189			890	
7	FRG	Marsollek, Marcus	2802	49	49	50	48	196			1044	
		Knappheide, Dirk		49	48	44	50	191			934	
		Zimmermann, Michael		48	45	46	47	186			824	
7	URS	Iagorachvili, Vakhtang	2802	48	49	48	48	193			978	
		Iouferov, Guerman		47	47	48	49	191			934	
		Avdeev, Anatoli		43	49	48	49	189			890	
9	JPN	Miwa, Tadafumi	2758	48	47	47	50	192			956	
		Saito, Hiroshi		48	47	48	49	192			956	
		Izumikawa, Hiroaki		45	47	46	49	187			846	
9	TCH	Fleissner, Tomas	2758	49	50	48	48	195			1022	
		Prokopius, Jiri		46	49	48	48	191			934	
		Kadlec, Milan		47	48	44	46	185			802	
11	BRN	Khalid, Abdul Rahman	2714	50	50	49	49	198			1088	
		Al Dosri, Ahmed		47	48	46	48	189			890	
		Farhan, Saleh		46	47	42	47	182			736	
11	FRA	Ruer, Christophe	2714	50	48	46	47	191			934	
		Genard, Bruno		49	45	47	49	190			912	
		Bouzou, Joel		46	48	48	46	188			868	
13	POL	Czyzowicz, Maciej	2692	49	47	49	49	194			1000	
		Skrzypaszek, Arkadiusz		48	46	49	48	191			934	
		Chmielewski, Wieslaw		46	44	46	47	183			758	
14	GBR	Mahony, Dominic	2604	47	48	48	46	189			890	
		Phelps, Richard		47	48	47	46	188			868	
		Brookhouse, Graham		48	48	45	46	187			846	
14	HUN	Mizser, Attila	2604	49	48	46	48	191			934	
		Martinek, Janos		46	49	46	47	188			868	
		Fabian, Laszlo		46	46	44	49	185			802	
16	MEX	Sisniega, Ivar	2560	47	47	46	49	189			890	
		Yrizar, Alejandro		47	47	48	47	189			890	
		Hoyo, Marcelo		46	46	44	48	184			780	
17	SUI	Jung, Andy	2472	47	49	47	47	190			912	
		Burger, Peter		45	46	45	48	184			780	
		Steinmann, Peter		45	45	49	45	184			780	
18	ESP	Centeno, Leopoldo	2362	50	45	47	50	192			956	
		Quesada, Jorge		45	47	48	44	184			780	
		Quesada, Eduardo		45	42	49	41	177			626	
19	CHI	Fuentes, Julio	2098	48	48	49	47	192			956	
		Falconi, Ricardo		41	46	46	49	182			736	
		Cortes, Gerardo		35	44	46	42	167			406	
20	TPE	Li, King-Ho	1758	47	46	47	49	189			890	
		Chuang, Tang-Fa		47	49	47	45	188			868	
21	URU	Michelena, Alejandro	934	48	48	49	46	191			934	
22	CHN	Zhang, Bin	890	45	49	46	49	189			890	
22	DEN	Hellstern, Tue	890	45	45	50	49	189			890	
24	AUT	Spannagl, Helmut	868	45	46	50	47	188			868	
25	POR	Barroso, Manuel	802	47	44	47	47	185			802	
26	AUS	Watson, Alexander	0	0	0	0	0	0			0	

Results have been changed due to the failure of player No. 3 (AUS) in doping control test.
Changement des resultats du a la disqualification de l'athlete No. 3 (AUS) apres le control anti-dopage.

Team Competition Cross Country/Sept. 22			Competition par equipes Course a Pied/22 Sept		
Rank Rang	Ctry Pays	Name Nom	Total	Time Temps	Points
1	HUN	Mizser, Attila	3678	12:37.88	1294
		Martinek, Janos		13:03.19	1216
		Fabian, Laszlo		13:19.24	1168
2	MEX	Signiega, Ivar	3486	13:04.47	1213
		Hoyo, Marcelo		13:11.76	1192
		Yrizar, Alejandro		13:48.31	1081
3	GBR	Brookhouse, Graham	3483	13:04.53	1213
		Phelps, Richard		13:10.96	1195
		Mahony, Dominic		13:50.52	1075
4	FRA	Ruer, Christophe	3417	13:04.47	1213
		Bouzou, Joel		13:18.51	1171
		Genard, Bruno		14:04.45	1033
5	SUI	Steinmann, Peter	3402	12:53.05	1246
		Burger, Peter		13:26.21	1147
		Jung, Andy		14:12.91	1009
6	TCH	Kadlec, Milan	3366	12:46.85	1267
		Prokopius, Jiri		13:58.84	1051
		Fleissner, Tomas		13:59.75	1048
7	ITA	Massullo, Carlo	3339	13:25.91	1240
		Masala, Daniele		13:47.16	1069
		Tiberti, Gianluca		13:50.92	1030
8	BRN	Al Doseri, Ahmed	3309	13:34.22	1180
		Farhan, Saleh		13:43.75	1081
		Khalid, Abdul Rahman		14:03.19	1048
8	URS	Iagorachvili, Vakhtang	3309	13:17.42	1150
		Iouferov, Guerman		13:47.16	1084
		Avdeev, Anatoli		13:50.92	1075
10	POL	Czyzowicz, Maciej	3255	13:34.22	1123
		Chmielewski, Wieslaw		13:43.75	1096
		Skrzypaszek, Arkadiusz		14:03.19	1036
11	JPN	Izumikawa, Hiroaki	3246	13:17.42	1174
		Saito, Hiroshi		13:30.40	1135
		Miwa, Tadafumi		14:36.06	937
12	CAN	Keyte, Lawrence	3165	13:15.28	1180
		Kennedy, Barry		13:58.52	1051
		Fekete, Nicholas		14:37.88	934
13	SWE	Rasmuson, Svante	3120	13:50.41	1075
		Martin, Roderick		14:06.94	1027
		Danielsson, Jan-Erik		14:09.16	1018
14	KOR	Kang, Kyung-Hyo	3018	14:01.34	1042
		Kim, Sung-Ho		14:16.86	997
		Kim, Myung-Gon		14:22.69	979
15	FRG	Marsollek, Marcus	2878	13:50.91	1075
		Zimmermann, Michael		14:30.23	955
		Knappheide, Dirk		13:59.10	848
16	USA	Stull, Robert	2832	14:06.02	1027
		Nieman, Robert		14:45.89	910
		Gostigan, Michael		14:50.75	895
17	EGY	Mahmoud, Ayman	2790	13:57.17	1054
		Abouelsouad, Mohamed		14:34.05	943
		Adam, Mostafa		15:24.42	793
18	CHI	Cortes, Gerardo	2730	14:37.63	934
		Falconi, Ricardo		14:44.71	913
		Fuentes, Julio		14:54.52	883
19	ESP	Quesada, Eduardo	2360	13:09.18	1198
		Centeno, Leopoldo		13:21.88	1162
		Quesada, Jorge		0:00.00	0
20	TPE	Li, King-Ho	1757	14:47.60	904
		Chuang, Tang-Fa		15:04.21	853
21	POR	Barroso, Manuel	1219	13:02.54	1219

Modern Pentathlon

Pentathlon Moderne

Team Competition Summary/Sept. 18-22			Competition par équipes Synthese/18-22 Sept						
Rank Rang	Ctry Pays	Name Nom	Team Total/ Equipe	Total	Rid. Equ.	Fenc. Esc.	Swimm. Nat.	Shoot. Tir	Run'ng Course
1	HUN	Martinek, Janos Mizser, Attila Fabian, Laszlo	15886	5404 5281 5201	1066 1010 876	990 847 1051	1264 1196 1304	868 934 802	1216 1294 1168
2	ITA	Massullo, Carlo Masala, Daniele Tiberti, Gianluca	15571	5379 5152 5040	1010 948 1040	881 837 674	1204 1232 1296	1044 1066 1000	1240 1069 1030
3	GBR	Phelps, Richard Mahony, Dominic Brookhouse, Graham	15276	5229 5047 5000	964 1036 986	898 898 643	1304 1148 1312	868 890 846	1195 1075 1213
4	FRA	Ruer, Christophe Bouzou, Joel Genard, Bruno	15268	5242 5198 4828	968 1004 912	779 983 711	1348 1172 1260	934 868 912	1213 1171 1033
5	URS	Iagorachvili, Vakhtang Iouferov, Guerman Avdeev, Anatoli	15214	5367 5007 4840	980 716 680	915 949 871	1344 1324 1324	978 934 890	1150 1084 1075
6	TCH	Kadlec, Milan Fleissner, Tomas Prokopius, Jiri	15043	5130 5010 4903	1064 1006 980	905 762 694	1092 1172 1244	802 1022 934	1267 1048 1051
7	SUI	Steinmann, Peter Jung, Andy Burger, Peter	14863	5181 4951 4731	920 974 938	983 864 694	1252 1192 1172	780 912 780	1246 1009 1147
8	MEX	Sisniega, Ivar Yrizar, Alejandro Hoyo, Marcelo	14785	5065 4920 4800	950 854 926	752 847 762	1260 1248 1140	890 890 780	1213 1081 1192
9	POL	Czyczowicz, Maciej Skrzypaszek, Arkadiusz Chmielewski, Wieslaw	14531	5048 4982 4501	770 1040 576	847 660 847	1308 1312 1224	1000 934 758	1123 1036 1096
10	FRG	Marsollek, Marcus Zimmermann, Michael Knappheide, Dirk	14511	4964 4782 4765	858 950 1034	847 813 677	1140 1240 1272	1044 824 934	1075 955 848
11	CAN	Keyte, Lawrence Fekete, Nicholas Kennedy, Barry	14309	4847 4785 4677	1032 1024 770	609 711 728	1092 1160 1128	934 956 1000	1180 934 1051
12	SWE	Rasmuson, Svante Danielsson, Jan-Erik Martin, Roderick	14205	4987 4956 4262	916 890 0	830 864 915	1232 1140 1276	934 1044 1044	1075 1018 1027
13	EGY	Abouelsouad, Mohamed Mahmoud, Ayman Adam, Mostafa	14113	4853 4675 4585	1100 946 1012	694 609 728	1072 1176 1140	1044 890 912	943 1054 793
14	KOR	Kim, Myung-Gon Kang, Kyung-Hyo Kim, Sung-Ho	14027	5099 5074 3854	1040 1070 0	762 830 609	1252 1264 1248	1066 868 1000	979 1042 997
15	BRN	Al Doseri, Ahmed Farhan, Saleh Khalid, Abdul Rahman	13743	4641 4600 4502	816 824 628	735 847 650	1020 1112 1088	890 736 1088	1180 1081 1048
16	USA	Nieman, Robert Stull, Robert Gostigan, Michael	13645	5034 4588 4023	944 470 0	932 983 820	1248 1240 1264	1000 868 1044	910 1027 895
17	JPN	Saito, Hiroshi Miwa, Tadafumi Izumikawa, Hiroaki	13120	4881 4517 3722	1096 962 0	718 582 694	976 1080 1008	956 956 846	1135 937 1174
18	CHI	Fuentes, Julio Falconi, Ricardo Cortes, Gerardo	12797	4325 4316 4156	782 980 950	548 575 762	1156 1112 1104	956 736 406	883 913 934
19	ESP	Quesada, Eduardo Centeno, Leopoldo Quesada, Jorge	9666	4852 4814 0	1010 797 0	762 643 0	1256 1256 0	626 956 0	1198 1162 0
20	TPE	Li, King-Ho Chuang, Tang-Fa	9117	4682 4435	1068 920	728 694	1092 1100	890 868	904 853
21	DEN	Hellstern, Tue	4940	4940	1060	745	1152	890	1093
22	POR	Barroso, Manuel	4844	4844	910	677	1236	802	1219
23	AUT	Spannagl, Helmut	4833	4833	1024	796	1160	868	985
24	CHN	Zhang, Bin	4081	4081	706	762	1080	890	643
25	URU	Michelena, Alejandro	3790	3790	912	429	812	834	703
26	AUS	Watson, Alexander	0	0	0	0	0	0	0

Player ranking has changed due to the correction of competition result
of player 30, KNAPPHEIDE, DIRK (FRG).

Changement du classement du a la modification des resultats de competition de l'athlete No. 30, KNAPPHEIDE, DIRK (FRG.)



조 정

Rowing/Aviron



Rowing/Aviron

Officials/Officiels

Fédération International des Sociétés d'Aviron (F.I.S.A.)

President/président Thomas Keller
Secretary General/secrétaire général Denis Oswald
Technical Delegates/délégués techniques

SLOOC Administrative Staff/Personnel Administratif du SLOOC

Commissioner/Directeur Huh Shin Koo
Secretary General/secrétaire général Hong Hyong Pyo
Deputy Secretary General/secrétaire général adjoint Han Young Joon
Competition Manager/chef de division des compétitions Lee Eun San

Competitors/Concurrents

Men Hommes	Competitors Competiteurs	Countries Pays
Single Sculls/un rameur	22	22
Double Sculls/deux rameurs en couple	34	17
Pair without Coxswain/deux rameurs en pointe	40	18
Pair with Coxswain/deux en pointe avec barreur	49	14
4 Sculls without Coxswain/quatre rameurs en couple	59	13
4 Oar without Coxswain/quatre en pointe sans barreur	68	15
4 Oar with Coxswain/quatre en pointe avec barreur	80	14
8 Oar with Coxswain/huit en pointe avec barreur	98	10

Women Femmes	Competitors Competiteurs	Countries Pays
Single Sculls/une rameuse	13	13
Double Sculls/deux rameuses en couple	20	10
Pair without Coxswain/deux rameuses en pointe		
4 Scull with Coxswain/quatre en couple avec barreuse	40	10
4 Oar with Coxswain/quatre en pointe avec barreuse	52	10
8 Oar with Coxswain/huit en pointe avec barreuse	65	7

Legend/Notation

(R) Intermediate rank at each point/Rang intermédiaire
WDR Withdrawn/Abandonné



Rowing

Aviron

Men Single Sculls Preliminary Heat 1/Sept. 19			Hommes/Un rameur Eliminatoire 1/19 Sept			
Rank Rang	Ctry Pays	Name Nom	500m (R)	1000m(R)	1500m (R)	2000m
1	GDR	Lange, Thomas	1:37.98(1)	3:25.37 (2) + 1:47.39	5:12.32(1) + 1:46.95	07:03.25 +1:50.93
2	USA	Sudduth, Andrew	1:39.77(3)	3:24.46(1) + 1:44.69	5:13.35(2) + 1:48.89	07:05.61 + 1:52.26
3	FRG	Kolbe, Petermichael	1:38.54(2)	3:26.17(3) + 1:47.63	5:16.95(3) + 1:50.78	07:12.35 + 1:55.40
4	POL	Broniewski, Kajetan	1:40.47(4)	3:30.11 (4) +1:49.64	5:16.95(3) + 1:48.66	07:13.77 +1:55.00
5	HOL	Zwolle, Henk Jan	1:44.42(5)	3:38.01 (6) + 1:53.59	5:31.29(5) + 1:53.28	07:29.68 + 1:58.39
6	PUR	Felix, Juan	1:44.73(6)	3:36.56 (5) + 1:51.83	5:41.51 (6) + 2:04.95	07:55.46 + 2:13.95
Weather/Temps			: cloudy			
Wind/Vent			: Velocity/Vitesse = 2.2 m/s Direction = S			
Temperature			: Air = 19.0 C Water/Eau = C			
Air Pressure/Pression Atm.			: 1026 mmHg			

Men Single Sculls Preliminary Heat 2/Sept. 19			Hommes/Un rameur Eliminatoire 2/19 Sept			
Rank Rang	Ctry Pays	Name Nom	500m (R)	1000m (R)	1500m (R)	2000m
1	AUS	Mcglashan, Hamish	1:46.30(1)	3:38.16(1) + 1:51.86	5:31.73(1) + 1:53.57	07:25.26 + 1:53.53
2	URU	Posse, Jesus	1:48.43(4)	3:45.38 (3) + 1:56.95	4:43.83 (3) +1:58.45	07:37.92 +1:54.09
3	URS	laanson, louri	1:46.59(2)	3:39.99 (2) +1:53.40	5:40.63 (2) + 2:00.64	07:41.28 + 2:00.65
4	JPN	Sakata, Masahiro	1:48.98(5)	3:47.42 (4) + 1:58.44	5:48.10(4) + 2:00.68	07:43.67 + 1:55.57
5	CAN	Henry, Gordon	1:47.89 (3)	3:48.71 (5) + 2:00.82	5:51.18(5) + 2:02.47	07:51.83 + 2:00.65
6	PHI	Maerina, Edgardo	2:04.52 (6)	4:20.37 (6) + 2:15.85	6:39.52 (6) + 2:19.15	08:54.90 + 2:15.38
Weather/Temps			: cloudy			
Wind/Vent			: Velocity/Vitesse = 1.6 m/s Direction = S			
Temperature			: Air = 19.0 C Water/Eau = C			
Air Pressure/Pression Atm.			: 1026 mmHg			

Men Single Sculls Preliminary Heat 3/Sept. 19			Hommes/Un rameur Eliminatoire 3/19 Sept			
Rank Rang	Ctry Pays	Name Nom	500m (R)	1000m (R)	1500m (R)	2000m
1	NZL	Verdonk, Eric	1:43.86(1)	3:34.66(1) + 1:50.80	5:25.34(1) + 1:50.68	07:18.69 + 1:53.35
2	FRA	Body, Pascal	1:46.90(4)	3:37.67 (3) + 1:50.77	5:28.65 (2) + 1:50.98	07:26.12 + 1:57.47
3	BEL	Crois, Dirk	1:46.57(3)	3:39.09 (4) + 1:52.52	5:33.90 (4) + 1:54.81	07:34.74 + 2:00.84
4	ITA	Calabrese, Giovanni	1:45.35 (2)	3:37.00 (2) + 1:51.65	5:31.37(3) + 1:54.37	07:45.02 + 2:13.65
5	BRA	Marinho, Denis	1:51.10(5)	3:47.09 (5) + 1:55.99	5:45.07 (5) + 1:57.98	07:48.33 + 2:03.26
Weather/Temps			: cloudy			
Wind/Vent			: Velocity/Vitesse = 1.2 m/s Direction = SSE			
Temperature			: Air = 20.0 C Water/Eau = C			
Air Pressure/Pression Atm.			: 1026 mmHg			

Men Single Sculls Preliminary Heat 4/Sept. 19			Hommes/Un rameur Eliminatoire 4/19 Sept.			
Rank Rang	Ctry Pays	Name Nom	500m (R)	1000m (R)	1500m (R)	2000m
1	SWE	Hulten, Fredrik	1:44.41 (2)	3:31.69(2) + 1:47.28	5:20.00(1) +1:48.31	07:12.98 + 1:52.98
2	FIN	Karppinen, Pertti	1:42.54(1)	3:30.68(1) + 1:48.14	5:21.04(2) + 1:50.36	07:24.72 + 2:03.68
3	AUT	Jonke, Arnold	1:46.58(4)	3:37.69 (3) + 1:51.11	5:29.96 (3) + 1:52.27	07:30.45 + 2:00.49
4	KOR	Lim, Kyung-suk	1:45.57(3)	3:44.14(4) + 1:58.57	5:45.19(4) + 2:01.05	07:39.94 + 1:54.75
5	KUW	Almohammad, Waleed	1:52.27(5)	3:54.99 (5) + 2:02.72	6:01.21 (5) + 2:06.22	08:05.35 + 2:04.14
Weather/Temps			: cloudy			
Wind/Vent			: Velocity/Vitesse = 0.6 m/s Direction = SSW			
Temperature			: Air = 20.0 C Water/Eau = C			
Air Pressure/Pression Atm.			: 1026 mmHg			

Men Single Sculls Repechage 1/Sept. 21			Hommes/Un rameur Repechage 1/21 Sept			
Rank Rang	Ctry Pays	Name Nom	500m (R)	1000m (R)	1500m (R)	2000m
1	FIN	Karppinen, Pertti	1:43.61 (1)	3:32.35(1) + 1:48.74	5:23.21 (1) + 1:50.86	07:14.91 + 1:51.70
2	HOL	Zwolle, Henk Jan	1:44.89 (3)	3:35.87 (3) + 1:50.98	5:27.90 (3) + 1:52.03	07:16.23 + 1:48.33
3	BEL	Crois, Dirk	1:44.30(2)	3:33.32 (2) +1:49.02	5:25.62 (2) + 1:52.30	07:19.94 + 1:54.32
4	JPN	Sakata, Masahiro	1:46.59(4)	3:40.40 (4) + 1:53.81	5:34.47 (4) + 1:54.07	07:26.66 + 1:52.19
Weather/Temps			: sunny			
Wind/Vent			: Velocity/Vitesse = 0.8 m/s Direction = WNW			
Temperature			: Air = 17.7 C Water/Eau = 23 C			
Air Pressure/Pression Atm.			: 767 mmHg			

Men Single Sculls Repechage 2/Sept. 21			Hommes/Un rameur Repechage 2/21 Sept			
Rank Rang	Ctry Pays	Name Nom	500m (R)	1000m (R)	1500m (R)	2000m
1	URS	laanson, louri	1:43.44(2)	3:30.20 (2) + 1:46.76	5:18.38(2) + 1:48.18	07:04.04 + 1:45.66
2	POL	Broniewski, Kajetan	1:41.36(1)	3:29.14(1) + 1:47.78	5:17.64(1) + 1:48.50	07:04.39 + 1:46.75
3	FRA	Body, Pascal	1:43.75(3)	3:31.09 (3) + 1:47.34	5:19.27(3) + 1:48.18	07:05.80 + 1:46.53
4	KUW	Almohammad, Waleed	1:52.29(4)	3:58.80 (4) + 2:06.51	6:09.85 (4) + 2:11.05	08:15.16 + 2:05.31
Weather/Temps			: sunny			
Wind/Vent			: Velocity /Vitesse = 1.1 m/s Direction = WNW			
Temperature			: Air = 19.4 C Water/Eau = 23.2 C			
Air Pressure/Pression Atm.			: 767 mmHg			

Men Single Sculls Repechage 3/Sept. 21			Hommes/Un rameur Repechage 3/21 Sept			
Rank Rang	Ctry Pays	Name Nom	500m (R)	1000m (R)	1500m (R)	2000m
1	FRG	Kolbe, Petermichael	1:40.52(2)	3:31.49(2) + 1:50.97	5:20.58(1) + 1:49.09	07:12.27 + 1:51.69
2	URU	Posse, Jesus	1:39.94(1)	3:29.01 (1) + 1:49.07	5:23.43 (2) + 1:54.42	07:17.43 + 1:54.00
3	BRA	Marinho, Denis	1:44.20(3)	3:34.46 (3) + 1:50.26	5:26.79 (3) + 1:52.33	07:22.84 + 1:56.05
4	KOR	Lim, Kyung-suk	1:45.58 (4)	3:41.13(4) + 1:55.60	5:43.37 (4) + 2:02.19	07:46.40 + 2:03.03
5	PHI	Maerina, Edgardo	1:55.19(5)	4:02.22 (5) + 2:07.03	6:14.32(5) + 2:12.10	08:27.02 + 2:12.70
Weather/Temps			: sunny			
Wind/Vent			: Velocity/Vitesse = 0.8 m/s Direction = NE			
Temperature			: Air = 19.5 C Water/Eau = 23.2 C			
Air Pressure/Pression Atm.			: 767 mmHg			

Men Single Sculls Repechage 4/Sept. 21			Hommes/Un rameur Repechage 4/21 Sept			
Rank Rang	Ctry Pays	Name Nom	500m (R)	1000m (R)	1500m (R)	2000m
1	USA	Sudduth, Andrew	1:41.64(1)	3:29.08(1) +1:47.44	5:14.88(1) + 1:45.80	07:05.52 + 1:50.64
2	ITA	Calabrese, Giovanni	1:42.03(2)	3:30.85 (2) + 1:48.82	5:19.57(2) + 1:48.72	07:12.93 + 1:53.36
3	AUT	Jonke, Arnold	1:47.46(5)	3:39.00 (5) + 1:51.54	5:30.41 (4) + 1:51.41	07:18.29 +1:47.88
4	PUR	Felix, Juan	1:42.49(3)	3:31.92(3) + 1:49.43	5:22.94 (3) + 1:51.02	07:18.77 + 1:55.83
5	CAN	Henry, Gordon	1:44.96 (4)	3:38.12(4) + 1:53.16	5:37.23 (5) + 1:59.11	07:37.48 + 2:00.25
Weather/Temps			: sunny			
Wind/Vent			: Velocity/Vitesse = 0.7 m/s Direction = E			
Temperature			: Air = 20.3 C Water/Eau = 23.2 C			
Air Pressure/Pression Atm.			: 767 mmHg			



Men Single Sculls Petite Final/Sept. 23			Hommes/Un rameur Petite Finale/23 Sept			
Rank Rang	Ctry Pays	Name Nom	500m (R)	1000m (R)	1500m (R)	2000m
1	FIN	Karppinen, Pertti	1:45.97 (3)	3:39.29 (2) + 1:53.32	5:37.33 (2) + 1:58.04	07:34.37 +1:57.04
2	URS	laanson, Iouri	1:44.00(1)	3:36.81 (1) + 1:52.81	5:35.93(1) + 1:59.12	07:35.09 + 1:59.16
3	SWE	Hulten, Fredrik	1:47.05 (5)	3:40.67 (3) +1:53.62	5:40.29 (3) + 1:59.62	07:40.07 +1:59.78
4	ITA	Calabrese, Giovanni	1:45.62(2)	3:42.14(4) + 1:56.52	5:43.73 (4) + 2:01.59	07:43.31 + 1:59.58
5	URU	Posse, Jesus	1:46.64 (4)	3:42.76 (5) + 1:56.12	5:46.03 (6) + 2:03.27	07:44.18 + 1:58.15
6	HOL	Zwolle, Henk Jan	1:48.20(6)	3:44.29 (6) +1:56.09	5:45.40 (5) + 2:01.11	07:44.92 +1:59.52

Weather/Temps : sunny
 Wind/Vent : Velocity/Vitesse = 3.0 m/s Direction = E
 Temperature : Air = 13.7 C Water/Eau = 22.0 C
 Air Pressure/Pression Atm. : 766 mmHg

Men Single Sculls Final/Sept. 24			Hommes/Un rameur Finale/24 Sept			
Rank Rang	Ctry Pays	Name Nom	500m (R)	1000m (R)	1500m (R)	2000m
1	GDR	Lange, Thomas	1:36.75 (2)	3:21.07(2) + 1:44.32	5:04.73(1) + 1:43.66	06:49.86 + 1:45.13
2	FRG	Kolbe, Petermichael	1:35.70(1)	3:20.38(1) +1:44.68	5:05.57 (2) + 1:45.19	06:54.77 + 1:49.20
3	NZL	Verdonk, Eric	1:39.83(4)	3:25.70 (3) + 1:45.87	5:12.42(3) +1:46.72	06:58.66 + 1:46.24
4	AUS	Mcglashan, Hamish	1:44.59 (6)	3:31.11 (6) +1:46.52	5:17.03(5) + 1:45.92	07:01.43 +1:44.40
5	POL	Broniewski, Kajetan	1:39.50(3)	3:26.74 (4) +1:47.24	5:15.61 (4) + 1:48.87	07:03.67 + 1:48.06
6	USA	Sudduth, Andrew	1:41.89(5)	3:29.63 (5) +1:47.74	5:20.85 (6) + 1:51.22	07:11.45 + 1:50.60

Weather/Temps : sunny
 Wind/Vent : Velocity/Vitesse = 1.5 m/s Direction = SSW
 Temperature : Air = 20.3 C Water/Eau = 22.7 C
 Air Pressure/Pression Atm. : 768 mmHg

Men Single Sculls Semi-final 1/Sept. 22			Hommes/Un rameur Demi-finale 1/22 Sept			
Rank Rang	Ctry Pays	Name Nom	500m (R)	1000m (R)	1500m (R)	2000m
1	GDR	Lange, Thomas	1:39.30(1)	3:24.65(1) + 1:45.35	5:12.43(1) + 1:47.78	06:58.65 + 1:46.22
2	USA	Sudduth, Andrew	1:41.90(4)	3:27.04 (3) + 1:45.14	5:13.80(2) +1:46.76	06:59.70 + 1:45.90
3	NZL	Verdonk, Eric	1:40.85(2)	3:26.77 (2) + 1:45.92	5:14.51 (3) + 1:47.74	07:11.98 + 1:57.47
4	URU	Posse, Jesus	1:42.87 (5)	3:31.42(5) + 1:48.55	5:25.98 (5) + 1:54.56	07:27.43 + 2:01.45
5	HOL	Zwolle, Henk Jan	1:44.65 (6)	3:38.85 (6) + 1:54.20	5:34.76 (6) + 1:55.91	07:30.45 + 1:55.69
6	URS	laanson, Iouri	1:41.60(3)	3:27.52 (4) + 1:45.92	5:19.45(4) + 1:51.93	07:32.51 + 2:13.06

Weather/Temps : sunny
 Wind/Vent : Velocity/Vitesse = 0.6 m/s Direction = WSW
 Temperature : Air = 23.9 C Water/Eau = 23.5 C
 Air Pressure/Pression Atm. : 767 mmHg

Men Double Sculls Preliminary Heat 1/Sept. 19			Hommes/Deux rameurs en couple Eliminatoire 1/19 Sept			
Rank Rang	Ctry Pays	Name Nom	500m (R)	1000m (R)	1500m (R)	2000m
1	URS	Iakoucha, Vassily Martchenko, Alexandre	1:28.84(1)	3:03.29(1) +1:34.45	4:40.70(1) + 1:37.41	06:16.77 + 1:36.07
2	NOR	Satersdal, Per albert Voll, Kjell sverre	1:32.13(4)	3:05.63 (2) + 1:33.50	4:42.84 (2) + 1:37.21	06:18.63 + 1:35.79
3	ESP	Bermudez, Jose manuel Vera, Manuel	1:31.76(3)	3:10.56(4) + 1:38.80	4:48.68 (3) + 1:38.12	06:26.78 + 1:38.10
4	CAN	Ford, Burce Walter, Patrick	1:32.83(5)	3:12.28(5) +1:39.45	4:54.44 (5) + 1:42.16	06:29.94 + 1:35.50
5	CHI	Rojas, Alejandro Rojas, Marcelo	1:31.15(2)	3:09.68 (3) + 1:38.53	4:51.87(4) + 1:42.19	06:33.23 + 1:41.36
6	USA	Florio, Glen Still, Kevin	1:34.76(6)	3:13.26(6) + 1:38.50	4:55.96 (6) + 1:42.70	06:33.75 + 1:37.79

Weather/Temps : rainy
 Wind/Vent : Velocity/Vitesse = 2.3 m/s Direction = NW
 Temperature : Air = 21.0 C Water/Eau = C
 Air Pressure/Pression Atm. : mmHg

Men Single Sculls Semi-final 2/Sept. 22			Hommes/Un rameur Demi-finale 2/22 Sept			
Rank Rang	Ctry Pays	Name Nom	500m (R)	1000m (R)	1500m (R)	2000m
1	FRG	Kolbe, Petermichael	1:38.80(1)	3:25.89(1) + 1:47.09	5:14.28(1) +1:48.39	07:01.76 + 1:47.48
2	AUS	Mcglashan, Hamish	1:43.41 (5)	3:29.71 (4) + 1:46.30	5:18.31 (3) +1:48.60	07:03.40 + 1:45.09
3	POL	Broniewski, Kajetan	1:39.82 (2)	3:26.83 (2) + 1:47.01	5:17.24(2) + 1:50.41	07:03.90 +1:46.66
4	SWE	Hulten, Fredrik	1:45.41 (6)	3:32.48 (5) + 1:47.07	5:19.64(4) + 1:47.16	07:04.36 +1:44.72
5	ITA	Calabrese, Giovanni	1:43.13(4)	3:32.88 (6) + 1:49.75	5:26.02 (6) + 1:53.14	07:23.69 + 1:57.67
6	FIN	Karppinen, Pertti	1:41.13(3)	3:29.11 (3) + 1:47.98	5:23.96 (5) + 1:54.85	07:32.78 + 2:08.82

Weather/Temps : sunny
 Wind/Vent : Velocity/Vitesse = 0.9 m/s Direction = SW
 Temperature : Air = 23.8 C Water/Eau = 23.5 C
 Air Pressure/Pression Atm. : 767 mmHg

Men Double Sculls Preliminary Heat 2/Sept. 19			Hommes/Deux rameurs en couple Eliminatoire 2/19 Sept			
Rank Rang	Ctry Pays	Name Nom	500m (R)	1000m (R)	1500m (R)	2000m
1	DEN	Eltang, Bjarne Rasmussen, Per H S	1:31.51 (4)	3:06.23 (4) + 1:34.72	4:40.39 (3) + 1:34.16	06:13.19 + 1:32.80
2	GDR	Heppler, Uwe Mund, Uwe	1:28.80 (2)	3:02.95 (2) + 1:34.15	4:38.44(1) + 1:35.49	06:13.72 + 1:35.28
3	BUL	Radev, Vassil Yordanov, Danail	1:28.09(1)	3:01.88(1) +1:33.79	4:39.24 (2) + 1:37.36	06:17.92 + 1:38.68
4	SUI	Bodenmann, Ueli Schwerzmann, Beat	1:29.65(3)	3:05.20 (3) +1:35.55	4:43.65 (4) + 1:38.45	06:22.39 + 1:38.74
5	MEX	Garcia, Luis Gomez, Joaquin	1:33.90 (5)	3:14.61 (5) + 1:40.71	4:58.38 (5) + 1:43.77	06:45.16 + 1:46.78
6	AUT	Faderbauer, Harald Musyl, Thomas	1:45.83 (6)	3:37.17(6) + 1:51.34	5:28.04 (6) + 1:50.87	07:17.11 + 1:49.07

Weather/Temps : rainy
 Wind/Vent : Velocity/Vitesse = 5.0 m/s Direction = WNW
 Temperature : Air = 19.0 C Water/Eau = C
 Air Pressure/Pression Atm. : mmHg

Rowing

Aviron

Men Double Sculls Preliminary Heat 3/Sept. 19			Hommes/Deux rameurs en couple Eliminatoire 3/19 Sept			
Rank Rang	Ctry pays	Name Nom	500m (R)	1000m (R)	1500m (R)	2000m
1	HOL	Florijn, Ronald Rienks, Nicolaas	1:29.99(1)	3:04.87(1) + 1:34.88	4:39.29(1) +1:34.42	06:16.32 + 1:37.03
2	FRG	Haendle, Christian Thienel, Ralf	1:31.25(3)	3:05.66 (2) + 1:34.41	4:42.08 (2) +1:36.42	06:21.95 + 1:39.87
3	ITA	Fusaro, Roberto Jagodnich, Mauro	1:30.93(2)	3:06.94 (3) + 1:36.01	4:45.31 (3) + 1:38.37	06:26.19 + 1:40.88
4	FIN	Karppinen, Reima Lehtela, Jorma	1:33.27(5)	3:08.91 (4) + 1:35.64	4:48.51 (4) +1:39.60	06:28.22 + 1:39.71
5	GRE	Ditsios, Constandinos Papaterpos, Pandelis	1:31.67(4)	3:10.43(5) + 1:38.76	4:52.94 (5) + 1:42.51	06:35.72 + 1:42.78
Weather/Temps			: rainy			
Wind/Vent			: Velocity/Vitesse = 3.7 m/s Direction = W			
Temperature			: Air = 18.0 C Water/Eau = C			
Air Pressure/Pression Atm.			: mmHg			

Men Double Sculls Repechage 1/Sept. 21			Hommes/Deux rameurs en couple Repechage 1/21 Sept			
Rank Rang	Ctry pays	Name Nom	500m (R)	1000m (R)	1500m (R)	2000m
1	GDR	Heppner, Uwe Mund, Uwe	1:34.14(1)	3:15.87(1) + 1:41.73	4:59.12(1) +1:43.25	06:40.67 + 1:41.55
2	FIN	Karppinen, Reima Lehtela, Jorma	1:35.85(2)	3:19.39(2) + 1:43.54	5:03.20 (3) + 1:43.81	06:42.99 + 1:39.79
3	ESP	Bermudez, Jose Manuel Vera, Manuel	1:36.28(3)	3:20.06 (3) + 1:43.78	5:02.41 (2) + 1:42.35	06:43.67 + 1:41.26
4	MEX	Garcia, Luis Gomez, Joaquin	1:38.17(5)	3:22.74 (5) + 1:44.57	5:05.44 (4) + 1:42.70	06:45.59 + 1:40.15
5	USA	Florio, Glen Still, Kevin	1:37.74(4)	3:21.67(4) + 1:43.93	5:08.90 (5) + 1:47.23	06:56.45 + 1:47.55
Weather/Temps			: sunny			
Wind/Vent			: Velocity/Vitesse = 0.8 m/s Direction = ENE			
Temperature			: Air = 13.9 C Water/Eau = 22.0 C			
Air Pressure/Pression Atm.			: 767 mmHg			

Men Double Sculls Repechage 2/Sept. 21			Hommes/Deux rameurs en couple Repechage 2/21 Sept			
Rank Rang	Ctry pays	Name Nom	500m (R)	1000m (R)	1500m (R)	2000m
1	SUI	Bodenmann, Ueli Schwierzmann, Beat	1:33.27(1)	3:13.46(1) + 1:40.19	4:55.16(1) + 1:41.70	06:37.86 +1:42.70
2	NOR	Satersdal, Per Albert Voll, Kjell Sverre	1:36.10(3)	3:16.01 (2) + 1:39.91	4:57.94 (2) + 1:41.93	06:41.15 + 1:43.21
3	ITA	Fusaro, Roberto Jagodnich, Mauro	1:35.70(2)	3:17.89(3) + 1:42.19	5:00.80 (3) + 1:44.91	06:43.22 + 1:42.42
4	CHI	Rojas, Alejandro Rojas, Marcelo	1:36.61 (4) +1:44.49	3:21.10(4) + 1:42.63	5:03.73 (4) + 1:44.99	06:48.72
Weather/Temps			: sunny			
Wind/Vent			: Velocity/Vitesse = 1.2 m/s Direction = ENE			
Temperature			: Air = 14.8 C Water/Eau = 24.0 C			
Air Pressure/Pression Atm.			: 768 mmHg			

Men Double Sculls Repechage 3/Sept. 21			Hommes/Deux rameurs en couple Repechage 3/21 Sept			
Rank Rang	Ctry Pays	Name Nom	500m (R)	1000m (R)	1500m (R)	2000m
1	FRG	Haendle, Christian Thienel, Ralf	1:33.86(2)	3:13.39(2) + 1:39.53	4:54.73(1) + 1:41.34	06:37.84 + 1:43.11
2	BUL	Radev, Vassil Yordanov, Danail	1:32.17(1)	3:12.49(1) +1:40.32	4:56.25 (2) + 1:43.76	06:41.10 + 1:44.85
3	CAN	Ford, Burce Walter, Patrick	1:37.71 (5)	3:21.84 (5) + 1:44.13	5:02.82 (4) +1:40.98	06:46.55 + 1:43.73
4	GRE	Ditsios, Constandinos Papaterpos, Pandelis	1:36.06(3)	3:18.72(4) + 1:42.66	5:08.32 (5) + 1:49.60	06:59.46 + 1:51.14
5	AUT	Faderbauer, Harald Musyl, Thomas	1:36.69 (4)	3:18.22(3) + 1:41.53	5:01.60(3) + 1:43.38	07:56.37 + 2:54.77
Weather/Temps			: sunny			
Wind/Vent			: Velocity/Vitesse = 1.8 m/s Direction = ESE			
Temperature			: Air = 15.3 C Water/Eau = 24.0 C			
Air Pressure/Pression Atm.			: 767mmHg			

Men Double Sculls Petite Final/Sept. 23			Hommes/Deux rameurs en couple Petite Finale/23 Sept			
Rank Rang	Ctry Pays	Name Nom	500m (R)	1000m (R)	1500m (R)	2000m
1	ESP	Bermudez, Jose Manuel Vera, Manuel	1:41.31 (6)	3:27.78 (3) +1:46.47	5:17.59(2) + 1:49.81	07:02.34 + 1:44.75
2	BUL	Radev, Vassil Yordanov, Danail	1:39.08(1)	3:25.73(1) + 1:46.65	5:15.70(1) + 1:49.97	07:04.39 +1:48.69
3	ITA	Fusaro, Roberto Jagodnich, Mauro	1:39.62(2)	3:27.32 (2) + 1:47.70	5:18.10(3) + 1:50.78	07:06.01 + 1:47.91
4	CAN	Ford, Burce Walter, Patrick	1:40.43(4)	3:29.77 (5) + 1:49.34	5:21.11 (5) + 1:51.34	07:07.31 + 1:46.20
5	NOR	Satersdal, Per Albert Voll, Kjell Sverre	1:40.84(5)	3:28.58 (4) + 1:47.74	5:20.68 (4) + 1:52.10	07:09.42 + 1:48.74
6	FIN	Karppinen, Reima Lehtela, Jorma	1:39.96(3)	3:32.70 (6) + 1:52.74	5:27.17(6) + 1:54.47	07:20.72 + 1:53.55
Weather/Temps			: sunny			
Wind/Vent			: Velocity/Vitesse = 2.6 m/s Direction = ESE			
Temperature			: Air = 12.4 C Water/Eau = 22.0 C			
Air Pressure/Pression Atm.			: 766 mmHg			

Men Double Sculls Semi-final 1/Sept. 22			Hommes/Deux rameurs en couple Demi-finale 1/22 Sept			
Rank Rang	Ctry Pays	Name Nom	500m (R)	1000m (R)	1500m (R)	2000m
1	URS	Iakoucha, Vassily Martchenko, Alexandre	1:27.77(1)	3:03.61 (1) + 1:35.84	4:42.90(1) + 1:39.29	06:21.78 +1:38.88
2	FRG	Haendle, Christian Thienel, Ralf	1:31.75 (4)	3:09.84 (4) + 1:38.09	4:48.49 (4) + 1:38.65	06:23.55 + 1:35.06
3	DEN	Eltang, Bjarne Rasmussen, Per H S	1:31.08 (3)	3:06.04 (2) + 1:34.96	4:45.56 (2) + 1:39.52	06:24.60 +1:39.04
4	NOR	Satersdal, Per Albert Voll, Kjell Sverre	1:30.45(2)	3:07.40 (3) + 1:36.95	4:46.75 (3) + 1:39.35	06:24.87 + 1:38.12
5	CAN	Ford, Burce Walter, Patrick	1:33.56(6)	3:13.68(6) + 1:40.12	4:56.58 (5) +1:42.90	06:37.95 + 1:41.37
6	FIN	Karppinen, Reima Lehtela, Jorma	1:33.13(5)	3:12.37(5) +1:39.24	4:57.65 (6) + 1:45.28	06:43.31 +1:45.66
Weather/Temps			: sunny			
Wind/Vent			: Velocity/Vitesse = 1.4 m/s Direction = ENE			
Temperature			: Air = 31.2 C Water/Eau = 23.5 C			
Air Pressure/Pression Atm.			: 767 mmHg			

Men Double Sculls Semi-final 2/Sept. 22			Hommes/Deux rameurs en couple Demi-finale 2/22 Sept			
Rank Rang	Ctry Pays	Name Nom	500m (R)	1000m (R)	1500m (R)	2000m
1	GDR	Heppner, Uwe Mund, Uwe	1:28.23(2)	3:04.40(1) + 1:36.17	4:41.80(1) +1:37.40	06:17.89 + 1:36.09
2	HOL	Florijn, Ronald Rienks, Nicolaas	1:29.46(4)	3:06.35 (3) + 1:36.89	4:43.14(2) + 1:36.79	06:19.57 +1:36.43
3	SUI	Bodenmann, Ueli Schwierzmann, Beat	1:29.16(3)	3:08.31 (5) + 1:39.15	4:46.17(4) + 1:37.86	06:19.99 +1:33.82
4	BUL	Radev, Vassil Yordanov, Danail	1:27.92(1)	3:05.25 (2) + 1:37.33	4:43.99 (3) + 1:38.74	06:20.33 + 1:36.34
5	ITA	Fusaro, Roberto Jagodnich, Mauro	1:29.94(5)	3:07.87 (4) + 1:37.93	4:46.90 (5) +1:39.03	06:27.60 + 1:40.70
6	ESP	Bermudez, Jose Manuel Vera, Manuel	1:31.07(6)	3:10.53(6) + 1:39.46	4:49.76 (6) + 1:39.23	06:31.03 + 1:41.27
Weather/Temps			: sunny			
Wind/Vent			: Velocity/Vitesse = 0.7 m/s Direction = SW			
Temperature			: Air = 24.1 C Water/Eau = 23.5 C			
Air Pressure/Pression Atm.			: 767 mmHg			



Men Double Sculls Final/Sept. 24			Hommes/Deux rameurs en couple Finale/24 Sept			
Rank Rang	Ctry Pays	Name Nom	500m (R)	1000m (R)	1500m (R)	2000m
1	HOL	Florijn, Ronald Rienks, Nicolaas	1:34.55(4)	3:10.33(2) + 1:35.78	4:45.87(1) + 1:35.54	06:21.13 + 1:35.26
2	SUI	Schwerzmann, Beat Bodenmann, Ueli	1:34.82(5)	3:13.35(5) + 1:38.53	4:50.14(4) + 1:36.79	06:22.59 + 1:32.45
3	URS	Martchenko, Alexandre Iakoucha, Vassily	1:31.61 (1)	3:09.26(1) + 1:37.65	4:47.92 (2) + 1:38.66	06:22.87 + 1:34.95
4	FRG	Haendle, Christian Thienel, Ralf	1:33.97(3)	3:12.74(4) + 1:38.77	4:51.27(5) + 1:38.53	06:24.97 + 1:33.70
5	GDR	Mund, Uwe Heppner, Uwe	1:32.91 (2)	3:10.79(3) + 1:37.88	4:49.38 (3) + 1:38.59	06:26.20 + 1:36.82
6	DEN	Rasmussen, Per H S Eltang, Bjarne	1:37.60(6)	3:14.55(6) + 1:36.95	4:52.29 (6) + 1:37.74	06:26.98 + 1:34.69

Weather/Temps : sunny
 Wind/Vent : Velocity/Vitesse = 1.5 m/s Direction = NE
 Temperature : Air = 20.7 C Water/Eau = 22.7 C
 Air Pressure/Pression Atm. : 768 mmHg

Men Pair-Oars without coxswain Preliminary Heat 3/Sept. 19			Hommes/Deux en pointe sans barreur Eliminatoire 3/19 Sept			
Rank Rang	Ctry Pays	Name Nom	500m (R)	1000m (R)	1500m (R)	2000m
1	GBR	Holmes, Andrew Redgrave, Steven	1:32.97(1)	3:14.45(1) + 1:41.48	4:55.94(1) + 1:41.49	06:42.43 + 1:46.49
2	FRG	Dietrich, Frank Twittmann, Michael	1:36.74(2)	3:17.45(2) + 1:40.71	4:59.22 (2) + 1:41.77	06:45.73 + 1:46.51
3	AUT	Bauer, Hermann Sinzinger, Karl	1:37.07(3)	3:21.11 (3) + 1:44.04	5:06.37 (3) + 1:45.26	06:54.62 + 1:48.25
4	ESP	Climent, Fernando Lasurtregui, Luis Maria	1:40.26(5)	3:26.74 (4) + 1:46.48	5:11.68(4) + 1:44.94	06:56.54 + 1:44.86
5	ARG	Aguila, Claudio S Scuri, Daniel Pablo	1:41.61(6)	3:28.62 (6) + 1:47.01	5:13.45(5) + 1:44.83	06:59.05 + 1:45.60
6	NOR	Andreassen, Ole Andreas Ovrebo, Tore	1:39.93(4)	3:27.58 (5) + 1:47.65	5:15.69(6) + 1:48.11	07:05.78 + 1:50.09

Weather/Temps : cloudy
 Wind/Vent : Velocity/Vitesse = 0.9 m/s Direction = WSW
 Temperature : Air = 17.0 C Water/Eau = C
 Air Pressure/Pression Atm. : 1026 mmHg

Men Pair-Oars without coxswain Preliminary Heat 1/Sept. 19			Hommes/Deux en pointe sans barreur Eliminatoire 1/19 Sept			
Rank Rang	Ctry Pays	Name Nom	500m (R)	1000m (R)	1500m (R)	2000m
1	ROM	Dobre, Danut Neagu, Dragos	1:34.48(2)	3:11.68(1) + 1:37.20	4:51.01 (1) + 1:39.33	06:31.95 + 1:40.94
2	BEL	Lewuillon, Alain Van Belleghem, Wim	1:36.74(4)	3:16.41 (3) + 1:39.67	4:55.19(2) + 1:38.78	06:36.62 + 1:41.43
3	USA	Bausback, Kurt Ives, Edward	1:35.97(3)	3:17.59(4) + 1:41.62	4:59.46 (4) + 1:41.87	06:40.16 + 1:40.69
4	URS	Vyrvitch, Yaleri Zuborenko, Igor	1:33.95(1)	3:15.57(2) + 1:41.62	4:58.09 (3) + 1:42.52	06:43.21 + 1:45.12
5	BRA	Carvalho, Ricardo Carvalho, Ronaldo	1:37.27(5)	3:20.72 (5) + 1:43.45	5:00.97 (5) + 1:40.25	06:45.20 + 1:44.23
6	CAN	Dickison, Don Johnson, David Leslie	1:38.98(6)	3:23.11 (6) + 1:44.13	5:10.56(6) + 1:47.45	06:57.59 + 1:47.03

Weather/Temps : rainy
 Wind/Vent : Velocity/Vitesse = 1.0 m/s Direction = NW
 Temperature : Air = 18.0 C Water/Eau = C
 Air Pressure/Pression Atm. : 1017 mmHg

Men Pair-Oars without coxswain Repechage 1/Sept.21			Hommes/Deux en pointe sans barreur Repechage 1/21 Sept			
Rank Rang	Ctry Pays	Name Nom	500m (R)	1000m (R)	1500m (R)	2000m
1	GDR	Ertel, Carl Gasch, Uwe	1:39.63(1)	3:24.55(1) + 1:44.92	5:16.42(3) + 1:51.87	07:02.15 + 1:45.73
2	FIN	Lindroos, Aarne Lindroos, Kari	1:41.67(5)	3:26.85 (3) + 1:45.18	5:15.09(2) + 1:48.24	07:03.72 + 1:48.63
3	USA	Bausback, Kurt Ives, Edward	1:41.24(4)	3:25.88 (2) + 1:44.64	5:14.14(1) + 1:48.56	07:04.99 + 1:50.55
4	ESP	Climent, Fernando Lasurtregui, Luis Maria	1:40.90(3)	3:28.18(4) + 47.28	5:18.07(4) + 1:49.89	07:09.10 + 1:51.03
5	CAN	Dickison, Don Johnson, David Leslie	1:39.99(2)	3:29.27 (5) + 1:49.28	5:22.92 (5) + 1:53.65	07:13.07 + 1:50.15

Weather/Temps : sunny
 Wind/Vent : Velocity/Vitesse = 1.3 m/s Direction = SSW
 Temperature : Air = 15.7 C Water/Eau = 24.0 C
 Air Pressure/Pression Atm. : 767 mmHg

Men Pair-Oars without coxswain Preliminary Heat 2/Sept. 19			Hommes/Deux en pointe sans barreur Eliminatoire 2/19 Sept			
Rank Rang	Ctry Pays	Name Nom	500m (R)	1000m (R)	1500m (R)	2000m
1	YUG	Mijic, Sadik Presern, Bojan	1:31.66(1)	3:11.64(1) + 1:39.98	4:54.17(1) + 1:42.53	06:36.35 + 1:42.18
2	GDR	Ertel, Carl Gasch, Uwe	1:33.39 (4)	3:15.04(3) + 1:41.65	4:59.14(3) + 1:44.10	06:40.74 + 1:41.60
3	FRA	Lacasa, Lavrent Perahia, Acex	1:32.01 (2)	3:13.92(2) + 1:41.91	4:58.03 (2) + 1:44.11	06:41.66 + 1:43.63
4	AUS	Batten, Malcolm Patten, Samuel	1:32.06(3)	3:16.34(4) + 1:43.28	5:00.99 (4) + 1:44.65	06:46.79 + 1:51.34
5	FIN	Lindroos, Aarne Lindross, Kari	1:36.82(5)	3:23.25 (5) + 1:46.43	5:10.95(5) + 1:47.70	07:00.29 + 1:51.34
6	JPN	Kobayashi, Maki Miyoshi, Satoru	1:39.22(6)	3:27.42 (6) + 1:48.20	5:18.24(6) + 1:50.82	07:07.51 + 1:49.27

Weather/Temps : cloudy
 Wind/Vent : Velocity/Vitesse = 0.7 m/s Direction = SSW
 Temperature : Air = 18.9 C Water/Eau = C
 Air Pressure/Pression Atm. : 1017 mmHg

Men Pair-Oars without coxswain Repechage 2/Sept. 21			Hommes/Deux en pointe sans barreur Repechage 2/21 Sept			
Rank Rang	Ctry Pays	Name Nom	500m (R)	1000m (R)	1500m (R)	2000m
1	BEL	Lewuillon, Alain Van Belleghem, Wim	1:40.44(4)	3:23.86 (3) + 1:43.42	5:09.11(1) + 1:45.25	06:54.57 + 1:45.46
2	AUT	Bauer, Hermann Sinzinger, Karl	1:38.31 (2)	3:22.80 (2) + 1:44.49	5:10.23(2) + 1:47.43	06:58.96 + 1:48.73
3	BRA	Carvalho, Ricardo Carvalho, Ronaldo	1:39.30(3)	3:24.89 (4) + 1:45.59	5:11.98(3) + 1:47.09	07:01.00 + 1:49.02
4	AUS	Batten, Malcolm Patten, Samuel	1:36.74(1)	3:22.05(1) + 1:45.31	5:13.38(4) + 1:51.33	07:06.17 + 1:52.79
5	NOR	Hadler-Olsen, Audun Ovrebo, Tore	1:48.21 (5)	3:40.05 (5) + 1:51.84	5:30.65 (5) + 1:50.60	07:20.88 + 1:50.23

Weather/Temps : sunny
 Wind/Vent : Velocity/Vitesse = 1.2 m/s Direction = ESE
 Temperature : Air = 17.1 C Water/Eau = 24.0 C
 Air Pressure/Pression Atm. : 767 mmHg

Men Pair-Oars without coxswain Repechage 3/Sept. 21			Hommes/Deux en pointe sans barreur Repechage 3/21 Sept			
Rank Rang	Ctry Pays	Name Nom	500m (R)	1000m (R)	1500m (R)	2000m
1	FRG	Dietrich, Frank Twittmann, Michael	1:37.99(3)	3:22.58 (2) + 1:44.59	5:08.57 (2) + 1:45.99	06:52.03 + 1:43.46
2	FRA	Lacasa, Lavrent Perahia, Alex	1:35.40(1)	3:20.14(1) + 1:44.74	5:07.21 (1) + 1:47.07	06:53.72 + 1:46.51
3	URS	Vyrvitch, Yaleri Zuborenko, Igor	1:37.44(2)	3:24.52 (3) + 1:47.08	5:10.35(3) + 1:45.83	06:57.39 + 1:47.04
4	ARG	Aguila, Claudio S Scuri, Daniel Pablo	1:38.42(4)	3:25.80 (4) + 1:47.38	5:13.90(4) + 1:48.10	07:06.57 + 1:52.67
5	JPN	Kobayashi, Maki Miyoshi, Satoru	1:43.63(5)	3:35.77 (5) + 1:52.14	5:27.85 (5) + 1:52.08	07:18.56 + 1:50.71

Weather/Temps : sunny
 Wind/Vent : Velocity/Vitesse = 0.3 m/s Direction = SSW
 Temperature : Air = 17.3 C Water/Eau = 24.0 C
 Air Pressure/Pression Atm. : 767 mmHg

Rowing

Aviron

Men Pair-Oars without coxswain Petite Final/Sept. 23				Hommes/Deux en pointe sans barreur Petite Finale/23 Sept			
Rank Rang	Ctry Pays	Name Nom	500m (R)	1000m (R)	1500m (R)	2000m	
1	FRG	Dietrich, Frank Twittmann, Michael	1:43.10(2)	3:33.84 (2) + 1:50.74	5:26.36(1) + 1:52.52	07:19.48 + 1:53.12	
2	FRA	Lacasa, Lavrent Perahia, Alex	1:41.21 (1)	3:32.31 (1) + 1:51.10	5:27.49 (2) + 1:55.18	07:22.36 + 1:54.87	
3	USA	Bausback, Kurt Ives, Edward	1:44.68(3)	3:37.00 (3) + 1:52.32	5:33.21 (3) + 1:56.21	07:28.30 + 1:53.44	
4	BRA	Carvalho, Ricardo Carvalho, Ronaldo	1:46:88(4)	3:40.56 (4) + 1:53.68	5:36.81 (4) + 1:56.25	07:28.30 + 1:51.49	
5	FIN	Lindroos, Aarne Lindroos, Kari	1:48.58(6)	3:42.30 (5) + 1:53.72	5:37.97(5) + 1:55.67	07:28.46 + 1:50.49	
6	AUT	Bauer, Hermann Sinzinger, Karl	1:47.25(5)	3:42.97 (6) + 1:55.72	6:31.16(6) + 2:48.19	10:45.56 + 4:14.40	

Weather/Temps : sunny
 Wind/Vent : Velocity/Vitesse = 2.6 m/s Direction = ESE
 Temperature : Air = 13.0 C Water/Eau = 22.0 C
 Air Pressure/Pression Atm. : 766 mmHg

Men Pair-Oars without coxswain Final /Sept. 24				Hommes/Deux en pointe sans barreur Finale /24 Sept			
Rank Rang	Ctry Pays	Name Nom	500m (R)	1000m (R)	1500m (R)	2000m	
1	GBR	Holmes, Andrew Redgrave, Steven	1:34.90(1)	3:15.41 (1) + 1:40.51	4:57.30(1) + 1:41.89	06:36.84 + 1:39.54	
2	ROM	Neagu, Dragos Dobre, Danut	1:36.44(2)	3:16.88(2) + 1:40.44	4:58.42 (2) + 1:41.54	06:38.06 + 1:39.64	
3	YUG	Presern, Bojan Mujkic, Sadik	1:37.20(3)	3:18.59(3) +1:41.39	4:59.91 (3) +1:41.32	06:41.01 +1:41.10	
4	BEL	Lewuillon, Alain Van Belleghem, Wim	1:42.91 (6)	3:19.36(4) + 1:36.45	5:01.08(4) + 1:41.72	06:45.47 + 1:44.39	
5	GDR	Ertel, Carl Gasch, Uwe	1:38.18(4)	3:21.05(5) + 1:42.87	5:06.45 (5) +1:45.40	06:48.86 + 1:42.41	
6	URS	Zuborenko, Igor Vyrvitch, Yalari	1:38.50(5)	3:22.02 (6) +1:43.52	5:07.11 (6) +1:45.09	06:51.11 +1:44.00	

Weather/Temps : sunny
 Wind/Vent : Velocity/Vitesse = 2.2 m/s Direction = NE
 Temperature : Air = 20.1 C Water/Eau = 22.7 C
 Air Pressure/Pression Atm. : 768 mmHg

Men Pair-Oars without coxswain Semi-final 1/Sept. 22				Hommes/Deux en pointe sans barreur Demi-finale 1/22 Sept			
Rank Rang	Ctry Pays	Name Nom	500m (R)	1000m (R)	1500m (R)	2000m	
1	ROM	Dobre, Danut Neagu, Dragos	1:35.35(2)	3:17.47(1) + 1:42.12	5:01.67(1) +1:44.20	06:46.70 + 1:45.03	
2	YUG	Mujkic, Sadik Presern, Bojan	1:34.79(2)	3:18.76(2) + 1:43.97	5:04.18(2) +1:45.42	06:49.44 + 1:45.26	
3	URS	Vyrvitch, Yalari Zuborenko, Igor	1:35.82(3)	3:20.82 (4) + 1:45.00	5:06.17(3) +1:45.35	06:50.49 + 1:46.40	
4	FRG	Dietrich, Frank Twittmann, Michael	1:37.20(4)	3:20.45 (3) + 1:43.25	5:07.84 (4) + 1:47.39	06:54.24 +1:46.40	
5	AUT	Bauer, Hermann Sinzinger, Karl	1:39.10(5)	3:25.46 (5) + 1:46.36	5:11.45(5) + 1:45.99	07:02.66 + 1:51.21	
6	FIN	Lindroos, Aarne Lindroos, Kari	1:42.59(6)	3:31.89(6) + 1:49.30	5:23.20 (6) + 1:51.31	07:15.36 + 1:52.16	

Weather/Temps : sunny
 Wind/Vent : Velocity/Vitesse = 1.8 m/s Direction = S
 Temperature : Air = 19.4 C Water/Eau = 23.5 C
 Air Pressure/Pression Atm. : 766 mmHg

Men Pair-Oars with coxswain Preliminary Heat 1/Sept. 20				Hommes/Deux en pointe avec barreur Eliminatoire 1/20 Sept.			
Rank Rang	Ctry Pays	Name Nom	500m (R)	1000m (R)	1500m (R)	2000m	
1	GDR	Kirchhoff, Detlef Rensch, Rene Streit, Mario	1:40.34(2)	3:29.84 (2) + 1:49.50	5:19.79(1) + 1:49.95	07:11.24 + 1:51.45	
2	BUL	Andreev, Atanas Groitzov, Emil Stoykov, Stefan	1:39.76(1)	3:28.88(1) + 1:49.12	5:21.21 (2) + 1:52.33	07:15.24 + 1:54.03	
3	NZL	Bird, Andrew Johnston, Gregory White, Christopher	1:42.32(3)	3:33.17(3) + 1:50.85	5:25.80 (3) + 1:52.63	07:22.32 +1:56.52	
4	CAN	Mckerlich, Ian Newman, Pat Ross, Dave	1:45.06(4)	3:37.43 (4) + 1:52.37	5:32.80 (4) + 1:55.37	07:25.18 + 1:52.38	
5	BRA	Alonco, Nilton Melo, Flavio Roso, Angelo	1:47.02(5)	3:40.35 (5) + 1:53.33	5:36.09 (5) + 1:55.74	07:27.68 + 1:51.59	

Weather/Temps : sunny
 Wind/Vent : Velocity/Vitesse = 0.7 m/s Direction = SW
 Temperature : Air = 14.2 C Water/Eau = C
 Air Pressure/Pression Atm. : 1026 mmHg

Men Pair-Oars without coxswain Semi-final 2/Sept. 22				Hommes/Deux en pointe sans barreur Demi-finale 2/22 Sept			
Rank Rang	Ctry Pays	Name Nom	500m (R)	1000m (R)	1500m (R)	2000m	
1	GBR	Holmes, Andrew Redgrave, Steven	1:33.25(1)	3:15.89(1) + 1:42.64	4:59.34(1) +1:43.45	06:45.03 + 1:45.69	
2	BEL	Lewuillon, alain Van Belleghem, Wim	1:37.63(5)	3:21.34(4) +1:43.71	5:04.21 (3) + 1:42.87	06:47.44 + 1:43.23	
3	GDR	Ertel, Carl Gasch, Uwe	1:36.52(4)	3:20.07 (3) + 1:43.55	5:05.30 (4) + 1:45.23	06:48.11 + 1:42.81	
4	FRA	Lacasa, Lavrent Perahia, Alex	1:35.58(2)	3:21.63(5) +1:46.05	5:06.42 (5) + 1:44.79	06:49.03 + 1:42.61	
5	USA	Bausback, Kurt Ives, Edward	1:35.90(3)	3:18.87(2) + 1:42.97	5:02.89 (2) +1:44.02	06:50.47 + 1:47.58	
6	BRA	Carvalho, Ricardo Carvalho, Ronaldo	1:40.25(6)	3:27.16(6) + 1:46.91	5:11.82(6) +1:44.66	06:54.89 + 1:43.07	

Weather/Temps : sunny
 Wind/Vent : Velocity/Vitesse = 0.6 m/s Direction = ENE
 Temperature : Air = 23.9 C Water/Eau = 23.5 C
 Air Pressure/Pression Atm. : 766 mmHg

Men Pair-Oars with coxswain Preliminary Heat 2/Sept. 20				Hommes/Deux en pointe avec barreur Eliminatoire 2/20 Sept			
Rank Rang	Ctry Pays	Name Nom	500m (R)	1000m (R)	1500m (R)	2000m	
1	URS	Kazantsev, Roman Korikov, Andre Lipski, Andre	1:43.81 (3)	3:33.63 (2) + 1:49.82	5:22.58(1) + 1:48.95	07:12.96 + 1:50.38	
2	YUG	Ambrozic, Roman Jansa, Milan Mirhanic, Saso	1:43.40(2)	3:34.58 (3) + 1:51.18	5:25.65 (3) + 1:51.07	07:14.96 + 1:49.31	
3	USA	Espeseth, Robert Fish, Jonathan Lyons, Daniel	1:42.66(1)	3:31.69(1) + 1:49.03	5:23.58 (2) + 1:51.89	07:17.36 + 1:53.78	
4	POL	Jankowski, Wojciech Omiecki, Ireneusz Streich, Jacek	1:45.05(4)	3:36.43 (4) + 1:51.38	5:28.40 (4) + 1:51.97	07:21.89 +1:53.49	
5	IRL	Mcdonagh, Patrick Moore, Francis Williams, Liam	1:46.44(5)	3:40.18(5) + 1:53.74	5:36.28 (5) + 1:56.10	07:33.16 + 1:56.88	

Weather/Temps : sunny
 Wind/Vent : Velocity/Vitesse = 0.6 m/s Direction = SSE
 Temperature : Air = 15.4 C Water/Eau = C
 Air Pressure/Pression Atm. : 1026 mmHg



Men Pair-Oars with coxswain Preliminary Heat 3/Sept. 20			Hommes/Deux en pointe avec barreur Repechage 3/20 Sept			
Rank Rang	Ctry Pays	Name Nom	500m (R)	1000m (R)	1500m (R)	2000m
1	ITA	Abbagnale, Carmine Abbagnale, Giuseppe Di Capua, Giuseppe	1:39.50(1)	3:26.81 (1) + 1:47.31	5:16.69(1) + 1:49.88	07:03.55 + 1:46.86
2	GBR	Holmes, Andrew Redgrave, Steven Sweeney, Patrick	1:40.60 (2)	3:28.12(2) + 1:47.52	5:18.29(2) + 1:50.17	07:04.04 + 1:45.75
3	ROM	Lovrenski, Ladislau Popescu, Dimitrie Tomoiaaga, Vasile	1:40.96 (3)	3:29.22 (3) + 1:48.26	5:19.00(3) + 1:49.78	07:04.48 + 1:45.48
4	TCH	Kabrhel, Jan Ptak, Jiri Skopek, Milan	1:42.28 (4)	3:34.21 (4) + 1:51.93	5:29.96 (4) + 1:55.75	07:26.53 + 1:56.57
Weather/Temps			: sunny			
Wind/Vent			: Velocity/Vitesse = 0.5 m/s Direction = ENE			
Temperature			: Air = 16.2 C Water/Eau = C			
Air Pressure/Pression Atm.			: 1026 mmHg			

Men Pair-Oars with coxswain Repechage 1/Sept. 21			Hommes/Deux en pointe avec barreur Repechage 1/21 Sept			
Rank Rang	Ctry Pays	Name Nom	500m (R)	1000m (R)	1500m (R)	2000m
1	TCH	Kabrhel, Jan Ptak, Jiri Skopek, Milan	1:43.89 (2)	3:34.23 (2) + 1:50.34	5:24.84(1) + 1:50.61	07:14.17 + 1:49.33
2	POL	Jankowski, Wojciech Omiecki, Ireneusz Streich, Jacek	1:41.96(1)	3:33.44(1) + 1:51.48	5:25.76 (2) + 1:52.32	07:18.21 + 1:52.45
3	CAN	Mckerlich, Ian Newman, Pat Ross, Dave	1:44.75 (3)	3:37.05 (3) + 1:52.30	5:29.81 (3) + 1:52.76	07:18.60 + 1:48.79
4	BRA	Alonco, Nilton Melo, Flavio Roso, Angelo	1:47.80 (5)	3:42.91 (5) + 1:55.11	5:33.28 (5) + 1:50.37	07:21.31 + 1:48.03
5	IRL	Mcdonagh, Patrick Moore, Francis Williams, Liam	1:46.31 (4)	3:38.79 (4) + 1:52.48	5:30.92 (4) + 1:52.13	07:23.87 + 1:52.95
Weather/Temps			: sunny			
Wind/Vent			: Velocity/Vitesse = 1.1 m/s Direction = WNW			
Temperature			: Air = 22.3 C Water/Eau = 24.0 C			
Air Pressure/Pression Atm.			: 766mmHg			

Men Pair-Oars with coxswain Petite Final/Sept. 23			Hommes/Deux en pointe avec barreur Petite Finale /23 Sept			
Rank Rang	Ctry Pays	Name Nom	500m (R)	1000m (R)	1500m (R)	2000m
1	TCH	Kabrhel, Jan Ptak, Jiri Skopek, Milan	1:41.08(1)	3:30.60(1) + 1:49.52	5:22.00(1) + 1:51.40	07:11.30 + 1:49.30
2	YUG	Ambrozic, Roman Jansa, Milan Mirjanic, Saso	1:42.12(2)	3:31.83(2) + 1:49.71	5:24.12(2) + 1:52.29	07:15.82 + 1:51.70
3	POL	Jankowski, Wojciech Omiecki, Ireneusz Streich, Jacek	1:43.65(4)	3:34.03 (4) + 1:50.38	5:26.50 (3) + 1:52.47	07:18.60 + 1:52.10
4	CAN	Mckerich, Ian Newman, Pat Ross, Dave	1:44.65(5)	3:36.95 (5) + 1:52.30	5:30.38 (5) + 1:53.43	07:18.89 + 1:48.51
5	USA	Espeseth, Robert Fish, Jonathan Lyons, Daniel	1:42.92 (3)	3:32.42 (3) + 1:49.50	5:28.71 (4) + 1:56.29	07:24.18 + 1:55.47
Weather/Temps			: cloudy			
Wind/Vent			: Velocity/Vitesse = 1.0 m/s Direction = ESE			
Temperature			: Air = 16.9 C Water/Eau = 22.0 C			
Air Pressure/Pression Atm.			: 766 mmHg			

Men Pair-Oars with coxswain Semi-final 1/Sept. 22			Hommes/Deux en pointe avec barreur Demi-finale 1/22 Sept			
Rank Rang	Ctry Pays	Name Nom	500m (R)	1000m (R)	1500m (R)	2000m
1	ITA	Abbagnale, Carmine Abbagnale, Giuseppe Di Capua, Giuseppe	1:37.16(1)	3:22.36(1) + 1:45.20	5:09.62(1) + 1:47.26	06:56.62 + 1:47.00
2	GDR	Kirchhoff, Detlef Rensch, Rene Streit, Mario	1:38.68(2)	3:24.84 (3) + 1:46.16	5:11.39(2) + 1:46.55	06:58.08 + 1:46.69
3	ROM	Lovrenski, Ladislau Popescu, Dimitrie Tomoiaaga, Vasile	1:39.34(3)	3:24.50 (2) + 1:45.16	5:12.90(3) + 1:48.40	07:00.36 + 1:49.46
4	YUG	Ambrozic, Roman Jansa, Milan Mirjanic, Saso	1:40.69(4)	3:27.90 (4) + 1:47.21	5:17.24(4) + 1:49.34	07:09.45 + 1:52.21
5	POL	Jankowski, Wojciech Omiecki, Ireneusz Streich, Jacek	1:41.54 (5)	3:30.66 (5) + 1:49.12	5:22.27 (5) + 1:51.61	07:13.48 + 1:51.21
	NZL	Bird, Andrew Johnston, Gregory White, Christopher				WDR
Weather/Temps			: sunny			
Wind/Vent			: Velocity/Vitesse = 1.6 m/s Direction = WNW			
Temperature			: Air = 23.0 C Water/Eau = 23.5 C			
Air Pressure/Pression Atm.			: 766 mmHg			

Men Pair-Oars with coxswain Semi-final 2/Sept. 22			Hommes/Deux en pointe avec barreur Demi-finale 2/22 Sept			
Rank Rang	Ctry Pays	Name Nom	500m (R)	1000m (R)	1500m (R)	2000m
1	BUL	Andreev, Atanas Groitzov, Emil Stoykov, Stefan	1:37.99(1)	3:24.50(1) + 1:46.51	5:12.46(1) + 1:47.96	07:01.23 + 1:48.77
2	GBR	Holmes, Andrew Redgrave, Steven Sweeney, Patrick	1:40.19(3)	3:26.53 (3) + 1:46.34	5:15.14(3) + 1:48.61	07:01.51 + 1:46.37
3	URS	Kazantsev, Roman Korikov, Andre Lipski, Andre	1:38.87 (2)	3:26.15(2) + 1:47.28	5:13.79(2) + 1:47.64	07:01.78 + 1:47.99
4	TCH	Kabrhel, Jan Ptak, Jiri Skopek, Milan	1:41.59(5)	3:28.48 (5) + 1:46.89	5:18.11 (4) + 1:49.63	07:04.20 + 1:46.09
5	CAN	Mckerlich, Ian Newman, Pat Ross, Dave	1:43.62 (6)	3:31.85 (6) + 1:48.23	5:20.22 (6) + 1:48.37	07:06.21 + 1:45.99
6	USA	Espeseth, Robert Fish, Jonathan Lyons, Daniel	1:40.53(4)	3:27.16(4) + 1:46.63	5:18.60(5) + 1:51.44	07:07.05 + 1:48.45
Weather/Temps			: sunny			
Wind/Vent			: Velocity/Vitesse = 1.1 m/s Direction = W			
Temperature			: Air = 23.0 C Water/Eau = 23.5 C			
Air Pressure/Pression Atm.			: 766 mmHg			

Men Pair-Oars with Coxswain Final/Sept. 25			Hommes/Deux en pointe avec barreur Finale/25 Sept			
Rank Rang	Ctry Pays	Name Nom	500m (R)	1000m (R)	1500m (R)	200m
1	ITA	Abbagnale, Carmine Abbagnale, Giuseppe Di Capua, Giuseppe	1:37.84(1)	3:23.43(1) + 1:45.59	5:10.60(1) + 1:47.17	06:58.79 + 1:48.19
2	GDR	Streit, Mario Kirchhoff, Detlef Rensch, Rene	1:41.65(5)	3:29.98 (5) + 1:48.33	5:17.60(5) + 1:47.62	07:00.63 + 1:43.03
3	GBR	Holmes, Andrew Redgrave, Steven Sweeney, Patrick	1:42.28(6)	3:28.68 (3) + 1:46.40	5:15.55(3) + 1:46.87	07:01.95 + 1:46.40
4	ROM	Popescu, Dimitrie Tomoiaaga, Vasile Lovrenski, Ladislau	1:41.05(4)	3:29.09 (4) + 1:48.04	5:16.92(4) + 1:47.83	07:02.60 + 1:45.68
5	BUL	Groitzov, Emil Andreev, Atanas Stoykov, Stefan	1:39.95(2)	3:26.71 (2) + 1:46.76	5:14.36(2) + 1:47.65	07:03.04 + 1:48.68
6	URS	Korikov, Andre Kazantsev, Roman Lipski, Andre	1:40.53(3)	3:30.75 (6) + 1:50.22	5:18.25(6) + 1:47.50	07:06.07 + 1:47.82
Weather/Temps			: sunny			
Wind/Vent			: Velocity/Vitesse = 2.2 m/s Direction = NE			
Temperature			: Air = 17.2 C Water/Eau = 22.5 C			
Air Pressure/Pression Atm.			: 759 mmHg			

Rowing

Men Quadruple Sculls Preliminary Heat 1/Sept. 20			Hommes/Quatre en couple sans barreur Eliminatoire 1/20 Sept			
Rank Rang	Ctry Pays	Name Nom	500m (R)	1000m (R)	1500m (R)	200m
1	GDR	Bogs, Steffen Habermann, Heiko Koeppen, Jens Zuehlke, Steffen	1:23.12(2)	2:50.90 (2) +1:27.78	4:18.96(1) + 1:28.06	05:48.70 + 1:29.74
2	AUS	Antonie, Peter Powell, Richard Reedy, Paul Terrell, Brenton	1:23.56(3)	2:50.04(1) + 1:26.48	4:20.04 (2) + 1:30.00	05:50.47 + 1:30.43
3	HUN	Dozsa, Ferenc Hompoth, Ferenc Mitring, Gabor Molnar, Zoltan	1:22.70(1)	2:52.94 (4) + 1:30.24	4:23.35 (4) + 1:30.41	05:51.75 + 1:28.40
4	POL	Cieslakowski, Slawomir Krzepinski, Andrzej Mruk, Miroslaw Swiatek, Tomasz	1:24.05(4)	2:51.83(3) + 1:27.78	4:22.40 (3) + 1:30.57	05:52.41 + 1:30.01
5	USA	Altekruese, Charles Frackelton, John Montesi, Greg Strotbeck, John	1:25.81 (5)	2:25.81 (5) + 1:28.61	4:24.78 (5) + 1:30.36	05:54.08 + 1:29.30
Weather/Temps			: sunny			
Wind/Vent			: Velocity/Vitesse = 0.9 m/s Direction = WNW			
Temperature			: Air = 17.4 C Water/Eau = C			
Air Pressure/Pression Atm.			: 1022 mmHg			

Men Quadruple Sculls Preliminary Heat 2/Sept. 20			Hommes/Quatre en couple sans barreur Eliminatoire 2/20 Sept			
Rank Rang	Ctry Pays	Name Nom	500m (R)	1000m (R)	1500m (R)	200m
1	ITA	Abbagnale, Agostino Farina, Gianluca Poli, Piero Tizzano, Davide	1:23.32(3)	2:51.78(3) + 1:28.46	4:19.32(1) + 1:27.54	05:48.77 + 1:29.45
2	URS	Kiniakine, Serguei Kroupko, Pavel Zaskalko, Alexandre Zelikovitch, Iouri	1:22.10(1)	2:49.68(1) + 1:27.58	4:20.29 (2) + 1:30.61	05:51.70 + 1:31.41
3	FRG	Agrikola, Georg Galandi, Christoph Gruener, Oliver Reinke, Andreas	1:22.81 (2)	2:50.76 (2) + 1:27.95	4:21.75(3) + 1:30.99	05:52.45 + 1:30.70
4	TCH	Chalupa, Vaclav Jakoubek, Jiri Luzek, Pavel Tichy, Martin	1:24.28 (4)	2:52.84 (4) + 1:28.56	4:23.21 (4) + 1:30.37	05:55.45 + 1:32.24
Weather/Temps			: sunny			
Wind/Vent			: Velocity/Vitesse = 1.0 m/s Direction = W			
Temperature			: Air = 17.8 C Water/Eau = C			
Air Pressure/Pression Atm.			: 1022 mmHg			

Men Quadruple Sculls Preliminary Heat 3/Sept. 20			Hommes/Quatre en couple sans barreur Eliminatoire 3/20 Sept			
Rank Rang	Ctry Pays	Name Nom	500m (R)	1000m (R)	1500m (R)	200m
1	NOR	Bjonness, Lars Hansen, Alf John Thorsen, Rolf Bernt Vinje, Vette	1:25.38 (3)	2:52.66(1) + 1:27.28	4:21.06(1) + 1:28.40	05:51.60 + 1:30.54
2	HOL	Bakker, Robbert Kelderman, Hans Nelis, Juergen V.D.Eerenbeemt, Hermanus	1:24.87(2)	2:54.86 (3) + 1:29.99	4:24.96 (3) + 1:30.10	05:53.42 + 1:28.46
3	CAN	Douma, Paul Hamilton, Douglas Laforme, Mel Mills, Robert	1:24.42(1)	2:53.62 (2) + 1:29.20	4:24.13(2) + 1:30.51	05:54.01 + 1:29.88
4	ARG	D'andrilli, Ruben G Fernandez, Marcelo G Fernandez, Sergio Abel Guindon, Claudio Luis	1:27.33(4)	2:58.01 (4) + 1:30.68	4:29.32 (4) + 1:31.31	06:04.77 + 1:35.45
Weather/Temps			: sunny			
Wind/Vent			: Velocity/Vitesse = 1.1 m/s Direction = WNW			
Temperature			: Air = 17.8 C Water/Eau = C			
Air Pressure/Pression Atm.			: 1022 mmHg			

Aviron

Men Quadruple Sculls Repechage 1/Sept. 21			Hommes/Quatre en couple sans barreur Repechage 1/21 Sept			
Rank Rang	Ctry Pays	Name Nom	500m (R)	1000m (R)	1500m (R)	200m
1	TCH	Chalupa, Vaclav Jakoubek, Jiri Luzek, Pavel Tichy, Martin	1:25.18(2)	2:56.04 (2) + 1:30.86	4:26.01 (1) + 1:29.97	05:55.80 + 1:29.79
2	POL	Cieslakowski, Slawomir Krzepinski, Andrzej Mruk, Miroslaw Swiatek, Tomasz	1:24.50(1)	2:55.12(1) + 1:30.62	4:26.91 (2) + 1:31.79	05:57.61 + 1:30.70
3	ARG	D'andrilli, Ruben G Fernandez, Marcelo G Fernandez, Sergio Abel Guindon, Claudio Luis	1:27.29(4)	2:59.65 (4) + 1:32.36	4:30.06 (4) + 1:30.41	05:58.27 + 1:28.21
4	USA	Altekruese, Charles Frackelton, John Montesi, Greg Strotbeck, John	1:25.96(3)	2:57.08 (3) + 1:31.12	4:28.64 (3) + 1:31.56	05:59.07 + 1:30.43
Weather/Temps			: sunny			
Wind/Vent			: Velocity/Vitesse = 1.3 m/s Direction = WNW			
Temperature			: Air = 23.6 C Water/Eau = 24.0 C			
Air Pressure/Pression Atm.			: 766 mmHg			

Men Quadruple Sculls Petite Final/Sept. 23			Hommes/Quatre en couple sans barreur Petite Finale/23 Sept			
Rank Rang	Ctry Pays	Name Nom	500m (R)	1000m (R)	1500m (R)	200m
1	POL	Cieslakowski, Slawomir Krzepinski, Andrzej Mruk, Miroslaw Swiatek, Tomasz	1:25.38(3)	2:54.96 (3) + 1:29.58	4:26.66 (2) + 1:31.70	05:55.39 + 1:28.73
2	HOL	Bakker, Robbert Kelderman, Hans Nelis, Juergen V.D.Eerenbeemt, Hermanus	1:24.97(2)	2:54.58 (2) + 1:29.61	4:27.03 (3) + 1:32.45	05:55.72 + 1:28.69
3	CAN	Douma, Paul Hamilton, Douglas Laforme, Mel Mills, Robert	1:24.62(1)	2:52.99(1) + 1:28.37	4:25.98(1) + 1:32.99	05:58.06 + 1:32.08
4	HUN	Dozsa, Ferenc Hompoth, Ferenc Mitring, Gabor Molnar, Zoltan	1:25.74(4)	2:57.70 (5) + 1:31.96	4:27.86 (4) + 1:30.16	05:58.37 + 1:30.51
5	TCH	Chalupa, Vaclav Jakoubek, Jiri Luzek, Pavel Tichy, Martin	1:27.02(6)	2:58.16(6) + 1:31.14	4:30.37 (5) + 1:32.21	05:58.70 + 1:28.33
6	ARG	D'andrilli, Ruben G Fernandez, Marcelo G Fernandez, Sergio Abel Guindon, Claudio Luis	1:26.69(5)	2:55.49 (4) + 1:28.80	4:31.58(6) + 1:36.09	06:04.47 + 1:32.89
Weather/Temps			: sunny			
Wind/Vent			: Velocity/Vitesse = 0.6 m/s Direction = WSW			
Temperature			: Air = 17.5 C Water/Eau = 22.0 C			
Air Pressure/Pression Atm.			: 766 mmHg			

Men Quadruple Sculls Semi-Final 1/Sept. 22			Hommes/Quatre en couple sans barreur Demi-finale 1/22 Sept			
Rank Rang	Ctry Pays	Name Nom	500m (R)	1000m (R)	1500m (R)	200m
1	ITA	Abbagnale, Agostino Farina, Gianluca Poli, Piero Tizzano, Davide	1:23.20(2)	2:50.18(1) + 1:26.98	4:18.83(1) + 1:28.65	05:47.50 + 1:28.67
2	GDR	Bogs, Steffen Habermann, Heiko Koeppen, Jens Zuehlke, Steffen	1:23.56(3)	2:51.60(3) + 1:28.04	4:21.51 (2) + 1:29.91	05:50.48 + 1:28.97
3	FRG	Agrikola, Georg Galandi, Christoph Gruener, Oliver Reinke, Andreas	1:22.87(1)	2:51.04(2) + 1:28.17	4:22.31 (3) + 1:31.27	05:50.96 + 1:28.65
4	HOL	Bakker, Robbert Kelderman, Hans Nelis, Juergen V.D.Eerenbeemt, Hermanus	1:23.90 (4)	2:52.14(4) + 1:28.24	4:23.16(4) + 1:31.02	05:52.84 + 1:29.68
5	ARG	D'andrilli, Ruben G Fernandez, Marcelo G Fernandez, Sergio Abel Guindon, Claudio Luis	1:26.28(6)	2:56.30 (6) + 1:30.02	4:27.79 (6) + 1:31.49	05:57.56 + 1:29.77
6	HUN	Dozsa, Ferenc Hompoth, Ferenc Mitring, Gabor Molnar, Zoltan	1:24.42(5)	2:53.64 (5) + 1:29.22	4:26.43 (5) + 1:32.79	05:58.23 + 1:31.80
Weather/Temps			: sunny			
Wind/Vent			: Velocity/Vitesse = 1.3 m/s Direction = S			
Temperature			: Air = 20.1 C Water/Eau = 23.5 C			
Air Pressure/Pression Atm.			: 766 mmHg			



Men Quadruple Sculls Semi-final 2/Sept. 22			Hommes/Quatre en couple sans barreur Demi-finale 2/22 Sept			
Rank Rang	Ctry Pays	Name Nom	500m (R)	1000m (R)	1500m (R)	200m
1	NOR	Bjonness, Lars Hansen, Alf John Thorsen, Rolf Bernt Vinje, Vette	1:25.83(5)	2:53.91 (2) + 1:28.08	4:23.62 (2) + 1:29.71	05:53.18 + 1:29.56
2	URS	Kiniakine, Serguei Kroupko, Pavel Zaskalko, Alexandre Zelikovitch, Iouri	1:23.00(1)	2:52.20(1) + 1:29.20	4:22.95(1) + 1:30.75	05:54.62 + 1:31.67
3	AUS	Antonie, Peter Powell, Richard Reedy, Paul Terrell, Brenton	1:24.85(3)	2:55.00 (4) + 1:30.15	4:27.09 (5) + 1:32.09	05:55.41 + 1:28.32
4	TCH	Chalupa, Vaclav Jakoubek, Jiri Luzek, Pavel Tichy, Martin	1:28.66(6)	2:55.57(5) + 1:26.91	4:25.54 (3) + 1:29.97	05:55.82 + 1:30.28
5	POL	Cieslakowski, Slawomir Krzepinski, Andrzej Mruk, Miroslaw Swiatek, Tomasz	1:23.75(2)	2:54.22 (3) + 1:30.47	4:26.14(4) + 1:31.92	05:57.32 + 1:31.18
6	CAN	Douma, Paul Hamilton, Douglas Laforme, Mel Mills, Robert	1:25.18(4)	2:56.12(6) + 1:30.94	4:28.93 (6) + 1:32.81	06:00.55 + 1:33.62
Weather/Temps			: sunny			
Wind/Vent			: Velocity/Vitesse = 2.2 m/s Direction = S			
Temperature			: Air = 19.7 C Water/Eau = 23.5 C			
Air Pressure/Pression Atm.			: 766 mmHg			

Men Quadruple Sculls Final/Sept. 25			Hommes/Quatre en couple sans barreur Finale/25 Sept			
Rank Rang	Ctry Pays	Name Nom	500m (R)	1000m (R)	1500m (R)	200m
1	ITA	Poli, Piero Farina, Gianluca Tizzano, Davide Abbagnale, Agostino	1:26.53(2)	2:54.80(1) + 1:28.27	4:24.48 (2) + 1:29.68	05:53.37 + 1:28.89
2	NOR	Bjonness, Lars Vinje, Vette Thorsen, Rolf Bernt Hansen, Alf John	1:28.85(5)	2:58.34 (4) + 1:29.49	4:29.10(5) + 1:30.76	05:55.08 + 1:25.98
3	GDR	Bogs, Steffen Zuehlke, Steffen Habermann, Heiko Koeppen, Jens	1:26.23(1)	2:56.48 (3) + 1:30.25	4:28.40 (4) + 1:31.92	05:56.13 + 1:27.73
4	URS	Kroupko, Pavel Zaskalko, Alexandre Kiniakine, Serguei Zelikovitch, Iouri	1:26.83(3)	2:56.22 (2) + 1:29.39	4:27.46 (3) + 1:31.24	05:57.18 + 1:29.72
5	AUS	Powell, Richard Terrell, Brenton Reedy, Paul Antonie, Peter	1:29.30 (6)	2:59.16(6) + 1:29.86	4:03.31 (1) + 1:04.15	05:59.15 + 1:55.84
6	FRG	Galandi, Christoph Gruener, Oliver Agricola, Georg Reinke, Andreas	1:28.04(4)	2:58.77(5) + 1:30.73	4:30.98 (6) + 1:32.21	05:59.59 + 1:28.61
Weather/Temps			: sunny			
Wind/Vent			: Velocity/Vitesse = 2.9 m/s Direction = NE			
Temperature			: Air = 18.0 C Water/Eau = 22.5 C			
Air Pressure/Pression Atm.			: 759 mmHg			

Men Four-Oars without coxswain Preliminary Heat 1/Sept. 20			Hommes/Quatre en pointe sans barreur Eliminatoire 1/20 Sept			
Rank Rang	Ctry Pays	Name Nom	500m (R)	1000m (R)	1500m (R)	200m
1	GDR	Brudel, Ralf Foerster, Olaf Greiner, Thomas Schroeder, Roland	1:25.67(1)	2:58.85(1) + 1:33.18	4:31.42(1) + 1:32.57	06:05.65 + 1:34.23
2	ITA	Caropreso, Sergio Gaddi, Carlo Marigliano, Pasquale Molea, Valter	1:28.98(3)	3:03.14(4) + 1:34.16	4:36.19(3) + 1:33.05	06:07.97 + 1:31.78
3	URS	Pimenov, Iouri Pimenov, Nikolai Smirnov, Serguei Vyssotski, Ivan	1:27.60(2)	3:00.14(2) + 1:34.54	4:33.74 (2) + 1:33.60	06:11.15 + 1:37.41
4	SWE	Brundin, Folke Claesson, Per-Olof Larsson, Anders Svensson, David	1:29.35(4)	3:01.82(3) + 1:32.47	4:38.40 (4) + 1:36.58	06:19.12 + 1:40.72
5	GRE	Christomanos, Christos Fotou, Georgios Gatos, Spyridon Lykomitros, Vassilios	1:30.61 (5)	3:09.94 (5) + 1:39.33	4:53.33 (5) + 1:43.39	06:39.28 + 1:45.95
Weather/Temps			: sunny			
Wind/Vent			: Velocity/Vitesse = 0.2 m/s Direction = SW			
Temperature			: Air = 16.2 C Water/Eau = C			
Air Pressure/Pression Atm.			: 1026 mmHg			

Men Four-Oars without coxswain Preliminary Heat 2/Sept. 20			Hommes/Quatre en pointe sans barreur Eliminatoire 2/20 Sept			
Rank Rang	Ctry Pays	Name Nom	500m (R)	1000m (R)	1500m (R)	200m
1	USA	Bohrer, Thomas Kennelly Jr, Richard Krmopotich, David Rodriguez, Raoul	1:26.11 (2)	2:57.76 (2) + 1:31.65	4:31.70(2) + 1:33.94	06:03.67 + 1:31.97
2	NZL	Clayton-Greene, Campbell Cotter, Geoffrey Coventry, William Gibson, Neil	1:24.79(1)	2:56.65(1) + 1:31.86	4:30.85(1) + 1:34.20	06:06.75 + 1:35.90
3	FRG	Grabow, Guido Grabow, Volker Kessler, Norbert Puttlitz, Jorg	1:26.72(3)	2:58.89 (3) + 1:32.17	4:34.17(3) + 1:35.28	06:13.16 + 1:38.99
4	CAN	Berkhout, Darcel Collier, Raymond Ossowski, John Robertson, Bruce	1:27.17(4)	3:02.55 (4) + 1:35.38	4:42.19(4) + 1:39.64	06:22.42 + 1:40.23
5	ESP	Aguirre, Jose Luis Alarcon, Bartolome Briones, Enrique Seguro, Jose Maria	1:28.53(5)	3:05.37 (5) + 1:36.84	4:48.26 (5) + 1:42.89	06:28.34 + 1:40.08
Weather/Temps			: sunny			
Wind/Vent			: Velocity/Vitesse = 1.0 m/s Direction = SSE			
Temperature			: Air = 16.5 C Water/Eau = C			
Air Pressure/Pression Atm.			: 1026 mmHg			

Men Four-Oars without coxswain Preliminary Heat 3/Sept. 20			Hommes/Quatre en pointe sans barreur Eliminatoire 3/20 Sept			
Rank Rang	Ctry Pays	Name Nom	500m (R)	1000m (R)	1500m (R)	200m
1	GBR	Berrisford, Simon Buckingham, Mark Mulkerrins, Peter Peel, Stephen	1:25.92(1)	2:57.10(1) + 1:31.18	4:31.06(1) + 1:33.96	06:06.52 1:35.46
2	FRA	Bahuaud, Pascal Lecoite, Dominique Martigne, Jean Jacqjei Pons, Olivier	1:28.05(2)	3:00.41(2) + 1:32.36	4:34.15(2) + 1:33.74	06:08.76 + 1:34.61
3	HOL	De Vries, Tjark Leutscher, Johannes Scharwz, Ralph Schwarz, Sven	1:28.60(3)	3:02.54(3) + 1:33.94	4:38.55(3) + 1:36.01	06:17.24 + 1:38.69
4	BRA	Arantes, Marcos Fantoni, Fernando Kuster, Oswaldo Trombeta, Waldemar	1:32.68(4)	3:10.11(4) + 1:37.43	4:50.50(4) + 1:40.39	06:29.61 + 1:39.11
5	KOR	Hong, Chul-Ho Lee, Hyung-Ki Yoon, Nam-Ho Yoon, Yong-Ho	1:34.67(5)	3:17.85(5) + 1:43.18	5:02.34(5) + 1:44.49	06:46.62 + 1:44.28
Weather/Temps			: sunny			
Wind/Vent			: Velocity/Vitesse = 1.2 m/s Direction = W			
Temperature			: Air = 16.4 C Water/Eau = C			
Air Pressure/Pression Atm.			: 1022 mmHg			

Rowing

Aviron

Men Four-Oars without coxswain Repechage 1/Sept. 21			Hommes/Quatre en pointe sans barreur Repechage 1/21 Sept			
Rank Rang	Ctry Pays	Name Nom	500m (R)	1000m (R)	1500m (R)	2000m
1	SWE	Brundin, Folke Claesson, Per-Olof Larsson, Anders Svensson, David	1:28.69(2)	3:05.52 (2) + 1:36.83	4:40.18(1) + 1:34.66	06:14.52 +1:34.34
2	CAN	Berkhout, Darcel Collier, Raymond Ossowski, John Robertson, Bruce	1:28.67(1)	3:04.60(1) + 1:35.93	4:41.44(2) + 1:36.84	06:16.88 + 1:35.44
3	GRE	Christomanos, Christos Fotou, Georgios Gatos, Spyridon Lykomitros, Vassilios	1:30.08(3)	3:07.07 (3) + 1:36.99	4:44.51 (4) + 1:37.44	06:17.49 + 1:32.98
4	ESP	Aguirre, Jose Luis Alarcon, Bartolome Briones, Elrique Sehurola, Jose Maria	1:30.76(4)	3:08.67 (4) + 1:37.91	4:43.28 (3) + 1:34.61	06:18.25 + 1:34.97
5	BRA	Arantes, Marcos Fantoni, Fernando Kuster, Oswaldo Trombeta, Waldemar	1:33.79(5)	3:11.98(5) + 1:38.19	4:50.46 (5) + 1:38.48	06:30.85 + 1:40.39
6	KOR	Hong, Chul-Ho Lee, Hyung-Ki Yoon, Nam-Ho Yoon, Yong-Ho	1:35.81 (6)	3:20.19(6) + 1:44.38	5:08.33 (6) + 1:48.14	06:50.47 + 1:42.14
Weather/Temps			: sunny			
Wind/Vent			: Velocity/Vitesse = 0.9 m/s Direction = SW			
Temperature			: Air = 23.4 C Water/Eau = 24.0 C			
Air Pressure/Pression Atm.			: 766 mmHg			

Men Four-Oars without coxswain Semi-final 1/Sept. 22			Hommes/Quatre en pointe sans barreur Demi-finale 1/22 Sept			
Rank Rang	Ctry Pays	Name Nom	500m (R)	1000m (R)	1500m (R)	2000m
1	GDR	Brudel, Ralf Foerster, Olaf Greiner, Thomas Schroeder, Roland	1:25.80 (2)	2:55.72(1) + 1:29.92	4:27.64(1) + 1:31.92	06:00.29 + 1:34.65
2	URS	Pimenov, Iouri Pimenov, Nikolai Smirnov, Serguei Vyssotski, Ivan	1:26.55 (4)	2:57.56 (3) + 1:31.01	4:31.52(3) + 1:33.96	06:03.25 + 1:31.73
3	GBR	Berrisford, Simon Buckingham, Mark Mulkerrins, Peter Peel, Stephen	1:25.50(1)	2:56.64 (2) + 1:31.14	4:30.43 (2) + 1:33.79	06:03.85 + 1:33.42
4	NZL	Clayton-Greene, Campbell Cotter, Geoffrey Coventry, William Gibson, Neil	1:26.19(3)	2:58.94 (4) + 1:32.75	4:33.86 (4) + 1:34.92	06:06.60 + 1:32.74
5	HOL	De Vries, Tjark Leutscher, Johannes Scharwz, Ralph Schwarz, Sven	1:29.10(6)	3:01.11 (5) + 1:32.01	4:37.00 (5) + 1:35.89	06:14.96 +1:37.96
6	CAN	Berkhout, Darcel Collier, Raymond Ossowski, John Robertson, Bruce	1:27.39(5)	3:02.26 (6) + 1:34.87	4:41.83 (6) +1:39.57	06:22.35 + 1:40.52
Weather/Temps			: sunny			
Wind/Vent			: Velocity/Vitesse = 2.3 m/s Direction = SW			
Temperature			: Air = 20.9 C Water/Eau = 23.5 C			
Air Pressure/Pression Atm.			: 766mmHg			

Men Four-Oars without coxswain Petite Final/Sept. 23			Hommes/Quatre en pointe sans barreur Petite Finale/23 Sept			
Rank Rang	Ctry Pays	Name Nom	500m (R)	1000m (R)	1500m (R)	2000m
1	NZL	Clayton-Greene, Campbell Cotter, Geoffrey Coventry, William Gibson, Neil	1:25.50(1)	2:56.02(1) + 1:30.52	4:31.17(1) + 1:35.15	06:04.74 + 1:33.57
2	FRA	Bahuaud, Pascal Lecointe, Dominique Martigne, Jean Jacqjei Pons, Olivier	1:27.00 (2)	2:59.82 (2) + 1:32.82	4:34.91 (2) + 1:35.09	06:08.60 + 1:33.69
3	HOL	De Vries, Tjark Leutscher, Johannes Scharwz, Ralph Schwarz, Sven	1:28.30 (3)	3:02.77(3) + 1:34.47	4:38.74 (3) + 1:35.97	06:15.32 + 1:36.58
4	SWE	Brundin, Folke Claesson, Per-Olof Larsson, Anders Svensson, David	1:29.65(6)	3:03.87(4) + 1:34.22	4:41.63(4) + 1:37.76	06:16.41 + 1:34.78
5	CAN	Berkhout, Darcel Henry, Gordon Ossowski, John Robertson, Bruce	1:28.59(4)	3:04.92 (6) + 1:36.33	4:42.23 (5) + 1:37.31	06:16.74 + 1:34.51
6	GRE	Christomanos, Christos Fotou, Georgios Gatos, Spyridon Lykomitros, Vassilios	1:28.96(5)	3:04.26 (5) + 1:35.30	4:44.60 (6) + 1:40.34	06:18.25 + 1:33.65
Weather/Temps			: sunny			
Wind/Vent			: Velocity/Vitesse = 0.6 m/s Direction = ESE			
Temperature			: Air = 16.7 C Water/Eau = 22.0 C			
Air Pressure/Pression Atm.			: 766 mmHg			

Men Four-Oars without coxswain Semi-final 2/Sept. 22			Hommes/Quatre en pointe sans barreur Demi-finale 2/22 Sept.			
Rank Rang	Ctry Pays	Name Nom	500m (R)	1000m (R)	1500m (R)	2000m
1	FRG	Grabow, Guido Grabow, Volker Kesslau, Norbert Puttlitz, Jorg	1:26.62(1)	2:57.16(1) + 1:30.54	4:30.22(1) + 1:33.06	06:04.17 + 1:33.95
2	ITA	Caropreso, Sergio Gaddi, Carlo Marigliano, Pasquale Molea, Valter	1:27.58 (3)	3:00.40 (3) + 1:34.82	4:33.80 (3) + 1:33.40	06:06.75 + 1:32.95
3	USA	Bohrer, Thomas Kennelly Jr, Richard Krmptich, David Rodriguez, Raoul	1:26.96 (2)	2:58.08 (2) + 1:31.12	4:32.98 (2) +1:34.90	06:07.71 + 1:34.73
4	FRA	Bahuaud, Pascal Lecointe, Dominique Krmptich, David Pons, Olivier	1:27.96(4)	3:01.32(4) + 1:33.36	4:35.60 (4) + 1:34.28	06:10.36 + 1:34.76
5	SWE	Brundin, Folke Claesson, Per-Olof Laraon, Anders Svensson, David	1:28.84 (6)	3:03.19(5) + 1:34.35	4:40.77 (5) + 1:37.58	06:16.28 + 1:35.51
6	GRE	Christomanos, Christos Fotou, Georgios Gatos, Spyridon Lykomitros, Vassilios	1:28.37 (5)	3:07.34 (6) + 1:38.97	4:51.71 (6) +1:44.37	06:37.24 +1:45.53
Weather/Temps			: sunny			
Wind/Vent			: Velocity/Vitesse = 1.7 m/s Direction = S			
Temperature			: Air = 20.5 C Water/Eau = 23.5 C			
Air Pressure/Pression Atm.			: 766 mmHg			



Men Four-Oars without coxswain Final/Sept. 25			Hommes/Quatre en pointe sans barreur Finale/25 Sept			
Rank Rang	Ctry Pays	Name Nom	500m (R)	1000m (R)	1500m (R)	2000m
1	GDR	Schroeder, Roland Greiner, Thomas Brudel, Ralf Foerster, Olaf	1:29.56(1)	3:01.51 (1) + 1:31.95	4:32.47(1) + 1:30.96	06:03.11 + 1:30.64
2	USA	Rodriguez, Raoul Bohrer, Thomas Krmptich, David Kennelly Jr, Richard	1:30.45(2)	3:03.16(2) + 1:32.71	4:35.63 (2) + 1:32.47	06:05.53 + 1:29.90
3	FRG	Kessler, Norbert Grabow, Volker Puttlitz, Jorg Grabow, Guido	1:31.65(4)	3:05.53 (4) + 1:33.88	4:36.22 (3) + 1:30.69	06:06.22 + 1:30.00
4	GBR	Buckingham, Mark Peel, Stephen Berrisford, Simon Mulkerrins, Peter	1:31.18(3)	3:04.48 (3) + 1:33.30	4:37.35 (4) + 1:32.87	06:06.74 + 1:29.39
5	ITA	Caropreso, Sergio Gaddi, Carlo Marigliano, Pasquale Molea, Valter	1:34.46(6)	3:07.20 (5) + 1:32.74	4:38.80 (5) + 1:31.60	06:09.55 + 1:30.75
6	URS	Vyssotski, Ivan Smirnov, Serguei Pimenov, Iouri Pimenov, Nikolai	1:32.19(5)	3:52.01 (6) + 2:19.82		11:03.77

Weather/Temps : sunny
 Wind/Vent : Velocity/Vitesse = 1.8 m/s Direction = NE
 Temperature : Air = 18.4 C Water/Eau = 22.5 C
 Air Pressure/Pression Atm. : 759 mmHg

Men Four-Oars with coxswain Preliminary Heat 2/Sept. 19			Hommes/Quatre en pointe avec barreur Eliminatoire 2/19 Sept			
Rank Rang	Ctry Pays	Name Nom	500m (R)	1000m (R)	1500m (R)	2000m
1	USA	Darling, Tom Huntington, Christopher Terwilliger, John Zembsch, Mark	1:28.95(3)	3:00.12(1) + 1:33.17	4:33.72(1) + 1:33.60	06:08.36 + 1:34.64
2	TCH	Dolecek, Milan Hejdusek, Oldrich Hlidek, Petr Machacek, Dusan Subrt, Michal	1:28.09(1)	3:01.31 (2) + 1:33.22	4:37.07(2) + 1:35.76	06:11.25 + 1:34.18
3	YUG	Banjanac, Vladimir Celent, Zlatko Marusic, Sead Pivac, Lazo Varga, Dario	1:29.49 (4)	3:03.86 (4) + 1:34.37	4:40.51 (4) + 1:36.65	06:12.33 + 1:31.82
4	ESP	Alarcon, Agustin Marguez, Baltasar Oyarzabal, Jose Ramon Urbieto, Ibon Vinolas, Xabier	1:28.54(2)	3:02.91 (3) + 1:34.37	4:39.25 (3) + 1:36.34	06:14.69 + 1:35.44
5	CAN	Backer, Harold Houlding, John Marland, Hobert Paul, Terrence Saunderson, Brian	1:32.04(5)	3:06.06 (5) + 1:34.02	4:42.68 (5) + 1:36.62	06:15.21 + 1:32.53

Weather/Temps : rainy
 Wind/Vent : Velocity/Vitesse = 2.7 m/s Direction = NNW
 Temperature : Air = 20.0 C Water/Eau = C
 Air Pressure/Pression Atm. : mmHg

Men Four-Oars with coxswain Preliminary Heat 1/Sept 19			Hommes/Quatre en pointe avec barreur Eliminatoire 1/19 Sept.			
Rank Rang	Ctry Pays	Name Nom	500m (R)	1000m (R)	1500m (R)	2000m
1	GDR	Eichwurzel, Bernd Klawonn, Frank Niesecke, Bernd Reiher, Hendrik Schmeling, Karsten	1:25.91 (2)	2:57.15(2) + 1:31.24	4:28.96(1) + 1:31.81	06:00.75 + 1:33.79
2	FRG	Baar, Roland Klapheck, Wolfgang Korte, Christoph Luetkefels, Andreas Ruppel, Martin	1:27.81 (3)	3:00.76 (4) + 1:34.95	4:32.12(3) + 1:31.36	06:02.98 + 1:30.86
3	NZL	Bird, Andrew Johnston, Gregory Keys, George White, Christopher Wright, Ian	1:24.90(1)	2:56.33(1) + 1:31.43	4:29.96 (2) + 1:33.63	06:03.35 + 1:33.39
4	ITA	Carando, Giuseppe Massa, Leonardo Maurogiovanni, Antonio Miccoli, Giovanni Lucchetta, Dino	1:28.93(5)	2:59.99 (3) + 1:31.06	4:32.89 (4) + 1:32.90	06:06.09 + 1:33.20
5	GBR	Clift, Adam Cross, Martin Maxey, John Thomas, Vaughan	1:28.49(4)	3:01.97(5) + 1:33.48	4:36.44 (5) + 1:34.47	06:20.89 + 1:44.45

Weather/Temps : cloudy
 Wind/Vent : Velocity/Vitesse = 2.3 m/s Direction = SSW
 Temperature : Air = 20.0 C Water/Eau = C
 Air Pressure/Pression Atm. : mmHg

Men Four-Oars with coxswain Preliminary Heat 3/Sept. 19			Hommes/Quatre en pointe avec barreur Eliminatoire 3/19 Sept			
Rank Rang	Ctry Pays	Name Nom	500m (R)	1000m (R)	1500m (R)	2000m
1	ROM	Gheorghe, Marin Popescu, Dimitrie Robu, Valentin Snep, Ioan Tomoiaaga, Vasile	1:26.59(1)	2:58.53(1) + 1:31.94	4:32.85(1) + 1:34.32	06:10.26 + 1:37.41
2	URS	Koutchinskis, Siguitas Narmontas, Ionas Romanishine, Vladimir Titov, Serguei Zotov, Igor	1:27.20(2)	3:01.62(2) + 1:34.42	4:36.92 (2) + 1:35.30	06:16.53 + 1:39.61
3	SUI	Honegger, Martin Hotz, Marcel Saile, Bruno Schneider, Guenter Weitnauer, Joerg	1:30.83(3)	3:07.05 (3) + 1:36.22	4:46.64 (3) + 1:39.59	06:27.52 + 1:40.88
4	KOR	Chung, Jae-Won Kang, Man-Koo Lee, Tae-Hwa Park, Sung-Lae Yang, Kwang-Jae	1:37.89(4)	3:23.16(4) + 1:45.27	5:11.42(4) + 1:48.26	06:57.99 + :46.57

Weather/Temps : rainy
 Wind/Vent : Velocity/Vitesse = 3.3 m/s Direction =WNW
 Temperature : Air = 20.0 C Water/Eau = C
 Air Pressure/Pression Atm. : mmHg

Rowing

Aviron

Men Four-Oars with coxswain Repechage 1/Sept. 21			Hommes/Quatre en pointe avec barreur Repechage 1/21 Sept			
Rank Rang	Ctry Pays	Name Nom	500m (R)	1000m (R)	1500m (R)	2000m
1	GBR	Clift, Adam Cross, Martin Garrett, John Maxey, John Thomas, Vaughan	1:33.62(3)	3:12.69(1) + 1:39.07	4:43.89(1) + 1:31.20	06:31.11 + 1:47.22
2	ITA	Carando, Giuseppe Massa, Leonardo Maurogiovanni, Antonio Miccoli, Giovanni Lucchetta, Dino	1:33.16(2)	3:13.48(2) + 1:40.32	4:55.58 (2) + 1:42.10	06:32.14 + 1:36.56
3	CAN	Backer, Harold Houlding, John Marland, Robert Paul, Terrence Saunderson, Brian	1:35.41 (4)	3:15.32(4) + 1:39.91	4:58.41 (4) + 1:43.09	06:33.05 + 1:34.64
4	ESP	Alarcon, Agustin Marquez, Baltasar Oyarzabal, Jose Ramon Urbieto, Ibon Vinolas, Xabier	1:32.78(1)	3:14.76(3) + 1:41.98	4:56.77 (3) + 1:42.01	06:34.36 + 1:37.59
5	KOR	Chung, Jae-Won Kang, Man-Koo Lee, Tae-Hwa Park, Sung-Lae Yang, Kwang-Jae	1:40.05(5)	3:32.45 (5) + 1:52.40	5:02.93(5) + 1:30.48	07:19.22 + 2:16.29
Weather/Temps			: sunny			
Wind/Vent			: Velocity/Vitesse = 1.1 m/s Direction = E			
Temperature			: Air = 13.8 C Water/Eau = 22.0 C			
Air Pressure/Pression Atm.			: 767 mmHg			

Men Four-Oars with coxswain Petite Final/Sept. 23			Hommes/Quatre en pointe avec barreur Petite Finale/23 Sept			
Rank Rang	Ctry Pays	Name Nom	500m (R)	1000m (R)	1500m (R)	2000m
1	FRG	Baar, Roland Klapheck, Wolfgang Korte, Christoph Luetkefels, Andreas Ruppel, Martin	1:35.02(2)	3:16.98(2) + 1:41.96	5:02.89 (3) + 1:45.91	06:42.65 + 1:39.76
2	TCH	Dolecek, Milan Hejdusek, Oldrich Hlidek, Petr Machacek, Dusan Subrt, Michal	1:33.93(1)	3:16.11 (1) + 1:42.18	5:01.50(1) + 1:45.39	06:43.64 + 1:42.14
3	CAN	Backer, Harold Houlding, John Marland, Robert Paul, Terrence Saunderson, Brian	1:38.39(4)	3:19.60(4) + 1:41.21	5:04.01 (4) + 1:44.41	06:44.95 + 1:40.94
4	ITA	Carando, Giuseppe Massa, Leonardo Maurogiovanni, Antonio Miccoli, Giovanni Lucchetta, Dino	1:35.94(3)	3:18.10(3) + 1:42.16	5:02.09 (2) + 1:43.99	06:45.39 + 1:43.30
	URS	Koutchinkas, Siguitas Narmontas, Ionas Romanishine, Vladimir Titov, Serguei Zotov, Igor				WDR
	SUI	Honegger, Martin Hotz, Marcel Saile, Bruno Schneider, Guenter Weitnauer, Joerg				WDR
Weather/Temps			: sunny			
Wind/Vent			: Velocity/Vitesse = 2.3 m/s Direction = ESE			
Temperature			: Air = 11.3 C Water/Eau = 22.0 C			
Air Pressure/Pression Atm.			: 766 mmHg			

Men Four-Oars with coxswain Semi-final 1/Sept. 22			Hommes/Quatre en pointe avec barreur Demi-finale 1/22 Sept			
Rank Rang	Ctry Pays	Name Nom	500m (R)	1000m (R)	1500m (R)	2000m
1	GDR	Eichwurz, Bernd Klawonn, Frank Niesecke, Bernd Reiher, Hendrik Schmeling, Karsten	1:27.40(2)	2:59.43 (2) + 1:32.03	4:33.43(1) + 1:34.00	06:07 .91 + 1:34.48
2	ROM	Gheorghe, Marin Popescu, Dimitrie Robu, Valentin Snep, Ioan Tomoaga, Vasile	1:27.01 (1)	2:58.97(1) + 1:31.96	4:35.21 (2) + 1:36.24	06:09.86 + 1:34.65
3	NZL	Bird, Andrew Johnston, Gregory Keys, George White, Christopher Wright, Ian	1:29.63 (5)	3:05.03 (5) + 1:35.40	4:38.05 (3) + 1:33.02	06:10.41 + 1:32.36
4	ITA	Carando, Giuseppe Massa, Leonardo Maurogiovanni, Antonio Miccoli, Giovanni Lucchetta, Dino	1:30.62(6)	3:05.43 (5) + 1:34.81	4:42.54 (5) + 1:37.11	06:15.93 + 1:33.39
5	TCH	Dolecek, Milan Hejdusek, Oldrich Hlidek, Petr Machacek, Dusan Subrt, Michal	1:29.03(4)	3:03.42 (4) + 1:34.39	4:41.35(4) + 1:37.93	06:20.42 + 1:39.07
6	SUI	Honegger, Martin Hotz, Marcel Saile, Bruno Schneider, Guenter Weitnauer, Joerg	1:27.81 (3)	3:00.84 (3) + 1:33.03	5:14.33(6) + 2:13.49	07:55.92 + 2:41.59
Weather/Temps			: sunny			
Wind/Vent			: Velocity/Vitesse = 1.5 m/s Direction = SE			
Temperature			: Air = 23.6 C Water/Eau = 23.5 C			
Air Pressure/Pression Atm.			: 767 mmHg			

Men Four-Oars with coxswain Semi-final 2/Sept. 22			Hommes/Quatre en pointe avec barreur Demi-finale 2/22 Sept			
Rank Rang	Ctry Pays	Name Nom	500m (R)	1000m (R)	1500m (R)	2000m
1	GBR	Clift, Adam Cross, Martin Garrett, John Maxey, John Thomas, Vaughan	1:31.92(5)	3:07.31 (5) + 1:35.39	4:44.22 (5) + 1:36.91	06:15.22 + 1:31.00
2	USA	Darling, Tom Huntington, Christopher Terwilliger, John Walters, John Zembsch, Mark	1:28.07(1)	3:01.66(1) + 1:33.59	4:38.90(1) + 1:37.24	06:15.30 + 1:36.40
3	YUG	Banjanac, Vladimir Celent, Zlatko Marusic, Sead Pivac, Lazo Varga, Dario	1:30.20(4)	3:06.95 (4) + 1:36.75	4:43.02 (4) + 1:36.07	06:15.72 + 1:32.70
4	FRG	Baar, Roland Klapheck, Wolfgang Korte, Christoph Luetkefels, Andreas Ruppel, Martin	1:29.17(3)	3:04.74 (3) + 1:35.57	4:40.80 (2) + 1:36.06	06:15.87 + 1:35.07
5	URS	Koutchinkas, Siguitas Narmontas, Ionas Romanishine, Vladimir Titov, Serguei Zotov, Igor	1:28.66(2)	3:04.24 (2) + 1:35.58	4:41.53(3) + 1:37.29	06:16.69 + 1:35.16
6	CAN	Backer, Harold Houlding, John Marland, Robert Paul, Terrence Saunderson, Brian	1:32.69(6)	3:09.64 (6) + 1:36.95	4:45.33 (6) + 1:35.69	06:17.36 + 1:32.03
Weather/Temps			: sunny			
Wind/Vent			: Velocity/Vitesse = 1.6 m/s Direction = NE			
Temperature			: Air = 24.1 C Water/Eau = 23.5 C			
Air Pressure/Pression Atm.			: 767 mmHg			



Men Four-Oars with coxswain Final/Sept. 24			Hommes/Quatre en pointe avec barreur Finale/24 Sept			
Rank Rang	Ctry Pays	Name Nom	500m (R)	1000m (R)	1500m (R)	2000m
1	GDR	Klawonn, Frank Eichwurz, Bernd Niesecke, Bernd Schmeling, Karsten Reiher, Hendrik	1:30.57(1)	3:05.11 (1) + 1:34.54	4:39.07(1) + 1:33.96	06:10.74 + 1:31.67
2	ROM	Popescu, Dimitrie Snep, Ioan Robu, Valentin Tomoiaga, Vasile Lovrenski, Ladislau	1:31.69(3)	3:07.73 (3) + 1:36.04	4:41.59(2) + 1:33.86	06:13.58 + 1:31.99
3	NZL	Keys, George Wright, Ina Johnston, Gregory White, Christopher Bird, Andrew	1:31.29(2)	3:07.32(2) + 1:36.03	4:42.38(3) + 1:35.06	06:15.78 + 1:33.40
4	GBR	Clift, Adam Maxey, John Garrett, John Cross, Martin Thomas, Vaughan	1:34.25(5)	3:12.10(6) + 1:37.85	4:47.92(6) + 1:35.82	06:18.08 + 1:30.16
5	USA	Tenwilliger, John Huntington, Christopher Darling, Tom Walters, John Zembsch, Mark	1:33.03(4)	3:10.17(4) + 1:37.14	4:45.27(4) + 1:35.10	06:18.47 + 1:33.20
6	YUG	Marusic, Sead Pivac, Lazo Celent, Zlatko Banjanac, Vladimir Varga, Dario	1:34.92(6)	3:10.77(5) + 1:35.85	4:47.18(5) + 1:36.41	06:23.28 + 1:36.10
Weather/Temps			: cloudy			
Wind/Vent			: Velocity/Vitesse = 1.1 m/s Direction = WNW			
Temperature			: Air = 19.9 C Water/Eau = 22.7 C			
Air Pressure/Pression Atm.			: 768 mmHg			

Men Eight-Oars with coxswain Preliminary Heat 1/Sept. 20			Hommes/Huit en pointe avec barreur Eliminatoire 1/20 Sept			
Rank Rang	Ctry Pays	Name Nom	500m (R)	1000m (R)	1500m (R)	2000m
1	URS	Bout, Venea Mine Didouk, Victor Doumtchev, Alexandre Gourkovsky, Pavel Komarov, Nikolai Loukianov, Alexandre Omelianovitch, Victor Tikhanov, Vassili Vassiliev, Andrei	1:20.73(3)	2:44.56 (2) + 1:23.83	4:09.16(1) + 1:24.60	05:34.95 + 1:25.79
2	CAN	Crosby, Andrew Dorland, Jason Main, Gerald Grant McMahon, Robert Brian Neufeld, Kevin Schaffer, Jamie Steele, Paul Telfer, Don Wallace, John	1:19.87(1)	2:45.83 (3) + 1:25.96	4:12.83(3) + 1:27.00	05:36.81 + 1:23.98
3	GBR	Beaumont, Peter Burfitt, Nicholas Dillon, Terence Hassan, Salih Jefferies, Simon Obholzer, Anton Stanhope, Richard Stewart, Gavin Turner, Stephen	1:20.26(2)	2:43.69(1) + 1:23.43	4:11.10(2) + 1:27.41	05:38.18 + 1:27.08
4	ITA	Baldacci, Antonio Bulgarelli, Ettore Carletto, Piero Di Palo, Giuseppe Gaeta, Renato Lucchetta, Dino Suarez, Giovanni Venier, Annibale Zucchi, Franco	1:23.59(5)	2:48.12(4) + 1:24.53	4:15.80(4) + 1:27.68	05:43.11 + 1:27.31
5	KOR	Chung, Boo-Young Chung, In-Kyo Chung, Kwang-Soo Ha, Jin-Sik Hyun, Sung-In Kim, Gap-Sik Koh, Kwang-Sun Lee, Hong-Keun Lim, Jae-Man	1:21.46(4)	3:01.71 (5) + 1:40.25	4:39.89(5) + 1:38.18	06:15.40 + 1:35.51
Weather/Temps			: sunny			
Wind/Vent			: Velocity/Vitesse = 0.7 m/s Direction = WSW			
Temperature			: Air = 10.4 C Water/Eau = C			
Air Pressure/Pression Atm.			: 1022 mmHg			

Men Eight-Oars with coxswain Preliminary Heat 2/Sept. 20			Hommes/Huit en pointe avec barreur Eliminatoire 2/20 Sept			
Rank Rang	Ctry Pays	Name Nom	500m (R)	1000m (R)	1500m (R)	2000m
1	FRG	Domian, Thomas Eichholz, Armin Klein, Manfred Maennig Dr., Wolfgang Mellinghaus, Matthias Moellenkamp, Thomas Rabe, Bahne Schultz, Eckhardt Wessling, Ansgar	1:19.85(1)	2:44.12(2) + 1:24.27	4:07.22(1) + 1:23.10	05:32.36 + 1:25.14
2	AUS	Caterson, Dale Cooper, Andrew Doyle, Mark Evans, Stephen Galloway, James Mckay, Michael Mclachlan, Hamish Popa, Ion Tomkins, James	1:20.27(2)	2:43.08(1) + 1:22.81	4:08.76 (2) + 1:25.68	05:33.94 + 1:25.18
3	USA	Bauer, Seth Burden, Doug Mclaughlin, Jeff Nordell, Peter Patton, Ted Pescatore, John Rusher, John Smith, John Teti, Mike	1:21.61 (4)	2:47.55 (4) + 1:25.94	4:11.36(3) + 1:23.81	05:39.26 + 1:27.90
4	BUL	Alexiev, Roumen Bondev, Emil Dyulguerov, Yuri Guelov, Ivo Kamburski, Dimitar Kantchev, Ventzislav Stanev, Ivan Tontchev, Dimitar Zlatanov, Nikola	1:20.73(3)	2:46.32 (3) + 1:25.59	4:16.45(4) + 1:30.13	05:48.25 + 1:31.80
5	JPN	Abe, Tadashi Chihara, Seiji Hirata, Akihisa Ishikawa, Yukiyasu Kawamoto, Shunsuke Maeguchi, Hideaki Nomura, Masahiko Okano, Tomoyuki Tsukinoki, Eiichi	1:24.74 (5)	2:53.47(5) + 1:28.73	4:24.32 (5) + 1:30.85	05:57.11 + 1:32.79
Weather/Temps			: sunny			
Wind/Vent			: Velocity/Vitesse = 0.5 m/s Direction = SSW			
Temperature			: Air = 18.5 C Water/Eau = C			
Air Pressure/Pression Atm.			: 1022 mmHg			

Men Eight-Oars with coxswain Repechage 1/Sept. 21			Hommes/Huit en pointe avec barreur Repechage 1/21 Sept			
Rank Rang	Ctry Pays	Name Nom	500m (R)	1000m (R)	1500m (R)	2000m
1	USA	Bauer, Seth Burden, Doug Mclaughlin, Jeff Nordell, Peter Patton, Ted Pescatore, John Rusher, John Smith, John Teti, Mike	1:19.82(1)	2:45.11 (1) + 1:25.29	4:10.34(1) + 1:25.23	05:35.63 + 1:25.29
2	CAN	Crosby, Andrew Dorland, Jason Main, Gerald grant McMahon, Robert brian Neufeld, Kevin Schaffer, Jamie Steele, Paul Telfer, Don Wallace, John	1:21.46(3)	2:49.72 (3) + 1:28.26	4:14.88(3) + 1:25.16	05:37.06 + 1:22.18
3	ITA	Baldacci, Antonio Bulgarelli, Ettore Carletto, Piero Di palo, Giuseppe Gaeta, Renato Lucchetta, Dino Suarez, Giovanni Venier, Annibale Zucchi, Franco	1:20.53(2)	2:46.37(2) + 1:25.84	4:13.15(2) + 1:26.78	05:39.86 + 1:26.71
4	JPN	Abe, Tadashi Chihara, Seiji Hirata, Akihisa Ishikawa, Yukiyasu Kawamoto, Shunsuke Maeguchi, Hideaki Nomura, Masahiko Okano, Tomoyuki Tsukinoki, Eiichi	1:26.22(4)	2:56.64 (4) + 1:30.42	4:25.49 (4) + 1:28.85	05:54.16 + 1:28.67
Weather/Temps			: sunny			
Wind/Vent			: Velocity/Vitesse = 0.6 m/s Direction = SSW			
Temperature			: Air = 23.1C Water/Eau = 24.0 C			
Air Pressure/Pression Atm.			: 766 mmHg			

Rowing

Aviron

Men Eight-Oars with coxswain Repechage 2/Sept. 21				Hommes/Huit en pointe avec barreur Repechage 2/21 Sept			
Rank Rang	Ctry Pays	Name Nom	500m (R)	1000m (R)	1500m (R)	2000m	
1	GBR	Beaumont, Peter Burfitt, Nicholas Dillon, Terence Hassan, Salih Jefferies, Simon Obholzer, Anton Stanhope, Richard Stewart, Gavin Turner, Stephen	1:20.90(1)	2:44.84(1) + 1:23.94	4:10.40(1) + 1:25.56	05:35.15 + 1:24.75	
2	AUS	Caterson, Dale Cooper, Andrew Doyle, Mark Evans, Stephen Galloway, James Mckay, Michael Mclachlan, Hamish Popa, Ion Tomkins, James	1:21.27(2)	2:45.77 (2) + 1:24.50	4:12.17(2) + 1:26.40	05:37.75 + 1:25.58	
3	BUL	Alexiev, Roumen Bondev, Emil Dyulguerov, Yuri Guelov, Ivo Kamburski, Dimitar Kantchev, Ventzislav Stanev, Ivan Tontchev, Dimitar Zlatanov, Nikola	1:22.19(3)	2:49.65 (3) + 1:27.46	4:16.90(3) + 1:27.25	05:40.93 +1:24.03	
4	KOR	Chung, Boo-Young Chung, In-Kyo Chung, Kwang-Soo Ha, Jin-Sik Hyun, Sung-In Kim, Gap-Sik Koh, Kwang-Sun Lee, Hong-Keun Lim, Jae-Man	1:31.16(4)	3:09.18(4) +1:38.02	4:47.00 (4) + 1:37.82	06:17.81 + 1:30.81	
			Weather/Temps	: sunny			
			Wind/Vent	: Velocity/Vitesse = 2.6 m/s Direction = W			
			Temperature	: Air = 23.4 C Water/Eau = 24.0 C			
			Air Pressure/Pression Atm.	: 766 mmHg			

Men Eight-Oars with coxswain Petite Final/Sept. 23				Hommes/Huit en pointe avec barreur Petite Final/23 Sept			
Rank Rang	Ctry Pays	Name Nom	500m (R)	1000m (R)	1500m (R)	2000m	
1	ITA	Baldacci, Antonio Bulgarelli, Ettore Carletto, Piero Di Palo, Giuseppe Gaeta, Renato Lucchetta, Dino Suarez, Giovanni Venier, Annibale Zucchi, Franco	1:21.59(2)	2:46.52(1) + 1:24.93	4:14.16(1) + 1:27.64	05:41.15 + 1:26.99	
2	BUL	Alexiev, Roumen Bondev, Emil Dyulguerov, Yuri Guelov, Ivo Kamburski, Dimitar Kantchev, Ventzislav Stanev, Ivan Tontchev, Dimitar Zlatanov, Nikola	1:21.32(1)	2:47.72 (2) + 1:26.40	4:18.10(2) + 1:30.38	05:49.99 + 1:31.89	
3	JPN	Abe, Tadashi Chihara, Seiji Hirata, Akihisa Ishikawa, Yukiyasu Kawamoto, Shunsuke Maeguchi, Hideaki Nomura, Masahiko Okano, Tomoyuki Tsukinoki, Eiichi	1:26.49 (3)	2:54.69 (3) + 1:28.20	4:24.83 (3) + 1:30.14	05:55.52 + 1:30.69	
4	KOR	Chung, Boo-Young Chung, In-Kyo Chung, Kwang-Soo Ha, Jin-Sik Hyun, Sung-In Kim, Gap-Sik Koh, Kwang-Sun Lee, Hong-Keun Lim, Jae-Man	1:27.83 (4)	3:02.40 (4) + 1:34.57	4:40.03 (4) + 1:37.63	06:16.73 + 1:36.70	
			Weather/Temps	: sunny			
			Wind/Vent	: Velocity/Vitesse = 1.1 m/s Direction = W			
			Temperature	: Air = 19.4 C Water/Eau = 22.0 C			
			Air Pressure/Pression Atm.	: 766 mmHg			

Men Eight-Oars with coxswain Final/Sept. 25				Hommes/Huit en pointe avec barreur Finale/25 Sept			
Rank Rang	Ctry Pays	Name Nom	500m (R)	1000m (R)	1500m (R)	2000m	
1	FRG	Moellenkamp, Thomas Mellinghaus, Matthias Schultz, Eckhardt Wessling, Ansgar Eichholz, Armin Domian, Thomas Maennig Dr., Wolfgang Rabe, Bahne Klein, Manfred	1:24.80 (2)	2:52.68 (3) + 1:27.88	4:20.32(1) + 1:27.64	05:46.05 + 1:25.73	
2	URS	Bout, Venea mine Komarov, Nikolai Tikhanov, Vassili Doutmchev, Alexandre Gourkovsky, Pavel Didouk, Victor Omelianovitch, Victor Vassiliev, Andrei Loukianov, Alexandre	1:25.15(3)	2:52.29 (2) + 1:27.14	4:22.91 (3) + 1:30.62	05:48.01 + 1:25.10	
3	USA	Teti, Mike Smith, John Patton, Ted Rusher, John Nordell, Peter Mclaughlin, Jeff Burden, Doug Pescatore, John Bauer, Seth	1:24.46(1)	2:51.89(1) + 1:27.43	4:21.22(2) + 1:29.33	05:48.26 + 1:27.04	
4	GBR	Stanhope, Richard Obholzer, Anton Beaumont, Peter Stewart, Gavin Dillon, Terence Hassan, Salih Turner, Stephen Burfitt, Nicholas Jefferies, Simon	1:25.50 (4)	2:53.44 (4) + 1:27.94	4:24.06 (4) + 1:30.62	05:51.59 + 1:27.53	
5	AUS	Galloway, James Mclachlan, Hamish Cooper, Andrew Mckay, Michael Doyle, Mark Tomkins, James Popa, Ion Evans, Stephen Caterson, Dale	1:26.26 (6)	2:56.48 (6) + 1:30.22	4:27.59 (6) + 1:31.11	05:53.73 + 1:26.14	
6	CAN	Telfer, Don Neufeld, Kevin Dorland, Jason Crosby, Andrew Steele, Paul Main, Gerald Grant Schaffer, Jamie Wallace, John McMahon, Robert Brian	1:25.85(5)	2:56.15(5) + 1:30.30	4:26.65 (5) + 1:30.50	05:54.26 + 1:27.61	
			Weather/Temps	: cloudy			
			Wind/Vent	: Velocity/Vitesse = 3.9 m/s Direction = NE			
			Temperature	: Air = 18.1 C Water/Eau = 22.5 C			
			Air Pressure/Pression Atm.	: 759 mmHg			

Women Single Sculls Preliminary Heat 1/Sept. 20				Femmes/Une rameuse Eliminatoire 1/20 Sept			
Rank Rang	Ctry Pays	Name Nom	500m (R)	1000m (R)	1500m (R)	2000m	
1	USA	Marden, Anne	1:52.17(1)	3:51.75(1) + 1:59.58	5:54.55(1) + 2:02.80	08:01.55 + 2:07.00	
2	DEN	Pors, Inger	1:56.63 (3)	3:58.74 (2) + 2:02.11	6:03.06 (2) + 2:04.32	08:09.55 + 2:06.49	
3	CAN	Hattin, Heather	2:03.26 (5)	4:03.55 (4) + 2:00.29	6:07.75 (3) + 2:04.20	08:15.04 + 2:07.29	
4	TCH	Loukotova, Michaela	1:58.04 (4)	4:02.30 (3) + 2:04.26	6:09.17(4) + 2:06.87	08:17.80 + 2:08.63	
5	SWE	Larsson, Annelie	1:55.66(2)	4:04.71 (5) + 2:09.05	6:16.53(5) + 2:11.82	08:29.70 + 2:13.17	
			Weather/Temps	: sunny			
			Wind/Vent	: Velocity/Vitesse = 0.9 m/s Direction = SE			
			Temperature	: Air = 10.7 C Water/Eau = C			
			Air Pressure/Pression Atm.:	: 1026mmHg			



Women Single Sculls Preliminary Heat 2/Sept. 20			Femmes/Une rameuse Eliminatoire 2/20 Sept			
Rank Rang	Ctry Pays	Name Nom	500m (R)	1000m (R)	1500m (R)	2000m
1	GDR	Behrendt, Jutta	1:49.33(1)	3:50.46(1) + 2:01.13	5:52.23(1) + 2:01.77	07:51.44 + 1:59.21
2	ROM	Popesou, Marioara	1:52.98(3)	3:54.31 (3) + 2:01.33	5:55.40 (2) + 2:01.09	07:53.75 + 1:58.35
3	HOL	Van ettekoven, Harriet	1:54.39 (4)	3:55.54 (4) + 2:01.15	5:58.09 (4) + 2:02.55	07:56.80 + 1:58.71
4	URS	Kvacha, Natalia	1:50.79(2)	3:52.91 (2) + 2:02.12	5:56.46 (3) + 2:03.55	07:59.95 + 2:03.49
Weather/Temps			: sunny			
Wind/Vent			: Velocity/Vitesse = 0.7 m/s Direction = SE			
Temperature			: Air = 10.7 C Water/Eau = C			
Air Pressure/Pression Atm.			: 1026 mmHg			

Women Single Sculls Preliminary Heat 3/Sept. 20			Femmes/Une rameuse Eliminatoire 3/20 Sept			
Rank Rang	Ctry Pays	Name Nom	500m (R)	1000m (R)	1500m (R)	2000m
1	BUL	Gueorguieva, Magdalena	1:48.24(1)	3:49.11 (1) + 2:00.87	5:50.72(1) + 2:01.61	07:50.64 + 1:59.92
2	BEL	Defauw, Rita	1:54.29 (2)	3:57.73 (2) + 2:03.44	6:03.32 (2) + 2:05.59	08:09.25 + 2:05.93
3	GRE	Zweir, Antonia	1:56.83(3)	4:00.08 (3) + 2:05.25	6:05.36 (3) + 2:05.28	08:12.13 + 2:06.77
4	FRA	Briero, Lydie	2:00.12(4)	4:10.18(4) + 2:10.06	6:20.65 (4) + 2:10.47	08:28.75 + 2:08.10
Weather/Temps			: sunny			
Wind/Vent			: Velocity/Vitesse = 0.7 m/s Direction = E			
Temperature			: Air = 11.5 C Water/Eau = C			
Air Pressure/Pression Atm.			: 1026 mmHg			

Women Single Sculls Repechage 1/Sept. 21			Femmes/Une rameuse Repechage 1/21 Sept			
Rank Rang	Ctry Pays	Name Nom	500m (R)	1000m (R)	1500m (R)	2000m
1	URS	Kvacha, Natalia	1:54.27(1)	3:53.94(1) + 1:59.67	5:58.56(1) + 2:04.62	08:06.11 + 2:07.55
2	TCH	Loukotova, Michaela	1:58.11 (3)	4:03.70 (2) + 2:05.59	6:08.30 (2) + 2:04.60	08:15.63 + 2:07.33
3	SWE	Larsson, Annelie	1:59.23(4)	4:05.10(3) + 2:05.87	6:11.29(3) + 2:06.19	08:20.20 + 2:08.91
4	FRA	Briero, Lydie	1:57.79(2)	4:07.05 (4) + 2:09.26	6:16.88(4) + 2:09.83	08:26.86 + 2:09.98
Weather/Temps			: sunny			
Wind/Vent			: Velocity/Vitesse = 0.9 m/s Direction = SSW			
Temperature			: Air = 22.2 C Water/Eau = 24.0 C			
Air Pressure/Pression Atm.			: 767 mmHg			

Women Single Sculls Petite Final/Sept. 23			Femmes/Une rameuse Petite Finale/23 Sept			
Rank Rang	Ctry Pays	Name Nom	500m (R)	1000m (R)	1500m (R)	2000m
1	GRE	Zweir, Antonia	1:54.70(2)	3:56.40 (3) + 2:01.70	5:59.26 (3) + 2:02.86	07:57.73 + 1:58.47
2	URS	Kvacha, Natalia	1:52.33(1)	3:54.42(1) + 2:02.09	5:57.53(1) + 2:03.11	08:00.73 + 2:03.20
3	BEL	Defauw, Rita	1:55.18(3)	3:55.21 (2) + 2:00.03	5:58.38 (2) + 2:03.17	08:04.90 + 2:06.52
4	CAN	Hattin, Heather	1:56.27 (4)	4:00.09 (4) + 2:05.82	6:05.40 (4) + 2:05.31	08:08.69 + 2:03.29
5	SWE	Larsson, Annelie	1:57.50(6)	4:02.22 (5) + 2:04.72	6:08.94 (5) + 2:06.72	08:11.69 + 2:02.75
6	TCH	Loukotova, Michaela	1:56.86(5)	4:02.96 (6) + 2:06.10	6:10.43(6) + 2:07.47	08:14.02 + 2:03.59
Weather/Temps			: sunny			
Wind/Vent			: Velocity/Vitesse = 0.6 m/s Direction = ENE			
Temperature			: Air = 14.2 C Water/Eau = 22.0 C			
Air Pressure/Pression Atm.			: 766 mmHg			

Women Single Sculls Semi-final 1/Sept. 22			Femmes/Une rameuse Demi-finale 1/22 Sept			
Rank Rang	Ctry Pays	Name Nom	500m (R)	1000m (R)	1500m (R)	2000m
1	GDR	Behrendt, Jutta	1:46.88(1)	3:42.37(1) + 1:55.49	5:39.08(1) + 1:56.71	07:37.69 + 1:58.61
2	USA	Marden, Anne	1:48.70(2)	3:43.42 (2) + 1:54.72	5:40.79 (2) + 1:57.37	07:40.51 + 1:59.72
3	HOL	Van ettekoven, Harriet	1:51.13(3)	3:47.53 (3) + 1:56.40	5:46.90 (3) + 1:59.37	07:48.84 + 2:01.94
4	CAN	Hattin, Heather	1:54.69 (5)	3:54.85 (5) + 2:00.16	5:55.76 (4) + 2:00.91	07:56.97 + 2:01.21
5	BEL	Defauw, Rita	1:51.95(4)	3:51.11 (4) + 1:59.16	5:57.54 (5) + 2:06.43	08:07.95 + 2:10.41
6	SWE	Larsson, Annelie	1:56.33(6)	3:59.23 (6) + 2:02.90	6:06.57 (6) + 2:07.34	08:11.21 + 2:04.64
Weather/Temps			: sunny			
Wind/Vent			: Velocity/Vitesse = 1.6 m/s Direction = WNW			
Temperature			: Air = 23.2 C Water/Eau = 23.5 C			
Air Pressure/Pression Atm.			: 766 mmHg			

Women Single Sculls Semi-final 2/Sept. 22			Femmes/Une rameuse Demi-finale 2/22 Sept			
Rank Rang	Ctry Pays	Name Nom	500m (R)	1000m (R)	1500m (R)	2000m
1	BUL	Gueorguieva, Magdalena	1:44.20(1)	3:39.69(1) + 1:55.49	5:38.59(1) + 1:58.90	07:35.47 + 1:56.88
2	ROM	Popesou, Marioara	1:48.17(2)	3:45.61 (2) + 1:57.44	5:44.95 (2) + 1:59.34	07:39.93 + 1:54.98
3	DEN	Pors, Inger	1:52.85(5)	3:50.07 (4) + 1:57.22	5:46.37 (3) + 1:56.30	07:42.76 + 1:56.39
4	URS	Kvacha, Natalia	1:49.71 (3)	3:47.85 (3) + 1:58.14	5:47.51 (4) + 1:59.66	07:45.50 + 1:57.99
5	GRE	Zweir, Antonia	1:51.91 (4)	3:50.45 (5) + 1:58.54	5:52.40 (5) + 2:01.95	07:49.15 + 1:56.75
6	TCH	Loukotova, Michaela	1:53.55 (6)	3:57.32 (6) + 2:03.77	6:03.40 (6) + 2:06.08	08:08.04 + 2:04.64
Weather/Temps			: sunny			
Wind/Vent			: Velocity/Vitesse = 1.3 m/s Direction = W			
Temperature			: Air = 23.2 C Water/Eau = 23.5 C			
Air Pressure/Pression Atm.			: 765 mmHg			

Women Single Sculls Final/Sept. 25			Femmes/Une rameuse Finale/25 Sept			
Rank Rang	Ctry Pays	Name Nom	500m (R)	1000m (R)	1500m (R)	2000m
1	GDR	Behrendt, Jutta	1:46.53(2)	3:44.60 (2) + 1:58.07	5:43.15(2) + 1:58.55	07:47.19 + 2:04.04
2	USA	Marden, Anne	1:51.05 (4)	3:48.80 (3) + 1:57.75	5:46.53 (3) + 1:57.73	07:50.28 + 2:03.75
3	BUL	Gueorguieva, Magdalena	1:46.02(1)	3:42.57(1) + 1:56.55	5:40.29(1) + 1:57.72	07:53.65 + 2:13.36
4	HOL	Van ettekoven, Harriet	1:55.03(5)	3:58.17(5) + 2:03.14	5:59.13(6) + 2:00.96	07:57.29 + 1:58.16
5	ROM	Popesou, Marioara	1:50.15(3)	3:54.92 (4) + 2:04.77	5:57.17(4) + 2:02.25	07:59.44 + 2:02.27
6	DEN	Pors, Inger	1:55.78(6)	3:59.25 (6) + 2:03.47	5:57.98 (5) + 1:58.73	07:59.77 + 2:01.79
Weather/Temps			: cloudy			
Wind/Vent			: Velocity/Vitesse = 1.5 m/s Direction = ENE			
Temperature			: Air = 17.9 C Water/Eau = 22.5 C			
Air Pressure/Pression Atm.			: 760 mmHg			

Rowing

Aviron

Women Double Sculls Preliminary Heat 1/Sept. 19			Femmes/Deux rameuses en couple Eliminatoire 1/19 Sept			
Rank Rang	Ctry Pays	Name Nom	500m (R)	1000m (R)	1500m (R)	2000m
1	ROM	Genes, Liliana Lipa, Elisabeta	1:41.08(1)	3:35.17(1) +1:54.09	5:33.19(1) + 1:58.02	07:30.09 + 1:56.90
2	URS	Joukova, Marina Omelianovitch, Maria	1:47.10(2)	3:44.57 (2) +1:57.47	5:41.27(2) +1:56.70	07:35.82 + 1:54.55
3	SWE	Brandin, Maria Gustafsson, Carina	1:50.02(4)	3:46.33 (3) +1:56.31	5:42.87 (3) + 1:56.54	07:38.14 + 1:55.27
4	USA	Havelka, Monica Tippett, Cathy	1:51.79(5)	3:48.67 (5) + 1:56.88	5:44.64 (4) + 1:55.97	07:38.62 + 1:53.98
5	CAN	Laumann, Silken Worthington, Kay	1:49.51 (3)	3:47.67 (4) + 1:58.16	5:46.29 (5) + 1:58.62	07:46.89 + 2:00.60
Weather/Temps			: cloudy			
Wind/Vent			: Velocity/Vitesse = 1.9 m/s Direction = SE			
Temperature			: Air = 20.0 C Water/Eau = C			
Air Pressure/Pression Atm.			: mmHg			

Women Double Sculls Preliminary Heat 2/Sept. 19			Femmes/Deux rameuses en couple Eliminatoire 2/19 Sept			
Rank Rang	Ctry Pays	Name Nom	500m (R)	1000m (R)	1500m (R)	2000m
1	GDR	Peter, Birgit Schroeter, Martina	1:43.84(1)	3:37.80(1) + 1:53.96	5:32.72(1) + 1:54.92	07:25.95 + 1:53.23
2	BUL	Madina, Stefka Ninova, Violeta	1:45.30(2)	3:41.80(2) + 1:56.50	5:38.26 (2) + 1:56.46	07:32.82 + 1:54.56
3	CHN	Cao, Mianying Guo, Mei	1:46.85(3)	3:43.98 (3) + 1:57.13	5:41.50(3) + 1:57.52	07:39.20 + 1:57.70
4	GBR	Andreae, Sally Gill, Alison	1:53.08(4)	3:55.38 (4) + 2:02.30	5:57.97 (4) + 2:02.59	08:01.34 + 2:03.37
5	KOR	Chang, Myung-Hee Han, Hye-soon	1:57.67(5)	4:05.30 (5) + 2:07.63	6:14.09(5) + 2:08.79	08:16.55 + 2:02.46
Weather/Temps			: cloudy			
Wind/Vent			: Velocity/Vitesse = 1.9 m/s Direction = ESE			
Temperature			: Air = 20.0 C Water/Eau = C			
Air Pressure/Pression Atm.			: mmHg			

Women Double Sculls Repechage 1/Sept. 21			Femmes/Deux rameuses en couple Repechage 1/21 Sept			
Rank Rang	Ctry Pays	Name Nom	500m (R)	1000m (R)	1500m (R)	2000m
1	URS	Joukova, Marina Omelianovitch, Maria	1:47.59(2)	3:43.61 (2) + 1:56.02	5:37.49(1) + 1:53.88	07:30.00 + 1:52.51
2	CHN	Cao, Mianying Guo, Mei	1:47.10(1)	3:42.76(1) + 1:55.66	5:38.10(2) + 1:55.34	07:32.39 + 1:54.29
3	CAN	Laumann, Silken Worthington, Kay	1:52.10(3)	3:48.22 (3) + 1:56.12	5:43.07 (3) + 1:54.85	07:36.80 + 1:53.73
4	GBR	Andreae, Sally Gill, Alison	1:53.57(4)	3:55.96 (4) + 2:02.39	5:59.31 (4) + 2:03.35	07:59.75 + 2:00.44
Weather/Temps			: sunny			
Wind/Vent			: Velocity/Vitesse = 1.8 m/s Direction = ESE			
Temperature			: Air = 11.1 C Water/Eau = 22.0 C			
Air Pressure/Pression Atm.			: 767 mmHg			

Women Double Sculls Repechage 2/Sept. 21			Femmes/Deux rameuses en couple Repechage 2/21 Sept			
Rank Rang	Ctry Pays	Name Nom	500m (R)	1000m (R)	1500m (R)	2000m
1	BUL	Madina, Stefka Ninova, Violeta	1:46.30(1)	3:41.94(1) + 1:55.64	5:34.47 (1) + 1:52.53	07:24.96 + 1:50.49
2	USA	Havelka, Monica Tippett, Cathy	1:50.97(3)	3:46.56 (3) + 1:55.59	5:39.14(3) + 1:52.58	07:29.52 + 1:50.38
3	SWE	Brandin, Maria Gustafsson, Carina	1:48.03(2)	3:44.51 (2) + 1:56.48	5:38.69 (2) + 1:54.18	07:30.23 + 1:51.54
4	KOR	Chang, Myung-Hee Han, Hye-soon	1:56.11(4)	4:03.86 (4) + 2:07.75	6:10.55(4) + 2:06.69	08:13.57 + 2:03.02
Weather/Temps			: sunny			
Wind/Vent			: Velocity/Vitesse = 1.5 m/s Direction = ESE			
Temperature			: Air = 11.8 C Water/Eau = 22.0 C			
Air Pressure/Pression Atm.			: 767 mmHg			

Women Double Sculls Petite Final/Sept. 23			Femmes/Deux rameuses en couple Petite Finale/23 Sept			
Rank Rang	Ctry Pays	Name Nom	500m (R)	1000m (R)	1500m (R)	2000m
1	CAN	Laumann, Silken Worthington, Kay	1:49.36(1)	3:50.64(1) + 2:01.28	5:55.46(1) + 2:04.82	08:03.56 + 2:08.10
2	SWE	Brandin, Maria Gustafsson, Carina	1:50.50(2)	3:51.61 (2) + 2:01.11	5:59.43 (2) + 2:07.82	08:09.35 + 2:09.92
3	GBR	Andreae, Sally Gill, Alison	1:51.98(3)	3:56.82 (3) + 2:04.84	6:07.84 (3) + 2:11.02	08:15.70 + 2:07.86
4	KOR	Chang, Myung-Hee Han, Hye-Soon	1:59.46(4)	4:17.48(4) + 2:18.02	6:42.38(4) + 2:24.90	08:58.45 + 2:16.07
Weather/Temps			: sunny			
Wind/Vent			: Velocity/Vitesse = 3.7 m/s Direction = ESE			
Temperature			: Air = 10.4 C Water/Eau = 22.0 C			
Air Pressure/Pression Atm.			: 766 mmHg			

Women Double Sculls Final/Sept. 24			Femmes/Deux rameuses en couple Finale/24 Sept			
Rank Rang	Ctry Pays	Name Nom	500m (R)	1000m (R)	1500m (R)	2000m
1	GDR	Peter, Birgit Schroeter, Martina	1:39.86(1)	3:26.23(1) + 1:46.37	5:13.90(1) + 1:47.67	07:00.48 + 1:48.58
2	ROM	Lipa, Elisabeta Cogeanu, Veronica	1:40.32(2)	3:28.09 (2) + 1:47.77	5:16.47(2) + 1:48.38	07:04.36 + 1:47.89
3	BUL	Ninova, Violeta Madina, Stefka	1:42.80(3)	3:32.24 (3) + 1:49.44	5:19.23(3) + 1:46.99	07:06.03 + 1:46.80
4	URS	Joukova, Marina Omelianovitch, Maria	1:43.63(4)	3:34.02 (4) + 1:50.39	5:24.84 (4) + 1:50.82	07:12.67 + 1:47.83
5	CHN	Guo, Mei Cao, Mianying	1:44.67(5)	3:34.98 (5) + 1:50.31	5:28.32 (5) + 1:53.34	07:18.69 + 1:50.37
6	USA	Havelka, Monica Tippett, Cathy	1:48.25(6)	3:38.15(6) + 1:49.90	5:30.88 (6) + 1:52.73	07:21.28 + 1:50.40
Weather/Temps			: sunny			
Wind/Vent			: Velocity/Vitesse = 1.4 m/s Direction = E			
Temperature			: Air = 20.2 C Water/Eau = 22.7 C			
Air Pressure/Pression Atm.			: 768 mmHg			

Women Pair-Oars without coxswain Preliminary Heat 1/Sept. 19			Femmes/Deux en pointe sans barreuse Eliminatoire 1/19 Sept			
Rank Rang	Ctry Pays	Name Nom	500m (R)	1000m (R)	1500m (R)	2000m
1	GDR	Schroeder, Katrin Spittler, Kerstin	1:53.66(3)	3:56.07 (3) + 2:02.41	5:59.59 (2) + 2:03.52	07:59.10 + 1:59.51
2	NZL	Hannen, Lynley Payne, Nicola	1:52.43(2)	3:54.63(1) + 2:02.20	5:58.50(1) + 2:03.87	08:02.39 + 2:03.89
3	USA	Keggi, Mara Kirch, Barbara	1:54.60(4)	4:00.00 (4) + 2:07.40	6:09.21 (4) + 2:09.21	08:16.85 + 2:07.64
4	URS	Smorodina, Marina Stone, Sarmite	1:50.31(1)	3:55.32(2) + 2:05.01	6:07.97 (3) + 2:12.65	08:23.68 + 2:15.71
5	KOR	Kong, Jeong-Bae Lee, Byung-In	2:01.83(5)	4:13.70(5) + 2:11.87	6:27.16(5) + 2:13.46	08:34.90 + 2:07.74
Weather/Temps			: cloudy			
Wind/Vent			: Velocity/Vitesse = 2.5 m/s Direction = SE			
Temperature			: Air = 20.0 C Water/Eau = C			
Air Pressure/Pression Atm.			: mmHg			

Women Pair-Oars without coxswain Preliminary Heat 2/Sept. 19			Femmes/Deux en pointe sans barreuse Eliminatoire 2/19 Sept			
Rank Rang	Ctry Pays	Name Nom	500m (R)	1000m (R)	1500m (R)	2000m
1	ROM	Arba, Rodica Homeghi, Olga	1:47.44(1)	3:43.96(1) + 1:56.52	5:42.14(1) + 1:58.18	07:42.53 + 2:00.39
2	BUL	Berberova, Lalka Stoyanova, Radka	1:51.96(2)	3:48.09 (2) + 1:56.13	5:47.54 (2) + 1:59.45	07:48.68 + 2:01.14
3	CAN	Barnes, Jennifer Kirsten Ogilvie, Sarah ann	1:58.93(4)	4:03.95 (3) + 2:05.02	6:07.77 (3) + 2:03.82	08:09.51 + 2:01.74
4	GBR	Bonner, Alison Thomas, Kim	1:58.45(3)	4:04.97 (4) + 2:06.52	6:12.19(4) + 2:07.22	08:14.52 + 2:02.33
5	FRG	Kampf, Bettina Keller, Cordula	2:01.49(5)	4:08.24 (5) + 2:06.75	6:14.43(5) + 2:06.19	08:19.76 + 2:05.33
Weather/Temps			: cloudy			
Wind/Vent			: Velocity/Vitesse = 1.6 m/s Direction = ESE			
Temperature			: Air = 21.0 C Water/Eau = C			
Air Pressure/Pression Atm.			: mmHg			

**Women Pair-Oars without coxswain
Repechage 1/Sept. 21**

Rank Rang	Ctry Pays	Name Nom	500m (R)	1000m (R)	1500m (R)	2000m
1	NZL	Hannen, Lynley Payne, Nicola	1:52.05(2)	3:54.44 (2) + 2:02.39	5:56.89(1) + 2:02.45	07:59.93 + 2:03.04
2	URS	Smorodina, Marina Stone, Sarmite	1:51.45(1)	3:53.59(1) + 2:02.14	6:00.50 (2) + 2:08.91	08:07.67 + 2:07.17
3	CAN	Barnes, Jennifer Kirsten Ogilvie, Sarah ann	1:57.35(3)	4:02.93 (3) + 2:05.58	6:09.57 (3) + 2:06.64	08:11.49 + 2:01.92
4	FRG	Kampf, Bettina Keller, Cordula	1:57.69(4)	4:03.69 (4) + 2:06.00	6:11.97(4) + 2:08.28	08:20.13 + 2:08.16
Weather/Temps			: sunny			
Wind/Vent			: Velocity/Vitesse = 1.9 m/s Direction = ESE			
Temperature			: Air = 12.4 C Water/Eau = 22.0 C			
Air Pressure/Pression Atm.			: 768 mmHg			

**Women Pair-Oars without coxswain
Repechage 2/Sept. 21**

Rank Rang	Ctry Pays	Name Nom	500m (R)	1000m (R)	1500m (R)	2000m
1	BUL	Berberova, Lalka Stoyanova, Radka	1:49.29(1)	3:47.75(1) + 1:58.46	5:49.04(1) + 2:01.29	07:50.94 + 2:01.90
2	USA	Keggi, Mara Kirch, Barbara	1:52.35 (2)	3:54.76 (2) + 2:02.41	5:59.60 (2) + 2:04.84	08:05.55 + 2:05.95
3	GBR	Bonner, Alison Thomas, Kim	1:53.09 (3)	3:57.47 (3) + 2:04.38	6:05.40 (3) + 2:07.93	08:13.13 + 2:07.73
4	KOR	Kong, Jeong-Bae Lee, Byung-In	1:57.32(4)	4:03.35 (4) + 2:06.03	6:12.47(4) + 2:09.12	08:18.62 + 2:06.15
Weather/Temps			: sunny			
Wind/Vent			: Velocity/Vitesse = 1.6 m/s Direction = ESE			
Temperature			: Air = 12.8 C Water/Eau = 22.0 C			
Air Pressure/Pression Atm.			: 767 mmHg			

**Women Pair-Oars without coxswain
Petite Final/Sept. 23**

Rank Rang	Ctry Pays	Name Nom	500m (R)	1000m (R)	1500m (R)	2000m
1	CAN	Barnes, Jennifer-Kirsten Ogilvie, Sarah ann	1:56.54(2)	3:58.85 (2) + 2:02.31	6:03.41 (1) + 2:04.56	08:09.10 + 2:05.69
2	GBR	Bonner, Alison Thomas, Kim	1:55.40(1)	3:57.95(1) + 2:02.55	6:04.59 (2) + 2:06.64	08:15.20 + 2:10.61
3	FRG	Kampf, Bettina Keller, Cordula	1:57.43(3)	4:01.38(3) + 2:03.95	6:09.72 (3) + 2:08.34	08:22.08 + 2:12.36
4	KOR	Kong, Jeong-bae Lee, Byung-in	1:59.80(4)	4:05.31 (4) + 2:05.51	6:15.42(4) + 2:10.11	08:25.14 + 2:09.72
Weather/Temps			: sunny			
Wind/Vent			: Velocity/Vitesse = 3.3 m/s Direction = E			
Temperature			: Air = 11.0 C Water/Eau = 22.0 C			
Air Pressure/Pression Atm.:			766mmHg			

**Women Pair-Oars without coxswain
Final/Sept. 24**

Rank Rang	Ctry Pays	Name Nom	500m (R)	1000m (R)	1500m (R)	2000m
1	ROM	Arba, Rodica Homeghi, Olga	1:44.70(1)	3:36.80(1) + 1:52.10	5:31.81 (1) + 1:55.01	07:28.13 + 1:56.32
2	BUL	Stoyanova, Radka Berberova, Lalka	1:48.11 (2)	3:40.94 (2) + 1:52.83	5:36.55 (2) + 1:55.61	07:31.95 + 1:55.40
3	NZL	Payne, Nicola Hannen, Lynley	1:49.69(3)	3:45.18(3) + 1:55.49	5:39.84 (3) + 1:54.66	07:35.68 + 1:55.84
4	GDR	Spittler, Kerstin Schroeder, Katrin	1:50.56(5)	3:45.47 (4) + 1:54.91	5:42.85 (4) + 1:57.38	07:40.47 + 1:57.62
5	URS	Stone, Sarmite Smorodina, Marina	1:50.23(4)	3:48.39 (5) + 1:58.16	5:50.91 (5) + 2:02.52	07:53.19 + 2:02.28
6	USA	Kirch, Barbara Keggi, Mara	1:52.08(6)	3:51.90(6) + 1:59.82	5:53.83 (6) + 2:01.93	07:56.27 + 2:02.44
Weather/Temps			: sunny			
Wind/Vent			: Velocity/Vitesse = 1.3 m/s Direction = SE			
Temperature			: Air = 20.2 C Water/Eau = 22.7 C			
Air Pressure/Pression Atm.			: 768 mmHg			

**Women Quadruple Sculls
Preliminary Heat 1/Sept. 20**

Rank Rang	Ctry Pays	Name Nom	500m (R)	1000m (R)	1500m (R)	2000m
1	BUL	Anohrieva, Galia Hristova, Pavlina Velinova, Iskra Tocheva, Krassimira	1:33.55(3)	3:10.01 (2) + 1:36.46	4:46.92 (2) + 1:36.91	06:23.22 + 1:36.30
2	ROM	Balan, Anisoara Ciucanu, Doina Cogeanu, Veronica Minea, Anisoara	1:28.95(1)	3:06.19(1) + 1:37.24	4:45.45(1) + 1:39.26	06:26.95 + 1:41.50
3	URS	Doumtcheva, Antonina Frolova, Inna Kalimbet, Irina Mazyi, Svetlana	1:29.89 (2)	3:11.51 (3) + 1:41.62	4:52.56 (3) + 1:41.05	06:35.55 + 1:42.99
4	TCH	Krejцова, Hana Kurhajcova, Lubica Mikyskova, Blanka Soukupova, Irena	1:36.34 (4)	3:18.51 (4) + 1:42.17	4:59.96 (4) + 1:41.45	06:41.03 + 1:41.07
5	FRA	Coupat, Monique Dubosquelle, Christine Gosse, Christine Lafon, Chantal	1:38.49(5)	3:21.13(5) + 1:42.64	5:05.29 (5) + 1:44.16	06:49.29 + 1:44.00
Weather/Temps			: sunny			
Wind/Vent			: Velocity/Vitesse = 0.7 m/s Direction = WNW			
Temperature			: Air = 12.8 C Water/Eau = C			
Air Pressure/Pression Atm.			: 1026 mmHg			

**Women Quadruple Sculls
Preliminary Heat 2/Sept. 20**

Rank Rang	Ctry Pays	Name Nom	500m (R)	1000m (R)	1500m (R)	2000m
1	GDR	Foerster, Kerstin Mundt, Kristina Schramm, Beate Sorgers, Jana	1:30.54(1)	3:09.16(1) + 1:38.62	4:52.24(1) + 1:43.08	06:31.40 + 1:39.16
2	USA	Cassuto, Sherry Herron, Angie Marshall, Jeannie Martin, Ann	1:35.98(2)	3:17.47(2) + 1:41.49	5:00.35 (2) + 1:44.88	06:42.93 + 1:42.58
3	BEL	Bredael, Annelies Focque, Lucia Haesebrouck, Ann Vandermoere, Marie-Anne	1:37.97 (3)	3:19.91 (3) + 1:41.94	5:02.49 (3) + 1:42.58	06:43.56 + 1:41.07
4	HOL	Compaan, Jos Pentenga, Marjan Wessel, Nicolette Zeekant, Marijke	1:38.82(5)	3:20.68 (4) + 1:41.86	5:04.62 (5) + 1:43.94	06:45.27 + 1:40.65
5	HUN	Bertenyi, Erika Cserey, Ildiko Kapocs, Aniko Sarlos, Katalin	1:38.31 (4)	3:22.29 (5) + 1:43.98	5:03.53(4) + 1:41.24	06:47.13 + 1:43.60
Weather/Temps			: sunny			
Wind/Vent			: Velocity/Vitesse = 0.8 m/s Direction = E			
Temperature			: Air = 12.9 C Water/Eau = C			
Air Pressure/Pression Atm.			: 1026 mmHg			

**Women Quadruple Sculls
Repechage 1/Sept. 21**

Rank Rang	Ctry Pays	Name Nom	500m (R)	1000m (R)	1500m (R)	2000m
1	ROM	Balan, Anisoara Ciucanu, Doina Cogeanu, Veronica Minea, Anisoara	1:29.97(1)	3:06.90(1) + 1:36.93	4:47.50(1) + 1:40.60	06:26.14 + 1:38.64
2	BEL	Bredael, Annelies Focque, Lucia Haesebrouck, Ann Vandermoere, Marie-Anne	1:36.62(3)	3:15.91 (3) + 1:39.29	4:56.39 (2) + 1:40.48	06:37.46 + 1:41.07
3	HOL	Compaan, Jos Pentenga, Marjan Wessel, Nicolette Zeekant, Marijke	1:38.19(4)	3:17.70(4) + 1:39.51	4:58.03 (3) + 1:40.33	06:38.95 + 1:40.92
4	FRA	Coupat, Monique Dubosquelle, Christine Gosse, Christine Lafon, Chantal	1:35.00(2)	3:15.35(2) + 1:40.35	4:59.11 (4) + 1:43.76	06:44.15 + 1:45.04
Weather/Temps			: sunny			
Wind/Vent			: Velocity/Vitesse = 1.2 m/s Direction = ESE			
Temperature			: Air = 22.7 C Water/Eau = 24.0 C			
Air Pressure/Pression Atm.			: 766 mmHg			

Rowing

Aviron

Women Quadruple Sculls Repechage 2/Sept. 21			Femmes/Quatre en couple sans barreuse Repechage 2/21 Sept			
Rank Rang	Ctry Pays	Name Nom	500m (R)	1000m (R)	1500m (R)	2000m
1	URS	Doumtcheva, Antonina Frolova, Inna Kalimbet, Irina Mazyi, Svetlana	1:29.41 (1)	3:05.96(1) + 1:36.55	4:46.92(1) + 1:40.96	06:27.75 + 1:40.83
2	TCH	Krejčova, Hana Kurhájčova, Lubica Mikyskova, Blanka Soukupova, Irena	1:33.63(2)	3:11.68(2) + 1:38.05	4:52.95 (2) + 1:41.27	06:33.36 + 1:40.41
3	USA	Cassuto, Sherry Herron, Angie Marshall, Jeannie Martin, Ann	1:35.39(4)	3:14.98(3) + 1:39.59	4:58.28 (3) + 1:43.30	06:39.10 + 1:40.82
4	HUN	Bertenyi, Erika Cserey, Ildiko Kapos, Aniko Sarlos, Katalin	1:34.51 (3)	3:15.41 (4) + 1:40.90	4:58.88 (4) + 1:43.47	06:41.24 + 1:42.36
Weather/Temps			: sunny			
Wind/Vent			: Velocity/Vitesse = 1.3 m/s Direction = WSW			
Temperature			: Air = 22.5 C Water/Eau = 24.0 C			
Air Pressure/Pression Atm.			: 766 mmHg			

Women Quadruple Sculls Petite Final/Sept. 23			Femmes/Quatre en couple sans barreuse Petite Finale/23 Sept			
Rank Rang	Ctry Pays	Name Nom	500m (R)	1000m (R)	1500m (R)	2000m
1	HOL	Compaan, Jos Pentenga, Marjan Wessel, Nicolette Zeekant, Marijke	1:37.11 (4)	3:18.49(2) + 1:41.38	4:59.80 (2) + 1:41.31	06:38.70 + 1:38.90
2	HUN	Bertenyi, Erika Cserey, Ildiko Kapos, Aniko Sarlos, Katalin	1:36.74(3)	3:18.97(3) + 1:42.23	5:01.76(4) + 1:42.79	06:40.91 + 1:39.15
3	USA	Cassuto, Sherry Herron, Angie Marshall, Jeannie Martin, Ann	1:35.45(1)	3:16.73(1) + 1:41.28	4:58.68(1) + 1:41.95	06:41.28 + 1:42.60
4	FRA	Coupat, Monique Dubosquelle, Christine Gosse, Christine Lafon, Chantal	1:36.26(2)	3:19.40(4) + 1:43.14	5:01.08(3) + 1:41.68	06:43.16 + 1:42.08
Weather/Temps			: sunny			
Wind/Vent			: Velocity/Vitesse = 0.5 m/s Direction = ENE			
Temperature			: Air = 16.6 C Water/Eau = 22.0 C			
Air Pressure/Pression Atm.			: 766 mmHg			

Women Quadruple Sculls Petite Final/Sept. 25			Femmes/Quatre en couple sans barreuse Petite Finale/25 Sept			
Rank Rang	Ctry Pays	Name Nom	500m (R)	1000m (R)	1500m (R)	2000m
1	GDR	Foerster, Kerstin Mundt, Kristina Schramm, Beate Sorgers, Jana	1:29.19(1)	3:07.54(1) + 1:38.35	4:45.82 (2) + 1:38.28	06:21.06 + 1:35.24
2	URS	Kalimbet, Irina Mazyi, Svetlana Frolova, Inna Doumtcheva, Antonina	1:31.51 (3)	3:10.34(4) + 1:38.83	4:49.66 (4) + 1:39.32	06:23.47 + 1:33.81
3	ROM	Balan, Anisoara Minea, Anisoara Cogeanu, Veronica Lipa, Elisabeta	1:29.87(2)	3:07.99 (2) + 1:38.12	4:45.22(1) + 1:37.23	06:23.81 + 1:38.59
4	BUL	Hristova, Pavlina Anohrieva, Galia Velinova, Iskra Tocheva, Krassimira	1:32.60(4)	3:10.05(3) + 1:37.45	4:47.78 (3) + 1:37.73	06:24.10 + 1:36.32
5	TCH	Krejčova, Hana Kurhájčova, Lubica Mikyskova, Blanka Soukupova, Irena	1:36.40 (5)	3:19.86(5) + 1:43.46	5:00.70 (5) + 1:42.84	06:41.86 + 1:41.16
6	BEL	Vandermoere, Marie-Anne Haesebrouck, Ann Focque, Lucia Bredael, Annelies	1:38.57(6)	3:22.19(6) + 1:43.62	5:03.62 (6) + 1:41.43	06:43.79 + 1:40.17
Weather/Temps			: cloudy			
Wind/Vent			: Velocity/Vitesse = 3.4 m/s Direction = NE			
Temperature			: Air = 16.9 C Water/Eau = 22.5 C			
Air Pressure/Pression Atm.			: 760 mmHg			

Women Four-Oars with coxswain Preliminary Heat 1/Sept. 19			Femmes/Quatre en points avec barreuse Eliminatoire 1/19 Sept			
Rank Rang	Ctry Pays	Name Nom	500m (R)	1000m (R)	1500m (R)	2000m
1	GDR	Doberschuetz, Gerlinde Hornig, Carola Rose, Sylvia Siech, Birte Walther, Martina	1:42.12(3)	3:30.88 (3) + 1:48.76	5:23.25 (3) + 1:52.37	07:11.01 + 1:47.76
2	BUL	Stoitchkova, Olia Stoyanova, Mariana Todorova, Katia Zareva, Teodora Zareva, Violeta	1:41.14(2)	3:29.79 (2) + 1:48.65	5:20.14(1) + 1:50.35	07:11.59 + 1:51.45
3	CHN	Hu, Yadong Li, Ronghua Yang, Xiao Zhang, Xianghua Zhou, Shouying	1:39.49(1)	3:28.73(1) + 1:49.24	5:22.27 (2) + 1:53.54	07:17.15 + 1:54.88
4	CAN	Clarke, Heather Smith, Tricia Thompson, Lesley Tregunno, E.jane Walinga, Jennifer	1:44.14(4)	3:37.90 (4) + 1:53.76	5:34.30 (4) + 1:56.40	07:31.02 + 1:56.72
5	KOR	Kang, Min-Heung Kook, In-Sook Lee, Kwang-Soon Nam, Sang-Lan Park, Mi-Jung	1:53.45(5)	3:57.09 (5) + 2:03.64	6:05.32 (5) + 2:08.23	08:09.58 + 2:04.26
Weather/Temps			: cloudy			
Wind/Vent			: Velocity/Vitesse = 2.5 m/s Direction = ESE			
Temperature			: Air = 19.0 C Water/Eau = C			
Air Pressure/Pression Atm.			: mmHg			

Women Four-Oars with coxswain Preliminary Heat 2/Sept. 19			Femmes/Quatre en pointe avec barreuse Eliminatoire 2/19 Sept			
Rank Rang	Ctry Pays	Name Nom	500m (R)	1000m (R)	1500m (R)	2000m
1	ROM	Armasescu, Mihaela Balan, Doina Ilian Bazon, Adriana Oancia, Ecaterina Trasca, Marroara	1:44.86(1)	3:35.58(1) + 1:50.72	5:29.16(1) + 1:53.58	07:21.43 + 1:52.27
2	URS	Khokhlova, Valentina Ribinskaite, Reda Tereshina, Elena Teterina, Irina Souprun, Marina	1:47.73(3)	3:40.99 (2) + 1:53.26	5:34.57 (2) + 1:53.58	07:28.73 + 1:54.16
3	POL	Blad, Grazyna Jankowska, Elzbieta Jarka, Zyta Lorenz, Elwira Szczepinska, Czeslawa	1:47.26(2)	3:43.05 (4) + 1:55.79	5:37.95 (4) + 1:54.90	07:29.72 + 1:51.77
4	USA	Bradley, Elizabeth Corbet, Jennifer Eckert, Cynthia Gengler, Sarah Santiago, Kimberly	1:48.27(4)	3:41.80(3) + 1:53.53	5:36.58 (3) + 1:54.78	07:33.42 + 1:56.84
5	GBR	Gough, Joanne Grose, Katherine Johnston, Fiona Norris, Alison Smith, Susan	1:50.04(5)	3:44.92 (5) + 1:54.88	5:40.93 (5) + 1:56.01	07:38.01 + 1:57.08
Weather/Temps			: cloudy			
Wind/Vent			: Velocity/Vitesse = 2.4 m/s Direction = ESE			
Temperature			: Air = 19.0 C Water/Eau = C			
Air Pressure/Pression Atm.			: mmHg			



Women Four-Oars with coxswain Repechage 1/Sept. 21			Femmes/Quatre en pointe avec barreuse Repechage 1/21 Sept			
Rank Rang	Ctry Pays	Name Nom	500m (R)	1000m (R)	1500m (R)	2000m
1	BUL	Durtchova, Svetla Mihaleva, Miglena Gueorguieva, Greta Zareva, Teodora Zareva, Violeta	1:43.15(1)	3:25.96(1) + 1:42.81	5:26.39(1) + 2:00.43	07:20.78 + 1:54.39
2	GBR	Gough, Joanne Grose, Katherine Johnston, Fiona Norrish, Alison Smith, Susan	1:47.07(4)	3:38.11 (3) + 1:51.04	5:31.25 (2) + 1:53.14	07:25.63 + 1:54.38
3	CAN	Clarke, Heather Smith, Tricia Thompson, Lesley Tregunno, E.jane Walinga, Jennifer	1:44.54(2)	3:34.59 (2) +1:50.05	5:32.13(3) + 1:57.54	07:29.71 + 1:57.58
4	POL	Blad, Grazyna Jankowska, Elzbieta Jarka, Zyta Lorenz, Elwira Szczepinska, Czeslawa	1:46.08(3)	3:41.52(4) + 1:55.44	5:35.83 (4) + 1:54.31	07:32.55 + 1:56.72
Weather/Temps			: sunny			
Wind/Vent			: Velocity/Vitesse = 2.2 m/s Direction = ESE			
Temperature			: Air = 9.7 C Water/Eau = 22.0 C			
Air Pressure/Pression Atm.			: 1023 mmHg			

Women Four-Oars with coxswain Final/Sept. 24			Femmes/Quatre en pointe avec barreuse Finale/24 Sept			
Rank Rang	Ctry Pays	Name Nom	500m (R)	1000m (R)	1500m (R)	2000m
1	GDR	Walther, Martina Doberschuetz, Gerlinde Hornig, Carola Siech, Birte Rose, Sylvia	1:38.62(3)	3:24.98 (2) + 1:46.36	5:11.24(2) + 1:46.26	06:56.00 + 1:44.76
2	CHN	Zhang, Xianghua Hu, Yadong Yang, Xiao Zhou, Shouying Li, Ronghua	1:36.96(1)	3:21.84(1) +1:44.88	5:09.46(1) + 1:47.62	06:58.78 + 1:49.32
3	ROM	Trasca, Marioara Necula, Veronica Anitas, Herta Balan, Doina Ilian Oancia, Ecaterina	1:38.36(2)	3:26.19(3) +1:47.83	5:14.02(3) +1:47.83	07:01.13 + 1:47.11
4	BUL	Zareva, Teodora Zareva, Violeta Mihaleva, Miglena Durtchova, Svetla Gueorguieva, Greta	1:40.00(4)	3:28.68(4) + 1:48.68	5:15.41 (4) + 1:46.73	07:02.27 + 1:46.86
5	USA	Corbet, Jennifer Gengler, Sarah Bradley, Elizabeth Eckert, Cynthia Santiago, Kimberly	1:41.62 (5)	3:32.38 (5) + 1:50.76	5:34.90 (6) + 2:02.52	07:09.12 + 1:34.22
6	GBR	Johnston, Fiona Grose, Katherine Gough, Joanne Smith, Susan Norrish, Alison	1:43.53(6)	3:33.30 (6) + 1:49.77	5:22.34 (5) + 1:49.04	07:10.80 + 1:48.46
Weather/Temps			: sunny			
Wind/Vent			: Velocity/Vitesse = 0.9 m/s Direction = SE			
Temperature			: Air = 19.5 C Water/Eau = 22.7 C			
Air Pressure/Pression Atm.			: 768 mmHg			

Women Four-Oars with coxswain Repechage 2/Sept. 21			Femmes/Quatre en pointe avec barreuse Repechage 2/21 Sept			
Rank Rang	Ctry Pays	Name Nom	500m (R)	1000m (R)	1500m (R)	2000m
1	CHN	Hu, Yadong Li, Ronghua Yang, Xiao Zhang, Xianghua Zhou, Shouying	1:44.09(1)	3:36.97(1) + 1:52.88	5:31.32(1) + 1:54.35	07:23.80 + 1:52.48
2	USA	Bradley, Elizabeth Corbet, Jennifer Eckert, Cynthia Gengler, Sarah Santiago, Kimberly	1:47.93(3)	3:43.36 (3) +1:55.43	5:36.20 (2) + 1:52.84	07:28.01 + 1:51.81
3	URS	Khokhlova, Valentina Ribinskaite, Reda Tereshina, Elena Teterina, Irina Souprun, Marina	1:46.27(2)	3:42.41 (2) + 1:56.14	5:39.67 (3) + 1:57.26	07:35.22 + 1:55.55
4	KOR	Kang, Min-Heung Kook, In-Sook Lee, Kwang-Soon Nam, Sang-Lan Park, Mi-Jung	1:56.21 (4)	4:01.42 (4) + 2:05.21	6:10.01 (4) + 2:08.59	08:13.07 + 2:03.06
Weather/Temps			: sunny			
Wind/Vent			: Velocity/Vitesse = 2.1 m/s Direction = ESE			
Temperature			: Air = 10.4 C Water/Eau = 22.0 C			
Air Pressure/Pression Atm.			: 1023 mmHg			

Women Eight-Oars with coxswain Preliminary Heat 1/Sept. 20			Femmes/Huit en pointe avec barreuse Eliminatoire 1/20 Sept			
Rank Rang	Ctry Pays	Name Nom	500m (R)	1000m (R)	1500m (R)	2000m
1	ROM	Anitas, Herta Armasescu, Mihaela Balan, Doina Ilian Bazon, Adriana Ilica, Viorica Necula, Veronica Oancia, Ecaterina Tianu, Livia Trasca, Marioara	1:27.69(1)	3:00.86(1) + 1:33.17	4:38.09(1) + 1:37.23	06:15.65 + 1:37.56
2	GDR	Balthasar, Ramona Haacker, Kathrin Kluge, Anja Neunast, Daniela Schroer, Beatrix Stange, Uta Strauch, Annegret Wild, Ute Zeidler, Judith	1:28.33 (2)	3:03.58 (2) +1:35.25	4:40.48 (2) + 1:36.90	06:16.29 + 1:35.81
3	FRG	Althoff, Ingeburg Hollaender, Meike Markwort, Elke Mehl, Gabriele Peters, Kerstin Petersmann, Cerstin Petersmann, Katrin Rehders, Kerstin Schaefer, Anja	1:31.37(3)	3:08.47 (3) + 1:37.10	4:53.84 (3) + 1:45.37	06:38.31 +1:44.47
4	BUL	Zareva, Teodora Zareva, Violeta Ivanova, Neviana Stoichkova, Olia Vassileva, Todorka Todorova, Rita Stoyanova, Mariana Oronova, Daniela Gueorguieva, Greta	1:35.44 (4)	3:18.91 (4) + 1:43.47	5:03.22 (4) + 1:44.31	06:47.99 + 1:44.77
Weather/Temps			: sunny			
Wind/Vent			: Velocity/Vitesse = 1.5 m/s Direction = ENE			
Temperature			: Air = 13.1 C Water/Eau = C			
Air Pressure/Pression Atm.			: 1026 mmHg			

Women Four-Oars with coxswain Petite Final/Sept. 23			Femmes/Quatre en pointe avec barreuse Petite Finale/23 Sept			
Rank Rang	Ctry Pays	Name Nom	500m (R)	1000m (R)	1500m (R)	2000m
1	CAN	Clarke, Heather Smith, Tricia Thompson, Lesley Tregunno, E.jane Walinga, Jennifer	1:45.20(3)	3:35.93 (3) + 1:50.73	5:29.42 (2) + 1:53.49	07:19.86 + 1:50.44
2	POL	Blad, Grazyna Jankowska, Elzbieta Jarka, Zyta Lorenz, Elwira Szczepinska, Czeslawa	1:42.80(1)	3:34.44(1) + 1:51.64	5:28.89(1) + 1:54.45	07:22.59 + 1:53.70
3	URS	Khokhlova, Valentina Ribinskaite, Reda Tereshina, Elena Teterina, Irina Souprun, Marina	1:43.11 (2)	3:35.45 (2) +1:52.34	5:31.30(3) +1:55.85	07:27.20 + 1:55.90
4	KOR	Kang, Min-Heung Kook, In-Sook Lee, Kwang-Soon Nam, Sang-Lan Park, Mi-Jung	1:53.03(4)	3:57.59 (4) + 2:04.56	6:00.90 (4) + 2:03.31	08:07.71 + 2:06.81
Weather/Temps			: sunny			
Wind/Vent			: Velocity/Vitesse = 1.9 m/s Direction = ESE			
Temperature			: Air = 11.0 C Water/Eau = 22.0 C			
Air Pressure/Pression Atm.			: 766 mmHg			

Rowing

Aviron

Women Eight-Oars with coxswain Preliminary Heat 2/Sept. 20			Femmes/Huit en pointe avec barreuse Eliminatoire 2/20 Sept			
Rank Rang	Ctry Pays	Name Nom	500m (R)	1000m (R)	1500m (R)	2000m
1	URS	Averianova, Lidia Brazaouskaite, Sandra Fedorenko, Natalia Goudeliounaite, Aouchra Poukhaeva, Elena Sougako, Nadejda Tesselko, Margarita Zakirova, Saria Znak, Marina	1:28.91 (1)	3:05.37(1) + 1:36.46	4:44.18(1) + 1:38.81	06:20.90 + 1:36.72
2	CHN	Han, Yaqin He, Yanwen Hu, Yadong Li, Ronghua Yang, Xiao Zhang, Xianghua Zhang, Yali Zhou, Shouying Zhou, Xiuhua	1:30.73(2)	3:09.06 (3) + 1:38.33	4:47.40 (3) + 1:38.34	06:23.33 + 1:35.93
3	USA	Beard, Elizabeth Broome, Susan Campbell, Christine Mallery, Margaret Maxwell, Stephanie Peck, Abigail Seaton, Anna Thompson, Juliet Townley, Alison	1:31.32(3)	3:07.41 (2) + 1:36.09	4:45.98 (2) + 1:38.57	06:24.55 + 1:38.57
Weather/Temps			: sunny			
Wind/Vent			: Velocity/Vitesse = 0.6 m/s Direction = SE			
Temperature			: Air = 13.3 C Water/Eau = C			
Air Pressure/Pression Atm.			: 1026 mmHg			

Women Eight-Oars with coxswain Final/Sept. 25			Femmes/Huit en pointe avec barreuse Finale/25 Sept			
Rank Rang	Ctry Pays	Name Nom	500m (R)	1000m (R)	1500m (R)	2000m
1	GDR	Strauch, Annegret Zeidler, Judith Haacker, Kathrin Wild, Ute Kluge, Anja Schroer, Beatrix Balthasar, Ramona Stange, Uta Neunast, Daniela	1:30.43(2)	3:04.64(1) + 1:34.21	4:41.68(1) + 1:37.04	06:15.17 + 1:33.49
2	ROM	Balan, Doina Ilian Trasca, Marioara Necula, Veronica Anitas, Herta Bazon, Adriana Armasescu, Mihaela Arba, Rodica Homeghi, Olga Oancia, Ecaterina	1:32.67(6)	3:10.65(6) + 1:37.98	4:44.34 (2) + 1:33.69	06:17.44 + 1:33.10
3	CHN	Zhou, Xiuhua Zhang, Yali He, Yanwen Han, Yaqin Zhang, Xianghua Zhou, Shouying Yang, Xiao Hu, Yadong Li, Ronghua	1:31.76(4)	3:08.72 (4) + 1:36.96	4:48.78 (5) + 1:40.06	06:21.83 + 1:33.05
4	URS	Tesselko, Margarita Znak, Marina Sougako, Nadejda Brazaouskaite, Sandra Poukhaeva, Elena Zakirova, Saria Fedorenko, Natalia Averianova, Lidia Goudeliounaite, Aouchra	1:29.33(1)	3:06.20 (2) + 1:36.87	4:46.82 (3) + 1:40.62	06:22.35 + 1:35.53
5	BUL	Zareva, Teodora Zareva, Violeta Ivanova, Neviana Stoitchkova, Olia Vassileva, Todorka Todorova, Rita Stoyanova, Mariana Oronova, Daniela Gueorguieva, Greta	1:31.18(3)	3:07.84 (3) + 1:36.66	4:48.39 (4) + 1:40.55	06:25.02 + 1:36.63
6	USA	Thompson, Juliet Campbell, Christine Peck, Abigail Mallery, Margaret Broome, Susan Maxwell, Stephanie Seaton, Anna Townley, Alison Beard, Elizabeth	1:32.27(5)	3:09.19(5) + 1:36.92	4:50.01 (6) + 1:40.82	06:26.66 + 1:36.65
Weather/Temps			: cloudy			
Wind/Vent			: Velocity/Vitesse = 1.5 m/s Direction = E			
Temperature			: Air = 16.9 C Water/Eau = 22.5 C			
Air Pressure/Pression Atm.			: 760 mmHg			

Women Eight-Oars with coxswain Repechage 1/Sept. 21			Femmes/Huit en pointe avec barreuse Repechage 1/21 Sept			
Rank Rang	Ctry Pays	Name Nom	500m (R)	1000m (R)	1500m (R)	2000m
1	GDR	Balthasar, Ramona Haacker, Kathrin Kluge, Anja Neunast, Daniela Schroer, Beatrix Stange, Uta Strauch, Annegret Wild, Ute Zeidler, Judith	1:27.17(1)	2:57.90(1) + 1:30.73	4:31.21 (1) + 1:33.31	06:05.50 + 1:34.29
2	BUL	Zareva, Teodora Zareva, Violeta Ivanova, Neviana Stoitchkova, Olia Vassileva, Todorka Todorova, Rita Stoyanova, Mariana Oronova, Daniela Gueorguieva, Greta	1:29.04 (4)	3:01.93(4) + 1:32.89	4:34.52 (2) + 1:32.59	06:08.26 + 1:33.74
3	CHN	Han, Yaqin He, Yanwen Hu, Yadong Li, Ronghua Yang, Xiao Zhang, Xianghua Zhang, Yali Zhou, Shouying Zhou, Xiuhua	1:27.60 (2)	3:01.05(2) + 1:33.45	4:35.48 (3) + 1:34.43	06:08.64 + 1:33.16
4	USA	Beard, Elizabeth Broome, Susan Campbell, Christine Mallery, Margaret Maxwell, Stephanie Peck, Abigail Seaton, Anna Thompson, Juliet Townley, Alison	1:28.00 (3)	3:01.44(3) + 1:33.44	4:36.42 (4) + 1:34.98	06:10.82 + 1:34.40
5	FRG	Althoff, Ingeburg Hollaender, Meike Markwort, Elke Mehl, Gabriele Peters, Kerstin Petersmann, Cerstin Petersmann, Katrin Rehders, Kerstin Schaefer, Anja	1:29.93(5)	3:03.78 (5) + 1:33.85	4:39.13(5) + 1:35.35	06:12.70 + 1:33.57
Weather/Temps			: sunny			
Wind/Vent			: Velocity/Vitesse = 0.8 m/s Direction = W			
Temperature			: Air = 22.4 C Water/Eau = 24.0 C			
Air Pressure/Pression Atm.			: 766 mmHg			



사격
Shooting/Tir



Shooting/Tir

Officials/Officiels

Union International de Tir (U.I.T.)

President/président	Olegario Vazquez Rana
Secretary General/secrétaire général	Horst G. Schreiber
Technical Delegates/délégués techniques	Allan R. Todd Fritz Schattleitner

SLOOC Administrative Staff/Personnel Administratif du SLOOC

Commissioner/directeur	Lee Woo Jae
Secretary General/secrétaire général	Kim Chang Ha
Deputy Secretary General/secrétaire général adjoint	Park Chong Suh
Competition Manager/chef de division des compétitions	Lee Kun Jae Seo Kang Wook

Competitors/Concurrents

Men Hommes	Competitors Competiteurs	Countries Pays
Rapid Fire Pistol/pistolet de tir rapide	32	24
Free Pistol/pistolet libre	43	32
Air Pistol/pistolet a air comprime	46	30
Running Game/cible courante	23	16
S.B. Rifle, 3 positions/ Carabine de petit calibre trois	47	25
S.B. Free Rifle, Prone/ Carabine de petit calibre couche	55	34
Air Rifle/carabine a air comprime	50	30
Olympic Trap/fosse Olympique (open)	49(5)	28
Olympic Skeet/skeet Olympique (open)	52(5)	30

Women Femmes	Competitors Competiteurs	Countries Pays
Air Rifle/carabine a air comprime	45	29
Standard Rifle/carabine standard de petit calibre	37	22
Sport Pistol/pistolet de tir sportif	35	25
Air Pistol/pistolet a air comprime	37	26

Legend/Notation

*	Ties are broken by the results of the most recent rounds/Les egalites sont brisees par les resultats des cibles les plus recents
A	Alphabetical order/Ordre alphabetique
#	Shoot off/Barrage
AB	Abandon/Abandonne
EOR	Equals Olympic Record/Egale Record Olympique
NOR	New Olympic Record/Nouveau Record Olympique
NFWR	New World Record (Final)/Nouveau Record Mondial (Finale)
EWR	Equals World Record/Egale Record Mondial
NWR	New World Record/Nouveau Record Mondial



Shooting

Tir

Olympic Trap Sept. 20			Fosse Olympique 20 Sept											
Rank Rang	Name Nom	Ctry Pays	1	2	3	4	5	6	7	8	Score	G-tot	Remark Remarque	
1	Monakov, Dmitri	URS	25	24	25	25	25	25	23	25	197		G	
									Final:	25	222		# = 8	
2	Bednarik, Miloslav	TCH	24	25	24	25	25	25	25	24	197		S	
									Final:	25	222		# = 7	
3	Peeters, Frans	BEL	24	24	25	24	25	25	23	25	195		B	
									Final:	24	219		# = 16	
4	Boza, Francisco	PER	25	25	24	24	24	25			195			
									Final:	24	219		# = 15	
5	Van Limbeek, Bean	HOL	25	24	24	25	25	25	24	23	195			
									Final:	24	219		# = 7	
6	Watanabe, Kazumi	JPN	25	23	25	25	25	24	25	23	195			
									Final:	21	216			
7	Saaliste, Ourmas	URS	25	25	24	23	24	25	24	24	194		*	
8	Nummela, Arimatti	FIN	25	24	24	25	25	24	23	24	194		*	
9	Carlisle, Daniel	USA	25	25	25	23	25	24	24	23	194		*	
10	Pera, Albano	ITA	24	25	23	24	24	25	24	24	193		*	
11	Axpe, Rafael	ESP	24	24	25	25	23	24	25	23	193		A	
12	Ballard, Brian	USA	25	24	24	23	23	25	24	24	192		A	
	Haas III, George	USA	24	25	22	23	25	24	25	24	192		A	
	Vallduvi, Eladio	ESP	23	25	25	24	24	24	25	22	192		A	
15	Damme, Joerg	GDR	21	24	25	24	24	25	24	24	191		A	
	Mark, Russell	AUS	23	24	25	23	24	25	24	23	191		A	
	Park, Chul-Sung	KOR	22	25	25	24	24	24	23	24	191		A	
18	Bladas, Jose	ESP	24	24	23	25	24	24	23	23	190		A	
	Giovannetti, Luciano	ITA	25	22	24	23	25	24	24	23	190		A	
	Primrose, John	CAN	24	24	20	25	25	25	24	23	190		A	
	Rebelo, Joao	POR	24	24	25	24	22	24	24	23	190		A	
22	Guelpha, Christophe	FRA	23	23	24	25	24	25	22	23	189		A	
	Maxwell, John	AUS	25	25	25	22	24	24	22	22	189		A	
24	Cioni, Daniele	ITA	25	25	23	22	24	25	24	20	188		A	
25	Kim, Kon-Il	KOR	25	24	24	21	24	24			142		A	
	Lavrinenko, Alexanre	URS	24	23	24	24	24	23			142		A	
	Pahlsson, Johnny	SWE	23	25	24	23	23	24			142		A	
	Peel, Ian	GBR	24	23	23	25	22	25			142		A	
	Saleh, Sherif	EGY	24	22	25	21	25	25			142		A	
30	Byun, Kyung-Soo	KOR	23	23	25	21	24	25			141		A	
	Jensen, Peter Aagard	DEN	24	23	22	23	25	24			141		A	
	Nattrass, Susan	CAN	23	24	24	23	24	23			141		A	
33	Berti, Gian Nicola	SMR	25	22	23	21	24	25			140		A	
	Leary, George	CAN	25	23	25	21	21	25			140		A	
	Usieto, Gemma	ESP	24	24	23	24	23	22			140		A	
	Valentini, Alfredo	SMR	23	24	23	21	25	24			140		A	
37	Cavaco, Helder	POR	25	21	24	23	24	22			139		A	
	Diaz, Domingo	AUS	24	24	23	23	21	24			139		A	
39	Cuentas, Alfredo	MEX	24	22	24	25	23	20			138		A	
40	Bastos, Rodrigo	BRA	20	25	23	23	25	21			137		A	
	Gao, E	CHN	23	22	24	20	24	24			137		A	
42	Garrido, Luis	PUR	20	22	25	22	24	23			136		A	
43	Bodo, Zoltan	HUN	22	22	24	21	25	21			135		A	
	Nieminen, Timo	FIN	25	21	20	23	23	23			135		A	
	Zhang, Bing	CHN	21	25	23	22	23	21			135		A	
46	Baldisserrri, Pia Lucia	ITA	23	24	22	23	23	19			134		A	
47	Koch, Carolyn	USA	24	23	19	21	22	21			130		A	
48	Al-Harathi, Matar	KSA	19	23	21	23	21	21			128		A	
49	Tudor-Cole Rodney	ZIM	19	23	18	20	24	21			125		A	

Olympic Trap Final/Sept. 20			Fosse Olympique Finale/20 Sept											
Rank Rang	Name Nom	Ctry Pays	Score	Tot	G-tot	Remark Remarque								
1	Monakov, Dmitri	URS	197	25	222	# = 8								
2	Bednarik, Miloslav	TCH	197	25	222	# = 7								
3	Peeters, Frans	BEL	195	24	219	# = 16								
4	Boza, Francisco	PER	195	24	219	# = 15								
5	Van Limbeek, Bean	HOL	195	24	219	# = 7								
6	Watanabe, Kazumi	JPN	195	21	216									

Olympic Skeet Sept. 24			Skeet Olympique 24 Sept											
Rank Rang	Name Nom	Ctry Pays	1	2	3	4	5	6	7	8	Score	G-tot	Remark Remarque	
1	Wegner, Axel	GDR	24	25	24	25	25	25	25	25	198		EOR G	
									Final:	24	222			
2	De Iruarrizaga, Alfonso	CHI	25	25	25	24	25	25	24	25	198		EOR S	
									Final:	23	221			
3	Guardiola, Jorge	ESP	24	24	25	24	25	25	24	25	196		B	
									Final:	24	220			
4	Carlisle, Daniel	USA	25	25	25	24	25	25	24	24	197			
									Final:	23	220			
5	Zhang, Weigang	CHN	21	25	25	25	25	25	25	25	196		*	
									Final:	23	219			
6	Raabe, Juergen	GDR	25	23	24	25	24	25	25	25	196		*	
									Final:	23	219			
7	Scribani Rossi, Luca	ITA	25	25	25	23	25	24	24	25	196		*	
8	Roberti, Firmo Emilio	ARG	25	24	24	25	24	25	25	24	196		*	
9	Swinkels, Eric	HOL	24	24	25	25	25	24	25	24	196		*	
10	Seeberger, Herbert	FRG	24	25	24	25	25	24	25	24	196		*	
11	Hochwald, Bernhard	GDR	24	25	25	25	24	24	25	24	196		A	
	Timokhine, Valeri	URS	25	25	25	25	25	24	23	24	196		A	
13	Demina, Svetlana	URS	25	23	25	25	25	25	23	24	195		A	
	Dompeling, Hendrikus	HOL	25	25	25	23	24	24	24	25	195		A	
	Hlavacek, Leos	TCH	24	25	25	25	25	21	25	195		A		
	Tcherkassov, Alexandre	URS	25	25	25	23	25	24	25	23	195		A	
	Thorwaldson, Bjorn	SWE	23	25	25	24	25	25	24	24	195		A	
	Torpii, Mehmetbulent	TUR	25	24	22	25	25	25	25	24	195		A	
	Wu, Lanying	CHN	24	24	25	25	24	24	25	24	195		A	

Rank Rang	Name Nom	Ctry Pays	1	2	3	4	5	6	7	8	Score	G-tot	Remark Remarque
20	Benelli, Andrea	ITA	25	24	24	23	25	24	25	24	194		A
	Lanfranchi, Jacques	FRA	23	25	24	24	24	25	24	25	194		A
	Malek, Petr	TCH	25	25	23	23	25	24	25	24	194		A
	Tymvios, Michael	CYP	24	25	24	25	25	23	24	24	194		A
24	Dryke, Mathew	USA	25	25	24	25	23	25	22	24	193		
25	Imnaichvili, Tamaz	URS	23	24	25	24	25	25			146		AB
26	Smith, Richard	USA	25	24	23	25	24	24			145		
27	Adamec, Lubos	TCH	25	25	24	23	24	23			144		A
	Giha, Juan Jorge	PER	24	25	24	23	25	23			144		A
	Harman, Ken	GBR	24	24	23	24	24	25			144		A
	Kwasnycia, Bohdan John	CAN	24	24	24	25	24	23			144		A
	Rasmussen, Ole Riber	DEN	24	23	24	24	24	25			144		A
	Wang, Zhonghua	CHN	23	25	25	24	23	24			144		A
33	Giardini, Celso	ITA	24	23	25	22	24	25			143		A
	Hahnenkamp, Josef	AUT	24	25	22	24	25	23			143		A
	Khorshed, Mohamed	EGY	24	25	23	25	23	23			143		A
	Woolley, John	NZL	24	24	24	23	24	24			143		A
	Yamashita, Tomoya	JPN	23	24	25	24	23	24			143		A
38	Furo, Yasumasa	JPN	25	25	23	24	22	23			142		A
	Molina M., Jorge E.	COL	23	22	24	25	25	23			142		A
40	Demoulin, Michel	BEL	24	23	25	23	23	23			141		A
	Kim, Ha-Yun	KOR											



Rank	Name	Ctry	1	2	3	4	5	6	Score	G-tot	Remark
Rang	Nom	Pays									Remarque
42	Jobst, Wolfgang	AUS	94	96	94	97	95	98	574		A
	Kaiser, Gilbert	LIE	97	95	96	93	95	98	574		A
44	Dufaux, Pierre Alain	SUI	96	95	95	96	96	95	573		
45	Romero, Hugo	ECU	93	95	99	95	95	95	572		
46	Chitty, Zal	SRI	94	94	93	94	94	94	563		
47	Allan, Alistar	GBR	0	0	0	0	0	0	0		A AB
	Cooper, Malcolm	GBR	0	0	0	0	0	0	0		A AB
	Hess, Olaf	GDR	0	0	0	0	0	0	0		A AB

Men Air Rifle Final/Sept. 20 **Hombres/Carabine a Air Comprime Finale/20 Sept**

Rank	Name	Ctry	Score	1	2	3	4	5	Tot	G-tot	Remark
Rang	Nom	Pays		6	7	8	9	10			Remarque
1	Maksimovic, Goran	YUG	594 NOR	10.7	10.4	10.2	10.0	10.3			
				10.2	10.5	9.1	10.3	9.9	101.6	695.6	
2	Berthelot, Nicolas	FRA	593 NOR	9.9	10.1	10.2	10.9	10.6			
				10.8	8.3	10.2	10.1	10.1	101.2	694.2	
3	Riederer, Johann	FRG	592 NOR	10.5	10.2	10.6	10.9	10.1			
				10.7	9.5	9.3	9.9	10.3	102.0	694.0	
4	Foth, Robert	USA	591 NOR	9.7	10.8	10.2	9.3	10.8			
				10.7	10.4	10.3	9.6	9.7	101.5	692.5	
5	Stenvaag, Harald	NOR	591 NOR	8.7	10.3	10.0	10.3	10.9			
				10.2	10.0	10.5	9.4	10.7	101.0	692.0	
6	Zahonyi, Attila	HUN	591 NOR	10.0	10.0	10.9	10.1	10.5			
				9.1	10.4	10.3	9.7	9.4	100.4	691.4	
7	An, Byung-Kyun	KOR	590 NOR	9.9	10.5	10.2	10.4	10.1			
				8.5	9.8	10.4	10.3	10.6	100.7	690.7	
8	Wolfram, Andreas	GDR	591 NOR	8.6	10.6	10.2	10.0	9.5			
				10.4	9.9	9.9	10.1	9.6	98.8	689.8	

Men SB. Free Rifle, Three Positions/Sept. 22 **Hombres Carabine de Petit Calibre Trois/22 Sept**

Rank	Name	Ctry	Position	1	2	3	4	Tot	Score	G-tot	Remark
Rang	Nom	Pays									Remarque
1	Cooper, Malcolm	GBR	Prone	100	100	100	100	400			
			Standing	97	94	97	99	387			
			Kneeling	99	97	99	98	393	1180		NOR G
								Final:	99.3	1279.3	
2	Allan, Alistar	GBR	Prone	100	100	100	99	399			
			Standing	99	95	95	97	386			
			Kneeling	98	99	100	99	396	1181		NOR S
								Final:	94.6	1275.6	
3	Ivanov, Kirill	URS	Prone	100	100	100	99	399			
			Standing	98	94	95	95	382			
			Kneeling	100	97	95	100	392	1173		EOR B
								Final:	102.0	1275.0	
4	Christensen, Klavs Jorn	DEN	Prone	99	100	100	100	399			
			Standing	96	98	97	96	387			
			Kneeling	98	99	96	98	391	1177		NOR
								Final:	96.6	1273.6	
5	Dubis, Glenn	USA	Prone	100	100	100	100	400			
								Final:	99.5	1273.5	
6	Petikiane, Gratchia	URS	Prone	99	95	100	100	394			
			Standing	95	97	99	96	387			
			Kneeling	98	99	97	98	392	1173		EOR
								Final:	99.2	1272.2	
7	Stenvaag, Harald	NOR	Prone	98	98	100	99	395			
			Standing	97	99	96	97	389			
			Kneeling	96	97	97	99	389	1173		EOR
								Final:	98.7	1271.7	
8	Maksimovic, Goran	YUG	Prone	100	99	100	100	399			
			Standing	95	97	96	95	383			
			Kneeling	96	98	100	97	391	1173		EOR
								Final:	98.5	1271.5	
9	Zhang, Yingzhou	CHN	Prone	100	98	100	99	397			
			Standing	97	94	96	99	386			
			Kneeling	98	95	98	98	389	1172		*
10	Wolfram, Andreas	GDR	Prone	99	99	98	100	396			
			Standing	98	94	97	96	385			
			Kneeling	98	99	97	97	391	1172		*
11	Skirbekk, Geir	NOR	Prone	98	99	100	100	397			
			Standing	97	96	93	97	383			
			Kneeling	97	98	98	97	390	1170		A
	Zahonyi, Attila	HUN	Prone	100	100	100	98	398			
			Standing	94	98	99	96	387			
			Kneeling	94	96	97	98	385	1170		A
13	Amat, Jean-Pierre	FRA	Prone	100	100	99	99	398			
			Standing	93	96	92	96	377			
			Kneeling	99	99	99	97	394	1169		A
	Durben, Daniel	USA	Prone	99	100	98	100	397			
			Standing	93	95	96	95	379			
			Kneeling	98	00	97	98	393	1169		A
15	Gonzalez, Jorge	ESP	Prone	100	100	99	100	399			
			Standing	94	96	98	91	379			
			Kneeling	98	96	97	99	390	1168		A
	Soukenik, Pavel	TCH	Prone	100	99	100	99	398			
			Standing	95	95	95	90	375			
			Kneeling	98	00	00	97	395	1168		A
17	Hirvi, Juha	FIN	Prone	100	98	100	99	397			
			Standing	95	97	96	96	384			
			Kneeling	96	100	97	93	386	1167		
18	Hess, Olaf	GDR	Prone	99	98	99	99	395			
			Standing	96	95	97	90	378			
			Kneeling	97	97	99	100	393	1166		A
	Lovbom, Stefan	SWE	Prone	99	100	100	100	399			
			Standing	89	96	97	94	376			
			Kneeling	97	97	99	98	391	1166		A

Rank	Name	Ctry	Position	1	2	3	4	Tot	Score	G-tot	Remark
Rang	Nom	Pays									Remarque
18	Sturny, Norbert	SUI	Prone	100	100	98	100	398			
			Standing	96	97	94	93	380			
			Kneeling	97	99	96	96	388	1166		A
21	Bessy, Pascal	FRA	Prone	99	100	98	98	395			
			Standing	94	97	93	97	381			
			Kneeling	97	95	100	97	389	1165		A
	Kwon, Taek-Yul	KOR	Prone	99	100	99	99	397			
			Standing	97	93	96	95	381			
			Kneeling	97	97	96	97	387	1165		A
	Papirov, Eduard	ISR	Prone	99	100	100	100	399			
			Standing	95	95	95	93	378			
			Kneeling	97	98	97	96	388	1165		A
	Pejovic, Srecko	YUG	Prone	99	100	99	97	395			
			Standing	93	93	96	95	377			
			Kneeling	99	98	97	99	393	1165		A
25	Senecal, Jean-Francois	CAN	Prone	99	99	100	99	397			
			Standing	96	94	96	94	380			
			Kneeling	96	98	96	97	387	1164		A
	Xu, Xiaoguang	CHN	Prone	100	99	100	98	397			
			Standing	92	94	95	97	378			
			Kneeling	99	97	100	93	389	1164		A
27	Zaprianov, Petar	BUL	Prone	100	98	100	100	398			
			Standing	95	94	97	93	379			
			Kneeling	94	96	98	97	385	1162		
28	Koba, Ryohei	JPN	Prone	99	100	98	99	398			
			Standing	96	96	94	95	381			
			Kneeling	95	96	96	95	382	1161		A
	Lee, Eun-Chul	KOR	Prone	99	100	99	97	395			
			Standing	94	95	95	95	379			
			Kneeling	97	98	96	96	387	1161		A
	Lind, Ulrich	FRG	Prone	100	100	100	99	399			
			Standing	91	90	96	98	375			
			Kneeling	97	96	98	96	387	1161		A
	Poliakov, Gueorgui	BUL	Prone	100	99	99	98	396			

Shooting

Tir

Men SB. Free Rifle, Three Positions Final/Sept. 22				Hommes/Carabine de Petit Calibre Trois P. Finale/22 Sept								
Rank	Name	Ctry	Score	1	2	3	4	5	Tot	G-tot	Remark	
Rang	Nom	Pays		6	7	8	9	10			Remarque	
1	Cooper, Malcolm	GBR	1180	10.0	10.1	10.2	10.5	9.5	99.3	1279.3		
2	Allan, Alister	GBR	1181	9.2	10.0	8.2	9.5	9.0	94.6	1275.6		
3	Ivanov, Kirill	URS	1173	10.3	10.8	9.9	10.1	10.9	102.0	1275.0		
4	Christensen, Klavs Jorn	DEN	1177	9.2	7.9	9.7	10.6	10.5	96.6	1273.6		
5	Dubis, Glenn	USA	1174	10.0	9.2	9.3	10.6	10.0	99.5	1273.5		
6	Petikiane, Gratchia	URS	1173	10.2	10.8	9.2	9.7	10.1	99.2	1272.2		
7	Stenvaag, Harald	NOR	1173	9.1	9.6	10.1	9.4	10.5	98.7	1271.7		
8	Maksimovic, Goran	YUG	1173	10.7	9.8	9.3	10.3	10.6	98.5	1271.5		

Men SB. Free Rifle, Prone Final/Sept. 19				Hommes/Carabine de Petit Calibre, Couche Finale/19 Sept								
Rank	Name	Ctry	Score	1	2	3	4	5	Tot	G-tot	Remark	
Rang	Nom	Pays		6	7	8	9	10			Remarque	
1	Varga, Miroslav	TCH	600	10.5	10.5	10.5	9.7	10.8	103.9	703.9		
2	Cha, Young-Chul	KOR	598	10.9	10.0	10.7	10.6	10.2	104.8	702.8		
3	Zahonyi, Attila	HUN	597	10.5	10.2	10.6	10.6	10.8	104.9	701.9		
4	Soukenik, Pavel	TCH	598	11.0	9.8	10.4	10.7	10.6	103.2	701.2		
5	Allan, Alister	GBR	598	10.4	10.4	10.2	10.1	10.7	102.9	700.9		
6	Xu, Xiaoguang	CHN	597	10.5	10.3	9.7	10.7	10.5	103.6	700.6		
7	Ruecker, Bernd	FRG	597	10.7	10.1	10.6	10.7	9.7	103.5	700.5		
8	Ashcroft, Michael	CAN	597	9.8	10.3	10.1	10.0	10.8	101.5	698.5		

Men SB. Free Rifle, Prone/Sept. 19			Hommes Carabine de Petit Calibre, Couche/19 Sept									
Rank	Name	Ctry	1	2	3	4	5	6	Score	G-tot	Remark	
Rang	Nom	Pays									Remarque	
1	Varga, Miroslav	TCH	100	100	100	100	100	100	600	EWR		
2	Cha, Young-Chul	KOR	100	100	99	100	99	100	598			
3	Zahonyi, Attila	HUN	100	100	98	99	100	100	597			
4	Soukenik, Pavel	TCH	100	99	100	100	100	99	598			
5	Allan, Alister	GBR	100	100	100	100	100	98	598			
6	Xu, Xiaoguang	CHN	100	100	99	99	99	100	597			
7	Ruecker, Bernd	FRG	100	100	100	98	99	100	597			
8	Ashcroft, Michael	CAN	100	99	100	99	100	99	597			
9	Gundersrud, Jan	NOR	100	100	99	97	100	100	596		*	
10	Petterson, Stephen	NZL	100	100	99	97	100	100	596		*	
11	Hansson, Per G.	SWE	100	100	99	98	100	99	596		A	
	Lovbom, Stefan	SWE	99	100	99	99	100	99	596		A	
	Maksimovic, Goran	YUG	100	98	100	100	99	99	596		A	
	Smith, Alan	AUS	99	100	100	100	100	97	596		A	
15	Christensen, Klavs Jorn	DEN	99	99	100	99	99	99	595		A	
	Dubis, Glenn	USA	99	99	100	99	100	98	595		A	
	Heinrich, Lothar	AUT	99	100	99	99	99	99	595		A	
	Hess, Olaf	GDR	100	98	99	100	99	99	595		A	
	Ivanov, Kirill	URS	100	99	100	99	98	99	595		A	
	Jiang, Rong	CHN	100	99	100	98	99	99	595		A	
	Lvov, Vladimir	URS	100	100	99	96	100	100	595		A	
	Matsuo, Kaoru	JPN	98	100	100	99	99	99	595		A	
	Wolfram, Andreas	GDR	97	100	100	100	100	98	595		A	
24	Dufaux, Pierre Alain	SUI	99	99	100	98	99	99	594		A	
	Hirvi, Juha	FIN	100	99	100	99	98	98	594		A	
	Kwak, Jung-Hoon	KOR	99	99	99	98	99	100	594		A	
	Papirov, Eduard	ISR	98	99	100	99	99	99	594		A	
	Sturny, Norbert	SUI	98	98	99	100	100	99	594		A	
	Thune, Kurt	FIN	100	98	98	100	100	98	594		A	
	Vamplaw, Patrick	CAN	100	99	97	100	100	98	594		A	
	Wright, Webster	USA	99	99	100	98	98	100	594		A	
32	Amat, Jean-Pierre	FRA	100	100	97	97	99	100	593		A	
	Bessy, Pascal	FRA	99	100	99	96	99	100	593		A	
	Gonzalez, Jorge	ESP	98	99	100	100	97	99	593		A	
	Poliakov, Gueorgui	BUL	98	100	99	99	97	100	593		A	
36	Bracero, Jorge	PUR	99	100	98	100	98	97	592		A	
	Cooper, Malcolm	GBR	100	99	98	99	98	98	592		A	
	Herlufsen, Jorgen Just	DEN	99	98	98	98	100	99	592		A	
39	Adilbish, Sangidorj	MGL	99	99	96	99	99	99	591		A	
	Alvarez, Jose	MEX	98	98	100	99	97	99	591		A	
41	Brook, Donald	AUS	97	97	98	99	100	99	590		A	
	Hillenbrand, Kurt	FRG	98	98	100	97	97	100	590		A	
	Iemma, Julio Cesar	ARG	99	98	98	99	100	96	590		A	
	Zaprianov, Petar	BUL	98	97	100	99	97	99	590		A	
45	Bereczky, Sandor	HUN	99	99	95	97	100	99	589		A	
	Deuring, Albert	AUT	99	97	98	99	97	99	589		A	
47	Pejovic, Srecko	YUG	98	100	99	96	98	97	588		A	
	Skirbekk, Geir	NOR	99	98	98	96	98	99	588		A	
49	Rajasinghe, Daya	SRI	100	99	97	99	99	93	587			
50	Meredith, Bruce	ISV	99	98	98	93	100	98	586			
51	Koba, Ryohei	JPN	99	99	96	96	97	97	584		A	
	Yonassi, Itzhak	ISR	99	99	96	93	99	98	584		A	
53	Jacoby, Roland	LUX	98	95	98	98	98	96	583			
54	Alshammari, Jadaan Tarjam	QAT	98	97	97	98	98	94	582			
55	Johnston, Kenneth	ZIM	98	96	99	93	97	97	580			

Men Air Pistol/Sept. 24			Hommes Pistolet a Air Comprime/24 Sept									
Rank	Name	Ctry	1	2	3	4	5	6	Score	G-tot	Remark	
Rang	Nom	Pays									Remarque	
1	Kiriakov, Taniou	BUL	99	98	96	95	99	98	585			
2	Buljung, Erich	USA	98	98	98	99	99	98	590	EWR		
3	Xu, Haifeng	CHN	98	97	98	97	98	96	584			
4	Babii, Sorin	ROM	98	98	98	99	98	97	588			
5	Bassinski, Igor	URS	95	98	98	98	96	98	583			
6	Ruzicka, Miroslav	TCH	97	97	99	96	95	98	582			
7	Pietrzak, Jerzy	POL	98	95	97	99	97	96	582			
8	Kokorev, Boris	URS	95	95	98	98	96	99	581			
9	Eder, Gernot	GDR	96	97	98	98	96	96	581		*	
10	Potteck, Jens	GDR	97	95	94	98	97	99	580		*	
11	Skanaker, Ragnar	SWE	96	94	99	97	99	95	580		A	
12	Cola, Philippe	FRA	96	96	96	97	98	96	579		A	
	Inagaki, Mamoru	JPN	97	97	94	94	99	98	579		A	
	Kaspar, Arndt	FRG	97	99	96	97	97	93	579		A	
15	Adams, Phillip	AUS	96	96	97	96	96	97	578		A	
	Kamis, Bengt	SWE	95	94	97	96	99	97	578		A	
	Wang, Yifu	CHN	97	98	98	96	95	94	578		A	
18	Messerschmitt, Alfons	FRG	93	95	99	95	98	97	577		A	
	Paasonen, Sakari	FIN	97	94	95	99	95	97	577		A	
	Palazzani, Dario	ITA	94	95	95	99	95	99	577		A	
	Park, Jong-sin	KOR	96	95	95	99	97	95	577		A	
22	Beutler, Rolf	SUI	95	96	97	97	94	97	576			
23	Bremond, Pierre	FRA	95	96	95	99	96	94	575		A	
	Diakov, Lyubtcho	BUL	97	94	97	95	96	96	575		A	
	Foidl, Hubert	DEN	97	96	95	95	95	97	575		A	
	Min, Young-sam	KOR	96	95	98	95	94	97	575		A	
	Semizuki, Fumihisa	JPN	94	99	93	95	97	97	575		A	
28	Nygord, Donald	USA	96	95	97	97	95	94	574			
29	Tovar, Bernardo	COL	96	96	98	96	93	94	573		A	
	Tu, Tai-hsing	TPE	93	96	94	97	96	97	573		A	
31	Sugezky, Lisandro d	ARG	96	97	97	94	96	92	572		A	
	Toth, Tamas	HUN	95	95	99	93	92	98	572		A	
33	Bogaerts, Jean	BEL	96	96	93	94	98	94	571			
34	Krasser, Horst	AUT	96	99	93	95	93	93	569		A	
	Leatherdale, Paul	GBR	95	92	96	96	95	95	569		A	
	Panageas, Konstantinos	GRE	97	96	94	94	93	95	569		A	
37	Sandstrom, Bengt	AUS	98	93	92	96	93	96	568			
38												



Men Free Pistol/Sept. 18		Hommes Pistolet Libre/18 Sept									
Rank Rang	Name Nom	Ctry Pays	1	2	3	4	5	6	Score	G-tot	Remark Remarque
1	Babii, Sorin	ROM	95	92	94	99	93	93	566		
									Final: 94.0	660.0	G
2	Skanaker, Ragnar	SWE	97	96	92	92	94	93	564		
									Final: 93.0	657.0	S
3	Bassinski, Igor	URS	94	94	98	96	93	95	570		
									Final: 87.0	657.0	B
4	Kiriakov, Taniou	BUL	92	95	93	99	96	91	566		
									Final: 90.0	656.0	
5	Eder, Gernot	GDR	93	93	92	96	93	94	561		
									Final: 93.0	654.0	
6	Karacsony, Gyula	HUN	97	93	94	95	96	89	564		
									Final: 90.0	654.0	
7	Kaspar, Arndt	FRG	91	93	97	93	96	92	562		
									Final: 89.0	651.0	
8	Wang, Yifu	CHN	94	96	93	90	93	97	563		
									Final: 88.0	651.0	
9	Potteck, Uwe	GDR	92	92	92	95	93	95	559		*
10	Papanitz, Zoltan	HUN	97	88	96	94	91	93	559		*
11	Nygord, Donald	USA	93	94	91	94	95	92	559		A
12	Melentiev, Alexandre	URS	91	94	92	93	95	93	558		A
	Palazzani, Dario	ITA	96	91	91	96	90	94	558		A
14	Ostlund, Benny	SWE	87	93	95	93	94	95	557		A
	Pietrzak, Jerzy	POL	90	94	93	93	94	93	557		A
16	Bogaerts, Jean	BEL	92	94	93	92	92	93	556		A
	Ruzicka, Miroslav	TCH	95	92	91	92	90	96	556		A
	Young, Darius	USA	91	96	95	90	91	93	556		A
19	Adams, Phillip	AUS	94	86	96	94	92	93	555		A
	Cola, Philippe	FRA	94	88	95	93	93	92	555		A
	Paasonen, Sakari	FIN	95	91	95	96	88	90	555		A
	Tu, Tai-Hsing	TPE	92	93	91	96	92	91	555		A
23	Di donna, Roberto	ITA	95	93	90	89	93	94	554		A
	Diakov, Lyubtcho	BUL	95	90	97	91	92	89	554		A
	Messerschmitt, Alfons	FRG	91	92	91	93	94	93	554		A
	Sandstrom, Bengt	AUS	93	94	88	91	95	93	554		A
	Semizuki, Fumihisa	JPN	95	92	91	90	95	91	554		A
	Xu, Haifeng	CHN	94	91	92	94	93	90	554		A
29	Min, Young-Sam	KOR	90	90	95	94	90	93	552		A
	Tovar, Bernardo	COL	87	93	95	95	91	91	552		A
	U, G. King Hung	HKG	91	90	90	95	94	92	552		A
32	Hierzer, Hans	AUT	94	92	89	95	92	88	550		
33	Deprez, Bruno	FRA	90	92	91	94	94	86	547		
34	Leatherdale, Paul	GBR	91	95	94	88	89	89	546		A
	Undralbat, Lkhagvaa	MGL	92	87	89	90	91	97	546		A
36	Beutler, Rolf	SUI	89	92	93	90	92	89	545		A
	Panageas, Konstantinos	GRE	86	92	92	89	94	92	545		A
38	Krasser, Horst	AUT	89	93	91	91	86	93	543		
39	Hora, Carlos	PER	90	88	90	91	88	93	540		
40	Sugezky, Lisandro D	ARG	90	88	89	88	89	95	539		
41	Yelavich, Gregory	NZL	91	91	85	91	88	89	535		
42	Adam, Shuaib	KEN	95	85	85	86	92	89	532		
43	Foidl, Hubert	DEN	90	87	90	88	90	86	531		

Men Free Pistol Final/Sept. 18		Hommes/Pistolet Libre Finale/18 Sept									
Rank Rang	Name Nom	Ctry Pays	Score	1 6	2 7	3 8	4 9	5 10	Tot	G-tot	Remark Remarque
1	Babii, Sorin	ROM	566	10.0	10.0	10.0	10.0	9.0			
				10.0	9.0	8.0	8.0	10.0	94.0	660.0	
2	Skanaker, Ragnar	SWE	564	10.0	10.0	9.0	7.0	9.0			
				9.0	10.0	10.0	10.0	9.0	93.0	657.0	
3	Bassinski, Igor	URS	570	9.0	9.0	9.0	8.0	9.0			
				6.0	10.0	9.0	10.0	8.0	87.0	657.0	
4	Kiriakov, Taniou	BUL	566	9.0	9.0	9.0	9.0	8.0			
				10.0	9.0	9.0	9.0	9.0	90.0	656.0	
5	Eder, Gernot	GDR	561	10.0	9.0	10.0	10.0	8.0			
				10.0	9.0	9.0	9.0	9.0	93.0	654.0	
6	Karacsony, Gyula	HUN	564	10.0	10.0	6.0	8.0	9.0			
				10.0	9.0	10.0	9.0	9.0	90.0	654.0	
7	Kaspar, Arndt	FRG	562	10.0	10.0	10.0	8.0	8.0			
				8.0	10.0	8.0	9.0	8.0	89.0	651.0	
8	Wang, Yifu	CHN	563	9.0	8.0	9.0	10.0	8.0			
				10.0	8.0	7.0	9.0	10.0	88.0	651.0	

Men Rapid Fire Pistol/Sept. 23		Hommes Pistolet de Tir Rapide/23 Sept												
Rank Rang	Name Nom	Ctry Pays	Sec	1	2	1+2	Tot	1	2	1+2	Tot	Score	G-tot	Remark Remarque
1	Kouzmine, Afanasi	URS	8	50	50	100		50	50	100				
			6	50	50	100		50	50	100				
			4	50	50	100	300	49	49	98	298	598		NOR G
												Final: 100.0	698.0	NFWR
2	Schumann, Ralf	GDR	8	50	50	100		50	50	100				
			6	49	50	99		50	50	100				
			4	49	50	99	298	49	50	99	299	597		EOR S
												Final: 99.0	696.0	
3	Kovacs, Zoltan	HUN	8	50	49	99		50	50	100				
			6	50	50	100		50	50	100				
			4	48	49	97	296	48	50	98	298	594		B
												Final: 99.0	693.0	
4	Sevieri, Alberto	ITA	8	49	50	99		50	50	100				
			6	50	50	100		50	50	100				
			4	49	48	97	296	50	50	100	300	596		
												Final: 97.0	693.0	
5	Kaczmarek, Adam	POL	8	50	50	100		50	50	100				
			6	49	50	99		49	50	99				
			4	49	49	98	297	49	50	99	298	595		
												Final: 96.0	691.0	
6	Tovar, Bernardo	COL	8	48	50	98		50	49	99				
			6	50	48	98		50	49	99				
			4	50	50	100	296	49	50	99	297	593		
												Final: 97.0	690.0	
7	McNally, John	USA	8	49	49	98		49	50	99				
			6	50	50	100		50	50	100				
			4	50	50	100	298	50	50	100	299	597		EOR
												Final: 93.0	690.0	
8	Koehler, Dirk	FRG	8	49	50	99		50	49	99				
			6	49	50	99		50	50	100				
			4	47	49	96	294	49	49	98	297	591		
												Final: 98.0	689.0	
9	Balogh, Laszlo	HUN	8	50	49	99		50	50	100				
			6	49	50	99		49	49	98				
			4	49	48	97	295	48	50	98	296	591		*
	Yang, Chung-Yul	KOR	8	50	49	99		50	50	100				
			6	49	50	99		49	49	98				
			4	50	47	97	295	48	50	98	296	591		*
11	Kucharczyk, Krzysztof	POL	8	50	49	99		50	50	100				
			6	50	50	100		50	50	100				
			4	49	48	97	296	47	48	95	295	591		A
	Meng, Gang	CHN	8	49	50	99		50	50	100				
			6	50	50	100		49	50	99				
			4	49	49	98	297	48	47	95	294	591		A
13	Arredondo, Rojelio	USA	8	50	49	99		49	50	99				
			6	50	50	100		50	49	99				
			4	47	50	97	296	49	47	96	294	590		A
	Nguyen Quoc, Cuong	V												

Shooting

Tir

Men Rapid Fire Pistol Final/Sept. 23			Hommes/Pistolet de Tir Rapide Finale/23 Sept									
Rank Rang	Name Nom	Ctry Pays	Score	1 6	2 7	3 8	4 9	5 10	Tot	G-tot	Remark Remarque	
1	Kouzmine, Afanasi	URS	598 NOR	10.0	10.0	10.0	10.0	10.0	100.0	698.0	NFWR	
2	Schumann, Ralf	GDR	597 EOR	9.0	10.0	10.0	10.0	10.0	99.0	696.0		
3	Kovacs, Zoltan	HUN	594	10.0	10.0	10.0	10.0	10.0	99.0	693.0		
4	Sevieri, Alberto	ITA	596	10.0	9.0	10.0	10.0	10.0	97.0	693.0		
5	Kaczmarek, Adam	POL	595	9.0	10.0	10.0	9.0	10.0	96.0	691.0		
6	Tovar, Bernardo	COL	593	10.0	10.0	10.0	10.0	9.0	97.0	690.0		
7	Mcnally, John	USA	597 EOR	9.0	10.0	10.0	8.0	10.0	93.0	690.0		
8	Koehler, Dirk	FRG	591	10.0	10.0	10.0	9.0	10.0	98.0	689.0		

Men Running Game Target/Sept. 23			Hommes Cible Courante/23 Sept									
Rank Rang	Name Nom	Ctry Pays	Score	1	2	Tot	1	2	Tot	Score	G-tot	Remark Remarque
1	Heiestad, Tor	NOR	150 149 299	146	146	292	146	146	292	591	98.0	NOR G
2	Huang, Shiping	CHN	150 146 296	147	146	293	147	146	293	589	98.0	EOR S
3	Avramenko, Guennadi	URS	147 147 294	149	148	297	149	148	297	591	95.0	NOR B
4	Kermiet, Jan	TCH	148 147 295	148	145	293	148	145	293	588	91.0	679.0
5	Doleschall, Andras	HUN	149 147 296	145	147	292	145	147	292	588		*10's = 49
6	Solti, Attila	HUN	146 150 296	145	147	292	145	147	292	588		*10's = 48
7	Pfeffer, Thomas	GDR	149 149 298	144	145	289	144	145	289	587		
8	Stuetzinger, Christian	FRG	150 147 297	147	142	289	147	142	289	586		*10's = 49
9	Petersson, Jan	SWE	146 146 292	148	146	294	148	146	294	586		*10's = 49
10	Ji, Gang	CHN	148 147 295	146	145	291	146	145	291	586		*10's = 48
11	Tricoire, Jean-Luc	FRA	146 149 295	145	146	291	145	146	291	586		*10's = 47
12	Greszkiewicz, Jerzy	POL	148 149 297	145	142	287	145	142	287	584		A
14	Racansky, Lubos	TCH	149 146 295	141	148	289	141	148	289	584		A
14	Moldovan, Oleg	URS	147 147 294	144	145	289	144	145	289	583		
15	Herrmann, Mike	GDR	146 149 295	144	143	287	144	143	287	582		A
	Karkusiewicz, Wojciech	POL	146 148 294	145	143	288	145	143	288	582		A
17	Bensley, Todd	USA	149 146 295	146	140	286	146	140	286	581		A
18	Swinney, Scott	USA	144 145 289	142	149	291	142	149	291	580		A
19	Donnianni, Valerio	ITA	146 145 291	145	141	286	145	141	286	577		A
	Hong, Seung-Pyo	KOR	142 149 291	141	145	286	141	145	286	577		A
21	Lee, David	CAN	145 147 292	142	139	281	142	139	281	573		A
	Wilson, Bryan	AUS	148 143 291	141	141	282	141	141	282	573		A
23	Silva-Mo Nterroso, Carlos	GUA	140 144 284	138	147	285	138	147	285	569		

Men Running Game Target Final/Sept. 23			Hommes/Cible Courante Finale/23 Sept									
Rank Rang	Name Nom	Ctry Pays	Score	1 6	2 7	3 8	4 9	5 10	Tot	G-tot	Remark Remarque	
1	Heiestad, Tor	NOR	591 NOR	10.0	10.0	10.0	10.0	10.0	98.0	689.0		
2	Huang, Shiping	CHN	589 EOR	10.0	10.0	9.0	10.0	10.0	98.0	687.0		
3	Avramenko, Guennadi	URS	591 NOR	10.0	7.0	10.0	10.0	9.0	95.0	686.0		
4	Kermiet, Jan	TCH	588	9.0	10.0	10.0	10.0	9.0	91.0	679.0		

Women Air Rifle/Sept. 18			Femmes Carabine a Air Comprime/18 Sept									
Rank Rang	Name Nom	Ctry Pays	Score	1	2	3	4	Score	G-tot	Remark Remarque		
1	Chilova, Irina	URS	97 100 100 98					395	NOR			
								Final: 103.5	498.5	G		
2	Sperber, Silvia	FRG	97 98 99 99					393	EOR			
								Final: 104.5	497.5	S		
3	Maloukhina, Anna	URS	97 97 100 100					394	NOR			
								Final: 101.8	495.8	B		
4	Zhang, Qiuping	CHN	98 99 100 98					395	NOR			
								Final: 99.7	494.7			
5	Peltola, Pirjo	FIN	97 99 98 99					393	EOR			
								Final: 100.6	493.6			
6	Meili, Launi	USA	100 96 99 100					395	NOR			
								Final: 98.3	493.3			
7	Bowes, Sharon	CAN	99 98 99 98					394	NOR			
								Final: 99.1	493.1			
8	Buehlmann, Gabriele	SUI	98 99 100 97					394	NOR			
								Final: 99.0	493.0			
9	Baldessarini, Sylvia	AUT	99 98 100 96					393	EOR	*		
10	Wigger, Deena	USA	97 97 99 99					392		*		
11	Joo, Eva	HUN	98 97 98 99					392		A		
12	Forian, Eva	HUN	98 98 97 98					391		A		
	Kang, Hye-Ja	KOR	98 96 99 98					391		A		
	Matova, Nonka	BUL	97 97 100 97					391		A		
15	Dufaux, Irene	SUI	94 99 98 99					390		A		
	Li, Dan	CHN	99 96 98 97					390		A		
17	Giese, Carmen	FRG	97 98 97 97					389		A		
	Letcheva, Vessela	BUL	96 99 96 98					389		A		
	Minamoto, Yoko	JPN	96 98 97 98					389		A		

Rank Rang	Name Nom	Ctry Pays	1	2	3	4	Score	G-tot	Remark Remarque
20	Aupretre, Dominique	FRA	96	95	100	97	388		A
	Malet, Valerie	FRA	98	97	97	96	388		A
22	Ashcroft Schulze, Christin	CAN	96	97	97	97	387		A
	Feast, Alison	AUS	98	98	95	96	387		A
	Jansson, Carina	SWE	97	97	97	96	387		A
	Kolouskova, Lenka	TCH	94	97	97	99	387		A
	Malenica, Mladenka	YUG	94	100	98	95	387		A
	Stormorken, Anne Grethe	HOL	97	95	98	97	387		A
28	Biva, Karin	BEL	96	99	95	96	386		A
	Oka, Zeynep	TUR	94	96	99	97	386		A
30	Bilkova, Dagmar	TCH	97	94	97	97	385		A
	Dutta, Soma	IND	98	97	95	95	385		A
	Lee, Mi-Kyung	KOR	98	97	95	95	385		A
33	Cooper, Sarah	GBR	97	97	94	95	383		A
	Karlsson, Anita	SWE	95	95	96	97	383		A
	Troger, Barbara	AUT	92	95	98	98	383		A
36	Landsem, Siri	NOR	95	97	93	97	382		
37	Klepp, Katja	GDR	95	96	94	96	381		
38	Kinoshita, Kyoko	JPN	94	95	96	95	380		
39	Liou, Yuh-Ju	TPE	94	94	94	97	379		A
	Olsen, May-Irene	NOR	96	97	95	91	379		A
41	Ylonen, Sirpa	FIN	90	95	96	96	377		A
	Zanfra, Flavia	ITA	97	92	96	92	377		A
43	Diato, Fabienne	MON	95	93	94	93	375		A
	Thapa, Parbati	NEP	92	93	97	93	375		A
45	Lopes, Jeanne Y.	AHO	94	88	92	90	364		

Women Air Rifle Final/Sept. 18			Femmes/Carabine a Air Comprime Finale/18 Sept									
Rank Rang	Name Nom	Ctry Pays	Score	1 6	2 7	3 8	4 9	5 10	Tot	G-tot	Remark Remarque	
1	Chilova, Irina	URS	395 NOR	10.4	10.3	9.8	10.7	10.7	103.5	498.5		
				10.5	9.8	10.2	10.8	10.3				
2	Sperber, Silvia	FRG	393 EOR	10.1	10.8	9.8	10.4	10.2	104.5	497.5		
				9.8	10.8	10.9	10.9	10.8				
3	Maloukhina, Anna	URS	394 NOR	9.6	10.2	9.5	10.5	10.4	101.8	495.8		
				10.7	10.5	10.4	10.7	9.3				
4	Zhang, Qiuping	CHN	395 NOR	8.9	10.0	9.2	10.8	10.3	99.7	494.7		
				9.8	9.6	10.3	10.7	10.1				
5	Peltola, Pirjo	FIN	393 EOR	9.5	10.4	10.7	9.8	10.3	100.6	493.6		
				10.7	10.3	10.8	9.5	8.6				
6	Meili, Launi	USA	395 NOR	9.6	9.6	8.4	10.2	10.8	98.3	493.3		
				10.6	8.2	10.9	10.4	9.6				
7	Bowes, Sharon	CAN	394 NOR	10.0	10.1	10.3	8.5	10.3	99.1	493.1		
				10.2	9.9	9.7	10.1	10.0				
8	Buehlmann, Gabriele	SUI	394 NOR	9.6	10.0	9.8	10.0	8.9	99.0	493.0		
				9.7	10.4	10.5	10.3	9.8				

Women SB. Standard Rifle, Three Positions/Sept. 21			Femmes Carabine Standard de Trois P/21 Sept									
Rank Rang	Name Nom	Ctry Pays	Position	1	2	Tot	Score	G-tot	Remark Remarque			
1	Sperber, Silvia	FRG	Prone Standing Kneeling	100 95 98	100 98 99	200 193 197	590	95.6	685.6	NOR G		
2	Letcheva, Vessela	BUL	Prone Standing Kneeling	99 95 97	100 97 92	199 192 192	583	100.2	683.2	NOR S		
3	Tcherka ssova, Valentina	URS	Prone Standing Kneeling	98 99								



Rank Rang	Name Nom	Ctry Pays	Position	1	2	Tot	Score	G-tot	Remark Remarque
13	Jewell, Wanda	USA	Prone	99	98	197			
			Standing	93	93	186			
			Kneeling	96	100	196	579		A
	Olsen, May-Irene	NOR	Prone	98	98	196			
			Standing	95	95	190			
			Kneeling	96	97	193	579		A
	Zhang, Qiuping	CHN	Prone	99	100	199			
			Standing	93	91	184			
			Kneeling	99	97	196	579		A
16	Baldessarini, Sylvia	AUT	Prone	98	99	197			
			Standing	92	98	190			
			Kneeling	95	96	191	578		A
16	Bilkova, Dagmar	TCH	Prone	96	97	193			
			Standing	94	95	189			
			Kneeling	99	97	196	578		A
	Kolouskova, Lenka	TCH	Prone	100	99	199			
			Standing	92	94	186			
			Kneeling	96	97	193	578		A
19	Ashcroft Schulze, Christin	CAN	Prone	100	99	199			
			Standing	92	90	182			
			Kneeling	98	98	196	577		
20	Deuring, Dorothee	AUT	Prone	99	99	198			
			Standing	90	94	184			
			Kneeling	98	96	194	576		A
	Joo, Eva	HUN	Prone	99	99	198			
			Standing	97	92	189			
			Kneeling	97	92	189	576		A
	Zhou, Danhong	CHN	Prone	99	99	198			
			Standing	91	93	184			
			Kneeling	97	97	194	576		A
23	Dutta, Soma	IND	Prone	100	98	198			
			Standing	94	89	183			
			Kneeling	97	97	194	575		A
	Esnault, Dominique	FRA	Prone	100	100	200			
			Standing	94	91	185			
			Kneeling	94	96	190	575		A
	Lee, Hye-Kyung	KOR	Prone	100	99	199			
			Standing	94	93	187			
			Kneeling	95	94	189	575		A
26	Forian, Eva	HUN	Prone	100	98	198			
			Standing	95	91	186			
			Kneeling	95	94	189	573		
27	Ylonen, Sirpa	FIN	Prone	99	98	197			
			Standing	95	91	186			
			Kneeling	95	94	189	572		
28	Feast, Alison	AUS	Prone	97	98	195			
			Standing	91	93	184			
			Kneeling	96	95	191	570		A
	Malenica, Mladenka	YUG	Prone	93	100	193			
			Standing	93	91	184			
			Kneeling	97	96	193	570		A
30	Heberle, Isabelle	FRA	Prone	99	96	195			
			Standing	89	94	183			
			Kneeling	97	93	190	568		A
	Kim, Young-Mi	KOR	Prone	97	99	196			
			Standing	95	90	185			
			Kneeling	93	94	187	568		A
32	Kinoshita, Kyoko	JPN	Prone	96	97	193			
			Standing	93	91	184			
			Kneeling	94	95	189	566		
33	Jansson, Carina	SWE	Prone	100	99	199			
			Standing	86	86	172			
			Kneeling	99	94	193	564		
34	Buehlmann, Gabriele	SUI	Prone	98	97	195			
			Standing	92	88	180			
			Kneeling	92	94	186	561		A
	Jinda, Thiranun	THA	Prone	95	99	194			
			Standing	89	87	176			
			Kneeling	95	96	191	561		A
36	Cooper, Sarah	GBR	Prone	99	99	198			
			Standing	93	75	168			
			Kneeling	96	95	191	557		
37	Landsem, Siri	NOR	Prone	99	96	195			
			Standing	90	89	179			
			Kneeling	94	88	182	556		

Women SB. Standard Rifle, Three Positions Final/Sept. 21				Femmes/Carabine Standard de Trois P. Finale/21 Sept							
Rank Rang	Name Nom	Ctry Pays	Score	1	2	3	4	5	Tot	G-tot	Remark Remarque
				6	7	8	9	10			
1	Sperber, Silvia	FRG	590 NOR	9.8	10.4	10.7	9.4	9.0			
				9.9	8.6	9.5	9.7	8.6	95.6	685.6	
2	Letcheva, Vessela	BUL	583 NOR	9.4	8.4	10.5	10.3	10.2			
				9.8	10.4	10.3	10.4	10.5	100.2	683.2	
3	Tcherka Ssova, Valentina	URS	586 NOR	9.0	9.7	7.9	11.0	8.8			
				10.9	9.9	8.8	9.9	9.5	95.4	681.4	
4	Klepp, Katja	GDR	584 NOR	9.2	9.9	9.1	10.4	8.4			
				9.6	9.3	10.5	9.5	10.6	96.5	680.5	*
5	Bowes, Sharon	CAN	584 NOR	9.5	10.3	9.3	9.2	8.8			
				10.1	8.9	8.9	10.7	10.8	96.5	680.5	*
6	Maloukhina, Anna	URS	585 NOR	8.5	10.8	8.1	8.3	8.0			
				9.5	9.9	9.9	10.3	10.1	93.4	678.4	
7	Meili, Launi	USA	582 NOR	8.3	9.6	10.0	9.4	10.2			
				10.0	9.7	8.9	9.2	9.2	94.5	676.5	
8	Karlsson, Anita	SWE	583 NOR	9.5	8.1	7.2	9.3	8.9			
				9.0	10.5	10.1	10.2	10.6	93.4	676.4	

Women Air Pistol/Sept. 21				Femmes Pistolet a Air Comprime/21 Sept						
Rank Rang	Name Nom	Ctry Pays	Score	1	2	3	4	Score	G-tot	Remark Remarque
1	Sekaric, Jasna	YUG	389 EWR	96	96	99	98	Final: 100.5	489.5	NFWR G
2	Saloukvadze, Nino	URS	390 NWR	96	96	99	99	Final: 97.9	487.9	S
3	Dobrantscheva, Marina	URS	385	100	94	96	95	Final: 100.2	485.2	B
4	Goffin, Anne	BEL	381	96	94	97	94	Final: 99.2	480.2	
5	Voelker, Anke	GDR	383	94	95	98	96	Final: 96.3	479.3	
6	Liu, Haiying	CHN	380	94	96	97	93	Final: 96.9	476.9	
7	Breker, Lieselotte	FRG	386	97	96	94	99	Final: 90.0	476.0	
8	Strahalm, Christine	AUT	379	94	93	93	99	Final: 93.6	472.6	
9	Kajd, Cris	SWE	379	96	96	92	95			*
10	Suarez, Eva	ESP	379	92	96	97	94			*
11	Hasegawa, Tomoko	JPN	379	93	95	97	94			A
12	Bidolach, Dorota	POL	378	97	91	94	96			A
	Manchon, Evelyne	FRA	378	93	95	96	94			A
	Matei, Anisoara	ROM	378	95	93	94	96			A
	Park, Jung-hee	KOR	378	96	92	94	96			A
16	Dyer, Kimberly	USA	377	95	98	92	92			A
	Goncz, Anna	HUN	377	96	95	94	92			A
	Wen, Zhifang	CHN	377	96	93	94	94			A
19	Bang, Hyun-joo	KOR	376	93	92	94	97			A
	Bodin, Kerstin	SWE	376	94	93	97	92			A
	Stein, Margit	FRG	376	92	93	96	95			A
22	Chikusa, Hisayo	JPN	375	97	97	92	89			A
	Fox, Ruby	USA	375	94	95	94	92			A
	Kassoumi, Agathi	GRE	375	96	91	95	93			A
25	Poljak, Eszter	YUG	373	95	92	93	93			A
	Winter, Valerie	AUS	373	95	95	93	90			A
27	Altantsetseg, Byambajav	MGL	372	89	93	95	95			A
	Fassoni, Tania	BRA	372	93	91	96	92			A
	Ferencz, Agnes	HUN	372	93	96	91	92			A
	Jezova, Yvonna	TCH	372	91	95	92	94			A
31	Amaral, Maria	BRA	369	90	95	89	95			
32	Adrian sofyana, Selvyana	INA	368	91	92	90	95			
33	Morin, Rachel	FRA	366	92	87	95	92			
34	Antonietti, Francine	SUI	365	90	89	93	93			A
	Thomas, Margaret	GBR	365	95	90	89	91			A
36	Surattee, S.khatijah	SIN	361	89	90	87	95			
37	Marggraf, Ines	ECU	351	86	93	86	86			

Women Air Pistol Final/Sept. 21				Femmes/Pistolet a Air Comprime Finale/21 Sept							
Rank Rang	Name Nom	Ctry Pays	Score	1	2	3	4	5	Tot	G-tot	Remark Remarque
				6	7	8	9	10			
1	Sekaric, Jasna	YUG	389 EWR	9.5	10.5	10.8	10.1	10.3			
				10.0	10.5	10.5	9.7	8.6	100.5	489.5	
2	Saloukvadze, Nino	URS	390 NWR	10.0	9.2	9.7	10.0	9.7			
				9.8	10.0	9.9	9.8	9.8	97.9	487.9	
3	Dobrantscheva, Marina	URS	385	10.7	8.8	10.2	10.6	8.4			
				10.4	10.5	9.2	10.8	10.6	100.2	485.2	
4	Goffin, Anne	BEL	381	9.8	10.5	9.0	9.3	9.3			

Rank Rang	Name Nom	Ctry Pays		1	2	3	4	5	6	Tot	Score	G-tot	Remark Remarque
9	Wen, Zhifang	CHN	Precision	47	48	48	50	47	50	290	583		
			Rapid	49	50	48	48	50	48	293			
10	Bidolach, Dorota	POL	Precision	49	47	49	48	50	48	291	582		*
			Rapid	49	48	48	49	49	48	291			
11	Thomas, Margaret	GBR	Precision	49	48	48	49	49	47	290	582		A
			Rapid	50	50	48	48	48	48	292			
12	Ellis, Britt-Marie	SWE	Precision	49	49	49	48	44	47	286	581		A
			Rapid	49	50	50	47	49	50	295			
	Goffin, Anne	BEL	Precision	49	49	50	47	50	50	295	581		A
			Rapid	49	45	48	46	48	50	286			
	Ito, Yoshiko	JPN	Precision	49	49	49	46	49	47	289	581		A
			Rapid	48	49	48	49	49	49	292			
	Kalinowski, Anetta	FRG	Precision	47	46	47	50	48	48	286	581		A
			Rapid	50	50	49	48	50	48	295			
	Matei, Anisoara	ROM	Precision	46	49	49	48	48	49	289	581		A
			Rapid	47	49	50	49	50	47	292			
	Yamfang, Rumpai	THA	Precision	48	49	48	49	46	49	289	581		A
			Rapid	48	50	49	47	49	49	292			
18	Guepin, Martine	FRA	Precision	47	48	46	47	49	47	284	580		A
			Rapid	49	49	50	50	48	50	296			
	Jazova, Yvonna	TCH	Precision	47	48	50	48	46	49	288	580		A
			Rapid	49	49	47	47	50	50	292			
	Poljak, Eszter	YUG	Precision	46	46	48	49	48	48	285	580		A
			Rapid	50	50	49	50	48	48	295			
18	Strahalm, Christine	AUT	Precision	48	49	47	47	49	49	289	580		A
			Rapid	49	48	46	50	49	49	291			
22	Amaral, Maria	BRA	Precision	46	49	47	49	46	50	287	579		A
			Rapid	49	48	49	49	48	49	292			
	Qi, Chunxia	CHN	Precision	45	46	46	46	50	49	282	579		A
			Rapid	50	49	50	50	49	49	297			
24	Dyer, Kimberly	USA	Precision	48	50	49	47	47	48	289	578		A
			Rapid	47	48	50	48	49	47	289			
	Voelker, Anke	GDR	Precision	49	46	46	48	47	48	284	578		A
			Rapid	47	49	49	50	50	49	294			
26	Fox, Ruby	USA	Precision	49	50	47	49	48	48	291	577		
			Rapid	46	47	50	49	46	48	286			
27	Boo, Sun-Hee	KOR	Precision	48	47	46	44	48	47	280	576		
			Rapid	48	50	50	50	48	50	296			
28	Goncz, Anna	HUN	Precision	48	47	47	48	46	48	284	575		A
			Rapid	49	48	48	49	49	48	291			
	Hong, Young-Ok	KOR	Precision	47	47	47	48	44	47	280	575		A
			Rapid	50	49	49	49	50	48	295			
30	Winter, Valerie	AUS	Precision	48	49	48	48	46	45	284	573		
			Rapid	48	49	47	48	49	48	289			
31	Kassoumi, Agathi	GRE	Precision	47	49	48	46	48	48	286	571		
			Rapid	48	49	40	49	50	49	285			
32	Antonietti, Francine	SUI	Precision	47	50	48	47	48	45	285	569		A
			Rapid	48	46	48	47	48	47	284			
	Fassoni, Tania	BRA	Precision	48	46	47	45	48	48	282	569		A
			Rapid	46	48	47	49	48	49	287			
	Suarez, Eva	ESP	Precision	47	49	46	46	46	43	277	569		A
			Rapid	50	47	49	49	49	48	292			
35	Adrian Sofyan, Selvyana	INA	Precision	49	47	48	45	48	47	284	568		
			Rapid	49	47	45	49	46	48	284			

Women Sport Pistol Final/Sept. 19				Femmes/Pistolet de Sport Finale/19 Sept									
Rank Rang	Name Nom	Ctry Pays	Score	1	2	3	4	5	Tot	G-tot	Remark Remarque		
				6	7	8	9	10					
1	Saloukvadze, Nino	URS	591 NOR	10.0	10.0	10.0	10.0	10.0	99.0	690.0			
				10.0	10.0	10.0	10.0	9.0					
2	Hasegawa, Tomoko	JPN	587 NOR	10.0	10.0	10.0	10.0	9.0	99.0	686.0			
				10.0	10.0	10.0	10.0	10.0					
3	Sekaric, Jasna	YUG	591 NOR	10.0	10.0	10.0	9.0	9.0	95.0	686.0			
				10.0	10.0	9.0	9.0	9.0					
4	Breker, Lieselotte	FRG	585 EOR	10.0	10.0	10.0	10.0	10.0	100.0	685.0	*		
				10.0	10.0	10.0	10.0	10.0					
5	Ferencz, Agnes	HUN	585 EOR	10.0	10.0	10.0	10.0	10.0	100.0	685.0	*		
				10.0	10.0	10.0	10.0	10.0					
6	Fries, Kristina	SWE	586 NOR	10.0	10.0	10.0	10.0	9.0	99.0	685.0			
				10.0	10.0	10.0	10.0	10.0					
7	Manchon, Evelyne	FRA	586 NOR	10.0	10.0	10.0	10.0	10.0	98.0	684.0			
				10.0	10.0	10.0	9.0	9.0					
8	Dobrantcheva, Marina	URS	585 EOR	10.0	10.0	10.0	10.0	9.0	97.0	682.0			
				10.0	10.0	10.0	10.0	9.0					



수영

Swimming/Natation



Swimming/Natation

Officials/Officiels

Fédération International de Natation Amateur (F.I.N.A.)

President/président	Mustapha Larfaoui
Secretary General/secrétaire général	E. Allan Harvey
Technical Delegates/délégués techniques	Georg Zorowka Alberto Amaya Cano Ante Lambasa Harm Beyer

SLOOC Administrative Staff/Personnel Administratif du SLOOC

Commissioner/directeur	Lee Myung Bak
Secretary General/secrétaire général	Kim Kwang Soo
Deputy Secretary General/secrétaire général adjoint	Choi Kyung Soo
Competition Manager/chef de division des compétitions	Kim Bong Joe Shin Min Ja Choi Woo Young Kim Chung Ha

Competitors/Concurrents

Men Hommes	Competitors Competiteurs	Countries Pays
50 M Freestyle/nage libre	70	44
100 M Freestyle/nage libre	77	50
200 M Freestyle/nage libre	63	41
400 M Freestyle/nage libre	49	33
1500 M Freestyle/nage libre	35	22
100 M Backstroke/dos	52	40
200 M Backstroke/dos	44	32
100 M Breaststroke/brasse	61	46
200 M Breaststroke/brasse	54	40
100 M Butterfly/papillon	51	36
200 M Butterfly/papillon	40	29
200 M Individual Medley/quatre nages	56	35
400 M Individual Medley/quatre nages	34	24
4x100 M Medley Relay/relais quatre nages	100	25
4x100 M Freestyle Relay/relais nage libre	88	22
4x200 M Freestyle Relay/relais nage libre	64	16
Springboard Diving/plongeon du tremplin	35	23
Platform Diving/plongeon haut-vol	26	15
Water-Polo/water-polo	156	12

Women Femmes	Competitors Competiteurs	Countries Pays
50 M Freestyle/nage libre	50	33
100 M Freestyle/nage libre	57	35
200 M Freestyle/nage libre	44	29
400 M Freestyle/nage libre	30	21
800 M Freestyle/nage libre	27	19
100 M Backstroke/dos	41	30
200 M Backstroke/dos	32	23
100 M Breaststroke/brasse	42	27
200 M Breaststroke/brasse	43	27
100 M Butterfly/papillon	40	28
200 M Butterfly/papillon	28	21
200 M Individual Medley/quatre nages	36	24
400 M Individual Medley/quatre nages	30	21
4x100 M Medley Relay/relais quatre nages	72	18
4x100 M Freestyle Relay/relais nages libre	60	15
Springboard Diving/plongeon du tremplin	28	20
Platform Diving/plongeon haut-vol	20	14
Synchronized Solo/synchronisee Solo	18	18
Synchronized Duet/synchronisee Duo	30	15

Legend/Notation

NOR	New Olympic Record/Nouveau Record Olympique
EOR	Equals Olympic Record/Egale Record Olympique
NWR	New World Record/Nouveau Record Mondial
DQ	Disqualified/Disqualifie
NS	Not Started/N'a Pas Participe
NP	Did not participated/N'a Pas Participe
FD	Failed Dive/Plongeon Manque
DNF	Did not finish/N'a pas fini
DD	Degree of Difficulty/Degre de Difficulte



Swimming

Men 50m Freestyle Heat 1/Sept. 24

Rank	Name	Ctry	50m	
Rang	Nom	Pays		
1	Ferguson, Garvin	BAH	24.25	NOR
2	Yelle, Paul	BAR	25.15	
3	Faftine, Sergio	MOZ	25.97	
4	Piva, Filippo	SMR	26.96	
5	El-Domyati, Amine	LIB	27.34	
6	Farajbilal, Mubarak	UAE	27.60	
7	Du Pont, Yul Mark	SWZ	27.93	

Hommes/50m nage libre Serie 1/24 Sept

Men 50m Freestyle Heat 2/Sept. 24

Rank	Name	Ctry	50m	
Rang	Nom	Pays		
1	Sorby, Warren	FIJ	25.64	
2	Barahona, Pablo	HON	25.79	
3	Castellanos, Plutarco	HON	26.00	
4	Alshammari, Hasan	KUW	26.27	
5	Chute, Jason	FIJ	26.46	
6	Faraj, Ahmad	UAE	26.60	
6	Piva, Michele	SMR	26.60	
8	Ncala, Trevor	SWZ	26.88	

Hommes/50m nage libre Serie 2/24 Sept

Men 50m Freestyle Heat 3/Sept. 24

Rank	Name	Ctry	50m	
Rang	Nom	Pays		
1	Oon, Jin Gee	SIN	24.86	
2	Pickard, Ronald	ISV	25.01	
3	Chiang, Chi-Li	TPE	25.26	
4	Smith, Vaughan	ZIM	25.29	
5	Thompson, Graham Lewis	ZIM	25.38	
6	Song, Kwang-Sun	KOR	25.40	
7	Sugriat, Wirmandi	INA	25.55	
8	Ndiaye, Bruno	SEN	25.63	

Hommes/50m nage libre Serie 3/24 Sept

Men 50m Freestyle Heat 4/Sept. 24

Rank	Name	Ctry	50m	
Rang	Nom	Pays		
1	Andrews, Mark	CAN	23.44	NOR
2	Buhain, Joseph Eric	PHI	24.26	
3	Bera, Richard Sam	INA	24.63	
4	Tahir, Murat	TUR	24.64	
5	Foerster, Hans	ISV	24.72	
6	Eskioğlu, Hakan	TUR	25.24	
	Lima, Pedro	ANG	DO	
	Diop, Mouhamedou	SEN	DQ	

Hommes/50m nage libre Serie 4/24 Sept

Men 50m Freestyle Heat 5/Sept. 24

Rank	Name	Ctry	50m	
Rang	Nom	Pays		
1	Guzman, Manuel	PUR	23.61	
2	Esteves, Sergio	POR	24.24	
3	Li, Khai Kam	HKG	24.30	
4	Fernandes, Jorge	BRA	24.40	
5	Wright, Michael	HKG	24.47	
6	Olafsson, Magnus	ISL	24.50	
7	Elazoul, Mohamed	EGY	24.64	
8	Hassan, Mohamed	EGY	25.11	

Hommes/50m nage libre Serie 5/24 Sept

Men 50m Freestyle Heat 6/Sept. 24

Rank	Name	Ctry	50m	
Rang	Nom	Pays		
1	Kalfayan, Christophe	FRA	23.47	
2	Fibbens, Mike	GBR	23.67	
3	Stachewicz, Thomas	AUS	23.72	
4	Clausse, Yves	LUX	23.99	
5	Trindade, Paulo	POR	24.02	
6	Opatril, Markus	AUT	24.32	
7	Pilhatsch, Alexander	AUT	24.42	
8	Zea, Urbano	MEX	24.86	

Hommes/50m nage libre Serie 6/24 Sept

Men 50m Freestyle Heat 7/Sept. 24

Rank	Name	Ctry	50m	
Rang	Nom	Pays		
1	Halsall, Dano	SUI	22.61	NOR
2	Tkashenko, Vladimir	URS	22.81	
3	Henter, Frank	FRG	22.98	
4	Caron, Stephan	FRA	23.22	
5	Hogholm, Vagn	DEN	23.50	
6	Foster, Mark	GBR	23.51	
7	Kladiva, Petr	TCH	23.53	
8	Moreira, Jose	BRA	24.26	

Hommes/50m nage libre Serie 7/24 Sept

Natation

Men 50m Freestyle Heat 8/Sept. 24

Rank	Name	Ctry	50m	
Rang	Nom	Pays		
1	Biondi, Matthew	USA	22.39	NOR
2	Baildon, Andrew	AUS	22.99	
3	Volery, Stefan	SUI	23.04	
4	Johansson, Per	SWE	23.12	
5	Titus, Goran	SWE	23.44	
6	Woods, Hilton	AHO	23.46	
7	Rohde, Peter	DEN	23.70	
8	Gonzalez, Rodrigo	MEX	24.01	

Hommes/50m nage libre Serie 8/24 Sept

Men 50m Freestyle Heat 9/Sept. 24

Rank	Name	Ctry	50m	
Rang	Nom	Pays		
1	Prigoda, Gennadi	URS	22.57	
2	Jager, Thomas	USA	22.61	
3	Ang, Peng Siong	SIN	23.08	
4	Guesgen, Stephan	FRG	23.22	
5	Shen, Jianqiang	CHN	23.41	
5	Golomeev, Tzvetan	BUL	23.41	
7	Feng, Qiangbiao	CHN	23.47	
8	Kroes, Hans	HOL	23.50	

Hommes/50m nage libre Serie 9/24 Sept

Men 50m Freestyle Sept. 24

Rank	Name	Ctry	50m	
Rang	Nom	Pays		
1	Biondi, Matthew	USA	22.39	NOR
2	Prigoda, Gennadi	URS	22.57	
3	Halsall, Dano	SUI	22.61	
3	Jager, Thomas	USA	22.61	
5	Tkashenko, Vladimir	URS	22.81	
6	Henter, Frank	FRG	22.98	
7	Baildon, Andrew	AUS	22.99	
8	Volery, Stefan	SUI	23.04	
9	Ang, Peng Siong	SIN	23.08	
10	Johansson, Per	SWE	23.12	
11	Caron, Stephan	FRA	23.22	
11	Guesgen, Stephan	FRG	23.22	
13	Golomeev, Tzvetan	BUL	23.41	
13	Shen, Jianqiang	CHN	23.41	
15	Andrews, Mark	CAN	23.44	
15	Titus, Goran	SWE	23.44	
17	Woods, Hilton	AHO	23.46	
18	Feng, Qiangbiao	CHN	23.47	
18	Kalfayan, Christophe	FRA	23.47	
20	Hogholm, Vagn	DEN	23.50	
20	Kroes, Hans	HOL	23.50	
22	Foster, Mark	GBR	23.51	
23	Kladiva, Petr	TCH	23.53	
24	Guzman, Manuel	PUR	23.61	
25	Fibbens, Mike	GBR	23.67	
26	Rohde, Peter	DEN	23.70	
27	Stachewicz, Thomas	AUS	23.72	
28	Clausse, Yves	LUX	23.99	
29	Gonzalez, Rodrigo	MEX	24.01	
30	Trindade, Paulo	POR	24.02	
31	Esteves, Sergio	POR	24.24	
32	Ferguson, Garvin	BAH	24.25	
33	Moreira, Jose	BRA	24.26	
33	Buhain, Joseph Eric	PHI	24.26	
35	Li, Khai Kam	HKG	24.30	
36	Opatril, Markus	AUT	24.32	
37	Fernandes, Jorge	BRA	24.40	
38	Pilhatsch, Alexander	AUT	24.42	
39	Wright, Michael	HKG	24.47	
40	Olafsson, Magnus	ISL	24.50	
41	Bera, Richard Sam	INA	24.63	
42	Elazoul, Mohamed	EGY	24.64	
42	Tahir, Murat	TUR	24.64	
44	Foerster, Hans	ISV	24.72	
45	Zea, Urbano	MEX	24.86	
45	Oon, Jin Gee	SIN	24.86	
47	Pickard, Ronald	ISV	25.01	
48	Hassan, Mohamed	EGY	25.11	
49	Yelle, Paul	BAR	25.15	
50	Eskioğlu, Hakan	TUR	25.24	
51	Chiang, Chi-Li	TPE	25.26	
52	Smith, Vaughan Andren	ZIM	25.29	
53	Thompson, Graham Lewis	ZIM	25.38	
54	Song, Kwang-Sun	KOR	25.40	
55	Sugriat, Wirmandi	INA	25.55	
56	Ndiaye, Bruno	SEN	25.63	
57	Sorby, Warren	FIJ	25.64	
58	Barahona, Pablo	HON	25.79	
59	Faftine, Sergio	MOZ	25.97	
60	Castellanos, Plutarco	HON	26.00	
61	Alshammari, Hasan	KUW	26.27	
62	Chute, Jason	FIJ	26.46	
63	Piva, Michele	SMR	26.60	
63	Faraj, Ahmad	UAE	26.60	
65	Ncala, Trevor	SWZ	26.88	
66	Piva, Filippo	SMR	26.96	
67	El-Domyati, Amine	LIB	27.34	
68	Farajbilal, Mubarak	UAE	27.60	
69	Du Pont, Yul Mark	SWZ	27.93	
	Lima, Pedro	ANG	DQ	

Hommes/50m nage libre 24 Sept



Men 50m Freestyle Final A/Sept. 24			Hommes/50m nage libre Finale A/24 Sept	
Rank Rang	Name Nom	Ctry Pays	50m	
1	Biondi, Matthew	USA	22.14	NWR NOR
2	Jager, Thomas	USA	22.36	
3	Prigoda, Gennadi	URS	22.71	
4	Halsall, Dano	SUI	22.83	
5	Volery, Stefan	SUI	22.84	
6	Tkashenko, Vladimir	URS	22.88	
7	Henter, Frank	FRG	23.03	
8	Baildon, Andrew	AUS	23.15	

Men 50m Freestyle Final B/Sept. 24			Hommes/50m nage libre Finale B/24 Sept	
Rank Rang	Name Nom	Ctry Pays	50m	
1	Titus, Goran	SWE	23.28	
2	Johansson, Per	SWE	23.37	
3	Ang, Peng Siong	SIN	23.39	
4	Shen, Jianqiang	CHN	23.40	
5	Kalfayan, Christophe	FRA	23.45	
6	Guesgen, Stephan	FRG	23.55	
7	Andrews, Mark	CAN	23.64	
8	Woods, Hilton	AHO	23.65	

Men 100m Freestyle Heat 1/Sept. 22			Hommes/100m nage libre Serie 1/22 Sept	
Rank Rang	Name Nom	Ctry Pays	50m	100m
1	Ferguson, Garvin	BAH	25.74	53.62
2	Yelle, Paul	BAR	26.40	55.35
3	Faftine, Sergio	MOZ	26.57	57.10
4	Chute, Jason	FIJ	28.12	58.14
5	Binagid, Mohammed	UAE	28.37	58.81
6	Lahoud, Emile	LIB	30.24	1:02.40
7	Du Pont, Yul Mark	SWZ	29.64	1:02.70

Men 100m Freestyle Heat 2/Sept. 22			Hommes/100m nage libre Serie 2/22 Sept	
Rank Rang	Name Nom	Ctry Pays	50m	100m
1	Diop, Mouhamedou	SEN	26.19	54.93
2	Castellanos, Plutarco	HON	26.81	56.11
3	Sorby, Warren	FIJ	26.63	56.66
4	Barahona, Pablo	HON	28.34	57.97
5	Piva, Michele	SMR	27.74	57.99
6	Piva, Filippo	SMR	27.83	58.39
7	Faraj, Ahmad	UAE	27.77	59.10
8	Ncala, Trevor	SWZ	27.53	59.25

Men 100m Freestyle Heat 3/Sept. 22			Hommes/100m nage libre Serie 3/22 Sept	
Rank Rang	Name Nom	Ctry Pays	50m	100m
1	Oon, Jin Gee	SIN	25.84	53.26
2	Foerster, Hans	ISV	25.99	54.29
3	Kwon, Sang-Won	KOR	25.78	54.34
4	Song, Kwang-Sun	KOR	26.28	54.63
5	Pickard, Ronald	ISV	25.52	54.72
6	Thompson, Graham Lewis	ZIM	26.49	55.20
7	Lima, Pedro	ANG	27.05	55.53
8	Alshammari, Hasan	KUW	26.91	56.44

Men 100m Freestyle Heat 4/Sept. 22			Hommes/100m nage libre Serie 4/22 Sept	
Rank Rang	Name Nom	Ctry Pays	50m	100m
1	Guzman, Manuel	PUR	24.59	51.25
2	Amer, Mostafa	EGY	26.06	53.57
3	Wright, Michael	HKG	25.71	53.64
4	Li, Khai Kam	HKG	26.27	53.70
5	Con Cepcion, Rene	PHI	26.37	53.84
6	Sakovich, Jonathan	GUM	26.64	54.24
7	Chiang, Chi-Li	TPE	26.43	55.87

Men 100m Freestyle Heat 5/Sept. 22			Hommes/100m nage libre Serie 5/22 Sept	
Rank Rang	Name Nom	Ctry Pays	50m	100m
1	Ogata, Shigeo	JPN	25.36	52.08
2	Scanavino, Carlos	URU	25.68	52.52
3	Opatril, Markus	AUT	25.32	52.66
4	Tahir, Murat	TUR	25.94	53.27
5	Smith, Vaughan Andren	ZIM	25.83	53.58
6	Bera, Richard Sam	INA	25.89	53.59
7	Eskioglu, Hakan	TUR	26.58	53.95
8	Escamilla, Ignacio	MEX	26.08	54.56

Men 100m Freestyle Heat 6/Sept. 22			Hommes/100m nage libre Serie 6/22 Sept	
Rank Rang	Name Nom	Ctry Pays	50m	100m
1	Olafsson, Magnus	ISL	25.39	52.01
2	Fernandes, Jorge	BRA	25.32	52.23
3	Arnould, Jean-marie	BEL	25.50	52.26
4	Clausse, Yves	LUX	24.24	52.27
5	Nascimento, Emanuel	BRA	25.54	52.41
6	Feng, Qiangbiao	CHN	25.07	52.45
7	Ang, Peng Siong	SIN	25.21	52.53
	Opatril, Stefan	AUT		DQ

Men 100m Freestyle Heat 7/Sept. 22			Hommes/100m nage libre Serie 7/22 Sept	
Rank Rang	Name Nom	Ctry Pays	50m	100m
1	Woods, Hilton	AHO	24.71	50.73
2	Halsall, Dano	SUI	24.12	51.21
3	Rohde, Peter	DEN	24.64	51.38
4	Gonzalez, Rodrigo	MEX	24.73	51.46
5	Kroes, Hans	HOL	24.36	51.65
6	Dybiona, Patrick	HOL	24.83	51.79
7	Anderson, Ross	NZL	25.18	52.33
	Lamberti, Giorgio	ITA		NS

Men 100m Freestyle Heat 8/Sept. 22			Hommes/100m nage libre Serie 8/22 Sept	
Rank Rang	Name Nom	Ctry Pays	50m	100m
1	Jacobs, Christopher	USA	23.90	49.20 NOR
2	Johansson, Per	SWE	24.11	50.22
3	Werner, Tommy	SWE	24.31	50.45
4	Mortensen, Franz	DEN	24.23	50.74
5	Lodziewski, Sven	GDR	24.77	50.77
6	Gleria, Roberto	ITA	24.67	50.97
7	Lee, Roland	GBR	24.41	51.20
8	Bodor, Mihly-Richard	HUN	24.84	52.77

Men 100m Freestyle Heat 9/Sept. 22			Hommes/100m nage libre Serie 9/22 Sept	
Rank Rang	Name Nom	Ctry Pays	50m	100m
1	Caron, Stephan	FRA	23.91	49.37
2	Bachkatov, Iouri	URS	24.49	50.08
3	Baildon, Andrew	AUS	23.72	50.34
4	Fahner, Thomas	FRG	24.63	50.78
5	Golomeev, Tzvetan	BUL	24.40	50.82
6	Stachewicz, Thomas	AUS	24.38	50.90
7	Wiegel, Torsten	FRG	24.90	51.02
8	Kalfayan, Christophe	FRA	24.81	51.05

Men 100m Freestyle Heat 10/Sept. 22			Hommes/100m nage libre Serie 10/22 Sept	
Rank Rang	Name Nom	Ctry Pays	50m	100m
1	Biondi, Matthew	USA	23.75	49.04 NOR
2	Prigoda, Gennadi	URS	23.86	50.13
3	Zesner, Steffen	GDR	24.60	50.73
4	Goss, Donald Alexander	CAN	24.66	50.81
5	Volery, Stefan	SUI	24.13	50.96
6	Jameson, Andy	GBR	24.58	51.18
7	Kladiva, Petr	TCH	24.67	51.39
8	Shen, Jianqiang	CHN	24.98	51.40

Men 100m Freestyle Sept. 22			Hommes/100m nage libre 22 Sept	
Rank Rang	Name Nom	Ctry Pays	50m	100m
1	Biondi, Matthew	USA	23.75	49.04 NOR
2	Jacobs, Christopher	USA	23.90	49.20
3	Caron, Stephan	FRA	23.91	49.37
4	Bachkatov, Iouri	URS	24.49	50.08
5	Prigoda, Gennadi	URS	23.86	50.13
6	Johansson, Per	SWE	24.11	50.22
7	Baildon, Andrew	AUS	23.72	50.34
8	Werner, Tommy	SWE	24.31	50.45
9	Zesner, Steffen	GDR	24.60	50.73
10	Woods, Hilton	AHO	24.71	50.73
11	Mortensen, Franz	DEN	24.23	50.74
12	Lodziewski, Sven	GDR	24.77	50.77
13	Fahner, Thomas	FRG	24.63	50.78
14	Goss, Donald Alexander	CAN	24.66	50.81
15	Golomeev, Tzvetan	BUL	24.40	50.82
16	Stachewicz, Thomas	AUS	24.38	50.90
17	Volery, Stefan	SUI	24.13	50.96
18	Gleria, Roberto	ITA	24.67	50.97
19	Wiegel, Torsten	FRG	24.90	51.02
20	Kalfayan, Christophe	FRA	24.81	51.05
21	Jameson, Andy	GBR	24.58	51.18
22	Lee, Roland	GBR	24.41	51.20
23	Halsall, Dano	SUI	24.12	51.21

Swimming

Rank Rang	Name Nom	Ctry Pays	50m	100m
24	Guzman, Manuel	PUR	24.59	51.25
25	Rohde, Peter	DEN	24.64	51.38
26	Kladiva, Petr	TCH	24.67	51.39
27	Shen, Jianqiang	CHN	24.98	51.40
28	Gonzalez, Rodrigo	MEX	24.73	51.46
29	Kroes, Hans	HOL	24.36	51.65
30	Dybiona, Patrick	HOL	24.83	51.79
31	Olafsson, Magnus	ISL	25.39	52.01
32	Ogata, Shigeo	JPN	25.36	52.08
33	Fernandes, Jorge	BRA	25.32	52.23
34	Arnould, Jean-Marie	BEL	25.50	52.26
35	Clausse, Yves	LUX	24.24	52.27
36	Anderson, Ross	NZL	25.18	52.33
37	Nascimento, Emanuel	BRA	25.54	52.41
38	Feng, Qiangbiao	CHN	25.07	52.45
39	Scanavino, Carlos	URU	25.68	52.52
40	Ang, Peng Siong	SIN	25.21	52.53
41	Opatril, Markus	AUT	25.32	52.66
42	Bodor, Mihly-Richard	HUN	24.84	52.77
43	Oon, Jin Gee	SIN	25.84	53.26
44	Tahir, Murat	TUR	25.94	53.27
45	Amer, Mostafa	EGY	26.06	53.57
46	Smith, Vaughan Andren	ZIM	25.83	53.58
47	Bera, Richard Sam	INA	25.89	53.59
48	Ferguson, Garvin	BAH	25.74	53.62
49	Wright, Michael	HKG	25.71	53.64
50	Li, Khai Kam	HKG	26.27	53.70
51	Con Cepcion, Rene	PHI	26.37	53.84
52	Eskiogtu, Hakan	TUR	26.58	53.95
53	Sakovich, Jonathan	GUM	26.64	54.24
54	Foerster, Hans	ISV	25.99	54.29
55	Kwon, Sang-Won	KOR	25.78	54.34
56	Escamilla, Ignacio	MEX	26.08	54.56
57	Song, Kwang-Sun	KOR	26.28	54.63
58	Pickard, Ronald	ISV	25.52	54.72
59	Diop, Mouhamedou	SEN	26.19	54.93
60	Thompson, Graham Lewis	ZIM	26.49	55.20
61	Yelle, Paul	BAR	26.40	55.35
62	Lima, Pedro	ANG	27.05	55.53
63	Chiang, Chi-Li	TPE	26.43	55.87
64	Castellanos, Plutarco	HON	26.81	56.11
65	Alshammari, Hasan	KUW	26.91	56.44
66	Sorby, Warren	FIJ	26.63	56.66
67	Faiftine, Sergio	MOZ	26.57	57.10
68	Barahona, Pablo	HON	28.34	57.97
69	Piva, Michele	SMR	27.74	57.99
70	Chute, Jason	FIJ	28.12	58.14
71	Piva, Filippo	SMR	27.83	58.39
72	Binabid, Mohammed	UAE	28.37	58.81
73	Faraj, Ahmad	UAE	27.77	59.10
74	Ncala, Trevor	SWZ	27.53	59.25
75	Lahoud, Emile	LIB	30.24	1:02.40
76	Du Pont, Yul Mark	SWZ	29.64	1:02.70
	Opatril, Stefan	AUT		DO
	Lamberti, Giorgio	ITA		NS

Men 100m Freestyle Final A/Sept. 22			Hommes/200m nage libre Finale A/22 Sept		
Rank Rang	Name Nom	Ctry Pays	50m	100m	
1	Biondi, Matthew	USA	23.21	48.63	NOR
2	Jacobs, Christopher	USA	23.76	49.08	
3	Caron, Stephan	FRA	23.79	49.62	
4	Prigoda, Gennadi	URS	23.46	49.75	
5	Bachkatov, Iouri	URS	24.07	50.08	
6	Baidon, Andrew	AUS	23.92	50.23	
7	Johansson, Per	SWE	24.21	50.35	
8	Werner, Tommy	SWE	24.29	50.54	

Men 100m Freestyle Final B/Sept. 22			Hommes/200m nage libre Finale B/22 Sept		
Rank Rang	Name Nom	Ctry Pays	50m	100m	
1	Stachewicz, Thomas	AUS	24.90	50.71	
2	Goss, Donald Alexander	CAN	24.20	50.73	
3	Volery, Stefan	SUI	24.23	50.74	
4	Lodziewski, Sven	GDR	24.97	51.00	
5	Mortensen, Franz	DEN	24.23	51.05	
6	Fahner, Thomas	FRG	24.58	51.12	
7	Golomeev, Tzvetan	BUL	24.41	51.16	
8	Woods, Hilton	AHO	24.80	51.25	

Men 200m Freestyle Heat 2/Sept. 18			Hommes/200m nage libre Serie 2/18 Sept			
Rank Rang	Name Nom	Ctry Pays	50m	100m	150m	200m
1	Wu, Ming-Hsun	TPE	28.83	59.29	1:30.23	2:00.43
2	Foerster, Hans	ISV	28.58	59.02	1:30.23	2:00.43
3	Singleton, Kristan	ISV	28.81	1:00.77	1:34.33	2:06.45
4	Chute, Jason	FIJ	28.85	1:00.81	1:34.97	2:09.05
5	Binabid, Mohammed	UAE	29.18	1:01.07	1:35.03	2:09.43
6	Faraj, Ahmad	UAE	30.09	1:03.42	1:39.20	2:13.21
7	Lahoud, Emile	LIB	31.66	1:06.55	1:42.21	2:16.39

Natation

Men 200m Freestyle Heat 3/Sept. 18			Hommes/200m nage libre Serie 3/18 Sept			
Rank Rang	Name Nom	Ctry Pays	50m	100m	150m	200m
1	Lim, David	SIN	27.35	56.40	1:26.94	1:56.44
2	Buhain, Joseph Eric	PHI	26.54	55.90	1:26.71	1:56.84
3	Kwon, Sang-Won	KOR	26.66	55.87	1:25.93	1:56.88
4	Oon, Jin Gee	SIN	26.93	56.13	1:26.37	1:57.28
5	Li, Arthur	HKG	27.41	57.35	1:28.23	1:58.10
6	Kwon, Soon-Kun	KOR	27.47	57.61	1:28.54	1:58.95
7	Tsang, Yi Ming	HKG	28.47	59.24	1:30.02	2:01.02
8	Gheel, Richard	IRL	28.22	58.86	1:30.16	2:01.73

Men 200m Freestyle Heat 4/Sept. 18			Hommes/200m nage libre Serie 4/18 Sept			
Rank Rang	Name Nom	Ctry Pays	50m	100m	150m	200m
1	Con Cepcion, Rene	PHI	27.26	56.25	1:25.60	1:55.58
2	Placheta, Alesander	AUT	27.10	56.75	1:26.01	1:56.11
3	Amer, Mostafa	EGY	27.49	57.25	1:27.27	1:57.50
4	Bera, Richard Sam	INA	27.44	57.16	1:27.40	1:57.60
5	Sakovich, Jonathan	GUM	27.69	57.05	1:27.72	1:57.72
6	Cullen, Stephen	IRL	27.86	58.13	1:28.24	1:57.90
7	Exkioglu, Hakan	TUR	27.65	57.63	1:27.37	1:58.45
8	Ong, Kuan Seng Jeffrey	MAL	27.71	57.93	1:29.00	1:58.62

Men 200m Freestyle Heat 5/Sept. 18			Hommes/200m nage libre Serie 5/18 Sept			
Rank Rang	Name Nom	Ctry Pays	50m	100m	150m	200m
1	Dybiona, Patrick	HOL	25.66	53.50	1:22.93	1:52.67
2	Volery, Stefan	SUI	26.76	55.42	1:24.39	1:52.94
3	Gonzalez, Rodrigo	MEX	26.87	55.26	1:24.25	1:52.99
4	Escamilla, Ignacio	MEX	26.61	55.13	1:24.12	1:53.63
5	Vassallo, Salvador	PUR	27.07	55.48	1:24.51	1:53.82
6	Clausse, Yves	LUX	26.73	55.64	1:25.35	1:54.90
7	Xie, Jun	CHN	26.19	54.29	1:24.12	1:55.04
8	Smith, Vaughan Andren	ZIM	26.59	55.40	1:25.24	1:56.13

Men 200m Freestyle Heat 6/Sept. 18			Hommes/200m nage libre Serie 6/18 Sept			
Rank Rang	Name Nom	Ctry Pays	50m	100m	150m	200m
1	Ogata, Shigeo	JPN	26.83	54.55	1:22.50	1:51.14
2	Green, Michael	GBR	27.44	56.09	1:24.68	1:53.03
3	Olafsson, Magnus	ISL	26.56	55.42	1:24.23	1:53.05
3	Serra, Daniel	ESP	27.01	55.48	1:24.44	1:53.05
5	Lopez, Julio	BRA	27.15	55.83	1:24.56	1:53.16
6	Larsen, Jan Patvel	DEN	27.06	55.51	1:23.99	1:53.61
7	Arnould, Jean-Marie	BEL	26.70	54.95	1:23.66	1:53.73
8	Szilagyi, Zoltan	HUN	27.34	55.96	1:24.86	1:53.75

Men 200m Freestyle Heat 7/Sept. 18			Hommes/200m nage libre Serie 7/18 Sept			
Rank Rang	Name Nom	Ctry Pays	50m	100m	150m	200m
1	Holmertz, Anders	SWE	25.61	53.48	1:21.78	1:49.28
2	Caron, Stephan	FRA	25.82	53.84	1:22.16	1:49.66
3	Lamberti, Giorgio	ITA	25.71	53.44	1:22.12	1:50.47
4	Kouznetsov, Alexei	URS	25.91	53.90	1:22.30	1:50.84
5	Podkoscielny, Mariusz	POL	26.04	53.69	1:22.13	1:50.95
6	Stachewicz, Thomas	AUS	25.84	53.52	1:21.91	1:51.02
7	Howe, Paul	GBR	26.54	54.42	1:22.88	1:51.22
8	Bottini, Alberto	SUI	25.83	54.08	1:22.94	1:51.45

Men 200m Freestyle Heat 8/Sept. 18			Hommes/200m nage libre Serie 8/18 Sept			
Rank Rang	Name Nom	Ctry Pays	50m	100m	150m	200m
1	Wojdat, Artur	POL	25.56	53.24	1:20.62	1:48.02
2	Biondi, Matthew	USA	25.01	52.11	1:20.20	1:48.39
3	Fahner, Thomas	FRG	25.65	53.70	1:21.41	1:49.02
4	Zesner, Steffen	GDR	25.58	53.36	1:21.05	1:49.13
5	Mortensen, Franz	DEN	25.41	52.72	1:21.13	1:51.15
6	Scanavino, Carlos	URU	26.05	53.90	1:22.43	1:51.42
7	Werner, Tommy	SWE	25.49	53.22	1:21.74	1:51.96
8	Depickere, Ludovic	FRA	25.75	53.98	1:23.46	1:53.81

Men 200m Freestyle Heat 9/Sept. 18			Hommes/200m nage libre Serie 9/18 Sept			
Rank Rang	Name Nom	Ctry Pays	50m	100m	150m	200m
1	Gross, Michael	FRG	25.16	52.32	1:20.31	1:48.55
2	Armstrong, Duncan	AUS	26.08	53.60	1:21.31	1:48.86
3	Dalbey, Troy	USA	25.31	52.69	1:20.53	1:48.96
4	Gleria, Roberto	ITA	25.58	53.06	1:21.53	1:49.51
5	Flemming, Thomas	GDR	25.76	53.24	1:21.51	1:49.52
6	Bachkatov, Iouri	URS	25.45	53.49	1:22.36	1:52.04
7	Michelena, Cristiano	BRA	26.54	54.70	1:23.75	1:52.34
8	Agh, Norbert	HUN	26.56	55.72	1:25.20	1:54.72

**Men 200m Freestyle
/Sept. 18-19****Hommes/200m nage libre
/18-19 Sept**

Rank Rang	Name Nom	Ctry Pays	50m	100m	150m	200m
1	Wojdat, Artur	POL	25.56	53.24	1:20.62	1:48.02
2	Biondi, Matthew	USA	25.01	52.11	1:20.20	1:48.39
3	Groos, Michael	FRG	25.16	52.32	1:20.31	1:48.55
4	Armstrong, Duncan	AUS	26.08	53.60	1:21.31	1:48.86
5	Dalbey, Troy	USA	25.31	52.69	1:20.53	1:48.96
6	Fahrner, Thomas	FRG	25.65	53.70	1:21.41	1:49.02
7	Zesner, Steffen	GDR	25.58	53.36	1:21.05	1:49.13
8	Holmertz, Anders	SWE	25.61	53.48	1:21.78	1:49.28
9	Gleria, Roberto	ITA	25.58	53.06	1:21.53	1:49.51
10	Flemming, Thomas	GDR	25.76	53.24	1:21.51	1:49.52
11	Caron, Stephan	FRA	25.82	53.84	1:22.16	1:49.66
12	Lamberti, Gioreio	ITA	25.71	53.44	1:22.12	1:50.47
13	Kouznetsov, Alexei	URS	25.91	53.90	1:22.30	1:50.84
14	Podkoscielny, Mariusz	POL	26.04	53.69	1:22.13	1:50.95
15	Stachewicz, Thomas	AUS	25.84	53.52	1:21.91	1:51.02
16	Ogata, Shigeo	JPN	26.83	54.55	1:22.50	1:51.14
17	Mortensen, Franz	DEN	25.41	52.72	1:21.13	1:51.15
18	Howe, Paul	GBR	26.54	54.42	1:22.88	1:51.22
19	Scanavino, Carlos	URU	26.05	53.90	1:22.43	1:51.42
20	Botini, Alberto	SUI	25.83	54.08	1:22.94	1:51.45
21	Werner, Tommy	SWE	25.49	53.22	1:21.74	1:51.96
22	Bachkatov, Iouri	URS	25.45	53.49	1:22.36	1:52.04
23	Michelena, Cristiano	BRA	26.54	54.70	1:23.75	1:52.34
24	Dybiona, Patrick	HOL	25.66	53.50	1:22.93	1:52.67
25	Volery, Stefan	SUI	26.76	55.42	1:24.39	1:52.94
26	Gonzalez, Rodrigo	MEX	26.87	55.26	1:24.25	1:52.99
27	Green, Michael	GBR	27.44	56.09	1:24.68	1:53.03
28	Serra, Daniel	ESP	27.01	55.48	1:24.44	1:53.05
28	Olafsson, Magnus	ISL	26.56	55.42	1:24.23	1:53.05
30	Lopez, Julio	BRA	27.15	55.83	1:24.56	1:53.16
31	Larsen, Jan Patvel	DEN	27.06	55.51	1:23.99	1:53.61
32	Escamilla, Ignacio	MEX	26.61	55.13	1:24.12	1:53.63
33	Arnould, Jean-Marie	BEL	26.70	54.95	1:23.66	1:53.73
34	Szilagyi, Zoltan	HUN	27.34	55.96	1:24.86	1:53.75
35	Depickere, Ludovic	FRA	25.75	53.98	1:23.46	1:53.81
36	Vassallo, Salvador	PUR	27.07	55.48	1:24.51	1:53.82
37	Agh, Norbert	HUN	26.56	55.72	1:25.20	1:54.72
38	Clausse, Yves	LUX	26.73	55.64	1:25.35	1:54.90
39	Xie, Jun	CHN	26.19	54.29	1:24.12	1:55.04
40	Con Cepcion, Rene	PHI	27.26	56.25	1:25.60	1:55.58
41	Placheta, Alesander	AUT	27.10	56.75	1:26.01	1:56.11
42	Smith, Vaughan Andren	ZIM	26.59	55.40	1:25.24	1:56.13
43	Lim, David	SIN	27.35	56.40	1:26.94	1:56.44
44	Buhain, Joseph Eric	PHI	26.54	55.90	1:26.71	1:56.84
45	Kwon, Sang-Won	KOR	26.66	55.87	1:25.93	1:56.88
46	Oon, Jin Gee	SIN	26.93	56.13	1:26.37	1:57.28
47	Amer, Mostafa	EGY	27.49	57.25	1:27.27	1:57.50
48	Bera, Richard Sam	INA	27.44	57.16	1:27.40	1:57.60
49	Sakovich, Jonathan	GUM	27.69	57.05	1:27.72	1:57.72
50	Cullen, Stephen	IRL	27.86	58.13	1:28.24	1:57.90
51	Li, Arthur	HKG	27.41	57.35	1:28.23	1:58.10
52	Eskioglu, Hakan	TUR	27.65	57.63	1:27.37	1:58.45
53	Ong, Kuan Seng Jeffrey	MAL	27.71	57.93	1:29.00	1:58.62
54	Kwon, Soon-Kun	KOR	27.47	57.61	1:28.54	1:58.95
55	Wu, Ming-Hsun	TPE	28.83	59.29	1:30.23	2:00.43
56	Tsang, Yi Ming	HKG	28.47	59.24	1:30.02	2:01.02
57	Gheel, Richard	IRL	28.22	58.86	1:30.16	2:01.73
58	Foerster, Hans	ISV	28.58	59.02	1:30.88	2:01.94
59	Singleton, Kristan	ISV	28.81	1:00.77	1:34.33	2:06.45
60	Chute, Jason	FIJ	28.85	1:00.81	1:34.97	2:09.05
61	Binabid, Mohammed	UAE	29.18	1:01.07	1:35.03	2:09.43
62	Faraj, Ahmad	UAE	30.09	1:03.42	1:39.20	2:13.21
63	Lahoud, Emile	LIB	31.66	1:06.55	1:42.21	2:16.39

**Men 200m Freestyle
Final A/Sept. 19****Hommes/200m nage libre
Finale A/19 Sept**

Rank Rang	Name Nom	Ctry Pays	50m	100m	150m	200m
1	Armstrong, Duncan	AUS	25.46	53.02	1:20.05	1:47.25 NWR NOR
2	Holmertz, Anders	SWE	25.16	52.21	1:20.03	1:47.89
3	Biondi, Matthew	USA	24.98	52.25	1:19.62	1:47.99
4	Wojdat, Artur	POL	25.66	53.58	1:20.80	1:48.40
5	Groos, Michael	FRG	25.65	53.36	1:20.88	1:48.59
6	Zesner, Steffen	GDR	25.59	53.37	1:21.33	1:48.77
7	Dalbey, Troy	USA	25.56	53.50	1:20.99	1:48.86
8	Fahrner, Thomas	FRG	25.75	53.71	1:21.89	1:49.19

**Men 200m Freestyle
Final B/Sept. 19****Hommes/200m nage libre
Finale B/19 Sept**

Rank Rang	Name Nom	Ctry Pays	50m	100m	150m	200m
1	Gleria, Roberto	ITA	26.88	55.25	1:22.76	1:49.28
2	Flemming, Thomas	GDR	26.74	55.16	1:22.99	1:50.18
3	Stachewicz, Thomas	AUS	26.24	55.33	1:23.87	1:50.83
4	Kouznetsov, Alexei	URS	26.34	54.79	1:23.32	1:51.03
5	Mortensen, Franz	DEN	26.19	54.69	1:22.74	1:51.44
6	Podkoscielny, Mariusz	POL	26.63	54.77	1:22.92	1:51.63
7	Ogata, Shigeo	JPN	26.87	55.11	1:23.62	1:51.89
8	Howe, Paul	GBR	26.67	55.16	1:24.05	1:51.99

**Men 400m Freestyle
Heat 1/Sept. 23****Hommes/400m nage libre
Serie 1/23 Sept**

Rank Rang	Name Nom	Ctry Pays	100m	200m	350m	400m
1	Alansari, Bassam	UAE	1:05.04	2:17.02	3:29.40	4:39.36
2	Lahoud, Emile	LIB	1:07.94	2:21.73	3:35.88	4:47.09
3	Binabid, Mohammed	UAE	1:02.98	2:15.69	3:29.58	4:47.28

**Men 400m Freestyle
Heat 2/Sept. 23****Hommes/400m nage libre
Serie 2/23 Sept**

Rank Rang	Name Nom	Ctry Pays	100m	200m	300m	400m
1	Wu, Ming-Hsun	TPE	59.70	2:01.99	3:04.74	4:06.66
2	Sakovich, Jonathan	GUM	59.31	2:02.61	3:06.32	4:06.89
3	Bera, Richard Sam	INA	59.09	2:02.57	3:05.84	4:08.70
4	Koh, Desmond	SIN	1:01.17	2:06.32	3:11.21	4:15.54
5	Li, Arthur	HKG	59.88	2:04.16	3:11.27	4:18.50
6	Boiling, Julian	SRI	1:01.15	2:06.28	3:13.07	4:18.88

**Men 400m Freestyle
Heat 3/Sept. 23****Hommes/400m nage libre
Serie 3/23 Sept**

Rank Rang	Name Nom	Ctry Pays	100m	200m	300m	400m
1	Majcen, Igor	YUG	59.01	1:59.81	3:00.30	3:58.90
2	Castro, David	BRA	58.45	2:00.17	3:01.89	4:02.48
3	Escamilla, Ignacio	MEX	58.63	2:00.39	3:01.89	4:03.16
4	Romo, Carlos	MEX	59.21	2:00.86	3:01.99	4:04.02
5	Ong, Kuan Seng Jeffrey	MAL	57.79	2:00.76	3:03.63	4:04.57
6	Gudomundsson, Ragnar	ISL	59.39	2:00.97	3:03.33	4:05.12
7	Yang, Wook	KOR	59.26	2:01.44	3:04.48	4:05.81
8	Kwon, Soon-Kun	KOR	58.75	2:01.46	3:04.70	4:08.02

**Men 400m Freestyle
Heat 4/Sept. 23****Hommes/400m nage libre
Serie 4/23 Sept**

Rank Rang	Name Nom	Ctry Pays	100m	200m	300m	400m
1	Vassallo, Salvador	PUR	56.97	1:56.23	2:55.56	3:55.30
2	Jangvall, Henrik	SWE	58.24	1:57.86	2:57.86	3:57.41
3	Serra, Daniel	ESP	57.66	1:57.95	2:57.95	3:57.46
4	Day, Tony	GBR	57.45	1:57.10	2:57.26	3:57.91
5	Botini, Alberto	SUI	57.35	1:57.54	2:58.33	3:57.92
6	Christensen, Claus	DEN	58.58	1:58.52	2:59.16	4:00.46
7	Mizumoto, Yoshiyuki	JPN	59.07	2:00.15	3:01.22	4:02.02
8	Ogata, Shigeo	JPN	57.42	1:58.40	3:01.39	4:05.68

**Men 400m Freestyle
Heat 5/Sept. 23****Hommes/400m nage libre
Serie 5/23 Sept**

Rank Rang	Name Nom	Ctry Pays	100m	200m	300m	400m
1	Podkoscielny, Mariusz	POL	55.91	1:54.07	2:52.14	3:49.51 NOR
2	Pfeiffer, Stefan	FRG	56.53	1:54.51	2:52.47	3:49.52
3	Henkel, Rainer	FRG	55.62	1:53.63	2:52.52	3:51.50
4	Kalaus, Valter	HUN	56.11	1:54.68	2:53.75	3:53.44
5	Hoffmann, Joerg	GDR	57.16	1:55.78	2:55.02	3:53.78
6	Petric, Darjan	YUG	57.11	1:56.29	2:56.51	3:56.94
7	Michelena, Cristiano	BRA	57.19	1:57.42	2:58.50	3:57.79
8	Vandermeulen, Gary	CAN	57.44	1:57.10	2:57.73	3:57.99

**Men 400m Freestyle
Heat 6/Sept. 23****Hommes/400m nage libre
Serie 6/23 Sept**

Rank Rang	Name Nom	Ctry Pays	100m	200m	300m	400m
1	Boyd, Kevin	GBR	56.27	1:54.30	2:51.98	3:50.01
2	Holmertz, Anders	SWE	55.78	1:54.31	2:53.10	3:50.06
3	Cetlinski, Matthew	USA	56.00	1:54.34	2:52.78	3:50.82
4	Brown, Ian	AUS	56.05	1:54.78	2:53.37	3:51.09
5	Lamberti, Giorgio	ITA	56.19	1:54.99	2:54.55	3:53.29
6	Scanavino, Carlos	URU	57.01	1:56.63	2:56.33	3:54.86
7	Szilagyi, Zoltan	HUN	56.57	1:55.70	2:55.40	3:56.29
8	Iacono, Franck	FRA	56.91	1:56.06	2:57.51	4:00.04

**Men 400m Freestyle
Heat 7/Sept. 23****Hommes/400m nage libre
Serie 7/23 Sept**

Rank Rang	Name Nom	Ctry Pays	100m	200m	300m	400m
1	Wojdat, Artur	POL	55.66	1:54.38	2:53.30	3:49.68
2	Dassler, Uwe	GDR	55.79	1:54.54	2:53.56	3:49.90
3	Armstrong, Duncan	AUS	56.41	1:56.39	2:54.42	3:50.64
4	Jorgensen, Daniel	USA	56.45	1:55.92	2:54.70	3:52.64
5	O'Hare, Turlough	CAN	56.96	1:56.89	2:56.23	3:55.35
6	Gleria, Roberto	ITA	55.96	1:55.11	2:56.02	3:56.33
7	Bazanov, Alexandre	URS	57.35	1:57.99	2:58.33	3:58.74
8	Arnould, Jean-Merie	BEL	57.33	1:57.26	2:58.89	3:59.91

Swimming

Natation

Men 400m Freestyle /Sept. 23			Hommes/400m nage libre /23 Sept				
Rank	Name	Ctry	100m	200m	300m	400m	
Rang	Nom	Pays					
1	Podkosielnny, Mariusz	POL	55.91	1:54.07	2:52.14	3:49.51	NOR
2	Pfeiffer, Stefan	FRG	56.53	1:54.51	2:52.47	3:49.52	
3	Wojdat, Artur	POL	55.66	1:54.38	2:53.30	3:49.68	
4	Dassler, Uwe	GDR	55.79	1:54.54	2:53.56	3:49.90	
5	Boyd, Kevin	GBR	56.27	1:54.30	2:51.98	3:50.01	
6	Holmertz, Anders	SWE	55.78	1:54.31	2:53.10	3:50.06	
7	Armstrong, Duncan	AUS	56.41	1:56.39	2:54.42	3:50.64	
8	Cetlinski, Matthew	USA	56.00	1:54.34	2:52.78	3:50.82	
9	Brown, Ian	AUS	56.05	1:54.78	2:53.37	3:51.09	
10	Henkel, Rainer	FRG	55.62	1:53.63	2:52.52	3:51.50	
11	Jorgensen, Daniel	USA	56.45	1:55.92	2:54.70	3:52.64	
12	Lamberti, Giorgio	ITA	56.19	1:54.99	2:54.55	3:53.29	
13	Kalaus, Valter	HUN	56.11	1:54.68	2:53.75	3:53.44	
14	Hoffmann, Joerg	GDR	57.16	1:55.78	2:55.02	3:53.78	
15	Scanavino, Carlos	URU	57.01	1:56.63	2:56.33	3:54.86	
16	Vassallo, Salvador	PUR	56.97	1:56.23	2:55.56	3:55.30	
17	O'Hare, Turlough	CAN	56.96	1:56.89	2:56.23	3:55.35	
18	Szilagyi, Zoltan	HUN	56.57	1:55.70	2:55.40	3:56.29	
19	Gleria, Roberto	ITA	55.96	1:55.11	2:56.02	3:56.33	
20	Petric, Darjan	YUG	57.11	1:56.29	2:56.51	3:56.94	
21	Jangvail, Henrik	SWE	58.24	1:57.86	2:57.86	3:57.41	
22	Serra, Daniel	ESP	57.66	1:57.95	2:57.95	3:57.46	
23	Michelena, Cristiano	BRA	57.19	1:57.42	2:58.50	3:57.79	
24	Day, Tony	GBR	57.45	1:57.10	2:57.26	3:57.91	
25	Bottini, Alberto	SUI	57.35	1:57.54	2:58.33	3:57.92	
26	Vandermeulen, Gary	CAN	57.44	1:57.10	2:57.73	3:57.99	
27	Bazanov, Alexandre	URS	57.35	1:57.99	2:58.33	3:58.74	
28	Majcen, Igor	YUG	59.01	1:59.81	3:00.30	3:58.90	
29	Arnould, Jean-Marie	BEL	57.33	1:57.26	2:58.89	3:59.91	
30	Iacono, Franck	FRA	56.91	1:56.06	2:57.51	4:00.04	
31	Christensen, Claus	DEN	58.58	1:58.52	2:59.16	4:00.46	
32	Mizumoto, Yoshiyuki	JPN	59.07	2:00.15	3:01.22	4:02.02	
33	Castro, David	BRA	58.45	2:00.17	3:01.89	4:02.48	
34	Escamilla, Ignacio	MEX	58.63	2:00.39	3:01.89	4:03.16	
35	Romo, Carlos	MEX	59.21	2:00.86	3:01.99	4:04.02	
36	Ong, Kuan Seng Jeffrey	MAL	57.79	2:00.76	3:03.63	4:04.57	
37	Gudomundsson, Ragnar	ISL	59.39	2:00.97	3:03.33	4:05.12	
38	Ogata, Shigeo	JPN	57.42	1:58.40	3:01.39	4:05.68	
39	Yang, Wook	KOR	59.26	2:01.44	3:04.48	4:05.81	
40	Wu, Ming-Hsun	TPE	59.70	2:01.99	3:04.74	4:06.66	
41	Sakovich, Jonathan	GUM	59.31	2:02.61	3:06.32	4:06.89	
42	Kwon, Soon-Kun	KOR	58.75	2:01.46	3:04.70	4:08.02	
43	Bera, Richard Sam	INA	59.09	2:02.57	3:05.84	4:08.70	
44	Koh, Desmond	SIN	1:01.17	2:06.32	3:11.21	4:15.54	
45	Li, Arthur	HKG	59.88	2:04.16	3:11.27	4:18.50	
46	Boiling, Julian	SRI	1:01.15	2:06.28	3:13.07	4:18.88	
47	Alansari, Bassam	UAE	1:05.04	2:17.02	3:29.40	4:39.36	
48	Lahoud, Emile	LIB	1:07.94	2:21.73	3:35.88	4:47.09	
49	Binabid, Mohammed	UAE	1:02.98	2:15.69	3:29.58	4:47.28	

Men 400m Freestyle Final A/Sept. 23			Hommes/400m nage libre Finale A/23 Sept				
Rank	Name	Ctry	100m	200m	300m	400m	
Rang	Nom	Pays					
1	Dassler, Uwe	GDR	55.30	1:53.17	2:51.40	3:46.95	NWR NOR
2	Armstrong, Duncan	AUS	56.41	1:55.10	2:52.13	3:47.15	
3	Wojdat, Artur	POL	54.78	1:52.98	2:51.06	3:47.34	
4	Cetlinski, Matthew	USA	54.57	1:52.45	2:50.46	3:48.09	
5	Podkosielnny, Mariusz	POL	55.34	1:53.52	2:51.65	3:48.59	
6	Pfeiffer, Stefan	FRG	56.17	1:54.22	2:52.19	3:49.96	
7	Boyd, Kevin	GBR	55.68	1:53.72	2:51.99	3:50.16	
8	Holmertz, Anders	SWE	54.48	1:52.32	2:51.08	3:51.04	

Men 400m Freestyle Final B/Sept. 23			Hommes/400m nage libre Finale B/23 Sept				
Rank	Name	Ctry	100m	200m	300m	400m	
Rang	Nom	Pays					
1	Hoffmann, Joerg	GDR	56.73	1:55.93	2:54.25	3:52.13	
2	Kalaus, Valter	HUN	56.61	1:56.06	2:55.61	3:53.24	
3	O'Hare, Turlough	CAN	56.81	1:56.45	2:56.15	3:54.33	
4	Scanavino, Carlos	URU	56.70	1:56.77	2:56.53	3:54.36	
5	Brown, Ian	AUS	56.08	1:55.96	2:55.45	3:54.63	
6	Jorgensen, Daniel	USA	56.11	1:56.06	2:55.94	3:55.34	
7	Vassallo, Salvador	PUR	56.99	1:56.26	2:56.17	3:55.39	
8	Szilagyi, Zoltan	HUN	57.03	1:56.93	2:57.01	3:56.00	

Men 1500m Freestyle Heat 1/Sept. 24			Hommes/1500m nage libre Serie 1/24 Sept				
Rank	Name	Ctry	100m	200m	300m	400m	500m
Rang	Nom	Pays	600m	700m	800m	900m	1000m
			1100m	1200m	1300m	1400m	1500m
1	Wu, Ming-Hsun	TPE	1:04.17	2:07.56	3:12.18	4:17.04	5:21.78
			6:26.20	7:30.70	8:34.86	9:39.51	10:43.69
			11:47.75	12:51.49	13:55.06	14:58.40	15:59.74
2	Yang, Wook	KOR	1:02.43	2:08.48	3:15.23	4:21.59	5:26.68
			6:30.95	7:35.32	8:39.58	9:45.22	10:51.12
			11:57.32	13:03.88	14:10.28	15:17.17	16:21.10
3	Sakovich, J	GUM	59.77	2:04.90	3:10.97	4:16.84	5:22.62
			6:27.75	7:33.51	8:39.63	9:46.00	10:52.46
			11:59.06	13:06.19	14:13.75	15:20.88	16:26.77

Men 1500m Freestyle Heat 2/Sept. 24			Hommes/1500m nage libre Serie 2/24 Sept				
Rank	Name	Ctry	100m	200m	300m	400m	500m
Rang	Nom	Pays	600m	700m	800m	900m	1000m
			1100m	1200m	1300m	1400m	1500m
1	Kalaus, Valter	HUN	59.96	2:02.42	3:04.97	4:07.44	5:09.56
			6:11.54	7:13.68	8:15.88	9:17.49	10:19.60
			11:21.59	12:23.27	13:24.42	14:25.27	15:23.01
2	Kato, Masashi	JPN	1:02.48	2:06.34	3:10.09	4:13.98	5:17.68
			6:21.27	7:24.83	8:28.10	9:31.53	10:34.90
			11:37.98	12:40.91	13:43.40	14:46.09	15:47.35
3	Michelena, C	BRA	1:01.19	2:04.58	3:08.67	4:12.49	5:16.39
			6:19.61	7:23.67	8:26.89	9:30.73	10:34.88
			11:38.42	12:42.37	13:46.39	14:50.14	15:50.50
4	Mizumoto, Y	JPN	1:01.29	2:04.88	3:08.28	4:11.49	5:14.02
			6:16.17	7:19.26	8:22.50	9:26.10	10:29.63
			11:33.69	12:38.10	13:43.25	14:49.22	15:52.06
5	Agh, Norbert	HUN	1:00.15	2:02.87	3:05.49	4:08.83	5:11.89
			6:14.99	7:18.90	8:22.63	9:27.25	10:32.52
			11:38.03	12:43.09	13:48.21	14:52.56	15:52.80
6	Ong, Kuan Seng	MAL	59.62	2:04.32	3:09.17	4:14.15	5:18.64
			6:22.41	7:26.58	8:29.75	9:34.24	10:38.53
			11:42.31	12:46.60	13:50.99	14:53.76	15:53.67
7	Costa, Artur	POR	1:01.14	2:05.45	3:09.70	4:13.50	5:17.86
			6:21.92	7:26.96	8:31.05	9:35.45	10:39.95
			11:43.96	12:47.97	13:52.53	14:55.81	15:56.13
8	Gudomundsson, R	ISL	1:03.58	2:08.26	3:12.19	4:16.21	5:19.81
			6:23.16	7:26.96	8:30.69	9:34.20	10:38.20
			11:42.38	12:46.85	13:51.48	14:55.59	15:57.54

Men 1500m Freestyle Heat 3/Sept. 24			Hommes/1500m nage libre Serie 3/24 Sept				
Rank	Name	Ctry	100m	200m	300m	400m	500m
Rang	Nom	Pays	600m	700m	800m	900m	1000m
			1100m	1200m	1300m	1400m	1500m
1	Pfeiffer, Stefan	FRG	58.80	1:59.73	3:00.66	4:01.46	5:01.91
			6:02.23	7:02.43	8:02.72	9:03.28	10:03.76
			11:04.48	12:05.35	13:06.63	14:07.73	15:07.85
2	Boyd, Kevin	GBR	59.35	2:00.89	3:02.13	4:03.65	5:05.25
			6:06.64	7:07.66	8:09.12	9:10.67	10:12.43
			11:14.66	12:15.54	13:16.47	14:17.40	15:17.56
3	Marchand, C	FRA	59.38	2:00.91	3:02.35	4:03.65	5:05.37
			6:06.80	7:07.93	8:09.01	9:10.54	10:12.60
			11:14.70	12:16.67	13:19.20	14:21.56	15:22.19
4	Chalmers, C	CAN	59.63	2:01.27	3:02.92	4:04.55	5:05.69
			6:07.45	7:09.37	8:11.45	9:13.22	10:14.98
			11:16.78	12:18.82	13:20.83	14:23.10	15:23.22
5	Taylor, Harry	CAN	1:00.26	2:02.61	3:04.14	4:06.02	5:07.66
			6:09.23	7:12.03	8:14.22	9:16.85	10:19.31
			11:21.78	12:24.71	13:27.36	14:30.43	15:30.31
6	Battistelli, S	ITA	59.44	2:01.18	3:02.51	4:04.12	5:05.20
			6:07.67	7:10.35	8:13.04	9:15.70	10:19.03
			11:22.48	12:26.48	13:30.39	14:34.09	15:36.54
7	Jorgensen, Lars	USA	58.75	2:00.05	3:01.08	4:02.36	5:03.87
			6:06.49	7:09.41	8:12.36	9:15.66	10:18.89
			11:23.25	12:27.63	13:32.16	14:36.61	15:39.51
8	Castro, David	BRA	1:00.03	2:02.62	3:05.55	4:09.17	5:13.14
			6:17.42	7:21.85	8:26.31	9:31.18	10:35.95
			11:40.53	12:45.28	13:49.73	14:54.40	15:57.89

**Men 1500m Freestyle
Heat 4/Sept. 24****Hommes/1500m nage libre
Serie 4/24 Sept**

Rank Rang	Name Nom	Ctry Pays	100m 600m 1100m	200m 700m 1200m	300m 800m 1300m	400m 900m 1400m	500m 1000m 1500m
1	Salnikov, V	URS	58.12 5:58.60 11:02.86	1:58.10 6:59.26 12:04.13	2:58.06 7:59.74 13:05.60	3:58.37 9:00.59 14:07.02	4:58.37 10:01.74 15:07.83
2	Dassler, Uwe	GDR	57.66 6:00.84 11:07.00	1:57.56 7:01.78 12:08.24	2:57.79 8:02.97 13:09.84	3:58.97 9:04.28 14:10.69	5:00.10 10:05.28 15:08.91
3	Podkoscielny, M	POL	58.80 6:02.75 11:09.36	1:59.27 7:03.77 12:10.62	3:00.06 8:04.98 13:11.70	4:00.88 9:06.40 14:12.01	5:01.97 10:07.98 15:11.19
4	Hoffmann, Joerg	GDR	57.98 6:01.69 11:08.72	1:58.06 7:02.63 12:10.60	2:58.44 8:03.96 13:12.24	3:59.31 9:05.34 14:13.73	5:00.54 10:06.89 15:14.13
5	Mckenzie, M	AUS	58.26 6:03.26 11:12.38	1:59.07 7:04.99 12:14.42	3:00.16 8:06.53 13:16.25	4:01.20 9:08.76 14:18.36	5:02.15 10:10.55 15:19.36
6	Iacono, Franck	FRA	58.53 6:06.17 11:14.28	1:59.45 7:08.00 12:15.57	3:00.92 8:10.13 13:17.72	4:02.58 9:11.82 14:20.69	5:04.38 10:12.89 15:22.66
7	Majcen, Igor	YUG	1:00.29 6:08.60 11:18.85	2:02.19 7:10.61 12:21.19	3:03.69 8:12.72 13:23.86	4:05.12 9:14.49 14:27.07	5:07.01 10:16.58 15:29.16
8	Wojdat, Artur	POL	59.08 6:10.07 11:25.52	2:00.68 7:13.12 12:28.94	3:02.90 8:16.19 13:32.26	4:05.31 9:19.41 14:35.72	5:07.40 10:22.08 15:37.52

**Men 1500m Freestyle
Heat 5/Sept. 24****Hommes/1500m nage libre
Serie 5/24 Sept**

Rank Rang	Name Nom	Ctry Pays	100m 600m 1100m	200m 700m 1200m	300m 800m 1300m	400m 900m 1400m	500m 1000m 1500m
1	Cetlinski, M	USA	58.68 6:03.46 11:05.15	2:00.22 7:03.79 12:05.86	3:01.27 8:04.04 13:06.93	4:02.38 9:04.27 14:07.54	5:03.11 10:04.64 15:07.41
2	Henkel, Rainer	FRG	1:00.10 6:05.52 11:09.75	2:01.70 7:06.12 12:10.61	3:02.74 8:06.78 13:12.21	4:03.92 9:07.21 14:14.17	5:04.68 10:08.90 15:14.64
3	Petric, Darjan	YUG	59.98 6:05.32 11:10.46	2:00.88 7:05.97 12:11.84	3:01.81 8:06.78 13:13.82	4:02.92 9:07.72 14:15.96	5:04.17 10:09.04 15:16.99
4	Pellegrini, Luca	ITA	1:00.35 6:08.15 11:15.08	2:01.93 7:09.45 12:16.42	3:03.76 8:10.55 13:18.24	4:05.27 9:11.92 14:19.89	5:06.72 10:13.38 15:18.80
5	Plummer, Jason	AUS	1:00.22 6:05.56 11:13.00	2:01.53 7:06.88 12:15.28	3:02.16 8:08.13 13:17.84	4:02.99 9:09.57 14:20.98	5:04.18 10:11.16 15:22.85
6	Persson, Stefan	SWE	59.99 6:10.75 11:19.55	2:02.34 7:12.89 12:21.69	3:04.53 8:14.35 13:23.39	4:06.69 9:16.12 14:24.84	5:08.67 10:17.79 15:24.33
7	Day, Tony	GBR	1:00.08 6:10.61 11:24.75	2:02.62 7:12.94 12:28.17	3:04.77 8:15.38 13:31.83	4:06.82 9:18.04 14:35.66	5:08.85 10:21.39 15:38.75
8	Wang, Dali	CHN	1:00.52 6:13.35 11:33.03	2:02.70 7:16.86 12:36.89	3:05.42 8:20.98 13:40.89	4:07.88 9:24.92 14:45.12	5:10.60 10:28.77 15:45.96

**Men 1500m Freestyle
/Sept. 24-25****Hommes/1500m nage libre
/24-25 Sept**

Rank Rang	Name Nom	Ctry Pays	100m 600m 1100m	200m 700m 1200m	300m 800m 1300m	400m 900m 1400m	500m 1000m 1500m
1	Cetlinski, M	USA	58.68 6:03.46 11:05.15	2:00.22 7:03.79 12:05.86	3:01.27 8:04.04 13:06.93	4:02.38 9:04.27 14:07.54	5:03.11 10:04.64 15:07.41
2	Salnikov, V	URS	58.12 5:58.60 11:02.86	1:58.10 6:59.26 12:04.13	2:58.06 7:59.74 13:05.60	3:58.37 9:00.59 14:07.02	4:58.37 10:01.74 15:07.83
3	Pfeiffer, Stefan	FRG	58.80 6:02.23 11:04.48	1:59.73 7:02.43 12:05.35	3:00.66 8:02.72 13:06.63	4:01.46 9:03.28 14:07.73	5:01.91 10:03.76 15:07.85
4	Dassler, Uwe	GDR	57.66 6:00.84 11:07.00	1:57.56 7:01.78 12:08.24	2:57.79 8:02.97 13:09.84	3:58.97 9:04.28 14:10.69	5:00.10 10:05.28 15:08.91
5	Podkoscielny, M	POL	58.80 6:02.75 11:09.36	1:59.27 7:03.77 12:10.62	3:00.06 8:04.98 13:11.70	4:00.88 9:06.40 14:12.01	5:01.97 10:07.98 15:11.19
6	Hoffmann, Joerg	GDR	57.98 6:01.69 11:08.72	1:58.06 7:02.63 12:10.60	2:58.44 8:03.96 13:12.24	3:59.31 9:05.34 14:13.73	5:00.54 10:06.89 15:14.13

Rank Rang	Name Nom	Ctry Pays	100m 600m 1100m	200m 700m 1200m	300m 800m 1300m	400m 900m 1400m	500m 1000m 1500m
7	Henkel, Rainer	FRG	1:00.10 6:05.52 11:09.75	2:01.70 7:06.12 12:10.61	3:02.74 8:06.78 13:12.21	4:03.92 9:07.21 14:14.17	5:04.68 10:08.90 15:14.64
8	Petric, Darjan	YUG	59.98 6:05.32 11:10.46	2:00.88 7:05.97 12:11.84	3:01.81 8:06.78 13:13.82	4:02.92 9:07.72 14:15.96	5:04.17 10:09.04 15:16.99
9	Boyd, Kevin	GBR	59.35 6:06.64 11:14.66	2:00.89 7:07.66 12:15.54	3:02.13 8:09.12 13:16.47	4:03.65 9:10.67 14:17.40	5:05.25 10:12.43 15:17.56
10	Pellegrini, Luca	ITA	1:00.35 6:08.15 11:15.08	2:01.93 7:09.45 12:16.42	3:03.76 8:10.55 13:18.24	4:05.27 9:11.92 14:19.89	5:06.72 10:13.38 15:18.80
11	Mckenzie, M	AUS	58.26 6:03.26 11:12.38	1:59.07 7:04.99 12:14.42	3:00.16 8:06.53 13:16.25	4:01.20 9:08.76 14:18.36	5:02.15 10:10.55 15:19.36
12	Marchand, C	FRA	59.38 6:06.80 11:14.70	2:00.91 7:07.93 12:16.67	3:02.35 8:09.01 13:19.20	4:03.65 9:10.54 14:21.56	5:05.37 10:12.60 15:22.19
13	Iacono, Franck	FRA	58.53 6:06.17 11:14.28	1:59.45 7:08.00 12:15.57	3:00.92 8:10.13 13:17.72	4:02.58 9:11.82 14:20.69	5:04.38 10:12.89 15:22.66
14	Plummer, Jason	AUS	1:00.22 6:05.56 11:13.00	2:01.53 7:06.88 12:15.28	3:02.16 8:08.13 13:17.84	4:02.99 9:09.57 14:20.98	5:04.18 10:11.16 15:22.85
15	Kalaus, Valter	HUN	59.96 6:11.54 11:21.59	2:02.42 7:13.68 12:23.27	3:04.97 8:15.88 13:24.42	4:07.44 9:17.49 14:25.27	5:09.56 10:19.60 15:23.01
16	Chalmers, C	CAN	59.63 6:07.45 11:16.78	2:01.27 7:09.37 12:18.82	3:02.92 8:11.45 13:20.83	4:04.55 9:13.22 14:23.10	5:05.69 10:14.98 15:23.22
17	Persson, Stefan	SWE	59.99 6:10.75 11:19.55	2:02.34 7:12.89 12:21.69	3:04.53 8:14.35 13:23.39	4:06.69 9:16.12 14:24.84	5:08.67 10:17.79 15:24.33
18	Majcen, Igor	YUG	1:00.29 6:08.60 11:18.85	2:02.19 7:10.61 12:21.19	3:03.69 8:12.72 13:23.86	4:05.12 9:14.49 14:27.07	5:07.01 10:16.58 15:29.16
19	Taylor, Harry	CAN	1:00.26 6:09.23 11:21.78	2:02.61 7:12.03 12:24.71	3:04.14 8:14.22 13:27.36	4:06.02 9:16.85 14:30.43	5:07.66 10:19.31 15:30.31
20	Battistelli, S	ITA	59.44 6:07.67 11:22.48	2:01.18 7:10.35 12:26.48	3:02.51 8:13.04 13:30.39	4:04.12 9:15.70 14:34.09	5:05.20 10:19.03 15:36.54
21	Wojdat, Artur	POL	59.08 6:10.07 11:25.52	2:00.68 7:13.12 12:28.94	3:02.90 8:16.19 13:32.26	4:05.31 9:19.41 14:35.72	5:07.40 10:22.08 15:37.52
22	Day, Tony	GBR	1:00.08 6:10.61 11:24.75	2:02.62 7:12.94 12:28.17	3:04.77 8:15.38 13:31.83	4:06.82 9:18.04 14:35.66	5:08.85 10:21.39 15:38.75
23	Jorgensen, Lars	USA	58.75 6:06.49 11:23.25	2:00.05 7:09.41 12:27.63	3:01.08 8:12.36 13:32.16	4:02.36 9:15.66 14:36.61	5:03.87 10:18.89 15:39.51
24	Wang, Dali	CHN	1:00.52 6:13.35 11:33.03	2:02.70 7:16.86 12:36.89	3:05.42 8:20.98 13:40.89	4:07.88 9:24.92 14:45.12	5:10.60 10:28.77 15:45.96
25	Kato, Masashi	JPN	1:02.48 6:21.27 11:37.98	2:06.34 7:24.83 12:40.91	3:10.09 8:28.10 13:43.40	4:13.98 9:31.53 14:46.09	5:17.68 10:34.90 15:47.35
26	Michelena, C	BRA	1:01.19 6:19.61 11:38.42	2:04.58 7:23.67 12:42.37	3:08.67 8:26.89 13:46.39	4:12.49 9:30.73 14:50.14	5:16.39 10:34.88 15:50.50
27	Mizumoto, Y	JPN	1:01.29 6:16.17 11:33.69	2:04.88 7:19.26 12:38.10	3:08.28 8:22.50 13:43.25	4:11.49 9:26.10 14:49.22	5:14.02 10:29.63 15:52.06
28	Agh, Norbert	HUN	1:00.15 6:14.99 11:38.03	2:02.87 7:18.90 12:43.09	3:05.49 8:22.63 13:48.21	4:08.83 9:27.25 14:52.56	5:11.89 10:32.52 15:52.80
29	Ong, Kuan Seng	MAL	59.62 6:22.41 11:42.31	2:04.32 7:26.58 12:46.60	3:09.17 8:29.75 13:50.99	4:14.15 9:34.24 14:53.76	5:18.64 10:38.53 15:53.67
30	Costa, Artur	POR	1:01.14 6:21.92 11:43.96	2:05.45 7:26.96 12:47.97	3:09.70 8:31.05 13:52.53	4:13.50 9:35.45 14:55.81	5:17.86 10:39.95 15:56.13
31	Gudomundsson, R	ISL	1:03.58 6:23.16 11:42.38	2:08.26 7:26.96 12:46.85	3:12.19 8:30.69 13:51.48	4:16.21 9:34.20 14:55.59	5:19.81 10:38.20 15:57.54
32	Castro, David	BRA	1:00.03 6:17.42 11:40.53	2:02.62 7:21.85 12:45.28	3:05.55 8:26.31 13:49.73	4:09.17 9:31.18 14:54.40	5:13.14 10:35.95 15:57.89

Swimming

Rank Rang	Name Nom	Ctry Pays	100m 600m 1100m	200m 700m 1200m	300m 800m 1300m	400m 900m 1400m	500m 1000m 1500m
33	Mu, Ming-Hsun	TPE	1:04.17 6:26.20 11:47.75	2:07.56 7:30.70 12:51.49	3:12.18 8:34.86 13:55.06	4:17.04 9:39.51 14:58.40	5:21.78 10:43.69 15:59.74
34	Yang, Wook	KOR	1:02.43 6:30.95 11:57.32	2:08.48 7:35.32 13:03.88	3:15.23 8:39.58 14:10.28	4:21.59 9:45.22 15:17.17	5:26.68 10:51.12 16:21.10
35	Sakovich, J	GUM	59.77 6:27.75 11:59.06	2:04.90 7:33.51 13:06.19	3:10.97 8:39.63 14:13.75	4:16.84 9:46.00 15:20.88	5:22.62 10:52.46 16:26.77

Men 1500m Freestyle Final/Sept. 25			Hommes/1500m nage libre Finale/25 Sept				
Rank Rang	Name Nom	Ctry Pays	100m 600m 1100m	200m 700m 1200m	300m 800m 1300m	400m 900m 1400m	500m 1000m 1500m
1	Sainikov, V	URS	58.14 6:00.41 10:59.79	1:58.94 7:00.60 11:59.42	2:59.50 8:00.67 12:59.01	3:59.76 9:00.62 13:59.19	5:00.14 10:00.17 15:00.40
2	Pfeiffer, Stefan	FRG	58.45 6:01.62 11:02.35	1:59.38 7:02.06 12:02.61	3:00.04 8:02.14 13:03.13	4:00.55 9:02.07 14:03.42	5:01.11 10:02.21 15:02.69
3	Dassler, Uwe	GDR	58.13 6:01.54 11:06.71	1:59.03 7:02.43 12:07.47	2:59.77 8:03.24 13:08.50	4:00.34 9:04.27 14:08.48	5:00.84 10:05.68 15:06.15
4	Cetlinski, M	USA	58.09 6:00.13 11:04.63	1:58.83 7:00.86 12:06.03	2:59.22 8:01.11 13:07.76	3:59.52 9:01.86 14:09.08	4:59.63 10:03.15 15:14.76
5	Podkoscielny, M	POL	58.48 6:04.11 11:11.13	1:59.80 7:05.45 12:12.57	3:00.71 8:06.79 13:14.21	4:01.61 9:08.20 14:15.31	5:02.78 10:09.66 15:14.76
6	Henkel, Rainer	FRG	59.09 6:04.07 11:09.36	2:00.03 7:04.81 12:11.47	3:01.24 8:06.07 13:13.97	4:02.47 9:06.65 14:16.57	5:03.47 10:08.07 15:18.19
7	Boyd, Kevin	GBR	58.70 6:05.38 11:13.70	1:59.87 7:06.91 12:15.81	3:01.21 8:08.64 13:18.14	4:02.72 9:10.24 14:20.26	5:04.03 10:12.03 15:21.16
8	Petric, Darjan	YUG	59.50 6:06.69 11:20.91	2:00.23 7:08.96 12:24.87	3:01.33 8:11.37 13:29.18	4:02.90 9:14.04 14:33.64	5:04.71 10:17.30 15:37.12

Men 100m Backstroke Heat 1/Sept. 24			Hommes/100m dos Serie 1/24 Sept	
Rank Rang	Name Nom	Ctry Pays	50m	100m
1	Piva, Filippo	SMR	32.04	1:07.63
2	Abdulla, Mohamed	UAE	32.76	1:08.91
3	Kantari, Rami	LIB	32.75	1:09.35
4	Binabid, Mohammed	UAE	33.49	1:10.01
5	Du Pont, Yul Mark Yelle, Paul	SWZ BAR	34.58	1:12.50 NS

Men 100m Backstroke Heat 2/Sept. 24			Hommes/100m dos Serie 2/24 Sept	
Rank Rang	Name Nom	Ctry Pays	50m	100m
1	Park, Dong-Pil	KOR	29.03	1:01.25
2	Sagisi, Patrick	GUM	29.40	1:01.86
3	Yip, Hor Man	HKG	29.49	1:01.91
3	Niehaus, Horst	CRC	29.81	1:01.91
5	Halford, Brett	ZIM	29.54	1:02.95
6	Greenwood, Eric	CRC	29.51	1:03.11
7	Barahona, Pablo	HON	30.94	1:03.90
8	Ndiaye, Bruno	SEN	30.91	1:05.06

Men 100m Backstroke Heat 3/Sept. 24			Hommes/100m dos Serie 3/24 Sept	
Rank Rang	Name Nom	Ctry Pays	50m	100m
1	Lim, David	SIN	27.23	57.34
2	Cochran, Neil	GBR	27.64	58.25
3	Alvizuri, Alejandro	PER	28.59	58.37
4	Cullen, Stephen	IRL	27.81	58.82
5	Vela, Ernesto	MEX	28.56	59.19
6	Malamas, Helias	GRE	28.52	59.24
7	Gheel, Richard	IRL	28.41	59.37
8	Amer, Amin	EGY	26.47	1:00.76

Natation

Men 100m Backstroke Heat 4/Sept. 24			Hommes/100m dos Serie 4/24 Sept	
Rank Rang	Name Nom	Ctry Pays	50m	100m
1	Guzman, Manuel	PUR	27.46	57.62
2	Harper, Neil	GBR	27.38	58.02
3	Lopez-Zubero, Martin	ESP	28.21	58.06
4	Ferland, Patrick	SUI	27.86	58.17
5	Deutsch, Tamas	HUN	28.29	58.65
6	Boucher, Renaud	FRA	28.49	58.90
7	Huang, Guoxiong	CHN	28.56	59.36
8	Ribeiro, Wladimir	BRA	27.62	59.76

Men 100m Backstroke Heat 5/Sept. 24			Hommes/100m dos Serie 5/24 Sept	
Rank Rang	Name Nom	Ctry Pays	50m	100m
1	Murphy, Sean	CAN	26.10	56.20
2	Richter, Dirk	GDR	27.11	56.52
3	Berndt, Jens-Peter	FRG	27.63	57.08
4	Mortenson, Jay	USA	27.02	57.19
5	Maruyama, Shigemori	JPN	27.31	57.54
6	Edvardsson, Edvard	ISL	27.49	57.70
7	Vokoun, Pavel	TCH	27.79	58.88
8	Upton, Simon	AUS	29.09	59.06

Men 100m Backstroke Heat 6/Sept. 24			Hommes/100m dos Serie 6/24 Sept	
Rank Rang	Name Nom	Ctry Pays	50m	100m
1	Polianski, Igor	URS	26.08	55.04 NOR
2	Tewksbury, Mark	CAN	26.66	56.20
3	Baltrusch, Frank	GDR	27.30	56.45
4	Schott, Franck	FRA	27.06	56.76
5	Mikhalev, Gueorgui	BUL	27.09	57.06
6	Lin, Laijiu	CHN	27.63	57.74
7	Sorensen, Lars Punja, Ranjoy	DEN IND	28.01	58.01 NS

Men 100m Backstroke Heat 7/Sept. 24			Hommes/100m dos Serie 7/24 Sept	
Rank Rang	Name Nom	Ctry Pays	50m	100m
1	Berkoff, David	USA	25.23	54.51 NWR NOR
2	Suzuki, Daichi	JPN	26.29	55.90
3	Zabolotnov, Serguei	URS	26.74	56.13
4	Hoffmeister, Frank	FRG	26.80	56.19
5	Kingsman, Paul	NZL	27.76	57.80
6	Romero, Rogerio	BRA	27.91	57.91
7	Wilson, Carl	AUS	27.72	58.40
8	Giambalvo, Valerio	ITA	28.26	59.48

Men 100m Backstroke Sept. 24			Hommes/100m dos 24 Sept	
Rank Rang	Name Nom	Ctry Pays	50m	100m
1	Berkoff, David	USA	25.23	54.51 NWR NOR
2	Polianski, Igor	URS	26.08	55.04
3	Suzuki, Daichi	JPN	26.29	55.90
4	Zabolotnov, Serguei	URS	26.74	56.13
5	Hoffmeister, Frank	FRG	26.80	56.19
6	Murphy, Sean	CAN	26.10	56.20
6	Tewksbury, Mark	CAN	26.66	56.20
8	Baltrusch, Frank	GDR	27.30	56.45
9	Richter, Dirk	GDR	27.11	56.52
10	Schott, Franck	FRA	27.06	56.76
11	Mikhalev, Gueorgui	BUL	27.09	57.06
12	Berndt, Jens-Peter	FRG	27.63	57.08
13	Mortenson, Jay	USA	27.02	57.19
14	Lim, David	SIN	27.23	57.34
15	Maruyama, Shigemori	JPN	27.31	57.54
16	Guzman, Manuel	PUR	27.46	57.62
17	Edvardsson, Edvard	ISL	27.49	57.70
18	Lin, Laijiu	CHN	27.63	57.74
19	Kingsman, Paul	NZL	27.76	57.80
20	Romero, Rogerio	BRA	27.91	57.91
21	Sorensen, Lars	DEN	28.01	58.01
22	Harper, Neil	GBR	27.38	58.02
23	Lopez-Zubero, Martin	ESP	28.21	58.06
24	Ferland, Patrick	SUI	27.86	58.17
25	Cochran, Neil	GBR	27.64	58.25
26	Alvizuri, Alejandro	PER	28.59	58.37
27	Wilson, Carl	AUS	27.72	58.40
28	Deutsch, Tamas	HUN	28.29	58.65
29	Cullen, Stephen	IRL	27.81	58.82
30	Vokoun, Pavel	TCH	27.79	58.88
31	Boucher, Renaud	FRA	28.49	58.90
32	Upton, Simon	AUS	29.09	59.06
33	Vela, Ernesto	MEX	28.56	59.19
34	Malamas, Helias	GRE	28.52	59.24
35	Huang, Guoxiong	CHN	28.56	59.36
36	Gheel, Richard	IRL	28.41	59.37
37	Giambalvo, Valerio	ITA	28.26	59.48
38	Ribeiro, Wladimir	BRA	27.62	59.76
39	Amer, Amin	EGY	28.47	1:00.76
40	Park, Dong-Pil	KOR	29.03	1:01.25
41	Sagisi, Patrick	GUM	29.40	1:01.86
42	Niehaus, Horst	CRC	29.81	1:01.91



Rank	Name	Ctry	50m	100m
Rang	Nom	Pays		
42	Yip, Hor Man	HKG	29.49	1:01.91
44	Halford, Brett	ZIM	29.54	1:02.95
45	Greenwood, Eric	CRC	29.51	1:03.11
46	Barahona, Pablo	HON	30.94	1:03.90
47	Ndiaye, Bruno	SEN	30.91	1:05.06
48	Piva, Filippo	SMR	32.04	1:07.63
49	Abdulla, Mohamed	UAE	32.76	1:08.91
50	Kantari, Rami	LIB	32.75	1:09.35
51	Binabid, Mohammed	UAE	33.49	1:10.01
52	Du Pont, Yul Mark	SWZ	34.58	1:12.50
	Yelle, Paul	BAR		NS
	Punja, Ranjoy	IND		NS

Men 100m Backstroke			Hommes/100m dos		
Final A/Sept. 24			Finale A/24 Sept		
Rank	Name	Ctry	50m	100m	
Rang	Nom	Pays			
1	Suzuki, Daichi	JPN	25.97	55.05	
2	Berkoff, David	USA	25.47	55.18	
3	Polianski, Igor	URS	26.06	55.20	
4	Zabolotnov, Serguei	URS	26.38	55.37	
5	Tewksbury, Mark	CAN	26.66	56.09	
6	Baltrusch, Frank	GDR	27.22	56.10	
7	Hoffmeister, Frank	FRG	26.71	56.19	
8	Murphy, Sean	CAN	26.34	56.32	

Men 100m Backstroke			Hommes/100m dos		
Final B/Sept. 24			Finale B/24 Sept		
Rank	Name	Ctry	50m	100m	
Rang	Nom	Pays			
1	Richter, Dirk	GDR	27.22	56.66	
2	Schott, Franck	FRA	27.16	56.98	
3	Mortenson, Jay	USA	26.83	57.06	
4	Maruyama, Shigemori	JPN	26.79	57.13	
5	Mikhalev, Gueorgui	BUL	27.37	57.17	
6	Lim, David	SIN	27.12	57.72	
7	Guzman, Manuel	PUR	27.38	57.95	
8	Edvardsson, Edvard	ISL	28.68	58.20	

Men 200m Backstroke			Hommes/200m dos			
Heat 1/Sept. 22			Serie 1/22 Sept			
Rank	Name	Ctry	50m	100m	150m	200m
Rang	Nom	Pays				
1	Halford, Brett	ZIM	30.91	1:05.77	1:41.08	2:17.84
2	Barahona, Pablo	HON	32.54	1:07.84	1:44.49	2:21.61
3	Abdulla, Mohamed	UAE	33.37	1:11.62	1:51.10	2:29.64
4	Binabid, Mohammed	UAE	34.83	1:14.25	1:55.83	2:36.21
5	Kantari, Rami	LIB	34.39	1:14.64	1:57.66	2:40.29

Men 200m Backstroke			Hommes/200m dos			
Heat 2/Sept. 22			Serie 2/22 Sept			
Rank	Name	Ctry	50m	100m	150m	200m
Rang	Nom	Pays				
1	Cullen, Stephen	IRL	29.52	1:01.48	1:33.74	2:06.98
2	Ferland, Patrick	SUI	28.56	1:00.30	1:33.33	2:07.77
3	Lim, David	SIN	29.50	1:02.18	1:34.98	2:08.65
4	Ribeiro, Wladimir	BRA	29.28	1:02.31	1:36.12	2:11.48
5	Niehaus, Horst	CRC	30.36	1:03.46	1:37.44	2:12.83
6	Greenwood, Eric	CRC	29.77	1:03.30	1:38.64	2:15.42
7	Sagisi, Patrick	GUM	31.15	1:05.84	1:39.77	2:15.82
	Park, Dong-Pil	KOR				DQ

Men 200m Backstroke			Hommes/200m dos			
Heat 3/Sept. 22			Serie 3/22 Sept			
Rank	Name	Ctry	50m	100m	150m	200m
Rang	Nom	Pays				
1	Binfield, Gary	GBR	28.53	59.46	1:31.00	2:03.79
2	Alvizuri, Alejandro	PER	28.13	59.08	1:31.06	2:04.29
3	Davey, John	GBR	28.73	1:00.42	1:32.32	2:04.70
4	Vela, Ernesto	MEX	29.53	1:01.12	1:33.07	2:05.08
5	Gheel, Richard	IRL	29.39	1:00.99	1:32.72	2:05.71
6	Lin, Laijiu	CHN	29.03	1:01.47	1:34.33	2:08.28
7	Maruyama, Shigemori	JPN	28.58	1:00.42	1:33.94	2:09.16
	Papanikolaou, Charalambos	GRE				DQ

Men 200m Backstroke			Hommes/200m dos			
Heat 4/Sept. 22			Serie 4/22 Sept			
Rank	Name	Ctry	50m	100m	150m	200m
Rang	Nom	Pays				
1	Richter, Dirk	GDR	28.50	58.99	1:30.11	2:01.54
2	Veatch, Daniel	USA	28.15	58.82	1:29.84	2:01.73
3	Mikhalev, Gueorgui	BUL	28.70	59.65	1:31.22	2:02.71
4	Hoffmeister, Frank	FRG	27.88	58.86	1:29.57	2:03.34
5	Bigelow, Steve	USA	28.60	59.95	1:31.54	2:03.64
6	Murphy, Sean	CAN	28.22	59.69	1:31.00	2:03.81
7	Vokoun, Pavel	TCH	28.62	1:00.19	1:33.01	2:07.24

Men 200m Backstroke			Hommes/200m dos			
Heat 5/Sept. 22			Serie 5/22 Sept			
Rank	Name	Ctry	50m	100m	150m	200m
Rang	Nom	Pays				
1	Baltrusch, Frank	GDR	28.18	58.45	1:29.38	2:01.49
2	Romero, Rogerio	BRA	28.23	59.51	1:30.64	2:02.26
3	Lopez-Zubero, Martin	ESP	29.02	1:00.29	1:31.88	2:03.33
4	Suzuki, Daichi	JPN	27.80	59.39	1:31.43	2:03.36
5	Battistelli, Stefano	ITA	28.87	1:00.32	1:31.39	2:03.63
6	Tewksbury, Mark	CAN	27.94	58.71	1:30.35	2:04.02
7	Edvardsson, Edvard	ISL	28.50	1:00.12	1:32.69	2:05.61
	Darnyi, Tamas	HUN				DQ

Men 200m Backstroke			Hommes/200m dos			
Heat 6/Sept. 22			Serie 6/22 Sept			
Rank	Name	Ctry	50m	100m	150m	200m
Rang	Nom	Pays				
1	Zabolotnov, Serguei	URS	27.31	57.91	1:29.54	2:01.27
2	Polianski, Igor	URS	27.20	58.11	1:28.76	2:01.70
3	Berndt, Jens-Peter	FRG	28.76	59.48	1:30.56	2:01.77
4	Kingsman, Paul	NZL	29.08	1:00.10	1:30.65	2:02.20
5	Deutsch, Tamas	HUN	28.36	59.73	1:31.88	2:03.17
6	Holderbach, David	FRA	29.26	1:00.69	1:32.77	2:04.83
7	Upton, Simon	AUS	29.36	1:01.04	1:33.02	2:05.08
8	Sorensen, Lars	DEN	29.39	1:00.89	1:33.19	2:05.73

Men 200m Backstroke			Hommes/200m dos			
Sept. 22			22 Sept			
Rank	Name	Ctry	50m	100m	150m	200m
Rang	Nom	Pays				
1	Zabolotnov, Serguei	URS	27.31	57.91	1:29.54	2:01.27
2	Baltrusch, Frank	GDR	28.18	58.45	1:29.38	2:01.49
3	Richter, Dirk	GDR	28.50	58.99	1:30.11	2:01.54
4	Polianski, Igor	URS	27.20	58.11	1:28.76	2:01.70
5	Veatch, Daniel	USA	28.15	58.82	1:29.84	2:01.73
6	Berndt, Jens-Peter	FRG	28.76	59.48	1:30.56	2:01.77
7	Kingsman, Paul	NZL	29.08	1:00.10	1:30.65	2:02.20
8	Romero, Rogerio	BRA	28.23	59.51	1:30.64	2:02.26
9	Mikhalev, Gueorgui	BUL	28.70	59.65	1:31.22	2:02.71
10	Deutsch, Tamas	HUN	28.36	59.73	1:31.88	2:03.17
11	Lopez-Zubero, Martin	ESP	29.02	1:00.29	1:31.88	2:03.33
12	Hoffmeister, Frank	FRG	27.88	58.86	1:29.57	2:03.34
13	Suzuki, Daichi	JPN	27.80	59.39	1:31.43	2:03.36
14	Battistelli, Stefano	ITA	28.87	1:00.32	1:31.39	2:03.63
15	Bigelow, Steve	USA	28.60	59.95	1:31.54	2:03.64
16	Binfield, Gary	GBR	28.53	59.46	1:31.00	2:03.79
17	Murphy, Sean	CAN	28.22	59.69	1:31.00	2:03.81
18	Tewksbury, Mark	CAN	27.94	58.71	1:30.35	2:04.02
19	Alvizuri, Alejandro	PER	28.13	59.08	1:31.06	2:04.29
20	Davey, John	GBR	28.73	1:00.42	1:32.32	2:04.70
21	Holderbach, David	FRA	29.26	1:00.69	1:32.77	2:04.83
22	Upton, Simon	AUS	29.36	1:01.04	1:33.02	2:05.08
22	Vela, Ernesto	MEX	29.53	1:01.12	1:33.07	2:05.08
24	Edvardsson, Edvard	ISL	28.50	1:00.12	1:32.69	2:05.61
25	Gheel, Richard	IRL	29.39	1:00.99	1:32.72	2:05.71
26	Sorensen, Lars	DEN	29.39	1:00.89	1:33.19	2:05.73
27	Cullen, Stephen	IRL	29.52	1:01.48	1:33.74	2:06.98
28	Vokoun, Pavel	TCH	28.62	1:00.19	1:33.01	2:07.24
29	Ferland, Patrick	SUI	28.56	1:00.30	1:33.33	2:07.77
30	Lin, Laijiu	CHN	29.03	1:01.47	1:34.33	2:08.28
31	Lim, David	SIN	29.50	1:02.18	1:34.98	2:08.65
32	Maruyama, Shigemori	JPN	28.58	1:00.42	1:33.94	2:09.16
33	Ribeiro, Wladimir	BRA	29.28	1:02.31	1:36.12	2:11.48
34	Niehaus, Horst	CRC	30.36	1:03.46	1:37.44	2:12.83
35	Greenwood, Eric	CRC	29.77	1:03.30	1:38.64	2:15.42
36	Sagisi, Patrick	GUM	31.15	1:05.84	1:39.77	2:15.82
37	Halford, Brett	ZIM	30.91	1:05.77	1:41.08	2:17.84
38	Barahona, Pablo	HON	32.54	1:07.84	1:44.49	2:21.61
39	Abdulla, Mohamed	UAE	33.37	1:11.62	1:51.10	2:29.64
40	Binabid, Mohammed	UAE	34.83	1:14.25	1:55.83	2:36.21
41	Kantari, Rami	LIB	34.39	1:14.64	1:57.66	2:40.29
	Papanikolaou, Charalambos	GRE				DQ
	Darnyi, Tamas	HUN				DQ
	Park, Dong-Pil	KOR				DQ

Men 200m Backstroke			Hommes/200m dos			
Final A/Sept. 22			Finale A/22 Sept			
Rank	Name	Ctry	50m	100m	150m	200m
Rang	Nom	Pays				
1	Polianski, Igor	URS	27.14	57.49	1:28.20	1:59.37
2	Baltrusch, Frank	GDR	27.98	58.57	1:29.02	1:59.60
3	Kingsman, Paul	NZL	28.74	59.48	1:29.53	2:00.48
4	Zabolotnov, Serguei	URS	27.23	57.53	1:28.97	2:00.52
5	Richter, Dirk	GDR	28.99	59.94	1:30.77	2:01.67
6	Berndt, Jens-Peter	FRG	28.69	59.42	1:30.66	2:01.84
7	Veatch, Daniel	USA	28.63	59.75	1:30.82	2:02.26
8	Romero, Rogerio	BRA	28.52	59.79	1:31.41	2:02.28

Men 200m Backstroke			Hommes/200m dos			
Heat 5/Sept. 22			Serie 5/22 Sept			
Rank	Name	Ctry	50m	100m	150m	200m
Rang	Nom	Pays				
1	Polianski, Igor	URS	27.14	57.49	1:28.20	1:59.37
2	Baltrusch, Frank	GDR	27.98	58.57	1:29.02	1:59.60
3	Kingsman, Paul	NZL	28.74	59.48	1:29.53	2:00.48
4	Zabolotnov, Serguei	URS	27.23	57.53	1:28.97	2:00.52
5	Richter, Dirk	GDR	28.99	59.94	1:30.77	2:01.67
6	Berndt, Jens-Peter	FRG	28.69	59.42	1:30.66	2:01.84
7	Veatch, Daniel	USA	28.63	59.75	1:30.82	2:02.26
8	Romero, Rogerio	BRA	28.52	59.79	1:31.41	2:02.28

Men 200m Backstroke			Hommes/200m dos			
Heat 6/Sept. 22			Serie 6/22 Sept			
Rank	Name	Ctry	50m	100m	150m	200m
Rang	Nom	Pays				
1	Zabolotnov, Serguei	URS	27.31	57.91	1:29.54	2:01.27
2	Polianski, Igor	URS	27.20	58.11	1:28.76	2:01.70
3	Berndt, Jens-Peter	FRG	28.76	59.48	1:30.56	2:01.77
4	Kingsman, Paul	NZL	29.08	1:00.10	1:30.65	2:02.20
5	Deutsch, Tamas	HUN	28.36	59.73	1:31.88	2:03.17
6	Holderbach, David	FRA	29.26	1:00.69	1:32.77	2:04.83
7	Upton, Simon	AUS	29.36	1:01.04	1:33.02	2:05.08
8	Sorens					

Swimming

Men 200m Backstroke Final B/Sept. 22			Hommes/200m dos Finale B/22 Sept			
Rank Rang	Name Nom	Ctry Pays	50m	100m	150m	200m
1	Hoffmeister, Frank	FRG	28.38	59.61	1:30.60	2:01.65
2	Bigelow, Steve	USA	28.90	1:00.01	1:31.58	2:02.95
3	Lopez-Zubero, Martin	ESP	29.08	1:00.33	1:32.11	2:03.70
4	Tewksbury, Mark	CAN	29.05	1:00.28	1:32.54	2:03.79
5	Mikhalev, Gueorgui	BUL	28.64	59.70	1:32.09	2:04.24
6	Deutsch, Tamas	HUN	29.01	1:00.92	1:32.90	2:04.42
7	Suzuki, Daichi	JPN	28.59	59.85	1:32.24	2:04.67
8	Binfield, Gary	GBR	28.55	1:00.21	1:32.32	2:04.90

Men 100m Breaststroke Heat 1/Sept. 18			Hommes/100m brasse Serie 1/18 Sept	
Rank Rang	Name Nom	Ctry Pays	50m	100m
1	Piva, Michele	SMR	33.70	1:13.94
2	El-Doyati, Amine	LIB	34.12	1:14.40
3	Fragata, Gaspar	ANG	35.13	1:16.18
4	Alrumaithi, Obaid	UAE	35.02	1:17.01
5	Fernandes, Vivaldo Ncala, Trevor	ANG SWZ	36.38	1:17.98 NS

Men 100m Breaststroke Heat 2/Sept. 18			Hommes/100m brasse Serie 2/18 Sept	
Rank Rang	Name Nom	Ctry Pays	50m	100m
1	Yokochi, Alexandre	POR	31.09	1:05.66
2	NG, Yur Meng	SIN	29.61	1:05.87
3	Sorensen, Lars	DEN	31.86	1:07.93
4	Ragnarsson, Arnthor	ISL	32.86	1:07.93
5	Watt, Kam Sing	HKG	31.59	1:08.03
6	Quach Hoai, Nam	VIE	32.55	1:10.90
7	Singleton, Kraig	ISV	33.89	1:11.68
8	Md Bazlur Rahman, Bazlur	BAN	34.40	1:14.97

Men 100m Breaststroke Heat 3/Sept. 18			Hommes/100m brasse Serie 3/18 Sept	
Rank Rang	Name Nom	Ctry Pays	50m	100m
1	Yoon, Joo-Il	KOR	30.99	1:04.68
2	Appleboom, Sidney	BEL	30.81	1:05.21
3	Careaga, Jabier	MEX	30.68	1:05.37
4	Sugriat, Wirmandi	INA	30.82	1:06.22
5	Van De Vondel, Luc	BEL	31.18	1:06.24
6	Gutierrez, Manuel	PAN	31.17	1:06.73
7	Con Cepcion, Lee Patrick	PHI	31.52	1:06.74
8	Ruderry, Victor	BER	31.72	1:09.49

Men 100m Breaststroke Heat 4/Sept. 18			Hommes/100m brasse Serie 4/18 Sept	
Rank Rang	Name Nom	Ctry Pays	50m	100m
1	Tsai, Hsin-Yen	TPE	30.68	1:04.58
2	Beinhauer, Radek	TCH	39.40	1:04.61
3	Fernandez, Joaquin	ESP	31.07	1:05.19
4	O'Toole, Gary	IRL	30.18	1:05.34
5	Beks, Anthony	NZL	30.80	1:05.65
6	Lopez, Sergio	ESP	30.99	1:06.08
7	Lockhart, Richard	NZL	31.17	1:06.27
8	Fokianos, Nikolaos	GRE	31.18	1:06.30

Men 100m Breaststroke Heat 5/Sept. 18			Hommes/100m brasse Serie 5/18 Sept	
Rank Rang	Name Nom	Ctry Pays	50m	100m
1	Watanabe, Kenju	JPN	30.09	1:04.35
2	Eberle, Pierre-Yves	SUI	30.08	1:04.53
3	Mcadam, Ian	AUS	30.15	1:04.56
3	Leblanc, David	FRA	30.10	1:04.56
5	Jin,Fu	CHN	30.65	1:05.02
6	Penicaud, Cedric	FRA	31.28	1:15.46
7	Torteli, Cicero	BRA	30.72	1:05.50
8	Shtigman, Eyal	ISR	30.78	1:05.92

Men 100m Breaststroke Heat 6/Sept. 18			Hommes/100m brasse Serie 6/18 Sept	
Rank Rang	Name Nom	Ctry Pays	50m	100m
1	Davis, Victor	CAN	29.44	1:02.48
2	Matveev, Alexei	URS	29.55	1:03.25
3	Mayer, Alexander	FRG	29.76	1:03.54
4	Watters, Daniel	USA	30.12	1:04.04
5	Chen Jianhong	CHN	29.49	1:04.09
6	Parrack, James	GBR	29.78	1:04.23
7	Marcek, Alexander	TCH	30.58	1:04.95
8	Olsen, Jan Erick	NOR	30.63	1:05.54

Natation

Men 100m Breaststroke Heat 7/Sept. 18			Hommes/100m brasse Serie 7/18 Sept	
Rank Rang	Name Nom	Ctry Pays	50m	100m
1	Minervini, Gianni	ITA	29.77	1:02.86
2	Schroeder, Richard	USA	29.30	1:03.05
3	Dekker, Ronald	HOL	29.32	1:03.08
3	Debnar, Tamas	HUN	29.69	1:03.08
5	Nagahata, Hironobu	JPN	30.04	1:04.02
6	Restrepo, Pablo	COL	30.34	1:04.43
7	Hannemann, Raik	GDR	29.68	1:04.46
8	Dagon, Etienne	SUI	29.82	1:04.71

Men 100m Breaststroke Heat 8/Sept. 18			Hommes/100m brasse Serie 8/18 Sept	
Rank Rang	Name Nom	Ctry Pays	50m	100m
1	Moorhouse, Adrian	GBR	29.50	1:02.19
2	Volkov, Dmitri	URS	28.62	1:02.49
3	Guttler, Karoly	HUN	29.26	1:02.80
4	Poswiat, Christian	GDR	29.08	1:02.99
5	Warnecke, Mark	FRG	29.42	1:03.56
6	Suominen, Petri	FIN	29.87	1:03.58
7	Boehm, Thomas	AUT	30.22	1:04.96
8	Grant, Cameron	CAN	30.23	1:05.10

Men 100m Breaststroke Sept. 18			Hommes/100m brasse 18 Sept	
Rank Rang	Name Nom	Ctry Pays	50m	100m
1	Moorhouse, Adrian	GBR	29.50	1:02.19
2	Davis, Victor	CAN	29.44	1:02.48
3	Volkov, Dmitri	URS	28.62	1:02.49
4	Guttler, Karoly	HUN	29.26	1:02.80
5	Minervini, Gianni	ITA	29.77	1:02.86
6	Poswiat, Christian	GDR	29.08	1:02.99
7	Schroeder, Richard	USA	29.30	1:03.05
8	Debnar, Tamas	HUN	29.69	1:03.08
8	Dekker, Ronald	HOL	29.32	1:03.08
10	Matveev, Alexei	URS	29.55	1:03.25
11	Mayer, Alexander	FRG	29.76	1:03.54
12	Warnecke, Mark	FRG	29.42	1:03.56
13	Suominen, Petri	FIN	29.87	1:03.58
14	Nagahata, Hironobu	JPN	30.04	1:04.02
15	Watters, Daniel	USA	30.12	1:04.04
16	Chen, Jianhong	CHN	29.49	1:04.09
17	Parrack, James	GBR	29.78	1:04.23
18	Watanabe, Kenji	JPN	30.09	1:04.35
19	Restrepo, Pablo	COL	30.34	1:04.43
20	Hannemann, Raik	GDR	29.68	1:04.46
21	Eberle, Pierre-Yves	SUI	30.08	1:04.53
22	Mcadam, Ian	AUS	30.15	1:04.56
22	Leblanc, David	FRA	30.10	1:04.56
24	Tsai, Hsin-Yen	TPE	30.68	1:04.58
25	Beinhauer, Radek	TCH	30.40	1:04.61
26	Yoon, Joo-Il	KOR	30.99	1:04.68
27	Dagon, Etienne	SUI	29.82	1:04.71
28	Marcek, Alexander	TCH	30.58	1:04.95
29	Boehm, Thomas	AUT	30.22	1:04.96
30	Jin, Fu	CHN	30.65	1:05.02
31	Grant, Cameron	CAN	30.23	1:05.10
32	Fernandez, Joaquin	ESP	31.07	1:05.19
33	Appleboom, Sidney	BEL	30.81	1:05.21
34	O'Toole, Gary	IRL	30.18	1:05.34
35	Careaga, Javier	MEX	30.68	1:05.37
36	Penicaud, Cedric	FRA	31.28	1:05.46
37	Torteli, Cicero	BRA	30.72	1:05.50
38	Olsen, Jan Erick	NOR	30.63	1:05.54
39	Beks, Anthony	NZL	30.80	1:05.65
40	Yokochi, Alexandre	POR	31.09	1:05.66
41	NG, Yue Meng	SIN	29.61	1:05.87
42	Shtigman, Eyal	ISR	30.78	1:05.92
43	Lopez, Sergio	ESP	30.99	1:06.08
44	Sugriat, Wirmandi	INA	30.82	1:06.22
45	Van de Vondel, Luc	BEL	31.18	1:06.24
46	Lockhart, Richard	NZL	31.17	1:06.27
47	Fokianos, Nikolaos	GRE	31.18	1:06.30
48	Sorensen, Lars	DEN	31.66	1:06.30
49	Gutierrez, Manuel	PAN	31.17	1:06.73
50	Con Cepcion, Lee Patrick	PHI	31.86	1:07.93
51	Ragnarsson, Arnthor	ISL	31.86	1:07.93
52	Watt, Kam Sing	HKG	31.59	1:08.03
53	Ruderry, Victor	BER	31.72	1:09.49
54	Quach Hoai, Nam	VIE	32.55	1:10.90
55	Singleton, Kraig	ISV	33.89	1:11.68
56	Piva, Michele	SMR	33.70	1:13.94
57	El-Domyati, Amine	LIB	34.12	1:14.40
58	Md Bazlur Rahman, Bazlur	BAN	34.40	1:14.97
59	Fragata, Gaspar	ANG	35.13	1:16.18
60	Alrumaithi, Obaid	UAE	35.02	1:17.01
61	Fernandes, Vivaldo Ncala, Trevor	ANG SWZ	36.38	1:17.98 NS

**Men 100m Breaststroke
Final A/Sept. 19****Hommes/100m brasse
Finale A/19 Sept**

Rank Rang	Name Nom	Ctry Pays	50m	100m
1	Moorhouse, Adrian	GBR	29.42	1:02.04
2	Guttler, Karoly	HUN	28.94	1:02.05
3	Volkov, Dmitri	URS	28.12	1:02.20
4	Davis, Victor	CAN	29.44	1:02.38
5	Debnar, Tamas	HUN	29.56	1:02.50
6	Schroeder, Richard	USA	28.97	1:02.55
7	Minervini, Gianni	ITA	28.96	1:02.93
8	Poswiat, Christian	GDR	29.31	1:03.43

**Men 200m Breaststroke
Heat 6/Sept. 23****Hommes/200m brasse
Serie 6/23 Sept**

Rank Rang	Name Nom	Ctry Pays	50m	100m	150m	200m
1	Gillingham, Nick	GBR	30.58	1:04.98	1:39.83	2:14.58
2	Szabo, Jozsef	HUN	31.56	1:06.06	1:40.63	2:14.97
3	Lopez, Sergio	ESP	31.78	1:06.82	1:41.57	2:17.06
4	Alexeev, Vadim	URS	31.06	1:05.64	1:40.75	2:17.15
5	Yokochi, Alexandre	POR	31.92	1:07.05	1:42.41	2:17.87
6	Penicaud, Cedric	FRA	32.18	1:07.52	1:43.19	2:18.72
7	Restrepo, Pablo	COL	32.07	1:07.73	1:43.06	2:19.58
8	Fernandez, Joaquin	ESP	32.63	1:08.40	1:44.30	2:20.34

**Men 100m Breaststroke
Final B/Sept. 19****Hommes/100m brasse
Finale B/19 Sept**

Rank Rang	Name Nom	Ctry Pays	50m	100m
1	Matveev, Alexei	URS	29.69	1:03.01
2	Dekker, Ronald	HOL	28.94	1:03.22
3	Warnecke, Mark	FRG	30.12	1:03.40
4	Mayer, Alexander	FRG	30.26	1:03.85
5	Nagahata, Hironobu	JPN	29.94	1:03.89
6	Suominen, Petri	FIN	30.17	1:04.04
7	Watters, Daniel	USA	30.33	1:04.17
8	Chen, Jianhonq	CHN	30.81	1:04.72

**Men 200m Breaststroke
Heat 7/Sept. 23****Hommes/200m brasse
Serie 7/23 Sept**

Rank Rang	Name Nom	Ctry Pays	50m	100m	150m	200m
1	Barrowman, Mike	USA	31.39	1:06.37	1:41.20	2:15.85
2	Szabo, Peter	HUN	31.21	1:06.19	1:41.17	2:17.10
3	Grant, Cameron	CAN	31.13	1:06.35	1:41.55	2:17.62
4	Takahashi, Shigehiro	JPN	31.39	1:06.51	1:41.77	2:17.69
5	Marcek, Alexander	TCH	31.73	1:07.28	1:42.86	2:18.44
6	Moorhouse, Adrian	GBR	31.76	1:07.43	1:42.79	2:18.51
7	Mcadam, Ian	AUS	31.61	1:06.95	1:42.70	2:19.68
8	Olsen, Jan Erick	NOR	32.59	1:09.46	1:47.61	2:26.70

**Men 200m Breaststroke
Heat 1/Sept. 23****Hommes/200m brasse
Serie 1/23 Sept**

Rank Rang	Name Nom	Ctry Pays	50m	100m	150m	200m
1	Beks, Anthony	NZL	31.77	1:07.79	1:46.30	2:27.26
2	Ng, Yue Meng	SIN	33.01	1:11.67	1:50.95	2:30.74
3	Singleton, Kraig	ISV	35.29	1:15.27	1:55.61	2:36.45
4	Quach Hoai, Nam	VIE	34.79	1:15.94	1:57.41	2:39.69
5	El-Domyati, Amine	LIB	35.97	1:18.45	2:01.98	2:44.34
6	Alrumaithi, Obaid	UAE	35.96	1:18.20	2:03.36	2:50.49

**Men 200m Breaststroke
/Sept. 23****Hommes/200m brasse
/23 Sept**

Rank Rang	Name Nom	Ctry Pays	50m	100m	150m	200m
1	Gillingham, Nick	GBR	30.58	1:04.98	1:39.83	2:14.58
2	Szabo, Jozsef	HUN	31.56	1:06.05	1:40.63	2:14.97
3	Barrowman, Mike	USA	31.59	1:06.37	1:41.20	2:15.85
4	Lozik, Valeri	URS	30.83	1:05.37	1:40.53	2:16.31
5	Cleveland, Jonathan	CAN	31.40	1:05.92	1:41.20	2:16.87
6	Lopez, Sergio	ESP	31.78	1:06.82	1:41.57	2:17.06
7	Szabo, Peter	HUN	31.21	1:06.19	1:41.17	2:17.10
8	Alexeev, Vadim	URS	31.06	1:05.64	1:40.75	2:17.15
9	Grant, Cameron	CAN	31.13	1:06.35	1:41.55	2:17.62
10	Takahashi, Shigehiro	JPN	31.39	1:06.51	1:41.77	2:17.69
11	Yokochi, Alexandre	POR	31.92	1:07.05	1:42.41	2:17.87
12	Appelboom, Sidney	BEL	32.37	1:08.10	1:43.04	2:18.02
12	Beinhauer, Radek	TCH	31.73	1:07.75	1:42.82	2:18.02
14	Marcek, Alexander	TCH	31.73	1:07.28	1:42.86	2:18.44
15	Moorhouse, Adrian	GBR	31.76	1:07.43	1:42.79	2:18.51
16	Dagon, Etienne	SUI	31.21	1:06.74	1:42.23	2:18.68
17	Penicaud, Cedric	FRA	32.18	1:07.52	1:43.19	2:18.72
18	O'Toole, Gary	IRL	31.44	1:06.82	1:42.53	2:18.93
19	Stackle, Kirk	USA	31.14	1:06.62	1:42.70	2:19.47
20	Restrepo, Pablo	COL	32.07	1:07.73	1:43.06	2:19.58
21	Mcadam, Ian	AUS	31.61	1:06.95	1:42.70	2:19.68
22	Yoon, Joo-Il	KOR	32.83	1:08.64	1:44.87	2:19.94
23	Careaga, Javier	MEX	31.92	1:07.24	1:43.21	2:20.11
24	Fernandez, Joaquin	ESP	32.63	1:08.40	1:44.30	2:20.34
25	Eberle, Pierre-Yves	SUI	31.86	1:08.17	1:43.99	2:20.65
26	Dekker, Ronald	HOL	31.17	1:07.20	1:43.81	2:20.84
27	Poswiat, Christian	GDR	32.77	1:09.40	1:45.72	2:20.99
28	Van De Vondel, Luc	BEL	32.40	1:09.07	1:45.08	2:21.50
29	Suominen, Petri	FIN	31.70	1:06.96	1:44.00	2:22.01
30	Nagahata, Hironobu	JPN	32.56	1:09.60	1:46.91	2:22.23
31	Warnecke, Mark	FRG	31.61	1:07.81	1:44.70	2:22.55
31	Wedekind, Hartmut	FRG	32.33	1:08.25	1:45.29	2:22.55
33	Tsai, Hsin-Yen	TPE	33.67	1:09.80	1:46.55	2:23.80
34	Boehm, Thomas	AUT	32.34	1:08.60	1:46.36	2:24.15
35	Chang, Qing	CHN	32.39	1:08.87	1:46.70	2:24.45
36	Lockhart, Richard	NZL	32.47	1:09.21	1:46.23	2:24.52
37	Shtigman, Eyal	ISR	32.64	1:08.96	1:46.38	2:25.18
38	Jin, Fu	CHN	32.29	1:09.65	1:47.03	2:26.05
39	Sugriat, Wirmandi	INA	33.18	1:10.53	1:48.30	2:26.17
40	Gutierrez, Manuel	PAN	32.38	1:09.02	1:47.33	2:26.57
41	Olsen, Jan Erick	NOR	32.59	1:09.46	1:47.61	2:26.70
42	Beks, Anthony	NZL	31.77	1:07.79	1:46.30	2:27.26
43	Ragnarsson, Arnthor	ISL	33.24	1:10.97	1:49.77	2:27.93
44	Tortelli, Cicero	BRA	32.90	1:09.89	1:48.62	2:28.82
45	Fokianos, Nikolaos	GRE	33.02	1:10.87	1:49.81	2:28.91
46	Con Cepcion, Lee Patrick	PHI	33.05	1:10.23	1:49.73	2:29.62
47	Ng, Yue Meng	SIN	33.01	1:11.67	1:50.95	2:30.74
48	Watt, Kam Sing	HKG	33.54	1:11.09	1:50.40	2:30.78
49	Singleton, Kraig	ISV	35.29	1:15.27	1:55.61	2:36.45
50	Quach Hoai, Nam	VIE	34.79	1:15.94	1:57.41	2:39.69
51	El-Domyati, Amine	LIB	35.97	1:18.45	2:01.98	2:44.34
52	Alrumaithi, Obaid	UAE	35.96	1:18.20	2:03.36	2:50.49
	Toft, Christian	DEN				DQ
	Leblanc, David	FRA				DQ

**Men 200m Breaststroke
Heat 4/Sept. 23****Hommes/200m brasse
Serie 4/23 Sept**

Rank Rang	Name Nom	Ctry Pays	50m	100m	150m	200m
1	Appelboom, Sidney	BEL	32.37	1:08.10	1:43.04	2:18.02
2	Yoon, Joo-Il	KOR	32.83	1:08.64	1:44.87	2:19.94
3	Dekker, Ronald	HOL	31.17	1:07.20	1:43.81	2:20.84
4	Poswiat, Christian	GDR	32.77	1:09.40	1:45.72	2:20.99
5	Van De Vondel, Luc	BEL	32.40	1:09.07	1:45.08	2:21.50
6	Suominen, Petri	FIN	31.70	1:06.96	1:44.00	2:22.01
7	Nagahata, Hironobu	JPN	32.56	1:09.60	1:46.91	2:22.23
8	Jin, Fu	CHN	32.29	1:09.65	1:47.03	2:26.05

**Men 200m Breaststroke
Heat 5/Sept. 23****Hommes/200m brasse
Serie 5/23 Sept**

Rank Rang	Name Nom	Ctry Pays	50m	100m	150m	200m
1	Lozik, Valeri	URS	30.83	1:05.37	1:40.53	2:16.31
2	Cleveland, Jonathan	CAN	31.40	1:05.92	1:41.20	2:16.87
3	Beinhauer, Radek	TCH	31.73	1:07.75	1:42.82	2:18.02
4	Dagon, Etienne	SUI	31.21	1:06.74	1:42.23	2:18.68
5	O'Toole, Gary	IRL	31.44	1:06.82	1:42.53	2:18.93
6	Stackle, Kirk	USA	31.14	1:06.62	1:42.70	2:19.47
7	Wedekind, Hartmut	FRG	32.33	1:08.25	1:45.29	2:22.55
	Leblanc, David	FRA				DQ

**Men 200m Breaststroke
Final A/Sept. 23****Hommes/200m brasse
Finale A/23 Sept**

Rank Rang	Name Nom	Ctry Pays	50m	100m	150m	200m
1	Szabo, Jozsef	HUN	30.57	1:04.81	1:38.99	2:13.52
2	Gillingham, Nick	GBR	30.45	1:04.92	1:39.25	2:14.12
3	Lopez, Sergio	ESP	31.10	1:05.52	1:40.15	2:15.21
4	Barrowman, Mike	USA	30.85	1:05.65	1:40.71	2:15.45
5	Lozik, Valeri	URS	29.98	1:03.86	1:38.75	2:16.16
6	Alexeev, Vadim	URS	30.49	1:04.73	1:39.71	2:16.70
7	Cleveland, Jonathan	CAN	31.52	1:06.63	1:41.76	2:17.10
8	Szabo, Peter	HUN	31.31	1:05.96	1:41.19	2:17.12

Swimming

Men 200m Breaststroke Final B/Sept. 23			Hommes/200m brasse Finale B/23 Sept			
Rank Rang	Name Nom	Ctry Pays	50m	100m	150m	200m
1	Yokochi, Alexandre	POR	31.80	1:07.20	1:42.70	2:18.01
2	Takahashi, Shigehiro	JPN	31.50	1:06.83	1:42.59	2:18.03
3	Appelboom, Sidney	BEL	32.11	1:08.17	1:42.56	2:18.08
4	Beinhauer, Radek	TCH	32.05	1:07.79	1:43.12	2:18.13
5	Dagon, Etienne	SUI	31.11	1:06.61	1:42.22	2:18.17
6	Grant, Cameron	CAN	31.51	1:06.99	1:42.70	2:18.36
7	Marcek, Alexander	TCH	31.82	1:07.81	1:43.53	2:18.51
8	Penicaud, Cedric	FRA	31.76	1:06.98	1:42.81	2:18.95

Men 100m Butterfly Heat 1/Sept. 20			Hommes/100m papillon Serie 1/20 Sept	
Rank Rang	Name Nom	Ctry Pays	50m	100m
1	Yelle, Paul	BAR	27.56	57.36
2	Faftine, Sergio	MOZ	29.25	1:01.15
3	Castellanos, Plutarco	HON	29.45	1:02.69
4	Md Abdus Salam, Salam	BAN	29.65	1:03.69
5	Binabid, Mohammed	UAE	30.74	1:06.25
6	Ncala, Trevor	SWZ	30.16	1:06.85
7	Gomes, Jorge	ANG	32.60	1:09.60
	Vassallo, Salvador	PUR		NS

Men 100m Butterfly Heat 2/Sept. 20			Hommes/100m papillon Serie 2/20 Sept	
Rank Rang	Name Nom	Ctry Pays	50m	100m
1	Leitner, Reinhold	AUT	26.87	56.72
2	Albuquerque, Mabilio	POR	27.14	57.30
3	Zea, Urbano	MEX	27.53	57.89
4	Lima, Pedro	ANG	28.09	59.21
5	Thompson, Graham Lewis	ZIM	27.71	1:00.13
6	Singleton, Kristan	ISV	28.69	1:00.97
7	Cleveland, William	ISV	28.84	1:01.10
	Oon, Jin Gee	SIN		NS

Men 100m Butterfly Heat 3/Sept. 20			Hommes 100m papillon Serie 3/20 Sept	
Rank Rang	Name Nom	Ctry Pays	50m	100m
1	Buhain, Joseph Eric	PHI	27.01	57.17
2	Ribeiro, Wladimir	BRA	26.99	57.25
3	Griniakakis, Theodoros	GRE	27.34	57.56
4	Camacho, Paulo	POR	27.42	57.62
5	Park, Young-Chul	KOR	27.15	57.74
6	Tsang, Yi Ming	HKG	27.33	57.84
	Kozelj, Matjaz	YUG		NS

Men 100m Butterfly Heat 4/Sept. 20			Hommes 100m papillon Serie 4/20 Sept	
Rank Rang	Name Nom	Ctry Pays	50m	100m
1	Wilson, David	AUS	26.56	55.54
2	Tanaka, Yukinori	JPN	26.30	56.19
3	Anderson, Ross	NZL	26.57	56.31
4	Poli, Eduardo	BRA	27.25	56.37
5	David, Theophile	SUI	26.97	56.77
6	Ang, peng Siong	SIN	26.95	57.41
7	Romo, Carlos	MEX	26.92	58.04
	Adam, Michael	AUT		NS
	Vassallo, Salvador	PUR		NS
	Oon, Jin Gee	SIN		NS
	Kozelj, Matjaz	YUG		NS

Men 100m Butterfly Heat 5/Sept. 20			Hommes 100m papillon Serie 5/20 Sept	
Rank Rang	Name Nom	Ctry Pays	50m	100m
1	Jameson, Andy	GBR	25.33	53.33
2	Ponting, Thomas	CAN	25.70	54.31
3	Mosse, Anthony	NZL	25.50	54.63
4	Cerny, Vlastimil	CAN	25.70	54.66
5	Zheng, Jian	CHN	25.27	54.69
6	Szukala, Rafal	POL	26.07	54.83
7	Shen, Jianqiang	CHN	26.13	54.86
8	Giambalvo, Valerio	ITA	26.80	56.57

Men 100m Butterfly Heat 6/Sept. 20			Hommes/100m papillon Serie 6/20 Sept	
Rank Rang	Name Nom	Ctry Pays	50m	100m
1	Nesty, Anthony	SUR	25.57	53.50
2	Iarochtchouk, Vadim	URS	25.10	54.17
3	Mortenson, Jay	USA	25.68	54.44
4	Cochran, Neil	GBR	25.77	54.75
5	Ballester, Jose Luis	ESP	25.84	55.27
6	Michelotti, Leonardo	ITA	26.14	55.83
7	Petrov, Konstantine	URS	25.54	55.84
8	Depickere, Ludovic	FRA	26.36	56.47

Natation

Men 100m Butterfly Heat 7/Sept. 20			Hommes/100m papillon Serie 7/20 Sept	
Rank Rang	Name Nom	Ctry Pays	50m	100m
1	Biondi, Matthew	USA	24.81	53.46
2	Gross, Michael	FRG	25.05	53.78
3	Sieben, Jonathan	AUS	25.44	53.85
4	Nielsen, Benny	DEN	25.75	54.52
5	Miura, Hiroshi	JPN	26.03	54.82
6	Herrmann, Martin	FRG	25.92	55.20
7	Drost, Frank	HOL	25.95	55.38
8	Wolf, Robert	TCH	25.67	55.73

Men 100m Butterfly Sept. 20-21			Hommes/100m papillon 20-21 Sept	
Rank Rang	Name Nom	Ctry Pays	50m	100m
1	Jameson, Andy	GBR	25.18	53.34
2	Biondi, Matthew	USA	24.81	53.46
3	Nesty, Anthony	SUR	25.57	53.50
4	Gross, Michael	FRG	25.05	53.78
5	Sieben, Jonathan	AUS	25.44	53.85
6	Iarochtchouk, Vadim	URS	25.10	54.17
7	Ponting, Thomas	CAN	25.70	54.31
8	Mortenson, Jay	USA	25.68	54.44
9	Nielsen, Benny	DEN	25.75	54.52
10	Mosse, Anthony	NZL	25.50	54.63
11	Cerny, Vlastimil	CAN	25.70	54.66
12	Zheng, Jian	CHN	25.27	54.69
13	Cochran, Neil	GBR	25.77	54.75
14	Miura, Hiroshi	JPN	26.03	54.82
15	Szukala, Rafal	POL	26.07	54.83
16	Shen, Jianqiang	CHN	26.13	54.86
17	Herrmann, Martin	FRG	25.92	55.20
18	Ballester, Jose Luis	ESP	25.84	55.27
19	Drost, Frank	HOL	25.95	55.38
20	Wilson, David	AUS	26.56	55.54
21	Wolf, Robert	TCH	25.67	55.73
22	Michelotti, Leonardo	ITA	26.14	55.83
23	Petrov, Konstantine	URS	25.54	55.84
24	Tanaka, Yukinori	JPN	26.30	56.19
25	Anderson, Ross	NZL	26.57	56.31
26	Poli, Eduardo	BRA	27.25	56.37
27	Depickere, Ludovic	FRA	26.36	56.47
28	Giambalvo, Valerio	ITA	26.80	56.57
29	Leitner, Reinhold	AUT	26.87	56.72
30	David, Theophile	SUI	26.97	56.77
31	Buhain, Joseph Eric	PHI	27.01	57.17
32	Ribeiro, Wladimir	BRA	26.99	57.25
33	Albuquerque, Mabilio	POR	27.14	57.30
34	Yelle, Paul	BAR	26.56	57.36
35	Ang, Peng Siong	SIN	26.95	57.41
36	Griniakakis, Theodoros	GRE	27.34	57.56
37	Camacho, Paulo	POR	27.42	57.62
38	Park, Young-Chul	KOR	27.15	57.74
39	Tsang, Yi Ming	HKG	27.33	57.84
40	Zea, Urbano	MEX	27.53	57.89
41	Romo, Carlos	MEX	26.92	58.04
42	Lima, Pedro	ANG	28.09	59.21
43	Thompson, Graham Lewis	ZIM	27.71	1:00.13
44	Singleton, Kristan	ISV	28.69	1:00.97
45	Cleveland, William	ISV	28.84	1:01.10
46	Faftine, Sergio	MOZ	29.25	1:01.15
47	Castellanos, Plutarco	HON	29.24	1:02.69
48	Md Abdus Salam, Salam	BAN	29.65	1:03.69
49	Binabid, Mohammed	UAE	30.74	1:06.25
50	Ncala, Trevor	SWZ	30.16	1:06.85
51	Gomes, Jorge	ANG	32.60	1:09.60
	Adam, Michael	AUT		NS
	Vassallo, Salvador	PUR		NS
	Oon, Jin Gee	SIN		NS
	Kozelj, Matjaz	YUG		NS

Men 100m Butterfly Final A/Sept. 21			Hommes/100m papillon Finale A/21 Sept	
Rank Rang	Name Nom	Ctry Pays	50m	100m
1	Nesty, Anthony	SUR	25.02	53.00 NOR
2	Biondi, Matthew	USA	24.53	53.01
3	Jameson, Andy	GBR	25.00	53.30
4	Sieben, Jonathan	AUS	24.75	53.33
5	Gross, Michael	FRG	25.01	53.44
6	Mortenson, Jay	USA	25.20	54.07
7	Ponting, Thomas	CAN	25.29	54.09
8	Iarochtchouk, Vadim	URS	25.14	54.60

Men 100m Butterfly Final B/Sept. 21			Hommes/100m papillon Finale B/21 Sept	
Rank Rang	Name Nom	Ctry Pays	50m	100m
1	Shen, Jianqiang	CHN	25.83	54.52
2	Mosse, Anthony	NZL	25.78	54.63
3	Nielsen, Benny	DEN	25.49	54.77
4	Cerny, Vlastimil	CAN	25.81	54.79
5	Szukala, Rafal	POL	25.90	54.80
6	Miura, Hiroshi	JPN	25.97	54.98
7	Zheng, Jian	CHN	25.76	55.05
8	Cochran, Neil	GBR	25.84	55.22

**Men 200m Butterfly
Heat 1/Sept. 24**

Rank Rang	Name Nom	Ctry Pays	50m	100m	150m	200m
1	Nascimento, Emanuel	BRA	29.44	1:02.39	1:35.29	2:09.40
2	Alotaibi, Sultan	KUW	29.68	1:03.51	1:37.38	2:12.89
3	Cleveland, William	ISV	30.41	1:03.90	1:38.06	2:13.19
4	Singleton, Kristan	ISV	30.72	1:06.33	1:43.21	2:19.68
	Boiling, Julian	SRI				NS

**Men 100m Butterfly
Heat 2/Sept. 24**

Rank Rang	Name Nom	Ctry Pays	50m	100m	150m	200m
1	Madeira, Diogo	POR	28.58	1:00.40	1:31.98	2:03.79
2	Santos, Joao	POR	29.40	1:00.10	1:31.96	2:04.74
3	Abdalla, Ahmed	EGY	28.47	59.98	1:32.35	2:05.28
4	Buhain, Joseph Eric	PHI	27.95	58.33	1:30.54	2:05.32
5	Park, Young-Chul	KOR	27.92	59.89	1:33.83	2:08.57
6	Koh, Desmond	SIN	29.48	1:02.70	1:36.54	2:10.86

**Men 200m Butterfly
Heat 3/Sept. 24**

Rank Rang	Name Nom	Ctry Pays	50m	100m	150m	200m
1	Hodgson, Nick	GBR	27.65	58.34	1:29.72	2:01.44
2	Anderson, Ross	NZL	27.98	59.27	1:30.86	2:02.40
3	Arnould, Jean-Marie	BEL	28.58	59.45	1:31.43	2:03.76
4	Wallin, Christer	SWE	28.61	59.07	1:31.03	2:03.79
5	Tokas, Khazansingh	IND	27.83	59.27	1:31.41	2:03.95
6	Zhan, Jiang	CHN	28.54	1:00.00	1:32.83	2:05.22
7	David, Theophile	SUI	28.15	59.54	1:32.47	2:05.58

**Men 200m Butterfly
Heat 4/Sept. 24**

Rank Rang	Name Nom	Ctry Pays	50m	100m	150m	200m
1	Mosse, Anthony	NZL	26.77	57.23	1:28.03	1:58.71
2	Kelly, Jon	CAN	27.28	57.49	1:28.35	1:59.40
3	Ponting, Thomas	CAN	26.84	57.44	1:28.51	2:00.08
4	Roberts, Martin	AUS	27.73	58.17	1:28.75	2:00.32
5	Jones, Tim	GBR	27.02	57.29	1:28.64	2:01.01
6	Szukala, Rafal	POL	27.95	58.85	1:30.07	2:01.91
7	Miura, Hiroshi	JPN	27.42	57.99	1:29.73	2:02.30
8	Bures, Ondrej	TCH	27.90	58.78	1:29.95	2:02.93

**Men 200m Butterfly
Heat 5/Sept. 24**

Rank Rang	Name Nom	Ctry Pays	50m	100m	150m	200m
1	Wilson, David	AUS	27.65	58.23	1:28.59	1:59.02
2	Nielsen, Benny	DEN	27.54	57.67	1:27.77	1:59.26
3	Iarochtkouk, Vadim	URS	26.98	58.09	1:29.20	2:01.05
4	Bordeau, Christophe	FRA	28.34	59.31	1:30.33	2:01.70
5	Leitner, Reinhold	AUT	27.61	58.48	1:29.88	2:02.18
6	Herrmann, Marin	FRG	27.70	59.08	1:31.32	2:02.61
7	Ballester, Jose Luis	ESP	28.05	59.16	1:30.19	2:03.32
	Kozelj, Matjaz	YUG				NS

**Men 200m Butterfly
Heat 6/Sept. 24**

Rank Rang	Name Nom	Ctry Pays	50m	100m	150m	200m
1	Gross, Michael	FRG	26.48	56.42	1:26.60	1:58.09
2	Stewart, Melvin	USA	26.74	56.94	1:27.62	1:59.78
3	Nesty, Anthony	SUR	27.21	57.28	1:28.36	2:00.17
4	Dean, Mark	USA	26.52	56.75	1:28.42	2:00.86
5	Drost, Frank	HOL	27.10	57.37	1:28.57	2:00.99
6	Takeda, Satoshi	JPN	27.75	58.05	1:29.26	2:01.42
7	Larsen, Jan Patvel	DEN	28.16	59.58	1:30.14	2:03.01
8	Poli, Eduardo	BRA	28.25	59.85	1:33.02	2:06.15

**Men 200m Butterfly
Sept. 24**

Rank Rang	Name Nom	Ctry Pays	50m	100m	150m	200m
1	Gross, Michael	FRG	26.48	56.42	1:26.60	1:58.09
2	Mosse, Anthony	NZL	26.77	57.23	1:28.03	1:58.71
3	Wilson, David	AUS	27.65	58.23	1:28.59	1:59.02
4	Nielsen, Benny	DEN	27.54	57.67	1:27.77	1:59.26
5	Kelly, Jon	CAN	27.28	57.49	1:28.35	1:59.40
6	Stewart, Melvin	USA	26.74	56.94	1:27.62	1:59.78
7	Ponting, Thomas	CAN	26.84	57.44	1:28.51	2:00.08
8	Nesty, Anthony	SUR	27.21	57.28	1:28.36	2:00.17
9	Roberts, Martin	AUS	27.73	58.17	1:28.75	2:00.32
10	Dean, Mark	USA	26.52	56.75	1:28.42	2:00.86
11	Drost, Frank	HOL	27.10	57.37	1:28.57	2:00.99
12	Jones, Tim	GBR	27.02	57.29	1:28.64	2:01.01
13	Iarochtkouk, Vadim	URS	26.98	58.09	1:29.20	2:01.05
14	Takeda, Satoshi	JPN	27.75	58.05	1:29.26	2:01.42
15	Hodgson, Nick	GBR	27.65	58.34	1:29.72	2:01.44
16	Bordeau, Christophe	FRA	28.34	59.31	1:30.33	2:01.70
17	Szukala, Rafal	POL	27.95	58.85	1:30.07	2:01.91
18	Leitner, Reinhold	AUT	27.61	58.48	1:29.88	2:02.18
19	Miura, Hiroshi	JPN	27.42	57.99	1:29.73	2:02.30
20	Anderson, Ross	NZL	27.98	59.27	1:30.86	2:02.40
21	Herrmann, Martin	FRG	27.70	59.08	1:31.32	2:02.61
22	Bures, Ondrej	TCH	27.90	58.78	1:29.95	2:02.93
23	Larsen, Jan Patvel	DEN	28.16	58.58	1:30.14	2:03.01
24	Ballester, Jose Luis	ESP	28.05	59.16	1:30.19	2:03.32
25	Arnould, Jean-Marie	BEL	28.58	59.45	1:31.43	2:03.76
26	Madeira, Diogo	POR	28.58	1:00.40	1:31.98	2:03.79
26	Wallin, Christer	SWE	28.61	59.07	1:31.03	2:03.79
28	Tokas, Khazansingh	IND	27.83	59.27	1:31.41	2:03.95
29	Santos, Joao	POR	28.40	1:00.10	1:31.96	2:04.74
30	Zhan, Jiang	CHN	28.54	1:00.00	1:32.83	2:05.22
31	Abdalla, Ahmed	EGY	28.47	59.98	1:32.35	2:05.28
32	Buhain, Joseph Eric	PHI	27.95	58.33	1:30.54	2:05.32
33	David, Theophile	SUI	28.15	59.54	1:32.47	2:05.58
34	Poli, Eduardo	BRA	28.25	59.85	1:33.02	2:06.15
35	Park, Young-Chul	KOR	27.92	59.89	1:33.83	2:08.57
36	Nascimento, Emanuel	BRA	29.44	1:02.39	1:35.29	2:09.40
37	Koh, Desmond	SIN	29.48	1:02.70	1:36.54	2:10.86
38	Alotaibi, Sultan	KUW	29.68	1:03.51	1:37.38	2:12.89
39	Cleveland, William	ISV	30.41	1:03.90	1:38.06	2:13.19
40	Singleton, Kristan	ISV	30.72	1:06.33	1:43.21	2:19.68
	Boiling, Julian	SRI				NS
	Kozelj, Matjaz	YUG				NS

**Men 200m Butterfly
Final A/Sept. 24**

Rank Rang	Name Nom	Ctry Pays	50m	100m	150m	200m
1	Gross, Michael	FRG	25.94	55.39	1:25.53	1:56.94 NOR
2	Nielsen, Benny	DEN	27.12	57.05	1:27.65	1:58.24
3	Mosse, Anthony	NZL	26.60	56.34	1:27.07	1:58.28
4	Ponting, Thomas	CAN	26.98	57.39	1:28.16	1:58.91
5	Stewart, Melvin	USA	26.69	57.00	1:27.50	1:59.19
6	Wilson, David	AUS	27.08	57.59	1:28.15	1:59.20
7	Kelly, Jon	CAN	27.35	57.67	1:28.34	1:59.48
8	Nesty, Anthony	SUR	26.79	56.91	1:28.15	2:00.80

**Men 200m Butterfly
Final B/Sept. 24**

Rank Rang	Name Nom	Ctry Pays	50m	100m	150m	200m
1	Dean, Mark	USA	26.66	56.79	1:28.32	2:00.26
2	Jones, Tim	GBR	27.16	57.46	1:28.87	2:00.32
3	Iarochtkouk, Vadim	URS	26.69	57.02	1:28.36	2:00.34
4	Hodgson, Nick	GBR	27.50	58.62	1:29.67	2:01.09
5	Bordeau, Christophe	FRA	27.99	58.74	1:29.74	2:01.46
6	Drost, Frank	HOL	27.36	58.15	1:29.67	2:01.59
7	Takeda, Satoshi	JPN	28.08	58.85	1:30.23	2:02.18
8	Roberts, Martin	AUS	27.55	59.08	1:31.26	2:04.28

**Men 200m Individual Medley
Heat 1/Sept. 25**

Rank Rang	Name Nom	Ctry Pays	50m	100m	150m	200m
1	Smith, Vaughan Andren	ZIM	28.14	1:04.07	1:45.92	2:18.07
2	Binabid, Mohammed	UAE	30.42	1:08.61	1:55.07	2:29.08
3	Abdulla, Mohamed	UAE	33.01	1:11.29	1:57.66	2:31.44
4	Kantari, Rami	LIB	32.11	1:10.77	1:59.20	2:34.53

**Men 200m Individual Medley
Heat 2/Sept. 25**

Rank Rang	Name Nom	Ctry Pays	50m	100m	150m	200m
1	Alotaibi, Sultan	KUW	29.03	1:05.26	1:44.30	2:15.63
2	Niehaus, Horst	CRC	29.08	1:02.07	1:42.11	2:16.16
3	Singleton, Kraig	ISV	28.48	1:03.71	1:44.04	2:16.93
4	Thompson, Graham Lewis	ZIM	28.20	1:04.73	1:45.10	2:17.06
5	Tsai, Hsin-Yen	TPE	28.76	1:07.40	1:44.74	2:17.95
6	Chiang, Chi-li	TPE	28.81	1:05.39	1:44.20	2:18.76
7	Diop, Mouhamedou	SEN	28.63	1:05.61	1:48.11	2:20.74
8	Ndiaye, Bruno	SEN	29.23	1:06.86	1:53.65	2:29.18

Swimming

Men 200m Individual Medley Heat 3/Sept. 25			Hommes/200m 4 nages Serie 3/25 Sept			
Rank Rang	Name Nom	Ctry Pays	50m	100m	150m	200m
1	Lee, Jae-Soo	KOR	28.13	1:02.63	1:40.73	2:11.88
2	Bera, Richard Sam	INA	28.82	1:03.76	1:43.99	2:13.90
3	Eskioğlu, Hakan	TUR	29.47	1:03.71	1:42.62	2:14.32
4	Koh, Desmond	SIN	28.78	1:03.77	1:43.13	2:14.77
5	Greenwood, Eric	CRC	28.07	1:00.48	1:41.75	2:15.64
6	Sakovich, Jonathan	GUM	29.96	1:05.79	1:46.29	2:16.70
7	Li, Arthur	HKG	30.02	1:05.69	1:46.91	2:17.10
	Con Cepcion, Lee Patrick	PHI				NS

Men 200m Individual Medley Heat 4/Sept. 25			Hommes/200m 4 nages Serie 4/25 Sept			
Rank Rang	Name Nom	Ctry Pays	50m	100m	150m	200m
1	Lopez, Julio	BRA	27.85	1:00.62	1:39.78	2:09.62
2	Madeira, Diogo	POR	27.96	1:01.58	1:39.72	2:10.21
3	Con Cepcion, Rene	PHI	27.89	1:02.29	1:38.83	2:10.37
4	Appelboom, Sidney	BEL	29.07	1:03.84	1:40.44	2:11.55
5	Lim, David	SIN	28.60	1:01.31	1:41.39	2:11.57
6	Sugriat, Wirmandi	INA	29.37	1:05.69	1:42.67	2:13.93
7	Yip, Hor Man	HKG	28.42	1:02.05	1:42.10	2:14.65

Men 200m Individual Medley Heat 5/Sept. 25			Hommes/200m 4 nages Serie 5/25 Sept			
Rank Rang	Name Nom	Ctry Pays	50m	100m	150m	200m
1	Fujimoto, Takahiro	JPN	27.58	59.85	1:37.09	2:07.23
2	Takeda, Satoshi	JPN	27.63	1:01.81	1:38.79	2:08.11
3	Careaga, Javier	MEX	27.09	1:01.34	1:37.47	2:09.38
4	Gonzalez, Rodrigo	MEX	27.56	1:01.29	1:39.25	2:09.52
5	Edvardsson, Edvard	ISL	28.31	1:01.47	1:38.83	2:10.18
6	Ramalho, Renato	BRA	28.56	1:00.93	1:40.12	2:10.32
7	Xie, Jun	CHN	27.78	1:00.91	1:40.00	2:10.52
7	Lopez-Zubero, Martin	ESP	27.73	59.51	1:39.49	2:10.52

Men 200m Individual Medley Heat 6/Sept. 25			Hommes/200m 4 nages Serie 6/25 Sept			
Rank Rang	Name Nom	Ctry Pays	50m	100m	150m	200m
1	Kuehl, Patrick	GDR	26.40	57.33	1:33.52	2:03.77
2	Zoubkov, Mikhail	URS	27.33	58.33	1:34.14	2:03.79
3	Anderson, Gary	CAN	27.30	58.86	1:35.20	2:04.00
4	Stapleton, Bill	USA	26.84	58.11	1:35.59	2:05.32
5	Sacchi, Luca	ITA	27.89	1:00.34	1:35.99	2:05.45
6	Davey, John	GBR	27.22	57.96	1:35.56	2:05.55
7	Cassio, Roberto	ITA	27.10	58.59	1:35.44	2:05.88
8	O'Toole, Gary	IRL	27.36	59.41	1:36.63	2:07.77

Men 200m Individual Medley Heat 7/Sept. 25			Hommes/200m 4 nages Serie 7/25 Sept			
Rank Rang	Name Nom	Ctry Pays	50m	100m	150m	200m
1	Bruce, Robert	AUS	27.37	58.85	1:35.29	2:04.31
2	Wharton, David	USA	27.14	58.60	1:35.59	2:04.64
3	Berndt, Jens-Peter	FRG	27.80	58.91	1:35.35	2:04.80
4	Bordeau, Christophe	FRA	27.13	59.10	1:35.83	2:04.95
5	Papanikolaou, Charalambos	GRE	27.46	58.82	1:35.43	2:05.53
6	Cochran, Neil	GBR	27.08	58.70	1:36.20	2:05.56
7	Szabo, Jozsef	HUN	27.96	1:01.48	1:38.03	2:09.08

Men 200m Individual Medley Heat 8/Sept. 25			Hommes/200m 4 nages Serie 8/25 Sept			
Rank Rang	Name Nom	Ctry Pays	50m	100m	150m	200m
1	Darnyi, Tamas	HUN	27.28	58.25	1:34.11	2:02.15
2	Iarochtkouk, Vadim	URS	25.70	56.89	1:32.97	2:02.77
3	Hannemann, Raik	GDR	26.18	57.90	1:33.75	2:04.03
4	Bermer, Peter	FRG	27.56	58.62	1:34.85	2:04.18
5	Woodhouse, Robert	AUS	27.87	58.98	1:36.20	2:05.87
6	Ward, Darren	CAN	26.58	58.57	1:37.37	2:07.84
7	Lopez, Sergio	ESP	29.14	1:06.05	1:41.59	2:13.48
	Bidman, Jan	SWE				NS

Natation

Men 200m Individual Medley Sept. 25			Hommes/200m 4 nages 25 Sept			
Rank Rang	Name Nom	Ctry Pays	50m	100m	150m	200m
1	Darnyi, Tamas	HUN	27.28	58.25	1:34.11	2:02.15
2	Iarochtkouk, Vadim	URS	25.70	56.89	1:32.97	2:02.77
3	Kuehl, Patrick	GDR	26.40	57.33	1:33.52	2:03.77
4	Zoubkov, Mikhail	URS	27.33	58.33	1:34.14	2:03.79
5	Anderson, Gary	CAN	27.30	58.86	1:35.20	2:04.00
6	Hannemann, Raik	GDR	26.18	57.90	1:33.75	2:04.03
7	Bermer, Peter	FRG	27.56	58.62	1:34.85	2:04.18
8	Bruce, Robert	AUS	27.37	58.85	1:35.29	2:04.31
9	Wharton, David	USA	27.14	58.60	1:35.59	2:04.64
10	Berndt, Jens-Peter	FRG	27.80	58.91	1:35.35	2:04.80
11	Bordeau, Christophe	FRA	27.13	59.10	1:35.83	2:04.95
12	Stapleton, Bill	USA	26.84	58.11	1:35.59	2:05.32
13	Sacchi, Luca	ITA	27.89	1:00.34	1:35.99	2:05.45
14	Papanikolaou, Charalambos	GRE	27.46	58.82	1:35.43	2:05.53
15	Davey, John	GBR	27.22	57.96	1:35.56	2:05.55
16	Cochran, Neil	GBR	27.08	58.70	1:36.20	2:05.56
17	Woodhouse, Robert	AUS	27.87	58.98	1:36.20	2:05.87
18	Cassio, Roberto	ITA	27.10	58.59	1:35.44	2:05.88
19	Fujimoto, Takahiro	JPN	27.58	59.85	1:37.09	2:07.23
20	O'Toole, Gary	IRL	27.36	59.41	1:36.63	2:07.77
21	Ward, Darren	CAN	26.58	58.57	1:37.37	2:07.84
22	Takeda, Satoshi	JPN	27.63	1:01.81	1:38.79	2:08.11
23	Szabo, Jozsef	HUN	27.96	1:01.48	1:38.03	2:09.08
24	Careaga, Javier	MEX	27.09	1:01.34	1:37.47	2:09.38
25	Gonzalez, Rodrigo	MEX	27.56	1:01.29	1:39.25	2:09.52
26	Lopez, Julio	BRA	27.85	1:00.62	1:39.78	2:09.62
27	Edvardsson, Edvard	ISL	27.31	1:01.47	1:38.83	2:10.18
28	Madeira, Diogo	POR	27.96	1:01.58	1:39.72	2:10.21
29	Ramalho, Renato	BRA	28.56	1:00.93	1:40.12	2:10.32
30	Con Cepcion, Rene	PHI	27.89	1:02.29	1:38.83	2:10.37
31	Xie, Jun	CHN	27.78	1:00.91	1:40.00	2:10.52
31	Lopez-Zubero, Martin	ESP	27.73	59.51	1:39.49	2:10.52
33	Appelboom, Sidney	BEL	29.07	1:03.84	1:40.44	2:11.55
34	Lim, David	SIN	28.60	1:01.31	1:41.39	2:11.57
35	Lee, Jae-Soo	KOR	28.13	1:02.63	1:40.73	2:11.88
36	Lopez, Sergio	ESP	29.14	1:06.05	1:41.59	2:13.48
37	Bera, Richard Sam	INA	28.82	1:03.76	1:43.99	2:13.90
38	Sugriat, Wirmandi	INA	29.37	1:05.69	1:42.67	2:13.93
39	Eskioğlu, Hakan	TUR	29.47	1:03.71	1:42.62	2:14.32
40	Yip, Hor Man	HKG	28.42	1:02.05	1:42.10	2:14.65
41	Koh, Desmond	SIN	28.78	1:03.77	1:43.13	2:14.77
42	Alotaibi, Sultan	KUW	29.03	1:05.26	1:44.30	2:15.63
43	Greenwood, Eric	CRC	28.07	1:00.48	1:41.75	2:15.64
44	Niehaus, Horst	CRC	29.08	1:02.07	1:42.11	2:16.16
45	Sakovich, Jonathan	GUM	29.96	1:05.79	1:46.29	2:16.70
46	Singleton, Kraig	ISV	28.48	1:03.71	1:44.04	2:16.93
47	Thompson, Graham Lewis	ZIM	28.20	1:03.73	1:45.10	2:17.06
48	Li, Arthur	HKG	30.02	1:05.69	1:46.91	2:17.10
49	Tsai, Hsin-Yen	TPE	28.76	1:07.40	1:44.74	2:17.95
50	Smith, Vaughan Andren	ZIM	28.14	1:04.07	1:45.92	2:18.07
51	Chinf, Chi-li	TPE	28.81	1:05.39	1:44.20	2:18.76
52	Diop, Mouhamedou	SEN	28.63	1:05.61	1:48.11	2:20.74
53	Binabid, Mohammed	UAE	30.42	1:08.61	1:55.07	2:29.08
54	Ndiaye, Bruno	SEN	29.23	1:06.86	1:53.65	2:29.18
55	Abdulla, Mohamed	UAE	33.01	1:11.29	1:57.66	2:31.44
56	Kantari, Rami	LIB	32.11	1:10.77	1:59.20	2:34.53
	Con Cepcion, Lee Patrick	PHI				NS
	Bidman, Jan	SWE				NS

Men 200m Individual Medley Final A/Sept. 25			Hommes/200m 4 nages Finale A/25 Sept			
Rank Rang	Name Nom	Ctry Pays	50m	100m	150m	200m
1	Darnyi, Tamas	HUN	27.06	57.33	1:32.44	2:00.17
2	Kuehl, Patrick	GDR	26.59	57.56	1:32.37	2:01.61
3	Iarochtkouk, Vadim	URS	25.60	56.24	1:32.20	2:02.40
4	Zoubkov, Mikhail	URS	27.18	58.45	1:33.97	2:02.92
5	Bermer, Peter	FRG	27.29	58.31	1:34.19	2:03.81
6	Bruce, Robert	AUS	26.69	58.14	1:34.73	2:04.34
7	Hannemann, Raik	GDR	26.25	58.12	1:34.46	2:04.82
8	Anderson, Gary	CAN	27.10	58.23	1:35.63	2:06.35

Men 200m Individual Medley Final B/Sept. 25			Hommes/200m 4 nages Finale B/25 Sept			
Rank Rang	Name Nom	Ctry Pays	50m	100m	150m	200m
1	Wharton, David	USA	26.86	58.05	1:34.25	2:03.05
2	Davey, John	GBR	27.44	58.72	1:35.30	2:04.17
3	Cochran, Neil	GBR	27.31	59.05	1:36.34	2:05.44
4	Bordeau, Christophe	FRA	27.42	59.54	1:36.48	2:05.51
5	Sacchi, Luca	ITA	28.17	1:00.53	1:36.48	2:05.68
6	Papanikolaou, Charalambos	GRE	27.78	59.65	1:36.86	2:06.61
7	Berndt, Jens-Peter	FRG	27.49	58.64	1:36.11	2:06.76
8	Stapleton, Bill	USA	27.56	59.24	1:37.02	2:06.82

Men 400m Individual Medley Heat 1/Sept. 20			Hommes/400m 4 nages Serie 1/20 Sept			
Rank Rang	Name Nom	Ctry Pays	100m	200m	300m	400m
1	Sakovich, Jonathan	GUM	1:04.74	2:19.63	3:43.11	4:44.78
2	Alotaibi, Sultan	KUW	1:02.82	2:19.18	3:42.17	4:50.16
3	Boiling, Julian	SRI	1:03.80	2:18.60	3:46.96	4:53.61

**Men 400m Individual Medley
Heat 2/Sept. 20****Hommes/400m 4 nages
Serie 2/20 Sept**

Rank Rang	Name Nom	Ctry Pays	100m	200m	300m	400m
1	Bures, Ondrej	TCH	59.03	2:07.82	3:25.52	4:29.62
2	Careaga, Javier	MEX	1:00.00	2:11.81	3:26.76	4:30.71
3	Borges, Rui	POR	1:01.70	2:10.40	3:27.49	4:30.79
4	Ramalho, Renato	BRA	1:01.89	2:10.64	3:30.09	4:31.95
5	Madeira, Diogo	POR	1:00.20	2:10.55	3:30.09	4:35.00
6	Lee, Jae-Soo	KOR	1:01.35	2:15.33	3:36.22	4:40.46
7	Con Cepcion, Rene Koh, Desmond	PHI SIN	1:03.14	2:19.97	3:41.05	4:48.00 DQ

**Men 400m Individual Medley
Final A/Sept. 21****Hommes/400m 4 nages
Finale A/21 Sept**

Rank Rang	Name Nom	Ctry Pays	100m	200m	300m	400m
1	Darnyi, Tamas	HUN	59.04	2:01.76	3:15.96	4:14.75 NWR NOR
2	Wharton, David	USA	58.17	2:04.27	3:19.58	4:17.36
3	Battistelli, Stefano	ITA	1:00.96	2:06.06	3:19.98	4:18.01
4	Szabo, Jozsef	HUN	59.56	2:07.76	3:19.21	4:18.15
5	Kuehl, Patrick	GDR	58.40	2:03.73	3:18.64	4:18.44
6	Berndt, Jens-Peter	FRG	59.80	2:05.94	3:21.29	4:21.71
7	Sacchi, Luca	ITA	1:00.35	2:07.20	3:22.05	4:23.23
8	Bermel, Peter	FRG	59.50	2:06.69	3:22.10	4:24.02

**Men 400m Individual Medley
Heat 3/Sept. 20****Hommes/400m 4 nages
Serie 3/20 Sept**

Rank Rang	Name Nom	Ctry Pays	100m	200m	300m	400m
1	Kuehl, Patrick	GDR	58.48	2:04.50	3:18.28	4:18.60
2	Bordeau, Christophe	FRA	1:00.42	2:08.18	3:23.04	4:23.46
3	Kostoff, Jeff	USA	1:01.06	2:09.80	3:24.09	4:24.10
4	Bruce, Robert	AUS	1:01.01	2:07.72	3:24.36	4:25.15
5	Zoubkov, Mikhail	URS	1:00.40	2:08.08	3:23.77	4:25.30
6	Journet, Laurent	FRA	1:01.23	2:10.66	3:27.24	4:29.03
7	Vassallo, Salvador	PUR	1:00.20	2:07.41	3:28.78	4:30.37
8	Fujimoto, Takahiro	JPN	59.09	2:08.18	3:28.44	4:33.03

**Men 400m Individual Medley
Final B/Sept. 21****Hommes/400m 4 nages
Finale B/21 Sept**

Rank Rang	Name Nom	Ctry Pays	100m	200m	300m	400m
1	Kostoff, Jeff	USA	59.76	2:07.94	3:22.41	4:22.95
2	Bordeau, Christophe	FRA	59.72	2:08.00	3:23.65	4:23.39
3	Bruce, Robert	AUS	1:00.37	2:07.35	3:23.74	4:24.33
4	Kelly, Jon	CAN	59.23	2:07.30	3:24.25	4:25.02
5	Zoubkov, Mikhail	URS	1:00.20	2:08.11	3:23.69	4:25.44
6	Woodhouse, Robert	AUS	1:01.24	2:08.57	3:25.34	4:26.14
7	Brew, Paul	GBR	1:00.78	2:08.94	3:26.79	4:26.77
8	Papanikolaou, Charalambos	GRE	1:01.15	2:08.15	3:26.48	4:27.95

**Men 400m Individual Medley
Heat 4/Sept. 20****Hommes/400m 4 nages
Serie 4/20 Sept**

Rank Rang	Name Nom	Ctry Pays	100m	200m	300m	400m
1	Wharton, David	USA	59.19	2:06.61	3:22.08	4:20.84
2	Szabo, Jozsef	HUN	59.76	2:08.98	3:21.04	4:20.85
3	Berndt, Jens-Peter	FRG	59.52	2:05.65	3:21.12	4:20.93
4	Brew, Paul	GBR	59.40	2:07.50	3:26.91	4:27.22
5	Mizumoto, Yoshiyuki	JPN	1:00.69	2:09.74	3:27.49	4:28.11
6	Lopez-Zubero, Martin Davey, John Bidrman, Jan	ESP GBR SWE	59.75	2:07.67	3:30.20	4:35.68 DQ NS

**Men 4 x 100m Medley Relay
Heat 1/Sept. 25****Hommes/Relais 4x100m 4 nages
Serie 1/25 Sept**

Rank Rang	Ctry Pays	Name Nom	50m	100m	Lap	Result Resultat
1	KOR	Park, Dong-Pil Yoon, Joo-Il Park, Young-Chul Kwon, Sang-won		1:01.38 1:04.42 56.96 54.18	1:01.38 2:05.80 3:02.76 3:56.94	3:56.94
2	ISV	Cleveland, William Singleton, Kraig Singleton, Kristan Foerster, Hans		1:05.06 1:13.73 1:01.93 54.31	1:05.06 2:18.79 3:20.72 4:15.03	4:15.03
3	UAE	Abdulla, Mohamed Alrumaiti, Obaid Binabid, Mohammed Faraj, Ahmad		1:08.35 1:15.72 1:06.57 57.91	1:08.35 2:24.07 3:30.64 4:28.55	4:28.55

**Men 400m Individual Medley
Heat 5/Sept. 20****Hommes / 400m 4 nages
Serie 5/20 Sept**

Rank Rang	Name Nom	Ctry Pays	100m	200m	300m	400m
1	Darnyi, Tamas	HUN	59.98	2:03.68	3:17.82	4:16.55 NOR
2	Battistelli, Stefano	ITA	1:00.85	2:05.95	3:19.68	4:20.43
3	Bermel, Peter	FRG	1:00.13	2:06.93	3:22.44	4:22.78
4	Sacchi, Luca	ITA	1:00.92	2:07.29	3:21.95	4:23.37
5	Kelly, Jon	CAN	59.00	2:07.74	3:23.82	4:24.62
6	Woodhouse, Robert	AUS	1:00.49	2:06.38	3:23.32	4:25.60
7	Papanikolaou, Charalambos	GRE	1:00.87	2:07.43	3:25.04	4:26.72
8	Meldrum, Michael	CAN	58.99	2:07.72	3:27.66	4:31.74

**Men 4 x 100m Medley Relay
Heat 2/Sept. 25****Hommes/Relais 4x100m 4 nages
Serie 2/25 Sept**

Rank Rang	Ctry Pays	Name Nom	50m	100m	Lap	Result Resultat
1	CAN	Tewksbury, Mark Davis, Victor Ponting, Thomas Goss, Donald Alexander		57.05 1:03.14 54.12 50.25	57.05 2:00.19 2:54.31 3:44.56	3:44.56
2	HOL	Kroes, Hans Dekker, Ronald Drost, Frank Dybion, Patrick		58.11 1:02.42 54.50 50.62	58.11 2:00.53 2:55.03 3:45.65	3:45.65
3	AUS	Wilson, Carl Mcadam, Ian Sieben, Jonathan Baildon, Andrew		58.31 1:05.17 54.65 49.27	58.31 2:03.48 2:58.13 3:47.40	3:47.40
4	TCH	Vokoun, Pavel Beinhauer, Radek Wolf, Robert Kladiva, Petr		59.25 1:03.71 56.23 50.71	59.25 2:02.96 2:59.19 3:49.90	3:49.90
5	HUN	Deutsch, Tamas Guttler, Karoly Kalaus, Valter Bodor, Mihly-Richard		58.52 1:03.59 58.30 51.83	58.52 2:02.11 3:00.41 3:52.24	3:52.24
6	CHN	Lin, Lajiu Chen, Jianhong Zheng, Jian Shen, Jianqiang		59.32 1:04.73 57.04 53.09	59.32 2:04.05 3:01.09 3:54.18	3:54.18
7	GRE	Malamas, Helias Fokianos, Nikolaos Griniazakis, Theodoros Papanikolaou, Charalambos		59.88 1:07.61 1:01.09 59.13	59.88 2:07.49 3:08.58 4:07.71	4:07.71

**Men 400m Individual
Medley/Sept. 20-21****Hommes/400m
4 nages/20-21 Sept**

Rank Rang	Name Nom	Ctry Pays	100m	200m	300m	400m
1	Darnyi, Tamas	HUN	59.98	2:03.68	3:17.82	4:16.55
2	Kuehl, Patrick	GDR	58.48	2:04.50	3:18.28	4:18.60
3	Battistelli, Stefano	ITA	1:00.85	2:05.95	3:19.68	4:20.43
4	Wharton, David	USA	59.19	2:06.61	3:22.08	4:20.84
5	Szabo, Jozsef	HUN	59.76	2:08.98	3:21.04	4:20.85
6	Berndt, Jens-Peter	FRG	59.52	2:05.65	3:21.12	4:20.93
7	Bermel, Peter	FRG	1:00.13	2:06.93	3:22.44	4:22.78
8	Sacchi, Luca	ITA	1:00.92	2:07.29	3:21.95	4:23.37
9	Bordeau, Christophe	FRA	1:00.42	2:08.18	3:23.04	4:23.46
10	Kostoff, Jeff	USA	1:01.06	2:09.80	3:24.09	4:24.10
11	Kelly, Jon	CAN	59.00	2:07.74	3:23.82	4:24.62
12	Bruce, Robert	AUS	1:01.01	2:07.72	3:24.36	4:25.15
13	Zoubkov, Mikhail	URS	1:00.40	2:08.08	3:23.77	4:25.30
14	Woodhouse, Robert	AUS	1:00.49	2:06.38	3:23.32	4:25.60
15	Papanikolaou, Charalambos	GRE	1:00.87	2:07.43	3:25.04	4:26.72
16	Brew, Paul	GBR	59.40	2:07.50	3:26.91	4:27.22
17	Mizumoto, Yoshiyuki	JPN	1:00.69	2:09.74	3:27.49	4:28.11
18	Journet, Laurent	FRA	1:01.23	2:10.66	3:27.24	4:29.03
19	Bures, Ondrej	TCH	59.03	2:07.82	3:25.52	4:29.62
20	Vassallo, Salvador	PUR	1:00.20	2:07.41	3:28.78	4:30.37
21	Careaga, Javier	MEX	1:00.00	2:11.81	3:26.76	4:30.71
22	Borges, Rui	POR	1:01.70	2:10.40	3:27.49	4:30.79
23	Meldrum, Michael	CAN	58.99	2:07.72	3:27.66	4:31.74
24	Ramalho, Renato	BRA	1:01.89	2:10.64	3:30.09	4:31.95
25	Fujimoto, Takahiro	JPN	59.09	2:08.18	3:28.44	4:33.03
26	Madeira, Diogo	POR	1:00.20	2:10.55	3:30.09	4:35.00
27	Lopez-Zubero, Martin	ESP	59.75	2:07.67	3:30.20	4:35.68
28	Lee, Jae-Soo	KOR	1:01.35	2:15.33	3:36.22	4:40.46
29	Sakovich, Jonathan	GUM	1:04.74	2:19.63	3:43.11	4:44.78
30	Con Cepcion, Rene	PHI	1:03.14	2:19.97	3:41.05	4:48.00
31	Alotaibi, Sultan	KUW	1:02.82	2:19.18	3:42.17	4:50.16
32	Boiling, Julian Davey, John Koh, Desmond Bidrman, Jan	SRI GBR SIN SWE	1:03.80	2:18.60	3:46.96	4:53.61 DQ DQ NS

Swimming

Natation

Men 4x100m Medley Relay Heat 3/Sept. 25

Hommes/Relais 4x100m 4 nages Serie 3/25 Sept

Rank Rang	Ctry Pays	Name Nom	50m	100m	Lap	Result Resultat
1	GBR	Binfield, Gary Moorhouse, Adrian Jameson, Andy Lee, Roland		57.89 1:02.33 53.47 50.75	57.89 2:00.22 2:53.69 3:44.44	3:44.44
2	URS	Zabolotnov, Serguei Lozik, Valeri Petrov, Konstantine Evseev, Nikolai		57.14 1:02.80 55.02 50.33	57.14 1:59.94 2:54.96 3:45.29	3:45.29
3	SUI	Ferland, Patrick Dagon, Etienne Halsall, Dano Volery, Stefan		58.27 1:04.61 55.71 49.50	58.27 2:02.88 2:58.59 3:48.09	3:48.09
4	NZL	Kingsman, Paul Beks, Anthony Mosse, Anthony Anderson, Ross		57.73 1:05.43 54.03 51.74	57.73 2:03.16 2:57.19 3:48.93	3:48.93
5	ITA	Giambalvo, Valerio Minervini, Gianni Michelotti, Leonardo Gleria, Roberto		59.70 1:05.06 56.76 50.54	59.70 2:04.76 3:01.52 3:52.06	3:52.06
6	BRA	Romero, Rogerio Torteli, Cicero Poli, Eduardo Nascimento, Emanuel		57.99 1:06.54 56.65 52.03	57.99 2:04.53 3:01.18 3:53.21	3:53.21
7	MEX	Vela, Ernesto Careaga, Javier Zea, Urbano Gonzalez, Rodrigo		59.16 1:06.07 57.66 51.32	59.16 2:50.23 3:02.89 3:54.21	3:54.21

Men 4x100m Medley Relay Heat 4/Sept. 25

Hommes/Relais 4x100m 4 nages Serie 4/25 Sept

Rank Rang	Ctry Pays	Name Nom	50m	100m	Lap	Result Resultat
1	USA	Berkoff, David Schroeder, Richard Mortenson, Jay Jager, Thomas		55.69 1:01.64 54.46 51.21	55.69 1:57.33 2:51.79 3:43.00	3:43.00
2	FRG	Hoffmeister, Frank Warnecke, Mark Gross, Michael Zikarsky, Bjoern		57.04 1:03.80 54.41 49.47	57.04 2:00.84 2:55.25 3:44.72	3:44.72
3	JPN	Suzuki, Daichi Nagahata, Hironobu Miura, Hiroshi Ogata, Shigeo		56.24 1:03.51 55.65 51.48	56.24 1:59.75 2:55.40 3:46.88	3:46.88
4	FRA	Schott, Franck Leblanc, David Depickere, Ludovic Gutzeit, Bruno		57.04 1:04.85 56.37 50.38	57.04 2:01.89 2:58.26 3:48.64	3:48.64
5	ESP	Lopez-Zubero, Martin Camallonga, Ramon Ballester, Jose Luis Hernando, Jose		58.05 1:04.67 55.66 51.09	58.05 2:02.72 2:58.38 3:49.47	3:49.47
6	DEN	Sorensen, Lars Toft, Christian Nielsen, Benny Mortensen, Franz		58.17 1:07.32 55.57 50.91	58.17 2:05.49 3:01.06 3:51.97	3:51.97
7	SIN	Lim, DavidNg, Ng, Yue Megn Ang, Peng Siong Oon, Jin Gee		58.03 1:05.89 56.63 52.31	58.03 2:03.92 3:00.55 3:52.86	3:52.86
8	HKG	Yip, Hor Man Watt, Kam Sing Tsang, Yi Ming Wright, Michael		1:03.23 1:08.53 59.44 54.08	1:03.23 2:11.76 3:11.20 4:05.28	4:05.28

Men 4x100m Medley Relay /Sept. 25

Hommes/Relais 4x100m 4 nages /25 Sept

Rank Rang	Ctry Pays	Name Nom	50m	100m	Lap	Result Resultat
1	USA	Berkoff, David Schroeder, Richard Mortenson, Jay Jager, Thomas		55.69 1:01.64 54.46 51.21	55.69 1:57.33 2:51.79 3:43.00	3:43.00
2	GBR	Binfield, Gary Moorhouse, Adrian Jameson, Andy Lee, Roland		57.89 1:02.33 53.47 50.75	57.89 2:00.22 2:53.69 3:44.44	3:44.44
3	CAN	Tewksbury, Mark Davis, Victor Ponting, Thomas Goss, Donald Alexander		57.05 1:03.14 54.12 50.25	57.05 2:00.19 2:54.31 3:44.56	3:44.56

Rank Rang	Ctry Pays	Name Nom	50m	100m	Lap	Result Resultat
4	FRG	Hoffmeister, Frank Warnecke, Mark Gross, Michael Zikarsky, Bjoern		57.04 1:03.80 54.41 49.47	57.04 2:00.84 2:55.25 3:44.72	3:44.72
5	URS	Zabolotnov, Serguei Lozik, Valeri Petrov, Konstantine Evseev, Nikolai		57.14 1:02.80 55.02 50.33	57.14 1:59.94 2:54.96 3:45.29	3:45.29
6	HOL	Kroes, Hans Dekker, Ronald Drost, Frank Dybiona, Patrick		58.11 1:02.42 54.50 50.62	58.11 2:00.53 2:55.03 3:45.65	3:45.65
7	JPN	Suzuki, Daichi Nagahata, Hironobu Miura, Hiroshi Ogata, Shigeo		56.24 1:03.51 55.65 51.48	56.24 1:59.75 2:55.40 3:46.88	3:46.88
8	AUS	Wilson, Carl Mcadam, Ian Sieben, Jonathan Baildon, Andrew		58.31 1:05.17 54.65 49.27	58.31 2:03.48 2:58.13 3:47.40	3:47.40
9	SUI	Ferland, Patrick Dagon, Etienne Halsall, Dano Volery, Stefan		58.27 1:04.61 55.71 49.50	58.27 2:02.88 2:58.59 3:48.09	3:48.09
10	FRA	Schott, Franck Leblanc, David Depickere, Ludovic Gutzeit, Bruno		57.04 1:04.85 56.37 50.38	57.04 2:01.89 2:58.26 3:48.64	3:48.64
11	NZL	Kingsman, Paul Beks, Anthony Mosse, Anthony Anderson, Ross		57.73 1:05.43 54.03 51.74	57.73 2:03.16 2:57.19 3:48.93	3:48.93
12	ESP	Lopez-Zubero, Martin Camallonga, Ramon Ballester, Jose Luis Hernando, Jose		58.05 1:04.67 55.66 51.09	58.05 2:02.72 2:58.38 3:49.47	3:49.47
13	TCH	Vokoun, Pavel Beinhauer, Radek Wolf, Robert Kladiva, Petr		59.25 1:03.71 56.23 50.71	59.25 2:02.96 2:59.19 3:49.90	3:49.90
14	DEN	Sorensen, Lars Toft, Christian Nielsen, Benny Mortensen, Franz		58.17 1:07.32 55.57 50.91	58.17 2:05.49 3:01.06 3:51.97	3:51.97
15	ITA	Giambalvo, Valerio Minervini, Gianni Michelotti, Leonardo Gleria, Roberto		59.70 1:05.06 57.76 50.54	59.70 2:04.76 3:01.52 3:52.06	3:52.06
16	HUN	Deutsch, Tamas Guttler, Karoly Kalaus, Valter Bodor, Mihly-Richard		58.52 1:03.59 58.30 51.83	58.52 2:02.11 3:00.41 3:52.24	3:52.24
17	SIN	Lim, David Ng, Yue Meng Ang, Peng Siong Oon, Jin Gee		58.03 1:05.89 56.63 52.31	58.03 2:03.92 3:00.55 3:52.86	3:52.86
18	BRA	Romero, Rogerio Torteli, Cicero Poli, Eduardo Nascimento, Emanuel		57.99 1:06.54 56.65 52.03	57.99 2:04.53 3:01.18 3:53.21	3:53.21
19	CHN	Lin, Laijiu Chen, Jiianhong Zheng, Jian Shen, Jianqiang		59.32 1:04.73 57.04 53.09	59.32 2:04.05 3:01.09 3:54.18	3:54.18
20	MEX	Vela, Ernesto Careaga, Javier Zea, Urbano Gonzalez, Rodrigo		59.16 1:06.07 57.66 51.32	59.16 2:05.23 3:02.89 3:54.21	3:54.21
21	KOR	Park, Dong-Pil Yoon, Joo-Il Park, Young-Chul Kwon, Sang-Won		1:01.38 1:04.42 56.96 54.18	1:01.38 2:05.80 3:02.76 3:56.94	3:56.94
22	HKG	Yip, Hor Man Watt, Kam Sing Tsang, Yi Ming Wright, Michael		1:03.23 1:08.53 59.44 54.08	1:03.23 2:11.76 3:11.20 4:05.28	4:05.28
23	GRE	Malamas, Helias Fokianos, Nikolaos Griniakakis, Theodoros Papanikolaou, Charalambos		59.88 1:07.61 1:01.09 59.13	59.88 2:07.49 3:08.58 4:07.71	4:07.71



Rank Rang	Ctry Pays	Name Nom	50m	100m	Lap	Result Resultat
24	ISV	Cleveland, William Singleton, Kraig Singleton, Kristan Foerster, Hans		1:05.06 1:13.73 1:01.93 54.31	1:05.06 2:18.79 3:20.72 4:15.03	4:15.03
25	UAE	Abdulla, Mohamed Alrumaithi, Obaid Binabid, Mohammed Faraj, Ahmad		1:08.35 1:15.72 1:06.57 57.91	1:08.35 2:24.07 3:30.64 4:28.55	4:28.55

Men 4x100M Medley Relay **Hommes/Relais 4x100m 4 nages**
Final/Sept. 25 **Finale/25 Sept**

Rank Rang	Ctry Pays	Name Nom	50m	100m	Lap	Result Resultat
1	USA	Berkoff, David Schroeder, Richard Biondi, Matthew Jacobs, Christopher		54.56 1:01.64 52.38 48.35	54.56 1:56.20 2:48.58 3:36.93	3:36.93 NWR NOR
2	CAN	Tewksbury, Mark Davis, Victor Ponting, Thomas Goss, Donald Alexander		56.11 1:00.90 53.52 48.75	56.11 1:57.01 2:50.53 3:39.28	3:39.28
3	URS	Polianski, Igor Volkov, Dmitri Iarochchouk, Vadim Prigoda, Gennadi		55.35 1:01.53 53.34 49.74	55.35 1:56.88 2:50.22 3:39.96	3:39.96
4	FRG	Hoffmeister, Frank mayer, Alexander Gross, Michael Zikarsky, Bjoern		57.18 1:03.12 53.17 49.51	57.18 2:00.30 2:53.47 3:42.98	3:42.98
5	JPN	Suzuki, Daichi Nagahata, Hironobu Miura, Hiroshi Ogata, Shigeo		55.87 1:02.75 54.18 51.56	55.87 1:58.62 2:52.80 3:44.36	3:44.36
6	AUS	Wilson, Carl Mcadam, Ian Sieben, Jonathan Baildon, Andrew		57.85 1:05.01 53.42 49.57	57.85 2:02.86 2:56.28 3:45.85	3:45.85
7	HOL	Kroes, Hans Dekker, Ronald Drost, Frank Dybiona, Patrick		58.26 1:03.40 54.48 50.41	58.26 2:01.66 2:56.14 3:46.55	3:46.55
	GBR	Harper, Neil Moorhouse, Adrian Jameson, Andy Foster, Mark				DQ

Men 4x100m Freestyle Relay **Hommes/Relais 4x100m nage libre**
Heat 1/Sept. 23 **Serie 1/23 Sept**

Rank Rang	Ctry Pays	Name Nom	50m	100m	Lap	Result Resultat
1	SWE	Werner, Tommy Milton, Richard Holmquist, Joakim Titus, Goran	24.56 24.12 23.38 23.55	50.92 51.38 50.48 50.31	50.92 1:42.30 2:32.78 3:23.09	3:23.09
2	CAN	Andrews, Mark Vandermeulen, Stephen Cerny, Vlastimil Goss, Donald Alexander	24.13 24.52 24.60 23.97	51.66 50.99 51.14 50.15	51.66 1:42.56 2:33.70 3:23.85	3:23.85
3	DEN	Mortensen, Franz Hogholm, Vagn Nielsen, Benny Rohde, Peter	24.38 24.14 24.29 23.94	51.21 50.97 51.73 51.24	51.21 1:42.18 2:33.91 3:25.15	3:25.15
4	HOL	Drost, Frand Dybiona, Patrick Kroes, Hans Dekker, Ronald	24.82 24.12 24.27 24.29	51.52 50.86 51.57 51.31	51.52 1:42.38 2:33.95 3:25.26	3:25.26
5	POR	Albuquerque, Mabilio Villaret, Henrique Sousa, Vasco Esteves, Sergio	24.45 25.32 25.79 25.61	53.06 52.87 53.73 53.65	53.06 1:45.93 2:39.66 3:33.31	3:33.31
6	ISV	Foerster, Hans Singleton, Kraig Singleton, Kristan Cleveland, William	26.30 26.93 27.53 26.39	54.23 56.51 57.78 54.71	54.23 1:50.74 2:48.52 3:43.23	3:43.23

Men 4x100m Freestyle Relay **Hommes/Relais 4x100m nage libre**
Heat 2/Sept. 23 **Serie 2/23 Sept**

Rank Rang	Ctry Pays	Name Nom	50m	100m	Lap	Result Resultat
1	FRG	Zikarsky, Bjoern Sitt, Peter Wiegel, Torsten Fahmer, Thomas	24.58 24.31 24.34 23.90	51.09 51.02 51.09 49.99	51.09 1:42.11 2:33.20 3:23.19	3:23.19
2	ITA	Rampazzo, Fabrizio Lamberti, Giorgio Ceccarini, Andrea Gleria, Roberto	25.33 24.01 24.53 24.52	51.83 49.93 51.25 50.34	51.83 1:41.76 2:33.01 3:23.35	3:23.35
3	GBR	Jameson, Andy Foster, Mark Fibbens, Mike Lee, Roland	24.73 24.03 23.79 24.25	51.40 50.81 50.68 50.82	51.40 1:42.21 2:32.89 3:23.71	3:23.71
4	BRA	Nascimento, Emanuel Michelena, Cristiano Fernandes, Jorge Lopez, Julio	25.41 25.15 25.10 25.20	52.13 52.13 52.05 51.86	52.13 1:44.26 2:36.31 3:28.17	3:28.17
5	MEX	Gonzalez, Rodrigo Excamilla, Ignacio Alarcon, Jorge Zea, Urbano	24.58 25.54 24.90 24.72	51.48 53.48 52.51 52.25	51.48 1:44.96 2:37.47 3:29.72	3:29.72
6	HKG	Wright, Michael Li, Khai Kam Li, Arthur Tsang, Yi Ming	26.06 25.16 25.85 26.59	53.74 52.79 53.48 54.77	53.74 1:46.53 2:40.01 3:34.78	3:34.78
7	KOR	Kwon, Sang-Won Yang, Wook Song, Kwang-Sun Kwon, Soon-Kun	25.89 26.04 25.98 26.83	54.18 54.17 54.25 55.45	54.18 1:48.35 2:42.60 3:38.05	3:38.05
	CHN	Shen, Jianqiang Li, Tao Xie, Jun Feng, Qiangbiao				DQ

Men 4x100m Freestyle Relay **Hommes/Relais 4x100m nage libre**
Heat 3/Sept. 23 **Serie 3/23 Sept**

Rank Rang	Ctry Pays	Name Nom	50m	100m	Lap	Result Resultat
1	USA	Lang, Brent Gjertsen, Douglas Jordan, Shaun Dalbey, Troy	23.95 24.11 23.98 23.39	50.18 49.64 50.19 49.51	50.18 1:39.82 2:30.01 3:19.52	3:19.52
2	URS	Majoulis, Raimoundas Borislavski, Alexei Evseev, Nikolai Tkashenko, Vladimir	24.08 23.85 23.80 23.41	50.90 49.95 49.21 49.83	50.90 1:40.85 2:30.06 3:19.89	3:19.89
3	GDR	Richter, Dirk Flemming, Thomas Hinneburg, Lars Zesner, Steffen	24.34 24.51 23.91 24.02	50.30 50.01 50.11 50.05	50.30 1:40.31 2:30.42 3:20.47	3:20.47
4	FRA	Caron, Stephan Kalfayan, Christophe Neuville, Laurent Gutzeit, Bruno	24.74 24.29 24.15 24.10	50.68 50.54 50.45 50.10	50.68 1:41.22 2:31.67 3:21.77	3:21.77
5	SIN	Ang, Peng Siang Lim, David Oon, Jin Gee Koh, Desmond	25.13 25.49 25.29 26.84	52.28 53.10 52.77 56.48	52.28 1:45.29 2:38.06 3:34.54	3:34.54
6	UAE	Faraj, Ahmad Abdulla, Mohamed Alansari, Bassam Binabid, Mohammed	28.18 29.35 28.88 28.31	58.29 1:00.80 1:00.92 58.91	58.29 1:59.09 3:00.01 3:58.92	3:58.92
7	EGY	Elazoul, Mohamed Amer, Amin Hassan, Mohamed Amer, Mostafa				DQ
8	AUT	Opatril, Stefan Opatril, Markus Placheta, Alesander Pilhatsch, Alexander				DQ

Swimming

Men 4 x 100m Freestyle Relay/Sept. 23			Hommes/Relais 4x100m nage libre/23 Sept			
Rank Rang	Ctry Pays	Name Nom	50m	100m	Lap	Result Resultat
1	USA	Lang, Brent Gjertsen, Douglas Jordan, Shaun Dalbey, Troy	23.95 24.11 23.98 23.39	50.18 49.64 50.19 49.51	50.18 1:39.82 2:30.01 3:19.52	3:19.52
2	URS	Majoulis, Raimondas Borislavski, Alexei Evseev, Nikolai Tkashenko, Vladimir	24.08 23.85 23.80 23.41	50.90 49.95 49.21 49.83	50.90 1:40.85 2:30.06 3:19.89	3:19.89
3	GDR	Richter, Dirk Flemming, Thomas Hinneburg, Lars Zesner, Steffen	24.34 24.51 23.91 24.02	50.30 50.01 50.11 50.05	50.30 1:40.31 2:30.42 3:20.47	3:20.47
4	FRA	Caron, Stephan Kalfayan, Christophe Neuville, Laurent Gutzeit, Bruno	24.74 24.29 24.15 24.10	50.68 50.54 50.45 50.10	50.68 1:41.22 2:31.67 3:21.77	3:21.77
5	SWE	Werner, Tommy Milton, Richard Holmquist, Joakim Titus, Goran	24.56 24.12 23.88 23.55	50.92 51.38 50.48 50.31	50.92 1:42.30 2:32.78 3:23.09	3:23.09
6	FRG	Zikarsky, Bjoern Sitt, Peter Wiegel, Torsten Fahrner, Thomas	24.58 24.31 24.34 23.90	51.09 51.02 51.09 49.99	51.09 1:42.11 2:33.20 3:23.19	3:23.19
7	ITA	Rampazzo, Fabrizio Lamberti, Giorgio Ceccarini, Andrea Gleria, Roberto	25.33 24.01 24.53 24.52	51.83 49.93 51.25 50.34	51.83 1:41.76 2:33.01 3:23.35	3:23.35
8	GBR	Jameson, Andy Foster, Mark Fibbens, Mike Lee, Roland	24.73 24.03 23.79 24.25	51.40 50.81 50.68 50.82	51.40 1:42.21 2:32.89 3:23.71	3:23.71
9	CAN	Andrews, Mark Vandermeulen, Stephen Cerny, Vlastimil Goss, Donald Alexander	24.13 24.52 24.60 23.97	51.66 50.90 51.14 50.15	51.66 1:42.56 2:33.70 3:23.85	3:23.85
10	DEN	Mortensen, Franz Hogholm, Vagn Nielsen, Benny Rohde, Peter	24.38 24.14 24.29 23.94	51.21 50.97 51.73 51.24	51.21 1:42.18 2:33.91 3:25.15	3:25.15
11	HOL	Drost, Frank Dybiona, Patrick Kroes, Hans Dekker, Ronald	24.82 24.12 24.27 24.29	51.52 50.86 51.57 51.31	51.52 1:42.38 2:33.95 3:25.26	3:25.26
12	BRA	Nascimento, Emanuel Michelena, Cristiano Fernandes, Jorge Lopez, Julio	25.41 25.15 25.10 25.20	52.13 52.13 52.05 51.86	52.13 1:44.26 2:36.31 3:28.17	3:28.17
13	MEX	Gonzalez, Rodrigo Escamilla, Ignacio Alarcon, Jorge Zea, Urbano	24.58 25.54 24.90 24.72	51.48 53.48 52.51 52.25	51.48 1:44.96 2:37.47 3:29.72	3:29.72
14	POR	Albuquerque, Mabilio Villaret, Henrique Sousa, Vasco Esteves, Sergio	25.45 25.32 25.79 25.61	53.06 52.97 53.73 53.65	53.06 1:45.93 2:39.66 3:33.31	3:33.31
15	SIN	Ang, Peng Siong Lim, David Oon, Jin Gee Koh, Desmond	25.13 25.49 25.29 26.84	52.28 53.01 52.77 56.48	52.28 1:45.29 2:38.06 3:34.54	3:34.54
16	HKG	Wright, Michael Li, Khai Kam Li, Arthur Tsang, Yi Ming	26.06 25.16 25.85 26.59	53.74 52.79 53.48 54.77	53.74 1:46.53 2:40.01 3:34.78	3:34.78
17	KOR	Kwon, Sang-Won Yang, Wook Song, Kwang-Sun Kwon, Soon-Kun	25.89 26.04 25.98 26.83	54.18 54.17 54.25 55.45	54.18 1:48.35 2:42.60 3:38.05	3:38.05
18	ISV	Foerster, Hans Singleton, Kraig Singleton, Kristan Cleveland, William	26.30 26.93 27.53 26.39	54.23 56.51 57.78 54.71	54.23 1:50.74 2:48.52 3:43.23	3:43.23
19	UAE	Faraj, Ahmad Abdulla, Mohamed Alansari, Bassam Binabid, Mohammed	28.18 29.35 28.88 28.31	58.29 1:00.80 1:00.92 58.91	58.29 1:59.09 3:00.01 3:58.92	3:58.92
	AUT	Opatril, Stefan Opatril, Markus Placheta, Alexander Phlhatsch, Alexander				DQ
	CHN	Shen, Jianqiang Li, Tao Xie, Jun Feng, Qiangbiao				DQ
	EGY	Elazoul, Mohamed Amer, Amin Hassan, Mohamed Amer, Mostafa				DQ

Natation

Men 4 x 100m Freestyle Relay Final/Sept. 23			Hommes/Relais 4x100m nage libre Finale/23 Sept			
Rank Rang	Ctry Pays	Name Nom	50m	100m	Lap	Result Resultat
1	USA	Jacobs, Christopher Dalbey, Troy Jager, Thomas Biondi, Matthew	23.91 23.68 22.99 22.75	49.63 49.75 49.34 47.81	49.63 1:39.38 2:28.72 3:16.53	3:16.53
2	URS	Prigoda, Gennadi Bachkatov, Iouri Evseev, Nikolai Tkashenko, Vladimir	24.05 23.72 23.40 23.53	50.24 49.30 49.27 49.52	50.24 1:39.54 2:28.81 3:18.33	3:18.33
3	GDR	Richter, Dirk Flemming, Thomas Hinneburg, Lars Zesner, Steffen	24.12 23.99 23.93 23.64	50.25 49.70 50.35 49.52	50.25 1:39.95 2:30.30 3:19.82	3:19.82
4	FRA	Caron, Stephan Kalfayan, Christophe Neuville, Laurent Gutzeit, Bruno	24.15 24.05 23.45 24.34	49.97 50.09 50.04 49.92	49.97 1:40.06 2:30.10 3:20.02	3:20.02
5	SWE	Johansson, Per Werner, Tommy Holmquist, Joakim Titus, Goran	24.18 23.78 23.55 23.72	50.58 50.00 50.47 50.02	50.58 1:40.58 2:31.05 3:21.07	3:21.07
6	FRG	Gross, Michael Fahrner, Thomas Zikarsky, Bjoern Sitt, Peter	24.15 23.83 24.44 23.86	50.66 50.00 50.40 50.59	50.66 1:40.66 2:31.06 3:21.65	3:21.65
7	GBR	Fibbens, Mike Foster, Mark Lee, Roland Jameson, Andy	24.54 23.53 23.78 23.77	51.36 50.20 50.33 49.82	51.36 1:41.56 2:31.89 3:21.71	3:21.71
8	ITA	Gleria, Roberto Lamberti, Giorgio Rampazzo, Fabrizio Ceccarini, Andrea	24.68 24.47 24.10 24.23	50.51 50.31 51.19 50.92	50.51 1:40.82 2:32.01 3:22.93	3:22.93

Men 4 x 200m Freestyle Relay Heat 1/Sept. 20			Hommes/Relais 4x200m nage libre Serie 1/20 Sept			
Rank Rang	Ctry Pays	Name Nom	100m	200m	Lap	Result Resultat
1	GDR	Dassler, Uwe Hinneburg, Lars Lodziewski, Sven Flemming, Thomas	54.67 53.25 52.44 52.95	1:49.47 1:49.64 1:48.87 1:48.63	1:49.47 3:39.11 5:27.98 7:16.61	7:16.61
2	USA	Oppel, Craig Jorgensen, Daniel Cetlinski, Matthew Gjertsen, Douglas	55.07 52.73 53.05 53.03	1:51.24 1:49.24 1:48.87 1:49.41	1:51.24 3:40.48 5:29.35 7:18.76	7:18.76
3	AUS	Plummer, Jason Brown, Ian Roberts, Martin Stachewicz, Thomas	55.41 53.09 54.00 53.41	1:51.44 1:48.89 1:51.31 1:49.82	1:51.44 3:40.33 5:31.64 7:21.46	7:21.46
4	ITA	Trevisan, Massimo Rampazzo, Fabrizio Giambalvo, Valerio Gleria, Roberto	54.67 53.77 53.43 53.91	1:50.95 1:51.47 1:50.97 1:48.46	1:50.95 3:42.42 5:33.39 7:21.85	7:21.85
5	GBR	Boyd, Kevin Howe, Paul Broughton, Jonathan Lee, Roland	54.75 54.11 55.26 54.24	1:52.00 1:1:51.58 1:52.81 1:53.38	1:52.00 3:43.58 5:36.39 7:29.77	7:29.77
6	DEN	Mortensen, Franz Christensen, Claus Larsen, Jan Patvel Rohde, Peter	54.32 55.08 53.71 55.26	1:51.21 1:52.08 1:52.61 1:57.41	1:51.21 3:43.29 5:35.90 7:33.31	7:33.31
7	KOR	Kwon, Sang-Won Yang, Wook Song, Kwang-Sun Kwon, Soon-Kun	55.99 57.21 57.17 57.09	1:57.08 1:57.29 1:59.11 1:59.45	1:57.08 3:54.37 5:53.48 7:52.93	7:52.93
8	ISV	Foerster, Hans Singleton, Kraig Pickard, Ronald Cleveland, William	58.77 1:00.69 1:00.17 58.47	2:01.34 2:05.63 2:07.66 2:00.88	2:01.34 4:06.97 6:14.63 8:15.51	8:15.51

**Men 4 x 200m Freestyle Relay
Heat 2/Sept. 20**
**Hombres/Relais 4x200m nage libre
Serie 2/20 Sept**

Rank Rang	Ctry Pays	Name Nom	100m	200m	Lap	Result Resultat
1	FRG	Sitt, Peter	54.08	1:50.31	1:50.31	7:19.38
		Henkel, Rainer	53.31	1:49.63	3:39.94	
		Pfeiffer, Stefan	53.08	1:50.06	5:30.00	
		Hochstein, Erik	52.99	1:49.38	7:19.38	
2	FRA	Caron, Stephan	53.79	1:49.41	1:49.41	7:23.03
		Pou, Michel	54.61	1:51.01	3:40.42	
		Fougeroud, Olivier	54.17	1:51.62	5:32.04	
		Neuville, Laurent	53.69	1:50.99	7:23.03	
3	SWE	Werner, Tommy	53.97	1:50.46	1:50.46	7:23.82
		Wallin, Christer	53.41	1:50.38	3:40.84	
		Jangvall, Henrik	53.72	1:52.33	5:33.17	
		Soderlund, Michael	53.49	1:50.65	7:23.82	
4	CAN	O'hare, Turlough	54.56	1:51.59	1:51.59	7:26.28
		Ward, Darren	54.40	1:52.27	3:43.86	
		Haddow, Donald	54.58	1:51.11	5:34.97	
		Vandermeulen, Gary	53.65	1:51.31	7:26.28	
5	BRA	Michelena, Cristiano	54.09	1:51.38	1:51.38	7:32.11
		Fernandes, Jorge	55.45	1:53.34	3:44.72	
		Nascimento, Emanuel	54.33	1:54.26	5:38.98	
		Lopez, Julio	53.99	1:53.13	7:32.11	
6	UAE	Faraj, Ahmad	1:04.39	2:15.64	2:15.64	9:01.03
		Abdulla, Mohamed	1:06.14	2:17.64	4:33.28	
		Alansari, Bassam	1:03.70	2:15.41	6:48.69	
		Binabid, Mohammed	1:03.06	2:12.34	9:01.03	
MEX		Escamilla, Ignacio				DQ
		Alarcon, Jorge				
		Romo, Carlos				
URS		Kouriaev, Serguei				DQ
		Bazanov, Alexandre				
		Evseev, Nikolai				
		Kouznetsov, Aleksei				

Rank Rang	Ctry Pays	Name Nom	100m	200m	Lap	Result Resultat
13	ISV	Foerster, Hans	58.77	2:01.34	2:01.34	8:15.51
		Singleton, Kraig	1:00.69	2:05.63	4:06.97	
		Pickard, Ronald	1:00.17	2:07.66	6:14.63	
		Cleveland, William	58.47	2:00.88	8:15.51	
14	UAE	Faraj, Ahmad	1:04.39	2:15.64	2:15.64	9:01.03
		Abdulla, Mohamed	1:06.14	2:17.64	4:33.28	
		Alansari, Bassam	1:03.70	2:15.41	6:48.69	
		Binabid, Mohammed	1:03.06	2:12.34	9:01.03	
MEX		Escamilla, Ignacio				DQ
		Alarcon, Jorge				
		Romo, Carlos				
URS		Kouriaev, Serguei				DQ
		Bazanov, Alexandre				
		Evseev, Nikolai				
		Kouznetsov, Aleksei				

**Men 4 x 200m Freestyle Relay
Final/Sept. 21**
**Hombres/Relais 4x200m nage libre
Finale/21 Sept**

Rank Rang	Ctry Pays	Name Nom	100m	200m	Lap	Result Resultat
1	USA	Dalbey, Troy	52.50	1:49.37	1:49.37	7:12.51
		Cetlinski, Matthew	52.71	1:48.44	3:37.81	
		Gjertsen, Douglas	52.69	1:48.26	5:26.07	
		Biondi, Matthew	50.99	1:46.44	7:12.51	
2	GDR	Dassler, Uwe	53.27	1:48.26	1:48.26	7:13.68
		Lodziewski, Sven	52.46	1:48.92	3:37.18	
		Flemming, Thomas	52.05	1:48.07	5:25.25	
		Zesner, Steffen	52.28	1:48.43	7:13.68	
3	FRG	Hochstein, Erik	54.06	1:49.91	1:49.91	7:14.35
		Fahrner, Thomas	52.28	1:47.25	3:37.66	
		Henkel, Rainer	52.88	1:49.42	5:27.08	
		Gross, Michael	51.49	1:47.27	7:14.35	
4	AUS	Stachewicz, Thomas	53.27	1:48.99	1:48.99	7:15.23
		Brown, Ian	53.26	1:49.05	3:38.04	
		Plummer, Jason	53.89	1:49.95	5:27.99	
		Armstrong, Duncan	52.23	1:47.24	7:15.23	
5	ITA	Gleria, Roberto	54.20	1:49.23	1:49.23	7:16.00
		Lamberti, Giorgio	51.83	1:47.29	3:36.52	
		Trevisan, Massimo	52.90	1:49.66	5:26.18	
		Giambalvo, Valerio	53.66	1:49.82	7:16.00	
6	SWE	Holmertz, Anders	52.72	1:48.06	1:48.06	7:19.10
		Werner, Tommy	51.83	1:49.41	3:37.47	
		Soderlund, Michael	53.06	1:50.57	5:28.04	
		Wallin, Christer	52.83	1:51.06	7:19.10	
7	FRA	Pou, Michel	54.93	1:52.05	1:52.05	7:24.69
		Iacono, Franck	53.64	1:50.04	3:42.09	
		Fougeroud, Olivier	54.78	1:52.14	5:34.23	
		Depickere, Ludovic	53.72	1:50.46	7:24.69	
8	CAN	O'hare, Turlough	55.51	1:51.45	1:51.45	7:24.91
		Goss, Donald Alexander	53.61	1:51.01	3:42.46	
		Haddow, Donald	54.80	1:51.46	5:33.92	
		Vandermeulen, Gary	54.12	1:50.99	7:24.91	

**Men 4 x 200m Freestyle
Relay/Sept. 20-21**
**Hombres/Relais 4x200m nage
libre/20-21 Sept**

Rank Rang	Ctry Pays	Name Nom	50m	100m	Lap	Result Resultat
1	GDR	Dassler, Uwe	54.67	1:49.47	1:49.47	7:16.61
		Hinneburg, Lars	53.25	1:49.64	3:39.11	
		Lodziewski, Sven	52.44	1:48.87	5:27.98	
		Flemming, Thomas	52.95	1:48.63	7:16.61	
2	USA	Oppel, Craig	55.07	1:51.24	1:51.24	7:18.76
		Jorgensen, Daniel	52.73	1:49.24	3:40.48	
		Cetlinski, Matthew	53.05	1:48.87	5:29.35	
		Gjertsen, Douglas	53.03	1:49.41	7:18.76	
3	FRG	Sitt, Peter	54.08	1:50.31	1:50.31	7:19.38
		Henkel, Rainer	53.31	1:49.63	3:39.94	
		Pfeiffer, Stefan	53.08	1:50.06	5:30.00	
		Hochstein, Erik	52.99	1:49.38	7:19.38	
4	AUS	Plummer, Jason	55.41	1:51.44	1:51.44	7:21.46
		Brown, Ian	53.09	1:48.89	3:40.33	
		Roberts, Martin	54.00	1:51.31	5:31.64	
		Stachewicz, Thomas	53.41	1:49.82	7:21.46	
5	ITA	Trevisan, Massimo	54.67	1:50.95	1:50.95	7:21.85
		Rampazzo, Fabrizio	53.77	1:51.47	3:42.42	
		Giambalvo, Valerio	53.43	1:50.97	5:33.39	
		Gleria, Roberto	53.91	1:48.46	7:21.85	
6	FRA	Caron, Stephan	53.79	1:49.41	1:49.41	7:23.03
		Pou, Michel	54.61	1:51.01	3:40.42	
		Fougeroud, Olivier	54.17	1:51.62	5:32.04	
		Neuville, Laurent	53.69	1:50.99	7:23.03	
7	SWE	Werner, Tommy	53.97	1:50.46	1:50.46	7:23.82
		Wallin, Christer	53.41	1:50.38	3:40.84	
		Jangvall, Henrik	53.72	1:52.33	5:33.17	
		Soderlund, Michael	53.49	1:50.65	7:23.82	
8	CAN	O'hare, Turlough	54.56	1:51.59	1:51.59	7:26.28
		Ward, Darren	54.40	1:52.27	3:43.86	
		Haddow, Donald	54.58	1:51.11	5:34.97	
		Vandermeulen, Gary	53.65	1:51.31	7:26.28	
9	GBR	Boyd, Kevin	54.75	1:52.00	1:52.00	7:29.77
		Howe, Paul	54.11	1:51.58	3:43.58	
		Broughton, Jonathan	55.26	1:52.81	5:36.39	
		Lee, Roland	54.24	1:53.38	7:29.77	
10	BRA	Michelena, Cristiano	54.09	1:51.38	1:51.38	7:32.11
		Fernandes, Jorge	55.45	1:53.34	3:44.72	
		Nascimento, Emanuel	54.33	1:54.26	5:38.98	
		Lopez, Julio	53.99	1:53.13	7:32.11	
11	DEN	Mortensen, Franz	54.32	1:51.21	1:51.21	7:33.31
		Christensen, Claus	55.08	1:52.08	3:43.29	
		Larsen, Jan Patvel	53.71	1:52.61	5:35.90	
		Rohde, Peter	55.26	1:57.41	7:33.31	
12	KOR	Kwon, Sang-Won	55.99	1:57.08	1:57.08	7:52.93
		Yang, Wook	57.21	1:57.29	3:54.37	
		Song, Kwang-Sun	57.17	1:59.11	5:53.48	
		Kwon, Soon-Kun	57.09	1:59.45	7:52.93	

**Women 50m Freestyle
Heat 1/Sept. 25**
**Femmes/50m nage libre
Serie 1/25 Sept**

Rank Rang	Name Nom	Ctry Pays	50m
1	Araujo, Carolina	MOZ	29.64 NOR
2	Khalaf, Nancy	LIB	30.77

**Women 50m Freestyle
Heat 2/Sept. 25**
**Femmes/50m nage libre
Serie 2/25 Sept**

Rank Rang	Name Nom	Ctry Pays	50m
1	Mauri, Carolina	CRC	27.96 NOR
2	Ollafsdottir, Bryndis	ISL	28.38
3	Munch, Cina	FIJ	28.55
4	Fogarty, Catherine Helen	ZIM	28.66
5	Lum, Sabrina	TPE	28.82
6	Cummings, Veronica	GUM	28.94
7	Birch, Angela	FIJ	29.01
8	Moreno, Katerine	BOL	29.42

Swimming

Natation

Women 50m Freestyle Heat 3/Sept. 25

Rank Rang	Name Nom	Ctry Pays	50m	
1	Rezemde, Monica	BRA	27.44	NOR
2	Han, Young-Hee	KOR	28.02	
3	Hung, Cee Kay	HKG	28.15	
4	Park, Joo-Li	KOR	28.20	
5	Fortin, Ana Joselina	HON	28.46	
6	Wang, Chi	TPE	28.73	
7	Tsang, Wing Sze	HKG	29.14	
8	Martins, Ana	ANG	29.74	

Femmes/50m nage libre Serie 3/25 Sept

Women 50m Freestyle Heat 4/Sept. 25

Rank Rang	Name Nom	Ctry Pays	50m	
1	Van Der Plaats, Diana	HOL	26.49	NOR
2	Pereira, Adriana	BRA	26.56	
3	Rivera, Maria	MEX	27.16	
4	Cripps, Annabelle	GBR	27.17	
5	dieffenthaler, Karen	TRI	27.27	
6	Thomson, Akiko	PHI	27.43	
7	Kohlmann, Patricia	MEX	27.45	
8	Freire, Elsa	ANG	29.54	

Femmes/50m nage libre Serie 4/25 Sept

Women 50m Freestyle Heat 5/Sept. 25

Rank Rang	Name Nom	Ctry Pays	50m	
1	Fetter, Leigh	USA	25.91	NOR
2	Armentero, Marie-Therese	SUI	26.32	
3	Pielke, Christiane	FRG	26.33	
4	Briennesse, Karin	HOL	26.54	
5	Dobrescu, Luminita Lil	ROM	26.56	
6	Jensen, Gitte P	DEN	26.61	
6	Sasaki, Kaori	JPN	26.61	
8	Gharbi, Senda	TUN	27.34	

Femmes/50m nage libre Serie 5/25 Sept

Women 50m Freestyle Heat 6/Sept. 25

Rank Rang	Name Nom	Ctry Pays	50m	
1	Otto, Kristin	GDR	25.85	NOR
2	Plewinski, Catherine	FRA	26.01	
3	Costache, Tamara Virgi	ROM	26.06	
4	Nakano, Ayako	JPN	26.44	
5	Totham, Kristin	CAN	26.50	
6	Nugent, Andrea	CAN	26.60	
7	Xia, Fujie	CHN	26.66	
8	Furuhed, Karin	SWE	26.85	

Femmes/50m nage libre Serie 6/25 Sept

Women 50m Freestyle Heat 7/Sept. 25

Rank Rang	Name Nom	Ctry Pays	50m	
1	Yang, Wenyi	CHN	25.67	NOR
2	Meissner, Katrin	GDR	25.77	
3	Sterkel, Jill	USA	26.02	
4	Van Wirdum, Karen	AUS	26.12	
5	Aizpors, Marion	FRG	26.20	
6	Abramova, Inna	URS	26.27	
7	Aberg, Helena	SWE	26.67	
8	Sheppard, Alison	GBR	27.14	

Femmes/50m nage libre Serie 7/25 Sept

Women 50m Freestyle /Sept. 25

Rank Rang	Name Nom	Ctry Pays	50m	
1	Yang, Wenyi	CHN	25.67	NOR
2	Meissner, Katrin	GDR	25.77	
3	Otto, Kristin	GDR	25.85	
4	Fetter, Leigh	USA	25.91	
5	Plewinski, Catherine	FRA	26.01	
6	Sterkel, Jill	USA	26.02	
7	Costache, Tamara Virgi	ROM	26.06	
8	Van Wirdum, karen	AUS	26.12	
9	Aizpors, Marion	FRG	26.20	
10	Abramova, Inna	URS	26.27	
11	Armentero, Marie-Therese	SUI	26.32	
12	Pielke, Christiane	FRG	26.33	
13	Nakano, Ayako	JPN	26.44	
14	Van Der Plaats, Diana	HOL	26.49	
15	Topham, Kristin	CAN	26.50	
16	Briennesse, Karin	HOL	26.54	
17	Pereira, Adriana	BRA	26.56	
17	Dobrescu, Luminita Lil	ROM	26.56	
19	Nugent, Andrea	CAN	26.60	
20	Jensen, Gitte P	DEN	26.61	
20	Sasaki, Kaori	JPN	26.61	
22	Xia, Fujie	CHN	26.66	
23	Aberg, Helena	SWE	26.67	
24	Furuhed, Karin	SWE	26.85	
25	Sheppard, Alison	GBR	27.14	

Femmes/50m nage libre /25 Sept

Rank Rang	Name Nom	Ctry Pays	50m	
26	Rivera, Maria	MEX	27.16	
27	Cripps, Annabelle	GBR	27.17	
28	Dieffenthaler, Karen	TRI	27.27	
29	Gharbi, Senda	TUN	27.34	
30	Thomson, Akiko	PHI	27.43	
31	Rezemde, Monica	BRA	27.44	
32	Kohlmann, Patricia	MEX	27.45	
33	Mauri, Carolina	CRC	27.96	
34	Han, Young-Hee	KOR	28.02	
35	Hung, Cee Kay	HKG	28.15	
36	Park, Joo-Li	KOR	28.20	
37	Ollafsdottir, Bryndis	ISL	28.38	
38	Fortin, Ana Joselina	HON	28.46	
39	Munch, Cina	FIJ	28.55	
40	Fogarty, Catherine Helen	ZIM	28.66	
41	Wang, Chi	TPE	28.73	
42	LUM, Sabrina	TPE	28.82	
43	Cummings, Veronica	GUM	28.94	
44	Birch, Angela	FIJ	29.01	
45	Tsang, Wing Sze	HKG	29.14	
46	Moreno, katerine	BOL	29.42	
47	Freike, Elsa	ANG	29.54	
48	Araujo, Carolina	MOZ	29.64	
49	Martins, Ana	ANG	29.74	
50	Khalaf, Nancy	LIB	30.77	

Women 50m Freestyle Final A/Sept. 25

Rank Rang	Name Nom	Ctry Pays	50m	
1	Otto, Kristin	GDR	25.49	NOR
2	Yang, Wenyi	CHN	25.64	
3	Meissner, Katrin	GDR	25.71	
3	Sterkel, Jill	USA	25.71	
5	Fetter, Leigh	USA	25.78	
6	Costache, Tamara Virgi	ROM	25.80	
7	Plewinski, Catherine	FRA	25.90	
8	Van Wirdum, Karen	AUS	26.01	

Femmes/50m nage libre Finale A/25 Sept

Women 50m Freestyle Final B/Sept. 25

Rank Rang	Name Nom	Ctry Pays	50m	
1	Aizpors, Marion	FRG	26.17	
2	Pielke, Christiane	FRG	26.22	
3	Armeniero, Marie-Therese	SUI	26.34	
4	Topham, Kristin	CAN	26.45	
4	Nakano, Ayako	JPN	26.45	
6	Abramova, Inna	URS	26.48	
7	Briennesse, Karin	HOL	26.66	
8	Van Der Plaats, Diana	HOL	26.80	

Femmes/50m nage libre Finale B/25 Sept

Women 100m Freestyle Heat 1/Sept. 18

Rank Rang	Name Nom	Ctry Pays	50m	100m
1	Araujo, Carolina	MOZ	30.72	1:05.11
2	Moreno, Katerine	BOL	30.42	1:05.39
	Garay, Ritajejan	PUR		NS

Femmes/100m nage libre Serie 1/18 Sept

Women 100m Freestyle Heat 2/Sept. 18

Rank Rang	Name Nom	Ctry Pays	50m	100m
1	Lum, Sabrina	TPE	30.28	1:02.11
2	Fogarty, Catherine Helen	ZIM	29.90	1:02.47
3	Cummings, Veronica	GUM	30.68	1:02.63
4	Birch, Angela	FIJ	30.04	1:02.91
5	Munch, Cina	FIJ	29.34	1:03.06
6	Khalaf, Nancy	LIB	31.03	1:06.73
7	Fernandes, Carla	ANG	31.81	1:08.15

Femmes/100m nage libre Serie 2/18 Sept

Women 100m Freestyle Heat 3/Sept. 18

Rank Rang	Name Nom	Ctry Pays	50m	100m
1	Thomson, Akiko	PHI	28.62	59.41
2	Mauri, Carolina	CRC	28.45	1:00.14
3	Kim, Eun-Jung	KOR	29.59	1:00.39
4	Fortin, Ana Joselina	HON	29.52	1:01.11
5	Ng, Fenella	HKG	29.75	1:01.27
6	Han, Young-Hee	KOR	29.92	1:01.55
7	Wang, Chi	TPE	29.90	1:01.72
8	Freire, Elsa	ANG	30.62	1:05.47

Femmes/50m nage libre Serie 3/18 Sept

**Women 100m Freestyle
Heat 4/Sept. 18****Femmes/100m nage libre
Serie 4/18 Sept**

Rank Rang	Name Nom	Ctry Pays	50m	100m
1	Baumer, Susanne	AUS	27.97	57.76
2	Pereira, Adriana	BRA	28.39	58.53
3	Dieffenthaler, Karen	TRI	28.03	58.64
4	Kohlmann, Patricia	MEX	28.22	59.05
5	Vieira, Isabele	BRA	28.86	59.15
6	Rivera, Maria	MEX	28.30	59.32
7	Ollafsdottir, Bryndis	ISL	28.92	59.56
8	Hung, Cee Kay	HKG	28.99	1:00:18

**Women 100m Freestyle
Heat 5/Sept. 18****Femmes/100m nage libre
Serie 5/18 Sept**

Rank Rang	Name Nom	Ctry Pays	50m	100m
1	Nakano, Ayako	JPN	27.43	57.29
2	Nyberg, Eva	SWE	28.02	57.57
3	Cripps, Annabelle	GBR	27.86	57.81
4	Furuhed, Karin	SWE	27.79	57.97
5	Croft, June	GBR	28.18	58.19
6	Delord, Jacqueline	FRA	28.05	58.22
7	Sasaki, Kaori	JPN	27.81	58.40
8	Gharbi, Senda	TUN	28.36	58.51

**Women 100m Freestyle
Heat 6/Sept. 18****Femmes/100m nage libre
Serie 6/18 Sept**

Rank Rang	Name Nom	Ctry Pays	50m	100m
1	Zhuang, Yong	CHN	27.25	55.84
2	Trefilova, Natalia	URS	27.64	56.66
3	Van Wirdum, Karen	AUS	27.21	56.84
4	Kremer, Mitzi	USA	27.72	56.97
5	Kerr, Jane	CAN	28.04	57.55
6	Lou, Yaping	CHN	28.05	57.79
7	Sorensen, Pia	DEN	27.93	57.82
8	Persi, Silvia	ITA	27.55	58.22

**Women 100m Freestyle
Heat 7/Sept. 18****Femmes/100m nage libre
Serie 7/18 Sept**

Rank Rang	Name Nom	Ctry Pays	50m	100m
1	Stellmach, Manuela	GDR	27.34	56.14
2	Briennesse, Karin	HOL	27.25	56.29
3	Van Bentum, Cornelia	HOL	27.56	56.50
4	Dobrescu, Luminita Lil	ROM	27.47	56.67
5	Costache, Tamara Virgi	ROM	27.17	56.79
6	Issakova, Svetlana	URS	27.67	57.17
7	Hristova, Natacha	BUL	28.11	57.80
8	Ziliox, Katja	FRG	27.87	58.39

**Women 100m Freestyle
Heat 8/Sept. 18****Femmes/100m nage libre
Serie 8/18 Sept**

Rank Rang	Name Nom	Ctry Pays	50m	100m
1	Plewinski, Catherine	FRA	26.67	55.53
2	Otto, Kristin	GDR	27.30	55.80
3	Poll, Silvia	CRC	27.14	56.16
4	Torres, Dara	USA	27.19	56.37
5	Jensen, Gitta P	DEN	27.95	57.28
6	Nugent, Andrea	CAN	27.70	57.33
7	Armentero, Marie-Therese	SUI	27.52	57.35
8	Pielke, Christiane	FRG	27.29	57.47

**Women 100m Freestyle
/Sept. 18-19****Femmes/100m nage libre
/18-19 Sept**

Rank Rang	Name Nom	Ctry Pays	50m	100m
1	Plewinski, Catherine	FRA	26.67	55.53
2	Otto, Kristin	GDR	27.30	55.80
3	Zhuang, Yong	CHN	27.25	55.84
4	Stellmach, Manuela	GDR	27.34	56.14
5	Poll, Silvia	CRC	27.14	56.16
6	Briennesse, Karin	HOL	27.25	56.29
7	Torres, Dara	USA	27.19	56.37
8	Van Bentum, Cornelia	HOL	27.56	56.50
9	Trefilova, Natalia	URS	27.64	56.66
10	Dobrescu, Luminita Lil	ROM	27.47	56.67
11	Costache, Tamara Virgi	ROM	27.17	56.79
12	Van Wirdum, Karen	AUS	27.21	56.84
13	Kremer, Mitzi	USA	27.72	56.97
14	Issakova, Svetlana	URS	27.67	57.17
15	Jensen, Gitta P	DEN	27.95	57.28
16	Nakano, Ayako	JPN	27.43	57.29
17	Nugent, Andrea	CAN	27.70	57.33
18	Armentero, Marie-Therese	SUI	27.52	57.35
19	Pielke, Christiane	FRG	27.29	57.47
20	Kerr, Jane	CAN	28.04	57.55
21	Nyberg, Eva	SWE	28.02	57.57
22	Baumer, Susanne	AUS	27.97	57.76
23	Lou, Yaping	CHN	28.05	57.79
24	Hristova, Natacha	BUL	28.11	57.80
25	Cripps, Annabelle	GBR	27.86	57.81
26	Sorensen, Pia	DEN	27.93	57.82

Rank Rang	Name Nom	Ctry Pays	50m	100m
27	Furuhed, Karin	SWE	27.79	57.97
28	Croft, June	GBR	28.18	58.19
29	Delord, Jacqueline	FRA	28.05	58.22
29	Persi, Silvia	ITA	27.55	58.22
31	Ziliox, Katja	FRG	27.87	58.39
32	Sasaki, Kaori	JPN	27.81	58.40
33	Gharbi, Senda	TUN	28.36	58.51
34	Pereira, Adriana	BRA	28.39	58.53
35	Dieffenthaler, Karen	TRI	28.03	58.64
36	Kohlmann, Patricia	MEX	28.22	59.05
37	Vieira, Isabele	BRA	28.86	59.15
38	Rivera, Maria	MEX	28.30	59.32
39	Thomson, Akiko	PHI	28.62	59.41
40	Ollafsdottir, Bryndis	ISL	28.92	59.56
41	Mauri, Carolina	CRC	28.45	1:00:14
42	Hung, Cee Kay	HKG	28.99	1:00:18
43	Kin, Eun-Jung	KOR	29.59	1:00:39
44	Fortin, Ana Joselina	HON	29.52	1:01:11
45	Ng, Fenella	HKG	29.75	1:01:27
46	Han, Young-Hee	KOR	29.92	1:01:72
47	Wang, Chi	TPE	29.90	1:01:72
48	Lum, Sabrina	TPE	30.28	1:02:11
49	Fogarty, Catherine Helen	ZIM	29.90	1:02:47
50	Cummings, Veronica	GUM	30.68	1:02:63
51	Birch, Angela	FIJ	30.04	1:02:91
52	Munch, Cina	FIJ	29.34	1:03:06
53	Araujo, Carolina	MOZ	30.72	1:05:11
54	Moreno, katerine	BOL	30.42	1:05:39
55	Freire, Elsa	ANG	30.62	1:05:47
56	Khalaf, Nancy	LIB	31.03	1:06:73
57	Fernandes, Carla	ANG	31.81	1:08:15
	Garay, Ritajeane	PUR		NS

**Women 100m Freestyle
Final A/Sept. 19****Femmes/100m nage libre
finale A/19 Sept**

Rank Rang	Name Nom	Ctry Pays	50m	100m
1	Otto, Kristin	GDR	26.36	54.93
2	Zhuang, Yong	CHN	26.84	55.47
3	Plewinski, Catherine	FRA	26.59	55.49
4	Stellmach, Manuela	GDR	27.00	55.52
5	Poll, Silvia	CRC	26.78	55.90
6	Briennesse, Karin	HOL	27.11	56.15
7	Torres, Dara	USA	26.71	56.25
8	Van Bentum, Cornelia	HOL	27.15	56.54

**Women 100m Freestyle
Final B/Sept. 19****Femmes/100m nage libre
finale B/19 Sept**

Rank Rang	Name Nom	Ctry Pays	50m	100m
1	Trefilova, Natalia	URS	27.38	56.48
2	Nakano, Ayako	JPN	27.29	56.72
3	Dobrescu, Luminita Lil	ROM	27.70	56.79
4	Kremer, Mitzi	USA	27.56	56.83
5	Jensen, Gitta P	DEN	27.34	57.02
6	Van Wirdum, Karen	AUS	27.31	57.04
7	Issakova, Svetlana	URS	27.94	57.07
8	Costache, Tamara Virgi	ROM	27.16	57.11

**Women 200m Freestyle
Heat 1/Sept. 20****Femmes/200m nage libre
Serie 1/20 Sept**

Rank Rang	Name Nom	Ctry Pays	50m	100m	150m	200m
1	Lohberg-Schulz, Birgit	FRG	29.35	1:00.48	1:31.91	2:02.77
2	Fogarty, Catherine Helen	ZIM	31.04	1:04.49	1:39.21	2:13.44
3	Birch, Angela	FIJ	31.16	1:05.72	1:41.68	2:16.79
4	Munch, Cina	FIJ	31.68	1:06.40	1:42.51	2:18.45
	Khalaf, Nancy	LIB				NS

**Women 200m Freestyle
Heat 2/Sept. 20****Femmes/200m nage libre
Serie 2/20 Sept**

Rank Rang	Name Nom	Ctry Pays	50m	100m	150m	200m
1	Ollafsdottir, Bryndis	ISL	30.19	1:02.76	1:35.47	2:07.11
2	Aguilar, Natasha	CRC	30.32	1:03.17	1:36.55	2:10.22
3	Ng, Fenella	HKG	30.51	1:03.23	1:36.35	2:10.43
4	Kim, Eun-Jung	KOR	30.71	1:03.80	1:37.49	2:10.85
5	Chang, Hui-Chien	TPE	30.83	1:03.58	1:37.43	2:11.50
6	Park, Joo-Li	KOR	31.10	1:04.69	1:38.47	2:11.53
7	Qian, Hong	CHN	30.84	1:04.80	1:39.59	2:12.44
8	Hung, Cee Kay	HKG	30.97	1:04.39	1:38.24	2:13.61

Swimming

Women 200m Freestyle Heat 3/Sept. 20			Femmes/200m nage libre Serie 3/20 Sept			
Rank Rang	Name Nom	Ctry Pays	50m	100m	150m	200m
1	Van Der Plaats, Adriana	HOL	28.67	59.84	1:31.42	2:03.02
2	Amorim, Patricia	BRA	29.73	1:01.27	1:32.95	2:04.74
3	Nurul, Hunda Abdullah	MAL	29.89	1:01.58	1:33.36	2:04.85
4	Sasaki, Kaori	JPN	28.44	59.53	1:32.79	2:06.18
5	Gharbi, Senda	TUN	29.58	1:00.93	1:33.36	2:06.60
6	Dieffenthaler, Karen	TRI	29.26	1:00.60	1:33.31	2:07.09
7	Garay, Ritajean	PUR	30.09	1:01.91	1:34.80	2:07.44
8	Kohlmann, Patricia	MEX	29.60	1:02.25	1:36.32	2:10.36

Women 200m Freestyle Heat 4/Sept. 20			Femmes/200m nage libre Serie 4/20 Sept			
Rank Rang	Name Nom	Ctry Pays	50m	100m	150m	200m
1	Trefilova, Natalia	URS	28.63	58.89	1:30.28	2:00.54
2	Kremer, Mitzi	USA	28.57	58.89	1:30.19	2:01.45
3	Jacobsen, Mette	DEN	29.26	1:00.40	1:31.73	2:01.80
4	Gillfillan, Ruth	GBR	28.88	59.86	1:31.34	2:02.11
5	Pura, Stela Marian	ROM	29.09	59.36	1:30.65	2:02.26
6	Brienesse, Karin	HOL	28.54	59.63	1:31.80	2:04.36
7	Jorgensen, Annette M	DEN	29.57	1:00.75	1:32.55	2:04.71
8	Baumer, Susanne	AUS	28.99	1:00.21	1:32.64	2:04.82

Women 200m freestyle Heat 5/Sept. 20			Femmes/200m nage libre Serie 5/20 Sept			
Rank Rang	Name Nom	Ctry Pays	50m	100m	150m	200m
1	Poll, Silvia	CRC	28.19	58.60	1:28.75	1:59.22
2	Stellmach, Manuela	GDR	28.24	58.61	1:29.49	2:00.30
3	Ortwig, Stephanie	FRG	28.43	58.74	1:30.00	2:00.66
4	Prunier, Cecile	FRA	28.92	59.32	1:30.46	2:01.60
5	Nakamori, Chikako	JPN	28.97	59.47	1:30.62	2:01.76
6	Zhuang, Yong	CHN	28.74	59.95	1:31.59	2:02.40
7	Burge-Lopez, Sheridan	AUS	29.52	1:00.59	1:32.12	2:03.42
8	Persi, Silvia	ITA	28.86	59.91	1:31.44	2:04.40

Women 200m Freestyle Heat 6/Sept. 20			Femmes/200m nage libre Serie 6/20 Sept			
Rank Rang	Name Nom	Ctry Pays	50m	100m	150m	200m
1	Friedrich, Heike	GDR	28.71	58.98	1:29.12	1:59.02
2	Wayte, Mary	USA	28.04	58.42	1:29.13	1:59.50
3	Dobrescu, Luminita Lil	ROM	28.36	58.99	1:30.81	2:01.93
4	Noall, Patricia	CAN	29.75	1:01.03	1:32.55	2:02.31
5	Arnould, Isabelle	BEL	29.53	1:00.80	1:32.32	2:03.32
5	Nilsson, Suzanne	SWE	29.35	1:00.23	1:31.76	2:03.32
7	Croft, June	GBR	29.37	1:00.90	1:32.31	2:03.63
8	Kerr, Jane	CAN	28.82	1:00.12	1:32.17	2:04.92

Women 200m Freestyle /Sept. 20-21			Femmes/200m nage libre /20-21 Sept			
Rank Rang	Name Nom	Ctry Pays	50m	100m	150m	200m
1	Friedrich, Heike	GDR	28.71	58.98	1:29.12	1:59.02
2	Poll, Silvia	CRC	28.19	58.60	1:28.75	1:59.22
3	Wayte, Mary	USA	28.04	58.42	1:29.13	1:59.50
4	Stellmach, Manuela	GDR	28.24	58.61	1:29.49	2:00.30
5	Trefilova, Natalia	URS	28.63	58.89	1:30.28	2:00.54
6	Ortwig, Stephanie	FRG	28.43	58.74	1:30.00	2:00.66
7	Kremer, Mitzi	USA	28.57	58.89	1:30.19	2:01.45
8	Prunier, Cecile	FRA	28.92	59.32	1:30.46	2:01.60
9	Nakamori, Chikako	JPN	28.97	59.47	1:30.62	2:01.76
10	Jacobsen, Mette	DEN	29.26	1:00.40	1:31.73	2:01.80
11	Dobrescu, Luminita Lil	ROM	28.36	58.99	1:30.81	2:01.93
12	Gillfillan, Ruth	GBR	28.88	59.86	1:31.34	2:02.11
13	Pura, Stela Marian	ROM	29.09	59.36	1:30.65	2:02.26
14	Noall, Patricia	CAN	29.75	1:01.03	1:32.55	2:02.31
15	Zhuang, Yong	CHN	28.74	59.95	1:31.59	2:02.40
16	Lohberg-Schulz, Birgit	FRG	29.35	1:00.48	1:31.91	2:02.77
17	Van Der Plaats, Adriana	HOL	28.67	59.84	1:31.42	2:03.02
18	Arnould, Isabelle	BEL	29.53	1:00.80	1:32.32	2:03.32
18	Nilsson, Suzanne	SWE	29.35	1:00.23	1:31.76	2:03.32
20	Burge-Lopez, Sheridan	AUS	29.52	1:00.59	1:32.12	2:03.42
21	Croft, June	GBR	29.37	1:00.90	1:32.31	2:03.63
22	Brienesse, Karin	HOL	28.54	59.63	1:31.80	2:04.36
23	Persi, Silvia	ITA	28.86	59.91	1:31.44	2:04.40
24	Jorgensen, Annette M	DEN	29.57	1:00.75	1:32.55	2:04.71
25	Amorim, Patricia	BRA	29.73	1:01.27	1:32.95	2:04.74
26	Baumer, Susanne	AUS	28.99	1:00.21	1:32.64	2:04.82
27	Nurul, Huda Abdullah	MAL	29.89	1:01.58	1:33.36	2:04.85
28	Kerr, Jane	CAN	28.82	1:00.12	1:32.17	2:04.92
29	Sasaki, Kaori	JPN	28.44	59.53	1:32.79	2:06.18
30	Gharbi, Senda	TUN	29.58	1:00.93	1:33.36	2:06.60
31	Dieffenthaler, Karen	TRI	29.26	1:00.60	1:33.31	2:07.09
32	Ollafsdoottir, Bryndis	ISL	30.19	1:02.76	1:35.47	2:07.11
33	Garay, Ritajean	PUR	30.09	1:01.91	1:34.80	2:07.44
34	Aguilari, Natasha	CRC	30.32	1:03.17	1:36.55	2:10.22
35	Kohlmann, Patricia	MEX	29.60	1:02.25	1:36.32	2:10.36
36	Ng, Fenella	HKG	30.51	1:03.23	1:36.35	2:10.43
37	Kim, Eun-Jung	KOR	30.71	1:03.80	1:37.49	2:10.85
38	Chang, Hui-Chien	TPE	30.83	1:03.58	1:37.43	2:11.50
39	Park, Joo-Li	KOR	31.10	1:04.69	1:38.47	2:11.53
40	Qian, Hong	CHN	30.84	1:04.80	1:39.59	2:12.44
41	Fogarty, Catherine Helen	ZIM	31.04	1:04.49	1:39.21	2:13.44

Natation

Rank Rang	Name Nom	Ctry Pays	50m	100m	150m	200m
42	Hung, Cee Kay	HKG	30.97	1:04.39	1:38.24	2:13.61
43	Birch, Angela	FIJ	31.16	1:05.72	1:41.68	2:16.79
44	Munch, Cina	FIJ	31.68	1:06.40	1:42.51	2:18.45
	Khalaf, Nancy	LIB				NS

Women 200m Freestyle Final A/Sept. 21			Femmes/200m nage libre Finale A/21 Sept			
Rank Rang	Name Nom	Ctry Pays	50m	100m	150m	200m
1	Friedrich, Heike	GDR	28.55	58.50	1:28.03	1:57.65 NOR
2	Poll, Silvia	CRC	28.47	58.78	1:28.46	1:58.67
3	Stellmach, Manuela	GDR	28.51	58.60	1:28.96	1:59.01
4	Wayte, Mary	USA	28.07	58.43	1:28.68	1:59.04
5	Trefilova, Natalia	URS	28.47	58.61	1:29.51	1:59.24
6	Kremer, Mitzi	USA	28.26	57.89	1:28.38	2:00.23
7	Ortwig, Stephanie	FRG	28.94	59.27	1:29.98	2:00.73
8	Prunier, Cecile	FRA	29.35	1:00.26	1:31.70	2:02.88

Women 200m Freestyle Final B/Sept. 21			Femmes 200m nage libre Finale B/21 Sept			
Rank Rang	Name Nom	Ctry Pays	50m	100m	150m	200m
1	Noall, Patricia	CAN	29.32	1:00.23	1:31.28	2:00.77
2	Gillfillan, Ruth	GBR	29.12	1:00.03	1:31.33	2:01.66
3	Jacobsen, Mette	DEN	29.44	1:00.32	1:31.40	2:01.84
4	Dobrescu, Luminita Lil	ROM	28.26	59.31	1:31.14	2:01.98
5	Pura, Stela Marian	ROM	29.12	59.81	1:31.20	2:02.30
6	Nakamori, Chikako	JPN	29.19	59.72	1:31.27	2:02.31
7	Lohberg-Schulz, Birgit	FRG	29.37	1:00.29	1:31.41	2:02.32
8	Zhuang, Yong	CHN	29.59	1:03.37	1:39.30	2:14.23

Women 400m Freestyle Heat 1/Sept. 22			Femmes/400m nage libre Serie 1/22 Sept			
Rank Rang	Name Nom	Ctry Pays	100m	200m	300m	400m
1	Nakamori, Chikako	JPN	1:02.12	2:06.52	3:11.46	4:15.51
2	Nurul, Huda Abdullah	MAL	1:03.36	2:08.32	3:13.67	4:19.33
3	Amorim, Patricia	BRA	1:03.53	2:08.90	3:14.35	4:19.64
4	Jensen, Pernille P	DEN	1:03.56	2:09.32	3:15.24	4:20.96
5	Garay, Ritajean	PUR	1:03.70	2:10.63	3:17.89	4:24.84
6	Gharbi, Senda	TUN	1:04.07	2:12.00	3:22.72	4:34.67

Women 400m Freestyle Heat 2/Sept. 22			Femmes/400m nage libre Serie 2/22 Sept			
Rank Rang	Name Nom	Ctry Pays	100m	200m	300m	400m
1	Moehring, Anke	GDR	1:01.93	2:05.37	3:08.51	4:10.64
2	Elford, Janelle	AUS	1:01.89	2:05.53	3:08.82	4:11.07
3	Trefilova, Natalia	URS	1:01.21	2:05.11	3:09.48	4:12.20
4	Strumenlieva, Antoaneta	BUL	1:01.31	2:04.93	3:09.57	4:13.25
5	Hosoda, Tomomi	JPN	1:03.37	2:08.83	3:13.82	4:17.30
6	Janssens, Christelle	BEL	1:03.84	2:09.68	3:15.19	4:19.95
7	Croft, June	GBR	1:03.07	2:09.31	3:15.88	4:21.98
8	Csabai, Judit	HUN	1:03.53	2:10.49	3:18.04	4:25.52

Women 400m Freestyle Heat 3/Sept. 22			Femmes/400m nage libre Serie 3/22 Sept			
Rank Rang	Name Nom	Ctry Pays	100m	200m	300m	400m
1	Friedrich, Heike	GDR	1:01.98	2:05.75	3:09.05	4:11.30
2	Lung, Noemi Ildko	ROM	1:02.05	2:06.09	3:10.09	4:12.42
3	Burge-Lopez, Sheridan	AUS	1:01.77	2:05.45	3:09.45	4:12.77
4	Melchiorri, Manuela	ITA	1:02.86	2:07.29	3:11.40	4:15.40
5	Prunier, Cecile	FRA	1:01.97	2:06.32	3:11.19	4:15.63
6	Dalby, Irene	NOR	1:02.27	2:06.63	3:11.50	4:16.22
7	Mortensen, Eva	DEN	1:02.89	2:07.56	3:13.32	4:18.06
8	Yan, Ming	CHN	1:02.91	2:08.49	3:14.31	4:18.58

Women 400m Freestyle Heat 4/Sept. 22			Femmes/400m nage libre Serie 4/22 Sept			
Rank Rang	Name Nom	Ctry Pays	100m	200m	300m	400m
1	Evans, Janet	USA	1:01.32	2:04.82	3:07.83	4:10.12
2	Bruce, Tami	USA	1:01.37	2:04.87	3:08.28	4:10.73
3	Arnould, Isabelle	BEL	1:01.98	2:05.49	3:08.56	4:11.71
4	Ortwig, Stephante	FRG	1:02.14	2:05.26	3:08.98	4:12.18
5	Pura, Stela Marian	ROM	1:01.64	2:05.45	3:10.67	4:15.78
6	Noall, Patricia	CAN	1:02.70	2:07.88	3:13.49	4:15.90
7	Gillfillan, Ruth	GBR	1:02.42	2:07.50	3:13.17	4:16.66
8	Russ, Alexandra	FRG	1:02.55	2:07.13	3:13.47	4:18.67

**Women 400m Freestyle
Sept. 22**

Rank Rang	Name Nom	Ctry Pays	100m	200m	300m	400m
1	Evans, Janet	USA	1:01.32	2:04.82	3:07.83	4:10.12
2	Moehring, Anke	GDR	1:01.93	2:05.37	3:08.51	4:10.64
3	Bruce, Tami	USA	1:01.37	2:04.87	3:08.28	4:10.73
4	Elford, Janelle	AUS	1:01.89	2:05.53	3:08.82	4:11.07
5	Friekrich, Heike	GDR	1:01.98	2:05.75	3:09.05	4:11.30
6	Arnould, Isabelle	BEL	1:01.98	2:05.49	3:08.56	4:11.71
7	Ortwig, Stephanie	FRG	1:02.14	2:05.26	3:08.98	4:12.18
8	Trefilova, Natlia	URS	1:01.21	2:05.11	3:09.48	4:12.20
9	Lung, Noemi Ilkiko	ROM	1:02.05	2:06.09	3:10.09	4:12.42
10	Burge-Lopez, Sheridan	AUS	1:01.77	2:05.45	3:09.45	4:12.77
11	Strumenlieva, Antoaneta	BUL	1:01.31	2:04.93	3:09.57	4:13.25
12	Melchiorri, Manuela	ITA	1:02.86	2:07.29	3:11.40	4:15.40
13	Nakamori, Chikako	JPN	1:02.12	2:06.52	3:11.46	4:15.51
14	Prunier, Cecile	FRA	1:01.97	2:06.32	3:11.19	4:15.63
15	Pura, Stela Marian	ROM	1:01.64	2:05.45	3:10.67	4:15.78
16	Noall, Patricia	CAN	1:02.70	2:07.88	3:13.49	4:15.90
17	Dalby, Irene	NOR	1:02.27	2:06.63	3:11.50	4:16.22
18	Giifillan, Ruth	GBR	1:02.42	2:07.50	3:13.17	4:16.66
19	Hosoda, Tomomi	JPN	1:03.37	2:08.83	3:13.82	4:17.30
20	Mortensen, Eva	DEN	1:02.89	2:07.56	3:13.32	4:18.06
21	Yan, Ming	CHN	1:02.91	2:08.49	3:14.31	4:18.58
22	Russ, Alexandra	FRG	1:02.55	2:07.13	3:13.47	4:18.67
23	Nurul, Huda Abdullah	MAL	1:03.36	2:08.32	3:13.67	4:19.33
24	Amorim, Patricia	BRA	1:03.53	2:08.90	3:14.35	4:19.64
25	Janssens, Christelle	BEL	1:03.84	2:09.68	3:15.19	4:19.95
26	Jensen, Pernille P	DEN	1:03.56	2:09.32	3:15.24	4:20.96
27	Croft, June	GBR	1:03.07	2:09.31	3:15.88	4:21.98
28	Garay, Ritajeane	PUR	1:03.70	2:10.63	3:17.89	4:24.84
29	Csabai, Judit	HUN	1:03.53	2:10.49	3:18.04	4:25.52
30	Gharbi, Senda	TUN	1:04.07	2:12.00	3:22.72	4:34.67

**Women 400m Freestyle
Final A/Sept. 22**

Rank Rang	Name Nom	Ctry Pays	100m	200m	300m	400m
1	Evans, Janet	USA	59.99	2:02.14	3:03.40	4:03.85 NWR NOR
2	Friedrich, Heike	GDR	1:00.23	2:02.49	3:03.56	4:05.94
3	Moehring, Anke	GDR	1:00.27	2:02.51	3:05.27	4:06.62
4	Bruce, Tami	USA	1:00.75	2:03.42	3:06.19	4:08.16
5	Esford, Janelle	AUS	1:01.05	2:04.20	3:07.74	4:10.64
6	Arnould, Isabelle	BEL	1:01.57	2:04.77	3:08.42	4:11.73
7	Ortwig, Stephanie	FRG	1:01.25	2:04.31	3:08.56	4:13.05
8	Trefilova, Natalia	URS	1:00.87	2:04.04	3:08.75	4:13.92

**Women 400m Freestyle
Final B/Sept. 22**

Rank Rang	Name Nom	Ctry Pays	100m	200m	300m	400m
1	Burge-Lopez, Sheridan	AUS	1:01.21	2:04.37	3:07.66	4:10.21
2	Lung, Noemi Ilkiko	ROM	1:01.16	2:04.69	3:08.70	4:11.68
3	Pura, Stela Marian	ROM	1:01.04	2:04.75	3:09.06	4:12.14
4	Strumenlieva, Antoaneta	BUL	1:01.25	2:05.28	3:09.93	4:13.43
5	Noall, Patricia	CAN	1:02.07	2:07.06	3:12.24	4:14.70
6	Melchiorri, Manuela	ITA	1:02.49	2:06.97	3:11.08	4:14.90
7	Nakamori, Chikako	JPN	1:01.79	2:06.21	3:11.13	4:15.59
8	Prunier, Cecile	FRA	1:02.16	2:07.65	3:14.24	4:21.03

**Women 800m Freestyle
Heat 1/Sept. 23**

Rank Rang	Name Nom	Ctry Pays	100m 500m	200m 600m	300m 700m	400m 800m
1	Amorim, Patricia	BRA	1:04.24 5:32.67	2:11.46 6:39.75	3:18.77 7:46.63	4:25.79 8:51.95
2	Atkin, Tracey	GBR	1:03.67 5:33.66	2:11.17 6:42.27	3:18.93 7:51.52	4:26.06 9:00.04
3	Garay, Ritajeane	PUR	1:04.00 5:38.15	2:11.71 6:47.55	3:19.80 7:57.05	4:29.39 9:04.62

**Femmes/400m nage libre
22 Sept****Women 800m Freestyle
Heat 2/Sept. 23**

Rank Rang	Name Nom	Ctry Pays	100m 500m	200m 600m	300m 700m	400m 800m
1	Bruce, Tami	USA	1:03.25 5:21.39	2:08.06 6:25.60	3:12.84 7:29.53	4:17.37 8:31.57
2	Elford, Janelle	AUS	1:02.84 5:20.93	2:07.25 6:25.32	3:12.00 7:29.53	4:16.68 8:32.14
3	Strumenlieva, Antoaneta	BUL	1:01.58 5:21.14	2:06.19 6:25.62	3:10.89 7:30.86	4:16.55 8:35.40
4	Melchiorri, Manuela	ITA	1:03.24 5:23.64	2:08.15 6:29.35	3:13.35 7:35.66	4:18.58 8:40.63
5	Faure, Karyn	FRA	1:03.55 5:25.81	2:08.98 6:31.34	3:14.67 7:37.19	4:20.16 8:41.64
6	Russ, Alexandra	FRG	1:03.35 5:28.75	2:09.02 6:35.87	3:15.18 7:43.14	4:21.83 8:49.31
7	Mortensen, Eva	DEN	1:03.75 5:30.47	2:09.31 6:38.63	3:15.44 7:47.20	4:22.72 8:53.67
8	Prunier, Cecile	FRA	1:03.93 5:33.19	2:10.47 6:41.29	3:17.88 7:49.63	4:25.44 8:57.22

**Women 800m Freestyle
Heat 3/Sept. 23**

Rank Rang	Name Nom	Ctry Pays	100m 500m	200m 600m	300m 700m	400m 800m
1	Strauss, Astrid	GKR	1:02.22 5:18.67	2:06.65 6:22.99	3:10.76 7:26.83	4:14.78 8:28.07
2	Evans, Janet	USA	1:02.44 5:18.72	2:06.70 6:22.99	3:10.70 7:26.77	4:14.69 8:28.13
3	Wurzburger, Debra Joanne	CAN	1:03.35 5:22.69	2:08.02 6:27.67	3:12.61 7:32.33	4:17.70 8:36.24
4	Ortwig, Stephanie	FRG	1:04.89 5:28.15	2:11.51 6:33.49	3:17.40 7:38.23	4:23.17 8:41.95
5	Mellor, Karen	GBR	1:03.05 5:25.00	2:08.12 6:31.47	3:13.24 7:38.58	4:18.98 8:44.64
6	Nurul, Huda Abdullah	MAL	1:02.49 5:26.84	2:07.53 6:34.99	3:12.85 7:43.18	4:19.52 8:50.84
7	Janssens, Christelle	BEL	1:04.55 5:31.55	2:11.60 6:38.39	3:18.07 7:45.89	4:24.96 8:51.22
8	Csabai, Judit	HUN	1:02.69 5:32.02	2:08.83 6:40.08	3:15.89 7:48.54	4:23.91 8:56.37

**Women 800m Freestyle
Heat 4/Sept. 23**

Rank Rang	Name Nom	Ctry Pays	100m 500m	200m 600m	300m 700m	400m 800m
1	Mcdonald, Julie	AUS	1:02.72 5:20.23	2:07.46 6:23.93	3:12.03 7:27.08	4:16.87 8:29.68
2	Moehring, Anke	GDR	1:02.25 5:19.86	2:06.35 6:24.18	3:11.16 7:28.11	4:15.65 8:30.95
3	Arnould, Isabelle	BEL	1:03.88 5:21.67	2:09.01 6:26.15	3:13.74 7:30.82	4:17.90 8:34.56
4	Dalby, Irene	NOR	1:03.45 5:23.99	2:08.27 6:28.73	3:13.38 7:34.35	4:18.75 8:38.33
5	Hosoda, Tomomi	JPN	1:03.90 5:26.05	2:09.58 6:31.06	3:14.96 7:36.07	4:20.52 8:39.55
6	Trefilova, Natalia	URS	1:02.79 5:24.09	2:07.24 6:30.98	3:12.57 7:37.55	4:18.33 8:43.19
7	Jensen, Pernille P	DEN	1:04.01 5:31.07	2:10.48 6:38.04	3:17.23 7:44.97	4:24.07 8:50.82
8	Yan, Ming	CHN	1:04.53 5:34.64	2:11.48 6:42.39	3:19.14 7:51.54	4:27.32 9:00.81

**Femmes/800m nage libre
Serie 1/23 Sept****Femmes/800m nage libre
Serie 2/23 Sept****Femmes/800m nage libre
Serie 3/23 Sept****Femmes/800m nage libre
Serie 4/23 Sept**

Swimming

Women 800m Freestyle Sept. 23-24			Femmes/800m nage libre 23-24 Sept			
Rank Rang	Name Nom	Ctry Pays	100m 500m	200m 600m	300m 700m	400m 800m
1	Strauss, Astrid	GDR	1:02.22 5:18.67	2:06.65 6:22.99	3:10.76 7:26.83	4:14.78 8:28.07
2	Evans, Janet	USA	1:02.44 5:18.72	2:06.70 6:22.99	3:10.70 7:26.77	4:14.69 8:28.13
3	Mcdonald, Julie	AUS	1:02.72 5:20.23	2:07.46 6:23.93	3:12.03 7:27.08	4:16.87 8:29.68
4	Moehring, Anke	GDR	1:02.25 5:19.86	2:06.35 6:24.18	3:11.16 7:28.11	4:15.65 8:30.95
5	Bruce, Tami	USA	1:03.25 5:21.39	2:08.06 6:25.60	3:12.84 7:29.53	4:17.37 8:31.57
6	Elford, Janelle	AUS	1:02.84 5:20.93	2:07.25 6:25.32	3:12.00 7:29.53	4:16.68 8:32.14
7	Arnould, Isabelle	BEL	1:03.88 5:21.67	2:09.01 6:26.15	3:13.74 7:30.82	4:17.90 8:34.56
8	Strumenlieva, Antoaneta	BUL	1:01.58 5:21.14	2:06.19 6:25.62	3:10.89 7:30.86	4:16.55 8:35.40
9	Wurzburger, Debra Joanne	CAN	1:03.35 5:22.69	2:08.02 6:27.67	3:12.61 7:32.33	4:17.70 8:36.24
10	Dalby, Irene	NOR	1:03.45 5:23.99	2:08.27 6:28.73	3:13.38 7:34.35	4:18.75 8:38.33
11	Hosoda, Tomomi	JPN	1:03.90 5:26.05	2:09.58 6:31.06	3:14.96 7:36.07	4:20.52 8:39.55
12	Melchiorri, Manuela	ITA	1:03.24 5:23.64	2:08.15 6:29.35	3:13.35 7:35.66	4:18.58 8:40.63
13	Faure, Karyn	FRA	1:03.55 5:25.81	2:08.98 6:31.34	3:14.67 7:37.19	4:20.16 8:41.64
14	Ortwig, Stephanie	FRG	1:04.89 5:28.15	2:11.51 6:33.49	3:17.40 7:38.23	4:23.17 8:41.95
15	Trefilova, Nataia	URS	1:02.79 5:24.09	2:07.24 6:30.98	3:12.57 7:37.55	4:18.33 8:43.19
16	Mellor, Karen	GBR	1:03.05 5:25.00	2:08.12 6:31.47	3:13.24 7:38.58	4:18.98 8:44.64
17	Russ, Alexandra	FRG	1:03.35 5:28.75	2:09.02 6:35.87	3:15.18 7:43.14	4:21.83 8:49.31
18	Jensen, Pernille P	DEN	1:04.01 5:31.07	2:10.48 6:38.04	3:17.23 7:44.97	4:24.07 8:50.82
19	Nurul, Huda Abdullah	MAL	1:02.49 5:26.84	2:07.53 6:34.99	3:12.85 7:43.18	4:19.52 8:50.84
20	Janssens, Christelle	BEL	1:04.55 5:31.55	2:11.60 6:38.39	3:18.07 7:45.89	4:24.96 8:51.22
21	Amorim, Patricia	BRA	1:04.24 5:32.67	2:11.46 6:39.75	3:18.77 7:46.63	4:25.79 8:51.95
22	Mortensen, Eva	DEN	1:03.75 5:30.47	2:09.31 6:38.63	3:15.44 7:47.20	4:22.72 8:53.67
23	Csabai, Judit	HUN	1:02.69 5:32.02	2:08.83 6:40.08	3:15.89 7:48.54	4:23.91 8:56.37
24	Prunier, Cecile	FRA	1:03.93 5:33.19	2:10.47 6:41.29	3:17.88 7:49.63	4:25.44 8:57.22
25	Atkin, Tracey	GBR	1:03.19 5:33.66	2:11.17 6:42.27	3:18.93 7:51.52	4:26.06 9:00.04
26	Van, Ming	CHN	1:04.53 5:34.64	2:11.48 6:42.39	3:19.14 7:51.54	4:27.32 9:00.81
27	Garay, Ritajean	PUR	1:04.00 5:38.15	2:11.71 6:47.55	3:19.80 7:57.05	4:29.39 9:04.62

Natation

Women 800m Freestyle Final/Sept. 24			Femmes/800m nage libre Finale/24 Sept			
Rank Rang	Name Nom	Ctry Pays	100m 500m	200m 600m	300m 700m	400m 800m
1	Evans, Janet	USA	1:01.13 5:12.68	2:04.04 6:15.60	3:06.76 7:18.40	4:10.06 8:20.20 NOR
2	Strauss, Astrid	GDR	1:01.47 5:15.56	2:05.03 6:18.48	3:09.06 7:21.38	4:12.96 8:22.09
3	Mcdonald, Julie	AUS	1:02.76 5:17.27	2:06.97 6:19.81	3:11.03 7:22.15	4:14.73 8:22.93
4	Moehring, Anke	GDR	1:01.84 5:17.10	2:05.87 6:19.80	3:10.05 7:22.57	4:14.01 8:23.09
5	Bruce, Tami	USA	1:02.53 5:18.71	2:06.90 6:22.99	3:11.10 7:27.22	4:15.08 8:30.86
6	Elford, Janelle	AUS	1:01.97 5:18.49	2:06.06 6:22.99	3:10.27 7:27.55	4:14.48 8:30.94
7	Arnould, Isabelle	BEL	1:03.41 5:22.37	2:07.92 6:27.51	3:12.73 7:33.13	4:17.73 8:37.47
8	Strumenlieva, Antoaneta	BUL	1:01.44 5:21.70	2:05.94 6:28.22	3:10.78 7:35.64	4:15.80 8:41.05

Women 100m Backstroke Heat 1/Sept. 22			Femmes/100m dos Serie 1/22 Sept	
Rank Rang	Name Nom	Ctry Pays	50m	100m
1	Birch, Angela	FIJ	34.51	1:13.48
2	Moreno, Katerine	BOL	35.86	1:14.42
3	Araujo, Carolina	MOZ	35.81	1:15.86

Women 100m Backstroke Heat 2/Sept. 22			Femmes/100m dos Serie 2/22 Sept	
Rank Rang	Name Nom	Ctry Pays	50m	100m
1	Fortin, Ana Josefina	HON	33.22	1:10.10
2	Duncan, Tricia	ISV	33.66	1:10.37
3	Tsang, Wing Sze	HKG	33.78	1:10.50
4	Pickering, Sharon	FIJ	34.30	1:12.14
5	Freire, Elsa	ANG	36.01	1:15.56
6	Fernandes, Carla	ANG	38.30	1:21.58

Women 100m Backstroke Heat 3/Sept. 22			Femmes/100m dos Serie 3/22 Sept	
Rank Rang	Name Nom	Ctry Pays	50m	100m
1	Wang, Bolin	CHN	31.70	1:05.15
2	Onogi, Tomoko	JPN	32.02	1:06.14
3	Smith, Michelle	IRL	32.16	1:06.22
4	Thomson, Akiko	PHI	31.97	1:06.51
5	Convery, Aileen	IRL	31.85	1:06.73
6	Hong, Ji-Hee	KOR	32.48	1:08.33
7	Garay, Ritajean	PUR	33.24	1:08.58
8	Wang, Chi	TPE	33.43	1:09.56

Women 100m Backstroke Heat 4/Sept. 22			Femmes/100m dos Serie 4/22 Sept	
Rank Rang	Name Nom	Ctry Pays	50m	100m
1	Mitchell, Betsy	USA	30.00	1:02.85
2	Patrascoiu, Aneta	ROM	30.67	1:03.29
3	Vigarani, Lorenza	ITA	30.63	1:03.96
4	Carosi, Manuela	ITA	30.86	1:04.69
5	Gospokinova, Bistra	BUL	31.32	1:04.91
6	Gysling, Eva	SUI	31.06	1:05.07
6	Guillou, Laurence	FRA	31.46	1:05.07
8	Hume, Sylvia	NZL	31.04	1:05.81

Women 100m Backstroke Heat 5/Sept. 22			Femmes/100m dos Serie 5/22 Sept	
Rank Rang	Name Nom	Ctry Pays	50m	100m
1	Sirch, Cornelia	GDR	29.74	1:01.63
2	Egerszegi, Krisztina	HUN	29.86	1:02.09
3	Poll, Silvia	CRC	30.05	1:03.21
4	Schlicht, Svenja	FRG	30.74	1:03.72
5	Melien, Lori	CAN	30.78	1:04.29
6	De Rover, Jolanda	HOL	31.02	1:04.39
7	Musson, Sharon	NZL	31.03	1:04.58
8	Page, Sharon	GBR	31.27	1:04.75



Women 100m Backstroke Heat 6/Sept. 22			Femmes/100m dos Serie 6/22 Sept	
Rank Rang	Name Nom	Ctry Pays	50m	100m
1	Otto, Krestin	GDR	29.60	1:01.45
2	Barr, Beth	USA	30.19	1:02.63
3	Livingstone, Nicole	AUS	30.81	1:03.26
4	Aizpors, Marion	FRG	29.92	1:03.27
5	Read, Katharine	GBR	31.17	1:04.62
6	Lord, Karen	AUS	31.15	1:04.69
7	Larsson, Johanna	SWE	31.13	1:05.10
8	Morishita, Satoko	JPN	31.69	1:05.38

Women 100m Backstroke Final B/Sept. 22			Femmes/100m dos Finale B/22 Sept	
Rank Rang	Name Nom	Ctry Pays	50m	100m
1	Patrascoiu, Aneta	ROM	30.68	1:03.33
2	Schlicht, Svenja	FRG	30.94	1:03.68
3	Carosi, Manuela	ITA	30.59	1:03.80
4	Melien, Lori	CAN	30.66	1:03.87
5	Vigarani, Lorenza	ITA	30.64	1:03.88
6	De Rover, Jolanda	HOL	30.81	1:04.11
7	Musson, Sharon	NZL	31.24	1:04.17
8	Read, Katharine	GBR	30.83	1:04.27

Women 100m Backstroke Swim Off/Sept. 22			Femmes/100m dos Barrage/22 Sept	
Rank Rang	Name Nom	Ctry Pays	50m	100m
1	Carosi, Manuela	ITA	31.25	1:04.62
2	Lord, Karen	AUS	31.25	1:04.75

Women 200m Backstroke Heat 1/Sept. 25			Femmes/200m dos Serie 1/25 Sept			
Rank Rang	Name Nom	Ctry Pays	50m	100m	150m	200m
1	Fortin, Ana Joselina	HON	34.55	1:12.92	1:52.03	2:32.13
2	Duncan, Tricia	ISV	34.90	1:13.78	1:53.44	2:33.97
3	Pickering, Sharon	FIJ	35.63	1:15.71	1:56.44	2:36.99

The result of first swim-off/Les resultats du barrage:

4	Lord, Karen	AUS	31.50	1:05.05
5	Carosi, Manuela	ITA	31.11	1:05.05

Women 200m Backstroke Heat 2/Sept. 25			Femmes/200m dos Serie 2/25 Sept			
Rank Rang	Name Nom	Ctry Pays	50m	100m	150m	200m
1	Lin, Li	CHN	32.24	1:07.28	1:42.88	2:18.11
2	Convery, Aileen	IRL	32.16	1:08.03	1:44.43	2:19.91
3	Garay, Ritajeane	PUR	33.42	1:08.83	1:45.40	2:23.73
4	Hong, Ji-Hee	KOR	33.38	1:09.44	1:46.77	2:24.58
5	Gysling, Eva	SUI	32.21	1:07.88	1:45.33	2:24.61
6	Wang, Chi	TPE	34.68	1:13.42	1:54.68	2:36.60
	Thomson, Akiko	PHI				NS

Women 100m Backstroke Sept. 22			Femmes/100m dos 22 Sept	
Rank Rang	Name Nom	Ctry Pays	50m	100m
1	Otto, Kristin	GDR	29.60	1:01.45
2	Sirch, Cornelia	GDR	29.74	1:01.63
3	Egerszegi, Krisztina	HUN	29.86	1:02.09
4	Barr, Beth	USA	30.19	1:02.63
5	Mitchell, Betsy	USA	30.00	1:02.85
6	Poll, Silvia	CRC	30.05	1:03.21
7	Livingstone, Nicole	AUS	30.81	1:03.26
8	Aizpors, Marion	FRG	29.92	1:03.27
9	Patrascoiu, Aneta	ROM	30.67	1:03.29
10	Schlicht, Svenja	FRG	30.74	1:03.72
11	Vigarani, Lorenza	ITA	30.63	1:03.96
12	Melien, Lori	CAN	30.78	1:04.29
13	De Rover, Jolanda	HOL	31.02	1:04.39
14	Musson, Sharon	NZL	31.03	1:04.58
15	Read, Katharine	GBR	31.17	1:04.62
16	Carosi, Manuela	ITA	30.86	1:04.69
17	Lord, Karen	AUS	31.15	1:04.69
18	Page, Sharon	GBR	31.27	1:04.75
19	Gospodinova, Bistra	BUL	31.32	1:04.91
20	Guillou, Laurence	FRA	31.46	1:05.07
21	Gysling, Eva	SUI	31.06	1:05.07
22	Larsson, Johanna	SWE	31.13	1:05.10
23	Wang, Bolin	CHN	31.70	1:05.15
24	Morishita, Satoko	JPN	31.69	1:05.38
25	Hume, Sylvia	NZL	31.04	1:05.81
26	Onogi, Tomoko	JPN	32.02	1:06.14
27	Smith, Michelle	IRL	32.16	1:06.22
28	Thomson, Akiko	PHI	31.97	1:06.51
29	Convery, Aileen	IRL	31.85	1:06.73
30	Hong, Ji-Hee	KOR	32.48	1:08.33
31	Garay, Ritajeane	PUR	33.24	1:08.58
32	Wang, Chi	TPE	33.43	1:09.56
33	Fortin, Ana Joselina	HON	33.22	1:10.10
34	Duncan, Tricia	ISV	33.66	1:10.37
35	Tsang, Wing sze	HKG	33.78	1:10.50
36	Pickering, Sharon	FIJ	34.30	1:12.14
37	Birch, Angela	FIJ	34.51	1:13.48
38	Moreno, Katerine	BOL	35.86	1:14.42
39	Freire, Elsa	ANG	36.01	1:15.56
40	Araujo, Carolina	MOZ	35.81	1:15.86
41	Fernandes, Carla	ANG	38.30	1:21.58

Women 200m Backstroke Heat 3/Sept. 25			Femmes/200m dos Serie 3/25 Sept			
Rank Rang	Name Nom	Ctry Pays	50m	100m	150m	200m
1	Zimmermann, Kathrin	GDR	31.34	1:04.54	1:38.33	2:12.81
2	Patrascoiu, Aneta	ROM	31.96	1:06.10	1:41.27	2:17.25
3	Larsson, Johanna	SWE	33.10	1:07.74	1:42.81	2:18.01
4	Melien, Lori	CAN	32.89	1:08.56	1:44.67	2:20.45
5	Hume, Sylvia	NAL	32.70	1:08.64	1:44.44	2:21.55
6	Magnier, Christine	FRA	33.97	1:10.17	1:46.78	2:24.15
7	Ziliox, Katja	FRG	33.74	1:10.42	1:48.13	2:26.25
	Hochstatter, Ruth	AUT				NS

Women 200m Backstroke Heat 4/Sept. 25			Femmes/200m dos Serie 4/25 Sept			
Rank Rang	Name Nom	Ctry Pays	50m	100m	150m	200m
1	Egerszegi, Krisztina	HUN	30.28	1:03.23	1:37.19	2:11.01 NOR
2	Barr, Beth	USA	31.67	1:05.51	1:39.76	2:13.91
3	De Rover, Jolanda	HOL	32.25	1:06.93	1:41.76	2:16.58
4	Schlicht, Svenja	FRG	31.93	1:06.43	1:42.03	2:16.81
5	Read, Katharine	GBR	32.08	1:06.49	1:41.46	2:17.22
6	Vigarani, Lorenza	ITA	31.85	1:06.27	1:41.52	2:17.35
7	Slatter, Helen	GBR	32.62	1:08.29	1:44.70	2:21.66
8	Wang, Bolin	CHN	32.30	1:07.74	1:44.22	2:21.70

Women 200m Backstroke Heat 5/Sept. 25			Femmes/200m dos Serie 5/25 Sept			
Rank Rang	Name Nom	Ctry Pays	50m	100m	150m	200m
1	Sirch, Cornelia	GDR	31.18	1:04.08	1:37.04	2:10.46 NOR
2	Hayes, Andrea	USA	31.99	1:05.78	1:40.12	2:14.77
3	Livingstone, Nicole	AUS	32.16	1:06.01	1:40.69	2:14.81
4	Lord, Karen	AUS	32.18	1:06.74	1:46.66	2:16.94
5	Musson, Sharon	NZL	32.33	1:06.76	1:42.07	2:17.47
6	Morishita, Satoko	JPN	33.24	1:07.92	1:43.38	2:18.74
7	Smith, Michelle	IRL	32.34	1:07.05	1:43.06	2:19.50
8	Onogi, Tomoko	JPN	32.83	1:08.06	1:44.18	2:21.46

Swimming

Women 200m Backstroke Sept. 25			Femmes/200m dos 25 Sept			
Rank Rang	Name Nom	Ctry Pays	50m	100m	150m	200m
1	Sirch, Cornelia	GDR	31.18	1:04.08	1:37.04	2:10.46 NOR
2	Egersaegi, Krisztina	HUN	30.28	1:03.23	1:37.19	2:11.01
3	Zimmermann, Kathrin	GDR	31.34	1:04.54	1:38.33	2:12.81
4	Barr, Beth	USA	31.67	1:05.51	1:39.76	2:13.91
5	Hayes, Andrea	USA	31.99	1:05.78	1:40.12	2:14.77
6	Livingstone, Nicole	AUS	32.16	1:06.01	1:40.69	2:14.81
7	De Rover, Jolanda	HOL	32.25	1:06.93	1:41.76	2:16.58
8	Schlicht, Svenja	FRG	32.93	1:06.43	1:42.03	2:16.81
9	Lord, Karen	AUS	32.28	1:06.74	1:41.66	2:16.94
10	Read, Katharine	GBR	32.08	1:06.49	1:41.46	2:17.22
11	Patrascoiu, Aneta	ROM	31.96	1:06.10	1:41.27	2:17.25
12	Vigarani, Lorenza	ITA	31.85	1:06.27	1:41.52	2:17.35
13	Musson, Sharon	NZL	32.33	1:06.76	1:42.07	2:17.47
14	Larsson, Johanna	SWE	33.10	1:07.74	1:42.81	2:18.01
15	Lin, Li	CHN	32.24	1:07.28	1:42.88	2:18.11
16	Morishita, Satoko	JPN	33.24	1:07.92	1:43.38	2:18.74
17	Smith, Michelle	IRL	32.34	1:07.05	1:43.06	2:19.50
18	Convery, Aileen	IRL	32.16	1:08.03	1:44.43	2:19.91
19	Melien, Lori	CAN	32.89	1:08.56	1:44.67	2:20.45
20	Onogi, Tomoko	JPN	32.83	1:08.06	1:44.18	2:21.46
21	Hume, Sylvia	NZL	32.70	1:08.64	1:44.44	2:21.55
22	Slatter, Helen	GBR	32.62	1:08.29	1:44.70	2:21.66
23	Wang, Bolin	CHN	32.30	1:07.74	1:44.22	2:21.70
24	Garay, Ritajena	PUR	33.42	1:08.83	1:45.40	2:23.73
25	Magnier, Christine	FRA	33.97	1:10.17	1:46.78	2:24.15
26	Hong, Ji-Hee	KOR	33.38	1:09.44	1:46.77	2:24.58
27	Gysling, Eva	SUI	32.21	1:07.88	1:45.33	2:24.61
28	Zisiox, Katja	FRG	33.74	1:10.42	1:48.13	2:26.25
29	Fortin, Ana Joselina	HON	34.55	1:12.92	1:52.03	2:32.13
30	Duncan, Tricia	ISV	34.90	1:13.78	1:53.44	2:33.97
31	Wang, Chi	TPE	34.68	1:13.42	1:54.68	2:36.60
32	Pickering, Sharon	FIJ	35.63	1:15.71	1:56.44	2:36.99
	Hochstatter, Ruth	AUT				NS
	Thomson, Akiko	PHI				NS

Women 200m Backstroke Final A/Sept. 25			Femmes/200m dos Finale A/25 Sept			
Rank Rang	Name Nom	Ctry Pays	50m	100m	150m	200m
1	Egerszegi, Krisztina	HUN	30.32	1:02.99	1:35.88	2:09.29 NOR
2	Zimmermann, Kathrin	GDR	30.83	1:03.59	1:37.03	2:10.61
3	Sirch, Cornelia	GDR	30.20	1:02.79	1:36.47	2:11.45
4	Barr, Beth	USA	31.34	1:04.98	1:38.72	2:12.39
5	Livingstone, Nicole	AUS	31.65	1:05.14	1:39.58	2:13.43
6	Hayes, Andrea	USA	31.59	1:05.66	1:40.23	2:15.02
7	De Rover, Jolanda	HOL	31.81	1:06.04	1:40.67	2:15.17
8	Schlicht, Svenja	FRG	32.23	1:06.61	1:41.54	2:15.94

Women 200m Backstroke Final B/Sept. 25			Femmes/200m dos Finale B/25 Sept			
Rank Rang	Name Nom	Ctry Pays	50m	100m	150m	200m
1	Patrascoiu, Aneta	ROM	31.84	1:05.75	1:40.70	2:15.75
2	Musson, Sharon	NZL	31.73	1:05.87	1:40.76	2:16.06
3	Lin, Li	CHN	31.35	1:05.61	1:41.39	2:16.68
4	Read, Katharine	GBR	32.03	1:06.70	1:42.15	2:18.20
5	Vigarani, Lorenza	ITA	31.95	1:06.37	1:42.36	2:18.69
6	Lord, Karen	AUS	32.26	1:06.75	1:42.54	2:18.78
6	Morishita, Satoko	JPN	32.75	1:07.55	1:43.10	2:18.78
	Larsson, Johanna	SWE				DQ

Women 100m Breaststroke Heat 1/Sept. 23			Femmes/100m brasse Serie 1/23 Sept	
Rank Rang	Name Nom	Ctry Pays	50m	100m
1	Hidalgo, Montserrat	CRC	37.11	1:18.42
2	Moreno, Katerine	BOL	39.89	1:22.62
3	Martins, Ana	ANG	39.50	1:24.01
4	Cruz, Nadia	ANG	39.94	1:24.46

Women 100m Breaststroke Heat 2/Sept. 23			Femmes/100m brasse Serie 2/23 Sept	
Rank Rang	Name Nom	Ctry Pays	50m	100m
1	Horning, Karen	PER	35.13	1:14.03
2	Seto, Carwai	TPE	35.59	1:15.47
3	Boscatto, Alicia Maria	ARG	36.30	1:15.67
4	Niehaus, Sigrid	CRC	36.08	1:16.65
5	Aracil, Valentina	ARG	38.18	1:19.60
6	Chanmugam, Dipika	SRI	37.91	1:20.18
7	Chen, Y.F. Kim Berly	TPE	38.17	1:20.95
	Munk, Annemarie	HKG		NS

Natation

Women 100m Breaststroke Heat 3/Sept. 23			Femmes/100m brasse Serie 3/23 Sept	
Rank Rang	Name Nom	Ctry Pays	50m	100m
1	Park, Sung-Won	KOR	34.51	1:12.32
2	Becue, Brigitte	BEL	35.49	1:12.90
3	Runnolfsdottir, Ragneidur	ISL	34.02	1:13.01
4	Nishioka, Yoshie	JPN	35.18	1:13.36
5	Bojaryn, Virginie	FRA	35.12	1:13.55
6	Arendt, Nancy	LUX	35.36	1:14.99
7	Bruehlhart, Patricia	SUI	35.36	1:15.00
8	Stawicka, Kornelia	POL	36.81	1:15.41

Women 100m Breaststroke Heat 4/Sept. 23			Femmes/100m brasse Serie 4/23 Sept	
Rank Rang	Name Nom	Ctry Pays	50m	100m
1	Dangalakova, Tania	BUL	32.15	1:08.35 NOR
2	Volkova, Elena	URS	32.87	1:09.86
3	Mcfarlane, Tracey	USA	32.64	1:10.59
4	Brownsdon, Susannah	GBR	33.43	1:11.66
5	Dahm, Britta	FRG	33.98	1:12.98
6	Louvrier, Pascaline	FRA	34.24	1:13.21
7	Chen, Huiling	CHN	34.96	1:13.65
	Esser, Heike	FRG		NS

Women 100m Breaststroke Heat 5/Sept. 23			Femmes/100m brasse Serie 5/23 Sept	
Rank Rang	Name Nom	Ctry Pays	50m	100m
1	Frenkeva, Antoaneta	BUL	33.25	1:10.09
2	Rex, Annett	GDR	32.56	1:10.61
3	Huang, Xiaomin	CHN	33.79	1:10.78
4	Kozumina, Svetlana	URS	33.65	1:10.83
5	Duggan, Keltie	CAN	33.54	1:10.95
6	Dalla Valle, Manuela	ITA	33.27	1:11.25
7	Moes, Linda	HOL	33.71	1:11.84
8	Hohmann, Margaret	GBR	33.92	1:12.67

Women 100m Breaststroke Heat 6/Sept. 23			Femmes 100m brasse Serie 6/23 Sept	
Rank Rang	Name Nom	Ctry Pays	50m	100m
1	Hoerner, Silke	GDR	31.84	1:08.35 NOR
2	Higson, Allison	CAN	32.74	1:09.39
3	Lempereur, Ingrid	BEL	34.07	1:11.00
4	Johnson, Susan	USA	32.94	1:11.09
5	Csepe, Gabriella	HUN	33.71	1:11.10
6	Hooiveld, Lara	AUS	33.65	1:11.40
7	Chylak, Dorota	POL	34.24	1:12.38
8	Nagasaki, Hiroko	JPN	36.15	1:16.63

Women 100m Breaststroke/Sept. 23			Femmes 100m brasse/23 Sept	
Rank Rang	Name Nom	Ctry Pays	50m	100m
1	Dangalakova, Tania	BUL	32.15	1:08.35 NOR
1	Hoerner, Silke	GDR	31.84	1:08.35 NOR
3	Higson, Allison	CAN	32.74	1:09.39
4	Volkova, Elena	URS	32.87	1:09.86
5	Frenkeva, Antoaneta	BUL	33.25	1:10.09
6	Mcfarlane, Tracey	USA	32.64	1:10.59
7	Rex, Annett	GDR	32.56	1:10.61
8	Huang, Xiaomin	CHN	33.79	1:10.78
9	Kouzmina, Svetlana	URS	33.65	1:10.83
10	Duggan, Keltie	CAN	33.54	1:10.95
11	Lempereur, Ingrid	BEL	34.07	1:11.00
12	Johnson, Susan	USA	32.94	1:11.09
13	Csepe, Gabriella	HUN	33.71	1:11.10
14	Dalla Valle, Manuela	ITA	33.27	1:11.25
15	Hooiveld, Lara	AUS	33.65	1:11.40
16	Brownsdon, Susannah	GBR	33.43	1:11.66
17	Moes, Linda	HOL	33.71	1:11.84
18	Park, Sung-Won	KOR	34.51	1:12.32
19	Chylak, Dorota	POL	34.24	1:12.38
20	Hohmann, Margaret	GBR	33.92	1:12.67
21	Becue, Brigitte	BEL	35.49	1:12.90
22	Dahm, Britta	FRG	33.98	1:12.98
23	Runnolfsdottir, Ragneidur	ISL	34.02	1:13.01
24	Louvrier, Pascaline	FRA	34.24	1:13.21
25	Nishioka, Yoshie	JPN	35.18	1:13.36
26	Bojaryn, Virginie	FRA	35.12	1:13.55
27	Chen, Huiling	CHN	34.96	1:13.65
28	Horning, Karen	PER	35.13	1:14.03
29	Arendt, Nancy	LUX	35.36	1:14.99
30	Bruehlhart, Patricia	SUI	35.36	1:15.00
31	Stawicka, Kornelia	POL	36.81	1:15.41
32	Seto, Carwai	TPE	35.59	1:15.47
33	Boscatto, Alicia Maria	ARG	36.30	1:15.67
34	Nagasaki, Hiroko	JPN	36.15	1:16.63
35	Niehaus, Sigrid	CRC	36.08	1:16.65
36	Hidalgo, Montserrat	CRC	37.11	1:18.42
37	Aracil, Valentina	ARG	38.18	1:19.60
38	Chanmugam, Dipika	SRI	37.91	1:20.18
39	Chen, Y.F. Kim Berly	TPE	38.17	1:20.95
40	Moreno, Katerine	BOL	39.89	1:22.62
41	Martins, Ana	ANG	39.50	1:24.01
42	Cruz, Nadia	ANG	39.94	1:24.46
	Esser, Heike	FRG		NS
	Munk, Annemarie	HKG		NS

**Women 100m Breaststroke
Final A/Sept. 23****Femmes/100m brasse
Finale A/23 Sept**

Rank Rang	Name Nom	Ctry Pays	50m	100m
1	Dangalakova, Tania	BUL	31.90	1:07.95 NOR
2	Frenkeva, Antoaneta	BUL	32.43	1:08.74
3	Hoerner, Silke	GDR	31.58	1:08.83
4	Higson, Allison	CAN	32.18	1:08.86
5	Volkova, Elena	URS	32.87	1:09.24
6	Mcfarlane, Tracey	USA	33.02	1:09.60
7	Huang, Xiaomin	CHN	33.64	1:10.53
8	Rex, Arinett	GDR	33.04	1:10.67

**Women 100m Breaststroke
Final B/Sept. 23****Femmes/100m brasse
Finale B/23 Sept**

Rank Rang	Name Nom	Ctry Pays	50m	100m
1	Kouzmina, Svetlana	URS	33.31	1:10.42
2	Duggan, Keltie	CAN	32.94	1:10.58
3	Lempereur, Ingrid	BEL	33.63	1:10.86
4	Dalla Valle, Manuela	ITA	33.70	1:10.95
5	Johnson, Susan	USA	33.46	1:11.08
6	Csepe, Gabriella	HUN	33.53	1:11.24
7	Hooiveld, Lara	AUS	33.13	1:11.26
8	Brownsdon, Susannah	GBR	33.65	1:11.95

**Women 200m Breaststroke
Heat 1/Sept. 20****Femmes/200m brasse
Serie 1/20 Sept**

Rank Rang	Name Nom	Ctry Pays	50m	100m	150m	200m
1	Seto, Carwai	TPE	36.53	1:17.45	1:59.52	2:42.31
2	Hidalgo, Montserrat	CRC	37.33	1:19.09	2:01.49	2:44.72
3	Chanmugam, Dipika	SRI	38.37	1:21.41	2:06.24	2:51.60

**Women 200m Breaststroke
Heat 2/Sept. 20****Femmes/200m brasse
Serie 2/20 Sept**

Rank Rang	Name Nom	Ctry Pays	50m	100m	150m	200m
1	Horning, Karen	PER	36.86	1:16.73	1:56.71	2:37.84
2	Park, Sung-Won	KOR	36.23	1:16.62	1:57.57	2:39.40
3	Arendt, Nancy	LUX	36.68	1:17.43	1:58.92	2:40.78
4	Frank, Helen	GBR	36.74	1:17.84	1:59.35	2:41.12
5	Bruehlhart, Patricia	SUI	36.58	1:17.06	1:58.81	2:42.82
6	Niehaus, Sigrid	CRC	36.79	1:17.82	2:00.95	2:45.35
7	Chen, Y.F. Kim Berly	TPE	38.59	1:21.61	2:05.72	2:50.84
	Aracil, Valentina	ARG				DQ

**Women 200m Breaststroke
Heat 3/Sept. 20****Femmes/200m brasse
Serie 3/20 Sept**

Rank Rang	Name Nom	Ctry Pays	50m	100m	150m	200m
1	Becue, Brigitte	BEL	35.09	1:14.56	1:54.33	2:33.13
2	Parera, Silvia	ESP	35.81	1:15.29	1:54.98	2:35.57
3	Runnolfsdottir, Ragneidur	ISL	35.28	1:15.68	1:57.40	2:39.10
4	Chylak, Dorota	POL	35.25	1:15.13	1:56.79	2:39.38
5	Hooiveld, Lara	AUS	34.72	1:15.49	1:57.75	2:39.97
6	Petricevic, Anamarija	YUG	36.57	1:17.02	1:58.71	2:40.80
7	Boscatto, Alicia Maria	ARG	37.26	1:18.63	2:01.84	2:45.80
8	Chen, Huiling	CHN	35.13	1:16.31	2:00.32	2:45.87

**Women 200m Breaststroke
Heat 4/Sept. 20****Femmes/200m brasse
Serie 4/20 Sept**

Rank Rang	Name Nom	Ctry Pays	50m	100m	150m	200m
1	Frenkeva, Antoaneta	BUL	33.18	1:10.20	1:48.86	2:29.57
2	Lempereur, Ingrid	BEL	34.89	1:13.46	1:52.17	2:30.07
3	DallaValle, Manuela	ITA	35.38	1:14.01	1:51.61	2:30.60
4	Kouzmina, Svetlana	URS	34.15	1:12.33	1:51.74	2:30.93
5	Nisiro, Annalisa	ITA	34.84	1:13.99	1:53.25	2:32.77
6	Dahm, Britta	FRG	35.09	1:13.96	1:54.10	2:35.06
7	Brownsdon, Susannah	GBR	35.20	1:15.24	1:55.53	2:36.14
8	Louvrier, Pascaline	FRA	35.62	1:15.21	1:55.84	2:38.75

**Women 200m Breaststroke
Heat 5/Sept. 20****Femmes/200m brasse
Serie 5/20 Sept**

Rank Rang	Name Nom	Ctry Pays	50m	100m	150m	200m
1	Bogatcheva, Ioulia	URS	34.85	1:13.04	1:51.05	2:28.94 NOR
2	Dangalakova, Tania	BUL	33.73	1:12.21	1:50.89	2:29.91
3	Huang, Xiaomin	CHN	33.65	1:11.48	1:50.48	2:30.03
4	Moes, Linda	HOL	34.58	1:13.19	1:52.60	2:31.98
5	Clouthier, Guylaine	CAN	34.53	1:12.99	1:53.54	2:34.36
6	Stawicka, Komelia	POI	37.21	1:17.02	1:56.92	2:36.86
7	Nagasaki, Hiroko	JPN	35.44	1:14.94	1:55.76	2:37.44
8	Sorensen, Pia	DEN	35.51	1:14.90	1:55.70	2:38.49

**Women 200m Breaststroke
Heat 6/Sept. 20****Femmes/200m brasse
Serie 6/20 Sept**

Rank Rang	Name Nom	Ctry Pays	50m	100m	150m	200m
1	Hoerner, Silke	GDR	33.10	1:10.46	1:48.37	2:27.63 NOR
2	Higson, Allison	CAN	33.53	1:11.35	1:50.10	2:29.67
3	Boernike, Susanne	GDR	34.87	1:12.55	1:51.54	2:30.71
4	Mcfarlane, Tracey	USA	34.44	1:13.33	1:52.63	2:32.11
5	Rapp, Susan	USA	34.86	1:13.24	1:52.89	2:34.21
6	Nishioka, Yoshie	JPN	36.13	1:15.56	1:56.27	2:35.81
7	Bojaryn, Virginie	FRA	35.29	1:14.49	1:55.42	2:37.38
8	Esser, Heike	FRG	36.37	1:16.19	1:57.92	2:41.34

**Women
200m Breaststroke/Sept. 20-21****Femmes
200m brasse/20-21 Sept**

Rank Rang	Name Nom	Ctry Pays	50m	100m	150m	200m
1	Hoerner, Silke	GDR	33.10	1:10.46	1:48.37	2:27.63 NOR
2	Bogatcheva, Ioulia	URS	34.85	1:13.04	1:51.05	2:28.94
3	Frenkeva, Antoaneta	BUL	33.18	1:10.20	1:48.86	2:29.57
4	Higson, Allison	CAN	33.53	1:11.35	1:50.10	2:29.67
5	Dangalakova, Tania	BUL	33.73	1:12.21	1:50.89	2:29.91
6	Huang, Xiaomin	CHN	33.65	1:11.48	1:50.48	2:30.03
7	Lempereur, Ingrid	BEL	34.89	1:13.46	1:52.17	2:30.07
8	Dalla Valle, Manuela	ITA	35.38	1:14.01	1:51.61	2:30.60
9	Boernike, Susanne	GDR	34.87	1:12.55	1:51.54	2:30.71
10	Douzmina, Svetlana	URS	34.15	1:12.33	1:51.74	2:30.93
11	Moes, Linda	HOL	34.58	1:13.19	1:52.60	2:31.98
12	Mcfarlane, Tracey	USA	34.44	1:13.33	1:52.63	2:32.11
13	Nisiro, Annalisa	ITA	34.84	1:13.99	1:53.25	2:32.77
14	Becue, Brigitte	BEL	35.09	1:14.56	1:54.33	2:33.13
15	Rapp, Susan	USA	34.86	1:13.24	1:52.89	2:34.21
16	Clouthier, Guylaine	CAN	34.53	1:12.99	1:53.54	2:34.36
17	Dahm, Britta	FRG	35.09	1:13.96	1:54.10	2:35.06
18	Parera, Silvia	ESP	35.81	1:15.29	1:54.98	2:35.57
19	Nishioka, Yoshie	JPN	36.13	1:15.56	1:56.27	2:35.81
20	Brownsdon, Susannah	GBR	35.20	1:15.24	1:55.53	2:36.14
21	Stawicka, Komelia	POL	37.21	1:17.02	1:56.92	2:36.86
22	Bojaryn, Virginie	FRA	35.29	1:14.49	1:55.42	2:37.38
23	Nagasaki, Hiroko	JPN	35.44	1:14.94	1:55.76	2:37.44
24	Homing, Karen	PER	36.86	1:16.73	1:56.71	2:37.84
25	Sorensen, Pia	DEN	35.51	1:14.90	1:55.70	2:38.49
26	Louvrier, Pascaline	FRA	35.62	1:15.21	1:55.84	2:38.75
27	Runnolfsdottir, Ragneidur	ISL	35.28	1:15.68	1:57.40	2:39.10
28	Chylak, Dorota	POL	35.25	1:15.13	1:56.79	2:39.38
29	Park, Sung-Won	KOR	36.23	1:16.62	1:57.57	2:39.40
30	Hooiveld, Lara	AUS	34.72	1:15.49	1:57.75	2:39.97
31	Arendt, Nancy	LUX	36.68	1:17.43	1:58.92	2:40.78
32	Petricevic, Anamarija	YUG	36.57	1:17.02	1:58.71	2:40.80
33	Frank, Helen	GBR	36.74	1:17.84	1:59.35	2:41.12
34	Esser, Heike	FRG	36.37	1:16.19	1:57.92	2:41.34
35	Seto, Carwai	TPE	36.53	1:17.45	1:59.52	2:42.31
36	Bruehlhart, Patricia	SUI	36.58	1:17.06	1:58.81	2:42.82
37	Hidalgo, Montserrat	CRC	37.33	1:19.09	2:01.49	2:44.72
38	Niehaus, Sigrid	CRC	36.79	1:17.82	2:00.95	2:45.35
39	Boscatto, Alicia Maria	ARG	37.26	1:18.63	2:01.84	2:45.80
40	Chen, Huiling	CHN	35.13	1:16.31	2:00.32	2:45.87
41	Chen, Y.F. Kim Berly	TPE	38.59	1:21.61	2:05.72	2:50.84
42	Chanmugam, Dipika	SRI	38.37	1:21.41	2:06.24	2:51.60
	Aracil, Valentina	ARG				DQ

**Women 200m Breaststroke
Final A/Sept. 21****Femmes/200m brasse
Finale A/21 Sept**

Rank Rang	Name Nom	Ctry Pays	50m	100m	150m	200m
1	Hoerner, Silke	GDR	32.88	1:10.24	1:47.38	2:26.71 NWR NOR
2	Huang, Xiaomin	CHN	34.00	1:11.41	1:49.22	2:27.49
3	Frenkeva, Antoaneta	BUL	33.16	1:10.32	1:48.83	2:28.34
4	Dangalakova, Tania	BUL	32.46	1:09.22	1:47.48	2:28.43
5	Bogatcheva, Ioulia	URS	34.44	1:12.44	1:49.98	2:28.54
6	Lempereur, Ingrid	BEL	34.79	1:13.39	1:52.02	2:29.42
7	Higson, Allison	CAN	32.71	1:09.91	1:48.56	2:29.60
8	Dalla Valle, Manuela	ITA	35.07	1:12.90	1:50.79	2:29.86

**Women 200m Breaststroke
Final B/Sept. 21****Femmes/200m brasse
Finale B/21 Sept**

Rank Rang	Name Nom	Ctry Pays	50m	100m	150m	200m
1	Boernike, Susanne	GDR	33.98	1:11.26	1:49.77	2:28.55
2	Kouzmina, Svetlana	URS	35.35	1:13.85	1:51.93	2:30.03
3	Moes, Linda	HOL	35.00	1:13.00	1:51.60	2:30.83
4	Nisiro, Annalisa	ITA	35.58	1:14.21	1:52.60	2:31.19
5	Rapp, Susan	USA	35.12	1:13.73	1:52.94	2:32.90
6	Mcfarlane, Tracey	USA	34.62	1:13.37	1:53.05	2:33.46
7	Clouthier, Guylaine	CAN	35.39	1:14.47	1:53.98	2:33.55
8	Becue, Brigitte	BEL	36.59	1:16.65	1:55.89	2:34.10

**Women 100m Butterfly
Heat 2/Sept. 23****Femmes/100m papillon
Serie 2/23 Sept**

Rank Rang	Name Nom	Ctry Pays	50m	100m
1	Cuesta, Marcela	CRC	31.55	1:07.66
2	Nguyen Kieu, Oanh	VIE	31.27	1:07.96
3	Fortin, Ana Joselina	HON	31.44	1:07.99
4	Munk, Annemarie	HKG	32.59	1:08.35
5	Pickering, Sharon	FIJ	33.12	1:10.51
6	Munch, Cina	FIJ	33.01	1:12.03
7	Freire, Elsa	ANG	33.73	1:12.27
8	Gayle, Barbara	GUM	34.26	1:12.84

Swimming

Women 100m Butterfly Heat 3/Sept. 23			Femmes/100m papillon Serie 3/23 Sept	
Rank Rang	Name Nom	Ctry Pays	50m	100m
1	Fernandez, Maria Luisa	ESP	29.66	1:02.47
2	Lee, Hong-Mi	KOR	29.49	1:04.36
3	Neves, Sandra	POR	30.87	1:04.60
4	Morales-Massella, Blanca J	GUA	30.14	1:05.02
5	Bruten, Marlene	MEX	30.59	1:05.37
6	Kim, Soo-Jin	KOR	31.26	1:06.14
7	Hung, Cee Kay	HKG	30.79	1:06.94
8	Chang, Hui-Chien	TPE	32.05	1:07.36

Women 100m Butterfly Heat 4/Sept. 23			Femmes/100m papillon Serie 4/23 Sept	
Rank Rang	Name Nom	Ctry Pays	50m	100m
1	Jorgensen, Janel	USA	28.98	1:00.97
2	Meagher, Mary T	USA	29.00	1:01.48
3	Miteva, Neviana	BUL	29.36	1:02.01
4	Takahashi, Kiyomi	JPN	29.65	1:02.04
5	Tocchini, Ilaria	ITA	29.42	1:02.07
6	Cripps, Annabelle	GBR	29.41	1:03.34
7	Pura, Stela Marian	ROM	30.18	1:03.91
7	Viola, Emanuela	ITA	29.63	1:03.91

Women 100m Butterfly Heat 5/Sept. 23			Femmes/100m papillon Serie 5/23 Sept	
Rank Rang	Name Nom	Ctry Pays	50m	100m
1	Otto, Kristin	GDR	28.49	1:00.40
2	Qian, Hong	CHN	28.49	1:00.66
3	Wang, Xiaohong	CHN	29.02	1:01.16
4	Delord, Jacqueline	FRA	29.06	1:02.24
5	Kitano, Takayo	JPN	29.38	1:02.35
6	Foot, Caroline	GBR	29.28	1:02.76
7	Beyermann, Ina	FRG	29.54	1:02.85
8	Nugent, Andrea	CAN	29.44	1:03.69

Women 100m Butterfly Heat 6/Sept. 23			Femmes/100m papillon Serie 6/23 Sept	
Rank Rang	Name Nom	Ctry Pays	50m	100m
1	Plewinski, Catherine	FRA	27.57	59.34
2	Weigang, Birte	GDR	28.59	59.97
3	Van Bentum, Cornelia	HOL	29.11	1:00.94
4	Koptchikova, Svetlana	URS	29.22	1:01.65
5	Alessandri, Fiona	AUS	29.29	1:01.90
6	Rehaa, Gabi	FRG	29.61	1:02.27
7	Kerr, Jane	CAN	29.67	1:02.91
8	Eriksson, Agneta	SWE	29.18	1:03.45

Women 100m Butterfly/Sept. 23			Femmes 100m papillon/23 Sept	
Rank Rang	Name Nom	Ctry Pays	50m	100m
1	Plewinski, Catherine	FRA	27.57	59.34
2	Weigang, Birte	GDR	28.59	59.97
3	Otto, Kristin	GDR	28.49	1:00.40
4	Qian, Hong	CHN	28.49	1:00.66
5	Van Bentum, Cornelia	HOL	29.11	1:00.94
6	Jorgensen, Janel	USA	28.98	1:00.97
7	Wang, Xiaohong	CHN	29.02	1:01.16
8	Meagher, Mary T	USA	29.00	1:01.48
9	Koptchikova, Svetlana	URS	29.22	1:01.65
10	Alessandri, Fiona	AUS	29.29	1:01.90
11	Miteva, Neviana	BUL	29.36	1:02.01
12	Takahashi, Kiyomi	JPN	29.65	1:02.04
13	Tocchini, Ilaria	ITA	29.42	1:02.07
14	Delord, Jacqueline	FRA	29.06	1:02.24
15	Rehaa, Gabi	FRG	29.61	1:02.27
16	Kitano, Takayo	JPN	29.38	1:02.35
17	Fernandez, Maria Luisa	ESP	29.66	1:02.47
18	Foot, Caroline	GBR	29.28	1:02.76
19	Beyermann, Ina	FRG	29.54	1:02.85
20	Kerr, Jane	CAN	29.67	1:02.91
21	Cripps, Annabelle	GBR	29.41	1:03.34
22	Eriksson, Agneta	SWE	29.18	1:03.45
23	Nugent, Andrea	CAN	29.44	1:03.69
24	Viola, Emanuela	ITA	29.63	1:03.91
24	Pura, Stela Marian	ROM	30.18	1:03.91
26	Lee, Hong-Mi	KOR	29.49	1:04.36
27	Neves, Sandra	POR	30.87	1:04.60
28	Morales-Massella, Blanca J	GUA	30.14	1:05.02
29	Bruten, Marlene	MEX	30.59	1:05.37
30	Kim, Soo-Jin	KOR	31.26	1:06.14
31	Hung, Cee Kay	HKG	30.79	1:06.94
32	Chang, Hui-Chien	TPE	32.05	1:07.36
33	Cuesta, Marcela	CRC	31.55	1:07.66
34	Nguyen Kieu, Oanh	VIE	31.27	1:07.96
35	Fortin, Ana Joselina	HON	31.44	1:07.99
36	Munk, Annemarie	HKG	32.59	1:08.35
37	Pickering, Sharon	FIJ	33.12	1:10.51
38	Munch, Cina	FIJ	33.01	1:12.03
39	Freire, Elsa	ANG	33.73	1:12.27
40	Gayle, Barbara	GUM	34.26	1:12.84

Natation

Women 100m Butterfly Final A/Sept. 23			Femmes/100m papillon Finale A/23 Sept	
Rank Rang	Name Nom	Ctry Pays	50m	100m
1	Otto, Kristin	GDR	27.95	59.00 NOR
2	Weigang, Birte	GDR	28.18	59.45
3	Qian, Hong	CHN	27.87	59.52
4	Plewinski, Catherine	FRA	27.54	59.58
5	Jorgensen, Janel	USA	28.61	1:00.48
6	Van Bentum, Cornelia	HOL	28.54	1:00.62
7	Meagher, Mary T	USA	29.20	1:00.97
8	Wang, Xiaohong	CHN	28.99	1:01.15

Women 100m Butterfly Final B/Sept. 23			Femmes/100m Papillon Finale B/23 Sept	
Rank Rang	Name Nom	Ctry Pays	50m	100m
1	Koptchikova, Svetlana	URS	29.20	1:01.48
2	Takahashi, Kiyomi	JPN	29.28	1:01.80
3	Delord, Jacqueline	FRA	29.54	1:02.45
4	Miteva, Neviana	BUL	29.59	1:02.47
5	Alessandri, Fiona	AUS	29.57	1:02.51
6	Kitano, Takayo	JPN	29.91	1:02.53
7	Rehaa, Gabi	FRG	29.79	1:02.63
8	Tocchini, Ilaria	ITA	29.61	1:02.78

Women 200m Butterfly Heat 1/Sept. 25			Femmes/200m papillon Serie 1/25 Sept			
Rank Rang	Name Nom	Ctry Pays	50m	100m	150m	200m
1	Morales-Massella, Blanca J	GUA	31.34	1:06.29	1:42.48	2:19.28
2	Bruten, Marlene	MEX	31.36	1:06.14	1:42.06	2:19.68
3	Arnould, Isabelle	BEL	31.45	1:06.26	1:42.80	2:20.74
4	Chang, Hui-Chien	TPE	32.55	1:09.05	1:47.05	2:25.50
5	Nguyen Kieu, Oanh	VIE	33.11	1:10.36	1:49.43	2:33.07

Women 200m Butterfly Heat 2/Sept. 25			Femmes/200m papillon Serie 2/25 Sept			
Rank Rang	Name Nom	Ctry Pays	50m	100m	150m	200m
1	Nord, Kathleen	GDR	30.61	1:04.49	1:38.00	2:11.81
2	Takahashi, Kiyomi	JPN	31.47	1:05.18	1:39.22	2:12.68
3	Cater, Mojca	CAN	31.07	1:04.59	1:38.70	2:13.21
4	Jacobsen, Mette	DEN	31.46	1:06.36	1:41.04	2:15.78
5	Neves, Sandra	POR	31.85	1:06.75	1:42.31	2:18.29
6	Mo, Wanlan	CHN	31.08	1:06.18	1:42.23	2:19.56
	Miginnis, Donna	CAN				DQ

Women 200m Butterfly Heat 3/Sept. 25			Femmes/200m papillon Serie 3/25 Sept			
Rank Rang	Name Nom	Ctry Pays	50m	100m	150m	200m
1	Weigang, Birte	GDR	29.17	1:02.36	1:37.23	2:11.97
2	Radke, Trina	USA	30.44	1:04.24	1:38.19	2:12.93
3	Wang, Xiaohong	CHN	30.19	1:04.01	1:38.29	2:13.05
4	Beyermann, Ina	FRG	31.00	1:05.07	1:39.44	2:13.56
5	Bewley, Helen	GBR	30.91	1:05.64	1:40.71	2:17.10
6	Miteva, Neviana	BUL	30.77	1:04.84	1:40.68	2:18.44
7	Kim, Soo-Jin	KOR	31.94	1:06.72	1:43.27	2:19.00
8	Supiot, Claire	FRA	31.78	1:07.16	1:44.67	2:21.65

Women 200m Butterfly Heat 4/Sept. 25			Femmes/200m papillon Serie 4/25 Sept			
Rank Rang	Name Nom	Ctry Pays	50m	100m	150m	200m
1	Meagher, Mary T	USA	30.74	1:04.80	1:38.53	2:12.35
2	Van Bentum, Cornelia	HOL	30.61	1:04.71	1:38.17	2:12.41
3	Pura, Stela Marian	ROM	30.56	1:04.50	1:38.59	2:12.53
4	Rehaa, Gabi	FRG	30.79	1:04.84	1:38.76	2:13.09
5	Koptchikova, Svetlana	URS	30.43	1:04.37	1:39.47	2:15.26
6	Kitano, Takayo	JPN	31.07	1:05.33	1:40.02	2:15.41
7	Wilson, Lynne	GBR	31.44	1:05.65	1:41.19	2:17.28
8	Procter, Donna	AUS	31.47	1:06.53	1:42.07	2:18.17



Women 200m Butterfly/Sept. 25			Femmes 200m papillon/25 Sept			
Rank Rang	Name Nom	Ctry Pays	50m	100m	150m	200m
1	Nord, Kathleen	GDR	30.61	1:04.49	1:38.00	2:11.81
2	Weigang, Birte	GDR	29.17	1:02.36	1:37.23	2:11.97
3	Meagher, Mary T	USA	30.74	1:04.80	1:38.53	2:12.35
4	Van Bentum, Cornelia	HOL	30.61	1:04.71	1:38.17	2:12.41
5	Pura, Stela Marian	ROM	30.56	1:04.50	1:38.59	2:12.53
6	Takahashi, Kiyomi	JPN	31.47	1:05.18	1:39.22	2:12.68
7	Radke, Trina	USA	30.44	1:04.24	1:38.19	2:13.05
8	Wang, Xiaohong	CHN	30.19	1:04.01	1:38.29	2:13.05
9	Rehaa, Gabi	FRG	30.79	1:04.84	1:38.76	2:13.09
10	Cater, Mojca	CAN	31.07	1:04.59	1:38.70	2:13.21
11	Beyermann, Ina	FRG	31.00	1:05.07	1:39.44	2:13.56
12	Koptchikova, Svetlana	URS	30.43	1:04.37	1:39.47	2:15.26
13	Kitano, Takayo	JPN	31.07	1:05.33	1:40.02	2:15.41
14	Jacobsen, Mette	DEN	31.46	1:06.36	1:41.04	2:15.78
15	Bewley, Helen	GBR	30.91	1:05.64	1:40.71	2:17.10
16	Wilson, Lynne	GBR	31.44	1:05.65	1:41.19	2:17.28
17	Procter, Donna	AUS	31.47	1:06.53	1:42.07	2:18.17
18	Neves, Sandra	POR	31.85	1:06.75	1:42.31	2:18.29
19	Miteva, Neviana	BUL	30.77	1:04.84	1:40.68	2:18.44
20	Kim, Soo-Jin	KOR	31.94	1:06.72	1:43.27	2:19.00
21	Morales-Massella, Blanca J	GUA	31.34	1:06.29	1:42.48	2:19.28
22	Mo, Wanlan	CHN	31.08	1:06.18	1:42.23	2:19.56
23	Bruten, Marlene	MEX	31.36	1:06.14	1:42.06	2:19.68
24	Arnould, Isabelle	BEL	31.45	1:06.26	1:42.80	2:20.74
25	Supiot, Claire	FRA	31.78	1:07.16	1:44.67	2:21.65
26	Chang, Hui-Chien	TPE	32.55	1:09.05	1:47.05	2:25.50
27	Nguyen Kieu, Oanh	VIE	33.11	1:10.36	1:49.43	2:33.07
	McGinnis, Donna	CAN				DQ

Women 200m Butterfly Final A/Sept. 25			Femmes/200m papillon Finale A/25 Sept			
Rank Rang	Name Nom	Ctry Pays	50m	100m	150m	200m
1	Nord, Kathleen	GDR	29.59	1:02.21	1:35.46	2:09.51
2	Weigang, Birte	GDR	28.61	1:00.60	1:34.15	2:09.91
3	Meagher, Mary T	USA	29.94	1:03.07	1:36.34	2:10.80
4	Pura, Stela Marian	ROM	30.07	1:03.27	1:37.01	2:11.28
5	Radke, Trina	USA	30.36	1:03.94	1:37.56	2:11.55
6	Takahashi, Kiyomi	JPN	30.33	1:03.84	1:38.16	2:11.62
7	Wang, Xiaohong	CHN	30.28	1:03.75	1:37.67	2:12.34
8	Van Bentum, Cornelia	HOL	30.00	1:03.77	1:37.85	2:13.17

Women 200m Butterfly Final B/Sept. 25			Femmes/200m papillon Finale B/25 Sept			
Rank Rang	Name Nom	Ctry Pays	50m	100m	150m	200m
1	Cater, Mojca	CAN	30.79	1:04.14	1:38.42	2:12.66
2	Beyermann, Ina	FRG	30.98	1:05.16	1:39.41	2:13.74
3	Rehaa, Gabi	FRG	30.92	1:05.04	1:39.37	2:14.20
4	Koptchikova, Svetlana	URS	30.05	1:04.01	1:38.93	2:14.43
5	Jacobsen, Mette	DEN	31.14	1:05.68	1:40.75	2:15.60
6	Kitano, Takayo	JPN	30.63	1:04.57	1:39.46	2:15.61
7	Bewley, Helen	GBR	31:01	1:05.84	1:40.91	2:17.11
8	Wilson, Lynne	GBR	31.64	1:06.22	1:42.31	2:18.66

Women 200m Individual Medley Heat 1/Sept. 24			Femmes/200m 4 nages Serie 1/24 Sept			
Rank Rang	Name Nom	Ctry Pays	50m	100m	150m	200m
1	Seto, Carwai	TPE	32.21	1:11.34	1:52.49	2:27.72
2	Kohlmann, Patricia	MEX	31.20	1:11.27	1:56.53	2:29.61
3	Chanmugam, Dipika	SRI	35.03	1:13.76	1:57.35	2:33.58
4	Munk, Annemarie	HKG	32.90	1:13.44	2:00.37	2:34.32
5	Chen, Y.F. Kim Berly	TPE	34.16	1:13.83	1:59.45	2:35.11
6	Pickering, Sharon	FIJ	33.31	1:12.26	2:00.38	2:35.22
7	Birch, Angela	FIJ	33.28	1:13.27	2:02.74	2:39.20

Women 200m Individual Medley Heat 2/Sept. 24			Femmes/200m 4 nages Serie 2/24 Sept			
Rank Rang	Name Nom	Ctry Pays	50m	100m	150m	200m
1	Procter, Donna	AUS	31.23	1:07.39	1:49.40	2:21.79
2	Poulsen, Annette	DEN	31.49	1:08.38	1:49.70	2:21.83
3	Harada, Hiroyo	JPN	31.45	1:07.01	1:49.04	2:22.59
4	Runnolfsdottir, Ragneidur	ISL	32.18	1:08.88	1:48.57	2:22.65
5	Smith, Michelle	IRL	31.64	1:07.17	1:51.25	2:25.53
6	Bruten, Marlene	MEX	31.32	1:09.07	1:54.35	2:26.89
7	Aracil, Valentina	ARG	33.06	1:13.36	1:56.77	2:31.53

Women 200m Individual Medley Heat 3/Sept. 24			Femmes/200m 4 nages Serie 3/24 Sept			
Rank Rang	Name Nom	Ctry Pays	50m	100m	150m	200m
1	Lung, Noemi Ildiko	ROM	30.32	1:03.75	1:44.44	2:15.55
2	Clatworthy, Jodie	AUS	30.57	1:05.18	1:45.33	2:17.29
3	Lohberg-Schulz, Birgit	FRG	29.94	1:05.52	1:46.34	2:17.46
4	Petricevic, Anamarija	YUG	31.00	1:06.12	1:47.00	2:19.38
5	Muis, Mildred	HOL	30.68	1:06.95	1:47.97	2:19.46
6	Long, Zara	GBR	30.54	1:06.88	1:49.43	2:22.64
	Wayte, Mary	USA				DQ
	Dangalakova, Tania	BUL				NS

Women 200m Individual Medley Heat 4/Sept. 24			Femmes/200m 4 nages Serie 4/24 Sept			
Rank Rang	Name Nom	Ctry Pays	50m	100m	150m	200m
1	Dendeberova, Elena	URS	30.16	1:04.90	1:43.00	2:15.30
2	Muis, Marianne	HOL	29.99	1:04.24	1:45.43	2:16.60
3	Lin, Li	CHN	29.51	1:03.58	1:44.54	2:17.09
4	Higson, Allison	CAN	31.04	1:08.05	1:46.37	2:19.54
5	Nishioka, Yoshie	JPN	30.74	1:07.35	1:46.64	2:20.20
6	Parera, Silvia	ESP	31.43	1:09.74	1:49.35	2:22.20
7	Dalla Valle, Manuela	ITA	31.22	1:09.24	1:47.86	2:22.85

Women 200m Individual Medley Heat 5/Sept. 24			Femmes/200m 4 nages Serie 5/24 Sept			
Rank Rang	Name Nom	Ctry Pays	50m	100m	150m	200m
1	Hunger, Daniela	GDR	29.39	1:04.20	1:44.93	2:16.23
2	Patrascoiu, Aneta	ROM	29.78	1:03.45	1:45.19	2:17.39
3	Hedgepeth, Whitney	USA	28.98	1:02.33	1:45.23	2:17.45
4	Hill, Jean	GBR	30.09	1:05.54	1:43.81	2:17.57
5	Philippson, Anette	SWE	31.31	1:05.88	1:46.60	2:18.86
6	Bogatcheva, Ioulia	URS	30.71	1:07.03	1:46.09	2:19.07
7	Felotti, Roberta	ITA	31.10	1:06.00	1:46.93	2:19.62
8	Schlicht, Svenja	FRG	30.18	1:04.45	1:47.10	2:20.31

Women 200m Individual Medley Sept. 24			Femmes/200m 4 nages Serie 24 Sept			
Rank Rang	Name Nom	Ctry Pays	50m	100m	150m	200m
1	Dendeberova, Elena	URS	30.16	1:04.90	1:43.00	2:15.30
2	Lung, Noemi Ildiko	ROM	30.32	1:03.75	1:44.44	2:15.55
3	Hunger, Daniela	GDR	29.39	1:04.20	1:44.93	2:16.23
4	Muis, Marianne	HOL	29.99	1:04.24	1:45.43	2:16.60
5	Lin, Li	CHN	29.51	1:03.58	1:44.54	2:17.09
6	Clatworthy, Jodie	AUS	30.57	1:05.18	1:45.33	2:17.29
7	Patrascoiu, Aneta	ROM	29.78	1:03.45	1:45.19	2:17.39
8	Hedgepeth, Whitney	USA	28.98	1:02.33	1:45.23	2:17.45
9	Lohberg-Schulz, Birgit	FRG	29.94	1:05.52	1:46.34	2:17.46
10	Hill, Jean	GBR	30.09	1:05.54	1:43.81	2:17.57
11	Philippson, Anette	SWE	31.31	1:05.88	1:46.60	2:18.86
12	Bogatcheva, Ioulia	URS	30.71	1:07.03	1:46.09	2:19.07
13	Petricevic, Anamarija	YUG	31.00	1:06.12	1:47.00	2:19.38
14	Muis, Mildred	HOL	30.68	1:06.95	1:47.97	2:19.46
15	Higson, Allison	CAN	31.04	1:08.05	1:46.37	2:19.54
16	Felotti, Roberta	ITA	31.10	1:06.00	1:46.93	2:19.62
17	Nishioka, Yoshie	JPN	30.74	1:07.35	1:46.64	2:20.20
18	Schlicht, Svenja	FRG	30.18	1:04.45	1:47.10	2:20.31
19	Procter, Donna	AUS	31.23	1:07.39	1:49.40	2:21.79
20	Poulsen, Annette	DEN	31.49	1:08.38	1:49.70	2:21.83
21	Parera, Silvia	ESP	31.43	1:09.74	1:49.35	2:22.20
22	Harada, Hiroyo	JPN	31.45	1:07.01	1:49.04	2:22.59
23	Long, Zara	GBR	30.54	1:06.88	1:49.43	2:22.64
24	Runnolfsdottir, Ragneidur	ISL	32.18	1:08.88	1:48.57	2:22.65
25	Dalla Valle, Manuela	ITA	31.22	1:09.24	1:47.86	2:22.85
26	Smith, Michelle	IRL	31.64	1:07.17	1:51.25	2:25.53
27	Bruten, Marlene	MEX	31.32	1:09.07	1:54.35	2:26.89
28	Seto, Carwai	TPE	32.21	1:11.34	1:52.49	2:27.72
29	Kohlmann, Patricia	MEX	31.20	1:12.27	1:56.53	2:29.61
30	Aracil, Valentina	ARG	33.06	1:13.36	1:56.77	2:31.53
31	Chanmugam, Dipika	SRI	35.03	1:13.76	1:57.35	2:33.58
32	Munk, Annemarie	HKG	32.90	1:13.44	2:00.37	2:34.32
33	Chen, Y.F. Kim Berly	TPE	34.16	1:13.83	1:59.45	2:35.11
34	Pickering, Sharon	FIJ	33.31	1:12.26	2:00.38	2:35.22
35	Birch, Angela	FIJ	33.28	1:13.27	2:02.74	2:39.20
	Dangalakova, Tania	BUL				NS
	Wayte, Mary	USA				DQ

Women 200m Individual Medley Final A/Sept. 24			Femmes/200m 4 nages Finale A/24 Sept			
Rank Rang	Name Nom	Ctry Pays	50m	100m	150m	200m
1	Hunger, Daniela	GDR	28.97	1:03.18	1:42.08	2:12.59 NOR
2	Dendeberova, Elena	URS	29.78	1:03.55	1:41.39	2:13.31
3	Lung, Noemi Ildiko	ROM	30.34	1:03.67	1:43.57	2:14.85
4	Clatworthy, Jodie	AUS	29.99	1:04.83	1:44.31	2:16.31
5	Muis, Marianne	HOL	30.00	1:04.08	1:45.07	2:16.40
6	Patrascoiu, Aneta	ROM	29.51	1:03.28	1:44.46	2:16.70
7	Lin, Li	CHN	29.46	1:04.16	1:45.04	2:17.42
8	Hedgepeth, Whitney	USA	28.98	1:02.92	1:45.97	2:17.99

Women 200m Individual Medley Final B/Sept. 24			Femmes/200m 4 nages Finale B/24 Sept			
Rank Rang	Name Nom	Ctry Pays	50m	100m	150m	200m
1	Muis, Mildred	HOL	30.31	1:05.94	1:46.53	2:17.73
2	Lohberg-Schulz, Birgit	FRG	29.87	1:05.02	1:46.41	2:17.85
3	Hill, Jean	GBR	30.36	1:06.61	1:46.18	2:19.20
4	Philippson, Anette	SWE	31.62	1:06.85	1:47.20	2:19.35
5	Felotti, Roberta	ITA	31.42	1:07.22	1:47.70	2:19.63
5	Petricevic, Anamarija	YUG	30.96	1:07.05	1:47.71	2:19.63
7	Bogatcheva, Ioulia	URS	30.61	1:06.63	1:46.83	2:19.91
8	Nishioka, Yoshie	JPN	30.87	1:07.59	1:46.66	2:20.43

Swimming

Women 400m Individual Medley Heat 1/Sept. 18			Femmes/400m 4 nages Serie 1/18 Sept			
Rank	Name	Ctry	50m	100m	150m	200m
Rang	Nom	Pays				
1	Harada, Hiroyo	JPN	1:07.79	2:21.42	3:51.54	5:00.92
2	Smith, Michelle	IRL	1:06.56	2:21.62	3:52.13	5:01.84
3	Bruten, Marlene	MEX	1:06.14	2:25.01	3:55.85	5:03.69
4	Chang, Hui-Chien	TPE	1:09.28	2:34.65	4:04.89	5:13.20
5	Aracil, Valentina	ARG	1:12.44	2:35.59	4:04.72	5:19.17
6	Munk, Annemarie	HKG	1:10.95	2:35.63	4:10.79	5:24.11
7	Chen, Y.F. Kim Berly	TPE	1:13.12	2:37.27	4:12.47	5:28.15

Women 400m Individual Medley Heat 2/Sept. 18			Femmes/400m 4 nages Serie 2/18 Sept			
Rank	Name	Ctry	50m	100m	150m	200m
Rang	Nom	Pays				
1	Procter, Donna	AUS	1:04.89	2:18.21	3:42.38	4:47.57
2	Yan, Ming	CHN	1:06.11	2:20.91	3:43.97	4:49.04
3	Hansen, Erika	USA	1:05.54	2:16.77	3:44.88	4:50.03
4	Strumenlieva, Antoaneta	BUL	1:04.85	2:19.26	3:47.51	4:51.58
5	Magnier, Christine	FRA	1:07.62	2:20.45	3:45.40	4:51.91
6	Philipsson, Anette	SWE	1:07.35	2:21.65	3:46.46	4:53.58
7	Poulsen, Annette	DEN	1:06.98	2:22.58	3:48.22	5:54.01
8	Atkin, Tracey	GBR	1:05.69	2:19.71	3:50.95	5:01.34

Women 400m Individual Medley Heat 3/Sept. 18			Femmes/400m 4 nages Serie 3/18 Sept			
Rank	Name	Ctry	50m	100m	150m	200m
Rang	Nom	Pays				
1	Lung, Noemi Ildiko	ROM	1:04.80	2:14.90	3:38.05	4:41.96
2	Nord, Kathleen	GDR	1:04.19	2:19.28	3:39.62	4:42.92
3	Clatworthy, Jodie	AUS	1:05.85	2:17.13	3:39.01	4:44.26
4	Dendeberova, Elena	URS	1:04.70	2:17.83	3:39.96	4:46.63
5	Link Li	CHN	1:05.82	2:18.93	3:41.36	4:48.89
6	Lohberg-Schulz, Birgit	FRG	1:05.30	2:19.90	3:46.31	4:52.05
7	Muis, Marianne	HOL	1:07.17	2:24.10	3:50.58	4:56.31
8	Muis, Mildred	HOL	1:07.27	2:25.58	3:51.81	4:56.89

Women 400m Individual Medley Heat 4/Sept. 18			Femmes/400m 4 nages Serie 4/18 Sept			
Rank	Name	Ctry	50m	100m	150m	200m
Rang	Nom	Pays				
1	Evans, Janet	USA	1:05.34	2:15.62	3:39.26	4:43.04
2	Hunger, Daniela	GDR	1:04.89	2:17.12	3:40.40	4:44.85
3	Felotti, Roberta	ITA	1:06.49	2:20.36	3:43.78	4:49.20
4	Petricovic, Anamarija	YUG	1:05.95	2:22.27	3:46.02	4:54.17
5	Brownsdon, Susannah	GBR	1:04.72	2:24.40	3:47.05	4:54.66
6	Nishioka, Yoshie	JPN	1:06.57	2:23.93	3:45.35	4:55.31
7	Dalby, Irene	NOR	1:06.83	2:22.27	3:50.29	4:58.14
	Bogatcheva, Ioulia	URS				NS

Women 400m Individual Medley Sept. 18-19			Femmes/400m 4 nages 18-19 Sept			
Rank	Name	Ctry	100m	200m	300m	400m
Rang	Nom	Pays				
1	Lung, Noemi Ildiko	ROM	1:04.80	2:14.90	3:38.05	4:41.96
2	Nord, Kathleen	GDR	1:04.19	2:19.28	3:39.62	4:42.92
3	Evans, Janet	USA	1:05.34	2:15.62	3:39.26	4:43.04
4	Clatworthy, Jodie	AUS	1:05.85	2:17.13	3:39.01	4:44.26
5	Hunger, Daniela	GDR	1:04.89	2:17.12	3:40.40	4:44.85
6	Dendeberova, Elena	URS	1:04.70	2:17.83	3:39.96	4:46.63
7	Procter, Donna	AUS	1:04.89	2:18.21	3:42.38	4:47.57
8	Lin, Li	CHN	1:05.82	2:18.93	3:41.36	4:48.89
9	Yan, Ming	CHN	1:06.11	2:20.91	3:43.97	4:49.04
10	Felotti, Roberta	ITA	1:06.49	2:20.36	3:43.78	4:49.20
11	Hansen, Erika	USA	1:05.54	2:16.77	3:44.88	4:50.03
12	Strumenlieva, Antoaneta	BUL	1:04.85	2:19.26	3:47.51	4:51.58
13	Magnier, Christine	FRA	1:07.62	2:20.45	3:45.40	4:51.91
14	Lohberg-Schulz, Birgit	FRG	1:05.30	2:19.90	3:46.31	4:52.05
15	Philipsson, Anette	SWE	1:07.35	2:21.65	3:46.46	4:53.58
16	Poulsen, Annette	DEN	1:06.98	2:22.58	3:48.22	4:54.01
17	Petricovic, Anamarija	YUG	1:05.95	2:22.27	3:46.02	4:54.17
18	Brownsdon, Susannah	GBR	1:04.72	2:24.40	3:47.05	4:54.66
19	Nishioka, Yoshie	JPN	1:06.57	2:23.93	3:45.35	4:55.31
20	Muis, Marianne	HOL	1:07.17	2:24.10	3:50.58	4:56.31
21	Muis, Mildred	HOL	1:07.27	2:25.58	3:51.81	4:56.89
22	Dalby, Irene	NOR	1:06.83	2:22.27	3:50.29	4:58.14
23	Harada, Hiroyo	JPN	1:07.79	2:21.42	3:51.54	5:00.92
24	Atkin, Tracey	GBR	1:05.69	2:19.71	3:50.95	5:01.34
25	Smith, Michelle	IRL	1:06.56	2:21.62	3:52.13	5:01.84
26	Bruten, Marlene	MEX	1:06.14	2:25.01	3:55.85	5:03.69
27	Chang, Hui-Chien	TPE	1:09.28	2:34.65	4:04.89	5:13.20
28	Aracil, Valentina	ARG	1:12.44	2:35.59	4:04.72	5:19.17
29	Munk, Annemarie	HKG	1:10.95	2:35.63	4:10.79	5:24.11
30	Chen, Y.F. Kim Berly	TPE	1:13.12	2:37.27	4:12.47	5:28.15
	Bogatcheva, Ioulia	URS				NS

Natation

Women 400m Individual Medley Final A/Sept. 19			Femmes/400m 4 nages Finale A/19 Sept			
Rank	Name	Ctry	100m	200m	300m	400m
Rang	Nom	Pays				
1	Evans, Janet	USA	1:04.55	2:12.79	3:34.26	4:37.76
2	Lung, Noemi Ildiko	ROM	1:04.75	2:13.83	3:35.97	4:39.46
3	Hunger, Daniela	GDR	1:04.53	2:16.01	3:36.78	4:39.76
4	Dendeberova, Elena	URS	1:04.52	2:17.84	3:35.85	4:40.44
5	Nord, Kathleen	DGR	1:03.43	2:17.81	3:37.46	4:41.64
6	Clatworthy, Jodie	AUS	1:06.21	2:18.02	3:39.30	4:45.86
7	Lin, Li	CHN	1:04.87	2:18.25	3:40.55	4:47.05
8	Procter, Donna	AUS	1:05.63	2:18.76	3:42.63	4:47.51

Women 400m Individual Medley Final B/Sept. 19			Femmes/400m 4 nages Finale B/19 Sept			
Rank	Name	Ctry	100m	200m	300m	400m
Rang	Nom	Pays				
1	Felotti, Roberta	ITA	1:06.76	2:20.54	3:44.11	4:49.53
2	Lohberg-Schulz, Birgit	FRG	1:05.84	2:20.51	3:46.48	4:50.54
3	Hansen, Erika	USA	1:04.99	2:15.53	3:45.70	4:51.93
4	Strumenlieva, Antoaneta	BUL	1:05.25	2:19.51	3:48.30	4:52.33
5	Philipsson, Anette	SWE	1:07.77	2:22.51	3:47.15	4:52.77
6	Magnier, Christine	FRA	1:08.08	2:21.15	3:46.38	4:53.29
7	Poulsen, Annette	DEN	1:06.66	2:22.47	3:48.54	4:54.40
8	Yan, Ming	CHN	1:06.16	2:22.05	3:47.14	4:55.92

Women 4x100m Medley Relay Heat 1/Sept. 24			Femmes/Relais 4 x 100m 4 nages Serie 1/24 Sept			
Rank	Ctry	Name	50m	100m	Lap	Result
Rang	Pays	Nom				Resultat
1	AUS	Livingstone, Nicole Hooiveld, Lara Alessandri, Fiona Van Wirdum, Karen		1:04.07	1:04.07	4:14.32
				1:10.97	2:15.04	
				1:02.12	3:17.16	
				57.16	4:14.32	
2	ITA	Vigarani, Lorenza Dalla Valle, Manuela Tocchini, Maria Persi, Silvia		1:03.64	1:03.64	4:14.68
				1:11.17	2:14.81	
				1:02.24	3:17.05	
				57.63	4:14.68	
3	JPN	Morishita, Satoko Nishioka, Yoshie Takahashi, Kiyomi Nakano, Ayako		1:05.23	1:05.23	4:18.88
				1:13.63	2:18.86	
				1:01.95	3:20.81	
				58.07	4:18.88	
4	ESP	Autric, Natalia Parera, Silvia Fernandez, Maria Luisa Garbayo, Amaia		1:06.74	1:06.74	4:21.84
				1:14.87	2:21.61	
				1:02.45	3:24.06	
				57.78	4:21.84	
5	TPE	Wang, Chi Seto, Carwai Chang, Hui-Chien Chen, Y.F. Kim Berly		1:10.75	1:10.75	4:39.49
				1:15.45	2:26.20	
				1:07.95	3:34.15	
				1:05.34	4:39.49	
	CHN	Yang, Wenyi Huang, Xiaomin Qian, Hong Zhuang, Yong				DQ

Women 4x100m Medley Relay Heat 2/Sept. 24			Femmes/Relais 4 x 100m 4 nages Serie 2/24 Sept			
Rank	Ctry	Name	50m	100m	Lap	Result
Rang	Pays	Nom				Resultat
1	GDR	Sirch, Cornelia Hoerner, Silke Weigang, Birte Stellmach, Manuela		1:02.34	1:02.34	4:08.53
				1:09.37	2:11.71	
				1:00.75	3:12.46	
				56.07	4:08.53	
2	CAN	Melien, Lori Duggan, Keltie Kerr, Jane Noll, Patricia		1:03.80	1:03.80	4:14.23
				1:11.58	2:15.38	
				1:02.42	3:17.80	
				56.43	4:14.23	
3	BUL	Gospodinova, Bistra Dangalakova, Tania Miteva, Neviana Hristova, Natacha		1:05.23	1:05.23	4:15.22
				1:09.31	2:14.54	
				1:02.82	3:17.36	
				57.86	4:15.22	
4	SWE	Larsson, Johanna Persson, Annakarin Eriksson, Agneta Nyberg, Eva		1:05.10	1:05.10	4:17.72
				1:12.40	2:17.50	
				1:02.95	3:20.45	
				57.27	4:17.72	
5	CRC	Poll, Silvia Niehaus, Sigrid Cuesta, Marcela Mauri, Carolina		1:04.02	1:04.02	4:31.75
				1:17.56	2:21.58	
				1:09.89	3:31.47	
				1:00.28	4:31.75	
	DEN	Jacobsen, Mette Sorensen, Pia Jorgensen, Annette M Jensen, Gitta P				DQ



Women 4x100m Medley Relay
Heat 3/Sept. 24

Femmes/Relais 4x100m 4 nages
Serie 3/24 Sept

Rank Rang	Ctry Pays	Name Nom	50m	100m	Lap	Result Resultat
1	USA	Mitchell, Betsy Mcfarlane, Tracy Meagher, Mary T Torres, Dara		1:02.66 1:10.55 1:01.64 55.75	1:02.66 2:19.99 3:14.63 4:10.38	4:10.38
2	HOL	De Rover, Jolanda Moes, Linda Van Bentum, Cornelia Briennesse, Karin		1:04.03 1:10.74 1:00.62 56.43	1:04.03 2:14.77 3:15.39 4:11.82	4:11.82
3	FRG	Schlicht, Svenja Dahm, Britta Rehaa, Gabi Aizpors, Marion		1:03.56 1:12.56 1:01.54 55.53	1:03.56 2:16.12 3:17.66 4:13.19	4:13.19
4	GBR	Read, Katharine Brownsdon, Susannah Foot, Caroline Coull, Joanna		1:04.86 1:11.74 1:01.97 57.61	1:04.86 2:16.60 3:18.57 4:16.18	4:16.18
5	FRA	Guillou, Laurence Louvrier, Pascaline Plewinski, Catherine Delord, Jacqueline		1:05.28 1:13.72 59.86 57.35	1:05.28 2:19.00 3:18.86 4:16.21	4:16.21
6	KOR	Hong, Ji-Hee Park, Sung-Won Lee, Hong-Mi Han, Young-Hee		1:08.52 1:14.57 1:05.73 1:00.08	1:08.52 2:23.09 3:28.82 4:28.90	4:28.90

Women 4x100m Medley Relay
Sept. 24

Femmes/Relais 4x100m 4 nages
24 Sept

Rank Rang	Ctry Pays	Name Nom	50m	100m	Lap	Result Resultat
1	GDR	Sirch, Cornelia Hoerner, Silke Weigang, Birte Stellmach, Manuela		1:02.34 1:09.37 1:00.75 57.07	1:02.34 2:11.71 3:12.46 4:08.53	4:08.53
2	USA	Mitchell, Betsy Mcfarlane, Tracey Meagher, Mary T Torres, Dara		1:02.66 1:10.33 1:01.64 55.75	1:02.66 2:12.99 3:14.63 4:10.38	4:10.38
3	HOL	De Rover, Jolanda Moes, Linda Van Bentum, Cornelia Briennesse, Karin		1:04.03 1:10.74 1:00.62 56.43	1:04.03 2:14.77 3:15.39 4:11.82	4:11.82
4	FRG	Schlicht, Svenja Dahm, Britta Rehaa, Gabi Aizpors, Marion		1:03.56 1:12.56 1:01.54 55.53	1:03.56 2:16.12 3:17.66 4:13.19	4:13.19
5	CAN	Melien, Lori Duggan, Keltie Kerr, Jane Noall, Patricia		1:03.80 1:11.58 1:02.42 56.43	1:03.80 2:15.38 3:17.80 4:14.23	4:14.23
6	AUS	Livingstone, Nicole Hooiveld, Lara Alessandri, Fiona Van Wirdum, Karen		1:04.07 1:10.97 1:02.12 57.16	1:04.07 2:15.04 3:17.16 4:14.32	4:14.32
7	ITA	Vigrani, Lorenza Dalla Valle, Manuela Tocchini, Ilaria Persi, Silvia		1:03.64 1:11.17 1:02.24 57.63	1:03.64 2:14.81 3:17.05 4:14.68	4:14.68
8	BUL	Gospodinova, Bistra Dangalakova, Tania Miteva, Neviana Hristova, Natacha		1:05.23 1:09.31 1:02.82 57.86	1:05.23 2:14.54 3:17.36 4:15.22	4:15.22
9	GBR	Read, Katharine Brownsdon, Susannah Foot, Caroline Coull, Joanna		1:04.86 1:11.74 1:01.97 57.61	1:04.86 2:16.60 3:18.57 4:16.18	4:16.18
10	FRA	Guillou, Laurence Louvrier, Pascaline Plewinski, Catherine Delord, Jacqueline		1:05.28 1:13.72 59.86 57.35	1:05.28 2:19.00 3:18.86 4:16.21	4:16.21
11	SWE	Larsson, Johanna Persson, Annakarin Eriksson, Agneta Nyberg, Eva		1:05.10 1:12.40 1:02.95 57.27	1:05.10 2:17.50 3:20.45 4:17.72	4:17.72
12	JPN	Morishita, Satoko Nishioka, Yoshie Takahashi, Kiyomi Nakano, Ayako		1:05.23 1:13.63 1:01.95 58.07	1:05.23 2:18.86 3:20.81 4:18.88	4:18.88
13	ESP	Autric, Natalia Parera, Silvia Fernandez, Maria Luisa Garbayo, Amaia		1:06.74 1:14.87 1:02.45 57.78	1:06.74 2:21.61 3:24.06 4:21.84	4:21.84
14	KOR	Hong, Ji-Hee Park, Sung-Won Lee, Hong-Mi Han, Young-Hee		1:08.52 1:14.57 1:05.73 1:00.08	1:08.52 2:23.09 3:28.82 4:28.90	4:28.90

Rank Rang	Ctry Pays	Name Nom	50m	100m	Lap	Result Resultat
15	CRC	Poll, Silvia Niehaus, Sigrid Cuesta, Marcela Mauri, Carolina		1:04.02 1:17.56 1:09.89 1:00.28	1:04.02 2:21.58 3:31.47 4:31.75	4:31.75
16	TPE	Wang, Chi Seto, Carwai Chang, Hui-Chien Chen, Y.F. Kim Berly		1:10.75 1:15.45 1:07.95 1:05.34	1:10.75 2:26.20 3:34.15 4:39.49	4:39.49
	CHN	Yang, Wenyi Huang, Xiaomin Qian, Hong Zhuang, Yong				DQ
	DEN	Jacobsen, Mette Sorensen, Pia Jorgensen, Annette M Jensen, Gitta P				DQ

Women 4x100m Medley Relay
Final/Sept. 24

Femmes/Relais 4x100m 4 nages
Finale/24 Sept

Rank Rang	Ctry Pays	Name Nom	50m	100m	Lap	Result Resultat
1	GDR	Otto, Kristin Hoerner, Silke Weigang, Birte Meissner, Katrin		1:01.03 1:08.20 59.51 55.00	1:01.03 2:09.23 3:08.74 4:03.74	4:03.74 NOR
2	USA	Barr, Beth Mcfarlane, Tracey Jorgensen, Janel Wayte, Mary		1:02.56 1:10.22 59.84 55.28	1:02.56 2:12.78 3:12.62 4:07.90	4:07.90
3	CAN	Melien, Lori Higson, Allison Kerr, Jane Nugent, Andrea		1:04.25 1:08.15 1:01.78 56.31	1:04.25 2:12.40 3:14.18 4:10.49	4:10.49
4	AUS	Livingstone, Nicole Hooiveld, Lara Alessandri, Fiona Van Wirdum, Karen		1:03.43 1:10.49 1:00.87 56.78	1:03.43 2:13.92 3:14.79 4:11.57	4:11.57
5	HOL	De Rover, Jolanda Moes, Linda Van Bentum, Cornelia Briennesse, Karin		1:03.76 1:11.40 1:00.30 56.73	1:03.76 2:15.16 3:15.46 4:12.19	4:12.19
6	BUL	Gospodinova, Bistra Dangalakova, Tania Miteva, Neviana Hristova, Natacha		1:04.87 1:07.95 1:02.76 56.78	1:04.87 2:12.82 3:15.58 4:12.36	4:12.36
7	FRG	Schlicht, Svenja Dahm, Britta Rehaa, Gabi Aizpors, Marion		1:03.46 1:12.36 1:01.79 55.28	1:03.46 2:15.82 3:17.61 4:12.89	4:12.89
8	ITA	Vigarani, Lorenza Dalla Valle, Manuela Tocchini, Ilaria Persi, Silvia		1:03.96 1:10.63 1:01.93 57.33	1:03.96 2:14.59 3:16.52 4:13.85	4:13.85

Women 4x100m Freestyle Relay
Heat 1/Sept. 22

Femmes/Relais 4x100m nage libre
Serie 1/22 Sept

Rank Rang	Ctry Pays	Name Nom	50m	100m	Lap	Result Resultat
1	GDR	Meissner, Katrin Schulze, Sabina Friedrich, Heike Hunger, Daniela	26.96 27.19 27.11 26.80	55.30 56.32 55.68 55.83	55.30 1:51.62 2:47.30 3:43.13	3:43.13
2	URS	Abramova, Inna Issakova, Svetlana Dendeberova, Elena Koptchikova, Svetlana	27.36 27.25 26.93 26.78	57.56 56.55 56.02 56.15	57.56 1:54.11 2:50.13 3:46.28	3:46.28
3	FRG	Seick, Karin Pielke, Christiane Ziliox, Katja Aizpors, Marion	28.13 27.27 27.21 26.32	57.54 56.94 57.75 55.80	57.54 1:54.48 2:52.23 3:48.03	3:48.03
4	SWE	Eriksson, Agneta Furuhed, Karin Nilsson, Suzanne Nyberg, Eva	27.77 27.44 27.32 27.79	58.31 57.31 57.59 57.29	58.31 1:55.62 2:53.21 3:50.50	3:50.50
5	GBR	Cripps, Annabelle Croft, June Donnelly, Linda Coull, Joanna	27.89 27.50 28.08 27.50	57.87 57.70 58.01 57.26	57.87 1:55.57 2:53.58 3:50.84	3:50.84
6	CRC	Aguilar, Natasha Cuesta, Marcela Mauri, Carolina Poll, Silvia	29.52 28.63 28.26 27.13	1:01.45 1:00.07 1:00.25 57.90	1:01.45 2:01.52 3:01.77 3:59.67	3:59.67
7	TPE	Wang, Chi Lum, Sabrina Seto, Carwai Chang, Hui-Chien	29.69 30.11 29.43 30.13	1:02.17 1:03.31 1:01.82 1:02.54	1:02.17 2:05.48 3:07.30 4:09.84	4:09.84

Swimming

Women 4x100m Freestyle Relay Heat 2/Sept. 22				Femmes/Relais 4x100m nage libre Serie 2/22 Sept			
Rank Rang	Ctry Pays	Name Nom	50m	100m	Lap	Result Resultat	
1	HOL	Van Bentum, Cornelia	27.82	56.34	56.34	3:44.12	
		Muis, Marianne	26.57	55.96	1:52.30		
		Muis, Mildred	26.80	55.85	2:48.15		
		Van Der Plaats, Diana	26.67	55.97	3:44.12		
2	USA	Walker, Laura	27.58	57.46	57.46	3:45.10	
		Zemina, Paige	27.36	56.51	1:53.97		
		Sterkel, Jill	26.67	56.07	2:50.04		
		Wayte, Mary	26.07	55.06	3:45.10		
3	CHN	Xia, Fujie	28.29	57.37	57.37	3:46.36	
		Lou, Yaping	27.48	57.23	1:54.60		
		Yang, Wenyi	26.77	55.86	2:50.46		
		Zhuang, Yong	27.13	55.90	3:46.36		
4	DEN	Jacobsen, Mette	28.44	57.10	57.10	3:48.83	
		Jensen, Gitta P	27.33	56.85	1:53.95		
		Sorensen, Pia	27.17	56.93	2:50.88		
		Jorgensen, Annette M	27.35	57.95	3:48.83		
5	CAN	Bald, Kathy	27.78	57.29	57.29	3:49.20	
		Topham, Kristin	27.97	58.08	1:55.37		
		Higson, Allison	27.55	57.09	2:52.46		
		Kerr, Jane	27.43	56.74	3:49.20		
6	BRA	Pereira, Adriana	28.51	58.59	58.59	3:56.29	
		Rezemde, Monica	28.30	59.37	1:57.96		
		Amorim, Patricia	29.19	59.92	2:57.88		
		Vieira, Isabele	28.19	58.41	3:56.29		
7	KOR	Kim, Eun-Jung	29.26	1:01.33	1:01.33	4:03.18	
		Han, Young-Hee	28.58	1:00.37	2:01.70		
		Park, Joo-Li	28.84	1:01.42	3:03.12		
		Lee, Hong-Mi	28.57	1:00.06	4:03.18		
8	HKG	Hung, Cee Kay	29.19	1:00.80	1:00.80	4:08.58	
		Ng, Fenella	29.68	1:01.15	2:01.95		
		Tsang, Wing Sze	29.73	1:03.67	3:05.62		
		Munk, Annemarie	29.08	1:02.96	4:08.58		

Women 4x100m Freestyle Relay Final/Sept. 22				Femmes/Relais 4x100m nage libre Finale/22 Sept			
Rank Rang	Ctry Pays	Name Nom	50m	100m	Lap	Result Resultat	
1	GDR	Otto, Kristin	27.01	55.11	55.11	3:40.63 NOR	
		Meissner, Katrin	26.19	54.73	1:49.84		
		Hunger, Daniela	26.50	55.69	2:45.53		
		Stellmach, Manuela	26.49	55.10	3:40.63		
2	HOL	Muis, Marianne	27.17	56.26	56.26	3:43.39	
		Muis, Mildred	27.14	56.36	1:52.62		
		Van Bentum, Cornelia	27.03	55.73	2:48.35		
		Briennesse, Karin	26.37	55.04	3:43.39		
3	USA	Wayte, Mary	26.88	55.88	55.88	3:44.25	
		Kremer, Mitzi	26.51	55.68	1:51.56		
		Walker, Laura	26.93	56.71	2:48.27		
		Torres, Dara	26.41	55.98	3:44.25		
4	CHN	Xia, Fujie	27.53	57.78	57.78	3:44.69	
		Yang, Wenyi	26.50	55.38	1:53.16		
		Lou, Yaping	27.52	57.28	2:50.44		
		Zhuang, Yong	26.07	54.25	3:44.69		
5	URS	Dendeberova, Elena	27.25	56.49	56.49	3:44.99	
		Issakova, Svetlana	26.74	56.20	1:52.69		
		Trefilova, Natalia	27.10	56.00	2:48.69		
		Koptchikova, Svetlana	26.86	56.30	3:44.99		
6	CAN	Bald, Kathy	27.50	57.01	57.01	3:46.75	
		Noall, Patricia	27.28	56.75	1:53.76		
		Nugent, Andrea	27.04	56.31	2:50.07		
		Kerr, Jane	27.04	56.68	3:46.75		
7	FRG	Ortwig, Stephanie	27.99	57.91	57.91	3:46.90	
		Aizpors, Marion	26.37	55.71	1:53.62		
		Pielke, Christiane	26.89	56.46	2:50.08		
		Seick, Karin	27.12	56.82	3:46.90		
8	DEN	Jensen, Gitta P	27.27	56.93	56.93	3:49.25	
		Sorensen, Pia	27.48	57.28	1:54.21		
		Jacobsen, Mette	27.74	56.95	2:51.16		
		Jorgensen, Annette M	27.80	58.09	3:49.25		

Natation

Men Springboard Diving Preliminary Dive 1/Sept. 19				Hommes/Plongeon du Tremplin Eliminatoires Plongeon 1/19 Sept								
Order Ordre	Ctry Pays	Name Nom	Type Saut	Diff Coef	1	2	3	4	5	6	7	Total
1	GBR	Morris, Graham	103 B	1.6	7.0	7.0	7.0	6.5	6.5	7.0	6.5	32.64
2	AUT	Stajkovic, Niki	101 A	1.6	7.5	8.0	8.0	7.5	7.5	7.5	8.0	36.96
3	POL	Rossa, Tomasz	101 B	1.5	7.5	8.0	8.5	7.5	7.0	7.5	7.5	34.20
4	GBR	Morgan, Robert	401 B	1.4	8.0	7.0	7.0	7.0	7.0	7.0	7.5	29.82
5	JPN	Yamagishi, Isao	101 C	1.4	7.5	7.0	7.0	7.0	7.0	7.0	7.5	29.82
6	BEL	Lemaire, Tom	101 A	1.6	7.0	7.0	7.5	7.0	6.5	7.0	7.5	34.08
7	USA	Louganis, Gregory	201 B	1.8	8.0	8.5	8.5	8.5	8.0	8.5	8.5	45.36
8	USA	Bradshaw, Mark Daniel	103 C	1.5	8.0	8.0	8.5	7.5	7.5	8.0	7.5	35.10
9	MEX	Mena, Jesus	103 B	1.6	6.5	6.5	7.5	7.0	7.5	7.5	7.0	34.08
10	ITA	Italiani, Piero	103 B	1.6	7.0	7.5	7.0	6.5	7.5	7.0	7.0	34.08
11	KOR	Lee, Sun-Gee	103 B	1.6	5.5	5.5	6.0	6.0	6.0	6.0	5.0	27.84
12	HKG	Tang, Kei Shan	101 B	1.5	4.0	4.0	3.5	4.5	4.5	4.0	4.0	18.45
13	AUS	Butler, Russell	103 B	1.6	6.5	7.5	7.0	6.5	7.0	7.0	6.5	32.64
14	FRA	Nalliod, Jerome	103 B	1.6	7.0	7.0	7.5	7.0	6.5	7.0	7.0	33.60
15	SWE	Andersson, Joakim	201 B	1.8	7.0	7.5	7.5	7.0	7.0	7.5	7.5	39.42
16	ITA	Castellani, Massimo	103 B	1.6	7.5	7.0	7.5	7.0	7.0	7.5	7.0	34.56
17	AUS	Banks, Graeme	103 B	1.6	7.0	7.0	7.0	7.0	6.5	7.0	6.0	33.12
18	JPN	Kaneto, Keita	103 C	1.5	8.0	8.0	8.0	7.5	7.5	8.0	8.0	35.55
19	FRG	Killat, Albin	103 B	1.6	8.5	8.5	8.5	7.0	8.0	8.0	8.5	39.84
20	ECU	Suarez, Abraham	403 C	1.9	7.5	7.0	7.0	7.5	7.0	6.5	7.0	40.47
21	FRG	Meyer, Willi	103 B	1.6	7.0	6.5	7.5	7.0	6.5	7.0	6.0	32.64
22	KUW	Altaqi, Majed	103 B	1.6	7.0	6.0	7.0	7.0	7.0	6.5	6.5	32.64
23	HKG	Wong, Kin Chung	403 B	2.1	5.5	4.5	5.0	5.0	5.5	5.5	5.0	32.76
24	AUT	Pils, Erich	101 A	1.6	5.5	5.0	7.0	6.5	7.0	6.5	7.5	31.20
25	ESP	Gil, Jose Miguel	301 B	1.9	7.0	7.0	7.5	7.5	7.5	7.0	6.5	41.04
26	MEX	Mondragon, Jorge	103 B	1.6	7.0	7.5	8.0	7.5	8.0	7.5	7.5	36.48
27	CHN	Li, Deliang	103 B	1.6	7.5	7.5	8.0	8.0	7.0	7.0	8.0	36.48
28	FIN	Ovaskainen, Juha	101 A	1.6	6.5	6.0	6.5	6.5	6.0	6.0	6.0	29.76
29	CHN	Tan, Liangde	103 B	1.6	8.5	8.0	8.0	7.5	8.0	8.0	7.5	37.92
30	URS	Gontcharov, Valeri	103 B	1.6	8.0	7.5	8.5	8.0	8.5	7.5	8.0	38.40
31	BAR	Honey, Christopher	103 B	1.6	5.5	5.5	6.0	6.0	6.0	6.0	5.5	27.84
32	CAN	Flewelling, Larry	401 B	1.4	7.0	6.5	7.5	7.5	7.0	7.5	7.0	30.24
33	HOL	Jongeans, Edwin	101 A	1.6	7.5	8.0	8.0	7.5	7.5	8.0	7.0	36.96
34	URS	Portnov, Alexandre	201 B	1.8	7.5	7.5	8.0	7.0	8.0	8.0	7.5	41.58
35	CAN	Bedard, David	101 A	1.6	6.5	7.0	6.5	7.0	6.0	6.5	6.0	31.20

Men Springboard Diving Preliminary Dive 2/Sept. 19				Hommes/Plongeon du Tremplin Eliminatoires Plongeon 2/19 Sept								
Order Ordre	Ctry Pays	Name Nom	Type Saut	Diff Coef	1	2	3	4	5	6	7	Total
1	GBR	Morris, Graham	201 B	1.8	7.0	6.0	7.0	7.0	6.0	6.0	6.5	35.10
2	AUT	Stajkovic, Niki	201 B	1.8	7.5	7.5	8.0	7.5	7.5	8.0	7.5	41.04
3	POL	Rossa, Tomasz	201 B	1.8	7.0	5.5	6.0	6.0	6.5	7.0	6.0	34.02
4	GBR	Morgan, Robert	201 B	1.8	7.0	7.0	7.5	7.0	7.0	7.5	7.0	38.34
5	JPN	Yamagishi, Isao	201 A	1.9	8.0	7.5	7.5	8.0	8.0	8.0	7.5	44.46
6	BEL	Lemaire, Tom	201 B	1.8	7.5	7.5	8.0	7.5	6.5	7.0	7.0	39.42
7	USA	Louganis, Gregory	301 B	1.9	8.0	8.5	9.0	8.0	8.5	8.5	8.0	47.31
8	USA	Bradshaw, Mark Daniel	201 A	1.9	7.5	7.0	7.5	7.0	7.0	7.5	7.5	41.61
9	MEX	Mena, Jesus	201 B	1.8	7.0	7.5	7.5	7.0	7.5	7.5	7.5	39.96
10	ITA	Italiani, Piero	201 B	1.8	7.0	7.0	7.5	7.5	7.0	7.0	7.5	38.88
11	KOR	Lee, Sun-Gee	201 B	1.8	7.0	7.0	7.5	7.5	7.0	7.0	7.0	38.34
12	HKG	Tang, Kei Shan	403 B	2.1	5.5	5.5	6.0	6.0	6.0	6.0	5.0	36.54
13	AUS	Butler, Russell	403 B	2.1	7.0	7.0	7.0	6.0	6.5	6.5	6.0	41.58
14	FRA	Nalliod, Jerome	201 B	1.8	6.5	7.0	7.5	7.0	7.0	7.5	7.5	38.88
15	SWE	Andersson, Joakim	301 B	1.9	7.0	7.5	7.5	7.5	7.5	8.0	7.5	42.75
16	ITA	Castellani, Massimo	201 B	1.8	6.0	6.0	6.5	7.0	6.0	6.0	6.0	32.94
17	AUS	Banks, Graeme	201 A	1.9	6.5	7.0	7.0	7.0	6.5	6.5	6.5	38.19
18	JPN	Kaneto, Keita	201 B	1.8	6.5	6.5	7.0	6.5	6.0	7.0	6.0	35.10
19	FRG	Killat, Albin	201 B	1.8	7.5	8.0	8.0	7.5	8.0	8.0	7.0	42.12
20	ECU	Suarez, Abraham	103 B	1.6	6.0	6.0	6.5	7.0	6.0	7.5	6.5	30.72
21	FRG	Meyer, Willi	201 B	1.8	6.5	6.0	7.0	6.5	6.5	6.5	6.5	35.10
22	KUW	Altaqi, Majed	201 B	1.8	6.5	6.0	7.0	6.5	6.5	6.0	6.5	34.56
23	HKG	Wong, Kin Chung	301 A	2.0	4.0	4.0	4.5	5.0	5.5	5.0	5.0	28.20
24	AUT	Pils, Erich	201 A	1.9	7.0	7.0	7.5	6.5	6.5	6.5	6.5	38.19
25	ESP	Gil, Jose Miguel	201 B	1.8	7.5	7.0	7.0	7.5	7.5	7		



Men Springboard Diving
Preliminary Dive 3/Sept. 19

Hommes/Plongeon du Tremplin
Eliminatoires Plongeon 3/19 Sept

Order Ordre	Ctry Pays	Name Nom	Type Saut	Diff Coef	1	2	3	Judge/Juge				Total
								4	5	6	7	
1	GBR	Morris, Graham	301 B	1.9	7.0	6.5	7.0	7.0	7.0	7.0	7.0	39.90
2	AUT	Stajkovic, Niki	301 B	1.9	7.0	7.5	7.5	7.5	7.5	7.5	7.0	42.18
3	POL	Rossa, Tomasz	301 A	2.0	7.5	7.5	8.0	7.5	7.0	7.0	7.5	44.40
4	GBR	Morgan, Robert	301 B	1.9	8.0	7.5	7.5	7.5	7.0	7.0	7.0	41.61
5	JPN	Yamagishi, Isao	301 A	2.0	8.0	8.0	7.5	8.0	8.0	8.0	7.5	47.40
6	BEL	Lemaire, Tom	301 B	1.9	8.0	7.5	7.5	8.0	7.5	7.5	7.5	43.32
7	USA	Louganis, Gregory	101 A	1.6	9.0	9.0	9.5	9.0	9.0	9.0	9.0	43.20
8	USA	Bradshaw, Mark Daniel	301 A	2.0	8.5	7.5	8.0	8.0	8.5	8.5	8.0	49.20
9	MEX	Mena, Jesus	301 B	1.9	6.0	6.0	7.5	7.0	7.5	7.5	7.5	40.47
10	ITA	Italiani, Piero	301 B	1.9	7.5	7.5	7.5	7.5	7.0	7.0	7.0	41.61
11	KOR	Lee, Sun-Gee	301 B	1.9	7.0	7.0	7.0	7.0	6.5	6.5	5.5	38.76
12	HKG	Tang, Kei-Shan	201 A	1.9	4.0	3.5	4.5	3.5	4.5	4.0	4.5	23.37
13	AUS	Butler, Russell	201 B	1.8	5.5	5.5	5.0	4.5	5.0	5.0	4.5	27.00
14	FRA	Nalliod, Jerome	301 B	1.9	7.0	6.5	7.0	7.5	7.0	7.5	7.0	40.47
15	SWE	Andersson, Joakim	403 B	2.1	7.0	6.0	6.5	7.0	6.0	6.5	6.5	40.95
16	ITA	Castellani, Massimo	301 B	1.9	7.5	7.5	7.5	7.0	7.0	7.0	7.0	41.04
17	AUS	Banks, Graeme	301 A	2.0	7.5	7.5	7.0	7.0	6.5	7.5	7.0	43.20
18	JPN	Kaneto, Keita	303 C	2.0	7.0	6.0	7.0	7.5	7.0	7.5	7.0	42.60
19	FRG	Killat, Albin	301 B	1.9	8.5	8.0	8.5	8.5	8.0	8.5	8.5	47.88
20	ECU	Suarez, Abraham	201 A	1.9	5.5	5.5	5.5	5.5	6.5	5.0	5.5	31.35
21	FRG	Meyer, Willi	301 B	1.9	7.5	7.0	7.5	7.5	7.0	7.5	7.0	41.61
22	KUW	Altaqi, Majed	403 B	2.1	6.5	6.0	6.5	6.0	7.0	6.0	7.0	40.32
23	HKG	Won, Kin Chung	5311 A	2.0	3.5	5.5	5.0	4.5	3.5	4.5	5.0	27.00
24	AUT	Pils, Erich	5132 D	2.1	7.0	7.5	7.5	7.0	6.5	7.0	6.5	44.10
25	ESP	Gil, Jose Miguel	101 A	1.6	8.0	7.5	8.0	8.0	7.5	7.5	7.5	36.96
26	MEX	Mondragon, Jorge	301 B	1.9	7.0	7.5	8.5	8.0	7.5	7.5	6.5	42.75
27	CHN	Li, Deliang	201 B	1.8	8.5	8.0	8.0	8.0	8.5	8.5	8.0	44.28
28	FIN	Ovaskainen, Juha	301 B	1.9	6.5	6.5	7.0	7.0	6.5	6.5	7.0	38.19
29	CHN	Tan, Liangde	301 B	1.9	8.0	9.0	7.5	7.5	8.0	8.0	8.0	45.03
30	URS	Gontcharov, Valeri	5331 D	2.1	6.5	7.5	7.5	7.5	7.5	7.5	7.5	47.25
31	BAR	Honey, Christopher	403 B	2.1	6.5	5.5	6.0	6.0	6.0	6.5	6.0	38.43
32	CAN	Flewelling, Larry	101 B	1.5	7.0	7.0	7.5	7.5	7.0	7.5	7.0	32.40
33	HOL	Jongejans, Edwin	301 B	1.9	8.0	7.5	8.0	7.5	8.0	8.0	8.0	45.03
34	URS	Portnov, Alexandre	301 B	1.9	8.0	8.0	8.0	7.5	8.0	8.0	8.5	45.60
35	CAN	Bedard, David	301 A	2.0	7.0	7.5	7.0	7.5	7.0	7.0	7.5	43.20

Men Springboard Diving
Preliminary Dive 5/Sept. 19

Hommes/Plongeon du Tremplin
Eliminatoires Plongeon 5/19 Sept

Order Ordre	Ctry Pays	Name Nom	Type Saut	Diff Coef	1	2	3	Judge/Juge				Total
								4	5	6	7	
1	GBR	Morris, Graham	5331 D	2.1	7.0	7.0	7.0	7.0	6.5	7.0	6.0	43.47
2	AUT	Stajkovic, Niki	5333 D	2.5	8.0	7.5	8.5	8.0	7.5	8.0	8.0	59.25
3	POL	Rossa, Tomasz	5132 D	2.1	8.0	7.5	7.5	7.5	7.5	7.5	7.0	47.25
4	GBR	Morgan, Robert	5235 D	2.8	7.0	7.0	6.5	7.0	7.0	7.0	6.5	57.96
5	JPN	Yamagishi, Isao	5132 D	2.1	8.0	8.0	7.0	8.0	7.0	8.0	7.0	47.88
6	BEL	Lemaire, Tom	5111 A	2.0	7.0	7.5	7.5	7.0	7.0	7.5	7.5	43.80
7	USA	Louganis, Gregory	5235 D	2.8	8.5	8.0	8.5	8.0	7.5	8.5	9.0	69.72
8	USA	Bradshaw, Mark Daniel	403 B	2.1	7.5	7.5	7.5	7.5	7.5	8.0	7.5	47.25
9	MEX	Mena, Jesus	5132 D	2.1	7.0	7.0	7.5	8.0	7.5	8.0	8.0	47.88
10	ITA	Italiani, Piero	5331 D	2.1	7.5	8.0	7.5	7.5	7.5	7.5	7.0	47.25
11	KOR	Lee, Sun-Gee	5132 D	2.1	7.0	6.5	7.0	7.0	6.5	6.5	6.5	42.21
12	HKG	Tang, Kei-Shan	5211 A	2.0	5.0	4.5	5.5	4.5	5.0	4.5	4.5	28.20
13	AUS	Butler, Russell	5132 D	2.1	6.5	7.0	7.0	7.0	6.5	7.0	6.5	43.47
14	FRA	Nalliod, Jerome	5331 D	2.1	6.0	4.5	6.5	6.5	7.0	7.0	6.5	40.95
15	SWE	Andersson, Joakim	5132 D	2.1	6.5	6.0	7.0	6.5	6.0	6.5	7.0	40.95
16	ITA	Castellani, Massimo	5132 D	2.1	7.5	7.5	7.5	7.5	7.0	7.5	7.5	47.25
17	AUS	Banks, Graeme	5134 D	2.5	6.5	7.0	7.0	6.5	7.0	6.5	6.0	50.25
18	JPN	Kaneto, Keita	5132 D	2.1	7.5	8.0	8.0	8.0	7.5	8.0	8.0	49.77
19	FRG	Killat, Albin	5132 D	2.1	8.0	8.5	8.0	8.5	7.5	8.5	8.0	51.66
20	ECU	Suarez, Abraham	5132 D	2.1	7.0	6.0	7.0	7.0	6.0	7.0	6.5	42.21
21	FRG	Meyer, Willi	5132 D	2.1	7.0	7.0	7.0	7.0	7.0	7.0	5.5	44.10
22	KUW	Altaqi, Majed	5132 D	2.1	5.0	6.0	6.5	6.0	6.5	6.5	6.0	39.06
23	HKG	Wong, Kin Chung	101 B	1.5	5.5	5.0	5.5	5.5	6.0	5.5	5.5	24.75
24	AUT	Pils, Erich	403 C	1.9	6.5	6.0	7.0	6.5	7.0	6.5	6.5	37.62
25	ESP	Gil, Jose Miguel	5132 D	2.1	7.5	7.0	7.0	7.5	6.5	7.0	7.0	44.73
26	MEX	Mondragon, Jorge	5132 D	2.1	7.0	7.0	7.5	7.5	8.0	7.5	7.5	46.62
27	CHN	Li, Deliang	403 B	2.1	8.0	7.5	8.0	7.5	7.0	7.5	7.5	47.88
28	FIN	Ovaskainen, Juha	5132 D	2.1	6.0	7.0	7.0	7.5	7.0	7.0	7.5	44.73
29	CHN	Tan, Liangde	403 B	2.1	9.0	8.5	8.0	8.0	8.5	8.0	8.5	52.29
30	URS	Gontcharov, Valeri	201 B	1.8	6.5	6.5	7.0	7.0	7.0	7.5	7.5	37.80
31	BAR	Honey, Christopher	301 B	1.9	4.5	3.5	4.5	4.5	4.5	4.5	5.5	25.65
32	CAN	Flewelling, Larry	5335 D	2.9	7.0	6.5	7.0	7.0	7.0	7.5	7.0	60.90
33	HOL	Jongejans, Edwin	5111 A	2.0	7.5	7.5	8.0	7.5	8.0	8.5	7.5	46.20
34	URS	Portnov, Alexandre	5331 D	2.1	7.5	6.0	7.5	7.5	8.0	7.5	7.0	46.62
35	CAN	Bedard, David	5111 A	2.0	7.0	7.5	8.0	8.0	7.5	8.0	7.5	46.20

Men Springboard Diving
Preliminary Dive 4/Sept. 19

Hommes/Plongeon du Tremplin
Eliminatoires Plongeon 4/19 Sept

Order Ordre	Ctry Pays	Name Nom	Type Saut	Diff Coef	1	2	3	Judge/Juge				Total
								4	5	6	7	
1	GBR	Morris, Graham	403 B	2.1	4.5	3.0	4.5	5.0	4.0	4.0	4.0	26.46
2	AUT	Stajkovic, Niki	401 A	1.7	7.0	8.0	8.0	7.5	7.5	8.0	8.0	39.78
3	POL	Rossa, Tomasz	403 B	2.1	6.5	6.5	7.5	7.5	7.0	7.0	8.0	44.73
4	GBR	Morgan, Robert	103 B	1.6	8.0	8.0	7.5	7.5	7.5	8.0	7.5	36.96
5	JPN	Yamagishi, Isao	403 B	2.1	7.0	7.5	7.5	7.5	7.0	7.0	7.5	45.99
6	BEL	Lemaire, Tom	403 B	2.1	7.5	7.0	7.0	6.5	7.5	7.0	7.0	44.73
7	USA	Louganis, Gregory	401 B	1.4	9.0	9.0	8.5	9.0	9.0	9.5	8.5	37.38
8	USA	Bradshaw, Mark Daniel	5111 A	2.0	8.0	6.5	8.0	7.5	7.5	8.0	7.5	46.20
9	MEX	Mena, Jesus	403 B	2.1	7.5	7.0	7.5	7.5	7.5	7.5	7.5	47.25
10	ITA	Italiani, Piero	403 B	2.1	7.0	7.0	7.0	6.5	7.0	6.5	7.0	43.47
11	KOR	Lee, Sun-Gee	403 B	2.1	7.0	6.5	6.5	6.0	6.0	6.0	5.5	39.69
12	HKG	Tang, Kei-Shan	301 A	2.0	3.5	4.5	4.0	4.0	4.5	4.0	4.0	24.60
13	AUS	Butler, Russell	301 B	1.9	5.5	5.5	6.0	5.5	5.5	5.0	5.0	30.78
14	FRA	Nalliod, Jerome	403 B	2.1	7.0	5.5	7.0	7.0	7.0	6.5	7.0	43.47
15	SWE	Andersson, Joakim	103 B	1.6	7.5	6.5	7.5	7.0	7.0	7.5	7.5	35.04
16	ITA	Castellani, Massimo	403 B	2.1	7.5	7.0	7.5	7.5	7.5	8.0	7.5	47.25
17	AUS	Banks, Graeme	401 B	1.4	6.5	7.0	6.5	7.0	6.5	7.0	6.0	28.14
18	JPN	Kaneto, Keita	403 B	2.1	7.0	7.5	8.0	7.5	8.0	8.0	8.0	49.14
19	FRG	Killat, Albin	403 B	2.1	8.0	7.5	8.5	8.0	8.0	8.0	8.0	50.40
20	ECU	Suarez, Abraham	301 A	2.0	7.0	7.0	7.5	7.0	7.5	7.5	7.0	43.20
21	FRG	Meyer, Willi	403 B	2.1	5.5	4.5	5.5	5.5	5.5	5.5	4.0	33.39
22	KUW	Altaqi, Majed	301 B	1.9	7.0	6.0	7.0	6.5	6.5	6.5	7.0	38.19
23	HKG	Wong, Kin chung	201 A	1.9	5.0	5.5	5.0	6.0	5.0	6.0	6.5	31.35
24	AUT	Pils, Erich	301 A	2.0	4.0	4.0	4.0	4.0	4.0	4.0	3.0	24.00
25	ESP	Gil, Jose-Miguel	403 B	2.1	6.5	5.5	6.5	6.5	6.5	6.0	5.0	39.06
26	MEX	Mondragon, Jorge	403 B	2.1	7.0	7.0	7.5	7.5	8.0	7.5	7.0	45.99
27	CHN	Li, Deliang	301 B	1.9	8.0	8.5	8.0	8.0	8.5	8.0	9.0	46.74
28	FIN	Ovaskainen, Juha	403 B	2.1	7.5	6.5	7.0	6.5	7.0	7.0	7.0	43.47
29	CHN	Tan, Liangde	5331 D	2.1	8.0	9.0	8.5	8.0	8.5	8.0	8.0	51.66
30	URS	Gontcharov, Valeri	301 B	1.9	7.5	6.0	7.0	6.0	7.0	7.5	6.5	38.76
31	BAR	Honey, Christopher	201 B	1.8	4.0	5.0	4.0	5.5	5.0	6.0	4.5	25.92
32	CAN	Flewelling, Larry	301 B	1.9	6.0	6.5	7.5	7.5				

Swimming

Natation

**Men Springboard Diving
Preliminary Dive 7/Sept. 19**

**Hommes/Plongeon du Tremplin
Eliminatoires Plongeon 7/19 Sept**

Order Ordre	Ctry Pays	Name Nom	Type Saut	Diff Coef	1	2	Judge/Juge					Total
							3	4	5	6	7	
1	GBR	Morris, Graham	305 C	2.8	6.0	5.5	6.5	6.0	6.5	6.0	5.0	50.40
2	AUT	Stajkovic, Niki	5335 D	2.9	7.0	6.0	7.0	7.0	6.5	7.0	7.0	60.03
3	POL	Rossa, Tomasz	5235 D	2.8	6.5	7.0	6.5	6.0	6.5	6.0	6.0	52.92
4	GBR	Morgan, Robert	405 C	2.7	7.0	6.5	5.5	5.5	5.5	6.0	5.5	46.98
5	JPN	Yamagishi, Isao	5136 D	2.9	6.0	6.5	6.0	6.0	6.0	6.0	5.0	52.20
6	BEL	Lemaire, Tom	107 C	2.8	7.0	6.5	6.5	6.0	6.5	7.0	5.5	54.60
7	USA	Louganis, Gregory	107 B	3.1	8.5	8.0	8.5	8.5	8.5	9.0	9.0	79.98
8	USA	Bradshaw, Mark Daniel	405 B	3.0	7.0	7.0	8.0	7.5	7.5	8.0	7.5	67.50
9	MEX	Mena, Jesus	205 B	3.0	6.0	5.5	6.0	6.0	6.5	6.5	5.5	54.00
10	ITA	Italiani, Piero	405 B	3.0	6.5	5.5	6.0	6.5	5.5	6.0	6.0	54.00
11	KOR	Lee, Sun-Gee	5235 D	2.8	5.5	4.5	5.5	5.0	4.5	4.5	4.5	40.32
12	HKG	Tang, Kei Shan	105 B	2.4	6.0	4.0	6.0	5.5	5.0	5.5	5.5	39.60
13	AUS	Butler, Russell	205 B	3.0	6.5	6.0	6.5	5.5	5.5	5.0	5.5	52.20
14	FRA	Nalliod, Jerome	5335 D	2.9	7.0	6.0	7.0	7.0	7.5	7.0	7.0	60.90
15	SWE	Andersson, Joakim	305 B	3.0	6.5	5.0	5.5	6.0	5.5	6.0	5.5	51.30
16	ITA	Castellani, Massimo	107 B	3.1	7.5	7.0	7.0	7.5	7.0	7.0	7.5	66.96
17	AUS	Banks, Graeme	205 B	3.0	6.0	5.5	5.5	6.0	5.5	6.5	5.5	51.30
18	JPN	Kaneto, Keita	205 B	3.0	7.0	7.0	8.0	7.5	6.5	7.5	7.5	65.70
19	FRG	Killat, Albin	107 B	3.1	6.0	5.0	7.0	7.0	5.5	5.5	6.0	55.80
20	ECU	Suarez, Abraham	107 C	2.8	4.5	4.5	4.0	4.5	4.5	4.0	4.5	36.96
21	FRG	Meyer, Willi	107 B	3.1	5.0	5.0	5.5	5.5	5.5	5.0	5.0	48.36
22	KUW	Altaqi, Majed	205 B	3.0	4.5	3.5	4.0	4.5	4.5	4.0	3.5	36.90
23	HKG	Wong, Kin Chung	105 B	2.4	6.5	6.5	6.0	6.0	6.0	7.0	6.0	44.64
24	AUT	Pils, Erich	405 C	2.7	7.0	6.5	6.5	7.0	7.0	7.0	7.0	55.89
25	ESP	Gil, Jose Miguel	107 B	3.1	5.0	4.5	4.5	5.0	5.5	5.0	4.0	44.64
26	MEX	Mondragon, Jorge	5235 D	2.8	7.0	7.0	7.5	7.5	7.5	7.5	7.5	62.16
27	CHN	Li, Deliang	405 B	3.0	7.0	7.5	8.0	7.5	7.5	7.0	7.0	65.70
28	FIN	Ovaskainen, Juha	107 C	2.8	7.5	7.0	7.5	7.5	7.5	8.0	6.0	63.00
29	CHN	Tan, Liangde	305 B	3.0	8.0	9.0	8.0	8.5	7.0	7.5	8.0	72.00
30	URS	Gontcharov, Valeri	107 B	3.1	6.5	6.0	6.0	6.0	5.5	6.0	5.5	54.87
31	BAR	Honey, Christopher	107 C	2.8	4.0	2.0	4.0	4.0	4.0	4.5	3.5	32.76
32	CAN	Flewelling, Larry	205 B	3.0	6.0	6.0	4.5	5.5	5.0	5.5	4.0	47.70
33	HOL	Jongeans, Edwin	205 B	3.0	6.0	7.0	7.0	7.0	6.5	7.0	7.0	62.10
34	URS	Portnov, Alexandre	107 B	3.1	4.0	4.0	4.0	4.5	4.5	5.0	4.5	39.99
35	CAN	Bedard, David	205 B	3.0	7.0	6.5	7.0	7.0	7.0	7.0	7.0	63.00

**Men Springboard Diving
Preliminary Dive 9/Sept. 19**

**Hommes/Plongeon du Tremplin
Eliminatoires Plongeon 9/19 Sept**

Order Ordre	Ctry Pays	Name Nom	Type Saut	Diff Coef	1	2	Judge/Juge					Total
							3	4	5	6	7	
1	GBR	Morris, Graham	5235 D	2.8	5.5	6.0	5.5	6.5	5.5	5.5	6.5	48.72
2	AUT	Stajkovic, Niki	305 B	3.0	5.5	5.5	6.0	6.0	5.5	5.5	5.5	50.40
3	POL	Rossa, Tomasz	205 B	3.0	4.5	4.5	3.5	4.0	5.0	4.0	4.0	37.80
4	GBR	Morgan, Robert	305 B	3.0	4.5	3.0	3.5	4.0	3.5	3.5	4.0	33.30
5	JPN	Yamagishi, Isao	305 B	3.0	5.0	4.5	5.0	4.5	5.5	4.5	4.5	42.30
6	BEL	Lemaire, Tom	305 C	2.8	7.5	6.0	7.5	7.0	7.5	7.5	7.0	61.32
7	USA	Louganis, Gregory	305 B	3.0	1.0	0.0	0.0	0.5	1.5	1.0	1.0	6.30
8	USA	Bradshaw, Mark Daniel	107 B	3.1	7.0	7.5	7.5	7.5	7.5	7.5	7.5	69.75
9	MEX	Mena, Jesus	305 B	3.0	6.5	6.5	7.5	7.0	8.0	7.0	7.5	63.90
10	ITA	Italiani, Piero	205 B	3.0	6.5	7.0	6.5	6.0	6.5	6.0	6.5	57.60
11	KOR	Lee, Sun-Gee	205 B	3.0	3.5	3.0	3.0	3.0	3.5	3.0	3.0	27.90
12	HKG	Tang, Kei Shan	205 B	3.0	4.0	3.0	2.5	3.5	3.0	4.5	4.0	31.50
13	AUS	Butler, Russell	405 C	2.7	7.0	7.5	7.5	7.5	7.5	7.0	7.0	59.13
14	FRA	Nalliod, Jerome	305 B	3.0	5.0	4.0	5.0	4.5	4.5	4.5	4.0	40.50
15	SWE	Andersson, Joakim	5235 D	2.8	7.0	7.0	7.5	7.5	7.0	7.0	7.5	60.48
16	ITA	Castellani, Massimo	305 B	3.0	6.5	6.0	7.0	6.5	7.0	7.0	6.5	60.30
17	AUS	Banks, Graeme	405 C	2.7	7.0	7.5	6.5	7.0	7.0	7.5	6.5	56.70
18	JPN	Kaneto, Keita	405 B	3.0	7.0	7.5	7.5	8.0	8.0	7.0	8.0	68.40
19	FRG	Killat, Albin	305 B	3.0	8.0	8.0	7.5	8.0	8.0	7.5	8.0	71.10
20	ECU	Suarez, Abraham	5335 D	2.9	5.0	3.5	5.0	5.0	5.0	5.0	4.0	41.76
21	FRG	Meyer, Willi	205 B	3.0	4.0	4.0	4.5	4.0	4.5	4.5	3.5	37.80
22	KUW	Altaqi, Majed	5134 D	2.5	4.5	4.5	5.5	4.5	4.0	3.0	4.5	33.00
23	HKG	Wong, Kin Chung	205 B	3.0	2.5	3.5	2.5	2.5	2.5	3.5	3.5	26.10
24	AUT	Pils, Erich	107 C	2.8	6.5	7.5	7.5	7.0	7.5	7.0	6.5	59.64
25	ESP	Gil, Jose Miguel	305 B	3.0	6.5	4.5	6.0	6.0	6.5	6.0	5.5	54.00
26	MEX	Mondragon, Jorge	107 B	3.1	5.5	4.5	5.5	5.0	5.5	5.0	4.5	47.43
27	CHN	Li, Deliang	205 B	3.0	7.5	8.5	7.5	7.5	7.0	7.0	7.5	66.60
28	FIN	Ovaskainen, Juha	305 B	3.0	7.0	5.5	6.5	7.0	7.0	7.0	7.0	62.10
29	CHN	Tan, Liangde	107 B	3.1	8.0	8.0	8.5	8.5	8.0	8.0	7.5	75.33
30	URS	Gontcharov, Valeri	5154 D	3.2	7.0	7.5	7.0	7.0	7.5	7.0	6.5	68.16
31	BAR	Honey, Christopher	405 C	2.7	6.0	4.5	5.5	5.5	5.5	5.0	5.0	42.93
32	CAN	Flewelling, Larry	305 B	3.0	6.5	6.5	6.5	7.0	6.5	6.5	6.0	58.50
33	HOL	Jongeans, Edwin	307 C	3.5	7.0	6.5	7.0	6.5	6.0	6.0	7.0	69.30
34	URS	Portnov, Alexandre	305 B	3.0	6.0	4.5	4.5	5.0	4.5	4.5	5.0	42.30
35	CAN	Bedard, David	405 B	3.0	5.0	5.0	5.5	5.5	5.0	4.5	4.5	45.00

**Men Springboard Diving
Preliminary Dive 8/Sept. 19**

**Hommes/Plongeon du Tremplin
Eliminatoires Plongeon 8/19 Sept**

Order Ordre	Ctry Pays	Name Nom	Type Saut	Diff Coef	1	2	Judge/Juge					Total
							3	4	5	6	7	
1	GBR	Morris, Graham	205 B	3.0	2.5	3.0	1.5	3.5	3.5	3.5	2.0	26.10
2	AUT	Stajkovic, Niki	205 B	3.0	5.0	6.0	5.5	5.5	5.5	5.0	5.5	48.60
3	POL	Rossa, Tomasz	305 B	3.0	4.5	3.0	3.5	5.5	4.0	3.0	2.5	32.40
4	GBR	Morgan, Robert	205 B	3.0	5.0	4.5	5.0	4.5	5.0	5.0	4.0	43.20
5	JPN	Yamagishi, Isao	205 B	3.0	7.0	7.0	7.0	7.0	6.5	7.0	6.5	62.10
6	BEL	Lemaire, Tom	5235 D	2.8	7.0	7.5	8.0	8.0	7.0	7.5	7.0	62.16
7	USA	Louganis, Gregory	205 B	3.0	8.0	7.5	8.0	8.0	8.0	8.5	8.5	72.90
8	USA	Bradshaw, Mark Daniel	305 B	3.0	5.5	4.0	4.0	4.0	4.5	4.5	4.0	37.80
9	MEX	Mena, Jesus	405 B	3.0	6.5	6.5	7.0	7.0	7.5	7.0	7.0	62.10
10	ITA	Italiani, Piero	305 B	3.0	6.5	4.5	5.5	5.0	5.5	5.5	5.0	47.70
11	KOR	Lee, Sun-Gee	305 C	2.8	5.0	3.5	4.0	4.5	4.5	4.0	3.0	34.44
12	HKG	Tang, Kei Shan	405 C	2.7	2.5	4.5	4.5	4.0	4.0	4.5	3.5	33.21
13	AUS	Butler, Russell	305 C	2.8	3.0	4.0	2.5	3.0	4.0	3.0	4.0	28.56
14	FRA	Nalliod, Jerome	205 B	3.0	6.0	5.0	6.0	6.0	5.5	6.0	5.5	52.20
15	SWE	Andersson, Joakim	5335 D	2.9	8.0	7.5	7.5	7.5	7.5	7.5	7.5	65.25
16	ITA	Castellani, Massimo	205 B	3.0	5.5	5.0	4.5	5.0	5.5	5.5	4.0	45.90
17	AUS	Banks, Graeme	305 B	3.0	5.5	6.0	5.5	5.5	6.0	6.0	5.5	51.30
18	JPN	Kaneto, Keita	305 B	3.0	6.0	6.5	6.5	7.0	6.0	7.0	6.5	58.50
19	FRG	Killat, Albin	205 B	3.0	7.5	7.0	7.0	7.5	7.0	7.5	6.5	64.80
20	ECU	Suarez, Abraham	5235 D	2.8	6.0	6.0	6.0	6.5	6.5	5.5	5.0	50.40
21	FRG	Meyer, Willi	5154 D	3.2	6.0	6.0	6.5	6.5	6.5	6.5	6.5	61.44
22	KUW	Altaqi, Majed	405 C	2.7	4.5	4.5	5.5	5.0	5.5	5.0	4.5	39.69
23	HKG	Wong, Kin Chung	203 A	2.4	2.0	4.0	3.5	4.5	4.0	4.5	4.0	28.80
24	AUT	Pils, Erich	305 C	2.8	7.0	7.0	7.5	7.5	7.0	7.0	7.0	59.64
25	ESP	Gil, Jose Miguel	205 B	3.0	2.5	2.0	2.5	2.5	3.0	2.5	1.5	21.60
26	MEX	Mondragon, Jorge	405 B	3.0	8.0	7.5	7.5	7.5	8.0	7.5	7.5	68.40
27	CHN	Li, Deliang	107 B	3.1	9.0	8.0	8.5	8.5	8.0	8.0	8.5	77.19
28	FIN	Ovaskainen, Juha	205 B	3.0	3.0	2.5	2.5	3.0	3.5	3.5	3.0	27.00
29	CHN	Tan, Liangde	405 B	3.0	9.0	9.0	9.0	8.5	9.0	9.0	8.0	81.00
30	URS	Gontcharov, Valeri	205 B	3.0	7.0	6.5	6.0	6.0	6.5	6.0	7.0	57.60
31	BAR	Honey, Christopher	5134 D	2.5	6.5	5.5	6.0	6.5	6.0	6.0	5.5	45.00
32	CAN	Flewelling, Larry	107 B	3.1	5.0	4.0	4.5	4.0	4.0	4		



**Men Springboard Diving
Preliminary Dive 11/Sept. 19**

**Hommes/Plongeon du Tremplin
Eliminatoires Plongeon 11/19 Sept**

Order Ordre	Ctry Pays	Name Nom	Type Saut	Diff Coef	1	2	Judge/Juge					Total
							3	4	5	6	7	
1	GBR	Morris, Graham	107 C	2.8	8.0	7.0	8.0	7.5	7.5	7.5	7.5	63.84
2	AUT	Stajkovic, Niki	107 B	3.1	8.0	7.5	8.0	7.5	8.0	8.0	8.5	73.47
3	POL	Rossa, Tomasz	107 B	3.1	5.0	4.5	4.5	3.5	3.5	4.5	4.0	39.96
4	GBR	Morgan, Robert	307 C	3.5	4.0	3.5	3.0	4.0	4.0	3.5	4.0	39.90
5	JPN	Yamagishi, Isao	405 B	3.0	7.5	7.5	7.5	7.5	7.5	7.5	7.5	67.50
6	BEL	Lemaire, Tom	5335 D	2.9	7.0	8.0	7.5	7.5	7.0	7.5	7.0	63.51
7	USA	Louganis, Gregory	307 C	3.5	7.0	6.5	6.5	7.0	6.5	6.5	6.5	69.30
8	USA	Bradshaw, Mark Daniel	5337 D	3.3	8.0	7.5	7.5	8.0	8.0	8.0	7.5	77.22
9	MEX	Mena, Jesus	5337 D	3.3	6.0	6.0	6.5	6.5	7.0	6.0	5.5	61.38
10	ITA	Italiani, Piero	107 C	2.8	6.5	6.0	6.5	6.5	6.0	6.0	6.0	52.08
11	KOR	Lee, Sun-Gee	107 C	2.8	3.5	3.0	3.0	3.0	2.0	3.5	2.0	24.36
12	HKG	Tang, Kei Shan	5132 D	2.1	4.5	3.5	5.0	4.5	4.0	4.0	4.5	27.09
13	AUS	Butler, Russell	5136 D	2.9	6.5	7.0	6.5	6.5	6.5	6.5	6.5	56.55
14	FRA	Nalliod, Jerome	405 C	2.7	6.5	6.0	6.5	6.0	4.5	5.5	6.0	48.60
15	SWE	Andersson, Joakim	205 B	3.0	6.0	6.0	6.0	5.5	7.0	6.0	6.5	54.90
16	ITA	Castellani, Massimo	5337 D	3.3	5.5	5.5	5.5	6.5	6.5	5.5	5.5	56.43
17	AUS	Banks, Graeme	5335 D	2.9	7.0	6.5	6.0	6.5	6.0	6.5	6.0	54.81
18	JPN	Kaneto, Keita	5335 D	2.9	8.0	7.0	7.5	7.5	7.0	7.5	7.5	64.38
19	FRG	Killat, Albin	5337 D	3.3	8.5	8.0	7.5	8.5	8.0	8.0	8.5	81.18
20	ECU	Suarez, Abraham	205 C	2.8	6.0	5.5	6.0	6.5	6.5	6.5	5.0	51.24
21	FRG	Meyer, Willi	405 B	3.0	6.0	6.5	6.0	6.5	6.5	6.0	6.0	55.80
22	KUW	Altaqi, Majed	5235 D	2.8	5.5	5.0	5.5	5.5	5.5	6.0	5.0	45.36
23	HKG	Wong, Kin Chung	5235 D	2.8								FD
24	AUT	Pils, Erich	5136 D	2.9	6.0	7.5	7.0	7.0	6.5	6.5	7.0	59.16
25	ESP	Gil, Jose Miguel	5335 D	2.9	7.0	6.5	6.5	7.0	6.5	7.0	6.0	58.29
26	MEX	Mondragon, Jorge	205 B	3.0	7.0	7.0	7.0	7.5	7.5	6.5	6.5	64.80
27	CHN	Li, Deliang	407 C	3.4	5.5	4.5	4.0	4.0	4.5	4.0	4.5	43.86
28	FIN	Ovaskainen, Juha	5235 D	2.8	5.5	5.0	5.5	6.5	5.5	6.0	5.5	47.04
29	CHN	Tan, Liangde	407 C	3.4	8.5	7.5	8.0	8.0	7.5	7.5	7.5	78.54
30	URS	Gontcharov, Valeri	5337 D	3.3	8.5	6.5	7.5	7.5	8.0	6.5	7.0	72.27
31	BAR	Honey, Christopher	305 C	2.8	3.5	3.5	4.0	3.5	4.5	3.5	3.0	30.24
32	CAN	Flewelling, Larry	5136 D	2.9	8.0	7.0	8.5	7.5	7.5	8.0	8.0	67.86
33	HOL	Jongejans, Edwin	5335 D	2.9	7.5	7.5	6.5	7.0	7.0	6.5	7.5	61.77
34	URS	Portnov, Alexandre	5152 D	2.8	8.0	7.5	7.5	7.5	8.0	8.0	8.0	65.52
35	CAN	Bedard, David	5136 D	2.9	6.5	7.0	6.5	6.5	6.5	5.5	5.5	54.81

Rank Rang	Ctry Pays	Name Nom	Results/Resultats						Total
			1	2	3	4	5	6	
			7	8	9	10	11		
19	AUT	Pils, Erich	31.20	38.19	44.10	24.00	37.62	62.16	532.92
			55.89	59.64	59.64	61.32	59.16		
20	CAN	Bedard, David	31.20	39.90	43.20	41.61	46.20	65.10	532.62
			63.00	63.00	45.00	39.60	54.81		
21	FRG	Meyer, Willi	32.64	35.10	41.61	33.39	44.10	59.64	511.98
			48.36	61.44	37.80	62.10	55.80		
22	FIN	Ovaskainen, Juha	29.76	38.34	38.19	43.47	44.73	55.80	500.76
			63.00	27.00	62.10	51.33	47.04		
23	AUS	Banks, Graeme	33.12	38.19	43.20	28.14	50.25	38.64	499.41
			51.30	51.30	56.70	53.76	54.81		
24	FRA	Nalliod, Jerome	33.60	38.88	40.47	43.47	40.95	57.96	496.17
			60.90	52.20	40.50	38.64	48.60		
25	ESP	Gil, Jose Miguel	41.04	39.42	36.96	39.06	44.73	52.08	483.12
			44.64	21.60	54.00	51.30	58.29		
26	GBR	Morris, Graham	32.64	35.10	39.90	26.46	43.47	54.60	478.74
			50.40	26.10	48.72	57.51	63.84		
27	POL	Rossa, Tomasz	34.20	34.02	44.40	44.73	47.25	54.90	475.44
			52.92	32.40	37.80	53.76	39.06		
28	AUS	Butler, Russell	32.64	41.58	27.00	30.78	43.47	42.84	470.19
			52.20	28.56	59.13	55.44	56.55		
29	GBR	Morgan, Robert	29.82	38.34	41.61	36.96	57.96	36.12	457.65
			46.98	43.20	33.30	53.46	39.90		
30	ECU	Suarez, Abraham	40.47	30.72	31.35	43.20	42.21	57.51	446.82
			36.96	50.40	41.76	21.00	51.24		
31	KUW	Altaqi, Majed	32.64	34.56	40.32	38.19	39.06	26.04	387.60
			36.90	39.69	33.00	21.84	45.36		
32	KOR	Lee, Sun-Gee	27.84	38.34	38.76	39.69	42.21	22.68	362.58
			40.32	34.44	27.90	26.04	24.36		
33	BAR	Honey, Christopher	27.84	37.17	38.43	25.92	25.65	24.48	347.22
			32.76	45.00	42.93	16.80	30.24		
34	HKG	Tang, Kei Shan	18.45	36.54	23.37	24.60	28.20	22.08	298.08
			39.60	33.21	31.50	13.44	27.09		
35	HKG	Wong, Kin Chung	32.76	28.20	27.00	31.35	24.75	16.20	263.16
			44.64	28.80	26.10	3.36	FD		

**Men Springboard Diving
Preliminary/Sept. 19**

**Hommes/Plongeon du Tremplin
Eliminatoires/19 Sept**

Rank Rang	Ctry Pays	Name Nom	Results/Resultats						Total
			1	2	3	4	5	6	
			7	8	9	10	11		
1	CHN	Tan, Liangde	37.92	45.90	45.03	51.66	52.29	72.90	682.65
			72.00	81.00	75.33	70.08	78.54		
2	FRG	Killat, Albin	39.84	42.12	47.88	50.40	51.66	74.82	642.60
			55.80	64.80	71.10	63.00	81.18		
3	USA	Louganis, Gregory	45.36	47.31	43.20	37.38	69.72	71.10	629.67
			79.98	72.90	6.30	87.12	69.30		
4	CHN	Li, Deliang	36.48	50.40	44.28	46.74	47.88	63.84	607.77
			65.70	77.19	66.60	64.80	43.86		
5	MEX	Mondragon, Jorge	36.48	41.58	42.75	45.99	46.62	65.25	594.36
			62.16	68.40	47.43	72.90	64.80		
6	HOL	Jongejans, Edwin	36.96	42.18	45.03	47.25	46.20	62.16	591.45
			62.10	67.20	69.30	51.30	61.77		
7	USA	Bradshaw, Mark Daniel	35.10	41.61	49.20	46.20	47.25	37.80	588.15
			67.50	37.80	69.75	78.72	77.22		
8	MEX	Mena, Jesus	34.08	39.96	40.47	47.25	47.88	59.52	581.01
			54.00	62.10	63.90	70.47	61.38		
9	AUT	Stajkovic, Niki	36.96	41.04	42.18	39.78	59.25	61.32	579.63
			60.03	48.60	50.40	66.60	73.47		
10	JPN	Kaneto, Keita	35.55	35.10	42.60	49.14	49.77	41.16	577.50
			65.70	58.50	68.40	67.20	64.38		
11	URS	Gontcharov, Valeri	38.40	46.62	47.25	38.76	37.80	62.10	570.63
			54.87	57.60	68.16	46.80	72.27		
12	URS	Portnov, Alexandre	41.58	36.48	45.60	50.40	46.62	61.20	561.81
			39.99	64.80	42.30	67.32	65.52		
13	ITA	Castellani, Massimo	34.56	32.94	41.04	47.25	47.25	63.51	553.74
			66.96	45.90	60.30	57.60	56.43		
14	SWE	Andersson, Joakim	39.42	42.75	40.95	35.04	40.95	60.45	549.99
			51.30	65.25	60.48	58.50	54.90		
15	BEL	Lemaire, Tom	34.08	39.42	43.32	44.73	43.80	60.75	549.09
			54.60	62.16	61.32	41.40	63.51		
16	ITA	Italiani, Piero	34.08	38.88	41.61	43.47	47.25	62.16	542.67
			54.00	47.70	57.60	63.84	52.08		
17	CAN	Flewelling, Larry	30.24	34.56	32.40	39.90	60.90	56.70	541.14
			47.70	38.13	58.50	74.25	67.86		
18	JPN	Yamagishi, Isao	29.82	44.46	47.40	45.99	47.88	42.78	540.72
			52.20	62.10	42.30	58.29	67.50		

**Men Springboard Diving
Final Dive 1/Sept. 20**

**Hommes/Plongeon du Tremplin
Finale Plongeon 1/20 Sept**

Order Ordre	Ctry Pays	Name Nom	Type Saut	Diff Coef	1	2	Judge/Juge					Total
							3	4	5	6	7	
1	URS	Portnov, Alexandre	201 B	1.8	8.0	8.0	8.0	8.0	7.5	7.5	8.0	42.66
2	URS	Gontcharov, Valeri	103 B	1.6	8.0	8.0	8.0	8.0	7.5	7.5	7.5	37.44
3	JPN	Kaneto, Keita	103 C	1.5	7.5	7.5	7.5	6.5	7.0	7.5	6.5	32.40
4	AUT	Stajkovic, Niki	101 A	1.6	9.0	8.5	8.0	7.5	7.5	8.0	8.5	38.88
5	MEX	Mena, Jesus	103 B	1.6	7.0	7.5	7.5	6.5	7.5	7.5	7.5	35.52
6	USA	Bradshaw, Mark Daniel	103 C	1.5	8.0	7.5	7.5	8.0	7.5	7.5	7.0	34.20
7	HOL	Jongejans, Edwin	101 A	1.6	7.5	7.5	7.5	7.5	8.0	8.0	7.0	36.48
8	MEX	Mondragon, Jorge	103 B	1.6	7.5	7.0	8.0	7.0	8.0	7.5	7.5	36.00
9	CHN	Li, Deliang	103 B	1.6	9.0	9.0	8.5	8.5	8.0	8.5	8.0	40.80
10	USA	Louganis, Gregory	201 B	1.8	9.0	9.0	9.0	9.0	9.0	9.0	9.0	48.60

Swimming

Natation

Men Springboard Diving Final Dive 3/Sept. 20			Hommes/Plongeon du Tremplin Finale Plongeon 3/20 Sept									
Order Ordre	Ctry Pays	Name Nom	Type Saut	Diff Coef	1	2	Judge/Juge					Total
							3	4	5	6	7	
1	URS	Portnov, Alexandre	301 B	1.9	8.5	8.0	8.0	8.5	8.0	7.5	7.5	45.60
2	URS	Gontcharov, Valeri	5331 D	2.1	7.5	6.5	8.0	7.0	7.0	8.0	7.0	45.99
3	JPN	Kaneto, Keita	303 C	2.0	7.0	8.0	8.0	8.0	7.5	8.0	7.5	46.80
4	AUT	Stajkovic, Niki	301 B	1.9	8.0	7.5	8.0	7.5	7.5	8.0	8.0	44.46
5	MEX	Mena, Jesus	301 B	1.9	7.0	6.0	7.5	8.0	8.0	7.5	7.5	42.75
6	USA	Bradshaw, Mark Daniel	301 A	2.0	8.5	8.0	8.0	7.5	7.0	8.0	8.0	47.40
7	HOL	Jongeans, Edwin	301 B	1.9	8.0	7.0	7.5	7.5	7.5	8.0	6.5	42.75
8	MEX	Mondragon, Jorge	301 B	1.9	7.5	7.5	8.5	7.0	7.5	8.0	7.5	43.32
9	CHN	Li, Deliang	201 B	1.8	9.0	8.0	8.0	8.5	8.0	8.0	8.5	44.28
10	USA	Louganis, Gregory	101 A	1.6	8.5	9.5	9.0	9.0	8.5	9.0	9.0	42.72
11	FRG	Killat, Albin	301 B	1.9	8.5	8.0	8.5	8.5	8.0	8.0	8.5	47.31
12	CHN	Tan, Liangde	301 B	1.9	8.5	8.5	8.5	8.5	8.5	8.0	7.5	47.88

Men Springboard Diving Final Dive 8/Sept. 20			Hommes/Plongeon du Tremplin Finale Plongeon 8/20 Sept									
Order Ordre	Ctry Pays	Name Nom	Type Saut	Diff Coef	1	2	Judge/Juge					Total
							3	4	5	6	7	
1	URS	Portnov, Alexandre	205 B	3.0	6.5	6.5	6.5	6.0	5.5	6.0	6.5	56.70
2	URS	Gontcharov, Valeri	205 B	3.0	7.0	7.0	7.0	6.5	6.5	7.0	7.0	62.10
3	JPN	Kaneto, Keita	305 B	3.0	7.0	6.0	7.0	6.5	6.5	7.0	7.0	61.20
4	AUT	Stajkovic, Niki	205 B	3.0	6.5	7.0	7.0	6.5	7.0	7.5	7.5	63.00
5	MEX	Mena, Jesus	405 B	3.0	7.5	8.0	7.5	7.5	7.5	7.5	8.0	68.40
6	USA	Bradshaw, Mark Daniel	305 B	3.0	7.5	6.5	7.5	6.5	6.5	7.5	7.0	63.00
7	HOL	Jongeans, Edwin	5152 D	2.8	8.0	8.0	8.0	8.5	8.0	7.5	8.0	67.20
8	MEX	Mondragon, Jorge	405 B	3.0	8.0	8.0	8.0	7.5	8.5	8.0	8.0	72.00
9	CHN	Li, Deliang	107 B	3.1	8.5	8.0	8.0	9.0	7.5	8.0	8.0	75.33
10	USA	Louganis, Gregory	205 B	3.0	8.5	9.0	8.5	8.0	8.5	8.5	9.0	77.40
11	FRG	Killat, Albin	205 B	3.0	7.5	8.5	7.0	8.0	8.0	8.0	7.5	70.20
12	CHN	Tan, Liangde	405 B	3.0	9.0	9.0	8.5	8.0	8.5	8.5	9.0	78.30

Men Springboard Diving Final Dive 4/Sept. 20			Hommes/Plongeon du Tremplin Finale Plongeon 4/20 Sept									
Order Ordre	Ctry Pays	Name Nom	Type Saut	Diff Coef	1	2	Judge/Juge					Total
							3	4	5	6	7	
1	URS	Portnov, Alexandre	403 B	2.1	8.0	7.0	7.5	7.0	7.0	8.0	8.0	47.25
2	URS	Gontcharov, Valeri	301 B	1.9	8.0	7.5	8.0	7.5	7.5	8.0	8.5	44.46
3	JPN	Kaneto, Keita	403 B	2.1	7.0	5.5	6.5	7.0	7.0	7.5	6.5	42.84
4	AUT	Stajkovic, Niki	401 A	1.7	7.5	7.5	8.0	7.0	7.0	7.0	7.5	37.23
5	MEX	Mena, Jesus	403 B	2.1	8.0	7.5	7.5	7.5	7.5	7.5	7.0	47.25
6	USA	Bradshaw, Mark Daniel	5111 A	2.0	8.0	8.0	7.5	8.0	7.0	7.5	7.5	46.20
7	HOL	Jongeans, Edwin	403 B	2.1	7.5	7.5	7.0	7.5	7.0	7.0	8.0	45.99
8	MEX	Mondragon, Jorge	403 B	2.1	8.0	7.5	8.0	7.5	7.5	7.5	8.0	48.51
9	CHN	Li, Deliang	301 B	1.9	8.5	8.5	8.0	8.0	8.0	8.0	8.0	46.17
10	USA	Louganis, Gregory	401 B	1.4	9.0	8.5	8.5	9.0	9.0	9.0	9.5	37.38
11	FRG	Killat, Albin	403 B	2.1	8.5	8.0	8.0	8.0	7.5	8.0	8.0	50.40
12	CHN	Tan, Liangde	5331 D	2.1	9.5	9.0	9.0	9.0	8.0	9.0	9.0	56.70

Men Springboard Diving Final Dive 9/Sept. 20			Hommes/Plongeon du Tremplin Finale Plongeon 9/20 Sept									
Order Ordre	Ctry Pays	Name Nom	Type Saut	Diff Coef	1	2	Judge/Juge					Total
							3	4	5	6	7	
1	URS	Portnov, Alexandre	305 B	3.0	6.5	5.5	6.5	6.5	6.0	6.0	6.5	56.70
2	URS	Gontcharov, Valeri	5154 D	3.2	6.5	4.5	7.0	6.5	5.5	6.5	6.5	60.48
3	JPN	Kaneto, Keita	405 B	3.0	6.0	7.0	7.0	7.0	7.0	6.5	7.0	62.10
4	AUT	Stajkovic, Niki	305 B	3.0	5.5	4.5	5.0	5.5	6.0	5.5	4.5	46.80
5	MEX	Mena, Jesus	305 B	3.0	7.0	6.5	7.0	7.5	7.0	6.5	6.5	61.20
6	USA	Bradshaw, Mark Daniel	107 B	3.1	9.0	7.5	8.0	8.0	7.5	8.5	8.5	75.33
7	HOL	Jongeans, Edwin	307 C	3.5	7.0	6.0	6.5	5.5	6.5	6.5	5.5	65.10
8	MEX	Mondragon, Jorge	107 B	3.1	7.0	6.5	7.5	6.5	7.0	7.0	6.0	63.24
9	CHN	Li, Deliang	205 B	3.0	7.5	7.5	7.5	7.0	7.0	6.5	7.5	65.70
10	USA	Louganis, Gregory	305 B	3.0	8.0	8.5	8.5	8.5	9.0	8.5	8.5	76.50
11	FRG	Killat, Albin	305 B	3.0	8.0	8.0	8.5	9.0	8.0	8.0	8.5	73.80
12	CHN	Tan, Liangde	107 B	3.1	9.0	9.0	8.5	8.5	8.5	8.0	9.0	80.91

Men Springboard Diving Final Dive 5/Sept. 20			Hommes/Plongeon du Tremplin Finale Plongeon 5/20 Sept									
Order Ordre	Ctry Pays	Name Nom	Type Saut	Diff Coef	1	2	Judge/Juge					Total
							3	4	5	6	7	
1	URS	Portnov, Alexandre	5331 D	2.1	8.0	7.5	8.0	7.5	7.0	7.5	7.0	47.25
2	URS	Gontcharov, Valeri	201 B	1.8	7.0	7.0	7.5	7.0	7.5	7.0	7.0	38.34
3	JPN	Kaneto, Keita	5132 D	2.1	8.5	8.0	7.5	7.5	7.5	8.0	8.0	49.14
4	AUT	Stajkovic, Niki	5333 D	2.5	8.5	7.0	8.0	7.5	7.5	7.0	7.5	56.25
5	MEX	Mena, Jesus	5132 D	2.1	7.5	8.0	8.0	7.5	7.5	7.0	8.5	48.51
6	USA	Bradshaw, Mark Daniel	403 B	2.1	8.0	7.5	7.5	7.5	7.5	8.0	7.5	47.88
7	HOL	Jongeans, Edwin	5111 A	2.0	6.5	6.5	6.5	7.0	7.5	7.5	7.5	42.00
8	MEX	Mondragon, Jorge	5132 D	2.1	7.5	7.5	7.0	7.5	7.5	7.0	6.5	45.99
9	CHN	Li, Deliang	403 B	2.1	8.5	7.0	8.0	8.0	8.0	8.0	8.0	50.40
10	USA	Louganis, Gregory	5235 D	2.8	9.0	8.0	8.5	8.5	9.0	9.0	9.0	73.92
11	FRG	Killat, Albin	5132 D	2.1	8.5	8.5	8.5	9.0	8.0	8.0	9.0	53.55
12	CHN	Tan, Liangde	403 B	2.1	9.0	8.5	8.5	8.5	8.5	8.0	8.5	53.55

Men Springboard Diving Final Dive 10/Sept. 20			Hommes Plongeon du Tremplin Finale Plongeon 10/20 Sept									
Order Ordre	Ctry Pays	Name Nom	Type Saut	Diff Coef	1	2	Judge/Juge					Total
							3	4	5	6	7	
1	URS	Portnov, Alexandre	5337 D	3.3	6.5	6.0	6.5	6.0	6.0	5.5	6.0	60.39
2	URS	Gontcharov, Valeri	305 B	3.0	6.5	7.0	6.5	6.5	6.0	5.5	7.0	58.50
3	JPN	Kaneto, Keita	5235 D	2.8	8.0	8.0	8.0	8.0	7.5	7.5	8.5	66.36
4	AUT	Stajkovic, Niki	405 B	3.0	7.0	7.0	7.0	7.5	7.5	7.0	7.0	63.90
5	MEX	Mena, Jesus	5136 D	2.9	7.0	7.0	7.0	6.5	6.5	7.0	5.5	59.16
6	USA	Bradshaw, Mark Daniel	5154 D	3.2	8.0	8.0	8.5	8.5	8.0	8.5	8.0	78.72
7	HOL	Jongeans, Edwin	405 B	3.0	7.5	7.0	6.5	6.0	7.0	7.0	7.0	62.10
8	MEX	Mondragon, Jorge	305 B	3.0	8.0	7.5	8.0	7.0	8.5	7.5	7.0	68.40
9	CHN	Li, Deliang	305 B	3.0	8.5	9.0	9.0	8.5	8.0	8.0	9.0	77.40
10	USA	Louganis, Gregory	5337 D	3.3	7.5	8.5	9.0	9.0	9.0	9.0	9.5	88.11
11	FRG	Killat, Albin	405 B	3.0	8.0	8.0	8.0	7.5	7.5	8.0	7.5	70.20
12	CHN	Tan, Liangde	5154 D	3.2	8.5	8.0	8.5	8.0	7.5	7.5	8.5	77.76

Men Springboard Diving Final Dive 6/Sept. 20			Hommes/Plongeon du Tremplin Finale Plongeon 6/20 Sept									
Order Ordre	Ctry Pays	Name Nom	Type Saut	Diff Coef	1	2	Judge/Juge					Total
							3	4	5	6	7	
1	URS	Portnov, Alexandre	405 B	3.0	7.0	5.5	6.5	6.5	7.5	6.5	7.0	60.30
2	URS	Gontcharov, Valeri	405 B	3.0	6.5	6.5	7.0	6.5	6.5	7.0	7.0	60.30
3	JPN	Kaneto, Keita	107 C	2.8	6.5	5.5	6.0	6.5	6.0	5.0	5.5	49.56
4	AUT	Stajkovic, Niki	5235 D	2.8	6.5	6.5	6.5	7.0	6.5	7.0	7.5	58.80
5	MEX	Mena, Jesus	107 B	3.1	7.5	6.5	7.5	7.5	7.5	7.5	7.5	69.75
6	USA	Bradshaw, Mark Daniel	205 B	3.0	7.5	7.0	7.0	6.5	6.0	7.0	6.5	61.20
7	HOL	Jongeans, Edwin	107 C	2.8	8.0	7.5	8.0	8.0	7.5	8.0	8.0	66.36
8	MEX	Mondragon, Jorge	5335 D	2.9	8.0	7.5	7.5	7.0	7.0	7.5	7.5	64.38
9	CHN	Li, Deliang	5235 D	2.8	7.0	7.5	7.5	8.0	7.5	7.0	8.0	63.00
10	USA	Louganis, Gregory	405 B	3.0	7.5	8.0	8.0	6.5	8.0	8.5	8.0	71.10
11	FRG	Killat, Albin	5136 D	2.9	8.5	8.5	8.5	8.0	7.5	7.5	8.0	70.47
12	CHN	Tan, Liangde	205 B	3.0	8.0	9.0	8.0	8.0	8.5	8.5	8.5	74.70

Men Springboard Diving Final Dive 11/Sept. 20			Hommes/Plongeon du Tremplin Finale Plongeon 11/20 Sept									
Order Ordre	Ctry Pays	Name Nom	Type Saut	Diff Coef	1	2	Judge/Juge					Total
							3	4	5	6	7	
1	URS	Portnov, Alexandre	5152 D	2.8	7.5	6.0	7.5	7.5	7.5	7.0	8.0	62.16
2	URS	Gontcharov, Valeri	5337 D	3.3	5.5	4.5	5.0	5.0	4.5	5.0	4.0	47.52
3	JPN	Kaneto, Keita	5335 D	2.9	6.0	6.5	6.5	6.0	6.5	7.0	5.0	54.81
4	AUT	Stajkovic, Niki	107 B	3.1	7.0	7.0	7.0	7.0	6.5	6.5	6.5	63.24
5	MEX	Mena, Jesus	5337 D	3.3	7.0	7.5	7.0	7.5	6.5	7.5	6.0	70.29
6	USA	Bradshaw, Mark Daniel	5337 D	3.3	8.0	7.5	7.0	6.0	6.5	7.5	7.5	71.28
7	HOL	Jongeans, Edwin</										



**Men Springboard Diving
Final/Sept. 20**

**Hommes/Plongeon du Tremplin
Finale/20 Sept**

Rank Rang	Ctry Pays	Name Nom	Results/Resultats						Total
			1 7	2 8	3 9	4 10	5 11	6	
1	USA	Louganis, Gregory	48.60 84.63	49.59 77.40	42.72 76.50	37.38 88.11	73.92 80.85	71.10 80.85	730.80
2	CHN	Tan, Liangde	39.84 69.30	45.36 78.30	47.88 80.91	56.70 77.76	53.55 80.58	74.70 80.58	704.88
3	CHN	Li, Deliang	40.80 73.80	52.92 75.33	44.28 65.70	46.17 77.40	50.40 75.48	63.00 75.48	665.28
4	FRG	Killat, Albin	39.36 52.08	46.98 70.20	47.31 73.80	50.40 70.20	53.55 87.12	70.47 87.12	661.47
5	USA	Bradshaw, Mark Daniel	34.20 75.60	42.18 63.00	47.40 75.33	46.20 78.72	47.88 71.28	61.20 71.28	642.99
6	MEX	Mondragon, Jorge	36.00 63.84	41.04 72.00	43.32 63.24	48.51 68.40	45.99 69.30	64.38 69.30	616.02
7	MEX	Mena, Jesus	35.52 52.20	43.74 68.40	42.75 61.20	47.25 59.16	48.51 70.29	69.75 70.29	598.77
8	HOL	Jongejans, Edwin	36.48 49.50	45.60 67.20	42.75 65.10	45.99 62.10	42.00 65.25	66.36 65.25	588.33
9	AUT	Stajkovic, Niki	38.88 59.16	38.88 63.00	44.46 46.80	37.23 63.90	56.25 63.24	58.80 63.24	570.60
10	URS	Porthov, Alexandre	42.66 48.36	36.00 56.70	45.60 56.70	47.25 60.39	47.25 62.16	60.30 62.16	563.37
11	JPN	Kaneto, Keita	32.40 55.80	41.04 61.20	46.80 62.10	42.84 66.36	49.14 54.81	49.56 54.81	562.05
12	URS	Gontcharov, Valeri	37.44 51.15	47.88 62.10	45.99 60.48	44.46 58.50	38.34 47.52	60.30 47.52	554.16

**Men Platform Diving
Preliminary Dive 3/Sept. 26**

**Hommes/Plongeon de Haut-vol
Eliminatoires Plongeon 3/26 Sept**

Order Ordre	Rank Rang	Ctry Pays	Name	Type Saut	Diff Coef	Judge / Juge							Total
						1	2	3	4	5	6	7	
1	1	CHN	Xiong, Ni	403 B	2.0	8.5	8.5	9.0	9.0	8.5	8.0	8.5	51.60
2	6	URS	Tchogovadze, Gueorgui	301 B	1.9	8.0	8.0	8.0	7.5	8.0	8.0	7.5	45.03
3	2	USA	Louganis, Gregory	301 B	1.9	9.0	8.5	8.0	8.5	8.5	8.0	9.0	48.45
4	8	CAN	Hirst, Jeffrey	403 B	2.0	7.5	7.5	7.5	7.5	7.0	7.5	7.5	45.00
5	12	ITA	Rinaldi, Domenico	301 B	1.9	7.0	7.5	7.5	7.5	7.5	7.5	7.5	42.75
6	25	USA	Jeffrey, Patrick	103 B	1.6	7.5	7.5	8.0	7.5	7.5	7.5	7.5	36.00
7	14	ITA	Bertone, Oscar	301 B	1.9	7.0	7.5	7.5	7.0	7.5	7.0	7.5	41.61
8	10	JPN	Yamagishi, Isao	301 A	2.0	7.5	7.5	7.5	8.0	7.5	7.0	7.0	44.40
9	24	GBR	Arbon, Jeffrey	301 B	1.9	6.5	6.5	6.5	6.5	6.5	7.0	7.0	37.62
10	17	MEX	Mena, Jesus	301 B	1.9	7.0	7.0	7.5	7.0	7.5	7.0	7.5	41.04
11	23	JPN	Kaneto, Keita	201 B	1.8	6.5	7.5	7.0	7.0	7.5	7.0	6.5	37.80
12	4	URS	Timochinine, Vladimir	301 B	1.9	8.0	8.0	8.0	8.0	8.5	8.0	8.0	45.60
13	20	GBR	Morgan, Robert	301 B	1.9	7.0	7.5	7.0	6.5	7.5	7.0	6.0	39.90
14	6	FRG	Killat, Albin	301 B	1.9	8.0	7.5	7.5	8.0	8.0	8.0	8.5	45.03
15	3	GDR	Hempel, Jan	612 B	1.9	8.0	8.0	7.5	8.0	8.5	8.5	8.0	46.17
16	18	BEL	Lemaire, Tom	301 B	1.9	6.5	7.0	7.0	7.0	7.5	7.0	8.0	40.47
17	26	ESP	Ratia, Emilio	103 B	1.6	6.5	6.5	7.0	6.0	6.5	6.5	6.5	31.20
18	21	CAN	Bedard, David	301 A	2.0	7.0	6.0	7.0	7.0	6.0	6.5	6.5	39.60
19	8	AUS	Rogerson, Craig	403 B	2.0	7.5	7.0	8.0	7.5	7.5	7.5	7.5	45.00
20	19	KOR	Lee, Sun-Gee	5132D	2.1	6.0	6.0	7.0	6.5	6.5	6.5	6.5	40.32
21	22	FRG	Meyer, Willi	301 B	1.9	6.5	6.5	7.0	6.5	7.0	7.0	7.0	38.76
22	14	MEX	Mondragon, Jorge	301 B	1.9	7.5	7.5	7.0	6.0	7.5	7.0	7.5	41.61
23	5	GDR	Haage, Steffen	5132D	2.1	7.0	7.0	7.5	7.0	7.0	7.5	7.5	45.36
24	14	FRA	Pierre, Frederic	612 B	1.9	7.0	7.5	7.5	7.0	7.0	7.5	7.5	41.61
25	21	CHN	Li, Kongzheng	301 B	1.9	8.0	7.5	7.5	7.5	7.5	7.5	7.5	42.75
26	11	AUS	Banks, Graeme	301 A	2.0	7.0	7.0	7.0	7.5	7.0	7.5	7.5	43.20

**Men Platform Diving
Preliminary Dive 1/Sept. 26**

**Hommes/Plongeon de Haut-vol
Eliminatoires Plongeon 1/26 Sept**

Order Ordre	Rank Rang	Ctry Pays	Name	Type Saut	Diff Coef	Judge / Juge							Total
						1	2	3	4	5	6	7	
1	6	CHN	Xiong, Ni	103 B	1.6	8.0	8.5	8.0	8.0	8.5	8.0	8.5	39.36
2	2	URS	Tchogovadze, Gueorgui	403 B	2.0	8.0	8.0	8.0	7.5	7.5	7.5	7.5	46.20
3	4	USA	Louganis, Gregory	113 B	1.8	8.0	8.5	7.5	6.5	7.5	7.5	8.5	42.12
4	18	CAN	Hirst, Jeffrey	103 B	1.6	7.0	7.5	7.5	6.5	7.0	7.5	7.5	35.04
5	12	ITA	Rinaldi, Domenico	103 B	1.6	7.0	8.0	7.5	7.0	7.5	7.5	8.0	36.00
6	1	USA	Jeffrey, Patrick	403 B	2.0	8.0	8.0	7.5	8.0	8.0	7.5	8.0	47.40
7	19	ITA	Bertone, Oscar	103 B	1.6	6.5	7.5	7.5	7.0	7.0	7.0	7.0	34.08
8	12	JPN	Yamagishi, Isao	103 B	1.6	7.5	7.5	7.0	7.5	8.0	7.5	8.0	36.00
9	25	GBR	Arbon, Jeffrey	103 B	1.6	6.0	7.0	7.0	6.0	7.0	6.5	6.5	31.68
10	19	MEX	Mena, Jesus	103 B	1.6	7.0	7.0	6.5	7.0	7.0	7.5	7.5	34.08
11	23	JPN	Kaneto, Keita	103 B	1.6	6.5	7.0	7.5	6.5	8.0	6.5	7.0	33.12
12	9	URS	Timochinine, Vladimir	103 B	1.6	7.5	7.5	8.0	8.0	7.5	8.0	8.0	37.44
13	3	GBR	Morgan, Robert	612 B	1.9	8.0	8.0	7.5	8.0	7.5	7.5	8.0	44.46
14	12	FRG	Killat, Albin	103 B	1.6	7.0	7.0	8.0	7.5	8.0	7.5	7.5	36.00
15	7	GDR	Hempel, Jan	103 B	1.6	8.5	8.0	8.0	8.0	8.0	7.0	8.0	38.40
16	9	BEL	Lemaire, Tom	103 B	1.6	8.0	7.5	7.5	8.0	7.5	8.0	8.0	37.44
17	12	ESP	Ratia, Emilio	403 B	2.0	6.0	6.0	6.5	6.0	6.0	6.0	6.0	36.00
18	23	CAN	Bedard, David	103 B	1.6	6.5	6.5	7.5	7.0	7.0	7.0	7.0	33.12
19	11	AUS	Rogerson, Craig	101 B	1.5	8.0	8.0	8.0	8.5	8.0	8.5	8.5	36.90
20	26	KOR	Lee, Sun-Gee	103 B	1.6	6.0	6.0	6.5	6.5	6.5	6.5	6.5	30.72
21	5	FRG	Meyer, Willi	403 B	2.0	6.5	7.0	7.5	7.0	7.5	7.0	6.5	42.00
22	8	MEX	Mondragon, Jorge	113 B	1.8	6.5	7.0	7.0	7.0	7.0	7.5	7.0	37.80
23	12	GDR	Haage, Steffen	103 B	1.6	7.0	7.5	7.5	7.5	7.5	7.5	7.5	36.00
24	22	FRA	Pierre, Frederic	103 B	1.6	6.0	7.0	7.0	7.0	7.0	7.5	7.0	33.60
25	12	CHN	Li, Kongzheng	103 B	1.6	7.5	7.0	7.5	7.5	8.0	7.5	7.5	36.00
26	19	AUS	Banks, Graeme	103 B	1.6	7.0	7.0	7.5	7.0	6.5	7.0	7.5	34.08

**Men Platform Diving
Preliminary Dive 4/Sept. 26**

**Hommes/Plongeon de Haut-vol
Eliminatoires Plongeon 4/26 Sept**

Order Ordre	Rank Rang	Ctry Pays	Name	Type Saut	Diff Coef	Judge / Juge							Total
						1	2	3	4	5	6	7	
1	1	CHN	Xiong, Ni	5132D	2.1	8.5	7.5	8.5	8.0	8.5	8.0	8.0	51.66
2	17	URS	Tchogovadze, Gueorgui	632 C	2.1	6.5	7.0	7.0	7.0	7.0	7.0	6.5	43.47
3	5	USA	Louganis, Gregory	403 B	2.0	8.0	8.5	8.0	7.5	8.0	7.5	8.0	47.40
4	22	CAN	Hirst, Jeffrey	301 B	1.9	7.5	7.0	7.5	7.0	7.0	7.0	7.0	41.04
5	11	ITA	Rinaldi, Domenico	5132D	2.1	7.0	7.0	7.0	7.0	7.0	7.0	7.0	44.10
6	19	USA	Jeffrey, Patrick	612 B	1.9	7.5	7.5	7.5	7.0	8.0	7.5	7.5	42.75
7	11	ITA	Bertone, Oscar	5132D	2.1	7.0	7.5	7.0	7.0	7.0	6.5	7.0	44.10
8	15	JPN	Yamagishi, Isao	403 B	2.0	7.0	7.5	7.5	6.5	7.5	7.5	7.0	43.80
9	23	GBR	Arbon, Jeffrey	5132D	2.1	6.5	6.5	7.0	6.0	6.5	6.5	6.5	40.95
10	11	MEX	Mena, Jesus	5132D	2.1	7.0	7.0	7.0	7.0	7.0	7.0	7.0	44.10
11	10	JPN	Kaneto, Keita	403 B	2.0	7.0	8.0	7.5	7.5	7.5	7.5	6.5	44.40
12	4	URS	Timochinine, Vladimir	632 C	2.1	7.0	7.5	7.5	7.5	8.0	8.0	7.5	47.88
13	7	GBR	Morgan, Robert	5132D	2.1	7.0	7.5	7.5	7.0	7.5	7.5	7.5	46.62
14	11	FRG	Killat, Albin	5132D	2.1	7.0	7.0	7.0	7.0	7.0	7.0	6.5	44.10
15	6	GDR	Hempel, Jan	5131D	2.1	8.0	7.5	7.5	8.0	7.0	7.0	7.5	47.25
16	7	BEL	Lemaire, Tom	632 C	2.1	7.5	7.5	7.0	7.5	7.0	7.5	7.5	46.62
17	25	ESP	Ratia, Emilio	5132D	2.1	6.0	6.0	7.0	5.5	6.5	6.5	6.0	39.6

Swimming

Natation

Men Platform Diving Preliminary Dive 5/Sept. 26				Hommes/Plongeon de Haut-vol Eliminatoires Plongeon 5/26 Sept									
Order Ordre	Rank Rang	Ctry Pays	Name	Type Saut	Diff Coef	1	2	Judge / Juge					Total
								3	4	5	6	7	
1	3	CHN	Xiong, Ni	107 B	3.0	8.5	7.5	7.5	7.5	8.0	8.0	7.5	69.30
2	1	URS	Tchogovadze, Gueorgui	5237D	3.2	8.0	8.0	8.0	7.5	7.5	8.0	7.5	74.88
3	7	USA	Louganis, Gregory	634 C	2.6	8.0	8.0	8.0	7.5	7.5	7.0	8.0	60.84
4	20	CAN	Hirst, Jeffrey	614 B	2.4	6.5	7.0	6.5	6.0	6.0	6.0	6.5	45.36
5	4	ITA	Rinaldi, Domenico	5237D	3.2	7.0	7.0	7.0	6.5	7.0	7.0	6.0	66.24
6	9	USA	Jeffrey, Patrick	634 C	2.6	8.0	7.5	7.5	7.5	7.5	7.5	7.5	58.50
7	17	ITA	Bertone, Oscar	407 C	3.2	5.5	4.5	6.0	5.0	5.5	5.0	5.0	49.92
8	14	JPN	Yamagishi, Isao	614 B	2.4	7.5	6.5	7.5	7.5	7.5	7.0	7.0	51.84
9	22	GBR	Arbon, Jeffrey	634 C	2.6	6.0	5.0	5.5	5.0	6.0	5.5	6.0	43.68
10	10	MEX	Mena, Jesus	634 C	2.6	6.5	7.5	7.0	7.5	7.0	7.5	7.5	56.94
11	24	JPN	Kaneto, Keita	107 B	3.0	4.5	4.5	5.5	4.5	5.5	5.0	4.5	43.20
12	5	URS	Timochinine, Vladimir	634 C	2.6	7.0	8.0	7.5	8.5	8.0	8.5	8.0	62.40
13	12	GBR	Morgan, Robert	634 C	2.6	7.0	7.5	7.0	7.0	6.5	6.5	7.0	53.82
14	14	FRG	Killat, Albin	614 B	2.4	7.5	7.0	7.5	7.5	8.0	6.5	6.5	51.84
15	2	GDR	Hempel, Jan	107 B	3.0	8.5	7.5	8.0	7.5	8.0	8.0	8.0	71.10
16	19	BEL	Lemaire, Tom	407 C	3.2	4.0	5.5	5.0	4.5	5.0	5.0	4.5	46.08
17	22	ESP	Ratia, Emilio	634 C	2.6	5.5	5.5	6.5	5.5	5.0	6.0	5.5	43.68
18	21	CAN	Bedard, David	107 B	3.0	5.0	5.0	5.0	4.5	5.0	5.5	5.0	45.00
19	25	AUS	Rogerson, Craig	634 C	2.6	5.5	5.0	5.5	5.5	6.0	5.0	5.5	42.12
20	11	KOR	Lee, Sun-Gee	634 C	2.6	7.0	7.0	7.5	7.5	6.5	6.0	7.0	54.60
21	13	FRG	Meyer, Willi	107 B	3.0	5.0	5.5	6.0	6.0	6.5	6.5	5.5	53.10
22	6	MEX	Mondragon, Jorge	5335D	2.9	7.0	7.0	7.0	7.0	7.0	7.0	7.0	60.90
23	16	GDR	Haage, Steffen	107 B	3.0	6.0	5.0	6.5	5.5	6.0	5.5	5.5	51.30
24	18	FRA	Pierre, Frederic	614 B	2.4	6.5	6.5	6.5	6.5	7.0	7.0	6.5	47.52
25	8	CHN	Li, Kongzheng	634 C	2.6	7.5	8.0	8.0	7.5	8.0	7.5	7.5	60.06
26	26	AUS	Banks, Graeme	634 C	2.6	4.0	4.0	4.0	4.0	4.0	4.5	4.0	31.20

Men Platform Diving Preliminary Dive 7/Sept. 26				Hommes/Plongeon de Haut-vol Eliminatoires Plongeon 7/26 Sept									
Order Ordre	Rank Rang	Ctry Pays	Name	Type Saut	Diff Coef	1	2	Judge / Juge					Total
								3	4	5	6	7	
1	3	CHN	Xiong, Ni	5237D	3.2	8.0	8.0	8.0	7.5	8.5	8.0	7.5	75.84
2	15	URS	Tchogovadze, Gueorgui	307 C	3.4	6.0	5.0	5.5	4.5	6.0	5.5	4.5	54.06
3	6	USA	Louganis, Gregory	407 C	3.2	7.5	7.0	7.0	7.0	7.5	6.5	7.5	69.12
4	25	CAN	Hirst, Jeffrey	207 C	3.3	4.5	3.0	4.0	3.0	3.0	3.0	3.5	32.67
5	18	ITA	Rinaldi, Domenico	634 C	2.6	6.5	6.0	6.0	5.5	6.0	6.5	6.5	48.36
6	4	USA	Jeffrey, Patrick	207 C	3.3	7.5	7.5	7.0	7.0	7.5	7.5	7.5	73.26
7	17	ITA	Bertone, Oscar	305 C	2.7	6.0	5.0	7.0	6.0	6.0	6.5	5.5	48.60
8	14	JPN	Yamagishi, Isao	5235D	2.8	6.0	7.5	7.0	6.0	7.0	6.5	7.0	56.28
9	22	GBR	Arbon, Jeffrey	207 C	3.3	3.5	3.5	5.0	4.0	5.0	4.0	3.0	39.60
10	7	MEX	Mena, Jesus	107 B	3.0	7.0	7.0	7.5	7.0	7.5	7.5	7.5	65.70
11	9	JPN	Kaneto, Keita	5237D	3.2	6.0	6.5	6.5	6.5	7.0	6.5	6.5	62.40
12	1	URS	Timochinine, Vladimir	307 C	3.4	8.0	8.0	8.0	8.0	8.0	8.5	8.0	81.60
13	12	GBR	Morgan, Robert	207 C	3.3	6.0	6.5	6.0	6.5	6.5	6.0	6.0	61.38
14	11	FRG	Killat, Albin	305 B	2.9	7.0	7.0	7.5	7.0	7.0	7.0	7.5	61.77
15	13	GDR	Hempel, Jan	616 C	2.8	7.5	7.0	7.5	7.0	7.0	7.0	7.0	59.64
16	23	BEL	Lemaire, Tom	107 C	2.7	3.5	4.5	4.0	4.5	4.5	4.5	4.5	35.64
17	21	ESP	Ratia, Emilio	407 C	3.2	4.0	5.0	4.5	4.0	4.0	4.5	4.0	40.32
18	5	CAN	Bedard, David	307 C	3.4	7.0	6.0	7.5	7.0	6.5	7.5	7.0	71.40
19	24	AUS	Rogerson, Craig	207 C	3.3	3.5	3.5	2.5	3.5	3.5	3.5	3.5	34.65
20	16	KOR	Lee, Sun-Gee	205 B	2.9	4.5	6.5	5.0	5.5	5.5	6.5	5.5	48.72
21	26	FRG	Meyer, Willi	207 C	3.3	3.5	3.0	3.5	2.0	3.0	2.0	2.5	27.72
22	10	MEX	Mondragon, Jorge	107 B	3.0	7.0	7.0	7.0	6.5	7.0	7.0	6.5	62.10
23	8	GDR	Haage, Steffen	207 C	3.3	6.5	6.0	6.5	7.0	6.0	6.5	6.5	63.36
24	19	FRA	Pierre, Frederic	107 B	3.0	5.0	5.0	6.0	5.0	5.0	5.5	4.5	45.90
25	2	CHN	Li, Kongzheng	207 C	3.3	7.5	8.0	8.5	8.5	8.0	7.5	8.0	79.20
26	20	AUS	Banks, Graeme	205 B	2.9	5.0	5.0	5.0	5.5	5.0	5.0	4.5	43.50

Men Platform Diving Preliminary Dive 6/Sept. 26				Hommes/Plongeon de Haut-vol Eliminatoires Plongeon 6/26 Sept									
Order Ordre	Rank Rang	Ctry Pays	Name	Type Saut	Diff Coef	1	2	Judge / Juge					Total
								3	4	5	6	7	
1	25	CHN	Xiong, Ni	634 C	2.6	4.5	5.0	5.0	4.5	4.5	4.0	4.5	35.88
2	4	URS	Tchogovadze, Gueorgui	207 C	3.3	7.0	7.0	7.0	7.0	7.0	7.5	7.0	69.30
3	1	USA	Louganis, Gregory	5337D	3.3	8.0	8.0	7.5	8.0	8.0	8.0	8.0	79.20
4	23	CAN	Hirst, Jeffrey	305 C	2.7	5.0	4.5	4.5	4.0	4.5	4.0	5.0	36.45
5	20	ITA	Rinaldi, Domenico	107 B	3.0	4.0	4.5	5.0	4.5	5.0	5.0	4.5	42.30
6	4	USA	Jeffrey, Patrick	107 B	3.0	7.5	7.0	8.0	8.0	7.5	7.5	8.0	69.30
7	22	ITA	Bertone, Oscar	614 B	2.4	5.5	5.0	5.5	5.5	5.0	5.5	6.0	38.88
8	9	JPN	Yamagishi, Isao	305 B	2.9	6.5	6.0	7.0	7.5	7.5	7.0	7.5	61.77
9	14	GBR	Arbon, Jeffrey	107 B	3.0	6.0	6.0	6.0	6.5	6.5	6.0	6.5	55.80
10	11	MEX	Mena, Jesus	207 C	3.3	6.0	5.5	6.0	5.5	6.5	6.0	6.5	59.40
11	15	JPN	Kaneto, Keita	634 C	2.6	6.5	7.0	7.5	7.0	7.0	6.5	7.5	54.60
12	8	URS	Timochinine, Vladimir	207 C	3.3	6.0	6.5	5.5	7.0	6.5	6.5	6.0	62.37
13	7	GBR	Morgan, Robert	107 B	3.0	6.5	7.0	7.5	7.5	7.0	7.5	7.0	64.80
14	16	FRG	Killat, Albin	107 B	3.0	3.5	5.0	5.0	5.5	5.5	5.5	5.5	47.70
15	2	GDR	Hempel, Jan	407 C	3.2	8.0	7.5	8.0	8.5	7.0	7.5	7.5	73.92
16	19	BEL	Lemaire, Tom	634 C	2.6	6.5	5.0	6.0	5.0	5.5	5.5	6.0	43.68
17	17	ESP	Ratia, Emilio	305 C	2.7	5.5	5.5	6.0	6.0	5.5	5.0	5.0	44.55
18	3	CAN	Bedard, David	207 C	3.3	7.0	6.0	7.5	7.0	7.0	7.5	7.0	70.29
19	23	AUS	Rogerson, Craig	305 C	2.7	4.5	4.0	5.0	4.0	4.5	4.5	4.5	36.45
20	26	KOR	Lee, Sun-Gee	405 B	2.8	5.0	4.0	4.0	3.5	4.5	4.5	3.5	34.44
21	18	FRG	Meyer, Willi	614 B	2.4	6.5	5.5	6.5	6.0	6.0	6.0	6.0	43.92
22	12	MEX	Mondragon, Jorge	634 C	2.6	7.5	7.5	7.5	8.0	7.0	7.5	8.0	59.28
23	13	GDR	Haage, Steffen	634 C	2.6	7.5	7.0	7.0	7.5	7.5	7.5	7.5	57.72
24	21	FRA	Pierre, Frederic	205 C	2.7	4.5	4.5	5.0	5.0	5.5	5.5	5.0	40.50
25	6	CHN	Li, Kongzheng	107 B	3.0	7.0	7.5	8.0	7.5	8.0	7.5	7.0	67.50
26	10	AUS	Banks, Graeme	305 C	2.7	7.5	7.5	7.5	8.0	7.5	7.5	8.0	61.56

Men Platform Diving Preliminary Dive 8/Sept. 26				Hommes/Plongeon de Haut-vol Eliminatoires Plongeon 8/26 Sept									
Order Ordre	Rank Rang	Ctry Pays	Name	Type Saut	Diff Coef	1	2	Judge / Juge					Total
								3	4	5	6	7	
1	1	CHN	Xiong, Ni	305 B	2.9	8.5	8.5	9.0	9.0	8.5	8.0	8.5	74.82
2	20	URS	Tchogovadze, Gueorgui	107 B	3.0	4.0	5.0	5.0	5.0	6.5	6.5	5.5	48.60
3	4	USA	Louganis, Gregory	107 B	3.0	7.5	7.5	7.5	6.5	8.0	7.0	7.5	66.60
4	9	CAN	Hirst, Jeffrey	107 B	3.0	6.0	6.5	6.5	6.5	7.0	6.5	6.5	58.50
5	12	ITA	Rinaldi, Domenico	405 B	2.8	7.0	6.5	7.0	7.0	6.5	6.5	6.5	56.28
6	16	USA	Jeffrey, Patrick	307 C	3.4	5.5	4.0	5.0	5.0	5.0	5.0	5.5	52.02
7	14	ITA	Bertone, Oscar	5237D	3.2	6.5	6.0	6.5	5.5	5.5	5.0	5.5	55.68
8	9	JPN	Yamagishi, Isao	107 B	3.0	6.5	6.0	6.0	6.5	7.0	6.5	7.0	58.50
9	18	GBR	Arbon, Jeffrey	305 C	2.7	6.5	5.0	6.0	6.0	6.0	6.0	6.5	49.41
10	22	MEX	Mena, Jesus	307 C	3.4	4.0	4.0	4.5	4.5	4.5	5.0	4.5	44.88
11	24	JPN	Kaneto, Keita	207 C	3.3	3.5	3.5	3.5	3.0	3.0	4.0	4.5	34.65
12	3	URS	Timochinine, Vladimir	107 B	3.0	7.0	7.5	7.5	7.5	7.5	8.5	7.5	67.50
13	19	GBR	Morgan, Robert	307 C	3.4	4.0	4.5	6.0	4.5	5.0	5.0	5.0	48.96
14	8	FRG	Killat, Albin	205 B	2.9	7.0	7.5	7.5	7.5	8.5	7.0	7.0	63.51
15	15	GDR	Hempel, Jan	305 B	2.9	6.5	6.5	6.5	6.5	5.5	6.0	6.0	54.81
16	26	BEL	Lemaire, Tom	205 B	2.9	2.5	2.0	2.0	2.0	2.0	2.5	2.5	19.14
17	7	ESP	Ratia, Emilio	107 B	3.0	7.0	7.0	7.0	7.0	7			



**Men Platform Diving
Preliminary Dive 9/Sept. 26**

**Hommes/Plongeon de Haut-vol
Eliminatoires Plongeon 9/26 Sept**

Order Ordre	Rank Rang	Ctry Pays	Name	Type Saut	Diff Coef	1	2	Judge / Juge					Total
						3	4	5	6	7			
1	1	CHN	Xiong, Ni	207 C	3.3	9.0	8.0	8.5	8.5	8.0	7.5	8.5	82.17
2	16	URS	Tchogovadze, Gueorgui	634 C	2.6	7.0	7.5	7.0	7.5	6.5	7.5	7.0	56.16
3	2	USA	Louganis, Gregory	207 C	3.3	8.0	8.5	8.0	8.0	8.5	8.0	8.5	81.18
4	21	CAN	Hirst, Jeffrey	407 C	3.2	6.5	5.0	6.0	4.5	5.5	5.5	5.5	52.80
5	11	ITA	Rinaldi, Domenico	305 C	2.7	7.0	8.0	7.5	8.0	7.0	7.5	7.5	60.75
6	5	USA	Jeffrey, Patrick	5237D	3.2	7.5	7.0	7.5	6.5	7.5	7.5	7.5	71.04
7	10	ITA	Bertone, Oscar	207 C	3.3	6.5	6.5	6.5	4.5	6.0	6.5	6.0	62.37
8	8	JPN	Yamagishi, Isao	205 B	2.9	7.0	7.0	7.5	7.5	7.0	7.5	6.5	62.64
9	9	GBR	Arbon, Jeffrey	407 C	3.2	6.5	6.5	6.5	6.5	6.5	6.5	6.0	62.40
10	6	MEX	Mena, Jesus	407 C	3.2	7.0	7.0	7.5	7.0	6.0	7.0	6.5	66.24
11	7	JPN	Kaneto, Keita	405 B	2.8	7.5	7.5	8.5	8.0	7.5	7.5	8.0	64.68
12	24	URS	Timochinine, Vladimir	407 C	3.2	4.5	5.0	5.5	5.0	5.0	6.0	6.0	50.88
13	14	GBR	Morgan, Robert	407 C	3.2	5.5	6.5	6.5	5.5	7.0	6.0	6.0	58.56
14	13	FRG	Killat, Albin	405 B	2.8	7.0	7.0	6.5	7.5	7.0	7.0	7.5	59.64
15	25	GDR	Hempel, Jan	207 C	3.3	5.0	4.5	5.0	5.0	5.0	5.5	5.0	49.50
16	17	BEL	Lemaire, Tom	305 C	2.7	6.5	6.5	7.0	7.0	7.0	7.0	7.5	55.89
17	26	ESP	Ratia, Emilio	5152D	2.7	5.5	6.0	6.0	6.0	5.5	6.5	6.5	48.60
18	23	CAN	Bedard, David	634 C	2.6	7.5	6.5	7.0	6.5	6.5	6.5	6.5	51.48
19	12	AUS	Rogerson, Craig	407 C	3.2	6.5	6.0	6.5	7.0	6.5	6.0	6.0	60.48
20	19	KOR	Lee, Sun-Gee	107 B	3.0	5.5	6.0	6.0	6.0	6.0	6.5	6.0	54.00
21	22	FRG	Meyer, Willi	305 C	2.7	7.0	6.5	6.5	6.5	6.0	6.0	6.5	51.84
22	3	MEX	Mondragon, Jorge	207 C	3.3	7.5	8.5	8.0	7.5	8.0	8.0	8.0	78.21
23	15	GDR	Haage, Steffen	307 C	3.4	5.0	5.5	6.0	5.5	6.0	5.0	6.0	57.12
24	20	FRA	Pierre, Frederic	407 C	3.2	5.5	5.0	6.5	6.0	5.5	6.0	5.0	53.76
25	4	CHN	Li, Kongzheng	407 C	3.2	8.0	8.5	7.5	7.5	8.0	8.0	8.0	75.84
26	18	AUS	Banks, Graeme	405 B	2.8	6.5	6.5	7.0	7.0	6.5	6.5	6.5	55.44

Rank Rang	Ctry Pays	Name Nom	Results / Resultats					Total	
			1	2	3	4	5		
			6	7	8	9	10		
9	CAN	Bedard, David	33.12	38.19	39.60	41.58	45.00		
			70.29	71.40	65.28	51.48	68.16	524.10	
10	MEX	Mena, Jesus	34.08	46.80	41.04	44.10	56.94		
			59.40	65.70	44.88	66.24	64.32	523.50	
11	MEX	Mondragon, Jorge	37.80	37.80	41.61	43.80	60.90		
			59.28	62.10	47.04	78.21	49.98	518.52	
12	JPN	Yamagishi, Isao	36.00	37.05	44.40	43.80	51.84		
			61.77	56.28	58.50	62.64	65.52	517.80	
13	FRG	Killat, Albin	36.00	45.00	45.03	44.10	51.84		
			47.70	61.77	63.51	59.64	62.64	517.23	
14	JPN	Kaneto, Keita	33.12	49.77	37.80	44.40	43.20		
			54.60	62.40	34.65	64.68	72.42	497.04	
15	GBR	Morgan, Robert	44.46	36.21	39.90	46.62	53.82		
			64.80	61.38	48.96	58.56	34.56	489.27	
16	ITA	Rinaldi, Domenico	36.00	42.60	42.75	44.10	66.24		
			42.30	48.36	56.28	60.75	36.63	476.01	
17	ITA	Bertone, Oscar	34.08	42.00	41.61	44.10	49.92		
			38.88	48.60	55.68	62.37	54.00	471.24	
18	AUS	Rogerson, Craig	36.90	40.80	45.00	51.03	42.12		
			36.45	34.65	55.80	60.48	66.24	469.47	
19	AUS	Banks, Graeme	34.08	41.61	43.20	45.00	31.20		
			61.56	43.50	51.84	55.44	55.44	462.87	
20	CAN	Hirst, Jeffrey	35.04	44.73	45.00	41.04	45.36		
			36.45	32.67	58.50	52.80	62.40	453.99	
21	GBR	Arbon, Jeffrey	31.68	42.00	37.62	40.95	43.68		
			55.80	39.60	49.41	62.40	47.04	450.18	
22	FRG	Meyer, Willi	42.00	37.05	38.76	35.64	53.10		
			43.92	27.72	57.60	51.84	61.44	449.07	
23	FRA	Pierre, Frederic	33.60	42.00	41.61	43.47	47.52		
			40.50	45.90	39.69	53.76	48.96	437.01	
24	BEL	Lemaire, Tom	37.44	44.40	40.47	46.62	46.08		
			43.68	35.64	19.14	55.89	64.32	433.68	
25	ESP	Ratia, Emilio	36.00	29.07	31.20	39.69	43.68		
			44.55	40.32	63.90	48.60	48.72	425.73	
26	KOR	Lee, Sun-Gee	30.72	42.00	40.32	42.18	54.60		
			34.44	48.72	25.11	54.00	48.36	420.45	

**Men Platform Diving
Preliminary Dive 10/Sept. 26**

**Hommes/Plongeon de Haut-vol
Eliminatoires Plongeon 10/26 Sept**

Order Ordre	Rank Rang	Ctry Pays	Name	Type Saut	Diff Coef	1	2	Judge / Juge					Total
						3	4	5	6	7			
1	2	CHN	Xiong, Ni	407 C	3.2	8.5	8.0	8.0	7.5	8.0	7.5	8.0	75.84
2	8	URS	Tchogovadze, Gueorgui	407 C	3.2	7.0	7.5	7.0	6.5	7.0	7.0	6.5	66.24
3	1	USA	Louganis, Gregory	307 C	3.4	8.0	8.0	7.5	7.0	8.0	7.5	8.0	79.56
4	14	CAN	Hirst, Jeffrey	5237D	3.2	6.5	6.5	7.0	6.5	6.5	6.5	6.5	62.40
5	25	ITA	Rinaldi, Domenico	207 C	3.3	3.0	3.0	4.5	3.5	4.0	4.5	3.5	36.63
6	16	USA	Jeffrey, Patrick	407 C	3.2	7.0	6.0	5.5	6.5	6.0	5.0	7.0	59.52
7	18	ITA	Bertone, Oscar	107 B	3.0	5.5	5.0	6.0	6.0	6.0	6.5	6.5	54.00
8	10	JPN	Yamagishi, Isao	405 B	2.8	8.0	7.5	8.0	8.0	7.5	7.5	8.0	65.52
9	24	GBR	Arbon, Jeffrey	5235D	2.8	5.0	6.0	6.0	5.5	5.5	5.5	5.5	47.04
10	11	MEX	Mena, Jesus	5237D	3.2	6.0	6.5	7.0	6.5	7.0	7.0	6.5	64.32
11	3	JPN	Kaneto, Keita	307 C	3.4	7.0	7.0	7.5	7.0	7.0	7.0	7.5	72.42
12	5	URS	Timochinine, Vladimir	5237D	3.2	7.5	7.0	7.0	7.5	7.5	8.0	7.0	70.08
13	26	GBR	Morgan, Robert	5237D	3.2	3.5	4.5	3.0	4.0	3.0	4.0	3.5	34.56
14	13	FRG	Killat, Albin	5136D	2.9	7.0	7.0	7.0	7.0	8.0	7.5	7.5	62.64
15	4	GDR	Hempel, Jan	5237D	3.2	7.0	6.0	7.5	7.0	7.0	7.5	8.0	71.04
16	11	BEL	Lemaire, Tom	5237D	3.2	6.5	6.5	6.5	6.0	7.0	7.5	7.0	64.32
17	22	ESP	Ratia, Emilio	205 B	2.9	4.5	5.5	6.0	5.5	5.0	6.0	6.0	48.72
18	6	CAN	Bedard, David	5237D	3.2	7.5	6.5	7.5	7.0	7.0	7.0	7.0	68.16
19	8	AUS	Rogerson, Craig	5237D	3.2	7.0	7.0	7.5	6.0	6.5	6.5	7.5	66.24
20	23	KOR	Lee, Sun-Gee	5154D	3.1	5.0	5.5	6.0	5.0	5.5	4.5	4.5	48.36
21	15	FRG	Meyer, Willi	5237D	3.2	6.5	6.5	6.5	6.0	6.0	6.5	7.0	61.44
22	20	MEX	Mondragon, Jorge	307 C	3.4	4.5	5.0	5.0	5.0	5.0	5.5	4.5	49.98
23	7	GDR	Haage, Steffen	5237D	3.2	7.0	7.5	7.5	7.0	6.5	6.5	7.0	67.20
24	21	FRA	Pierre, Frederic	5237D	3.2	5.0	5.0	4.5	5.5	5.0	5.0	5.5	48.96
25	19	CHN	Li, Kongzheng	5337D	3.3	5.0	5.5	5.5	5.5	6.0	5.0	5.5	53.46
26	17	AUS	Banks, Graeme	5235D	2.8	6.5	6.5	6.5	7.0	6.5	6.0	7.0	55.44

**Men Platform Diving
Final Dive 1/Sept. 27**

**Hommes/Plongeon de Haut-vol
Finale Plongeon 1/27 Sept**

Order Ordre	Rank Rang	Ctry Pays	Name	Type Saut	Diff Coef	1	2	Judge / Juge					Total
						3	4	5	6	7			
1	11	JPN	Yamagishi, Isao	103 B	1.6	8.0	7.0	7.5	7.5	7.0	7.0	7.0	35.04
2	5	MEX	Mondragon, Jorge	103 B	1.6	7.5	7.5	6.5	7.0	7.0	7.5	7.5	39.42
3	9	MEX	Mena, Jesus	103 B	1.6	7.5	7.5	7.5	7.5	8.0	7.5	7.5	36.00
4	12	CAN	Bedard, David	103 B	1.6	7.5	7.0	7.5	7.0	7.0	7.0	7.5	34.56
5	7	GDR	Haage, Steffen	103 B	1.6	8.0	8.0	8.0	8.0	7.0	7.5	7.5	37.44
6	1	URS	Tchogovadze, Gueorgui	403 B	2.0	8.0	8.0	8.5	8.0	8.0	8.5	8.0	48.60
7	2	USA	Jeffrey, Patrick	403 B	2.0	7.5	7.5	8.0	7.0	7.5	7.5	7.5	45.00
8	4	GDR	Hempel, Jan	103 B	1.6	8.0	8.5	9.0	8.5	8.5	8.5	8.5	40.80
9	9	URS	Timochinine, Vladimir	103 B	1.6	7.5	8.0	7.5	7.5	7.5	7.5	7.5	36.00
10	6	CHN	Li, Kongzheng	103 B	1.6	8.0	7.5	8.0	7.0	8.0	8.0	8.0	37.92
11	7	CHN	Xiong, Ni	103 B	1.6	7.0	8.0	8.0	7.5	7.0	8.5	8.5	37.44
12	3	USA	Louganis, Gregory	103 B	1.8	8.5	8.0	9.0	7.5	8.0	8.5	8.5	44.82

**Men Platform Diving
Preliminary/Sept. 26**

**Hommes/Plongeon de Haut-vol
Eliminatoires/26 Sept**

Rank Rang	Ctry Pays	Name	Results / Resultats					Total	
			1	2	3	4	5		
			6	7	8	9	10		
1	USA	Louganis, Gregory	42.12	43.20	48.45	47.40	60.84		
			79.20	69.12	66.60	81.18	79.56	617.67	
2	CHN	Xiong, Ni	39.36	45.03	51.60	51.66	69.30		
			35.88	75.84	74.82				

Swimming

Natation

Men Platform Diving Final Dive 3/Sept. 27				Hommes/Plongeon de Haut-vol Finale Plongeon 3/27 Sept									
Order Ordre	Rank Rang	Ctry Pays	Name	Type Saut	Diff Coef	1	2	Judge / Juge					Total
								3	4	5	6	7	
1	11	JPN	Yamagishi, Isao	301 A	2.0	7.0	7.0	7.0	6.5	6.0	7.0	7.0	41.40
2	8	MEX	Mondragon, Jorge	301 B	1.9	8.0	7.5	7.0	8.0	7.0	7.5	8.0	43.32
3	8	MEX	Mena, Jesus	301 B	1.9	8.0	7.5	7.5	7.5	7.0	7.5	8.0	43.32
4	10	CAN	Bedard, David	301 A	2.0	7.0	7.0	7.5	7.0	7.0	7.0	7.5	42.60
5	6	GDR	Haage, Steffen	5132D	2.1	7.0	7.5	8.0	7.0	7.0	7.5	7.5	45.99
6	7	URS	Tchogovadze, Gueorgui	301 B	1.9	8.0	7.5	8.0	7.5	8.0	8.0	8.0	45.03
7	12	USA	Jeffrey, Patrick	103 B	1.6	7.5	7.5	7.0	7.5	7.0	7.0	7.5	35.04
8	4	GDR	Hempel, Jan	612 B	1.9	8.0	8.5	8.5	8.0	7.5	8.5	8.0	46.74
9	2	URS	Timochinine, Vladimir	301 B	1.9	9.0	8.5	8.5	8.5	8.5	8.5	7.5	48.45
10	4	CHN	Li, Kongzheng	301 B	1.9	8.5	8.5	8.0	7.5	8.0	8.0	8.5	46.74
11	1	CHN	Xiong, Ni	403 B	2.0	7.5	8.0	9.0	9.0	9.0	8.5	8.0	51.00
12	2	USA	Louganis, Gregory	301 B	1.9	9.0	8.5	8.5	8.5	8.0	8.5	8.5	48.45

Men Platform Diving Final Dive 8/Sept. 27				Hommes/Plongeon de Haut-vol Finale Plongeon 8/27 Sept									
Order Ordre	Rank Rang	Ctry Pays	Name	Type Saut	Diff Coef	1	2	Judge / Juge					Total
								3	4	5	6	7	
1	12	JPN	Yamagishi, Isao	107 B	3.0	5.5	4.5	5.0	5.0	5.5	5.5	5.5	47.70
2	7	MEX	Mondragon, Jorge	407 C	3.2	6.0	6.5	6.0	5.5	6.5	6.5	6.5	60.48
3	1	MEX	Mena, Jesus	307 C	3.4	7.5	7.5	7.0	7.5	7.5	7.5	8.0	76.50
4	4	CAN	Bedard, David	407 C	3.2	6.5	6.5	7.0	7.0	6.0	6.5	6.5	63.36
5	4	GDR	Haage, Steffen	407 C	3.2	6.5	7.0	6.5	7.0	6.5	6.5	6.5	63.36
6	10	URS	Tchogovadze, Gueorgui	107 B	3.0	6.5	5.5	6.0	6.0	6.0	5.5	6.0	53.10
7	8	USA	Jeffrey, Patrick	307 C	3.4	6.0	5.5	5.5	5.5	5.5	6.0	5.5	57.12
8	11	GDR	Hempel, Jan	305 B	2.9	5.5	6.0	6.0	5.5	5.5	6.0	5.5	49.59
9	3	URS	Timochinine, Vladimir	107 B	3.0	6.5	7.5	8.0	7.0	8.0	6.5	7.5	65.70
10	9	CHN	Li, Kongzheng	307 C	3.4	4.0	6.0	5.0	4.5	5.0	6.0	6.0	54.06
11	2	CHN	Xiong, Ni	305 B	2.9	9.0	8.5	7.5	8.0	8.5	8.5	8.5	73.08
12	6	USA	Louganis, Gregory	107 B	3.0	8.5	7.5	6.5	7.0	7.5	6.5	6.5	63.00

Men Platform Diving Final Dive 4/Sept. 27				Hommes/Plongeon de Haut-vol Finale Plongeon 4/27 Sept									
Order Ordre	Rank Rang	Ctry Pays	Name	Type Saut	Diff Coef	1	2	Judge / Juge					Total
								3	4	5	6	7	
1	7	JPN	Yamagishi, Isao	403 B	2.0	7.5	7.5	7.0	7.5	7.5	7.5	7.5	45.00
2	9	MEX	Mondragon, Jorge	403 B	2.0	8.0	7.5	7.5	7.0	7.0	7.5	7.5	44.40
3	3	MEX	Mena, Jesus	5132D	2.1	8.0	7.5	8.0	8.0	7.5	8.0	8.0	49.77
4	11	CAN	Bedard, David	5231D	2.1	6.0	7.0	7.5	6.5	7.0	7.0	6.5	42.84
5	8	GDR	Haage, Steffen	301 B	1.9	8.0	8.0	7.5	7.5	7.5	8.0	8.0	44.46
6	1	URS	Tchogovadze, Gueorgui	632 C	2.1	8.5	.5	8.5	8.0	8.0	8.0	8.0	51.03
7	12	USA	Jeffrey, Patrick	612 B	1.9	7.5	7.0	6.0	7.0	6.5	7.0	7.5	39.90
8	5	GDR	Hempel, Jan	5231D	2.1	7.5	8.0	7.5	7.5	7.0	7.5	7.5	47.25
9	10	URS	Timochinine, Vladimir	632 C	2.1	7.0	7.0	6.5	6.5	7.0	7.0	7.5	43.47
10	1	CHN	Li, Kongzheng	5132D	2.1	8.0	8.0	8.5	7.5	7.5	8.5	8.5	51.03
11	6	CHN	Xiong, Ni	5132D	2.1	6.5	7.0	7.0	7.0	8.0	8.0	7.5	45.99
12	4	USA	Louganis, Gregory	403 B	2.0	9.0	8.5	8.0	8.0	8.0	8.5	8.0	49.20

Men Platform Diving Final Dive 9/Sept. 27				Hommes/Plongeon de Haut-vol Finale Plongeon 9/27 Sept									
Order Ordre	Rank Rang	Ctry Pays	Name	Type Saut	Diff Coef	1	2	Judge / Juge					Total
								3	4	5	6	7	
1	7	JPN	Yamagishi, Isao	205 B	2.9	8.0	8.0	7.0	8.0	7.0	7.5	7.5	66.12
2	9	MEX	Mondragon, Jorge	207 C	3.3	7.5	6.5	5.0	6.0	6.5	7.0	7.0	65.34
3	5	MEX	Mena, Jesus	407 C	3.2	7.5	7.0	7.5	7.5	7.0	7.5	7.5	71.04
4	11	CAN	Bedard, David	634 C	2.6	6.5	6.5	7.0	6.5	7.0	6.5	6.5	51.48
5	6	GDR	Haage, Steffen	307 C	3.4	5.5	7.0	6.0	7.0	7.5	7.5	7.0	70.38
6	8	URS	Tchogovadze, Gueorgui	634 C	2.6	8.5	8.5	8.5	8.5	8.5	8.0	8.0	65.52
7	10	USA	Jeffrey, Patrick	5237D	3.2	5.0	5.5	5.0	5.5	5.5	5.5	6.0	51.84
8	3	GDR	Hempel, Jan	207 C	3.3	8.5	8.0	7.5	7.5	7.0	7.5	8.0	76.23
9	12	URS	Timochinine, Vladimir	407 C	3.2	5.0	4.5	4.0	4.5	5.5	4.5	5.0	45.12
10	4	CHN	Li, Kongzheng	407 C	3.2	7.5	8.0	8.0	7.5	7.5	7.5	7.5	72.96
11	1	CHN	Xiong, Ni	207 C	3.3	8.5	8.5	7.5	9.0	8.5	8.5	8.5	84.15
12	2	USA	Louganis, Gregory	207 C	3.3	8.0	8.5	8.0	8.5	8.5	8.5	8.5	83.16

Men Platform Diving Final Dive 5/Sept. 27				Hommes/Plongeon de Haut-vol Finale Plongeon 5/27 Sept									
Order Ordre	Rank Rang	Ctry Pays	Name	Type Saut	Diff Coef	1	2	Judge / Juge					Total
								3	4	5	6	7	
1	11	JPN	Yamagishi, Isao	614 B	2.4	7.0	7.5	7.5	7.0	7.0	7.0	6.5	51.12
2	8	MEX	Mondragon, Jorge	5335D	2.9	6.5	7.0	6.5	6.5	6.0	6.5	6.5	56.55
3	4	MEX	Mena, Jesus	634 C	2.6	7.5	7.5	8.0	8.5	8.0	8.0	8.0	61.62
4	5	CAN	Bedard, David	107 B	3.0	6.0	6.5	7.0	7.0	6.5	7.0	6.5	60.30
5	10	GDR	Haage, Steffen	107 B	3.0	6.5	5.5	6.0	6.0	6.0	5.0	5.0	51.30
6	1	URS	Tchogovadze, Gueorgui	5237D	3.2	8.0	8.0	8.0	8.0	7.5	8.0	8.0	76.80
7	9	USA	Jeffrey, Patrick	634 C	2.6	6.5	6.5	6.5	7.0	7.0	6.5	6.5	51.48
8	3	GDR	Hempel, Jan	107 B	3.0	8.0	8.0	8.5	8.0	8.0	8.5	8.5	73.80
9	6	URS	Timochinine, Vladimir	634 C	2.6	8.0	7.0	8.0	8.0	8.5	7.0	7.5	60.06
10	12	CHN	Li, Kongzheng	634 C	2.6	4.0	4.5	3.0	3.5	4.5	4.0	4.5	31.98
11	2	CHN	Xiong, Ni	107 B	3.0	8.5	8.5	9.0	9.0	8.5	8.0	8.0	76.50
12	7	USA	Louganis, Gregory	634 C	2.6	7.5	7.5	8.5	7.5	7.5	7.5	7.5	58.50

Men Platform Diving Final Dive 10/Sept. 27				Hommes Plongeon de Haut-vol Finale Plongeon 10/27 Sept									
Order Ordre	Rank Rang	Ctry Pays	Name	Type Saut	Diff Coef	1	2	Judge / Juge					Total
								3	4	5	6	7	
1	9	JPN	Yamagishi, Isao	405 B	2.8	6.0	6.0	7.0	7.0	6.5	7.0	6.5	55.44
2	12	MEX	Mondragon, Jorge	307 C	3.4	3.0	4.0	3.5	4.0	4.0	4.5	4.5	40.80
3	3	MEX	Mena, Jesus	5237D	3.2	8.0	7.5	7.5	7.5	8.0	7.5	8.0	73.92
4	7	CAN	Bedard, David	5237D	3.2	7.0	6.0	6.0	7.0	6.5	6.0	6.5	61.44
5	8	GDR	Haage, Steffen	5237D	3.2	6.0	6.5	6.0	5.5	6.5	6.0	6.0	58.56
6	4	URS	Tchogovadze, Gueorgui	407 C	3.2	7.0	7.5	7.5	7.5	8.0	7.5	7.0	71.04
7	10	USA	Jeffrey, Patrick	407 C	3.2	5.5	5.5	4.5	6.0	6.0	5.5	5.5	53.76
8	6	GDR	Hempel, Jan	5237D	3.2	6.5	7.5	6.0	6.5	7.0	6.5	6.5	63.36
9	5	URS	Timochinine, Vladimir	5237D	3.2	7.0	7.5	7.0	7.0	7.0	7.0	7.0	67.20
10	11	CHN	Li, Kongzheng	5337D	3.3	5.0	6.0	5.5	5.0	4.5	6.5	5.5	53.46
11	2	CHN	Xiong, Ni	407 C	3.2	8.5	8.5	9.0	9.0	7.0	8.5	8.5	82.56
12	1	USA	Louganis, Gregory	307 C	3.4	8.5	8.5	8.5	8.5	8.0	8.5	9.0	86.70

Men Platform Diving Final Dive 6/Sept. 27				Hommes/Plongeon de Haut-vol Finale Plongeon 6/27 Sept									
Order Ordre	Rank Rang	Ctry Pays	Name	Type Saut	Diff Coef	1	2	Judge / Juge					Total
								3	4	5	6	7	
1	7	JPN	Yamagishi, Isao	305 B	2.9	7.5	7.0	7.5	7.0	7.0	7.0	7.5	62.64
2	8	MEX	Mondragon, Jorge	634 C	2.6	8.0	7.5	7.5	8.0	7.5	8.0	7.5	60.06
3	2	MEX	Mena, Jesus	207 C	3.3	8.5	7.5	7.5	7.5	7.5	8.0	8.5	77.22
4	12	CAN	Bedard, David	207 C	3.3	4.0	4.0	4.0	3.5	5.0	5.0	5.0	43.56
5	11	GDR	Haage, Steffen	634 C	2.6	7.5	6.5	7.0	6.5	6.5	7.5	7.0	53.82
6	4	URS	Tchogovadze, Gueorgui	207 C	3.3	7.5	7.0	7.0	7.5	7.5	7.5	.5	73.26
7	10	USA	Jeffrey, Patrick	107 B	3.0	5.0	6.0	6.0	7.0	6.5	6.5	7.0	57.60
8	1	GDR	Hempel, Jan	407 C	3.2	8.0	8.5	8.5	7.0	7.5	8.5	8.0	77.76
9	9	URS	Timochinine, Vladimir	207 C	3.3	6.5	6.0	5.5	6.0	6.0	5.0	6.5	59.40
10	5	CHN	Li, Kongzheng	107 B	3.0	8.0	8.0	8.0	.5	8.0	8.0	8.0	72.00
11	6	CHN	Xiong, Ni	634 C	2.6	8.5	8.0	8.5	8.5	7.5	8.0	8.0	63.96
12	3	USA	Louganis, Gregory	5337D	3.3	7.5	8.0	7.5	6.5	8.0	7.5	7.5	75.24

Men Platform Diving Final/Sept. 27				Hommes/Plongeon de Haut-vol Finale/27 Sept										
Rank Rang	Ctry Pays	Name Nom		1	2	Results /Resultats					Total			
				6	7	3	4	5	6	7	8	9	10	
1	USA	Louganis, Gregory		44.82	46.98	48.45	49.20	58.50	</					



**Women Springboard Diving
Preliminary Dive 1/Sept. 24**

**Femmes/Plongeon du Tremplin
Eliminatoires Plongeon 1/24 Sept**

Order Ordre	Ctry Pays	Name Nom	Type Saut	Diff Coef	1	2	Judge/Juge					Total
							3	4	5	6	7	
1	URS	Babkova, Marina	103 B	1.6	7.5	7.0	8.0	7.5	6.5	7.0	6.0	34.08
2	KOR	Kim, Eun-Hee	101 B	1.5	6.5	5.0	6.5	7.0	6.5	6.0	6.0	28.35
3	GBR	Roscoe, Carolyn	101 C	1.4	7.0	7.0	7.0	7.5	7.5	6.5	6.5	29.40
4	BAH	Roberts, Lori	101 A	1.6	5.5	5.0	5.5	6.0	6.0	4.5	5.0	25.92
5	FRG	Muehlbauer, Anke	103 B	1.6	7.0	6.5	6.5	6.0	6.5	6.5	6.0	30.72
6	FRG	Heinrichs, Elke	101 B	1.5	7.5	7.5	7.0	7.0	7.0	6.0	7.0	31.95
7	CHN	Gao, Min	103 B	1.6	7.5	8.0	8.5	8.5	8.5	8.0	8.0	39.36
8	HOL	Jongehans, Daphne	101 A	1.6	7.5	7.5	7.0	7.5	8.0	7.5	8.5	36.48
9	ARG	Ribot, Veronica G	101 A	1.6	7.0	6.5	7.0	7.0	7.5	7.5	7.5	34.56
10	HUN	Gerlach, Agnes	103 B	1.6	7.5	6.5	6.5	6.5	6.5	7.5	7.0	32.64
11	NOR	Gamme, Kamilla	103 B	1.6								NP
12	AUS	Donnet, Jennifer	101 B	1.5	7.0	7.0	7.0	6.5	7.0	7.0	8.0	31.50
13	ZIM	Cox, Tracy Linda	5231 D	2.0	6.5	6.5	6.5	7.0	6.5	6.5	6.5	39.00
14	SUI	Buerki, Beatrice	201 B	1.8	6.5	6.0	5.5	6.0	6.0	5.5	5.5	31.32
15	USA	Lucero, Wendy	101 B	1.5	8.0	7.5	7.5	8.0	7.5	8.0	8.0	34.65
16	CHN	Li, Qing	201 B	1.8	7.0	7.5	7.0	8.5	7.5	7.5	7.5	39.96
17	CAN	Fuller, Debbie	403 B	2.1	6.5	7.0	6.5	6.5	7.0	6.5	6.0	41.58
18	JPN	Motobuchi, Yuki	103 B	1.6	7.0	6.5	7.0	7.0	7.0	7.0	6.0	33.12
19	URS	Lachko, Irina	201 B	1.8	8.0	8.0	7.5	7.5	7.5	8.0	8.0	42.12
20	GDR	Baldus, Brita	103 B	1.6	7.0	7.0	6.5	7.0	6.5	6.5	6.0	32.16
21	CAN	Bush, Barbara	401 A	1.7	6.0	7.0	6.0	6.5	7.0	6.0	5.0	32.13
22	HUN	Haasz, Katalin	103 B	1.6	7.0	6.5	6.0	6.0	6.5	6.5	6.0	30.24
23	BRA	Ribeiro, Angela	201 B	1.8	5.5	5.5	6.0	6.0	6.5	6.5	6.0	32.40
24	MEX	Alcala, Maria	103 B	1.6	6.5	6.0	6.5	6.5	5.5	6.5	6.0	30.24
25	GBR	Bishop, Naomi	103 B	1.6	6.0	6.0	6.0	6.0	6.0	6.0	6.5	28.80
26	JPN	Asada, Masako	103 B	1.6	6.5	6.5	6.5	7.0	7.0	7.5	6.5	32.16
27	USA	McCormick, Kelly Anne	101 A	1.6	6.0	6.5	7.0	8.0	6.5	7.0	7.0	32.64
28	SWE	Rossing, Anita	101 A	1.6	7.0	7.0	7.5	7.0	7.5	6.5	7.5	34.56

**Women Springboard Diving
Preliminary Dive 3/Sept. 24**

**Femmes/Plongeon du Tremplin
Eliminatoires Plongeon 3/24 Sept**

Order Ordre	Ctry Pays	Name Nom	Type Saut	Diff Coef	1	2	Judge/Juge					Total
							3	4	5	6	7	
1	URS	Babkova, Marina	301 B	1.9	7.0	7.5	7.5	7.5	7.0	7.5	7.5	42.18
2	KOR	Kim, Eun-Hee	301 A	2.0	6.0	6.0	5.5	6.0	6.5	5.5	6.0	35.40
3	GBR	Roscoe, Carolyn	5132D	2.1	6.5	6.0	6.5	6.5	6.5	6.0	6.0	39.69
4	BAH	Roberts, Lori	301 B	1.9	5.0	3.5	5.0	6.0	6.0	5.0	5.0	29.64
5	FRG	Muehlbauer, Anke	301 A	2.0	6.5	6.0	5.5	6.0	5.5	6.5	6.0	36.00
6	FRG	Heinrichs, Elke	301 B	1.9	6.0	6.0	6.0	6.0	7.0	6.0	5.5	34.20
7	CHN	Gao, Min	301 B	1.9	8.0	8.0	8.0	8.0	8.0	7.5	8.0	45.60
8	HOL	Jongehans, Daphne	301 B	1.9	7.0	6.5	7.5	7.5	7.0	7.5	7.0	41.04
9	ARG	Ribot, Veronica G	301 B	1.9	7.5	7.5	8.0	8.0	7.5	7.5	7.5	43.32
10	HUN	Gerlach, Agnes	301 B	1.9	7.0	6.5	6.5	6.0	7.0	6.5	7.0	38.19
11	NOR	Gamme, Kamilla	301 A	2.0								NP
12	AUS	Donnet, Jennifer	301 A	2.0	6.0	6.0	6.0	6.5	7.0	7.0	7.5	39.00
13	ZIM	Cox, Tracy Linda	201 A	1.9	6.5	6.5	6.0	6.5	7.0	6.5	7.0	37.62
14	SUI	Buerki, Beatrice	301 B	1.9	6.5	6.0	6.0	6.5	6.5	6.0	6.5	35.91
15	USA	Lucero, Wendy	301 A	2.0	6.5	5.5	6.5	6.5	7.0	7.0	7.5	40.20
16	CHN	Li, Qing	103 B	1.6	7.5	7.5	9.0	8.0	8.0	7.5	8.0	37.44
17	CAN	Fuller, Debbie	201 B	1.8	7.0	7.5	7.5	7.0	7.0	7.0	7.0	38.34
18	JPN	Motobuchi, Yuki	301 B	1.9	6.5	6.5	6.0	7.0	6.5	6.0	5.5	35.91
19	URS	Lachko, Irina	403 B	2.1	7.0	7.0	7.5	7.5	7.0	7.0	7.5	45.36
20	GDR	Baldus, Brita	301 B	1.9	7.0	6.5	7.0	7.5	7.5	6.5	6.0	39.33
21	CAN	Bush, Barbara	5233D	2.4	5.5	5.5	6.0	6.0	6.5	7.0	6.0	43.20
22	HUN	Haasz, Katalin	301 B	1.9	7.0	6.5	6.0	6.0	6.5	6.0	6.0	35.34
23	BRA	Ribeiro, Angela	103 B	1.6	5.5	6.0	5.5	6.0	5.5	6.0	6.0	27.84
24	MEX	Alcala, Maria	201 B	1.8	5.5	5.5	5.5	6.0	5.5	5.5	5.0	29.70
25	GBR	Bishop, Naomi	301 A	2.0	6.0	5.5	4.5	5.0	6.0	5.5	6.0	33.60
26	JPN	Asada, Masako	301 B	1.9	6.0	5.5	5.0	5.5	6.0	6.0	6.5	33.06
27	USA	McCormick, Kelly Anne	301 B	1.9	7.5	7.5	8.0	8.0	7.5	7.5	7.5	43.32
28	SWE	Rossing, Anita	301 B	1.9	6.5	6.0	6.5	6.0	7.0	5.5	5.0	34.77

**Women Springboard Diving
Preliminary Dive 2/Sept. 24**

**Femmes/Plongeon du Tremplin
Eliminatoires Plongeon 2/24 Sept**

Order Ordre	Ctry Pays	Name Nom	Type Saut	Diff Coef	1	2	Judge/Juge					Total
							3	4	5	6	7	
1	URS	Babkova, Marina	201 B	1.8	6.5	7.0	7.5	7.0	7.0	6.5	7.0	37.26
2	KOR	Kim, Eun-Hee	201 A	1.9	6.5	6.5	6.5	6.5	6.0	7.0	6.0	36.48
3	GBR	Roscoe, Carolyn	301 A	2.0	7.0	6.5	6.5	6.5	6.5	6.0	6.5	39.00
4	BAH	Roberts, Lori	5111 A	2.0	4.0	4.0	3.5	4.0	4.0	3.5	3.0	22.80
5	FRG	Muehlbauer, Anke	201 B	1.8	7.0	6.0	7.0	7.0	6.5	7.0	6.0	36.18
6	FRG	Heinrichs, Elke	201 B	1.8	6.0	6.0	6.0	6.0	6.0	6.0	6.5	32.40
7	CHN	Gao, Min	201 B	1.8	6.5	6.5	7.5	7.5	8.5	8.5	8.5	41.58
8	HOL	Jongehans, Daphne	201 B	1.8	7.0	7.0	7.0	7.5	7.0	7.0	8.0	38.34
9	ARG	Ribot, Veronica G	5111 A	2.0	5.5	6.0	6.0	7.0	7.0	7.0	5.5	37.80
10	HUN	Gerlach, Agnes	201 B	1.8	6.5	7.0	7.0	7.0	7.0	7.0	8.0	37.80
11	NOR	Gamme, Kamilla	201 A	1.9								NP
12	AUS	Donnet, Jennifer	201 A	1.9	5.5	6.5	5.5	5.5	6.0	5.5	6.5	33.06
13	ZIM	Cox, Tracy Linda	101 B	1.5	6.0	6.5	6.5	6.5	6.5	6.5	7.0	29.25
14	SUI	Buerki, Beatrice	103 B	1.6	7.0	6.5	7.0	6.5	6.0	6.5	6.5	31.68
15	USA	Lucero, Wendy	201 A	1.9	7.0	7.0	7.0	6.5	6.5	7.0	6.0	38.76
16	CHN	Li, Qing	301 B	1.9	7.5	7.0	6.5	7.0	7.5	7.5	7.5	41.61
17	CAN	Fuller, Debbie	101 A	1.6	6.5	7.0	7.5	7.0	7.0	7.0	6.5	33.12
18	JPN	Motobuchi, Yuki	201 B	1.8	6.0	7.0	6.0	7.0	6.5	6.0	6.0	34.02
19	URS	Lachko, Irina	301 B	1.9	8.5	8.5	8.5	7.5	8.5	8.5	8.5	48.45
20	GDR	Baldus, Brita	201 B	1.8	7.0	7.0	6.5	6.5	7.5	7.0	6.5	36.72
21	CAN	Bush, Barbara	201 B	1.8	7.0	7.5	7.0	6.5	7.0	7.0	8.0	38.34
22	HUN	Haasz, Katalin	201 B	1.8	7.0	7.0	7.0	7.0	7.0	6.5	7.0	37.80
23	BRA	Ribeiro, Angela	301 B	1.9	6.5	6.5	7.5	6.5	7.0	6.5	7.0	38.19
24	MEX	Alcala, Maria	301 B	1.9	6.5	6.5	5.5	5.5	7.0	6.0	6.5	35.34
25	GBR	Bishop, Naomi	201 A	1.9	5.0	5.0	5.0	5.0	5.5	4.5	5.0	28.50
26	JPN	Asada, Masako	201 B	1.8	7.5	7.5	7.5	7.5	7.5	8.0	7.5	40.50
27	USA	McCormick, Kelly Anne	201 B	1.8	7.0	7.5	7.5	7.5	6.5	7.0	7.0	38.88
28	SWE	Rossing, Anita	201 B	1.8	7.0	6.0	6.5	7.0	7.0	6.5	7.0	36.72

**Women Springboard Diving
Preliminary Dive 4/Sept. 24**

**Femmes/Plongeon du Tremplin
Eliminatoires Plongeon 4/24 Sept**

Order Ordre	Ctry Pays	Name Nom	Type Saut	Diff Coef	1	2	Judge/Juge					Total
							3	4	5	6	7	
1	URS	Babkova, Marina	403 B	2.1	7.5	7.5	7.5	7.0	7.0	7.5	7.5	46.62
2	KOR	Kim, Eun-Hee	403 B	2.1	6.5	6.0	6.5	7.0	6.5	6.0	6.5	40.32
3	GBR	Roscoe, Carolyn	403 B	2.1	6.0	6.5	6.0	6.0	6.5	5.5	6.0	38.43
4	BAH	Roberts, Lori	201 B	1.8	5.5	5.5	6.0	6.0	6.0	6.0	6.0	31.86
5	FRG	Muehlbauer, Anke	403 B	2.1	5.0	6.0	4.5	5.0	5.0	5.0	4.0	30.87
6	FRG	Heinrichs, Elke	403 B	2.1	6.5	6.5	6.0	6.0	6.5	6.5	6.5	40.32
7	CHN	Gao, Min	403 B	2.1	7.5	7.5	7.5	7.5	8.0	8.0	8.5	48.51
8	HOL	Jongehans, Daphne	401 A	1.7	6.0	7.0	7.0	7.0	7.5	7.0	8.0	36.21
9	ARG	Ribot, Veronica G	201 B	1.8	7.0	7.0	7.5	8.0	7.0	7.5	7.5	39.42
10	HUN	Gerlach, Agnes	403 B	2.1	7.0	7.0	6.5	7.0	7.0	6.5	6.0	42.84
11	NOR	Gamme, Kamilla	401 A	1.7								NP
12	AUS	Donnet, Jennifer	403 B	2.1	6.5	6.0	6.5	6.0	6.5	6.0	7.0	39.69
13	ZIM	Cox, Tracy Linda	301 A	2.0	7.0	7.0	7.0	6.5	7.0	6.5	6.5	40.80
14	SUI	Buerki, Beatrice	403 B	2.1	6.5	6.5	6.0	6.5	6.5	5.5	5.5	39.06
15	USA	Lucero, Wendy	5111 A	2.0	6.0	7.0	6.5	6.5	6.5	6.5	6.5	39.00
16	CHN	Li, Qing	5132 D	2.1	7.0	7.5	8.0	7.5	7.5	7.0	7.5	46.62

Swimming

Natation

Women Springboard Diving Preliminary Dive 5/Sept. 24				Femmes/Plongeon du Tremplin Eliminatoires Plongeon 5/24 Sept								
Order Ordre	Ctry Pays	Name Nom	Type Saut	Diff Coef	1	2	Judge/Juge		5	6	7	Total
1	URS	Babkova, Marina	5132 D	2.1	7.5	6.5	7.5	7.5	7.0	7.0	7.0	45.36
2	KOR	Kim, Eun-Hee	5111 A	2.0	5.5	5.0	4.5	4.5	6.0	5.0	5.0	30.00
3	GBR	Roscoe, Carolyn	201 A	1.9	6.5	6.0	5.5	5.5	6.5	6.5	7.0	35.34
4	BAH	Roberts, Lori	403 B	2.1	5.0	4.5	5.0	4.5	5.0	4.5	5.0	30.24
5	FRG	Muehlbauer, Anke	5311 A	2.0	6.0	6.0	6.0	4.5	6.0	5.5	6.0	35.40
6	FRG	Heinrichs, Elke	5132 D	2.1	6.5	6.0	6.5	6.5	6.5	6.0	5.5	39.69
7	CHN	Gao, Min	5132 D	2.1	8.0	8.0	8.0	8.5	7.5	7.0	8.0	49.77
8	HOL	Jongehans, Daphne	5134 D	2.5	6.5	6.0	6.5	7.0	6.0	5.5	6.0	46.50
9	ARG	Ribot, Veronica G	403 B	2.1	6.0	6.5	7.0	7.0	7.0	6.5	6.0	41.58
10	HUN	Gerlach, Agnes	5211 A	2.0	6.5	6.0	6.0	6.5	7.0	6.5	6.5	38.40
11	NOR	Gamme, Kamilla	5132 D	2.1								NP
12	AUS	Donnet, Jennifer	5111 A	2.0	5.5	6.0	5.0	6.0	6.5	6.0	7.0	36.00
13	ZIM	Cox, Tracy Linda	403 B	2.1	6.5	6.5	6.0	6.0	6.0	6.5	6.5	39.69
14	SUI	Buerki, Beatrice	5132 D	2.1	6.0	6.0	5.5	5.5	5.5	6.5	5.5	35.91
15	USA	Lucero, Wendy	403 B	2.1	7.0	7.0	7.0	7.0	7.5	7.0	8.0	44.73
16	CHN	Li, Qing	403 B	2.1	8.0	7.5	7.5	7.5	7.5	7.5	8.0	47.88
17	CAN	Fuller, Debbie	5132 D	2.1	7.0	7.5	7.0	7.0	7.0	7.0	6.0	44.10
18	JPN	Motobuchi, Yuki	5132 D	2.1	7.0	7.5	7.5	7.0	6.5	7.0	6.5	44.10
19	URS	Lachko, Irina	5132 D	2.1	7.0	7.0	8.0	7.5	7.0	7.0	7.5	45.36
20	GDR	Baldus, Brita	5132 D	2.1	6.5	6.0	6.5	6.5	6.5	6.5	6.0	40.32
21	CAN	Bush, Barbara	301 B	1.9	7.0	7.5	7.5	7.5	7.0	7.0	7.5	41.61
22	HUN	Haasz, Katalin	5132 D	2.1	7.0	6.5	6.5	6.0	6.5	6.0	6.0	39.69
23	BRA	Ribeiro, Angela	5132 D	2.1	6.0	5.5	6.5	6.5	6.0	5.5	6.0	37.80
24	MEX	Alcala, Maria	403 B	2.1	6.5	6.0	6.0	6.5	6.5	6.0	6.5	39.69
25	GBR	Bishop, Naomi	5132 D	2.1	6.0	5.5	6.5	6.0	6.0	6.0	6.0	37.80
26	JPN	Asada, Masako	5132 D	2.1	7.0	6.5	6.0	7.0	7.0	7.0	5.5	42.21
27	USA	Mc Cormick, Kelly Anne	5132 D	2.1	6.5	6.0	7.0	7.0	7.0	7.0	8.0	43.47
28	SWE	Rossing, Anita	5132 D	2.1	6.5	6.5	6.5	6.5	6.5	7.0	7.5	41.58

Women Springboard Diving Preliminary Dive 7/Sept. 24				Femmes/Plongeon du Tremplin Eliminatoires Plongeon 7/24 Sept								
Order Ordre	Ctry Pays	Name Nom	Type Saut	Diff Coef	1	2	Judge/Juge		5	6	7	Total
1	URS	Babkova, Marina	205 C	2.8	5.5	6.0	5.5	5.5	5.5	6.0	7.0	47.88
2	KOR	Kim, Eun-Hee	203 A	2.4	4.5	5.0	6.0	6.0	5.5	4.5	5.5	38.16
3	GBR	Roscoe, Carolyn	205 C	2.8	4.5	4.5	4.0	4.5	4.0	5.0	4.5	36.96
4	BAH	Roberts, Lori	105 B	2.4	5.5	5.0	4.5	5.5	4.5	4.5	4.0	34.56
5	FRG	Muehlbauer, Anke	205 C	2.8	6.0	6.0	5.0	6.0	5.5	6.0	5.5	48.72
6	FRG	Heinrichs, Elke	205 C	2.8	5.5	5.0	5.5	6.0	6.0	5.5	5.5	47.04
7	CHN	Gao, Min	205 C	2.8	8.0	7.5	8.0	7.5	7.0	7.5	7.5	63.84
8	HOL	Jongehans, Daphne	305 C	2.8	5.5	5.5	4.5	5.0	6.0	5.0	5.5	44.52
9	ARG	Ribot, Veronica G	5134 D	2.5	5.5	5.5	5.5	5.5	6.0	5.0	5.0	40.50
10	HUN	Gerlach, Agnes	405 C	2.7	5.5	4.5	4.5	5.5	5.0	5.0	5.5	41.31
11	NOR	Gamme, Kamilla	203 B	2.2								NP
12	AUS	Donnet, Jennifer	205 C	2.8	5.5	5.0	5.5	5.0	5.5	5.5	5.5	45.36
13	ZIM	Cox, Tracy Linda	305 C	2.8	6.0	5.0	6.0	6.0	6.0	6.5	6.0	50.40
14	SUI	Buerki, Beatrice	105 B	2.4	6.5	6.5	6.5	6.0	6.5	5.5	6.5	46.08
15	USA	Lucero, Wendy	205 C	2.8	6.5	6.0	7.0	6.5	7.0	7.5	7.5	57.96
16	CHN	Li, Qing	105 B	2.4	6.0	7.0	7.5	7.5	7.5	8.0	8.5	54.00
17	CAN	Fuller, Debbie	205 C	2.8	5.5	6.0	6.0	5.5	6.0	6.0	6.0	49.56
18	JPN	Motobuchi, Yuki	305 C	2.8	6.5	6.5	6.5	6.5	6.5	7.0	7.0	55.44
19	URS	Lachko, Irina	5152 D	2.8	5.5	6.0	5.5	6.0	6.0	6.5	5.5	48.72
20	GDR	Baldus, Brita	107 C	2.8	6.0	6.5	7.5	6.5	7.0	7.0	6.0	55.44
21	CAN	Bush, Barbara	305 C	2.8	5.0	5.0	3.5	4.5	5.0	4.5	4.5	39.48
22	HUN	Haasz, Katalin	405 C	2.7	5.0	5.0	5.0	5.5	5.5	5.0	4.5	41.31
23	BRA	Ribeiro, Angela	205 C	2.8	6.5	6.5	6.0	6.5	6.5	6.0	7.0	53.76
24	MEX	Alcala, Maria	205 C	2.8	4.0	4.0	4.0	4.0	4.0	4.0	5.0	33.60
25	GBR	Bishop, Naomi	205 C	2.8	4.0	4.5	3.5	4.0	4.0	4.0	4.5	34.44
26	JPN	Asada, Masako	5335 D	2.9	2.0	3.0	3.5	3.5	3.5	4.0	3.5	29.58
27	USA	Mc Cormick, Kelly Anne	205 B	3.0	5.5	6.0	6.0	5.5	5.5	6.0	5.5	51.30
28	SWE	Rossing, Anita	205 C	2.8	5.0	5.0	5.0	4.5	5.0	5.0	5.5	42.00

Women Springboard Diving Preliminary Dive 6/Sept. 24				Femmes/Plongeon du Tremplin Eliminatoires Plongeon 6/24 Sept								
Order Ordre	Ctry Pays	Name Nom	Type Saut	Diff Coef	1	2	Judge/Juge		5	6	7	Total
1	URS	Babkova, Marina	105 B	2.4	6.5	7.0	7.0	7.0	6.5	7.0	7.5	49.68
2	KOR	Kim, Eun-Hee	105 B	2.4	6.5	6.0	6.5	6.5	6.0	6.5	6.5	46.08
3	GBR	Roscoe, Carolyn	405 C	2.7	5.5	4.5	4.5	5.5	5.5	5.5	5.0	42.12
4	BAH	Roberts, Lori	404 C	2.4	4.0	4.0	4.0	4.5	5.0	4.0	4.5	30.24
5	FRG	Muehlbauer, Anke	105 B	2.4	6.5	6.0	6.5	6.0	6.5	6.0	5.5	44.64
6	FRG	Heinrichs, Elke	105 B	2.4	6.0	6.0	5.5	5.5	6.5	6.5	6.0	43.20
7	CHN	Gao, Min	105 B	2.4	8.0	7.5	7.5	8.0	7.5	7.5	8.0	55.44
8	HOL	Jongehans, Daphne	105 B	2.4	7.5	7.5	7.5	7.5	7.0	7.5	7.5	54.00
9	ARG	Ribot, Veronica G	105 B	2.4	7.0	6.0	7.0	7.0	7.0	6.0	6.0	47.52
10	HUN	Gerlach, Agnes	105 B	2.4	7.5	6.5	7.5	6.0	6.5	6.5	6.0	47.52
11	NOR	Gamme, Kamilla	105 B	2.4								NP
12	AUS	Donnet, Jennifer	105 B	2.4	6.5	6.0	7.0	6.5	6.5	7.0	7.5	48.24
13	ZIM	Cox, Tracy Linda	105 B	2.4	7.0	6.5	7.0	6.5	6.5	7.0	6.5	48.24
14	SUI	Buerki, Beatrice	5235 D	2.8	6.0	5.5	6.5	6.0	6.0	6.5	7.0	52.08
15	USA	Lucero, Wendy	105 B	2.4	7.5	8.0	7.5	7.5	7.0	7.5	7.5	54.00
16	CHN	Li, Qing	405 C	2.7	7.5	7.0	6.5	7.0	7.0	6.5	7.5	56.70
17	CAN	Fuller, Debbie	105 B	2.4	7.0	7.5	7.5	7.0	7.0	6.5	6.5	50.40
18	JPN	Motobuchi, Yuki	105 B	2.4	7.5	7.0	7.5	6.5	7.0	7.5	6.5	51.12
19	URS	Lachko, Irina	107 C	2.8	7.0	6.5	7.0	7.0	7.5	7.5	5.5	58.80
20	GDR	Baldus, Brita	405 C	2.7	6.0	4.5	6.0	6.0	6.0	5.5	5.5	46.98
21	CAN	Bush, Barbara	405 C	2.7	6.5	7.0	6.5	6.5	7.0	6.0	7.0	54.27
22	HUN	Haasz, Katalin	105 B	2.4	6.0	5.0	5.5	5.5	4.0	5.5	6.0	39.60
23	BRA	Ribeiro, Angela	105 B	2.4	6.0	5.5	5.5	6.0	6.0	6.0	5.5	41.76
24	MEX	Alcala, Maria	105 B	2.4	6.5	6.0	5.5	6.5	5.5	5.5	5.5	41.76
25	GBR	Bishop, Naomi	105 B	2.4	5.5	5.0	6.0	5.5	5.5	5.5	5.5	39.60
26	JPN	Asada, Masako	105 B	2.4	6.5	5.5	5.0	5.5	6.0	6.5	5.0	41.04
27	USA	Mc Cormick, Kelly Anne	405 C	2.7	7.5	8.0	8.0	7.0	7.5	7.0	7.5	60.75
28	SWE	Rossing, Anita	105 B	2.4	7.0	6.5	7.0	6.5	7.0	6.5	7.0	48.96

Women Springboard Diving Preliminary Dive 8/Sept. 24				Femmes/Plongeon du Tremplin Eliminatoires Plongeon 8/24 Sept								
Order Ordre	Ctry Pays	Name Nom	Type Saut	Diff Coef	1	2	Judge/Juge		5	6	7	Total
1	URS	Babkova, Marina	305 C	2.8	6.0	5.0	5.5	5.0	6.0	6.0	6.0	47.88
2	KOR	Kim, Eun-Hee	303 C	2.0	4.5	4.5	5.0	5.5	5.5	5.0	5.0	30.00
3	GBR	Roscoe, Carolyn	5134 D	2.5	6.5	6.5	6.5	6.0	6.5	6.0	6.0	47.25
4	BAH	Roberts, Lori	5132 D	2.1	5.0	4.0	2.5	3.0	3.0	3.5	3.0	20.79
5	FRG	Muehlbauer, Anke	305 C	2.8	5.5	6.0	6.0	4.5	5.5	5.5	5.5	47.04
6	FRG	Heinrichs, Elke	305 C	2.8	3.0	3.0	3.0	2.5	3.5	4.0	3.5	26.88
7	CHN	Gao, Min	305 C	2.8	7.5	7.5	8.0	7.5	8.0	7.5	8.0	63.84
8	HOL	Jongehans, Daphne	405 C	2.7	6.0	6.0	6.5	6.5	6.5	6.0	6.5	51.03
9	ARG	Ribot, Veronica G	305 C	2.8	4.0	4.0	4.0	4.0	4.5	4.5	4.0	34.44
10	HUN	Gerlach, Agnes	305 C	2.8	4.5	4.5	4.5	4.5	4.5	4.0	4.0	36.96
11	NOR	Gamme, Kamilla	5134 D	2.5								NP
12	AUS	Donnet, Jennifer	305 C	2.8	6.5	6.5	7.0	6.5	6.5	6.0	6.5	54.60
13	ZIM	Cox, Tracy Linda	205 C	2.8	5.0	5.5	5.5	5.5	6.0	5.0	5.0	44.52
14	SUI	Buerki, Beatrice	305 C	2.8	6.5	6.5	6.5	7.0	6.5	6.5	6.0	54.60
15	USA	Lucero, Wendy	305 C	2.8	6.5	6.0	5.5	5.5	6.5	6.0	6.0	50.40
16	CHN	Li, Qing	5235 D	2.8	7.5	6.5	7.0	7.0	7.0	7.0	6.0	57.96
17	CAN	Fuller, Debbie	305 C	2.8	6.0	6.0	6.5	6.0	6.0	6.0	6.5	51.24
18	JPN	Motobuchi, Yuki	205 C	2.8	4.0	3.5	2.5	3.0	4.0	4.0	4.5	31.08
19	URS	Lachko, Irina	205 B	3.0	6.5	6.0	6.5	7.0	6.5	6.5	7.0	59.40
20	GDR	Baldus, Brita	205 C	2.8	6.5	6.0	6.5	6.0	6.5	6.		



**Women Springboard Diving
Preliminary Dive 9/Sept. 24**

**Femmes/Plongeon du Tremplin
Eliminatoires Plongeon 9/24 Sept**

Order Ordre	Ctry Pays	Name Nom	Type Saut	Diff Coef	1	2	Judge/Juge					Total
							3	4	5	6	7	
1	URS	Babkova, Marina	405 C	2.7	7.0	6.5	7.5	7.5	6.5	6.5	7.0	55.89
2	KOR	Kim, Eun-Hee	404 C	2.4	5.0	5.0	5.0	5.0	5.0	5.0	5.0	36.00
3	GBR	Roscoe, Carolyn	305 C	2.8	4.0	5.0	6.0	5.5	6.0	5.5	6.0	47.04
4	BAH	Roberts, Lori	303 C	2.0	5.5	6.0	5.0	5.5	4.0	5.5	4.0	30.60
5	FRG	Muehlbauer, Anke	405 C	2.7	5.0	6.0	5.0	6.0	6.0	5.5	6.0	46.17
6	FRG	Heinrichs, Elke	405 C	2.7	6.5	6.0	6.0	6.5	6.0	6.5	6.5	51.03
7	CHN	Gao, Min	405 C	2.7	8.5	8.5	8.0	8.0	8.0	7.5	8.0	65.61
8	HOL	Jongehans, Daphne	205 C	2.8	6.5	6.5	7.0	6.5	6.5	7.0	6.5	55.44
9	ARG	Ribot, Veronica G	405 C	2.7	4.0	4.0	5.0	5.5	5.5	5.0	5.0	39.69
10	HUN	Gerlach, Agnes	205 C	2.8	5.0	5.0	4.0	4.5	4.5	4.5	5.5	39.48
11	NOR	Gamme, Kamilla	305 C	2.8								NP
12	AUS	Donnet, Jennifer	405 C	2.7	6.0	6.5	6.5	6.0	6.5	7.0	7.0	52.65
13	ZIM	Cox, Tracy Linda	405 C	2.7	6.0	6.0	7.0	6.0	6.0	7.0	7.0	51.84
14	SUI	Buerki, Beatrice	205 C	2.8	5.5	5.0	5.5	6.0	5.0	4.5	5.5	44.52
15	USA	Lucero, Wendy	5335 D	2.9	6.0	6.5	7.5	7.5	6.5	6.5	7.0	59.16
16	CHN	Li, Qing	305 C	2.8	7.0	6.5	6.5	7.0	7.0	6.5	7.5	57.12
17	CAN	Fuller, Debbie	5134 D	2.5	7.0	7.5	7.5	6.5	7.0	7.0	7.0	53.25
18	JPN	Motobuchi, Yuki	405 C	2.7	5.0	4.5	4.5	5.0	6.0	6.0	4.5	40.50
19	URS	Lachko, Irina	305 B	3.0	5.5	4.5	5.0	4.5	4.5	5.0	5.5	44.10
20	GDR	Baldus, Brita	305 C	2.8	7.0	6.5	6.5	6.5	6.5	7.0	7.0	56.28
21	CAN	Bush, Barbara	205 C	2.8	6.5	6.0	6.0	6.0	6.0	6.5	7.5	52.08
22	HUN	Haasz, Katalin	205 C	2.8	4.0	5.5	4.5	4.5	5.0	4.0	5.0	38.64
23	BRA	Ribeiro, Angela	5134 D	2.5	1.0	2.5	3.0	4.5	2.0	2.0	2.5	18.00
24	MEX	Alcala, Maria	5134 D	2.5	6.5	6.5	6.0	6.5	6.0	5.5	6.0	46.50
25	GBR	Bishop, Naomi	403 B	2.1	6.5	6.5	6.5	6.0	6.0	6.0	7.0	39.69
26	JPN	Asada, Masako	205 C	2.8	3.5	4.0	3.5	3.5	3.0	3.5	4.0	30.24
27	USA	Mc Cormick, Kelly Anne	305 B	3.0	6.0	6.0	5.0	5.5	5.5	5.5	5.5	50.40
28	SWE	Rossing, Anita	405 C	2.7	5.0	5.0	6.0	5.5	6.0	5.5	6.0	45.36

**Women Springboard Diving
Preliminary/Sept. 24**

**Femmes/Plongeon du Tremplin
Eliminatoire/24 Sept**

Rank Rang	Ctry Pays	Name Nom	Results/Resultats					Total
			1 6	2 7	3 8	4 9	5 10	
1	CHN	Gao, Min	39.36 55.44	41.58 63.84	45.60 63.84	48.51 65.61	49.77 66.12	539.67
2	CHN	Li, Qing	39.96 56.70	41.61 54.00	37.44 57.96	46.62 57.12	47.88 62.10	501.39
3	URS	Lachko, Irina	42.12 58.80	48.45 48.72	45.36 59.40	34.56 44.10	45.36 61.56	488.43
4	USA	Lucero, Wendy	34.65 54.00	38.76 57.96	40.20 50.40	39.00 59.16	44.73 59.13	477.99
5	USA	Mc Cormick, Kelly Anne	32.64 60.75	38.88 51.30	43.32 53.28	46.62 50.40	43.47 53.07	473.73
6	GDR	Baldus, Brita	32.16 46.98	36.72 55.44	39.33 53.76	44.73 56.28	40.32 58.29	464.01
7	HOL	Jongehans, Daphne	36.48 54.00	38.34 44.52	41.04 51.03	36.21 55.44	46.50 58.29	461.85
8	URS	Babkova, Marina	34.08 49.68	37.26 47.88	42.18 47.88	46.62 55.89	45.36 49.59	456.42
9	CAN	Fuller, Debbie	41.58 50.40	33.12 49.56	38.34 51.24	37.62 53.25	44.10 54.27	453.48
10	CAN	Bush, Barbara	32.13 54.27	38.34 39.48	43.20 48.75	35.52 52.08	41.61 48.96	434.34
11	AUS	Donnet, Jennifer	31.50 48.24	33.06 45.36	39.00 54.60	39.69 52.65	36.00 53.07	433.17
12	ZIM	Cox, Tracy linda	39.00 48.24	29.25 50.40	37.62 44.52	40.80 51.84	39.69 49.50	430.86
13	SWE	Rossing, Anita	34.56 48.96	36.72 42.00	34.77 47.88	40.32 45.36	41.58 42.48	414.63
14	ARG	Ribot, Veronica G	34.56 47.52	37.80 40.50	43.32 34.44	39.42 39.69	41.58 47.04	405.87
15	JPN	Motobuchi, Yuki	33.12 51.12	34.02 55.44	35.91 31.08	40.32 40.50	44.10 39.15	404.76
16	SUI	Buerki, Beatrice	31.32 52.08	31.68 46.08	35.91 54.60	39.06 44.52	35.91 29.16	400.32
17	FRG	Muehlbauer, Anke	30.72 44.64	36.18 48.72	36.00 47.04	30.87 46.17	35.40 44.52	400.26
18	GBR	Roscoe, Carolyn	29.40 42.12	39.00 36.96	39.69 47.25	38.43 47.04	35.34 44.64	399.87
19	BRA	Ribeiro, Angela	32.40 41.76	38.19 53.76	27.84 52.08	42.84 18.00	37.80 51.84	396.51
20	MEX	Alcala, Maria	30.24 41.76	35.34 33.60	29.70 54.60	37.80 46.50	39.69 42.93	392.16
21	JPN	Asada, Masako	32.16 41.04	40.50 29.58	33.06 46.20	42.21 30.24	42.21 43.74	380.94
22	HUN	Haasz, Katalin	30.24 39.60	37.80 41.31	35.34 30.24	42.21 38.64	39.69 43.20	378.27
23	FRG	Heinrichs, Elke	31.95 43.20	32.40 47.04	34.20 26.88	40.32 51.03	39.69 27.75	374.46
24	KOR	Kim, Eun-Hee	28.35 46.08	36.48 38.16	35.40 30.00	40.32 36.00	30.00 37.17	357.96
25	HUN	Gerlach, Agnes	32.64 47.52	37.80 41.31	38.19 36.96	42.84 39.48	38.40 FD	355.14
26	GBR	Bishop, Naomi	28.80 39.60	28.50 34.44	33.60 29.40	31.11 39.69	37.80 46.50	349.44
27	BAH	Roberts, Lori	25.92 30.24	22.80 34.56	29.64 20.79	31.86 30.60	30.24 36.30	292.95
	NOR	Gamme, Kamilla						NP

**Women Springboard Diving
Preliminary Dive 10/Sept. 24**

**Femmes/Plongeon du Tremplin
Eliminatoires Plongeon 10/24 Sept**

Order Ordre	Ctry Pays	Name Nom	Type Saut	Diff Coef	1	2	Judge/Juge					Total
							3	4	5	6	7	
1	URS	Babkova, Marina	5335 D	2.9	6.0	6.0	5.5	5.0	5.5	6.5	5.5	49.59
2	KOR	Kim, Eun-Hee	5132 D	2.1	6.0	5.5	6.0	6.5	6.0	6.0	5.0	37.17
3	GBR	Roscoe, Carolyn	105 B	2.4	6.0	6.0	6.5	6.0	6.5	6.0	7.0	44.64
4	BAH	Roberts, Lori	203 B	2.2	5.0	5.5	6.0	5.0	5.5	5.5	6.5	36.30
5	FRG	Muehlbauer, Anke	5235 D	2.8	5.0	6.0	5.5	4.5	5.5	5.0	5.5	44.52
6	FRG	Heinrichs, Elke	5333 D	2.5	3.5	3.0	3.5	3.5	4.5	4.0	4.0	27.75
7	CHN	Gao, Min	5335 D	2.9	7.0	7.5	8.0	7.5	6.5	8.0	8.0	66.12
8	HOL	Jongehans, Daphne	5335 D	2.9	6.5	6.5	7.0	6.5	6.5	7.0	7.0	58.29
9	ARG	Ribot, Veronica G	205 C	2.8	5.5	5.5	5.5	5.0	6.0	5.5	6.0	47.04
10	HUN	Gerlach, Agnes	5134 D	2.5								FD
11	NOR	Gamme, Kamilla	403 B	2.1								NP
12	AUS	Donnet, Jennifer	5136 D	2.9	5.5	6.0	6.5	6.5	5.0	6.5	6.0	53.07
13	ZIM	Cox, Tracy Linda	5333 D	2.5	6.5	6.5	7.0	6.0	6.0	7.0	7.0	49.50
14	SUI	Buerki, Beatrice	405 C	2.7	3.5	3.5	3.0	4.0	3.0	4.5	4.0	29.16
15	USA	Lucero, Wendy	405 C	2.7	6.5	7.5	7.0	6.5	7.5	8.0	8.0	59.13
16	CHN	Li, Qing	205 B	3.0	6.5	6.5	7.0	7.0	7.0	7.0	7.5	62.10
17	CAN	Fuller, Debbie	405 C	2.7	6.5	7.0	6.5	6.5	7.0	6.5	7.0	54.27
18	JPN	Motobuchi, Yuki	5335 D	2.9	3.5	3.5	4.0	4.5	6.0	4.5	6.0	39.15
19	URS	Lachko, Irina	405 C	2.7	8.0	8.0	7.5	7.5	7.5	7.5	7.5	61.56
20	GDR	Baldus, Brita	5335 D	2.9	7.5	7.0	7.0	6.5	6.0	6.0	7.0	58.29
21	CAN	Bush, Barbara	105 B	2.4	7.0	7.0	7.0	7.0	6.5	6.5	6.0	48.96
22	HUN	Haasz, Katalin	5233 D	2.4	6.0	6.0	6.5	4.5	6.0	6.0	6.0	43.20
23	BRA	Ribeiro, Angela	405 C	2.7	6.0	6.5	6.5	6.0	6.5	6.5	6.5	51.84
24	MEX	Alcala, Maria	405 C	2.7	4.5	5.0	5.5	5.5	6.0	5.0	5.5	42.93
25	GBR	Bishop, Naomi	5134 D	2.5	6.5	6.0	6.5	6.0	6.5	6.0	5.5	46.50
26	JPN	Asada, Masako	405 C	2.7	5.5	5.0	5.0	5.5	5.5	5.5	5.5	43.74
27	USA	Mc Cormick, Kelly Anne	5335 D	2.9	6.5	7.0	5.5	5.5	6.5	5.5	6.5	53.07
28	SWE	Rossing, Anita	5233 D	2.4	5.5	6.0	6.0	6.0	6.5	5.5	6.0	42.48

Swimming

Natation

Women Springboard Diving Final Dive 1/Sept. 25				Femmes/Plongeon du Tremplin Finale Plongeon 1/25 Sept								
Order Ordre	Ctry Pays	Name Nom	Type Saut	Diff Coef	1	2	Judge/Juge				Total	
							3	4	5	6	7	
1	ZIM	Cox, Tracy Linda	5231D	2.0	6.5	7.0	6.5	6.5	7.0	7.0	6.5	40.20
2	AUS	Donnet, Jennifer	101 B	1.5	6.5	6.5	7.0	7.0	7.0	7.0	7.5	31.05
3	CAN	Bush, Barbara	401 A	1.7	7.0	7.5	7.0	7.0	7.0	6.0	7.5	36.21
4	CAN	Fuller, Debbie	403 B	2.1	7.0	7.0	6.5	6.0	7.0	7.0	6.5	42.84
5	URS	Babkova, Marina	103 B	1.6	7.5	7.0	7.0	7.0	7.0	7.0	7.5	34.08
6	HOL	Jongehans, Daphne	101 A	1.6	7.5	7.5	7.5	7.5	7.0	7.5	7.0	35.52
7	GDR	Baldus, Brita	103 B	1.6	7.0	7.0	6.5	7.0	7.0	6.5	6.5	32.64
8	USA	Mc Cormick, Kelly Anne	101 A	1.6	7.5	8.0	8.0	8.0	7.5	8.0	7.5	37.44
9	USA	Lucero, Wendy	101 B	1.5	8.5	8.5	7.5	8.0	8.0	8.5	8.0	36.90
10	URS	Lachko, Irina	201 B	1.8	7.5	7.5	8.0	8.0	8.0	8.5	8.5	42.66
11	CHN	Li, Qing	201 B	1.8	8.5	8.5	8.5	8.5	8.5	9.0	8.0	45.90
12	CHN	Gao, Min	103 B	1.6	8.0	8.0	8.0	8.5	8.0	8.0	8.0	38.40

Women Springboard Diving Final Dive 6/Sept. 25				Femmes/Plongeon du Tremplin Finale Plongeon 6/25 Sept								
Order Ordre	Ctry Pays	Name Nom	Type Saut	Diff Coef	1	2	Judge/Juge				Total	
							3	4	5	6	7	
1	ZIM	Cox, Tracy Linda	105 B	2.4	6.5	6.5	6.0	6.0	6.5	6.5	6.0	45.36
2	AUS	Donnet, Jennifer	105 B	2.4	7.5	7.0	7.5	6.5	7.0	6.5	7.0	50.40
3	CAN	Bush, Barbara	305 C	2.8	4.5	4.0	4.0	4.0	5.0	4.0	3.5	34.44
4	CAN	Fuller, Debbie	105 B	2.4	7.0	7.5	7.5	7.0	7.0	7.5	7.0	51.84
5	URS	Babkova, Marina	105 B	2.4	7.5	7.0	7.5	7.5	7.0	7.5	8.0	53.28
6	HOL	Jongehans, Daphne	105 B	2.4	7.5	7.5	8.0	7.5	7.5	8.0	8.0	55.44
7	GDR	Baldus, Brita	405 C	2.7	7.5	7.5	7.0	7.5	7.0	7.5	7.5	59.94
8	USA	Mc Cormick, Kelly Anne	405 C	2.7	8.0	8.0	8.0	8.0	8.0	7.5	7.5	63.99
9	USA	Lucero, Wendy	105 B	2.4	8.5	8.0	8.0	8.0	8.5	9.0	8.5	59.76
10	URS	Lachko, Irina	107 C	2.8	6.5	7.5	7.5	6.5	8.0	7.0	6.5	58.80
11	CHN	Li, Qing	405 C	2.7	6.5	6.0	6.0	7.0	7.0	6.0	6.0	51.03
12	CHN	Gao, Min	105 B	2.4	8.5	8.5	9.0	8.5	8.5	9.0	9.0	62.64

Women Springboard Diving Final Dive 2/Sept. 25				Femmes/Plongeon du Tremplin Finale Plongeon 2/25 Sept								
Order Ordre	Ctry Pays	Name Nom	Type Saut	Diff Coef	1	2	Judge/Juge				Total	
							3	4	5	6	7	
1	ZIM	Cox, Tracy Linda	101 B	1.5	7.5	7.0	7.0	7.0	7.5	6.5	6.5	31.50
2	AUS	Donnet, Jennifer	201 A	1.9	6.5	6.5	6.0	6.5	6.5	7.0	6.5	37.05
3	CAN	Bush, Barbara	201 B	1.8	6.0	7.0	7.0	7.0	7.0	7.0	7.5	37.80
4	CAN	Fuller, Debbie	101 A	1.6	7.5	7.0	7.5	7.0	7.5	7.0	7.0	34.56
5	URS	Babkova, Marina	201 B	1.8	7.5	7.5	7.5	7.5	8.0	8.0	8.0	41.58
6	HOL	Jongehans, Daphne	201 B	1.8	7.0	7.5	7.5	6.5	7.5	7.5	6.5	38.88
7	GDR	Baldus, Brita	201 B	1.8	7.5	7.0	7.0	7.0	7.5	7.5	7.0	38.88
8	USA	Mc Cormick, Kelly Anne	201 B	1.8	7.0	7.0	7.0	8.0	7.5	7.5	7.5	39.42
9	USA	Lucero, Wendy	201 A	1.9	7.5	7.5	7.5	7.5	7.5	7.5	7.0	42.75
10	URS	Lachko, Irina	301 B	1.9	8.0	8.5	9.0	7.5	8.5	8.0	8.0	46.74
11	CHN	Li, Qing	301 B	1.9	8.5	8.5	9.0	8.5	8.0	8.0	8.5	47.88
12	CHN	Gao, Min	201 B	1.8	8.0	8.0	8.0	8.0	8.5	8.0	8.0	43.20

Women Springboard Diving Final Dive 7/Sept. 25				Femmes/Plongeon du Tremplin Finale Plongeon 7/25 Sept								
Order Ordre	Ctry Pays	Name Nom	Type Saut	Diff Coef	1	2	Judge/Juge				Total	
							3	4	5	6	7	
1	ZIM	Cox, Tracy Linda	305 C	2.8	5.0	5.5	5.5	6.0	4.5	5.0	4.5	42.84
2	AUS	Donnet, Jennifer	205 C	2.8	4.5	4.5	5.5	4.5	4.5	4.0	5.0	38.64
3	CAN	Bush, Barbara	5333 D	2.5	6.5	7.0	6.0	6.0	6.5	5.0	6.5	47.25
4	CAN	Fuller, Debbie	205 C	2.8	6.0	5.5	5.0	5.0	5.0	5.0	6.0	44.52
5	URS	Babkova, Marina	205 C	2.8	7.5	7.5	7.0	7.0	6.5	7.5	8.0	61.32
6	HOL	Jongehans, Daphne	305 C	2.8	6.0	6.0	5.0	6.0	6.5	6.0	5.0	48.72
7	GDR	Baldus, Brita	107 C	2.8	6.5	5.5	6.0	6.0	6.0	6.0	5.5	49.56
8	USA	Mc Cormick, Kelly Anne	205 B	3.0	6.5	7.0	7.0	7.5	6.0	6.0	6.0	58.50
9	USA	Lucero, Wendy	205 C	2.8	5.0	5.5	4.5	4.5	5.5	5.0	5.0	42.00
10	URS	Lachko, Irina	5152 D	2.8	7.5	7.5	8.0	7.5	8.0	7.5	8.0	64.68
11	CHN	Li, Qing	105 B	2.4	7.0	7.5	8.0	7.5	7.5	7.5	7.5	54.00
12	CHN	Gao, Min	205 C	2.8	9.0	8.5	8.0	8.0	7.5	8.5	8.0	68.88

Women Springboard Diving Final Dive 3/Sept. 25				Femmes/Plongeon du Tremplin Finale Plongeon 3/25 Sept								
Order Ordre	Ctry Pays	Name Nom	Type Saut	Diff Coef	1	2	Judge/Juge				Total	
							3	4	5	6	7	
1	ZIM	Cox, Tracy Linda	201 A	1.9	7.0	6.5	6.0	6.0	6.5	6.5	7.0	37.05
2	AUS	Donnet, Jennifer	301 A	2.0	7.0	6.0	6.0	6.5	7.0	7.5	7.0	40.20
3	CAN	Bush, Barbara	5233D	2.4	6.5	6.0	6.0	6.5	6.0	6.0	6.0	43.92
4	CAN	Fuller, Debbie	201 B	1.8	7.0	7.0	7.0	6.5	6.5	7.0	6.5	36.72
5	URS	Babkova, Marina	301 B	1.9	7.5	8.0	7.5	7.5	7.5	8.5	8.0	43.89
6	HOL	Jongehans, Daphne	301 B	1.9	7.0	8.0	8.0	8.0	7.0	8.5	8.5	45.03
7	GDR	Baldus, Brita	301 B	1.9	7.5	6.0	7.0	6.5	7.5	6.5	7.5	39.90
8	USA	Mc Cormick, Kelly Anne	301 B	1.9	8.0	8.0	8.5	8.0	8.5	8.0	8.0	46.17
9	USA	Lucero, Wendy	301 A	2.0	7.5	7.5	6.5	7.0	8.0	7.5	8.0	45.00
10	URS	Lachko, Irina	403 B	2.1	7.5	7.0	7.5	7.5	8.0	7.5	7.5	47.25
11	CHN	Li, Qing	103 B	1.6	7.0	8.0	8.0	8.0	8.5	8.5	8.0	38.88
12	CHN	Gao, Min	301 B	1.9	8.0	8.0	8.5	8.5	8.5	8.0	8.5	47.31

Women Springboard Diving Final Dive 8/Sept. 25				Femmes/Plongeon du Tremplin Finale Plongeon 8/25 Sept								
Order Ordre	Ctry Pays	Name Nom	Type Saut	Diff Coef	1	2	Judge/Juge				Total	
							3	4	5	6	7	
1	ZIM	Cox, Tracy Linda	205 C	2.8	3.5	4.5	4.5	4.5	5.0	3.5	4.0	35.28
2	AUS	Donnet, Jennifer	305 C	2.8	5.5	6.5	6.5	5.5	6.0	6.0	6.0	50.40
3	CAN	Bush, Barbara	405 C	2.7	6.5	7.5	6.5	6.5	6.5	7.0	6.0	53.46
4	CAN	Fuller, Debbie	305 C	2.8	6.0	5.0	6.0	6.5	5.5	5.0	5.5	47.04
5	URS	Babkova, Marina	305 C	2.8	7.5	8.0	7.5	7.5	7.5	7.5	8.0	63.84
6	HOL	Jongehans, Daphne	405 C	2.7	7.0	7.5	7.5	7.5	7.0	7.0	6.5	58.32
7	GDR	Baldus, Brita	205 C	2.8	6.0	5.0	5.5	5.5	6.0	6.5	5.5	47.88
8	USA	Mc Cormick, Kelly Anne	105 B	2.4	7.5	7.5	7.5	6.5	7.0	7.5	7.5	53.28
9	USA	Lucero, Wendy	305 C	2.8	6.0	6.0	6.0	6.0	6.5	6.5	6.0	51.24
10	URS	Lachko, Irina	205 B	3.0	5.5	5.0	6.5	6.0	5.5	5.5	6.5	52.20
11	CHN	Li, Qing	5235 D	2.8	7.5	7.0	7.0	7.0	7.5	6.5	8.0	60.48
12	CHN	Gao, Min	305 C	2.8	8.5	8.5	8.0	8.5	8.0	8.5	8.5	70.56

Women Springboard Diving Final Dive 4/Sept. 25				Femmes/Plongeon du Tremplin Finale Plongeon 4/25 Sept								
Order Ordre	Ctry Pays	Name Nom	Type Saut	Diff Coef	1	2	Judge/Juge				Total	
							3	4	5	6	7	
1	ZIM	Cox, Tracy Linda	301 A	2.0	7.5	7.0	6.5	6.0	7.0	7.0	7.0	41.40
2	AUS	Donnet, Jennifer	403 B	2.1	6.5	6.5	7.0	5.5	7.0	7.0	7.0	42.84
3	CAN	Bush, Barbara	101 A	1.6	7.5	7.5	7.5	7.0	7.0	7.0	7.0	34.56
4	CAN	Fuller, Debbie	301 B	1.9	7.5	7.5	7.5	7.5	7.0	7.0	7.0	41.61
5	URS	Babkova, Marina	403 B	2.1	8.0	8.0	8.0	7.5	8.0	7.5	8.0	49.77
6	HOL	Jongehans, Daphne	401 A	1.7	7.0	7.5	7.5	8.0	8.0	7.0	7.5	38.25
7	GDR	Baldus, Brita	403 B	2.1	7.0	7.5	7.0	7.0	7.0	7.0	7.0	44.10
8	USA	Mc Cormick, Kelly Anne	403 B	2.1	8.0	8.5	8.5	7.5	8.0	8.5	8.0	51.66
9	USA	Lucero, Wendy	5111A	2.0	7.0	7.5	7.0	7.5	7.0	7.5	7.0	43.20
10	URS	Lachko, Irina	103 B	1.6	7.5	7.5	8.0	8.0	7.5	7.0	7.5	36.48
11	CHN	Li, Qing	5132D	2.1	8.0	8.0	8.0	8.0	8.0	8.0	8.0	50.40
12	CHN	Gao, Min	403 B	2.1	8.5	8.0	8.0	8.0	8.0	8.5	8.5	51.66

Women Springboard Diving Final Dive 9/Sept. 25				Femmes/Plongeon du Tremplin Finale Plongeon 9/25 Sept								
Order Ordre	Ctry Pays	Name Nom	Type Saut	Diff Coef	1	2	Judge/Juge				Total	
							3	4	5	6	7	
1	ZIM	Cox, Tracy Linda	405 C	2.7	6.5	6.0	6.5	6.5	6.5	7.0	6.0	51.84
2	AUS	Donnet, Jennifer	405 C	2.7	5.5	6.5	6.0	6.0	6.5	6.5	6.5	51.03
3	CAN	Bush, Barbara	205 C	2.8	5.5	6.0	6.0	6.0	6.0	6.5	7.0	51.24
4	CAN	Fuller, Debbie	5134 D	2.5	7.5	7.0	7.0	7.0	6.5	6.5	6.5	46.00
5	URS	Babkova, Marina	405 C	2.7	6.0	5.0	6.0	6.0	5.5	5.5	5.5	46.17
6	HOL	Jongehans, Daphne	205 C	2.8	4.5	4.5	4.5	4.5	4.5	4.0	4.0	36.96
7	GDR	Baldus, Brita	305 C	2.8	7.5	7.0	7.0	7.0	7.0			

**Women Springboard Diving
Final/Sept. 25****Femmes/Plongeon du Tremplin
Finale/25 Sept**

Rank Rang	Ctry Pays	Name Nom	Results/Resultats					Total
			1 6	2 7	3 8	4 9	5 10	
1	CHN	Gao, Min	38.40 62.64	43.20 68.88	47.31 70.56	51.66 72.90	47.25 77.43	580.23
2	CHN	Li, Qing	45.90 51.03	47.88 54.00	38.88 60.48	50.40 70.56	50.40 64.80	534.33
3	USA	Mc Cormick, Kelly Anne	37.44 63.99	39.42 58.50	46.17 53.28	51.66 66.60	49.14 66.99	533.19
4	URS	Lachko, Irina	42.66 58.80	46.74 64.68	47.25 52.20	36.48 67.50	50.40 59.94	526.65
5	URS	Babkova, Marina	34.08 53.28	41.58 61.32	43.89 63.84	49.77 46.17	47.25 65.25	506.43
6	USA	Lucero, Wendy	36.90 59.76	42.75 42.00	45.00 51.24	43.20 64.38	50.40 63.18	498.81
7	GDR	Baldus, Brita	32.64 59.94	38.88 49.56	39.90 47.88	44.10 59.64	46.62 60.03	479.19
8	HOL	Jongehans, Daphne	35.52 55.44	38.88 48.72	45.03 58.32	38.25 36.96	57.00 51.33	465.45
9	CAN	Fuller, Debbie	42.84 51.84	34.56 44.52	36.72 47.04	41.61 51.00	43.47 56.70	450.30
10	AUS	Donnet, Jennifer	31.05 50.40	37.05 38.64	40.20 50.40	42.84 51.03	39.00 52.20	432.81
11	CAN	Bush, Barbara	36.21 34.44	37.80 47.25	43.92 53.46	34.56 51.24	39.90 50.40	429.18
12	ZIM	Cox, Tracy Linda	40.20 45.36	31.50 42.84	37.05 35.28	41.40 51.84	40.95 51.00	417.42

**Women Platform Diving
Preliminary Dive 1/Sept. 17****Femmes/Plongeon du Haut-vol
Eliminatoires Plongeon 1/17 Sept**

Order Ordre	Ctry Pays	Name Nom	Type Saut	Diff Coef	Judge/Juge							Total
					1	2	3	4	5	6	7	
1	MEX	Alcala, Maria	103 B	1.6	7.5	6.5	6.5	7.5	6.5	7.0	7.5	33.60
2	NOR	Gamme, Kamilla	103 B	1.6	7.5	7.0	7.5	3.0	7.5	8.0	7.0	36.00
3	CHN	Chen, Xiaodan	103 B	1.6	7.0	6.5	7.0	7.0	7.0	7.5	7.0	33.60
4	AUS	Kent, Julie	401 B	1.4	7.5	7.0	6.5	7.5	6.5	6.5	6.5	28.56
5	GBR	Roscoe, Carolyn	101 B	1.5	7.0	7.5	7.5	7.0	7.0	7.5	7.5	32.85
6	KOR	Kim, Eun-Hee	103 B	1.6	7.0	6.5	6.0	7.5	6.5	6.5	6.5	31.68
7	URS	Stassioulevitch, Anjela	403 B	2.0	8.0	8.0	8.0	8.0	8.0	8.0	8.0	48.00
8	CAN	Fuller, Wendy	403 B	2.0	7.0	6.0	6.5	6.5	6.5	6.5	7.0	39.60
9	JPN	Asada, Masako	201 B	1.8	8.0	7.5	8.0	8.0	7.5	7.5	8.0	42.12
10	URS	Mirochina, Elena	103 B	1.6	8.5	7.5	7.5	7.5	8.0	7.5	8.0	36.48
11	HUN	Kelemen, Ildiko	103 C	1.5	6.5	6.0	7.0	6.5	6.5	6.5	6.5	29.25
12	CAN	Fuller, Debbie	103 B	1.6	7.0	6.0	6.5	7.0	7.5	7.0	7.0	33.12
13	ARG	Ribot, Veronica G	113 B	1.8	7.0	7.5	7.0	7.5	7.0	7.0	6.5	38.34
14	GDR	Abicht, Silke	103 B	1.6	8.0	8.0	8.5	8.5	8.5	7.5	8.0	39.36
15	USA	Williams, Wendy Lian	401 B	1.4	7.0	6.0	7.0	7.0	7.0	7.5	7.5	29.82
16	FRG	Kuehn, Monika	103 B	1.6	6.0	5.5	5.5	6.0	6.5	6.0	6.0	28.32
17	FRG	Pecher, Doris	103 B	1.6	7.5	7.5	7.5	8.0	7.5	7.0	7.5	36.00
18	CHN	Xu, Yanmei	403 B	2.0	8.0	8.0	8.5	8.0	8.0	8.0	8.0	48.00
19	JPN	Motobuchi, Yuki	103 B	1.6	7.0	7.0	7.0	7.0	7.0	7.0	7.0	33.60
20	USA	Mitchell, Michele	103 C	1.5	8.5	7.5	8.0	7.5	7.5	8.0	8.5	35.55

**Women Platform Diving
Preliminary Dive 2/Sept. 17****Femmes/Plongeon du Haut-vol
Eliminatoires Plongeon 2/17 Sept**

Order Ordre	Ctry Pays	Name Nom	Type Saut	Diff Coef	Judge/Juge							Total
					1	2	3	4	5	6	7	
1	MEX	Alcala, Maria	201 B	1.8	6.5	6.5	6.0	6.5	6.0	6.5	6.0	34.02
2	NOR	Gamme, Kamilla	403 B	2.0	6.5	5.5	6.5	7.0	6.0	6.5	6.0	37.80
3	CHN	Chen, Xiaodan	403 B	2.0	7.5	7.5	8.0	8.0	7.0	7.5	7.5	45.60
4	AUS	Kent, Julie	301 A	2.0	7.0	5.5	6.5	7.0	6.0	6.0	6.0	37.80
5	GBR	Roscoe, Carolyn	403 B	2.0	5.0	5.0	6.0	5.5	6.0	6.0	5.5	33.60
6	KOR	Kim, Eun-Hee	403 B	2.0	7.0	8.0	8.0	8.0	7.5	8.0	7.5	46.80
7	URS	Stassioulevitch, Anjela	103 B	1.6	8.0	8.0	7.5	8.0	8.0	8.5	8.5	38.88
8	CAN	Fuller, Wendy	301 A	2.0	7.5	6.0	7.0	7.0	6.5	7.0	7.0	41.40
9	JPN	Asada, Masako	301 B	1.9	4.0	4.0	5.0	5.5	4.5	6.0	5.5	27.93
10	URS	Mirochina, Elena	403 B	2.0	8.0	7.5	8.0	7.5	8.0	8.0	8.0	47.40
11	HUN	Kelemen, Ildiko	301 A	2.0	6.5	5.5	7.0	7.5	7.5	7.0	7.0	42.00
12	CAN	Fuller, Debbie	301 B	1.9	7.5	7.5	7.0	7.5	7.5	7.0	8.0	42.18
13	ARG	Ribot, Veronica G	403 B	2.0	7.0	7.0	7.0	6.0	6.5	6.5	6.5	40.20
14	GDR	Abicht, Silke	403 B	2.0	7.0	6.5	8.0	7.5	7.0	7.0	7.0	42.60
15	USA	Williams, Wendy Lian	113 B	1.8	7.5	7.0	7.0	7.0	7.5	7.0	7.5	38.88
16	FRG	Kuehn, Monika	403 B	2.0	5.5	6.5	6.5	6.5	7.0	6.5	6.0	38.40
17	FRG	Pecher, Doris	5231 D	2.1	6.0	5.5	5.0	6.0	6.0	5.5	6.5	36.54
18	CHN	Xu, Yanmei	301 A	2.0	9.0	8.0	7.5	8.0	7.5	8.0	8.5	48.00
19	JPN	Motobuchi, Yuki	5132 D	2.1	6.0	6.0	6.5	7.0	6.5	6.5	6.5	40.32
20	USA	Mitchell, Michele	612 B	1.9	7.5	8.5	8.0	8.0	7.5	8.0	8.0	45.03

**Women Platform Diving
Preliminary Dive 3/Sept. 17****Femmes/Plongeon du Haut-vol
Eliminatoires Plongeon 3/17 Sept**

Order Ordre	Ctry Pays	Name Nom	Type Saut	Diff Coef	Judge/Juge							Total
					1	2	3	4	5	6	7	
1	MEX	Alcala, Maria	301 B	1.9	6.5	6.5	6.5	7.0	6.0	6.5	7.0	37.62
2	NOR	Gamme, Kamilla	612 B	1.9	7.5	6.5	7.5	7.5	7.5	7.0	7.5	42.18
3	CHN	Chen, Xiaodan	301 B	1.9	6.5	8.0	8.0	8.0	7.5	7.5	8.0	44.46
4	AUS	Kent, Julie	201 A	1.9	6.0	5.0	4.5	6.0	5.0	5.0	5.0	29.64
5	GBR	Roscoe, Carolyn	5132 D	2.1	6.5	6.0	7.0	7.0	6.5	6.5	7.0	42.21
6	KOR	Kim, Eun-Hee	301 B	1.9	3.5	4.0	5.0	5.5	5.0	5.0	4.5	26.79
7	URS	Stassioulevitch, Anjela	612 B	1.9	7.0	8.5	8.0	7.5	7.5	8.5	7.5	44.46
8	CAN	Fuller, Wendy	103 C	1.5	7.5	6.5	6.5	7.5	7.5	7.5	7.0	32.40
9	JPN	Asada, Masako	403 B	2.0	8.0	9.0	7.5	8.0	8.0	8.0	8.0	48.00
10	URS	Mirochina, Elena	612 B	1.9	8.0	8.5	8.0	7.5	8.0	8.0	7.5	45.03
11	HUN	Kelemen, Ildiko	5331 D	2.1	5.5	6.0	6.0	6.0	6.5	6.0	5.0	37.17
12	CAN	Fuller, Debbie	403 B	2.0	6.5	5.5	6.5	6.5	6.0	5.5	6.5	37.20
13	ARG	Ribot, Veronica G	301 B	1.9	8.0	8.5	8.0	8.5	8.0	8.0	8.0	46.17
14	GDR	Abicht, Silke	5231 D	2.1	8.0	8.0	7.5	7.5	7.5	7.5	7.5	47.88
15	USA	Williams, Wendy Lian	301 A	2.0	8.0	7.0	7.5	7.5	7.0	7.0	7.5	43.80
16	FRG	Kuehn, Monika	301 B	1.9	6.5	6.0	6.0	7.0	6.5	6.5	6.0	35.91
17	FRG	Pecher, Doris	403 B	2.0	6.5	7.0	7.0	7.5	7.5	6.5	7.0	42.00
18	CHN	Xu, Yanmei	101 B	1.5	8.0	8.5	8.5	8.5	8.5	8.0	8.0	37.35
19	JPN	Motobuchi, Yuki	301 B	1.9	6.5	7.0	7.0	7.0	6.5	7.0	7.0	39.33
20	USA	Mitchell, Michele	5235 D	2.8	8.0	7.5	8.0	7.5	7.5	8.0	7.5	64.68

**Women Platform Diving
Preliminary Dive 4/Sept. 17****Femmes/Plongeon du Haut-vol
Eliminatoires Plongeon 4/17 Sept**

Order Ordre	Ctry Pays	Name Nom	Type Saut	Diff Coef	Judge/Juge							Total
					1	2	3	4	5	6	7	
1	MEX	Alcala, Maria	403 B	2.0	6.5	7.0	6.0	6.5	6.0	6.5	7.0	39.00
2	NOR	Gamme, Kamilla	5132 D	2.1	7.0	7.0	7.5	7.5	7.0	7.0	7.0	44.73
3	CHN	Chen, Xiaodan	5132 D	2.1	7.0	7.5	7.0	7.0	7.0	7.5	7.5	45.99
4	AUS	Kent, Julie	105 B	2.3	6.5	5.5	6.0	6.5	6.0	6.0	6.5	42.78
5	GBR	Roscoe, Carolyn	301 A	2.0	7.0	7.0	6.5	7.0	6.0	6.5	6.5	40.20
6	KOR	Kim, Eun-Hee	5132 D	2.1	6.0	6.0	6.0	6.5	6.0	6.0	6.0	37.80
7	URS	Stassioulevitch, Anjela	5132 D	2.1	6.5	7.5	7.5	7.5	7.5	8.0	7.0	46.62
8	CAN	Fuller, Wendy	5132 D	2.1	6.0	5.5	6.5	6.0	6.0	6.0	5.5	37.17
9	JPN	Asada, Masako	113 B	1.8	5.5	5.0	6.5	6.0	6.0	6.5	6.0	32.40
10	URS	Mirochina, Elena	5132 D	2.1	7.0	7.5	7.0	7.5	7.5	8.0	7.5	46.62
11	HUN	Kelemen, Ildiko	403 B	2.0	7.0	8.0	7.5	7.5	7.5	7.0	7.0	43.80
12	CAN	Fuller, Debbie	5132 D	2.1	6.5	6.0	7.0	7.0	6.5	6.5	7.0	42.21
13	ARG	Ribot, Veronica G	201 B	1.8	7.0	7.5	6.5	7.5	7.5	7.0	6.5	

Swimming

Natation

Women Platform Diving Preliminary Dive 6/Sept. 17				Femmes/Plongeon du Haut-vol Eliminatoires Plongeon 6/17 Sept								
Order Ordre	Ctry Pays	Name Nom	Type Saut	Diff Coef	1	2	Judge/Juge				Total	
							3	4	5	6	7	
1	MEX	Alcala, Maria	305 C	2.7	6.5	6.5	6.0	6.0	6.5	6.5	7.0	51.84
2	NOR	Gamme, Kamilla	614 B	2.4	6.5	6.5	6.5	6.5	6.0	6.5	6.0	46.08
3	CHN	Chen, Xiaodan	407 C	3.2	8.5	8.0	8.0	8.0	8.0	7.5	7.5	75.84
4	AUS	Kent, Julie	107 C	2.7	6.0	6.0	6.0	7.0	6.0	5.5	6.0	48.60
5	GBR	Roscoe, Carolyn	405 B	2.8	5.5	5.5	6.0	6.0	6.0	6.0	5.5	48.72
6	KOR	Kim, Eun-Hee	405 B	2.8	6.5	7.0	7.5	7.0	6.5	7.5	7.0	58.80
7	URS	Stassioulevitch, Anjela	5235 D	2.8	7.0	7.5	7.5	7.5	8.0	8.0	7.5	63.84
8	CAN	Fuller, Wendy	205 B	2.9	5.0	4.5	5.5	5.0	5.5	5.0	6.0	45.24
9	JPN	Asada, Masako	405 B	2.8	8.0	7.5	7.5	7.5	7.5	7.5	8.0	63.84
10	URS	Mirochina, Elena	107 B	3.0	6.0	6.0	5.5	6.5	6.5	6.5	6.5	56.70
11	HUN	Kelemen, Ildiko	405 B	2.8	6.5	6.5	7.0	7.0	6.5	6.5	6.0	55.44
12	CAN	Fuller, Debbie	205 B	2.9	5.5	4.5	6.0	5.0	5.5	5.0	6.0	46.98
13	ARG	Ribot, Veronica G	107 C	2.7	4.5	5.0	4.0	5.5	5.0	5.5	4.5	39.69
14	GDR	Abicht, Silke	405 B	2.8	7.0	7.0	7.5	6.5	7.5	7.5	7.0	60.48
15	USA	Williams, Wendy Lian	205 B	2.9	7.0	6.0	7.0	7.5	6.5	6.5	7.0	59.16
16	FRG	Kuehn, Monika	205 B	2.9	5.0	4.0	5.0	4.5	5.5	5.5	5.0	43.50
17	FRG	Pecher, Doris	107 C	2.7	3.0	3.5	4.0	4.5	4.5	4.0	4.5	33.21
18	CHN	Xu, Yanmei	107 B	3.0	6.0	6.5	6.5	7.0	7.0	7.0	6.5	60.30
19	JPN	Motobuchi, Yuki	305 C	2.7	4.5	5.5	6.0	6.5	5.5	5.0	6.0	45.36
20	USA	Mitchell, Michele	405 B	2.8	8.0	7.0	7.5	7.5	7.5	7.5	8.0	63.84

Women Platform Diving Preliminary Dive 7/Sept. 17				Femmes/Plongeon du Haut-vol Eliminatoires Plongeon 7/17 Sept								
Order Ordre	Ctry Pays	Name Nom	Type Saut	Diff Coef	1	2	Judge/Juge				Total	
							3	4	5	6	7	
1	MEX	Alcala, Maria	405 B	2.8	6.5	7.0	7.0	6.5	6.5	6.5	6.5	55.44
2	NOR	Gamme, Kamilla	405 B	2.8	6.5	6.0	6.5	7.0	7.0	6.5	6.5	55.44
3	CHN	Chen, Xiaodan	5337 D	3.3	8.5	8.0	8.0	9.0	8.0	8.0	8.5	81.18
4	AUS	Kent, Julie	205 C	2.7	7.0	6.0	6.5	7.5	6.0	6.5	7.0	53.46
5	GBR	Roscoe, Carolyn	5134 D	2.5	5.5	5.0	5.5	5.0	5.0	5.5	5.5	39.75
6	KOR	Kim, Eun-Hee	105 B	2.3	5.5	5.5	5.5	6.0	5.5	5.0	6.0	38.64
7	URS	Stassioulevitch, Anjela	614 B	2.4	7.5	6.5	7.0	7.0	7.0	7.0	7.0	50.40
8	CAN	Fuller, Wendy	305 C	2.7	3.0	3.5	3.5	3.0	3.0	2.5	4.0	25.92
9	JPN	Asada, Masako	205 B	2.9	2.5	2.0	2.0	2.5	2.0	2.0	3.0	19.14
10	URS	Mirochina, Elena	407 C	3.2	7.0	6.5	8.0	7.5	8.0	8.0	7.0	72.00
11	HUN	Kelemen, Ildiko	203 A	2.4	7.5	7.5	6.0	7.0	6.5	6.0	5.5	47.52
12	CAN	Fuller, Debbie	405 B	2.8	7.0	7.0	6.5	7.5	7.0	7.0	7.5	59.64
13	ARG	Ribot, Veronica G	305 C	2.7	6.5	6.0	7.0	7.0	6.5	6.0	6.5	52.65
14	GDR	Abicht, Silke	205 B	2.9	5.5	6.0	6.5	6.5	6.0	5.5	6.0	52.20
15	USA	Williams, Wendy Lian	305 C	2.7	5.5	5.0	5.5	6.0	5.5	6.5	5.5	45.36
16	FRG	Kuehn, Monika	405 B	2.8	5.5	6.0	5.5	6.0	6.0	5.5	5.0	47.88
17	FRG	Pecher, Doris	205 B	2.9	3.0	3.0	4.0	3.5	3.5	3.5	3.5	29.58
18	CHN	Xu, Yanmei	305 C	2.7	8.0	8.0	8.5	9.0	8.5	8.0	9.0	68.04
19	JPN	Motobuchi, Yuki	205 B	2.9	3.0	4.5	5.0	4.5	4.0	4.5	4.5	38.28
20	USA	Mitchell, Michele	5237 D	3.2	7.5	7.0	7.5	7.0	6.5	7.0	7.5	69.12

Women Platform Diving Preliminary Dive 8/Sept. 17				Femmes/Plongeon du Haut-vol Eliminatoires Plongeon 8/17 Sept								
Order Ordre	Ctry Pays	Name Nom	Type Saut	Diff Coef	1	2	Judge/Juge				Total	
							3	4	5	6	7	
1	MEX	Alcala, Maria	5235 D	2.8	6.5	7.5	6.5	7.0	6.5	7.0	6.0	56.28
2	NOR	Gamme, Kamilla	5235 D	2.8	5.5	5.0	5.5	6.0	5.5	5.5	5.5	46.20
3	CHN	Chen, Xiaodan	207 C	3.3	6.0	6.0	6.5	7.0	6.0	6.0	6.5	61.38
4	AUS	Kent, Julie	5235 D	2.8	6.5	6.0	6.5	7.5	6.0	6.5	6.5	53.76
5	GBR	Roscoe, Carolyn	205 B	2.9	4.0	4.0	3.5	4.0	4.0	4.5	4.0	34.80
6	KOR	Kim, Eun-Hee	614 B	2.4								FD
7	URS	Stassioulevitch, Anjela	107 C	2.7	6.5	6.5	7.0	7.5	7.0	7.0	5.0	55.08
8	CAN	Fuller, Wendy	5235 D	2.8	7.5	7.5	7.5	7.5	7.0	7.5	7.5	63.00
9	JPN	Asada, Masako	5235 D	2.8	6.0	5.0	6.5	6.0	5.5	6.5	6.0	50.40
10	URS	Mirochina, Elena	5237 D	3.2	3.5	5.0	3.5	4.5	4.5	5.5	5.0	43.20
11	HUN	Kelemen, Ildiko	5134 D	2.5	7.0	6.5	6.5	7.0	6.5	7.0	7.0	51.00
12	CAN	Fuller, Debbie	5235 D	2.8	7.5	7.5	7.0	7.5	7.5	7.0	7.5	62.16
13	ARG	Ribot, Veronica G	205 B	2.9	7.5	7.5	7.5	7.5	7.0	7.0	7.0	63.51
14	GDR	Abicht, Silke	107 B	3.0	5.5	5.0	6.5	6.5	6.0	6.0	6.0	54.00
15	USA	Williams, Wendy Lian	405 B	2.8	8.5	8.0	8.0	7.5	7.5	8.0	8.0	66.36
16	FRG	Kuehn, Monika	5235 D	2.8	5.5	5.5	6.5	6.0	6.0	5.5	6.0	48.72
17	FRG	Pecher, Doris	405 B	2.8	6.5	6.0	6.0	6.0	6.5	6.0	6.5	52.08
18	CHN	Xu, Yanmei	205 B	2.9	4.5	5.0	6.5	5.5	6.0	5.0	5.5	46.98
19	JPN	Motobuchi, Yuki	5235 D	2.8	5.0	5.5	6.0	6.0	4.5	5.5	4.5	44.52
20	USA	Mitchell, Michele	107 C	2.7	8.5	8.0	8.0	7.5	8.0	8.0	8.5	65.61

Women Platform Diving Preliminary/Sept. 17				Femmes/Plongeon du Haut-vol Eliminatoire/17 Sept									
Rank Rang	Ctry Pays	Name Nom	Type Saut	Diff Coef	1	2	Judge/Juge				Total		
							3	4	5	6	7		
1	CHN	Chen, Xiaodan			33.60	45.60	44.46	45.99					
					68.40	75.84	81.18	61.38				456.45	
2	USA	Mitchell, Michele			35.55	45.03	64.68	31.50					
					51.12	63.84	69.12	65.61				426.45	
3	CHN	Xu, Yanmei			48.00	48.00	37.35	50.40					
					67.20	60.30	68.04	46.98				426.27	
4	USA	Williams, Wendy Lian			29.82	38.88	43.80	56.16					
					63.00	59.16	45.36	66.36				402.54	
5	URS	Stassioulevitch, Anjela			48.00	38.88	44.46	46.62					
					53.76	63.84	50.40	55.08				401.04	
6	URS	Mirochina, Elena			36.48	47.40	45.03	46.62					
					51.84	56.70	72.00	43.20				399.27	
7	GDR	Abicht, Silke			39.36	42.60	47.88	42.75					
					54.72	60.48	52.20	54.00				393.99	
8	ARG	Ribot, Veronica G			38.34	40.20	46.17	38.34					
					58.80	39.69	52.65	63.51				377.70	
9	CAN	Fuller, Debbie			33.12	42.18	37.20	42.21					
					42.93	46.98	59.64	62.16				366.42	
10	MEX	Alcala, Maria			33.60	34.02	37.62	39.00					
					51.84	51.84	55.44	56.28				359.64	
11	NOR	Gamme, Kamilla			36.00	37.80	42.18	44.73					
					48.30	46.08	55.44	46.20				356.73	
12	HUN	Kelemen, Ildiko			29.25	42.00	37.17	43.80					
					48.99	55.44	47.52	51.00				355.17	
13	CAN	Fuller, Wendy			39.60	41.40	32.40	37.17					
					63.00	45.24	25.92	63.00				347.73	
14	AUS	Kent, Julie			28.56	37.80	29.64	42.78					
					45.36	48.60	53.46	53.76				339.96	
15	FRG	Kuehn, Monika			28.32	38.40	35.91	40.95					
					52.20	43.50	47.88	48.72				335.88	
16	JPN	Motobuchi, Yuki			33.60	40.32	39.33	40.80					
					51.24	45.36	38.28	44.52				333.45	
17	JPN	Asada, Masako			42.12	27.93	48.00	32.40					
					44.10	63.84	19.14	50.40				327.93	
18	GBR	Roscoe, Carolyn			32.85	33.60	42.21	40.20					
					50.22	48.72	39.75	34.80				322.35	
19	FRG	Pecher, Doris			36.00	36.54	42.00	27.36					
					53.76	33.21	29.58	52.08				310.53	
20	KOR	Kim, Eun-Hee			31.68	46.80	26.79	37.80					
					43.74	58.80	38.64	FD				284.25	

Women Platform Diving Final Dive 1/Sept. 18				Femmes/Plongeon du Haut-vol Finale Plongeon 1/18 Sept								
Order Ordre	Ctry Pays	Name Nom	Type Saut	Diff Coef	1	2	Judge/Juge				Total	
							3	4	5	6	7	
1	HUN	Kelemen, Ildiko	103 C	1.5	7.0	7.0	7.0	7.0	7.0	7.0	6.5	31.50
2	NOR	Gamme, Kamilla	103 B	1.6	7.5	7.5	7.5	7.5	7.5	7.5	7.0	36.00
3	MEX	Alcala, Maria	103 B	1.6	7.0	7.0	6.5	6.5	6.5	6.5	7.0	32.16
4	CAN	Fuller, Debbie	103 B	1.6	7.0	7.0	6.5	7.0	6.5	7.0	6.5	32.64
5	ARG	Ribot, Veronica G	113 B	1.8	7.0	6.5	7.5	7.0	7.5	7.5	6.0	38.34
6	GDR	Abicht, Silke	103 B	1.6	8.0	8.0	8.0	7.5	8.5			



**Women Platform Diving
Final Dive 3/Sept. 18**

**Femmes/Plongeon du Haut-vol
Finale Plongeon 3/18 Sept**

Order Ordre	Ctry Pays	Name Nom	Type Saut	Diff Coef	Judge/Juge							Total
					1	2	3	4	5	6	7	
1	HUN	Kelemen, Ildiko	5331 D	2.1	5.5	6.0	6.5	6.5	6.5	5.5	5.5	37.80
2	NOR	Gamme, Kamilla	612 B	1.9	8.0	7.5	7.5	7.0	7.5	7.5	8.5	43.32
3	MEX	Alcala, Maria	301 B	1.9	6.0	6.5	6.0	7.0	7.0	6.0	6.0	37.05
4	CAN	Fuller, Debbie	403 B	2.0	6.0	6.0	6.5	6.0	6.0	6.5	6.0	36.60
5	ARG	Ribot, Veronica G	301 B	1.9	8.0	7.0	7.5	7.5	8.0	8.0	7.5	43.89
6	GDR	Abicht, Silke	5231 D	2.1	8.0	7.0	7.5	7.0	7.5	7.5	8.0	47.25
7	URS	Mirochina, Elena	612 B	1.9	7.0	7.0	8.0	7.5	7.0	7.0	7.0	40.47
8	URS	Stassioulevitch, Anjela	612 B	1.9	6.5	8.5	7.5	7.5	8.0	7.0	6.5	41.61
9	USA	Williams, Wendy Lian	301 A	2.0	8.5	7.5	7.0	7.0	7.5	7.0	7.0	43.20
10	CHN	Xu, Yanmei	101 B	1.5	9.0	9.0	8.5	8.5	9.0	8.5	8.5	39.15
11	USA	Mitchell, Michele	5235 D	2.8	8.5	7.5	8.0	8.0	7.5	8.0	8.0	66.36
12	CHN	Chen, Xiaodan	301 B	1.9	8.0	7.5	7.5	7.5	7.0	7.5	7.5	42.75

**Women Platform Diving
Final Dive 8/Sept. 18**

**Femmes/Plongeon du Haut-vol
Finale Plongeon 8/18 Sept**

Order Ordre	Ctry Pays	Name Nom	Type Saut	Diff Coef	Judge/Juge							Total
					1	2	3	4	5	6	7	
1	HUN	Kelemen, Ildiko	5134 D	2.5	7.0	6.5	6.0	6.0	7.0	6.5	6.0	48.00
2	NOR	Gamme, Kamilla	5235 D	2.8	7.5	7.0	7.0	6.5	6.5	7.0	6.5	57.12
3	MEX	Alcala, Maria	5235 D	2.8	6.0	6.5	6.5	7.0	7.0	6.5	6.5	55.44
4	CAN	Fuller, Debbie	5235 D	2.8	7.0	7.0	6.5	6.5	6.0	6.5	7.0	56.28
5	ARG	Ribot, Veronica G	205 B	2.9	4.5	4.0	5.5	5.5	4.5	5.0	4.0	40.89
6	GDR	Abicht, Silke	107 B	3.0	5.0	5.5	4.5	5.0	5.0	5.5	5.0	45.90
7	URS	Mirochina, Elena	5237 D	3.2	5.5	5.0	5.0	5.0	4.5	5.0	5.5	48.96
8	URS	Stassioulevitch, Anjela	107 C	2.7	4.0	4.5	6.0	5.5	5.5	5.0	5.0	41.31
9	USA	Williams, Wendy Lian	405 B	2.8	8.5	7.5	8.0	8.0	8.0	8.0	8.0	67.20
10	CHN	Xu, Yanmei	205 B	2.9	8.0	8.0	7.5	8.0	8.0	7.0	8.0	68.73
11	USA	Mitchell, Michele	107 C	2.7	8.0	7.0	7.5	7.5	7.5	7.5	7.5	60.75
12	CHN	Chen, Xiaodan	207 C	3.3	2.0	3.0	2.5	3.0	2.0	2.0	1.5	22.77

**Women Platform Diving
Final Dive 4/Sept. 18**

**Femmes/Plongeon du Haut-vol
Finale Plongeon 4/18 Sept**

Order Ordre	Ctry Pays	Name Nom	Type Saut	Diff Coef	Judge/Juge							Total
					1	2	3	4	5	6	7	
1	HUN	Kelemen, Ildiko	403 B	2.0	6.0	6.5	6.5	5.5	6.0	6.0	6.0	36.60
2	NOR	Gamme, Kamilla	5132 D	2.1	6.5	6.0	6.5	6.0	6.5	6.5	6.5	40.32
3	MEX	Alcala, Maria	403 B	2.0	6.5	6.5	6.5	6.5	6.5	6.5	6.0	39.00
4	CAN	Fuller, Debbie	5132 D	2.1	6.5	7.0	6.5	6.0	6.5	6.5	6.0	40.32
5	ARG	Ribot, Veronica G	201 B	1.8	5.5	5.0	5.5	6.0	5.5	5.0	6.0	29.70
6	GDR	Abicht, Silke	301 B	1.9	6.5	6.5	6.0	6.0	6.5	6.5	6.5	36.48
7	URS	Mirochina, Elena	5132 D	2.1	5.5	6.0	6.0	6.0	6.0	6.0	6.0	37.80
8	URS	Stassioulevitch, Anjela	5132 D	2.1	6.0	7.0	6.5	7.0	7.5	7.0	7.5	44.10
9	USA	Williams, Wendy Lian	5233 D	2.4	8.0	7.0	7.5	7.0	8.6	7.5	7.5	54.00
10	CHN	Xu, Yanmei	5132 D	2.1	7.5	8.0	7.5	7.5	7.5	7.5	8.0	47.88
11	USA	Mitchell, Michele	401 B	1.4	8.5	8.5	8.0	8.0	8.0	8.5	8.5	34.86
12	CHN	Chen, Xiaodan	5132 D	2.1	7.5	8.0	7.5	7.5	7.5	8.0	8.0	48.51

**Women Platform Diving
Final/Sept. 18**

**Femmes/Plongeon du Haut-vol
Finale/18 Sept**

Order Ordre	Ctry Pays	Name Nom	Judge/Juge				Total
			1 5	2 6	3 7	4 8	
1	CHN	Xu, Yanmei	45.00 67.20	46.20 63.00	39.15 68.04	47.88 68.73	445.20
2	USA	Mitchell, Michele	36.90 53.28	43.32 64.68	66.36 76.80	34.86 60.75	436.95
3	USA	Williams, Wendy Lian	29.40 63.84	33.48 58.29	43.20 51.03	54.00 67.20	400.44
4	URS	Stassioulevitch, Anjela	45.60 62.16	38.40 60.48	41.61 52.56	44.10 41.31	386.22
5	CHN	Chen, Xiaodan	31.20 60.30	45.60 51.84	42.75 81.18	48.51 22.77	384.15
6	URS	Mirochina, Elena	33.12 51.84	40.20 58.50	40.47 71.04	37.80 48.96	381.93
7	NOR	Gamme, Kamilla	36.00 44.85	39.00 50.40	43.32 55.44	40.32 57.12	366.45
8	GDR	Abicht, Silke	38.88 46.08	43.20 56.28	47.25 36.54	36.48 45.90	350.61
9	MEX	Alcala, Maria	32.16 43.74	37.26 51.84	37.05 52.92	39.00 55.44	349.41
10	CAN	Fuller, Debbie	32.64 33.21	42.75 47.85	36.60 51.24	40.32 56.28	340.89
11	HUN	Kelemen, Ildiko	31.50 42.09	41.40 36.96	37.80 48.24	36.60 48.00	322.59
12	ARG	Ribot, Veronica G	38.34 30.24	39.60 46.98	43.89 27.54	29.70 40.89	297.18

**Women Platform Diving
Final Dive 5/Sept. 18**

**Femmes/Plongeon du Haut-vol
Finale Plongeon 5/18 Sept**

Order Ordre	Ctry Pays	Name Nom	Type Saut	Diff Coef	Judge/Juge							Total
					1	2	3	4	5	6	7	
1	HUN	Kelemen, Ildiko	105 B	2.3	6.5	6.0	6.0	6.0	6.5	6.0	6.0	42.09
2	NOR	Gamme, Kamilla	105 B	2.3	7.0	6.5	6.5	6.0	7.0	5.5	6.5	44.85
3	MEX	Alcala, Maria	107 C	2.7	5.5	5.0	5.5	6.0	5.5	5.0	5.5	43.74
4	CAN	Fuller, Debbie	107 C	2.7	4.0	4.5	4.0	4.0	4.0	4.0	4.5	33.21
5	ARG	Ribot, Veronica G	405 B	2.8	3.0	3.5	4.0	4.0	3.5	5.5	3.0	30.24
6	GDR	Abicht, Silke	5237 D	3.2	4.5	4.5	5.5	4.0	5.0	5.0	5.0	46.08
7	URS	Mirochina, Elena	614 B	2.4	7.5	7.0	7.0	7.5	7.0	7.5	7.0	51.84
8	URS	Stassioulevitch, Anjela	405 B	2.8	7.0	7.5	7.5	7.0	7.5	7.5	7.5	62.16
9	USA	Williams, Wendy Lian	5235 D	2.8	8.0	7.5	7.5	7.5	7.5	7.5	8.0	63.84
10	CHN	Xu, Yanmei	405 B	2.8	8.0	8.0	8.0	8.0	8.0	8.0	8.5	67.20
11	USA	Mitchell, Michele	614 B	2.4	7.5	7.5	7.5	7.0	6.5	7.5	7.5	53.28
12	CHN	Chen, Xiaodan	107 B	3.0	6.5	7.0	7.0	6.5	6.5	6.5	7.0	60.30

**Women Platform Diving
Final Dive 6/Sept. 18**

**Femmes/Plongeon du Haut-vol
Finale Plongeon 6/18 Sept**

Order Ordre	Ctry Pays	Name Nom	Type Saut	Diff Coef	Judge/Juge							Total
					1	2	3	4	5	6	7	
1	HUN	Kelemen, Ildiko	405 B	2.8	5.5	3.5	5.0	5.0	4.5	3.5	4.0	36.96
2	NOR	Gamme, Kamilla	614 B	2.4	7.0	7.0	7.0	6.5	7.5	6.5	7.5	50.40
3	MEX	Alcala, Maria	305 C	2.7	6.0	6.5	6.5	6.5	6.5	6.0	7.0	51.84
4	CAN	Fuller, Debbie	205 B	2.9	4.5	5.5	6.0	6.0	5.5	5.0	5.5	47.85
5	ARG	Ribot, Veronica G	107 C	2.7	5.0	5.5	6.0	6.0	7.0	6.0	5.5	46.98
6	GDR	Abicht, Silke	405 B	2.8	7.5	7.0	6.5	6.0	7.0	6.5	6.5	56.28
7	URS	Mirochina, Elena	107 B	3.0	7.0	6.5	6.5	7.0	6.0	6.5	6.0	58.50
8	URS	Stassioulevitch, Anjela	5235 D	2.8	7.5	6.0	7.5	7.0	7.5	7.0	7.0	60.48
9	USA	Williams, Wendy Lian	205 B	2.9	7.0	7.0	6.5	6.5	6.5	6.5	7.0	58.29
10	CHN	Xu, Yanmei	107 B	3.0	7.0	7.0	7.0	7.0	7.0	7.0	7.5	63.00
11	USA	Mitchell, Michele	405 B	2.8	8.0	7.5	8.0	8.0	7.5	7.5	7.5	64.68
12	CHN	Chen, Xiaodan	407 C	3.2	5.5	5.0	6.0	5.0	5.0	6.0	5.5	51.84

**Women Platform Diving
Final Dive 7/Sept. 18**

**Femmes/Plongeon du Haut-vol
Finale Plongeon 7/18 Sept**

Order Ordre	Ctry Pays	Name Nom	Type Saut	Diff Coef	Judge/Juge							Total
					1	2	3	4	5	6	7	
1	HUN	Kelemen, Ildiko	203 A	2.4	6.0	7.0	6.5	6.5	6.5	7.0	7.5	48.24
2	NOR	Gamme, Kamilla	405 B	2.8	7.0	6.0	6.5	6.5	7.0	6.5	6.5	55.44
3	MEX	Alcala, Maria	405 B	2.8	5.5	6.5	6.5	6.5	6.5	6.0	6.0	52.92
4	CAN	Fuller, Debbie	405 B	2.8	6.5	6.0	6.0	6.0	6.0	7.0	6.0	51.24
5	ARG	Ribot, Veronica G	305 C	2.7	2.5	3.5	3.0	3.5	4.5	3.5	3.5	27.54
6	GDR	Abicht, Silke	205 B	2.9	4.0	3.5	5.0	3.0	4.5	4.0	5.5	36.54
7	URS	Mirochina, Elena	407 C	3.2	6.5	7.0	7.5	7.5	8.0	7.5	7.5	71.04
8	URS	Stassioulevitch, Anjela	614 B	2.4	7.5	7.5	7.5	7.0	7.5	7.0	7.0	52.56
9	USA	Williams, Wendy Lian	305 C	2.7	6.5	6.0	6.5	6.0	6.0	6.5	7.0	51.03
10	CHN	Xu, Yanmei	305 C	2.7	9.0	8.5	8.5	8.5	8.0	8.5	7.5	68.04
11	USA	Mitchell, Michele	5237 D	3.2	8.5	8.0	8.0	8.0	7.5	9.0	7.5	76.80
12	CHN	Chen, Xiaodan	5337 D	3.3	8.5	9.0	8.0	7.5	8.0	7.5	8.0	81.18

Swimming

Synchronized Swimming Figures/Sept. 28			Nage synchronisee Imposees/28 Sept	
Rank Rang	Name Nom	Ctry Pays	Figures Imposees	
1	Waldo, Carolyn	CAN	101.150	
2	Ruiz-Conforto, Tracie	USA	98.633	
3	Josephson, Sarah	USA	98.000	
4	Josephson, Karen	USA	97.367	
5	Cameron, Michelle	CAN	96.683	
6	Kotani, Mikako	JPN	94.250	
7	Hermine, Muriel	FRA	93.500	
8	Larsen, Karin	CAN	92.250	
9	Tanaka, Miyako	JPN	91.267	
10	Singer, Karin	SUI	90.600	
11	Titova, Tatiana	URS	89.333	
12	Schuler, Karine	FRA	89.050	
13	Shearn, Nicola	GBR	88.733	
14	Ito, Megumi	JPN	88.517	
15	Capron, Anne	FRA	88.133	
16	Tscherniaeva, Mariia	URS	88.000	
17	Boss, Edith	SUI	87.300	
18	Falassinidi, Khristina	URS	87.050	
19	Scheller, Gerlind	FRG	85.583	
20	Jacobsson, Marie	SWE	84.800	
21	Mcdavid, Erika	BRA	84.733	
21	Cardenas, Sonia	MEX	84.733	
23	Candini, Lourdes	MEX	84.533	
24	Peczinka, Claudia	SUI	84.067	
25	Goodwin, Lian	GBR	83.817	
26	Giusty, Maria	VEN	83.733	
27	Kim, Mijinsu	KOR	83.650	
28	Tan, Min	CHN	83.600	
29	Candini, Susana	MEX	83.067	
30	Carvalho, Paula	BRA	82.517	
31	Riera, Eva	BRA	82.117	
32	Friedrich, Heike	FRG	82.000	
33	Luo, Xi	CHN	81.883	
34	Zhang, Ying	CHN	81.150	
35	Ha, Soo-Kyung	KOR	80.750	
36	Lieschke, Lisa	AUS	80.433	
36	Eisenhofer, Doris	FRG	80.433	
38	Choi, Jung-Yoon	KOR	79.150	
39	Lopez, Eva	ESP	78.983	
40	Rohloff, Semon	AUS	78.850	
41	Serneels, Patricia	BEL	78.750	
42	Ayala, Nuria	ESP	75.967	
43	Thuis, Yvette	ARU	74.266	
44	Amoros, Marta	ESP	74.100	
45	Lopez, Roswitha	ARU	70.483	
	Seeburg, Joanne	GBR	DNF	

Synchronized Swimming Figures/Sept. 28			Nage synchronisee Imposees/28 Sept	
Order Ordre	Name Nom	DD	Panel Panneau	
1	Walkover, Front	1.5	1	
2	Dolpholina	2.1	1	
3	Barracuda	1.8	2	
4	Spiral	2.0	2	
5	Flamingo Bent Knee	1.8	3	
6	Kip Continuous Spin	1.9	3	

Synchronized Swimming Solo Routine/Preliminary/Sept. 26			Nage synchronisee solo Epreuve Libre/Eliminatoire/26 Sept								
Rank Rang	Name Nom	Ctry Pays	1	2	3	4	5	6	7	Pen	Routine
1	Ruiz-Conforto, Tracie	USA	9.9	9.8	9.8	9.9	9.8	9.8	9.9		98.400
2	Waldo, Carolyn	CAN	9.8	9.9	9.8	9.8	9.9	9.8	9.8		98.200
3	Kotani, Mikako	JPN	9.7	9.7	9.7	9.7	9.7	9.5	9.7		97.000
4	Hermine, Muriel	FRA	9.6	9.6	9.6	9.5	9.6	9.4	9.5		95.600
5	Singer, Karin	SUI	9.4	9.5	9.5	9.5	9.3	9.3	9.5		94.400
6	Falassinidi, Khristina	URS	9.5	9.4	9.2	9.4	9.5	9.1	9.3		93.600
7	Shearn, Nicola	GBR	9.2	9.3	9.5	9.2	9.4	9.2	9.2		92.600
8	Zhang, Ying	CHN	9.0	9.0	8.9	8.9	9.0	8.7	9.0		89.600
9	Ha, Sop-Kyung	KOR	8.9	8.9	8.9	9.0	8.9	8.8	9.0		89.200
10	Scheller, Gerlind	FRG	8.8	8.7	8.9	9.0	8.7	9.2	8.9		88.600
11	Lopez, Eva	ESP	8.7	8.9	8.9	8.8	8.5	8.9	8.9		88.400
12	Jacobsson, Marie	SWE	8.9	8.6	8.8	8.9	8.8	8.7	8.8		88.000
12	Candini, Lourdes	MEX	8.8	9.1	9.1	8.6	8.7	8.4	8.8		88.000
14	Serneels, Patricia	BEL	8.9	8.7	8.2	8.6	8.5	8.4	8.7		85.800
15	Giusty, Maria	VEN	8.5	8.8	8.5	8.7	8.6	8.5	8.6		85.600
16	Lieschke, Lisa	AUS	8.3	8.8	8.5	8.6	8.4	8.4	8.7		85.200
17	Carvalho, Paula	BRA	8.2	8.6	8.4	8.0	8.4	8.3	8.7		83.800
18	Lopez, Roswitha	ARU	7.7	8.0	7.9	8.3	7.9	8.0	8.4		80.200

Natation

Synchronized Swimming Solo Preliminary/Sept. 28			Nage synchronisee solo Eliminatoires/28 Sept		
Rank Rang	Name Nom	Ctry Pays	Figures Imposees	Routine	Total
1	Waldo, Carolyn	CAN	101.150	98.200	199.350
2	Ruiz-Conforto, Tracie	USA	98.633	98.400	197.033
3	Kotani, Mikako	JPN	94.250	97.000	191.250
4	Hermine, Muriel	FRA	93.500	95.600	189.100
5	Singer, Karin	SUI	90.600	94.400	185.000
6	Shearn, Nicola	GBR	88.733	92.600	181.333
7	Falassinidi, Khristina	URS	87.050	93.600	180.650
8	Scheller, Gerlind	FRG	85.583	88.600	174.183
9	Jacobsson, Marie	SWE	84.800	88.000	172.800
10	Candini, Lourdes	MEX	84.533	88.000	172.533
11	Zhang, Ying	CHN	81.150	89.600	170.750
12	Ha, Soo-Kyung	KOR	80.750	89.200	169.950
13	Giusty, Maria	VEN	83.733	85.600	169.333
14	Lopez, Eva	ESP	78.983	88.400	167.383
15	Carvalho, Paula	BRA	82.517	83.800	166.317
16	Lieschke, Lisa	AUS	80.433	85.200	165.633
17	Serneels, Patricia	BEL	78.750	85.800	164.550
18	Lopez, Roswitha	ARU	70.483	80.200	150.683

Synchronized Swimming Solo Routine Final/Sept. 30			Nage synchronisee solo Epreuve Libre / Finale/30 Sept								
Rank Rang	Name Nom	Ctry Pays	1	2	3	4	5	6	7	Pen	Routine
1	Ruiz-Conforto, Tracie	USA	10.0	9.9	9.9	9.9	9.8	9.9	9.9		99.000
1	Waldo, Carolyn	CAN	9.8	10.0	9.9	9.9	9.9	9.9	9.9		99.000
3	Kotani, Mikako	JPN	9.8	9.8	9.8	9.7	9.7	9.7	9.8		97.600
4	Hermine, Muriel	FRA	9.9	9.7	9.7	9.7	9.6	9.6	9.6		96.600
5	Singer, Karin	SUI	9.5	9.5	9.6	9.5	9.4	9.5	9.5		95.000
6	Fatessinidi, Khristina	URS	9.4	9.3	9.4	9.4	9.3	9.4	9.3		93.600
7	Shearn, Nicola	GBR	9.3	9.2	9.5	9.2	9.4	9.3	9.4		93.200
8	Scheller, Gerlind	FRG	9.0	9.0	9.1	9.1	9.0	9.0	9.1		90.400

Synchronized Swimming Solo Final/Sept. 30			Nage synchronisee solo Finale/30 Sept		
Rank Rang	Name Nom	Ctry Pays	Figures Imposees	Routine	Total
1	Waldo, Carolyn	CAN	101.150	99.000	200.150
2	Ruiz-Conforto, Tracie	USA	98.633	99.000	197.633
3	Kotani, Mikako	JPN	94.250	97.600	191.850
4	Hermine, Muriel	FRA	93.500	96.600	190.100
5	Singer, Karin	SUI	90.600	95.000	185.600
6	Shearn, Nicola	GBR	88.733	93.200	181.933
7	Falassinidi, Khristina	URS	87.050	93.600	180.650
8	Scheller, Gerlind	FRG	85.583	90.400	175.983

Synchronized Swimming Duet Routine/Preliminary/Sept. 27			Nage synchronisee duo Epreuve Libre/Eliminatoire/27 Sept								
Rank Rang	Name Nom	Ctry Pays	1	2	3	4	5	6	7	Pen	Routine
1	Josephson, Sarah Josephson, Karen	USA	9.9	9.8	9.9	9.9	9.8	9.8	9.9		98.600
2	Cameron, Michelle Waldo, Carolyn	CAN	9.8	9.9	9.9	9.9	9.8	9.8	9.7		98.400
3	Tanaka, Miyako Kotani, Mikako	JPN	9.7	9.6	9.7	9.7	9.7	9.7	9.6		96.800
4	Schuler, Karine Capron, Anne	FRA	9.5	9.5	9.4	9.6	9.5	9.6	9.5		95.200
5	Boss, Edith Singer, Karin	SUI	9.5	9.4	9.5	9.4	9.3	9.5	9.3		94.200
6	Tscherniaeva, Mariia Titova, Tatiana	URS	9.4	9.3	9.4	9.3	9.4	9.3	9.4		93.600
7	Shearn, Nicola Goodwin, Lian	GBR	9.1	9.2	9.3	9.1	9.3	9.0	9.1		91.600
8	Candini, Susana Candini, Lourdes	MEX	9.3	9.0	8.9	9.0	9.2	9.3	9.1		91.200
9	Tan, Min Luo, Xi	CHN	9.1	9.1	9.1	8.8	9.2	9.0	9.2		91.000
10	Kim, Mijinsu Ha, Soo-Kyung	KOR	9.2	9.0	9.0	8.9	9.1	8.8	8.8		89.600
11	Friedrich, Heike Scheller, Gerlind	FRG	9.0	8.9	8.9	8.9	8.7	8.7	9.0		88.800
12	Mcdavid, Erika Riera, Eva	BRA	8.9	8.7	8.7	8.8	8.8	8.8	8.4		87.400
13	Lieschke, Lisa Rohloff, Semon	AUS	8.8	8.6	8.4	8.7	8.6	8.5	8.9		86.400
14	Lopez, Eva Ayala, Nuria	ESP	8.7	8.7	8.7	8.7	8.5	8.5	8.3		86.200
15	Thuis, Yvette Lopez, Roswitha	ARU	8.1	8.0	8.0	7.9	7.8	7.9	8.0		79.600



**Synchronized Swimming Duet
Preliminary/Sept. 28**

**Nage synchronisee duo
Eliminatoires/28 Sept**

Rank Rang	Name Nom	Ctry Pays	Figures Imposees	Routine	Total
1	Cameron, Michelle Waldo, Carolyn	CAN	98.917	98.400	197.317
2	Josephson, Sarah Josephson, Karen	USA	97.684	98.600	196.284
3	Tanaka, Miyako Kotani, Mikako	JPN	92.759	96.800	189.559
4	Schuler, Karine Capron, Anne	FRA	88.592	95.200	183.792
5	Boss, Edith Singer, Karin	SUI	88.950	94.200	183.150
6	Tscherniaeva, Mariia Titova, Tatiana	URS	88.667	93.600	182.267
7	Shearn, Nicola Goodwin, Lian	GBR	86.275	91.600	177.875
8	Candini, Susana Candini, Lourdes	MEX	83.800	91.200	175.000
9	Tan, Min Luo, Xi	CHN	82.742	91.000	173.742
10	Friedrich, Heike Scheller, Gerlind	FRG	83.792	88.800	172.592
11	Kim, Mijinsu Ha, Soo-Kyung	KOR	82.200	89.600	171.800
12	Mcdavid, Erika Riera, Eva	BRA	83.425	87.600	171.025
13	Lieschke, Lisa Rohloff, Semon	AUS	79.642	86.400	166.042
14	Lopez, Eva Ayala, Nuria	ESP	77.475	86.200	163.675
15	Thuis, Yvette Lopez, Roswitha	ARU	72.375	79.600	151.975

**Synchronized Swimming Duet
Routine/Final/Oct. 1**

**Nage synchronisee duo
Epreuve Libre/Finale/1 Oct**

Rank Rang	Name Nom	Ctry Pays	Judges/Juges							Pen	Routine
			1	2	3	4	5	6	7		
1	Josephson, Sarah Josephson, Karen	USA	10.0	9.8	10.0	10.0	9.9	9.9	10.0		99.600
2	Cameron, Michelle Waldo, Carolyn	CAN	9.8	10.0	10.0	9.9	9.9	9.8	9.8		98.800
3	Tanaka, Miyako Kotani, Mikako	JPN	9.8	9.7	9.9	9.7	9.7	9.8	9.7		97.400
4	Schuler, Karine Capron, Anne	FRA	9.6	9.6	9.7	9.8	9.5	9.6	9.6		96.200
5	Boss, Edith Singer, Karin	SUI	9.5	9.5	9.6	9.6	9.4	9.4	9.5		95.000
6	Tscherniaeva, Mariia Titova, Tatiana	URS	9.4	9.4	9.4	9.4	9.4	9.4	9.3		94.000
7	Shearn, Nicola Goodwin, Lian	GBR	9.3	9.3	9.4	9.4	9.3	9.1	9.1		92.800
8	Candini, Lourdes Cardenas, Sonia	MEX	9.2	9.2	9.2	9.3	9.2	9.3	9.2		92.200

**Synchronized Swimming Duet
Final/Oct. 1**

**Nage synchronisee duo
Finale/1 Oct**

Rank Rang	Name Nom	Ctry Pays	Figures Imposees	Routine	Total
1	Cameron, Michelle Waldo, Carolyn	CAN	98.917	98.400	197.317
2	Josephson, Sarah Josephson, Karen	USA	97.684	98.600	197.284
3	Tanaka, Miyako Kotani, Mikako	JPN	92.759	97.400	190.159
4	Schuler, Karine Capron, Anne	FRA	88.592	96.200	184.792
5	Boss, Edith Singer, Karin	SUI	88.950	95.000	183.950
6	Tscherniaeva, Mariia Titova, Tatiana	URS	88.667	94.000	182.667
7	Shearn, Nicola Goodwin, Lian	GBR	86.275	92.800	179.075
8	Candini, Lourdes Cardenas, Sonia	MEX	84.633	92.200	176.833

**Men Waterpolo
Preliminary Round Gr.A Match 1/Sept. 21**

**Hommes/Waterpolo
Tour Elimatoire Gr.A Renc. 1/21 Sept**

Cap Bonn	Name Nom	Goals Buts	Cap Bonn	Name Nom	Goals Buts
ITA 9 — 9 URS (2-3, 1-2, 3-2, 3-2)					
ITA			URS		
1	Trapanese, Paolo	0	1	Charonov, Evgueni	0
2	Misaggi, Alfio	0	2	Mendygaliyev, Nourlan	0
3	Pisano, Andrea	1	3	Grichine, Evgeni	0
4	Steardo, Antonello	0	4	Kolotov, Alexandre	1
5	Campagna, Alessandro	3	5	Naoumov, Sergei	0
6	Caldarella, Paolo	0	6	Berendiouga, Victor	0
7	Fiorillo, Mario	3	7	Kotenko, Serguei	1
8	Porzio, Francesco	1	8	Apanasenko, Dmitri	5
9	Postiglione, Stefano	0	9	Mchvenieradze, Georgui	1
10	Tempestini, Riccardo	1	10	Ivanov, Mikhail	0
11	Ferretti, Massimiliano	0	11	Markotch, Serguei	1
12	D'altrui, Marco	0	12	Smirnov, Nikolai	0
13	Averaimo, Gianni	0	13	Giorgadze, Mikhail	0
Coach/Entraîneur: Fritz, Dennerlein			Coach/Entraîneur: Popov, Boris		
Referee/Arbitre: ESP ASENCIO, EUGENIO HOL VAN DORP, FRED Goal judge/Juge de but: USA HERMSTAD, THOMAS HUN CSASZAR, GYORGY					

**Men Waterpolo
Preliminary Round Gr.A Match 2/Sept. 21**

**Hommes/Waterpolo
Tour Elimatoire Gr.A Renc. 2/21 Sept**

Cap Bonn	Name Nom	Goals Buts	Cap Bonn	Name Nom	Goals Buts
FRA 16-5 KOR (3-0, 4-1, 3-1, 6-3)					
FRA			KOR		
1	Bouet, Arnaud	0	1	Lee, Jung-Suk	0
2	Brisfer, Marc	0	2	Chang, Si-Young	0
3	Crousillat, Marc	1	3	Kim, Sung-Eun	0
4	Garsau, Pierre	5	4	Yoo, Seung-Hoon	0
5	Boyadjian, Bruno	0	5	Kim, Ki-Choon	0
6	Herve, Philippe	3	6	Kim, Jae-Yun	2
7	Idoux, Michel	2	7	Choi, Sun-Young	0
8	Alimondo, Thierry	0	8	Kim, Kil-Hwan	1
9	Crousillat, Michel	0	9	Kim, Jin-Tae	0
10	Marischael, Nicolas	1	10	Song, Seung-Ho	0
11	Jeleff, Nicolas	3	11	Hong, Soon-Bo	0
12	Perot, Pascal	1	12	Lee, Taek-Won	2
13	Volpi, Christian	0	13	Park, Sang-Won	0
Coach/Entraîneur: Jean Paul Clemencou			Coach/Entraîneur: Kim, Jong-Ku		
Referee/Arbitre: YUG DROBNJAK, MILAN IRN AMINI, KHOSROW Goal judge/Juge de but: HUN VUSZEK, ANTON CHN HE, LIANDE					

**Men Waterpolo
Preliminary Round Gr.A Match 3/Sept. 21**

**Hommes/Waterpolo
Tour Elimatoire Gr.A Renc. 3/21 Sept**

Cap Bonn	Name Nom	Goals Buts	Cap Bonn	Name Nom	Goals Buts
AUS (11-13 FRG (4-4, 1-2, 3-3, 3-4)					
AUS			FRG		
1	Townsend, Glenn	0	1	Roehle, Peter	0
2	Pengelly, Richard	0	2	Jacoby, Dirk	0
3	Harrison, Christopher	0	3	Otto, Frank	4
4	Stockwell, Troy	0	4	Sterzik, Uwe	0
5	Wightman, Andrew	0	5	Fernandez, Armando	1
6	Kerr, Andrew	2	6	Ehrl, Andreas	1
7	Mayers, Raymond	1	7	Borgmann, Ingo	0
8	Clark, Geoffrey	3	8	Osselmann, Rainer	0
9	Fox, John	1	9	Stamm, Hagen	3
10	Wybrow, Christopher	4	10	Huber, Thomas	0
13	Asher, Simon	0	11	Theismann, Dirk	3
12	Taylor, Andrew	0	12	Reimann, Rene	1
11	Cameron, Donald	0	13	Obschernikat, Werner	0
Coach/Entraîneur: Tom, Hoad			Coach/Entraîneur: Firiuo, Nicola		
Referee/Arbitre: ESP CILLERO, LUIS USA LEE, ROBERT Goal judge/Juge de but: YUG KLARIC, ZELJKO GRE TSANTAS, APOSTOLOS					

Swimming

Natation

Men Waterpolo Preliminary Round Gr.A Match 4/Sept. 22			Hommes/Waterpolo Tour Elimatoire Gr.A Renc. 4/22 sept		
Cap Bonn	Name Nom	Goals Buts	Cap Bonn	Name Nom	Goals Buts

KOR 1-11 ITA (0-5, 1-2, 0-1,0-3)

KOR			ITA		
1	Lee, Jung-Suk	0	1	Trapanese, Paolo	0
2	Chang, Si-Young	0	2	Misaggi, Alfio	1
3	Kim, Sung-Eun	0	3	Pisano, Andrea	2
4	Yoo, Seung-Hoon	0	4	Steardo, Antonello	1
5	Kim, Ki-Choon	0	5	Campagna, Alessandro	1
6	Kim, Jae-Yun	0	6	Caldarella, Paolo	0
7	Choi, Sun-Young	0	7	Fiorillo, Mario	0
8	Kim, Kil-Hwan	0	8	Porzio, Francesco	1
9	Kim, Jin-Tae	0	9	Postiglione, Stefano	2
10	Song, Seung-Ho	1	10	Tempestini, Riccardo	0
11	Hong, Soon-Bo	0	11	Ferretti, Massimiliano	3
12	Lee, Taek-Won	0	12	D'altrui, Marco	0
13	Park, Sang-Won	0	13	Averaimo, Gianni	0

Coach/Entraîneur: Kim, Jong-Ku

Coach/Entraîneur: Fritz, Dennerlein

Referee/Arbitre: HUN CSASZAR, GYORGY
CHN HE, LIANDE
Goal judge/Juge de but: ESPASENCIO, EUGENIO
USA LEE, ROBERT

Men Waterpolo Preliminary Round Gr.A Match 7/Sept. 23			Hommes/Waterpolo Tour Elimatoire Gr.A Renc. 7/23 sept		
Cap Bonn	Name Nom	Goals Buts	Cap Bonn	Name Nom	Goals Buts

KOR 2-18 FRG (0-5, 1-3, 0-6, 1-4)

KOR			FRG		
1	Lee, Jung-Suk	0	1	Roehle, Peter	0
2	Chang, Si-Young	0	2	Jacoby, Dirk	1
3	Kim, Sung-Eun	0	3	Otto, Frank	3
4	Yoo, Seung-Hoon	0	4	Sterzik, Uwe	1
5	Kim, Ki-Choon	0	5	Fernandez, Armando	2
6	Kim, Jae-Yun	0	6	Ehrl, Andreas	0
7	Choi, Sun-Young	0	7	Borgmann, Ingo	0
8	Kim, Kil-Hwan	0	8	Osselmann, Rainer	0
9	Kim, Jin-Tae	0	9	Stamm, Hagen	6
10	Song, Seung-Ho	1	10	Huber, Thomas	2
11	Hong, Soon-Bo	0	11	Theismann, Dirk	2
12	Lee, Taek-Won	1	12	Reimann, Rene	1
13	Park, Sang-Won	0	13	Obschernikat, Werner	0

Coach/Entraîneur: Kim, Jong-Ku

Coach/Entraîneur: Furuio, Nicola

Referee/Arbitre: USA LEE, ROBERT
CHN HE, LIANDE
Goal judge/Juge de but: GRE TSANTAS, APOSTOLOS
ESP CILLERO, LUIS

Men Waterpolo Preliminary Round Gr.A Match 5/Sept. 22			Hommes/Waterpolo Tour Elimatoire Gr.A Renc. 5/22 sept		
Cap Bonn	Name Nom	Goals Buts	Cap Bonn	Name Nom	Goals Buts

FRA 9-10 FRG (2-2, 3-3, 1-2, 3-3)

FRA			FRG		
1	Bouet, Arnaud	0	1	Roehle, Peter	0
2	Brisfer, Marc	0	2	Jacoby, Dirk	0
3	Crousillat, Marc	0	3	Otto, Frank	0
4	Garsau, Pierre	3	4	Sterzik, Uwe	0
5	Boyadjian, Bruno	1	5	Fernandez, Armando	0
6	Herve, Philippe	2	6	Ehrl, Andreas	2
7	Idoux, Michel	2	7	Borgmann, Ingo	0
8	Alimondo, Thierry	0	8	Osselmann, Rainer	0
9	Crousillat, Michel	0	9	Stamm, Hagen	2
10	Marischael, Nicolas	0	10	Huber, Thomas	0
11	Jeleff, Nicolas	1	11	Theismann, Dirk	2
12	Perot, Pascal	0	12	Reimann, Rene	2
13	Volpi, Christian	0	13	Obschernikat, Werner	2

Coach/Entraîneur: Jean Paul Clemencou

Coach/Entraîneur: Furuio, Nicola

Referee/Arbitre: HUN VUSZEK, ANTON
GRE TSANTAS, APOSTOLOS
Goal judge/Juge de but: ESP CILLERO, LUIS
YUG DROBNJAK, MILAN

Men Waterpolo Preliminary Round Gr.A Match 8/Sept. 23			Hommes/Waterpolo Tour Elimatoire Gr.A Renc. 8/23 sept		
Cap Bonn	Name Nom	Goals Buts	Cap Bonn	Name Nom	Goals Buts

AUS 5-7 ITA (1-1, 0-3, 2-2, 2-1)

AUS			ITA		
1	Townsend, Glenn	0	1	Trapanese, Paolo	0
2	Pengelly, Richard	0	2	Misaggi, Alfio	0
3	Harrison, Christopher	0	3	Pisano, Andrea	2
4	Stockwell, Troy	2	4	Steardo, Antonello	1
5	Wightman, Andrew	0	5	Campagna, Alessandro	0
6	Kerr, Andrew	0	6	Caldarella, Paolo	1
7	Mayers, Raymond	1	7	Fiorillo, Mario	0
8	Clark, Geoffrey	1	8	Porzio, Francesco	0
9	Fox, John	0	9	Postiglione, Stefano	0
10	Wybrow, Christopher	0	10	Tempestini, Riccardo	0
11	Asher, Simon	1	11	Ferretti, Massimiliano	3
12	Taylor, Andrew	0	12	D'altrui, Marco	0
13	Cameron, Donald	0	13	Averaimo, Gianni	0

Coach/Entraîneur: Tom, Hoad

Coach/Entraîneur: Fritz, Dennerlein

Referee/Arbitre: YUG KLARIC, ZELJKO
ESP ASENCIO, EUGENIO
Goal judge/Juge de but: USA HERMSTAD, THOMAS
HUN CSASZAR, GYORGY

Men Waterpolo Preliminary Round Gr.A Match 6/Sept. 22			Hommes/Waterpolo Tour Elimatoire Gr.A Renc. 6/22 Sept		
Cap Bonn	Name Nom	Goals Buts	Cap Bonn	Name Nom	Goals Buts

AUS 4-11 URS (3-3, 0-1,0-2, 1-5)

AUS			URS		
1	Townsend, Glenn	0	1	Charonov, Evgueni	0
2	Pengelly, Richard	0	2	Mendygaliyev, Nourlan	2
3	Harrison, Christopher	0	3	Grichine, Evgeni	0
4	Stockwell, Troy	0	4	Kolotov, Alexandre	1
5	Wightman, Andrew	0	5	Naoumov, Sergei	0
6	Kerr, Andrew	1	6	Berendiouga, Victor	0
7	Mayers, Raymond	0	7	Kotenko, Serguei	3
8	Clark, Geoffrey	0	8	Apanasenko, Dmitri	0
9	Fox, John	0	9	Mchvenieradze, Georgui	1
10	Wybrow, Christopher	1	10	Ivanov, Mikhail	1
11	Asher, Simon	2	11	Markotch, Serguei	2
12	Taylor, Andrew	0	12	Smirnov, Nikolai	1
13	Cameron, Donald	0	13	Giorgadze, Mikhail	0

Coach/Entraîneur: Tom, Hoad

Coach/Entraîneur: Popov, Boris

Referee/Arbitre: HOL VAN DORP, FRED
USA HERMSTAD, THOMAS
Goal judge/Juge de but: YUG KLARIC, ZELJKO
KOR LEE, UNG-KI

Men Waterpolo Preliminary Round Gr.A Match 9/Sept. 23			Hommes/Waterpolo Tour Elimatoire Gr.A Renc. 9/23 sept		
Cap Bonn	Name Nom	Goals Buts	Cap Bonn	Name Nom	Goals Buts

FRA 4-18 URS (2-5, 0-4, 1-5, 1-4)

FRA			URS		
1	Bouet, Arnaud	0	1	Charonov, Evgueni	0
2	Brisfer, Marc	0	2	Mendygaliyev, Nourlan	2
3	Crousillat, Marc	0	3	Grichine, Evgeni	0
4	Garsau, Pierre	1	4	Kolotov, Alexandre	2
5	Boyadjian, Bruno	0	5	Naoumov, Sergei	1
6	Herve, Philippe	2	6	Berendiouga, Victor	1
7	Idoux, Michel	0	7	Kotenko, Serguei	0
8	Alimondo, Thierry	0	8	Apanasenko, Dmitri	2
9	Crousillat, Michel	0	9	Mchvenieradze, Georgui	5
10	Marischael, Nicolas	0	10	Ivanov, Mikhail	0
11	Jeleff, Nicolas	1	11	Markotch, Serguei	2
12	Perot, Pascal	0	12	Smirnov, Nikolai	3
13	Volpi, Christian	0	13	Giorgadze, Mikhail	0

Coach/Entraîneur: Jean Paul Clemencou

Coach/Entraîneur: Popov, Boris

Referee/Arbitre: YUG DROBNJAK, MILAN
HUN VUSZEK, ANTON
Goal judge/Juge de but: HOL VAN DORP, FRED
TUR TOYGARLI, HALUK



Men Waterpolo
Preliminary Round Group A Match 10/Sept. 26

Cap	Name	Goals
Bonn	Nom	Buts

ITA 7-10 FRG (2-4, 3-2, 1-2, 1-2)

ITA			FRG		
1	Trapanese, Paolo	0	1	Roehle, Peter	0
2	Misaggi, Alfio	1	2	Jacoby, Dirk	0
3	Pisano, Andrea	1	3	Otto, Frank	3
4	Steardo, Antonello	0	4	Sterzik, Uwe	0
5	Campagna, Alessandro	0	5	Fernandez, Armando	0
6	Caldarella, Paolo	0	6	Ehrl, Andreas	1
7	Fiorillo, Mario	0	7	Borgmann, Ingo	0
8	Porzio, Francesco	2	8	Osselmann, Rainer	2
9	Postiglione, Stefano	0	9	Stamm, Hagen	1
10	Tempestini, Riccardo	0	10	Huber, Thomas	0
11	Ferretti, Massimiliano	3	11	Theismann, Dirk	3
12	D'altrui, Marco	0	12	Reimann, Rene	0
13	Averaimo, Gianni	0	13	Obschernikat, Werner	0

Coach/Entraîneur: Fritz, Dennerlein

Coach/Entraîneur: Firiou, Nicola

Referee/Arbitre: YUG KLARIC, ZELJKO
ESPASENCIO, EUGENIO
Goal judge/Juge de but: USA HERMSTAD, THOMAS
HUN YUSZEK, ANTON

Men Waterpolo
Preliminary Round Group A Match 13/Sept. 27

Cap	Name	Goals
Bonn	Nom	Buts

FRA 8-14 ITA (3-3, 2-3, 1-3, 2-5)

FRA			ITA		
1	Bouet, Arnaud	0	1	Trapanese, Paolo	0
2	Brisfer, Marc	0	2	Misaggi, Alfio	1
3	Crousillat, Marc	1	3	Pisano, Andrea	2
4	Garsau, Pierre	2	4	Steardo, Antonello	2
5	Bouadjian, Bruno	0	5	Campagna, Alessandro	3
6	Herve, Philippe	2	6	Caldarella, Paolo	1
7	Idoux, Michel	0	7	Fiorillo, Mario	0
8	Alimondo, Thierry	1	8	Porzio, Francesco	3
9	Crousillat, Michel	0	9	Postiglione, Stefano	0
10	Marischael, Nicolas	0	10	Tempestini, Riccardo	0
11	Jeleff, Nicolas	1	11	Ferretti, Massimiliano	2
12	Perot, Pascal	1	12	D'altrui, Marco	0
13	Volpi, Christian	0	13	Averaimo, Gianni	0

Coach/Entraîneur: Jean Paul Clemenccon

Coach/Entraîneur: Fritz, Dennerlein

Referee/Arbitre: HUN CSASZAR, GYORGY
KOR LEE, UNG-KI
Goal judge/Juge de but: BEL VAN DE VREKEN, PIERRE
YUG KLARIC, ZELJKO

Men Waterpolo
Preliminary Round Group A Match 11/Sept. 26

Cap	Name	Goals
Bonn	Nom	Buts

KOR 4-17 URS (1-6, 1-3, 1-2, 1-6)

KOR			URS		
1	Lee, Jung-suk	0	1	Charonov, Evgueni	0
2	Chang, Si-Young	0	2	Mendygaliyev, Nourlan	1
3	Kim, Sung-Eun	0	3	Grichine, Evgeni	1
4	Yoo, Seung-Hoon	0	4	Kolotov, Alexandre	1
5	Kim, Ki-Choon	0	5	Naoumov, Sergei	2
6	Kim, Jae-Yun	0	6	Berendiouga, Victor	0
7	Choi, Sun-Young	1	7	Kotenko, Serguei	1
8	Kim, Kil-Hwan	0	8	Apanasenko, Dmitri	1
9	Kim, Jin-Tae	0	9	Mchvenieradze, Georgui	2
10	Song, Seung-Ho	3	10	Ivanov, Mikhail	3
11	Hong, Soon-Bo	0	11	Markotch, Serguei	3
12	Lee, Taek-Won	0	12	Smirnov, Nikolai	2
13	Park, Sang-Won	0	13	Giorgadze, Mikhail	0

Coach/Entraîneur: Kim, Jong-Ku

Coach/Entraîneur: Popov, Boris

Referee/Arbitre: GRE TSANTAS, APOSTOLOS
ESP CILLERO, LUIS
Goal judge/Juge de but: CHN HE, LIANDE
TUR TOYGARLI, HALUK

Men Waterpolo
Preliminary Round Group A Match 14/Sept. 27

Cap	Name	Goals
Bonn	Nom	Buts

AUS 13-2 KOR (3-0, 2-0, 3-1, 5-1)

AUS			KOR		
1	Townsend, Glenn	0	1	Lee, Jung-Suk	0
2	Pengelly, Richard	1	2	Chang, Si-Young	0
3	Harrison, Christopher	1	3	Kim, Sung-Eun	0
4	Stockwell, Troy	2	4	Yoo, Seung-Hoon	0
5	Wightman, Andrew	2	5	Kim, Ki-Choon	0
6	Kerr, Andrew	0	6	Kim, Jae-Yun	1
7	Mayers, Raymond	1	7	Choi, Sun-Young	1
8	Clar, Geoffrey	2	8	Kim, Kil-Hwan	0
9	Fox, John	2	9	Kim, Jin-Tae	0
10	Wybrow, Christopher	2	10	Song, Seung-Ho	0
11	Asher, Simon	0	11	Hong, Soon-Bo	0
12	Taylor, Andrew	0	12	Lee, Taek-Won	0
13	Cameron, Donald	0	13	Park, Sang-Won	0

Coach/Entraîneur: Tom, Hoad

Coach/Entraîneur: Kim, Jong-Ku

Referee /Arbitre: IRN AMINI, KHOSROW
ESP CILLERO, LUIS
Goal judge/Juge de but: USA LEE, ROBERT
GRE TSANTAS, APOSTOLOS

Men Waterpolo
Preliminary Round Group A Match 12/Sept. 26

Cap	Name	Goals
Bonn	Nom	Buts

AUS 7-6 FRA (3-1, 1-1, 2-0, 1-4)

AUS			FRA		
1	Townsend, Glenn	0	1	Bouet, Arnaud	0
2	Pengelly, Richard	1	2	Brisfer, Marc	0
3	Harrison, Christopher	0	3	Crousillat, Marc	0
4	Stockwell, Troy	1	4	Garsau, Pierre	0
5	Wightman, Andrew	0	5	Boyadjian, Bruno	0
6	Kerr, Andrew	0	6	Herve, Philippe	1
7	Mayers, Raymond	0	7	Idoux, Michel	2
8	Clark, Geoffrey	3	8	Alimondo, Thierry	1
9	Fox, John	0	9	Crousillat, Michel	0
10	Wybrow, Christopher	1	10	Marischael, Nicolas	0
11	Cameron, Donald	0	11	Jeleff, Nicolas	2
12	Taylor, Andrew	1	12	Perot, Pascal	0
13	Asher, Simon	0	13	Volpi, Christian	0

Coach/Entraîneur: Tom, Hoad

Coach/Entraîneur: Uean Paul Clemenccon

Referee/Arbitre: HUN CSASZAR, GYORGY
USA LEE, ROBERT
Goal judge/Juge de but: YUG DROBNJAK, MILAN
KOR LEE, UNG-KI

Men Waterpolo
Preliminary Round Group A Match 15/Sept. 27

Cap	Name	Goals
Bonn	Nom	Buts

URS 8-9 FRG (4-2, 0-3, 1-4, 3-0)

URS			FRG		
1	Charonov, Evgueni	0	1	Roehle, Peter	0
2	Mendygaliyev, Nourlan	0	2	Jacoby, Dirk	2
3	Grichine, Evgeni	0	3	Otto, Frank	0
4	Kolotov, Alexandre	1	4	Sterzik, Uwe	0
5	Naoumov, Sergei	0	5	Fernandez, Armando	0
6	Berendiouga, Victor	0	6	Ehrl, Andreas	0
7	Kotenko, Serguei	2	7	Borgmann, Ingo	0
8	Apanasenko, Dmitri	2	8	Osselmann, Rainer	3
9	Mchvenieradze, Georgui	1	9	Stamm, Hagen	2
10	Ivanov, Mikhail	0	10	Huber, Thomas	1
11	Markotch, Serguei	1	11	Theismann, Dirk	1
12	Smirnov, Nikolai	1	12	Reimann, Rene	0
13	Giorgadze, Mikhail	0	13	Obschernikat, Werner	0

Coach/Entraîneur: Popov, Boris

Coach/Entraîneur: Firiou, Nicola

Referee/Arbitre: USA HERMSTAD, THOMAS
HUN VUSZEK, ANTON
Goal judge/Juge de but: ESPASENCIO, EUGENIO
YUG DROBNJAK, MILAN

Swimming

Men Waterpolo Preliminary Round Gr.B Match 1/Sept. 21			Hommes/Waterpolo Tour Elimatoire Gr. B Renc. 1/21 Sept		
Cap Bonn	Name Nom	Goals Buts	Cap Bonn	Name Nom	Goals Buts

HUN 12-10 GRE (5-1, 2-3, 3-2, 2-4)

HUN			GRE		
1	Kuna, Peter	0	1	Christoforidis, Nikolaos	0
2	Bujka, Gabor	4	2	Kaiafas, Philippos	0
3	Schmiedt, Gabor	0	3	Samartzidis, Epaminondas	0
4	Petovary, Zsolt	3	4	Tsikaris, Anastassios	0
5	Pinter, Istvan	0	5	Giannopoulos, Kyriakos	4
6	Keszthelyi, Tibor	0	6	Kefalogiannis, Aris	1
7	Vincze, Balazs	0	7	Venetopoulos, Nikolaos	1
8	Mohi, Zoltan	0	8	Seletopoulos, Dimitrios	1
9	Pardi, Tibor	0	9	Aronis, Andonios	2
10	Toth, Laszlo	1	10	Pateros, Evangelos	1
11	Gyongyosi, Andras	0	11	Mavrotas, Georgios	0
12	Kosz, Zoltan	0	12	Patras, Evangelos	0
13	Toth, Imre	4	13	Papanastassiou, Anastassio	0

Coach/Entraîneur: Zoltan Kasas

Coach/Entraîneur: Losifidis, Koulis

Referee/Arbitre: FRA PAPA ZIAN, RICHARD
AUS WHITEHOUSE, JOHN
Goal judge/Juge de but: TUR TOYGARLI, HALUK
SIN LIEW, KONG CHUNG LIONEL

Natation

Men Waterpolo Preliminary Round Gr.B Match 4/Sept. 22			Hommes/Waterpolo Tour Elimatoire Gr. B Renc. 4/22 Sept		
Cap Bonn	Name Nom	Goals Buts	Cap Bonn	Name Nom	Goals Buts

GRE 10-7 CHN (3-1, 1-2, 4-3, 2-1)

GRE			CHN		
1	Christoforidis, Nikolaos	0	1	Ni, Shiwei	0
2	Kaiafas, Philippos	0	2	Wang, Minhui	1
3	Samartzidis, Epaminondas	0	3	Yang, Yong	3
4	Tsikaris, Anastassios	0	4	Yu, Xiang	0
5	Giannopoulos, Kyriakos	2	5	Huang, Long	1
6	Kefalogiannis, Aris	0	6	Huang, Qijiang	0
7	Venetopoulos, Nikolaos	2	7	Cui, Shiping	0
8	Seletopoulos, Dimitrios	1	8	Zhao, Bilong	0
9	Aronis, Andonios	4	9	Li, Jianxiong	0
10	Pateros, Evangelos	0	10	Cai, Shengliu	1
11	Mavrotas, Georgios	1	11	Wen, Fan	0
12	Patras, Evangelos	0	12	Ge, Jianqing	1
13	Papanastassiou, Anastassio	0	13	Zheng, Qing	0

Coach/Entraîneur: Losifidis, Koulis

Coach/Entraîneur: Perg, Shaorong

Referee/Arbitre: URS CHIRUNAS, JONAS
BEL VAN DE VREKEN, PIERRE
Goal judge/Juge de but: FRA DEMEY, JEAN-CLAUDE
FRA PAPA ZIAN, RICHARD

Men Waterpolo Preliminary Round Gr.B Match 2/Sept. 21			Hommes/Waterpolo Tour Elimatoire Gr. B Renc. 2/21 Sept		
Cap Bonn	Name Nom	Goals Buts	Cap Bonn	Name Nom	Goals Buts

USA 7-6 YUG (1-1, 1-1, 2-2, 3-2)

USA			YUG		
1	Wilson, Craigm. M	0	1	Sostar, Aleksandar	0
2	Robertson, Kevin	1	2	Lusic, Deni	2
3	Bergeson, James H.	1	3	Simenc, Dubravko	1
4	Campbell, George Peter	0	4	Bukic, Perica	0
5	Kimbell, Douglas C.	0	5	Djuho, Veselin	0
6	Klass, Edward Craig	0	6	Andric, Dragan	2
7	Mouchawar, Alan E.	1	7	Vicevic, Mirko	1
8	Campbell, Jeffrey G.	0	8	Gocanin, Igor	0
9	Boyer, Gregory V.	0	9	Bezmalinovic, Mislav	0
10	Schroeder, Terry A.	1	10	Paskvalin, Tomislav	0
11	Campbell, Jody D.	0	11	Milanovic, Igor	0
12	Duplanty, Christopher D.	0	12	Radjenovic, Goran	0
13	Evans, Michaels.	2	13	Posinkovic, Renco	0

Coach/Entraîneur: Barnett, Bill

Coach/Entraîneur: Rudic, Ratko

Referee/Arbitre: ITA PAGGI, ERNANI
FRG POLLMAN, KARL-HEINZ
Goal judge/Juge de but: URS CHIRUNAS, JONAS
FRG BLAN, JURGEN

Men Waterpolo Preliminary Round Gr.B Match 5/Sept. 22			Hommes/Waterpolo Tour Elimatoire Gr. B Renc. 5/22 Sept		
Cap Bonn	Name Nom	Goals Buts	Cap Bonn	Name Nom	Goals Buts

USA 7-9 ESP (1-3, 1-0, 2-3, 3-3)

USA			ESP		
1	Wilson, Craig M.	0	1	Rollan, Jesus	0
2	Robertson, Kevin	0	2	Chillida, Miguel	0
3	Bergeson, James H.	3	3	Gonzalez, Marco Antonio	0
4	Campbell, George Peter	2	4	Perez, Miguel	0
5	Kimbell, Douglas C.	0	5	Estiarte, Manuel	2
6	Klass, Edward Craig	0	6	Robert, Pere	0
7	Mouchawar, Alan E.	0	7	Paya, Jorge	1
8	Campbell, Jeffrey G.	1	8	Rodriguez, Jose Antonio	0
9	Boyer, Gregory V.	1	9	Sans, Jorge	1
10	Schroeder, Terry A.	0	10	Gomez, Salvador	2
11	Campbell, Jody D.	0	11	Moya, Mariano	0
12	Duplanty, Christopher D.	0	12	Neira, Jorge	0
13	Evans, Michaels.	0	13	Garcia, Pedro	3

Coach/Entraîneur: Barnett, Bill

Coach/Entraîneur: Antonio, Esteller

Referee/Arbitre: FRG BLAN, JURGEN
ITA DI STEFANO, PIETRO
Goal judge/Juge de but: AUS WHITEHOUSE, JOHN
IRN AMINI, KHOSROW

Men Waterpolo Preliminary Round Gr.B Match 3/Sept. 21			Hommes/Waterpolo Tour Elimatoire Gr. B Renc. 3/21 Sept		
Cap Bonn	Name Nom	Goals Buts	Cap Bonn	Name Nom	Goals Buts

CHN 6-13 ESP (1-4, 1-3, 2-2, 2-4)

CHN			ESP		
1	Ni, Shiwei	0	1	Rollan, Jesus	0
2	Wang, Minhui	2	2	Chillida, Miguel	0
3	Yang, Yong	3	3	Gonzalez, Marco Antonio	0
4	Yu, Xiang	0	4	Perez, Miguel	0
5	Huang, Long	0	5	Estiarte, Manuel	6
6	Huang, Qijiang	0	6	Robert, Pere	0
7	Cui, Shiping	0	7	Paya, Jorge	1
8	Zhao, Bilong	1	8	Rodriguez, Jose antonio	0
9	Li, Jianxiong	0	9	Sans, Jorge	2
10	Cai, Shengliu	0	10	Gomez, Salvador	2
11	Wen, Fan	0	11	Moya, Mariano	0
12	Ge, Jianqing	0	12	Neira, Jorge	0
13	Zheng, Qing	0	13	Garcia, Pedro	2

Coach/Entraîneur: Peng, Shaorong

Coach/Entraîneur: Antonio, Esteller

Referee/Arbitre: FRA DEMEY, JEAN-CLAUDE
BEL VAN DE VREKEN, PIERRE
Goal judge/Juge de but: URS TROITSKY, EVGENN
KOR LEE, UNG-KI

Men Waterpolo Preliminary Round Gr.B Match 6/Sept. 22			Hommes/Waterpolo Tour Elimatoire Gr.B Renc. 6/Sept 22		
Cap Bonn	Name Nom	Goals Buts	Cap Bonn	Name Nom	Goals Buts

HUN 9-10 YUG (1-3, 3-1, 1-4, 4-2)

HUN			YUG		
1	Kuna, Peter	0	1	Sostar, Aleksandar	0
2	Bujka, Gabor	2	2	Lusic, Deni	1
3	Schmiedt, Gabor	0	3	Simenc, Dubravko	0
4	Petovary, Zsolt	2	4	Bukic, Perica	2
5	Pinter, Istvan	0	5	Djuho, Veselin	3
6	Keszthelyi, Tibor	0	6	Andric, Dragan	1
7	Vincze, Balazs	0	7	Vicevic, Mirko	0
8	Mohi, Zoltan	0	8	Gocanin, Igor	2
9	Pardi, Tibor	0	9	Bezmalinovic, Mislav	0
10	Toth, Laszlo	1	10	Paskvalin, Tomislav	1
11	Gyongyosi, Andras	3	11	Milanovic, Igor	0
12	Kosz, Zoltan	0	12	Radjenovic, Goran	0
13	Toth, Imre	1	13	Posinkovic, Renco	0

Coach/Entraîneur: Zoltan, Kasas

Coach/Entraîneur: Rudic, Ratko

Referee/Arbitre: URS TROITSKY, EVGENN
ITA PAGGI, ERNANI
Goal judge/Juge de but: FRG POLLMAN, KARL-HEINZ
KOR PARK, YONG-WOON



Men Waterpolo
Preliminary Round Gr.B Match 7/Sept. 23

Hommes/Waterpolo
Tour Elimatoire Gr. B Renc. 7/23 Sept

Cap Bonn	Name Nom	Goals Buts	Cap Bonn	Name Nom	Goals Buts
USA 14-7 CHN (4-3, 4-3, 3-1, 3-0)					
USA			CHN		
1	Wilson, Craig M.	0	1	Ni, Shiwei	0
2	Robertson, Kevin	0	2	Wang, Minhui	0
3	Bergeson, James H.	0	3	Yang, Yong	1
4	Campbell, George Peter	2	4	Yu, Xiang	0
5	Kimbell, Douglas D.	1	5	Huang, Long	2
6	Klass, Edward Craig	1	6	Huang, Qijiang	0
7	Mouchawar, Alan E.	0	7	Cui, Shiping	1
8	Campbell, Jeffrey G.	0	8	Zhao, Bilong	0
9	Boyer, Gregory V.	0	9	Li, Jianxiang	1
10	Schroeder, Terry A.	4	10	Cai, Shengliu	1
11	Campbell, Jody D.	3	11	Wen, Fan	1
12	Duplanty, Christopher D.	0	12	Ge, Jianqing	0
13	Evans, Michaels.	3	13	Zheng, Qing	0

Coach/Entraîneur: Barnett, Bill

Coach/Entraîneur: Peng, Shaorong

Referee/Arbitre: FRA PAPA ZIAN, RICHARD
ITA DI STEFANO, PIETRO
Goal judge/Juge de but: URS CHIRUNAS, JONAS
AUS WHITEHOUSE, JOHN

Men Waterpolo
Preliminary Round Group B Match 10/Sept. 26

Hommes/Waterpolo
Tour Elimatoire Gr. B Renc. 10/26 Sept

Cap Bonn	Name Nom	Goals Buts	Cap Bonn	Name Nom	Goals Buts
USA 18-9 GRE (5-3, 5-1, 4-4, 4-1)					
USA			GRE		
1	Wilson, Craig M.	0	1	Christoforidis, Nikolaos	0
2	Robertson, Kevin	2	2	Kaiafas, Philippos	0
3	Bergeson, James H.	3	3	Samartzidis, Epaminondas	2
4	Campbell, George Peter	2	4	Tsikaris, Anastassios	0
5	Kimbell, Douglas D.	0	5	Giannopoulos, Kyriakos	2
6	Klass, Edward Craig	1	6	Kefalogiannis, Aris	2
7	Mouchawar, Alan E.	3	7	Venetopoulos, Nikolaos	1
8	Campbell, Jeffrey G.	0	8	Seletopoulos, Dimitrios	0
9	Boyer, Gregory V.	1	9	Aronis, Andonios	2
10	Schroeder, Terry A.	1	10	Pateros, Evangelos	0
11	Campbell, Jody D.	4	11	Mavrotas, Georgios	0
12	Duplanty, Christopher D.	0	12	Patras, Evangelos	0
13	Evans, Michaels.	1	13	Papanastassiou, Anastassio	0

Coach/Entraîneur: Barnett, Bill

Coach/Entraîneur: Losifidis, Koulis

Referee/Arbitre: FRG BLAN, JURGEN
ITA PAGGI, ERNANI
Goal judge/Juge de but: FRA PAPA ZIAN, RICHARD
TUR TOYGARLI, HALUK

Men Waterpolo
Preliminary Round Gr.B Match 8/Sept. 23

Hommes/Waterpolo
Tour Elimatoire Gr. B Renc. 8/23 Sept

Cap Bonn	Name Nom	Goals Buts	Cap Bonn	Name Nom	Goals Buts
GRE 7-17 YUG (1-6, 0-3, 3-5, 3-3)					
GRE			YUG		
1	Christoforidis, Nikolaos	0	1	Sostar, Aleksandar	0
2	Kaiafas, Philippos	0	2	Lusic, Deni	0
3	Samartzidis, Epaminondas	1	3	Simenc, Dubravko	2
4	Tsikaris, Anastassios	0	4	Bukic, Perica	3
5	Giannopoulos, Kyriakos	3	5	Djuho, Veselin	1
6	Kefalogiannis, Aris	0	6	Andric, Dragan	2
7	Venetopoulos, Nikolaos	2	7	Vicevic, Mirko	1
8	Seletopoulos, Dimitrios	0	8	Gocanin, Igor	0
9	Aronis, Andonios	0	9	Bezmalinovic, Mislav	1
10	Pateros, Evangelos	0	10	Paskvalin, Tomislav	1
11	Mavrotas, Georgios	0	11	Milanovic, Igor	3
12	Patras, Evangelos	0	12	Radjenovic, Goran	3
13	Papanastassiou, Anastassio	1	13	Posinkovic, Renco	0

Coach/Entraîneur: Losifidis, Koulis

Coach/Entraîneur: Rudic, Ratko

Referee/Arbitre: FRG POLLMAN, KARL-HEINZ
IRN AMINI, KHOSROW
Goal judge/Juge de but: FRA DEMEY, JEAN-CLAUDE
ITA PAGGI, ERNANI

Men Waterpolo
Preliminary Round Group B Match 11/Sept. 26

Hommes/Waterpolo
Tour Elimatoire Gr. B Renc. 11/26 Sept

Cap Bonn	Name Nom	Goals Buts	Cap Bonn	Name Nom	Goals Buts
HUN 14-7 CHN (4-2, 3-0, 4-2, 3-3)					
HUN			CHN		
1	Kuna, Peter	0	1	Ni, Shiwei	0
2	Bujka, Gabor	1	2	Wang, Minhui	0
3	Schmiedt, Gabor	1	3	Yang, Yong	2
4	Petovary, Zsolt	1	4	Yu, Xiang	0
5	Pinter, Istvan	0	5	Huang, Long	0
6	Keszthelyi, Tibor	1	6	Huang, Qijiang	0
7	Vincze, Balazs	0	7	Cui, Shiping	0
8	Mohi, Zoltan	0	8	Zhao, Bilong	1
9	Pardi, Tibor	0	9	Li, Jianxiang	1
10	Toth, Laszlo	5	10	Cai, Shengliu	1
11	Gyongyosi, Andras	5	11	Wen, Fan	0
12	Kosz, Zoltan	0	12	Ge, Jianqing	2
13	Toth, Imre	0	13	Zheng, Qing	0

Coach/Entraîneur: Zoltan, Kasas

Coach/Entraîneur: Peng, Shaorong

Referee/Arbitre: URS CHIRUNAS, JONAS
ITA DI STEFANO, PIETRO
Goal judge/Juge de but: FRG POLLMAN, KARL-HEINZ
FRA DEMEY, JEAN-CLAUDE

Men Waterpolo
Preliminary Round Gr.B Match 9/Sept. 23

Hommes/Waterpolo
Tour Elimatoire Gr. B Renc. 9/23 Sept

Cap Bonn	Name Nom	Goals Buts	Cap Bonn	Name Nom	Goals Buts
HUN 6-6 ESP (0-3, 3-1, 2-1, 1-1)					
HUN			ESP		
1	Kuna, Peter	0	1	Rollan, Jesus	0
2	Bujka, Gabor	1	2	Chillida, Miguel	0
3	Schmiedt, Gabor	0	3	Gonzalez, Marco Antonio	0
4	Petovary, Zsolt	0	4	Perez, Miguel	0
5	Pinter, Istvan	0	5	Estiarte, Manuel	2
6	Keszthelyi, Tibor	1	6	Robert, Pere	0
7	Vincze, Balazs	0	7	Paya, Jorge	0
8	Mohi, Zoltan	1	8	Rodriguez, Jose Antonio	0
9	Pardi, Tibor	0	9	Sans, Jorge	2
10	Toth, Laszlo	1	10	Gomez, Salvador	0
11	Gyongyosi, Andras	2	11	Moya, Mariano	0
12	Kosz, Zoltan	0	12	Neira, Jorge	2
13	Toth, Imre	0	13	Garcia, Pedro	0

Coach/Entraîneur: Zoltan, Kasas

Coach/Entraîneur: Antonio, Esteller

Referee/Arbitre: FRG BLAN, JURGEN
BEL VAN DE VREKEN, PIERRE
Goal judge/Juge de but: TUR TOYGARLI, HALUK
URS TROITSKY, EVGENN

Men Waterpolo
Preliminary Round Group B Match 12/Sept. 26

Hommes/Waterpolo
Tour Elimatoire Gr. B Renc. 12/26 Sept

Cap Bonn	Name Nom	Goals Buts	Cap Bonn	Name Nom	Goals Buts
ESP 8-10 YUG (0-4, 3-2, 2-2, 3-2)					
ESP			YUG		
1	Rollan, Jesus	0	1	Sostar, Aleksandar	0
2	Chillida, Miguel	0	2	Lusic, Deni	1
3	Gonzalez, Marco Antonio	0	3	Simenc, Dubravko	0
4	Perez, Miguel	0	4	Bukic, Perica	1
5	Estiarte, Manuel	3	5	Djuho, Veselin	1
6	Robert, Pere	0	6	Andric, Dragan	2
7	Paya, Jorge	0	7	Vicevic, Mirko	0
8	Rodriguez, Jose Antonio	0	8	Gocanin, Igor	0
9	Sans, Jorge	1	9	Bezmalinovic, Mislav	0
10	Gomez, Salvador	1	10	Paskvalin, Tomislav	2
11	Moya, Mariano	0	11	Milanovic, Igor	2
12	Neira, Jorge	1	12	Radjenovic, Goran	1
13	Garcia, Pedro	2	13	Posinkovic, Renco	0

Coach/Entraîneur: Antonio, Esteller

Coach/Entraîneur: Rudio, Ratko

Referee/Arbitre: HOL VAN DORP, FRED
URS TROITSKY, EVGENN
Goal judge/Juge de but: BEL VAN DE VREKEN, PIERRE
AUS WHITEHOUSE, JOHN

Swimming

Men Waterpolo Preliminary Round Group B Match 13/Sept. 27			Hommes/Waterpolo Tour Elimatoire Gr. B Renc. 13/27 Sept		
Cap	Name	Goals	Cap	Name	Goals
Bonn	Nom	Buts	Bonn	Nom	Buts

GRE 9-12 ESP (1-3, 3-3, 4-2, 1-4)

GRE			ESP		
1	Christoforidis, Nikolaos	0	1	Rollan, Jesus	0
2	Kaiafas, Philippos	0	2	Chillida, Miguel	0
3	Samarzidis, Epaminondas	1	3	Gonzalez, Marco Antonio	0
4	Tsikaris, Anastassios	0	4	Perez, Miguel	1
5	Giannopoulos, Kyriakos	3	5	Estiarte, Manuel	6
6	Kefalogiannis, Aris	1	6	Robert, Pere	1
7	Venetopoulos, Nikolaos	1	7	Paya, Jorge	0
8	Seletopoulos, Dimitrios	0	8	Rodriguez, Jose Antonio	0
9	Aronis, Andonios	2	9	Sans, Jorge	3
10	Pateros, Evangelos	1	10	Gomez, Salvador	1
11	Mavrotas, Georgios	0	11	Moya, Mariano	0
12	Patras, Evangelos	0	12	Neira, Jorge	0
13	Papanastassiou, Anastassio	0	13	Garcia, Pedro	0

Coach/Entraîneur: Losifidis, Koulis

Coach/Entraîneur: Antonio, Esteller

Referee/Arbitre: URS TROITSKY, EVGENN
FRA PAPA ZIAN, RICHARD
Goal judge/Juge de but: TUR TOYGARLI, HALUK
KOR PARK, YONG-WOON

Men Waterpolo Preliminary Round Group B Match 14/Sept. 27			Hommes/Waterpolo Tour Elimatoire Gr. B Renc. 14/27 Sept		
Cap	Name	Goals	Cap	Name	Goals
Bonn	Nom	Buts	Bonn	Nom	Buts

USA 10-9 HUN (2-1, 1-2, 2-3, 5-3)

USA			HUN		
1	Wilson, Craig M.	0	1	Kuna, Peter	0
2	Robertson, Kevin	2	2	Bujka, Gabor	0
3	Bergeson, James H.	1	3	Schmiedt, Gabor	1
4	Campbell, George Peter	1	4	Petovary, Zsolt	2
5	Kimbell, Douglas D.	0	5	Pinter, Istvan	0
6	Klass, Edward Craig	0	6	Keszthelyi, Tibor	1
7	Mouchawar, Alan E.	0	7	Vincze, Balazs	0
8	Campbell, Jeffrey G.	0	8	Mohi, Zoltan	0
9	Boyer, Gregory V.	0	9	Pardi, Tibor	0
10	Schroeder, Terry A.	2	10	Toth, Laszlo	1
11	Campbell, Jody D.	2	11	Gyongyosi, Andras	3
12	Duplanty, Christopher D	0	12	Kosz, Zoltan	0
13	Evans, Michaels.	2	13	Toth, Imre	1

Coach/Entraîneur: Barnett, Bill

Coach/Entraîneur: Zoltan, Kasas

Referee/Arbitre: HOL VAN DORP, FRED
AUS WHITEHOUSE, JOHN
Goal judge/Juge de but: FRG BLAN, JURGEN
ITA DI STEFANO, PIETRO

Men Waterpolo Preliminary Round Group B Match 15/Sept. 27			Hommes/Waterpolo Tour Elimatoire Gr. B Renc. 15/27 Sept		
Cap	Name	Goals	Cap	Name	Goals
Bonn	Nom	Buts	Bonn	Nom	Buts

CHN 7-17 YUG (1-5, 3-1, 1-6, 2-5)

CHN			YUG		
1	Ni, Shiwei	0	1	Sostar, Aleksandar	0
2	Wang, Minhui	0	2	Lusic, Deni	1
3	Yang, Yong	2	3	Simenc, Dubravko	0
4	Yu, Xiang	0	4	Bukic, Perica	3
5	Huang, Long	0	5	Djuho, Veselin	3
6	Huang, Qijiang	0	6	Andric, Dragan	1
7	Cui, Shiping	0	7	Vicevic, Mirko	1
8	Zhao, Bilong	0	8	Gocanin, Igor	1
9	Li, Jianxiong	1	9	Bezmalinovic, Mislav	1
10	Cai, Shengliu	1	10	Paskvalin, Tomislav	0
11	Wen, Fan	2	11	Milanovic, Igor	5
12	Ge, Jianqing	1	12	Radjenovic, Goran	1
13	Zheng, Qing	0	13	Posinkovic, Renco	0

Coach/Entraîneur: Peng, Shaorong

Coach/Entraîneur: Rudio, Ratko

Referee/Arbitre: FRA DEMEY, JEAN-CLAUDE
FRG POLLMAN, KARL-HEINZ
Goal judge/Juge de but: URS CHIRUNAS, JONAS
ITA PAGGI, ERNANI

Natation

Men Waterpolo Preliminary/Sept. 21-27						Hommes/Waterpolo Eliminatoires/21-27 Sept				
Rank	Ctry	Points	Played	Won	Tied	Lost	For	Against	Diff	
Rang	Pays	Joues	Gagnes	Nuls	Perdus	Pour	Contre			

* Group A/Groupe A

1	FRG	10	5	5	0	0	60	37	23
2	URS	7	5	3	1	1	63	30	33
3	ITA	7	5	3	1	1	48	33	15
4	AUS	4	5	2	0	3	40	39	1
5	FRA	2	5	1	0	4	43	54	-11
6	KOR	0	5	0	0	5	14	75	-61

< Round Progress/Deroulement Manche >

	AUS	FRA	KOR	ITA	URS	FRG
AUS	*	7- 6	13- 2	5- 7	4-11	11-13
FRA	6- 7	*	16- 5	8-14	4-18	9-10
KOR	2-13	5-16	*	1-11	4-17	2-18
ITA	7-5	14-8	11-1	*	9-9	7-10
URS	11-4	18-4	17-4	9-9	*	8-9
FRG	13-11	10-9	18-2	10-7	9-8	*

* Group B/Groupe B

1	USA	8	5	4	0	1	56	40	16
2	YUG	8	5	4	0	1	60	38	22
3	ESP	7	5	3	1	1	48	38	10
4	HUN	5	5	2	1	2	50	43	7
5	GRE	2	5	1	0	4	45	66	-21
6	CHN	0	5	0	0	5	34	68	-34

< Round Progress/Deroulement Manche >

	USA	HUN	GRE	CHN	ESP	YUG
USA	*	10-9	18- 9	14-7	7-9	7- 6
HUN	9-10	*	12-10	14-7	6-6	9-10
GRE	9-18	10-12	*	10-7	9-12	7-17
CHN	7-14	7-14	7-10	*	6-13	7-17
ESP	9-7	6-6	12- 9	13-6	*	8-10
YUG	6-7	10-9	17-7	17-7	10-8	*

If two teams shall have equal points, further classification shall be established in accordance with FINA Rule OG.7.1.2-7.1.20.
Si deux equipes venaient a etre a egalite, le classement sera etabli conformement au reglement OG7.1.2-7.1.20 de la FINA.

Men Waterpolo Classification Round Gr. D Match 1/Sept. 30			Hommes/Waterpolo Tour de Classement Gr. D Renc.1/30 Sept.		
Cap	Name	Coals	Cap	Name	Goals
Bonn	Nom	Buts	Bonn	Nom	Buts

ITA 9-9 HUN (2-1, 1-2, 2-4, 4-2)

ITA			HUN		
1	Trapanese, Paolo	0	1	Kuna, Peter	0
2	Misaggi, Alfio	1	2	Bujka, Gabor	0
3	Pisano, Andrea	1	3	Schmiedt, Gabor	1
4	Steardo, Antonello	0	4	Petovary, Zsolt	0
5	Campagna, Alessandro	2	5	Pinter, Istvan	1
6	Caldarella, Paolo	0	6	Keszthelyi, Tibor	2
7	Fiorillo, Mario	0	7	Vincze, Balazs	0
8	Porzio, Francesco	2	8	Mohi, Zoltan	0
9	Postiglione, Stefano	0	9	Pardi, Tibor	1
10	Tempestini, Riccardo	1	10	Toth, Laszlo	0
11	Ferretti, Massimiliano	1	11	Gyongyosi, Andras	3
12	D' Altrui, Marco	1	12	Kosz, Zoltan	0
13	Averaimo, Gianni	0	13	Toth, Imre	1

Coach/Entraîneur: Fritz, Dennerlein

Coach/Entraîneur: Zoltan, Kasas

Referee/Arbitre: YUG DROBNJAK, MILAN
USA LEE, ROBERT
Goal judge/Juge de but: FRG POLLMAN, KARL-HEINZ
FRA PAPA ZIAN, RICHARD



Men Waterpolo
Classification Round Gr. D Match 2/Sept. 30

Hombres/Waterpolo
Tour de Classement Gr. D Renc. 2/30 Sept.

Cap Bonn	Name Nom	Goals Buts	Cap Bonn	Name Nom	Goals Buts
AUS 8-7 ESP (2-0, 1-3, 3-0, 2-4)					
AUS			ESP		
1	Townsend, Glenn	0	1	Rollan, Jesus	0
2	Pengelley, Richard	1	2	Chillida, Miguel	0
3	Harrison, Christopher	0	3	Gonzalez, Marco Antonio	0
4	Stockwell, Troy	0	4	Perez, Miguel	0
5	Wightman, Andrew	0	5	Estiarte, Manuel	5
6	Kerr, Andrew	1	6	Robert, Pere	0
7	Mayers, Raymond	1	7	Paya, Jorge	0
8	Clark, Geoffrey	3	8	Rodriguez, Jose Antonio	0
9	Fox, John	1	9	Sans, Jorge	0
10	Wubrow, Christopher	1	10	Gomez, Salvador	0
13	Asher, Simon	0	11	Moya, Mariano	0
12	Taylor, Andrew	0	12	Neira, Jorge	0
13	Cameron, Donald	0	13	Garcia, Pedro	2

Coach/Entraîneur: Tom, Hoad

Coach/Entraîneur: Antonico, Esteller

Referee/Arbitre: FRA DEMEY, JEAN-CLAUDE
YUG KLARIC, ZELJKO
Goal judge/Juge de but: ITA PAGGI, ERNANI
URS TROITSKY, EVGENN

Men Waterpolo
Classification Round Gr. E Match 1/Sept. 30

Hombres/Waterpolo
Tour de Classement Gr. E Renc. 1/30 Sept

Cap Bonn	Name Nom	Goals Buts	Cap Bonn	Name Nom	Goals Buts
FRA 11-4 CHN (4-0, 3-2, 1-2, 3-0)					
FRA			CHN		
1	Bouet, Arnaud	0	1	Ni, Shiwei	0
2	Brtsfer, Marc	1	2	Wang, Minhui	1
3	Crousillat, Marc	1	3	Yang, Yong	0
4	Garsau, Pierre	8	4	Yu, Xiang	0
5	Boyadjian, Bruno	0	5	Huang, Long	0
6	Herve, Philippe	1	6	Huang, Qijiang	0
7	Idoux, Michel	0	7	Cui, Shiping	0
8	Alimondo, Thierry	0	8	Zhao, Bilong	0
9	Crousillat, Michel	0	9	Li, Jianxiong	2
10	Marischael, Nicolas	0	10	Cai, Shengliu	0
11	Jeleff, Nicolas	0	11	Wen, Fan	0
12	Perot, Pascal	0	12	Ge, Jianqing	1
13	Volpi, Christian	0	13	Zheng, Qing	0

Coach/Entraîneur: Jean Paul Clemencou

Coach/Entraîneur: Peng, Shaorong

Referee/Arbitre: URS CHIRUNAS, JONAS
HUN VUSZEK, ANTON
Goal judge/Juge de but: USA HERMSTAD, THOMAS
KOR PARK, YONG-WOON

Men Waterpolo
Classification Round Gr. D Match 3/Oct. 1

Hombres/Waterpolo
Tour de Classement Gr. D Renc. 3/1 Oct.

Cap Bonn	Name Nom	Goals Buts	Cap Bonn	Name Nom	Goals Buts
AUS 5-13 HUN (2-2, 1-3, 1-3, 1-5)					
AUS			HUN		
1	Townsend, Glenn	0	1	Kuna, Peter	0
2	Pengelley, Richard	0	2	Bujka, Gabor	3
3	Harrison, Christopher	0	3	Schmiedt, Gabor	1
4	Stockwell, Troy	0	4	Petovary, Zsolt	0
5	Wightman, Andrew	0	5	Pinter, Istvan	0
6	Kerr, Andrew	0	6	Keszthelyi, Tibor	2
7	Mayers, Raymond	1	7	Vincze, Balazs	0
8	Clark, Geoffrey	2	8	Mohi, Zoltan	1
9	Fox, John	1	9	Pardi, Tibor	0
10	Wybrow, Christopher	1	10	Toth, Laszlo	1
13	Asher, Simon	0	11	Gyongyosi, Andras	3
12	Taylor, Andrew	0	12	Kosz, Zoltan	0
11	Cameron, Donald	0	13	Toth, Imre	2

Coach/Entraîneur: Tom, Hoad

Coach/Entraîneur: Zoltan, Kasas

Referee/Arbitre: FRG BLAN, JURGEN
URS CHIRUNAS, JONAS
Goal judge/Juge de but: ITA PAGGI, ERNANI
ESP CILLERO, LUIS

Men Waterpolo
Classification Round Gr. E Match 2/Sept. 30

Hombres/Waterpolo
Tour de Classement Gr. E Renc. 2/30 Sept

Cap Bonn	Name Nom	Goals Buts	Cap Bonn	Name Nom	Goals Buts
KOR 7-17 GRE (1-5, 1-3, 2-5, 3-4)					
KOR			GRE		
1	Lee, Jung-Suk	0	1	Christoforidis, Nikolaos	0
2	Chang, Si-Young	0	2	Kaiafas, Philippos	0
3	Kim, Sung-Eun	1	3	Samartzidis, Epaminondas	4
4	Yoo, Seung-Hoon	2	4	Tsikaris, Anastassios	2
5	Kim, Ki-Choon	0	5	Giannopoulos, Kyriakos	3
6	Kim, Jae-Yun	2	6	Kefalogiannis, Aris	1
7	Choi, Sun-Young	2	7	Venetopoulos, Nikolaos	2
8	Kim, Kil-Hwan	0	8	Seletopoulos, Dimitrios	0
9	Kim, Jin-Tae	0	9	Aronis, Andonios	4
10	Song, Seung-Ho	0	10	Pateros, Evangelos	0
11	Hong, Soon-Bo	0	11	Mavrotas, Georgios	1
12	Lee, Taek-Won	0	12	Patras, Evangelos	0
13	Park, Sang-Won	0	13	Papanastassiou, Anastassio	0

Coach/Entraîneur: Kim, Jong-Ku

Coach/Entraîneur: Losifidis, Koulis

Referee/Arbitre: BEL VAN DE VREKEN, PIERRE
ESP CILLERO, LUIS
Goal judge/Juge de but: TUR TOYGARLI, HALUK
CHN HE, LIANDE

Men Waterpolo
Classification Round Gr. D Match 4/Oct. 1

Hombres/Waterpolo
Tour de Classement Gr. D Renc. 4/1 Oct.

Cap Bonn	Name Nom	Goals Buts	Cap Bonn	Name Nom	Goals Buts
ITA 9-11 ESP (3-2, 4-2, 1-4, 1-3)					
ITA			ESP		
1	Trapanese, Paolo	0	1	Rollan, Jesus	0
2	Misaggi, Alfio	0	2	Chillida, Miguel	0
3	Pisano, Andrea	1	3	Gonzalez, Marco Antonio	0
4	Stearo, Antonello	1	4	Perez, Miguel	0
5	Campagna, Alessandro	3	5	Estiarte, Manuel	3
6	Caldarella, Paolo	1	6	Robert, Pere	0
7	Fiorillo, Mario	1	7	Paya, Jorge	1
8	Porzio, Francesco	2	8	Rodriguez, Jose Antonio	0
9	Postiglione, Stefano	0	9	Sans, Jorge	4
10	empestini, Riccardo	0	10	Gomez, Salvador	2
11	Ferretti, Massimiliano	0	11	Moya, Mariano	0
12	D' Altrui, Marco	0	12	Neira, Jorge	1
13	Averaimo, Gianni	0	13	Garcia, Pedro	0

Coach/Entraîneur: Fritz, Dennerlein

Coach/Entraîneur: Antonio, Esteller

Referee/Arbitre: GRE TSANTAS, APOSTOLOS
FRA PAPAIZIN, RICHARD
Goal judge/Juge de but: URS TROITSKY, EVGENN
BEL VAN DE VREKEN, PIERRE

Men Waterpolo
Classification Round Gr. E Match 3/Oct. 1

Hombres/Waterpolo
Tour de Classement Gr. E Renc. 3/1 Oct

Cap Bonn	Name Nom	Goals Buts	Cap Bonn	Name Nom	Goals Buts
KOR 7-14 CHN (2-2, 2-4, 1-2, 2-6)					
KOR			CHN		
1	Lee, Jung-Suk	0	1	Ni, Shiwei	0
2	Chang, Si-Young	1	2	Wang, Minhui	1
3	Kim, Sung-Eun	0	3	Yang, Yong	5
4	Yoo, Seung-Hoon	1	4	Yu, Xiang	0
5	Kim, Ki-Choon	0	5	Huang, Long	3
6	Kim, Jae-Yun	1	6	Huang, Qijiang	0
7	Choi, Sun-Young	1	7	Cui, Shiping	1
8	Kim, Kil-Hwan	0	8	Zhao, Bilong	3
9	Kim, Jin-Tae	0	9	Li, Jianxiong	1
10	Song, Seung-Ho	2	10	Cai, Shengliu	0
11	Hong, Soon-Bo	0	11	Wen, Fan	0
12	Lee, Taek-Won	1	12	Ge, Jianqing	0
13	Park, Sang-Won	0	13	Zheng, Qing	0

Coach/Entraîneur: Kim, Jong-Ku

Coach/Entraîneur: Peng, Shaorong

Referee/Arbitre: FRG POLLMAN, KARL-HEINZ
YUG KLARIC, ZELJKO
Goal judge/Juge de but: ESP CILLERO, LUIS
HUN CSASZAR, GYORGY

Swimming

Men Waterpolo Classification Round Gr. E Match 4/Oct. 1			Hommes/Waterpolo Tour de Classement Gr. E Renc. 4/1 Oct		
Cap Bonn	Name Nom	Goals Buts	Cap Bonn	Name Nom	Goals Buts

FRA 7-10 GRE (3-4, 2-4, 0-1, 2-1)

FRA			GRE		
1	Bouet, Arnaud	0	1	Christoforidis, Nikolaos	0
2	Brisfer, Marc	2	2	Kaiafas, Philippos	1
3	Crousillat, Marc	0	3	Samartzidis, Epaminondas	2
4	Garsau, Pierre	1	4	Tsikaris, Anastassios	0
5	Boyadjian, Bruno	1	5	Giannopoulos, Kyriakos	1
6	Herve, Philippe	0	6	Kefalogiannis, Aris	1
7	Idoux, Michel	1	7	Venetopoulos, Nikolaos	0
8	Alimondo, Thierry	0	8	Seletopoulos, Dimitrios	2
9	Crousillat, Michel	0	9	Aronis, Andonios	2
10	Marischael, Nicolas	1	10	Pateros, Evangelos	0
11	Jeleff, Nicolas	1	11	Mavrotas, Georgios	0
12	Perot, Pascal	0	12	Patras, Evangelos	0
13	Volpi, Christian	0	13	Papanastassiou, Anastassio	1

Coach/Entraîneur: Jean Paul Clemencou

Coach/Entraîneur: Losifidis, Koulis

Referee/Arbitre: USA HERMSTAD, THOMAS
TUR TOYGARLI, HALUK
Goal judge/Juge de but: USA LEE, ROBERT
CHN HE, LIANDE

Men Waterpolo Semi-final Match 1/Sept. 30			Hommes/Waterpolo Demi-finale Renc. 1/30 Sept		
Cap Bonn	Name Nom	Goals Buts	Cap Bonn	Name Nom	Goals Buts

FRG 10-14 YUG (2-3, 3-3, 2-3, 3-5)

FRG			YUG		
1	Roehle, Peter	0	1	Sostar, Aleksandar	0
2	Jacoby, Dirk	0	2	Lusic, Deni	4
3	Otto, Frank	3	3	Simenc, Dubravko	0
4	Sterzik, Uwe	1	4	Bukic, Perica	0
5	Fernandez, Armando	0	5	Djuho, Veselin	0
6	Ehrl, Andreas	2	6	Andric, Dragan	1
7	Borgmann, Ingo	0	7	vicevic, Mirko	0
8	Osselmann, Rainer	1	8	Gocanin, Igor	0
9	Stamm, Hagen	0	9	Bezmalinovic, Mislav	2
10	Huber, Thomas	0	10	Paskvalin, Tomislav	2
11	Theismann, Dirk	2	11	Milanovic, Igor	4
12	Reimann, Rene	1	12	Radjenovic, Goran	1
13	Obschernikat, Werner	0	13	Posinkovic, Renco	0

Coach/Entraîneur: Firiuo, Nicola

Coach/Entraîneur: Rudio, Ratko

Referee/Arbitre: HOL VAN DORP, FRED
ITA DI STEFANO, PIETRO
Goal judge/Juge de but: GRE TSANTAS, APOSTOLOS
HUN CSASZAR, GYORGY

Men Waterpolo Semi-final Match 2/Sept. 30			Hommes/Waterpolo Demi-finale Renc 2/30 Sept		
Cap Bonn	Name Nom	Goals Buts	Cap Bonn	Name Nom	Goals Buts

URS 7 — 8 USA (1-1, 2-3, 2-3, 2-1)

URS			USA		
1	Charonov, Evgueni	0	1	Wilson, Carraig M.	0
2	Mendygaliyev, Nourlan	0	2	Robertson, Kevin	2
3	Grichine, Evgeni	2	3	Bergeson, James H.	0
4	Kolotov, Alexandre	0	4	Campbell, George Peter	2
5	Naoumov, Sergei	0	5	Kimbell, Douglas D.	1
6	Berendiouga, Victor	0	6	Klass, Edward Craig	0
7	Kotenko, Serguei	3	7	Mouchawar, Alan E.	0
8	Apanasenko, Demitri	1	8	Campbell, Jeffrey G.	0
9	Mchvenieradze, Georgui	0	9	Boyer, Gregory V.	1
10	Ivanov, Mikhail	1	10	Schroeder, Terry A.	1
11	Markotch, Serguei	0	11	Campbell, Jody D.	0
12	Smirnov, Nikolai	0	12	Duplanty, Christopher D.	0
13	Giorgadze, Mikhail	0	13	Evans, Michaels.	1

Coach/Entraîneur: Popov, Boris

Coach/Entraîneur: Barnett, Bill

Referee/Arbitre: ESP ASENSIO, EUGENIO
AUS WHITEHOUSE, JOHN
Goal Judge/Juge de but: FRG BLAN, JURGEN
TUR TOYGARLI, HALUK

Natation

Men Waterpolo Final Match 1 (3-4)/Oct. 1			Hommes/Waterpolo Finale Renc. 1 (3-4)/1 Oct		
Cap Bonn	Name Nom	Goals Buts	Cap Bonn	Name Nom	Goals Buts

FRG 13 — 14 URS (1-5, 6-2, 4-4, 2-3)

FRG			URS		
1	Roehle, Peter	0	1	Charonov, Evgueni	0
2	Jacoby, Dirk	0	2	Mendygaliyev, Nourlan	0
3	Otto, Frank	3	3	Grichine, Evgeni	1
4	Sterzik, Uwe	1	4	Kolotov, Alexandre	0
5	Fernandez, Armando	1	5	Naoumov, Sergei	2
6	Ehrl, Andreas	0	6	Berendiouga, Victor	0
7	Borgmann, Ingo	0	7	Kotenko, Serguei	2
8	Osselmann, Rainer	2	8	Apanasenko, Dmitri	3
9	Stamm, Hagen	1	9	Mchvenieradze, Georgui	4
10	Huber, Thomas	0	10	Ivanov, Mikhail	0
11	Theismann, Dirk	4	11	Markotch, Serguei	0
12	Reimann, Rene	1	12	Smirnov, Nikolai	2
13	Obschernikat, Werner	0	13	Giorgadzem, Mikhail	0

Coach/Entraîneur: Firiuo, Nicola

Coach/Entraîneur: Popov, Boris

Referee/Arbitre: HOL VAN DORP, FRED
FRA DEMEY, JEAN-CLAUDE
Goal judge/Juge de but: BEL VAN DE VREKEN, PIERRE
TUR TOYGARLI, HALUK

Men Waterpolo Final Match 2 (1-2)/Oct. 1			Hommes/Waterpolo Finale Renc. 2 (1-2)/1 Oct.		
Cap Bonn	Name Nom	Goals Buts	Cap Bonn	Name Nom	Goals Buts

YUG 9-7 USA (1-2, 1-2, 3-1, 1-1, 3-1)

YUG			USA		
1	Sostar, Aleksandar	0	1	Wilson, Craig M.	0
2	Lusic, Deni	1	2	Robertson, Kevin	1
3	Simenc, dubravko	0	3	Bergeson, James H.	1
4	Bukic, Perica	1	4	Campbell, George Peter	0
5	Djuho, Veselin	1	5	Kimbell, Douglas D.	0
6	Andric, Dragan	2	6	Klass, Edward Craig	0
7	Vicevic, Mirko	0	7	Mouchawar, Alan E.	0
8	Gocanin, Igor	2	8	Campbell, Jeffrey G.	0
9	Bezmalinovic, Mislav	0	9	Boyer, Gregory V.	1
10	Paskvalin, Tomislav	0	10	Schroeder, Terry A.	1
11	Milanovic, Igor	2	11	Campbell, Jody D.	2
12	Radjenovic, Goran	0	12	Duplanty, Christopher D.	0
13	Posinkovic, Renco	0	13	Evans, Michaels.	1

Coach/Entraîneur: Rudio, Ratko

Coach/Entraîneur: Barnett, Bill

Referee/Arbitre: AUS WHITEHOUSE, JOHN
ESP ASENSIO, EUGENIO
Goal judge/Juge de but: ITA DI STEFANO, PIETRO
URS CHIRUNAS, JONAS



Men Waterpolo
/Sept. 21-Oct. 1

Hommes/Waterpolo
/21 Sept-1 Oct

< Preliminary Round/Tour Elimatoire >

* Group A/Groupe A

	FRG	URS	ITA	AUS	FRA	KOR	Won	Tied	Lost	Pts	
1	FRG	*	09-08	10-07	13-11	10-09	18-02	5	0	0	10
2	URS	08-09	*	09-09	11-04	18-04	17-04	3	1	1	7
3	ITA	07-10	09-09	*	07-05	14-08	11-01	3	1	1	7
4	AUS	11-13	04-11	05-07	*	07-06	13-02	2	0	3	4
5	FRA	09-10	04-18	08-14	06-07	*	16-05	1	0	4	2
6	KOR	02-18	04-17	01-11	02-13	05-16	*	0	0	5	0

* Group B/Groupe B

	USA	YUG	ESP	HUN	GRE	CHN	Won	Tied	Lost	Pts	
1	USA	*	07-06	07-09	10-09	18-09	14-07	4	0	1	8
2	YUG	06-07	*	10-08	10-09	17-07	17-07	4	0	1	8
3	ESP	09-07	08-10	*	06-06	12-09	13-06	3	1	1	7
4	HUN	09-10	09-10	06-06	*	12-10	14-07	2	1	2	5
5	GRE	09-18	07-17	09-12	10-12	*	10-07	1	0	4	2
6	CHN	07-14	07-17	06-13	07-14	07-10	*	0	0	5	0

< 9-12 Places/9eme-12eme Places >

	GRE	FRA	CHN	KOR	Won	Tied	Lost	Pts	
1	GRE	*	10-07	10-07	17-07	3	0	0	6
2	FRA	07-10	*	11-04	16-05	2	0	1	4
3	CHN	07-10	04-11	*	14-07	1	0	2	2
4	KOR	07-17	05-16	07-14	*	0	0	3	0

< 5-8 Places/5eme-8eme Places >

	HUN	ESP	ITA	AUS	Won	Tied	Lost	Pts	
1	HUN	*	06-06	09-09	13-05	1	2	0	4
2	ESP	06-06	*	11-09	07-08	1	1	1	3
3	ITA	09-09	09-11	*	07-05	1	1	1	3
4	AUS	05-13	08-07	05-07	*	1	0	2	2

< Semi-Final/Demi-Finale >

Semi-Final Match 1
FRG-YUG 10-14
Semi-Final Match 2
URS-USA 7-8

< Final/Finale >

Final Match 1 (3-4)
FRG-URS 13-14
Final Match 2 (1-2)
YUG-USA 9-7

< Final Standing/Classement Final >

- 1 YUG Yugoslavia
- 2 USA United States of America
- 3 URS U.S.S.R.
- 4 FRG Federal Republic of Germany
- 5 HUN Hungary
- 6 ESP Spain
- 7 ITA Italy
- 8 AUS Australia
- 9 GRE Greece
- 10 FRA France
- 11 CHN People's Republic of China
- 12 KOR Korea



탁구

Table Tennis/Table de tennis

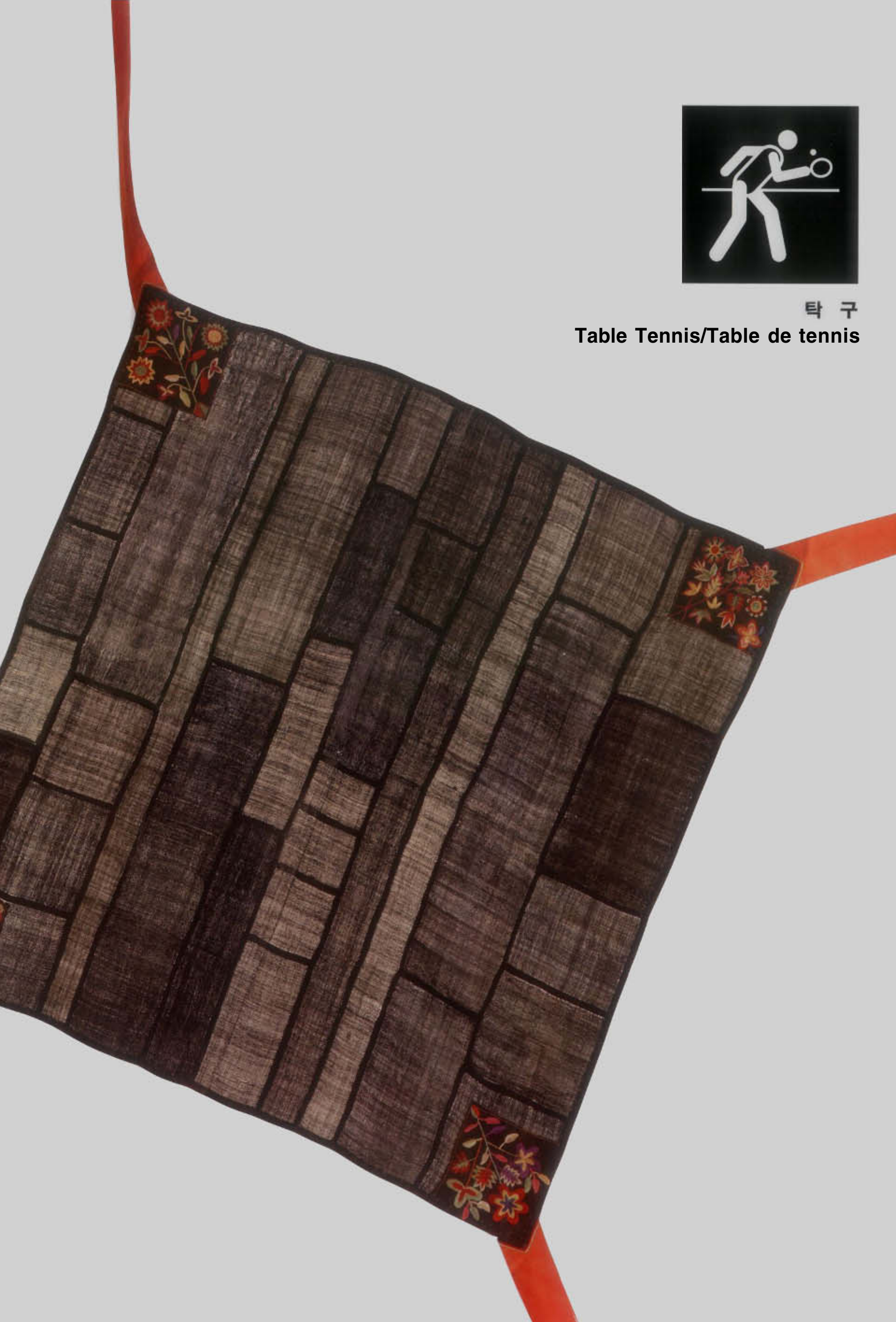

Table Tennis/Table de tennis

Officials/Officiels

International Table Tennis Federation (I.T.T.F.)

President/président	Ichiro Ogimura
Secretary General/secrétaire général	Anthony A. Brooks
Technical Delegates/délégués techniques	Yap Yong Yih Hans Giesecke

SLOOC Administrative Staff/Personnel Administratif du SLOOC

Commissioner/directeur	Choi Won Suk
Secretary General/secrétaire général	Kim Chang Jae
Deputy Secretary General/secrétaire général adjoint	Hong Tae Kyung
Competition Manager/chef de division des compétitions	Kim Chung Yong

Competitors/Concurrents

	Men Hommes	Competitors Competiteurs	Countries Pays
Singles/Simples		64	35
Doubles		64	23
	Women Femmes	Competitors Competiteurs	Countries Pays
Singles/Simples		48	28
Doubles		32	16

Legend/Notation

Pos.	Position
P	Played/Joués
W	Won/Gagnes
L	Lost/Perdus
*	Winner/Gagnant

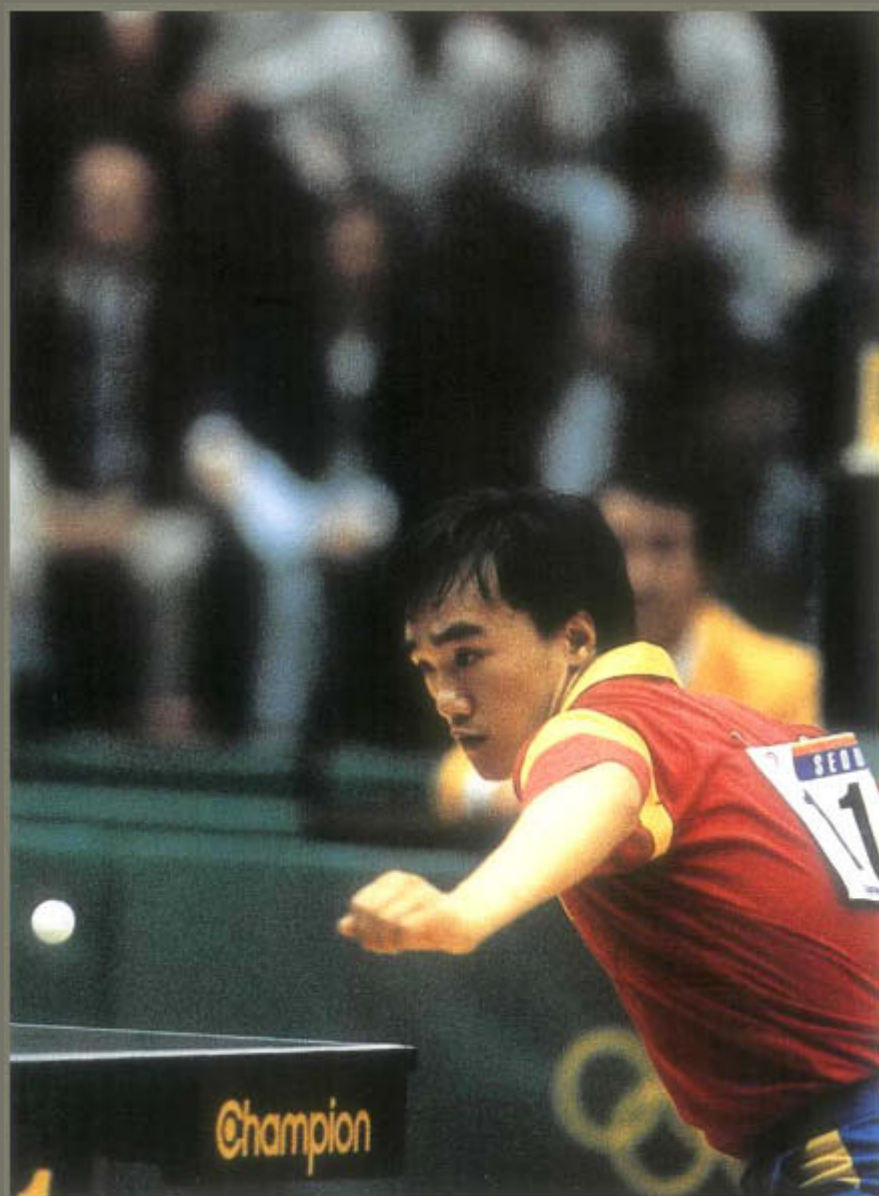

Table Tennis

Men's Singles 1st Stage Group A/Sept. 23-28		Simplex Hommes 1er Tour Groupe A/23-28 Sept								
Pos.	Name	(CHN)	(HUN)	(FRA)	(GBR)	(BEL)	(USA)	(BRA)	(TUN)	
1	Jiang, Jialiang	(CHN)	XXXXX	*3:1	*3:0	*3:0	*3:0	*3:0	*3:0	*3:0
2	Klampar, Tibor	(HUN)	1:3*	XXXXX	*3:2	*3:1	*3:2	*3:0	*3:0	*3:0
3	Gatien, Jean P	(FRA)	0:3*	2:3*	XXXXX	1:3*	2:3*	*3:0	*3:1	*3:0
4	Cooke, Alan	(GBR)	0:3*	1:3*	*3:1	XXXXX	*3:0	*3:0	*3:0	*3:0
5	Saive, Jean-M	(BEL)	0:3*	2:3*	*3:2	0:3*	XXXXX	*3:0	*3:0	*3:0
6	O'Neill, Sean	(USA)	0:3*	0:3*	0:3*	0:3*	0:3*	XXXXX	*3:2	*3:0
7	Kawai, Carlos	(BRA)	0:3*	0:3*	1:3*	0:3*	0:3*	2:3*	XXXXX	*3:0
8	Lofti, Joudi	(TUN)	0:3*	0:3*	0:3*	0:3*	0:3*	0:3*	XXXXX	

< Round Team Place/Classement Provisoire >

Place	Name	Ctry	Pos.	Matches			Games			Points			
				P	W	L	W/L	W	L	W/L	L	W/L	
1	Jiang, Jialiang	(CHN)	1	7	7	0	9.990	21	1	21.000	459	323	1.421
2	Klampar, Tibor	(HUN)	2	7	6	1	6.000	19	8	2.370	543	445	1.220
3	Cooke, Alan	(GBR)	4	7	5	2	2.500	16	7	2.280	462	370	1.248
4	Saive, Jean-M	(BEL)	5	7	4	3	1.333	14	11	1.270	470	431	1.090
5	Gatien, Jean P	(FRA)	3	7	3	4	0.750	14	13	1.070	512	486	1.053
6	O'Neill, Sean	(USA)	6	7	2	5	0.400	6	17	0.350	346	450	0.768
7	Kawai, Carlos	(BRA)	7	7	1	6	0.166	6	18	0.330	396	470	0.842
8	Lofti, Joudi	(TUN)	8	7	0	7	0.000	0	21	0.000	228	441	0.517

Men's Singles 1st Stage Group B/Sept. 23-28		Simplex Hommes 1er Tour Groupe B/23-28 Sept								
Pos.	Name	(SWE)	(CHN)	(FRG)	(FRA)	(TPE)	(NZL)	(INA)	(MRI)	
1	Waldner, Jan Ove	(SWE)	XXXXX	*3:2	*3:0	*3:0	*3:0	*3:0	*3:0	*3:0
2	Xu, Zengcai	(CHN)	2:3*	XXXXX	*3:0	*3:0	*3:0	*3:0	*3:0	*3:0
3	Boehm, Georg	(FRG)	0:3*	0:3*	XXXXX	*3:0	*3:1	*3:1	*3:0	*3:0
4	Birocheau, P	(FRA)	0:3*	0:3*	0:3*	XXXXX	*3:1	2:3*	*3:1	*3:0
5	Chih, Chin Long	(TPE)	0:3*	0:3*	1:3*	1:3*	XXXXX	*3:0	*3:0	*3:0
6	Griffiths, Barry	(NZL)	0:3*	0:3*	1:3*	*3:2	0:3*	XXXXX	2:3*	*3:1
7	Meringgi, Tonny	(INA)	0:3*	0:3*	0:3*	1:3*	0:3*	*3:2	XXXXX	*3:0
8	Hosnani, Gilani	(MRI)	0:3*	0:3*	0:3*	0:3*	0:3*	1:3*	0:3*	XXXXX

< Round Team Place/Classement Provisoire >

Place	Name	Ctry	Pos.	Matches			Games			Points			
				P	W	L	W/L	W	L	W/L	L	W/L	
1	Waldner, Jan Ove	(SWE)	1	7	7	0	9.990	21	2	10.500	465	327	1.422
2	Xu, Zengcai	(CHN)	2	7	6	1	6.000	20	3	6.660	460	301	1.528
3	Boehm, Georg	(FRG)	3	7	5	2	2.500	15	8	1.870	446	369	1.208
4	Birocheau, P	(FRA)	4	7	3	4	0.750	11	14	0.780	422	436	0.967
5	Chih, Chin Long	(TPE)	5	7	3	4	0.750	11	12	0.910	407	417	0.976
6	Meringgi, Tonny	(INA)	7	7	2	5	0.400	7	17	0.410	374	469	0.797
7	Griffiths, Barry	(NZL)	6	7	2	5	0.400	9	18	0.500	452	522	0.865
8	Hosnani, Gilani	(MRI)	8	7	0	7	0.000	1	21	0.040	271	456	0.594

Table de tennis

Men's Singles 1st Stage Group C/Sept. 23-28		Simplex Hommes 1er Tour Groupe C/23-28 Sept									
Pos.	Name	(CHN)	(HKG)	(TPE)	(AUT)	(HUN)	(NGR)	(IRQ)	(MRI)		
1	Chen, Longcan	(CHN)	XXXXX	*3:2	*3:0	1:3*	*3:0	*3:1	*3:0	*3:0	
2	Lo, Chuen Tsung	(HKG)	2:3*	XXXXX	*3:1	2:3*	*3:0	*3:0	*3:0	*3:0	
3	Wu, Wen Chia	(TPE)	0:3*	1:3*	XXXXX	0:3*	1:3*	*3:0	*3:0	*3:0	
4	Ding, Yi	(AUT)	*3:1	*3:2	*3:0	XXXXX	*3:0	*3:0	*3:0	*3:0	
5	Harczi, Zsolt	(HUN)	0:3*	0:3*	*3:1	0:3*	XXXXX	2:3*	*3:0	*3:0	
6	Bankole, Yom	(NGR)	1:3*	0:3*	0:3*	0:3*	*3:2	XXXXX	*3:1	*3:0	
7	Ali, Abdul Wahab	(IRQ)	0:3*	0:3*	0:3*	0:3*	0:3*	1:3*	XXXXX	*3:0	
8	Choo Choy, Alain	(MRI)	0:3*	0:3*	0:3*	0:3*	0:3*	0:3*	0:3*	XXXXX	

< Round Team Place/Classement Provisoire >

Place	Name	Ctry	Pos.	Matches			Games			Points			
				P	W	L	W/L	W	L	W/L	L	W/L	
1	Ding, Yi	(AUT)	4	7	7	0	9.990	21	3	7.000	476	341	1.395
2	Chen, Longcan	(CHN)	1	7	6	1	6.000	19	6	3.160	495	366	1.352
3	Lo, Chuen Tsung	(HKG)	2	7	5	2	2.500	19	7	2.710	500	382	1.308
4	Wu, Wen Chia	(TPE)	3	7	3	4	0.750	11	12	0.910 (1.330)	417	391	1.066 (1.101)
5	Harczi, Zsolt	(HUN)	5	7	3	4	0.750	11	13	0.840 (1.250)	401	436	0.919 (0.986)
6	Bankole, Yom	(NGR)	6	7	3	4	0.750	10	15	0.660 (0.600)	395	448	0.881 (0.920)
7	Ali, Abdul Wahab	(IRQ)	7	7	1	6	0.166	4	18	0.220	328	437	0.750
8	Choo Choy, Alain	(MRI)	8	7	0	7	0.000	0	21	0.000	230	441	0.521

Men's Singles 1st Stage Group D/Sept. 23-28		Simplex Hommes 1er Tour Groupe D/23-28 Sept								
Pos.	Name	(POL)	(JPN)	(FRG)	(YUG)	(NGR)	(AUS)	(IND)	(VEN)	
1	Grubba, Andrzej	(POL)	XXXXX	*3:0	*3:0	*3:0	*3:0	*3:1	*3:0	*3:0
2	Miyazaki, Y	(JPN)	0:3*	XXXXX	2:3*	0:3*	*3:0	*3:0	*3:0	*3:0
3	Roskopf, Joerg	(FRG)	0:3*	*3:2	XXXXX	1:3*	*3:2	*3:1	*3:0	*3:0
4	Primorac, Zoran	(YUG)	0:3*	*3:0	*3:1	XXXXX	1:3*	*3:0	*3:0	*3:0
5	Musa, Atanda	(NGR)	0:3*	0:3*	2:3*	*3:1	XXXXX	*3:1	*3:1	*3:0
6	Haberl, Gary	(AUS)	1:3*	0:3*	1:3*	0:3*	1:3*	XXXXX	*3:2	*3:0
7	Ghorpade, Sujay	(IND)	0:3*	0:3*	0:3*	0:3*	1:3*	2:3*	XXXXX	*3:2
8	Lopez, Francisco	(VEN)	0:3*	0:3*	0:3*	0:3*	0:3*	0:3*	2:3*	XXXXX

< Round Team Place/Classement Provisoire >

Place	Name	Ctry	Pos.	Matches			Games			Points			
				P	W	L	W/L	W	L	W/L	L	W/L	
1	Grubba, Andrzej	(POL)	1	7	7	0	9.990	21	1	21.000	460	310	1.483
2	Primorac, Zoran	(YUG)	4	7	5	2	2.500	16	7	2.280	452	389	1.161
3	Roskopf, Joerg	(FRG)	3	7	5	2	2.500	16	11	1.450	514	462	1.112
4	Miyazaki, Y	(JPN)	2	7	4	3	1.333	14	9	1.550	407	398	1.022
5	Musa, Atanda	(NGR)	5	7	4	3	1.333	14	12	1.160	484	473	1.023
6	Haberl, Gary	(AUS)	6	7	2	5	0.400	9	17	0.520	448	490	0.914
7	Ghorpade, Sujay	(IND)	7	7	1	6	0.166	6	20	0.300	383	515	0.743
8	Lopez, Francisco	(VEN)	8	7	0	7	0.000	2	21	0.090	361	472	0.764



Men's Singles
1st Stage Group E/Sept. 23-28

Simplex Hommes
1er Tour Groupe E/23-28 Sept

Pos.	Name	(SWE)	(KOR)	(JPN)	(BUL)	(IND)	(POL)	(CHI)	(EGY)
1	Persson, Jorgen	(SWE)	XXXXX	2:3*	*3:2	*3:0	*3:1	*3:1	*3:0
2	Kim, Ki Taik	(KOR)	*3:2	XXXXX	*3:2	*3:0	*3:0	*3:1	*3:0
3	Saito, Kiyoshi	(JPN)	2:3*	2:3*	XXXXX	*3:0	*3:0	*3:0	*3:0
4	Loukov, Mariano	(BUL)	0:3*	0:3*	0:3*	XXXXX	1:3*	*3:0	*3:2
5	Mehta, Kamlesh	(IND)	1:3*	0:3*	0:3*	*3:1	XXXXX	*3:1	*3:0
6	Molenda, Piotr	(POL)	1:3*	0:3*	0:3*	0:3*	1:3*	XXXXX	*3:1
7	Gambra, Jorge	(CHI)	0:3*	1:3*	0:3*	2:3*	0:3*	1:3*	XXXXX
8	Elsaket, Sherif	(EGY)	0:3*	0:3*	0:3*	1:3*	1:3*	1:3*	0:3*

< Round Team Place/Classement Provisoire >

Place	Name	Ctry	Pos.	Matches				Games				Points	
				P	W	L	W/L	W	L	W/L	W	L	W/L
1	Kim, Ki Taik	(KOR)	2	7	7	0	9.990	21	5	4.200	514	394	1.304
2	Persson, Jorgen	(SWE)	1	7	6	1	6.000	20	7	2.850	516	384	1.343
3	Saito, Kiyoshi	(JPN)	3	7	5	2	2.500	19	6	3.160	499	397	1.256
4	Mehta, Kamlesh	(IND)	5	7	4	3	1.333	13	12	1.080	470	457	1.028
5	Loukov, Mariano	(BUL)	4	7	3	4	0.750	10	15	0.660	425	473	0.898
6	Molenda, Piotr	(POL)	6	7	2	5	0.400	8	17	0.470	405	474	0.854
7	Gambra, Jorge	(CHI)	7	7	1	6	0.166	7	18	0.380	413	490	0.842
8	Elsaket, Sherif	(EGY)	8	7	0	7	0.000	3	21	0.140	324	497	0.651

Men's Singles
1st Stage Group F/Sept. 23-28

Simplex Hommes
1er Tour Groupe F/23-28 Sept

Pos.	Name	(SWE)	(GBR)	(YUG)	(BRA)	(TPE)	(PAK)	(EGY)	(DOM)
1	Lindh, Erik	(SWE)	XXXXX	*3:0	*3:2	*3:1	*3:2	*3:1	*3:0
2	Douglas, Desmond	(GBR)	0:3*	XXXXX	*3:0	*3:1	*3:1	*3:0	*3:0
3	Kalinic, Zoran	(YUG)	2:3*	0:3*	XXXXX	*3:2	1:3*	1:3*	*3:0
4	Kano, Claudio	(BRA)	1:3*	1:3*	2:3*	XXXXX	0:3*	0:3*	*3:1
5	Huang, Hhei C	(TPE)	2:3*	1:3*	*3:1	*3:0	XXXXX	*3:0	*3:0
6	Saif, Farjad	(PAK)	1:3*	0:3*	*3:1	*3:0	0:3*	XXXXX	1:3*
7	Abdelhalim, A	(EGY)	0:3*	0:3*	0:3*	1:3*	0:3*	*3:1	XXXXX
8	Fermin Martinez	(DOM)	1:3*	0:3*	0:3*	0:3*	0:3*	1:3*	1:3*

< Round Team Place/Classement Provisoire >

Place	Name	Ctry	Pos.	Matches				Games				Points	
				P	W	L	W/L	W	L	W/L	W	L	W/L
1	Lindh, Erik	(SWE)	1	7	7	0	9.990	21	7	3.000	558	414	1.347
2	Douglas, Desmond	(GBR)	2	7	6	1	6.000	18	5	3.600	451	350	1.288
3	Huang, Hhei C	(TPE)	5	7	5	2	2.500	18	7	2.570	469	388	1.208
4	Saif, Farjad	(PAK)	6	7	3	4	0.750	11	14	0.780	431	483	0.892
5	Kalinic, Zoran	(YUG)	3	7	3	4	0.750	13	14	0.920	503	493	1.020
6	Kano, Claudio	(BRA)	4	7	2	5	0.400	10	16	0.620	452	488	0.926
7	Abdelhalem, A	(EGY)	7	7	2	5	0.400	7	17	0.410	379	467	0.811
8	Fermin martinez	(DOM)	8	7	0	7	0.000	3	21	0.140	331	491	0.674

Men's Singles
1st Stage Group G/Sept. 23-28

Simplex Hommes
1er Tour Groupe G/23-28 Sept

Pos.	Name	(KOR)	(POL)	(GBR)	(TCH)	(HKG)	(CAN)	(DOM)	(TUN)
1	Yoo, Nam Kyu	(KOR)	XXXXX	*3:0	*3:1	*3:0	*3:0	*3:0	*3:0
2	Kucharski, L	(POL)	0:3*	XXXXX	*3:0	*3:1	*3:1	*3:2	*3:0
3	Prean, Carl	(GBR)	1:3*	0:3*	XXXXX	2:3*	*3:0	*3:1	*3:1
4	Pansky, Jindrich	(TCH)	0:3*	1:3*	*3:2	XXXXX	*3:1	*3:0	*3:1
5	Vong, lu Veng	(HKG)	0:3*	1:3*	0:3*	1:3*	XXXXX	*3:2	*3:0
6	Ng, Gideon Joe	(CAN)	0:3*	2:3*	1:3*	0:3*	2:3*	XXXXX	*3:0
7	Alvarez Soto, M	(DOM)	0:3*	0:3*	1:3*	1:3*	2:3*	0:3*	XXXXX
8	Sta, Mourad	(TUN)	0:3*	1:3*	0:3*	0:3*	0:3*	0:3*	XXXXX

< Round Team Place/Classement Provisoire >

Place	Name	Ctry	Pos.	Matches				Games				Points	
				P	W	L	W/L	W	L	W/L	W	L	W/L
1	Yoo, Nam Kyu	(KOR)	1	7	7	0	9.990	21	1	21.000	463	308	1.503
2	Kucharski, L	(POL)	2	7	6	1	6.000	18	8	2.250	504	445	1.132
3	Pansky, Jindrich	(POL)	4	7	5	2	2.500	16	10	1.600	501	480	1.043
4	Prean, Carl	(GBR)	3	7	4	3	1.333	15	11	1.360	508	445	1.141
5	Vong, lu Veng	(HKG)	5	7	3	4	0.750	11	16	0.680	496	524	0.946
6	Ng, Gideon Joe	(CAN)	6	7	2	5	0.400	11	15	0.730	481	500	0.962
7	Alvarez Soto, M	(DOM)	7	7	1	6	0.166	7	18	0.380	404	487	0.829
8	Sta, Mourad	(TUN)	8	7	0	7	0.000	1	21	0.040	289	457	0.632

Men's Singles
1st Stage Group H/Sept. 23-28

Simplex Hommes
1er Tour Groupe H/23-28 Sept

Pos.	Name	(URS)	(KOR)	(YUG)	(JPN)	(HKG)	(ITA)	(CHI)	(JAM)
1	Mazounov, Andrei	(URS)	XXXXX	1:3*	2:3*	*3:2	2:3*	*3:0	*3:0
2	Kim, Wan	(KOR)	*3:1	XXXXX	0:3*	1:3*	1:3*	*3:1	*3:0
3	Lupulesku, Ilija	(YUG)	*3:2	*3:0	XXXXX	*3:1	*3:0	*3:1	*3:0
4	Ono, Seiji	(JPN)	2:3*	*3:1	1:3*	XXXXX	*3:2	*3:2	*3:0
5	Liu, Fuk Man	(HKG)	*3:2	*3:1	0:3*	2:3*	XXXXX	*3:0	*3:0
6	Costantini, M	(ITA)	0:3*	1:3*	1:3*	2:3*	0:3*	XXXXX	*3:0
7	Nunez, Marcos	(CHI)	0:3*	0:3*	0:3*	0:3*	0:3*	0:3*	XXXXX
8	Jones, Garfield	(JAM)	0:3*	0:3*	0:3*	0:3*	0:3	2:3*	1:3*

< Round Team Place/Classement Provisoire >

Place	Name	Ctry	Pos.	Matches				Games				Points	
				P	W	L	W/L	W	L	W/L	W	L	W/L
1	Lupulesku, Ilija	(YUG)	3	7	7	0	9.990	21	4	5.250	514	388	1.324
2	Ono, Seiji	(JPN)	4	7	5	2	2.500	18	11	1.630	557	515	1.081
3	Liu, Fuk Man	(HKG)	5	7	5	2	2.500	17	9	1.880	495	411	1.204
4	Kim, Wan	(KOR)	2	7	4	3	1.333	14	11	1.270	477	423	1.127
5	Mazounov, Andrei	(URS)	1	7	4	3	1.333	17	11	1.540	542	500	1.084
6	Costantini, M	(ITA)	6	7	2	5	0.400	10	17	0.580	470	521	0.902
7	Nunez, Marcos	(CHI)	7	7	1	6	0.166	3	19	0.150	331	435	0.760
8	Jones, Garfield	(JAM)	8	7	0	7	0.000	3	21	0.140	293	486	0.602

Table Tennis

Table de tennis

Men's Singles /Sept. 23-Oct. 01

< Eighth-finals/Huitieme de Finale >				*: Winner/Gagnant		
No.	Name	Ctry	Results	No.	Name	Ctry
Eighth-finals Match 1						
0113	Jiang, Jialiang	(CHN)*	VS. 3:1 (21:18,21:18,22:24,21:13)	1028	Douglas, Desmond	(GBR)
Eighth-finals Match 2						
0144	Ono, Seiji	(JPN)	VS. 0:3 (22:24, 17:21, 16:21)	*0164	Lindh, Erik	(SWE)
Eighth-finals Match 3						
0150	Yoo, Nam Kyu	(KOR)*	VS. 3:0 (21:19,21:07,21:15)	0181	Primorac, Zoran	(YUG)
Eighth-finals Match 4						
0165	Persson, Jorgen	(SWE)*	VS. 3:1 (21:18,21:10, 19:21,21:19)	0160	Grubba, Andrzej	(POL)
Eighth-finals Match 5						
0103	Ding, Yi	(AUT)	VS. 1:3 (06:21, 14:21,21:16, 11:21)	*0135	Klampar, Tibor	(HUN)
Eighth-finals Match 6						
0112	Chen, Longcan	(CHN)*	VS. 3:0 (21:13,21:18,21:11)	0180	Lupulesku, Ilija	(YUG)
Eighth-finals Match 7						
0148	Kim, Ki Taik	(KOR)*	VS. 3:2 (17:21, 19:21,21:10,21:19,21:07)	0115	Xu, Zengcai	(CHN)
Eighth-finals Match 8						
0161	Kucharski, L	(POL)	VS. 2:3 (23:21, 20:22, 21:17, 17:21, 14:21)	*0166	Waldner, Jan Ove	(SWE)

< Quarter-finals/Quarts de Finale >

< Quarter-finals/Quarts de Finale >				*: Winner/Gagnant		
No.	Name	Ctry	Results	No.	Name	Ctry
Quarter-final Match 1						
0113	Jang, Jialiang	(CHN)	VS. 1:3 (21:16, 12:21, 13:21, 20:22)	*0164	Lindh, Erik	(SWE)
Quarter-final Match 2						
0150	Yoo, Nam Kyu	(KOR)*	VS. 3:1 (19:21,21:16,21:15,21:09)	0165	Persson, Jorgen	(SWE)
Quarter-final Match 3						
0135	Klampar, Tibor	(HUN)*	VS. 3:2 (21:19,07:21, 11:21,21:19,21:19)	0112	Chen Longcan	(CHN)
Quarter-final Match 4						
0148	Kim, Ki Taik	(KOR)*	VS. 3:2 (17:21, 21:17, 20:22, 21:17, 21:18)	0166	Waldner, Jan Ove	(SWE)
Losers of Quarter-final Match 1						
0113	Jiang, Jialiang	(CHN)*	VS. 3:1 (16:21,21:11,21:11,21:15)	0165	Persson, Jorgen	(SWE)
Losers of Quarter final Match 2						
0112	Chen, Longcan	(CHN)*	VS. 3:0 (21:11,23:21,21:08)	0166	Waldner, Jan Ove	(SWE)

< Semi-finals/Demi-finales >

< Semi-finals/Demi-finales >				*: Winner/Gagnant		
No.	Name	Ctry	Results	No.	Name	Ctry
Semi-final (1st Part)						
0164	Lindh, Erik	(SWE)	VS. 0:3 (10:21,22:24,09:21)	*0150	Yoo, Nam Kyu	(KOR)
Semi-final (2nd Part)						
0135	Klampar, Tibor	(HUN)	VS. 0:3 (18:21,09:21, 14:21)	*0148	Kim, Ki Taik	(KOR)

< Finals/Finales >

No.	Name	Ctry	Results	No.	Name	Ctry
Positions 7-8						
0165	Persson, Jorgen	(SWE)*	VS. 3:0 (21:15,21:16,21:17)	0166	Waldner, Jan Ove	(SWE)
Positions 5-6						
0113	Jiang, Jialiang	(CHN)*	VS. 3:0 (21:12,21:16,21:17)	0112	Chen, Longcan	(CHN)
Positions 3-4						
0164	Lindh, Erik	(SWE)*	VS. 3:1 (14:21,21:17,21:17,21:16)	0135	Klampar, Tibor	(HUN)
Final						
0150	Yoo, Nam Kyu	(KOR)*	VS. 3:1 (17:21,21:19,21:11,23:21)	0148	Kim, Ki Taik	(KOR)

< Final Ranks/Rang Final >

Rank	Name	Ctry
Rang	Nom	Pays
1	Yoo, Nam Kyu	(KOR)
2	Kim, Ki Taik	(KOR)
3	Lindh, Erik	(SWE)
4	Klampar, Tibor	(HUN)
5	Jiang, Jialiang	(CHN)
6	Cehn, Longcan	(CHN)
7	Persson, Jorgen	(SWE)
8	Waldner, Jan Ove	(SWE)

Men's Doubles 1st Stage Group A/Sept. 23-28

< Round Progress/Deroulement de la Poule >										*: Winner/Gagnant			
Pos	Name	(CHN)	(SWE)	(JPN)	(HUN)	(GBR)	(HKG)	(IND)	(TUN)				
1	Chen, Longcan Wei, Qingguang	(CHN)	XXXXX *2:0	*2:0	*2:1	*2:0	*2:0	*2:0	*2:0				
2	Persson, Jorgen Lindh, Erik	(SWE)	0:2*	XXXXX *2:0	*2:0	*2:0	*2:0	*2:0	*2:0				
3	Miyazaki, Y Ono, Seiji	(JPN)	0:2*	0:2*	XXXXX 1:2*	*2:0	*2:0	*2:0	*2:0				
4	Klampar, Tibor Kriston, Zsolt	(HUN)	1:2*	0:2*	*2:1	XXXXX 0:2*	*2:0	*2:1	*2:1				
5	Prean, Carl Cooke, Alan	(GBR)	0:2*	0:2*	0:2*	*2:0	XXXXX *2:0	*2:0	*2:1				
6	Liu, Fuk Man Chan, Chi Ming	(HKG)	0:2*	0:2*	0:2*	0:2*	0:2*	XXXXX 0:2*	*2:1				
7	Mehta, Kamlesh Ghorpade, Sujay	(IND)	0:2*	0:2*	0:2*	1:2*	0:2*	*2:0	XXXXX *2:0				
8	Sta, Mourad Bel Taiof, S	(TUN)	0:2*	0:2*	0:2*	1:2*	1:2*	1:2*	0:2*	XXXXX			

< Round Team Place/Classement Provisoire>

Place	Name	Ctry	Pos.	Matches			Games			Points			
				P	W	L	W/L	W	L	W/L	W	L	W/L
1	Chen, Longcan Wei, Qingguang	(CHN)	1	7	7	0	9.990	14	1	14.000	304	214	1.420
2	Persson, Jorgen Lindh, Erik	(SWE)	2	7	6	1	6.000	12	2	6.000	294	227	1.295
3	Miyazaki, Y Ono, Seiji	(JPN)	3	7	4	3	1.333	9	6	1.500 (1.500)	291	247	1.178 (0.901)
4	Prean, Carl Cooke, Alan	(GBR)	5	7	4	3	1.333	8	7	1.140 (1.000)	283	281	1.007 (1.103)
5	Klampar, Tibor Kriston, Zsolt	(HUN)	4	7	4	3	1.333	9	9	1.000 (0.660)	337	323	1.043 (1.000)
6	Mehta, Kamlesh Ghorpade, Sujay	(IND)	7	7	2	5	0.400	5	10	0.500	266	286	0.930
7	Liu, Fuk Man Chan, Chi Ming	(HKG)	6	7	1	6	0.166	2	13	0.150	210	302	0.695
8	Sta, Mourad Bel Taiof, S	(TUN)	8	7	0	7	0.000	3	14	0.210	235	340	0.691



Men's Doubles		Doubles Hommes									
1st Stage Group B/Sept. 23-Sept. 28		1er Tour Groupe B/23 Sept-28 Sept									
Pos.	Name	(SWE)	(TPE)	(KOR)	(GBR)	(AUT)	(FRG)	(NZL)	(DOM)		
1	Waldner, Jan Ove Appelgren, M	(SWE)	XXXXX	*2:0	*2:1	0:2*	*2:1	*2:0	*2:0	*2:0	
2	Chih, Chin Long Chih, Chin Shui	(TPE)	0.2*	XXXXX	0.2*	1.2*	*2:0	*2.1	*2:0	*2:0	
3	Kim, Ki Taik Kim, Wan	(KOR)	1.2*	*2:0	XXXXX	*2:0	*2:0	*2.1	*2:0	*2:0	
4	Douglas, Desmond Andrew, Skylet	(GBR)	*2:0	*2.1	0.2*	XXXXX	1.2*	*2.1	*2:0	*2:0	
5	Ding, Yi Baer, Gottfried	(AUT)	1.2*	0.2*	0.2*	*2.1	XXXXX	*2:0	0.2*	*2.1	
6	Boehm, Georg Rebel, Juergen	(FRG)	0.2*	1.2*	1.2*	1.2*	0.2*	XXXXX	*2:0	*2:0	
7	Griffiths, Barry Jackson, Peter	(NZL)	0.2*	0.2*	0.2*	0.2*	*2:0	0.2*	XXXXX	0.2*	
8	Alvarez Soto, M Fermin Martinez	(DOM)	0.2*	0.2*	0.2*	0.2*	1.2*	0.2*	*2:0	XXXXX	

< Round Team Place/Classement Provisoire>

Place	Name	Ctry	Pos.	Matches				Games				Points	
				P	W	L	W/L	W	L	W/L	W	L	W/L
1	Waldner, Jan Ove Appelgren, M	(SWE)	1	7	6	1	6.000	12	4	3.000	329	274	1.200
2	Kim, Mi Taik Kim, Wan	(KOR)	3	7	6	1	6.000	13	3	4.330	317	252	1.257
3	Douglas, Desmond Andrew, Skylet	(GBR)	4	7	5	2	2.500	11	6	1.830	330	305	1.081
4	Chih, Chin Long Chih, Chin Shui	(TPE)	2	7	4	3	1.333	9	7	1.280	300	286	1.048
5	Ding, Yi Baer, Gottfried	(AUT)	5	7	3	4	0.750	7	10	0.700	318	321	0.990
6	Boehm, Georg Rebel, Juergen	(FRG)	6	7	2	5	0.400	7	10	0.700	295	300	0.983
7	Alvarez Soto, M Fermin Martinez	(DOM)	8	7	1	6	0.166	3	12	0.250	220	304	0.723
8	Griffiths, Barry Jackson, Peter	(NZL)	7	7	1	6	0.166	2	12	0.160	231	298	0.775

Men's Doubles		Doubles Hommes									
1st Stage Group C/Sept. 23-28		1er Tour Groupe C/23-28 Sept									
Pos.	Name	(YUG)	(CHN)	(FRA)	(URS)	(TPE)	(NGR)	(CAN)	(MRI)		
1	Lupulesku, Ilija Primorac, Zoran	(YUG)	XXXXX	0:2*	*2:0	*2:0	*2:1	*2:1	*2:0	*2:0	
2	Jiang, Jialiang Xu, Zengcai	(CHN)	*2:0	XXXXX	*2:1	*2:0	*2:1	*2:0	*2:0	*2:0	
3	Gatien, Jean P Birocheau, P	(FRA)	0:2*	1:2*	XXXXX	*2:1	*2:1	*2:0	0:2*	*2:0	
4	Mazounov, Andrei Rosenberg, Boris	(URS)	0:2*	0:2*	1:2*	XXXXX	0:2*	0:2*	0:2*	*2:0	
5	Wu, Wen Chia Huang, Hhei C	(TPE)	1:2*	1:2*	1:2*	*2:0	XXXXX	*2:0	*2:0	*2:0	
6	Musa, Atanda Omotara, Titus	(NGR)	1:2*	0:2*	0:2*	*2:0	0:2*	XXXXX	0:2*	*2:0	
7	Pintea, Horatio Ng, Gideon Joe	(CAN)	0:2*	0:2*	*2:0	*2:0	0:2*	*2:0	XXXXX	*2:0	
8	Choo Choy, Alain Hosnani, Gilani	(MRI)	0:2*	0:2*	0:2*	0:2*	0:2*	0:2*	0:2*	XXXXX	

< Round Team Place/Classement Provisoire>

Place	Name	Ctry	Pos.	Matches				Games				Points	
				P	W	L	W/L	W	L	W/L	W	L	W/L
1	Jiang, Jialiang Xu, Zengcai	(CHN)	2	7	7	0	9.990	14	2	7.000	332	254	1.307
2	Lupulesku, Ilija Primorac, Zoran	(YUG)	1	7	6	1	6.000	12	4	3.000	315	255	1.235
3	Wu, Wen Chia Huang, Hhei C	(TPE)	5	7	4	3	1.333	11	6	1.830 (1.500)	332	270	1.229 (0.942)
4	Pintea, Horatio Ng, Gideon Joe	(CAN)	7	7	4	3	1.333	8	6	1.330 (1.000)	258	254	1.015 (1.101)
5	Gatien, Jean P Birocheau, P	(FRA)	3	7	4	3	1.333	9	8	1.120 (0.660)	318	317	1.003 (0.960)
6	Musa, Atanda Omotara, Titus	(NGR)	6	7	2	5	0.400	5	10	0.500	256	298	0.859
7	Mazounov, Andrei Rosenberg, Boris	(URS)	4	7	1	6	0.166	3	12	0.250	264	297	0.888
8	Choo Choy, Alain Hosnani, Gilani	(MRI)	8	7	0	7	0.000	0	14	0.000	165	295	0.559

Men's Doubles		Doubles Hommes									
1st Stage Group D/Sept. 23-28		1er Tour Groupe D/23-28 Sept									
Pos	Name	(POL)	(KOR)	(FRG)	(JPN)	(HKG)	(BRA)	(NGR)	(CHI)		
1	Grubba, Andrzej Kucharski, L	(POL)	XXXXX	0:2*	*2:0	*2:0	*2:0	*2:1	*2:0	*2:0	
2	Yoo, Nam Kyu Ahn, Jae Hyung	(KOR)	*2:0	XXXXX	*2:1	*2:0	*2:0	*2:0	*2:0	*2:0	
3	Roskopf, Joerg Fetzner, Steffen	(FRG)	0:2*	1:2*	XXXXX	*2:0	*2:1	*2:1	*2:0	*2:0	
4	Saito, Kiyoshi Watanabe, T	(JPN)	0:2*	0:2*	0:2*	XXXXX	*2:0	*2:1	*2:0	*2:0	
5	Lo, Chuen Tsung Vong, lu Veng	(HKG)	0:2*	0:2*	1:2*	0:2*	XXXXX	0:2*	*2:0	*2:0	
6	Kano, Claudio Kawai, Carlos	(BRA)	1:2*	0:2*	1:2*	1:2*	*2:0	XXXXX	1:2*	*2:0	
7	Adeyemo, Fatai Bankole, Yom	(NGR)	0:2*	0:2*	0:2*	0:2*	0:2*	*2:1	XXXXX	1:2*	
8	Gambra, Jorge Nunez, Marcos	(CHI)	0:2*	0:2*	0:2*	0:2*	0:2*	0:2*	*2:1	XXXXX	

< Round Team Place/Classement Provisoire>

Place	Name	Ctry	Pos.	Matches				Games				Points	
				P	W	L	W/L	W	L	W/L	W	L	W/L
1	Yoo, Nam Kyu Ahn, Jae Hyung	(KOR)	2	7	7	0	9.990	14	1	14.000	312	199	1.567
2	Grubba, Andrzej Kucharski, L	(POL)	1	7	6	1	6.000	12	3	4.000	300	244	1.229
3	Roskopf, Joerg Fetzner, Steffen	(FRG)	3	7	5	2	2.500	11	6	1.830	320	290	1.103
4	Saito, Kiyoshi Watanabe, T	(JPN)	4	7	4	3	1.333	8	7	1.140	265	284	0.933
5	Kano, Claudio Kawai, Carlos	(BRA)	6	7	2	5	0.400	8	10	0.800	329	335	0.982
6	Lo, Chuen Tsung Vong, lu Veng	(HKG)	5	7	2	5	0.400	5	10	0.500	269	298	0.902
7	Gambra, Jorge Nunez, Marcos	(CHI)	8	7	1	6	0.166	2	13	0.150	232	305	0.760
8	Adeyemo, Fatai Bankole, Yom	(NGR)	7	7	1	6	0.166	3	13	0.230	249	321	0.775

Table Tennis

Table de tennis

Men's Doubles Sept. 23-30				Doubles Hommes 23-30 Sept		
<Quarter-finals/Quarts de Finale >				*: Winner/Gagnant		
No.	Name	Ctry	Results	No.	Name	Ctry
Quarter-final Match 1						
0112	Chen, Longcan	(CHN)*	VS.	0160	Grubba, Andrzej	(POL)
0114	Wei, Qingguang			0161	Kucharski, L	
			2:1			
			(21:07, 12:21,21:19)			
Quarter-final Match 2						
0164	Lindh, Erik	(SWE)	VS.	*0147	Ahn, Jae Hyung	(KOR)
0165	Persson, Jorgen			0150	Yoo, Nam Kyu	
			0:2			
			(13:21,11:21)			
Quarter-final Match 3						
0113	Jiang, Jialiang	(CHN)	VS.	*0148	Kim, Ki Taik	(KOR)
0115	Xu, Zengcai			0149	Kim, Wan	
			0:2			
			(18:21, 20:22)			
Quarter-final Match 4						
0180	Lupulesku, Ilija	(YUG)*	VS.	0163	Appelgren, M	(SWE)
0181	Primorac, Zoran			0166	Waldner, Jan Ove	
			2:1			
			(21:19, 19:21, 21:19)			
Losers of Quarter-final Match 1						
0160	Grubba, Andrzej	(POL)*	VS.	0164	Lindh, Erik	(SWE)
016	Kucharski, L			0165	Persson, Jorgen	
			2:0			
			(21:16, 21:13)			
Losers of Quarter-final Match 2						
0113	Jiang, Jialiang	(CHN)*	VS.	0163	Appelgren, M	(SWE)
0115	Xu, Zengcai			0166	Waldner, Jan Ove	
			2:1			
			(10:21,22:20,21:17)			
< Semi-finals/Demi-finales > *: Winner/Gagnant						
No.	Name	Ctry	Results	No.	Name	Ctry
Semi-final (1st Part)						
0112	Chen, Longcan	(CHN)*	VS.	0147	Ahn, Jae Hyung	(KOR)
0114	Wei, Qingguang			0150	Yoo, Nam Kyu	
			2:0			
			(21:10,21:14)			
Semi-final (2nd Part)						
0148	Kim, Ki Taik	(KOR)	VS.	*0180	Lupulesku, Ilija	(YUG)
0149	Kim, Wan			0181	Primorac, Zoran	
			1:2			
			(21:23,21:19, 15:21)			
< Finals/Finales >						
No.	Name	Ctry	Results	No.	Name	Ctry
Positions 7-8						
0164	Lindh, Erik	(SWE)*	VS.	0163	Appelgren, M	(SWE)
0165	Persson, Jorgen			0166	Waldner, Jan Ove	
			2:0			
			(21:10,21:14)			
Positions 5-6						
0160	Grubba, Andrzej	(POL)	VS.	*0113	Jiang, Jialiang	(CHN)
0161	Kucharski, L			0115	Xu, Zengcai	
			0:2			
			(07:21, 12:21)			
Positions 3-4						
0147	Ahn, Jae Hyung	(KOR)*	VS.	0148	Kim, Ki Taik	(KOR)
0150	Yoo, Nam Kyu			0149	Kim, Wan	
			2:0			
			(21:13,21:16)			
Final						
0112	Chen, Longcan	(CHN)*	VS.	0180	Lupulesku, Ilija	(YUG)
0114	Wei, Qingguang			0181	Primorac, Zoran	
			2:1			
			(20:22,21:08,21:09)			
< Final Ranks/Rang Final >						
Rank	Name	Ctry				
Rang	Nom	Pays				
1	Chen, Longcan	(CHN)				
2	Wei, Qingguang	(YUG)				
3	Lupulesku, Ilija	(KOR)				
4	Primorac, Zoran	(KOR)				
5	Ahn, Jae Hyung	(KOR)				
6	Yoo, Nam Kyu	(KOR)				
7	Kim, Ki Taik	(KOR)				
8	Kim, Wan	(KOR)				
9	Jiang, Jialiang	(CHN)				
10	Xu, Zengcai	(CHN)				
11	Grubba, Andrzej	(POL)				
12	Kucharski, L	(POL)				
13	Lindh, Erik	(SWE)				
14	Persson, Jorgen	(SWE)				
15	Appelgren, M	(SWE)				
16	Waldner, Jan Ove	(SWE)				

Women's Singles 1st Stage Group A/Sept. 23-28							Simple Dames 1er Tour Groupe A/23-28 Sept						
< Round Progress/Deroulement de la Poule >							*: Winner/Gagnant						
Pos.	Name	(CHN)	(HUN)	(URS)	(CAN)	(USA)	(DOM)						
1	Jiao, Zhimin	(CHN)	XXXXX	*3:1	*3:2	*3:1	*3:0	*3:0					
2	Urban, Edit	(HUN)	1:3*	XXXXX	*3:0	*3:0	*3:0	*3:0					
3	Kovtoun, Elena	(URS)	2:3*	0:3*	XXXXX	*3:0	*3:0	*3:0					
4	Domonkos, M	(CAN)	1:3*	0:3*	0:3*	XXXXX	*3:2	*3:0					
5	Gee, Diana	(USA)	0:3*	0:3*	0:3*	2:3*	XXXXX	*3:0					
6	Alejo, Blanca	(DOM)	0:3*	0:3*	0:3*	0:3*	0:3*	XXXXX					
< Round Team Place/Classement Provisoire>													
Place	Name	Ctry	Pos.	Matches			Games			Points			
				P	W	L	W/L	W	L	W/L	W	L	W/L
1	Jiao, Zhimin	(CHN)	1	5	5	0	9.990	15	4	3.750	386	248	1.556
2	Urban, Edit	(HUN)	2	5	4	1	4.000	13	3	4.330	301	246	1.223
3	Kovtoun, Elena	(URS)	3	5	3	2	1.500	11	6	1.830	304	288	1.055
4	Domonkos, M	(CAN)	4	5	2	3	0.666	7	11	0.630	318	335	0.949
5	Gee, Diana	(USA)	5	5	1	4	0.250	5	12	0.410	291	315	0.923
6	Alejo, Blanca	(DOM)	6	5	0	5	0.000	0	15	0.000	147	315	0.466
Women's Singles 1st Stage Group B/Sept. 23-28													
< Round Progress/Deroulement de la Poule >							Simple Dames 1er Tour Groupe B/23-28 Sept						
Pos.	Name	(KOR)	(TCH)	(HKG)	(TPE)	(VEN)	(JOR)						
1	Yang, Young Ja	(KOR)	XXXXX	*3:0	*3:0	*3:0	*3:0	*3:0					
2	Kasalova, Renata	(TCH)	0:3*	XXXXX	*3:2	*3:0	*3:0	*3:0					
3	Hui, So Hung	(HKG)	0:3*	2:3*	XXXXX	1:3*	*3:0	*3:0					
4	Lin, Li-Ju	(TPE)	0:3*	0:3*	*3:1	XXXXX	*3:0	*3:0					
5	Popper, E	(VEN)	0:3*	0:3*	0:3*	0:3*	XXXXX	*3:0					
6	Duqom, Jaklein	(JOR)	0:3*	0:3*	0:3*	0:3*	0:3*	XXXXX					
< Round Team Place/Classement Provisoire>													
Place	Name	Ctry	Pos.	Matches			Games			Points			
				P	W	L	W/L	W	L	W/L	W	L	W/L
1	Yang, Young Ja	(KOR)	1	5	5	0	9.990	15	0	9.990	316	168	1.880
2	Kasalova, Renata	(TCH)	2	5	4	1	4.000	12	5	2.400	325	262	1.240
3	Lin, Li-vu	(TPE)	4	5	3	2	1.500	9	7	1.280	270	247	1.093
4	Hui, So Hung	(HKG)	3	5	2	3	0.666	9	9	1.000	309	288	1.072
5	Popper, E	(VEN)	5	5	1	4	0.250	3	12	0.250	213	272	0.783
6	Duqom, Jaklein	(JOR)	6	5	0	5	0.000	0	15	0.000	119	315	0.377



Women's Singles 1st Stage Group C/Sept. 23-28			Simple Dames 1er Tour Groupe C/23-28 Sept					
< Round Progress/Deroulement de la Poule >			*: Winner/Gagnant					
Pos.	Name	(CHN)	(JPN)	(URS)	(USA)	(AUS)	(TUN)	
1	Chen, Jing	(CHN)	XXXXX	*3:0	*3:0	*3:0	*3:0	
2	Uchiyama, Kyoko	(JPN)	0:3*	XXXXX	0:3*	*3:2	*3:0	
3	Popova, V	(URS)	0:3*	*3:0	XXXXX	*3:0	*3:0	
4	Bhushan, In Sook	(USA)	0:3*	2:3*	0:3*	XXXXX	*3:0	
5	Bisiach, Nadia	(AUS)	0:3*	0:3*	0:3*	0:3*	XXXXX	
6	Ben, Alssa, Faiza	(TUN)	0:3*	0:3*	0:3*	0:3*	XXXXX	

< Round Team Place/Classement Provisoire >													
Place	Name	Ctry	Pos.	Matches			Games			Points			
				P	W	L	W/L	W	L	W/L	W	L	W/L
1	Chen, Jing	(CHN)	1	5	5	0	9.990	15	0	9.990	315	177	1.779
2	Popova, V	(URS)	3	5	4	1	4.000	12	3	4.000	300	207	1.449
3	Uchiyama, Kyoko	(JPN)	2	5	3	2	1.500	9	8	1.120	296	241	1.228
4	Bhushan, In Sook	(USA)	4	5	2	3	0.666	8	9	0.880	279	269	1.037
5	Bisiach, Nadia	(AUS)	5	5	1	4	0.250	3	12	0.250	184	282	0.652
6	Ben, Alssa, Faiza	(TUN)	6	5	0	5	0.000	0	15	0.000	117	315	0.371

Women's Singles 1st Stage Group F/Sept. 23-28			Simple Dames 1er Tour Groupe F/23-28 Sept					
< Round Progress/Deroulement de la Poule >			*: Winner/Gagnant					
Pos.	Name	(URS)	(TCH)	(TPE)	(BEL)	(MAL)	(IND)	
1	Boulatova, F	(URS)	XXXXX	*3:2	*3:1	*3:0	*3:0	
2	Hrachova, Marie	(TCH)	2:3*	XXXXX	*3:1	*3:1	*3:0	
3	Chang, Hsiu-Yu	(TPE)	1:3*	1:3*	XXXXX	*3:0	*3:0	
4	Bogaerts, Karina	(BEL)	0:3*	1:3*	0:3*	XXXXX	*3:0	
5	Leong, Mee Wan	(MAL)	0:3*	0:3*	0:3*	0:3*	XXXXX	
6	Roy, Niyati	(IND)	0:3*	0:3*	0:3*	0:3*	XXXXX	

< Round Team Place/Classement Provisoire >													
Place	Name	Ctry	Pos.	Matches			Games			Points			
				P	W	L	W/L	W	L	W/L	W	L	W/L
1	Boulatova, F	(URS)	1	5	5	0	9.990	15	3	5.000	364	244	1.491
2	Hrachova, Marie	(TCH)	2	5	4	1	4.000	14	5	2.800	380	280	1.357
3	Chang, Hsiu-Yu	(TPE)	3	5	3	2	1.500	11	6	1.830	310	276	1.123
4	Bogaerts, Karina	(BEL)	4	5	2	3	0.666	7	9	0.770	239	280	0.853
5	Leong, Mee Wan	(MAL)	5	5	1	4	0.250	3	12	0.250	196	305	0.642
6	Roy, Niyati	(IND)	6	5	0	5	0.000	0	15	0.000	211	315	0.669

Women's Singles 1st Stage Group D/Sept. 23-28			Simple Dames 1er Tour Groupe D/23-28 Sept					
< Round Progress/Deroulement de la Poule >			*: Winner/Gagnant					
Pos.	Name	(CHN)	(HKG)	(JPN)	(AUS)	(MAL)	(GHA)	
1	Li, Huifen	(CHN)	XXXXX	*3:0	*3:0	*3:0	*3:0	
2	Mok, Ka Sha	(HKG)	0:3*	XXXXX	*3:0	*3:0	*3:0	
3	Ishida, Kiyomi	(JPN)	0:3*	0:3*	XXXXX	*3:1	*3:0	
4	Tepper, Kerri	(AUS)	0:3*	0:3*	1:3*	XXXXX	*3:1	
5	Lau, Wai Cheng	(MAL)	0:3*	0:3*	0:3*	*3:0	XXXXX	
6	Offei, Patricia	(GHA)	0:3*	0:3*	0:3*	1:3*	1:3*	

< Round Team Place/Classement Provisoire >													
Place	Name	Ctry	Pos.	Matches			Games			Points			
				P	W	L	W/L	W	L	W/L	W	L	W/L
1	Li, Huifen	(CHN)	1	5	5	0	9.990	15	0	9.990	315	151	2.086
2	Mok, Ka Sha	(HKG)	2	5	4	1	4.000	12	3	4.000	292	184	1.586
3	Ishida, Kiyomi	(JPN)	3	5	3	2	1.500	9	7	1.280	275	279	0.985
4	Tepper, Kerri	(AUS)	4	5	2	3	0.666	7	10	0.700	282	313	0.900
5	Lau, Wai Cheng	(MAL)	5	5	1	4	0.250	3	13	0.230	191	323	0.591
6	Offei, Patricia	(GHA)	6	5	0	5	0.000	2	15	0.130	249	354	0.703

Women's Singles 1st Stage Group G/Sept. 23-28			Simple Dames 1er Tour Groupe G/23-28 Sept					
< Round Progress/Deroulement de la Poule >			*: Winner/Gagnant					
Pos.	Name	(HOL)	(BUL)	(TCH)	(YUG)	(ARG)	(EGY)	
1	Vriesekoop, B	(HOL)	XXXXX	*3:1	*3:0	*3:0	*3:0	
2	Guergueltcheva	(BUL)	1:3*	XXXXX	*3:0	*3:2	*3:0	
3	Safarova, Alena	(TCH)	0:3*	0:3*	XXXXX	*3:0	*3:0	
4	Perkucin, G	(YUG)	0:3*	2:3*	0:3*	XXXXX	*3:0	
5	De Rimasa, Kim	(ARG)	0:3*	0:3*	0:3*	0:3*	XXXXX	
6	Meshref, Nihal	(EGY)	0:3*	0:3*	0:3*	0:3*	1:3*	

< Round Team Place/Classement Provisoire >													
Place	Name	Ctry	Pos.	Matches			Games			Points			
				P	W	L	W/L	W	L	W/L	W	L	W/L
1	Vriesekoop, B	(HOL)	1	5	5	0	9.990	15	1	15.000	333	197	1.690
2	Guergueltcheva	(BUL)	2	5	4	1	4.000	13	5	2.600	357	266	1.342
3	Safarova, Alena	(TCH)	3	5	3	2	1.500	9	6	1.500	268	225	1.191
4	Perkucin, G	(YUG)	4	5	2	3	0.666	8	9	0.880	282	296	0.952
5	De Rimasa, Kim	(ARG)	5	5	1	4	0.250	3	13	0.230	214	319	0.670
6	Meshref, Nihal	(EGY)	6	5	0	5	0.000	1	15	0.060	182	333	0.546

Women's Singles 1st Stage Group E/Sept. 23-28			Simple Dames 1er Tour Groupe E/23-28 Sept					
< Round Progress/Deroulement de la Poule >			*: Winner/Gagnant					
Pos.	Name	(KOR)	(JPN)	(YUG)	(FRG)	(PER)	(NGR)	
1	Hyun, Jung Hwa	(KOR)	XXXXX	*3:0	*3:1	*3:0	*3:1	
2	Hoshino, Mika	(JPN)	0:3*	XXXXX	*3:0	*3:2	*3:1	
3	Fazlic, Jasna	(YUG)	1:3*	0:3*	XXXXX	*3:2	*3:0	
4	Nolten, Katja	(FRG)	0:3*	2:3*	2:3*	XXXXX	*3:2	
5	Liyau, Monica	(PER)	1:3*	0:3*	0:3*	2:3*	XXXXX	
6	Owolabi, Kuburat	(NGR)	0:3*	1:3*	0:3*	2:3*	*3:2	

< Round Team Place/Classement Provisoire >													
Place	Name	Ctry	Pos.	Matches			Games			Points			
				P	W	L	W/L	W	L	W/L	W	L	W/L
1	Hyun, Jung Hwa	(KOR)	1	5	5	0	9.990	15	2	7.500	346	232	1.491
2	Hoshino, Mika	(JPN)	2	5	4	1	4.000	12	6	2.000	352	299	1.177
3	Fazlic, Jasna	(YUG)	3	5	3	2	1.500	10	8	1.250	321	318	1.009
4	Nolten, Katja	(FRG)	4	5	2	3	0.666	10	13	0.760	411	415	0.990
5	Owolabi, Kuburat	(NGR)	6	5	1	4	0.250	6	14	0.420	333	392	0.849
6	Liyau, Monica	(PER)	5	5	0	5	0.000	5	15	0.330	291	398	0.731

Women's Singles 1st Stage Group H/Sept. 23-28			Simple Dames 1er Tour Groupe H/23-28 Sept					
< Round Progress/Deroulement de la Poule >			*: Winner/Gagnant					
Pos.	Name	(HUN)	(FRG)	(HOL)	(KOR)	(NGR)	(CHI)	
1	Batorfi, Csilla	(HUN)	XXXXX	2:3*	2:3*	*3:1	*3:0	
2	Nemes, Olga	(FRG)	*3:2	XXXXX	*3:0	1:3*	*3:0	
3	Kloppenburger, M	(HOL)	*3:2	0:3*	XXXXX	2:3*	*3:1	
4	Hong, Cha Ok	(KOR)	1:3*	*3:1	*3:2	XXXXX	*3:0	
5	Akanmu, Iyabo	(NGR)	0:3*	0:3*	1:3*	0:3*	XXXXX	
6	Diaz, Jacqueline	(CHI)	0:3*	0:3*	0:3*	0:3*	*3:1	

< Round Team Place/Classement Provisoire >													
Place	Name	Ctry	Pos.	Matches			Games			Points			
				P	W	L	W/L	W	L	W/L	W	L	W/L
1	Hong, Cha Ok	(KOR)	4	5	4	1	4.000	13	6	2.160	368	308	1.194
2	Nemes, Olga	(FRG)	2	5	4	1	4.000	13	5	2.600	362	307	1.179
3	Kloppenburger, M	(HOL)	3	5	3	2	1.500	11	9	1.220	388	350	1.108
4	Batorfi, Csilla	(HUN)	1	5	3	2	1.500	13	7	1.850	398	340	1.170
5	Diaz, Jacqueline	(CHI)	6	5	1	4	0.250	3	13	0.230	225	319	0.705
6	Akanmu, Iyabo	(NGR)	5	5	0	5	0.000	2	15	0.130	232	349	0.664

Table Tennis

Table de tennis

Women's Singles Sept. 23-Oct. 1

< Eighth-finals/Huitieme de Finale >				*: Winner/Gagnant		
No.	Name	Ctry	Results	No.	Name	Ctry
Eighth-finals Match 1						
0509	Jiao, Zhimin	(CHN)*	VS. 3:2	0524	Hoshino, Mika	(JPN)
(15:21,21:12,21:08,17:21,21:11)						
Eighth-finals Match 2						
0536	Kasalova, Renata	(TCH)	VS. 0:3	*0527	Hong, Cha Ok	(KOR)
(14:21,06:21, 13:21)						
Eighth-finals Match 3						
0528	Hyun, Jung Hwa	(KOR)	VS. 0:3	*0543	Popova, V	(URS)
(14:21,13:21,23:25)						
Eighth-finals Match 4						
0513	Nemes, Olga	(FRG)	VS. 1:3	*0510	Li, Huifen	(CHN)
(21:15,18:21,15:21,10:21)						
Eighth-finals Match 5						
0508	Chen, Jing	(CHN)*	VS. 3:0	0505	Guerguelcheva	(BUL)
(21:15,21:07,22:20)						
Eighth-finals Match 6						
0517	Mok, Ka Sha	(HKG)	VS. 2:3	*0541	Boulatova, F	(URS)
(21:17, 14:21,24:22,15:21, 10:21)						
Eighth-finals Match 7						
0519	Vriesekoop, B	(HOL)*	VS. 3:2	0521	Urban, Edit	(HUN)
(21:07, 19:21,21:15, 18:21,21:18)						
Eighth-finals Match 8						
0535	Hrachova, Marie	(TCH)*	VS. 3:1	0529	Yang, Young Ja	(KOR)
(21:18, 11:21,23:21,21:18)						

<Quarter-finals/Quarts de Finale > *: Winner/Gagnant

No.	Name	Ctry	Results	No.	Name	Ctry
Quarter-finals Match 1						
0509	Jiao, Zhimin	(CHN)*	VS. 3:0	0527	Hong, Cha Ok	(KOR)
(21:09,21:09,21:11)						
Quarter-finals Match 2						
0543	Popova, V	(URS)	VS. 0:3	*0510	Li, Huifen	(CHN)
(13:21, 12:21, 19:21)						
Quarter-finals Match 3						
0508	Chen, Jing	(CHN)*	VS. 3:0	0541	Boulatova, F	(URS)
(21:04,21:11,21:02)						
Quarter-finals Match 4						
0519	Vriesekoop, B	(HOL)	VS. 0:3	*0535	Hrachova, Marie	(TCH)
(08:21,15:21,19:21)						
Losers of Quarter-final Match 1						
0527	Hong, Cha Ok	(KOR)	VS. 0:3	*0543	Popova, V	(URS)
(18:21,12:21,12:21)						
Losers of Quarter-final Match 2						
0541	Boulatova, F	(URS)*	VS. 3:0	0519	Vriesekoop, B	(HOL)
(21:16,21:17,21:17)						

< Semi-finals/Demi-finales > *: Winner/Gagnant

No.	Name	Ctry	Results	No.	Name	Ctry
Semi-final (1st Part)						
0509	Jiao, Zhimin	(CHN)	VS. 0:3	*0510	Li, Huifen	(CHN)
(16:21, 17:21, 11:21)						
Semi-final (2nd Part)						
0508	Chen, Jing	(CHN)*	VS. 3:0	0535	Hrachova, Marie	(TCH)
(21:15,21:12,21:12)						

< Finals/Finales > *: Winner/Gagnant

No.	Name	Ctry	Results	No.	Name	Ctry
Positions 7-8						
0527	Hong, Cha Ok	(KOR)	VS. 0:3	*0519	Vriesekoop, B	(HOL)
(19:21, 16:21, 23:25)						
Positions 5-6						
0543	Popova, V	(URS)	VS. 0:3	*0541	Boulatova, F	(URS)
(16:21, 11:21, 20:22)						
Positions 3-4						
0509	Jiao, Zhimin	(CHN)*	VS. 3:0	0535	Hrachova, Marie	(TCH)
(21:18, 21:19,21:17)						
Final						
0510	Li, Huifen	(CHN)	VS. 2:3	*0508	Chen, Jing	(CHN)
(17:21,16:21,23:21,21:15,15:21)						

< Final Ranks/Rang Final >

Rank	Name	Ctry
Rang	Nom	Pays
1	Chen, Jing	(CHN)
2	Li, Huifen	(CHN)
3	Jiao, Zhimin	(CHN)
4	Hrachova, Marie	(TCH)
5	Boulatova, F	(URS)
6	Popova, V	(URS)
7	Vriesekoop, B	(HOL)
8	Hong, Cha Ok	(KOR)

Women's Doubles 1st Stage Group A/Sept. 23-28

< Round Progress/Deroulement de la Poule >										*: Winner/Gagnant	
Pos.	Name	(KOR)	(HUN)	(URS)	(TPE)	(YUG)	(HKG)	(AUS)	(NGR)		
1	Yang, Young Ja Hyun, Jung Hwa	(KOR)	XXXXX	*2:0	*2:0	*2:1	*2:0	*2:0	*2:0	*2:0	
2	Batorfi, Csilla Urban, Edit	(HUN)	0:2*	XXXXX	1:2*	*2:1	0:2*	*2:0	*2:1	*2:0	
3	Boulatova, F Kovtoun, Elena	(URS)	0:2*	*2:1	XXXXX	0:2*	*2:0	*2:1	*2:0	*2:0	
4	Chang, Hsiu-Yu Lin, Li-Ju	(TPE)	1:2*	1:2*	*2:0	XXXXX	0:2*	*2:1	*2:0	*2:0	
5	Fazlic, Jasna Perkucin, G	(YUG)	0:2*	*2:0	0:2*	*2:0	XXXXX	*2:0	*2:0	*2:0	
6	Mok, Ka Sha Hui, So Hung	(HKG)	0:2*	0:2*	1:2*	1:2*	0:2*	XXXXX	1:2*	*2:0	
7	Tepper, Kerri Bisiach, Nadia	(AUS)	0:2*	1:2*	0:2*	0:2*	0:2*	*2:1	XXXXX	0:2*	
8	Owolabi, Kuburat Akanmu, Iyabo	(NGR)	0:2*	0:2*	0:2*	0:2*	0:2*	*2:0	XXXXX		

< Round Team Place/Classement Provisoire >

Place	Name	Ctry	Pos.	Matches			Games			Points			
				P	W	L	W/L	W	L	W/L	W	L	W/L
1	Yang, Young Ja Hyun, Jung Hwa	(KOR)	1	7	7	0	9.990	14	1	14.000	313	169	1.852
2	Boulatova, F Kovtoun, Elena	(URS)	3	7	5	2	2.500	10	6	1.660	295	262	1.125
3	Fazlic, Jasna Perkucin, G	(YUG)	5	7	5	2	2.500	10	4	2.500	267	229	1.165
4	Batorfi, Csilla Urban, Edit	(HUN)	2	7	4	3	1.333	9	8	1.120	301	312	0.964
5	Chang, Hsiu-Yu Lin, Li-Ju	(TPE)	4	7	4	3	1.333	10	7	1.420	319	290	1.100
6	Mok, Ka Sha Hui, So Hung	(HKG)	6	7	1	6	0.166	5	12	0.410 (1.500)	262	333	0.786 (1.194)
7	Owolabi, Kuburat Akanmu, Iyabo	(NGR)	8	7	1	6	0.166	2	12	0.160 (1.000)	206	288	0.715 (0.806)
8	Tepper, Kerri Bisiach, Nadia	(AUS)	7	7	1	6	0.166	3	13	0.230 (0.660)	248	328	0.756 (1.041)



Women's Doubles
1st Stage Group B/Sept. 23-28

Doubles Dames
1er Tour Groupe B/23-28 Sept

< Round Progress/Deroulement de la Poule >											*: Winner/Gagnant
Pos.	Name	(CHN)	(JPN)	(TCH)	(FRG)	(HOL)	(USA)	(MAL)			
1	Jiao, Zhimin Chen, Jing	(CHN)	XXXXX	*2:0	*2:0	*2:0	*2:0	*2:1	*2:0	1201	
2	Hoshino, Mika Ishida, Kiyomi	(JPN)	0:2*	XXXXX	0:2*	*2:1	1:2*	*2:0	*2:0	1216	
3	Hrachova, Marie Kasalova, Renata	(TCH)	0:2*	*2:0	XXXXX	*2:0	*2:0	*2:1	*2:0	1226	
4	Nemes, Olga Nolten, Katja	(FRG)	0:2*	1:2*	0:2*	XXXXX	1:2*	*2:1	*2:0	1211	
5	Vriesekoop, B Kloppenburg, M	(HOL)	0:2*	*2:1	0:2*	*2:1	XXXXX	*2:0	*2:0	1223	
6	Bhushan, In Sook Gee, Diana	(USA)	1:2*	0:2*	1:2*	1:2*	0:2*	XXXXX	*2:0	1206	
7	Lau, Wai Cheng Leong, Mee Wan	(MAL)	0:2*	0:2*	0:2*	0:2*	0:2*	XXXXX		1220	

< Round Team Place/Classement Provisoire >

Place	Name	Ctry	Pos.	Matches			Games			Points			
				P	W	L	W/L	W	L	W/L	W	L	W/L
1	Jiao, Zhimin Chen, Jing	(CHN)	1	6	6	0	9.990	12	1	12.000	266	147	1.809
2	Hrachova, Marie Kasalova, Renata	(TCH)	3	6	5	1	5.000	10	3	3.330	254	232	1.094
3	Vriesekoop, B Kloppenburg, M	(HOL)	5	6	4	2	2.000	8	6	1.330	259	247	1.048
4	Hoshino, Mika Ishida, Kiyomi	(JPN)	2	6	3	3	1.000	7	7	1.000	258	261	0.988
5	Nemes, Olga Nolten, Katja	(FRG)	4	6	2	4	0.500	6	9	0.660	282	290	0.972
6	Bhushan, In Sook Gee, Diana	(USA)	6	6	1	5	0.200	5	10	0.500	241	276	0.873
7	Lau, Wai Cheng Leong, Mee Wan	(MAL)	7	6	0	6	0.000	0	12	0.000	147	254	0.578

Women's Doubles
Sept. 23-30

Doubles Dames
23-30 Sept

<Quarter-finals/Quarts de Finale >				*: Winner/Gagnant		
No.	Name	Ctry	Results	No.	Name	Ctry
Quarter-finals Match 1						
0528	Hyun, Jung Hwa	(KOR)*	VS.	0518	Kloppenburg, M	(HOL)
0529	Yang, Young Ja		2:0	0519	Vriesekoop, B	
(21:15,21:12)						
Quarter-finals Match 2						
0524	Hoshino, Mika	(JPN)*	VS.	0541	Boulatova, F	(URS)
0525	Ishida, Kiyomi		2:0	0542	Kovtoun, Elena	
(21:18,21:11)						
Quarter-finals Match 3						
0535	Hrachova, Marie	(TCH)	VS.	*0547	Fazlic, Jasna	(YUG)
0536	Kasalova, Renata		0:2	0548	Perkucic, G	
(19:21, 17:21)						
Quarter-finals Match 4						
0520	Batorfi, Csilla	(HUN)	VS.	*0508	Chen, Jing	(CHN)
0521	Urban, Edit		0:2	0509	Jiao, Zhimin	
(10:21, 14:21)						
Losers of Quarter-final Match 1						
0518	Kloppenburg, M	(HOL)	VS.	*0541	Boulatova, F	(URS)
0519	Vriesekoop, B		0:2	0542	Kovtoun, Elena	
(07:21, 18:21)						
Losers of Quarter-final Match 2						
0535	Hrachova, Marie	(TCH)*	VS.	0520	Batorfi, Csilla	(HUN)
0536	Kasalova, Renata		2:1	0521	Urban, Edit	
(20:22,21:12,21:16)						

< Semi-finals/Demi-finales >							*: Winner/Gagnant		
No.	Name	Ctry	Results	No.	Name	Ctry			
Semi-final (1st Part)									
0528	Hyun, Jung Hwa	(KOR)*	VS.	0524	Hoshino, Mika	(JPN)			
0529	Yang, Young Ja		2:0	0525	Ishida, Kiyomi				
(21:19,21:09)									
Semi-final (2nd Part)									
0547	Fazlic, Jasna	(YUG)	VS.	*0508	Chen, Jing	(CHN)			
0548	Perkucic, G		1:2	0509	Jiao, Zhimin				
(19:21, 21:14, 18:21)									

< Finals/Finales >							*: Winner/Gagnant		
No.	Name	Ctry	Results	No.	Name	Ctry			
Positions 7-8									
0518	Kloppenburg, M	(KOR)*	VS.	0520	Batorfi, Csilla	(HUN)			
0519	Vriesekoop, B		2:1	0521	Urban, Edit				
(21:18,21:23,21:17)									
Positions 5-6									
0541	Boulatova, F	(URS)	VS.	*0535	Hrachova, Marie	(TCH)			
0542	Kovtoun, Elena		1:2	0536	Kasalova, Renata				
(10:21,21:08, 19:21)									
Positions 3-4									
0524	Hoshino, Mika	(JPN)	VS.	*0547	Fazlic, Jasna	(YUG)			
0525	Ishida, Kiyomi		1:2	0548	Perkucic, G				
(14:21,21:11,16:21)									
Final									
0528	Hyun, Jung Hwa	(KOR)*	VS.	0508	Chen, Jing	(CHN)			
0529	Yang, Young Ja		2:1	0509	Jiao, Zhimin				
(21:19, 16:21,21:10)									

< Final Ranks/Rang Final >

Rank	Name	Ctry
Rang	Nom	Pays
1	Hyun, Jung Hwa Yang, Young Ja	(KOR)
2	Chen, Jing Jiao, Zhimin	(CHN)
3	Fazlic, Jasna Perkucic, G	(YUG)
4	Hoshino, Mika Ishida, Kiyomi	(JPN)
5	Hrachova, Marie Kasalova, Renata	(TCH)
6	Boulatova, F Kovtoun, Elena	(URS)
7	Kloppenburg, M Vriesekoop, B	(HOL)
8	Batorfi, Csilla Urban, Edit	(HUN)



테니스

Tennis/Tennis



Tennis/Tennis

Officials/Officiels

Fédération International de Tennis (I.T.F.)

President/président	Philippe Chatrier
Secretary General/secrétaire général	Shirley Woodhead
Technical Delegates/délégués techniques	Eiichi Kawatei Peter Bellenger

SLOOC Administrative Staff/Personnel Administratif du SLOOC

Commissioner/directeur	Cho Choong Kun
Secretary General/secrétaire général	Kim Moon Il
Deputy Secretary General/secrétaire général adjoint	Park Kye Eun
Competition Manager/chef de division des compétitions	Kim Sung Ho

Competitors/Concurrents

Men
Hommes

Competitors Competiteurs	Countries Pays
81	37

Women
Femmes

Competitors Competiteurs	Countries Pays
48	26



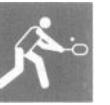

Men Doubles
Competition Summary

Doubles Messieurs
Tableau de la Competition

1/16	1/8	Quarter-final/Quart de Finale	Semi-final/Demi-finale	Final/Finale
Flach, Ken (USA) Seguso, Robert Suharyadi, Suhar (INA) Walalangi, Donal Lavalle, Leonard (MEX) Moreno, Augustin Markovics, Laszl (HUN) Koeves, Gabor Collins, Eoin (IRL) Casey, Owen Mansdorf, Amos (ISR) Bloom, Gilad Christensen, Mor (DEN) Tauson, Michael Michibata, Glenn (CAN) Connell, Grant Forget, Guy (FRA) Leconte, Henri Odizor, Nduka (NGR) Mmoh, Tony Mattar, Luiz (BRA) Acioly, Ricardo Matsuoka, Shuzo (JPN) Tsuchihashi, Tos Yoo, Jin-Sun (KOR) Kim, Bong-Soo Amritraj, Vijay (IND) Amritraj, Anand Liu, Shuhua (CHN) Ma, Keqin Mecir, Miloslav (TCH) Srejber, Milan Edberg, Stefan (SWE) Jarryd, Anders Steeb, Carl-Uwe (FRG) Jelen, Eric Caballero, Victo (PAR) Chapacu, Hugo Tuckniss, James (ZIM) Gurr, Mark Frana, Javier (ARG) Jaite, Martin Evernden, Kelly (NZL) Derlin, Bruce Kalovelonis, Geo (GRE) Bavelas, Anastas Cahill, Darren (AUS) Fitzgerald, John Bates, Jeremy (GBR) Castle, Anorew Zivojinovic, Slo (YUG) Ivanisevic, Gora Camporese, Omar (ITA) Nargiso, Diego Gunthardt, Heinz (SUI) Hlasek, Jakob Skoff, Horst (AUT) Antonitsch, Alex Jordan Urbina, A (COL) Gonzalez Alvare Volkov, Alexande (URS) Olkhovsky, Andre Sanchez, Emilio (ESP) Casal, Sergio	Flach, Ken Seguso, Robert 6:3 6:1 7:5 Markovics, Laszl Koeves, Gabor 3:6 6:3 6:7 6:4 6:4 Mansdorf, Amos Bloom, Gilad 6:2 7:6 4:6 7:5 Christensen, Mor Tauson, Michael 7:5 6:2 6:7 7:5 Forget, Guy Leconte, Henri 6:3 6:2 6:7 7:6 Mattar, Luiz Acioly, Ricardo 4:6 6:4 6:2 6:2 Amritraj, Vijay Amritraj, Anand 6:3 7:6 6:2 Mecir, Miloslav Srejber, Milan 7:5 6:1 6:4 Edberg, Stefan Jarryd, Anders 6:4 4:6 6:4 6:2 Tuckniss, James Gurr, Mark 4:6 6:3 6:3 6:1 Evernden, Kelly Derlin, Bruce (RET) -6:4 4:1 Cahill, Darren Fitzgerald, John 6:2 4:6 6:1 6:1 Zivojinovic, Slo Ivanisevic, Gora 7:5 2:6 6:3 7:6 Gunthardt, Heinz Hlasek, Jakob 3:6 7:6 6:3 7:6 Skoff, Horst Antonitsch, Alex (DEF) Sanchez, Emilio Casal, Sergio 6:3 6:3 6:1	Flach, Ken Seguso, Robert 6:4 6:4 6:4 Christensen, Mor Tauson, Michael 7:5 6:3 6:2 Forget, Guy Leconte, Henri 4:6 7:5 6:4 6:1 Mecir, Miloslav Srejber, Milan 4:6 6:4 4:6 6:4 6:2 Edberg, Stefan Jarryd, Anders 6:0 6:1 6:4 Cahill, Darren Fitzgerald, John 6:7 6:4 6:2 3:6 6:1 Zivojinovic, Slo Ivanisevic, Gora 6:3 7:6 6:3 Sanchez, Emilio Casal, Sergio 6:1 7:6 6:3 Sanchez, Emilio Casal, Sergio 6:4 6:2 6:1	Flach, Ken Seguso, Robert 6:4 7:5 6:2 Mecir, Miloslav Srejber, Milan 3:6 4:6 7:5 6:3 9:7 Edberg, Stefan Jarryd, Anders 6:3 6:4 6:3 Sanchez, Emilio Casal, Sergio 6:1 1:6 6:3 6:2	Flach, Ken Seguso, Robert 6:2 6:4 6:1 6:3 6:4 6:7 6:7 9:7

Tennis

Tennis

Women's Singles Competition Summary

Simple Dames Tableau de la Competition

1/32	1/16	1/8	Quarter-final/Quart de Finale	Semi-final/Demi-finale	Final/Finale
Graf, Steffi (FRG)	Graf, Steffi	Graf, Steffi	Graf, Steffi	Graf, Steffi	Graf, Steffi
BYE					
Rajchrtova, Regi (TCH)	Meshki, Leila	7:5 6:1			
Meshki, Leila (URS)	7:5 7:5				
Suire, Catherine (FRA)	Suire, Catherine		6:3 6:0		
Basuki, Rahayu N (INA)	6:3 3:6 6:0	Suire, Catherine			
Lee, Jeong-Myung (KOR)	Lee, Jeong-Myung	7:5 4:6 7:5			
BYE					
Savchenko, Laris (URS)	Savchenko, Laris			6:2 4:6 6:3	
BYE					
Gomer, Sara (GBR)	Gomer, Sara	6:7 7:6 9:7			
Cordwell, Belind (NZL)	4:6 7:5 6:2		Savchenko, Laris		
Kim, IL-Soon (KOR)	Kim, Il-Soon		6:3 7:6		
Inoue, Etsuko (JPN)	6:3 3:6 7:5	Kim, Il-Soon			
Sukova, Helena (TCH)	Sukova, Helena	6:2 4:6 6:2			
BYE					
Shriver, Pam (USA)	Shriver, Pam				6:2 6:0
BYE					
Hetherington, Ji (CAN)	Hetherington, Ji	6:2 6:3			
Berger, Ilana (ISR)	6:1 6:4		Shriver, Pam		
Kelesi, Helen (CAN)	Miro, Gisele		6:3 3:6 6:2		
Miro, Gisele (BRA)	7:5 7:5	Maleeva, Katerin			
Maleeva, Katerin (BUL)	Maleeva, Katerin	7:5 6:1			
BYE					
Demongeot, Isabe (FRA)	Novotna, Jana			Garrison, Zina	
Novotna, Jana (TCH)	6:4 6:3			6:3 6:2	
Paulus, Barbara (AUT)	Paulus, Barbara	6:4 6:3			
Fulco, Bettina (ARG)	7:6 6:4		Garrison, Zina		
Hernandez, Claud (MEX)	Hernandez, Claud		7:5 6:2		
BYE					
Garrison, Zina (USA)	Garrison, Zina	6:1 6:4			
BYE					
Zvereva, Natalia (URS)	Zvereva, Natalia				6:3 6:3
BYE					
Minter, Anne (AUS)	Minter, Anne	6:4 3:6 6:1			
Escobedo, Xochit (MEX)	6:1 6:3		Zvereva, Natalia		
Turnbull, Wendy (AUS)	Turnbull, Wendy		6:1 6:2		
Wood, Clare (GBR)	6:1 6:3	Scheur-Larsen, T			
Bouchabou, Oarda (ALG)	Scheur-Larsen, T	6:4 6:3			
Scheur-Larsen, T (DEN)	6:0 6:1				
Hanika, Sylvia (FRG)	Hanika, Sylvia			Sabatini, Gabrie	
BYE				6:4 6:3	
Muir, Julia (ZIM)	Muir, Julia	6:1 6:1			
BYE					
Sanchez, Arantxa (ESP)	Goles, sabrina			1:6 6:4 6:2	
Goles, Sabrina (YUG)	6:4 6:2	Sabatini, Gabrie			
Sabatini, Gabrie (ARG)	Sabatini, Gabrie	6:1 6:0			
BYE					
Maleeva, Manuela (BUL)	Maleeva, Manuela				Sabatini, Gabrie
BYE					6:1 6:1
Paz, Mercedes (ARG)	Paz, Mercedes	6:1 6:2			
Tsarbopoulou, Oi (GRE)	7:6 6:3		Maleeva, Manuela		
Okamoto, Kumiko (JPN)	Lindqvist, Cater		6:1 6:0		
Lindqvist, Cater (SWE)	7:6 7:5	Lindqvist, Cater			
Tauziat, Natmali (FRA)	Tauziat, Natmali	2:6 6:3 6:4			
Bassett-Seguso, (CAN)	7:6 6:1				
Kohde-Kilsch, Cl (FRG)	Kohde-Kilsch, Cl			Maleeva, Manuela	
BYE				6:3 6:4	
Smylie, Elizabet (AUS)	Reggi, Rafaella	4:6 7:6 6:3			
Reggi, Rafaella (ITA)	7:6 6:0		Reggi, rafaella		
Cecchini, Anna M (ITA)	Cecchini, Anna M		2:6 6:4 6:1		
BYE					
Evert, Chris (USA)	Evert, Chris	6:2 6:2			
BYE					



**Women's Doubles
Competition Summary**

**Doubles Dames
Tableau de la Competition**

1/8	Quarter-final/Quart de Finale	Semi-final/Demi-finale	Final/Finale
Shriver, Pam (USA) Garrison, Zina	Shriver, Pam Garrison, Zina	Shriver, Pam Garrison, Zina	Shriver, Pam Garrison, Zina
BYE			
Tauziat, Natmali (FRA) Demongeot, Isabe	Tauziat, Natmali Demongeot, Isabe	7:5 6:2	
Gomer, Sara (GBR) Wood, Clare			
Savchenko, Laris (URS) Zvereva, Natalia	Savchenko, Laris Zvereva, Natalia	Smylie, Elizabet Turnbull, Wendy	
Escobedo, Xochit (MEX) Hernandez, Claud			
Maleeva, Manuela (BUL) Maleeva, Katerin	Smylie, Elizabet Turnbull, Wendy	6:3 6:2	
Smylie, Elizabet (AUS) Turnbull, Wendy			
Inoue, Etsuko (JPN) Okamoto, Kumiko	Inoue, Etsuko Okamoto, Kumiko	Novotna, Jana Sukova, Helena	
Cecchini, Anna M (ITA) Reggi, Rafaella			
Kim, Il-Soon (KOR) Lee, Jeong-Myung	Novotna, Jana Sukova, Helena	6:3 6:2	
Novotna, Jana (TCH) Sukova, Helena			
Bassett-Seguso, (CAN) Hetherington, Ji	Bassett-Seguso, Hetherington, Ji	Novotna, Jana Sukova, Helena	
Sabatini, Gabrie (ARG) Paz, Mercedes			
Graf, Steffi (FRG) Kohde-Kilsch, Cl	Graf, Steffi Kohde-Kilsch, Cl	6:3 3:6 6:2	
BYE			
			4:6 6:2 10:8
			7:6 6:4
			7:5 6:3



배 구

Volleyball/Volley-ball

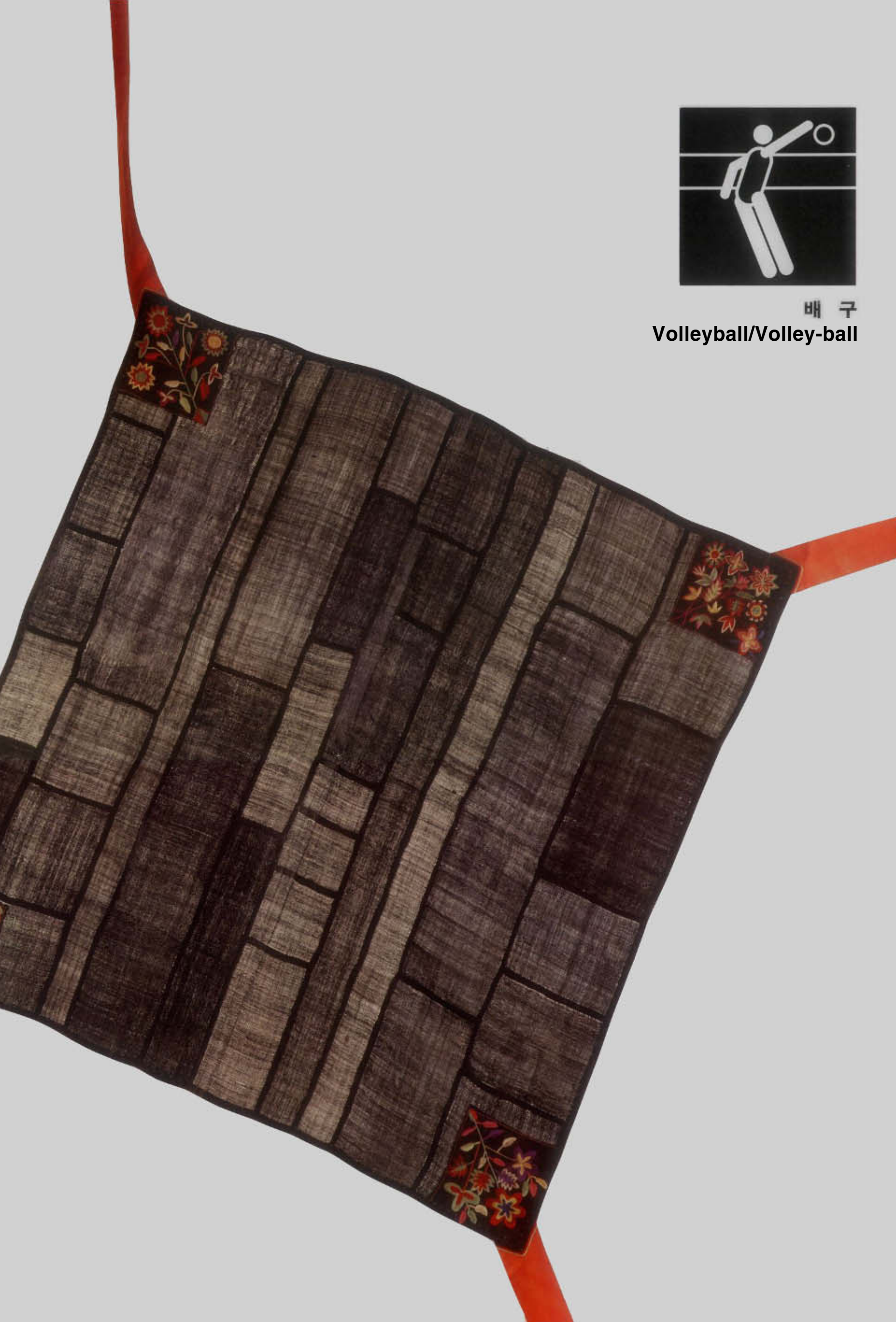

Volleyball/Volley-ball

Officials/Officiels

Fédération Internationale de Volley-ball (F.I.V.B.)

President/président	Ruben Acosta
Secretary General/secrétaire général	Chadly Zouiten
Technical Delegates/délégués techniques	Youri Tchesnokov Endre Holvay

SLOOC Administrative Staff/Personnel Administratif du SLOOC

Commissioner/directeur	Kim Jung Won
Secretary General/secrétaire général	Lee Jung Su
Deputy Secretary General/secrétaire général adjoint	Suh Yong Han Jae Sup
Competition Manager/chef de division des compétitions	Yim Hyung Bin Kim Kwang Ho

Competitors/Concurrents

Men Hommes	Competitors Competiteurs	Countries Pays
	144	12
Women Femmes	Competitors Competiteurs	Countries Pays
	96	8

Legend/Notation

P	Played/Joués
*	Participated in/Participé
Dig	Court Defence/Defence d'Aire
Pass	Serve Reception/Reception de Service
Set	Setting

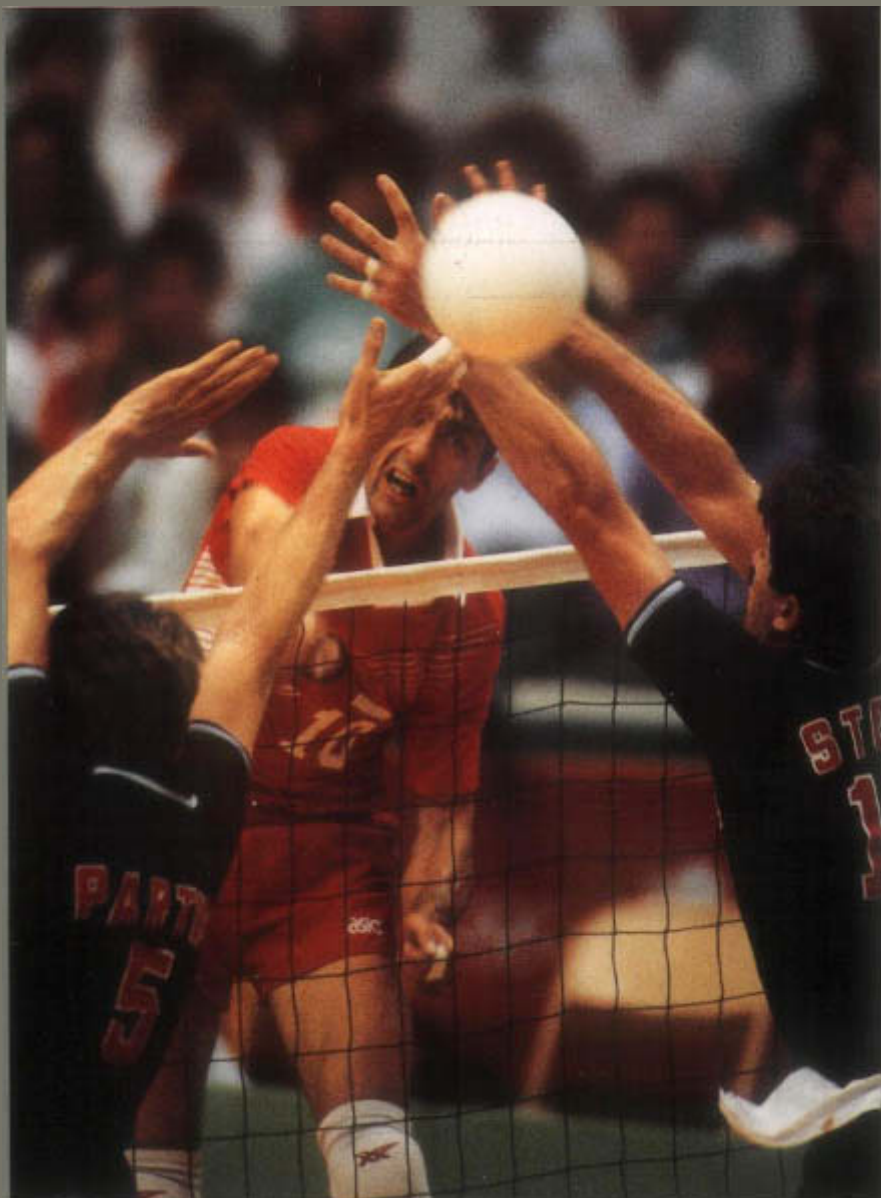

Volleyball

Men Preliminary Group A Match 1/Sept. 17			Hommes Preliminaires Groupe A Match 1/17 Sept		
No.	Name	P	No.	Name	P
SWE 3-2 KOR (10-15) (5-15) (15-12) (17-15) (15-4)					
02	Lennartsson, Urban	*	01	Choi, Chon-Sik	*
04	Kalmazidis, Jannis		02	Lee, Sang-Yul	*
05	Hedengard, Jan		03	Chang, Yun-Chang	*
07	Karlsson, Mats	*	04	Han, Jang-Sok	*
08	Hoszek, Tomas	*	05	Lee, Sung-Hee	*
09	Lundmark, Anders		06	Kim, Eun-Sok	*
10	Saaf, Per-Anders	*	07	Park, Sam-Yong	*
11	Gustafson, Bengt	*	08	Lee, Myung-Hak	*
12	Bjorne, Hakan	*	09	Kim, Ho-Chul	*
13	Nilsson, Lars	*	10	Lee, Chae-On	*
14	Tholse, Peter	*	11	Lee, Jong-Kyung	*
15	Johansson, Patrik	*	12	Jung, Eu-Tak	*
Coach	Kristiansson, Anders		Coach	Lee, Kyu-So	
Referee-1/Arbitre-1	EGY	Hassan, Ahmed			
Referee-2/Arbitre-2	USA	Stewart, Jim			

Men Preliminary Group A Match 2/Sept. 18			Hommes Preliminaires Groupe A Match 2/18 Sept		
No.	Name	P	No.	Name	P
ITA 0-3 BRA (7-15) (4-15) (15-17)					
01	Gardini, Andrea	*	01	Lima, Mauricio	*
02	Giani, Andrea	*	02	Rocha, Wagner	*
03	Lucchetta, Pierpaolo	*	03	Roese, Paulo	*
04	De Giorgi, Ferdinando	*	04	Montanaro Juniro, Jose	*
05	Bracci, Marco		05	Da Silva, Paulo	*
06	Galli, Claudio	*	06	Zotto, Renan Dal	*
07	Bernardi, Lorenzo	*	07	Da Silva, William	*
08	Lazzeroni, Alessandro	*	08	Ribeiro, Amauri	*
09	Castagna, Massimo	*	09	Gouveia, Antonio	*
10	Zorzi, Andrea	*	10	Lampariello Neto, Domingos	*
11	Cantagalli, Luca	*	11	De pra Filho, Leonidio	*
12	Lucchetta, Andrea		12	Ferreira, Andre	
Coach	Pittera, Carmelo		Coach	Freitas, Paulo	
Referee-1/Arbitre-1	JPN	Sasaki, Hiroshi			
Referee-2/Arbitre-2	CHN	Chen, You Xin			

Men Preliminary Group A Match 3/Sept. 18			Hommes Preliminaires Groupe A Match 3/18 Sept		
No.	Name	P	No.	Name	P
URS 3-0 BUL (15-7) (15-9) (15-8)					
01	Pantchenko, Iouri		01	Mitev, Kostadin	
02	Kouzentsov, Andrei	*	02	Draguiev, Petyo	*
03	Zaitsev, Viatcheslay		03	Kyossev, Borislav	*
04	Rounov, Igor		04	Ganev, Ljubomir	*
05	Chkourikhine, Vladimir	*	05	Kaziiski, Ilian	*
06	Krasilnikov, Evgueny		06	Tonev, Dimo	*
07	Vilde, Raimond	*	07	Petkov, Petko	*
08	Lossev, Valeri	*	08	Hristov, Plamen	*
09	Sapega, Iouri		09	Kovatchev, Sava	*
10	Sorokolet, Alexandre	*	11	Naydenov, Nayden	*
11	Antonov, Iaroslav	*	12	Milanov, Miltcho	*
12	Tcherednik, Iouri		14	Florov, Tzvetan	
Coach	Kondra, Vladimir		Coach	Piperkov, Todor	
Referee-1/Arbitre-1	JPN	Yamagishi, Norio			
Referee-2/Arbitre-2	ARG	Paredes, G. Enrique			

Men Preliminary Group A Match 4/Sept. 19			Hommes Preliminaires Groupe A Match 4/19 Sept		
No.	Name	P	No.	Name	P
SWE 0-3 URS (8-15) (7-15) (14-16)					
02	Lennartsson, Urban		01	Pantchenko, Iouri	
04	Kalmazidis, Jannis		02	Kouzentsov, Andrei	*
05	Hedengard, Jan	*	03	Zaitsev, Viatcheslav	*
07	Karlsson, Mats		04	Rounov, Igor	*
08	Hoszek, Tomas	*	05	Chkourikhine, Vladimir	*
09	Lundmark, Anders		06	Krasilnikov, Evgueny	
10	Saaf, Per-Anders	*	07	Vilde, Raimond	*
11	Gustafson, Bengt	*	08	Lossev, Valeri	*
12	Bjorne, Hakan	*	09	Sapega, Iouri	
13	Nilsson, Lars	*	10	Sorokolet, Alexandre	*
14	Tholse, Peter	*	11	Antonov, Iaroslav	*
15	Johansson, Patrik	*	12	Tcherednik, Iouri	
Coach	Kristiansson, Anders		Coach	Parchine, Guennadi	
Referee-1/Arbitre-1	USA	Stewart, Jim			
Referee-2/Arbitre-2	HOL	Scheffer, Peter			

Volley-ball

Men Preliminary Group A Match 5/Sept. 19			Hommes Preliminaires Groupe A Match 5/19 Sept		
No.	Name	P	No.	Name	P
ITA 0-3 BUL (7-15) (8-15) (6-15)					
01	Gardini, Andrea	*	01	Mitev, Kostadin	
02	Giani, Andrea	*	02	Draguiev, Petyo	*
03	Lucchetta, Pierpaolo	*	03	Kyossev, Borislav	*
04	De Giorgi, Ferdinando	*	04	Ganev, Ljubomir	*
05	Bracci, Marco	*	05	Kaziiski, Ilian	*
06	Galli, Claudio	*	06	Tonev, Dimo	*
07	Bernardi, Lorenzo	*	07	Petkov, Petko	
08	Lazzeroni, Alessandro	*	08	Hristov, Plamen	*
09	Castagna, Massimo	*	09	Kovatchev, Sava	
10	Zorzi, Andrea	*	11	Naydenov, Nayden	*
11	Cantagalli, Luca	*	12	Milanov, Miltcho	*
12	Lucchetta, Andrea		14	Florov, Tzvetan	*
Coach	Pittera, Carmelo		Coach	Piperkov, Todor	
Referee-1/Arbitre-1	ARG	Paredes, G. Enrique			
Referee-2/Arbitre-2	JPN	Yamagishi, Norio			

Men Preliminary Group A Match 6/Sept. 19			Hommes Preliminaires Groupe A Match 6/19 Sept		
No.	Name	P	No.	Name	P
BRA 2-3 KOR (17-19) (8-15) (15-6) (15-11) (12-15)					
01	Lima, Mauricio		01	Choi, Chon-Sik	*
02	Rocha, Wagner	*	02	Lee, Sang-Yul	*
03	Rose, Paulo	*	03	Chang, Yun-Chang	*
04	Montanaro Junior, Jose	*	04	Han, Jang-Sok	*
05	Da Silva, Paulo	*	05	Lee, Sung-Hee	
06	Zotto, Renan Dal	*	06	Kim, Eun-Sok	*
07	Da Silva, William	*	07	Park, Sam-Yong	
08	Ribeiro, Amauri	*	08	Lee, Myung-Hak	*
09	Gouveia, Antonio	*	09	Kim, Ho-Chul	*
10	Lampariello Neto, Domingos	*	10	Lee, Chae-On	*
11	De Pra Filho, Leonidio	*	11	Lee, Jong-Kyung	*
12	Ferreira, Andre	*	12	Jung, Eu-Tak	*
Coach	Freitas, Paulo		Coach	Lee, Kyu-So	
Referee-1/Arbitre-1	FRA	Marty, Jean-Francois			
Referee-2/Arbitre-2	TUN	Djerad, Abdelmajir			

Men Preliminary Group A Match 7/Sept. 22			Hommes Preliminaires Groupe A Match 7/22 Sept		
No.	Name	P	No.	Name	P
BRA 3-1 BUL (13-15) (15-6) (15-12) (15-12)					
01	Lima, Mauricio		01	Mitev, Kostadin	
02	Rocha, Wagner		02	Draguiev, Petyo	*
03	Roese, Paulo	*	03	Kyossev, Borislav	*
04	Montanaro Junior, Jose	*	04	Ganev, Ljubomir	*
05	Da Silva, Paulo	*	05	Kaziiski, Ilian	
06	Zotto, Renan Dal		06	Tonev, Dimo	*
07	Da Silva, William	*	07	Petkov, Petko	*
08	Ribeiro, Amauri	*	08	Hristov, Plamen	*
09	Gouveia, Antonio	*	09	Kovatchev, Sava	*
10	Lampariello Neto, Domingos	*	11	Naydenov, Nayden	*
11	De Pra Filho, Leonidio	*	12	Milanov, Miltcho	*
12	Ferreira, Andre	*	14	Florov, Tzvetan	
Coach	Freitas, Paulo		Coach	Piperkov, Todor	
Referee-1/Arbitre-1	EGY	Hassan, Ahmed			
Referee-2/Arbitre-2	USA	Clark, Bob			

Men Preliminary Group A Match 8/Sept. 22			Hommes Preliminaires Groupe A Match 8/22 Sept		
No.	Name	P	No.	Name	P
SWE 2-3 ITA (15-9) (6-15) (15-12) (12-15) (3-15)					
02	Lennartsson, Urban		01	Gardini, Andrea	*
04	Kalmazidis, Jannis		02	Giani, Andrea	*
05	Hedengard, Jan	*	03	Lucchetta, Pierpaolo	*
07	Karlsson, Mats	*	04	De Giorgi, Ferdinando	*
08	Hoszek, Tomas	*	05	Bracci, Marco	
09	Lundmark, Anders		06	Galli, Claudio	*
10	Saaf, Per-Anders	*	07	Bernardi, Lorenzo	*
11	Gustafson, Bengt	*	08	Lazzeroni, Alessandro	*
12	Bjorne, Hakan	*	09	Castagna, Massimo	*
13	Nilsson, Lars	*	10	Zorzi, Andrea	*
14	Tholse, Peter	*	11	Cantagalli, Luca	*
15	Johansson, Patrik	*	12	Lucchetta, Andrea	
Coach	Kristiansson, Anders		Coach	Pittera, Carmelo	
Referee-1/Arbitre-1	HOL	Scheffer, Peter			
Referee-2/Arbitre-2	USA	Stewart, Jim			



Men Preliminary Group A Match 9/Sept. 22			Hommes Preliminaires Groupe A Match 9/22 Sept		
No.	Name	P	No.	Name	P
URS 3-0 KOR (15-6) (15-7) (15-13)					
01	Pantchenko, Iouri		01	Choi, Chon-Sik	*
02	Kouzentsov, Andrei	*	02	Lee, Sang-Yul	*
03	Zaitsev, Viatcheslav	*	03	Chang, Yun-Chang	*
04	Rounov, Igor	*	04	Han, Jang-Sok	*
05	Chkourikhine, Vladimir	*	05	Lee, Sung-Hee	*
06	Krasilnikov, Evgueny	*	06	Kim, Eun-Sok	*
07	Vilde, Raimond	*	07	Park, Sam-Yong	*
08	Lossev, Valeri	*	08	Lee, Myung-Hak	*
09	Sapega, Iouri	*	09	Kim, Ho-Chul	*
10	Sorokolet, Alexandre	*	10	Lee, Chae-On	*
11	Antonov, Iaroslav	*	11	Lee, Jong-Kyung	*
12	Tcherednik, Iouri	*	12	Jung, Eu-Tak	*
Coach	Parchine, Guennadi		Coach	Lee, Kyu-So	
Referee-1/Arbitre-1	ARG	Paredes, G. Enrique			
Referee-2/Arbitre-2	FRA	Marty, Jean-Francois			

Men Preliminary Group A Match 13/Sept. 26			Hommes Preliminaires Groupe A Match 13/26 Sept		
No.	Name	P	No.	Name	P
ITA 3-0 KOR (15-10) (15-7) (15-5)					
01	Gardini, Andrea	*	01	Choi, Chon-Sik	*
02	Giani, Andrea	*	02	Lee, Sang-Yul	*
03	Lucchetta, Pierpaolo	*	03	Chang, Yun-Chang	*
04	De Giorgi, Ferdinando	*	04	Han, Jang-Sok	*
05	Bracci, Marco	*	05	Lee, Sung-Hee	*
06	Galli, Claudio	*	06	Kim, Eun-Sok	*
07	Bernardi, Lorenzo	*	07	Park, Sam-Yong	*
08	Lazzeroni, Alessandro	*	08	Lee, Myung-Hak	*
09	Castagna, Massimo	*	09	Kim, Ho-Chul	*
10	Zorzi, Andrea	*	10	Lee, Chae-On	*
11	Cantagalli, Luca	*	11	Lee, Jong-Kyung	*
12	Lucchetta, Andrea	*	12	Jung, Eu-Tak	*
Coach	Pittera, Carmelo		Coach	Lee, Kyu-So	
Referee-1/Arbitre-1	EGY	Hassan, Ahmed			
Referee-2/Arbitre-2	USA	Clark, Bob			

Men Preliminary Group A Match 10/Sept. 24			Hommes Preliminaires Groupe A Match 10/24 Sept		
No.	Name	P	No.	Name	P
SWE 1-3 BRA (6-15) (15-13) (0-15) (12-15)					
02	Lennartsson, Urban	*	01	Lima, Mauricio	*
04	Kalmazidis, Jannis	*	02	Rocha, Wagner	*
05	Hedengard, Jari	*	03	Roese, Paulo	*
07	Karlsson, Mats	*	04	Montanaro Junior, Jose	*
08	Hoszek, Tomas	*	05	Da Silva, Paulo	*
09	Lundmark, Anders	*	06	Zotto, Renan Dal	*
10	Saaf, Per-Anders	*	07	Da Silva, William	*
11	Gustafson, Bengt	*	08	Ribeiro, Amauri	*
12	Bjorne, Hakan	*	09	Gouveia, Antonio	*
13	Nilsson, Lars	*	10	Lampariello Neto, Domingos	*
14	Tholse, Peter	*	11	De Pra Filho, Leonidio	*
15	Johansson, Patrik	*	12	Ferreira, Andre	*
Coach	Kristiansson, Anders		Coach	Freitas, Paulo	
Referee-1/Arbitre-1	USA	Stewart, Jim			
Referee-2/Arbitre-2	JPN	Sasaki, Hiroshi			

Men Preliminary Group A Match 14/Sept. 26			Hommes Preliminaires Groupe A Match 14/26 Sept		
No.	Name	P	No.	Name	P
URS 2-3 BRA (15-12) (15-9) (8-15) (11-15) (6-15)					
01	Pantchenko, Iouri	*	01	Lima, Mauricio	*
02	Kouzentsov, Andrei	*	02	Rocha, Wagner	*
03	Zaitsev, Viatcheslav	*	03	Roese, Paulo	*
04	Rounov, Igor	*	04	Montanaro Junior, Jose	*
05	Chkourikhine, Vladimir	*	05	Da Silva, Paulo	*
06	Krasilnikov, Evgueny	*	06	Zotto, Renan Dal	*
07	Vilde, Raimond	*	07	Da Silva, William	*
08	Lossev, Valeri	*	08	Ribeiro, Amauri	*
09	Sapega, Iouri	*	09	Gouveia, Antonio	*
10	Sorokolet, Alexandre	*	10	Lampariello Neto, Domingos	*
11	Antonov, Iaroslav	*	11	De Pra Filho, Leonidio	*
12	Tcherednik, Iouri	*	12	Ferreira, Andre	*
Coach	Parchine, Guennadi		Coach	Freitas, Paulo	
Referee-1/Arbitre-1	JPN	Yamagishi, Norio			
Referee-2/Arbitre-2	USA	Stewart, Jim			

Men Preliminary Group A Match 11/Sept. 24			Hommes Preliminaires Groupe A Match 11/24 Sept		
No.	Name	P	No.	Name	P
BUL 3-0 KOR (15-7) (15-10) (15-8)					
01	Mitey, Kostadin	*	01	Choi, Chon-Sik	*
02	Draguiev, Petyo	*	02	Lee, Sang-Yul	*
03	Kyossev, Borislav	*	03	Chang, Yun-Chang	*
04	Ganev, Ljubomir	*	04	Han, Jang-Sok	*
05	Kaziiski, Ilian	*	05	Lee, Sung-Hee	*
06	Tonev, Dimo	*	06	Kim, Eun-Sok	*
07	Petkov, Petko	*	07	Park, Sam-Yong	*
08	Hristov, Plamen	*	08	Lee, Myung-Hak	*
09	Kovatchev, Sava	*	09	Kim, Ho-Chul	*
11	Naydenov, Nayden	*	10	Lee, Chae-On	*
12	Milanov, Miltcho	*	11	Lee, Jong-Kyung	*
14	Florov, Tzvetan	*	12	Jung, Eu-Tak	*
Coach	Piperkov, Todor		Coach	Lee, Kyu-So	
Referee-1/Arbitre-1	ARG	Paredes, G. Enrique			
Referee-2/Arbitre-2	USA	Clark, Bob			

Men Preliminary Group A Match 15/Sept. 26			Hommes Preliminaires Groupe A Match 15/26 Sept		
No.	Name	P	No.	Name	P
SWE 3-0 BUL (15-11) (15-12) (15-8)					
02	Lennartsson, Urban	*	01	Mitey, Kostadin	*
04	Kalmazidis, Jannis	*	02	Draguiev, Petyo	*
05	Hedengard, Jan	*	03	Kyossev, Borislav	*
07	Karlsson, Mats	*	04	Ganev, Ljubomir	*
08	Hoszek, Tomas	*	05	Kaziiski, Ilian	*
09	Lundmark, Anders	*	06	Tonev, Dimo	*
10	Saaf, Per-Anders	*	07	Petkov, Petko	*
11	Gustafson, Bengt	*	08	Hristov, Plamen	*
12	Bjorne, Hakan	*	09	Kovatchev, Sava	*
13	Nilsson, Lars	*	11	Naydenov, Nayden	*
14	Tholse, Peter	*	12	Milanov, Miltcho	*
15	Johansson, Patrik	*	14	Florov, Tzvetan	*
Coach	Kristiansson, Anders		Coach	Piperkov, Todor	
Referee-1/Arbitre-1	CHN	Chen, You Xin			
Referee-2/Arbitre-2	TCH	Kovalik, Vladimir			

Men Preliminary Group A Match 12/Sept. 24			Hommes Preliminaires Groupe A Match 12/24 Sept		
No.	Name	P	No.	Name	P
URS 3-1 ITA (15-9) (15-9) (12-15) (15-12)					
01	Pantchenko, Iouri	*	01	Gardini, Andrea	*
02	Kouzentsov, Andrei	*	02	Giani, Andrea	*
03	Zaitsev, Viatcheslav	*	03	Lucchetta, Pierpaolo	*
04	Rounov, Igor	*	04	De Giorgi, Ferdinando	*
05	Chkourikhine, Vladimir	*	05	Bracci, Marco	*
06	Krasilnikov, Evgueny	*	06	Galli, Claudio	*
07	Vilde, Raimond	*	07	Bernardi, Lorenzo	*
08	Lossev, Valeri	*	08	Lazzeroni, Alessandro	*
09	Sapega, Iouri	*	09	Castagna, Massimo	*
10	Sorokolet, Alexandre	*	10	Zorzi, Andrea	*
11	Antonov, Iaroslav	*	11	Cantagalli, Luca	*
12	Tcherednik, Iouri	*	12	Lucchetta, Andrea	*
Coach	Parchine, Guennadi		Coach	Pittera, Carmelo	
Referee-1/Arbitre-1	TCH	Kovalik, Vladimir			
Referee-2/Arbitre-2	JPN	Yamagishi, Norio			

Men Preliminary Group B Match 1/Sept. 17			Hommes Preliminaires Groupe B Match 1/17 Sept		
No.	Name	P	No.	Name	P
FRA 1-3 HOL (8-15) (15-7) (11-15) (7-15)					
01	Blain, Philippe	*	01	Teffer, Martin	*
02	Martzluff, Jean-Baptiste	*	04	Leeuwerink, Pieter-Jan	*
03	Mazzon, Herve	*	05	Boudrie, Ronald	*
04	N'Gapeth, Eric	*	06	Posthuma, Jan-Marcus	*
05	Bouvier, Eric	*	07	Zoodma, Ronald	*
06	Meneau, Christophe	*	08	Zwerver, Ronald	*
07	Jurkovitz, Jean-Marc	*	09	Selinger, Avital	*
09	Tillie, Laurent	*	10	Benne, Edwin	*
10	Rossard, Olivier	*	11	Buys, Teunis	*
11	Duflos, Patrick	*	12	Blange, Peter	*
12	Fabiani, Alain	*	13	Brouwers, Marco	*
15	Salvan, Philippe	*	15	Grabert, Karl	*
Coach	Daniel, Eric		Coach	Selinger, Arie	
Referee-1/Arbitree	URS	Samedov, Ramis			
Referee-2/Arbitree	MEX	Arredondo, Torres Genard			

Volleyball

Men Preliminary Group B Match 2/Sept. 18			Hommes Preliminaires Groupe B Match 2/18 Sept		
No.	Name	P	No.	Name	P
JPN 0-3 USA (13-15) (2-15) (2-15)					
01	Kasama, Yuji	*	01	Tanner, Troy R	
02	Iwashima, Akihiro	*	02	Saunders, David P	*
03	Kumada, Yasunori	*	03	Root, Jon E	*
04	Mitsuhashi, Eizaburo	*	04	Ctvrlik, Robert J	*
05	Manabe, Masayoshi	*	05	Partie, Robert D	*
06	Yoneyama, kazutomo	*	06	Timmons, Stephen D	*
07	Kageyama, Hiromichi	*	07	Buck, Craig W	*
08	Hara, Hideharu	*	08	Fortune, Scott T	*
09	Sugimoto, Kimio	*	09	Luyties, Ricci J	*
10	Inoue, Yuzuru	*	10	Stork, Jeffery M	*
11	Kaito, Masaki	*	11	Sato, Eric A	*
12	Kawai, Shunichi	*	15	Kiraly, Charles K	*
Coach	Mitake, Kazuya		Coach	Dunphy, Marvin	
Referee-1/Arbitre-1	TCH	Kavalik, Vladimir			
Referee-2/Arbitre-2	BRA	Desouza, Learte			

Men Preliminary Group B Match 3/Sept. 18			Hommes Preliminaires Groupe B Match 3/18 Sept		
No.	Name	P	No.	Name	P
TUN 0-3 ARG (5-15) (11-15) (6-15)					
01	Ben Amara, Faycal		01	Zulianello, Claudio F	
02	Sarsar, Mohamed	*	02	Castellani, Daniel Jorge	*
03	Bousarsar, Rachid	*	03	Martinez, Eduardo E	*
04	Ben Slimane, Lotfi		04	Diz, Alejandro	*
05	Lahmar, Msaddak	*	05	Colla, Daniel M	
06	Bousarsar, Hedi	*	06	Weber, Carlos J	*
07	Ben Messaoud, Abderrazak		07	Conte, Hugo Nestor	*
08	Chenoufi, Raouf	*	08	Kantor, Waldo Ariel	*
09	Ben Amira, Hichem		09	Quiroga, Raul Nicolas	*
10	Tebourski, Mourad		10	Uriarte, Jon Emili	*
11	Ben Abdallah, Abdelaziz	*	11	De Palma, Esteban	*
12	Ghariani, Fethi		12	Cuminetti, Juan Carlos	*
Coach	Wagner, Hubert		Coach	Muchaga, Luis F	
Referee-1/Arbitre-1	KOR	Cho, Young-Ho			
Referee-2/Arbitre-2	URS	Stepanian, Surev			

Men Preliminary Group B Match 4/Sept. 19			Hommes Preliminaires Groupe B Match 4/19 Sept		
No.	Name	P	No.	Name	P
USA 3-1 HOL (15-7) (12-15) (15-1)(15-11)					
01	Tanner, Troy R	*	01	Teffer, Martin	
02	Saunders, David P	*	04	Leeuwerink, Pieter-Jan	
03	Root, Jon E		05	Boudrie, Ronald	
04	Ctvrlik, Robert J	*	06	Posthuma, Jan-Marcus	*
05	Partie, Robert D	*	07	Zoodsma, Ronald	*
06	Timmons, Stephen D	*	08	Zwerver, Ronald	*
07	Buck, Craig W	*	09	Selinger, Avital	*
08	Fortune, Scott T		10	Benne, Edwin	*
09	Luyties, Ricci J	*	11	Buys, Teunis	
10	Stork, Jeffery M		12	Blange, Peter	*
11	Sato, Eric A	*	13	Brouwers, Marco	
15	Kiraly, Charles K	*	15	Grabert, Karl	*
Coach	Dunphy, Marvin		Coach	Selinger, Arie	
Referee-1/Arbitre-1	KOR	Kim, Young-Dae			
Referee-2/Arbitre-2	BRA	Kuroki George Hideyuki			

Men Preliminary Group B Match 5/Sept. 19			Hommes Preliminaires Groupe B Match 5/19 Sept		
No.	Name	P	No.	Name	P
FRA 3-0 TUN (15-10) (15-3) (15-9)					
01	Blain, Philippe	*	01	Ben Amara, Faycal	
02	Martzluff, Jean-Baptiste		02	Sarsar, Mohamed	
03	Mazzon, Herve	*	03	Bousarsar, Rachid	*
04	N'Gapeth, Eric	*	04	Ben Slimane, Lotfi	
05	Bouvier, Eric	*	05	Lahmar, Msaddak	*
06	Meneau, Christophe	*	06	Bousarsar, Hedi	*
07	Jurkovitz, Jean-Marc	*	07	Ben Messaoud, Abderrazak	*
09	Tillie, Laurent	*	08	Chenoufi, Raouf	*
10	Rossard, Olivier	*	09	Ben Amira, Hichem	
11	Duffos, Patrick		10	Tebourski, Mourad	*
12	Fabiani, Alain	*	11	Ben Abdallah, Abdelaziz	*
15	Salvan, Philippe		12	Ghariani, Fethi	*
Coach	Daniel, Eric		Coach	Wagner, Hubert	
Referee-1/Arbitre-1	BRA	Desouza, Learte			
Referee-2/Arbitre-2	KOR	Cho, Young-Ho			

Volley-ball

Men Preliminary Group B Match 6/Sept. 19			Hommes Preliminaires Groupe B Match 6/19 Sept		
No.	Name	P	No.	Name	P
JPN 1-3 ARG (11-15) (12-15) (15-11) (11-15)					
01	Kasama, Yuji		01	Zulianello, Claudio F	*
02	Iwashima, Akihiro	*	02	Castellani, Daniel Jorge	*
03	Kumada, Yasunori	*	03	Martinez, Eduardo E	*
04	Mitsuhashi, Eizaburo	*	04	Diz, Alejandro	*
05	Manabe, Masayoshi	*	05	Colla, Daniel M	
06	Yoneyama, Kazutomo	*	06	Weber, Carlos J	*
07	Kageyama, Hiromichi	*	07	Conte, Hugo Nestor	*
08	Hara, Hideharu	*	08	Kantor, Waldo Ariel	
09	Sugimoto, Kimio	*	09	Quiroga, Raul Nicolas	*
10	Inoue, Yuzuru	*	10	Uriarte, Jon Emili	*
11	Kaito, Masaki	*	11	De Palma, Esteban	*
12	Kawai, Shunichi	*	12	Cuminetti, Juan Carlos	*
Coach	Mitake, Kazuya		Coach	Muchaga, Luis F	
Referee-1/Arbitre-1	BUL	Stoyanov, Stoyan			
Referee-2/Arbitre-2	EGY	Hassan, Ahmed			

Men Preliminary Group B Match 7/Sept. 22			Hommes Preliminaires Groupe B Match 7/22 Sept		
No.	Name	P	No.	Name	P
USA 3-2 ARG (11-15) (11-15) (15-4) (17-15) (15-7)					
01	Tanner, Troy R	*	01	Zulianello, Claudio F	*
02	Saunders, David P		02	Castellani, Daniel Jorge	*
03	Root, Jon E		03	Martinez, Eduardo E	*
04	Ctvrlik, Robert J	*	04	Diz, Alejandro	*
05	Partie, Robert D	*	05	Colla, Daniel M	
06	Timmons, Stephen D	*	06	Weber, Carlos J	*
07	Buck, Craig W	*	07	Conte, Hugo Nestor	*
08	Fortune, Scott T	*	08	Kantor, Waldo Ariel	*
09	Luyties, Ricci J	*	09	Quiroga, Raul Nicolas	*
10	Stork, Jeffery M	*	10	Uriarte, Jon Emili	*
11	Sato, Eric A	*	11	De Palma, Esteban	*
15	Kiraly, Charles K	*	12	Cuminetti, Juan Carlos	*
Coach	Dunphy, Marvin		Coach	Muchaga, Luis F	
Referee-1/Arbitre-1	URS	Samedov, Ramis			
Referee-2/Arbitre-2	SWE	Dawiskibas, Sigmund			

Men Preliminary Group B Match 8/Sept. 22			Hommes Preliminaires Groupe B Match 8/22 Sept		
No.	Name	P	No.	Name	P
FRA 3-1 JPN (10-15) (15-10) (17-15) (15-12)					
01	Blain, Philippe	*	01	Kasama, Yuji	*
02	Martzluff, Jean-Baptiste		02	Iwashima, Akihiro	*
03	Mazzon, Herve	*	03	Kumada, Yasunori	*
04	N'Gapeth, Eric	*	04	Mitsuhashi, Eizaburo	*
05	Bouvier, Eric	*	05	Manabe, Masayoshi	*
06	Meneau, Christophe	*	06	Yoneyama, Kazutomo	*
07	Jurkovitz, Jean-Marc	*	07	Kageyama, Hiromichi	*
09	Tillie, Laurent	*	08	Hara, Hideharu	*
10	Rossard, Olivier		09	Sugimoto, Kimio	
11	Duffos, Patrick		10	Inoue, Yuzuru	*
12	Fabiani, Alain	*	11	Kaito, Masaki	
15	Salvan, Philippe	*	12	Kawai, Shunichi	*
Coach	Daniel, Eric		Coach	Mitake, Kazuya	
Referee-1/Arbitre-1	MEX	Arredondo, Torres Genard			
Referee-2/Arbitre-2	TCH	Kovalik, Vladimir			

Men Preliminary Group B Match 9/Sept. 22			Hommes Preliminaires Groupe B Match 9/22 Sept		
No.	Name	P	No.	Name	P
TUN 0-3 HOL (6-15) (10-15) (5-15)					
01	Ben Amara, Faycal		01	Teffer, Martin	
02	Sarsar, Mohamed		04	Leeuwerink, Pieter-Jan	
03	Bousarsar, Rachid	*	05	Boudrie, Ronald	
04	Ben Slimane, Lotfi		06	Posthuma, Jan-Marcus	*
05	Lahmar, Msaddak	*	07	Zoodsma, Ronald	*
06	Bousarsar, Hedi	*	08	Zwerver, Ronald	*
07	Ben Messaoud, Aboderrazak	*	09	Selinger, Avital	*
08	Chenoufi, Raouf	*	10	Benne, Edwin	*
09	Ben Amira, Hichem		11	Buys, Teunis	
10	Tebourski, Mourad	*	12	Blange, Peter	*
11	Ben Abdallah, Abdelaziz	*	13	Brouwers, Marco	
12	Ghariani, Fethi	*	15	Grabert, Karl	*
Coach	Wagner, Hubert		Coach	Selinger, Arie	
Referee-1/Arbitre-1	CHN	Chen, You Xin			
Referee-2/Arbitre-2	ITA	Paradiso, Erasmo			



Men Preliminary Group B Match 10/Sept. 24			Hommes Preliminaires Groupe B Match 10/24 Sept		
No.	Name	P	No.	Name	P
FRA 0-3 USA (15-17) (6-15) (13-15)					
01	Blain, Philippe	*	01	Tanner, Troy R	*
02	Martzluff, Jean-Baptiste		02	Saunders, David P	
03	Mazzon, Herve	*	03	Root, Jon E	
04	N'Gapeth, Eric	*	04	Ctvrlik, Robert J	*
05	Bouvier, Eric	*	05	Partie, Robert D	*
06	Meneau, Christophe	*	06	Timmons, Stephen D	*
07	Jurkovicz, Jean-Marc	*	07	Buck, Craig W	*
09	Tillie, Laurent	*	08	Fortune, Scott T	*
10	Rossard, Olivier	*	09	Luyties, Ricci J	
11	Duflos, Patrick		10	Stork, Jeffery M	*
12	Fabiani, Alain	*	11	Sato, Eric A	*
15	Salvan, Philippe	*	15	Kiraly, Charles K	*
Coach	Daniel, Eric		Coach	Dunphy, Marvin	
Referee-1/Arbitre-1	BRA Desouza, Learte				
Referee-2/Arbitre-2	KOR Cho, Young-Ho				

Men Preliminary Group B Match 14/Sept. 26			Hommes Preliminaires Groupe B Match 14/26 Sept		
No.	Name	P	No.	Name	P
TUN 0-3 USA (4-15) (6-15) (4-15)					
01	Ben Amara, Faycal		01	Tanner, Troy R	*
02	Sarsar, Mohamed		02	Saunders, David P	*
03	Bousarsar, Rachid	*	03	Root, Jon E	*
04	Ben Slimane, Lotfi		04	Ctvrlik, Robert J	*
05	Lahmar, Msaddak	*	05	Partie, Robert D	*
06	Bousarsar, Hedi	*	06	Timmons, Stephen D	*
07	Ben Messaoud, Abderrazak	*	07	Buck, Craig W	*
08	Chenoufi, Raouf	*	08	Fortune, Scott T	*
09	Ben Amira, Hichem		09	Luyties, Ricci J	
10	Tebourski, Mourad	*	10	Stork, Jeffery M	*
11	Ben Abdallah, Abdelaziz	*	11	Sato, Eric A	*
12	Ghariani, Fethi	*	15	Kiraly, Charles K	*
Coach	Wagner, Hubert		Coach	Dunphy, Marvin	
Referee-1/Arbitre-1	URS Stepanian, Surev				
Referee-2/Arbitre-2	GDR Richter, Frank				

Men Preliminary Group B Match 11/Sept. 24			Hommes Preliminaires Groupe B Match 11/24 Sept		
No.	Name	P	No.	Name	P
TUN 0-3 JPN (4-15) (11-15) (7-15)					
01	Ben Amara, Faycal	*	01	Kasama, Yuji	*
02	Sarsar, Mohamed		02	Iwashima, Akihiro	*
03	Bousarsar, Rachid	*	03	Kumada, Yasunori	*
04	Ben Slimane, Lotfi		04	Mitsuhashi, Eizaburo	*
05	Lahmar, Msaddak	*	05	Manabe, Masayoshi	*
06	Bousarsar, Hedi	*	06	Yoneyama, Kazutomo	*
07	Ben Messaoud, Abderrazak	*	07	Kageyama, Hiromichi	*
08	Chenoufi, Raouf	*	08	Hara, Hideharu	*
09	Ben amira, Hichem		09	Sugimoto, Kimio	*
10	Tebourski, Mourad	*	10	Inoue, Yuzuru	*
11	Ben Abdallah, Abdelaziz	*	11	Kaito, Masaki	*
12	Ghariani, Fethi	*	12	Kawai, Shunichi	*
Coach	Wagner, Hubert		Coach	Mitake, Kazuya	
Referee-1/Arbitre-1	SWE Dawiskibas, Sigmund				
Referee-2/Arbitre-2	URS Samedov, Ramis				

Men Preliminary Group B Match 15/Sept. 26			Hommes Preliminaires Groupe B Match 15/26 Sept		
No.	Name	P	No.	Name	P
JPN 0-3 HOL (7-15) (4-15) (8-15)					
01	Kasama, Yuji	*	01	Teffer, Martin	
02	Iwashima, Akihiro	*	04	Leeuwerink, Pieter-Jan	
03	Kumada, Yasunori	*	05	Boudrie, Ronald	
04	Mitsuhashi, Eizaburo	*	06	Posthuma, Jan-Marcus	*
05	Manabe, Masayoshi	*	07	Zoodsma, Ronald	*
06	Yoneyama, Kazutomo	*	08	Zwerver, Ronald	*
07	Kageyama, Hiromichi	*	09	Selinger, Avital	
08	Hara, Hideharu		10	Benne, Edwin	*
09	Sugimoto, Kimio		11	Buyts, Teunis	*
10	Inoue, Yuzuru	*	12	Blange, Peter	*
11	Kaito, Masaki		13	Brouwers, Marco	
12	Kawai, Shunichi	*	15	Grabert, Karl	*
Coach	Mitake, Kazuya		Coach	Selinger, Arie	
Referee-1/Arbitre-1	MEX Arredondo, Torres Genard				
Referee-2/Arbitre-2	PER Gonzales, Concha				

Men Preliminary Group B Match 12/Sept. 24			Hommes Preliminaires Groupe B Match 12/24 Sept		
No.	Name	P	No.	Name	P
ARG 3-0 HOL (15-11) (15-7) (15-8)					
01	Zulianello, Claudio F		01	Teffer, Martin	
02	Castellani, Daniel Jorge	*	04	Leeuwerink, Pieter-Jan	*
03	Martinez, Eduardo E	*	05	Boudrie, Ronald	
04	Diz, Alejandro	*	06	Posthuma, Jan-Marcus	*
05	Colla, Daniel M		07	Zoodsma, Ronald	*
06	Weber, Carlos J	*	08	Zwerver, Ronald	*
07	Conte, Hugo Nestor	*	09	Selinger, Avital	*
08	Kantor, Waldo Ariel	*	10	Benne, Edwin	*
09	Quiroga, Raul Nicolas	*	11	Buyts, Teunis	*
10	Uriarte, Jon Emili	*	12	Blange, Peter	*
11	De Palma, Esteban	*	13	Brouwers, Marco	*
12	Cuminetti, Juan Carlos	*	15	Grabert, Karl	*
Coach	Muchaga, Luis F		Coach	Selinger, Arie	
Referee-1/Arbitre-1	KOR Kim, Young-Dae				
Referee-2/Arbitre-2	EGY Hassan, Ahmed				

Men Preliminary/Sept. 17-26			Hommes Preliminaires/17-26 Sept											
	Rank	Ctry	Points	Matches			Won	Lost	Sets	W/L	For	Points	Against	F/A
				Played	Won	Lost								
Group A	1	URS	9	05	04	01	14	04	3.50	248	190	1.30		
	2	BRA	9	05	04	01	14	07	2.00	296	225	1.31		
	3	SWE	7	05	02	03	09	11	0.81	220	262	0.83		
	4	BUL	7	05	02	03	07	09	0.77	190	194	0.97		
	5	ITA	7	05	02	03	07	11	0.63	203	222	0.91		
	6	KOR	6	05	01	04	05	14	0.35	200	264	0.75		
< Round Progress/Deroulement de la Ronde >														
		SWE	URS	ITA	BRA	BUL	KOR							
	SWE	*	0-3	2-3	1-3	3-0	3-2							
	URS	3-0	*	3-1	2-3	3-0	3-0							
	ITA	3-2	1-3	*	0-3	0-3	3-0							
	BRA	3-1	3-2	3-0	*	3-1	2-3							
	BUL	0-3	0-3	3-0	1-3	*	3-0							
	KOR	2-3	0-3	0-3	3-2	0-3	*							
Group B	1	USA	10	05	05	00	15	03	5.00	263	155	1.69		
	2	ARG	8	05	03	02	11	07	1.57	219	211	1.03		
	3	FRA	8	05	03	02	10	07	1.42	222	190	1.16		
	4	HOL	8	05	03	02	10	07	1.42	202	183	1.10		
	5	JPN	6	05	01	04	05	12	0.41	182	225	0.80		
	6	TUN	5	05	00	05	00	15	0.00	101	225	0.44		
< Round Progress/Deroulement de la Ronde >														
		FRA	TUN	JPN	USA	ARG	HOL							
	FRA	*	3-0	3-1	0-3	3-0	1-3							
	TUN	0-3	*	0-3	0-3	0-3	0-3							
	JPN	1-3	3-0	*	0-3	1-3	0-3							
	USA	3-0	3-0	3-0	*	3-2	3-1							
	ARG	0-3	3-0	3-1	2-3	*	3-0							
	HOL	3-1	3-0	3-0	1-3	0-3	*							

Men Preliminary Group B Match 13/Sept. 26			Hommes Preliminaires Groupe B Match 13/26 Sept		
No.	Name	P	No.	Name	P
FRA 3-0 ARG (15-7) (15-5) (15-5)					
01	Blain, Philippe	*	01	Zulianello, Claudio F	*
02	Martzluff, Jean-Baptiste		02	Castellani, Daniel Jorge	*
03	Mazzon, Herve		03	Martinez, Eduardo E	*
04	N'Gapeth, Eric	*	04	Diz, Alejandro	*
05	Bouvier, Eric	*	05	Colla, Daniel M	
06	Meneau, Christophe	*	06	Weber, Carlos J	*
07	Jurkovicz, Jean-Marc	*	07	Conte, Hugo Nestor	*
09	Tillite, Laurent	*	08	Kantor, Waldo Ariel	*
10	Rossardo, Olivier		09	Quiroga, Raul Nicolas	
11	Duflos, Patrick		10	Uriarte, Jon Emili	*
12	Fabiani, Alain	*	11	De Palma, Esteban	
15	Salvan, Philippe	*	12	Cuminetti, Juan Carlos	*
Coach	Daniel, Eric		Coach	Muchaga, Luis F	
Referee-1/Arbitre-1	KOR Cho, Young-Ho				
Referee-2/Arbitre-2	TUN Djerad, Abdelmajid				

Volleyball

Volley-ball

Men Semi-final Match 1/Sept. 30			Hommes Demi-finale Match 1/30 Sept		
No.	Name	P	No.	Name	P
URS 3-0 ARG (15-11) (17-15) (15-8)					
01	Pantchenko, Iouri		01	Zulianello, Claudio F	*
02	Kouzentsov, Andrei	*	02	Castellani, Daniel Jorge	*
03	Zaitsev, Viatcheslav		03	Martinez, Eduardo E	*
04	Rounov, Igor		04	Diz, Alejandro	*
05	Chkourikhine, Vladimir	*	05	Colla, Daniel M	
06	Krasilnikov, Evgueny		06	Weber, Carlos J	*
07	Vilde, Raimond	*	07	Corte, Hugo Nestor	*
08	Lossev, Valeri	*	08	Kantor, Waldo Ariel	*
09	Sapega, Iouri	*	09	Quiroga, Raul Nicolas	*
10	Sorokolet, Alexandre	*	10	Uriarte, Jon Emili	*
11	Antonov, Iaroslav	*	11	De Palma, Esteban	*
12	Tcherednik, Iouri		12	Cuminetti, Juan Carlos	*
Coach	Parchine, Guennadi		Coach	Muchaga, Luis F	
	Referee-1/Arbitre-1	KOR	Cho, Young-Ho		
	Referee-2/Arbitre-2	EGY	Hassan, Ahmed		

Men Semi-final Match 5/Sept. 28			Hommes Demi-finale Match 5/28 Sept		
No.	Name	P	No.	Name	P
ITA 3-0 TUN (15-2) (15-2) (15-5)					
01	Gardini, Andrea	*	01	Ben Amara, Faycal	
02	Giani, Andrea	*	02	Sarsar, Mohamed	
03	Lucchetta, Pierpaolo		03	Bousarsar, Rachid	*
04	De Giorgi, Ferdinando	*	04	Ben Slimane, Lotfi	
05	Bracci, Marco		05	Lahmar, Msaddak	*
06	Galli, Claudio	*	06	Bousarsar, Hedi	*
07	Bernardi, Lorenzo		07	Ben Messaoud, Abderrazak	*
08	Lazzeroni, Alessandro		08	Chenoufi, Raouf	*
09	Castagna, Massimo	*	09	Ben Amira, Hichem	
10	Zorzi, Andrea	*	10	Tebourski, Mourad	*
11	Cantagalli, Luca	*	11	Ben Abdallah, Abdelaziz	*
12	Lucchetta, Andrea		12	Ghariani, Fethi	
Coach	Pittera, Carmelo		Coach	Wagner, Hubert	
	Referee-1/Arbitre-1	USA	Clark, Bob		
	Referee-2/Arbitre-2	CHN	Chen, You Xin		

Men Semi-final Match 2/Sept. 30			Hommes Demi-finale Match 2/30 Sept		
No.	Name	P	No.	Name	P
BRA 0-3 USA (3-15) (5-15) (11-15)					
01	Lima, Mauricio	*	01	Tanner, Troy R	*
02	Rocha, Wagner	*	02	Saunders, David P	*
03	Roese, Paulo	*	03	Root, Jon E	
04	Montanaro Junior, Jose	*	04	Ctvrlik, Robert J	*
05	Da Silva, Paulo	*	05	Partie, Robert D	*
06	Zotto, Renan Dal	*	06	Timmons, Stephen D	*
07	Da Silva, Willian	*	07	Buck, Craig W	*
08	Ribeiro, Amauri	*	08	Fortune, Scott T	*
09	Gouveia, Antonio	*	09	Luyties, Ricci J	
10	Lampariello Neto, Domingos	*	10	Stork, Jeffery M	*
11	De Pra Filho, Leonidio	*	11	Sato, Eric A	*
12	Ferreira, Andre	*	15	Kiraly, Charles K	*
Coach	Freitas, Paulo		Coach	Dunphy, Marvin	
	Referee-1/Arbitre-1	BUL	Stoyanov, Stoyan		
	Referee-2/Arbitre-2	JPN	Yamagishi, Norio		

Men Semi-final Match 6/Sept. 28			Hommes Demi-finale Match 6/28 Sept		
No.	Name	P	No.	Name	P
KOR 2-3 JPN (15-13) (15-6) (9-15) (13-15) (9-15)					
01	Choi, Chon-Sik	*	01	Kasama, Yuji	*
02	Lee, Sang-Yul	*	02	Iwashima, Akihiro	*
03	Chang, Yun-Chang	*	03	Kumada, Yasunori	*
04	Han, Jang-Sok	*	04	Mitsuhashi, Eizaburo	*
05	Lee, Sung-Hee		05	Manabe, Masayoshi	*
06	Kim, Eun-Sok	*	06	Yoneyama, Kazutomo	*
07	Park, Sam-Yong		07	Kageyama, Hiromichi	*
08	Lee, Myung-Hak	*	08	Hara, Hideharu	*
09	Kim, Ho-Chul	*	09	Sugimoto, Kimio	*
10	Lee, Chae-On	*	10	Inoue, Yuzuru	*
11	Lee, Jong-Kyung	*	11	Kaito, Masaki	
12	Jung, Eu-Tak	*	12	Kawai, Shunichi	*
Coach	Lee, Kyu-So		Coach	Mitake, Kazuya	
	Referee-1/Arbitre-1	URS	Samedov, Ramis		
	Referee-2/Arbitre-2	MEX	Arredondo, Torres Genard		

Men Semi-final Match 3/Sept. 28			Hommes Demi-finale Match 3/28 Sept		
No.	Name	P	No.	Name	P
SWE 2-3 HOL (10-15) (15-13) (15-8) (11-15) (14-16)					
02	Lennartsson, Urban		01	Teffer, Martin	
04	Kalmazidis, Jannis		04	Leeuwerink, Pieter-Jan	*
05	Hedengard, Jan	*	05	Boudrie, Ronald	*
07	Karlsson, Mats		06	Posthuma, Jan-Marcus	*
08	Hoszek, Tomas	*	07	Zoodma, Ronald	*
09	Lundmark, Anders		08	Zwenver, Ronald	*
10	Saaf, Per-Anders	*	09	Selinger, Avital	*
11	Gustafson, Bengt	*	10	Benne, Edwin	*
12	Bjorne, Hakan	*	11	Buys, Teunis	*
13	Nilsson, Lars	*	12	Blange, Peter	*
14	Tholse, Peter	*	13	Brouwers, Marco	*
15	Johansson, Patrik		15	Grabert, Karl	*
Coach	Kristiansson, Anders		Coach	Selinger, Arie	
	Referee-1/Arbitre-1	BRA	Desouza, Learte		
	Referee-2/Arbitre-2	URS	Stepanian, Surev		

Men Final Match 1/Oct. 2			Hommes Finale Match 1/2 Oct		
No.	Name	P	No.	Name	P
URS 1-3 USA (15-13) (10-15) (4-15) (8-15)					
01	Pantchenko, Iouri	*	01	Tanner, Troy R	
02	Kouzentsov, Andrei	*	02	Saunders, David P	*
03	Zaitsev, Viatcheslav	*	03	Root, Jon E	
04	Rounov, Igor		04	Ctvrlik, Robert J	*
05	Chkourikhine, Vladimir	*	05	Partie, Robert D	*
06	Krasilnikov, Evgueny		06	Timmons, Stephen D	*
07	Vilde, Raimond	*	07	Buck, Craig W	*
08	Lossev, Valeri	*	08	Fortune, Scott T	*
09	Sapega, Iouri	*	09	Luyties, Ricci J	*
10	Sorokolet, Alexandre	*	10	Stork, Jeffery M	
11	Antonov, Iaroslav	*	11	Sato, Eric A	*
12	Tcherednik, Iouri		15	Kiraly, Charles K	*
Coach	Parchine, Guennadi		Coach	Dunphy, Marvin	
	Referee-1/Arbitre-1	JPN	Sasaki, Hiroshi		
	Referee-2/Arbitre-2	EGY	Hassan, Ahmed		

Men Semi-final Match 4/Sept. 28			Hommes Demi-finale Match 4/28 Sept		
No.	Name	P	No.	Name	P
BUL 3-0 FRA (15-8) (15-12) (15-11)					
01	Mitev, Kostadin		01	Blain, Philippe	*
02	Draguiev, Petyo	*	02	Martzluff, Jean-Baptiste	
03	Kyossev, Borislav	*	03	Mazzon, Herve	*
04	Ganev, Ljubomir	*	04	N'Gapeth, Eric	*
05	Kaziiski, Ilian		05	Bouvier, Eric	*
06	Tonev, Dimo	*	06	Meneau, Christophe	
07	Petkov, Petko	*	07	Jurkovitz, Jean-Marc	*
08	Hristov, Plamen	*	09	Tillie, Laurent	*
09	Kovatchev, Sava		10	Rossard, Olivier	*
11	Naydenov, Nayden	*	11	Duflos, Patrick	*
12	Milanov, Miltcho		12	Fabiani, Alain	
14	Florov, Tzvetan		15	Salvan, Philippe	*
Coach	Piperkov, Todor		Coach	Daniel, Eric	
	Referee-1/Arbitre-1	JPN	Sasaki, Hiroshi		
	Referee-2/Arbitre-2	GDR	Richter, Frank		

Men Final Match 2/Oct. 2			Hommes Finale Match 2/2 Oct		
No.	Name	P	No.	Name	P
ARG 3-2 BRA (15-10) (15-17) (15-8) (12-15) (15-9)					
01	Zulianello, Claudio F	*	01	Lima, Mauricio	*
02	Castellani, Daniel Jorge	*	02	Rocha, Wagner	
03	Martinez, Eduardo E	*	03	Roese, Paulo	*
04	Diz, Alejandro	*	04	Montanaro Junior, Jose	*
05	Colla, Daniel M		05	Da Silva, Paulo	*
06	Weber, Carlos J	*	06	Zotto, Renan Dal	*
07	Conte, Hugo Nestor	*	07	Da Silva, Willian	*
08	Kantor, Waldo Ariel	*	08	Ribeiro, Amauri	*
09	Quiroga, Raul Nicolas	*	09	Gouveia, Antonio	*
10	Uriarte, Jon Emili	*	10	Lampariello Neto, Domingos	*
11	De Palma, Esteban		11	De Pra Filho, Leonidio	*
12	Cuminetti, Juan Carlos	*	12	Ferreira, Andre	*
Coach	Muchaga, Luis F		Coach	Freitas, Paulo	
	Referee-1/Arbitre-1	TCH	Kovalik, Vladimir		
	Referee-2/Arbitre-2	MEX	Arredondo, Torres Genard		



Men Final Match 3/Oct. 1			Hommes Finale Match 3/1 Oct		
No.	Name	P	No.	Name	P
HOL 3-0 BUL (15-6) (15-8) (15-10)					
01	Teffer, Martin	*	01	Mitev, Kostadin	*
04	Leeuwerink, Pieter-Jan	*	02	Draguiev, Petyo	*
05	Boudrie, Ronald	*	03	Kyossev, Borislav	*
06	Posthuma, Jan-Marcus	*	04	Ganev, Ljubomir	*
07	Zoodsma, Ronald	*	05	Kaziiski, Ilian	*
08	Zwerver, Ronald	*	06	Tonev, Dimo	*
09	Selinger, Avital	*	07	Petkov, Petko	*
10	Benne, Edwin	*	08	Hristov, Plamen	*
11	Buys, Teunis	*	09	Kovatchev, Sava	*
12	Blange, Peter	*	11	Naydenov, Nayden	*
13	Brouwers, Marco	*	12	Milanov, Miltcho	*
15	Grabert, Karl	*	14	Florov, Tzvetan	*
Coach	Selinger, Arie		Coach	Piperkov, Todor	
	Referee-1/Arbitre-1	JPN	Sasaki, Hiroshi		
	Referee-2/Arbitre-2	BRA	Desouza, Learte		

Men Final Match 4/Oct. 1			Hommes Finale Match 4/1 Oct		
No.	Name	P	No.	Name	P
SWE 3-2 FRA (12-15) (15-5) (8-15) (15-12) (15-12)					
02	Lennartsson, Urban	*	01	Blain, Philippe	*
04	Kalmazidis, Jannis	*	02	Martzluff, Jean-Baptiste	*
05	Hedengard, Jan	*	03	Mazzon, Herve	*
07	Karlsson, Mats	*	04	N'Gapeth, Eric	*
08	Hoszek, Tomas	*	05	Bouvier, Eric	*
09	Lundmark, Anders	*	06	Meneau, Christophe	*
10	Saaf, Per-Anders	*	07	Jurkovitz, Jean-Marc	*
11	Gustafson, Bengt	*	09	Tillie, Laurent	*
12	Bjorne, Hakan	*	10	Rossard, Olivier	*
13	Nilsson, Lars	*	11	Duflos, Patrick	*
14	Tholse, Peter	*	12	Fabiani, Alain	*
15	Johansson, Patrik	*	15	Salvan, Philippe	*
Coach	Kristiansson, Anders		Coach	Daniel, Eric	
	Referee-1/Arbitre-1	KOR	Kim, Young-Dae		
	Referee-2/Arbitre-2	GDR	Richter, Frank		

Men Final Match 5/Sept. 30			Hommes Finale Match 5/30 Sept		
No.	Name	P	No.	Name	P
ITA 3-2 JPN (15-11) (15-11) (12-15) (13-15) (15-7)					
01	Gardini, Andrea	*	01	Kasama, Yuji	*
02	Giani, Andrea	*	02	Iwashima, Akihiro	*
03	Lucchetta, Pierpaolo	*	03	Kumada, Yasunori	*
04	De Giorgi, Ferdinando	*	04	Mitsuhashi, Eizaburo	*
05	Bracci, Marco	*	05	Manabe, Masayoshi	*
06	Galli, Claudio	*	06	Yoneyama, Kazutomo	*
07	Bernardi, Lorenzo	*	07	Kageyama, Hiromichi	*
08	Lazzeroni, Alessandro	*	08	Hara, Hideharu	*
09	Castagna, Massimo	*	09	Sugimoto, Kimio	*
10	Zorzi, Andrea	*	10	Inoue, Yuzuru	*
11	Cantagalli, Luca	*	11	Kaito, Masaki	*
12	Lucchetta, Andrea	*	12	Kawai, Shunichi	*
Coach	Pittera, Carmelo		Coach	Mitake, Kazuya	
	Referee-1/Arbitre-1	ARG	Paredes, G.Enrique		
	Referee-2/Arbitre-2	USA	Clark, Bob		

Men Final Match 6/Sept. 30			Hommes Finale Match 6/30 Sept		
No.	Name	P	No.	Name	P
TUN 0-3 KOR (11-15) (9-15) (7-15)					
01	Ben Amara, Faycal	*	01	Choi, Chon-Sik	*
02	Sarsar, Mohamed	*	02	Lee, Sang-Yul	*
03	Bousarsar, Rachid	*	03	Chang, Yun-Chang	*
04	Ben Slimane, Lotfi	*	04	Han, Jang-Sok	*
05	Lahmar, Msaddak	*	05	Lee, Sung-Hee	*
06	Bousarsar, Hedi	*	06	Kim, Eun-Sok	*
07	Ben Messaoud, Abderrazak	*	07	Park, Sam-Yong	*
08	Chenoufi, Raouf	*	08	Lee, Myung-Hak	*
09	Ben Amira, Hichem	*	09	Kim, Ho-Chul	*
10	Tebourski, Mourad	*	10	Lee, Chae-On	*
11	Ben Abdallah, Abdelaziz	*	11	Lee, Jong-Kyung	*
12	Ghariani, Fethi	*	12	Jung, Eu-Tak	*
Coach	Wagner, Hubert		Coach	Lee, Kyu-So	
	Referee-1/Arbitre-1	HOL	Scheffer, Peter		
	Referee-2/Arbitre-2	PER	Gonzales, Concha		

Men Final Sept. 17-Oct. 2			Hommes Finale 17 Sept-2 Oct		
Place.	Match No.	Ctry/Pays	Time/Temps	Results/Resultats	
1-4	8001	A1-URS:B2-ARG	09/30 20:30	3-0	15-11, 17-15, 15-8
1-4	8002	A2-BRA:B1-USA	09/30 09:45	0-3	3-15,5-15,11-15
5-8	8003	A3-SWE:B4-HOL	09/28 20:30	2-3	10-15, 15-13, 15-8, 11-15, 14-16
5-8	8004	A4-BUL:B3-FRA	09/28 09:45	3-0	15-8, 15-12, 15-11
9-12	8005	A5-ITA:B6-TUN	09/28 12:00	3-0	15-2,15-2,15-5
9-12	8006	A6-KOR:B5-JPN	09/28 18:00	2-3	15-13, 15-6,9-15, 13-15,9-15
Semi-finals/Demi-finales					
Finals/Finales					
1-2	9001	URS:USA	10/02 12:55	1-3	15-13,10-15,4-15,8-15
3-4	9002	ARG:BRA	10/02 09:45	3-2	15-10, 15-17, 15-8, 12-15, 15-9
5-6	9003	HOL:BUL	10/01 12:28	3-0	15-6, 15-8, 15-10
7-8	9004	SWE: FRA	10/01 09:45	3-2	12-15,15-5-8-15,15-12,15-12
9-10	9005	ITA:JPN	09/30 18:00	3-2	15-11, 15-11, 12-15, 13-15, 15-7
11-12	9006	TUN: KOR	09/30 12:00	0-3	11-15,9-15,7-15

< Final Standing/Classement Final >

1	USA	United States of America
2	URS	U.S.S.R.
3	ARG	Argentina
4	BRA	Brazil
5	HOL	Netherlands
6	BUL	Bulgaria
7	SWE	Sweden
8	FRA	France
9	ITA	Italy
10	JPN	Japan
11	KOR	Korea
12	TUN	Tunisia

Men/Sept. 17-Oct. 2			Hommes/17 Sept-2 Oct						
Skill	Rank	Ctry	Rate %	Tot Atts	Ace (4)%	Exce (3)%	Good (2)%	Poor (1)%	Fault (0)%
Serve	01	BUL	39.7	816	3	13	33	42	9
	02	BRA	39.3	1153	3	13	34	37	13
	03	URS	39.0	946	3	13	30	47	8
	04	ITA	38.6	922	3	13	29	45	10
	04	USA	38.6	1013	2	9	35	47	6
	05	HOL	38.4	976	2	14	28	46	10
	06	JPN	37.8	1006	3	9	32	50	7
	07	FRA	37.2	1028	2	10	35	42	11
	08	ARG	37.1	1033	2	9	33	47	9
09	SWE	36.9	1084	3	8	32	48	9	
	1-3	Average	39.3		2	13	32	41	10
	1-6	Average	38.9		2	12	31	43	9
Block	01	HOL	36.6	1178	13	4	23	37	24
	02	USA	36.4	1180	10	4	27	40	19
	03	ARG	34.5	1261	11	4	21	40	24
	04	BRA	33.8	1265	11	4	19	42	24
	05	ITA	33.7	1055	10	4	23	38	25
	06	URS	33.4	1133	11	3	23	36	27
	06	SWE	33.4	1341	9	4	23	42	23
	07	BUL	33.2	968	10	4	20	39	27
	08	KOR	32.4	1065	9	4	19	46	23
09	FRA	31.8	1179	8	3	20	47	22	
	1-3	Average	35.8		11	3	23	40	22
	1-6	Average	34.8		10	3	22	39	23
Attack	01	USA	72.0	1176	54	8	21	6	11
	02	BRA	71.7	1390	55	9	19	5	13
	03	URS	70.7	1199	51	10	24	4	12
	04	ITA	70.2	1101	52	8	22	5	13
	05	FRA	69.8	1299	50	10	21	7	12
	06	HOL	69.5	1189	52	8	23	2	15
	07	ARG	69.1	1332	48	11	23	5	13
	08	BUL	68.7	1048	48	11	22	7	13
	09	JPN	67.5	1384	46	11	24	5	14
	1-3	Average	71.4		53	8	21	4	12
	1-6	Average	70.6		52	8	21	4	12

Volleyball

Volley-ball

Men/Sept. 17-Oct. 2			Hommes/17 Sept-2 Oct						
Skill	Rank	Ctry	Rate %	Tot Atts	Feat (4)%	Exce (3)%	Good (2)%	Poor (1)%	Fault (0)%
Pass	01	USA	68.8	757	4	73	17	3	2
	02	FRA	66.9	914	3	72	16	6	2
	03	URS	66.0	839	4	64	25	4	2
	04	JPN	65.7	959	5	65	22	5	3
	05	HOL	64.9	857	3	65	26	3	4
	06	SWE	64.8	1007	7	58	26	5	4
	07	ARG	64.3	941	2	65	24	6	3
	08	BRA	64.0	1036	3	64	24	6	4
	09	BUL	63.8	760	5	60	26	5	5
1-3	Average	67.2		3	68	19	4	2	
1-6	Average	66.1		4	65	20	4	3	
Dig	01	URS	37.2	804	8	26	17	5	44
	02	HOL	37.1	787	6	29	15	5	44
	03	JPN	35.9	886	7	24	20	5	45
	04	USA	35.7	921	5	27	17	6	45
	05	ARG	35.1	961	5	25	18	6	45
	06	BUL	34.4	711	4	25	19	5	46
	07	FRA	34.1	973	5	23	19	6	46
	08	ITA	33.6	745	5	23	20	7	46
	09	BRA	33.2	922	5	22	20	4	48
1-3	Average	36.7		6	26	17	4	44	
1-6	Average	35.9		6	26	17	5	45	
Set	01	URS	70.7	1137	12	60	26	1	1
	02	ITA	69.5	1055	12	58	27	1	2
	03	BRA	69.1	1326	9	61	27	1	1
	04	ARG	68.8	1293	9	60	29	2	0
	05	JPN	68.7	1400	9	60	28	1	1
	05	KOR	68.7	1161	10	58	31	1	1
	06	BUL	68.6	983	9	60	29	1	1
	07	HOL	68.3	1152	12	55	30	2	2
	08	USA	67.6	1135	11	53	33	2	1
09	SWE	66.9	1371	6	60	31	2	1	
1-3	Average	69.8		11	59	26	1	1	
1-6	Average	69.2		9	60	27	1	0	

Men/Sept. 17-Oct. 2			Hommes/17 Sept-2 Oct								
Skill	Rank	No.	Name	Ctry	Rate %	Tot Atts	Feat (4)%	Exce (3)%	Good (2)%	Poor (1)%	Fault (0)%
Pass	1	04	Ctvrlik, R	USA	69.5	404	4	75	18	1	2
	2	01	Blain, Philippe	FRA	68.8	402	4	75	15	5	1
	3	04	Mitsuhashi, E	JPN	68.3	267	4	73	17	4	2
	4	06	Kim, Eun-Sok	KOR	68.3	89	8	64	24	2	2
	5	09	Tillie, Laurent	FRA	68.2	246	0	80	12	5	2
	6	15	Kiraly, C	USA	68.2	223	4	74	17	3	3
	7	11	Naydenov, Nayden	BUL	67.9	211	6	66	23	3	2
	8	02	Kouzentsov, A	URS	67.5	349	3	70	23	3	1
	9	02	Iwashima, A	JPN	66.9	229	5	68	20	4	3
	10	10	Sorokolet, A	URS	66.8	230	7	61	25	6	1
1-10	Average			68.0							
Dig	1	04	Mitsuhashi, E	JPN	45.4	162	6	38	20	7	30
	2	04	De Giorgi, F	ITA	45.1	96	13	31	15	7	34
	3	15	Grabert, Karl	HOL	43.1	123	5	41	12	7	36
	4	10	Sorokolet, A	URS	41.9	157	13	29	13	4	41
	5	04	Ctvrlik, R	USA	41.7	174	7	36	13	3	40
	6	02	Castellani, D	ARG	41.5	123	9	30	15	9	37
	7	15	Kiraly, C	USA	41.4	189	6	33	18	4	38
	8	07	Zoodsma, Ronald	HOL	41.0	94	5	37	14	3	40
	9	02	Kouzentsov, A	URS	40.9	134	9	28	19	4	40
	10	02	Iwashima, A	JPN	40.8	157	6	30	23	2	39
1-10	Average			42.3							
Set	1	04	De Giorgi, F	ITA	72.5	672	15	63	19	1	1
	2	08	Lossev, Valeri	URS	72.4	818	15	60	24	0	0
	3	06	Yoneyama, K	JPN	71.6	479	14	62	23	0	1
	4	12	Fabiani, Alain	FRA	70.8	705	17	54	26	2	1
	5	09	Kim, Ho-Chul	KOR	70.5	978	11	61	26	1	0
	6	07	Da Silva, W	BRA	70.3	1009	11	63	24	1	1
	7	10	Stork, Jeffery M	USA	70.3	603	13	59	26	1	1
	8	08	Kantor, W	ARG	70.1	1079	10	62	26	1	0
	9	03	Zaitsev, V	URS	69.9	133	8	68	22	0	2
	10	05	Manabe, M	JPN	69.5	607	10	62	25	1	1
1-10	Average			70.8							

Men/Sept. 17-Oct. 2			Hommes/17 Sept-2 Oct								
Skill	Rank	No.	Name	Ctry	Rate %	Tot Atts	Ace (4)%	Exce (3)%	Good (2)%	Poor (1)%	Fault (0)%
Serve	1	08	Zwerver, Ronald	HOL	47.0	159	3	31	30	25	11
	2	10	Zorzi, Andrea	ITA	46.4	147	9	29	21	22	19
	3	10	Sorokolet, A	URS	45.9	145	6	30	24	22	18
	4	04	Ganev, Ljubomir	BUL	45.7	121	5	22	34	28	11
	5	09	Quiroga, R	ARG	43.3	115	3	24	29	32	12
	6	05	Bouvier, Eric	FRA	43.2	158	2	22	39	23	15
	7	03	Kyossev, B	BUL	42.6	121	1	16	45	31	8
	8	07	Buck, Craig W	USA	40.8	163	2	13	38	39	8
	9	10	Stork, Jeffery M	USA	40.7	126	3	10	39	41	6
	10	07	Zoodsma, Ronald	HOL	40.6	147	3	23	29	25	20
1-10	Average			43.6							
Block	1	06	Timmons, S	USA	38.9	366	12	5	27	40	16
	2	02	Giani, Andrea	ITA	38.3	260	13	5	25	33	23
	3	08	Hristov, Plamen	BUL	38.0	210	17	5	20	30	28
	4	06	Posthuma, J	HOL	37.6	495	13	4	24	35	23
	5	15	Kiraly, C	USA	37.6	292	10	5	27	41	17
	6	12	Blange, Peter	HOL	37.5	250	13	5	26	30	26
	7	10	Lampariello Net	BRA	37.4	153	14	5	18	40	22
	8	08	Lossev, Valeri	URS	37.3	193	15	3	24	33	25
	9	02	Castellani, D	ARG	37.0	279	12	2	27	39	20
	10	08	Fortune, Scott T	USA	36.8	121	7	6	33	34	20
1-10	Average			37.6							
Attack	1	01	Gardini, Andrea	ITA	77.7	129	57	10	26	3	5
	2	07	Zoodsma, Ronald	HOL	76.5	178	61	6	21	2	10
	3	12	Ferreira, Andre	BRA	74.8	143	58	10	17	3	12
	4	09	Tillie, Laurent	FRA	74.3	238	54	9	22	9	6
	5	09	Sapega, Iouri	URS	74.2	120	50	13	26	5	6
	6	07	Buck, Craig W	USA	73.9	137	59	4	20	5	11
	7	09	Gouveia, Antonio	BRA	73.5	291	58	9	15	4	13
	8	15	Kiraly, C	USA	73.3	227	58	5	19	6	11
	9	04	Ganev, Ljubomir	BUL	73.2	317	53	12	21	4	10
	10	05	Partie, Robert D	USA	73.0	122	53	8	25	3	10
1-10	Average			74.4							



Women Preliminary Group A Match 1/Sept. 20			Femmes Preliminaires Groupe A Match 1/20 Sept		
No.	Name	P	No.	Name	P
JPN 3-2 URS (15-2) (8-15) (15-12) (10-15) (19-17)					
01	Maruyama, Yumi	*	01	Oguienko, Valentina	*
02	Sugiyama, Kayoko	*	03	Volkova, Elena	*
03	Takizawa, Reiko	*	04	Koumych, Marina	*
04	Yamashita, Miyako	*	05	Smirnova, Irina	*
05	Sugiyama, Akemi	*	06	Sidorenko, Tatiana	*
06	Sato, Ichiko	*	07	Parkhomtchouk, Irina	*
07	Hiro, Norie	*	08	Krainova, Tatiana	*
08	Nakada, Kumi	*	09	Chkournova, Olga	*
09	Kawase, Yukari	*	10	Nikoulina, Marina	*
10	Obayashi, Motoko	*	11	Ovtchinnikova, Elena	*
11	Takahashi, Yukiko	*	12	Krivocheeva, Olga	*
12	Fujita, Sachiko	*	13	Korytova, Svetlana	*
Coach	Muneuchi, Noriyuki		Coach	Karpol, Nikolai	
Referee-1/Arbitre-1	USA	Clark, Bob			
Referee-2/Arbitre-2	PER	Gonzales, Concha			

Women Preliminary Group A Match 5/Sept. 25			Femmes Preliminaires Groupe A Match 5/25 Sept		
No.	Name	P	No.	Name	P
GDR 0-3 URS (16-18) (7-15) (4-15)					
01	Schmidt, Steffi	*	01	Oguienko, Valentina	*
02	Lahme, Susanne	*	03	Volkova, Elena	*
03	Beu, Monika	*	04	Koumych, Marina	*
04	Radfan, Ariane	*	05	Smirnova, Irina	*
05	Langschwager, Kathrin	*	06	Sidorenko, Tatiana	*
06	Arlt, Maike	*	07	Parkhomtchouk, Irina	*
07	Wiedemann, Brit	*	08	Krainova, Tatiana	*
08	Steppin, Ute	*	09	Chkournova, Olga	*
09	Jensen, Grit	*	10	Nikoulina, Marina	*
10	Stuedemann, Doerte	*	11	Ovtchinnikova, Elena	*
11	Jensen, Heike	*	12	Krivocheeva, Olga	*
12	Langenau, Ute	*	13	Korytova, Svetlana	*
Coach	Koehler, Siegfried		Coach	Karpol, Nikolai	
Referee-1/Arbitre-1	EGY	Hassan, Ahmed			
Referee-2/Arbitre-2	BRA	Kuroki, George Hideyuki			

Women Preliminary Group A Match 2/Sept. 20			Femmes Preliminaires Groupe A Match 2/20 Sept		
No.	Name	P	No.	Name	P
GDR 1-3 KOR (6-15) (16-14) (10-15) (7-15)					
01	Schmidt, Steffi	*	01	Park, Mi-Hee	*
02	Lahme, Susanne	*	02	Kim, Kyung-Hee	*
03	Beu, Monika	*	03	Kim, Kui-Soon	*
04	Radfan, Ariane	*	04	Lim, Hye-Sook	*
05	Langschwager, Kathrin	*	05	Yoo, Young-Mi	*
06	Arlt, Maike	*	06	Nam, Soon-Ok	*
07	Wiedemann, Brit	*	07	Yoon, Chung-Hye	*
08	Steppin, Ute	*	08	Park, Bok-Rye	*
09	Jensen, Grit	*	09	Kim, Yoon-Hye	*
10	Stuedemann, Doerte	*	10	Sun, Mi-Sook	*
11	Jensen, Heike	*	11	Moon, Sun-Hee	*
12	Langenau, Ute	*	12	Ji, Kyung-Hee	*
Coach	Koehler, Siegfried		Coach	Hwang, Sung-On	
Referee-1/Arbitre-1	MEX	Arredondo, Torres Genard			
Referee-2/Arbitre-2	CHN	Chen, You Xin			

Women Preliminary Group A Match 6/Sept. 25			Femmes Preliminaires Groupe A Match 6/25 Sept		
No.	Name	P	No.	Name	P
JPN 3-1 KOR (8-15) (15-3) (15-11) (15-8)					
01	Maruyama, Yumi	*	01	Park, Mi-Hee	*
02	Sugiyama, Kayoko	*	02	Kim, Kyung-Hee	*
03	Takizawa, Reiko	*	03	Kim, Kui-Soon	*
04	Yamashita, Miyako	*	04	Lim, Hye-Sook	*
05	Sugiyama, Akemi	*	05	Yoo, Young-Mi	*
06	Sato, Ichiko	*	06	Nam, Soon-Ok	*
07	Hiro, Norie	*	07	Yoon, Chung-Hye	*
08	Nakada, Kumi	*	08	Park, Bok-Rye	*
09	Kawase, Yukari	*	09	Kim, Yoon-Hye	*
10	Obayashi, Motoko	*	10	Sun, Mi-Sook	*
11	Takahashi, Yukiko	*	11	Moon, Sun-Hee	*
12	Fujita, Sachiko	*	12	Ji, Kyung-Hee	*
Coach	Muneuchi, Noriyuki		Coach	Hwang, Sung-On	
Referee-1/Arbitre-1	FRA	Marty, Jean-Francois			
Referee-2/Arbitre-2	PER	Gonzales, Concha			

Women Preliminary Group A Match 3/Sept. 23			Hommes Preliminaires Groupe A Match 3		
No.	Name	P	No.	Name	P
GDR 3-2 JPN (11-15) (16-14) (4-15) (15-2) (15-7)					
01	Schmidt, Steffi	*	01	Maruyama, Yumi	*
02	Lahme, Susanne	*	02	Sugiyama, Kayoko	*
03	Beu, Monika	*	03	Takizawa, Reiko	*
04	Radfan, Ariane	*	04	Yamashita, Miyako	*
05	Langschwager, Kathrin	*	05	Sugiyama, Akemi	*
06	Arlt, Maike	*	06	Sato, Ichiko	*
07	Wiedemann, Brit	*	07	Hiro, Norie	*
08	Steppin, Ute	*	08	Nakada, Kumi	*
09	Jensen, Grit	*	09	Kawase, Yukari	*
10	Stuedemann, Doerte	*	10	Obayashi, Motoko	*
11	Jensen, Heike	*	11	Takahashi, Yukiko	*
12	Langenau, Ute	*	12	Fujita, Sachiko	*
Coach	Koehler, Siegfried		Coach	Muneuchi, Noriyuki	
Referee-1/Arbitre-1	PER	Gonzales, Concha			
Referee-2/Arbitre-2	SWE	Dawiskibas, Sigmund			

Women Preliminary Group B Match 1/Sept. 20			Femmes Preliminaires Groupe B Match 1/20 Sept		
No.	Name	P	No.	Name	P
CHN 3-0 USA (15-9) (15-5) (15-7)					
02	Li, Guojun	*	01	Mc Linden, Melissa	*
03	Zhao, Hong	*	02	Rock, Angela	*
04	Hou, Yuzhu	*	03	Masakayan, Elizabeth	*
05	Wang, Yajun	*	04	Oden, Kimberly	*
06	Yang, Xilan	*	06	Ruddins, Kimberly	*
07	Su, Huijuan	*	07	Kemner, Caren	*
08	Jiang, Ying	*	08	Webb, Tammy	*
09	Cui, Yongmei	*	09	Collins, Deitre	*
10	Yang, Xiaojun	*	10	Kessel, Laurel	*
11	Zheng, Meizhu	*	12	Phipps, Prikeba	*
12	Wu, Dan	*	14	Sato, Liane	*
15	Li, Yueming	*	15	Mc Hugh, Jayne	*
Coach	Li, Yaoxian		Coach	Liskevych, Taras	
Referee-1/Arbitre-1	GDR	Richter, Frank			
Referee-2/Arbitre-2	KOR	Kim, Young-Dae			

Women Preliminary Group A Match 4/Sept. 23			Femmes Preliminaires Groupe A Match 4/23 Sept		
No.	Name	P	No.	Name	P
URS 3-0 KOR (15-5) (15-8) (15-7)					
01	Oguienko, Valentina	*	01	Park, Mi-Hee	*
03	Volkova, Elena	*	02	Kim, Kyung-Hee	*
04	Koumych, Marina	*	03	Kim, Kui-Soon	*
05	Smirnova, Irina	*	04	Lim, Hye-Sook	*
06	Sidorenko, Tatiana	*	05	Yoo, Young-Mi	*
07	Parkhomtchouk, Irina	*	06	Nam, Soon-Ok	*
08	Krainova, Tatiana	*	07	Yoon, Chung-Hye	*
09	Chkournova, Olga	*	08	Park, Bok-Rye	*
10	Nikoulina, Marina	*	09	Kim, Yoon-Hye	*
11	Ovtchinnikova, Elena	*	10	Sun, Mi-Sook	*
12	Krivocheeva, Olga	*	11	Moon, Sun-Hee	*
13	Korytova, Svetlana	*	12	Ji, Kyung-Hee	*
Coach	Karpol, Nikolai		Coach	Hwang, Sung-On	
Referee-1/Arbitre-1	BRA	Kuroki, George Hideyuki			
Referee-2/Arbitre-2	BUL	Stoyanov, Stoyan			

Women Preliminary Group B Match 2/Sept. 20			Femmes Preliminaires Groupe B Match 2/20 Sept		
No.	Name	P	No.	Name	P
PER 3-0 BRA (15-11) (15-11) (15-3)					
01	Horny, Katherine	*	01	Santos, Kerly	*
02	Uribe, Cenaida	*	02	Moser, Ana Beatriz	*
03	Garcia, Rosa	*	03	Mossa, Vera	*
04	Gallardo, Miriam	*	05	Costa, Eliani	*
05	Perez Del Solar, Gabriela	*	06	Richa, Ana Maria	*
06	Heredia, Isabel	*	07	Trade, Maria	*
07	Tiit, Cecilia	*	08	Ramos, Ana Claudia	*
08	Cervera, Luisa	*	09	Cunha, Marcia	*
09	Fajardo, Demisse	*	11	Barros, Ana Lucia	*
10	De La Guerra, Alejandra	*	12	Suruagy, Sandra	*
11	Torrevalva, Gina	*	14	Venturini, Fernanda	*
12	Malaga, Natalia	*	15	Storm, Simone	*
Coach	Park, Man-Bok		Coach	Araujo, Jorge	
Referee-1/Arbitre-1	URS	Stepanian, Surev			
Referee-2/Arbitre-2	JPN	Sasaki, Hiroshi			

Volleyball

Women Preliminary Group B Match 3/Sept. 23					Femmes Preliminaires Groupe B Match 3/23 Sept								
No.	Name	P	No.	Name	P								
BRA 2-3 USA (16-14) (5-15) (13-15) (15-12) (7-15)													
01	Santos, Kerly		01	Mc Linden, Melissa	*								
02	Moser, Ana Beatriz	*	02	Rock, Angela	*								
04	Mossa, Vera	*	03	Masakayan, Elizabeth	*								
05	Costa, Eliani	*	04	Oden, Kimberly	*								
06	Richa, Ana Maria	*	06	Ruddins, Kimberly	*								
07	Trade, Maria	*	07	Kemner, Caren	*								
08	Ramos, Ana Claudia	*	08	Webb, Tammy	*								
09	Cunha, Marcia	*	09	Collins, Deitre	*								
11	Barros, Ana Lucia	*	10	Kessel, Laurel	*								
12	Suruagy, Sandra	*	12	Phipps, Prikeba	*								
14	Venturini, Fernanda	*	14	Sato, Liane	*								
15	Storm, Simone		15	Mc Hugh, Jayne									
Coach	Araujo, Jorge		Coach	Liskevych, Taras									
	Referee-1/Arbitre-1	KOR	Cho, Young-Ho										
	Referee-2/Arbitre-2	GDR	Richter, Frank										

Women Preliminary Group B Match 4/Sept. 23					Femmes Preliminaires Groupe B Match 4/23 Sept								
No.	Name	P	No.	Name	P								
CHN 2-3 PER (15-13) (13-15) (15-7) (12-15) (14-16)													
02	Li, Guojun		01	Horny, Katherine									
03	Zhao, Hong		02	Uribe, Ceniaida	*								
04	Hou, Yuzhu	*	03	Garcia, Rosa	*								
05	Wang, Yajun		04	Gallardo, Miriam									
06	Yang, Xilan	*	05	Perez Del Solar, Gabriela	*								
07	Su, Huijuan		06	Heredia, Isabel	*								
08	Jiang, Ying	*	07	Tiit, Cecilia	*								
09	Cui, Yongmei	*	08	Cervera, Luisa	*								
10	Yang, Xiaojun	*	09	Fajardo, Demisse	*								
11	Zheng, Meizhu	*	10	De La Guerra, Alejandra	*								
12	Wu, Dan	*	11	Torrealva, Gina	*								
15	Li, Yueming	*	12	Malaga, Natalia	*								
Coach	Li, Yaoxian		Coach	Park, Man-Bok									
	Referee-1/Arbitre-1	ITA	Paradiso, Erasmo										
	Referee-2/Arbitre-2	URS	Stepanian, Surev										

Women Preliminary Group B Match 5/Sept. 25					Femmes Preliminaires Groupe B Match 5/25 Sept								
No.	Name	P	No.	Name	P								
CHN 3-1 BRA (2-15) (15-7) (15-12) (15-11)													
02	Li, Guojun	*	01	Santos, Kerly									
03	Zhao, Hong		02	Moser, Ana Beatriz	*								
04	Hou, Yuzhu	*	04	Mossa, Vera	*								
05	Wang, Yajun		05	Costa, Eliani	*								
06	Yang, Xilan	*	06	Richa, Ana Maria	*								
07	Su, Huijuan		07	Trade, Maria									
08	Jiang, Ying	*	08	Ramos, Ana Claudia	*								
09	Cui, Yongmei	*	09	Cunha, Marcia	*								
10	Yang, Xiaojun	*	11	Barros, Ana Lucia	*								
11	Zheng, Meizhu	*	12	Suruagy, Sandra	*								
12	Wu, Dan	*	14	Venturini, Fernanda	*								
15	Li, Yueming	*	15	Storm, Simone	*								
Coach	Li, Yaoxian		Coach	Araujo, Jorge									
	Referee-1/Arbitre-1	MEX	Arredondo, Torres Genard										
	Referee-2/Arbitre-2	ITA	Paradiso, Erasmo										

Women Preliminary Group B Match 6/Sept. 25					Femmes Preliminaires Groupe B Match 6/25 Sept								
No.	Name	P	No.	Name	P								
PER 3-2 USA (12-15) (9-15) (15-4) (15-5) (15-9)													
01	Horny, Katherine		01	Mc Linden, Melissa	*								
02	Uribe, Ceniaida	*	02	Rock, Angela	*								
03	Garcia, Rosa	*	03	Masakayan, Elizabeth	*								
04	Gallardo, Miriam		04	Oden, Kimberly	*								
05	Perez Del Solar, Gabriela	*	06	Ruddins, Kimberly	*								
06	Heredia, Isabel		07	Kemner, Caren	*								
07	Tiit, Cecilia	*	08	Webb, Tammy	*								
08	Cervera, Luisa	*	09	Collins, Deitre	*								
09	Fajardo, Demisse	*	10	Kessel, Laurel	*								
10	De La Guerra, Alejandra	*	12	Phipps, Prikeba	*								
11	Torrealva, Gina	*	14	Sato, Liane	*								
12	Malaga, Natalia	*	15	Mc Hugh, Jayne									
Coach	Park, Man-Bok		Coach	Liskevych, Taras									
	Referee-1/Arbitre-1	BUL	Stoyanov, Stoyan										
	Referee-2/Arbitre-2	HOL	Scheffer, Peter										

Volleyball

Women Preliminary Sept. 20-25					Femmes Preliminaires 20-25 Sept							
	Rank	Ctry	Points	Matches	Won	Lost	Won	Sets	W/L	For	Points	FA
	Rang	Pays	Points	Played	Joue	Perdu	Gagne	Perdu	G/P	Pour	Contre	P/C
Group A	1	URS	5	03	02	01	08	03	2.66	154	114	1.35
	2	JPN	5	03	02	01	08	06	1.33	173	159	1.08
	3	KOR	4	03	01	02	04	07	0.57	116	137	0.84
	4	GDR	4	03	01	02	04	08	0.50	127	160	0.79
< Round Progress/Deroulement de la Ronde >												
	GDR	JPN	URS	KOR								
	*	3-2	0-3	1-3								
	JPN	2-3	*	3-2	3-1							
	URS	3-0	2-3	*	3-0							
	KOR	3-1	1-3	0-3	*							
Group B	1	PER	6	03	03	00	09	04	2.25	177	142	1.24
	2	CHN	5	03	02	01	08	04	2.00	161	132	1.21
	3	USA	4	03	01	02	05	08	0.62	140	167	0.83
	4	BRA	3	03	00	03	03	09	0.33	126	163	0.77

< Round Progress/Deroulement de la Ronde >

	CHN	PER	BRA	USA
CHN	*	2-3	3-1	3-0
PER	3-2	*	3-0	3-2
BRA	1-3	0-3	*	2-3
USA	0-3	2-3	3-2	*

Women Semi-final Match 1 Sept. 27					Femmes Demi-finale Match 1 27 Sept								
No.	Name	P	No.	Name	P								
URS 3-0 CHN (15-0) (15-9) (15-2)													
01	Oguienko, Valentina	*	02	Li, Guojun									
03	Volkova, Elena		03	Zhao, Hong									
04	Koumych, Marina		04	Hou, Yuzhu	*								
05	Smirnova, Irina	*	05	Wang, Yajun									
06	Sidorenko, Tatiana	*	06	Yang, Xilan	*								
07	Parkhomtchouk, Irina	*	07	Su, Huijuan	*								
08	Krainova, Tatiana		08	Jiang, Ying	*								
09	Chkournova, Olga		09	Cui, Yongmei	*								
10	Nikoulina, Marina	*	10	Yang, Xiaojun	*								
11	Ovtchinnikova, Elena	*	11	Zheng, Meizhu	*								
12	Krivocheeva, Olga		12	Wu, Dan	*								
13	Korytova, Svetlana		15	Li, Yueming									
Coach	Karpol, Nikolai		Coach	Li, Yaoxian									
	Referee-1/Arbitre-1	MEX	Arredondo, Torres Genard										
	Referee-2/Arbitre-2	BRA	Desouza, Learte										

Women Semi-final Match 2 Sept. 27					Femmes Demi-finale Match 2 27 Sept								
No.	Name	P	No.	Name	P								
JPN 2-3 PER (9-15) (6-15) (15-6) (15-10) (13-15)													
01	Maruyama, Yumi	*	01	Horny, Katherine									
02	Sugiyama, Kayoko	*	02	Uribe, Ceniaida	*								
03	Takizawa, Reiko	*	03	Garcia, Rosa	*								
04	Yamashita, Miyako		04	Gallardo, Miriam									
05	Sugiyama, Akemi		05	Perez Del Solar, Gabriela	*								
06	Sato, Ichiko	*	06	Heredia, Isabel									
07	Hiro, Norie	*	07	Tiit, Cecilia	*								
08	Nakada, Kumi	*	08	Cervera, Luisa	*								
09	Kawase, Yukari		09	Fajardo, Demisse	*								
10	Obayashi, Motoko	*	10	De La Guerra, Alejandra	*								
11	Takahashi, Yukiko	*	11	Torrealva, Gina	*								
12	Fujita, Sachiko	*	12	Malaga, Natalia	*								
Coach	Muneuchi, Noriyuki		Coach	Park, Man-Bok									
	Referee-1/Arbitre-1	TCH	Kovalik, Vladimir										
	Referee-2/Arbitre-2	USA	Stewart, Jim										

**Women Semi-final Match 3
Sept. 27**

No.	Name	P	No.	Name	P
KOR 2-3 BRA (6-15) (17-15) (15-8) (4-15) (15-17)					
01	Park, Mi-Hee	*	01	Santos, Kerly	*
02	Kim, Kyung-Hee	*	02	Moser, Ana Beatriz	*
03	Kim, Kui-Soon	*	04	Mossa, Vera	*
04	Lim, Hye-Sook	*	05	Costa, Eliani	*
05	Yoo, Young-Mi	*	06	Richa, Ana Maria	*
06	Nam, Soon-Ok	*	07	Trade, Maria	*
07	Yoon, Chung-Hye	*	08	Ramos, Ana Claudia	*
08	Park, Bok-Rye	*	09	Cunha, Marcia	*
09	Kim, Yoon-Hye	*	11	Barros, Ana Lucia	*
10	Sun, Mi-Sook	*	12	Suruagy, Sandra	*
11	Moon, Sun-Hee	*	14	Venturini, Fernanda	*
12	Ji, Kyung-Hee	*	15	Storm, Simone	*
Coach	Hwang, Sung-On		Coach	Araujo, Jorge	
Referee-1/Arbitre-1	ITA	Paradiso, Erasmo			
Referee-2/Arbitre-2	EGY	Hassan, Ahmed			

**Women Final Match 3
Sept. 29**

No.	Name	P	No.	Name	P
BRA 1-3 GDR (9-15) (4-15) (15-11) (11-15)					
01	Santos, Kerly	*	01	Schmidt, Steffi	
02	Moser, Ana Beatriz	*	02	Lahme, Susanne	
04	Mossa, Vera	*	03	Beu, Monika	*
05	Costa, Eliani	*	04	Radfan, Ariane	*
06	Richa, Ana Maria	*	05	Langschwager, Kathrin	*
07	Trade, Maria	*	06	Artl, Maik	*
08	Ramos, Ana Claudia	*	07	Wiedemann, Brit	*
09	Cunha, Marcia	*	08	Steppin, Ute	*
11	Barros, Ana Lucia	*	09	Jensen, Grit	*
12	Suruagy, Sandra	*	10	Stuedemann, Doerte	*
14	Venturini, Fernanda	*	11	Jensen, Heike	*
15	Storm, Simone	*	12	Langenau, Ute	*
Coach	Araujo, Jorge		Coach	Koehler, Siegfried	
Referee-1/Arbitre-1	KOR	Cho, Young-Ho			
Referee-2/Arbitre-2	USA	Clark, Bob			

**Women Semi-final Match 4
Sept. 27**

No.	Name	P	No.	Name	P
GDR 3-1 USA (15-13) (15-11) (10-15) (15-8)					
01	Schmidt, Steffi		01	Mc Linden, Melissa	*
02	Lahme, Susanne	*	02	Rock, Angela	*
03	Beu, Monika	*	03	Masakayan, Elizabeth	*
04	Radfan, Ariane	*	04	Oden, Kimberly	*
05	Langschwager, Kathrin	*	06	Ruddins, Kimberly	*
06	Artl, Maik	*	07	Kemner, Caren	*
07	Wiedemann, Brit	*	08	Webb, Tammy	*
08	Steppin, Ute	*	09	Collins, Deitre	*
09	Jensen, Grit	*	10	Kessel, Laurel	*
10	Stuedemann, Doerte	*	12	Phipps, Prikeba	*
11	Jensen, Heike	*	14	Sato, Liane	*
12	Langenau, Ute	*	15	Mc Hugh, Jayne	*
Coach	Koehler, Siegfried		Coach	Liskevych, Taras	
Referee-1/Arbitre-1	ARG	Paredes, G. Enrique			
Referee-2/Arbitre-2	JPN	Sasaki, Hiroshi			

**Women Final Match 4
Sept. 29**

No.	Name	P	No.	Name	P
KOR 2-3 USA (4-15) (15-12) (15-13) (9-15) (8-15)					
01	Park, Mi-Hee	*	01	Mc Linden, Melissa	*
02	Kim, Kyung-Hee	*	02	Rock, Angela	*
03	Kim, Kui-Soon	*	03	Masakayan, Elizabeth	*
04	Lim, Hye-Sook	*	04	Oden, Kimberly	*
05	Yoo, Young-Mi	*	06	Ruddins, Kimberly	*
06	Nam, Soon-Ok	*	07	Kemner, Caren	*
07	Yoon, Chung-Hye	*	08	Webb, Tammy	*
08	Park, Bok-Rye	*	09	Collins, Deitre	*
09	Kim, Yoon-Hye	*	10	Kessel, Laurel	*
10	Sun, Mi-Sook	*	12	Phipps, Prikeba	*
11	Moon, Sun-Hee	*	14	Sato, Liane	*
12	Ji, Kyung-Hee	*	15	Mc Hugh, Jayne	*
Coach	Hwang, Sung-On		Coach	Liskevych, Taras	
Referee-1/Arbitre-1	FRA	Marty, Jean-Francois			
Referee-2/Arbitre-2	BRA	Kuroki, George Hideyuki			

**Women Final Match 1
Sept. 29**

No.	Name	P	No.	Name	P
URS 3-2 PER (10-15) (12-15) (15-13) (15-7) (17-15)					
01	Oguienko, Valentina	*	01	Homy, Katherine	*
03	Volkova, Elena	*	02	Uribe, Cenaída	*
04	Koumych, Marina	*	03	Garcia, Rosa	*
05	Smimova, Irina	*	04	Gallardo, Miriam	*
06	Sidorenko, Tatiana	*	05	Perez Del Solar, Gabriela	*
07	Parkhomtchouk, Irina	*	06	Heredia, Isabel	*
08	Krainova, Tatiana	*	07	Tiit, Cecilia	*
09	Chkournova, Olga	*	08	Cervera, Luisa	*
10	Nikoulina, Marina	*	09	Fajardo, Demisse	*
11	Ovtchinnikova, Elena	*	10	De La Guerra, Alejandra	*
12	Krivocheeva, Olga	*	11	Torrevalva, Gina	*
13	Korytova, Svetlana	*	12	Malaga, Natalia	*
Coach	Karpol, Nikolai		Coach	Park, Man-Bok	
Referee-1/Arbitre-1	EGY	Hassan, Ahmed			
Referee-2/Arbitre-2	JPN	Sasaki, Hiroshi			

**Women Final
Sept. 20-29**

Semi-finals/Demi-finales				
Places	Match No.	Ctry/Pays	Time/Temps	Results/Resultats
1-4	8001	A1-URS:B2-CHN	09/27 20:30	3-0 15-0, 15-9, 15-2
1-4	8002	A2-JPN:B1-PER	09/27 09:45	2-3 9-15, 6-15, 15-6, 15-10, 13-15
5-8	8003	A3-KOR:B4-BRA	09/27 12:00	2-3 6-15, 17-15, 15-8, 4-15, 15-17
5-8	8004	A4-GDR:B3-USA	09/27 18:00	3-1 15-13, 15-11, 10-15, 15-8
Finals/Finales				
1-2	9001	URS: PER	09/29 20:30	3-2 10-15, 12-15, 15-13, 15-7, 17-15
3-4	9002	CHN: JPN	09/29 18:00	3-0 15-13, 15-6, 15-6
5-6	9003	BRA: GDR	09/29 12:00	1-3 9-15, 4-15, 15-11, 11-15
7-8	9004	KOR: USA	09/29 09:45	2-3 4-15, 15-12, 15-13, 9-15, 8-15
Final Standing/Clasement Final				
1	URS	U.S.S.R.		
2	PER	Peru		
3	CHN	People's Republic of China		
4	JPN	Japan		
5	GDR	German Democratic Republic		
6	BRA	Brazil		
7	USA	United States of America		
8	KOR	Korea		

**Women Final Match 2
Sept. 29**

No.	Name	P	No.	Name	P
CHN 3-0 JPN (15-13) (15-6) (15-6)					
02	Li, Guojun		01	Maruyama, Yumi	*
03	Zhao, Hong		02	Sugiyama, Kayoko	*
04	Hou, Yuzhu	*	03	Takizawa, Reiko	*
05	Wang, Yajun	*	04	Yamashita, Miyako	*
06	Yang, Xilan	*	05	Sugiyama, Akemi	*
07	Su, Huijuan	*	06	Sato, Ichiko	*
08	Jiyang, Ying	*	07	Hiro, Norie	*
09	Cui, Yongmei	*	08	Nakada, Kumi	*
10	Yang, Xiaojun	*	09	Kawase, Yukari	*
11	Zheng, Meizhu	*	10	Obayashi, Motoko	*
12	Wu, Dan	*	11	Takahashi, Yukiko	*
15	Li, Yueming	*	12	Fujita, Sachico	*
Coach	Li, Yaoxian		Coach	Muneuchi, Noriyuki	
Referee-1/Arbitre-1	URS	Samedov, Ramis			
Referee-2/Arbitre-2	ARG	Paredes, G. Enrique			

Volleyball

Volley-ball

Women Sept. 20-29				Femmes 20-29 Sept					
Skill	Rang	Ctry	Rate %	Tot Atts	Ace (4)%	Exce (3)%	Good (2)%	Poor (1)%	Fault (0)%
Serve	01	JPN	43.5	685	5	13	36	41	4
	01	URS	43.5	618	6	14	36	38	6
	02	GDR	42.2	619	5	11	38	42	5
	03	PER	41.7	781	4	11	37	43	5
	04	USA	41.6	658	4	12	39	35	10
	05	KOR	41.2	634	3	11	38	45	3
	06	BRA	40.8	640	4	9	41	38	8
	07	CHN	39.5	573	4	10	34	44	9
1-3	Average	43.1		4	12	36	38	5	
1-6	Average	41.9		4	11	36	39	6	
Block	01	PER	38.3	1057	8	5	31	42	13
	02	GDR	37.8	877	10	8	24	39	19
	03	URS	36.7	742	11	6	24	38	21
	04	CHN	36.6	802	7	5	29	42	16
	05	USA	36.5	954	8	6	28	40	18
	06	BRA	35.9	866	6	6	29	44	15
	07	KOR	35.1	929	7	6	24	47	17
	08	JPN	34.7	962	8	3	26	45	18
1-3	Average	37.4		9	6	26	39	17	
1-6	Average	37.2		8	6	28	40	16	
Attack	01	URS	70.2	785	49	11	24	5	11
	02	CHN	67.5	874	41	12	33	6	9
	03	PER	65.1	1187	38	13	31	6	12
	04	JPN	65.0	1050	40	8	36	5	11
	05	GDR	64.6	913	39	11	32	5	13
	06	USA	64.3	1063	39	11	31	6	13
	07	KOR	63.0	1049	36	10	34	7	12
	08	BRA	62.9	1044	38	10	31	8	13
1-3	Average	67.3		42	12	29	5	10	
1-6	Average	65.4		40	11	32	5	11	

Women Sept. 20-29				Femmes 20-29 Sept					
Skill	Rank	Ctry	Rate %	Tot Atts	Feat (4)%	Exce (3)%	Good (2)%	Poor (1)%	Fault (0)%
Pass	01	JPN	61.3	665	4	59	22	8	6
	02	KOR	61.0	643	5	52	30	7	6
	03	USA	60.9	646	3	54	30	8	4
	04	PER	60.8	681	1	57	29	8	4
	05	BRA	60.5	630	1	56	30	9	4
	06	CHN	59.7	531	3	53	30	9	5
	07	URS	57.0	518	3	51	26	13	8
	08	GDR	56.6	579	3	42	38	10	7
1-3	Average	61.0		4	55	27	7	5	
1-6	Average	60.6		2	55	28	8	5	
Dig	01	USA	43.2	808	5	35	19	7	33
	02	CHN	42.8	751	6	37	16	5	36
	03	PER	40.9	1026	6	33	18	4	39
	03	GDR	40.9	692	4	36	18	4	38
	04	BRA	40.5	910	4	33	21	6	36
	05	URS	39.4	545	5	32	19	5	39
05	JPN	39.4	826	8	29	17	6	40	
06	KOR	39.1	875	6	29	20	7	39	
1-3	Average	42.5		5	34	17	5	36	
1-6	Average	41.4		5	33	18	5	36	
Set	01	CHN	69.4	819	11	59	28	1	1
	02	URS	68.1	765	9	59	29	2	1
	03	JPN	67.0	1027	10	53	34	2	1
	04	PER	66.3	1070	6	57	36	2	0
	05	KOR	66.1	996	7	55	35	2	1
	06	USA	64.9	1028	6	51	41	2	1
	07	BRA	64.4	964	3	56	37	2	1
	08	GDR	64.2	879	6	51	40	3	1
1-3	Average	68.1		9	58	30	1	1	
1-6	Average	66.9		7	56	34	1	0	

Women Sept. 20-29				Femmes 20-29 Sept							
Skill	Rank	No.	Name	Ctry	Rate %	Tot Atts	Ace (4)%	Exce (3)%	Good (2)%	Poor (1)%	Fault (0)%
Serve	1	09	Jensen, Grit	GDR	48.9	131	8	15	45	31	2
	2	12	Fujita, Sachiko	JPN	48.8	81	2	23	43	28	2
	3	02	Sugiyama, Kayoko	JPN	47.8	102	13	18	25	38	7
	4	06	Sidorenko, T	URS	47.7	88	10	15	36	33	6
	5	05	Yoo, Young-Mi	KOR	46.6	103	5	17	46	26	7
	6	11	Ovtchinnikova, E	URS	45.6	86	7	26	27	24	16
	7	01	Maruyama, Yumi	JPN	44.7	113	3	16	45	30	6
	8	03	Masakayan, E	USA	44.6	84	6	23	30	27	14
	9	01	Oguienko, V	URS	44.5	127	6	12	39	39	4
	10	09	Collins, Deitre	USA	44.1	93	5	16	38	31	10
1-10	Average				46.3						
Block	1	02	Lahme, Susanne	GDR	42.1	129	16	9	23	31	21
	2	05	Perez Del Solar	PER	40.5	522	10	6	31	41	12
	3	02	Uribe, Ceneda	PER	40.4	153	8	5	37	39	10
	4	12	Malaga, Natalia	PER	39.7	134	8	9	30	40	13
	5	03	Beu, Monika	GDR	39.7	121	13	14	15	34	24
	6	10	Yang, Xiaojun	CHN	39.0	341	7	6	33	41	12
	7	12	Wu, Dan	CHN	39.0	221	9	6	34	34	17
	8	06	Richa, Ana Maria	BRA	39.0	210	7	9	30	43	12
	9	10	Nikoulina, M	URS	39.0	182	8	9	31	34	18
	10	06	Nam, Soon-Ok	KOR	38.9	104	12	5	27	41	15
1-10	Average				39.7						
Attack	1	04	Oden, Kimberly	USA	73.3	174	50	11	29	3	7
	2	11	Ovtchinnikova, E	URS	72.8	89	51	12	25	2	10
	3	12	Wu, Dan	CHN	72.7	141	50	12	26	5	8
	4	05	Smirnova, Irina	URS	71.3	286	50	12	23	6	10
	5	09	Jensen, Grit	GDR	70.8	198	46	10	32	4	8
	6	07	Hiro, Norie	JPN	70.6	237	47	8	33	4	8
	7	01	Oguienko, V	URS	70.1	132	52	6	23	6	12
	8	12	Langenau, Ute	GDR	69.8	92	47	7	33	8	7
	9	08	Jiang, Ying	CHN	68.5	207	41	13	35	3	8
	10	04	Hou, Yuzhu	CHN	68.1	215	43	10	33	5	9
1-10	Average				70.8						

Women Sept. 20-29				Femmes 20-29 Sept							
Skill	Rank	No.	Name	Ctry	Rate %	Tot Atts	Feat (4)%	Exce (3)%	Good (2)%	Poor (1)%	Fault (0)%
Pass	1	01	Park, Mi-Hee	KOR	67.4	109	10	62	17	7	3
	2	09	Fajardo, Demisse	PER	67.0	125	2	73	19	5	2
	3	06	Arlt, Maike	GDR	65.4	83	5	60	30	1	4
	4	01	Maruyama, Yumi	JPN	65.0	105	3	63	30	1	4
	5	07	Kemner, Caren	USA	62.8	193	4	58	28	6	4
	6	05	Perez Del Solar	PER	62.8	149	1	60	32	5	3
	7	10	Yang, Xiaojun	CHN	62.0	133	5	55	27	8	5
	8	01	Oguienko, V	URS	62.0	127	9	50	27	9	6
	9	12	Ji, Kyung-Hee	KOR	61.8	150	3	57	29	5	5
	10	07	Hiro, Norie	JPN	61.8	108	5	61	19	8	7
1-10	Average				63.8						
Dig	1	06	Arlt, Maike	GDR	50.7	102	5	50	15	4	26
	2	12	Wu, Dan	CHN	48.6	110	7	45	15	3	31
	3	03	Garcia, Rosa	PER	48.5	132	9	34	25	5	27
	4	03	Masakayan, E	USA	47.1	119	6	39	21	7	28
	5	01	Park, Mi-Hee	KOR	47.0	134	4	43	19	4	29
	6	14	Venturini, F	BRA	46.2	170	5	37	23	6	28
	7	04	Radfan, Ariane	GDR	46.0	112	9	38	16	4	34
	8	06	Yang, Xilan	CHN	45.4	108	9	31	22	6	31
	9	02	Rock, Angela	USA	45.4	81	6	37	19	9	30
	10	02	Sugiyama, Kayoko	JPN	45.2	114	13	33	11	5	37
1-10	Average				47.0						
Set	1	06	Yang, Xilan	CHN	71.1	635	13	61	24	1	1
	2	07	Parkhomtchouk, I	URS	69.3	619	10	60	27	2	1
	3	08	Nakada, Kumi	JPN	68.7	819	12	55	31	1	1
	4	03	Garcia, Rosa	PER	68.1	839	7	61	31	1	0
	5	02	Kim, Kyung-Hee	KOR	68.1	260	10	54	33	2	0
	6	04	Lim, Hye-Sook	KOR	67.8	509	8	59	31	2	1
	7	10	Kessel, Laurel	USA	66.1	832	7	53	38	1	1
	8	10	Stuedemann, D	GDR	66.0	673	7	54	36	2	1
	9	15	Storm, Simone	BRA	65.6	177	3	58	36	3	0
	10	06	Richa, Ana Maria	BRA	65.4	668	4	57	35	2	1
1-10	Average				67.6						



역도

Weightlifting/Haltérophilie



Weightlifting/Haltérophilie

Officials/Officiels

International Weightlifting Federation (IWF)

President/président	Gottfried Schod
Secretary General/secrétaire général	Tamas Ajan
Technical Delegates/délégués techniques	Tamas Ajan Lazar Baroga

SLOOC Administrative Staff/Personnel Administratif du SLOOC

Commissioner/directeur	Jin Oh Hyun
Secretary General/secrétaire général	Lee Jong Sup
Deputy Secretary General/secrétaire général adjoint	Kim Sang Hwan
Competition Manager/chef de division des compétitions	Hur Rok

Competitors/Concurrents

Men Hommes	Competitors Competiteurs	Countries Pays
Up to/Jusqu'a (52 kg)	26	18
Up to/Jusqu'a (56 kg)	25	17
Up to/Jusqu'a (60 kg)	19	14
Up to/Jusqu'a (67.5 kg)	30	25
Up to/Jusqu'a (75 kg)	26	20
Up to/Jusqu'a (82.5 kg)	23	20
Up to/Jusqu'a (90 kg)	31	23
Up to/Jusqu'a (100 kg)	23	17
Up to/Jusqu'a (110 kg)	22	15
Over/Plus de (110 kg)	20	13

Legend/Notation

X	Missed/A Manque
NWR	New World Record/Nouveau Record Mondial
NOR	New Olympic Record/Nouveau Record Olympique
EOR	Equal Olympic Record/Egale Record Olympique
EL	Eliminated/Éliminé
DP	Doping Failed
IJ	Injured/Blesse

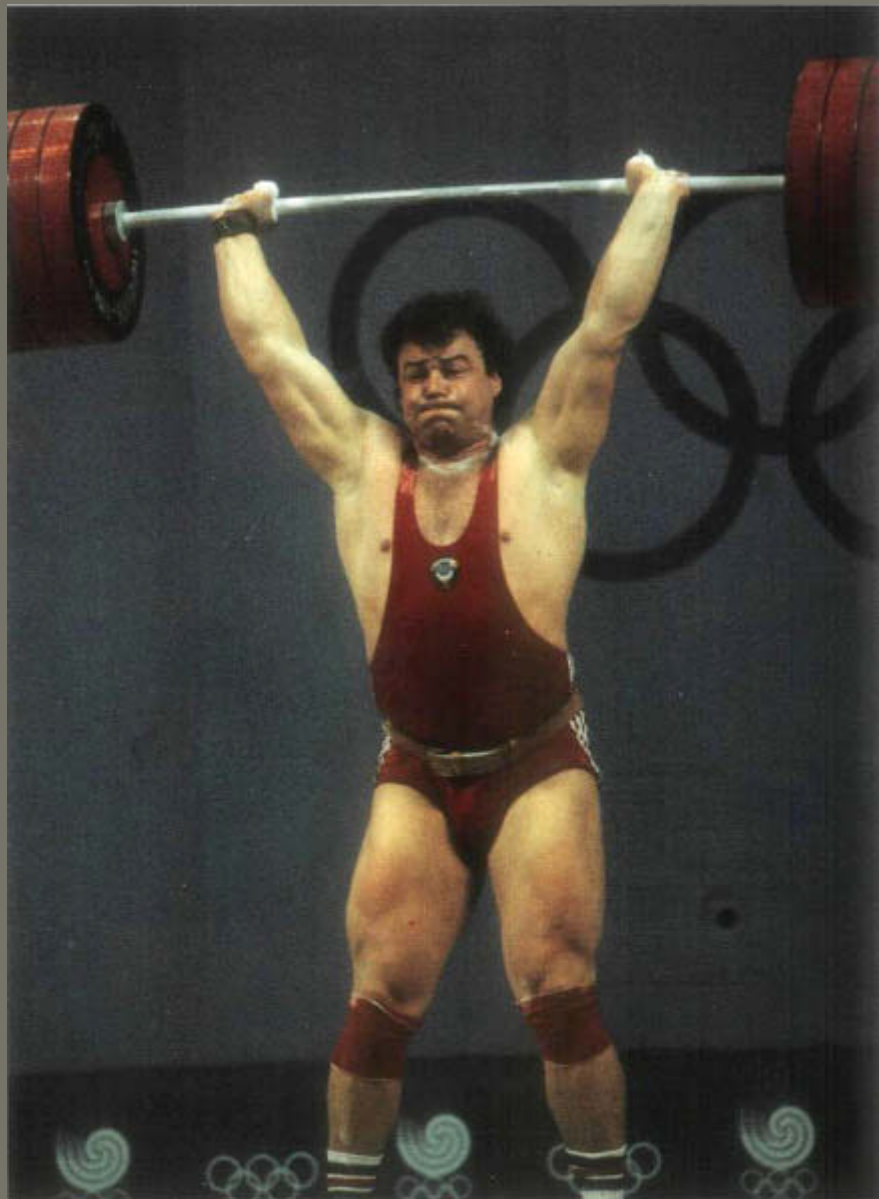
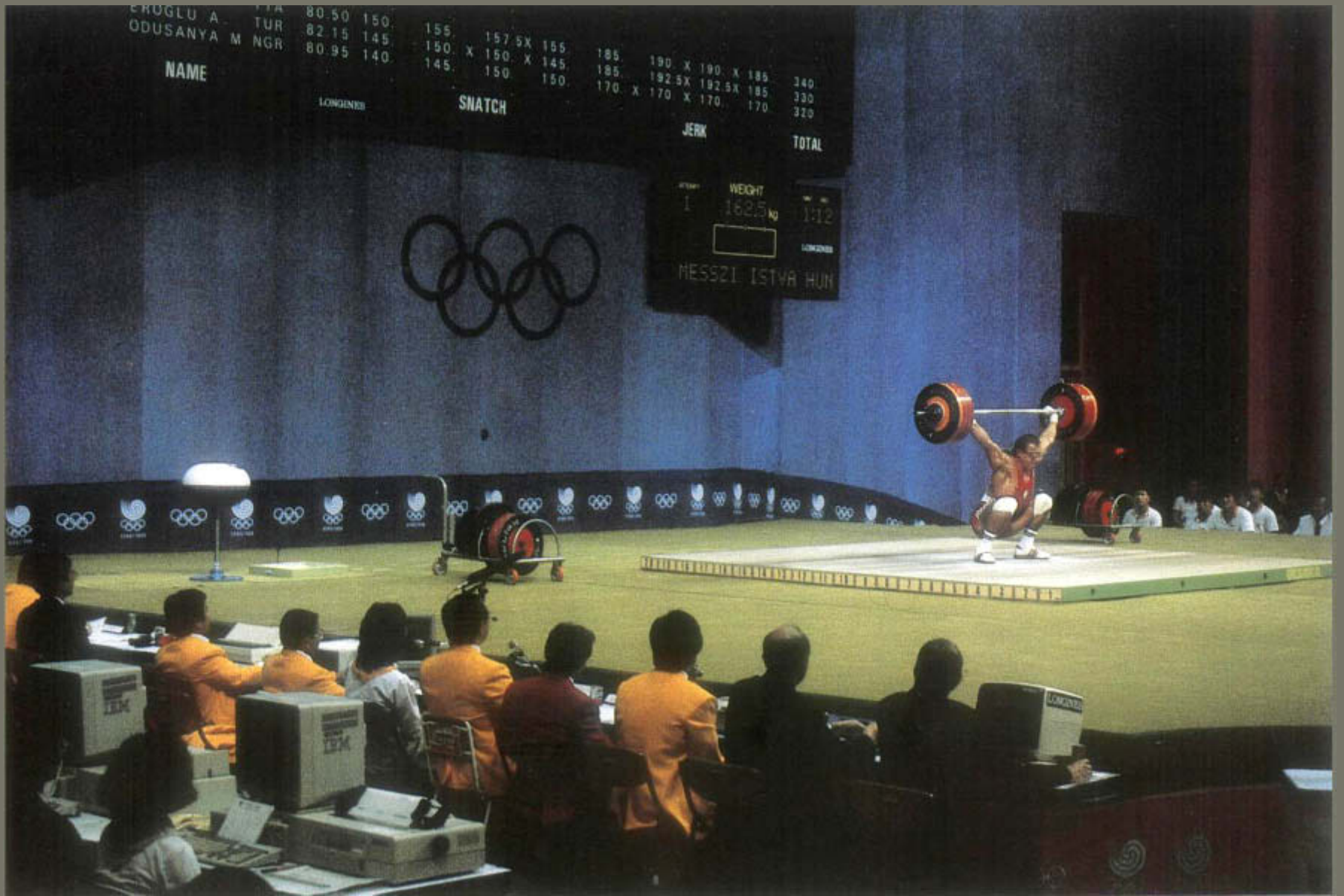

Weightlifting

Haltérophilie

Up to 52 kg (Snatch) Group A+B+C/Sept. 18				Jusqu'a 52 kg (Arrache) Groupe A+B+C/18 Sept				
Rank	Name	Ctry	Weight	GR	1st	2nd	3rd	Result
Rang	Nom	Pays	Poids		1er	2eme	3eme	Resultat
1	Marinov, Sevdalin	BUL	51.85	A	112.5 NOR	117.5 NOR	120.0 NWR	120.0
2	Zhang, Shoulie	CHN	51.50	A	110.0 EOR	115.0 NOR	117.5 X	115.0
3	Gutowski, Jacek	POL	51.45	A	112.5 NOR	117.5 X	117.5 X	112.5
4	He, Zhuoqiang	CHN	51.45	A	112.5 X	112.5 NOR	117.5 X	112.5
5	Chun, Byung-Kwan	KOR	51.65	A	107.5	112.5 NOR	115.0 X	112.5
6	Ciharean, Traian ioach	ROM	51.65	A	110.0 EOR	115.0 X	115.0 X	110.0
7	Olah, Bela	HUN	51.65	A	102.5	107.5	110.0X	107.5
8	Manabe, Kazushito	JPN	51.60	A	105.0	110.0 X	110.0 X	105.0
9	Muthuswamy, Gurunathan	IND	51.95	B	95.0	100.0	102.5	102.5
10	Namiki, Yoshinori	JPN	51.70	B	95.0	100.0	102.5 X	100.0
11	Martinez, Jose Luis	ESP	51.75	B	95.0	100.0 X	100.0	100.0
12	Fuentes, Humberto	VEN	51.75	A	100.0 X	100.0 X	100.0	100.0
13	Hwang, In-Dong	KOR	51.80	A	95.0 X	95.0	100.0	100.0
14	Aly, Ramadan	EGY	51.95	B	95.0	100.0 X	100.0	100.0
15	Chung, Yung-Chi	TPE	51.90	B	97.5 X	97.5 X	97.5	97.5
16	Ibanez, Jose Andres	ESP	51.70	B	95.0 X	95.0	100.0 X	95.0
17	Sodikin, Sodikin	INA	51.85	B	95.0 X	95.0	100.0 X	95.0
18	Hayman, Gregory	AUS	51.55	B	87.5	92.5 X	92.5	92.5
19	Erdogan, Levent	TUR	51.85	B	92.5	97.5 X	97.5 X	92.5
20	Chanderasekaran, Raghavan	IND	51.90	B	92.5	97.5 X	97.5 X	92.5
21	Chiang, Ming-Hsiung	TPE	51.90	B	92.5 X	92.5	95.0 X	92.5
22	Colonia, Gregorio	PHI	52.00	B	90.0	95.0 X	95.0 X	90.0
23	Olaywan, Khodr	LIB	51.70	B	80.0	85.0	87.5 X	85.0
24	Sawad, Bharat	NEP	51.30	B	75.0	82.5 X	82.5 X	75.0

Up to 56 kg (Snatch) Group A+B+C/Sept. 19				Jusqu'a 56 kg (Arrache) Groupe A+B+C/19 Sept				
Rank	Name	Ctry	Weight	GR	1st	2nd	3rd	Result
Rang	Nom	Pays	Poids		1er	2eme	3eme	Resultat
1	Liu, Shoubin	CHN	55.35	A	127.5 X	127.5 X	127.5 NOR	127.5
2	Mirzoian, Oxen	URS	55.75	A	122.5	127.5 NOR	130.0 X	127.5
3	He, Yingqiang	CHN	55.65	A	125.0 EOR	130.0 X	130.0 X	125.0
4	Wihardja, Dirdja	INA	55.80	A	107.5	112.5 X	112.5	112.5
5	Valle, Joaquin	ESP	55.90	B	107.5	112.5	115.0 X	112.5
6	Zurera, Jose	ESP	55.15	B	105.0	110.0	112.5 X	110.0
7	Scarantino, Giovanni	ITA	55.40	A	110.0	115.0 X	115.0 X	110.0
8	Kim, Kwi-Shik	KOR	55.80	A	110.0	115.0 X	115.0 X	110.0
9	Ichiba, Takashi	JPN	55.75	B	107.5	112.5 X	112.5 X	107.5
10	Basbas, Azzedine	ALG	55.95	B	102.5 X	102.5	107.5	107.5
11	Alegada, Samuel	PHI	56.00	B	107.5 X	107.5	112.5 X	107.5
12	Ojalehto, Arvo	FIN	55.40	A	105.0 X	105.0	110.0 X	105.0
13	Hara, Toru	JPN	55.55	A	105.0	110.0X	110.0 X	105.0
14	Fombertasse, Laurent	FRA	55.70	B	100.0 X	100.0	105.0	105.0
15	Arnou, Pascal	FRA	55.80	B	100.0	105.0	107.5 X	105.0
16	Liao, Hsing-Chou	TPE	55.80	B	105.0 X	105.0 X	105.0	105.0
17	Penagos, Oscar	COL	55.85	B	100.0	105.0	110.0 X	105.0
18	Haryono, Yon	INA	55.85	B	100.0 X	100.0 X	100.0	100.0
19	Diaz, Jose	PAN	55.70	B	95.0	100.0 X	100.0 X	95.0
20	Mata, Edwin	ECU	55.95	B	92.5	97.5 X	97.5 X	92.5
	Rivera Gomez, Cristian	DOM	55.40	B	105.0 X	105.0 X	107.5 X	0.0
	Tsai, Wen-Yee	TPE	55.95	A	122.5 X	122.5 X	122.5 X	0.0
	Grablev, Mitko	BUL	55.85	A	122.5	127.5	130.0	DP

Up to 52 kg (CLN&JRK) Group A+B+C/Sept. 18				Jusqu'a 52 kg (EP&Jete) Groupe A+B+C/18 Sept				
Rank	Name	Ctry	Weight	GR	1st	2nd	3rd	Result
Rang	Nom	Pays	Poids		1er	2eme	3eme	Resultat
1	Marinov, Sevdalin	BUL	51.85	A	142.5 NOR	147.5 NOR	150.0 NOR	150.0
2	Chun, Byung-Kwan	KOR	51.65	A	140.0 NOR	147.5 NOR	157.5 X	147.5
3	He, Zhuoqiang	CHN	51.45	A	145.0 X	145.0 X	145.0 NOR	145.0
4	Zhang, Shoulie	CHN	51.50	A	137.5 EOR	142.5 NOR	145.0 X	142.5
5	Gutowski, Jacek	POL	51.45	A	135.0 X	135.0 X	135.0	135.0
6	Olah, Bela	HUN	51.65	A	130.0	135.0 X	135.0 X	130.0
7	Ciharean, Train loach	ROM	51.65	A	130.0 X	130.0	140.0 X	130.0
8	Hwang, In-Dong	KOR	51.80	A	130.0 X	130.0	135.0 X	130.0
9	Chiang, Ming-Hsiung	TPE	51.90	B	122.5	130.0	140.0 X	130.0
10	Ibanez, Jose Andres	ESP	51.70	B	120.0	125.0	127.5	127.5
11	Fuentes, Humberto	VEN	51.75	A	127.5 X	127.5	132.5 X	127.5
12	Manabe, Kazushito	JPN	51.60	A	120.0	125.0	130.0 X	125.0
13	Martinez, Jose Luis	ESP	51.75	B	120.0	125.0	127.5 X	125.0
14	Erdogan, Levent	TUR	51.85	B	117.5	122.5	125.0	125.0
15	Muthuswamy, Gurunathan	IND	51.95	B	120.0	125.0	127.5 X	125.0
16	Sodikin, Sodikin	INA	51.85	B	122.5	127.5 X	127.5 X	122.5
17	Hayman, Gregory	AUS	51.55	B	115.0	120.0 X	120.0 X	115.0
18	Namiki, Yoshinori	JPN	51.70	B	115.0	120.0 X	122.5 X	115.0
19	Chanderasekaran, Raghavan	IND	51.90	B	115.0 X	115.0	120.0 X	115.0
20	Colonia, Gregorio	PHI	52.00	B	115.0	120.0 X	120.0 X	115.0
21	Sawad, Bharat	NEP	51.30	B	95.0	105.0	107.5 X	105.0
22	Olaywan, Khodr	LIB	51.70	B	100.0	105.0 X	105.0 X	100.0
	Aly, Ramadan	EGY	51.95	B	117.5 X	117.5 X	120.0 X	0.0
	Chung, Yung-Chi	TPE	51.90	B	EL	EL	EL	EL

Up to 56 kg (CLN&JRK) Group A+B+C/Sept. 19				Jusqu'a 56 kg (EP&Jete) Groupe A+B+C/19 Sept				
Rank	Name	Ctry	Weight	GR	1st	2nd	3rd	Result
Rang	Nom	Pays	Poids		1er	2eme	3eme	Resultat
1	Mirzoian, Oxen	URS	55.75	A	160.0 NOR	165.0 NOR	172.5 X	165.0
2	He, Yingqiang	CHN	55.65	A	150.0	162.5 NOR	167.5 X	162.5
3	Ichiba, Takashi	JPN	55.75	B	137.5	142.5	145.0	145.0
4	Kim, Kwi-Shik	KOR	55.80	A	142.5	147.5 X	147.5 X	142.5
5	Wihardja, Dirdja	INA	55.80	A	137.5	142.5	147.5 X	142.5
6	Liu, Shoubin	CHN	55.35	A	140.0	150.0 X	150.0 X	140.0
7	Arnou, Pascal	FRA	55.80	B	135.0	140.0	142.5 X	140.0
8	Ojalehto, Arvo	FIN	55.40	A	137.5 X	137.5	142.5 X	137.5
9	Haryono, Yon	INA	55.85	B	132.5	137.5	140.0 X	137.5
10	Basbas, Azzedine	ALG	55.95	B	130.0	137.5	140.0 X	137.5
11	Scarantino, Giovanni	ITA	55.40	A	135.0	142.5 X	142.5 X	135.0
12	Hara, Toru	JPN	55.55	A	135.0	142.5 X	142.5 X	135.0
13	Liao, Hsing-Chou	TPE	55.80	B	135.0	142.5 X	142.5 X	135.0
14	Valle, Joaquin	ESP	55.90	B	135.0	140.0 X	140.0 X	135.0
15	Alegada, Samuel	PHI	56.00	B	135.0	140.0 X	140.0 X	135.0
16	Zurera, Jose	ESP	55.15	B	127.5	132.5 X	132.5	132.5
17	Fombertasse, Laurent	FRA	55.70	B	132.5	137.5 X	137.5 X	132.5
18	Penagos, Oscar	COL	55.85	B	127.5	132.5	135.0 X	132.5
19	Diaz, Jose	PAN	55.70	B	125.0	130.0 X	130.0 X	125.0
20	Mata, Edwin	ECU	55.95	B	125.0	130.0 X	130.0 X	125.0
	Rivera gomez, Cristian	DOM	55.40	B	EL	EL	EL	EL
	Tsai, Wen-Yee	TPE	55.95	A	EL	EL	EL	EL
	Grablev, Mitko	BUL	55.85	A	162.5	167.5	172.5 X	DP

Up to 52 kg (Total) Group A+B+C/Sept. 18				Jusqu'a 52 kg (Total) Groupe A+B+C/18 Sept			
Rank	Name	Ctry	Weight	Group	Snatch	CLN&JRK	Total
Rang	Nom	Pays	Poids	Groupes	Arrache	EP&Jete	
1	Marinov, Sevdalin	BUL	51.85	A	120.0 NWR	150.0 NOR	270.0 NWR
2	Chun, Byung-Kwan	KOR	51.65	A	112.5 NOR	147.5 NOR	260.0 NOR
3	He, Zhuoqiang	CHN	51.45	A	112.5 NOR	145.0 NOR	257.5 NOR
4	Zhang, Shoulie	CHN	51.50	A	115.0 NOR	142.5 NOR	257.5 NOR
5	Gutowski, Jacek	POL	51.45	A	112.5 NOR	135.0	247.5 NOR
6	Ciharean, Train Loach	ROM	51.65	A	110.0 EOR	130.0	240.0
7	Olah, Bela	HUN	51.65	A	107.5	130.0	237.5
8	Manabe, Kazushito	JPN	51.60	A	105.0	125.0	230.0
9	Hwang, In-Dong	KOR	51.80	A	100.0	130.0	230.0
10	Fuentes, Humberto	VEN	51.75	A	100.0	127.5	227.5
11	Muthuswamy, Gurunathan	IND	51.95	B	102.5	125.0	227.5
12	Martinez, Jose Luis	ESP	51.75	B	100.0	125.0	225.0
13	Ibanez, Jose Andres	ESP	51.70	B	95.0	127.5	222.5
14	Chiang, Ming-Hsiung	TPE	51.90	B	92.5	130.0	222.5
15	Sodikin, Sodikin	INA	51.85	B	95.0	122.5	217.5
16	Erdogan, Levent	TUR	51.85	B	92.5	125.0	217.5
17	Namiki, Yoshinori	JPN	51.70	B	100.0	115.0	215.0
18	Hayman, Gregory	AUS	51.55	B	92.5	115.0	207.5
19	Chanderasekaran, Raghavan	IND	51.90	B	92.5	115.0	207.5
20	Colonia, Gregorio	PHI	52.00	B	90.0	115.0	205.0
21	Olaywan, Khodr	LIB	51.70	B	85.0	100.0	185.0
22	Sawad, Bharat	NEP	51.30	B	75.0	105.0	180.0
	Aly, Ramadan	EGY	51.95	B	100.0	0.0	0.0
	Chung, Yung-Chi	TPE	51.90	B	97.5	EL	EL

Up to 56 kg (Total) Group A+B+C/Sept. 19				Jusqu'a 56 kg (Total) Groupe A+B+C/19 Sept			
Rank	Name	Ctry	Weight	Group	Snatch	CLN&JRK	Total
Rang	Nom	Pays	Poids	Groupes	Arrache	EP&Jete	
1	Mirzoian, Oxen	URS	55.75	A	127.5 NOR	165.0 NOR	292.5 NOR
2	He, Yingqiang	CHN	55.65	A	125.0 EOR	162.5 NOR	287.5 NOR
3	Liu, Shoubin	CHN	55.35	A	127.5 NOR	140.0	267.5
4	Wihardja, Dirdja	INA	55.80	A	112.5	142.5	255.0
5	Ichiba, Takashi	JPN	55.75	B	107.5	145.0	252.5
6	Kim, Kwi-Shik	KOR	55.80	A	110.0	142.5	252.5
7	Valle, Joaquin	ESP	55.90	B	112.5	135.0	247.5
8	Scarantino, Giovanni	ITA	55.40	A	110.0	135.0	245.0
9	Arnou, Pascal	FRA	55.80	B	105.0	140.0	245.0
10	Basbas, Azzedine	ALG	55.95	B	107.5	137.5	245.0
11	Zurera, Jose	ESP	55.15	B	110.0	132.5	242.5
12	Ojalehto, Arvo	FIN	55.40	A	105.0	137.5	242.5
13	Alegada, Samuel	PHI	56.00	B	107.5	135.0	242.5
14	Hara, Toru	JPN	55.55	A	105.0	135.0	240.0
15	Liao, Hsing-Chou	TPE	55.80	B	105.0	135.0	240.0



**Up to 60 kg (Snatch)
Group A+B+C/Sept. 20**

Rank Rang	Name Nom	Ctry Pays	Weight Poids	GR	Jusqu'a 60 kg (Arrache) Groupe A+B+C/20Sept			Result Resultat
					1st 1er	2nd 2eme	3rd 3eme	
1	Suleymanoglu, Naim	TUR	59.70	A	145.0 NOR	150.5 NWR	152.5 NWR	152.5
2	Topourov, Stefan	BUL	59.70	A	137.5 NOR	142.5 X	142.5 X	137.5
3	Muraki, Yosuke	JPN	59.30	A	120.0	125.0	127.5	127.5
4	Ye, Huanming	CHN	59.70	A	127.5	132.5 X	132.5 X	127.5
5	Wang, Caixi	CHN	59.35	A	125.0	130.0 X	130.0 X	125.0
6	Min, Joon-Ki	KOR	59.60	A	120.0	125.0	127.5 X	125.0
7	Sidiropoulos, Giannis	GRE	59.45	B	115.0 X	115.0	120.0	120.0
8	Murillo, Tolentino	COL	59.75	B	115.0	120.0	125.0 X	120.0
9	Oguri, Kazushige	JPN	59.60	A	117.5 X	117.5	122.5 X	117.5
10	Gondran, Lionel	FRA	59.75	B	110.0	115.0	117.5 X	115.0
11	Salazar, John	COL	59.80	B	105.0	110.0	112.5 X	110.0
12	Garcia, Joe	ECU	59.40	B	105.0 X	105.0 X	105.0	105.0
13	Arroyo, Angel	PUR	59.70	B	95.0	100.0	105.0 X	100.0
14	Abudu, Juma	KEN	59.80	B	80.0	90.0 X	90.0	90.0
	Munoz, Dionisio	ESP	59.30	A	120.0 X	120.0 X	122.5 X	0.0
	Studi, Catur mei	INA	59.65	B	110.0 X	110.0 X		0.0
	Czanka, Attila	ROM	59.80	A	130.0 X	130.0 X	130.0 X	0.0

**Up to 60 kg (CLN&JRK)
Group A+B+C/Sept. 20**

Rank Rang	Name Nom	Ctry Pays	Weight Poids	GR	Jusqu'a 60 kg (EP&Jete) Groupe A+B+C/20 Sept			Result Resultat
					1st 1er	2nd 2eme	3rd 3eme	
1	Suleymanoglu, Naim	TUR	59.70	A	175.0 NOR	188.5 NWR	190.0 NWR	190.0
2	Topourov, Stefan	BUL	59.70	A	165.0 NOR	175.0 NOR		175.0
3	Ye, Huanming	CHN	59.70	A	155.0	160.0 EOR	162.5 X	160.0
4	Min, Joon-Ki	KOR	59.60	A	155.0	160.0 X	162.5 X	155.0
5	Muraki, Yosuke	JPN	59.30	A	150.0 X	150.0	155.0 X	150.0
6	Salazar, John	COL	59.80	B	142.5	150.0	155.0 X	150.0
7	Sidiropoulos, Giannis	GRE	59.45	B	145.0 X	145.0	150.0 X	145.0
8	Oguri, Kazushige	JPN	59.60	A	137.5	142.5	150.0 X	142.5
9	Murillo, Tolentino	COL	59.75	B	135.0	140.0 X	140.0	140.0
10	Arroyo, Angel	PUR	59.70	B	130.0	135.0	140.0 X	135.0
11	Abudu, Juma	KEN	59.80	B	110.0 X	110.0	115.0 X	110.0
	Wang, Caixi	CHN	59.35	A	157.5 X	157.5 X	157.5 X	0.0
	Garcia, Joe	ECU	59.40	B	140.0 X	140.0 X	140.0 X	0.0
	Gondran, Lionel	FRA	59.75	B	140.0 X	140.0 X	140.0 X	0.0
	Munoz, Dionisio	ESP	59.30	A	EL			EL
	Studi, Catur Mei	INA	59.65	B	EL			EL
	Czanka, Attila	ROM	59.80	A	EL			EL

**Up to 60 kg (Total)
Group A+B+C/Sept. 20**

Rank Rang	Name Nom	Ctry Pays	Weight Poids	Group Groupe	Jusqu'a 60 kg (Total) Groupe A+B+C/20 Sept			Total
					Snatch Arrache	CLN&JRK EP&Jete		
1	Suleymanoglu, Naim	TUR	59.70	A	152.5 NWR	190.0 NWR	342.5 NWR	
2	Topourov, Stefan	BUL	59.70	A	137.5 NOR	175.0 NOR	312.5 NOR	
3	Ye, Huanming	CHN	59.70	A	127.5	160.0 EOR	287.5	
4	Min, Joon-ki	KOR	59.60	A	125.0	155.0	280.0	
5	Muraki, Yosuke	JPN	59.30	A	127.5	150.0	277.5	
6	Sidiropoulos, Giannis	GRE	59.45	B	120.0	145.0	265.0	
7	Oguri, Kazushige	JPN	59.60	A	117.5	142.5	260.0	
8	Murillo, Tolentino	COL	59.75	B	120.0	140.0	260.0	
9	Salazar, John	COL	59.80	B	110.0	150.0	260.0	
10	Arroyo, Angel	PUR	59.70	B	100.0	135.0	235.0	
11	Abudu, Juma	KEN	59.80	B	90.0	110.0	200.0	
	Wang, Caixi	CHN	59.35	A	125.0	0.0	0.0	
	Garcia, Joe	ECU	59.40	B	105.0	0.0	0.0	
	Gondran, Lionel	FRA	59.75	B	115.0	0.0	0.0	
	Munoz, Dionisio	ESP	59.30	A	0.0	EL	EL	
	Studi, Catur mei	INA	59.65	B	0.0	EL	EL	
	Czanka, Attila	ROM	59.80	A	0.0	EL	EL	

**Up to 67.5 kg (Snatch)
Group A+B+C/Sept. 21**

Rank Rang	Name Nom	Ctry Pays	Weight Poids	GR	Jusqu'a 67.5 kg (Arrache) Groupe A+B+C/21 Sept			Result Resultat
					1st 1er	2nd 2eme	3rd 3eme	
1	Militossian, Israel	URS	67.10	A	155.0 NOR	160.0 X	160.0 X	155.0
2	Kunz, Joachim	GDR	67.20	A	142.5	147.5 EOR	150.0 NOR	150.0
3	Li, Jinhe	CHN	67.20	A	142.5	147.5 EOR	150.0 X	147.5
4	Seweryn, Marek	POL	66.80	A	140.0	145.0 X	145.0	145.0
5	Batmaz, Ergun	TUR	67.45	C	140.0 X	140.0	145.0	145.0
6	Cote, Langis	CAN	67.15	B	132.5	137.5	140.0 X	137.5
7	Constandinidis, Christos	GRE	67.20	B	132.5 X	132.5	137.5	137.5
8	Kiiskila, Reijo	FIN	67.40	B	130.0	135.0 X	135.0	135.0
9	Chang, Shun-Chien	TPE	66.15	C	125.0	132.5	135.0 X	132.5
10	Xiao, Minglin	CHN	66.45	A	132.5	137.5 X	137.5 X	132.5
11	Kerek, Istvan	HUN	66.75	A	132.5	140.0 X	140.0 X	132.5
12	Kim, Ki-Woong	KOR	66.95	B	130.0 X	130.0	135.0 X	130.0
13	Taira, Choji	JPN	67.05	B	122.5	127.5	130.0 X	127.5
14	Iquabom, Lawrence	NGR	67.10	B	125.0 X	125.0	130.0 X	125.0
15	Duarte, Paulo	POR	67.35	C	120.0	125.0	127.5 X	125.0
16	Jacques, Michael	USA	67.35	C	120.0 X	120.0	125.0	125.0
17	Santos, Edwaldo	BRA	67.35	B	110.0	115.0	120.0	120.0
18	Rodriguez, Tomas	PAN	67.25	C	117.5	122.5 X	122.5 X	117.5
19	Ofisa, Taveuni	SAM	67.20	C	100.0	107.5	112.5 X	107.5
20	Malaibi, Pinye	NGU	66.95	C	90.0	102.5	105.0	105.0
21	Alaywan, Mohamadamine	LIB	66.65	C	90.0	95.0	100.0 X	95.0
22	Kaddu Kuteesa, Joseph	UGA	65.15	C	90.0	92.5 X		90.0
23	Fejeran, Pete	GUM	67.40	C	82.5	87.5 X	87.5 X	82.5
	Casadei, Paolo	SMR	67.20	C	107.5 X	107.5 X	107.5 X	0.0
	Park, Tae-Min	KOR	67.20	A	132.5 X	132.5 X	132.5 X	0.0
	Gronman, Jouni	FIN	67.20	A	140.0 X	140.0 X	140.0 X	0.0
	Sasaki, Yasushige	JPN	67.25	B	130.0 X	130.0 X	130.0 X	0.0
	Mariaca, Fernando	ESP	66.80	B	127.5	132.5 X	132.5 X	DP
	Guenchev, Angel	BUL	67.35	A	150.0	157.5	160.0	DP

**Up to 67.5 kg (CLN&JRK)
Group A+B+C/Sept. 21**

Rank Rang	Name Nom	Ctry Pays	Weight Poids	GR	Jusqu'a 67.5 kg (EP&Jete) Groupe A+B+C/21 Sept			Result Resultat
					1st 1er	2nd 2eme	3rd 3eme	
1	Kunz, Joachim	GDR	67.20	A	180.0	190.0 X	190.0	190.0
2	Militossian, Israel	URS	67.10	A	182.5	187.5 X	187.5 X	182.5
3	Li, Jinhe	CHN	67.20	A	177.5	182.5 X	182.5 X	177.5
4	Xiao, Minglin	CHN	66.45	A	172.5	177.5 X	177.5 X	172.5
5	Seweryn, Marek	POL	66.80	A	172.5 X	172.5 X	172.5	172.5
6	Batmaz, Ergun	TUR	67.45	C	165.0	172.5	175.0 X	172.5
7	Kerek, Istvan	HUN	66.75	A	170.0	175.0 X	175.0 X	170.0
8	Taira, Choji	JPN	67.05	B	165.0	170.0	172.5 X	170.0
9	Constandinidis, Christos	GRE	67.20	B	162.5 X	162.5	167.5 X	162.5
10	Kiiskila, Reijo	FIN	67.40	B	162.5 X	162.5	167.5 X	162.5
11	Iquabom, Lawrence	NGR	67.10	B	150.0	155.0	160.0	160.0
12	Cote, Langis	CAN	67.15	B	160.0	165.0 X	165.0 X	160.0
13	Jacques, Michael	USA	67.35	C	150.0	157.5 X	157.5	157.5
14	Duarte, Paulo	POR	67.35	C	150.0	155.0 X	155.0 X	150.0
15	Rodriguez, Tomas	PAN	67.25	C	145.0	150.0 X	150.0 X	145.0
16	Ofisa, Taveuni	SAM	67.20	C	142.5 X	142.5 X	142.5	142.5
17	Santos, Edwaldo	BRA	67.35	B	140.0 X	140.0	150.0 X	140.0
18	Kim, Ki-Woong	KOR	66.95	B	130.0			130.0
19	Kaddu Kuteesa, Joseph	UGA	65.15	C	120.0	125.0	127.5 X	125.0
20	Malaibi, Pinye	NGU	66.95	C	115.0	125.0 X	125.0	125.0
21	Alaywan, Mohamadamine	LIB	66.65	C	115.0	120.0 X	122.5	122.5
22	Fejeran, Pete	GUM	67.40	C	105.0	110.0	115.0 X	110.0
	Chang, Shun-Chien	TPE	66.15	C	IJ			IJ
	Casadei, Paolo	SMR	67.20	C	EL			EL
	Park, Tae-Min	KOR	67.20	A	EL			EL
	Gronman, Jouni	FIN	67.20	A	EL			EL
	Sasaki, Yasushige	JPN	67.25	B	EL			EL
	Mariaca, Fernando	ESP	66.80	B	160.0	165.0 X	165.0 X	DP
	Guenchev, Angel	BUL	67.35	A	190.0	197.5	202.5	DP

**Up to 67.5 kg (Total)
Group A+B+C/Sept. 21**

Rank Rang	Name Nom	Ctry Pays	Weight Poids	Group Groupe	Jusqu'a 67.5 kg (Total) Groupe A+B+C/21 Sept			Total
					Snatch Arrache	CLN&JRK EP&Jete		
1	Kunz, Joachim	GDR	67.20	A	150.0 NOR	190.0	340.0	
2	Militossian, Israel	URS	67.10	A	155.0 NOR	182.5	337.5	
3	Li, Jinhe	CHN	67.20	A	147.5 EOR	177.5	325.0	
4	Seweryn, Marek	POL	66.80	A	145.0	172.5	317.5	
5	Batmaz, Ergun	TUR	67.45	C	145.0	172.5	317.5	
6	Xiao, Minglin	CHN	66.45	A	132.5	172.5	305.0	
7	Kerek, Istvan	HUN	66.75	A	132.5	170.0	302.5	
8	Constandinidis, Christos	GRE	67.20	B	137.5	162.5	300.0	
9	Taira, Choji	JPN	67.05	B	127.5	170.0	297.5	
10	Cote, Langis	CAN	67.15	B	137.5	160.0	297.5	
11	Kiiskila, Reijo	FIN	67.40	B	135.0	162.5	297.5	
12	Iquabom, Lawrence	NGR	67.10	B	125.0	160.0	285.0	
13	Jacques, Michael	USA	67.35	C	125.0	157.5	282.5	
14	Duarte, Paulo	POR	67.35	C	125.0	150.0	275.0	
15	Rodriguez, Tomas	PAN	67.25	C	117.5	145.0	262.5	
16	Kim, Ki-Woong	KOR	66.95	B	130.0	130.0	260.0	
17	Santos, Edwaldo	BRA	67.35	B	120.0	140.0	260.0	
18	Ofisa, Taveuni	SAM	67.20	C	107.5	142.5	250.0	
19	Malaibi, Pinye	NGU	66.95	C	105.0	125.0	230.0	
20	Alaywan, Mohamadamine	LIB	66.65	C	95.0	122.5	217.5	
21	Kaddu Kuteesa, Joseph	UGA	65.15	C	90.0	125.0	215.0	
22	Fejeran, Pete	GUM	67.40	C	82.5	110.0	192.5	
	Chang, Shun-Chien	TPE	66.15	C	132.5	IJ	IJ	
	Casadei, Paolo	SMR	67.20	C	0.0	EL	EL	
	Gronman, Jouni	FIN	67.20	A	0.0	EL	EL	
	Park, Tae-Min	KOR	67.20	A	0.0	EL	EL	
	Sasaki, Yasushige	JPN	67.25	B	0.0	EL	EL	
	Mariaca, Fernando	ESP	66.80	B	127.5 DP	160.0 DP	287.5 DP	

Weightlifting

Haltérophilie

Up to 75 kg (Snatch) Group A+B+C/Sept. 22				Jusqu'a 75 kg (Arrache) Groupe A+B+C/22 Sept				
Rank	Name	Ctry	Weight	GR	1st	2nd	3rd	Result
Rang	Nom	Pays	Poids		1er	2eme	3eme	Resultat
1	Guidikov, Borislav	BUL	74.80	A	160.0 EOR	165.0 NOR	167.5 NOR	167.5
2	Steinboefel, Ingo	GDR	74.40	A	160.0 EOR	165.0 NOR	170.0 X	165.0
3	Cai, Yanshu	CHN	74.50	A	157.5 X	157.5 X	157.5	157.5
4	Varbanov, Alexander	BUL	74.55	A	157.5	162.5 X	162.5 X	157.5
5	Kosinski, Waldemar	POL	72.45	B	152.5	160.0 X	160.0 X	152.5
6	Willey, Dean	GBR	74.30	B	152.5	157.5 X	157.5 X	152.5
7	Socaci, Andrei	ROM	74.50	A	152.5	157.5 X	157.5 X	152.5
8	Urrutia, Roberto	USA	74.65	B	142.5	150.0	152.5 X	150.0
9	Ma, Wenzhu	CHN	74.65	A	150.0	155.0 X	155.0 X	150.0
10	Mannironi, Angelo	ITA	74.50	B	142.5	147.5	150.0 X	147.5
11	Sudarma, Inyoman	INA	74.55	C	135.0	140.0	145.0	145.0
12	Elsayed, Khalil	EGY	74.60	B	142.5	147.5 X	147.5 X	142.5
13	Kim, Byung-Chan	KOR	74.10	C	135.0	140.0 X	140.0	140.0
14	Lindqvist, Mats	SWE	74.85	B	140.0	145.0 X	145.0 X	140.0
15	Chaplin, Ricky	GBR	75.00	C	140.0	145.0 X		140.0
16	Puiia, Pietro	ITA	74.70	B	137.5	142.5 X	142.5 X	137.5
17	Harrison, Paul	AUS	74.75	C	132.5	137.5 X	137.5	137.5
18	Pirkkio, Jaarli	FIN	74.75	B	137.5	142.5 X	142.5 X	137.5
19	Menge, Sahin	TUR	74.90	B	137.5	142.5 X	142.5 X	137.5
20	Laycock, Ronald	AUS	74.65	B	130.0 X	130.0	135.0	135.0
21	Token, Roger	NGU	74.65	C	100.0 X	100.0	110.0	110.0
22	Maina, David	KEN	74.65	C	105.0	115.0 X	115.0 X	105.0
23	Hoffman, Paul	SWZ	74.50	C	80.0	85.0	87.5	87.5
24	Bennie Fafal, Benjamin	SOL	68.70	C	80.0	85.0 X	85.0	85.0
	Csengeri, Kalman	HUN	74.65	A	150.0	155.0 X	155.0	DP

Up to 82.5 kg (Snatch) Group A+B+C/Sept. 24				Jusqu'a 82.5 kg (Arrache) Groupe A+B+C/24 Sept				
Rank	Name	Ctry	Weight	GR	1st	2nd	3rd	Result
Rang	Nom	Pays	Poids		1er	2eme	3eme	Resultat
1	Messzi, Istvan	HUN	81.85	A	162.5	167.5	170.0	170.0
2	Arsamakov, Israil	URS	82.15	A	167.5 X	167.5	170.0 X	167.5
3	Morgan, David	GBR	80.45	A	165.0 X	165.0	167.5 X	165.0
4	Siemion, Krzysztof	POL	81.50	A	155.0	160.0	162.5	162.5
5	Barsi, Laszlo	HUN	81.60	A	162.5	167.5 X	167.5 X	162.5
6	Lee, Hyung-Kun	KOR	81.65	A	160.0 X	160.0	165.0 X	160.0
7	Tosi, Fausto	ITA	80.50	B	150.0	155.0	157.5 X	155.0
8	Isaoka, Ryoji	JPN	81.10	A	155.0 X	155.0	160.0 X	155.0
9	Odusanya, Muiyiwa	NGR	80.95	B	140.0	145.0	150.0	150.0
10	Sfakianakis, Charalambos	GRE	81.35	B	145.0 X	145.0	150.0 X	145.0
11	Perez Cepeda, Frank Alexis	DOM	81.90	B	145.0	152.5 X	152.5 X	145.0
12	Eroglu, Ali	TUR	82.15	B	145.0	150.0 X	150.0 X	145.0
13	Letriz, William	PUR	82.30	B	130.0	137.5	142.5	142.5
14	Cheng, Chia-Tso	TPE	81.65	B	140.0 X	140.0 X	140.0	140.0
15	White, Curt	USA	81.95	B	130.0	137.5	140.0	140.0
16	Crass, Derrick	USA	82.30	B	140.0 X	140.0 X	140.0	140.0
17	Sichel, John	ECU	82.00	B	125.0	130.0 X	130.0 X	125.0
18	Elizondo, Rafael	CRC	81.80	B	112.5	117.5	120.0 X	117.5
19	Moir, Jose	MRI	79.80	B	100.0	110.0	115.0 X	110.0
20	Faagu, Lopesi	ASA	80.95	B	80.0	90.0	100.0 X	90.0
21	Doherty, Percy S	SLE	78.70	B	60.0	65.0	70.0 X	65.0
	Shabangu, Absalom	SWZ	81.40	B	80.0 X	80.0 X	80.0 X	0.0

Up to 75 kg (CLN&JRK) Group A+B+C/Sept. 22				Jusqu'a 75 kg (EP&Jete) Groupe A+B+C/22 Sept				
Rank	Name	Ctry	Weight	GR	1st	2nd	3rd	Result
Rang	Nom	Pays	Poids		1er	2eme	3eme	Resultat
1	Guidikov, Borislav	BUL	74.80	A	200.0 EOR	205.0 NOR	207.5 NOR	207.5
2	Varbanov, Alexander	BUL	74.55	A	200.0 EOR	210.0 X	210.0 X	200.0
3	Steinboefel, Ingo	GDR	74.40	A	190.0	195.0	200.0 X	195.0
4	Socaci, Andrei	ROM	74.50	A	190.0	195.0	197.5 X	195.0
5	Cai, Yanshu	CHN	74.50	A	190.0	195.0 X	195.0 X	190.0
6	Kosinski, Waldemar	POL	72.45	B	180.0	187.5 X	187.5 X	180.0
7	Willey, Dean	GBR	74.30	B	180.0	185.0 X	185.0 X	180.0
8	Pirkkio, Jaarli	FIN	74.75	B	175.0	180.0 X	180.0	180.0
9	Chaplin, Ricky	GBR	75.00	C	160.0	180.0	187.5 X	180.0
10	Mannironi, Angelo	ITA	74.50	B	177.5	182.5 X	182.5 X	177.5
11	Urrutia, Roberto	USA	74.65	B	177.5 X	177.5 X	177.5	177.5
12	Sudarma, Inyoman	INA	74.55	C	165.0	172.5	175.0	175.0
13	Laycock, Ronald	AUS	74.65	B	175.0	182.5 X	182.5 X	175.0
14	Lindqvist, Mats	SWE	74.85	B	170.0	175.0	180.0 X	175.0
15	Menge, Sahin	TUR	74.90	B	170.0	175.0 X	175.0	175.0
16	Elsayed, Khalil	EGY	74.60	B	172.5	177.5 X	177.5 X	172.5
17	Puiia, Pietro	ITA	74.70	B	165.0	172.5	172.5	172.5
18	Kim, Byung-Chan	KOR	74.10	C	170.0	175.0 X	175.0 X	170.0
19	Harrison, Paul	AUS	74.75	C	162.5	170.0	172.5 X	170.0
20	Token, Roger	NGU	74.65	C	140.0	145.0 X	145.0	145.0
21	Hoffman, Paul	SWZ	74.50	C	105.0	110.0	112.5 X	110.0
22	Bennie Fafale, Benjamin	SOL	68.70	C	100.0	105.0	107.5 X	105.0
	Maina, David	KEN	74.65	C	145.0 X	145.0 X	147.5 X	0.0
	Ma, Wenzhu	CHN	74.65	A	182.5 X	182.5 X	182.5 X	0.0
	Csengeri, Kalman	HUN	74.65	A	182.5	190.0	195.0	DP

Up to 82.5 kg (CLN&JRK) Group A+B+C/Sept. 24				Jusqu'a 82.5 kg (EP&Jete) Groupe A+B+C/24 Sept				
Rank	Name	Ctry	Weight	GR	1st	2nd	3rd	Result
Rang	Nom	Pays	Poids		1er	2eme	3eme	Resultat
1	Arsamakov, Israil	URS	82.15	A	205.0	210.0 X	210.0	210.0
2	Lee, Hyung-Kun	KOR	81.65	A	200.0	207.5	212.5 X	207.5
3	Morgan, David	GBR	80.45	A	195.0	200.0	202.5 X	200.0
4	Messzi, Istvan	HUN	81.85	A	200.0	205.0 X	205.0 X	200.0
5	Isaoka, Ryoji	JPN	81.10	A	195.0	202.5 X	202.5 X	195.0
6	Siemion, Krzysztof	POL	81.50	A	195.0	200.0 X	200.0 X	195.0
7	Tosi, Fausto	ITA	80.50	B	185.0	190.0 X	190.0 X	185.0
8	Eroglu, Ali	TUR	82.15	B	185.0	192.5 X	192.5 X	185.0
9	Crass, Derrick	USA	82.30	B	175.0	182.5 X	182.5 X	175.0
10	Perez Cepeda, Frank Alexis	DOM	81.90	B	172.5	177.5 X	177.5 X	172.5
11	Odusanya, Muiyiwa	NGR	80.95	B	170.0 X	170.0 X	170.0	170.0
12	Cheng, Chia-Tso	TPE	81.65	B	170.0 X	170.0 X	170.0	170.0
13	White, Curt	USA	81.95	B	165.0	172.5 X	172.5 X	165.0
14	Letriz, William	PUR	82.30	B	165.0	172.5 X	172.5 X	165.0
15	Sichel, John	ECU	82.00	B	152.5	157.5 X	157.5	157.5
16	Elizondo, Rafael	CRC	81.80	B	147.5	152.5 X	152.5 X	147.5
17	Moir, Jose	MRI	79.80	B	125.0	130.0 X	130.0	130.0
18	Faagu, Lopesi	ASA	80.95	B	120.0	130.0	135.0 X	130.0
19	Doherty, Percy S	SLE	78.70	B	90.0	100.0	105.0 X	100.0
	Sfakianakis, Charalambos	GRE	81.35	B	185.0 X	185.0 X	185.0 X	0.0
	Barsi, Laszlo	HUN	81.60	A	IJ			IJ
	Shabangu, Absalom	SWZ	81.40	B	EL			EL

Up to 75 kg (Total) Group A+B+C/Sept. 22				Jusqu'a 75 kg (Total) Groupe A+B+C/22 Sept			
Rank	Name	Ctry	Weight	Group	Snatch	CLN&JRK	Total
Rang	Nom	Pays	Poids	Groupe	Arrache	EP&Jete	
1	Guidikov, Borislav	BUL	74.80	A	167.5 NOR	207.5 NOR	375.0 NOR
2	Steinboefel, Ingo	GDR	74.40	A	165.0 NOR	195.0	360.0 EOR
3	Varbanov, Alexander	BUL	74.55	A	157.5	200.0 EOR	357.5
4	Cai, Yanshu	CHN	74.50	A	157.5	190.0	347.5
5	Socaci, Andrei	ROM	74.50	A	152.5	195.0	347.5
6	Kosinski, Waldemar	POL	72.45	B	152.5	180.0	332.5
7	Willey, Dean	GBR	74.30	B	152.5	180.0	332.5
8	Urrutia, Roberto	USA	74.65	B	150.0	177.5	327.5
9	Mannironi, Angelo	ITA	74.50	B	147.5	177.5	325.0
10	Sudarma, Inyoman	INA	74.55	C	145.0	175.0	320.0
11	Chaplin, Ricky	GBR	75.00	C	140.0	180.0	320.0
12	Pirkkio, Jaarli	FIN	74.75	B	137.5	180.0	317.5
13	Elsayed, Khalil	EGY	74.60	B	142.5	172.5	315.0
14	Lindqvist, Mats	SWE	74.85	B	140.0	175.0	315.0
15	Menge, Sahin	TUR	74.90	B	137.5	175.0	312.5
16	Kim, Byung-Chan	KOR	74.10	C	140.0	170.0	310.0
17	Laycock, Ronald	AUS	74.65	B	135.0	175.0	310.0
18	Puiia, Pietro	ITA	74.70	B	137.5	172.5	310.0
19	Harrison, Paul	AUS	74.75	C	137.5	170.0	307.5
20	Token, Roger	NGU	74.65	C	110.0	145.0	255.0
21	Hoffman, Paul	SWZ	74.50	C	87.5	110.0	197.5
22	Bennie Fafal, Benjamin	SOL	68.70	C	85.0	105.0	190.0
	Maina, David	KEN	74.65	C	105.0	0.0	0.0
	Ma, Wenzhu	CHN	74.65	A	150.0	0.0	0.0
	Csengeri, Kalman	HUN	74.65	A	155.0 DP	195.0 DP	350.0 DP

Up to 82.5 kg (Total) Group A+B+C/Sept. 24				Jusqu'a 82.5 kg (Total) Groupe B/24 Sept			
Rank	Name	Ctry	Weight	Group	Snatch	CLN&JRK	Total
Rang	Nom	Pays	Poids	Groupe	Arrache	EP&Jete	
1	Arsamakov, Israil	URS	82.15	A	167.5	210.0	377.5
2	Messzi, Istvan	HUN	81.85	A	170.0	200.0	370.0
3	Lee, Hyung-kun	KOR	81.65	A	160.0	207.5	367.5
4	Morgan, David	GBR	80.45	A	165.0	200.0	365.0
5	Siemion, Krzysztof	POL	81.50	A	162.5	195.0	357.5
6	Isaoka, Ryoji	JPN	81.10	A	155.0	195.0	350.0
7	Tosi, Fausto	ITA	80.50	B	155.0	185.0	340.0
8	Eroglu, Ali	TUR	82.15	B	145.0	185.0	330.0
9	Odusanya, Muiyiwa	NGR	80.95	B	150.0	170.0	320.0
10	Perez Cepeda, Frank Alexis	DOM	81.90	B	145.0	172.5	317.5
11	Crass, Derrick	USA	82.30	B	140.0	175.0	315.0
12	Cheng, Chia-Tso	TPE	81.65	B	140.0	170.0	310.0
13	Letriz, William	PUR	82.30	B	142.5	165.0	307.5
14	White, Curt	USA	81.95	B	140.0	165.0	305.0
15	Sichel, John	ECU	82.00				



**Up to 90 kg (Snatch)
Group A+B+C/Sept. 25**

Rank Rang	Name Nom	Ctry Pays	Weight Poids	GR	1st 1er	2nd 2eme	3rd 3eme	Result Resultat
1	Khrapatyi, Anatoli	URS	89.45	A	180.0 NOR	185.0 NOR	187.5 NOR	187.5
2	Zawada, Slawomir	POL	89.50	A	180.0 NOR	185.0 X	185.0 X	180.0
3	Moukhamediarov, Nail	URS	89.40	A	172.5 EOR	177.5 NOR	182.5 X	177.5
4	Buda, Attila	HUN	88.50	A	170.0 X	170.0	175.0 NOR	175.0
5	Piotrowski, Andrzej	POL	89.55	A	165.0 X	165.0	170.0 X	165.0
6	Balazsfi, Zoltan	HUN	89.75	A	160.0	165.0 X	165.0 X	160.0
7	Boxell, Keith	GBR	89.35	B	152.5	157.5 X	157.5	157.5
8	Mercer, David	GBR	89.90	B	157.5 X	157.5	162.5 X	157.5
9	Greavette, Guy	CAN	89.05	B	152.5 X	152.5	157.5 X	152.5
10	Feldhotter, Roland	FRG	89.20	B	150.0	155.0 X	155.0 X	150.0
11	Kritsky, Arn	USA	86.85	B	142.5	147.5 X	147.5	147.5
12	Larsen, Per	DEN	88.80	B	145.0 X	145.0	150.0 X	145.0
13	Guzman Reynoso, Francisco	DOM	89.85	C	142.5	147.5 X	147.5 X	142.5
14	Chun, Byung-Kook	KOR	86.70	B	140.0	145.0 X	145.0 X	140.0
15	Brian, Bret	USA	89.05	B	140.0 X	140.0 X	140.0	140.0
16	Awosina, Olusola	NGR	89.10	B	140.0 X	140.0	150.0 X	140.0
17	Tozdjian, German	URU	89.45	B	140.0	145.0 X	145.0 X	140.0
18	Solis, Ramon	PHI	89.00	C	137.5 X	137.5	142.5 X	137.5
19	El-Kaissi, Hassan	LIB	86.15	C	127.5	135.0	137.5 X	135.0
20	Fayad, Mohamad	SYR	89.40	B	135.0	142.5 X	142.5 X	135.0
21	Elmagrisi, Ahmed	LBA	89.45	C	130.0	135.0 X	135.0	135.0
22	Dantas, Edmilson	BRA	89.85	C	127.5	135.0 X	135.0	135.0
23	Juma, Suleman	KEN	88.65	C	110.0	115.0	120.0	120.0
24	Cortez, Hernan	BOL	88.20	C	110.0	115.0 X	115.0 X	110.0
25	Kavuma, Ali	UGA	88.85	C	92.5	97.5	100.0	100.0
26	Kauvai, Joseph	COK	89.40	C	80.0	85.0	90.0 X	85.0
	Mussa, Abdalla	LBA	88.30	C	130.0 X	130.0 X	135.0 X	0.0
	Mahgoub, Mahmoud	EGY	88.55	A	150.0 X	150.0 X	152.5 X	0.0
	Schult, Mario	GDR	89.55	A	IJ			IJ

**Up to 90 kg (CLN&JRK)
Group A+B+C/Sept. 25**

Rank Rang	Name Nom	Ctry Pays	Weight Poids	GR	1st 1er	2nd 2eme	3rd 3eme	Result Resultat
1	Khrapatyi, Anatoli	URS	89.45	A	225.0 NOR	237.5 X	237.5 X	225.0
2	Moukhamediarov, Nail	URS	89.40	A	212.5	222.5 NOR	227.5 X	222.5
3	Zawada, Slawomir	POL	89.50	A	210.0	220.0 EOR	225.0 X	220.0
4	Feldhotter, Roland	FRG	89.20	B	190.0	195.0	200.0	200.0
5	Piotrowski, Andrzej	POL	89.55	A	200.0	210.0 X	210.0 X	200.0
6	Mercer, David	GBR	89.90	B	195.0	200.0	202.5 X	200.0
7	Awosina, Olusola	NGR	89.10	B	180.0	185.0	192.5	192.5
8	Boxell, Keith	GBR	89.35	B	192.5	197.5 X	197.5 X	192.5
9	Chun, Byung-kook	KOR	86.70	B	190.0	195.0 X	195.0 X	190.0
10	Kritsky, Arn	USA	86.85	B	180.0	185.0	190.0 X	185.0
11	Buda, Attila	HUN	88.50	A	185.0	200.0 X	200.0 X	185.0
12	Greavette, Guy	CAN	89.05	B	185.0	195.0 X	195.0 X	185.0
13	Fayad, Mohamad	SYR	89.40	B	180.0	185.0	187.5 X	185.0
14	Balazsfi, Zoltan	HUN	89.75	A	185.0	192.5 X	192.5 X	185.0
15	Solis, Ramon	PHI	89.00	C	175.0 X	175.0	180.0	180.0
16	Brian, Bret	USA	89.05	B	180.0	190.0 X	190.0 X	180.0
17	El-kaissi, Hassan	LIB	86.15	C	167.5	172.5	177.5 X	172.5
18	Larsen, Per	DEN	88.80	B	172.5	180.0 X	180.0 X	172.5
19	Elmagrisi, Ahmed	LBA	89.45	C	165.0	172.5	175.0 X	172.5
20	Guzman Reynoso, Francisco	DOM	89.85	C	170.0 X	170.0	177.5 X	170.0
21	Dantas, Edmilson	BRA	89.85	C	155.0	165.0	172.5 X	165.0
22	Juma, Suleman	KEN	88.65	C	145.0	150.0 X	150.0 X	145.0
23	Cortez, Hernan	BOL	88.20	C	140.0 X	140.0 X	140.0	140.0
24	Kavuma, Ali	UGA	88.85	C	125.0	130.0	132.5	132.5
25	Kauvai, Joseph	COK	89.40	C	105.0	110.0	115.0	115.0
	Tozdjian, German	URU	89.45	B	IJ			IJ
	Schult, Mario	GDR	89.55	A	IJ			IJ
	Mussa, Abdalla	LBA	88.30	C	EL			EL
	Mahgoub, Mahmoud	EGY	88.55	A	EL			EL

**Up to 90 kg (Total)
Group A+B+C/Sept. 25**

Rank Rang	Name Nom	Ctry Pays	Weight Poids	Group Groupe	Snatch Arrache	CLN&JRK EP&Jete	Total
1	Khrapatyi, Anatoli	URS	89.45	A	187.5 NOR	225.0 NOR	412.5 NOR
2	Moukhamediarov, Nail	URS	89.40	A	177.5 NOR	222.5 NOR	400.0 NOR
3	Zawada, Slawomir	POL	89.50	A	180.0 NOR	220.0 EOR	400.0 NOR
4	Piotrowski, Andrzej	POL	89.55	A	165.0	200.0	365.0
5	Buda, Attila	HUN	88.50	A	175.0 NOR	185.0	360.0
6	Mercer, David	GBR	89.90	B	157.5	200.0	357.5
7	Feldhotter, Roland	FRG	89.20	B	150.0	200.0	350.0
8	Boxell, Keith	GBR	89.35	B	157.5	192.5	350.0
9	Balazsfi, Zoltan	HUN	89.75	A	160.0	185.0	345.0
10	Greavette, Guy	CAN	89.05	B	152.5	185.0	337.5
11	Kritsky, Arn	USA	86.85	B	147.5	185.0	332.5
12	Awosina, Olusola	NGR	89.10	B	140.0	192.5	332.5
13	Chun, Byung-Kook	KOR	86.70	B	140.0	190.0	330.0
14	Brian, Bret	USA	89.05	B	140.0	180.0	320.0
15	Fayad, Mohamad	SYR	89.40	B	135.0	185.0	320.0
16	Larsen, Per	DEN	88.80	B	145.0	172.5	317.5
17	Solis, Ramon	PHI	89.00	C	137.5	180.0	317.5
18	Guzman Reynoso, Francisco	DOM	89.85	C	142.5	170.0	312.5
19	El-kaissi, Hassan	LIB	86.15	C	135.0	172.5	307.5
20	Elmagrisi, Ahmed	LBA	89.45	C	135.0	172.5	307.5
21	Dantas, Edmilson	BRA	89.85	C	135.0	165.0	300.0
22	Juma, Suleman	KEN	88.65	C	120.0	145.0	265.0
23	Cortez, Hernan	BOL	88.20	C	110.0	140.0	250.0
24	Kavuma, Ali	UGA	88.85	C	100.0	132.5	232.5
25	Kauvai, Joseph	COK	89.40	C	85.0	115.0	200.0
	Tozdjian, German	URU	89.45	B	140.0	IJ	IJ
	Schult, Mario	GDR	89.55	A	IJ	IJ	IJ
	Mussa, Abdalla	LBA	88.30	C	0.0	EL	EL
	Mahgoub, Mahmoud	EGY	88.55	A	0.0	EL	EL

**Up to 100 kg (Snatch)
Group A+B+C/Sept. 26**

Rank Rang	Name Nom	Ctry Pays	Weight Poids	GR	1st 1er	2nd 2eme	3rd 3eme	Result Resultat
1	Kouznetsov, Pavel	URS	99.70	A	185.0 NOR	190.0 X	190.0 NOR	190.0
2	Vlad, Nicu	ROM	99.50	A	180.0 EOR	185.0 NOR	190.0 X	185.0
3	Bokfi, Janos	HUN	99.75	A	175.0	180.0 EOR	182.5 X	180.0
4	Ciernik, Milos	TCH	98.55	A	175.0	180.0 X	180.0 X	175.0
5	Immesberger, Peter	FRG	99.60	A	175.0	180.0 X	180.0 X	175.0
6	Langthaler, Franz	AUT	98.60	A	172.5	177.5 X	177.5 X	172.5
7	Tournefier, Francis	FRA	99.15	A	162.5	167.5	170.0	170.0
8	Nill, Maik	FRG	98.55	B	162.5	167.5 X	167.5	167.5
9	Hwang, Woo-Won	KOR	99.15	B	157.5	162.5	165.0 X	162.5
10	Magrini, Fabio	ITA	98.35	B	150.0	160.0 X	160.0	160.0
11	Garon, Denis	CAN	98.65	B	152.5 X	152.5	160.0	160.0
12	Tomatsu, Nobutaka	JPN	99.85	B	155.0	160.0	165.0 X	160.0
13	May, Peter	GBR	93.95	B	152.5	157.5	160.0 X	157.5
14	Saxton, Andrew	GBR	98.80	B	152.5	160.0 X	160.0 X	152.5
15	Soderholm, Tom	SWE	96.00	B	150.0 X	150.0 X	150.0	150.0
16	Nkwayed, Theodore	CMR	98.80	B	140.0 X	140.0	145.0	145.0
17	Liao, Chin-Ming	TPE	98.20	B	130.0	137.5	145.0 X	137.5
18	Tererui, Michael	COK	96.30	B	100.0	105.0	107.5 X	105.0
	Blake, Kevin	NZL	98.45	B	155.0 X	155.0 X	155.0 X	0.0
	Dudas, Juraj	TCH	99.20	A	172.5 X	172.5 X	172.5 X	0.0
	Szanyi, Andor	HUN	97.30	A	185.0 X	185.0	190.0 X	DP

**Up to 100 kg (CLN&JRK)
Group A+B+C/Sept. 26**

Rank Rang	Name Nom	Ctry Pays	Weight Poids	GR	1st 1er	2nd 2eme	3rd 3eme	Result Resultat
1	Kouznetsov, Pavel	URS	99.70	A	230.0 NOR	235.0 NOR	243.0 X	235.0
2	Garon, Denis	CAN	98.65	B	210.0	217.5 EOR	222.5 NOR	222.5
3	Hwang, Woo-Won	KOR	99.15	B	210.0	215.0	220.0 NOR	220.0
4	Immesberger, Peter	FRG	99.60	A	215.0	220.0 EOR	230.0 X	220.0
5	Vlad, Nicu	ROM	99.50	A	212.5	217.5 EOR	220.0 X	217.5
6	Tournefier, Francis	FRA	99.15	A	205.0	210.0	215.0	215.0
7	Bokfi, Janos	HUN	99.75	A	207.5	212.5	220.0 X	212.5
8	Magrini, Fabio	ITA	98.35	B	200.0	210.0 X	210.0	210.0
9	Langthaler, Franz	AUT	98.60	A	205.0	210.0 X	210.0 X	205.0
10	Nill, Maik	FRG	98.55	B	202.5	210.0 X	210.0 X	202.5
11	Saxton, Andrew	GBR	98.80	B	195.0	200.0	202.5 X	200.0
12	Tomatsu, Nobutaka	JPN	99.85	B	195.0	200.0 X	200.0 X	195.0
13	May, Peter	GBR	93.95	B	187.5	192.5	197.5 X	192.5
14	Nkwayed, Theodore	CMR	98.80	B	170.0	175.0 X	175.0	175.0
15	Liao, Chin-Ming	TPE	98.20	B	150.0	170.0	170.0	170.0
16	Tererui, Michael	COK	96.30	B	125.0	132.5	137.5	137.5
	Ciernik, Milos	TCH	98.55	A	210.0 X	210.0 X	210.0 X	0.0
	Soderholm, Tom	SWE	96.00	B	IJ			IJ
	Blake, Kevin	NZL	98.45	B	EL			EL
	Dudas, Juraj	TCH	99.20	A	EL			EL
	Szanyi, Andor	HUN	97.30	A	222.5	235.0 X	240.0 X	DP

**Up to 100 kg (Total)
Group A+B+C/Sept. 26**

Rank Rang	Name Nom	Ctry Pays	Weight Poids	Group Groupe	Snatch Arrache	CLN&JRK EP&Jete	Total
1	Kouznetsov, Pavel	URS	99.70	A	190.0 NOR	235.0 NOR	425.0 NOR
2	Vlad, Nicu	ROM	99.50	A	185.0 NOR	217.5 EOR	402.5 NOR
3	Immesberger, Peter	FRG	99.60	A	175.0	220.0 NOR	395.0 EOR
4	Bokfi, Janos	HUN	99.75	A	180.0 EOR	212.5	392.5
5	Tournefier, Francis	FRA	99.15	A	170.0	215.0	385.0
6	Garon, Denis	CAN	98.65	B	160.0	222.5 NOR	382.5
7	Hwang, Woo-Won	KOR	99.15	B	162.5	220.0 NOR	382.5
8	Langthaler, Franz	AUT	98.60	A	172.5	205.0	377.5
9	Magrini, Fabio	ITA	98.35	B	160.0	210.0	370.0
10	Nill, Maik	FRG	98.55	B	167.5	202.5	370.0

Weightlifting

Up to 110 kg (Snatch) Group A+B+C/Sept. 27				Jusqu'a 110 kg (Arrache) Groupe A+B+C/27 Sept					
Rank	Name	Ctry	Weight	GR	1st	2nd	3rd	Result	
Rang	Nom	Pays	Poids		1er	2eme	3eme	Resultat	
1	Zakharevitch, Yuri	URS	109.55	A	195.0	NOR	205.0	NWR	210.0
2	Jacso, Jozsef	HUN	106.90	A	182.5		190.0	X	190.0
3	Weller, Ronny	GDR	107.75	A	190.0	X	190.0	X	190.0
4	Schubert, Michael	GDR	108.85	A	182.5		187.5	NOR	190.0
5	Popov, Alexandre	URS	103.45	A	182.5		187.5	NOR	187.5
6	Oberburger, Norberto	ITA	106.70	A	182.5		187.5	X	187.5
7	Malysa, Stanislaw	POL	109.45	A	175.0	X	175.0		180.0
8	Ohlinger, Eduard	FRG	108.00	B	165.0		170.0		175.0
9	Baraniak, Anton	TCH	108.75	A	175.0	X	175.0		175.0
10	Nilsson, Rickard	SWE	109.20	B	175.0		180.0	X	175.0
11	Seipelt, Frank	FRG	109.30	A	165.0		170.0		170.0
12	Michels, Jeff	USA	108.80	B	155.0		162.5		167.5
13	Strombo, Frank Juul	DEN	106.00	B	160.0		165.0		165.0
14	Schutz, Rich	USA	102.10	B	155.0		160.0	X	160.0
15	Thomas, Mark	GBR	108.35	B	155.0		160.0	X	155.0
16	Yousfi, Omar	ALG	108.55	B	140.0		147.5	X	140.0
17	Ochieng, Pius	KEN	107.20	B	125.0	X	125.0		125.0
18	Timoti, Tauama	ASA	108.90	B	110.0		120.0		120.0
19	Cukovic, Milan	GUM	109.35	B	95.0				95.0
	Davies, Andrew	GBR	109.90	A	190.0	X	190.0	X	0.0

Up to 110 kg (CLN&JRK) Group A+B+C/Sept. 27				Jusqu'a 110 kg (EP&Jete) Groupe A+B+C/27 Sept					
Rank	Name	Ctry	Weight	GR	1st	2nd	3rd	Result	
Rang	Nom	Pays	Poids		1er	2eme	3eme	Resultat	
1	Zakharevitch, Yuri	URS	109.55	A	245.0	NOR	251.0	X	245.0
2	Jacso, Jozsef	HUN	106.90	A	220.0		227.5		237.5
3	Weller, Ronny	GDR	107.75	A	230.0	X	230.0		235.0
4	Schubert, Michael	GDR	108.85	A	222.5		230.0		235.0
5	Popov, Alexandre	URS	103.45	A	227.5		232.5		232.5
6	Oberburger, Norberto	ITA	106.70	A	220.0		227.5		227.5
7	Seipelt, Frank	FRG	109.30	A	210.0		217.5		217.5
8	Malysa, Stanislaw	POL	109.45	A	215.0	X	215.0		215.0
9	Thomas, Mark	GBR	108.35	B	195.0		205.0	X	205.0
10	Strombo, Frank Juul	DEN	106.00	B	202.5		210.0	X	202.5
11	Schuijz, Rich	USA	102.10	B	192.5		200.0		200.0
12	Nilsson, Rickard	SWE	109.20	B	200.0		205.0	X	200.0
13	Michels, Jeff	USA	108.80	B	185.0		192.5		192.5
14	Ochieng, Pius	KEN	107.20	B	160.0		170.0		170.0
15	Yousfi, Omar	ALG	108.55	B	170.0		180.0		170.0
16	Timoti, Tauama	ASA	108.90	B	140.0	X	140.0		140.0
17	Cukovic, Milan	GUM	109.35	B	120.0		125.0		125.0
	Ohlinger, Eduard	FRG	108.00	B	195.0	X			0.0
	Baraniak, Anton	TOH	108.75	A	220.0	X	220.0	X	0.0
	Davies, Andrew	GBR	109.90	A	EL				EL

Up to 110 kg (Total) Group A+B+C/Sept. 27				Jusqu'a 110 kg (Total) Groupe A+B+C/27 Sept					
Rank	Name	Ctry	Weight	Group	Snatch	CLN&JRK	Total		
Rang	Nom	Pays	Poids	Groupe	Arrache	EP&Jete			
1	Zakharevitch, Yuri	URS	109.55	A	210.0	NWR	455.0	NWR	
2	Jacso, Jozsef	HUN	106.90	A	190.0	NOR	237.5	427.5	NOR
3	Weller, Ronny	GDR	107.75	A	190.0	NOR	235.0	425.0	NOR
4	Schubert, Michael	GDR	108.85	A	190.0	NOR	235.0	425.0	NOR
5	Popov, Alexandre	URS	103.45	A	187.5	NOR	232.5	420.0	
6	Oberburger, Norberto	ITA	106.70	A	187.5	NOR	227.5	415.0	
7	Malysa, Stanislaw	POL	109.45	A	180.0		215.0	395.0	
8	Seipelt, Frank	FRG	109.30	A	170.0		217.5	387.5	
9	Nilsson, Rickard	SWE	109.20	B	175.0		200.0	375.0	
10	Strombo, Frank Juul	DEN	106.00	B	165.0		202.5	367.5	
11	Schutz, Rich	USA	102.10	B	160.0		200.0	360.0	
12	Thomas, Mark	GBR	108.35	B	155.0		205.0	360.0	
13	Michels, Jeff	USA	108.80	B	167.5		192.5	360.0	
14	Yousfi, Omar	ALG	108.55	B	140.0		170.0	310.0	
15	Ochieng, Pius	KEN	107.20	B	125.0		170.0	295.0	
16	Timoti, Tauama	ASA	108.90	B	120.0		140.0	260.0	
17	Cukovic, Milan	GUM	109.35	B	95.0		125.0	220.0	
	Ohlinger, Eduard	FRG	108.00	B	175.0		0.0	0.0	
	Baraniak, Anton	TCH	108.75	A	175.0		0.0	0.0	
	Davies, Andrew	GBR	109.90	A	0.0		EL	EL	

Haltérophilie

Over 110 kg (Snatch) Group A+B+C/Sept. 29				Plus de 110 kg (Arrache) Groupe A+B+C/29 Sept						
Rank	Name	Ctry	Weight	GR	1st	2nd	3rd	Result		
Rang	Nom	Pays	Poids		1er	2eme	3eme	Resultat		
1	Kourlovitch, Alexandre	URS	132.20	A	202.5	NOR	207.5	NOR	212.5	
2	Nerlinger, Manfred	FRG	149.80	A	190.0	X	190.0		195.0	190.0
3	Zawieja, Martin	FRG	127.55	A	182.5		187.5	X	190.0	182.5
4	Elbatoty, Reda	EGY	120.15	A	170.0	X	170.0		175.0	175.0
5	Hudecek, Petr	TCH	128.60	A	175.0		180.0	X	180.0	175.0
6	Martinez, Mario	USA	139.45	A	175.0	X	175.0		182.5	175.0
7	Bergman, John	USA	132.80	B	155.0		162.5		167.5	167.5
8	Garzarella, Charles	AUS	148.10	B	155.0		160.0		162.5	162.5
9	Saltsidis, Pavlos	GRE	112.55	B	155.0		160.0		165.0	160.0
10	Vine, Matthew	GBR	117.00	B	150.0		155.0		157.5	157.5
11	Mohamed, Adham	EGY	120.85	B	152.5		160.0	X	160.0	152.5
12	Stamp, Calvin	JAM	119.20	B	145.0		150.0	X	150.0	150.0
13	Guzman Reynoso, Jose Migue	DOM	124.50	B	142.5		147.5	X		142.5
14	Marchinares, Rolando	PER	127.80	B	142.5		150.0	X	150.0	142.5
15	Takou, Dieudonne	CMR	111.65	B	140.0		150.0	X	150.0	140.0
	Aduche, Gilbert ojadi	NGR	119.45	A	160.0	X	160.0	X	165.0	0.0
	Zubricky, Jiri	TCH	164.95	A	185.0	X	185.0	X		0.0
	Tsintsaris, Giannis	GRE	131.55	A		IJ				IJ

Over 110 kg (CLN&JRK) Group A+B+C/Sept. 29				Plus de 110 kg (EP&Jete) Groupe A+B+C/29 Sept						
Rank	Name	Ctry	Weight	Gr	1st	2nd	3rd	Result		
Rang	Nom	Pays	Poids		1er	2eme	3eme	Resultat		
1	Kourlovitch, Alexandre	URS	132.20	A	245.0		250.0	X	250.0	
2	Nerlinger, Manfred	FRG	149.80	A	240.0		266.0	X	240.0	
3	Zawieja, Martin	FRG	127.55	A	220.0		227.5		232.5	
4	Martinez, Mario	USA	139.45	A	217.5		232.5		242.5	232.5
5	Hudecek, Petr	TCH	128.60	A	210.0		217.5		225.0	225.0
6	Elbatoty, Reda	EGY	120.15	A	200.0		210.0		217.5	217.5
7	Saltsidis, Pavlos	GRE	112.55	B	200.0	X	200.0		207.5	207.5
8	Garzarella, Charles	AUS	148.10	B	200.0		205.0		207.5	207.5
9	Vine, Matthew	GBR	117.00	B	195.0		205.0	X	205.0	195.0
10	Stamp, Calvin	JAM	119.20	B	185.0		192.5	X	195.0	195.0
11	Takou, Dieudonne	CMR	111.65	B	190.0	X	190.0		195.0	190.0
12	Mohamed, Adham	EGY	120.85	B	190.0	X	190.0		200.0	190.0
13	Guzman Reynoso, Jose Migue	DOM	124.50	B	190.0		195.0	X	195.0	190.0
14	Bergman, John	USA	132.80	B	185.0		192.5	X	192.5	185.0
15	Marchinares, Rolando	PER	127.80	B	182.5		192.5	X	192.5	182.5
	Tsintsaris, Giannis	GRE	131.55	A		IJ				IJ
	Aduche, Gilbert Ojadi	NGR	119.45	A		EL				EL
	Zubricky, Jiri	TCH	164.95	A		EL				EL

Over 110 kg (Total) Group A+B+C/Sept. 29				Plus de 110 kg (Total) Groupe A+B+C/29 Sept					
Rank	Name	Ctry	Weight	Group	Snatch	CLN&JRK	Total		
Rang	Nom	Pays	Poids	Groupe	Arrache	EP&Jete			
1	Kourlovitch, Alexandre	URS	132.20	A	212.5	NOR	250.0	462.5	NOR
2	Nerlinger, Manfred	FRG	149.80	A	190.0		240.0	430.0	
3	Zawieja, Martin	FRG	127.55	A	182.5		232.5	415.0	
4	Martinez, Mario	USA	139.45	A	175.0		232.5	407.5	
5	Hudecek, Pe	TCH	128.60	A	175.0		225.0	400.0	
6	Elbatoty, Reda	EGY	120.15	A	175.0		217.5	392.5	
7	Garzarella, Charles	AUS	148.10	B	162.5		207.5	370.0	
8	Saltsidis, Pavlos	GRE	112.55	B	160.0		207.5	367.5	
9	Vine, Matthew	BGR	117.00	B	157.5		195.0	352.5	
10	Bergman, John	USA	132.80	B	167.5		185.0	352.5	
11	Stamp, Calvin	JAM	119.20	B	150.0		195.0	345.0	
12	Mohamed, Adham	EGY	120.85	B	152.5		190.0	342.5	
13	Guzman Reynoso, Jose Migueq	DOM	124.50	B	142.5		190.0	332.5	
14	Takou, Dieudonne	CMR	111.65	B	140.0		190.0	330.0	
15	Marchinares, Rolando	PER	127.80	B	142.5		182.5	325.0	
	Tsintsaris, Giannis	GRE	131.55	A		IJ			IJ
	Aduche, Gilbert Ojadi	NGR	119.45	A	0.0		EL		EL
	Zubricky, Jiri	TCH	164.95	A	0.0		EL		EL



레슬링

Wrestling/Lutte

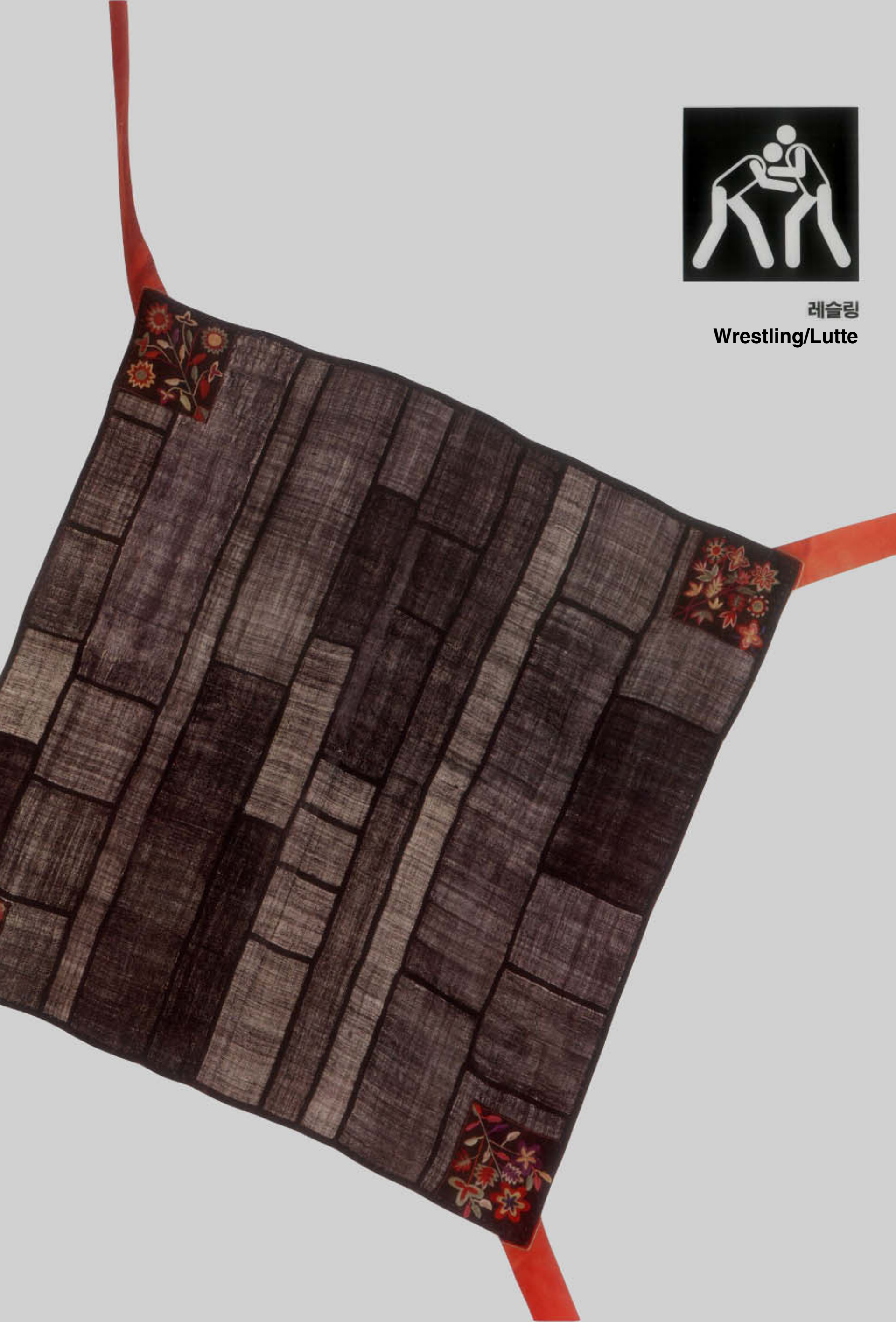

Wrestling/Lutte

Officials/Officiels

Fédération Internationale de Lutte Amateur (F.I.L.A)

President/président	Milan Ercegan
Secretary General/secrétaire général	Michael Dusson
Technical Delegates/délégués techniques	Mihaly Biro Raphy Martinetti

SLOOC Administrative Staff/Personnel Administratif du SLOOC

Commissioner/directeur	Lee Kun Hee
Secretary General/secrétaire général	Jang Chang Sun
Deputy Secretary General/secrétaire général adjoint	Choi Kyu Chul
Competition Manager/chef de division des compétitions	Chang Ho Song

Competitors/Concurrents

Freestyle Style Libre	Competitors Competiteurs	Countries Pays
Light Flyweight/mi-mouche (48 kg)	19	19
Flyweight/mouche (52 kg)	30	30
Bantamweight/coq (57 kg)	25	25
Featherweight/plume (62 kg)	28	28
Lightweight/leger (68 kg)	30	30
Welterweight/welter (74 kg)	30	30
Middleweight/moyen (82 kg)	29	29
Light Heavyweight/mi-lourd (90 kg)	28	28
Heavyweight/lourd (100kg)	22	22
Super Heavyweight/super-lourd (+100 kg)	15	15

Greco-Roman Style Greco-romain	Competitors Competiteurs	Countries Pays
Light Flyweight (48 kg)	16	16
Flyweight (52 kg)	21	21
Bantamweight (57 kg)	21	21
Featherweight (62 kg)	17	17
Lightweight (68 kg)	31	31
Welterweight (82 kg)	19	19
Middleweight (82 kg)	21	21
Light Heavyweight (90 kg)	22	22
Heavyweight (100 kg)	18	18
Super Heavyweight (+100 kg)	16	16

Legend/Notation

*	Winner/Gagnant
PS	Passivity while leading by 12-14 points/Passivite en avance de 12-14 points
FR	Forfeit/Forfait
F	Fall/Tomber
BYE	Bye/Exempt
P1	Passivity while leading by 1-11 points/passivite en avance de 1-11 points
I	Injury/Blessure
PO	Passivity scoring zero points/passivite aucun points
TF	Technical Fall/Grande Superiorite
DQ	Disqualified/Disqualifie
EL	Eliminated/Elimine

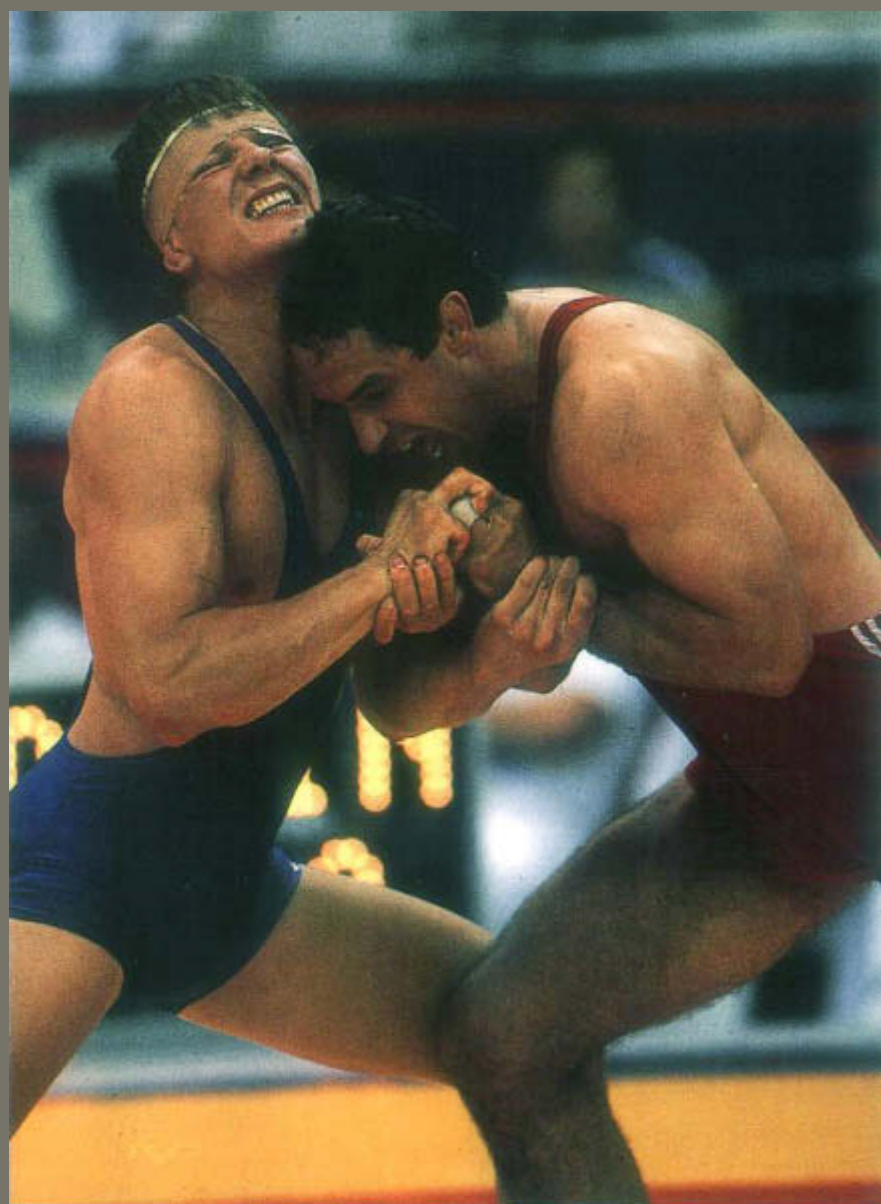

Wrestling

Greco-Roman Style 48Kg Round 1/Sept. 18				Style Greco-Romain 48Kg Tour 1/18 Sept				
Gr	Ctry	Name	Result	Time	***** Points***** bef/av.			No. of Loss
	Pays	Nom		Temps	Match	Match	Total	No. de Def.
A	JPN	Saito, Ikuzo	1		1.0	1.0	1	
	*USA	Fuller, Mark	3	6:00	3.0	3.0		
	*ITA	Maenza, Vincenzo	11	6:00	3.0	3.0		
	NOR	Ronningen, Lars	0		0.0	0.0	1	
	*FRG	Scherer, Markus	10	6:00	3.0	3.0		
	IRN	Simkhah, Majid	5		1.0	1.0	1	
	*BUL	Tzenov, Bratan	PS	2:10	3.5	3.5		
	CHN	Yang, Zhizhong			0.0	0.0	1	
B	*POL	Glab, Andrzej	10	6:00	3.0	3.0		
	URS	Allakhverdiev, M	5		1.0	1.0	1	
	*ISR	Grobermann, Dov	FR	0:00	4.0	4.0		
	YAR	Alizani, Avdalla			0.0	0.0	1	
	*SYR	Alfaraj, Khaled	F	5:11	4.0	4.0		
	COL	Capacho Pinto, V			0.0	0.0	1	
	*KOR	Kwon, Duk-Yong	1	6:00	3.0	3.0		
	HUN	Farago, Jozsef	0		0.0	0.0	1	

Greco-Roman Style 48Kg Round 2/Sept. 18				Style Greco-Romain 48Kg Tour 2/18 Sept				
Gr	Ctry	Name	Result	Time	***** Points***** bef/av.			No. of Loss
	Pays	Nom		Temps	Match	Match	Total	No. de Def.
A	JPN	Saito, Ikuzo	1		1.0	1.0	2.0	2
	*ITA	Maenza, Vincenzo	9	6:00	3.0	3.0	6.0	
	USA	Fuller, Mark	4		3.0	1.0	4.0	1
	*NOR	Ronningen, Lars	6	6:00	0.0	3.0	3.0	1
	FRG	Scherer, Markus	3		3.0	0.5	3.5	1
	*BUL	Tzenov, Bratan	15	6:00	3.5	3.5	7.0	
	IRN	Simkhah, Majid	0		1.0	0.0	1.0	2
	*CHN	Yang, Zhizhong	16	4:44	0.0	4.0	4.0	1
B	*POL	Glab, Andrzej	16	6:00	3.0	3.0	6.0	
	ISR	Grobermann, Dov	7		4.0	1.0	5.0	1
	*URS	Allakhverdiev, M	16	6:00	1.0	3.5	4.5	1
	SYR	Alfaraj, Khaled	4		4.0	0.5	4.5	1
	COL	Capacho Pinto, V	1		0.0	1.0	1.0	2
	*KOR	Kwon, Duk-Yong	2	6:00	3.0	3.0	6.0	
	HUN	Farago, Jozsef	BYE		0.0	0.0	1	

Greco-Roman Style 48Kg Round 3/Sept. 18				Style Greco-Romain 48Kg Tour 3/18 Sept				
Gr	Ctry	Name	Result	Time	***** Points***** bef/av.			No. of Loss
	Pays	Nom		Temps	Match	Match	Total	No. de Def.
A	USA	Fuller, Mark	4		4.0	1.0	5.0	2
	*ITA	Maenza, Vincenzo	7	6:00	6.0	3.0	9.0	
	NOR	Ronningen, Lars	4		3.0	0.5	3.5	2
	*BUL	Tzenov, Bratan	16	6:00	7.0	3.5	10.5	
	*FRG	Scherer, Markus	13	6:00	3.5	3.0	6.5	1
	CHN	Yang, Zhizhong	4		4.0	1.0	5.0	2
B	HUN	Farago, Jozsef			0.0	0.0	0.0	2
	*POL	Glab, Andrzej	P1	5:49	6.0	3.0	9.0	
	*URS	Allakhverdiev, M	7	6:00	4.5	3.0	7.5	1
	ISR	Grobermann, Dov	1		5.0	1.0	6.0	2
	*SYR	Alfaraj, Khaled	8	6:00	4.5	3.0	7.5	1
	KOR	Kwon, Duk-Yong	5		6.0	1.0	7.0	1

Lutte

Greco-Roman Style 48Kg Round 4/Sept. 19				Style Greco-Romain 48Kg Tour 4/19 Sept				
Gr	Ctry	Name	Result	Time	***** Points***** bef/av.			No. of Loss
	Pays	Nom		Temps	Match	Match	Total	No. de Def.
A	*ITA	Maenza, Vincenzo	15	6:00	9.0	3.5	12.5	
	FRG	Scherer, Markus	1		6.5	0.5	7.0	2
	BUL	Tzenov, Bratan	BYE		10.5		10.5	
B	*POL	Glab, Andrzej	10	6:00	9.0	3.0	12.0	
	SYR	Alfaraj, Khaled	5		7.5	1.0	8.5	2
	*URS	Allakhverdiev, M	2	6:00	7.5	3.0	10.5	1
	KOR	Kwon, Duk-Yong	1		7.0	1.0	8.0	2

Greco-Roman Style 48Kg Round 5/Sept. 19				Style Greco-Romain 48Kg Tour 5/19 Sept				
Gr	Ctry	Name	Result	Time	***** Points***** bef/av.			No. of Loss
	Pays	Nom		Temps	Match	Match	Total	No. de Def.
A	*ITA	Maenza, Vincenzo	4	6:42	12.5	3.0	15.5	
	BUL	Tzenov, Bratan	3		10.5	1.0	11.5	1

Greco-Roman Style 48Kg Finals/Sept. 20				Style Greco-Romain 48Kg Finale/20 Sept		
	Ctry	Name	Result	Time	Points	
	Pays	Nom	Resultat	Temps	Points	

1-2 PLACE

*ITA Maenza, Vincenzo 3 6:00 3.0
POL Glab, Andrzej 0 0.0

3-4 PLACE

*BUL Tzenov, Bratan P1 7:28 3.0
URS Allakhverdiev, M 0.0

5-6 PLACE

FRG Scherer, Markus 6 1.0
*SYR Alfaraj, Khaled 16 6:00 3.0

*** Final "B" ***

7-8 PLACE

*CHN Yang, Zhizhong I 0:00 4.0
KOR Kwon, Duk-Yong 0.0

Greco-Roman Style 48Kg Sept. 18-20				Style Greco-Romain 48Kg 18-20 Sept			
---------------------------------------	--	--	--	---------------------------------------	--	--	--

Group A/Groupe A

01	Saito, Ikuzo	JPN	1.0	1.0				EL R.2
05	Fuller Mark	USA	3.0	1.0	1.0			EL R.3
05	Maenza, Vincenzo	ITA	3.0	3.0	3.0	3.5	3.0	1ST
07	Ronningen, Lars	NOR	0.0	3.0	0.5			EL R.3
09	Scherer, Markus	FRG	3.0	0.5	3.0	0.5		3 RD
11	Simkhah, Majid	IRN	1.0	0.0				EL R.2
13	Tzenov-Gavrailo	BUL	3.5	3.5	3.5	0.0	1.0	2ND
15	Yang, Zhizhong	CHN	0.0	4.0	1.0			4TH

Group B/Groupe B

02	Glab, Andrzej	POL	3.0	3.0	3.0	3.0		1ST
04	Allakhverdiev, M	URS	1.0	3.5	3.0	3.0		2ND
06	Grobermann, Dov	ISR	4.0	1.0	1.0			EL R.3
08	Alizani, A	YAR	0.0					EL R.1
10	Alfaraj, Khaled	SYR	4.0	0.5	3.0	1.0		3RD
12	Capacho Pinto, V	COL	0.0	1.0				EL R.2
14	Kwon, Duk-Yong	KOR	3.0	3.0	1.0	1.0		4TH
16	Farago, Jozsef	HUN	0.0	0.0	0.0			EL R.3

Final/Finale

1-2	Maenza, Vincenzo Glab, Andrzej	ITA POL	3.0 0.0	D	6:00	03-00
3-4	Tzenov-Gavrailo Allakhverdiev, M	BUL URS	3.0 0.0	P1	7:28	
5-6	Alfaraj, Khaled Scherer, Markus	SYR FRG	3.0 1.0	D	6:00	16-06
7-8	Yang, Zhizhong Kwon, Duk-Yong	CHN KOR	4.0 0.0	I	0:00	
1)	Maenza, Vincenzo	ITA				
2)	Glab, Andrzej	POL				
3)	Tzenov, Bratan	BUL				
4)	Allakhverdiev, Maguiatdine	URS				
5)	Alfaraj, Khaled	SYR				
6)	Scherer, Markus	FRG				
7)	Yang, Zhizong	CHN				
8)	Kwon, Duk-Yong	KOR				

**Greco-Roman Style 52Kg
Round 1/Sept. 19**

Gr	Ctry	Name	Result	Time	Style Greco-Romain 52Kg Tour 1/19 Sept			No. of Loss No.de Def.
					***** bef/av. Match	***** Match	***** Total	
A	*TUR	Kemah, Erol	18	1:50	4.0	4.0		
	PHI	Tirante, Florent	0		0.0	0.0	1	
	*BUL	Fiiev, Hristo	16	0:39	4.0	4.0		
	JOR	Sharif, Jihad	0		0.0	0.0	1	
	*TCH	Jankovics, Tobor	F	0:49	4.0	4.0		
	GUA	Vasquez, Edwin-E			0.0	0.0		
	FRA	Robert, Serge	0		0.0	0.0	1	
	*JPN	Miyahara, Atsuji	9	6:00	3.0	3.0		
	IRN	Kakahadji, Karim	8		1.0	1.0	1	
	*FIN	Murtoaro, Esa	10	6:00	3.0	3.0		
	URS	Ignatenko, Alexa	BYE			0.0		
B	POR	Marques, Jose			0.0	0.0	1	
	*SWE	Stjernberg, Pete	I	4:08	4.0	4.0		
	*KOR	Lee, Jae-Suk	17	3:45	4.0	4.0		
	MAR	Naanaa, Abderrah	2		0.0	0.0	1	
	HUN	Vadasz, Csaba	0		0.0	0.0	1	
	*POL	Kierpacz, Roman	10	6:00	3.0	3.0		
	KEN	Elimu, Lamachi	2		0.0	0.0	1	
	*CHN	Huricha,	18	2:59	4.0	4.0		
	*NOR	Ronningen, Jon	4	6:00	3.0	3.0		
	USA	Sheldon, Shawn	1		1.0	1.0	1	

**Greco-Roman Style 52Kg
Round 2/Sept. 19**

Gr	Ctry	Name	Result	Time	Style Greco-Romain 52Kg Tour 2/19 Sept			No. of Loss No.de Def.
					***** bef/av. Match	***** Match	***** Total	
A	*URS	Ignatenko, Alexa	F	5:53	0.0	4.0	4.0	
	TUR	Kemah, Erol			4.0	0.0	4.0	1
	PHI	Tirante, Florent			0.0	0.0	0.0	2
	*BUL	Fiiev, Hristo	FR	0:00	4.0	4.0	8.0	
	JOR	Sharif, Jihad		0:0	0.0	0.0	0.0	2
	*TCH	Jankovics, Tobor	FR	0:00	4.0	4.0	8.0	
	GUA	Vasquez, Edwin-E	0		0.0	0.0	0.0	2
	*FRA	Robert, Serge	15	2:22	0.0	4.0	4.0	1
	*JPN	Miyahar, Atsuji	6	6:00	3.0	3.0	6.0	
	IRN	Kakahadji, Karim	1		1.0	1.0	2.0	2
	FIN	Murtoaro, Esa	BYE		3.0		3.0	
B	POR	Marques, Jose			0.0	0.0	0.0	2
	*KOR	Lee, Jae-Suk	I	0:00	4.0	4.0	8.0	
	*SWE	Stjernberg, Pete	5	6:00	4.0	3.0	7.0	
	MAR	Naanaa, Abodrrah	3		0.0	1.0	1.0	2
	*HUN	Vadasz, Csaba	F	1:20	0.0	4.0	4.0	1
	KEN	Elimu, Lamachi			0.0	0.0	0.0	2
	POL	Kierpacz, Roman	5		3.0	1.0	4.0	1
	*NOR	Ronningen, Jon	6	6:00	3.0	3.0	6.0	
	*CHN	Huricha,	P0	4:08	4.0	2.0	6.0	
	USA	Sheldon, Shawn			1.0	0.0	1.0	2

**Greco-Roman Style 52Kg
Round 3/Sept. 19**

Gr	Ctry	Name	Result	Time	Style Greco-Romain 52Kg Tour 3/19 Sept			No. of Loss No.de Def.
					***** bef/av. Match	***** Match	***** Total	
	Pays	Nom		Temps				
A	FIN	Murtoaro, Esa	0		3.0	0.0	3.0	1
	*URS	Ignatenko, Alexa	10	6:00	4.0	3.0	7.0	
	TUR	Kemah, Erol	0		4.0	0.0	4.0	2
	*BUL	Fiiev, Hristo	17	2:28	8.0	4.0	12.0	
	*TCH	Jankovics, Tobor	P1	4:14	8.0	3.0	11.0	
	FRA	Robert, Serge			4.0	0.0	4.0	2
	JPN	Miyahara, Atsuji	BYE		6.0		6.0	
	SWE	Stjernberg, Pete	5		7.0	1.0	8.0	1
	*KOR	Lee, Jae-Suk	7	6:00	8.0	3.0	11.0	
	HUN	Vadasz, Csaba	0		4.0	0.0	4.0	2
	*NOR	Ronningen, Jon	6	6:00	6.0	3.0	9.0	
	*POL	Kierpacz, Romna	3	6:00	4.0	3.0	7.0	1
	CHN	Huricha,	1		6.0	1.0	7.0	1

**Greco-Roman Style 52Kg
Round 4/Sept. 20**

Gr	Ctry	Name	Result	Time	Style Greco-Romain 52Kg Tour 4/20 Sept			No. of Loss No.de Def.
					***** bef/av. Match	***** Match	***** Total	
	Pays	Nom		Temps				
A	*JPN	Miyahara, Atsuji	16	5:01	6.0	4.0	10.0	
	FIN	Murtoaro, Esa	0		3.0	0.0	3.0	2
	*URS	Ignatenko, Alexa	PS	5:12	7.0	3.5	10.5	
	BUL	Fiiev, Hristo			12.0	0.0	12.0	1
	TCH	Jankovics, Tobor	BYE		11.0		11.0	
B	SWE	Stjernberg, Pete	2		8.0	1.0	9.0	2
	*POL	Kierpacz, Roman	8	6:00	7.0	3.0	10.0	1
	*KOR	Lee, Jae-Suk	P1	5:35	11.0	3.0	14.0	
	CHN	Huricha,			7.0	0.0	7.0	2
	NOR	Ronningen, Jon	BYE		9.0		9.0	

**Greco-Roman Style 52Kg
Round 5/Sept. 20**

Gr	Ctry	Name	Result	Time	Style Greco-Romain 52Kg Tour 5/20 Sept			No. of Loss No.de Def.
					***** bef/av. Match	***** Match	***** Total	
	Pays	Nom		Temps				
A	TCH	Jankovics, Tobor			11.0	0.0	11.0	1
	*URS	Ignatenko, Alexa	P1	4:23	10.5	3.0	13.5	
	*JPN	Miyahara, Atsuji	10	6:00	10.0	3.0	13.0	
	BUL	Fiiev, Hristo	6		12.0	1.0	13.0	2
B	*NOR	Ronningen, Jon	5	6:00	9.0	3.0	12.0	
	KOR	Lee, Jae-Suk	1		14.0	1.0	15.0	1
	POL	Kierpacz, Roman	BYE		10.0		10.0	1

**Greco-Roman Style 52Kg
Round 6/Sept. 21**

Gr	Ctry	Name	Result	Time	Style Greco-Romain 52Kg Tour 6/21 Sept			No. of Loss No.de Def.
					***** bef/av. Match	***** Match	***** Total	
	Pays	Nom		Temps				
A	TCH	Jankovics, Tobor			11.0	0.0	11.0	2
	*JPN	Miyahara, Atsuji	P1	3:53	13.0	3.0	16.0	
B	POL	Kierpacz, Roman	3		10.0	1.0	11.0	2
	*KOR	Lee, Jae-Suk	4	6:00	15.0	3.0	18.0	1

**Greco-Roman Style 52Kg
Round 7/Sept. 21**

Gr	Ctry	Name	Result	Time	Style Greco-Romain 52Kg Tour 7/21 Sept			No. of Loss No.de Def.
					***** bef/av. Match	***** Match	***** Total	
	Pays	Nom		Temps				
A	*JPN	Miyahara, Atsuji	4	6:00	16.0	3.0	19.0	
	URS	Ignatenko, Alex	3		13.5	1.0	14.5	2

Wrestling

Greco-Roman Style 52Kg Finals/Sept. 21			Style Greco-Romain 52Kg Finale/21 Sept		
Ctry	Name	Result	Time	Points	
Pays	Nom	Resultat	Temps	Points	
1-2 PLACE					
JPN	Miyahara, Atsuji	7		1.0	
*NOR	Ronningen, Jon	12	6:00	3.0	
3-4 PLACE					
URS	Ignatenko, Alexa	3		1.0	
*KOR	Lee, Jae-Suk	4	6:00	3.0	
5-6 PLACE					
TCH	Jankovics, Tobor			0.0	
*POL	Kierpacz, Roman	P1	3:29	3.0	
* * *Final "B" * * *					
7-8 PLACE					
*BUL	Fiiev, Hristo	9	6:00	3.0	
SWE	Stjernberg, Pete	3		1.0	

Greco-Roman Style 52Kg Sept. 19-21			Style Greco-Romain 52Kg 19-21 Sept			
Group A/Groupe A						
01	Kemah, Erol	TUR	4.0	0.0	0.0	EL R.3
03	Tirante, F	PHI	0.0	0.0		EL R.2
05	Fiiev, Hristo	BUL	4.0	4.0	4.0 0.0 1.0	4TH
07	Snarif, Jihad	JOR	0.0	0.0		EL R.2
09	Jankovics, Tobor	TCH	4.0	4.0	3.0 0.0 0.0 0.0	3RD
11	Vasquez, E	GUA	0.0	0.0		EL R.2
13	Robert, Serge	FRA	0.0	4.0	0.0	EL R.3
15	Miyahara, Atsuji	JPN	3.0	3.0	0.0 4.0 3.0 3.0	1ST
17	Kakahadji, Karim	IRN	1.0	1.0		EL R.2
19	Murtoaro, Esa	FIN	3.0	0.0	0.0 0.0	EL R.4
21	Ignatenko, A	URS	0.0	4.0	3.0 3.5 3.0 1.0	2ND
Group B/Groupe B						
02	Marques, Jose	POR	0.0	0.0		EL R.2
04	Stjernberg, P	SWE	4.0	3.0	1.0 1.0	4TH
06	Lee, Jae-Suk	KOR	4.0	4.0	3.0 3.0 1.0 3.0	2ND
08	Naanaa, A	MAR	0.0	1.0		EL R.2
10	Vadasz, Csaba	HUN	0.0	4.0	0.0	EL R.3
12	Kierpacz, Roman	POL	3.0	1.0	3.0 0.0 1.0	3RD
14	Elimu, Lamachi	KEN	0.0	0.0		EL R.2
16	Huricha	CHN	4.0	2.0	1.0 0.0	EL R.4
18	Ronningen, Jon	NOR	3.0	3.0	0.0 3.0	1ST
20	Sheldon, Shawn	USA	1.0	0.0		EL R.2
Final/Finale						
1-2	Ronningen, Jon	NOR	3.0	D	6:00 12-07	
	Miyahara, Atsuji	JPN	1.0			
3-4	Lee, Jae-Suk	KOR	3.0	D	6:00 04-03	
	Ignatenko, A	URS	1.0			
5-6	Kierpacz, Roman	POL	3.0	P1	3:29	
	Jankovics, Tobor	TCH	0.0			
7-8	Fiiev, Hristo	BUL	3.0	D	6:00 09-03	
	Stjernberg, P	SWE	1.0			
1)	Ronningen, Jon	NOR				
2)	Miyahara, Atsuji	JPN				
3)	Lee, Jae-Suk	KOR				
4)	Ignatenko, Alexandre	URS				
5)	Kierpacz, Roman	POL				
6)	Jankovics, Tobor	TCH				
7)	Fiiev, Hristo	BUL				
8)	Stjernberg, Peter	SWE				

Lutte

Greco-Roman Style 57Kg Round 1/Sept. 20			Style Greco-Romain 57Kg Tour 1/20 Sept				
Gr	Ctry	Name	Result	Time	***** Points ***** bef/av.	No. of Loss	
	Pays	Nom		Temps	Match Match Total	No. de Def.	
A	USA	Amado, Anthony			0.0	0.0	1
	*KOR	Huh, Byung-Ho	P1	6:42	3.0	3.0	
	*NOR	Sigde, Ronny	F	1:36	4.0	4.0	
	IRN	Pazach, Ahad			0.0	0.0	1
	URS	Chestakov, Alexa			0.0	0.0	1
	*GRE	Holidis, Charala	P1	5:07	3.0	3.0	
	*SWE	Ljungbeck, Benni	5	6:00	3.0	3.0	
	FIN	Pehkonen, Keijo	0		0.0	0.0	1
	YUG	Galovic, Zoran	0		0.0	0.0	1
	*BUL	Balov, Stoyan	16	2:29	4.0	4.0	
	MAR	Bouallouche, Kac	BYE			0.0	
B	*HUN	Sike, Andras	6	6:00	3.0	3.0	
	JPN	Nakadome, Shunji	0		0.0	0.0	1
	*CHN	Yang, Changling	3	6:00	3.0	3.0	
	POL	Wolny, Ryszard	2		1.0	1.0	1
	PAN	Mena, Ramon	2		1.0	1.0	1
	*FRA	Mourier, Patrice	13	6:00	3.0	3.0	
	*FRG	Yildiz, Rifat	12	6:00	3.5	3.5	
	TUN	Chaambi, Mehdi	0		0.0	0.0	1
	*IRQ	Salah, Ghazi F	15	6:00	3.0	3.0	
	MEX	Ponce, Adrian	8		1.0	1.0	1

Greco-Roman Style 57Kg Round 2/Sept. 20			Style Greco-Romain 57Kg Tour 2/20 Sept				
Gr	Ctry	Name	Result	Time	***** Points ***** bef/av.	No. of Loss	
	Pays	Nom		Temps	Match Match Total	No. de Def.	
A	MAR	Bouallouche, Kac			0.0	0.0	1
	*USA	Amado, Anthony	F	1:05	0.0	4.0	1
	*KOR	Huh, Byung-Ho	19	4:33	3.0	4.0	7.0
	NOR	Sigde, Ronny	0		4.0	0.0	4.0
	IRN	Pazach, Ahad	0		0.0	0.0	0.0
	*URS	Chestakov, Alexa	15	1:55	0.0	4.0	4.0
	*GRE	Holidis, Charala	P1	5:22	3.0	3.0	6.0
	SWE	Ljungbeck, Benni			3.0	0.0	3.0
	*FIN	Pehkonen, Keijo	6	6:00	0.0	3.0	3.0
	YUG	Galovic, Zoran	1		0.0	1.0	1.0
	BUL	Balov, Stoyan	BYE		4.0		4.0
B	*HUN	Sike, Andras	F	5:41	3.0	4.0	7.0
	CHN	Yang, Changling			3.0	0.0	3.0
	*JPN	Nakadome, Shunji	14	6:00	0.0	3.5	3.5
	POL	Wolny, Ryszard	1		1.0	0.5	1.5
	PAN	Mena, Ramon	0		1.0	0.0	1.0
	*FRG	Yildiz, Rifat	16	2:22	3.5	4.0	7.5
	FRA	Mourier, Patrice			3.0	0.0	3.0
	*IRQ	Salah, Ghazi F	1	1:13	3.0	4.0	7.0
	*TUN	Chaambi, Mehdi	15	5:16	0.0	4.0	4.0
	MEX	Ponce, Adrian	0		1.0	0.0	1.0

Greco-Roman Style 57Kg Round 3/Sept. 21			Style Greco-Romain 57Kg Tour 3/21 Sept				
Gr	Ctry	Name	Result	Time	***** Points ***** bef/av.	No. of Loss	
	Pays	Nom		Temps	Match Match Total	No. de Def.	
A	*BUL	Balov, Stoyan	16	3:42	4.0	4.0	8.0
	MAR	Bouallouche, Kac	0		0.0	0.0	0.0
	*USA	Amado, Anthony	10	6:00	4.0	3.0	7.0
	NOR	Sigde, Ronny	7		4.0	1.0	5.0
	KOR	Huh, Byung-Ho	4		7.0	1.0	8.0
	*GRE	Holidis, Charala	7	6:00	6.0	3.0	9.0
	*URS	Chestakov, Alexa	P1	3:43	4.0	3.0	7.0
	SWE	Ljungbeck, Benni			3.0	0.0	3.0
	FIN	Pehkonen, Keijo	BYE		3.0		3.0
B	*HUN	Sike, Andras	P1	5:30	7.0	3.0	10.0
	FRG	Yildiz, Rifat			7.5	0.0	7.5
	JPN	Nakadome, Shunji	8		3.5	1.0	4.5
	*CHN	Yang, Changling	11	6:00	3.0	3.0	6.0
	IRQ	Salah, Ghazi F	BYE		7.0		7.0



Greco-Roman Style 57Kg				Style Greco-Romain 57Kg			
Round 4/Sept. 21				Tour 4/21 Sept			
Gr	Ctry	Name	Result	Time	Points	Points	No. of Loss
	Pays	Nom		Temps	Match	Match	No. de Def.
A	FIN	Pehkonen, Keijo	2		3.0	1.0	4.0
	*BUL	Balov, Stoyan	3	6:00	8.0	3.0	11.0
	USA	Amado, Anthony			7.0	0.0	7.0
	*GRE	Holidis, Charala	F	2:49	9.0	4.0	13.0
	*KOR	Huh, Byung-Ho	10	6:00	8.0	3.0	11.0
	URS	Chestakov, Alexa	9		7.0	1.0	8.0
B	IRQ	Salah, Ghazi F	0		7.0	0.0	7.0
	*HUN	Sike, Andras	16	1:41	10.0	4.0	14.0
	*CHN	Yang, Changling	8	6:00	6.0	3.0	9.0
	FRG	Yildiz, Rifat	5		7.5	1.0	8.5

Greco-Roman Style 57Kg				Style Greco-Romain 57Kg			
Round 5/Sept. 21				Tour 5/21 Sept			
Gr	Ctry	Name	Result	Time	Points	Points	No. of Loss
	Pays	Nom		Temps	Match	Match	No. de Def.
A	*BUL	Balov, Stoyan	5	6:00	11.0	3.0	14.0
	KOR	Huh, Byung-Ho	2		11.0	1.0	12.0
	GRE	Holidis, Charala	BYE		13.0		13.0
B	IRQ	Salah, Ghazi F	2		7.0	1.0	8.0
	*CHN	Yang, Changling	10	6:00	9.0	3.0	12.0

Greco-Roman Style 57Kg				Style Greco-Romain 57Kg			
Round 6/Sept. 22				Tour 6/22 Sept			
Gr	Ctry	Name	Result	Time	Points	Points	No. of Loss
	Pays	Nom		Temps	Match	Match	No. de Def.
A	GRE	Holidis, Charala	0		13.0	0.0	13.0
	*BUL	Balov, Stoyan	8	6:00	14.0	3.0	17.0

Greco-Roman Style 57Kg				Style Greco-Romain 57Kg			
Finals/Sept. 22				Finale/22 Sept			
	Ctry	Name	Result	Time	Points	Points	
	Pays	Nom	Resultat	Temps	Points	Points	
1-2 PLACE							
	BUL	Balov, Stoyan			0.0		
	*HUN	Sike, Andras	I	3:38	4.0		
3-4 PLACE							
	*GRE	Holidis, Charala	6	6:00	3.0		
	CHN	Yang, Changling	1		1.0		
5-6 PLACE							
	*KOR	Huh, Byung-Ho	F	1:44	4.0		
	IRQ	Salah, Ghazi F			0.0		
* * * Final "B" * * *							
7-8 PLACE							
	*URS	Chestakov, Alexa	FR	0:00	4.0		
	FRG	Yildiz, Rifat			0.0		

Greco-Roman Style 57Kg				Style Greco-Romain 57Kg			
Sept. 20-22				20-22 Sept			
Group A/Groupe A							
Gr	Ctry	Name	Result	Time	Points	Points	No. of Loss
	Pays	Nom		Temps	Match	Match	No. de Def.
01	USA	Amado, Anthony	0.0	4.0	3.0	0.0	
03	KOR	Huh, Byung-Ho	3.0	4.0	1.0	3.0	1.0
05	NOR	Sigde, Ronny	4.0	0.0	1.0		
07	IRN	Pazach, Ahad	0.0	0.0			
09	URS	Chestakov, A	0.0	4.0	3.0	1.0	
11	GRE	Holidis, C	3.0	3.0	3.0	4.0	0.0
13	SWE	Ljungbeck, Benni	3.0	0.0	0.0		
15	FIN	Pehkonen, Keijo	0.0	3.0	0.0	1.0	0.0
17	YUG	Galovic, Zoran	0.0	1.0			
19	BUL	Balov, Stoyan	4.0	0.0	4.0	3.0	3.0
21	MAR	Bouallouche, K	0.0	0.0	0.0		

Group B/Groupe B							
Gr	Ctry	Name	Result	Time	Points	Points	No. of Loss
	Pays	Nom		Temps	Match	Match	No. de Def.
02	HUN	Sike, Andras	3.0	4.0	3.0	4.0	1ST
04	JPN	Nakadome, Shunji	0.0	3.5	1.0		EL R.3
06	CHN	Yang, Changling	3.0	0.0	3.0	3.0	2ND
08	POL	Wolny, Ryszard	1.0	0.5			EL R.2
10	PAN	Mena, Ramon	1.0	0.0			EL R.2
12	FRA	Mourier, Patrice	3.0	0.0			EL R.2
14	FRG	Yildiz, Rifat	3.5	4.0	0.0	1.0	4TH
16	TUN	Chaambi, Rehdi	0.0	4.0			EL R.2
18	IRQ	Salah, Ghazi F	3.0	4.0	0.0	0.0	3RD
20	MEX	Ponce, Adrian	1.0	0.0			EL R.2

Final/Finale							
Gr	Ctry	Name	Result	Time	Points	Points	No. of Loss
	Pays	Nom		Temps	Match	Match	No. de Def.
1-2	HUN	Sike, Andras	4.0	I	3:38		
	BUL	Balov, Stoyan	0.0				
3-4	GRE	Holidis, C	3.0	D	6:00	06-01	
	CHN	Yang, Changling	1.0				
5-6	KOR	Huh, Byung-Ho	4.0	F	1:44		
	IRQ	Salah, Ghazi F	0.0				
7-8	URS	Chestakov, A	4.0	FR	0:00		
	FRG	Yildiz, Rifat	0.0				
1)	HUN	Sike, Andras					
2)	BUL	Balov, Stoyan					
3)	GRE	Holidis, Charalambos					
4)	CHN	Yang, Changling					
5)	KOR	Huh, Byung-Ho					
6)	IRQ	Salah, Ghazi F					
7)	URS	Chestakov, Alexandre					

Greco-Roman Style 62Kg				Style Greco-Romain 62Kg			
Round 1/Sept. 18				Tour 1/18 Sept			
Gr	Ctry	Name	Result	Time	Points	Points	No. of Loss
	Pays	Nom		Temps	Match	Match	No. de Def.
A	*USA	Anderson, Isaac	3	6:00	3.0	3.0	
	POL	Tracz, Mieczysla	2		1.0	1.0	1
	*MAR	Loksairi, Brahim	2	6:00	3.0	3.0	
	TUN	Lakhal, Habib	1		1.0	1.0	1
	IRN	Javan-Saleh, Aha	3		1.0	1.0	1
	*URS	Madjidov, Kamand	8	6:00	3.0	3.0	
	*KOR	An, Dae-Hyun	P1	3:59	3.0	3.0	
	FRA	Jalabert, Gilles			0.0	0.0	1
	CHN	Gu, Guohong	BYE			0.0	
B	FIN	Loikas, Jukka	6		1.0	1.0	1
	*JPN	Nishiguchi, Shig	9	6:00	3.0	3.0	
	*BUL	Vanguelov, Jivko	1	6:00	3.0	3.0	
	HUN	Bodi, Jeno	0		0.0	0.0	1
	*FRG	Behl, Peter	15	5:46	4.0	4.0	
	ESP	Fernandez, Carlo	0		0.0	0.0	1
	*SUI	Dietsche, Hugo	3	6:00	3.0	3.0	
	TUR	Sahin, Zeki	2		1.0	1.0	1

Wrestling

Lutte

Greco-Roman Style 62Kg Round 2/Sept. 18				Style Greco-Romain 62Kg Tour 2/18 Sept			
Gr	Ctry	Name	Result	Time	Points	Points	No. of Loss
	Pays	Nom		Temps	Match	Match	No. de Def.
A	CHN	Gu, Guohong			0.0	0.0	1
	*USA	Anderson, Isaac	P1	4:13	3.0	3.0	6.0
	*POL	Tracz, Mieczysla	P1	5:31	1.0	3.0	4.0
	MAR	Loksairi, Brahim			3.0	0.0	3.0
	TUN	Lakhal, Habib	0		1.0	0.0	1.0
	*IRN	Javan-Saleh, Aha	5	6:00	1.0	3.0	4.0
	*URS	Madjidov, Kamand	P1	5:24	3.0	3.0	6.0
	KOR	An, Dae-Hyun			3.0	0.0	3.0
	FRA	Jalabert, Gilles	BYE		0.0		0.0
B	FIN	Loikas, Jukka	0		1.0	0.0	1.0
	*BUL	Vanguelov, Jivko	7	6:00	3.0	3.0	6.0
	JPN	Nishiguchi, Shig	0		3.0	0.0	3.0
	*HUN	Bodi, Jeno	7	6:00	0.0	3.0	3.0
	FRG	Behl, Peter			4.0	0.0	4.0
	*SUI	Dietsche, Hugo	P1	4:59	3.0	3.0	6.0
	ESP	Fernandez, Carlo	0		0.0	0.0	0.0
	*TUR	Sahin, Zeki	12	6:00	1.0	3.5	4.5

Greco-Roman Style 62Kg Round 3/Sept. 18				Style Greco-Romain 62Kg Tour 3/18 Sept			
Gr	Ctry	Name	Result	Time	Points	Points	No. of Loss
	Pays	Nom		Temps	Match	Match	No. de Def.
A	*FRA	Jalabert, Gilles	13	6:00	0.0	3.0	3.0
	CHN	Gu, Guohong	4		0.0	1.0	1.0
	*USA	Anderson, Isaac	P1	3:21	6.0	3.0	9.0
	MAR	Loksairi, Brahim			3.0	0.0	3.0
	POL	Tracz, Mieczysla	0		4.0	0.0	4.0
	*URS	Madjidov, Kamand	3	6:00	6.0	3.0	9.0
	IRN	Javan-Saleh, Aha			4.0	0.0	4.0
	*KOR	An, Dae-Hyun	DQM	4:55	3.0	4.0	7.0
B	JPN	Nishiguchi, Shig			3.0	0.0	3.0
	*BUL	Vanguelov, Jivko	F	1:06	6.0	4.0	10.0
	*HUN	Bodi, Jeno	4	6:00	3.0	3.0	6.0
	SUI	Dietsche, Hugo	1		6.0	1.0	7.0
	*FRG	Behl, Peter	P1	4:07	4.0	3.0	7.0
	TUR	Sahin, Zeki			4.5	0.0	4.5

Greco-Roman Style 62Kg Round 4/Sept. 19				Style Greco-Romain 62Kg Tour 4/19 Sept			
Gr	Ctry	Name	Result	Time	Points	Points	No. of Loss
	Pays	Nom		Temps	Match	Match	No. de Def.
A	FRA	Jalabert, Gilles			3.0	0.0	3.0
	*URS	Madjidov, Kamand	P1	4:14	9.0	3.0	12.0
	USA	Anderson, Isaac	0		9.0	0.0	9.0
	*KOR	An, Dae-Hyun	2	6:00	7.0	3.0	10.0
B	*BUL	Vanguelov, Jivko	F	2:14	10.0	4.0	14.0
	SUI	Dietsche, Hugo			7.0	0.0	7.0
	*HUN	Bodi, Jeno	10	6:00	6.0	3.0	9.0
	FRG	Behl, Peter	1		7.0	1.0	8.0

Greco-Roman Style 62Kg Round 5/Sept. 19				Style Greco-Romain 62Kg Tour 5/19 Sept			
Gr	Ctry	Name	Result	Time	Points	Points	No. of Loss
	Pays	Nom		Temps	Match	Match	No. de Def.
A	USA	Anderson, Isaac	1		9.0	1.0	10.0
	*URS	Madjidov, Kamand	2	6:00	12.0	3.0	15.0

Greco-Roman Style 62Kg Finals/Sept. 20				Style Greco-Romain 62Kg Finale/20 Sept			
	Ctry	Name	Result	Time	Points	Points	
	Pays	Nom	Resultat	Temps	Points	Points	
1-2 PLACE							
	*URS	Madjidov, Kamand	6	6:00	3.0		
	BUL	Vanguelov, Jivko	2		1.0		
3-4 PLACE							
	*KOR	An, Dae-Hyun	P1	3:15	3.0		
	HUN	Bodi, Jeno			0.0		
5-6 PLACE							
	USA	Anderson, Isaac	1		1.0		
	*FRG	Behl, Peter	5	6:00	3.0		
*** Final "B" ***							
7-8 PLACE							
	*FRA	Jalabert, Gilles	1	0:00	4.0		
	SUI	Dietsche, Hugo			0.0		

Greco-Roman Style 62Kg Sept. 18-20				Style Greco-Romain 62Kg 18-20 Sept			
Gr	Ctry	Name	Result	Time	Points	Points	No. of Loss
	Pays	Nom		Temps	Match	Match	No. de Def.
Group A/Groupe A							
01	USA	Anderson, Isaac	3.0	3.0	3.0	0.0	1.0
03	POL	Tracz, M	1.0	3.0	0.0		
05	MAR	Loksairi, Brahim	3.0	0.0	0.0		
07	TUN	Lakhal, Habib	1.0	0.0			
09	IRN	Javan-Saleh, A	1.0	3.0	0.0		
11	URS	Madjidov, K	3.0	3.0	3.0	3.0	3.0
13	KOR	An, Dae-Hyun	3.0	0.0	4.0	3.0	
15	FRA	Jalabert, Gilles	0.0	0.0	3.0	0.0	
17	CHN	Gu, Guohong	0.0	0.0	1.0		
Group B/Groupe B							
02	FIN	Loikas, Jukka	1.0	0.0			
04	JPN	Nishiguchi, S	3.0	0.0	0.0		
06	BUL	Vanguelov, Jivko	3.0	3.0	4.0	4.0	
08	HUN	Bodi, Jeno	0.0	3.0	3.0	3.0	
10	FRG	Behl, Peter	4.0	0.0	3.0	1.0	
12	ESP	Fernandez, C	0.0	0.0			
14	SUI	Dietsche, Hugo	3.0	3.0	1.0	0.0	
16	TUR	Sahin, Zeki	1.0	3.5	0.0		
Final/Finale							
1-2	URS	Madjidov, K	3.0	D	6:00	06-02	
	BUL	Vanguelov, Jivko	1.0				
3-4	KOR	An, Dae-Hyun	3.0	P1	3:15		
	HUN	Bodi, Jeno	0.0				
5-6	FRG	Behl, Peter	3.0	D	6:00	05-01	
	USA	Anderson, Isaac	1.0				
7-8	FRA	Jalabert, Gilles	4.0	1	0:00		
	SUI	Dietsche, Hugo	0.0				

1)	URS	Madjidov, Kamandar
2)	BUL	Vanguelov, Jivko
3)	KOR	An, Dae-Hyun
4)	HUN	Bodi, Jeno
5)	FRG	Behl, Peter
6)	USA	Anderson, Isaac
7)	FRA	Jalabert, Gilles
8)	SUI	Dietsche, Jugo

Greco-Roman Style 68Kg
Round 1/Sept. 20
Style Greco-Romain 68Kg
Tour 1/20 Sept

Gr	Ctry	Name	Result	Time	***** Points *****			No. of Loss
					Temp	Match	Total	
		Pays	Nom			No. de Def.		
A	SYR	Hory, Zouheir			0.0	0.0	1	
	*PAN	Hidalgo, Hermini	P1	4:25	3.0	3.0		
	*ESP	Barcia, Francisc	7	6:00	3.0	3.0		
	ARG	Navarrete, Danie	5		1.0	1.0	1	
	NOR	Brekke, Morten	0		0.0	0.0	1	
	*KOR	Kim, Sung-Moon	5	6:00	3.0	3.0		
	YAR	Alshamsi, Abdull			0.0	0.0	1	
	*JPN	Okubo, Yasuhiro	F	2:43	4.0	4.0		
	*IRN	Ghadimi, Masoud	2	6:00	3.0	3.0		
	CHN	Zhao, Jianqiang	1		1.0	1.0	1	
FRA	Abrial, Franck	0		0.0	0.0	1		
*FRG	Passarelli, Clau	7	6:00	3.0	3.0			
*MAR	Souaken, Said	P1	5:40	3.0	3.0			
ESA	Manzur, Gustavo			0.0	0.0	1		
YUG	Nandor, Sabo	0		0.0	0.0	1		
*FIN	Sipila, Tapio	13	6:00	3.5	3.5			
B	*POL	Kopanski, Jerzy	P1	5:36	3.0	3.0		
	TUR	Kocak, Sumer			0.0	0.0	1	
	EGY	Abdellatif, Abde	0		0.0	0.0	1	
	*SWE	Lagerborg, Lars	9	6:00	3.0	3.0		
	*GRE	Grigorakis, Aris	15	3:31	4.0	4.0		
	JOR	Almasri, Muneir	0		0.0	0.0	1	
	PER	Ichillumpa, Edmu	0		0.0	0.0	1	
	*USA	Seras, Andrew	16	1:53	4.0	4.0		
	AUT	Pittner, Markus	2		1.0	1.0	1	
	*ROM	Carare, Petrica	5	6:00	3.0	3.0		
CAN	Yeats, Douglas	0		0.0	0.0	1		
*URS	Djoufalakian, L	15	2:10	4.0	4.0			
KEN	Salbei, Kiptoo	0		0.0	0.0	1		
*BUL	Karamanliev, Gue	15	1:09	4.0	4.0			
HUN	Repka, Attila	BYE			0.0			

Greco-Roman Style 68Kg
Round 2/Sept. 20
Style Greco-Romain 68Kg
Tour 2/20 Sept

Gr	Ctry	Name	Result	Time	***** Points *****			No. of Loss
					Temp	Match	Total	
		Pays	Nom			No. de Def.		
A	*SYR	Hory, Zouheir	15	1:24	0.0	4.0	4.0	1
	ESP	Barcia, Francisc	0		3.0	0.0	3.0	1
	*PAN	Hidalgo, Hermini	P1	5:42	3.0	3.0	6.0	
	ARG	Navarrete, Danie			1.0	0.0	1.0	2
	*NOR	Brekke, Morten	17	1:38	0.0	4.0	4.0	1
	YAR	Alshamsi, Abdull	0		0.0	0.0	0.0	2
	*KOR	Kim, Sung-Moon	10	6:00	3.0	3.0	6.0	
	JPN	Okubo, Yasuhiro	1		4.0	1.0	5.0	1
	IRN	Ghadimi, Masoud			3.0	0.0	3.0	1
	*FRA	Abrial, Franck	F	1:07	0.0	4.0	4.0	1
CHN	Zhao, Jianqiang	1		1.0	1.0	2.0	2	
*FRG	Passarelli, Clau	8	6:00	3.0	3.0	6.0		
MAR	Souaken, Said			3.0	0.0	3.0	1	
*YUG	Nandor, Sabo	P1	1:59	0.0	3.0	3.0	1	
ESA	Manzur, Gustavo	0		0.0	0.0	0.0	2	
*FIN	Sipila, Tapio	15	0:55	3.5	4.0	7.5		
B	HUN	Repka, Attila	0		0.0	0.0	0.0	1
	*POL	Kopanski, Jerzy	4	6:00	3.0	3.0	6.0	
	*TUR	Kocak, Sumer	F	4:34	0.0	4.0	4.0	1
	EGY	Abdellatif, Abde			0.0	0.0	0.0	2
	*SWE	Lagerborg, Lars	P1	5:17	3.0	3.0	6.0	
	GRE	Grigorakis, Aris			4.0	0.0	4.0	1
	JOR	Almasri, Muneir			0.0	0.0	0.0	2
	*PER	Ichillumpa, Edmu	F	1:16	0.0	4.0	4.0	1
	*USA	Seras, Andrew	15	5:17	4.0	4.0	8.0	
	AUT	Pittner, Markus	0		1.0	0.0	1.0	2
*ROM	Carare, Petrica	P1	3:45	3.0	3.0	6.0		
CAN	Yeats, Douglas			0.0	0.0	0.0	2	
*URS	Djoufalakian, L	16	1:00	4.0	4.0	8.0		
KEN	Salbei, Kiptoo	0		0.0	0.0	0.0	2	
BUL	Karamanliev, Gue	BYE		4.0		4.0		

Greco-Roman Style 68Kg
Round 3/Sept. 21
Style Greco-Romain 68Kg
Tour 3/21 Sept

Gr	Ctry	Name	Result	Time	***** Points *****			No. of Loss
					Temp	Match	Total	
		Pays	Nom			No. de Def.		
A	SYR	Hory, Zouheir			4.0	0.0	4.0	2
	*NOR	Brekke, Morten	P1	5:24	4.0	3.0	7.0	1
	*PAN	Hidalgo, Hermini	P1	4:31	6.0	3.0	9.0	
	ESP	Barcia, Francisc			3.0	0.0	3.0	2
	*KOR	Kim, Sung-Moon	DQ	5:46	6.0	4.0	10.0	
	IRN	Ghadimi, Masoud			3.0	0.0	3.0	2
	*JPN	Okubo, Yasuhiro	7	6:00	5.0	3.0	8.0	1
	FRA	Abrial, Franck	6		4.0	1.0	5.0	2
	FRG	Passarelli, Clau	3		6.0	1.0	7.0	1
	*YUG	Nandor, Sabo	4	6:00	3.0	3.0	6.0	1
MAR	Souaken, Said	0		3.0	0.0	3.0	2	
*FIN	Sipila, Tapio	7	6:00	7.5	3.0	10.5		
B	BUL	Karamanliev, Gue			4.0	0.0	4.0	1
	*HUN	Repka, Attila	P1	5:10	0.0	3.0	3.0	1
	POL	Kopanski, Jerzy	2DQ	5:22	6.0	0.0	6.0	1
	SWE	Lagerborg, Lars			6.0	0.0	6.0	1
	*TUR	Kocak, Sumer	P1	4:14	4.0	3.0	7.0	1
	GRE	Grigorakis, Aris			4.0	0.0	4.0	2
	PER	Ichillumpa, Edmu	0		4.0	0.0	4.0	2
	*ROM	Carare, Petrica	19	1:46	6.0	4.0	10.0	
	USA	Seras, Andrew	2		8.0	1.0	9.0	1
	*URS	Djoufalakian, L	9	6:00	8.0	3.0	11.0	

Greco-Roman Style 68Kg
Round 4/Sept. 21
Style Greco-Romain 68Kg
Tour 4/21 Sept

Gr	Ctry	Name	Result	Time	***** Points *****			No. of Loss	
					Temp	Match	Total		
		Pays	Nom			No. de Def.			
A	PAN	Hidalgo, Hermini	1		9.0	1.0	10.0	1	
	*NOR	Brekke, Morten	4	6:00	7.0	3.0	10.0	1	
	*KOR	Kim, Sung-Moon	P1	5:08	10.0	3.0	13.0		
	FRG	Passarelli, Clau			7.0	0.0	7.0	2	
	*JPN	Okubo, Yasuhiro	2	7:02	8.0	3.0	11.0	1	
	YUG	Nandor, Sabo	1		6.0	1.0	7.0	2	
	FIN	Sipila, Tapio	BYE		10.5		10.5		
	B	BUL	Karamanliev, Gue			4.0	0.0	4.0	2
		*POL	Kopanski, Jerzy	P1	5:29	6.0	3.0	9.0	1
		*HUN	Repka, Attila	P1	3:35	3.0	3.0	6.0	1
TUR		Kocak, Sumer			7.0	0.0	7.0	2	
SWE		Lagerborg, Lars	2DQ	5:33	6.0	0.0	6.0	2	
USA		Seras, Andrew			9.0	0.0	9.0	2	
ROM		Carare, Petrica	4		10.0	1.0	11.0	1	
*URS		Djoufalakian, L	8	6:39	11.0	3.0	14.0		

Greco-Roman Style 68Kg
Round 5/Sept. 21
Style Greco-Romain 68Kg
Tour 5/21 Sept

Gr	Ctry	Name	Result	Time	***** Points *****			No. of Loss
					Temp	Match	Total	
		Pays	Nom			No. de Def.		
A	*FIN	Sipila, Tapio	2	6:00	10.5	3.0	13.5	
	NOR	Brekke, Morten	0		10.0	0.0	10.0	2
	PAN	Hidalgo, Hermini	2		10.0	0.0	10.0	2
*KOR	Kim, Sung-Moon	18	4:37	13.0	4.0	17.0		
JPN	Okubo, Yasuhiro	BYE		11.0		11.0	1	
B	HUN	Repka, Attila	0		6.0	0.0	6.0	2
	*ROM	Carare, Petrica	1	6:00	11.0	3.0	14.0	1
	POL	Kopanski, Jerzy			9.0	0.0	9.0	2
*URS	Djoufalakian, L	F	0:34	14.0	4.0	18.0		

Greco-Roman Style 68Kg
Round 6/Sept. 22
Style Greco-Romain 68Kg
Tour 6/22 Sept

Gr	Ctry	Name	Result	Time	***** Points *****			No. of Loss
					Temp	Match	Total	
		Pays	Nom			No. de Def.		
A	JPN	Okubo, Yasuhiro	0		11.0	0.0	11.0	2
	*FIN	Sipila, Tapio	10	6:00	13.5	3.0	16.5	
	KOR	Kim, Sung-Moon	BYE		17.0		17.0	

Wrestling

Greco-Roman Style 68Kg Finals/Sept. 22					Style Greco-Romain 68Kg Finale/22 Sept				
Gr	Lot No. No. Sort	Ctry Pays	Name Nom	Result	Time Temps	Points bef/av. Match	Points Match	Points Total	No. of Loss No. de Def.
A	*11 31	KOR FIN	Kim, Sung-Moon Sipila, Tapio	8 3	6:00	17.0 16.5	3.0 1.0	20.0 17.5	1

Greco-Roman Style 68kg Finals/Sept. 22					Style Greco-Romain 68kg Finale/22 Sept						
	Ctry	Name	Result	Time	Points		Pays	Nom	Resultat	Temps	Points

1-2 PLACE											
	KOR	Kim, Sung-Moon	3		1.0		*URS	Djouffalakian, L	9	6:00	3.0

3-4 PLACE											
	*FIN	Sipila, Tapio	7	6:00	3.0			Carare, Petrica	4		1.0

5-6 PLACE											
	JPN	Okubo, Yasuhiro			0.0		*POL	Kopanski, Jerzy	P1	5:07	3.0

*** Final * B " ***

7-8 PLACE											
	*NOR	Brekke, Morten	6	6:42	3.0		HUN	Repka, Attila	5		1.0

Greco-Roman Style 68Kg /Sept. 20-22					Style Greco-Romain 68Kg /20-22 Sept				
--	--	--	--	--	--	--	--	--	--

Group A/Groupe A											
01	Hory, Zouheir	SYR	0.0	4.0	0.0						EL R.3
03	Hidalgo, H	PAN	3.0	3.0	3.0	1.0	0.0				EL R.5
05	Barcia, F	ESP	3.0	0.0	0.0						EL R.3
07	Navarrete, D	ARG	1.0	0.0							EL R.2
09	Brekke, Morten	NOR	0.0	4.0	3.0	3.0	0.0				4TH
11	Kim, Sung-Moon	KOR	3.0	3.0	4.0	3.0	4.0	0.0	3.0		1ST
13	Alshamsi, A	YAR	0.0	0.0							EL R.2
15	Okubo, Yasuhiro	JPN	4.0	1.0	3.0	3.0	0.0	0.0			3RD
17	Ghadimi, Masoud	IRN	3.0	0.0	0.0						EL R.3
19	Zhao, Jianqiang	CHN	1.0	1.0							EL R.2
21	Abrial, Franck	FRA	0.0	4.0	1.0						EL R.3
23	Passarelli, C	FRG	3.0	3.0	1.0	0.0					EL R.4
25	Souaken, Said	MAR	3.0	0.0	0.0						EL R.3
27	Manzur, Gustavo	ESA	0.0	0.0							EL R.2
29	Nandor, Sabo	YUG	0.0	3.0	3.0	1.0					EL R.4
31	Sipila, Tapio	FIN	3.5	4.0	3.0	0.0	3.0	3.0	1.0		2ND

Group B/Groupe B											
02	Kopanski, Jerzy	POL	3.0	3.0	0.0	3.0	0.0				3RD
04	Kocak, Sumer	TUR	0.0	4.0	3.0	0.0					EL R.4
06	Abdellatif, A	EGY	0.0	0.0							EL R.2
08	Lagerborg, Lars	SWE	3.0	3.0	0.0	0.0					EL R.4
10	Grigorakis, A	GRE	4.0	0.0	0.0						EL R.3
12	Almasri, Muneir	JOR	0.0	0.0							EL R.2
14	Ichillumpa, E	PER	0.0	4.0	0.0						EL R.3
16	Seras, Andrew	USA	4.0	4.0	1.0	0.0					EL R.4
18	Pittner, Markus	AUT	1.0	0.0							EL R.2
20	Carare, Petrica	ROM	3.0	3.0	4.0	1.0	3.0				2ND
22	Yeats, Douglas	CAN	0.0	0.0							EL R.2
24	Djouffalakian, L	URS	4.0	4.0	3.0	3.0	4.0				1ST
26	Salbei, Kiptoo	KEN	0.0	0.0							EL R.2
28	Karamanliev, G	BUL	4.0	0.0	0.0	0.0					EL R.4
30	Repka, Attila	HUN	0.0	0.0	3.0	3.0	0.0				4TH

Final/Finale

1-2	Djouffalakian, L	URS	3.0	D	6:00	09-03	Kim, Sung-Moon	KOR	1.0
3-4	Sipila, Tapio	FIN	3.0	D	6:00	07-04	Carare, Petrica	ROM	1.0
5-6	Kopanski, Jerzy	POL	3.0	P1	5:07		Okubo, Yasuhiro	JPN	0.0
7-8	Brekke, Morten	NOR	3.0	D	6:42	06-05	Repka, Attila	HUN	1.0

- 1) Djouffalakian, Levon URS
- 2) Kim, Sung-Moon KOR
- 3) Sipila, Tapio FIN
- 4) Carare, Petrica ROM
- 5) Kopanski, Jerzy POL
- 6) Okubo, Yasuhiro JPN
- 7) Brekke, Morten NOR
- 8) Repka, Attila HUN

Lutte

Greco-Roman Style 74Kg Round 1/Sept. 19					Style Greco-Romain 74Kg Tour 1/19 Sept				
Gr	Ctry	Name	Result	Time	Points bef/av. Match	Points Match	Points Total	No. of Loss No. de Def.	

A	*POL	Tracz, Jozef	6	6:00	3.0	3.0		
	USA	Butler, David	3		1.0	1.0	1	
	ESP	Sanchez, Oscar			0.0	0.0	1	
	*YUG	Podisek, Franc	F	2:40	4.0	4.0		
	*JPN	Ito, Hiromichi	8	6:00	3.0	3.0		
	CHN	Wei, Qingkun	4		1.0	1.0	1	
	SYR	Albahah, Zouheir	0		0.0	0.0	1	
	*KOR	Kim, Young-Nam	8	6:00	3.0	3.0		
	*BUL	Velitchkov, Bori	16	3:00	4.0	4.0		
	CMR	Manga, Jean	0		0.0	0.0	1	
B	*SWE	Tallroth, Roger	7	6:00	3.0	3.0		
	FIN	Salomaki, Jouko	5		1.0	1.0	1	
	*FRA	Mischler, Maria	P1	4:13	3.0	3.0		
	TUR	Balci, Erhan			0.0	0.0	1	
	IRN	Anduz, Reza			0.0	0.0	1	
	*URS	Tourlykhanov, Da	F	2:06	4.0	4.0		
	TCH	Zeman, Jaroslav	2		1.0	1.0	1	
	*HUN	Takacs, Abdelaziz Bye	5	6:00	3.0	3.0		
	MAR	Tahir, Abdelaziz Bye				0.0		

Greco-Roman Style 74Kg Round 2/Sept. 19					Style Greco-Romain 74Kg Tour 2/19 Sept				
Gr	Ctry	Name	Result	Time	Points bef/av. Match	Points Match	Points Total	No. of Loss No. de Def.	

A	*POL	Tracz, Jozef	F	1:51	3.0	4.0	7.0	
	ESP	Sanchez, Oscar			0.0	0.0	0.0	2
	*USA	Butler, David	P0	5:31	1.0	2.0	3.0	1
	YUG	Podisek, Franc			4.0	0.0	4.0	1
	*JPN	Ito, Hiromichi	P1	4:19	3.0	3.0	6.0	
	SYR	Albahah, Zouheir			0.0	0.0	0.0	2
	CHN	Wei, Qingkun	0		1.0	0.0	1.0	2
	*BUL	Velitchkov, Bori	4	6:00	4.0	3.0	7.0	
	*KOR	Kim, Young-Nam	F	1:49	3.0	4.0	7.0	
	CMR	Manga, Jean			0.0	0.0	0.0	2
B	MAR	Tahir, Abdelaziz			0.0	0.0	0.0	1
	*SWE	Tallroth, Roger	P1	3:27	3.0	3.0	6.0	
	FIN	Salomaki, Jouko	3		1.0	1.0	2.0	2
	*FRA	Mischler, Martia	4	6:00	3.0	3.0	6.0	
	*TUR	Balci, Erhan	P1	4:10	0.0	3.0	3.0	1
	IRN	Anduz, Reza			0.0	0.0	0.0	2
	*URS	Tourlykhanov, Da	F	3:24	4.0	4.0	8.0	
	TCH	Zeman, Jaroslav			1.0	0.0	1.0	2
	HUN	Takacs, Janos	BYE		3.0		3.0	

74Kg Greco-Roman Style Round 3/Sept. 19					74Kg Style Greco-Romain Tour 3/19 Sept				
Gr	Ctry	Name	Result	Time	Points bef/av. Match	Points Match	Points Total	No. of Loss No. de Def.	

A	POL	Tracz, Jozef	0		7.0	0.0	7.0	1
	*YUG	Podisek, Franc	5	6:00	4.0	3.0	7.0	1
	*USA	Butler, David	6	6:00	3.0	3.0	6.0	1
	JPN	Ito, Hiromichi	2		6.0	1.0	7.0	1
	*KOR	Kim, Young-Nam	3	6:00	7.0	3.0	10.0	
	BUL	Velitchkov, Bori	1		7.0	1.0	8.0	1
B	*HUN	Takacs, Janos	7	6:00	3.0	3.0	6.0	
	MAR	Tahir, Abdelaziz	1		0.0	1.0	1.0	2
	SWE	Tallroth, Roger	2		6.0	1.0	7.0	1
	*FRA	Mischler, Martia	3	7:11	6.0	3.0	9.0	
	TUR	Balci, Erhan			3.0	0.0	3.0	2
	*URS	Tourlykhanov, Da	P1	2:27	8.0	3.0	11.0	



Greco-Roman Style 74Kg				Style Greco-Romain 74Kg			
Round 4/Sept. 20				Tour 4/20 Sept			
Gr	Ctry	Name	Result	Time	***** bef/av.	Points *****	No. of Loss
	Pays	Nom		Temps	Match	Match	No. de Def.
A	*POL	Tracz, Jozef	4	6:00	7.0	3.0	10.0
	JPN	Ito, Hiromichi	1		7.0	1.0	8.0
	USA	Butler, David	0		6.0	0.0	6.0
	*KOR	Kim, Young-Nam	2	6:00	10.0	3.0	13.0
	YUG	Podlessek, Franc	0		7.0	0.0	7.0
	*BUL	Velitchkov, Bori	1	6:00	8.0	3.0	11.0
B	HUN	Takacs, Janos			6.0	0.0	6.0
	*SWE	Tallroth, Roger	P1	4:38	7.0	3.0	10.0
	FRA	Mischler, Martia			9.0	0.0	9.0
	*URS	Tourlykhanov, Da	F	4:30	11.0	4.0	15.0

Greco-Roman Style 74Kg				Style Greco-Romain 74Kg			
Round 5/Sept. 20				Tour 5/20 Sept			
Gr	Ctry	Name	Result	Time	***** bef/av.	Points *****	No. of Loss
	Pays	Nom		Temps	Match	Match	No. de Def.
A	POL	Tracz, Jozef	2DQ	7:14	10.0	0.0	10.0
	KOR	Kim, Young-Nam			13.0	0.0	13.0
	BUL	Velitchkov, Bori	BYE		11.0		11.0
B	*HUN	Takacs, Janos	4	6:00	6.0	3.0	9.0
	FRA	Mischler, Martia	1		9.0	1.0	10.0
	SWE	Tallroth, Roger			10.0	0.0	10.0
	*URS	Tourlykhanov, Da	P1	5:04	15.0	3.0	18.0

Greco-Roman Style 74Kg				Style Greco-Romain 74Kg			
Round 6/Sept. 21				Tour 6/21 Sept			
Gr	Ctry	Name	Result	Time	***** bef/av.	Points *****	No. of Loss
	Pays	Nom		Temps	Match	Match	No. de Def.
A	BUL	Velitchkov, Bori	4		11.0	1.0	12.0
	*POL	Tracz, Jozef	5	6:00	10.0	3.0	13.0
B	HUN	Takacs, Janos	0		9.0	0.0	9.0
	*URS	Tourlykhanov, Da	10	6:00	18.0	3.0	21.0

Greco-Roman Style 74Kg				Style Greco-Romain 74Kg			
Finals/Sept. 21				Finale/21 Sept			
	Ctry	Name	Result	Time	Points		
	Pays	Nom	Resultat	Temps	Points		

1-2 PLACE							
	*KOR	Kim, Young-Nam	2	6:00	3.0		
	URS	Tourlykhanov, Da	1		1.0		

3-4 PLACE							
	*POL	Tracz, Jozef	2	6:00	3.0		
	HUN	Takacs, Janos	0		0.0		

5-6 PLACE							
	BUL	Velitchkov, Bori	1		1.0		
	*FRA	Mischler, Martia	4	6:00	3.0		

*** Final "B" ***

7-8 PLACE							
	JPN	Ito, Hiromichi	1		1.0		
	*SWE	Tallroth, Roger	5	6:00	3.0		

Greco-Roman Style 74Kg				Style Greco-Romain 74Kg			
/Sept. 19-21				/19-21 Sept			
Group A/Groupe A							
Gr	Ctry	Name	Result	Time	***** bef/av.	Points *****	No. of Loss
	Pays	Nom		Temps	Match	Match	No. de Def.
01	Tracz, Jozef	POL	3.0	4.0	0.0	3.0	0.0
03	Butler, David	USA	1.0	2.0	3.0	0.0	2ND
05	Sanchez, Oscar	ESP	0.0	0.0			EL R.2
07	Podlessek, Franc	YUG	4.0	0.0	3.0	0.0	EL R.4
09	Ito, Hiromichi	JPN	3.0	3.0	1.0	1.0	4TH
11	Wei, Qingkun	CHN	1.0	0.0			EL R.2
13	Albalah, Zouheir	SYR	0.0	0.0			EL R.2
15	Kim, Young-Nam	KOR	3.0	4.0	3.0	3.0	1ST
17	Velitchkov, B	BUL	4.0	3.0	1.0	3.0	3RD
19	Manga, Jean	CMR	0.0	0.0		1.0	EL R.2

Group B/Groupe B							
Gr	Ctry	Name	Result	Time	***** bef/av.	Points *****	No. of Loss
	Pays	Nom		Temps	Match	Match	No. de Def.
02	Tallroth, Roger	SWE	3.0	3.0	1.0	3.0	0.0
04	Salomaki, Jouko	FIN	1.0	1.0			4TH
06	Mischler, M	FRA	3.0	3.0	3.0	0.0	EL R.2
08	Balci, Erhan	TUR	0.0	3.0	0.0		3RD
10	Anduz, Reza	IRN	0.0	0.0			EL R.3
12	Tourlykhanov, D	URS	4.0	4.0	3.0	4.0	EL R.2
14	Zeman, Jaroslav	TCH	1.0	0.0			1ST
16	Takacs, Janos	HUN	3.0	0.0	3.0	0.0	EL R.2
18	Tahir, Abdelaziz	MAR	0.0	0.0	1.0	3.0	2ND

Final/Finale							
Gr	Ctry	Name	Result	Time	***** bef/av.	Points *****	No. of Loss
	Pays	Nom		Temps	Match	Match	No. de Def.
1-2	Kim, Young-Nam	KOR	3.0	D	6:00	02-01	
	Tourlykhanov, D	URS	1.0				
3-4	Tracz, Jozef	POL	3.0	D	6:00	02-00	
	Takacs, Janos	HUN	0.0				
5-6	Mischler, M	FRA	3.0	D	6:00	04-01	
	Velitchkov, B	BUL	1.0				
7-8	Tallroth, Roger	SWE	3.0	D	6:00	05-01	
	Ito, Hiromichi	JPN	1.0				

- 1) Kim, Young-Nam KOR
- 2) Tourlykhanov, Daoulet URS
- 3) Tracz, Jozef POL
- 4) Takacs, Janos HUN
- 5) Mischler, Martial FRA
- 6) Velitchkov, Borislav BUL
- 7) Tallroth, Roger SWE
- 8) Ito, Hiromichi JPN

Greco-Roman Style 82Kg				Style Greco-Romain 82Kg			
Round 1/Sept. 20				Tour 1/20 Sept			
Gr	Ctry	Name	Result	Time	***** bef/av.	Points *****	No. of Loss
	Pays	Nom		Temps	Match	Match	No. de Def.
A	FRG	Goessner, Roger			0.0	0.0	1
	*HUN	Komaromi, Tibor	P1	6:00	3.0	3.0	
	TCH	Frinta, Pavel			0.0	0.0	1
	*USA	Morgan, John	F	1:04	4.0	4.0	
	CMR	Nto, Barthelemy			0.0	0.0	1
	*EGY	Hussein, Moustaf	F	2:52	4.0	4.0	
	*BUL	Stoykov, Anguel	14	6:00	3.5	3.5	
	IRN	Moradi-Ganjeh, M	0		0.0	0.0	1
	SWE	Fredriksson, Mag	1		1.0	1.0	1
	*NOR	Kleven, Stig Ari	3	6:00	3.0	3.0	
	SEN	Ngom, Oumar	BYE			0.0	
B	*POL	Daras, Bogdan	3	6:00	3.0	3.0	
	ITA	Razzino, Ernesto	2		1.0	1.0	1
	PUR	Rodriguez, Ubald	0		0.0	0.0	1
	*URS	Mamiachvili, Mik	15	4:34	4.0	4.0	
	JPN	Mukai, Takahiro	0		0.0	0.0	1
	*GDR	Bullmann, Maik	6	6:00	3.0	3.0	
	ARG	Iglesias, Daniel	0		0.0	0.0	1
	*KOR	Kim, Sang-Kyu	16	1:43	4.0	4.0	
	FIN	Niemi, Timo			0.0	0.0	1
	*YUG	Kasum, Goran	P1	3:56	3.0	3.0	

Wrestling

Greco-Roman Style 82Kg Round 2/Sept. 20				Style Greco-Romain 82Kg Tour 2/20 Sept				
Gr	Ctry	Name	Result	Time	***** Points ***** bef/av.			No. of Loss
	Pays	Nom		Temps	Match	Match	Total	No. de Def.
A	SEN	Ngom, Oumar			0.0	0.0	0.0	1
	*FRG	Goessner, Roger	F	1:06	0.0	4.0	4.0	1
	*HUN	Komaromi, Tibor	DQ	5:16	3.0	4.0	7.0	
	TCH	Frinta, Pavel			0.0	0.0	0.0	2
	*USA	Morgan, John	DQ	5:50	4.0	4.0	8.0	
	CMR	Nto, Barthelemy			0.0	0.0	0.0	2
	EGY	Hussein, Moustaf			4.0	0.0	4.0	1
	*BUL	Stoykov, Anguel	P1	2:50	3.5	3.0	6.5	
	IRN	Moradi-Ganjeh, M			0.0	0.0	0.0	2
	*SWE	Fredriksson, Mag	P1	5:13	1.0	3.0	4.0	1
	NOR	Kleven, Stig Ari	BYE		3.0		3.0	
B	*POL	Daras, Bogdan	17	5:57	3.0	4.0	7.0	
	PUR	Rodriguez, Ubald	1		0.0	0.0	0.0	2
	ITA	Razzino, Ernesto			1.0	0.0	1.0	2
	*URS	Mamiachvili, Mik	P1	4:10	4.0	3.0	7.0	
	*JPN	Mukai, Takahiro	15	1:44	0.0	4.0	4.0	1
	ARG	Iglesias, Daniel	0		0.0	0.0	0.0	2
	GDR	Bullmann, Maik	3		3.0	1.0	4.0	1
	*FIN	Niemi, Timo	5	6:00	0.0	3.0	3.0	1
	*KOR	Kim, Sang-Kyu	3	6:00	4.0	3.0	7.0	
	YUG	Kasum, Goran	0		3.0	0.0	3.0	1

Greco-Roman Style 82Kg Round 3/Sept. 21				Style Greco-Romain 82Kg Tour 3/21 Sept				
Gr	Ctry	Name	Result	Time	***** Points ***** bef/av.			No. of Loss
	Pays	Nom		Temps	Match	Match	Total	No. de Def.
A	NOR	Kleven, Stig Ari			3.0	0.0	3.0	1
	*FRG	Goessner, Roger	P1	5:36	4.0	3.0	7.0	1
	*HUN	Komaromi, Tibor	17	5:44	7.0	4.0	11.0	
	EGY	Hussein, Moustaf	0		4.0	0.0	4.0	2
	USA	Morgan, John	2DQ	5:48	8.0	0.0	8.0	1
	BUL	Stoykov, Anguel			6.5	0.0	6.5	1
	SWE	Fredriksson, Mag	BYE		4.0		4.0	1
B	POL	Daras, Bogdan			7.0	0.0	7.0	1
	*URS	Mamiachvili, Mik	P1	5:16	7.0	3.0	10.0	
	JPN	Mukai, Takahiro	2		4.0	1.0	5.0	2
	*FIN	Niemi, Timo	4	6:00	3.0	3.0	6.0	1
	*GDR	Bullmann, Maik	7	6:00	4.0	3.0	7.0	1
	KOR	Kim, Sang-Kyu	6		7.0	1.0	8.0	1
	YUG	Kasum, Goran	BYE		3.0		3.0	1

Greco-Roman Style 82Kg Round 4/Sept. 21				Style Greco-Romain 82Kg Tour 4/21 Sept				
Gr	Ctry	Name	Result	Time	***** Points ***** bef/av.			No. of Loss
	Pays	Nom		Temps	Match	Match	Total	No. de Def.
A	*SWE	Fredriksson, Mag	3	6:00	4.0	3.0	7.0	1
	FRG	Goessner, Roger	1		7.0	1.0	8.0	2
	*NOR	Kleven, Stig Ari	3	6:00	3.0	3.0	6.0	1
	USA	Morgan, John	2		8.0	1.0	9.0	2
	*HUN	Komaromi, Tibor	6	6:00	11.0	3.0	14.0	
	BUL	Stoykov, Anguel	1		6.5	1.0	7.5	2
B	*YUG	Kasum, Goran	P1	5:18	3.0	3.0	6.0	1
	POL	Daras, Bogdan			7.0	0.0	7.0	2
	*URS	Mamiachvili, Mik	11	6:00	10.0	3.0	13.0	
	GDR	Bullmann, Maik	0		7.0	0.0	7.0	2
	*KOR	Kim, Sang-Kyu	3	6:00	8.0	3.0	11.0	1
	FIN	Niemi, Timo	1		6.0	1.0	7.0	2

Lutte

Greco-Roman Style 82Kg Round 5/Sept. 21				Style Greco-Romain 82Kg Tour 5/21 Sept				
Gr	Ctry	Name	Result	Time	***** Points ***** bef/av.			No. of Loss
	Pays	Nom		Temps	Match	Match	Total	No. de Def.
A	SWE	Fredriksson, Mag			7.0	0.0	7.0	2
	*HUN	Komaromi, Tibor	P1	4:55	14.0	3.0	17.0	
B	YUG	Kasum, Goran	3		6.0	1.0	7.0	2
	*URS	Mamiachvili, Mik	6	6:00	13.0	3.0	16.0	
	KOR	Kim, Sang-kyu	BYE		11.0		11.0	1

Greco-Roman Style 82Kg Round 6/Sept. 22				Style Greco-Romain 82Kg Tour 6/22 Sept				
Gr	Ctry	Name	Result	Time	***** Points ***** bef/av.			No. of Loss
	Pays	Nom		Temps	Match	Match	Total	No. de Def.
A	NOR	Kleven, Stig Ari	0		6.0	0.0	6.0	3
	*HUN	Komaromi, Tibor	10	6:00	17.0	3.0	20.0	
B	KOR	Kim, Sang-Kyu	0		11.0	0.0	11.0	2
	*URS	Mamiachvili, Mik	8	6:00	16.0	3.0	19.0	

Greco-Roman Style 82Kg Finals/Sept. 22				Style Greco-Romain 82Kg Finale/22 Sept				
Ctry	Name	Result	Time	Points				
Pays	Nom	Resultat	Temps	Points				
HUN	Komaromi, Tibor	1		1.0				
*URS	Mamiachvili, Mik	10	6:00	3.0				
NOR	Kleven, Stig Ari	5		1.0				
*KOR	Kim, Sang-Kyu	6	6:00	3.0				
SWE	Fredriksson, Mag			0.0				
*YUG	Kasum, Goran	PO	4:26	2.0				
*** Final * B * ***								
USA	Morgan, John	NAW	0:00	4.0				
POL	Daras, Bogdan			0.0				

1-2 PLACE

HUN	Komaromi, Tibor	1		1.0
*URS	Mamiachvili, Mik	10	6:00	3.0

3-4 PLACE

NOR	Kleven, Stig Ari	5		1.0
*KOR	Kim, Sang-Kyu	6	6:00	3.0

5-6 PLACE

SWE	Fredriksson, Mag			0.0
*YUG	Kasum, Goran	PO	4:26	2.0

*** Final * B * ***

7-8 PLACE

*USA	Morgan, John	NAW	0:00	4.0
POL	Daras, Bogdan			0.0

Greco-Roman Style 82Kg /Sept. 20-22				Style Greco-Romain 82Kg /20-22 Sept				
Gr	Ctry	Name	Result	Time	***** Points ***** bef/av.			No. of Loss
	Pays	Nom		Temps	Match	Match	Total	No. de Def.
01	FRG	Goessner, Roger			0.0	4.0	3.0	1.0
03	HUN	Komaromi, Tibor			3.0	4.0	4.0	3.0
05	TCH	Frinta, Pavel			0.0	0.0		
07	USA	Morgan, John			4.0	4.0	0.0	1.0
09	CMR	Nto, B			0.0	0.0		
11	EGY	Hussein, M			4.0	0.0	0.0	
13	BUL	Stoykov, Anguel			3.5	3.0	0.0	1.0
15	IRN	Moradi-Ganjeh, M			0.0	0.0		
17	SWE	Fredriksson, M			1.0	3.0	0.0	3.0
19	NOR	Kleven, S			3.0	0.0	0.0	3.0
21	SEN	Ngom, Oumar			0.0	0.0		

Group A/Groupe A

01	FRG	Goessner, Roger	0.0	4.0	3.0	1.0	EL R.4
03	HUN	Komaromi, Tibor	3.0	4.0	4.0	3.0	1ST
05	TCH	Frinta, Pavel	0.0	0.0			EL R.2
07	USA	Morgan, John	4.0	4.0	0.0	1.0	4TH
09	CMR	Nto, B	0.0	0.0			EL R.2
11	EGY	Hussein, M	4.0	0.0	0.0		EL R.3
13	BUL	Stoykov, Anguel	3.5	3.0	0.0	1.0	EL R.4
15	IRN	Moradi-Ganjeh, M	0.0	0.0			EL R.2
17	SWE	Fredriksson, M	1.0	3.0	0.0	3.0	3RD
19	NOR	Kleven, S	3.0	0.0	0.0	3.0	2ND
21	SEN	Ngom, Oumar	0.0	0.0			EL R.2

Group B/Groupe B

02	POL	Daras, Bogdan	3.0	4.0	0.0	0.0	4TH
04	ITA	Razzino, Ernesto	1.0	0.0			EL R.2
06	PUR	Rodriguez, U	0.0	0.0			EL R.2
08	URS	Mamiachvili, M	4.0	3.0	3.0	3.0	1ST
10	JPN	Mukai, Takahiro	0.0	4.0	1.0		EL R.3
12	GDR	Bullmann, Maik	3.0	1.0	3.0	0.0	EL R.4
14	ARG	Iglesias, D	0.0	0.0			EL R.2
16	KOR	Kim, Sang-Kyu	4.0	3.0	1.0	3.0	2ND
18	FIN	Niemi, Timo	0.0	3.0	3.0	1.0	EL R.4
20	YUG	Kasum, Goran	3.0	0.0	0.0	3.0	3RD



Final/Finale						
1-2	Mamiachvili, M Komaromi, Tibor	URS HUN	3.0 1.0	D	6:00	10-01
3-4	Kim, Sang-Kyu Kleven, S	KOR NOR	3.0 1.0	D	6:00	06-05
5-6	Kasum, Goran Fredriksson, M	YUG SWE	2.0 0.0	P0	4:26	
7-8	Morgan, John Daras, Bogdan	USA POL	4.0 0.0	NAW	0:00	

1) Mamiachvili, Mikhail URS
 2) Komaromi, Tibor HUN
 3) Kim, Sang-Kyu KOR
 4) Kleven, Stig Arild NOR
 5) Kasum, Goran YUG
 6) Fredriksson, Magnus SWE
 7) Morgan, John USA

Greco-Roman Style 90Kg Round 1/Sept. 18				Style Greco-Romain 90Kg Tour 1/18 Sept			
Gr	Ctry	Name	Result	Time	***** bef/av.	Points* Match	No. of Loss No. de Def.
	Pays	Nom		Temps	Match	Total	
A	*AUT POL	Pitschmann, Fran Malina, Andrzej	F	4:47	4.0 0.0	4.0 0.0	1
	JPN *BUL	Moriyama, Yasuto Komchev, Atanas	0 2	6:00	0.0 3.0	0.0 3.0	1
	MTN *GRE	Adama, Samba Pikilidis, Georg	F	2:45	0.0 4.0	0.0 4.0	1
	*SWE FRA	Gullden, Christe Court, Jeanfranc	P1	3:24	3.0 0.0	3.0 0.0	1
	*ISR EGY	Bernstein, Evan Ibrahim, Kamal	11 8	6:00	3.0 1.0	3.0 1.0	1
	BRA	Leitao, Roberto	BYE			0.0	
B	SEN *URS	Gueye, Moustapha Popov, Vladimir	F	1:12	0.0 4.0	0.0 4.0	1
	YUG *FIN	Ban, Bernard Koskela, Harri	0 4	6:00	0.0 3.0	0.0 3.0	1
	*HUN KOR	Major, Sandor Um, Jin-Han	3 0	6:00	3.0 0.0	3.0 0.0	1
	*GDR USA	Koschnitzke, Ola Foy, Michial	F	4:20	4.0 0.0	4.0 0.0	1
	CAN *FRG	Cox, Charles Dou Steinbach, Andre	0 16	3:48	0.0 4.0	0.0 4.0	1
	CMR	Youmbi, Jean-B-L	BYE			0.0	

Greco-Roman Style 90Kg Round 2/Sept. 18				Style Greco-Romain 90Kg Tour 2/18 Sept			
Gr	Ctry	Name	Result	Time	***** bef/av.	Points* Match	No. of Loss No. de Def.
	Pays	Nom		Temps	Match	Total	
A	BRA *AUT	Leitao, Roberto Pitschmann, Fran	0 14	6:00	0.0 4.0	0.0 3.5	0.0 7.5
	*POL JPN	Malina, Andrzej Moriyama, Yasuto	2 0	6:00	0.0 0.0	3.0 0.0	1 2
	*BUL MTN	Komchev, Atanas Adama, Samba	F	1:10	3.0 0.0	4.0 0.0	7.0 0.0
	GRE *SWE	Pikilidis, Georg Gullden, Christe	1 5	6:00	4.0 3.0	1.0 3.0	5.0 6.0
	*FRA ISR	Court, Jeanfranc Bernstein, Evan	P1	4:02	0.0 3.0	3.0 0.0	3.0 3.0
	EGY	Ibrahim, Kamal	BYE		1.0		1
B	*CMR SEN	Youmbi, Jean-B-L Gueye, Moustapha	11 5	6:00	0.0 0.0	3.0 1.0	3.0 1.0
	*URS YUG	Popov, Vladimir Ban, Bernard	15 0	4:50	4.0 0.0	4.0 0.0	8.0 0.0
	*FIN HUN	Koskela, Harri Major, Sandor	3 2	6:00	3.0 3.0	3.0 1.0	6.0 4.0
	KOR *GDR	Um, Jin-Han Koschnitzke, Ola	0 4	6:00	0.0 4.0	0.0 3.0	0.0 7.0
	*USA CAN	Foy, Michial Cox, Charles Dou	F	0:19	0.0 0.0	4.0 0.0	4.0 0.0
	FRG	Steinbach, Andre	BYE		4.0		4.0

Greco-Roman Style 90Kg Round 3/Sept. 18				Style Greco-Romain 90Kg Tour 3/18 Sept			
Gr	Ctry	Name	Result	Time	***** bef/av.	Points* Match	No. of Loss No. de Def.
	Pays	Nom		Temps	Match	Total	
A	*EGY BRA	Ibrahim, Kamal Leitao, Roberto	17 0	2:36	1.0 0.0	4.0 0.0	5.0 0.0
	AUT *BUL	Pitschmann, Fran Komchev, Atanas	2 12	6:00	7.5 7.0	1.0 3.0	8.5 10.0
	POL *SWE	Malina, Andrzej Gullden, Christe	0 1	6:00	3.0 6.0	0.0 3.0	3.0 9.0
	*GRE FRA	Pikilidis, Georg Court, Jeanfranc	P1	5:13	5.0 3.0	3.0 0.0	8.0 3.0
	ISR	Bernstein, Evan	BYE		3.0		3.0
B	*FRG CMR	Steinbach, Andre Youmbi, Jean-B-L	P1	4:30	4.0 3.0	3.0 0.0	7.0 3.0
	URS *FIN	Popov, Vladimir Koskela, Harri	1 4	6:00	8.0 6.0	1.0 3.0	9.0 9.0
	*HUN GDR	Major, Sandor Koschnitzke, Ola	13 9	6:00	4.0 7.0	3.0 1.0	7.0 8.0
	USA	Foy, Michial	BYE		4.0		4.0

Greco-Roman Style 90Kg Round 4/Sept. 19				Style Greco-Romain 90Kg Tour 4/19 Sept			
Gr	Ctry	Name	Result	Time	***** bef/av.	Points* Match	No. of Loss No. de Def.
	Pays	Nom		Temps	Match	Total	
A	ISR *AUT	Bernstein, Evan Pitschmann, Fran	P1	5:26	3.0 8.5	0.0 3.0	3.0 11.5
	EGY *GRE	Ibrahim, Kamal Pikilidis, Georg	0 9	6:00	5.0 8.0	0.0 3.0	5.0 11.0
	*BUL SWE	Komchev, Atanas Gullden, Christe	4 0	6:00	10.0 9.0	3.0 0.0	13.0 9.0
B	USA *FRG	Foy, Michial Steinbach, Andre	5 15	6:00	4.0 7.0	1.0 3.0	5.0 10.0
	CMR *FIN	Youmbi, Jean-B-L Koskela, Harri	F	1:11	3.0 9.0	0.0 4.0	3.0 13.0
	*URS HUN	Popov, Vladimir Major, Sandor	4 0	6:00	9.0 7.0	3.0 0.0	12.0 7.0
	GDR	Koschnitzke, Ola	BYE		8.0		8.0

Greco-Roman Style 90Kg Round 5/Sept. 19				Style Greco-Romain 90Kg Tour 5/19 Sept			
Gr	Ctry	Name	Result	Time	***** bef/av.	Points* Match	No. of Loss No. de Def.
	Pays	Nom		Temps	Match	Total	
A	AUT *SWE	Pitschmann, Fran Gullden, Christe	1 3	6:00	11.5 9.0	1.0 3.0	12.5 12.0
	*BUL GRE	Komchev, Atanas Pikilidis, Georg	6 3	6:00	13.0 11.0	3.0 1.0	16.0 12.0
B	GDR *URS	Koschnitzke, Ola Popov, Vladimir	F	2:52	8.0 12.0	0.0 4.0	8.0 16.0
	FRG *FIN	Steinbach, Andre Koskela, Harri	1 2	6:53	10.0 13.0	1.0 3.0	11.0 16.0

Greco-Roman Style 90Kg Round 6/Sept. 20				Style Greco-Romain 90Kg Tour 6/20 Sept			
Gr	Ctry	Name	Result	Time	***** bef/av.	Points* Match	No. of Loss No. de Def.
	Pays	Nom		Temps	Match	Total	
B	FRG *URS	Steinbach, Andre Popov, Vladimir	0 3	6:00	11.0 16.0	0.0 3.0	11.0 19.0

Wrestling

Greco-Roman Style 90Kg Finals/Sept. 20			Style Greco-Romain 90Kg Finale/20 Sept		
Ctry	Name	Result	Time	Points	
Pays	Nom	Resultat	Temps	Points	
12 PLACE					
*BUL	Komchev, Atanas	4	6:00	3.0	
FIN	Kosdela, Harri	0		0.0	
3-4 PLACE					
SWE	Gullden, Chpiste			0.0	
*URS	Popov, Vladimir	F	1:36	4.0	
5-6 PLACE					
AUT	Pitschmann, Fran			0.0	
*FRG	Steinbach, Andre	P1	4:43	3.0	
* * *Final "B" * * *					
7-8 PLACE					
GRE	Pikilidis, Georg			0.0	
*GDR	Koschnitzke, Ola	FR	0:00	4.0	

Greco-Roman Style 90Kg /Sept. 18-20			Style Greco-Romain 90Kg /18-20 Sept					
Group A/Groupe A								
01	Pitschmann, F	AUT	4.0	3.5	1.0	3.0	1.0	3RD
03	Malina, Andrzej	POL	0.0	3.0	0.0			EL R.3
05	Moriyama, Y	JPN	0.0	0.0				EL R.2
07	Komchev, Atanas	BUL	3.0	4.0	3.0	3.0	3.0	1ST
09	Adama, Samba	MTN	0.0	0.0				EL R.2
11	Pikilidis, G	GRE	4.0	1.0	3.0	3.0	1.0	4TH
13	Gullden, C	SWE	3.0	3.0	3.0	0.0	3.0	2ND
15	Court, J	FRA	0.0	3.0	0.0			EL R.3
17	Bernstein, Evan	ISR	3.0	0.0	0.0	0.0		EL R.4
19	Ibrahim, Kamal	EGY	1.0	0.0	4.0	0.0		EL R.4
21	Leitao, Roberto	BRA	0.0	0.0	0.0			EL R.3
Group B/Groupe B								
02	Gueye, Moustapha	SEN	0.0	1.0				EL R.2
04	Popov, Vladimir	URS	4.0	4.0	1.0	3.0	4.0	3.0
06	Ban, Bernard	YUG	0.0	0.0				EL R.2
08	Koskela, Harri	FIN	3.0	3.0	3.0	4.0	3.0	1ST
10	Major, Sandor	HUN	3.0	1.0	3.0	0.0		EL R.4
12	Um, Jin-Han	KOR	0.0	0.0				EL R.2
14	Koschnitzke, O	GDR	4.0	3.0	1.0	0.0	0.0	4TH
16	Foy, Michial	USA	0.0	4.0	0.0	1.0		EL R.4
18	Cox, C	CAN	0.0	0.0				EL R.2
20	Steinbach, A	FRG	4.0	0.0	3.0	3.0	1.0	0.0
22	Youmbi, Jean-B-L	CMR	0.0	3.0	0.0	0.0		EL R.4
Final/Finale								
1-2	Komchev, Atanas	BUL	3.0	D	6:00	04-00		
	Koskela, Harri	FIN	0.0					
3-4	Popov, Vladimir	URS	4.0	F	1:36			
	Gullden, C	SWE	0.0					
5-6	Steinbach, A	FRG	3.0	P1	4:43			
	Pitschmann, F	AUT	0.0					
7-8	Koschnitzke, O	GDR	4.0	FR	0:00			
	Pikilidis, G	GRE	0.0					
	1) Komchev, Atanas	BUL						
	2) Koskela, Harri	FIN						
	3) Popov, Vladimir	URS						
	4) Gullden, Christer	SWE						
	5) Steinbach, Andreas	FRG						
	6) Pitschmann, Franz	AUT						
	7) Koschnitzke, Olaf	GDR						

Lutte

Greco-Roman Style 100Kg Round 1/Sept. 19			Style Greco-Romain 100Kg Tour 1/19 Sept				
Gr	Ctry	Name	Result	Time	***** bef/av.	Points* * * * *	No. of Loss
	Pays	Nom		Temps	Match	Match	No. de Def.
A	*CAN	Marshall, Steve	P1	5:43		3.0	3.0
	FIN	Ahokas, Juha				0.0	0.0
	*USA	Koslowski, Denni	16	3:57		4.0	4.0
	JPN	Fukube, Masahiko	0			0.0	0.0
	*YUG	Tertei, Jozef	P1	3:21		3.0	3.0
	TCH	Masar, Dusan				0.0	0.0
	*ROM	Andrei, Vasile	4	6:00		3.0	3.0
	URS	Guedekhour, Cou	1			1.0	1.0
	POL	Wronski, Andrzej	BYE				0.0
B	BRA	Spiess, Floriano	0			0.0	0.0
	*HUN	Gaspar, Tamas	15	1:56		4.0	4.0
	*BUL	Gueorguiev, Ilia	F	1:49		4.0	4.0
	SEN	Sarr, Ambroise				0.0	0.0
	*FRG	Himmel, Gerhard	P1	5:07		3.0	3.0
	SWE	Claesson, Soren				0.0	0.0
	*MTN	Sy, Oumar Samba	F	1:47		4.0	4.0
	KEN	Obwoege, Maisiba				0.0	0.0
	KOR	Yoo, Young-Tai	BYE				0.0

Greco-Roman Style 100Kg Round 2/Sept. 19			Style Greco-Romain 100Kg Tour 2/19 Sept				
Gr	Ctry	Name	Result	Time	***** bef/av.	Points* * * * *	No. of Loss
	Pays	Nom		Temps	Match	Match	No. de Def.
A	*POL	Wronski, Andrzej	2	6:00		0.0	3.0
	CAN	Marshall, Steve	0			3.0	0.0
	FIN	Ahokas, Juha	0			0.0	0.0
	*USA	Koslowski, Denni	15	5:23		4.0	4.0
	JPN	Fukube, Masahiko	2			0.0	0.0
	*YUG	Tertei, Jozef	17	4:52		3.0	4.0
	TCH	Masar, Dusan	0			0.0	0.0
	*ROM	Andrei, Vasile	6	6:00		3.0	3.0
	URS	Guedekhour, Cou	BYE			1.0	1.0
B	*KOR	Yoo, Young-Tai	18	2:55		0.0	4.0
	BRA	Spiess, Floriano	2			0.0	0.0
	*HUN	Gaspar, Tamas	2	6:00		4.0	3.0
	BUL	Gueorguiev, Ilia	1			4.0	1.0
	SEN	Sarr, Ambroise				0.0	0.0
	*FRG	Himmel, Gerhard	F	2:57		3.0	4.0
	*SWE	Claesson, Soren	F	1:27		0.0	4.0
	MTN	Sy, Oumar Samba				4.0	0.0
	KEN	Obwoege, Maisiba	BYE				0.0

Greco-Roman Style 100Kg Round 3/Sept. 19			Style Greco-Romain 100Kg Tour 3/19 Sept				
Gr	Ctry	Name	Result	Time	***** bef/av.	Points* * * * *	No. of Loss
	Pays	Nom		Temps	Match	Match	No. de Def.
A	*URS	Guedekhour, Cou	F	3:48		1.0	4.0
	POL	Wronski, Andrzej				3.0	0.0
	CAN	Marshall, Steve				3.0	0.0
	*USA	Koslowski, Denni	P1	4:51		8.0	3.0
	*YUG	Tertei, Jozef	1	6:00		7.0	3.0
	ROM	Andrei, Vasile	0			6.0	0.0
B	KEN	Obwoege, Maisiba				0.0	0.0
	*KOR	Yoo, Young-Tai	F	0:34		4.0	4.0
	HUN	Gaspar, Tamas				7.0	0.0
	*FRG	Himmel, Gerhard	I	1:13		7.0	4.0
	*BUL	Gueorguiev, Ilia	14	6:00		5.0	3.5
	SWE	Claesson, Soren	2			4.0	0.5
	MTN	Sy, Oumar Samba	BYE				4.0



**Greco-Roman Style 100Kg
Round 4/Sept. 20**

**Style Greco-Romain 100Kg
Tour 4/20 Sept**

Gr	Ctry	Name	Result	Time	***** Points *****			No. of Loss
	Pays	Nom		Temps	bef/av. Match	Match	Total	No. de Def.
A	*URS	Guedekhour, Cou	5	6:00	5.0	3.0	8.0	1
	USA	Koslowski, Denni	4		11.0	1.0	12.0	1
	*POL	Wronski, Andrzej	1	6:00	3.0	3.0	6.0	1
	YUG	Tertei, Jozef	0		10.0	0.0	10.0	1
	ROM	Andrei, Vasile	BYE		6.0		6.0	1
B	KOR	Yoo, Young-Tai	0		8.0	0.0	8.0	1
	*BUL	Gueorguiev, Ilia	17	1:50	8.5	4.0	12.5	1
	FRG	Himmel, Gerhard	BYE		11.0		11.0	

**Greco-Roman Style 100Kg
Round 5/Sept. 20**

**Style Greco-Romain 100Kg
Tour 5/20 Sept**

Gr	Ctry	Name	Result	Time	***** Points *****			No. of Loss
	Pays	Nom		Temps	bef/av. Match	Match	Total	No. de Def.
A	ROM	Andrei, Vasile	P1	5:50	6.0	0.0	6.0	2
	*POL	Wronski, Andrzej			6.0	3.0	9.0	1
	URS	Guedekhour, Cou	0		8.0	0.0	8.0	2
	*YUG	Tertei, Jozef	4	6:00	10.0	3.0	13.0	1
	USA	Koslowski, Denni	BYE		12.0		12.0	1
B	*FRG	Himmel, Gerhard	7	6:00	11.0	3.0	14.0	
	KOR	Yoo, Young-tai	0		8.0	0.0	8.0	2
	BUL	Gueorguiev, Ilia	BYE		12.5		12.5	1

**Greco-Roman Style 100Kg
Round 6/Sept. 21**

**Style Greco-Romain 100Kg
Tour 6/21 Sept**

Gr	Ctry	Name	Result	Time	***** Points *****			No. of Loss
	Pays	Nom		Temps	bef/av. Match	Match	Total	No. de Def.
A	USA	Koslowski, Denni	0		12.0	0.0	12.0	2
	*POL	Wronski, Andrzej	1	6:00	9.0	3.0	12.0	1
B	BUL	Gueorguiev, Ilia			12.5	0.0	12.5	2
	*FRG	Himmel, Gerhard	P1	4:49	14.0	3.0	17.0	

**Greco-Roman Style 100Kg
Round 7/Sept. 21**

**Style Greco-Romain 100Kg
Tour 7/21 Sept**

Gr	Ctry	Name	Result	Time	***** Points *****			No. of Loss
	Pays	Nom		Temps	bef/av. Match	Match	Total	No. de Def.
A	YUG	Tertei, Jozef	0		13.0	0.0	13.0	3
	*USA	Koslowski, Denni	2	6:00	12.0	3.0	15.0	2

**Greco-Roman Style 100Kg
Finals/Sept. 21**

**Style Greco-Romain 100Kg
Finale/21 Sept**

	Ctry	Name	Result	Time	Points
	Pays	Nom	Resultat	Temps	Points
1-2 PLACE					
	*POL	Wronski, Andrzej	3	6:00	3.0
	FRG	Himmel, Gerhard	1		1.0
3-4 PLACE					
	*USA	Koslowski, Denni	6	6:00	3.0
	BUL	Gueorguiev, Ilia	0		1.0
5-6 PLACE					
	*YUG	Tertei, Jozef	1	0:00	4.0
	KOR	Yoo, Young-Tai			0.0
** *Final *B* ** *					
7-8 PLACE					
	*URS	Guedekhour, Cou	1	0:00	4.0
	HUN	Gaspar, Tamas			0.0

**Greco-Roman Style 100Kg
/Sept. 19-21**

**Style Greco-Romain 100Kg
/19-21 Sept**

Group A/Groupe A

01	Marshall, Steve	CAN	3.0	0.0	0.0							EL R.3
03	Ahokas, Juha	FIN	0.0	0.0								EL R.2
05	Koslowski, D	USA	4.0	4.0	3.0	1.0	0.0	0.0	3.0			2ND
07	Fukube, Masahiko	JPN	0.0	0.0								EL R.2
09	Tertei, Jozef	YUG	3.0	4.0	3.0	0.0	3.0		0.0			3RD
11	Masar, Dusan	TCH	0.0	0.0								EL R.2
13	Andrei, Vasile	ROM	3.0	3.0	0.0	0.0	0.0					EL R.5
15	Guedekhour, C	URS	1.0	0.0	4.0	3.0	0.0					4TH
17	Wronski, Andrzej	POL	0.0	3.0	0.0	3.0	3.0	3.0				1ST

Group B/Groupe B

02	Spieß, Floriano	BRA	0.0	0.0								EL R.2
04	Gaspar, Tamas	HUN	4.0	3.0	0.0							4TH
06	Gueorguiev, Ilia	BUL	4.0	1.0	3.5	4.0	0.0	0.0				2ND
08	Sarr, Ambroise	SEN	0.0	0.0								EL R.2
10	Himmel, Gerhard	FRG	3.0	4.0	4.0	0.0	3.0	3.0				1ST
12	Claesson, Soren	SWE	0.0	4.0	0.5							EL R.3
14	Sy, Oumar Samba	MTN	4.0	0.0	0.0							EL R.3
16	Obwoye, Maisiba	KEN	0.0	0.0	0.0			0.0				EL R.3
18	Yoo, Young-Tai	KOR	0.0	4.0	4.0	0.0	0.0					3RD

Final/Finale

1-2	Wronski, Andrzej	POL	3.0	D	6:00	03-01
	Himmel, Gerhard	FRG	1.0			
3-4	Koslowski, D	USA	3.0	D	6:00	06-00
	Gueorguiev, Ilia	BUL	0.0			
5-6	Tertei, Jozef	YUG	4.0	I	0:00	
	Yoo, Young-Tai	KOR	0.0			
7-8	Guedekhour, C	URS	4.0	I	0:00	
	Gaspar, Tamas	HUN	0.0			

- 1) Wronski, Andrzej POL
- 2) Himmel, Gerhard FRG
- 3) Koslowski, Dennis USA
- 4) Gueorguiev, Ilia BUL
- 5) Tertei, Jozef YUG
- 6) Yoo, Young-Tai KOR
- 7) Guedekhour, Couram URS
- 8) Gaspar, Tamas HUN

**Greco-Roman Style 130Kg
Round 1/Sept. 20**

**Style Greco-Romain 130Kg
Tour 1/20 Sept**

Gr	Ctry	Name	Result	Time	***** Points *****			No. of Loss
	Pays	Nom		Temps	bef/av. Match	Match	Total	No. de Def.
A	*USA	Koslowski, Duane	5	6:00	3.0	3.0		
	AUT	Neumuller, Alexa	3		1.0	1.0	1	
	LIB	Bechara, Khodr			0.0	0.0	1	
	*TCH	David, Lubomir	F	0:30	4.0	4.0		
	*HUN	Klauz, Laszlo	P1	5:30	3.0	3.0		
	FRG	Gerdsmeyer, Frit			0.0	0.0	1	
	*URS	Kareline, Alexan	P1	4:00	3.0	3.0		
	SWE	Johansson, Tomas			0.0	0.0	1	
B	*EGY	Elhadad, Hassan	F	2:09	4.0	4.0		
	MRI	Ramsaran, Navind			0.0	0.0	1	
	IRQ	Mohammad, Fiarha			0.0	0.0	1	
	*JPN	Deguchi, Kazuya	P1	3:51	3.0	3.0		
	*BUL	Gueroski, Rangu	P1	5:44	3.0	3.0		
	CAN	Payne, Daniel			0.0	0.0	1	
	ITA	Valguarnera, Fab	2DQ	5:49	0.0	0.0	1	
	POL	Wroclawski, Roma			0.0	0.0	1	

Wrestling

Greco-Roman Style 130Kg Round 2/Sept. 20				Style Greco-Romain 130Kg Tour 2/20 Sept					
Gr	Ctry	Name	Result	Time	***** bef/av.	***** Match	***** Match	***** Total	No. of Loss No. de Def.
	Pays	Nom		Temps					
A	* USA	Koslowski, Duane	F	1:12	3.0	4.0	7.0		
	LIB	Bechara, Khodr			0.0	0.0	0.0	2	
	*AUT	Neumuller, Alexa	I	3:44	1.0	4.0	5.0	1	
	TCH	David, Lubomir			4.0	0.0	4.0	1	
	HUN	Klauz, Laszlo			3.0	0.0	3.0	1	
	*URS	Kareline, Alexan	P1	4:43	3.0	3.0	6.0		
	FRG	Gerdsmeier, Frit	1		0.0	1.0	1.0	2	
	*SWE	Johansson, Tomas	2	6:00	0.0	3.0	3.0	1	
B	*EGY	Elhadad, Hassan	P1	4:16	4.0	3.0	7.0		
	IRQ	Mohammad, Fiarha			0.0	0.0	0.0	2	
	MRI	Ramsaran, Navind			0.0	0.0	0.0	2	
	*JPN	Deguchi, Kazuya	F	0:48	3.0	4.0	7.0		
	*BUL	Guerovski, Rangu	P1	5:27	3.0	3.0	6.0		
	ITA	Valguamera, Fab			0.0	0.0	0.0	2	
	CAN	Payne, Daniel			0.0	0.0	0.0	2	
	*POL	Wroclawski, Roma	F	4:19	0.0	4.0	4.0	1	

Greco-Roman Style 130Kg Round 3/Sept. 21				Style Greco-Romain 130Kg Tour 3/21 Sept					
Gr	Ctry	Name	Result	Time	***** bef/av.	***** Match	***** Match	***** Total	No. of Loss No. de Def.
	Pays	Nom		Temps					
A	USA	Koslowski, Duane	0		7.0	0.0	7.0	1	
	*HUN	Klauz, Laszlo	2	6:00	3.0	3.0	6.0	1	
	AUT	Neumuller, Alexa			5.0	0.0	5.0	2	
	*URS	Kareline, Alexan	F	4:10	6.0	4.0	10.0		
	SWE	Johansson, Tomas	BYE		3.0		3.0	1	
B	*EGY	Elhadad, Hassan	F	2:14	7.0	4.0	11.0		
	JPN	Deguchi, Kazuya			7.0	0.0	7.0	1	
	*BUL	Guerovski, Rangu	P1	4:23	6.0	3.0	9.0		
	POL	Wroclawski, Roma			4.0	0.0	4.0	2	

Greco-Roman Style 130Kg Round 4/Sept. 21				Style Greco-Romain 130Kg Tour 4/21 Sept					
Gr	Ctry	Name	Result	Time	***** bef/av.	***** Match	***** Match	***** Total	No. of Loss No. de Def.
	Pays	Nom		Temps					
A	*SWE	Johansson, Tomas	2	6:00	3.0	3.0	6.0	1	
	HUN	Klauz, Laszlo	1		6.0	1.0	7.0	2	
	USA	Koslowski, Duane	0		7.0	0.0	7.0	2	
	*URS	Kareline, Alexan	15	2:23	10.0	4.0	14.0		
B	EGY	Elhadad, Hassan	0		11.0	0.0	11.0	1	
	*BUL	Guerovski, Rangu	5	6:00	9.0	3.0	12.0		
	JPN	Deguchi, Kazuya	BYE		7.0		7.0	1	

Greco-Roman Style 130Kg Round 5/Sept. 21				Style Greco-Romain 130Kg Tour 5/21 Sept					
Gr	Ctry	Name	Result	Time	***** bef/av.	***** Match	***** Match	***** Total	No. of Loss No. de Def.
	Pays	Nom		Temps					
B	JPN	Deguchi, Kazuya	0		7.0	0.0	7.0	2	
	*BUL	Guerovski, Rangu	14	6:00	12.0	3.5	15.5		

Lutte

Greco-Roman Style 130Kg Finals/Sept. 22				Style Greco-Romain 130Kg Finale/22 Sept		
	Ctry	Name	Result	Time	Points	
	Pays	Nom	Resultat	Temps	Points	
1-2 PLACE						
	*URS	Kareline, Alexan	5	6:00	3.0	
	BUL	Guerovski, Rangu	3		1.0	
3-4 PLACE						
	*SWE	Johansson, Tomas	P1	5:04	3.0	
	EGY	Elhadad, Hassan			0.0	
5-6 PLACE						
	*HUN	Klauz, Laszlo	PS	5:00	3.5	
	JPN	Deguchi, Kazuya			0.0	
*** Final "B"***						
7-8 PLACE						
	USA	Koslowski, Duane		0:00		
	*POL	Wroclawski, Roma	FR	0:00	4.0	

Greco-Roman Style 130Kg /Sept. 20-22				Style Greco-Romain 130Kg /20-22 Sept				
Group A/Groupe A								
01	Koslowski, Duane	USA	3.0	4.0	0.0	0.0		4TH
03	Neumuller, A	AUT	1.0	4.0	0.0			EL R.3
05	Bechara, Khodr	LIB	0.0	0.0				EL R.2
07	David, Lubomir	TCH	4.0	0.0				EL R.2
09	Klauz, Laszlo	HUN	3.0	0.0	3.0	1.0		3RD
11	Gerdsmeier, F	FRG	0.0	1.0				EL R.2
13	Kareline, A	URS	3.0	3.0	4.0	4.0		1ST
15	Johansson, Tomas	SWE	0.0	3.0	0.0	3.0		2ND
Group B/Groupe B								
02	Elhadad, Hassan	EGY	4.0	3.0	4.0	0.0		2ND
04	Ramsaran, Navind	MRI	0.0	0.0				EL R.2
06	Mohammad, F	IRQ	0.0	0.0				EL R.2
08	Deguchi, Kazuya	JPN	3.0	4.0	0.0	0.0	0.0	3RD
10	Guerovski, R	BUL	3.0	3.0	3.0	3.0	3.5	1ST
12	Payne, Daniel	CAN	0.0	0.0				EL R.2
14	Valguamera, F	ITA	0.0	0.0				EL R.2
16	Wroclawski, R	POL	0.0	4.0	0.0			4TH

Final/Finale								
1-2	Kareline, Alexander	URS	3.0	D	6:00	05-03		
	Guerovski, Ranguel	BUL	1.0					
3-4	Johnsson, Tomas	SWE	3.0	P1	5:04			
	Elhadad, Kazuya	EGY	0.0					
5-6	Klauz, Laszlo	HUN	3.5	PS	5:00			
	Deguchi, Kazuya	JPN	0.0					
7-8	Wroclawski, R	POL	4.0	FR	0:00			
	Koslowski, Duane	USA	0.0					
	1) Kareline, Alexander	URS						
	2) Guerovski, Ranguel	BUL						
	3) Johnsson, Tomas	SWE						
	4) Elhadad, Kazuya	EGY						
	5) Klauz, Laszlo	HUN						
	6) Deguchi, Kazuya	JPN						
	7) Wroclawski, Roman	POL						

**Free Style 48Kg
Round 1/Sept. 27**
**Style Libre 48Kg
Tour 1/27 Sept**

Gr	Ctry	Name	Result	Time	Points*	Points*	No. of Loss
	Pay	Nom		Temps	bef/av. Match	Match Total	No. de Def.
A	*FRG	Heugabel, Reiner	F	3:52	4.0	4.0	1
	MGL	Suhbatar, Tumend			0.0	0.0	
	CHN	Liang, Dejin	7		1.0	1.0	1
	*IND	Kumar, Rajesh	13	6:00	3.0	3.0	
	*AFG	Razigul	12	6:00	3.0	3.0	
	INA	Suryadi, Suryadi	3		1.0	1.0	1
	*URS	Karamtchakov, Se	7	6:00	3.0	3.0	
	BUL	Tzonov, Ivan	1		1.0	1.0	1
	*GDR	Anger, Volker	14	6:00	3.0	3.0	
	TPE	Hour, Jiunn-Yih	5		1.0	1.0	1
B	ESP	Marcuno, Alfredo	0		0.0	0.0	1
	*USA	Vanni, Tim	16	4:16	4.0	4.0	
	KOR	Lee, Sang-Ho			0.0	0.0	1
	*JPN	Kobayashi, Takas	1	0:44	4.0	4.0	
	*IRN	Zeinalnia, Naser	17	5:59	4.0	4.0	
	COL	Delgado Cerquer	0		0.0	0.0	1
	*TUR	Sukruoglu, Ilyas	8	6:00	3.0	3.0	
	NGR	Ojo, Amos	1		1.0	1.0	1
	SYR	Almsouti, Mohama	BYE			0.0	

**Free Style 48Kg
Round 2/Sept. 27**
**Style Libre 48Kg
Tour 2/27 Sept**

Gr	Ctry	Name	Result	Time	Points*	Points*	No. of Loss
	Pays	Nom		Temps	bef/av. Match	Match Total	No. de Def.
A	*FRG	Heugabel, Reiner	F	2:55	4.0	4.0	8.0
	CHN	Liang, Dejin			1.0	0.0	1.0
	MGL	Suhbatar, Tumend	6		0.0	1.0	1.0
	*IND	Kumar, Rajesh	7	6:37	3.0	3.0	6.0
	AFG	Razigul	2		3.0	1.0	4.0
	*URS	Karamtchakov, Se	12	6:00	3.0	3.0	6.0
	INA	Suryadi, Suryadi	4		1.0	1.0	2.0
	*GDR	Anger, Volker	10	6:00	3.0	3.0	6.0
	*BUL	Tzonov, Ivan	19	5:11	1.0	4.0	5.0
	TPE	Hour, Jiunn-Yih	3		1.0	0.0	1.0
B	*SYR	Almsouti, Mohama	10	6:00	0.0	3.0	3.0
	ESP	Marcuno, Alfredo	3		0.0	1.0	1.0
	USA	Vanni, Tim			4.0	0.0	4.0
	*JPN	Kobayashi, Takas	F	1:48	4.0	4.0	8.0
	*IRN	Zeinalnia, Naser	4	6:00	4.0	3.0	7.0
	TUR	Sukruoglu, Ilyas	3		3.0	1.0	4.0
	*COL	Delgado cerquer	8	6:00	0.0	3.0	3.0
	NGR	Ojo, Amos	6		1.0	1.0	2.0

**Free Style 48Kg
Round 3/Sept. 27**
**Style Libre 48Kg
Tour 3/27 Sept**

Gr	Ctry	Name	Result	Time	Points*	Points*	No. of Loss
	Pays	Nom		Temps	bef/av. Match	Match Total	No. de Def.
A	*FRG	Heugabel, Reiner	12	6:00	8.0	3.5	11.5
	IND	Kumar, Rajesh	0		6.0	0.0	6.0
	AFG	Razigul	3		4.0	1.0	5.0
	*BUL	Tzonov, Ivan	10	6:00	5.0	3.0	8.0
	*URS	Karamtchakov, Se	2	6:00	6.0	3.0	9.0
	GDR	Anger, Volker	0		6.0	0.0	6.0
B	SYR	Almsouti, Mohama	1		3.0	0.5	3.5
	*USA	Vanni, Tim	13	6:00	4.0	3.5	7.5
	*JPN	Kobayashi, Takas	F	3:23	8.0	4.0	12.0
	IRN	Zeinalnia, Naser			7.0	0.0	7.0
	COL	Delgado cerquer	6		3.0	1.0	4.0
	*TUR	Sukruoglu, Ilyas	9	6:00	4.0	3.0	7.0

**Free Style 48Kg
Round 4/Sept. 28**
**Style Libre 48Kg
Tour 4/28 Sept**

Gr	Ctry	Name	Result	Time	Points*	Points*	No. of Loss
	Pays	Nom		Temps	bef/av. Match	Match Total	No. de Def.
A	*FRG	Heugabel, Reiner	P0	5:01	11.5	2.0	13.5
	URS	Karamtchakov, Se			9.0	0.0	9.0
	IND	Kumar, Rajesh	8		6.0	1.0	7.0
	*BUL	Tzonov, Ivan	11	6:00	8.0	3.0	11.0
	GDR	Anger, Volker	BYE		6.0		6.0
B	SYR	Almsouti, Mohama	0		3.5	0.0	3.5
	*JPN	Kobayashi, Takas	15	3:21	12.0	4.0	16.0
	*USA	Vanni, Tim	F	4:25	7.5	4.0	11.5
	IRN	Zeinalnia, Naser			7.0	0.0	7.0
	TUR	Sukruoglu, Ilyas	BYE		7.0		7.0

**Free Style 48Kg
Round 5/Sept. 28**
**Style Libre 48Kg
Tour 5/28 Sept**

Gr	Ctry	Name	Result	Time	Points*	Points*	No. of Loss
	Pays	Nom		Temps	bef/av. Match	Match Total	No. de Def.
A	GDR	Anger, Volker	P1	4:28	6.0	0.0	6.0
	*FRG	Heugabel, Reiner			13.5	3.0	16.5
	BUL	Tzonov, Ivan	BYE		11.0		11.0
B	TUR	Sukruoglu, Ilyas	3		7.0	1.0	8.0
	*USA	Vanni, Tim	5	6:00	11.5	3.0	14.5
	JPN	Kobayashi, Takas	BYE		16.0		16.0

**Free Style 48Kg
Round 6/Sept. 28**
**Style Libre 48Kg
Tour 6/28 Sept**

Gr	Ctry	Name	Result	Time	Points*	Points*	No. of Loss
	Pays	Nom		Temps	bef/av. Match	Match Total	No. de Def.
A	FRG	Heugabel, Reiner	0		16.5	0.0	16.5
	*BUL	Tzonov, Ivan	3	6:00	11.0	3.0	14.0
B	*JPN	Kobayashi, Takas	6	6:00	16.0	3.0	19.0
	TUR	Sukruoglu, Ilyas	5		8.0	1.0	9.0

**Free Style 48Kg
Finals/Sept. 29**
**Style Libre 48Kg
Finale/29 Sept**

Gr	Ctry	Name	Result	Time	Points
	Pays	Nom	Resultat	Temps	Points
1-2 PLACE					
	BUL	Tzonov, Ivan	4		0.5
	*JPN	Kobayash, Takas	16	6:00	3.5
3-4 PLACE					
	*URS	Karamtchakov, Se	3	6:00	3.0
	USA	Vanni, Tim	1		1.0
5-6 PLACE					
	*FRG	heugabel, Reiner	P1	4:27	3.0
	TUR	Sukruoglu, Ilyas			0.0
*** Final "B" ***					
7-8 PLACE					
	*GDR	Anger, Volker	NAW	0:00	4.0
	IRN	Zeinalnia, Naser			0.0

Wrestling

Lutte

Free Style 48Kg Sept. 27-29				Style Libre 48 Kg 27-29 Sept					
Group A/Groupe A									
01	Heugabel, Reiner	FRG	4.0	4.0	3.5	2.0	3.0	0.0	3RD
03	Suhbatar, T	MGL	0.0	1.0					EL R.2
05	Liang, Dejin	CHN	1.0	0.0					EL R.2
07	Kumar, Rajesh	IND	3.0	3.0	0.0	1.0			EL R.4
09	Razigul	AFG	3.0	1.0	1.0				EL R.3
11	Suryadi, Suryadi	INA	1.0	1.0					EL R.2
13	Karamtchakov, S	URS	3.0	3.0	3.0	0.0			2ND
15	Tzonov, Ivan	BUL	1.0	4.0	3.0	3.0	0.0	3.0	1ST
17	Anger, Volker	GDR	3.0	3.0	0.0	0.0	0.0		4TH
19	Hour, Jiunn-Yih	TPE	1.0	0.0					EL R.2
Group B/Groupe B									
02	Marcuno, Alfredo	ESP	0.0	1.0					EL R.2
04	Vanni, Tim	USA	4.0	0.0	3.5	4.0	3.0		2ND
06	Lee, Sang-Ho	KOR	0.0						EL R.1
08	Kobayashi, T	JPN	4.0	4.0	4.0	4.0	0.0	3.0	1ST
10	Zeinalnia, Naser	IRN	4.0	3.0	0.0	0.0			4TH
12	Delgado Cerquer	COL	0.0	3.0	1.0				EL R.3
14	Sukruoglu, Ilyas	TUR	3.0	1.0	3.0	0.0	1.0	1.0	3RD
16	Ojo, Amos	NGR	1.0	1.0					EL R.2
18	Almsouti, M	SYR	0.0	3.0	0.5	0.0			EL R.4
Final/Finale									
1-2	Kobayashi, T	JPN	3.5	S	6:00	16-04			
	Tzonov, Ivan	BUL	0.5						
3-4	Karamtchakov, S	URS	3.0	D	6:00	03-01			
	Vanni, Tim	USA	1.0						
5-6	Heugabel, Reiner	FRG	3.0	P1	4:27				
	Sukruoglu, Ilyas	TUR	0.0						
7-8	Anger, Volker	GDR	4.0	NAW	0:00				
	Zeinalnia, Naser	IRN	0.0						
	1) Kobayashi, Takashi	JPN							
	2) Tzonov, Ivan	BUL							
	3) Karamtchakov, Serguei	URS							
	4) Vanni, Tim	USA							
	5) Heugabel, Reiner	FRG							
	6) Sukruoglu, Ilyas	TUR							
	7) Anger, Volker	GDR							

Free Style 52Kg Round 2/Sept. 28				Style Libre 52Kg Tour 2/28 Sept			
Gr	Ctry	Name	Result	Time	Points*	Points*	No. of Loss
	Pays	Nom		Temps	bef/av.	Match	No. de Def.
A	*IRN	Torkan, Majid	F	5:42	4.0	4.0	8.0
	CAN	Woodcroft, Chris			0.0	0.0	0.0
	TPE	Lo, Chao-Cheng			0.0	0.0	0.0
	*URS	Togouzov, Vladim	F	0:42	4.0	4.0	8.0
	*TUR	Seyhanli, Asian	16	5:26	4.0	4.0	8.0
	NGR	Lame, Garba	1		0.0	0.0	0.0
	INA	Saputera, Surya			0.0	0.0	0.0
	*POL	Stecyk, Wladysla	F	1:48	4.0	4.0	8.0
	MEX	Olvera, Bernardo	7		4.0	1.0	5.0
	*USA	Chertow, Kenneth	10	6:00	1.0	3.0	4.0
	GUA	Vasquez, Edvin-E	0		0.0	0.0	0.0
	*FRA	Bourdin, Thierry	16	2:30	3.0	4.0	7.0
	*BUL	Dimitrov, Valent	17	2:57	4.0	4.0	8.0
	GUI	Diallo, Oushane	1		0.0	0.0	0.0
	PUR	Negron, Carlos R	1		0.0	0.0	0.0
	*YUG	Trstena, Saban	16	4:32	4.0	4.0	8.0
B	PHI	Tirante, Florent			0.0	0.0	0.0
	*VIE	Nguyen Kim, Huon	F	2:02	0.0	4.0	4.0
	*HUN	Biro, Laszlo	11	6:00	4.0	3.0	7.0
	IND	Singh, Kuldeep	5		4.0	1.0	5.0
	KEN	Elimu, Lamachi			0.0	0.0	0.0
	*MGL	Enebayar, Tseren	F	1:02	3.0	4.0	7.0
	*COL	Munoz Echeverry	8	6:00	4.0	3.0	7.0
	IRQ	Minati, Fayadh L	1		1.0	1.0	2.0
	CHN	Xu, Jihua			1.0	0.0	1.0
	*JPN	Sato, Mitsuru	F	4:02	4.0	4.0	8.0
	*KOR	Kim, Jong-Oh	8	6:00	3.0	3.0	6.0
	AFG	Nasirahmad	5		3.0	1.0	4.0
	JOR	Sharif, Jihad			0.0	0.0	0.0
	*FRG	Tutsch, Herbert	F	2:16	1.0	4.0	5.0

Free Style 52Kg Round 1/Sept. 28				Style Libre 52Kg Tour 1/28 Sept			
Gr	Ctry	Name	Result	Time	Points*	Points*	No. of Loss
	Pays	Nom		Temps	Match	Match	No. de Def.
A	*IRN	Torkan, Majid	15	2:18	4.0	4.0	1
	TPE	Lo, Chao-Cheng	0		0.0	0.0	1
	CAN	Woodcroft, Chris	0		0.0	0.0	1
	*URS	Togouzov, Vladim	16	2:42	4.0	4.0	1
	*TUR	Seyhanli, Asian	15	3:48	4.0	4.0	1
	INA	Saputera, Surya	0		0.0	0.0	1
	NGR	Lame, Garba			0.0	0.0	1
	*POL	Stecyk, Wladysla	F	5:18	4.0	4.0	1
	*MEX	Olvera, Bernardo	F	2:41	4.0	4.0	1
	GUA	Vasquez, Edvin-E			0.0	0.0	1
	USA	Chertow, Kenneth	1		1.0	1.0	1
	*FRA	Bourdin, Thierry	5	6:00	3.0	3.0	1
	*BUL	Dimitrov, Valent	F	2:02	4.0	4.0	1
	PUR	Negron, Carlos R			0.0	0.0	1
	GUI	Diallo, Oushane	0		0.0	0.0	1
	*YUG	Trstena, Saban	15	3:00	4.0	4.0	1
B	PHI	Tirante, Florent			0.0	0.0	1
	*HUN	Biro, Laszlo	F	0:16	4.0	4.0	1
	VIE	Nguyen Kim, Huon	3		0.0	0.0	1
	*IND	Singh, Kuldeep	18	5:35	4.0	4.0	1
	KEN	Elimu, Lamachi			0.0	0.0	1
	*COL	Munoz Echeverry	F	1:11	4.0	4.0	1
	*MGL	Enebayar, Tseren	12	6:00	3.0	3.0	1
	IRQ	Minati, Fayadh L	7		1.0	1.0	1
	CHN	Xu, Jihua	8		1.0	1.0	1
	*KOR	Kim, Jong-Oh	15	6:00	3.0	3.0	1
	*JPN	Sato, Mitsuru	F	0:45	4.0	4.0	1
	JOR	Sharif, Jihad			0.0	0.0	1
	*AFG	Nasirahmad	7	6:00	3.0	3.0	1
	FRG	Tutsch, Herbert	3		1.0	1.0	1

Free Style 52Kg Round 3/Sept. 28				Style Libre 52Kg Tour 3/28 Sept			
Gr	Ctry	Name	Result	Time	Points*	Points*	No. of Loss
	Pays	Nom		Temps	Match	Match	No. de Def.
A	IRN	Torkan, Majid	2		8.0	1.0	9.0
	*URS	Togouzov, Vladim	4	6:00	8.0	3.0	11.0
	*TUR	Seyhanli, Asian	8	6:00	8.0	3.0	11.0
	POL	Stecyk, Wladysla	4		8.0	1.0	9.0
	MEX	Olvera, Bernardo			5.0	0.0	5.0
	*FRA	Bourdin, Thierry	P1	5:08	7.0	3.0	10.0
	USA	Chertow, Kenneth	6		4.0	0.5	4.5
	*BUL	Dimitrov, Valent	19	6:00	8.0	3.5	11.5
	YUG	Trstena, Saban	BYE		8.0		8.0
B	*HUN	Biro, Laszlo	P1	4:16	7.0	3.0	10.0
	VIE	Nguyen Kim, Hyon			4.0	0.0	4.0
	*IND	Singh, Kuldeep	12	6:00	5.0	3.0	8.0
	COL	Munoz Echeverry	6		7.0	1.0	8.0
	MGL	Enebayar, Tseren	3		7.0	1.0	8.0
	*KOR	Kim, Jong-Oh	11	6:00	6.0	3.0	9.0
	*JPN	Sato, Mitsuru	F	1:44	8.0	4.0	12.0
	AFG	Nasirahmad			4.0	0.0	4.0
	FRG	Tutsch, Herbert	BYE		5.0		5.0



Free Style 52Kg Round 4/Sept. 29				Style Libre 52Kg Tour 4/29 Sept					
Gr	Ctry	Name	Result	Time	Points	Points	Points	No. of Loss	
	Pays	Nom		Temps	Match	Match	Total	No. de Def.	
A	*YUG IRN	Trstena, Saban Torkan, Majid	I	0:21	8.0 9.0	4.0 0.0	12.0 9.0	2	
	*URS TUR	Togouzov, Vladimir Seyhanli, Asian	5 4	6:00	11.0 11.0	3.0 1.0	14.0 12.0	1	
	*POL FRA	Stecyk, Wladysla Bourdin, Thierry	6 2	6:00	9.0 10.0	3.0 1.0	12.0 11.0	1	
	BUL	Dimitrov, Valent	BYE		11.5		11.5		
B	FRG *HUN	Tutsch, Herbert Biro, Laszlo	F	1:14	5.0 10.0	0.0 4.0	5.0 14.0	2	
	IND *MGL	Singh, Kuldeep Enebayar, Tseren	9 16	6:00	8.0 8.0	1.0 3.0	9.0 11.0	2 1	
	COL *KOR	Munoz Echeverry Kim, Jong-Oh	4 12	6:00	8.0 9.0	1.0 3.0	9.0 12.0	2	
	JPN	Sato, Mitsuru	BYE		12.0		12.0		

Free Style 52Kg Round 5/Sept. 29				Style Libre 52Kg Tour 5/29 Sept					
Gr	Ctry	Name	Result	Time	Points	Points	Points	No. of Loss	
	Pays	Nom		Temps	Match	Match	Total	No. de Def.	
A	*YUG BUL	Trstena, Saban Dimitrov, Valent	11 5	6:00	12.0 11.5	3.0 1.0	15.0 12.5	1	
	*URS POL	Togouzov, Vladimir Stecyk, Wladysla	17 1	2:52	14.0 12.0	4.0 0.0	18.0 12.0	2	
	*TUR FRA	Seyhanli, Asian Bourdin, Thierry	3 2	6:00	12.0 11.0	3.0 1.0	15.0 12.0	1 2	
B	*JPN MGL	Sato, Mitsuru Enebayar, Tseren	F	0:53	12.0 11.0	4.0 0.0	16.0 11.0	2	
	*HUN KOR	Biro, Laszlo Kim, Jong-Oh	8 4	6:00	14.0 12.0	3.0 1.0	17.0 13.0	1	

Free Style 52Kg Round 6/Sept. 29				Style Libre 52Kg Tour 6/29 Sept					
Gr	Ctry	Name	Result	Time	Points	Points	Points	No. of Loss	
	Pays	Nom		Temps	Match	Match	Total	No. de Def.	
A	BUL *URS	Dimitrov, Valent Togouzov, Vladimir	1 14	6:00	12.5 18.0	0.5 3.5	13.0 21.5	2	
	*YUG TUR	Trstena, Saban Seyhanli, Asian	7 3	6:00	15.0 15.0	3.0 1.0	18.0 16.0	2	
B	*JPN HUN	Sato, Mitsuru Biro, Laszlo	F	2:55	16.0 17.0	4.0 0.0	20.0 17.0	1	
	KOR	Kim, Jong-Oh	BYE		13.0		13.0	1	

Free Style 52Kg Round 7/Sept. 30				Style Libre 52Kg Tour 7/30 Sept					
Gr	Ctry	Name	Result	Time	Points	Points	Points	No. of Loss	
	Pays	Nom		Temps	Match	Match	Total	No. de Def.	
A	*YUG URS	Trstena, Saban Togouzov, Vladimir	3 0	6:00	18.0 21.5	3.0 0.0	21.0 21.5	1	
B	KOR *JPN	Kim, Jong-Oh Sato, Mitsuru	0 15	4:02	13.0 20.0	0.0 4.0	13.0 24.0	2	
	HUN	Biro, Laszlo	BYE		17.0		17.0	1	

Free Style 52Kg Finals/Sept. 30				Style Libre 52Kg Finale/30 Sept			
	Ctry	Name	Result	Time	Points		
	Pays	Nom	Resultat	Temps	Points		
1-2 PLACE							
	YUG	Trstena, Saban	2		1.0		
	*JPN	Sato, Mitsuru	13	6:00	3.0		
3-4 PLACE							
	*URS	Togouzov, Vladimir	14	6:00	3.5		
	HUN	Biro, Laszlo	1		0.5		
5-6 PLACE							
	*TUR	Seyhanli, Asian	5	6:00	3.0		
	KOR	Kim, Jong-Oh	4		1.0		
*** Final "B" ***							
7-8 PLACE							
	BUL	Dimitrov, Valent			0.0		
	*MGL	Enebayar, Tseren	I	0:00	4.0		

Free Style 52Kg /Sept. 28-30				Style Libre 52Kg /28-30 Sept			
Group A/Groupe A							
Gr	Ctry	Name	Result	Time	Points	Points	Points
01	IRN	Torkan, Majid	4.0	4.0	1.0	0.0	EL R.4
03	TPE	Lo, Chao-Cheng	0.0	0.0			EL R.2
05	CAN	Woodcroft, C	0.0	0.0			EL R.2
07	URS	Togouzov, V	4.0	4.0	3.0	4.0	3.5
09	TUR	Seyhanli, Asian	4.0	4.0	3.0	1.0	3.0
11	INA	Saputera, Surya	0.0	0.0			EL R.2
13	NGR	Lame, Garba	0.0	0.0			EL R.2
15	POL	Stecyk, W	4.0	4.0	1.0	3.0	0.0
17	MEX	Olvera, Bernardo	4.0	1.0	0.0		EL R.3
19	GUA	Vasquez, E	0.0	0.0			EL R.2
21	USA	Chertow, Kenneth	1.0	3.0	0.5		EL R.3
23	FRA	Bourdin, Thierry	3.0	4.0	3.0	1.0	1.0
25	BUL	Dimitrov, V	4.0	4.0	3.5	0.0	1.0
27	PUR	Negron, C	0.0	0.0			EL R.2
29	GUI	Diallo, Oushane	0.0	0.0			EL R.2
31	YUG	Trstena, Saban	4.0	4.0	0.0	4.0	3.0

Group B/Groupe B							
Gr	Ctry	Name	Result	Time	Points	Points	Points
02	PHI	Tirante, F	0.0	0.0			EL R.2
04	HUN	Biro, Laszlo	4.0	3.0	3.0	4.0	3.0
06	VIE	Nguyen Kim, H	0.0	4.0	0.0		EL R.3
08	IND	Singh, Kuldeep	4.0	1.0	3.0	1.0	EL R.4
10	KEN	Elimu, Lamachi	0.0	0.0			EL R.2
12	COL	Munoz Echeverry	4.0	3.0	1.0	1.0	EL R.4
14	MGL	Enebayar, T	3.0	4.0	1.0	3.0	0.0
16	IRQ	Minati, Fayadh L	1.0	1.0			EL R.2
18	CHN	Xu, Jihua	1.0	0.0			EL R.2
20	KOR	Kim, Jong-Oh	3.0	3.0	3.0	3.0	1.0
22	GBR	Morris, A	0.0	0.0			EL R.0
24	JPN	Sato, Mitsuru	4.0	4.0	4.0	0.0	4.0
26	JOR	Sharif, Jihad	0.0	0.0			EL R.2
28	AFG	Nasirahmad	3.0	1.0	0.0		EL R.3
30	FRG	Tutsch, Herbert	1.0	4.0	0.0	0.0	EL R.4

Final/Finale							
Gr	Ctry	Name	Result	Time	Points	Points	Points
1-2	JPN	Sato, Mitsuru	3.0	D	6:00	13-02	
	YUG	Trstena, Saban	1.0				
3-4	URS	Togouzov, V	3.5	S	6:00	14-01	
	HUN	Biro, Laszlo	0.5				
5-6	TUR	Seyhanli, Asian	3.0	D	6:00	05-04	
	KOR	Kim, Jong-Oh	1.0				
7-8	MGL	Enebayar, T	4.0	I	0:00		
	BUL	Dimitrov, V	0.0				

- 1) Sato, Mitsuru JPN
- 2) Trstena, Saban YUG
- 3) Togouzov, Vladimir URS
- 4) Biro, Laszlo HUN
- 5) Seyhanli, Asian TUR
- 6) Kim, Jong-Oh KOR
- 7) Enebayar, Tserenbatar MGL
- 8) Dimitrov, Valentin BUL

Wrestling

Free Style 57Kg Round 1/Sept. 29				Style Libre 57Kg Tour 1/29 Sept				
Gr	Ctry	Name	Result	Time	***** Points *****			No. of Loss
	Pays	Nom		Temps	bef/av. Match	Match	Total	No. de Def.
A	*USA	Davis, Barry	11	6:00		3.0	3.0	
	TCH	Schwendtner, Jos	2			1.0	1.0	1
	*HUN	Nagy, Bela	F	0:39		4.0	4.0	
	IND	Kumar, Vinod				0.0	0.0	1
	*CAN	Holmes, Lawrence	4	6:00		3.0	3.0	
	POL	Grzywinski, Dari	3			1.0	1.0	1
	*URS	Beloglazov, Serg	4	6:00		3.0	3.0	
	FRG	Scheibe, Juergen	1			1.0	1.0	1
	GBR	Ogden, David	0			0.0	0.0	1
	*JPN	Kanehama, Ryo	17	3:19		4.0	4.0	
B	*PAK	Mohd Azeem	P1	4:35		3.0	3.0	
	AUT	Auer, Georg-Jose				0.0	0.0	1
	TUR	Ak, Ahmet	BYE				0.0	
	MEX	Olvera, Jorge	1			1.0	1.0	1
	*YUG	Sorov, Zoran	11	6:00		3.0	3.0	
	MLT	Giordmaina, Jesm	1			0.0	0.0	1
	*KOR	Noh, Kyung-Sun	16	3:20		4.0	4.0	
	MGL	Battul, Haltma				0.0	0.0	1
	*IRN	Mohammadian, Ask	F	2:47		4.0	4.0	
	*TUN	Zelfani, Mourad	18	3:36		4.0	4.0	
KEN	Kimani, Waruingi	0			0.0	0.0	1	
CHN	Chen, Yongliang	1			0.0	0.0	1	
*BUL	Ivanov, Valentin	17	5:11		4.0	4.0		
*NZL	Hollamby, Brent	12	6:00		3.0	3.0		
PAN	Mena, Ramon	4			1.0	1.0	1	

Free Style 57Kg Round 2/Sept. 29				Style Libre 57Kg Tour 2/29 Sept				
Gr	Ctry	Name	Result	Time	***** Points *****			No. of Loss
	Pays	Nom		Temps	bef/av. Match	Match	Total	No. de Def.
A	*TUR	Ak, Ahmet	11	6:00		0.0	3.0	3.0
	USA	Davis, Barry	5			3.0	1.0	4.0
	TCH	Schwendtner, Jos	3			1.0	1.0	2.0
	*HUN	Nagy, Bela	6	6:00		4.0	3.0	7.0
	*IND	Kumar, Vinod	6	6:00		0.0	3.0	3.0
	CAN	Holmes, Lawrence	3			3.0	1.0	4.0
	POL	Grzywinski, Dari				1.0	0.0	1.0
	*URS	Beloglazov, Serg	F	1:31		3.0	4.0	7.0
	*FRG	Scheibe, Juergen	14	6:00		1.0	3.0	4.0
	GBR	Ogden, David	3			0.0	1.0	1.0
B	*JPN	Kanehama, Ryo	9	6:00		4.0	3.0	7.0
	PAK	Mohd Azeem	6			3.0	1.0	4.0
	AUT	Auer, Georg-Jose	BYE			0.0		0.0
	*MEX	Olvera, Jorge	10	6:00		1.0	3.0	4.0
	MLT	Giordmaina, Jesm	5			0.0	1.0	1.0
	YUG	Sorov, Zoran	5			3.0	1.0	4.0
	*KOR	Noh, Kyung-Sun	9	6:00		4.0	3.0	7.0
	*MGL	Battul, Haltma	15	5:40		0.0	4.0	4.0
	TUN	Zelfani, Mourad	0			4.0	0.0	4.0
	*IRN	Mohammadian, Ask	15	3:08		4.0	4.0	8.0
KEN	Kimani, Waruingi	0			0.0	0.0	0.0	
*CHN	Chen, Yongliang	14	6:00		0.0	3.0	3.0	
NZL	Hollamby, Brent	4			3.0	1.0	4.0	
*BUL	Ivanov, Valentin	F	2:09		4.0	4.0	8.0	
PAN	Mena, Ramon				1.0	0.0	1.0	

Lutte

Free Style 57Kg Round 3/Sept. 30				Style Libre 57Kg Tour 3/30 Sept				
Gr	Ctry	Name	Result	Time	***** Points *****			No. of Loss
	Pays	Nom		Temps	bef/av. Match	Match	Total	No. de Def.
A	AUT	Auer, Georg-Jose	0			0.0	0.0	0.0
	*TUR	Ak, Ahmet	15	4:05		3.0	4.0	7.0
	USA	Davis, Barry				4.0	0.0	4.0
	*HUN	Nagy, Bela	F	2:00		7.0	4.0	11.0
	IND	Kumar, Vinod				3.0	0.0	3.0
	*URS	Beloglazov, Serg	F	1:44		7.0	4.0	11.0
	*CAN	Holmes, Lawrence	8	6:00		4.0	3.0	7.0
	FRG	Scheibe, Juergen	6			4.0	1.0	5.0
	JPN	Kanehama, Ryo	BYE			7.0		7.0
	B	MEX	Olvera, Jorge	3			4.0	0.0
*KOR		Noh, Kyung-Sun	19	5:11		7.0	4.0	11.0
YUG		Sorov, Zoran	1			4.0	1.0	5.0
*MGL		Battul, Haltma	9	6:00		4.0	3.0	7.0
*IRN		Mohammadian, Ask	F	1:57		8.0	4.0	12.0
CHN		Chen, Yongliang				3.0	0.0	3.0
TUN		Zelfani, Mourad				4.0	0.0	4.0
*BUL		Ivanov, Valentin	F	1:04		8.0	4.0	12.0
NZL		Hollamby, Brent	BYE			4.0		4.0

Free Style 57Kg Round 4/Sept. 30				Style Libre 57Kg Tour 4/30 Sept					
Gr	Ctry	Name	Result	Time	***** Points *****			No. of Loss	
	Pays	Nom		Temps	bef/av. Match	Match	Total	No. de Def.	
A	JPN	Kanehama, Ryo	4			7.0	1.0	8.0	
	*TUR	Ak, Ahmet	5	6:00		7.0	3.0	10.0	
	*HUN	Nagy, Bela	F	2:40		11.0	4.0	15.0	
	CAN	Holmes, Lawrence				7.0	0.0	7.0	
	URS	Beloglazov, Serg	BYE			11.0		11.0	
	B	NZL	Hollamby, Brent	4			4.0	0.0	4.0
		*MGL	Battul, Haltma	19	4:28		7.0	4.0	11.0
		KOR	Noh, Kyung-Sun	1			11.0	0.0	11.0
		*IRN	Mohammadian, Ask	16	4:27		12.0	4.0	16.0
		BUL	Ivanov, Valentin	BYE			12.0		12.0

Free Style 57Kg Round 5/Sept. 30				Style Libre 57Kg Tour 5/30 Sept					
Gr	Ctry	Name	Result	Time	***** Points *****			No. of Loss	
	Pays	Nom		Temps	bef/av. Match	Match	Total	No. de Def.	
A	*URS	Beloglazov, Serg	F	2:04		11.0	4.0	15.0	
	JPN	Kanehama, Ryo				8.0	0.0	8.0	
	*TUR	Ak, Ahmet	11	6:00		10.0	3.0	13.0	
	HUN	Nagy, Bela	4			15.0	1.0	16.0	
	B	BUL	Ivanov, Valentin	4			12.0	1.0	13.0
		*IRN	Mohammadian, Ask	5	6:19		16.0	3.0	19.0
		*KOR	Noh, Kyung-Sun	6	6:00		11.0	3.0	14.0
		MGL	Battul, Haltma	4			11.0	1.0	12.0

Free Style 57Kg Round 6/Sept. 30				Style Libre 57Kg Tour 6/30 Sept					
Gr	Ctry	Name	Result	Time	***** Points *****			No. of Loss	
	Pays	Nom		Temps	bef/av. Match	Match	Total	No. de Def.	
A	*URS	Beloglazov, Serg	12	6:00		15.0	3.0	18.0	
	TUR	Ak, Ahmet	3			13.0	1.0	14.0	
	HUN	Nagy, Bela	BYE			16.0		16.0	
	B	BUL	Ivanov, Valentin	5			13.0	1.0	14.0
		*KOR	Noh, Kyung-Sun	7	6:00		14.0	3.0	17.0
		IRN	Mohammadian, Ask	BYE			19.0		19.0



Free Style 57Kg Round 7/Oct. 1				Style Libre 57Kg Tour 7/1 Oct				
Gr	Ctry	Name	Result	Time	***** Points bef/av.	***** Points Match	***** Points Total	No. of Loss No. de Def.
	Pays	Nom		Temps	Match	Match	Total	

A	HUN	Nagy, Bela			16.0	0.0	16.0	2
	*URS	Beloglazov, Serg	F	1:06	18.0	4.0	22.0	

Free Style 57Kg Finals/Oct. 1			Style Libre 57Kg Finale/1 Oct		
Ctry	Name	Result	Time	Points	
Pays	Nom	Resultat	Temps	Points	

1-2 PLACE					
	*URS	Beloglazov, Serg	5	6:00	3.0
	IRN	Mohammadian, Ask	1		1.0

3-4 PLACE					
	TUR	Ak, Ahmet	8		1.0
	*KOR	Noh, Kyung-Sun	9	9:00	3.0

5-6 PLACE					
	HUN	Nagy, Bela	3		1.0
	*BUL	Ivanov, Valentin	5	6:00	3.0

*** Final "B" ***

7-8 PLACE					
	JPN	Kanehama, Ryo	3		1.0
	*MGL	Battul, Haltma	4	6:00	3.0

Free Style 57Kg Sept. 29-Oct. 1				Style Libre 57Kg 29 Sept-1 Oct			
------------------------------------	--	--	--	-----------------------------------	--	--	--

Group A/Groupe A									
01	Davis, Barry	USA	3.0	1.0	0.0				EL R.3
03	Schwendtner, J	TCH	1.0	1.0					EL R.2
05	Nagy, Bela	HUN	4.0	3.0	4.0	4.0	1.0	0.0	3RD
07	Kumar, Vinod	IND	0.0	3.0	0.0				EL R.3
09	Holmes, Lawrence	CAN	3.0	1.0	3.0	0.0			EL R.4
11	Grzywinski, D	POL	1.0	0.0					EL R.2
13	Beloglazov, S	URS	3.0	4.0	4.0	0.0	4.0	3.0	1ST
15	Scheibe, Juergen	FRG	1.0	3.0	1.0				EL R.3
17	Ogden, David	GBR	0.0	1.0					EL R.2
19	Kanehama, Ryo	JPN	4.0	3.0	0.0	1.0	0.0		4TH
21	Mohd Azeem	PAK	3.0	1.0					EL R.2
23	Auer, G	AUT	0.0	0.0	0.0				EL R.3
25	Ak, Ahmet	TUR	0.0	3.0	4.0	3.0	3.0	1.0	2ND

Group B/Groupe B									
02	Olvera, Jorge	MEX	1.0	3.0	0.0				EL R.3
04	Sorov, Zoran	YUG	3.0	1.0	1.0				EL R.3
06	Giordmaina, J	MLT	0.0	1.0					EL R.2
08	Noh, Kyung-Sun	KOR	4.0	3.0	4.0	0.0	3.0	3.0	2ND
10	Abttul, Haltma	MGL	0.0	4.0	3.0	4.0	1.0		4TH
12	Mohammadian, A	IRN	4.0	4.0	4.0	4.0	3.0	0.0	1ST
14	Zelfani, Mourad	TUN	4.0	0.0	0.0				EL R.3
16	Kimani, Waruingi	KEN	0.0	0.0					EL R.2
18	Chen, Yongliang	CHN	0.0	3.0	0.0				EL R.3
20	Ivanov, Valentin	BUL	4.0	4.0	4.0	0.0	1.0	1.0	3RD
22	Hollamby, Brent	NZL	3.0	1.0	0.0	0.0			EL R.4
24	Mena, Ramon	PAN	1.0	0.0					EL R.2

Final/Final						
1-2	Beloglazov, s	URS	3.0	D	6:00	05-01
	Mohammadian, A	IRN	1.0			
3-4	Noh, Kyung-Sun	KOR	3.0	D	9:00	09-08
	Ak, Ahmet	TUR	1.0			
5-6	Ivanov, Valentin	BUL	3.0	D	6:00	05-03
	Nagy, Bela	HUN	1.0			
7-8	Abttul, Haltma	MGL	3.0	D	6:00	04-03
	Danehama, Ryo	JPN	1.0			

- 1) Beloglazov, Serguei URS
- 2) Mohammadian, Askari IRN
- 3) Noh, Kyung-Sun KOR
- 4) Ak, Ahmet TUR
- 5) Ivanov, Valentin BUL
- 6) Nagy, Bela HUN
- 7) Battul, Haltma MGL
- 8) Kanehama, Ryo JPN

Free Style 62Kg Round 1/Sept. 27				Style Libre 62Kg Tour 1/27 Sept				
Gr	Ctry	Name	Result	Time	***** Points bef/av.	***** Points Match	***** Points Total	No. of Loss No. de Def.
	Pays	Nom		Temps	Match	Match	Total	

A	*FIN	Lehto, Mika	10	6:00	3.0	3.0		
	PAN	Oporta, Arturo	2		1.0	1.0	1	
	*POL	Skubacz, Marian	8	6:00	3.0	3.0		
	AFG	Alidad	4		1.0	1.0	1	
	*USA	Smith, John.	11	6:00	3.0	3.0		
	HUN	Orban, Jozsef	4		1.0	1.0	1	
	*BUL	Chterev, Simeon	2	6:00	3.0	3.0		
	JPN	Sakae, Kazuhito	1		1.0	1.0	1	
	AUS	Cumming, Daniel	0		0.0	0.0	1	
	*MGL	Enhe, Avirmed	16	4:03	4.0	4.0		
	ESP	Caceres, Vicente	4		1.0	1.0	1	
	*SWE	Dikanda, Theodor	6	6:00	3.0	3.0		
	TPE	Huang, Chien-Lun	2		0.0	0.0	1	
	*ITA	Schillaci, Giova	18	4:25	4.0	4.0		

B	*TUR	Kaygusuz, Selman	F	1:20	4.0	4.0		
	CMR	Yinga, Francois			0.0	0.0	1	
	CHN	Li, Xianji	10		1.0	1.0	1	
	*CAN	Bohay, Gary	15	6:00	3.0	3.0		
	NZL	Reinsfield, Stev			0.0	0.0	1	
	*GDR	Polky, Karsten	P1	5:33	3.0	3.0		
	*URS	Sarkissian, Step	16	6:00	4.0	4.0		
	GBR	Singh tutt, Ravi	0		0.0	0.0	1	
	COL	Rincon, Javier E			0.0	0.0	1	
	*SUI	Kueng, Ludwig	F	3:30	4.0	4.0		
	*FRG	Helmdach, Joerg	8	6:00	3.0	3.0		
	KOR	Kim, Yun-Man	4		1.0	1.0	1	
	MLT	Farrugia, Paul	0		0.0	0.0	1	
	*IRN	Fallah, Akbar	15	2:01	4.0	4.0		

Free Style 62Kg Round 2/Sept. 27				Style Libre 62Kg Tour 2/27 Sept				
Gr	Ctry	Name	Result	Time	***** Points bef/av.	***** Points Match	***** Points Total	No. of Loss No. de Def.
	Pays	Nom		Temps	Match	Match	Total	

A	FIN	Lehto, Mika	1		3.0	1.0	4.0	1
	*POL	Skubacz, Marian	4	6:00	3.0	3.0	6.0	
	PAN	Oporta, Arturo	0		1.0	0.0	1.0	2
	*AFG	Alidad	7	6:00	1.0	3.0	4.0	1
	*USA	Smith, John	6	6:00	3.0	3.0	6.0	
	BUL	Chterev, Simeon	3		3.0	1.0	4.0	1
	HUN	Orban, Jozsef	4		1.0	1.0	2.0	2
	*JPN	Sakae, Kazuhito	5	6:00	1.0	3.0	4.0	1
	*AUS	Cumming, Daniel	11	6:00	0.0	3.0	3.0	1
	ESP	Caceres, Vicente	5		1.0	1.0	2.0	2
	*MGL	Enhe, Avirmed	15	2:18	4.0	4.0	8.0	
	TPE	Huang, Chien-Lun	0		0.0	0.0	0.0	2
	SWE	Dikanda, Theodor	1		3.0	1.0	4.0	1
	*ITA	Schillaci, Giova	7	6:00	4.0	3.0	7.0	

B	*TUR	Kaygusuz, Selman	13	6:00	4.0	3.0	7.0	
	CHN	Li, Xianji	5		1.0	1.0	2.0	2
	CMR	Yinga, Francois			0.0	0.0	0.0	2
	*CAN	Bohay, Gary	F	2:45	3.0	4.0	7.0	
	NZL	Reinsfield, Stev	0		0.0	0.0	0.0	2
	*URS	Sarkissian, Step	13	6:00	4.0	3.5	7.5	
	*GDR	Polky, Karsten	F	1:20	3.0	4.0	7.0	
	GBR	Singh tutt, Ravi			0.0	0.0	0.0	2
	COL	Rincon, Javier E	0		0.0	0.0	0.0	2
	*FRG	Heldach, Joerg	4	6:00	3.0	3.0	6.0	
	*SUI	Kueng, Ludwig	F	0:33	4.0	4.0	8.0	
	MLT	Farrugia, Paul			0.0	0.0	0.0	2
	KOR	Kim, Yun-Man	3		1.0	1.0	2.0	2
	*IRN	Fallah, Akabar	4	6:00	4.0	3.0	7.0	

Wrestling

Free Style 62Kg Round 3/Sept. 27				Style Libre 62Kg Tour 3/27 Sept				
Gr	Ctry	Name	Result	Time	Points	Points	Points	No. of Loss
	Pays	Nom		Temps	bef/av. Match	Match	Total	No. de Def.
A	*FIN	Lehto, Mika	7	6:00	4.0	3.0	7.0	1
	AFG	Alidad	0		4.0	0.0	4.0	2
	POL	Skubacz, Marian	2		6.0	1.0	7.0	1
	*USA	Smith, John	4	6:00	6.0	3.0	9.0	
	*BUL	Chterev, Simeon	F	2:45	4.0	4.0	8.0	1
	AUS	Cumming, Daniel			3.0	0.0	3.0	2
	*JPN	Sakae, Kazuhito	F	5:32	4.0	4.0	8.0	1
	SWE	Dikanda, Theodor			4.0	0.0	4.0	2
	*MGL	Enhe, Avirmed	6	6:00	8.0	3.0	11.0	
	ITA	Schillaci, Giova	2		7.0	1.0	8.0	1
B	TUR	Kaygusuz, Selman	5		7.0	1.0	8.0	1
	*CAN	Bohay, Gary	6	6:00	7.0	3.0	10.0	
	GDR	Polky, Karsten	1		7.0	0.5	7.5	1
	*URS	Sarkissian, Step	13	6:00	7.5	3.5	11.0	
	SUI	Kueng, Ludwig	0		8.0	0.0	8.0	1
	*FRG	Helmdach, Joerg	6	6:00	6.0	3.0	9.0	
	IRN	Fallah, Akbar	BYE		7.0		7.0	

Free Style 62Kg Round 4/Sept. 28				Style Libre 62Kg Tour 4/28 Sept				
Gr	Ctry	Name	Result	Time	Points	Points	Points	No. of Loss
	Pays	Nom		Temps	bef/av. Match	Match	Total	No. de Def.
A	FIN	Lehto, Mika	6		7.0	1.0	8.0	2
	*USA	Smith, John	16	6:00	9.0	3.0	12.0	
	POL	Skubacz, Marian	0		7.0	0.0	7.0	2
	*BUL	Chterev, Simeon	2	6:00	8.0	3.0	11.0	1
	JPN	Sakae, Kazuhito	1		8.0	1.0	9.0	2
	*MGL	Enhe, Avirmed	7	6:00	11.0	3.0	14.0	
	ITA	Schillaci, Giova	BYE		8.0		8.0	1
B	*IRN	Fallah, Akbar	6	6:00	7.0	3.0	10.0	
	CAN	Bohay, Gary	1		10.0	1.0	11.0	1
	*GDR	Polky, Karsten	7	6:00	7.5	3.0	10.5	1
	SUI	Kueng, Ludwig	3		8.0	1.0	9.0	2
	*URS	Sarkissian, Step	7	6:00	11.0	3.0	14.0	
	FRG	Helmdach, Joerg	2		9.0	1.0	10.0	1

Free Style 62Kg Round 5/Sept. 28				Style Libre 62Kg Tour 5/28 Sept				
Gr	Ctry	Name	Result	Time	Points	Points	Points	No. of Loss
	Pays	Nom		Temps	bef/av. Match	Match	Total	No. de Def.
A	ITA	Schillaci, Giova			8.0	0.0	8.0	2
	*USA	Smith, John	F	5:54	12.0	4.0	16.0	
	*BUL	Chterev, Simeon	P1	5:25	11.0	3.0	14.0	1
	MGL	Enhe, Avirmed			14.0	0.0	14.0	1
B	*IRN	Fallah, Akbar	10	6:00	10.0	3.0	13.0	
	GDR	Polky, Karsten	3		10.5	1.0	11.5	2
	CAN	Bohay, Gary	1		11.0	1.0	12.0	2
	*URS	Sarkissian, Step	8	6:00	14.0	3.0	17.0	
	FRG	Helmdach, Joerg	BYE		10.0		10.0	1

Free Style 62Kg Round 6/Sept. 28				Style Libre 62Kg Tour 6/28 Sept				
Gr	Ctry	Name	Result	Time	Points	Points	Points	No. of Loss
	Pays	Nom		Temps	bef/av. Match	Match	Total	No. de Def.
A	*USA	Smith, John	12	6:00	16.0	3.0	19.0	
	MGL	Enhe, Avirmed	7		14.0	1.0	15.0	2
B	FRG	Helmdach, Joerg	0		10.0	0.0	10.0	2
	*IRN	Fallah, Akbar	5	6:00	13.0	3.0	16.0	
	URS	Sarkissian, Step	BYE		17.0		17.0	

Lutte

Free Style 62Kg Round 7/Sept. 29				Style Libre 62Kg Tour 7/29 Sept				
Gr	Ctry	Name	Result	Time	Points	Points	Points	No. of Loss
	Pays	Nom		Temps	bef/av. Match	Match	Total	No. de Def.
B	*URS	Sarkissian, Step	12	6:00	17.0	3.0	20.0	
	IRN	Fallah, Akbar	1		16.0	1.0	17.0	1

Free Style 62Kg Finals/Sept. 29				Style Libre 62Kg Finale/29 Sept				
	Ctry	Name	Result	Time	Points			
	Pays	Nom	Resultat	Temps	Points			

1-2 PLACE	*USA	Smith, John	4	6:00	3.0			
	URS	Sarkissian, Step	0		0.0			
3-4 PLACE	*BUL	Chterev, Simeon	5	6:00	3.0			
	IRN	Fallah, Akbar	2		1.0			
5-6 PLACE	MGL	Enhe, Avirmed	4		1.0			
	*FRG	Helmdach, Joerg	5	6:00	3.0			
*** Final "B" ***								
7-8 PLACE	*ITA	Schillaci, Giova	5	6:00	3.0			
	CAN	Bohay, Gary	0		0.0			

Free Style 62Kg /Sept. 27-29				Style Libre 62Kg /27-29 Sept				
Group A/Groupe A								
01	Lehto, Mika	FIN	3.0	1.0	3.0	1.0		EL R.4
03	Oporta, Arturo	PAN	1.0	0.0				EL R.2
05	Skubacz, Marian	POL	3.0	3.0	1.0	0.0		EL R.4
07	Alidad	AFG	1.0	3.0	0.0			EL R.3
09	Smith, John	USA	3.0	3.0	3.0	3.0	4.0	3.0
11	Orban, Jozsef	HUN	1.0	1.0				EL R.2
13	Chterev, Simeon	BUL	3.0	1.0	4.0	3.0	3.0	2ND
15	Sakae, Kazuhito	JPN	1.0	3.0	4.0	1.0		EL R.4
17	Cumming, Daniel	AUS	0.0	3.0	0.0			EL R.3
19	Enhe, Avirmed	MGL	4.0	4.0	3.0	3.0	0.0	1.0
21	Caceres, Vicente	ESP	1.0	1.0				EL R.2
23	Dikanda, T	SWE	3.0	1.0	0.0			EL R.3
25	Huang, C	TPE	0.0	0.0				EL R.2
27	Schillaci, G	ITA	4.0	3.0	1.0	0.0	0.0	4TH

Group B/Groupe B								
02	Kaygusuz, Selman	TUR	4.0	3.0	1.0			EL R.3
04	Yinga, Francois	CMR	0.0	0.0				EL R.2
06	Li, Xianji	CHN	1.0	1.0				EL R.2
08	Bohay, Gary	CAN	3.0	4.0	3.0	1.0	1.0	4TH
10	Reinsfield, S	NZL	0.0	0.0				EL R.2
12	Polky, Karsten	GDR	3.0	4.0	0.5	3.0	1.0	EL R.5
14	Sarkissian, S	URS	4.0	3.5	3.5	3.0	3.0	0.0
16	Singh tutt, R	GBR	0.0	0.0				EL R.2
18	Rincon, J	COL	0.0	0.0				EL R.2
20	Kueng, Ludwig	SUI	4.0	4.0	0.0	1.0		EL R.4
22	Helmdach, Joerg	FRG	3.0	3.0	3.0	1.0	0.0	3RD
24	Kim, Yun-Man	KOR	1.0	1.0				EL R.2
26	Farrugia, Paul	MLT	0.0	0.0				EL R.2
28	Fallah, Akbar	IRN	4.0	3.0	0.0	3.0	3.0	1.0

Final/Finale								
1-2	Smith, John	USA	3.0	D	6:00	04-00		
	Sarkissian, S	URS	0.0					
3-4	Chterev, Simeon	BUL	3.0	D	6:00	05-02		
	Fallah, Akbar	IRN	1.0					
5-6	Helmdach, Joerg	FRG	3.0	D	6:00	05-04		
	Enhe, Avirmed	MGL	1.0					
7-8	Schillaci, G	ITA	3.0	D	6:00	05-00		
	Bohay, Gary	CAN	0.0					

- 1) Smith, John USA
- 2) Sarkissian, Stepan URS
- 3) Chterev, Simeon BUL
- 4) Fallah, Akbar IRN
- 5) Helmdach, Joerg FRG
- 6) Enhe, Avirmed MGL
- 7) Schillaci, Giovanni ITA
- 8) Bohay, Gary CAN



Free Style 68Kg Round 1/Sept. 29				Style Libre 68Kg Tour 1/29 Sept			
Gr	Ctry	Name	Result	Time	***** bef/av.	Points * * * * *	No. of Loss
	Pays	Nom		Temps	Match	Match	No. de Def.
A	*EGY	Elkhodary, Essam	19	3:57		4.0	4.0
	ESA	Manzur, Gustavo	3		0.0	0.0	1
	*SYR	Wattar, Amar	17	4:32		4.0	4.0
	PER	Ichillumpa, Edmu	2		0.0	0.0	1
	*JPN	Akaishi, Kosei	F	1:13		4.0	4.0
	PHI	Manibog, Dean ca			0.0	0.0	1
	*PAN	Hidalgo, Hermini	19	4:34		4.0	4.0
	KEN	Salbei, Kiptoo	3		0.0	0.0	1
	*GRE	Athanassiadis, G	15	4:03		4.0	4.0
	CHN	Hobisgaltu	0		0.0	0.0	1
BUL	Yassenov, Anguel	4		1.0	1.0	1	
*URS	Fadzaev, Arsen	12	6:00		3.0	3.0	
ESP	Caride, Juan			0.0	0.0	1	
*FIN	Rauhala, Jukka	F	4:05		4.0	4.0	
IRN	Khadem, Amir-Rez	BYE			0.0		
B	*AUS	Brown, Cris	13	6:00		3.0	3.0
	ARG	Navarrete, Danie	3		1.0	1.0	1
	JOR	Almasri, Muneir	0		0.0	0.0	1
	*CAN	Mckay, David	15	2:24		4.0	4.0
	FRA	Santoro, Gerard	4		1.0	1.0	1
	*KOR	Park, Jang-Soon	9	6:00		3.0	3.0
	SUI	Neyer, Rene	8		1.0	1.0	1
	*POL	Kubiak, Andrzej	14	6:00		3.0	3.0
	*FRG	Leipold, Alexand	11	6:00		3.0	3.0
	IND	Satyawan	1		1.0	1.0	1
*MGL	Amara, Henmedeh	15	2:56		4.0	4.0	
AFG	Shirmohammed	0		0.0	0.0	1	
*USA	Carr, Nate	16	4:43		4.0	4.0	
HUN	Podolszki, Attil	1		0.0	0.0	1	
TUR	Seker, Fevzi	BYE			0.0		

Free Style 68Kg Round 2/Sept. 29				Style Libre 68Kg Tour 2/29 Sept			
Gr	Ctry	Name	Result	Time	***** bef/av.	Points * * * * *	No. of Loss
	Pays	Nom		Temps	Match	Match	No. de Def.
A	*IRN	Khadem, Amir-Rez	16	2:04		0.0	4.0
	EGY	Elkhodary, Essam	0		4.0	0.0	4.0
	ESA	Manzur, Gustavo	3		0.0	0.5	0.5
	*SYR	Wattar, Amar	16	6:00		4.0	3.5
	PER	Ichillumpa, Edmu	0		0.0	0.0	0.0
	*JPN	Akaishi, Kosei	15	1:15		4.0	4.0
	PHI	Manibog, Dean ca	0		0.0	0.0	0.0
	*PAN	Hidalgo, Hermini	15	3:56		4.0	4.0
	KEN	Salbei, Kiptoo			0.0	0.0	0.0
	*GRE	Athanassiadis, G	F	0:17		4.0	4.0
CHN	Hobisgaltu	3		0.0	1.0	1.0	
*BUL	Yassenov, Anguel	12	6:00		1.0	3.0	
*URS	Fadzaev, Arsen	F	3:50		3.0	4.0	
ESP	Caride, Juan			0.0	0.0	0.0	
FIN	Rauhala, Jukka	BYE			4.0		
B	TUR	Seker, Fevzi	2		0.0	1.0	1.0
	*AUS	Brown, Cris	3	6:00		3.0	3.0
	*ARG	Navarrete, Danie	15	3:25		1.0	4.0
	JOR	Almasri, Muneir	0		0.0	0.0	0.0
	*CAN	Mckay, David	7	6:00		4.0	3.0
	FRA	Santoro, Gerard	1		1.0	1.0	2.0
	*KOR	Park, Jang-Soon	15	4:46		3.0	4.0
	SUI	Neyer, Rene	0		1.0	0.0	1.0
	POL	Kubiak, Andrzej	2		3.0	1.0	4.0
	*FRG	Leipold, Alexand	3	6:00		3.0	3.0
IND	Satyawan	2		1.0	1.0	2.0	
*MGL	Amara, Henmedeh	7	6:00		4.0	3.0	
AFG	Shirmohammed	0		0.0	0.0	0.0	
*USA	Carr, Nate	15	4:54		4.0	4.0	
HUN	Podolszki, Attil	BYE			0.0	0.0	

Free Style 68Kg Round 3/Sept. 30				Style Libre 68Kg Tour 3/30 Sept			
Gr	Ctry	Name	Result	Time	***** bef/av.	Points * * * * *	No. of Loss
	Pays	Nom		Temps	Match	Match	No. de Def.
A	*FIN	Rauhala, Jukka	8	6:00		4.0	3.0
	IRN	Khadem, Amir-Rez	7		4.0	1.0	5.0
	EGY	Elkhodary, Essam	3		4.0	1.0	5.0
	*SYR	Wattar, Amar	14	6:00		7.5	3.0
	*JPN	Akaishi, Kosei	15	2:11		8.0	4.0
	PAN	Hidalgo, hermini	0		8.0	0.0	8.0
	GRE	Athanassiadis, G	2		8.0	1.0	9.0
	*BUL	Yassenov, Anguel	3	6:00		4.0	3.0
	URS	Fadzaev, Arsen	BYE			7.0	
	HUN	Podolszki, Attil			0.0	0.0	0.0
*TUR	Seker, Fevzi	1	0:00		1.0	4.0	
*AUS	Brown, Cris	7	6:00		6.0	3.0	
CAN	Mckay, David	1		7.0	1.0	8.0	
ARG	Navarrete, Danie	0		5.0	0.0	5.0	
*KOR	Park, Jang-Soon	15	3:38		7.0	4.0	
POL	Kubiak, Andrzej	2		4.0	1.0	5.0	
*MGL	Amara, Henmedeh	4	6:00		7.0	3.0	
FRG	Leipold, Alexand	3		6.0	1.0	7.0	
*USA	Carr, Nate	11	6:00		8.0	3.0	

Free Style 68Kg Round 4/Sept. 30				Style Libre 68Kg Tour 4/30 Sept			
Gr	Ctry	Name	Result	Time	***** bef/av.	Points * * * * *	No. of Loss
	Pays	Nom		Temps	Match	Match	No. de Def.
A	*URS	Fadzaev, Arsen	10	6:00		7.0	3.0
	FIN	Rauhala, Jukka	1		7.0	1.0	8.0
	*IRN	Khadem, Amir-Rez	17	5:08		5.0	4.0
	SYR	Wattar, Amar	1		10.5	0.0	10.5
	*JPN	Akaishi, Kosei	5	6:00		12.0	3.0
	GRE	Athanassiadis, G	4		9.0	1.0	10.0
	PAN	Hidalgo, Hermini			8.0	0.0	8.0
	*BUL	Yassenov, Anguel	F	1:31		7.0	4.0
	TUR	Seker, Fevzi	7		5.0	1.0	6.0
	*CAN	Mckay, David	9	6:00		8.0	3.0
AUS	Brown, Cris	2		9.0	1.0	10.0	
*KOR	Park, Jang-Soon	5	6:00		11.0	3.0	
*FRG	Leipold, Alexand	5	7:50		7.0	3.0	
MGL	Amara, Henmedeh	3		10.0	1.0	11.0	
USA	Carr, Nate	BYE			11.0		

Free Style 68Kg Round 5/Sept. 30				Style Libre 68Kg Tour 5/30 Sept				
Gr	Ctry	Name	Result	Time	***** bef/av.	Points * * * * *	No. of Loss	
	Pays	Nom		Temps	Match	Match	No. de Def.	
A	*URS	Fadzaev, Arsen	12	6:00		10.0	3.0	
	IRN	Khadem, Amir-Rez	4		9.0	1.0	10.0	
	*FIN	Rauhala, Jukka	12	6:00		8.0	3.5	
	SYR	Wattar, Amar	0		10.5	0.0	10.5	
	*JPN	Akaishi, Kosei	5	6:00		15.0	3.0	
	BUL	Yassenov, Anguel	3		11.0	1.0	12.0	
	B	*USA	Carr, Nate	6	6:00		11.0	3.0
		AUS	Brown, Cris	0		10.0	0.0	10.0
		*CAN	Mckay, David	11	6:00		11.0	3.0
		FRG	Leipold, Alexand	7		10.0	1.0	11.0
*KOR		Park, Jang-Soon	5	6:00		14.0	3.0	
MGL		Amara, Henmedeh	0		11.0	0.0	11.0	

Free Style 68Kg Round 6/Sept. 30				Style Libre 68Kg Tour 6/30 Sept			
Gr	Ctry	Name	Result	Time	***** bef/av.	Points * * * * *	No. of Loss
	Pays	Nom		Temps	Match	Match	No. de Def.
A	*URS	Fadzaev, Arsen	9	6:00		13.0	3.0
	JPN	Akaishi, Kosei	0		18.0	0.0	18.0
	FIN	Rauhala, Jukka	BYE			11.5	
B	*USA	Carr, Nate	9	6:00		14.0	3.0
	CAN	Mckay, David	0		14.0	0.0	14.0
	KOR	Park, Jang-Soon	BYE			17.0	

Wrestling

Lutte

Free Style 68Kg Round 7/Oct. 1				Style Libre 68Kg Tour 7/1 Oct				
Gr	Ctry	Name	Result	Time	***** Points *****			No. of Loss
	Pays	Nom		Temps	bef/av. Match	Match	Total	No. de Def.
A	FIN	Rauhala, Jukka	0		11.5	0.0	11.5	2
	*JPN	Akaishi, Kosei	5	6:00	18.0	3.0	21.0	1
	URS	Fadzaev, Arsen	BYE		16.0		16.0	
B	*KOR	Park, Jang-Soon	3	6:00	17.0	3.0	20.0	
	USA	Carr, Nate	2		17.0	1.0	18.0	1
	CAN	Makay, David	BYE		14.0		14.0	2

Free Style 68Kg Round 8/Oct. 1				Style Libre 68Kg Tour 8/1 Oct				
Gr	Ctry	Name	Result	Time	***** Points *****			No. of Loss
	Pays	Nom		Temps	bef/av. Match	Match	Total	No. de Def.
B	CAN	Mckay, David	4		14.0	1.0	15.0	3
	*KOR	Park, Jang-Soon	13	6:00	20.0	3.0	23.0	
	USA	Carr, Nate	BYE		18.0		18.0	1

Free Style 68Kg Finals/Oct. 1				Style Libre 68Kg Finale/1 Oct				
Ctry	Name	Result	Time	Points				
Pays	Nom	Resultat	Temps	Points				

1-2 PLACES

*URS	Fadzaev, Arsen	6	6:00	3.0
KOR	Park, Vang-Soon	0		0.0

3-4 PLACE

JPN	Akaishi, Kosei	1		1.0
*USA	Carr, Nate	5	6:00	3.0

5-6 PLACE

FIN	Rauhala, Jukka	1		1.0
*CAN	Mckay, David	4	6:00	3.0

7-8 PLACE

BUL	Yassenov, Anguel	10		1.0
*FRG	Leipold, Alexand	14	6:00	3.0

Free Style 68Kg Sept. 29-Oct. 1				Style Libre 68Kg 29 Sept-1 Oct						
Group A/Groupe A										
Gr	Ctry	Name	Result	Time	***** Points *****			No. of Loss		
	Pays	Nom		Temps	bef/av. Match	Match	Total	No. de Def.		
01	EGY	Elkhodary, Essam	4.0	0.0	1.0			EL R.3		
03	ESA	Manzur, Gustavo	0.0	0.5				EL R.2		
05	SYR	Wattar, Amar	4.0	3.5	3.0	0.0	0.0	EL R.5		
07	PER	Ichillumpa, E	0.0	0.0				EL R.2		
09	JPN	Akaishi, Kosei	4.0	4.0	4.0	3.0	3.0	0.0	3.0	2ND
11	PHI	Manibog, D	0.0	0.0				EL R.2		
13	PAN	Hidalgo, H	4.0	4.0	0.0	0.0		EL R.4		
15	KEN	Salbei, Kiptoo	0.0	0.0				EL R.2		
17	GRE	Athanassiadis, G	4.0	4.0	1.0	1.0		EL R.4		
19	CHN	Hobisgaitu	0.0	1.0				EL R.2		
21	BUL	Yassenov, Naguel	1.0	3.0	3.0	4.0	1.0	4TH		
23	URS	Fadzaev, Arsen	3.0	4.0	0.0	3.0	3.0	3.0	0.0	1ST
25	ESP	Caride, Juan	0.0	0.0				EL R.2		
27	FIN	Rauhala, Jukka	4.0	0.0	3.0	1.0	3.5	0.0	0.0	3RD
29	IRN	Khadem, A	0.0	4.0	1.0	4.0	1.0			EL R.5

Group B/Groupe B

02	AUS	Brown, Cris	3.0	3.0	3.0	1.0	0.0			EL R.5	
04	ARG	Navarrete, D	1.0	4.0	0.0					EL R.3	
06	JOR	Almasri, Muneir	0.0	0.0						EL R.2	
08	CAN	Mckay, David	4.0	3.0	1.0	3.0	3.0	0.0	0.0	1.0	3RD
10	FRA	Santoro, Gerard	1.0	1.0						EL R.2	
12	KOR	Park, Jang-Soon	3.0	4.0	4.0	3.0	3.0	0.0	3.0	3.0	1ST
14	SUI	Neyer, Rene	1.0	0.0						EL R.2	
16	POL	Kubiak, Andrzej	3.0	1.0	1.0					EL R.3	
18	FRG	Leipold, A	3.0	3.0	1.0	3.0	1.0			4TH	
20	IND	Satyawan	1.0	1.0						EL R.2	
22	MGL	Anara, Hemnedeh	4.0	3.0	3.0	1.0	0.0			EL R.5	
24	AFG	Shirmohammed	0.0	0.0						EL R.2	
26	USA	Carr, Nate	4.0	4.0	3.0	0.0	3.0	3.0	1.0	0.0	2ND
28	HUN	Podolszki, A	0.0	0.0	0.0					EL R.3	
30	TUR	Seker, Fevzi	0.0	1.0	4.0	1.0				EL R.4	

Final/Finale								
Gr	Ctry	Name	Result	Time	***** Points *****			No. of Loss
	Pays	Nom		Temps	bef/av. Match	Match	Total	No. de Def.
1-2	URS	Fadzaev, Arsen	3.0	D	6:00	06-00		
	KOR	Park, Jang-Soon	0.0					
3-4	USA	Carr, Nate	3.0	D	6:00	05-01		
	JPN	Akaishi, Kosei	1.0					
5-6	CAN	Mckay, David	3.0	D	6:00	04-01		
	FIN	Rauhala, Jukka	1.0					
7-8	FRG	Leipold, A	3.0	D	6:00	14-10		
	BUL	Yassenov, Naguel	1.0					

- 1) Fadzaev, Arsen URS
- 2) Park, Jang-Soon KOR
- 3) Carr, Nate USA
- 4) Akaishi, Kosei JPN
- 5) Mckay, David CAN
- 6) Rauhala, Jukka FIN
- 7) Leipold, Alexander FRG
- 8) Yassenov, Anguel BUL

Free Style 74Kg Round 1/Sept. 28				Style Libre 74Kg Tour 1/28 Sept				
Gr	Ctry	Name	Result	Time	***** Points *****			No. of Loss
	Pays	Nom		Temps	bef/av. Match	Match	Total	No. de Def.
A	SWE	Gustafsson, Lars	1		1.0	1.0	1	
	*ROM	Tamadiuanu, Clau	2	6:00	3.0	3.0		
	IRL	Harmon, David	0		0.0	0.0	1	
	*IRQ	Jibara, Haitham	16	4:20	4.0	4.0		
	*URS	Varaev, Adlan	5	6:00	3.0	3.0		
	IRN	Vagozari, Ayatol	3		1.0	1.0	1	
	*PAK	Mohd Anwar	F	4:24	4.0	4.0		
	SEN	Diouf, Djib			0.0	0.0	1	
	GUI	Diallo, Mamadoud			0.0	0.0	1	
	*IND	Kumar, Naresh	P1	5:07	3.0	3.0		
B	*GDR	Westendorf, Uwe	4	6:00	3.0	3.0		
	NGR	Eguabor, Monday	1		1.0	1.0	1	
	*BUL	Sofiadi, Rakhmad	F	1:24	4.0	4.0		
	CMR	Manga, Jean			0.0	0.0	1	
	JPN	Hara, Yoshihiko	BYE			0.0		
	GBR	Walker, Fitzlloy	0		0.0	0.0	1	
	*USA	Monday, Kenneth	12	6:00	3.5	3.5		
	MEX	Jessel, Alfonso	1		0.5	0.5	1	
	*HUN	Nagy, Janos	14	6:00	3.5	3.5		
	*KOR	Yoon, Kyung-Jae	15	2:40	4.0	4.0		
C	ESP	Serna, Eusebio	0		0.0	0.0	1	
	*CAN	Holmes, Gary	15	2:56	4.0	4.0		
	MTN	Ould Houibib, Sa	0		0.0	0.0	1	
	*MGL	Enhbayar, Lodoy	12	6:00	3.0	3.0		
	FRA	Beudet, Bruno	4		1.0	1.0	1	
	YAR	Algrbi, Abdullah			0.0	0.0	1	
	*FIN	Rauhala, Pekka	F	0:42	4.0	4.0		
	SAM	lutaga, Uati			0.0	0.0	1	
	*GAM	Damballey, Adama	F	0:55	4.0	4.0		
	YUG	Sejdi, Saban	BYE			0.0		



Free Style 74Kg Round 2/Sept. 28				Style Libre 74Kg Tour 2/28 Sept				
Gr	Ctry	Name	Result	Time	***** bef/av. Match	Points ***** Match	***** Total	No. of Loss No. de Def.
	Pays	Nom		Temps				
A	*JPN	Hara, Yoshihiko	7	6:00	0.0	3.0	3.0	
	SWE	Gustafsson, Lars	1		1.0	1.0	2.0	2
	*ROM	Tamaduianu, Clau	15	4:18	3.0	4.0	7.0	
	IRL	Harmon, David	0		0.0	0.0	0.0	2
	IRQ	Jibara, Haitham	0		4.0	0.0	4.0	1
	*URS	Varaev, Adlan	9	6:00	3.0	3.0	6.0	
	*IRN	Vagozari, Ayatol	20	6:00	1.0	3.0	4.0	1
	PAK	Mohd anwar	9		4.0	1.0	5.0	1
	SEN	Diouf, Djib			0.0	0.0	0.0	2
	*GUI	Diallo, Mamadoud	P1	7:25	0.0	3.0	3.0	1
B	IND	Kumar, Naresh	2		3.0	1.0	4.0	1
	*GDR	Westendorf, Uwe	11	6:00	3.0	3.0	6.0	
	NGR	Eguabor, Monday	0		1.0	0.0	1.0	2
	*BUL	Sofiadi, Rakhmad	15	4:41	4.0	4.0	8.0	
	CMR	Manga, Jean	BYE		0.0		0.0	1
	*YUG	Sejdi, Saban	10	6:00	0.0	3.0	3.0	
	GBR	Walker, Fitzloy	0		0.0	0.0	0.0	2
	*USA	Monday, Kenneth	F	2:00	3.5	4.0	7.5	
	MEX	Jessel, Alfonso			0.5	0.0	0.5	2
	HUN	Nagy, Janos	3		3.5	1.0	4.5	1
*KOR	Yoon, Kyung-Jae	9	6:00	4.0	3.0	7.0		
ESP	Serna, Eusebio	0		0.0	0.0	0.0	2	
*CAN	Holmes, Gary	16	3:39	4.0	4.0	8.0		
MTN	Ould houibib, Sa			0.0	0.0	0.0	2	
*MGL	Enhbayar, Lodoy	F	0:27	3.0	4.0	7.0		
*FRA	Beudet, Bruno	16	2:00	1.0	4.0	5.0	1	
YAR	Algrbi, Abdullah	0		0.0	0.0	0.0	2	
*FIN	Rauhala, Pekka	F	0:40	4.0	4.0	8.0		
SAM	Iutaga, Uati			0.0	0.0	0.0	2	
GAM	Damballey, Adama	BYE		4.0		4.0		

Free Style 74Kg Round 3/Sept. 28				Style Libre 74Kg Tour 3/28 Sept				
Gr	Ctry	Name	Result	Time	***** bef/av. Match	Points ***** Match	***** Total	No. of Loss No. de Def.
	Pays	Nom		Temps				
A	CMR	Manga, Jean			0.0	0.0	0.0	2
	*JPN	Hara, Yoshihiko	F	1:56	3.0	4.0	7.0	
	*ROM	Tamaduianu, Clau	7	6:00	7.0	3.0	10.0	
	IRQ	Jibara, Haitham	4		4.0	1.0	5.0	2
	*URS	Varaev, Adlan	F	0:21	6.0	4.0	10.0	
	PAK	Mohd anwar			5.0	0.0	5.0	2
	*IRN	Vagozari, Ayatol	F	5:51	4.0	4.0	8.0	1
	IND	Kumar, Naresh			4.0	0.0	4.0	2
	GUI	Diallo, Mamadoud			3.0	0.0	3.0	2
	*GDR	Westendorf, Uwe	F	1:30	6.0	4.0	10.0	
B	BUL	Sofiadi, Rakhmad	BYE		8.0		8.0	
	GAM	Damballey, Adama			4.0	0.0	4.0	1
	*YUG	Sejdi, Saban	F	0:54	3.0	4.0	7.0	
	*USA	Monday, Kenneth	3	6:00	7.5	3.0	10.5	
	HUN	Nagy, Janos	2		4.5	1.0	5.5	2
	KOR	Yoon, Kyung-Jae	1		7.0	1.0	8.0	1
	*MGL	Enhbayar, Lodoy	8	6:00	7.0	3.0	10.0	
	*CAN	Holmes, Gary	6	6:00	8.0	3.0	11.0	
	FRA	Beudet, Bruno	4		5.0	1.0	6.0	2
	FIN	Rauhala, Pekka	BYE		8.0		8.0	

Free Style 74Kg Round 4/Sept. 29				Style Libre 74Kg Tour 4/29 Sept					
Gr	Ctry	Name	Result	Time	***** bef/av. Match	Points ***** Match	***** Total	No. of Loss No. de Def.	
	Pays	Nom		Temps					
A	*BUL	Sofiadi, Rakhmad	7	6:00	8.0	3.0	11.0		
	JPN	Hara, Yoshihiko	3		7.0	1.0	8.0	1	
	ROM	Tamaduianu, Clau	1		10.0	1.0	11.0	1	
	*URS	Varaev, Adlan	10	6:00	10.0	3.0	13.0		
	*IRN	Vagozari, Ayatol	6	6:00	8.0	3.0	11.0	1	
	GDR	Westendorf, Uwe	3		10.0	1.0	11.0	1	
	B	*FIN	Rauhala, Pekka	F	1:20	8.0	4.0	12.0	
		GAM	Damballey, Adama			4.0	0.0	4.0	2
		YUG	Sejdi, Saban	0		7.0	0.0	7.0	1
		*USA	Monday, Kenneth	4	6:00	10.5	3.0	13.5	
*KOR		Yoon, Kyung-Jae	7	6:00	8.0	3.0	11.0	1	
CAN		Holmes, Gary	4		11.0	1.0	12.0	1	
MGL		Enhbayar, Lodoy	BYE		10.0		10.0		

Free Style 74Kg Round 5/Sept. 29				Style Libre 74Kg Tour 5/29 Sept					
Gr	Ctry	Name	Result	Time	***** bef/av. Match	Points ***** Match	***** Total	No. of Loss No. de Def.	
	Pays	Nom		Temps					
A	*BUL	Sofiadi, Rakhmad	14	6:00	11.0	3.5	14.5		
	ROM	Tamaduianu, Clau	2		11.0	0.5	11.5	2	
	JPN	Hara, Yoshihiko	9		8.0	1.0	9.0	2	
	*IRN	Vagozari, Ayatol	12	6:14	11.0	3.0	14.0	1	
	*URS	Varaev, Adlan	4	6:00	13.0	3.0	16.0		
	GDR	Westendorf, Uwe	2		11.0	1.0	12.0	2	
	B	*MGL	Enhbayar, Lodoy	P1	5:39	10.0	3.0	13.0	
		FIN	Rauhala, Pekka			12.0	0.0	12.0	1
		YUG	Sejdi, Saban	2		7.0	1.0	8.0	2
		*KOR	Yoon, Kyung-Jae	4	6:00	11.0	3.0	14.0	1
*USA		Monday, Kenneth	6	6:00	13.5	3.0	16.5		
CAN		Holmes, Gary	0		12.0	0.0	12.0	2	

Free Style 74Kg Round 6/Sept. 29				Style Libre 74Kg Tour 6/29 Sept					
Gr	Ctry	Name	Result	Time	***** bef/av. Match	Points ***** Match	***** Total	No. of Loss No. de Def.	
	Pays	Nom		Temps					
A	BUL	Sofiadi, Rakhmad	2		14.5	1.0	15.5	1	
	*URS	Varaev, Adlan	5	6:00	16.0	3.0	19.0		
	IRN	Vagozari, Ayatol	BYE		14.0		14.0	1	
	B	MGL	Enhbayar, Lodoy	0		13.0	0.0	13.0	1
		*USA	Monday, Kenneth	2	6:00	16.5	3.0	19.5	
		*FIN	Rauhala, Pekka	F	2:19	12.0	4.0	16.0	1
		KOR	Yoon, Kyung-Jae			14.0	0.0	14.0	2

Free Style 74Kg Round 7/Sept. 30				Style Libre 74Kg Tour 7/30 Sept					
Gr	Ctry	Name	Result	Time	***** bef/av. Match	Points ***** Match	***** Total	No. of Loss No. de Def.	
	Pays	Nom		Temps					
A	IRN	Vagozari, Ayatol			14.0	0.0	14.0	2	
	*BUL	Sofiadi, Rakhmad	I	0:00	15.5	4.0	19.5	1	
	URS	Varaev, Adlan	BYE		19.0		19.0		
	B	FIN	Rauhala, Pekka	0		16.0	0.0	16.0	2
		*USA	Monday, Kenneth	7	6:00	19.5	3.0	22.5	
		MGL	Enhbayar, Lodoy	BYE		13.0		13.0	1

Wrestling

Free Style 74Kg Finals/Sept. 30		Style Libre 74Kg Finale/30 Sept			
Ctry	Name	Result	Time	Points	
Pays	Nom	Resultat	Temps	Points	
1-2 PLACE					
URS	Varaev, Adlan	2		1.0	
*USA	Monday, Kenneth	5	6:42	3.0	
3-4 PLACE					
*BUL	Sofiadi, Rakhmad	8	6:00	3.0	
MGL	Enhbayar, Lodoy	3		1.0	
5-6 PLACE					
IRN	Vagozari, Ayatol			0.0	
*FIN	Rauhala, Pekka	I	3:00	4.0	
* * *Final*B** * *					
7-8 PLACE					
GDR	Westendorf, Uwe			0.0	
*KOR	Yoon, Kyung-jae	I	0:00	4.0	

Free Style 74Kg /Sept. 28-30		Style Libre 74Kg /28-30 Sept								
Group A/Groupe A										
01	Gustafsson, Lars	SWE	1.0	1.0	EL R.2					
03	Tamadiuanu, C	ROM	3.0	4.0	3.0	1.0	0.5	EL R.5		
05	Harmon, David	IRL	0.0	0.0	EL R.2					
07	Jibara, H	IRQ	4.0	0.0	1.0	EL R.3				
09	Varaev, Adlan	URS	3.0	3.0	4.0	3.0	3.0	3.0	0.0	1ST
11	Vagozari, A	IRN	1.0	3.0	4.0	3.0	3.0	0.0	0.0	3RD
13	Mohd anwar	PAK	4.0	1.0	0.0	EL R.3				
15	Diouf, Djib	SEN	0.0	0.0	EL R.2					
17	Diallo, M	GUI	0.0	3.0	0.0	EL R.3				
19	Kumar, Naresh	IND	3.0	1.0	0.0	EL R.3				
21	Westendorf, Uwe	GDR	3.0	3.0	4.0	1.0	1.0	4TH		
23	Eguabor, Monday	NGR	1.0	0.0	EL R.2					
25	Sofiadi, Rakhmad	BUL	4.0	4.0	0.0	3.0	3.5	1.0	4.0	2ND
27	Manga, Jean	CMR	0.0	0.0	0.0	EL R.3				
29	Hara, Yoshihiko	JPN	0.0	3.0	4.0	1.0	1.0	EL R.5		
Group B/Groupe B										
02	Walker, F	GBR	0.0	0.0	EL R.2					
04	Monday, Kenneth	USA	3.5	4.0	3.0	3.0	3.0	3.0	3.0	1ST
06	Jessel, Alfonso	MEX	0.5	0.0	EL R.2					
08	Nagy, Janos	HUN	3.5	1.0	1.0	EL R.3				
10	Yoon, Kyung-Jae	KOR	4.0	3.0	1.0	3.0	3.0	0.0	4TH	
12	Serna, Eusebio	ESP	0.0	0.0	EL R.2					
14	Holmes, Gary	CAN	4.0	4.0	3.0	1.0	0.0	EL R.5		
16	Ould houibib, S	MTN	0.0	0.0	EL R.2					
18	Enhbayar, Lodoy	MGL	3.0	4.0	3.0	0.0	3.0	0.0	0.0	2ND
20	Beudet, Bruno	FRA	1.0	4.0	1.0	EL R.3				
22	Algrbi, Abdullah	YAR	0.0	0.0	EL R.2					
24	Rauhala, Pekka	FIN	4.0	4.0	0.0	4.0	0.0	4.0	0.0	3RD
26	Iutaga, Uati	SAM	0.0	0.0	EL R.2					
28	Damballey, Adama	GAM	4.0	0.0	0.0	0.0	EL R.4			
30	Sejdi, Saban	YUG	0.0	3.0	4.0	0.0	1.0	EL R.5		

Final/Finale						
1-2	Monday, Kenneth	USA	3.0	D	6:42	05-02
	Varaev, Adlan	URS	1.0			
3-4	Sofiadi, Rakhmad	BUL	3.0	D	6:00	08-03
	Enhbayar, Lodoy	MGL	1.0			
5-6	Rauhala, Pekka	FIN	4.0	I	3:00	
	Vagozari, A	IRN	0.0			
7-8	Yoon, Kyung-Jae	KOR	4.0	I	0:00	
	Westendorf, Uwe	GDR	0.0			
	1) Monday, Kenneth	USA				
	2) Varaev, Adlan	URS				
	3) Sofiadi, Rakhmad	BUL				
	4) Bayar, Lodoy	MGL				
	5) Rauhala, Pekka	FIN				
	6) Vagozari, A	IRN				
	7) Yoon, Kyung-Jae	KOR				
	8) Westendorf, Uwe	GDR				

Lutte

Free Style 82Kg Round 1/Sept. 29		Style Libre 82Kg Tour 1/29 Sept					
Gr	Ctry	Name	Result	Time	***** Point*****	No. of Loss	
	Pays	Nom		Temps	bef/av. Match Match Total	No. de Def.	
A	CMR	Nto, Barthelemy			0.0	0.0	1
	*IRN	Afghan, Ahmad	F	2:28	4.0	4.0	
	*KOR	Han, Myung-Woo	6	6:00	3.0	3.0	
	CAN	Rinke, Christoph	2		1.0	1.0	1
	*TCH	Lohyna, Josef	15	5:40	4.0	4.0	
	SUI	Jollien, Pierre-	0		0.0	0.0	1
	GAM	Jarju, Matarr			0.0	0.0	1
	*ARG	Iglesias, Daniel	F	3:24	4.0	4.0	
	*JPN	Ito, Atsushi	4	6:00	3.0	3.0	
	EGY	Hussein, Moustaf	0		0.0	0.0	1
	*TPE	Chi, Man-Hsien	F	4:19	4.0	4.0	
	YUG	Nikolovski, Cedo			0.0	0.0	1
	*MGL	Suhbat, Puntsag	15	4:22	4.0	4.0	
	SEH	Ngom, Oumar	0		0.0	0.0	1
	ESP	Iglesias, Franci	BYE			0.0	
B	PUR	Rodriguez, Ubald	0		0.0	0.0	1
	*SYR	Zayar, Mohamad	11	6:00	3.0	3.0	
	*NGR	Kodei, Victor	15	6:00	3.0	3.0	
	GBR	Doyle, Martin	9		1.0	1.0	1
	BUL	Nanev, Alexander	0		0.0	0.0	1
	*USA	Schultz, Mark	4	6:00	3.0	3.0	
	POL	Radomski, Andrze	9		1.0	1.0	1
	*FRG	Trik, Reiner	12	6:00	3.0	3.0	
	HUN	Dvorak, Laszlo			0.0	0.0	1
	*TUR	Gencalp, Necmi	F	1:44	4.0	4.0	
	*GDR	Gstoettner, Hans	15	5:58	4.0	4.0	
	IRQ	Jabouri, Mohammed	0		0.0	0.0	1
	*URS	Tamboutsev, Ale	3	6:00	3.0	3.0	
	FIN	Ilomaki, Jouni	0		0.0	0.0	1

Free Style 82Kg Round 2/Sept. 29		Style Libre 82Kg Tour 2/29 Sept					
Gr	Ctry	Name	Result	Time	***** Points*****	No. of Loss	
	Pays	Nom		Temps	bef/av. Match Match Total	No. de Def.	
A	ESP	Iglesias, Franci	0		0.0	0.0	1
	*IRN	Afghan, Ahmad	15	5:42	4.0	4.0	8.0
	*KOR	Han, Myung-Woo	2	6:00	3.0	3.0	6.0
	TCH	Lohyna, Josef	1		4.0	1.0	5.0
	*CAN	Rinke, Christoph	10	6:00	1.0	3.0	4.0
	SUI	Jollien, Pierre-	0		0.0	0.0	0.0
	GAM	Jarju, Matarr			0.0	0.0	0.0
	*JPN	Ito, Atsushi	F	1:35	3.0	4.0	7.0
	ARG	Iglesias, Daniel	5		4.0	1.0	5.0
	*EGY	Hussein, Moustaf	10	6:00	0.0	3.0	3.0
	TPE	Chi, Man-Hsien	3		4.0	0.5	4.5
	*MGL	Suhbat, Puntsag	16	6:00	4.0	3.5	7.5
	*YUG	Nikolovski, Cedo	6	6:00	0.0	3.0	3.0
	SEN	Ngom, Oumar	1		0.0	1.0	1.0
B	PUR	Rodriguez, Ubald			0.0	0.0	0.0
	*NGR	Kodei, Victor	F	1:53	3.0	4.0	7.0
	*SYR	Zayar, Mohamad	6	6:00	3.0	3.0	6.0
	GBR	Doyle, Martin	1		1.0	1.0	2.0
	BUL	Nanev, Alexander	1		0.0	1.0	1.0
	*POL	Radomski, Andrze	4	6:00	1.0	3.0	4.0
	*USA	Schultz, Mark	16	5:16	3.0	4.0	7.0
	FRG	Trik, Reiner	1		3.0	0.0	3.0
	HUN	Dvorak, Laszlo	0		0.0	0.0	0.0
	*GDR	Gstoettner, Hans	4	6:00	4.0	3.0	7.0
	*TUR	Gencalp, Necmi	5	6:00	4.0	3.0	7.0
	URS	Tamboutsev, Ale	4		3.0	1.0	4.0
	IRQ	Jabouri, Mohammed	0		0.0	0.0	0.0
	*FIN	Ilomaki, Jouni	7	6:00	0.0	3.0	3.0



Free Style 82Kg Round 3/Sept. 30				Style Libre 82Kg Tour 3/30 Sept				No. of Loss No. de Def.
Gr	Ctry	Name	Result	Time	***** bef/av.	Points	*****	
	Pays	Nom		Temps	Match	Match	Total	
A	ESP	Iglesias, Franci	0		0.0	0.0	0.0	2
	*KOR	Han, Myung-Woo	13	6:00	6.0	3.5	9.5	
	IRN	Afghan, Ahmad	6		8.0	1.0	9.0	1
	*CAN	Rinke, Christoph	7	6:41	4.0	3.0	7.0	1
	*TCH	Lohyna, Josef	F	0:35	5.0	4.0	9.0	1
	ARG	Iglesias, Daniel			5.0	0.0	5.0	2
	*JPN	Ito, Atsushi	F	1:37	7.0	4.0	11.0	
	TPE	Chi, Man-Hsien			4.5	0.0	4.5	2
	EGY	Hussein, Moustaf	4		3.0	1.0	4.0	2
	*YUG	Nikolovski, Cedo	6	6:00	3.0	3.0	6.0	1
	MGL	Suhbat, Puntsag	BYE		7.5		7.5	
B	SYR	Zayar, Mohamad	1		6.0	1.0	7.0	1
	*NGR	Kodei, Victor	7	6:00	7.0	3.0	10.0	
	*USA	Schultz, Mark	8	6:00	7.0	3.0	10.0	
	POL	Radomski, Andrzej	1		4.0	1.0	5.0	2
	FRG	Trik, Reiner	0		3.0	0.0	3.0	2
	*TUR	Gencalp, Necmi	8	6:00	7.0	3.0	10.0	
	GDR	Gstoettner, Hans	4		7.0	1.0	8.0	1
	*URS	Tamboutsev, Ale	7	6:00	4.0	3.0	7.0	1
	FIN	Ilomaki, Jouni	BYE		3.0		3.0	1

Free Style 82Kg Round 4/Sept. 30				Style Libre 82Kg Tour 4/30 Sept				No. of Loss No. de Def.
Gr	Ctry	Name	Result	Time	***** bef/av.	Points	*****	
	Pays	Nom		Temps	Match	Match	Total	
A	*MGL	Suhbat, Puntsag	15	2:19	7.5	4.0	11.5	
	IRN	Afghan, Ahmad	0		9.0	0.0	9.0	2
	*KOR	Han, Myung-Woo	6	6:00	9.5	3.0	12.5	
	JPN	Ito, Atsushi	0		11.0	0.0	11.0	1
	CAN	Rinke, Christoph	0		7.0	0.0	7.0	2
*TCH	Lohyna, Josef	10	6:00	9.0	3.0	12.0	1	
	YUG	Nikolovski, Cedo	BYE		6.0		6.0	1
B	*FIN	Ilomaki, Jouni	P1	5:08	3.0	3.0	6.0	1
	SYR	Zayar, Mohamad			7.0	0.0	7.0	2
	NGR	Kodei, Victor			10.0	0.0	10.0	1
	*USA	Schultz, Mark	F	1:41	10.0	4.0	14.0	
	TUR	Gencalp, Necmi	6		10.0	1.0	11.0	1
	*GDR	Gstoettner, Hans	8	6:00	8.0	3.0	11.0	1
		URS	Tamboutsev, Ale	BYE		7.0		7.0

Free Style 82Kg Round 5/Sept. 30				Style Libre 82Kg Tour 5/30 Sept				No. of Loss No. de Def.
Gr	Ctry	Name	Result	Time	***** bef/av.	Points	*****	
	Pays	Nom		Temps	Match	Match	Total	
A	YUG	Nikolovski, Cedo	0		6.0	0.0	6.0	2
	*KOR	Han, Myung-Woo	10	6:00	12.5	3.0	15.5	
	MGL	Suhbat, Puntsag	0		11.5	0.0	11.5	1
	*TCH	Lohyna, Josef	11	6:00	12.0	3.0	15.0	1
		JPN	Ito, Atsushi	BYE		11.0		11.0
B	*URS	Tamboutsev, Ale	F	2:40	7.0	4.0	11.0	1
	NGR	Kodei, Victor			10.0	0.0	10.0	2
	FIN	Ilomaki, Jouni	1		6.0	1.0	7.0	2
	*TUR	Gencalp, Necmi	2	6:00	11.0	3.0	14.0	1
	*USA	Schultz, Mark	F	2:02	14.0	4.0	18.0	
	GDR	Gstoettner, Hans			11.0	0.0	11.0	2

Free Style 82Kg Round 6/Oct. 1				Style Libre 82Kg Tour 6/1 Oct				No. of Loss No. de Def.
Gr	Ctry	Name	Result	Time	***** bef/av.	Points	*****	
	Pays	Nom		Temps	Match	Total	No. de	
A	JPN	Ito, Atsushi	1		11.0	0.5	11.5	2
	*TCH	Lohyna, Josef	14	6:00	15.0	3.5	18.5	1
	MGL	Suhbat, Puntsag	4		11.5	1.0	12.5	2
	*KOR	Han, Myung-Woo	5	6:00	15.5	3.0	18.5	
		URS	Tamboutsev, Ale	7	6:00	11.0	3.0	14.0
B	USA	Schultz, Mark	3		18.0	1.0	19.0	1
	TUR	Gencalp, Necmi	BYE		14.0		14.0	1

Free Style 82Kg Round 7/Oct. 1				Style Libre 82Kg Tour 7/1 Oct				No. of Loss No. de Def.
Gr	Ctry	Name	Result	Time	***** bef/av.	Points	*****	
	Pays	Nom		Temps	Match	Match	Total	
B	*TUR	Gencalp, Necmi	14	6:00	14.0	3.5	17.5	1
	USA	Schultz, Mark	0		19.0	0.0	19.0	2
	URS	Tamboutsev, Ale	BYE		14.0		14.0	1

Free Style 82Kg Finals/Oct. 1				Style Libre 82Kg Finale/1 Oct		
	Ctry	Name	Result	Time	Points	
	Pays	Nom	Resultat	Temps	Points	

1-2 PLACE

*KOR	Han, Myung-Woo	4	6:00	3.0
TUR	Gencalp, Necmi	0		0.0

3-4 PLACE

*TCH	Lohyna, Josef	PI	7:54	3.0
URS	Tamboutsev, Ale			0.0

5-6 PLACE

*MGL	Suhbat, Puntsag	I	0:00	4.0
USA	Schultz, Mark			0.0

* * *Final "B" * * *

7-8 PLACE

*JPN	Ito, Atsushi	5	6:29	3.0
GDR	Gstoettner, Hans	4		1.0

Free Style 82Kg Sept. 29-Oct. 1				Style Libre 82Kg 29 Sept-1 Oct			
------------------------------------	--	--	--	-----------------------------------	--	--	--

Group A/Group A

01	Nto, B	CMR	0.0						EL R.1
03	Afghan, Ahmad	IRN	4.0	4.0	1.0	0.0			EL R.4
05	Han, Myung-Woo	KOR	3.0	3.0	3.5	3.0	3.0		1ST
07	Rinke, C	CAN	1.0	3.0	3.0	0.0			EL R.4
09	Lohyna, Josef	TCH	4.0	1.0	4.0	3.0	3.0	3.5	2ND
11	Jollien, P	SUI	0.0	0.0					EL R.2
13	Jarju, Matarr	GAM	0.0	0.0					EL R.2
15	Iglesias, D	ARG	4.0	1.0	0.0				EL R.3
17	Ito, Atsushi	JPN	3.0	4.0	4.0	0.0	0.0	0.5	4TH
19	Hussein, M	EGY	0.0	3.0	1.0				EL R.3
21	Chi, Man-Hsien	TPE	4.0	0.5	0.0				EL R.3
23	Nikolovski, Cedo	YUG	0.0	3.0	3.0	0.0	0.0		EL R.5
25	Suhbat, Puntsag	MGL	4.0	3.5	0.0	4.0	0.0	1.0	3RD
27	Ngom, Oumar	SEN	0.0	1.0					EL R.2
29	Iglesias, F	ESP	0.0	0.0	0.0				EL R.3

Group B/Group B

02	Rodriguez, U	PUR	0.0	0.0					EL R.2
04	Zayar, Mohamad	SYR	3.0	3.0	1.0	0.0			EL R.4
06	Kodei, Victor	NGR	3.0	4.0	3.0	0.0	0.0		EL R.5
08	Doyle, Martin	GBR	1.0	1.0					EL R.2
10	Nanev, Alexander	BUL	0.0	1.0					EL R.2
12	Schultz, Mark	USA	3.0	4.0	3.0	4.0	4.0	1.0	3RD
14	Radomski, A	POL	1.0	3.0	1.0				EL R.3
16	Trik, Reiner	FRG	3.0	0.0	0.0				EL R.3
18	Dvorak, Laszlo	HUN	0.0	0.0					EL R.2
20	Gencalp, Necmi	TUR	4.0	3.0	3.0	1.0	3.0	3.5	1ST
22	Gstoettner, Hans	GDR	4.0	3.0	1.0	3.0	0.0		4TH
24	Jabouri, M	IRQ	0.0	0.0					EL R.2
26	Tamboutsev, A	URS	3.0	1.0	3.0	0.0	4.0	3.0	2ND
28	Ilomaki, Jouni	FIN	0.0	3.0	0.0	3.0	1.0		EL R.5

Final/Finale

1-2	Han, Myung-Woo	KOR	3.0	D	6:00	04-00
	Gencalp, Necmi	TUR	0.0			

3-4	Lohyna, Josef	TCH	3.0	PI	7:54
	Tamboutsev, A	URS	0.0		

5-6	Suhbat, Puntsag	MGL	4.0	I	0:00
	Schultz, Mark	USA	0.0		

7-8	Ito, Atsushi	JPN	3.0	D	6:29	05-04
	Gstoettner, Hans	GDR	1.0			

- 1) Han, Myung-Woo KOR
- 2) Gencalp, Necmi TUR
- 3) Lohyna, Josef TCH
- 4) Tamboutsev, Alexandre URS
- 5) Suhbat, Puntsag MGL
- 6) Schultz, Mark USA
- 7) Ito, Atsushi JPN
- 8) Gstoettner, Hans GDR

Wrestling

Free Style 90Kg Round 1/Sept. 27				Style Libre 90Kg Tour 1/27 Sept				
Gr	Ctry	Name	Result	Time	***** bef/av. Match	Points * * * * *	No. of Loss No. de Def.	
	Pays	Nom		Temps	Match	Total		
A	*JPN	Ota, Akira	12	6:00		3.0	3.0	
	NGR	Iloanusi, Christ	6			1.0	1.0	
	AUS	Koenig, Walter				0.0	0.0	
	*PAK	Abdul Majid	F	2:03		4.0	4.0	
	IND	Verma, Subhash	4			1.0	1.0	
	*HUN	Toth, Gabor	11	6:00		3.0	3.0	
	CAN	Cox, Charles Dou	7			1.0	1.0	
	*USA	Scherr, James	10	6:00		3.0	3.0	
	*GBR	English, Graeme	F	2:13		4.0	4.0	
	SEN	Gueye, Moustapha				0.0	0.0	
	MTN	Adama, Samba				0.0	0.0	
	*GRE	Deskoulidis, Ira	F	2:45		4.0	4.0	
	AFG	Tajmohammed	4			1.0	1.0	
	*TUR	Turkaya, Mehmet	14	6:00		3.0	3.0	
B	*MGL	Duvchin, Zeveg	F	1:20		4.0	4.0	
	GUM	Tucker, Reuben				0.0	0.0	
	BRA	Leitao, Roberto	6			1.0	1.0	
	*BEL	Bindels, Hubert	10	6:00		3.0	3.0	
	*BUL	Alabakov, Roumen	9	6:00		3.0	3.0	
	POL	Niec, Jerzy	3			1.0	1.0	
	*IRN	Tupchi, Mohammad	3	6:00		3.0	3.0	
	FRG	Lukowski, Bodo	2			1.0	1.0	
	CMR	Youmbi, Jean-B-L	0			0.0	0.0	
	*URS	Khadartsev, Makh	15	3:00		4.0	4.0	
	*KOR	Kim, Tae-Woo	8	6:00		3.0	3.0	
	SYR	Alshamy, Ahmad	2			1.0	1.0	
	*AUT	Lins, Edwin	F	1:35		4.0	4.0	
	GAM	Sanneh, Bakary				0.0	0.0	

Free Style 90Kg Round 2/Sept. 27				Style Libre 90Kg Tour 2/27 Sept				
Gr	Ctry	Name	Result	Time	***** bef/av. Match	Points * * * * *	No. of Loss No. de Def.	
	Pays	Nom		Temps	Match	Total		
A	*JPN	Ota, Akira	F	1:12		3.0	4.0	
	AUS	Koenig, Walter				0.0	0.0	
	NGR	Iloanusi, Christ				1.0	0.0	
	*PAK	Abdul Majid	P1	3:26		4.0	3.0	
	*IND	Verma, Subhash	15	2:41		1.0	4.0	
	CAN	Cox, Charles Dou	0			1.0	0.0	
	HUN	Toth, Gabor	1			3.0	1.0	
	*USA	Scherr, James	3	6:00		3.0	3.0	
	*GBR	English, Graeme	F	1:24		4.0	4.0	
	MTN	Adama, Samba				0.0	0.0	
	SEN	Gueye, Moustapha				0.0	0.0	
	*AFG	Tajmohammed	F	1:30		1.0	4.0	
	GRE	Deskoulidis, Ira	2DQ	5:09		4.0	0.0	
	TUR	Turkaya, Mehmet				3.0	0.0	
B	*MGL	Duvchin, Zeveg	9	6:00		4.0	3.0	
	BRA	Leitao, Roberto	2			1.0	1.0	
	GUM	Tucker, Reuben				0.0	0.0	
	*BEL	Bindels, Hubert	F	0:36		3.0	4.0	
	*BUL	Alabakov, Roumen	3	6:00		3.0	3.0	
	IRN	Tupchi, Mohammad	2			3.0	1.0	
	POL	Niec, Jerzy				1.0	0.0	
	*FRG	Lukowski, Bodo	P1	5:08		1.0	3.0	
	CMR	Youmbi, Jean-B-L				0.0	0.0	
	*KOR	Kim, Tae-Woo	PS	4:41		3.0	3.5	
	*URS	Khadartsev, Makh	10	6:00		4.0	3.0	
	AUT	Lins, Edwin	1			4.0	1.0	
	*SYR	Alshamy, Ahmad	F	1:55		1.0	4.0	
	GAM	Sanneh, Bakary				0.0	0.0	

Lutte

Free Style 90Kg Round 3/Sept. 27				Style Libre 90Kg Tour 3/27 Sept				
Gr	Ctry	Name	Result	Time	***** bef/av. Match	Points * * * * *	No. of Loss No. de Def.	
	Pays	Nom		Temps	Match	Total		
A	*JPN	Ota, Akira	F	1:52		7.0	4.0	
	PAK	Abdul Majid				7.0	0.0	
	IND	Verma, Subhash	3			5.0	1.0	
	*USA	Scherr, James	6	6:00		6.0	3.0	
	*HUN	Toth, Gabor	10	6:00		4.0	3.0	
	GBR	English, Graeme	0			8.0	0.0	
	*GRE	Deskoulidis, Ira	F	1:52		4.0	4.0	
	AFG	Tajmohammed				5.0	0.0	
	TUR	Turkaya, Mehmet	BYE			3.0		
B	*MGL	Duvchin, Zeveg	3	6:00		7.0	3.0	
	BEL	Bindels, Hubert	1			7.0	1.0	
	*BUL	Alabakov, Roumen	3	6:00		6.0	3.0	
	FRG	Lukowski, Bodo	2			4.0	1.0	
	IRN	Tupchi, Mohammad				4.0	0.0	
	*KOR	Kim, Tae-Woo	P1	3:27		6.5	3.0	
	*URS	Khadartsev, Makh	F	2:47		7.0	4.0	
	SYR	Alshamy, Ahmad				5.0	0.0	
	AUT	Lins, Edwin	BYE			5.0		

Free Style 90Kg Round 4/Sept. 28				Style Libre 90Kg Tour 4/28 Sept				
Gr	Ctry	Name	Result	Time	***** bef/av. Match	Points * * * * *	No. of Loss No. de Def.	
	Pays	Nom		Temps	Match	Total		
A	TUR	Turkaya, Mehmet	F	5:51		3.0	0.0	
	*JPN	Ota, Akira				11.0	4.0	
	PAK	Abdul Majid	2			7.0	1.0	
	*HUN	Toth, Gabor	6	6:00		7.0	3.0	
	*USA	Scherr, James	15	3:49		9.0	4.0	
	GBR	English, Graeme	0			8.0	0.0	
	GRE	Deskoulidis, Ira	BYE			8.0		
B	*AUT	Lins, Edwin	6	6:48		5.0	3.0	
	MGL	Duvchin, Zeveg	5			10.0	1.0	
	BEL	Bindels, Hubert	0			8.0	0.0	
	*BUL	Alabakov, Roumen	9	6:00		9.0	3.0	
	*URS	Khadartsev, Makh	F	3:54		11.0	4.0	
	KOR	Kim, Tae-Woo				9.5	0.0	

Free Style 90Kg Round 5/Sept. 28				Style Libre 90Kg Tour 5/28 Sept				
Gr	Ctry	Name	Result	Time	***** bef/av. Match	Points * * * * *	No. of Loss No. de Def.	
	Pays	Nom		Temps	Match	Total		
A	GRE	Deskoulidis, Ira	0			8.0	0.0	
	*HUN	Toth, Gabor	4	6:00		10.0	3.0	
	*JPN	Ota, Akira	F	5:06		15.0	4.0	
	USA	Scherr, James				13.0	0.0	
B	AUT	Lins, Edwin				8.0	0.0	
	*BUL	Alabakov, Roumen	F	1:41		12.0	4.0	
	MGL	Duvchin, Zeveg				11.0	0.0	
	*URS	Khadartsev, Makh	F	1:46		15.0	4.0	
	KOR	Kim, Tae-Woo	BYE			9.5		

Free Style 90Kg Round 6/Sept. 28				Style Libre 90Kg Tour 6/28 Sept				
Gr	Ctry	Name	Result	Time	***** bef/av. Match	Points * * * * *	No. of Loss No. de Def.	
	Pays	Nom		Temps	Match	Total		
A	JPN	Ota, Akira	4			19.0	1.0	
	*HUN	Toth, Gabor	5	6:00		13.0	3.0	
	*KOR	Kim, Tae-Woo	5	6:00		9.5	3.0	
	BUL	Alabakov, Roumen	3			16.0	1.0	
	URS	Khadartsev, Makh	BYE			19.0		



Free Style 90Kg Round 7/Sept. 29				Style Libre 90Kg Tour 7/29 Sept			
Gr	Ctry	Name	Result	Time	***** bef/av.	Points* Match	No. of Loss No. de Def.
	Pays	Nom		Temps	Match	Match	Total

B	BUL	Alabakov, Roumen		17.0	0.0	17.0	2
	*URS	Khadartsev, Makh	F	5:27	19.0	4.0	23.0

Free Style 90Kg Finals/Sept. 29				Style Libre 90Kg Finale/29 Sept			
	Ctry	Name	Result	Time	Points		
	Pays	Nom	Resultat	Temps	Points		

1-2 PLACE							
	JPN	Ota, Akira	0		0.0		
	*URS	Khadartsev, Makh	16	3:27	4.0		

3-4 PLACE							
	HUN	Toth, Gabor	0		0.0		
	*KOR	Kim, Tae-Woo	1	6:00	3.0		

5-6 PLACE							
	*USA	Scherr, James	3	6:00	3.0		
	BUL	Alabakov, Roumen	1		1.0		

* * *Final*B* * * *

7-8 Place							
	*GRE	Deskoulidis, Ira	4	6:00	3.0		
	MGL	Duvchin, Zeveg	2		1.0		

Free Style 90Kg /Sept. 27-29				Style Libre 90Kg /27-29 Sept			
---------------------------------	--	--	--	---------------------------------	--	--	--

Group A/Groupe A									
01	Ota, Akira	JPN	3.0	4.0	4.0	4.0	4.0	1.0	1ST
03	Iloanusi, C	NGR	1.0	0.0					EL R.2
05	Koenig, Walter	AUS	0.0	0.0					EL R.2
07	Abdul majid	PAK	4.0	3.0	0.0	1.0			EL R.4
09	Verma, Subhash	IND	1.0	4.0	1.0				EL R.3
11	Toth, Gabor	HUN	3.0	1.0	3.0	3.0	3.0	3.0	2ND
13	Cox, C	CAN	1.0	0.0					EL R.2
15	Scherr, James	USA	3.0	3.0	3.0	4.0	0.0		3RD
17	English, Graeme	GBR	4.0	4.0	0.0	0.0			EL R.4
19	Gueye, Moustapha	SEN	0.0	0.0					EL R.2
21	Adama, Samba	MTN	0.0	0.0					EL R.2
23	Deskoulidis, I	GRE	4.0	0.0	4.0	0.0	0.0		4TH
25	Tajmohammed	AFG	1.0	4.0	0.0				EL R.3
27	Turkaya, Mehmet	TUR	3.0	0.0	0.0	0.0			EL R.4

Group B/Groupe B									
02	Duvchin, Zeveg	MGL	4.0	3.0	3.0	1.0	0.0		4TH
04	Tucker, Reuben	GUM	0.0	0.0					EL R.2
06	Leitao, Roberto	BRA	1.0	1.0					EL R.2
08	Bindels, Hubert	BEL	3.0	4.0	1.0	0.0			EL R.4
10	Alabakov, Roumen	BUL	3.0	3.0	3.0	3.0	4.0	1.0	0.0
12	Niec, Jerzy	POL	1.0	0.0					EL R.2
14	Tupchi, M	IRN	3.0	1.0	0.0				EL R.3
16	Lukowski, Bodo	FRG	1.0	3.0	1.0				EL R.3
18	Youmbi, Jean-B-L	CMR	0.0	0.0					EL R.2
20	Khadartsev, M	URS	4.0	3.0	4.0	4.0	4.0	0.0	4.0
22	Kim, Tae-Woo	KOR	3.0	3.5	3.0	0.0	0.0	3.0	
24	Alshamy, Ahmad	SYR	1.0	4.0	0.0				EL R.3
26	Lins, Edwin	AUT	4.0	1.0	0.0	3.0	0.0		EL R.5
28	Sanneh, Bakary	GAM	0.0	0.0					EL R.2

Final/Finale									
1-2	Khadartsev, M	URS	4.0	TF	3:27	16-00			
	Ota, Akira	JPN	0.0						
3-4	Kim, Tae-Woo	KOR	3.0	D	6:00	01-00			
	Toth, Gabor	HUN	0.0						
5-6	Scherr, James	USA	3.0	D	6:00	03-01			
	Alabakov, Roumen	BUL	1.0						
7-8	Deskoulidis, I	GRE	3.0	D	6:00	04-02			
	Duvchin, Zeveg	MGL	1.0						
	1) Khadartsev, Makharbek	URS							
	2) Ota, Akira	JPN							
	3) Kim, Tae-Woo	KOR							
	4) Toth, Gabor	HUN							
	5) Scherr, James	USA							
	6) Alabakov, Roumen	BUL							
	7) Deskoulidis, Iraklis	GRE							
	8) Duvchin, Zeveg	MGL							

Free Style 100Kg Round 1/Sept. 28				Style Libre 100Kg Tour 1/28 Sept			
Gr	Ctry	Name	Result	Time	***** bef/av.	Points* Match	No. of Loss No. de Def.
	Pays	Nom		Temps	Match	Match	Total

A	KOR	Joe, Byung-Eun	3		1.0	1.0	1
	*MGL	Javhlantugs, Bol	5	6:00	3.0	3.0	
	*IND	Singh, Kartar	3	6:00	3.0	3.0	
	JPN	Honda, Tamon	2		1.0	1.0	1
	*GDR	Neupert, Uwe	F	0:56	4.0	4.0	
	BRA	Spiess, Floriano			0.0	0.0	1
	*TUR	Sezgin, Hayri	F	1:42	4.0	4.0	
	NGR	Bidei, Jackson			0.0	0.0	1
	SAM	Solovi, Fred			0.0	0.0	1
	*URS	Khabelov, Leri	F	2:42	4.0	4.0	
	CAN	Davis, Clark	BYE			0.0	
	*BUL	Karadouchev, Gue	2	6:00	3.0	3.0	
	FRG	Colling, Wilfrie	0		0.0	0.0	1
	*ROM	Puscasu, Vasile	F	1:08	4.0	4.0	
	KEN	Obwoege, Maisiba			0.0	0.0	1
	*MTN	Sar, Babacar	F	2:16	4.0	4.0	
	ASA	Sione, Alesana			0.0	0.0	1
	HUN	Robotka, Istvan	0		0.0	0.0	1
	*GBR	Loban, Noel	8	6:00	3.0	3.0	
	POL	Wala, Wojciech			0.0	0.0	1
	*USA	Scherr, William	F	5:26	4.0	4.0	
	TCH	Strnisko, Julius	BYE			0.0	

Free Style 100Kg Round 2/Sept. 28				Style Libre 100Kg Tour 2/28 Sept			
Gr	Ctry	Name	Result	Time	***** bef/av.	Points* Match	No. of Loss No. de Def.
	Pays	Nom		Temps	Match	Match	Total

A	CAN	Davis, Clark	2		0.0	1.0	1.0	1
	*KOR	Joe, Byung-Eun	6	6:00	1.0	3.0	4.0	1
	*MGL	Javhlantugs, Bol	P1	4:27	3.0	3.0	6.0	
	IND	Singh, Kartar			3.0	0.0	3.0	1
	JPN	Honda, Tamon			1.0	0.0	1.0	2
	*GDR	Neupert, Uwe	F	1:53	4.0	4.0	8.0	
	*BRA	Spiess, Floriano	11	6:00	0.0	3.0	3.0	1
	SAM	Solovi, Fred	7		0.0	1.0	1.0	2
	TUR	Sezgin, Hayri	2		4.0	1.0	5.0	1
	*URS	Khabelov, Leri	9	6:00	4.0	3.0	7.0	
B	TCH	Strnisko, Julius	1		0.0	1.0	1.0	1
	*BUL	Karadouchev, Gue	7	6:00	3.0	3.0	6.0	
	FRG	Colling, Wilfrie	0		0.0	0.0	0.0	2
	*ROM	Puscasu, Vasile	4	6:00	4.0	3.0	7.0	
	KEN	Obwoege, Maisiba			0.0	0.0	0.0	2
	*MTN	Sar, Babacar	F	2:59	4.0	4.0	8.0	
	ASA	Sione, Alesana			0.0	0.0	0.0	2
	*HUN	Robotka, Istvan	FR	0:00	0.0	4.0	4.0	1
	*GBR	Loban, Noel	11	6:00	3.0	3.0	6.0	
	POL	Wala, Wojciech	2		0.0	1.0	1.0	2
	USA	Scherr, William	BYE		4.0		4.0	

Free Style 100Kg Round 3/Sept. 28				Style Libre 100Kg Tour 3/28 Sept			
Gr	Ctry	Name	Result	Time	***** bef/av.	Points* Match	No. of Loss No. de Def.
	Pays	Nom		Temps	Match	Match	Total

A	CAN	Davis, Clark	3		1.0	1.0	2.0	2
	*MGL	Javhlantugs, Bol	8	6:00	6.0	3.0	9.0	
	*KOR	Joe, Byung-Eun	16	4:29	4.0	4.0	8.0	1
	IND	Singh, Kartar	1		3.0	0.0	3.0	2
	*GDR	Neupert, Uwe	5	6:00	8.0	3.0	11.0	
	TUR	Sezgin, Hayri	3		5.0	1.0	6.0	2
	BRA	Spiess, Floriano			3.0	0.0	3.0	2
	*URS	Khabelov, Lri	F	3:45	7.0	4.0	11.0	
B	*USA	Scherr, William	11	6:00	4.0	3.0	7.0	
	TCH	Strnisko, Julius	3		1.0	1.0	2.0	2
	BUL	Karadouchev, Gue	3		6.0	1.0	7.0	1
	*ROM	Puscasu, Vasile	7	6:00	7.0	3.0	10.0	
	MTN	Sar, Babacar			8.0	0.0	8.0	1
	*HUN	Robotka, Istvan	F	0:22	4.0	4.0	8.0	1
	GBR	Loban, Noel	BYE		6.0		6.0	

Wrestling

Free Style 100Kg Round 4/Sept. 29				Style Libre 100Kg Tour 4/29 Sept				
Gr	Ctry	Name	Result	Time	***** bef/av. Match	Points ***** Match	No. of Loss No. de Def.	
	Pays	Nom		Temps				
A	KOR	Joe, Byung-Eun			8.0	0.0	8.0	2
	*GDR	Neupert, Uwe	F	1:16	11.0	4.0	15.0	
	MGL	Javhlantugs, Bol			9.0	0.0	9.0	1
	*URS	Khabelov, Leri	F	1:50	11.0	4.0	15.0	
B	GBR	Loban, Noel	2		6.0	1.0	7.0	1
	*USA	Scherr, William	5	6:00	7.0	3.0	10.0	
	*BUL	Karadouchev, Gue	F	0:47	7.0	4.0	11.0	1
	MTN	Sar, Babacar			8.0	0.0	8.0	2
	*ROM	Puscasu, Vasile	5	6:00	10.0	3.0	13.0	
	HUN	Robotka, Istvan	4		8.0	1.0	9.0	2

Free Style 100Kg Round 5/Sept. 29				Style Libre 100Kg Tour 5/29 Sept				
Gr	Ctry	Name	Result	Time	***** bef/av. Match	Points ***** Match	No. of Loss No. de Def.	
	Pays	Nom		Temps				
A	MGL	Javhlantugs, Bol			9.0	0.0	9.0	2
	*GDR	Neupert, Uwe	F	1:48	15.0	4.0	19.0	
	URS	Khabelov, Leri	BYE		15.0		15.0	
B	GBR	Loban, Noel	3		7.0	1.0	8.0	2
	*BUL	Karadouchev, Gue	5	6:00	11.0	3.0	14.0	1
	USA	Scherr, William	1		10.0	1.0	11.0	1
	*ROM	Puscasu, Vasile	4	6:00	13.0	3.0	16.0	

Free Style 100Kg Round 6/Sept. 30				Style Libre 100Kg Tour 6/30 Sept				
Gr	Ctry	Name	Result	Time	***** bef/av. Match	Points ***** Match	No. of Loss No. de Def.	
	Pays	Nom		Temps				
A	*URS	Khabelov, Leri	3	6:00	15.0	3.0	18.0	
	GDR	Neupert, Uwe	1		19.0	1.0	20.0	1
	MGL	Javhlantugs, Bol	BYE		9.0		9.0	2
B	*USA	Scherr, William	6	6:00	11.0	3.0	14.0	1
	BUL	Karadouchev, Gue	1		14.0	1.0	15.0	2
	ROM	Puscasu, Vasile	BYE		16.0		16.0	

Free Style 100Kg Finals/Sept. 30				Style Libre 100Kg Finale/30 Sept		
	Ctry	Name	Result	Time	Points	
	Pays	Nom	Resultat	Temps	Points	

1-2 PLACE

URS	Khabelov, Leri	0		0.0
*ROM	Puscasu, Vasile	1	6:00	3.0

3-4 PLACE

GDR	Neupert, Uwe			0.0
*USA	Scherr, William	F	3:31	4.0

5-6 PLACE

MGL	Javhlantugs, Bol			0.0
*BUL	Karadouchev, Gue	F	1:32	4.0

* * *Final "B" * * *

7-8 Place

KOR	Joe, Byung-Eun			0.0
*GBR	Loban, Noel	I	0:00	4.0

Lutte

Free Style 100Kg /Sept. 28-30				Style Libre 100Kg /28-30 Sept							
Group A/Groupe A											
Gr	Ctry	Name	Result	Time	***** bef/av. Match	Points ***** Match	No. of Loss No. de Def.				
01	KOR	Joe, Byung-Eun			1.0	3.0	4.0	4TH			
03	MGL	Javhlantugs, B			3.0	3.0	3.0	3RD			
05	IND	Singh, Kartar			3.0	0.0	0.0	EL R.3			
07	JPN	Honda, Tamon			1.0	0.0		EL R.2			
09	GDR	Neupert, Uwe			4.0	4.0	3.0	4.0	4.0	1.0	2ND
11	BRA	Spiess, Floriano			0.0	3.0	0.0				EL R.3
13	TUR	Sezgin, Hayri			4.0	1.0	1.0				EL R.3
15	NGR	Bidei, Jackson			0.0						EL R.1
17	SAM	Solovi, Fred			0.0	1.0					EL R.2
19	URS	Khabelov, Leri			4.0	3.0	4.0	4.0	0.0	3.0	1ST
21	CAN	Davis, Clark			0.0	1.0	1.0				EL R.3

Group B/Groupe B

02	BUL	Karadouchev, G			3.0	3.0	1.0	4.0	3.0	1.0	3RD
04	FRG	Colling, W			0.0	0.0					EL R.2
06	ROM	Puscasu, Vasile			4.0	3.0	3.0	3.0	3.0	0.0	1ST
08	KEN	Obwoye, Maisiba			0.0	0.0					EL R.2
10	MTN	Sar, Babacar			4.0	4.0	0.0	0.0			EL R.4
12	ASA	Sione, Alesana			0.0	0.0					EL R.2
14	HUN	Robotka, Istvan			0.0	4.0	4.0	1.0			EL R.4
16	GBR	Loban, Noel			3.0	3.0	0.0	1.0	1.0		4TH
18	POL	Wala, Wojciech			0.0	1.0					EL R.2
20	USA	Scherr, William			4.0	0.0	3.0	3.0	1.0	3.0	2ND
22	TCH	Strnisko, Julius			0.0	1.0	1.0				EL R.3

Final/Finale

1-2	ROM	Puscasu, Vasile	D	6:00	01-00
	URS	Khabelov, Leri	0.0		
3-4	USA	Scherr, William	F	3:31	
	GDR	Neupert, Uwe	0.0		
5-6	BUL	Karadouchev, G	F	1:32	
	MGL	Javhlantugs, B	0.0		
7-8	GBR	Loban, Noel	I	0:00	
	KOR	Joe, Byung-Eun	0.0		

- 1) Puscasu, Vasile ROM
- 2) Khabelov, Leri URS
- 3) Scherr, William USA
- 4) Neupert, Uwe GDR
- 5) Karadouchev, Gueorgui BUL
- 6) Javhlantugs, Bold MGL
- 7) Loban, Noel GBR
- 8) Joe, Byung-Eun KOR

Free Style 130Kg Round 1/Sept. 29				Style Libre 130Kg Tour 1/29 Sept				
Gr	Ctry	Name	Result	Time	***** bef/av. Match	Points ***** Match	No. of Loss No. de Def.	
	Pays	Nom		Temps				
A	*USA	Baumgartner, Bru	DQM	0:00		4.0	4.0	
	EGY	Elhadad, Hassan				0.0	0.0	1
	*GDR	Schroeder, Andre	F	1:12		4.0	4.0	
	POL	Sandurski, Adam				0.0	0.0	1
	*KOR	Ham, Duk-Won	6	6:00		3.0	3.0	
	ESP	Montesdeoca, Jes	4			1.0	1.0	1
	*CAN	Payne, Daniel	F	0:21		4.0	4.0	
	MRI	Ramsaran, Navind				0.0	0.0	1
B	*HUN	Klauz, Laszlo	16	5:19		4.0	4.0	
	TCH	Luberda, Mirosla	0			0.0	0.0	1
	FRG	Bremmer, Ralf	4			1.0	1.0	1
	*JPN	Obata, Hiroyuki	8	6:00		3.0	3.0	
	*URS	Gobedjichvili, D	17	4:47		4.0	4.0	
	SYR	Atiyeh, Dennis	0			0.0	0.0	1
	BUL	Atanassov, Atana	BYE				0.0	



Free Style 130Kg Round 2/Sept. 29				Style Libre 130Kg Tour 2/29 Sept				
Gr	Ctry	Name	Result	Time	***** Points *****			No. of Loss
	Pays	Nom		Temps	bef/av. Match	Match	Total	No. de Def.
A	*USA	Baumgartner, Bru	11	6:00	4.0	3.0	7.0	
	GDR	Schroeder, Andre	1		4.0	1.0	5.0	1
	*POL	Sandurski, Adam	F	1:00	0.0	4.0	4.0	1
	KOR	Ham, Duk-Won			3.0	0.0	3.0	1
	ESP	Montesdeoca, Jes			1.0	0.0	1.0	2
	*CAN	Payne, Daniel	P1	4:14	4.0	3.0	7.0	
	MRI	Ramsaran, Navind	BYE		0.0		0.0	1
B	BUL	Atanassov, Atana			0.0	0.0	0.0	1
	*HUN	Klauz, Laszlo	P1	5:17	4.0	3.0	7.0	
	TCH	Luberda, Mirosla			0.0	0.0	0.0	2
	*FRG	Bremmer, Ralf	F	4:11	1.0	4.0	5.0	1
	JPN	Obata, Hiroyuki			3.0	0.0	3.0	1
	*URS	Gobedjichvili, D	F	2:43	4.0	4.0	8.0	
	SYR	Atiyeh, Dennis	BYE		0.0		0.0	1

Free Style 130Kg Round 3/Sept. 30				Style Libre 130Kg Tour 3/30 Sept				
Gr	Ctry	Name	Result	Time	***** Points *****			No. of Loss
	Pays	Nom		Temps	bef/av. Match	Match	Total	No. de Def.
A	MRI	Ramsaran, Navind	0		0.0	0.0	0.0	2
	*USA	Baumgartner, Bru	15	2:22	7.0	4.0	11.0	
	*GDR	Schroeder, Andre	F	1:05	5.0	4.0	9.0	1
	KOR	Ham, Duk-Won			3.0	0.0	3.0	2
	*POL	Sandurski, Adam	4	6:26	4.0	3.0	7.0	1
	CAN	Payne, Daniel	3		7.0	1.0	8.0	1
B	SYR	Atiyeh, Dennis	0		0.0	0.0	0.0	2
	*BUL	Atanassov, Atana	15	5:26	0.0	4.0	4.0	1
	*HUN	Klauz, Laszlo	F	0:17	7.0	4.0	11.0	
	JPN	Obata, Hiroyuki			3.0	0.0	3.0	2
	FRG	Bremmer, Ralf			5.0	0.0	5.0	2
	*URS	Gobedjichvili, D	P1	4:43	8.0	3.0	11.0	

Free Style 130Kg Round 4/Sept. 30				Style Libre 130Kg Tour 4/30 Sept				
Gr	Ctry	Name	Result	Time	***** Points *****			No. of Loss
	Pays	Nom		Temps	bef/av. Match	Match	Total	No. de Def.
A	*USA	Baumgartner, Bru	17	5:49	11.0	4.0	15.0	
	POL	Sandurski, Adam	0		7.0	0.0	7.0	2
	*GDR	Schroeder, Andre	15	6:00	9.0	3.5	12.5	1
	CAN	Payne, Daniel	3		8.0	0.5	8.5	2
B	BUL	Atanassov, Atana	1		4.0	1.0	5.0	2
	*URS	Gobedjichvili, D	6	6:00	11.0	3.0	14.0	
	HUN	Klauz, Laszlo	BYE		11.0		11.0	

Free Style 130Kg Round 5/Oct. 01				Style Libre 130Kg Tour 5/01 Oct				
Gr	Ctry	Name	Result	Time	***** Points *****			No. of Loss
	Pays	Nom		Temps	bef/av. Match	Match	Total	No. de Def.
B	HUN	Klauz, Laszlo	0		11.0	0.0	11.0	1
	*URS	Gobedjichvili, D	10	6:00	14.0	3.0	17.0	

Free Style 130Kg Finals/Oct. 1				Style Libre 130Kg Finale/1 Oct		
	Ctry	Name	Result	Time	Points	
	Pays	Nom	Resultat	Temps	Points	
1-2 PLACE						
	USA	Baumgartner, Bur	1		1.0	
	*URS	Gobedjichvili, D	3	6:00	3.0	
3-4 PLACE						
	*GDR	Schroeder, Andre	P1	4:21	3.0	
	HUN	Klauz, Laszlo			0.0	
5-6 PLACE						
	CAN	Payne, Daniel	3		1.0	
	*BUL	Atanassov, Atana	8	6:00	3.0	
* * * Final "B" * * *						
7-8 Place						
	*POL	Sandurski, Adam	7	6:00	3.0	
	FRG	Bremmer, Ralf	5		1.0	

Free Style 130Kg Sept. 29-Oct. 1				Style Libre 130Kg 29 Sept-1 Oct				
Group A/Groupe B								
01	Baumgartner, B	USA	4.0	3.0	4.0	4.0		1ST
03	Elhadad, Hassan	EGY	0.0					EL R.1
05	Schroeder, A	GDR	4.0	1.0	4.0	3.5		2ND
07	Sandurski, Adam	POL	0.0	4.0	3.0	0.0		4TH
09	Ham, Duk-Won	KOR	3.0	0.0	0.0			EL R.3
11	Montesdeoca, J	ESP	1.0	0.0				EL R.2
13	Payne, Daniel	CAN	4.0	3.0	1.0	0.5		3RD
15	Ramsaran, Navind	MRI	0.0	0.0	0.0			EL R.3
Group B/Groupe B								
02	Klauz, Laszlo	HUN	4.0	3.0	4.0	0.0	0.0	2ND
04	Luberda, M	TCH	0.0	0.0				EL R.2
06	Bremmer, Ralf	FRG	1.0	4.0	0.0			4TH
08	Obata, Hiroyuki	JPN	3.0	0.0	0.0			EL R.3
10	Gobedjichvili, D	URS	4.0	4.0	3.0	3.0	3.0	1ST
12	Atiyeh, Dennis	SYR	0.0	0.0	0.0			EL R.3
14	Atanassov, A	BUL	0.0	0.0	4.0	1.0		3RD
Final/Finale								
1-2	Gobedjichvili, D	URS	3.0	D	6:00	03-01		
	Baumgartner, B	USA	1.0					
3-4	Schroeder, A	GDR	3.0	P1	4:21			
	Klauz, Laszlo	HUN	0.0					
5-6	Atanassov, A	BUL	3.0	D	6:00	08-03		
	Payne, Daniel	CAN	1.0					
7-8	Sandurski, Adam	POL	3.0	D	6:00	07-05		
	Bremmer, Ralf	FRG	1.0					
1)	Gobedjichvili, David	URS						
2)	Baumgartner, Bruce	USA						
3)	Schroeder, Andreas	GDR						
4)	Klauz, Laszlo	HUN						
5)	Atanassov, Atanas	BUL						
6)	Payne, Daniel	CAN						
7)	Sandurski, Adam	POL						
8)	Bremmer, Ralf	FRG						



요 트

Yachting/Yachting



Yachting/Yachting

Officials/Officiels

International Yacht Racing Union (IYRU)

President/président	Peter Tallberg
Secretary General/secrétaire général	Mike Evans
Technical Delegates/délégués techniques	

SLOOC Administrative Staff/Personnel Administratif du SLOOC

Commissioner/directeur	Rhee Suk Hee
Secretary General/secrétaire général	Bae Su Yong
Director of Race/Sous-chef de compétitions	Cheong Kee Taek

Competitors/Concurrents

Men Hommes	Competitors Competiteurs	Countries Pays
Division-II		
Soling	60	20
Flying Dutchman	44	22
Star	42	21
Finn	33	33
Tornado	46	23
470	58	29
Women Femmes	Competitors Competiteurs	Countries Pays
470	42	21

Legend/Notation

RET	Retired/Abandon
DSQ	Disqualified/Disqualifié
DNC	Did not compete/N'a pas concourru
PMS	Prematurely started/Est parti trop tôt
YMP	Yacht materially prejudiced/Yacht notablement lésé



Yachting

Yachting

Soling Class Race 1/Sept. 20			Classe Soling Course 1/20 Sept			
Rank Rang	Ctry Pays	N.letters N.lettres	Name Nom	Points	Note	Time Temps
1	GDR	DDR	Schuemann, Jochen Flach, Thomas Jaekel, Bernd	0.00		14:40:08
2	USA	US	Kostecki, John Baylis, William Billingham, Robert	3.00		
3	BRA	BL	Dias, Jose Paulo Dias, Jose Augusto Adler, Daniel	5.70		
4	NZL	KZ	Dodson, Thomas Daubney, Simon Hansen, Aran	8.00		
5	ITA	I	Lamaro, Gianluca Dalla Vecchia, Aurelio Romano, Valerio	10.00		
6	GBR	K	Smith, Lawrie Leask, Edward Richards, Jeremy	11.70		
7	SWE	S	Persson, Lennart Oberg, Eje Wallin, Tony	13.00		
8	CAN	KC	Thomson, Robert Paul Flinn, Robert Stuart Gow, Philip	14.00		
9	DEN	D	Bank, Jesper Mathiasen, Jan Dupont Secher, Steen	15.00		
10	AUS	KA	Wilmot, Robert Percy, Matthew Read, Glenn	16.00		
11	JPN	J	Komatsu, Kazunori Hanaoka, Kazuo Ikeda, Tadashi	17.00		
12	FRG	G	Wrede, Jens-Peter Adamczewski, Matthias Knabe, Stefan	18.00		
13	URS	SR	Chaidouko, Georgi Miron, Oleg Poliakov, Nikolai	19.00		
14	GRE	GR	Boundouris, Anastassios Boundouris, Andonios Deligiannis, Dimitrios	20.00		
15	ARG	A	Lange, Santiago R Ferrero, Pedro Lena, Raul Ariel	21.00		
16	ESP	E	Gorostegui, Antonio Monjo, Jaime Valades, Jose Manuel	22.00		
17	URU	U	Carabeli, Horacio Ansorena, Heber Chiaparro, Luis	23.00		
18	CHI	X	Gonzalez, Mannel Zvazola, Rodrigo Schacht, German	24.00		
19	FRA	F	Kermarec, Michel Dripaux, Stanislas Phelipon, Xavier	25.00		
20	FIJ	KF	Ashby, David Dunlop, Colin Philp, Anthony C	26.00		14:49:33

Soling Class Race 2/Sept. 21			Classe Soling Course 2/21 Sept			
Rank Rang	Ctry Pays	N.letters N.lettres	Name Nom	Points	Note	Time Temps
1	USA	US	Kostecki, John Baylis, William Billingham, Robert	0.00		14:10:39
2	DEN	D	Bank, Jesper Mathiasen, Jan Dupont Secher, Steen	3.00		
3	GDR	DDR	Schuemann, Jochen Flach, Thomas Jaekel, Bernd	5.70		
4	FRA	F	Kermarec, Michel Dripaux, Stanislas Phelipon, Xavier	8.00		
5	AUS	KA	Wilmot, Robert Percy, Matthew Read, Glenn	10.00		
6	BRA	BL	Dias, Jose Paulo Dias, Jose Augusto Adler, Daniel	11.70		
7	ITA	I	Lamaro, Gianluca Dalla Vecchia, Aurelio Romano, Valerio	13.00		
8	GBR	K	Smith, Lawrie Leask, Edward Richards, Jeremy	14.00		
9	NZL	KZ	Dodson, Thomas Daubney, Simon Hansen, Aran	15.00		
10	SWE	S	Persson, Lennart Oberg, Eje Wallin, Tony	16.00		
11	URS	SR	Chaidouko, Georgi Miron, Oleg Poliakov, Nikolai	17.00		
12	CAN	KC	Thomson, Robert Paul Flinn, Robert Stuart Gow, Philip	18.00		
13	ARG	A	Lange, Santiago R Ferrero, Pedro Lena, Raul Ariel	19.00		
14	CHI	X	Gonzalez, Mannel Zvazola, Rodrigo Schacht, German	20.00		
15	URU	U	Carabeli, Horacio Ansorena, Heber Chiaparro, Luis	21.00		
16	ESP	E	Gorostegui, Antonio Monjo, Jaime Manrique, Domingo	22.00		
17	JPN	J	Komatsu, Kazunori Hanaoka, Kazuo Ikeda, Tadashi	23.00		
18	FRG	G	Wrede, Jens-Peter Adamczewski, Matthias Knabe, Stefan	24.00		
19	FIJ	KF	Ashby, David Dunlop, Colin Philp, Anthony C	25.00		14:19:22
20	GRE	GR	Boundouris, Anastassios Boundouris, Andonios Deligiannis, Dimitrios	27.00	RET	



Soling Class Race 3/Sept. 22							Classe Soling Course 3/22 Sept			Soling Class Race 4/Sept. 23				Classe Soling Course 4/23 Sept		
Rank Rang	Ctry Pays	N.letters N.lettres	Name Nom	Points	Note	Time Temps	Rank Rang	Ctry Pays	N.letters N.lettres	Name Nom	Points	Note	Time Temps			
1	ARG	A	Lange, Santiago R Ferrero, Pedro Lena, Raul Ariel	0.00		15:21:50	1	USA	US	Kostecki, John Baylis, William Billingham, Robert	0.00		14:48:49			
2	GDR	DDR	Schuemann, Jochen Flach, Thomas Jaekel, Bernd	3.00			2	CAN	KC	Thomson, Robert Paul Flinn, Robert Stuart Gow, Philip	3.00					
3	SWE	S	Persson, Lennart Oberg, Eje Wallin, Tony	5.70			3	GBR	K	Smith, Lawrie Leask, Edward Richards, Jeremy	5.70					
4	USA	US	Kostecki, John Baylis, William Billingham, Robert	8.00			4	SWE	S	Persson, Lennart Oberg, Eje Wallin, Tony	8.00					
5	FRA	F	Kermarec, Michel Dripaux, Stanislas Phelipon, Xavier	10.00			5	BRA	BL	Dias, Jose Paulo Dias, Jose Augusto Adler, Daniel	10.00					
6	GBR	K	Smith, Lawrie Leask, Edward Richards, Jeremy	11.70			6	GDR	DDR	Schuemann, Jochen Flach, Thomas Jaekel, Bernd	11.70					
7	NZL	KZ	Dodson, Thomas Daubney, Simon Hansen, Aran	13.00			7	JPN	J	Komatsu, Kazunori Hanaoka, Kazuo Ikeda, Tadashi	13.00					
8	JPN	J	Komatsu, Kazunori Hanaoka, Kazuo Ikeda, Tadashi	14.00			8	ARG	A	Lange, Santiago R Ferrero, Pedro Lena, Raul Ariel	14.00					
9	GRE	GR	Boundouris, Anastassios Boundouris, Andonios Deligiannis, Dimitrios	15.00			9	URU	U	Carabeli, Horacio Ansorena, Heber Chiaparro, Luis	15.00					
10	FRG	G	Wrede, Jens-Peter Adamczewski, Matthias Knabe, Stefan	16.00			10	URS	SR	Chaidouko, Georgi Miron, Oleg Poliakov, Nikolai	16.00					
11	URS	SR	Chaidouko, Georgi Miron, Oleg Poliakov, Nikolai	17.00			11	FRA	F	Kermarec, Michel Dripaux, Stanislas Phelipon, Xavier	17.00					
12	DEN	D	Bank, Jesper Mathiasen, Jan Dupont Secher, Steen	18.00			12	ESP	E	Gorostegui, Antonio Monjo, Jaime Manrique, Domingo	18.00					
13	CAN	KC	Thomson, Robert Paul Flinn, Robert Stuart Gow, Philip	19.00			13	AUS	KA	Wilmot, Robert Percy, Matthew Read, Glenn	19.00					
14	ITA	I	Lamaro, Gianluca Dalla Vecchia, Aurelio Romano, Valerio	20.00			14	FRG	G	Wrede, Jens-Peter Adamczewski, Matthias Knabe, Stefan	20.00					
15	AUS	KA	Wilmot, Robert Percy, Matthew Read, Glenn	21.00			15	DEN	D	Bank, Jesper Mathiasen, Jan Dupont Secher, Steen	21.00					
16	URU	U	Carabeli, Horacio Ansorena, Heber Chiaparro, Luis	22.00			16	NZL	KZ	Dodson, Thomas Daubney, Simon Hansen, Aran	22.00					
17	FIJ	KF	Ashby, David Dunlop, Colin Philp, Anthony C.	23.00			17	ITA	I	Lamaro, Gianluca Dalla Vecchia, Aurelio Romano, Valerio	23.00					
18	ESP	E	Gorostegui, Antonio Monjo, Jaime Manrique, Domingo	24.00			18	GRE	GR	Boundouris, Anastassios Prekas, Georgios Deligiannis, Dimitrios	24.00					
19	CHI	X	Gonzalez, Mannel Zvazola, Rodrigo Schacht, German	25.00		15:27:45	19	CHI	X	Gonzalez, Mannel Zvazola, Rodrigo Schacht, German	25.00					
20	BRA	BL	Dias, Jose Paulo Dias, Jose Augusto Adler, Daniel	27.00	DSQ		20	FIJ	KF	Ashby, David Dunlop, Colin Philp, Anthony C	26.00		14:56:28			

Yachting

Yachting

Soling Class Race 5/Sept. 24				Classe Soling Course 5/24 Sept		
Rank Rang	Ctry Pays	N.letters N.lettres	Name Nom	Points	Note	Time Temps
1	GDR	DDR	Schuemann, Jochen Flach, Thomas Jaekel, Bernd	0.00		13:57:07
2	USA	US	Kostecki, John Baylis, William Billingham, Robert	3.00		
3	NZL	KZ	Dodson, Thomas Daubney, Simon Hansen, Aran	5.70		
4	DEN	D	Bank, Jesper Mathiasen, Jan Dupont Secher, Steen	8.00		
5	GBR	K	Smith, Lawrie Leask, Edward Richards, Jeremy	10.00		
6	FRA	F	Kermarec, Michel Dripaux, Stanislas Phelipon, Xavier	11.70		
7	URS	SR	Chaidouko, Georgi Miron, Oleg Poliakov, Nikolai	13.00		
8	ARG	A	Lange, Santiago R Ferrero, Pedro Lena, Raul Ariel	14.00		
9	FRG	G	Wrede, Jens-Peter Adamczewski, Matthias Knabe, Stefan	15.00		
10	JPN	J	Komatsu, Kazunori Hanaoka, Kazuo Ikeda, Tadashi	16.00		
11	BRA	BL	Dias, Jose Paulo Dias, Jose Augusto Adler, Daniel	17.00		
12	AUS	KA	Wilmot, Robert Percy, Matthew Read, Glenn	18.00		
13	ESP	E	Gorostegui, Antonio Monjo, Jaime Manrique, Domingo	19.00		
14	URU	U	Carabeli, Horacio Ansorena, Heber Chiaparro, Luis	20.00		
15	FIJ	KF	Ashby, David Dunlop, Colin Philp, Anthony C	21.00		14:06:57
16	CAN	KC	Thomson, Robert Paul Flinn, Robert Stuart Gow, Philip	27.00	RET	
16	CHI	X	Gonzalez, Mannel Zvazola, Rodrigo Schacht, German	27.00	RET	
16	GRE	GR	Boundouris, Anastassios Prekas, Georgios Deligiannis, Dimitrios	27.00	DSQ	
16	ITA	I	Lamaro, Gianluca Dalla Vecchia, Aurelio Romano, Valerio	27.00	RET	
16	SWE	S	Persson, Lennart Oberg, Eje Wallin, Tony	27.00	RET	

Soling Class Race 6/Sept. 26				Classe Soling Course 6/26 Sept		
Rank Rang	Ctry Pays	N.letters N.lettres	Name Nom	Points	Note	Time Temps
1	GDR	DDR	Schuemann, Jochen Flach, Thomas Jaekel, Bernd	0.00		14:51:49
2	DEN	D	Bank, Jesper Mathiasen, Jan Dupont Secher, Steen	3.00		
3	JPN	J	Komatsu, Kazunori Hanaoka, Kazuo Ikeda, Tadashi	5.70		
4	URS	SR	Chaidouko, Georgi Miron, Oleg Poliakov, Nikolai	8.00		
5	USA	US	Kostecki, John Baylis, William Billingham, Robert	10.00		
6	FRA	F	Kermarec, Michel Dripaux, Stanislas Phelipon, Xavier	11.70		
7	FRG	G	Wrede, Jens-Peter Adamczewski, Matthias Knabe, Stefan	13.00		
8	GBR	K	Smith, Lawrie Leask, Edward Richards, Jeremy	14.00		
9	BRA	BL	Dias, Jose Paulo Dias, Jose Augusto Bergman, Christoph	15.00		
10	ITA	I	Lamaro, Gianluca Dalla Vecchia, Aurelio Romano, Valerio	16.00		
11	ARG	A	Lange, Santiago R Ferrero, Pedro Lena, Raul Ariel	17.00		
12	SWE	S	Persson, Lennart Oberg, Eje Wallin, Tony	18.00		
13	CAN	KC	Thomson, Robert Paul Flinn, Robert Stuart Gow, Philip	19.00		
14	GRE	GR	Boundouris, Anastassios Prekas, Georgios Deligiannis, Dimitrios	20.00		
15	NZL	KZ	Dodson, Thomas Daubney, Simon Hansen, Aran	21.00		
16	AUS	KA	Wilmot, Robert Percy, Matthew Read, Glenn	22.00		
17	ESP	E	Gorostegui, Antonio Monjo, Jaime Manrique, Domingo	23.00		
18	CHI	X	Gonzalez, Mannel Zvazola, Rodrigo Schacht, German	24.00		
19	URU	U	Carabeli, Horacio Ansorena, Heber Chiaparro, Luis	25.00		
20	FIJ	KF	Ashby, David Dunlop, Colin Philp, Anthony C	26.00		14:59:56



Soling Class Race 7/Sept. 27				Classe Soling Course 7/27 Sept		
Rank Rang	Ctry Pays	N.letters N.lettres	Name Nom	Points	Note	Time Temps
1	USA	US	Kostecki, John Baylis, William Billingham, Robert	0.00		13:51:24
2	GDR	DDR	Schuemann, Jochen Flach, Thomas Jaekel, Bernd	3.00		
3	DEN	D	Bank, Jesper Mathiasen, Jan Dupont Secher, Steen	5.70		
4	BRA	BL	Dias, Jose Paulo Dias, Jose Augusto Bergman, Christoph	8.00		
5	FRA	F	Kermarec, Michel Dripaux, Stanislas Phelipon, Xavier	10.00		
6	NZL	KZ	Dodson, Thomas Daubney, Simon Hansen, Aran	11.70		
7	URS	SR	Chaidouko, Georgi Miron, Oleg Poliakov, Nikolai	13.00		
8	AUS	KA	Wilmot, Robert Percy, Matthew Read, Glenn	14.00		
9	ITA	I	Lamaro, Gianluca Dalla Vecchia, Aurelio Romano, Valerio	15.00		
10	CAN	KC	Thomson, Robert Paul Flinn, Robert Stuart Gow, Philip	16.00		
11	SWE	S	Persson, Lennart Oberg, Eje Wallin, Tony	17.00		
12	ARG	A	Lange, Santiago R Ferrero, Pedro Lena, Raul Ariel	18.00		
13	JPN	J	Komatsu, Kazunori Hanaoka, Kazuo Ikeda, Tadashi	19.00		
14	FRG	G	Wrede, Jens-Peter Adamczewski, Matthias Knabe, Stefan	20.00		
15	URU	U	Carabeli, Horacio Ansorena, Heber Chiaparro, Luis	21.00		
16	FIJ	KF	Ashby, David Dunlop, Colin Philp, Anthony C	22.00		14:06:31
17	CHI	X	Gonzalez, Mannel Zvazola, Rodrigo Schacht, German	27.00	RET	
17	ESP	E	Gorostegui, Antonio Monjo, Jaime Manrique, Domingo	27.00	RET	
17	GBR	K	Smith, Lawrie Leask, Edward Richards, Jeremy	27.00	RET	
17	GRE	GR	Boundouris, Anastassios Prekas, Georgios Deligiannis, Dimitrios	27.00	RET	

Soling Class Summary/Sept. 20-27				Classe Soling Sommaire/20-27 Sept									
Rank Rang	Ctry Pays	N.letters N.lettres	Name Nom	1	2	3	4	5	6	7	Total	Net	
1	GDR	DDR	Schuemann, J Flach, Thomas Jaekel, Bernd	1	3	2	6	1	1	2	23.40	11.70	
2	USA	US	Kostecki, John Baylis, William Billingham, R	2	1	4	1	2	5	1	24.00	14.00	
3	DEN	D	Bank, Jesper Mathiasen, J Secher, Steen	9	2	12	15	4	2	3	73.70	52.70	
4	GBR	K	Smith, Lawrie Leask, Edward Richards, Jeremy	6	8	6	3	5	8	RET	94.10	67.10	
5	BRA	BL	Dias, Jose Paulo Dias, J Bergman, C	3	6	DSQ	5	11	9	4	94.40	67.40	
6	FRA	F	Kermarec, Michel Dripaux, S Phelipon, Xavier	19	4	5	11	6	6	5	93.40	68.40	
7	NZL	KZ	Dodson, Thomas Daubney, Simon Hansen, Aran	4	9	7	16	3	15	6	96.40	74.40	
8	SWE	S	Persson, Lennart Oberg, Eje Wallin, Tony	7	10	3	4	RET	12	11	104.70	77.70	
9	ARG	A	Lange, S Ferrero, Pedro Lena, Raul ariel	15	13	1	8	8	11	12	103.00	82.00	
10	URS	SR	Chaidouko, G Miron, Oleg Poliakov, N	13	11	11	10	7	4	7	103.00	84.00	
11	JPN	J	Komatsu, K Hanaoka, Kazuo Ikeda, Tadashi	11	17	8	7	10	3	13	107.70	84.70	
12	CAN	KC	Thomson, R Flinn, R Gow, Philip	8	12	13	2	RET	13	10	116.00	89.00	
13	ITA	I	Lamaro, Gianluca Dalla Vecchia, A Romano, Valerio	5	7	14	17	RET	10	9	124.00	97.00	
14	AUS	KA	Wilmot, Robert Percy, Matthew Read, Glenn	10	5	15	13	12	16	8	120.00	98.00	
15	FRG	G	Wrede, J Adamczewski, M Knabe, Stefan	12	18	10	14	9	7	14	126.00	102.00	
16	URU	U	Carabeli, H Ansorena, Heber Chiaparro, Luis	17	15	16	9	14	19	15	147.00	122.00	
17	ESP	E	Gorostegui, A Monjo, Jaime Manrique, D	16	16	18	12	13	17	RET	155.00	128.00	
18	GRE	GR	Boundouris, A Prekas, Georgios Deligiannis, D	14	RET	9	18	DSQ	14	RET	160.00	133.00	
19	FIJ	KF	Ashby, David Dunlop, Colin Philp, A	20	19	17	20	15	20	16	169.00	143.00	
20	CHI	X	Gonzalez, Mannel Zvazola, Rodrigo Schacht, German	18	14	19	19	RET	18	RET	172.00	145.00	

Yachting

Yachting

Flying Dutchman Class Race 1/Sept. 20				Classe Flying Dutchman Course 1/20 Sept		
Rank Rang	Ctry Pays	N.letters N.lettres	Name Nom	Points	Note	Time Temps
1	DEN	D	Bojsen-Moller, Jorgen Gronborg, Christian	0.00		13:37:06
2	NZL	KZ	Jones, Murray Knowles, Gregory	3.00		
3	NOR	N	Pollen, Olepetter Bjorkum, Erik	5.70		
4	BRA	BL	Adler, Alan Temke, Marcus	8.00		
5	CAN	KC	Mclaughlin, Frank Millen, John	10.00		
6	ISR	IS	Sela, Yoel Amir, Eldad	11.70		
7	FRA	F	Delage, Laurent Ferre, Daniel	13.00		
8	SUI	Z	Schroff, Alexander Schroff, Daniel	14.00		
9	SWE	S	Nyberg, Mats Eriksson, Peter	15.00		
10	URS	SR	Borodinov, Serguei Boudantsev, Victor	16.00		
11	ESP	E	Doreste, Luis Noguer, Miguel	17.00		
12	GBR	K	Yeoman, Roger Mcdonald, Neal	18.00		
13	FRG	G	Batzill, Albert Lang, Peter	19.00		
14	ITA	I	Celon, Mario Celon, Claudio	20.00		
15	IRL	IR	Wilkins, David Kennedy, Peter	21.00		
16	HOL	H	Koning, Henry Schelling, Johannes	22.00		
17	GDR	DDR	Lehmann, Ulf Maedicke, Stefan	23.00		
18	USA	US	Foerster, Paul Goldman, Andrew	24.00		
19	JPN	J	Sato, Saburo Wakinaga, Tatsuya	25.00		
20	HKG	KH	Lockeyear, Eric Parsons, Timothy	26.00		
21	AUS	KA	Smith, Gary Connor, David	27.00		
22	KOR	RK	Oh, Jong-Yul Kim, Ki-Han	28.00		14:01:57

Flying Dutchman Class Race 2/Sept. 21				Classe Flying Dutchman Course 2/21 Sept		
Rank Rang	Ctry Pays	N.letters N.lettres	Name Nom	Points	Note	Time Temps
1	NZL	KZ	Jones, Murray Knowles, Gregory	0.00		13:39:19
2	FRG	G	Batzill, Albert Lang, Peter	3.00		
3	BRA	BL	Adler, Alan Temke, Marcus	5.70		
4	DEN	D	Bojsen-Moller, Jorgen Gronborg, Christian	8.00		
5	NOR	N	Pollen, Olepetter Bjorkum, Erik	10.00		
6	CAN	KC	Mclaughlin, Frank Millen, John	11.70		
7	IRL	IR	Wilkins, David Kennedy, Peter	13.00		
8	GDR	DDR	Lehmann, Ulf Maedicke, Stefan	14.00		
9	FRA	F	Delage, Laurent Ferre, Daniel	15.00		
10	SUI	Z	Schroff, Alexander Schroff, Daniel	16.00		
11	GBR	K	Yeoman, Roger Mcdonald, Neal	17.00		

Rank Rang	Ctry Pays	N.letters N.lettres	Name Nom	Points	Note	Time Temps
12	URS	SR	Borodinov, Serguei Boudantsev, Victor	18.00		
13	AUS	KA	Smith, Gary Connor, David	19.00		
14	USA	US	Foerster, Paul Goldman, Andrew	20.00		
15	SWE	S	Nyberg, Mats Eriksson, Peter	21.00		
16	ESP	E	Doreste, Luis Noguer, Miguel	22.00		
17	HOL	H	Koning, Henry Schelling, Johannes	23.00		
18	ITA	I	Celon, Mario Celon, Claudio	24.00		
19	JPN	J	Sato, Saburo Wakinaga, Tatsuya	25.00		
20	HKG	KH	Lockeyear, Eric Parsons, Timothy	26.00		
21	KOR	RK	Oh, Jong-Yul Kim, Ki-Han	27.00		13:54:13
22	ISR	IS	Sela, Yoel Amir, Eldad	29.00	DNC	

Flying Dutchman Class Race 3/Sept. 22				Classe Flying Dutchman Course 3/22 Sept		
Rank Rang	Ctry Pays	N.letters N.lettres	Name Nom	Points	Note	Time Temps
1	CAN	KC	Mclaughlin, Frank Millen, John	0.00		13:49:36
2	DEN	D	Bojsen-Moller, Jorgen Gronborg, Christian	3.00		
3	NOR	N	Pollen, Olepetter Bjorkum, Erik	5.70		
4	ISR	IS	Sela, Yoel Amir, Eldad	8.00		
5	FRG	G	Batzill, Albert Lang, Peter	10.00		
6	BRA	BL	Adler, Alan Temke, Marcus	11.70		
7	HOL	H	Koning, Henry Schelling, Johannes	13.00		
8	AUS	KA	Smith, Gary Connor, David	14.00		
9	NZL	KZ	Jones, Murray Knowles, Gregory	15.00		
10	USA	US	Foerster, Paul Goldman, Andrew	16.00		
11	FRA	F	Delage, Laurent Ferre, Daniel	17.00		
12	IRL	IR	Wilkins, David Kennedy, Peter	18.00		
13	ESP	E	Doreste, Luis Noguer, Miguel	19.00		
14	URS	SR	Borodinov, Serguei Boudantsev, Victor	20.00		
15	GDR	DDR	Lehmann, Ulf Maedicke, Stefan	21.00		
16	SUI	Z	Schroff, Alexander Schroff, Daniel	22.00		
17	SWE	S	Nyberg, Mats Eriksson, Peter	23.00		
18	ITA	I	Celon, Mario Celon, Claudio	24.00		
19	JPN	J	Sato, Saburo Wakinaga, Tatsuya	25.00		
20	HKG	KH	Lockeyear, Eric Parsons, Timothy	26.00		
21	GBR	K	Yeoman, Roger Mcdonald, Neal	27.00		
22	KOR	RK	Oh, Jong-Yul Kim, Ki-Han	28.00		14:09:02



**Flying Dutchman Class
Race 4/Sept. 23**

Rank Rang	Ctry Pays	N.letters N.lettres	Name Nom	Points	Note	Time Temps
1	ISR	IS	Sela, Yoel Amir, Eldad	0.00		13:56:32
2	DEN	D	Bojsen-Moller, Jorgen Gronborg, Christian	3.00		
3	USA	US	Foerster, Paul Goldman, Andrew	5.70		
4	NZL	KZ	Jones, Murray Knowles, Gregory	8.00		
5	URS	SR	Borodinov, Serguei Boudantsev, Victor	10.00		
6	GBR	K	Yeoman, Roger Mcdonald, Neal	11.70		
7	ESP	E	Doreste, Luis Noguer, Miguel	13.00		
8	FRG	G	Batzill, Albert Lang, Peter	14.00		
9	ITA	I	Celon, Mario Celon, Claudio	15.00		
10	GDR	DDR	Lehmann, Ulf Maedicke, Stefan	16.00		
11	HOL	H	Koning, Henry Schelling, Johannes	17.00		
12	CAN	KC	Mclaughlin, Frank Millen, John	18.00		
13	BRA	BL	Adler, Alan Temke, Marcus	19.00		
14	SUI	Z	Schroff, Alexander Schroff, Daniel	20.00		
15	NOR	N	Pollen, Olepetter Bjorkum, Erik	21.00		
16	AUS	KA	Smith, Gary Connor, David	22.00		
17	SWE	S	Nyberg, Mats Eriksson, Peter	23.00		
18	FRA	F	Delage, Laurent Ferre, Daniel	24.00		
19	JPN	J	Sato, Saburo Wakinaga, Tatsuya	25.00		
20	KOR	RK	Oh, Jong-Yul Kim, Ki-Han	26.00		
21	HKG	KH	Lockeyear, Eric Parsons, Timothy	27.00		14:07:37
22	IRL	IR	Wilkins, David Kennedy, Peter	29.00	DSQ	

**Flying Dutchman Class
Race 5/Sept. 25**

Rank Rang	Ctry Pays	N.letters N.lettres	Name Nom	Points	Note	Time Temps
1	IRL	IR	Wilkins, David Kennedy, Peter	0.00		15:08:57
2	NOR	N	Pollen, Olepetter Bjorkum, Erik	3.00		
3	FRA	F	Delage, Laurent Ferre, Daniel	5.70		
4	AUS	KA	Smith, Gary Connor, David	8.00		
5	GDR	DDR	Lehmann, Ulf Maedicke, Stefan	10.00		
6	DEN	D	Bojsen-Moller, Jorgen Gronborg, Christian	11.70		
7	GBR	K	Yeoman, Roger Mcdonald, Neal	13.00		
8	HOL	H	Koning, Henry Schelling, Johannes	14.00		
9	CAN	KC	Mclaughlin, Frank Millen, John	15.00		
10	USA	US	Foerster, Paul Goldman, Andrew	16.00		
11	ESP	E	Doreste, Luis	17.00		

**Classe Flying Dutchman
Course 4/23 Sept**

Rank Rang	Ctry Pays	N.letters N.lettres	Name Nom	Points	Note	Time Temps
			Noguer, Miguel			
12	NZL	KZ	Jones, Murray Knowles, Gregory	18.00		
13	SWE	S	Nyberg, Mats Eriksson, Peter	19.00		
14	FRG	G	Batzill, Albert Lang, Peter	20.00		
15	URS	SR	Borodinov, Serguei Boudantsev, Victor		YMP	
16	SUI	Z	Schroff, Alexander Schroff, Daniel	22.00		
17	JPN	J	Sato, Saburo Wakinaga, Tatsuya	23.00		
18	HKG	KH	Lockeyear, Eric Parsons, Timothy	24.00		
19	ISR	IS	Sela, Yoel Amir, Eldad	25.00		
20	KOR	RK	Oh, Jong-Yul Kim, Ki-Han	26.00		15:17:05
21	BRA	BL	Adler, Alan Temke, Marcus	29.00	DSQ	
21	ITA	I	Celon, Mario Celon, Claudio	29.00	PMS	

**Flying Dutchman Class
Race 6/Sept. 26**

Rank Rang	Ctry Pays	N.letters N.lettres	Name Nom	Points	Note	Time Temps
1	ISR	IS	Sela, Yoel Amir, Eldad	0.00		13:54:05
2	GBR	K	Yeoman, Roger Mcdonald, Neal	3.00		
3	DEN	D	Bojsen-Moller, Jorgen Gronborg, Christian	5.70		
4	USA	US	Foerster, Paul Goldman, Andrew	8.00		
5	NOR	N	Pollen, Olepetter Bjorkum, Erik	10.00		
6	CAN	KC	Mclaughlin, Frank Millen, John	11.70		
7	FRG	G	Batzill, Albert Lang, Peter	13.00		
8	HOL	H	Koning, Henry Schelling, Johannes	14.00		
9	BRA	BL	Adler, Alan Temke, Marcus	15.00		
10	URS	SR	Borodinov, Serguei Boudantsev, Victor	16.00		
11	GDR	DDR	Lehmann, Ulf Maedicke, Stefan	17.00		
12	FRA	F	Delage, Laurent Ferre, Daniel	18.00		
13	IRL	IR	Wilkins, David Kennedy, Peter	19.00		
14	NZL	KZ	Jones, Murray Knowles, Gregory	20.00		
15	ITA	I	Celon, Mario Celon, Claudio	21.00		
16	SUI	Z	Schroff, Alexander Schroff, Daniel	22.00		
17	ESP	E	Doreste, Luis Noguer, Miguel	23.00		
18	AUS	KA	Smith, Gary Connor, David	24.00		
19	HKG	KH	Lockeyear, Eric Parsons, Timothy	25.00		
20	KOR	RK	Oh, Jong-Yul Kim, Ki-Han	26.00		
21	JPN	J	Sato, Saburo Wakinaga, Tatsuya	27.00		14:02:36
22	SWE	S	Nyberg, Mats Eriksson, Peter	29.00	DSQ	

**Classe Flying Dutchman
Course 5/25 Sept**

Yachting

Yachting

Flying Dutchman Class Race 7/Sept. 27				Classe Flying Dutchman Course 7/27 Sept			
Rank Rang	Ctry Pays	N.letters N.lettres	Name Nom	Points	Note	Time Temps	
1	CAN	KC	Mclaughlin, Frank Millen, John	0.00		13:18:39	
2	NOR	N	Pollen, Olepetter Bjorkum, Erik	3.00			
3	GDR	DDR	Lehmann, Ulf Maedicke, Stefan	5.70			
4	ESP	E	Doreste, Luis Noguer, Miguel	8.00			
5	GBR	K	Yeoman, Roger Mcdonald, Neal	10.00			
6	DEN	D	Bojsen-Moller, Jorgen Gronborg, Christian	11.70			
7	SUI	Z	Schroff, Alexander Schroff, Daniel	13.00			
8	IRL	IR	Wilkins, David Kennedy, Peter	14.00			
9	ISR	IS	Sela, Yoel Amir, Eldad	15.00			
10	NZL	KZ	Jones, Murray Knowles, Gregory	16.00			
11	BRA	BL	Adler, Alan Temke, Marcus	17.00			
12	HOL	H	Koning, Henry Schelling, Johannes	18.00			
13	FRA	F	Delage, Laurent Ferre, Daniel	19.00			
14	USA	US	Foerster, Paul Goldman, Andrew	20.00			
15	AUS	KA	Smith, Gary Connor, David	21.00			
16	URS	SR	Borodinov, Serguei Boudantsev, Victor	22.00			
17	ITA	I	Celon, Mario Celon, Claudio	23.00			
18	SWE	S	Nyberg, Mats Eriksson, Peter	24.00			
19	HKG	KH	Lockeyear, Eric Parsons, Timothy	25.00		13:55:20	
20	FRG	G	Batzill, Albert Lang, Peter	29.00	RET		
20	JPN	J	Sato, Saburo Wakinaga, Tatsuya	29.00	DSQ		
20	KOR	RK	Oh, Jong-Yul Kim, Ki-Han	29.00	RET		

Flying Dutchman Class Summary/Sept. 20-27				Classe Flying Dutchman Sommaire/20-27 Sept				Total	Net			
Rank Rang	Ctry Pays	N.letters N.lettres	Name Nom	1	2	3	4	5	6	7		
1	DEN	D	Bojsen-moller, J Gronborg, C	1	4	2	2	6	3	6	43.10	31.40
2	NOR	N	Pollen, O Bjorkum, Erik	3	5	3	15	2	5	2	58.40	37.40
3	CAN	KC	Mclaughlin, F Millen, John	5	6	1	12	9	6	1	66.40	48.40
4	ISR	IS	Sela, Yoel Amir, Eldad	6	DNC	4	1	19	1	9	88.70	59.70
5	NZL	KZ	Jones, Murray Knowles, Gregory	2	1	9	4	12	14	10	80.00	60.00
6	GBR	K	Yeoman, Roger Mcdonald, Neal	12	11	21	6	7	2	5	99.70	72.70
7	BRA	BL	Adler, Alan Temke, Marcus	4	3	6	13	DSQ	9	11	105.40	76.40
8	FRG	G	Batzill, Albert Lang, Peter	13	2	5	8	14	7	RET	108.00	79.00
9	GDR	DDR	Lehmann, Ulf Maedicke, Stefan	17	8	15	10	5	11	3	106.70	83.70
10	IRL	IR	Wilkins, David Kennedy, Peter	15	7	12	DSQ	1	13	8	114.00	85.00
11	USA	US	Foerster, Paul Goldman, Andrew	18	14	10	3	10	4	14	109.70	85.70

Rank Rang	Ctry Pays	N.letters N.lettres	Name Nom	1	2	3	4	5	6	7	Total	Net
12	FRA	F	Delage, Laurent Ferre, Daniel	7	9	11	18	3	12	13	111.70	87.70
13	ESP	E	Doreste, Luis Noguer, Miguel	11	16	13	7	11	17	4	119.00	96.00
14	URS	SR	Borodinov, S Boudantsev, V	10	12	14	5	YMP	10	16	118.00	96.00
15	HOL	H	Koning, Henry Schelling, J	16	17	7	11	8	8	12	121.00	98.00
16	SUI	Z	Schroff, A Schroff, Daniel	8	10	16	14	16	16	7	129.00	107.00
17	AUS	KA	Smith, Gary Connor, David	21	13	8	16	4	18	15	135.00	108.00
18	SWE	S	Nyberg, Mats Eriksson, Peter	9	15	17	17	13	DSQ	18	154.00	125.00
19	ITA	I	Celon, Mario Celon, Claudio	14	18	18	9	PMS	15	17	156.00	127.00
20	JPN	J	Sato, Saburo Wakinaga, T	19	19	19	19	17	21	DSQ	179.00	150.00
21	HKG	KH	Lockeyear, Eric Parsons, Timothy	20	20	20	21	18	19	19	179.00	152.00
22	KOR	RK	Oh, Jong-Yul Kim, Ki-Han	22	21	22	20	20	20	RET	190.00	161.00

Star Class Race 1/Sept. 20				Classe Star Course 1/20 Sept			
Rank Rang	Ctry Pays	N.letters N.lettres	Name Nom	Points	Note	Time Temps	
1	BRA	BL	Grael, Torben Falcao, Nelson	0.00		14:19:40	
2	FRG	G	Hagen, Alexander Girr, Fritz	3.00			
3	CAN	KC	Macdonald, David Ross Macdonald, Donald Bruce	5.70			
4	AUS	KA	Beashel, Colin Torpy, Gregory	8.00			
5	URS	SR	Soloviev, Viktor Zybine, Alexandre	10.00			
6	GBR	K	Mcintyre, Michael Valie, Pmphil Bryn	11.70			
7	GRE	GR	Hadjipavlis, Helias Manthos, Constandinos	13.00			
8	USA	US	Reynolds, Mark Haenel, Hal	14.00			
9	HOL	H	Bakker, Steven Vandenberg, Jacobus	15.00			
10	ITA	I	Gorla, Giorgio Peraboni, Alfio	16.00			
11	ESP	E	Costas, Juan Perez, Jose	17.00			
12	SWE	S	Johansson, Mats Hansson, Mats	18.00			
13	AUT	OE	Raudaschl, Hubert Puxkandl, Stephan	19.00			
14	SUI	Z	Vuithier, Jean-Claude Hayner, Christian	20.00			
15	ARG	A	Zanetti, Alberto E A Labandeira, Julio A	21.00			
16	POR	P	De Barros, Patricio Anjos, Henrique	22.00			
17	ISV	VI	Foster, John Foster, John Jr.	23.00			
18	BAH	BA	Knowles, Durward Kelly, Steven	24.00		14:32:50	
19	BAR	KBA	Green, Michael Palmer, Howard	28.00	RET		
19	DEN	D	Geert-Jensen, Anders Just, Mogens	28.00	PMS		
19	URU	U	Knuppel, Bernd Ferreiro, Alejandro	28.00	RET		



Star Class
Race 2/Sept. 21

Rank Rang	Ctry Pays	N.letters N.lettres	Name Nom	Points	Note	Time Temps
1	GBR	K	Mcintyre, Michael Vaile, Pmilip Bryn	0.00		14:23:11
2	ITA	I	Gorla, Giorgio Peraboni, Alfio	3.00		
3	HOL	H	Bakker, Steven Vandenberg, Jacobus	5.70		
4	USA	US	Reynolds, Mark Haenel, Hal	8.00		
5	SWE	S	Johansson, Mats Hansson, Mats	10.00		
6	FRG	G	Hagen, Alexander Girr, Fritz	11.70		
7	BRA	BL	Grael, Torben Falcao, Nelson	13.00		
8	AUS	KA	Beashel, Colin Torpy, Gregory	14.00		
9	GRE	GR	Hadjipavlis, Helias Manthos, Constandinos	15.00		
10	DEN	D	Geert-Jensen, Anders Just, Mogens	16.00		
11	CAN	KC	Macdonald, David Ross Macdonald, Donald Bruce	17.00		
12	ESP	E	Costas, Juan Perez, Jose	18.00		
13	POR	P	De Barros, Patricio Anjos, Henrique	19.00		
14	URS	SR	Soloviev, Viktor Zybine, Alexandre	20.00		
15	SUI	Z	Vuithier, Jean-Claude Hayner, Christian	21.00		
16	ARG	A	Zanetti, Alberto E A Labandeira, Julio A	22.00		
17	ISV	VI	Foster, John Foster, John Jr.	23.00		
18	BAR	KBA	Green, Michael Palmer, Howard	24.00		
19	BAH	BA	Knowles, Durward Kelly, Steven	25.00		14:29:59
20	AUT	OE	Raudaschl, Hubert Puxkandl, Stephan	28.00	RET	
20	URU	U	Knuppel, Bernd Ferreiro, Alejandro	28.00	DNC	

Star Class
Race 3/Sept. 22

Rank Rang	Ctry Pays	N.letters N.lettres	Name Nom	Points	Note	Time Temps
1	USA	US	Reynolds, Mark Haenel, Hal	0.00		14:28:09
2	BRA	BL	Grael, Torben Falcao, Nelson	3.00		
3	GRE	GR	Hadjipavlis, Helias Manthos, Constandinos	5.70		
4	GBR	K	Mcintyre, Michael Vaile, Pmilip Bryn	8.00		
5	FRG	G	Hagen, Alexander Girr, Fritz	10.00		
6	ITA	I	Gorla, Giorgio Peraboni, Alfio	11.70		
7	HOL	H	Bakker, Steven Vandenberg, Jacobus	13.00		
8	POR	P	De Barros, Patricio Anjos, Henrique	14.00		
9	SWE	S	Johansson, Mats Hansson, Mats	15.00		
10	DEN	D	Geert-Jensen, Anders Just, Mogens	16.00		
11	AUT	OE	Raudaschl, Hubert Puxkandl, Stephan	17.00		

Classe Star
Course 2/21 Sept

Rank Rang	Ctry Pays	N.letters N.lettres	Name Nom	Points	Note	Time Temps
12	CAN	KC	Macdonald, David Ross Macdonald, Donald Bruce	18.00		
13	AUS	KA	Beashel, Colin Torpy, Gregory	19.00		
14	BAR	KBA	Green, Michael Palmer, Howard	20.00		
15	ARG	A	Zanetti, Alberto E A Labandeira, Julio A	21.00		
16	URS	SR	Soloviev, Viktor Zybine, Alexandre	22.00		
17	BAH	BA	Knowles, Durward Kelly, Steven	23.00		
18	URU	U	Knuppel, Bernd Ferreiro, Alejandro	24.00		
19	SUI	Z	Vuithier, Jean-Claude Hayner, Christian	25.00		
20	ISV	VI	Foster, John Foster, John Jr.	26.00		14:37:19
21	ESP	E	Costas, Juan Perez, Jose	28.00	RET	

Star Class
Race 4/Sept. 23

Rank Rang	Ctry Pays	N.letters N.lettres	Name Nom	Points	Note	Time Temps
1	SWE	S	Johansson, Mats Hansson, Mats	0.00		14:42:21
2	CAN	KC	Macdonald, David Ross Macdonald, Donald Bruce	3.00		
3	ITA	I	Gorla, Giorgio Peraboni, Alfio	5.70		
4	FRG	G	Hagen, Alexander Girr, Fritz	8.00		
5	USA	US	Reynolds, Mark Haenel, Hal	10.00		
6	AUS	KA	Beashel, Colin Torpy, Gregory	11.70		
7	GBR	K	Mcintyre, Michael Vaile, Pmilip Bryn	13.00		
8	URS	SR	Soloviev, Viktor Zybine, Alexandre	14.00		
9	DEN	D	Geert-Jensen, Anders Just, Mogens	15.00		
10	ARG	A	Zanetti, Alberto E A Labandeira, Julio A	16.00		
11	BRA	BL	Grael, Torben Falcao, Nelson	17.00		
12	BAR	KBA	Green, Michael Palmer, Howard	18.00		
13	HOL	H	Bakker, Steven Vandenberg, Jacobus	19.00		
14	ESP	E	Costas, Juan Perez, Jose	20.00		
15	AUT	OE	Raudaschl, Hubert Puxkandl, Stephan	21.00		
15	SUI	Z	Vuithier, Jean-Claude Hayner, Christian	21.00	YMP	
16	POR	P	De Barros, Patricio Anjos, Henrique	22.00		
17	BAH	BA	Knowles, Durward Kelly, Steven	23.00		
18	ISV	VI	Foster, John Foster, John Jr.	24.00		
19	URU	U	Knuppel, Bernd Ferreiro, Alejandro	25.00		14:52:14
20	GRE	GR	Hadjipavlis, Helias Manthos, Constandinos	28.00	DSQ	

Yachting

Star Class Race 5/Sept. 25				Classe Star Course 5/25 Sept		
Rank Rang	Ctry Pays	N.letters N.lettres	Name Nom	Points	Note	Time Temps
1	CAN	KC	Macdonald, David Ross Macdonald, Donald Bruce	0.00		15:37:30
2	BRA	BL	Grael, Torben Falcao, Nelson	3.00		
3	URS	SR	Soloviev, Viktor Zybine, Alexandre	5.70		
4	USA	US	Reynolds, Mark Haenel, Hal	8.00		
5	SWE	S	Johansson, Mats Hansson, Mats	10.00		
6	ITA	I	Gorla, Giorgio Peraboni, Alfio	11.70		
7	BAR	KBA	Green, Michael Palmer, Howard	13.00		
8	DEN	D	Geert-Jensen, Anders Just, Mogens	14.00		
9	AUT	OE	Raudaschl, Hubert Puxkandl, Stephan	15.00		
10	HOL	H	Bakker, Steven Vandenberg, Jacobus	16.00		
11	BAH	BA	Knowles, Durward Kelly, Steven	17.00		
12	AUS	KA	Beashel, Colin Torpy, Gregory	18.00		
13	GBR	K	Mcintyre, Michael Vaile, Pmilip Bryn	19.00		
14	POR	P	De Barros, Patricio Anjos, Henrique	20.00		
15	ARG	A	Zanetti, Alberto E A Labandeira, Julio A	21.00		
16	SUI	Z	Vuithier, Jean-Claude Calderari, Marco	22.00		
17	GRE	GR	Hadjipavlis, Helias Manthos, Constandinos	23.00		
18	ISV	VI	Foster, John Foster, John Jr.	24.00		
19	ESP	E	Costas, Juan Perez, Jose	25.00		
20	URU	U	Knuppel, Bernd Ferreiro, Alejandro	26.00		15:45:49
21	FRG	G	Hagen, Alexander Girr, Fritz	28.00	DSQ	

Star Class Race 6/Sept. 26				Classe Star Course 6/26 Sept		
Rank Rang	Ctry Pays	N.letters N.lettres	Name Nom	Points	Note	Time Temps
1	AUT	OE	Raudaschl, Hubert Puxkandl, Stephan	0.00		14:45:15
2	DEN	D	Geert-jensen, Anders Just, Mogens	3.00		
3	URS	SR	Soloviev, Viktor Zybine, Alexandre	5.70		
4	USA	US	Reynolds, Mark Haenel, Hal	8.00		
5	GRE	GR	Hadjipavlis, Helias Manthos, Constandinos	10.00		
6	AUS	KA	Beashel, Colin Torpy, Gregory	11.70		
7	GBR	K	Mcintyre, Michael Vaile, Pmilip Bryn	13.00		
8	HOL	H	Bakker, Steven Vandenberg, Jacobus	14.00		
9	ESP	E	Costas, Juan Perez, Jose	15.00		
10	SWE	S	Johansson, Mats Hansson, Mats	16.00		
11	ITA	I	Gorla, Giorgio Peraboni, Alfio	17.00		

Yachting

Rank Rang	Ctry Pays	N.letters N.lettres	Name Nom	Points	Note	Time Temps
12	URU	U	Knuppel, Bernd Ferreiro, Alejandro	18.00		
13	ARG	A	Zanetti, Alberto E A Labandeira, Julio A	19.00		
14	CAN	KC	Macdonald, David Ross Macdonald, Donald Bruce	20.00		
15	ISV	VI	Foster, John Foster, John Jr.	21.00		
16	POR	P	De Barros, Patricio Anjos, Henrique	22.00		
17	BAR	KBA	Green, Michael Palmer, Howard	23.00		
18	BAH	BA	Knowles, Durward Kelly, Steven	24.00		14:53:40
19	BRA	BL	Grael, Torben Falcao, Nelson	28.00	RET	
19	FRG	G	Hagen, Alexander Girr, Fritz	28.00	DSQ	
19	SUI	Z	Vuithier, Jean-Claude Calderari, Marco	28.00	DNC	

Star Class Race 7/Sept. 27				Classe Star Course 7/27 Sept		
Rank Rang	Ctry Pays	N.letters N.lettres	Name Nom	Points	Note	Time Temps
1	GBR	K	Mcintyre, Michael Vaile, Pmilip Bryn	0.00		13:59:52
2	AUS	KA	Beashel, Colin Torpy, Gregory	3.00		
3	SWE	S	Johansson, Mats Hansson, Mats	5.70		
4	HOL	H	Bakker, Steven Vandenberg, Jacobus	8.00		
5	DEN	D	Geert-Jensen, Anders Just, Mogens	10.00		
6	FRG	G	Hagen, Alexander Girr, Fritz	11.70		
7	URS	SR	Soloviev, Viktor Zybine, Alexandre	13.00		
8	BRA	BL	Grael, Torben Falcao, Nelson	14.00		
9	ITA	I	Gorla, Giorgio Peraboni, Alfio	15.00		
10	BAR	KBA	Green, Michael Palmer, Howard	16.00		
11	SUI	Z	Vuithier, Jean-Claude Calderari, Marco	17.00		
12	POR	P	De Barros, Patricio Anjos, Henrique	18.00		
13	AUT	OE	Raudaschl, Hubert Puxkandl, Stephan	19.00		
14	GRE	GR	Hadjipavlis, Helias Manthos, Constandinos	20.00		
15	ARG	A	Zanetti, Alberto E A Labandeira, Julio A	21.00		
16	ISV	VI	Foster, John Foster, John Jr.	22.00		14:09:03
17	BAH	BA	Knowles, Durward Kelly, Steven	28.00	DNC	
17	CAN	KC	Macdonald, David Ross Macdonald, Donald Bruce	28.00	RET	
17	ESP	E	Costas, Juan Perez, Jose	28.00	PMS	
17	URU	U	Knuppel, Bernd Ferreiro, Alejandro	28.00	RET	
17	USA	US	Reynolds, Mark Haenel, Hal	28.00	RET	



Star Class
Summary/Sept. 20-27

Classe Star
Sommaire/20-27 Sept

Rank	Ctry	N.letters	Name	Race/Course							Total	Net
Rang	Pays	N.lettres	Nom	1	2	3	4	5	6	7		
1	GBR	K	Mcintyre, M Vaile, Bryn	6	1	4	7	13	7	1	64.70	45.70
2	USA	US	Reynolds, Mark Haenel, Hal	8	4	1	5	4	4	RET	76.00	48.00
3	BRA	BL	Grael, Torben Falcao, Nelson	1	7	2	11	2	RET	8	78.00	50.00
4	SWE	S	Johansson, Mats Hansson, Mats	12	5	9	1	5	10	3	74.70	56.70
5	ITA	I	Gorla, Giorgio Peraboni, Alfio	10	2	6	3	6	11	9	80.10	63.10
6	CAN	KC	Macdonald, D Macdonald, D	3	11	12	2	1	14	RET	91.70	63.70
7	AUS	KA	Beashel, Colin Torpy, Gregory	4	8	13	6	12	6	2	85.40	66.40
8	URS	SR	Soloviev, Viktor Zybina, A	5	14	16	8	3	3	7	90.40	68.40
9	HOL	H	Bakker, Steven Vandenberg, J	9	3	7	13	10	8	4	90.70	71.70
10	FRG	G	Hagen, Alexander Girr, Fritz	2	6	5	4	DSQ	DSQ	6	100.40	72.40
11	DEN	D	Geert-jensen, A Just, Mogens	PMS	10	10	9	8	2	5	102.00	74.00
12	GRE	GR	Hadjipavlis, H Manthos, C	7	9	3	DSQ	17	5	14	114.70	86.70
13	AUT	OE	Raudaschl, H Puxkandl, S	13	RET	11	15	9	1	13	119.00	91.00
14	BAR	KBA	Green, Michael Palmer, Howard	RET	18	14	12	7	17	10	142.00	114.00
15	POR	P	De Barros, P Anjos, Henrique	16	13	8	16	14	16	12	137.00	115.00
16	ARG	A	Zanetti, A Labandeira, J	15	16	15	10	15	13	15	141.00	119.00
17	ESP	E	Costas, Juan Perez, Jose	11	12	RET	14	19	9	PMS	151.00	123.00
18	SUI	Z	Vuithier, J Calderari, Marco	14	15	19	YMP	16	DNC	11	154.00	126.00
19	BAH	BA	Knowles, Durward Kelly, Steven	18	19	17	17	11	18	DNC	164.00	136.00
20	ISV	VI	Foster, John Foster, John Jr.	17	17	20	18	18	15	16	163.00	137.00
21	URU	U	Knuppel, Bernd Ferreiro, A	RET	DNC	18	19	20	12	RET	177.00	149.00

Finn Class
Race 1/Sept. 20

Classe Finn
Course 1/20 Sept

Rank	Ctry	N.letters	Name	Points	Note	Time
Rang	Pays	N.lettres	Nom			Temps
1	DEN	D	Hjortnes, Lasse	0.00		14:15:51
2	FRG	G	Schmid, Thomas	3.00		
3	IRL	IR	O'hara, William	5.70		
4	GBR	K	Childerley, Stuart	8.00		
5	MEX	MX	Mergenthaler, Eric	10.00		
6	HOL	H	Heiner, Roy	11.70		
7	ESP	E	Doreste, Jose Luis	13.00		
8	FIN	L	Rechardt, Lauri	14.00		
9	NZL	KZ	Cutler, John	15.00		
10	SWE	S	Caap, Mats	16.00		
11	GRE	GR	Ortolano, Armando	17.00		
12	HUN	M	Szekely, Antal	18.00		
13	CAN	KC	Lemieux, Lawrence	19.00		
14	AUS	KA	Pratt, Christopher	20.00		
15	TUR	TK	Babacan, Halit Haluk	21.00		
16	USA	US	Ledbetter, Brian	22.00		
17	ISV	VI	Holmberg, Peter	23.00		

Rank	Ctry	N.letters	Name	Points	Note	Time
Rang	Pays	N.lettres	Nom			Temps
18	POL	PZ	Blaszka, Henryk	24.00		
19	BRA	BL	Zarif, Jorge	25.00		
20	ARG	A	Campero, Gonzalo Jose	26.00		
21	JPN	J	Takasawa, Takayoshi	27.00		
22	KOR	RK	Park, Kil-Chul	28.00		
23	ITA	I	Semeraro, Paolo	29.00		
24	FRA	F	Choley, Luc	30.00		
25	INA	RI	Suprpto, Eddy. S	31.00		
26	HKG	KH	Bryan, Nicholas	32.00		
27	BAR	KBA	Atwell, Shane	33.00		
28	MON	MO	Battaglia, Philippe	34.00		
29	GUM	GM	Griffin, Gary	35.00		14:40:00
30	AUT	OE	Spitzauer, Hans	40.00	DSQ	
30	FIJ	KF	Philp, Colin	40.00	RET	
30	PHI	PH	Soriano, Nestor	40.00	RET	
30	URS	SR	Khoperski, Oleg	40.00	DSQ	

Finn Class
Race 2/Sept. 21

Classe Finn
Course 2/21 Sept

Rank	Ctry	N.letters	Name	Points	Note	Time
Rang	Pays	N.lettres	Nom			Temps
1	FIN	L	Rechardt, Lauri	0.00		14:44:03
2	ISV	VI	Holmberg, Peter	3.00		
3	ESP	E	Doreste, Jose Luis	5.70		
4	AUS	KA	Pratt, Christopher	8.00		
5	CAN	KC	Lemieux, Lawrence	10.00		
6	HOL	H	Heiner, Roy	11.70		
7	ITA	I	Semeraro, Paolo	13.00		
8	MEX	MX	Mergenthaler, Eric	14.00		
9	FRG	G	Schmid, Thomas	15.00		
10	NZL	KZ	Cutler, John	16.00		
11	URS	SR	Khoperski, Oleg	17.00		
12	USA	US	Ledbetter, Brian	18.00		
13	AUT	OE	Spitzauer, Hans	19.00		
14	GBR	K	Childerley, Stuart	20.00		
15	GRE	GR	Ortolano, Armando	21.00		
16	IRL	IR	O'hara, William	22.00		
17	BRA	BL	Zarif, Jorge	23.00		
18	KOR	RK	Park, Kil-Chul	24.00		
19	POL	PZ	Blaszka, Henryk	25.00		
20	HUN	M	Szekely, Antal	26.00		
21	TUR	TK	Babacan, Halit Haluk	27.00		
22	FRA	F	Choley, Luc	28.00		
23	ARG	A	Campero, Gonzalo Jose	29.00		
24	SWE	S	Caap, Mats	30.00		
25	JPN	J	Takasawa, Takayoshi	31.00		
26	HKG	KH	Bryan, Nicholas	32.00		
27	INA	RI	Suprpto, Eddy. S	33.00		
28	BAR	KBA	Atwell, Shane	34.00		
29	MON	MO	Battaglia, Philippe	35.00		
30	FIJ	KF	Philp, Colin	36.00		
31	GUM	GM	Griffin, Gary	37.00		14:57:18
32	DEN	D	Hjortnes, Lasse	40.00	RET	
32	PHI	PH	Soriano, Nestor	40.00	RET	

Yachting

Yachting

Finn Class Race 3/Sept. 22				Classe Finn Course 3/22 Sept		
Rank Rang	Ctry Pays	N.letters N.lettres	Name Nom	Points	Note	Time Temps
1	ESP	E	Doreste, Jose Luis	0.00		15:07:32
2	DEN	D	Hjortnes, Lasse	3.00		
3	ISV	VI	Holmberg, Peter	5.70		
4	NZL	KZ	Cutler, John	8.00		
5	GBR	K	Childerley, Stuart	10.00		
6	ITA	I	Semeraro, Paolo	11.70		
7	ARG	A	Campero, Gonzalo Jose	13.00		
8	USA	US	Ledbetter, Brain	14.00		
9	HOL	H	Heiner, Roy	15.00		
10	POL	PZ	Blaszka, Henryk	16.00		
11	MEX	MX	Mergenthaler, Eric	17.00		
12	SWE	S	Caap, Mats	18.00		
13	FRG	G	Schmid, Thomas	19.00		
14	AUS	KA	Pratt, Christopher	20.00		
15	HUN	M	Szekely, Antal	21.00		
16	JPN	J	Takasawa, Takayoshi	22.00		
17	GRE	GR	Ortolano, Armando	23.00		
18	BRA	BL	Zarif, Jorge	24.00		
19	FRA	F	Choley, Luc	25.00		
20	CAN	KC	Lemieux, Lawrence	26.00		
21	IRL	IR	O'Hara, William	27.00		
22	TUR	TK	Babacan, Halit Haluk	28.00		
23	KOR	RK	Park, Kil-Chul	29.00		
24	MON	MO	Battaglia, Philippe	30.00		
25	HKG	KH	Bryan, Nicholas	31.00		
26	FIJ	KF	Philp, Colin	32.00		
27	BAR	KBA	Atwell, Shane	33.00		
28	GUM	GM	Griffin, Gary	34.00		
29	INA	RI	Suprpto, Eddy. S	35.00		
30	PHI	PH	Soriano, Nestor	36.00		15:25:25
31	AUT	OE	Spitzauer, Hans	40.00	DSQ	
31	FIN	L	Rehardt, Lauri	40.00	RET	
31	URS	SR	Khoperski, Oleg	40.00	DSQ	

Rank Rang	Ctry Pays	N.letters N.lettres	Name Nom	Points	Note	Time Temps
18	MEX	MX	Mergenthaler, Eric	24.00		
19	JPN	J	Takasawa, Takayoshi	25.00		
20	TUR	TK	Babacan, Halit Haluk	26.00		
21	KOR	RK	Park, Kil-Chul	27.00		
22	SWE	S	Caap, Mats	28.00		
23	POL	PZ	Blaszka, Henryk	29.00		
24	FIJ	KF	Philp, Colin	30.00		
25	MON	MO	Battaglia, Philippe	31.00		
26	INA	RI	Suprpto, Eddy. S	32.00		
27	HKG	KH	Bryan, Nicholas	33.00		
28	BAR	KBA	Atwell, Shane	34.00		
29	GUM	GM	Griffin, Gary	35.00		
30	PHI	PH	Soriano, Nestor	36.00		15:51:12
31	ARG	A	Campero, Gonzalo Jose	40.00	RET	
31	ESP	E	Doreste, Jose luis	40.00	DSQ	
31	ISV	VI	Holmberg, Peter	40.00	PMS	

Finn Class Race 4/Sept. 23				Classe Finn Course 4/23 Sept		
Rank Rang	Ctry Pays	N.letters N.lettres	Name Nom	Points	Note	Time Temps
1	URS	SR	Khoperski, Oleg	0.00		15:32:35
2	GBR	K	Childerley, Stuart	3.00		
3	AUT	OE	Spitzauer, Hans	5.70		
4	NZL	KZ	Cutler, John	8.00		
5	DEN	D	Hjortnes, Lasse	10.00		
6	FRG	G	Schmid, Thomas	11.70		
7	FIN	L	Rehardt, Lauri	13.00		
8	IRL	IR	O'hara, William	14.00		
9	AUS	KA	Pratt, Christopher	15.00		
10	USA	US	Ledbetter, Brian	16.00		
11	HOL	H	Heiner, Roy	17.00		
12	CAN	KC	Lemieux, Lawrence	18.00		
13	HUN	M	Szekely, Antal	19.00		
14	FRA	F	Choley, Luc	20.00		
15	GRE	GR	Ortolano, Armando	21.00		
16	BRA	BL	Zarif, Jorge	22.00		
17	ITA	I	Semeraro, Paolo	23.00		

Finn Class Race 5/Sept. 24				Classe Finn Course 5/24 Sept		
Rank Rang	Ctry Pays	N.letters N.lettres	Name Nom	Points	Note	Time Temps
1	ISV	VI	Holmberg, Peter	0.00		13:48:02
2	CAN	KC	Lemieux, Lawrence	3.00	YMP	
2	GBR	K	Childerley, Stuart	3.00		
3	ESP	E	Doreste, Jose Luis	5.70		
4	URS	SR	Khoperski, Oleg	8.00		
5	DEN	D	Hjortnes, Lasse	10.00		
6	FRG	G	Schmid, Thomas	11.70		
7	HOL	H	Heiner, Roy	13.00		
8	NZL	KZ	Cutler, John	14.00		
9	MEX	MX	Mergenthaler, Eric	15.00		
10	FRA	F	Choley, Luc	16.00		
11	SWE	S	Caap, Mats	17.00		
12	AUT	OE	Spitzauer, Hans	18.00		
13	ARG	A	Campero, Gonzalo Jose	19.00		
14	FIN	L	Rehardt, Lauri	20.00		
15	AUS	KA	Pratt, Christopher	21.00		
16	POL	PZ	Blaszka, Henryk	22.00		
17	IRL	IR	O'hara, William	23.00		
18	HUN	M	Szekely, Antal	24.00		
19	USA	US	Ledbetter, Brian	25.00		
21	TUR	TK	Babacan, Halit Haluk	27.00		
22	KOR	RK	Park, Kil-Chul	28.00		
23	HKG	KH	Bryan, Nicholas	29.00		14:15:55
24	FIJ	KF	Philp, Colin	30.00	YMP	
25	BRA	BL	Zarif, Jorge		YMP	
25	BAR	KBA	Atwell, Shane	40.00	RET	
25	GRE	GR	Ortolano, Armando	40.00	DNF	
25	GUM	GM	Griffin, Gary	40.00	DNF	
25	INA	RI	Suprpto, Eddy. S	40.00	DNF	
25	ITA	I	Semeraro, Paolo	40.00	DSQ	
25	JPN	J	Takasawa, Takayoshi	40.00	RET	
25	MON	MO	Battaglia, Philippe	40.00	RET	
25	PHI	PH	Soriano, Nestor	40.00	DNC	



Finn Class
Race 6/Sept. 26

Rank	Ctry	N.letters	Name	Points	Note	Time
Rang	Pays	N.lettres	Nom			Temps
1	NZL	KZ	Cutler, John	0.00		15:07:49
2	URS	SR	Khoperski, Oleg	3.00		
3	ISV	VI	Holmberg, Peter	5.70		
4	ESP	E	Doreste, Jose Luis	8.00		
5	HOL	H	Heiner, Roy	10.00		
6	FRG	G	Schmid, Thomas	11.70		
7	USA	US	Ledbetter, Brian	13.00		
8	ARG	A	Campero, Gonzalo Jose	14.00		
9	GBR	K	Childerley, Stuart	15.00		
10	ITA	I	Semeraro, Paolo	16.00		
11	BRA	BL	Zarif, Jorge	17.00		
12	DEN	D	Hjortnes, Lasse	18.00		
13	CAN	KC	Lemieux, Lawrence	19.00		
14	SWE	S	Caap, Mats	20.00		
15	GRE	GR	Ortolano, Armando	21.00		
16	AVT	OE	Spitzauer, Hans	22.00		
17	TUR	TK	Babacan, Halit Haluk	23.00		
18	HUN	M	Szekely, Antal	24.00		
19	FRA	F	Choley, Luc	25.00		
20	POL	PZ	Blaszka, Henryk	26.00		
21	FIN	L	Rechardt, Lauri	27.00		
22	MEX	MX	Mergenthaler, Eric	28.00		
23	JPN	J	Takasawa, Takayoshi	29.00		
24	HKG	KH	Bryan, Nicholas	30.00		
25	INA	RI	Suprpto, Eddy. S	31.00		
26	BAR	KBA	Atwell, Shane	32.00		
27	GUM	GM	Griffin, Gary	33.00		15:22:20
28	AUS	KA	Pratt, Christopher	40.00	PMS	
28	FIJ	KF	Philp, Colin	40.00	DSQ	
28	IRL	IR	O'hara, William	40.00	DSQ	
28	KOR	RK	Park, Kil-Chul	40.00	DSQ	
28	MON	MO	Battaglia, Philippe	40.00	PMS	
28	PHI	PH	Soriano, Nestor	40.00	PMS	

Finn Class
Race 7/Sept. 27

Rank	Ctry	N.letters	Name	Points	Note	Time
Rang	Pays	N.lettres	Nom			Temps
1	NZL	KZ	Cutler, John	0.00		13:53:06
2	ISV	VI	Holmberg, Peter	3.00		
3	ESP	E	Doreste, Jose Luis	5.70		
4	USA	US	Ledbetter, Brian	8.00		
5	DEN	D	Hjortnes, Lasse	10.00		
6	GBR	K	Childerley, Stuart	11.70		
7	URS	SR	Khoperski, Oleg	13.00		
8	POL	PZ	Blaszka, Henryk	14.00		
9	AUS	KA	Pratt, Christopher	15.00		
10	GRE	GR	Ortolano, Armando	16.00		
11	HUN	M	Szekely, Antal	17.00		
12	KOR	RK	Park, Kil-Chul	18.00		
13	BRA	BL	Zarif, Jorge	19.00		
14	AUT	OE	Spitzauer, Hans	20.00		
15	TUR	TK	Babacan, Halit Haluk	21.00		
16	ARG	A	Campero, Gonzalo Jose	22.00		
17	SWE	S	Caap, Mats	23.00		

Classe Finn
Course 6/26 Sept

Rank	Ctry	N.letters	Name	Points	Note	Time
Rang	Pays	N.lettres	Nom			Temps
18	HKG	KH	Bryan, Nicholas	24.00		
19	BAR	KBA	Atwell, Shane	25.00		
20	FIJ	KF	Philp, Colin	26.00		
21	CAN	KC	Lemieux, Lawrence	27.00		
22	MON	MO	Battaglia, Philippe	28.00		
23	GUM	GM	Griffin, Gary	29.00		14:21:49
24	FIN	L	Rechardt, Lauri		YMP	
24	FRA	F	Choley, Luc	40.00	RET	
24	FRG	G	Schmid, Thomas	40.00	RET	
24	HOL	H	Heiner, Roy	40.00	RET	
24	INA	RI	Suprpto, Eddy. S	40.00	RET	
24	IRL	IR	O'hara, William	40.00	RET	
24	ITA	I	Semeraro, Paolo	40.00	RET	
24	JPN	J	Takasawa, Takayoshi	40.00	RET	
24	MEX	MX	Mergenthaler, Eric	40.00	DNC	
24	PHI	PH	Soriano, Nestor	40.00	RET	

Finn Class
Summary/Sept. 20-27

Rank	Ctry	N.letters	Name	Race/Course							Total	Net
Rang	Pays	N.lettres	Nom	1	2	3	4	5	6	7		
1	ESP	E	Doreste, J	7	3	1	DSQ	3	4	3	78.10	38.10
2	ISV	VI	Holmberg, Peter	17	2	3	PMS	1	3	2	80.40	40.40
3	NZL	KZ	Cutler, John	9	10	4	4	8	1	1	61.00	45.00
4	GBR	K	Childerley, S	4	14	5	2	2	9	6	70.70	50.70
5	DEN	D	Hjortnes, Lasse	1	RET	2	5	5	12	5	91.00	51.00
6	FRG	G	Schmid, Thomas	2	9	13	6	6	6	RET	112.10	72.10
7	HOL	H	Heiner, Roy	6	6	9	11	7	5	RET	118.40	78.40
8	URS	SR	Khoperski, Oleg	DSQ	11	DSQ	1	4	2	7	121.00	81.00
9	FIN	L	Rechardt, Lauri	8	1	RET	7	14	21	YMP	128.80	88.80
10	USA	US	Ledbetter, Brian	16	12	8	10	19	7	4	116.00	91.00
11	CAN	KC	Lemieux, L	13	5	20	12	YMP	13	21	122.00	95.00
12	AUS	KA	Pratt, C	14	4	14	9	15	PMS	9	139.00	99.00
13	MEX	MX	Mergenthaler, E	5	8	11	18	9	22	DNC	148.00	108.00
14	GRE	GR	Ortolano, A	11	15	17	15	DNF	15	10	159.00	119.00
15	AUT	OE	Spitzauer, Hans	DSQ	13	DSQ	3	12	YMP	14	159.70	119.70
16	SWE	S	Caap, Mats	10	24	12	22	11	14	17	152.00	122.00
17	ARG	A	Campero, G	20	23	7	RET	13	8	16	163.00	123.00
18	HUN	M	Szekely, Antal	12	20	15	13	18	18	11	149.00	123.00
19	BRA	BL	Zarif, Jorge	19	17	18	16	YMP	11	13	151.00	126.00
20	POL	PZ	Blaszka, Henryk	18	19	10	23	16	20	8	156.00	127.00
21	IRL	IR	O'hara, William	3	16	21	8	17	DSQ	RET	171.70	131.70
22	ITA	I	Semeraro, Paolo	23	7	6	17	DSQ	10	RET	172.70	132.70
23	FRA	F	Choley, Luc	24	22	19	14	10	19	RET	184.00	144.00
24	TUR	TK	Babacan, H	15	21	22	20	21	17	15	173.00	145.00
25	KOR	RK	Park, Kil-Chul	22	18	23	21	22	DSQ	12	194.00	154.00
26	JPN	J	Takasawa, T	21	25	16	19	RET	23	RET	214.00	174.00
27	HKG	KH	Bryan, Nicholas	26	26	25	27	23	24	18	211.00	178.00
28	BAR	KBA	Atwell, Shane	27	28	27	28	RET	26	19	231.00	191.00
29	FIJ	KF	Philp, Colin	RET	30	26	24	24	DSQ	20	234.00	194.00
30	MON	MO	Battaglia, P	28	29	24	25	RET	PMS	22	238.00	198.00
31	INA	RI	Suprpto, Eddy. S	25	27	29	26	DNF	25	RET	242.00	202.00
32	GUM	GM	Griffin, Gary	29	31	28	29	DNF	27	23	243.00	203.00
33	PHI	PH	Soriano, Nestor	RET	RET	30	30	DNC	PMS	RET	272.00	232.00

Yachting

Tornado Class Race 1/Sept. 20				Classe Tornado Course 1/20 Sept		
Rank Rang	Ctry Pays	N.letters N.lettres	Name Nom	Points	Note	Time Temps
1	FRA	F	Le Deroff, Jean-Yves Henard, Nicolas	0.00		14:37:12
2	AUT	OE	Petschel, Norbert Claus, Christian	3.00		
3	NOR	N	Nilsen, Per Arne Johannessen Carl, E	5.70		
4	HOL	H	Van Bladel, Wil Van Bladel, Cees	8.00		
5	SWE	S	Marstrom, Goran Strandman, Karl	10.00		
6	USA	US	Melvin, James Muglia, Patrick	11.70		
7	AUS	KA	Schafferius, Bradley Colman, Roger	13.00		
8	BRA	BL	Grael, Lars Freitas, Clinio	14.00		
9	ITA	I	Zuccoli, Giorgio Santella, Luca	15.00		
10	NZL	KZ	Timms, Christopher Sellers, Rex	16.00		
11	CAN	KC	Sweeney, David Smith, Kevin	17.00		
12	GBR	K	White, Robert Newman, Jeremy	18.00		
13	URS	SR	Konovalov, Iouri Kravtsov, Serguei	19.00		
14	PUR	PR	Figueroa, Enrique Mercado, Oscar	20.00		
15	FRG	G	Gaebler, Roland Pfohe, Hans-Juergen	21.00		
16	DEN	D	Elvstrom, Paul Elvstrom Myralf, Inge Trine	22.00		
17	BER	KB	Astwood, Glenn Bardgett, Edward	23.00		
18	SUI	Z	Cattin, Raymond Roethlisberger, Edgar	24.00		
19	ESP	E	Garcia de Soto, Francisco Lopez, Luis	25.00		
20	JPN	J	Ogawa, Naoyuki Tamura, Takashi	26.00		
21	ISV	VI	Braure, Jean Reiter, Hans	27.00		15:22:54
22	ARG	A	Garcia Guevara, Fernando Miguens, Diego F	30.00	RET	
22	KOR	RK	Park, Byung-Ki Shim, Kyu-Hae	30.00	RET	

Tornado Class Race 2/Sept. 21				Classe Tornado Course 2/21 Sept		
Rank Rang	Ctry Pays	N.letters N.lettres	Name Nom	Points	Note	Time Temps
1	BRA	BL	Grael, Lars Freitas, Clinio	0.00		14:00:19
2	FRA	F	Le Deroff, Jean-Yves Henard, Nicolas	3.00		
3	NZL	KZ	Timms, Christopher Sellers, Rex	5.70		
4	URS	SR	Konovalov, Iouri Kravtsov, Serguei	8.00		
5	NOR	N	Nilsen, Per Arne Johannessen Carl, E	10.00		
6	ITA	I	Zuccoli, Giorgio Santella, Luca	11.70		
7	GBR	K	White, Robert Newman, Jeremy	13.00		
8	FRG	G	Gaebler, Roland Pfohe, Hans-Juergen	14.00		
9	CAN	KC	Sweeney, David Smith, Kevin	15.00		
10	USA	US	Melvin, James Muglia, Patrick	16.00		
11	AUT	OE	Petschel, Norbert Claus, Christian	17.00		

Yachting

Rank Rang	Ctry Pays	N.letters N.lettres	Name Nom	Points	Note	Time Temps
12	PUR	PR	Figueroa, Enrique Mercado, Oscar	18.00		
13	AUS	KA	Schafferius, Bradley Colman, Roger	19.00		
14	DEN	D	Elvstrom, Paul Elvstrom Myralf, Inge Trine	20.00		
15	BER	KB	Astwood, Glenn Bardgett, Edward	21.00		
16	HOL	H	Van Bladel, Wil Van Bladel, Cees	22.00		
17	SWE	S	Marstrom, Goran Strandman, Karl	23.00		
18	KOR	RK	Park, Byung-Ki Shim, Kyu-Hae	24.00		
19	SUI	Z	Cattin, Raymond Roethlisberger, Edgar	25.00		
20	ESP	E	Garcia de Soto, Francisco Lopez, Luis	26.00		
21	ARG	A	Garcia Guevara, Fernando Miguens, Diego F	27.00		
22	JPN	J	Ogawa, Naoyuki Tamura, Takashi	28.00		
23	ISV	VI	Braure, Jean Reiter, Hans	29.00		14:32:15

Tornado Class Race 3/Sept. 22				Classe Tornado Course 3/22 Sept		
Rank Rang	Ctry Pays	N.letters N.lettres	Name Nom	Points	Note	Time Temps
1	NZL	KZ	Timms, Christopher Sellers, Rex	0.00		15:31:21
2	FRA	F	Le deroff, Jean-Yves Henard, Nicolas	3.00		
3	ITA	I	Zuccoli, Giorgio Santella, Luca	5.70		
4	URS	SR	Konovalov, Iouri Kravtsov, Serguei	8.00		
5	GBR	K	White, Robert Newman, Jeremy	10.00		
6	BRA	BL	Grael, Lars Freitas, Clinio	11.70		
7	AUS	KA	Schafferius, Bradley Colman, Roger	13.00		
8	AUT	OE	Petschel, Norbert Claus, Christian	14.00		
9	SWE	S	Marstrom, Goran Strandman, Karl	15.00		
10	CAN	KC	Sweeney, David Smith, Kevin	16.00	YMP	
10	NOR	N	Nilsen, Per Arne Johannessen Carl, E	16.00		
11	FRG	G	Gaebler, Roland Pfohe, Hans-Juergen	17.00		
12	PUR	PR	Figueroa, Enrique Mercado, Oscar	18.00		
13	HOL	H	Van Bladel, Wil Van Bladel, Cees	19.00		
14	KOR	RK	Park, Byung-Ki Shim, Kyu-Hae	20.00		
15	SUI	Z	Cattin, Raymond Roethlisberger, Edgar	21.00		
16	ARG	A	Garcia Guevara, Fernando Miguens, Diego F	22.00		
17	JPN	J	Ogawa, Naoyuki Tamura, Takashi	23.00		
18	BER	KB	Astwood, Glenn Bardgett, Edward	24.00		
19	ESP	E	Garcia de Soto, Francisco Lopez, Luis	25.00		
20	ISV	VI	Braure, Jean Reiter, Hans	26.00		16:03:33
21	DEN	D	Elvstrom, Paul Elvstrom Myralf, Inge Trine	30.00	RET	
21	USA	US	Melvin, James Muglia, Patrick	30.00	RET	



Tornado Class Race 4/Sept. 23				Classe Tornado Course 4/23 Sept		
Rank Rang	Ctry Pays	N.letters N.lettres	Name Nom	Points	Note	Time Temps
1	FRA	F	Le Deroff, Jean-Yves Henard, Nicolas	0.00		15:01:01
2	URS	SR	Konovalov, Iouri Kravtsov, Serguei	3.00		
3	BRA	BL	Grael, Lars Freitas, Clinio	5.70		
4	NZL	KZ	Timms, Christopher Sellers, Rex	8.00		
5	AUT	OE	Petschel, Norbert Claus, Christian	10.00		
6	GBR	K	White, Robert Newman, Jeremy	11.70		
7	ITA	I	Zuccoli, Giorgio Santella, Luca	13.00		
8	CAN	KC	Sweeney, David Smith, Kevin	14.00		
9	HOL	H	Van Bladel, Wil Van Bladel, Cees	15.00		
10	AUS	KA	Schafferius, Bradley Colman, Roger	16.00		
11	SWE	S	Marstrom, Goran Strandman, Karl	17.00		
12	NOR	N	Nilsen, Per Arne Johannessen Carl, E	18.00		
13	PUR	PR	Figueroa, Enrique Mercado, Oscar	19.00		
14	USA	US	Melvin, James Muglia, Patrick	20.00		
15	SUI	Z	Cattin, Raymond Roethlisberger, Edgar	21.00		
16	DEN	D	Elvstrom, Paul Elvstrom Myralf, Inge Trine	22.00		
17	KOR	RK	Park, Byung-Ki Shim, Kyu-Hae	23.00		
18	ESP	E	Garcia de Soto, Francisco Lopez, Luis	24.00		
19	JPN	J	Ogawa, Naoyuki Tamura, Takashi	25.00		
20	BER	KB	Astwood, Glenn Bardgett, Edward	26.00		
21	ISV	VI	Braure, Jean Reiter, Hans	27.00		15:50:02
22	ARG	A	Garcia Guevara, Fernando Miguens, Diego F	30.00	RET	
23	FRG	G	Gaebler, Roland Pfohe, Hans-Juergen	30.00	RET	

Tornado Class Race 5/Sept. 24				Classe Tornado Course 5/24 Sept		
Rank Rang	Ctry Pays	N.letters N.lettres	Name Nom	Points	Note	Time Temps
1	FRA	F	Le Deroff, Jean-Yves Henard, Nicolas	0.00		13:47:01
2	ITA	I	Zuccoli, Giorgio Santella, Luca	3.00		
3	BRA	BL	Grael, Lars Freitas, Clinio	5.70		
4	AUT	OE	Petschel, Norbert Claus, Christian	8.00		
5	DEN	D	Elvstrom, Paul Elvstrom Myralf, Inge Trine	10.00		
6	NZL	KZ	Timms, Christopher Sellers, Rex	11.70		
7	HOL	H	Van Bladel, Wil Van Bladel, Cees	13.00		

Rank Rang	Ctry Pays	N.letters N.lettres	Name Nom	Points	Note	Time Temps
8	KOR	RK	Park, Byung-Ki Shim, Kyu-Hae	14.00		
9	CAN	KC	Sweeney, David Smith, Kevin	15.00		
10	PUR	PR	Figueroa, Enrique Mercado, Oscar	16.00		
11	SWE	S	Marstrom, Goran Strandman, Karl	17.00		
12	BER	KB	Astwood, Glenn Bardgett, Edward	18.00		
13	AUS	KA	Schafferius, Bradley Colman, Roger	19.00		13:59:32
14	ARG	A	Garcia Guevara, Fernando Miguens, Diego F	30.00	DNC	
14	ESP	E	Garcia de Soto, Francisco Lopez, Luis	30.00	RET	
14	FRG	G	Gaebler, Roland Pfohe, Hans-Juergen	30.00	DNC	
14	GBR	K	White, Robert Newman, Jeremy	30.00	RET	
14	ISV	VI	Braure, Jean Reiter, Hans	30.00	DNS	
14	JPN	J	Ogawa, Naoyuki Tamura, Takashi	30.00	RET	
14	NOR	N	Nilsen, Per Arne Johannessen Carl, E	30.00	DNC	
14	SUI	Z	Cattin, Raymond Roethlisberger, Edgar	30.00	RET	
14	URS	SR	Konovalov, Iouri Kravtsov, Serguei	30.00	RET	
14	USA	US	Melvin, James Muglia, Patrick	30.00	DSQ	

Tornado Class Race 6/Sept. 26				Classe Tornado Course 6/26 Sept		
Rank Rang	Ctry Pays	N.letters N.lettres	Name Nom	Points	Note	Time Temps
1	NZL	KZ	Timms, Christopher Sellers, Rex	0.00		14:09:00
2	AUT	OE	Petschel, Norbert Claus, Christian	3.00		
3	HOL	H	Van Bladel, Wil Van Bladel, Cees	5.70		
4	CAN	KC	Sweeney, David Smith, Kevin	8.00		
5	FRA	F	Le Deroff, Jean-Yves Henard, Nicolas	10.00		
6	GBR	K	White, Robert Newman, Jeremy	11.70		
7	URS	SR	Konovalov, Iouri Kravtsov, Serguei	13.00		
8	BRA	BL	Grael, Lars Freitas, Clinio	14.00		
9	USA	US	Melvin, James Muglia, Patrick	15.00		
10	SWE	S	Marstrom, Goran Strandman, Karl	16.00		
11	AUS	KA	Schafferius, Bradley Colman, Roger	17.00		
12	NOR	N	Nilsen, Per Arne Johannessen Carl, E	18.00		
13	PUR	PR	Figueroa, Enrique Mercado, Oscar	19.00		
14	KOR	RK	Park, Byung-Ki Shim, Kyu-Hae	20.00		

Yachting

Yachting

Rank Rang	Ctry Pays	N.letters N.lettres	Name Nom	Points	Note	Time Temps
15	ITA	I	Zuccoli, Giorgio Santella, Luca	21.00		
16	SUI	Z	Cattin, Raymond Roethlisberger, Edgar	22.00		
17	BER	KB	Astwood, Glenn Bardgett, Edward	23.00		
18	ESP	E	Garcia de Soto, Francisco Lopez, Luis	24.00		
19	DEN	D	Elvstrom, Paul Elvstrom Myralf, Inge Trine	25.00		
20	JPN	J	Ogawa, Naoyuki Tamura, Takashi	26.00		
21	ISV	VI	Braure, Jean Reiter, Hans	27.00		14:37:58
22	ARG	A	Garcia Guevara, Fernando Miguens, Diego F	30.00	DNC	
22	FRG	G	Gaebler, Roland Pfohe, Hans-Juergen	30.00	DNC	

Tornado Class Race 7/Sept. 27			Classe Tornado Course 7/27 Sept			
Rank Rang	Ctry Pays	N.letters N.lettres	Name Nom	Points	Note	Time Temps

1	NOR	N	Nilsen, Per Arne Johannessen Carl, E	0.00		14:02:41
2	BRA	BL	Grael, Lars Freitas, Clinio	3.00		
3	GBR	K	White, Robert Newman, Jeremy	5.70		
4	AUT	OE	Petschel, Norbert Claus, Christian	8.00		
5	NZL	KZ	Timms, Christopher Sellers, Rex	10.00		
6	ITA	I	Zuccoli, Giorgio Santella, Luca	11.70		
7	DEN	D	Elvstrom, Paul Elvstrom Myralf, Inge Trine	13.00		
8	PUR	PR	Figueroa, Enrique Mercado, Oscar	14.00		
9	CAN	KC	Sweeney, David Smith, Kevin	15.00		
10	SUI	Z	Cattin, Raymond Roethlisberger, Edgar	16.00		
11	KOR	RK	Park, Byung-Ki Shim, Kyu-Hae	17.00		
12	USA	US	Melvin, James Muglia, Patrick	18.00		
13	URS	SR	Konovalov, Iouri Kravtsov, Serguei	19.00		14:31:34
14	ARG	A	Garcia Guevara, Fernando Miguens, Diego F	30.00	DNC	
14	AUS	KA	Schafferius, Bradley Colman, Roger	30.00	RET	
14	BER	KB	Astwood, Glenn Bardgett, Edward	30.00	RET	
14	ESP	E	Garcia de Soto, Francisco De Borbon, Cristina	30.00	RET	
14	FRA	F	Le Deroff, Jean-Yves Henard, Nicolas	30.00	DNC	
14	FRG	G	Gaebler, Roland Pfohe, Hans-Juergen	30.00	DNC	
14	HOL	H	Van Bladel, Wil Van Bladel, Cees	30.00	RET	
14	ISV	VI	Braure, Jean Reiter, Hans	30.00	RET	
14	JPN	J	Ogawa, Naoyuki Tamura, Takashi	30.00	DNF	
14	SWE	S	Marstrom, Goran Strandman, Karl	30.00	RET	

Tornado Class Summary/Sept. 20-27				Classe Tornado Sommaire/20-27 Sept									
Rank Rang	Ctry Pays	N.letters N.lettres	Name Nom	Race/Course							Total	Net	
				1	2	3	4	5	6	7			

1	FRA	F	Le Deroff, J Henard, Nicolas	1	2	2	1	1	5	DNC	46.00	16.00
2	NZL	KZ	Timms, C Sellers, Rex	10	3	1	4	6	1	5	51.40	35.40
3	BRA	BL	Grael, Lars Freitas, Clinio	8	1	6	3	3	8	2	54.10	40.10
4	AUT	OE	Petschel, N Claus, Christian	2	11	8	5	4	2	4	63.00	46.00
5	ITA	I	Zuccoli, Giorgio Santella, Luca	9	6	3	7	2	15	6	81.10	60.10
6	NOR	N	Nilsen, Per Arne Johannessen, C	3	5	10	12	DNC	12	1	97.70	67.70
7	URS	SR	Konovalov, Iouri Kravtsov, S	13	4	4	2	RET	7	13	100.00	70.00
8	GBR	K	White, Robert Newman, Jeremy	12	7	5	6	RET	6	3	100.10	70.10
9	HOL	H	Van Bladel, Wil Van Bladel, Cees	4	16	13	9	7	3	RET	112.70	82.70
10	CAN	KC	Sweeney, David Smith, Kevin	11	9	YMP	8	9	4	9	100.00	83.00
11	AUS	KA	Schafferius, B Colman, Roger	7	13	7	10	13	11	RET	127.00	97.00
12	SWE	S	Marstrom, Goran Strandman, Karl	5	17	9	11	11	10	RET	128.00	98.00
13	PUR	PR	Figueroa, E Mercado, Oscar	14	12	12	13	10	13	8	124.00	104.00
14	USA	US	Melvin, James Muglia, Patrick	6	10	RET	14	DSQ	9	12	140.70	110.70
15	DEN	D	Elvstrom, Paul Elvstrom Myralf	16	14	RET	16	5	19	7	142.00	112.00
16	KOR	RK	Park, Byung-Ki Shim, Kyu-Hae	RET	18	14	17	8	14	11	148.00	118.00
17	SUI	Z	Cattin, Raymond Roethlisberger	18	19	15	15	RET	16	10	159.00	129.00
18	BER	KB	Astwood, Glenn Bardgett, Edward	17	15	18	20	12	17	RET	165.00	135.00
19	FRG	G	Gaebler, Roland Pfohe, H	15	8	11	RET	DNC	DNC	DNC	172.00	142.00
20	ESP	E	Garcia de Soto De Borbon, C	19	20	19	18	RET	18	RET	184.00	154.00
21	JPN	J	Ogawa, Naoyuki Tamura, Takashi	20	22	17	19	RET	20	DNF	188.00	158.00
22	ISV	VI	Braure, Jean Reiter, Hans	21	23	20	21	DNS	21	RET	196.00	166.00
23	ARG	A	Garcia Guevara Miguens, Diego F	RET	21	16	RET	DNC	DNC	DNC	199.00	169.00

Division II Class Race 1/Sept. 20				Classe Division II Course 1/20 Sept		
Rank Rang	Ctry Pays	N.letters N.lettres	Name Nom	Points	Note	Time Temps

1	AHO	HA	Boersma, Jan D.	0.00		13:13:40
2	SUI	Z	Bonga, Jan	3.00		
3	NZL	KZ	Kendall, Bruce	5.70		
4	USA	US	Gebhardt, Michael	8.00		
5	ESP	E	Iniesta, Carlos	10.00		
6	ARG	A	Garcia Velazco, Jorge Ruben	11.70		
7	ITA	I	Wirz, Francesco	13.00		
8	CAN	KC	Myerscough, Richard	14.00		
9	NOR	N	Nissen-Lie, Hakon M.	15.00		
10	FRG	G	Meyer, Dirk	16.00		
11	GBR	K	Goody, Simon	17.00		
12	HOL	H	Verschoor, Bart	18.00		
13	BRA	BL	Rebello, George	19.00		
14	AUS	KA	Lawrence, Christopher	20.00		
15	FRA	F	Nagy, Robert	21.00		
16	POL	PZ	Myszkowski, Grzegorz	22.00		
17	AUT	OE	Wallner, Thomas	23.00		
18	SWE	S	Torell, Magnus	24.00		
19	GRE	GR	Georgosopoulos, Stelios	25.00		
20	JPN	J	Asano, Ryo	26.00		
21	CHN	CH	Jiang, Chen	27.00		
22	PUR	PR	Alcaide, Osvaldo	28.00		
23	POR	P	Calico, Luis	29.00		



Rank Rang	Ctry Pays	N.letters N.lettres	Name Nom	Points	Note	Time Temps
24	VEN	V	Milosevic, Roland	30.00		
25	ISV	VI	Baldauf, Luke	31.00		
26	KOR	RK	Lee, Han-Lim	32.00		
27	IVB	KV	Arneborg, Matthew	33.00		
28	FUJ	KF	Philp, Anthony S.	34.00		
29	THA	TH	Hohsuwan, Anan	35.00		
30	URS	SR	Kravtchenko, Nikolai	36.00		
31	INA	RI	Faisal, Abdul Malik	37.00		
32	MLT	MT	Fieri Soler, Jean-Paul	38.00		
33	SMR	SM	Conti, Giovanni	39.00		
34	GUM	GM	Iriarte, Jan	40.00		
35	TUR	TK	Kakis, Ibrahim	41.00		
36	PHI	PH	Paz, Richard	42.00		
37	HKG	KH	Wong, Sam Tak Sum	43.00		
38	DJI	DJ	Adou, Ali	44.00		
39	MON	MO	Gamerding, Didier	45.00		
40	MEX	MX	Ozib, Nilo	46.00		
41	ZIM	ZB	Lapham, Vernon Wright	47.00		13:45:07
42	ANT	ANU	Fvler, Eli		YMP	
42	BAR	KBA	Talma, Brian	52.00	DSQ	
42	NGU	KP	Numa, Graham	52.00	RET	
42	QAT	QA	Al-Kaabi, Mohamed	52.00	RET	

Division II Class Race 2/Sept. 21			Classe Division II Course 2/21 Sept			
Rank Rang	Ctry Pays	N.letters N.lettres	Name Nom	Points	Note	Time Temps
1	USA	US	Gebhardt, Michael	0.00		13:12:38
2	ITA	I	Wirz, Francesco	3.00		
3	NZL	KZ	Kendall, Bruce	5.70		
4	AUS	KA	Lawrence, Christopher	8.00		
5	HOL	H	Verschoor, Bart	10.00		
6	POL	PZ	Myszkowski, Grzegorz	11.70		
7	CAN	KC	Myerscough, Richard	13.00		
8	AHO	HA	Boersma, Jan D.	14.00		
9	FRG	G	Meyer, Dirk	15.00		
10	SWE	S	Torell, Magnus	16.00		
11	ARG	A	Garcia Velazco, Jorge Ruben	17.00		
12	VEN	V	Milosevic, Roland	18.00		
13	CHN	CH	Jiang, Chen	19.00		
14	FRA	F	Nagy, Robert	20.00		
15	GBR	K	Goody, Simon	21.00		
16	AUT	OE	Wallner, Thomas	22.00		
17	THA	TH	Hohsuwan, Anan	23.00		
18	JPN	J	Asano, Ryo	24.00		
19	SUI	Z	Bonga, Jan	25.00		
20	PUR	PR	Alcaide, Osvaldo	26.00		
21	ESP	E	Iniesta, Carlos	27.00		
22	IVB	KV	Arneborg, Matthew	28.00		
23	BRA	BL	Rebello, George	29.00		
24	INA	RI	Faisal, Abdul Malik	30.00		
25	ISV	VI	Baldauf, Luke	31.00		
26	POR	P	Calico, Luis	32.00		
27	GRE	GR	Georgosopoulos, Stelios	33.00		
28	TUR	TK	Kakis, Ibrahim	34.00		

Rank Rang	Ctry Pays	N.letters N.lettres	Name Nom	Points	Note	Time Temps
29	MLT	MT	Fieri Soler, Jean-Paul	35.00		
30	ANT	ANU	Fvler, Eli	36.00		
31	DJI	DJ	Adou, Ali	37.00		
32	MON	MO	Gamerding, Didier	38.00		
33	HKG	KH	Wong, Sam Tak Sum	39.00		
34	URS	SR	Kravtchenko, Nikolai	40.00		
35	PHI	PH	Paz, Richard	41.00		
36	SMR	SM	Conti, Giovanni	42.00		
37	BAR	KBA	Talma, Brian	43.00		
38	MEX	MX	Ozib, Nilo	44.00		
39	NGU	KP	Numa, Graham	45.00		
40	ZIM	ZB	Lapham, Vernon Wright	46.00		13:35:26
41	FUJ	KF	Philp, Anthony S.	52.00	DSQ	
41	GUM	GM	Iriarte, Jan	52.00	DSQ	
41	KOR	RK	Lee, Han-Lim	52.00	PMS	
41	NOR	N	Nissen-Lie, Hakon M.	52.00	DSQ	
41	QAT	QA	Al-Kaabi, Mohamed	52.00	DNC	

Division II Class Race 3/Sept. 22			Classe Division II Course 3/22 Sept			
Rank Rang	Ctry Pays	N.letters N.lettres	Name Nom	Points	Note	Time Temps
1	NZL	KZ	Kendall, Bruce	0.00		13:17:37
2	FRA	F	Nagy, Robert	3.00		
3	ARG	A	Garcia Velazco, Jorge Ruben	5.70		
4	HOL	H	Verschoor, Bart	8.00		
4	NOR	N	Nissen-Lie, Hakon M.	8.00		
6	VEN	V	Milosevic, Roland	11.70		
7	GBR	K	Goody, Simon	13.00		
8	AHO	HA	Boersma, Jan D.	14.00		
9	AUS	KA	Lawrence, Christopher	15.00		
10	ITA	I	Wirz, Francesco	16.00		
11	USA	US	Gebhardt, Michael		YMP	
12	FRG	G	Meyer, Dirk	18.00		
13	CHN	CH	Jiang, Chen	19.00		
14	POR	P	Calico, Luis	20.00		
15	JPN	J	Asano, Ryo	21.00		
16	SUI	Z	Bonga, Jan	22.00		
17	SWE	s	Torell, Magnus	23.00		
18	FUJ	KF	Philp, Anthony S.	24.00		
19	KOR	RK	Lee, Han-Lim	25.00		
20	INA	RI	Faisal, Abdul Malik	26.00		
21	PUR	PR	Alcaide, Osvaldo	27.00		
22	CAN	KC	Myerscough, Richard	28.00		
23	BRA	BL	Rebello, George	29.00		
24	POL	PZ	Myszkowski, Grzegorz	30.00		
25	THA	TH	Hohsuwan, Anan	31.00		
26	MON	MO	Gamerding, Didier	32.00		
27	ESP	E	Iniesta, Carlos	33.00		
28	IVB	KV	Arneborg, Matthew	34.00		
29	URS	SR	Kravtchenko, Nikolai	35.00		
30	ISV	VI	Baldauf, Luke	36.00		
31	MLT	MT	Fieri Soler, Jean-Paul	37.00		
32	DJI	DJ	Adou, Ali	38.00		
33	PHI	PH	Paz, Richard	39.00		

Rank Rang	Ctry Pays	N.letters N.lettres	Name Nom	Points	Note	Time Temps
34	HKG	KH	Wong, Sam Tak Sum	40.00		
35	MEX	MX	Ozib, Nilo	41.00		
36	ANT	ANU	Fvler, Eli	42.00		
37	GUM	GM	Iriarte, Jan	43.00		
38	ZIM	ZB	Lapham, Vernon Wright	44.00		
39	BAR	KBA	Talma, Brian	45.00		
40	TUR	TK	Kakis, Ibrahim	46.00		
41	SMR	SM	Conti, Giovanni	47.00		
42	NGU	KP	Numa, Graham	48.00		13:41:55
43	AUT	OE	Wallner, Thomas	52.00	RET	
43	GRE	GR	Georgosopoulos, Stelios	52.00	RET	
43	QAT	QA	Al-kaabi, Mohamed	52.00	DNC	

Division II Class Race 4/Sept. 23				Classe Division II Course 4/23 Sept		
Rank Rang	Ctry Pays	N.letters N.lettres	Name Nom	Points	Note	Time Temps

1	ESP	E	Iniesta, Carlos	0.00		13:30:18
2	ITA	I	Wirz, Francesco	3.00		
3	FRA	F	Nagy, Robert	5.70		
4	HOL	H	Verschoor, Bart	8.00		
5	NZL	KZ	Kendall, Bruce	10.00		
6	AHO	HA	Boersma, Jan D.	11.70		
7	FRG	G	Meyer, Dirk	13.00		
8	VEN	V	Milosevic, Roland	14.00		
9	BRA	BL	Rebello, George	15.00		
10	AUT	OE	Wallner, Thomas	16.00		
11	USA	US	Gebhardt, Michael	17.00		
12	ARG	A	Garcia Velazco, Jorge Ruben	18.00		
13	PUR	PR	Alcaide, Osvaldo	19.00		
14	POL	PZ	Myszkowski, Grzegorz	20.00		
15	POR	P	Calico, Luis	21.00		
16	NOR	N	Nissen-Lie, Hakon M.	22.00		
17	AUS	KA	Lawrence, Christopher	23.00		
18	THA	TH	Hohsuwan, Anan	24.00		
19	JPN	J	Asano, Ryo	25.00		
20	SWE	S	Torell, Magnus	26.00		
21	GBR	K	Goody, Simon	27.00		
22	ISV	VI	Baldauf, Luke	28.00		
23	FIJ	KF	Philp, Anthony S.	29.00		
24	SUI	Z	Bonga, Jan	30.00		
25	IVB	KV	Arneborg, Matthew	31.00		
26	PHI	PH	Paz, Richard	32.00		
27	GRE	GR	Georgosopoulos, Stelios	33.00		
28	KOR	RK	Lee, Han-Lim	34.00		
29	URS	SR	Kravtchenko, Nkolai	35.00		
30	MON	MO	Gamerding, Didier	36.00		
31	HKG	KH	Wong, Sam Tak Sum	37.00		
32	INA	RI	Faisal, Abdul Malik	38.00		
33	TUR	TK	Kakis, Ibrahim	39.00		
34	MLT	MT	Fieri Soler, Jean-Paul	40.00		
35	BAR	KBA	Talma, Brian	41.00		
36	ANT	ANU	Fvler, Eli	42.00		
37	DJI	DJ	Adou, Ali	43.00		

Rank Rang	Ctry Pays	N.letters N.lettres	Name Nom	Points	Note	Time Temps
38	GUM	GM	Iriarte, Jan	44.00		
39	SMR	SM	Conti, Giovanni	45.00		
40	ZIM	ZB	Lapham, Vernon Wright	46.00		13:49:13
41	CHN	CH	Jiang, Chen		YMP	
41	CAN	KC	Myerscough, Richard	52.00	DSQ	
41	MEX	MX	Ozib, Nilo	52.00	PMS	
41	NGU	KP	Numa, Graham	52.00	PMS	
41	QAT	QA	Al-Kaabi, Mohamed	52.00	DNC	

Division II Class Race 5/Sept. 24				Classe Division II Course 5/24 Sept		
Rank Rang	Ctry Pays	N.letters N.lettres	Name Nom	Points	Note	Time Temps

1	AHO	HA	Boersma, Jan D.	0.00		13:17:25
2	ESP	E	Iniesta, Carlos	3.00		
3	HOL	H	Verschoor, Bart	5.70		
4	SUI	Z	Bonga, Jan	8.00		
5	USA	US	Gebhardt, Michael	10.00		
6	ARG	A	Garcia Velazco, Jorge Ruben	11.70		
7	AUT	OE	Wallner, Thomas	13.00		
8	NZL	KZ	Kendall, Bruce	14.00		
9	POR	P	Calico, Luis	15.00		
10	JPN	J	Asano, Ryo	16.00		
11	FRG	G	Meyer, Dirk	17.00		
12	NOR	N	Nissen-Lie, Hakon M.	18.00		
13	BRA	BL	Rebello, George	19.00		
14	SWE	S	Torell, Magnus	20.00		
15	GBR	K	Goody, Simon	21.00		
16	POL	PZ	Myszkowski, Grzegorz	22.00		
17	PHI	PH	Paz, Richard	23.00		
18	FIJ	KF	Philp, Anthony S.	24.00		
19	BAR	KBA	Talma, Brian	25.00		14:23:17
20	AUS	KA	Lawrence, Christopher		YMP	
20	CAN	KC	Myerscough, Richard		YMP	
20	FRA	F	Nagy, Robert		YMP	
20	ANT	ANU	Fvler, Eli	52.00	RET	
20	CHN	CH	Jiang, Chen	52.00	RET	
20	DJI	DJ	Adou, Ali	52.00	PMS	
20	GRE	GR	Georgosopoulos, Stelios	52.00	RET	
20	GUM	GM	Iriarte, Jan	52.00	RET	
20	HKG	KH	Wong, Sam Tak Sum	52.00	RET	
20	INA	RI	Faisal, Abdul Malik	52.00	RET	
20	ISV	VI	Baldauf, Luke	52.00	RET	
20	ITA	I	Wirz, Francesco	52.00	RET	
20	IVB	KV	Arneborg, Matthew	52.00	RET	
20	KOR	RK	Lee, Han-Lim	52.00	RET	
20	MEX	MX	Ozib, Nilo	52.00	RET	
20	MLT	MT	Fieri Soler, Jean-Paul	52.00	RET	
20	MON	MO	Gamerding, Didier	52.00	RET	
20	NGU	KP	Numa, Graham	52.00	PMS	
20	PUR	PR	Alcaide, Osvaldo	52.00	RET	
20	QAT	QA	Al-Kaabi, Mohamed	52.00	DNC	
20	SMR	SM	Conti, Giovanni	52.00	RET	



Rank Rang	Ctry Pays	N.letters N.lettres	Name Nom	Points	Note	Time Temps
20	THA	TH	Hohsuwan, Anan	52.00	RET	
20	TUR	TK	Kakis, Ibrahim	52.00	RET	
20	URS	SR	Kravtchenko, Nkolai	52.00	DNC	
20	VEN	V	Milosevic, Roland	52.00	RET	
20	ZIM	ZB	Lapham, Vernon Wright	52.00	PMS	

Division II Class Race 6/Sept. 26 **Classe Division II Course 6/26 Sept**

Rank Rang	Ctry Pays	N.letters N.lettres	Name Nom	Points	Note	Time Temps
1	NZL	KZ	Kendall, Bruce	0.00		13:29:50
2	ITA	I	Wirz, Francesco	3.00		
3	FRA	F	Nagy, Robert	5.70		
4	ARG	A	Garcia Velazco, Jorge Ruben	8.00		
5	AUS	KA	Lawrence, Christopher	10.00		
6	HOL	H	Verschoor, Bart	11.70		
7	CAN	KC	Myerscough, Richard	13.00		
8	USA	US	Gebhardt, Michael	14.00		
9	VEN	V	Milosevic, Roland	15.00		
10	AHO	HA	Boersma, Jan D.	16.00		
11	AUT	OE	Wallner, Thomas	17.00		
12	SUI	Z	Bonga, Jan	18.00		
13	BRA	BL	Rebello, George	19.00		
14	GBR	K	Goody, Simon	20.00		
15	CHN	CH	Jiang, Chen	21.00		
16	JPN	J	Asano, Ryo	22.00		
17	SWE	S	Torell, Magnus	23.00		
18	NOR	N	Nissen-Lie, Hakon M.	24.00		
19	POL	PZ	Myszkowski, Grzegorz	25.00		
20	THA	TH	Hohsuwan, Anan	26.00		
21	ISV	VI	Baldauf, Luke	27.00		
22	PHI	PH	Paz, Richard	28.00		
23	POR	P	Calico, Luis	29.00		
24	ESP	E	Iniesta, Carlos	30.00		
25	PUR	PR	Alcaide, Osvaldo	31.00		
26	FRG	G	Meyer, Dirk	32.00		
27	FIJ	KF	Philp, Anthony S.	33.00		
28	IVB	KV	Arneborg, Matthew	34.00		
29	MEX	MX	Ozib, Nilo	35.00		
30	INA	RI	Faisal, Abdul Malik	36.00		
31	TUR	TK	Kakis, Ibrahim	37.00		
32	KOR	RK	Lee, Han-Lim	38.00		
33	MON	MO	Gamerding, Didier	39.00		
34	ANT	ANU	Fvler, Eli	40.00		
35	DJI	DJ	Adou, Ali	41.00		
36	HKG	KH	Wong, Sam Tak Sum	42.00		
37	BAR	KBA	Talma, Brian	43.00		

Rank Rang	Ctry Pays	N.letters N.lettres	Name Nom	Points	Note	Time Temps
38	MLT	MT	Fieri Soler, Jean-Paul	44.00		
39	SMR	SM	Conti, Giovanni	45.00		
40	GUM	GM	Iriarte, Jan	46.00		
41	ZIM	ZB	Lapham, Vernon Wright	47.00		13:53:15
42	GRE	GR	Georgosopoulos, Stelios	52.00	RET	
42	NGU	KP	Numa, Graham	52.00	RET	
42	QAT	QA	Al-Kaabi, Mohamed	52.00	DNC	
42	URS	SR	Kravtchenko, Nkolai	52.00	DNC	

Division II Class Race 7/Sept. 27 **Classe Division II Course 7/27 Sept**

Rank Rang	Ctry Pays	N.letters N.lettres	Name Nom	Points	Note	Time Temps
1	AUT	OE	Wallner, Thomas	0.00		13:51:08
2	AHO	HA	Boersma, Jan D.	3.00		
3	SUI	Z	Bonga, Jan	5.70		
4	USA	US	Gebhardt, Michael	8.00		
5	HOL	H	Verschoor, Bart	10.00		
6	ESP	E	Iniesta, Carlos	11.70		
7	CAN	KC	Myerscough, Richard	13.00		
8	GBR	K	Goody, Simon	14.00		
9	NZL	KZ	Kendall, Bruce	15.00		
10	ARG	A	Garcia Velazco, Jorge Ruben	16.00		
11	FRA	F	Nagy, Robert	17.00		
12	POR	P	Calico, Luis	18.00		
13	AUS	KA	Lawrence, Christopher	19.00		
14	FRG	G	Meyer, Dirk	20.00		
15	ISV	VI	Baldauf, Luke	21.00		
16	JPN	J	Asano, Ryo	22.00		
17	BRA	BL	Rebello, George	23.00		
18	VEN	V	Milosevic, Roland	24.00		
19	ITA	I	Wirz, Francesco	25.00		
20	SWE	S	Torell, Magnus	26.00		
21	INA	RI	Faisal, Abdul Malik	27.00		
22	POL	PZ	Myszkowski, Grzegorz	28.00		
23	PHI	PH	Paz, Richard	29.00		
24	ANT	ANU	Fvler, Eli	30.00		
25	PUR	PR	Alcaide, Osvaldo	31.00		
26	CHN	CH	Jiang, Chen	32.00		
27	BAR	KBA	Talma, Brian	33.00		
28	MEX	MX	Ozib, Nilo	34.00		
29	TUR	TK	Kakis, Ibrahim	35.00		
30	KOR	RK	Lee, Han-Lim	36.00		
31	GUM	GM	Iriarte, Jan	37.00		
32	MON	MO	Gamerding, Didier	38.00		
33	THA	TH	Hohsuwan, Anan	39.00		14:33:28
34	DJI	DJ	Adou, Ali	52.00	RET	
34	FIJ	KF	Philp, Anthony S.	52.00	RET	
34	GRE	GR	Georgosopoulos, Stelios	52.00	RET	
34	HKG	KH	Wong, Sam Tak Sum	52.00	RET	

Yachting

Rank	Ctry	N.letters	Name	Points	Note	Time
Rang	Pays	N.lettres	Nom			Temps
34	IVB	KV	Arneborg, Matthew	52.00	RET	
34	MLT	MT	Fieri Soler, Jean-Paul	52.00	RET	
34	NGU	KP	Numa, Graham	52.00	DNC	
34	NOR	N	Nissen-Lie, Hakon M.	52.00	DSQ	
34	QAT	QA	Al-Kaabi, Mohamed	52.00	DNC	
34	SMR	SM	Conti, Giovanni	52.00	RET	
34	URS	SR	Kravtchenko, Nikolai	52.00	DNC	
34	ZIM	ZB	Lapham, Vernon Wright	52.00	RET	

Division II Class Summary/Sept. 20-27				Classe Division II Sommaire/20-27 Sept									
Rank	Ctry	N.letters	Name	Race/Course							Total	Net	
Rang	Pays	N.lettres	Nom	1	2	3	4	5	6	7			
1	NZL	KZ	Kendall, Bruce	3	3	1	5	8	1	9	50.40	35.40	
2	AHO	HA	Boersma, Jan D	1	8	8	6	1	10	2	58.70	42.70	
3	USA	US	Gebhardt, M	4	1	YMP	11	5	8	4	65.00	48.00	
4	HOL	H	Verschoor, Bart	12	5	4	4	3	6	5	71.40	53.40	
5	FRA	F	Nagy, Robert	15	14	2	3	YMP	3	11	82.70	61.70	
6	ITA	I	Wirz, Francesco	7	2	10	2	RET	2	19	115.00	63.00	
7	ARG	A	Garcia Velazco	6	11	3	12	6	4	10	88.10	70.10	
8	ESP	E	Iniesta, Carlos	5	21	27	1	2	24	6	114.70	81.70	
9	SUI	Z	Bonga, Jan	2	19	16	24	4	12	3	111.70	81.70	
10	AUS	KA	Lawrence, C	14	4	9	17	YMP	5	13	109.40	86.40	
11	AUT	OE	Wallner, Thomas	17	16	RET	10	7	11	1	143.00	91.00	
12	CAN	KC	Myerscough, R	8	7	22	DSQ	YMP	7	7	149.20	97.20	
13	FRG	G	Meyer, Dirk	10	9	12	7	11	26	14	131.00	99.00	
14	GBR	K	Goody, Simon	11	15	7	21	15	14	8	133.00	106.00	
15	VEN	V	Milosevic, R	24	12	6	8	RET	9	18	164.70	112.70	
16	BRA	BL	Rebello, George	13	23	23	9	13	13	17	153.00	124.00	
17	POL	PZ	Myszkowski, G	16	6	24	14	16	19	22	158.70	128.70	
18	JPN	J	Asano, Ryo	20	18	15	19	10	16	16	156.00	130.00	
19	POR	P	Calico, Luis	23	26	14	15	9	23	12	164.00	132.00	
20	SWE	S	Torell, Magnus	18	10	17	20	14	17	20	158.00	132.00	
21	NOR	N	Nissen-Lie, H	9	DSQ	4	16	12	18	DSQ	191.00	139.00	
22	CHN	CH	Jiang, Chen	21	13	13	YMP	RET	15	26	193.60	141.60	
23	PUR	PR	Alcaide, Osvaldo	22	20	21	13	RET	25	25	214.00	162.00	
24	ISV	VI	Baldauf, Luke	25	25	30	22	RET	21	15	226.00	174.00	
25	THA	TH	Hohsuwan, Anan	29	17	25	18	RET	20	33	230.00	178.00	
26	PHI	PH	Paz, Richard	36	35	33	26	17	22	23	234.00	192.00	
27	INA	RI	Faisal, A	31	24	20	32	RET	30	21	246.00	194.00	
28	FIJ	KF	Philp, A	28	DSQ	18	23	18	27	RET	248.00	196.00	
29	IVB	KV	Arneborg, M	27	22	28	25	RET	28	RET	264.00	212.00	
30	KOR	RK	Lee, Han-Lim	26	PMS	19	28	RET	32	30	269.00	217.00	
31	ANT	ANU	Fvller, Eli	YMP	30	36	36	RET	34	24	280.00	228.00	
32	MON	MO	Gamerdinge, D	39	32	26	30	RET	33	32	280.00	228.00	
33	BAR	KBA	Talma, Brian	DSQ	37	39	35	19	37	27	282.00	230.00	
34	TUR	TK	Kakis, Ibrahim	35	28	40	33	RET	31	29	284.00	232.00	
35	MLT	MT	Fieri Soler, J	32	29	31	34	RET	38	RET	298.00	246.00	
36	GRE	GR	Georgosopoulos, S	19	27	RET	27	RET	RET	RET	299.00	247.00	
37	URS	SR	Kravtchenko, N	30	34	29	29	DNC	DNC	DNC	302.00	250.00	
38	MEX	MX	Ozib, Nilo	40	38	35	PMS	RET	29	28	304.00	252.00	
39	HKG	KH	Wong, S	37	33	34	31	RET	36	RET	305.00	253.00	
40	DJI	DJ	Adou, Ali	38	31	32	37	PMS	35	RET	307.00	255.00	
41	GUM	GM	Iriarte, Jan	34	DSQ	37	38	RET	40	31	314.00	262.00	
42	SMR	SM	Conti, Giovanni	33	36	41	39	RET	39	RET	322.00	270.00	
43	ZIM	ZB	Lapham, V	41	40	38	40	PMS	41	RET	334.00	282.00	
44	NGU	KP	Numa, Graham	RET	39	42	PMS	PMS	RET	DNC	353.00	301.00	
45	QAT	QA	Al-Kaabi, M	RET	DNC	DNC	DNC	DNC	DNC	DNC	364.00	312.00	

Yachting

Men 470 Class Race 1/Sept. 20				Hommes/Classe 470 Course 1/20 Sept		
Rank	Ctry	N.letters	Name	Points	Note	Time
Rang	Pays	N.lettres	Nom			Temps
1	FRA	F	Peponnet, Thierry Pillot, Luc	0.00		13:23:23
2	FRG	G	Hunger, Wolfgang Hunger, Joachim	3.00		
3	NZL	KZ	Evans, Peter Mander, Simon	5.70		
4	ESP	E	Leon, Fernando Sanchez, Luna Francisco	8.00		
5	USA	US	Shadden, John Mc Kee, Charlie	10.00		
6	HOL	H	Drontmann, Robert Drontmann, Mark	11.70		
7	BRA	BL	Wanderley, Carlos Arndt, Bernardo	13.00		
8	CAN	KC	Cochrane, Nigel McIlquham, Gordon	14.00		
9	ISR	IS	Torten, Dan-Noam Torten, Ram-Jacob	15.00		
10	JPN	J	Nakamura, Kenji Takahashi, Masayuki	16.00		
11	URS	SR	Tyniste, Tynou Tyniste, Toomas	17.00		
12	SWE	S	Haggbom, Jonas Liljeblad, Anders	18.00		
13	NOR	N	Johannessen, Herman Horn Jensen, Karl Einar	19.00		
14	DEN	D	Natorp, Hans Natorp, Paul	20.00		
15	AUT	OE	Binder, Christian Hecht, Heimo	21.00		
16	GBR	K	Belben, Jason Hemmings, Andrew	22.00		
17	ARG	A	Irigoyen, Carlos A Parada, Guillermo P	23.00		
18	GDR	DDR	Brietzke, Juergen Schulz, Ekkehard	24.00		
19	IND	IND	Tarapore, Farokh Rao, Kelly	25.00		
20	CHN	CH	Yang, Shanfeng Lin, Bo	26.00		
21	ISL	IL	Jonasson, Gunnlaugur Fridriksson, Isleifur	27.00		
22	KOR	RK	Park, Ki-Chul Shin, Kwang-Soo	28.00		
23	CYP	CP	Karapatakis, Andreas Christoforou, Christos	29.00		
24	PAK	PK	Sadiq, Mamoon Rasool, Javed	30.00		
25	SIN	KS	Siew, Shaw Her Chan, Joseph	31.00		13:37:02
26	FIN	L	Koskull Von, Peter Koskull Von, Johan	36.00	RET	
26	HUN	M	Nyari, Gyula Nyari, Zoltan Zsolt	36.00	DSQ	
26	ITA	I	Montefusco, Sandro Montefusco, Paolo	36.00	DSQ	
26	SUI	Z	Wicki, Jodok Frey, Andreas	36.00	PMS	



Men 470 Class Race 2/Sept. 21							Hommes/Classe 470 Course 2/21 Sept							Men 470 Class Race 3/Sept. 22							Hommes/Classe 470 Course 3/22 Sept						
Rank	Ctry	N.letters	Name	Points	Note	Time	Rank	Ctry	N.letters	Name	Points	Note	Time	Rank	Ctry	N.letters	Name	Points	Note	Time	Rank	Ctry	N.letters	Name	Points	Note	Time
Rang	Pays	N.lettres	Nom			Temps	Rang	Pays	N.lettres	Nom			Temps	Rang	Pays	N.lettres	Nom			Temps	Rang	Pays	N.lettres	Nom			Temps
1	ITA	I	Montefusco, Sandro Montefusco, Paolo	0.00		14:30:00	1	FRA	F	Peponnet, Thierry Pillot, Luc	0.00		14:53:15	1	FRA	F	Peponnet, Thierry Pillot, Luc	0.00		14:53:15	1	FRA	F	Peponnet, Thierry Pillot, Luc	0.00		14:53:15
2	USA	US	Shadden, John Mc Kee, Charlie	3.00			2	USA	US	Shadden, John Mc Kee, Charlie	3.00			2	USA	US	Shadden, John Mc Kee, Charlie	3.00			2	USA	US	Shadden, John Mc Kee, Charlie	3.00		
3	FRA	F	Peponnet, Thierry Pillot, Luc	5.70			3	CAN	KC	Cochrane, Nigel McIlquham, Gordon	5.70			3	CAN	KC	Cochrane, Nigel McIlquham, Gordon	5.70			3	CAN	KC	Cochrane, Nigel McIlquham, Gordon	5.70		
4	URS	SR	Tyniste, Tynou Tyniste, Toomas	8.00			4	ESP	E	Leon, Feranado Sanchez, Luna Francisco	8.00			4	ESP	E	Leon, Feranado Sanchez, Luna Francisco	8.00			4	ESP	E	Leon, Feranado Sanchez, Luna Francisco	8.00		
5	FRG	G	Hunger, Wolfgang Hunger, Joachim	10.00			5	GDR	DDR	Brietzke, Juergen Schulz, Ekkehard	10.00			5	GDR	DDR	Brietzke, Juergen Schulz, Ekkehard	10.00			5	GDR	DDR	Brietzke, Juergen Schulz, Ekkehard	10.00		
6	FIN	L	Koskull Von, Peter Koskull Von, Johan	11.70			6	FIN	L	Koskull Von, Peter Koskull Von, Johan	11.70			6	FIN	L	Koskull Von, Peter Koskull Von, Johan	11.70			6	FIN	L	Koskull Von, Peter Koskull Von, Johan	11.70		
7	HOL	H	Drontmann, Robert Drontmann, Mark	13.00			7	ITA	I	Montefusco, Sandro Montefusco, Paolo	13.00			7	ITA	I	Montefusco, Sandro Montefusco, Paolo	13.00			7	ITA	I	Montefusco, Sandro Montefusco, Paolo	13.00		
8	NZL	KZ	Evans, Peter Mander, Simon	14.00			8	JPN	J	Nakamura, Kenji Takahashi, Masayuki	14.00			8	JPN	J	Nakamura, Kenji Takahashi, Masayuki	14.00			8	JPN	J	Nakamura, Kenji Takahashi, Masayuki	14.00		
9	BRA	BL	Wanderley, Carlos Arndt, Bernardo	15.00			9	FRG	G	Hunger, Wolfgang Hunger, Joachim	15.00			9	FRG	G	Hunger, Wolfgang Hunger, Joachim	15.00			9	FRG	G	Hunger, Wolfgang Hunger, Joachim	15.00		
10	CAN	KC	Cochrane, Nigel McIlquham, Gordon	16.00			10	NOR	N	Johannessen, Herman Horn Jensen, Karl Einar	16.00			10	NOR	N	Johannessen, Herman Horn Jensen, Karl Einar	16.00			10	NOR	N	Johannessen, Herman Horn Jensen, Karl Einar	16.00		
11	ESP	E	Leon, Feranado Sanchez, Luna Francisco	17.00			11	NZL	KZ	Evans, Peter Mander, Simon	17.00			11	NZL	KZ	Evans, Peter Mander, Simon	17.00			11	NZL	KZ	Evans, Peter Mander, Simon	17.00		
12	JPN	J	Nakamura, Kenji Takahashi, Masayuki	18.00			12	URS	SR	Tyniste, Tynou Tyniste, Toomas	18.00			12	URS	SR	Tyniste, Tynou Tyniste, Toomas	18.00			12	URS	SR	Tyniste, Tynou Tyniste, Toomas	18.00		
13	NOR	N	Johannessen, Herman Horn Jensen, Karl Einar	19.00			13	GBR	K	Belben, Jason Hemmings, Andrew	19.00			13	GBR	K	Belben, Jason Hemmings, Andrew	19.00			13	GBR	K	Belben, Jason Hemmings, Andrew	19.00		
14	GBR	K	Belben, Jason Hemmings, Andrew	20.00			14	ISR	IS	Torten, Dan-Noam Torten, Ram-Jacob	20.00			14	ISR	IS	Torten, Dan-Noam Torten, Ram-Jacob	20.00			14	ISR	IS	Torten, Dan-Noam Torten, Ram-Jacob	20.00		
15	GDR	DDR	Brietzke, Juergen Schulz, Ekkehard	21.00			15	HOL	H	Drontmann, Robert Drontmann, Mark	21.00			15	HOL	H	Drontmann, Robert Drontmann, Mark	21.00			15	HOL	H	Drontmann, Robert Drontmann, Mark	21.00		
16	SWE	S	Haggbom, Jonas Liljebblad, Anders	22.00			16	SWE	S	Haggbom, Jonas Liljebblad, Anders	22.00			16	SWE	S	Haggbom, Jonas Liljebblad, Anders	22.00			16	SWE	S	Haggbom, Jonas Liljebblad, Anders	22.00		
17	ISL	IL	Jonasson, Gunnlaugur Fridriksson, Isleifur	23.00			17	SUI	Z	Wicki, Jodok Frey, Andreas	23.00			17	SUI	Z	Wicki, Jodok Frey, Andreas	23.00			17	SUI	Z	Wicki, Jodok Frey, Andreas	23.00		
18	DEN	D	Natorp, Hans Natorp, Paul	24.00			18	AUT	OE	Binder, Christian Hecht, Heimo	24.00			18	AUT	OE	Binder, Christian Hecht, Heimo	24.00			18	AUT	OE	Binder, Christian Hecht, Heimo	24.00		
19	AUT	OE	Binder, Christian Hecht, Heimo	25.00			19	IND	IND	Tarapore, Farokh Rao, Kelly	25.00			19	IND	IND	Tarapore, Farokh Rao, Kelly	25.00			19	IND	IND	Tarapore, Farokh Rao, Kelly	25.00		
20	IND	IND	Tarapore, Farokh Rao, Kelly	26.00			20	ISL	IL	Jonasson, Gunnlaugur Fridriksson, Isleifur	26.00			20	ISL	IL	Jonasson, Gunnlaugur Fridriksson, Isleifur	26.00			20	ISL	IL	Jonasson, Gunnlaugur Fridriksson, Isleifur	26.00		
21	ARG	A	Irigoyen, Carlos A Parada, Guillermo P	27.00			21	CHN	CH	Yang, Shanfeng Lin, Bo	27.00			21	CHN	CH	Yang, Shanfeng Lin, Bo	27.00			21	CHN	CH	Yang, Shanfeng Lin, Bo	27.00		
22	CHN	CH	Yang, Shanfeng Lin, Bo	28.00			22	DEN	D	Natorp, Hans Natorp, Paul	28.00			22	DEN	D	Natorp, Hans Natorp, Paul	28.00			22	DEN	D	Natorp, Hans Natorp, Paul	28.00		
23	HUN	M	Nyari, Gyula Nyari, Zoltan Zsolt	29.00			23	ARG	A	Irigoyen, Carlos A Parada, Guillermo P	29.00			23	ARG	A	Irigoyen, Carlos A Parada, Guillermo P	29.00			23	ARG	A	Irigoyen, Carlos A Parada, Guillermo P	29.00		
24	KOR	RK	Park, Ki-Chul Shin, Kwang-Soo	30.00			24	HUN	M	Nyari, Gyula Nyari, Zoltan Zsolt	30.00			24	HUN	M	Nyari, Gyula Nyari, Zoltan Zsolt	30.00			24	HUN	M	Nyari, Gyula Nyari, Zoltan Zsolt	30.00		
25	CYP	CP	Karapatakis, Andreas Christoforou, Christos	31.00			25	SIN	KS	Siew, Shaw Her Chan, Joseph	31.00			25	SIN	KS	Siew, Shaw Her Chan, Joseph	31.00			25	SIN	KS	Siew, Shaw Her Chan, Joseph	31.00		
26	PAK	PK	Sadiq, Mamoon Rasool, Javed	32.00			26	CYP	CP	Karapatakis, Andreas Christoforou, Christos	32.00			26	CYP	CP	Karapatakis, Andreas Christoforou, Christos	32.00			26	CYP	CP	Karapatakis, Andreas Christoforou, Christos	32.00		
27	SIN	KS	Siew, Shaw Her Chan, Joseph	33.00		14:39:59	27	KOR	RK	Park, Ki-Chul Shin, Kwang-Soo	33.00			27	KOR	RK	Park, Ki-Chul Shin, Kwang-Soo	33.00			27	KOR	RK	Park, Ki-Chul Shin, Kwang-Soo	33.00		
28	SUI	Z	Wicki, Jodok Frey, Andreas		YMP		28	PAK	PK	Sadiq, Mamoon Rasool, Javed	34.00		15:04:07	28	PAK	PK	Sadiq, Mamoon Rasool, Javed	34.00		15:04:07	28	PAK	PK	Sadiq, Mamoon Rasool, Javed	34.00		15:04:07
28	ISR	IS	Torten, Dan-Noam Torten, Ram-Jacob	36.00			29	BRA	BL	Wanderley, Carlos Arndt, Bernardo	36.00		DSQ	29	BRA	BL	Wanderley, Carlos Arndt, Bernardo	36.00		DSQ	29	BRA	BL	Wanderley, Carlos Arndt, Bernardo	36.00		DSQ

Yachting

Men 470 Class Race 4/Sept. 23				Hommes/Classe 470 Course 4/23 Sept		
Rank Rang	Ctry Pays	N.letters N.lettres	Name Nom	Points	Note	Time Temps
1	URS	SR	Tyniste, Tynou Tyniste, Toomas	0.00		15:33:00
2	CAN	KC	Cochrane, Nigel McIlquham, Gordon	3.00		
3	ISR	IS	Torten, Dan-Noam Torten, Ram-Jacob	5.70		
4	ESP	E	Leon, Feranado Sanchez, Luna Francisco	8.00		
5	HUN	M	Nyari, Gyula Nyari, Zoltan Zsolt	10.00		
6	IND	IND	Tarapore, Farokh Rao, Kelly	11.70		
7	HOL	H	Drontmann, Robert Drontmann, Mark	13.00		
8	FIN	L	Koskull Von, Peter Koskull Von, Johan	14.00		
9	ITA	I	Montefusco, Sandro Montefusco, Paolo	15.00		
10	FRA	F	Peponnet, Thierry Pillot, Luc	16.00		
11	USA	US	Shadden, John Mc kee, Charlie	17.00		
12	JPN	J	Nakamura, Kenji Takahashi, Masayuki	18.00		
13	FRG	G	Hunger, Wolfgang Hunger, Joachim	19.00		
14	NOR	N	Johannessen, Herman Horn Jensen, Karl Einar	20.00		
15	ISL	IL	Jonasson, Gunnlaugur Fridriksson, Isleifur	21.00		
16	AUT	OE	Binder, Christian Hecht, Heimo	22.00		
17	SUI	Z	Wicki, Jodok Frey, Andreas	23.00		
18	NZL	KZ	Evans, Peter Mander, Simon	24.00		
19	BRA	BL	Wanderley, Carlos Arndt, Bernardo	25.00		
20	GBR	K	Belben, Jason Hemmings, Andrew	26.00		
21	GDR	DDR	Brietzke, Juergen Schulz, Ekkehard	27.00		
22	ARG	A	Irigoyen, Carlos A Parada, Guillermo P	28.00		
23	SWE	S	Haggbom, Jonas Liljeblad, Anders	29.00		
24	CHN	CH	Yang, Shanfeng Lin, Bo	30.00		
25	SIN	KS	Siew, Shaw Her Chan, Joseph	31.00		
26	PAK	PK	Sadiq, Mamooun Rasool, Javed	32.00		
27	CYP	CP	Karapatakis, Andreas Christoforou, Christos	33.00		15:46:23
28	DEN	D	Natorp, Hans Natorp, Paul	36.00	PMS	
28	KOR	RK	Park, Ki-Chul Shin, Kwang-Soo	36.00	PMS	

Yachting

Men 470 Class Race 5/Sept. 24				Hommes/Classe 470 Course 5/24 Sept		
Rank Rang	Ctry Pays	N.letters N.lettres	Name Nom	Points	Note	Time Temps
1	URS	SR	Tyniste, Tynou Tyniste, Toomas	0.00		13:02:06
2	NZL	KZ	Evans, Peter Mander, Simon	3.00		
3	FRG	G	Hunger, Wolfgang Hunger, Joachim	5.70		
4	GDR	DDR	Brietzke, Juergen Schulz, Ekkehard	8.00		
5	USA	US	Shadden, John Mc Kee, Charlie	10.00		
6	BRA	BL	Wanderley, Carlos Arndt, Bernardo	11.70		
7	SUI	Z	Wicki, Jodok Frey, Andreas	13.00		
8	GBR	K	Belben, Jason Hemmings, Andrew	14.00		
9	NOR	N	Johannessen, Herman Horn Jensen, Karl Einar	15.00		
10	SWE	S	Haggbom, Jonas Liljeblad, Anders	16.00		
11	FRA	F	Peponnet, Thierry Pillot, Luc	17.00		
12	HUN	M	Nyari, Gyula Nyari, Zoltan Zsolt	18.00		
13	CAN	KC	Cochrane, Nigel McIlquham, Gordon	19.00		
14	JPN	J	Nakamura, Kenji Takahashi, Masayuki	20.00		
15	ITA	I	Montefusco, Sandro Montefusco, Paolo	21.00		
16	ARG	A	Irigoyen, Carlos A Parada, Guillermo P	22.00		
17	AUT	OE	Binder, Christian Hecht, Heimo	23.00		
18	DEN	D	Natorp, Hans Natorp, Paul	24.00		
19	KOR	RK	Park, Ki-Chul Shin, Kwang-Soo	25.00		13:28:50
20	ISR	IS	Torten, Dan-Noam Torten, Ram-Jacob		YMP	
20	CHN	CH	Yang, Shanfeng Lin, Bo	36.00	PMS	
20	CYP	CP	Karapatakis, Andreas Christoforou, Christos	36.00	DNF	
20	ESP	E	Leon, Feranado Sanchez, Luna Francisco	36.00	PMS	
20	FIN	L	Koskull Von, Peter Koskull Von, Johan	36.00	PMS	
20	HOL	H	Drontmann, Robert Drontmann, Mark	36.00	RET	
20	IND	IND	Tarapore, Farokh Rao, Kelly	36.00	RET	
20	ISL	IL	Jonasson, Gunnlaugur Fridriksson, Isleifur	36.00	DNF	
20	PAK	PK	Sadiq, Mamooun Rasool, Javed	36.00	DNC	
20	SIN	KS	Siew, Shaw Her Chan, Joseph	36.00	RET	



Men 470 Class Race 6/Sept. 26							Hommes/Classe 470 Course 6/26 Sept							Men 470 Class Race 7/Sept. 27							Hommes/Classe 470 Course 7/27 Sept						
Rank Rang	Ctry Pays	N.letters N.lettres	Name Nom	Points	Note	Time Temps	Rank Rang	Ctry Pays	N.letters N.lettres	Name Nom	Points	Note	Time Temps	Rank Rang	Ctry Pays	N.letters N.lettres	Name Nom	Points	Note	Time Temps	Rank Rang	Ctry Pays	N.letters N.lettres	Name Nom	Points	Note	Time Temps
1	ESP	E	Leon, Feranado Sanchez, Luna Francisco	0.00		14:23:07	1	BRA	BL	Wanderley, Carlos Arndt, Bernardo	0.00		13:19:05	1	BRA	BL	Wanderley, Carlos Arndt, Bernardo	0.00		13:19:05	1	BRA	BL	Wanderley, Carlos Arndt, Bernardo	0.00		13:19:05
2	URS	SR	Tyniste, Tynou Tyniste, Toomas	3.00			2	FRA	F	Peponnet, Thierry Pillot, Luc	3.00			2	FRA	F	Peponnet, Thierry Pillot, Luc	3.00			2	FRA	F	Peponnet, Thierry Pillot, Luc	3.00		
3	GDR	DDR	Brietzke, Juergen Schulz, Ekkehard	5.70			3	ITA	I	Montefusco, Sandro Montefusco, Paolo	5.70			3	ITA	I	Montefusco, Sandro Montefusco, Paolo	5.70			3	ITA	I	Montefusco, Sandro Montefusco, Paolo	5.70		
4	FRG	G	Hunger, Wolfgang Hunger, Joachim	8.00			4	USA	US	Shadden, John Mc Kee, Charlie	8.00			4	USA	US	Shadden, John Mc Kee, Charlie	8.00			4	USA	US	Shadden, John Mc Kee, Charlie	8.00		
5	FRA	F	Peponnet, Thierry Pillot, Luc	10.00			5	NZL	KZ	Evans, Peter Mander, Simon	10.00			5	NZL	KZ	Evans, Peter Mander, Simon	10.00			5	NZL	KZ	Evans, Peter Mander, Simon	10.00		
6	HOL	H	Drontmann, Robert Drontmann, Mark	11.70			6	NOR	N	Johannessen, Herman Horn Jensen, Karl Einar	11.70			6	NOR	N	Johannessen, Herman Horn Jensen, Karl Einar	11.70			6	NOR	N	Johannessen, Herman Horn Jensen, Karl Einar	11.70		
7	NZL	KZ	Evans, Peter Mander, Simon	13.00			7	HOL	H	Drontmann, Robert Drontmann, Mark	13.00			7	HOL	H	Drontmann, Robert Drontmann, Mark	13.00			7	HOL	H	Drontmann, Robert Drontmann, Mark	13.00		
8	ITA	I	Montefusco, Sandro Montefusco, Paolo	14.00			8	ESP	E	Leon, Feranado Sanchez, Luna Francisco	14.00			8	ESP	E	Leon, Feranado Sanchez, Luna Francisco	14.00			8	ESP	E	Leon, Feranado Sanchez, Luna Francisco	14.00		
9	JPN	J	Nakamura, Kenji Takahashi, Masayuki	15.00			9	JPN	J	Nakamura, Kenji Takahashi, Masayuki	15.00			9	JPN	J	Nakamura, Kenji Takahashi, Masayuki	15.00			9	JPN	J	Nakamura, Kenji Takahashi, Masayuki	15.00		
10	NOR	N	Johannessen, Herman Horn Jensen, Karl Einar	16.00			10	CAN	KC	Cochrane, Nigel Mcilquham, Gordon	16.00			10	CAN	KC	Cochrane, Nigel Mcilquham, Gordon	16.00			10	CAN	KC	Cochrane, Nigel Mcilquham, Gordon	16.00		
11	CAN	KC	Cochrane, Nigel Mcilquham, Gordon	17.00			11	FRG	G	Hunger, Wolfgang Hunger, Joachim	17.00			11	FRG	G	Hunger, Wolfgang Hunger, Joachim	17.00			11	FRG	G	Hunger, Wolfgang Hunger, Joachim	17.00		
12	USA	US	Shadden, John Mc kee, Charlie	18.00			12	GDR	DDR	Brietzke, Juergen Schulz, Ekkehard	18.00			12	GDR	DDR	Brietzke, Juergen Schulz, Ekkehard	18.00			12	GDR	DDR	Brietzke, Juergen Schulz, Ekkehard	18.00		
13	BRA	BL	Wanderley, Carlos Arndt, Bernardo	19.00			13	ARG	A	Irigoyen, Carlos A Parada, Guillermo P	19.00			13	ARG	A	Irigoyen, Carlos A Parada, Guillermo P	19.00			13	ARG	A	Irigoyen, Carlos A Parada, Guillermo P	19.00		
14	FIN	L	Koskull Von, Peter Koskull Von, Johan	20.00			14	SWE	S	Haggbom, Jonas Liljebblad, Anders	20.00			14	SWE	S	Haggbom, Jonas Liljebblad, Anders	20.00			14	SWE	S	Haggbom, Jonas Liljebblad, Anders	20.00		
15	ARG	A	Irigoyen, Carlos A Parada, Guillermo P	21.00			15	IND	IND	Tarapore, Farokh Rao, Kelly	21.00			15	IND	IND	Tarapore, Farokh Rao, Kelly	21.00			15	IND	IND	Tarapore, Farokh Rao, Kelly	21.00		
16	SWE	S	Haggbom, Jonas Liljebblad, Anders	22.00			16	ISL	IL	Jonasson, Gunnlaugur Fridriksson, Isleifur	22.00			16	ISL	IL	Jonasson, Gunnlaugur Fridriksson, Isleifur	22.00			16	ISL	IL	Jonasson, Gunnlaugur Fridriksson, Isleifur	22.00		
17	SUI	Z	Wicki, Jodok Frey, Andreas	23.00			17	DEN	D	Natorp, Hans Natorp, Paul	23.00			17	DEN	D	Natorp, Hans Natorp, Paul	23.00			17	DEN	D	Natorp, Hans Natorp, Paul	23.00		
18	DEN	D	Natorp, Hans Natorp, Paul	24.00			18	GBR	K	Belben, Jason Hemmings, Andrew	24.00			18	GBR	K	Belben, Jason Hemmings, Andrew	24.00			18	GBR	K	Belben, Jason Hemmings, Andrew	24.00		
19	GBR	K	Belben, Jason Hemmings, Andrew	25.00			19	KOR	FK	Park, Ki-Chul Shin, Kwang-Soo	25.00			19	KOR	FK	Park, Ki-Chul Shin, Kwang-Soo	25.00			19	KOR	FK	Park, Ki-Chul Shin, Kwang-Soo	25.00		
20	IND	IND	Tarapore, Farokh Rao, Kelly	26.00			20	CYP	CP	Karapatakis, Andreas Christoforou, Christos	26.00			20	CYP	CP	Karapatakis, Andreas Christoforou, Christos	26.00			20	CYP	CP	Karapatakis, Andreas Christoforou, Christos	26.00		
21	ISL	IL	Jonasson, Gunnlaugur Fridriksson, Isleifur	27.00			21	SIN	KS	Siew, Shaw Her Chan, Joseph	27.00			21	SIN	KS	Siew, Shaw Her Chan, Joseph	27.00			21	SIN	KS	Siew, Shaw Her Chan, Joseph	27.00		
22	HUN	M	Nyari, Gyula Nyari, Zoltan Zsolt	28.00			22	PAK	PK	Sadiq, Mamoona Rasool, Javed	28.00			22	PAK	PK	Sadiq, Mamoona Rasool, Javed	28.00			22	PAK	PK	Sadiq, Mamoona Rasool, Javed	28.00		
23	SIN	KS	Siew, Shaw Her Chan, Joseph	29.00			23	CHN	CH	Yang, Shanfeng Lin, Bo	29.00		13:49:49	23	CHN	CH	Yang, Shanfeng Lin, Bo	29.00		13:49:49	23	CHN	CH	Yang, Shanfeng Lin, Bo	29.00		13:49:49
24	CHN	CH	Yang, Shanfeng Lin, Bo	30.00			24	AUT	OE	Binder, Christian Hecht, Heimo	36.00	RET		24	AUT	OE	Binder, Christian Hecht, Heimo	36.00	RET		24	AUT	OE	Binder, Christian Hecht, Heimo	36.00	RET	
25	PAK	PK	Sadiq, Mamoona Rasool, Javed	31.00		14:41:40	24	FIN	L	Koskull Von, Peter Koskull Von, Johan	36.00	PMS		24	FIN	L	Koskull Von, Peter Koskull Von, Johan	36.00	PMS		24	FIN	L	Koskull Von, Peter Koskull Von, Johan	36.00	PMS	
26	AUT	OE	Binder, Christian Hecht, Heimo	36.00	RET		24	HUN	M	Nyari, Gyula Nyari, Zoltan Zsolt	36.00	RET		24	HUN	M	Nyari, Gyula Nyari, Zoltan Zsolt	36.00	RET		24	HUN	M	Nyari, Gyula Nyari, Zoltan Zsolt	36.00	RET	
26	CYP	CP	Karapatakis, Andreas Christoforou, Christos	36.00	RET		24	ISR	IS	Torten, Dan-Noam Torten, Ram-Jacob	36.00	DNC		24	ISR	IS	Torten, Dan-Noam Torten, Ram-Jacob	36.00	DNC		24	ISR	IS	Torten, Dan-Noam Torten, Ram-Jacob	36.00	DNC	
26	ISR	IS	Torten, Dan-Noam Torten, Ram-Jacob	36.00	DNC		24	SUI	Z	Wicki, Jodok Frey, Andreas	36.00	RET		24	SUI	Z	Wicki, Jodok Frey, Andreas	36.00	RET		24	SUI	Z	Wicki, Jodok Frey, Andreas	36.00	RET	
26	KOR	RK	Park, Ki-Chul Shin, Kwang-Soo	36.00	DSQ		24	URS	SR	Tyniste, Tynou Tyniste, Toomas	36.00	RET		24	URS	SR	Tyniste, Tynou Tyniste, Toomas	36.00	RET		24	URS	SR	Tyniste, Tynou Tyniste, Toomas	36.00	RET	

Yachting

Yachting

Men 470 Class Summary/Sept. 20-27				Hommes/Classe 470 Sommaire/20-27 Sept									
Rank Rang	Ctry Pays	N.letters N.lettres	Name Nom	Race/Course							Total	Net	
				1	2	3	4	5	6	7			
1	FRA	F	Peponnet, T Pillot, Luc	1	3	1	10	11	5	2	51.70	34.70	
2	URS	SR	Tyniste, Tynou Tyniste, Toomas	11	4	12	1	1	2	RET	82.00	46.00	
3	USA	US	Shadden, John Mc Kee, Charlie	5	2	2	11	5	12	4	69.00	51.00	
4	ESP	E	Leon, Fernando Sanchez, F	4	11	4	4	PMS	1	8	91.00	55.00	
5	FRG	G	Hunger, Wolfgang Hunger, Joachim	2	5	9	13	3	4	11	77.70	58.70	
6	NZL	KZ	Evans, Peter Mander, Simon	3	8	11	18	2	7	5	86.70	62.70	
7	ITA	I	Montefusco, S Montefusco, P	DSQ	1	7	9	15	8	3	104.70	68.70	
8	CAN	KC	Cochrane, Nigel McIlquham, G	8	10	3	2	13	11	10	90.70	71.70	
9	HOL	H	Drontmann, R Drontmann, Mark	6	7	15	7	RET	6	7	119.40	83.40	
10	BRA	BL	Wanderley, C Arndt, Bernardo	7	9	DSQ	19	6	13	1	119.70	83.70	
11	GDR	DDR	Brietzke, J Schulz, Ekkehard	18	15	5	21	4	3	12	113.70	86.70	
12	JPN	J	Nakamura, Kenji Takahashi, M	10	12	8	12	14	9	9	116.00	96.00	
13	NOR	N	Johannessen, H Jensen, K	13	13	10	14	9	10	6	116.70	96.70	
14	SWE	S	Haggborn, Jonas Liljebblad, A	12	16	16	23	10	16	14	149.00	120.00	
15	GBR	K	Belben, Jason Hemmings, Andrew	16	14	13	20	8	19	18	150.00	124.00	
16	FIN	L	Vonkoskull, P Vonkoskull, J	RET	6	6	8	PMS	14	PMS	165.40	129.40	
17	IND	IND	Tarapore, Farokh Rao, Kelly	19	20	19	6	RET	20	15	170.70	134.70	
18	ISR	IS	Torten, Dan-Noam Torten, R	9	RET	14	3	YMP	DNC	DNC	171.20	135.20	
19	ARG	A	Irigoyen, C Parada, G	17	21	23	22	16	15	13	169.00	140.00	
20	SUI	Z	Wicki, Jodok Frey, Andreas	PMS	YMP	17	17	7	17	RET	177.60	141.60	
21	DEN	D	Natorp, Hans Natorp, Paul	14	18	22	PMS	18	18	17	179.00	143.00	
22	ISL	IL	Jonasson, G Fridriksson, I	21	17	20	15	DNF	21	16	182.00	146.00	
23	HUN	M	Nyari, Gyula Nyari, Z	DSQ	23	24	5	12	22	RET	187.00	151.00	
24	AUT	OE	Binder, C Hecht, Heimo	15	19	18	16	17	RET	RET	187.00	151.00	
25	CHN	CH	Yang, Shanfeng Lin, Bo	20	22	21	24	PMS	24	23	206.00	170.00	
26	KOR	RK	Park, Ki-Chul Shin, Kwang-Soo	22	24	27	PMS	19	DSQ	19	213.00	177.00	
27	SIN	KS	Siew, Shaw Her Chan, Joseph	25	27	25	25	RET	23	21	218.00	182.00	
28	CYP	CP	Karapatakis, A Christoforou, C	23	25	26	27	DNF	RET	20	223.00	187.00	
29	PAK	PK	Sadiq, Mamoon Rasool, Javed	24	26	28	26	DNC	25	22	223.00	187.00	

Women 470 Class Race 1/Sept. 20				Hommes/Classe 470 Course 1/20 Sept		
Rank Rang	Ctry Pays	N.letters N.lettres	Name Nom	Points	Note	Time Temps
2	AUS	KA	Green, Nicola Davis, Karyn	3.00		
3	USA	US	Jolly, Allison Jewell, Lynne	5.70		
4	URS	SR	Moskalenko, Larissa Tchounikhovskaia, Irina	8.00		
5	FIN	L	Lemstrom, Bettina Lemstrom, Annika	10.00		
6	DEN	D	Munch, Mette Sorensen, Lone	11.70		
7	GDR	DDR	Theel, Susanne Preuss, Silke	13.00		
8	ESP	E	Gonzalez, Adelina Guerra, Patricia	14.00		
9	FRA	F	Le Brun, Florence Berge, Sophie	15.00		
10	HOL	H	Vegter, Henry Bultman, Marion	16.00		
11	FRG	G	Meyer, Susanne Adlkofer, Katrin	17.00		
12	BRA	BL	Knoth, Cinthia Pellicano, Marcia	18.00		
13	CAN	KC	Johnson, Karen Johnson, Gail	19.00		
14	JPN	J	Nogami, Keiko Saito, Aiko	20.00		
15	IRL	IR	Mac Aleavey, Cathy Byrne, Aisling	21.00		
16	NZL	KZ	Galloway, Fiona Shearer, Janet	22.00		
17	CHN	CH	Chen, Ruili Chen, Xiumei	23.00		
18	MEX	MX	Fierro, Eliane Fierro, Tania	24.00		
19	KOR	RK	Kim, Hye-Sook Han, Jung-Mi	25.00		
20	ITA	I	Bacchiega, Anna Monico, Nives	26.00		13:54:50
21	GBR	K	Jarvis, Debra Hay, Susan	28.00	DSQ	

**Women 470 Class
Race 2/Sept. 21**
**Femmes/Classe 470
Course 2/21 Sept**

Rank Rang	Ctry Pays	N.letters N.lettres	Name Nom	Points	Note	Time Temps
1	USA	US	Jolly, Allison Jewell, Lynne	0.00		14:00:02
2	SWE	S	Soderstrom, Marit Bengtsson, Birgitta	3.00		
3	URS	SR	Moskalenko, Larissa Tchounikhovskaia, Irina	5.70		
4	FIN	L	Lemstrom, Bettina Lemstrom, Annika	8.00		
5	NZL	KZ	Galloway, Fiona Shearer, Janet	10.00		
6	ESP	E	Gonzalez, Adelina Guerra, Patricia	11.70		
7	DEN	D	Munch, Mette Sorensen, Lone	13.00		
8	CAN	KC	Johnson, Karen Johnson, Gail	14.00		
9	GBR	K	Jarvis, Debra Hay, Susan	15.00		
10	ITA	I	Bacchiega, Anna Monico, Nives	16.00		
11	HOL	H	Vegter, Henny Bultman, Marion	17.00		
12	FRG	G	Meyer, Susanne Adlkofer, Katrin	18.00		
13	IRL	IR	Mac Aleavey, Cathy Byrne, Aisling	19.00		
14	AUS	KA	Green, Nicola Davis, Karyn	20.00		
15	FRA	F	Le brun, Florence Berge, Sophie	21.00		
16	JPN	J	Nogami, Keiko Saito, Aiko	22.00		
17	MEX	MX	Fierro, Eliane Fierro, Tania	23.00		14:11:09
18	BRA	BL	Knoth, Cinthia Pellicano, Marcia	28.00	RET	
18	CHN	CH	Chen, Ruili Chen, Xiumei	28.00	DSQ	
18	GDR	DDR	Theel, Susanne Preuss, Silke	28.00	DSQ	
18	KOR	RK	Kim, Hye-Sook Han, Jung-Mi	28.00	RET	

Rank Rang	Ctry Pays	N.letters N.lettres	Name Nom	Points	Note	Time Temps
13	GDR	DDR	Theel, Susanne Preuss, Silke	19.00		
14	AUS	KA	Green, Nicola Davis, Karyn	20.00		
15	GBR	K	Jarvis, Debra Hay, Susan	21.00		
16	BRA	BL	Knoth, Cinthia Pellicano, Marcia	22.00		
17	MEX	MX	Fierro, Eliane Fierro, Tania	23.00		
18	JPN	J	Nogami, Keiko Saito, Aiko	24.00		
19	IRL	IR	Mac Aleavey, Cathy Byrne, Aisling	25.00		
20	CHN	CH	Chen, Ruili Chen, Xiumei	26.00		
21	KOR	RK	Kim, Hye-Sook Han, Jung-Mi	27.00		15:16:51

**Women 470 Class
Race 4/Sept. 23**
**Femmes/Classe 470
Course 4/23 Sept**

Rank Rang	Ctry Pays	N.letters N.lettres	Name Nom	Points	Note	Time Temps
1	URS	SR	Moskalenko, Larissa Tchounikhovskaia, Irina	0.00		13:42:17
2	USA	US	Jolly, Allison Jewell, Lynne	3.00		
3	FRG	G	Meyer, Susanne Adlkofer, Katrin	5.70		
4	FIN	L	Lemstrom, Bettina Lemstrom, Annika	8.00		
5	ESP	E	Gonzalez, Adelina Guerra, Patricia	10.00		
6	GBR	K	Jarvis, Debra Hay, Susan	11.70		
7	CAN	KC	Johnson, Karen Johnson, Gail	13.00		
8	GDR	DDR	Theel, Susanne Preuss, Silke	14.00		
9	ITA	I	Bacchiega, Anna Monico, Nives	15.00		
10	AUS	KA	Green, Nicola Davis, Karyn	16.00		
11	DEN	D	Munch, Mette Sorensen, Lone	17.00		
12	IRL	IR	Mac Aleavey, Cathy Byrne, Aisling	18.00		
13	NZL	KZ	Galloway, Fiona Shearer, Janet	19.00		
14	BRA	BL	Knoth, Cinthia Pellicano, Marcia	20.00		
15	SWE	S	Soderstrom, Marit Bengtsson, Birgitta	21.00		
16	JPN	J	Nogami, Keiko Saito, Aiko	22.00		
17	HOL	H	Vegter, Henny Bultman, Marion	23.00		
18	FRA	F	Le Brun, Florence Berge, Sophie	24.00		
19	MEX	MX	Fierro, Eliane Fierro, Tania	25.00		13:50:12
20	CHN	CH	Chen, Ruili Chen, Xiumei	28.00	DNF	
20	KOR	RK	Kim, Hye-Sook Han, Jung-Mi	28.00	DNF	

**Women 470 Class
Race 3/Sept 22**
**Femmes/Classe 470
Course 3/22 Sept**

Rank Rang	Ctry Pays	N.letters N.lettres	Name Nom	Points	Note	Time Temps
1	USA	US	Jolly, Allison Jewell, Lynne	0.00		15:05:32
2	FIN	L	Lemstrom, Bettina Lemstrom, Annika	3.00		
3	FRG	G	Meyer, Susanne Adlkofer, Katrin	5.70		
4	ESP	E	Gonzalez, Adelina Guerra, Patricia	8.00		
5	FRA	F	Le Brun, Florence Berge, Sophie	10.00		
6	ITA	I	Bacchiega, Anna Monico, Nives	11.70		
7	URS	SR	Moskalenko, Larissa Tchounikhovskaia, Irina	13.00		
8	DEN	D	Munch, Mette Sorensen, Lone	14.00		
9	HOL	H	Vegter, Henny Bultman, Marion	15.00		
10	SWE	S	Soderstrom, Marit Bengtsson, Birgitta	16.00		
11	NZL	KZ	Galloway, Fiona Shearer, Janet	17.00		
12	CAN	KC	Johnson, Karen Johnson, Gail	18.00		

Yachting

Yachting

Women 470 Class Race 5/Sept. 24				Femmes/Classe 470 Course 5/24 Sept		
Rank Rang	Ctry Pays	N.letters N.lettres	Name Nom	Points	Note	Time Temps
1	GDR	DDR	Theel, Susanne Preuss, Silke	0.00		13:18:25
2	AUS	KA	Green, Nicola Davis, Karyn	3.00		
3	URS	SR	Moskalenko, Larissa Tchounikhovskaia, Irina	5.70		
4	FIN	L	Lemstrom, Bettina Lemstrom, Annika	8.00		
5	SWE	S	Soderstrom, Marit Bengtsson, Birgitta	10.00		
6	GBR	K	Jarvis, Debra Hay, Susan	11.70		
7	NZL	KZ	Galloway, Fiona Shearer, Janet	13.00		
8	DEN	D	Munch, Mette Sorensen, Lone	14.00		
9	HOL	H	Vegter, Henny Bultman, Marion	15.00		
10	FRA	F	Le Brun, Florence Berge, Sophie	16.00		
11	ITA	I	Bacchiega, Anna Monico, Nives	17.00		
12	CAN	KC	Johnson, Karen Johnson, Gail	18.00		
13	JPN	J	Nogami, Keiko Saito, Aiko	19.00		
14	MEX	MX	Fierro, Eliane Fierro, Tania	20.00		13:36:07
15	BRA	BL	Knoth, Cinthia Pellicano, Marcia	28.00	RET	
15	CHN	CH	Chen, Ruili Chen, Xiumei	28.00	RET	
15	ESP	E	Gonzalez, Adelina Guerra, Patricia	28.00	RET	
15	FRG	G	Meyer, Susanne Adlkofer, Katrin	28.00	RET	
15	IRL	IR	Mac Aleavey, Cathy Byrne, Aisling	28.00	RET	
15	KOR	RK	Kim, Hye-Sook Han, Jung-Mi	28.00	RET	
15	USA	US	Jolly, Allison Jewell, Lynne	28.00	DSQ	

Women 470 Class Race 6/Sept. 26				Femmes/Classe 470 Course 6/26 Sept		
Rank Rang	Ctry Pays	N.letters N.lettres	Name Nom	Points	Note	Time Temps
1	FRG	G	Meyer, Susanne Adlkofer, Katrin	0.00		14:33:48
2	USA	US	Jolly, Allison Jewell, Lynne	3.00		
3	GDR	DDR	Theel, Susanne Preuss, Silke	5.70		
4	SWE	S	Soderstrom, Marit Bengtsson, Birgitta	8.00		
5	FIN	L	Lemstrom, Bettina Lemstrom, Annika	10.00		
6	FRA	F	Le Brun, Florence Berge, Sophie	11.70		
7	NZL	KZ	Galloway, Fiona Shearer, Janet	13.00		
8	URS	SR	Moskalenko, Larissa Tchounikhovskaia, Irina	14.00		
9	AUS	KA	Green, Nicola Davis, Karyn	15.00		
10	CAN	KC	Johnson, Karen Johnson, Gail	16.00		
11	HOL	H	Vegter, Henny Bultman, Marion	17.00		
12	BRA	BL	Knoth, Cinthia Pellicano, Marcia	18.00		

Rank Rang	Ctry Pays	N.letters N.lettres	Name Nom	Points	Note	Time Temps
13	ITA	I	Bacchiega, Anna Monico, Nives	19.00		
14	GBR	K	Jarvis, Debra Hay, Susan	20.00		
15	CHN	CH	Chen, Ruili Chen, Xiumei	21.00		
16	MEX	MX	Fierro, Eliane Fierro, Tania	22.00		
17	IRL	IR	Mac Aleavey, Cathy Byrne, Aisling	23.00		
18	JPN	J	Nogami, Keiko Saito, Aiko	24.00		
19	KOR	RK	Kim, Hye-Sook Han, Jung-Mi	25.00		14:42:57
20	DEN	D	Munch, Mette Sorensen, Lone	28.00	RET	
20	ESP	E	Gonzalez, Adelina Guerra, Patricia	28.00	DSQ	

Women 470 Class Race 7/Sept. 27				Femmes/Classe 470 Course 7/27 Sept		
Rank Rang	Ctry Pays	N.letters N.lettres	Name Nom	Points	Note	Time Temps
1	AUS	KA	Green, Nicola Davis, Karyn	0.00		13:33:07
2	SWE	S	Soderstrom, Marit Bengtsson, Birgitta	3.00		
3	GDR	DDR	Theel, Susanne Preuss, Silke	5.70		
4	FRA	F	Le Brun, Florence Berge, Sophie	8.00		
5	FRG	G	Meyer, Susanne Adlkofer, Katrin	10.00		
6	NZL	KZ	Galloway, Fiona Shearer, Janet	11.70		
7	URS	SR	Moskalenko, Larissa Tchounikhovskaia, Irina	13.00		
8	CAN	KC	Johnson, Karen Johnson, Gail	14.00		
9	USA	US	Jolly, Allison Jewell, Lynne	15.00		
10	HOL	H	Vegter, Henny Bultman, Marion	16.00		
11	ITA	I	Bacchiega, Anna Monico, Nives	17.00		
12	BRA	BL	Knoth, Cinthia Pellicano, Marcia	18.00		
13	ESP	E	Gonzalez, Adelina Guerra, Patricia	19.00		13:47:31
14	CHN	CH	Chen, Ruili Chen, Xiumei	28.00	RET	
14	DEN	D	Munch, Mette Sorensen, Lone	28.00	RET	
14	FIN	L	Lemstrom, Bettina Lemstrom, Annika	28.00	RET	
14	GBR	K	Jarvis, Debra Hay, Susan	28.00	RET	
14	IRL	IR	Mac Aleavey, Cathy Byrne, Aisling	28.00	RET	
14	JPN	J	Nogami, Keiko Saito, Aiko	28.00	RET	
14	KOR	RK	Kim, Hye-Sook Han, Jung-Mi	28.00	RET	
14	MEX	MX	Fierro, Eliane Fierro, Tania	28.00	RET	



Women 470 Class
Summary/Sept. 20-27

Femmes/Classe 470
Sommaire/20-27 Sept

Rank	Ctry	N.letters	Name	Race/Course							Total	Net
Rang	Pays	N.lettres	Nom	1	2	3	4	5	6	7		
1	USA	US	Jolly, Allison Jewell, Lynne	3	1	1	2	DSQ	2	9	54.70	26.70
2	SWE	S	Soderstrom, M Bengtsson, B	1	2	10	15	5	4	2	61.00	40.00
3	URS	SR	Moskalenko, L Tchounikhovskai	4	3	7	1	3	8	7	59.40	45.40
4	FIN	L	Lemstrom, B Lemstrom, Annika	5	4	2	4	4	5	RET	75.00	47.00
5	FRG	G	Meyer, Susanne Adlkofer, Katrin	11	12	3	3	RET	1	5	84.40	56.40
6	AUS	KA	Green, Nicola Davis, Karyn	2	14	14	10	2	9	1	77.00	57.00
7	GDR	DDR	Theel, Susanne Preuss, Silke	7	DSQ	13	8	1	3	3	85.40	57.40
8	FRA	F	Le Brun, F Berge, Sophie	9	15	5	18	10	6	4	105.70	81.70
9	NZL	KZ	Galloway, Fiona Shearer, Janet	16	5	11	13	7	7	6	105.70	83.70
10	ESP	E	Gonzalez, A Guerra, Patricia	8	6	4	5	RET	DSQ	13	118.70	90.70
11	CAN	KC	Johnson, Karen Johnson, Gail	13	8	12	7	12	10	8	112.00	93.00
12	ITA	I	Bacchiaga, Anna Monico, Nives	20	10	6	9	11	13	11	121.70	95.70
13	HOL	H	Vegter, Henny Bultman, Marion	10	11	9	17	9	11	10	119.00	96.00
14	DEN	D	Munch, Mette Sorensen, Lone	6	7	8	11	8	RET	RET	125.70	97.70
15	GBR	K	Jarvis, Debra Hay, Susan	DSQ	9	15	6	6	14	RET	135.40	107.40
16	BRA	BL	Knoth, Cinthia Pellicano, M	12	RET	16	14	RET	12	12	152.00	124.00
17	JPN	J	Nogami, Keiko Saito, Aiko	14	16	18	16	13	18	RET	159.00	131.00
18	IRL	IR	Mac Aleavey, C Byrne, Aisling	15	13	19	12	RET	17	RET	162.00	134.00
19	MEX	MX	Fierro, Eliane Fierro, Tania	18	17	17	19	14	16	RET	165.00	137.00
20	CHN	CH	Chen, Ruiii Chen, Xiumei	17	DSQ	20	DNF	RET	15	RET	182.00	154.00
21	KOR	RK	Kim, Hye-Sook Han, Jung-Mi	19	RET	21	DNF	RET	19	RET	189.00	161.00



야 구

Baseball/Base-ball



Baseball/Base-ball

Officials/Officiels

International Base-ball Association (IBA)

President/président	Robert E. Smith
Secretary General/secrétaire général	Casper Pielak
Technical Delegates/délégués techniques	

SLOOC Administrative Staff/Personnel Administratif du SLOOC

Commissioner/directeur	Choi In Chul
Secretary General/secrétaire général	Go Ik Dong
Deputy Secretary General/secrétaire général adjoint	Lee Young Sun
Competition Manager/chef de division des compétitions	Hwang Kee Dae

Competitors/Concurrents

Men
Hommes

Competitors
Competiteurs

Countries
Pays

161

8

Legend/Notation

PH	Pinch hitter/Frappeur de remplacement
PR	Pinch runner/Coureur de renplacant
LF	Left fielder/Joueur de champ gauche
CF	Center fielder/Joueur de champ centre
RF	Right fielder/Joueur de champ droit
IB	First baseman/Joueur de premier base
2B	Second baseman/Joueur de deuxieme base
3B	Third baseman/Joueur de troisieme base
SS	Shord Stop/Joueur d'arret court
C	Catcher/Receveur
P	Pitcher/Lanceur
Pos	Fielding position/Position defensive
AB	Times at bat/Passages a la batte
R	Runs/Points
H	Hits/Coups surs
HR	Home Runs
RBI	Runs batted in/Points Produits



Baseball

Preliminary Blue Division Game 1 /Sept. 20

Prelim. Division Bleue Partie 1 /20 Sept

TPE	VS.	HOL																				
(1	—	6)																				
Ctry	1	2	3	4	5	6	7	8	9	10	11	12	13	14	15	16	17	18	19	20	Total	
HOL	0	3	0	0	1	0	0	0	2												6	
TPE	0	0	0	0	1	0	0	0	0												1	

Name	Pos	AB	R	H	RBI	Name	Pos	AB	R	H	RBI				
Chiang, T	LF	3	0	1	0	Halderman, G	C	5	1	2	0				
Lo, Kuo-Chong	2B	4	0	0	1	Bos, Frank	2B	5	0	2	3				
Lin, Tzung-Chiu	D	4	0	2	0	Eenhoorn, Robert	SS	5	0	1	0				
Lee, Chu-Ming	CF	4	0	1	0	Knol, Robert	D	4	1	2	0				
Wang, Kuang-Huei	1B	3	0	1	0	Groot, Bill	1B	4	1	1	0				
Wu, Shih-Hsin	1B	1	0	0	0	Kruyt, Marcel	CF	4	0	0	0				
Wu, Fu-Lien	SS	4	0	0	0	Joost, Marcel	RF	3	1	1	0				
Tseng, Chi-Chen	C	2	0	0	0	Renselaar Van, H	LF	3	1	1	2				
Hong, I-Chung	C	2	0	1	0	Koot, Frank	3B	3	1	0	1				
Hong, Cheng-Chin	3B	3	0	0	0						Total	36	6	10	6
Chen, Chin-Mou	3B	1	0	0	0										
Huang, C	RF	4	1	1	0										

Umpire/Arbitre REYNOLD, MAURICE PERCIVAL (AUS)
 1B ROSARIO, ANIBAL (PUR)
 2B SON, SUNG-HO (KOR)
 3B FUSE, KATSUHISA (JPN)

Preliminary Blue Division Game 2 /Sept. 22

Prelim. Division Bleue Partie 2 /22 Sept

TPE	VS.	JPN																				
(3	—	4)																				
Ctry	1	2	3	4	5	6	7	8	9	10	11	12	13	14	15	16	17	18	19	20	Total	
TPE	0	0	0	0	0	0	3	0	0	0	0	0	0	0							3	
JPN	0	0	0	0	0	1	0	2	0	0	0	0	1							4		

Name	Pos	AB	R	H	RBI	Name	Pos	AB	R	H	RBI			
Chiang, T	LF	5	1	1	2	Nishi, Masafumi	3B	6	0	0	0			
Lo, Kuo-Chong	2B	5	0	2	0	Katsuragi, H	3B	3	0	0	0			
Wu, Shih-Hsin	3B	5	0	0	0	Nomura, Kenjiro	SS	3	1	1	0			
Lin, Tzung-Chiu	D	6	0	1	0	Tsutsui, Daisuke	RF	5	2	2	0			
Wu, Fu-Lien	SS	5	0	0	0	Nakajima, T	1B	5	0	4	2			
Hong, I-Chung	C	6	0	2	0	Omori, Takeshi	D	6	0	2	1			
Lee, Chu-Ming	CF	4	1	1	0	Tomashino, Kenji	PR	0	1	0	0			
Wang, Kuang-Huei	1B	6	0	2	0	Matsumoto, Y	LF	6	0	2	0			
Lin, I-Tseng	RF	4	1	0	1	Ogawa, Hirofumi	2B	4	0	1	0			
										Total	48	4	15	4

Umpire/Arbitre UM, CHANG-JOO (KOR)
 1B REYNOLD, MAURICE PERCIVAL (AUS)
 2B ROSARIO, ANIBAL (PUR)
 3B LEE, JONG-SUL (KOR)

Preliminary Blue Division Game 3 /Sept. 24

Prelim. Division Bleue Partie 3 /24 Sept

TPE	VS.	PUR																				
(0	—	2)																				
Ctry	1	2	3	4	5	6	7	8	9	10	11	12	13	14	15	16	17	18	19	20	Total	
TPE	0	0	0	0	0	0	0	0	0												0	
PUR	0	0	0	0	2	0	0	0	X												2	

Name	Pos	AB	R	H	RBI	Name	Pos	AB	R	H	RBI				
Lo, Kuo-Chong	2B	4	0	1	0	Robles, Jorge	3B	3	0	0	0				
Wu, Fu-Lien	SS	2	0	1	0	Ramos, Luis	SS	3	0	0	0				
Chen, Chin-Mou	PH	1	0	0	0	Morales, A	CF	3	0	0	0				
Chiang, T	LF	2	0	0	0	Garcia, Efrain	1B	3	0	0	0				
Hong, Cheng-Chin	PH	1	0	0	0	Horrio, Eddie	LF	3	1	1	0				
Wu, Shih-Hsin	3B	3	0	0	0	Bracero, Albert	D	3	1	1	0				
Lin, Tzung-Chiu	D	3	0	2	0	Garcia, Anthony	RF	3	0	1	0				
Hong, I-Chung	C	2	0	0	0	Lorenzana, Jose	C	3	0	0	0				
Tseng, Chi-Chen	C	1	0	0	0	Santana, Roberto	2B	3	0	1	0				
Lee, Chu-Ming	CF	3	0	0	0						Total	27	2	4	0
Lin, I-Tseng	RF	3	0	1	0										
Wang, Kuang-Huei	1B	2	0	0	0										
Huang, C	1B	1	0	0	0										

Umpire/Arbitre RIGGERS, MICHAEL (USA)
 1B CRESSMAN, JAMES DOUGLAS (CAN)
 2B PIETERS, CHRIS (HOL)
 3B LIM, GYONG-GO (KOR)

Base-ball

Preliminary Blue Division Game 4 /Sept. 24

Prelim. Division Bleue Partie 4 /24 Sept

HOL	VS.	JPN																				
(1	—	6)																				
Ctry	1	2	3	4	5	6	7	8	9	10	11	12	13	14	15	16	17	18	19	20	Total	
JPN	2	0	0	2	0	0	0	2	0												6	
HOL	0	0	0	0	0	0	0	0	1												1	

Name	Pos	AB	R	H	RBI	Name	Pos	AB	R	H	RBI				
Halderman, G	C	3	0	0	0	Katsuragi, H	3B	4	0	0	0				
Stoovelaar, R	C	1	0	0	0	Yonezaki, Kunji	SS	1	1	0	0				
Faneyte, Rikkert	CF	4	0	1	0	Nomura, Kenjiro	SS	3	0	0	0				
Eenhoorn, Robert	SS	4	0	1	0	Tsutsui, Daisuke	RF	5	1	2	0				
Knol, Robert	2B	4	1	1	0	Nakajima, T	1B	5	1	2	1				
Groot, Bill	1B	4	0	2	0	Omori, Takeshi	D	3	0	1	1				
Kruyt, Marcel	CF	2	0	0	0	Matsumoto, Y	LF	4	2	1	1				
Bruin De, Eric	LF	2	0	0	0	Ogawa, Hirofumi	2B	4	1	3	1				
Joost, Marcel	RF	3	0	0	0	Furuta, Atsuya	C	3	0	0	1				
Leeuw De, Alfred	PH	1	0	0	0	Otake, Atsuyoshi	C	1	0	0	0				
Jacoba, Jacky	D	1	0	0	0	Tomashino, Kenji	CF	4	0	1	1				
Koot, Frank	3B	3	0	1	0						Total	37	6	10	6

Umpire/Arbitre SON, SUNG-HO (KOR)
 1B ROSARIO, ANIBAL (PUR)
 2B REYNOLD, MAURICE PERCIVAL (AUS)
 3B UM, CHANG-JOO (KOR)

Preliminary Blue Division Game 5 /Sept. 22

Prelim. Division Bleue Partie 5 /22 Sept

HOL	VS.	PUR																				
(4	—	7)																				
Ctry	1	2	3	4	5	6	7	8	9	10	11	12	13	14	15	16	17	18	19	20	Total	
PUR	1	1	1	0	0	1	1	2	0												7	
HOL	0	0	0	0	1	2	1	0	0												4	

Name	Pos	AB	R	H	RBI	Name	Pos	AB	R	H	RBI			
Halderman, G	C	4	1	2	0	Robles, Jorge	3B	4	2	4	1			
Bos, Frank	2B	5	0	1	0	Ramos, Luis	SS	4	1	2	2			
Eenhoorn, Robert	SS	5	0	1	0	Morales, A	CF	4	0	3	1			
Knol, Robert	3B	4	1	2	1	Garcia, Efrain	1B	4	0	0	0			
Groot, Bill	1B	4	1	1	2	Horrio, Eddie	LF	5	0	0	0			
Kruyt, Marcel	CF	4	0	1	0	Bracero, Albert	D	4	1	2	0			
Joost, Marcel	RF	4	0	2	0	Garcia, Anthony	RF	4	1	2	1			
Faneyte, Rikkert	LF	4	1	1	0	Lorenzana, Jose	C	5	1	2	1			
Jacoba, Jacky	D	4	0	1	1	Santana, Roberto	2B	5	1	2	0			
										Total	38	4	12	4

Umpire/Arbitre CRESSMAN, JAMES DOUGLAS (CAN)
 1B RIGGERS, MICHAEL (USA)
 2B LIM, GYONG-GO (KOR)
 3B SON, SUNG-HO (KOR)

Preliminary Blue Division Game 6 /Sept. 20

Prelim. Division Bleue Partie 6 /20 Sept

JPN	VS.	PUR																				
(7	—	1)																				
Ctry	1	2	3	4	5	6	7	8	9	10	11	12	13	14	15	16	17	18	19	20	Total	
PUR	0	0	0	1	0	0	0	0	0												1	
JPN	3	0	3	0	0	0	1	0	X												7	

Name	Pos	AB	R	H	RBI	Name	Pos	AB	R	H	RBI				
Katsuragi, H	3B	4	0	0	0	Robles, Jorge	3B	4	1	1	0				
Nishi, Masafumi	SS	4	3	3	0	Ramos, Luis	SS	4	0	1	0				
Yonezaki, Kunji	SS	0	0	0	0	Morales, A	CF	3	0	0	0				
Tsutsui, Daisuke	1B	4	1	1	0	Garcia, Efrain	1B	3	0	0	0				
Nakajima, T	1B	3	2	2	2	Poupart, B	D	2	0	0	0				
Tomashino, Kenji	LF	0	0	0	0	Garcia, Anthonny	PH	1	0	0	0				
Omori, Takeshi	D	4	1	1	2	Horrio, Eddie	RF	3	0	1	0				
Matsumoto, Y	RF	4	0	2	2	Davila, Luis O.	LF	3	0	0	0				
Ogawa, Hirofumi	2B	4	0	2	0	Lorenzana, Jose	C	3	0	0	0				
Furuta, Atsuya	C	4	0	2	0	Santana, Roberto	2B	3	0	1	0				
Maeda, Makoto	CF	3	0	1	0						Total	29	1	4	0

Umpire/Arbitre CRESSMAN, JAMES DOUGLAS (CAN)
 1B RIGGERS, MICHAEL (USA)
 2B LIM, GYONG-GO (KOR)
 3B PIETERS, CHRIS (HOL)

Baseball

Semi-final Game 1 /Sept. 26

JPN	VS.	KOR																			
(3	—	1)																			
Ctry	1	2	3	4	5	6	7	8	9	10	11	12	13	14	15	16	17	18	19	20	Total
KOR	0	0	0	0	0	0	0	1	0	0											1
JPN	0	0	0	0	0	0	1	2	X											3	

Name	Pos	AB	R	H	RBI	Name	Pos	AB	R	H	RBI
Katsuragi, H	3B	3	1	0	0	Baek, Jae-Woo	CF	4	0	0	0
Nishi, Masafumi	SS	4	0	1	1	Kwon, Taek-Jae	1B	3	0	0	0
Tsutsui, Daisuke	RF	4	0	0	0	Kang, Ki-Woong	D	3	1	2	0
Nakajima, T	1B	4	1	1	1	Roh, Chan-Yup	LF	4	0	2	0
Omori, Takeshi	D	3	0	0	0	Choi, Hae-Myoung	2B	4	0	0	0
Ogawa, Hirofumi	2B	3	0	0	0	Lee, Suk-Jae	RF	2	0	0	0
Matsumoto, Y	LF	3	1	1	0	Choi, Hoon-Jae	RF	2	0	1	1
Furuta, Atsuya	C	2	0	1	1	Kang, Young-Soo	3B	3	0	0	0
Maeda, Makoto	CF	2	0	1	0	Kim, Dong-Soo	PH	1	0	0	0
						Hwang, Dae-Yeon	SS	3	0	1	0
						Kim, Kyung-Ki	PH	1	0	0	0
						Chang, Ho-ick	C	2	0	0	0
						Kim, Tae-Hyung	C	0	0	0	0
Total		28	3	5	3	Total		32	1	6	1

Umpire/Arbitre RIGGERS, MICHAEL (USA)
 1B ROSARIO, ANIBAL (PUR)
 2B CHEN, YON KAO (TPE)
 3B REYNOLD, MAURICE PERCIVAL (AUS)

Semi-final Game 2 /Sept. 26

USA	VS.	PUR																			
(7	—	2)																			
Ctry	1	2	3	4	5	6	7	8	9	10	11	12	13	14	15	16	17	18	19	20	Total
PUR	0	0	0	1	0	0	0	0	1											2	
USA	4	1	0	0	0	0	2	0	X											7	

Name	Pos	AB	R	H	RBI	Name	Pos	AB	R	H	RBI
Griffin, Tyrome	2B	4	2	2	2	Robles, Jorge	3B	4	0	1	0
Barberie, Bret	2B	0	0	0	0	Rosario, Abimael	3B	1	0	0	1
Fiore, Mitchell	LF	3	1	0	0	Ramos, Luis	SS	5	0	0	0
Ventura, Robin	3B	4	1	2	1	Morales, A	CF	4	0	1	0
Martinez, Tino	1B	3	1	1	0	Garcia, Efrain	1B	4	1	2	0
Wood, Edward	RF	4	0	1	1	Horrio, Eddie	LF	4	0	1	1
Sprague, Edward	D	4	0	1	1	Bracero, Albert	D	4	0	1	0
Silvestri, David	SS	4	0	0	0	Garcia, Anthony	RF	4	1	1	0
Goodwin, Tom	CF	3	0	0	0	Lorenzana, Jose	C	3	0	2	0
Servais, Scott	C	2	2	1	0	Mateo, Roberto	PR	0	0	0	0
						Santana, Roberto	2B	3	0	0	0
Total		31	7	8	5	Total		36	2	9	2

Umpire/Arbitre CRESSMAN, JAMES DOUGLAS (CAN)
 1B PIETERS, CHRIS (HOL)
 2B FUSE, KATSUHISA (JPN)
 3B LIM, GYONG-GO (KOR)

Final (1-2 Places) /Sept. 28

JPN	VS.	USA																			
(3	—	5)																			
Ctry	1	2	3	4	5	6	7	8	9	10	11	12	13	14	15	16	17	18	19	20	Total
USA	0	0	0	3	1	0	0	1	0											5	
JPN	0	1	0	0	0	2	0	0	0											3	

Name	Pos	AB	R	H	RBI	Name	Pos	AB	R	H	RBI
Katsuragi, H	3B	2	0	0	0	Griffin, Tyrome	2B	4	1	2	0
Nomura, Kenjiro	SS	3	0	1	0	Barberie, Bret	2B	0	0	0	0
Nishi, Masafumi	3B	5	0	1	0	Fiore, Mitchell	LF	5	0	0	0
Tsutsui, Daisuke	RF	4	0	0	0	Ventura, Robin	3B	4	1	1	0
Nakajima, T	1B	4	1	1	0	Martinez, Tino	1B	4	2	3	4
Omori, Takeshi	D	4	2	3	0	Wood, Edward	RF	4	1	2	0
Ogawa, Hirofumi	2B	4	0	1	0	Goodwin, Tom	CF	4	0	1	0
Matsumoto, Y	LF	3	0	0	1	Sprague, Edward	D	4	0	0	0
Furuta, Atsuya	C	2	0	0	1	Silvestri, David	SS	4	0	1	1
Maeda, Makoto	CF	1	0	0	0	Robbins, Douglas	C	4	0	1	0
Tomashino, Kenji	CF	2	0	0	1						
Total		34	3	7	3	Total		37	5	11	5

Umpire/Arbitre ROSARIO, ANIBAL (PUR)
 1B CRESSMAN, JAMES DOUGLAS (CAN)
 2B LIM, GYONG-GO (KOR)
 3B SON, SUNG-HO (KOR)

Base-ball

Final (3-4 Places) /Sept. 28

KOR	VS.	PUR																			
(0	—	7)																			
Ctry	1	2	3	4	5	6	7	8	9	10	11	12	13	14	15	16	17	18	19	20	Total
PUR	0	0	0	1	0	4	2	0	0											7	
KOR	0	0	0	0	0	0	0	0	0											0	

Name	Pos	AB	R	H	RBI	Name	Pos	AB	R	H	RBI
Baek, Jae-Woo	CF	4	0	0	0	Robles, Jorge	3B	5	0	1	0
Kwon, Taek-Jae	1B	4	0	2	0	Ramos, Luis	SS	4	0	1	0
Kang, Ki-Woong	D	4	0	2	0	Morales, A	CF	4	2	1	1
Roh, Chan-Yup	LF	4	0	0	0	Garcia, Efrain	1B	5	2	1	2
Choi, Hoon-Jae	RF	3	0	0	0	Garcia, Anthony	RF	3	1	3	0
Choi, Hae-Myoung	2B	3	0	0	0	Bracero, Albert	D	3	1	1	1
Kim, Dong-Soo	C	3	0	0	0	Horrio, Eddie	LF	4	1	1	1
Kang, Young-Soo	3B	2	0	0	0	Lorenzana, Jose	C	4	0	1	2
Hwang, Dae-Yeon	SS	2	0	0	0	Santana, Roberto	2B	3	0	1	0
Total		29	0	4	0	Total		35	7	11	7

Umpire/Arbitre PIETERS, CHRIS (HOL)
 1B RIGGERS, MICHAEL (USA)
 2B CHEN, YON KAO (TPE)
 3B FUSE, KATSUHISA (JPN)

Preliminary Round Robin /Sept. 19-28

Blue Division/Division Bleue					White Division/Division Blanche			
	TPE	HOL	JPN	PUR	AUS	CAN	KOR	USA
TPE	*	1-6	3-4	0-2	AUS	*	7-6	1-2
HOL	6-1	*	1-6	4-7	CAN	6-7	*	3-5
JPN	4-3	6-1	*	7-1	KOR	2-1	5-3	*
PUR	2-0	7-4	1-7	*	USA	12-2	7-8	5-3

* Division Standing/Classement dans les Divisions

Blue Division/Division Bleue							White Division/Division Blanche										
Rank	Ctry	GP	W	L	T	For	Los	W.Pct	Rank	Ctry	GP	W	L	T	For	Los	W.Pct
1	JPN	3	3	0	0	17	5	1.00	1	USA	3	2	1	0	24	13	0.67
2	PUR	3	2	1	0	10	11	0.67	2	KOR	3	2	1	0	10	9	0.67
3	HOL	3	1	2	0	11	14	0.33	3	AUS	3	1	2	0	10	20	0.33
4	TPE	3	0	3	0	4	12	0.00	4	CAN	3	1	2	0	17	19	0.33

2. Tournament System (Semi-final, Final)/Systeme tournoi (Demi-finale, Finale)

	Match-No	Team Home	VS	Team Vist.	Schedule	Results
Semi-final/	8001	JPN	VS	KOR	9/26 10:00	3-1
Demi-finale	8002	USA	VS	PUR	9/26 14:01	7-2
Final/	9001	JPN	VS	USA	9/28 14:00	3-5
Finale	9002	KOR	VS	PUR	9/28 10:00	0-7

* Final Standing/Classement Final

Medal	Rank	Ctry
Gold/Or	1	United States of America
Silver/Argent	2	Japan
Bronze	3	Puerto Rico
	4	Korea



태권도

Taekwondo/Taekwondo



Taekwondo/Taekwondo

Officials/Officiels

The World Taekwondo Federation (W.T.F.)

President/président	Kim Un Yong
Secretary General/secrétaire général	Chong Ho Bae
Technical Delegates/délégués techniques	Kang Won Sik Song Sang Keun

SLOOC Administrative Staff/Personnel Administratif du SLOOC

Commissioner/directeur	Kim Un Yong
Secretary General/secrétaire général	Uhm Wbon Kyu
Deputy Secretary General/secrétaire général adjoint	Jun Hyo Sik
Competition Manager/chef de division des compétitions	Hwang Choon Seong

Competitors/Concurrents

Men Hommes	Competitors Competiteurs	Countries Pays
Fin Weight/Mi-mouche (-50 Kg)	16	16
Fly Weight/Mouche (50-54 kg)	16	16
Bantam Weight/Coq (54-58 kg)	14	14
Feather Weight/plume (58-64 kg)	15	15
Light Weight/leger (64-70 kg)	14	14
Welter Weight/Wetler (70-76 kg)	16	16
Middle Weight/Moyen(76-83 kg)	16	16
Heavy Weight/Lourd (+ 83 kg)	13	13

Women Femmes	Competitors Competiteurs	Countries Pays
Fin Weight/Mi-mouche (-43 kg)	8	8
Fly Weight/Mouche (43-47 kg)	8	8
BantamWeight/Coq (47-51 kg)	8	8
Feather Weight/Plume (51-55 kg)	8	8
Light Weight/Léger (55-60 kg)	8	8
Welter Weight/Welter (60-65 kg)	7	7
MiddleWeight/Moyen (65-70 kg)	8	8
Heavy Weight/Lourd (+70 kg)	8	8

Legend/Notation

PTS	Won by points/Victoire aux Points
SUP	Won by Superiority/Victoire par Superiorite
DIS	Opponent did not participate in weigh-in
RSC	Won by Referee Stopping the Contest/Victoire par Arrêt de l'arbitre
INJ	Won by Injury/Victoire par Blessure
KO	Won by Knock-Out/Victoire par Knock-Out
WIT	Won by Withdraw/Victoire par Abandon
BYE	An Unearned Win/Gain du Match Sans Combat



Taekwondo

Taekwondo

Men Fin Weight -50Kg
Competition Summary

Hommes/Mi-Mouche -50Kg
Tableau de la Competition

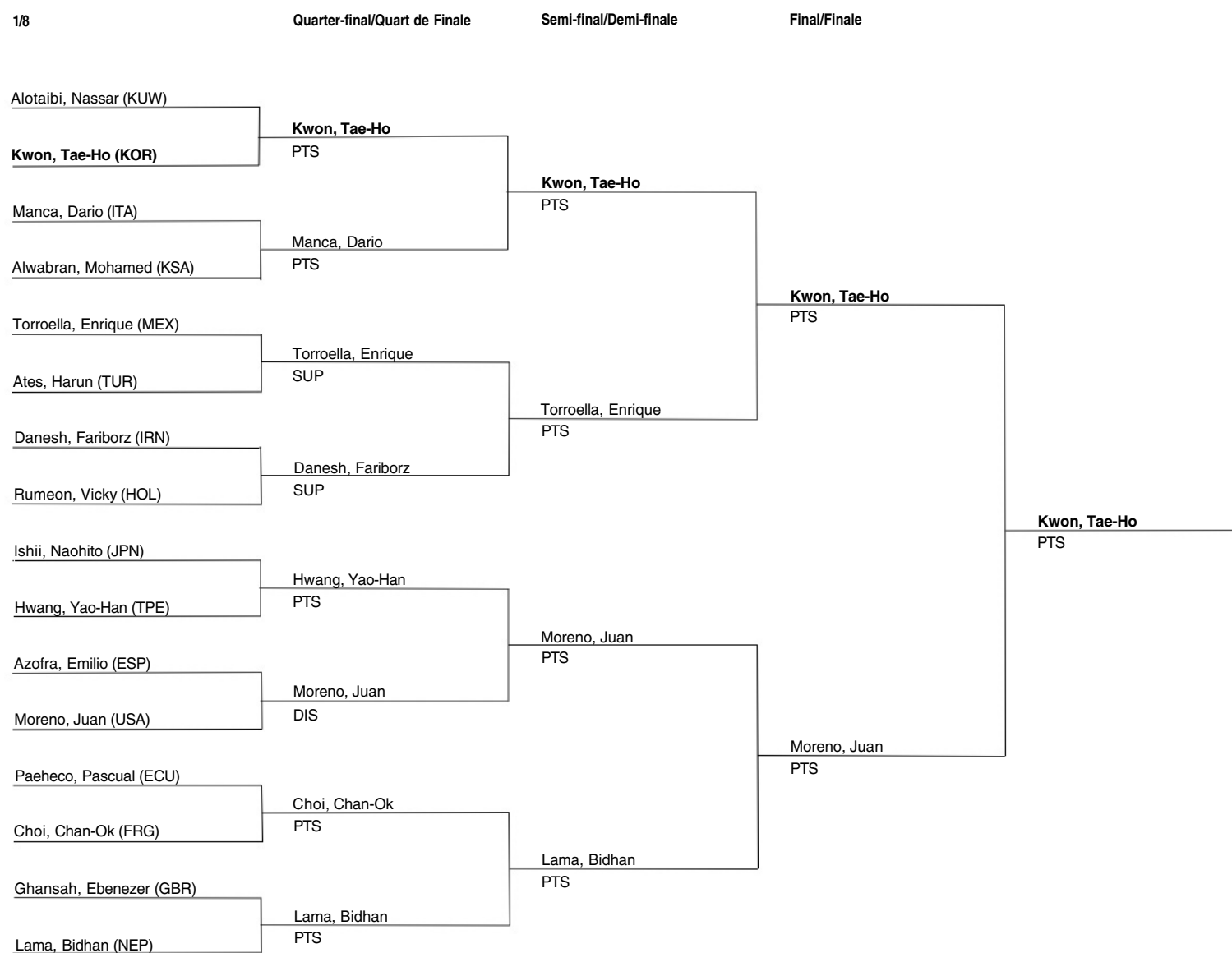

Women Fin Weight -43Kg
Competition Summary

Femmes/Mi-Mouche -43Kg
Tableau de la Competition

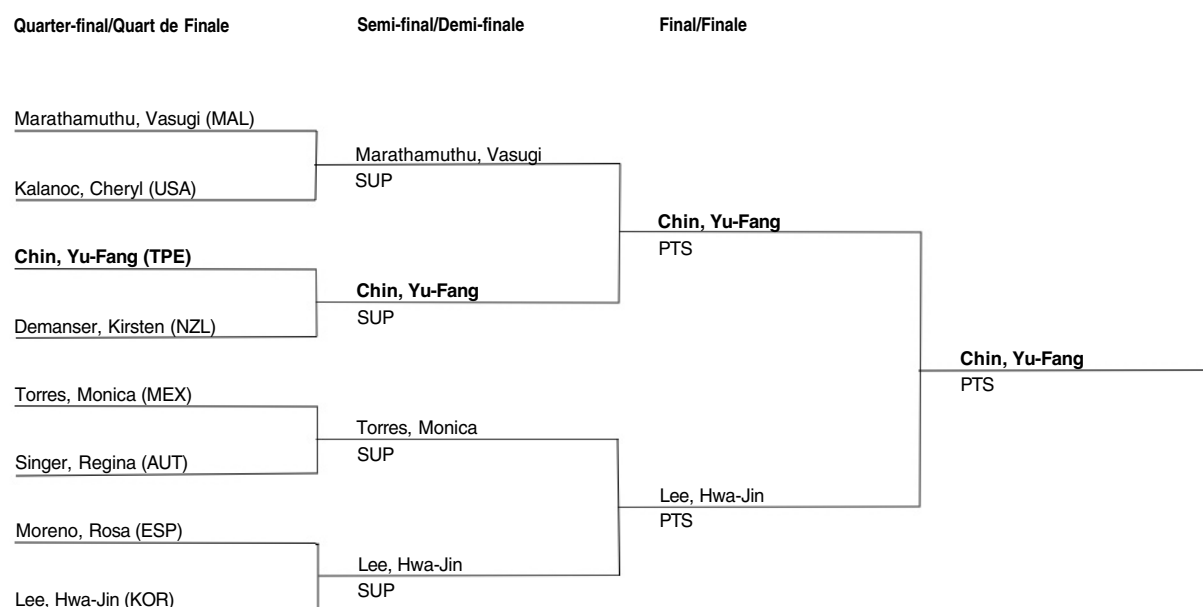



Men Fly Weight 50Kg-54Kg
Competition Summary

Hombres/Mouche 50Kg-54Kg
Tableau de la Competition

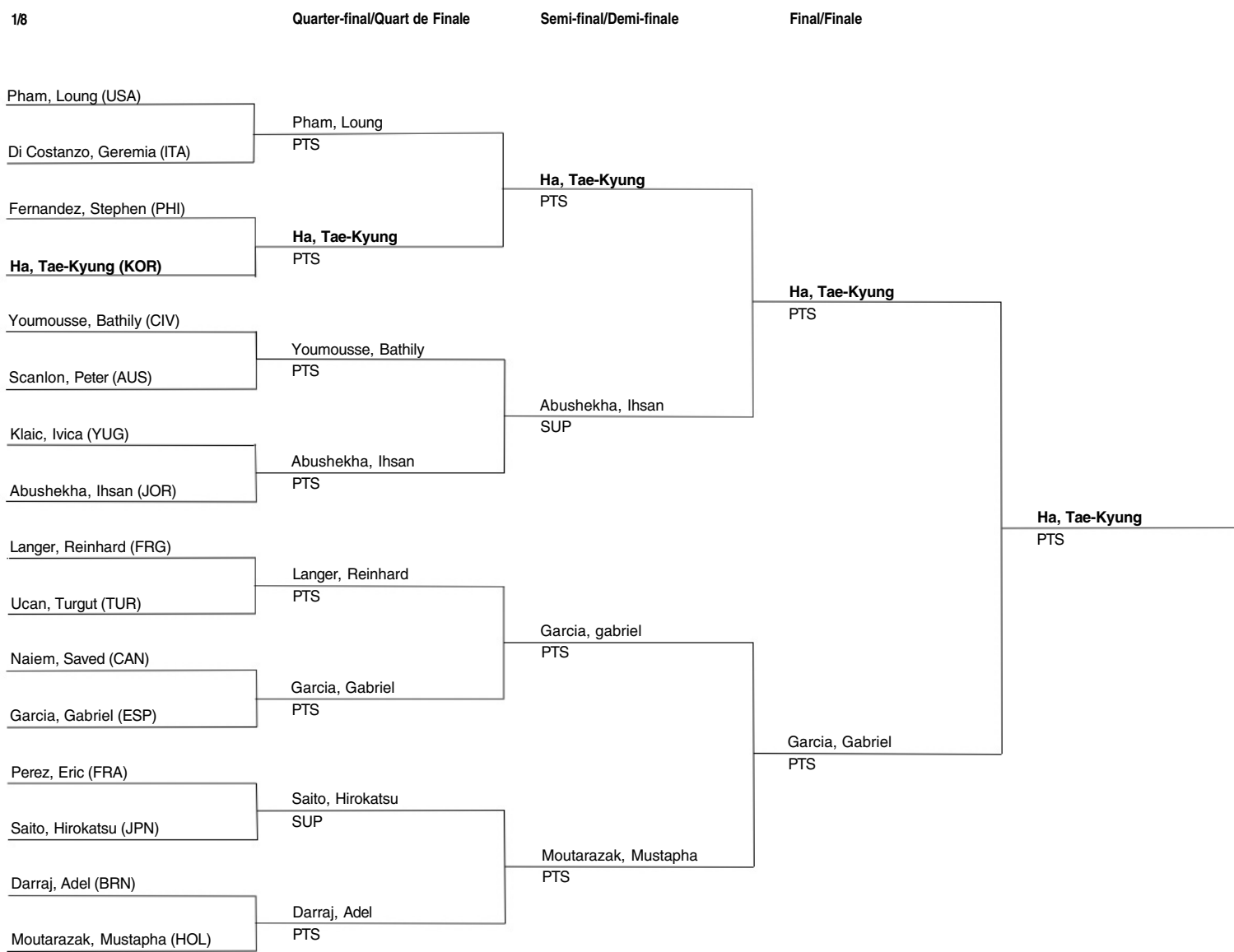

Women Fly Weight 43Kg-47Kg
Competition Summary

Femmes/Mouche 43Kg-47Kg
Tableau de la Competition

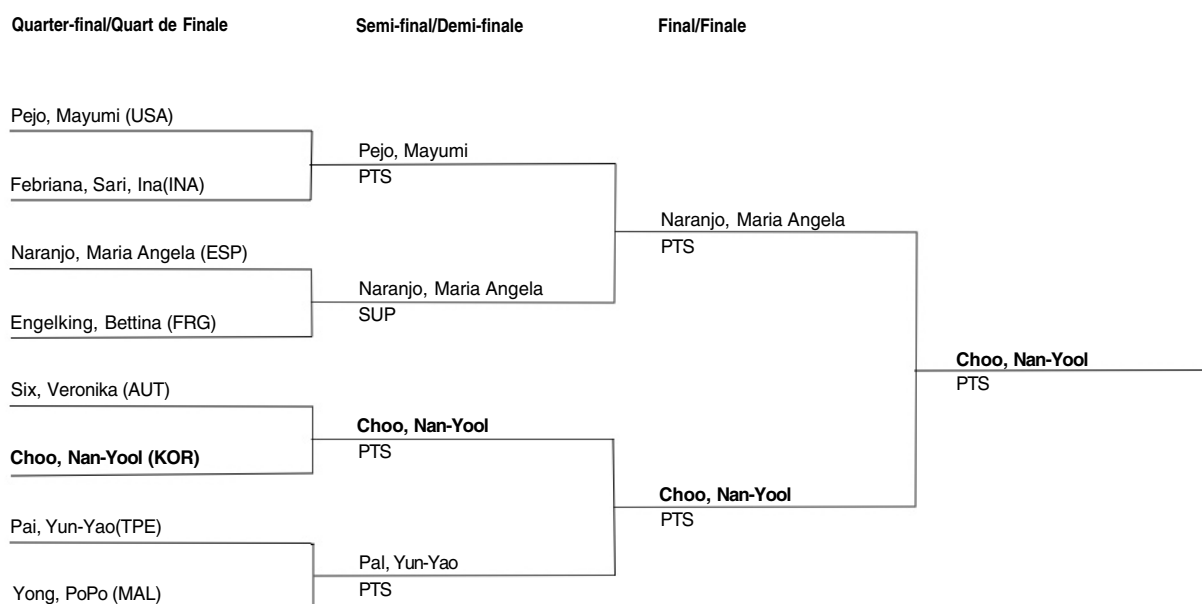

Taekwondo

Taekwondo

Men Bantam Weight 54Kg-58Kg
Competition Summary

Hommes/Coq 54Kg-58Kg
Tableau de la Competition

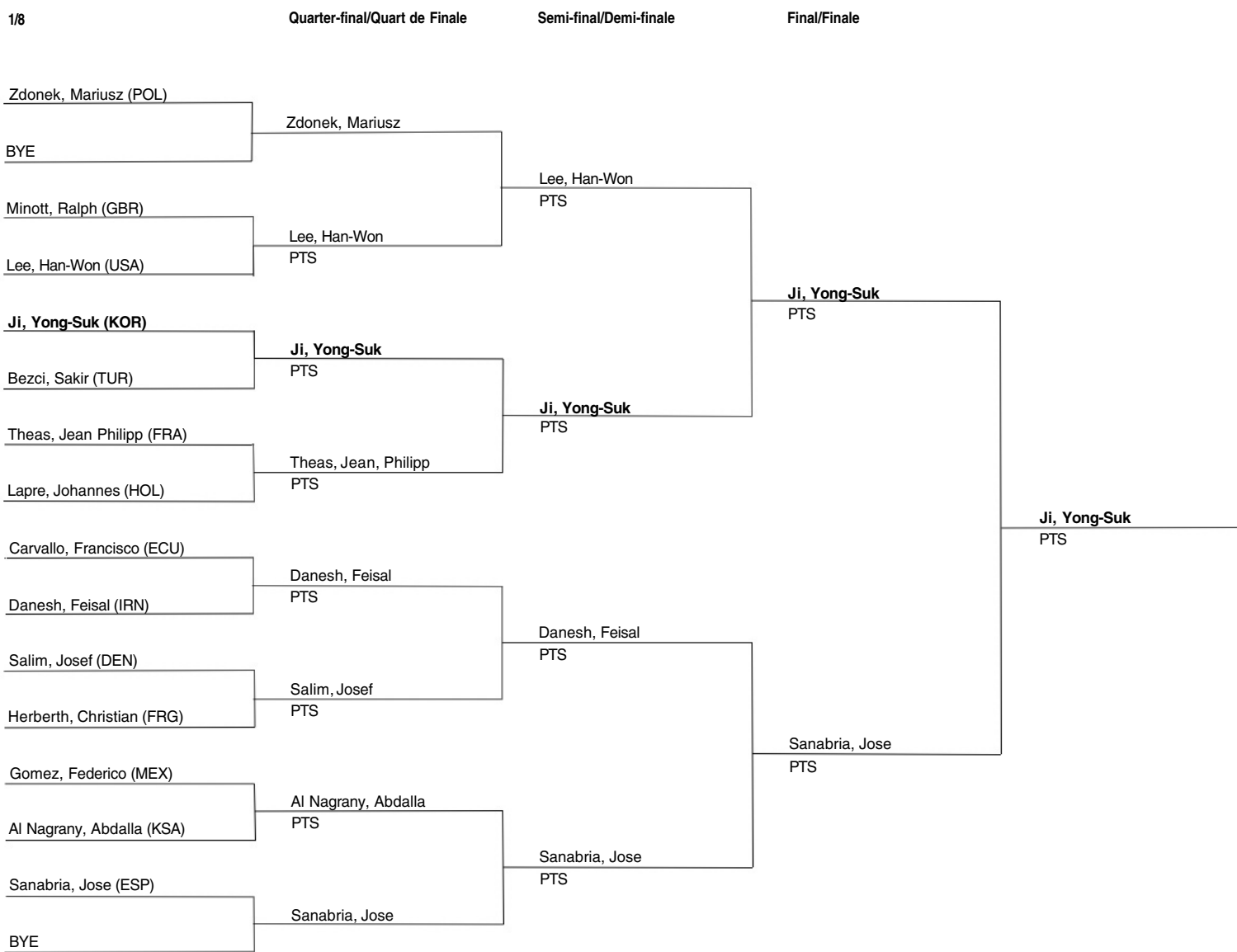

Women Bantam Weight 47Kg-51 Kg
Competition Summary

Femmes/Coq 47Kg-51Kg
Tableau de la Competition

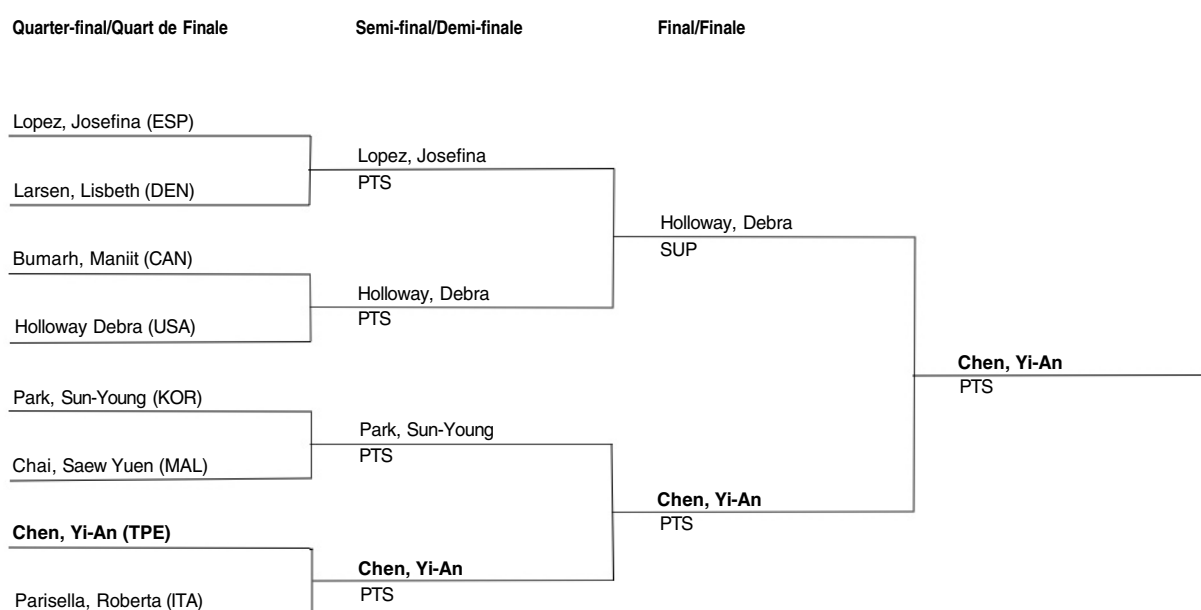



Men Feather Weight 58Kg-64Kg
Competition Summary

Hommes/Pluem 58Kg-64Kg
Tableau de la Competition

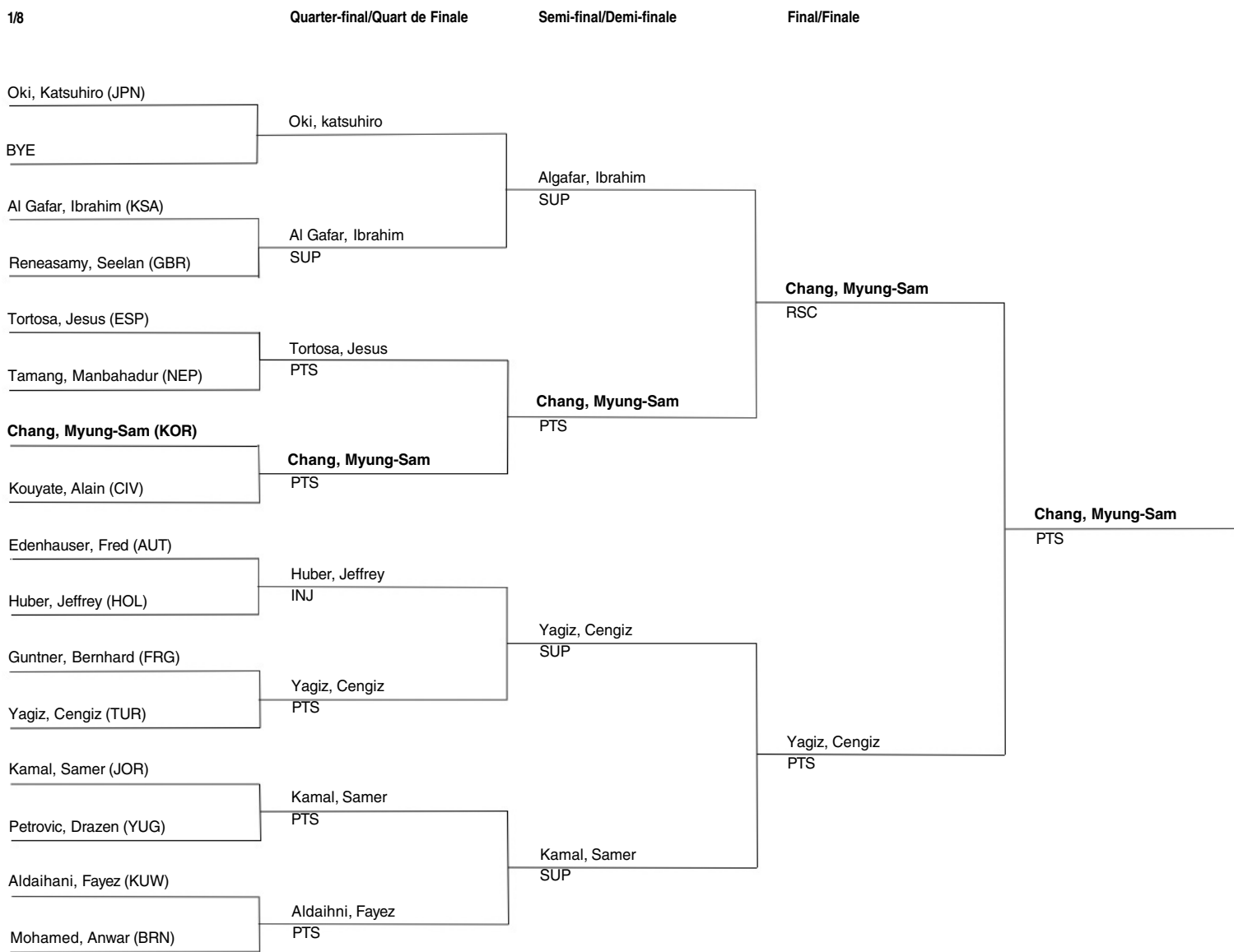

Women Feather Weight 51Kg-55Kg
Competition Summary

Femmes/Plume 51Kg-55Kg
Tableau de la Competition

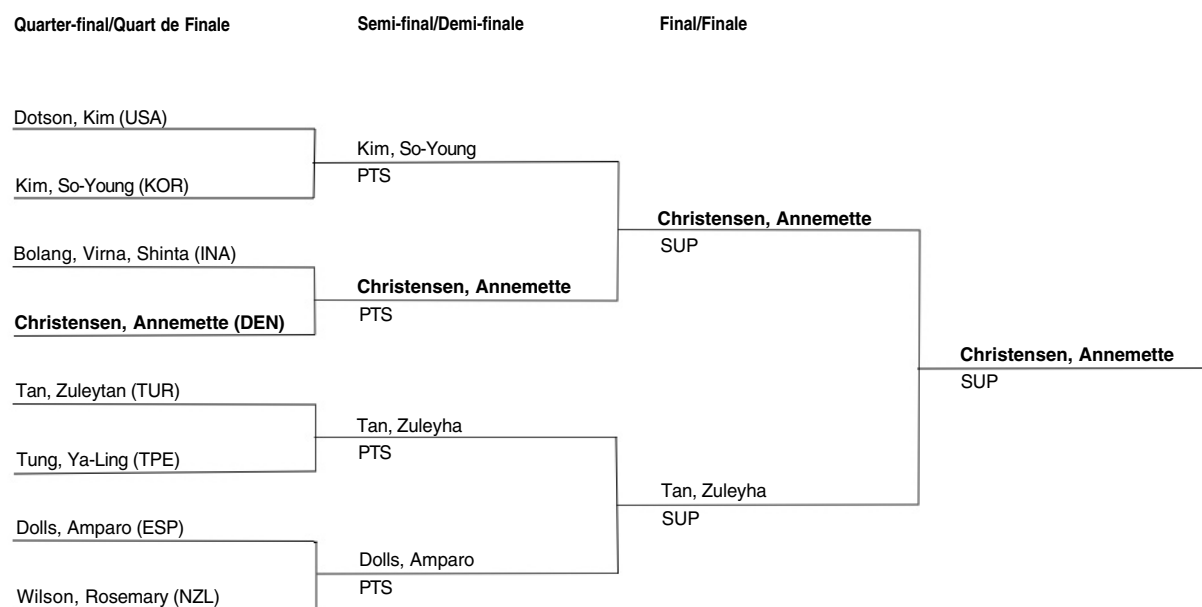

Taekwondo

Taekwondo

Men Light Weight 64Kg-70Kg
Competition Summary

Hommes/Leger 64Kg-70Kg
Tableau de la Competition

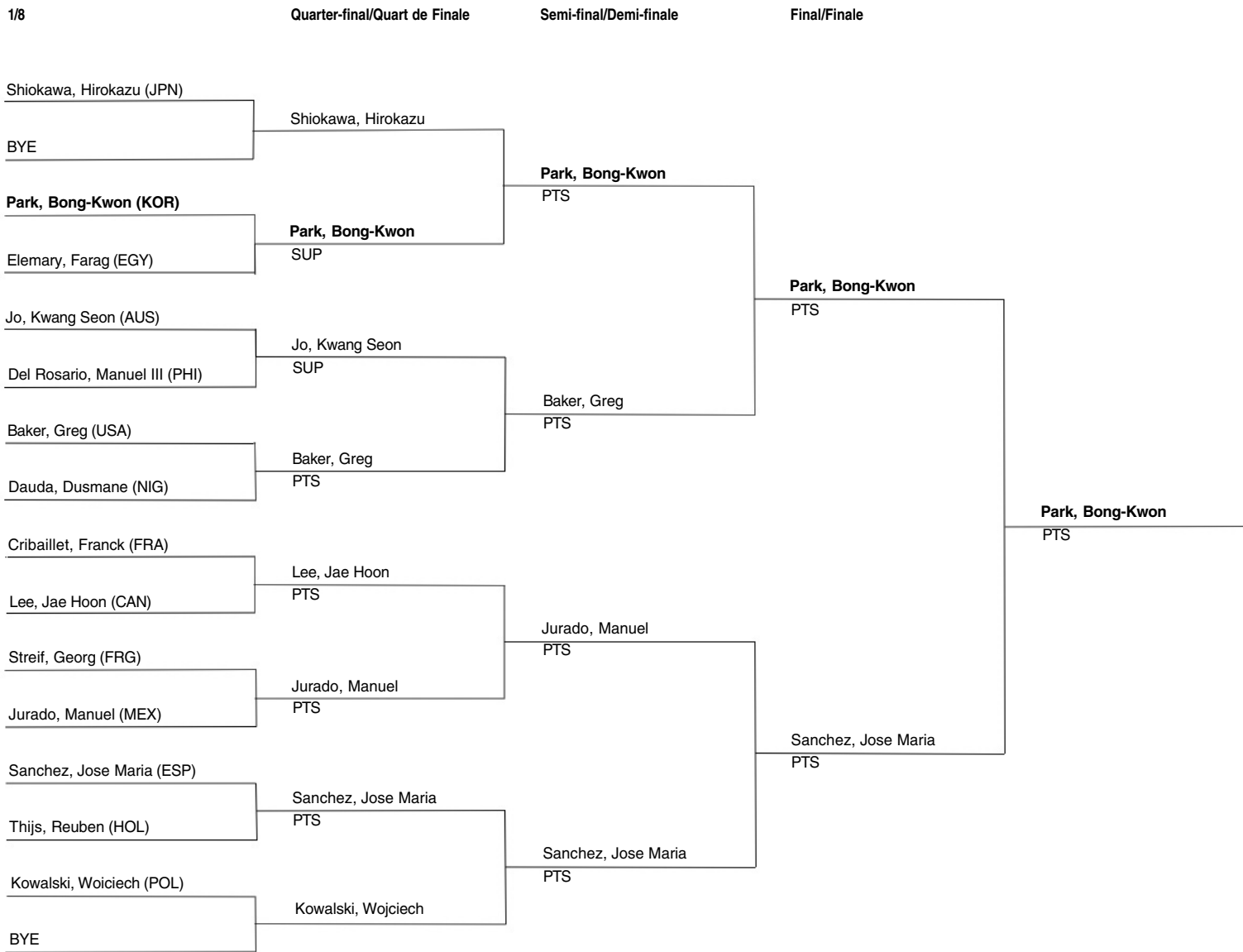

Women Light Weight 55Kg-60Kg
Competition Summary

Femmes/Leger 55Kg-60Kg
Tableau de la Competition

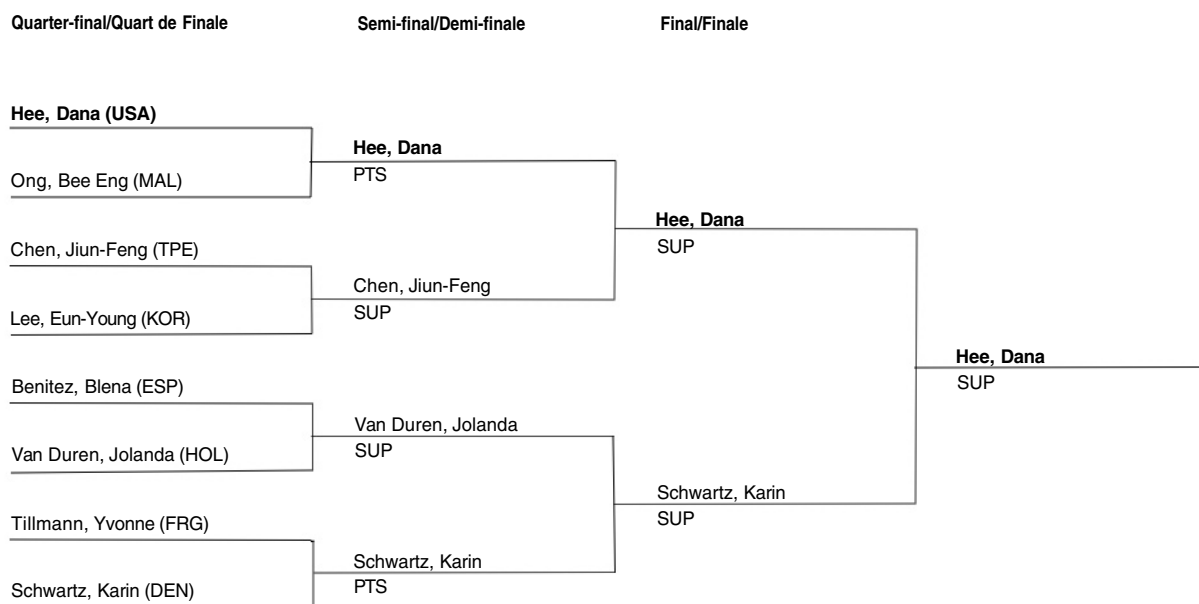



Men Welter Weight 70Kg-76Kg
Competition Summary

Hommes/Welter 70Kg-76kg
Tableau de la Competition

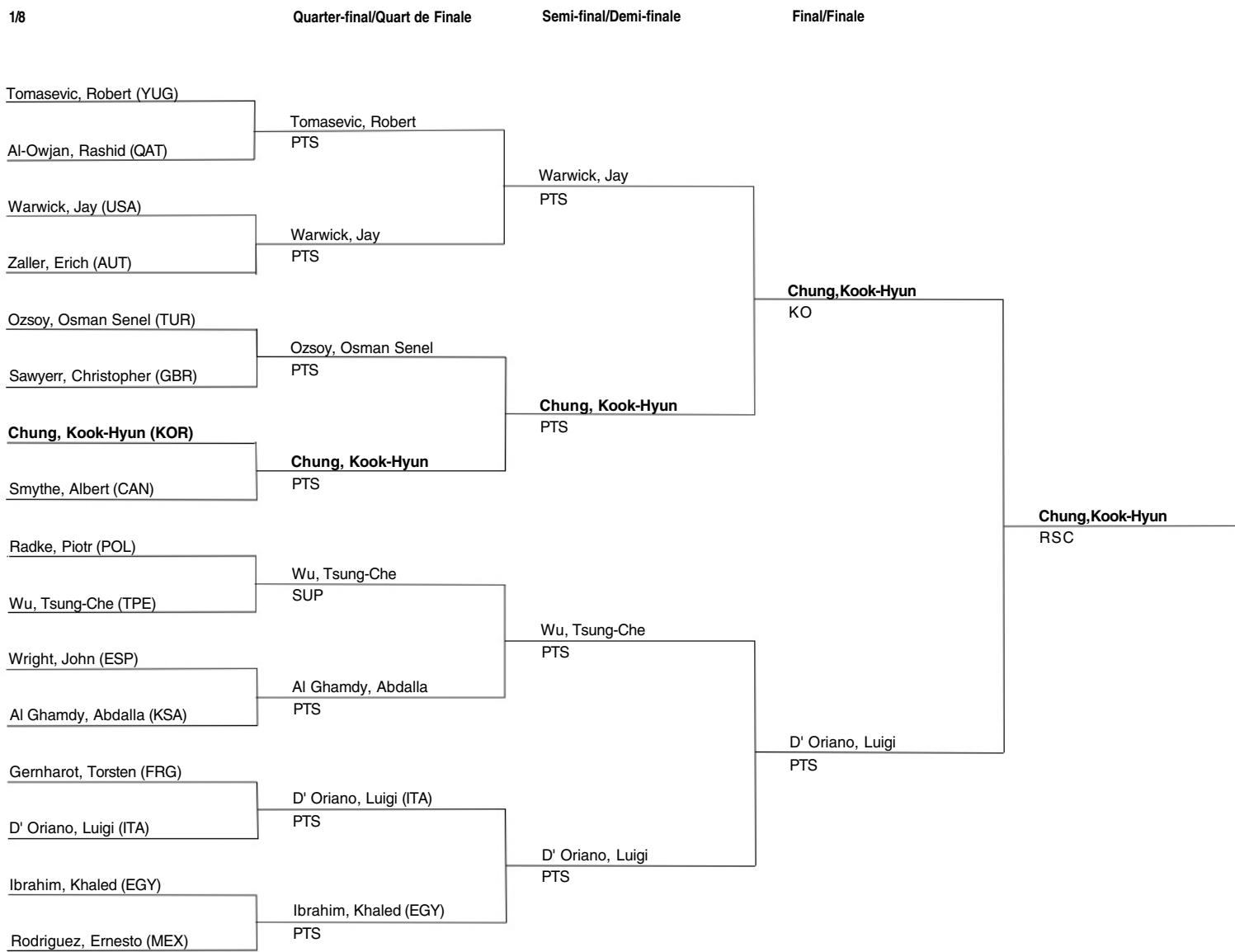

Women Welter Weight 60Kg-65Kg
Competition Summary

Femmes/Welter 60Kg-65Kg
Tableau de la Competition

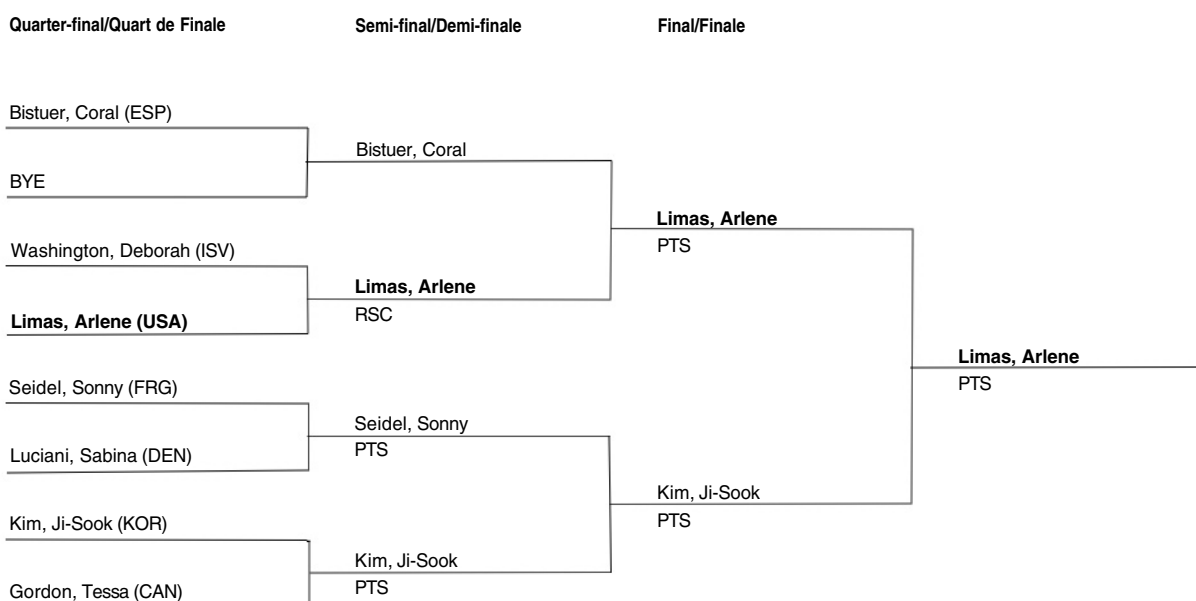

Taekwondo

Taekwondo

Men Middle Weight 76Kg-83Kg
Competition Summary

Hommes/Moyen 76Kg-83Kg
Tableau de la Competition

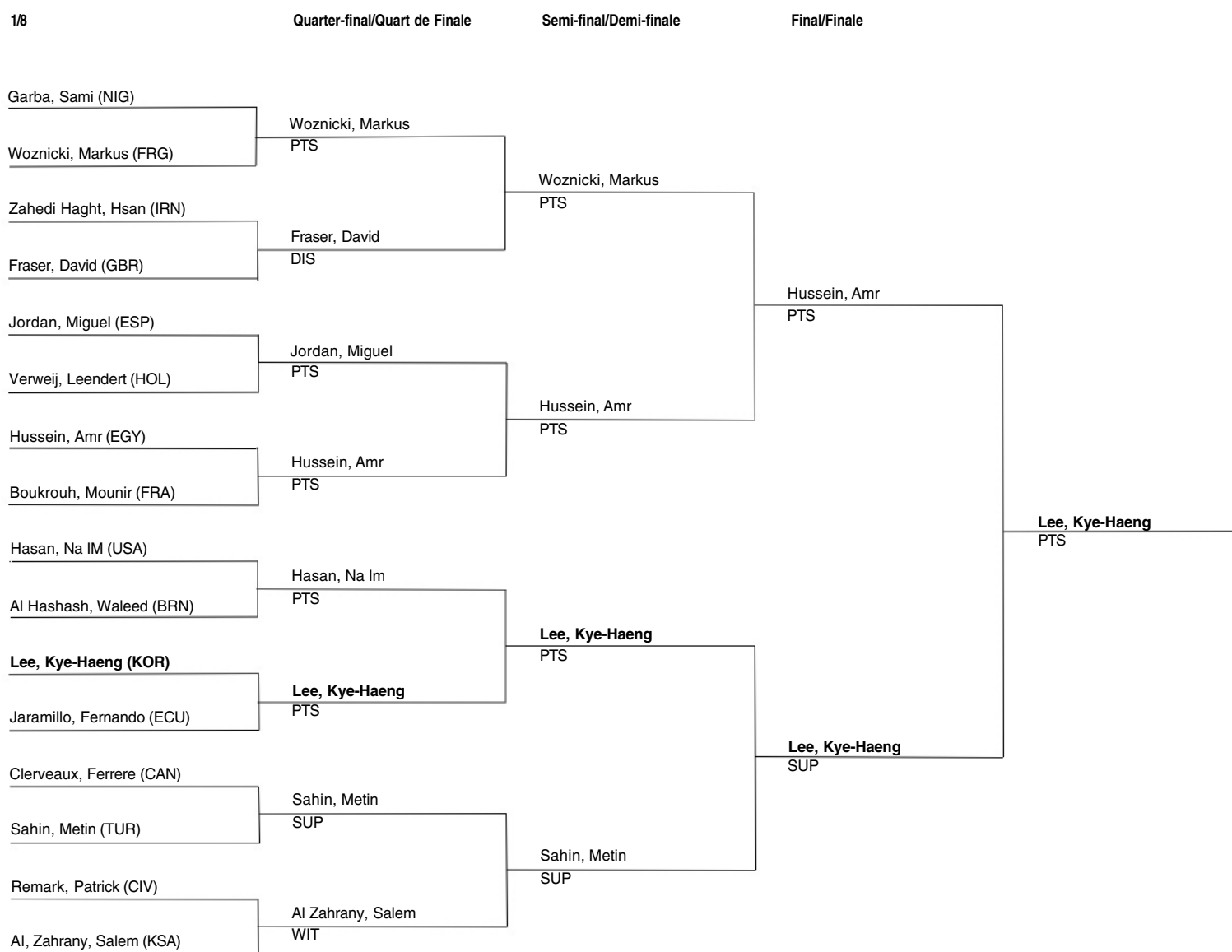

Women Middle Weight 65Kg-70Kg
Competition Summary

Femmes/Moyen 65Kg-70Kg
Tableau de la Competition

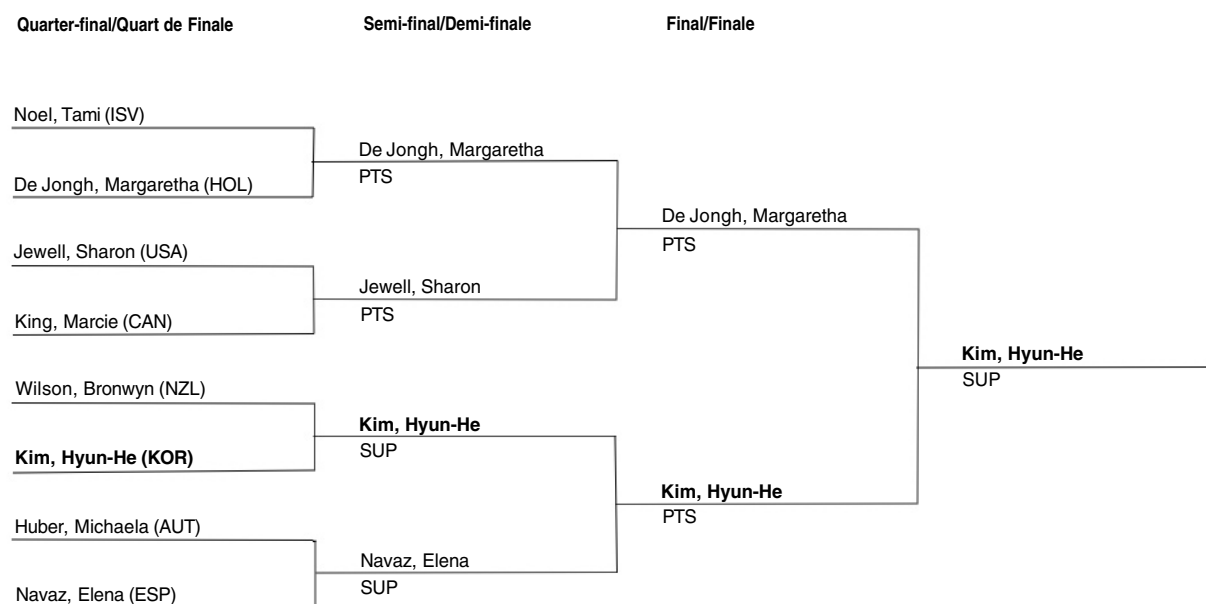



Men Heavy Weight +83Kg
Competition Summary

Hommes/Lourd +83Kg
Tableau de la Competition

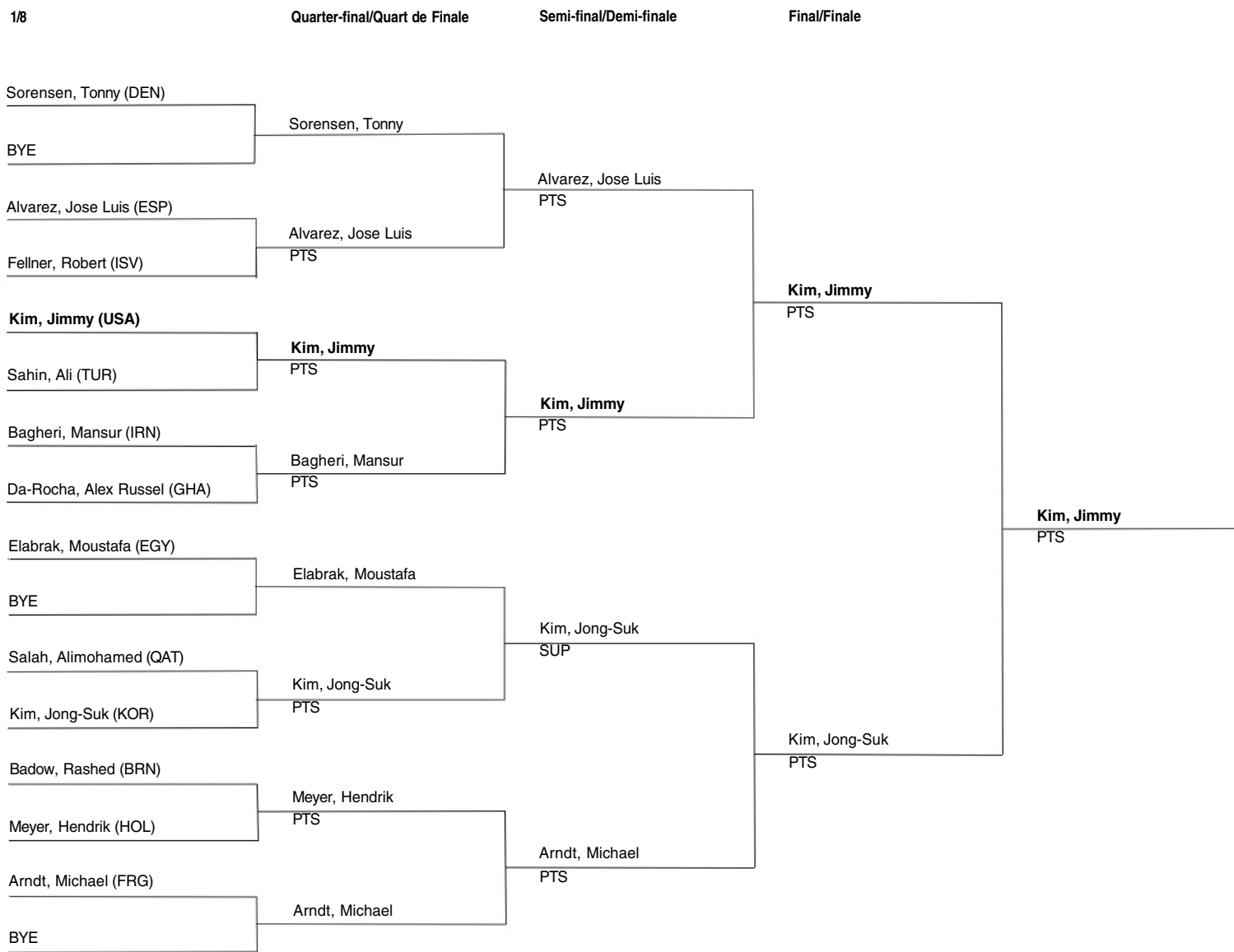

Women Heavy Weight +70Kg
Competition Summary

Femmes/Lourd +70 Kg
Tableau de la Competition

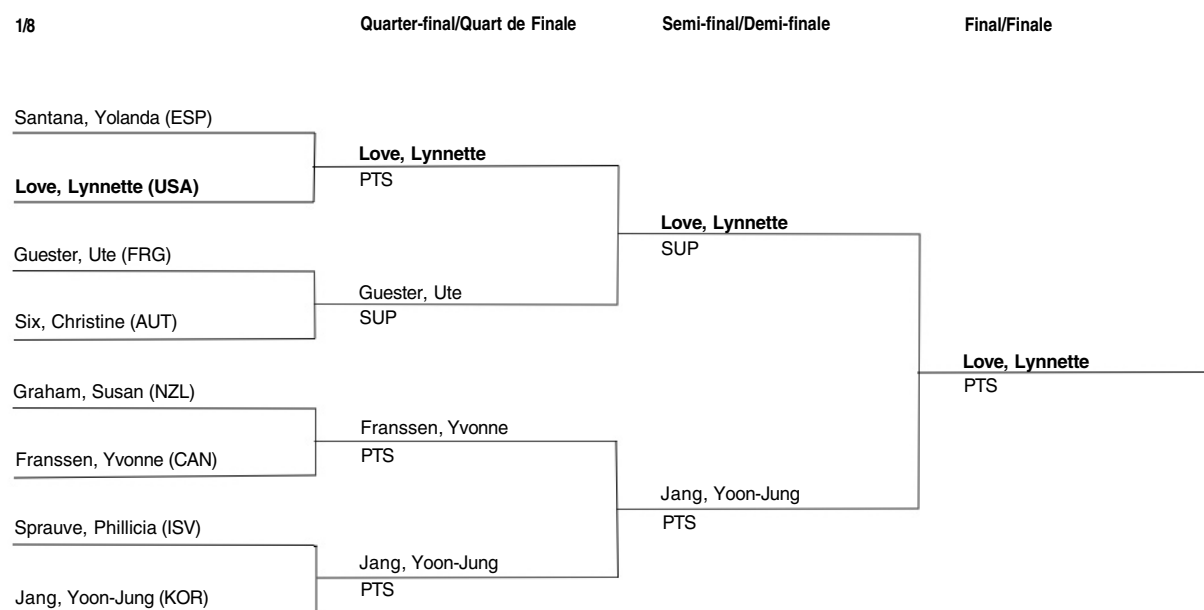

Staff of the Official Report

Seoul Olympic Organizing Committee

- **Chairman/Settlement Board**
Kim Ock-jin
- **Secretary-General**
Chyun Sang-jin
- **Director-General/Business Settlement**
Lee Jae-hong
- **Report Publication Div.**
 - Director Koo Dong-chul
 - Kim Sea-kwon
 - Kim Yoon-kee
 - Hong Hyoung-gi
 - Kim Eung-shik
- **Official Photographers**
 - Kim Kee-sun
 - Kim Kwong-bu
 - Kim Bo-hwan
 - Kim Se-kwon
 - Kim Yong-hwi
 - Kim Han-yong
 - Park Jae-hoon
 - Park Chang-hae
 - Suh Il-song
 - Song Kee-yeop
 - Shin Book-jin
 - Yang Se-min
 - Lee Dong-shik
 - Lee Yong-kwon
 - Lee Yong-joung
 - Lee Eung-jun
 - Lee Jae-kyong
 - Lee Hee-kyu
 - Im Bom-taek
 - Chang Kwan-hyo
 - Chun Cyong-kook
 - Chong Dong-song
 - Chong Jong-woong
 - Cho Il-nam
 - Choi Jae-hong
 - Hong Sun-tae
 - Hong Chang-il
- **Contributing Photographers**
 - Kim Jong-uk
 - Yoo Kyong-sun
 - Yoon Bok-ho
 - Kim Jea-song
 - Yang Un-hwan
 - Lee Kee-chul

Korea Textbook Co., Ltd.

- **President**
Kang Hee-tae
- **Executive Director**
Yoon Hyung-kiw
- **Production Manager**
Shim Min-sup
- **Korean Edition**
 - Managing Editor Roh Sang-kook
 - Writers Lee Bom-yeul
 - Kwon Young-dae
 - Byun Jong-ku
 - Lee Kwang-seok
 - Lee Bang-won
 - Copy Editors Kim Kwang-hee
 - Oh Do-kwang
 - Proofreaders Bang Jae-suk
 - Hwang Eun-ju
 - Lee Kyea-youl
 - Kim Boung-sun
- **English Edition**
 - Managing Editor Lee Kyong-hee
 - Translators Kim Heung-joong
 - Hahn Churl-mo
 - Han Tak-bae
 - Copy Editor Bryan Matthews
 - Proofreaders Chang Anna
 - Cho An-sook
 - Kim Jong-eun
 - Lee Joo-eun
 - Kang Hee-sun
 - Sim Soo-jung
 - Lee Yun
 - Oh Kyong-soo
- **French Edition**
 - Managing Editor Lee Bong-jie
 - Translators Eum Du-eun
 - Suh Eun-young
 - Kim Ju-kyung
 - Copy Editors Lee Hong
 - Claude Garti
 - Proofreaders Kim Mal-sook
 - Kim Mi-eun
 - Kim Man-hee
 - Joung Ju-hee

- **Art Directors**
 - Volume I Oh Boung-kwon
 - Volume II Lee Dae-il
- **Planning & Layout Manager**
Kim Il-young
- **Design**
 - Kim Jong-rok
 - Kim Woong-sup
 - Kim Duk-jai
 - Lee Myong-su
 - Park Mi-he
 - Kim Kwang-sook
- **Typesetting**
 - Korean Min Soo-shik
 - Kim Hak-shik
 - Park Ki-nam
 - Cho Mi-kyong
 - Chun Hyun-mee
 - English/French Moon Mi-sun
 - Jeong Jeong-muk
 - Huh Soon
 - Kim Eun-sook
- **Production**
 - Lee Chang-kyu
 - You Oh-jun
 - Kim Un-bae
 - Park Sung-kee
 - Kim Dae-young

Copyright, © 2004, Amateur Athletic Foundation of Los Angeles

Notes on the digitized version of the Official Report of the Organizing Committee for the Games of the XXIVth Olympiad Seoul 1988, Volume 2 – Competition Summary and Results.

The digital version of the Official Report of the Games of the XXIVth Olympiad was created with the intention of producing the closest possible replica of the original printed document. These technical notes describe the differences between the digital and printed documents and the technical details of the digital document.

The original document

The original paper version of the 1988 Official Report (Volume 2) has dimensions of 10.2 x 14.9” (26 cm x 38 cm).

The volume’s spine is of blue cloth. The words “Official Report Games of the XXIVth Olympiad Seoul 1988” and “2 Competition Summary and Results” appear in gold on the spine.

The book has 728 pages.

The fonts used in the digital version book for text, photograph captions and chapter headings are Helvetica and such system fonts as best approximate the original fonts.

Special features of the digital version:

- The spine is not included in the digital version.
- Blank pages are not included in the digital version.
- The digital version includes a bookmark list that functions as a hyper linked table of contents. Selecting a topic heading will take you to the corresponding section in the document.

Profile of the digital version:

File name: 1988v2.pdf

File size: 49,173 KB

Format: Portable Document Format (PDF) 1.4 (Adobe Acrobat 5.0)

Source document: The Official Report of the Organizing Committee for the Games of the XXIVth Olympiad Seoul 1988, Volume 2: Competition Summary and Results

Printed by the Korea Textbook Co., Ltd.

Creation Platform: Windows XP

Creation Date: May 2004

Conversion Software: Adobe Acrobat, FineReader, VistaScan, FahrenEX

Image Resolution: 96 dpi for color and grayscale images

Digital Fonts: Helvetica

Conversion Service: Exgenis Technologies, Goa, India

www.digitization.info