

# VACUUM TUBE VALLEY

Published Quarterly  
Price \$6.50

Celebrating the History and Quality of Vacuum Tube Technology

Issue 2 Volume 1  
Fall 1995



Heath W-6M

## In This Issue..

### Tube Industry News

Check out the latest happenings in the world of vacuum tubes. Learn the results of a recent survey of tube distributors and sellers conducted by VTV.

**Eric Barbour** outlines the latest news and views. **Page 15**

### Guitar Amplifiers - Learn about how to get the best guitar tone.

**Charlie Kittleson** interviews **Terry Buddingh**, Tube Amp Expert from *Guitar Player Magazine*. **Page 20**

### Tube Matching: Get the best sounds from your amp.

Matched tubes are essential for optimum performance from push-pull amps.

**John Atwood** explains tube matching techniques for the layman. **Page 22**

See our new features in this month's expanded issue

### Heathkit: Early Tube Hi-Fi years.

Heathkit was the largest manufacturer of electronic kits in the US, at one time, selling over 350 different types of kits. Learn more about the early days of Heath Hi-Fi. **Page 3**



Heath W-4AM



Heath W-5M

### Magnum SE Amplifier

Dave Wolze recently designed and built an SE amp with power and punch. **Page 17**

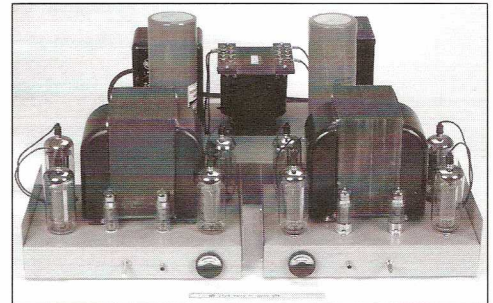

### Tube Review: EL-34

In existence since 1953 and one of the most popular audio tubes of all time, the EL-34 has many variations and performance characteristics. **Page 8**



Mullard EL-34s

### Early Cinema Sound

VTV examines an early Western Electric theater sound system. **Page 24**



**Vacuum Tube Valley** is published quarterly for electronic enthusiasts interested in the colorful past, present and future of vacuum tube electronics.

Written and Printed in the United States of America



**VTV CONTROL GRID**

by **Charlie Kittleson**

**Welcome to Issue 2**

With our first issue, VTV has succeeded in getting the word out to tube enthusiasts around the planet. We are striving to provide quality historical, performance and technical information on vacuum tube technology. Our writers have tons of articles on tubes, transformers, new and vintage equipment coming up in future issues of VTV.

Throughout the 1990s tubes will begin to wander back into mainstream audio. They are already being seen in tube CD players, many new tube hifi amps, tube guitar amps and tube recording studio equipment. Sweeten up your music; put vacuum tubes in the signal path!

**Write Us Please**

We are being overwhelmed by incessant phone calls from tube enthusiasts. We simply cannot handle all of the calls. There are three rules you should remember when trying to contact VTV:

**1. Contact us by fax or in writing only!** We will not handle technical inquiries over the telephone. Please FAX or write us with your questions and we will respond if we can help you. VTV FAX 408-733-6146 (send facsimile after the recorded message).

**2. All subscription and product payments must be by check or money order. We do not accept credit cards.** Please provide payment by bank, certified, or personal check or money order payable in US dollars. Foreign subscribers - be sure your payment is payable from a US bank and is magnetically encoded.

**3. Do not call, FAX or write us asking for rare tubes or obscure information.** Rare audio and guitar amp tubes are a scarce commodity. Please do not contact us asking for these tubes. Some are available from tube dealers or may be obtained by placing an ad in *Audiomart*. Also, we are not the Library of Congress, so please don't call us asking for a schematic for your 1934 RCA Theater amp.

**Dynaco Visit to VTV**

Recently, the VTV offices were visited by Raymond Sassoon, Executive Vice President of Dynaco/Panor Corporation. Raymond is very interested in bringing innovative tube hifi products to market at reasonable prices. VTV also auditioned the new PAS-4 preamp, CD-1 Tube Compact Disc Player and the Stereo 80 Power Amplifier. All of Dynaco's new tube products performed very well.



**For Something Different-Try V.A.L.V.E.**

Those of you interested in another unique tube-enthusiast publication, should try **VALVE**. This is a tube club publication put out by **Dan Schmalte** of Poulsbo, WA. It features lots of neat articles on vintage hifi, tube comparisons, vintage system listening tests and more. A one year (12 issues) subscription to the VALVE newsletter is US\$20.00/\$30.00 Foreign. What a bargain for the useful information you will get!

Send your check to VALVE, 1127 N.W. Brightstar Lane, Poulsbo, WA 98370 (360) 697-1936

**Readers - We Need Your Help!!**

We are planning articles on the history of Fisher, Harman-Kardon, McIntosh, Marantz, Radio Craftsmen and H.H. Scott next year. If you have any information including literature, history or other data on these American HiFi companies from 1947 through 1965 please send it to us. Photocopies are OK. We are trying to obtain the most accurate information possible on these companies. Also, if you know anyone who worked at these companies during the Golden Era of HiFi, help us get in contact with them ASAP!!!

**A Call to Authors!**

We are also seeking quality articles from our readership. In particular, historical perspectives, broadcasting history, early recording studio equipment, early theater sound systems, speaker and equipment manufacturer profiles and more. We will also consider technical articles on your audio, radio or electronics construction projects relating to vacuum tubes. Send us your manuscripts, along with schematics, illustrations and photos.

We will pay for quality articles that are published in VTV.

**EDITORIAL STAFF**

*Vacuum Tube Valley* is published quarterly for electronic enthusiasts interested in the colorful past, present and future of vacuum tube electronics.

Subscription rate is US\$25.00/year (4 issues) US and US\$35.00 Foreign

To subscribe, renew or change address call or FAX us at (408)733-6146.

- Charles Kittleson** - Editor and Publisher
- John Atwood** - Technical Editor
- Eric Barbour** - Associate Editor
- Steve Parr** - Electronic Publishing Consultant
- Jeri Markiewicz** - Copy Editing

Copyright 1995 Vacuum Tube Valley  
All rights reserved.

No part of this publication may be reprinted or otherwise reproduced without written permission of the publisher.

Send circulation and editorial correspondence to:

VTV  
1095 E. Duane Ave., Suite 106  
Sunnyvale, CA 94086 USA



**HEATHKIT -  
The Early HI-FI Years**

by Charlie Kittleson

**POST-WAR HI-FI IN THE US**

Hi Fi for the home really got a boost in the years immediately after World War II. Returning GIs got their first taste of live classical music while stationed in places like Italy and France. They enjoyed the experience and liked what they heard. But when they returned to the States after the war to play back such recorded performances, they found most of the audio equipment available at the time to be mediocre at best.

Many of the early audio enthusiasts had military training in electronics or were radio enthusiasts who were able to construct their own amplifiers and speakers using old radio parts and war surplus electronics and following plans published in enthusiast publications like *Radio Electronics* magazine.

In Great Britain, about the same time, similar trends were developing. Then, in 1947, a monumental event occurred in the world of audio. D.T.N. Williamson developed the famous Williamson Amplifier circuit and published the plans with a schematic in *Wireless World*, a British electronics publication. The Williamson design was one of the first amplifiers to effectively combine feedback, a high quality output transformer, specially-designed front-end topology and the British high performance valve — the KT-66. The front-end circuit consisted of a voltage amplifier, a split-load inverter and a non-inverting differential pair. It produced 15 watts RMS.

D.T.N. Williamson's creation delivered performance that was nothing short of sensational. It was the first post-war amplifier design to be widely accepted. Within a few years, several UK and US companies introduced complete "Williamson" type amplifiers such as the Altec-Lansing A-323, Brook 12A3, H.H. Scott 210A and RadioCraftsmen C-500. Many of the American electronics magazines published amplifier plans and schematics based on the Williamson design. American versions of the Williamson amp typically used 6L6 or 807 type output tubes, dual 6SN7 front-end tubes, and a high-quality output transformer such as the UTC LS-55 and LS-57 or similar designs from Chicago,



**Build it  
YOURSELF**

**Heathkit  
HIGH FIDELITY  
PREAMPLIFIER**

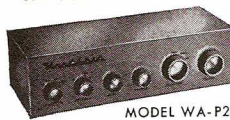

MODEL WA-P2

formance and most attractive in appearance. Fulfills every requirement for true high fidelity performance. Shpg. Wt. 7 lbs. . . . . **\$19.75**

**Heathkit  
WILLIAMSON TYPE  
25 WATT AMPLIFIER  
(PEERLESS TRANSFORMER)**

This latest and most advanced Heathkit hi-fi amplifier has all the extras so important to the super-critical listener. Featuring KT-66 tubes, special Peerless output transformer, and new circuit design, it offers brilliant performance by any standard.

Bass response is extended more than a full octave below other Heathkit Williamson circuits, along with higher power output, reduced intermodulation and harmonic distortion, better phase shift characteristics and extended high frequency response. A new type balancing circuit makes balancing easier, and at the same time permits a closer "dynamic" balance between tubes.

Aside from these outstanding engineering features, the W-5 manifests new physical design as well. A protective cover fits over all above-chassis components, forming a most attractive assembly—suitable for mounting in or out of a cabinet. All connectors are brought out to the front chassis apron for convenience of connection.

Model W-5M consists of main amplifier and power supply on single chassis with protective cover. Shpg. Wt. 31 lbs. **\$59.75**  
Express only. . . . .  
Model W-5 consists of W-5M, plus WA-P2 Preamplifier shown on this page. Shpg. Wt. 38 lbs. **\$79.50**  
Express only. . . . .

**Heathkit  
HIGH FIDELITY  
20 WATT AMPLIFIER**

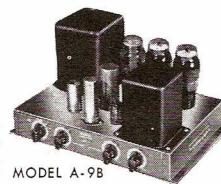

MODEL A-9B

This particular 20 watt Amplifier combines high fidelity with economy. Single chassis construction provides preamplifier, main amplifier and power supply function. True hi-fi performance ± 1 db, 20 cps to 20,000 cps. Preamplifier affords 4 switch-selected compensated inputs. Push-pull 6L6 tubes used for surprisingly clean output signal with excellent response characteristics and adequate power reserve. Full tone control action. Extremely low cost for real high fidelity performance. Shpg. **\$35.50**  
Wt. 18 lbs. . . . .

**HEATHKIT**  
*High Fidelity*  
**"BUILD IT YOURSELF"**  
**amplifier  
kits**

**Heathkit  
WILLIAMSON TYPE  
(ACROSOUND  
TRANSFORMER)**

This dual-chassis high fidelity amplifier kit provides installation flexibility. It features the Acrosound "ultra-linear" output transformer, and has a frequency response within 1 db from 10 cps to 100,000 cps. Harmonic distortion and intermodulation distortion are less than .5% at 5 watts, and maximum power output is well over 20 watts. A truly outstanding performer. W-3M consists of main amplifier and power supply. Shpg. Wt. 29 lbs., Express **\$49.75** only. . . . .  
Model W-3 consists of W-3M plus WA-P2 Preamplifier listed on this page. Shpg. Wt. 37 lbs., Express **\$69.50** only. . . . .

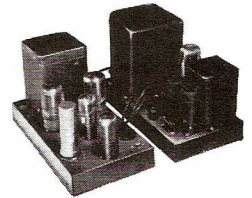

**Heathkit  
WILLIAMSON TYPE  
(CHICAGO TRANSFORMER)**

This hi-fi amplifier is constructed on a single chassis, thereby affecting a reduction in cost. Uses new Chicago high fidelity output transformer and provides the same high performance as Model W-3 listed above. An unbeatable dollar value. The lowest price ever quoted for a complete Williamson Type Amplifier circuit. Model W-4M consists of main amplifier and power supply on single chassis. Shpg. Wt. 28 lbs., Express **\$39.75** only. . . . .  
Model W-4 consists of W-4M plus WA-P2 Preamplifier. Shpg. Wt. 35 lbs., Express only. . . . . **\$59.50**

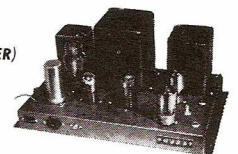

COMBINATION  
W-5M and WA-P2



**HEATH  
COMPANY**  
A SUBSIDIARY OF DAYSTROM, INC.  
**BENTON HARBOR 25,  
MICHIGAN**

**Write FOR FREE CATALOG AND SCHEMATICS**



Peerless or Stancor. Properly restored, these amps still have excellent sound.

**THE BEGINNINGS OF HEATH COMPANY**

Edward Heath, the company's founder and first president, was originally in the aviation and related parts business. Heath introduced the "Parasol," one of the first airplane kits in the early 1930s. Unfortunately, Mr. Heath was killed in an airplane crash in 1934.<sup>1</sup> The second president, Howard Anthony, carried on the airplane business until after the war. Anthony was very involved in aviation, but always had a strong interest in radio and electronics. When the military contracts for airplane parts dried up, Anthony decided to get into the booming post-war electronics' business. Heath began bidding on war surplus lots and secured millions of pounds of aircraft parts and electronics. Another company bought the airplane parts and Heath kept the electronics. Heath began re-marketing war surplus electronics and selling electronic test equipment through a monthly flyer.

Heath's first kit was an oscilloscope (O-1), they then introduced other types of electronic test equipment including VTVMs, audio oscillators, signal generators, tube testers, capacitor checkers and other units. The kits were meant for anyone, with skills from a novice to an expert, who was interested in electronics. Lots of Heathkits were sold to high schools and colleges to be used by budding future electronic engineers. The kits came with a thorough and well-illustrated assembly manual, with exploded views and large blueprint-like schematics, punched and finished chassis and all the parts needed to complete the project.

**THE FIRST HEATH AMPLIFIERS**

In 1947, Heath began selling amplifier kits under the Heathkit name. These were primitive-looking units with all of the components mounted on a single chassis formed from piece of sheet metal. Heath's first amplifiers (A-1, A-2, A-3 and A-4) were developed from circuits found in the *Radiotron Designer's Handbook*. They typically employed a pair of surplus metal type 6L6 or 6V6 outputs and a potted output transformer (probably a Chicago unit). Apparently, not very many of these were sold and few have survived. During the early Fifties, Heath also sold kit tuners including the FM-1 and

FM-2 tube FM tuners. They also featured the BC-1, a mono AM tuner.



A-5

The A-5 (1951) was a 10 watt amplifier featuring a pair of 6L6s and an all octal front end. Note the variable tap power transformer, a surplus unit. It was finished in light silver hammertone. The output iron appears to be a potted Chicago unit. A similar unit, the A-6, followed the A-5 1952.

**HEATH WILLIAMSON AMPLIFIER YEARS**



W1-A1

Heath decided to get serious about their audio products during the early Fifties Hi-Fi craze. Responding to the Williamson amp popularity, Heathkit introduced the W1-A1 amplifier kit (\$49.95) in 1952. It was offered as a two-chassis amplifier with the power supply on one chassis and the amplifier on the other. The separate power supply design was used to reduce hum, improve installation flexibility and was connected by an umbilical cord. It was rated at 15 watts RMS. Tube complement included two 6SN7 octal dual triodes for the driver and phase inverter, a pair of 807 transmitting type tetrodes connected in triode for the push-pull output, and a 5U4G full-wave rectifier. A high quality Peerless 16258 output transformer was used. The power supply utilized a potted choke and a potted power transformer, both manufactured by Chicago. The amplifier and power supply chassis were

finished in gray hammertone metallic paint.

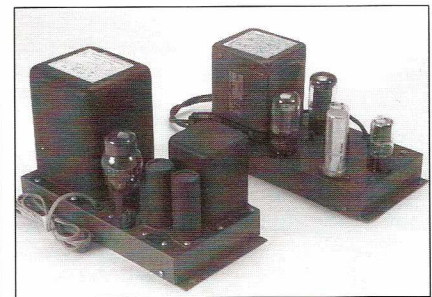

W-2M

The W1-A1 was replaced by the W-2M (\$49.95) in 1953. This was a similar design, except for the use of the 5881 beam tetrode introduced by Tung-Sol in 1953. The 5881 was a compact and ruggedized version of the 6L6G. It was capable of more plate voltage (400+) and featured a gold-plated control grid for better stability and longer life. This amp could be configured either triode-connected or pentode connected through the use of additional primary winding taps on the output transformer. The W-2M featured the same two chassis layout as the W1-A1, but the output transformer was an Altec Lansing 20-20 Peerless 16277 and the rectifier was the 5V4G. The chassis were finished in the same gray metallic hammertone paint. The W-2M was discontinued in 1955. Over 8,000 W-2Ms were sold.



WA-P1

Heathkit also introduced the WA-P1 (\$19.95), a compact phono/line stage preamp. The preamp was powered from the power amp (WM-1 or 2) through an umbilical cord. The WA-P1 was a flat, unobtrusive unit that was finished in gray hammertone enamel. It employed a 12AU7 and a 12AX7 in the circuit. Note the extended control shafts which were scored to be cut at half-inch intervals for custom installations.





W-3M

The Heathkit W-3M (\$49.95), introduced in late 1953, was identical to the W-2M except for an Acrosound TO-300 high quality output transformer. This transformer was designed and produced by Herb Keroes and David Hafler of Acrosound Corporation, Philadelphia, Pennsylvania. It featured the famous Ultralinear circuitry that reportedly gave tetrode power with triode sound. Having owned several W-2Ms and W-3Ms, I can tell you that they sound distinctly different. The Peerless unit on the W-2M has a euphonic and romantic sound, while the Acrosound unit on the W-3M is brighter, has better controlled bass and seems more detailed. For a while, in the early 1950s, the W-2M and W-3M were offered in the same catalogs. The W-3M featured the gray hammertone-finished chassis in early versions, and was later sold with a gold metallic finish from 1959 to 1962. The W-3M was a very popular amplifier for its day. Over 12,000 of them were sold.

**HI FI ON A BUDGET**

In the early Fifties, the Hi-Fi craze was gaining momentum. Several companies began to offer high-quality amps. When you consider that the average weekly wage was about \$50 to \$60 a week, a \$200.00 amplifier cost a month's salary. To get more music lovers into Hi-Fi, Heathkit introduced the A-7, A-8 and A-9 integrated amplifiers. None of these amplifiers were of the Williamson design, but were similar to circuits found in the *Radiotron Designer's Handbook*.



A-7D

The A-7 (\$15.50, 1952) employed push-pull 6V6s for 6 watts in the output



W-4AM

stage with Chicago power and output iron. The chassis was finished in baked gray hammertone enamel. The front end was all octal. Sold through the early 1960s, there were four variants of the A-7: A-7, A-7B, A-7C and A-7D (shown).

Another integrated amplifier, the A-8, was made from 1952 thru 1954. It featured an all octal front end with 6L6 outputs. The chassis was finished in baked gray hammertone enamel. The audio transformer was a non-potted Peerless unit. The A-8 was the forerunner for the A-9 series.



A-8

Introduced in late 1953, the A-9A (\$35.50) was also an integrated amplifier featuring 20 watt 6L6G push-pull output stage. Preamp and front-end tubes were miniature 9 pin 12AX7 and 12AU7. The chassis was finished in baked gray hammertone enamel. The power transformer was a smaller Chicago potted unit and the output was a small non-potted Peerless unit similar to the A-8 amp. First introduced in 1954, the A-9 featured a larger potted Chicago power transformer and a potted Chicago audio transformer. In 1955, the A-9B was introduced; it featured minor

styling changes including different knobs. The last variant of the A-9 was the A-9C, introduced in 1957. The A-9C had minor styling updates. Early 1960s versions of the A-9C were finished in baked gold enamel.



A-9

Trying to penetrate the beginner audio enthusiast market, Heath introduced the W-4M (\$39.95) in 1954. The tube complement and circuitry were similar to the W-3M, except that the entire amplifier was on one chassis. In addition, the output transformer was a high-quality Chicago Transformer potted unit instead of a premium Acrosound or Peerless. These changes saved the buyer about \$10.00 (about a day's pay in 1954).

The amplifier was rated at 20 watts RMS, but actually put out about 17 watts RMS. The first versions of the W-4M were finished in gray hammertone metallic paint. Another variant was the W-4AM (1955-59), which was the first to feature stenciled lettering on the chassis. The W-4AM, featuring either a gold or gray enamel chassis, was introduced in late 1959. The W-4B, featuring a slide type power switch on





W-5M

the front panel was introduced in 1961. The last version of the W-4 amp was the AA-71, sold in the early 1960's. It was similar to the W-4B, except for the black enamel finish. We estimate that over 25,000 kit and factory assembled W-4s were produced.

**MID-FIFTIES HEATHKITS**

Perhaps the amplifier that most of us associate with early Heathkit is the W-5M (\$59.95). Introduced in 1955; it was accepted almost immediately by the audiophiles of the time. It was truly a "high-end" amplifier for a budget price tag. The amplifier was and still is a beautiful audio artifact. Finished in bright gold metallic lacquer and topped off with a complete cage finished in black wrinkle, it featured the famous Williamson design, this time with premium British-made Genalex KT-66 output tetrodes. Front-end design featured two 12AU7 dual triodes for the phase inverter and driver circuits.



WA-P2 Preamp and FM-3 Tuner

A 5R4GY dual-diode full-wave type rectifier was employed. The power supply featured an abundance of filter-capacitor stages and a higher voltage (450v+) potted power transformer with

potted choke. The power rating of the W-5M was 25 watts RMS, but some sets test at more than 30 watts RMS.

Through 1957, W-5Ms featured the larger Peerless 16458 output transformer. From 1957 through 1963, the newer design and smaller 16309 Peerless output transformer was employed. Though more common, the 16309 is no slouch. It has exceptional characteristics and performance. Some Heath experts claim that the 16309 Peerless has more extended highs.



W-5M with large Peerless 16458

The W-5M also featured a patented "tweeter saver" and an easy to use "Bias Balance" bias adjustment. A properly restored and calibrated W-5M with fresh vintage KT-66 valves can outperform \$1000+ modern amplifiers. Heathkit's W-5M is probably the most popular American version of the Williamson design. It is estimated that over 30,000 W-5M kits were sold.

As a companion to the W-5M, the WA-P2 mono phono and line preamp (\$19.95) was introduced. It was not self-powered, obtaining power from an umbilical cord plugged into the power

amp. It featured Mullard ECC82 (12AU7) and ECC83 (12AX7) dual triodes and was finished in gold enamel. The XO-1 tube electronic crossover was also introduced in 1955. It was finished in gold enamel and featured a black tube cage. The compact gold finished FM-3 mono FM tuner and BC-1A AM tuner were introduced in 1956.



XO-1 Electronic Cross-over

Without question, the rarest and most exotic of all Heathkit amplifiers is the W-6M(\$109.95), introduced in 1957.

Generating over 70 watts RMS and 140 peak music watts, it was Heathkit's most powerful mono tube amplifier. It was a large unit with a gold enamel chassis and a small, black metal tube cage, mounted directly over the tubes. Bias, variable damping, power switch and meter were located on the front panel. The output tubes were the famous Tung-Sol 6550s. Tung-Sol introduced these tubes in 1955 specifically for audio use. Properly driven and biased, with a 600v+ plate voltage, a pair of 6550's could produce 100 watts RMS in Class AB1. They featured gold-plated grid wire for bias stability and long life.

The W-6M was the first Heathkit power amplifier to feature silicon diode rectification. The heart of this unit was a massive and extremely high-quality potted Peerless 16431 output transformer. This transformer tests as having one of the widest bandwidths and best square wave response of any Hi-Fi transformer available then and now. It can easily handle 140 watts RMS. The driver and phase inverter circuit feature one 12AX7, one 12AU7 and one 12BH7. There are also bias and input level adjustments as well as a bias meter on the front panel.

Although one of the few consumer amplifiers to use cathode-follower-driven output tubes, the W-6M was marred by design flaws: too much current drawn through the 12BH7, making the bias very dependent on the age of the 12BH7, and insufficient bias adjustment range. The result was that





the W-6M could not bias many perfectly good 6550s. Perhaps as a result of this, the W-6A, replacing the W-6M and produced from 1960 to 1962, had additional bias controls and input level controls on the front panel.

Over 90% of amplifiers sold during the mid-Fifties produced 30 watts RMS or less. It is obvious that the W-6M was designed for the audiophile who needed the "ultimate" amplifier. Some experts estimate that less than 2000 W-6M amps were ever sold. That would make the W-6M and W-6A the most collectable of the Heath tube amplifiers.

In 1957, the Heath Company was sold to Daystrom, which expanded the production facilities and increased capacity. Later that same year, the UA-1, a small mono 12 watt power amp using push-pull EL-84s in the output stage was introduced for \$22.95.

Numerically, the last of the Heathkit Williamson amplifiers was the W-7M (\$54.95). Introduced in 1958, it was the first "a dollar-a-watt" high-powered amplifier. It was not really a Williamson design, but resembled a Mark II Dynaco. The front-end circuit consisted of a pentode driving a split-load inverter. It was rated at 55 watts RMS from a pair of Mullard EL-34s. The driver/phase-inverter stage was a single 6AN8. Rectification was handled by silicon diodes. The chassis was baked gold and clear-coated enamel. The W-7M was equipped with a louvered black wrinkle cage covering the entire amp.

A later variant of the W-7M was the

AA-91, available in the early 1960s. It featured a black enamel chassis and a gold painted cage.

#### ENJOYING AND RESTORING YOUR HEATH AMPLIFIER

Properly restored Heath Williamson type amplifiers can sound great with the right speakers. If you plan to use an early Heathkit amplifier in your system, carefully plan your project and take the time to do a good job. Vintage tube Hi Fi restoration involves: removing dust and grime, detailing, replacement of coupling, bypass and filter capacitors (both paper and electrolytic), tube socket cleaning, tube testing, tube replace-

ment, overall circuit inspection, and repair. Some collectors will not pay top dollar for restored amplifiers, insisting that all components must be original. It is a good idea to save all original resistors and capacitors in a plastic bag to be installed later if you sell the unit to a collector. When replacing capacitors and resistors, be accurate and thorough. Use exact values and equal or greater voltage ratings for capacitor replacement. Check all soldering joints and re-solder as needed. Remember, many of these were kits assembled by neophytes who were just learning to solder! Remember to enjoy your work, take your time and do a quality job!

#### CONCLUSION

This article covered the early tube mono Hi-Fi years of Heath Company. The Heath - Daystrom and Heath - Schlumberger tube Hi-Fi era, 1957-64, will be covered in a future issue of VTV. Production figures listed for Heath equipment are estimates. We welcome your comments and/or substantiated corrections to this article.

*Special thanks to Bill Short of Edmonds, Washington and Ken Wilson of San Jose, California for their assistance with this article.*

<sup>1</sup> *Heath Nostalgia*, 1992, Terry Perdue, 4320 - 196th S.W., Suite B-111, Lynwood, WA 98036-6754 (This is an excellent book on the history of Heath Company.)

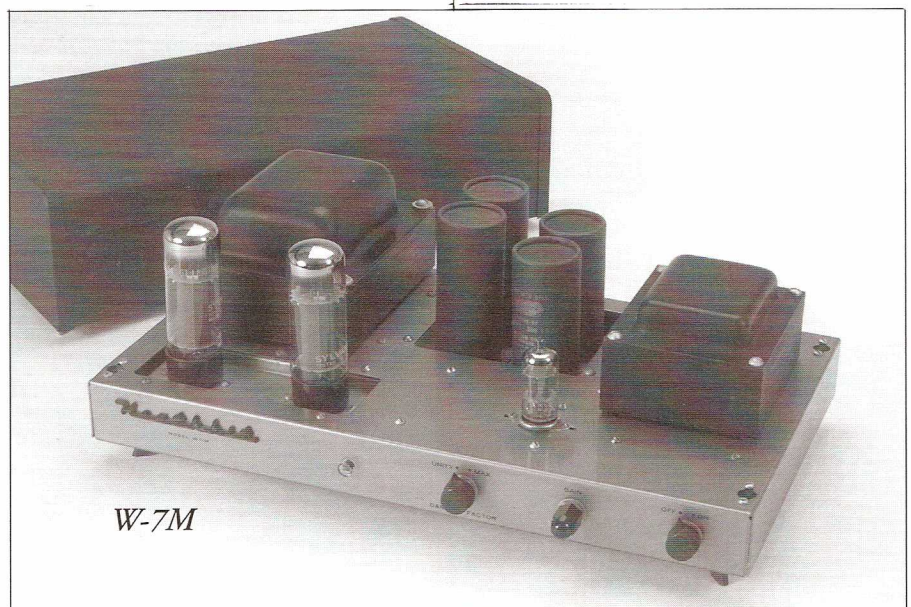



**THE EL34 REPORT:**

History and Comparisons

by Eric Barbour

**1. History**

The tube industry has seen plenty of ironic changes. So many twists and turns go by, leading us to the 21st century without a clear idea of why a given tube is still popular. For example: what if Leo Fender had used 2A3s in his guitar amplifiers instead of 6L6s and 6V6s? Today's guitarists would likely have developed a very different idea of what a good guitar sound is.

The same is often true for the tube Hi-Fi community, whether they recognize it or not. One of the most popular power tubes of all was originally intended as a cheap way of getting 40 watts with high sensitivity. The purpose was to allow amplifier designers to make a driver/phase splitter with a minimum component count. Low distortion was incidental, as this tube was to be used in a push-pull pair with negative feedback, and other applications (such as radio transmitters) were not really even addressed. Although beam-power tetrodes had taken over the market in the 1940s, this new tube was a true pentode, an archaic design by the standards of the day. This may have been done in order to circumvent RCA's patents on beam tubes.

Strange as all this must have seemed, Mullard took just this big leap when they introduced the EL34 in late 1953. In spite of the low-cost intent, the early EL34 was an excellent tube. The Mullard early version (recognizable by the metal ring around its base) could defeat any 6L6 easily, and was almost a match for the 6550. It gave easy drive and considerable peak power, from a tall and thin glass envelope that saved space on chassis. Mullard's book *Circuits For Audio Amplifiers*, first published in 1959 and recently reprinted by Audio Amateur Publications, featured the EL34 in the largest power-output design. All the other amps in that book used the much smaller EL84 or ECL82.

Among the first amps to use it were the Marantz 2 (1955), Dynaco Mark II, and the Pye Mozart, a single-ended 9-watt British unit from 1956. The easy drive requirements allowed a 30-40 watt amp to be built using only 3 tubes: the two EL34s, and a triode-pentode as the voltage amp and phase splitter. This made the EL34 a must for Dynaco to

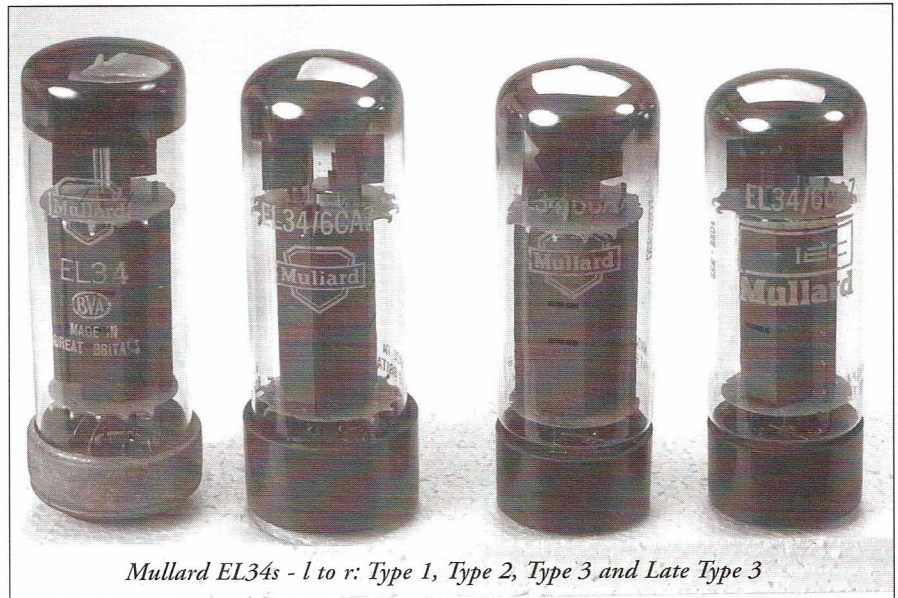

Mullard EL34s - l to r: Type 1, Type 2, Type 3 and Late Type 3

use in their Mark II and its low-cost stereo version, the Stereo-70. At least half a million Stereo-70s were sold from 1958 to 1977. The EL34 is also found in the Marantz 5, 8A, 8B and 9; the H. H. Scott 240, 250, 280 and 290; the Eico HF 50, HF 60, HF87, HF 89; the Heath W-7A; the Acrosound UL-II, UL-120; the Fisher SA-300 and X-1000; and many, many others. These are some of the best tube Hi-Fi amplifiers ever made, all using "a cheap way of getting 40 watts." So it wasn't such a bad tube after all. And in fact, many audiophiles prefer it over the 6550 and other types.

The EL34's popularity was sealed when Jim Marshall selected it for his JTM 45 guitar amp in 1965. He went with it because it was cheaper and easier to get in England than the 5881 he had used previously. The JTM 45 became a standard for the British blues-rock sound. The EL34 also found its way into Hiwatt, Orange, Traynor and Laney amps, all made in Britain. Because the EL34 has a much more pronounced distortion characteristic than the 6550 or other similar power tubes, its sound is distinctive and is a major influence on the heavy-rock sound palette. Marshalls are often run full-tilt, which has caused reliability problems. In fact, the American importer of Marshalls was putting more-rugged 6550s in the amps during the late 1970s and early 80s. But when new distribution was set up in 1986, Marshall was adamant that the amps be equipped with EL34s exclusively.

Why do EL34s sound so different

from other tubes in guitar use? Because they were low in cost and had a less massive plate structure than 6550s and similar types. Since the signal voltages in a tube amp can get very high at times, the tube's piezoelectric and mechanical behavior can influence the sound. Overall, most EL34s have a softer distortion tone than 6L6s or 6550s because of the construction differences and the pentode design.

The so-called 'STRs' and KT77 are actually beam types and tend toward more "hard" quality. This is usually not easy to hear at low volumes, but is quite apparent when the amp is pushed into clipping distortion, especially in a guitar amp. So personal preference can be a major factor.

**2. Versions**

No power tube can compare with the 6L6 for sheer number of variations, but the EL34 was quite popular, and thus many EL34s and EL34-likes have been marketed over the years. This is still true, with five (soon to be six) versions currently being manufactured in 1995. But the perfectionists still look to NOS versions for the standards.

Mullard sold three major editions, all quite different but all of very good quality. The first we have already mentioned: the metal-base version, called the "Type I." The base ring is actually a stamping of nickel-plated steel. The tube inside it is one of the best; original Mullard data sheets give maximum voltage ratings of 650 for the plate, 500 for the screen. Dissipation has always been listed at 25 watts, but could usually be



exceeded (and often was in certain guitar amps). This may seem unlikely, but well-used Type Is often have heat-stress cracks in the metal ring yet can still test like new. The Type I was believed to have been manufactured by Dutch Phillips.

The Type II had a large base of dark-brown bakelite, but was quite similar in other respects to the Type I. This version appeared around 1959. It is often seen relabeled 6CA7/EL34, with RCA, GE or Sylvania logos. (The American JEDEC designation 6CA7 apparently was bestowed around 1960.) The Type II was also the original tube seen in 60s Dynaco amps, with the Dynaco brand. All the Mullards can be recognized by a pair of 4-digit production codes imprinted on the glass with a permanent paint. The Type I and II had crimped plates with two rectangular holes on either side, the classic profile.

The Type III appeared around 1968-69. Its base was black and smaller than the Type I or II base, with a similar structure inside. There were three variations of the Type III: first with two getter "haloes," then with one, and finally (in the 1980s) with one halo and a spot-welded plate. Experts say that Mullard's quality started to slip in the 1980s, and the welded plate EL34s, the least consistent of all, had screen-dissipation problems and ended up being the last true Mullards. The plant was torn down in 1982. Since Philips owned Mullard, some Philips and Norelco EL34s were actually made by Mullard (see Amperex below).

Probably the first competitor was the Telefunken, sometimes branded AEG. It looked similar to the Mullard,



*l to r - '60s Bugle Boy, '70s Amperex, '80s Amperex, '70s Amperex (Japan)*

having a metal ring which is even more prone to cracking. The plate was welded and had one rectangular hole. This version was sold until the 1960s, when the base became plain bakelite. There were three versions with the plain base: one with one rectangular plate hole, another with two round plate holes, and one with a small U-shaped tab welded to each side of the plate. Real Teles were apparently made till the 1970s, and EL34s branded Telefunken after that were probably made by Siemens or Tungram. There have also been beam-power versions with the Telefunken brand; their origin is unknown and they were seen in the American market in the 1970s.

The Siemens appeared in the late 50s. It was much copied and rebranded, being especially inexpensive due to some production in East Germany. It has distinctive "staple" protrusions holding its plate halves together. This was the first type to claim a plate voltage capability of 800 volts. It was often sold by other companies as a 6CA7/EL34, and the data sheets in old Tung-Sol, RCA and GE data books reflect the 800-volt rating. The Siemens plant was shut down after the fall of the Berlin Wall in 1991. Tungram, the huge Hungarian lamp maker, made a very close imitation of the Siemens' starting in the 1970s. Tooling must have been bought from Siemens, as it is almost impossible to tell them apart. And the Tungrams were often rebranded and marked as having been made in Germany. Things get really complicated with Amperex/ Philips.

I personally have seen Mullard (not surprising since Mullard was owned by Philips), Siemens, Tungram and even Matsushita EL34s carrying the Amperex "Bugle Boy" logo. Rebrands became epidemic in the 1980s, and the Siemens, Tungram and Tesla versions still pop up with all kinds of brands on them. Some have even been spotted with "Made in England" imprints. Supposedly, Dutch Philips made its own EL34s in the 1950s which were sold as Bugle Boys—they are very scarce in the United States today and I have never seen one. Philips bought

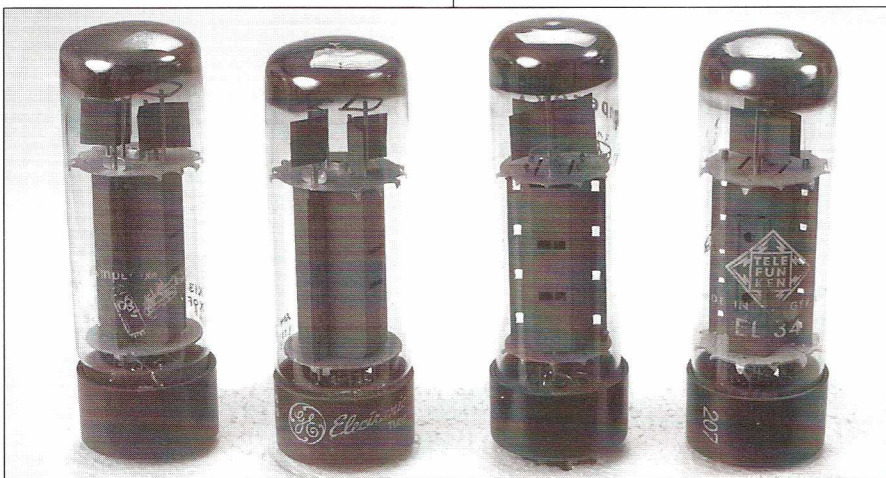

*l to r: Dutch Amperex Bugle Boy, GE labeled Mullard, Amperex labeled Tungram, Later Telefunken*



Amperex, an American maker of industrial tubes, in 1955 and began marketing its own production in the USA under the Amperex name. Although some receiving tubes were made at the Amperex plant in Brooklyn, the manufacture of EL34s is unconfirmed.

In 1959, the Marconi-Osram Valve Co. or MOV (a division of British General Electric, GEC-AEI) produced its own version of the EL34. The KT77 isn't even a pentode; it is a beam tetrode like the 6L6. It was made this way to circumvent a Mullard patent on the EL34 design. Although the KT77 looks like a skinny EL34 of European make, it is not a true EL34. Its tiny brown bakelite base and red "Genalex Made In U.K." decals are distinctive. It is the proof that a really tough tube can be made in a small bottle. The original KT77 data sheet lists plate dissipation of 32 watts, maximum plate voltage of 850, screen voltage of 650, and cathode current of 200 milliamps. These numbers are suitable for a transmitting tube. Two KT77s are claimed to be capable of 70 watts in class-AB1 operation. Since guitar amps were destroying themselves with regular EL34s more and more frequently, the KT77 was put in many Marshall amps and became a popular classic overnight. It does not sound like an EL34, but some guitarists came to prefer it. Sadly, production ceased around 1990, and NOS samples are selling for \$100 or more today. (Rumors are circulating that MOV may be coming back to life in 1996.)



*l to r: Chinese EL34, '90s Tesla EL34, Tesla E34-L*

Tesla was a large manufacturer of lamps and tubes in Czechoslovakia. Their EL34s started appearing in America in the 1970s, usually rebranded to avoid the large tariffs on products from Warsaw-pact countries. The earlier Teslas came in two versions: EL34, with a brown base with flat-ended large pins, and the black-based E34L, supposedly a "premium" version with 30% more power. Having tested and listened to both kinds, I am unable to detect a major difference in electrical behavior or sound. For a brief time in the late 1980s, Tesla produced an EL34 with cobalt-blue glass, now a collectors item. Tesla's tube plant was shut down in 1991, and apparently some production

equipment was bought by former employees, who started making EL34s and E34Ls again. These 1990s versions have a shorter glass envelope with a domed top, and a different black base, but appear to have the same structure inside. Trying to get information about these products has been difficult, since the company went through liquidation and changed hands twice during the 1990s.

Toshiba and Matsushita made EL34s in the 1960s. Japanese power tubes have a poor reputation for reliability overall, and the ones I have tested were all substandard electrically and visually. One Amperex/Matsushita EL34 I tested showed very unstable plate current at 500v plate, 300v screen, 75 mA. This was a problem with Japanese brands in general. I recently saw a McIntosh MC-240 amp with one Japanese 6L6GC and all the rest GEs. The GEs were OK, the Japanese one was red-hot, yet it worked fine on a tube tester.

One frequent question I get is, "what caused the STR to be made?" and I have yet to find the exact reason. What I do know is that Sylvania had been relabeling Mullards in the 1960s with the designation 6CA7/EL34, and selling them in America. Then, in 1973, the "STR" (special test requirement) 6CA7 appeared. Rumor has it that Mesa-Boogie approached Sylvania and asked them to make a rugged version of the EL34 or KT77 to be used in Boogie guitar amps. Because Fender's STR version of the 6L6GC appeared before it, and looks quite similar, it is suspected that both these tubes are based on the same structure, which is just the standard Sylvania 6L6GC of the late 1960s.



*l to r: '80s Tesla EL34, E34L, '80s Tungsram EL34, Sovtek EL34G*





*l to r GE-6CA7, Phillips 6CA7*

The 6CA7 STR is a beam tetrode, but apparently with the screen grid not aligned with the control grid. The result is not quite a pentode and not quite a beam-power type. In spite of this, the tube is one of the most rugged versions of the EL34 ever. It ended up being designed into many guitar amps in the 1970s and 1980s, to the sorrow of their current owners, as modern EL34s may not take the punishment these amps can inflict. Sylvania made three versions of the 6CA7 STR; the early one having a round top and top getter, and two later versions having a more squared-off top, one with an additional side getter. RCA took these tubes and sold them, as did Mesa and other guitar-amp manufacturers. GE started making their own version in 1975. Both these tough tubes are now out of production, and musicians are regretting it. Both tubes are rated 800 volts plate, 425 volts screen, but still 25 watts dissipation which, in this case, was quite conservative.

Ironically, the term "STR" started out as Sylvania internal technical jargon, but has become generic for the "fat" 6CA7, regardless of manufacturer. There is now the Sovtek 6CA7, which looks like the Sylvania and is colloquially called the "Sovtek STR." The Sovtek New Sensor people have two versions for sale now. One is a skinny pentode in the European style, called an EL34G (to settle all the arguments, the "G" doesn't seem to have any special meaning). The other is much like the old Sylvania 6CA7-STR. It's made with different materials and so is easy to spot. I will say no more about Sovteks because New Sensor refuses to discuss their products or reveal production details.

Shuguang has been making EL34s for at least 10 years. Their version is not very good, but had seized the market for some time. Early ones were never built straight, and frequently developed shorts. The current ones have brown bases and seem to be a little more consistent. Because other tube factories are defunct, and because this tube is so inexpensive (the two facts may be inter-related), this item is commonly sold by many distributors. As with other Chinese tubes, the cathodes are not well-processed and are made with impure materials, so the lifetime will be shorter than with NOS types.

Svetlana has a skinny EL34 that, as of this writing, is almost ready for introduction. I received some early samples, and they appear to have great promise. Early samples did not use flash getters, instead attaching two pill getters to the plate. That, combined with a hard glass

envelope, makes a solid foundation for a good power tube. It is not shown in the test charts here, because the samples were pre-production. Later versions have flash getters..

### 3. The Tests and Results

Since I wanted to find out for myself which versions of given tubes were the best, I built a single-ended amplifier especially for test-bench use. The amp has two power supplies: 500 volts DC for plate power, and 300 volts DC for plate or screen. A variable bias is applied to the control grid via a potentiometer and a 47k resistor. The output load is a One Electron UBT-1, used with an 8-ohm load connected to the 4-ohm tap. This gives an apparent 3200-ohm primary load to the tube. Such a load may not be exactly what manufacturers' data sheets recommend, but it makes a good compromise for a wide range of tubes, from 2A3s to EL84s. So long as tubes of a similar type or family are compared, the results form a useful database. The driver is a 6EA7 with the high- $\mu$  triode as the gain stage, and the low- $\mu$  triode directly coupled to it and serving as a cathode follower with a 12k-ohm load. The output is coupled to the power tube with a 2- $\mu$ F Sprague polypropylene capacitor. When driving about 10-20 volts RMS into a tube under test, this driver has distortion of less than 0.02%. Distortion was always measured at one watt into the 8-ohm load, at 1000 Hz, using my Vu-Data 101B analyzer.

Because third harmonic distortion at one watt is barely readable with all of these tubes, only second harmonic is shown. There is one weakness which the EL34 is prey to, and that is screen overheating. Because this tube is a "true" pentode, the screen's wires can be directly in the electron streams passing through the control grid. If the tube is triode connected, the screen may develop hot spots. If the screen gets too hot, the control grid next to it will also overheat and emit electrons, thus causing runaway plate current and destruction. This is dependent on the plate voltage and current. Most amplifiers run them at 500 volts on the plate at 50 milliamperes, which is 25 watts, the rated limit. A given tube that has a small defect (which will not appear on a tube tester) may go into thermal runaway once plugged into an amp. The Mullard data sheet recommends a resistor of at least 1000 ohms in series with the screen in order to prevent this.

Most EL34 guitar amps have these

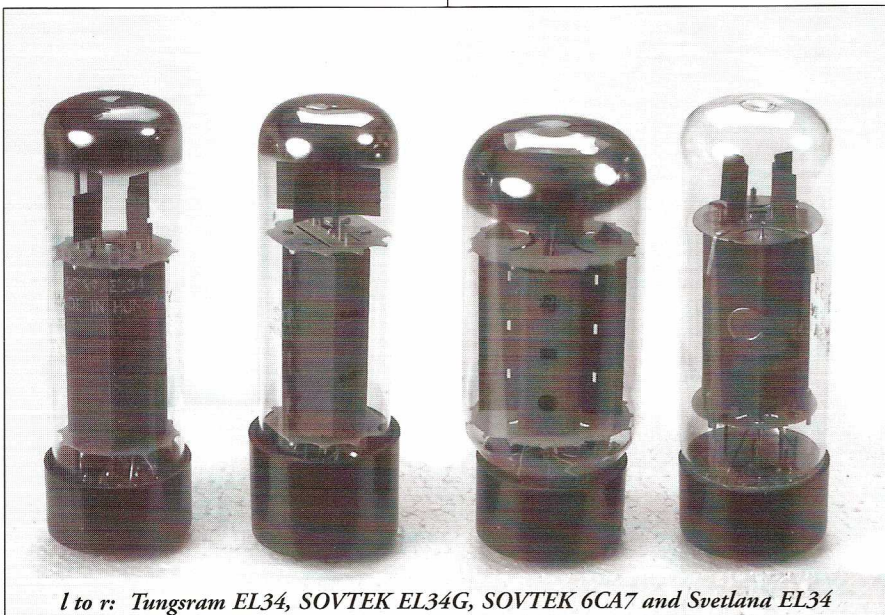

*l to r: Tungram EL34, SOVTEK EL34G, SOVTEK 6CA7 and Svetlana EL34*



resistors, but the users frequently run them deep into clipping for long periods, which can be risky. Most Hi-Fi amps, such as the Dyna Mark II and Stereo-70, are in ultralinear connection, which runs the screen at slightly more than the plate voltage and has no screen resistor. The screen tap on the transformer doesn't really limit screen current, so a tube might idle OK with no signal and go berserk when the volume is cranked up. The current imported tubes have serious problems with this.

Until today's manufacturers start using gold-plated grids and better processing (as Mullard and most other pre-1980 makers did), this will be a major sticking point. Gold keeps the grids from emitting electrons. It need not be a very heavy plating. For that matter, platinum would be even better, and is seen in some transmitting tubes. Until improved new EL34s appear on the market, amp owners should consider taking some drastic action. If either A or B below is done, your amp will even accept cheap Shuguang EL34s with little or no danger. These mods will cost \$150-\$200 each, but may pay for themselves by allowing you to avoid option C below.

**A** - Have your amp modified to lower the plate/screen voltage. This can be done by adding a choke or two to the plate supply, or by putting an autotransformer on the amp and powering the main supply from it (which requires adding a filament transformer, wired in before the autotransformer, to provide proper voltage to the filaments). This is the best way to run ultralinear Hi-Fi amps. Note that you will get less maximum power. (Some experts recommend just running the EL34s at lower quiescent current, say 40 mA instead of 50. This will help only if the amp idles for long periods. A guitar amp is often pushed hard, and screen dissipation must be limited at ALL times, not just at idle.) A power resistor can be inserted in series with the HV winding, before the rectifier. This both lowers the plate voltage and protects the rectifier, but reduces power supply voltage regulation.

**B** - The EL34s could also be connected as pentodes; this is a major job on most Hi-Fi amps; you should consult with an experienced tech. It can be done easily on most guitar amps by changing the screen resistors to larger values (5k ohms or more), and then putting 500v filter capacitors to ground from each screen. This is a good mod for a guitar amp. It will change the sound; some people find it acceptable or even better, some don't.

**C** - pay the price for NOS tubes. Be warned, these prices can only increase. There are dealers for NOS, but the supplies can be described as extremely unreliable. Often, dealers obtain NOS tubes from people who sell their personal stashes; often they appear at estate sales or in military surplus auctions. The people who make a living this way have to work very hard at it. Old KT77s, Mullards and Telefunken are especially scarce now. I have seen Type I Mullards sell for \$150 each.

That said, we will now go into the test results. Note that all of the tubes were tested in pentode mode at 500v on the plate, 300v on the screen, 75 mA.

This is quite a test, but virtually all of the older tubes handled it without showing any hot spots on their screens (except for three: a Type III Mullard that had plate overheating; a 1970s Japanese Amperex that showed red-hot screen wires in two places; and an Amperex-Mullard Bugle Boy of 1960s vintage that went bad due to loose elements. All three were used and had been knocking around in the bottoms of cardboard cartons for years).

Current production is a different story. One of the Sovtek 6CA7s, two of the Sovtek EL34Gs, and two of the current Shuguangs had serious hot spots on their screens (visible through the slots in the plate). All of these tubes were new out of the box. For pentode connection, this is unacceptable. A Marshall guitar head might "do a Jim Phelps" if it were equipped with these tubes. I tried some tubes in 500v triode, and most Shuguangs and Sovteks quickly developed red-hot screens, while the NOS units only had a few glowing spots. The distortion tests are a good way of checking how careful a factory was in winding its grids, and often are an overall indicator of quality. I will note that all of these tubes were either NOS or very healthy used units. Excuse the small number of samples in some cases; just getting two or three of some of them is extraordinarily difficult. It's safe to take the samples of 5 or less as advisory, not hard fact. I will also note that there were only 3 testable Amperexes, and the Japanese one dragged the other two (which were Mullards from the 1960s) down. If the use intended is Hi-Fi, tubes from the upper parts of the list are preferable. If you're going to play thrash-metal through them, perhaps the lower ones are what you prefer (provided your amp is modified to reduce screen dissipation).

**Table 1:** average distortion at 1 watt, EL34 samples. Arranged in order of increasing distortion. Second harmonic only is shown. Tubes were new in original boxes except as indicated.

Type	Distortion	# Samples
KT77 MO	0.503%	3 (used)
Telefunken type I	0.515	2 (used)
Telefunken later	0.528	6 (used)
Tesla EL34 current	0.550	2
Mullard type I	0.553	3 (2 used)
Sylv 6CA7-STR	0.613	16 (12 used)
GE 6CA7-STR	0.623	6 ( used)
Sovtek 6CA7	0.623	3
Tesla EL34 1980	0.624	7
Tesla E34L 1980s	0.630	4
Mullard type II	0.639	11 (7 used)
Shuguang 1980s	0.643	3
Tesla E34L current	0.650	2
Shuguang current	0.650	3
Sovtek EL34G	0.659	51
Amperex	0.663	3 (1 used)
Siemens	0.664	7
Mullard type II	0.665	6 (2 used)
Tungsram	0.688	9 (4 used)

Another test performed was peak-power output. The input signal was simply turned up until the RMS output reading peaked and started to drop. This test is rather approximate, but gives some idea of how much current a cathode can deliver. If these tubes were to be used in a Class-C transmitter, this test would be especially important. For Hi-Fi duty, it is useful but not critical. For a guitar amp, it may mean nothing since tone is of more concern. Note how well the current Teslas did—not surprising, as materials (at least the knowledge of them) have improved since 1953.

**Table 2:** peak-power averages, EL34 samples. Measured at 1000Hz into a 3200-ohm primary, readings in volts RMS across the 8-ohm load. These are the same samples seen in the distortion table above.

TYPE	PEAK OUT VRMS
Tesla EL34 current	16.0 v
Tesla E34L current	16.0
Shuguang 80s	15.7
Amperex	15.5
Mullard type II	15.3
Mullard type I	15.2
Mullard type III	15.2
Sovtek 6CA7	15.2
Siemens	15.0
Shuguang current	15.0
GE 6CA7-STR	14.8
Tesla EL34 80	14.7



Sovtek EL34G .....14.7  
 Tungstram .....14.6  
 KT77 MOV .....14.5  
 Telefunken type I .....14.5  
 Sylvania 6CA7-STR .....14.4  
 Telefunken later .....14.3  
 Tesla E34L 80s .....14.1

**4. Outro**

It is ultimately up to the user to decide on which tube is best. Personal tastes vary, especially among guitarists (some are very conservative perfectionists, others are always open to new sounds). Hi-fi is also subjective, but to a lesser extent than musical amplification; whether the some audiophiles admit it or not. Since most EL34 hi-fi amps use negative feedback, they are less sensitive to the quality of the tubes used, as far as distortion goes. But a well-made tube, with low distortion and stability, is an asset which is (unfortunately) getting harder to find in the 1990s. This is especially true of the EL34, a classic but not necessarily the finest power tube ever.

*Many thanks to Haden Boardman and Aspen Pittman for their help with historical information. Also thanks to John and Charlie for loaning me their NOS tubes for testing.*

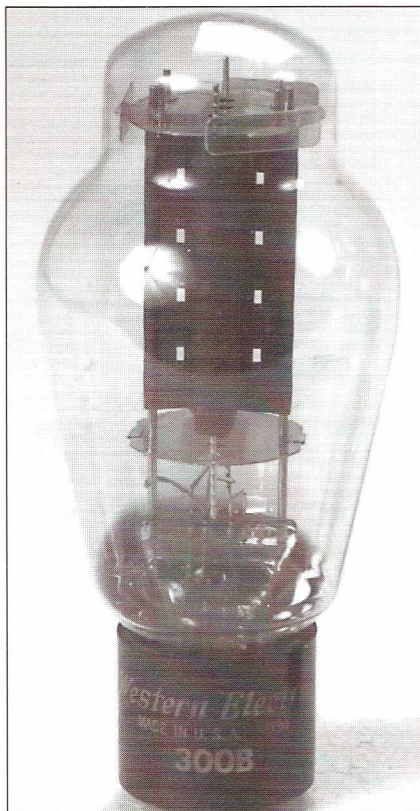

*Eric tests 300Bs in the Winter '95 VTV*

**The Audio Test Bench**

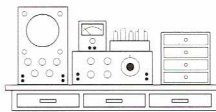

by  
**John Atwood**

**The Test Bench and Tools**

This is the first of a series of articles describing in depth the tools and equipment needed to design, build, and test audio equipment, with a special emphasis on vacuum tube technology. This is not a retrospective series; it sometimes calls upon the technology of the 1990s to implement a productive working environment. However, vintage equipment that is still usable will also be described. While the focus is on audio work, much of the tools and equipment is applicable to radio and industrial electronics as well.

Anyone who builds or fixes electronic equipment needs a place to open up their equipment, make small repairs, and run electrical tests. This can be as simple and temporary as setting up on the kitchen table to as complex as a dedicated industrial test bench. If you do more than just occasional construction and repair work, then a dedicated work space is very helpful. This can be a corner of the garage or basement, part of an unused room, or a bench at your workplace. Stocked with the right tools and equipment, a dedicated workspace will facilitate the process, freeing up your mind to concentrate on the problem at hand.

This series draws on my direct experience from working as an audio technician in college, a computer hardware engineer in industry, and as an audio designer for my own company. Sometimes the choice of tools or equipment is based on personal

preference – others may have different preferences. Readers are welcome to submit their own ideas; interesting or constructive contributions will be summarized in future issues.

**The Test Bench**

A test bench needs to meet the following criteria. It must:

1. Be comfortable to work at. This includes good lighting and a good chair.
2. Provide enough bench space to work on your equipment with enough room for parts, notebooks, etc.
3. Provide enough electrical outlets to power all the test equipment and unit under test in a safe manner.
4. Hold tools and frequently used parts close to your work position such as in drawers or bins.
5. Provide enough space for test equipment without compromising on benchtop space.

In the electronics industry, the standard work benches are 36 inches tall, often with add-on drawers, an overhead shelf, and built-in power strips. New, these benches can cost hundreds of dollars, but can often be found at industrial surplus stores for under \$100. It is also possible to build them from wood or from kits available from hardware stores.

I've found these high benches somewhat inconvenient, requiring special high "lab" chairs. I prefer to work at a regular height desk; this allows the use of commonly available desk chairs and accessories. Desks also have convenient drawers and pull-out surfaces. It is important to use a deep desk (34" or more), otherwise your test equipment will not leave much area to work, especially if you use older tube-type test equipment. My favorite test bench is an old wooden executive desk





(the kind that has two stand-alone drawer sections with a large wooden top and center drawer connecting the two). It is beat-up enough that I don't care about scratching the top, and its capacious drawers hold plenty of parts, tools and documentation.

It is helpful to have a shelf over the desk or workbench to hold test equipment. This can be purchased or made from plywood. Be careful, though, because many shelf units made for regular office use have closed backs, making it difficult to handle deep equipment and wiring. They also may not be strong enough to hold heavy equipment. In earthquake-prone areas, it would be prudent to anchor the shelf and fasten the equipment to the shelf, to avoid injury or damage in an earthquake. If the desk is metal, the frame should be connected to the protective ground (the green wire in American wiring), and an insulating mat be placed on the surface. The mat can be of the black conductive type (anti-ESD mat) if the resistance of the mat is high (over 1 megohm). These precautions are not usually needed for low-voltage solid-state work, but with the high voltages used with vacuum tubes, it is important to prevent unanticipated stray paths that could cause a severe shock.

### Hand Tools

The heart of anyone's test bench is their collection of hand tools. These mechanical aids to assembly and disassembly are the most intimate link between man and hardware. Of all the tools and equipment described in this series, good quality and appropriate hand tools will provide the best productivity and satisfaction. This is why master mechanics have their own tool box, and jealously protect their tools.

Note: the sizes of the tools described here are from the American point of view, with sizes specified in inches. In other countries, metric sizes would be appropriate, although certain common sizes, such as 1/4" hex-head screws, seem to show up in non-American equipment, especially computers.

### Screwdrivers

The minimum set of screwdrivers would be: Flat blade type: 1/4", 3/16", and 3/32", Phillips type: #1 (3/16") and #2 (1/4"). To this could be added other sizes, such as 1/8" and 5/32" flat blade type, and #0 (1/8") Phillips type. An overlooked type that is very handy for electronics work is the "Pozidriv". This looks like a Phillips, but the shape of the tip matches the screws so often used in Asian



audio and computer equipment. My Stanley 64-131 1-point Pozidriv screwdriver has been very helpful in loosening tight screws made of soft metal that would have been ruined by regular Phillips screwdrivers. Xcelite is the dominant brand in the American electronics industry, but premium quality screwdrivers from other manufacturers, such as Paladin (Weralit), Proto, Snap-On, Stanley, Vermont American, Crescent, and others are just as good or better. Strangely, Xcelite does not make a Pozidriv type with a regular plastic handle.

### Allen and Other Hex-Socket Type Wrenches

Most setscrews in knob and shaft hardware as well as some regular screws use the Allen hex socket head. Initially, a combination set of hex wrenches ranging from .050" to 3/16" can be used. I find that the .050", 1/16", 5/64", and 3/32" sizes are used the most, and so have plastic-handled versions of these. If you do any repair or disassembly of military equipment, you will need a set of Bristol spline screwdrivers. These are hard to find, but Xcelite makes a combination set of these (part number 99-PS-60). You may need a few Torx screwdrivers, although these are used more in industrial and computer equipment than in audio equipment.

### Nutdrivers and Wrenches

The minimum set of nutdrivers is rather large, but this is because they are so convenient, and avoid damage that can be caused by using pliers or regular wrenches. The minimum sizes to have are: 3/16", 1/4", 5/15", 11/32", 3/8", 1/2", and 9/16". Hollow shaft types are strongly rec-

ommended, especially for the sizes used for controls and switches (1/2" and 9/16"). Avoid the cheap combination sets; their metal is usually soft, and will deform after only a little use. For nuts that can't be handled by the nutdrivers, an adjustable wrench (sometimes called a Crescent wrench) is useful. A set of midget wrenches (from 7/32" to 7/16") is handy for holding nuts in hard-to-reach places. A very useful tool that anyone who has built a Heathkit will remember is a nut starter. This is a plastic tube shaped to hold 1/4" and 3/16" nuts and get them started on the threaded screw shaft.

### Pliers

The single most important hand tool for electronics work is a good long-nose pliers. These will bear the brunt of bending wires, exploring circuits, desoldering, holding parts, and many other tasks. Most electronic technicians have their own preferred brand. Mine is the D301-5C 5" long-nose pliers by Klein Tools. Other good brands include Diamond, Xcelite, and Erem. Look for long-nose pliers with ends that close tightly and have little play. For vacuum tube work, with its extensive point-to-point wiring, a somewhat heavier-duty plier, such as the D301-5C, is better than the tiny pliers used for contemporary electronic construction. A pair of regular slip-joint pliers is useful for general assembly or disassembly. The Vise-Grip or equivalent locking pliers are useful for holding work, inserting line cord stress reliefs or destructively loosening tight nuts.

### Wire Cutters and Strippers

Second in importance to good long-



nose pliers are good wire cutters. They should be flush on one side to assist in trimming circuit board leads. The cutting edge should meet evenly and the joint should have little play. The good manufacturers of electronic wire cutters are the same as for long-nose pliers. My favorite type is the Klein D244-5C. A large electrician's wire cutter is good for fat wires or steel wires that will damage the smaller pliers. There are many good wire strippers, some of them fairly complex, to prevent nicking the wire and to accommodate different wire sizes. I prefer to use the simple type, such as the Xcelite #100, and modulate the depth of the cut by feel. When cutting very fine wire, such as Wire Wrap wire (30 gauge), I use Clauss No Nik strippers.

**Miscellaneous Tools**

Other useful tools include: tweezers, a paint brush for cleaning, forceps to hold wires, coax cable cutters, coax connector crimpers, a crimping tool, small files, dental mirror, lead-forming gauge, Xacto knife, and fuse-puller. Not covered in this article are the many tools used in chassis and other mechanical construction.

**Soldering Tools**

Soldering has been the basis of most electrical connections from the turn of the century to the latest surface-mount technologies. The intricacies of soldering and soldering techniques will not be covered here; just the tools commonly used for solder at the work bench will be described.

**Soldering Iron**

There are three types of soldering irons: uncontrolled, magnetically controlled, and electronically controlled. The uncontrolled type is the cheapest, and suitable for casual uses and non-critical point-to-point wiring. It is not suited to PC board wiring, since it has a high tip temperature which can damage the PC board and its components. A controlled-temperature soldering iron has a thermostat-type sensor that keeps the tip within a certain temperature range.

The cheapest controlled-temperature soldering iron is the magnetically-controlled type that uses the Curie temperature of a magnetic alloy as the sensing mechanism. The Weller W60P and WTCPT are typical of this type. Tips are available in 600°F, 700°F, and 800°F ratings. The controlled temperature make these irons safe for PC boards, and the thermostatic control gives the sense of a much larger heat capacity for a given size of iron, making point-to-point soldering easier. There is no need for the giant "American Beauty" soldering irons that

women used on the electronic production lines of the 1940s and 1950s.

The electronically controlled soldering irons allow adjustable tip temperature and closer temperature control. The fancier units have temperature read-outs, and some are even microprocessor-controlled. These units are primarily for production work on high-density PC boards.

I use the Weller WTCPT magnetically-controlled iron, with three tips: a 1/16" 600°F tip for fine PC board work, a 3/32" 700°F tip for general purpose work, and a 3/16" 800°F tip for heavy-duty work, where the high temperature is not a problem.

**Solder**

Solder is becoming an area of high-end designer products, but the metallurgy for high-quality, long-lifetime solder joints has been understood for many years. The traditional 60/40 solder, also called Sn60 (60% tin, 40% lead) is actually quite good. Eutectic solder (63% tin, 37% lead, called Sn63) has no "pasty" state, and so solidifies most cleanly. Silver bearing solder (62% tin, 36% lead, 2% silver, called Sn62) is needed to solder to ceramic terminals, such as those found in Tektronix equipment. I use Sn63 for most soldering, but am preparing to try some other types for their sonic qualities.

Flux is an essential part of soldering. Nearly all electronic wire-type solders have RMA flux cores (RMA = Rosin, Mildly Activated), which is good for nearly all hand-soldered electronic needs. Be careful not to use so-called acid-core solders unless you very carefully remove all flux residue. Major brands of solder include Kester, Alpha, and Ersin.

**Desoldering Tools**

Desoldering is an important part of repairing or disassembling electronic equipment. For through-hole PC board desoldering, the spring-loaded solder sucker or solder-wick desoldering braid is good. For taking the solder out of a point-to-point wired connections, I find that the rubber bulb solder sucker has the best control. It gets clogged frequently, so I use the leads of an old 2-watt resistor to clear the sucker.

**Holding Tools**

When soldering small parts or sub-assemblies, you sometimes wish you had three hands. There are various holding tools available, including the well-know Pana-Vise. I use a heavy-duty, but effective alternative: a drill press vise. It doesn't skitter around like some lighter-weight holders. Alligator clips or forceps are

sometimes helpful for holding wires or components in place while soldering.

**Where To Get Tools**

If you are lucky enough to live in an area with lots of electronic industry, retail stores and industrial distributors will carry the tools described above. Mail order outfits that specialize in electronic tools include: Techni-Tool (610 941-2400, FAX 610 828-5623) and Jensen Tools (800 426-1194, FAX 800 366-9662).

Note: I am not an employee of, nor receiving any compensation from any of the companies mentioned here.

*The Audio Test Bench topic for next issue: DC Meters.*

**Tube Industry News**

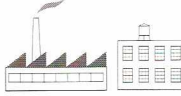

by  
**Eric Barbour**

**SURVEY RESULTS**

The results of the tube industry survey are in. We sent questionnaires to all of the major distributors and mail-order dealers, with generalized questions about the numbers of preamp and power tubes (not including industrial and transmitting types) they had sold in 1994. The average dealer sold 79,000 tubes last year, of both types. The total is estimated at about \$12 million in power tubes, \$8 million in pre-amp types, for an industry total of about 1 million tubes. Note that these are approximate figures, and do not include some OEM sales. Most of this is direct sales to consumers plus smaller OEM business. The origin of these tubes is something like this:

NOS (American and European)	23%
Russian.....	30%
Chinese .....	30%
Tesla .....	16%
others .....	<1%
(error: approx 8%)	

There is still significant business for NOS products today. In fact, the largest distributor is doing large quantities of business just by selling its old stock off. Some mail-order dealers are handling NOS as a speciality, and the demand seems to be increasing, even as the supplies dwindle. Good news for you hoarders. Most significantly, the demand for audio tubes in general increased last year. Only one dealer reported that sales were



flat, and none reported that sales had declined. In the words of one dealer, "things are exploding." This is especially amusing when you compare it to the U.S. Department of Commerce's own figures on receiving tubes. Their latest figures were for 1989-1990, and they were blunt: "investment opportunities are poor." They had only about \$26 million in sales for that period, and issued proclamations of doom for the American manufacturers (all of which had already shut down their factories, except for MPD and Richardson). Try calling information in the 814 area code. Ask for the number of Philips Components, Sylvania or Philips ECG. (This was the former home of Sylvania's main factory.) They have no such listing; that factory is totally gone, maybe prematurely. By the way, 5 out of 13 companies ignored us completely – what have they got to hide?

### THE 6V6 GOES POOF

Have you tried to buy a 6V6GT recently? Suddenly, the NOS supply has dried up. The reason is that, although this baby 6L6 is not popular in Hi-Fi amps, its use in classic guitar amps (such as the Fender Princeton Reverb and Deluxe) guarantees a good demand. The street prices for those circa-1960 guitar amps are rising. So, has somebody bought all the old 6V6s? The Russian ones are of inferior quality, and these amps run at high voltages so the low-cost Russian product gives a high failure rate. The situation is getting so desperate that some guitar-tube dealers are either selling those skinny Russian 6L6s (actually called 6P3S, and not a real 6L6GC at all) as 6V6 replacements, or else selling 6EY6s and 6EZ5s to musicians. The Russian tube was never meant for use above 400 volts, yet some people have tried to sell them for that, resulting in many fried guitar amplifiers. They seem to be OK as 6V6 replacements, although the bias points and other characteristics are quite different. The 6EY6/6EZ5 are old TV vertical-driver tubes that just happen to be pretty good and have 6V6-like pinouts. (They are only rated for 315 volts max, but I won't tell any guitar dudes if you won't.) Rumor has it that somebody is trying to start up a new tube factory in the USA (not Western Electric). They intend to keep it a secret until they can produce some good-quality samples. The guitar-amp market is everything to them, as it dwarfs the high-end market; so don't expect any 2A3s. But I wonder if the first tube they make will be a 6V6GT. Maybe if we ask with big smiles, they will also make some 7591s. Have you ever noticed how similar those two tubes look?

### VAIC VV52B

This giant power triode is new to the world market. It is intended to be a serious competitor to the 211 and 845, but uses a standard 2A3-type socket and has an oxide-coated filament.

Filament – 6.0 to 6.4V AC/DC, at 2.0 to 2.4 amps

Plate voltage – 650V max.

Cathode current – 200 mA max.

Plate dissipation – 85 watts max.

Transconductance – 6000  $\mu$ S min.

Plate resistance – 600 ohms max.

Mu – 4

Grid current: – 1  $\mu$ A max at 65W, 4  $\mu$ A max at 85W

Recommended load resistance – 1500-3500 ohms for 18-28 watts linear output.

Vaic recommends forced-air cooling above 80 watts dissipation. The glass temperature must be kept under 200C, and the tube should be mounted at least 5 cm away from anything else. Typical operation with a 2500-ohm single-ended transformer has 500 volts plate, -96 to -110 volts grid bias, 150 mA plate current, and gives an output power of 25 watts with 33% efficiency. Grid resistor recommended is 100k ohms or less. The warning in the data sheet says: "Not using with fixed grid bias without automatical regulation according to emissivity!" which, I think, means that they would prefer use of an auto-bias. The tube is also suitable for use with cathode bias, the resistor being in the 470-1000 ohm range at 50 watts. The VV52B is available exclusively from:

Triode Supply Japan, 227-1-101 Kasimada, Saiwai-ku, Kawasaki, Kanagawaken, Japan; phone 81-44-511-6343, fax 81-44-511-3492. Price is 108,000 yen each.



WE 205D

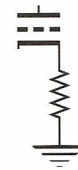

### Cathode Bias

by  
John Atwood

### Help Conserve a Finite Resource

Despite claims that the source of tubes are "drying up", there are still warehouses full of tubes, and numerous personal collections around the world. Given that hundreds of millions of tubes were manufactured per year during the 1950s and 1960s, it is not surprising that left-over spares are still around. Common types are still being manufactured in Russia and China, but many prefer "N.O.S." (New Old Stock) for either their sound or their ruggedness. But prices on certain of these N.O.S. types are skyrocketing! Aside from the early or industrial types that were never made in the quantities of later types (such as the 50 and 300B), recent, common tubes are becoming scarce. First it was the 7591, now it is the 6V6GT and 6L6GC. Even small tubes, such as Amperex 6DJ8s, are beginning to appear in collectors' want lists. Yet tubes not in current demand, such as TV types or military/industrial types, languish in warehouses.

Unfortunately, conventional vacuum tube manufacturing technology is labor- and capital-intensive, and greatly benefits from the economies of scale. Even in the 1950s, when nearly all consumer electronics and military equipment used tubes, the cost of tubes (adjusted for inflation) was still higher than the cost of newly-manufactured tubes coming out of Russia or China today. As those countries phase out their vacuum-tube military equipment, the only significant remaining market for new "receiving" tubes is the audio and music amplifier business. Unless the usage of tubes in these areas sustains a massive increase, the existing factories may not have the economic incentive for keeping their production lines open. At that point, since there still would be a demand, smaller factories would make tubes on a much smaller scale, charging very high prices. Current examples of this include Richardson Electronics and VAIC.

So, today we are faced with a finite and shrinking pool of desirable N.O.S. tubes, and an uncertain source of new tubes, many of which are not as good as the N.O.S. types. Yet how many times do you see guitarists burn-out a set of tubes after one or two concerts, or audiophiles who replace all their tubes every few



months, or inexperienced technicians who don't test for leaking coupling capacitors – leading to premature tube failures? Or, on the manufacturer's side, designs that run tubes far beyond their ratings, whether through ignorance or a belief that running the tubes "hot" improves their sound. Good N.O.S. tubes, run conservatively within their ratings, should last from 2,000 to more than 10,000 hours. But many of the practices listed above cause tubes to be thrown away after only a few hundred hours or less. This rapidly depletes the finite number of N.O.S. tubes in existence.

What can be done? The best long-term solution would be for a revolution in manufacturing techniques that would allow tubes to be made inexpensively in relatively small quantities. The progress in "smart" manufacturing may allow this in the near future. But until then, here are some recommendations to the vacuum tube users and equipment manufacturers:

**Tube Equipment Manufacturers:**

1. Know of all of a tube's maximum ratings, and design within them. An especially common problem is running output tetrodes or pentodes in triode or ultra-linear connection with a high B+ voltage, which often brings the screen voltage and screen dissipation far above their maximum ratings.
2. Run tubes conservatively. Tubes last a lot longer if they are run below their maximum ratings.
3. Make the circuit insensitive (within reason) to declines in the tube's emission and transconductance. Don't require specially selected tubes.
4. If you find that running tubes at high voltage or high current makes them sound better, it may be that you are just moving the operating point closer to a "sweet spot." Try seeing if a different load impedance can achieve the same effect.
5. Delay the B+ turn-on until the tubes are warmed-up, especially for power tubes.
6. For products with small production runs, consider using some of the neglected TV or industrial tube types. There are still lots of them around, and many are quite good.

**Tube Equipment Users:**

1. Be sure your equipment is in good shape, and properly biased. If a particular tube location fails frequently, bring the unit in for repair.

2. Don't leave your equipment on all the time (unless you actually use it all the time—like a radio station). Tubes deteriorate with use. On the other hand, don't turn equipment on and off frequently. Turning it on and off once or twice a day is a good compromise.

3. Instead of changing all tubes at once, replace only those that are weak or impair the sound. If a tube doesn't sound good, but is otherwise strong, try using it in a less demanding location. Often only one or two tubes in a unit are very sensitive to tube variations.

4. Check your power line voltage. The average line voltage is now higher than what it was when most older equipment was designed. If it is too high, reduce it with a Variac (variable transformer) or a filament transformer connected to cancel some of the line voltage. It is best to check the filament voltage right at the tube socket. (This should not be a problem for regulated filament supplies.)

5. Don't replace vacuum tube rectifiers, especially heater-cathode types (such as the 5V4G or 5AR4/GZ34), with silicon rectifiers, unless you compensate for the increased B+ voltage and provide for a delayed B+ turn-on.

6. Avoid manufacturers that have a reputation for building unreliable equipment or equipment that "eats" tubes.

These recommendations will help preserve the supply of good tubes so that more of us can enjoy the benefits of tubes!

**The Magnum Single-Ended Amp**

by David A. Wolze

*This is the first amplifier circuit design article for VTV. It is not presented as a step-by-step construction article, but rather to give ideas to more experienced constructors and designers. – Tech. Ed.*

Single-ended amps really sound great, but most are low powered and expensive. Many use filamentary triodes, which are expensive, short lived, and hard to interface. When using filamentary triodes, DC filament power is often required in order to control output hum. But apparently there is nothing else available; tube manufacturers went to beam power tubes in the '30s, abandoning triodes for audio. Then the SE craze hit, and to get linear output devices, we had to use tubes designed with 1920s technology.

**The Design Challenge**

I wanted to design an SE amp that had high power, a simple design, and that good SE sound using inexpensive components. As a practicing electronics engineer, I must meet similar goals when I do design work on the job. Doing this for a hobby amplifier was therefore second nature for me. Of course, there were a couple of tricks involved with pulling this off. Tricks are also part of engineering, otherwise the man could replace me with a machine!!!

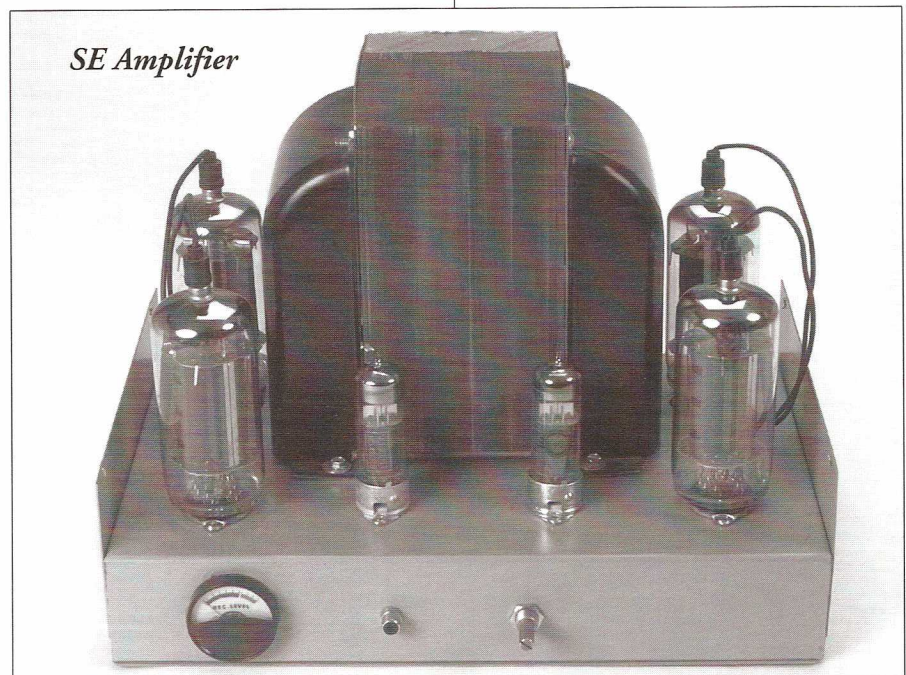



# THE MAGNUM SINGLE-ENDED AMP

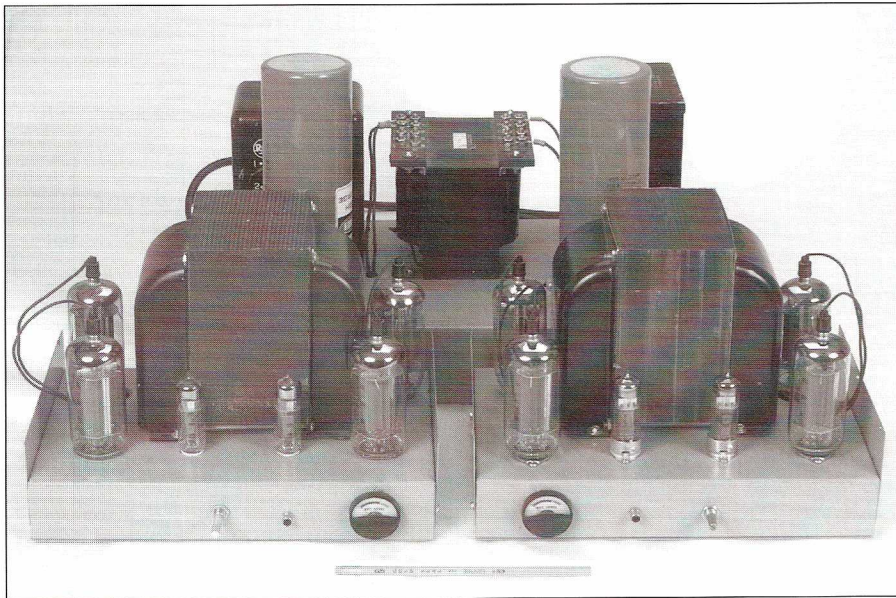

## Converting the Transformer

The first trick is to convert an inexpensive push-pull transformer to accommodate SE operation. Isn't it ironic that while a single-ended amp needs a much larger output transformer for a given power level, all the big iron out there is for push-pull??? WHERE'S THE BEEF??? If one wants to get a beefy output for their SE amp, a push-pull unit must be converted to SE.

The Hammond 1650W output is the transformer that I chose for my Magnum SE amplifier. Rated at 280 watts and 1900 ohms primary impedance, these

BEEFY units are just the ticket for high-power tube amps. Rumor has it that these transformers are used in a famous maker guitar BASS amplifier. Hmmmm...

The 1650W is supplied as a push-pull unit. It has the standard 'EI' iron core configuration. It is built by first winding the coil and then inserting the 'E' sections into the coil and capping the 'E' with an 'I'. The orientation of the 'E's and 'I's are alternated, forming a solid iron core to build a push-pull type transformer.

To convert a push-pull transformer to single-ended, an air gap must be introduced into each of the two magnetic 'cir-

cuits' in the EI core. When one is starting from scratch, the 'E' sections would merely be inserted into the coil without alternating them. The resulting two-piece core has the air gap introduced by shimming the 'I' section from the 'E's with a non-magnetic material.

Figure 1 Transformer Modifications

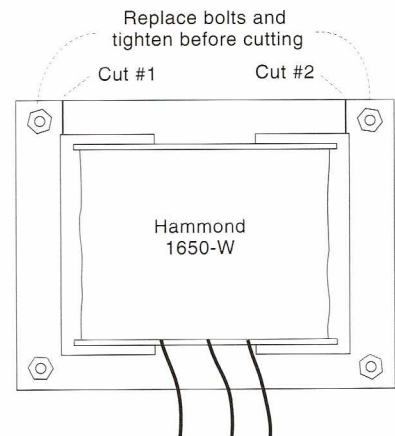

It is not easy to cleanly disassemble the core of a push-pull transformer. The air gaps must be introduced by cutting through the iron with a hacksaw. It may be possible to have a machine shop do this. Remove the end bells and replace and tighten the bolts on the core, to prevent it from delaminating while you cut it. Make two cuts; one on each side of the coil, as shown in Fig 1. The metal is soft, but there is a LOT of it. It took me three hours to make the two cuts.

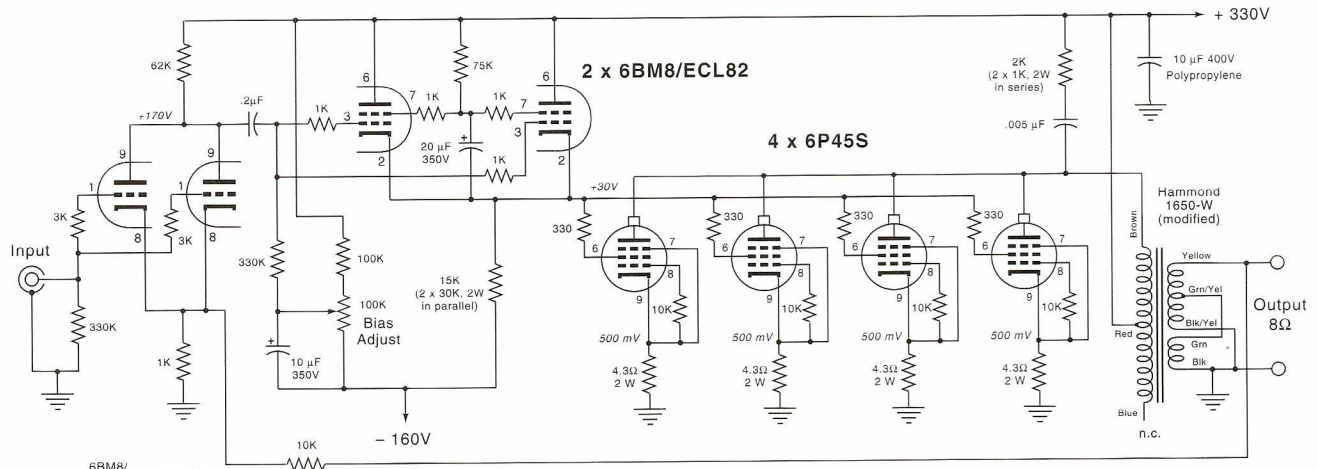

## The Magnum SE Amplifier

by David Wolze

- Notes: 1. All resistors are 2 watt, except for grid stopper resistors (connected to pins 1, 3 and 7 of 6BM8 and pins 6 and 8 of 6P45S) which are 1/2 watt.  
2. Typical DC operating voltages shown in italics

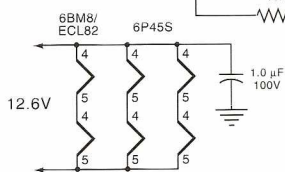



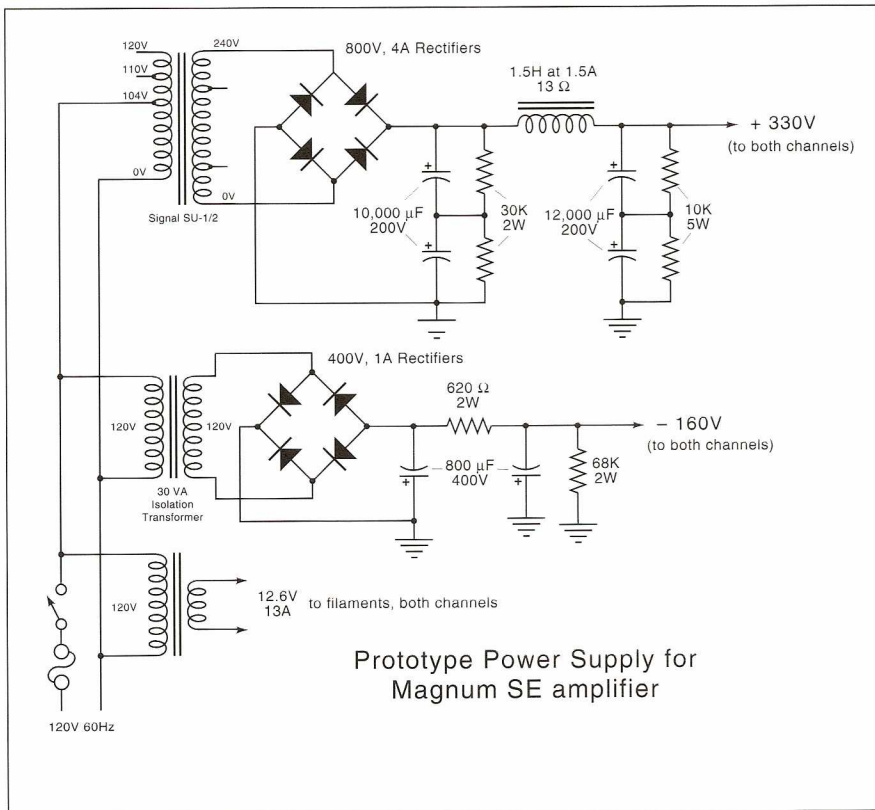

Prototype Power Supply for  
Magnum SE amplifier

The resulting transformer was tested with a small signal on the primary. Frequency response was within 3 dB at 10 Hz. I figured that the power bandwidth would be good down to about 30 Hz on this transformer. The high frequency response was improved, as the reduced inductance raised the resonant frequency. (Resonant frequency was over 200kHz.)

### Converting TV Sweep Tubes

The second trick involves the use of TV sweep tubes in a novel configuration. I have been a fan of sweep tubes for years. Built like miniature transmitting tubes, these rugged units represent 1960s technology. Their advanced materials and precise construction are light-years ahead of those 1920's filamentary triodes. They are rugged, beefy, and no one fights me over them at the swap meets. Indeed, the last Antique Electronics tube sale featured 21GY5 sweep tubes at the lofty price of 50 cents!!! Two recent developments have only served to increase my desire to use sweep tubes in my Magnum amplifier designs.

First, Svetlana has come out with a really nice EL-509/6KG6 equivalent, the 6P45S with limited availability. This tube is extremely rugged, with a heavy glass envelope and a heavy duty heater and cathode construction. I have built several push-pull and SE amplifiers using these

tubes as straight pentodes or ultralinear, with excellent results. The EL509/6KG6 or other similarly-rated sweep tubes could be used, but are not as rugged as the 6P45S, so be careful.

Second, Tim de Paravicini recently had his 'enhanced' screen grid driven circuit published. This elegant idea will only work well with sweep tubes. Not only is the sound improved over pentode operation, but also the front end circuit complexity is cut in half. The BEAUTY of this screen-grid drive idea is that the close screen grid spacing in a sweep tube, once considered a disadvantage for audio applications of these tubes, is turned into an advantage!!! Now, the high perveance and rugged construction are combined with good linearity. No other tube type can hold a candle to the lowly sweep tube operated by driving audio to its screen grid!!!

Application of the screen grid drive is simple. The control grid is tied to the cathode through a 10K resistor, and the screen grid is driven by a direct coupled cathode follower. The screen grid then acts as the control grid of a low mu power triode. Its plate resistance is about 2000 ohms, and at 12 watts out, distortion is under 1.3% into a 1900 ohm load, with the plate at 300 volts and the cathode running 150 mA.

### Building the Amplifier

The chassis, tube sockets, pots, binding posts, transformers, etc. can all be ordered from Antique Electronic Supply (602) 820-5411). I used two 8" by 12" chassis for the amps, and a 10" by 17" chassis for the power supply. It is nice to get the cages, too; they look good and they prevent injury to pets and children. The tubes are available from Svetlana, represented by R & G International in Huntsville, Alabama, (800) 456-5642.

Use the photograph of the amplifier as a layout suggestion for placement of the components. To mount the small components under the chassis, I prefer to use surplus copper clad PCB material that I cut with a Dremel tool to form pads to which I solder the resistors, capacitors, and wires. These boards are then wired to the tube sockets and attached to the chassis with silicone glue.

A higher power amplifier requires a damping factor of at least 10 in order to control large speaker excursions. Therefore, I applied about 15 dB of negative feedback to obtain the necessary damping (see schematic for details).

### Testing the Amplifier

With the amp built, the bias pot was turned down and the power supply was attached and slowly brought up with a Variac. No smoke was seen, so bias was advanced until an average of 500 millivolts was seen across each of the 4.3 ohm cathode resistors. This corresponds to a total plate current of 470 ma. My Heath IG-18 oscillator and H-P 330B tubed distortion analyzer were then hooked up to the amp, along with the scope, to get the following specs:

Eb (plate voltage): 330V (see schematic on this page for a suggested power supply). Ib (plate current): 600mA (total, including front end current)

Vout at clipping - 65V P-P across 8 Ohms (68 watts RMS)

Distortion at 50 Watts - 1.5% (mostly 2nd harmonic)

Distortion at 8 Watts - 0.4% (mostly 2nd harmonic)

Distortion at 0.5 Watts - 0.5% (mostly noise)

Power Bandwidth +/- 3 dB - 30 Hz to 20 kHz

Frequency Response @ 8 Watts - 20 Hz to 50 kHz +/- 0.5 dB

Frequency Response @ 1 Watt - 10 Hz to 100 kHz +/- 0.5 dB



Square Wave Response – No overshoot; about 5 cycles of 200 kHz ringing at the beginning of the pulse; peak amplitude of ringing about 2%. 30 watts output @ 1 kHz.

**Listening Tests**

Three listening tests were held to evaluate the new Magnum SE amplifiers. First, I listened to them myself. This was the first time that I had heard DECENT BASS from an SE amp. Yet the grace of the top end let me know that this was a single-ended amplifier.

Next, the amps were brought to Vacuum Tube Valley for a critical evaluation by a group. The panel was duly impressed by the Magnum SEs. Solid bottom end backed up by incredibly detailed mids and highs were enjoyed by all in the listening session, which lasted three hours. (Speakers used at VTV were Klipsch Chorus 1s)

Finally, the amps were brought to a large outdoor party. (Don't try THIS with your wimpo 8 watt jobs!!!) The speakers used at the party were DBX Soundfield IV cabinets, closed box with a volume of four cubic feet. The boxes were braced and modified so that the woofer fires forward. The woofers were JBL D-140 with crossover at 1000 Hz. The midranges were 4-206 125 Hex ETON with a first order crossover. The tweeter was a Phillips AD216008 ribbon tweeter with a first order crossover at 5000Hz.

Through the heat of the day and well into the night, the amps played on. People just assumed that this was pro audio gear; it effortlessly handled Gershwin as well as the loudest disco beat.

\* Dave Wolze is a San Jose, California based electronic engineer.



Gibson GH-100 Guitar Amp

**TUBE GUITAR AMPS:**

An interview with **Terry Buddingh** of Guitar Player Magazine

by **Charlie Kittleson**

CK - Terry, are vintage guitar amplifiers still a hot item amongst professional players?

TB- *Very much so, especially over the last few years. We are still trying to figure out why a lot of new amps don't sound as good. The vintage amps have a certain richness and complexity of tone, while many newer amps sound one dimensional, harsher and stiffer.*

CK- What is so special about the sound of older guitar amplifiers?

TB - *They simply have a more compelling sound. They are typically not as harsh, tight or constricted sounding as many of the new tube guitar amps. The older amps have more tonal coloration and character, possibly caused by the aging components. Everything in the signal path matters. Tubes, resistors, capacitors, wire, transformers, and especially speakers, all have their special contribution to the sound. Most of the older amps are very basic in design and construction, and with tone, less is more. The quest for great tone is an art that perhaps transcends science.*

CK - What are some of the favorite low to mid- power guitar amps of the top recording artists?

TB - *Many of the pre-1965 (pre-CBS) Fender amps including the Deluxe Reverb and Super Reverb. The 1950s era tweed Deluxes and the tweed Bassman amps sound great! Actually, all the tweed era amps can sound incredible when properly set up with good N.O.S. tubes, etc. Of course the VOX AC-30 sets the standard for lively, ringing tone with its remarkably chimy treble. Gibson amps are real sleepers now. The smaller combo amps using cathode bias circuits, point-to-point wiring, 6V6 or EL-84 tubes sound great. The smaller tubes can "sing" and "voice" notes better at lower volumes.*

CK - What are the favorite larger amps used by rock concert artists?

TB - *The '69 to '73 Marshall 100 watt Super Leads using 4 - EL34s and point-to-point wiring. Also the '65 to '69 "Plexi" series Marshalls. The mid '73 and later amps used printed circuit boards and lack some of the richness and character. The earlier amps sound more alive and have a bigger, more complex tone.*

*The incredibly full and powerful sound of the '60s era Marshalls played an essential role in the development of Jimi Hendrix's innovative style. I doubt he would have created the same incredible music without a raging stack of Marshalls. Also, the black-face era Fender Twin Reverbs are great for a cleaner, less aggressive sound. The lesser known British Hi Watt amps are also incredible sounding.*

CK - What newer amps achieve that "vintage" sound these days?

TB - *The Kendrick line of amps, which really was the first of the "boutique" amp companies starting in the late 1980's. Trainwreck amps, made by Ken Fischer, sound amazing. The entire Matchless line, especially the 100 watt Super Chief and VOX AC-30 inspired DC-30. Matchless features impeccable point-to-point wiring on terminal strips and premium tubes. Holland Amplifiers of Virginia produces a quality clone of the 1959 Bassman. Victoria Amplifier Company of Illinois builds an awesome sounding late '50s tweed Bandmaster design featuring 3 - 10" speakers. Tony Bruno and Dr. Z both make great VOX AC-30 inspired variants. All of these amps feature quality point-to-point wiring, select components, above average vacuum tube quality and careful fine tuning to get the best tone.*

CK - What are some of the new trends in modifying guitar amps?

TB - *The trend is to de-mod and restore them to original condition using exact original capacitors, resistors, transformers and tubes. These older amps sound just fine the way they were originally designed. Players are getting away from adding another gain stage, effects loops, etc. to older amps. The current trend is away from the digital rack-mounted effects processors so prevalent in the '80s and more towards the "stomp box" effects that were common in the '60s and '70s. Vintage effects boxes are becoming collectibles.*

CK - Does re-capping an old amp really change the sound that much?

TB - *The power supply electrolytic capacitors have a short, finite life. Their replacement is inevitable. Different electrolytics have different sounds. Coupling caps contribute significantly to an amp's sound. When you re-cap an old amp with say Polypropylene Sprague Orange Drop capacitors, it definitely changes the tone. The complexity and color washes out. For retaining the vintage Fender, sound the yellow Astrons and the blue plastic tubu-*



lar caps are essential. Also, carbon composition resistors like the Allen-Bradley types help to achieve the "vintage tone." If you want to "clone" the old sound you need to use the old parts. Modern parts all sound different from the old stuff.

CK- What do you think of the newer Chinese and Russian tubes in guitar amplifier applications?

TB - Even the best examples can't even begin to compare to the sound of the great old tubes from the past. The Russian tubes lack the richly complex and musical midrange, balance, and purity of tone. They have a higher failure rate than the vintage N.O.S. stuff. They wear out faster. The Russian 5881 has become the de facto standard for new amp builders, simply because there is nothing better available in mass quantities. The Chinese output tubes have even higher failure rates and shorter service life than the Russians, and even sound cheesier.



CK - Let's talk about the best tubes for electric guitar applications. What are your favorite vintage 12AX7 tubes in guitar amps?

TB - For Marshalls, I like the early Mullards with the seams in the glass on the top of the tube. The early large-plate Mullards can sound especially full and rich. They all have the aggressive, forward, driving midrange that is so essential to the Marshall sound. For black face era Fender amps, I like the smooth, sweetly delicate sound of a smooth or ribbed plate Telefunken in the first gain stage. For the phase inverter, I like the rich fullness of a matched Tung-Sol 12AT7. GEs or RCAs are an excellent choice for the other amp stages. For the tweed Fender amps, I prefer a GE 5751 in the first gain stage, or a 12AY7 which has a cleaner, more detailed sound with "lacier" highs. 12AX7s have too much gain for a tweed's first stage and sacrifice clarity, detail and nuance for volume.

CK - Terry, what about 6L6 type tubes. Which ones do you like best?

TB - The Genalex KT-66 has the most incredibly refined sense of midrange presentation and detail. The Tung-Sol 5881 has a grindy twang that sounds great in early Fenders. The RCA 6L6GC, round top, "black plates" from the late '50s and early '60s are especially full and rich sounding. The Sylvania's have a tight, firm bottom and a hard, stiff midrange and top. The Mullard EL-37s are incredible - sonically, they're between a Mullard EL 34 and GE 6L6 - strong and punchy with good richness and complexity in the mid-range. The Sovtek 5881s have a clean, colorless midrange and slicey top. The better amp designers are redesigning their circuits to compensate for the shortcomings of this tube.

CK - A lot of guitar amps, especially Marshalls use the EL-34/6CA7, which ones do you think perform best?

TB - In Marshalls, I prefer Mullards, preferably the early metal base variety. They have the most complex and lively upper midrange and lower treble. They have the incredible capability of sounding mean and sweet at the same time. Later Mullard examples retain the punchy midrange, but are noticeably less exciting in the treble. The GE 6CA7s can sound good, but are harder, stiffer and tighter, with less midrange push.

CK - Many of the smaller vintage 10-20 watt combo amps use the 6V6. Which ones do you like?

TB - The post war RCA type with the gray graphite coating inside the bottle. They simply sound right - rich, full, smooth and creamy. The other types tend to lack tonal balance.

CK - A lot of newer amps are using the EL-84/6BQ5. What are your faves?

TB - The essence of an EL-84 is its incredibly lively and complex upper midrange and treble, combined with a smooth richness in the bass and lower mids. The European types including Mullard, Telefunken and Amperex, all sound spectacular. The GE EL-84s are



also excellent. The newer EL-84 Russian types lack the richness, complexity, refinement and balance of the older tubes.



CK - Last, but certainly not least, what 6550 type is your preference?

TB - The Tung Sol 6550 (may be branded GE, RCA, Raytheon, etc.) coke bottle type. They have the right tonal balance, complexity, refinement, exquisite detail, sweet upper mids, lacey highs and air. The GE 6550As sound fine but are not as detailed or refined. The new Svetlana 6550B is also showing some promise, but bias stability and reliability are still questionable

CK - Terry, what are some of the trends you see in the tube guitar amp business over the next five years?

TB - We are rounding the corner on the tube amp revival. I see more boutique amp builders popping up. Why? Because there is no way to match attention to detail. Many of these hand-built amps are also individually tuned and personalized to match the player's taste and style. This is impossible to do with mass produced products.

Hopefully, the current trend of "canonizing" the classics of the past will develop into a more creative trend of experimentation with different, unusual and new tube types, circuit hybrids and such. Let's relearn the lost lessons of the past, then continue to develop and refine the art of amp building. We should all strive to surpass the classics of the past, rather than being content with merely imitating them. The quest for great tone is never ending.

\* Terry Budding, based in Livermore, CA is a performing guitarist, amp technician, writer and equipment reviewer for *Guitar Player Magazine*, a Miller Freeman Publication.

\* Guitar amp photos courtesy Groove Tubes amp collection as featured in *The Tube Amp Book*



## Tube Matching

by John Atwood

This article is a follow-up to the article on Screening Vacuum Tubes in VTV issue #1. Most of the material here was presented at a meeting of the Bay Area Tube Enthusiasts on June 24, 1995, in San Francisco, CA.

In nearly every vacuum tube price list, matched tubes are offered, often at a substantial premium. What exactly are these matched tubes, and when are they needed? This article will look at the need for matched tubes, and techniques used for matching.

### Characteristics of Matched Tubes

Tubes can be matched in various ways. The primary parameters that can be matched are:

#### Idle current

Every tube in class A or AB amplifiers, whether low-level driver tubes or output tubes, has a certain idle current that is determined by the plate voltage, the grid-to-cathode voltage, and the characteristics of the tube itself. It will be seen later that, in certain applications, identical idle current is important.

#### Transconductance

Transconductance is defined as:

$gm = \text{incremental change in plate current} / \text{incremental change in grid voltage}$

at a given operating point, and is the main measure of gain in tetrodes and pentodes. Transconductance naturally varies with different plate currents and plate voltages, so a transconductance specification is only meaningful if the operating point for a given transconductance is also given. Transconductance declines as tubes age. Perfectly matched tubes will have the same transconductance, but tubes with the same transconductance will not necessarily be matched in other respects, so transconductance itself is not a complete indication of a good match.

#### Mu

Mu is defined as:

$\mu = \text{incremental change in plate voltage} / \text{incremental change in grid voltage}$

at a given operating point, and is the main indicator of gain in triodes. Mu is generally invariant over different operating conditions and age, except as the tube approaches cut-off or emission becomes very low. Mu itself is not a complete indication of a good match.

### Output Power

In power amplifiers, it will be found that some tubes have a higher maximum power than others. Often, this is caused by different characteristics which move the operating point closer to the point of higher power. Sometimes the actual cathode emission can limit the power output.

### Manufacturing Batch

Even if two tubes are perfectly matched, if they come from different manufacturing batches or have different amounts of usage, they may not stay matched over time. This is usually most important for low-level gain and voltage offsets that are critical in DC amplifiers. The more divergent the origins of the two halves of a matched pair, the less chance they will stay matched.

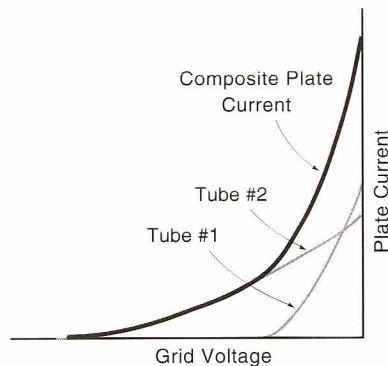

Figure 1 Grossly mismatched paralleled triodes

### Appearance

Although mainly a psychological issue, if the tubes in a matched set look different, the user can feel that something isn't quite right, and their impression of the sound quality may suffer.

### The Need For Matched Tubes

Not all circuits need matched tubes, and those that do often need only certain parameters to be matched.

### Low-level amplifiers and DC amplifiers

DC amplifiers often use matched tubes or tube sections (usually two triodes within the same envelope) in order to cancel out variations due to aging and changing heater current. In audio and oscilloscope circuits, differential amplifiers are used to cancel common-mode input signals. In these circuits, the degree of common-mode rejection is dependent on the closeness of the matching. DC balance controls can overcome mismatching in the tubes to a certain degree, but starting with matched tubes helps, especially as the tubes age. The type of matching needed

for differential amplifiers covers nearly all areas: idle current, transconductance,  $\mu$ , and manufacturing batch.

Differential amplifiers are also used as phase splitters, but there is an inherent imbalance in this type of circuit which make close matching less important than in a fully balanced differential amplifier.

In audio circuits, most common low-level amplifiers do not use balanced circuits that require tube matching. Exceptions, however, include fully differential designs, such as those used in modern balanced-input designs, and on a few power amplifiers, such as the Acrosound UL-2, and the Audio Research amplifiers.

### Paralleled Tubes

Tubes are paralleled to achieve higher power output or give a lower output impedance. The transfer characteristic (plate current vs negative grid voltage) is the sum of the characteristics of each tube. If the  $\mu$  and/or transconductance are grossly mismatched, the transfer curve becomes non-linear, as shown in Figure 1. However, minor mismatches get averaged-out, especially if there are a large number of tubes paralleled. Matching of idle current is not critical here.

### Push-pull output stages

There are two reasons that tubes in push-pull output stages need to be matched: to cancel DC flux in the output transformer and to cancel even-order harmonic distortion.

Unbalanced DC current in a transformer can cause saturation of the iron, resulting in lower inductance (thus degraded low-frequency performance) and increased distortion. Putting an air gap in the core, as is done on single-ended output transformers, reduces saturation, but at the expense of lower inductance. This lower inductance would have to be compensated for with more turns, which aggravates high-frequency response problems. Thus most transformer manufacturers prefer to minimize the air gap, thus requiring low unbalanced DC currents. This is especially an issue with toroidal transformers which have no air gap at all.

Aside from any issues of transformer saturation, a perfectly-balanced push-pull circuit cancels any even-order (2nd, 4th, 6th, etc.) harmonic distortion created in its amplifying elements. (It does not cancel even-order distortion present on the incoming signal!) This is important in class AB and class B amplifiers, where the tubes are cut-off for part of the time. So, a perfectly balanced push-pull circuit will



lower the overall distortion by eliminating the even harmonics. However, even harmonics are the "better"-sounding harmonics, and the odd harmonics, especially the high-order ones, give a harsh, hard sound. Thus striving to perfectly balance tubes in a push-pull stage may reduce the total distortion, but leave the "sonic imprint" of odd-order distortion.

Balanced idle current is important in eliminating transformer saturation at low signal levels. This is where the amplifier spends most of its time, so is the most important. Matching at large signal levels is also needed in order to prevent "rectification" effects if the tubes are unbalanced. This rectification will cause an unbalanced DC to flow that is proportional to the signal level.

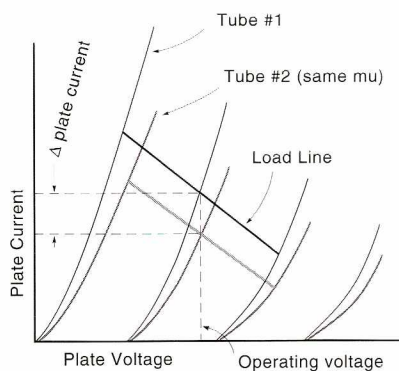

Figure 2 Same mu, different current

The degree of matching required in push-pull output tubes depends on the sophistication of the bias and drive circuits. If there is no bias adjustment (as in most cheap amplifiers, as well as some receivers like the Fisher 500), or a single bias adjustment per channel (such as in the Dynaco ST-70, Mark III, and Mark IV), then the overall matching of output tubes for idle current is critical. Any unbalance in idle current will cause unbalanced DC to flow in the output transformer. If there is a bias adjustment per tube or a bias balance adjustment (sometimes called DC balance), then matching of idle currents is much less critical, and just overall similarity in characteristics is needed. If an AC balance is provided (which can alter the amount of drive voltage to each side of the push-pull stage), then large-signal balancing is even less critical. Unfortunately, it is difficult to effectively adjust an AC balance control without the use of a distortion analyzer.

### Techniques for Matching

The following techniques for tube matching were developed several years ago

when Tim Eding and I bought a large quantity of EL34s and 6BQ5s and determined to find the best way to match them.

### Burn-in

Most tubes will shift in characteristics over the first few hours of use. In the past, tubes for sensitive DC amplifiers were often run for 48 hours before being shipped. Tim Eding found that in the power tubes he tested (Chinese and Hungarian EL34s and Yugoslavian 6BQ5s), the DC idle current would generally stabilize within a few hours of use at normal operating current. We decided on a burn-in time of 12 hours as a good compromise between stability and overall throughput on our test fixtures. Not all tubes stabilize in the same way, so tubes that are matched without a burn-in are likely to be unmatched after a little use.

### Tube Testers

For most tube users, the only piece of equipment that will give a quantitative measurement of a tube is a tube tester, so it is pretty common for people to match tubes on a tube tester. Perfectly matched tubes should give the same readings, but so can some unmatched ones. This is shown in Figure 2, where two triodes with identical mu but different transfer characteristics give rather different idle currents. Figure 3 similarly shows two different triodes with the same transconductance, but different idle currents. Since most tube testers test for transconductance, not DC current, it is clear that tube testers are ill-suited for matching tubes.

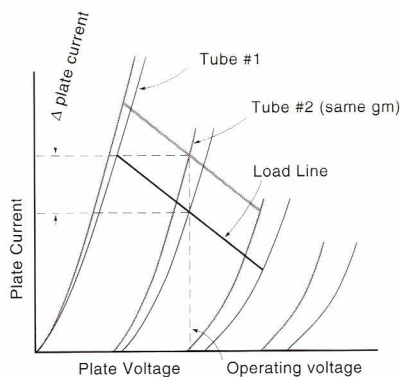

Figure 3 Same gm, different current

### Static DC Measurements

The best way to match tubes for idle current is to put them into a test fixture that runs the tubes under identical conditions to those that will be encountered in the amplifier, adjusting the bias for the desired current, then recording the bias voltage needed to achieve this current.

Large-signal matching can be done by also taking measurements at higher voltages and currents, and insuring that matched tubes have the same characteristics at these different operating points. Be careful not to exceed screen or plate dissipation ratings for too long while doing this kind of test.

### Dynamic In-circuit Measurements

One way to match tubes is to test them in a push-pull amplifier. DC balance can be tested by looking at what frequency the core saturates. This is done by applying a sine wave at full output into a dummy load, and lowering the frequency until the sine wave becomes visibly distorted. With good transformers, this is typically 40 Hz or lower. Dynamic matching can be done by selecting pairs of tubes that give the minimum 2nd harmonic distortion.

In-circuit matching, as described above, can give good matches if the tubes are matched in the amplifier where they will eventually be used. However, some special equipment is needed, and because of possible imbalances in the amplifier, the tubes may not be well-matched for use in other amplifiers. It is difficult to match more than just a pair this way.

### Curve Tracing

The fastest way to match tubes over their whole operating range is to use a tube curve tracer, such as the Tektronix 570. The characteristic curves of two tubes can be visually compared on a CRT. If the curves match up, then the tubes will be matched over the entire operating range checked by the curve tracer. It is a little hard to get accurate quantitative information off the screen, so a good way to match tubes using a curve tracer is to first run all the tubes to be matched through a static DC test, as described above. Then pairs with the same bias points can be put onto the curve tracer. They will often be a perfect match at this point. If not, choose another pair with a similar bias point. Eventually, you should be able to make matches of most, if not all, of your tubes.

Figures 4 and 5 show the characteristic curves of two different KT-66s with similar current at a fixed operating point (at the center of the screen), but different characteristics elsewhere. Figure 4 shows an older British KT66 (with the grey carbon inner coating) and figure 5 shows a later (perhaps mid-1970s) General Electric 7581A/KT66. On both curves, the grid voltage step was 5 volts, the X-axis is 50 V per division and the Y-axis is 20 ma per



division. Although fairly well matched around the center, they deviate from each other at both the high and low current extremes.

Some tips for matching using curve tracing:

When matching a pair of tubes, either turn on their heaters at the same time, or allow a long time (several minutes) for the cathode temperature to stabilize.

If the tubes will only be used in triode-connected mode, it is OK to triode connect them on the curve tracer. If used in tetrode or ultra-linear mode, use a fixed screen voltage somewhat below the peak plate voltage.

If the curves seem distorted or have bits of "fuzz" on them, the tube is probably going into parasitic oscillation. Try moving the connecting leads around, make sure that there are "stopping" resistors on the control grid and screen grid leads near the socket. If these measures fail, try putting a small (.001  $\mu$ F) capacitor from the plate and/or screen to cathode, at the tube socket.

### Commercially Available Matched Tubes

This article will not review commercially matched tubes, but will point out things to look for when buying commercially-matched tubes. At a discussion at a recent Bay Area Tube Enthusiasts meeting in San Francisco, the experiences when buying matched tubes were discussed. When asked about their matching techniques, most tube dealers either didn't know how they were matched or refused to tell, claiming their methods were proprietary. Some people reported finding their matched pairs to be truly matched, while others reported significant mismatches when the tubes were tested on a curve tracer. Here are some questions that

should be asked of a tube dealer about their matching process:

1. Are the tubes burned-in? For how long? Are they burned in under load, or are the filaments simply heated? (Heating only the filament doesn't stabilize the tube.)
2. At what plate and screen voltages are the tubes matched? (Ideally these should be close to what your amplifier uses.)
3. Are the tubes matched at a single operating point or are they matched at multiple operating points? (A computer-driven tester or an analog curve-tracer are common ways testing at multiple points is done).
4. How closely are the tubes matched? (5% or better is good) What parameters are matched? (Bias voltage for a given plate current is most valuable. Don't accept just transconductance matching.)

Secret or proprietary matching techniques can often hide shoddy testing. There is no need to hide the matching process, and buyers should insist on knowing how their tubes are matched.

### Summary

Tube matching is not a black art, nor is it necessary in every application. However, if you keep the following in mind, you will get the best performance out of your tubes for the money:

Small low-level tubes seldom need to be matched, except for DC amplifier circuits (uncommon nowadays) or fully-balanced circuits.

Only get closely-matched tubes for amps that need them – ironically often the cheapest amps (without DC balance controls.)

Make sure the matched tubes are burned-in and matched for bias voltage at a specified current. Don't get tubes that were only matched on a tube tester.

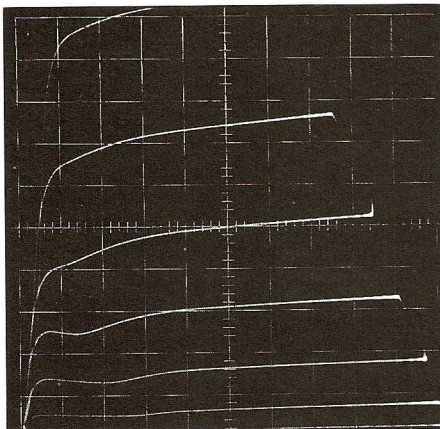

Figure 4 Old British KT66

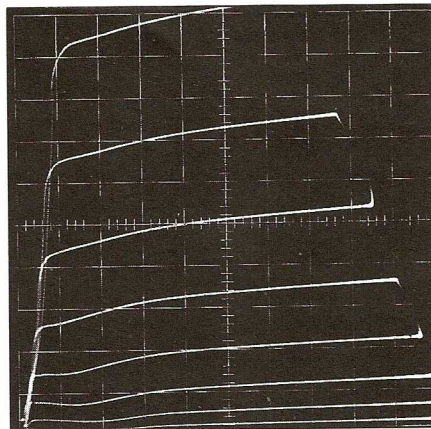

Figure 5 GE 7581A/KT66

## 1927-34 WESTERN ELECTRIC LARGE THEATER SOUND SYSTEM

by Charlie Kittleson

Although recorded music was played through amplifiers during "silent" motion pictures throughout the mid-twenties, the first widely accepted production to employ this new technology was the Warner Brother 1927 production, "The Jazz Singer." The amplifier system used to play the audio portion of many other pioneering sound movies was the Western Electric \* Type 8, 9 and 10. This amplifier used the Type 8 gain stage, the Type 9 amplifier and the Type 10 Power amplifier. The Type 10 amplifier used four WE-242 or Type 211 transmitting triodes for the output stage. The audio portion was recorded on 78 rpm records that were played on a Type 203 Western Electric non-synco dual turntable system.

After "The Jazz Singer" phenomenon, theaters sprung up all over the country and many of them were large capacity structures that needed complex sound systems to be effective. The next Western Electric Cinema sound system for large theaters was the amplifier rack containing the Types: 41, 42 and 43A. Including the rack, this amplifier system weighed in at over 350 pounds. This system was made from late 1927 to 1935. Some theaters used up to four of these amplifier racks, depending on their size. Several of the amplifier racks were still in service until the mid-Fifties. It is estimated that approximately 10,000 of these amplifiers were manufactured.

On the top of the rack is the Type 200 Output Control Panel, the Western Electric Type 41 Gain Stage using three Type 239 vacuum tubes that are similar to the WD-11 tubes. The gain stage was finished in gloss black "japanned" enamel and featured extremely well-made stepped attenuators for filament supply voltage and gain control. There are separate meters for plate and filament current.

In the middle of the rack is the Type 42 amplifier/driver using four Type 205 triodes that are round "tennis ball" shape with a tip on the top. Two of the 205s were used for the full-wave rectifier and two were used for the preamplifier. Controls included a power switch and a plate current meter.

The Western Electric 43A power amplifier was introduced for theater use in late 1927. It featured four-type 211



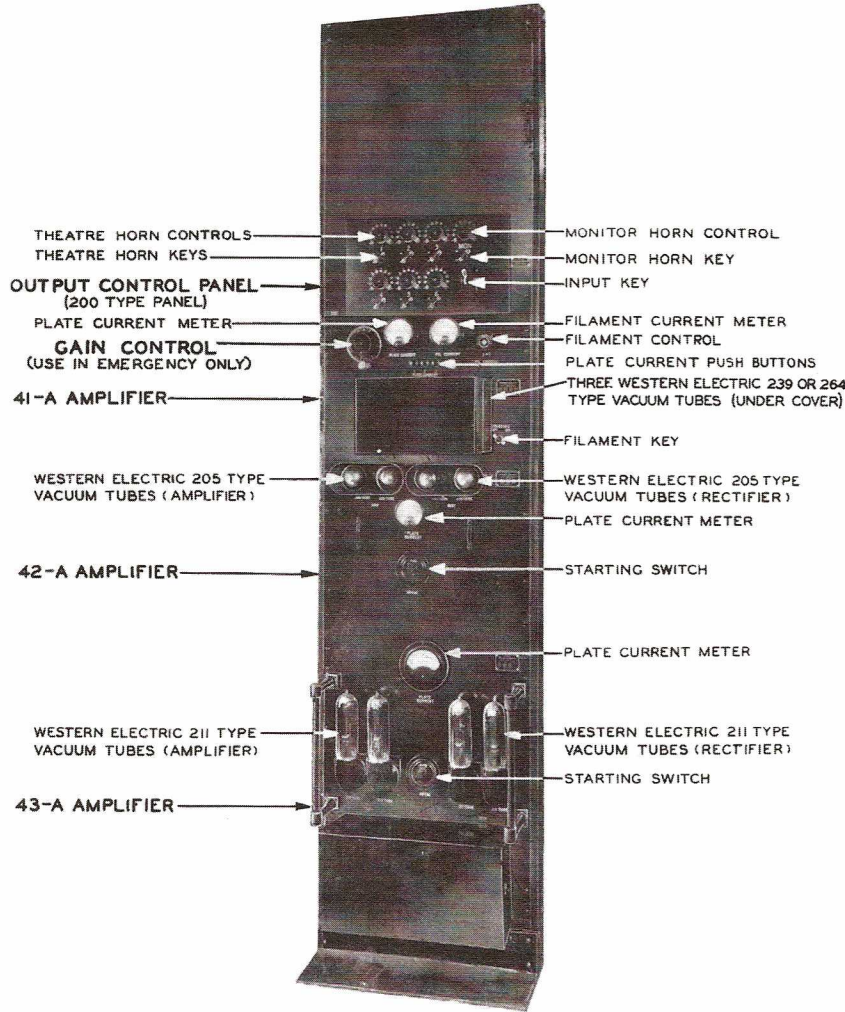

- THEATRE HORN CONTROLS
- THEATRE HORN KEYS
- OUTPUT CONTROL PANEL (200 TYPE PANEL)
- PLATE CURRENT METER
- GAIN CONTROL (USE IN EMERGENCY ONLY)
- 41-A AMPLIFIER
- WESTERN ELECTRIC 205 TYPE VACUUM TUBES (AMPLIFIER)
- 42-A AMPLIFIER
- WESTERN ELECTRIC 211 TYPE VACUUM TUBES (AMPLIFIER)
- 43-A AMPLIFIER
- MONITOR HORN CONTROL
- MONITOR HORN KEY
- INPUT KEY
- FILAMENT CURRENT METER
- FILAMENT CONTROL
- PLATE CURRENT PUSH BUTTONS
- THREE WESTERN ELECTRIC 239 OR 264 TYPE VACUUM TUBES (UNDER COVER)
- FILAMENT KEY
- WESTERN ELECTRIC 205 TYPE VACUUM TUBES (RECTIFIER)
- PLATE CURRENT METER
- STARTING SWITCH
- PLATE CURRENT METER
- WESTERN ELECTRIC 211 TYPE VACUUM TUBES (RECTIFIER)
- STARTING SWITCH

41, 42, AND 43 TYPE AMPLIFIERS, AND OUTPUT CONTROL PANEL

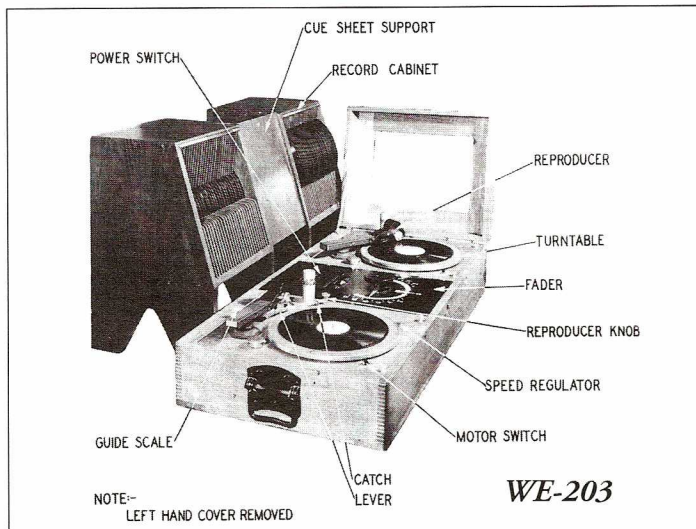

- POWER SWITCH
- CUE SHEET SUPPORT
- RECORD CABINET
- REPRODUCER
- TURNTABLE
- FADER
- REPRODUCER KNOB
- SPEED REGULATOR
- MOTOR SWITCH
- GUIDE SCALE
- CATCH LEVER

NOTE-- LEFT HAND COVER REMOVED

WE-203



WE 555

or WE-242 transmitting triodes in the circuit. Two of the tubes were used for full-wave DC rectification and two were used for the power output stage. The 43A push-pull triode amp produced about 20 watts in Class A with a frequency

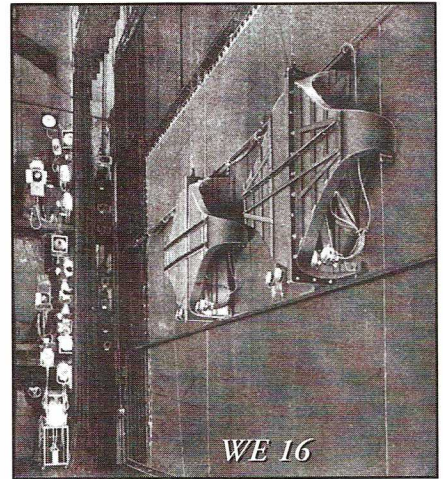

WE 16

response from 50 to 10,000 Hz. Although these specifications are not phenomenal now, they were in the late Twenties.

The 43A weighed in at over 175 pounds. Controls included a power and standby switch and a plate current meter. The box on the bottom front cover contains a huge capacitor bank.

People who have listened to the 43A compare it to a "big Brook 12A" sound or similar to a low volume Altec Lansing 1570A theater amplifier. The mids are big and sweet, but the bass is semi-mushy.

The 43A pictured came from the New York area and was probably used in one of the early movie palaces in the Big Apple. The output transformer in this particular 43A was replaced by a later Altec-Lansing unit that increased the power output and improved the frequency response.



# EARLY CINEMA SOUND

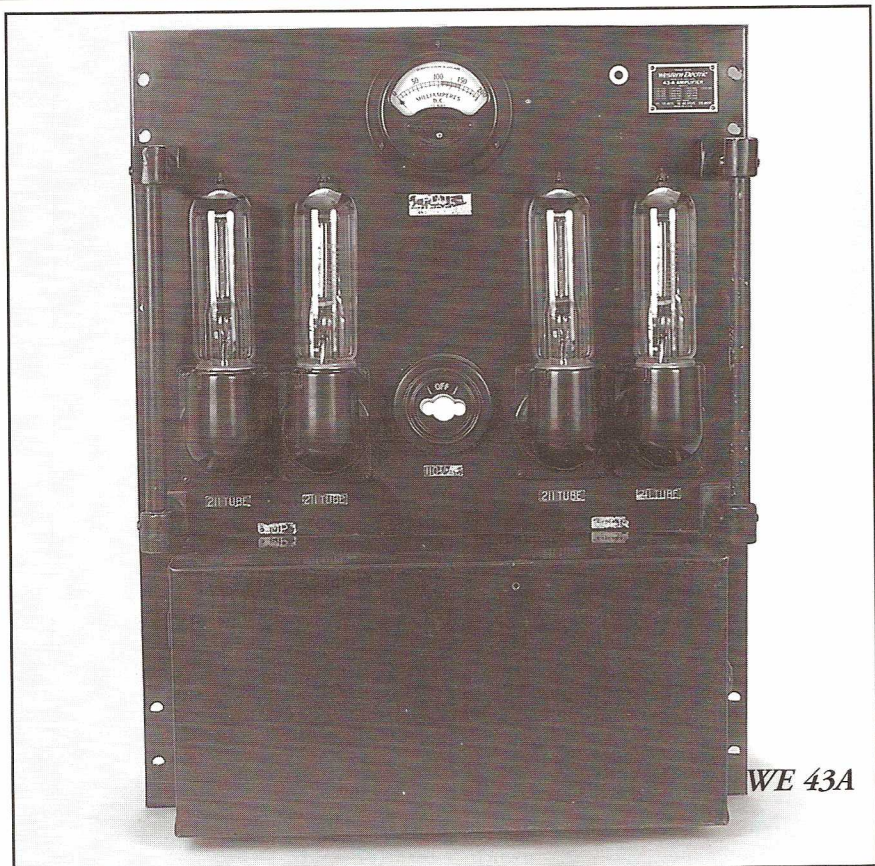

**WE 43A**

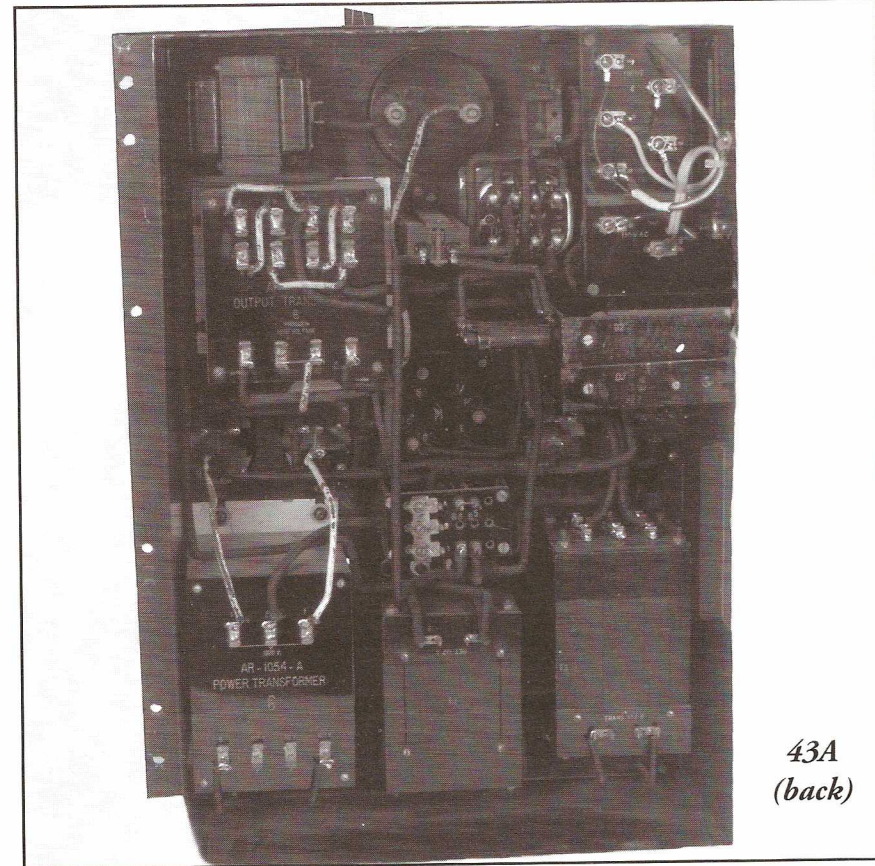

**43A  
(back)**

improved the frequency response.

The sound for the early movies was recorded on numbered 78 rpm records that were played on the Western Electric Type 203 dual non-synchronous turntable (pictured). This system was used before the advent of the light valve optical soundtrack.

The Western Electric horn speaker system used in the larger theaters was the Type 16 that was over 9 feet wide. It used four-Type 555 electro-dynamic horn drivers (pictured). Larger theaters could have used two or even four of the Type 16 horn systems. Or they may have used multiple Type 12A "big snail" horns with a single Type 555 horn driver.

The 555 driver was the electro-dynamic type using a field coil operating at 7 volts. It was rated at 10 watts. To this day, it is still the only compression driver that can go below 100 Hz. Its frequency response is 80-10,000 Hz with less than 1% distortion at 100 Hz.

This and other Western Electric equipment are now collectors' items and, if found, should be carefully restored to preserve the heritage of American ingenuity during our Industrial Age.

*A special thanks to Don Pettee of Sunnyvale, CA for his assistance in research for this article.*

*\* WESTERN ELECTRIC audio equipment and tubes are now being marketed by Westrex Corporation, ATT Promenade II, 1230 Peachtree St., Suite 3750, Atlanta, Georgia 30309-3575*

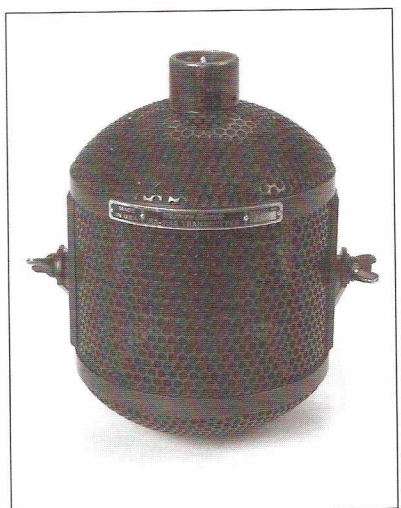

*Early 30s WE ribbon microphone used in Hollywood and New York sound stages.*

## VACUUM TUBE VALLEY



**High Fidelity Techniques**

John H. Newitt - Author

*A Vintage Book Review*

by **Paul J. Bourbin**

This review is the first in a series covering books of significance that were written during the Golden Age of High Fidelity. Often one finds books a garage sales, flea markets and used book stores, or sees a book listed for sale through the mail and wonders if it will be a useful addition to one's collection.

John Newitt wanted *High Fidelity Techniques*, 1953 to be a practical guide to audio and dispel the myths and misinformation then currently in existence. The book was written for: engineers who were not versed in Hi-Fi, home constructors of Hi-Fi systems, servicemen, operators of recording studios, PA and audio technicians. The book was designed to have something for everybody, covering a broad subject for a broad audience.

The following is a summary of the chapters of this book: The first chapter is one of definitions and what makes a good Hi-Fi system. The second chapter discusses the property of sound, the human ear and the psychological effects of hearing and the acoustical control of sound. This is an important part of the Hi-Fi equation sometimes overlooked by audiophiles. Loudspeakers and their technology at the time are covered in chapter three. Various constructional aspects are discussed and related to their overall response. There is a nice section covering British loudspeakers. Reproducer enclosures for both cone and horn loudspeakers are covered in the fourth chapter. What follows is a discussion of the individual components and how they relate to the whole. The chapter concludes with some examples of good commercial systems.

Crossover theory and technology are covered quite well in chapter five. Various types of distortion including: frequency, phase, harmonic, intermodulation are discussed in chapter six. Hum, noise, and interference are also reviewed. The next chapter covers circuits peculiar to Hi-Fi such as: compensation circuits, feedback, phase inverters, tone controls, expanders, compressors, automatic bias and synthetic bass circuits. These are the circuits that separate high fidelity from the run-of-the-mill.

Chapter eight deals with amplifiers

and their characteristics. The first half covers the attributes necessary for a good amplifier followed by some hints for the home constructor. Next, there is a discussion of high quality and moderate cost commercial amplifiers. The chapter concludes with a section on noise suppressor amplifiers and some high quality commercial amplifier components.

Now that one has an amplifier and speaker system, the next step is the addition of program material. Chapter nine gives a thorough explanation of the AM and FM tuner circuits then in use with a conclusionary section devoted to commercial apparatus. The tenth chapter covers records and record players. Naturally, the only record mentioned are test records (although recording methods are covered) and no record changers are mentioned. Various quality turntables, tone arms and cartridges are shown. Chapter eleven explains magnetic tape recording, its theory, operation and equipment. There is also an interesting comparison of magnetic tape vs disk recording methods. Hints are given in the choice of machines, tape and related components. The final chapter puts it all together. It covers custom installations. Since Hi-Fi equipment is made of individual components, and each listener and listening environment are different, every installation amounts to a custom one. The determination of listener requirements and technical considerations are discussed. The chapter concludes with ideas and examples of custom installations. Four appendices follow giving: Electrical, Acoustical and Mechanical analogies, bass reflex equations, design charts and acoustical horn design data. After you have read the book, you can try answering the questions at the end of the book. There is also a very helpful subject index.

*High Fidelity Techniques* is a very good book for both neophytes and the seasoned audiophile. Practicality supercedes theory. There is not much math and it is used only where necessary. The book is profusely illustrated with graphs and drawings as well as several good photographs of high quality commercial equipment. The explanations are thorough and clear without tedium. ***If you find a copy of this book, buy it!***

*Paul J. Bourbin is a San Francisco, CA based radio collector, historian, and writer. He has published articles in Antique Radio Classified and related periodicals.*

**FEATURED ARTICLES IN THE WINTER 1995 EDITION OF VACUUM TUBE VALLEY:**

**\*TUBE SURVEY - 300B and medium sized filamentary triodes**

Eric Barbour evaluates and tests all versions of this historic and popular audio tube along with newer, related variants including the SV-811 and the VV-30.

**\*McIntosh MI-200 - restoration, modification and listening tests of this awesome tube power amplifier.**

David Wolze tells us the story on how he obtained these monster amps, his restoration, modification and resultant listening sessions.

**\*FM: Why 88 to 108Mhz?**

John Atwood explores the early days of FM and why the lower FM band became obsolete..

**\*GOLDEN ERA - EICO**

The famous maker of test equipment introduced an excellent line of high fidelity equipment kits in 1955. Charlie Kittleson documents and reviews the entire mono EICO lineup of amps, pre-amps and tuners.

**\*The Audio Test Bench: DC Meters**

John Atwood describes the DC measurement needs of the contemporary audio test bench, as well as describes some vintage DC meters.

*\* Plus more interesting and informative articles on capacitors, speakers and transformers from the VTV editors and contributors.*

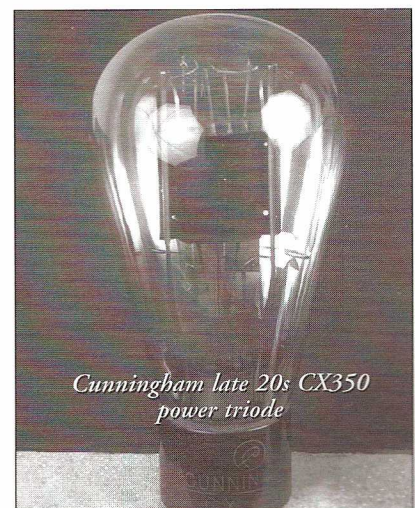

*Cunningham late 20s CX350 power triode*



# Are You Into Tubes?



Then You Need

## VACUUM TUBE VALLEY

Now Available

A New High Quality Publication devoted to the Best in Modern and Vintage Vacuum Tube Electronics.  
**Hi-Fi Amps, Guitar Amps, Tubes, Tuners, Speakers, and More!**

4 Issues - 1 Yr.  
 \$25 US or \$35 Foreign  
 No Credit Cards

Vacuum Tube Valley  
 1095 E. Duane Ave. #106  
 Sunnyvale, CA 94086

# Have You Been Wondering Which Tubes Sound The Best? Then You Need This Report!

Eric Barbour of Glass Audio and Vacuum Tube Valley, recently tested more than 1000 audio tubes-both vintage NOS and current production. These tests resulted in a list of distortion readings that correspond to the sound clarity. Now YOU can know what tube dealers know.

### Tubes Covered

EL-34	300B	6DJ8	7591	6550
2A3	6L6	12AX7	8417	6V6

The test reports in VTV were derived from this raw data!

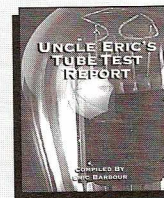

**\$79** Send Check or Money Order To:

**METASONICS**  
 1095 E. Duane #106  
 Sunnyvale, CA 94086

## one electron™

Products and Services...

### UBT-1 Single-Ended Output Transformer

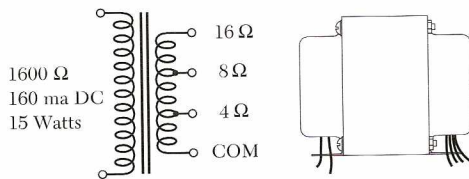

### Recycled Tubes - The U.S. Defense Dept's Finest

Removed from gov't equipment - fully checked

0A2	6AK5/5654	6V6GT	5687
0B2	6AQ5/6005	7F8	5751
2C51/5670	6AU6/6136	12AT7/6201	5814
5R4GYB	6AL5/5726	12AU7/6189	6080

... and more

### Design Services:

- Audio designs - specializing in tubes
- Digital system and IC design
- PC Board Layout

Write or FAX for information and prices.

**One Electron**  
 65 Washington Street, Suite 137  
 Santa Clara, California 95050 USA  
 FAX: 408 985-2006



## Life in a Vacuum.

The resurgence of interest in tubed equipment has taken the audio industry by storm. With new circuit designs and much improved passive components and materials, tubes are sounding better than ever. The Parts Connection takes this very seriously - in a fun sort of way.

In our ongoing search of the world for New Old Stock (NOS) tubes, The Parts Connection has accumulated a large stock of rare finds. If you would like to be part of our mailing to receive this NOS listing, exceeding over a hundred varieties of tubes (not to mention paper-in-oil capacitors), give us a call and we'll be glad to send it to you.

In addition to our NOS listing, we also carry newly manufactured tubes. RAM Labs, Ruby, Gold Aero, Golden Dragon, Western Electric, Audio Glassic, Svetlana, Sovtek®, and Vaic Valves can bring about some exciting possibilities and are available in matched pairs or quads.

For those of you starting from scratch, modifying or repairing, The Parts Connection also carries a wide range of speciality, audio-proven parts to make the most of your projects. If you're looking for something special, give us a call. Or if you would like to order our soon to be completed catalog - drop us a line, call or fax with credit card information. We'll add you to our waiting list and charge the \$10 US upon shipment.

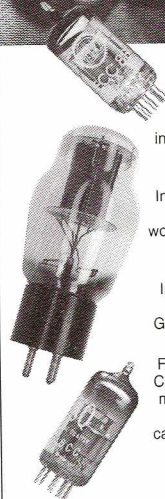

2790 Brighton Road, Oakville, Ontario, Canada L6H 5T4  
 Telephone (905) 829-5858 Facsimile (905) 829-5388  
 Toll Free Order Line 1-800-769-0747 (U.S. & Canada only)

**THE PARTS CONNECTION**  
 A DIVISION OF SONIC FRONTIERS INC

### ASK ABOUT OUR VOLUME DISCOUNTS, UP TO 30% OFF TOTAL ORDERS

- MIT MultiCap • Wonder Cap • Kimber Kap • Solo • Hovland MusiCap • Solen • Siemens • Wima
- Holco • Rel-Cap • Draloric • IRC • Allen-Bradley • Jensen • Resista • Vishay • Mills • Caddock
- Matsushita • TKD • Noble • Cardas • Kimber Kable • van den Hul • Discovery • Audioquest • MIT
- Alps • Bourns • Shalco • Elma • Electroswitch • Gold Aero • RAM • Mallory • Panasonic HFQ
- Nichicon • Elna • N.O.S. • Ruby Tubes • UltraAnalog • Burr-Brown • Crystal • Linear Technology
- Analog Devices • Edison Price • Motorola • UCC • International Rectifier • Hitachi • MagneQuest
- Sonic Frontiers • Pearl • Tube Sockets • WBT • Neutrik • Sound Coat • Curcio Audio Engineering
- Assemblage and other kits



# Old-Time SOUND



**ELECTRICAL CHARACTERISTICS**  
Maximum Ratings

Filament Voltage	6.3	Volts
Filament Current	4	Amps
Max. Plate Voltage	800	Volts
Max. Signal DC Plate Current	160	mA
Plate Dissipation	65	Watts
Amplification Factor	10	

From A

# Brand New TUBE

**Introducing the new Svetlana SV811-10.**

With its traditional triode configuration and low mu design, this tube delivers a clean, vintage, high-fidelity sound. Improved gettering and a stable cathode provide consistently better sound over a longer lifetime.

Call today for more information on the SV811-10 and other fine tubes from Svetlana.

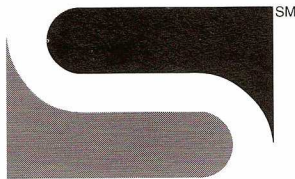

**Svetlana**  
ELECTRON DEVICES

**Headquarters:**  
8200 South Memorial Parkway  
Huntsville, Alabama 35802  
Phone 205 882 1344  
Fax 205 880 8077  
Toll Free 800 239 6900

**Marketing & Engineering:**  
3000 Alpine Road  
Portola Valley, California 94028  
Phone 415 233 0429  
Fax 415 233 0439  
Toll Free 800-5-SVELTANA  
(800-578-3852)

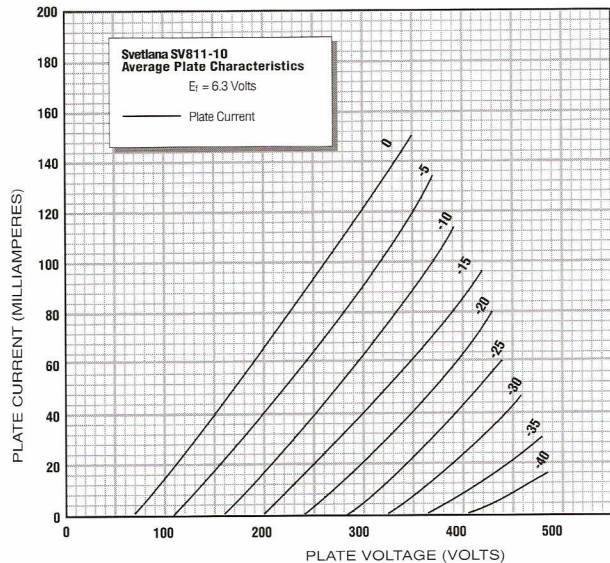



# LOOKING FOR SOME REALLY GOOD PARTS FOR D.I.Y. TUBE AUDIO?

## Audio Note "Experimenter" Output Transformers For Single-Ended/P.S.E.

1.25K, 20W, 300B/2A3 PSE, 150mA, \$135  
2.5K, 15W, 300B/2A3 SE, 90mA, \$68!!!  
6K, 20W, 845/801/VT62 SE, 100mA, \$120

## Audio Note "Audiophile Standard" Output Transformers For Single-Ended/PSE

1.25K, 30W, 2A3/6B4 PSE, 130mA, \$160  
1.25K, 50W, 300B etc. PSE, 180mA, \$240  
1.5K, 30W, EL34/6CA7 PSE, 180mA, \$175  
2.1K, 30W, 5881/KT66 PSE, 140mA, \$170  
2.3K, 60W, KT88/6550 PSE, 110mA, \$200  
2.5K, 25W, 300B/2A3 SE, 90mA, \$145  
2.5K, 50W, 845 etc. PSE, 180mA, \$275  
2.6K, 20W, EL84/6V6 PSE, 100mA, \$155  
3K, 30W, W.E. 300B SE etc., 140mA, \$160  
5K, 75W, 211/VT4C PSE, 240mA, \$350  
10K, 30W, 211/VT4C SE, 150mA, \$200  
10K, 50W, 211/845 SE, 150mA Ongaku, \$225  
All A.N. SE trans. are air-gapped. Most are 4/8 ohm secondaries. As found on the excellent A.N. UK SE amps! 1000's of these fine music transformers are now in service worldwide!

## Audio Note "Deluxe C-Core" Output Transformers For Single-Ended/PSE

1.25K, 50W, 300B PSE, 4/8/16, 180mA, \$450  
2.5K, 25W, 300B SE etc., 4/8/16, 90mA, \$400  
10K, 50W, 211/845 SE, 4/8/16, 150mA, \$475  
Massive double C-core construction! The new heavy weight champ of audio transformers!

## Audio Note Pure Silver Wired Output Transformers For Single-Ended

2.5K, 25W, 300B/2A3 SE, 90mA, \$2500  
10K, 50W, 211/845 SE, 150mA, \$3000

## Bartolucci Double C-Core Output Transformers For Single-Ended/PSE

1.25K, 52W, 6C33/300B PSE, 220mA, \$225  
2.5K, "10W", 300B/2A3 SE, 90mA, \$215  
3K, 30W, W.E. 300B/2A3 SE, 90mA, \$225  
10K, 50W, 211/845 SE, 150mA, \$250

Individually wound in Italy by G. Bartolucci and his audiophile craftsmen! These fine output transformers feature the double C-Core construction found on Tango and some of the best vintage iron. All have 4/8/16 sec., solid brass hookup terminals on the bottom, and are potted in beautiful handmade black finished steel enclosures. Each transformer comes with an individual, signed test report.

## Bartolucci "UNIVERSAL" Double C-Core Output Transformers For SE/UL-PP/UL!!!

A unique, "breakthrough" product! Configurable for 3K SE 300B OF for 3K EL34 SE with 50% Ultralinear/Screen tap! Also for push pull 3.2K, 48W UL! Just think of all the different KOOL stuff you can build with a pair of these! Potted in finished steel cans, brass hookup terminals, 4/8/16 secondaries, \$180!

## Bartolucci Double C-Core Output Transformers for Push-Pull UL

4.3K, 60W, KT88/EL34 etc. PP/UL, \$160!  
2.5K, 100W, KT88/EL34 PPP/UL, \$240.  
Excellent choice for popular Dyna/Acro etc. "Ultralinear" designs, 4/8/16 secondaries.

## Audio Note "Audiophile Standard" Output Transformers for Push-Pull and Push-Pull Parallel Tube Amps

2.2K, 100W, KT88/EL34PPP UL, \$200  
3K, 50W, 5881/6L6/KT66 PPP, \$100  
4.3K, 60W, KT88/EL34 PP UL, \$110  
5K, 30W, 300B/2A3/6B4G PP, \$85  
6K, 25W, 5881/6L6/EL34/300B PP, \$80  
6.6K, 50W, 5881/6L6/807 PP, \$115  
6.8K, 50W, 845 etc. PP, \$180  
8K, 15W, EL84/6V6/ECL86 etc. PP, \$50  
All impedances are calculated for Class A. Most have 4/8 ohm secondaries. "Dyna-Acro" etc. "Ultralinear" with screen taps and 4/8/16 ohm secondaries. Made in England.

## Audio Note Chokes and Inductors

.5H/400mA, \$30  
3H/100mA, \$26  
3H/250mA for Ongaku, etc. \$38  
5H/150mA, \$34  
5H/400mA, \$50  
10H/125mA, \$42  
10H/200mA, \$55  
20H/50mA, \$40

## Audio Note Power Transformers

1. For Stereo 300B SE amp, Kit One, \$160  
2. For Stereo 211 SE "Ongaku" replica, \$175  
Send SASE for schematic diagrams of above.

## Angela "Universal" Monoblock Power Transformer for Tube Amp D.I.Y. Projects! NEW! NEW! NEW!

120V/240V primary! 380-320-55 (BIAS TAP!)-0-320-380 at 200+mA! 5V at 3 amps! 5VCT at 1.5A so you can run a 300B or a 2A3! Simple color-coded hookup leads; send SASE for schematic. Build a Western Electric Model 91 style amp! Build a 50W Acro/Dyna KT88/EL34 amp with fixed bias, using the convenient 55V bias tap! YOU be the **BIG BOSS MAN!** Made in USA! Conventional upright end bell mounting. FIVE YEAR GUARANTEE! EACH \$110!

## 'MIL. SPEC.' Potted Power Transformers for Tube Amps

120V primary, 6.3V at 5.5A, 560VCT at 110mA! Built like a little tank! Potted sealed, welded steel cans like old UTC military units! MINT condition USA GONZO government surplus! **KILLER** for building compact single-ended EL34, 6L6, KT88, 5881, and other tube monoblock amps! Mounting studs and hookup lugs are on the bottom of the transformer. Approx. 3.5"x3"x4" tall. TONS IN STOCK! \$38! WOW!

## Need "HEAVY DUTY" Power Iron? Here's a "REAL MUTHA" FOR YA!!!

Chicago Standard MASSIVE potted USA N.O.S. military power transformers! 115/230V dual primary, 980VCT at 250mA, 5VCT at 2A for rectifiers, 6.3V at 5A. Build a "high power" triode amp! Build an 80W 6146 amp! Sealed steel can with nice looking rounded edges! Schematic printed on side of can! BIG ASS mounting studs and solder terminals on bottom! This is one SERIOUS piece of iron! \$55 EACH!

## HAMMOND Transformers In Stock Now!

1. 10H/125mA choke for tube amps, \$22  
2. 1.5H/200mA choke for Dyna junk, \$18!!!  
3. 2H/200mA choke, \$22.

## Audio Note 99.99% Silver Wire

Priced per meter: 0.55mm (\$30), .2mm (\$40), .6mm (\$50), .8mm (\$60).

## Audio Note UK Kit Amplifiers

**Kit One!** 8 glorious watts of pure Class A single-ended triode power! Tubes: 2-300B, 2-5887, 6SN7, 5U4-GZ37. Designed for the experienced D.I.Y. tube audio enthusiast but several absolute beginners have also crashed the party! If you can mod a Dyna you can build this kit! Price \$1200, TUBES INCLUDED! We ship anywhere!

**Curious?** 50 page Kit One manual available for \$15 postpaid. If you'd like to hear the Kit One call us for an appointment when you're in the Washington-Baltimore area. Hundreds of these fine amps are now in service worldwide!

**Kit Two!** 6550 single-ended, 15W Class A on a stereo chassis! Can be adapted by homebrew gangstas to use other output tubes! Uses the same chassis as the Kit One! \$875! CHASSIS ONLY FOR \$150.

**Kit Three!** Essentially a monoblock version of the Kit One with double the power, the same components and on two chassis instead of one. Features two 300B per channel running in parallel single-ended yielding 17 watts. Price \$2400. Kit Three Assembly Instruction Manual only \$17 ppd.

**Kit Four!** 6V6 push-pull, 10W, Class A, stereo chassis, DUE OUT FALL '95! \$295!

## Audio Note Kit One Chassis Only \$150!

All tube, phono & line, \$199, UNBELIEVABLE!

## Angela Model 91 Single-Ended 300B Triode Mono Amps/PLANS!

Our simplified pictorial plans for building 300B Western Electric Model 91 style monoblock amps as featured in Issue One of **Sound Practices** includes a parts list, beautiful oversize easy to follow pictorial by Adam Apostolos, and more, ALL FOR \$7 POSTPAID! We also sell ALL of the individual parts, including metal-work and transformers, to those of you who prefer "scratch" building. Dozens of our crafty customers worldwide have successfully built these fine amplifiers. Our '91' compares very favorably to similar designs costing thousands more. The Angela Model 91 amps are also available from us assembled for \$1800 per pair.

## Audio Note Paper In Oil Signal Caps

2.2/50V, \$19  
1.2/200V, \$5  
.56/200V, \$8  
.001/400V, Silver Leads, \$8  
.0028/400V, Silver Leads, \$8  
.0082/400V, Silver Leads, \$9  
.01/400V, Silver Leads, \$9  
.015/400V, \$5  
.022/400V, Silver Leads, \$9  
.047/400V, Silver Leads, \$10  
.082/400V, \$7  
.12/400V, \$8  
.15/400V, Silver Leads, \$11  
.18/400V, Silver Leads, \$9  
.22/400V, Silver Leads, \$10  
33/400V, \$11  
1uF/400V, Silver Leads, \$21  
1.4uF/400V, \$25  
.00018/630V, \$5  
.0004/630V, \$5  
.00082/630V, \$5  
.0015/630V, \$5  
.0047/630V, \$5  
.012/630V, \$6  
.015/630V, \$7  
.022/630V, Silver Leads, \$10  
.033/630V, \$6  
.039/630V, \$7  
.047/630V, Silver Leads, \$10  
.056/630V, \$7  
.065/630V, \$7  
.072/630V, \$7  
.082/630V, \$8  
.1/630V, \$10  
.15/630V, Silver Leads, \$13  
.18/630V, \$9  
.22/630V, \$12  
.22/630V, Silver Leads, \$16  
.27/630V, \$10  
.33/630V, \$12  
.36/630V, \$13  
.39/630V, \$14  
.47/630V, Silver Leads, \$16  
.018/1000V, \$8  
.22/1000V, \$12  
.39/1000V, \$19  
.68/1000V, \$23  
1.2uF/1000V, \$27  
.22/1600V, \$16  
.22/2000V, \$20  
.1/4000V, \$50

These axial lead caps are thought by many D.I.Y. hipsters to be superior to ANY of the other oil or plastic caps available today!

## Great UPGRADE for old or new tube amps!

## Audio Note Paper In Oil Copper Foil Axial Lead Signal Capacitors

.001/630V, Silver Leads, \$19  
.0028/630V, Silver Leads, \$19  
.0082/630V, Silver Leads, \$19  
.01/630V, Silver Leads, \$21  
.022/630V, Silver Leads, \$22  
.047/630V, Silver Leads, \$25  
.1/630V, Silver Leads, \$27  
.15/630V, Silver Leads, \$29  
.22/630V, Silver Leads, \$36  
.33/630V, Silver Leads, \$43  
.47/630V, Silver Leads, \$50  
1uF/630V, Silver Leads, \$80

These beautiful sounding caps feature silver axial leads and oxygen-free copper foil. Highly recommended for premium applications!

## Audio Note Paper In Oil Silver Foil Axial Lead Signal Capacitors

.047/630V, \$65  
.1/630V, \$120  
.15/630V, \$160  
.22/630V, \$215  
.47/630V, \$315  
1uF/630V, \$775

## Audio Note Silver Solder! THE BEST!

1.50 grammes or about 9 meters, 1mm diameter, acid and chloride free, \$30.

2. One kilo roll, 1mm diameter, \$245.

## Angela Oil/Polypropylene Filter Capacitors for Tube Amplifiers

15MFD/600VDC, 1.75" diam., \$10  
50MFD/515VDC, 2.50" diam., \$16  
30MFD/515VDC, 1.75" diam., \$12  
Mounting clamps for above, \$2.  
GREAT FOR TUBE POWER SUPPLIES!

## Audio Note Tube Sockets

1. Octal for EL34, 6L6, etc., chassis mounts to a 1.125" hole on old Dyna, Marshall and most other gear. Finest ceramic/gold! EACH \$7  
3. 9 pin chassis mount from above, gold plated metal parts for 12AX7, etc., \$5.75.  
4. 9 pin chassis mount from below, finest white ceramic/gold plated metal parts, \$5.75  
5. 9 pin chassis mount from above, silver plated metal parts/white ceramic, \$5.75  
6. 9 pin chassis mount from below, silver plated metal parts/white ceramic, \$5.75  
7. 9 pin PC mount, gold plated metal parts, fits old Dyna, ARC, CJ, etc., each \$6.50  
8. 9 pin PC mount, silver plated, each \$6.50  
9. 7 pin chassis mount above, gold, \$8  
10. 7 pin chassis mount below, gold, \$8  
11. 7 pin chassis mount above, silver, \$8  
12. 7 pin chassis mount below, silver, \$8  
13. 7 pin PC mount, ceramic/gold, \$8  
14. 7 pin PC mount, ceramic/silver, \$8  
15. UX4 sockets for 300B, 2A3 and other 'antique' inodes, finest white ceramic with gold plated metal parts, mounts from below to a 1.1875" chassis opening, \$8.50.  
16. UX4 like above but ceramic/silver, \$8.50  
17. Western Electric/Johnson 224 style socket for 300B, etc., white ceramic/silver, KILLER, \$22  
18. 5 pin for 807 etc., mounts from below chassis to a 1.1875" hole, ceramic/gold, \$11  
A.N. sockets are the very best you can buy! As used on Ongaku, etc. Finest white ceramic and special alloy GOLD or SILVER plated metal contacts. Essential for all serious D.I.Y. projects or for upgrading mod HIGH END gear!

## Shinkoh Tantalum Film .5W Resistors

Available in the following values: 10, 12, 15, 22, 27, 39, 47, 56, 68, 82, 100, 120, 150, 220, 270, 330, 390, 470, 560, 600, 620, 680, 820, 1K, 1.1K, 1.2K, 1.5K, 1.8K, 2K, 2.2K, 2.7K, 3.9K, 4.7K, 5.6K, 6.8K, 8.2K, 10K, 12K, 15K, 22K, 27K, 33K, 39K, 47K, 56K, 62K, 68K, 75K, 82K, 91K, 100K, 120K, 150K, 220K, 250K, 2700K, 330K, 390K, 430K, 470K, 510K, 560K, 620K, 680K, 820K, 1 MEG. EACH \$4. Ongaku style!

## Audio Note Tantalum 1Watt Resistors

15, 47, 91, 100, 150, 220, 330, 470, 600, 680, 890, 910, 1K, 1.24K, 1.33K, 1.5K, 2.2K, 2.7K, 3.3K, 4.7K, 6.8K, 9.1K, 10K, 15K, 17K, 22K, 33K, 39K, 47K, 56K, 68K, 82K, 100K, 150K, 178K, 182K, 220K, 270K, 470K, 620K, 1 MEG., all 1%, EACH \$6! THE BEST for audio!

## Black Gate Unconventional Electrolytic Caps

1. 100+100/500V, standard 1.3125" diam., clamp mount, solder lugs on bottom, \$100!  
2. 100/500V, 1.3125" diam. like above, \$78!  
3. 47+47/500V, standard 1.3125" diam., clamp mount type, solder lugs on bottom, \$78  
4. 100/100V, popular 'bias' cap, \$12.

## ELNA CERAFINE Electrolytic Capacitors

Due Fall '95! 47/500V (\$15), 47+47/500V (\$17), 100/500V (\$20), 100+100/500V (\$28), 220/500V (\$32), 220+220/500V (\$50), 330/500V (\$45). Power supply upgrades!

## TONS OF GREAT N.O.S. TUBES IN STOCK!

1. EL34, N.O.S. Mullard UK 72, THE REAL THING! Welded plates, perfect for old Marantz! Matched pairs \$120, matched quads \$240!  
2. EL34 Siemens German '80s, quads \$92!  
3. 7027A Philips '80s, hard to find! Quads \$150!  
4. EL84/6BQ5 Philips '80s USA, quads \$60!  
5. 5691 Philips '80s JAN tubes, KILLER 6SL7! Some guru say best version ever made! \$15!  
6. 5691 RCA '50s RED TUBES, \$50 each.  
7. 5887, Philips '80s JAN military tubes, \$3!  
8. 5842, like W.E. 417A, '80s JAN USA, \$2!  
9. GZ34 Mullard UK '70s, THE BEST! \$4!  
10. GZ37 Mullard UK '60s, KILLER 5U4! \$18!  
11. 6DJ8 Westinghouse matched pairs, \$25!  
12. 6V6GT Philips '80s for Fenders, pairs \$35!  
13. 5881/6L6WGB Philips '80s, quads \$64!

## ORDERING INFORMATION: G-O-O-P-S! VISA, MC, AND AMEX OK FOR PHONE/FAX/MAIL ORDERS OR PREPAY CERT. FUNDS. ALL GOODS SHIPPED ON 7 DAY APPROVAL! WE SHIP WORLDWIDE EVERY BUSINESS DAY!

ORDERING INFORMATION: NEW CATALOG! THE ANGELA INSTRUMENTS '96 CATALOG WILL BE OUT THIS FALL. OVER 250+ PAGES OF EXOTIC TUBE SPECIALTY ITEMS, RARE BOOKS N.O.S. TUBES, MO! \$5 USA, \$8 ELSEWHERE!

ANGELA INSTRUMENTS, 10830 GUILFORD ROAD, SUITE 309, ANNAPOLIS JUNCTION, MARYLAND USA 20701. PHONE (301) 725-0451 FAX (301) 725-8823





The company with the largest selection of tubes, components and books!

**WE HAVE THE PRICES YOU WANT...**  
**...FOR THE THE TUBES YOU NEED!**

6CA7 (SOVTEK)	\$8.90	6L6GC (SOVTEK)	\$3.60	6550B (SVETLANA)	\$22.00
6CA7 (TESLA)	\$10.90	12AT7WC (PHILLIPS ECG JAN)	\$7.00	6550B3 (SVETLANA)	\$30.00
EL34 (SVETLANA)	\$17.00	12AX7WXT (SOVTEK)	\$4.90	6922 (PHILLIPS ECG JAN)	\$7.90
E34L (TESLA)	\$11.90	12AX7 (EURO, SIEMENS)	\$15.00	6922 (SOVTEK)	\$6.25
6BQ5/EL84 (US)	\$6.70	12AX7 (TELE DIAMOND)	\$45.00	7308 (SIEMENS, MFG BY SYL.)	\$9.60
6BQ5 (SOVTEK)	\$3.50	SV811-3 (SVETLANA)	\$30.00	7581/KT66 (PHILLIPS ECG)	\$26.95
6SL7GT (US)	\$5.95	SV811-10 (SVETLANA)	\$30.00	ECC803S (TESLA)	\$25.00
6SL7GT (SOVTEK)	\$3.25	5687WB (PHILLIPS ECG JAN)	\$3.50	6146W (PHILLIPS ECG JAN)	\$16.05
6SN7GT (US)	\$5.25	5693 (US)	\$12.85	5AR4 (SOVTEK)	\$6.90
6SN7GT (SOVTEK)	\$4.80	5965 (US)	\$2.90	5U4G (SOVTEK)	\$4.95
6V6GT (US)	\$10.00	5881/6L6WGB (SOVTEK)	\$6.75	5U4G (SVETLANA)	\$11.00
6V6GT (SOVTEK)	\$3.90	5881WXT (SOVTEK)	\$8.75	7025 (SOVTEK)	\$3.90

Matching available at an additional cost. Save 50% on matching by mentioning this ad.  
 Mention this ad to receive tubes at prices shown.

**...AND THE BOOKS YOU USE!**

RCA RECEIVING TUBE MANUAL	B-654	\$10.95
GE ESSENTIAL CHARACTERISTICS	B-377	\$12.95
SEVENTY FIVE YEARS OF WESTERN ELECTRIC TUBE MANUFACTURING	B-634	\$16.95
RCA TRANSMITTING TUBE MANUAL	B-676	\$12.95
PRINCIPLES OF ELECTRON TUBES	B-693	\$34.95
SAGA OF THE VACUUM TUBE	B-376	\$18.95
SEVENTY YEARS OF RADIO TUBES AND VALVES	B-365	\$25.95
HISTORY OF THE BRITISH VALVE	B-641	\$29.95
THE SEARCH FOR MUSICAL ECSTASY	B-684	\$24.95
COMPLETE GUIDE TO HIGH END AUDIO	B-687	\$29.95
MULLARD CIRCUITS FOR AUDIO AMPLIFIERS	B-655	\$16.95
THE WILLIAMSON AMPLIFIER	B-560	\$4.95
AUDIO FREQUENCY DESIGN	B-679	\$19.95
THE TUBE AMP BOOK	B-581	\$29.95
THE DESKTOP REFERENCE TO HIP GUITAR AMPS	B-663	\$26.95
THE ULTIMATE TONE	B-695	\$55.00

We offer prompt service and delivery! We accept orders by phone, fax and mail.

We accept Visa, Mastercard and American Express.

\$10.00 minimum order; add shipping cost and \$2.00 handling fee.

---

WRITE OR CALL FOR OUR 36 PAGE CATALOG OF OTHER  
 TUBES, PARTS, BOOKS AND SUPPLIES.  
 TOLL FREE FAX IN THE U.S. AND CANADA  
 1-800-706-6789



