

**I Campeonato del Mundo para Ciegos**  
**I World Blind Sports Championships**

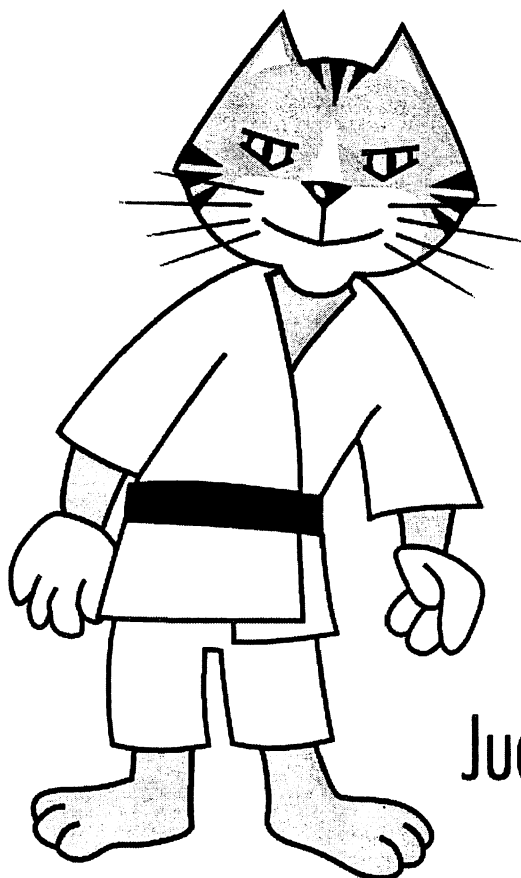

Judo

**Resultados Oficiales**  
**Official Results**

# I CAMPEONATO MUNDIAL DE DEPORTES PARA CIEGOS

## 1st WORLD BLIND SPORTS CHAMPIONSHIPS

SUMAR. PARTICIPANTES

STATISTICAL SUMMARY



JUDO  
JUDO

### Instalaciones Deportivas CSD

PAIS	HOMBRES	MUJERES	TOTAL
ARG ARGENTINA	2	0	2
AUS AUSTRALIA	1	1	2
AUT AUSTRIA	1	0	1
BRA BRASIL	3	0	3
BUR BURKINA FASO	2	0	2
CAN CANADA	2	0	2
CHN REP. POP. CHINA	3	2	5
CUB CUBA	4	0	4
ESP ESPAÑA	7	6	13
FRA FRANCIA	7	1	8
GBR GRAN BRETAÑA	6	3	9
GER ALEMANIA	5	5	10
GUA GUATEMALA	1	0	1
IRI IRAN	7	0	7
IRL IRLANDA	4	0	4
ITA ITALIA	4	1	5
JPN JAPON	7	0	7
KOR COREA	3	0	3
LTU LITUANIA	3	0	3
MAR MARRUECOS	1	0	1
RUS RUSIA	6	0	6
THA TAILANDIA	2	0	2
TPE CHINA TAIPEI	4	1	5



# I CAMPEONATO MUNDIAL DE DEPORTES PARA CIEGOS 1<sup>st</sup> WORLD BLIND SPORTS CHAMPIONSHIPS

SUMAR. PARTICIPANTES

STATISTICAL SUMMARY



JUDO  
JUDO

## Instalaciones Deportivas CSD

	PAIS	HOMBRES	MUJERES	TOTAL
UKR	UCRANIA	6	0	6
USA	ESTADOS UNIDOS	6	5	11
TOTAL	25	97	25	122

# I CAMPEONATO MUNDIAL DE DEPORTES PARA CIEGOS

## 1st WORLD BLIND SPORTS CHAMPIONSHIPS



**PARTICIPANTES/PAIS**

**ATHLETES/COUNTRY**



**JUDO**  
**JUDO**

*Instalaciones Deportivas CSD*

PAIS	SEXO	Cla.	NOMBRE	EVENTO
ARG ARGENTINA	Hombres	B1	RAMIREZ, Fabien	Hasta 73 Kgr.
		B1	SALINAS, Miguel	Hasta 81 Kgr.
			<b>TOTAL 2</b>	
AUS AUSTRALIA	Hombres	B1	CLARKE, Anthony	Hasta 90 Kgr.
	Mujeres	B1	ALAN, Desiree	Hasta 52 Kgr.
			<b>TOTAL 2</b>	
AUT AUSTRIA	Hombres	B3	HANL, Walter	Hasta 100 Kgr.
			<b>TOTAL 1</b>	
BRA BRASIL	Hombres	B1	CUNHA, Leonel	Mas de 100kg.
		B1	TENORIO, Antonio	Equipos Hasta 90 Kgr.
		B2	MACIEL, Helder	Equipos Hasta 60 Kgr.
			<b>TOTAL 3</b>	Equipos
BUR BURKINA FASO	Hombres	B1	DIEDAMBA, Thiombiano	Hasta 60 Kgr.
		B2	BELGO, Abidantia	Hasta 66 Kgr.
			<b>TOTAL 2</b>	
CAN CANADA	Hombres	B1	MORTEN, Pier	Hasta 66 Kgr.
		B2	MORGAN, Bill	Hasta 81 Kgr.
			<b>TOTAL 2</b>	
CHN REP. POP. CHINA	Hombres	B1	MEN , Runming	Hasta 90 Kgr.
		B1	TIAN, Longbing	Equipos Hasta 81 Kgr.
		B3	CUI , Baoji	Equipos Hasta 73 Kgr.
	Mujeres	B2	WANG, Yanling	Equipos Hasta 63 - 70 kgr.
		B2	XUE , Lanmei	Mas de 70 Kgr.
			<b>TOTAL 5</b>	
CUB CUBA	Hombres	B1	BROTTON, Lazaro	Hasta 73 Kgr.
		B3	CRUZ, Isao	Equipos Hasta 81 Kgr.
		B3	PEREZ, Pedro	Equipos Hasta 66 Kgr.
				Equipos

# I CAMPEONATO MUNDIAL DE DEPORTES PARA CIEGOS

## 1st WORLD BLIND SPORTS CHAMPIONSHIPS

PARTICIPANTES/PAIS

ATHLETES/COUNTRY



JUDO  
JUDO

Instalaciones Deportivas CSD

PAIS	SEXO	Cla.	NOMBRE	EVENTO
CUB CUBA	Hombres	B3	PEREZ, Sergio	Equipos Hasta 60 Kgr.
			<b>TOTAL 4</b>	
ESP ESPAÑA	Hombres	B2	BOEDO, Francisco	Equipos Hasta 81 Kgr.
		B2	RUIZ, Jose	Hasta 60 Kgr.
		B3	CAMPOS, Fermin	Equipos Hasta 90 Kgr.
		B3	GALLARDO, Antonio	Equipos Mas de 100kg.
		B3	GARCIA, David	Equipos Hasta 66 Kgr.
		B3	MORENO, Rafael	Equipos Hasta 100 Kgr.
		B3	SANTANA, Andres	Equipos Hasta 73 Kgr.
	Mujeres	B1	ROBLEDO, Celia	63 - 70 kgr.
		B2	ARANA, Juana	Hasta 48 Kgr.
		B2	MARISCAL, Gema	Hasta 52 Kgr.
		B3	ARCE, Marta	Hasta 57 Kgr.
		B3	HERRERA, Carmen	Mas de 70 Kgr.
		B3	SOSA, Maria	63 - 70 kgr.
			<b>TOTAL 13</b>	
FRA FRANCIA	Hombres	B1	CENSIER, Eric	Mas de 100kg. Equipos
		B1	GUILLAUME, David	Equipos Hasta 90 Kgr.
		B2	ROLLO, Gerald	Hasta 73 Kgr. Equipos
		B2	SIDOROWIEZ, Michel	Hasta 100 Kgr.
		B3	FARGEAU, Didier	Hasta 60 Kgr.
		B3	LE MEAUX, Sebastien	Equipos Hasta 81 Kgr.
		B3	MOREL, Cyril	Hasta 66 Kgr. Equipos
	Mujeres	B3	CASTANO, Marie.	Hasta 52 Kgr.
			<b>TOTAL 8</b>	
GBR GRAN BRETAÑA	Hombres	B1	POWELL, Terence	Equipos Hasta 100 Kgr.

# I CAMPEONATO MUNDIAL DE DEPORTES PARA CIEGOS

## 1st WORLD BLIND SPORTS CHAMPIONSHIPS



JUDO  
JUDO

**PARTICIPANTES/PAIS**

**ATHLETES/COUNTRY**

*Instalaciones Deportivas CSD*

PAIS	SEXO	Cla.	NOMBRE	EVENTO
GBR	GRAN BRETAÑA	Hombres	B1 RIGG, John	Hasta 66 Kgr.
			B2 JACKSON, Simon	Equipos
			B3 HALL, Philip	Hasta 81 Kgr.
			B3 QUILTER, Ben	Equipos
			B3 ROSE, Ian	Hasta 73 Kgr.
	Mujeres	B1 UTECHT, Sara	Equipos	
		B2 BASTIN, Berveley	Hasta 60 Kgr.	
		B2 HALL, Anita	Equipos	
		TOTAL 9	Hasta 90 Kgr.	
GER	ALEMANIA	Hombres	B2 ESSER, Michael	Hasta 52 Kgr.
			B2 OSEWALD, Martin	63 - 70 kgr.
			B2 RICHTER, Michael	Hasta 57 Kgr.
			B3 DAHMEN, Thomas	
			B3 ZEILERMEIER, C.	
	Mujeres	B2 BISCHLER, Beate	Hasta 73 Kgr.	
		B2 CHRISTEN, SIENA	Equipos	
		B3 ARNDT, Astrid	Equipos	
		B3 BRUSSIG, Ramona	Mas de 100kg.	
		B3 SCHUETZEL, Susann	Equipos	
TOTAL 10	Hasta 90 Kgr.			
GUA	GUATEMALA	Hombres	B2 HERNANDEZ, Byron	Hasta 81 Kgr.
			TOTAL 1	Equipos
IRI	IRAN	Hombres	B1 BAGHERI, Aboutaleb	Hasta 60 Kgr.
			B1 BAGHERZADEH, Mahmoud	
			B1 FOOLADVAND, A.	
			B1 GHAJAR, Aliakbar	
			B1 MARDANPOUR, Ghasem	

# I CAMPEONATO MUNDIAL DE DEPORTES PARA CIEGOS

## 1st WORLD BLIND SPORTS CHAMPIONSHIPS



**PARTICIPANTES/PAIS**

**ATHLETES/COUNTRY**



**JUDO**  
**JUDO**

*Instalaciones Deportivas CSD*

PAIS	SEXO	Cla.	NOMBRE	EVENTO				
IRI	IRAN	Hombres	B1 SAFARNEGAD, Ali	Hasta 66 Kgr. Equipos				
			B2 SHAJARI, Reza	Hasta 60 Kgr. Equipos				
			<b>TOTAL 7</b>					
IRL	IRLANDA	Hombres	B1 CULHANE, Tim	Hasta 66 Kgr.				
			B1 WALSH, Esmund	Hasta 81 Kgr.				
			B1 WHITE, Tony	Hasta 90 Kgr.				
			B3 NAZARALI, Rahim	Hasta 73 Kgr.				
			<b>TOTAL 4</b>					
ITA	ITALIA	Hombres	B1 MARIANO, Giuseppe	Hasta 60 Kgr. Equipos				
			B1 ROSSO, Michele	Hasta 81 Kgr. Equipos				
			B2 DELL'AGNOLO, Daniel	Hasta 66 Kgr. Equipos				
			B3 ARDIT, Matteo	Hasta 73 Kgr. Equipos				
			<b>TOTAL 5</b>					
			Mujeres	B1 COLTRIOLI, Roberta	Hasta 57 Kgr.			
				<b>TOTAL 5</b>				
				JPN	JAPON	Hombres	B1 KATO, Yuji	Hasta 90 Kgr. Equipos
							B1 MATSUMOTO, Yoshikazu	Hasta 100 Kgr. Equipos
							B1 MIYAUCHI, Eiji	Mas de 100kg. Equipos
B2 FUJIMOTO, Satoshi	Hasta 66 Kgr. Equipos							
B2 HIROSE, Makoto	Hasta 60 Kgr. Equipos							
B2 NAKAMURA, Kenichi	Hasta 81 Kgr. Equipos							
B2 TAKAHASHI, Tomohiro	Hasta 73 Kgr. Equipos							
<b>TOTAL 7</b>								
KOR	COREA	Hombres	B1 KIM, Il-Keum	Hasta 66 Kgr.				
			B1 YANG, Jai-Joon	Hasta 73 Kgr.				
			B3 AN, You-Sung	Hasta 90 Kgr.				
			<b>TOTAL 3</b>					
LTU	LITUANIA	Hombres	B2 STOSKUS, Jonas	Hasta 90 Kgr.				

# I CAMPEONATO MUNDIAL DE DEPORTES PARA CIEGOS

## 1st WORLD BLIND SPORTS CHAMPIONSHIPS

**PARTICIPANTES/PAIS**

**ATHLETES/COUNTRY**



**JUDO**  
**JUDO**

*Instalaciones Deportivas CSD*

PAIS	SEXO	Cla.	NOMBRE	EVENTO
LTU LITUANIA	Hombres	B3	BAGDISANKA, Stasys	Hasta 66 Kgr.
		B3	STEPANOVAS, Andrejus	Hasta 60 Kgr.
			<b>TOTAL 3</b>	
MAR MARRUECOS	Hombres	B1	BOUZAI, Abderrahim	Hasta 73 Kgr.
			<b>TOTAL 1</b>	
RUS RUSIA	Hombres	B1	MITCHOURINE, V.	Equipos Hasta 60 Kgr.
		B1	VOLKOV, Vladimir	Mas de 100kg. Equipos
		B2	ATNABAEV, Ravkhat	Hasta 73 Kgr. Equipos
		B2	CHAVACHOV, Oleg	Equipos Hasta 66 Kgr.
		B2	CHNEIDERMANE, G.	Equipos Hasta 100 Kgr.
		B3	BYTCHKOV, Vladimir	Equipos Hasta 81 Kgr.
			<b>TOTAL 6</b>	
THA TAILANDIA	Hombres	B1	POLIEA, Narong	Hasta 60 Kgr.
		B1	TAKIENKARM, Manop	Hasta 66 Kgr.
			<b>TOTAL 2</b>	
TPE CHINA TAIPEI	Hombres	B1	HSIAO, Huang-Chi	Hasta 81 Kgr. Equipos
		B2	LEE , Ching-Cheng	Equipos Hasta 66 Kgr.
		B2	LEE , Ching-Chung	Hasta 60 Kgr. Equipos
		B2	SHIN, Yuang-Jen	Hasta 73 Kgr. Equipos
	Mujeres	B3	LEE , Ching-Hua	Hasta 48 Kgr.
			<b>TOTAL 5</b>	
UKR UCRANIA	Hombres	B1	SYDORENKO, Sergiy	Hasta 66 Kgr.
		B2	BYCHKOVSKYY, K.	Hasta 60 Kgr.
		B2	DUB , Vasyi	Hasta 81 Kgr. Equipos
		B3	BYCHKOVSKYY, K.	Equipos
		B3	LYVYTSKYI, Mykola	Equipos Hasta 90 Kgr.



# I CAMPEONATO MUNDIAL DE DEPORTES PARA CIEGOS

## 1st WORLD BLIND SPORTS CHAMPIONSHIPS



JUDO  
JUDO

**PARTICIPANTES/PAIS**

**ATHLETES/COUNTRY**

*Instalaciones Deportivas CSD*

PAIS	SEXO	Cla.	NOMBRE	EVENTO
UKR UCRANIA	Hombres	B3	SYDORENKO, Sergiy	Equipos
			<b>TOTAL 6</b>	
USA ESTADOS UNIDOS	Hombres	B1	MANNING, Lynn	Equipos
			B1 MASTRO, James	Hasta 90 Kgr.
			B2 KEENY, Richard	Equipos
			B2 LOPEZ, Marlon	Hasta 100 Kgr.
			B2 SZOTT, Kevin	Hasta 81 Kgr.
			B3 MOORE, Scott	Equipos
				Hasta 66 Kgr.
				Mas de 100kg.
				Equipos
				Hasta 73 Kgr.
				Equipos
	Mujeres	B2	JONES, Edie	Hasta 52 Kgr.
		B2	MARTINEZ, Lisa	Hasta 57 Kgr.
		B2	PEREZ, Mary	63 - 70 kgr.
		B3	DEVILLE, Nicole	Hasta 48 Kgr.
		B3	SEVERE, Amy	63 - 70 kgr.
			<b>TOTAL 11</b>	
<b>TOTAL</b>			<b>25</b>	

# I CAMPEONATO MUNDIAL DE DEPORTES PARA CIEGOS

## 1st WORLD BLIND SPORTS CHAMPIONSHIPS



**HORARIO**

**TIMETABLE**



**JUDO**  
**JUDO**

*Instalaciones Deportivas CSD*

FECHA	HORA	Tal.	SEXO	EVENTO	RONDA	Part.	CLA.	NOMBRE	CLA.	NOMBRE	JUECES
18/07/98	16:00		Hombres	Hasta 73 Kgr.	1/8 FINAL	1	B1	BAGHERI, Aboutaleb	IRI	B3 NAZARALI, Rahim	IRL
18/07/98	16:00		Hombres	Hasta 73 Kgr.	1/8 FINAL	2	B3	MOORE, Scott	USA	B2 SHIN, Yuang-Jen	TPE
18/07/98	16:00		Hombres	Hasta 73 Kgr.	1/8 FINAL	3	B1	BROTTON, Lazero	CUB	B2 TAKAHASHI, Tomohiro	JPN
18/07/98	16:00		Hombres	Hasta 73 Kgr.	1/8 FINAL	4	B1	BOUZAI, Abderrahim	MAR	B3 SANTANA, Andres	ESP
18/07/98	16:00		Hombres	Hasta 73 Kgr.	1/8 FINAL	5	B2	ROLLO, Gerald	FRA	B2 ATNABAEV, Ravkhat	RUS
18/07/98	16:00		Hombres	Hasta 73 Kgr.	1/8 FINAL	6	B3	ARDIT, Matteo	ITA	B1 YANG, Jai-Joon	KOR
18/07/98	16:00		Hombres	Hasta 73 Kgr.	1/8 FINAL	7	B1	RAMIREZ, Fabien	ARG	B3 CUI, Baoji	CHN
18/07/98	16:00		Hombres	Hasta 73 Kgr.	1/8 FINAL	8	B2	ESSER, Michael	GER	B3 HALL, Phillip	GBR
18/07/98	16:00		Hombres	Hasta 73 Kgr.	1/4 FINAL	9		W1		W2	
18/07/98	16:00		Hombres	Hasta 73 Kgr.	1/4 FINAL	10		W3		W4	
18/07/98	16:00		Hombres	Hasta 73 Kgr.	1/4 FINAL	11		W5		W6	
18/07/98	16:00		Hombres	Hasta 73 Kgr.	1/4 FINAL	12		W7		W8	
18/07/98	16:00		Hombres	Hasta 73 Kgr.	REPESCA	13		PERDEDOR E1/8 FINAL		PERDEDOR DE1/4 FINAL	
18/07/98	16:00		Hombres	Hasta 73 Kgr.	REPESCA	14		PERDEDOR E1/8 FINAL		PERDEDOR DE1/4 FINAL	
18/07/98	16:00		Hombres	Hasta 73 Kgr.	REPESCA	15		PERDEDOR E1/8 FINAL		PERDEDOR DE1/4 FINAL	
18/07/98	16:00		Hombres	Hasta 73 Kgr.	REPESCA	16		PERDEDOR E1/8 FINAL		PERDEDOR DE1/4 FINAL	
18/07/98	16:00		Hombres	Hasta 73 Kgr.	REPESCA	17		W13		W14	
18/07/98	16:00		Hombres	Hasta 73 Kgr.	REPESCA	18		W15		W16	
18/07/98	16:00		Hombres	Hasta 73 Kgr.	SEMIFINAL	19		W9		W10	
18/07/98	16:00		Hombres	Hasta 73 Kgr.	SEMIFINAL	20		W11		W12	
18/07/98	16:00		Hombres	Hasta 81 Kgr.	1/8 FINAL	1	B1	SALINAS, Miguel	ARG	B2 MORGAN, Bill	CAN
18/07/98	16:00		Hombres	Hasta 81 Kgr.	1/8 FINAL	2	B1	GHAJAR, Alekbar	IRI	B1 TIAN, Longbing	CHN
18/07/98	16:00		Hombres	Hasta 81 Kgr.	1/8 FINAL	3	B2	DUB, Vasyi	UKR	B3 DAHMEN, Thomas	GER
18/07/98	16:00		Hombres	Hasta 81 Kgr.	1/8 FINAL	4	B3	CRUZ, Isao	CUB	B3 BYTCHKOV, Vladimir	RUS
18/07/98	16:00		Hombres	Hasta 81 Kgr.	1/8 FINAL	5	B1	HSIAO, Huang-Chi	TPE	B2 BOEDO, Francesco	ESP
18/07/98	16:00		Hombres	Hasta 81 Kgr.	1/8 FINAL	6	B3	LE MEAUX, Sebastien	FRA	B2 NAKAMURA, Kenichi	JPN
18/07/98	16:00		Hombres	Hasta 81 Kgr.	1/8 FINAL	7	B2	JACKSON, Simon	GBR	B2 KEENY, Richard	USA
18/07/98	16:00		Hombres	Hasta 81 Kgr.	1/8 FINAL	8	B1	ROSSO, Michele	ITA	B1 WALSH, Eamund	IRL
18/07/98	16:00		Hombres	Hasta 81 Kgr.	1/4 FINAL	9		W1		W2	
18/07/98	16:00		Hombres	Hasta 81 Kgr.	1/4 FINAL	10		W3		W4	
18/07/98	16:00		Hombres	Hasta 81 Kgr.	1/4 FINAL	11		W5		W6	
18/07/98	16:00		Hombres	Hasta 81 Kgr.	1/4 FINAL	12		W7		W8	
18/07/98	16:00		Hombres	Hasta 81 Kgr.	REPESCA	13		PERDEDOR E1/8 FINAL		PERDEDOR DE1/4 FINAL	
18/07/98	16:00		Hombres	Hasta 81 Kgr.	REPESCA	14		PERDEDOR E1/8 FINAL		PERDEDOR DE1/4 FINAL	
18/07/98	16:00		Hombres	Hasta 81 Kgr.	REPESCA	15		PERDEDOR E1/8 FINAL		PERDEDOR DE1/4 FINAL	
18/07/98	16:00		Hombres	Hasta 81 Kgr.	REPESCA	16		PERDEDOR E1/8 FINAL		PERDEDOR DE1/4 FINAL	
18/07/98	16:00		Hombres	Hasta 81 Kgr.	REPESCA	17		W13		W14	
18/07/98	16:00		Hombres	Hasta 81 Kgr.	REPESCA	18		W15		W16	
18/07/98	16:00		Hombres	Hasta 81 Kgr.	SEMIFINAL	19		W9		W10	
18/07/98	16:00		Hombres	Hasta 81 Kgr.	SEMIFINAL	20		W11		W12	
18/07/98	16:00		Hombres	Hasta 90 Kgr.	1/8 FINAL	1	B1	CLARKE, Anthony	AUS	B1 WHITE, Tony	IRL
18/07/98	16:00		Hombres	Hasta 90 Kgr.	1/8 FINAL	3	B1	MEN, Runming	CHN	B3 AN, You-Sung	KOR
18/07/98	16:00		Hombres	Hasta 90 Kgr.	1/8 FINAL	4	B1	MARDANPOUR, Ghasem	IRI	B1 GUILLAUME, David	FRA
18/07/98	16:00		Hombres	Hasta 90 Kgr.	1/8 FINAL	5	B3	LYVYTSKYI, Mykola	UKR	B1 MANNING, Lynn	USA
18/07/98	16:00		Hombres	Hasta 90 Kgr.	1/8 FINAL	6	B2	STOSKUS, Jonas	LTU	B3 ROSE, Ian	GBR
18/07/98	16:00		Hombres	Hasta 90 Kgr.	1/8 FINAL	8	B2	RICHTER, Michael	GER	B1 KATO, Yuji	JPN
18/07/98	16:00		Hombres	Hasta 90 Kgr.	1/4 FINAL	9		W1		W2	
18/07/98	16:00		Hombres	Hasta 90 Kgr.	1/4 FINAL	10		W3		W4	
18/07/98	16:00		Hombres	Hasta 90 Kgr.	1/4 FINAL	11		W5		W6	
18/07/98	16:00		Hombres	Hasta 90 Kgr.	1/4 FINAL	12		W7		W8	
18/07/98	16:00		Hombres	Hasta 90 Kgr.	REPESCA	13		PERDEDOR E1/8 FINAL		PERDEDOR DE1/4 FINAL	
18/07/98	16:00		Hombres	Hasta 90 Kgr.	REPESCA	14		PERDEDOR E1/8 FINAL		PERDEDOR DE1/4 FINAL	
18/07/98	16:00		Hombres	Hasta 90 Kgr.	REPESCA	15		PERDEDOR E1/8 FINAL		PERDEDOR DE1/4 FINAL	
18/07/98	16:00		Hombres	Hasta 90 Kgr.	REPESCA	16		PERDEDOR E1/8 FINAL		PERDEDOR DE1/4 FINAL	
18/07/98	16:00		Hombres	Hasta 90 Kgr.	REPESCA	17		W13		W14	
18/07/98	16:00		Hombres	Hasta 90 Kgr.	REPESCA	18		W15		W16	
18/07/98	16:00		Hombres	Hasta 90 Kgr.	SEMIFINAL	19		W9		W10	
18/07/98	16:00		Hombres	Hasta 90 Kgr.	SEMIFINAL	20		W11		W12	
18/07/98	16:00		Hombres	Hasta 100 Kgr.	1/4 FINAL	1	B3	HANL, Walter	AUT	B1 POWELL, Terence	GBR
18/07/98	16:00		Hombres	Hasta 100 Kgr.	1/4 FINAL	2	B3	MORENO, Rafael	ESP	B2 CHNEIDERMANE, G.	RUS
18/07/98	16:00		Hombres	Hasta 100 Kgr.	1/4 FINAL	3	B1	FOOLADVAND, A.	IRI	B1 MASTRO, James	USA
18/07/98	16:00		Hombres	Hasta 100 Kgr.	1/4 FINAL	4	B2	SIDOROWIEZ, Michel	FRA	B1 MATSUMOTO, Yoshikazu	JPN

# I CAMPEONATO MUNDIAL DE DEPORTES PARA CIEGOS

## 1st WORLD BLIND SPORTS CHAMPIONSHIPS

**HORARIO**

**TIMETABLE**



**JUDO**  
**JUDO**

*Instalaciones Deportivas CSD*

FECHA	HORA	Tal.	SEXO	EVENTO	RONDA	Part.	CLA.	NOMBRE	CLA.	NOMBRE	JUECES
18/07/98	16:00		Hombres	Hasta 100 Kgr.	REPESCA	5		W1		W2	
18/07/98	16:00		Hombres	Hasta 100 Kgr.	REPESCA	6		W3		W4	
18/07/98	16:00		Hombres	Hasta 100 Kgr.	SEMIFINAL	7		W1		W2	
18/07/98	16:00		Hombres	Hasta 100 Kgr.	SEMIFINAL	8		W3		W4	
18/07/98	16:00		Hombres	Mas de 100kg.	1/4 FINAL	1	B3	GALLARDO, Antonio	ESP	B1 MIYAUCHI, Eiji	JPN
18/07/98	16:00		Hombres	Mas de 100kg.	1/4 FINAL	2	B1	CUNHA, Leonel	BRA	B2 SZOTT, Kevin	USA
18/07/98	16:00		Hombres	Mas de 100kg.	1/4 FINAL	4	B2	OSEWALD, Martin	GER	B1 VOLKOV, Vladimir	RUS
18/07/98	16:00		Hombres	Mas de 100kg.	REPESCA	6		W1		W2	
18/07/98	16:00		Hombres	Mas de 100kg.	REPESCA	6		W3		W4	
18/07/98	16:00		Hombres	Mas de 100kg.	SEMIFINAL	7		W1		W2	
18/07/98	16:00		Hombres	Mas de 100kg.	SEMIFINAL	8		W3		W4	
18/07/98	10:00		Hombres	Hasta 60 Kgr.	1/8 FINAL	1	B2	SHAJARI, Reza	IRI	B3 QUILTER, Ben	GBR
18/07/98	10:00		Hombres	Hasta 60 Kgr.	1/8 FINAL	2	B1	DIEDAMBA, Thiombiano	SUR	B2 RUIZ, Jose	ESP
18/07/98	10:00		Hombres	Hasta 60 Kgr.	1/8 FINAL	3	B3	PEREZ, Sergio	CUB	B3 STEPANOVAS, Andrejus	LTU
18/07/98	10:00		Hombres	Hasta 60 Kgr.	1/8 FINAL	4	B2	BYCHKOVSKYY, K.	UKR	B1 POLIEA, Narong	THA
18/07/98	10:00		Hombres	Hasta 60 Kgr.	1/8 FINAL	5	B1	MITCHOURINE, V.	RUS	B2 LEE, Ching-Chung	TPE
18/07/98	10:00		Hombres	Hasta 60 Kgr.	1/8 FINAL	6	B1	MARIANO, Giuseppe	ITA	B3 FARGEAU, Didier	FRA
18/07/98	10:00		Hombres	Hasta 60 Kgr.	1/8 FINAL	8	B2	HERNANDEZ, Byron	GUA	B2 HIROSE, Makoto	JPN
18/07/98	10:00		Hombres	Hasta 60 Kgr.	1/4 FINAL	8		W1		W2	
18/07/98	10:00		Hombres	Hasta 60 Kgr.	1/4 FINAL	10		W3		W4	
18/07/98	10:00		Hombres	Hasta 60 Kgr.	1/4 FINAL	11		W5		W6	
18/07/98	10:00		Hombres	Hasta 60 Kgr.	1/4 FINAL	12		W7		W8	
18/07/98	10:00		Hombres	Hasta 60 Kgr.	REPESCA	13		PERDEDOR E1/8 FINAL		PERDEDOR DE1/4 FINAL	
18/07/98	10:00		Hombres	Hasta 60 Kgr.	REPESCA	14		PERDEDOR E1/8 FINAL		PERDEDOR DE1/4 FINAL	
18/07/98	10:00		Hombres	Hasta 60 Kgr.	REPESCA	15		PERDEDOR E1/8 FINAL		PERDEDOR DE1/4 FINAL	
18/07/98	10:00		Hombres	Hasta 60 Kgr.	REPESCA	16		PERDEDOR E1/8 FINAL		PERDEDOR DE1/4 FINAL	
18/07/98	10:00		Hombres	Hasta 60 Kgr.	REPESCA	17		W13		W14	
18/07/98	10:00		Hombres	Hasta 60 Kgr.	REPESCA	18		W15		W16	
18/07/98	10:00		Hombres	Hasta 60 Kgr.	SEMIFINAL	19		W9		W10	
18/07/98	10:00		Hombres	Hasta 60 Kgr.	SEMIFINAL	20		W11		W12	
18/07/98	10:00		Hombres	Hasta 66 Kgr.	1/16 Final	1	B2	DELL'AGNOLO, Daniel	ITA	B1 MORTEN, Pier	CAN
18/07/98	10:00		Hombres	Hasta 66 Kgr.	1/16 Final	16	B2	LEE, Ching-Cheng	TPE	B2 LOPEZ, Marlon	USA
18/07/98	10:00		Hombres	Hasta 66 Kgr.	1/8 FINAL	17		W1		W2	
18/07/98	10:00		Hombres	Hasta 66 Kgr.	1/8 FINAL	18		W3		W4	
18/07/98	10:00		Hombres	Hasta 66 Kgr.	1/8 FINAL	19		W5		W6	
18/07/98	10:00		Hombres	Hasta 66 Kgr.	1/8 FINAL	20		W7		W8	
18/07/98	10:00		Hombres	Hasta 66 Kgr.	1/8 FINAL	21		W9		W10	
18/07/98	10:00		Hombres	Hasta 66 Kgr.	1/8 FINAL	22		W11		W12	
18/07/98	10:00		Hombres	Hasta 66 Kgr.	1/8 FINAL	23		W13		W14	
18/07/98	10:00		Hombres	Hasta 66 Kgr.	1/8 FINAL	24		W15		W16	
18/07/98	10:00		Hombres	Hasta 66 Kgr.	1/4 FINAL	25		W17		W18	
18/07/98	10:00		Hombres	Hasta 66 Kgr.	1/4 FINAL	26		W19		W20	
18/07/98	10:00		Hombres	Hasta 66 Kgr.	1/4 FINAL	27		W21		W22	
18/07/98	10:00		Hombres	Hasta 66 Kgr.	1/4 FINAL	28		W23		W24	
18/07/98	10:00		Hombres	Hasta 66 Kgr.	REPESCA	29		PERDEDOR E1/16 Fina		PERDEDOR DE1/8 FINAL	
18/07/98	10:00		Hombres	Hasta 66 Kgr.	REPESCA	30		PERDEDOR E1/16 Fina		PERDEDOR DE1/8 FINAL	
18/07/98	10:00		Hombres	Hasta 66 Kgr.	REPESCA	31		PERDEDOR E1/16 Fina		PERDEDOR DE1/8 FINAL	
18/07/98	10:00		Hombres	Hasta 66 Kgr.	REPESCA	32		PERDEDOR E1/16 Fina		PERDEDOR DE1/8 FINAL	
18/07/98	10:00		Hombres	Hasta 66 Kgr.	REPESCA	33		W29		PERDEDOR DE1/4 FINAL	
18/07/98	10:00		Hombres	Hasta 66 Kgr.	REPESCA	34		W30		PERDEDOR DE1/4 FINAL	
18/07/98	10:00		Hombres	Hasta 66 Kgr.	REPESCA	35		W31		PERDEDOR DE1/4 FINAL	
18/07/98	10:00		Hombres	Hasta 66 Kgr.	REPESCA	36		W32		PERDEDOR DE1/4 FINAL	
18/07/98	10:00		Hombres	Hasta 66 Kgr.	REPESCA	37		W33		W34	
18/07/98	10:00		Hombres	Hasta 66 Kgr.	REPESCA	38		W35		W36	
18/07/98	10:00		Hombres	Hasta 66 Kgr.	SEMIFINAL	39		W25		W26	
18/07/98	10:00		Hombres	Hasta 66 Kgr.	SEMIFINAL	40		W27		W28	
18/07/98	10:00		Mujeres	Hasta 48 Kgr.	GRUPO A	1-2	B3	DEVILLE, Nicole	USA	B2 ARANA, Juana	ESP
18/07/98	10:00		Mujeres	Hasta 48 Kgr.	GRUPO A	3-4	B3	ARNDT, Astrid	GER	B3 LEE, Ching-Hua	TPE
18/07/98	10:00		Mujeres	Hasta 48 Kgr.	GRUPO A	1-3	B3	DEVILLE, Nicole	USA	B3 ARNDT, Astrid	GER
18/07/98	10:00		Mujeres	Hasta 48 Kgr.	GRUPO A	2-4	B2	ARANA, Juana	ESP	B3 LEE, Ching-Hua	TPE
18/07/98	10:00		Mujeres	Hasta 48 Kgr.	GRUPO A	1-4	B3	DEVILLE, Nicole	USA	B3 LEE, Ching-Hua	TPE
18/07/98	10:00		Mujeres	Hasta 48 Kgr.	GRUPO A	2-3	B2	ARANA, Juana	ESP	B3 ARNDT, Astrid	GER

# I CAMPEONATO MUNDIAL DE DEPORTES PARA CIEGOS

## 1st WORLD BLIND SPORTS CHAMPIONSHIPS

**HORARIO**

**TIMETABLE**



**JUDO**  
**JUDO**

*Instalaciones Deportivas CSD*

FECHA	HORA	Tal.	SEXO	EVENTO	RONDA	Part.	CLA.	NOMBRE	CLA.	NOMBRE	JUECES	
19/07/98	10:00		Mujeres	Hasta 52 Kgr.	1/4 FINAL	1	B1	ALAN, Deshae	AUS	B2	MARISCAL, Gemma	ESP
19/07/98	10:00		Mujeres	Hasta 52 Kgr.	1/4 FINAL	4	B1	UTECHT, Sara	GBR	B3	SCHUETZEL, Susann	GER
19/07/98	10:00		Mujeres	Hasta 52 Kgr.	SEMIFINAL	5		W1			W2	
19/07/98	10:00		Mujeres	Hasta 52 Kgr.	SEMIFINAL	6		W3			W4	
19/07/98	10:00		Mujeres	Hasta 52 Kgr.	REPESCA	7		PERDEDOR E1/4 FINAL			PERDEDOR DESEMIFINAL	
19/07/98	10:00		Mujeres	Hasta 52 Kgr.	REPESCA	8		PERDEDOR E1/4 FINAL			PERDEDOR DESEMIFINAL	
19/07/98	10:00		Mujeres	Hasta 52 Kgr.	3° - 5°	9		W7			L5	
19/07/98	10:00		Mujeres	Hasta 52 Kgr.	3° - 5°	10		W8			L6	
19/07/98	10:00		Mujeres	Hasta 52 Kgr.	FINAL	11		W5			W6	
19/07/98	10:00		Mujeres	Hasta 57 Kgr.	GRUPO A	1-2	B1	COLTRIOLI, Roberta	ITA	B3	ARCE, Maria	ESP
19/07/98	10:00		Mujeres	Hasta 57 Kgr.	GRUPO A	3-4	B2	HALL, Anita	GBR	B3	BRUSSIG, Ramona	GER
19/07/98	10:00		Mujeres	Hasta 57 Kgr.	GRUPO A	1-6	B1	COLTRIOLI, Roberta	ITA	B2	MARTINEZ, Lisa	USA
19/07/98	10:00		Mujeres	Hasta 57 Kgr.	GRUPO A	2-3	B3	ARCE, Marta	ESP	B2	HALL, Anita	GBR
19/07/98	10:00		Mujeres	Hasta 57 Kgr.	GRUPO A	4-6	B3	BRUSSIG, Ramona	GER	B2	MARTINEZ, Lisa	USA
19/07/98	10:00		Mujeres	Hasta 57 Kgr.	GRUPO A	1-3	B1	COLTRIOLI, Roberta	ITA	B2	HALL, Anita	GBR
19/07/98	10:00		Mujeres	Hasta 57 Kgr.	GRUPO A	2-6	B3	ARCE, Marta	ESP	B2	MARTINEZ, Lisa	USA
19/07/98	10:00		Mujeres	Hasta 57 Kgr.	GRUPO A	1-4	B1	COLTRIOLI, Roberta	ITA	B3	BRUSSIG, Ramona	GER
19/07/98	10:00		Mujeres	Hasta 57 Kgr.	GRUPO A	3-6	B2	HALL, Anita	GBR	B2	MARTINEZ, Lisa	USA
19/07/98	10:00		Mujeres	Hasta 57 Kgr.	GRUPO A	2-4	B3	ARCE, Marta	ESP	B3	BRUSSIG, Ramona	GER
19/07/98	10:00		Mujeres	83 - 70 kgr.	1/4 FINAL	1	B2	WANG, Yexiling	CHN	B3	SOSA, Maria	ESP
19/07/98	10:00		Mujeres	83 - 70 kgr.	1/4 FINAL	3	B1	ROBLEDO, Celia	ESP	B2	BASTIN, Barvelay	GBR
19/07/98	10:00		Mujeres	83 - 70 kgr.	SEMIFINAL	5		W1			W2	
19/07/98	10:00		Mujeres	83 - 70 kgr.	SEMIFINAL	6		W3			W4	
19/07/98	10:00		Mujeres	83 - 70 kgr.	REPESCA	7		PERDEDOR E1/4 FINAL			PERDEDOR DESEMIFINAL	
19/07/98	10:00		Mujeres	83 - 70 kgr.	REPESCA	8		PERDEDOR E1/4 FINAL			PERDEDOR DESEMIFINAL	
19/07/98	10:00		Mujeres	83 - 70 kgr.	3° - 5°	9		W7			L5	
19/07/98	10:00		Mujeres	83 - 70 kgr.	3° - 5°	10		W8			L6	
19/07/98	10:00		Mujeres	83 - 70 kgr.	FINAL	11		W5			W6	
19/07/98	10:00		Mujeres	Mas de 70 Kgr.	GRUPO A	1-2	B2	XUE, Lanmei	CHN	B3	HERRERA, Carmen	ESP
19/07/98	10:00		Mujeres	Mas de 70 Kgr.	GRUPO A	3-4	B2	CHRISTEN, SIENA	GER	B2	BISCHLER, Beate	GER
19/07/98	10:00		Mujeres	Mas de 70 Kgr.	GRUPO A	1-3	B2	XUE, Lanmei	CHN	B2	CHRISTEN, SIENA	GER
19/07/98	10:00		Mujeres	Mas de 70 Kgr.	GRUPO A	2-4	B3	HERRERA, Carmen	ESP	B2	BISCHLER, Beate	GER
19/07/98	10:00		Mujeres	Mas de 70 Kgr.	GRUPO A	1-4	B2	XUE, Lanmei	CHN	B2	BISCHLER, Beate	GER
19/07/98	10:00		Mujeres	Mas de 70 Kgr.	GRUPO A	2-3	B3	HERRERA, Carmen	ESP	B2	CHRISTEN, SIENA	GER
19/07/98	16:00		Hombres	Hasta 60 Kgr.	3° - 5°	21		W17			L20	
19/07/98	16:00		Hombres	Hasta 60 Kgr.	3° - 5°	22		W18			L19	
19/07/98	16:00		Hombres	Hasta 60 Kgr.	FINAL	23		W19			W20	
19/07/98	16:00		Hombres	Hasta 66 Kgr.	3° - 5°	41		W37			L40	
19/07/98	16:00		Hombres	Hasta 66 Kgr.	3° - 5°	42		W38			L39	
19/07/98	16:00		Hombres	Hasta 66 Kgr.	FINAL	43		W39			W40	
19/07/98	16:00		Hombres	Hasta 73 Kgr.	3° - 5°	21		W17			L20	
19/07/98	16:00		Hombres	Hasta 73 Kgr.	3° - 5°	22		W18			L19	
19/07/98	16:00		Hombres	Hasta 73 Kgr.	FINAL	23		W19			W20	
19/07/98	16:00		Hombres	Hasta 81 Kgr.	3° - 5°	21		W17			L20	
19/07/98	16:00		Hombres	Hasta 81 Kgr.	3° - 5°	22		W18			L19	
19/07/98	16:00		Hombres	Hasta 81 Kgr.	FINAL	23		W19			W20	
19/07/98	16:00		Hombres	Hasta 90 Kgr.	3° - 5°	21		W17			L20	
19/07/98	16:00		Hombres	Hasta 90 Kgr.	3° - 5°	22		W18			L19	
19/07/98	16:00		Hombres	Hasta 90 Kgr.	FINAL	23		W19			W20	
19/07/98	16:00		Hombres	Hasta 100 Kgr.	3° - 5°	9		W5			L8	
19/07/98	16:00		Hombres	Hasta 100 Kgr.	3° - 5°	10		W6			L7	
19/07/98	16:00		Hombres	Hasta 100 Kgr.	FINAL	11		W7			W8	
19/07/98	16:00		Hombres	Mas de 100kg.	3° - 5°	9		W5			L8	
19/07/98	16:00		Hombres	Mas de 100kg.	3° - 5°	10		W6			L7	
19/07/98	16:00		Hombres	Mas de 100kg.	FINAL	11		W7			W8	
20/07/98	10:00		Hombres	Equipos	1/8 FINAL	1		BRASIL			ITALIA	
20/07/98	10:00		Hombres	Equipos	1/8 FINAL	2		REP. POP. CHINA			ESTADOS UNIDOS	
20/07/98	10:00		Hombres	Equipos	1/8 FINAL	3		CUBA			GOREA	
20/07/98	10:00		Hombres	Equipos	1/8 FINAL	4		ESPAÑA			CHINA TAIPEI	
20/07/98	10:00		Hombres	Equipos	1/8 FINAL	5		FRANCIA			UCRANIA	
20/07/98	10:00		Hombres	Equipos	1/8 FINAL	6		GRAN BRETAÑA			RUSIA	
20/07/98	10:00		Hombres	Equipos	1/8 FINAL	8		IRAN			JAPON	

# I CAMPEONATO MUNDIAL DE DEPORTES PARA CIEGOS

## 1st WORLD BLIND SPORTS CHAMPIONSHIPS



JUDO  
JUDO

HORARIO

TIMETABLE

### Instalaciones Deportivas CSD

FECHA	HORA	Tal.	SEXO	EVENTO	RONDA	Part.	CLA.	NOMBRE	CLA.	NOMBRE	JUECES
20/07/98	10:00		Hombres	Equipos	1/4 FINAL	9		W1		W2	
20/07/98	10:00		Hombres	Equipos	1/4 FINAL	10		W3		W4	
20/07/98	10:00		Hombres	Equipos	1/4 FINAL	11		W5		W6	
20/07/98	10:00		Hombres	Equipos	1/4 FINAL	12		W7		W8	
20/07/98	10:00		Hombres	Equipos	REPESCA	13		RE1		RE6	
20/07/98	10:00		Hombres	Equipos	REPESCA	14		RE1		RE6	
20/07/98	10:00		Hombres	Equipos	REPESCA	15		RE1		RE6	
20/07/98	10:00		Hombres	Equipos	REPESCA	16		RE1		RE6	
20/07/98	10:00		Hombres	Equipos	REPESCA	17		W13		W14	
20/07/98	10:00		Hombres	Equipos	REPESCA	18		W15		W16	
20/07/98	10:00		Hombres	Equipos	SEMIFINAL	19		W9		W10	
20/07/98	10:00		Hombres	Equipos	SEMIFINAL	20		W11		W12	
20/07/98	10:00		Hombres	Equipos	3º - 5º	21		W17		L20	
20/07/98	10:00		Hombres	Equipos	3º - 5º	22		W18		L19	
20/07/98	10:00		Hombres	Equipos	FINAL	23		W19		W20	

# I CAMPEONATO MUNDIAL DE DEPORTES PARA CIEGOS

## 1st WORLD BLIND SPORTS CHAMPIONSHIPS



JUDO  
JUDO

<b>Equipos</b>	<b>Team</b>
<b>Hombres</b>	<b>Men</b>
<b>PARTICIPANTES PRUEBA      ATHLETES EVENT</b>	

*Instalaciones Deportivas CSD*

PAIS	NOMBRE
<b>BRA BRÁSIL</b>	CUNHA, Leonel TENORIO, Antonio MACIEL, Helder
<b>CHN REP. POP. CHINA</b>	MEN , Runming CUI , Baoji TIAN, Longbing
<b>CUB CUBA</b>	PEREZ, Sergio PEREZ, Pedro CRUZ, Isao BROTTON, Lazaro
<b>ESP ESPAÑA</b>	RUIZ, Jose GARCIA, David SANTANA, Andres BOEDO, Francisco CAMPOS, Fermin MORENO, Rafael GALLARDO, Antonio
<b>FRA FRANCIA</b>	CENSIER, Eric GUILLAUME, David LE MEAUX, Sebastien ROLLO, Gerald MOREL, Cyril
<b>GBR GRAN BRETAÑA</b>	HALL, Philip JACKSON, Simon QUILTER, Ben POWELL, Terence ROSE, Ian RIGG, John
<b>GER ALEMANIA</b>	ZEILERMEIER, C. ESSER, Michael OSEWALD, Martin DAHMEN, Thomas RICHTER, Michael
<b>IRI IRAN</b>	BAGHERZADEH, Mahmoud BAGHERI, Aboutaleb FOOLADVAND, A. MARDANPOUR, Ghasem SHAJARI, Reza GHAJAR, Aliakbar SAFARNEGAD, Ali

# I CAMPEONATO MUNDIAL DE DEPORTES PARA CIEGOS

## 1st WORLD BLIND SPORTS CHAMPIONSHIPS



JUDO  
JUDO

<b>Equipos</b>	<b>Team</b>
<b>Hombres</b>	<b>Men</b>

**PARTICIPANTES PRUEBA      ATHLETES EVENT**

*Instalaciones Deportivas CSD*

<b>PAIS</b>	<b>NOMBRE</b>
-------------	---------------

**ITA    ITALIA**

**MARIANO, Giuseppe  
DELL'AGNOLO, Daniel  
ARDIT, Matteo  
ROSSO, Michele**

**JPN    JAPON**

**MIYAUCHI, Eiji  
KATO, Yuji  
NAKAMURA, Kenichi  
TAKAHASHI, Tomohiro  
FUJIMOTO, Satoshi**

**RUS    RUSIA**

**MITCHOURINE, V.  
CHAVACHOV, Oleg  
ATNABAEV, Ravkhat  
BYTCHKOV, Vladimir  
CHNEIDERMANE, G.  
VOLKOV, Vladimir**

**TPE    CHINA TAIPEI**

**LEE , Ching-Chung  
HSIAO, Huang-Chi  
SHIN, Yuang-Jen  
LEE , Ching-Cheng**

**UKR    UCRANIA**

**BYCHKOVSKYY, K.  
SYDORENKO, Sergiy  
LYVYTSKY, Mykola  
DUB , Vasyi**

**USA    ESTADOS UNIDOS**

**KEENY, Richard  
LOPEZ, Marlon  
MANNING, Lynn  
MOORE, Scott  
SZOTT, Kevin  
MASTRO, James**

**TOTAL    14**

# I CAMPEONATO MUNDIAL DE DEPORTES PARA CIEGOS 1st WORLD BLIND SPORTS CHAMPIONSHIPS



JUDO  
JUDO

<b>Equipos</b>	<b>Team</b>
<b>Hombres</b>	<b>Men</b>

## SUMARIO FINAL

## FINAL SUMMARY

Instalaciones Deportivas CSD

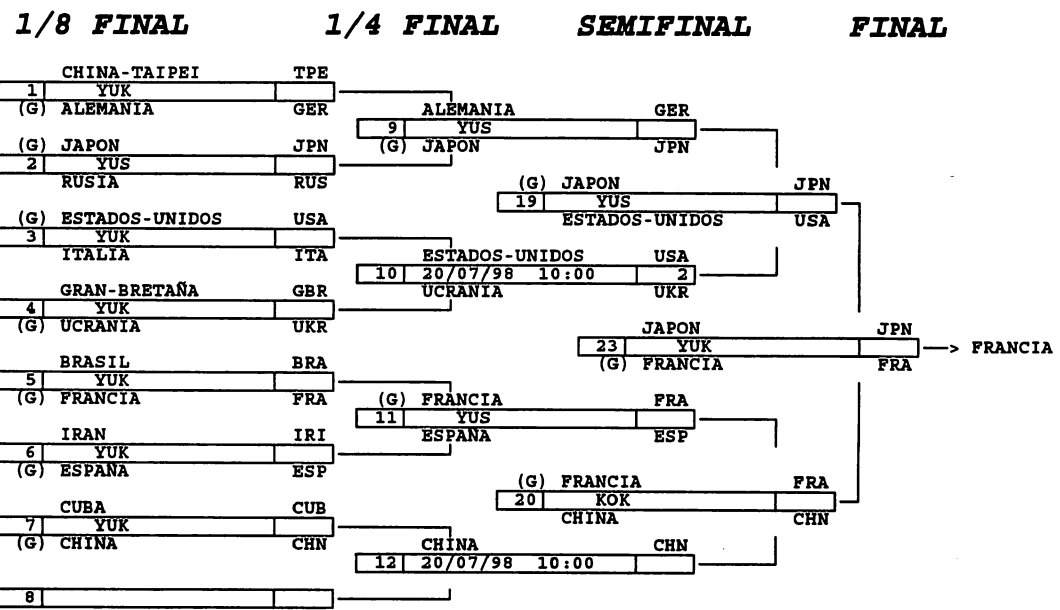

### REPESCA

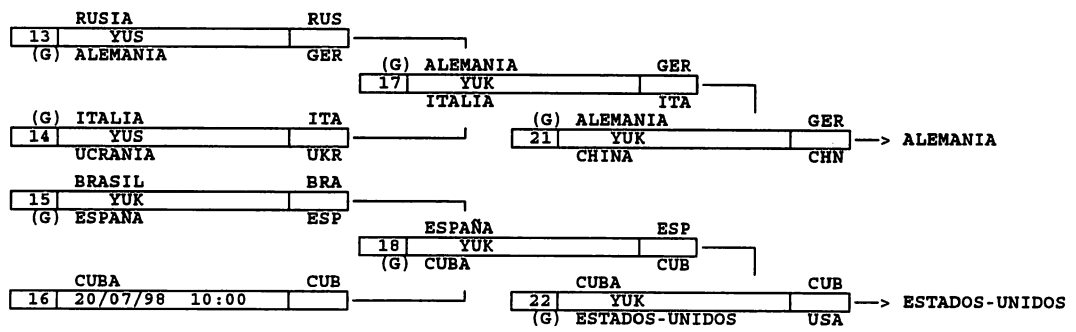

### CLASIFICACION FINAL

1	FRA	FRANCIA	<b>ORO</b>
2	JPN	JAPON	<b>PLATA</b>
3	GER	ALEMANIA	<b>BRONCE</b>
	USA	ESTADOS UNIDOS	<b>BRONCE</b>
5	CHN	REP. POP. CHINA	
	CUB	CUBA	
7	ITA	ITALIA	
	ESP	ESPAÑA	

**CORRECCION**



El Corte Inglés



Carrier España Servicio





# I CAMPEONATO MUNDIAL DE DEPORTES PARA CIEGOS

## 1st WORLD BLIND SPORTS CHAMPIONSHIPS



JUDO  
JUDO

<b>Equipos</b>	<b>Team</b>
<b>Hombres</b>	<b>Men</b>
<b>RESULTADOS</b>	<b>RESULTS</b>

*Instalaciones Deportivas CSD*

RONDA	Part.	FECHA	HORA	Tat.	GANADOR	PERDEDOR	RES.	DUR.	TEC.
1/8 FINAL	4	20/07/98	10:03		UCRANIA	GRAN BRETAÑA	5-0(50-0)		
1/8 FINAL	1	20/07/98	10:00	1	ALEMANIA	CHINA TAIPEI	4-1(40-7)		
1/8 FINAL	3	20/07/98	10:02	1	ESTADOS UNIDOS	ITALIA	5-0(50-0)		
1/8 FINAL	6	20/07/98	10:05	1	ESPAÑA	IRAN	3-2(27-20)		
1/8 FINAL	2	20/07/98	10:01	2	JAPON	RUSIA	4-1(40-10)		
1/8 FINAL	5	20/07/98	10:04	2	FRANCIA	BRASIL	5-0(50-0)		
1/8 FINAL	7	20/07/98	10:06	2	REP. POP. CHINA	CUBA	3-1(21-10)		
1/4 FINAL	11	20/07/98	10:09	1	FRANCIA	ESPAÑA	3-2(30-6)		
1/4 FINAL	9	20/07/98	10:07	2	JAPON	ALEMANIA	4-1(40-10)		
1/4 FINAL	10	20/07/98	10:08	2	ESTADOS UNIDOS	UCRANIA	4-1(24-1)		
REPESCA	13	20/07/98	10:10	1	ALEMANIA	RUSIA	4-1(37-10)		
REPESCA	15	20/07/98	10:12	1	ESPAÑA	BRASIL	3-2(30-20)		
REPESCA	14	20/07/98	10:11	2	ITALIA	UCRANIA	4-1(31-10)		
REPESCA	18	20/07/98	10:14	1	CUBA	ESPAÑA	3-2(27-20)		
REPESCA	17	20/07/98	10:13	2	ALEMANIA	ITALIA	4-1(40-1)		
SEMIFINAL	20	20/07/98	10:21	1	FRANCIA	REP. POP. CHINA	3-2(23-20)		
SEMIFINAL	19	20/07/98	10:20	2	JAPON	ESTADOS UNIDOS	3-2(30-20)		
3° -5°	21	20/07/98	10:22	2	ALEMANIA	REP. POP. CHINA	5-0(50-0)		
3° -5°	22	20/07/98	10:23	2	ESTADOS UNIDOS	CUBA	3-2(30-20)		
FINAL	23	20/07/98	10:30	1	FRANCIA	JAPON	3-2(30-20)		



# I CAMPEONATO MUNDIAL DE DEPORTES PARA CIEGOS

## 1st WORLD BLIND SPORTS CHAMPIONSHIPS

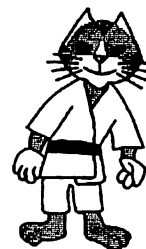

JUDO  
JUDO

<b>Equipos</b>	<b>Team</b>
<b>Hombres</b>	<b>Men</b>
<b>CLASIFICACION</b>	<b>CLASSIFICATION</b>

*Instalaciones Deportivas CSD*

POS.	COUNTRY	MEDAL
1	FRANCE	Gold
2	JAPAN	Silver
3	GERMANY	Bronze
3	UNITED STATES	Bronze
5	PEOPLE'S REP. CHINA	
5	CUBA	
7	SPAIN	
7	ITALY	

# I CAMPEONATO MUNDIAL DE DEPORTES PARA CIEGOS

## 1st WORLD BLIND SPORTS CHAMPIONSHIPS

Hasta 60 Kgr.  
Hombres

Up to 60 Kgr.  
Men

**PARTICIPANTES PRUEBA**

**ATHLETES EVENT**

*Instalaciones Deportivas CSD*



JUDO  
JUDO

Cla.	NOMBRE	PAIS
B1	DIEDAMBA, Thiombiano	BURKINA FASO
B3	PEREZ, Sergio	CUBA
B2	SHAJARI, Reza	IRAN
B1	MARIANO, Giuseppe	ITALIA
B1	MITCHOURINE, V.	RUSIA
B2	BYCHKOVSKYY, K.	UCRANIA
B2	MACIEL, Helder	BRASIL
B2	RUIZ, Jose	ESPAÑA
B3	FARGEAU, Didier	FRANCIA
B3	QUILTER, Ben	GRAN BRETAÑA
B2	HERNANDEZ, Byron	GUATEMALA
B2	HIROSE, Makoto	JAPON
B3	STEPANOVAS, Andrejus	LITUANIA
B1	POLIEA, Narong	TAILANDIA
B2	LEE , Ching-Chung	CHINA TAIPEI
	<b>TOTAL</b>	<b>15</b>

# I CAMPEONATO MUNDIAL DE DEPORTES PARA CIEGOS

## 1st WORLD BLIND SPORTS CHAMPIONSHIPS

Hasta 60 Kgr.  
Hombres

Up to 60 Kgr.  
Men

### SUMARIO FINAL

### FINAL SUMMARY

Instalaciones Deportivas CSD



JUDO  
JUDO

#### 1/8 FINAL

#### 1/4 FINAL

#### SEMIFINAL

#### FINAL

B2(G) SHAJARI, Reza IRI 1 IPPON\1:01\IPO	B3 QUILTER, Ben GBR	B2 SHAJARI, Reza IRI 9 YUS\HAN	B2(G) RUIZ, Jose ESP
2 19/07/98 10:00	B2 RUIZ, Jose ESP	B2 RUIZ, Jose ESP 19 IPPON\1:13\IPO	B3(G) PEREZ, Sergio CUB
B3(G) PEREZ, Sergio CUB 3 IPPON\54\IPO	B3 STEPANOVAS, AndrejusLTU	B3(G) PEREZ, Sergio CUB 10 IPPON\1:40\IPO	B2 BYCHKOVSKYY, K. UKR
B2(G) BYCHKOVSKYY, K. UKR 4 IPPON\35\IPO	B1 POLIEA, Narong THA	B3(G) PEREZ, Sergio CUB 23 IPPON\3:27\IPO	B2 HIROSE, Makoto JPN
B1(G) MITCHOURINE, V. RUS 5 YUS\HAN	B2 LEE, Ching-Chung TPE	B1(G) MITCHOURINE, V. RUS 11 IPPON\1:41\IPO	B3 FARGEAU, Didier FRA
B1 MARIANO, Giuseppe ITA 6 IPPON\12\IPO	B3(G) FARGEAU, Didier FRA	B1 MITCHOURINE, V. RUS 20 IPPON\34\IPO	B2(G) HIROSE, Makoto JPN
B2 MACIEL, Helder BRA 7 19/07/98 10:00	B2 MACIEL, Helder BRA 12 IPPON\2:38\IPO	B2(G) HIROSE, Makoto JPN	
B2 HERNANDEZ, Byron GUA 8 IPPON\4\IPO	B2(G) HIROSE, Makoto JPN		
B2(G) HIROSE, Makoto JPN			

#### REPESCA

13 19/07/98 10:00	B2 SHAJARI, Reza IRI	B2 SHAJARI, Reza IRI 17 IPPON\39\IPO	B2(G) BYCHKOVSKYY, K. UKR
B3 STEPANOVAS, AndrejusLTU 14 IPPON\3:15\IPO	B2(G) BYCHKOVSKYY, K. UKR	B2(G) BYCHKOVSKYY, K. UKR 21 WAZ\1:46\IPO	B1 MITCHOURINE, V. RUS
B2(G) LEE, Ching-Chung TPE 15 IPPON\23\IPO	B3 FARGEAU, Didier FRA	B2(G) LEE, Ching-Chung TPE 18 IPPON\28\IPO	B2 MACIEL, Helder BRA
B2 HERNANDEZ, Byron GUA 16 IPPON\7\IPO	B2(G) MACIEL, Helder BRA	B2(G) LEE, Ching-Chung TPE 22 IPPON\3\IPO	B2 RUIZ, Jose ESP
B2(G) MACIEL, Helder BRA			

#### CLASIFICACION FINAL

1	CUB	PEREZ, Sergio	ORO
2	JPN	HIROSE, Makoto	PLATA
3	TPE	LEE, Ching-Chung	BRONCE
	UKR	BYCHKOVSKYY, K.	BRONCE
5	RUS	MITCHOURINE, V.	
	ESP	RUIZ, Jose	
7	BRA	MACIEL, Helder	
	IRI	SHAJARI, Reza	

# I CAMPEONATO MUNDIAL DE DEPORTES PARA CIEGOS

## 1st WORLD BLIND SPORTS CHAMPIONSHIPS



Hasta 60 Kgr.  
Hombres

Up to 60 Kgr.  
Men

RESULTADOS

RESULTS

Instalaciones Deportivas CSD



JUDO  
JUDO

RONDA	Part.	FECHA	HORA	Tat.	CLA.	GANADOR	CLA.	PERDEDOR	RES.	DUR.	TEC.
1/8 FINAL	1	19/07/98	10:00	1	B2	SHAJARI, Reza IRI	B3	QUILTER, Ben GBR	IPPON	1:01	IP0
1/8 FINAL	3	19/07/98	10:00	1	B3	PEREZ, Sergio CUB	B3	STEPANOVAS, Andrejus LTU	IPPON	54	IP0
1/8 FINAL	4	19/07/98	10:00	1	B2	BYCHKOVSKYY, K. UKR	B1	POLIEA, Narong THA	IPPON	35	IP0
1/8 FINAL	5	19/07/98	10:00	1	B1	MITCHOURINE, V. RUS	B2	LEE, Ching-Chung TPE	YUS		HAN
1/8 FINAL	6	19/07/98	10:00	1	B3	FARGEAU, Didier FRA	B1	MARIANO, Giuseppe ITA	IPPON	12	IP0
1/8 FINAL	8	19/07/98	10:00	1	B2	HIROSE, Makoto JPN	B2	HERNANDEZ, Byron GUA	IPPON	4	IP0
1/4 FINAL	9	19/07/98	10:00	1	B2	RUIZ, Jose ESP	B2	SHAJARI, Reza IRI	YUS		HAN
1/4 FINAL	10	19/07/98	10:00	1	B3	PEREZ, Sergio CUB	B2	BYCHKOVSKYY, K. UKR	IPPON	1:40	IP0
1/4 FINAL	11	19/07/98	10:00	1	B1	MITCHOURINE, V. RUS	B3	FARGEAU, Didier FRA	IPPON	1:41	IP0
1/4 FINAL	12	19/07/98	10:00	1	B2	HIROSE, Makoto JPN	B2	MACIEL, Helder BRA	IPPON	2:38	IP0
REPESCA	14	19/07/98	10:00	1	B2	BYCHKOVSKYY, K. UKR	B3	STEPANOVAS, Andrejus LTU	IPPON	3:15	IP0
REPESCA	15	19/07/98	10:00	1	B2	LEE, Ching-Chung TPE	B3	FARGEAU, Didier FRA	IPPON	23	IP0
REPESCA	16	19/07/98	10:00	1	B2	MACIEL, Helder BRA	B2	HERNANDEZ, Byron GUA	IPPON	7	IP0
REPESCA	17	19/07/98	10:00	1	B2	BYCHKOVSKYY, K. UKR	B2	SHAJARI, Reza IRI	IPPON	39	IP0
REPESCA	18	19/07/98	10:00	1	B2	LEE, Ching-Chung TPE	B2	MACIEL, Helder BRA	IPPON	28	IP0
SEMIFINAL	19	19/07/98	10:00	1	B3	PEREZ, Sergio CUB	B2	RUIZ, Jose ESP	IPPON	1:13	IP0
SEMIFINAL	20	19/07/98	10:00	1	B2	HIROSE, Makoto JPN	B1	MITCHOURINE, V. RUS	IPPON	34	IP0
3° -5°	21	19/07/98	16:00	1	B2	BYCHKOVSKYY, K. UKR	B1	MITCHOURINE, V. RUS	WAZ	1:46	IP0
3° -5°	22	19/07/98	16:00	2	B2	LEE, Ching-Chung TPE	B2	RUIZ, Jose ESP	IPPON	3	IP0
FINAL	23	19/07/98	16:00	1	B3	PEREZ, Sergio CUB	B2	HIROSE, Makoto JPN	IPPON	3:27	IP0

**I CAMPEONATO MUNDIAL DE DEPORTES PARA CIEGOS**  
**1st WORLD BLIND SPORTS CHAMPIONSHIPS**

**Hasta 60 Kgr.**  
**Hombres**

**Up to 60 Kgr.**  
**Men**

**CLASIFICACION**

**CLASSIFICATION**

*Instalaciones Deportivas CSD*



**JUDO**  
**JUDO**

POS.	NAME	CTRY	MEDAL
1	PEREZ, Sergio	CUB	Gold
2	HIROSE, Makoto	JPN	Silver
3	LEE, Ching-Chung	TPE	Bronze
3	BYCHKOVSKYY, K.	UKR	Bronze
5	RUIZ, Jose	ESP	
5	MITCHOURINE, V.	RUS	
7	MACIEL, Helder	BRA	
7	SHAJARI, Reza	IRI	

# I CAMPEONATO MUNDIAL DE DEPORTES PARA CIEGOS

## 1st WORLD BLIND SPORTS CHAMPIONSHIPS



Hasta 66 Kgr.  
Hombres

Up to 66 Kgr.  
Men

**PARTICIPANTES PRUEBA**

**ATHLETES EVENT**

*Instalaciones Deportivas CSD*



JUDO  
JUDO

Cla.	NOMBRE	PAIS
B3	PEREZ, Pedro	CUBA
B3	MOREL, Cyril	FRANCIA
B3	ZEILERMEIER, C.	ALEMANIA
B1	SAFARNEGAD, Ali	IRAN
B2	DELL'AGNOLO, Daniel	ITALIA
B1	KIM , Il-Keum	COREA
B2	CHAVACHOV, Oleg	RUSIA
B1	SYDORENKO, Sergiy	UCRANIA
B2	BELGO, Abidantia	BURKINA FASO
B1	MORTEN, Pier	CANADA
B3	GARCIA, David	ESPAÑA
B1	RIGG, John	GRAN BRETAÑA
B1	CULHANE, Tim	IRLANDA
B2	FUJIMOTO, Satoshi	JAPON
B3	BAGDISANKA, Stasys	LITUANIA
B1	TAKIENKARM, Manop	TAILANDIA
B2	LEE , Ching-Cheng	CHINA TAIPEI
B2	LOPEZ, Marlon	ESTADOS UNIDOS
	<b>TOTAL</b>	<b>18</b>

# I CAMPEONATO MUNDIAL DE DEPORTES PARA CIEGOS

## 1st WORLD BLIND SPORTS CHAMPIONSHIPS



Hasta 66 Kgr.  
Hombres

Up to 66 Kgr.  
Men

### SUMARIO FINAL

### FINAL SUMMARY

Instalaciones Deportivas CSD

JUDO  
JUDO

1/16 F.      1/8 F.      1/4 F.      SEMIFI.





# I CAMPEONATO MUNDIAL DE DEPORTES PARA CIEGOS

## 1st WORLD BLIND SPORTS CHAMPIONSHIPS

Hasta 66 Kgr.  
Hombres

Up to 66 Kgr.  
Men

SUMARIO FINAL

FINAL SUMMARY

Instalaciones Deportivas CSD



JUDO  
JUDO

### REPESCA

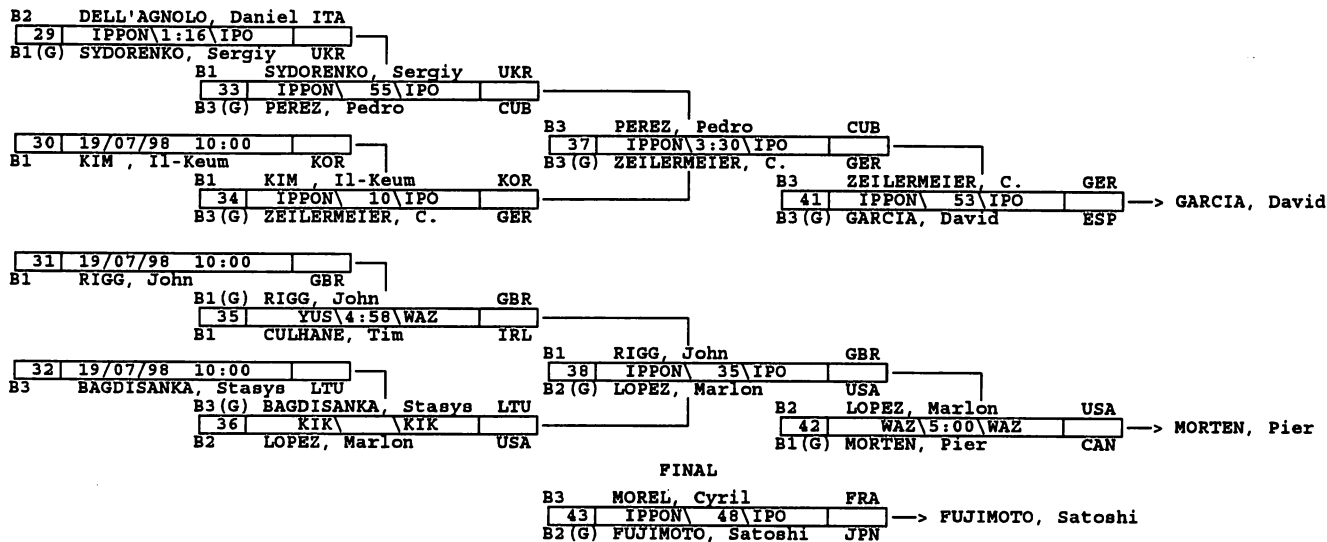

### CLASIFICACION FINAL

1	JPN	FUJIMOTO, Satoshi	<b>ORO</b>
2	FRA	MOREL, Cyril	<b>PLATA</b>
3	CAN	MORTEN, Pier	<b>BRONCE</b>
	ESP	GARCIA, David	<b>BRONCE</b>
5	USA	LOPEZ, Marlon	
	GER	ZEILERMEIER, C.	
7	GBR	RIGG, John	
	CUB	PEREZ, Pedro	

# I CAMPEONATO MUNDIAL DE DEPORTES PARA CIEGOS

## 1st WORLD BLIND SPORTS CHAMPIONSHIPS



Hasta 66 Kgr.  
Hombres

Up to 66 Kgr.  
Men

RESULTADOS

RESULTS



JUDO  
JUDO

Instalaciones Deportivas CSD

RONDA	Part.	FECHA	HORA	Tat.	CLA.	GANADOR	CLA.	PERDEDOR	RES.	DUR.	TEC.
1/16 Final	1	19/07/98	10:00	2	B1	MORTEN, Pier CAN	B2	DELL'AGNOLO, Daniel ITA	IPPON	1:00	IPO
1/16 Final	16	19/07/98	10:00	2	B2	LOPEZ, Marlon USA	B2	LEE, Ching-Cheng TPE	YUK	4:00	YUK
1/8 FINAL	17	19/07/98	10:00	2	B1	MORTEN, Pier CAN	B1	SYDORENKO, Sergly UKR	IPPON	4:00	IPO
1/8 FINAL	18	19/07/98	10:00	2	B3	PEREZ, Pedro CUB	B2	CHAVACHOV, Oleg RUS	YUK	4:10	YUK
1/8 FINAL	19	19/07/98	10:00	2	B3	MOREL, Cyril FRA	B1	KIM, Il-Keum KOR	IPPON	2:05	IPO
1/8 FINAL	20	19/07/98	10:00	2	B3	ZEILERMEIER, C. GER	B1	SAFARNEGAD, Ali IRI	IPPON	1:20	IPO
1/8 FINAL	22	19/07/98	10:00	2	B2	FUJIMOTO, Satoshi JPN	B1	RIGG, John GBR	IPPON	25	IPO
1/8 FINAL	23	19/07/98	10:00	2	B3	GARCIA, David ESP	B3	BAGDISANKA, Stasys LTU	IPPON	3:40	IPO
1/8 FINAL	24	19/07/98	10:00	2	B2	LOPEZ, Marlon USA	B1	TAKIENKARM, Manop THA	IPPON	25	IPO
1/4 FINAL	25	19/07/98	10:00	2	B1	MORTEN, Pier CAN	B3	PEREZ, Pedro CUB	WAZ	5:00	WAZ
1/4 FINAL	26	19/07/98	10:00	2	B3	MOREL, Cyril FRA	B3	ZEILERMEIER, C. GER	YUS	5:00	HAN
1/4 FINAL	27	19/07/98	10:00	2	B2	FUJIMOTO, Satoshi JPN	B1	CULHANE, Tim IRL	IPPON	1:03	IPO
1/4 FINAL	28	19/07/98	10:00	2	B3	GARCIA, David ESP	B2	LOPEZ, Marlon USA	WAZ	5:00	WAZ
REPESCA	29	19/07/98	10:00		B1	SYDORENKO, Sergly UKR	B2	DELL'AGNOLO, Daniel ITA	IPPON	1:16	IPO
REPESCA	33	19/07/98	10:00	2	B3	PEREZ, Pedro CUB	B1	SYDORENKO, Sergly UKR	IPPON	55	IPO
REPESCA	34	19/07/98	10:00	2	B3	ZEILERMEIER, C. GER	B1	KIM, Il-Keum KOR	IPPON	10	IPO
REPESCA	35	19/07/98	10:00	2	B1	RIGG, John GBR	B1	CULHANE, Tim IRL	YUS	4:58	WAZ
REPESCA	36	19/07/98	10:00	2	B2	LOPEZ, Marlon USA	B3	BAGDISANKA, Stasys LTU	KIK		KIK
REPESCA	37	19/07/98	10:00	2	B3	ZEILERMEIER, C. GER	B3	PEREZ, Pedro CUB	IPPON	3:30	IPO
REPESCA	38	19/07/98	10:00	2	B2	LOPEZ, Marlon USA	B1	RIGG, John GBR	IPPON	35	IPO
SEMIFINAL	39	19/07/98	10:00		B3	MOREL, Cyril FRA	B1	MORTEN, Pier CAN	KOK	3:30	KOK
SEMIFINAL	40	19/07/98	10:00		B2	FUJIMOTO, Satoshi JPN	B3	GARCIA, David ESP	IPPON	3:45	IPO
3°-5°	41	19/07/98	16:00	1	B3	GARCIA, David ESP	B3	ZEILERMEIER, C. GER	IPPON	53	IPO
3°-5°	42	19/07/98	16:00	2	B1	MORTEN, Pier CAN	B2	LOPEZ, Marlon USA	WAZ	6:00	WAZ
FINAL	43	19/07/98	16:00	1	B2	FUJIMOTO, Satoshi JPN	B3	MOREL, Cyril FRA	IPPON	48	IPO



# I CAMPEONATO MUNDIAL DE DEPORTES PARA CIEGOS

## 1st WORLD BLIND SPORTS CHAMPIONSHIPS

Hasta 66 Kgr.  
Hombres

Up to 66 Kgr.  
Men

**CLASIFICACION**

**CLASSIFICATION**

*Instalaciones Deportivas CSD*



JUDO  
JUDO

POS.	NAME	CTRY	MEDAL
1	FUJIMOTO, Satoshi	JPN	Gold
2	MOREL, Cyril	FRA	Silver
3	MORTEN, Pier	CAN	Bronze
3	GARCIA, David	ESP	Bronze
5	ZEILERMEIER, C.	GER	
5	LOPEZ, Marlon	USA	
7	PEREZ, Pedro	CUB	
7	RIGG, John	GBR	

# I CAMPEONATO MUNDIAL DE DEPORTES PARA CIEGOS 1st WORLD BLIND SPORTS CHAMPIONSHIPS



Hasta 73 Kgr. Hombres	Up to 73 Kgr. Men
--------------------------	----------------------

**PARTICIPANTES PRUEBA      ATHLETES EVENT**

*Instalaciones Deportivas CSD*



**JUDO  
JUDO**

Cla.	NOMBRE	PAIS
------	--------	------

B1	BROTTON, Lazaro	CUBA
B2	ROLLO, Gerald	FRANCIA
B1	BAGHERI, Aboutaleb	IRAN
B3	ARDIT, Matteo	ITALIA
B1	BOUZAIDI, Abderrahim	MARRUECOS
B3	MOORE, Scott	ESTADOS UNIDOS
B1	RAMIREZ, Fabien	ARGENTINA
B3	CUI, Baoji	REP. POP. CHINA
B3	SANTANA, Andres	ESPAÑA
B3	HALL, Philip	GRAN BRETAÑA
B2	ESSER, Michael	ALEMANIA
B3	NAZARALI, Rahim	IRLANDA
B2	TAKAHASHI, Tomohiro	JAPON
B1	YANG, Jai-Joon	COREA
B2	ATNABAEV, Ravkhat	RUSIA
B2	SHIN, Yuang-Jen	CHINA TAIPEI
<b>TOTAL      16</b>		





# I CAMPEONATO MUNDIAL DE DEPORTES PARA CIEGOS

## 1st WORLD BLIND SPORTS CHAMPIONSHIPS



JUDO  
JUDO

Hasta 73 Kgr.  
Hombres

Up to 73 Kgr.  
Men

### SUMARIO FINAL

### FINAL SUMMARY

Instalaciones Deportivas CSD

#### 1/8 FINAL

#### 1/4 FINAL

#### SEMIFINAL

#### FINAL

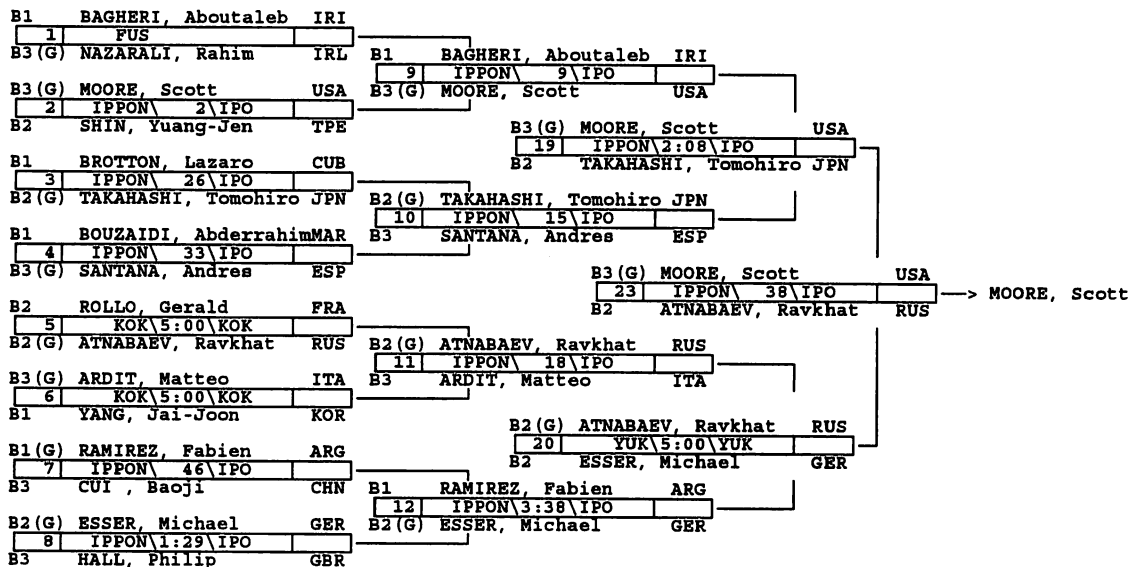

#### REPESCA

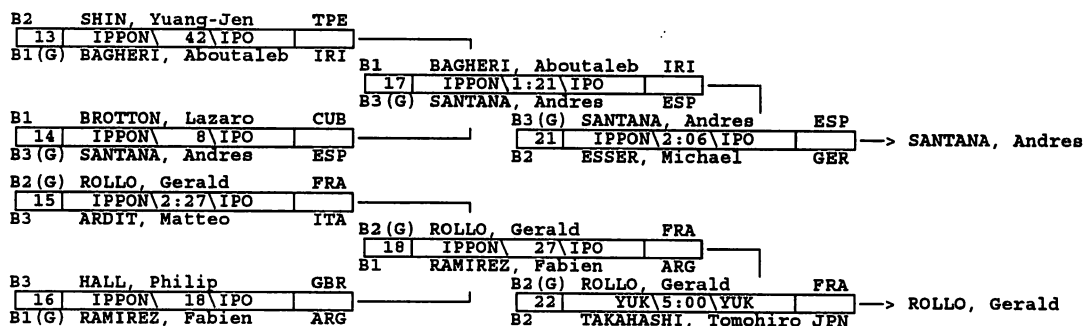

### CLASIFICACION FINAL

1	USA	MOORE, Scott	ORO
2	RUS	ATNABAEV, Ravkhat	PLATA
3	ESP	SANTANA, Andres	BRONCE
5	FRA	ROLLO, Gerald	BRONCE
7	GER	ESSER, Michael	
	JPN	TAKAHASHI, Tomohiro	
	ARG	RAMIREZ, Fabien	
	IRI	BAGHERI, Aboutaleb	

# I CAMPEONATO MUNDIAL DE DEPORTES PARA CIEGOS

## 1st WORLD BLIND SPORTS CHAMPIONSHIPS

Hasta 73 Kgr.  
Hombres

Up to 73 Kgr.  
Men

RESULTADOS

RESULTS

Instalaciones Deportivas CSD



JUDO  
JUDO

RONDA	Part.	FECHA	HORA	Tat.	CLA.	GANADOR	CLA.	PERDEDOR	RES.	DUR.	TEC.
1/8 FINAL	1	18/07/98	16:00	1	B1	BAGHERI, Aboutaleb IRI	B3	NAZARALI, Rahim IRL	FUS		
1/8 FINAL	2	18/07/98	16:00	1	B3	MOORE, Scott USA	B2	SHIN, Yuang-Jen TPE	IPPON	2	IPO
1/8 FINAL	3	18/07/98	16:00	1	B2	TAKAHASHI, Tomohiro JPN	B1	BROTTON, Lazaro CUB	IPPON	26	IPO
1/8 FINAL	4	18/07/98	16:00	1	B3	SANTANA, Andres ESP	B1	BOUZAI, Abderrahim MAR	IPPON	33	IPO
1/8 FINAL	5	18/07/98	16:00	1	B2	ATNABAEV, Ravkhat RUS	B2	ROLLO, Gerald FRA	KOK	5:00	KOK
1/8 FINAL	6	18/07/98	16:00	1	B3	ARDIT, Matteo ITA	B1	YANG, Jai-Joon KOR	KOK	5:00	KOK
1/8 FINAL	7	18/07/98	16:00	1	B1	RAMIREZ, Fabien ARG	B3	CUI, Baoji CHN	IPPON	46	IPO
1/8 FINAL	8	18/07/98	16:00	1	B2	ESSER, Michael GER	B3	HALL, Phillip GBR	IPPON	1:29	IPO
1/4 FINAL	9	18/07/98	16:00	1	B3	MOORE, Scott USA	B1	BAGHERI, Aboutaleb IRI	IPPON	9	IPO
1/4 FINAL	10	18/07/98	16:00	1	B2	TAKAHASHI, Tomohiro JPN	B3	SANTANA, Andres ESP	IPPON	15	IPO
1/4 FINAL	11	18/07/98	16:00	1	B2	ATNABAEV, Ravkhat RUS	B3	ARDIT, Matteo ITA	IPPON	18	IPO
1/4 FINAL	12	18/07/98	16:00	1	B2	ESSER, Michael GER	B1	RAMIREZ, Fabien ARG	IPPON	3:38	IPO
REPESCA	13	18/07/98	16:00	1	B1	BAGHERI, Aboutaleb IRI	B2	SHIN, Yuang-Jen TPE	IPPON	42	IPO
REPESCA	14	18/07/98	16:00	1	B3	SANTANA, Andres ESP	B1	BROTTON, Lazaro CUB	IPPON	8	IPO
REPESCA	15	18/07/98	16:00	1	B2	ROLLO, Gerald FRA	B3	ARDIT, Matteo ITA	IPPON	2:27	IPO
REPESCA	16	18/07/98	16:00	1	B1	RAMIREZ, Fabien ARG	B3	HALL, Phillip GBR	IPPON	18	IPO
REPESCA	17	18/07/98	16:00	1	B3	SANTANA, Andres ESP	B1	BAGHERI, Aboutaleb IRI	IPPON	1:21	IPO
REPESCA	18	18/07/98	16:00	1	B2	ROLLO, Gerald FRA	B1	RAMIREZ, Fabien ARG	IPPON	27	IPO
SEMIFINAL	19	18/07/98	16:00	1	B3	MOORE, Scott USA	B2	TAKAHASHI, Tomohiro JPN	IPPON	2:08	IPO
SEMIFINAL	20	18/07/98	16:00	1	B2	ATNABAEV, Ravkhat RUS	B2	ESSER, Michael GER	YUK	6:00	YUK
3º - 5º	21	19/07/98	16:00	1	B3	SANTANA, Andres ESP	B2	ESSER, Michael GER	IPPON	2:06	IPO
3º - 5º	22	19/07/98	16:00	2	B2	ROLLO, Gerald FRA	B2	TAKAHASHI, Tomohiro JPN	YUK	6:00	YUK
FINAL	23	19/07/98	16:00	1	B3	MOORE, Scott USA	B2	ATNABAEV, Ravkhat RUS	IPPON	38	IPO

# I CAMPEONATO MUNDIAL DE DEPORTES PARA CIEGOS

## 1<sup>st</sup> WORLD BLIND SPORTS CHAMPIONSHIPS



Hasta 73 Kgr.  
Hombres

Up to 73 Kgr.  
Men

CLASIFICACION

CLASSIFICATION

*Instalaciones Deportivas CSD*

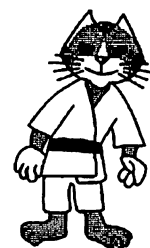

JUDO  
JUDO

POS.	NAME	CTRY	MEDAL
1	MOORE, Scott	USA	Gold
2	ATNABAEV, Ravkhat	RUS	Silver
3	SANTANA, Andres	ESP	Bronze
3	ROLLO, Gerald	FRA	Bronze
5	ESSER, Michael	GER	
5	TAKAHASHI, Tomohiro	JPN	
7	RAMIREZ, Fabien	ARG	
7	BAGHERI, Aboutaleb	IRI	

# I CAMPEONATO MUNDIAL DE DEPORTES PARA CIEGOS 1st WORLD BLIND SPORTS CHAMPIONSHIPS

Hasta 81 Kgr.  
Hombres

Up to 81 Kgr.  
Men

**PARTICIPANTES PRUEBA**

**ATHLETES EVENT**

*Instalaciones Deportivas CSD*



JUDO  
JUDO

Cla.	NOMBRE	PAIS
B1	SALINAS, Miguel	ARGENTINA
B3	CRUZ, Isao	CUBA
B3	LE MEAUX, Sebastien	FRANCIA
B2	JACKSON, Simon	GRAN BRETAÑA
B1	GHAJAR, Aliakbar	IRAN
B1	ROSSO, Michele	ITALIA
B1	HSIAO, Huang-Chi	CHINA TAIPEI
B2	DUB, VasyI	UCRANIA
B2	MORGAN, Bill	CANADA
B1	TIAN, Longbing	REP. POP. CHINA
B2	BOEDO, Francisco	ESPAÑA
B3	DAHMEN, Thomas	ALEMANIA
B1	WALSH, Esmund	IRLANDA
B2	NAKAMURA, Kenichi	JAPON
B3	BYTCHKOV, Vladimir	RUSIA
B2	KEENY, Richard	ESTADOS UNIDOS
	<b>TOTAL</b>	<b>16</b>



# I CAMPEONATO MUNDIAL DE DEPORTES PARA CIEGOS

## 1st WORLD BLIND SPORTS CHAMPIONSHIPS



JUDO  
JUDO

Hasta 81 Kgr. Up to 81 Kgr.  
Hombres Men  
**SUMARIO FINAL** **FINAL SUMMARY**

Instalaciones Deportivas CSD

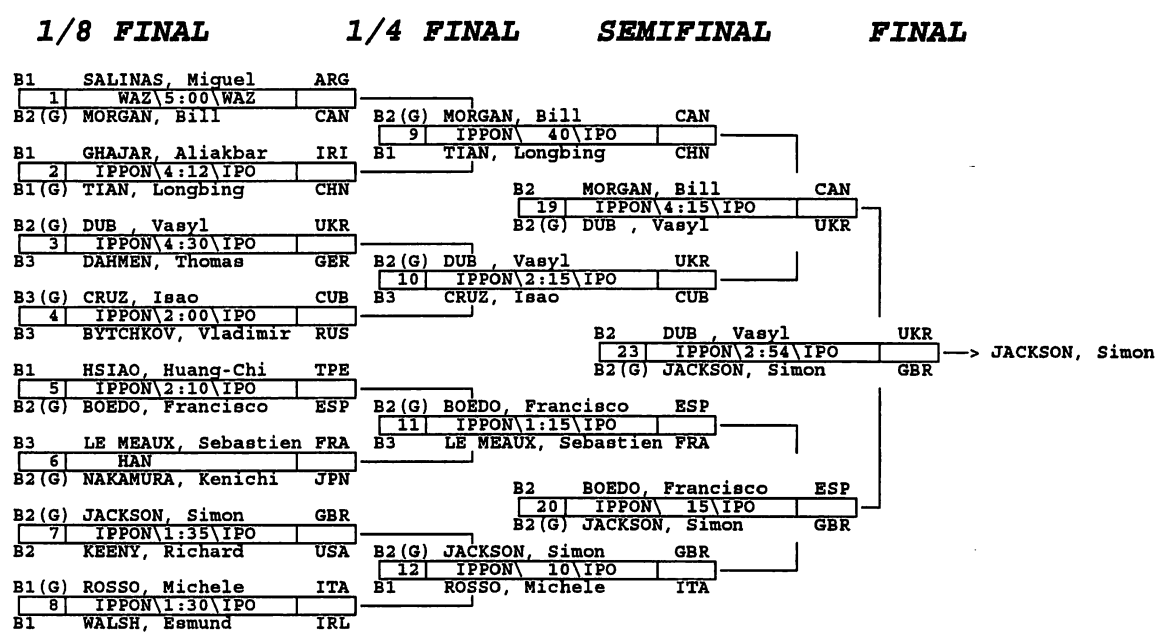

**REPESCA**

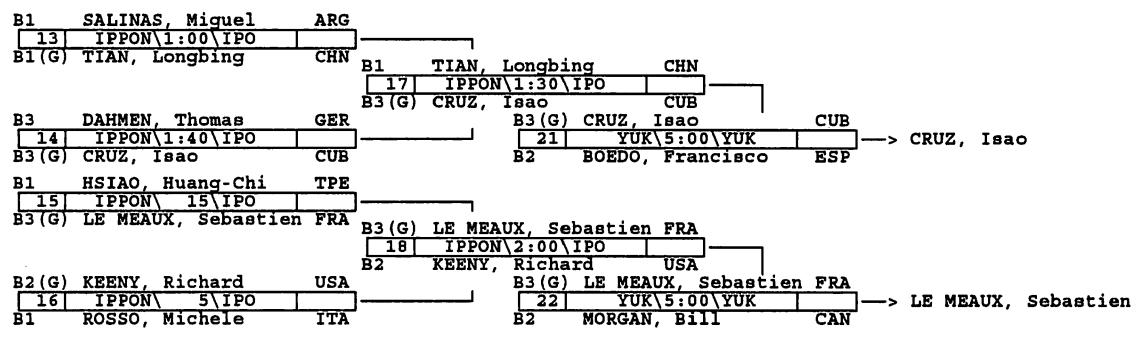

**CLASIFICACION FINAL**

1	GBR	JACKSON, Simon	<b>ORO</b>
2	UKR	DUB, VasyI	<b>PLATA</b>
3	CUB	CRUZ, Isao	<b>BRONCE</b>
	FRA	LE MEAUX, Sebastien	<b>BRONCE</b>
5	ESP	BOEDO, Francisco	
	CAN	MORGAN, Bill	
7	CHN	TIAN, Longbing	
	USA	KEENY, Richard	



# I CAMPEONATO MUNDIAL DE DEPORTES PARA CIEGOS

## 1st WORLD BLIND SPORTS CHAMPIONSHIPS



Hasta 81 Kgr.  
Hombres

Up to 81 Kgr.  
Men

RESULTADOS

RESULTS

Instalaciones Deportivas CSD



JUDO  
JUDO

RONDA	Part.	FECHA	HORA	Tat.	CLA.	GANADOR	CLA.	PERDEDOR	RES.	DUR.	TEC.
1/8 FINAL	1	18/07/98	16:00	2	B2	MORGAN, Bill CAN	B1	SALINAS, Miguel ARG	WAZ	5:00	WAZ
1/8 FINAL	2	18/07/98	16:00	2	B1	TIAN, Longbing CHN	B1	GHAJAR, Allakbar IRI	IPPON	4:12	IPO
1/8 FINAL	3	18/07/98	16:00	2	B2	DUB , Vasyi UKR	B3	DAHMEN, Thomas GER	IPPON	4:30	IPO
1/8 FINAL	4	18/07/98	16:00	2	B3	CRUZ, Isao CUB	B3	BYTCHKOV, Vladimir RUS	IPPON	2:00	IPO
1/8 FINAL	5	18/07/98	16:00	2	B2	BOEDO, Francisco ESP	B1	HSIAO, Huang-Chi TPE	IPPON	2:10	IPO
1/8 FINAL	6	18/07/98	16:00	2	B3	LE MEAUX, Sebastien FRA	B2	NAKAMURA, Kenichi JPN	HAN		
1/8 FINAL	7	18/07/98	16:00	2	B2	JACKSON, Simon GBR	B2	KEENY, Richard USA	IPPON	1:35	IPO
1/8 FINAL	8	18/07/98	16:00	2	B1	ROSSO, Michele ITA	B1	WALSH, Edmund IRL	IPPON	1:30	IPO
1/4 FINAL	9	18/07/98	16:00	2	B2	MORGAN, Bill CAN	B1	TIAN, Longbing CHN	IPPON	40	IPO
1/4 FINAL	10	18/07/98	16:00	2	B2	DUB , Vasyi UKR	B3	CRUZ, Isao CUB	IPPON	2:15	IPO
1/4 FINAL	11	18/07/98	16:00	2	B2	BOEDO, Francisco ESP	B3	LE MEAUX, Sebastien FRA	IPPON	1:15	IPO
1/4 FINAL	12	18/07/98	16:00	2	B2	JACKSON, Simon GBR	B1	ROSSO, Michele ITA	IPPON	10	IPO
REPESCA	13	18/07/98	16:00	2	B1	TIAN, Longbing CHN	B1	SALINAS, Miguel ARG	IPPON	1:00	IPO
REPESCA	14	18/07/98	16:00	2	B3	CRUZ, Isao CUB	B3	DAHMEN, Thomas GER	IPPON	1:40	IPO
REPESCA	15	18/07/98	16:00	2	B3	LE MEAUX, Sebastien FRA	B1	HSIAO, Huang-Chi TPE	IPPON	15	IPO
REPESCA	16	18/07/98	16:00	2	B2	KEENY, Richard USA	B1	ROSSO, Michele ITA	IPPON	5	IPO
REPESCA	17	18/07/98	16:00	2	B3	CRUZ, Isao CUB	B1	TIAN, Longbing CHN	IPPON	1:30	IPO
REPESCA	18	18/07/98	16:00	2	B3	LE MEAUX, Sebastien FRA	B2	KEENY, Richard USA	IPPON	2:00	IPO
SEMIFINAL	19	18/07/98	16:00	2	B2	DUB , Vasyi UKR	B2	MORGAN, Bill CAN	IPPON	4:15	IPO
SEMIFINAL	20	18/07/98	16:00	2	B2	JACKSON, Simon GBR	B2	BOEDO, Francisco ESP	IPPON	15	IPO
3° -5°	21	19/07/98	16:00	1	B3	CRUZ, Isao CUB	B2	BOEDO, Francisco ESP	YUK	6:00	YUK
3° -5°	22	19/07/98	16:00	2	B3	LE MEAUX, Sebastien FRA	B2	MORGAN, Bill CAN	YUK	6:00	YUK
FINAL	23	19/07/98	16:00	1	B2	JACKSON, Simon GBR	B2	DUB , Vasyi UKR	IPPON	2:54	IPO

# I CAMPEONATO MUNDIAL DE DEPORTES PARA CIEGOS

## 1st WORLD BLIND SPORTS CHAMPIONSHIPS



Hasta 81 Kgr.  
Hombres

Up to 81 Kgr.  
Men

**CLASIFICACION**

**CLASSIFICATION**

*Instalaciones Deportivas CSD*



JUDO  
JUDO

POS.	NAME	CTRY	MEDAL
1	JACKSON, Simon	GBR	Gold
2	DUB , Vasyi	UKR	Silver
3	CRUZ, Isao	CUB	Bronze
3	LE MEAUX, Sebastien	FRA	Bronze
5	MORGAN, Bill	CAN	
5	BOEDO, Francisco	ESP	
7	TIAN, Longbing	CHN	
7	KEENY, Richard	USA	

Domingo 19 de Julio de 1998 - ( 17:30 )

Pág. - 1/1

digital



M G E  
UPS SYSTEMS

LEXMARK.



DELL

INFORMÁTICA  
SOLUCIONES Y SERVICIOS  
El Corte Inglés



Level data

Carrier España Servicio

# I CAMPEONATO MUNDIAL DE DEPORTES PARA CIEGOS

## 1st WORLD BLIND SPORTS CHAMPIONSHIPS



Hasta 90 Kgr.  
Hombres

Up to 90 Kgr.  
Men

**PARTICIPANTES PRUEBA**

**ATHLETES EVENT**

*Instalaciones Deportivas CSD*

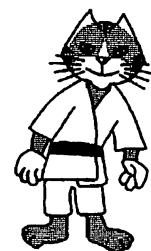

JUDO  
JUDO

Cla.	NOMBRE	PAIS
B1	CLARKE, Anthony	AUSTRALIA
B1	TENORIO, Antonio	BRASIL
B1	MEN , Runming	REP. POP. CHINA
B1	MARDANPOUR, Ghasem	IRAN
B2	STOSKUS, Jonas	LITUANIA
B3	LYVYTSKY, Mykola	UCRANIA
B3	CAMPOS, Fermin	ESPAÑA
B1	GUILLAUME, David	FRANCIA
B3	ROSE, Ian	GRAN BRETAÑA
B2	RICHTER, Michael	ALEMANIA
B1	WHITE, Tony	IRLANDA
B1	KATO, Yuji	JAPON
B3	AN , You-Sung	COREA
B1	MANNING, Lynn	ESTADOS UNIDOS
	<b>TOTAL</b>	<b>14</b>

# I CAMPEONATO MUNDIAL DE DEPORTES PARA CIEGOS

## 1st WORLD BLIND SPORTS CHAMPIONSHIPS



JUDO  
JUDO

Hasta 90 Kgr.  
Hombres

Up to 90 Kgr.  
Men

### SUMARIO FINAL

### FINAL SUMMARY

Instalaciones Deportivas CSD

#### 1/8 FINAL

#### 1/4 FINAL

#### SEMIFINAL

#### FINAL

B1(G) CLARKE, Anthony 1 IPPON\1:58\IPO AUS	WHITE, Tony IRL	B1(G) CLARKE, Anthony 9 IPPON\2:21\IPO AUS	TENORIO, Antonio BRA
B1 TENORIO, Antonio 2 18/07/98 16:00 BRA		B1 TENORIO, Antonio BRA	
B1(G) MEN, Runming 3 IPPON\2:50\IPO CHN	AN, You-Sung KOR	B1(G) CLARKE, Anthony 19 IPPON\1:26\IPO AUS	MEN, Runming CHN
B3 AN, You-Sung KOR		B1 MEN, Runming CHN	
B1 MARDANPOUR, Ghasem 4 IPPON\1:38\IPO IRI	GUILLAUME, David FRA	B1 GUILLAUME, David FRA	
B1(G) GUILLAUME, David FRA		B1(G) CLARKE, Anthony 23 IPPON\2:35\IPO AUS	CAMPOS, Fermin ESP
B3 LYVYTSKY, Mykola 5 WAZ\3:09\WAZ UKR	MANNING, Lynn USA	B3 CLARKE, Anthony AUS	CLARKE, Anthony AUS
B1(G) MANNING, Lynn USA		B3 CAMPOS, Fermin ESP	
B2 STOSKUS, Jonas 6 IPPON\2:33 LTU	ROSE, Ian GBR	B1 MANNING, Lynn USA	
B3(G) ROSE, Ian GBR		B3(G) ROSE, Ian GBR	
B3 CAMPOS, Fermin 7 18/07/98 16:00 ESP	CAMPOS, Fermin ESP	B3 ROSE, Ian GBR	
		B20 YUS\5:00\YUS ESP	
B2 RICHTER, Michael 8 IPPON\30\IPO GER	KATO, Yuji JPN	B3(G) CAMPOS, Fermin ESP	
B1(G) KATO, Yuji JPN		B12 IPPON\1:50\IPO JPN	
		B1 KATO, Yuji JPN	

#### REPESCA

B1 WHITE, Tony 13 IPPON\20\IPO IRL	TENORIO, Antonio BRA	B1(G) TENORIO, Antonio 17 IPPON\4:35\IPO BRA	GUILLAUME, David FRA
B1(G) TENORIO, Antonio BRA		B1 GUILLAUME, David FRA	
B3 AN, You-Sung 14 IPPON\4:13\IPO KOR	GUILLAUME, David FRA	B1(G) TENORIO, Antonio 21 YUK\1:27\YUK BRA	TENORIO, Antonio BRA
B1(G) GUILLAUME, David FRA		B3 ROSE, Ian GBR	
B2(G) STOSKUS, Jonas 15 IPPON\2:08\IPO LTU	MANNING, Lynn USA	B2 STOSKUS, Jonas 18 IPPON\1:43\IPO LTU	
B1 MANNING, Lynn USA		B1(G) KATO, Yuji JPN	
		B1 KATO, Yuji JPN	
16 18/07/98 16:00 KATO, Yuji JPN		B22 IPPON\4:10\IPO CHN	MEN, Runming CHN
		B1(G) MEN, Runming CHN	

### CLASIFICACION FINAL

1	AUS	CLARKE, Anthony	ORO
2	ESP	CAMPOS, Fermin	PLATA
3	CHN	MEN, Runming	BRONCE
	BRA	TENORIO, Antonio	BRONCE
5	GBR	ROSE, Ian	
	JPN	KATO, Yuji	
7	FRA	GUILLAUME, David	
	LTU	STOSKUS, Jonas	

# I CAMPEONATO MUNDIAL DE DEPORTES PARA CIEGOS

## 1st WORLD BLIND SPORTS CHAMPIONSHIPS



Hasta 90 Kgr.  
Hombres

Up to 90 Kgr.  
Men

RESULTADOS

RESULTS



JUDO  
JUDO

Instalaciones Deportivas CSD

RONDA	Part.	FECHA	HORA	Tat.	CLA.	GANADOR		CLA.	PERDEDOR		RES.	DUR.	TEC.
1/8 FINAL	1	18/07/98	16:00	1	B1	CLARKE, Anthony	AUS	B1	WHITE, Tony	IRL	IPPON	1:58	IP0
1/8 FINAL	3	18/07/98	16:00	1	B1	MEN , Runming	CHN	B3	AN , You-Sung	KOR	IPPON	2:50	IP0
1/8 FINAL	4	18/07/98	16:00	1	B1	GUILLAUME, David	FRA	B1	MARDANPOUR, Ghasem	IRI	IPPON	1:38	IP0
1/8 FINAL	5	18/07/98	16:00	1	B1	MANNING, Lynn	USA	B3	LYVYTSKY, Mykola	UKR	WAZ	3:09	WAZ
1/8 FINAL	6	18/07/98	16:00	1	B3	ROSE, Ian	GBR	B2	STOSKUS, Jonas	LTU	IPPON	2:33	
1/8 FINAL	8	18/07/98	16:00	1	B1	KATO, Yuji	JPN	B2	RICHTER, Michael	GER	IPPON	30	IP0
1/4 FINAL	9	18/07/98	16:00	1	B1	CLARKE, Anthony	AUS	B1	TENORIO, Antonio	BRA	IPPON	2:21	IP0
1/4 FINAL	10	18/07/98	16:00	1	B1	MEN , Runming	CHN	B1	GUILLAUME, David	FRA	IPPON	1:10	IP0
1/4 FINAL	11	18/07/98	16:00	1	B3	ROSE, Ian	GBR	B1	MANNING, Lynn	USA	IPPON	1:18	IP0
1/4 FINAL	12	18/07/98	16:00	1	B3	CAMPOS, Fermin	ESP	B1	KATO, Yuji	JPN	IPPON	1:50	IP0
REPESCA	13	18/07/98	16:00	1	B1	TENORIO, Antonio	BRA	B1	WHITE, Tony	IRL	IPPON	20	IP0
REPESCA	14	18/07/98	16:00	1	B1	GUILLAUME, David	FRA	B3	AN , You-Sung	KOR	IPPON	4:13	IP0
REPESCA	15	18/07/98	16:00	1	B2	STOSKUS, Jonas	LTU	B1	MANNING, Lynn	USA	IPPON	2:08	IP0
REPESCA	17	18/07/98	16:00	1	B1	TENORIO, Antonio	BRA	B1	GUILLAUME, David	FRA	IPPON	4:35	IP0
REPESCA	18	18/07/98	16:00	1	B1	KATO, Yuji	JPN	B2	STOSKUS, Jonas	LTU	IPPON	1:43	IP0
SEMIFINAL	19	18/07/98	16:00	1	B1	CLARKE, Anthony	AUS	B1	MEN , Runming	CHN	IPPON	1:26	IP0
SEMIFINAL	20	18/07/98	16:00	1	B3	CAMPOS, Fermin	ESP	B3	ROSE, Ian	GBR	YUS	5:00	YUS
3° -5°	21	19/07/98	16:00	1	B1	TENORIO, Antonio	BRA	B3	ROSE, Ian	GBR	YUK	1:27	YUK
3° -5°	22	19/07/98	16:00	2	B1	MEN , Runming	CHN	B1	KATO, Yuji	JPN	IPPON	4:10	IP0
FINAL	23	19/07/98	16:00	1	B1	CLARKE, Anthony	AUS	B3	CAMPOS, Fermin	ESP	IPPON	2:35	IP0

# I CAMPEONATO MUNDIAL DE DEPORTES PARA CIEGOS

## 1st WORLD BLIND SPORTS CHAMPIONSHIPS

Hasta 90 Kgr.  
Hombres

Up to 90 Kgr.  
Men

CLASIFICACION

CLASSIFICATION

*Instalaciones Deportivas CSD*



JUDO  
JUDO

POS.	NAME	CTRY	MEDAL
1	CLARKE, Anthony	AUS	Gold
2	CAMPOS, Fermin	ESP	Silver
3	TENORIO, Antonio	BRA	Bronze
3	MEN, Runming	CHN	Bronze
5	ROSE, Ian	GBR	
5	KATO, Yuji	JPN	
7	GUILLAUME, David	FRA	
7	STOSKUS, Jonas	LTU	



# I CAMPEONATO MUNDIAL DE DEPORTES PARA CIEGOS 1st WORLD BLIND SPORTS CHAMPIONSHIPS

Hasta 100 Kgr.  
Hombres

Up to 100 Kgr.  
Men

**PARTICIPANTES PRUEBA**

**ATHLETES EVENT**

*Instalaciones Deportivas CSD*



JUDO  
JUDO

Cla.	NOMBRE	PAIS
B3	HANL, Walter	AUSTRIA
B3	MORENO, Rafael	ESPAÑA
B1	FOOLADVAND, A.	IRAN
B2	SIDOROWIEZ, Michel	FRANCIA
B1	POWELL, Terence	GRAN BRETAÑA
B1	MATSUMOTO, Yoshikazu	JAPON
B2	CHNEIDERMANE, G.	RUSIA
B1	MASTRO, James	ESTADOS UNIDOS
	<b>TOTAL</b>	<b>8</b>





# I CAMPEONATO MUNDIAL DE DEPORTES PARA CIEGOS

## 1st WORLD BLIND SPORTS CHAMPIONSHIPS



JUDO  
JUDO

Hasta 100 Kgr.  
Hombres

Up to 100 Kgr.  
Men

SUMARIO FINAL

FINAL SUMMARY

Instalaciones Deportivas CSD

### 1/4 FINAL

### SEMIFINAL

### FINAL

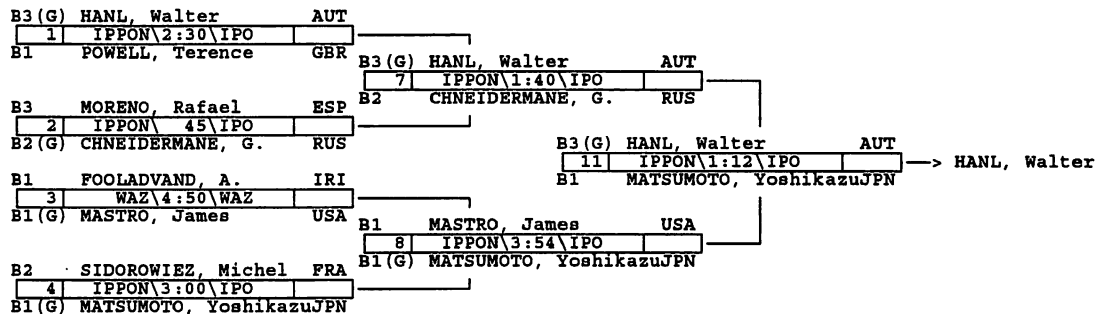

### REPESCA

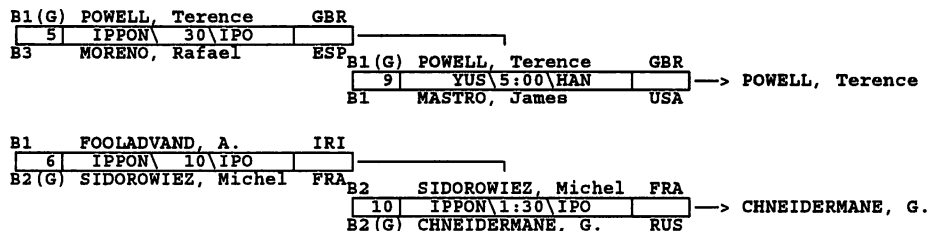

### CLASIFICACION FINAL

1	AUT	HANL, Walter	ORO
2	JPN	MATSUMOTO, Yoshikazu	PLATA
3	RUS	CHNEIDERMANE, G.	BRONCE
5	GBR	POWELL, Terence	BRONCE
	USA	MASTRO, James	
	FRA	SIDOROWIEZ, Michel	



# I CAMPEONATO MUNDIAL DE DEPORTES PARA CIEGOS

## 1st WORLD BLIND SPORTS CHAMPIONSHIPS

Hasta 100 Kgr.  
Hombres

Up to 100 Kgr.  
Men

**RESULTADOS**

**RESULTS**

*Instalaciones Deportivas CSD*



**JUDO**  
**JUDO**

RONDA	Part.	FECHA	HORA	Tat.	CLA.	GANADOR		CLA.	PERDEDOR		RES.	DUR.	TEC.
1/4 FINAL	1	18/07/98	16:00		B3	HANL, Walter	AUT	B1	POWELL, Terence	GBR	IPPON	2:30	IP0
1/4 FINAL	2	18/07/98	16:00		B2	CHNEIDERMANE, G.	RUS	B3	MORENO, Rafael	ESP	IPPON	45	IP0
1/4 FINAL	3	18/07/98	16:00		B1	MASTRO, James	USA	B1	FOOLADVAND, A.	IRI	WAZ	4:50	WAZ
1/4 FINAL	4	18/07/98	16:00		B1	MATSUMOTO, Yoshikazu	JPN	B2	SIDOROWIEZ, Michel	FRA	IPPON	3:00	IP0
REPESCA	5	18/07/98	16:00		B1	POWELL, Terence	GBR	B3	MORENO, Rafael	ESP	IPPON	30	IP0
REPESCA	6	18/07/98	16:00		B2	SIDOROWIEZ, Michel	FRA	B1	FOOLADVAND, A.	IRI	IPPON	10	IP0
SEMIFINAL	7	18/07/98	16:00		B3	HANL, Walter	AUT	B2	CHNEIDERMANE, G.	RUS	IPPON	1:40	IP0
SEMIFINAL	8	18/07/98	16:00		B1	MATSUMOTO, Yoshikazu	JPN	B1	MASTRO, James	USA	IPPON	3:54	IP0
3° -5°	9	19/07/98	16:00	1	B1	POWELL, Terence	GBR	B1	MASTRO, James	USA	YUS	6:00	HAN
3° -5°	10	19/07/98	16:00	2	B2	CHNEIDERMANE, G.	RUS	B2	SIDOROWIEZ, Michel	FRA	IPPON	1:30	IP0
FINAL	11	19/07/98	16:00	1	B3	HANL, Walter	AUT	B1	MATSUMOTO, Yoshikazu	JPN	IPPON	1:12	IP0

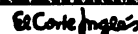

# I CAMPEONATO MUNDIAL DE DEPORTES PARA CIEGOS

## 1st WORLD BLIND SPORTS CHAMPIONSHIPS



Hasta 100 Kgr.  
Hombres

Up to 100 Kgr.  
Men

CLASIFICACION

CLASSIFICATION

*Instalaciones Deportivas CSD*



JUDO  
JUDO

POS.	NAME	CTRY	MEDAL
1	HANL, Walter	AUT	Gold
2	MATSUMOTO, Yoshikazu	JPN	Silver
3	POWELL, Terence	GBR	Bronze
3	CHNEIDERMANE, G.	RUS	Bronze
5	SIDOROWIEZ, Michel	FRA	
5	MASTRO, James	USA	

# I CAMPEONATO MUNDIAL DE DEPORTES PARA CIEGOS 1st WORLD BLIND SPORTS CHAMPIONSHIPS



Mas de 100kg.  
Hombres

Over 100kg  
Men

**PARTICIPANTES PRUEBA**

**ATHLETES EVENT**

*Instalaciones Deportivas CSD*



**JUDO  
JUDO**

Cla.	NOMBRE	PAIS
B1	CUNHA, Leonel	BRASIL
B3	GALLARDO, Antonio	ESPAÑA
B1	CENSIER, Eric	FRANCIA
B2	OSEWALD, Martin	ALEMANIA
B1	MIYAUCHI, Eiji	JAPON
B1	VOLKOV, Vladimir	RUSIA
B2	SZOTT, Kevin	ESTADOS UNIDOS
	<b>TOTAL</b>	<b>7</b>

# I CAMPEONATO MUNDIAL DE DEPORTES PARA CIEGOS 1st WORLD BLIND SPORTS CHAMPIONSHIPS



JUDO  
JUDO

Mas de 100kg. Over 100kg  
Hombres Men

SUMARIO FINAL

FINAL SUMMARY

Instalaciones Deportivas CSD

1/4 FINAL

SEMIFINAL

FINAL

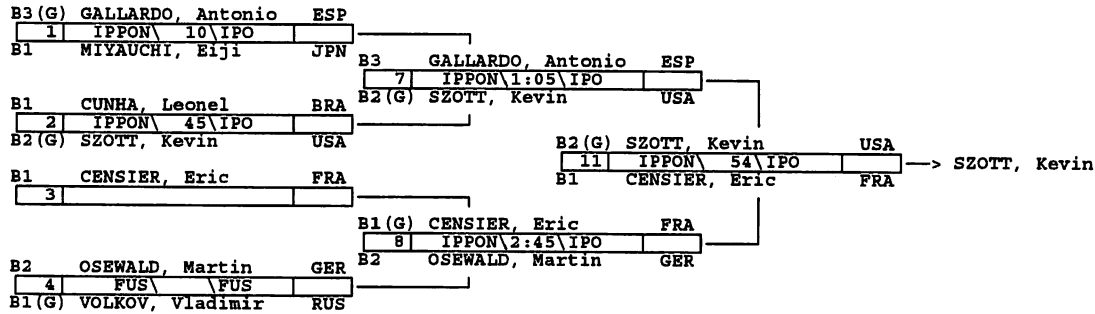

REPESCA

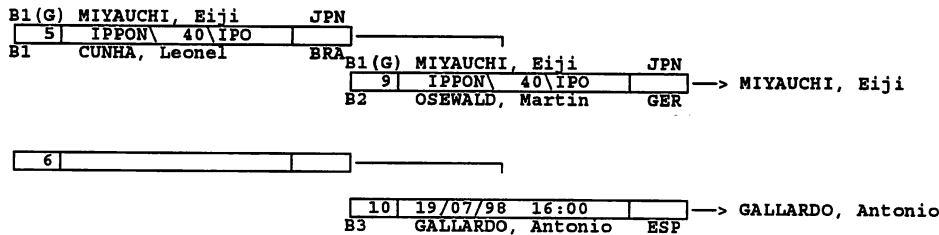

CLASIFICACION FINAL

1	USA	SZOTT, Kevin	ORO
2	FRA	CENSIER, Eric	PLATA
3	ESP	GALLARDO, Antonio	BRONCE
	JPN	MIYAUCHI, Eiji	BRONCE
5	GER	OSEWALD, Martin	

# I CAMPEONATO MUNDIAL DE DEPORTES PARA CIEGOS

## 1st WORLD BLIND SPORTS CHAMPIONSHIPS



Mas de 100kg.  
Hombres

Over 100kg  
Men

**RESULTADOS**

**RESULTS**

*Instalaciones Deportivas CSD*



JUDO  
JUDO

RONDA	Part.	FECHA	HORA	Tat.	CLA.	GANADOR	CLA.	PERDEDOR	RES.	DUR.	TEC.
1/4 FINAL	1	18/07/98	16:00		B3	GALLARDO, Antonio ESP	B1	MIYAUCHI, Eiji JPN	IPPON	10	IPO
1/4 FINAL	2	18/07/98	16:00		B2	SZOTT, Kevin USA	B1	CUNHA, Leonel BRA	IPPON	45	IPO
1/4 FINAL	4	18/07/98	16:00		B2	OSEWALD, Martin GER	B1	VOLKOV, Vladimir RUS	FUS		FUS
REPESCA	5	18/07/98	16:00		B1	MIYAUCHI, Eiji JPN	B1	CUNHA, Leonel BRA	IPPON	40	IPO
SEMIFINAL	7	18/07/98	16:00		B2	SZOTT, Kevin USA	B3	GALLARDO, Antonio ESP	IPPON	1:05	IPO
SEMIFINAL	8	18/07/98	16:00		B1	CENSIER, Eric FRA	B2	OSEWALD, Martin GER	IPPON	2:45	IPO
3° -5°	9	19/07/98	16:00	2	B1	MIYAUCHI, Eiji JPN	B2	OSEWALD, Martin GER	IPPON	40	IPO
FINAL	11	19/07/98	16:00	1	B2	SZOTT, Kevin USA	B1	CENSIER, Eric FRA	IPPON	54	IPO

Martes 21 de Julio de 1998 - ( 22:04 )

Pág. - 1/1

digital



MGE  
UPS SYSTEMS

LEXMARK.



DELL

INFORMÁTICA  
SOLUCIONES Y SERVICIOS  
El Corte Inglés



Level data

Carrier España Servicio

# I CAMPEONATO MUNDIAL DE DEPORTES PARA CIEGOS 1st WORLD BLIND SPORTS CHAMPIONSHIPS

Mas de 100kg.  
Hombres

Over 100kg  
Men

CLASIFICACION

CLASSIFICATION

*Instalaciones Deportivas CSD*



JUDO  
JUDO

POS.	NAME	CTRY	MEDAL
1	SZOTT, Kevin	USA	Gold
2	CENSIER, Eric	FRA	Silver
3	GALLARDO, Antonio	ESP	Bronze
3	MIYAUCHI, Eiji	JPN	Bronze
5	OSEWALD, Martin	GER	

# I CAMPEONATO MUNDIAL DE DEPORTES PARA CIEGOS 1st WORLD BLIND SPORTS CHAMPIONSHIPS

Hasta 48 Kgr.  
Mujeres

Up to 48 Kgr.  
Women

**PARTICIPANTES PRUEBA**

**ATHLETES EVENT**

*Instalaciones Deportivas CSD*



JUDO  
JUDO

Cla.	NOMBRE	PAIS
B3	ARNDT, Astrid	ALEMANIA
B3	LEE , Ching-Hua	CHINA TAIPEI
B3	DEVILLE, Nicole	ESTADOS UNIDOS
B2	ARANA, Juana	ESPAÑA
	<b>TOTAL</b>	<b>4</b>



# I CAMPEONATO MUNDIAL DE DEPORTES PARA CIEGOS

## 1st WORLD BLIND SPORTS CHAMPIONSHIPS

Hasta 48 Kgr.  
Mujeres

Up to 48 Kgr.  
Women

SUMARIO PRELIMINAR

ROUND SUMMARY

Instalaciones Deportivas CSD



JUDO  
JUDO

GRUPO A			1	2	3	4
1	USA	DEVILLE, Nicole		D	D	D
2	ESP	ARANA, Juana	IPPON 2:40/IPO		YUK 5:00/YUK	KOK 5:00/KOK
3	GER	ARNDT, Astrid	IPPON 2:47/IPO	D		IPPON 1:30/IPO
4	TPE	LEE , Ching-Hua	IPPON 1:11/IPO	D	D	

### CLASIFICACION DEL GRUPO

PT.	NOMBRE	COD.	Enfrentamientos			
			JUG.	GAN.	PER.	
1	ARANA, Juana	B2 ESP	3	3	0	ORO
2	ARNDT, Astrid	B3 GER	3	2	1	PLATA
3	LEE , Ching-Hua	B3 TPE	3	1	2	BRONCE
4	DEVILLE, Nicole	B3 USA	3	0	3	BRONCE

Domingo 19 de Julio de 1998 - ( 17:46 )

Pág. - 1/1

digital



M G E  
UPS SYSTEMS

LEXMARK.

ADATEL  
COMUNICACIONES DE EMPRESA

DELL

INFORMÁTICA  
SOLUCIONES Y SERVICIOS  
El Corte Inglés



Level data

Carrier España Servicio

# I CAMPEONATO MUNDIAL DE DEPORTES PARA CIEGOS

## 1st WORLD BLIND SPORTS CHAMPIONSHIPS

ON  
CE  
IB  
SA



Hasta 48 Kgr.  
Mujeres

Up to 48 Kgr.  
Women

RESULTADOS

RESULTS

*Instalaciones Deportivas CSD*



JUDO  
JUDO

RONDA	Part.	FECHA	HORA	Tat.	CLA.	GANADOR	CLA.	PERDEDOR	RES.	DUR.	TEC.
GRUPO A	1-2	19/07/98	10:00	1	B2	ARANA, Juana ESP	B3	DEVILLE, Nicole USA	IPPON	2:40	IPO
GRUPO A	3-4	19/07/98	10:00	1	B3	ARNDT, Astrid GER	B3	LEE, Ching-Hua TPE	IPPON	1:30	IPO
GRUPO A	1-3	19/07/98	10:00	1	B3	ARNDT, Astrid GER	B3	DEVILLE, Nicole USA	IPPON	2:47	IPO
GRUPO A	2-4	19/07/98	10:00	1	B2	ARANA, Juana ESP	B3	LEE, Ching-Hua TPE	KOK	5:00	KOK
GRUPO A	1-4	19/07/98	10:00	1	B3	LEE, Ching-Hua TPE	B3	DEVILLE, Nicole USA	IPPON	1:11	IPO
GRUPO A	2-3	19/07/98	10:00	1	B2	ARANA, Juana ESP	B3	ARNDT, Astrid GER	YUK	5:00	YUK

# I CAMPEONATO MUNDIAL DE DEPORTES PARA CIEGOS 1st WORLD BLIND SPORTS CHAMPIONSHIPS

Hasta 48 Kgr.  
Mujeres

Up to 48 Kgr.  
Women

CLASIFICACION

CLASSIFICATION

*Instalaciones Deportivas CSD*



JUDO  
JUDO

POS.	NAME	CTRY	MEDAL
1	ARANA, Juana	ESP	Gold
2	ARNDT, Astrid	GER	Silver
3	LEE, Ching-Hua	TPE	Bronze
3	DEVILLE, Nicole	USA	Bronze

Domingo 19 de Julio de 1998 - ( 16:58 )

Pág. - 1/1

digital



MGE  
UPS SYSTEMS

LEXMARK.



DELL

INFORMÁTICA  
SOLUCIONES Y SERVICIOS  
El Corte Inglés



Level data

Carrier España Servicio

# I CAMPEONATO MUNDIAL DE DEPORTES PARA CIEGOS

## 1st WORLD BLIND SPORTS CHAMPIONSHIPS



Hasta 52 Kgr.  
Mujeres

Up to 52 Kgr.  
Women

**PARTICIPANTES PRUEBA**

**ATHLETES EVENT**

*Instalaciones Deportivas CSD*



JUDO  
JUDO

Cla.	NOMBRE	PAIS
B1	ALAN, Desiree	AUSTRALIA
B3	CASTANO, Marie.	FRANCIA
B1	UTECHT, Sara	GRAN BRETAÑA
B2	JONES, Edie	ESTADOS UNIDOS
B2	MARISCAL, Gema	ESPAÑA
B3	SCHUETZEL, Susann	ALEMANIA
	<b>TOTAL</b>	<b>6</b>



# I CAMPEONATO MUNDIAL DE DEPORTES PARA CIEGOS 1st WORLD BLIND SPORTS CHAMPIONSHIPS



JUDO  
JUDO

Hasta 52 Kgr. Up to 52 Kgr.  
Mujeres Women

## SUMARIO FINAL FINAL SUMMARY

Instalaciones Deportivas CSD

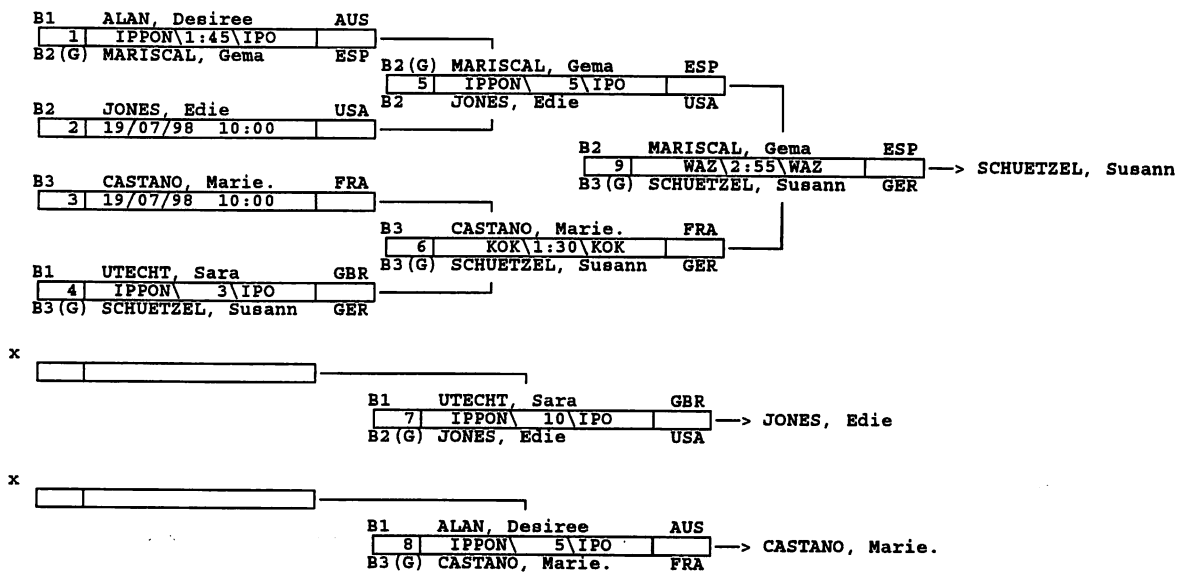

### CLASIFICACION FINAL

1	GER	SCHUETZEL, Susann	<b>ORO</b>
2	ESP	MARISCAL, Gema	<b>PLATA</b>
3	FRA	CASTANO, Marie.	<b>BRONCE</b>
	USA	JONES, Edie	<b>BRONCE</b>
5	GBR	UTECHT, Sara	
	AUS	ALAN, Desiree	



# I CAMPEONATO MUNDIAL DE DEPORTES PARA CIEGOS

## 1st WORLD BLIND SPORTS CHAMPIONSHIPS



Hasta 52 Kgr.  
Mujeres

Up to 52 Kgr.  
Women

**RESULTADOS**

**RESULTS**

*Instalaciones Deportivas CSD*

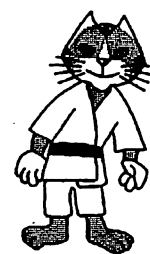

**JUDO**  
**JUDO**

RONDA	Part.	FECHA	HORA	Tat.	CLA.	GANADOR	CLA.	PERDEDOR	RES.	DUR.	TEC.
1/4 FINAL	1	19/07/98	10:00	2	B2	MARISCAL, Gema ESP	B1	ALAN, Desiree AUS	IPPON	1:45	IPO
1/4 FINAL	4	19/07/98	10:00	2	B3	SCHUETZEL, Susann GER	B1	UTECHT, Sara GBR	IPPON	3	IPO
SEMIFINAL	5	19/07/98	10:00	2	B2	MARISCAL, Gema ESP	B2	JONES, Edie USA	IPPON	5	IPO
SEMIFINAL	6	19/07/98	10:00	2	B3	SCHUETZEL, Susann GER	B3	CASTANO, Marie. FRA	KOK	1:30	KOK
3° -5°	7	19/07/98	10:00	2	B2	JONES, Edie USA	B1	UTECHT, Sara GBR	IPPON	10	IPO
3° -5°	8	19/07/98	10:00	2	B3	CASTANO, Marie. FRA	B1	ALAN, Desiree AUS	IPPON	5	IPO
FINAL	9	19/07/98	10:00	2	B3	SCHUETZEL, Susann GER	B2	MARISCAL, Gema ESP	WAZ	2:55	WAZ



# I CAMPEONATO MUNDIAL DE DEPORTES PARA CIEGOS 1<sup>st</sup> WORLD BLIND SPORTS CHAMPIONSHIPS



JUDO  
JUDO

Hasta 52 Kgr. Mujeres	Up to 52 Kgr. Women
<b>CLASIFICACION</b>	<b>CLASSIFICATION</b>

*Instalaciones Deportivas CSD*

POS.	NAME	CTRY	MEDAL
1	SCHUETZEL, Susann	GER	Gold
2	MARISCAL, Gema	ESP	Silver
3	CASTANO, Marie.	FRA	Bronze
3	JONES, Edie	USA	Bronze
5	ALAN, Desiree	AUS	
5	UTECHT, Sara	GBR	



# I CAMPEONATO MUNDIAL DE DEPORTES PARA CIEGOS 1st WORLD BLIND SPORTS CHAMPIONSHIPS

Hasta 57 Kgr.  
Mujeres

Up to 57 Kgr.  
Women

**PARTICIPANTES PRUEBA**

**ATHLETES EVENT**

*Instalaciones Deportivas CSD*



JUDO  
JUDO

Cla.	NOMBRE	PAIS
B2	HALL, Anita	GRAN BRETAÑA
B1	COLTRIOLI, Roberta	ITALIA
B3	ARCE, Marta	ESPAÑA
B3	BRUSSIG, Ramona	ALEMANIA
B2	MARTINEZ, Lisa	ESTADOS UNIDOS
	<b>TOTAL</b>	<b>5</b>



# I CAMPEONATO MUNDIAL DE DEPORTES PARA CIEGOS

## 1st WORLD BLIND SPORTS CHAMPIONSHIPS

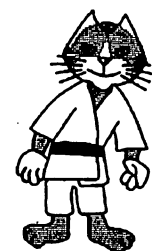

JUDO  
JUDO

Hasta 57 Kgr.  
Mujeres

Up to 57 Kgr.  
Women

SUMARIO PRELIMINAR

ROUND SUMMARY

Instalaciones Deportivas CSD

GRUPO A			1	2	3	4	5
1	ITA	COLTRIOLI, Roberta		KOK 3:07/KOK	WAZ 5:00/WAZ	D	IPPON 2:28/IPO
2	ESP	ARCE, Marta	D		IPPON 4:27/IPO	D	IPPON 4:18/IPO
3	GBR	HALL, Anita	D	D		D	D
4	GER	BRUSSIG, Ramona	IPPON 1:13/IPO	IPPON 1:55/IPO	IPPON 1:07/IPO		IPPON 1:38/IPO
5	USA	MARTINEZ, Lisa	D	D	YUS /HAN	D	

### CLASIFICACION DEL GRUPO

PT.	NOMBRE	COD.	Enfrentamientos			
			JUG.	GAN.	PER.	
1	BRUSSIG, Ramona	B3 GER	4	4	0	ORO
2	COLTRIOLI, Roberta	B1 ITA	4	3	1	PLATA
3	ARCE, Marta	B3 ESP	4	2	2	BRONCE
4	MARTINEZ, Lisa	B2 USA	4	1	3	BRONCE
5	HALL, Anita	B2 GBR	4	0	4	

Domingo 19 de Julio de 1998 - ( 17:48 )

Pág. - 1/1

digital



MGE  
UPS SYSTEMS

LEXMARK.

ADATEL  
CONSEJO REGULADOR DE COMPUTA

DELL

INFORMÁTICA  
SOLUCIONES PERSONALIZADAS  
El Corte Inglés



Level data

Carrier España Servicio

# I CAMPEONATO MUNDIAL DE DEPORTES PARA CIEGOS

## 1<sup>st</sup> WORLD BLIND SPORTS CHAMPIONSHIPS

Hasta 57 Kgr.  
Mujeres

Up to 57 Kgr.  
Women

**RESULTADOS**

**RESULTS**

*Instalaciones Deportivas CSD*

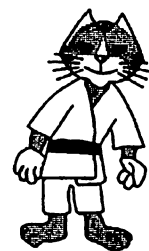

JUDO  
JUDO

RONDA	Part.	FECHA	HORA	Tat.	CLA.	GANADOR		CLA.	PERDEDOR		RES.	DUR.	TEC.
GRUPO A	1-2	19/07/98	10:00	1	B1	COLTRIOLI, Roberta	ITA	B3	ARCE, Marta	ESP	KOK	3:07	KOK
GRUPO A	3-4	19/07/98	10:00	1	B3	BRUSSIG, Ramona	GER	B2	HALL, Anita	GBR	IPPON	1:07	IPO
GRUPO A	1-5	19/07/98	10:00	1	B1	COLTRIOLI, Roberta	ITA	B2	MARTINEZ, Lisa	USA	IPPON	2:28	IPO
GRUPO A	2-3	19/07/98	10:00	1	B3	ARCE, Marta	ESP	B2	HALL, Anita	GBR	IPPON	4:27	IPO
GRUPO A	4-5	19/07/98	10:00	1	B3	BRUSSIG, Ramona	GER	B2	MARTINEZ, Lisa	USA	IPPON	1:38	IPO
GRUPO A	1-3	19/07/98	10:00	1	B1	COLTRIOLI, Roberta	ITA	B2	HALL, Anita	GBR	WAZ	5:00	WAZ
GRUPO A	2-5	19/07/98	10:00	1	B3	ARCE, Marta	ESP	B2	MARTINEZ, Lisa	USA	IPPON	4:18	IPO
GRUPO A	1-4	19/07/98	10:00	1	B3	BRUSSIG, Ramona	GER	B1	COLTRIOLI, Roberta	ITA	IPPON	1:13	IPO
GRUPO A	3-5	19/07/98	10:00	1	B2	MARTINEZ, Lisa	USA	B2	HALL, Anita	GBR	YUS		HAN
GRUPO A	2-4	19/07/98	10:00	1	B3	BRUSSIG, Ramona	GER	B3	ARCE, Marta	ESP	IPPON	1:55	IPO



# I CAMPEONATO MUNDIAL DE DEPORTES PARA CIEGOS 1st WORLD BLIND SPORTS CHAMPIONSHIPS

Hasta 57 Kgr.  
Mujeres

Up to 57 Kgr.  
Women

**CLASIFICACION**

**CLASSIFICATION**

*Instalaciones Deportivas CSD*



JUDO  
JUDO

POS.	NAME	CTRY	MEDAL
1	BRUSSIG, Ramona	GER	Gold
2	COLTRIOLI, Roberta	ITA	Silver
3	ARCE, Marta	ESP	Bronze
3	MARTINEZ, Lisa	USA	Bronze
5	HALL, Anita	GBR	

# I CAMPEONATO MUNDIAL DE DEPORTES PARA CIEGOS

## 1st WORLD BLIND SPORTS CHAMPIONSHIPS



<b>63 - 70 kgr.</b>	<b>63 - 70 Kgr.</b>
<b>Mujeres</b>	<b>Women</b>

<b>PARTICIPANTES PRUEBA</b>	<b>ATHLETES EVENT</b>
-----------------------------	-----------------------

*Instalaciones Deportivas CSD*

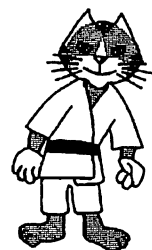

**JUDO**  
**JUDO**

<b>Cla.</b>	<b>NOMBRE</b>	<b>PAIS</b>
<b>B2</b>	<b>WANG, Yanling</b>	<b>REP. POP. CHINA</b>
<b>B1</b>	<b>ROBLEDO, Celia</b>	<b>ESPAÑA</b>
<b>B3</b>	<b>SOSA, Maria</b>	<b>ESPAÑA</b>
<b>B2</b>	<b>BASTIN, Berveley</b>	<b>GRAN BRETAÑA</b>
<b>B2</b>	<b>PEREZ, Mary</b>	<b>ESTADOS UNIDOS</b>
<b>B3</b>	<b>SEVERE, Amy</b>	<b>ESTADOS UNIDOS</b>
	<b>TOTAL</b>	<b>6</b>





# I CAMPEONATO MUNDIAL DE DEPORTES PARA CIEGOS

## 1st WORLD BLIND SPORTS CHAMPIONSHIPS



JUDO  
JUDO

**63 - 70 kgr. Mujeres** **63 - 70 Kgr. Women**

### SUMARIO FINAL

### FINAL SUMMARY

*Instalaciones Deportivas CSD*

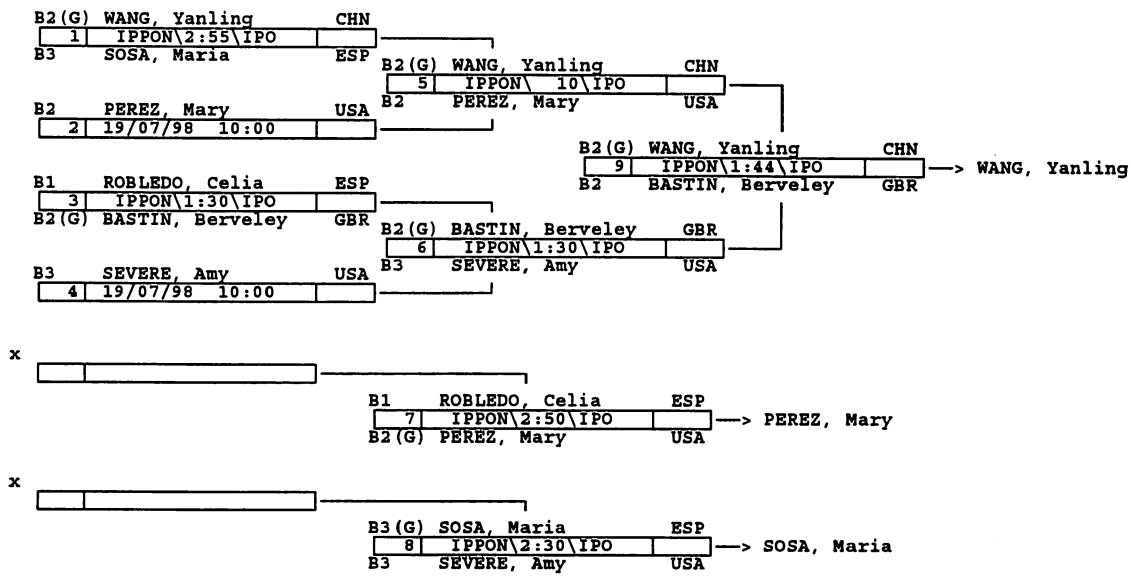

### CLASIFICACION FINAL

1	CHN	WANG, Yanling	<b>ORO</b>
2	GBR	BASTIN, Berveley	<b>PLATA</b>
3	ESP	SOSA, Maria	<b>BRONCE</b>
	USA	PEREZ, Mary	<b>BRONCE</b>
5	ESP	ROBLEDO, Celia	
	USA	SEVERE, Amy	





# I CAMPEONATO MUNDIAL DE DEPORTES PARA CIEGOS 1st WORLD BLIND SPORTS CHAMPIONSHIPS

63 - 70 kgr.  
Mujeres

63 - 70 Kgr.  
Women

**RESULTADOS**

**RESULTS**

*Instalaciones Deportivas CSD*



JUDO  
JUDO

RONDA	Part.	FECHA	HORA	Tat.	CLA.	GANADOR	CLA.	PERDEDOR	RES.	DUR.	TEC.
1/4 FINAL	1	19/07/98	10:00	2	B2	WANG, Yanling CHN	B3	SOSA, Maria ESP	IPPON	2:55	IPO
1/4 FINAL	3	19/07/98	10:00	2	B2	BASTIN, Berveley GBR	B1	ROBLEDO, Celia ESP	IPPON	1:30	IPO
SEMIFINAL	5	19/07/98	10:00	2	B2	WANG, Yanling CHN	B2	PEREZ, Mary USA	IPPON	10	IPO
SEMIFINAL	6	19/07/98	10:00	2	B2	BASTIN, Berveley GBR	B3	SEVERE, Amy USA	IPPON	1:30	IPO
3° -5°	7	19/07/98	10:00	2	B2	PEREZ, Mary USA	B1	ROBLEDO, Celia ESP	IPPON	2:50	IPO
3° -5°	8	19/07/98	10:00	2	B3	SOSA, Maria ESP	B3	SEVERE, Amy USA	IPPON	2:30	IPO
FINAL	9	19/07/98	10:00	2	B2	WANG, Yanling CHN	B2	BASTIN, Berveley GBR	IPPON	1:44	IPO



# I CAMPEONATO MUNDIAL DE DEPORTES PARA CIEGOS 1st WORLD BLIND SPORTS CHAMPIONSHIPS



JUDO  
JUDO

63 - 70 kgr.  
Mujeres

63 - 70 Kgr.  
Women

CLASIFICACION

CLASSIFICATION

Instalaciones Deportivas CSD

POS.	NAME	CTRY	MEDAL
1	WANG, Yanling	CHN	Gold
2	BASTIN, Berveley	GBR	Silver
3	SOSA, Maria	ESP	Bronze
3	PEREZ, Mary	USA	Bronze
5	ROBLEDO, Celia	ESP	
5	SEVERE, Amy	USA	

# I CAMPEONATO MUNDIAL DE DEPORTES PARA CIEGOS

## 1st WORLD BLIND SPORTS CHAMPIONSHIPS



Mas de 70 Kgr.  
Mujeres

Over 70 Kgr.  
Women

**PARTICIPANTES PRUEBA**

**ATHLETES EVENT**

*Instalaciones Deportivas CSD*

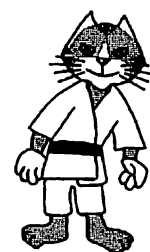

JUDO  
JUDO

Cla.	NOMBRE	PAIS
B2	XUE , Lanmei	REP. POP. CHINA
B3	HERRERA, Carmen	ESPAÑA
B2	CHRISTEN, SIENA	ALEMANIA
B2	BISCHLER, Beate	ALEMANIA
	<b>TOTAL</b>	<b>4</b>



# I CAMPEONATO MUNDIAL DE DEPORTES PARA CIEGOS 1st WORLD BLIND SPORTS CHAMPIONSHIPS



Mas de 70 Kgr.

Over 70 Kgr.

Mujeres

Women

SUMARIO PRELIMINAR

ROUND SUMMARY

Instalaciones Deportivas CSD



JUDO  
JUDO

GRUPO A		1	2	3	4
1	CHN XUE , Lanmei		IPPON 1:30/IPO	KOK 5:00/KOK	IPPON 3:51/IPO
2	ESP HERRERA, Carmen	D		D	YUK 1:08/IPO
3	GER CHRISTEN, SIENA	D	YUS /HAN		IPPON 2:25/IPO
4	GER BISCHLER, Beate	D	D	D	

## CLASIFICACION DEL GRUPO

PT.	NOMBRE	COD.	Enfrentamientos			
			JUG.	GAN.	PER.	
1	XUE , Lanmei	B2 CHN	3	3	0	ORO
2	CHRISTEN, SIENA	B2 GER	3	2	1	PLATA
3	HERRERA, Carmen	B3 ESP	3	1	2	BRONCE
4	BISCHLER, Beate	B2 GER	3	0	3	BRONCE

Domingo 19 de Julio de 1998 - ( 17:46 )

Pág. - 1/1

digital



M G E  
UPS SYSTEMS

LEXMARK.

ADATEL  
COMUNICACIONES DE EMPRESA

DELL

INFORMÁTICA  
SOLUCIONES Y SERVICIOS  
El Corte Inglés

Carrier  
Carrier España Servicio

Level data



# I CAMPEONATO MUNDIAL DE DEPORTES PARA CIEGOS 1st WORLD BLIND SPORTS CHAMPIONSHIPS



JUDO  
JUDO

Mas de 70 Kgr.  
Mujeres

Over 70 Kgr.  
Women

RESULTADOS

RESULTS

Instalaciones Deportivas CSD

RONDA	Part.	FECHA	HORA	Tat.	CLA.	GANADOR	CLA.	PERDEDOR	RES.	DUR.	TEC.
GRUPO A	1-2	19/07/98	10:00		B2	XUE , Lanmei CHN	B3	HERRERA, Carmen ESP	IPPON	1:30	IPO
GRUPO A	3-4	19/07/98	10:00		B2	CHRISTEN, SIENA GER	B2	BISCHLER, Beate GER	IPPON	2:25	IPO
GRUPO A	1-3	19/07/98	10:00	1	B2	XUE , Lanmei CHN	B2	CHRISTEN, SIENA GER	KOK	5:00	KOK
GRUPO A	2-4	19/07/98	10:00	1	B3	HERRERA, Carmen ESP	B2	BISCHLER, Beate GER	YUK	1:08	IPO
GRUPO A	1-4	19/07/98	10:00	1	B2	XUE , Lanmei CHN	B2	BISCHLER, Beate GER	IPPON	3:51	IPO
GRUPO A	2-3	19/07/98	10:00	1	B2	CHRISTEN, SIENA GER	B3	HERRERA, Carmen ESP	YUS		HAN

# I CAMPEONATO MUNDIAL DE DEPORTES PARA CIEGOS 1st WORLD BLIND SPORTS CHAMPIONSHIPS

Mas de 70 Kgr.  
Mujeres

Over 70 Kgr.  
Women

CLASIFICACION

CLASSIFICATION

Instalaciones Deportivas CSD



JUDO  
JUDO

POS.	NAME	CTRY	MEDAL
1	XUE , Lanmei	CHN	Gold
2	CHRISTEN. SIENA	GER	Silver
3	HERRERA, Carmen	ESP	Bronze
3	BISCHLER, Beate	GER	Bronze

# I CAMPEONATO MUNDIAL DE DEPORTES PARA CIEGOS

## 1st WORLD BLIND SPORTS CHAMPIONSHIPS



MEDALLAS

MEDALS



JUDO  
JUDO

Instalaciones Deportivas CSD

### Equipos Hombres

<b>Oro</b>	<b>FRANCIA</b> Eric CENSIER David GUILLAUME S. LE MEAUX Gerald ROLLO Cyril MOREL	<b>20/07/98</b>
<b>Plata</b>	<b>JAPON</b> Eiji MIYAUCHI Yuji KATO K. NAKAMURA T. TAKAHASHI S. FUJIMOTO	<b>20/07/98</b>
<b>Bronce</b>	<b>ALEMANIA</b> C. ZEILERMEIER Michael ESSER Martin OSEWALD Thomas DAHMEN Michael RICHTER <b>ESTADOS UNIDOS</b> Richard KEENY Marlon LOPEZ Lynn MANNING Scott MOORE Kevin SZOTT James MASTRO	<b>20/07/98</b>      <b>20/07/98</b>

### Hasta 60 Kgr. Hombres

<b>Oro</b>	PEREZ, Sergio	<b>CUBA</b>	<b>19/07/98</b>
<b>Plata</b>	HIROSE, Makoto	<b>JAPON</b>	<b>19/07/98</b>
<b>Bronce</b>	LEE, Ching-Chung BYCHKOVSKYY, K.	<b>CHINA TAIPEI</b> <b>UCRANIA</b>	<b>19/07/98</b> <b>19/07/98</b>

### Hasta 66 Kgr. Hombres

<b>Oro</b>	FUJIMOTO, Satoshi	<b>JAPON</b>	<b>19/07/98</b>
<b>Plata</b>	MOREL, Cyril	<b>FRANCIA</b>	<b>19/07/98</b>
<b>Bronce</b>	MORTEN, Pier GARCIA, David	<b>CANADA</b> <b>ESPAÑA</b>	<b>19/07/98</b> <b>19/07/98</b>

# I CAMPEONATO MUNDIAL DE DEPORTES PARA CIEGOS

## 1st WORLD BLIND SPORTS CHAMPIONSHIPS



**MEDALLAS**

**MEDALS**



**JUDO**  
**JUDO**

*Instalaciones Deportivas CSD*

**Hasta 73 Kgr. Hombres**

<b>Oro</b>	MOORE, Scott	ESTADOS UNIDOS	19/07/98
<b>Plata</b>	ATNABAEV, Ravkhat	RUSIA	19/07/98
<b>Bronce</b>	SANTANA, Andres ROLLO, Gerald	ESPAÑA FRANCIA	19/07/98 19/07/98

**Hasta 81 Kgr. Hombres**

<b>Oro</b>	JACKSON, Simon	GRAN BRETAÑA	19/07/98
<b>Plata</b>	DUB, Vasyi	UCRANIA	19/07/98
<b>Bronce</b>	CRUZ, Isao LE MEAUX, Sebastien	CUBA FRANCIA	19/07/98 19/07/98

**Hasta 90 Kgr. Hombres**

<b>Oro</b>	CLARKE, Anthony	AUSTRALIA	19/07/98
<b>Plata</b>	CAMPOS, Fermin	ESPAÑA	19/07/98
<b>Bronce</b>	TENORIO, Antonio MEN, Runming	BRASIL REP. POP. CHINA	19/07/98 19/07/98

**Hasta 100 Kgr. Hombres**

<b>Oro</b>	HANL, Walter	AUSTRIA	19/07/98
<b>Plata</b>	MATSUMOTO, Yoshikazu	JAPON	19/07/98
<b>Bronce</b>	POWELL, Terence CHNEIDERMANE, G.	GRAN BRETAÑA RUSIA	19/07/98 19/07/98

**Mas de 100kg. Hombres**

<b>Oro</b>	SZOTT, Kevin	ESTADOS UNIDOS	19/07/98
<b>Plata</b>	CENSIER, Eric	FRANCIA	19/07/98
<b>Bronce</b>	GALLARDO, Antonio MIYAUCHI, Eiji	ESPAÑA JAPON	19/07/98 19/07/98

# I CAMPEONATO MUNDIAL DE DEPORTES PARA CIEGOS

## 1st WORLD BLIND SPORTS CHAMPIONSHIPS

MEDALLAS

MEDALS



JUDO  
JUDO

Instalaciones Deportivas CSD

### Hasta 48 Kgr. Mujeres

<b>Oro</b>	ARANA, Juana	ESPAÑA	19/07/98
<b>Plata</b>	ARNDT, Astrid	ALEMANIA	19/07/98
<b>Bronce</b>	LEE, Ching-Hua DEVILLE, Nicole	CHINA TAIPEI ESTADOS UNIDOS	19/07/98 19/07/98

### Hasta 52 Kgr. Mujeres

<b>Oro</b>	SCHUETZEL, Susann	ALEMANIA	19/07/98
<b>Plata</b>	MARISCAL, Gema	ESPAÑA	19/07/98
<b>Bronce</b>	CASTANO, Marie. JONES, Edie	FRANCIA ESTADOS UNIDOS	19/07/98 19/07/98

### Hasta 57 Kgr. Mujeres

<b>Oro</b>	BRUSSIG, Ramona	ALEMANIA	19/07/98
<b>Plata</b>	COLTRIOLI, Roberta	ITALIA	19/07/98
<b>Bronce</b>	ARCE, Marta MARTINEZ, Lisa	ESPAÑA ESTADOS UNIDOS	19/07/98 19/07/98

### 63 - 70 kgr. Mujeres

<b>Oro</b>	WANG, Yanling	REP. POP. CHINA	19/07/98
<b>Plata</b>	BASTIN, Berveley	GRAN BRETAÑA	19/07/98
<b>Bronce</b>	SOSA, Maria PEREZ, Mary	ESPAÑA ESTADOS UNIDOS	19/07/98 19/07/98

### Mas de 70 Kgr. Mujeres

<b>Oro</b>	XUE, Lanmei	REP. POP. CHINA	19/07/98
<b>Plata</b>	CHRISTEN, SIENA	ALEMANIA	19/07/98
<b>Bronce</b>	HERRERA, Carmen BISCHLER, Beate	ESPAÑA ALEMANIA	19/07/98 19/07/98

# I CAMPEONATO MUNDIAL DE DEPORTES PARA CIEGOS 1st WORLD BLIND SPORTS CHAMPIONSHIPS



JUDO  
JUDO

MEDALLAS/ESTADO

MEDALS/COUNTRY

*Instalaciones Deportivas CSD*

PT	PAIS	ORO	PLATA	BRONCE	TOTAL
1	ALEMANIA	2	2	2	6
2	ESTADOS UNIDOS	2	-	5	7
3	REP. POP. CHINA	2	-	1	3
4	JAPON	1	3	1	5
5	ESPAÑA	1	2	6	9
6	FRANCIA	1	2	3	6
7	GRAN BRETAÑA	1	1	1	3
8	CUBA	1	-	1	2
9	AUSTRALIA	1	-	-	1
	AUSTRIA	1	-	-	1
11	RUSIA	-	1	1	2
	UCRANIA	-	1	1	2
13	ITALIA	-	1	-	1
14	CHINA TAIPEI	-	-	2	2
15	BRASIL	-	-	1	1
	CANADA	-	-	1	1
<b>TOTAL 16</b>					





JUDO  
JUDO

MEDALLAS/ESTADO

MEDALS/COUNTRY

*Instalaciones Deportivas CSD*

GER ALEMANIA				
Oro	2	Hasta 57 Kgr. Mujeres Hasta 52 Kgr. Mujeres	BRUSSIG, Ramona SCHUETZEL, Susann	19/07/98 19/07/98
Plata	2	Hasta 48 Kgr. Mujeres Mas de 70 Kgr. Mujeres	ARNDT, Astrid CHRISTEN, SIENA	19/07/98 19/07/98
Bronce	2	Mas de 70 Kgr. Mujeres Equipos Hombres	BISCHLER, Beate ALEMANIA C. ZEILERMEIER Michael ESSER Martin OSEWALD Thomas DAHMEN Michael RICHTER	19/07/98 20/07/98
USA ESTADOS UNIDOS				
Oro	2	Hasta 73 Kgr. Hombres Mas de 100kg. Hombres	MOORE, Scott SZOTT, Kevin	19/07/98 19/07/98
Bronce	5	63 - 70 kgr. Mujeres Hasta 57 Kgr. Mujeres Hasta 52 Kgr. Mujeres Equipos Hombres	PEREZ, Mary MARTINEZ, Lisa JONES, Edie ESTADOS UNIDOS Richard KEENY Marlon LOPEZ Lynn MANNING Scott MOORE Kevin SZOTT James MASTRO DEVILLE, Nicole	19/07/98 19/07/98 19/07/98 20/07/98
		Hasta 48 Kgr. Mujeres		19/07/98
CHN REP. POP. CHINA				
Oro	2	Mas de 70 Kgr. Mujeres 63 - 70 kgr. Mujeres	XUE, Lanmei WANG, Yanling	19/07/98 19/07/98
Bronce	1	Hasta 90 Kgr. Hombres	MEN, Runming	19/07/98
JPN JAPON				
Oro	1	Hasta 66 Kgr. Hombres	FUJIMOTO, Satoshi	19/07/98



# I CAMPEONATO MUNDIAL DE DEPORTES PARA CIEGOS

## 1st WORLD BLIND SPORTS CHAMPIONSHIPS



MEDALLAS/ESTADO

MEDALS/COUNTRY

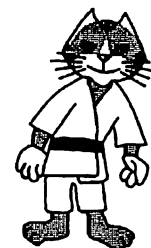

JUDO  
JUDO

Instalaciones Deportivas CSD

JPN		JAPON		
<b>Plata</b>	<b>3</b>	<b>Hasta 60 Kgr. Hombres</b> <b>Hasta 100 Kgr. Hombres</b> <b>Equipos Hombres</b>	<b>HIROSE, Makoto</b> <b>MATSUMOTO, Yoshikazu</b> <b>JAPON</b> <b>Eiji MIYAUCHI</b> <b>Yuji KATO</b> <b>K. NAKAMURA</b> <b>T. TAKAHASHI</b> <b>S. FUJIMOTO</b>	<b>19/07/98</b> <b>19/07/98</b> <b>20/07/98</b>
<b>Bronce</b>	<b>1</b>	<b>Mas de 100kg. Hombres</b>	<b>MIYAUCHI, Eiji</b>	<b>19/07/98</b>
ESP		ESPAÑA		
<b>Oro</b>	<b>1</b>	<b>Hasta 48 Kgr. Mujeres</b>	<b>ARANA, Juana</b>	<b>19/07/98</b>
<b>Plata</b>	<b>2</b>	<b>Hasta 90 Kgr. Hombres</b> <b>Hasta 52 Kgr. Mujeres</b>	<b>CAMPOS, Fermin</b> <b>MARISCAL, Gema</b>	<b>19/07/98</b> <b>19/07/98</b>
<b>Bronce</b>	<b>6</b>	<b>Mas de 70 Kgr. Mujeres</b> <b>63 - 70 kgr. Mujeres</b> <b>Hasta 66 Kgr. Hombres</b> <b>Hasta 57 Kgr. Mujeres</b> <b>Mas de 100kg. Hombres</b> <b>Hasta 73 Kgr. Hombres</b>	<b>HERRERA, Carmen</b> <b>SOSA, Maria</b> <b>GARCIA, David</b> <b>ARCE, Marta</b> <b>GALLARDO, Antonio</b> <b>SANTANA, Andres</b>	<b>19/07/98</b> <b>19/07/98</b> <b>19/07/98</b> <b>19/07/98</b> <b>19/07/98</b> <b>19/07/98</b>
FRA		FRANCIA		
<b>Oro</b>	<b>1</b>	<b>Equipos Hombres</b>	<b>FRANCIA</b> <b>Eric CENSIER</b> <b>David GUILLAUME</b> <b>S. LE MEAUX</b> <b>Gerald ROLLO</b> <b>Cyril MOREL</b>	<b>20/07/98</b>
<b>Plata</b>	<b>2</b>	<b>Mas de 100kg. Hombres</b> <b>Hasta 66 Kgr. Hombres</b>	<b>CENSIER, Eric</b> <b>MOREL, Cyril</b>	<b>19/07/98</b> <b>19/07/98</b>
<b>Bronce</b>	<b>3</b>	<b>Hasta 73 Kgr. Hombres</b>	<b>ROLLO, Gerald</b>	<b>19/07/98</b>

# I CAMPEONATO MUNDIAL DE DEPORTES PARA CIEGOS 1st WORLD BLIND SPORTS CHAMPIONSHIPS

MEDALLAS/ESTADO

MEDALS/COUNTRY



JUDO  
JUDO

*Instalaciones Deportivas CSD*

FRA FRANCIA				
<i>Bronce</i>	<b>3</b>	<i>Hasta 81 Kgr. Hombres Hasta 52 Kgr. Mujeres</i>	<i>LE MEAUX, Sebastien CASTANO, Marie.</i>	<i>19/07/98 19/07/98</i>
GBR GRAN BRETAÑA				
<i>Oro</i>	<b>1</b>	<i>Hasta 81 Kgr. Hombres</i>	<i>JACKSON, Simon</i>	<i>19/07/98</i>
<i>Plata</i>	<b>1</b>	<i>63 - 70 kgr. Mujeres</i>	<i>BASTIN, Berveley</i>	<i>19/07/98</i>
<i>Bronce</i>	<b>1</b>	<i>Hasta 100 Kgr. Hombres</i>	<i>POWELL, Terence</i>	<i>19/07/98</i>
CUB CUBA				
<i>Oro</i>	<b>1</b>	<i>Hasta 60 Kgr. Hombres</i>	<i>PEREZ, Sergio</i>	<i>19/07/98</i>
<i>Bronce</i>	<b>1</b>	<i>Hasta 81 Kgr. Hombres</i>	<i>CRUZ, Isao</i>	<i>19/07/98</i>
AUS AUSTRALIA				
<i>Oro</i>	<b>1</b>	<i>Hasta 90 Kgr. Hombres</i>	<i>CLARKE, Anthony</i>	<i>19/07/98</i>
AUT AUSTRIA				
<i>Oro</i>	<b>1</b>	<i>Hasta 100 Kgr. Hombres</i>	<i>HANL, Walter</i>	<i>19/07/98</i>
RUS RUSIA				
<i>Plata</i>	<b>1</b>	<i>Hasta 73 Kgr. Hombres</i>	<i>ATNABAEV, Ravkhat</i>	<i>19/07/98</i>
<i>Bronce</i>	<b>1</b>	<i>Hasta 100 Kgr. Hombres</i>	<i>CHNEIDERMANE, G.</i>	<i>19/07/98</i>

# I CAMPEONATO MUNDIAL DE DEPORTES PARA CIEGOS

## 1st WORLD BLIND SPORTS CHAMPIONSHIPS

MEDALLAS/ESTADO

MEDALS/COUNTRY



JUDO  
JUDO

*Instalaciones Deportivas CSD*

UKR UCRANIA				
Plata	1	Hasta 81 Kgr. Hombres	DUB , VasyI	19/07/98
Bronce	1	Hasta 60 Kgr. Hombres	BYCHKOVSKYY, K.	19/07/98
ITA ITALIA				
Plata	1	Hasta 57 Kgr. Mujeres	COLTRIOLI, Roberta	19/07/98
TPE CHINA TAIPEI				
Bronce	2	Hasta 60 Kgr. Hombres	LEE , Ching-Chung	19/07/98
		Hasta 48 Kgr. Mujeres	LEE , Ching-Hua	19/07/98
BRA BRASIL				
Bronce	1	Hasta 90 Kgr. Hombres	TENORIO, Antonio	19/07/98
CAN CANADA				
Bronce	1	Hasta 66 Kgr. Hombres	MORTEN, Pier	19/07/98