

# FEDERATION CYNOLOGIQUE INTERNATIONALE (AISBL)

13, Place Albert 1er, B - 6530 Thuin (Belgique), tel : ++32.71.59.12.38, fax :++32.71.59.22.29, interne : <http://www.fci.be>

---

## REGULATIONS

FOR THE

INTERNATIONAL UTILITY DOG TRIALS

AND THE

INTERNATIONAL TRACKING DOG TRIAL

OF THE FCI



**Executed by order of the FCI-Utility Dogs commission:**

Frans Jansen (NL)  
Guenther Diegel (D)  
Wilfried Schaepermeier (D)  
Edgar Scherkl(D)  
Pierre Walhstroem (S)  
Fons Van den Bosch (B)  
Robert Markschlaeger (A)

**These Rules were approved by the FCI General Committee in Rom on April 13 2011.  
They are effective from January 1<sup>st</sup> 2012.**



## **Preamble**

Since more than 12,000 years, the dog has been the companion of mankind. Through the domestication of the dog, a close social relationship was formed with mankind and is in some respects dependent on him. With this comes a certain responsibility on the part of man to ensure the well-being of the dog.

Directly when it comes to training the physical as well as the psychological health of the dog is top priority. It is imperative then that the dog be handled in a fair, orderly and humane way. This also should include adequate care of the dog through proper nutrition and water as well as maintaining his health which needs to include regular vaccinations and veterinary examinations. In addition to this there is an additional duty to the dog to properly socialize him and to ensure exercise to meets his needs.

During the course of history, the dog has had various jobs to help man. In the modern day world, many of these duties have been relegated to technology. For this reason, the dog owner has the responsibility to ensure that the dog has other activities due to the loss of past jobs as well as adequate exercise and activities that offer close contact to people. Under this point of view the Companion Test – BH - , the versatility test for the utility dog, the tracking test – FH – and the article search test – STP – need to be factored in. The dog should be occupied according to his abilities and capabilities. Besides adequate exercise, he should have intense work with activities that take into consideration his learning ability, his exercise requirements as well as his other abilities. The various forms of the dog sport provide these excellent venues. Dogs that do not have enough activities stand out and this can lead to public complaints.

A person who trains or does sport with his dog, has to undertake a method of careful training with the goal in mind to achieve the best possible harmony between himself and the dog. The goal of all training is to convey to the dog what it is we want him to do in such a way that he can understand. The harmonious agreement between man and his dog, regardless of the dog sport one does, is the basis for all activities. To achieve harmony, it is important to goes into the dog's world and his understands his abilities.

It remains the ethical responsibility of man to raise and adequately train the dog. The applied methods must meet the standards of behavioural scientists, especially in regards to the breed. In order to achieve the upbringing, training or training effect, it is important to not utilize force and to use positive methods for the dog. Furthermore it is imperative to decline the use of techniques that do not utilize the proper training, raising and training aides. Using a dog for dog sport has to be oriented to his capabilities, his competitive spirit and his willingness. Influencing the dogs learning capabilities through the use of medication or animal cruelty is to be declined. One must carefully acknowledge the capabilities of his dog. To demand work of a dog that does not have the capability to do so, contradicts every ethical level of consciousness. Only someone who takes the responsibility to be a true friend to his dog will take a healthy and capable dog to trials, competitions and training.



<b>Contents:</b>	Page 3
General Part	Page 4
Validity	Page 4
General information	Page 4
Trial season	Page 5
Trial organization/Trial secretary (PL)	Page 5
Trial judges (LR)	Page 5
Trial participants	Page 6
Collar requirement/carrying a leash	Page 7
Termination due to illness/injury	Page 8
Muzzle obligation	Page 8
Permission to enter a trial	Page 8
Temperament Test	Page 9
Evaluation	Page 10
Disqualification	Page 11
Helps	Page 11
Evaluation	Page 12
Working title	Page 12
Scorebook	Page 12
Liability	Page 13
Vaccinations	Page 13
Trial days	Page 13
Trial supervision	Page 14
Awards ceremony / trophies	Page 14
Helper regulations	Page 14-18
Disciplinary rights	Page 18
“TSB” evaluation - Phase “C” (valid for all trial levels)	Page 19
Special rules	Page 19
World Championship	Page 19
Temperament evaluation	Page 19-20
Companion trial with temperament test and documentation check for the dog handler	Page 21-28
A-Utility Dog Trial 1 to 3 (Apr 1-3)	Page 29
Tracking 1 to 3 (FPr 1-3)	
Obedience 1 to 3 (UPr 1-3)	Page 29
Defense 1 to 3 (SPr 1-3)	Page 29-30
Breed suitability test (IPO ZTP)	Page 31-39
International Utility Dog trial – IPO-VO	Page 40-46
International Utility Dog trial – IPO -1	Page 47-67
International Utility Dog trial – IPO -2	Page 67-87
International Utility Dog trial – IPO -3	Page 88-111
Tracking Dog trial – Level 1 - FH 1	Page 112-114
Tracking Dog trial – Level 2 - FH 2	Page 115-117
International Tracking Dog trial - IPO-FH	Page 118-121
Article Indication Trial 1-3 (StPr 1-3)	Page 122-125
Attachments for IPO layouts	Page 126-128



### **General abbreviations**

FCI – Federation Cynologique Internationale	PL - Trial Secretary
IPO – International Trial Rules	HL - Helper
LAO – National Organization	HF - Handler
AKZ – Training degree	FL - Track layer
LR – Trial judge	HZ - Verbal Command

### **Reference:**

Under the text the designated commands have to be translated into the respective commands of the country.

As soon as this trial ruling takes effect, all previous rules lose their validity. The German text is the official version and binding for translations.

### **General Part:**

#### **Validity:**

These regulations were drawn up by the FCI Utility Dogs Commission and were approved and confirmed by the FCI General Committee in **Rome, Italy on 13<sup>th</sup> of April 2011**. They are effective from **January 1, 2012** and replace all previous rules.

The regulations were written German language and approved by the Commission. In case of uncertainty, the German text takes precedence over other language translations.

The regulations are valid for all FCI members and contract partners.

All international trial events in terms of training and competitions are subject to these regulations.

### **General information**

Trial events and competition should serve two purposes. After passing a test, the individual dog should receive recognition for its' particular purpose while on the other hand the working trials contribute to the overall health and work ethic of the dog in regards maintaining his utility from generation to generation and/or to increase it. They also play a part in promoting health and fitness. Passing a trial serves as proof that the dog is breed worthy.

The National Organization is encouraged to promote the IPO. Especially international competitions should be conducted under the IPO concept. All trials and competitions are subject to the proper execution and behaviour of those participating under the sportsmanlike rules. The rules governing the regulations are binding. All participants have to meet the same working degree demands. The trials are to be made public advising the place and start time to the members.

Trial events and competitions must correspond with complete trial levels or individual complete phases of the respective trial levels. Only one completed trial level passed in an event will count as a title. The titles must be accepted by all FCI member countries.



**In countries where laws prohibit the stick test, these regulations can be implemented without it.**

### **Trial Season**

Trials may be conducted year round if weather conditions are conducive and the well-being of both handler and dog are not at risk. Otherwise, the event cannot be held. This is the sole decision made by the trial judge. The individual national organization can impose restrictions regarding the trial season for their area.

### **Trial Organization / Trial Secretary (PL)**

The Trial Secretary (PL) is responsible to organize the event. He/she finalizes and supervises all required levels of work to prepare and conduct a trial. He/she must guarantee the orderly execution of the event and must be at the judge's disposal for the duration of the event.

The Trial Secretary (PL) may not show a dog or accept other duties. He/she is responsible for:

- Obtaining the necessary event documents
- Locating suitable tracking fields for all trial levels according to the rules
- Make arrangements with the property owners of the tracking fields and park ranger
- Having experienced volunteers available such as helpers for protection, tracklayers, group, etc.
- Obtaining the event authorization
- Make available the required equipment and proper protection gear for the helper.
- Make available the written forms such as judges trial sheets, trial lists for all levels.
- Have available the scorebooks, pedigrees, vaccination certificates and if necessary proof of insurance.

Three days in advance, the Trial Secretary (PL) must inform the judge (LR) the location, start times, directions, type of trial and number of dogs entered. Failure to provide this information can result in the judge (LR) declining to officiate.

The event authorization is to be provided to the judge (LR) prior to the start of the trial.

### **Trial Judges (LR)**

Judges (LR), who are authorized to judge an IPO event, can be invited by the hosting club or as determined by the National Organization (LAO). In regards to world championships, the judge (LR) can be requested through the FCI Utility Dogs Commission. The number of judges (LR) invited is up to the hosting club, whereby any given judge may only judge up to a maximum of 36 individual phases per day (not valid for world championships).

FPr Level 1-3	equivalent to one phase
UPr Level 1-3	equivalent to one phase
SPr Level 1-3	equivalent to one phase
StPr Level 1-3	equivalent to one phase
BH/VT	equivalent to 2 phases
IPO-VO IPO ZTP	equivalent to 3 phases
IPO-1, IPO-2, IPO 3	equivalent to 3 phases
FH 1 – FH 2	equivalent to 3 phases



IPO-FH equivalent to 3 phases

For major events scheduled by the National Organization (LAO), special regulations can be established.

Trial judges (LR) are not permitted to judge dogs that are in his ownership or are in his possession, or dogs whose owners reside with him, or dogs that are owned by another person of the same household.

A trial judge is not permitted to handle a dog in a trial in which he is officiating as a judge.

The trial judge (LR) is not permitted to disturb or influence the work of the dog through his behaviour. The trial judge (LR) is responsible for the compliance and correct adherence to the governing rules. He is authorized to terminate the trial by failure of compliance of the rules and his instructions are not complied with. In such cases, the judge must provide a written report to the appropriate office of the National Organization.

The trial judge (LR) is authorized to disqualify a handler in the event of unsportsmanlike behaviour, carrying of motivational articles, non-compliance with the rules, non-compliance with animal rights regulations, and anything against the local cultural customs. A premature termination of a trial must be annotated in the scorebook. In the event of a disqualification all acquired points will not be recognized.

The judge's decision is final and incontestable. Any form of criticism concerning the decision, can lead dismissal from the site and eventually lead to disciplinary measures. In justified cases, not based on factual decisions, rather violations of the rules by the judge (LR), a complaint may be submitted within 8 days of the occurrence. This complaint must be made in writing, whereby the plaintiff and at least one witness signs it and submits it via the trial secretary of the hosting club or the National Organization (LAO). Filing a complaint does not automatically lead to a dismissal of the judge (LR)'s decision. The decision concerning a complaint affects the National Committee (LAO), who can submit the claim to the FCI Utility Dogs Commission, who makes the final determination.

### **Trial Participants**

The trial participant must meet the entry deadline for the event. The participant also agrees to pay the entry fee upon submission of the entry form. If the participant cannot participate for whatever reason, he/she must advise the Trial Secretary (PL) immediately. The participant is required to provide the vaccination certificate and uphold the animal rights regulations. The participant must adhere to the instructions of the judge (LR) as well as the Trial Secretary (LR). The handler must present his/her dog in a sportsmanlike manner and regardless of the results in any given phase, he is obliged to continue for the remaining phases of the event. The trial ends with the results (awards ceremony) and the return of the scorebook.

The judge (LR) is authorized to terminate a performance due to injury or incapacitation of the dog, even if the handler (HF) does not concur. If a handler (HF) pulls his/her dog, then the notation of "insufficient due to termination" is entered into the scorebook. If a handler (HF) pulls his/her dog with a noticeable injury or upon presentation of a veterinarian certificate, then the scorebook is annotated with "termination due to illness". The trial judge (LR) is permitted to terminate the performance in view of unsportsmanlike behaviour on the part of the handler (HF), carrying of motivational articles, violations against the trial rules or against the rules of the animal rights provisions and against any cultural customs. A premature termination is to be noted in the scorebook with the respective reason. All earned points will not be acknowledged in the event of disqualification.



The handler (HF) must carry a leash with him throughout the trial. This includes that the dog wear a simple, single-row loose-fitting choke collar, which is not hooked to the live setting. Other collars, such as leather collars, flea/tick collars, pinch collars, etc. are not permitted during the trial. These rules do not apply to the BH trial with the behavioural test, as here other collar attire is permitted.

The trial begins with the temperament test and is maintained for the duration of the trial including the awards ceremony. The leash can be hidden or worn over the left shoulder to the bottom right.

Commands that are embodied in the trial rules are spoken in a normal, short and in a one word manner. They may be done in any language, however must remain the same for an exercise. (valid for all phases). The commands provided in the rules are suggestions. The same word is to be used for the same exercise.

If several participants enter the trial level, then a draw must take place to determine starting positions.

The minimum number of participants is four. A single entry is not permitted.

A dog handler who is handicapped and unable to show his dog on the left side, may show him on the right side. In such cases, the previously outlined rules take precedence in the manner in which a dog is to be shown in regards to showing on the right as opposed to on the left.

Each title may be repeated as often as one likes, the tests are to be taken in sequence of 1 – 2 – 3. In order for a handler to participate in the next higher level, he must have successfully passed the previous lower one. The dog must always be shown in the next highest level, except when a when a trial is not connected to a qualification or ranking.

### **Collar requirement / Carrying a leash**

Due to insurance liability reasons the handler is to carry a leash with him for the duration of the trial. It can be worn around the handler (clasp side away from the dog) or out of sight, this includes that the dog is to always have a collar on. The judge, therefore, must maintain a visual check that this is the case at all times. The choke collar may not have spikes, claws or other hooks. It must be worn loose. So-called flea/tick collars must be removed prior to the trial.

The type of choke collar, especially in regards to its weight, may not deviate from the normal marketed products. If suspicion arises, then the judge can request that the collar be changed. This, however, must take place prior to beginning the phase. If suspicion also arises as to fraud in view of a spiked collar or the like, the judge will disqualify the handler from further testing.

**Entry in the scorebook: "Disqualification due to unsportsmanlike conduct"**

All previous points are deleted.

For the Tracking phase the dog may wear a harness in addition to the choke collar or a vest.

If the dog is injured during the trial or his work ability is restricted in some way, the judge reserves the right to terminate the trial for this dog, even against the protest of the handler.



### Termination due to illness/injury

If a dog presented for a trial is sick, this is to be handled in the following manner:

If the handler (HF) reports in after having completed a phase with a sick dog, he is to go to the vet and obtain a certificate. Entry in the trial documentation "Terminated due to illness". If the handler (HF) refuses to go to the vet, then the entry is to be shown as: "Insufficient due to termination". The certification may be sent retro-actively. If the handler (HF) does not submit this certificate within 4 days, the judge (LR)'s entry in the scorebook remains as "Insufficient due to termination". The scorebook will be returned to the handler (HF). If the handler (HF) refuses to leave the scorebook with the judge (LR), then the entry "Insufficient due to termination" will be immediately recorded. The handler (HF) is responsible for any costs in connection with the return of his scorebook.

**Remark:** It remains clear that the judge (LR) himself can decide to terminate if he determines that the dog is according to him sick or injured. The same applies to older dogs who due to animal rights laws may not be able to continue. Entry in scorebook: "Termination due to injury".

### Muzzle obligation

The requirements for having a dog in public is mandated by the laws of the individual countries laws. Handlers (HF), who are bound by these laws, may show their dogs in the BH/VT test with a muzzled dog.

If the dog is injured during the trial or in some way is unable to perform due to work ability restrictions, the judge (LR) must terminate the trial for this dog even against the protest of the handler.

### Permission to enter a trial

On the day of testing, the dog must have met the required age limit. No exceptions are permitted. The dog is required to have passed the BH-VT in accordance with the rules set forth by the LAO.

BH/VT - IPO-VO	15 months	IPO – 1	18 months
IPO ZTP	15 months	IPO – 2	19 months
FPr 1-3	15 months	IPO – 3	20 months
UPr 1-3	15 months	FH 1	18 months
SPr 1-3	18 months	FH 2	18 months
Article search (StPr 1-3)	15 months	IPO-FH	20 months

Under the signs FPr 1-3 one has to understand the single exercises of tracking according to the IPO, under the signs UPr 1-3, the single exercise in obedience according to the IPO 1-3 and under the signs SPr 1-3, the exercises in protection according to phase C of the IPO rulebook.

These exercises can be tested as single phases, without getting any official certificate.

All dogs regardless of size, breed or heritage may participate at a trial. The dog must be in a position to complete the requirements of the IPO.





A handler (HF) may only participate in one trial a day. A dog handler (HF) may only show maximum 2 dogs at a given trial. A dog may only achieve one title at a trial.

Exception: BH/VT and IPO level 1 or FH 1.

Females in heat may participate at all trail events, however, must be shown separately from the other handlers' dogs. In phase A, they will run according to the time frame, but in the remaining phase they will be shown at the end. Females, who are visibly pregnant or who are nursing or who have puppies with them, may not be trailed.

Sick and dogs suspect of contagious disease are excluded from all trail events.

## **Temperament test**

### **Executing the temperament test**

Before the trial starts, prior to the first phase, the judge (LR) has to conduct an impartiality test on the dog. This is to include the identity inspection (e.g.: checking the tattoo or the chip, etc.). Furthermore, dogs that do not pass this part of the test may not participate in the trial or for that matter be disqualified. Owners whose dogs are chipped are responsible for having a chip reader available.

In addition to this, the judge (LR) observes the temperament of the dog during the course of the entire trial. The judge (LR) is required to terminate any dog who displays faulty temperament. This must be recorded in the scorebook. Dogs that are disqualified due to faulty temperament must be reported to the National Organization in written format.

### **Execution of the temperament test**

1. The temperament test must be performed under normal environmental conditions in a neutral location for the dog.
2. All participants must present their dogs separately to the LR.
3. The dog is to be presented with a regular leash. The leash must be held loosely.
4. The judge (LR) must avoid any provocation. The dog has to accept to be touched.

### **Judgment**

- a) Positive behaviour of the dog: The dog conducts himself in neutral, self-confident, sure, attentive, energetic, impartial manner.
- b) Still acceptable borderline cases: The dog is slightly unstable or slightly nervous, slightly insecure. These dogs are still permitted to trial, but are to be closely monitored for the duration of the trial.
- c) Negative behaviour of the dog or faulty temperament: the dog that is shy, insecure, scared, gun-sensitive, out of control, that bites or that is aggressive will be disqualified.

**Evaluation**

The evaluation of the performance is noted with ratings (qualification) and points. The rating (qualification) and the corresponding points must reflect the quality of the respective exercise.

Point table:

Highest points	Excellent	Very good	Good	Satisfactory	Insufficient
5,0	5,0	4,5	4,0	3,5	3,0 – 0
10,0	10,0	9,5 - 9,0	8,5 - 8,0	7,5 - 7,0	6,5 – 0
15,0	15,0 - 14,5	14,0 - 13,5	13,0 - 12,0	11,5 - 10,5	10,0 – 0
20,0	20,0 - 19,5	19,0 - 18,0	17,5 - 16,0	15,5 - 14,0	13,5 – 0
30,0	30,0 - 29,0	28,5 - 27,0	26,5 - 24,0	23,5 - 21,0	20,5 – 0
35,0	35,0 – 33,0	32,5 – 31,5	31,5- 28,0	27,5 - 24,5	24,0 – 0
70,0	70,0 - 66,5	66,0 - 63,0	62,5 - 56,0	55,5 - 49,0	48,5 – 0
80,0	80,0 - 76,0	75,5 - 72,0	71,5 - 64,0	63,5 - 56,0	55,5 – 0
100,0	100,0 - 96,0	95,5 - 90,0	89,5 - 80,0	79,5 - 70,0	69,5 – 0

**Calculation of percentage**

Evaluation	Awarded percentage	Deduction
<b>Excellent</b>	= at least 96 %	or up to minus 4 %
<b>Very Good</b>	= 95 to 90 %	or minus 5 to 10 %
<b>Good</b>	= 89 to 80 %	or minus 11 to 20 %
<b>Satisfactory</b>	= 79 to 70 %	or minus 21 to 30 %
<b>Insufficient</b>	= under 70 %	or minus 31 to 100 %

During the evaluation of a particular phase only full points are to be awarded. However with individual exercises, partial points can be given. For final results if points are awarded with partial levels, then they can be either rounded up or down.

In case of a tie, then the highest points in level C prevail. If these are the same, then the highest points in level B prevail. Scores that coincide in all three phases are to be listed as an equal placing.



### Disqualification

If a dog leaves the handler (HF) or the field and does not return after three commands, the dog will be disqualified.

All points awarded up to that point of disqualification will be deleted. No points or ratings will be entered into the scorebook. If a judge determines that the dog has faulty temperament, unsportsmanlike behaviour on the part of the handler (e.g. alcohol, carrying motivational objects and/or food), violations of the rules, violations against the animal rights laws or violations against the cultural customs, the team will be disqualified from further testing.

If the dog is out of control of the handler (e.g. side/back transport, the dog leaves the handler or the field during the trial and does not return after three commands, the dog does not out; the dog grips the helper anywhere other than the sleeve) then this team likewise is disqualified from further testing.

Conduct	Consequence
<ul style="list-style-type: none"><li>• Unsportsmanlike behaviour of the handler e.g. carrying motivational objects and/or food</li><li>• Violations against the trial rules, animal rights laws, or cultural customs</li><li>• Suspicion of fraud in collar use e.g. hidden spikes, rubberband, etc.</li></ul> <p>Is valid for the entire trial area</p>	<p>DISQUALIFICATION and non-recognition of ALL achieved points, no rating.</p> <p>NO CRITIQUE!!!</p>
<p>Not passing the temperament test</p>	<p>DISQUALIFICATION due to lack of proper temperament and non-recognition of ALL achieved points, no rating</p> <p>NO CRITIQUE!!</p>
<p>Dog leaves the handler and the field and does not return after three commands</p>	<p>DISQUALIFICATION, no-recognition of all achieved points, no rating</p> <p>NO CRITIQUE!!</p>

### Helps

The prescribed mandatory deductions in the trial rules are to be taken into consideration. If a handler helps his dog, these have to be decided upon and to deduct.



## Evaluation

A trial is considered as “passed” when the dog has received a minimum of 70% of the possible points.

Highest Points	Excellent	Very Good	Good	Satisfactory	Insufficient
100 points	100-96	95-90	89-80	79-70	69-0
300 points	300-286	285-270	269-240	239-210	209-0
200 points (APr)	200-192	191-180	179-160	159-140	139-0

## Working Title

The title “International Working Champion” (CIT) will be granted by the FCI by application of the handler (HF) through the National Organization (LAO).

The CACIT award and the Reserve CACIT for dogs are provided at competitions that have received permission from the FCI and for dogs which were presented at the highest level (Class 3). All FCI National Organizations (LAO) must be invited to a CACIT event. A minimum of 2 judges (LR) must be invited with one judge being from another National Organization (LAO). The awards are granted upon proposal of the judges (LR). The CACIT and Reserve CACIT can only be awarded to dogs under these recommendations:

- The minimum show rating “very good” has been achieved at a show event.
- At the trial the minimum rating of “Very Good” was received. The award is not automatically linked to the achieved rating.
- The dog breeds belonging to groups 1, 2 and 3 of the Breeds Nomenclature of the FCI which are subject to a working trial (utility and tracking dogs)

The title “National Working Champion” will be regulated through the National Organization (LAO).

## Scorebook

A scorebook is mandatory for every participating dog. Issuance of the scorebook is done according to the instructions of the handler’s corresponding National Organization. Important to note, only one scorebook may be issued per dog. This is the responsibility of the issuing organization. The trial results must be recorded in the scorebook under all circumstances by the judge (LR) as well as the Trial Secretary (PL), who is to double check the entry and sign the book.

As from 2012 it will be required that the following entries be made: Members number, name and breed of the dog, identification of the dog (tattoo nr. / Chip Nr.) Name and address of the owner of the dog, entry of the total points in Phase A, B and C, qualification and TSB rating. Name of the judge and his signature.



## Liability

The owner of the dog is liable for any personal injury or material damage caused by his/her dog. Therefore, he/she must have adequate coverage for such cases. In the event of an accident during the trial, the handler (HF) is liable for himself/herself and his/her dog. The handler (HF) is to concur with the instructions of the judge (LR) and the organizing club and thereby executes of his/her own free will the instructions at his/her own risk.

## Vaccinations

Proof of vaccinations as performed by a certified authority (vaccination certificate) must be presented to the judge (LR) or the Trial Secretary (PL).

## Trial Days

### a) Saturday, Sunday and Holidays

Trial days are generally on the weekend as well as legal Holidays.

BH/VT tests can also only be done on official trial days.

It is possible to trial for the BH/VT and the IPO-1/FH 1 tests in tandem with a two day trial (Friday-Saturday), (Saturday-Sunday) at one or 2 different clubs. A waiting time between the BH/VT and IPO-1/FH 1 does not exist.

Example: Friday Saturday BH, Sunday Saturday IPO-1 or FH 1

### b) Friday Trials

A Friday trial day may only be in tandem with a Saturday trial.

**Remark:** Friday can only be secured if more dogs are presented on Saturday than can be accommodated.

Start time is not before 12:00 noon. The participant number for the IPO/FH is condensed to half.

For pure BH/VT trials up to 7 dogs may be tested.

A Friday trial in tandem with a Saturday trial secured for IPO/FH tests must end on Saturday.

Individual dogs may also complete their trial on Friday.

**Exception:** If participants, who plan on trailing their dogs on Friday for the BH/VT test, they may start on Friday if then on Saturday they test for IPO-1 or FH 1 and there is no "overage" in the number of participants. Be attentive to the event authorization regulations.

### c) Holiday regulations

On Holidays the about information can be analogous.

**Exception:** Be attentive to the rules governing Holidays for individual countries as well as FCI-MV guidelines.

Half days prior to a Holiday that fall within a week cannot be secured.



## **Trial supervision**

National Organizations (NAO) of the FCI is entitled to supervise. The National Organization (NAO) of the FCI can assign a knowledgeable person to oversee an event to ensure that the event is conducted in accordance with the regulations as stated in the regulations.

## **Awards Ceremony / trophies**

Award ceremonies are to be held separately after the various trial phases.  
IPO 1 – 3, FH 1, FH 2, IPO-FH, BH/VT – Tests

If the same number of points are awarded to more dogs in the IPO level 1 -3 the result of the phase C is the deciding factor. If the points awarded here are the same, then phase B is the deciding factor. If points result equally for all phases, then all dogs receive the same rating. Repeat performances will not be taken into consideration and will be placed at the end. Generally, all participants are to be present at the awards ceremony. The trial ends officially with the award ceremony and handing out of the trial paperwork.

## **Helper Regulations**

### **A) Pre-requisites for employment as a helper in Phase “C”**

1. The guidelines and regulations of the trial rules regarding help work must be followed.
2. The helper (HL) in phase “C” is the assistant to the judge on the day of the trial.
3. In view of his personal protection as well as due to insurance liability, the helper, whether in training or on a given trial day or competitions, must wear protective clothing, (protection pants, protection jacket, sleeve, cup, and if necessary gloves).
4. The helper (HL)'s shoes must be weather-proof and suitable for the ground conditions, secure stance and ensure good traction.
5. Prior to the trial work in phase “C”, the helper (HL) receives instructions from the judge (LR). He must perform the work in accordance to the judge's instructions.
6. The helper (HL) must follow the instructions of the handler (HF) during disarming/search of the helper in accordance with the trial rules. He must give the handler (HF) the opportunity to position his dog in the correct heel position for the side/back transport.
7. The handler may work with the helper (HL) at club trials. If there are more than 6 dogs, then 2 helpers (HL) are required. For trials at a National level, such as competitions, qualification trails, championships, etc. generally 2 helpers (HL) are mandatory. For all or any of these trials, a helper (HL) living in the same household as one of the handlers (HF) may participate.

### **B) Regulations governing the conduct of trial helpers.**

#### **1. General:**

During a trial the level of training, the quality of the dog being presented (e.g. his drives, stress-level, self-confidence and obedience) should be evaluated by the judge. The judge (LR) can objectively evaluate what he/she visually and acoustically observes during the course of the trial.

This aspect, particularly maintaining the sportsmanlike character of the trial (i.e. this means offering the same conditions for all participants) ensures that the helper offers the judge (LR) a broad impartial picture to the judge.

Therefore, it cannot be left up to the help (HL) how the phase “C” work is to be structured. Furthermore, the helper must follow definitive regulations.

The judge (LR) must check that the individual elements of the most important evaluation criteria for phase “C” are met. For example, these are, stress-level, self-confidence, drives, obedience. In addition hereto, the grip quality of the presented dog is evaluated. So that the judge can properly evaluate the grip, the helper must give the dog the opportunity to have a “good grip”, and where the stress-level is to be tested, the helper must be able to put proper pressure on the dog. The helper must strive to have the most uniform level of helper work, so that the requirements of the evaluation are met.

## **2. “Bark and Hold”**

The helper stand – not visible for the dog and handler – with a slightly angulated sleeve position motionless und without a threatening body position in a designated blind. The sleeve acts as body protection. At the hold and bark, the dog is to watch the helper, any motivation on the part of the helper is not allowed. The soft stick is held at the helper’s side.



## **3. “Prevention of an attempted escape of the helper”**

After the hold and bark exercise, the handler calls the help out of the blind, who is to exit in a normal pace and places himself/herself at the designated spot as assigned by the judge (marked spot). The position of the helper must ensure that the handler can place his dog at a distance of 5 paces on the side where the helper’s protection sleeve is at the helper’s designated spot. The flight path must be clearly recognizable for the handler.

Under the direction of the judge, the helper escapes in a quick and assertive pace in a straight line, without running in an uncontrolled or exaggerated manner. The sleeve must remain steady and the dog should be given an optimal grip possibility. The helper may not turn to face the dog at any time, but can keep the dog in his/her field of vision. The helper must refrain from pulling the sleeve away. Once the dog has gripped, the helper continues to run in a straight direction, and while running pulls the sleeve in tight to his/her body.



The judge determines how far the helper needs to escape. Under the direction of the judge, the helper terminates the escape. When the corresponding dynamic work of the helper is carried out, it provides the judge with the optimal opportunity to evaluate the performance. Any type of helper assistance in the way of, excessive offering the sleeve before the grip, verbal agitation, or hitting the soft stick against his pants before or during the escape, limply held sleeve position, reducing the speed of the escape independent termination of the escape, etc., are not permitted.

Stopping the exercise – see point 8 (valid for all exercises)

#### **4. “Defense against an attack during the guarding phase”**

After the guarding phase, the helper makes an attack on the dog at the instructions of the judge. The soft stick is used in a threatening motion above the sleeve without hitting the dog. At the same moment, the dog grips in a frontal and forward movement with corresponding resistance, without the sleeve being set into motion. The protection sleeve will be carried tight and in front of the body. Once the dog has gripped, he is to be placed out of motion to the side and the pressure phase begins in a straight direction. Turning at the start of this exercise is not permitted. The helper must drive all dogs in the same direction. It is important that the judge must place himself/herself in such a position so as to observe and evaluate the behaviour of the dog during the attack, the pressure phase, the grip behaviour, the out and the guarding phase. Driving the dog to the handler is not permitted.

The stick hit pressure tests are to be placed on the shoulder and in the area of the withers. The stick hits are to be executed with the same intensity for all dogs. The first stick hit test is performed after approximate 4 – 5 paces, the second stick hit test after an additional 4 – 5 paces during the pressure phase. After the second stick hit test, additional pressure is demonstrated without stick hits.

The duration of the pressure phase is determined by the judge. Under the direction of the judge, the helper terminates the pressure phase. When the corresponding dynamic work of the helper is carried out, it provides the judge with the optimal opportunity to evaluate the performance. Any assistance given by the helper in the way of offering Any type of helper assistance in the way of, offering the sleeve before the grip, verbal agitation, or hitting the soft stick against his pants before or during the escape, limply held sleeve position after the grip during the pressure phase, inconsistent intensity during the pressure phase and at the stick hits, independent termination when weakness is determined in the dog etc., are not permitted.

Termination of the exercise – see point 8

#### **5. “Back transport (Trial levels 2 + 3)”**

Under the direction of the handler, the helper demonstrates a back transport over a distance of approximately 30 paces at a normal pace. The judge determines the course of the transport. The helper may not any sudden moves during the transport. The soft stick and the sleeve are to be carried in such a way that it does not stimulate the dog. The soft stick especially has to be carried out of sight. The helper is to move at the same pace for every dog.





**6. “Attack on the dog out of the back transport (Trial levels 2 + 3)”**

The attack out of the back transport is performed out of motion and under the direction of the judge. The helper performs the attack by making a dynamic left and right turn and running with purpose towards the dog. The soft stick is to be held above the sleeve and swung in a threatening motion. The dog has to be intercepted with a flexible position of the protection sleeve, whereby the helper cannot come to a halt. Upon intercepting the dog, the body should – if possible – turn in order to catch the dog and flow with his body movement. Additional movement of the sleeve is to be avoided. Once the dog grips, the helper places the dog out of motion to the side and the pressure phase is conducted in a straight direction. The helper must drive all dogs in the same direction. It is important that the judge must place himself/herself in such a position so as to observe and evaluate the behaviour of the dog during the attack, the pressure phase, the grip behaviour, the out and the guarding phase. Driving the dog to the handler is not permitted.

The duration of the pressure phase is determined by the judge. Under the direction of the judge, the helper terminates the pressure phase. When the corresponding dynamic work of the helper is carried out, it provides the judge with the optimal opportunity to evaluate the performance. Any assistance given by the helper in the way of offering Any type of helper assistance in the way of, offering the sleeve before the grip, verbal agitation, or hitting the soft stick against his pants before or during the escape, limply held sleeve position after the grip during the pressure phase, inconsistent intensity during the pressure phase and at the stick hits, independent termination when weakness is noticed in the dog etc., are not permitted.

Termination of the exercise – see point 8

**7. “Attack on the dog out of motion”**

Under the direction of the judge (LR), the helper leaves the assigned blind and moves at a running pace to the centreline without breaking stride and with threatening verbal and gestures attacks the dog and handler with a frontal attack with the soft stick.

The dog must be intercepted with the helper not stopping and presenting a flexible sleeve. Upon intercepting the dog, the body should – if possible – turn in order to catch the dog and flow to maintain the momentum. The helper may not in any way run around the dog. Once the dog grips, the helper places the dog out of motion to the side and the pressure phase is conducted in a straight direction. It is imperative to avoid overrunning the dog. The helper has to drive all dogs in the same direction. It is important that the judge must place himself/herself in such a position so as to observe and evaluate the behaviour of the dog during the attack, the pressure phase, the grip behaviour, the out and the guarding phase. Driving the dog to the handler is not permitted.

The duration of the pressure phase is determined by the judge (LR). Under the direction of the judge, the helper terminates the pressure phase. When the corresponding dynamic work of the helper is carried out, it provides the judge with the optimal opportunity to evaluate the performance. Any assistance given by the helper in the way of offering any type of helper assistance in the way of, slowing down the speed of the attack, intercepting the dog at a stand, side-stepping the dog before the grip, holding the sleeve in a limp fashion after the grip, varying intensity of the pressure phase, independent termination when weakness in the dog is noticed, etc. are not permitted.



Termination see point 8 (valid for all exercises)

**8. “Termination of the defence exercise”**

Stopping all defence exercises must be conducted in such a manner that the judge (LR) has the opportunity to observe the grip, the out and the guarding phase of the dog (do not turn your back to the judge (LR), maintain visual contact with the judge (LR)). Once stopping the defence exercise, the helper must minimize the resistance towards the dog, he/she has to reduce the stimulation by not definitively moving the sleeve. The sleeve is not to be carried at a high angle, but will be held in the same position during the previous exercise. The soft stick is held out of sight at the side. No help is to be provided by the helper during the out phase. After the out, the help is to maintain eye contact with the dog, whereby any additional stimulation or help of any kind is not permitted. In order to maintain eye contact to the dog, the helper is allowed to turn for a dog that circles, but without any sudden movements.

**9. “Insecurities and failure of the dog”**

A dog that does not grip during a defence exercise, or releases the grip in a pressure phase and outs, must be driven by the helper until the judge (LR) terminates the exercise. In such instances, the helper may not give any help to the dog or stop the exercise independently. Dogs that do not release, the helper may not use the soft stick in movement to get him to out. Dogs that have a tendency to leave the helper during the holding phase may not be stimulated by the helper to stay with the helper. In all or parts of any exercise the helper must present himself/herself active or neutral in accordance with the trial rules. If the dog bumps or grips during the holding phase, the helper must avoid making any defensive motions.

**Disciplinary rights**

The trail Secretary is responsible to guarantee order and the safety in the entire trial area.

The judge (LR) is authorized to terminate the trial if the order and safety is compromised in any way. Violations by the handler against the prevailing rules, against the trial rules, against the animal rights laws and against the cultural customs will lead to a termination of the trial.

The decision of the judge (LR) is final and incontestable. Any critique concerning the decision can result in expulsion from the trial area and lead to further disciplinary action. In documented cases, that do not relate to factual decision rather are violations against the rules of the judge, a complaint may be submitted. This complain, must be done in writing to the respective club/organization.

It can only be turned in via the head of the club and must be signed by the complainant, the chairman of the club and an additional witness. This complaint needs to be done within 8 days after the trial. Acceptance of such a complaint does not mean that the decision of the judge will be revoked and video clips are not considered as proof.



### **TSB Evaluation – Phase “C” (valid for all trial levels)**

The TSB evaluation should describe the temperament characteristics of the dog for breeding purposes. The TSB has no influence over the final result of the trial or a placing. To achieve a TSB evaluation, the dog must have been completed at least one protection phase.

The ratings pronounced (a), present (vh) and not sufficient (ng) the following characteristics are described: **Drive, self-confidence and stress-tolerance.**

#### **TSB – “pronounced”**

is given to a dog that displays a strong willingness to work, clear instinctive behaviour, goal-oriented determination in the exercises, self-confident manner, unrestricted attention and exceptional ability to handle stress.

#### **TSB – “sufficient”**

Is given to a dog that is restricted in his willingness to work, the instinctive behaviour, in self-confidence, his attention and stress tolerance.

#### **TSB – “insufficient”**

Is given to a dog that lacks a willingness to work, lacking instinctive behaviour, lacks self-confidence and insufficient stress-tolerance.

### **Special rules**

The National Organizations (LAO) of the FCI are authorized to enhance their general regulations, e.g. entry requirements, veterinarian, animal rights, medical regulations or any rules governed through the country. Commands may be given in the country’s language.

### **World Championship**

The Specifications for the organization of the various world championships of the FCI are valid. The publishing and revision of said specifications are the duty of the Utility Dogs Commission.

### **Temperament Evaluation**

The temperament test is to be conducted throughout the duration of the trial including the awards ceremony. If a dog stands out with a temperament problem, then he cannot pass for this reason even though results up to that point are positive. If a dog fails the temperament test it is to be noted in the records. The dog is disqualified.

1. Principles
  - a) The temperament test takes place prior to each trial.
  - b) The test is to be conducted in a neutral place. In the selection of the place, there should be no close connection to the trial or tracking fields.
  - c) Every dog is to be evaluated independently.



- d) The time-frame should be such that the dog is not immediately to start tracking or go on the trial field.
- e) The dogs are to be on leash (short leash – without tracking harness, etc.). The leash is to be held loose. Commands are not to be given.

Following rules are to be adhered to during the evaluation:

A systematic evaluation is not permitted, it is up to the judge to determine the way it is to be conducted, whereby there are not to be extreme variations and the less a judge (LR) tries to make a point, the smoother and safer the test will run.

The evaluation is to be done in a more normal everyday setting, the dog is not to be challenged, as otherwise it would invoke a natural reaction, unnatural stimuli are to be avoided. The identity control is a mandatory part of the temperament test. The temperament test does not only take place at the beginning of the trial, but also during the entire event. If the judge determines a temperament weakness, he has to test it exactly (e.g. gun test). Repetitions are permitted to make a determination, the judge is **not** permitted to touch the dog.

## **2. Conducting the identity control**

The identity control is a mandatory part of the test. This can be done by either checking the tattoo number or using a chip reader for a chipped dog. Dogs that do not have a pedigree or a tattoo number, must be chipped. The judges must note in their records that the control was carried out.

If tattoo numbers are not easily recognizable, those numbers that are needed to be recorded. The tattoo number must coincide with the one entered on the pedigree. If difficulty arises (e.g. unable to read a number), then a remark must be made accordingly.

If chip numbers are not identified through the chip reader, then a remark must be recorded. The dog may compete if it is plausible to determine that the dog was correctly chipped in that country (e.g. a corresponding remark is noted in the LU or health certificate).

Handlers that had their dogs chipped in a foreign country, or who have purchased a dog from another country, are responsible that the appropriate chip reader is made available. Dogs that cannot be definitively identified may not participate in a trial event.

## **3. Results of the temperament test**

### **Positive presentation = passed**

- Dog is self-confident
- Dog is calm, secure and attentive
- Dog is lively and attentive
- Dog is impartial and good-natured

### **Borderline = requires special attention**

- Dog is unsteady but not aggressive and is balanced throughout the trial
- Slightly agitated, but gets calmer throughout the trial

### **Dogs that may not participate in the trial:**

- Insecure and frightened, move away from a person
- Nervous, aggressive, dogs sounding an alarm, fear biters.
- Aggressive, biting dogs.



#### **4. Entries**

A dog that clearly stands out that he has to be removed from the trial the following remarks are to be made: "Disqualification" due to lack of temperament.

All previous given points are to be stricken.

Points are not given, if points were already announced.

#### **5. Banning**

If a dog does not pass the temperament due to lack of temperament, he is removed from the trial. Any resulting conclusions and decisions are to be handled through the organizing club itself.

##### **Dogs that do not show gun-sureness:**

First, it is important to determine that dogs who are gun aggressive, do not fall into this category. The aggressive conduct falls within the temperament evaluation.

If a dog is gun-shy, then he is immediately terminated from the trial. No points will be awarded.

What does one understand under the term "gun-shy?"

- Examples:
- The dog gets up and shows fear and runs away
  - Runs under the same manner to his handler
  - Shows panic and fear and tries to leave the area or leaves it
  - Shows panic and fear and runs wildly around

During the evaluation, it must be determined if the behaviour is due to a training error or if his getting up is not related to the gun shot.

In dubious cases, the judge (LR) is responsible to determine if it is gun sensitivity by having the handler put the dog on leash. From a distance of about 15 paces, the judge (LR) will request additional shots be fired whereby the dog is to be held on a loose leash.

### **Companion trial with temperament test and documentation check for dog handler**

All trials and competitions are subject to the conditions in the execution and conducting of participating sports events. The manner of execution and the respective evaluation is described as follows. The rules are valid for all involved and all participants have to fulfil these requirements.

The events must be made public; the place and start time of the trial is to be openly made known to the members, can only be conducted if the FCI Member organization has obtained the event authorization. The member organizations are bound by this framework of rules.

#### **General rules**

All dog handlers are permitted to participate who have the proof that the written test governing the rules was successfully taken to acquire the FCI certificate, or those who have proof of a locally issued certificate.



Participants, who participate for the first-time in a FCI BH (Begleithund) trial and who do not have proof of the certificate for the written test, must first pass the test on the day of the trial before they are allowed to take part in the practical test.

All dogs of all breeds and size are permitted to participate. The minimum age requirement is 15 months. In order to conduct a BH test at least four dogs must participate in the trial. If the BH test is combined with another phase, then a minimum of four participants must trial (e.g. IPO, FH, BH). The number of participating handlers on any given trial day may vary between 10 and 15 and this is determined by the number of the phases being tested, whereby the limit of 30 may not be exceeded. (BH tests including the written part counts as 3 phases, without the theoretical part it is then considered as 2 phases.

### **Temperament test**

Prior to the BH trial all participating dogs must undergo a temperament evaluation, whereby an identity control of the tattoo number and/or chip number is also to be done. Dogs that have no identification cannot participate in a trial. The evaluation of temperament is carried out for the duration of the trial. Dogs which have not passed the temperament test are excluded from further participation in the trial. If a dog that initially passed the temperament test displays a weakness during the trial, the judge may exclude him from further trailing and makes a notation in the scorebook – “Temperament test/Behaviour test not passed”. A gun test is not conducted for the BH/VT test.

### **Evaluation**

Dogs that did not achieve the required 70% of the point value in level A, may not continue the traffic portion of the test of level B.

At the end of the trial, the point results are not given, but rather only a “pass” of “not passed” will be made known by the judge (LR). The trial is passed if 70% of points are achieved for part A. And the judge states that an adequate level was reached in part B. It is up to the judge (LR), at the request of the hosting club, to place the participants at the awards’ ceremony.

The earned title is not valid for breeding, show breed survey or placement for an exhibition of a member FCI organization. There is no time-frame to repeat this test. Each trial result is independently recorded in the scorebook.

### **A) Companion test on the training field. Total 60 points**

Each Individual exercise begins and ends with the basic position. The dog sits at the left side in a straight, calm and attentive manner next to the handler with his right shoulder blade level with the handler’s knee. Assuming the basic position is only once at the beginning of an exercise. The handler assumes the basic position in a sporty manner. A splay-legged stance is not permitted. The final basic position of the previous exercise may be used as the basic position for the start of the next exercise. Handler body help is not permitted, as this will lead to point deductions. Carrying of motivational articles or toys is not permitted. If a handler is physically handicapped and cannot correctly execute a portion of an exercise, he must bring this to the attention of the judge prior to the start of the trial. If a handicapped handler cannot heel his dog on the left side, then he may do so on the right side.

The judge signals the start of each exercise. Everything else, such as about turns, halts, changes of pace, etc. , is done independently. However, it is permissible to ask the judge for instructions.

Praising a dog is permitted after each exercise is completed. After that the handler may assume a new basic position. There needs to be a definitive break between praise and a new start (approx. 3 seconds). The dog is to be in heel position between exercises.

Sketch: **Healing on leash/Off-leash**

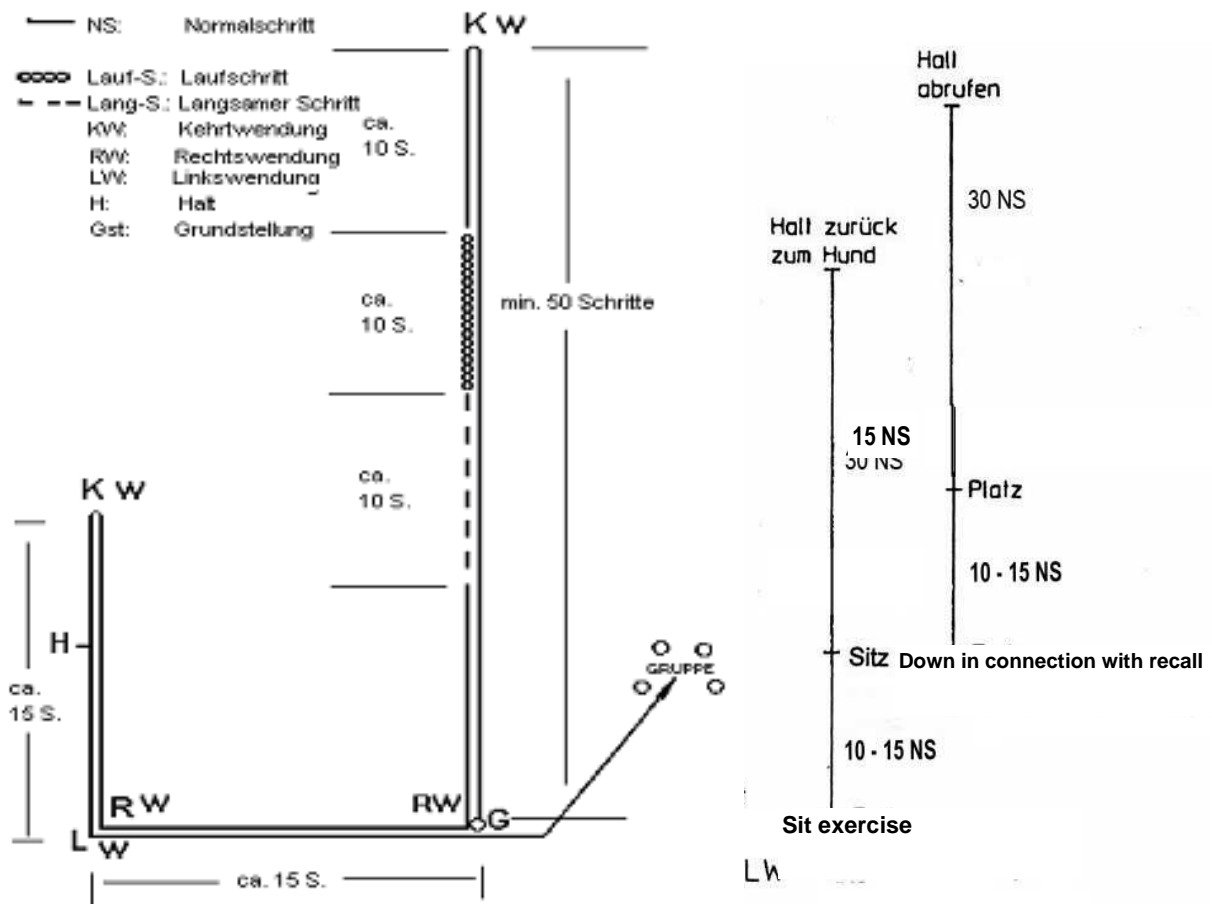

The starting basic position "G" is also the basic position at the end of the exercise. In the group, the DH and his dog has to circle around one person from the left and one person from the right side.



## **1. Heeling on Leash (15 points)**

### **Command “ Heel”**

From the basic position, the dog, wearing a certified commercial collar or harness meeting animal protection laws, is to follow the handler happily on lead. The collar may not be worn on the live ring.

When the second handler, after taken his dog to the place for the exercise “down under distraction” , is in the basic position for this exercise, the first handler has to be also in the basic position and from this moment the examination starts for both dogs.

At the beginning of the exercise, the handler goes out straight to 50 paces with his dog without stopping, does an about turn and after 10 to 15 paces shows fast and slow pace always with the voice command “Heel”. The transition from fast pace to slow pace is to be performed without any transitional steps. At a normal pace at least two right turns, one left and two about turns are to be executed according to the sketch. (As well as halting after the second about turn.

The dog is to remain at the left side of the handler with his shoulder at the handler’s knee height. The about turn is to be executed by the handler as a left about turn.

The halt is to be shown at least once at a normal pace according to the schematic after the second about turn.

The handler is permitted to use the verbal command “Fuss/Heel” when beginning an exercise and when changing pace. When the handler tops the dog is to assume a quick sit without any help from the help from the handler. The handler may not alter the basic position and not move closer to the dog if the dog is positioned away from the handler. The leash is to be held in the left hand during the heeling and must be carried loose. At the end of the exercise and upon instructions from the judge, the handler is to proceed through a group of a minimum of 4 people.

Lagging, forging, heeling wide, slowly sitting near the handler are considered faulty.

### **Group**

Heeling through a group of moving people is to be shown both on- and off leash. The handler must go at least one time to the left and right (e.g. figure 8) around the people. Each time the handler goes through the group, he has to halt at least once near a person. It is up to the judge to request a repeat. On instruction of the judge, the handler and his dog leave the group and assume a basic position. Praising the dog is only permitted after leaving the group and in the final basic position.

### **About turn (180 degrees)**

The about turn is to be demonstrated by the handler at a 180 degree turn in place to the left. There are two variables possible:

- The dog turns behind the handler to the right
- The dog shows a left about turn by turning 180 degrees in place.

Within a given trial only one of the two variables is permitted.





**2. Off-Leash (15 points)**

**Verbal command "Heel"**

Under the direction of the judge the dog is taken off-leash. The handler either hangs the leash over his shoulder or puts it in his pocket (in either case away from the side of the dog) and immediately goes back into the moving group of people in order to halt at least one time in the group. After leaving the group, the handler assumes the basic position once again and then begins the off-leash heeling exercise 1.

**3. Sit exercise ( 10 points)**

**Verbal command "Sit"**

From the basic position the handler goes with his free-heeling dog in a straight direction. After a minimum of 10 to 15 paces the handler assumes basic position and commands the dog to "sit" and goes another 15 paces and turns facing the dog. Under the direction of the judge, the handler returns to his dog and places himself on the right side of the dog. If the dog does anything other than sit, for instance lies down or stands, then 5 points are deducted.

**4. Down in connection with recall (10 points)**

**Verbal command "Down – Heel"**

From the basic position the handler goes out in a straight direction after giving his dog the heel command. After 10 to 15 paces the handler assumes the basic position and commands "Platz/Down". He continues another 30 paces and turns facing the dog. Under the direction of the judge the handler recalls the dog to him. The dog is to return happy and quickly and sit close in front of the handler. At the "Fuss/Heel" command the dog is to finish by sitting close next to the handler.

If the dog stands or sits, but otherwise comes perfectly back to the handler, then 5 points will be deducted.

**5. Down under distraction (10 points)**

**Verbal command "Heel " Down" , "Sit"**

Prior to the beginning of phase "B" of the other dog and as per the judge's instructions of a designated area, the handler takes his off-leashed dog and commands "Platz/Down" in a straight lying position and without leaving a leash or other object next to the dog. The handler leaves the dog without looking back and after at least 30 paces remains in sight of the dog with his back turned to him. The dog has to lie quietly without any influence of the handler while the other dog performs exercises 1 through 4. Under the direction of the judge, the handler returns to his dog and stands at his right side. After 3 seconds and at the instruction of the judge, the dog is to assume the sit position quickly and straight at the verbal command to do so.

Restless behaviour of the handler as well as any hidden handler help, restless behaviour of the dog as well as standing/sitting up at the time of pick up results in point deduction. If the dog sits or stands, but does remain in place then only partial point deduction will result.



If the dog leaves the designated area by more than 3 meters prior to the other dog completing exercise 2, then the exercise is evaluated with zero points. If the dog leaves the designated area after the end of exercise 2, it is given partial point for that exercise. If the dog goes towards the handler, when he goes to pick up the dog, there is a up to 3 point deduction.

## **B) Testing in Traffic**

### **General provisions**

The exercises listed below are conducted in a suitable public area outside of the training field. The judge and the trial secretary determine where and how the traffic exercises will be conducted (streets, walkways or squares). Public traffic may not be interfered with.

The execution of this part of the test requires a significant amount of time to complete. The performance requirements may not be reduced by superficially examining a substantial number of dogs.

Points are not awarded for individual exercises of part B. In order to pass this part of the test, the overall impression concerning the behaviour of the dog moving through the traffic and public areas is important.

The following noted exercises are examples and may be modified by the judge depending on the local conditions. The judge is authorized to repeat or modify exercises in questionable cases when evaluating the dog.

### **Trial execution**

#### **1. Encounter with a group of people**

At the instruction of the judge the handler and his on-leashed dog walk a designated stretch of a sidewalk. The judge follows at an appropriate distance.

The dog follows the handler willingly at his left side with a loose hanging leash with his shoulder at knee height of the handler.

The dog is to remain indifferent to the pedestrians and traffic.

A passing pedestrian (previously assigned) will cut off the handler and the dog is to remain neutral and uninfluenced.

Handler and dog continue through the casual group of a minimum of 6 people, whereby one person addresses the handler and shakes his hand. The dog, who receives the "sit" or "down" command by the handler, is to remain calmly in place during the conversation.

#### **2. Encounter with bicyclist**

The on-leashed dog goes with his handler along a path and is overtaken by a bicyclist from behind, who rings a warning bell. After a good distance, the bicyclist turns around and approaches the handler and



dog. Again the warning bell is sounded. Passing is done so that the dog is between the handler and the bicyclist.

The on-leashed dog is to remain neutral towards the bicyclist.

### **3. Encounter with cars**

The handler goes passed several cars with his on-leashed dog. One of the car's engine will be started. With another the door will be slammed shut. While the dog and handler continue, a car will stop next to them. The window will be put down and the handler will be asked for information. The dog is to either "sit" or "down" at the command of the handler. The dog is to remain calm and neutral towards cars and all other traffic noises.

### **4. Encounter with joggers or inline skaters**

The handler walks with his on-leashed dog along a quiet path. A minimum of two joggers pass him without slower down their speed. After the joggers are at a distance, another jogger runs towards the dog and handler and runs passed them without reducing his speed. The dog does not need to be in proper heel position may however not interfere with the passing jogger. It is permitted to have the handler place his dog in a sit or down position.

Instead of joggers, it is permissible to use one or two inline skaters to pass the dog and handler and then approach them from the front.

### **5. Encounter with other dogs**

In passing or encountering another dog and his handler, the dog is to remain neutral. The handler may give and repeat the command "Fuss/Heel" or place the dog in a sit or down position.

### **6. Behaviour of the tethered dog towards other animals when left alone**

Under the direction of the judge the handler walks with his on-leash dog along a relatively low traffic road. After a short distance the handler stops and at the direction of the judge tethers his dog with the leash to a fence, wall or something similar. The handler goes out of sight into a store or a house entrance.

The dog may stand, sit or lie down.

During the absence of the handler, a passing pedestrian walks past with his on-leashed dog at a side distance of approximately 5 paces.

The dog left alone has to remain calm during the absence of his handler. The dog passing by (no dog-aggressive animal is to be used), he is to let pass by without showing aggressiveness (pulling strongly on the leash, constant barking). At the direction of the judge, the dog is picked up.



**Remarks**

It is at the judge's discretion whether he wants to have the individual exercises done at the same location for each dog or if he wants to see only several trailing dogs do individual exercises and then moves on to another testing location and conducts the test in the same way.



**A- Utility Dog Trial 1 to 3 (APr 1-3)**

**Maximum points 200**

The Apr 1-3 Utility Dog trial only consist in phases B and C of the IPO 1-3. The tracking is not to be shown in this examination.

**A title valid for breeding, show breed survey or placement for an exhibition of a FCI member organization is not awarded.**

Maximum points	Excellent	Very Good	Good	Satisfactory	Insufficient
200 points	191 - 200	180 - 190	160 - 179	140 - 159	0 - 139

**Tracking 1 – 3 (FPr 1 – 3)**

The tracking examinations in the levels 1-3 only consist in phase A of the IPO examination levels 1-3. They can be carried out as a supplement of the number of participants, if at least 4 participants will start in the sections BH-VT/ IPO or tracking. The handler is free to choose in which level he will show his/her dog. **A title valid for breeding, show breed survey or placement for an exhibition of a FCI member organization is not awarded.**

Maximum points	Excellent	Very Good	Good	Satisfactory	Insufficient
100 Points	96 – 100	90 – 95	80 – 89	70 – 79	0 - 69

**Obedience 1 – 3 (UPr 1 – 3)**

The obedience examinations in the levels 1-3 only consist in phase „B“ of the IPO examination levels 1-3. They can be carried out as a supplement of the number of participants, if at least 4 participants will start in the sections BH-VT/ IPO or tracking. The handler is free to choose in which level he will show his/her dog.

**A title valid for breeding, show breed survey or placement for an exhibition of a FCI member organization is not awarded.**

Maximum points	Excellent	Very Good	Good	Satisfactory	Insufficient
100 points	96 – 100	90 – 95	80 – 89	70 – 79	0 - 69

The obedience examination is not compulsory to be shown in the sequence 1-3.

**Defense 1 – 3 (SPr 1 – 3)**

The defence examinations in the levels 1-3 only consist in phase „C“ of the IPO examinations levels 1-3.

They can be carried out as a supplement of the number of participants, if at least 4 participants will start in the sections BH-VT/ IPO or tracking. The handler is free to choose in which level he will show his/her dog. **A title valid for breeding, show breed survey or placement for an exhibition of a FCI member organization is not awarded.**



**Remark: trails in only phase „C“ are not allowed**

<b>Maximum points</b>	<b>Excellent</b>	<b>Very Good</b>	<b>Good</b>	<b>Satisfactory</b>	<b>Insufficient</b>
<b>100 Points</b>	96 – 100	90 – 95	80 – 89	70 – 79	0 - 69

The protection examination is not compulsory to be shown in the sequence 1-3.



### **IPO ZTP (Breed Suitability Test)**

**IPO ZTP trial is arranged as follows:**

Phase A	100 points
Phase B	100 points
Phase C	100 points
<b>Total:</b>	<b>300 points</b>

#### **Participating Regulations.**

On the day of the trail event, the dog must have reached the prescribed age. There are no exceptions to be made. Condition to start is a passed BH/VT exam according to the national rules of the country.

#### **IPO ZTP Phase "A"**

**Handler track, minimum of 300 paces, 3 legs, 2 turns (approx. 90degrees) 2 articles belonging to the handle, minimum aged 20 minutes, execution time 15 min.**

Maintaining the track:	79 points
Article (11 + 10)	21 points
Total	100 points

If the dog does not find any article, the evaluation can only be satisfactory.

#### **General rules:**

The judge (LR) or the person in charge of tracking determine the pattern of the track in accordance with the field conditions. The tracks must be laid in varying patterns. It is not permitted to have for each track, for example, the individual turns and articles placed at the same distance from each other. The start must be clearly marked with a marker, which must be placed in the ground to the left of the scent pad.

The order of participants will be down by virtue of a draw in the presence of the judge (LR).

The handler (= tracklayer- HF) has to show the judge (LR) or the responsible track person the articles prior to laying the track. Only well-scented articles of the tracklayer (minimum of 30 minutes) may be used. The handler (=tracklayer - HF) remains for a brief time at the scent pad and then proceeds at a normal pace in the prescribed direction. The turns are also done at a normal pace (see sketch). The first article will be placed after a minimum of 100 paces not within 20 paces before or 20 paces after a turn, on the first or second leg, the last article at the end. The articles must be placed in movement. After the last article is place, the tracklayer is to take several extra steps in a direct fashion away from the track. On any given track different articles must be used (material: e.g. leather, textiles, wood). The articles be approx. 10cm long, 2-3 cm wide and have a thickness of 0,5-1 cm and may not stand out in colour from the terrain. During the track laying, the dog is out of sight.

The judge (LR) and any accompanying persons are not permitted in the area where the dog and handler (HF) have the right to track.



a) One command to: "Such/Track"

The command to "Such /Track" is only permitted at the beginning of the track and after the first article.

b) Execution: The handler (HF) prepares his dog for the track. The dog can track free or on a 10meter line. The 10meter line may be placed over the back, sideways or between the front and/or rear legs. The line may be attached to the dead ring of the collar or on the harness ring (permitted are harness and Böttger-harnesses, without additional straps).

When called the handler (HF) is to report to the judge (LR) at the basic position and advised whether his dog picks up or indicates. Before the track, at the start and during the track any form of force is to be avoided. Under the direction of the judge, the dog will be taken slowly and calmly to the scent pad and started. The dog has to work the scent pad intently, calmly and with a deep nose. The dog then is to track with a deep nose and at a steady pace intently following the track. The handler (HF) follows his dog at a distance at the end of the 10 meter line. A certain amount of slack is permissible, as long as the line remain in the handler's (HF) hands.

The dog must work out the turns. After the turn the dog has to continue the track at the same steady pace.

As soon as the dog finds an article, he has to pick it up or indicate it without any influence from the handler. He can stand, sit or return to the handler when picking up the article. Moving forward or lying down is considered faulty.

The indication can be done lying down, sitting or standing (alternating is permitted). Once the dog has indicated or picked up the article, the handler then drops the line and goes to his dog.

By holding the article up high, the handler shows that the dog has found the article. Then the handler (HF) picks up the line and continues to work the track with his dog. The handler must show the articles to the judge (LR) upon completion of the track.

c) Evaluation: The speed of the track is not a factor in scoring, if the track is intensely, steady and definitively worked out and the dog shows a positive tracking attitude. A dog's checking to convince himself of the track is not faulty. Casting, high nose, emptying, circling at the corners, continuous encouragement, line or verbal help to maintain the track or at the articles, faulty pickup or faulty indication of the articles, false indication receive appropriate point deductions. If the dog leaves the track by more than a line length, the track will be terminated. If the dog leaves the track and held back by the handler, he will receive the instructions from the judge to continue to follow his dog. If the instructions of the judge are not followed, the track will be terminated by the judge (LR).

If after 15 minutes of the start the end of the track has not been reached, the track will be terminated by the judge. The performance up to that point will be evaluated.

If a dog shows both the possibilities of picking up or indicating the articles, this is considered faulty. The articles will only be evaluated as per the initial notification.

False indication is evaluated in tandem with the performance of the respective leg.





Articles that are not indicated or picked up receive no point value.

The distribution of points for each individual leg has to reflect the length and degree of difficulty of the leg. The evaluation of the individual legs is evaluated by points and ratings.

If the dog does not track (lingering at the same place without tracking) the track can be terminated even if the dog is still on the track.

**IPO ZTP Phase “B”**

Exercise 1:	Off-Leash heeling	25 points
Exercise 2:	Sit in motion	15 points
Exercise 3:	Down with recall	20 points
Exercise 4:	Retrieve on the flat	20 points
Exercise 5:	Retrieve over the jump	10 points
Exercise 6:	Down under distraction	10 points

**Total: 100 points**

**General rules:**

The judge (LR) advises when to start an exercise. All other exercises, such as turns, halting, changing pace etc., are done without instructions.

The commands (HZ) are provided in the regulations. Commands (HZ) are to be spoken in a normal tone, short and consisting of a one word command. They may be done in any language, but whereby they must the same used for the respective exercise. If a dog does not execute a command (HZ) after the third command or does not execute the command at all, that exercise is not evaluated.

When calling the dog on the recall, the name of the dog may also be used. The name of the dog with the respective command (HZ) is considered a double command.

The dog is to sit close and straight to the left of the handler (HF) in the basic position so that the dog’s shoulder is at knee height. Each exercise begins and ends with the basic position. Assuming the basic position is only permitted once at the beginning of the exercise. Praise may be given only at the end of each completed exercise. After that the handler (HF) may assume a new basic position .However, there needs to be a minimum of 3 seconds from the time the praise is given and the start of the new exercise.

A so-called new development starts for each basic position. The handler (HF) must take a minimum of 10 maximum 15 paces before the respective command (HZ) is given for that particular exercise. Between the various exercise parts, such as “sit in front”, “finish” as well as returning to the dog whether in the sitting, standing or down position, a pause of at least 3 seconds is to be held prior to giving another command (HZ). When returning to the dog, the handler may approach from the front or the back.

Heeling off-leash must be demonstrated between the individual exercises.



Also when getting the dumbbell, the dog is to be in heel position. It is not permitted to play with the dog or pump him up when retrieving the dumbbell.

The about turn is to be executed to the left by the handler (HF). The dog may turn either behind the handler or front to the back but must remain the same for the duration of the trial.

After sitting in front the dog may either go behind the handler or approach from the front when finishing.

The fixed hurdle is 80 cm high and 150cm wide. All dogs in the trial must jump the same obstacles.

For the retrieve exercises dumbbells weighting 650 Gram are allowed. The same dumbbells as provided by the organizer must be used by all participants. Prior to the retrieve, the dumbbell may not be placed in the mouth of the dog.

If the handler (HF) forgets an exercise, the judge (LR) instructs the handler (HF) of the missing exercise. No points are deducted for this.

A verbal command (HZ) is permitted to give the basic position.

**1. Heeling off-leash 25 points**

- a) "Fuss/Heel" is permitted to start the exercise
- b) Execution: the handler (HF) approaches the judge (LR) with his dog on-leash, assumes a basic position and reports in. From the basic position the dog has to go in an attentive and happy manner to the left of the handler (HF) with his shoulder at knee height of the handler (HF). The leash may not be taut. At the beginning of the exercise the handler goes out straight 50 paces without stopping, does an about turn, and after 10 to 15 paces the handler has to demonstrate a running pace and then a slow pace (again a minimum of 10 paces). The transition to the slow pace may not have steps taken in between. The two different paces must be distinctly different in speed.

While the handler (HF) and dog heel on the first straight-away, two shots (6mm calibre) are fired five seconds apart at a distance. The shots are fired at a distance of at least 15 paces from the dog. The dog must be indifferent to the shots. During the normal pace, a minimum of at least two right, a left and two about turns are to be demonstrated as well as a halt after the second about turn. The about turn is to be shown to the left (180 degrees turning in place). (Take note of the schematic). Two variations are permitted.

- The dog returns to the handler behind him at a right turn
- The dog shows a left about turn turning 180 degrees in place.

Only one variation is permitted for the duration of the trial.

The halt is to be demonstrated once from the normal pace according to the sketch after the second about turn.



At the instruction of the judge (LR), the handler (HF) moves through a group of at least 4 persons. The handler (HF) has to halt at least once in the group. The handler (HF) leaves the group, assumes a basic position and unleashes his dog.

c) Evaluation: Forging, heeling wide, lagging, additional commands, physical help from the handler, inattentiveness, and/or a dog showing pressure are evaluated accordingly.

**2. Sit out of Motion 15 points**

- a) One verbal command each for "Heel" and "Sit"
- b) Execution: From a straight basic position, the handler (HF) goes out with his free heeling dog in a straight direction. After 10-15 paces the dog has to sit immediately upon command (HZ) and in the direction of movement without the handler breaking stride, changing pace or looking back. After an additional 15 paces the handler (HF) stops and turns around immediately facing at his dog.
- c) Evaluation: Faulty development, slow sit, restlessness and inattentive sitting are evaluated accordingly. If the dog lays down or stands instead of sitting, 10 points are deducted.

**3. Down in connection with recall 20 points**

- a) One verbal command for "Heel /Fuss", "Down", "Here /Hier"
- b) Execution: From the basic position, the handler (HF) moves straight forward with his free-heeling dog. After 10-15 paces the dog is to "Platz/Down" immediately upon command (HZ) and in the direction of movement without the handler breaking stride, changing pace or looking back. The handler (HF) is to go an additional 30 paces straight forward, halts and turns immediately facing his dog. At the instruction of the judge (LR), the handler (HF) commands the dog to return to him either with "Here" or using the name of the dog. The dog has to return happily, quickly and directly and sit close and straight in front of the handler (HF) for the command (HZ) to "Heel/ Fuss" the dog must sit quickly and straight to the left of the handler with his shoulder at knee height.
- c) Evaluation: Faulty development, slowing down, restless down, slow return or slowing down as he approaches, straddle position of the handler (HF), mistakes sitting in front or finishing are evaluated accordingly. If the dog sits or stands at the command (HZ) to down, 13 points are deducted.

**4. Retrieve on the Flat 20 points**

- a) One verbal command for "Bring" "Out/ Aus" "Heel/ Fuss"
- b) Execution: from a straight basic position, the handler (HF) throws the dumbbell (650gram weight) approx, 10 paces away. The command (HZ) to "Bringen/Bring" may first be given after the dumbbell comes to a full stop. The quiet and off-leash dog sitting next to the handler (HF) must run to the dumbbell in a quick and direct manner, pick it up immediately, and bring it back in a quick and direct manner sitting in front of the handler (HF).



The dog has to sit close and straight in front of the handler (HF) and hold it in his mouth calmly until he is given the command after 3 seconds to release the dumbbell upon command.

The dumbbell is retrieved with outstretched arms and placed to the right side of the handler. At the "Heel/Fuss" command (HZ) the dog has to quickly and in a straight manner return to the left side of his handler (HF) with the shoulder at knee height. The handler (HF) may not leave his position during the course of the entire exercise.

- c) Evaluation: Faulty basic position, slow go-out, faulty pick-up, slow coming back, dropping the dumbbell, playing or mouthing the dumbbell, straddle- position of the handler (HF), faulty sit in front and basic position are evaluated accordingly.

Throwing the dumbbell too short and handler (HF) help without changing position leads to point deduction. If the handler (HF) leaves his position before the end of the exercise, the exercise will be evaluated as "unsatisfactory" If the dog does not retrieve, the exercise will be evaluated with "0" points.

**5. Jump over hurdle (80cm) 10 points**

- a) One verbal command each: "Jump", "Here", "Heel"
- b) Execution: The handler (HF) assumes the basic position with his dog approx. 5 meters in front of the jump. The handler (HF) goes to the other side of the jump and stands approx 5 meters away. At the command (HZ) "Springen/Jump" the dog is to jump the hurdle and at the command (HZ) "herankommen/Return" to sit close and straight in front of the handler (HF). At the command "Heel" (HZ), the dog is to go quickly and directly left to the handler (HF) with his shoulder at knee height. At the end of the exercise the dog is put on leash.
- c) Evaluation: Faulty basic position, slow to jump, faulty sit in front or in basic position, handler (HF) help are evaluated accordingly. If the dog touches the jump, up to 2 points are deducted and for stepping on the hurdle, up to 4 points are deducted. If the dog does not jump, the exercise is evaluated with zero points.

**6. Down under distraction 10 points**

- a) One verbal command each for "Down", "Sit"
- b) Execution: Before the beginning of another dog's obedience performance phase B, the handler (HF) goes with his dog to a place assigned by the judge (LR) and unleashes the dog in the basic position. Then the handler (HF) commands his dog to "Ablegen/Down" without leaving the leash or other object next to the dog. The handler (HF) then walks away without looking back and goes at least 20 paces within the trial area and stands in sight of the dog with his back to the dog. The dog must

Without handler (HF) influence remain calmly in place, while the other dog performs exercise 1 through 5. At the instructions of the judge (LR) the handler (HF) returns to his dog and stands to the



right of him. At the instruction of the judge (LR) for the “Aufsetzen/Sit” command (HZ), the dog has to sit quickly and straight in the basic position.

The dog is put on leash.

c) Evaluation: Restless behaviour of the handler (HF) as well as other hidden helps, restless lying down on the part of the dog or sitting/standing up prematurely prior to pick up is evaluated accordingly. If the dog sits or stands but remains in place, partial points are given. If the dog leaves the designated area by more than 3 meters, the exercise receives zero points.

### IPO ZTP Phase “C”

Exercise 1: Hold and Bark	15 points
Exercise 2: Charging and attack on the handler	10/30 points
Exercise 3: Attacking the handler and his dog	40 points
Exercise 4: Transport to the judge	5 points
<b>Total:</b>	<b>100 points</b>

#### 1. Bark and Hold **15 points**

a) One verbal command for “Revere”

b) Execution: The helper is located at an approximate distance of 20 paces from the handler (HF) and his dog and not visible to the dog in a blind. Under the direction of the judge, the handler unleashes his dog, sends the dog to the blind with the command to revere and/or visual command by raising the arm. The dog has to hold the helper actively, attentively and continuously bark. The dog may neither jump on the helper nor grip him. The handler (HF) goes immediately to the dog at the instruction of the judge (LR) and holds him by the collar. After the helper steps out, the dog is put on leash and takes up the basic position in the blind.

c) Evaluation: Limitations when holding, promoting barking and forceful holding are evaluated accordingly. Bothering the helper, e.g. bumping him, jumping up, etc., results in up to 3 points deduction, if gripping firmly, up to 12 points can be deducted. If the dog does not remain at the helper, partial points result with insufficient. If the dog does not engage the helper, phase C is to be terminated.

#### 2. Charging and attack on the handler **charging 10 points – attack 30 points**

- a) One verbal command (HZ) each for: “Aus”/“Out”, “Fuss”/“Heel”
- b) At the instruction of the judge (LR), the handler assumes the basic position marked 30 paces from the blind and unleashes his dog. The leash is to be worn around the shoulder or hidden. At the direction of the judge (LR), the handler proceeds with his free heeling dog in the direction of the blind. The dog must be in close heel position. At the instruction of the judge, the helper engages in an attack on the handler and dog with vocal threats when the handler or the dog is 10 paces from the blind.



The dog must immediately defend the attack confidently and energetically by deploying a firm and gull grip. When the dog grips, he receives 2 soft stick hits from the helper. Hits are to be placed in the area of the withers. He may only grip the helper (HL) on the protection sleeve.

The handler (HF) may not leave his place where he stopped. The handler may give the dog encouragement while defending the attack.

At the instruction of the judge (LR), the helper stops the attack and stands quietly. The dog must either independently or via a "Aus/Out" command release and watch the helper.

If the dog does not release after the first command (HZ), the handler (HF) then receives up to two additional times under the instruction from the judge to command "Aus"/"out". If the dog does not release after this command (HZ) (one permitted and two additional), disqualification will result. During the command phase to "Aus"/"Out" the handler (HF) has to remain calmly standing and not influence the dog.

At the instruction of the judge, the handler (HF) goes immediately at a normal pace in a direct manner back to his dog and takes him into basic position by commanding "Fuss"/"heel".

- c) Evaluation: Limitations in the important criteria are evaluated accordingly: energetic defence with strong grip, full and calm grip until the release, after the release attentive and closely guarding the helper.

If the dog leaves the helper during the guarding phase or the handler (HF) give him a command (HZ) so that the dog remains with the helper the exercise is evaluated with insufficient.

If the dog leaves the handler (HF) during the charge, this must be repeated and will be evaluated with zero points by the judge (LR). If the dog removes himself during the second attempt, this results in a disqualification and the protection work is terminated.

**2. Attack on the handler and his dog 40 points**

- a) One verbal command each for: "Attack/Defend", "Aus"/"Out", "Fuss"/"Heel"
- b) Execution: The dog is held on the collar, may however not be stimulated by the handler (HF). At the instructions of the judge (LR), the helper proceeds at a normal pace away from the handler (HF) and dog. After approx. 40 paces the helper turns towards the handler (HF) and his dog and through verbal shouting and definitive threatening gestures making a frontal attack. At the instruction of the judge (LR), the handler (HF) releases his dog at an approximate distance of 30 paces with the command (HZ) "Attack/defend". Without hesitation the dog is to block the attack by means of an energetic and strong grip. He may only grip the protection sleeve. The handler (HF) may not leave the place where he stopped. At the instruction of the judge (LR), the helper stands still. After the helper stops, the dog must release immediately. The handler (HF) may give an independent command (HZ) to "Aus/Out" within a reasonable time.

If the dog does not release at the first command (HZ) the handler (HF) will receive instructions from the judge for up to two additional commands (HZ) to release. If the dog does not release after this command (HZ) (one permitted and two additional), disqualification will result.



During the command (HZ) to “Aus” /”Out” the handler (HF) stands still. After the out the dogs must remain close to the helper and attentively guard him. At the instruction of the judge, the handler (HF) is to proceed immediately at a normal pace in the most direct way back to his dog and commands him to heel into the basic position. The handler (HF) puts his on leash.

- c) Evaluation: Limitations in the important evaluation criteria are evaluated accordingly: Energetic defence with a strong grip, full and calm grip until the “release”, after the “release” attentive and close guarding of the helper.

If the dog leaves the helper during the guarding phase or if the handler (HF) gives a command (HZ) so that the dog remains with the helper, the exercise is evaluated as insufficient.

**3. Transport to the judge**

**5 points**

- a) One verbal command each for: “Heel”
- b) Execution: A side transport of the helper to the judge (PR) is performed at a distance of about 10 paces. A command (HZ) to “heel” is permitted. The dog is to be on the right side of the helper so that the dog is between the helper and the handler (HF). The dog is to watch the help intently during the transport. He may not bother the helper, jump on him or grip him. The group stops in front of the judge and reports out for phase C.
- c) Evaluation: Limitations in the important evaluation criteria are evaluated accordingly: Attentive watching of the helper, heeling exactly on a loose leash.



## IPO- Preliminary Trial (IPO-VO)

### Arranged as:

Phase A 100 points

Phase B 100 points

Phase C 100 points

**Total: 300 points**

### Participating regulations

On the day of the trail event, the dog must have reached the prescribed age. No exceptions can be made. Condition to start is a passed BH/VT exam according to the national rules of the country. A IPO-VO is broken down into three phases, so that any given judge can judge a maximum of 12 dogs per day.

### General requirements

This preliminary stage for the IPO-1 test was prepared by the Commission for Utility Dogs of the FCI. This test can be conducted:

1. as an pre-admission test for entry in the Working Class.
2. as a condition for entry to the IPO-1, whereby the National Organization can independently decide if they will stipulate the test for their area.

The IPO-VO was prepared and taken under advisement in the German language. In questionable cases especially with translations into another language, the German text is binding.

If not specifically stated, the regulations of the "General Part" of valid IPO 2012 rules are to be adhered to.

### Temperament test

At the beginning of each test, with the first performance phase, the judge (LR) must undertake an impartiality or temperament test of the dog. See valid "Temperament Test".

### IPO-VO Phase "A"

Self-laid track approx. 200 paces, 2 legs, 1 turn (approx 90 degrees), one handler (HF) owned article, no waiting time to run, execution time 10 minutes.

Scent pad	10 points
Maintaining the track	59 points
Turn	10 points
Article	21 points
<b>Total</b>	<b>100 points</b>

If the dog does not find any articles, the final evaluation can only be rated as satisfactory.

### General Requirements:

A marker is required at the start of the track, which is to be placed in the ground to the left of the scent pad.





The handler (HF) (=tracklayer) (FL) has to show the judge (LR) or the responsible track coordinator the article. Only one well scented article belonging to the handler (HF) is permitted, whereby it has to be 15 cm long, 3-5 cm wide and approx 1 cm thick and differentiate itself in colour from the terrain. The handler (HF) (= tracklayer) (FL) remains a short time on the scent pad and then proceeds at a normal pace in the designated direction. The turn is also to be put down at a normal pace (see sketch), the article at the end of the track.

The judge (LR) and accompanying person may not be in the area of the track where the dog/handler (HF) has the right to track.

- a) command to "Such/Track"
- b) Execution: The handler (HF) prepares his dog for the track. The dog may either track free or on a 10 meter line. The 10 meter line may be used over the back, on the side or between the front and/or left legs. It can be placed directly on the collar – not on the live ring – or hooked to the ring on the harness (permitted are the harness or Böttger harness without additional straps). When called the handler (HF) reports to the judge (LR) with his dog in heel position and advises whether the dog indicates or picks up. Any force, prior to the track, at the start and for the duration of the track is to be avoided. At the instruction of the judge (LR), the dog is led slowly and calmly to the scent pad. The dog has to work the scent pad intensively, calmly and with a deep nose. The dog then must track at an even tempo with a deep nose. The handler (HF) follows his dog at a 10 meter distance. If the dog is tracked free, then the 10 meter distance is also to be maintained. A certain amount of slack in the line is permissible, as long as the handler keeps the line in his hand. The dog has to work out the turn confidently. As soon as the dog locates the article, he must, without any handler (HF) influence, immediately pick it up or indicate it. If he picks up, he may remain standing, sit or return to the handler (HF). If the dog picks up and returns to the handler (HF), the handler (HF) is to remain standing. Proceeding forward or picking up the article while lying down is faulty. Indication may be done sitting, standing or lying down. When the dog indicates or picks up the article, the handler (HF) drops the line and approaches his dog. By raising his arm with the article in hand, he shows that the dog has found the article.
- c) Evaluation: The speed with which the track is worked out is not a factor in scoring, if the track is otherwise intensely worked out, at an even pace and convincingly and the dog shows a positive work attitude. A dog's checking to convince himself of the actual track is not faulty, casting, high nose, emptying, circling, receiving constant encouragement from the handler, line or verbal help to maintain the track or displaying incorrect behaviour at the article or a faulty indication of the article are evaluated accordingly. If the dog leaves the track by more than a line length, the track is terminated. If the dog leaves the track and the handler (HF) restrains him, the handler will receive the notification to follow the dog. If the instructions are not adhered to, the judge will terminate the track. If within 10 minutes the track is not executed after the scent pad, the judge (LR) will terminate the track. Up until termination of the track, the performance will be evaluated.



The evaluation of the leg is done both in points and rating. If the dog does not track at all (lingers at the same place for quite some time without tracking) the track is terminated, even if the dog is still on the track.

**IPO-VO Phase B**

Exercise 1:	On-Leash heeling	30 points
Exercise 2:	Off-Leash heeling	20 points
Exercise 3:	Down with recall	15 points
Exercise 4:	Retrieve	10 points
Exercise 5:	Jump over a hurdle	10 points
Exercise 6:	Down under distraction	15 points
<b>Total:</b>		<b>100 points</b>

**General requirements:**

A command (HZ) to “Sit” is permitted for the basic position.

**1. On-Leash heeling 30 points**

a) One verbal command to “Heel”

b) Execution: The dog handler (HF) takes his heeling dog into the basic position to the judge and reports in. At the basic position, the dog must follow the handler (HF) attentively, happy, with the shoulder at knee height to the left of the handler (HF) when commanded to “Fuss/Heel”. The leash may not be taut. To start with, the handler (HF) goes out straight 30 paces without stopping, after the about turn a minimum of a right and a left turn must be demonstrated. While the handler (HF) is proceeding straight out with his dog, 2 shots (6mm calibre) are to be fired after a minimum of 15 paces and 5 seconds apart. The dog has to be impartial to the shots. At the instruction of the judge (PR), the handler (HF) goes with his dog into a moving group consisting of a minimum of 4 persons. The handler (HF) must halt one time with his dog in the group. The handler then leaves the group, assumes a basic position and takes his dog off leash.

c) Evaluation: Forging, heeling wide, lagging, receiving additional commands (HZ), physical help, inattentiveness and/or showing pressure are evaluated accordingly.

**2. Off-Leash heeling 20 points**

a) One verbal command to “Heel”

b) Execution: From the basic position, the dog must follow the handler (HF) attentively, happy, with the shoulder at knee height to the left of the handler when commanded (HZ) to “Fuss/Heel”. At the beginning of the exercise, the handler proceeds with his free-heeling dog 30 paces in a straight direction without stopping, after the about turn a minimum of a right and a left turn are to be demonstrated. At the end of the exercise, the handler (HF) assumes the basic position and puts his dog on leash.

c) Evaluation: Forging, heeling wide, lagging, slow or hesitant sit, additional commands (HZ), physical help, inattentiveness, and/or showing pressure are evaluated accordingly.



**3. Down with Recall 15 points**

- a) One verbal command to “Heel/ Fuss”, “Down”, “Here”
- b) Execution: from the basic position the handler (HF) proceeds with his off leash dog in a straight direction. After 10 to 15 paces, the dog is to lie down immediately at the “Ablegen/Down” command (HZ) without the handler breaking stride, altering pace and/or looking back. The handler (HF) proceeds approximately 15 paces in a straight direction, remains standing and immediately turns around facing his dog in the down position. At the instruction of the judge (LR), the handler (HF) calls his dog to him with “here” and/or the name of the dog. The dog must return happily, quickly and in a direct way and sit close and straight in front of the handler. At the command (HZ) to “Heel/Fuss” the dog must place himself quickly and to the direct left of the handler (HF) with his shoulder at knee height position. The dog is put on leash
- c) **Evaluation:** Faulty build up, slow downing, restlessness, slow recal or slowing down while approaching the handler, splay-legged stance of the handler, faulty sit in front of the handler and a faulty finish are to be evaluated accordingly. If the dog remains sitting or standing after receiving the command „plats/down“ 7 points will be deducted

**4. Retrieve 10 points**

- a) One verbal command to: “Bring”, “Out”, “ Heel/ Fuss”
- b) Execution: The dog is taken off leash in the basic position. The handler (HF) throws his own article approximately 5 paces away. The command (HZ) to “Bringen/Bring” is first given after the article comes to rest. The calmly and off-leash dog sitting next to his handler (HF) must go out quickly and directly to the article at the command (HZ) “Bringen/Bring”, pick it up immediately and bring it back quickly and directly to the handler (HF). The dog has to sit close and straight in front of the handler (HF) and hold the article calmly until after approximately 3 seconds he is commanded to “Aus/Out’. At the command (HZ) “Heel/Fuss” the dog has to assume the sit position quickly and straight at the left of the handler (HF) with his shoulder at knee height. At the end of the exercise the dog is put on leash.
- c) Evaluation: Faulty basic position, slow go-out, faulty pick up, slow return, dropping it playing or mouthing the article, splayed stance of the handler (HF), not sitting correct in front or at the end are evaluated accordingly. Handler (HF) help while not moving out of position are also evaluated accordingly. If the handler (HF) moves out of place before the end of the exercise, the exercise is rated as insufficient. If the dog does not bring the article, the exercise receives 0 points.

**5. Jump over a hurdle (80cm) 10 points**

- a) One verbal command to: “Jump”, “Here”, “Heel”
- b) Execution: The handler (HF) with his dog stands a minimum of 5 paces in front of the jump and takes his dog off leash. The calm and off-leash dog sits next to his handler (HF) and must jump over the hurdle at the “Jump” command (HZ) and at the “Here” command, he has to jump immediately over the hurdle and sit close and straight in front of his handler (HF).



At the command “Heel/Fuss” the dog must quickly return to his handler sitting straight to his left with the shoulder at knee height. The handler (HF) may move 2 paces when giving the dog the command (HZ) to “jump”. At the end of the exercise the dog is put on leash.

c) Evaluation: Faulty basic position, hesitant jump, faulty sit in front and at the end, handler (HF) help are evaluated accordingly. If the dog tips the jump than up to 1 point is deducted per jump, if he steps on the jump, the up to 2 points can be deducted.

**6. Down under distraction**

**15 points**

a) One verbal command to: “Down/Platz”, “Sit”

b) Evaluation: at the beginning of another dog’s obedience for phase B, the handler (HF) goes with his dog to a place as assigned by the judge (LR) and unleashes his dog while in the basic position. Then the handler (HF) downs his dog with the command (HZ) “Down/Platz” and without leaving a leash or other article with the dog. The handler (HF) then leaves his dog without looking back approximately 20 paces within the trial area and remains calmly standing with his back to the dog. The dog has to remain calmly lying down with any influence of the handler (HF) while the other dog performs exercise 1 through 3. At the instruction of the judge (LR), the handler (HF) returns to his dog and stand to the right of his dog. At the instruction of the judge (PR), the dog is to execute the “Sit” command (HZ) quickly and straight in the basic position. The dog is put on leash.

c) Evaluation: Restless behaviour of the handler as well as other hidden handler help, restless lying down, or standing/sitting up prematurely are evaluated accordingly. If the dog stands or sits, but remains in place, partial points are awarded. If the dog leaves the area before the other dog has completed exercise 3 and the dog goes more than 3 meters from the designated spot, the exercise is evaluated with 0 points.

**IPO-VO Phase “C”**

Exercise 1: Bark and Hold	15 points
Exercise 2: Prevention of helper escape	30 points
Exercise 3: Attack on the handler and his dog	50 points
Exercise 4: Transport to the judge	5 points
<b>Total:</b>	<b>100 points</b>

**General requirements:**

There is no TSB Evaluation. The helper uses a soft stick as a threat to the dog without striking him. The command (HZ) to “Aus/Out” is allowed only once for all defensive exercises. See the table below for the evaluation for the “Aus/Out”



Slow "out"	First additional command with immediate "out"	First additional command with slow "out"	Second additional command with immediate "out"	Second additional command with slow "out"	No "out" after second command or other attempts
0,5-3,0	3,0	3,5-6,0	6,0	6,5-9,0	disqualification

**1. Hold and Bark 15 points**

a) One verbal command to: "Revere/ Revieren "

b) Execution: The helper is located at an approximate distance of 20 paces from the handler (HF) and his dog, whereby he cannot be seen by the dog. At the instruction of the judge (LR), the handler (HF) unleashes his dog and sends him with the command "revieren/revere" and/or by raising his arm to the blind. The dog has to actively and attentively hold and continuously bark. The dog may neither jump on the helper nor grip him. At the instruction of the judge (LR), the handler (HF) goes immediately to his dog and holds him by the collar.

c) Judgement: Limitations regarding the continuous and demanding bark and forceful hold, are to be deducted accordingly. Bothering of the helper, for example bumping, jumping up on the helper etc. leads to a deduction of up to 3 points. Up to 12 points may be deducted for heavy gripping. If the dog leaves the helper a partial score is given reflecting an "insufficient" rating. If the dog does not want to cooperate, phase „C“ is to be terminated.

**2. Prevention of an attempted helper's escape 30 points**

a) One verbal command (HZ) to: "Out/ Aus "

b) Execution: While the handler (HF) holds his dog by the collar, the helper steps out of the blind and attempts to escape. At the instruction of the judge (LR), the handler (HF) releases his dog. The dog has to independently prevent the escape by means of an energetic and strong grip. He may only grip the protection sleeve of the helper (HL). At the instruction of the judge (LR), the helper stands still. After the helper stops, the dog must release immediately. The handler (HF) may give a command (HZ) "Aus/Out" within a reasonable amount of time.

If the dog does not out on the first permitted command (HZ), the handler (HF) then will receive instructions from the judge for two additional commands (HZ) to "Aus/Out". If the dog does not out after the third command (HZ) (one permitted and 2 additional), the result is termination. During the "Aus/Out" command (HZ) the handler (HF) has to remain standing still without influencing the dog. After the "out" the dog must remain close to the helper and watch him attentively. The handler (HF) goes immediately to the dog at the instruction of the judge (LR) and holds him on his collar.

c) Evaluation: restrictions in the important evaluation criteria are rated accordingly: Quick, energetic reaction and pursuit with a strong grip and effective prevention of the escape, full and calm grip until the release attentively and closely guarding the helper. If the dog does not prevent the escape within 20 paces by gripping and holding, then phase C is terminated.



**3. Attack on the handler and his dog 50 points**

a) One verbal command to: *“Defend”*, *“Out/Aus”*, *“Heel/Fuss”*

b) Execution: The dog is held by the collar may however not be stimulated by the handler (HF). At the instruction of the judge (LR), the helper goes in a normal pace away from the handler (HF). After approximately 20 paces, the helper turns and attacks the handler (HF) and his dog from the front all the while yelling loudly and making definitive strong threats. The handler (HF) releases his dog with the command (HZ) *“defend”*. The dog has to defend the attack without hesitation and with a strong grip. He may only grip the protection sleeve of the helper (HL). The handler (HF) must remain in place. At the instruction of the judge (LR), the helper stands still. After the helper stops, the dog is to release immediately. The handler (HF) may give a command (HZ) to *“Aus/Out”* within a reasonable amount of time.

If the dog does not out on the first permitted command (HZ), the handler (HF) then will receive instructions from the judge for two additional commands (HZ) to *“Aus/Out”*. If the dog does not out after the third command (HZ) (one permitted and 2 additional), the result is termination. During the *“Aus/Out”* command (HZ) the handler (HF) has to remain standing still without influencing the dog. After the *“out”* the dog must remain close to the helper (HL) and watch him attentively. The handler (HF) goes immediately to the dog at the instruction of the judge (LR) at a normal pace and in the most direct manner and places the dog in the basic position by commanding (HZ) *“Heel/ Fuss”*. The handler (HF) puts his dog on leash.

c) Evaluation: Restrictions in the most important evaluation criteria are rated:

Energetic defence with a strong grip, full and calm grip until the release, after the release attentively and closely guarding the helper.

If the dog leaves the helper during the guarding phase or the handler (HF) gives him a command (HZ) so that the dog stays with the helper, the exercise is rated as insufficient.

**4. Transport to the judge 5 points**

a) One verbal command to: *“Heel/Fuss”*

b) Execution: A side transport of the helper is conducted to the judge (LR) over an approximate distance of 10 paces. The command (HZ) *“Fuss/Heel”* is permitted. The dog is to be at the right side of the helper, so that the dog is between the helper and the handler (HF). For the duration of the transport, the dog has to attentively watch the helper. He may not crowd the helper, jump up or grip. The group halts in front of the judge (LR) and reports out with phase C ended.

c) Evaluation: Restrictions in the most important evaluation criteria leads to deduction



## **IPO – 1**

Arranged as follows: Phase A	100 points
Phase B	100 points
Phase C	100 points
<b>Total:</b>	<b>300 points</b>

### **Participating regulations**

On the day of the trail event, the dog must have reached the prescribed age. No exceptions can be made. Condition to start is a passed BH/VT exam according to the national rules of the country.

### **IPO – 1 Phase “A” – Tracking**

**Handler track, minimum 300 paces, 3 legs, 2 turns (approx. 90 degrees), 2 handler (HF) articles, minimum 20 minutes aged, execution time 15 minutes.**

Maintaining the track:	79 points
Articles (11+10)	21 points
<b>Total</b>	<b>100 points</b>

If the dog does not find the article, the evaluation can only be rated as “satisfactory”.

#### **General requirements:**

The officiating judge (LR) or the responsible track coordinator determines the pattern of the track considering the layout of the area. Varying patterns must be used for the tracks. It is not permitted that the articles and corners on each track are placed at the same distance from each other.

The scent pad needs to be well marked with a sign, which must be placed in the ground directly to the left of the start.

The judge will draw for the order of participants after the tracks are laid.

#### **Acceptable Tracking Fields**

All natural terrain, i.e., grass, plowed fields and forest surface are acceptable tracking areas.

Visual tracking is to be avoided. For all tracking levels it is possible to have suitable change of terrain.

#### **Laying the tracks**

The responsibilities of the officiating judge or track coordinator are:

- organize the layout of the track
- organize the track layers
- observe the laying of the track

The layout of the track is contingent on the actual fields.



When laying the tracks, it is important to note that they are laid in a natural walking pace. The track layer (FL) may not provide help such as unnatural walking on the legs, turns, articles.

The tracklayer (FL) (=Handler) Must show the articles to either the judge or the track coordinator. Only articles that have been scented at least 30 minutes may be used. The handler (HF) (tracklayer) remains for a brief time at the scent pad and then proceeds at a normal pace in the designated direction. The legs are to be laid at a normal pace with breaking stride or scuffing. The distance between the individual legs must be at least 30 paces.

The turns are likewise to be done at a normal pace, so that this affords the dog the possibility to continue the track pattern (see sketch). Scuffing or breaking stride is not permitted. A break in the track may not happen. While the track is being laid, the dog is out of sight.

### **Placing the article**

The first article is placed either on the first or second leg after a distance of minimum 100 paces, not within 20 paces before or within 20 paces after the corner, the second at the end of the track. The articles have to be placed while walking the track. After the last article is placed, the tracklayer continues several paces moving in a straight direction.

### **Tracking Articles**

Only articles that have been scented by the tracklayer (FL) (handler) for at least 30 minutes may be used. Within a given track different articles are to be utilized (material: e.g. leather, textile, wood) and must be approximately 10 cm long, 2-3 cm wide, 0,5-1 cm thick. The articles may not stand out in colour from the terrain.

For above regional events, the articles must be numbered. The numbers have to coincide with the track number.

While the dog is tracking, the judge (LR), the tracklayer and any accompanying person(s) are not permitted in the area where the dog/handler (HF) have the right to track.

### **Commands:**

- a) One verbal command for: "*Track*"  
The command (HZ) to "*suchen/track*" is only permitted at the start and after the first article or after a false indication.

### **Execution and judgment of the tracking work**

- b) The handler (HF) prepares the dog for the track. The dog may track free or on a 10 m line. The 10 meter line may be held over the dog's back, to the side or between his front and/or back legs. The tracking line may be attached directly to the collar, but not the live ring or attached to the harness ring (harness or böttger harness without additional straps). When called the handler (HF) goes with his dog into basic position and reports in to the judge (LR) and advises if the dog will pick up or indicate. Prior to the track, at the scent pad and for the duration of the track, no force is to be applied.





The tracking line must be a minimum of 10 meters long. The judge may check the length of the line, the collar and the harness only prior to the start of the track. Flexible leashes are not permitted.

### **Scent Pad**

At the instruction of the judge (LR), the dog is led to the scent pad slowly and calmly. A brief sit by the dog approximate 2 meters in front of the scent pad is permitted.

The start has to be worked out independently by the dog (even when restarting at the articles) A certain amount of slack in the line is permissible.

The dog is to take the scent at the start intensely, calmly and with a deep nose. This has to be done without any handler help (except for the command to "*Such/track*"). There is no time limit set for the scent pad; rather the judge (LR) orients himself to the *behaviour* of the dog on the first leg as to how intensely the scent was detected.

After 3 attempts to work out the scent pad to determine the direction of the track, the track work will be terminated.

The dog has to track with a deep nose maintaining a steady pace. The handler (HF) follows his dog at as distance of 10 meters at the end of the tracking line. If the dog tracks free, then the handler (HF) is to maintain a distance of 10 meters as well. There may be some slack in the tracking line, but whereby the handler (HF) keeps it in his hand(s) and a definitive shortening of the line to get closer to the dog may not happen. Touching the ground is not faulty.

### **Track Performance**

The dog must follow the track intensely, with endurance and when possible at an even speed (depending on the terrain, degree of difficulty). The handler is not obliged to follow the course of the track. A rapid or slow track execution cannot be a criterion towards the rating, when the track is consistently and convincingly worked out.

### **Turns**

The dog has to work out the turns confidently. Checking, without leaving the track, is not faulty. Circling at the turn is faulty. After then turn the dog is to continue tracking at the same speed. In the area of the turn, the handler is to maintain the prescribed distance if possible.

### **Indicating or picking up the articles**

As soon as the dog has found the articles, he has to convincingly and without handler (HF) help either pick up or indicate. If he picks up he may either remain standing, sit or return to the handler, who has to remain standing. Continuing with the article or lying down is faulty. The indication may be done either lying down, sitting or standing (also alternating is permitted).

Not lying completely straight at the article is not faulty, lying to the side of the article or turn around looking at the handler is however faulty.



Articles that are done with strong handler help are considered to be overrun. This would be the case for instance, if the dog does not indicate the article and the handler either by use of the line or through verbal command hinders the dog from continuing to track.

When the dog either picks up or indicates the article, the handler is to drop the line and go to his dog. By raising his arm with the article in hand, he advises that the dog has found the article. Picking up and indicating are faulty.

Any action done with the article or picking up while lying down is faulty. If the dog returns back to the handler, the handler does not approach the dog.

When the handler approaches his dog to release the article or when picking up, the handler must stand next to the dog.

The dog is to remain calmly in place if indicating or where he picked up the article until released to track whereby the handler deploys him holding the line short.

### **Leaving the track**

If the handler restrains the dog from leaving the track, then the handler receives instructions from the judge to follow the dog. The handler must follow these instructions. Tracking will be terminated if the dog is more than a line length off of the track (over 10 meters with a free tracking dog) or the handler does not heed the judge's instructions.

### **Praising the dog**

Occasional praising in the level 1 phase is permitted (the command to "*such/track*" is not considered praise). A short praise may be given also at the articles.

### **Reporting out**

After completing the track, the found articles are to be presented to the judge. Playing or feeding the dog after picking up or indicating the last article prior to reporting out and receiving the awarded points is not permitted. Reporting out is to be done in basic position.

### **Evaluation**

The evaluation of Phase "A" begins with the start of the dog tracking. A convincing, intensive and dedicated nosework as well as a good training base are expected of the dog.

**The handler** has to become part of the process and experience it. He has to interpret the reactions of the dog, be concentrated on the work and ignore any external influences.

The judge has to observe not only the dog and handler, but also the tracking area, the weather, possible cross tracks and the time-frame. In his evaluation he has to take into consideration all factors.

- Track behaviour ( speed on the legs, before and after the turns, before and after the articles)
- Training status of the dog (i.e., hectic start, showing pressure, avoidance)



- Any handler help
- Difficulty in working the track through:
  - Ground conditions (overgrown, sand, change of terrain, fog)
  - Wind conditions
  - Wild game
  - Weather (heat, rain, snow)
  - Scent change

The evaluation should be contingent upon these conditions.

After the handler has reported in for the track, the judge has to strategically place himself so as to be able to observe the track work and listen to verbal commands or see any other influence by the handler.

He has to select a distance from the handler so that he does not interrupt the dog's work and so that the handler does not feel crowded. The judge has to be able to experience the entire track work.

He has to evaluate the dog's work based on his enthusiasm, confidence or insecurity or flightiness.

A fast or slow track work is not part of the criteria for the evaluation, if the track is worked out intensely, even and convincingly and the dog maintains a positive attitude.

Checking without leaving the track is permitted and not faulty. Casting, emptying, circling at the turns, constant encouragement, line or verbal helps within the tracking area, or at the articles, faulty pick up or faulty indication of the articles are evaluated accordingly (up to 4 point deduction).

Definitive casting, lacking intensity, wildly tracking, emptying, hunting mice, etc. can receive up to an 8 point deduction.

If the dog leaves the track by more than a leash length, the track is terminated. If the dog leaves the track and is restrained by the handler, judge advises the handler to follow his dog. If the instructions are not followed, the track will be terminated by the judge.

If after the maximum allowable time (Level 1 and 2 = 15 minutes) (Level 3 = 20 minutes) to work out the scent pad is not met, the track work is terminated by the judge. Any awarded points up to this point are made known.

If the dog shows both styles of article work, namely "*picking up*" and "*indicating*" on a given track, this is considered faulty. The articles will only be evaluated and scored as per the initial report.

Pick up or faulty indication of the articles, false indication, are to be deducted accordingly up to 4 points, if the restart is next to the dog and another 2 points obligation deduction if the handler makes the restart at the end of the tracking- lease.

If articles are not found, then no points are awarded. If no handler articles are found, the phase "A" can only be rated as "satisfactory". Also this must be taken into consideration that the handler cannot restart his dog at an article.



If the dog follows his hunt drive and chasing game, the handler may give the command to “down” in order to maintain control. The track work will continue at the instruction of the judge. If this does not work, the trial is terminated. (Evaluation: disqualified due to lack of control).

**Termination/Disqualification**

Behaviour	Consequence
Dog is restarted at the scent pad 3x	<b>Terminated</b>
- All Levels: Dog leaves the track by more than a line length or the handler does not heed the judge’s instructions - Dog does not meet the time limit for the track Level 1: 15 minutes after the start	<b>Terminated</b> - points will be awarded up to that point <b>CRITIQUE UP TO TERMINATION!!</b>
- Dog picks up the article but refuses to release it. - Dog chases game and cannot be restarted.	<b>DISQUALIFICATION</b> due to lack of control

**Track layouts:**

The following layouts may be done as a mirror image as well.

**IPO-1 and 2**

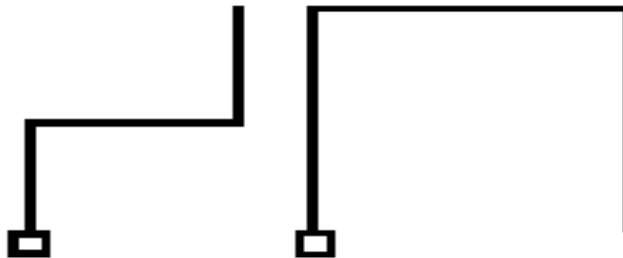



### IPO-1 Phase “B” Obedience

Exercise 1: Off-Leash heeling	20 points
Exercise 2: Sit in motion	10 points
Exercise 3: Down with recall	10 points
Exercise 4: Retrieve on the flat	10 points
Exercise 5: Retrieve over a hurdle	15 points
Exercise 6: Retrieve over the scaling wall	15 points
Exercise 7: Send out with down	10 points
Exercise 8: Down under distraction	10 points
<b>Total:</b>	<b>100 points</b>

### General requirements

For Level IPO-1 the handler appears with his dog on leash, reports in the basic position and then unleashes his dog.

Especially in the obedience attention must be paid to the fact that the dog exhibits no pressure from the handler demonstrating that his self-confidence has been deflated and that he does not appear to be just “sport equipment” of the handler.

During all exercises a happy work ethic and the required concentration must be displayed towards the handler. Attention must be paid to the happy work ethic in conjunction with the correct execution of the work and will be evaluated as such.

If a handler forgets an entire exercise, the judge will request that he is to show this missing exercise. There is no point deduction for this.

No later than at the start of the obedience, all equipment as prescribed in the rules must have been checked by the judge (LR). The equipment must meet the governing rules.

The gun to be used during the “Off-Leash” and “Down under Distraction” exercises must be of 6 mm calibre.

The judge (LR) advises the start of each individual exercise. Anything further, such as turns, halting, change of pace, etc. are done independently.

The commands (HZ) are engraved in the rules. Commands (HZ) are to be spoken in a normal tone, brief, consisting of a one-word command. They may be given in any language, however must be the same for the related exercise. If a dog does not execute an exercise after a command (HZ) is give three times, then the exercise receives no points. When recalling the dog, the name of the dog may be used instead of command (HZ) for “Return”. The name of the dog used in conjunction with a command (HZ) is considered a double command.

### Beginning an exercise

The judge (LR) advises when the exercise is to begin.



### **Basic Position**

The basic position is to be assumed, when the second dog handler, who has taken his dog to the designated area for the down under distraction exercise, has taken his place. At this juncture the evaluation for both dogs begins.

Each exercise begins and ends with a basic position. The handler is to stand in a sporty manner. A splayed stance is not permitted for any exercise.

The dog is to sit at the left side of his handler (HF) in a close, straight, calm and attentive manner, so that his shoulder is knee high to the handler (HF) when demonstrating the basic position that is only allowed to be shown only once in the forward direction. Assuming the basic position is only allowed once. A short praise is permitted at the end of each completed exercise. Thereafter the handler (HF) may assume another basic position. Between praise and a new start a definitive time lapse of approx 3 seconds must take place.

An exercise is developed from the basic position. The handler (HF) must take at least 10 paces, up to 15 paces maximum, before he gives the command (HZ) to execute an exercise. Between all fronts and finishes, as well as when the handler returns to the sitting, standing or lying dog, a distinct pause of 3 seconds is to be maintained. In returning to the dog, the handler (HF) may approach him from front or go behind the dog. Mistakes in the basic position and the development phase are evaluated accordingly.

Correct heeling position is to be demonstrated even between exercises. Even when retrieving the dumbbell, the dog is to accompany the handler. Motivating or playing with the dog at this juncture is not permitted.

The about turn is to be demonstrated to the left by the handler (HF). The dog may complete the about turn either by going behind the handler or from the front, but whereby the style must remain consistent within a given trial.

After sitting in front, the dog may either go behind the handler or assume the basic position from the front.

The fixed jump needs to be 100cm high and 150 cm wide. The scaling wall consists of two planks secured at the top and must be 150cm wide and 191 cm high. At the base, the two sides are to be set apart so that there is a vertical height of 180 cm. The entire surface of the scaling wall must be covered with a non-skid material. On the walls themselves 3 cleats must be affixed near the top half with each being 24/48mm. All dogs must negotiate the same obstacles.

For the retrieve exercise only dumbbells are permitted. The dumbbells as provided by the event coordinator must be used by all dogs. It is not permitted to place the dumbbell in the dog's mouth prior to the exercise.

If the handler (HF) forgets an exercise, the missing exercise will be advised by the judge, without any point deduction.



### Categorizing the exercises

2 part exercises, such as “Sit in motion” “Down with recall”, “Stand in normal pace”, “Stand in motion” may, to get a partial score, be divided into two parts as follows :

a) “Basic position, development, execution” = 5 points

b) “further behaviour up until completion of the exercise” = 5 points

The evaluation of the dog is to be done for each exercise by observing him from beginning at basic position to the end of the exercise.

### Additional commands

If a dog does not complete the exercise after 3 commands, the exercise is evaluated as unsatisfactory (=0 points). If the dog completes the exercise after the third command, then the exercise is evaluated as “unsatisfactory”.

When recalling the dog the dog’s name may be used in lieu of “Here”. The name of the dog used in conjunction with the command is considered a double command.

Evaluation:	1. additional command	satisfactory for part of an exercise
	2. additional command	unsatisfactory for part of an exercise

Examples: 5 point exercise

1. additional command: satisfactory	5 points =	-1.5 points
2. additional command: unsatisfactory	5 points =	-2,5 points

Between the individual parts exercises sitting in front and finish, as well as approaching the sitting, standing or lying dog, a definitive pause of minimum 3 seconds must be maintained.

When the dog on the long down exercise is taken to the respective area and the basic position has been taken, the handler starting the off-leash work is also to assume the basic position.

### 1. Off-Leash heeling 20 points

a) One verbal command is permitted to “Heel”  
The handler (HF) may give this command (HZ) at the start of heeling and when changing pace.

b) Execution: the handler (HF) approaches the judge (LR) with his dog on leash, has the dog sit and reports in. When the judge (LR) dispatches him, he goes with his free-heeling dog to the start position. When the judge gives further instructions, the handler begins the exercise. From a straight basic position, the dog is to follow the handler (HF) at the “heel” command in an attentive, happy and straight manner with his shoulder blade at knee height and to the left of the handler (HF) and sits straight, independently and quickly at the halt. At the beginning of the exercise the handler (HF) goes out with his dog 50 paces without stopping, after the about turn the handler (HF) runs showing 10 to 15 paces, then changes over to a slow pace showing a minimum of 10 paces.



The change from fast to normal paces must be done in transition without taking any steps in between. The changes of pace must show clear delineation. At the normal pace at least two right and two left turns and two about turns are to be demonstrated as well as a halt after one of the about turns. The handler must show the about turn to the left (180 degree turn in place) (see prescribed sketch). Two variables are possible:

- The dog goes behind the handler with a right turn.
- The dog turns in place at 180 degrees for the left about turn.

Within a trial only one given variable is permitted.

The halt must be shown after the second about turn at least once at a normal pace according to the sketch.

While the handler is heeling with his dog on the first straight away, two shots (6mm calibre) are fired within a time-frame of 5 seconds and at a distance of minimum 15 paces. The dog must show impartiality to the gun shots. If the dog shows gun shyness, the result is disqualification and all awarded points are not recognized. At the end of the exercise, the handler (HF) goes with his dog into a group of at least 4 moving people. The handler (HF) has to go around a person both to the left and the right and must halt once in the group. The judge (LR) may request a repeat. At the instruction of the judge (LR), the handler (HF) leaves the group and assumes the basic position.

This basic position is the beginning of the next exercise.

## **2. Sit in Motion**

**10 points**

- a) One verbal command to: *“Heel”*, *“Sit”*
- b) Execution: From a straight basic position, the handler (HF) goes with his dog off-leash straight out. In the development phase, the dog is to heel with his handler in an attentive, happy, quick and concentrated manner. He has to remain in a straight position at knee height of the handler. After 10-15 paces, the dog is to execute the sit command immediately and in the direction of moving without the handler (HF) breaking stride, changing pace or looking back. After an additional 15 paces the handler (HF) stands still and turns immediately to his calm and attentively sitting dog. At the instruction of the judge (LR), the handler (HF) returns to his dog and stands to the right of the dog. The handler may approach either from the front or around the back.
- c) Evaluation: Mistakes in the basic position, development, slow sit, restless and inattentive sitting are evaluated accordingly. If the dog stands or lies down instead of sitting 5 points are deducted. Other mistakes are taken into account.

## **3. Down with Recall**

**10 points**

- a) One verbal command to: *“Heel”*, *“Down”*, *“Here”*
- b) Execution: From the basic position, the handler (HF) goes straight out with his dog off leash. In the development phase, the dog is to heel with his handler in an attentive, happy, quick and concentrated manner. He has to remain in a straight position at knee of the handler.





After 10-15 paces, the dog is to execute the “down” command (HZ) immediately and in the direction of moving without the handler (HF) breaking stride, changing pace or looking back. After an additional 30 paces the handler (HF) stands still and turns immediately to his calm and attentively lying dog. At the instruction of the judge (LR), the handler (HF) recalls his dog either using the “here” command or the dog’s name, the dog has to come happy, quickly and directly to the handler (HF) and sit close and straight in front. At the “Heel” command (HZ) the dog is to go quickly to sit straight next to the left of the handler with his shoulder at knee height of the handler (HF).

c) Evaluation: Mistakes in the development, lying down slowly, restless lying, slow return or slows down when approaching the handler, splayed stance of the handler (HF), mistakes in sitting and at the finish are evaluated accordingly. If the dog sits or stands at the “down” command (HZ) 5 points are deducted.

**4. Retrieve on the flat 10 points**

a) One verbal command to: “Bring”, “Out/Aus”, “Heel/Fuss ”

b) Execution: From the basic position the handler (HF) throws a dumbbell (650grams) approximately 10 meters out. The command (HZ) to “bring” may first be given when the dumbbell comes to a full stop. The handler may not move from his position. The dog sitting calmly and off leash next to the handler (HF), may first go out to the dumbbell In a quick and direct manner after the command to “bring” is given, must pick it up immediately and bring it to his handler (HF) in a quick and direct manner. The dog is to sit closely and straight in front of the handler (HF). The dog is to hold the dumbbell calmly in his mouth until the handler (HF) after a pause of about 3 seconds commands (HZ) the “out”. The handler (HF) must hold the dumbbell calmly in his right hand with the right arm stretched out alongside the right side of his body. On the verbal command (HZ) to “Heel /Fuss”, the dog must quickly go into basic position and sit straight on the handler (HF)’s left side with the shoulder level to the handler (HF)’s knee. The handler (HF) is not permitted to change positions during the entire exercise.

c) Evaluation: Mistakes in the basic position, slow go out, mistakes in picking up, slow return, dropping the dumbbell, playing or mouthing the dumbbell, splayed stance of the handler, mistakes when sitting in front or finishing are evaluated accordingly. If the handler moves out of position before the exercise is completed, the rating is insufficient. If the dog does not retrieve, the exercise is valued at 0 points.

**5. Retrieve over a hurdle (100 cm) 15 points**

a) One verbal command to: “Jump”, “Bring” , “Out/ Aus”, “Heel/Fuss”

b) Execution: the handler (HF) assumes a basic position with his dog a minimum of 5 paces in front of the jump. From the straight basic position the handler (HF) throws the dumbbell (650 grams) over the 100 cm high hurdle. The command (HZ) to “jump” is first given when the dumbbell comes to a complete stop. The calm and off leash dog sits next to the handler (HF) and when given the command (HZ) to “jump” and “bring” (the command (HZ) to “bring” must be given when the dog is jumping over the hurdle), he must jump over the hurdle quickly and run directly to the dumbbell, pick it up immediately and jump immediately back over the hurdle and bring it directly and quickly to his handler (HF).



The dog must sit close in front and hold the dumbbell calmly in his mouth to present it until the handler (HF) commands him to “*release*” it after approx. 3 seconds.

The handler (HF) must hold the dumbbell calmly in his right hand with the right arm outstretched alongside the right side of his body. At the “*heel*” command (HZ) the dog is to assume the basic position quickly and straight to the left of the handler (HF) with the shoulder at knee height. The handler (HF) may not change positions during the entire exercise.

c) Evaluation: Mistakes in the basic position, slow, weak jumping underestimating the jump and running towards it, slow pick up, slow weak return jump (underestimating it) dropping it, playing or mouthing it, splayed stance of the handler (HF) mistakes sitting in front and at the end are evaluated accordingly. If the dog touches the jump one point is deducted per jump, stepping on it then 2 points are deducted.

Point structure for retrieve over a hurdle:

Going out jump	Retrieve	Return jump
5 points	5 points	5 points

A partial score for the exercise is only possible if at least on jump and a part of the retrieve work of the three parts of the exercise (going out – retrieve –return) are demonstrated.

Jumping and retrieving flawlessly	=	15 points
Jumping over or return jump no executed, dumbbell brought flawlessly	=	10 points
Jump over and back flawless, dumbbell refused	=	0 points

If the thrown dumbbell lands too far to one side of the hurdle or is poorly visible for the dog, the handler (HF) may ask the judge (LR) for a re-throw or the judge asks that it be re-thrown, no points are deducted. The dog must remain sitting during this time. If the dog follows the handler (HF) in retrieving the dumbbell, the exercise is rated with 0 points. If he leaves his basic position but remains in front of the jump, then the exercise is evaluated accordingly.

Handler (HF) help without change of position are evaluated accordingly. If the handler (HF) leaves his position before the exercise is ended, the exercise is rated as unsatisfactory. If the hurdle is knocked over, the exercise is to be repeated, whereby the first jump is rated at the lower level of insufficient (- 4 points). If the dog does not release the dumbbell after 3 commands, the dog is to be disqualified, as phase “B” cannot continue otherwise.

**6. Retrieve over a scaling wall (180cm) 15 points**

- a) One verbal command to: “*Jump*”, “*Bring*”, “*Out*”, “*Heel*”
- b) Execution: The handler (HF) assumes the basic position with his dog 5 paces in front of the scaling wall. From a straight basic position, the handler (HF) throws the dumbbell (650 gram) over the scaling wall. The calm and off leash dog sits next to the handler (HF) and when given the command (HZ) to “*jump*” and “*bring*” (the command HZ to “*bring*” must be given when the dog is jumping over the wall), he must climb over the hurdle quickly and run directly to the dumbbell, pick it up immediately and climb immediately back over the hurdle and bring it directly and quickly to his handler (HF).



The dog must sit close in front and hold the dumbbell calmly in his mouth to present it until the handler (HF) commands him to release it after approx. 3 seconds. The handler (HF) must hold the dumbbell calmly in his right hand with the right arm outstretched alongside the right side of his body. At the command (HZ) to “heel”, the dog is to assume the basic position quickly and straight to the left of the handler (HF) with his shoulder at knee height. The handler (HF) may not change positions during the entire exercise.

c) Evaluation: Mistakes in the basic position, slow, weak jumping and go out, mistakes in picking up, slow weak return jump, dropping the dumbbell, splaying or mouthing the dumbbell, splayed stance of the handler, mistakes sitting in front or at the end are evaluated accordingly.

Point structure for retrieve over a scaling wall:

Going out jump	Retrieve	Return jump
5 points	5 points	5 points

A partial score for the exercise is only possible if at least on jump and a part of the retrieve work of the three parts of the exercise (going out – retrieve –return) are demonstrated.

- Jumping and retrieve flawlessly = 15 points
- Refusal to jump over and back, dumbbell is retrieved = 10 points
- Jump over and back flawless, but dumbbell not retrieved = 0 points

If the thrown dumbbell lands too far to one side of the hurdle or is poorly visible for the dog, the handler (HF) may ask the judge for a re-throw or the judge asks that it be re-thrown, no points are deducted. The dog must remain sitting during this time.

Handler (HF) help without change of position are evaluated accordingly. If the handler (HF) leaves his position before the exercise is ended, the exercise is rated as unsatisfactory.

If the dog does not release the dumbbell after 3 commands, the dog is to be disqualified, as phase “B” cannot continue otherwise.

**7. Send out with down 10 points**

a) one verbal command to: “Go out”, “Down”, “Sit”

b) Execution: From the basic position, the handler (HF) walks out straight with his dog off leash in the designated direction. After 10-15 paces, the handler (HF) gives the “go out” command (HZ) while simultaneously raising his arm and remains standing. The dog must go out goal-oriented, in a straight line and at a quick pace a minimum of 30 paces in the designated direction. At the judge (LR)’s instructions, the handler (HF) gives the “down” command (HZ) whereby the dog must lie down immediately. The handler (HF) may keep his arm raised until the dog lies down. At the direction of the judge (LR), the handler (HF) goes to his dog and places himself to the right side of the dog. After approx. 3 seconds and at the instruction of the judge (LR) the handler (HF) gives the command to “sit”, whereby the dog is to sit quickly and straight in the basic position.



c) Evaluation: Mistakes in the development, handler (HF) following the dog, too slow of a go out on the dog's part, strong deviation to the side, too short of a distance, hesitant or premature downing, restless down or premature standing up/sitting are valuated accordingly. Additional help at the time of giving the "go out" or "down" command(s) are evaluated as well.

After reaching the required distance, the judge (LR) will principally give the direction to down the dog. If the dog does not allow itself to be stopped, the exercise is rated with 0 points.

One additional command to "down" = -1,5 points  
A second additional command to "down" = -2,5 points  
Dog does stop, but does not lie down after a second command = -3,5 points

Additional faults will be evaluated accordingly. If the dog leaves, or comes back to the handler (HF), the entire exercise is evaluated with 0 points.

**8. Down under distraction 10 points**

a) One verbal command to: "Down/ Platz", "Sit"

b) Execution: Before the beginning of another dog's obedience work of phase B, the handler (HF) goes with his dog to a places as assigned by the judge and unleashes his dog while in the basic position. Then the handler (HF) downs his dog with the command (HZ) "Down/Platz" and without leaving a leash or other article with the dog. The handler (HF) then leaves his dog without looking back approximately 30 paces within the trial area and remains calmly standing with his back to the dog. The dog has to remain calmly lying down without any influence of the handler (HF) while the other dog performs exercise 1 through 6. At the instruction of the judge (LR), the handler (HF) returns to his dog and stand to the right of his dog. At the instruction of the judge, the dog is to execute the "Sit" command (HZ) after a pause of approx 3 seconds quickly and straight in the basic position.

c) Evaluation: Restless behaviour of the part of the handler (HF) as well as other hidden help, restless lying down on the part of the dog, or standing/sitting prematurely before being picked up is evaluated accordingly. If the dog stands or sits, but does not leave the designated area, a partial awarding of points will result. If the dog leaves the designated area by more than 3 meters, prior to exercise 3, the exercise is rated with 0 points. If the dog leaves the designated area after exercise 3, he receives a partial evaluation. If the dog approaches the handler (HF), when the handler returns, up to 3 points can be deducted.

**IPO-1 Phase "C" Protection**

Exercise 1: Search for the helper 5 points  
Exercise 2. Bark and hold 10 points  
Exercise 3: Prevention of an attempted helper escape 20 points  
Exercise 4: Defence of an attack in the guarding phase 35 points  
Exercise 5: Attack on the dog out of motion 30 points  
**Total: 100 points**



**General Requirements:**

In a suitable location, six (6) blinds are to be set up, 3 on each side, in a staggered fashion (see sketch). The necessary markings are to be clearly visible for the handler (HF), the judge (LR) and helper (HL).

**Protection helper/Protection clothing**

The helper must be equipped with a protection suit, protection sleeve and a soft stick. The protection sleeve must have a grip bar, the cover made of natural jute (burlap) fibre. If the helper has to maintain visual contact with the dog during the guarding phase, then he may move accordingly. He may not assume a threatening position nor make any defensive gestures. He must protect his body with the protection sleeve. The style in which the handler (HF) takes the soft stick away from the helper (HL) is up to him.

It is possible to work with only one helper at all examination levels. If more than 7 dogs are entered at the same test level, then an additional helper is required. All dogs within the same test level must be worked by the same helper/helpers.

A one-time change of the helper is permitted, if the helper is an active handler at the event.

**Reporting in**

- a) The handler reports in with his dog on leash
- b) Thereafter he takes the dog to the start position for the “revere” exercise. The dog is taken off leash at this point.
- c) The dog will be dispatched from the basic position at the instruction of the judge.

**Remark:**

If the handler and dog cannot report in in the proper manner, for instance the dog is not under control and runs for example to the bark and hold blind or from the field, the handler may give up to 3 commands to recall the dog.

If the dog does not come back after the 3<sup>rd</sup> recall, then phase “C” is regarded as a “disqualification due to lack of control”.

Dogs that are not under the control of the handler (HF), that after a defence exercise are not under control or where the handler (HF) must intervene to have the dog out, that grip other parts of the body rather than the protection sleeve must be disqualified. There is no “TSB”.

**Markings:**

The markings as prescribed in the rules must be visible for the handler, judge and helper.

These markings are:

- Place where the handler (HF) stands to recall his dog out of the bark and hold blind
- Place where the helper stands for the escape and defence and where he is to stop
- Place where the dog is in a down position for the escape
- Marking for the handler for the exercise “Attack on the dog out of motion”



Dogs that fail the defence exercise or allow themselves to be driven, phase “C” is terminated. There is no evaluation. The “TSB” is made known.

The command (HZ) to “Out” is permitted only once for each defence exercise. Evaluation for the “out” is as per the following table:

Slow “out”	First “out” with “out”	additional command with immediate	First “out” with slow “out”	additional command	Second “out” with “out”	additional command with immediate	Second “out” with slow “out”	additional command	No “out” after second command or handler influence
0,5-3,0		3,0		3,5-6,0		6,0		6,5-9,0	disqualification

**1. Search for the helper**

**5 points**

a) One verbal command to: “Search”, “Here”(the “here” command (HZ) may be used in conjunction with the dog’s name)

b) Execution: The helper is located in the last blind out of the dog’s sight. The handler (HF) positions himself with his off leashed dog between the fourth and fifth blind so that two side sweeps are possible and then take his dog off leash. At the instruction of the judge (LR), phase “C” begins with a short command to “search” with the visual aide by raising the right or left arm – this can be repeated – the dog must quickly be dispatched from the handler and run to the fifth blind goal-oriented, go around it tightly and attentive.

When the dog executes the side sweep, the handler (HF) calls the dog to him with the “here” command (HZ) and in movement directs him to the find blind. The handler (HF) moves at a normal pace down an imaginary line that his not permitted to leave. The dog has to run in front of the handler (HF). When the dog has reached the helper blind, the handler (HF) must stop and not further commands (HZ) verbal or visual may be given.

c) Evaluation: Limitations in directability, fast and goal-oriented running to the blind as well as tight and attentive running around the blind are evaluated accordingly.

Faulty is among others:

- Not assuming a calm and attentive basic position at the beginning of the exercise
- Additional verbal or visual commands
- Not maintaining the middle imaginary line
- Not maintaining a normal pace
- Wide search
- Independent searching with reacting to the commands of the handler
- Blinds are not searched or not attentively searched
- Dog needs more direction and guidance

If the dog does not successfully find the helper at the last blind after the third attempt, the protection work is terminated. If the dog is commanded by the handler to heel at any time during the exercise, the protection work is also terminated.(“Terminated” without point entry; all other remaining points in the trial are entered).



**2. Bark & Hold**

**10 points**

a) One verbal command to: *“Here”*, *“Heel”*

The commands (HZ) to *“here”* and *“finish”* must be given at the same time

b) Execution: The dog has to actively and attentively hold the helper and continuously bark. The dog may not jump on the helper or grip him. After the dog has barked for approx. 20 seconds, the handler (HF) approaches the dog at the instruction of the judge (LR) and stops about 5 paces away from it. At the direction of the judge (LR), the handler (HF) calls his dog to the basic position. As an alternative the handler may pick up his dog commanding *“heel”* and putting him at the marked area. Both variables are equally evaluated.

After the judge releases the helper, the handler calls the helper out of the blind and has him take the designated place for the escape exercise. The dog is to sit quietly (without barking) straight and attentive in the basic position.

c) Evaluation: Limitations with continuous barking and determinately holding until the command (HZ) is given without the intervention of the judge (LR) or handler (HF) are evaluated accordingly. For continuous barking 5 points are awarded. If the dog displays a weak bark only 2 points, the non-barking dog that actively and attentively watches the helper 5 points are deducted. Bothering the helper such as bumping, jumping up etc. must have a 2 point deduction and 9 if the dog grips strongly.

If the dog grips in the blind and does not independently release, the handler (HF) is requested to approach the blind at the place marked 5 paces in front of it. A one-time command to *“here/heel”* – may be given as a simultaneous command (not the command to *“out”*) is permitted. If the dog does not come, then the team is disqualified. If the dog does come, then the exercise is rated as a low satisfactory (- 9 points). If the dog intentionally grips other body parts (not bumping), the dog is disqualified.

If the dog leaves the helper, before the judge’s directs the handler (HF) to leave the middle line, the dog may be redeployed to the helper.

If the dog remains with the helper, then phase C can continue, whereby the bark and hold are evaluated at a lower insufficient rating (- 9 points). If the dog does not allow himself to be redeployed or leaves the helper again, then phase C is terminated. If the dog comes towards the handler (HF) as he approaches the blind, or the dog comes back to the handler (HF) prior to receiving a verbal command a partial rating as insufficient is given.

**Rating for “barking”**

For continuous barking 5 points are awarded. Weak barking (no pressure, non energetic) and no continuously barking lead to a -2 point deduction. If the dog displays an attentive hold without barking, then mandatory 5 points are deducted.

**3. Preventing and escape by the helper 20 points**

- a) One verbal command to: *“Heel”, “Down”, “Go out or stop”, “Out”*
- b) Execution: At the direction of the judge (LR) the handler (HF) orders the helper out of the blind. The helper moves at a normal pace to the designated location for the escape. At the direction of the judge (LR), the handler (HF) takes his free heeling dog to designated location for the dog to down before the escape. The dog is to show a happy, attentive and concentrated heel exercise and execute heeling positioned at the knee of the handler in a straight and quick manner. Prior to the command *“down”*, the dog is to sit in the basic position straight, calmly and attentive. He is to directly and quickly do the *“down”* command and remain in the designated location calmly, confident and be attentive to the helper.

The distance between the helper and the dog is to be 5 paces. The handler leaves his dog on watch position, dog in the down position and goes to the blind. He remains in visual contact to his dog, the helper (HL) and the judge (LR).

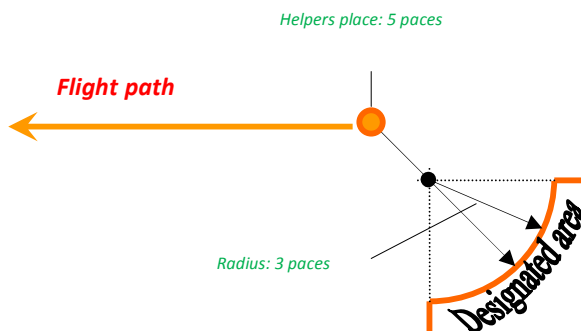

At the direction of the judge (LR), the helper undertakes the escape. Simultaneously the handler (HF) commands the dog to *“go on or stop”* to have the dog prevent the escape of the helper (HL). Without hesitation the dog is to prevent the escape by means of a high dominance ratio and relatively fast grip deploying an energetic and strong grip. He may only grip the protection sleeve of the helper (HL). At the instruction of the judge (LR), the handler stops. After the helper stops the dog has to release after a brief transition period. The handler (HF) may give a command (HZ) to *“out”* in a reasonable amount of time.

If the dog does not out after the first permitted command (HZ), the handler (HF) will receive instructions from the judge for a second command (HZ) to *“out”*.

If the dog does not out after the third command (HZ) (one permitted – two additional), a disqualification will result. The handler (HF) is to remain calmly standing when giving the *“out”* command (HZ) and without influencing the dog. After the release, the dog is to remain close to the helper and watch him attentively.





c) Evaluation: Limitations in the important evaluation criteria: high dominance, quick energetic reaction and pursuit with a strong grip with a relatively quick grip action and effective hindrance of the escape with a calm grip until release, attentive hold close to the helper are evaluated accordingly.

If the dog remains down or the dog does not prevent the escape through gripping or holding within 20 paces, phase C is terminated.

If the dog engages without a command from the handler, the exercise is rated minus a point. If the dog is slightly attentive in the holding phase and/or slightly bothersome, the exercise is rated minus a point, the dog very inattentively holds the helper, and/or is very bothersome, a two point deduction will result. If the dog does not hold the helper, remains however with him, a three point deduction will result. If the dog leaves the helper or the handler (HF) gives a command (HZ) so that the dog stays with the helper, phase C is terminated.

**4. Defense of an attack during the guarding phase 35 points**

a) One verbal command to: *“Out/ Aus”, “Heel/Fuss”*

b) Execution: After the holding phase of approximately 5 seconds, the helper under the direction of the judge (LR) attacks the dog. Without intervention by the handler (HF), the dog must defend himself by means of an energetic and strong grip. The dog may only grip the protection sleeve of the helper (HL). The helper is to pressure the dog by way of threatening stick gestures and driving him. The dog is to be closely observed when pressured especially concerning his activity and stability. Two tests are conducted with the stick pressure. The dog may only grip the protection sleeve of the helper. Stick hits are only to be deployed on the shoulders or in the withers area. The dog has to be impartial during the pressure phase and has to show a full, energetic and above all a constant grip during the entire defence exercise. At the instructions of the judge (LR), the helper stands still. After the helper stops the dog is to release after a relatively brief transition period. The handler (HF) may give a command (HZ) to *“out”* within a reasonable amount of time.

If the dog does not out after the first permitted command (HZ), the handler receives the instruction from the judge to give two additional commands (HZ) for the *“out”*. If the dog does not out after these commands (HZ) (one permitted two additional), a disqualification will result. When giving the *“out”* command (HZ), the handler (HF) is to remain calmly in place and not influence the dog. After the release, the dog is to remain close to the helper and watch him attentively. At the judge (LR)'s instruction, the handler (HF) goes at a normal pace in the most direct way to his dog and takes him into the basic position by commanding (HZ) *“Heel/Fuss”*. The soft stick is not taken from the helper.

c) Evaluation: Limitations concerning the important evaluation criteria are evaluated accordingly: Quick and strong grip, full and calm grip up to release, after the release an attentive close guarding of the helper. If the dog does not withstand the pressure of the helper, comes off of the protection sleeve and allows himself to be chased, phase *“C”* is terminated.

If the dog is slightly inattentive and/or slightly bothersome, a one point deduction will result, the dog guards the helper very inattentively and/or is very bothersome, a two point deduction will result.

If the dog does not guard the helper, but remains with the helper, a three point deduction will result. If the dog comes towards the handler when he approaches, the exercise is rated as insufficient.



If the dog leaves the helper or the handler gives a command so that the dog stays with the helper, phase C is terminated.

**5. Attack on the dog out of motion**

**30 points**

a) One verbal command to: *"Sit", "Out", "Heel"*

b) Execution: The handler (HF) is advised to go to the designated place with his dog on the middle line at the level of the first blind. The dog is to heel attentive to the handler, happy and concentrated. He moves straight at knee height of the handler. At the level of the first blind, the handler stops and turns around. With the command to *"sit"*, the dog is placed in basic position. The straight, calm and attentively sitting dog facing the helper may be held on the collar, may however not be stimulated by the handler. At the direction of the judge (LR), the helper comes out of the blind and goes in a running pace to the middle line.

Ignoring the shout of the handler (HF), the helper (HL) (still running) charges the dog and handler (HF) in a frontal attack with loud shouts and threatening gestures. As soon as the helper (HL) reaches the handler (HF) and his dog at about 40 to 30 paces the handler (HF) under the direction of the judge (LR) releases his dog. Without hesitation and on one command to *"go on"* the dog is to effectively prevent the attack through a high dominance factor and relatively quick speed. He may only grip the protection sleeve of the helper. The handler (HF) may not leave the place where he stopped.

In the pressure phase, he has to be uninfluenced and during the entire defence exercise, he has to display a full, energetic and above all a constant grip. At the direction of the judge (LR) the helper stops. After the helper stops, the dog is to release in a brief transition time. The handler may give a command to *"out"* in a reasonable amount of time.

If the dog does not out after the first permitted command (HZ), the handler (HF) receives the instruction from the judge to give two additional commands (HZ) for the *"out"*. If the dog does not out after these commands (one permitted two additional), a disqualification will result. When giving the *"out"* command (HZ), the handler (HF) is to remain calmly in place and not influence the dog. After the release, the dog is to remain close to the helper and watch him attentively. At the judge's instruction, the handler (HF) goes at a normal pace in the most direct way to his dog and takes him into the basic position by commanding *"Heel/Fuss"* The soft stick is taken from the helper.

A side transport of the helper now takes place to the judge (LR) over a distance of about 20 paces. A command to *"heel"* is permitted. The dog is to go at the right side of the helper so that the dog is between the helper and the handler (HF). During the transport the dog is to be attentive to the helper. He may not however crowd the helper, jump on him or grip. The group stops in front of the judge (LR). The handler (HF) gives the soft stick to the judge (LR) and reports out ending phase C. At the instruction of the judge (LR), the handler (HF) goes with his dog on leash to a place where the critique will be given and the helper will receive instructions from the judge (LR) to leave the field. Prior to the critique and under the direction of the judge (LR), the dog is put on leash.

c) Evaluation: Limitations concerning the important evaluation criteria are evaluated accordingly: Energetic defence with strong grip, full and calm grip until release, after the release attentive and close guarding of the helper.



If the dog is slightly inattentive and/or slightly bothersome, a one point deduction will result, the dog guards the helper very inattentively and/or is very bothersome, a two point deduction will result. If the dog does not guard the helper, but remains with the helper, a three point deduction will result. If the dog comes towards the handler (HF) when he approaches, the exercise is rated as insufficient. If the dog leaves the helper before the judge instructs the handler to approach or the handler (HF) gives a command (HZ) so that the dog stays with the helper, phase C is terminated.

## **IPO-2**

Arranged as follows:	Phase A	100 points
	Phase B	100 points
	Phase C	100 points
<b>Total:</b>		<b>300 points</b>

### **IPO-2 phase "A" Tracking**

**Track laid by a stranger, minimum 400 paces, 3 legs, 2 turns (approx 90 degrees), 2 articles, aged minimum 30 minutes, execution time 15 minutes.**

Maintaining the track	79 points
Articles (11 + 10)	21 points
<b>Total:</b>	<b>100 points</b>

If the dog does not find the articles, he can only receive a "satisfactory" rating.

### **General Requirements:**

The judge (LR) or the person in charge of tracking determines the pattern of the track taking into consideration the available area. Varying patterns must be utilized. It is not possible that the articles and corners of each track are located at the same distance from each other. The start is to be clearly marked with a sign, which must be placed directly in the ground to the left of the scent pad.

After the tracks are laid, the starting positions are determined through a draw in the presence of the judge (LR).

### **Track terrain**

Acceptable terrain is all natural ground cover, such as grass, plowed fields and forest.

Visual tracks are to be avoided. In all trial levels adaptations of the tracks to the available tracking-grounds is possible.

### **Laying the track**

The judge or the track coordinator is responsible for:

- organizing the track layout,
- integrating the track layers,
- observing how tracks are laid.



The available terrain determines how the individual tracks are to be laid.

When laying the tracks, note should be taken, to walk in a natural manner. Help of the tracklayer by means of unnatural walking on the legs, at the turns, articles for the entire track are not permitted.

For Level 2 and up experienced track layers are to be especially used.

The tracklayer (FL) must show the articles to the judge (LR) prior to laying the track. The tracklayer (FL) pauses for a brief moment at the scent pad and then continues at a normal pace in the assigned direction. The turns are also done at a normal pace. Scuffing or integrating a break in stride is not permitted.

The legs are to be laid also at a normal pace without scuffing or breaking of stride. The distance between the individual legs must be a minimum of 30 paces.

The turns (approx 90 degrees) are also done at a normal pace in order to ensure a seamless tracking flow for the dog into the next leg. A break in the track is not permitted (see sketch). The dog is out of sight while the track is being laid.

### **Placing the articles**

The first article is placed at least a minimum of 100 paces, not within 20 paces before or 20 paces after a turn, on the first or second leg, the second at the end of the track. The articles must be placed in movement. After placing the last article, the tracklayer is to go several more paces in a straight direction.

### **Track articles**

Only articles that the tracklayer (FL) has carried for a minimum of 30 minutes may be used. Within a given track various articles may be used (such as leather, textiles, wood). The articles must be approx. 10cm long, 2-3cm wide and 0,5-1cm thick. The articles may not stand out in colour from the terrain.

For above regional events the articles must be numbered whereby the number must coincide with the respective track.

While the dog is working out the track, the judge (LR), tracklayers and any accompanying person(s) are not permitted in the area where the dog/handler team has the right to track.

### **Commands**

The command (HZ) to "track" is permitted at the start of the track and by restarting after the first article or after a "false indication".

### **Execution and evaluation of the track work**

The handler (HF) prepares the dog for the track. The dog may track free or on a 10 m line. The 10 meter line may be held over the dog's back, to the side or between his front and/or back legs. The tracking line may be attached directly to the collar, but not the live ring or attached to the harness ring (harness or böttger harness without additional straps). When called the handler (HF) goes with his dog into basic position and reports in to the judge (LR) and advises if the dog will pick up or indicate. Prior to the track, at the scent pad and for the duration of the track, no force is to be applied.

The tracking line must be a minimum of 10 meters long. The judge (LR) may check the length of the line, the collar and the harness only prior to the start of the track. Flexible leashes are not permitted.



### **Start**

At the direction of the judge (LR), the dog is taken slowly and calmly to the scent pad and started. Briefly sitting prior to the track (approx. 2 meters) is permitted.

The start (also after the restarts after locating the articles) must be done by the dog. A certain amount of slack is permitted in using the line. The dog has to start intensely, calm and with a deep nose. Taking the scent must be done without handler influence (except for the command to "Track"). The scent pad is not under any time constraints; furthermore the judge (LR) has to observe the behaviour of the dog at the beginning of the first leg as to how intensely he orients himself to the taking the scent.

After a third attempt to start the dog at the scent pad, the track is terminated.

The dog has to track with a deep nose maintaining a steady pace. The handler follows his dog at a distance of 10 meters at the end of the tracking line. If the dog tracks free, then the handler is to maintain a distance of 10 meters as well. There may be some slack in the tracking line, but whereby the handler (HF) keeps it in his hand(s) and a definitive shortening of the line to get closer to the dog may not happen. Touching the ground is not faulty.

### **Track work**

The dog must follow the track intensely, with endurance and when possible at an even speed (depending on the terrain, degree of difficulty). The handler is not obliged to follow the course of the track. A rapid or slow track execution cannot be a criterion towards the rating, when the track is consistently and convincingly worked out.

### **Turns**

The dog has to work out the turns confidently. Checking without leaving the track is permitted and is not faulty. Circling at the turns is faulty. After the turn the dog is to continue tracking at the same even speed. In the area of the turn, the handler should maintain the required distance if possible.

### **Indicating or picking up the articles**

As soon as the dog has found the articles, he has to convincingly and without handler (HF) help either pick up or indicate. If he picks up he may either remain standing, sit or return to the handler, who has to remain standing. Continuing with the article or lying down are faulty. The indication may be done either lying down, sitting or standing (also alternating is permitted).

Not lying completely straight at the article is not faulty, lying to the side of the article or turn around looking at the handler is however faulty. Articles that are done with strong handler help are considered to be overrun. This would be the case for instance, if the dog does not indicate the article and the handler either by use of the line or through verbal command hinders the dog from continuing to track.

When the dog either picks up or indicates the article, the handler is to drop the line and go to his dog. By raising his arm with the article in hand, he advises that the dog has found the article. Picking up and indicating are faulty.



Any action done with the article or picking up while lying down is faulty. If the dog returns back to the handler, the handler does not approach the dog.

When the handler approaches his dog to release the article or when picking up, the handler must stand next to the dog.

The dog is to remain calmly in place if indicating or where he picked up the article until released to track whereby the handler deploys him holding the line short.

### **Leaving the track**

If the handler restrains the dog from leaving the track, then the handler receives instructions from the judge to follow the dog. The handler must follow these instructions. Tracking will be terminated if the dog is more than a line length off of the track (over 10 meters with a free tracking dog) or the handler does not heed the judge's instructions.

### **Praising the dog**

Occasional praising in the level 1 phase is permitted (the command to "*Such/track*" is not considered praise). This occasional praising in level 1 is not permitted at the turns. The dog may be praised at the articles. A short praise may be given either before or after the article is shown.

### **Reporting out**

After completing the track, the found articles are to be presented to the judge. Playing or feeding the dog after picking up or indicating the last article prior to reporting out and receiving the awarded points is not permitted. Reporting out is to be done in basic position.

### **Evaluation**

The evaluation of Phase "A" begins with the start of the dog tracking.

A convincing, intensive and dedicated nose work as well as a good training base are expected of the dog.

**The handler** has to become part of the process and experience it. He has to interpret the reactions of the dog, be concentrated on the work and ignore any external influences.

The judge has to observe not only the dog and handler, but also the tracking area, the weather, possible cross tracks and the time-frame. In his evaluation he has to take into consideration all factors.

- Track behaviour ( speed on the legs, before and after the turns, before and after the articles)
- Training status of the dog (i.e., hectic start, showing pressure, avoidance)
- Any handler help
- Difficulty in working the track through:
  - Ground conditions (overgrown, sand, change of terrain, fog)
  - Wind conditions
  - Wild game
  - Weather (heat, rain, snow)
  - Scent change

The evaluation should be contingent upon these conditions.



After the handler has reported in for the track, the judge has to strategically place himself so as to be able to observe the track work and listen to verbal commands or see any other influence by the handler.

He has to select a distance from the handler so that he does not interrupt the dog's work and so that the handler does not feel crowded. The judge has to be able to experience the entire track work.

He has to evaluate the dog's work based on his enthusiasm, confidence or insecurity or flightiness.

A fast or slow track work is not part of the criteria for the evaluation, if the track is worked out intensely, even and convincingly and the dog maintains a positive attitude.

Checking without leaving the track is permitted and not faulty. Casting, emptying, circling at the turns, constant encouragement, line or verbal helps within the tracking area, or at the articles, faulty pick up or faulty indication of the articles are evaluated accordingly (up to 4 point deduction).

Definitive casting, lacking intensity, wildly tracking, emptying, hunting mice, etc. can receive up to an 8 point deduction.

If the handler leaves the track by more than a leash length, the track is terminated. If the dog leaves the track and is restrained by the handler, judge advises the handler to follow his dog. If the instructions are not followed, the track will be terminated by the judge.

If after the maximum allowable time (Level 1 and 2 = 15 minutes) (Level 3 = 20 minutes) to work out the scent pad is not met, the track work is terminated by the judge. Any awarded points up to this point are made known.

If the dog shows both styles of article work, namely "picking up" and "indicating" on a given track, this is considered faulty. Only the reported/shown articles will be evaluated.

Pick up or faulty indication of the articles, false indication, are to be deducted accordingly up to 4 points, if the restart is next to the dog and another 2 points obligation deduction if the handler makes the restart at the end of the tracking- lease.

If articles are not found, then no points are awarded. If no articles are found, the phase "A" can only be rated as "satisfactory". Also this must be taken into consideration that the handler cannot restart his dog at an article.

If the dog follows his hunt drive and chasing game, the handler may give the command to "down" in order to maintain control. The track work will continue at the instruction of the judge. If this does not work, the trial is terminated. (Evaluation: disqualified due to lack of control).

**Termination/Disqualification**

<b>Behaviour</b>	<b>Consequence</b>
Dog is restarted at the scent pad 3x	<b>Terminated</b>
<ul style="list-style-type: none"> <li>- All Levels: Dog leaves the track by more than a line length or the handler does not heed the judge's instructions</li> <li>- Dog does not meet the time limit for the track Level 2: 15 minutes after the start</li> </ul>	<p><b>Terminated</b> - points will be awarded up to that point</p> <p><b>CRITIQUE UP TO TERMINATION!!</b></p>
<ul style="list-style-type: none"> <li>- Dog picks up the article but refuses to release it.</li> <li>- Dog chases game and cannot be restarted.</li> </ul>	<b>DISQUALIFICATION</b> due to lack of control

**Track layouts:**

The following layouts may be done as a mirror image as well.

**IPO-1 and 2**

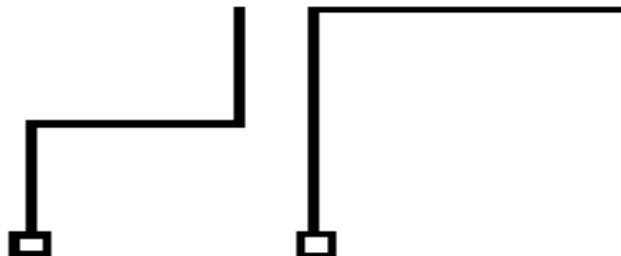

**IPO-2 Phase "B" Obedience**

Exercise 1:	Off-Leash heeling	10 points
Exercise 2:	Sit in motion	10 points
Exercise 3:	Down with recall	10 points
Exercise 4:	Stand while walking	10 points
Exercise 5:	Retrieve on the flat	10 points
Exercise 6:	Retrieve over the hurdle	15 points
Exercise 7:	Retrieve over the scaling wall	15 points
Exercise 8:	Send out with down	10 points
Exercise 9:	Down under distraction	10 points
<b>Total</b>		<b>100 points</b>





## **General Requirements**

For Level IPO-2 the handler appears with his dog off leash, reports in the basic position to the judge.

Especially in the obedience attention must be paid to the fact that the dog exhibits no pressure from the handler demonstrating that his self-confidence has been deflated and that he does not appear to be just “sport equipment” of the handler.

During all exercises a happy work ethic and the required concentration must be displayed towards the handler. Attention must be paid to the happy work ethic in conjunction with the correct execution of the work and will be evaluated as such.

If a handler forgets an entire exercise, the judge (LR) will request that he is to show this missing exercise. There is no point deduction for this.

No later than at the start of the obedience, all equipment must have been checked by the judge (LR). The equipment must meet the governing rules.

The gun to be used during the “Off-Leash” and “Down under Distraction” exercises must be of 6 mm calibre.

The judge (LR) advises the start of each individual exercise. Anything further, such as turns, halting, change of pace, etc. are done independently.

The commands (HZ) are engraved in the rules. Commands (HZ) are to be spoken in a normal tone, brief, consisting of a one-word command. They may be given in any language, however must be the same for the related exercise. If a dog does not execute an exercise after a command (HZ) is given three times, then the exercise receives no points. When recalling the dog, the name of the dog may be used. The name of the dog used in conjunction with a command (HZ) is considered a double command.

### **Beginning an exercise**

The judge (LR) advises when the exercise is to begin.

### **Basic Position**

The basic position is to be assumed, when the second dog handler, who has taken his dog to the designated area for the down under distraction exercise, has taken his place. At this juncture the evaluation for both dogs begins.

Each exercise begins and ends with a basic position. The handler is to stand in a sporty manner. A splayed stance is not permitted for any exercise.

The dog is to sit at the left side of his handler in a close, straight, calm and attentive manner, so that his shoulder is knee high to the handler (HF) when demonstrating the basic position that is only allowed to be shown only once in the forward direction. Assuming the basic position is only allowed once. A short praise is permitted at the end of each completed exercise. Thereafter the handler (HF) may assume another basic position. Between praise and a new start a definitive time lapse of approx 3 seconds must take place.



An exercise is developed from the basic position. The handler must take at least 10 paces, up to 15 paces maximum, before he gives the command to execute an exercise. Between all fronts and finishes, as well as when the handler returns to the sitting, standing or lying dog, a distinct pause of 3 seconds is to be maintained. In returning to the dog, the handler may approach him from front or go behind the dog. Mistakes in the basic position and the development phase are evaluated accordingly.

Correct heeling position is to be demonstrated even between exercises. Even when retrieving the dumbbell, the dog is to accompany the handler. Motivating or playing with the dog at this juncture is not permitted.

The about turn is to be demonstrated to the left by the handler (HF). The dog may complete the about turn either by going behind the handler (HF) or from the front, but whereby the style must remain consistent within a given trial.

After sitting in front, the dog may either go behind the handler or assume the basic position from the front.

The fixed jump needs to be 100cm high and 150 cm wide. The scaling wall consists of two planks secured at the top and must be 150cm wide and 191 cm high. At the base, the two sides are to be set apart so that there is a vertical height of 180 cm. The entire surface of the scaling wall must be covered with a non-skid material. On the walls themselves 3 cleats must be affixed near the top half with each being 24/48mm. All dogs must negotiate the same hurdles.

For the retrieve exercise only dumbbells are permitted which has the prescribed weight. (on the flat-1000 gram, hurdle and scaling wall 650 gram). The dumbbells as provided by the event coordinator must be used by all dogs. It is not permitted to place the dumbbell in the dog's mouth prior to the exercise.

If the handler (HF) forgets an exercise, the missing exercise will be advised by the judge (LR), without any point deduction.

When the dog on the long down exercise is taken to the respective area and the basic position has been taken, the handler (HF) starting the off leash work is to assume the basic position.

### **Categorizing the exercises**

2-part exercises, such as "Sit in motion" "Down with recall", "Stand in normal pace", "Stand in motion" may, to have a partial judgement, be divided into two parts as follows:

- a) "Basic position, development, execution" = 5 points**
- b) "further behaviour up until completion of the exercise" = 5 points**

The evaluation of the dog is to be done for each exercise by observing him from beginning at basic position to the end of the exercise.



### Additional commands

If a dog does not complete the exercise after 3 commands, the exercise is evaluated as unsatisfactory (=0 points). If the dog completes the exercise after the third command, then the exercise is evaluated as unsatisfactory.

When recalling the dog the dog's name may be used in lieu of "Here". The name of the dog used in conjunction with the command is considered a double command.

Evaluation: 1. additional command                      satisfactory for part of an exercise  
                  2. additional command                      unsatisfactory for part of an exercise

Examples: 5-point exercise

- 1. additional command: satisfactory    5 points = -1.5 points
- 2. additional command: unsatisfactory    5 points = -2,5 points

Between the individual parts exercises sitting in front and finish, as well as approaching the sitting, standing or lying dog, a definitive pause of minimum 3 seconds must be maintained.

When the dog on the long down exercise is taken to the respective area and the basic position has been taken, the handler (HF) starting the off leash work is to assume the basic position.

### 1. Off-Leash heeling

**10 points**

a) One verbal command is permitted to "Heel"

The handler (HF) may give this command (HZ) at the start of heeling and when changing pace.

b) Execution: the handler (HF) approaches the judge (LR) with his dog off leash, has the dog sit and reports in. From a straight basic position, the dog is to follow the handler (HF) at the "heel" command (HZ) in an attentive, happy and straight manner with his shoulder blade at knee height and to the left of the handler (HF) and sits straight, independently and quickly at the halt. At the beginning of the exercise the handler (HF) goes out with his dog 50 paces without stopping, after the about turn the handler runs showing 10 to 15 paces, then changes over to a slow pace showing a minimum of 10 paces. The change from fast to normal paces must be done in transition without taking any steps in between. The changes of pace must show clear delineation. At the normal pace at least two right and two left turns and two about turns are to be demonstrated as well as a halt after one of the about turns. The handler must show the about turn to the left (180 degree turn in place. (see prescribed sketch). Two variables are possible:

- The dog goes behind the handler with a right turn.
- The dog turns in place at 180 degrees for the left about turn.

**Within a trial only one given variable is permitted.**

The halt must be shown after the second about turn at least once at a normal pace according to the sketch.



The dog is to remain constantly with his shoulder blade at knee height to the left side of the handler; he may not forge, lag or heel wide. The about turn is to be shown as a left about turn by the handler.

While the handler (HF) is heeling with his dog on the first straight away, two shots (6mm calibre) are fired within a time-frame of 5 seconds and at a distance of minimum 15 paces. The dog must show impartiality to the gun shots. At the end of the exercise, the handler (HF) goes with his dog into a group of at least 4 moving people. The handler (HF) has to go around a person both to the left and the right and must halt once in the group. The judge (LR) may request a repeat. The handler (HF) leaves the group and assumes the basic position. This basic position is the beginning of the next exercise.

c) Evaluation: Forging, heeling wide, lagging, slow or hesitant sit, additional handler physical help, inattentiveness in all paces and turns and/or dog shows pressure are evaluated accordingly.

**2. Sit in Motion**

**10 points**

a) One verbal command to: "Heel", "Sit"

b) Execution: From a straight basic position, the handler (HF) goes with his dog off-leash straight out. In the development phase, the dog is to heel with his handler in an attentive, happy, quick and concentrated manner. He has to remain in a straight position at knee of the handler. After 10-15 paces, the dog is to execute the sit command (HZ) immediately and in the direction of moving without the handler (HF) breaking stride, changing pace or looking back. After an additional 15 paces the handler (HF) stands still and turns immediately to his calm and attentively sitting dog. At the instruction of the judge (LR), the handler (HF) returns to his dog and stands to the right of the dog. The handler may approach either from the front or around the back.

c) Evaluation: Mistakes in the basic position, development, slow sit, restless and inattentive sitting are evaluated accordingly. If the dog stands or lies down instead of sitting 5 points are deducted. Other mistakes are taken into account.

**3. Down with Recall**

**10 points**

a) One verbal command to: "Heel", "Down", "Here"

b) Execution: From the basic position, the handler (HF) goes straight out with his dog off leash. After 10-15 paces, the dog is to execute the "down" command (HZ) immediately and in the direction of moving without the handler breaking stride, changing pace or looking back. After an additional 30 paces the handler (HF) stands still and turns immediately to his calm and attentively lying dog. At the instruction of the judge (LR), the handler (HF) recalls his dog either using the "here" command (HZ) or the dog's name, the dog has to come happy, quickly and directly to the handler (HF), and sit close and straight in front. At the "Heel" command (HZ) the dog is to go quickly to sit straight next to the left of the handler with his shoulder at knee height of the handler.

c) Evaluation: Mistakes in the development, lying down slowly, restless lying, slow return or slows down when approaching the handler, splayed stance of the handler (HF), mistakes in sitting and at the finish are evaluated accordingly. If the dog sits or stands at the down command (HZ) 5 points are deducted.



**4. Stand while walking**

**10 points**

- a) One verbal command to: “Heel”, “Stand”, “Sit”
- b) Execution: From a straight basic position, the handler (HF) goes with his off leash dog straight out. After 10-15 paces the dog is to stand immediately in the direction of movement at the “stand” command (HZ). After an additional 15 paces the handler (HF) stops and turns immediately around to his quietly and attentive standing dog. At the direction of the judge (LR), the handler (HF) returns directly to his dog and positions himself on the right side. After approx. 3 seconds, at the instruction of the judge (LR), the dog is to sit quickly and straight at the “sit” command (HZ).
- c) Evaluation: Faults in the development, lagging at the command (HZ), restless standing, inattentive standing, restlessness when the handler (HF) approaches, slow sit at the end are evaluated accordingly. If the dog sits or lies down at the “stand” command (HZ), 5 points are deducted accordingly.

**5. Retrieve on the flat**

**10 points**

- a) One verbal command to: “Bring”, “Out”, “Heel”
- b) Execution: From the basic position the handler (HF) throws a dumbbell (1000 grams) approximately 10 meters out. The command (HZ) to “bring” may first be given when the dumbbell comes to a full stop. The dog sitting calmly and off leash next to the handler (HF), may first go out to the dumbbell in a quick and direct manner after the command (HZ) to “bring” is given, must pick it up immediately and bring it to his handler (HF) in a quick and direct manner. The dog is to sit closely and straight in front of the handler (HF). The dog is to hold the dumbbell calmly in his mouth until the handler (HF) after a pause of about 3 seconds commands (HZ) the “out”.  
The handler must hold the dumbbell calmly in his right hand with the right arm stretched out alongside the right side of his body. On the verbal command (HZ) to “heel”, the dog must quickly go into basic position and sit straight on the handler (HF) 's left side with the shoulder level to the handler (HF)'s knee. The handler (HF) is not permitted to change positions during the entire exercise.
- c) Evaluation: Mistakes in the basic position, slow go out, mistakes in picking up, slow return, dropping the dumbbell, playing or mouthing the dumbbell, splayed stance of the handler (HF), mistakes when sitting in front or finishing are evaluated accordingly. If the dumbbell is thrown not far enough and handler (HF) help without moving from his position are evaluated accordingly. If the handler (HF) moves out of position before the exercise is completed, the rating is insufficient. If the dog does not retrieve, the exercise is valued at 0 points.

**6. Retrieve over a hurdle (100 m)**

**15 points**

- a) One verbal command to: “Jump”, “Bring”, “Out”, “Heel”
- b) Execution: the handler (HF) assumes a basic position with his dog a minimum of 5 paces in front of the jump. From the straight basic position the handler (HF) throws the dumbbell (650 grams) over the 100 cm high hurdle.



The command (HZ) to “jump” is first given when the dumbbell comes to a complete stop. The calm and off leash dog sits next to the handler (HF) and when given the command (HZ) to “jump” and “bring” (the command (HZ) to “bring” must be given when the dog is jumping over the hurdle), he must jump over the hurdle quickly and run directly to the dumbbell, pick it up immediately and jump immediately back over the hurdle and bring it directly and quickly to his handler (HF). The dog must sit close in front and hold the dumbbell calmly in his mouth to hold it until the handler (HF) commands him to release it after approx. 3 seconds. The handler (HF) must hold the dumbbell calmly in his right hand with the right arm outstretched alongside the right side of his body. At the “heel” command (HZ) the dog is to assume the basic position quickly and straight to the left of the handler (HF) with the shoulder at knee height. The handler may not change positions during the entire exercise.

c) Evaluation: Mistakes in the basic position, slow, weak jumping underestimating the jump and running towards it, slow pick up, slow weak return jump (underestimating it) dropping it, playing or mouthing it, splayed stance of the handler (HF) mistakes sitting in front and at the end are evaluated accordingly. If the dog touches the jump one point is deducted per jump, stepping on it then 2 points are deducted.

Point structure:

Going out jump	Retrieve	Return jump
5 points	5 points	5 points

A partial score for the exercise is only possible if at least on jump and a part of the retrieve work of the three parts of the exercise (going out – retrieve –return) are demonstrated.

Jumping and retrieving flawlessly	=	15 points
Jumping over or return jump no executed, dumbbell brought flawlessly	=	10 points
Jump over and back flawless, dumbbell refused	=	0 points

If the thrown dumbbell lands too far to one side of the hurdle or is poorly visible for the dog, the handler (HF) may ask the judge (LR) for a re-throw or the judge asks that it be re-thrown, no points are deducted. The dog must remain sitting during this time. If the dog follows the handler in retrieving the dumbbell, the exercise is rated with 0 points. If he leaves his basic position but remains in front of the jump, then the exercise is evaluated accordingly.

Handler (HF) help without change of position are evaluated accordingly. If the handler (HF) leaves his position before the exercise is ended, the exercise is rated as unsatisfactory.

If the hurdle is knocked over, the exercise is to be repeated, whereby the first jump is rated at the lower level of insufficient (- 4 points). If the dog does not release the dumbbell after 3 commands, the dog is to be disqualified, as phase “B” cannot continue otherwise.

**7. Retrieve over a scaling wall (180cm) 15 points**

a) one verbal command to: “Jump”, “Bring”, “Out,” “Heel”



b) Execution: The handler assumes the basic position with his dog 5 paces in front of the scaling wall. From a straight basic position, the handler (HF) throws the dumbbell (650 gram) over the scaling wall. The calm and off leash dog sits next to the handler (HF) and when given the command (HZ) to “jump” and “bring” (the command (HZ) to “bring” must be given when the dog is jumping over the wall), he must climb over the hurdle quickly and run directly to the dumbbell, pick it up immediately and climb immediately back over the hurdle and bring it directly and quickly to his handler (HF). The dog must sit close in front and hold the dumbbell calmly in his mouth to present it until the handler (HF) commands him to release it after approx. 3 seconds. The handler (HF) must hold the dumbbell calmly in his right hand with the right arm outstretched alongside the right side of his body. At the command (HZ) to “heel”, the dog is to assume the basic position quickly and straight to the left of the handler with his shoulder at knee height. The handler (HF) may not change positions during the entire exercise.

c) Evaluation: Mistakes in the basic position, slow, weak jumping and go out, mistakes in picking up, slow weak return jump, dropping the dumbbell, splaying or mouthing the dumbbell, splayed stance of the handler (HF), mistakes sitting in front or at the end are evaluated accordingly.

Point structure:

Going out jump	Retrieve	Return jump
5 points	5 points	5 points

A partial score for the exercise is only possible if at least on jump and a part of the retrieve work of the three parts of the exercise (going out – retrieve –return) are demonstrated.

- Jumping and retrieve flawlessly = 15 points
- Refusal to jump over and back, dumbbell is retrieved = 10 points
- Jump over and back flawless, but dumbbell not retrieved = 0 points

If the thrown dumbbell lands too far to one side of the hurdle or is poorly visible for the dog, the handler (HF) may ask the judge (LR) for a re-throw or the judge asks that it be re-thrown, no points are deducted. The dog must remain sitting during this time.

Handler (HF) help without change of position are evaluated accordingly. If the handler (HF) leaves his position before the exercise is ended, the exercise is rated as unsatisfactory.

If the dog does not release the dumbbell after 3 commands, the dog is to be disqualified, as phase “B” cannot continue otherwise.

**8. Send out with down 10 points**

- a) one verbal command to: “Go out”, “Down”, “Sit”
- b) Execution: From the basic position, the handler walks out straight with his dog off leash in the designated direction. After 10-15 paces, the handler (HF) gives the “go out” command (HZ) while simultaneously raising his arm and remains standing. The dog must go out goal-oriented, in a straight line and at a quick pace a minimum of 30 paces in the designated direction.



At the judge (LR)'s instructions, the handler (HF) gives the "down" command (HZ) whereby the dog must lie down immediately. The handler (HF) may keep his arm raised until the dog lies down. At the direction of the judge (LR), the handler (HF) goes to his dog and places himself to the right side of the dog. After approx. 3 seconds and at the instruction of the judge (LR) the handler (HF) gives the command (HZ) to "sit", whereby the dog is to sit quickly and straight in the basic position.

c) Evaluation: Mistakes in the development, handler following the dog, too slow of a go out on the dog's part, strong deviation to the side, too short of a distance, hesitant or premature downing, restless down or premature standing up/sitting are valuated accordingly. Additional help at the time of giving the "go out" or "down" command(s) are evaluated as well.

After reaching the required distance, the judge will principally give the direction to down the dog. If the dog does not allow itself to be stopped, the exercise is rated with 0 points.

One additional command to "down"	= -1,5 points
A second additional command to "down"	= -2,5 points
Dog does stop, but does not lie down after a second command	= -,3.5 points

Additional faults will be evaluated accordingly. If the dog leaves, or comes back to the handler (HF), the entire exercise is evaluated with 0 points.

**9. Down under distraction**

**10 points**

a) One verbal command to: "Down/ Platz", "Sit"

b) Execution: Before the beginning of another dog's obedience work of phase B, the handler (HF) goes with his dog to a place as assigned by the judge (LR) and unleashes his dog while in the basic position. Then the handler (HF) downs his dog with the command "Down/ Platz" and without leaving a leash or other article with the dog. The handler (HF) then leaves his dog without looking back approximately 30 paces within the trial area and remains calmly standing with his back to the dog. The dog has to remain calmly lying down without any influence of the handler while the other dog performs exercise 1 through 7. At the instruction of the judge (LR), the handler (HF) returns to his dog and stand to the right of his dog. At the instruction of the judge (LR), the dog is to execute the "Sit" command (HZ) after a pause of approx 3 seconds quickly and straight in the basic position. The dog is put on leash.

c) Evaluation: Restless behaviour of the part of the handler (HF) as well as other hidden help, restless lying down on the part of the dog, or standing/sitting prematurely before being picked up is evaluated accordingly. If the dog stands or sits, but does not leave the designated area, a partial awarding of points will result. If the dog leaves the designated area by more than 3 meters, prior to exercise 4, the exercise is rated with 0 points. If the dog leaves the designated are after exercise 4, he receives a partial evaluation. If the dog approaches the handler, when the handler returns, up to 3 points can be deducted.





## IPO-2 Phase “C” Protection

Exercise 1: Search for the helper	5 points
Exercise 2: Bark and Hold	10 points
Exercise 3: Preventing an escape by the helper	10 points
Exercise 4: Defence of an attack in motion	20 points
Exercise 5: Back transport	5 points
Exercise 6: Attack on the dog out of the back transport	30 points
Exercise 7: Attack on the dog in movement	20 points
<b>Total:</b>	<b>100 points</b>

### General requirements

In a suitable location, six (6) blinds are to be set up, 3 on each side, in a staggered fashion (see sketch). The necessary markings are to be clearly visible for the handler (HF), the judge (LR) and helper (HL).

### Protection helper/Protection clothing

The helper must be equipped with a protection suit, protection sleeve and a soft stick. The protection sleeve must have a grip bar, the cover made of natural jute (burlap) fibre. If the helper has to maintain visual contact with the dog during the guarding phase, then he may move accordingly. He may not assume a threatening position nor make any defensive gestures. He must protect his body with the protection sleeve. The style in which the handler (HF) takes the soft stick away from the helper (HL) is up to him.

It is possible to work with only one helper at all examination levels. If more than 7 dogs are entered at the same test level, then an additional helper is required. All dogs within the same test level must be worked by the same helper/helpers.

A one-time change of the helper is permitted, if the helper is an active handler at the event.

### Reporting in

- The handler reports in with his dog off leash
- Thereafter he takes the dog to the start position for the “revere” exercise.
- The dog will be dispatched from the basic position at the instruction of the judge.

### Remark:

If the handler and dog cannot report in the proper manner, for instance the dog is not under control and runs for example to the bark and hold blind or from the field, the handler may give up to 3 commands to recall the dog. If the dog does not come back after the 3<sup>rd</sup>. recall, then phase “C” is regarded as a “disqualification due to lack of control”.

Dogs that are not under the control of the handler (HF), that after a defence-exercise are not under control or where the handler (HF) must intervene to have the dog out, that grip other parts of the body rather than the protection sleeve must be disqualified. There is no “TSB”.



**Markings:**

The markings as prescribed in the rules must be visible for the handler, judge and helper.

These markings are:

- Place where the handler stands to recall his dog out of the bark and hold blind,
- Place where the helper stands for the escape and defence and where he is to stop,
- Place where the dog is in a down position for the escape,
- Marking for the handler for the exercise “Attack on the dog out of motion”

Dogs that fail the defence exercise or allow themselves to be driven, phase “C” is terminated. There is no evaluation. The “TSB” is made known.

The command (HZ) to “Out” is permitted only once for each defense exercise. Evaluation for the “out” is as per the following table:

Hesitant release	First “out” with “out”	additional command with immediate	First “out” with slow	additional command “out”	Second “out” with “out”	additional command with immediate	Second “out” with slow	additional command “out”	No “out” after second command or handler influence
0,5-3,0		3,0		3,5-6,0		6,0		6,5-9,0	disqualification

**1. Search for the helper**

**5 points**

a) One verbal command to: “search”, “here”

(The “here” command (HZ) may be used in conjunction with the dog’s name.

b) Execution: The helper is located in the last blind out of the dog’s sight. The handler (HF) positions himself with his off leashed dog between the second and third blinds so that two side sweeps are possible. At the instruction of the judge (LR), phase “C” begins.

With a short command to “search” with the visual aide by raising the right or left arm – this can be repeated – the dog must dispatch quickly from the handler (HF) and run to the designated blind goal-oriented, go around it tightly and attentive. When the dog executes the side sweep, the handler (HF) calls the dog to him with the “here” command (HZ) and in movement directs him to the next blind. The handler (HF) moves at a normal pace down an imaginary line that his not permitted to leave. The dog has to run in front of the handler (HF). When the dog has reached the helper blind, the handler must stop and no further commands (HZ) verbal or visual may be given.

c) Evaluation: Limitations in directability, fast and goal-oriented running to the blind as well as tight and attentive running around the blind are evaluated accordingly.

Faulty is:

- Not assuming a calm and attentive basic position at the beginning of the exercise
- Additional verbal or visual commands
- Not maintaining the middle imaginary line
- Not maintaining a normal pace
- Wide search
- Independent searching with reacting to the commands of the handler
- Blinds are not searched or not attentively searched
- Dog needs more direction and guidance



If the dog does not successfully find the helper at the last blind after the third attempt, the protection work is terminated. If the dog is commanded by the handler to heel at any time during the exercise, the protection work is also terminated. ("Terminated" without point entry; all other remaining points in the trial are entered).

**2. Bark & Hold 10 points**

a) One verbal command to: "Here", "Heel"

The command (HZ) to "here" and "Heel" must be given in tandem.

b) Execution: The dog has to actively and attentively hold the helper and continuously bark. The dog may not jump on the helper or grip him. After the dog has barked for approx. 20 seconds, the handler (HF) approaches the dog at the instruction of the judge and stops about 5 paces away from it. At the direction of the judge (LR), the handler (HF) calls his dog to the basic position.

After the judge releases the helper, the handler calls the helper out of the blind and has him take the designated place for the escape exercise. The dog is to sit quietly (without barking) straight and attentive in the basic position.

c) Evaluation: Limitations with continuous barking and determinately holding until the command (HZ) is given without the intervention of the judge (LR) or handler (HF) are evaluated accordingly. For continuous barking 5 points are awarded. If the dog displays a weak bark only 2 points, the non-barking dog that actively and attentively watches the helper 5 points are deducted. Bothering the helper such as bumping, jumping up etc. must have a 2 point deduction and 9 if the dog grips strongly.

If the dog grips in the blind and does not independently release, the handler is requested to approach the blind at the place marked 5 paces in front of it. A one-time command to "here/heel" – may be given as a simultaneous command (not the command (HZ) to "out") is permitted. If the dog does not come, then the team is disqualified. If the dog does come, then the exercise is rated as a low satisfactory (-9 points). If the dog intentionally grips other body parts (not bumping), the dog is disqualified.

If the dog leaves the helper, before the judge's directs the handler (HF) to leave the imaginary middle line, the dog may be redeployed to the helper. If the dog remains with the helper, then phase C can continue, whereby the bark and hold are evaluated at a lower insufficient rating (-9 points). If the dog does not allow himself to be redeployed or leaves the helper again, then phase C is terminated. If the dog comes towards the handler as he approaches the blind, or the dog comes back to the handler prior to receiving a verbal command a partial rating as insufficient is given.

**Rating for "barking"**

For continuous barking 5 points are awarded. Weak barking (no pressure, non energetic) and no continuously barking lead to a -2 point deduction. If the dog displays an attentive hold without barking, then 5 mandatory points are deducted.

**3. Preventing and escape by the helper**

**10 points**

- a) One verbal command to: *“Heel”, “Down”, “Go on”, “Out”*

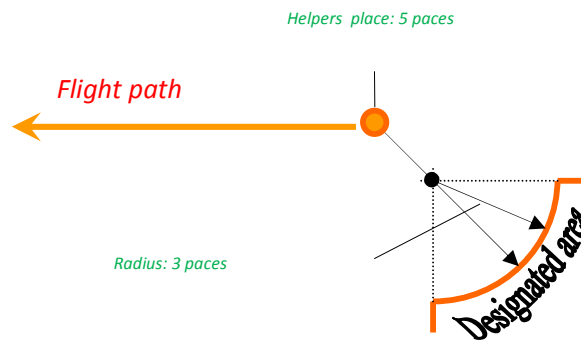

b) Execution: At the direction of the judge (LR) the handler (HF) orders the helper out of the blind. The helper moves at a normal pace to the designated location for the escape. At the direction of the judge (LR), the handler (HF) takes his free heeling dog to designated location for the dog to down before the escape. The distance between the handler and the helper is 5 paces. The handler (HF) leaves his guarding dog in the down position and goes to the blind. He has visual contact to his dog, the judge (LR) and the helper (HL). At the instruction of the judge (LR), the helper attempts an escape. The dog is to show a happy, attentive and concentrated heel exercise and execute heeling positioned at the knee of the handler in a straight and quick manner.

Prior to the command “down”, the dog is to sit in the basic position straight, calmly and attentive. He is to directly and quickly do the “down” command and remain in the designated location calmly, confident and be attentive to the helper. The distance between the helper and the dog is to be 5 paces. The dog leaves his on watch position, dog in the down position and goes to the blind. He remains in visual contact to his dog, the helper (HL) and the judge (LR).

At the instruction of the judge (LR), the helper (HL) makes an attempt to escape. Simultaneously the handler (HF) commands the dog to “go on or stop” to have the dog prevent the escape of the helper (HL). Without hesitation the dog is to prevent the escape by means of a high dominance ratio and relatively fast grip deploying an energetic and strong grip. He may only grip the protection sleeve of the helper (HL). At the instruction of the judge (LR), the handler stops. After the helper stops the dog has to release after a brief transition period. The handler (HF) may give a command (HZ) to “out” in a reasonable amount of time.

If the dog does not out after the first permitted command (HZ), the handler (HF) will receive instructions from the judge for a second command (HZ) to “out”. If the dog does not out after the third command (HZ) (one permitted – two additional), a disqualification will result. The handler is to remain calmly standing when giving the “out: command and without influencing the dog. After the release, the dog is to remain close to the helper and watch him attentively.



c) Evaluation: Limitations in the important evaluation criteria: high dominance, quick energetic reaction and pursuit with a strong grip with a relatively quick grip action and effective hindrance of the escape with a calm grip until release, attentive hold close to the helper are evaluated accordingly.

If the dog remains down or the dog does not prevent the escape through gripping or holding within 20 paces, phase C is terminated.

If the dog engages without a command from the handler, the exercise is rated minus a point. If the dog is slightly attentive in the holding phase and/or slightly bothersome, the exercise is rated minus a point, the dog very inattentively holds the helper, and/or is very bothersome, a two point deduction will result. If the dog does not hold the helper, remains however with him, a three point deduction will result.

If the dog leaves the helper or the handler gives a command so that the dog stays with the helper, phase C is terminated.

**4. Defence of an attack during the guarding phase 20 points**

a) One verbal command to: *“Out”*, *“Heel”*

b) Execution: After the holding phase of approximately 5 seconds, the helper under the direction of the judge (LR), attacks the dog. Without intervention by the handler (HF), the dog must defend himself by means of an energetic and strong grip. The dog may only grip the protection sleeve of the helper.

The helper is to pressure the dog by way of threatening stick gestures and driving. The dog is to be closely observed when pressured especially concerning his activity and stability. Two tests are conducted with the stick pressure. The dog may only grip the protection sleeve of the helper. Stick hits are only to be deployed on the shoulders or in the withers area. The dog has to be impartial during the pressure phase and has to show a full, energetic and above all a constant grip during the entire defense exercise. At the instructions of the judge (LR), the helper stands still. After the helper stops the dog is to release after a relatively brief transition period. The handler (HF) may give a command (HZ) to: *“out”* within a reasonable amount of time.

If the dog does not out after the first permitted command (HZ), the handler (HF) receives the instruction from the judge to give two additional commands (HZ) for the *“out”*. If the dog does not out after these commands (HZ) (one permitted two additional), a disqualification will result. When giving the *“out”* command (HZ), the handler (HF) is to remain calmly in place and not influence the dog. After the release, the dog is to remain close to the helper and watch him attentively. At the judge’s instruction, the handler (HF) goes at a normal pace in the most direct way to his dog and takes him into the basic position by commanding *“Heel”*. The soft stick is not taken from the helper.

c) Evaluation: Limitations concerning the important evaluation criteria are evaluated accordingly: Quick and strong grip, full and calm grip up to release, after the release an attentive close guarding of the helper. If the dog does not withstand the pressure of the helper, comes off of the protection sleeve and allows himself to be chased, phase *“C”* is terminated.

If the dog is slightly inattentive and/or slightly bothersome, a one point deduction will result, the dog guards the helper very inattentively and/or is very bothersome, a two point deduction will result. If the dog does not guard the helper, but remains with the helper, a three point deduction will result. If the dog comes towards the handler (HF) when he approaches, the exercise is rated as insufficient. If the dog leaves the helper or the handler (HF) gives a command (HZ) so that the dog stays with the helper, phase C is terminated.



**5. Back transport**

**5 points**

- a) One verbal command to: *“Heel”*
- b) Execution: After exercise 4 the transport of the helper over a distance of approx. 30 paces follows. How the back transport is conducted is determined by the judge (LR). The handler (HF) orders the helper to move out and goes with his dog off leash, who is attentively watching the helper, approx 5 paces behind the helper. The distance of 5 paces must be maintained throughout the back transport.
- c) Evaluation: Limitations in the important evaluation criteria are evaluated accordingly. Watching the helper attentively, exact heeling, maintaining a distance of 5 paces.

**6. Attack on the dog out of the Back Transport**

**30 points**

- a) One verbal command to: *“Out”, “Heel”*
- b) Execution: During the back transport the judge (LR) advises to attack the dog while still moving. Without intervention by the handler (HF) and without hesitation, the dog is to defend himself by an energetic and strong grip. He may only grip the protection sleeve of the helper (HL). As soon as the dog has a grip on the sleeve, the handler is to stand still. The helper stops at the instruction of the judge (LR). After the helper stops, the dog is to release within a reasonable amount of time. The handler (HF) may also give the command (HZ) to *“out”* within a reasonable amount of time. If the dog does not out after the first permitted command (HZ), the handler (HF) receives the instruction from the judge to give two additional commands (HZ) for the *“out”*. If the dog does not out after these commands (HZ) (one permitted two additional), a disqualification will result. When giving the *“out”* command (HZ), the handler (HF) is to remain calmly in place and not influence the dog. After the release, the dog is to remain close to the helper and watch him attentively. At the judge’s instruction, the handler (HF) goes at a normal pace in the most direct way to his dog and takes him into the basic position by commanding *“Heel”*. The soft stick is taken from the helper. A side transport of the helper now takes place to the judge (LR) over a distance of about 20 paces. A command (HZ) to *“heel”* is permitted. The dog is to go at the right side of the helper so that the dog is between the helper and the handler. During the transport the dog is to be attentive to the helper. He may not however crowd the helper, jump on him or grip. The group stops in front of the judge (LR). The handler (HF) gives the soft stick to the judge (LR) and reports the ending of the first part of phase C.
- c) Evaluation: Limitations in the important evaluation criteria are evaluated accordingly: Quick and strong grip, full and calm grip up to the release, after releasing attentively guarding the helper. If the dog is slightly inattentive and/or slightly bothersome, a one point deduction will result, the dog guards the helper very inattentively and/or is very bothersome, a two point deduction will result. If the dog does not guard the helper, but remains with the helper, a three point deduction will result. If the dog comes towards the handler (HF) when he approaches, the exercise is rated as insufficient. If the dog leaves the helper before the judge instructs the handler to approach or the handler (HF) gives a command (HZ) so that the dog stays with the helper, phase C is terminated.



**7. Attack on the dog out of motion**

**20 points**

a) One verbal command to: *"Sit", "Out", "Heel"*

b) Execution: The handler (HF) is advised to go to the designated place with his dog on the middle line at the level of the first blind. The dog is to heel attentive to the handler, happy and concentrated. He moves straight at knee height of the handler. At the level of the first blind, the handler stops and turns around. With the command to *"sit"*, the dog is placed in basic position. The straight, calm and attentively sitting dog facing the helper may be held on the collar, may however not be stimulated by the handler (HF). At the direction of the judge (LR), the helper comes out of the blind and goes in a running pace to the middle line. Ignoring the shout of the handler, the helper (still running) charges the dog and handler in a frontal attack with loud shouts and threatening gestures. As soon as the helper reaches the handler (HF) and his dog at about 40 to 50 paces, the handler (HF) under the direction of the judge (LR) releases his dog. Without hesitation and on one command (HZ) to *"defend"* the dog is to effectively prevent the attack through a high dominance factor and relatively quick speed. He may only grip the protection sleeve of the helper (HL). The handler (HF) may not leave the place where he stopped.

In the pressure phase, he has to be uninfluenced and during the entire defence exercise, he has to display a full, energetic and above all a constant grip. At the direction of the judge (LR) the helper stops. After the helper stops, the dog is to release in a brief transition time. The handler (HF) may give a command (HZ) to *"out"* in a reasonable amount of time.

If the dog does not out after the first permitted command (HZ), the handler (HF) receives the instruction from the judge to give two additional commands (HZ) for the *"out"*. If the dog does not out after these commands (HZ) (one permitted two additional), a disqualification will result. When giving the *"out"* command (HZ), the handler (HF) is to remain calmly in place and not influence the dog. After the release, the dog is to remain close to the helper and watch him attentively. At the judge's instruction, the handler (HF) goes at a normal pace in the most direct way to his dog and takes him into the basic position by commanding *"Heel"*. The soft stick is taken from the helper.

A side transport of the helper now takes place to the judge (LR) over a distance of about 20 paces. A command (HZ) to *"heel"* is permitted. The dog is to go at the right side of the helper so that the dog is between the helper and the handler (HF). During the transport the dog is to be attentive to the helper. He may not however crowd the helper, jump on him or grip. The group stops in front of the judge (LR). The handler (HF) gives the soft stick to the judge (LR) and reports out ending phase C. At the instruction of the judge (LR), the handler (HF) goes with his dog off leash to a place where the critique will be given and the helper will receive instructions from the judge to leave the field. Prior to the critique and under the direction of the judge (LR), the dog is put on leash.

c) Evaluation: Limitations concerning the important evaluation criteria are evaluated accordingly: Energetic defence with strong grip, full and calm grip until release, after the release attentive and close guarding of the helper.

If the dog is slightly inattentive and/or slightly bothersome, a one point deduction will result, the dog guards the helper very inattentively and/or is very bothersome, a two point deduction will result. If the dog does not guard the helper, but remains with the helper, a three point deduction will result. If the dog comes towards the handler (HF) when he approaches, the exercise is rated as insufficient. If the dog leaves the helper before the judge instructs the handler to approach or the handler (HF) gives a command (HZ) so that the dog stays with the helper, phase C is terminated.



## **IPO-3**

Arranged as: Phase A	100 points
Phase B	100 points
Phase C	100 points
<b>Total:</b>	<b>300 points</b>

### **IPO-3 Phase “A” Tracking**

**The track is laid by a stranger, minimum 600 paces, 5 legs, 4 corners (approx 90 degrees), 3 articles, aged minimum 60 minutes, execution time 20 minutes.**

Maintaining the track	79 points
Article (7+7+7)	21 points
<b>Total:</b>	<b>100 points</b>

If the dog does not find any articles, the maximum rating can only be “sufficient”.

#### **General Requirements:**

The judge (LR) or the person in charge of tracking determines the pattern of the track taking into consideration the available area. Varying patterns must be utilized. It is not possible that the articles and corners of each track are located at the same distance from each other. The start is to be clearly marked with a sign, which must be placed directly in the ground to the left of the scent pad.

The judge (LR) and all accompanying persons may not be in the tracking area where the dog and handler (HF) have the right to track.

After the tracks are laid, the starting positions are determined through a draw in the presence of the judge (LR).

#### **Track terrain**

Acceptable terrain is all natural ground cover, such as grass, plowed fields and forest.

Visual tracks are to be avoided. In all trial levels adaptation of the tracks to the available tracking-grounds is possible.

#### **Laying the track**

The judge or the track coordinator is responsible for:

- organizing the track layout,
- integrating the track layers,
- observing how tracks are laid.

The available terrain determines how the individual tracks are to be laid.





When laying the tracks, note should be taken, for walking in a natural manner. Help by means of unnatural walking on the legs, at the turns and at the articles is not permitted.

Experienced track layers (FL) are to be especially used.

The tracklayer (FL) must show the articles to the judge (LR) prior to laying the track. The tracklayer (LR) pauses for a brief moment at the scent pad and then continues at a normal pace in the assigned direction. The turns are also done at a normal pace. Scuffing or integrating a break in stride is not permitted.

The legs are to be laid also at a normal pace without scuffing or breaking of stride. The distance between the individual legs must be a minimum of 30 paces.

The turn (approx 90 degrees) is also done at a normal pace in order to ensure a seamless tracking flow for the dog into the next leg. A break in the track is not permitted (see sketch).

The dog is out of sight while the track is being laid.

### **Placing the articles**

The first article is placed at least a minimum of 100 paces on the first or second leg not within 20 paces before or 20 paces after a turn, the second article laid at the direction of the judge (LR), the third article at the end of the track. The articles must be placed in movement. After placing the last article, the tracklayer is to go several more paces in a straight direction.

### **Track articles**

Only articles that the tracklayer (FL) has carried for a minimum of 30 minutes may be used. Within a given track various articles may be used (such as leather, textiles, wood). The articles must be approx. 10 cm long, 2-3cm wide and 0,5-1cm thick. The articles may not stand out in colour from the terrain.

For above regional events the articles must be numbered whereby the number must coincide with the respective track. While the dog is working out the track, the judge, tracklayers and any accompanying person(s) are not permitted in the area where the dog/handler team has the right to track.

### **Commands**

a) One command to "track"

The command to "track" is permitted at the art of the track and by restarting after the first article or after a false indication.

### **Execution and evaluation of the track work**

b) Execution:

The handler prepares the dog for the track. The dog may track free or on a 10 m line. The 10 meter line may be held over the dog's back, to the side or between his front and/or back legs. The tracking line may be attached directly to the collar, but not the live ring or attached to the harness ring (harness or böttger harness without additional straps). When called the handler goes with his dog into basic position and reports in to the judge and advises if the dog will pick up or indicate. Prior to the track, at the scent pad and for the duration of the track, no force is to be applied.



The tracking line must be a minimum of 10 meters long. The judge may check the length of the line, the collar and the harness only prior to the start of the track. Flexible leashes are not permitted.

### **Start**

At the direction of the judge, the dog is taken slowly and calmly to the scent pad and started. Briefly sitting prior to the track (approx. 2 meters) is permitted.

The start (also after the restart after locating the article) must be done by the dog. A certain amount of slack is permitted in using the line. The dog has to start intensely, calm and with a deep nose. Taking the scent must be done without handler influence (except for the command to "Track"). The scent pad is not under any time constraints; furthermore the judge has to observe the behaviour of the dog at the beginning of the first leg as to how intensely he orients himself to the taking the scent.

After a third attempt to start the dog at the scent pad, the track is terminated.

The dog has to track with a deep nose maintaining a steady pace. The handler follows his dog at a distance of 10 meters at the end of the tracking line. If the dog tracks free, then the handler is to maintain a distance of 10 meters as well. There may be some slack in the tracking line, but whereby the handler keeps it in his hand(s) and a definitive shortening of the line to get closer to the dog may not happen. Touching the ground is not faulty.

### **Track work**

The dog must follow the track intensely, with endurance and when possible at an even speed (depending on the terrain, degree of difficulty). The handler is not obliged to follow the course of the track. A rapid or slow track execution cannot be a criteria towards the rating, when the track is consistently and convincingly worked out.

### **Turns**

The dog has to work out the turns confidently. Checking without leaving the track is permitted and is not faulty. Circling at the turns is faulty. After the turn the dog is to continue tracking at the same even speed. In the area of the turn, the handler should maintain the required distance if possible.

### **Indicating or picking up the articles**

As soon as the dog has found the articles, he has to convincingly and without handler help either pick up or indicate. If the dog picks up he may either remain standing, sit or return to the handler, who has to remain standing. Continuing with the article or lying down are faulty. The indication may be done either lying down, sitting or standing (also alternating is permitted).

Not lying completely straight at the article is not faulty, lying to the side of the article or turn around looking at the handler is however faulty,. Articles that are done with strong handler help are considered to be overrun. This would be the case for instance, if the dog does not indicate the article and the handler either by use of the line or through verbal command hinders the dog from continuing to track.



When the dog either picks up or indicates the article, the handler is to drop the line and go to his dog. By raising his arm with the article in hand, he advises that the dog has found the article. Picking up and indicating are faulty.

Any action done with the article or picking up while lying down is faulty. If the dog returns back to the handler, the handler does not approach the dog.

When the handler approaches his dog to release the article or when picking up, the handler must stand next to the dog.

The dog is to remain calmly in place if indicating or where he picked up the article until released to track whereby the handler deploys him holding the line short.

### **Leaving the track**

If the handler restrains the dog from leaving the track, then the handler receives instructions from the judge to follow the dog. The handler must follow these instructions. Tracking will be terminated if the dog is more than a line length off of the track (over 10 meters with a free tracking dog) or the handler does not heed the judge's instructions.

### **Praising the dog**

Occasional praising in the level 1 phase is permitted (the command to such/track" is not considered praise). This occasional praising in level 1 is not permitted at the turns. The dog may be praised at the articles. A short praise may be given either before or after the article is shown.

### **Reporting out**

After completing the track, the found articles are to be presented to the judge. Playing or feeding the dog after picking up or indicating the last article prior to reporting out and receiving the awarded points is not permitted. Reporting out is to be done in basic position.

### **Evaluation**

The evaluation of Phase "A" begins with the start of the dog tracking.

A convincing, intensive and dedicated nose work as well as a good training base are expected of the dog.

The handler has to become part of the process and experience it. He has to interpret the reactions of the dog, be concentrated on the work and ignore any external influences.

The judge has to observe not only the dog and handler, but also the tracking area, the weather, possible cross tracks and the time-frame. In his evaluation he has to take into consideration all factors.

- Track behaviour ( speed on the legs, before and after the turns, before and after the articles)
- Training status of the dog (i.e., hectic start, showing pressure, avoidance)
- Any handler help
- Difficulty in working the track through:
  - Ground conditions (overgrown, sand, change of terrain, fog)
  - Wind conditions
  - Wild game
  - Weather (heat, rain, snow)



- Scent change

The evaluation should be contingent upon these conditions.

After the handler has reported in for the track, the judge has to strategically place himself so as to be able to observe the track work and listen to verbal commands or see any other influence by the handler.

He has to select a distance from the handler so that he does not interrupt the dog's work and so that the handler does not feel crowded. The judge has to be able to experience the entire track work.

He has to evaluate the dog's work based on his enthusiasm, confidence or insecurity or flightiness.

A fast or slow track work is not part of the criteria for the evaluation, if the track is worked out intensely, even and convincingly and the dog maintains a positive attitude.

Checking without leaving the track is permitted and not faulty. Casting, emptying, circling at the turns, constant encouragement, line or verbal helps within the tracking area, or at the articles, faulty pick up or faulty indication of the articles are evaluated accordingly. (up to 4 point deduction)

Definitive casting, lacking intensity, wildly tracking, emptying, hunting mice, etc. can receive up to an 8 point deduction.

If the handler leaves the track by more than a leash length, the track is terminated. If the dog leaves the track and is restrained by the handler, judge advises the handler to follow his dog. If the instructions are not followed, the track will be terminated by the judge.

If after the maximum allowable time (Level 1 and 2 = 15 minutes) (Level 3 = 20 minutes) to work out the scent pad is not met, the track work is terminated by the judge. Any awarded points up to this point are made known. If the dog shows both styles of article work, namely picking up and indicating on a given track, this is considered faulty. The articles will only be evaluated and scored as per the initial report.

Pick up or faulty indication of the articles , false indication, are to be deducted accordingly up to 4 points, if the restart is next to the dog and another 2 points obligation deduction if the handler makes the restart at the end of the tracking-lease

If articles are not found, then no pints are awarded. If no handler articles are found, the phase "A" can only be rated as "satisfactory". Also this must be taken into consideration that the handler cannot restart his dog at an article.

If the dog follows his hunt drive and chasing game, the handler may give the command to "down" in order to maintain control. The track work will continue at the instruction of the judge. If this does not work, the trial is terminated. (Evaluation: disqualified due to lack of control).



**Termination/Disqualification**

Behaviour	Consequence
Dog is restarted at the scent pad 3x	<b>Terminated</b>
- All Levels: Dog leaves the track by more than a line length or the handler does not heed the judge's instructions - Dog does not meet the time limit for the track Level 3: 20 minutes after the start	<b>Terminated</b> - points will be awarded up to that point <b>CRITIQUE UP TO TERMINATION!!</b>
- Dog picks up the article but refuses to release it. - Dog chases game and cannot be restarted	DISQUALIFICATION due to lack of control

Track Layouts

The following schematic for track layouts may also be done as a mirror image.

IPO-3

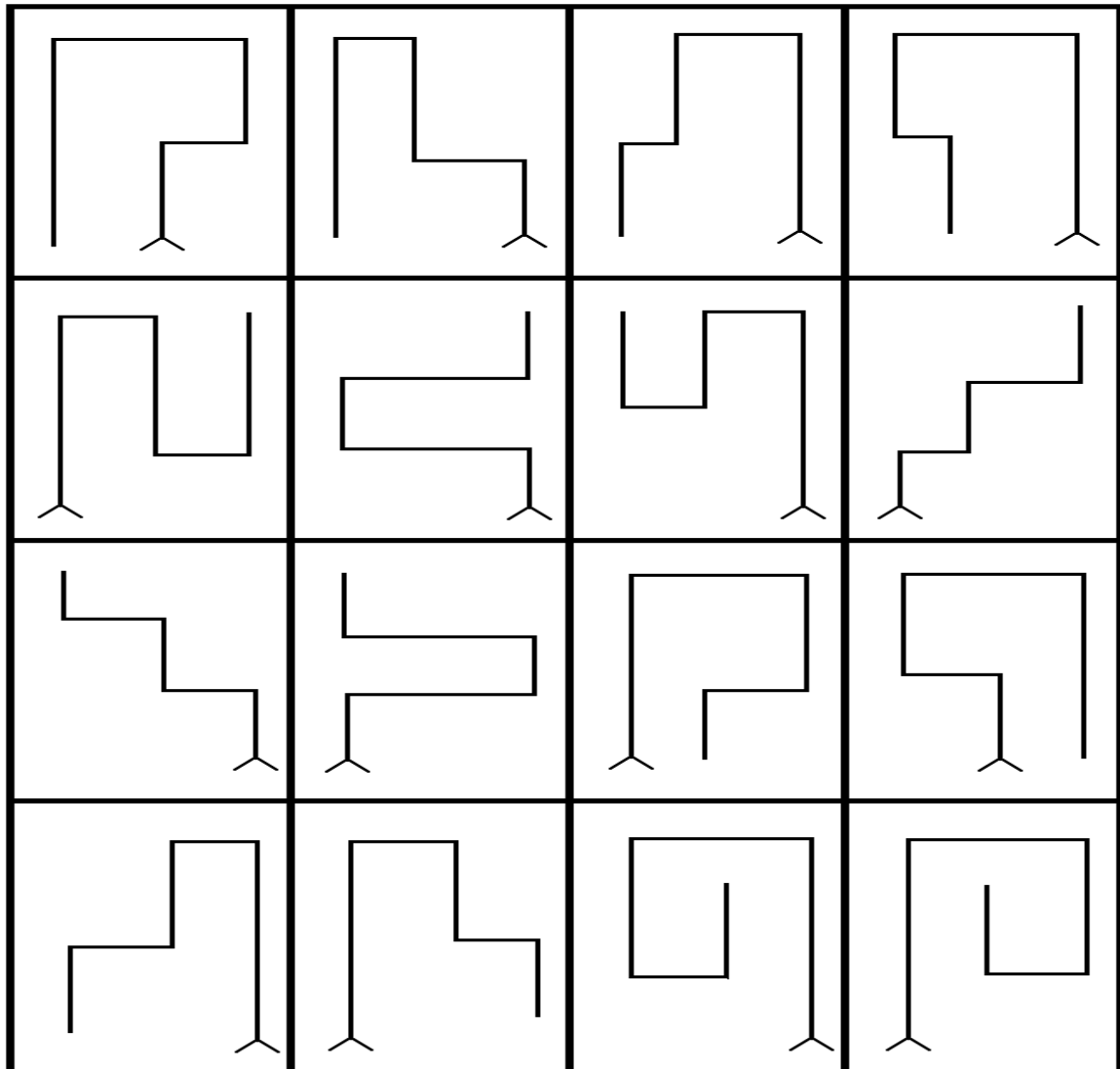



### **IPO-3 Phase “B” Obedience**

Exercise 1: Off leash	10 points
Exercise 2: Sit in motion	10 points
Exercise 3: Down with recall	10 points
Exercise 4: Stand while running	10 points
Exercise 5: Retrieve on the flat	10 points
Exercise 6: Retrieve over the jump	15 points
Exercise 7: Retrieve over the scaling wall	15 points
Exercise 8: Send out with down	10 points
Exercise 9: Down under distraction	10 points
<b>Total:</b>	<b>100 points</b>

### **General Requirements**

For Level IPO-3 the handler appears with his dog on leash, reports in the basic position to the judge.

Especially in the obedience attention must be paid to the fact that the dog exhibits no pressure from the handler demonstrating that his self-confidence has been deflated and that he does not appear to be just “sport equipment” of the handler.

During all exercises a happy work ethic and the required concentration must be displayed towards the handler. Attention must be paid to the happy work ethic in conjunction with the correct execution of the work and will be evaluated as such.

If a handler forgets an entire exercise, the judge will request that he is to show this missing exercise. There is no point deduction for this.

No later than at the start of the obedience, all equipment must have been checked by the judge. The equipment must meet the governing rules.

The gun to be used during the “Off-Leash” and “Down under Distraction” exercises must be of 6 mm calibre.

The judge advises the start of each individual exercise. Anything further, such as turns, halting, change of pace, etc. are done independently.

The commands are engraved in the rules. Commands are to be spoken in a normal tone, brief, consisting of a one-word command. They may be given in any language, however must be the same for the related exercise. If a dog does not execute an exercise or a part of an exercise, after a command is given three times, then the exercise receives no points. When recalling the dog, the name of the dog may be used. The name of the dog used in conjunction with a command is considered a double command.

### **Beginning an exercise**

The judge advises when the exercise is to begin.



### **Basic Position**

The basic position is to be assumed, when the second dog handler, who has taken his dog to the designated area for the down under distraction exercise, has taken his place. At this juncture the evaluation for both dogs begins.

Each exercise begins and ends with a basic position. The handler is to stand in a sporty manner. A splayed stance is not permitted for any exercise.

The dog is to sit at the left side of his handler in a close and straight, so that his shoulder is knee high to the handler when demonstrating the basic position that is allowed to be shown only once in the forward direction. Each exercise begins and ends with the basic position. Assuming the basic position is only allowed once. A short praise is permitted at the end of each completed exercise. Thereafter the handler may assume another basic position. Between praise and a new start a definitive time lapse of approx 3 seconds must take place.

An exercise is developed from the basic position. The handler must take at least 10 paces, up to 15 paces maximum, before he gives the command to execute an exercise. Between all fronts and finishes, as well as when the handler returns to the sitting, standing or lying dog, a distinct pause of 3 seconds is to be maintained. In returning to the dog, the handler may approach him from front or go behind the dog. Mistakes in the basic position and the development phase are evaluated accordingly.

Correct off leash heeling position is to be demonstrated even between exercises. Even when retrieving the dumbbell, the dog is to accompany the handler. Motivating or playing with the dog at this juncture is not permitted.

The about turn is to be demonstrated to the left by the handler. The dog may complete the about turn either by going behind the handler or from the front, but whereby the style must remain consistent within a given trial.

After sitting in front, the dog may either go behind the handler or assume the basic position from the front.

The fixed jump needs to be 100cm high and 150 cm wide. The scaling wall consists of two planks secured at the top and must be 150cm wide and 191 cm high. At the base, the two sides are to be set apart so that there is a vertical height of 180 cm. The entire surface of the scaling wall must be covered with a nonskid material. On the walls themselves 3 cleats must be affixed near the top half with each being 24/48mm. All dogs must negotiate the same obstacles.

For the retrieve exercise only dumbbells are permitted. The dumbbells as provided by the event coordinator must be used by all dogs(2000 gram jump – 650 gram scaling wall). It is not permitted to place the dumbbell in the dog's mouth prior to the exercise.

If the handler forgets an exercise, the missing exercise will be advised by the judge, without any point deduction.







At the normal pace at least two right and two left turns and two about turns are to be demonstrated as well as a halt after one of the about turns. The handler must show the about turn to the left (180 degree turn in place. (see prescribed sketch). Two variables are possible:

- The dog goes behind the handler with a right turn
- The dog turns in place at 180 degrees for the left about turn.

Within a trial only one given variable is permitted.

The halt must be shown after the second about turn at least once at a normal pace according to the sketch.

The dog is to remain constantly with his shoulder blade at knee height to the left side of the handler; he may not forge, lag or heel wide. The about turn is to be shown as a left about turn by the handler. A halt from a normal pace must be performed at least once.

While the dog is heeling with his dog on the first straight away, two shots (6mm calibre) are fired within a time-frame of 5 seconds and at a distance of minimum 15 paces. The dog must show impartiality to the gun shots. At the end of the exercise, the handler goes with his dog into a group of at least 4 moving people. The handler has to go around a person both to the left and the right and must halt once in the group. The judge may request a repeat. The handler leaves the group and assumes the basic position. This basic position is the beginning of the next exercise.

c) Evaluation: (valid for all movement exercises) Forging, heeling wide, lagging, slow or hesitant sit, additional commands, handler physical help, inattentiveness in all paces and turns and/or dog shows pressure are evaluated accordingly.

**2. Sit in Motion**

**10 points**

a) One verbal command to: "Heel", "Sit"

b) Execution: From a straight basic position, the handler goes with his dog off-leash straight out. In the development phase, the dog is to heel with his handler in an attentive, happy, quick and concentrated manner. He has to remain in a straight position at knee of the handler. After 10-15 paces, the dog is to execute the sit command immediately and in the direction of moving without the handler breaking stride, changing pace or looking back. After an additional 15 paces the handler stands still and turns immediately to his calm and attentively sitting dog. At the instruction of the judge, the handler returns to his dog and stands to the right of the dog. The handler may approach either from the front or around the back.

d) Evaluation: Mistakes in the basic position, development, slow sit, restless and inattentive sitting are evaluated accordingly. If the dog stands or lies down instead of sitting 5 points are deducted. Other mistakes are taken into account.



**3. Down with Recall 10 points**

- a) One verbal command to: "Heel", "Down", "Here"
- b) Execution: From a basic position, the handler moves straight forward with his free heeling dog. After 10-15 paces at a normal pace, followed by 10-15 paces at a running pace, the handler gives the dog the verbal command 'down'. The dog is to execute the "down" command immediately and in the direction of moving (straight) without the handler breaking stride, changing pace or looking back. After an additional 30 paces the handler stands still and turns immediately to his calm and attentively lying dog. At the instruction of the judge, the handler recalls his dog either using the "here" command or the dog's name, the dog has to come happy, quickly and directly to the handler and sit close and straight in front. At the "heel" command the dog is to go quickly to sit straight next to the left of the handler with his shoulder at knee height of the handler.
- c) Evaluation: Mistakes in the development, lying down slowly, restless lying, slow return or slows down when approaching the handler, splayed stance of the handler, mistakes in sitting and at the finish are evaluated accordingly. If the dog sits or stands at the down command 5 points are deducted.

**4. Stand while running 10 points**

- a) One verbal command to: "Heel", "Stand", "Sit"

Execution: From a straight basic position, the handler runs with his off leash dog straight out at a running pace. After 10-15 running paces the dog is to stand immediately in the direction of movement at the "stand" command without the handler breaking stride, changes pace or turns around. After an additional 30 paces the handler stops and turns immediately around to his quietly and attentive standing dog. At the direction of the judge, the handler recalls his dog either by the command "here" or using the dog's name. The dog must come happy, quick and directly and sit close and straight in front of the handler. On the verbal command to "heel", the dog must quickly go into basic position and sit straight on the handler's left side with the shoulder level to the handler's knee. The handler is not permitted to change positions during the entire exercise.

- b) Evaluation: Faults in the development, lagging at the command, restless standing, inattentive standing, restlessness when the handler approaches, slow sit at the end are evaluated accordingly. If the dog sits or lies down at the "stand" command, 5 points are deducted accordingly.

**5. Retrieve on the flat 10 points**

- a) One verbal command to: "Bring", "Out", "Heel"

b) Execution: From the basic position the handler throws a dumbbell (2000grams) approximately 10 paces out. The command to "bring" may first be given when the dumbbell comes to a full stop. The dog sitting calmly and off leash next to the handler, may first go out to the dumbbell In a quick and direct manner after the command to "bring" is given, must pick it up immediately and bring it to his handler in a quick and direct manner. The dog is to sit closely and straight in front of the handler. The dog is to hold



the dumbbell calmly in his mouth until the handler after a pause of about 3 seconds commands the “out”. The handler must hold the dumbbell calmly in his right hand with the right arm stretched out alongside the right side of his body.

On the verbal command to “heel”, the dog must quickly go into basic position and sit straight on the handler’s left side with the shoulder level to the handler’s knee. The handler is not permitted to change positions during the entire exercise.

c) Evaluation: Mistakes in the basic position, slow go out, mistakes in picking up, slow return, dropping the dumbbell, playing or mouthing the dumbbell, splayed stance of the handler, mistakes when sitting in front or finishing are evaluated accordingly. If the dumbbell is not thrown far enough and handler help without moving from his position are evaluated accordingly. If the handler moves out of position before the exercise is completed, the rating is insufficient. If the dog does not retrieve, the exercise is valued at 0 points.

**6. Retrieve over a hurdle (100cm) 15 points**

a) One verbal command to: “Jump”, “Bring”, “Out”, “Heel”

b) Execution: the handler assumes a basic position with his dog a minimum of 5 paces in front of the jump. From the straight basic position the handler throws the dumbbell (650grams) over the 100 cm high hurdle. The command to “jump” is first given when the dumbbell comes to a complete stop. The calm and off leash dog sits next to the handler and when given the command to “jump” and “bring” (the command to “bring” must be given when the dog is jumping over the hurdle), he must jump over the hurdle quickly and run directly to the dumbbell, pick it up immediately and jump immediately back over the hurdle and bring it directly and quickly to his handler. The dog must sit close in front and hold the dumbbell calmly in his mouth to hold it until the handler commands him to release it after approx. 3 seconds. The handler must hold the dumbbell calmly in his right hand with the right arm outstretched alongside the right side of his body. At the “heel” command the dog is to assume the basic position quickly and straight to the left of the handler with the shoulder at knee height. The handler may not change positions during the entire exercise.

c) Evaluation; Mistakes in the basic position, slow, weak jumping underestimating the jump and running towards it, slow pick up, slow weak return jump (underestimating it) dropping it, playing or mouthing it, splayed stance of the handler mistakes sitting in front and at the end are evaluated accordingly. If the dog touches the jump one point is deducted per jump, stepping on it then 2 points are deducted.

Point structure:

Going out jump	Retrieve	Return jump
5 points	5 points	5 points

A partial score for the exercise is only possible if at least on jump and a part of the retrieve work of the three parts of the exercise (going out – retrieve –return) are demonstrated.

Jumping and retrieving flawlessly = 15 points  
Jumping over or return jump no executed, dumbbell = 10 points



Brought flawlessly

Jump over and back flawless, dumbbell refused = 0 points

If the thrown dumbbell lands too far to one side of the hurdle, or is poorly visible for the dog, the handler may ask the judge for a re-throw or the judge asks that it be re-thrown, no points are deducted. The dog must remain sitting during this time. If the dog follows the handler in retrieving the dumbbell, the exercise is rated with 0 points. If he leaves his basic position but remains in front of the jump, then the exercise is evaluated accordingly.

Handler help without change of position are evaluated accordingly. If the handler leaves his position before the exercise is ended, the exercise is rated as unsatisfactory.

If the hurdle is knocked over, the exercise is to be repeated, whereby the first jump is rated at the lower level of insufficient (- 4 points). If the dog does not release the dumbbell after 3 commands, the dog is to be disqualified, as phase "B" cannot continue otherwise.

**7. Retrieve over a scaling wall (180cm)**

**15 points**

a) One verbal command to: "Jump", "Bring", "Out", "Heel"

b) Execution: The dog assumes the basic position with his dog 5 paces in front of the scaling wall. From a straight basic position, the handler throws the dumbbell (650 gram) over the scaling wall. The calm and off leash dog sits next to the handler and when given the command to "jump" and "bring" (the command to "bring" must be given when the dog is jumping over the wall), he must climb over the hurdle quickly and run directly to the dumbbell, pick it up immediately and climb immediately back over the hurdle and bring it directly and quickly to his handler. The dog must sit close in front and hold the dumbbell calmly in his mouth to present it until the handler commands him to release it after approx. 3 seconds. The handler must hold the dumbbell calmly in his right hand with the right arm outstretched alongside the right side of his body. At the command to "heel", the dog is to assume the basic position quickly and straight to the left of the handler with his shoulder at knee height. The handler may not change positions during the entire exercise.

c)Evaluation: Mistakes in the basic position, slow, weak jumping (gestimating) and go out, mistakes in picking up, slow weak return jump (gestimating), dropping the dumbbell, splaying or mouthing the dumbbell, splayed stance of the handler, mistakes sitting in front or at the end are evaluated accordingly.

Point structure:

Going out jump	Retrieve	Return jump
5 points	5 points	5 points

A partial score for the exercise is only possible if at least on jump and a part of the retrieve work of the three parts of the exercise (going out – retrieve –return) are demonstrated.

Jumping and retrieve flawlessly = 15 points



Refusal to jump over and back, dumbbell is retrieved = 10 points  
Jump over and back flawless, but dumbbell not retrieved = 0 points

If the thrown dumbbell lands too far to one side of the hurdle or is poorly visible for the dog, the handler may ask the judge for a re-throw or the judge asks that it be re-thrown, no points are deducted. The dog must remain sitting during this time.

Handler help without change of position are evaluated accordingly. If the handler leaves his position before the exercise is ended, the exercise is rated as unsatisfactory.

If the dog does not release the dumbbell after 3 commands, the dog is to be disqualified, as phase "B" cannot continue otherwise.

**8. Send out with down 10 points**

a) One verbal command to: "Go out", "Down", "Sit"

b) Execution: From the basic position, the handler walks out straight with his dog off leash in the designated direction. After 10-15 paces, the handler gives the "go out" command while simultaneously raising his arm and remains standing. The dog must go out goal-oriented, in a straight line and at a quick pace a minimum of 30 paces in the designated direction. At the judge's instructions, the handler gives the "down" command whereby the dog must lie down immediately. The handler may keep his arm raised until the dog lies down. At the direction of the judge, the handler goes to his dog and places himself to the right side of the dog. After approx. 3 seconds and at the instruction of the judge the handler gives the command to "sit", whereby the dog is to sit quickly and straight in the basic position.

c) Evaluation: Mistakes in the development, handler following the dog, too slow of a go out on the dog's part, strong deviation to the side, too short of a distance, hesitant or premature downing, restless down or premature standing up/sitting are evaluated accordingly.

One additional command to "down" = -1,5 points  
A second additional command to "down" = -2,5 points  
Dog does stop, but does not lie down after a second command = -3,5 points

Additional faults will be evaluated accordingly. If the dog leaves, or comes back to the handler, the entire exercise is evaluated with 0 points.

**9. Down under distraction 10 points**

a) One verbal command to: "Down", "Sit"

b) Execution: Before the beginning of another dog's obedience work of phase B, the handler goes with his dog to a place as assigned by the judge and unleashes his dog while in the basic position. Then the handler downs his dog with the command "Ablegen/down" and without leaving a leash or other article with the dog. The handler then leaves his dog without looking back approximately 30 paces going out of



sight of the dog.. The dog has to remain calmly lying down without any influence of the handler while the other dog performs exercises 1 through 7. If the dog leaves the area before exercise 6 by more than 3 meters, the exercise is evaluated at zero points.

At the instruction of the judge, the handler returns to his dog and stand to the right of his dog. At the instruction of the judge, the dog is to execute the "Sit" command after a pause of approx 3 seconds quickly and straight in the basic position.

c) Evaluation: Restless behaviour of the part of the handler as well as other hidden help, restless lying down on the part of the dog, or standing/sitting prematurely before being picked up is evaluated accordingly. If the dog stands or sits, but does not leave the designated area, a partial awarding of points will result. If the dog leaves the designated area after exercise 6, he receives a partial evaluation. If the dog approaches the handler, when the handler returns, up to 3 points can be deducted.

### **IPO-3 Phase "C" Protection Work**

Exercise 1: Search for the helper	10 points
Exercise 2: Bark & Hold	10 points
Exercise 3: Prevent and escape of the helper	10 points
Exercise 4: Defence of an attack in the guarding phase	20 points
Exercise 5: Back transport	5 points
Exercise 6: Attack on the dog out of the back transport	15 points
Exercise 7: Attack on the dog in motion	10 points
Exercise 8: Defence of an attack in the guarding phase	20 points
<b>Total</b>	<b>100 points</b>

### **General requirements**

In a suitable location, six blinds are to be set up, 3 on each side, in a staggered fashion (see sketch). The necessary markings are to be clearly visible for the handler, the judge and helper.

### **Protection helper/Protection clothing**

The helper must be equipped with a protection suit, protection sleeve and a soft stick. The protection sleeve must have a grip bar, the cover made of natural jute (burlap) fibre. If the helper has to maintain visual contact with the dog during the guarding phase, then he may move accordingly. He may not assume a threatening position nor make any defensive gestures. He must protect his body with the protection sleeve. The style in which the handler takes the soft stick away from the helper is up to him.

It is possible to work with only one helper at all examination levels. If more than 7 dogs are entered at the same test level, then an additional helper is required. All dogs within the same test level must be worked by the same helper/helpers.

A one-time change of the helper is permitted, if the helper is an active handler at the event.



Reporting in

- a) The handler reports in with his dog off leash
- b) Thereafter he takes the dog to the start position for the “revere” exercise. (position towards the judge)
- c) The dog will be dispatched for the revere from the basic position at the instruction of the judge.

**Remark:**

If the handler and dog cannot report in the proper manner, for instance the dog is not under control and runs for example to the bark and hold blind or from the field, the handler may give up to 3 commands to recall the dog.

If the dog does not come back after the 3<sup>rd</sup>. recall, then phase “C” is regarded as a “disqualification due to lack of control”. Dogs that are not under the control of the handler, that after a defence exercise are not under control or where the handler must intervene to have the dog out, that grip other parts of the body rather than the protection sleeve must be disqualified. There is no “TSB”.

**Markings:**

The markings as prescribed in the rules must be visible for the handler, judge and helper.

These markings are:

- Place where the handler stands to recall his dog out of the bark and hold blind
- Place where the helper stands for the escape and defence and where he is to stop
- Place where the dog is in a down position for the escape
- Marking for the handler for the exercise “Attack on the dog out of motion”

Dogs that fail the defence exercise or allow themselves to be driven, phase “C” is terminated. There is no evaluation. The “TSB” is made known.

The command to “Out” is permitted only once for each defence exercise. Evaluation for the “out” is as per the following table:

Hesitant release	First additional “out” command with immediate “out”	First additional “out” command with slow “out”	Second additional “out” command with immediate “out”	Second additional “out” command with slow “out”	No “out” after second command or handler influence
0,5-3,0	3,0	3,5-6,0	6,0	6,5-9,0	disqualification

**1. Search for the helper**

**10 points**

- a) One verbal command to: “Search”, “Here”(the “here” command may be used in conjunction with the dog’s name.





b) Execution: The helper is located in the last blind out of the dog's sight. The handler positions himself with his dog in front of the first blind so that six side sweeps are possible. At the instruction of the judge, phase "C" begins.

With a short command to "search" with the visual aide by raising the right or left arm – this can be repeated – the dog must dispatch quickly from the handler and run to the designated blind goal-oriented, go around it tightly and attentive. When the dog executes the side sweep, the handler calls the dog to him with the "here" command and in movement directs him to the next blind. The handler moves at a normal pace down an imaginary line that his not permitted to leave.

The dog has to run in front of the handler. When the dog has reached the helper blind, the handler must stop and no further commands verbal or visual may be given.

c) Evaluation: Limitations in directability, fast and goal-oriented running to the blind as well as tight and attentive running around the blind are evaluated accordingly.

Faulty is:

- Not assuming a calm and attentive basic position at the beginning of the exercise
- Additional verbal or visual commands
- Not maintaining the middle imaginary line
- Not maintaining a normal pace
- Wide search
- Independent searching with reacting to the commands of the handler
- Blinds are not searched or not attentively searched
- Dog needs more direction and guidance

If the dog does not successfully find the helper at the last blind after the third attempt, the protection work is terminated. If the dog is commanded by the handler to heel at any time during the exercise, the protection work is also terminated. ("Terminated" without point entry; all other remaining points in the trial are entered).

**3. Bark & Hold**

**10 points**

a) One verbal command to: "Here", "Heel"

The command to "here" and "Heel" must be given at the same time

b) Execution: The dog has to actively and attentively hold the helper and continuously bark. The dog may not jump on the helper or grip him. After the dog has barked for approx. 20 seconds, the handler approaches the dog at the instruction of the judge and stops about 5 paces away from it. At the direction of the judge, the handler calls his dog to the basic position. After the judge releases the helper, the handler calls the helper out of the blind and has him take the designated place for the escape exercise. The dog is to sit quietly (without barking) straight and attentive in the basic position.

c) Evaluation: Limitations with continuous barking and determinately holding until the command is given without the intervention of the judge or handler are evaluated accordingly. For continuous barking 5 points are awarded. If the dog displays a weak bark only 2 points, the non-barking dog that actively and attentively watches the helper 5 points are deducted. Bothering the helper such as bumping, jumping up etc. must have a 2 point deduction and 9 if the dog grips strongly.

If the dog grips in the blind and does not independently release, the handler is requested to approach the blind at the place marked 5 paces in front of it. A one-time command to “here”/”heel” – may be given as a simultaneous command (not the command to “out”) is permitted. If the dog does not come, then the team is disqualified. If the dog does come, then the exercise is rated as a low satisfactory (-9 points). If the dog intentionally grips other body parts (not bumping), the dog is disqualified.

If the dog leaves the helper, before the judge’s directs the handler to leave the imaginary middle line, the dog may be redeployed to the helper.

If the dog remains with the helper, then phase C can continue, whereby the bark and hold are evaluated at a lower insufficient rating (-9 points). If the dog does not allow himself to be redeployed or leaves the helper again, then phase C is terminated. If the dog comes towards the handler as he approaches the blind, or the dog comes back to the handler prior to receiving a verbal command a partial rating as insufficient is given.

**Rating for “barking”**

For continuous barking 5 points are awarded. Weak barking (no pressure, non energetic) and no continuously barking lead to a -2 point deduction. If the dog displays an attentive hold without barking, then 5 mandatory points are deducted.

**2. Preventing and escape by the helper 10 points**

- a) One verbal command to: “Heel”, “Down”, “Go on”, “Out”

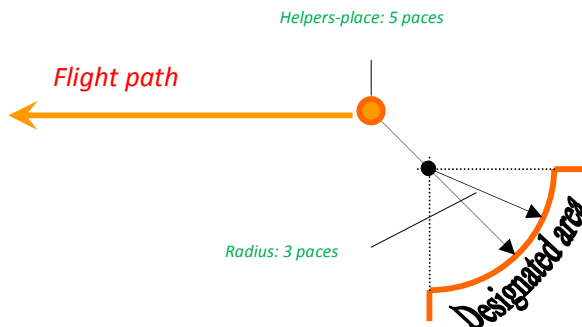

- b) Execution: At the direction of the judge (LR) the handler (HF) orders the helper out of the blind. The helper moves at a normal pace to the designated location for the escape. At the direction of the judge, the handler takes his free heeling dog to designated location for the dog to down before the escape. The distance between the handler and the helper is 5 paces. The handler leaves his watching dog in the down position and goes to the blind. He has visual contact to his dog, the judge and the helper. At the instruction of the judge (LR), the helper (HL) attempts an escape. The dog is to show a happy,



attentive and concentrated heel exercise and execute heeling positioned at the knee of the handler in a straight and quick manner. Prior to the command “down”, the dog is to sit in the basic position straight, calmly and attentive. He is to directly and quickly do the “down” command and remain in the designated location calmly, confident and be attentive to the helper. The distance between the helper and the dog is to be 5 paces. The dog leaves his on watch position, dog in the down position and goes to the blind. He remains in visual contact to his dog, the helper and the judge. At the direction of the judge, the handler requests the helper to exit the blind. The helper goes to the designated marked place at a normal pace for the escape. The handler takes his off leash dog to the marked place for the escape. The distance between the handler and the helper is 5 paces.

The handler leaves his dog in the down position and goes into the blind. He has visual contact to his dog, the helper and the judge. At the instruction of the judge, the helper makes an attempt to escape. Simultaneously the handler commands the dog to “go on or stop” to have the dog prevent the escape of the helper. Without hesitation the dog is to prevent the escape by means of a high dominance ratio and relatively fast grip deploying an energetic and strong grip. He may only grip the protection sleeve of the helper. At the instruction of the judge, the handler stops. After the helper stops the dog has to release after a brief transition period. The handler may give a command to “out” in a reasonable amount of time. If the dog does not out after the first permitted command, the handler will receive instructions from the judge for a second command to “out”. If the dog does not out after the third command (one permitted – two additional), a disqualification will result. The handler is to remain calmly standing when giving the “out: command and without influencing the dog. After the release, the dog is to remain close to the helper and watch him attentively.

c) Evaluation: Limitations in the important evaluation criteria: high dominance, quick energetic reaction and pursuit with a strong grip with a relatively quick grip action and effective hindrance of the escape with a calm grip until release, attentive hold close to the helper are evaluated accordingly.

If the dog remains down or the dog does not prevent the escape through gripping or holding within 20 paces, phase C is terminated. If the dog engages without a command from the handler, the exercise is rated minus a point.

If the dog is slightly attentive in the holding phase and/or slightly bothersome, the exercise is rated minus a point, the dog very inattentively holds the helper, and/or is very bothersome, a two point deduction will result. If the dog does not hold the helper, remains however with him, a three point deduction will result.

If the dog leaves the helper or the handler gives a command so that the dog stays with the helper, phase C is terminated.

### **3. Defense of an attack during the guarding phase 20 points**

a) One verbal command to: “Out”, “Heel”

b) Execution: After the holding phase of approximately 5 seconds, the helper under the direction of the judge, attacks the dog. Without intervention by the handler, the dog must defend himself by means of an energetic and strong grip. The dog may only grip the protection sleeve of the helper.

The helper is to pressure the dog by way of threatening stick gestures and driving. The dog is to be closely observed when pressured especially concerning his activity and stability. Two tests are conducted



with the stick pressure. The dog may only grip the protection sleeve of the helper. Stick hits are only to be deployed on the shoulders or in the withers area. The dog has to be impartial during the pressure phase and has to show a full, energetic and above all a constant grip during the entire defence exercise. At the instructions of the judge, the helper stands still. After the helper stops the dog is to release after a relatively brief transition period. The handler may give a command to “out” within a reasonable amount of time.

If the dog does not out after the first permitted command, the handler receives the instruction from the judge to give two additional commands for the “out”. If the dog does not out after these commands (one permitted two additional), a disqualification will result. When giving the “out” command, the handler is to remain calmly in place and not influence the dog. After the release, the dog is to remain close to the helper and watch him attentively. At the judge’s instruction, the handler goes at a normal pace in the most direct way to his dog and takes him into the basic position by commanding “Heel”. The soft stick is not taken from the helper.

c) Evaluation: Limitations concerning the important evaluation criteria are evaluated accordingly: Quick and strong grip, full and calm grip up to release, after the release an attentive close guarding of the helper. If the dog does not withstand the pressure of the helper, comes off of the protection sleeve and allows himself to be chased, phase “C” is terminated. If the dog is slightly inattentive and/or slightly bothersome, a one point deduction will result, the dog guards the helper very inattentively and/or is very bothersome, a two point deduction will result. If the dog does not guard the helper, but remains with the helper, a three point deduction will result. If the dog comes towards the handler when he approaches, the exercise is rated as insufficient. If the dog leaves the helper or the handler gives a command so that the dog stays with the helper, phase C is terminated.

**5. Back transport**

**5 points**

- a) One verbal command to: “Heel”
- b) Execution: After exercise 4 the transport of the helper over a distance of approx. 30 paces follows. How the back transport is conducted is determined by the judge. The handler orders the helper to move out and goes with his dog off leash, who is attentively watching the helper, approx 5 paces behind the helper. The distance of 5 paces must be maintained throughout the back transport.
- c) Evaluation: Limitations in the important evaluation criteria are evaluated accordingly. Watching the helper attentively, exact heeling, maintaining a distance of 5 paces to the helper.

**6. Attack on the dog out of the Back Transport**

**15 points**

- a) One verbal command to: “Out”, “Heel”
- b) Execution: During the back transport the judge advises to attack the dog while still moving. Without intervention by the handler and without hesitation, the dog is to defend himself by an energetic and strong grip. He may only grip the protection sleeve of the helper. As soon as the dog has a grip on the sleeve, the handler is to stand still. The helper stops at the instruction of the judge. After the helper stops, the dog is to release within a reasonable amount of time. The handler may also give the command to “out” within a reasonable amount of time.



If the dog does not out after the first permitted command, the handler receives the instruction from the judge to give two additional commands for the "out". If the dog does not out after these commands (one permitted two additional), a disqualification will result. When giving the "out" command, the handler is to remain calmly in place and not influence the dog. After the release, the dog is to remain close to the helper and watch him attentively. At the judge's instruction, the handler goes at a normal pace in the most direct way to his dog and takes him into the basic position by commanding "finish". The soft stick is taken from the helper.

A side transport of the helper now takes place to the judge over a distance of about 20 paces. A command to "heel" is permitted. The dog is to go at the right side of the helper so that the dog is between the helper and the handler. During the transport the dog is to be attentive to the helper. He may not however crowd the helper, jump on him or grip. The group stops in front of the judge. The handler gives the soft stick to the judge and reports out ending phase C.

d) Evaluation: Limitations in the important evaluation criteria are evaluated accordingly: Quick and strong grip, full and calm grip up to the release, after releasing attentively guarding the helper.

If the dog is slightly inattentive and/or slightly bothersome, a one point deduction will result, the dog guards the helper very inattentively and/or is very bothersome, a two point deduction will result.

If the dog does not guard the helper, but remains with the helper, a three point deduction will result. If the dog comes towards the handler when he approaches, the exercise is rated as insufficient. If the dog leaves the helper before the judge instructs the handler to approach or the handler gives a command so that the dog stays with the helper, phase C is terminated.

**7. Attack on the dog out of motion**

**10 points**

a) One verbal command to: "Sit", "Defend", "Out"

b) Execution: The handler is advised to go to the designated place with his dog on the middle line at the level of the first blind. The dog is to heel attentive to the handler, happy and concentrated. He moves straight at knee height of the handler. At the level of the first blind, the handler stops and turns around. With the command to "sit", the dog is placed in basic position. The straight, calm and attentively sitting dog facing the helper may be held on the collar, may however not be stimulated by the handler. At the direction of the judge, the helper comes out of the blind and goes in a running pace to the middle line. Ignoring the shout of the handler, the helper (still running) charges the dog and handler in a frontal attack with loud shouts and threatening gestures. As soon as the helper reaches the handler and his dog at about 40 to 50 paces, the handler under the direction of the judge releases his dog to "defend". Without hesitation and on one command to "go on and hold" the dog is to effectively prevent the attack through a high dominance factor and relatively quick speed. He may only grip the protection sleeve of the helper. The handler may not leave the place where he stopped.

In the pressure phase, he has to be uninfluenced and during the entire defence exercise, he has to display a full, energetic and above all a constant grip. At the direction of the judge the helper stops. After the helper stops, the dog is to release in a brief transition time. The handler may give a command to "out" in a reasonable amount of time.



If the dog does not out after the first permitted command, the handler receives the instruction from the judge to give two additional commands for the “out”. If the dog does not out after these commands (one permitted two additional), a disqualification will result. When giving the “out” command, the handler is to remain calmly in place and not influence the dog. After the release, the dog is to remain close to the helper and watch him attentively.

c) Evaluation: Limitations concerning the important evaluation criteria are evaluated accordingly: Energetic defence with strong grip, full and calm grip until release, after the release attentive and close guarding of the helper.

If the dog is slightly inattentive and/or slightly bothersome, a one point deduction will result, the dog guards the helper very inattentively and/or is very bothersome, a two point deduction will result. If the dog does not guard the helper, but remains with the helper, a three point deduction will result. If the dog leaves the helper before the judge instructs the handler to approach or the handler gives a command so that the dog stays with the helper, phase C is terminated.

## **8. Defense of the dog out of the guarding phase 20 points**

a) One verbal command to “Out”, “Heel”

b) Execution: After the guarding phase of about 5 seconds and upon a signal from the judge, the helper makes an attack on the dog. Without influence of the handler the dog must defend himself through energetic and powerful gripping. The dog may only grip the protection sleeve of the helper. The dog is put under pressure through stick threats and pressured by the helper. During the pressure phase his activity and stability is to be closely monitored. There are two tests conducted with the stick hits. Only permitted are stick hits on the shoulders or in the area of the withers. At the instruction of the judge, the helper stands still. After the helper stops, the dog must release after a short transition. The handler may give a command to “out” after an appropriate time.

If the dog does not release after the first permitted command, the handler will receive instructions from the judge for up to two additional commands to “out”. If the dog does not release after this command (one permitted and two additional), a disqualification will result. During the command to “out”, the handler is to remain calmly standing without influencing the dog. After the out, the dog is to remain close to the helper and guard him attentively. At the instruction of the judge, the handler goes in a normal pace directly to his dog and commands him to “heel” into basic position. The soft stick is taken from the helper.

A side transport of the helper now takes place to the judge over a distance of about 20 paces. A command to “heel” is permitted. The dog is to go at the right side of the helper so that the dog is between the helper and the handler. During the transport the dog is to be attentive to the helper. He may not however crowd the helper, jump on him or grip. The group stops in front of the judge. The handler gives the soft stick to the judge and reports out ending phase C. At the instruction of the judge, the handler goes with his dog off leash to a place where the critique will be given and the helper will receive instructions from the judge to leave the field. Prior to the critique and under the direction of the judge, the dog is put on leash.



c) Evaluation: Limitations concerning the important evaluation criteria are evaluated accordingly: Energetic defence with strong grip, full and calm grip until release, after the release attentive and close guarding of the helper.

If the dog is slightly inattentive and/or slightly bothersome, a one point deduction will result, the dog guards the helper very inattentively and/or is very bothersome, a two point deduction will result.

If the dog does not guard the helper, but remains with the helper, a three point deduction will result. If the dog comes towards the handler when he approaches, the exercise is rated as insufficient. If the dog leaves the helper before the judge instructs the handler to approach or the handler gives a command so that the dog stays with the helper, phase C is terminated.

**Tracking Dog Trial– Level 1****FH 1**

<b>Maintaining the track</b>	<b>79 points</b>
<b>Articles (3 x 5, 1 x 6) =</b>	<b>21 points</b>
<b>Total</b>	<b>100 points</b>

**Cross track, execution time: 30 minutes**

**Participating regulations.**

On the day of the trail event, the dog must have reached the prescribed age. No exceptions can be made. Condition to start is a passed BH/VT exam according to the national rules of the country.

**1. Tracking Performance**

The dog has to demonstrate his confidence in tracking on a track of a minimum of 1200 paces that is a minimum of three hours aged and laid by a stranger, with six 90 degree turns (see sketch) that conform to the terrain, whereby the track must be crossed by at least two fresh tracks of a stranger at varying points separate from one another. Along the track, at irregular distances, four articles with the definitive scent of the tracklayer are placed, whereby the tracklayer must have carried the articles at least 30 minutes prior to laying the track in his pocket. Within a given track, different types of articles must be utilized (Material: e.g., leather, textile, wood). The articles must have a length of approximately 10 cm, a width of 2-3 cm and a thickness of 0,5 – 1 cm. The articles may not differentiate themselves in colour to the given terrain.

All articles must have a number that coincides with the number of the start marker. These articles are to be located by the dog by either indicating or picking up.

Prior to beginning the exercise, the handler is to report to the judge and advise if his dog picks up or indicates the article. Picking up and indicating are considered faulty. The articles will only be evaluated as per the initial instructions of the handler. (Picking up or indicating)

The dog handler may choose to track with or without a tracking line.

The tracking line may show slack as long as it does not drop out of the handler's hand.

**2. Laying the tracks**

The track layer who is a stranger to the dog receives a layout sketch from the judge or the track coordinator. The judge/track coordinator sketches a layout of the track based on terrain landmarks such as standing trees, utility poles, huts, etc. The start must be clearly marked by means of a marker, which is to be placed in the ground at the left side of the start and must remain in place for the duration of the track work. After the track layer pauses for a while at the start, he then goes according to the sketched layout as advised by the judge.

The articles are to be placed at irregular distances on the track not within 20 paces before or 20 paces after a turn. The first article may not be placed under a distance of 250 paces from the start position.





The fourth and last article will be placed at the end of the track. Articles may not be placed at the turns or in the immediate vicinity of a turn. The articles must be placed on the track not near it. Where the articles are placed are to be noted on the sketch with an "x".

It is mandatory that that the track be laid on different ground cover. A well travelled hard surface road is not necessarily required. A track must be laid so that it corresponds to reality. Pattern tracks are to be avoided.

Thirty minutes prior to competing laying the track, a second tracklayer, also a stranger to the dog, receives instructions from the judge to go to a distinctive place to lay two cross tracks, not within 40 steps before or 40 steps after a turn (not on the first or last legs).

### **3. Execution of the track**

The dog should be given time to note the scent. He should be trained in such a manner that he is calm, work without influence from the handler (permitted is the command to "Track") to start to track. At no time should the handler encourage the dog to move forward to stimulate his tracking. If the handler is of the opinion that the dog did not get the scent, he may restart the dog whereby the dog may not be more than 15 paces from the start. In this case a mandatory 4 point deduction will result.

The track should be worked out calmly so that the handler can follow in a walking pace. If the dog finds an article, then he is to immediately pick it up or clearly indicate it. Indicating can be done by sitting, lying or standing. The handler is to go immediately to his dog and show the article by raising his hand. The handler praises his dog and allows him to continue tracking. If the dog locates an article that does not belong to the tracklayer, he may not pick it up or indicate it. If the dog switches over to the cross track and follows this for approximately 25 paces, the track work is terminated. If after 30 minutes of starting the track, the end has not been reached, the track work will be terminated by the judge.

### **4. Evaluation:**

The highest score of 100 points may only be given to a dog if the dog demonstrates a convincing track work from beginning to the end and has either picked up or indicated all four articles. All turns must be worked out confidently. The dog may not be influenced by the cross tracks. There are no points awarded for article that are not located. If no articles as laid by the track layers were not found, then the maximum rating of "Satisfactory" can only be awarded. If the dog indicates falsely (e.g. no article or one that does not belong to the track layer), then a general 2 point deduction will result. If the dog leaves the track by more than a line length, the track is to be terminated.

### **5. Awarding the title of FH 1**

The title of FH 1 may only be awarded if the dog has achieved a minimum of 70 points.  
Rating indicator:



Maximum points	Excellent	Very good	Good	Satisfactory	Insufficient
100 points	96 - 100	90 - 95	80 - 89	70 - 79	0 - 69

**FH 1: Track Layouts**

**FH 1:**

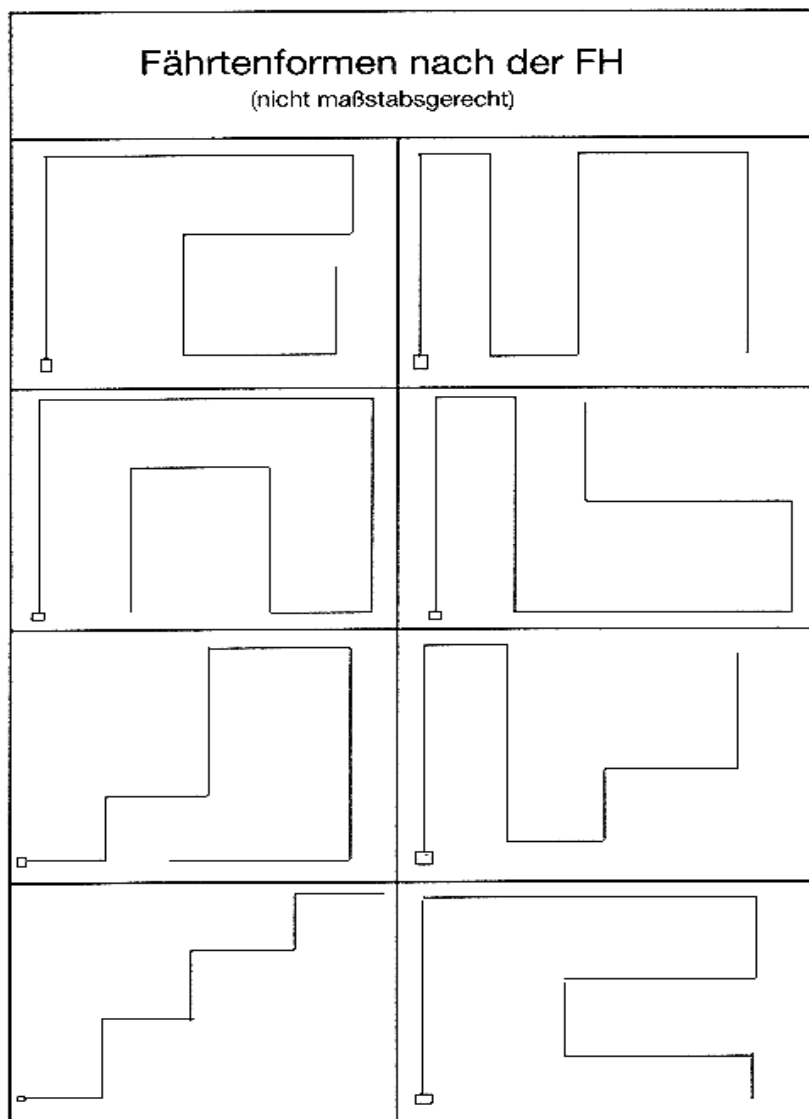



## **Tracking Dog Trial - FH Level 2**

## **FH 2**

**Track laid by a stranger of approximately 1800 paces, 8 legs, 7 turns, 7 articles aged approximated 180 minutes, cross tracks, execution time 45 minutes.**

### **Point division:**

<b>Maintaining the track</b>	<b>79</b>
<b>Articles 7x3</b>	<b>21</b>
<b>Total</b>	<b>100</b>

(If no articles are found, the maximum rating of “satisfactory” can only be awarded.)

### **Participating regulations.**

On the day of the trail event, the dog must have reached the prescribed age. No exceptions can be made. Condition to start is a passed BH/VT exam according to the national rules of the country.

### **General Requirements:**

The judge or the tracking-coordinator determines the layout of the tracks according to the respective terrain. It is not permitted to have on each track, for instance, the individual turns or article placed at the same intervals or for that matter at the distance. The start must be designated with a marker, which must be placed to the immediate left of the scent pad.

The order in which the tracks are run will be drawn by the judge after the tracks have been laid.

The track layer must show the articles to the judge prior to laying the track. Only articles that have been well scented (at least 30 minutes) may be used. The track layer is to pause briefly at the scent pad and then continues at a normal pace in the designated direction. The legs and turns (see sketch) are also done at a normal pace, whereby the first article is placed at least after 100 paces on the 1<sup>st</sup> or 2<sup>nd</sup> leg, the others can be placed as preferred, also two on a given leg are permitted and the 7<sup>th</sup> at the end of the track. The legs should be laid suitable to the terrain. One leg must be laid in an arc with a radius of at least 3 track line lengths (approx. 30m). The arc begins and ends with 90 degree turns, a minimum of two turns must be acute. Acute turns must be laid within 30 to 60 degrees. The different articles (Material: e.g. leather, textile, wood) can be placed irregularly, not within 20 paces before or 20 paces after a turn, the last article must be placed at the end of the track. The articles must be placed on the track while in movement. After placing the last article, the tracklayer is to proceed several paces in a straight direction. The articles must be approx. 10cm in length, 2-3cm wide and be 0,5-1cm in thickness and may not stand out in colour from the terrain. All articles must coincide in number with the track number. While the track is being laid, the handler and his dog must be out of sight. A half hour prior to working out the track, an additional tracklayer lays a cross track, which must cross 2 legs not under 60 degrees and not within 40 steps before or 40 steps after a turn. The cross track may not be laid within 40 paces before or 40 paces after a turn and may not cross the first or last leg or any given leg twice.



The judge, tracklayer and accompanying person may not be in the area where the team (handler and his dog) have the right to work.

- a) **Command to: "Track"**  
The command may be given at the start of the track and after each article. Occasional praise and occasional commands to "track" are permitted, except at the turns and at the articles.
  
- b) **Execution:** The handler prepares his dog for the track. The dog may track free or on a 10 meter line. The 10 meter line may be placed over the back, on the side or between the front and/or back legs. It can be placed on the collar, not the live ring, or on the designated clasp of the harness (permitted are Harness or Böttger harness without additional straps). When called, the handler reports with his dog in basic position to the judge, and tells if his dog will pick up or indicate the articles. Before, during the start and throughout the entire track no force is to be displayed. At the direction of the judge the dog is slowly and calmly led to the start and deployed. The dog must work the start intensely, calm and with a deep nose. The dog must then continue at an even pace and follow the track intensively. The dog must confidently work out the turns. The handler follows the dog at distance of 10 meters at the end of the line. If free tracking is done, then the distance of 10 meters must be maintained. The tracking line may have slack in it as long as it does not drop from the handler's hands. After the turns the dogs must continue at the same pace. As soon as the dog has found an article, he must immediately pick it up or convincingly indicate it without any influence from the handler. When picking up, he may stand, sit or return to the handler. Continuing with the article or lying down is faulty. Indication can be done lying down, sitting or standing (also interchangeably). When the dog has picked up/indicated the article, the handler drops the line and goes to his dog. By raising his arm with the article in hand, he advises that the dog has located the article. After this the handler picks up the tracking line and continues tracking with his dog. After completing the track, the handler presents the articles to the judge. Giving the dog food rewards during the track is not permitted. The handler may interrupt the track with the permission of the judge, if he feels the dog's physical well being is compromised or that the weather conditions (e.g. extreme heat) require that a break is necessary. Any breaks in the tracking are counted against the time allowed to execute the track. The handler is permitted to clean his dog's head, eyes and nose during a break or at an article. He may also utilize a wet cloth or wet sponge. These aides must be shown to the judge prior to tracking. Any other aides are not permitted.
  
- c) **Evaluation:** In order to receive the training degree, both tracks must be awarded with 70 points. The speed with which the track is worked out is not evaluated as a criterion, if the track is worked out intensively, even and convincingly and the dog shows a positive tracking attitude. Checking without leaving the track is not faulty. Restarts, casting, high nose, emptying, circling at the turns, continuous encouragement, line or verbal help in the tracking area or at the articles, faulty picking up or faulty indication of the articles, false indication, are evaluated accordingly. If the dog leaves the track by more than a line length, the track is terminated. If the dog leaves the track and is held back by the handler, he will receive instructions from the judge to follow the dog. If these instructions are not followed, the judge will terminate the track work.



If the end of the track has not been reached within the allotted time of 45 minutes after starting the track, then the track work will be terminated by the judge. Exceptionally if the dog is tracking on the last leg, then the track work will not be terminated. The track is evaluated up to the point of termination.

It is considered faulty if the dog shows both, picks up or indicates an article on the same track. Only those articles will be evaluated that were advised by the handler at the start of the track. False indication is considered in the evaluation on the respective leg. Articles that are overrun are not shown to the handler.

For non-indicated articles or picked up articles, no points are awarded.

The division of points for maintaining the legs of the track are distributed as per the length and degree of difficulty. The evaluation of the individual legs, are evaluated by ratings and points. If a dog does not track (lengthy pauses at the same spot without tracking), the track can be terminated even if the dog is still on the track.



## **IPO-FH**

**Two stranger laid tracks with approximately 1800 paces, 8 legs, 7 turns, 7 articles, aged approximately 180 minutes,, execution time 45 minutes.**

Point division:

	1 <sup>st</sup> day	2 <sup>nd</sup> day	Total
Maintaining the track	79	79	158
Articles 7 x 3	21	21	42
<b>Total</b>	<b>100</b>	<b>100</b>	<b>200</b>

(If no articles are found, the maximum rating of “satisfactory” can only be awarded.)

### **Participating regulations.**

On the day of the trail event, the dog must have reached the prescribed age. No exceptions can be made. Condition to start is a passed BH/VT exam according to the national rules of the country.

### **General Requirements:**

The judge or the tracking-coordinator determines the layout of the tracks according to the respective terrain. The tracks need to be laid differently over two days span. It is not permitted to have on each track, for instance, the individual turns or article placed at the same intervals or for that matter at the distance. The start must be designated with a marker, which must be place to the immediate left of the scent pad in the ground.

Both tracks are laid by a stranger over the course of two days at a given event in different places and with different track layers.

The order in which the tracks are run will be drawn by the judge after the tracks have been laid.

The track layer must show the articles to the judge prior to laying the track. Only articles that have been well scented (at least 30 minutes) may be used. The track layer is to pause briefly at the scent pad and then continues at a normal pace in the designated direction. The legs and turns are also done at a normal pace, whereby the first article is placed at least after 100 paces on the 1<sup>st</sup> or 2<sup>nd</sup> leg, the others can be placed as preferred, also two on a given leg are permitted and the 7<sup>th</sup> at the end of the track. The legs should be laid suitable to the terrain. One leg must be laid in an arc with a radius of at least 3 track line lengths (approx. 30m). The arc begins and ends with 90 degree turns (see sketch), a minimum of two turns must be acute. Acute turns must be laid within 30 to 60 degrees (see sketch) The different articles (Material: e.g. leather, textile, wood) can be placed irregularly, but not within 20 paces before or 20 paces after a turn the last article must be placed at the end of the track. The articles must be placed on the track while in movement. After placing the last article, the tracklayer is to proceed several paces in a straight direction. The articles must be approx. 10cm in length, 2-3cm wide and be 0,5-1cm in thickness and may not stand out in colour from the terrain. All articles must coincide in number with the track number. While the track is being laid, the handler and his dog must be out of sight.



A half hour prior to working out the track, an additional tracklayer lays a cross track, which must cross 2 legs not under 60 degrees and not within 40 steps before or 40 steps after the turn. The cross track may not cross the first or last leg or any given leg twice.

The judge, tracklayer and accompanying person may not be in the area where the team (handler and his dog) have the right to work.

a) Command to: "Track"

The command may be given at the start of the track and after each article. Occasional praise and occasional commands to "track" are permitted, except at the turns and at the articles.

b) Execution: The handler prepares his dog for the track. The dog may track free or on a 10 meter line. The 10 meter line may be placed over the back, on the side or between the front and/or back legs. It can be placed on the collar, not the live ring, or on the designated clasp of the harness (permitted are Harness or Böttger harness without additional straps). When called, the handler reports to the judge, with his dog in basic position and tells if his dog will pick up or indicate the articles. Before, during the start and throughout the entire track no force is to be displayed. At the direction of the judge the dog is slowly and calmly led to the start and deployed. The dog must work the start intensely, calm and with a deep nose. The dog must then continue at an even pace and follow the track intensively. The dog must confidently work out the turns. The handler follows the dog at distance of 10 meters at the end of the line. If free tracking is done, then the distance of 10 meters must be maintained. The tracking line may have slack in it as long as it does not drop from the handler's hands. After the turns the dogs must continue at the same pace. As soon as the dog has found an article, he must immediately pick it up or convincingly indicate it without any influence from the handler. When picking up, he may stand, sit or return to the handler. Continuing with the article or lying down is faulty. Indication can be done lying down, sitting or standing (also interchangeably). When the dog has picked up/indicated the article, the handler drops the line and goes to his dog. By raising his arm with the article in hand, he advises that the dog has located the article. After this the handler picks up the tracking line and continues tracking with his dog. After completing the track, the handler presents the articles to the judge. Giving the dog food rewards during the track is not permitted. The handler may interrupt the track with the permission of the judge, if he feels the dog's physical well being is compromised or that the weather conditions (e.g. extreme heat) require that a break is necessary. Any breaks in the tracking are counted against the time allowed to execute the track. The handler is permitted to clean his dog's head, eyes and nose during a break or at an article. He may also utilize a wet cloth or wet sponge. These aides must be shown to the judge prior to tracking. Any other aides are not permitted.

c) Evaluation: In order to receive the training degree, both tracks must be awarded with 70 points. The speed with which the track is worked out is not evaluated as a criterion, if the track is worked out intensively, even and convincingly and the dog shows a positive tracking attitude. Checking without leaving the track is not faulty. Restarts, casting, high nose, emptying, circling at the turns, continuous encouragement, line or verbal help in the tracking area or at the articles, faulty picking up or faulty indication of the articles, false indication, are evaluated accordingly. If the dog leaves the track by more than a line length, the track is terminated. If the dog leaves the track and is held back by the handler, he will receive instructions from the judge to follow the dog. If these instructions are not followed, the judge will terminate the track work.



If the end of the track has not been reached within the allotted time of 45 minutes after starting the track, then the track work will be terminated by the judge. Exceptionally if the dog is tracking on the last leg, then the track work will not be terminated. The track is evaluated up to the point of termination.

It is considered faulty if the dog both: picks up or indicates an article on the same track. Only those articles will be evaluated that were advised by the handler at the start of the track. False indication is considered in the evaluation on the respective leg. Articles that are overrun are not shown to the handler.

For non-indicated articles or picked up articles, no points are awarded.

The division of points for maintaining the legs of the track are distributed as per the length and degree of difficulty. The evaluation of the individual legs, are evaluated by ratings and points. If a dog does not track, (lengthy pauses at the same spot without tracking), the track can be terminated even if the dog is still on the track.



**FH 2 and IPO-FH: (Track Layouts)**

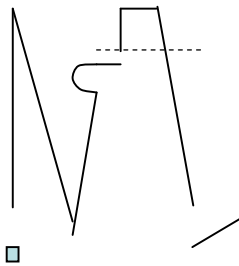
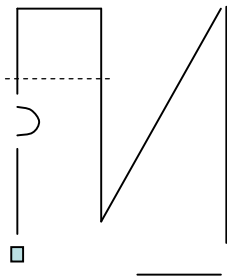
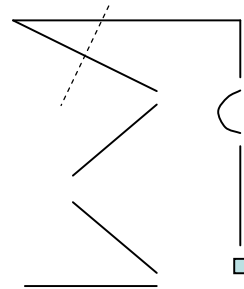
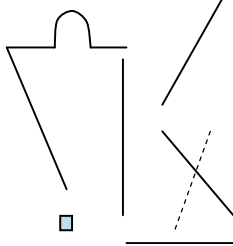
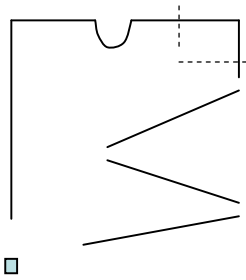
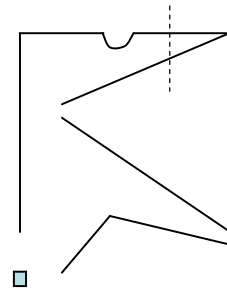
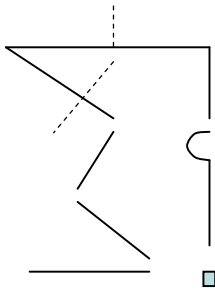
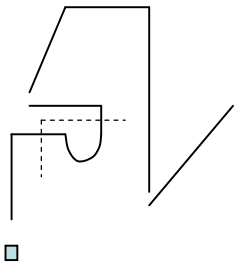
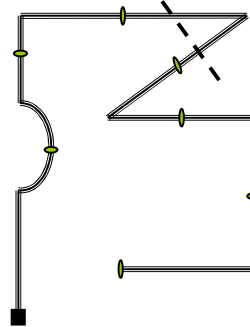
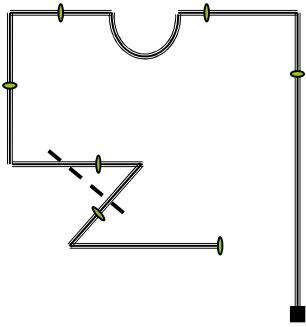



### **Article Indication Trial 1 – 3 (StPr 1 – 3)**

#### **1. Test levels for the Article Indication Test**

The requirements are set at different levels and reflect the individual testing levels.

<b>Level</b>	<b>Indication Area</b>	<b>Articles</b>	<b>Points</b>	<b>Execution Time</b>
<b>1</b>	20 x 30 m	2 Handler Articles Size: 10 x 3 x 1 cm Material = same type permitted 1 article left, 1 article right	10 / 10	10 minutes
<b>2</b>	20 x 40 m	4 Stranger Articles Size: 10 x 3 x 1 cm Material = different 2 articles left, 2 articles right	5 / 5 / 5 / 5	12 minutes
<b>3</b>	30 x 50 m	5 Stranger Articles Size: 5 x 3 x 1 cm Material: Different Placed at discretion	4 / 4 / 4 / 4 / 4	15 minutes

#### **2. General Requirements**

In order to take this test, it is required that the respective dog is a minimum of 15 months old and has passed the FCI-BH/VT test or has passed a national BH/VT test.

The handler reports in with his name and that of his dog in a sportsmanlike manner and advises the judge which level of test he is undertaking. Thereafter, he goes with his dog on leash to the designated start position and assumes the basic position.

The dog is taken off leash for the indication work. The handler is to keep the leash with him.

Any force or punishment is to be avoided.

Slightly going out of the boundaries is not faulty.

Spectators are to be a reasonable distance away from the indication field.

#### **3. Type of area for the Indication Work**

Terrain: all natural ground (grass, plowed field, wooded area). Tree stock is also permitted. (avoid any opportunity for visual indication, so avoid short grass or other similar areas.)



Prior to laying out the articles, the indication area should be crossed by people several times, so that no one track is indicated.

Markings may be placed around the indication area.

#### **4. Articles**

Material: Wood, leather, artificial leather, textile

Placed articles may not differentiate themselves in colour to the terrain and should not be visible.

Handler and dog must remain out of sight while the articles are placed.

There is no waiting time to begin. The dog may begin to search immediately after the articles are placed.

#### **5. Deploying the dog to locate**

The imaginary center line and the bordering sides of the indication area will be made known to the handler by the judge.

At the beginning a short conditioning of the dog to start working at the imaginary center line of the indication area is permitted.

The handler moves within the imaginary center line. He may only leave this to retrieve the article. Thereafter the dog is restarted from the middle line to locate the remaining article(s). Both verbal and visual commands are permitted. The command "lost" may be supported with the "search" command.

Locating the article(s) with a "high Nose" is not faulty.

The indication area may be repeatedly searched..

#### **6. Behaviour at the articles**

Articles must be convincingly indicated and may not be touched by the dog. The articles may be indicated by sitting, standing or lying down or in varying styles. A command to indicate is not permitted and leads to the article not being evaluated.

No commands are permitted to get the dog to indicate the articles. If the dog has indicated an article, the handler goes to his dog and shows the judge the article by raising it up, then he returns to the middle line and restarts his dog to continue the article indication work.

The lying down position for the articles is not stipulated. The located article must however be in the immediate area of the dog's front paws.

The handler always approaches his dog from the side and may not stand in front of the dog. Praising the dog after the article is shown is permitted.



After the dog has located the last article, he is placed on leash. Thereafter, the handler shows the article and reports out to the judge.

**7. Evaluation**

The highest points for each of the article indication tests 1 – 3, is 100 points for each.  
At least 70 points must be achieved.

The evaluation criteria for all three levels:

- a) Obedience 20 points (following the verbal/visual commands of the handler)
- b) Intensity of searching 20 points (willing to intensively pick up the scent)
- c) Endurance 20 points (maintaining the search drive to locate the articles)
- d) Behaviour of the handler 20 points (influence on the dog)
- e) Article indication 20 points (convincing indication)

<b>Highest points</b>	<b>Excellent</b>	<b>Very Good</b>	<b>Good</b>	<b>Satisfactory</b>	<b>Insufficient</b>
<b>100 points</b>	96 – 100	90 – 95	80 – 89	70 – 79	0 - 69

**8. Execution requirements**

The exercise begins with the basic position at the border of the indication area and ends with the reporting out to the judge. Articles located by the dog must be presented.

Positive Criteria:

Even, calm and smooth work. Quickly dispatching from the handler. Immediate reaction to the commands. Enduring and goal-oriented work on the part of the dog. Broad side sweeps by the dog.

Faulty:

Picking up the articles by the dog, those that require strong intervention by the handler to indicate are not evaluated.

- Touching the articles 1 – 3 point deduction
- Premature getting up, additional command 1 – 3 point deduction
- Leaving the centre line on the part of the handler 2 – 5 point deduction
- Catching mice, emptying, etc. 4 – 8 points
- Lackluster work on the part of the dog 4 – 8 point deduction

Going over the allowed time allotment results in termination of the work. Points awarded up to that time are granted.

Further additional negative evaluation criteria: restless behaviour when indicating, barking, not permitted handler help, going away over the boundaries of the indication area.



Layout of the indication fields level 1 - 3

	<p><b>Level 1</b> Indication area 20 x 30 m</p>
	<p><b>Level 2</b> Indication area 20 x 40 m</p>
	<p><b>Level 3</b> Indication area 30 x 50 m</p>

**Attachments for IPO layouts**

**a) Jump**

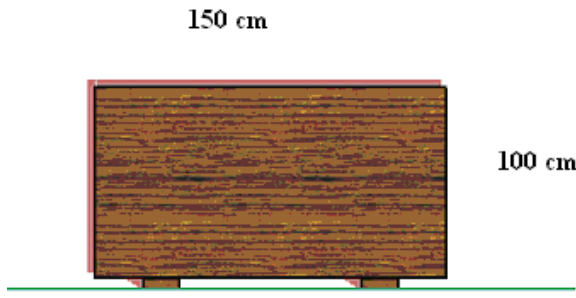
 <p style="text-align: center;">150 cm</p> <p style="text-align: right;">100 cm</p>	<p>The jump has a height of 100 cm and a width of 150 cm (see sketch)</p> <p>Test jumps are not permitted during the presentation.</p>
--	--

**b) Scaling wall**

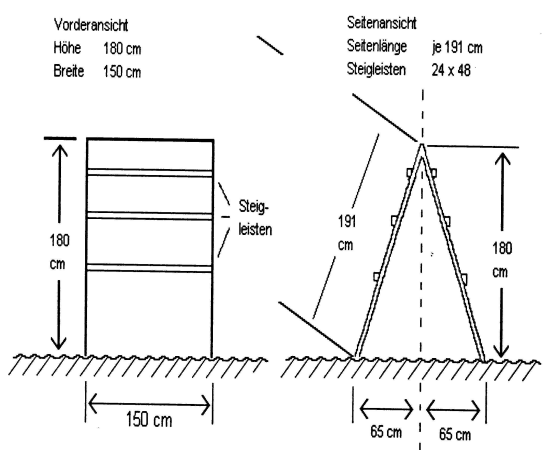
<p><b>Schrägwand</b></p> <p>Vorderansicht          Höhe 180 cm          Breite 150 cm</p> <p>Seitenansicht          Seitenlänge je 191 cm          Steigleisten 24 x 48</p> 	<p>The scaling wall consists of 2 sides joined at the top and must be 150 cm wide and 190cm high. At the bottom both sides stand apart so that it is a horizontal height of 180cm The entire area of the scaling wall must be covered with anti skid material. At the upper part of the sides 3 cleats 24/48mm must be fixed. All dogs must jump the same obstacles.</p> <p>Test jumps are not permitted during the presentation.</p>
---	---

**c) Dumbbells**

	<b>IPO 1</b>	<b>IPO 2</b>	<b>IPO 3</b>
<b>On the flat</b>	650 gr	1.000 gr	2.000 gr
<b>Jump</b>	650 gr	650 gr	650 gr
<b>Scaling wall</b>	650 gr	650 gr	650 gr

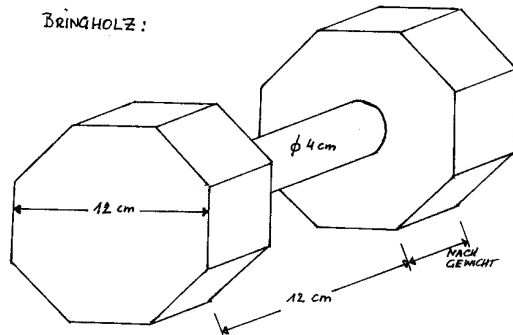

For the retrieve exercises only dumbbells are permitted. All participants are required to use the specified dumbbells are provided by the hosting club. Handler owned dumbbells are not permitted.

The sketch of the dumbbell as shown in the rules is only a sample. Important is the fact that the weights are correct and that the braces are made of wood and that the braces are 4cm from the ground.

d) Execution

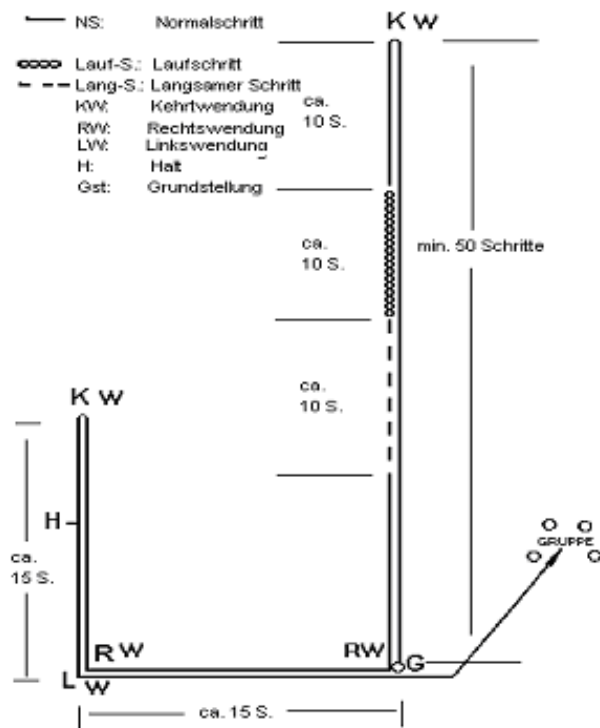

The handler goes with his dog on leash for the IPO-1 and for IPO-2 and 3 with his dog off leash to the judge, has his dog sit and reports in.

After the judge the release to start, the handler assumes the start position with his dog off leash. After additional instructions by the judge the handler begins the exercise. From a straight, calm and attentive basic position, the dog follows the handler and at the "heel" command proceeds attentive, happy, straight and quickly. With the shoulder blade at knee height of the handler the dog remains to the left of the handler and at the halt sits independently, quick and straight.

At the beginning of the exercise the handler goes 50 paces with his dog without halting in a straight direction. After the about turn and an additional 10 to 15 paces, the handler demonstrates a running pace and the slow pace – 10-15 paces using the "heel" command each time. The transition from the running pace to the slow pace must be done without intermittent steps.

The starting basic position is also the place of the basic position at the end of an exercise. In the group the Handler and his dog must turn around one person to from the right and one person from the left

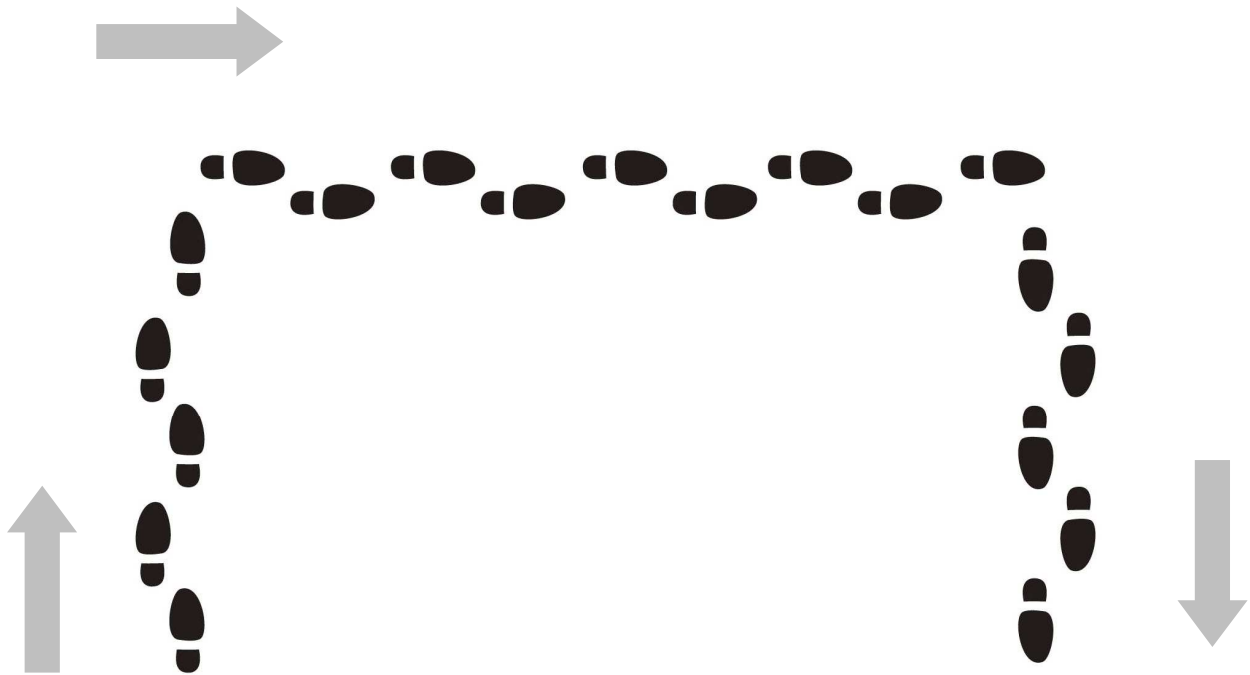

The way turns has to be put on the track.  
Turns must be "closed", without a termination of the previous leg.

