



**NORTHERN REGION
BALTIMORE DIVISION
TIMETABLE NO. 4**

**EFFECTIVE
SATURDAY, JANUARY 1, 2005
AT 0001 HOURS
CSX STANDARD TIME**

**C. M. Sanborn
Division Manager**

BALTIMORE DIVISION TABLE OF CONTENTS

GENERAL INFORMATION					SPECIAL INSTRUCTIONS		
DESCRIPTION			PAGE		INST	DESCRIPTION	PAGE
Table of Contents					1	Instructions Relating to CSX Operating Rules	
Timetable Legend					2	Instructions Relating to Safety Rules	
Legend – Sample Subdivision					3	Instructions Relating to Company Policies And Procedures	
Region and Division Officers					4	Instructions Relating to Equipment Handling Rules	
Emergency Telephone Numbers					5	Instructions Relating to Air Brake and Train Handling Rules	
Train Dispatchers					6	Instructions Relating to Equipment Restrictions	
					7	Miscellaneous	
SUBDIVISIONS							
NAME	CODE	DISP	PAGE				
Baltimore Terminal	BZ	AV					
Bergen	BG	NJ					
Capital	WS	AU					
Cumberland	CU	CM					
Cumberland Terminal	C3	CM					
Hanover	HV	AV					
Harrisburg	HR	NI					
Herbert	HB	NI					
Keystone	MH	CM					
Landover	L0	NI					
Lurgan	LR	AV					
Metropolitan	ME	AU					
Mon	M4	AS					
Old Main Line	OM	AU					
P&W	PW	AS					
Philadelphia	PA	AV					
Pittsburgh	PI	AS.AT					
Popes Creek	P0	NI					
RF&P	RR	CQ					
S&C	SC	CN					
Shenandoah	SJ	CN					
Trenton	TN	NI					
W&P	WP	AT					

TIMETABLE LEGEND

GENERAL

Unless otherwise indicated on subdivision pages, the Train Dispatcher controls all Main Tracks, Sidings, Interlockings, Controlled Points and Yard Limits.

STATION LISTING AND DIAGRAM PAGES

1- HEADING

The subdivision is identified by name and by 2 letter identifier

2 - COLUMN HEADINGS AND LISTINGS

A. AUTHORIZED SPEED

The maximum speed permitted between mileposts listed. This may also include restrictions over road crossings or other defined locations. Where speeds differ between various classes of trains, they will be listed in separate columns.

Abbreviations used are (P) – Passenger, (F) – Freight. Designations for other trains will be identified in Subdivision Special Instructions. Where speeds differ in multiple track territory, the speeds for individual tracks will be listed. Special speeds, such as city ordinances, will be shown in shaded blocks.

B. MILE POST

The alpha-numeric mile post for the station or reference point. At locations to check speed indicators the mileposts will be listed without alpha prefixes and will be shown with a wide border.

C. STATION

The Controlled Point, Interlocking, Station or other reference point name. The miles between stations listed in bold letters will be shown on the right side of the column and total miles will be shown at end of diagram.

D. TRACK DIAGRAM

The timetable assigned direction from the first listing to the last is defined above the track diagram by arrows and direction.

E. TWC – Track Warrant Control Rules

TWC-DTC – Listing of TWC-DTC blocks for permanent or temporary use.

TWC-DCS – Listing TWC-DCS stations with the letter 'D' for permanent or temporary use as dispatching points.

F. AUTH FOR MOVE (AUTHORITY FOR MOVEMENT)

The authority for movement rules applicable to the track segment of the subdivision.

G. NOTES

Where station page information may need to be further defined, a note will refer to "STATION PAGE NOTES" listed at the end of the diagram.

3 – SYMBOLS USED IN THE DIAGRAM

N – North, **S** – South, **E** – East, **W** – West;
NB – Northbound, **SB** – Southbound,
EB – Eastbound, **WB** – Westbound

Mile post used for checking speed indicator accuracy will be shown without alpha prefixes and will be bordered like this:

28.0
29.0

(P)	Passenger Station
CP	Controlled Point
(X)	Interlocking
(R)	Remotely Controlled
RT	Running Track
IT	Industrial Track
ss	Spring Switch
(A)	Automatic
ABS	Automatic Block Signal Rules
CPS	Control Point Signal Rules
TTB	Through Truss Bridge
CSS	Cab Signal System Rules
ATC	Automatic Train Control Rules
EQHR	Equipment Handling Rules
SDF	Slide Detector Fence
SDS	Slide Detector Signal
SDG	Siding
SSDG	Signal Siding
CSDG	Control Signal Siding
ABTH	Air Brake Train Handling Rules

Communications text boxes show Dispatcher, Operator, Yardmaster or other station. AAR channel, call-in tone and where used, the number of "clicks" to call the station. If there is a separate road channel, it will be shown as "RD –"

CM DISP.
94 – 7
RD – 08

Defect Detectors

(1)	Type 1 (Equipment Handling Rules)
(2)	Type 2 (Equipment Handling Rules)
AD	Audible Detector
DED	Dragging Equipment Detector
DEDAC	Dragging Equipment Detector, Axle Counter
HBD	Hot Box Detector
HCD	High Car Detector
HCDAD	High Car Detector, Axle Counter
HWD	Hot Wheel Detector
PDD	Protruding Door Detector
SWD	Sliding Wheel Detector
WID	Wheel Impact Detector

LEGEND - SAMPLE SUBDIVISION - SS

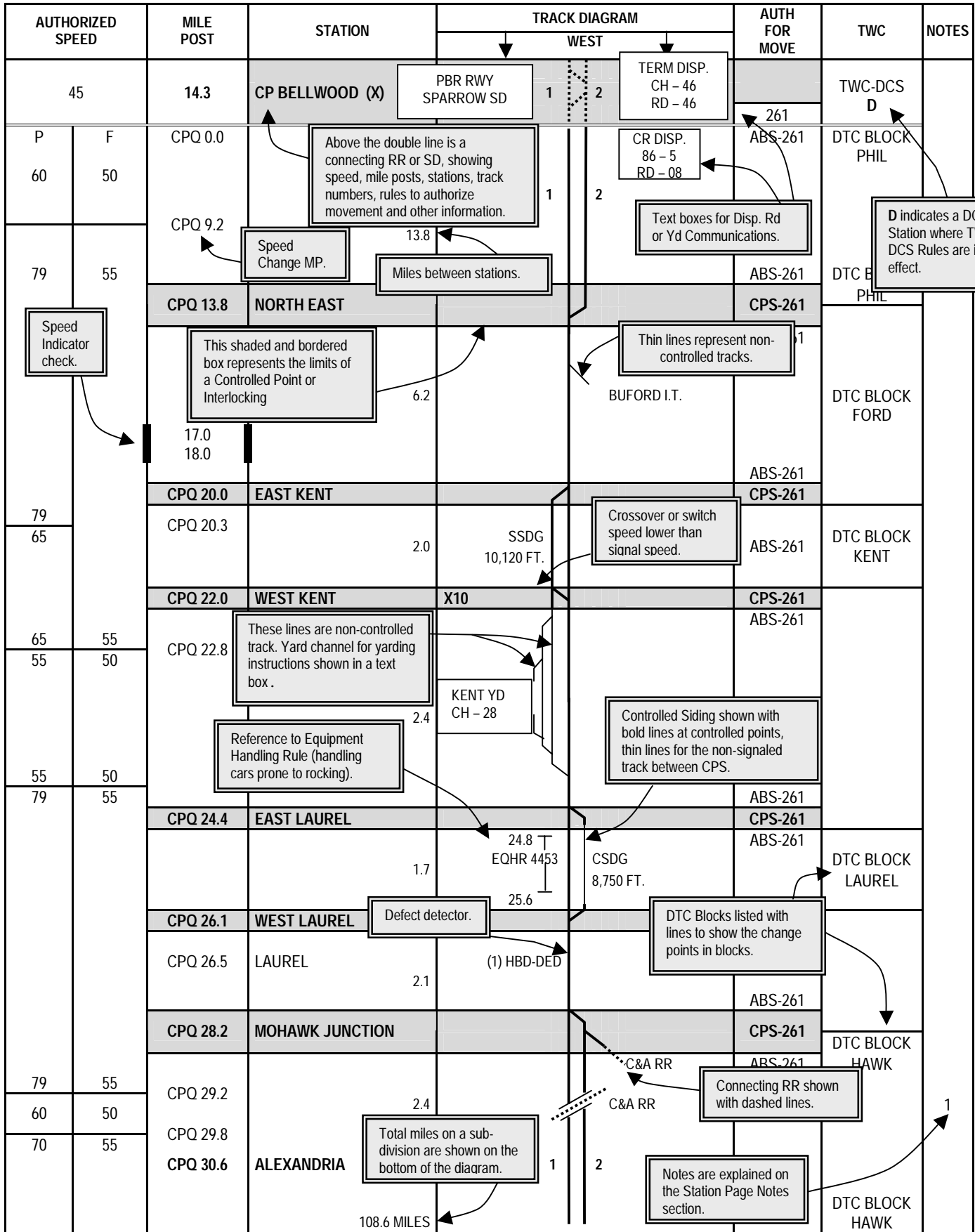

BALTIMORE DIVISION OFFICERS

A.J. TucheK
Vice President – North
 4724 Hollins Ferry Road
 Baltimore, MD 21227
C.M. Sanborn
Division Manager

B.E. Lusty Manager of Safety and Operating Practices	J.D. Lewandowski Asst. Division Manager M.D. Ramsey Division Engineer W.J. Diamond Senior Road Foreman	P.D. Rahn Supt. Line of Road D.J. Broadbent Mechanical Superintendent D.D. Ferguson Manager of Conductor Training	D.M. Zink Division Signal Engineer
---	---	--	---------------------------------------

Location and Names	Title	Location and Names	Title
Baltimore, MD		Jacksonville, FL	
E.J. Cindric	Terminal Superintendent	P.W. Sinsel	Chief Dispatcher
T.D. Turner	Asst. Terminal Superintendent	D. L. Hoover	Director Train Operations
G.A. Ferguson	Trainmaster		
R.L. Plitt	Trainmaster	Langhorne, PA	
D.C. Robey	Trainmaster	J.J. Frain	Trainmaster
K.A. Yanky	Trainmaster	J.A. Pewdo	Roadmaster
T.L. Brown	Trainmaster		
D.W. Hermes	Trainmaster	Meyersdale, PA	
R.R. Daniels	Engineer Track	C.L. Nelms	Roadmaster
J.L. Wallace	Manager Bridges East		
D.T. Taubken	Manager Bridges West	New Castle, PA	
M.C. RauPach	Bridge Inspector	D.S. Heron	Trainmaster
R.A. Hitchcock	Manager Signals	K.C. Mannka	Trainmaster
W./J. Jo;debramd	Asst. Roadmaster		
L.J. Frangella	Staff Engineer	North Bergen, NJ	
T.W/ Coglianesse	Senior General Foreman	S.E. Makoski	Trainmaster
T. Gross	General Foreman		
W.C. Benson	Road Foreman	Philadelphia, PA	
M. C. Gross	Road Foreman	L.R. Koster	Terminal Superintendent
C.E. Wietscher	Road Foreman	J.J. Darrah	Trainmaster
		K.W. Miles	Trainmaster
Brunswick, MD		M.R. Ankany	Road Foreman
N.N. Moore	Trainmaster	K.J. Dutil	General Foreman
K.C. Houlton	Trainmaster	W.A. Pietrovich	General Foreman
Connellsville, PA		Pittsburgh, PA	
R.E. Ruck	Trainmaster	R.J. Wehrle	Trainmaster
B.A. Laugherty	Road Foreman	D.R. Giusti	Trainmaster
R.J. Baer	Engineer Track	G.E. Gable	Roadmaster
G.M. Grimm	Asst. Roadmaster	R.S. Waite	General Foreman
Cumberland, MD		Point of Rocks	
R.M. Morriss	Terminal Superintendent	R.R. Taylor	Roadmaster
K.D. Stafford	Asst. Terminal Superintendent	J.A. Seale	Asst Roadmaster
D.E. Bittner	Trainmaster		
M.E. Stump	Trainmaster	Richmond, VA	
E.J. Koelker	Trainmaster	D.L. Hayden	Trainmaster
K.H. Spivey	Trainmaster		
D.C. Long	Trainmaster	S. Kearny, NJ	
R.J. Kelly	Trainmaster	D.L. Bogner	Terminal Superintendent
G.L. Appel	Roadmaster	M.M. McGee	Trainmaster
H. Doll	Asst. Roadmaster	D.A. Roman	Trainmaster
J.J. Camp	Manager Facilities	M.J. Bayus	Road Foreman
G.L. Carlo	Senior General Foreman	T.D. Murphy	Senior General Foreman
L.A. Griffin	General Foreman	R. Malkowski	General Foreman
T.J. Curtis	Road Foreman	F.S. Minervini	Asst. General Foreman
Fredericksburg, VA		Jessup, MD	
T.J. Wirth	Manager Signals	M.M. Beccio	Trainmaster
		D.W. Bush	Roadmaster
Hagerstown, MD		M.R. McGowen	Asst Roadmaster
D.J. Kiner	Trainmaster		
L.M. Wharton	Engineer Track	Wilmington, DE	
R.W. Hinchman	Roadmaster	S.C. Deery	Trainmaster
		S. Jednorski	Trainmaster
Hanover, PA		C.B. Beilharz	Roadmaster
T.F. Barron	Trainmaster	D.R. Lachford	Asst. Roadmaster

BALTIMORE DIVISION TELEPHONE NUMBERS

BALTIMORE DIVISION		
	RNX	BELL
Division Manager	463-8220	410-525-8220
Assistant Division Manager	463-8228	410-525-8228
Superintendent Line of Road	463-8227	410-525-8227
Manager Safety & Operating Rules	463-8287	410-525-8287
Senior Road Foreman	468-2166	301-759-2166
Division Engineer	463-8292	410-525-8292
Mechanical Superintendent	463-8230	410-525-8230
Division Signal Engineer	463-8227	410-525-8227
Manager of Conductor Training	463-8562	410-525-8562

EMERGENCY ASSISTANCE		
	RNX	BELL
SAFETY HOT LINE - DIVISION ** Recorded – Leave message	462-5008	410-613-5008
CSX RAILROAD POLICE	1-800-232-0144	

EMERGENCY ASSISTANCE			
VIA TELEPHONE		VIA RADIO	
JACKSONVILLE DISPATCHED TERRITORY		JACKSONVILLE DISPATCHED TERRITORY	
BALTIMORE CHIEF DISPATCHER	800-232-0144	SELECT THE TRAIN DISPATCHER'S CHANNEL ON THE RADIO AND PRESS TONE 9 ON THE KEY PAD. NO TONE BACK WILL BE HEAQRD. THE DISPATCHER WILL	
POLICE AND FIRE DEPARTMENTS	800-232-0144		
ALBANY DISPATCHED TERRITORY		ALBANY DISPATCHED TERRITORY	
HAZARDOUS MATERIAL HOTLINE	518-767-6123	ON THE ROAD CHANNEL, PRESS 911 ON THE KEYPAD. THE DISPATCHER WILL RESPOND.	
ACCIDENTS AND INJURIES	518-767-6911		

ALBANY TRAIN DISPATCHING OFFICE					
One Bell Crossing Road Selkirk, NY 12158					
	RNX	BELL		RNX	BELL
Supervisor Train Operations	245-6900	518-767-6900		River Assistant Chief	245-6122 618-767-6122
Sr. Supervisor Train Operations	245-6140	518-767-6140		NI Dispatcher	245-6119 518-767-6119
NJ Dispatcher Bergen Subdivision	245-6120	518-767-6120		Harrisburg Subdivision Herbert Subdivision Landover Subdivision Popes Creek Subdivision Trenton Subdivision	

JACKSONVILLE OPERATIONS CENTER					
3019 Warrington St. Jacksonville, FL 32254					
	RNX	BELL		RNX	BELL
Baltimore Chief Dispatcher	388-2784	904-381-2784		CM Dispatcher	388-2667 904-381-2667 800-854-5688
Supervisor Train Operations	388-3676	904-332-3676		Cumberland Subdivision Cumberland Terminal Subdivision Keystone Subdivision Shenandoah Subdivision S&C Subdivision	
AV Dispatcher Baltimore Terminal Subdivision Hanover Subdivision Philadelphia Subdivision Lurgan Subdivision	388-5418	904-381-5418 800921-2223		AS Dispatcher Mon Subdivision P&W Subdivision Pittsburgh Subdivision, to P&W Jct. W&P Subdivision	388-2132 904-381-2132 800-219-1174
AU Dispatcher Capital Subdivision Metropolitan Subdivision Old Main Line Subdivision	388-2665 388-2666	904-381-2665 904-381-2666 800-854-5687 800-854-0498		CQ Dispatcher RF&P Subdivision	388-4131 904-381-4131 800-299-0030
AT Dispatcher Pittsburgh SD, P&W Jct. To BG 58.4	388-5560	904-381-5560 800-854-5698			

BALTIMORE TERMINAL SUBDIVISION - BZ

AUTHORIZED SPEED	MILE POST	STATION	TRACK DIAGRAM		AUTH FOR MOVE	TWC	NOTES	
			↓	↓				
50			PHILA SD	1 2	AV DISP 66-5, RD 08	ABS-261	DTC BLOCK ROSE	
50	BAK 89.6	BAY VIEW	BALTIMORE TERM SD	1 2	BAY VIEW YD - CH 28 PENN MARY YD - CH 63 AV DISP 66-4, RD - 08	CPS-261	DTC BLOCK BAY	1
	BAK 90.6		1.9	1 2		ABS-261		
35	BAK 91.5	CLIFTON PARK		1 2		CPS-261		
	BAK 92.0	WAVERLY AD	(1) HBD-DED		HARFORD RD TUNNEL			
			MAIN		GREENMOUNT AVE TUNNEL	ABS-261	DTC BLOCK CLIFTON	
			2.0		BARCLAY AVE TUNNEL			
					GUILFORD AVE TUNNEL			
35	BAK 93.4				ST. PAUL & CALVERT ST. TUNNEL			
25	BAK 93.5	HUNTINGDON AVE			CHARLES AND OAK ST. TUNNEL			
					HUNTINGDON AVE TUNNEL	CPS-261		
	SDG 10		1.1		NORTH AVE. SSDG 4,600 FT.	ABS-261	DTC BLOCK ROYAL	2
					TWIN TUNNELS			
	BAK 94.6	MT. ROYAL				CPS-261		
			1.6		HOWARD ST. TUNNEL TO TURN LIGHTS ON: CH 08, 613" TO TURN LIGHTS OFF: CH 08, 613#			
25		CAMDEN	CAMDEN STATION 3 2 1		MP BAK 95.8 MP BAA 0.0	ABS-261	DTC BLOCK TUNNEL	3, 4, 6
	BAK 0.2		0.2		CPI ABS			
	BAK 0.4	HB			MAIN	CPS-261		
15	BAK 0.5		MARC 2 MARC 1					
25			0.3		LOCUST POINT BR.	ABS-261	DTC BLOCK HAM	
	BAK 0.7	BAILEY				CPS-261		
	BAK 0.8		0.8		1 2	ABS-261	DTC BLOCK BAILEY	
			MARC 1					

BALTIMORE TERMINAL SUBDIVISION - BZ

AUTHORIZED SPEED		MILE POST	STATION	TRACK DIAGRAM		AUTH FOR MOVE	TWC	NOTES
				WEST				
MARC 1	1 & 2	BAA 1.2	0.8			ABS-261	DTC BLOCK BAILEY	
P 25	F 25							
P 25	F 25							
P 25	F 25							
25	25	BAA 1.5	CARROLL			CPS-261		
50	40					ABS-261		
3 & 4	1 & 2	BAC 2.8	CURTIS BAY JUNCTION				DTC BLOCK CARROLL	5
20								
50		BAA 3.1				ABS-261		
45		BAC 3.2	BAA 3.2	WEST BALTIMORE		CPS-261		
NO. 3						ABS-261		
20			0.5					
50		BAA 3.8	LANSDOWNE (NO. 1 ONLY)			CPS-261	DTC BLOCK HALE	
			2.0	STORAGE TRK		ABS-261		
20	50	BAC 5.8	BAA 5.8	HALETHORPE		CPS-261		
			12.0 MILES					
OML SD	CAP SD	OML SD	CAP SD			ABS-261	DTC BLOCK DENIS OML SD	
25	50	BAC 5.9	BAA 5.9				DTC BLOCK RELAY CAPITAL SD	
						ABS-261		

STATION PAGE NOTES

- NOTE 1:** All signals in Baltimore Terminal are signal rules 1280 – 1298.
- NOTE 2:** Multi-level and Double Stacked Containers must not operate on North Avenue Passing Siding.
- NOTE 3:** Reverse movement of helper engines: Rule 274 is in effect for eastward helper engines only. If helper engine is stopped in Howard Street Tunnel when assisting eastward train, crew will immediately cut helper engine off and reverse movement to WAS HB and call AV Train Dispatcher, Jacksonville.
- NOTE 4:** During periods of heavy or persistent rain, trains must not exceed 10 MPH through Howard Street Tunnel account flooding conditions.
- NOTE 5:** Mt. Winans tracks used on instructions of Yardmaster Locust Point.
- NOTE 6:** Anyone spotted inside Howard Street Tunnel who cannot be identified as a CSXT employee should be immediately reported to the Train Dispatcher.

BALTIMORE TERMINAL SUBDIVISION - BZ LOCUST POINT BRANCH

AUTHORIZED SPEED	MILE POST	STATION	TRACK DIAGRAM		AUTH FOR MOVE	TWC	NOTES
			↓	↓			
P 15 F 10	BAM 0.0	BARNEY ST			96/46		1
	BAM 0.5	LEADENHALL ST					
E WYE 10 15			0.2	0.2 MILES	ABS-261		
			CP HB, BALTO TERM SD	WEST WYE			
25	BAA 0.7	BAILEY	BALTIMORE TERMINAL SD	AV DISP 66 - 4 RD 08	CPS-261		

STATION DIAGRAM NOTES

NOTE 1: AV Train Dispatcher controls all movements on no. 1 Locust Point Yard, Leadenhall St to Riverside.

BALTIMORE TERMINAL SUBDIVISION - BZ MT. CLARE BRANCH

AUTHORIZED SPEED	MILE POST	STATION	TRACK DIAGRAM		AUTH FOR MOVE	TWC	NOTES
			↓	↓			
25	BAA 1.5	CARROLL	BALTIMORE TERM. SD	AV DISP 66 - 4 RD - 08	CPS-261		
10	BAN 0.0	CARROLL	0.5	AV DISP 66 - 4 RD - 08	ABS-261		
	BAN 0.5	WASHINGTON BLVD			CPS-261		
10			1.7	4 RUNNER	46		1,2
			2.2 MILES	3 RUNNER			
	BAN 2.2	CURTIS BAY JUNCTION	MT CLARE A YARD	HANOVER SD			
20	BAC 2.8	CURTIS BAY JUNCTION	BALTIMORE TERM. SD	AV DISP 66 - 4 RD - 08	CPS-261		

STATION PAGE NOTES

NOTE 1: Running tracks used on direction of the Terminal Trainmaster Mt. Clare/ Yard tracks used on direction of the yardmaster Locust Point.
NOTE 2: Track Distances: Washington Blvd - to Office - 5,100 ft.; to I-95 - 5,900 ft.; to Deering Ave. - 8,900 ft.; to Jackson's Bridge - 7,600 to CG - 9,300 ft.; to Gable Ave. - 10,500 ft.; Gable Ave to entrance to Mt. Clare on Running - 5,300 ft.

BALTIMORE TERMINAL SUBDIVISION - BZ WESTPORT BRANCH

AUTHORIZED SPEED	MILE POST	STATION	TRACK DIAGRAM		AUTH FOR MOVE	TWC	NOTES
			↓ WEST ↓				
10	BRN 0.5	WESTPORT			46		1
10	BAS 0.0 BAS 0.5	1.0 MT. WINANS					
		1.0 MILES			TWC-DTC		

STATION DIAGRAM NOTES

NOTE 1: Height restrictions: No. 1 - 18' 5", No. 2 16' 5".

BALTIMORE TERMINAL SUBDIVISION - BZ CURTIS BAY BRANCH

AUTHORIZED SPEED	MILE POST	STATION	TRACK DIAGRAM		AUTH FOR MOVE	TWC	NOTES
			↓ WEST ↓				
10					46		
15	BAO 0.0	BROOKLYN					
		1.6			ABS-261	DTC BLOCK BROOK	
15	BAO 1.6	CLIFFORD					
		1.5			ABS-261	DTC BLOCK ZEPP	1
15	BAO 3.1	ZEPP					
		0.2			CPS-261		
	BAO 3.3	CURTIS BAY JUNCTION					
20	BAC 2.8	CURTIS BAY JUNCTION			CPS-261		
		3.3 MILES					

STATION PAGE NOTES

NOTE 1: Crossing indicators are located on the North side of tracks approximately 70 feet east of Hollins Ferry Rd and govern Westbound movements. Indicator for No. 1 track is on the right side, for No. 2 on the left side. Westbound trains receiving an Approach or Restricted Proceed signal at Clifford must not foul Hollins Ferry Road until indicator is flashing.

BALTIMORE TERMINAL SUBDIVISION SPECIAL INSTRUCTIONS

1. INSTRUCTIONS RELATING TO OPERATING RULES.

ENGINE HORN

14-1 Between Clifton Park and HB Tower – Use of horn prohibited except in emergency.

14-2 Locust Point Branch – Engine horn must not be used between the hours of 0200 and 0600 except in emergency.

BLUE FLAGS, CURTIS BAY

GR-102 Shop tracks 1 through 4 at Curtis Bay are under control of the Mechanical Department, and when in use by mechanical forces, will be blue flagged.

When necessary to use shop tracks while mechanical forces are working the yard master will make arrangement with the Mechanical Department to enter tracks, noting date, time and name of person granting permission.

DRAWBRIDGES AND RAILROAD CROSSINGS AT GRADE

98-1 Marley Neck I.T. – Curtis Creek Drawbridge – When signal-governing movement over drawbridge displays proceed (green), train may proceed without stopping. When signal displays stop (red), after movement has stopped and bridge tender has inspected bridge to determine it is safe, movement may be made on hand signal or verbal permission from bridge tender.

98-2 Bear Creek Drawbridge – When signal governing movement of drawbridge displays proceed (lunar), train may proceed without stopping. When signal displays STOP (red), after movement has stopped and bridge tender has inspected bridge to determine it is safe, movement may be made on hand signal or verbal permission from the bridge tender.

Westward movements to Grays Yard will ascertain that Bear Creek Drawbridge will be lined for movement before blocking Chesterwood and Cove Road crossings.

98-3 Penn Mary YD – Canton RR – Rules 243-246 are in effect between the absolute signals. When absolute signal displays STOP, movement must stop. If no conflicting movement is evident on the Canton Railroad, movement may proceed. When CSX crews operate on the Canton RR and must cross CSXT Tracks, trains and engines must stop. If no conflicting movement is evident on CSX tracks, movement may proceed.

98-4 Penn Mary Rd. – NS RR

Stop signs are in place. Trains must stop, and if no conflicting movement is evident on NS, trains may proceed.

ROAD CROSSINGS AT GRADE

100-1 Waterview Avenue

Trains will stop before crossing Waterview Ave. (140-384W) and operate control boxes to provide protection against vehicular traffic. Manual control boxes are located on north and south side of crossing and are operated by switch key. Turning switch to "Take" position will cause highway traffic light to display red. After traffic is stopped train will proceed over crossing. It is not necessary to operate switch to "Cancel", as traffic light will automatically display green after movement is completed.

100-2 Warner, Ridgley, Bayard, Bush Streets

These crossings are equipped with constant time motion detectors, refer to Operating Rule 100-E, 5.

100-3 Hollins Ferry Road – MP BAA 2.2

Eastward trains on No. 1 and No. 2 Track exceeding 2,200 feet in length that receive other than a Clear or Approach Medium at West Baltimore will not foul Hollins Ferry Road unless they receive a signal at Carroll to proceed. Eastward trains on Mt. Winans Lead will not foul Hollins Ferry Road without permission of the Train Dispatcher.

100-4 Merritt Blvd. FRA 140-315N Sparrows Pt. I.T.

Red or no light = Stop and flag crossing,
Green = Proceed.

100-5 General Motors Crossing No. 314.7 – Penn Mary

Movements on other than main track will not exceed 2 MPH approaching crossing, as warning device will operate automatically only when crossing is occupied.

Note: Traffic type wayside signal located 20 feet east and west of crossing in service.

EMERGENCY BRAKE APPLICATIONS

90-1 Emergency Brake Applications

Trains, which sustain an emergency application of the brakes, will make emergency transmissions on AAR Channel 08 and on channels listed below before notifying CSX Dispatcher.

At Bay View – Over Amtrak – AAR 54

At Becks – "Over NS at Trappe Road" – AAR 46

HAND BRAKES

103-1 Sherwyn Williams - 100% Hand brakes are required on cars left in Sherwin Williams.

103-1 Mt. Winans - All trains left standing in Mt. Winans Yard must be secured by applying 10% hand brakes to the cars, plus 2 additional brakes.

103-3 Bay View:

- A. Cars left standing will be secured with 10% hand brakes, plus 2 additional hand brakes. Additional brakes may be required during switching operations to meet these requirements.
- B. No single cars or locomotives will be left standing unattended. They will be coupled to other equipment and secured.
- C. All locomotive units left unattended at Bay View Will have hand brakes applied and tested on each unit.

HAND OPERATED SWITCHES

104-1 Mt. Clare Branch

All hand-operated switches on the Mt. Clare Branch are equipped with locks and must be lined for the direction of movement, and then locked, before making any movement over these switches.

TRACKS OTHER THAN MAIN TRACKS

96-1 South Baltimore I.T. BBP 0.0 Carroll, and BBP 1.64 Clifford

Movements on the South Baltimore Industrial Track will be made on permission of the train dispatcher. Eastward movements may accept signal aspect to proceed at Carroll as permission of train dispatcher.

Conductor or engineer must report clear. After having reported, clear of the track must not be reentered without additional permission. Direction on the South Baltimore Industrial track is:

1. Carroll to Clifford – East
2. Clifford to Carroll – West

96-2 Locust Point Yard

Movements on No. 1 Track between Riverside and Barney St. will be made on permission of the AV Dispatcher, Jacksonville. Movements on No. 2 Track between Riverside and Barney St. will be made on permission of the Yardmaster at Locust Point. Movements on No. 1 Track between clearance point on Number 1 Riverside and shop tracks 3, 4, 5, and Barney St. will be made on permission of the AV Train Dispatcher, Jacksonville.

Eastward movements for Locust Point Yard unless otherwise instructed will not pass Barney St. without permission of the yardmaster at Locust Point.

96-3 Marley Neck I.T. Mile Posts: BAO 4.2 (Patapsco Ave.) to BAO 5.2 (400 FT. east of Benhill St.), BAO 5.2 – BBR 0.0. BBR0.0 (400 FT east of Benhill St.) to BBR 5.6 (BGE)

96-4 Seawall I.T. Mile Posts: Crisp (Curtis Bay Yd) BBQ 0.0 and end of track BBQ 2.4

96-5 Sparrows Point I.T. Mile Posts: Becks BAL 0.0 and Gray BAL 6.5. Direction Becks to Gray is west.

The yardmaster at Penn Mary will issue instructions for use of the Sparrows Point I.T. When no yardmaster is on duty at Bay View, the yardmaster at Penn Mary will also issue instructions for use of the eastbound and westbound between Bay View and Becks.

120A DISPATCHER BULLETINS

Dispatcher bulletin printers and fax machines are located at the crew rooms at Riverside, Mt. Clare, Penn Mary, Bay View, Curtis Bay and Locust Point.

120A-1. Train and engine crews originating at Baltimore and crews called to relieve a train on line of road, must receive train bulletin with release form before occupying Main Tracks.

120A-2. Passenger crews making more than one trip will receive a release form and train bulletin for each train they operate, unless otherwise instructed by the Train Dispatcher.

120A-3. Passenger crews originating in Washington will receive release form and train bulletin at Washington before departing.

2. INSTRUCTIONS RELATING TO SAFETY RULES

2105-1 Riding equipment on the East End or West End of Bayview Yard from the siding thru No. 13 track is prohibited when equipment is on adjacent tracks.

Riding equipment on the West End of No. 3 thru No. 7 tracks in Curtis Bay Yard is prohibited.

2150-1 Close Clearances

a) Curtis Bay

1. Between 9 & 10 Yard track – Seawall
2. Tracks CO3 thru CO7 West end of yard
3. Hobleman Auto Facility – Telephone pole east of "A" track switch on the south side
4. Delta Chemical – The concrete barrier between the South and North tracks
5. Jarvis Lumber – The building just west of Jarvis gate on the North side
6. Sasol Chemical – Loading rack south side of No. 6 track
7. Peridot Chemical – The corner of the building adjacent to the acid track.

b) Locust Point

1. Grain Elevator – South end of elevator lead underneath Fort Ave. Bridge
2. New Yard – West side of 7 at Fort Avenue
3. New Yard – 7 and 4 South End Grain Elevator for 7 car lengths
4. New Yard – No. 7 25 car lengths west of Fort Avenue between 7 and 8
5. New Yard – East side of 8 at Fort Ave. Bridge
6. New Yard – East side of No. 10 at Fort Avenue
7. Philadelphia Yard – No. 16 10 car lengths east of entrance to track between lower 15 and 17.
8. Philadelphia Yard – between 17 and 18, 2 cars east of entrance to track, both sides
9. Philadelphia yard – No. 19, 7 cars east of entrance to track to end of track
10. Brunswick Yard – No. 20, 21 and 22, both sides and entire length
11. Riverside Yard – No. 3 and 4 from 20 cars east of key highway to east end of switch
12. Chesapeake Paper – From gate to inside of building
13. Sun Paper – Inside building next to loading dock
14. Lewis and Peat Rubber – between track and building
15. Southern States – Dock side of track
16. U.S. Wood Products - Between track and dock
17. Tate and Lyle North (American Sugars/Domino Sugars) – Between track 2 and 3; and on both tracks at the bulk unloading station under the shed.

c) Bay View/Penn Mary

1. Bay View – Between all tracks in the yard
2. Weyerhaeuser – Between the loading dock and track
3. Mid Eastern Box – Between the loading dock and track
4. Run around track – Between track and standing brush
5. Eastbound and Westbound Hill – Between either track, when other track is occupied.
6. NS interchange – Between track and Bridge abutment at Trappe Road
7. General Motors – Inside building on all tracks – look out for racks beyond yellow Lines

3. INSTRUCTIONS RELATING TO COMPANY POLICIES AND PROCEDURES

NONE

4. INSTRUCTIONS RELATING TO EQUIPMENT HANDLING RULES

NONE

5. INSTRUCTIONS RELATING TO AIR BRAKE AND TRAIN HANDLING RULES/BTH RULES

5604 Helper Engines – Baltimore Terminal

Engineers of Helpers assisting Eastward trains will not exceed third throttle position until after passing HB.

6. INSTRUCTIONS RELATING TO RESTRICTED EQUIPMENT

- A. **Bridge 1C Eastern Avenue** – Cars with gross weight exceeding 251,000 lbs. must not exceed 10 MPH.
- B. **Trappe Road, on NS, under Bridge 1-C** – Equipment in excess of 17'0" must not operate.
- C. **Bridge 7-A1 Curtis Bay** – SD35, SD40, SD40-2, SD50, SW9, SW1200, U23B, U30B, cars with gross weight exceeding 180,000, and coal hoppers must not operate.
- D. **Curtis Bay Coal Piers: Tracks between East End Thaw House and Dumpers** – Equipment except coal hoppers must not operate under probes.
- E. **Mt. Winans No. 2 Track Westport Branch** – Cars exceeding 16'5" high must not operate.
- F. **Mt. Winans No. 1 Track Westport Branch** – Cars exceeding 18'5" high must not operate.
- G. **Locust Point Yd Hopper Yard Lead** – Loaded uncovered multilevel cars, or covered multilevel cars must not operate under Fort Avenue.
- H. **Marley Neck I.T.** – 6 axle units may operate to Benhill St. on Branch Main only. May not operate through curved leg of turnouts.
- I. **Seawall I.T.** – 6 axle units may operate to Vera St. on main only. May not operate through curved leg of turnouts.

7. MISCELLANEOUS

A. Main Tracks Bay View to Halethorpe

A-1 – Howard Street Tunnel – Crews of trains moving through Howard Street Tunnel will have all locomotive doors and windows closed while moving through the tunnel.

A-2 – Mt. Winans – Crews picking up or setting off cars or locomotives at either Mt. Winans or Mt. Clare must contact the yardmaster at Locust Point for instructions.

A-3 – Halethorpe Storage Track – If practical, eastward trains occupying the Halethorpe storage track and being held or terminated will stop or leave train approximately 500 feet west of the Landsdowne Inn. Yellow and white painted ties will designate the area.

A-4 – Kaufmans Lead – Crews using electric lock switch at Kaufmans Lead, Milepost A&P 5.2 (A&P switch), must take pad lock out, then step on pedal and wait 30 seconds before operation.

A-5 – Halethorpe – Trains receiving stop indication on Westward absolute signal at Halethorpe will stop back far enough to clear walkway located 500 feet East of Westward Absolute Signal Halethorpe.

A-6 – A derail is installed on the north side of the J.C. Perry Lead off the “HX spur”. This derail is located just west of the switch near Halethorpe Farms Road, and east of the spot locations for J.C. Perry.

B. Penn Mary Yard

B-1 – Crews of trains terminating at Penn Mary must obtain yarding instructions from the yardmaster at Penn Mary. Trailer trains exceeding 580 feet in length must be cut at Fait Avenue. Crews of these trains will receive further instructions from the yardmaster.

B-2 – All switches leading from CSXT trackage to General Motors Assembly Plant side tracks “GM” 1, 2, 3, and 4 will be set and maintained in a position against movement into the “GM” Plant unless the “GM” Assembly Plant is being serviced. Specific switches are as follows:

- a) SPARROWS POINT INDUSTRIAL TRACK- Sparrows Point Subdivision switch to “GM” 4 must always be left lined for the Sparrows Point Subdivision unless “GM” 4 track is actively being switched.
- b) Switch from Penn Mary 2/Chevy A/Chevy B lead track to “GM” 1 track must always be set for Chevy B track unless “GM” 1 track is actively being switched.
- c) Switch from M18 track to “GM” 2 track must always be left set for M18 track unless “GM” 2 track is actively being switched.
- d) Switch from M18 to Chevy 10 track must always be left set for Chevy 11 track and the crossover switch from Chevy 11 to Chevy 10 track must always be left set for Chevy 11 track unless “GM” 3 track is actively being switched.

In addition, under no circumstances will a locomotive or locomotive consist, that is detached from cars, be left unattended between Holabird Avenue grade crossing and the west side of Broening Highway Bridge.

B-3 – Seagirt – Before entering the Seagirt Intermodal facility crews will call on Channel 80 to announce their arrival.

B-4 – Seagirt – All engines operating at Seagirt will ring the engine bell continuously when moving on any track within this facility.

B-5 – Seagirt – Yard crews working seagirt will contact the ramp manager for a job briefing prior to beginning

work. If the crew arrives via light power the manager will come out to meet the crew. If the crew arrives by taxi they will meet the manager at the ramp office.

B-6 – Dundalk – Chesterwood Road Crossing – Crossing warning devices consisting of flashing light signals, bell and motion sensors are in service. These warning devices will activate 616 feet east and West of Chesterwood Road crossing.

B-7 – Seagirt – All crews operating in the Seagrit Intermodal Facility must sound horn prior to crossing the “Splits” on track 1 through 4.

B-8 – Grays Yard – All tracks are excepted tracks. Crews destined to Grays Yard will contact the PBR yardmaster on AAR 32 to announce arrival and departure.

C. Bay View

C-1 – Bay View – Bay View yardmaster hours of operation.
Mon-Fri – 0630 to 1430

Penn Mary operates 24/7. When the yardmaster at Bay View is not on duty contact Penn Mary for instructions.

C-2 – Consol – Speed on all tracks at Consol is 5 MPH. Crews arriving Consol will report clear of NS tracks to the NS Yardmaster at Bay View South End. Crews pulling empties from Consol will also report clear of NS tracks.

C-3 – Switch at Becks – There is a switch lock applied to the eastbound/westbound switch at Becks. There will be no train, yard movement, or light engine moves eastbound (from Penn Mary towards Bay View) past the eastbound/westbound switch at Becks if there is not a lock properly securing the keeper on the switch. If a movement discovers the absence of a proper lock securing this switch the move must be stopped until:

- A. The absence of proper lock securing this switch is reported to the yardmaster at Penn Mary, and
- B. A member of the crew detrains, examines the switch and verifies the switch is properly lined and latched for the movement, and
- C. A member of the crew stays at the switch while the entire movement is made past the switch.

C-4 – Remote Control Locomotive Operation at Bay View

- A. Remote Control Locomotive (RCL) Operation is Established at Bay View Yard. RCL operation and special instructions are stated in a separate general bulletin (Baltimore General Bulletin No. 105). Remote control zones, when activated, may be utilized in conjunction with RCL operation.
- B. A remote zone (RZC) is established in Bay View Yard and RCZ signs are in place as follows:

1. On the lead track from the clearance point of the wye track east to the clearance point of "A" Lead Track.
- C. Instructions for train, engine, or on-track equipment movements arriving at Bay View Yard.
1. All movements inbound to Bay View Yard from the main track or Penn Mary Yard must contact the yardmaster in charge of Bay View before entering the yard.

D Locust Point

D-1 – 2000-2400 Time Limits (Switching windows) have been established at the following Trans Flo Facility

A – During normal switching hours, hazardous materials will not be transferred in the terminal.

B – Other than switching hours the facility will be blue flagged.

C – If a switch is removed other than during switching hours, a Trans Flo Facility Supervisor will meet the rail switch crew, remove Blue Flags and will verify terminal activity and that all hazardous material transfers are shut down.

D-2 – Locks are installed on the crossover between No. 1 and No. 2 tracks east of Hanover Street and on the switch on the West End of the Pocket.

D-3 – Remote Control Locomotive Operation at Locust Point Yard.

A – Remote Control Locomotive (RCL) operation is established at Locust Point Yard. RCL operation and special instructions are stated in a separate system bulletin. Remote control Zones, when activated, may be utilized in conjunction with RCL operation.

B – A remote control zone (RCZ is established in Locust Point Yard and RCZ signs are in place to the south side of 4 track between the crossover at Key Highway and at the clearance point for 3-4 tracks at Andre Street.

- 1 – All train, engine and on-track equipment movements inbound to Locust Point will not pass Barney St. without contacting the yardmaster at Locust Point.

E. Curtis Bay

E-1 – Seawall Branch – Do not exceed 5 MPH while operating at the new Hobleman facility.

E-2 – Switch Protection – Curtis Bay – The switches for crossovers from No. 2 yard lead to No. 1 yard lead and No. 1 yard lead to Ought track and the Seawall Branch Lead will be lined for straight track movement after using unless the yardmaster Curtis Bay-Seawall protects the switches. A clear understanding for the

protection of these switches must exist between the crew and yardmaster.

E-3 – Remote Control Locomotive Operation at Curtis Bay

A – Remote control locomotive (RCL) operation is established at Curtis Bay Yard. RCL operation and special instructions are stated in a separate system bulletin. Remote control zones, when activated, may be utilized in conjunction with RCL operation.

B – A remote zone (RZC) is established in Curtis Bay Yard and RCZ signs are in place on number 2 track, between the location of the former "BX" tower at Brooklyn, and the first switch east of the hump.

- 1 – All train, engine or on-track equipment movements inbound to Curtis Bay will not pass the eastward absolute signal Brooklyn without contacting the yardmaster at Curtis Bay.

NOTES

NOTES

NOTES

BERGEN SUBDIVISION – BG

AUTHORIZED SPEED	MILE POST	STATION	TRACK DIAGRAM		AUTH FOR MOVE	TWC	NOT ES
			↓	↓			
CP-1 SOUTH 25			CONRAIL	N. JERSEY DISP. 50 – 2# – 4C RIDGEFIELD PARK	NORAC INT ABS-261	D	1
30	2.0	CP – 2 (X) (CONRAIL – SAC)	BERGEN YARD	NJ DISP 58 – 3# – 5C BOGOTA	ABS-261		4
NO.1 30		QR 2.1					
NO.2 30							
		QR 2.8	CP – 3 (X)	NJ DISP 58 – 3# – 5C BOGOTA	CPS-261	D	3
30	30	QR 3.0	RUNNING TRACK 3	NYS&W			
40	40	QR 4.2	NORTHERN RT	NORTHERN RT	ABS-261		2
			BELLMAN'S BRIDGE	NYS&W			
		QR 5.8	CP – 5 (X)		CPS-261	D	
	40	QR 6.0		NYS&W			
	50	QR 7.0	BOGOTA (BALTIMORE DIV.)	(2)HCD 20'- 4"	ABS-261		
NO.1 30	SS DG 30	QR 7.6	CP – 7 (ALBANY DIV.) (X)	NJ DISP 58 – 5# – 4C BOGOTA	CPS-261	D	
		QR 8.5	HOLD POINT – SOUTH	EAST CS —			

STATION PAGE NOTES

- NOTE 1:** Southbound trains destined to Oak Island via the National Docks Branch: The conductor must ensure that there are no cars exceeding 19'2" in the train, and must so inform the train dispatcher.
- NOTE 2:** NJ Dispatcher is in charge of the Northern Running track. The Northern Running track is excepted track between MP 14.0 and MP 22.7. Maximum speed 10 MPH.
- NOTE 3:** CP-3 TO QR 2.6: Southward trains entering North Bergen Yard must stop at 69th Street grade crossing and ensure warning devices are in Operation for 20 seconds before proceeding. Circuit for crossing on yard tracks is located 100 feet north of the crossing. Automatic grade crossing predictor circuits are added to the approaches to 69th Street on the Bergen Running Track.
- NOTE 4:** All signal rules on the Bergen SD are rules CR 1277 through CR 1294A.

SOUTH KEARNY YARD

AUTHORIZED SPEED	MILE POST	STATION	TRACK DIAGRAM		DTC/DCS	AUTH FOR MOVE	NOTES		
			↓	↓					
15	1.5	HACK (X)	CONRAIL (SAC) P&H LINE N. JERSEY DISP CH - 50	NRTB* S	NORAC RULES	D	1		
				WESTBOUND RT	S. KEARNY YD. CH - 92			600-616	
OVER KARNY MOVABLE BR - 15	3.4	KARNY (X)			600-616			D	
30				2 1	ABS-251 E-1,W-2				

STATION PAGE NOTES

NOTE 1: The P&H is a Conrail property. This section of the P&H is shown for relation to S. Kearny Yd. Refer to Conrail timetable for special instructions.

BERGEN SUBDIVISION SPECIAL INSTRUCTIONS

1. INSTRUCTIONS RELATING TO OPERATING RULES

100.1

QR 2.58 to CP-3 – Southward trains entering North Bergen Yard must stop at 69th Street grade crossing and insure crossing warning devices are in operation for 20 seconds before proceeding. Circuit for crossing on the yard tracks is located 100 feet north of the crossing.

Automatic Grade crossing predictor circuits are added to the approaches to 69th Street on Bergen Running Track.

CR-1290-1

When Lunar White (Rule CR-1290, FIG. CC5) is displayed, the dispatcher has requested signals for switching movements, which allows the signal return to Lunar White (Rule CR-1290, FIG CC5) when the move through the interlocking is complete, without a new request from the dispatcher.

When a movement is made into the interlocking on a Lunar White aspect (Rule CR-1290, FIG CC5) a reverse move (Rule 611 and 612) may be made without permission of the dispatcher.

2. INSTRUCTIONS RELATING TO SAFETY RULES

A non-lethal electric security fence is installed in South Kearny – Meadows Yard and along the lead track for the protection of train crews from armed thieves pursuing freight in containers.

South Kearny Yard – A non-lethal electric security fence is installed in South Kearny – Meadows Yard.

The fence is marked with yellow signs, with black lettering and the words:

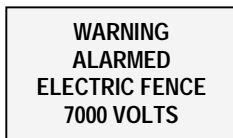

3. INSTRUCTIONS RELATING TO COMPANY POLICIES AND PROCEDURES

NONE

4. INSTRUCTIONS RELATING TO EQUIPMENT HANDLING RULES

NONE

5. INSTRUCTIONS RELATING TO AIR BRAKE AND TRAIN HANDLING RULES

5300-1 5300-2 ABTH APPENDIX C ATC/CS EQUIPMENT

Trains destined to the RF&P Subdivision with a lead locomotive with ATC/CS equipment with self-test capability must have the self-test performed prior to departure from Cumberland Brunswick, Philadelphia, Baltimore or Acca.

6. INSTRUCTIONS RELATING TO RESTRICTED EQUIPMENT

NONE

7. MISCELLANEOUS

NONE

NOTES

NOTES

NOTES

CAPITAL SUBDIVISION - WS

AUTHORIZED SPEED		MILE POST	STATION	TRACK DIAGRAM		AUTH FOR MOVE	TWC	NOTES
				↓	↓			
No. 3 No. 4	No. 1 & 2 P F				3 4 1 2			
20	50 40	BAC 5.8 BAA 5.8	HALETHORPE		BALTIMORE TERMINAL SD	AV DISP 66 - 4 RD - 08	CPS-261	DTC BLOCK HALE
P 50	F 45	BAA 5.8	HALETHORPE		AMTRAK	AU DISP 14 - 6 RD - 08		1
35	30	BAA 6.7		1.0	(2) HBD, DED			2
		BAA 6.8	ST. DENIS (P)					3
		BAA 9.0	RELAY					
		BAA 10.1		4.6				
70	55	BAA 10.5	MURRAY'S SINK		1	2	ABS-261	DTC BLOCK RELAY
60		11.0						
		11.7		2.9				
70		12.0						
		13.0						
		13.3	DORSEY (P)					
		13.4	DORSEY				CPS-261	
		14.0		2.4			ABS-261	DTC BLOCK DORSEY
		BAA 15.8	JESSUP (P)					
		BAA 15.8	JESSUP				CPS-261	
				1.8	EAST LEAD WATERLOO I.T. COLUMBIA I.T.		ABS-261	DTC BLOCK JESSUP
					JESSUP YD CH 92			
		BAA 17.6	MEADE (NO. 1) PA (NO. 2)				CPS-261	
		BAA 18.1	SAVAGE (P)	0.5	WESTBOUND STORAGE TRACK		ABS-261	DTC BLOCK SAVAGE
				1.3	CORRIDOR I.T. SAVAGE I.T.			
70		BAA 19.4	SAVAGE				CPS-261	
65		BAA 19.5		1.9				
		BAA 20.8						
		BAA 20.9	LAUREL RACE TRACK (P)					
		BAA 21.3	LAUREL (P)	0.4	1	2	ABS-261	DTC BLOCK KIRK
		BAA 21.7	LAUREL		(2) HBD-DED			
		BAA 22.6	CHERRY LANE	0.9				
70	55			2.3				

CAPITAL SUBDIVISION - WS

AUTHORIZED SPEED	MILE POST	STATION	TRACK DIAGRAM		AUTH FOR MOVE	TWC	NOTES	
			↓	↓				
70	55	BAA 24.9	MUIRKIRK (P)	2.3		ABS-261	DTC BLOCK KIRK	
		BAA 25.8	AMMENDALE	0.9		CPS-261		
		BAA 28.0	SUNNYSIDE	2.2	1	2	ABS-261	DTC BLOCK BERWYN
		BAA 29.0	GREENBELT (P)	1.0			CPS-261	
		BAA 30.0	BERWYN	2.4	BERWYN SDG			
		BAA 31.4	COLLEGE PARK (P)	32.0			ABS-261	DTC BLOCK JD
		BAA 32.4	RIVERDALE PARK (P)	0.3				
		BAA 32.7	RIVERDALE PARK				CPS-261	
				0.9			ABS-261	
		BAA 33.6	JD				CPS-261	
BAA 33.7	HYATTSVILLE (2)	1.2	HBD-DED-HCD 19'2"			DTC BLOCK LANGDON		
BAA 34.8	BRENTWOOD	2.2		1	2		ABS-261	
BAA 37.0	F TOWER						CPS-261	
BAA 37.7	C TOWER						ABS-261	
20P	15F	BAA 38.7	WASHINGTON			NORAC 600-616		
			30.8 MILES					

STATION PAGE NOTES

- NOTE 1:** All signals on the Capital SD are signal rules 1280 – 1298 except signals on the Alexandria Extension are covered in Signal Rules CR-1277 – CR-1294A, Signal Aspect and Indication Booklet.
- NOTE 2:** Eastbound freight trains will stop to clear St. Denis Station between the hours of 0545 and 0845 and between 1745 and 1945 daily except Saturday, Sunday and Holidays, unless signal aspect more favorable than Restricted Proceed is displayed at Halethorpe.
- NOTE 3:** The distance between BAA 6.0 and BAA 9.0 is 6987 ft. MP 7 and 8 are not used.
- NOTE 4:** Eastward trains being held at Dorsey will stop back 1200 ft. from the E.A.S. Dorsey. This location is in the cut west of the road, and will place trains in a position unable to see the signal. Trains not exceeding 6750 feet total length will clear Montevedio Road by 300 ft. Trains exceeding 6750 feet total length will stop to clear Montevedio Road or will cut the crossing, and will proceed to Dorsey when so advised by the train dispatcher.
- NOTE 5:** Between the hours of 0600 and 0900, and 1610 to 1925 daily except Saturday, Sunday and Holidays, freight trains stopped on No. 1 main track must not block passenger platforms at Savage Station, BAA 18.1.
- NOTE 6:** Freight trains are prohibited from using the sidings of the Greenbelt Station, BAA 29.0.
- NOTE 7:** Berwyn – Washington Post. Locomotives are prohibited from entering the Washington Post building to prevent activation of the fire alarm and sprinkler system.

CAPITAL SUBDIVISION - WS ALEXANDRIA EXTENSION

AUTHORIZED SPEED		MILE POST	STATION	TRACK DIAGRAM		AUTH FOR MOVE	TWC	NOTES
				WEST				
70P	55F	BAA 33.6 BAA 32.7	JD RIVERDALE PARK	1 2	RIVERDALE PARK	CPS-261	DTC BLOCK JONES	
WEST WYE - 10 MAIN 25 MPH - 121.7-121.3 15 MPH - 121.3-121.0				0.3	EST WYE	ABS-261		1
25		CFP 121.0	APEX OF WYE	0.0	MAIN	CFP 121.3 CFP 121.7	CPS-261	2
		CFP 120.5 CFP 120.6	UPSHUR ST. UPSHUR ST.	2.0	HCD 17'-4" (1)HBD-DED	AU DISP 14 - 6 RD - 0R	ABS-261	
		CFP 119.2	JONES HILL (CP EAST ONLY)				CPS-261	
				2.0			ABS-261	6
		CFP 117.2	CHESAPEAKE JCT (CP EAST ONLY)		ss		CPS-261	3
		CFP 116.0	BENNING	1.2 0.6	3 2	BENNING A TRACK LANDOVER SD	ABS-251 W-3 E-2	5
25		CFP 115.4	SHEPHERD JCT		ss		CPS-261	4
15				0.6	4 5	SHEPHERD IT BAZ 0.0 - BAZ 0.2	ABS-261	DTC BLOCK EDGEMORE
30		CFP 114.8	ANACOSTIA		3 2	TTB ANACOSTA RIVER	CPS-261 CSS	DTC BLOCK JERSEY
30							ABS-251 W-3, E-2 CSS	
25		CFP 113.8	M STREET		RF&P SD	CQ DISP 20 - 3 RD - 9A	CPS-261	DTC BLOCK TIDAL
25			SOUTH					

STATION DIAGRAM NOTES

- NOTE 1:** Speeds at the wye are: 25 MPH for CFP 121.7 to CFP 121.3, 15 MPH for CFP 121.3 to CFP 121.0 (main track), 10 MPH for BAR 0.0 to BAR 0.3.
- NOTE 2:** No signal is in place for Movements West Wye Track to Single Main at The Apex of the Wye. Movements on the main from Riverdale do have a signal in place for westward moves at the Apex of the Wye.
- NOTE 3:** Normal position for the spring switch at Chesapeake Jct. is for moves Single Main to No. 1 Main Westward. Speed is 25 MPH
- NOTE 4:** Normal position for the spring switch at Shepherd Jct. is for moves Single Main to No. 2 Main Eastward. Speed is 15 MPH
- NOTE 5:** Emergency announcements: Amtrak - AAR 54, Landover SD - AAR 46, WMATA - advise CSX Dispatcher.
- NOTE 6:** Note at Anacostia and M Street - (Trains routed to and from Shepherd Jct. at CP Anacostia are affected by cab signals only between the westbound absolute signal at CP Anacostia and M Street. Cab signals are not coded through CP Anacostia for these movements).

CAPITAL SUBDIVISION SPECIAL INSTRUCTIONS

1. INSTRUCTIONS RELATING TO OPERATING RULES

EXCEPTED TRACKS

Shepherd Industrial Track

ENGINE HORN SIGNALS

14-1 Engine horn will be sounded 2 long sounds approaching passenger stations between 0500 and 2,100 hours, beginning approximately 1,100 feet from the station. Additional warning will be sounded as necessary. At other times the whistle will not be sounded at passenger stations unless people are present.

PW signs designate whistle requirements at passenger stations.

ROAD CROSSINGS AT GRADE

100-1 Riverdale Park

Westward trains receiving STOP indication on W.A.S. Riverdale Park will stop clear of Queensbury Rd.

102-1 EMERGENCY BRAKE APPLICATIONS

Trains which sustain an emergency application of the brakes will make emergency transmissions on AAR channel 08 and on channels listed below before notifying CSX Dispatcher.

1. **Capital Subdivision:** Alexandria extension
Over Amtrak – AAR 54
Over Landover SD – AAR 46
2. **Halethorpe** – Over Amtrak - AAR 54
3. **Ivy City** – Next to Amtrak - Amtrak AAR 54

USE OF SPECIFIED TRACKS

95-1 Shepherd I.T.

Shepherd I.T. MP are BAZ 6.0 at Shepherd Jct. to BAZ 12.1 end of track.

Movements of hazardous material cars through Bolling Air Force Base, and Naval Research Laboratory must not be made until respective base security police are notified.

GR-21 MEETING POINTS

Eastward trains being held at Dorsey will stop back 1,200 feet from the eastward absolute signal at Dorsey. The identifying point of this restriction is identified by a sign marked "Hold Back Point".

Trains not exceeding 6,750 feet total length will meet this restriction and will clear Montevideo Road by 300 feet.

Trains exceeding 6,750 feet total length will STOP to clear Montevideo Road, or will cut the crossing, and will proceed to Dorsey when so advised by the train dispatcher.

STOP SIGNALS

226-A Shepherd Junction. When STOP aspect is displayed by the absolute signal governing westward movements from No. 2 main track to the single main track at Shepherd Jct., train will be governed as follows.

- a) Contact the AY Train Dispatcher, Jacksonville on channel AAR 14, T-6.
- b) After receiving permission from the control station, crew will operate key box (located on the east side of the relay case, south of track) by inserting a switch key and turning in a clockwise direction, then key may be released. This should cause the dwarf signal to display an aspect to proceed if conditions permit.

350-1 (East item in Division Special Instructions.)

350-1 Train Not Equipped With Cab Signals – Cab Signals – Exceptions for trains not equipped - The following exceptions authorized for trains and engines not equipped with cab signals:

Engines used in switching, transfer work service and freight, with or without cars, between Landover and CP Virginia; between Anacostia and CP Virginia; between RO and AF Seminary; between CP Penrose and CP Field, 700, CP Bensenal and CP Phil.

2. INSTRUCTIONS RELATING TO SAFETY RULES

CLOSE CLEARANCE

2150.1 Jessup

Jessup – Old Ramp

Because of insufficient clearance on the Old Ramp, all cars left on 'C' Pads must be spotted. Additionally, no more than three (3) cars will be left spotted on 'C' Pads.

Waterloo Branch

Produce Center – C&D tracks against the dock
Terminal Corporation – against the docks
Merchants – against the docks

Columbia Branch
Sequoia – against the dock
Serio Lead
Serio – against the dock
W. D. Class – against the dock

3. INSTRUCTIONS RELATING TO COMPANY POLICIES AND PROCEDURES

NONE

2150-2 Jones Hill

Bardon Inc. (Jones Hill)

Between buildings on the lead from the main track passing the dumper entering the plant – very close clearance next to engine – do not lean out cab window.

4. INSTRUCTIONS RELATING TO EQUIPMENT HANDLING RULES

NONE

5. INSTRUCTIONS RELATING TO AIR BRAKE AND TRAIN HANDLING RULES.

5206(B)-1

Crews pulling cars eastward from the westbound storage track into Jessup Yard will apply rule 5206 when required, with the following change to step 3.

Step 3 – Make certain that the air brakes apply on the cars that can be seen from the south (#1 Main) side of the westbound storage track. Secure block protection for #1 main between “Savage” and “Meade” while performing the air test.

5300-1 5300-2 ABTH APPENDIX C ATC/CS EQUIPMENT

Trains destined to the RF&P Subdivision with a lead locomotive with ATC/CS equipment with self-test capability must have the self-test performed prior to departure from Cumberland Brunswick, Philadelphia, Baltimore or Acca.

5502-1 Jones Hill

Between the MP BAA 32.7, Capital Subdivision, Riverdale, and MP CFP 119.2, Alexandria extension, Jones Hill: When making a back-up movement with more than 50 cars, not more than 18 powered axles may be used. (Note: all AC locomotives must be as 9 axles when figuring axle restriction). Extra units will be isolated beginning with the rear unit of consist, continuing toward the lead unit until the required units are cut out. A maximum of 70 loads are allowed in this movement, in addition to the shoving platform.

A maximum of 24 axles may be used to shove trains from the Alexandria Extension into Landover Subdivision Tracks A, B, No. 4 or No. 5 main tracks.

6. INSTRUCTIONS RELATING TO RESTRICTED EQUIPMENT

Freight equipment restrictions within Washington Terminal limit cars to 15'6" in height, Conductors with freight equipment destined for the terminal will ensure that cars exceeding this height are not moved to Washington Terminal.

7. MISCELLANEOUS

A. During the days and hours of commuter train operations, please avoid if possible, blocking passenger stations at the following locations:

Dorsey, MP BA 13.3, when operating on #1 track.
Muirkirk, MP BA 25.0, when operating on #2 track.

If your train will unavoidably block any of these specific locations, contact the train dispatcher for further instructions.

B. ALEXANDRIA EXTENSION

Joint CSXT – WMATA (Metro) Emergency Notification Procedures

The following procedures must be strictly adhered to for emergency notification and safety precautions on the Capital Subdivision between CFP 118.0 and CFP116.0 known as the joint CSXT – WMATA (Metro) corridor.

1. Jacksonville Dispatcher

- a. The WMATA (Metro) hot line between the “AU” dispatcher Jacksonville and Metro must be tested daily and records of the test maintained in the dispatching center.
- b. Any emergency situation within a Metro corridor such as, but not limited to, trains in emergency, derailments, etc., that could in any way affect the safety of the Metro train operations, or the activation of any warning alarms, will require the attention of the “AU” dispatcher to immediately contact the WMATA (Metro) control center via the “hot line” telephone and advise the metro control center of the situation. The “AU” dispatcher will immediately stop all CSXT trains moving within the affected corridor or approaching that corridor and hold such trains until it can be ascertained from both CSXT and Metro personnel that all train operations may be safely resumed. After the “AU” Dispatcher is assured that all CSXT trains have been stopped, he/she will so inform Metro.

When the Chief Train Dispatcher or the “AU” Dispatcher has been informed by both CSXT and Metro personnel that the emergency conditions have been fully corrected on both CSXT and Metro, and it is determined that safe train operations may

be resumed, he/she will inform all affected CSXT trains and allow them to resume operation as he/she directs.

- c. In addition to these instructions, the "AU" dispatcher in Jacksonville must at all times, take any other action as deemed necessary, to provide protection and safety to all trains operating with the joint CSXT – WMATA (Metro) corridors.

2. Train and Engine Employees:

- a. Train crews must immediately make an emergency call to the "AU" dispatcher in Jacksonville when any emergency condition is encountered such as, but not limited to, their train brakes applied in emergency application, a derailment, a track condition or obstruction etc., that may endanger the safety of the train traffic or the public.

An emergency condition will also include the activation of any recorded radio messages, conditions associated with the weather, other trains or work force either CSXT or Metro, and any interference from outside parties not associated with CSXT or Metro. Your attention is directed to Operating Rule GR-14.

- b. Emergency calls will not relieve employees of full compliance with Operating Rule 90.

3. Signal, Communication and Engineering Employees:

Whenever any emergency conditions are observed on either CSXT or Metro that may interfere with the safety of trains or the public, the condition must be immediately reported to the "AU" dispatcher in Jacksonville by the quickest means available. In addition, employees when possible, must communicate the emergency condition to any trains, other CSXT employees or Metro personnel in the affected area.

4. All employees:

The "AU" train dispatcher in Jacksonville may be contacted in emergency by calling 1-800-232-0143.

If there is any doubt as to the proper application of these procedures, contact your local supervisor for clarification.

- C. **Jessup – Columbia Wye Track** – Normal position of apex switch to Columbia Wye track is for movement to west leg of Wye.

1. Jessup: Spotting multi-levels

Do not spot any hangers on the new ramp.

2. Remote Control Locomotive Operation At Jessup

- A – Remote control locomotive (RCL) operation is established at Jessup yard. RCL operation and special instructions are stated in system bulletin. Remote control zones, when activated, may be utilized in conjunction with RCL operation.

- B – A remote zone (RZC) operation is established at Jessup Yard and RCZ signs are in place as follows:

- 1 - On the east lead from a point 700 feet west of the eastbound absolute signal and the runaround to the ramp gate.

- C - A portable derail will be placed 100 feet west of the eastward absolute signal on the east lead. It will be in use only when the Zone is activated.

- 1 – All train, engine, or on-track equipment movements inbound to Jessup Yard from the main track must contact the yardmaster in charge of Jessup before entering the yard.

- D - Train, Engine or On-Track Equipment

- 1 – All movements inbound to Jessup Yard from the main track must contact the yardmaster in charge of Jessup before entering the yard.

- D – Meade: Vulcan Materials** – The number of cars that can be spotted on the dead end track is 13.

NOTES

CUMBERLAND SUBDIVISION - CU

AUTHORIZED SPEED		MILE POST	STATION	TRACK DIAGRAM		AUTH FOR MOVE	TWC	NOTES
				WEST	EAST			
P 40	F 35							
		BA 78.8	WEVERTON	METROPOLITAN SD	AU DISP 14 - 6 RD - 08	CPS-261		
40	35 40	BA 79.7		1.2		CM DISP 94 - 4 RD - 08	ABS-261	DTC BLOCK HARPER
50		BA 80.2						
60		BA 80.5	SANDY HOOK			1 2	CPS-261	
45	40	BA 81.0		1.3			ABS-261	DTC BLOCK ENGLE
45		BA 81.3	HARPERS FERRY		HARPERS FERRY TUNNEL - 927 FT		CPS-261	
45	35	BA 81.6	HARPERS FERRY (P)				ABS-261	
40		BA 81.8	PULP MILL (WB)		1.6	POTOMAC R.	SHENANDOAH SD	
40	40	BA 82.0						
45		BA 83.2						
45	50	BA 83.3	PEACHERS HILL			CM DISP 94 - 7 RD - 08		
45		BA 84.7	ENGLES		1.5			
60	40	BA 85.3		1.4				
60		BA 86.2	REEDSON		1.7			
60	50	BA 87.7	DUFFIELDS EAST		1			
50		BA 87.9	DUFFIELDS (P)		1.9			
50	40	BA 88.4	DUFFIELDS WEST					
50		BA 89.0			1.8			
65	50	BA 89.2	SHEN				ABS-261	DTC BLOCK ENGLE
65		BA 90.7	HOBBS				CPS-261	
50	40	BA 91.3		1.8				
50		BA 91.6						
65	50	BA 91.8	RUTHERFORD					
		BA 92.9	KEARNEYSVILLE		1.9			
65	50	94.0						
		94.6	VA HOSPITAL		1.9			
65	50	95.0						
		BA 95.6	VAN CLEVESVILLE		2.3	(1)HBD-DED		
50	40	BA 95.9						
45		BA 96.6	COUCHMANS CURVE					
45	40	BA 96.7						
45		BA 97.0			1			
65	50	BA 98.3	BYRD				ABS-261	DTC BLOCK MARTIN
65		BA 98.3	BYRD				CPS-261	
45	40	BA 98.7		1.3			ABS-261	
45		BA 99.6	BURKE ST.			KELLY ISLAND IT		

CUMBERLAND SUBDIVISION - CU

AUTHORIZED SPEED		MILE POST	STATION	TRACK DIAGRAM		AUTH FOR MOVE	TWC	NOTES	
				↓	↓				
P	F			1.3		ABS-261			
45	40	BA 99.8	MARTINSBURG		FROG HOLLOW I. T.	CPS-261		3,4	
		BA 99.9	MARTINSBURG (P)		OPERATOR CH - 08	ABS-261		5	
40	40	BA 99.9	QUEEN STREET (WB)		W&W RR		DTC BLOCK MARTIN		
		BA 100.8	STEWARTS	1.5					
50	45	BA 100.9	CV CONNECTION						
60	50	BA 101.2	DRY RUN						
		BA 102.2			1.8				
50	40	BA 102.9							
60	50	BA 103.2	PEARSON						
		BA 103.7 BA 104.0		PEARSON YARD					
		NO. 4 BAQ	NO. 1 & 2 BA			ABS-261			
NO. 4 40	NO. 1 & 2 P F	11.6	105.0	WEST CUMBO		CPS 261			
			105.8		1 & 2 - 3.0	ABS-261			
40	50 40	7.6	106.1	N. MOUNTAIN (1 & 2)	1 & 2 - 2.6		DTC BLOCK CHERRY		
			108.0						NEWKIRK FILL (NO 4)
			108.2						
			108.5						
			110.6	BACK CREEK. (NO. 1 & 2)	4 1 2				
			110.8						
			111.1						
40	65 50	4.4		BACK CREEK (NO 4)	1 & 2 - 3.0	ABS-261			
					LURIGAN SD				
P	F	0.8	113.6	CHERRY RUN		CPS-261			
65	50	BA 114.2				ABS-261			
50		BA 114.7		2.7			DTC BLOCK SLEEPY		
60		BA 115.8							
65		BA 116.3	SLEEPY CREEK		(1) HBD-DED				
		BA 117.4	SLEEPY CREEK						
65		BA 118.6	HARLEY MICHAEL	2.3					
		BA 120.7	RED ROCK	2.1	1 2				
65		BA 122.7		2.4					
60		BA 122.9	HANCOCK			ABS-261		6	
		BA 123.1	HANCOCK		YARD	CPS-261			
					HO TOWER				
					OPERATOR CH - 08				
		SDG.			YARD		DTC BLOCK ORLEANS		
60	50 25					ABS-261			
50	40	BA 124.5		2.0	SSDG 10,500 FT				

CUMBERLAND SUBDIVISION - CU

AUTHORIZED SPEED			MILE POST	STATION	TRACK DIAGRAM		AUTH FOR MOVE	TWC	NOTES
					↓	↓			
P	F	SDG.							
50	40	25	BA 125.0	2.0			ABS-261		
65	50		BA 125.1	GRASSHOPPER HOLLOW	CP NO 1		CPS-261		
40	35		BA 126.1	1.6			ABS-261		
	40		BA 126.5						
	40		BA 126.7	AMBROSE					
	50		BA 127.5	2.1	1	2			
65	50		BA 128.8	SIR JOHNS RUN					
60	50		BA 129.2	2.1					
	50		BA 130.7						DTC BLOCK ORLEANS
55	45		BA 130.9	DRYWALL					
	50		BA 131.5	2.0					
65	50		BA 132.9	GREAT CACAPON					
	50		BA 134.8	2.0					
50	45		BA 134.9	SIDELING HILL					
	35		BA 136.0	2.2					
50	40		BA 136.5						
	40		BA 137.1	TURKEY FOOT			ABS-261		
			BA 139.4	ORLEANS ROAD			CPS-261		
			BA 140.9	2.2	(1) HBD-DED		ABS-261		
50	40		BA 141.6	DOE GULLY	142.0 - RANDOLPH TUNNEL - 1,015 FT				
			BA 142.2	2.1					
			BA 142.6						
			BA 143.7	HANSROTE					
55	50		BA 145.7	MAGNOLIA	144.5 - STUART TUNNEL - 3355 FT				
			BA 146.2		145.8 - GRAHAM TUNNEL - 1,592 FT				
			BA 146.7	1.8	POTOMAC R.				
50	45		BA 147.0						
40	40		BA 147.3						DTC BLOCK PAW
60	50		BA 147.5	CAROTHERS (WB)	147.7- CAROTHERS TUNNEL - 993 FT				
			BA 147.9	PAW PAW (EB)					
			MP 149 TO 155 IS 1271 FT. MP 150 TO MP 154 ARE NOT USED	1.8	E. OF CAROTHERS TO LITTLE NIAGARA				
			BA 155.8	LITTLE NIAGARA					
			157	3.0			ABS-261		
			158						
			BA 158.1	OKONOKO			CPS-261		
60			BA 159.1						DTC BLOCK PAT
55			BA 159.4	2.2	1	2	ABS-261		
60	50								

CUMBERLAND SUBDIVISION - CU

AUTHORIZED SPEED		MILE POST	STATION	TRACK DIAGRAM		AUTH FOR MOVE	TWC	NOTES
				↓	↓			
P 60	F 50	BA 160.3	LONGS CROSSINGS	2.2	WEST	ABS-261		
WB ONLY 40			BA 162.3					
		BA 162.4	SOUTH BRANCH (TYPE 1)		HBD-DED	S. BRANCH, POTOMAC R.		
		BA 162.5						
60	50							
40	35	BA 162.7		3.3	1	2		
65	50	BA 163.6					ABS-261	
		BA 163.8	GREEN SPRING				CPS-261	
		SDG						
		166	KERNS CURVE	2.5	GREENSPRING SDG.	SBV RR	ABS-261	7
		166.2				SCALE		
		167						
65		BA 167.6		1.9	1	2		
60		BA 168.1	DANS RUN					
		BA 170.2		2.5			ABS-261	
		25						
30	30	BA 170.6	PATTERSON CREEK				CPS-261	
		BA 170.8				PATTERSON CK.	ABS-261	
50	40	BA 171.2		1.4				
		BA 171.4						
60	50	BA 172.0	NORTH BRANCH			N. BRANCH		
		BA 173.0		1.4	1	2	CM DISP 94 - 4 RD - 08	
40	35			95.4 MILES			ABS-261	1
60	40	BA 173.4	MEXICO		CUMBERLAND TERMINAL SD	CM DISP 94 - 4 RD - 08	CPS-261	

STATION PAGE NOTES

- NOTE 1:** All signals on the Cumberland SD are signal rules 1281 – 1298.
- NOTE 2:** Obtain permission from the NS dispatcher in Roanoke before using the delivery track beyond the east end clearance point. Telephone is on the pole at the Northwest end of the building at Shenandoah Junction.
- NOTE 3:** Eastbound trains on either main track at Pearson Intermediate signal MP BA 103.7, that receive signals less than clear will STOP before fouling Stewarts Road Crossing MP BA 100.66 unless otherwise instructed by CM Train Dispatcher.
- NOTE 4:** Refer to miscellaneous instructions for working Capital Cement.
- NOTE 5:** Trains operating on the siding at Stewarts Crossing must occupy the circuit with in 50 feet of the crossing, and allow the warning devices to function for 20 seconds prior to occupying the crossing.
- NOTE 6:** Berkeley Springs industrial track will be used on permission of the train dispatcher. Do not exceed 5 mph between Hancock and West end Bridge No. 5 on the industrial track.
- NOTE 7:** A shoving platform is kept on the east wye at Greenspring for use by crews shoving to the interchange track on the South Branch Valley RR.
- NOTE 8:** Sound horn (14L) at Sleepy Creek Road Crossing

CUMBERLAND SUBDIVISION SPECIAL INSTRUCTIONS

1. INSTRUCTIONS RELATING TO OPERATING RULES

Def-1 EXCEPTED TRACKS

Frog Hollow Industrial Track
Berkeley Springs Industrial Track
Kelly Island Industrial Track

ENGINE HORN SIGNALS

14-1 Engine horn will be sounded 2 long sounds approaching passenger stations between 0500 and 2100 hours, beginning approximately 1,100 FT. from the station. Additional warning will be sounded as necessary. At other times the whistle will not be sounded at passenger stations unless people are present. PW signs designate whistle requirements at passenger stations.

PROVIDING CROSSING PROTECTION

100-1 Burke St., Martinsburg

Trains will provide protection against vehicular traffic before moving over Burke St. in Martinsburg, W. Va.

SWITCHES

104-1 NS Running Track and NS Delivery at Shenandoah Jct.

Switches will be left lined for NS Running (main) track.

USE OF SPECIFIED TRACKS

95-1 Shenandoah Junction

Interchange track must not be used beyond clearance point at the east and without permission of the NS dispatcher. Telephone on Pole will allow communication with NA Tower and NS dispatcher.

2. INSTRUCTIONS RELATING TO SAFETY RULES

NONE

3. INSTRUCTIONS RELATING TO COMPANY POLICIES AND PROCEDURES.

NONE

4. INSTRUCTIONS RELATING TO EQUIPMENT HANDLING RULES

NONE

5. INSTRUCTIONS RELATING TO AIR BRAKE AND TRAIN HANDLING RULES

NONE

6. INSTRUCTIONS RELATING TO RESTRICTED EQUIPMENT

A. Harpers Ferry Tunnel – Double stack equipment loaded with double stack cars must not exceed 15 MPH on No. 1 AND No. 2 tracks

B. Martinsburg – C. A. Miller Springs Bridge – Cars and engines exceeding 220,000 pounds must not operate.

C. Berkeley Springs IT – 6 axle locomotives must not operate.

D. Okonoko and Orleans Rd. – Trains with cars 20 feet or higher must use no. 1 track.

7. MISCELLANEOUS

A. During the days and hours of commuter train operations, please avoid if possible, blocking passenger stations at the following locations:

Duffields, MP BA 87.9, when operating on #2 track.

Martinsburg, MP BA 99.9, when operating on #2 track.

NOTE: If your train will unavoidably block any of these specific locations, contact the train dispatcher for further instructions.

B. Green Spring Scale Track Siding

The scales are bi-directional and will weigh eastward or westward. Eastbound and westbound trains entering Scale Track siding will weigh unless otherwise instructed.

When the lead engine fouls the 200 ft. approach sign, the scale will turn on and transmit "CSX Green Spring scale is ready." Speed must be maintained between 4.5 and 9 MPH. Train speed will be transmitted after every 5th car when above speed is maintained. If train speed increased over 8.5 MPH, the speed will be transmitted after every car. If train speed increases to over 9 MPH, the scale will stop weighing. Train must be stopped and crew will contact the Control Station for instructions.

If the train is to be re-weighed, it must be backed up clear of the 200 ft. approach sign before starting to weigh.

If the scale fails at any time during weighing, it will transmit "Scale has Failed." If this occurs, contact the Control Station. When train has completed

weighing, the scale transmits "CSX Green Spring scale is clear X X X total cars."

NOTES

When trains weighed STOP on the scale for any reason before weighing is completed, a member of crew will contact Control Station, giving number of cars standing on scale and location of car in train from head end. A member of crew will be advised by Control Station whether or not to back off and re-weigh or proceed without backing up. Failure or irregularities in the operation of audible speed indicators, or any other condition, must be immediately reported to the Control Station.

Trains using scale track siding for purposes other than weighing will not exceed 10 MPH while passing over scale.

Movements between the ETC Sign 349 feet west of scale and the switch at the east end of the siding must not exceed 15 MPH.

Hand-operated switches on the siding must be left lined and locked for straight track movement after being used.

C. Additional Switching Instructions for Capital Cement

When a train enters the Frog Hollow Industrial track at Martinsburg, enroute to Capital Cement, the operator at "NA" Tower will notify the shift supervisor at Capital Cement (telephone number 303-267-8966, ext. 275 or ext. 266) to inform them that the train is enroute to their plant. Record the name of the supervisor notified, along with the time, on the bottom of the block sheet for future reference. When work is completed, the trick supervisor must be notified.

The train crew must verify from "NA" Tower that notification has been made prior to entering onto Capital Cement tracks. If notification has not been made, then the train crew will notify the shift supervisor prior to entering onto Capital Cement tracks.

Shoving movements will be made in accordance with Rules 46 and 95, looking out for workers and vehicular traffic near the tracks.

NOTES

CUMBERLAND TERMINAL SUBDIVISION - C3

AUTHORIZED SPEED		MILE POST	STATION	TRACK DIAGRAM		AUTH FOR MOVE	TWC	NOTES
				↓	↓			
40	35	BA 173.4	MEXICO	CUMBERLAND SD	1 2	CM DISP 94 - 4 RD - 08	ABS-261	
P	F	BA 173.4	MEXICO		PPG LEAD	CM DISP 94 - 4 RD - 08	CPS-261	1, 5
60	50	BA 174.4		1	2	CUMBERLAND YARD YDMSTR - 08 & 70	ABS-261	
50	45	BA 174.6	2.3				ABS-261	
60	50	BA 175.5					ABS-261	
55	50	BA 175.7	WEST HUMP (CP NO.2)				CPS-261	2
60	50	BA 176.1	1.3				ABS-261	
60	50	BA 176.7					ABS-261	
40	35	BA 177.0	VIRGINIA AVE				CPS-261	6
15	15	BA 178.2					ABS-261	
15	15	BA 178.3	CUMBERLAND (P)				ABS-261	
15	15	BA 178.7	BALTIMORE ST. 1.9	1	2		ABS-261	3
P	F	P	F					4
20	20	25	25	BA 178.9	VIADUCT JCT. 5.5 MILES	X10 TO & FROM MOUNTAIN SD	CPS-261	5
KEYSTONE								
P	F	BA 179.5	BEALL ST. 6.1 MILES	KEYSTONE SD CM DISP 94-2 RD - 08	1 2	HUNTINGTON DIV MOUNTAIN SD CM DISP 94-2 RD - 08	ABS-251 W-1 E-2	5

STATION PAGE NOTES

- NOTE 1:** All signals on the Cumberland Terminal Subdivision are signal rules 1280 – 1298.
- NOTE 2:** The Yardmaster at the West Hump controls all movements on the North Lead and 1 yard, including crossover movements. The signals at Virginia, when set as switching signals, will restore to restricting for switching movements. They will display better indications for movements yard to main.
- NOTE 3:** Cumberland code states that crossings will not be blocked for more than 5 minutes. Make every effort to not block crossings in Cumberland.
- NOTE 4:** Trains departing the yard AT Viaduct Jct. must not foul the Amtrak station or Baltimore Street unless advised that the dispatcher will take the train. When departing at Viaduct, crews will advise the Yardmaster of their departure.
- NOTE 5:** Arriving freight trains must contact the Yardmaster at the West Hump for instructions prior to entering the yard.
- NOTE 6:** Trains using other than main tracks at Virginia Ave. must not foul switches without permission of the Yardmaster, West Hump.

CUMBERLAND TERMINAL SPECIAL INSTRUCTIONS

1. INSTRUCTIONS RELATING TO OPERATING RULES

Def – 1 EXCEPTED TRACKS

Ridgeley Yard
Maryland Junction
Knobmount Yard

ENGINE HORN

- 14.1 Engineers must not sound horn except in case of emergency at the following road crossings at Cumberland, Md.

Franklin Street
Pear Street
Valley Street
Knox Street
Baltimore Street

ROAD CROSSINGS AT GRADE

- 100.1 **Road Crossings** – Every reasonable effort must be made to not block any road crossing in the city of Cumberland, Maryland. Cumberland city code states that no train will prevent the use of any street for the purpose of travel for a period of time longer than five (5) minutes.

- 100.2 **Grade Crossing Warning Device Operation** – The following grade crossing warning device changes will apply at Baltimore Street, MP BA 178.6:

Number one main track and number two main track are equipped with motion detectors.
Freight track is equipped with motion detectors
Number one yard has no grade crossing warning device. Rule 100B and 1 will apply.
City Track is equipped with an island circuit only, extending 100 feet from crossing in an east and west direction. Rule 100B will apply.

SWITCHES CUMBERLAND YARD

- 104.1 The crossing switch at Air Compressor from Open Track to South Lead will be left as follows: West end of the crossover lined green for Open Track and east end of the crossover lined yellow for North Lead, or as instructed by Yardmaster, West Hump.

104.2 SWITCHES AT VIRGINIA AVE.

The yard switches at Virginia Ave. will be left lined as last used or as instructed by the Yardmaster, West Hump.

2. INSTRUCTIONS RELATING TO SAFETY RULES

NONE

3. INSTRUCTIONS RELATING TO COMPANY POLICIES AND PROCEDURES

NONE

4. INSTRUCTIONS RELATING TO EQUIPMENT HANDLING RULES

NONE

5. INSTRUCTIONS RELATING TO AIR BRAKE AND TRAIN HANDLING RULES

5300-1 Locomotive Inspection

Trains originating at Cumberland and destined to the RF&P must have tested train control units on the head end. When units are tested, and the test fails, the yardmaster and dispatcher must be advised.

5300-2 Calendar Day Inspection

Locomotive calendar day inspections will be made for yard assignments in Cumberland at the end of the third shift.

Engineers will notify supervisors during their tour of duty of defects needing repair, so that locomotives may be repaired and kept in service.

6. EQUIPMENT RESTRICTIONS

A. North Branch I.T., Pittsburgh Plate Glass

- Engines with coupler limiting blocks positioned inside coupler pockets must not couple to other equipment on 1, 2, 3 and 4 tracks.
- Cars longer than 70 feet must not operate West of West switch on 3 track or through crossovers between No.'s 4 and 5 tracks.

B. Cumberland scales – 5 MPH

C. Cumberland Retarders

- Master retarders – Engines other than 8227, 4551, 4556, 4565, 4567, 4568, 4569, 4572, 4573, 4577, 4614, 4615, 4616, 4617, 8375, 8972, 2431, 2432 and 2433 must not operate through retarders.
- Secondary retarders – Engines must not be operated through secondary retarders without permission of the yardmaster, and must not exceed 5 MPH.

D. Humping Cars

When humping cars at Cumberland Terminal, the maximum number of cars in a draft that may be released off of the hump through either the master or

secondary retarder is five. This maximum car draft count includes drafts with loaded and/or empty cars.

If any questions regarding these instructions, contact the TM on duty, be governed accordingly.

7. MISCELLANEOUS

A. Cumberland – Yarding Instructions

1. Westbound trains exiting at Viaduct must not foul Baltimore Street without knowledge that the dispatcher will take the train. Notify yardmaster when departing.
2. Westbound trains departing on 1 or 2 main tracks must not foul Baltimore St. or the Amtrak station without knowledge that the dispatcher will take the train.
3. Crews of eastbound trains must advise the yardmaster when departing, and provide the dispatcher with the following information before departing the yard.
 - 1) Locomotive consist
 - 2) Loads/empties
 - 3) Tonnage
 - 4) Speed or clearance restricted cars
 - 5) Any local work
 - 6) Train weight
4. All trains entering the yard must contact the yardmaster West Hump prior to arrival for yarding instructions.
5. When yarding trains on receiving yard tracks in Cumberland Terminal, five (5) hand brakes maximum must be applied, unless otherwise instructed by the yardmaster.
6. When removing ground air lines make a heavy brake pipe reduction by use of angle cock.
7. Williams Street Yard Access and Instructions

To access No. 2 yard, contact the yardmaster for instructions to proceed on No. 3 yard. No. 2 yard begins from east to west at the Macaroni Factory. No. 2 yard from west to east begins approximately 310 feet west of I-68 overpass.

B. Engine Load Testing Track

Maximum authorized speed for engine load testing track 6-1/2 (test track) at the Cumberland locomotive servicing shop is 30 MPH. All other engine movement will be in compliance with Operating Rule 46.1C.

C. Inbound Power to Service Tracks

- a) Do not contact the service track foreman (STF) until your consist has "arrived" and "stopped" at Shuman's derail.

- b) Contact the service track foreman on Radio Channel #36.
- c) Request permission to enter the servicing area. Once contact is made, the (STF) will ask the inbound crew to verify whether the derail is in the "off" position and has the oscillating blue light changed to amber? Once this information is verified, permission will be granted to move onto one of the inbound tracks. (Note: If you are requested to place power onto number two (2) inbound, do not foul the crossover switch for number one (1) or number three (3) inbound tracks.)
- d) Once your consist has cleared the derail, properly 'tie-down' your engine(s), immediately contact the (SFT) and notify him/her you are in the clear of their derail. (Note: If other engines are occupying the same track, do "not" couple to the power.)
- e) Do "not" handle your consist beyond the derails on the inbound tracks to the pit without the Ready Track Foreman's permission. Do not couple to locomotives already on the pit.

D. Outbound Power from Service Track:

- a) Go to (SFT) office to get power assignment and its location.
- b) When in (service track area) always wear hearing protection and safety glasses.
- c) Go to outbound tracks and retrieve your consist.
- d) Once your consist is retrieved and you are ready to depart, contact the (STF) on Radio Channel #36 to receive further instruction.
- e) The (STF) will ask you to verify whether the derail is in the "off" position and has the blue oscillating light changed to amber? Once this information is verified, permission will be granted to move off the outbound track(s).
- f) After clearing the derail(s), contact the (STF) and notify him/her that your consist is in the clear of their derail.

E. Remote Control Operation

A - Remote control locomotive (RCL) operation is established at Cumberland Terminal. RCL operation and special instructions are stated in System Bulletin. Remote control zones, when activated, may be utilized in conjunction with RCL operation.

1. When activated and controlled by the control station, RCO operators in this zone are relieved of that portion of CSX Operating Rule 46 requiring the crew of stopping within one-half the range of vision, short of a train, a car, an obstruction, a derail or an improperly lined switch, and on-

track equipment. Crews must comply with all other requirements of the rule.

NOTES

2. Track Protection

A. Humping Instruction for RCO operations.

Upon commencing the initial shove of a track in the receiving yard (WR1 through WR8) by RCO hump job, to the hump, CM Dispatcher will provide protection by lining away the switches connected to the entrance to affected track and will record and communicate to the RCO operator the track and time blocking protection is provided. The permission will be done by radio communications between RCO operator and CM Dispatcher clearly identifying the track or tracks being requested and time protection is provided. Also, RCO operator must report clear of the affected track or tracks and the time given back to the CM dispatcher.

B. Making reverse move in eastward direction.

3. Head end protection when pulling east to the receiving yard from the HO Yard, East Yard and or the bowl.

A. On initial moves eastward to the receiving yard.

B. After movement has stopped

After movement is stopped it will be confirmed that protection has been provided at the east end of the receiving track. This will be done via radio communications between RCO foreman and CM dispatcher, as described in Item 2-A.

B – Instructions for train, engine, or on-track equipment movements arriving Cumberland Terminal

1 – All movements inbound to Cumberland Terminal will not enter the yard without contacting the yardmaster, West Hump.

NOTES

HANOVER SUBDIVISION - HV

AUTHORIZED SPEED		MILE POST	STATION	TRACK DIAGRAM		AUTH FOR MOVE	TWC	NOTES
				↓	↓			
10	EQHR 4453 0.4	BAS 0.5	MT. WINANS	BALTIMORE TERMINAL SD	1 2	AV DISP 66-4 RD-08	46	
25	15 MPH AT 3.8	BAS 0.5	MT. WINANS	3.5	FULTON IT	AV DISP 86-1 RD-08	TWC-DTC	5,7
25		BAS 3.8	WALBROOK JCT					
25	5.8	BAS 7.7	LEAHIGH EE	3.7	1% EOT REF ↓ 6.6	DTC BLOCK TIDE	7	
25	8.8	BAS 7.8	DTC BLOCK SIGN	0.1				
40	9.1	BAS 9.8		9.6	----- BALTIMORE CITY LINE	DTC BLOCK EMORY	1	
	13.0			14.0				
40	18.2	BAS 14.2	OWINGS MILLS (TYPE 1)	4.8	HBD-DED	DTC BLOCK BAUGHER	3	
		BAS 17.4	DTC BLOCK SIGN					
25	22.0	BAS 22.2	EMORY GROVE	4.8	MMID	DTC BLOCK FOWBLE	7	
25		BAS 22.2	DTC BLOCK SIGN	7.1				
30	36.3	BAS 29.3	HAMPSTEAD	7.1	1% EOT REF ↓ 6.6	DTC BLOCK PORTER	6	
		BAS 30.1	DTC BLOCK SIGN	0.8				
25	43.9	BAS 36.7		8.8	33.8 ↓ 37.0	DTC BLOCK LINE	2	
25		BAS 38.9	LINEBORO	0.1				
30	43.9	BAS 39.0	DTC BLOCK SIGN	0.1	YORK RAIL	DTC BLOCK PORTER	6	
		BAS 47.5		9.3				
25		BAS 48.3	DTC BLOCK SIGN	0.4	YORK RAIL	TWC-DTC	2	
		BAS 48.7	PORTERS WYE	4.4				
		BAS 49.2	JCT SWITCH	4.4	MP 54.3 YORKRAIL	193 YARD LIMITS	HANOVER YARD LIMITS	
		BAS 53.1	HANOVER	2.4				
		BAS 53.2		2.4	TWC-DTC	DTC BLOCK CAMP	2	
		BAS 55.5	ELM	1.5				
		BAS 57.0	BITTINGER	1.0	TWC-DTC	DTC BLOCK CAMP	2	
		BAS 58.0	DTC BLOCK SIGN	1.0				
25	60.2	BAS 59.0	BERLIN JCT	1.0	TWC-DTC	DTC BLOCK CAMP	2	
10	61.6	BAS 60.2		1.5				
		BAS 60.5	NEW OXFORD	1.5	TWC-DTC	DTC BLOCK CAMP	2	
		BAS 61.8		10.3				

HANOVER SUBDIVISION - HV

AUTHORIZED SPEED	MILE POST	STATION	TRACK DIAGRAM		AUTH FOR MOVE	TWC	NOTES
			↓	↓			
25	EQHR 4453	BAS 70.8	GETTYSBURG	10.3	<div style="text-align: center;">WEST</div>	TWC-DTC	4
10 MPH OVER ROAD CROSSINGS GETTYSBURG		BAS 72.0	DTC BLOCK SIGN	1.2		DTC BLOCK CAMP	
25		73.0	74.0	10.2		DTC BLOCK TANNA	
83.3		BAS 82.3	DTC BLOCK SIGN	7.6		DTC BLOCK PEN	
1% EOT REF		BAS 89.9	DTC BLOCK SIGN	0.4		TWC-DTC	
93.1		BAS 90.3	GREENSTONE	2.8		193 YARD LIMITS	
99.8		BAS 93.1	HIGHFIELD	0.6		HIGHFIELD YARD LIMITS	
101.9		BAS 93.7	VISTA	0.4		DTC BLOCK HAGER	
102.5		BAS 94.1	DTC BLOCK SIGN	0.4		TWC-DTC	
104.5		BAS 106.7	DTC BLOCK SIGN	107.0		DTC BLOCK HAGER	
106.2	107.0	SECURITY	107.3	193 YARD LIMITS			
25	108.0	SECURITY	108.5	SECURITY YARD LIMITS			
10	BAS 108.5	BAS 109.8	109.3 MILES	LURGAN SD	AV DISP 86-1 RD-08	193 YARD LIMITS	SECURITY YARD LIMITS
10	HW 73.7	CP TOWN (X)	NS LURGAN BRANCH	HARRISBURG TERM DISP 58-4#-5c	NORAC RULES 600-616	D	46
				HAGERSTOWN YARD			

STATION PAGE NOTES

- NOTE 1:** Storage tracks at Emory Grove are designated interchange tracks between CSX and Maryland Midland Railroad (MMID). MMID engines and trains may use CSX tracks from BAS 17.4 to BAS 21.0 for the purpose of interchange. When setting off cars to the Maryland Midland RR, interchange track at Emory Grove, MP BAS 20.0, shove the cars east of the east crossover.
- NOTE 2:** Trains and engines must approach crossing at MP 54.3 prepared to STOP and may proceed if no conflicting movement is evident.
- NOTE 3:** STOP and flag Reisterstown Rd, MP 14.8
- NOTE 4:** STOP and flag Shealer Rd, MP 68.9 when switching in Camp Siding.
- NOTE 5:** When STOP indication is displayed for westward movements at Mt. Winans, trains will STOP clear of Washington Blvd.
- NOTE 6:** Hanover - Broadway St.: To avoid blocking crossing, westbound trains may leave train at east end of Hanover; eastbound trains may leave train at west end of Hanover.
- NOTE 7:** Baltimore: Local ordinance, prohibits, except in emergency, the sounding of the horn when approaching street grade crossings, except at Patterson Avenue.

HANOVER SUBDIVISION SPECIAL INSTRUCTIONS

1. INSTRUCTIONS RELATING TO OPERATING RULES

ENGINE HORN

14-1 City Ordinance Instructions

Within the limits of Hagerstown, local ordinance prohibits, except in emergency, the sounding of the engine horn when approaching street grade crossings, except when the adjacent track is occupied by another train or draft of cars.

ROAD CROSSINGS AT GRADE

100-1 Security

Provide crossing protection at Security Rd.

TRACKS OTHER THAN MAIN TRACKS

95-1 Porters Yorkrail Operations –

- a) All tracks at Porters on the Yorkrail and Smith's Siding on the Hanover Subdivision are designated interchange tracks between CSX and Yorkrail.
- b) CSX crews will not occupy any part of the Yorkrail or the Wye tracks at Porters, except to pick up interchange cars. If it becomes necessary to make other moves at Porters, the Yorkrail Train Dispatcher must be contacted for permission at (717) 771-1744 between the hours of 0700 and 1700, Monday through Friday.
- c) Yorkrail has trackage rights between Porters and the east switch Hanover Brands east of York Road.
- d) Before entering the Hanover Subdivision main track, Yorkrail crews must contact the CSX "AV" Dispatcher, and secure permission to enter the main track. At that time the CSX dispatcher will deliver to the Yorkrail crew any train messages in effect between Porters and the east end Hanover Brands, east of York Road for interchange purposes, and also for engine movements only, between Hanover brands and YRC connection track at MP BAS 54, the old MPA.
- g) All cars for interchange to Yorkrail will be left on the east end of Smith's Siding for Yorkrail pick-up.
- h) After returning to Porters, Yorkrail must report clear of the CSX main track by calling the CSX "AV" Train Dispatcher.

105-3 Sweetheart Cup Industrial Tracks: Movement must not exceed 4 MPH. Cars must not be detached from motive power and permitted to run on their own momentum of these tracks.

105-4 Antietam Industrial Track mileposts:
BET 0.0 Security Junction
BET 3.0 Security

2. INSTRUCTIONS RELATING TO SAFETY RULES

2150-1 Close Clearance - Gettysburg

Close clearance exists between the CSXT and GBRY railroad main tracks in Gettysburg, Pa. at CSXT milepost marker 71.0.

When placing cars on the GBRY, crews must leave them at least 3 car lengths west of that CSXT marker post. Fluorescent orange and yellow marks are painted on the ties and rail of both the GBRY and CSXT mains to mark the clearance points. Cars must be left west of these markings.

Crews must continue to exercise caution at this location in the event cars are placed east of the clearance point.

GBRY Railroad crews have also been notified as to placement of cars per this bulletin.

3. INSTRUCTIONS RELATING TO COMPANY POLICIES AND PROCEDURES

NONE

4. INSTRUCTIONS RELATING TO EQUIPMENT HANDLING RULES

NONE

5. INSTRUCTIONS RELATING TO AIR BRAKE AND TRAIN HANDLING RULES

NONE

6. INSTRUCTIONS RELATING TO RESTRICTED EQUIPMENT

A. Hanover Foods

6-axle units must not operate on No. 1 track

B. Hanover Yard

6-axle units must not operate on 3 & 4 yard tracks.

C. Security

6-axle units must not operate on tracks at St. Lawrence Cement and Maryland Metals.

D. Gettysburg

Not more than one 6-axle unit may operate at Spectra-Koat.

E. Berlin Jct.

Not more than one 6-axle engine may operate at Glen Gary Brick.

F. Owings Mills

6-axle units must not operate on 1, 2, 3 and 4 tracks at Maryland Cup. No engine or car movements are permitted on 2 or 3 track when the adjacent track is occupied by any type of equipment between the storage track and the car or cars spotted for loading opposite the 14 ft. door of the loading platform. Due to curvature, more than two 4-axle units must not enter track tracks with multiple units, reachers will not be used.

Employees are prohibited from riding on the side of equipment into or out of tracks serving this industry.

7. MISCELLANEOUS

The Gettysburg Railroad has installed a derail at the point of their east and west wye track. Posts mark it on each side. The normal position will be in the down, or non-derailing position to accommodate our interchange set offs.

HARRISBURG SUBDIVISION - HR

AUTHORIZED SPEED	MILE POST	STATION	TRACK DIAGRAM		AUTH FOR MOVE	TWC	NOTES
			WEST	EAST			
RUNNING TKS RESTRICTED SPEED MAX 10					46		1
30	QHE 2.7	CP PENROSE			CPS-261	D	3
30	QHE 1.5	MIFFLIN ST			ABS 261 CSS		
GRAY - ARSENAL 30 GRAY - FIELD 15 ARSENAL - FIELD 20	QHE 0.2	CP GRAY			CPS-261 CSS	D	
	QHE 0.0 QHW 0.0 QH 0.0	CP FIELD			ABS-261 CSS	D	
20	QH 0.0	FIELD (2)			ABS-261		2
	QH 2.3	ZOO (2)			ABS- 261CSS		2
20	QH 4.0	CP BELMONT			CPS-261 CSS	D	
25	CS 30 QH 5.2				ABS-261	NORAC 261	
25	QH 5.2	CP RIVER			CPS-261 CSS	D	

STATION PAGE NOTES

- NOTE 1:** Yardmaster south Philadelphia is in charge of running tracks Penrose to Broad Street.
- NOTE 2:** Plug door detector at CP Field and Zoo only scans south side of train.
- NOTE 3:** All signals on the Harrisburg Subdivision are signal rules CR1277-CR1294A.

HARRISBURG SUBDIVISION – HR
58th ST CONNECTING TRACK & ARSENAL CONNECTING TRACK

AUTHORIZED SPEED	MILE POST	STATION	TRACK DIAGRAM		AUTH FOR MOVE	TWC	NOTES	
			←	→				
Gray – Field – 15 Gray – Arsenal – 30 Arsenal – Field – 20 Arsenal Conn. Trk 20 58 th ST Conn. Trk. 30	FIELD QH 0.0 GRAY QHX 1.5 QHW 0.0		WEST 		ABS-261 CSS	D	1	
	QHX 1.2		CP ARSENAL		CPS-261 CSS			
	Arsenal Conn. Trk 20 58 th ST Conn. Trk. 30	Arsenal Conn. Trk QHW 0.9 58 th ST Conn. Trk. QHX 0.0						ARSE. CONN. TRK. ABS-261 CSS
		QHW 1.2	CP PHIL AMTK					
30	BAK3.1	58 th ST		PHILADELPHIA SD 1 2 AV DISP 66 – 5 RD - 08	CPS-261			

STATION PAGE NOTES

NOTE 1: The Amtrak train dispatcher in charge of CP Phil will not be required to copy form D, lines 2,3 or 4. The NI dispatcher will accept verbal confirmation of blocking device application record from the Amtrak train dispatcher. The NI dispatcher must record on the Dispatcher Record of Train Movements the time blocking devices are applied and removed, and the name of the Amtrak train dispatcher involved.

HARRISBURG SUBDIVISION SPECIAL INSTRUCTIONS

1. INSTRUCTIONS RELATING TO OPERATING RULES

350-1 Train Not Equipped with Cab Signals

Trains and engines not equipped with cab signals are permitted to operate between CP Penrose and CP Field Z00 and CP Penrose; CP field and CP Phil; CP Gray and CP Arsenal

2. INSTRUCTIONS RELATING TO SAFETY RULES

NONE

3. INSTRUCTIONS RELATING TO COMPANY POLICIES AND PROCEDURES

NONE

4. INSTRUCTIONS RELATING TO EQUIPMENT HANDLING RULES

NONE

5. INSTRUCTIONS RELATING TO AIR BRAKE TRAIN HANDLING RULES

NONE

6. INSTRUCTIONS RELATING TO RESTRICTED EQUIPMENT

LOCATIONS OF HEIGHT RESTRICTIONS

Greenwich Yard:

Cars, loads, or other equipment higher than 13'6" prohibited under tipple.

7. MISCELLANEOUS

REMOTE CONTROL LOCOMOTIVE OPERATION

1. Greenwich Yard

A – Remote control locomotive operation is established at Greenwich Yard. RCL Operation and special instructions are stated in a separate system bulletin. Remote control zones, when activated, may be utilized in conjunction with RCL operation.

B - A remote control zone (RCZ) is established in Greenwich Yard and RCZ signs are in place as follows:

1. On the engine service lead, west of Rd. 1 & 2 lead, and east of G Yard lead.

C – All train, engine or on-track equipment movements inbound to Greenwich Yard must contact the yardmaster prior to entering the yard.

D – Remote control engines are not permitted to operate on the Chester Secondary or the SEPTA Main Line to Lansdale.

2. Cars Left Standing

Cars left standing at "G" Yard will be secured with 10% hand brakes plus 2 additional hand brakes. Additional hand brakes may be required during switching operations to meet these requirements.

NOTES

NOTES

NOTES

HERBERT SUBDIVISION - HB

AUTHORIZED SPEED	MILE POST	STATION	TRACK DIAGRAM		AUTH FOR MOVE	TWC	NOTES
			↓	↓			
30	QP 24.6	NORTH LEG OF WYE	<div style="border: 1px solid black; padding: 2px; width: fit-content; margin: 0 auto;">POPES CREEK SD</div>	<div style="border: 1px solid black; padding: 2px; width: fit-content; margin: 0 auto;">NI DISP 64 - 4# RD - 64</div>	TWC-DCS		
10	QJ 0.0 QJ 0.2 QJ 0.4	DAN LONG SIDING	S. WYE 10 MPH 	<div style="border: 1px solid black; padding: 2px; width: fit-content; margin: 0 auto;">NI DISP 64 - 4# RD - 64</div>	TWC-DCS	D	
30	QJ 8.5 QJ 10.3 QJ 11.0 QJ 11.4	GALLANT GREEN MASON HERB HERBERT		<div style="border: 1px solid black; padding: 2px; width: fit-content; margin: 0 auto;">NI DISP 64 - 6# RD - 64</div>	TWC-DCS	D	
30	QJ 17.3	CHALK CHALK POINT			TWC-DCS	D	

HERBERT SUBDIVISION SPECIAL INSTRUCTIONS

1. INSTRUCTIONS RELATING TO OPERATING RULES

NONE

2. INSTRUCTIONS RELATING TO SAFETY RULES

NONE

3. INSTRUCTIONS RELATING TO COMPANY POLICIES AND PROCEDURES

NONE

4. INSTRUCTIONS RELATING TO EQUIPMENT HANDLING RULES

NONE

5. INSTRUCTIONS RELATING TO AIR BRAKE AND TRAIN HANDLING RULES

Train Handling Rule 3.1.2 is modified to Permit 27 powered axles for the operating locomotives that are pulling a train or cut of cars on the Landover Line, Herbert Subdivision.

6. INSTRUCTIONS RELATING TO RESTRICTED EQUIPMENT

Cars exceeding Plate F must not operate on Amtrak's Northeast Corridor between Landover and Grove.

Cars exceeding Plate C must not operate on Amtrak's Northeast Corridor No. 2 and 3 main tracks between Landover and Grove.

Conducting of trains operating on the Northeast Corridor between Landover and Grove must check their consists for the above listed restricted cars if advised to operate on 2 or 3 main tracks.

7. MISCELLANEOUS

NONE

NOTES

KEYSTONE SUBDIVISION - MH

AUTHORIZED SPEED				MILE POST	STATION	TRACK DIAGRAM		AUTH FOR MOVE	TWC	NOTES	
NO. 1		NO. 2				↓	WEST				↓
P	F	P	F	BA 178.2	VIADUCT JCT	<div style="display: flex; justify-content: space-around; align-items: center;"> <div style="border: 1px solid black; padding: 2px; font-size: 8px;">CUMBERLAND TERMINAL SD</div> <div style="border: 1px solid black; padding: 2px; font-size: 8px;">CM DISP 94 - 4 RD 08</div> </div>		ABS-261			
20	20	25	25						CPS-261		
NO. 1 & 2						BF 178.9	VIADUCT JCT			ABS-261	
P	F			1.1				ABS-261			
35	25			BF 179.3	FRANKLIN ST	CP EAST ONLY		CPS-261			
				BF 180.7	2.0		<div style="border: 1px solid black; padding: 2px; font-size: 8px;">CM DISP 94 - 2 RD 08</div>	ABS-261	DTC BLOCK SAVAGE	2	
40	35			BF 181.3	MT SAVAGE (NO. 1)						
				BF 181.6	MT SAVAGE (NO. 2)						
79	50			BF 182.3	2.5	1	2			3	
75				BF 183.8	ELLERSLIE						
60				BF 183.9							
79				BF 184.4							
				BF 185.2	3.2						
55				185.5							
				186.5							
				BF 186.2				ABS-261	DTC BLOCK COOK		
				BF 187.0	COOKS MILLS (TYPE 1)	AD		CPS-261			
				BF 188.8	1.8			ABS-261			
79				BF 188.8	1.4						
				BF 190.2	HYNDMAN			CPS-261			
				BF 190.8				ABS-261			
55				BF 191.4	1.7						
				BF 191.9	DOWNTOWN HYNDMAN (NO. 1)	191.8	TTB				
60	50			BF 192.6	2.4	1% EOT REF					
No. 1		No. 2		BA 193.7							
P	F	P	F								
35	25	35	30	BA 194.1							
30				BF 194.3	BRACKENS				DTC BLOCK HYND		
35				BF 194.6	2.6						
				BF 195.3		195.3					
30				BF 195.4		196.2					
				BF 196.9	MAXWELL						
35	35			BF 197.5	2.5	1	2				
30				BF 197.5		1% EOT REF					
				BF 199.4	FO TOWER	X20		ABS-261			

KEYSTONE SUBDIVISION - MH

AUTHORIZED SPEED				MILE POST	STATION	TRACK DIAGRAM		AUTH FOR MOVE	TWC	NOTES
						WEST				
NO. 1		NO. 2								
P	F	P	F							
35	25	30	30	BF 199.5	FO TOWER CROSSOVERS			ABS-261	DTC BLOCK FO	
		35		BF 199.6						
			30	Bf 200.2	GLENCOE 2.5	200.5				
			35	BF 201.7		(2) HBD-DED				
		35		BF 201.9	GLENCOE					
		50	35	BF 202.1		203.1				
35				BF 202.2						
50		50		BF 204.2	PHILSON		1 2			
				BF 205.6						
40		40		BF 206.5	NA TOWER					
			35	BF 206.9		1% EOT REF				
		35	30	BF 207.0						
				BF 208.4				ABS-261		
		35		BF 209.0			X10 X20			
	25		30	BF 209.1				CPS-261		
P		F		BF 209.2	MANILA					
40			30	BF 209.8		209.8				
45								ABS-261	DTC BLOCK FO	
			30	BF 211.0	SAND PATCH					
			35	BF 211.1			1 2	CPS-261		
				BF 212.7				ABS-261		
45				BF 213.7	GLADE CITY					
				BF 215.1	MEYERSDALE					
				BF 216.0	SALISBURY JCT.	2.7 (1)HBD-DED				
45				BF 216.3	SALISBURY					
				BF 216.4						
40				BF 217.7		2.1				
								ABS-261		
35				BF 218.4	YODER			CPS-261		
				BF 219.2		1.1		ABS-261		
				BF 219.5	GARRETT			CPS-261		
40			35						DTC BLOCK SALI	

KEYSTONE SUBDIVISION - MH

AUTHORIZED SPEED		MILE POST	STATION	TRACK DIAGRAM		AUTH FOR MOVE	TWC	NOTES
				↓	↓			
40	35	BF 220.9	3.0 ATLANTIC	2.0	1 2	ABS-251 E-2, W-1	DTC BLOCK SALI	
45		BF 221.7						
40		BF 222.5						
NO. 1 P F 50 45		NO. 2 P F 50 45		2.3	1 2	ABS-251 E-1, W-1	DTC BLOCK SALI	
45	40	BF 223.1	BF 224.5					
45	40	BF 225.6				ABS-251 E-1, W-1		
		BF 226.8	ROCKWOOD	S&C SD	1 2	CPS-261	DTC BLOCK PINK	
45	40	BF 227.0	1.3 ROCKWOOD WE SDG (NO. 1)	1.8	1 2	ABS-251 E-2, W-1	DTC BLOCK PINK	
55	45	BF 228.1						
		BF 228.4	1.8 SAND SPRING (NO. 2)	1.6	1 2	ABS-251 E-2, W-1	DTC BLOCK PINK	
		BF 228.6						
		BF 229.9	1.6 MIDDLE CREEK (NO. 1)	2.2	1 2	ABS-251 E-2, W-1	DTC BLOCK PINK	
55	50	BF 230.2						
		BF 230.4	2.2 MIDDLE CREEK (NO. 2)	1.6	1 2	ABS-251 E-2, W-1	DTC BLOCK PINK	
45	45	BF 231.4						
		BF 231.5	2.2 CASSLEMAN W OF CASSLEMAN (NO. 1)	1.6	1 2	ABS-251 E-2, W-1	DTC BLOCK PINK	
		BF 232.0						
		BF 232.2	1.6 MARKLETON (NO. 2)	1.6	1 2	ABS-251 E-2, W-1	DTC BLOCK PINK	
50	45	BF 232.6						
		BF 233.7	1.6 MARKLETON (NO. 1)	1.6	1 2	ABS-251 E-2, W-1	DTC BLOCK PINK	
50	45	BF 234.1						
		BF 235.2	PINKERTON			CPS-261	DTC BLOCK SHOO	
MAIN P F 35 30		EHR 4453		1.7	1 2	ABS-261	DTC BLOCK SHOO	
				1.7	1 2	ABS-261	DTC BLOCK SHOO	
NO. 1 & 2 P F 40 30		BF 237.0	SHOO FLY	1.7	1 2	CPS-261	DTC BLOCK BROOK	
		BF 238.7	BROOK	1.7	1 2	CPS-261	DTC BLOCK BROOK	
		BF 239.0= BFJ 6.0		2.2	1 2	ABS-261	DTC BLOCK BROOK	
		BF MP ON NO. 1 BFJ MP ON NO. 2						
NO. 1 P F 30 30		NO. 2 P F 30 30		2.2	1 2	ABS-261	DTC BLOCK BROOK	
50	40	BF 239.6	BROOK					
		BF 239.8	2.2 BENFORD (NO. 2)	1.6	1 2	ABS-261	DTC BLOCK BROOK	
		BFJ 5.2						
		BFJ 4.4	2.2 URSINA (No. 1 - WB)	1.6	1 2	ABS-261	DTC BLOCK BROOK	
50	40	BF 240.9						

KEYSTONE SUBDIVISION - MH

AUTHORIZED SPEED				MILE POST	STATION	TRACK DIAGRAM		AUTH FOR MOVE	TWC	NOTES
						WEST				
NO 1		NO 2								
P	F	P	F							
40	35			BF 241.4	JENKINS	2.0			ABS-261	DTC BLOCK PINK
		40		BFJ 3.5 BFJ 3.2	JENKINS (NO. 2)					
40		35		BFJ 1.0	CONFLUENCE (WB)		242.9'			
NO 1 & 2				BF 242.9 = BFJ 0.0	1.4				ABS-261	
P		F		BF 244.3	DRAKETOWN				CPS-261	
40		35								
55		40		BBF 245.6		1.9	1	2	ABS-251 E-2, W-1	DTC BLOCK BID
				BF 246.3	MARBLE HILL	1.9				
55				BF 247.8		1.9				
45				BF 248.3 BF 249.0	BIDWELL (TYPE 1) BIDWELL	1.9	AD			
		40		BF 250.1		1.2	1	2		
40		35		BF 251.2	VICTORIA					
				BF 251.5	HK	1.7	(1) AD			
45		40		BF 251.8 BF 252.0	HK TOWER HK					
				BF 253.0						
30		30		BF 253.7		2.2				DTC BLOCK OHIO
40				BF 255.1	STULL RUN					
				BF 256.5		2.3				
30				BF 257.4						
35				BF 258.4		1.5				
40				BF 258.5 BF 258.8	STEWARTON					
				BF 259.1						
40				BF 259.4		2.2				
				BF 260.9 261.0	NO. 1 CUT					DTC BLOCK PYLE
				262.0						
40		30		BF 263.0		2.1				
55				263.5 BF 263.8	INDIAN CREEK		1	2		
				264.5		1.7				
55									ABS-251 E-2, W-1	

KEYSTONE SUBDIVISION - MH

AUTHORIZED SPEED		MILE POST	STATION	TRACK DIAGRAM		AUTH FOR MOVE	TWC	NOTES
				↓	↓			
50	45	BF 265.4				ABS-251 E-2, W-1 BF 266.0	DTC BLOCK PYLE	
		NO 4 10	BF 266.0	CASPARIS (CP NO, 4)				
45	40	BF 266.2	CASPARIS WB #1			ABS-251 E-2,W-1		
		BF 266.2	CASPARIS	0.8	NO. 1 ONLY AD			
55	45	BF 266.9	BLUE STONE		CP ON 2 ONLY	CPS-261		
		BF267.2		1.7				
		BF 268.6	GREENE JCT			CPS-261		
55	45	BF 269.7	CONNELLSVILLE			ABS-261	DTC BLOCK GREENE	
50		BF 270.1		1.7	CONNELLSVILLE YARDMASTER CH 08			
35	25	BF 270.3	SODEM			CPS-261		
		BF 270.5		1.2	RR W&LE	ABS-261		
45	40	BF 271.2				CPS-261	DTC BLOCK SODEM	
	45	BF 271.5	W YOUGH (CP NO. 2)		CP ON 2 ONLY	ABS-261		
				1.2				
45		BF 272.7	BROADFORD			CPS-261		
		BF 272.8			MT PLEASANT I.T.	ABS-251 E-2, W-1		
60		BF 272.7		1.4				
		BF 273.6						
50	45	274.0	JACKSON CURVE					
		274.1						
		275.0						
		BF 275.3	DAWSON		NO. 2 ONLY (1) AD		DTC BLOCK LAVA	
		BF 275.7		2.0				
30	30	BF 276.1	DAWSON					
		BF 276.2		2.0				
40	35	BF 278.1	LAUREL RUN					
				2.6				
		BF 278.4						
35	30	BF 278.8	LAVENIA					
		BF 279.3						
40	35	BF 279.8	YOUNGS				DTC BLOCK LAY	
		BF 281.7						
		BF 282.0						
35	30	BF 282.4		2.0				
50	45	BF 283.0	LAYTON				DTC BLOCK	
		BF 283.7						
		BF 283.9				ABS-251		
45	40	BF 285.0		1.8		E-2, W-1	YOUNG	
		BF 285.1						

KEYSTONE SUBDIVISION - MH

AUTHORIZED SPEED		MILE POST	STATION	TRACK DIAGRAM		AUTH FOR MOVE	TWC	NOTES
				↓	↓			
P	F	BF 285.5	HAGERMAN'S ROCK			ABS-251 E-2, W-1	DTC BLOCK YOUNG	
55	45	BF 286.0		1	2			
60		286.1	2.0					
		287.1	2.0					
		BF 287.5	JACOB CREEK					
		BF 288.7		1	2			
60	45	BF 288.8						
45	40	BF 289.3	SMITHTON				DTC BLOCK JACOBS	
		BF 289.5						
50	45	BF 291.0	FITZ HENRY (TYPE 1)	AD				
		BF 291.1						
45	40	BF 292.7	REDUCTION					
		BF 293.5						
55	45	BF 294.5	EE WEST NEWTON					
		BF 294.6						
30	30	BF 295.2					DTC BLOCK SCOTT	
45	45	BF 295.9	YOUGH SLOPE					
		BF 296.2						
	40	BF 296.4						
	45	BF 296.5	GRATZTOWN					
55		BF 297.8						
		BF 299.8	SCOTT HAVEN					
		BF 299.9						
		BF 300.3						
45	45	BF 300.7						
	40	BF 300.9						
55	45	BF 301.6	VISTA					
	35	BF 301.8						
	40	BF 302.2						
40		BF 303.1	SHANNER				DTC BLOCK VISTA	
	35	BF 303.2						
		BF 303.8						
50	45	BF 304.4	ROBBINS (NO. 2)					
	40	BF 305.0						
		BF 305.1	COULDER (NO. 1)					
	45	BF 305.5						
55		306.1	COULDER (NO. 2)					
		307.0						
		307.1	ALPSVILLE (NO. 1)					
50	45	BF 307.2	EMBLEM (NO. 2)	1	2	ABS-261 E-2, W-1		

KEYSTONE SUBDIVISION - MH

AUTHORIZED SPEED		MILE POST	STATION	TRACK DIAGRAM		AUTH FOR MOVE	TWC	NOTES
				↓	↓			
P 50	F 45	BF 307.3	2.9	<div style="display: flex; justify-content: space-around;"> <div style="border: 1px solid black; padding: 5px;">1</div> <div style="border: 1px solid black; padding: 5px;">2</div> </div>	<div style="display: flex; justify-content: space-around;"> <div style="border: 1px solid black; padding: 5px;">YARD LIMITS</div> </div>	ABS-251 E-2, W-1	DTC BLOCK VISTA	4
60	45	BF 308.7	ELLROD 0.7					
45	40	BF 309.7 BF 309.9 BF 311.7	CENTER ST. SINNS 132.8 MILES					
		BF 311.7 PLY 16.9	SINNS	PITTSBURGH SD	AS DISP 14 - 6 RD - 08	CPS-261	DTC BLOCK SINNS	

STATION PAGE NOTES

- NOTE 1:** All signals on the Keystone SD are signal rules 1280 – 1298.
- NOTE 2:** Mt. Savage – Eastward trains with an Approach Signal at Mt. Savage will stop at MP BF 179.6.
- NOTE 3:** Ellerslie - Eastbound trains being held at Ellerslie will STOP in the vicinity of MP BF 184.3.
- NOTE 4:** Westbound freight trains on No. 1 and No. 2 track with an approach signal at Ellrod will STOP in the vicinity of BF 309.7 unless permission is received from the train dispatcher to pass Center Street, Versailles.
- NOTE 5:** Salisbury I.T. is excepted track. 6 axle locomotives are prohibited.

KEYSTONE SUBDIVISION SPECIAL INSTRUCTIONS

1. INSTRUCTIONS RELATING TO OPERATING RULES

14-1 ENGINE HORN

Engineers must not sound horn except in case of emergency at the following road crossings:

Franklin Street
Pear Street
Valley Street
Knox Street
Baltimore Street

95 SPRING SWITCHES

Casparis – East end of No. 4 track Normal for movements on No. 2 track Speed - 20 MPH facing movement 10 MPH trailing movement 4 to 2.

100-1 ROAD CROSSINGS AT GRADE

Road Crossings – Every reasonable effort must be made to not block any road crossing in the city of Cumberland, Maryland. Cumberland city code states that no train will prevent the use of any street for the purpose of travel for a period of time longer than five (5) minutes.

103D-1 HAND BRAKES

When necessary to secure trains at the locations listed below, 30% handbrakes must be applied:

Between Ellerslie & Garrett
Between Pinkerton & Draketown
Between Ohio Pyle & Indian Creek

103D.2 Rule 103-D Exception

Crews setting off conventional TOFC-COFC, loaded spine cars, multi-platform double stack cars or single axle double-stack cars will apply 10% hand brakes plus 2 brakes.

All other equipment will be secured in accordance with Operating Rule 103-D.

104- 1 USE OF SPECIFIED TRACKS

Salisbury I.T.

The Salisbury Industrial track is excepted track from MP 0.0 to end of track. The industrial track is located at MP BF 216.3, No. 2 track, Keystone Subdivision

CSX-W&LE Connection Track

That portion of CSX owned track from the EAS Sodem to the W&LE Railroad ownership, a distance of 5,478 feet is renamed the W&LE Connection Track.

2. INSTRUCTIONS RELATING TO SAFETY RULES

NONE

3. INSTRUCTIONS RELATING TO COMPANY POLICIES AND PROCEDURES

NONE

4. INSTRUCTIONS RELATING TO EQUIPMENT HANDLING RULES

4466-1 Empty car placement Train Classification Instructions:

Empty cars 80 feet and longer (other than box cars) must be placed in the train in such a location that the trailing tonnage behind these empty cars does not exceed the amount listed below. In territory where helper locomotives are used on the rear of the train, their tonnage rating should be added to the trailing tonnage listed on this chart when determining the location for the restricted car(s).

Hyndman and Sand Patch westbound – 3,500 tons
Connellsville and Sand Patch eastbound – 5,100 tons
Connellsville and New Castle E & W – 13,300 tons

2. INSTRUCTIONS RELATING TO AIR BRAKE TRAIN HANDLING RULES

5502-1 Maximum units on line

If the temperature is less than 25 degrees Fahrenheit the following classes of locomotives must be kept on line with diesel engines running even if not needed: SW-15, MP-15, MP-15T, U18B, B30-7

Other classes in the CSXT fleet have been equipped with an automatic rev-up feature to prevent damage and can remain isolated.

5559-1 AIR BRAKE INSTRUCTIONS FOR DECENDING SANDPATCH

Brake Pipe Pressure

The brake pipe pressure on the rear of eastbound loaded trains must be 70 lbs. or higher prior to passing over summit at Sand Patch.

A running release of the train brake will not be made on eastward freight trains operating in this territory.

When the total brake pipe reduction exceeds eighteen (18) pounds on any eastbound freight

train operating in this territory, train will be stopped and sufficient hand brakes applied to the head end of the train to hold it on the grade during the recharging procedure. Three (3) hand brakes for each ten (10) cars in train will be sufficient.

Use of Pressure Maintaining Valves

Keystone Subdivision Timetable Special Instructions

The use of retaining valves will not be required on eastward trains when:

- The controlling unit of the lead locomotive consist is equipped with an operative pressure maintaining feature;
- The lead locomotive consist has a minimum of eight (8) traction motors operating in dynamic braking.

Exceptions:

Grain Trains – The use of retaining valves will be required on eastward grain trains with over 100 cars unless:

- The controlling unit of the lead locomotive consist is equipped with an operative pressure maintaining feature, and;
- The lead locomotive consist has a minimum of 12 traction motors operating in dynamic braking.

Empty Trains – The use of retaining valves will not be required on eastward trains that consist entirely of empty cars when the controlling unit of the lead locomotive is equipped with an operative pressure maintaining feature.

The use of retaining valves will not be required in eastward freight trains consisting of not more than 36 cars when the controlling locomotive is equipped with an operative pressure maintaining feature and controlling locomotive has a minimum of 4 traction motors operating in dynamic braking, or not more than 48 cars with 6 traction motors operating in dynamic braking.

Train Handling

Stretch braking is permitted for Eastward Trains between Mance and Hyndman.

Cresting Grade At Sand Patch

Stopping And Starting Train

When eastbound train will be stopped between East Portal and West Portal Sand Patch tunnel and Manila to cut off helper or for any other reason, crest the grade at Sand Patch at a speed not exceeding ten (10) MPH. Have dynamic brake fully applied in order to bunch slack and complete STOP using as small a total reduction as possible.

After stopping, all trains except grain trains will release train brakes and then wait a minimum of 10 minutes to recharge train brake

system before proceeding. Trains will be started by placing dynamic brake in full application and gradually reducing the independent brake, until the train begins to move. The independent brake should be fully released when speed reaches 5 MPH.

Grain trains will be started by using power without releasing the train brakes when possible to do so. When grain trains cannot be started in this manner, release train brakes and recharge for a minimum of 20 minutes, after which following the same starting procedure outlined for other trains.

As speed increases to 15-17 MPH with dynamic brake fully applied, make an initial brake pipe application of 5 to 7 PSI with all trains except those trains exceeding an average of 100 tons per car. With these trains, make an initial brake application of 5 to 7 PSI before speed exceeds 12 MPH. Closely monitor acceleration rate and if necessary, modulate dynamic brake, and/or make additional light reductions in order to keep speed between 25 to 30 MPH passing BF208.

Continuous Movement

As train crests grade continue to use power and make an initial application of 5-7 PSI between 20 to 22 MPH. Then gradually reduce throttle and apply dynamic brake in such a manner to have speed between 25 and 30 MPH, passing BF208.

MP BF208.0 to BF202.1 – In the vicinity of MP BF207, train speed will gradually increase due to the heavier grade. When this occurs make additional light brake applications if necessary, modulating the dynamic brake to hold speed between 32 and 34 MPH, between MP BF207 and BF202.1.

MP BF202.0 to 191.1 – Approaching MP BF202 the grade becomes less severe and the speed restriction at BF202.1 is reduced from 35 MPH to 30 MPH. Therefore, watch deceleration rate very closely, and apply power if necessary to keep speed between 20 and 30 MPH between MP BF202 and MP BF198.0. In the vicinity of MP BF197.0, grade again increases and train speed will generally begin to increase. If this occurs, it may be necessary to apply dynamic brake, or to make an additional light brake application in order to maintain speed at 30 MPH. This speed should then be maintained by modulating the dynamic brake or throttle to Hyndman MP BF191.0. Then if conditions permit, release train brakes and handle train in accordance with good train handling.

5559-2

Effective immediately, eastbound trains on the Keystone Subdivision will be governed by the following grade chart in reference to Air Brake and Train Handling Rules 5559A-2 concerning total trailing tonnage on loaded unit trains 16,001 to 19,000 tons.

Keystone Subdivision 1.0% to 1.5% Grade Requirements			
Total Trailing Tonnage (Including locomotives not in dynamic brakes)	Maximum speed for loaded unit trains (coal, grain, etc.)		
	20 MPH	25 MPH	30 MPH
	Minimum EDDBA		
16,001 to 17,000	14	17	20
17,001 to 18,000	15	18	20
18,001 to 19,000	16	18	20

Keystone Subdivision 1.51% to 1.75% Grade Requirements			
Total Trailing Tonnage (Including locomotives not in dynamic brakes)	Maximum speed for loaded unit trains (coal, grain, etc.)		
	20 MPH	25 MPH	30 MPH
	Minimum EDDBA		
16,001 to 17,000	18	20	-
17,001 to 18,000	18	20	-
18,001 to 19,000	18	20	-

6. INSTUCTIONS RELATING TO RESTRICTED EQUIPMENT

NONE

7. MISCELLANEOUS

NONE

NOTES

NOTES

LANDOVER SUBDIVISION - LO

AUTHORIZED SPEED				MILE POST	STATION	TRACK DIAGRAM		AUTH FOR MOVE	TWC	NOTES
FREIGHT SPEED						SOUTH				
50				PW LINE 128.8	CP LANDOVER			NORAC RULES 261 CSS/ATC	D	
						AMTRAK NE CORRIDOR	CTEC - 1 54 RD - 54	NI DISP 46 - 1# RD - 46	ABS-251 N-4, S-5 CSS	
NO. 2 P 25	NO. 1 F 25	NO. 2 P 25	NO. 1 F 25	QL 128.8	LANDOVER			ABS-251 N-4, S-5 CSS		1,4
				QL 130.0	SIGNAL F1300					
				QL 130.7	RUSSELL					
				QL 131.2	LANDOVER (Dispatcher Readout)					
				QL 131.5	LANDOVER					
				QL 132.4	DEANWOOD					
				QL 133.1						
				QL 133.5	BENNING YARD					2,3
25	25	25	25	QL 134.2				ABS-251 N-4, S-5 CSS		4
ANACOSTIA BR. N-2 or S-1 - 20 MPH				CFP 114.8	CP ANACOSTIA	ANACOSTIA RIVER		CPS-261 CSS		
30	30	30	30			TTB		NORAC 251 N-1, S-2 CSS		
30	30	30	30	QL 134.5		CAPITAL SD		AU DISP 19-6 RD-08		

STATION PAGE NOTES

- NOTE 1:** Norac signal rules CR-1277 – CR-1294a in effect.
- NOTE 2:** Prior to entering A or B tracks trains must have permission of the Yardmaster Benning.
- NOTE 3:** A maximum of 24 axles may be used to shove into A, B, 1 or 2 main tracks.
- NOTE 4:** Movements made against the current of traffic between Landover and Anacostia will approach facing point switches at Restricted Speed.

LANDOVER SUBDIVISION SPECIAL INSTRUCTIONS

1. INSTRUCTIONS RELATING TO OPERATING RULES

103-1 SHOVING MOVEMENTS

Shoving movements made at CP Virginia M Street southbound into Virginia Ave Tunnel to clear the northbound signal at Anacostia may be made without a trainman on the leading end under the following conditions:

1. The dispatcher is advised of the movement and places appropriate blocking devices at CP Virginia.
2. A approach signal or better is displayed at M St.
3. A fusee must be placed on the leading car shoved into the tunnel.
4. The movement must not exceed that necessary to clear the northbound signal at CP Anacostia.

167-1 Unattended Equipment

Crews leaving equipment unattended on main tracks of the Landover SD will provide the yardmaster at Benning with the information required by Operating Rule 167. The yardmaster at Benning will maintain a record of cars and/or engines left on the main tracks and notify the train dispatcher when cars and/or engines are removed.

2. INSTRUCTIONS RELATING TO SAFETY RULES

NONE

3. INSTRUCTIONS RELATING TO COMPANY POLICIES AND PROCEDURES

NONE

4. INSTRUCTIONS RELATING TO EQUIPMENT HANDLING RULES

NONE

5. INSTRUCTIONS RELATING TO AIR BRAKE AND TRAIN HANDLING RULES

5502-1 POWERED AXLES FOR SHOVING MOVEMENTS

A maximum 24 axles is allowed for shoving movement into A or B tracks and 1 or 2 main tracks.

5502-2 POWERED AXLES

Train handling rule 5502-A is modified to permit 27 powered axles for the operating locomotives that are pulling a train or cut of cars on the Landover Subdivision.

6. INSTRUCTIONS RELATING TO EQUIPMENT RESTRICTIONS

1. Cars exceeding Plate F must not operate on Amtrak's Northeast Corridor between Landover and Grove.
2. Cars exceeding Plate C must not operate on Amtrak's Northeast Corridor on No. 2 and 3 main tracks between Landover and Grove.
3. Conductors of trains operating on Northeast Corridor between Landover and Grove must check their consists for the above listed restricted cars if advised to operate on 2 or 3 main tracks.

7. MISCELLANEOUS

NONE

NOTES

LURGAN SUBDIVISION - LR

AUTHORIZED SPEED	MILE POST	STATION	TRACK DIAGRAM		AUTH FOR MOVE	TWC	NOTES
			WEST	EAST			
			NS HARRISBURG DIV	HARRISBURG TERMINAL DISP 58 - 3#, RD - 58	NORAC RULES		
25	BAV 32.2	LURGAN	32.1-32.2	4453	TWC-DTC		1
	BAV 26.2	CULBERTSON				DTC BLOCK KOBEEEN	
	BAV 24.8	PLAINFIELD					
25	BAV 22.57	CHAMBERSBURG EAST	24.4-End of Track	4453	TWC-DTC		2, 3
10	SDG. 10 MPH	CHAMBERSBURG WEST BRANDON	End of Track-20.3 4453		TWC-DTC	DTC BLOCK GRIND	
	19.8	CONBOY	EHR 4453 SIDING 18.1-16.1 MAIN 16.4-16.1 & 15.0-14.0			DTC BLOCK WING	
	12 MPH NORTHERN AVE - EB HEAD END ONLY	WAYNECASTLE			TWC-DTC		
25	BAV 8.9	PIKE TOWN	OVER RD. CROSSING HAGERSTOWN 10 MPH	PIKE YL	193 YL	SECURITY YL	
25	BAV 0.0		HANOVER SD				
10	HW 73.7	CP TOWN		NS RY.	NORAC 600-616	D	
10	BAE 86.7 BAE 87.3	ANTIETAM ST. HAGERSTOWN YARD	YARD CH 70		193 YL	ANTIETAM YL	
40	BAE 89.9	DTC BLOCK SIGN	88.0		TWC-DTC		
35	BAE 92.3						DTC BLOCK GATE
40	BAE 92.6		13.3				
30	BAE 95.0						
40	BAE 95.2						
40	BAE 99.7	DTC BLOCK SIGN BIG SPRING	EOT 1% GRADE REFERENCE				DTC BLOCK POOL
	100.0 101.0		92.5				
	BAE 104.9	BIG POOL					
25	BAE 105.5	DTC BLOCK SIGN	6.7		TWC-DTC		
	BAE 106.4	CHERRY RUN	50.23 MILES		93 243-246 WB	CHERRY RUN YL	4
40	BA 113.6	CHERRY RUN			CM DISP 94 - 4 RD - 08	DTC BLOCK SLEEPY	

STATION PAGE NOTES

- NOTE 1:** Eastbound trains clearing the Lurgan SD must report clear to the AV Dispatcher
- NOTE 2:** Chambersburg Industrial Track: Derailer must not be operated without permission of the NS Harrisburg Terminal Dispatcher.
- NOTE 3:** Gate at Letterkenny Army Depot must remain closed during the time a train is switching, and must be closed when train leaves. Sound the engine horn at all crossings within the facility.
- NOTE 4:** Operating rules 243-246 are in effect for westbound movements only. Trains must have dispatcher permission to enter these limits and must report clear.

LURGAN SUBDIVISION SPECIAL INSTRUCTIONS

1. INSTRUCTIONS RELATING TO OPERATING RULES

DEF-1 EXCEPTED TRACKS

Hagerstown Industrial Track

193-1 Yard Limits

Crews will obtain permission of the Train Dispatcher before occupying yard limits.

Road Crossings at Grade

100-1 Stop and flag the following road crossings at Hagerstown:

Burhans Blvd.	Steffey and Findley
Summit Ave.	Industrial Track
Garlinger Ave.	" "
Oak Ridge Dr.	" "
Poffenberger Rd.	" "
Wagman Rd.	" "
Leslie Dr.	" "
Plainfield	
Salem Rd.	County Road
MP 19.9	
Antietam IT	
Rose Hill Rd.	
Kuhn Ave.	
Wilson Blvd.	
Oak St.	
First St.	
Frederick St.	
Eastern Ave.	

Trains must STOP and flag highway crossings at grade between MP BAV 0.0 and MP BAV 32.2 unless it can be determined that crossing warning devices have been operating for a minimum of 20 seconds before the train reaches the crossing, per Rule 100E, 7, b. Lurgan Subdivision, from MP BAV 0.0 to MP BAV 32.2.

100-2 Chambersburg, PA

Stop and Flag S. Main Street, Chambersburg, MP 20.7.

103-1 Handbrakes

All cars set off on the following industry tracks must have 100% handbrakes applied:

Purina Mills
Drisco Pipe

At all other industries, not less than 50% handbrakes must be applied. Handbrakes must be tested in accordance with Rule 103C.

104-1 Switches

The normal position for the hand thrown switch at CP Town is for movement CP Town to the Hanover SD.

Use of Specified Tracks

96-1 Hagerstown Yard – All tracks from Antietam St. to BAE 89.9.

Unless instructions have been received before arrival BAE 89.9, eastbound trains must communicate with train dispatcher before proceeding.

96-2 Hagerstown Yard - Cars handled on west end of an engine on the westbound descending grade at west end of yard must have operative air brakes and air coupled through all cars and members of crew in place to control cars by effective handbrakes.

96-3 Hagerstown I.T., BAW 19.0 end of track, BAW 22.0 Security Jct., BAW 23.9 Hagerstown.

6 Axle Units Must Not Operate

96-4 Antietam I.T. Mileposts are BET 0.0 Security Junction and BET 3.0 Security

2. INSTRUCTIONS RELATING TO SAFETY RULES

2101-1 Getting On and Off Moving Equipment

Mounting or dismounting moving equipment will be permitted between BAE 87.3 and BAE 89.5, only when necessary to avoid severe train handling problems associated with physical characteristics of the specific location and to avoid injury due to slack action. Mounting or dismounting moving equipment will not be permitted when speeds or conditions render it unsafe.

3. INSTRUCTIONS RELATING TO COMPANY POLICIES AND PROCEDURES

NONE

4. INSTRUCTIONS RELATING TO EQUIPMENT HANDLING RULES

NONE

5. INSTRUCTIONS RELATING TO AIR BRAKE AND TRAIN HANDLING RULES

5200-1 Ground Air

Westward trains from Lurgan arriving at Hagerstown must be secured and left on ground air unless otherwise instructed.

5203.B.3-1 Unit Coal Trains

All unit coal trains being interchanged to the NS at Lurgan will carry an air brake inspection and test certificate on the lead locomotive in accordance with ABTH Rule 5203.B.3.A. If certificate is not available, contact TM at W. hump in Cumberland for a duplicate copy.

NOTES

Jacksonville customer service center will issue both work orders and computer generated air brake inspection and test certificate to the crew pulling and making the test at the origin mine. This air certification will remain with the train to the final destination. Trains will clearly be identified as train VXXXYY (XXX identifies the train symbol and YY the date) to all crews pulling these trains from the mine.

At crew change locations where locomotives are left on the train, inbound engineer will leave air brake inspection and test certificate on control stand of lead locomotive.

At locations where locomotives are changed, inbound engineer will make arrangements with yardmaster or train dispatcher as to where the certificate is to be left.

If another air brake inspection and test certificate becomes necessary, the yardmaster, operator or train dispatcher will notify the Jacksonville Service Center who will issue another certificate to the outbound engineer. The outbound engineer will notify the proper authority if he/she does not receive a blank air certificate. Also, if the outbound engineer is unable to find the air certificate on his/her train, it must be reported to the train dispatcher.

6. INSTRUCTIONS RELATING TO RESTRICTED EQUIPMENT

NONE

7. MISCELLANEOUS

NONE

NOTES

NOTES

NOTES

METROPOLITAN SUBDIVISION - ME

AUTHORIZED SPEED	MILE POST	STATION	TRACK DIAGRAM		AUTH FOR MOVE	TWC	NOTES		
			WEST	EAST					
AMTK 20	BA 0.0	WASHINGTON	WASHINGTON TERMINAL		NORAC 600-616	D			
P	F	BAA 37.0	F TOWER	CAPITAL SD	AU DISP 14-6 RD-08	AMTK K TOWER CH 54	CPS-261	DTC BLOCK IVY	
70	55								
P	F	BA 1.0	F TOWER / C TOWER	1	2	MAIN	ABS-261	DTC BLOCK WASH	1
30	30		1.1						
60		BA 2.1	QN TOWER			AU DISP 14-6 RD-08	CPS-261		2
		BA 4.0	TERRA COTTA	1.9					
		BA 6.4	TAKOMA PARK	2.4	1	2	ABS-261	DTC BLOCK SPRING	
		BA 7.5	SILVER SPRING (P)	1.9					
60	30	BA 8.3	GEORGETOWN JCT.				CPS-261		2
70	55								
		BA 9.3					ABS-261		
55	50					GEORGETOWN I.T.			3
		BA 10.6		2.9					
70	55	BA 11.0	KENSINGTON (P)						
		BA 11.2	KENSINGTON						
		BA 11.7	KENSINGTON	(2) HBD-DED-HCD				DTC BLOCK RAND	
		BA 12.2							
79		BA 12.4	GARRETT PARK(P)	2.5					
		BA 13.7	RANDOLPH ROAD						
		15.0		3.0					
		16.0							
70		BA 16.7	ROCKVILLE (P)						
		BA 17.2		2.9			ABS-261		
79		BA 19.6	DERWOOD				CPS-261		
		BA20.5							
75		BA 20.8	WASHINGTON GROVE (P)				ABS-261		
79		BA 21.6	GAITHERSBURG (P)						
65		BA 21.9		2.6					
		BA 22.2	WARD						
		BA 23.6	METROPOLITAN GROVE (P)	2.2				DTC BLOCK BOYD	
79		BA 24.3	CLOPPER						
		BA 24.4	CLOPPER	(1) HBD-DED-HCD					
		BA 24.9							
65		BA 26.4	GERMANTOWN (P)	3.0					
		BA 26.6							
79		BA 27.4	SENECA FILL		1	2			
		BA 28.9	BOYD (P)	2.6			ABS-261		
		BA 30.0	BUCK LODGE				CPS-261	DTC BLOCK BARN	
	55								

METROPOLITAN SUBDIVISION - ME

AUTHORIZED SPEED		MILE POST	STATION	TRACK DIAGRAM		AUTH FOR MOVE	TWC	NOTES
				WEST				
P	F	BA 31.0				ABS-261		
70	55	BA 32.9	3.5					
79		BA 33.2 BA 33.3 BA 33.5		33.1	1 2		DTC BLOCK BARN	
		BA 34.9						
70		BA 35.5	3.5	1% EOT GRADE REFERENCE				
		BA 36.4						
		BA 36.7			PEPCO	ABS-261		
65		BA 37.0				CPS-261		
		BA 37.3		37.3		ABS-261		
79		BA 38.5	2.3					
		BA 38.7						
79		39.0 39.3 39.9					DTC BLOCK PEP	
		40.0						
70		BA 40.2	3.3		1 2			
		BA 41.6				ABS-261		
65	55	BA 42.6				CPS-261		
			0.2	OML SD		ABS-261		
30	30	BA 42.8				CPS-261		4
		BA 69.2				ABS-261		
		BA 69.4	1.9					
60	40	BA 70.1			1 2			
		BA 70.3						
		BA 70.4						
55	40	BA 70.5					DTC BLOCK ROCK	
		BA 70.6	2.6					
40	35	BA 70.8						
60	40	BA 72.1				ABS-261		
		BA 72.2						
		BA 72.5						
60		BA 73.1				CPS-261		
60	40		2.5			ABS-261		

METROPOLITAN SUBDIVISION - ME

AUTHORIZED SPEED		MILE POST	STATION	TRACK DIAGRAM		AUTH FOR MOVE	TWC	NOTES
				↓	↓			
P 60	F 40	BA 75.6	WB TOWER	WEST		ABS-261		
MAPLE AVE. 50				OPERATOR WB CH 08	2	2	CPS-261	
60	40	BA 78.0	3.2	3 RUNNER	4 RUNNER	ABS-261		
40	35	BA 78.8	WEVERTON	1	2	CPS-261		
			52.9 MILES					
40	35			CUMBERLAND SUBDIVISION	CM DISP 94 - 4 RD - 08	ABS-261		

STATION PAGE NOTES

- NOTE 1:** All signals on the Metropolitan SD are signal rules 1280-1298.
- NOTE 2:** Corridor integrity monitor is in service between MP BA 2.6 and BA 8.4. See SD special instructions for operation.
- NOTE 3:** Georgetown I.T. is designated excepted track. MP are BAB 0.2 to BAB 0.23.
- NOTE 4:** The distance between MP BA 42 and MP BA 69 is 6269 FT. Mileposts 43 through 68 are not used.

METROPOLITAN SUBDIVISION SPECIAL INSTRUCTIONS

1. INSTRUCTIONS RELATING TO OPERATING RULES

Def –1 Excepted Tracks

Georgetown Industrial Track BAB 0.2 and BAB 0.23

14-1 Engine horn will be sounded 2 long sounds approaching stations between 0500 and 2100 hours

The horn will be sounded beginning approximately 1100 feet from the station. Additional warnings will be sounded as necessary. At other times the whistle will not be sounded at passenger stations unless people are present.

PW signs designate whistle sound requirements At passenger stations.

EMERGENCY BRAKE APPLICATIONS

METROPOLITAN SUBDIVISION Ivy City – AMTRAK overpass.

90-1 Should your train sustain an emergency application of the brakes, in addition to the requirements of Operating Rule 102 to make emergency on AAR 08, also make emergency transmissions on channel AAR 54 before notifying our train dispatcher. EX: “Emergency, Emergency, Emergency, CSX Train Q41029 is in Emergency on CSX at Ivy City.”

USE OF SPECIFIED TRACKS

Table 11. Use of Specified Track

Location or Tracks	Instructions
96-1 Brunswick: No. 3 Running Track	Westward Movements will be made on verbal permission from operator WB Tower. Operator WB Tower will ascertain from AU Dispatcher that blocking devices are in place on Eastbound signals and/or switches to number 3 track at Weverton before permitting movement.
96-2 No. 4 Running Track	Westward movements will be made on verbal permission from operator WB Tower, who must know track is clear of opposing movements. Operator at WB Tower will ascertain from AU Dispatcher that blocking devices are in place on Eastbound signals and/or switches to number 4 track at Weverton before permitting movement.

Location or Tracks	Instructions
96-3 No. 5 & No. 6 Running Tracks Ready Track	Movements on these tracks will be made on permission of the Yardmaster at Brunswick, MD. Before engines are moved from the ready Track, or before fouling any other track or Ladder Track, permission must be obtained from the Yardmaster at Brunswick, MD.

2. INSTRUCTIONS RELATING TO SAFETY RULES

2150-1 Main Line – Washington to Weverton

Close Clearance

- 1) Martin-Wiegand Lumber – against the dock
- 2) Montgomery Co. Liquor – against the dock

2150-2 Northeast Waste Management Recovery Plant:

The overhead bridge located in the area of the crossover at the Northeast Waste Management Recovery Plant, Pepco, has substandard clearance.

3. INSTRUCTIONS RELATING TO COMPANY POLICIES AND PROCEDURES

NONE

4. INSTRUCTIONS RELATING TO EQUIPMENT HANDLING RULES

NONE

5. INSTRUCTIONS RELATING TO AIR BRAKE AND TRAIN HANDLING RULES

5604 B Helpers

Helpers on train destined east of “JD” will normally be detached at Derwood, MP BA 19.6. Head-end helpers should be detached before the head end passes Derwood, and rear-end helpers should be detached east of the W.A.S Derwood.

Trains requiring helper to remain attached, such as those requiring assistance over Jones Hill on the Alexandria Extension, will not apply power when any part of the train being shoved is along the Metro Corridor between the following points:

Derwood, MP BA 19.6 and Randolph, MP BA 14.1

Georgetown Junction, MP BA 8.2 and QN, MP BA 2.0.

NOTE: In event of inoperative dynamic brakes, train will be controlled by stretch braking method making reduction before half the train has crested Barnesville.

6. INSTRUCTIONS RELATING TO RESTRICTED EQUIPMENT

Location	Equipment	Restriction
Brunswick/No. 1 Main Track	Shipments between 12 ft. 3 in. and 12 ft. 8 in width	Must not exceed 10 MPH Passing any equipment on north lead from East Brunswick to WB Tower

7. MISCELLANEOUS

Joint CSXT – WMATA (Metro) Emergency Notification Procedures

A During the days and hours of commuter train operations, please avoid if possible, blocking passenger stations at the following locations:

Pt. Rocks, MP BA 42.8, when operating on #1 track.

Metropolitan Grove, MP BA 23.7, when operating on #2 track.

Garrett Park, MP BA 12.6, when operating on #2 track.

NOTE: If your train will unavoidably block any of these specific locations, contact the train dispatcher for further instructions.

B The following procedures must be strictly adhered to for emergency notification and safety precautions on the Metropolitan SD between BA2.1 and BA8.3 known as the joint CSXT – WMATA (Metro) corridor.

a) Jacksonville Dispatcher:

- 1) The WMATA (Metro) hot line between the “AU” Dispatcher Jacksonville and Metro must be tested daily and records of the test maintained in the dispatching center.
- 2) Any emergency situation within a metro corridor such as, but not limited to, trains in emergency, derailments, etc., that could in any way affect the safety of the metro train operations, or the activation of any warning alarms, will require the attention of the “AU” Dispatcher to immediately contact the WMATA (Metro) control center via the “hot line” telephone and advise the metro control center of the situation.

The “AU” Dispatcher will immediately stop all CSXT trains moving within the affected corridor or approaching that corridor and hold such trains until it can be ascertained from both CSXT and Metro personnel that all train operations may be safely resumed. After the “AU” Dispatcher is assured that all CSXT trains have been stopped, he/she will so inform Metro.

When the Chief Train Dispatcher or the “AU” Dispatcher has been informed by both CSXT and Metro personnel that the emergency conditions have been fully corrected on both CSXT and Metro, and it is determined that safe train operations may be resumed, he/she will inform all affected CSXT trains and allow them to resume operation as he/she directs.

- 3) In addition to these instructions, the “AU” Dispatcher in Jacksonville must at all times, take any other action as deemed necessary, to provide protection and safety to all trains operating with the joint CSXT – WMATA (Metro) corridors.

Train and Engine Employees:

- 1) Train crews must immediately make an emergency call to the “AU” Dispatcher in Jacksonville when any emergency condition is encountered such as, but not limited to, their train brakes applied in emergency application, a derailment, a track condition or obstruction etc., that may endanger the safety of the train traffic or the public.

An emergency condition will also include the activation of any recorded radio messages, conditions associated with the weather, other trains or work forces of either CSXT or Metro, and any interference from outside parties not associated with CSXT or metro. Your attention is directed to Operating Rule 514.

- 2) Emergency calls will not relieve employees of full compliance with Operating Rule 102.

b) Signal, Communication and Engineering Employees:

Whenever any emergency conditions are observed on either CSXT or Metro that may interfere with the safety of trains or the public, the condition must be immediately reported to the “AU” Dispatcher in Jacksonville by the quickest means available.

In addition, employees when possible, must communicate the emergency condition to any trains, other CSXT employees or Metro personnel in the affected area.

c) **All Employees:**

The "AU" Train Dispatcher in Jacksonville may be contacted in emergency by following the instructions as found in this timetable under items 1006.05 (Emergency Radio Call-in Procedure).

The chief train dispatcher in Jacksonville may be contacted FOR EMERGENCY PURPOSES ONLY by calling 1-800-232-0143.

If there is any doubt as to the proper application of these procedures, contact your local supervisor for clarification.

C - Brunswick Yard

M1 Crossover at Brunswick:

The normal position for M1 crossover, located at BA74.8, in Brunswick, will be lined and locked for crossover movement.

This crossover is equipped with a lock and banners.

Setting Off In Yard

Trains setting off a solid block of flat cars with trash containers attached will pull into or shove into only a clear track within Brunswick Terminal.

MON SUBDIVISION - M4

AUTHORIZED SPEED	MILE POST	STATION	TRACK DIAGRAM		AUTH FOR MOVE	TWC	NOTES
			WEST	WEST			
10	0.0	CP BROWN	NS PITTSBURGH DIVISION	NS MGA NS PITTSBURGH LINE DISP. CH 64	NORAC RULES CPS-261		
10	PLM 53.9 PLM 53.3	BROWN	NEWELL RUNNING TRACK	EAST SECONDARY	46		1
	PLM 51.6		4 CROSSOVER 3 CROSSOVER	EAST MIDDLE SECONDARY	46	ALL TRACKS 46.0 TO 53.9 RULE 105	1
	PLM 49.5	NEWELL YARD OFFICE	7.9 AS DISP 14-6 RD-08 2 CROSSOVER 1 CROSSOVER	MIDDLE SECONDARY			1
			NEWELL COAL DIRECTOR, CH-08 SEE NOTE 4	2 YARD 1 YARD WEST SECONDARY			4
10	PLM 47.7				46		1
25	PLM 46.0	DTC BLOCK SIGN WEST END NEWELL	AD	MAIN	TWC-DTC		1
	PLM 45.0	MP 45 (TYPE 1)				DTC BLOCK FAYETTE	2
	PLM 40.7	DTC BLOCK SIGN ROSTRAVER	5.3	MAIN			2
			2.9	ROSTRAVER SIDING		DTC BLOCK MONESS	2
	PLM 40.2	ROSTRAVER CROSSOVER MONESSEN		SS			2
SDG 25	PLM 37.8	DTC BLOCK SIGN SHEPLER	2.9	SS		DTC BLOCK WEBB	2
	PLM 35.9	DTC BLOCK SIGN WEBSTER	11.6	SS		DTC BLOCK BUNOLA	2
	PLM 27.2	BUNOLA		CAMP/PL/CANASTRL SIDING			2
25	PLM 24.3	DTC BLOCK SIGN		MAIN			2
	PLM 23.0						2
10	PLM 22.2	ELIZABETH	6.6	AD		DTC BLOCK BELL	3
25	PLM 21.9			SS			2
	PLM 20.0	MP 20 (TYPE 1) DTC BLOCK SIGN COURSIN		AD			2
	PLM 19.8			SS			2
	PLM 17.6	GLASSPORT		GLASSPORT SIDING		DTC BLOCK GLASS	2
25	PLM 16.8 PLM 15.3	HARRISON ST McKEESPORT 38.6 MILES			TWC-DTC		2
P & F							
NO. 1 25	NO. 2 20	PLY 15.3	McKEESPORT (CP 15Y)	PITTSBURGH SD	AS DISP 14-6 RD-08	CPS-261	DTC BLOCK SINNS

STATION PAGE NOTES

- NOTE 1:** Radio controlled switches are used at Newell. Refer to special instructions for operation.
- NOTE 2:** Refer to special instructions for spring switch positions and signals.
- NOTE 3:** Refer to special instructions for use of horn at Elizabeth.
- NOTE 4:** Trains will receive arriving and departing instructions from the CSX Coal Director at Newell.

MON SUBDIVISION SPECIAL INSTRUCTIONS

1. INSTRUCTIONS RELATING TO OPERATING RULES

14-1 Engine Horn Instructions

PLM 21.9 and PLM 23.0 – Elizabeth – Engine horn and bell must be sounded at street intersections in Elizabeth, except between the hours of 2200 and 0600.

Normal grade crossing horn signal (14l) to be sounded when approaching the town of Elizabeth from either direction.

A short horn blast only, to be sounded approximately at each of the seven streets that intersect the main track in Elizabeth.

NOTE: Horn must be sounded anytime, when needed to warn people or vehicles on or near the tracks.

36-1 Spring Switches

36-A.2 applies

PLM 37.8 Webster Siding East end
Normal position Westward – facing point to main track.
25 MPH facing and trailing movement

PLM 35.9 Webster Siding West end
Normal position eastward – facing point for siding 25 MPH facing and trailing movement

PLM 19.8 Glassport siding switch East end
Normal position westward – facing point for main track 25 MPH facing movement 10 MPH trailing movement

a) Color light spring switch indicator signals are located in the vicinity of the above named switches, which will display the following aspects:

Color light signals

1. A green light indicates that the switch is properly lined in the normal position.
2. A red light indicates that the switch may not be properly lined.

b) Color light spring switch approach signals are in service at approximate mileposts as indicated below:

1. Westward approach signal at MP PLM 40.3 Rostraver.
2. Eastbound approach signal at MP PLM 33.8 Sunnyside
3. Westward approach signal at MP PLM 21.6 Wylie.

c) Approach spring switch signal aspects

1. Yellow – indicates spring switch signal is displaying a red aspect.
2. Green – indicates spring switch signal is displaying a green aspect.

Road Crossings at Grade

100-1 State laws make it unlawful for a train, railroad car or engine to obstruct public travel at a public crossing at grade for an excessive period of time, except where such train, railroad car or engine cannot be moved by reason or circumstances over which the railroad has no control as follows:

Pennsylvania – over 5 minutes (15 minutes at private crossings)

If a train is delayed an excessive period of time, train crews must document the date, time of blockage, city, state, road crossing, and circumstances. This information must be forwarded to the supervisor in charge of the territory.

100-2 Glassport –

1. Trains or engines moving westward on the Glassport Siding must comply with Operating Rule 100-E (7) at Harrison St. road crossing due to short approach circuit for automatic crossing protection.
2. Trains and engines using Glassport Siding must comply with Operating Rule 100-E (7) at all road crossings with automatic protection due to rusty rail conditions.
3. All trains using westend of GTC Yard, placing or pulling cars, must avoid blocking the road crossing to GTC (MON Valley Trans.) and Plotkins Bros. If at all possible. During the hours of 0800 to 1800, all coal trains coming out of Newell, PA destined to GTC at Glassport, PA are to use the east end of the yard to deliver their trains to GTC, unless otherwise instructed. During the hours of 1800 to 0600 trains will use the access from the west end of the yard to place their trains in GTC.

100-3 Elizabeth –

1. Eastward trains not having a Bunola DTC Block authority must STOP west of road crossing at approximate MP PLM 21.6 to avoid blocking road crossings in the Wylie/Elizabeth areas.

100-4 Monessen –

1. Trains and engines using Rostraver Siding must comply with Operating Rule 100-E (7) at all road crossings with automatic warning devices due to rusty rail conditions.

100-5 Newell –

1. Westbound and eastbound trains changing crews in the Newell area must avoid stopping on circuits and activating automatic crossing warning devices.
2. Trains using the secondary track must comply with operating rule 100-E (7) at Morgan and Miller Streets account short approach circuits and/or rusty rail conditions.

104-1 Switches

A) Hydraulic Switches at Newell, PA

Item 1. Hydraulic switches placed in service at the following locations:

- a. MP PLM 47.7 – ‘E’ secondary to main
- b. MP PLM 49.1 – West Crossover main to ‘E’ secondary
- c. MP PLM 49.1 – East Crossover main to ‘E’ secondary
- d. MP PLM 49.2 – West Crossover main to ‘E’ secondary
- e. MP PLM 49.2 – East Crossover main to ‘E’ secondary
- f. MP PLM 51.6 – West Crossover main to ‘E’ secondary
- g. MP PLM 51.6 – East Crossover main to ‘E’ secondary
- h. MP PLM 53.3 – ‘E’ secondary to main

NOTE: Above named hydraulic switches are considered ‘hand-operated switches.’

Unless otherwise directed, train crews may leave hand thrown switches and crossovers in last used position, between CP Brown and PLM 47.7, except hand thrown switch at PLM 53.6 to Assad Iron and Metal must be relined for normal movement.

Item 2. Operation of the hydraulic switches

- a. Remote radio control from radio equipped with ‘keypad’
 1. West end switch at MP PLM 47.7
 - Normal or reverse – key #4741
 - Switch position inquiry – key #4743
 2. Crossover No. 1 – West Crossover at MP PLM 49.1
 - Normal – key #4911
 - Reverse – key #4913

3. Crossover No. 2 – East Crossover at MP PLM 49.2
 - Normal – key #4921
 - Reverse – key #4923
4. Crossover No. 3 – West Crossover at MP PLM 51.6
 - Normal – key #5161
 - Reverse – key #5163
5. Crossover No. 4 – East Crossover at MP PLM 51.6
 - Normal – key #5141
 - Reverse – key #5143
6. East end switch at MP PLM 53.3
 - Normal or Reverse – key #5361
 - Switch Position Inquiry – key #5363

B) Push button Control

1. Operation toggle switch or push button is located at the switch inside a small metal box locked with a CSX switch lock.

NOTES:

1. If points are gapped, amber strobe light will light and remain lit until points are cleared of obstruction.
2. If points are gapped, no radio confirmation of throw will be announced over radio.
3. When train is in protection zone (loop in switch area installed on ties), switch is inoperable. Manual button or radio control cannot throw switch.

C) Hand Throw Operation

Hand throw pump and the following instructions will be found in the black metal box located at the base of the switch.

1. Insert the pump handle into the pump socket.
2. Locate the directional valve on the front face of the pump manifold.
3. Place the valve handle in the appropriate position.
 - a. To move the switch points toward the switch machine, rotate the valve handle “clockwise” or “down”.
 - b. To move the switch points away from the switch machine, rotate the valve handle “counter clockwise” or “up”.
4. Move the pump handle up and down until the points are firmly against the stock rail (approximately 20 pumps)
5. Visually check to assure a good closure of the points. Always move the valve handle to the center position after completing the manual positioning of the points and before closing the hand throw cover.

- A. Newell –
 - 1. Newell Running Track from Brown, PLM 53.9 to PLM 46.0.
 - 2. 'E' Secondary Track from PLM 53.5 to PLM 47.7.
 - 3. Yard Tracks – Track Designations at P PLM 49.5 from North to South are Track 1, Track 2, Stub track, Welland Chemical Lead track.
 - 4. Yarding Purposes – The main and 'E' Secondary Track between MP PLM 53.3 and MP PLM 47.7 are divided and designated as follows:
 - a. East – Between MP PLM 53.3 and crossover at MP PLM 51.6
 - b. Middle – Between crossover MP PLM 51.6 and crossover MP PLM 49.5
 - c. West – Between crossover MP PLM 49.5 and MP PLM 47.7

2. INSTRUCTIONS RELATING TO SAFETY RULES

NONE

3. INSTRUCTIONS RELATING TO COMPANY POLICIES AND PROCEDURES

NONE

4. INSTRUCTIONS RELATING TO EQUIPMENT HANDLING RULES

4451– 1 Wreck Cranes

- A. Wreck cranes must not be moved over any bridge unless separated from engines by a spacer car having a gross weight not exceeding 160,000 lbs., with minimum truck centers of 30 feet.
- B. Wreck cranes must not be placed on any bridge for the purpose of handling any car without permission of the Division Engineer.

5. INSTRUCTIONS RELATING TO AIR BRAKE TRAIN HANDLING RULES

NONE

6. INSTRUCTIONS RELATING TO RESTRICTED EQUIPMENT

NONE

7. MISCELLANEOUS

NONE

OLD MAIN LINE SUBDIVISION - OM

AUTHORIZED SPEED		MILE POST	STATION	TRACK DIAGRAM		AUTH FOR MOVE	TWC	NOTES
				↓	↓			
P	F							
50	40	BAA 5.8 <small>BAC 5.9/BAA 5.9</small>	HALETHORPE			CPS-261	DTC BLOCK HALE	
25		BAC 6.8 BAA 7.0 BAC 7.4	ST. DENIS (P) RELAY 2.0	SPUR (2) HBD		ABS-261	DTC BLOCK DENIS	1 2
30		BAC 7.9 8.0 9.0	EAST AVALON 1.9			CPS-261 ABS-261	DTC BLOCK AVALON	
		BAC 9.8	WEST AVALON			CPS-261 ABS-261		
30		BAC 10.5 BAC 12.5	ELLICOTT CITY 2.2		ILCHESTER TUNNEL - 1,404 FT. TTB PATAPSCO	ABS-261		
25		BAC 12.7 BAC 12.8 BAC 15.1 BAC 15.2 BAC 17.8 BAC 18.1	ELLICOTT CITY 2.7 UNION DAM DANIELS DANIELS		UNION DAM TUNNEL - 810 FT. HBD-DED		DTC BLOCK WEBER	
		BAC 19.1 BAC 19.9	2.2 EAST DAVIS		DORSEY TUNNEL - 1,022 FT. DAVIS TUNNEL - 497 FT.	ABS-261 CPS-261		
		BAC 20.0	1.9		SSDG 9,200 FT	ABS-261	DTC BLOCK DAVIS	
		BAC 21.9	WEST DAVIS			CPS-261 ABS-261		
		BAC 24.1 BAC 25.1	MARRIOTTSVILLE 2.2		HENRYTON TUNNEL - 430 FT.	ABS-261		
		BAC 26.2	GORSUCH 2.1				DTC BLOCK SYKES	
		BAC 29.0 BAC 29.6	SYKESVILLE 2.8					
25		BAC 30.1	2.5		SYKESVILLE TUNNEL - 240 FT.	ABS-261		
30		BAC 31.5	EAST HOOD			CPS-261 ABS-261		
		BAC 32.0	1.6		SSDG 8,253 FT	ABS-261	DTC BLOCK HOOD	
35		BAC 33.1	WEST HOOD			CPS-261 ABS-261		
		BAC 33.6	2.7		WOODBINE TUNNEL - 385 FT.	ABS-261		
		BAC 36.1	WATERSVILLE 3.0				DTC BLOCK WATER	
		BAC 38.9 BAC 38.9	TWIN ARCH RIDGEVILLE		HBD-DED			
35		BAC 40.3	2.3		MT. AIRY TUNNEL - 2,758 FT.	ABS-261		

OLD MAIN LINE SUBDIVISION - OM

AUTHORIZED SPEED	MILE POST	STATION	TRACK DIAGRAM		AUTH FOR MOVE	AUTH FOR MOVE	NOTES
			↓	↓			
35			WEST		ABS-261	DTC BLOCK WATER	3
	BAC 41.1	EAST PLANE	MT. AIRY I.T.		CPS-261		
		2.1	SSDG 10,750 FT.		ABS-261	DTC BLOCK PLANE	
	BAC 43.2	WEST PLANE			CPS-261		
35	BAC 46.1	MONROVIA	2.9		ABS-261	DTC BLOCK JAM	
30	BAC 47.9		3.2				
25	BAC 49.3	IJAMSVILLE					
	BAC 50.8		2.1	HARTMAN TUNNEL - 215 FT.			
	BAC 51.2				ABS-261		
P	F						
35	30	BAC 51.3					
35	BAC 51.4	EAST REEL			CPS-261	DTC BLOCK REEL	5 5
		2.4	SSDG 11,950 FT.		ABS-261		
	BAC 53.8	WEST REEL			CPS-261		
35			0.4	MONOCACY R.		ABS-261	5
	BAC 54.2	FREDERICK JCT.		MARC FREDERICK BR.		CPS-261	
P	F						
45	40	BAC 54.9	2.2		ABS-261	DTC BLOCK LIME	
45		BAC 56.4	LIME KILN	2.6			
	59.0	MANOR WOOD	3.0	EASTALCO			
45	60.0				ABS-261		
40	BAC 62.0	DOUB			CPS-261	DTC BLOCK DOUB	
P	F						
45	40	BAC 63.0		3 4	ABS-261		
45		BAC 64.2	2.3				
30	WYE 25P, 15F	BAC 64.3	SATTERWHITE			CPS-261	
		BAC 64.7	POINT OF ROCKS				
30	BA 42.8	59.2 MILES POINT OF ROCKS		<div style="border: 1px solid black; padding: 2px; display: inline-block;">METROPOLITAN SD</div>			

STATION PAGE NOTES

- NOTE 1:** All signals on the Old Main Line SD are signal rules 1280-1298.
- NOTE 2:** Eastbound trains will stop to clear St. Denis Station between 0545 and 0845, and between 1745 and 1945 daily, except Saturday, Sunday and Holidays, unless signal aspect more favorable than Restricted Proceed is displayed at Halethorpe.
- NOTE 3:** No more than 3 cars at a time may be dropped on the Mt. Airey Industrial Track. Mt. Airey Cold Storage may have an engine operating between 674 feet west of Hill Street to Hill Street. Be alert.
- NOTE 4:** Trains required to STOP between Doub and Point of Rocks must not block farm crossings at MP 62.9 and 63.2.
- NOTE 5:** For clearance purposes allow 6200 feet East Reel to Reels Mill Rd; 5200 feet Reels Mill Rd to West Reel; and 7100 feet Reels Mill Rd to Frederick Junction.

**OLD MAIN LINE SUBDIVISION - OM
FREDERICK BRANCH
(MARYLAND DEPT. OF TRANSPORTATION OWNERSHIP)**

AUTHORIZED SPEED	MILE POST	STATION	TRACK DIAGRAM		AUTH FOR MOVE	TWC	NOTES	
			←	→				
45	BAC 54.2	FREDERICK JUNCTION	← EAST →		CPS-261			
E WYE - 15 P, 10 F W WYE - 15 P, 10 F	BAX 0.0	FREDERICK JUNCTION	EAST WYE	WEST WYE	ABS-261	DTC BLOCK MONO	1,2	
P F	BAX 0.15	APEX OF WYE					3	
30 25	BAX 0.8	MONOCACY STATION (P)						
45	BAX 1.0	MONOCACY			ABS-261			
	BAX 1.1				CPS-261			
	BAX 2.1	WEST YARD	YARD TRACKS		ABS-261			
25	BAX 2.2	EAST YARD			CPS-261		DTC BLOCK FRED	5,6,7,8
	BAX 2.4				ABS-261			
10	BAX 3.1							
	BAX 3.2	WISNER ST			CPS-261		5,9	
	BAX 3.3	FREDERICK STATION			46		5	
	BAX 3.4	END OF TRACK 3.4 MILES					9	

STATION PAGE NOTES

- NOTE 1:** Signal rules 1280-1298 in effect on the Frederick Branch.
- NOTE 2:** Hand operated switch at the Apex of the Wye must be left lined and locked for movements on the West Wye.
- NOTE 3:** Cars for Wickes Lumber must be spotted inside their gate.
- NOTE 4:** Freight trains must not operate on main track at Monocacy Station, and must instead operate on the siding. Light engines may use the main track to run around cars on the siding, but must not exceed 10 mph.
- NOTE 5:** Extremely close clearance exists between equipment on the main and the platforms at Monocacy and Frederick Stations, and on the south side of No. 2 Marc yard at fuel pad.
- NOTE 6:** Rule 105 is in effect on the Monocacy Siding and on all yard tracks. Derails are installed on the Monocacy Siding.
- NOTE 7:** Unless otherwise instructed, P891 will yard in No. 2 track, P893 will yard in No. 3 track, and P895 will yard in No. 4 track.
- NOTE 8:** Yd. Tracks 1 through 4 are considered locomotive servicing tracks and are restricted to 5 MPH. Freight trains will use No. 1 Yard only on permission of the AU Dispatcher.
- NOTE 9:** Wisner St.
A) - An unnumbered automatic dwarf signal is in effect for Eastbound movements to Frederick Station. Rules 243-246 are in effect. Red indicates track is occupied, Lunar indicates track is clear. Eastbound movements to the station with a red aspect may proceed at Restricted Speed.
B) - To activate the Westbound Absolute Signal, operate the "request signal" button at the high block platform.
- NOTE 10:** Before freight engines or cars may be operated East of the high Block Platform at Frederick Station a crew member must be stationed on the ground in a position to observe for close clearance and stop the movement if necessary.

OLD MAIN LINE SUBDIVISION SPECIAL INSTRUCTIONS

1. INSTRUCTIONS RELATING TO OPERATING RULES

Glossary – Excepted Tracks

1. Mount Airy Industrial Track

ROAD CROSSINGS AT GRADE

Providing Crossing Protection

100-5 East Avalon – Eastward trains leaving East Avalon must not exceed 15 MPH between eastward absolute signal East Avalon and Gun Road Crossing.

100-5 West Davis MD Route 125 (Woodstock Rd.) – Crossing indicator is located on north side of siding 50 feet east of road crossing. Westbound trains entering siding at East Davis must not foul MD Route 125 until crossing indicator is flashing. Westbound trains operating on the main track to West Davis, after receiving Approach or Restricted Proceed Signal at East Davis, must not foul MD Route 125 until signal aspect more favorable than STOP is displayed at West Davis.

100-5 East Hood (MD Route 97, Hoods Mill Rd.) – Head end of eastbound trains departing from East Hood must not exceed 25 MPH between eastbound absolute signal East Hood and MD Route 97 Road Crossing.

100-4 Lime Kiln

Prior to fouling Geoffrey Way Road Crossing, on the spur, MP BAC 56.2, crews must insure that the crossing gates are in the fully lowered position.

100-5 Essroc – 100.43

Essroc Crossing is a private crossing, however, engineers will sound whistle signal 14(L) approaching this crossing.

USE OF SPECIFIED TRACKS

96-1 Mount Airy Industrial Track – Look out for Mt. Airy Cold Storage engine occupying the track from Hill Street to a point 674 feet west thereof.

REVERSE MOVEMENTS

272-A-1 Helper engines assisting eastward trains will cut off before passing MP BAC 36.0 and will not make reverse movement without permission of train dispatcher.

2. INSTRUCTIONS RELATING TO SAFETY RULES

Close clearance on No. 5 and No. 6 tracks at Eastalco.

3. INSTRUCTIONS RELATING TO COMPANY POLICIES AND PROCEDURES

NONE

4. INSTRUCTIONS RELATING TO EQUIPMENT HANDLING RULES

NONE

5. INSTRUCTIONS RELATING TO AIR BRAKE AND TRAIN HANDLING RULES

NONE

6. INSTRUCTIONS RELATING TO RESTRICTED EQUIPMENT

At MP BAC 57.0, Tamko, no more than one 6 axle locomotive without steerable trucks will be permitted to operate on No. 3 Track.

7. MISCELLANEOUS

A – Main tracks, Halethorpe to Point of Rocks

1. EASTALCO

- a) Crews must ensure that the gate remains open when switching inside the facility at Eastalco Aluminum, MP BAC 59.0.
- b) When departing the facility, crews must close and lock gate.

NOTES

P&W SUBDIVISION - PW

AUTHORIZED SPEED		MILE POST	STATION	TRACK DIAGRAM		AUTH FOR MOVE	TWC	NOTES
				WEST	EAST			
30		PLY 9.1	BRADDOCK	1	2	AS DISP 14 - 6 RD - 08	CPS-261	
P 30	F 30	BF 319.0	BRADDOCK	MAIN		AS DISP 14 - 6 RD - 08	ABS-261	DTC BLOCK GLENN
55	40	BF 319.2						
40		25	BF 322.5			W&P SD GLENNWOOD YARD	CPS-261	
30			BF 323.5			MAIN	ABS-261	DTC BLOCK LAUGH
			BF 325.0	P&W SD WEST OF BF 322.8 IS LEASED TO & OPERATED BY THE ALLEGHENY VALLEY RR (AVR) AND THE BUFFALO AND PITTSBURGH RR (B&P). CSX DISPATCHES THE RR				
30			BF 325.1	LAUGHLIN JUNCTION			CPS-261	
			BF 325.9	2.1			ABS-261	
			BF 326.1		1 2		ABS-261	
			BF 326.3	EAST SCHENLEY			CPS-261	
					SCHENLEY TUNNEL - 2,872 FT.		ABS-261	DTC BLOCK SCHEN
			BG 1.0	FIELD	1.0	NS X30 - P, X10 - F NS CONNECTION	CPS-261	
30	25		BG 1.3		EQHR 4453	NS ALLEGHENY RIVER	ABS-261	DTC BLOCK ETNA
20	20		BG 2.6	WILLOW GROVE	3.7 Max 10 2.1 36 TH ST YD AVR RR	TTB		
20	20		BG 4.0			PINE CREEK RUN-AROUND		
25	25		BG 4.7	ETNA			CPS-261	
25	25		BG 5.3			ETNA TUNNEL - 424 FT.	ABS-261	DTC BLOCK GIB
KITTANNING ST. GRANT ST. 10 MPH HEAD END			BG 5.5			WITTMER SIDING		
			BG 5.6					
25	25		BG 7.5	GLENSHAW	14.3	GLENSHAW TUNNEL - 199 FT.		
			BG 9.4	ELFINWILD		MAIN		
			BG 10.2					
			BG 12.5	SAMPLES			CPS-261	
			BG 13.7				ABS-261	
			BG 14.3	WILDWOOD			CPS-261	
25	25						ABS-261	

P&W SUBDIVISION - PW

AUTHORIZED SPEED		MILE POST	STATION	TRACK DIAGRAM		AUTH FOR MOVE	TWC	NOTES
				↓	↓			
P 25	F 25	BG 16.6	14.3			ABS-261	DTC BLOCK GIBB	4
		BG 18.2	BAKERSTOWN		1,800 FT.			
		BG 19.0	BAKERSTOWN SIDING WE					
		BG20.1	VALENCIA			CPS-261		
		BG 20.3 BG 21.2 BG 23.3	DAWNIEVILLE 9.0	(1) AD	MAIN	ABS-261		
		BG 28.0	EVANS CITY			CPS-261		
		BG 28.6	2.5		SSDG 10,600 FT EVANS CITY SIDING 10 MPH	ABS-261		
		BG 30.5	EIDENAU EAST END			CPS-261	DTC BLOCK MARS	
		BG 30.9	0.5	WYE 10 MPH B&P RR		ABS-261		
		BG 31.0	EIDENAU WEST END			CPS-261		
		BG 33.2 BG 34.6 BG 34.8	4.2			ABS-261		
		BG 35.2	EE OLD FURNACE			CPS-261		
			1.6		SSDG 8,250 FT. 10 MPH	ABS-261		
		BG 37.0	WE OLD FURNACE			CPS-261		
25	25	BG 38.9	10.3			ABS-261	DTC BLOCK CHEW	
20	20	BG 44.5 BG 44.7	4 TH ST ELWOOD CITY 6 TH ST ELWOOD CITY					
25	25	BG 46.0 BG 47.1 BG 48.1 BG 48.3 BG 50.8	KLINE 5.1		MAIN		DTC BLOCK EDGE	
25	25					ABS-261		

P&W SUBDIVISION - PW

AUTHORIZED SPEED		MILE POST	STATION	TRACK DIAGRAM		AUTH FOR MOVE	TWC	NOTES
				↓	↓			
P	F	BG 51.2	5.1	MAIN	<div style="border: 1px solid black; padding: 5px; width: fit-content; margin: auto;"> AS DISP 14 - 6 RD - 08 </div>	ABS-261	DTC BLOCK EDGE	2,5 5
25	25							
40	40	BG 52.2	60.1 MILES					
40	40	BG 55.4= PLE 43.7	P&W JUNCTION	PITTSBURGH SD	<div style="border: 1px solid black; padding: 5px; width: fit-content; margin: auto;"> AT DISP 14 - 8 RD - 08 </div>	CPS-261		
		BG 55.4				ABS-261		

STATION PAGE NOTES

- NOTE 1:** All signals on the P&W SD are signal rules 1280-1298.
- NOTE 2:** Tonnage restriction for empty cars 80 feet or longer. See division special instructions.
- NOTE 3:** When STOP aspect is displayed on EAS at Braddock, eastbound trains will STOP west of the Braddocksfield Crossing.
- NOTE 4:** Evans City Siding - Trains or cars left standing must be left on the west end of the siding.
- NOTE 5:** MP Equations: MP BG 52.2 equals MP BG 55.4. MP BG 52.3 to BG 55.4 do not exist.

P&W SUBDIVISION SPECIAL INSTRUCTIONS

1. INSTRUCTIONS RELATING TO OPERATING RULES

GLOSSARY-1 EXCEPTED TRACKS

The following tracks are designated as excepted track:

Lower Allegheny

36th Street and Heinz Lead Industrial Tracks

ROAD CROSSINGS AT GRADE

100-1 Providing Crossing Protection

Trains will provide protection against vehicular traffic before moving over highway or street crossings designated below:

Table 11. Providing Crossing Protection	
Location	Instructions
Allegheny	Heinz Co. River Ave. (3 Crossings)
Ellwood City	6 th St. Crossing on tracks not included between automatic crossing gates.
Braddock: Braddockfield Plant Road	When "STOP" aspect is displayed on EAS at Braddock, eastbound trains will STOP west of the crossing so that automatic timeout and restart feature will function to raise automatic highway crossing gates
Hazelwood: Hazelwood Ave. & Tecumseh St.	Single unit diesel without cars will approach these crossings prepared to STOP unless automatic crossing protection is operating.

100-2 Siding Evans City – Due to rusty rail conditions, trains and engines using siding, Evans City, Old Furnace will approach all road crossings protected by automatic flasher lights prepared to stop unless it is known that crossing protection is working. All of these tracks must not be blocked with cars or equipment unless authorized by the train dispatcher.

100-3 Due to rusty rail conditions, all trains and engines using the following tracks must provide crossing protection as per operating rules:

a) BG24.8, Myoma Spur Track.

b) BG30.6, East leg of Y track at Eidenau.

100-4 Edgemoor Road Crossing – Edgemoor BG50.9, westbound trains will not pass Edgemoor Road crossing unless train has received a more favorable signal aspect than approach at Chewton

BG48.9 or permission of the P&W Subdivision Train Dispatcher.

103-1 SWITCHING

1. Bids Terminal – During the normal switching hours of 0700 to 0900, hazardous materials will not be transferred in the terminal. Other than switching hours the facility will be blue flagged. If a switch is required other than switching hours a bids terminal supervisor will meet the rail switch crew, remove blue flags and will verify terminal activity and that all hazardous material transfers are shut down.

USE OF SPECIFIED TRACKS

96-1 Glenwood No. 3 Running Track – Between Swissvale and Glenwood Jct. will be used on permission of yardmaster at Glenwood or Demmler Yard.

96-2 Willow Grove – Track Nos. 7 and 8 at Pine Creek, NS Track No. 102 Millvale to Herr and NS No. 2 Main Track between East Pitt and West Pitt are designated interchange tracks.

96-3 Running track between Willow Grove and switch off main and end of track will be used on permission of yardmaster at Glenwood or Demmler.

96-4 Bloom – No. 2 main track between East Pitt and West P. H. and Island Avenue Yard are designated interchange tracks.

288-1 INTERLOCKING OFFICES

Glenwood Jct. (WJ) is open continuously.

2. INSTRUCTIONS RELATING TO SAFETY RULES

NONE

3. INSTRUCTIONS RELATING TO COMPANY POLICIES AND PROCEDURES

NONE

4. EQUIPMENT HANDLING RULES

4466B – 1

Train classification instructions for empty cars 80 feet and longer other than box cars.

Empty cars 80 feet and longer (other than box cars) must be placed in the train in such a location that the trailing tonnage behind these empty cars does not exceed the amount listed below.

In territory where helper locomotives are used on the rear of the train, their tonnage rating should be added to the trailing tonnage listed on this chart

when determining the location for the restricted car(s).

NOTES

Southward	Tonnage	
	Westbound	Eastbound
Laughlin Jct. And Bakerstown	4000	4400
Eidenau and Bakerstown		

5. INSTRUCTIONS RELATING TO AIR BRAKE TRAIN HANDLING RULES

NONE

.6. INSTRUCTIONS RELATING TO RESTRICTED EQUIPMENT

A. East Schenley – Bellefield Boiler House over bridge 202B/1 engines and cars with gross weight exceeding 150,000 lbs must not operate

B. Allegheny River Jct., 20th St. – Cars with gross weight exceeding 251,000 lbs must not operate

7. MISCELLANEOUS

NONE

NOTES

NOTES

NOTES

PHILADELPHIA SUBDIVISION - PA

AUTHORIZED SPEEDS		MILE POST	STATION	TRACK DIAGRAM		AUTH FOR MOVE	TWC	NOTES
				↓	↓			
20	QA 0.3	CP PARK		WEST	WEST	CPS-261 NI DISP 58 - 4# RD - 58	D	1
						ABS-261		
19	BBF 1.3 QA 0.0	PARK JUNCTION 1.3	0.8-0.5 EHR 4453	PARK TUNNEL	AV DISP 66 - 5 RD - 08	ABS-261		3
NO 1	NO 2	BBF 0.0	VINE ST			CPS-261		
30	19		0.5	1 2		ABS-261		
		BAK 0.5	LOCUST ST	X10		CPS-261		
			1.0	HARRISBURG SD 3 YARD 4 R.T.		ABS-261		
		BAK 1.5	GRAYS FERRY	X10 GRAYS FERRY TUNNEL	CP EAST SIDE	CPS-261		
			0.4		3 R.T.	GRAY'S FERRY EASTSIDE YARD RG		
		BAK 1.9	EASTSIDE YARD					
			0.1		EAST SIDE YARD CH - 08			
		BAK 2.0	RG	X10		ABS-261		
			0.1		Moveable TTb	CPS-261		
		BAK 2.1	BRIDGE BOARD	SCHUYLKILL R.		ABS-261		
			0.2	1 2		CPS-261		
30	19	BAK 2.3	EASTWICK	X10		ABS-261		
19			0.8	HARRISBURG SD 58 TH ST. CONNECTING TRACK NI DISP, 58 - 4# RD - 58	CONRAIL CHESTER SECONDARY S. JERSEY DISPATCHER 64 - 9# RD - 64	CPS-261		
			QHX 0.0		AMTRAK NEC CH - 54	ABS-261		
NO. 1	NO. 2	BAK 3.1	58 TH STREET	X10		CPS-261		
30	30					ABS-261	TWC-DTC DARBY	
		BAK 4.9	DARBY			CPS-261		
30		BAK 4.97			DARBY CREEK BOONE TUNNEL - 627 FT.	ABS-261	TWC-DTC CHESTER	
			1.6	MAIN			5	

PHILADELPHIA SUBDIVISION - PA

AUTHORIZED SPEEDS	MILE POST	STATION	TRACK DIAGRAM		AUTH FOR MOVE	TWC	NOTES
			↓	↓			
30	BAK 6.5	COLLINGDALE	(2) HBD-DED		ABS-261	DTC BLOCK CHESTER	4
	BAK 6.5	COLLINGDALE					
50	BAK 6.7				ABS-261	DTC BLOCK CHESTER	
	8.0						
	8.7	HOLMES	MAIN				
	9.0						
	BAK 11.8	CHESTER			CPS-261		
NO. 1 50	NO. 2 30		1 2		ABS-261	DTC BLOCK RADNOR	
	BAK 13.9	E. FELTONVILLE			CPS-261		
			TWIN OAKS		ABS-261	DTC BLOCK FELTON	
			MEETINGHOUSE RD.				
50	BAK 17.2	W. FELTONVILLE			CPS-261		
50	BAK 20.3	SILVERSIDE	(1) HBD-DED		ABS-261	DTC BLOCK SILVER	
	BAK 21.5	CARRCROFT					
	BAK 22.5	CLIFFS					
	BAK 24.7	BRANDYWINE					
50	BAK 24.8						
40							
50	BAK 25.5						
			BVRY		ABS-261	6	
	BAK 27.2	ELSMERE JCT.	MARKET ST IT		CPS-261		
SDG 25			SSDG 10,050 FT		ABS-261		
			WILSMERE YD CH - 28				
			CENTERVILLE RD				
	BAK 29.4	LANDENBERG JCT.	W&W RR		CPS-261	6	
	BAK 31.7	STANTON			ABS-261		
	32						
	33						
	BAK 34.1	HARMONY				DTC BLOCK NEWARK	
50							
OVER ROAD CROSSINGS 40 MPH	BAK 36.5	NEWARK	RING BELL				
	BAK 37.4	NEWARK					
50	BAK 39.1	STATE LINE			ABS-261		

PHILADELPHIA SUBDIVISION - PA

AUTHORIZED SPEEDS	MILE POST	STATION	TRACK DIAGRAM		AUTH FOR MOVE	TWC	NOTES	
			↓	↓				
50		2.5			ABS-261	DTC BLOCK NEWARK		
	BAK 41.6	EAST SINGERLY		ELK MILLS ROAD	CPS-261			
			2.1	4600 FT. RD XING	SSDG 10,800 FT.	ABS-261	DTC BLOCK SING	
						5500 FT.		CPS-261
	BAK 45.9 BAK 46.3	EDER EDER	2.2		MAIN	ABS-261	DTC BLOCK FOYS	
			2.2	(1) HBD-DED				
	BAK 48.1	LESLIE		MD MATERIALS				
	BAK 50.5	HARBISON WALKER	2.4					
	BAK 52.9	BELVEDERE	2.4		GE SIDING 6,000 FT.			
			1.6					ABS-261
BAK 54.5	E. AIKIN				CPS-261			
		1.9		SSDG 10,000 FT.	ABS-261	DTC BLOCK AIKIN		
50	BAK 56.4	W. AIKIN		PERRYVILLE BR	CPS-251			
40	BAK 58.1		TTB	SUSQUEHANNA RIVER	ABS-261	DTC BLOCK DEEN		
50	BAK 58.9	HARVE de GRACE	2.2					
	BAK 61.1	OSBOURNE	2.0					
	BAK 63.1	ABERDEEN	2.6					
	BAK 65.7	STEPNEY	2.2	RIVERSIDE I.T.	BELCAMP SIDING			
	BAK 67.9 BAK 68.2	BELCAMP BELCAMP	2.1	(1) HBD-DED			ABS-261	
	BAK 70.0	E. VAN BIBBER					CPS-261	
		2.1		SSDG 10,450 FT.	ABS-261		DTC BLOCK VAN	
BAK 72.1	W. VAN BIBBER				CPS-261			
BAK 74.5	CLAYTON	2.4		MAIN	ABS-261	DTC BLOCK CLAYTON		
BAK 76.1	BRADSHAW	1.6						
BAK 76.9		2.2	BIG GUNPOWDER		ABS-261			
40								

PHILADELPHIA SUBDIVISION - PA

AUTHORIZED SPEED	MILE POST	STATION	TRACK DIAGRAM		AUTH FOR MOVE	AUTH FOR MOVE	NOTES
			↓	↓			
40		2.2			ABS-261		
50	BAK 78.2						
	BAK 78.3	LORELEY					
	80.0						
	80.3	WHITE MARSH					
	80.5	WHITE MARSH	(1) DED				DTC BLOCK CLAYTON
	81.0						
	BAK 82.5	POPLAR			ABS-261		
		1.9					
	BAK 84.4	ROSSVILLE			CPS-261		
			1 2		ABS-261		
			5,180 FT.				
			CONTRACTORS RD				
			2,133 FT.				
			SCHAFFERS LANE				
		2.8	934 FT.				
			TODDS LANE				
			1670 FT.				
			BATAVIA FARM RD				DTC BLOCK ROSE
	BAK 87.0	ROSEDALE	5,387 FT.				
			DUMP RD				
		2.4	NORTHPOINT BLVD				
50		90.9 MI.	BAY VIEW YD CH 28		ABS-261		
50	BAK 89.6	BAY VIEW	BALTIMORE TERMINAL SD		CPS-261		DTC BLOCK BAY
			AV DISP 66 - 4 RD 08				
			1 2				

STATION PAGE NOTES

- NOTE 1:** All signals on the Philadelphia SD are signal rules 1280-1298.
- NOTE 2:** Twin Oaks – Crossing indicators are in service at MP 15.5 for westbound movements. Westward trains receiving approach type signals at East Feltonville must STOP at the indicators unless they flash. The indicators flash with a lunar light, which is the authority to proceed to the signal at West Feltonville. It does not give information regarding indication of next signal.
- NOTE 3:** Yardmaster RG is in charge of 3 and 4 tracks between Locust St. and Grays Ferry. See special instructions for engineering department employees.
- NOTE 4:** A no parking zone exists between Darby and Chester. See special instructions for train operation.
- NOTE 5:** A crossing indicator is in service at MP BAK 4.97. Eastbound trains receiving other than clear or approach medium signal indications at Collingdale will not pass the indicator at BAK 4.97 unless the lights are flashing.
- NOTE 6:** Main Track switches at east leg of wye at BAK 27.0 and No. 4 yard BAK 29.0 must first unlock the switch then unlock the derail.

PHILADELPHIA SUBDIVISION SPECIAL INSTRUCTIONS

1. INSTRUCTIONS RELATING TO OPERATING RULES

Glossary Excepted Tracks

Market Street Industrial Track

TRAIN BULLETIN AND RELEASE FORM

Foreign Line Crews

120-A Foreign Line crews, with trains destined for CSX tracks in Philadelphia, will contact the AV Train Dispatcher in Jacksonville to sign up their trains. The toll free number for the AV Train Dispatcher is 800-921-2223. The following information must be provided to the dispatcher.

Foreign Line train symbols and destination on CSX Crew engineer, conductor, and other crew members or riders
Engines assigned
Train loading – loads, empties, and tons

The CSX AV Dispatcher will assign a CSX designation to the train, which will be a "Z" letter and a 400 series number. He will then issue by fax machine a CSX train bulletin for the crew.

Crews operating over CSX main tracks must have a train bulletin in their possession prior to occupying CSX tracks. Crews must also have the latest CSX system and Baltimore district bulletins affecting their movement before operating over CSX. The train bulletin will identify the latest system or Baltimore district general bulletin in effect.

DRAWBRIDGE

97-1 Drawbridge is located in Philadelphia over Schuylkill River and its use will be governed by signal indication.

ROAD CROSSINGS AT GRADE

100D-1 Comply with Rule 100D at the following Crossings.

A. Philadelphia

Wolfe St. (FRA 140-681P)
Weccacoe Ave. (FRA 140-682W)
Snyder Ave. (FRA 140-683D)
Delaware Ave. (FRA 140-685S)

B. Wilmington

Wilmington: Maryland Ave.(FRA 193)	
Centerville Rd.	Crossing must not be blocked at any time for a period more than 5 minutes.

C. Belcamp

Mercedes Drive in Riverside Industrial Park at Belcamp is the only access for several industries within the park. This road crossing must not be blocked by standing equipment. Twenty-seven 60-foot cars (or cars and engines) will fit between the derail and Mercedes Drive. Arrange your work to ensure that no standing movements block this crossing.

D. Rossville to Bay View

Crossings must not be unnecessarily blocked by standing trains.

Westbound trains receiving an indication less favorable than clear on the westbound absolute signal Rossville will STOP to clear Contractors Road Crossing, MP BAK 85.53, and will contact the Jacksonville Train Dispatcher for instructions before proceeding. The Jacksonville Train Dispatcher will advise if there are trains stopped ahead. If it is necessary to advance a train, crew will make arrangements to cut their train to allow vehicular access.

Dispatchers and train crews will use the measured distances on the station pages as a guide in determining if trains will fit between crossings.

100E-1 Road Crossing Warning Approach Circuits

Constant time approach circuits have been installed on the approach to the following road crossings:

- Fairview Road
- Swarthmore Avenue
- Amosland Road
- South Avenue
- Ashland Avenue
- Oak Lane
- Main Street (Darby)
- Fifth Street (Darby)

Refer to CSX Operating Rule 100-E.5

EMERGENCY BRAKE APPLICATION

90-1 Should your train sustain an emergency application of the brakes, in addition to the requirements of Operating Rule 90 to make emergency radio transmission on AAR 08, also make emergency radio transmission on the channels listed below before notifying the CSX Train Dispatcher.

1. West Aiken – Over NS – AAR46
2. 58th Street – Over Amtrak – AAR54

HAND BRAKES

103-1 When necessary to apply handbrakes on cars on the siding at Feltonville, crews will apply brakes on the main track side, and will request block protection as prescribed by TTSI 1040.09.

USE OF SPECIFIED TRACKS

105-1 Delaware Industrial track extends from Grays Ferry Tunnel at BCB 0.0 through East Side Yard, at BCB1.0 through 4 RT Penrose to Broad St. to spring switch at Greenwich MP BCB 5.7.

704 & 707 ON TRACK EQUIPMENT MOVEMENTS

OTE movements between CP Park and Vine St.:

704-1 On track equipment movements between CP Park and Park Junction must be made by contacting NI train dispatcher.

On track equipment movements between Park Junction and Vine Street must be made by contacting AV train dispatcher.

NI and AV dispatchers will provide appropriate blocking protection for the movements until the on track equipment is reported clear of the railroad.

Engineering employees working on signaled tracks at RG:

707-1 The request for engineering employees to work on signaled tracks at RG will include all tracks, which are intended to be occupied. These will be number 1 or number 2 main tracks, or 3 runner between W.A.S. Grays Ferry and RG Tower.

2. INSTRUCTION RELATING TO SAFETY RULES

Close Clearances

2150-1. Philadelphia

Close clearances exist by all unloading dock and entrances to warehouses.

Delaware Avenue:

Pier 38 and Pier 40 platforms
Pier 40 gate on the south side
78 annex – inside the door, east side
80 JH, south side

Procacci Brothers:

Track 5 and Track 7
Building 1
Industrial track, toward building 1

Levin:

Fence on east side of Jetro Lead

Food Fair

“A”, “B” and “C” doors

2150-2. Feltonville

Radnor Industrial Park
Entrance to and inside all buildings

2150-3. Wilsmere Yard

Eastbound Yard – Telephone Pole at 18 switch, very close middle of yard across from yard office.

24 and 4 track – fence between track

General Motors – 5 track

2150-4. Barksdale

Barksdale – All unloading stations – spots 1 Thru 6

2150-5. Northeast

Northeast – Maryland materials siding under Mechanics Valley Road Bridge.

2150-6 Rosedale

Gibson-Homans Loading dock

3. INSTRUCTIONS RELATING TO COMPANY POLICIES AND PROCEDURES

NONE

4. INSTRUCTIONS RELATING TO EQUIPMENT HANDLING RULES

NONE

5. INSTRUCTIONS RELATING TO AIR BRAKE AND TRAIN HANDLING RULES

3.3.3-1 Philadelphia –

Grade Operation Eastbound freight trains requiring helper engine will not pass EAS at Locust St. until engineer is advised helper engine is attached.

DIV 5.5 – 5300-2

6. INSTRUCTIONS RELATING TO RESTRICTED EQUIPMENT

Intermodal Car Restrictions

- A. **TOFC/COFC** measuring in excess of 17 feet inches ATR, 8 feet six inches wide must not be moved between Philadelphia and Collingdale without specific clearance authority.
- B. **Chester – Trans Flo** Engines, and excessive dimension cars are prohibited from passing auger located on No. 4 track 335 feet from point of switch from lead at Transflo Terminal, Chester.

7. MISCELLANEOUS

A. Philadelphia

1. **Time Limits** Time Limits (switching windows) have been established at the following Transflo Facilities:

Continuous window from 2300 Friday until 06—

During normal switching hours, hazardous materials will not be transferred in the terminal.

Other than switching hours the facility will be blue flagged.

If a switch is required other than switching hours a Transflo Terminal Supervisor will meet the rail switch crew, remove blue flags and will verify terminal activity and that all hazardous material transfers are shut down.

2. All trains originating at Philadelphia destined for the RF&P Subdivision with train control units on the head end must test the train control before departure. If the train control fails, it must be reported as soon as possible to the yardmaster and dispatcher.
3. The Roundhouse Foreman will have exclusive control of the locomotive tracks. Crews will contact the Roundhouse Foreman on Channel 08 before entering the locomotive service tracks. Crews receiving engines on the service track will not move engines without permission of the Roundhouse Foreman.
4. Effective immediately all road and yard crews going on duty in the Philadelphia/Wilmington Terminal must contact the trainmaster or yardmaster within 10 minutes of their on duty time for a safety job briefing. This will be done without fail.
5. Remote Control Locomotives

Remote control locomotives are not permitted to operate on the Chester Secondary or on the SEPTA Main Line.

B. Darby to Chester

No Parking Zones

1. Trackage on the Philadelphia Subdivision between MP BAK4.8 and MP BAK11.0 is designated as a "No Parking Zone."

A "No Parking Zone" is defined as a crossing that is not to be blocked for any reason, other than an emergency, in the even tone (or more) of the crossings designated as "No Parking Zones" is blocked by a train, it must be immediately cut in accordance with the Operating Rules (reference CSXT Operating Rules 100-D and 100-G).

The following locations will be used to hold additional trains from entering the limits of the "No Parking Zone."

Eastbound Trains –

- 1st Train – at the west end of Darby
- 2nd Train – at "RG" on the Philadelphia Subdivision or on the 58th Street Connection, and
- 3rd Train – at Park on the Trenton Line or Arsenal on the Harrisburg Line.

- C. **Feltonville** – When necessary to apply handbrakes on cars on the siding at Feltonville, crews will apply brakes on the main track side, and will request block protection as prescribed by TTSI 1040.09.

D. Twin Oaks

- a) **Instructions For Working Twin Oaks** – When shoving in to spot loads or when pulling empties from the plant, hold onto no more than 28 multilevel cars. Avoid fouling Meetinghouse Road or causing the gates or lights to activate at Meetinghouse Road.

When spotting loads on a track, do not hold onto more than 10 cars. (It may be necessary to set over to additional tracks, then come back to spot cars previously set over). When pulling empties, pull each track away from the east end of the track prior to pulling cars from the facility.

When spotting cars, place the east end wheel on the yellow line at "A" pad.

Spacing between cars spotted must be between 35 and 45 inches.

Hand brakes must be applied on each end and to the middle of a 5-car cut spotted between each pad.

Do not leave cars standing between "C" pad and pull-in switch unless the facility is full.

- b) Westbound trains out of Philadelphia, working Twin Oaks, will contact the local freight or utility switchman at Twin Oaks to coordinate movements, prior to occupying Feltonville Siding.
- c) Trains originating in Philadelphia with multi-level pick-ups at Twin Oaks may operate without train documentation from Twin Oaks to Wilsmere, but must not leave Wilsmere without train documentation.

E. Wilsmere

Trains Working at Wilsmere

Crews of trains listed below will call the yardmaster at Wilsmere to ascertain if there is any work for the train to perform:

Eastward Trains – Q406, Q346, Q216, Q408

Westward Trains – Q405, Q375, Q217

Landenberg Jct.

All crews operating on the west end of Wilsmere Yard, either setting off or picking up, who ask for a signal WAS Landenberg Junction, must go beyond the signal called for a sufficient distance to cause the signal to display a STOP. If this procedure is not followed, the crossing warning will remain in effect for a minimum of eight minutes from the time the reverse move is made.

Effective immediately all road and yard crews going on duty in the Philadelphia/Wilmington Terminal must contact the trainmaster or yardmaster within 10 minutes of their on duty time for a safety job briefing. This will be done without fail.

No yardmaster will be on duty at Wilsmere Yard between the hours of 2200 hours and 0600 hours, 7 days per week, and between 0600 hours and 1400 hours, Saturday and Sunday, during these hours the yardmaster at “RG” Tower, Philadelphia, PA, will supervise road and yard crews at Wilsmere. The yardmaster at “RG” can be contacted on Channel 28-28 at Wilsmere or at 215-339-2734 or RNX 446-2734 by telephone.

Crews will be responsible for locking the yard office at Wilsmere when not occupied.

All special instruction references to the yardmaster at Wilsmere will apply to the yardmaster “RG” when there is no yardmaster on duty at Wilsmere.

Wilsmere, Market Street Industrial Track

6 axle engines are prohibited on the Market Street Industrial Track past Maryland Ave.

F. Belcamp

Trains picking up non-placarded cars at Belcamp may move cars to next terminal without CSX train documentation.

G. Belvedere Siding

Refer to Baltimore Division timetable No. 4, Philadelphia Subdivision Miscellaneous Instructions, page 80, item F is replaced with the following:

Trains picking up non-placarded cars at Belvedere may move cars to next terminal without CSX train documentation.

A compressor will be used to keep cars on air after their initial terminal brake test. The Wilmington Car Department will pre-test a maximum of 29 cars for pickup by westbound trains. A 75 foot hose is attached to an air line outlet which is painted fluorescent orange to allow flexibility in spotting the west end car. A door on the front of the compressor is secured by a railroad lock and is the location of the start switch.

The crew picking up the cars will find the completed BTC-100 on the clip inside the door. The outbound conductor, after coupling to the pickup, obtains the air slip and turns the compressor off by turning the dial to the left. He then closes the angle cock on the cars and then on the air line located at the base of the rail and the air is automatically bled down.

Be careful to place the air hose next to the rail to avoid cutting it in two.

NOTES

PITTSBURGH SUBDIVISION - PI

AUTHORIZED SPEED		MILE POST	STATION	TRACK DIAGRAM		AUTH FOR MOVE	TWC	NOTES
				↓	↓			
P 45	F 40	BF 311.7	SINNS	KEYSTONE SD	CM DISP 94-2 RD-08	ABS-251 E-2, W-1		
P 40	F 40	PLY 17.2	SINNS SINNS	AD	SINNS I. T. AS DISP 14-6 RD-08	CPS-261	DTC BLOCK SINNS	1
1 30	2 25	PLY 15.5	1.5	1	MON SD	ABS-261		
2 25	1 20	PLY 15.1	McKEESPORT	TTB	YOUGHIOGHENY R.	CPS-261		3
P & F 40			1.0	EAST CROSSOVER 10X		ABS-261		
	SSDG 10	PLY 14.3	RIVERTON	RIVERTON YARD CH 08	MKC RR	ABS-261	DTC BLOCK DENMLER	3
		PLY 12.2	DEMMLER	DEMMLER YARD CH 28	SSDG 12,600 FT	ABS-261		3
	10	PLY 11.6	DEMMLER		AD	CPS-261		7
			1.1			ABS-261	DTC BLOCK RANKIN	
			1.2		WIRE MILL LEAD MP 9.35	CPS-261		
		PLY 9.1	BRADDOCK	P&W SD		ABS-261		
40 30		PLY 8.1		AS DISP 14-6 RD-08	MAIN TTB	ABS-261	DTC BLOCK BECKS	
	30 40	PLY 7.4		MONONGAHELA R.				
		PLY 6.5 PLY 6.4	HOMESTEAD GALVTECH	3.0	MAIN			4
		PLY 4.4	LUCAS					
	40	PLY 2.8	34 TH ST. 1.9					
		PLY 2.4			J & L TUNNEL	ABS-261	DTC BLOCK BECKS	
30		PLY 1.8	J & L TUNNEL	1	2	CPS-261		
			1.8			ABS-261		

PITTSBURGH SUBDIVISION - PI

AUTHORIZED SPEED	MILE POST	STATION	TRACK DIAGRAM		AUTH FOR MOVE	TWC	NOTES	
			↓	↓				
30	PLY 0.0	1.8	1	2	ABS-261	DTC BLOCK BECKS	2, 6	
50	PLY 0.0 PLE 0.0 PLE 0.2	PITTSBURGH	AD					
	PLE 0.7	PITTSBURGH HOLDOUT (EB)			W&LE RR	CPS-261		
	PLE 0.7	PITTSBURGH (WB)						
	PLE 3.6	MCKEES ROCKS	2.2		TTB	ABS-261	DTC BLOCK MCKEES	3
					GLASS HOUSE LEAD			
	PLE 5.7	NEVILLE				CPS-261		
	PLE 8.2	GROVETON	3.1		NEVILLE ISLAND I.T. YD CH 28	ABS-261	DTC BLOCK GROVE	3
	PLE 9.0			1	2			
	PLE 9.8	CORAOPOLIS				CPS-261		
	PLE 11.4	KENDALL	8.8			ABS-261	DTC BLOCK CORA	3, 4
	PLE 14.1	BRIGGSTON		AD	MAIN			
	PLE 18.4	WEST ECONOMY				CPS-261		
	SS 10	PLE 20.4	ALIQUIPPA	4.6		ALIQUIPPA YD CH - 08	ABS-261	DTC BLOCK QUIP
						BLACKS R UN YARD SSDG 18,650 FT.		
	10	PLE 23.0	BLACKS RUN				CPS-261	
	50	PLE 28.6		6.5		OHIO RIVER SECONDARY TRK	ABS-261	DTC BLOCK MONACA
45	PLE 29.5	BEAVER FALLS			OHIO R.	CPS-261		
	PLE 32.0	COLLEGE	10.9			ABS-261	DTC BLOCK BEAVER	
45	PLE 33.8							
50	PLE 40.4	WAMPUM				CPS-261		
			2.8			ABS-261	DTC BLOCK NEWPORT	
	PLE 43.2	WEST PITTSBURGH				CPS-261		
50			0.5			ABS-261		

PITTSBURGH SUBDIVISION - PI

AUTHORIZED SPEED	MILE POST	STATION	TRACK DIAGRAM		AUTH FOR MOVE	TWC	NOTES					
			WEST	WEST								
50		0.5	P&W SD	1	2	AS DISP 14 - 6 RD - 08	ABS-261					
50	BG 54.4		AT DISP.									
No 3 25	No 1 30	No 2 40	P&W JUNCTION	3	1	2	AT DISP 14 - 8 RD - 08	CPS-261	5,8			
			0.2				ABS-261					
	30		BG 55.6	UN CONTROL POINT			CPS-261					
25	20		BG 56.2	CENTER YD. (NO. 2)	2.2	1 AUX	NC YARD CH - 08	1		2	RUNNING TRK	ABS-261
			BG 57.8	WEST END YARD (NO. 1)	0.4		NS	CPS-261		ABS-261		
			BG 58.2	NEW CASTLE	60.3 MILES		X25 ON CONNECTION	CPS-261		8		
60	55	BG 58.3	NEW CASTLE		1	2	AT DISP 14 - 8 RD - 08	ABS-251 W-1, E-2				

STATION PAGE NOTES

- NOTE 1:** All signals on the Pittsburgh Subdivision are signal rules 1280-1298.
- NOTE 2:** Eastbound trains not receiving a proceed signal at Pittsburgh Holdout, must stop head end of movement approximately 2500 feet west of the EAS in order to avoid activation of detector, thereby eliminating possibility of an erroneous axle count.
- NOTE 3:** Engine horn restrictions apply - Refer to Pittsburgh SD special instructions.
- NOTE 4:** Hold back points exist at road crossings to avoid blocking vehicular traffic. Refer to Pittsburgh SD special instructions.
- NOTE 5:** MP Equations: MP BG 55.2 equals BG 55.4. MP 52.3 to 55.4 do not exist MP BG 55.4 equals PLE 43.7
- NOTE 6:** McKees Rocks, MP PLE 3.6 - If the signal indicates that trains may be stopped in the block ahead, trains must not pass intermediate signal at McKees Rocks without permission from the train dispatcher.
- NOTE 7:** Road Crossings - Westbound trains receiving a signal indication at CP Demler that indicates train will be stopped at CP Braddock must not pass MP PLY 10.5 without permission of the AS Train Dispatcher. This is to avoid blocking road crossings in Braddock.
- NOTE 8:** Temporary speed restrictions and work authority time and track limits for the railroad between P&W Junction, MP BG 55.4, and New Castle, MP BG 58.3 will continue to be carried in train messages for the New Castle Subdivision. That portion of the railroad will continue to be dispatched by the AT Train Dispatcher. All restrictions will still be carried under the New Castle Subdivision for this portion of the railroad. Crews operating between P&W Junction and New Castle must ensure that they carry New Castle Subdivision train messages. Engineering Department employees requesting to issue speed restrictions or secure work authorities will specify New Castle Subdivision as the location. Any changes to this portion of the railroad between BG 55.4 and BG 58.3 will be issued by the Baltimore Division under the Pittsburgh Subdivision heading.

PITTSBURGH SUBDIVISION SPECIAL INSTRUCTIONS

1. INSTRUCTIONS RELATING TO OPERATING RULES

GLOSSARY EXCEPTED TRACKS

1. No. 1 and No. 3 tracks East Blacks Run Yard
2. McKees Rocks West Yard

3. No. 3 through No. 11 Tracks Riverton West Yard

4. CSX crews working on Union Railroad property will be governed by instructions published on URR General Order No. 30 dated January 23, 1996. These instructions were reprinted in their entirety on a CSX Glenwood, Pa. Trainmaster's Notice.

14-1 ENGINE HORN INSTRUCTIONS

PLY14.0 and PLY14.9 – Engineer must not sound horn except in case of emergency.

PLY14.9 and PLY15.1 – Engineer must sound horn signal 14L and the bell approaching and occupying the Yough River Bridge.

Trains and engines using main tracks must sound horn signal 14(L) and the bell when passing Riverton Yard between Milepost PLY14 and PLY13.2.

Trains and engines using the Demmler signaled siding must sound horn signal 14(L) and the bell when passing Demmler Yard.

The above due to our employees working in close proximity of the main tracks in Riverton Yard and to the siding in Demmler Yard.

40-1 ENGINE SPEED INDICATORS AND ODOMETERS

Engine speed indicators, odometers and RDU equipment must be checked between the first encountered mile posts after leaving terminal.

ROAD CROSSINGS AT GRADE

100-1 State laws make it unlawful for a train, railroad car or engine to obstruct public travel at a public crossing at grade for an excessive period of time, except where such train, railroad car or engine cannot be moved by reason or circumstances over which the railroad has no control as follows:

Table 10 Providing Crossing Protection

Location	Instructions
Pennsylvania	Over 5 Minutes (15 Minutes at Private Crossings)

If a train is delayed an excessive period of time, train crews must document the date, time of blockage, city, state, road crossing and circumstances. This information must be forwarded to the supervisor in charge of the territory.

100-2 Beaver Falls – Westbound trains not having a proceed indication at WAS Beaver Falls, must STOP east of Sixth Avenue Road Crossing, at approximately MP PLE 29.3.

100-3 Coraopolis – Eastbound trains receiving a signal indication at Stoops Ferry that their train may be stopped at CP Corapolis, must not pass Russel, Burdsall and Ward private road crossing at MP PLE 11.8 without permission of the train dispatcher. This is to avoid blocking road crossings in Coraopolis, PA

100-4 Groveton – Westbound trains not having a proceed indication at WAS Corapolis, must STOP east of Equipment Corp. road crossing, at approximately MP PLE 8.9.

100-5 PLY 5.3 – STOP and flag Glen Road crossing on the Keystone Iron and Metal I.T.

100-6 PLY 9.2 – STOP and flag 1st Street Braddock Road Crossing on the Wire Mill Lead

SWITCHES

104-1.1 Electric Switch Heaters – Emergency shut off switches are provided at controlled points equipped with electric switch heaters. Should a derailment occur in the vicinity of power switches, persons must avoid coming in contact with any exposed switch heater wires. Electric current must be shut off at the emergency electrical switch which is located on outside of electric case in a 4"X6" box stenciled "Electric Switch Heater Emergency Shut-Off Switch". The box is locked with a standard switch lock.

104-1.2 Aliquippa – Normal position of switches on the Ohio River Secondary Track is for movement on that track.

USE OF SPECIFIED TRACKS

96-1 Demmler Running Track – Will be used on permission of yardmaster at Demmler or Glenwood Yard.

96-2 Demmler –

- a) Eastbound trains using controlled siding between Demmler and Riverton with work at Demmler Yard must not STOP until rear of train clears WAS at Demmler (CP 11Y).

McKees Rocks –

- a) Movements over Neville Island Bridge between Neville and POHC Connection will be made on permission of the Neville Island Yardmaster.



96-3 105.4 Aliquippa –

- a) Yardmaster Aliquippa will grant permission to use Koppel Secondary Track between West Ellwood Jct. and Koppel and the Ohio River Industrial Track between Blacks Run and Kobuta.
- b) NOVA – Crews must comply with NOVA policy of wearing hard hats and safety glasses while on NOVA property. Also, excessive facial hair which interferes with the sealing surface of a respirator is prohibited.

When Yardmaster cannot be contacted to get authority to use a specified track under his jurisdiction, the Train Dispatcher will be contacted.

280-1 BLOCK, INTERLOCKING AND OTHER FIXED SIGNAL ASPECTS AND INDICATIONS.

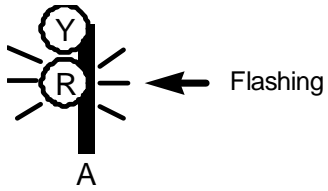
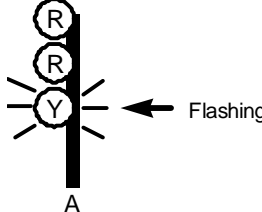
Rules 1281 through 1298 apply on the Pittsburgh Subdivision. Signal aspects not in conformity with Rules 1281 through 1298 are located from and including the east absolute signal CP Pittsburgh to and including the west absolute signal CP Sinns.

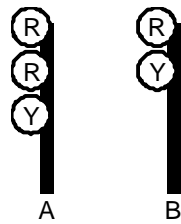
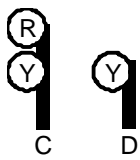
PLE-1286	
DWARF SIGNAL	
	
<p>Name – Medium Approach Indication – Medium Speed through turnouts, crossovers, sidings and over power-operated switches; then proceed, prepared to stop at the next signal.</p>	
PLE-1288	
HIGH SIGNAL	DWARF SIGNAL
	
<p>Name – Slow Approach Indication – Slow Speed through turnouts, crossovers, sidings and over power-operated switches; then proceed, prepared to stop at the next signal.</p>	
PLE-1290	
HIGH SIGNAL	DWARF SIGNAL
	
<p>Name – Restricting Indication – Proceed at Restricted Speed.</p>	

PLE-1287
HIGH SIGNAL

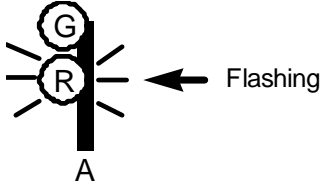
<p>Name – Slow Clear Indication – Slow Speed through turnouts, crossovers, sidings, and over power-operated switches; then proceed.</p>

PLE-1283
DWARF SIGNAL

<p>Name – Medium Clear Indication – Medium Speed through turnouts, crossovers, sidings and over power-operated switches; then proceed.</p>

2. INSTRUCTIONS RELATING TO SAFETY RULES

NONE

3. INSTRUCTIONS RELATING TO COMPANY POLICIES AND PROCEDURES

NONE

4. INSTRUCTIONS RELATING TO EQUIPMENT HANDLING RULES

4300-1 DEFECT DETECTORS

Table 8 Defect Detectors

Mile Post/Location	Type
PLY16.8 Sinns	Voice instruction
PLY12.2 Demmler	Voice instruction (Dragging Equipment Only)
PLE0.2 Pittsburgh	Voice Instruction
PLE14.0 Briggston	
PLE20.4 Aliquippa	Voice Instruction (Dragging Equipment Only)
PLE32.0 College	Voice instruction

Eastbound trains not receiving a proceed signal aspect as CP Pittsburgh, must stop head end of movement approximately 900 feet west of the EAS, in order to avoid activation of detector, thereby eliminating possibility of an erroneous axle count.

4. EQUIPMENT RESTRICTIONS

Heavy Cars

- 1) Wreck cranes must not be moved over any bridge unless separated from engines by a spacer car having a gross weight not exceeding 160,000 lbs., with minimum truck centers of 30 feet.
- 2) Wreck cranes must not be placed on any bridge for the purpose of handling any car without permission of the Chief Engineer.
- 3) Loaded foreign line short ore cars (Jenny type) must not move over the Ohio River Bridge unless the adjacent track is clear.

5. INSTRUCTIONS RELATING TO AIR BRAKE AND TRAIN HANDLING RULES

Train Handling Rule 5502-A is modified to permit 27 powered axles for the operating locomotives that are pulling a train or cut of cars on the Pope's Creek Subdivision.

6. INSTRUCTIONS RELATING TO RESTRICTED EQUIPMENT

NONE

7. MISCELLANEOUS

1. Passenger Cars

Passenger type equipment must not pass hot metal ladles, any loads or equipment in excess of published clearances on adjacent tracks between Braddock and Sinns.

2. Coal Movements, First Energy Power Plant at Shippingport, PA, Ohio River Industrial Track.

After the switches at the east end of the unloading and ammonia tracks are lined, and further protection will be required for the east end of the cars during the unloading operation.

The Crew called to assist the empty coal train back to Aliquippa will not pass PLO 9 until radio communication is established with the coal train

NOTES

POPES CREEK SUBDIVISION - P0

AUTHORIZED SPEED	MILE POST	STATION	TRACK DIAGRAM		AUTH FOR MOVE	TWC	NOTES	
			↓ SOUTH ↓					
FRT 40	120.5	CP BOWIE (X)	AMTRAK NEC	1 2 3 ↓ ↓ ↓ ┌───┴───┐ └───┬───┘ ┌───┴───┐ └───┬───┘	CTEC-1 DISP CH - 54 RD - 54	NORAC 261 CSS/ATC	D	1
30	QP 0.0	BOWIE			TWC-DCS		1,2	
30	QP 3.0 QP 3.0 QP 4.0 QP 7.9	COLLINGTON COLL HALL			5,200 FT.	D		
25	10.0 11.0							
30	QP 11.0 QP 13.6 QP 13.8	PRINCE MARLBORO				D		
	QP 20.4	DUDLEY						
	QP 22.1	CHELTENHAM						
	QP 24.6 QP 24.8 QP 24.9	NORTH LEG OF WYE BRAN SOUTH LEG OF WYE			HERBERT SD		3	
	QP 26.6	WINE				D		
	QP 31.1	WALDORF			NI DISP 64 - 4#			
	QP 35.0 QP 34.2	NAV INDIAN HEAD JCT.				D		
	QP 38.7	LA PLATA	NI DISP 64 - 5#					
30	QP 45.6	POPE		TWC-DCS	D			
			MORGANTOWN I. T.			4		

STATION PAGE NOTES

- NOTE 1:** NORAC signal rules in effect. Automatic Train Control equipped locomotives are required on the North East Corridor.
- NOTE 2:** Hydraulic spring switch located at MP 0.3 leads to the south wye. Normal position is as last used. Southbound trains may trail through the switch. Northbound trains must approach the switch at restricted speed and must ensure that the switch is properly lined before proceeding.
- NOTE 3:** Hydraulic spring switch located at MP 24.6 leads to the Herbert SD. Normal position is as last used. Northbound trains may trail through the switch. Southbound trains must approach the switch at restricted speed and must ensure that the switch is properly lined before proceeding.
- NOTE 4:** Use of the Morgantown I.T. – Procedure for Mirant crews or contractors to provide protection when working this track.
1. Mirant will establish an out of service condition for the industrial track when they desire to move equipment or provide protection for their crews. To establish this protection Mirant will advise NI train dispatcher that the track is out of service. NI will record this out of service condition and so advise crews who need to operate on the industrial track. When the out of service condition no longer exists, Mirant will so advise NI train dispatcher.
 2. CSX crews who need to operate on the industrial track will inquire of NI train dispatcher if the track is out of service, and will not operate on this track until advised by NI train dispatcher that the track is restored to service. The Morgantown Industrial Track continues to be a restricted speed track with a maximum permissible speed of 10 MPH

POPE'S CREEK SUBDIVISION SPECIAL INSTRUCTIONS

1. INSTRUCTIONS RELATING TO OPERATING RULES

104.1 All southbound trains must stop at spring switch QP 24.6 and hand throw switch for movement.

2. INSTRUCTIONS RELATING TO SAFETY RULES

NONE

3. INSTRUCTIONS RELATING TO COMPANY POLICIES AND PROCEDURES

NONE

4. INSTRUCTIONS RELATING TO EQUIPMENT HANDLING RULES

NONE

5. INSTRUCTIONS RELATING TO AIR BRAKE AND TRAIN HANDLING RULES

Train Handling Rule 3.1.2 is modified to Permit 27 powered axles for the operating locomotives that are pulling a train or cut of cars on the Pope's Creek Subdivision.

6. INSTRUCTIONS RELATING TO RESTRICTED EQUIPMENT

1. Cars exceeding Plate F must not operate on Amtrak's Northeast Corridor between Landover and Grove.
2. Cars exceeding Plate C must not operate on Amtrak's Northeast Corridor on No. 2 or 3 Main tracks between Landover and Grove.
3. Conductors of trains operating on Northeast Corridor between Landover and Grove must check their consists for the above listed restricted cars if advised to operate on 2 or 3 main tracks.

7. MISCELLANEOUS

NONE

NOTES

NOTES

RF&P SUBDIVISION - RR

AUTHORIZED SPEED				MILE POST	STATION	TRACK DIAGRAM		AUTH FOR MOVE	TWC	NOTES
						SOUTH				
30				CFP 113.8	M STREET	<div style="border: 1px solid black; padding: 2px; display: inline-block;">CAPITAL SD ALEXANDRIA EXTENSION</div> 3	<div style="border: 1px solid black; padding: 2px; display: inline-block;">AU DISP. 14-6 RD - 08</div> 2	ABS-251 E-2, W-3 CSS	DTC BLOCK JERSEY	
P 25	IM 25	F 25	M 25	CFP113.8	M STREET			CPS-261 CSS	DTC BLOCK TIDAL	1,2,7 12
						VIRGINIA AVE TUNNEL MAIN	<div style="border: 1px solid black; padding: 2px; display: inline-block;">CO DISP 20-3 RD - 96</div>	ABS-261 CSS		
				CFP 112.2	CP VIRGINIA			CPS-261	DTC BLOCK JEFFERSON	11
				CFP 112.1						
25				CFP 111.9	L'ENFANT STATION (P)					
40				CFP 111.8	1.0					
30				CFP 111.3	14 TH STREET	3	2	ABS-261 CSS		
40				CFP 111.2						
30				CFP 110.8	1.2					
40				CFP 110.5	DC - VA LINE					
45	25	25	25	CFP 110.2	POT YARD, VA	HCD - 17'4"				
P 40	IM 40	F 40	M 40	CFP 110.1	RO	LSL SPEEDS S-25	LSL SPEEDS	CPS-261	DTC BLOCK POTOMAC	1,2,7,14 15
					1.1	3	2	ABS-261 CSS/ATC		
				CFP 109.0	SRO			CPS-261		
40	40	40	40	CFP 108.8						
45	45	45	45	CFP 108.6	2.7	3	1	ABS-261 CSS/ATC		
60	55	55		CFP 107.4		2				
65	60			CFP 107.5	4 MILE RUN					
				CFP 106.3	SLATERS LANE, CP-1	NS		CPS-261		
				CFP 106.5	SLATERS LANE	(1) AD				
65	60	55	45	CFP 105.2	1.1			<div style="border: 1px solid black; padding: 2px; display: inline-block;">NO. 1 TRACK 105.7-105.2 - 45 MPH 105.2-104.8 - 40 MPH 104.8-104.3 - 45 MPH</div>		
40	40	40	40	CFP 105.1	ALEXANDRIA (P)			ABS-261 CSS/ATC		
70	60	55	45	CFP 104.8	1.2					

RF&P SUBDIVISION - RR

AUTHORIZED SPEED				MILE POST	STATION	TRACK DIAGRAM		AUTH FOR MOVE	TWC	NOTES
70	60	55	45			↓ SOUTH ↓		ABS-261	DTC BLOCK POTOMAC	2,3
				CFP 104.3	AF	<div style="border: 1px solid black; padding: 2px; display: inline-block;">AF SIDING (SS) 45 MPH 2,400 FT</div>		CPS-261		
						<div style="border: 1px solid black; padding: 2px; display: inline-block;">NO. 4 60 MPH</div> 4 SET-OFF TRK		ABS-261	DTC BLOCK RAVENSWORTH	12
				CFP 103.9	SEMINARY	HORN ——— NS ———		CPS-261		
3				CFP 103.2		1.8		ABS-261	DTC BLOCK RAVENSWORTH	12
65				CFP 102.8		1.3	S-50			
				CFP 102.5	CAMERON RUN		S-50		DTC BLOCK RAVENSWORTH	12
				CFP 101.2	VAN DORN		S-50			
				CFP 100.5		1.9			DTC BLOCK RAVENSWORTH	12
3				CFP 99.8						
65				CFP 99.3	FRANCONIA				DTC BLOCK RAVENSWORTH	12
				99.0		2.6	3	2		
				CFP 98.0				ABS-261	DTC BLOCK RAVENSWORTH	12
				CFP 96.7	RAVENSWORTH		S-45	CPS-261		
				CFP 95.8	NEWINGTON	2.4	(1)HBD-DED-HCD 17-4	ABS-261	DTC BLOCK POSSUM	10
				CFP 94.3	POHICK LORTON		AMTRAK			
				93.0					DTC BLOCK POSSUM	10
				92.0						
				92.3	LORTON (CP NO. 3)			CPS-261	DTC BLOCK POSSUM	10
				91.0		2.4				
				CFP 89.9	COLCHESTER		3	2	DTC BLOCK POSSUM	10
				CFP 88.9	WOODBIDGE (P)	2.9	TTB	OCCOQUAN RIVER		
				88.0				ABS-261	DTC BLOCK POSSUM	10
				87.0	FEATHERSTONE			CPS-261		
				CFP 85.7	RIPPON (P)	1.7		ABS-261	DTC BLOCK FEATHERSTONE	10
				CFP 85.3	RIPPON					
				CFP 84.6	NEABSCO	1.8	(1) HBD-DED	NEABSCO CK. POWELLS CK.	DTC BLOCK FEATHERSTONE	10
				CFP 83.5	POWELLS CREEK			N-50		
70	60	55	45							

RF&P SUBDIVISION - RR

AUTHORIZED SPEED				MILE POST	STATION	TRACK DIAGRAM		AUTH FOR MOVE	TWC	NOTES
						↓	↓			
P	IM	F	M		2.2			ABS-261	DTC BLOCK FEATHER-STONE	
70	60	55	45	CFP 81.3	N. POSSUM POINT			CPS-261		
					1.6		NO. 1 - CSDG 8,110 FT. 10 MPH	ABS-261	DTC BLOCK VEPCO	
70	60			CFP 79.7	POSSUM POINT			CPS-261		
55	55				0.6		QUANTICO CK.	ABS-261	DTC BLOCK QUANTICO	
				CFP 79.1	QUANTICO			CPS-261		
				CFP 78.9	QUANTICO (P)			ABS-261		4
55	55			CFP 78.5			3,500 FT.			
70	60			CFP 76.9	BROWN FIELD		INCENELATOR RD.			
					2.4		2 8,000 FT.			
				CFP 74.5	WIDEWATER	S-55	BASE RD.			
				CFP 73.0	ARKENDALE	S-55				4
				CFP 71.3	AQUIA		AQUIA CK.		N-50	
				CFP 69.1	BROOKE	S-50			N-45	
70	60			CFP 68.5						
60	55			CFP 68.0	BROOKE (P)					
70	60			CFP 67.2	ROSS				N-55	
				CFP 66.6	ROSS	(1)HBD-DED				
				CFP 65.0	POTOMAC RUN	S-55	POTOMAC RUN			
				64.0						
				63.5	LEELAND				NO. 3, N-40	
				63.4	LEELAND (P)				NO. 2, N-45	
				63.0						
2	65			CFP 61.7						
				CFP 61.4						
				CFP 61.1	DAHLGREN JUNCTION					16
70	60						DAHLGREN BRANCH			
55	55			CFP 60.4						
				CFP 59.7				ABS-261		
70	60	55	45	CFP 59.3	FREDERICKSBURG (P)		RAPAHANNOCK RIVER		DTC BLOCK FREDERICKSBURG	
40	40	40	40	CFP 58.8	FREDERICKSBURG CP ON NO. 2 ONLY			CPS-261		
				CFP 58.6						
70	60	55	45	CFP 57.2	POPLAR		SSDG, CSS/ATC 15,875 FT. 10 MPH	ABS-261		

RF&P SUBDIVISION - RR

AUTHORIZED SPEED				MILE POST	STATION	TRACK DIAGRAM		AUTH FOR MOVE	TWC	NOTES
						↓	↓			
P	IM	F	M	CFP 55.7	HAMILTON			CPS-261	DTC BLOCK FREDERICKS- BURG	
70	60	55	45	CFP 54.8	MASSAPONAX	0.9		ABS-261		
				CFP 53.2	XR	1.6		CPS-261		
				CFP 51.5	SUMMIT	1.4	(1) HBD-DED	ABS-261	DTC BLOCK MILFORD	
				CFP 51.8	SUMMIT	1.9	S-45			
				CFP 49.9	COUNTY LINE	1.9	S-55			
				48.0		2.1				
				47.8	GUINEA	2.1	3	2		
				47.0		2.2				
				CFP 45.6	JONES CROSSING	2.2				
				CFP 43.4	COLLINS	2.2				
				CFP 41.2	RIXEY	2.2	S-50			
				40.0	1.8					
				39.4	HOLLY HILL		S-45	N-50		
				39.0				ABS-261		
				CFP 37.8	MILFORD			CPS-261		
				36.0		2.0		ABS-261		
				35.8	SOUTH MILFORD			CPS-261		
				35.0		1.7				
				CFP 34.1	PLEASANT HILL			N-45	DTC BLOCK DOSWELL	
				CFP 34.2	PLEASANT HILL	2.2	(1) HBD-DED			
				CFP 31.9	POLECAT CREEK	2.3		ABS-261		
				CFP 29.6	COLEMANS MILL	2.3				
				CFP 27.3	RUTHER GLEN	2.3	3	2		
				CFP 25.0	CHANDLER	2.3	S-45	N-55		
				1.9						
				CFP 23.1	NORTH DOSWELL			CPS-261		
						1.3	NO. 4, CSDG 2,880 FT. 10 MPH	ABS-261		
70	60	55	45	OVER DIAMOND						
50	50	50	45	CFP 21.8	DOSWELL DIAMOND			CPS-261	16	
70	60	55	40					ABS-261		
			45	CFP 21.6	DOSWELL			CPS-261		
						2.6				
				CFP 19.6	TAYLORSVILLE		(1) HBD-DED			
				CFP 19.2	TAYLORSVILLE			ABS-261		
				19.0		2.1	3	2		
				18.0						
70	60	55	45	CFP 17.1	ELLETT			N-50		

RF&P SUBDIVISION - RR

AUTHORIZED SPEED				MILE POST	STATION	TRACK DIAGRAM		AUTH FOR MOVE	TWC	NOTES
						SOUTH				
P	IM	F	M	CFP 15.6	VAUGHN ROAD 1.9	S-35	N-45	ABS-261	DTC BLOCK ASHLAND	8
70	60	55	45							
ASHLAND HEAD END RESTRICTIONS 35-0700-1900 DAILY 35-1900-2200 FRIDAY 45 ALL OTHER TIMES RING BELL CONTINUOUSLY				CFP 15.2	NORTH ASHLAND 2.3	13.9	ASHCAKE N-40	ABS-261	DTC BLOCK ASHLAND	5
70 60 55 45										
70 60 55 45				CFP 14.8	ASHLAND (P) 2.3	12.95	KENWOOD	ABS-261	DTC BLOCK ASHLAND	5
70 60 55 45										
70 60 55 45				CFP 13.9	LANGFORD 2.2	9,500 FT.	MILL ROAD	ABS-261	DTC BLOCK ASHLAND	5
70 60 55 45										
70 60 55 45				CFP 13.4	ELMONT 2.1	11.15	HUNGARY	ABS-261	DTC BLOCK ASHLAND	5
70 60 55 45										
70 60 55 45				CFP 11.7	HUNTON 2.1	9.65	HERMITAGE	ABS-261	DTC BLOCK ASHLAND	5
70 60 55 45										
70 60 55 45				CFP 9.0	GLEN ALLEN 2.5	7,200 FT.	(1) DBD-DED	ABS-261	DTC BLOCK ASHLAND	5
70 60 55 45										
70 60 55 45				CFP 9.6	LAUREL 2.4	8,000 FT.	HUNGARY	ABS-261	DTC BLOCK ASHLAND	5
70 60 55 45										
70 60 55 45				CFP 8.1	105.3 MILES 2.4	5,800 FT.	HERMITAGE	ABS-261	DTC BLOCK ASHLAND	6,9,14
70 60 55 45										
70 60 55 45				CFP 7.2	GREENDALE 2.4	3	2	CPS-261	DTC BLOCK ASHLAND	6,9,14
70 60 55 45										
70 60 55 45				CFP 5.5	105.3 MILES 2.4	8.1	HUNGARY	CPS-261	DTC BLOCK ASHLAND	6,9,14
70 60 55 45										
70 60 55 45				CFP 4.8	GREENDALE 2.4	6.6	HUNGARY	CPS-261	DTC BLOCK ASHLAND	6,9,14
70 60 55 45										
70 60 55 45				CFP 4.8	GREENDALE 2.4	5.4	HERMITAGE	CPS-261	DTC BLOCK ASHLAND	6,9,14
70 60 55 45										
P--#1 25, #2 & #3 40 F--#1,2,3 25				CFP 4.8	GREENDALE 2.4	FLORENCE DIV RICHMOND TERMINAL	CQ DISP 20 - 3 RD - 96	CPS-261	DTC BLOCK ASHLAND	6,9,14
P--#1 25, #2 & #3 40 F--#1,2,3 25										

STATION PAGE NOTES

- NOTE 1:** All signals on the RF&P SD, RO and south are 1280-1298 rules. All signals north of RO are signal rules CR1277-CR1294A.
- NOTE 2:** Train and engine movements not equipped with Automatic Train Control/Cab Signal Apparatus may operate on single main, and No. 1,2 & 3 between CFP 113.8-112.2, and CFP 110.1-103.9 wayside indication, but must not exceed 25 MPH. Such train and engine movements must not pass a signal displaying a Restricting or Restricted Proceed unless authorized by the train dispatcher.
- NOTE 3:** Coal train movements to CSX from NS must not exceed 10 MPH.
- NOTE 4:** Single white light indicators are mounted on the masts of the northbound signals at Arkendale. Northbound freight trains must STOP to clear road crossings between CFP 76.7 and Quantico when these indicators display a dark aspect.
- NOTE 5:** Ashland restrictions: 1. The whistle must not be sounded in Ashland between N. Ashland and Langford signals, except in case of emergency.
2. The speed restrictions between MP 15.6 and 13.4 apply to the head end of the movement only.
- NOTE 6:** Train and engine movements not equipped with Automatic train Control/Cab Signal Apparatus may operate on No. 2 & 3 between CFP 4.8 and MP CFP 7.0 by wayside indication, but must not exceed restricted speed.
- NOTE 7:** Speed column designators: IM – intermodal, M – mineral (coal, phosphate, sand and gravel, stone)
- NOTE 8:** Trains longer than 6,000 ft in length must contact CQ dispatcher prior to passing Vaughn's road, MP CFP 15.6.
- NOTE 9:** The speed restriction MP 4.8 to 5.5 is for Northbound trains only and applies until engine occupies Hermitage Road Crossing, MP 5.5.
- NOTE 10:** Southbound trains with a STOP signal will hold short of the pedestrian walkway.
- NOTE 11:** The high car detector at MP 110.2 reports at 17'4" for Virginia Avenue Tunnel on AAR Channel 96, and dispatcher receives an office indication at 16'4" for trains destined to the Amtrak B&P Tunnel in Baltimore.
- NOTE 12:** Refer to Special Instructions for southbound shoving movements into Virginia Tunnel.
- NOTE 13:** Northbound intermodal and merchandise freight trains must approach the intermediate signals at Van Dorn and Cameron Run not exceeding 50 MPH and must not increase to timetable speed until it can be seen that clear signals can be seen at these locations.
- NOTE 14:** Cab signal system (CSS) and automatic train control (ATC) rules are in effect between CFP 110.1 and CFP 4.8.
- NOTE 15:** LSL restrictions are listed in the station pages in the track diagram column as in this example:
LSL Speeds
S-25 (This is a southward train – 25 mph)
These speeds must be applied to all trains with LSL equipped locomotives in the lead. The signals at the locations indicated by these restrictions must be approached in such a manner that the train speed does not exceed the listed, unless the signal is seen to display an indication better than approach.
- NOTE 16:** CSS/ATC Movements – Locomotives not equipped with cab signal and automatic train control apparatus may operate on cab signaled main tracks at Doswell and Dahlgren Junction. These movements will be limited to the distance necessary to accomplish the required moves.
Example: Pull a train with a non-equipped locomotive from the Dahlgren Branch to clear the southward signal.
Turn a non-equipped locomotive at Doswell.

RF&P SUBDIVISION - RR DAHLGREN BRANCH

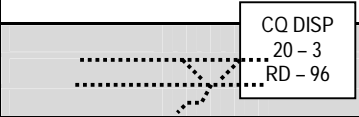
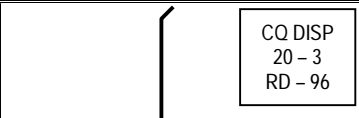
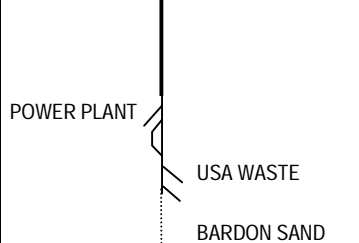
AUTHORIZED SPEED				MILE POST	STATION	TRACK DIAGRAM		AUTH FOR MOVE	TWC	NOTES
						SOUTH				
P	IM	F	U			↓				
70	60	55	45	CFP 61.1	DAHLGREN JCT			CPS-261		
10				CFQ 0.0	DAHLGREN JUNCTION			ABS-261	DTC BLOCK DAHLGREN	
10				CFQ 3.0	DTC BLOCK SIGN				DTC BLOCK SEALSTON	
10				CFQ 10.1	SEALSTON			46		
10					10.1 MILES					

STATION PAGE NOTES

NOTE 1: - Speed column designators: IM - Intermodal, M - mineral (coal, phosphate, sand, gravel, and stone)

RF & P SUBDIVISION SPECIAL INSTRUCTIONS

1. INSTRUCTIONS RELATING TO OPERATING RULES

GLOSSARY-1 EXCEPTED TRACKS

The following tracks are designated as excepted track.

1. Service Distributors track, CFP 94.7.
2. Davis Industries track, CFP 91.5.
3. L. C. Smith track, CFP 61.2.
4. All industrial tracks off of No. 1 track between CFP 58.8 and CFP 55.7, except Spotsylvania Industrial Park Tracks.
5. Wye track around the Maintenance of Way Shop Building, CFP 58.1.
6. Maintenance of Way Shop track, CFP 58.1.
7. Owen Steel track, CFP 53.2.
8. All Milford Yard tracks, except No. 1 track south of Milford Interlocking and north of Milford Rd. Crossing.
9. Ruther Glen, CFP 27.2.
10. Doswell Stone track, CFP 22.0.
11. Doswell Yard stub-end storage tracks (3), CFP2 1.9.
12. Best Products Lead, CFP1 7.4.
13. 84 Lumber track, CFP 6.0.

WHISTLE SIGNALS

14-1 Entire Subdivision – Engine horn will be sounded with 2 long sounds approaching passenger stations between 0500 and 2330 hours. At all other times the whistle will not be sounded at passenger station unless people are present.

MOVEMENT OF TRAINS

92-1 Milford

Switching indicators, consisting of clear lights, are located on back of Dwarf Signal governing northbound movements from No. 1 Track to Yard at Milford and on back of Dwarf Signal governing southbound movements from Yard to No. 1 track at Milford.

Crews who request and receive switching indicators may occupy track governed by the associated Dwarf Signals and make reverse movements within the limits of the Interlocking so long as the lights are displayed.

ROAD CROSSING AT GRADE

100-1 An automatic timing device is in service at the following gate protected highway grade crossings: CFP 22.0, Doswell; CFP67.5, Culleys Yd.

If train movement is delayed and does not reach crossing within two and one-half minutes, the crossing warning will cease to operate and gates will clear for highway traffic. Twenty seconds prior to warning cut-out locomotive cab signal will display "Restricting" aspect.

100-2 Single unit white light indicators are mounted on the signal masts of intermediate Signals 730 and 730A and are offset east and west of those respective signal units. These indicators govern northward freight train movements only and when respective track the movement must stop so as not to foul road crossings between Brown Field, CFP 76.7 and Quantico Interlocking, CFP 79.1.

100-3 Due to rusty rail conditions Dahlgren Industrial Lead Main Track between MPCFQ0.0 and MP CFQ 10.1 and on Solite Lead at Sealston, train and engine movements over grade crossings equipped with automatic warning device must be flagged unless it is known that warning device has been actuated.

100-4 Unless otherwise instructed by train dispatcher, southbound trains in excess of 6000 feet in length must stop north of Vaughn's road crossing CFP 15.6, when it is known that conditions exist that will prevent the trains arrival in Acca Yard.

100-5 Due to rusty rail conditions, trains operating on No. 1 track must flag Hamilton road crossing at CFP 54.8.

103-1 Shoving Movements

Shoving movements made in a southbound direction from M Street into Virginia Tunnel, to clear the northward signal at CP Anacostia (On the Alexandria Extension), may be made without a trainman on the leading end under the following conditions:





- 1 – The Dispatcher is advised of the movement and places appropriate blocking devices at CP Virginia.
- 2 – An Approach signal or better is displayed at M. Street.
- 3 – A fussee must be placed on the leading car shoved into the tunnel.
- 4 – The movement must not exceed that distance necessary to cross the northbound signal at CP Anacostia.
- 5 – An observer must remain in the vicinity of M Street until the eastbound movement has cleared, to assure that the train is complete, unless a working EOT is attached.

1280-1 Signals not in conformity with operating rules

- 1 - All signals north of RO are signal aspect and indication Rules CR-1280a-CR-1294a.
- 2 - All signals at RO and south to Greendale are signal aspect and indication rules 1280-1298, with the exceptions illustrated below.
- 3 - Cab Signal Aspects

In accordance with Timetable Special Instruction "Conformity between Cab Signals and Fixed Signals," the following chart illustrates the cab signal aspect that must conform to the applicable fixed signal.

Note: All illuminated lights are lunar lights.

NAME	ASPECTS
CLEAR	
APPROACH MEDIUM	
APPROACH	
RESTRICTING	

The following chart identifies the cab signal(s) that must be displayed to conform to each fixed signal, in accordance with Timetable Special Instruction, "Conformity between Cab Signals and Fixed Signals."

FIXED SIGNAL	Conforming cab signal (s)
Clear	Clear
Limited Clear	Approach Medium
Medium Clear	Restricting
Approach Limited	Approach Medium
Approach Medium	
Medium approach	Restricting
Approach	Approach
Slow Clear	Restricting
Restricting	
Restricted proceed	
Stop Signal	Approach
Limited Approach	

1280-1 SIGNALS NOT IN CONFORMITY WITH OPERATING RULES

Signals RF&P-281 through RF&P-298 apply exclusively on the former RF&P Railroad. Aspects shown are those displayed on color light signals. Numbers shown on number plates are illustrations only.

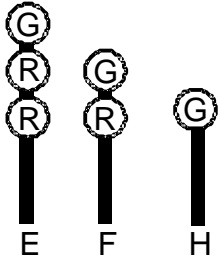
RF&P-1281	
HIGH SIGNAL	DWARF SIGNAL
	
<p>Name – Clear. Indication – Proceed.</p>	

RF&P-1281-B	
HIGH SIGNAL	DWARF SIGNAL
	<p>Flashing</p> 
<p>Name – Approach Limited Indication – Proceed approaching next signal not exceeding limited speed.</p>	

RF&P-1282	
HIGH SIGNAL	DWARF SIGNAL
	
<p>Name – Approach Medium Indication – Proceed approaching next signal not exceeding medium speed.</p>	

RF&P-1283	
HIGH SIGNAL	DWARF SIGNAL
<p>Name – Medium Clear Indication – Medium speed through turnouts, crossovers, sidings, and over power-operated switches; then proceed.</p>	

RF&P-1287	
HIGH SIGNAL	DWARF SIGNAL
<p>Name – Slow Clear Indication – Slow speed through turnouts, crossovers, sidings and over power-operated switches, then proceed.</p>	

RF&P-1285	
HIGH SIGNAL	DWARF SIGNAL
<p>Name – Approach Indication – Proceed prepared to stop at the next signal. Trains exceeding Medium Speed must immediately begin reduction to medium speed as soon as the engine passes the Approach Signal.</p>	

RF&P-1290	
HIGH SIGNAL	DWARF SIGNAL
<p>Name – Restricting Indication – Proceed at Restricted Speed.</p>	

RF&P-1286	
HIGH SIGNAL	DWARF SIGNAL
<p>Name – Medium Approach Indication – Medium speed through turnouts, crossovers, sidings, and over power-operated switches; then proceed prepared to stop at the next signal.</p>	

RF&P-1292	
HIGH SIGNAL	DWARF SIGNAL
<p>Name – STOP Indication – STOP</p>	

2. INSTRUCTIONS RELATING TO SAFETY RULES

NONE

3. INSTRUCTIONS RELATING TO COMPANY POLICIES AND PROCEDURES

NONE

4. INSTRUCTIONS RELATING TO EQUIPMENT HANDLING RULES

NONE

5. INSTRUCTIONS RELATING TO AIR BRAKE AND TRAIN HANDLING RULES

Appendix B&C-1

Locomotives equipped with either LSL or conventional automatic train control equipment must have this equipment cut-in and tested prior to operation over the RF&P Subdivision.

Appendix B&C-2

Instructions Per Automatic Train Control and Cab Signals on the RF&P

Full cycle train control test facilities are located at north and south end of Bryan Park Terminal; north end of Greendale Amtrak Station on Nos. 2 and 3 main tracks; No. 4 Station track south of pedestrian crossing; on No. 4 track just south of the hand throw crossover between No. 3 main track and No. 4 track at CFP 57.9

When engineer performs ATC/CS departure test the following will govern:

- a) Determine that equipment on locomotive is energized and sealed.
- b) Actuate test cycle at test loop location.
- c) Independent brake valve applied, automatic brake valve released.
- d) Cab signal will go to Green (Clear), drop to Yellow over Green (Approach-Medium), Yellow (Approach) and Red (Restricting). Acknowledge each change of the cab signal and see that application pressure holds and brakes remain released.
- e) Cab signal will go up to Green (Clear). Place throttle in Run 1. Cab signal will drop to Red (Restricting). Do not acknowledge. After time delay application pipe pressure will start decreasing, causing the equalizing reservoir and brake pipe pressure to decrease. The power control switch (PCS) Will open and engine RPM will return to idle. The initial brake pipe reduction will be equivalent to a Minimum Reduction and after approximately twenty seconds, brake pipe reduction at a service rate will occur.

- f) Acknowledge the red cab signal. Return throttle to idel.
- g) Place automatic brake valve in Suppression position to recover from penalty. When application pipe pressure reaches approximately 120 PSI, PCS switch should close. Then place automatic brake valve in release position and equalizing reservoir and brake pipe pressure will be restored.
- h) Prepare train control departure test Form No. MP-485 and sign.
- i) Place the completed form in holder located in locomotive cab and secure with clamp attached to wall.
- j) Notify the train dispatcher that test is complete and equipment is functioning properly.

6. INSTRUCTIONS RELATING TO RESTRICTED EQUIPMENT

- 1. Six axle locomotives must not operate on the following tracks:
 - a) Langford – Team Track CFP13.8.
 - b) Ellett – East side, Best Products Lead.
 - c) N. Doswell – Old Weyerhaeuser side track.
 - d) Milford – Side tracks off of No. 1 Main Track.
 - e) Fredericksburg – All side tracks except Nos. 1, 4, Bank and Middle Tracks.
 - f) Quantico – All side tracks.
 - g) Featherstone – All side tracks on west side.
 - h) Franconia – Fleet Warehouse side track.
- 2. JTMX cars are restricted to 10 MPH on the Dahlgren Branch main track between MP CFQ0.0 and MP CFQ10.1
- 3. Cars or equipment in excess of 19'0" must not operate on No. 2 Track between MP CFP 69.0 and MP CFP 69.1 account of close clearance.

7. MISCELLANEOUS

A. – Empty Hopper Trains

Hopper trains originating at Benning enroute Doswell will have engines lined up so when cut off train control, 2nd unit will be headed correctly for movement on Piedmont Subdivision.

B. – Sealston Train Movements

Crews called for train movements from Richmond (ACCA or Fulton) to Sealston, or crews taxing to Sealston for empties, will be sure an EOT is on the train, or will be sure an EOT is with them in the taxi.

S&C SUBDIVISION - SC

AUTHORIZED SPEED	MILE POST	STATION	TRACK DIAGRAM		AUTH FOR MOVE	TWC	NOTES
			WEST	WEST			
	BF 226.8	ROCKWOOD	KEYSTONE SD		CM DISP 94-3 RD-08	ABS261	
WYE - 5 MPH				WEST WYE		TWC-DTC	1, 2
15	BFC 0.0	ROCKWOOD	1.2	G&W RUNNING TRK	CM DISP 94-3 RD-08		
	BFC 1.1	G&W JUNCTION		ROCKWOOD RUNNING TRACK			
	BFC 1.2	DTC BLOCK SIGN					
25	BFC 1.2	FOGLE JUNCTION					
	BFC 1.3	WILSON CREEK	1.9	WILSON CREEK SDG. 4,760 FT.		DTC BLOCK SHAM	
	BFC 3.1	DTC BLOCK SIGN		BOGNAR I.T.			
	BFC 6.1	ROBERTS		ROBERTS RUNNING TRACK			
25	BFC 8.5		6.7	EAST YARD		DTC BLOCK SOMER	
10 MPH HEAD END ONLY	BFC 8.6			WEST YARD			
25	BFC 9.2	SOMERSET					
	BFC 9.8	DTC BLOCK SIGN					
	BFC 11.0	MUKDEN					
25	BFC 11.3		6.9	GEIGER TUNNEL - 145 FT.		DTC BLOCK COLE	
20	BFC 11.4						
25	BFC 16.7	DTC BLOCK SIGN					
	BFC 16.9	VANG JCT.		COLEMAN I.T.			
	BFC 17.4	COLEMAN					
25	BFC 17.5						
20	BFC 21.8	STOYESTOWN	13.3	TTB STONY CREEK		DTC BLOCK LAND	
	BFC 23.6	ROWENA					
	BFC 26.7	HV SIDING					
	BFC 30.0	DTC BLOCK SIGN					
	BFC 31.1	JEROME JCT.		JEROME SDG			
	BFC 32.2	HOLSOPPLE	11.3	32.1 EHR 4453 32.4		DTC BLOCK FERN	
20	BFC 34.3	S&C BRIDGE					
10	BFC 34.5						
20						TWC-DTC	

S&C SUBDIVISION - SC

AUTHORIZED SPEED	MILE POST	STATION	TRACK DIAGRAM	AUTH FOR MOVE	TWC	NOTES
			WEST			
20	BFC 36.2	BORDER DAM 11.3		TWC-DTC	DTC BLOCK FERN	
25	BFC 36.7					
10	BFC 41.1	DTC BLOCK SIGN				
25	BFC 41.5					
10 MPH OSBORNE ST TO 800 FT W OF CLINTON ST.	BFC 43.3	OSBORNE ST		46		
	BFC 45.1	CLINTON ST.				

STATION PAGE NOTES
<p>NOTE 1: East Wye extends from switch on No. 1 Main to Switch for Rockwood Running Track and is lined for movement to S&C Main. West Wye extends from No. 1 Main to the East Wye.</p> <p>NOTE 2: Refer to SD special instructions for 6 – axle locomotive restrictions</p> <p>NOTE 3: East Yard – West end tracks 2,3,5 in service. No. 1 track out of service</p> <p>NOTE 4: Rockwood Running track – Out of service BFC 0.4 & BFC 0.6</p>

S & C SUBDIVISION SPECIAL INSTRUCTIONS

1. INSTRUCTIONS RELATING TO OPERATING RULES

100-1 ROAD CROSSINGS AT GRADE

Providing Crossing Protection

Trains will provide protection against vehicular traffic before moving over highway or street crossings designated below:

Table 9. Providing Crossing Protection	
Location	Instructions
Somerset	Cannell Street
S&M Branch Johnstown	
Poplar Street No. 2	Messenger Street
Coyer Alley	Apple Alley
	Coyer Good Alley

USE OF SPECIFIED TRACKS

96-1 The following tracks are designated as other than main tracks and Rule 105 will govern movement:

BFC 413 and Johnstown
Boswell Industrial Track
Coleman Industrial Track

96-2 West Leg and East Leg of Wye Tracks, Rockwood – East Leg of Wye extends from switch on Main Line Subdivision to switch leading to Rockwood Running Track and is lined for movement to S&C Main Track. West Leg of Wye extends from switch on Main Line Subdivision to switch on East Leg of Wye.

2. INSTRUCTIONS RELATING TO SAFETY RULES

NONE

3. INSTRUCTIONS RELATING TO COMPANY POLICIES AND PROCEDURES

NONE

4. INSTRUCTIONS RELATING EQUIPMENT HANDLING RULES

4456-1 80 Ft Cars

Train Classification instructions for empty cars 80 feet and longer cars other than box cars.

Between	Safe Trailing	
	Direction	Tonnage
Rockwood and Mukden	Westbound	3900
Johnston and Mukden	Eastbound	2600

5. INSTRUCTIONS RELATING TO AIR BRAKE AND TRAIN HANDLING

NONE

6. INSTRUCTIONS RELATING TO RESTRICTED EQUIPMENT

6 axle locomotives must not operate between BFC 2.0 and BFC 45.1 except as noted below:

- A. Locomotives permitted in Cambria coal train service
- B. 6 axle locomotives with steerable trucks are permitted on the following tracks on the S&C Subdivision:
 1. Main track from MP BFC0.0 to MB BFC19.0
 2. Rockwood Running Track
 3. Wilson Creek Siding
 4. Coleman Industrial track with includes the Coleman Siding at MP BFC17 and the Cambria Coal Facility tracks.

6 Axle Identification – CSX 6 axle locomotives with steerable trucks (ST) are identified in the locomotive data guide of the CSX Train Handling Rules.

- C. 6 axle locomotives without steerable trucks are prohibited on the S&C Subdivision as per current timetable special instruction.

7. MISCELLANEOUS

Vang Jct.

The main track switch located at Vang Jct. MP BFC16.9 leading to the Coleman Industrial track will be left in the position last used.

All trains and OTE's will approach this switch prepared to STOP, and must examine the switch to see it is properly lined for their movement.

NOTES

NOTES

NOTES

SHENANDOAH SUBDIVISION - SJ

AUTHORIZED SPEED	MILE POST	STATION	TRACK DIAGRAM		AUTH FOR MOVE	TWC	NOTES
			↓	↓			
P F				WEST			
45 40	BA 81.3	HARPERS FERRY (CP NO. 2 ONLY)	<div style="display: flex; justify-content: space-around; align-items: center;"> <div style="border: 1px solid black; padding: 2px;">CUMBERLAND SD 1</div> <div style="border: 1px solid black; padding: 2px;">CM DISP 94 - 4 RD - 08</div> </div>		CPS-261	DTC BLOCK HARPER	
10	BAD 0.0	HARPERS FERRY			TWC-DTC		1
25	BAD 0.8					DTC BLOCK MILL	
10	BAD 2.0		3.0				
25	BAD 2.5				TWC-DTC		
	BAD 3.0	DTC BLOCK SIGN					
	BAD 4.1	MILLVILLE		2.0		193 STONE YARD LIMITS	
	BAD 5.0	DTC BLOCK SIGN					
	BAD 6.0	HALLTOWN ROAD			TWC-DTC		
25	BAD 8.0			5.8			DTC BLOCK HALL
	BAD 9.4						
10	BAD 10.3	CHARLES TOWN					
	BAD 10.6						
25	BAD 10.8	DTC BLOCK SIGN NS CROSSING		6.7			2
	BAD 17.5	DTC BLOCK SIGN					
	BAD 18.0	SUMMIT POINT		10.5			
	BAD 26.5	FREYCO			TWC-DTC	DTC BLOCK SUMMIT	
	BAD 28.0	DTC BLOCK SIGN					
	BAD 30.5	CV JUNCTION					
25	BAD 30.6			3.7		193 WINCHESTER YD. LIMITS	
10	BAD 31.7	WINCHESTER		1.6			
	BAD 33.0	W&W JUNCTION					
	BAD 33.3	DTC BLOCK SIGN					
10	BAD 35.3			6.0		TWC-DTC	DTC BLOCK KERN
25	BAD 39.3	DTC BLOCK SIGN					
	BAD 44.2	MIDDLETOWN		6.7			DTC BLOCK MIDDLE
	BAD 46.0	DTC BLOCK SIGN					
25	BAD 49.9	DTC BLOCK SIGN			TWC-DTC		DTC BLOCK STRASBURG
10	BAD 50.4	STRASBURG JUNCTION				193 SOU. YD. LIMITS	
		50.4 MILES		NS			

STATION PAGE NOTES

NOTE 1: Signal rules 1280 – 1298 in effect at The NS crossing. Signal rules 1280-1298 are in effect on the APP marker at MP BAD 0.9.
NOTE 2: Rule 226-B(3), and special instructions in this timetable are in effect at Charles Town at the NS crossing.

SHENANDOAH SUBDIVISION SPECIAL INSTRUCTIONS

1. INSTRUCTIONS RELATING TO OPERATING RULES

98-1 NS RAILWAY CROSSING AT CHARLESTOWN

When absolute signal displays STOP indication and no conflicting movement is evident on NS Railway, secure permission from NS train dispatcher to operate push button in metal box marked "B&O" on pole near crossing. NS Train Dispatcher may be contacted by radio, via Telephone on pole at crossing (1-800-323-4782) or via the CSX "CM" Train Dispatcher at Jacksonville. If communication is not available wait 15 minutes and if no conflicting movement is evident on NS railway, depress push button one time only, then release. Signal should indicate proceed after eight minutes. If signal fails to indicate proceed, pass the signal but do not foul crossing. Wait 15 minutes and then proceed.

100-1 ROAD CROSSINGS

MP BAD 47.3 – When temperature is below freezing, all trains will STOP at road crossing at west end of Global Stone, Oranda, VA, Main Track, walk lead unit of train over crossing and then proceed.

MP BAD 9.5 – Charles Town – To avoid blocking street crossings, westbound trains will contact the NS Dispatcher on channel 22-22 and by pressing tone 5 three times on the keyboard keying in 2 on the keypad, before fouling 5th Ave. (BAD 9.5). Train will proceed after being advised by the train dispatcher that there are no conflicting movements in the vicinity. If communication is not available or if signal at NS Railway crossing fails to indicate proceed, movement will proceed in accordance with Paragraph 1&2.

2. INSTRUCTIONS RELATING TO SAFETY RULES

NONE

3. INSTRUCTIONS RELATING TO COMPANY POLICIES AND PROCEDURES

NONE

4. INSTRUCTIONS RELATING TO EQUIPMENT HANDLING RULES

NONE

5. INSTRUCTIONS RELATING TO AIR BRAKE AND TRAIN HANDLING RULES

NONE

6. INSTRUCTIONS RELATING TO RESTRICTED EQUIPMENT

A – 6 axle locomotives with steerable trucks may operate on the Shenandoah SD, except SD-80 MAC unit.

6 axle locomotives without steerable trucks may not operate.

7. MISCELLANEOUS

1. Telephone Locations and Numbers Winchester Station – 540-662-6316. Fax No is 540-667-3520
2. Joint Use of Tracks CSX trains and engines will use the tracks of other railroads in accordance with their timetables, rules and regulations as follows:

Winchester – Tracks within yard limits on W&W between W&W Jct. and Virginia Cold Storage Company Siding.

Millville – Storage and Scale Track – Look out for Millville Quarry using these tracks.

Oranda – When cars are left standing on Main Track for loading Oranda, VA, MP BAD 47.0, Global Stone employees will apply a portable derail on Main Track at MP BAD 46.8 when cars are being loaded and will remove same after cars are loaded and secured.

NOTES

TRENTON SUBDIVISION - TN

AUTHORIZED SPEED	MILE POST	STATION	TRACK DIAGRAM		AUTH FOR MOVE	TWC	NOTES	
			↓	↓				
50	57.3	CP PORT READING JUNCTION (X)	CONRAIL LEHIGH LINE	N. JERSEY DISP 50 - 4	NORAC 261-ABS	D		
50	QA 57.3	PORT READING JCT	(2) HBD-DED (2) HBD-DED HCD(S) 17'3"	NI DISP 58 - 2# - 4c RD 58	ABS-261 CSX RULES	D	1,4	
	QA 56.3	MANVILLE YARD KYLE		NI DISP 58 - 3# - 6c RD 58				
	QA 50.0	BELLE MEADE						
	QA 48.4	HARLINGEN						
	QA 45.8	SKILLMAN						
	QA 42.6	HOPEWELL						
50	QA 38.5	GLENMORE					2	
	QA 37.9	PENNINGTON			ABS-261 CSX RULES			
No. 1 50	No. 2 50	QA 35.7 CP WING (X)		1 2	CPS-261	D	13	
			NI DISP 58 - 4# - 4c RD 58	TRENTON I.T.	NORAC 261-ABS			
NO. 1 P 60 F 40	NO. 2 P 60 F 40	QA 32.6 CP TRENT (R WIND) (X) QA 32.5 WEST TRENTON (P)		1 2	NORAC 600-616	D	3,4	
		QA 30.7 YARDLEY (P) 29.0 28.0		1 2	SEPTA CONTROL DESK 2 CH - 58	NORAC 261-ABS		
60	60	QA 26.6 CP WOOD (R WIND) (X)	WOOD CONNECTING TRACK	1 2	NI DISP 58 - 2# - 5c RD 58	NORAC 600-616	D	5
70	70			1 2	MAIN	1&2 MAIN 251 S-1 N-2		
	60	QA 26.5 WOODBOURNE (P)				NORAC 600-616	D	6
	70	QA 26.4 CP WOODBOURNE (X)				#1 251 S-1,N-2	CPS 261	10
	50			1 2	WOODBOURNE YD FAIRLESS BR	NORAC 251 S-1 N-2	D	11
		QA 25.3 CP FAIRLESS (X)		1 2	X25		CPS 261	10
70	70	QA 24.0 LANGHORNE (P)	(2) HBD-DED		NI DISP 58 - 2# - 5c RD 58	251 S-1 N-2		10
	70	QA 21.9 NESHAMINY (P) QA 19.2	SEPTA			251 S-1 N-2	ABS 261	

TRENTON SUBDIVISION - TN

AUTHORIZED SPEED	MILE POST	STATION	TRACK DIAGRAM		AUTH FOR MOVE	TWC	NOTES
			↓	↓			
50 CS 40					ABS-261		
	QA 18.8	CP NESH (X)			CPI-261	D	
				CSDG 13,680 FT		ABS-261 CSX RULES	
	QA 16.2	CP BERRY (X)			NI DISP 58 - 7# - 6c RD 58	D	
	16.0 15.0						
	QA 13.3	BUSTLETON					
	QA 9.7	CHELTENHAM (2) HBD/DED		SEPTA FOXCHASE LINE		ABS-261 CSX RULES	14
	QA 9.6	CP CHELTENHAM JCT. (R-WAYNE)				NORAC 600-616	D 13
No. 1 P F 50 40		QA 9.1					
No. 2 P F 50 40		QA 9.0	LAWNDALE (P)				
----- 60 60		QA 7.3	OLNEY (P)	1 2			
----- 40 40		QA 7.2			SEPTA CONTROL, DESK 2 CH - 58	NORAC 261-ABS	
----- 60 60		QA 6.5					
----- 40 40		QA 6.3		SEPTA MAIN LINE (R-WAYNE)			
----- 60 40 60 60							
	QA 6.2	CP NEWTOWN JCT. (X)				NORAC 600-616	D 13
				BLUE LINE BR		ABS-261 CSX RULES	
	QA 4.4	CP NICE (X)					D 7
				3 4	NI DISP 58 - 4# - 7c RD 58		
	QA 3.0	LAUREL HILL		1 2			8
	QA 2.9	CP LAUREL HILL (X)					D 9
				NS HARRISBURG LINE, CP FALLS MAIN LINE DISP 46 - 7# - 5c			
	QA 2.5	CP RIVER (X)					D 12
				TRENTON SD 1 & 2			
				BELMONT CS HARRISBURG SD MAIN	1 2	ABS-261 CSX RULES	

TRENTON SUBDIVISION - TN

AUTHORIZED SPEED	MILE POST	STATION	TRACK DIAGRAM		AUTH FOR MOVE	TWC	NOTES
			↓ SOUTH	↓			
25	QA 1.2	CP BELMONT (X)			ABS-261	D	
25							
20	QA 0.3	CP PARK (X)			ABS-261	D	
20	QA 0.0	PARK JUNCTION					
19	BBF 1.3	PARK JUNCTION	PHILADELPHIA SD	AV DISP 66 - 5 RD - 08	ABS-261		

STATION PAGE NOTES

- NOTE 1:** All signals on the Trenton Subdivision are signal rules CR1277-CR1294A..
- NOTE 2:** Trains destined to the Morrisville Line may disregard the high car alarm.
- NOTE 3:** Southbound trains with a STOP signal displayed at Trent will stop at the "CC" sign 400 FT. north of MP 33, and will proceed only with a favorable signal or with permission of the SEPTA "A" dispatcher or the operator at Wind.
- NOTE 4:** Train crews operating on Septa controlled track must carry SEPTA Bulletin Orders.
- NOTE 5:** Southbound freight trains on No. 1 track receiving a STOP signal at CP Wood will STOP north of Township Line Road crossing, MP 27.4, and be governed as follows:
- a – A crew member will immediately proceed to relay case and manually interrupt highway warning device with switch key for no. 1 track only and relock the control box.
 - b – Protections must be provided by on ground personnel for trains operating on adjacent track.
 - c – Upon receiving a signal to proceed at CP Wood, freight trains must not proceed over Township Line Road crossing until reaching circuit which will reestablish the operation of crossing warning devices, and ensuring that they have operated for at least 20 seconds. Note that it is not necessary to restore crossing warning devices from the manual mode. Warning devices will restore for normal automatic Operation as the train departs.
- NOTE 6:** Passenger train speed over Woodbourne Road crossing, on No. 2 track is reduced to 60 MPH.
- NOTE 7:** Movements must secure permission from the Yardmaster at Morrisville before occupying the Richmond Industrial Track.
- NOTE 8:** Movements enroute to the SEPTA Main Line, north of MP 10.0, or Richmond Industrial Track must inform the Train Dispatcher prior to arriving at MP 3.0 so the dispatcher will enable the alarm 2 detector.
- NOTE 9:** Interlocking No. 1 track only.
- NOTE 10:** Langhorne and Woodbourne stations: In the application of Rule 121-C, trains operating on No. 2 track are to discharge and receive passengers across no. 1 track.
- NOTE 11:** Woodbourne Road Crossing
- A. Northbound Trains on the single main track must hold at or south of the "CC" sign located 425 FT. south of MP QA 26, to avoid unnecessary operation of the warning devices (and roadway blockage) at Woodbourne Rd. Proceed north of the "CC" sign only when permission is given from the dispatcher, or the northbound signal at the CP Woodbourne upgrades as a result of the SEPTA dispatcher lining the route at CP Wood for northbound freight move.
 - B. Northbound trains on the yard lead must hold south of the painted insulated joint located 650 FT. from the south edge of the crossing to avoid unnecessary operation of the warning devices (and roadway blockage) at Woodbourne Rd. unless instructions to proceed north are received from the dispatcher. If head room is needed between the painted joints and the northbound signal for shifting in the yard, make certain the signal is not displayed.
 - C. The signal 2N-2 at Woodbourne, MP QA 26.4, for northbound movements out of Woodburne Yard will display an aspect at all times. Do not foul the circuit until signal 2N-2 displays an aspect greater than STOP when it's needed.
 - D. In order to avoid unnecessary operation of the warning devices (and roadway blockage) at Woodbourne Rd., the southbound signal at CP Woodbourne is not to be displayed with a train occupying the single track between CP Woodbourne and CP Wood until the train is ready to proceed south of the CSX single track. The dispatcher must avoid displaying a southbound signal at CP Woodbourne for a southbound freight move if the track between CP Woodbourne and CP Wood is occupied by the local shifter. Do not display the signal until the shifter has cleared the track north into CP Wood interlocking.
- NOTE 12:** Remote Control Locomotives – Remote control locomotives are not permitted to operate on the Chester Secondary, or on the SEPTA Main Line to Lansdale.
- NOTE 13:** NORAC Operating rules are in effect from northward Home Signal CP Wing to northward Home Signal CP Wood, and from southward Home Signal CP Cheltenham Jct. to northward Home Signal CP Newtown Jct.
- NOTE 14:** Between the hours of 0600 and 2359 all southbound trains that activate the HBD/DED located at QA 9.7 are to clear Lawndale passenger station before stopping to inspect.

TRENTON SUBDIVISION - TN BLUELINE BRANCH

AUTHORIZED SPEED	MILE POST	STATION	TRACK DIAGRAM		AUTHORITY FOR MOVE	TWC	NOTES
			↓	↓			
25	QA 4.4	CP - NICE (X)	TRENTON SD NI DISP 58 - 4# - 7c RD - 58		CPS-261	D	
10	QAB 0.0	NICE	TRENTON SD NI DISP 58 - 4# - 7c RD - 58		ABS-261		
	QAB 0.7	WAYNE	SEPTA CH - 46		ABS-261		
	QAB 0.7	WAYNE (X)	SEPTA CH - 46		NORAC RULES CPS-261	D	

TRENTON SUBDIVISION - TN FAIRLESS BRANCH

AUTHORIZED SPEED	MILE POST	STATION	TRACK DIAGRAM		AUTH FOR MOVE	TWC	NOTES
			↓	↓			
50	QA 25.3	CP FAIRLESS JCT. (X)	NI DISP 58 - 7# - 6c RD - 58		ABS-261	D	
10	QAF0.0	FAIRLESS	NI DISP 58 - 7# - 6c RD - 58		ABS-261		
10	0.9	WOODBOURNE WOODBOURNE YARD	CS MAIN		ABS-261		
	2.9	CP-MA (X) MORRISVILLE LINE	CONRAIL S JERSEY DISP 64 - 8#		NORAC RULES CPS-261		

**TRENTON SUBDIVISION - TN
STONEY CREEK BRANCH - S6**

AUTHORIZED SPEED	MILE POST	STATION	TRACK DIAGRAM		AUTH FOR MOVE	TWC	NOTES
			↓	↓			
			EAST		NORAC RULES		
		DALE (X)	SEPTA MAIN LINE R - WIND		261	D	
10	QAC 0.0	DALE	SEPTA DESK "A" DISP CH - 58		TWC DCS		
	QAC 2.5	WEST POINT					
10	QAC 4.9	BELFRY					
NS OWNERSHIP 4.9 TO 9.9							

TRENTON SUBDIVISION SPECIAL INSTRUCTIONS

1. INSTRUCTIONS RELATING TO OPERATING RULES

GLOSSARY – 1 EXCEPTED TRACK

Nabisco Industrial Park, MP 15.5 – entire park

2. INSTRUCTIONS RELATING TO SAFETY RULES

Operation in electrified territory

A. CSX catenary – CP Newtown Jct. to CP Trent
Conditions affecting the traction power system are to be reported to the power dispatcher located at Wayne Junction substation via the SEPTA train dispatcher. The bell telephone number of the SEPTA power dispatcher is 215-580-6844

B. Foreign Line Catenary
The following items should be followed when specific information has not been provided by the foreign railroad.

C. Emergencies
When emergency requires that power be shut off in the overhead catenary system, immediately contact the Power Dispatcher or Train Dispatcher. Power will not be restored until the Power Dispatcher has been notified by a responsible person that it is safe to do so.

Do not touch any overhead wires even though the power dispatcher reports that he has cut off the power, unless a qualified electrical employee is present and has placed a visible ground connection on that wire. Any wire of the over-system without a visible ground connection must be considered alive at all times and coming in contact with such a wire may cause serious injury.

Employees must not touch dangling wires nor attempt to move them by any means, but must report their location immediately to the Train Dispatcher or Power Dispatcher and should, if possible, leave someone to watch such wires until their removal. Other persons in danger should be warned of their location.

Employees must report to the Train Dispatcher or Power Dispatcher any attachments of the overhead wire system which are out of place and state whether or not they are in such a position that they can foul the pantograph of an electric car or the top of a locomotive.

Loose connections to the traction and impedance bonds which is a low profile box in the gauge of the track with cables leading to each rail and must be regarded as alive and report must be made promptly to the Train

Dispatcher or Power Dispatcher, made promptly to the employees observing excessive flashes or Arcs at overhead bridges, trolley wires, shaking violently, flashes on or about the car or overhead equipment indicating some irregularity in the electrical operation should immediately arrange for all pantographs to be lowered if practicable and notify the Train Dispatcher or the Power Dispatcher. Delay in reporting such cases may result in damage to equipment or train delays.

D. Qualified Employees
Whenever the term qualified employees is used in the following instructions it refers to those employees in the electric service who by examination and approval of their superior officers are qualified to perform certain duties and are classed as follows:

Class 1 - Employees competent to erect, maintain and repair electrical apparatus or supervise and protect other employees performing such work.

Class 2 - Employees such as Engineers operating electric equipment, electricians on electric rolling equipment and other employees in electric service permitted to go on high equipment for purposes and under conditions hereinafter authorized.

E. Handling work near overhead wires.
All overhead wires including catenary, transmission and signal lines in electrified zones are to be considered alive at all times. Insulating covering or wire should not be depended upon for protection against shock.

- No employee except class 1 employee shall do any work near high voltage wires or apparatus where it is possible for any part of his body or tools and material with which he is working to come within 3 feet of such wires, unless a Class 1 Employee is assigned to protect him against personal injury.

- When persons other than Class 1 or Class 2 employees are required to go work near overhead wires and apparatus they must be protected by a Class 1 Employee who will take necessary precautions for their safety before starting and during progress of the work.

F. Keep off top of high equipment.
Employees (excepting Class 1 and Class 2 Electric Service Employees

and others under their supervision in the discharge of their duties) are prohibited from going on top of box cars, locomotives other high equipment while on tracks electrified with high voltage overhead wires or while movements are being made to such tracks from sidings, yards or other tracks which are not electrified.

Keep at least 3 feet from overhead wires.

Employees assigned to duty as pilots with foreign crews of other divisions using tracks electrified with high voltage overhead wires must arrange to have each member of such crews notified that he must not get on top of high equipment within the electrified zone.

G. Locomotive Operation.

It will be specific duty of the Engineer to know before entering any electrified zone, that no part of his engine or engine equipment will foul the overhead catenary construction.

H. Fires within electrified territory.

- When fires occur near overhead wires, or when fire apparatus is tested near live wires, the poser should be cut off and the wires grounded.
- Water must not be used to extinguish an electrical equipment fire. Dry chemical and sand may be used on electrical equipment fires, on arcs, or other exposed energized parts.
- Any employee noticing fires or other trouble on electric cars, wires, poles or in manholes must immediately notify the Train Dispatcher or Power Dispatcher

3. INSTRUCTIONS RELATING TO COMPANY POLICIES AND PROCEDURES

NONE

4. INSTRUCTIONS RELATING TO EQUIPMENT HANDLING RULES

Engines with six (6) axles are prohibited beyond 400 feet from point of switch on No. 2 track at CP Trent.

5. INSTRUCTIONS RELATING TO AIR BRAKE AND TRAIN HANDLING RULES

NONE

6. INSTRUCTIONS RELATING TO RESTRICTED EQUIPMENT

NONE

7. MISCELLANEOUS

NONE

NOTES

W&P SUBDIVISION - WP

AUTHORIZED SPEED	MILE POST	STATION	TRACK DIAGRAM		AUTH FOR MOVE	TWC	NOTES
			↓	WEST			
	BF 323.0	GLENWOOD JCT.	P&W SD	AS DISP 14 - 6 RD - 08	CPS-261		
15	BO 5.0	GLENWOOD JCT.	BO 5.1	TTB	MONONGAHELA R.	TWC-DTC	1
25	BO 5.8		EHR 4453		AT DISP 14 - 4 RD - 08		
10	BO 6.5		BO 6.5				
25	BO 7.0	7.0					
20	BO 8.9						
25	BO 9.2			WHITEHALL TUNNEL - 1,633 FT.		DTC BLOCK FIN	
10	BO 12.0	DTC BLOCK SIGN BRUCETON		W&LE			
	BO 12.1	5.8					
	BO 13.2	EXPERIMENT					
25	BO 15.0	SNOWDEN					
	BO 17.8	DTC BLOCK SIGN					
	BO 17.9	FINLEYVILLE		FINLEYVILLE RUNAROUND			
	BO 24.4	GILKESON					
10	BO 26.8						
	BO 26.9						
25	BO 31.3	ZEDIKER				DTC BLOCK WASH	
	BO 34.4	WADE					
10 OVER MAIN ST.	BO 35.3	WASHINGTON					
25	BO 35.9	TCS TOWER		TTB			
	BO 36.9	TYLERDALE JCT.	TYLERDALE I. T.				
10	BO 38.1	END OF TRACK 33.1 MILES	TYLERDALE RUNAROUND 2,100 FT.			TWC-DTC	

STATION PAGE NOTES

NOTE 1: The W&P Subdivision is leased to and will be operated by the Allegheny Valley RR (AVR)

W & P SUBDIVISION - WP

1. INSTRUCTIONS RELATING TO OPERATING RULES

NOTES

Road Crossings at Grade

100-1 Entire Subdivision – Due to rusty rail conditions, trains and engines will approach all road crossing protected by Automatic Flasher Lights prepared to stop, unless it is known that crossing protection is working.

2. INSTRUCTIONS RELATING TO SAFETY RULES

NONE

3. INSTRUCTIONS RELATING TO COMPANY POLICIES AND PROCEDURES

NONE

4. INSTRUCTIONS RELATING TO EQUIPMENT HANDLING RULES

4463-1 Train Classification instructions for empty cars 80 feet and longer other than box cars:

Between	Safe Training Tonnage	
	Westbound	Eastbound
Glenwood Jct. and BO 38.1	2200	2900

Empty cars 80 feet and longer other than box cars must be placed in the train in such a location that the trailing tonnage behind these empty cars does not exceed the amount listed above.

In territory where helper locomotives are used on the rear of the train, their tonnage rating should be added to the trailing tonnage listed on this cart when determining for the restricted car(s).

5. INSTRUCTIONS RELATING TO AIR BRAKE AND TRAIN HANDLING RULES

NONE

6. INSTRUCTIONS RELATING TO RESTRICTED EQUIPMENT

NONE

7. MISCELLANEOUS

NONE

NOTES

BALTIMORE DIVISION SPECIAL INSTRUCTIONS

1. INSTRUCTIONS RELATING TO OPERATING RULES.

C FRA ENGINEER CERTIFICATION RIDES

Locomotive engineers must notify the office of the road foreman of engines if they have not had the prescribed FRA engineer certification ride, for the purpose of monitoring operation performance, by October 1st of each year. If the road foreman of engines is not available or cannot be contacted, the division road foreman of engines must be notified.

REQUIRED EXAMINATIONS

Train and engine employees and yardmasters must complete the required examinations for annual rules training by July 1. CSX operating rules and other required courses will be covered in multi-media pods.

N-1 Employees Permitted to Ride On Engines and Freight Trains

In addition to the assigned train and engine crew members, the equipment operator, or employees properly assigned for qualification purposes;

The following designated employees will be permitted to ride on engines, freight trains, track cars and front & rear ends of passenger trains:

- Staff officers (system, region, division)
- Transportation Department supervisors
- Dispatching offices personnel, including STO's Chief Dispatchers, Assistant Chief Dispatchers and Dispatchers
- Yardmasters
- Engineering Department supervision
- Engineering Department employees (track, bridge & building, train control/C&S within their territory)
- Mechanical Department supervision
- Mechanical Department employees in performance of their duties
- Railroad police officers in performance of their duties
- Federal and state inspectors upon presentation of proper credentials

Other persons require proper identification and authorization issued by the division manager or the line of road superintendent.

GR-1 Protecting Assignments

Any employee who has marked off due to sickness (illness) Thursday, Friday, Saturday or Sunday and who has record of absenteeism will be charged with a serious offense. CSXT believes there is sufficient evidence that employees are marking off under a false pretense as sick or sickness in family and those individuals will be administrative processed. As a serious offense you will be placed in the individual

development and personal accountability policy (IDPAP) and have the opportunity to present evidence supporting your claim. If you or a family member are truly ill you should mark off prepared to prove it during the subsequent IDPAP process.

CSXT will not charge any employee marking off for an FMLA approved illness. If you claim an FMLA mark off, but it has not been previously approved, you will be subject to a charge, but the charge will be held in abeyance to allow you time to file the requisite papers to have the FMLA approved. Papers can be obtained by calling the Benefits Department at (904) 359-2345.

GR-104 TIMETABLES

Employees working off the division to other CSX divisions may carry, in lieu of complete timetables, those pages applicable to the territory over which they operate.

At minimum carry the division special instructions and applicable subdivision pages.

GR-105 GENERAL BULLETINS AND NOTICES

Baltimore Division General Bulletins will include all Baltimore Division subdivisions in one bulletin district. Baltimore Division General Notices will include all Baltimore Division subdivisions in one notice district.

Trainmaster & Road Foreman notices and bulletins can be found in the CCBB computer library under the following program listings. Employees affected by these instructions must read and understand these notices and bulletins:

BALTTM: Trainmaster Notice – Baltimore
CUMBTM: Trainmaster Notice – Cumberland
NEWCTM: Trainmaster Notice – New Castle
PITTTM: Trainmaster Notice – Pittsburgh
ERFBALTO: Employee Reading File – Baltimore Division
BALENGRS: Employee Reading File – Baltimore Division

19 MARKERS

VRE and MARC trains in push-pull service, with the locomotive on the rear, may display illuminated marker lights in lieu of a rear headlight.

34A COMMUNICATION OF SIGNALS

Passenger train crews will announce over the radio the arrival and departure of their trains at stations where work is to be performed. Crews of other trains operating in the vicinity of scheduled passenger stops will be alert to these announcements to provide for public safety.

46 SPEED ON OTHER THAN MAIN TRACKS

All tracks on the division which are tracks other than main or signaled tracks are restricted to a maximum of 10 MPH unless a signal indication more favorable than restricting is displayed, or unless special instructions permit a higher speed.

SPEED THRU TURNOUTS AND SIDINGS

Do not exceed 10 MPH through turnouts, crossovers and sidings except where signal indications or special instructions permits higher speed.

92-1 EQUIPMENT UNATTENDED

Before leaving equipment unattended on any main track, the conductor or engineer must convey the following information to the control station:

1. The specific location of head end and rear end (if known) of train.
2. Number of engines on train, including the lead engine number.
3. Number of cars in train.
4. Any unusual facts about train, such as oversize shipments, speed restrictions, and ETD not present or malfunctioning.

100-1 ROAD CROSSINGS AT GRADE STATE LAWS:

State laws make it unlawful for a train, railroad car or engine to obstruct public travel at a public crossing at grade for an excessive period of time, except where such train, railroad car or engine cannot be moved by reason or circumstances over which the railroad has no control as follows:

State	Excessive Period of Time
Pennsylvania	Over 5 minutes (over 15 minutes at a private crossing)

If a train is delayed an excessive period of time, train crews must document the date, time of blockage, city, state, road crossing and circumstances. This information must be forwarded to the supervisor in charge of the territory.

100-2 AUTOMATIC GRADE CROSSING WARNING DEVICES

Where provided, a flashing white light at a highway grade crossing indicates where automatic cutout circuits are provided to interrupt operation of automatically controlled railroad-highway traffic control devices when trains or engines are delayed on the approach track circuits. A white light, located at the crossing, flashes as an indication to trains or engines on the approach track circuit that the automatic traffic control devices are functioning. When the flashing white light is not operating, it indicates to the train or engine that has been delayed in its movement, or that has stopped on the approach track circuit, that the automatic cutout has functioned to stop operation of the traffic control devices to permit highway traffic to proceed.

Trains or engines stopped or delayed within 3,000 feet of the crossing will be considered as delayed on the approach track circuit and must stop before proceeding over the crossing unless the flashing white light is operating. If the flashing white light is not operating the stop must be made about 50 feet before reaching the crossing to ensure actuating the track circuit indicated by yellow insulated track joints located approximately 70 feet from the crossing. This will start the operation of the traffic control devices and, after 20 seconds of operation, the flashing white light will be actuated. Trains or engines may then proceed over the crossing.

In the event the flashing white light does not operate after complying with the foregoing instructions, a member of the crew must go to the crossing and ascertain that the traffic control devices have been operating for not less than 20 seconds before the train or engine proceeds over the crossing. In case the traffic control devices are not functioning for the train or engine movement, crossing must be protected by a member of the crew.

100-3 KEY BOX OPERATION

Where installed, key boxes are provided to activate highway warning devices. Insert key, turn horizontal for activation and then back to vertical position for removal.

Leaving the key in a horizontal position will leave circuits activated.

100-4 USE OF BACK-UP HOSE IN STATE OF PENNSYLVANIA

The use of a back-up hose in all train operations shall be for emergency STOP of the train movement; however, the use of a back-up hose for car spotting operations shall be permitted, provided that communication with the engineman is available to ensure the safety of the movement.

103-D SECURING TRAINS AT CREW CHANGE POINTS

Freight trains left unattended at the following crew change points for less than one hour may be left with only the locomotive consist hand brakes applied.

Mt. Clare, Halethorpe, Cumberland Terminal, Connellsville, Landowne, St. Denis

In the application of the CSX Operating Rules 103-D and 104-B, on a track where yellow ties are located, the yellow ties will be considered the clearance point.

104-1 HAND OPERATED SWITCHES

The only switches that may be trailed through are switches designated as spring switches. Although at certain locations we may have hand-operated switches that in the past were designated as "run

through switches”, these switches must be operated by hand before equipment passes over the switches.

104-2 SWITCH TARGETS

Siding and yard switch targets and/or lights may display white (lunar) when set for straight track.

410-1 SELECTING CHANNEL NUMBERS

Employees are required to monitor the radio channel designation assigned to the area in which they are working. If necessary to use another channel designation temporarily, they must immediately return to the assigned channel designation after transmission is completed.

GR-19 POSITION OF CREW MEMBERS

Operating Rule GR-19 is modified for crews to permit conductors and conductor pilots to ride the 2nd unit for instructional purposes when insufficient seating is available on the lead unit.

720-1 ON TRACK EQUIPMENT

Rail highway type passenger equipment may be permitted to operate up to 50 MPH in accordance with the provisions of Rule 720.

2. INSTRUCTIONS RELATING TO SAFETY RULES

2004F-1 SHOES

During accumulations of ice and snow, you must be suitably dressed to perform your duties safely and in a manner that will not interfere with the free use of your feet. Therefore, to provide a safe environment the use of anti-slip, grit footwear is mandatory.

2050 – Block Protection

1. Crews or car inspectors walking a train adjacent to the main will request block protection.
2. The dispatchers will place an O. S. block to prevent him from inadvertently running a train without advising of the movement.
3. When trains approach, the dispatcher will advise the approaching train to proceed prepared to STOP at the location until he has talked with the employee on the ground, and will advise the employee requesting protection of the approaching train.
4. When finished with the block protection, employees involved must release track to the dispatcher.

2101-1 GETTING ON, OFF, OR RIDING EQUIPMENT

When practicable, employees will mount or dismount freight cars only to apply or release hand brakes.

Exception: Cars may be ridden only after the employee has determined that riding is the safest course of action.

2105-1 RIDING PLATFORMS

For safety purposes a shoving platform will be made available for back up moves only. Employees are not to ride a designated shoving platform for any other movement.

2105-2 Riding Cars on Shoving Movements

In the application of Safety Rule 2105(A), the phrase “Cars being shoved” will refer to any car or block or cars that are either coupled to an engine or rolling free from a static drop.

COMPANY PROGRAMS-1 DIESEL EXHAUST

When trains stall in tunnels, and it is apparent that the problem cannot be quickly fixed, secure the train, cut the power away and move it from the tunnel. Advise the train dispatcher of the move and allow exhaust to clear before returning to the train.

3. INSTRUCTIONS RELATING TO COMPANY POLICIES AND PROCEDURES

NONE

4. INSTRUCTIONS RELATING TO EQUIPMENT HANDLING RULES

4473-1 HANDLING RIDING PLATFORMS

On the Baltimore Division riding platforms may be positioned within the train not to exceed 25 cars from the rear of the train.

Shoving movements may be made with not more than 25 cars ahead of the riding platform.

4475-1 HANDLING PASSENGER EQUIPMENT

Speed restrictions for MARC III 7800 cars and VRE Bi-Levels with over inflated air springs:

- | | |
|-------------------------------------|--------|
| (A) Through crossovers and turnouts | 15 MPH |
| (B) All other movements | 30 MPH |

There are no restrictions when air springs are under inflated.

4559-1 1004.09. Snowplows

(a) When hauled in trains, must:

- Be handled on rear of train (ahead of caboose when provided);
- Have wings secured and equipment headed in forward position;
- Not exceed 35 MPH.

(b) When plowing, must not:

- Have short hood of locomotive against snow plow;
- Be shoved by a locomotive consist exceeding two units;
- Handle more than 5 cars, including snowplow and caboose;
- Exceed track speed and will be governed by instructions of supervisor accompanying the movement as to further speed restrictions.

Note: Item (b) applies to ditcher-spreader cars being used to plow snow.

4555-1 HOPPER CARS WITH STRAIGHT AIR

APAX 100-206 are open-top hoppers and APAX 501-606 are flat bottom gondolas. APAX cars are equipped with a straight air hose on the opposite side of the car from the trainline hose. The straight air is not to be used in normal operation.

Cars are stenciled on the end sill just above the trainline and straight air line. The straight air line is stenciled "STRAIGHT AIR" and the trainline is stenciled "TRAIN LINE". The straight air hose should remain coupled and the straight air cocks and/or angle cocks open at all times these cars are coupled.

5 INSTRUCTIONS RELATING TO AIR BRAKE AND TRAIN HANDLING RULES

Table 9. Calendar Day Inspections	
Train	Locations
Q137	Baltimore, Md.
Q138	
Q173	N. Bergen – Jacksonville, FL
Q174	Jacksonville, FL – Kearny, NJ
Q171	Baltimore

These instructions will apply so long as the train(s) will reach the aforementioned inspection point(s) before midnight of the day following the current calendar day inspection.

Locomotive calendar day inspections will be made for local and yard assignments as indicated below.

1. Philadelphia, PA –

Yard Jobs – Will be performed at the end of the first trick.

2. Wilsmere, DE –

Yard Jobs – Will be done during first trick.

Locals – Will be done at the beginning of tour of duty if not previously completed.

3. Baltimore, MD –

Yard Jobs – Will be done at the end of the first trick.

Locals – D777 will be done at the beginning of tour of duty.

4. Jessup, MD –

Locals – Will be done for shared ramp engine at the end of tour of duty 3rd trick. Shared local engine will be inspected by D780 at the beginning of tour of duty.

5. Brunswick, MD and Winchester, VA –

Locals – Will be done at the beginning of tour of duty.

6. Hanover, PA –

Locals –

D785 and D795 will be inspected at the beginning of tour of duty.

Rock Runner will perform inspection at beginning of tour of duty.

7. Hagerstown, MD –

Locals – D799 and D773 will be inspected at the beginning of tour of duty.

8. Fredericksburg –

Locals – D793 will be inspected at the beginning of tour of duty.

5300-2, ABTH APPENDIX C ATC/CS EQUIPMENT

Trains destined to the RF&P Subdivision with a lead locomotive with ATC/CS equipment with self-test capability must have the self-test performed prior to departure from Cumberland, N. Jersey, Brunswick, Philadelphia, Baltimore, or Acca.

5300-3 ABTH APPENDIX C – OPERATION OF THE ON BOARD TESTER: PHW EQUIPMENT

Note: The circuit breaker is located in electrical cabinet marked (ATC) and must be closed or in the on position at all times. The self tester will only test in non-cab signal territory.

Begin Test

1. The "IN/OUT" switch on the audio display unit (ADU) must be in the "IN" position.

2. Move the automatic brake handle to the suppression position, wait until the permanent suppression light on the "ADU" comes on.

3. Turn the "TEST SWITCH" on the "ADU" to the test position. The permanent suppression light will go out and the "ON TEST" light will flash, within two (2) or three (3) seconds, the clear aspect will be displayed.

4. Turn the "TEST SWITCH" on the "ADU" to the advance position (this is a momentary spring return to center switch) the test light will now flash at a slower rate, within one and one-half (1 ½) to three (3) seconds the "CLEAR ASPECT" will go out and the

“APPROACH MEDIUM” aspect will light, the alarm will sound, press the acknowledge button to silence the alarm.

5. Turn the test switch on the “ADU” to the advance position. The test light will now flash slower, within one and one-half (1 ½) to three (3) seconds the “APPROACH” aspect will light. The alarm will sound, press the acknowledge button to silence the alarm.
6. Turn the test switch on the “ADU” to the advance position. The test light will now be on steady. Within one and one-half (1 ½) to three (3) seconds the “APPROACH” aspect light will go out and the “RESTRICTING” aspect will light. The alarm will sound, “DO NOT” acknowledge the alarm, monitor the time it takes from the time the alarm sounds until the brake value de-energizes. This time should be between five and one-half (5 ½) to eight (8) seconds.
5. Turn the test switch to the off position. The “ON TEST” light will go out. Reset the penalty brake application.

5401-1 STRETCH BRAKING

1. To prevent stalling, stretch braking is permitted on descending grade where running release of train brakes is prohibited.
2. On descending grades, where speed restrictions are in effect requiring a speed of less than 25 MPH, stretch braking will be permitted through the limits of the restrictions.

5502-1 Maximum Tonnage Handled

Trains destined to Baltimore from Cumberland or Richmond must not exceed the tonnage ratings for the belt line.

On grades where this tonnage limitation will be exceeded, trains will have a rear-end or appropriately positioned in-train helper, or the trailing tonnage must be reduced.

5502-2 Proper power for train

Crews on the following trains, before departing Cumberland, must be sure that their train is properly powered for Halethorpe to Bay View (Baltimore Beltline):

Q370, , all Consol, Chase and Philadelphia coal trains (except those over 90 cars).

If train is not powered for the Baltimore Beltline, the terminal trainmaster at Cumberland and the train dispatcher must be informed prior to train departing Cumberland.

5502-3

All crews heading north from Richmond, when checking your tonnage rating through Baltimore or

Brunswick, in addition to notifying AACA also call the CQ dispatcher before departing the terminal.

5355-1 LIGHT DIESEL UNITS

When making extended movements with light diesel units, movement will be controlled from cab of leading unit in direction of movement when possible.

5559-1 Heavy Grades

Review these rules prior to operating in territory with grades:

Air Brake and Train Handling Rules

- 5556 – Conditioning Brakes
- 5559 – Steep Grade Train Handling
- If helper service is involved, review: 5600 through 5605

5602-1 Helper Placement Instructions

Train Makeup	Helper Placement
Solid loaded bulk commodity trains	Westbound up to 18 axles on Eastbound up to 20 axles on in excess of the above axles cut in (Note)
Trains with cars with single axles trucks such as TTFX, TTOX and TTUX Westbound mixed trains with empty cars in rear 20 cars	Up to 6 axles on rear. Up to 12 axles cut in train or split helper adding one to head end and one to rear trains (Note)
Solid empty bulk commodity trains; trains without cars with single axle trucks; eastbound mixed trains with empty cars in rear 20 cars 5 westbound mixed trains with rear 20 cars loaded; westbound mixed trains when the rear 50 cars are empty unit train cars.	Up to 12 axles on rear. Exceeding 12 axles cut in train. (Note)

Note: When cutting in helper in trains it will be cut in at that point in the train where the tonnage behind the helper would be as close as possible to the tonnage rating of all helper units except the lead unit of the helper.

NOTES

5701-1

All freight trains required to pick up or set off cars, or locomotives on the following subdivision, running tracks, and industrial tracks are required to be equipped with tested and armed two-way telemetry.

Subdivision/Track	Between
Baltimore Terminal SD Main Track	West Baltimore and Carroll
Cumberland SD Main Track	Harpers Ferry and Cherry Run
Keystone SD Main Track	Cumberland and Connellsville
Metropolitan SD Main Tracks	QN and Silver Spring
Old Main Line SD Main Tracks Mt. Airy I.T.	BAC 26.0 and BAC 52.0 Entire Track
P&W SD	Entire SD
Philadelphia SD Main Tracks	BAK 3.1 and BAK 2.0
W&P SD	Entire SD

6. INSTRUCTIONS RELATING TO RESTRICTED EQUIPMENT

4463-1 DOUBLESTACK AND MULTILEVEL MOVEMENTS

Unless otherwise authorized by a clearance bureau wire or by the director system control, the following are the maximum double stack and multi-level heights allowed on main tracks and sidings. CSXT Train Documentation will list this equipment as restricted and will show applicable height dimensions.

Subdivisions	Double Stack	Multi-Level
Bergen	20'2"	20'2"
Harrisburg		
Baltimore Terminal (Notes 1&2)	18'2"	19'1"
Cumberland Terminal		
Capital		
Alexander Extension	Prohibited	Prohibited
Hanover		
Landover		
Trenton		
Mon SD		
Shenandoah		
Metropolitan		
Old Main Line	18'2"	19'1"
Philadelphia (Note 3)		
RF&P		
Lurgan		
Keystone, Pittsburgh, P&W		

Note:

1. **Double stack and multilevel equipment** exceeding the maximum equipment heights listed must not operate on:
 - a) Marley Neck Branch
 - b) Seawall Branch East of Conoco Yard
 - c) Camden Station Lead
 - d) Locust Point – Hopper Yard Lead under Fort Avenue
2. **Baltimore Terminal** – Multilevel equipment and double loaded double stack equipment must not be operated on North Avenue Siding.
3. **Philadelphia Subdivision**
 - a) Multi-level equipment must not operate between Philadelphia and BAK 12.0
 - b) Single loaded and empty double stack equipment may operate between Bay View and Philadelphia, subject to clearance limits. Double loaded double stack equipment must not operate between Bay View and Philadelphia.

4463-2 20' 2" HIGH MULTILEVEL CARS

20'2" high multilevel cars are authorized on the Bergen SD, but not on any of the other subdivisions of the division.

7. MISCELLANEOUS

Condition Of Locomotives

Engineers of trains terminating in Baltimore Terminal must report the condition of the locomotive consist to the trainmaster at Mt. Clare.

For trains destined to Curtis Bay, the direction of the units must also be provided.

NOTES

NOTES

NOTES

SPEED TABLE

Time Per Mile		Mile Per Hour	Time Per Mile		Mile Per Hour	Time Per Mile		Mile Per Hour
Min.	Sec		Min.	Sec		Min.	Sec	
0	45	80.00	1	32	39.13	2	19	25.90
0	46	78.26	1	33	38.71	2	20	25.71
0	47	76.59	1	34	38.29	2	21	25.53
0	48	75.00	1	35	37.89	2	22	25.35
0	49	73.47	1	36	37.50	2	23	25.17
0	50	72.00	1	37	37.11	2	24	25.00
0	51	70.59	1	38	36.73	2	25	24.83
0	52	69.23	1	39	36.36	2	26	24.66
0	53	67.92	1	40	36.00	2	27	24.49
0	54	66.66	1	41	35.64	2	28	24.32
0	55	65.45	1	42	35.29	2	29	24.16
0	56	64.28	1	43	34.95	2	30	24.00
0	57	63.16	1	44	34.61	2	31	23.84
0	58	62.07	1	45	34.29	2	32	23.68
0	59	61.02	1	46	33.96	2	33	23.53
1	00	60.00	1	47	33.64	2	34	23.38
1	01	59.02	1	48	33.33	2	35	23.23
1	02	58.06	1	49	33.03	2	36	23.08
1	03	57.14	1	50	32.73	2	37	22.93
1	04	56.25	1	51	32.43	2	38	22.78
1	05	55.38	1	52	32.14	2	39	22.64
1	06	54.54	1	53	31.86	2	40	22.50
1	07	53.73	1	54	31.58	2	41	22.36
1	08	52.94	1	55	31.30	2	42	22.22
1	09	52.18	1	56	31.03	2	43	22.08
1	10	51.43	1	57	30.77	2	44	21.95
1	11	50.70	1	58	30.51	2	45	21.82
1	12	50.00	1	59	30.25	2	46	21.69
1	13	49.31	2	00	30.00	2	47	21.56
1	14	48.65	2	01	29.75	2	48	21.43
1	15	48.00	2	02	29.51	2	49	21.30
1	16	47.37	2	03	29.27	2	50	21.18
1	17	46.75	2	04	29.03	2	51	21.05
1	18	46.15	2	05	28.80	2	52	20.93
1	19	45.45	2	06	28.57	2	53	20.81
1	20	45.00	2	07	28.34	2	54	20.70
1	21	44.44	2	08	28.12	2	55	20.58
1	22	43.90	2	09	27.91	2	56	20.45
1	23	43.37	2	10	27.69	2	57	20.34
1	24	42.86	2	11	27.48	2	58	20.22
1	25	42.35	2	12	27.27	2	59	20.11
1	26	41.86	2	13	27.07	3	00	20.00
1	27	41.38	2	14	26.87	4	00	15.00
1	28	40.91	2	15	26.66	6	00	10.00
1	29	40.45	2	16	26.47	12	00	5.00
1	30	40.00	2	17	26.28			
1	31	39.56	2	18	26.09			