

# MIT Lincoln Laboratory

Technology in Support of National Security

MASSACHUSETTS INSTITUTE OF TECHNOLOGY  
LINCOLN LABORATORY

















# **MIT Lincoln Laboratory**

Technology in Support of National Security

**Edited by Alan A. Grometstein**

**Lincoln Laboratory  
Massachusetts Institute of Technology  
Lexington, Massachusetts**





© 2011 MIT Lincoln Laboratory

All rights reserved. No part of this book, or portions thereof, may be reproduced in any form without the written permission of Lincoln Laboratory of the Massachusetts Institute of Technology. All images in this book have been reproduced with the knowledge and prior consent of the artists concerned and no responsibility is accepted by the producer, publisher, or printer for any infringement of copyright or otherwise, arising from the contents of this publication. Every effort has been made to ensure that credits accurately comply with information supplied.

Published in the United States of America by

Lincoln Laboratory  
Massachusetts Institute of Technology  
244 Wood Street  
Lexington, Massachusetts 02420  
Telephone: (781) 981-5500  
[www.ll.mit.edu](http://www.ll.mit.edu)

**Printed and bound**  
in the United States of America

ISBN Number: 978-0-615-42880-2  
Library of Congress Number: 2010940675

### **Introductory images**

---

Inside front cover: Lincoln Laboratory in 1956, after the completion of Building F and the cafeteria.

Opposite: Lincoln Laboratory main entrance in 1955.

Inside back cover: Lincoln Laboratory in 2010, main entrance.







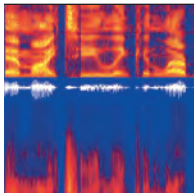




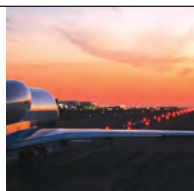

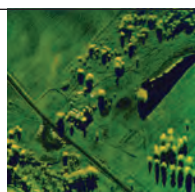
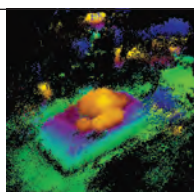






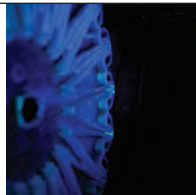
# Contents

*Click on a chapter title to move directly to that page. Alternatively, you may use the Bookmarks menu at left.*

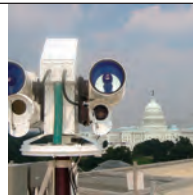
<b>Foreword</b> vii	<b>Preface</b> ix	<b>Acknowledgments</b> x	<b>Introduction</b> xiii		
	<b>1 Beginnings</b> 1		<b>2 The SAGE Air Defense System</b> 15		<b>3 Early-Warning Systems</b> 35
	<b>4 Long-Range Terrestrial Communications</b> 51		<b>5 Satellite Communications</b> 65		<b>6 Communication Networks and Cyber Security</b> 85
	<b>7 Speech and Language Processing</b> 103		<b>8 Knowledge Extraction and Decision Support</b> 115		<b>9 Ballistic Missile Defense</b> 125
	<b>10 Space Situational Awareness</b> 163		<b>11 Environmental Monitoring</b> 195		<b>12 Air Traffic Control</b> 207
	<b>13 Air Defense and Air Vehicle Survivability</b> 223		<b>14 Tactical Battlefield Surveillance</b> 251		<b>15 Intelligence, Surveillance, and Reconnaissance</b> 271



**16**  
**Counterterrorism**  
**and**  
**Counterinsurgency**  
279



**17**  
**Biological and**  
**Chemical Defense**  
287



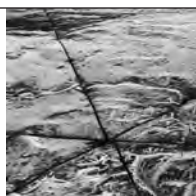
**18**  
**Homeland**  
**Protection**  
301



**19**  
**Engineering**  
**Advanced**  
**Technology**  
309



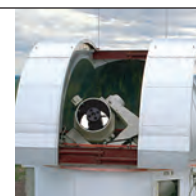
**20**  
**Energy**  
321



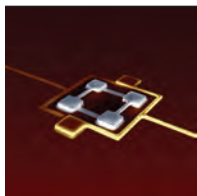
**21**  
**Seismic**  
**Discrimination**  
331



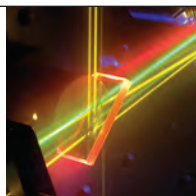
**22**  
**Space Science**  
337



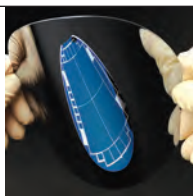
**23**  
**LINEAR and**  
**Other Programs**  
347



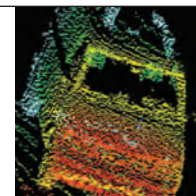
**24**  
**Solid-State**  
**Research**  
361



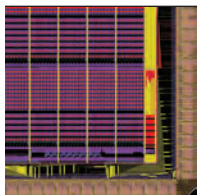
**25**  
**Laser Systems**  
409



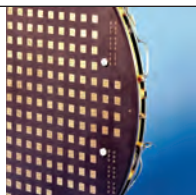
**26**  
**Charge-Coupled**  
**Imagers**  
433



**27**  
**Photon-Counting**  
**Laser Radar**  
449



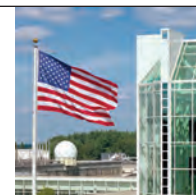
**28**  
**High-**  
**Performance**  
**Computing**  
461



**29**  
**Adaptive Sensor**  
**Array Processing**  
487



**30**  
**Open Systems**  
**Architecture**  
501



**31**  
**The Laboratory's**  
**Style of Operation**  
511



**32**  
**Life at Lincoln**  
**Laboratory**  
519



**33**  
**Benefits of**  
**Laboratory**  
**Innovation**  
531



**34**  
**Looking Forward**  
547

**Lincoln**  
**Laboratory**  
**Directors**  
551

**Steering**  
**Committee**  
**Members**  
**1951–2011**  
552

**Acronyms**  
553

**Index**  
557

**Image Credits**  
568

**Colophon**  
570







# Foreword



**MIT President Dr. Susan Hockfield (seated), Provost Dr. L. Rafael Reif (standing, right), and Vice President for Research and Associate Provost Dr. Claude R. Canizares (standing, left).**

**Opposite: The McLaurin Building at MIT campus (top) and an aerial view of MIT Lincoln Laboratory (bottom).**

In 2011, as the Massachusetts Institute of Technology marks its 150th anniversary, we celebrate its heritage of advancing scientific knowledge to benefit American industry and society. A vital factor in fulfilling that mission has been the work of Lincoln Laboratory, which in 2011 commemorates its 60th anniversary of providing cutting-edge systems and technologies in support of the Department of Defense and other federal agencies.

Lincoln Laboratory has upheld the Institute-wide tradition of pioneering research. Its first project, the Semi-Automatic Ground Environment (SAGE) system, not only introduced real-time computer control of a system of geographically distant radars and direction centers but also empowered the emerging computer industry. Over decades, as the Laboratory developed systems for air and missile defense, space and terrestrial surveillance, and laser communications, it again brought to bear remarkable creativity and innovation. To enable these sophisticated systems, the Laboratory also redefined the state of the art in imaging, high-performance computing, signal processing, and decision support tools. These advances have benefited not only the defense industry but a wide range of other firms and sectors as well.

Given the shifting character of the threats to national security, Lincoln Laboratory has continually adapted to meet Department of Defense needs, as evidenced by the broad range of its current research and development efforts. This sustained pursuit of innovative solutions to new problems springs from a dedication to excellence and a well-defined vision.

A commitment to excellence infuses the culture at Lincoln Laboratory. The scientists and engineers responsible for 60 years of strikingly inventive technical achievements are among the most accomplished in the nation. By continually upgrading laboratories and developing specialized facilities, such as the Microelectronics Laboratory and the RF Systems Test Facility, the Laboratory makes sure that researchers have access to appropriate, modern tools. A strong professional development program helps staff maintain excellence, and research collaborations with MIT have led to exciting discoveries.

Driving the Laboratory's success is a dedication to a noble vision — serving the nation. Strong working partnerships with Department of Defense and other government sponsors promote effective problem solving. A determination to serve as an unbiased, critical judge of technological advances has earned the trust of sponsors who rely on the Laboratory's assessments in deliberations over acquisitions and funding. To help maintain the nation's position as a world leader, the Laboratory actively strives to transition its technical knowledge to U.S. industry and to fellow researchers.

This year, as both MIT and Lincoln Laboratory honor past achievements, we look to the future, seeking the ideas that will invigorate the nation's economy, provide citizens with a secure quality of life, and protect U.S. assets. In addition, we pledge to seek new ways to inspire the next generation of scientists and engineers.

MIT is proud to operate Lincoln Laboratory and commends the production of this book, which not only preserves the history of a vital American resource but also energizes the people who are, and will be, the architects of the next 60 years of innovation.

Dr. Susan Hockfield  
*President*

Dr. L. Rafael Reif  
*Provost*

Dr. Claude R. Canizares  
*Vice President for Research and Associate Provost*





WELLS FARGO INSTITUTE OF TECHNOLOGY  
LINCOLN LABORATORY



# Preface



**Director of Lincoln Laboratory  
Dr. Eric D. Evans**

**Opposite: MIT Lincoln Laboratory  
main entrance.**

This book, produced to coincide with MIT Lincoln Laboratory's 60th anniversary, presents a narrative account of the Laboratory's origins and extraordinary accomplishments since its founding in 1951. The book is a significant expansion of an earlier edition that covered the first 44 years of the Laboratory's technology contributions. Over the past 16 years, national security needs have evolved, and the Laboratory has built upon its legacy of technical excellence and innovation to develop new mission areas and expertise. This book includes much of this new work, as well as updating the progress of our ongoing programs.

Lincoln Laboratory is a Department of Defense (DoD) Federally Funded Research and Development Center (FFRDC) with a mission to develop technology in support of national security. Its role as a DoD FFRDC is unique because of the significant level of hardware and software development, testing and field measurements, and technology transfer that occurs as a part of Laboratory programs. The Laboratory takes on many of the most challenging national security problems and creates fundamentally new systems and technology. Our products are the system concepts, technology components, system prototypes, and measured data that transition directly to users or to the nation's industry base. The Laboratory's success is widely recognized, and the challenging and exciting work draws some of the best talent from across the country.

Traditionally, Lincoln Laboratory has had strong programs in air and missile defense, advanced electronics, communications, and space sensing. As a part of these programs, the Laboratory has led the way in developing new capabilities for radar and optical sensing, advanced terrestrial and satellite communications, solid-state lasers, and high-performance embedded computing. Over the past several years, the Laboratory has added programs in homeland protection; intelligence, surveillance, and reconnaissance (ISR) systems; counterterrorism; and cyber security. For many of these programs, the threat is evolving rapidly, and the Laboratory has developed a rapid technology prototyping and transition approach to address current needs. In parallel, long-term research and development continues on a large scale to create the innovations needed for future systems.

The Laboratory has also been strengthening its non-DoD programs that address civilian needs. Programs are growing in support of the Federal Aviation Administration's needs for new radar technology, air traffic collision-avoidance systems, and weather prediction tools. Work has begun with the Department of Homeland Security to develop sensors and network technology for disaster relief and counterterrorism. The Laboratory is initiating programs in biomedical research, civilian space systems, and alternative energy solutions. Much of this work draws upon technology investments made by the DoD.

The Laboratory has enhanced its support for community outreach and service, including initiating many new projects for K-12 science, technology, engineering, and mathematics (STEM) education, such as Science on Saturday seminars, robotics leagues, student and teacher internships, and other programs for local students and educators. We view this service as fundamental to the Laboratory's mission.

The core strength of Lincoln Laboratory draws upon its close relationship with MIT and the high quality of its technical and support staff. The number of collaborative research efforts with MIT professors and students is at an all-time high, and the Laboratory continues to hire some of the best graduates from MIT and other top schools. The work presented in this book is a testament to MIT's national service through Lincoln Laboratory and to the steady stream of talented people who have been involved in Laboratory programs over 60 years. The strength of our current new staff makes us feel very optimistic about continuing the Laboratory's great legacy. We hope that this book will give you a sense of how proud we are of this legacy, and how we continue to look forward to developing new technology in support of national security.

Dr. Eric D. Evans  
*Director*



# Acknowledgments

---

## Notes

**1** “MIT Lincoln Laboratory — Technology in the National Interest,” E.C. Freeman, ed. Lexington, Mass.: MIT Lincoln Laboratory, 1995.

**2** On 26 July 1951, representatives of the Air Force, Army, and Navy signed the charter that brought Project Lincoln into existence. The name was changed in 1952 to Lincoln Laboratory.

In 1995, Lincoln Laboratory published a history of its operations since its formation in 1951.<sup>1</sup> The book, edited by Eva C. Freeman and now out of print, was well received.

In April 2008, Dr. Eric Evans, the director of Lincoln Laboratory, established an editorial committee with the goal of updating the 1995 history book. To this end, the committee has labored to produce the volume you hold in your hands; it includes material from the first volume, augmented by descriptions of Laboratory programs of the past fifteen years. The new volume makes its appearance in 2011, which marks the 60th anniversary of the founding of the Laboratory.<sup>2</sup>

It is my pleasant duty, as chair of the committee, to acknowledge the many people whose efforts brought the new history into existence.

- The director himself, and his staff within the Director’s Office, were uniform in their backing of the history project.

- The text of the book was created by Lincoln Laboratory personnel working within their technical divisions. The enthusiasm of the authors, and the generous spirit in which division management made its staff available for this task, were gratifying. Below are listed the authors who contributed to this book, followed by a list of those who contributed to the first volume. So many authors were responsible for each volume that there are doubtless errors of omission in the lists. The committee apologizes to any author whose name has been inadvertently omitted.

- The committee enjoyed the services of copyeditors, graphic designers, photographers, and reference librarians who transformed the drafts submitted by the authors into accurate and clear text, who ensured that the figures accompanying the drafts were precise, that the photographs were of high quality, that textual conventions were established and maintained, and that the aesthetic impact of the volume was attractive. These professionals are Jon Barron, Thomas Burbine, Heather Clark, Barbra Gottschalk, Tamar Granovsky, Gregory Hamill, Susan Hersey, Dorothy Ryan, and Nora Zaldivar.

---

## Principal Authors, 2011 edition

Robert Atkins	Timothy Dasey	Bernadette Johnson	Theodore Lyszczarz	Charles Rader	Bor-Yeu Tsaur
Brian Aull	Curt Davis	Leonard Johnson	Thomas Macdonald	Richard Ralston	George Turner
Herbert Aumann	William Davis	Paul Juodawlkis	Donald MacLellan	Stephan Rejto	Joseph Usoff
Gregory Berthiaume	Constantine Digenis	Craig Keast	Richard Marino	Kenneth Roth	Gregory Ushomirsky
William Blackwell	Brian Donahue	Jakub Kedzierski	Douglas Marquis	Mordechai Rothschild	Simon Verghese
Daniel Bliss	Keh-Ping Dunn	William Keicher	David Martinez	Kenneth Senne	James Ward
Robert Bond	Eric Evans	Kevin Kelly	Stephen McGarry	Anthony Sharon	Mark Weber
Roy Bondurant	James Flavin	Jeremy Kepner	Ivars Melngailis	David Shaver	Clifford Weinstein
Carl Bozler	Jack Fleischman	Matthew Kercher	Jeremy Muldavin	Israel Soibelman	Marilyn Wolfson
Barry Burke	Andrew Gerber	William Kindred	R. Allen Murphy	William Song	Peter Wyatt
Hsiao-hua Burke	Mark Gouker	Stephen Kogon	Aradhana Narula-Tam	David Spears	John Zayhowski
James Calvin	Darryl Greenwood	Dean Kolba	John Nelson	Scott Stadler	Marc Zissman
David Chan	James Gregory	Bernard Kosicki	Carl Nielsen	Ernest Stern	George Zollinger
Chaw-Bing Chang	Michael Gruber	James Kuchar	Daniel O’Connor	Grant Stokes	
Peter Cho	Gary Hatke	Roderick Kunz	William Oliver	Melvin Stone	
Daniel Chuang	Louis Hebert	Benjamin Lax	William Payne	Vyshnavi Suntharalingam	
Kevin Cohen	Richard Heinrichs	Vincent Leslie	Craig Perini	John Tabaczynski	
Gary Condon	Forrest Hunsberger	Zong-Long Liau	Eric Pearce	Kenneth Teitelbaum	
Robert Cunningham	Thomas Jeys	W. Gregory Lyons	Charles Primmerman		



- Marc Bernstein read the final manuscript, examining the content for completeness and accuracy. Stephen Weiner and Karen Challberg reviewed the preliminary draft, checking for consistency in style and syntax. The Committee's heartfelt thanks are extended to these three reviewers for their valuable contributions.
- One of the strengths of the editorial committee lay in its stability; its composition remained virtually unchanged over the three years of its existence, so that it grew into a cohesive and coherent unit. The one major change the committee suffered was a sad subtraction: Roger Sudbury, a long-time member of the Laboratory and a stalwart of the committee, died as the new volume was taking on its final form. A biographical sketch of Roger is on the right.

The committee members were Alan Grometstein, chair; Alan Bernard; Nadya Bliss; Melissa Choi; David Granchelli; Donald MacLellan; Richard Ralston; Roger Sudbury; Lee Upton; and John Wilkinson.

Alan A. Grometstein  
*Chair*

#### Principal Authors, 1995 edition

---

Allen Anderson	William Keicher	Bob Richardson
John Andrews	Herbert Kleiman	Mordechai Rothschild
Robert Bergemann	Israel Kupiec	Edward Schwartz
John Beusch	Melvin Labitt	Irwin Shapiro
Sidney Borison	Richard Lacos	Jay Sklar
Thomas Bryant	Benjamin Lax	David Spears
Barry Burke	Robert Lerner	Ernest Stern
William Delaney	Jacob Lifszitz	Irvin Stiglitz
Gerald Dionne	Richard Lippmann	Melvin Stone
Daniel Dustin	Theodore Lyszczarz	Roger Sudbury
Seymour Edelberg	Alan McWhorter	Leo Sullivan
John Evans	Ivars Melngailis	Donald Temme
James Forgie	Walter Morrow	Bor-Yeu Tsaor
Thomas Goblick	Edward Muehe	William Ward
Alan Grometstein	R. Allen Murphy	Stephen Weiner
Dennis Hall	Burt Nichols	Clifford Weinstein
Harold Heggstad	Charles Primmerman	Jerry Welch
Robert Hull	Charles Rader	Walter Wells
Leonard Johnson	Richard Ralston	

#### Roger W. Sudbury, 1938–2010

Roger W. Sudbury was recognized as a knowledgeable advisor, a wise mentor, and a friendly confidant to many at Lincoln Laboratory. His breadth of experience and clarity of vision played an important role in producing the first edition of the Laboratory history book in 1995. He devoted countless hours checking facts to assure the book's accuracy. Without his insightful counsel, that edition would not have been the fine work it is.

And so it is with the new edition of the history. Roger served on the committee that produced this edition, and supplied, as few of his colleagues could, a sense of long-term continuity in chronicling the profound impacts Lincoln Laboratory has had on the technology underlying national security.

Roger joined MIT Lincoln Laboratory in 1969. Over the next 41 years, he served the Laboratory in roles of increasing responsibility, advancing from technical staff member in the Array Radars Group to associate group leader in the System Engineering Group. He became associate manager of the Kiernan Reentry Measurements Site at Kwajalein in the Marshall Islands, later the Laboratory's Executive Officer, and finally served as a member of the Director's Office staff, working on special projects. One of those projects was the preparation of this book.

Roger was nationally recognized as a leader in the development of gallium-arsenide monolithic circuits for applications in electronically scanned radars. He also led the fielding and operation of Cobra Eye, an airborne infrared data collection platform. The work that he directed at the Laboratory influenced efforts at a number of major electronic firms, and contributed to the United States' preeminence in solid-state military radars for missile and air defense.



Before joining Lincoln Laboratory, Roger served as a captain in the U.S. Army, and was responsible for the helicopter avionics package that became the Army standard. He earned a bachelor's degree in electrical engineering with highest honors from the Georgia Institute of Technology and a master's degree, also in electrical engineering, from the Massachusetts Institute of Technology.

A Life Fellow of the Institute of Electrical and Electronics Engineers (IEEE), Roger was deeply committed to the organization, serving it in many capacities: he was a member of its Technical Activities and Educational Activities Boards, vice chairman of its Membership Development Committee, president of its Microwave Theory and Techniques (MTT) Society, and member of the IEEE Board. In 2010, he received the MTT Society's Distinguished Service Award for his dedication to the society and its goals.

Roger did not live to see the final version of the new edition of the history; the committee hopes that it would have made him proud.







# Introduction

**Since Lincoln Laboratory's establishment in 1951, the national security challenges have evolved from defending against strategic confrontations to addressing adversaries with poorly defined borders and ideologies. The core competencies required to provide technologies to respond to this changing reality — systems analysis, advanced electronic device technology, rapid prototyping, field testing, and ultimately effective transition to the user community — have become hallmarks of the Laboratory's work and will ensure its continued service to the nation.**

Left: Strobe tracking on a manual plotting board for the Experimental SAGE Subsector.

The end of the Cold War in the early 1990s and the rise of terrorist nation states and activities in the new millennium inaugurated an era of substantial political shifts and regional conflicts. Near-instantaneous worldwide communication capabilities benefited the United States and its allies, but worked to the advantage of their opponents as well. The world changed from one in which the nation knew who its opponents were to one in which adversaries “hiding in plain sight” are a reality. For Lincoln Laboratory, these changes marked the beginning of a new era, one that requires refocusing many efforts, rapidly responding to volatile circumstances, and redirecting talents. The 1995 book *Technology in the National Interest* reviewed the Laboratory's historical achievements, documented major contributions made during the Cold War years, and outlined future activities in developing technology for national security. This second edition retains the essence of the original history book and updates the historical narrative for the years from 1995 to 2011, the 60th anniversary of the Laboratory's formation.

A history of Lincoln Laboratory begins with the nation's need for improved air defense. By the end of the 1940s, the Union of Soviet Socialist Republics had developed long-range aircraft that could deliver an atomic bomb to the United States. The possibility that Soviet bombers might be able to launch an atomic attack on the United States suddenly became a terrible reality, and the Truman administration asked the U.S. Air Force to develop a system to defend the nation against that threat. The Air Force called on the Massachusetts Institute of Technology for technical assistance, and in 1951 MIT founded Lincoln Laboratory as a “Laboratory for Air Defense.” Its mission was to develop a defense system that could detect, identify, intercept, and direct resources against hostile aircraft.

The design of the air defense system known as the Semi-Automatic Ground Environment (SAGE) system called for widely ranging scientific and engineering advances in the fields associated with integrating humans, aircraft, interceptor weapons, and computers and software into a real-time, dispersed, multimode defense system. Such a system did not exist in 1951, but Lincoln Laboratory took on the job and, through a combination of hard work and inspiration, successfully developed the technology and worked with industry to demonstrate and complete the

SAGE design. The SAGE program had an extraordinary impact on the high-technology industry throughout the United States and especially in Massachusetts. It is no exaggeration to say that SAGE created the computer industry and digital communications. International Business Machines, the prime contractor for SAGE computers, utilized the expertise it developed during the SAGE program to become the world's largest commercial computer manufacturer. Much of the Massachusetts high-technology electronics industry originated in the engineering talent and financial resources that flowed from the SAGE program.

In 1952, Lincoln Laboratory hosted a Summer Study to assess the vulnerability of the United States to surprise air attack and to evaluate the need for early warning of such an attack. This study led to the creation of the Distant Early Warning (DEW) Line, a network of radars stretching from Alaska to Greenland. The Laboratory assisted the Air Force in the development of radars and long-range communication systems for the DEW Line and for the Ballistic Missile Early Warning System (BMEWS), which led to the Laboratory's participation in the development of radar systems for ballistic missile defense and satellites for military communications.

Because the Laboratory's role as an MIT research and development organization did not extend to system implementation, in 1958 some personnel from Lincoln Laboratory left to form the MITRE Corporation to complete the engineering for SAGE deployment. For Lincoln Laboratory, this was the end of the early air defense era; it was a critical moment in its history. With its mission accomplished, the Laboratory was faced with the question of whether operations should continue. In 1951, the assumption had been that the Laboratory would close once the air defense program was completed. The personnel office had even made a practice of informing new employees that their moving expenses would be covered when the program ended.

The Laboratory did not close down; it entered its second era, one characterized by a significant reduction in activity. Between 1958 and 1960, funding fell by nearly 30%. Yet during this period of uncertainty, it became very clear that much of the work on SAGE was of value to other programs of national interest. The solid-state physics group, for instance, had already achieved an



---

**Note**

**1** Lincoln Laboratory received formal notification of its assignment to BMD research in a letter dated October 3, 1960, from Brigadier General Charles Terhune, Jr., U.S. Air Force, to Carl Overhage, director of Lincoln Laboratory. Terhune's letter included a copy of the August 29, 1960, DDR&E memorandum.

international reputation in its own right. The long-range communications group, originally devoted to SAGE, had embarked on a major effort to explore the feasibility of using passive satellites for communications.

But the clearest example of the value and potential of Lincoln Laboratory resources was in the ballistic missile defense (BMD) program. This effort had begun in 1953 with the BMEWS activity, but at a moderate priority because ballistic missiles were then considered less of a threat than long-range bombers.

In August 1957, the Soviet Union announced that it had successfully test-fired an intercontinental ballistic missile (ICBM). A month later, Sputnik I was placed into orbit, confirming the Soviet missile capability. BMEWS was impotent against an ICBM attack because, although the system could warn of approaching missiles, it lacked the capability to intercept them. SAGE was designed with reaction times appropriate for air-breathing bombers; it was helpless against missiles approaching at hypersonic speeds. Abruptly, BMD was assigned the highest priority.

The Department of Defense once again turned to Lincoln Laboratory for help with the nation's security. In a memorandum issued on August 29, 1960, to the Army, Navy, and Air Force, Herbert York, Director of Defense Research and Engineering (DDR&E), wrote:

“In order to eliminate unnecessary duplication, coordinate instrumentation and evaluation facilities, and to provide a single integrated effort in support of penetration aids, target identification, and reentry physics programs of the Department of Defense, responsibility for technical supervision will be placed with a single agency. Lincoln Laboratory will be required to take this assignment.”<sup>1</sup>

That Lincoln Laboratory was directed to become the nation's specialist in BMD did not come as a surprise because the Laboratory had unique capabilities for addressing the challenge of missile defense. The work on BMEWS had given the Laboratory a basic foundation in BMD, and SAGE had provided a solid background in target interception. With the DDR&E memorandum, the Laboratory entered the era of ballistic missile defense.

As part of its BMD charter, the Laboratory was also named scientific director of Project PRESS, the reentry measurements program then being established on the Kwajalein Atoll in the Marshall Islands. Reentry measurements were of central importance to the development of successful BMD, which required that interceptors be able to destroy reentering missile warheads in the presence of debris from launch systems and accompanying countermeasures (“penetration aids”). Achieving a discrimination capability that would permit the targeting of missile warheads became a major focus of the Laboratory's BMD efforts.

Throughout the 1960s, BMD continued to be a major program at Lincoln Laboratory, but other programs, particularly in military satellite communications, took on prominence as well. In fact, throughout this period, the director's annual reports to the president of MIT described the Laboratory as “sharply focused on two major fields, reentry technology and space communications.”

The space communications program was a natural outgrowth of Lincoln Laboratory's extensive work on long-range communications. As soon as the United States achieved a space capability, the Laboratory embarked on Project West Ford, the first effort to use deployed space objects for military communications. By 1963, the Laboratory had been officially assigned responsibility for developing military communications satellites, a program that led to the launching of eight Lincoln Experimental Satellites between 1965 and 1976. By the second half of the 1960s, military satellite communications had become as important at Lincoln Laboratory as BMD.

As military use of space grew in the 1960s, so did the need for space surveillance. The Laboratory already had the radars and the expertise for monitoring resident space objects as well as new foreign launches. A battery of radars operated by the Laboratory soon came into existence for carrying out space surveillance tasks. These radars included those on the Kwajalein Atoll (when they were not carrying out BMD tasks) as well as several in Massachusetts. In the 1970s, when the Laboratory demonstrated the ability to track and image objects in space out to synchronous orbits and beyond, space surveillance became a major mission area.



A tactical battlefield-surveillance program began in 1967 as an effort to protect U.S. soldiers fighting in the Vietnam War. Although Lincoln Laboratory never played a large role in that conflict, the battlefield-surveillance activity initiated during that period led to ground-surveillance systems deployed in Vietnam and signaled the beginning of another mission area.

By the end of the 1960s, the United States was withdrawing its support of the government of South Vietnam, and a national backlash against defense-related work led to extensive cutbacks in all DoD-supported activities. For the first time, the Air Force gave the Laboratory permission to work on nondefense programs sponsored by federal agencies in the civil sector. A new era for the Laboratory had begun, marked by its entry into civilian research and development.

Although Lincoln Laboratory did not receive its first nondefense funding until 1971, these activities grew quickly thereafter. Efforts were initiated in a wide range of civilian programs, including solar energy, health care, education technology, and air traffic control surveillance systems. By 1974, nondefense funding accounted for almost 10% of the Laboratory's budget, the largest component of which was an air traffic control program. Nondefense activity has over the years amounted to 10 to 18% of the Laboratory's funding.

Despite the interest in developing civilian technologies, Lincoln Laboratory remained, with the guidance and oversight of its DoD Joint Advisory Committee, predominantly a defense laboratory, and the bulk of its funding continued to come from the military services and other DoD activities. Much of the Laboratory's growth in the 1970s came from initiation of an activity in air defense, a field in which the Laboratory had not participated for nearly a decade. However, the new work on air defense was focused not on bombers but on cruise missile detection and air vehicle survivability evaluation (AVSE) issues. The focus of the AVSE program, which continues today, is upon an integrated systems analysis and experimental test program. Architectures and performance hypotheses must be validated by testing and performance verification in the field under realistic conditions. Much of the technology developed in this program draws directly on the work of the Laboratory's fundamental research

groups, particularly in pattern recognition, digital signal processing, and collection of calibrated data for decision making.

During the 1970s, Congress cut military spending and devoted relatively more U.S. resources to nondefense programs; during the same period, the Soviet Union built up its military arsenal. When Ronald Reagan became president in January 1981, he asked for and received a commitment from Congress to enhance the U.S. defense posture with respect to the Soviet Union. Funding for military research increased dramatically; funding for civilian research declined. Most nondefense programs at Lincoln Laboratory were terminated, with the exception of the growing activity in air traffic control supported by the Federal Aviation Administration. The other nondefense programs had never been large, however, and the renewal of interest in defense made the 1980s a decade of significant growth.

On March 23, 1983, President Reagan announced the Strategic Defense Initiative (SDI), a program to develop a near-leakproof shield against nuclear attack. Because much of the BMD work then in progress at Lincoln Laboratory fitted SDI research and development needs, the Laboratory was called upon to make major contributions to this activity.

One important area for SDI was ground-to-space propagation of high-energy laser beams, either to destroy missiles directly or to power satellite systems that could destroy missiles. The Laboratory had already made significant progress toward the development of adaptive optics that could permit the transmission of high-energy laser beams through the atmosphere, and high-energy laser propagation became another major mission area during the SDI buildup.

Ballistic missile defense also took on increased importance, with the focus now on destroying incoming missiles in each phase of trajectory: boost, deployment, midcourse, and terminal. The surveillance mission areas — space, air, and ground — expanded as the United States looked for new ways to detect hostile satellites, missiles, aircraft, and artillery. General research also grew, largely in support of the optics, communications, and computing requirements of SDI.



Although the Soviet Union attempted to keep pace with the renewed U.S. focus on defense technology, it could not sustain the financial burden. Russian control over Eastern Europe and over the non-Russian republics within the Soviet Union collapsed. On July 1, 1991, the Soviet Union and the five other member nations of the Warsaw Pact formally agreed to end their political and military alliance. Within a few months, the republics that had made up the Union of Soviet Socialist Republics had become independent countries, tied loosely together as the Commonwealth of Independent States. The nations of Eastern Europe held free elections and voted out their Communist leaders. The Cold War was over.

The United States began to cut back on defense spending. This budgetary policy meant a major realignment of missions and goals for the Laboratory. The work on control of high-energy laser beams was stopped, and several other SDI-related programs were reduced. Despite these changes, the DoD commitment to the Laboratory remained firm. With the initial move to the new Building S (South Laboratory) in 1994 and completion of Building S in 1995, the central Laboratory facility reached a total of approximately one-and-a-half million square feet. With the completion of this building and the other parts of the modernization and expansion program, the Laboratory was able to bring personnel and equipment back from scattered locations to work together in a single facility.

In retrospect, the period from the 1950s to the early 1990s now appears to be one of relative stability. During this 40-year interval, the Laboratory's main mission areas — air defense, ballistic missile defense, tactical systems, surface surveillance, satellite communications, space surveillance, and advanced electronics — were established and steadily evolved in response to new technical developments and changing operational needs. The next two decades witnessed the start of another era, one in which the Laboratory experienced major changes occasioned by two historic events: the realignment of the U.S. defense contractor establishment in response to the end of the Cold War and the attack on the World Trade Center on September 11, 2001. This era, continuing today, is marked by a broadening of the Laboratory in many dimensions: the number of new sponsors and individual programs; the nature of the Laboratory's programs; the internal Laboratory

operational arrangements for carrying out these programs; and the expansion of personnel policies in recognition of generational and social changes. The challenge to the Laboratory is to accommodate all these changes within the constraints of the DoD-imposed professional staff ceiling.

The end of the Cold War resulted in a marked decrease in the number of industrial organizations engaged in research and development of military-specific technology. The military technology base and deep system analysis skills that the Laboratory developed across a broad technical front was of great interest to new Laboratory sponsors and to industry. The Laboratory, to an increasing degree, has become the system architect for its DoD sponsors. Examples of this evolving association include the Navy's air and missile defense systems and the Missile Defense Agency's concepts for ballistic missile defense. Lincoln Laboratory's contributions include developments in surveillance sensors, adaptive suppression of interference, target identification, precision track, and defensive weapon systems. The Laboratory also plays a key role in performance assessment (for example, as in the AVSE program). This new era brought a major change in the Laboratory's operating style. Not only are there more sponsors, but they urge the Laboratory to consult with them frequently in framing approaches to relevant problems, and to interact strongly with industry in effecting technology transfer.

After the second historic event, the attacks of September 11, the number of organizations seeking Lincoln Laboratory's services expanded even further. The U.S. military operations in Iraq and Afghanistan called for innovative technical solutions to address urgent operational problems. The rapid change in the tactics and materials used by irregular forces led to the need for advanced applications of technology to be deployed on an entirely new time scale. The Laboratory responded to these needs with new "rapid reaction" program approaches, leading to the early deployment of systems aiding the DoD in the battle to counter insurgencies and terrorists. The conventional schedule of years for development and prototyping was replaced by a period of months from concept to operational use.



Meanwhile, the explosive growth of commercial information technology and instant broadband communications opened the U.S. military and civilian worlds to attacks on information security that are unprecedented in their vastness and depth. Cyber security quickly blossomed into an area of major national concern, and the Laboratory's long-term expertise was enlisted.

At the same time, the newly established Department of Homeland Security was facing significant threats that fell within the Laboratory's technical domain. As the Laboratory moves to help the nation improve its capability in homeland protection, it is facing the complexities involved — the diverse range of targets presented by the homeland; the need to defend against very significant attacks involving weapons of mass destruction; the extent of U.S. land and maritime borders; a domestic environment that presents conflicting privacy, political, and economic concerns; and the confusing command and control environment caused by the overlapping responsibilities of federal, state, and local entities. The Laboratory has responded with new programs in air defense for the National Capital Region, chemical and biological defense for urban areas, border security, critical infrastructure protection, and disaster response.

Lincoln Laboratory's mission areas continue to meet key defense needs, and its innovative technologies, with an emphasis on dual use, will find various applications in the civil sector as well. The Laboratory continues to work with industry for technology transfer and to participate in sponsor-approved working arrangements with industrial partners. Since 1993, the Laboratory has worked with industry in cooperative research and development agreements to strengthen the nation's industrial capability.

As the end of each era ushers in a new one, Lincoln Laboratory meets the technical demands of the new era by developing concepts, carrying out research and data collection, designing components and systems, and building prototypes. Once a prototype is ready for production, the Laboratory transfers the technology to the government and to industrial contractors, and then takes on a new task. This approach requires adaptable, imaginative staff who flourish on new challenges.

The technical challenges may have changed from era to era, but the underlying reason for the Laboratory's success — intelligent, creative people working in a flexibly structured environment — has remained the same. This is how Lincoln Laboratory has contributed to the security of the nation in the past and will endeavor to do so in the future.







# Beginnings

**Tensions arising during the early years of the Cold War compelled the United States to search for ways to defend the nation against the threat of air attack. An Air Force study evaluated the feasibility of air defense concepts, conducted tests, and established the need for an air defense research laboratory. At the government's request, MIT undertook Project Charles and Project Lincoln, which would evolve into Lincoln Laboratory.**

**Left: Lincoln Laboratory's early unclassified work was carried out in Building 20 on the MIT campus.**

On September 3, 1949, a U.S. Air Force modified WB-29 aircraft from the 375th Weather Reconnaissance Squadron landed at Eielson Air Force Base, Alaska, with filter paper samples collected east of the Soviet Union's Kamchatka Peninsula. Tests on the samples showed anomalously high levels of airborne radioactive debris — high enough to be explained only by an atomic explosion.

Intelligence sources in the United States had reported that scientists in the Soviet Union were pushing hard to develop a nuclear capability, but it appeared that they were having trouble. The consensus was that the Soviets were still about three years away from completing a working atomic bomb. Nevertheless, the United States had begun routine monitoring to detect atomic explosions in the Soviet Union.

The radioactive filter paper samples were flown to Tracerlab in Berkeley, California, and the test results were reported to the Air Force Office of Atomic Testing (AFOAT-1). Independent tests were conducted by the Los Alamos Scientific Laboratory on an AFOAT-1 sample, by the British Atomic Energy Authority on airborne samples collected north of Scotland, and by the Naval Research Laboratory on rainwater collected in Kodiak, Alaska, and in Washington, D.C. Each of the tests confirmed high levels of radioactivity.

On September 19, Vannevar Bush, then president of the Carnegie Institution, convened a special panel in the AFOAT-1 headquarters war room in Washington, D.C. This panel formally concluded that the USSR had exploded its first atomic bomb, code-named Joe-1, on August 29, 1949.<sup>1</sup>

The announcement by President Harry Truman on September 23, 1949, of an atomic explosion in the Soviet Union shocked the nation. Even worse news came out a short time later. Not only did the Soviet Union have the bomb, it had also developed long-range aircraft able to reach the United States via an Arctic route. The United States had no defense against nuclear attack.<sup>2</sup> The Ground Control of Intercept (GCI) radar network developed during World War II had been designed to defend against an attack with conventional weapons, and it could detect and intercept a sizable percentage

of incoming hostile aircraft. A single bomber carrying a nuclear weapon, however, would almost certainly succeed in evading detection by these radars.

A sense of fear and helplessness began to pervade the United States. Civil-defense groups built air-raid shelters, and parents trained their children for the possibility of a nuclear war. Today, these perceptions and actions might seem unrealistic and excessive, but, in 1949, these fears were very real.

The United States had grown accustomed to having a monopoly in nuclear weapons. Americans had felt invulnerable, and efforts to maintain military installations had been reduced to minimal levels. The development of an atomic bomb by the Soviet Union, which had become the Red Menace, ended this period of complacency. Stories about Joseph Stalin's purges and labor camps, though incomplete, inspired dread. That Stalin might use nuclear weapons seemed entirely plausible.

These perceptions compelled the Department of Defense (DoD) to reevaluate the nation's defenses against nuclear attack. As a part of the process, the DoD assigned the U.S. Air Force the task of improving the air defense system. The Air Force, in turn, asked the Massachusetts Institute of Technology for assistance — and this led to the formation of MIT Lincoln Laboratory.

The mood of the early 1950s — of alarm and of a demand for immediate action — is well conveyed by the opening sentences of the *Final Report of Project Charles*. Conducted in 1951, the Project Charles study led directly to the establishment of Lincoln Laboratory. The report opens with the words:

“For the first time in its history, as a consequence of the atomic explosion in the Soviet Union, the United States is confronted with a really serious threat of a devastating attack by a foreign power. This new danger has necessitated major changes in the scale and methods for the defense of this country, particularly on the part of the Air Force, which has the primary responsibility for defense against air attack.”<sup>3</sup>

Lincoln Laboratory was organized to make these changes in the country's defense and to take on that responsibility.



**Figure 1-1**  
**George Valley, Jr.**

### **The Air Defense Systems Engineering Committee**

The story of Lincoln Laboratory begins with George Valley (Figure 1-1). An associate professor in the MIT Physics Department, Valley was well known for his concern over nuclear weapons; after World War II, he had lobbied energetically against a bill that proposed to place nuclear energy entirely under DoD control. In 1949, after learning of the Soviet atomic bomb, Valley became worried about the quality of U.S. air defenses. Conversations with other professors led him to conclude that the United States had virtually no protection against nuclear attack.

In his concern over the possibility of nuclear attack, Valley was like many Americans. But in his desire to address the problem, he was unique. Valley decided to make the task of securing U.S. air defenses his personal responsibility.

Valley was in an excellent position to evaluate U.S. air defenses. As a member of the Electronics Panel of the Air Force Scientific Advisory Board (SAB), he was able to arrange a visit to a radar station operated by the Air Force Continental Air Command. What he saw appalled him. The equipment had been brought back from World War II and was inappropriate for detecting long-range aircraft. Moreover, the operators had received only minimal instruction in the problems of air defense. He was particularly struck by the site's use of high-frequency (HF) radios; the quality of HF communications is dependent on the state of the ionosphere.

Following his visit to the radar station, Valley collected more information on U.S. air defenses, none of it reassuring, and then called Theodor von Karman,

chairman of SAB. Von Karman asked Valley to put his concerns in writing, and Valley did in a letter dated November 8, 1949. In a key paragraph, he wrote:

“I therefore propose to you that the Board set up an Air Defense Committee to consist of members from several of its panels. The work of the committee would fall into two phases, the implementation of the second phase to depend on the results of the first.”<sup>4</sup>

Von Karman relayed Valley's suggestions to General Hoyt Vandenberg, the Air Force chief of staff. Vandenberg approved the idea and instructed his vice chief of staff, General Muir Fairchild, to take immediate action. By December 15, Fairchild had organized a committee of eight scientists, with Valley as the chair, to analyze the air defense system and to propose improvements. On January 20, 1950, the committee, officially named the Air Defense Systems Engineering Committee (ADSEC) but informally known as the Valley Committee, began to meet weekly.

The eight members of ADSEC provided expertise in a broad range of technical fields, including aeronautics, mechanical engineering, meteorology, physics, and radar. Five of the eight were associated with MIT. In addition to Valley, the MIT members included Charles Draper, head of the Department of Aeronautics and Astronautics and director of the Instrumentation Laboratory; William Hawthorne, professor of mechanical engineering and an expert on jet engines; Henry Houghton, head of the Department of Meteorology; and H. Guyford Stever, a professor in the Department of Aeronautics and Astronautics. All of these individuals were also members of SAB, as was Allen Donovan, an aerodynamicist and vice

1950



J.B. Wiesner



J.V. Harrington



---

## Notes

**1** C. Ziegler, "Waiting for Joe-1: Decisions Leading to the Detection of Russia's First Atomic Bomb Test," *Social Studies of Science, Vol. 18*. London: SAGE, 1988, p. 197.

**2** Much of this chapter is from G.E. Valley, Jr., "How the SAGE Development Began," *Ann. Hist. Comput.* **7(3)**, 196–226 (1985). The article provides an extensive account of the formation of Lincoln Laboratory and tells fascinating stories about many of the key individuals.

**3** *Problems of Air Defense: Final Report of Project Charles, Vol. I*. Cambridge, Mass.: MIT, 1951, p. xvii.

**4** Valley, "How the SAGE Development Began," p. 199.

president of the Cornell Aeronautical Laboratory. The remaining two members were George Comstock, vice president of Airborne Instrumentation Laboratory, and John Marchetti, director of radio physics research at the Air Force Cambridge Research Laboratory (AFCRL).

The members of ADSEC agreed to begin their study with a set of basic assumptions about hostile aircraft and U.S. air defenses. First, ADSEC members agreed that, in order for a hostile nation to carry out a successful long-range attack against the United States, the aircraft would need to (1) fly at high altitude to maximize their range, (2) carry enough nuclear explosives to destroy at least two U.S. cities, (3) fly at subsonic speeds, and (4) be refueled in flight. Second, the committee members agreed that U.S. air defenses were nearly useless against a nuclear attack. The GCI radars in the existing network were, because of the earth's curvature, spaced too widely to find low-flying, penetrating aircraft. Ground echoes also posed a serious problem, particularly in hilly terrain.

These assumptions led to a single model for a Soviet nuclear attack, and ADSEC decided to address only that one scenario. In this view, a Soviet bomber would fly over the north polar region at high altitude and then descend as it approached its target. While the aircraft flew at high altitudes, it would be able to detect ground radar before the radar could detect the aircraft; at low altitudes, it could fly under the beam and be virtually undetectable.

Donovan calculated that, to attack a city in the northern part of the United States, a Soviet bomber would need to fly at low altitude for only about 10% of its journey. Therefore, the range penalty for low-altitude flight would be small. And, if aerial refueling were performed

near the Arctic Circle, the entire United States could be vulnerable to Soviet attack. Spaced as they were, the then-existing GCI radars gave virtually no protection. A low-flying aircraft could find a clear path to almost every city in the United States.

Thus, ADSEC determined that the weakest link in the nation's air defenses was the radars that were supposed to detect low-flying aircraft. The committee further concluded that, in the event of a nuclear attack, an enemy would be most likely to exploit that weakness.

Now that ADSEC had identified the problem, the next step was to find a solution. The committee, therefore, focused primarily on finding a way to prevent hostile aircraft from taking advantage of the presence of either ground clutter or low-altitude shielding caused by the curvature of the earth.

A partial solution to the problem of ground clutter had been developed during World War II: the moving target indicator (MTI), which used measurements of frequency shifts due to the Doppler effect to remove ground clutter. The basic concept of the MTI apparatus was that, because aircraft were moving, the frequency of their radar echoes would differ slightly from that of the ground clutter. The implementation of MTI was not simple. In hilly terrain, the echo from an aircraft flying at 500 ft could be a million times weaker than the echo from the ground clutter. Nonetheless, ground clutter was not an insurmountable problem.

The problem of the earth's curvature was more difficult. Each radar's range was limited by its horizon, and, by flying at low altitude, aircraft could hide from the



MIT Building 20



MIT Sloan Building



Whittemore Building



**Figure 1-2**  
**Jay Forrester examining an early memory array.**

widely spaced GCI radars. Since air-based or space-based surveillance was not an option in 1950, the only solution was to install ground-based radar systems closer together. In a burst of enthusiasm, Valley and Marchetti formulated plans to place radars on telephone poles every 10 mi along the northern perimeter of the United States.

In 1950, these plans were grandiose and unrealistic. But fortunately for the future Lincoln Laboratory, ADSEC continued to evaluate the problem and reduced it to two major issues.

First, in order to interpret the signals from a large number of radars, there had to be a way to transmit the radar data to a central computer, which could aggregate the data. Second, since the objective was to detect and intercept the hostile aircraft, the computer had to analyze the data in real time.

When Valley called several computer manufacturers to inquire about the possibility of using one of their systems to test his ideas, he was dismissed as a crackpot. Real-time operation was simply inconceivable in 1950. However, the answers to the problems of data transmission and of real-time operation were waiting to be addressed nearby. At the AFCRL, John Harrington had developed the digital radar relay (DRR), an apparatus capable of converting analog radar signals into digital code that could be transmitted over telephone lines. At the MIT Servomechanisms Laboratory, Jay Forrester was heading up a group that was developing the world's first real-time computer (Figure 1-2).

Valley needed a computer fast enough to handle real-time data analysis. As he began his search, Valley ran into Professor Jerome Wiesner, then associate director of the Research Laboratory of Electronics, and learned that the computer he required was already on the MIT campus. It was in the Servomechanisms Laboratory, and it was about to be abandoned by its sponsor.

During World War II, the emphasis in the Servomechanisms Laboratory had been on developing gun-positioning instruments. After the end of the war, the laboratory had begun a program to demonstrate a flight simulator, the Airplane Stability and Control Analyzer (ASCA), for the Office of Naval Research. Plans had called for ASCA to simulate virtually every aircraft then

in existence. Because this would require a powerful computer, the Servomechanisms Laboratory had begun to develop its own computer, code-named Whirlwind (Figure 1-3).

ASCA was never built. The cost, projected in 1945 at \$875,000, had seemed reasonable. But as the computer development effort, led by Forrester, dragged on, expenses grew to many millions of dollars, and the Office of Naval Research lost interest. By 1950, Whirlwind had become an orphan. The Navy had given up on ASCA and cut off support for the program.

From his talk with Forrester, Valley was convinced that Whirlwind was suited to the ADSEC project. From then on, Forrester was a regular participant in ADSEC. Whirlwind was in a relatively early stage of its construction, with only 5 words of random-access memory and 27 words of programmable read-only memory. Yet its high speed and 16-bit word length made it adequate for ADSEC to test the feasibility of the concepts that radar data could be transmitted to a computer via the DRR and that the computer could respond to the information in real time and direct an interception.

Because ADSEC wanted to carry out a test as quickly as possible, the committee assumed the costs of continuing Whirlwind. They worked fast. By March 1950, Whirlwind had a budget for fiscal 1951 of \$930,000. The computer was no longer an orphan — it had a mission and a budget.

Forrester promptly began preparing to receive and process digitized radar signals. The feasibility demonstration of the radar/digital data concept took place at the Laurence G. Hanscom Field in September 1950. The radar, which was an original experimental model of a microwave early-warning unit built by the wartime MIT Radiation Laboratory, closely resembled the radars used in the D-Day invasion of Normandy.

While military observers watched closely, an aircraft flew past the radar, the DRR transmitted the signal from the radar to Whirlwind via a telephone line, and the result appeared on the computer's monitor. The demonstration was a complete success and proved the feasibility of ADSEC's air defense concept.



The demonstration at Hanscom Field signaled the end of the first phase of ADSEC's work. The committee's focus shifted from evaluation to implementation; a laboratory dedicated to air defense problems began to be discussed. But that was not ADSEC's responsibility. The committee had accomplished its objective and was formally dissolved in January 1952.

The invasion of the Republic of South Korea by North Korea on June 25, 1950, heightened interest in ADSEC's air defense system. In particular, Louis Ridenour, chief scientist of the Air Force, had strong enough feelings about the air defense issue that he decided to push for continuation of the ADSEC program. On November 20, 1950, Ridenour wrote in a memo to Major General Gordon Saville, deputy chief of staff for development in the Air Force, "It is now apparent that the experimental work necessary to develop, test, and evaluate the systems proposals made by ADSEC will require a substantial amount of laboratory and field effort."

Ridenour's memo was the first document to propose a laboratory dedicated to air defense research. He estimated that such a laboratory would require a staff of about 100 and a budget of about \$2 million per year. (During the 1950s, Lincoln Laboratory actually would have a staff of about 1800 and an annual budget in excess of \$20 million.)

A few weeks later, on December 15, Valley joined Ridenour for lunch at the Pentagon. Ridenour persuaded Valley that they should ask MIT to set up an electronics laboratory that could develop ADSEC's air defense ideas.

Valley later recalled that he wrote a letter in about an hour and that Ridenour recast it in "appropriate general officer's diction." By four o'clock, the letter had been signed by General Vandenberg and was on its way to James Killian, Jr., president of MIT (Figure 1-4).

The Vandenberg letter led directly to the formation of Lincoln Laboratory:

"The Air Force feels it is now time to implement the work of the part-time ADSEC group by setting up a laboratory which will devote itself intensively to air defense problems. We think it would be best to do this in the Cambridge area, since we intend this laboratory



**Figure 1-3**  
**The Whirlwind console room in 1950.**  
**Seated at left: Stephen Dodd, Jr.**  
**Standing: Jay Forrester (left) and**  
**Robert Everett (right). Seated at the**  
**right: Ramona Ferenz.**

**Figure 1-4**  
**James Killian, Jr., MIT president,**  
**1948–1959.**



**Figure 1-5**  
**F. Wheeler Loomis, first director of**  
**Lincoln Laboratory.**



to have the continuing advice and guidance of ADSEC, and because the new laboratory must work closely with the existing Air Force Cambridge Research Laboratories.

“The Massachusetts Institute of Technology is almost uniquely qualified to serve as contractor to the Air Force for the establishment of the proposed laboratory. Its experience in managing the Radiation Laboratory of World War II, the participation in the work of ADSEC by Professor Valley and other members of the MIT staff, its proximity to AFCRL and its demonstrated competence in this sort of activity have convinced us that we should be fortunate to secure the services of MIT in the present connection.

“The air defense problem which faces the Air Force is of great importance to the people of this country. The problem is technically complicated and difficult. The Air Force must urgently increase its research and development effort in this area and in this we ask your help. I sincerely hope that you will be able to give the matter serious consideration.”<sup>5</sup>

#### **Project Charles**

President Killian had serious reservations about MIT starting up a new laboratory. In his autobiography, *The Education of a College President*, Killian recalled his concerns:

“MIT was understandably reluctant to undertake the establishment and management of a large research laboratory devoted to military objectives, having devoted itself so intensively to the conduct of the Radiation Laboratory and other large war projects.”<sup>6</sup>





## Notes

5 H.S. Vandenberg in W.H. Wood, ed., *Case History on Project Lincoln*. Hanscom AFB, Mass.: Historical Branch, Office of Information Services, 1957, pp. 24–25.

6 J.R. Killian, Jr., *The Education of a College President*. Cambridge, Mass.: MIT Press, 1985, p. 71.

7 *Problems of Air Defense: Final Report of Project Charles*, Vol. I. Cambridge, Mass.: MIT, 1951, p. xx.

Ridenour provided Killian with a reason for setting up a laboratory that, although unrelated to national defense, was particularly persuasive. Ridenour suggested that a laboratory to address air defense problems would serve as a stimulus for the nation's small electronics industry. He predicted that the state that became the home of the new laboratory would emerge as a center for the electronics industry. Ridenour's words were prophetic, as evidenced by the growth of the electronics and computer industry along Route 128, the circumferential highway around Boston.

Because Killian was not eager for MIT to become involved in air defense, he asked the Air Force if MIT could first conduct a study to evaluate the need for a new laboratory and to determine its scope. Killian's proposal was approved, and a study named Project Charles (for the river that flows past MIT) was carried out between February and August of 1951.

Project Charles was conducted by a group of 28 scientists, 11 of whom were associated with MIT. The director was F. Wheeler Loomis, the University of Illinois professor who subsequently became Lincoln Laboratory's first director (Figure 1-5). Albert Hill and Carl Overhage, also members of the study, became the Laboratory's second and fourth directors, respectively. Most of the other members of Project Charles also went on to join the Laboratory.

The Project Charles study investigated the general problem of defense against air attack. During the first month, the study group visited laboratories and military installations and was briefed intensively by scientists and members of the military.

After the first month, Loomis divided Project Charles into four working groups: (1) aircraft control and warning — long-term program; (2) aircraft control and warning — early improvements; (3) passive defense; and (4) air defense weapons. Each working group studied its area intensively for about two months, and then all four groups presented their conclusions in Washington on June 28, 1951. The Project Charles Final Report, entitled *Problems of Air Defense*, was issued on August 1. Ten volumes of research reports, committee notes, and memoranda were gathered separately.

*Problems of Air Defense* was a remarkable document. It described the basic concepts, and many of the details, of the air defense system exactly as they would eventually be implemented. The Cape Cod System proposed by Project Charles turned out to be almost identical to the Cape Cod System built by Lincoln Laboratory a few years later. The authors suffered, perhaps, from excessive humility, for they wrote, "Few, if any, of the ideas embodied in this report will be found new or original."<sup>7</sup>

The Final Report divided the problems of air defense into seven areas. These seven areas became, in a general way, the backbone of the Laboratory: (1) meeting a surprise attack; (2) aircraft control and warning — early improvement; (3) aircraft control and warning — long-term program; (4) air defense weapons; (5) electronic warfare; (6) passive defense against air attack; and (7) manpower in air defense.

1955



Construction of Project Lincoln buildings, Lexington

---

## Notes

**8** *Problems of Air Defense*, p. viii.

**9** *Problems of Air Defense*, p. x.

**10** F.W. Loomis in H.W. Serig, ed., *Project Lincoln Case History, Vol. II*. Hanscom AFB, Mass.: Air Force Cambridge Research Center, 1952, p. 6.

**11** J.R. Killian, Jr., in *Project Lincoln Case History, Vol. II*, p. 2.

**12** Killian in *Project Lincoln Case History, Vol. II*, pp. 3–4.

The members of Project Charles agreed that the United States needed an improved air defense system and that Valley had developed the correct plan: “We endorse the concept of a centralized system as proposed by the Air Defense Systems Engineering Committee, and we agree that the central coordinating apparatus of this system should be a high-speed electronic digital computer.”<sup>8</sup>

Project Charles came out unequivocally in support of the formation of a laboratory dedicated to air defense problems:

“Experimental work on certain of these problems is planned in a laboratory to be operated by the Massachusetts Institute of Technology jointly for the Army, the Navy, and the Air Force, to be known as PROJECT LINCOLN.”<sup>9</sup>

This statement was the approval by a technically trained panel that Killian had wanted. The decision to found the new laboratory, with the unusual support of all three services, became final.

### Project Lincoln

The name Project Lincoln reflects the original plans for the air defense program. At the time of the signing of the Charter for the Operation of Project Lincoln, it was expected that the program would last five years at most. In fact, the employment package offered in 1951 included a promise to pay employees’ moving expenses to their next place of work after the project terminated.

Why the name Lincoln? The Charter for the Operation of Project Lincoln had stated that the Air Force was planning to build a laboratory where the Massachusetts towns of Bedford, Lexington, and Lincoln meet. There had already been a Project Bedford (on antisubmarine warfare) and a Project Lexington (on nuclear propulsion of aircraft), so Major General Putt, who was in charge of drafting the Charter, decided to name the project for the town of Lincoln.

Loomis took over as director of Project Lincoln. He had a small staff, unsure funding, and a promise to construct a laboratory. Moreover, he faced an immense challenge — to design a reliable air defense system for the continent of North America.

Before Loomis could begin to hire the staff for Project Lincoln, he had to set up a structure for the organization. For this, he drew upon a model originated by the Radiation Laboratory in 1942. The organizational structure he followed consisted of a director’s office, a steering committee, and a staff divided into divisions and groups. Each division was in charge of developing a system, and each group designed a component of that system.

The concept of divisions and groups proved effective and efficient. Its simplicity enabled Project Lincoln to operate with far fewer managers — and with far less internal politics — than many other organizations. In fact, the structure worked so well that it has remained in use in Lincoln Laboratory.

Project Lincoln was divided into five technical divisions: aircraft control and warning, communications and components, weapons, special systems, and digital computers. It also had two service divisions: business administration and technical services. The divisions were divided into one to six groups. Each division examined one aspect of the continental air defense problem; each group looked at one element of its division’s task.

By September 1951, Project Lincoln had more than 300 employees. Within a year, it employed 1300. One year later, Lincoln Laboratory had grown to 1800 personnel, a level that would remain fixed for several years.

Despite the Air Force’s commitment to the concept of continental air defense, funding for Project Lincoln was inconsistent. The first few months went smoothly, but the situation soon deteriorated.

By December 1951, Loomis had been told that the Air Force was planning to decrease its allocation for fiscal year 1952. Even worse, he heard a rumor that the Air Force also intended to cut its maximum allowable commitment for 1953.

Lincoln Laboratory had submitted a 1952 budget of \$11.85 million, plus \$4.41 million for ADSEC. But only \$4 million had actually been allocated for *both* projects.

Loomis decided to confront the issue of financial support directly. On December 21, 1951, he wrote to President Killian, urging him to “bring the whole problem of the



support of Project Lincoln to the authoritative level in the services, especially in the Air Force.” Loomis continued:

“If MIT were to commit itself deeply to the Lincoln program with insufficient assurance of adequate and continuous support despite the to-be-expected fluctuations in the international situation and in the size of the overall military budget, it would run a grave risk of seriously harming its reputation by a large and awkward instability in its employment of scientists and by having incurred the odium of a major technical failure.”<sup>10</sup>

The possibility that Project Lincoln could harm MIT’s reputation was, of course, exactly why Killian had been reluctant to agree to the program. He sent a letter to Air Force Secretary Thomas Finletter the same day, stressing one key point:

“Project Lincoln is somewhat unique in that there is a critical minimum below which the project cannot go and still be successful. This condition is brought about by that part of the project which has to do with the development of a centralized digital air defense system. To carry through this development requires an all-out development if it is to have any value at all, and there is no point in carrying this part of the project part way. Moreover, if this part of the project is to have a significant effect on the course of the air defense program, it should be carried through with all possible dispatch.”<sup>11</sup>

Killian emphasized that the current Lincoln budget figures were “firm conclusions” and that the time had come when “we must squarely face the question as to whether budgetary arrangements can be made which can assure the necessary continuity of the project.”

MIT’s own policies caused some of the financial problems. Internal regulations prohibited the transfer of funds from MIT’s endowment to Project Lincoln — even if the funds had already been allotted. Because MIT could not give Project Lincoln a financial cushion, Killian asked Finletter for reassurance that it should be managing the program:

“The Institute would welcome objective and outside judgment as to the advisability (1) of the project itself being carried through and (2) as to whether MIT is the best agency to do it.”<sup>12</sup>

## The Project Lincoln Charter

**Representatives of the Air Force, the Army, and the Navy signed the Charter for the Operation of Project Lincoln on July 26, 1951.\* This document contains the first official definition of Lincoln Laboratory and its role with respect to the armed forces:**

### **Charter for the Operation of Project Lincoln**

**The three departments of the national military establishment propose to establish, under the management of the Massachusetts Institute of Technology, a program of research and development to be known as Project Lincoln. The Project will be under prime contract with the Air Force.**

**The primary mission of the Project will be air defense. It is agreed that the most effective way of pursuing this mission is to encompass where possible any problems pertinent to air defense. Continental air defense is considered to be a specific part of this mission.**

**In order to conserve manpower and resources available to the Massachusetts Institute of Technology, this Project may include projects now covered by U.S. Army Signal Corps contract DA 36-039 ac-5450. As a further mission, the subject of strategic reconnaissance and intelligence may also be incorporated. Additional projects falling outside of the fields specified above may from time to time be undertaken by amendment of the contract of Project Lincoln.**

**It is agreed that this Project will serve the Air Force, the Army and the Navy, and it is anticipated that each of the services will allocate funds under this contract in proportion to its interest. By agreement between the contractor and the service involved, projects falling within the scope of the task defined above may be initiated by the contractor within the funds available. When requested, the Project will serve as a consultant to the services in its**

**fields of competence. It is expected that some of the work in the Project, important to the missions specified above, will have general applicability not limited to the fields of this mission.**

**MIT will be authorized, under the provisions of its contract with the Air Force, to procure such laboratory equipment as required for the operation of the Project from funds available under the contract. General laboratory equipment will be provided from Air Force funds made available to the contractor. Special laboratory equipment required by a specific project undertaken for one of the departments will be provided from funds made available by that department.**

**To give the Project the fullest possible tripartite character, the Army, the Navy and the Air Force will appoint an advisory committee, representing equally all three services with the representative of the Air Force serving as chairman.**

**The Air Force has planned the establishment of a research center in the Bedford-Lincoln-Lexington area. Within this installation a facility known as the Air Defense Research Laboratory will be made available to Project Lincoln. This facility will be operated by MIT under the contract for Project Lincoln. Any portions of this facility not required by Project Lincoln will be used by the Air Force.**

**M.E. Curts, Rear Admiral, USN  
D.L. Putt, Major General, USAF  
W.H. Maris, Major General, USA**

---

\*Reprinted in full from H.W. Serig, ed., *Project Lincoln Case History, Vol. I*. Hanscom AFB, Mass.: Air Force Cambridge Research Center, 1952, p. 155.

---

## Notes

**13** T.K. Finletter in *Project Lincoln Case History, Vol. II*, p. 68.

**14** Meeting notes recorded by J.G. Perry, in *Project Lincoln Case History, Vol. II*, p. 71.

The reply from Finletter on February 5, 1952, emphatically assured Killian of MIT's suitability as a contractor for air defense research.<sup>13</sup> However, his letter begged the question of how the Air Force could meet all its financial responsibilities. Finletter promised that 1952 funds would be forthcoming, but he did not offer any reassurance for 1953.

Finletter's letter notwithstanding, Brigadier General Donald Yates, director of Air Force research and development and chairman of the Joint Advisory Committee (JAC), instructed Loomis to cut \$4 million from his 1953 budget of \$18.2 million. Yates also warned Loomis that further cuts were likely, and he requested a detailed breakdown of the program budget.

Loomis was mastering the skills for working with the government. He submitted a 25-page budget proposal, divided into two sections: itemized expenses for each division and project, and detailed descriptions of the projects. A one-page analysis summarized the status of the six-month-old Project Lincoln.

A JAC meeting was held on February 11, 1952, to review the proposed technical program and budget for 1953. At this landmark meeting, General Yates stated that the Air Force was looking to Project Lincoln "as the focal point for Air Defense Research and Development."<sup>14</sup> Upon his recommendation, the committee approved an \$18.2 million budget for 1953.

With staff coming on board and the funding secure, Loomis now turned his attention to the construction of buildings. The space on the MIT campus was already inadequate, and hundreds of employees were joining the project.

The sole site available on campus for classified work was Building 22 (Figure 1-6). Unclassified research was carried out in Building 20, and administrative offices of Project Lincoln were located in the Sloan Building at MIT. Temporary housing for the motor pool, the electronics shops, and the publications office was found in a two-story commercial building on Vassar Street.

Although the MIT Digital Computer Laboratory (originally part of the Servomechanisms Laboratory) became part of Project Lincoln, work on Whirlwind

continued to be carried out in the Barta Building on Massachusetts Avenue (Figure 1-7) and in the Whittemore Building on Albany Street.

Space was not the only issue. Killian believed that MIT should not be carrying out classified research on the Cambridge campus. He thought that MIT had an obligation to disseminate its research results throughout the academic community and that classified research was inherently incompatible with this obligation. Therefore, Killian wanted MIT to maintain its integrity by conducting Project Lincoln off campus. The Bedford-Lincoln-Lexington area mentioned in the Charter for the Operation of Project Lincoln had space for new construction, and it was a comfortable distance from Cambridge.

This site was the Laurence G. Hanscom Field, now Hanscom Air Force Base and still the home of Lincoln Laboratory. Hanscom Field became a Commonwealth of Massachusetts facility in May 1941, when the state legislature acquired 509 acres for the construction of an airport. It was located in part in each of the towns of Concord, Lincoln, Lexington, and Bedford on a flat area between the Concord and Shawsheen rivers. The official groundbreaking ceremony for the airfield, then known simply as the Boston Auxiliary Airport at Bedford, was held on June 26, 1941.

On February 11, 1943, the site was named the Laurence G. Hanscom Field, Boston Auxiliary Airport at Bedford, in memory of a *Worcester Telegraph* State House reporter who had died in an aircraft accident in 1941. Hanscom had been an aviation enthusiast and had served as the first commander of the Massachusetts Wing of the Civilian Air Reserve.

Following the United States' entry into World War II, Hanscom Field was pressed into service for national defense. The Army Corps of Engineers signed a lease with the Massachusetts Department of Public Works, and Army Air Forces units began to operate out of the airfield. Squadrons from Hanscom engaged in combat in both the Mediterranean and the European theaters of combat. After the war, control over the airfield, now expanded by about 600 acres, passed to the Commonwealth of Massachusetts, but military activity continued.





**Figure 1-6**  
Building 22 at MIT, constructed to house the Radiation Laboratory during World War II, was the site of early work on Project Lincoln.



**Figure 1-7**  
The Barta Building, home of Whirlwind.





**Figure 1-8**  
Original Lincoln Laboratory building  
complex in Lexington.



On October 12, 1951, as a result of the AFCRL's requirement for increased facilities, the secretary of the Air Force informed the governor of Massachusetts of a military need for the airfield. The Commonwealth preferred to continue to lease the facility, and several months of negotiations ensued. On May 7, 1952, the federal and state governments reached a compromise: 396 acres were deeded to the United States, 641 acres were leased to the United States, and 83 acres were retained by the Commonwealth.

A major construction project was carried out from 1952 to 1953. Taxiways, hangars, offices, and military residences were constructed. The Shawsheen River was relocated, swamps were drained, hills were leveled, and woodlands were cleared.

Groundbreaking for Project Lincoln began in 1951 at the foot of Katahdin Hill in Lexington. The site lay directly below 47 acres of farmland that had been acquired by MIT in 1948 as a site for cosmic-ray research. Twenty-six acres were transferred to the Army, and the remaining 21 acres were assigned to Project Lincoln.

The new buildings were laid out in an open-wing configuration with alternate wings along a central axis. The plans called for four wings (Buildings A, B, C, and D) plus a concrete-block utility structure (Building E).

The Boston firm of Cram and Ferguson was chosen as the architect. Although the firm was among the oldest and largest of its kind in the United States, it was not generally associated with laboratory construction. In fact, the firm was better known for Gothic and art deco architecture, such as the Cathedral of St. John the Divine in New York City and the 1948 John Hancock Building in Boston.

Cram and Ferguson came up with a modular design for the buildings, with each staff member allotted  $9 \times 9$  sq ft. The main corridor of each building was 400 ft long, which yielded 44 modules along each side. Supporting columns were spaced 18 ft apart, and movable partitions were used for the internal walls.

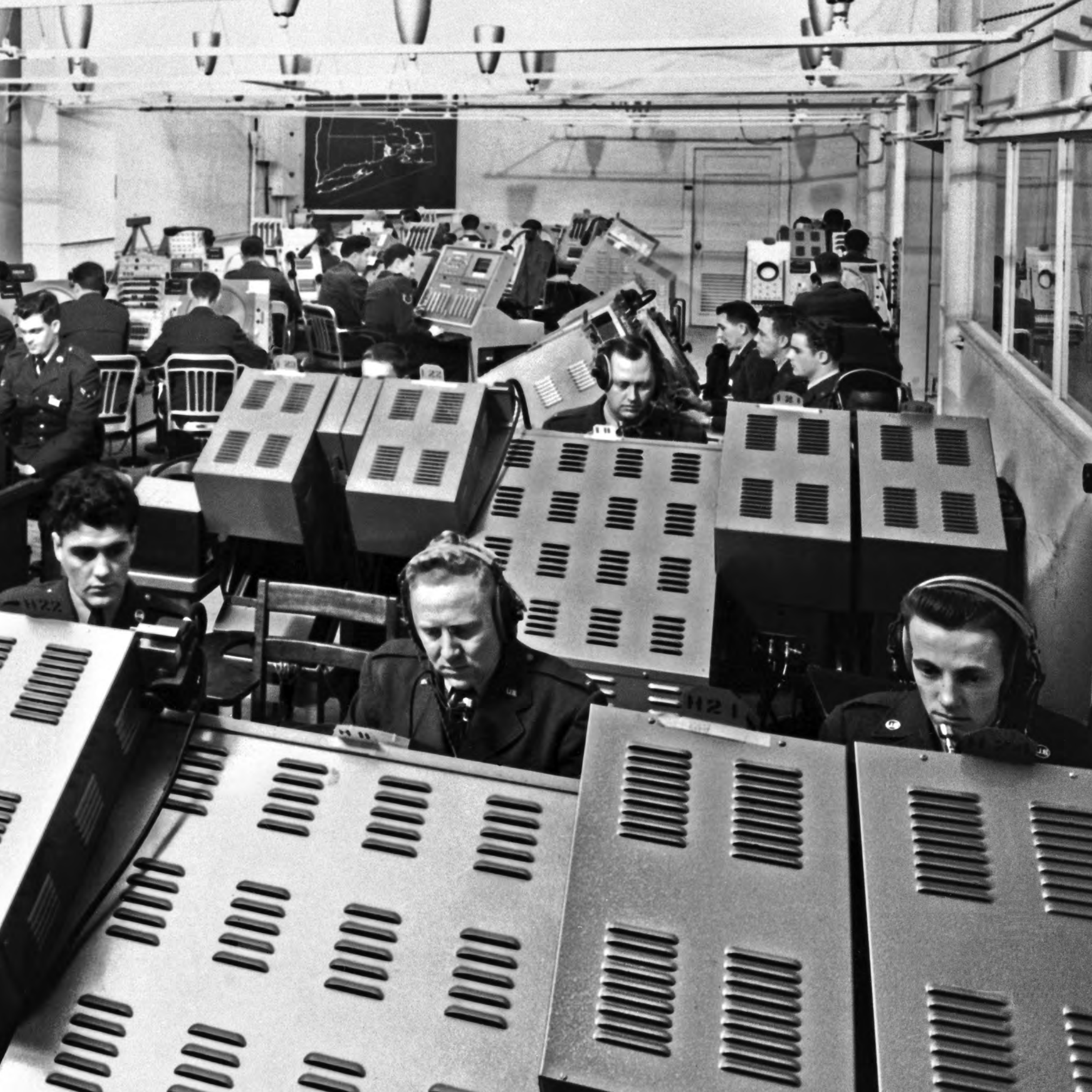
Buildings were 60 ft wide, with 15 ft wide corridors. Because laboratories required more space than offices, modules were 18 ft deep on one side of the corridor and 27 ft deep on the other. Buildings B and C each had four stories, three above and one below ground level. Buildings A and D had three stories, and the lowest levels were only partially below ground. Building E had a single story and a small basement. It held the receiving room, stockroom, storage area, shops, and garage.

The Army Corps of Engineers contracted with the Volpe Construction Company to erect Building B on a cost-plus basis. Predictably, the bill was extremely high. After this experience, the Corps insisted on fixed-price bids for the remainder of the construction.

Building B was completed on March 31, 1952, barely two years after the first meeting of ADSEC and less than a year after the Project Charles Final Report. Buildings D, A, C, and E (Figure 1–8) followed.

Fear of nuclear holocaust pervaded the thinking of Americans in the 1950s, and the government of the United States was committed to protecting the country against this threat. Because Project Lincoln's mission was vital to the security of the nation, red tape was eliminated at all stages.

The Air Force had put its resources at the disposal of Project Lincoln. The staff had only one more problem to solve — they had to deliver a reliable air defense system for North America. They would succeed.





**With the establishment of Lincoln Laboratory, efforts turned from validation of air defense concepts to system implementation and testing. Over a period of seven years, the Laboratory broke new ground in a wide range of technologies, developed the digital computer as a real-time control system, and successfully completed the design of the SAGE air defense system.**

**Left: Cape Cod System direction center in the Barta Building. The operators in the foreground are intercept monitors.**

By the spring of 1952, Project Lincoln had become a major activity at MIT. Within only one year, its personnel had grown from zero to 550. It was time to give the program a greater sense of permanence.

The transition from Project Lincoln to Lincoln Laboratory was remarkably informal. F. Wheeler Loomis, the director of Project Lincoln, simply decided that the name Project Lincoln was obsolete and changed it. Loomis made the name Lincoln Laboratory official in a letter to MIT President James Killian on April 17, 1952:

“The Lincoln Steering Committee is inclined to be rather dissatisfied with the appellation ‘Project Lincoln’ because the word ‘Project’ seems to us to convey unnecessary implications of impermanence and probably also to be inappropriate to an organization of the scale of Lincoln.

“We propose, with your approval, to begin at once using the name ‘Lincoln Laboratory’ for the organization.

“I believe that this change can be instituted without higher approval, and without amendment of the Lincoln Charter since, in that instrument, it is the program which is denominated ‘Project Lincoln.’”<sup>1</sup>

Loomis resigned his position as director on July 9, 1952. When he had originally agreed to become Lincoln Laboratory’s first director, he had made it clear that he would be willing to serve in that capacity for no more than a year. And so, almost exactly one year after the signing of the Charter for the Operation of Project Lincoln, Loomis resumed his teaching duties at the University of Illinois.

Albert Hill became Lincoln Laboratory’s second director, a position he held until May 5, 1955. George Valley continued to serve as associate director.

By 1952, the air defense program was already approaching a degree of maturity. A radar network had been assembled, and Lincoln Laboratory was ready to begin operational tests. The reliability of the computer, however, still posed a problem. Before plans for a nationwide air defense system could be taken seriously, the computer would have to become much more reliable.

### **Magnetic-Core Memory**

Storage-tube memories, used for internal memory up to the early 1950s, were large and slow. Worst of all, they were unreliable.

The greatest breakthrough in the development of Whirlwind was the invention of magnetic-core memory (Figure 2-1). That invention was the key development leading to the widespread adoption of computers for industrial applications because, unlike computers with storage-tube memories, computers with magnetic-core memories were reliable.

In 1947, while working on Whirlwind in the MIT Servomechanisms Laboratory, Jay Forrester began to think about developing a new type of memory. He conceived of a new way of configuring memory units — in a three-dimensional structure. Although Forrester initially thought of using glow-discharge tubes, preliminary tests indicated that the emission process was too unreliable.

Lacking a good way to implement a three-dimensional memory, Forrester dropped work on his concept for a couple of years. Then, in spring 1949, he saw an advertisement from the Arnold Engineering Company for a reversibly magnetizable material called Deltamax. Forrester immediately recognized that this was the material he needed for the three-dimensional memory structure.

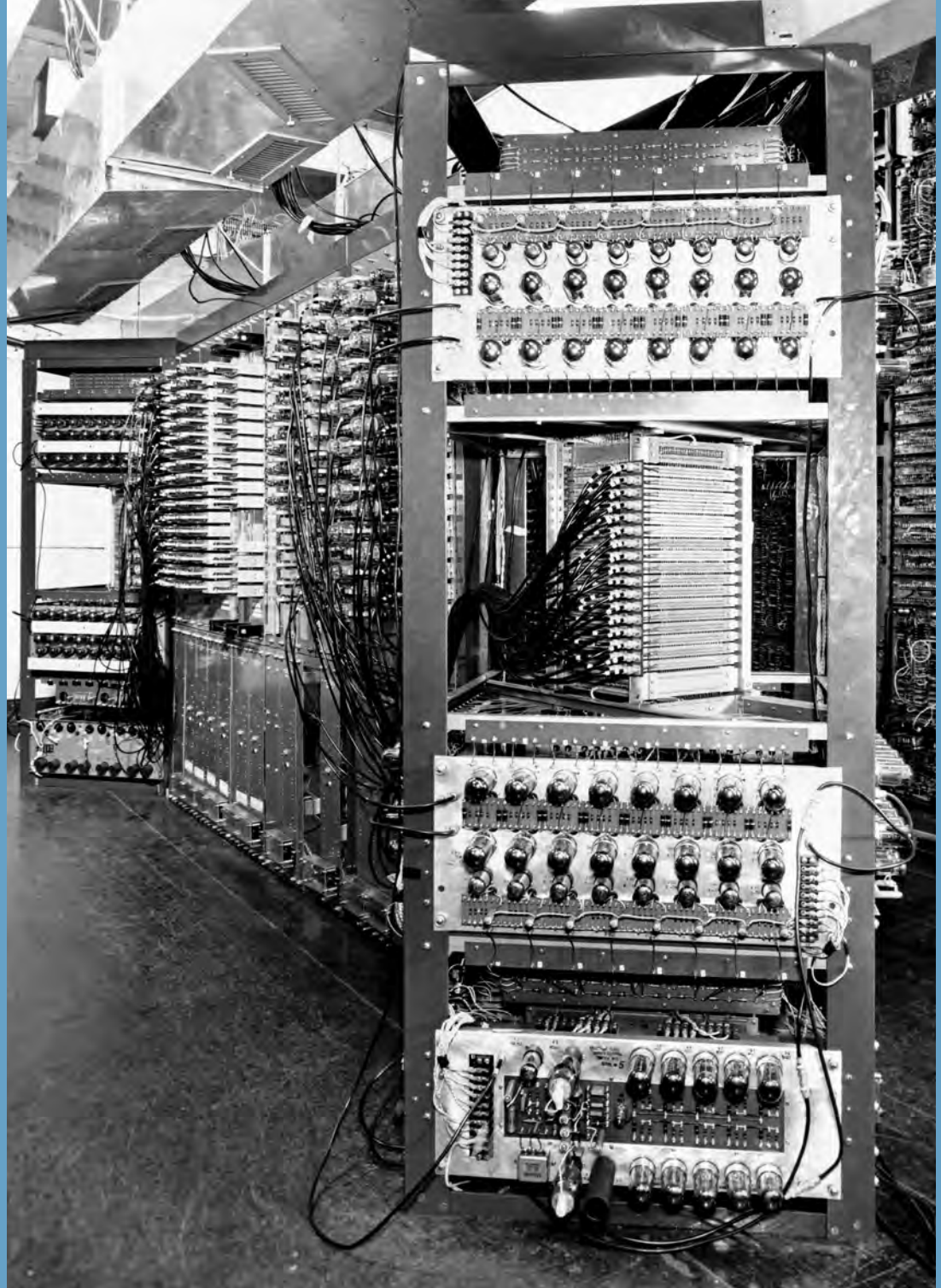
Forrester directed one of his students, William Papian, to study combinations of small toroidal-shaped cores made of ferromagnetic materials possessing rectangular hysteresis loop characteristics. Papian’s master’s thesis, “A Coincident-Current Magnetic Memory Unit,” completed in August 1950, described the concept of magnetic-core memories and showed how the cores could be combined in planar arrays, which could in turn be connected into three-dimensional assemblies.

Papian fabricated the first magnetic-core memory, a  $2 \times 2$  array, in October 1950. The early results were encouraging, and, by the end of 1951, a  $16 \times 16$  array of metallic cores was completed.

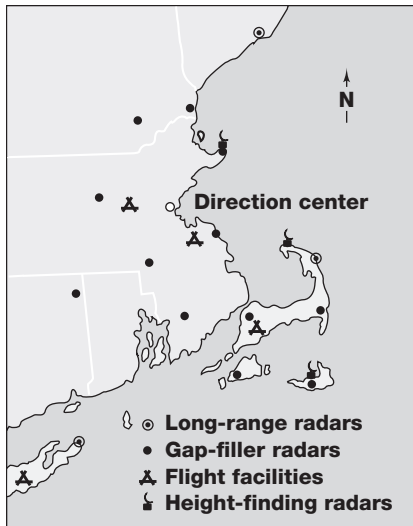
Figure 2-1  
Magnetic-core-memory array.



Figure 2-2  
Whirlwind core-memory banks.







**Figure 2-3**  
Map of the Cape Cod System.

#### Notes

**1** F.W. Loomis in H.W. Serig, ed., *Project Lincoln Case History*, Vol. II. Hanscom AFB, Mass.: Air Force Cambridge Research Center, 1952, p. 125.

**2** This section has been taken largely from C.R. Wieser, "The Cape Cod System," *Ann. Hist. Comput.* **5(4)**, 362–369 (1983).

The organization and direction of Project Whirlwind now went through a major change. The task of developing a flight simulator was abandoned, and the focus of the program shifted to air defense. In September 1951, all members of the Servomechanisms Laboratory who were working on Whirlwind were assigned to a new laboratory — the MIT Digital Computer Laboratory, headed by Forrester. Six months later, the Digital Computer Laboratory was absorbed by Lincoln Laboratory as the Digital Computer Division. Lincoln Laboratory took over the development of magnetic-core memories.

Operation of the early metallic magnetic-core memories was still unsatisfactory — switching times were 30  $\mu$ sec or longer. Therefore, in cooperation with the Solid State and Transistor Group, Forrester began an investigation of ferrites. These nonconducting magnetic materials had weaker output signals than the metallic cores had, but their switching times were at least ten times faster.

In May 1952, a  $16 \times 16$  array of ferrite cores was operated as a memory, with an adequate signal and a switching time of less than a microsecond. So promising was the performance of the new array that the Digital Computer Division began construction of a  $32 \times 32 \times 6$  memory, the first three-dimensional memory.

Whirlwind was by this time in considerable demand, so a new machine called the Memory Test Computer was built to evaluate the 16,384-bit core memory. When the Memory Test Computer went into operation in May 1953, the magnetic-core memory, in sharp contrast to the electrostatic-storage-tube memory in Whirlwind, was highly reliable.

Forrester promptly removed the core memory from the Memory Test Computer and installed it in Whirlwind. The first bank of core storage was wired into Whirlwind on August 8, 1953 (Figure 2-2). A month later, a second bank went in. A different memory was subsequently installed in the Memory Test Computer, enabling that machine to be used in other applications. The improvement

in Whirlwind's performance was dramatic. Operating speed doubled; the input data rate quadrupled. Maintenance time on the memory dropped from four hours per day to two hours per week, and the mean time between memory failures jumped from two hours to two weeks.

The invention of core memory was a watershed in the development of commercial computers. The technology was quickly adopted by International Business Machines (IBM), and the first nonmilitary system to use magnetic-core memories, the IBM 704, went on the market in 1955. Magnetic cores were used in virtually all computers until 1974, when they were superseded by semiconductor integrated-circuit memories.

#### The Cape Cod System

While the Digital Computer Division wrestled with Whirlwind, the Aircraft Control and Warning Division concentrated its efforts on verifying the underlying concepts of air defense.<sup>2</sup> A key recommendation in the Project Charles *Final Report* was that a small air defense system should be constructed and evaluated before work on a more extensive system began. The report proposed that the experimental network be established in eastern Massachusetts, that it include ten to fifteen radars, and that all radars be connected to Whirlwind.

As soon as the air defense program began, Lincoln Laboratory started to set up an experimental system and named it, for its location, the Cape Cod System (Figure 2-3). It was functionally complete; all air defense functions could be demonstrated, tested, and modified. The Cape Cod System was a model air defense system, scaled down in size but realistically embodying all operational functions.

Cape Cod, which was chosen because of its convenience to the Laboratory, was a good test site. It covered an area large enough for realistic testing of air defense functions. In addition, its location was challenging — hilly and bounded on two sides by the ocean, with highly variable weather and a considerable amount of air traffic.

---

**Note**

3 Lincoln Laboratory,  
*Joint Progress Report*  
*JPR-2, 1 Dec. 1953,*  
p. 4.

Every aspect of the Cape Cod System called for innovation. Not only did it require radar netting, but radar data filtering was also needed to remove clutter that was not cancelled by the moving target indicator (MTI). Phone-line noise also had to be held within acceptable limits.

A long-range AN/FPS-3 radar, the workhorse of the operational air defense net, was installed at South Truro, Massachusetts, near the tip of Cape Cod, and equipped with an improved digital radar relay. Less powerful radars, known as gap fillers, were installed to enhance the coverage provided by the long-range system (Figure 2-4). Because near-total coverage was required, the beams of the radars in the network would have to overlap. This overlap meant that the radars could be separated by no more than 25 miles.

Initially, two SCR-584 radars that had been developed during World War II by the MIT Radiation Laboratory were installed as gap fillers at Scituate and Rockport, Massachusetts. Early tests of these radars showed much shorter ranges than expected. Improvements in the components and the test equipment not only resolved the problem but also helped to establish an important policy: activate sites well before the start of data acquisition.

As new radars became operational, each included a Mark-X identification friend-or-foe (IFF) system, and reports were multiplexed with the radar data. Dedicated telephone circuits to the Barta Building in Cambridge were leased and tested.

Buffer storage had to be added to Whirlwind I to handle the insertion of data from the asynchronous radar network, and the software had to be expanded considerably. A direction center needed to be designed and constructed to permit Air Force personnel to operate the system: to control the radar data filtering, initiate and monitor tracks, identify aircraft, and assign and monitor interceptors.

A high priority was to develop a radar mapper to filter data at the direction center. The radar MTI of the early 1950s was analog and provided limited subclutter

visibility, especially at short range. Since targets could not be detected in dense clutter, insertion of dense clutter data into the computer wasted its capacity. A simple, ingenious solution was devised. It consisted of a polar plan position indicator (PPI) display of the incoming data for each radar. A single photocell was mounted above the horizontal cathode-ray-tube (CRT) face, and the photocell response to the bright blue initial flash from displayed position reports controlled a gate that passed the data into the computer. Consequently, any area of the tube face that was masked (opaque to blue light) resulted in rejection of the radar data. The mask material, a paint that could be applied or removed manually, transmitted the afterglow on the tube face so that data under the mask were visible to the operator but not to the photocell. Changes in clutter patterns were relatively slow since they were caused by changes in weather. Another key problem was solved.

Construction of a realistic direction center depended heavily on the development of an interactive display console. Nothing comparable had ever been done before, and the technology was primitive. What was needed was a computer-generated PPI display that would include alphanumeric characters (for labels on aircraft tracks) and a separate electronic tote-board status display. Then, the console operator could select display categories of information (for example, hostile aircraft tracks) without being distracted by all of the information available.

The Cape Cod display console was developed around the Stromberg-Carlson Charactron CRT. The tube contained an alphanumeric mask in the path of the electron beam. The beam was deflected to pass through the desired character on the mask, refocused, and then deflected a second time to the desired location on the tube face — this was electronically complex, but it worked.

The console operator had a keyboard for data input and a light-sensing gun that was used to recognize positional information and enter it into the computer (Figure 2-5). This novel means of control for high-speed computers was invented at the Laboratory by Robert Everett.





**Figure 2-4**  
Gap-filler radar.



**Figure 2-5**  
An Air Force airman uses a light gun to select tracks for identification and display.

A large part of the Cape Cod System effort was devoted to software development. For example, integration of the external storage drum was a software problem as well as a hardware problem. The scarcity of internal memory capacity required that much of the software be stored on the drum and transferred into the central computer when needed. The radar network data, also stored on a drum, had to be read into the computer and transformed into a common coordinate system for proper registration.

The software task was to quickly develop the largest real-time control program ever coded and to do all the coding in machine language since higher-order languages did not yet exist. Furthermore, the code had to be assembled, checked, and realistically tested on a one-of-a-kind computer that was a shared test bed for software development, hardware development, demonstrations for visiting officials, and training of the first crew of Air Force operators.

Even though radars were a critical element in the air defense system, Lincoln Laboratory did not contribute to the Semi-Automatic Ground Environment (SAGE) radar hardware because the Laboratory was forbidden to get involved in the design of the radars, which was the responsibility of the Air Defense Command (ADC). Lincoln Laboratory's assignment was to integrate the radars into an operational system. However, the Laboratory did perform field tests on various radars, and ADC based its specifications and procurements on those tests.

All these complex engineering tasks were carried out in parallel, on schedule, and with little reworking. By September 1953, just two years and five months after the go-ahead, the Cape Cod System was fully operational. The radar network consisted of gap-filler radars, height-finding radars, and long-range radars.

The software program could handle, in abbreviated form, most of the air defense tasks of an operational system. Facilities were in place to initiate and track 48 aircraft, identify and find the height of targets, control ten simultaneous interceptions from two air bases, and give early warning and transmit data on twelve tracks to an antiaircraft operations center.<sup>3</sup>

## Working in a Free-Wheeling Environment

On October 26, 1982, several key individuals in the design and development of SAGE met at MITRE Corporation to reflect on their shared experience. Included were Jay Forrester, Robert Everett, Norman Taylor, and Herbert Benington, each of whom had worked for Lincoln Laboratory during the design of SAGE, and Major General Albert Shiely, the primary Air Force technical manager for SAGE. Their recollections at a seminar on SAGE were recorded in a special issue of the *Annals of the History of Computing*.\*

### **Benington:**

*I was having lunch with my boss, Jack Arnou, and I told him that Whirlwind reliability was so bad, that the computer programs were so complex, that we were making very little progress in checking out the system and having to work too many hours. Within a day or so, Jay [Forrester] called a staff meeting and said that we would replace the storage-tube memory by transferring the core memory from the Memory Test Computer to Whirlwind. That's when we started getting 99 percent reliability out of Whirlwind and we could check the programs out.*

*When we had the AN/FSQ-7(XD-1) operating and had 8000 words of core, I started realizing then that we couldn't get the job done because there would have to be so much paging in and out from drums that we'd spend too much of our available time doing that. I was also having lunch with my boss that day, and I told him my conclusions. Jay dropped by at lunch and said, "Well, we've been developing a 65,000-word core memory, so we'll put it in." That eightfold increase made the program possible.*

### **Everett:**

*I think all these things are right, but several other things were important. First of all, we didn't make a design and send one bunch of people off to build the computer — another bunch of people off to do this and that — and*

*put it all together several years later only to find out that it was wrong. We took it step by step. We were actually looking at real radar data, and tracking real aircraft, long before system designs were all complete.*

*The second thing is that the technology was improving rapidly, and it seemed to stay about even with our recognition of the size of the problem.*

*The third comment I might make is that we didn't sit down and say, "We need a machine of such and such size, and if we can't make it we give up." What we did say was, "We think we can make a machine of such and such size, and given that machine, we could do the following things." As the machine got better, the job got bigger, and we were able to handle it. Even if the machine had been half as capacious, we still would have done something, although it would not have been quite the same thing.*

*I make these remarks because very often in today's military-development world, people try to do everything and end up doing nothing.*

### **Forrester:**

*The freedom to be decisive and to settle on things that worked, even if there might be somewhere in the offing an idea that would be better, made it possible to build the SAGE system.*

### **Taylor:**

*I think Bob [Everett] put his finger on one important thing: the freedom to do something without approval from top management. Take the case of the 65,000-word memory we just heard about. We knew the memory was too small; we didn't have to wait for Herb [Benington] to worry about it.*

*We could hardly run a test program on these small memories, and we knew we had to build bigger ones. Down in the basement of the Lincoln Lab, we started out with TX-0, which was really designed not to test*

*transistorized computers but to test that big memory. That's all it did. We built that big memory, and we didn't go to the steering committee to get approval for it. We didn't go up there and say, "Now, here's what we ought to do, it's going to cost this many million dollars, it's going to take us this long, and you must give us approval for it." We just had a pocket of money that was for advanced research. We didn't tell anybody what it was for; we didn't have to. [Note: the core memory was an immediate success when it was installed in August 1953. It doubled the operating speed and quadrupled the input data rate. Maintenance time was reduced from four hours a day to two hours a week, and the mean time to failure was increased from two hours to two weeks.]*

*Take any one of those developments — whether it was that memory, the Memory Test Computer, or the cathode-ray tubes and the Charactron tubes — if we had had to go through the management stuff that we have to go through now to get \$100,000 worth of freedom, we would never have done any of them. We were able to do it. We'd have a meeting with Bob and me and one other person — and with Jay if he were there. Occasionally these projects failed or needed more funds or more time. On these occasions, the issues did rise to higher management levels — first the Lincoln Steering Committee, next the Air Force, and as needed the New York ADES [Air Defense Engineering Services] meetings. The atmosphere was one of asking for help, and usually the response was positive. As stated earlier, the problems rose to the surface, not the successes, so management addressed problems. As long as it worked, we were winners.*

### **Shiely:**

*We were building and designing and doing everything simultaneously. The first and most important thing was that there was a national perception of the emergency need for an improved air defense system; there wasn't any*

*argument. We had to do something about it, and we were told to go do it — do it as fast as we could and make it work. There was an understanding at the topmost part of the government that the need was urgent. I might add that the willingness on the part of the military side of the family to give people like ourselves in New York the authority and freedom to move and the backing to make the decisions involved, even at the price of tearing up some of the organizational structures in the process, were the keys to success as far as that side of the program was concerned. That got us the license and the freedom to do the things mentioned here.*

### **Forrester:**

*One thing running through the whole program was central to its success. That was an attitude of being open about recognition of mistakes and shortcomings. When a mistake was recognized, it was admitted and fixed rather than evaded or denied. An example was the second computer or the duplex computer in the SAGE centers. The decision to insist on a second computer occurred one weekend when we began to realize that there wasn't going to be the reliability in a single machine that we had been promising. By that time the Air Force had already budgeted the whole system. To double the number of computers required going back to the Air Force for the extra money. There was a lot of flak from that, but our position was that it had to be done. We wouldn't stand behind the system if they didn't. The Air Force supported such changes very effectively.*

---

\* H.S. Tropp, "A Perspective on SAGE: Discussion," *Ann. Hist. Comput.* 5(4), 375–398 (Oct–Dec 1983).



### **Radar Data Transmission**

The air defense system comprised three parts: the radars, the central computer, and the data transmission equipment that linked the radars to the computer. As previously mentioned, Lincoln Laboratory had been directed to stay out of radar development. But both the radar data transmission equipment and the computer needed considerable improvement since neither performed well enough to meet the requirements of an operational air defense system.

The need to transmit radar data over telephone lines led Jack Harrington and his group at the Air Force Cambridge Research Laboratory to invent what is now known as a modem. The group transferred to Project Lincoln in 1952, and Harrington became leader of the Data Transmission Group.

The basic work on the digital radar relay was completed, but the implementation in the Cape Cod System still posed formidable technical challenges. First, there was a need to detect radar reflections automatically from an airborne target. The target was often immersed in a high level of radar noise, ground clutter, and other unwanted returns. The digital radar relay had to be selective or else the limited transmission capacity would become overloaded. The detection had to take into account that the target return occurs over many radar pulses — that is, the large number of radar hits per beamwidth. Some form of signal integration was essential if efficient detection was to be achieved.

The principle of signal-to-noise improvement through the integration of a repetitive signal in noise was well recognized, but the high-capacity electronic storage necessary to accomplish the video addition in real time was lacking. Initially, delay lines were used in a comb-filter arrangement; however, these were restricted to one repetition rate and displayed marginal stability for large numbers of additions. Therefore, the Lincoln Laboratory group concentrated on the barrier-grid storage tube developed by RCA Laboratories at Princeton, New Jersey. This tube gave good results for video integration and, later, for digital storage as well.

A second challenge in the development of the digital radar relay was in the encoding of the target range and azimuth coordinates. The simplest technique, and the one that was adopted, was to count either range or azimuth marks in a simple array counter, with the counter reset at range and azimuth zero and to read those out at the precise time the integrated radar signal exceeded a preset threshold. A voltage-encoding tube was also developed and had multiple high-speed encoding applications.

One of the most difficult requirements in the implementation of the digital radar relay was the provision of enough high-speed storage for the range and azimuth code groups when they were generated — and storage of them for a variable time until the slow-speed transmission channel was clear to take them. A number of choices were available, but none were attractive; digital storage was expensive and limited.

A 16-bit coordinate word had to be stored in a few microseconds, depending on the radar range resolution desired; hence, fairly high storage speed was required. A random-access store seemed the most suitable for the nonuniform rate at which the targets occurred and for the slower but more uniform rate of readout for transmission. The barrier-grid storage tube was found the most promising for both storage and signal integration.

At first, transmission of the target coordinates over a telephone channel was accomplished by modulating a family of nine tones in the 500 to 2500 Hz band at about a 50 to 100 Hz rate to transmit 8 bits plus a marker bit in parallel. This procedure was relatively inefficient and wasteful of bandwidth; however, it easily handled many of the idiosyncrasies of the telephone lines, particularly the effects of delay distortion and the frequency changes introduced by single-sideband carrier systems.

Over the course of the air defense program, three schemes for data transmission were employed. The first, the digital radar relay, was used primarily for the Air Defense Systems Engineering Committee (ADSEC) experiments.

Because the digital radar relay was complicated and unreliable, a second technique, slowed-down video, was developed. This system was designed for all of the Cape Cod radars and used during the early years of the program. The idea of slowed-down video was that when radar signals were integrated over the repetition intervals in one radar beamwidth and subsequently read out over a longer period of time, a relatively narrowband signal resulted that could be directly transmitted over a telephone line. The addition of fairly simple azimuth synchronization allowed the entire picture to be reproduced essentially in real time at a remote point. Slowed-down video was inexpensive and effective. It was implemented in several different forms, depending on the range requirements and on the type of storage.

The disadvantage of slowed-down video was that it faithfully relayed all returns in a radar picture. Its accuracy was inherently poor: one antenna beamwidth in azimuth and one range interval. The bandwidth was kept narrow by making measurements with coarse granularity, and yet the technique yielded a surprisingly useful and accurate picture for elementary aircraft tracking.

The group developed two slowed-down video designs: one employed flip-flop storage and was used on the gap-filler radars in the Cape Cod network; the other was a storage-tube slowed-down video system. The Lewyt Corporation took the storage-tube design into production as the AN/FST-1.

The difficulties of trying to achieve accurate aircraft tracks at the central point from relatively coarse slowed-down video data led to the development of the fine-grain data system. The fine-grain data scheme was a variation of the original digital radar relay, but with a much more elegant detector that could identify the center of the target and code its coordinates more accurately. It required storage of a relatively large number of radar repetition intervals so that the signals in any one range interval could be examined over the full beamwidth.

A breadboard model for fine-grain data was completed and installed in South Truro in January 1955. In August, the system was adapted to receive Mark-X beacon signals from interceptors, and the experimental fine-grain data unit gave satisfactory results. Extensive testing verified that fine-grain data met or surpassed the desired tracking accuracy requirements:  $0.2^\circ$  in azimuth and 1/4 mi in range.

Fine-grain data designs and associated equipment evolved through the next year. Once the development process was complete, a production contract was signed with Burroughs. The prototype became the AN/FST-2, also known as the Burroughs Coordinate Data Transmitting Set, and was eventually used in each of the direction center sites.

#### **The AN/FSQ-7 Computer**

The heart of the air defense system was the computer. The Whirlwind project at MIT's Digital Computer Laboratory had demonstrated real-time control, the key ingredient for the Project Lincoln air defense concept. Whirlwind also provided an experimental test bed for the system design (Figure 2-6).

By the spring of 1952, Whirlwind was working well enough to be used as part of the Cape Cod System. The focus of the program within the Digital Computer Division shifted, therefore, to development of a production computer, Whirlwind II.

Whirlwind I was more of a breadboard than a prototype of a computer that could be used in the air defense system. The Whirlwind II group dealt with a wide range of design questions, including whether transistors were ready for large-scale employment (they were not) and whether the magnetic-core memory was ready for exploitation as a system component (it was). The most important goal for Whirlwind II was that there should be no more than a few hours of down time per year.

To turn the ideas and inventions developed in the Whirlwind program into a reproducible, maintainable operating device required the participation of an industrial contractor. A team was set up to evaluate



contractors: Forrester, head of the Digital Computer Division; Everett, associate head of the Digital Computer Division; C. Robert Wieser, leader of the Cape Cod System design group; and Norman Taylor, chief engineer of the division. This team was responsible for finding the most appropriate computer designer and manufacturer to translate the progress made in the Cape Cod System into a design for an operational air defense system.

The team surveyed the possible engineering and manufacturing candidates and chose four for further evaluation: IBM, Remington Rand (two divisions), and Raytheon. They visited all three companies, reviewed their capabilities, and graded them on the basis of personnel, facilities, and experience.

Consideration was given to the technical contributions of the companies in terms of reliable tubes and other components, circuits, hardware, packaging, storage systems, and magnetic tape units. The companies were graded on their potential for bringing the Whirlwind II from development to production, based on their experience in setting up production of high-quality electronics, their understanding of tests required, and the availability of trained people. The team evaluated the production operation, quality of assembly work, size of organization, similarity of the proposed work to the company's standard product, production capacity, service organization, and training ability. Proximity to MIT was also considered.

IBM received the highest score and was issued a six-month subcontract in October 1952. Over the next few months, the IBM group visited Lincoln Laboratory frequently to study the Cape Cod System, to become acquainted with the overall design strategy, and to learn the specifics of the central processor design.

In January 1953, system design began in earnest. The Lincoln Laboratory Whirlwind II team organized itself along major subsystem lines: arithmetic-element, memory, and drum-design sections. The IBM team organized itself similarly. The computer was designed

by joint Lincoln Laboratory and IBM committees that managed to merge the best elements of their members' diverse backgrounds to produce a result that advanced the state of the art in many directions.

The schedule was tight. Lincoln Laboratory set a target date of January 1, 1955, to complete the prototype computer and its associated equipment. Installation, testing, and integration of the equipment in the air defense system were scheduled to start on July 1, 1954. The nine months preceding this, October 1, 1953, to July 1, 1954, would be needed for procurement of materials and construction. The schedule left about nine months for engineering tasks in connection with the preparation of specifications, block-diagram work, development of basic circuit units, special equipment design, and everything else necessary before construction could begin.

In April 1953, IBM received a prime contract to design the computer. A short time later, the name Whirlwind II was dropped in favor of Air Force nomenclature, and the computer was designated AN/FSQ-7 (Figure 2-7).

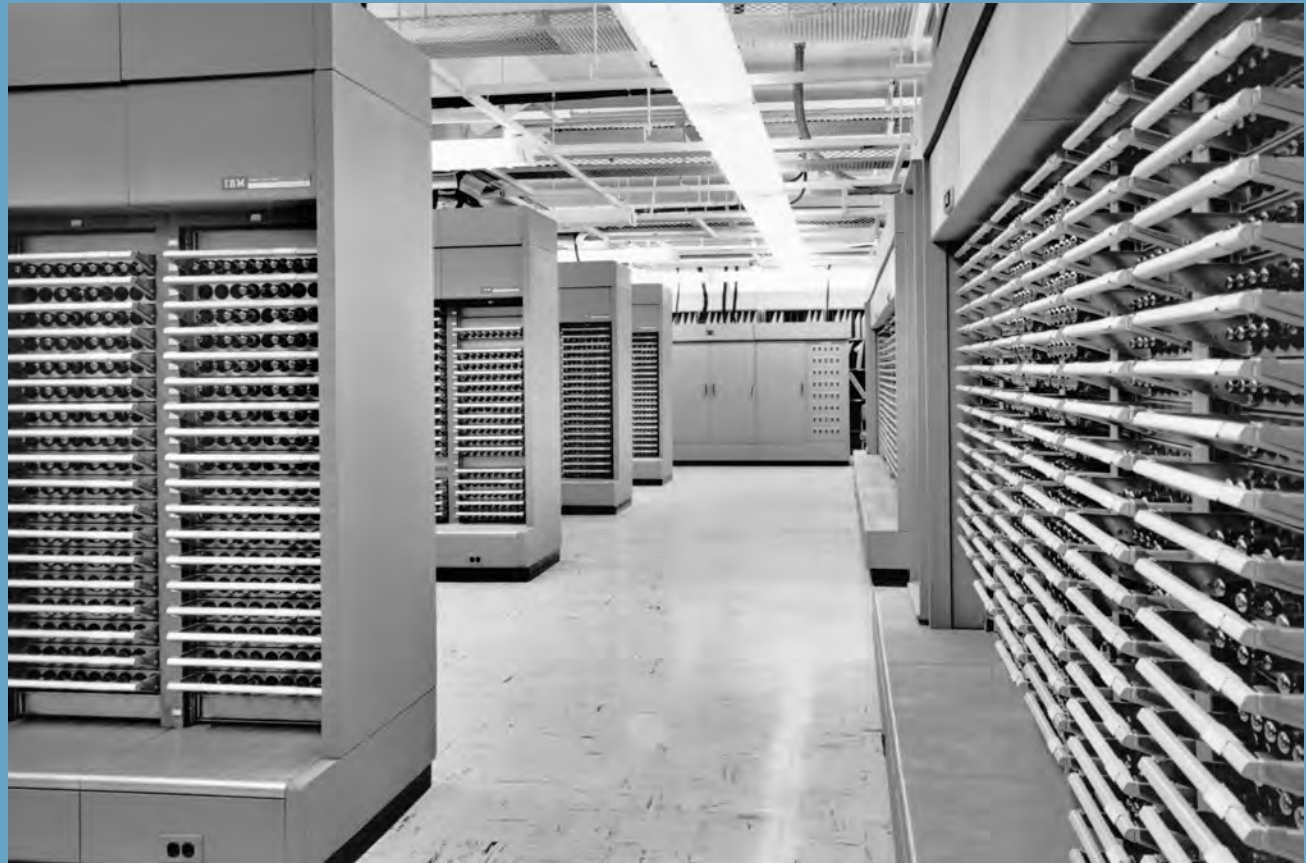
In September, IBM received a contract to build two single-computer prototype systems, AN/FSQ-7(XD-1) and AN/FSQ-7(XD-2). (The XD stands for experimental development.) The AN/FSQ-7(XD-1) replaced Whirlwind in the Cape Cod System during 1955. IBM kept the AN/FSQ-7(XD-2) in Poughkeepsie, New York, and used the machine to support software development and to provide a hardware test bed.

As the plans for the continental air defense system began to take shape, it became evident to the Air Force that automating the combat centers would be desirable. (Each combat center directed operations and allocated weapons for several direction centers.) The combat centers needed a computer like the AN/FSQ-7 but with a specialized display system; this system was named the AN/FSQ-8. The AN/FSQ-8 display console could show the status of an entire sector. Its inputs and outputs did not handle radar or other field data, but were dedicated to communication with direction centers and with higher-level headquarters.



Figure 2-6  
The Whirlwind computer at MIT  
in 1952.

Figure 2-7  
The AN/FSQ-7 computer.





---

**Note**

4 *Problems of Air Defense: Final Report of Project Charles*, Vol. I, Cambridge, Mass.: MIT, 1951, p. 91.

IBM received its first production contract in February 1954. The first AN/FSQ-7 was declared operational at McGuire Air Force Base, New Jersey, on July 1, 1958. IBM eventually manufactured twenty-four AN/FSQ-7s and three AN/FSQ-8s.

Each AN/FSQ-7 weighed 250 tons, had a 3000 kW power supply, and required 49,000 vacuum tubes. To ensure continuous operation, each computer was duplexed; it actually consisted of two machines. The percentage of time that both machines in a system were down for maintenance was 0.043%, or 3.77 hours averaged over a year.

**Competition**

Between 1951 and 1953, while Lincoln Laboratory was pulling together the parts of the air defense system — the computer, the data transmission hardware, the radars — MIT was hard at work resolving funding and political issues. President Killian faced a difficult task: convincing the Air Force to back the Lincoln Laboratory approach to the exclusion of alternatives.

In 1951, the same year that the Air Force Cambridge Research Laboratory set up Project Lincoln, the Rome Air Development Center at Griffiss Air Force Base, New York, began a parallel effort at the Michigan Aeronautical Research Center in Willow Run, Michigan, commonly known as Willow Run. For more than two years, Lincoln Laboratory and Willow Run conducted their programs in an environment of intense competition.

Politics figured heavily in the competition. Both Massachusetts and Michigan hoped to become a center for the fast-growing electronics and computer industries, and representatives of both states pushed hard for their respective programs.

The University of Michigan's program, the Air Defense Integrated System (ADIS), used the Boeing and Michigan Aeronautical Research Center (Bomarc) missile as the core of its air defense approach. By 1952, ADIS included radars, data processing hardware, and weapons-assignment capabilities.

ADIS was discussed extensively during Project Charles, and the *Final Report* was strongly critical:

“It is stated that prototype missiles are to be tested at the Joint Long-Range Proving Ground in 1953, and Michigan is preparing a ground system for this purpose. So far as we can determine, these tests do not require a full AC&W [Aircraft Control and Warning] system, but only radars, trackers, and course computers. There is, in the test, little traffic to be confused with the missile, no identification problem, and only one missile will be fired at a time.”<sup>4</sup>

Nonetheless, the Air Force decided that the wisest course was to support both programs until one was proven superior. This evenhandedness, however, put a serious strain on the Air Force budget.

Both programs were soon struggling for funds. Therefore, in January 1953, President Killian wrote to Secretary of the Air Force Thomas Finletter and demanded that the Air Force make its choice:

“I believe the time has come for another review of Project Lincoln to be undertaken, particularly directed to a technical evaluation of its program. I wish in behalf of MIT as contractor to now request such a review be made. The technical review which I propose should concern itself with an evaluation of the overall Lincoln Project and should give particular attention to the relationship of its program to Air Defense Systems based upon centralized digital computation. I believe it vital that this review be conducted by the best qualified technical personnel from within and without the Armed Services.

“In requesting a thorough going technical appraisal of Project Lincoln, the Institute would also welcome objective and outside judgment as to whether MIT continues to be the best agency to serve as contractor.

---

## Notes

**5** H.W. Serig, *Project Lincoln Case History, Vol. III*, Hanscom AFB, Mass.: Historical Branch, Office of Information Services, 1952, pp. 21–22.

**6** *Project Lincoln Case History, Vol. III*, p. 23.

**7** *Project Lincoln Case History, Vol. III*, p. 26.

**8** *Project Lincoln Case History, Vol. III*, p. 80.

“If the conclusion is reached that some agency other than MIT should be the contractor for the Project, we stand ready to withdraw since the Project involves many hazards for the Institute, particularly financial hazards, and since it is not the kind of Project the Institute would normally wish to undertake, we feel it important that there be no question whatsoever with regard to our serving as contractor. From the standpoint of the Institute’s interest, it must be said that it would be better for us not to be the contractor. The decision as to whether we should continue must rest solely upon the test of whether such continuance is absolutely required by the national interest.”<sup>5</sup>

Killian’s mention of air defense systems based on centralized digital computation was a pointed reference to the Willow Run program, which relied on an analog computer. Finletter replied to Killian’s letter promptly, but he postponed a review of the Lincoln Laboratory program for several months even though he renewed his assurances “that there is no doubt anywhere in the Air Force as to whether MIT should continue as the contractor.” But he added with remarkable candor:

“I should like to point out that there are other technical groups who have ideas on Air Defense and equipment for Air Defense which will probably be available before the Lincoln Project can provide any such. We feel it is our duty to support such efforts but assure you that they will not detract from the Lincoln program.”<sup>6</sup>

Two weeks later, Killian and President Harlan Hatcher of the University of Michigan received a letter from the Air Force that was, in effect, an ultimatum:

“Due to the budget cycle, it is urgent that sufficient progress be made during the next nine months for the Air Force to make further decisions on the production and quantities of either or both systems.”<sup>7</sup>

Informal conversations with Air Force officers led Valley to conclude that Lincoln Laboratory was losing ground to Willow Run. The main problem was in communications with the sponsor; the Air Force did not completely understand what Lincoln Laboratory was trying to do. The Willow Run management, by contrast, kept in close contact with its sponsors.

Valley and Forrester quickly created the document *TM-20, A Proposal for Air Defense System Evolution: The Transition Phase*. This 166-page report, filled with diagrams, charts, tables, and photographs, gave a thorough portrait of the goals, structure, and status of the Lincoln Laboratory effort. *TM-20* also gave the program its first name: the Lincoln Transition System.

The Air Force continued to believe that ADIS would be ready well before the Lincoln Transition System and went so far as to declare that ADIS was the official air defense system. In addition, a directive was issued that all weapon systems under development must be made compatible with ADIS.

1950



A.G. Hill



But ADIS was running into its share of problems. When the Air Force asked for a demonstration, Willow Run supplied a simulated interception that was carried out on a pen plotter. Lincoln Laboratory countered with a live interception.

On May 6, 1953, Lieutenant General Partridge addressed letters to Presidents Killian and Hatcher and to Lincoln Laboratory Director Hill, informing them that the Air Force no longer had “conflicting estimates as to the state of development of each system and as to the date of availability of each,” and that a single approach would now be taken “oriented toward the Lincoln Laboratory Transition Air Defense System.”<sup>8</sup>

The competition for funds was over. Lincoln Laboratory was now the official air defense laboratory of the Air Force.

#### Testing the Cape Cod System

Formal trials of the Cape Cod System began in October 1953, with flight tests two afternoons a week. The primary areas of interest were system related, including radar orientation, height finding, antiaircraft liaison, and the effectiveness of the manual intervention equipment. The tests continued until June 15, 1954.

Analysis of the 1953 Cape Cod System tests, which was completed in August 1954, was highly favorable. Track initiation, tracking, and identification were accomplished successfully.

As the reliability of the air defense system improved, its name, the Lincoln Transition System, became a misnomer. Lincoln Laboratory was no longer working on an interim system to serve until a better one was

developed but was building an air defense system for the United States. Finally, in July 1954, it received a permanent designation, the Semi-Automatic Ground Environment system — SAGE: *semiautomatic* because the operator was responsible for distinguishing between friendly and hostile aircraft but the computer automated the identification process; *ground environment* because the elements of the system — control centers, intercept facilities, and radars — were on the ground.

Over the next few months, the Cape Cod System was expanded to include long-range AN/FPS-3 radars at Brunswick, Maine, and Montauk Point on the eastern tip of Long Island, New York. Additional gap fillers were built and integrated, completing the expanded radar network in the summer of 1954.

Jet interceptors were assigned to support the experiments: twelve Air Force F-89Cs at Hanscom Field and a group of Navy F-3Ds at South Weymouth, Massachusetts. Later, an operational Air Defense Command squadron of F-86Ds based at the Suffolk County Airfield on Long Island was integrated into the Cape Cod System, and the Air Force arranged for Strategic Air Command training flights in the Cape Cod area so the Cape Cod System could be used for large-scale air defense exercises against Strategic Air Command B-47 jet bombers.

The time had come to test the Cape Cod System with a live interception. In a joint experiment with the MIT Instrumentation Laboratory (now the Charles Stark Draper Laboratory), a B-26 aircraft equipped with an autopilot was connected to the Whirlwind computer, and interceptor vectoring commands were transmitted automatically over the data link to the autopilot.



Whirlwind computer



C.R. Weiser

---

**Notes**

**9** *SAGE Operational Plan*, Ent AFB, Colorado Springs, Colo.: Air Defense Command, 1955, p. iii.

**10** Lincoln Laboratory, *Quarterly Progress Report: Div. 2, 15 May 1956*, p. 19.

The interception went as planned. The pilot soon sighted the target aircraft and let the autopilot complete a successful interception. Another important first had been accomplished.

The year 1955 was a watershed for the SAGE effort because the focus of the program changed from installation and component testing to integrated system testing. The style of the program changed as well because the Air Force had given SAGE a precisely defined set of specifications.

On March 7, ADC headquarters issued the Operational Plan for SAGE, prepared jointly by ADC and Lincoln Laboratory. The 300 pages provided “an overall understanding of the system, the concept of its operation, and the method by which it will be integrated into the Air Defense Command.”<sup>9</sup> The Operational Plan specified the equipment and personnel, the operational interactions between them, and their relationship within ADC (Figure 2-8). From that time on, work on SAGE had one overriding goal — to meet the specifications in the Operational Plan.

Another major change in 1955 was the resignation of Hill as director of Lincoln Laboratory. Hill had found himself in frequent contention with Valley and Forrester, two opinionated and forceful individuals, and disputes over Laboratory policy contributed to Hill’s decision to accept a position at the Institute for Defense Analyses. In 1956, Forrester also left Lincoln Laboratory to resume his position as a professor at MIT.

Although Valley expected to be appointed director, MIT instead chose Marshall Holloway, who became Lincoln Laboratory’s third director on May 5, 1955. Holloway’s background was in nuclear weapons development, and he had difficulty assuming technical leadership of the Lincoln Laboratory staff, most of whom were trained in electronics. Internal tensions and disagreements with the Air Force became a serious problem and contributed to Holloway’s resignation on February 1, 1957. Valley also left Lincoln Laboratory in 1957, returning to the MIT Physics Department as a professor.

The period of turmoil ended with the appointment of Carl Overhage as Lincoln Laboratory’s fourth director. Overhage had been a member of Project Charles and had gone on to join Lincoln Laboratory. As a Lincoln Laboratory insider, he was immediately able to command the respect that had eluded Holloway. Overhage served as director for seven years, until February 1, 1964.

### **Cape Cod Testing Begins**

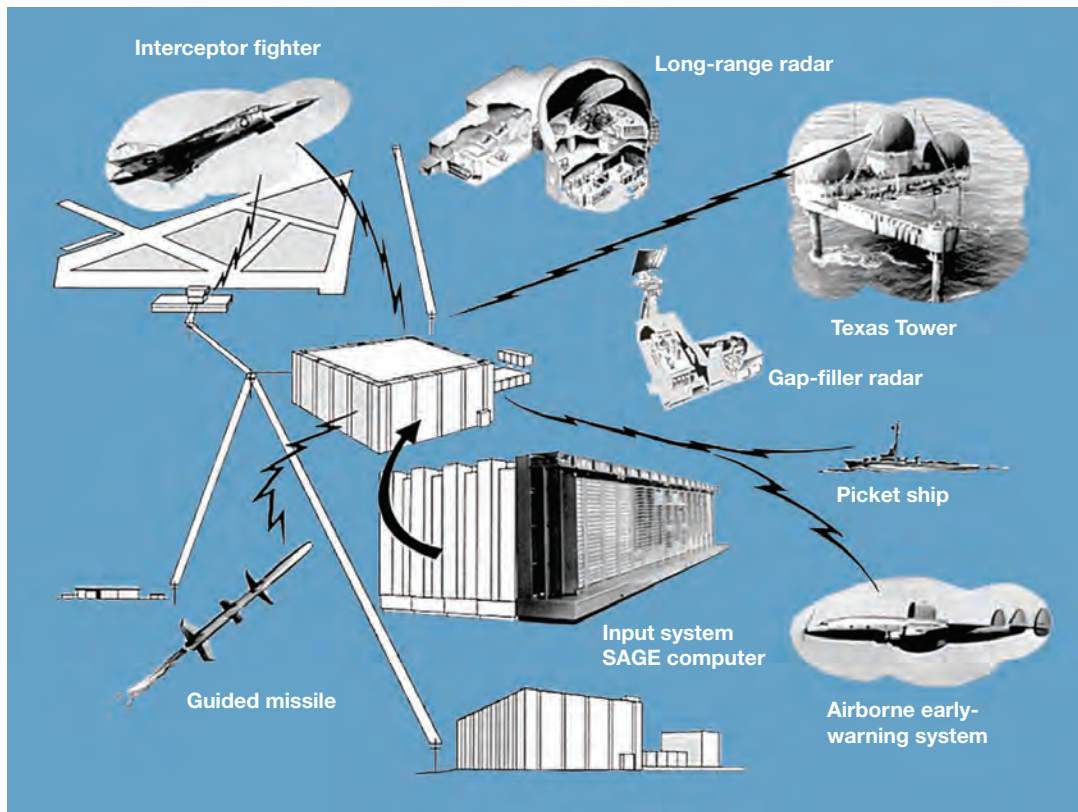
A new series of Cape Cod tests began in August 1955. Operator tasks in the direction center were changed so that they more closely resembled an actual SAGE subsector. Weapons-direction procedures were refined and training facilities were improved.

The computer was able to process data from all thirteen radars, and it could control manned interceptors and guide antiaircraft operation centers. The system had a capacity of 48 tracks that could be viewed in track situation displays, which geographically showed Air Defense Identification Zone lines and antiaircraft circles.

Each console also had a 5-inch CRT for digital information display. Audible alert signals were used, with a different signal for each symbol on a situation display.

Computer software was in an embryonic state at the beginning of the SAGE effort. In fact, the art of computer programming was essentially invented for SAGE. Among the innovations was more efficient programming, both in computer time and storage, achieved through elimination of the requirement for one-to-one correspondence between air defense functions (such as height finding and identification) and the computer subprograms performing these functions. A new concept, the central service (or bookkeeping) subprogram, was introduced. Documentation procedures provided a detailed record of system operations and demonstrated the importance of system documentation. Checkout was made immensely faster and easier with utility subprograms that helped locate program errors. These general-purpose subprograms served, in effect, as the first computer compiler. The size of the program — 25,000 instructions — was extraordinary for 1955; it was the first large, fully integrated digital computer





**Figure 2-8**  
**The SAGE air defense system included long-range early-warning radars at sites within the United States and in the ocean, automated gap-filler radars, airborne early-warning radars, interceptor fighters and missiles, all under the control of the central computer system.**

program developed for any application. Whirlwind was equal to the task: between June and November 1955, the computer operated on a 24-hour, 7-day schedule with 97.8% reliability.

A major goal of the Cape Cod tests was to gather data that could be used for simulating interceptions. Simulations in the early series were based entirely on live tests, but the data gathered in 1955 made it possible to combine live clutter data and live flight data to create new combat situations.

The ability to use test data to simulate new conditions was a ground-breaking innovation in computer programming. Outside Lincoln Laboratory, the simulations occasioned doubt and controversy, but the results of the simulations established their accuracy and realism, and they were ultimately accepted as a practical alternative and a valid technique.

Beginning in November 1955, Lincoln Laboratory initiated a set of system exercises with live aircraft, known as the System Operation Test (SOT) series. These tests were conducted in a series of missions of increasing complexity.

The Series I SOT comprised eight tests, flown between November 15, 1955, and January 31, 1956. During each test, B-29 strike aircraft made radial attacks against Boston, which was defended by aircraft from the Hanscom and South Weymouth air bases. A total of 50 aircraft were sent against the system. Against these aircraft, 62 interceptors were sent to defend the airspace, 24 of which successfully intercepted the strikes.<sup>10</sup>

The Series II SOT, flown between February 14 and April 25, 1956, was still more dramatic and realistic. As many as 32 high-speed B-47 aircraft flown by the Strategic Air Command attacked targets in Boston as well as Martha's Vineyard, Massachusetts, and Portsmouth, New Hampshire. Raids included multiple aircraft performing complex maneuvers: flying less than 1000 ft apart, making turns, and crossing, splitting, or joining tracks.

## Notes

**11** Lincoln Laboratory, *Quarterly Progress Report: Div. 2, August 1956*, p. 20. The conclusions as stated were conditional upon five specific input characteristics: blip-scan ratio >70%; no severe ducting or extensive precipitation; strike aircraft flying at least 10 mi apart; no mapped-out area in critical test regions; and no electronic countermeasures.

**12** Lincoln Laboratory, *Quarterly Progress Report: Div. 6, 15 March 1955*, p. 3. This report contains the most detailed description of the master DCA program structure.

In the Series III SOT, carried out between July 6 and November 7, 1956, Boston was given a defense force of sixteen interceptors from four air bases: Otis, Westover, Hanscom, and South Weymouth. Waves of B-47s attacked in groups of twelve to sixteen aircraft, with the aircraft closely spaced and performing numerous crossing maneuvers.

The final series of Cape Cod System tests, carried out in 1957, focused on the development of new tracking techniques and of new interception logic, and they produced two significant results. First, the tests showed that as long as the intercept-direction capacity was not exceeded, the Cape Cod System was capable of guiding interceptors sufficiently to achieve an interception rate of almost 100%. Second, they demonstrated that about 70% of the interceptions would permit successful firing passes.<sup>11</sup>

The Cape Cod System was a great success for Lincoln Laboratory. The basic concepts of automated air defense were demonstrated, and the tests showed that an automated air defense system could detect and intercept incoming aircraft.

Success in the Cape Cod program, however, was not sufficient. The Operational Plan for SAGE called for a fully functional prototype, and the Cape Cod System was only a simplified model with the most basic tracking and intercept-direction functions.

The conclusion of the Cape Cod System tests signaled the end of an era for Lincoln Laboratory. The Laboratory had been founded as an institution for research and

development, but the focus of its work was changing to operational testing and production. Both within Lincoln Laboratory and at MIT, concern was growing about the future of the program. Was it within Lincoln Laboratory's charter to produce an operational system? Or should Lincoln Laboratory, as a part of a great technical university, restrict its efforts to research and development?

Within a year, these questions would break Lincoln Laboratory apart. Over the next few months, however, a prototype system had to be tested.

### The Experimental SAGE Subsector

The Experimental SAGE Subsector (ESS) was essentially an expansion of the Cape Cod System. But, unlike the Cape Cod System, ESS was a fully operational prototype.

The emphasis during the ESS phase was on evaluation of the AN/FSQ-7(XD-1) before IBM began production of the AN/FSQ-7. ESS included most of the Cape Cod System sites, as well as some new ones, and it emulated the performance of an operational subsector. Radar data, aircraft flight plans, and meteorological information were transmitted automatically to the computer. The system was required to have overlapping radars, automatic cross-telling, height finding, a command post, and weather and weapons status totes. Radar coverage of the ESS in scale represented a SAGE subsector, although the boundaries actually overlapped the future McGuire, Stewart, and Brunswick subsectors.

The ESS direction center was located in Lincoln Laboratory's Building F, completed in 1955, and all ESS sites were connected to the AN/FSQ-7(XD-1). The

1955



AN/FPS-6  
height-finding radar

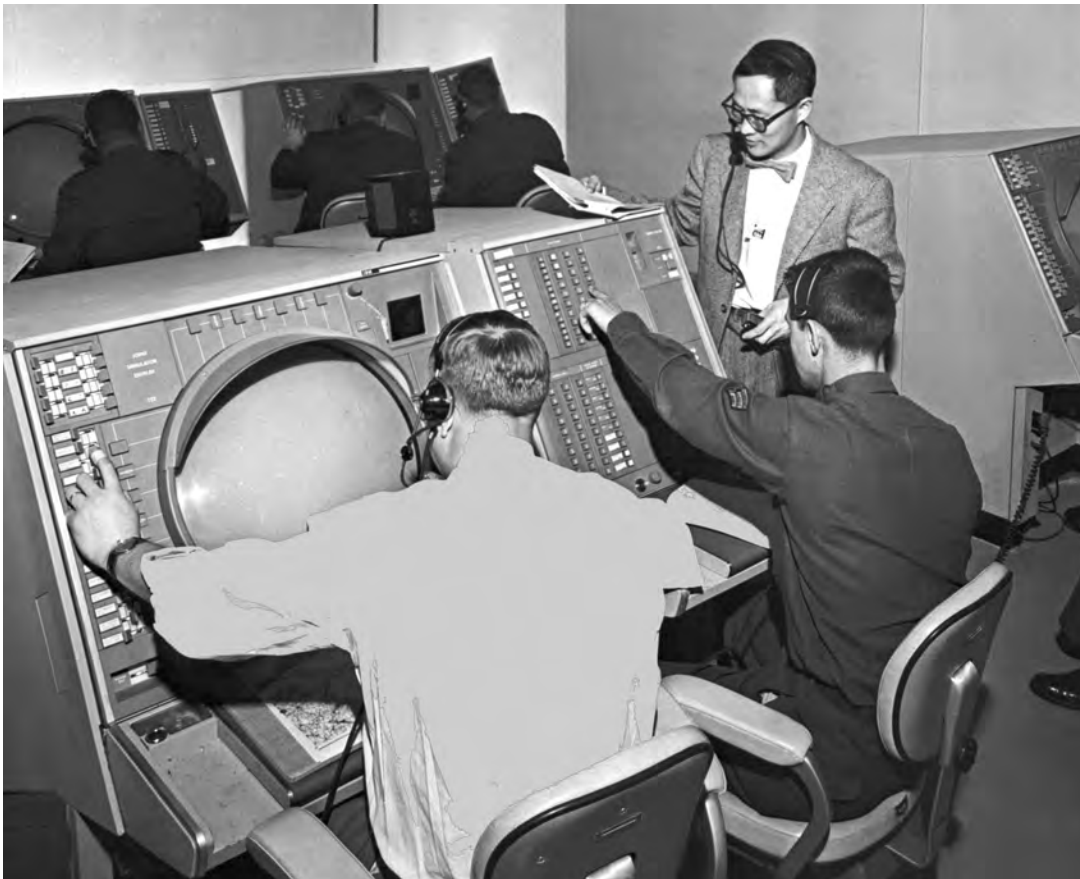


Radar data plotting



M.G. Holloway





**Figure 2-9**  
**Chi-Sun Lin (standing) and Harold Mercer (seated left) training Air Force personnel in the Building F direction center.**

computer occupied the first floor, the direction center was on the second floor, and the power equipment was in the basement (Figure 2-9).

The activities of the direction center were defined as a set of operational and mathematical specifications — the direction center active (DCA) program.<sup>12</sup> The DCA program was written in four successive packages, each of which performed a specific group of air defense functions. It eventually contained close to half a million instructions.

Because of the complexity of the software, Lincoln Laboratory became one of the first institutions to enforce rigid documentation procedures. The software creation process included flow charts; program listings; parameter and assembly test specifications; system and program operating manuals; and operational, program, and coding specifications. About one-quarter of the instructions supported operational air defense missions. The remainder were used to help generate programs, to test systems, to document the process, and to support the managerial and analytic chores essential to good software.

These programs were large, and because MIT did not want further increases in the Lincoln Laboratory staff, the Rand Corporation was asked to assist in the programming task. Rand was eager to play a role in the SAGE effort and began work on the software in April 1955. By December, the section of Rand in charge of SAGE programming — the System Development Division — had 500 staff members.

1960



AN/FSQ-7(XD-1) console



ESS consoles

ESS command stations



**Figure 2-10**  
**Robert Everett (seated) and John Jacobs at Lincoln Laboratory prior to the formation of MITRE Corporation.**

#### Note

**13** The achievements of the SAGE program have been chronicled in a number of articles. See (1) K.C. Redmond and T.M. Smith, "Lessons from Project Whirlwind," *IEEE Spectrum* **14**, 50 (October 1977); (2) K.C. Redmond and T.M. Smith, *Project Whirlwind*, Bedford, Mass: Digital Press, 1980, chap. 14; (3) C. Baum, *The System Builders*, Santa Monica, Calif.: System Development Corp., 1981, p. 24; (4) J.F. Jacobs, *The SAGE Air Defense System*, Bedford, Mass.: The MITRE Corporation, 1990, back cover; (5) M.M. Astrahan and J.F. Jacobs, "History of the Design of the SAGE Computer — The AN/FSQ-7," *Ann. Hist. Comput.* **5**(4), 340–349 (1983).

Within a year, the System Development Division had a staff of 1000 and was larger than the rest of Rand put together. The division left its parent company in November 1956 and formed the nonprofit System Development Corporation, with a \$20 million contract to continue the work started by Rand and with additional contracts for programming the SAGE computers. SAGE had spawned another company, and another industry.

Besides creating the SAGE master program and its ESS adaptation, Lincoln Laboratory was responsible for delivering DCA programs to the first three SAGE production installations: the direction centers at McGuire and Stewart Air Force Bases and the combat center at Hancock Air Force Base. The SAGE installation at McGuire required 100 System Development Corporation programmers; Stewart required 40; and ultimately 15 became the standard. Eight programmers and four trainers remained at each site to maintain and update programs.

#### A New Role

Lincoln Laboratory was becoming overwhelmed by its responsibilities. The next phase of the SAGE program was integrating interception weapons into the software, and that job was so massive that the Laboratory would have had to double in size. MIT, however, was unwilling to let Lincoln Laboratory grow any larger. Furthermore, the original purpose of the Laboratory — research and development — had nothing to do with system implementation of such a vast engineering task. Nonetheless, the SAGE program was continuing. Direction centers were under construction, and weapons had begun to be integrated.

Late in 1957, Secretary of the Air Force James Douglas began a discussion with MIT about the future of the program. The Institute had grown increasingly reluctant to continue its involvement in a program that had less and less to do with the academic world.

The Air Force had approached other contractors, but they were either uninterested or unsuitable. What the Air Force needed was a contractor that understood the increasingly complex SAGE system, and Lincoln Laboratory was the only candidate.

One option was left — to create a new organization. The Secretary of the Air Force suggested that the part of Lincoln Laboratory dedicated to SAGE, the Digital Computer Division, be spun off from the rest of the Laboratory to continue the systems engineering for SAGE on its own. MIT agreed with the proposal, and the MITRE Corporation was established.

James McCormack, Jr., the retired Air Force general who had become MIT's vice president for industrial and governmental relations, assumed an important role in setting up MITRE. He had already played a leading role in setting up two similar organizations: Sandia Corporation, established by Western Electric, and the Institute for Defense Analyses, created by MIT and four other universities.

MITRE was incorporated as a nonprofit organization in July 1958; Robert Everett and John Jacobs left Lincoln Laboratory to become technical director and associate technical director, respectively (Figure 2-10). Clair Halligan, who as director of military engineering at Bell Telephone Laboratories had worked on continental air defense for eight years, was chosen to be the first president of MITRE.

On January 1, 1959, 485 Lincoln Laboratory employees transferred to MITRE — under thoroughly amicable conditions. Neither MIT nor Lincoln Laboratory was officially connected with MITRE, but its technical competence was assured.



<b>SAGE Firsts</b>
<b>Hardware Design</b> Magnetic-core storage Digital phone-line transmission Digital track while scan
<b>Software Techniques</b> Multiple, simultaneous users System data structures Structured program modules Global data definitions Table-driven software Software debugging tools Data description language
<b>User Interfaces</b> Interactive graphic displays Light-pen input Online common database
<b>High-Reliability Operations</b> Marginal checking Internal parity checking Built-in test data reduction Duplex computers

**Figure 2-11**  
**Real-time computer system innovations developed for the SAGE system.**

Lincoln Laboratory had fulfilled its original charter. With the departure of almost 500 personnel, the Laboratory had become a much smaller organization, and without a focused mission. But after a pause for reevaluation, Lincoln Laboratory found new mission areas, particularly in ballistic missile defense and communications, and grew once again.

#### **Reflections on SAGE**

The SAGE period was unique in the history of Lincoln Laboratory. Only a few other programs — the Radiation Laboratory radar activity, the development of the atomic bomb, the program to put a man on the moon — have given scientists and engineers such a focused and rewarding experience.

Staff members had exactly what they needed: a goal and the funds to reach it. They were unencumbered by bureaucracy and reports were infrequent. Management was spare, assignments were flexible, and the task was accomplished. This had been the World War II MIT Radiation Laboratory style, and it was successfully adopted by Lincoln Laboratory.

For the individuals who participated in the SAGE program, it was a heady experience. Though they worked long hours, the camaraderie and the rapid progress kept morale high because they were exploring, and expanding, the limits of radars, computers, and communications.

Computers were in their infancy when Valley first approached Forrester to discuss developing an air defense network. The breakthroughs that came about in the course of the SAGE program created, to a large extent, the modern computer system (Figure 2-11).<sup>13</sup>

The SAGE program was a driving force behind the formation of the American computer and electronics industry. The contract to build the AN/FSQ-7 played a sizable role in the metamorphosis of IBM from a business machine vendor to the world's largest computer manufacturer.

The concept of the modular computer, developed at the Laboratory by Kenneth Olsen for the SAGE Memory Test Computer, became a key part of the design of the PDP series of minicomputers. He led his company, the Digital Equipment Corporation, to become a major computer manufacturer.

Three nonprofit institutions were formed during the SAGE program. The first was Lincoln Laboratory. MITRE was then spun off to complete the weapons integration and to implement the design. The System Development Corporation was founded to handle the immense software requirements of SAGE and became, because of the lack of trained programmers, the first training center for computer professionals.

For the individuals who worked on SAGE, however, the most memorable part of the program was simply the opportunity to participate. Reminiscences of that era are uniformly enthusiastic, and veterans of the SAGE development say that no other period in their lives was more personally or professionally rewarding.







**Complementing the work on radars and computer systems for the SAGE system was an extensive radar development effort to increase response times through early attack warning. Systems were developed for use in the air, over water, and in the Arctic. The activity in early-warning systems for ballistic missile attack detection led the Laboratory from air defense to a new focus on ballistic missile defense.**

**Left: Ballistic Missile Early Warning System test site on the island of Trinidad. The two antennas are a parabolic torus fed by an organ-pipe scanner and a paraboloid tracker.**

In summer 1952, a group of scientists, engineers, and military personnel met at Lincoln Laboratory to consider ways to improve the air defense of North America.<sup>1</sup> Headed by Jerrold Zacharias, the group included Albert Hill, director of Lincoln Laboratory, Herbert Weiss, and Malcolm Hubbard, among others from the Laboratory, and a number of distinguished scientists, including J. Robert Oppenheimer, Isidor Rabi, and Robert Pound.

The 1952 Summer Study undertook the tasks of assessing the vulnerability of the United States to surprise air attack and recommending ways to lessen that vulnerability. Since the greatest threat appeared to be an air attack by the Soviet Union via the North Pole, the study group focused its attention on the airspace above the 55th parallel, where Soviet bombers, having passed over the Pole, could fly undetected nearly to the border of the United States.

The plan for the Semi-Automatic Ground Environment (SAGE), already under way, was to detect, identify, track, and intercept just such aircraft. However, without early warning of an approaching attack, the readiness of interceptors and depth of airspace in which interception could take place would be drastically limited.

The Summer Study concluded it would be feasible to install a network of surveillance radars and communication links across northernmost North America from Alaska to Greenland that could give three to six hours' early warning against the threat envisioned. The results and recommendations of the study were briefed to key personnel of the Department of Defense (DoD) in late August 1952 and were well received.

### The DEW Line

The DoD approved the 1952 Summer Study configuration for what would soon be known as the Distant Early Warning (DEW) Line and directed the Air Force to take immediate implementing action. By December, the Air Force had awarded a contract to Western Electric for the construction and operation of a radar and communications network across northern Canada. The difficulties of installing, operating, and maintaining radars in the Arctic environment were immense, and the DEW Line, which became operational in 1957, remains an extraordinary feat of engineering (Figure 3-1).

In addition to hosting the Summer Study, Lincoln Laboratory provided numerous technical contributions to the DEW Line. One of the first issues the Summer Study had to resolve concerned the feasibility of long-distance communications in the Arctic. The frequent occurrence of solar disturbances in the far north ruled out the then standard forms of ionospheric-reflection high-frequency communications. Fortunately, however, researchers at Lincoln Laboratory and MIT had already developed a better form of long-range communication — very-high-frequency (VHF) ionospheric scatter propagation, which was not susceptible to solar disturbances.

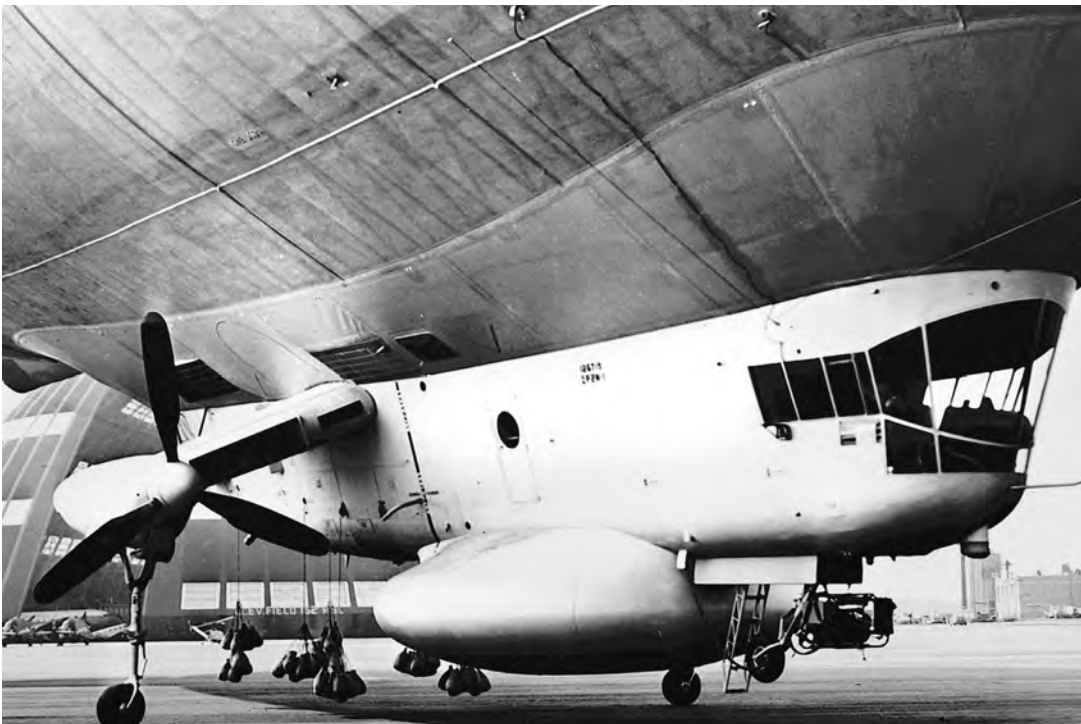
VHF scatter propagation used the inhomogeneities of the ionosphere to provide a reliable method of long-distance communications, even in the Arctic. Solar disturbances did not disrupt this form of communications; in fact, they often improved it. Moreover, VHF scatter propagation required only moderate-power transmitters — 10 to 50 kW. Until the advent of satellite communications, therefore, VHF scatter communications provided a reliable method of rearward communications for the DEW Line. In addition, tropospheric scatter propagation, also investigated in large part by Lincoln Laboratory, was adopted for multichannel lateral communication between stations along the DEW Line.

Another issue discussed at meetings of the Summer Study was the staffing of the installations. It was clearly desirable to post as few technicians as possible at each site, and the automatic alerting radar developed by Lincoln Laboratory provided a way to reduce personnel requirements. An automatic alerting radar sounds an alarm whenever an aircraft enters the area of surveillance, thus freeing site technicians from 24-hour plan position indicator (PPI) scope vigilance. This radar was especially useful in the far northern regions because the PPI scope was generally empty. With reasonably well-trained personnel, a typical site could be maintained with fewer than twenty technicians.

The X-1 automatic alerting radar was designed and fabricated in a five-month crash program at Lincoln Laboratory. Following the completion of this program, models X-2 through X-6 were designed and assembled in rapid succession for installation by Western Electric at test sites in Illinois and the Arctic. The design of the X-3 automatic alerting radar was turned over to



**Figure 3-1**  
One of the DEW Line radar sites.



**Figure 3-2**  
Navy blimp installation of the  
UHF AEW radar.

Raytheon for engineering as a modification of the AN/TPS-1D, and production models were installed along the DEW Line. This radar was designated the AN/FPS-19. Lincoln Laboratory also had a hand in developing a continuous-wave (CW) bistatic fence radar that was used as a gap filler between AN/FPS-19 radars to detect low-flying aircraft. In the design of these radars, later designated AN/FPS-23, and in the improvement of large search radars, new techniques and components were introduced to decrease false-alarm rates and enhance automatic operation.

Yet another radar, the Sentinel (AN/FPS-30), was designed for the DEW Line East, an extension of the original line. This radar was built specifically for early-warning operation in the far north and was characterized by improved high-altitude coverage, increased reliability, transistorized automatic alarm circuits, and velocity filtering to minimize false alarms.

Lincoln Laboratory's efforts in radar design focused primarily on electrical engineering issues, but the high winds and extreme temperatures of the Arctic environment compelled Lincoln Laboratory to advance the mechanical engineering aspects of radars as well. Antenna shelters had to offer sufficient structural strength to withstand Arctic windstorms and still cause minimal attenuation of the radar beam. Before the development of the DEW Line, inflatable radomes had been occasionally used as antenna shelters, but inflatable radomes had great difficulty surviving Arctic conditions. Lincoln Laboratory solved this problem by developing rigid, electromagnetically transparent radomes. These radomes made possible not only uninterrupted operation of the DEW Line, but also a new generation of very large, precisely steerable antennas for long-range surveillance. This kind of rigid radome continues to be manufactured for many purposes.

Personnel in the newly formed Engineering Group approached Buckminster Fuller, inventor of the geodesic dome, and asked him for assistance in designing a rigid radome. Fuller suggested a three-quarter-sphere design and recommended polyester-bonded fiberglass, which offered a high strength-to-weight ratio, excellent weather resistance, and reasonable cost.



---

**Notes**

**1** Material for this section was contributed by Daniel Dustin.

**2** Material for this section was provided by William Ward.

The concept of the geodesic dome seemed feasible, so the Engineering Group at Lincoln Laboratory procured a series of prototype rigid radomes. The first one (31 ft equatorial diameter) was erected on the roof of Building C. It was unexpectedly pummeled by Hurricane Carol in August 1954, with winds estimated up to 110 mph, and no damage was inflicted. The radome was then disassembled and erected on Mount Washington in New Hampshire, and it successfully survived that mountain's fierce environment. A second 31 ft diameter radome was erected over an AN/FPS-8 antenna on the roof of Building C. Tests demonstrated that the radome's effect on radar performance was negligible.

Lincoln Laboratory designed and procured a series of 50 ft diameter rigid radomes that were installed in Thule, Greenland; Saglek Bay, Newfoundland; and Truro, Massachusetts. A second radome was also erected on the roof of Building C, where it sheltered the Sentinel antenna. The program culminated with the installation of a 150 ft diameter radome at the Haystack Observatory (see chapter 22, "Space Science").

Western Electric carried out the immense and highly successful project of installing the DEW Line radars. The DEW Line was completed in October 1962 with an extension to Iceland, giving the Air Force a 6000 mi radar surveillance chain from the Aleutians to Iceland.

#### **UHF Airborne Early-Warning Radar**

Construction of the DEW Line resolved concerns about the security of the northern perimeter of the United States.<sup>2</sup> But, as was recognized both during the 1952 Summer Study and subsequently, the DEW Line did nothing to reduce the vulnerability of the east and west coasts to an attack over the ocean.

With no land to the east or west of the United States, the logical counterpart to the DEW Line was airborne radar. The members of the Summer Study discussed the need for airborne early-warning (AEW) radar and identified the most important requirements.

In particular, they observed that it was more important to alert SAGE of distant aircraft intrusion than to control interceptors. Range resolution, azimuth resolution, and height-finding capability were, therefore, less important characteristics for AEW radars than was sheer range. The

need for the greatest possible range mandated the use of a relatively low operating frequency.

As radar wavelength increases (and frequency decreases), the effect of ripples and waves at the surface of the sea becomes progressively less noticeable. The sea is more mirrorlike at longer wavelengths, reflecting more incident radar energy and scattering less. Thus, a double benefit was to be gained by changing from S-band (3000 MHz, the operating frequency of the AN/APS-20 AEW radar developed by the MIT Radiation Laboratory during World War II) to ultrahigh frequency (UHF, 300 to 600 MHz). Sea-clutter returns received by the radar were reduced and the detection range was increased. In addition, since the Doppler shift of a sea-clutter return was smaller at lower frequencies, the airborne moving target indicator (AMTI) circuit of a UHF AEW radar would cancel most of the sea-clutter spectrum (narrower by the ratio of the wavelengths) without also cancelling a significant fraction of the high-speed airborne targets of interest.

The Summer Study concluded that UHF AEW radar looked like a winner, and it proved to be just that. A program began at Lincoln Laboratory in summer 1952 to study existing radars and to test the feasibility of UHF radar. The first goal was to set up a UHF search radar to see if the hoped-for benefits were real. The frequency chosen for the first radar was 425 MHz, primarily because a few dozen war-surplus Western Electric 7C22 dual-cavity triodes were available. Their limited mechanical tuning range covered that frequency. The experiments were successful, and 425 MHz became the frequency of choice for Lincoln Laboratory radars. In fact, Lincoln Laboratory's use of 425 MHz for numerous subsequent radars followed directly from the availability of 7C22s in 1952.

In 1953, recognizing the importance of flight-test support for the development of AEW radars, the Navy established a unit at South Weymouth Naval Air Station, Massachusetts, to support several Lincoln Laboratory programs. The Air Force based an RC-121D and a B-29 at Hanscom Air Force Base for the same purpose.

An early demonstration of UHF AEW radar was on a Navy blimp (Figure 3-2). Its operating altitude was limited to a few thousand feet, but its comparatively low velocity made AMTI easier.

Lincoln Laboratory modified a standard AN/APS-20 transmitter to accommodate the UHF triode operating as an oscillator. The maximum unambiguous range was 500 km.

Flight testing commenced in March 1954. Side-by-side tests with a low-power UHF AEW radar in one blimp and an AN/APS-20 S-band AEW radar in another proved the advantage of lower-frequency operation.

Despite some advantages, blimps failed as AEW radar platforms because their operation was restricted to low altitudes. However, heartened by successful flight tests in the blimp, Lincoln Laboratory set out to install an AEW radar in a Super Constellation-class aircraft and to increase the transmitted power.

The new radar, the AN/APS-70, was fielded in three experimental development (XD) versions. Two AN/APS-70(XD-1) radars were built at Lincoln Laboratory. Two each of the AN/APS-70(XD-2) and AN/APS-70(XD-3) radars were built by Hazeltine Electronics and by General Electric (GE), respectively. The broadband 425 MHz antennas with identification-friend-or-foe (IFF) provisions for the AN/APS-70(XD-2) and the AN/APS-70(XD-3) were supplied by Hughes. All three firms carried out production under contract to Lincoln Laboratory, and the technology was thus transferred to industry.

Lincoln Laboratory had demonstrated in 1954 that UHF AEW radar gave better results than did S-band systems, but the Air Force felt that independent testing was warranted. Therefore, it carried out a series of flight-test comparisons of S-band and UHF AEW radars in 1956. In these tests, called Project Gray Wheel, an RC-121D aircraft was equipped with the AN/APS-20E (the most advanced configuration) S-band AEW radar, and another RC-121D aircraft was outfitted with Lincoln Laboratory's AN/APS-70(XD-1) UHF AEW radar.

The tests proved the superiority of the UHF system in detecting bombers. Moreover, they demonstrated the capability of the UHF system to direct interceptors to the bombers. The success of the AN/APS-70-equipped aircraft helped convince the Air Force to outfit its fleet of RC-121 Super Constellations with UHF aircraft early-warning and control (AEW&C) radar.

The Laboratory produced an improved UHF AEW radar prototype of the AN/APS-95 that featured single-knob tuning and other features not included in the AN/APS-70. Hazeltine produced the production AN/APS-95 UHF AEW radar for the Air Force, and GE produced an advanced version, the AN/APS-96 UHF AEW radar, for the Navy.



J.R. Zacharias



H.G. Weiss



Even though UHF operation helped remove some sea clutter, a way to remove more of it without losing low-flying targets was badly needed. By 1952, long-range ground-based air surveillance radars could discriminate between targets that were moving radially and those that were not by pulse-to-pulse subtraction of successive received signals after detection. However, the radar transmitter could not be counted on to produce the exact same frequency and starting phase each time it was pulsed, so the CW reference signal had to be coherently locked to the transmitted signal for every pulse.

Lincoln Laboratory developed a two-part solution to the problem of AMTI. First, the CW reference signal was locked to a sample of the clutter return from surface scatterers at close range. This technique was called time-averaged-clutter coherent airborne radar (TACCAR).

For moderate levels of sea clutter, TACCAR worked well. As the radar antenna scanned through  $360^\circ$  in azimuth, TACCAR automatically took care of the problem of when the radar was looking forward or backward. The implementation of TACCAR at a radar's intermediate frequency (IF) was an early application of the phase-locked loop.

The second part of the solution was the displaced phase center antenna (DPCA), first suggested by engineers at GE. DPCA compensated for the translation of an

aircraft by comparing successive received pulses for AMTI; by contrast, without DPCA, the sea-clutter spectrum became wider as the airborne antenna looked away in azimuth from the airplane's ground track. GE's demonstration of DPCA used an X-band (9375 MHz) radar with dual antenna feeds offset in azimuth. A hybrid junction provided sum-pattern transmission and monopulse sum- and difference-pattern reception. Radar echoes received through the sum pattern both ahead of and behind the central axis of the scanning beam were simultaneously adjusted in phase by vector addition with the radar echoes received through the difference pattern. The resulting signals were processed by noncoherent AMTI circuitry.

The Laboratory's existing UHF AEW radar antennas were easily adapted to DPCA operation. The conventional pattern resulting from uniform in-phase illumination of the horizontal aperture for transmission and reception was supplemented on reception by a difference pattern corresponding to illumination of the right and left halves  $180^\circ$  out of phase. The received signals were then combined to provide the DPCA function. The sea-clutter spectrum narrowed accordingly, and the full clutter-cancellation capabilities of the IF TACCAR AMTI system were achieved at all azimuths.



M.M. Hubbard



First geodesic radome



AEW&C Super Constellation



**Figure 3-3**  
**AN/APS-70 UHF AEW radar installed**  
**with its rotodome antenna in a**  
**Lockheed Super Constellation aircraft.**  
**This aircraft was the forerunner of the**  
**carrier-based Hawkeye and the land-**  
**based AWACS aircraft.**

The integration of DPCA techniques with IF TACCAR AMTI was demonstrated by Lincoln Laboratory and was then implemented in the AN/APS-95.

Lincoln Laboratory subsequently demonstrated a radio-frequency (RF) version of TACCAR, which was made compatible with antijam circuitry. Because an airborne radar could be vulnerable to jamming, a tool kit was developed to strengthen the AN/APS-95 in this regard.

Both TACCAR and DPCA required a stable reference-signal oscillator that was locked in frequency and phase to sea-clutter echoes averaged over several sweeps. Maintaining that stability in an aircraft proved to be a challenge; it was met by building truly rugged hardware.

To improve target-detection performance and at the same time to narrow the beamwidth of the UHF radar, the Navy's Bureau of Aeronautics sponsored the installation of a large rotating radome high above the fuselage of a Super Constellation (Figure 3-3). One of Lincoln Laboratory's AN/APS-70(XD-3) AEW radars was installed in the fuselage. Although the combination proved to be very effective, tests of the aircraft showed it was often on the verge of stalling.

By late 1957, the UHF AEW radars (with improved AMTI systems) had become accurate enough to be considered for incorporation into the SAGE system. To test the compatibility of the radars with SAGE, Lincoln Laboratory began the airborne long-range input (ALRI) test program.

The ALRI tests were conducted by flying an AN/APS-70-equipped AEW aircraft within line of sight of the Experimental SAGE Subsector installation at South Truro, Massachusetts. The video output from the radar's AMTI receiver was quantized and relayed to the ground over a wideband UHF data link. At the Experimental SAGE Subsector site, the data were fed into a fine-grain data system as if they were coming from a radar nearby. ALRI was a complex improvisation, but it worked. In 1958, ALRI was spun off to the newly formed MITRE Corporation, where it eventually evolved into the Airborne Warning and Control System (AWACS).

The AMTI radar technology that Lincoln Laboratory developed and demonstrated in the AN/APS-70 series of radars provided the foundation for the AN/APS-96. This radar used a high-power UHF vacuum-tube amplifier for the transmission of linear FM pulse-compression signals. The finer-grained range resolution afforded by the compressed pulse after reception improved the target-to-sea-clutter ratio, making the AMTI job easier. The radar's sharper discrimination in range between closely spaced targets made the job of a combat information center easier. Another important feature was a height-finding capability for every target on every scan.

The Air Force retrofitted its RC-121C/Ds with Hazeltine AN/APS-95 UHF AEW radars, and the Navy installed GE AN/APS-96 UHF radars in Grumman W2F-1 Hawkeye turboprop aircraft.

Lincoln Laboratory's success in developing UHF AMTI radars led to the suggestion that the same techniques might be applied to shipboard air surveillance radars. Two installations of shipboard moving target indication (SMTI) were made. In 1956, a clutter-locked SMTI kit based on Lincoln Laboratory's AMTI circuits was added to the AN/SPS-6B L-band (1300 MHz) radar aboard the USS *Hawkins*. Tests at sea gave mixed results.

In 1959, a modified AN/APS-70(XD-1) UHF AEW radar incorporating IF TACCAR SMTI was installed in the destroyer USS *Richard E. Kraus* and tested at sea. The results demonstrated impressive reduction of land clutter as well as sea clutter. Some of the radar's features were incorporated in the AN/SPS-40 shipboard radar.

Lincoln Laboratory's AEW radar program came to an end in the middle of 1959. Not only had the seven-year effort reopened the UHF spectrum for airborne radar applications, but highly effective AMTI systems had been developed and techniques needed to integrate AEW aircraft with SAGE had been demonstrated. Contractors were hard at work building radars that could apply these advances to Air Force and Navy aircraft. The Laboratory's assignment was complete.





**Figure 3-4**  
Jug Handle Hill UHF GCI radar in West Bath, Maine.

#### Note

3 F.R. Dickey, Jr., M. Labitt, and F.M. Staudaher, "Development of Airborne Moving Target Radar for Long Range Surveillance," *IEEE Trans. Aerosp. Electron. Syst.* **27**, 959–972 (1991).

Many years later, Lincoln Laboratory's contributions to the development of UHF AEW radar received additional recognition. In 1991, Melvin Labitt of Lincoln Laboratory was one of three individuals selected to receive the IEEE Aerospace and Electronic Systems Society's Pioneer Award. On the occasion of the award, Labitt and his corecipients published an excellent review of AEW radar and of Lincoln Laboratory's development of TACCAR.<sup>3</sup>

#### The Northern Lights

By 1954, it had become apparent that the L- and S-band ground control of intercept (GCI) radars used in the Cape Cod System were showing an unacceptable amount of clutter on their PPI displays. At the same time, the ongoing development of UHF AEW radar systems equipped with moving target indication was demonstrating the advantages of radars operating at longer wavelengths. GCI radars operating at a longer wavelength appeared to address all the problems that beset those at L-band and S-band. However, the horizontal aperture of the rotating radar antenna would have to be larger in proportion to the wavelength in order to maintain the same angular resolution in azimuth. For the planned radar, the antenna had to be 120 ft wide by 16 ft high, but because its mechanical tolerances in terms of wavelength were no more stringent than those of the L-band (1300 MHz), it was not expected to be a great challenge to construct.

The new radar was designated the AN/FPS-31. A site was chosen on Jug Handle Hill in West Bath, Maine, making the AN/FPS-31 the counterpart of shoreline GCI radars at South Truro, Massachusetts, and Montauk Point, New York.

The original design called for the rotating antenna to be carried on sets of bogie wheels at the ends of a three-armed spider that rolled on a smooth, level, circular track at the top of the tower. This system caused trouble from the start. The track had not been made sufficiently smooth, and the wheels soon wore out. Pressure to get the AN/FPS-31 radar into operation led to the decision to go to a large central ball bearing upon which the entire rotating assembly would ride. Although this modification presented its own challenges, the mechanical problems were eventually worked out and reliable operation of the large rotating antenna

was achieved. The experience Lincoln Laboratory gained in solving these problems paid off in the subsequent successful mechanical designs of the counter-countermeasure (CCM) radar Mark I, the angle-tracking antenna of the Millstone radar, the AN/FPS-49 tracking radars, and others.

The AN/FPS-31 radar began to operate in October 1955 (Figure 3-4). By April 1956, it had been found to display clutter of an unexpected sort. Echoes resembling returns from storms were observed, but they had unusual characteristics, that is, high scatterer velocities, sharply defined azimuth boundaries, and consistent occurrences in the general direction of magnetic north. Consultation with Communications Division personnel at Lincoln Laboratory yielded the suggestion that the AN/FPS-31 radar was receiving echoes at 425 MHz from the aurora borealis — the Northern Lights. This surmise was verified when observations in Maine were correlated with those from a 50 MHz radar located in Ottawa, Ontario. Correlation of the radar data with the occurrence of solar flares and sudden ionospheric disturbances led to the conclusion that auroral clutter showed up on the AN/FPS-31 radar about 48 hours after a solar flare.

Auroral activity in the skies above New England is rare. What was happening with the AN/FPS-31 radar was that it was so sensitive it could detect echoes backscattered from the actual aurora (high in the atmosphere and far to the north). The auroral clutter could overlie any part of the radar's unambiguous range. The velocity distribution of the ions constituting the aurora was so broad that there was no possibility of eliminating the backscattered signals by moving target indication. The clutter simply had to be mapped out when it occurred.

It had not been generally believed beforehand that auroral echoes could be observed at frequencies above 200 MHz. The AN/FPS-31 radar yielded auroral echoes at 425 MHz, and the Sentinel radar did so at 600 MHz.

### **The Boston Hill Radar**

In 1956, following assignment of the Jug Handle Hill radar to the SAGE Experimental Subsector test program, Lincoln Laboratory decided to build an experimental advanced UHF radar to be used to evaluate new techniques. The experimental radar, designated as the CCM radar Mark I, was of particular importance because the UHF frequency range was to be employed in the frequency-diversity radars then under development.

Design of the antenna and tower started in September 1956. In February 1957, an area on top of Boston Hill in North Andover, Massachusetts, was leased for the radar. Construction began immediately and the radar was first energized in August 1958 (Figure 3-5).

The main purpose of the Boston Hill radar was to serve as an instrument for testing automatic detection and tracking of distant objects at a sufficiently high data rate to serve as an input to the SAGE system. The experimental work emphasized measures designed to enable the radar to operate both actively and passively in a jamming environment.

A number of investigations were carried out, including observations of communication-balloon firings from Wallops Island, Virginia. The radar was transferred to the MITRE Corporation in April 1960.

### **Radars in the Ocean**

The final link in the early-warning network protecting the perimeter of the United States was a set of radar installations located in the Atlantic Ocean. In 1952, Lincoln Laboratory first suggested that permanent platforms be erected in shallow water at selected points along the Continental Shelf to provide a seaward extension of the radar warning system. These permanent marine radar stations were not inexpensive to build; nonetheless, they were both cheaper and more effective than radar picket ships.

Successful use of such platforms off the Gulf Coast for oil-drilling operations (thus the nickname Texas Towers) made the plan seem feasible. After thorough study, the Air Force decided to adopt the Lincoln Laboratory suggestion. By January 1955, plans were being laid for the construction and installation of radar platforms off the coasts of Cape Cod, Massachusetts, and Long Island, New York.

The feasibility of long-distance communications was one of the main considerations in evaluating the practicality of a fixed marine radar station. Other radar stations used telephone lines and microwave line-of-sight radio for communications. The ocean-based towers, more than 100 mi offshore (beyond line of sight), could use neither. The conventional solution, transatlantic cable, was too expensive for the number of circuits needed.

The solution to the long-range communications problem came from Lincoln Laboratory's development of UHF tropospheric scatter communication. In fact, the Texas Towers pioneered the use of UHF tropospheric scatter propagation for overwater communication.

The UHF link between each tower and its direction center provided the equivalent of 72 four-wire telephone channels. Communication between each tower and aircraft for interceptor control was by line-of-sight UHF radio.

The first Texas Tower, located on Georges Shoal about 100 mi from Truro, Massachusetts, went into operation a year later. A total of five platforms were eventually built.

Standing on 10 ft diameter steel caissons driven into the sea floor, each Texas Tower was a half-acre steel island elevated 67 ft above the sea (Figure 3-6). The uppermost of the four decks carried three radomes, housing an AN/FPS-3 search radar and two AN/FPS-6 height-finding radars. The deck also held IFF equipment, a Mark X beacon, and four AN/FST-2 digital data transmitters. The remaining three decks housed the personnel and maintenance equipment, control equipment, water, and fuel. Fifty Air Force personnel, two meteorologists, and twenty civilians operated each station.





Figure 3-5  
Boston Hill UHF GCI/CCM radar in  
North Andover, Massachusetts.



**Figure 3-6**  
The Texas Tower radar stations  
provided early warning against hostile  
aircraft arriving over water.





**Figure 3-7**  
AN/FPS-17 radar antenna in Laredo,  
Texas.

**Note**

<sup>4</sup> Material for this section was provided by William Ward and Robert Lerner.

**The AN/FPS-17 Coded-Pulse Radar**

In 1954, the United States learned that the Soviet Union was making rapid progress in the development of ballistic missiles.<sup>4</sup> But information about the Soviet ballistic missile program was scanty. What the U.S. government needed was a way to observe Soviet missile tests from a site outside the Soviet Union. Once again, they called on Lincoln Laboratory.

GE had been approached first by the Air Force to produce a radar that could monitor Soviet missile tests and had produced an initial design employing TV transmitters and an array of six 60 ft diameter paraboloids. However, because the scheme used long pulses to obtain sufficient power at a 1000 km range, the range resolution was inadequate.

Lincoln Laboratory was then asked to improve on the design, which it did by developing the AN/FPS-17 coded-pulse radar, with a 200 MHz parabolic antenna and a pulse-compression system that provided the necessary range resolution. The Laboratory conceived, designed, tested, installed, and operated the AN/FPS-17 coded-pulse radar within less than two years after the go-ahead in November 1954. It was the first radar built for tracking targets at very long ranges (Figure 3-7). In almost every aspect — transmitter, antenna, feed system, transmitted-signal generation, received-signal processing — the AN/FPS-17 concepts pushed hard on the existing state of the art.

The nearest site available for tracking Soviet missile tests was in northeastern Turkey, more than 1000 km from the testing area at Krasny Yar in central Asia. To track small targets at such a range, the radar had to have a large antenna and a powerful transmitter.

A study of technology trade-offs led to the selection of a radar frequency of 200 MHz. The antenna was designed to be as large as possible without exceeding the coherence limits for atmospheric propagation at that frequency. The resulting beam was narrow and thus imposed stringent requirements on scanning. The beam also needed a feed arrangement that could handle high peak and high average transmitted powers, while having low noise characteristics. The distance to the targets called for a low pulse-repetition rate, which, when used with mechanical scanning of the beam, allowed only a few pulses to be transmitted in each beam position.

The ballistic missile targets of interest to the AN/FPS-17 were small and distant; they could be detected only if an immense amount of energy were transmitted in each pulse. The peak power of the available transmitter, however, was limited. The solution was to transmit very long pulses.

Once a target was detected, the AN/FPS-17 was used as a tracker. And, tracking a target is a completely different task from detecting it. For detection, the optimal pulse is simply a long one to obtain power aperture; for improved tracking performance, the pulse needs to have a structure.

To establish a precise track on a target, the radar had to measure the target's position and its velocity simultaneously. But accurate range and velocity measurements call for exactly opposite types of measurements. Precise range measurements need a wide bandwidth, which generally means short transmitted pulses. Precise velocity measurements require long transmitted pulses, with correspondingly narrow signal bandwidths. The solution was to construct a long pulse from short pulses. The short pulses were separated by giving them 180° phase shifts with respect to a reference signal. To prevent jamming, the phase shifts followed a linear-shift-register pseudonoise sequence.

For the AN/FPS-17, a target echo from its 2 msec transmitted coded-phase pulse was compressed to a 20 μsec spike at the receiver output. The peak signal-to-noise power ratio at the wideband receiver output was equal to the ratio that could have been achieved by a narrowband receiver matched to a simple CW transmitted pulse.

The AN/FPS-17's circuitry for generating the coded pulse and for compressing the received echoes from a target was based on acoustic delay lines. Lincoln Laboratory built eight sets of receiver/exciter systems. The central cabinet contained a 2 msec Invar acoustic delay line, 10 m long, which formed the transmitted pulse. An index of equipment complexity is the vacuum-tube count of the systems — each set contained 331 tubes.

A single 20 μsec pulse of a 200 kHz sinusoidal wave was launched by a piezoelectric transducer and propagated along the rod. Small fractions of the wave were picked



off by magnetostrictive sensors at 100 points, 20  $\mu$ sec apart. The 100 sinusoidal pulses, adjacent in time, were weighted in a summing network to form the 2 msec phase-coded pulse. The expanded pulse was translated in frequency to about 200 MHz for high-power amplification and transmission. Since returning echo signals could not be received until the transmitted pulse ended, the same acoustic delay line could be used to compress them.

Doppler-shifted target echoes had to be detected separately. The AN/FPS-17 had eighteen frequency bins, which covered the likely spread of Doppler shifts. The bins were processed simultaneously by using a matrix of eighteen different resistive networks to add up the signals from the tapped Invar delay line. The data-recording arrangement allowed the range rate of the target (observed in as many as three adjacent frequency bins) to be estimated more accurately than to within a single bin, depending on the signal-to-noise ratio of the radar echo.

The phase-coded-pulse technique conceived for the AN/FPS-17 shared many features with the linear-frequency-modulation (chirp) technique of pulse compression. However, unlike the chirp technique, the AN/FPS-17 technique provided simultaneous measurements of range and of range rate on each pulse.

The antenna system for the AN/FPS-17 was designed by Lincoln Laboratory and was fabricated in old shipyard facilities, under rush orders, by the D.S. Kennedy Company of Hingham, Massachusetts. The reflector occupied almost half an acre.

In 1956, the AN/FPS-17 was installed at Laredo Air Force Base, Texas. Its scanning beam was aimed in a generally northwest direction, toward the White Sands Missile Range in New Mexico, several hundred miles away. In July, sounding rockets launched from Holloman Air Force Base (adjacent to White Sands) were observed by the radar. The tests demonstrated that the newly developed coded-pulse technique could simultaneously measure the range and velocity of a target.

The real-world checkout of the radar revealed a surprising problem: echoes from ionized meteor trails activated the automatic target-detection circuitry. The system was modified to eliminate the unacceptable background of false alarms.

The site chosen for the operational installation of the AN/FPS-17 was Pirinçlik, near Diyarbakir in northeastern Turkey. GE set up and managed the radar site, which was selected with convenience to a railhead as a consideration. Material had to be brought in, buildings and the antenna had to be erected, and equipment had to be installed — all in an undeveloped rural environment.

A key factor in the choice of Pirinçlik was that the site had elevated terrain between it and the USSR, so that the radar could not be jammed by a transmitter within the Soviet Union's borders. Jamming was further discouraged because the transmitter frequency had been chosen within a band being used for navigation on the Black Sea.

In 1957, the Soviets launched Sputnik I from the Baikonur Cosmodrome near Tyuratam (several hundred miles north and slightly east of Pirinçlik). The AN/FPS-17 radar had good coverage of that launch, as it did of numerous subsequent launches.



BMEWS tracker antenna,  
Trinidad



Prince Albert Radar  
Laboratory, Saskatchewan

---

## Notes

**5** “How U.S. Taps Soviet Missile Secrets,” *Aviation Week*, October 21, 1957, p. 26.

**6** W.M. Siebert, “The Development of AN/FPS-17 Coded-Pulse Radar at Lincoln Laboratory,” *IEEE Trans. Aerosp. Electron. Syst.* **24(6)**, 833–837 (1988).

The AN/FPS-17 turned out to be a successful radar, yielding much valuable data. The installation at Pirinlik later became part of the U.S. SPACETRACK network.

Although the initial installation of the AN/FPS-17 in Turkey was classified, rumors of the system spread and a partial description of the system was noted in 1957 in *Aviation Week*.<sup>5</sup> A similar account appeared in a Czech book on military applications of electronics and in a German article. The most complete report of the AN/FPS-17 was given by William Siebert upon receiving the 1988 IEEE Aerospace and Electronic Systems Society’s Pioneer Award for the development of coded-pulse radar.<sup>6</sup>

The motivations for the AN/FPS-17 project were straightforward — to replace speculations with facts and to avoid surprise. By 1954, the understanding of the fundamentals of radar theory had advanced far enough that Lincoln Laboratory and GE could build this extraordinary radar and help to stabilize the global balance of power.

### The Ballistic Missile Early Warning System

During 1953 and 1954, Lincoln Laboratory carried out several preliminary studies of the properties of ballistic missile trajectories, the problems of radar systems for detection and tracking of long-range ballistic missiles, and the effects of meteors on such radar detection systems. By then, it had become clear from intelligence sources that the Soviet Union was rapidly developing intercontinental ballistic missiles (ICBM). These early studies suggested that radar was the only sensor technology that offered the near-term possibility of developing a warning system against these missiles.

The development of ICBMs armed with nuclear weapons compelled the DoD to rethink its approach to strategic defense. The underlying assumption for SAGE — that an approaching bomber could be detected, tracked, and intercepted — did not apply. Based on the premise that it would be virtually impossible to intercept incoming missiles, a new concept came into vogue: mutual assured destruction. According to this concept, the only practical defense was to develop such a forbidding counterstrike capability of bombers and missiles that no sane individual or nation would launch an attack on the United States; the citizens of any country that did so would be assuring themselves of their own destruction.

Mutual assured destruction thus called for the development of a robust counterstrike capability, a key element of which was the assured capability to detect an attack as soon as it commenced. Reliable early warning of even a few minutes was critical, perhaps even more so than it had been for air defense.

The success of the DEW Line led the Air Force to approach the Laboratory for support in designing and developing a new radar system to provide warning of a Soviet ICBM attack against North America. Beginning in 1955, this became a major Laboratory activity and remained so until the Ballistic Missile Early Warning System (BMEWS) was well into production in the early 1960s. Lincoln Laboratory’s role was its usual one — to provide solid technical advice to the Air Force sponsor and to the contractors that would ultimately build BMEWS.

1960



BMEWS search radars,  
Thule, Greenland





**Figure 3-8**  
**Antenna and supporting structure**  
**of the long-range UHF tracking**  
**radar on Millstone Hill in Westford,**  
**Massachusetts.**

#### Notes

**7** G.H. Pettengill and D.E. Dustin, "A Comparison of Selected ICBM Warning Radar Configurations," *Lincoln Laboratory Technical Report No. 127*. Lexington, Mass.: MIT Lincoln Laboratory, 13 August 1956.

**8** M.I. Skolnik, "A Long Range Radar Warning System for the Detection of ICBMs," *Lincoln Laboratory Technical Report No. 128*. Lexington, Mass.: MIT Lincoln Laboratory, 15 August 1956.

The Laboratory formed the Systems Research Group in 1955 to study problems that would have to be understood in designing a reliable warning system. Problems such as the radar reflection properties of ICBMs; effects of propagation, meteor trails, and aurora effects; and the optimization of prediction methods for estimating missile impacts from radar observations were to be dealt with.

The Systems Research Group compared various radar warning system configurations,<sup>7</sup> and the most promising one, which consisted of detection radars scanning several pencil beams in azimuth at fixed elevations and an associated pencil-beam tracking radar, was studied extensively.<sup>8</sup> This warning system was recommended by the Laboratory and adopted by the Air Force and the DoD as the basic configuration for BMEWS.

The Air Force awarded the prime contract for BMEWS to the Radio Corporation of America in January 1958. Four objectives were defined for the system: (1) a fifteen-minute warning of a mass ICBM attack directed against North America; (2) a reliability of 0.9999; (3) a maximum false-alarm rate of one during a three-month period; and (4) an inherent flexibility and growth potential.

The Laboratory supported BMEWS with research, development, and engineering programs. The model for the AN/FPS-50 BMEWS surveillance radar was assembled by GE at Trinidad, British West Indies. This large scanning-beam radar used a large parabolic torus reflector (165 ft high and 400 ft wide) with an organ-pipe feed and incorporated many components and specifications developed and tested at Lincoln Laboratory.

The operational BMEWS network consisted of three radar sites — Clear, Alaska; Thule, Greenland; and Fylingdale Moor, Yorkshire, England — and a data processing center in the Cheyenne Mountain complex near Colorado Springs, Colorado.

The BMEWS radar effort at Lincoln Laboratory began with the design and construction of a prototype UHF tracking radar on Millstone Hill in Westford, Massachusetts. The radar served as a test bed for the components and techniques of BMEWS, including the data processing and display equipment. It went into operation in fall 1957, just in time to observe returns

from Sputnik I. Since then, the Millstone radar has observed virtually every space vehicle that has risen above its horizon.

The original Millstone radar was unusual in many respects, among them its high power at 440 MHz and its agile 84 ft antenna system (Figure 3-8). The transmitter produced a peak power of 1 MW and an average power of 60 kW, feeding an antenna with a rotating conical feed horn.

It was the first radar to use a digital computer as an integral part of the radar system for real-time data processing and control. The CG-24 computer, designed and built at Lincoln Laboratory for this purpose and installed at Millstone in 1958, was also the first completely solid-state computer.

In addition to demonstrating the value of automatic pointing and tracking of radar antennas, the CG-24 was a major factor in the development of real-time signal processing techniques that were essential to the evolution of modern space-tracking and measurement radars.

As with so many of Lincoln Laboratory's programs, a number of groups were able to contribute to the eventual success of the Millstone radar. The sensitivity of the radar was increased by reducing the system noise through the use of the cooled parametric amplifier and the maser amplifier, developed in the Laboratory's Solid State Division.

The first evaluation of the noise temperature of an operating maser amplifier was made at Lincoln Laboratory in 1957. By early the next year, a UHF maser was ready to be used in the Millstone radar, resulting in a fivefold increase in sensitivity.

Millstone was the model for the BMEWS AN/FPS-49 tracking radars installed in Greenland and England and the AN/FPS-92 (an improved version of the AN/FPS-49) tracking radar installed in Alaska. It also served as the basis for large tracking and measurements radars at a NASA installation near Wallops Island, Virginia, and for an Air Force downrange tracking station in Trinidad and the Prince Albert Radar Laboratory in Saskatchewan, Canada.

The Millstone radar was rebuilt in 1962 for L-band (1295 MHz) operation. The focus of work at Millstone then changed to basic science, with an extensive study of the physics of the ionosphere, and to space surveillance, which is currently the site's principal task. The original antenna was moved to Turkey, where it replaced the AN/FPS-17, thus evolving from a prototype to an element of the U.S. surveillance network.

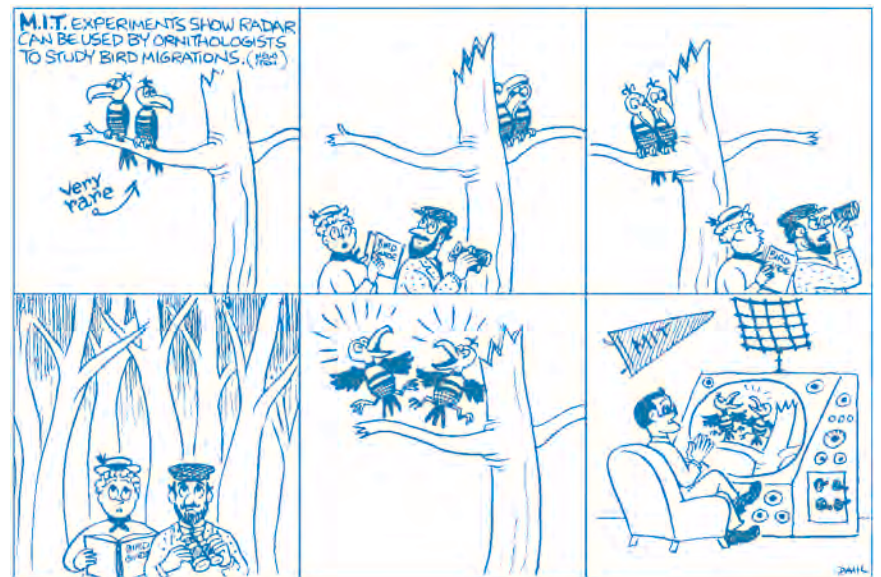
The scope of the BMEWS supporting effort expanded in the late 1950s to include overall systems analysis, with special emphasis on the data processing done by the BMEWS Missile Impact Prediction computers. A set of software programs, called the BMEWS Operational Simulation System (BOSS), was written for the Laboratory's IBM 704 computer.

BOSS supported systems studies of deghosting methods, orbit-computation and impact-prediction methods, single-fan discrimination techniques, and the use of tracking radars. An improved data-reduction program was designed to simplify the process of getting desired data from BOSS runs.

The Laboratory also designed, developed, and vigorously tested a number of components, including the entire organ-pipe feed system that would be required for the BMEWS scanning-beam surveillance radar, the AN/FPS-50. The components and specifications for the organ-pipe feed were turned over to GE, which produced AN/FPS-50 radars for the BMEWS sites at Clear and Thule.

Work continued on advanced radar techniques and components, including pulse-compression methods and phased-array radars. Research on propagation problems gave auroral measurements a high priority.

The BMEWS sites were completed in January 1964, at a cost of more than one billion dollars. The system has been upgraded several times, and it continues in operation today.



### Tracking Birds

One result of Lincoln Laboratory's early radar was completely unexpected — an improved understanding of the patterns of bird migration.\* The foray into ornithology started during the Cape Cod tests as part of an examination into sea clutter, a term being applied to those overwater targets that were not rejected by the radar moving target indicator. Sea clutter had been making the South Truro radar beam unusable for the first 50 miles of its range, where the moving target indicator should have been most useful.

In 1957, Lincoln Laboratory decided to launch an investigation into the cause of sea clutter. Robert Richardson and Joseph Stacey went to Cape Cod and, for several days each month over several months, photographed a PPI display every 12 seconds over a 24-hour period. Playback of the film showed that the sea clutter was concentrated near the shore at dawn, moved out to sea during the day, and then returned to the shore at night — behavior that was characteristic of birds.

Richardson modified the radar gain control circuitry to remove the effect of birds from the PPI displays by adjusting the gain to vary with the fourth power of the range so that targets of a specified size would be accepted at all ranges, and echoes from birds would be rejected.

The investigation then shifted from radar clutter to bird behavior. Presentations by Richardson and a cartoon in the *Boston Globe* sparked widespread interest among ornithologists and, at the request of the Massachusetts Audubon Society, Lincoln Laboratory embarked on a year-long study that accumulated a rich store of information on the bird-migration patterns over Cape Cod.

This study changed many long-held views in ornithology. For instance, most ornithologists had believed that birds traveled over land during their migrations, but the radar measurements proved conclusively that overwater travel was common. Bird counts also had to be revised. The study demonstrated that when migrating birds encountered a weather front, they turned, sometimes even reversing direction. This work thus showed that the same birds had often been counted more than once.

The Massachusetts Audubon scientists working in collaboration with Lincoln Laboratory were the first ornithologists to use radar to study the migration of birds. Dozens of subsequent studies drew on the results of their work, and radar has become a standard tool in ornithology.

\* This material was contributed by Robert Richardson.





**Until supplanted by satellite communications, worldwide communication was possible only through the use of scatter or reflection techniques. Lincoln Laboratory activities in tropospheric scatter communications permitted contact with remote sites, particularly in Arctic regions. Later, long-range systems were developed to communicate information successfully with submarines in distant locations.**

**Left: The Round Hill Field Station in South Dartmouth, Massachusetts, with the Round Hill mansion built by “Colonel” E.H.R. Green.**

Each of Lincoln Laboratory’s major programs in the 1950s and 1960s — the Semi-Automatic Ground Environment (SAGE), the Distant Early Warning (DEW) Line, and the Ballistic Missile Early Warning System — depended upon reliable long-range communications because each had radars in remote locations. In the Arctic, on the Texas Towers, and for many ships, neither telephone nor line-of-sight communications were possible.

The curvature of the earth sets the limit on direct radio transmissions; a signal can travel long distances only if it is reflected by something above the horizon. This limitation compelled Lincoln Laboratory to begin a complex and extensive program on long-range communications.

Today, satellites provide a straightforward solution to the problem of worldwide communication. But before there were satellites, the only way to transmit a signal over the horizon was to use the ionosphere or troposphere to reflect, refract, or scatter the signal back to earth. In a sense, ionospheric/tropospheric communications simply used atmospheric layers as natural passive satellites. Natural fluctuations, however, made scatter communications a difficult and complex task. Nonetheless, before satellites, it was the only choice for long-range terrestrial communications.

The programs on long-distance beyond-the-horizon communications technology at Lincoln Laboratory originated at the MIT Research Laboratory of Electronics under the leadership of William Radford. All personnel and equipment of this facility were transferred to Lincoln Laboratory in 1951. These individuals formed the nucleus of the effort that continued the work and started new projects. Through 1958, experiments were conducted over a wide range of frequencies at a variety of sites in the eastern sections of the United States and out at sea.

The ionosphere, located at altitudes of 100 to 250 km, reflects high-frequency (HF, 3 to 30 MHz) radio waves over long distances, a phenomenon that amateur radio operators and commercial stations have used since its discovery early in the last century. Up to World War II, HF radio was the principal means of long-distance

communication for aircraft, ships, and fixed stations. During and just after the war, long-distance ionospheric and tropospheric scatter propagation were discovered; research on these modes became a major undertaking at Lincoln Laboratory. At the same time, however, the Laboratory continued to seek ways to improve conventional HF communications.

## High-Frequency Communications

High frequency has always challenged communications engineers.<sup>1</sup> It can provide worldwide communication with relatively small, low-power transmitting and receiving terminal equipment. However, HF links are subject to strong daily variations and modifications to the ionosphere caused by solar storms. Most problematic for defense applications, HF links are easily jammed because they lack a wide bandwidth for spreading the signal and because it is hard to use antenna directivity to discriminate against jammers.

The central feature of antijam communications is to hide the carrier signal by spreading it over a wide bandwidth. Lincoln Laboratory developed the NOMAC system to conduct jam-resistant HF communications. NOMAC stands for noise modulation and correlation, which aptly describes the system. Transmitted signals were generated with the aid of noise modulation; received signals were decoded by means of a correlation technique.

The carrier signal was hidden by giving it 180° phase shifts with respect to itself according to a pseudonoise pattern and by supplying the pattern only to the intended receiver. The family of pseudonoise patterns known as direct sequences was used for NOMAC; the binary pattern — to phase-shift or not to phase-shift — was generated by digital circuits.

The transmitted power was spread across the occupied band at all times, giving a low power level in any of its segments. For this reason, the use of direct sequences offered covertness. Without the sequences, a receiver probably would not even have been able to determine that a transmission was taking place, much less make sense of it.

## Notes

**1** This section is based on the article by W.W. Ward, "The NOMAC and Rake Systems," *Linc. Lab. J.* **5(3)**, 351–366 (1992).

**2** P.E. Green, Jr., R.S. Berg, C.W. Bergman, and W.B. Smith, "Performance of the Lincoln F9C Radio-teletype System," *Lincoln Laboratory Technical Report No. 88*. Lexington, Mass.: MIT Lincoln Laboratory, 28 October 1955, DTIC AD 80345.

The information stream was associated with the carrier signal by making available at the transmitter two spread-spectrum carrier signals, derived from the same sequence but slightly offset in their nominal center frequencies and for the most part overlapping each other. The successive ones and zeros of the information stream then keyed the transmission of one or the other carrier signal. The correlation receiver multiplied two copies of the received signal by a replica of the transmitted signal at a particular instant in time, smoothed the result, and used the larger of the two for each bit decision.

In the transmitted reference NOMAC systems, a separate radio channel was used to transmit the key sequence to the receiving terminal. This approach had an obvious vulnerability because a second communication link, which was itself vulnerable to interference and jamming, had to be set up and operated. Moreover, the second link could itself be detected and exploited.

A transmitted reference NOMAC system was first demonstrated over the air by Lincoln Laboratory on October 23, 1952. A teletype transmission from the Army Signal Corps Engineering Laboratories in Fort Monmouth, New Jersey, was sent to Lexington (a distance of 230 mi) at a frequency of 5.4325 MHz. The P9D very-high-frequency (VHF) dual-diversity NOMAC teletype system, a transmitted reference NOMAC system operable at any of five frequencies between 31 and 38 MHz, was implemented at Lincoln Laboratory in early 1953.

The P9D system was developed to provide the features of NOMAC communications systems to the radio links connecting the radar stations of the DEW Line with SAGE direction centers. Six sets of equipment were built. The shortcomings of the transmitted reference system were ultimately sufficient to discourage its use, however, and tropospheric scatter communications systems were used for the DEW Line.

The problems with transmitted reference NOMAC were alleviated by adopting the stored reference approach. In this method, the key sequence was transferred to the receiving terminal before the time when it was to be used. Tests on the bench at Lincoln Laboratory confirmed that the stored reference technique reduced vulnerability to jamming.

Lincoln Laboratory took a novel approach to stored reference NOMAC in the design of the F9C.<sup>2</sup> In this system developed in 1953, reference signals at both ends of the link, clocked by primary frequency standards, generated long-period trains of pulses (the pseudonoise key sequences) that were used to shock-excite bandpass filters of the same width as the spectrum to be occupied by the transmission. The filters' transient responses to this excitation provided noiselike signals of long period, easily greater than a day, which was the rekeying interval.

The signal in the transmitter could be used to generate the spread-spectrum ones and zeros. The signal in the receiver could be used (by cross correlation with the received signal) to determine which detected signal segments corresponded to ones and which to zeros. This way of generating the required reference signals was called a matched-filter approach, but it was essentially a stored reference scheme.

1950



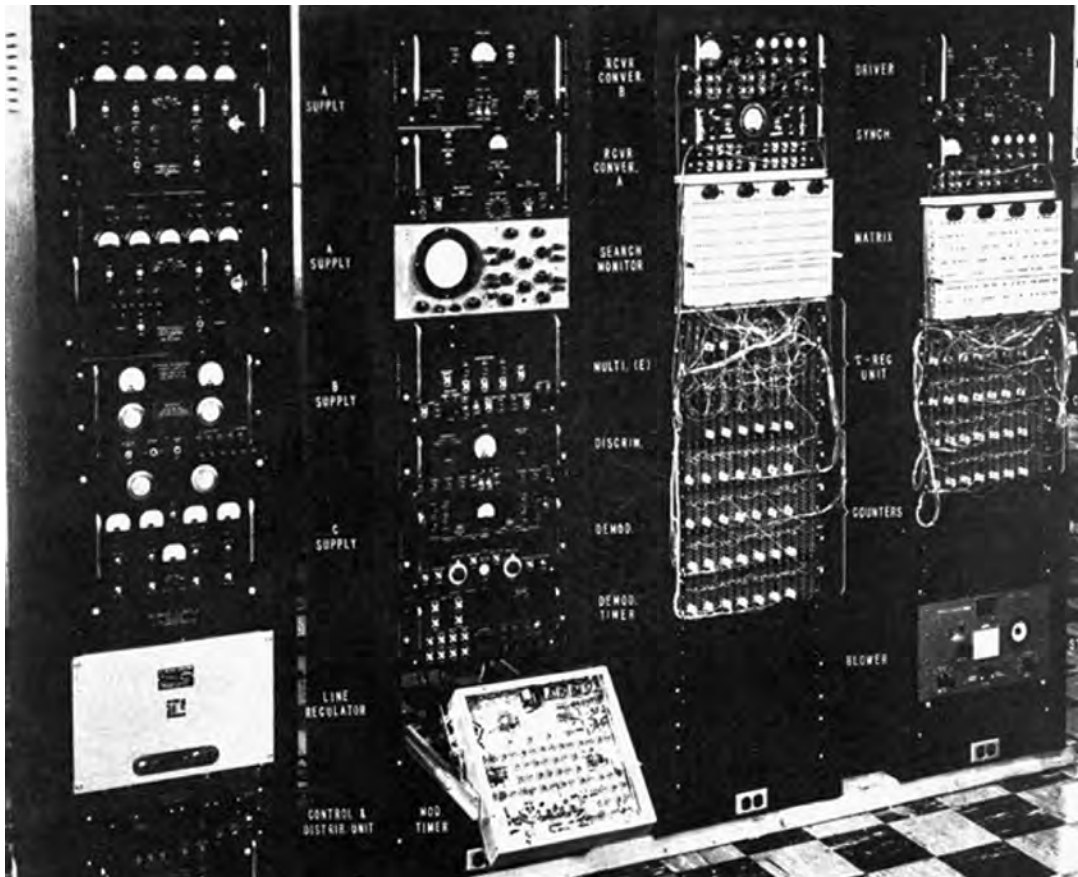
W.H. Radford



NOMAC transmitter



W.B. Davenport



**Figure 4-1**  
**NOMAC receiver containing 502**  
**vacuum tubes and 100 transistors.**

A transcontinental HF NOMAC link from an Army facility at Davis, California, to a Signal Corps facility at Deal, New Jersey, was put into operation on August 12, 1954 (Figure 4-1). Provisions were made for parallel testing with a conventional frequency-shift keying (FSK) link and for the introduction of jamming signals by transmitters in Cedar Rapids, Iowa (at 12.27 MHz), and in Honolulu (at 17.46 MHz). The receiving equipment had to keep the locally generated stored reference signal synchronized with the incoming signal, despite continuous changes in the length of the HF propagation path due to variations in the ionosphere.

The testing program quickly demonstrated that multipath propagation was causing the F9C to do poorly in the unjammed environment. The F9C offered no advantage over other communications methods, except in the presence of interference. The additional complexity of NOMAC equipment could be justified only for communication links on which jamming could be expected or for which covertness was a paramount issue.

The testing was halted in October 1954 so that an improved version, the F9C-B, could be developed. Through the use of time diversity, the F9C-B provided a significant improvement: two channels independently tracked the two strongest received signals and then combined the signals to yield a single data stream that was superior to either alone.

Transcontinental tests resumed in February 1955 and ended in May. On the basis of the success that was achieved, the Signal Corps funded the production and manufacture of the F9C-A, an HF time-diversity NOMAC system. Two Lincoln Laboratory staff members, Robert Berg and William McLaughlin,

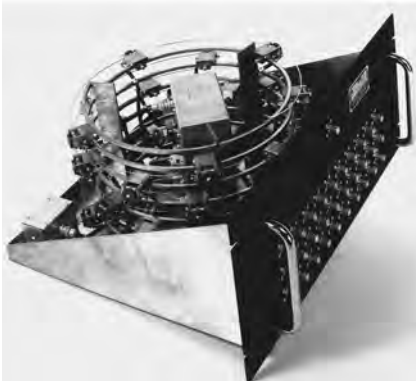


P.E. Green, Jr.



R. Price





**Figure 4-2**  
Helical ultrasonic delay line for the Rake receiver.

were sent to Sylvania's Electronic Defense Laboratory in Mountain View, California, to facilitate the technology transfer, and Sylvania built six F9C-A systems. Two F9C-A systems were also built by the Fischback & Moore Company of Dallas.

The theoretical jamming resistance for NOMAC was 23 dB; the ratio of the spread-signal bandwidth (10 kHz) to the reciprocal of the teletype baud interval (22 msec) provided this processing gain. The time-diversity approach actually enabled the F9C-A to achieve as much as 17 dB of jamming protection. Acquiring the remaining 6 dB required the development of Rake, which detected and summed the received signals from many propagation paths.

The missing 6 dB of jamming protection were lost because the F9C-A processed only the two strongest received signals. What Rake did was to compensate for the effects of all other signal-path delays.

The concept of Rake was to synthesize (and refine) an adaptive matched filter that corresponded to most of the linear propagation paths that produced the received signal.<sup>3</sup> The final output was, to a large extent, exactly what it would have been had there been only one propagation path from transmitter to receiver.

The maximum spread in HF radio was only about 3 msec. Therefore, a delay with 30 taps sufficed to characterize the received signal fully. Each tap output was adjusted in amplitude and shifted in phase by feedback circuits so that the algebraic sum of all 30 taps was a good approximation to the ideal received signal.

The delay line bristling with its taps resembled a garden rake, so the communications system was named Rake. The actual delay line was built in the form of a helix (Figure 4-2).

During the next several years, other reports and papers put Rake firmly on record, and the concept was patented.<sup>4</sup> Rake performance approached the bounds of achievable performance. It was tested in 1956 over the same transcontinental link that had been used to evaluate NOMAC, with the same transmissions. It worked very well, achieving nearly the full 23 dB of jamming resistance.

The Army Signal Corps promptly arranged for the National Radio Company of Malden, Massachusetts, to produce twelve Rake modification kits for the F9C-A NOMAC systems that were being built by Sylvania. Production units of NOMAC/Rake equipment saw wide service. Of particular importance was the availability of this spread-spectrum/antijam/antimultipath communications system between Washington and West Berlin during tense times in the early 1960s.

NOMAC/Rake was the first practical implementation of a channel-adaptive communications system. Rake was also the earliest example of what later became the field of adaptive modems.

Beginning with Paul Green's 1953 MIT Sc.D. thesis, NOMAC went through field tests and into production as the F9C-A in less than three years. In 1981, William Davenport, leader of the Communications Techniques Group at Lincoln Laboratory, and Green, the assistant group leader, along with Robert Price, their principal collaborator, received recognition from the Institute of Electrical and Electronics Engineers (IEEE) for their achievements. Davenport and Green received the 1981 Pioneer Award from the IEEE Aerospace and Electronics Systems Society.<sup>5</sup> Price received the 1981 Edwin Howard Armstrong Achievement Award from the IEEE Communications Society.

#### Notes

**3** R. Price and P.E. Green, Jr., "A Communication Technique for Multipath Channels," *Proc. IRE* **46**, 555-569 (1958).

**4** R. Price and P.E. Green, Jr., "Anti-Multipath Receiving System," U.S. Patent No. 2,982,853, May 2, 1961.

**5** "1981 Pioneer Award," *IEEE Trans. Aerosp. Electron. Syst.* **AES-18**, 157-160 (1982); W.B. Davenport, Jr., and P.E. Green, Jr., "The M.I.T. Lincoln Laboratory F9C System," *IEEE Trans. Aerosp. Electron. Syst.* **AES-18**, 157-160 (1982).

## Notes

**6** The section on scatter communications was written by Burt Nichols, based in part on W.E. Morrow, Jr., and W.T. Burke, "A History of the Effort of MIT Lincoln Laboratory in the UHF/SHF Tropospheric-Scatter Communication Field Utilizing Frequency Modulation," *Lincoln Laboratory Group Report 36-25*. Lexington, Mass.: MIT Lincoln Laboratory, 1 January 1958.

**7** W.G. Abel, J.T. deBettencourt, J.F. Roche, and J.H. Chisholm, "Investigations of Scattering and Multipath Properties of Ionospheric Propagation at Radio Frequencies Exceeding the MUF," *Lincoln Laboratory Technical Report No. 81*. Lexington, Mass.: MIT Lincoln Laboratory, 3 June 1955.

**8** D.G. Brennan and M.L. Phillips, "Phase and Amplitude Variability in Medium-Frequency Ionospheric Transmission," *Lincoln Laboratory Technical Report No. 93*. Lexington, Mass.: MIT Lincoln Laboratory, 16 September 1957.

**9** The October 1955 issue of the *Proceedings of the IRE* was entirely dedicated to scatter propagation and is possibly the most detailed and comprehensive report on the topic. Another outstanding overview of scatter communications appeared five years later, entitled "Radio Transmission by Ionospheric and Tropospheric Scatter," *Proc. IRE* **48(1)**, 4–44 (1960). This article was written by the IRE Joint Technical Advisory Committee Ad Hoc Subcommittee on Forward Scatter Transmission, which was headed by Radford and composed largely of Lincoln Laboratory staff members.

**10** (a) Morrow and Burke, "A History of the Effort of MIT Lincoln Laboratory in the UHF/SHF," *Lincoln Laboratory Group Report 36-25*. Lexington, Mass.: MIT Lincoln Laboratory, 1 January 1958; (b) J.H. Chisholm, W.E. Morrow, Jr., B.E. Nichols, J.F. Roche, and A.E. Teachman, "Properties of 400 Mcps Long-Distance Tropospheric Circuits," *Proc. IRE* **50(12)**, 2464–2482 (1962); (c) B.E. Nichols, "Performance of a 640-Mile 24-Channel UHF-SSB Experimental Communication System," *IRE Trans. Commun. Syst.* **CS-8(1)**, 26–33 (1960).

## Long-Range Scatter Communications

Despite the advances of NOMAC/Rake, the HF medium remained difficult and unreliable. Other forms of long-range communications, particularly at the higher frequencies, offered the potential for greater reliability and capacity than did HF ionospheric reflection. Therefore, Lincoln Laboratory began a series of programs on three other techniques for long-range communications: HF ionospheric scatter; medium-frequency ionospheric scatter; and VHF, ultrahigh-frequency (UHF), and super-high-frequency (SHF) tropospheric scatter. These programs began at the start of Lincoln Laboratory in 1951 and continued until 1958.<sup>6</sup>

The work on HF ionospheric scatter showed that, in the frequency range of 20 to 50 MHz, ionospheric scatter transmissions could be useful for point-to-point narrowband communications of up to 1000 mi. However, because fluctuations in the atmosphere disturbed the quality of HF transmissions, receiving equipment had to be designed to handle a wide dynamic range of received power. At distances of less than 350 mi, differential time delays due to multipath propagation particularly limited the useful bandwidth. High-power (10 kW) and high-gain (20 dB) antennas were needed. Good antenna directivity was also essential to minimize multipath propagation. During periods of high sunspot activity, the frequency range just above the HF band — close to 50 MHz — gave the best results.

HF ionospheric scatter communications never became widely used except for the DEW Line rearward link. Fading remained a problem, as did the low channel capacity. Lincoln Laboratory concluded the HF scatter study in 1955.<sup>7</sup>

Lincoln Laboratory's study of medium frequency (300 to 3000 kHz) ionospheric-reflection transmissions began at the request of the U.S. State Department. The Voice of America, a radio network affiliated with the State Department, was using a medium-frequency signal to transmit to Eastern Europe. Voice of America was interested in the possibility of improving the strength of its signal by installing an array of high-power transmitters in Western Europe. Because the State Department did not have the technical expertise to assess

the value of this scheme, it asked Lincoln Laboratory to determine whether a beam formed by a spaced array on the ground could be sustained by an ionospheric path.

Experiments were carried out at 543 kHz over a 380 mi path between the Round Hill Field Station in South Dartmouth, Massachusetts, and Fort Belvoir, Virginia. This path provided midlatitude ionospheric propagation uncontaminated by a ground wave. In a four-month measurement program, four separate transmitters at Round Hill aimed signals toward the receiving station at Fort Belvoir.

Results were unfavorable. In a technical report issued in September 1957, Donald Brennan and M. Lindeman Phillips wrote that the experiment showed that a broadside array up to about two wavelengths long would perform well on an ionospheric path.<sup>8</sup> When they studied signal propagation from these arrays, however, they measured substantial beam losses. As a result of the study, the Voice of America proposal was not implemented.

## Tropospheric Scatter

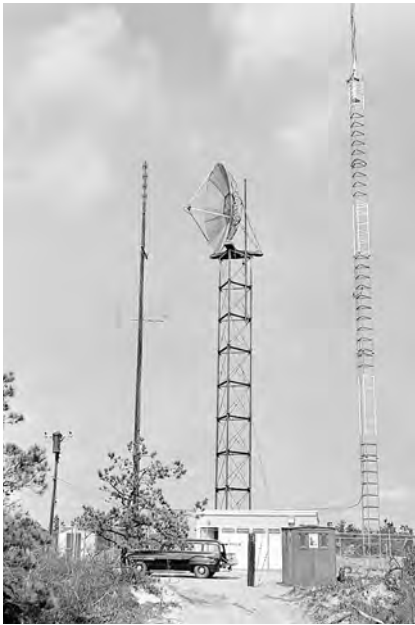
Most of Lincoln Laboratory's research on long-range terrestrial communications, particularly the most successful research, was on tropospheric scatter, sometimes called forward scatter.<sup>9</sup> Tropospheric scatter communications utilize the presence of inhomogeneities in the troposphere to scatter radio signals back to earth. On the basis of the success of the program, numerous military and civilian systems were installed, some of which continue to be used around the world today. Numerous staff members participated in this program, and several reviews of Laboratory work were published.<sup>10</sup>

The tropospheric scatter mode at the higher frequencies offers reliability, a wide bandwidth, and a significant number of communication channels. The Lincoln Laboratory program on tropospheric scatter investigated communications in three frequency bands: VHF, near 50 MHz; UHF, at 385 to 425 MHz, 900 to 950 MHz, and 2290 MHz; and SHF, at 3670 to 5050 MHz.



Figure 4-3  
The antenna farm at the Round Hill  
Field Station.





**Figure 4-4**  
**South Truro, Massachusetts, terminal**  
**(center) of the UHF tropospheric link.**

In general, the studies showed that as the communication frequency increased, so did the bandwidth, but that propagation losses decreased the range. In the VHF investigation, for example, it was found that limitations in the available bandwidth made the band useful only for narrowband, low-capacity communications; not many VHF circuits were ever implemented.

The low UHF band was shown to offer the longest distance for wideband multichannel service — as much as 600 miles. For the shorter distances, the upper UHF and lower SHF bands offered greater channel capacity.

The UHF scatter communication program established a high-power (1 to 10 kW) UHF system over a 150 to 200 mi path that used 30 to 60 ft diameter parabolic antennas for transmission and reception. Existing experimental data suggested that narrowband receivers would allow signals to be received at greater distances for these transmission powers. However, in view of the uncertainties about the effects of multipath fading and the seasonal variation of signal levels on useful communications, the initial experimental paths were restricted to distances of 200 mi or less.

The SHF program established a high-power SHF pulse system over a path of 150 to 200 mi. For this program, 30 ft diameter antennas provided narrow beamwidths that permitted a study of the possible reduction of time-delayed multipath contributions. The antennas also had beam-rotating features that permitted a study of the vertical and horizontal angular scattering characteristics of the troposphere. Even though the antenna's plane-wave gains could not be fully realized because of multipath contributions, the received signal-to-noise ratios permitted a study of the fading of the received-pulse amplitude variation and the multipath distortion.

The UHF program was implemented by the establishment of an experimental propagation path from Alpine, New Jersey, to the MIT Round Hill Field Station in South Dartmouth, Massachusetts. An experimental high-power 425 MHz transmitter installed at Alpine was used for one-way transmission over the 161 mi path.

The Round Hill Field Station, the principal site for long-range communications research, was located on the North Atlantic shore with overland radio paths to the south, west, and north, and overwater radio paths to the east. Round Hill, the estate of “Colonel” Edward Green, was donated to MIT in the 1940s and used by MIT until 1964. The centerpiece of the estate was a 60-room granite and marble mansion. Lincoln Laboratory used the mansion to house transmitters and receivers, and the huge lawns as the antenna farms (Figure 4-3).

A short time after communications began between Round Hill and Alpine, another UHF path was set up, one that linked Round Hill with the U.S. Army Signal Corps’ Coles Signal Laboratory in New Jersey, a distance of 184 mi. This two-way circuit, which operated from May 1954 to February 1955, used 5 kW klystron transmitters. Coles transmitted signals at 399.5 MHz; Round Hill transmitted at 385.5 MHz.

Another UHF (407 and 412 MHz) system was installed in July 1954. This circuit, an 80 mi, two-way link between South Truro, Massachusetts, and the Lincoln Laboratory Field Station on Katahdin Hill in Lexington, operated as a high-capacity experimental system until August 1955 (Figure 4-4).

A shorter UHF tropospheric scatter circuit was installed and put into operation in March 1955. Operating between the Round Hill and the Lexington field stations, it was primarily used for demonstrations.

While the early UHF programs were still in progress, an experimental SHF circuit was set up between Crawford Hill, New Jersey, and the Round Hill Field Station. This circuit, part of a cooperative program with Bell Telephone Laboratories, used a modified Navy pulse radar as an experimental 3670 MHz transmitter. Pulse receivers and recording equipment were installed at Round Hill; preliminary experimental operations began on this narrow-beam system in April 1953 and continued until February 1955. With the support of Western Electric, a regular weekly schedule of signal-level recordings was established. Approximately 3000 hours were recorded over this circuit.

Again in cooperation with Bell Telephone Laboratories, an experimental 5050 MHz continuous-wave radar was modified to provide a microwave frequency-division multiplex communications system for operation over the path between Crawford Hill and Round Hill. This circuit began operations in November 1953, and experiments continued for nine months.

Working with experimental results from these test circuits, Lincoln Laboratory staff began to design systems for military applications. In 1953, the Laboratory assisted the Air Force in designing a UHF tropospheric scatter system along the northeast coast of North America. This system, named Polevault, linked stations along the Pinetree radar line.

On the basis of the Lincoln Laboratory and Bell Laboratories tests and early results from Polevault, Western Electric developed the White Alice network of UHF trunk routes for the territory of Alaska. The White Alice and Polevault systems were subsequently tied into the DEW Line through the use of multichannel, beyond-the-horizon tropospheric scatter radio relay systems.

New circuits for theoretical studies of tropospheric scatter propagation continued to be set up. Simultaneous 3670 and 412 MHz propagation tests were added to the Round Hill-to-Crawford Hill path, and extended to the Rising Sun and Alpha Field Stations in Maryland, at distances of 300 and 350 mi from Round Hill, respectively. A study of short-hop communication was conducted by installing a site at Riverhead, New York, at the midpath of the Maryland-to-Massachusetts circuit. UHF transmissions were recorded at Alpha on a regular basis from May 1955 to July 1957.

A new station at Chillum, near Washington, D.C., 375 mi from Round Hill, extended the path from Round Hill and Coles Signal Laboratory. This circuit became operational in March 1955 and was deactivated a year later.

The underlying reason for Lincoln Laboratory's extensive involvement in long-distance communications was, of course, for SAGE, particularly to support the offshore radars on the Texas Towers. A tropospheric scatter communications system was designed and built to

provide radio communication between the Texas Tower offshore radars and terminals located in North Truro, Massachusetts, and Stewart Air Force Base in Newburgh, New York. An experimental copy of the system was used as the first multichannel communications system for the Texas Tower-to-shore link.

The next step was to extend the range of tropospheric scatter communications. The transmitter at Round Hill, normally used for the Coles-to-Chillum circuit, was briefly diverted in July 1955 for a study of overwater propagation. A Navy ship was used as a receiver, and signals were propagated via tropospheric scatter out to a distance of 460 mi. The following February, winter overwater propagation was studied at distances exceeding 700 mi with a new antenna and a higher transmitting power.

Another long-distance propagation study was conducted, this time overland, by setting up a site at Winston-Salem, North Carolina, 619 mi from Round Hill. This site, which began operations in November 1955, was used in conjunction with a new high-power UHF transmitter and a high-gain rotatable parabolic antenna at Round Hill. Operations continued for two years.

By July 1956, the Laboratory was ready for an even more ambitious circuit. A UHF receiving site was installed in Elberton, Georgia, 830 mi from Round Hill. The site, which received transmissions in parallel with Winston-Salem, operated for one year.

Each of these circuits served as a test facility to evaluate the reliability and performance of equipment designed for UHF and SHF communications. These studies led to a steady, rapid series of advances in tropospheric scatter communications. The rate of improvement was indeed impressive — the length of the communication paths grew from 161 to 830 mi in only three years.

Major modifications to the design of each system, from the receivers and transmitters to the communication techniques, made these improvements possible. Much of the equipment for the early work on tropospheric scatter was loaned by the military and other organizations. In early 1953, the Laboratory started a program of

development and procurement of reliable exciter and multicavity klystron transmitter equipment that was designed specifically for UHF or SHF tropospheric scatter service. The information and experience obtained from developing and testing transmitters led to the fabrication of klystron transmitters that could operate in the 400 and 2000 MHz ranges with average powers up to 50 kW.

Like the early transmitters, the early receivers were modified commercial units or military equipment. Within a short time, however, Lincoln Laboratory began to produce receivers. Extremely sensitive, low-noise, highly selective FM receivers were designed and placed in use on experimental circuits. The design of the limiter-discriminator section of the receivers included high-speed limiters and wideband, high-linearity discriminators, which were necessary for good performance under multipath conditions.

The first antennas had 28 ft diameter paraboloidal reflectors. But one of the factors that limited the range of the communication circuits was the gain, determined by the diameters of the transmitting and receiving antennas. Therefore, two 60 ft diameter paraboloidal antennas were constructed. The usefulness of the antennas for the propagation research program was enhanced by adding two steerable mounts: one capable of rotating a 28 ft diameter paraboloid 360° in azimuth, the other capable of rotating a 60 ft diameter paraboloid 360° in azimuth and 105° in elevation (Figure 4-5). Additional work was carried out on reflector configurations other than paraboloidal: helical arrays, corner arrays, and dipoles with reflectors.

Other design studies evaluated antenna feed horns. New feed horns, designed, constructed, and installed in the 28 ft diameter paraboloidal reflector at Crawford Hill, made the system capable of radiating linearly polarized fields of equal horizontal and vertical amplitudes. A cross-polarized feed horn for reception was also designed, constructed, and installed at Round Hill. It permitted simultaneous reception of horizontally and vertically polarized components for a dual-channel receiver. A similar feed horn was subsequently designed for operation at 400 and 2000 MHz.

Each antenna was a large and costly piece of equipment, so diplexed operation (transmitting and receiving simultaneously on two different frequencies) was desirable. Filters had to be added to the systems to prevent the transmitter output power at the transmitter frequency from reaching the receiver input terminals and to prevent any transmitter output power at the receiver frequency from reaching the receiver input terminals.

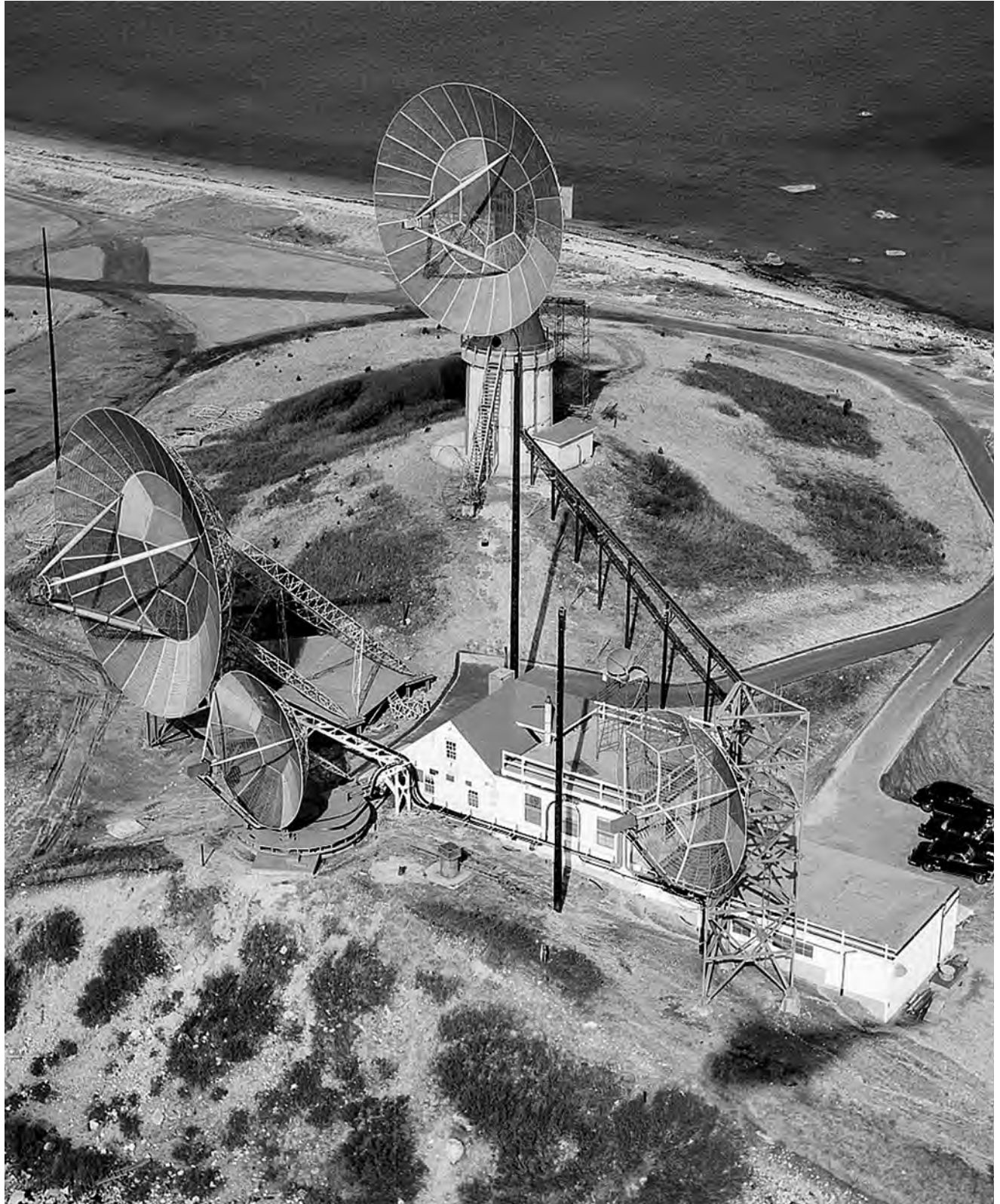
By October 1954, a pair of coaxial-line stub filters had been designed, tested, and installed on the Truro-Lexington link. These filters (407.45 and 415.15 MHz) provided over 70 dB attenuation in the stop band and less than 1 dB attenuation in the pass band for a bandwidth of 0.7 MHz. A diplexer was also designed and fabricated for use at Round Hill on the Round Hill-to-Coles 400 and 2000 MHz dual-diversity circuit. This diplexer provided more than 100 dB isolation and an insertion loss of less than 0.25 dB. Waveguide diplexer units were designed and fabricated for use with the 10 kW transmitters at Stewart Air Force Base and Truro. The transmitting and receiving frequencies in this case were separated by 50 MHz around a nominal frequency of 900 MHz. The experience in the design, fabrication, and operation of various types of branching filters at many frequencies and power levels led to long-stub and cavity-type filters for quadruple-diversity service on a 400 MHz duplex circuit with transmitters of 50 kW peak power capability.

Diversity, a technique that makes use of multiple independent transmission paths to generate a received signal, can help to reduce the effects of fading. Investigations into the use of diversity techniques to improve UHF and SHF tropospheric scatter communications systems began as early as 1953. At that time, two small, horizontally polarized receiving antennas were set up at Round Hill to receive 425 MHz signals transmitted from Alpine. A few months later, five dipoles — with reflectors spaced at 1, 2, 4, 8, and 16 wavelengths — went into dual space-diversity service at Round Hill on that circuit.



**Figure 4-5**

The array of fixed and rotating antennas, 28 and 60 ft in diameter, that was used for UHF transmissions from the Round Hill Field Station in South Dartmouth, Massachusetts.





**Figure 4-6**  
**Millstone Hill terminal of the AN/FRC-47(XD-1) UHF single-sideband tropospheric scatter communications system in Westford, Massachusetts.**



**Figure 4-7**  
**The 120 ft tropospheric scatter antennas at the Thule, Greenland, site. Snow coated the reflector screens during the winter.**

In October 1955, Lincoln Laboratory (and, independently, the Federal Telecommunication Laboratories) proposed a new method of diversity that permitted full utilization of the existing path geometry with no increase in either space or spectrum requirements. In this system, the plane of polarization of the transmitting antenna became the characteristic that enabled the receiver to distinguish between sources. By placing two antennas at a site to provide space diversity and by exploiting polarization diversity, any order of diversity up to four could be obtained. After design and fabrication of the necessary dual-polarization, dual-frequency horn feeds, the technique was tested and found satisfactory. The fourth-order diversity technique was used in both the AN/FRC-56 communications system and in the single-sideband (SSB) AN/FRC-47 communications system.

One of the most important advances that came out of the Laboratory effort in tropospheric scatter was a new technique — diversity combination — that minimized Rayleigh-distributed fading. (A diversity combination system compares the quality of signals received from each of several receiving systems and selects the best one.) Three approaches to diversity combination were investigated: antenna switching, receiver-output switching, and a nonswitching parallel combiner. The nonswitching approach was the most successful and is now the standard military diversity circuit for UHF long-range receivers. Diversity combination was extremely effective; the transmitter power levels and antenna sizes that were needed to overcome the effect of fading decreased by one to two orders of magnitude.

One of the primary goals of the long-range communications program was to measure attenuation of signal strength as a function of distance from a transmitter. In the UHF range, multipath propagation introduced path losses of 60 to 110 dB in excess of expected line of sight, therefore reinforcing the importance of high-power transmitters and large antennas.

Lincoln Laboratory's final project in tropospheric scatter communications was to design a system with the highest possible range. This system, the AN/FRC-47, became a vital part of the Air Force's Arctic operations.

In the 1950s, the Strategic Air Command carried out frequent training missions from the Thule Air Force Base in Greenland. The survival of bombers flying in the remote Arctic skies depended on timely rendezvous information, and the unreliability of shortwave radio had been a cause of considerable concern. Therefore, the Strategic Air Command asked Lincoln Laboratory to develop a UHF SSB radio for Arctic operations.

Financial support for this program was expedited by General Curtis LeMay, commander of the Strategic Air Command. LeMay had a strong personal interest in SSB radio because, while flying on remote missions, he had found that it was the only form of communication that came through.

A test communication path was set up between Millstone Hill and Winston-Salem, located at a distance comparable to that of the Baffin Island, Canada-to-Thule link. Single-sideband amplitude modulation was chosen to maximize sensitivity. But the choice of SSB posed a new difficulty because of the possibility of intermodulation distortion. This problem was eliminated by making the exciter, transmitter (including the final power amplifier), and receivers linear. During the summer and winter of 1958, two series of tests were run to measure the system's performance.

The Millstone and Winston-Salem sites each had 120 ft diameter paraboloidal antennas with realized gains of about 40 dB (Figure 4-6). The power amplifier tube was a 50 kW four-cavity klystron. Four receivers, with signals from four paths, provided fourth-order diversity. The system provided highly successful voice and teletype communications, and, during periods of good propagation, all 24 channels could be used. During periods of poor propagation, some voice and teletype channels remained available.

Three tropospheric scatter communications systems developed at Lincoln Laboratory became production models: AN/FRC-47, -39, and -56. An AN/FRC-47 placed in service between Baffin Island, Canada, and Thule became the last link in a circuit that connected the continental United States with the Thule Air Force Base (Figure 4-7).



## From Knowledge, Seapower!

**On a night in December 1972, Ira Richer and Arthur Levasseur, members of the Lincoln Laboratory Project Sanguine team, boarded an operational nuclear submarine, the USS *Tinosa*, in the inner harbor of Naples, Italy, for an Atlantic crossing. The submarine had been equipped with an experimental Laboratory ELF receiver, with its digital portion implemented on a Varian 620/L-100 computer. The Naval Underwater Systems Center provided a trailing wire antenna that could be deployed from the sail of the submarine.**

**A demonstration of the entire ELF receiving system performing in an operations environment was conducted while the submarine was in transit to New London, Connecticut. The goal of this critical test was to see if a submerged submarine could receive an ELF message transmitted at long range from the United States. The test was conducted with the submarine submerged and under way in the North Atlantic at approximately 45°N latitude and 30°W longitude. At a low data rate (0.03 bps) and with a test transmitter that radiated less than 1 W, a binary minimum shift-keying bandsread technique on a 76 Hz carrier was used to transmit the twenty-character message.**

**When decoded on board the USS *Tinosa*, the message that firmly established the technical basis for ELF communication with submerged submarines was the motto of the U.S. Naval Academy — *ex scientia, tridens!* — which roughly translates as “from knowledge, seapower!”**

### Extremely Low-Frequency Communications

For the nation’s fleet of missile-carrying submarines, establishing a credible and secure command communication link is especially important and difficult. The physical characteristics of the ocean that make it attractive as a secure operating environment for a submarine also make it essentially opaque at all the conventional radio communication frequencies. However, there is a transmission window that offers the opportunity for communication in the extremely low-frequency (ELF) band.

At frequencies below 100 Hz, electromagnetic waves can penetrate deeply into sea water. Moreover, above the surface, propagation at these frequencies takes place in the waveguide formed between the earth and the ionosphere; low propagation losses allow nearly worldwide communication from a single transmitter. By contrast, transmissions from satellites (which are at higher frequencies) cannot be received underwater. Because of these properties, the U.S. Navy sponsored a program at Lincoln Laboratory from 1966 to 1975 that examined the natural parameters of the ELF channel in general and with respect to the design of a system for communicating from a U.S.-based transmitter to submerged submarines worldwide.<sup>11</sup> This activity was pursued under a program named Project Sanguine.<sup>12</sup>

Particular emphasis was placed on designing an ELF system that could withstand a severe direct nuclear attack on the transmitter and propagation medium. The very large transmitter antenna array (tens of miles on each side) was to be built with considerable redundancy. Because the system was so large and induced voltages into neighboring conductors, such as fences and

telephone wires, it sparked considerable controversy with regard to both its feasibility and its effect on the environment.

Project Sanguine was a national effort, and Lincoln Laboratory was one of the major technical contributors. The Laboratory performed and analyzed signal and noise propagation measurements and carried out system engineering of the overall communications system. The most significant of the Laboratory’s accomplishments resulted from the evaluation of ELF atmospheric noise effects on Sanguine system operation. It was established that a factor of 100 reduction in transmitted power over the previous Sanguine system design was possible because of the statistical properties of atmospheric noise in the ELF band.

The savings resulted primarily from nonlinear noise processing and efficient signal coding. Since reduction in transmitter size reduced cost and environmental impact, this achievement made the design considerably more feasible.

The Laboratory developed a highly power-efficient and jamming-resistant signal structure that applied minimum FSK modulation to binary convolutional coding. A submarine receiver with adaptive nonlinear processing and ocean filter compensation was implemented and ran in real time on a minicomputer. It included adaptive nulling of local power interference and an efficient sequential decoder; Michael Burrows designed and tested a long-wire, magnetic field sensing antenna that allowed submarines to receive signals without changing course. The Laboratory helped to resolve a number of technical issues related to the antennas. For the transmitting

1955



Round Hill field station



## Notes

**11** The visible band can also be used for submarine communications. During this period, the Laboratory conducted a parallel program on optical submarine communication and developed such components as the atomic resonance filter for optical communication. *Quarterly Technical Summary, Division 6, Space Communication*. Lexington, Mass.: MIT Lincoln Laboratory, 15 June 1971, DTIC AD-8870361.

**12** Lincoln Laboratory's Project Sanguine activity was summed up in a 1974 article: S.L. Bernstein, M.L. Burrows, J.E. Evans, A.S. Griffiths, D.A. McNeill, C.W. Niessen, I. Richer, D.P. White, and D.K. Willim, "Long-Range Communications at Extremely Low Frequencies," *Proc. IEEE* **62(3)**, 292-312 (1974), and in an IEE book on the subject: M.L. Burrows, *ELF Communications Antennas*. Stevenage, England: Peter Peregrinus, 1978.



**Figure 4-8**  
ELF propagation receiver sites for signals sent from the Wisconsin Test Facility in the Chequamegon National Forest near Clam Lake, Wisconsin.

antenna, the Laboratory worked on the design of grounding systems and the effect of burial. For the towed-wire receiving antennas, various antenna noise sources were evaluated and techniques were developed to reduce them.

A series of experiments was conducted in which modulated signals were transmitted from the Navy's Wisconsin Test Facility and received in real time at locations worldwide (Figure 4-8). The first tests took place in August 1972 with a receiver on Plum Island, Massachusetts; the follow-up tests, also land based, used receiving sites in Norway, Malta, Saipan, and elsewhere; the third and most telling demonstration was made with a receiver aboard the nuclear submarine *USS Tinosa* in submerged transit from Naples, Italy, to New London, Connecticut. Excellent results were obtained during the tests, with successful message decoding occurring consistently at all times. Both the transmitter and the receiver operated reliably, and time synchronization between the two was maintained over long periods. The Navy ELF transmitter at the Wisconsin Test Facility was radiating less than 1 W, and yet the signal was decoded more than 6000 km from the source.

By April 1974, the Navy had accepted the feasibility of ELF communications, and Lincoln Laboratory began working on a concept validation system in preparation for going operational. The Lincoln Laboratory ELF program ended in July 1975 with a system design in place.

The Navy ELF system went into operation with two jointly operating transmitter sites, one in Wisconsin and one in northern Michigan. The official Navy command activation ceremony was held at Sawyer Air Force Base, Michigan, in July 1985.



Texas Tower communication antenna



Tropospheric scatter communication antennas, Thule, Greenland



UNITED  
66

STATES

NASA

ATLAS  
CENTAUR  
GENERAL DYNAMICS



**Military satellite systems were designed to address the need for routine, robust communications. Through the development of experimental satellites, terminals, and satellite communications payloads, Lincoln Laboratory successfully led the advancement of techniques for reliable communications.**

**Left: Atlas/Centaur launch of the FLTSAT-7 with an EHF package from Cape Canaveral, Florida, on December 4, 1986.**

When the Lincoln Laboratory space communications program began more than 45 years ago, the objective was simply to make long-range military communications routinely available for large, fixed terminals. The focus of the program soon shifted to providing satellite-based communications for small, mobile terminals. After that goal was reached, the emphasis changed again, to making the communications systems electromagnetically and physically survivable, capable of functioning despite determined efforts by an adversary to interfere with them by jamming or by physical attack.<sup>1</sup> This work has been conducted within the Communications Division, headed by Thomas Rogers when it was established and under the successive leaderships of Gerald Dinneen, Walter Morrow, John Wozencraft, Paul Rosen, Donald MacLellan, Barney Reiffen, Vincent Vitto, Vincent Chan, Edward Taylor, and J. Scott Stadler.

#### **Project West Ford**

The impetus for Lincoln Laboratory's first work in space communications<sup>2</sup> came from the HARDTACK series of high-altitude nuclear tests, which were carried out in the Pacific Ocean near Johnston Island in August 1958. The first of these thermonuclear detonations disturbed the ionosphere over a vast area around the test site, interrupting a great many high-frequency radio communications links.

In 1958, Walter Morrow and Harold Meyer, an employee of Ramo-Wooldridge Corporation, proposed a solution to the problem of high-frequency radio communication failures. They suggested that, if the ionosphere became unavailable to serve as a natural reflector because of thermonuclear detonations or such phenomena as solar storms, an orbiting artificial reflector could replace the ionosphere. Morrow and Meyer proposed the construction of an artificial reflector in space that consisted of a pair of belts (one circumpolar, one equatorial) of resonant scatterers revolving in orbit a few thousand kilometers above the surface of the earth.

The scatterers in each belt would be conducting objects, such as lengths of wire, that would resonate at the system's operating wavelength and therefore reradiate radio frequency (RF) signals. The smaller the objects, the shorter the wavelength, and the easier their distribution from an orbiting dispenser. The wavelengths could not be too small, however, or construction of adequate transmitting and receiving terminals would become excessively difficult.

The Lincoln Laboratory group proposed an experiment to demonstrate transcontinental communications by sending full-duplex transmissions between terminals in Camp Parks, California, and Westford, Massachusetts. The orbiting scatterers would act as halfwave dipoles resonating at about 8 GHz, midway between the transmitted frequency limits of 7750 and 8350 MHz. The experiment was planned to release approximately 480 million copper dipoles, each with a 0.0007-inch diameter and 0.7-inch length, into an orbital belt. These dipoles would weigh 40  $\mu\text{g}$  each and have an average separation of 0.3 km (Figure 5-1).

Sixty-foot-diameter paraboloidal antennas would be fed by transmitters on the ground with 20 to 40 kW average power. Maser receivers would provide what was then the lowest attainable system noise temperature at that wavelength, approximately 60 K. The waveforms were selected to satisfy the requirements of communication via forward scatter from the orbiting dipoles and to probe the characteristics of the belt via radar backscatter and forward scatter.

Recognizing that a proposal to place vast numbers of anything into orbit would be controversial, Lincoln Laboratory designed the proposed experiment, named Project West Ford,<sup>3</sup> to ensure that the dipole scatterers were in a resonant orbit such that the pressure of incident solar radiation on the orbiting dipoles would cause their orbits to decay. After a few years, the orbits would dip into the upper atmosphere of the earth, where atmospheric drag would rapidly cause them to fall back to earth. Then the experimental dipole belt would disappear.





**Figure 5-1**  
**The Project West Ford orbiting dipoles**  
**were hairlike segments of copper wire.**

While Project West Ford had initially been classified secret, the necessity for openness was clear to all involved. In 1960, Lincoln Laboratory unveiled West Ford in virtually complete detail. Of particular importance was allaying the concerns of optical and radio astronomers who perceived the experimental belt as capable of interference with scientific observations and as a precursor of worse experiments to come.

On October 21, 1961, the first experiment was launched into circular polar orbit. It was unsuccessful; the dipoles did not deploy as planned. On May 8, 1963, a second launch, in the same manner but with improved dipole-dispensing arrangements, achieved a substantial degree of success. The belt formed and closed over a period of about 40 days; its density was approximately five dipoles per cubic kilometer.

As expected, the effectiveness of the scatterers proved greatest in the early stages of belt formation, when the dipoles were less widely dispersed. The dipoles' density in the common volume illuminated by the beams of the two terminal antennas allowed communication at data rates of up to 20,000 bps.

Project West Ford demonstrated the feasibility of space communications from orbiting dipole belts. Over the next two years, the belt became progressively less effective for scatter communications, testimony that it was indeed cleaning itself out of orbit. By early 1966, the removal process was almost complete. At the conclusion of the measurements and demonstrations, the Camp Parks and Westford terminals were converted to other uses.

Although Project West Ford was an undeniable success, active satellite communications had already superseded passive scatter communications. The use of passive satellites like the West Ford dipoles required large investments in complex terminals and provided only limited capabilities. Because of their success and burgeoning availability, active communications satellites quickly swept the field.

### **First Television Transmission via Satellite**

The equipment developed for Project West Ford was used to transmit a television picture via satellite for the first time on April 24, 1962. The Echo I satellite, actually a balloon that had been launched almost two years earlier by the National Aeronautics and Space Administration (NASA), was in an orbit approximately 1000 mi above the earth. The satellite had been in use for transcontinental voice and facsimile experiments by the California Institute of Technology's Jet Propulsion Laboratory and the Bell Telephone Laboratories. Following the conclusion of these experiments, Lincoln Laboratory began an effort to use Echo I to bounce a television signal across the United States.

The microwave frequency transmission and receiving equipment utilized was developed at the Laboratory. The transmitter was located at the Project West Ford site in Camp Parks, the receiver on Millstone Hill in Westford, Massachusetts. The Lincoln Laboratory team responsible for the first transmission of a television picture via a communications satellite included Daniel Hamilton, Harold Hoover, Richard Locke, Donald MacLellan, Walter Morrow, Burt Nichols, Thomas Rogers, and Philip Waldron.

By the time of this experiment, the balloon had deflated partially, making it difficult to track. In addition, its orbit was unpredictable over more than a short period because of the effects of solar pressure. The effects of solar pressure on Echo I had actually been discovered first by the Millstone radar a few days after the satellite's launch.

For this experiment, Echo I was tracked by optical telescopes to determine its exact orbit and to permit the narrow transmitting and receiving antenna beams to be maintained on the satellite. Both the transmitting and receiving sites were equipped with 60 ft diameter antennas; the receiver also included a low-noise maser amplifier. Signals were transmitted at a frequency of 8.350 GHz with a power of 20 kW. Although the low received signal level relative to the electrical noise background limited the quality of the transmission, the picture was clear. This simple televised message added yet another first to MIT's accomplishments (Figure 5-2).

## Notes

**1** This chapter is largely taken from W.W. Ward and F.W. Floyd, "Thirty Years of Research and Development in Space Communications at Lincoln Laboratory," *Linc. Lab. J.* **2(1)**, 5–34 (1989).

**2** An entire issue of the *Proceedings of the IEEE* was devoted to Project West Ford, including an overview, a discussion about the concerns of scientists, and detailed descriptions of the program. See *Proc. IEEE* **52(5)**, 451–640 (1964).

**3** The effort was originally called Project Needles because of the shape of the dipoles, but the name attracted negative publicity and was soon changed to Project West Ford.

**4** The characteristics of Lincoln Laboratory's communication satellites have been extensively reviewed by three sources:

(a) H. Sherman, D.C. MacLellan, and P. Waldron, "The Lincoln Satellite Technology Program through 1 January 1968: An Annotated Bibliography," *Lincoln Laboratory Technical Report 450*. Lexington, Mass.: MIT Lincoln Laboratory, 12 June 1968, DTIC AD-679-559; (b) M.T. Brown, Jr., *Compendium of Communication and Broadcast Satellites — 1958 to 1980*. New York: IEEE, 1981; (c) D.H. Martin, *Communication Satellites 1958–1988*. El Segundo, Calif.: Aerospace Corp., 1988.

## Space Communications at Superhigh Frequency

Lincoln Laboratory's first program in active satellite communications emphasized enhancing satellite downlinks. The downlink signal (from a satellite to a surface terminal) is generally the weak link in satellite communications. The uplink can be improved by increasing the power of a transmitter; the downlink can be strengthened only by maximizing the effective radiated power per unit mass in orbit — a more complex task.

To resolve the downlink problem in satellite communications, the Lincoln Laboratory group set out to develop high-efficiency spacecraft transmitters in the downlink frequency band. These and other spacecraft-related technologies were addressed by a series of Lincoln Experimental Satellites (LES), which were launched between 1965 and 1976.<sup>4</sup>

High-efficiency systems of modulation and demodulation, together with encoding and decoding signals for detection and correction of errors, promised significant advantages for communication terminals. Also needed were interference-resistant, multiple-access signaling techniques that would permit simultaneous use of a satellite by tens or hundreds of users, some of them mobile, without invoking elaborate systems for synchronization and centralized control. These and other terminal-related problems were addressed by a series of Lincoln Experimental Terminals (LET) that went hand in hand with the LESs.

The Lincoln Laboratory satellite communications program got under way in 1963 with a charter to build and demonstrate satellite communications systems that addressed military needs. The initial program objective was to build a LES and a LET that would work together as a system and demonstrate practical military satellite communications (MILSATCOM). The availability of Project West Ford's advanced RF technology at superhigh frequency (SHF) — 7 to 8 GHz — contributed to the decision to design LES-1 and LET-1 for that band.



**Figure 5-2**  
First television picture transmission  
via satellite.

## Notes

**5** P. Rosen and R.V. Wood, "The Lincoln Experimental Terminal," *IEEE Comm. Conv. Rec., Boulder, Colo.*, June 1965, p. 355; P.R. Drouilhet, Jr., "The Lincoln Experimental Terminal Signal Processing System," *IEEE Comm. Conv. Rec., Boulder, Colo.*, June 1965, p. 335; I.L. Lebow, "Sequential Decoding for Efficient Channel Utilization," *IEEE Comm. Conv. Rec., Boulder, Colo.*, June 1965, p. 47.

**6** J.M. Wozencraft and B. Reiffen, *Sequential Decoding*. Cambridge, Mass.: MIT Press, 1961.

**7** K.E. Perry and J.M. Wozencraft, "SECO: A Self-Regulating Error Correcting Coder-Decoder," *IRE Trans. Inf. Theory* **8(5)**, 128–135 (1962).

**8** R.M. Fano, "A Heuristic Discussion of Probabilistic Decoding," *IEEE Trans. Inf. Theory* **9(2)**, 64–74 (1963).

**9** H. Sherman, D.C. MacLellan, R.M. Lerner, and P. Waldron, "Lincoln Experimental Satellite Program (LES-1, -2, -3, -4)," *J. Spacecr. Rockets* **4(11)**, 1448–1452 (1967).

Both LES-1 and its twin, LES-2, were built as small polyhedrons with masses of 37 kg, solar powered, and spin stabilized. Each satellite's communications transponder acted as a bent pipe in the sky; it translated signals received at the uplink frequency to the downlink frequency after passing the signals through a 20 MHz wide filter at intermediate frequency and a hard limiter. In response to measurements by visible-light sensors of the earth's position, an autonomous electronic antenna-switching system would connect one of eight SHF horn antennas on the corners of the polyhedron to the transponder. A magnetic attitude-control system (pulsed electromagnets working against the earth's magnetic field synchronously with sensor outputs) kept the satellite's spin axis oriented perpendicular to the line of sight with the sun, and thus avoided thermal problems.

The Titan III-A boosters that carried LES-1 and -2 were capable of carrying satellites to inclined circular orbits at altitudes of about 2800 km. To reach a higher altitude, allowing tests that would better represent operational MILSATCOM systems, LES-1 and -2 were each equipped with a perigee kick motor, a solid rocket that would place the satellite in an inclined elliptic orbit with 15,000 km apogee.

LES-1, launched from Cape Canaveral, Florida, on February 11, 1965, accomplished only a few of its goals. Apparently because of ordnance-circuitry miswiring, the satellite never left its circular orbit. LES-2 did much better: on May 6, 1965, it achieved its planned final orbit.

A complete, self-contained, transportable ground terminal, LET-1 was equipped to test and demonstrate evolving satellite communications techniques in realistic

environments.<sup>5</sup> The terminal included a modulation/demodulation system based on 16-ary frequency-shift keying, frequency hopped over a 20 MHz wide band at SHF. Sequential decoding<sup>6</sup> had been demonstrated at Lincoln Laboratory with the design and construction of a sequential encoder-decoder, a convolutional encoder and sequential decoder for a two-way communications system.<sup>7</sup> For the LET-1, a more efficient decoding implementation that used the Fano algorithm reduced the equipment substantially.<sup>8</sup> This set of features, tailored to match the characteristics of LES-1 and -2, provided protection against interference, whether by happenstance or by intention, and was applicable for communication over dispersive channels that used orbiting scatterers such as the moon or the West Ford dipole belt.

LET-2 and -3, each consisting of only a signal processing van (thus not incorporating a transmitter or an antenna), were built at about the same time as LET-1. One of these terminals was used with the SHF West Ford terminal at Westford; the other was transferred to the Army Signal Corps for service with SHF terminals at Camp Roberts, California, and Fort Monmouth, New Jersey. The signal processing features of LET-1, -2, and -3 included advanced vocoders for speech compression and reconstruction, and convolutional encoders and sequential decoders for detecting and correcting errors in the received data stream. The incorporation of cryogenically cooled varactor-diode parametric amplifiers, which provided a system noise temperature of about 55 K, improved the sensitivity of LET-1's receiving system.

The next step in Lincoln Laboratory's program in satellite communications was to place a satellite in geosynchronous orbit, and LES-4 was built to fulfill that mission.

1955



T.F. Rogers



G.P. Dinneen



W.E. Morrow, Jr.



The satellite was an outgrowth of LES-1 and -2; the 53 kg satellite had a greater number of solar cells and an enlarged array of sun and earth sensors.<sup>9</sup> The SHF transponder on LES-4 was essentially identical to the ones on LES-1 and -2, although its electronically switched SHF antenna system to despin the antenna beam was more sophisticated. LES-4 carried an instrument for measuring spatial and temporal variations of the energy spectrum, in five energy ranges, of trapped electrons encountered in orbit. This instrument was added to provide information of scientific interest and for use in the design of future spacecraft.

A Titan-IIIC booster was to carry LES-4 and its companion, LES-3, to a near-geosynchronous altitude and deposit them in circular, near-equatorial orbits with eastward drift in subsatellite longitude of about 30° per day. These satellites did not have onboard propulsion systems. The satellites would be visible to any given terminal for about five days, then disappear in the east. Unfortunately, the booster failed to finish its job, leaving these satellites stranded in their transfer ellipses. This disappointment, however, had its bright side: LES-4's repeated trips between perigee (195 km) and apogee (33,700 km) gave it many opportunities to measure the radiation environment over a wide range of altitudes.

LES-4's communications system worked as well as it could under the handicap of being in the wrong orbit. Ultimately, as with the West Ford dipoles, LES-4 descended into the upper atmosphere and burned up.

Lincoln Laboratory's accomplishments in SHF satellite communications opened up a part of the electromagnetic spectrum that remains heavily used today. In fact, SHF satellites now form the space segment of the Defense Satellite Communication System (DSCS).

### Space Communications at Ultrahigh Frequency

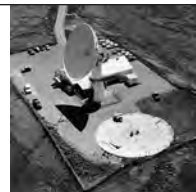
LES-1, -2, and -4 and the LETs demonstrated the capabilities of SHF for reliable communication between large fixed and mobile ground terminals. These technologies, however, were not useful for small tactical units such as vehicles, ships, aircraft, and infantry, all of which needed direct, dependable communication. Only a large command-post airplane or a sizable ship could be equipped with an SHF terminal that could work with the DSCS satellites in orbit and with those planned for the immediate future.

Because high levels of RF power at SHF could not be generated in the satellites, the downlink continued to limit system performance. Each terminal needed a large antenna aperture to capture enough of the weak downlink signal, and the price for a large antenna aperture at SHF was a narrow antenna beam that had to be pointed precisely toward the satellite. Small tactical units could not accommodate such complex antenna systems, particularly if the platform carrying the terminal would be in motion.

Communication links at much lower frequencies (in the military ultrahigh-frequency [UHF] band, 225 to 400 MHz) solved the downlink problem. Solid-state circuits could generate substantial amounts of RF power at UHF in a satellite. A relatively uncomplicated low-gain terminal antenna could provide a sizable effective receiving area, which permitted closing of the link, and a broad beam, which simplified the task of pointing an antenna in the direction of the satellite. Such antennas were particularly appealing for aircraft installation. UHF terminals promised to be comparatively simple and inexpensive, and they could be readily produced in large numbers.



Project West Ford orbiting dipole belt



Project West Ford terminal, Westford, Mass.

Project West Ford terminal, Camp Parks, Calif.



First photograph transmitted by satellite

---

## Notes

**10** D.C. MacLellan, H.A. MacDonald, P. Waldron, and H. Sherman, "Lincoln Experimental Satellites 5 and 6," *Progress in Astronautics and Aeronautics, Vol. 26, Communication Satellites for the 70s: Systems*, eds. N.E. Feldman and C.M. Kelly. Cambridge, Mass.: MIT Press, 1971, p. 375.

**11** I.L. Lebow, K.L. Jordan, Jr., and P.R. Drouilhet, Jr., "Satellite Communications to Mobile Platforms," *Proc. IEEE* **59(2)**, 139–159 (1971).

**12** P.R. Drouilhet, Jr., and S.L. Bernstein, "TATS — A Band-Spread Modulation-Demodulation System for Multiple Access Tactical Satellite Communications," *EASCON '69 Conf. Rec.* New York: IEEE, 1969, p. 126.

**13** E.A. Bucher and D.P. White, "Time Diversity Modulation for UHF Satellite Communication during Scintillation," *National Comm. Conf.*, Vol. 3. New York: IEEE, 1976, p. 43.4–1.

In 1965, the Department of Defense (DoD) approved a program to evaluate the potential usefulness of satellite communications in the military UHF band, and it was agreed that Lincoln Laboratory would provide the satellites essential to the test program.

Lincoln Laboratory carried out two programs to measure the characteristics of the UHF environment. In the first, receiving equipment was installed in aircraft and flown over representative cities and varied terrain to measure RF noise. In the second, propagation phenomena between satellites and airborne terminals were examined. For this program, LES-3 was built in haste, with technology from LES-1, -2, and -4, and was launched along with LES-4 on December 21, 1965.

LES-3 was essentially a signal generator in orbit. It radiated a signal near 233 MHz that was biphasic modulated by a 15-bit maximal-length shift-register sequence at a clock rate of 100,000 bps. Correlation of the signal received in an aircraft with a replica of the known sequence brought out time-delay structures in the propagation path. Multipath propagation effects were expected, and they were observed: relative to the 1 m free-space wavelength of 300 MHz (the middle of the military UHF band), much of earth's surface is mirrorlike, so electromagnetic waves can be propagated between the satellite and the airborne terminal by a direct path and also by paths involving reflection off the earth's surface. By knowing the likely parameters of the signal delays, the Lincoln Laboratory group was able to design systems of modulation and demodulation for UHF satellite communications that would not be confounded by multipath propagation effects.

As mentioned, booster problems trapped LES-3 and -4 in elliptical transfer orbits. The orbit of LES-3, however, was quite adequate for gathering multipath propagation data over a wide variety of terrains. As had LES-4, LES-3 descended, reentered the atmosphere, and disintegrated.

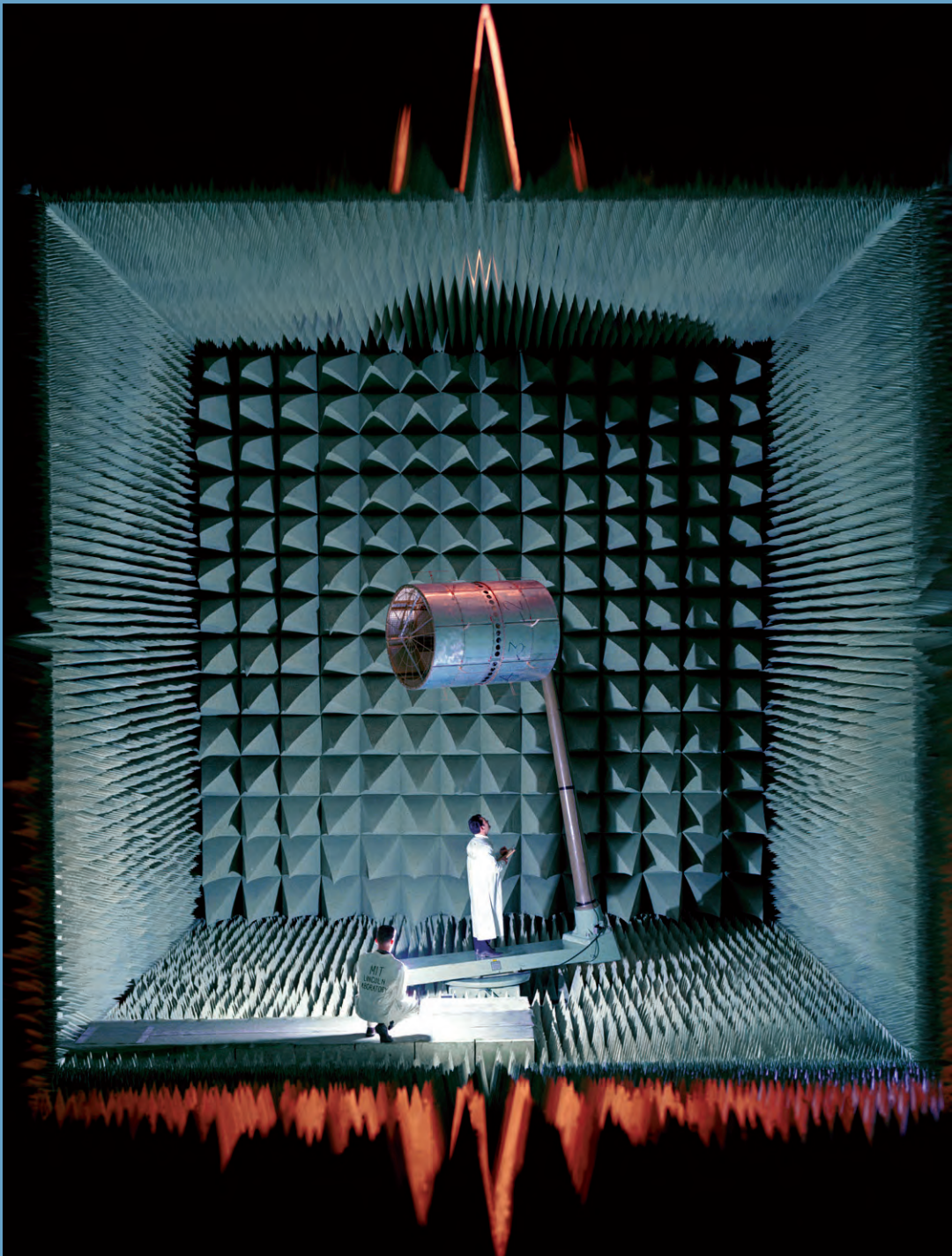
LES-5, launched by a Titan-IIIC booster on July 1, 1967, and LES-6, launched in the same way on September 26, 1968, share a strong family resemblance.<sup>10</sup> Each satellite is powered by solar cells and is spin stabilized around an axis nominally perpendicular to the near-equatorial orbit plane. The central feature of each of these satellites is a broadband, hard-limiting, frequency-translating UHF-to-UHF transponder (Figure 5-3).

The Lincoln Laboratory program showed that satellite communications in the military UHF band worked well.<sup>11</sup> The Tri-Service terminals in ships and aircraft and in the field communicated readily through LES-5 in orbit. To enhance satellite communications at UHF to and from mobile platforms, Lincoln Laboratory developed a special antijam/multiple-access system of modulation and demodulation based on frequency hopping and coded multiple-frequency-shift keying (MFSK). The Tactical Transmission System (TATS) that worked with LES-5 was completed at the last minute, after the launch, but before the insertion into final orbit! TATS met its performance goals and was put into production by the DoD.<sup>12</sup>

LES-6 placed substantial communications resources in geostationary orbit (Figure 5-4). Since the LETs for UHF were small, with relatively low-gain antennas, the DoD decided to procure large quantities of UHF terminals.

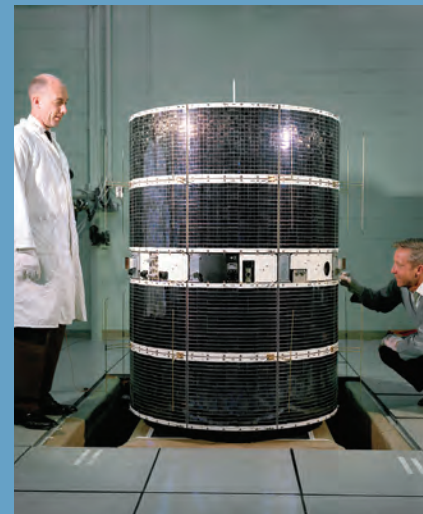
As will be discussed, it is very difficult to defend a communications satellite with a UHF uplink against a determined jamming attack. Nevertheless, since the simplicity and comparative cheapness of UHF MILSATCOM terminals make this part of the spectrum highly attractive, it is likely to remain in use for a long time.

UHF satellite communications tests soon revealed that electromagnetic signals were sometimes subject to amplitude scintillations due to propagation through the turbulent ionosphere that could disrupt communication links. Because these effects occurred most often near the geomagnetic poles and the geomagnetic equator, the Laboratory studied transmissions from Guam. These observations were used to develop and test a successful time-diversity system for use with the Navy UHF fleet broadcast.<sup>13</sup>



**Figure 5-3**  
Earl Hunter (left) and Benjamin Steinberg (right) with an antenna model of LES-6 in an anechoic chamber.

**Figure 5-4**  
Andrew Howitt (left) and Claude Gillaspie (right) inspect the LES-6 satellite. Launched on September 26, 1968, LES-6 had a long and useful career before it was retired after many years of service. A test conducted in December 1993 showed that the satellite remained functional.





---

## Notes

**14** L.E. Taylor and S.L. Bernstein, "TACS — A Demand Assignment System for FLEETSAT," *IEEE Trans. Commun.* **COM-27(10)**, 1484–1496 (1979).

**15** F.W. Sarles, Jr., L.W. Bowles, L.P. Farnsworth, and P. Waldron, "The Lincoln Experimental Satellites LES-8 and LES-9," *EASCON-77 Rec. 1977*, 21-1A (1977). IEEE No. 77CH1255-9 EASCON.

As the number of UHF satellite communications terminals grew, so did the importance of increasing the utilization efficiency of the UHF satellite transponders. Lincoln Laboratory developed a system that accomplished this goal by improving the ground terminals. A laboratory demonstration of the Terminal Access Control System (TACS) led to the Navy's procurement of the demand-assigned multiple-access system for its UHF satellite communications systems.<sup>14</sup>

LEs have often accommodated space-technology experiments. LES-6 carried a solar cell experiment for measurement of degradation effects, a detector for measurement of particle radiation (similar to one on LES-4), a pulsed-plasma-thruster system for orbit control, a system for autonomous attitude control, and a system for automatically station-keeping the satellite in longitude. Lincoln Laboratory also conducted a study of the characteristics of the RF environment near the altitude of geosynchronous orbit.

After the LES-6 test program was successfully completed, LES-6 began a long period of operational communications support. The satellite was placed on reserve status in March 1976.

A condition check of the LES-6 communications transponder, carried out between December 13 and 15, 1993, showed that it still worked after 25 years in space. The satellite's output power and receiving sensitivity were found to be significantly poorer than they were during the years just after launch. However, LES-6 would still have been able to provide limited communications support at that time; its stalwart endurance testifies to the extremely long, useful lives of spacecraft systems.

### Multiple-Beam Antennas

Although UHF technology had been the main focus for LES-5 and -6 because it would permit affordable operation to mobile platforms, SHF was more desirable for MILSATCOM applications. In particular, the greater bandwidth of SHF permitted the use of antijam communication links and of higher data-transfer rates. Moreover, LES-1, -2, and -4 and the LETs showed that SHF could provide reliable communication with appropriate ground terminals. Therefore, for the design of LES-7, Lincoln Laboratory returned to the SHF band.

The antenna systems on earlier SHF satellites had been small in terms of wavelength, and their beams were much larger than earth coverage (which is about 18° from synchronous altitude). The next level of sophistication in SHF space communications was a satellite antenna system with a mechanically pointable, less-than-earth-coverage beam. Lincoln Laboratory undertook to develop and demonstrate, in orbit, an antenna system that could allow satellite operators to aim the transmit (downlink) power to receivers and simultaneously reduce the receiving (uplink) sensitivity in directions that might include sources of jamming or other interference.

Lincoln Laboratory adopted the multiple-beam-antenna (MBA) approach to shape the downlink beam. In this method, many separate antenna feeds form a dense set of narrow pencil beams covering the earth. The signals from this collection of beams are adjusted in amplitude and phase and then combined to approximate the desired antenna pattern.

Lincoln Laboratory began a program to demonstrate, in orbit, a nineteen-beam MBA for uplink reception at SHF. A single earth-coverage horn was to be used for transmission. The 30-inch-diameter aperture of the nineteen receiving antenna beams was designed to yield a nominal 3° resolution throughout the cone subtended by the earth from geosynchronous satellite altitude. The nineteen beams could be weighted to approximate the desired antenna pattern.

As a design concept, the MBA would be kept facing the earth by the satellite's three-axis stabilized attitude-control system. Solar-cell arrays were to be sun oriented to collect energy as LES-7 revolved during its orbit around the earth. Work got under way to develop the satellite bus — consisting of structure and housekeeping systems, power, propulsion, attitude control, thermal control, telemetry, and telecommand — in parallel with the development of the MBA and of the communications system associated with it.



**Figure 5-5**  
**LES-8 (left) and LES-9 (right)**  
 assembled at Cape Canaveral Air  
 Force Station, Florida. The satellite  
 assembly was integrated with the  
 Titan-IIIC booster.

By early 1970, it became apparent that LES-7 was ahead of its time. Since there was not enough support in the DoD for the mission, the funding required for the satellite's development, launch, and evaluation in orbit was not available. Lincoln Laboratory, with considerable regret, put aside the LES-7 flight program. The critical technology of the MBA was carried through final development and was placed on the shelf. Happily, in a few years, the MBA concept found application on DSCS-III, the third generation of the Defense Satellite Communications System, for which it was adopted, almost without change, as the primary antenna system.

#### **Space Communications at Extremely High Frequency**

LES-8 and -9 were a pair of experimental communications satellites that Lincoln Laboratory developed and built to demonstrate high-reliability, survivable, strategic communications technologies (Figure 5-5).<sup>15</sup> They were designed to operate in coplanar, inclined, circular, geosynchronous orbits and to communicate with each other via intersatellite links (crosslinks) at extremely high frequency (EHF), and with terminals operating on or near the surface of the earth at both EHF and UHF. The overall system provided for assured communications between a limited number of strategic terminals at data rates ranging from teletype (75 bps) to vocoded voice (2400 bps) and computer data exchange (19,200 bps). The system design incorporated a number of band-spreading and signal processing techniques for electromagnetic survivability, including encoding/decoding, interleaving/deinterleaving, multiplexing/demultiplexing, frequency hopping/dehopping and demodulation, crossbanding, and remodulation on board the satellite.

The EHF portion of the spectrum held out the promise of abundant bandwidth to accommodate many simultaneous users and spread-spectrum systems of modulation and demodulation for electromagnetically survivable (i.e., hard, antijam) communication links. For reasons of convenience, operating frequencies in the Ka-band (36 to 38 GHz) were selected for the LES-8 and -9 experiments.

One of the strengths of Lincoln Laboratory's program in satellite communications is that it encompasses the development of terminals and of satellites in one organization. The LES-8 and -9 experiments were

sufficiently complex that in 1971 the Communications Division established a project office headed by Donald MacLellan to manage the program.

Transmission and reception for satellite links providing substantial antijam capability, such as links through LES-8 and -9, are complex when compared to links that rely on unprotected transponders, such as links through LES-1, -2, -4, -5, and -6. It would be very difficult if the space and terrestrial segments of a modern MILSATCOM system were developed separately and if their first operating encounter took place after launch. Lincoln Laboratory conducted extensive end-to-end testing of communication links before launch, including the terminals that Lincoln Laboratory developed and those developed by the Air Force and the Navy. The generally smooth course of the communication-link testing in orbit owed a great deal to the prelaunch testing at Lincoln Laboratory.

The LES-8 and -9 intersatellite links successfully addressed the key technical problems that confronted the implementation of satellite-to-satellite communications. The two satellites were launched together on March 14, 1976. The Titan-IIIC booster placed them in nearly coplanar, circular, geosynchronous orbits with equatorial inclinations of about 25°.

LES-8 and -9 were powered by radioisotope thermoelectric generators and had no solar cells or batteries. These generators performed superbly. They provided continuous electrical power throughout the seasonal eclipses of the sun by the earth that geostationary satellites experience.

The daily latitude excursions of LES-8 and -9 (now between 17°N and 17°S) are very different from those of most commercial communications satellites, which are station-kept in latitude and longitude to a small fraction of a degree. (Station-keeping enables commercial satellites to serve customers who have terminals without a satellite-tracking capability.) But what might seem to be a problem became an advantage. The motion of LES-8 and -9 relative to ground-based terminals provided a good way to test the motion-compensation circuitry of terminals that operate on moving platforms. Moreover, daily north/south excursions yielded long intervals of visibility from sites in the Arctic and in the Antarctic.

---

**Note**

**16** M.D. Semprucci, "The First 'Switchboard in the Sky': An Autonomous Satellite-Based Access/Resource Controller," *Linc. Lab. J.* **1**, 5 (1988).

After the demonstration phase in which the LES-8 and -9 onboard signal processing and crosslink capabilities were extensively tested, the government has used the LES-8 and -9 features, especially the tunable UHF receivers, to complement critical operations. One such activity involved using LES-9 for several years to provide connectivity to the U.S. Naval Support Force Antarctica so that business could be transacted and people stationed in Antarctica could talk to the folks back home.

LES-8 and -9 represented significant achievements of Lincoln Laboratory's program in satellite communications. In addition to the complex communications system, these satellites included systems and subsystems for housekeeping functions, including attitude control, onboard propulsion, telemetry, and telecommand.

LES-8 was retired in 2004, but LES-9 is still supporting government operations, and Lincoln Laboratory continues to be responsible for its upkeep. The Lincoln Experimental Satellite Operations Center (LESOC) operates and maintains LES-9, and will continue to serve it as long as it remains useful.

The satellites' many features, alternatives, and backup modes give them capabilities that were neither advertised nor appreciated before launch. For example, the hopped local oscillator in the uplink receiver can be set by telecommand, so the satellite can listen to nearly any frequency over a broad stretch of the military UHF band. Instrument-quality power-measurement circuitry in the uplink receiver then gives readings that are telemetered to LESOC. Reduction of an extended collection of these data yields a statistical analysis of spectrum occupancy at the measured frequency by terrestrial terminals, a technique that is a significant advance over the less flexible RF environment measurements made by LES-5 and LES-6.

For another example, consider LES-8's contributions to radio astronomy. The radio telescopes needed for millimeter-wave and submillimeter-wave observations have to be large and have highly accurate reflecting surfaces. These surfaces are usually made up of a number of precision replicated panels, each a portion of a paraboloid of revolution. The assembly of the primary reflector presents the problem of positioning the panels relative to one another in a way that best approximates the desired overall reflector shape.

Techniques have been developed to measure the local shape of a reflector by holographic analysis of signals received from a distant, monochromatic RF source. The Ka-band transmitting systems of LES-8, pointed toward an antenna under test, are well suited to this purpose. Eight radio-astronomy observatories have made use of this service and found that using LES-8 to map their reflector surfaces at 38 GHz and then to adjust the panels for a better fit to the desired overall shape yields improved performance at frequencies many times higher (e.g., 230 GHz).

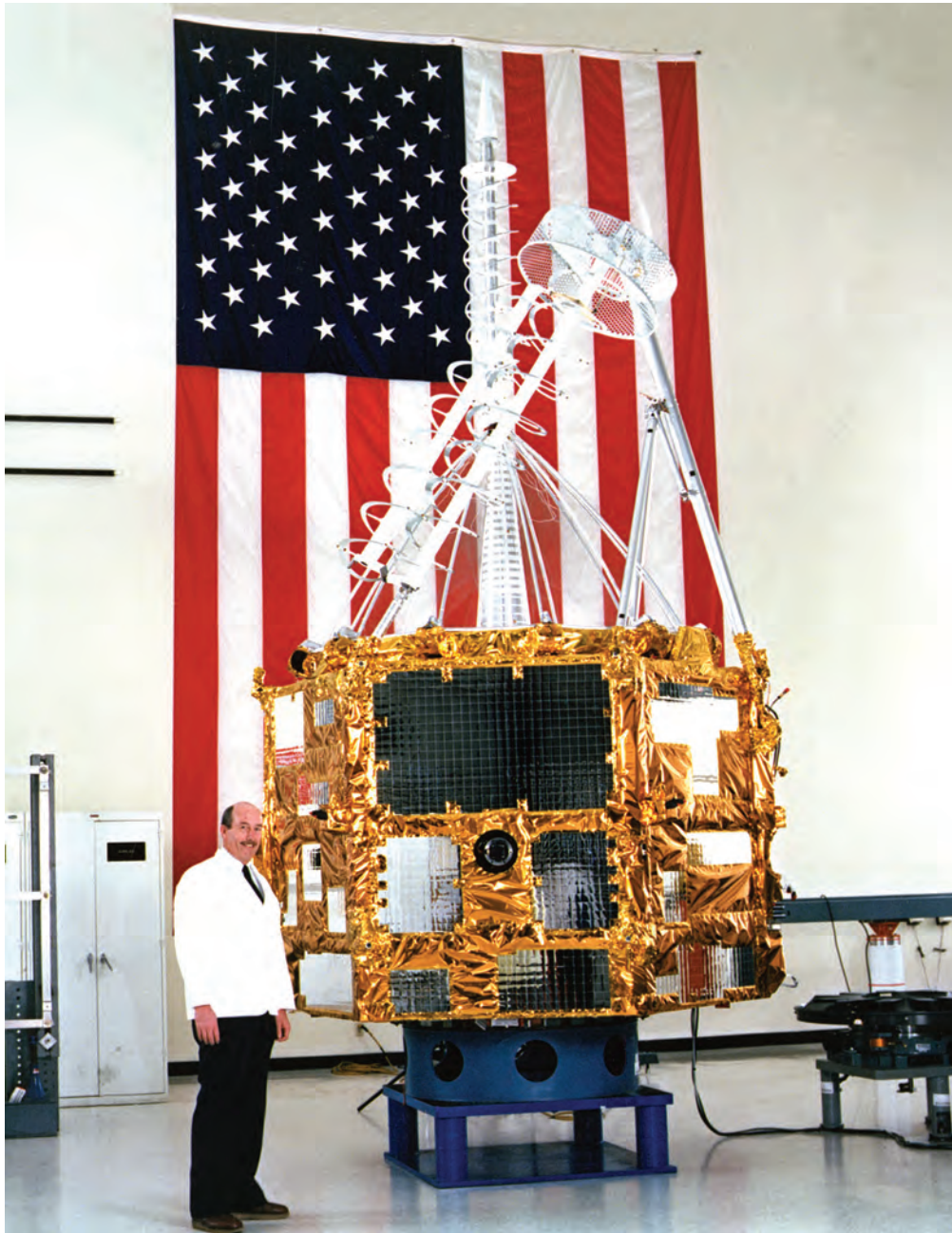
### **Switchboards in the Sky**

Following the launch of LES-8 and -9 in 1976, Lincoln Laboratory intensively addressed the problem of providing affordable antijam communications to many small, mobile users. Because military UHF does not have enough available bandwidth to provide required levels of antijam protection, communications systems in the military UHF band (225 to 400 MHz) are not convincingly robust. Thus all space communications links intended for survival were moved into the EHF domain.

The major advantage to military users is that EHF supplies the bandwidths necessary to implement robust, antijam systems based on spread-spectrum technologies. By using advanced spread-spectrum techniques with uplink-antenna beam discrimination, extensive onboard signal processing, and downlink-antenna beam hopping, a modest-size satellite can simultaneously serve large numbers of small, mobile users with highly jam-resistant communication channels.<sup>16</sup> The probability that covert transmissions from terminals that wish to remain unnoticed will be intercepted is reduced at EHF. However, the effects of rain attenuation on link operation at EHF require that — to minimize outage — the minimum elevation angle of the satellite relative to the terminal must be significantly higher than for lower-frequency systems.

In consultation with its sponsors, Lincoln Laboratory designed a potential EHF system and built test-bed satellite and terminal hardware that incorporated the features mentioned above and served as a focus for a Laboratory technology development program. The essential features of the system were demonstrated on the bench at Lincoln Laboratory in 1980 and 1981 in the combined operation of a test-bed spacecraft and a test-bed terminal.





**Figure 5-6**  
**Andrew Howitt with the TRW-built FLTSAT-7 satellite. The first Lincoln Laboratory-built FLTSAT EHF Package was integrated into this satellite as the bottom ring.**

The EHF system concept and the associated technologies in development at Lincoln Laboratory served as a point of departure for thinking about EHF systems within the DoD MILSATCOM community. In particular, Lincoln Laboratory was asked to build FLTSAT EHF Packages (FEP) for TRW's Fleet Satellite Communications (FLTSAT) UHF/SHF communications satellites. The first FEP was integrated with FLTSAT-7 and launched from Cape Canaveral by an Atlas/Centaur booster on December 4, 1986 (Figure 5-6); the second was part of FLTSAT-8, launched September 25, 1989. The electronics and antenna assemblies of each FEP were built by Lincoln Laboratory under very tight power (305 W) and mass (111 kg) constraints.

The FEP's uplink and downlink frequency bands, near 44 GHz (EHF) and 20 GHz (SHF), conform to the allocations set at the 1979 World Administrative Radio Conference. The FEP's antenna assembly provides an earth-coverage beam and a mechanically steered approximately 5° spot beam in both the uplink and downlink bands. Lincoln Laboratory put aside its usual preference for all-solid-state circuitry in this instance and incorporated a traveling-wave-tube amplifier, because of the power requirements, plus a spare, in the downlink transmitter time-shared between the two antennas. This amplifier has worked well.

Two technological innovations are key to the development of the FEP. First, the application of surface-acoustic-wave chirp/Fourier-transform devices developed and fabricated by the Laboratory's Solid State Division has made it possible for the satellite receivers to demodulate simultaneously — with minimum demand for dc input power — the MFSK signals received in many of the narrowband frequency bins. Second, a computer-based resource controller sets up data channels that operate at different data rates, via different antenna beams and other means, to support individual-user communications needs. Although the computer-to-computer dialogues between the FEP and the users' terminals are complex, the required human/machine interactions are user-friendly and are easily performed by the terminal operators.

## Communications Support for Operation Desert Storm

In the fall of 1990, as the United States and coalition forces began the buildup of force that led to the liberation of Kuwait, it became clear that additional communications capabilities were needed in the theater of operations. Most U.S. satellites were positioned over the western hemisphere and, therefore, could not support communications in the Persian Gulf area. Some communications resources were available, but they were inadequate for the demands then being anticipated for Operation Desert Storm.

The command, control, and communications support effort of the Joint Staff approached Lincoln Laboratory and asked the Communications Division if it could provide additional communications resources. The answer was affirmative. A Lincoln Laboratory FEP was directed to provide an antijam EHF/SHF communications capability between the United States and the command headquarters in the Gulf area. LES-9 could also be configured to support communications in the Persian Gulf. Although the satellite was approaching its fifteenth year in space, it still worked well. LES-9 was stationed at a longitude of 105°W, but onboard thrusters allowed the satellite to change its position.

On December 20, 1990, LESOC commanded LES-9 to initiate a thrusting operation. The objective was to place the satellite in geostationary orbit at a longitude of 10°W, a position that would provide around-the-clock visibility of the satellite to coalition forces in the theater of operations.

Time was critical. To reach the objective before Operation Desert Storm commenced, LES-9 had to move at a rate of 4.4° per day—about eight times faster than the satellite had ever moved before. To provide enough electrical power for the satellite's heaters, it was necessary to change the UHF transponder transmitter from high-power to low-power operation.

LES-9 drifted freely eastward until it was time to commence west-face thrusting to stop the satellite. The stopping operation was complicated by the fact that, as LES-9 approached its new station, it ceased to be visible to LESOC around the clock. Thrusting was carried out only while LES-9 could be seen and controlled from LESOC.

LES-8, meanwhile, was also called to duty. The satellite was shifted from its station at 65°W longitude to a new position at 105°W longitude, where it could replace LES-9 to a significant extent. Thrusting operations for LES-8 began on January 2 and concluded on February 8, 1991.

On January 21, 1991, LES-9 arrived at a longitude of 10°W, and high-power operation of the UHF transmitter was restored. The air-war phase of Operation Desert Storm had just begun; through the rest of the air war and through the 100-hour ground war in February, the satellite provided an important communications asset for the forces in the Persian Gulf region.

The resource controller in the orbiting FEP carried out most of its computer-to-computer transactions with users and would-be users without supervisory intervention. Two FEP operations centers were built: one was installed at Lincoln Laboratory; the other, transportable though by no means mobile, was installed at a Navy facility near Prospect Harbor, Maine. (The Navy was the operational manager of the FEP communications system.) After 21 years of service (18 for FEP-8), FEP-7 and -8 were retired in 2007.

During the FEP program, Lincoln Laboratory concentrated on the challenging technologies required for the FEP, taking advantage of the satellite-bus technologies already developed and proven in space by TRW's series of FLTSAT satellites. The success of the FEP program speaks well for Lincoln Laboratory's approach to implementation and its quality assurance in building reliable spacecraft.

### Protected Communications

The FEP payloads blazed the trail for low-data-rate (LDR) protected communications spanning data rates from 75 bps to 2400 bps. The Lincoln Laboratory technologies and concepts demonstrated by FEP and LES-8 and -9 were built into the DoD Milstar I (first launched in 1994) and UHF Follow-On EHF Package (first launched in 1995) payloads. The LDR terminals that were developed to work with these satellites were tested operationally using the on-orbit FEP payloads.

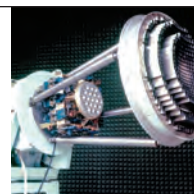
1970



C.E. Shannon, P. Rosen, and J.M. Wozencraft with first self-regulating error-correcting coder-decoder



LES 1  
LES-4



Waveguide-lens multiple-beam antenna  
D.C. MacLellan

Meanwhile, the Laboratory worked on extending the data rates supported by protected satellite communications and on reducing the size, weight, and power required for the electronic subsystems. Based on a frequency-hopped, differential phase-shift keyed waveform proposed by Lincoln Laboratory for increasing the data rate supported by EHF satellite communications, the Milstar II medium-data-rate (MDR) capability was developed to allow data rates up to 1.544 Mbps to be supported. The development of this MDR waveform and the Laboratory's lightweight EHF satellite communications technologies led to a combined LDR/MDR satellite communications test bed, developed under Army sponsorship, that included both payload and terminal subsystems. This test bed served as the gold standard for EHF LDR and MDR communications. It was used for interoperability testing of Army, Navy, and Air Force terminals at the Laboratory, in Army field tests with a tower-based payload antenna system, and in Milstar II payload interoperability testing.

The capabilities of this test terminal to assist significantly in payload testing led to its replication and delivery to the Milstar space segment of the Milstar Universal System Test Terminal, which was used for many years in EHF payload developmental testing. Both LDR and MDR satellite communications services are provided by the three DoD Milstar II satellites successfully launched in 2001, 2002, and 2003.

The protected communications capacity of the Milstar II satellites is more than an order of magnitude greater than the capacity on the Milstar I satellites. However, demand for even greater satellite capacities led the Laboratory to explore ways to get another order-of-magnitude capacity increase. Lincoln Laboratory's technical leadership was crucial in developing many of the key features needed for this next step in protected satellite communications capability — the Advanced EHF (AEHF) satellite communications system.

The AEHF system includes bandwidth-efficient, protected signaling for many users, higher data rates (up to 8 Mbps per service), and lightweight implementations that allow a higher capacity system (~300 Mbps per satellite) for strategic and tactical warfighter support. The eXtended Data Rate (XDR) waveform developed for AEHF allowed these enhanced services.

The Laboratory played a key role in defining the wideband XDR waveform, which provided four times more throughput per terminal in the same channel bandwidth, and in defining the narrowband XDR waveform, which could support more than 60 users in the same bandwidth as a single narrowband user on Milstar II. Another of the Laboratory's technology developments for AEHF was an onboard packet-switched capability. However, this capability was not included in the AEHF system development — it remained a circuit-switched system. This technology advancement would need to wait for a next-generation program (see chapter 6, "Communication Networks and Cyber Security").



Advanced-development-model SCOTT RF assembly  
D.M. Snider with SCAMP

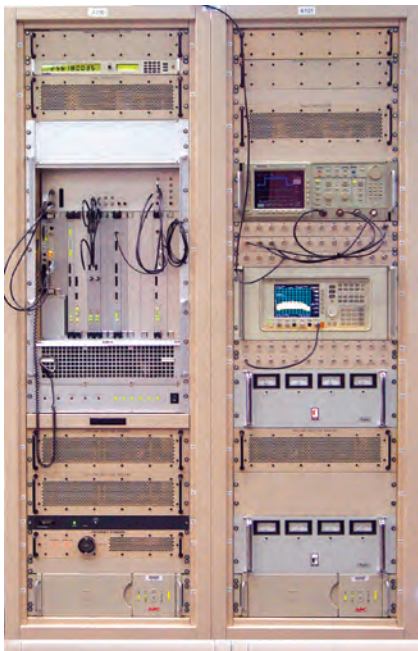
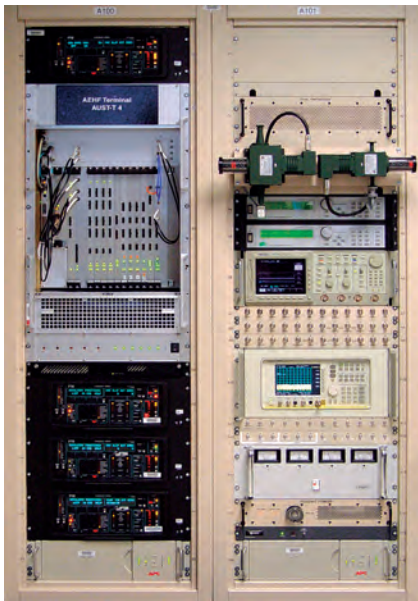


Lincoln Laboratory FEPOC  
Transportable FEPOC,  
Prospect Harbor, Maine



V. Vitto





**Figure 5-7**  
The AEHF test terminal (top) and test payload (bottom) form the heart of the unified AEHF national test infrastructure.

The XDR waveform for AEHF was the first step into efficient use of the EHF spectrum while maintaining spectrum spreading. The XDR waveform allows efficient use of the spectrum in two of its many modes. In order to increase system capacity beyond this, spectral efficiency must be considered for all modes and under a variety of conditions. The Laboratory’s research into innovative protected waveforms contributed to the development of an advanced satellite communications waveform at EHF that includes compatibility with Internet protocol (IP) packet communications. This waveform has been dubbed XDR+ by the satellite communications community.

The XDR+ waveform includes power- and bandwidth-efficient modes, dynamic resource allocation to allow adaptation to changing link conditions and traffic demands, and efficient packing of channels within the hopping band. The XDR+ waveform utilizes onboard decoding of uplink signals and recoding of the signals for downlink transmission. A reduced-complexity, high-performance serial concatenated convolutional code developed at Lincoln Laboratory allows this onboard processing to be accomplished with acceptable size, weight, and power impacts while providing significant coding gain to communications services. This coding enables more than another order-of-magnitude increase in per satellite capacity to about 4000 Mbps.

Under David McElroy’s leadership, the Laboratory’s gold standard satellite communications test systems, which built off the Milstar II test system legacy, were developed to provide a unified, national AEHF test infrastructure consisting of AEHF satellite simulators for use in terminal testing and AEHF Universal System Test Terminals (AUST-T) for use in satellite testing. The AEHF test terminal and test payload are shown in Figure 5-7. Multiple copies of these test assets have been deployed to terminal and satellite contractor factories to aid in the development of the AEHF system.

A similar test infrastructure approach was in development for the protected satellite communications system generation after AEHF — the Transformational Communications Satellite (TSAT) System (see chapter 6, “Communication Networks and Cyber Security”). The Laboratory’s XDR+ waveform prototype system for TSAT was built from a new

advanced signal processing digital-core architecture. This digital core allows for multiple communications waveforms to be hosted on the same basic signal processing hardware. Although the DoD subsequently cancelled the overall TSAT System development, the Laboratory’s digital-core architecture is being leveraged for research pertinent to future MILSATCOM systems. For example, techniques for improving the portability of waveform code and for reusing communications processing hardware are being investigated, using this architecture for a variety of satellite communications and line-of-sight communications applications.

The factory-based AUST-T test terminal for AEHF has also been extended to an over-the-air capability to support calibration of the AEHF satellites after launch. This AEHF Calibration Facility (ACF) terminal has been further leveraged to provide command-and-control (C2) support to AEHF on an interim basis in service to the nation. Because of a schedule disconnect with the intended C2 terminal, Lincoln Laboratory was asked to extend the capabilities of the terminal to support both the calibration mission and an interim command-and-control (IC2) mission. The ACF-IC2 terminals have been developed in both fixed and transportable installation configurations. Multiple copies of the ACF-IC2 terminals have been delivered to the Air Force for use in controlling both the Milstar system and the AEHF system.

A key new element for the ACF-IC2 terminal was the HSV-1 cryptographic unit, the Laboratory’s first National Security Agency-certified cryptographic unit development. This unit plays a key role in providing the proper interface security between the terminal’s Lincoln Laboratory-developed modem and the contractor-developed AEHF command-and-control system, which operates the AEHF and Milstar systems.

#### **Advanced EHF/SHF Terminals**

In a Milstar-related activity, Lincoln Laboratory designed and built the Single-Channel Objective Tactical Terminal (SCOTT), the advanced development model of the Army’s Milstar EHF/SHF terminal.<sup>17</sup> In 1983, Army personnel successfully tested this terminal, mounted in a tracked military vehicle, against a satellite simulator in the field (Figure 5-8).

**Figure 5-8**  
**SCOTT for EHF communications was installed in an armored personnel carrier and operated in the field by military crews with a satellite simulator.**



**Figure 5-9**  
**Clement Edgar is testing the Advanced SCAMP, a low-cost portable antijam satellite communications terminal. It is self-contained, incorporating an antenna, miniaturized transmitter, very-low-noise SHF receiver, and agile RF generator.**



#### Note

17 R.F. Bauer, "EHF Terminal Technology," *AIAA Ninth Communications Satellite Systems Conf.* New York: AIAA, 1982, paper no. AIAA-82-9546.

The Army's production version of SCOTT has many of the features that were first demonstrated in Lincoln Laboratory's advanced development model.

As an outgrowth of the SCOTT work, Lincoln Laboratory conducted a feasibility study in 1983 that resulted in a conceptual design for a man-portable, Milstar-compatible EHF/SHF terminal. The development of the Single-Channel Anti-jam Man-Portable (SCAMP) terminal was completed shortly after the launch of the first FEP, and it operated successfully with the FEP.

The Advanced SCAMP is a complete redesign of the original system (Figure 5-9). Developed in the early 1990s, it provides message or voice communication through a Milstar spot-beam antenna. To achieve the desired size, weight, and performance goals, the Advanced SCAMP incorporates miniature solid-state RF and transmitter circuitry, displaced-axis petal reflector antennas, application-specific, very-large-scale integrated devices, and innovative software codes. A second version of the SCAMP terminal was subsequently developed to further reduce the weight and power and to provide risk reduction for the contractor's portable EHF terminal developments.

#### Optical Communication

From almost the day the laser was invented, it was recognized as affording the potential for much smaller, lower-power, higher-data-rate, and more secure communication links than RF could provide. All of these advantages come from the vast difference in frequency of the two forms of electromagnetic radiation: optical waves are typically measured in THz (terahertz,  $10^{14}$  Hz), whereas RF is typically measured in GHz (gigahertz,  $10^9$  Hz). The corresponding wavelength for a 30 GHz EHF link is 1 cm; optical wavelengths are about  $1 \mu\text{m}$ . An EHF signal at 30 GHz, emitted from a 30 cm dish antenna in geosynchronous orbit will illuminate a 1300 km diameter spot on the earth. An optical signal, emitted from a 30 cm antenna (e.g., a telescope) will form a spot only 130 m in diameter. This extreme improvement in directionality means that even gigabits-per-second data rates can be transmitted very securely by a few watts of power between very small terminals; for example, someone on the earth outside the 130 m spot can neither intercept nor jam the link. Of course, there is a price to pay: the highly directional optical beams must be pointed very precisely.



On the angular scales of interest, satellites in orbit are very unstable platforms and vibrations due to gyros, solar array drive motors, and even electrical relays can jitter an optical beam off target. Solving the so-called spatial tracking problem was one of the biggest obstacles to successfully using lasers in space. The potential of optical techniques for improving satellite communications was recognized very early on at the Laboratory.

In 1971, even as Lincoln Laboratory engineers were designing the LES-8 and -9 satellites, which were to have the first RF crosslinks between them, consideration was given to include a crosslink based on the new laser technology that had been invented in 1960. This was an extraordinarily forward-looking idea. Not surprisingly, the Laboratory's communications engineers were many years (30 in this case) ahead of their time; optical links from satellites would not be demonstrated until 2001.

Nevertheless, to meet these challenges, the LES-8 and -9 engineers began to formulate designs and build engineering models. Ultimately, it was decided not to include the optical crosslink on LES-8 and -9 because of the lack of lasers that were reliable in the space environment. Lincoln Laboratory did not give up on the idea, however. After LES-8 and -9, a systematic effort was begun to develop the necessary understanding, system concepts, and technology to make space laser communications a reality. It was not until about 1980 that this effort began to gain significant momentum. The Air Force, as part of the Defense Support Program, was building a series of missile-warning satellites and was considering including laser crosslinks.

The effort was led by Vincent Chan, an assistant leader in the Communications Technology Group. The Laboratory's approach was based on first understanding

the fundamental limits imposed by the laws of physics and then identifying technology developments that could close the gap between theory and practice. This "top-down" approach continues to be the hallmark of the Laboratory's approach to laser communications. The system approach was to use the simple, low-cost semiconductor lasers that were emerging commercially for the compact-disk-player market to provide very high-data-rate crosslinks. A systematic technology development program demonstrated the communication functions, as well as the critical related functions of pointing and tracking. By 1985, complete end-to-end system functionality had been demonstrated in the laboratory environment. So great was the potential of the Laboratory's approach to reduce the size, weight, and power, and to increase data rate as compared to other laser communications systems under development, that a space flight demonstration program started in 1985. This program, called LITE for Laser Intersatellite Transmission Experiment, sought to demonstrate a 220 Mbps coherent link from a geosynchronous satellite to ground. The laser communications payload was to be supplied by Lincoln Laboratory and was to have flown aboard the NASA Advanced Communications Technology Satellite. A piggyback NASA direct detection modem was intended as part of the demonstration and would have worked through the Laboratory-built optomechanical system.

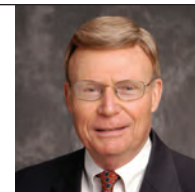
Unfortunately, because of budget difficulties, the flight program was cancelled after it had successfully completed its critical design review in 1987. The Air Force did, however, rescope the Laboratory's effort into an engineering model program wherein all the critical subsystems were built, space qualified, and assembled in an end-to-end test bed. This activity was largely complete by 1990, and it demonstrated



V.W.S. Chan

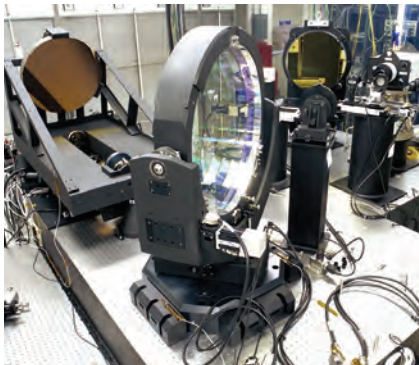
Second version  
of the SCAMP  
terminal

C.W. Niessen



D.R. McElroy





**Figure 5-10**  
Channel simulator optics in the Optical Standards Validation Suite testing area.

significant technical advances. One thing in particular was learned: it is very difficult to build an “optical bench in the sky” because all the pieces have to be maintained in close alignment while subjected to the thermal and mechanical perturbations of the space environment. Either the system must be massive or operate with multiple complex active control systems to maintain alignment. This realization occurred just at the time that the fiber-optics industry was emerging, and although the marriage of intersatellite optical communications and fiber optics may at first seem an unlikely union, it did offer major advantages.

#### **Fiber Optics to the Rescue**

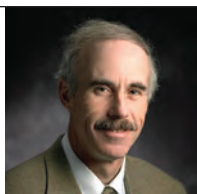
Lincoln Laboratory researchers immediately recognized that if the transmitter and receiver subsystems could somehow be remotely located from the rest of the optomechanical structure and not be required to be rigidly aligned, the design would become significantly simpler. The challenge was coupling light into the fiber in the presence of angle-of-arrival variation caused by the motion within the satellite. The scheme hit upon is reminiscent of conical-scanning radar: if the tip of the fiber is moved physically in a slightly offset circular path, then, unless the incoming light is directly aligned with the fiber, the amount of light coupled into the fiber will vary in time. The offset direction can be ascertained and used to control a steering mirror to keep the light on axis. Outgoing light from the transmitter can be reflected off the same steering mirror to eliminate pointing errors. This “fiber nutation” approach was perfected very quickly and revolutionized free-space optical communication. As a result, all the mass-produced, highly reliable technology of the telecommunications industry was now available for use in space.

Between 1997 and 2001, Lincoln Laboratory participated in the Geosynchronous Lightweight Integrated Technology Experiment program. Although the details remain classified, a Laboratory-developed laser communication system was successfully operated, demonstrating the viability of inserting laser technology into operational systems.

#### **Transformational Communication**

In 2001, planning began for a new military satellite communication system that had laser links as integral to its architecture. Named the Transformational Communications Satellite (TSAT) System, the new system was intended to provide orders of magnitude more capacity than its predecessors. As part of the TSAT program, Lincoln Laboratory performed its customary role of technology transition, helping move the lessons of laser communications into the contractor base. To this end, the Laboratory helped develop a set of open standards for laser communications terminals that would allow systems built by different contractors to interoperate, and then became the government’s test and validation agent for laser communications. The Laboratory established an extensive and sophisticated testing facility, the Optical Standards Validation Suite, where contractor hardware could be tested to demonstrate compliance with the standards (Figure 5-10). This facility was crucial in aiding contractors to develop their hardware and then demonstrate the required technology maturity level at critical program milestones. The DoD subsequently cancelled the overall TSAT development program, but the laser communications technology base continues to be leveraged for other high-data-rate initiatives.

2005



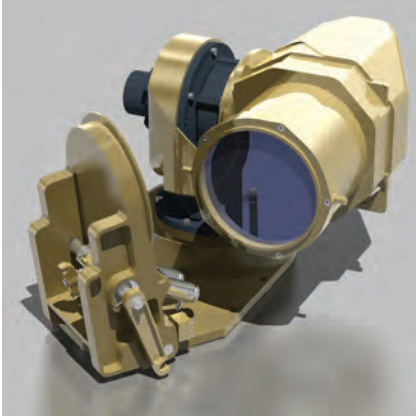
E.G. Taylor



Transportable ACF-IC2 terminal



J.S. Stadler



**Figure 5-11**  
**Rendering of telescope and gimbal for the LLCD space payload. The telescope aperture is 4 inches in diameter.**

## NASA

At about the same time that the TSAT investigations were under way, NASA approached the Laboratory about providing high-data-rate (~100 Mbps) optical communications from Mars and the outer planets. NASA had long been interested in optics for this purpose but had not yet found a practical or affordable path forward.

The deep-space communication problem is far different from the usual military satellite communications problem, mainly because of the extreme distances involved. For example, the moon is about ten times further away from earth than is a geosynchronous satellite; therefore, it is 100 times harder (in terms of required power and/or aperture size) to communicate with the moon. Mars can be eight orders of magnitude harder, and the outer planets many orders of magnitude more difficult.

It was clear that technology enhancements beyond those needed for TSAT would be required for deep space. A 10 Gbps link designed for geosynchronous orbit could only support 100 bps from Mars. A first-principles analysis based on considerations of channel capacity indicated that it should be possible to construct a link that would require reasonable transmitter powers and receiver aperture sizes. However, it was the conjunction of a particularly useful technology development, having nothing to do with communications, that made the whole picture complete. The piece of technology was the Geiger-mode avalanche photodiode (APD) array, which had been developed for laser radar applications (see chapter 27, “Photon-Counting Laser Radar”).

The APD array enabled the efficient detection of single photons with highly precise time resolution; the output is effectively the time at which detection occurred. The fact that it was an array of detectors meant that it could handle many photons at once and so could accommodate high levels of background light. Since the output is simply a number, the output of many such devices from many separate (small and low-cost) telescopes can be easily combined digitally to act as an equivalent very large aperture. This concept was termed the Lincoln Distributed Optical Receive Array (L-DORA). The exquisite timing resolution available, on the order of one-half nanosecond, meant that time-division modulation

formats and error-correction codes could be employed, enabling many bits of information to be represented by the arrival time of a single photon, thus keeping the required transmitter power low. This entire concept was developed in a 2003 study that resulted in a system concept for deep-space communication that could affordably be implemented by existing technology.

NASA began a flight demonstration in late 2003 to prove the ideas from the study. The Mars Laser Communication Demonstration (MLCD) was to fly a Lincoln Laboratory–provided laser communications terminal in 2010 aboard the Mars Telecom Orbiter mission, which was going to provide RF relay services to rovers on Mars’s surface. The Laboratory was also providing a version of L-DORA for a ground terminal, and one of the project partners, the Jet Propulsion Laboratory, would provide a more traditional large-aperture ground terminal by adding a communication modem to the 200-inch Hale telescope at Mount Palomar, California.

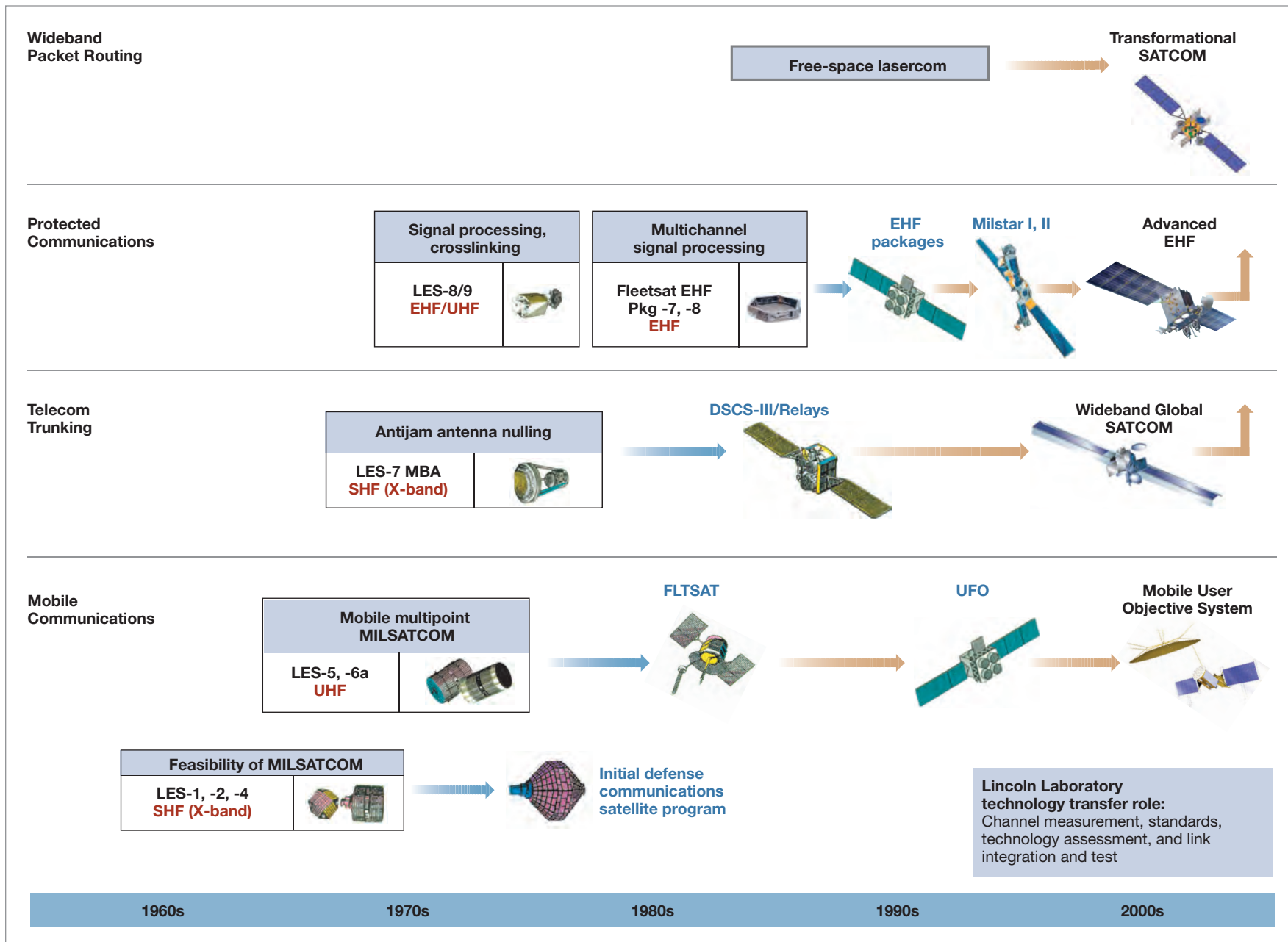
The project successfully completed its preliminary design review but was ultimately cancelled by NASA in 2005 as part of a reprioritization of objectives when NASA’s exploration agenda was shifted to the moon. After the MLCD cancellation, NASA maintained a strong technology development activity at Lincoln Laboratory, and in 2008 began a new effort to demonstrate optical communication from the moon. This new program, the Lunar Laser Communication Demonstration (LLCD), will demonstrate a 622 Mbps laser communication link from the moon. The Laboratory is developing the space payload as well as the ground receiver (Figure 5-11 and Figure 5-12). The system is scheduled to launch in 2013, and the laser communication payload has so far successfully passed the critical-design-review phase.

## Looking Ahead

In the more than 45 years of Lincoln Laboratory’s program, satellite communications has reached a high level of maturity (Figure 5-13). The job, however, is not yet complete. Successes achieved in making communications systems available and survivable must be followed up by breakthroughs in making the technologies affordable, so that both tactical and strategic users can benefit from reliable communications.



**Figure 5-12**  
**Rendering of telescopes and gimbal for the LLCD ground terminal. Each telescope is 16 inches in diameter.**



**Figure 5-13**  
Lincoln Laboratory space communications activities.







# Communication Networks and Cyber Security

**Warfighters require access to computer networks to send and receive voice and imagery data, and to access other data services. These networks and services must be accessible to forces moving through land, sea, and air. Lincoln Laboratory architected, developed, and demonstrated technology for secure, next-generation military networks.**

Left: SATCOM-on-the-move prototype.

## Extending the Internet to the Tactical Warfighter *Technology Beginnings*

The first Gulf War stressed the communications infrastructure available to the U.S. military in a number of unexpected ways. Up to that time, military satellite communications (MILSATCOM) systems and the associated concept of operations had been developed to meet Cold War demands against a peer enemy. Military equipment and personnel were to be prepositioned to overwhelm a well-known threat in force-on-force engagements. However, the Gulf War unfolded at a pace that made it impossible to sustain the required communications infrastructure. The available rapidly deployable terrestrial wireless communications equipment was unable to keep pace as the troops advanced. This inability shifted significant communications demand to MILSATCOM, which relies on a readily available space-based infrastructure instead of a tactically deployed infrastructure. It also changed the demand for protected MILSATCOM from small numbers of fixed strategic users to large numbers of highly mobile tactical users — a significant challenge for the protected MILSATCOM service.

Lincoln Laboratory responded to this communications challenge with a number of novel system and technology approaches that included waveforms that efficiently share communications channels among many small users (see chapter 5, “Satellite Communications”) and a proposal to incorporate networking technologies into the forthcoming Advanced Extremely High Frequency (AEHF) system. The Laboratory’s AEHF networking activities from 1995 to 2000 defined an end-to-end system architecture, developed component technologies, and demonstrated that they would work in the overall system context.

While networking technology was being aggressively pursued by the commercial sector during this time frame, a number of unique aspects of space networking presented significant challenges. The commercial focus was on terrestrial fiber links that offer low latency, high data rate, and low error rates, while space networking has high latency (because of propagation time to geostationary orbit), much lower data rates, and higher error rates inherent in the wireless links. Furthermore, systems deployed in orbit force an approach that minimizes weight and power.

The system architecture employed on-orbit packet switching. Packets would be received from terminals on the uplinks and would be routed to an appropriate downlink on the basis of the address in the header of the packet. The architecture was designed to work with the next generation of protected satellites (AEHF) and to provide backward compatibility with the (then) existing population of terminals to enable a smooth transition from circuit to packet services.<sup>1</sup>

J. Scott Stadler led the Lincoln Laboratory team that developed an EHF networking test bed to prototype the architecture and to enable the test and demonstration of the component technologies in an end-to-end context (Figure 6-1). The test bed included a functional prototype of a packet switch that integrated with existing EHF satellite emulators and test terminals, link emulators that inserted realistic channel impairments (latency, errors, and data-rate restrictions), and networking protocols and enhancements that enabled protocols designed for terrestrial use to be seamlessly extended via satellite.<sup>2</sup> The key Laboratory contribution was the integration of packet switching into the existing protected MILSATCOM system design.<sup>3</sup>

While the EHF networking test bed successfully demonstrated the feasibility and value of networking in space, Department of Defense (DoD) MILSATCOM users had not included packet switching in their system requirements. Thus, the AEHF system was specified and procured without a networking capability.

## *National Shift in Communication Policy*

The experiences of the 1990s led to a reexamination of the DoD’s systems, tactics, and plans. A 1999 Defense Science Board (DSB) report cataloged multiple deficiencies in military communications and recommended a radical shift from the set of “stove-piped” communications systems to a flexible, packetized, routed wideband space, airborne, and terrestrial transport system based on the adaptation of commercial Internet technologies.

During this period, the concept of network-centric warfare evolved through large-scale exercises, leading to use in Operation Iraqi Freedom. A key tenet of network-centric warfare is the shift from “massed forces” to “massed effects.” Massed effects in the absence of massed



**Figure 6-1**  
Advanced EHF networking test bed.

forces require individual geographically disparate units to mutually synchronize in order to align their effects both spatially and temporally. From a communications perspective, this synchronization requires connectivity among peer force units, a significant departure from current communications doctrine that tends to mimic force hierarchy.

Early in 2002, development began on a Transformational Communications Architecture (TCA) that would provide a road map for addressing the unmet needs of the DoD, intelligence community, and civilian government user communities. Lincoln Laboratory, drawing on previous work in communications satellites, terminals, networking, laser communications (lasercom), and protected waveforms, was a significant contributor to the effort that specifically addressed the deficiencies described in the 1999 DSB report.

#### *Transformational Communications Satellite*

The flagship component of the TCA was a proposed new MILSATCOM system consisting of the Transformational Communications Satellite (TSAT) and terminals that provide network services with ten times the protected capacity of existing MILSATCOM systems. Architecturally, TSAT played two roles in the TCA: the first role was to provide a space-based analog to the worldwide terrestrial fiber backbone, and the second was to provide satellites that function as access nodes that can connect to large numbers of geographically distributed users, route traffic among them, and aggregate out-of-theater traffic for transport on the backbone.

TSAT created the backbone by using high-rate lasercom crosslinks that leverage the same protocols and even some of the same optical components used in the terrestrial Internet and telephone fiber systems. These crosslinks allow the capacity of multiple satellites to be focused in a small area to support large-scale operations and enable global transport of large quantities of data without reliance on overseas ground infrastructure that may be controlled or disrupted by adversaries. Lincoln Laboratory's Geosynchronous Lightweight Integrated Technology Experiment demonstration showed the feasibility of space lasercom crosslinks and formed the basis of the Lasercom Interoperability Standard (LIS) used in TSAT.

Lincoln Laboratory played a key role in the definition and development of the TSAT system, building a collection of test beds that enabled the end-to-end validation of the system architecture and the component technologies used to implement them (Figure 6-2). The test beds provided a high-fidelity functional realization of the operational environment, enabling the system to be tested as thoroughly as possible early in the program. Key technologies that the Laboratory developed and demonstrated included protected bandwidth-efficient waveforms, dynamic bandwidth resource allocation, LIS-based laser communication, and networking protocols that have been modified to work in a space environment.

The future of the TCA is uncertain. Despite the significant technical progress, budget pressures first resulted in removal of some planned capabilities and then eventually led to cancellation of the TSAT program. Whether some of the key TSAT technologies (e.g., space-based routing and laser crosslinks) can be incorporated into future blocks of existing military communications satellite programs or will form the basis of some new future system remains to be seen.

#### **Networking on the Move**

##### *Protected Mobile Satellite Communications*

The use of ultrahigh frequencies (UHF) for satellite communications permits the ground terminals to be relatively small with simple antennas (see chapter 5, "Satellite Communications"). These features allow UHF terminals to be used easily while on the move. Unfortunately, communications at ultrahigh frequencies are susceptible to hostile jamming, so a relatively unsophisticated adversary could use inexpensive, readily accessible technology to deny communications, even with nominal antijam features in the communications waveform. Satellite communications (SATCOM) systems operating at higher frequencies (e.g., EHF) offer many opportunities for protection against jamming. However, such systems are difficult to use on the move since the directional antennas required to focus the high-frequency signal need to be pointed very accurately, and typically this pointing is achievable only when the vehicle is halted. Thus, most U.S. military forces have come to rely on UHF SATCOM for beyond-line-of-sight communications while on the move, exposing these forces to an adversary's electronic attack.

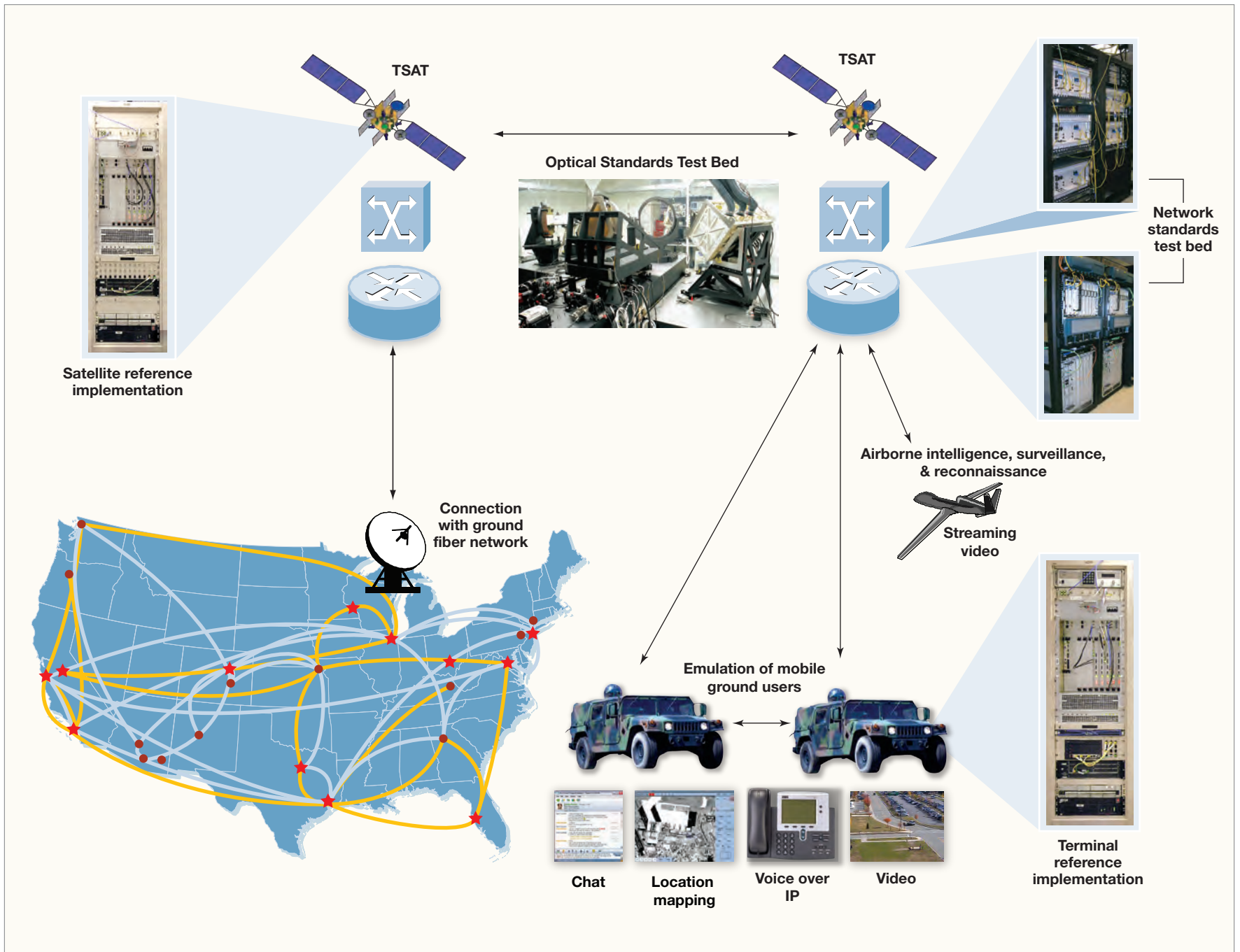
#### **Notes**

**1** J.S. Stadler, "Packet Multiple Access for Broadband Satellite Channels," Satellite Comm. Architectures and Networks Wkshp., Int. Comm. Conf., Vancouver, Canada, June 10, 1999.

**2** J.S. Stadler, J. Gelman, and J. Howard, "Performance Enhancement for TCP/IP on Wireless Links," 9th Virginia Tech/MPRG Symp. on Wireless Personal Comm., June 2-4, 1999, pp. 233-244; J.S. Stadler, and J. Gelman, "Performance Enhancement for TCP/IP on a Satellite Channel," *Proc. IEEE Mil. Comm. Conf.* **1**, 270-276 (1998); J. Gelman and J.S. Stadler, Wireless IP Suite Enhancer, U.S. Patent Pending, 1998; J. S. Stadler, "A Link Layer Protocol for Efficient Transmission of TCP/IP via Satellite," *Proc. IEEE Mil. Comm. Conf.* **2**, 723-727 (1997).

**3** J.S. Stadler and E. Modiano, "An On-board Packet Processing Architecture for the Advanced EHF Satellite System," *Proc. IEEE Mil. Comm. Conf.* **2**, C377-C382 (1997).





**Figure 6-2**  
TSAT test bed concept.



**Figure 6-3**  
**Result of a SATCOM link-blockage measurement campaign in downtown Boston. Green shows locations where the link is unobstructed and communication is possible; red shows locations where the link is blocked, making communication impossible.**

**Note**

4 M. Gouker, "Technology Challenges for Satellite Communications on-the-Move," *Army Communicator* **26(2)** (2001).

Starting in the late 1990s, Lincoln Laboratory initiated a series of efforts to create mobile SATCOM systems for the EHF band that were robust against jamming. Accomplishing this goal required creating small, rugged vehicle-mounted modems and an antenna system that could dynamically point a narrow directional EHF beam from a vehicle traversing rough terrain.<sup>4</sup> (These same techniques were also useful on aircraft platforms for air-to-air, air-to-ground, and satellite links.)

A series of field experiments conducted with vehicles driving over a variety of terrain profiles defined the platform motions that the antenna control system would have to accommodate to maintain accurate pointing of the antenna beam. Starting in 2001, a number of prototype SATCOM vehicles were built (see photograph on p. 84). These prototypes successfully demonstrated protected SATCOM on the move, allowing the Army to establish an acquisition strategy for procuring this capability in large quantities.

A major benefit of the prototype field experiments was the data that accurately characterized link performance as the vehicle moved over a variety of terrains through different ambient environments. At EHF operating frequencies (~40 GHz), the satellite signal is completely blocked if an obstruction comes between the antenna and the satellite. Two thorough measurement campaigns captured data in a variety of link-blockage conditions (Figure 6-3). The mobile vehicle was driven around Boston, Massachusetts, and there were many locations, indicated by the red markings, in which the vehicle was unable to maintain connectivity to the satellite. This urban environment is quite severe with many "urban canyons." Measurements taken in less congested rural and suburban areas indicate much higher likelihoods of connectivity.

These link-blockage statistics helped drive the design of communications and networking protocols that adapt to periodic outages and rapidly reestablish communications when the satellite signal is no longer blocked. Through these prototyping and measurement campaigns, Lincoln Laboratory confirmed that reliable protected communications to mobile nodes is best provided by a collection of communications approaches. As described in the next section, an implementation with multiple links being used in combination provides a capability greater than the sum of the individual parts.



## Satellite Networking

The use of Internet protocols in networks that include space-based segments has received considerable attention. Lincoln Laboratory has addressed these challenges by developing and demonstrating a number of technology components.

### *Packet Switch*

The AEHF packet switch developed by William Zuk had all of the features necessary to provide reliable service among tactical users. It was designed to work with EHF waveforms that protect the communications from jamming, detection, and interception. A control plane set up virtual circuits among users so that a fast switching engine could forward packets on the basis of the virtual circuit identification in the packet header. The switch supported eight levels of prioritization to ensure that high-priority traffic obtained service even in a resource-constrained scenario.

The Laboratory also developed and demonstrated the capability to route application network traffic based on the link state and capacity of line-of-sight and beyond-line-of-sight radio links. This approach permits applications to send and receive data robustly via a set of commonly shared radio links versus requiring a dedicated, frequently blocked radio link for each application.

### *Packet Uplink Multiple Access*

Satellite links are often statically configured in response to a Communications Service Request. For constant-rate traffic, as is the case for some forms of voice and video, this approach leads to the link being idle when no communication

is taking place. For packet data, which is bursty in nature, there will always be periods of inactivity on a link. Packet multiple access is a technique that fills in the gaps left by an inactive user with packets from an active user, thus greatly increasing the efficiency with which satellite resources are utilized. The Laboratory's Packet Uplink Multiple Access technique used a random-access reservation approach to reserve resources for active users. This approach balanced the responsiveness of the system at low utilization with good stability at high utilization.

### *Protocol Enhancement*

In order to take advantage of the commercial investment in networking technologies, it is necessary to use the Internet protocols (TCP/IP) in DoD systems. Unfortunately, these protocols perform inefficiently under some scenarios that traverse satellite links. Lincoln Laboratory developed solutions that enable unmodified commercial protocols to work seamlessly with satellite links. The first approach uses a link layer that hides errors on the satellite link from the TCP/IP protocols. This approach is the most generally applicable but limits the improvement that can be obtained. A second approach transparently converts the Internet protocol to a more appropriate protocol at the entrance to the space portion of the network and then converts back upon exiting, yielding near optimum performance.

### *Airborne-to-Ground and Air-to-Air Networking*

If ground vehicles are susceptible to adversary jamming at UHF frequencies, aircraft are even more disadvantaged for directed jamming by an adversary. Aircraft operating at high altitudes are visible to an adversary's jamming attack from many ground or air vantage points. Military line-of-sight tactical communications systems incorporate various protection schemes at these relatively low operating frequencies, including power spreading across wide frequency bands, e.g., fast frequency hopping of the transmitted signals. These techniques have improved the protection of tactical data systems from jamming, but they operate at relatively low data rates (~10s of kilobits per second). A proven method to avert the effects of a jammer uses receiver antenna directionality that favors received energy from the intended transmitter while attenuating unwanted signals from a spatially off-axis jammer.

In the 1980s, the Air Force developed a series of high-data-rate, line-of-sight data link technologies collectively called Common Data Link or CDL. These links provided point-to-point data transfers through highly directional antennas. The Army and the Air Force considered using similar systems to extend the communication reach through an airborne relay and to provide a high-rate, extended-range airborne network backbone to the air and ground forces. In parallel, industry and academia were moving quickly to adopt Internet protocols. Adopting Internet protocol standards for emerging military wireless networks meant the possibility existed of rapidly inserting future technologies in much the same way that the commercial market has evolved. Numerous challenges in this approach (antenna-pointing control, network topology management, routing architectures, and dynamic operations for highly mobile nodes operating without the benefit of a fixed infrastructure) were unique to the DoD and unlikely to be addressed by the commercial base.

In the early 2000s, Lincoln Laboratory started building prototype systems to demonstrate solutions to these challenges. The earliest problem addressed was the automatic control and switching logic (for two or more antennas variously mounted on the aircraft fuselage) that would manage the link state for changes in aircraft orientation, thus maintaining connectivity to ground sites and other aircraft in a distributed network. A significant

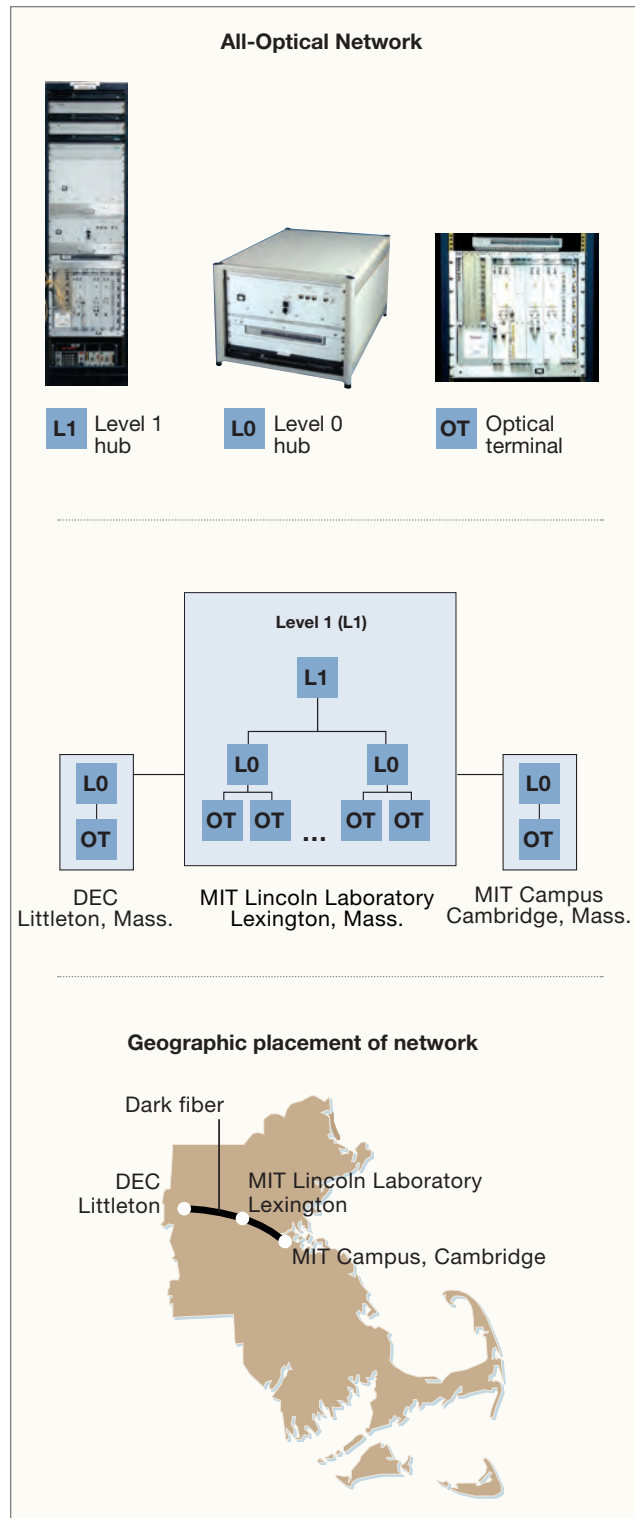




**Figure 6-4**  
The Paul Revere aircraft is a heavily modified Boeing 707 that Lincoln Laboratory operates as a communications and sensor test bed.



**Figure 6-5**  
Communications and networking experiments on board the Paul Revere test bed.



**Figure 6-6, right**  
All-optical networking test bed.

contribution was the development of a communications and networking control architecture, which led directly to the implementation of a prototype control broker that managed the configuration of the antenna and the topology of the network.

#### *Paul Revere Airborne Test Bed*

Starting in 2002, Lincoln Laboratory conducted a series of tests aboard the Paul Revere aircraft, a 707 configured as an airborne test bed, to characterize the air-to-ground communications conditions of a mobile airborne node (Figure 6-4 and Figure 6-5). Through a series of flight tests conducted over the Gulf of Maine, at Nellis Air Force Base, and down the Eastern Seaboard, the Laboratory accumulated a large data set of positioning, link conditions, and topology changes managed by the prototype antenna-control broker, as well as the data exchange required on the network to maintain a high availability of the link for a maneuvering aircraft. Indeed, the data links could be maintained with a high level of availability, with control channels operating at relatively low data rates on nondirectional communications systems.

#### *Optical Terrestrial Networks*

By the late 1980s, the rise in commercial and DoD use of telecommunication networks and the Internet was leading to projections of future “electronic bottlenecks” — communication networks that would be limited by the electronic switching and routing mechanisms employed. During the Gulf War of the 1990s, the DoD and intelligence community’s use of very large data sets for relaying imagery and other products encountered significant bottlenecks, and the DoD trends for bandwidth growth were an order of magnitude greater than the commercial growth expected at the time. Further, the DoD expected that they would eventually need to leverage some commercial telecommunication infrastructure for their future needs. Between 1990 and 1991, the Defense Advanced Research Projects Agency (DARPA) and Lincoln Laboratory began discussions about defining a dual-use (commercial and DoD) technology of fiber-based all-optical networks that might alleviate the bottlenecks of electronics and serve the rapidly expanding needs of the DoD and intelligence community.

## Adapted Use of Technology

An application of some of the very sensitive optical receiver technology developed as part of the space laser-com and fiber-networking efforts was transitioned to the medical world. The technology, called optical coherence tomography, was licensed by MIT to commercial medical diagnostic device integrators. The initial work, conducted jointly with the MIT campus and the Massachusetts General Hospital, verified the ability to image tissues behind the retina, allowing ophthalmologists to get information about tissues behind the surface of the retina that had been previously inaccessible without invasive surgery.\* Additional applications to cardiac diagnostics were also pursued.

---

\* D. Huang, E.A. Swanson, C.P. Lin, J.S. Schuman, W.G. Stinson, W. Chang, M.R. Hee, T. Flotte, K. Gregory, C.A. Puliafito, et al., “Optical Coherence Tomography,” *Science* 254(5035), 1178–1181 (1991).

### All-Optical Network Program

An all-optical networking consortium was formed that included Lincoln Laboratory (Vincent Chan, lead and consortium chairman), MIT campus, AT&T Bell Laboratories, and the Digital Equipment Corporation (DEC) as the principal members. The consortium’s intent was to create significant follow-on commercial activity around the architecture and technologies developed.

The consortium approach ensured consideration of commercial telecommunications (AT&T), commercial computation and networking (DEC), and government (Lincoln Laboratory) interests. Optical networking was the centerpiece of the joint investment to explore the possibility of 1000 times more bandwidth. A strong desire for scalability of these networks in geographic extent, data rate, and number of users led to a design having distinct long-haul, metropolitan-area, and local-area network components supporting simultaneous wavelength-division-multiplexed and time-division-multiplexed services, all controlled by a separate control channel. Optical switch technology integrated by Lincoln Laboratory was used for the wide area; a phased-array waveguide grating router developed by AT&T was used to optically route metropolitan-area traffic; and an optical broadcast scheme developed by the MIT campus and the Laboratory was used for the local area. Erbium-doped fiber amplifiers provided a key component for avoiding electronic regeneration that was often the cause of electronic bottlenecks in competing architectures. Lincoln Laboratory developed an eleven-terminal prototype optical network operated over a set of fiber installed in the metropolitan Boston area for approximately two years (Figure 6-6). Data rates as high as one trillion bits per second in a single fiber were demonstrated — a data rate that fifteen years later is still quite advanced.

A time-division-multiplexed effort was also initiated to attempt 100 Gbps all-optical local-area networks based upon the use of solitons. This work demonstrated some early technologies for more advanced optical networks, including optical memories, all-optical switching, optical multiplexing and demultiplexing techniques for eventual interface to “slower” 10 Gbps electronic systems, optical binary logic, optical cryptography, and femtosecond lasers (pulses of  $\sim 2 \times 10^{-15}$  sec).

### ONRAMP and BOSSNET

Several significant follow-on efforts were funded, including a second consortium to further the metropolitan networking architecture and technology (called Optical Network for Regional Access using Multiwavelength Protocols [ONRAMP]), architectural work on integrating a global network containing both fiber-based terrestrial networks with space-based networks, and a wide-area optical switching effort (called Multiwavelength Optical Networking [MONET]). Theoretical efforts in secure all-optical networking also received attention. The Boston South Network (BOSSNET), a 1000 km fiber-optic test bed connecting Lincoln Laboratory to Washington, D.C., provided a realistic test bed for future optical networking transport and high-demand applications. As part of the DARPA-funded Wideband Networked Sensors initiative, wideband radar data from the Haystack Auxiliary and Haystack radars were streamed in real time over the BOSSNET, permitting remote processing and display, and enabling remote radar operations and significant associated cost savings (see chapter 10, “Space Situational Awareness”).

Experience with Internet-based applications led a number of Lincoln Laboratory personnel to participate in the founding of several Internet-related companies, including Ciena, Sycamore Networks, and PhotonEx.

### Cyber Security

As communication networks grew in importance to all the military services and many government agencies, it became clear that the computers and computer networks needed to be considered as both assets and liabilities in future conflicts. Computer networks did not just passively transmit data — they were an essential part of the command-and-control loop — and they could be attacked and should be defended just as any other source of situational awareness or provider of command and control. Thus, the DoD began addressing the problems of cyber security, including computer network defense (CND), computer network attack (CNA), and computer network exploitation (CNE).

The U.S. government’s significant lead in employing computer networks for strategic and tactical use afforded advantages in data and command-and-control transmission, but left the nation more vulnerable to

---

## Notes

**5** Results of the program's work were presented at the DARPA Information Survivability Conference and Exposition in January 2000.

**6** R.P. Lippmann, D.J. Fried, I. Graf, J.W. Haines, K.R. Kendall, D. McClung, D. Weber, S.E. Webster, D. Wyschogrod, R.K. Cunningham, and M.A. Zissman, "Evaluating Intrusion Detection Systems: The 1998 DARPA Off-Line Intrusion Detection Evaluation," *Proc. 2000 DARPA Inform. Survivability Conf. and Expo. (DISCEX) 2*, 12–26 (2000).

**7** R.P. Lippmann, J.W. Haines, D.J. Fried, J. Korba, and K. Das, "Analysis and Results of the 1999 DARPA Off-Line Intrusion Detection Evaluation," *Proc. 3rd Int. Recent Advances in Intrusion Detection Wkshp. (RAID 2000)*, in Lecture Notes in Computer Science Series, eds. H. Debar, L. Me, and S.F. Wu, Berlin: Springer Verlag, 2000, pp. 162–182.

**8** T.M. Parks and C.J. Weinstein, "Information Survivability for Mobile Wireless Systems," *Linc. Lab. J.* **12(1)**, 65–80 (2000).

CNA and CNE than its potential adversaries. To limit that exposure, Lincoln Laboratory started an aggressive effort in CND and helped develop the national strategy. A key element of this defense relied on preserving the confidentiality, integrity, and availability of information flow. Early work focused on protection, which today relies on access control and interposing devices, such as firewalls and intrusion prevention devices, and data encapsulation and verification using cryptography. Lincoln Laboratory's expertise in sensors and detectors, coupled with its historical understanding of and access to U.S. government data, enabled Laboratory researchers to design and develop quantitative performance evaluations of intrusion detection systems (IDS).<sup>5</sup> These systems monitor existing network traffic flow, and detect and report on attacks in that flow.

### *Intrusion Detection Systems Assessments*

Lincoln Laboratory's early evaluations focused on assessing IDS performance on an Air Force network of Unix<sup>6</sup> (and later Windows<sup>7</sup>) systems. The Laboratory pursued several options to acquire and distribute real benign traffic and auditing data, eventually settling on modeling users and driving real applications. This approach has the advantages of accurately representing protocol implementations (and flaws!), of not infringing on real users' privacy, of not releasing sensitive information, and of producing data for which malicious and benign acts could be definitively known and labeled. The most accurate tests performed today use a similar approach. For the first evaluations, a team led by Richard Lippmann, Robert Cunningham, Joshua Haines, and Marc Zissman designed and managed the test bed, produced background and attack traffic, marked ground truth of benign and malicious flows and network packets, and provided automated scoring tools.

Attacks were also needed to measure the accuracy of the IDS, expressed in terms of false positives and false negatives. The Laboratory developed attack taxonomies and a model of an adversary that considers the dimensions of an attack surface, the methods of attack, and the impact of the attack. Attacks can be launched against network infrastructure components, hosts, and users, and can result in the data and control being modified, exfiltrated, or prevented from being communicated. The tests employed attacks representing many of these combinations. Lincoln Laboratory's early CND work

also recognized the special vulnerabilities to cyber attack associated with mobile wireless networks and introduced techniques for addressing these vulnerabilities, with a focus on group communication over wireless networks.<sup>8</sup>

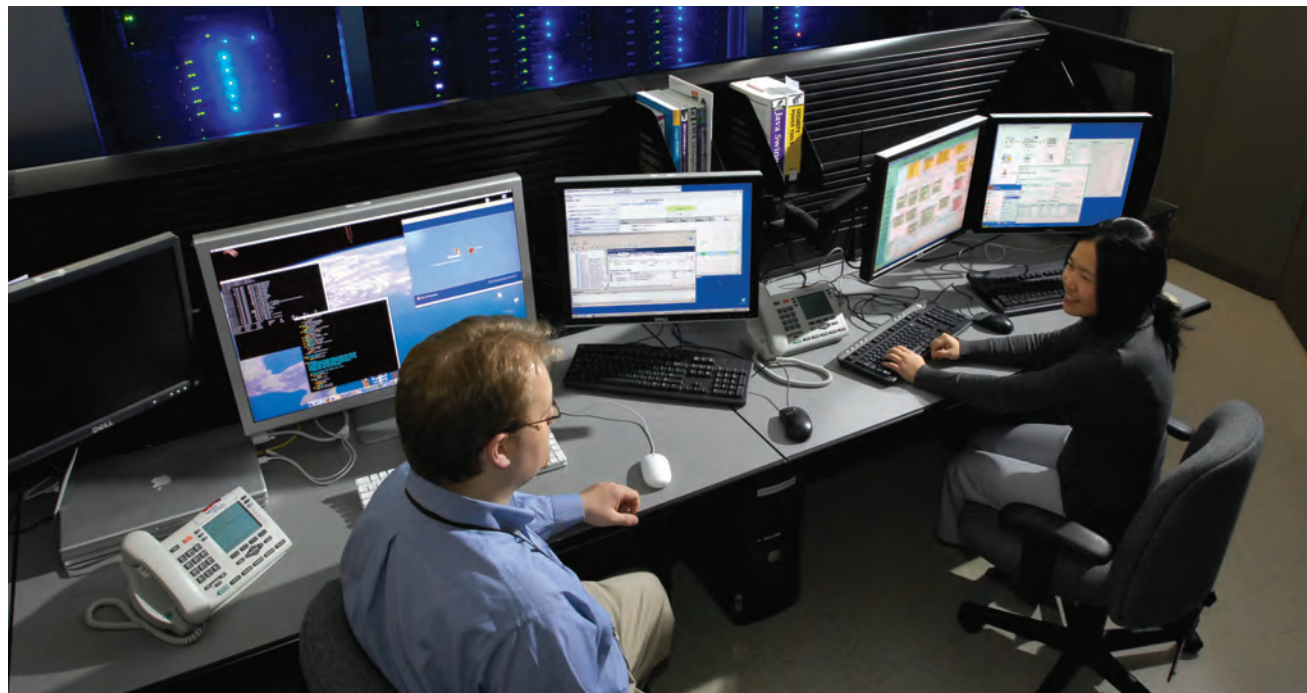
Even after researchers developed virtual users, an understanding of attacks, and automated scoring tools, the generation of required training and testing data was more difficult than anticipated. Hosts relied on network connections and on services supplied by others, so the Laboratory's tests needed to supply these. Externally provided protocols set computers' clocks, map site names to Internet protocol addresses, transmit and receive mail, and serve web sites. Most attacks only work in specific configurations of host and network. Scale was a challenge too — real Air Force base users would visit thousands of different service providers on a daily basis, but it was cost-prohibitive to use a single physical device per service. Custom software, clever configurations of existing systems and copies of web sites, and unclassified and open-source content were used to provide the desired level of realism at the scales required. Even on moderate-scale test beds, hardware failures occurred and resulted in the unrealistic simultaneous outage of hundreds of services, thereby invalidating a day's test. The key idea of using single hosts to provide many occasionally used services continues in tests today, although commercial virtualization tools enable more reliable operation.

Earlier work by commercial virus-detection companies focused on finding attacks by using signatures with very low false-positive rates; however, these systems would miss attacks that were even modestly mutated. The best research systems of the time were focused on detecting attack behaviors rather than specific attack signatures, and researchers claimed these systems could find both known and unknown attacks. Testing this hypothesis meant that Lincoln Laboratory needed to provide both existing and new attacks. The Laboratory's evaluations were the first to include attacks that disassociated code propagation from attack activation and the first to include attacks intentionally modified to mimic background traffic. The six tested research systems proved to have good overall performance (a 60% detection rate at ten false alarms per day), but poor new attack performance (below 25%, even at impractically high false-alarm rates). The corpus and rules for scoring



**Figure 6-7**

**Christopher Connelly and Tamara Yu developing LARIAT.**



**Notes**

**9** M. Zitser, R.P. Lippmann, and T.R. Leek, "Testing Static Analysis Tools Using Exploitable Buffer Overflows from Open Source Code," *Proc. 12th ACM SIGSOFT Int. Symp. on Foundations SW Eng.* (2004).

**10** L.M. Rossey, R.K. Cunningham, D. Fried, J.C. Rabek, R.P. Lippmann, J. Haines, and M.A. Zissman, "LARIAT: Lincoln Adaptable Real-Time Information Assurance Testbed," *Proc. IEEE Aerospace Conf.* **6**, 6-2671–6-2682 (2002).

a self-administered test were published, and hundreds of researchers and commercial companies used these to build a better IDS. Researchers are still using this data more than ten years later, despite the fact that network traffic has changed significantly.

In 2004, Lincoln Laboratory used the same detection metric to determine the accuracy of emerging systems that claimed to find vulnerabilities in software — including buffer overflows. Two approaches are commonly used to do this: the first uses static analysis techniques and scans code for constructions that can result in vulnerabilities, and the second uses dynamic analysis and runs the code. Laboratory researchers measured the best available systems and found that static analysis systems were good at detecting vulnerabilities, but had a high false-positive rate. Dynamic analysis systems had a lower probability of detection and a near-zero probability of false alarm, but required input to verify the vulnerability.<sup>9</sup> Again, Lincoln Laboratory published several corpora, and other organizations began to refine their systems, leading to a growing number of commercial products. Today, the National Institute of Standards and Technology continues similar evaluations as part of their Software Assurance Metrics and Tool Evaluation project.

*Lincoln Adaptable Real-time Information Assurance Testbed*

As important as detection accuracy is, metrics related to networks and effecting correct control need to be measured too. Some attacks are best detected by sharing information among multiple sensors, so bandwidth use matters. Most CND systems include some response mechanism, so latency and time to shut down attacks also need to be measured. And, since CND systems are sometimes collocated with the systems they are protecting, system processor use must also be measured. Bandwidth, latency, and processor usage are affected by the network design and the environment of the test; hence, the Lincoln Adaptable Real-time Information Assurance Testbed (LARIAT) software system was developed and distributed,<sup>10</sup> and continues to be refined (Figure 6-7). To date, LARIAT has been used in hundreds of government tests on multiple, large-scale ranges.

Other evaluation programs explored even more complete measures of effectiveness. Lincoln Laboratory developed and tested technology related to ensuring services remained available for use in tactical networks. The Laboratory also designed and developed tests related

## Notes

**11** T.R. Leek, G.Z. Baker, R.E. Brown, and M.A. Zhivich, "Coverage Maximization Using Dynamic Taint Tracing," *Lincoln Laboratory Technical Report 1112*, Lexington, Mass.: MIT Lincoln Laboratory, 28 March 2007, DTIC ADA-465167.

**12** V. Ganesh, T.R. Leek, and M. Rinard, "Taint-based Directed Whitebox Fuzzing," *Proc. 31st IEEE Int. Conf. on SW Eng.*, 474–484 (2009).

**13** R.P. Lippmann, K. Ingols, C. Scott, K. Piwowarski, K. Kratkiewicz, and R.K. Cunningham, "Validating and Restoring Defense in Depth Using Attack Graphs," *IEEE Mil. Comm. Conf.* (2006).

**14** L. Williams, R.P. Lippmann, and K. Ingols, "GARNET: A Graphical Attack Graph and Reachability Network Evaluation Tool," *Proc. 5th Int. Visual. Comp. Sec. Wkshp. (VizSec 2008)*, in *Lecture Notes in Computer Science Series*, eds. J.R. Goodall, G. Conti, and K.-L. Ma, pp. 44–59. Berlin: Springer Verlag, 2008.

to shortening the time required to produce tasking orders. These higher-level tests required systems to fuse sensor data from different parts of networks and to make coordinated decisions.

### Securing Government Systems

Testing others' systems led to a deep understanding of the advantages and disadvantages of multiple approaches to computer security. It also allowed Laboratory scientists to understand where the major technical gaps existed.

Challenges existed in architecting secure systems, preventing and detecting supply-chain and lifecycle attacks, developing highly accurate systems, and making those systems work on disadvantaged networks.

In order to architect a secure system, one needed to focus on security at three distinct times: development time, configuration time, and use time. Each of these required different groups of people acting to build a secure system, increasing the potential for mistakes (or intentional malicious actions) that can result in weak system security.

Development-time security required software and hardware interfaces designed so that system assembly likely results in a secure system. Lincoln Laboratory has built several systems to assist developers in automatically verifying that their software does not contain common vulnerabilities. The Laboratory built upon the observation that static analysis techniques could be used to find likely vulnerability loci, and dynamic analysis techniques could be used to drive down the false-alarm rate. Lincoln Laboratory

developed static analysis tools, instrumentation to support dynamic analysis, and an automated testing infrastructure.<sup>11, 12</sup> These tools have been used to test and find vulnerabilities in large software systems, including some used for the AEHF program.

Configuration-time security requires that components be connected and set for secure use, with external access limited to a few regularly patched computers and all access limited to essential services. But patching and limiting access while maximizing service availability is challenging and time-consuming. To help focus efforts, Lincoln Laboratory developed and patented key elements of an attack-graph analysis system that gathered together information about the topology of a network, access controls, and unpatched vulnerabilities.<sup>13</sup> The resulting system could recommend configuration changes that would best protect even extremely large networks. Subsequent enhancements enabled scalable visualization of the current configuration and the impact of changes due to discovered attacks, reconfigured access controls, or patched systems.<sup>14</sup> This tool has been used to find and fix significant U.S. configuration vulnerabilities.

Use-time security requires system designs that do not rely on users to do extra security tasks in the course of normal business and that provide support for monitoring systems and for educating and training personnel relying on the communications infrastructure. Lincoln Laboratory measured the willingness of individuals to ignore security warnings — and found that most ignore

1990



All-optical terminal

## Notes

**15** A. Ozment, S.E. Schechter, and R. Dhamija, "Web Sites Should Not Need to Rely on Users to Secure Communications," presented at W3C Workshop on Transparency and Usability of Web Authentication, New York, N.Y., March 15–16, 2006.

**16** R.I. Khazan, R.A. Figueiredo, R. Canetti, C.D. McLain, and R.K. Cunningham, "Securing Communication of Dynamic Groups in Dynamic Network-Centric Environments," *IEEE Mil. Comm. Conf.* (2006).

**17** R.K. Cunningham and C.S. Stevenson, "Accurately Detecting Source Code of Attacks That Increase Privilege," *Proc. 4th Int. Symp. Recent Advances in Intrusion Detection (RAID 2001)*, in *Lecture Notes in Computer Science* Series, pp. 104–116, Berlin: Springer Verlag, 2001.

**18** R. Basu, R.K. Cunningham, S.E. Webster, and R.P. Lippmann, "Detecting Low-Profile Probes and Novel Denial-of-Service Attacks," presented at IEEE Sys., Man, and Cybernetics Info. Assur. & Sec. Wkshp. 2001, West Point, New York, 2001.

**19** R.P. Lippmann, I.D. Wyschogrod, S.E. Webster, D.J. Weber, and S. Gorton, "Using Bottleneck Verification to Find Novel New Attacks with a Low False Alarm Rate," presented at Recent Advances in Intrusion Detection, Louvain-la-Neuve, Belgium, 1998.

**20** R.K. Cunningham, S. Cheung, M. Fong, U. Lindqvist, D. Nicol, R. Pawlowski, E. Robinson, W. Sanders, S. Singh, A. Valdes, B. Woodworth, and M. Zhivich, "Securing Current and Future Process Control Systems," in *Critical Infrastructure Protection*, eds. E. Goetz and S. Shenoi, pp. 99–115, IFIP Int. Fed for Info Processing Series vol. 253. Boston: Springer, 2007.

warnings in favor of completing a task.<sup>15</sup> As a result, the Laboratory has designed protocols that automate security tasks and graphical user interfaces that enable users to accomplish tasks in a secure fashion without needing to focus on security. The Laboratory has focused on developing protocols suited to disadvantaged and large-scale networks. For example, researchers designed cryptographically secure group keying protocols for tactical networks and developed a user interface to support secure chat applications.<sup>16</sup> These tools have been used in multiple DoD exercises (e.g., Red Flag 2007 and Empire Challenge 2008).

Network situational awareness needs to be developed and maintained for network operations and defense. A key component of these tasks is that networks must be monitored — usually with the help of intrusion detection systems. Early IDS work followed the virus-detection community and employed signature verification to find attacks. Lincoln Laboratory demonstrated that attacks could be found more accurately by using machine-learning techniques to select signatures, detecting remote-to-local attacks, attack source code<sup>17</sup> and probes, and denial-of-service attacks.<sup>18</sup> A new algorithm, called "bottleneck verification," enabled quick and accurate detection of attacks that elevated privilege,<sup>19</sup> by checking to see that software passed through intentional and beneficial security bottlenecks, and by alerting when it observed a change of privilege level without a concomitant transition through those bottlenecks. This basic algorithm was first developed and demonstrated for use in the U.S. Air Force's

Automated Security Incident Measurement network IDS, was ported as a key element of the Army's Battlefield IDS, and is now used in several commercial products.

To complete the protection of systems during use and to make sure government personnel understand the range of solutions required to secure its networks, Lincoln Laboratory has started offering courses on computer network defense.

### *Process Control System Defense*

Lincoln Laboratory has also been concerned about securing the devices and networks that enable production and distribution of energy. To address the problem of securing process control networks,<sup>20</sup> the Laboratory participated in a study to assess the needs of existing operators and vendors, considered a variety of solutions, and worked with and subsequently led a team of national security experts from other federally funded research and development centers, from the Department of Energy and commercial research laboratories, and from academia. As with other computer systems, process control systems need to be secure as developed, configured, and used. Accordingly, the Laboratory participated in a national team, sponsored by the Department of Homeland Security (DHS), that developed tools and patented procedures targeted at securing vendor software, defining secure process control network configurations, and monitoring the special protocols that effect controls at refineries and distribution centers.



J.S. Stadler



AEHF packet switch



Because the majority of plants and centers are in private hands, a number of challenges arose and were addressed. First, before agreeing to new equipment expenditures, operator management needed to understand the business justification for each purchase. Also, because plant downtime implied lost production, a case needed to be developed to cover both the cost of taking a plant offline and the usual costs of purchasing, installing, configuring, and operating new equipment. The team created a tool to develop a business case, linking network components with high-level business goals. This tool was subsequently commercialized and is in use today.

Unlike the enterprise information technology markets in which computers are replaced every few years, process control systems remain in use and operating for decades. Old systems and protocols need to be tolerated, and the desire for backward compatibility has led to purpose-built, hardwired network protocols being transmitted via Internet protocol networks. Further, most process control systems are real-time systems with hard deadlines, but the networks used to support these systems do not guarantee delivery. Without replacing those systems, the best one can do is ensure access is carefully limited and the components are secured. An industry advisory board was employed to help focus on the most important problems and verify the commercial viability of tools to make these tasks easy. These tools were developed and tested for functionality, and validation was performed by means of trial deployments through process control system vendors and operators. Several systems were licensed by industry for commercial use, and these systems help protect our critical infrastructure today.

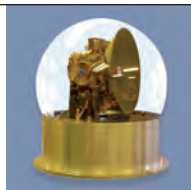
Unlike DoD systems for which the government sets standards and specifications, process control networks often conform to industry standards established by national trade associations; therefore, the national team allied itself with these organizations. Lincoln Laboratory and the DHS-funded team presented their growing understanding of process control system security to industry representatives and members, and members were invited to attend and participate in workshops. The team also helped develop and refine computer security “best practices” for industry.

Because process control system defense remains in its infancy, team members worked to develop sector road maps, and participated in a congressionally supported forum considering future directions for the security of process control networks.

#### **Network-Centric Operations**

Lincoln Laboratory has a long history of building large systems-of-systems using networks. At its inception, Lincoln Laboratory was charged with designing and implementing the prototype Semi-Automatic Ground Environment (SAGE) system, which included a network of sensors (see chapter 2, “The SAGE Air Defense System”). The success of the SAGE system and many others to follow in the areas of ballistic missile defense, space surveillance, and air traffic control eventually led in the 1990s to the emergence within DoD of the military concept of network-centric, often abbreviated to net-centric, operations (NCO).

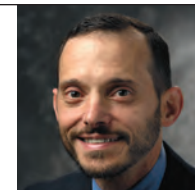
2000



On-the-move antenna



TSAT terminal



M.A. Zissman

## Note

**21** The following are relevant NCO documents. “Guidance for Implementing Net-Centric Data Sharing,” DoD Directive 8320.2, April 12, 2006; “Interoperability and Supportability of Information Technology and National Security Systems,” DoD Directive 4630.05, May 5, 2004; “Net Ready Key Performance Parameters,” Chairman of the Joint Chiefs of Staff Instruction 6212.01, enclosure E, section 3; “Net Centric Checklist, version 2.1.4,” Office of the Assistant Secretary of Defense for Networks and Information Integration/DoD Chief Information Officer, July 30, 2004.

Net-centric operations call for information networks to connect sensors, weapons, and battle managers together into an agile, interoperable system.<sup>21</sup> This Internet-like system seeks to provide rapid and straightforward information sharing among worldwide military forces. NCO encourages the migration from systems built for a single mission to a set of networked systems that can rapidly be assembled to handle any mission. The value delivered by NCO can be derived from four tenets:

- A robustly networked force improves information sharing.
- Information sharing enhances the quality of information and shared situational awareness.
- Shared situational awareness enables collaboration and self-synchronization, and enhances sustainability and speed of command.
- These three capabilities, in turn, dramatically increase mission effectiveness.

In 2007, Lincoln Laboratory’s ongoing NCO efforts converged into a unified thrust to create common architectures and standards that would maximize interoperability. The Laboratory’s NCO goals were to create common architectures, tools, and test beds across its broad spectrum of national-security domains. Serving as a microcosm for the DoD’s Global Information Grid (GIG), Lincoln Laboratory would develop and test NCO architectures and ensure interoperability among the Laboratory’s diverse mission areas.

Under the leadership of Stephan Rejto, the Lincoln NCO Center was formed to focus on four activities: (1) development of a research portfolio to go beyond contemporary service-oriented architectures; (2) development and standardization of “sidecars” for making existing sensors network accessible (discussed later); (3) development of a “tool kit” repository of software services to allow rapid dissemination of, and to avoid duplication of, same/similar services; and (4) development of a test bed used to integrate cross-military domain systems in mission-relevant demonstrations. In addition to the four focus areas, Lincoln Laboratory staff developed architecture standards and, in cooperation with other federal laboratories and government officials, taught courses in net-centric methods, architectures, and applications at the Naval War College and other venues. Early application was found in the space situational awareness (SSA) domain, with additional demonstrations including intelligence, surveillance, and reconnaissance (ISR); cyber; maritime; homeland air defense; and ballistic missile defense (BMD) domains.

### *Net-Centric Research*

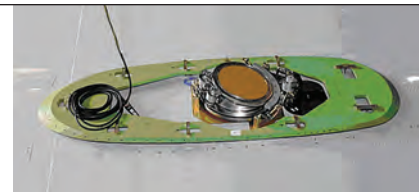
Connecting people with the information they need is an ongoing challenge that spans Laboratory mission areas. In an era of unanticipated threats and rapidly evolving operational needs, traditional stove-piped systems have proved to be impediments to information sharing. Fortunately, the pull of commerce and the push of creative research provide a basis for addressing these problems through the World Wide Web, Web Services,



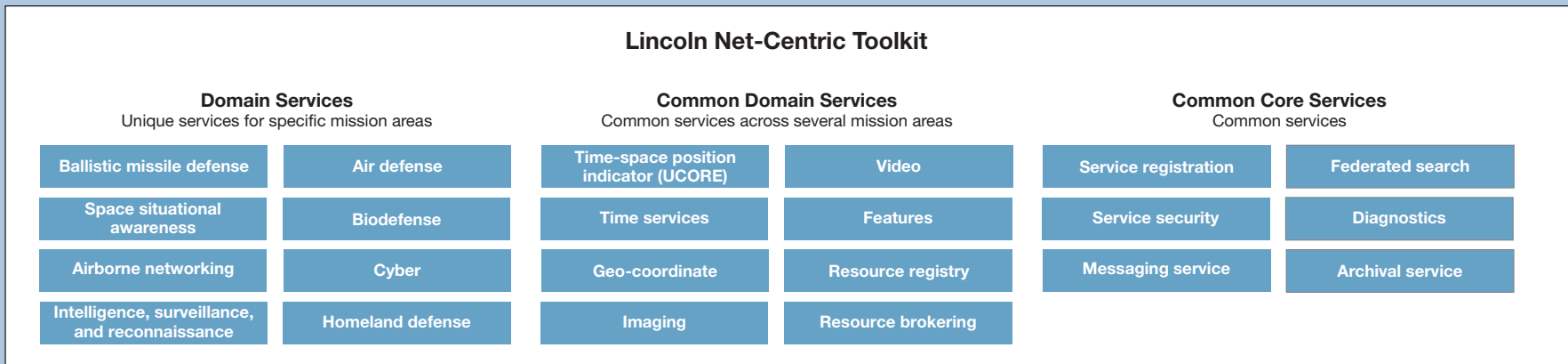
Antenna/pedestal system used on the Paul Revere to provide connectivity to Milstar



S.B. Rejto

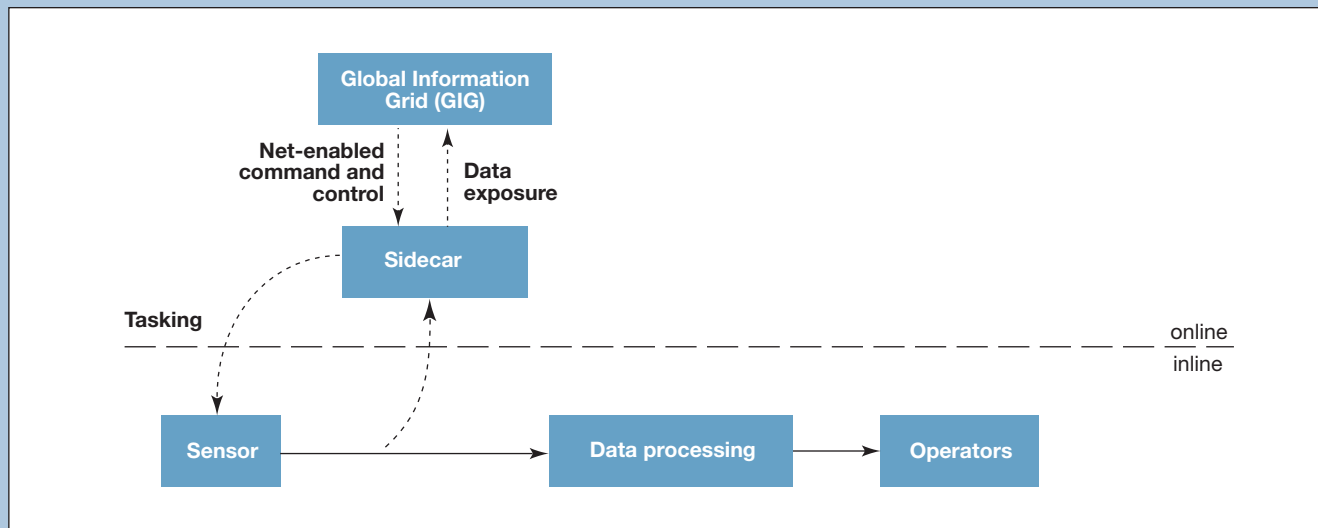


Advanced Multiband Communications Antenna used on Paul Revere for 2009 test flight



**Figure 6-8**  
Lincoln Net-Centric Toolkit.

**Figure 6-9**  
A sidecar interfacing to a sensor system.





the Semantic Web, and Semantic Web Services. This technology area is undergoing rapid evolution and is a rich source of research challenges with high potential payoff. Lincoln Laboratory pursued two research areas that focused on increasing information connectivity: data integration and service composition.

In the area of data integration, researchers at Lincoln Laboratory developed algorithms and an architecture that enable heterogeneous information sharing across communities of users. The Laboratory developed a heterogeneous data integration approach employing a logical repository, user and autonomous agent tools, interfaces for data ingest and access, and a semantic data model. Working with researchers at the MIT Computer Science and Artificial Intelligence Laboratory (CSAIL) and at the Worcester Polytechnic Institute Computer Science Department, Lincoln Laboratory integrated and developed semantic linkages across data sets, community-based collaborative algorithms, and an incremental, value-based integration architecture.

In the area of service composition, Lincoln Laboratory developed approaches for dynamically composing services with the goal of rapid, automatic orchestration of services into workflows to accomplish a specific mission. The Laboratory explored techniques for semantically describing services and developed an architecture for composing services offered by different communities of interest in a scalable and distributed fashion. In this effort, the Laboratory worked with researchers at the MIT CSAIL and at Booz Allen Hamilton, Inc.

#### *Net-Centric Toolkit*

In order to maximize the benefit of NCO, the Laboratory developed a tool kit of software services. The tool kit is based on a common net-centric architecture with interoperable standards based on Net-Centric Enterprise Services (NCES), a Defense Information Systems Agency program created to enable the DoD's data and services strategy. The NCES provide various core enterprise services to connect producers and consumers of information. These enterprise services include registration and discovery, security, messaging, collaboration, and others, and are based on industry standards such as Web Services.

The tool kit (Figure 6-8) contains software and services categorized into three areas:

1. Core services: These are basic infrastructure services primarily designed to allow a developer to register, discover, and secure services. These services also include software development kits, application program interfaces, templates, and frameworks that developers can leverage to build their services. The data transfer service (DTS) is a messaging service that allows consumers and producers to share data by means of a common interface but with plug-in data-feed technologies. Using DTS promotes interoperability across many existing standards and provides an upgrade path to new technologies without having to modify the application software.
2. Common domain services: These are general-purpose services (e.g., resource brokering, video services) that have broad utility across several mission areas. An important cross-domain service that the tool kit team has developed is the "resource broker," an initial step at standardizing command and control for net-centric systems. The goal of the resource broker is to allow users to ask for information in a declarative way instead of in a resource-specific way by decoupling tasking requests from the specific resource that can perform the task.
3. Domain-specific services: This class of services is applicable to a specific mission area (e.g., BMD, cyber, homeland defense, ISR, or space). For each mission area, a set of services is being developed that has value within that community. Examples include a space conjunction service that can determine whether two objects in space will collide or a BMD discrimination service that can determine the lethality of a ballistic target.

#### *Sidecars*

A critical part of NCO is exposing and sharing information. For the warfighter, live sensors (e.g., radars) are a critical source of data. Regrettably, many U.S. military sensors are not able to expose and share data across networks, and the ones that can share often do so in mission-specific formats. Over the last decade, Lincoln Laboratory has deployed nearly a dozen sidecars to provide a bridge from a sensor system to a network and enable net-centric operations (Figure 6-9).

The sidecar is a low-cost computer that interfaces with a sensor at various points and collects and processes sensor-specific data. Those data and new data created by the sidecar are then exposed to the network through common protocols and common data standards. In this role, the sidecar can massage raw data into new data products or translate sensor-specific data formats into common formats on the network. In addition, the sidecar provides a platform for running discoverable services. Clients on the network can discover and subscribe to services that exist on the sidecar. A federation of networked nodes consisting of sidecars connected to their respective sensors can enable net-centric operations. Users connected to the network can discover and subscribe to services and data feeds that are exposed by the sidecars using common formats.

In 2007, work began on the use of sidecars to permit networked-enabled command and control. For this use, the role of a sidecar is reversed in that the sidecar processes command-and-control commands from the network and translates them into specific commands that are used to control the sensor. The sidecar is connected to the sensor control interface and/or battle management ports and can act as a virtual operator for the sensor. The ability to control a sensor by means of a sidecar was demonstrated in 2008.

Together, the capabilities provided by the sidecar provide a simple but very powerful mechanism to enable unique, legacy sensors to connect into a network and form part of the net-centric architecture.

#### *Net-Centric Demonstrations*

The true power of NCO is the ability to confront uncertain events with an agile set of capabilities. Given a specific threat, the NCO system allows the orchestration of capabilities (sensors, software components, displays, etc.) to be assembled quickly in support of the warfighter.

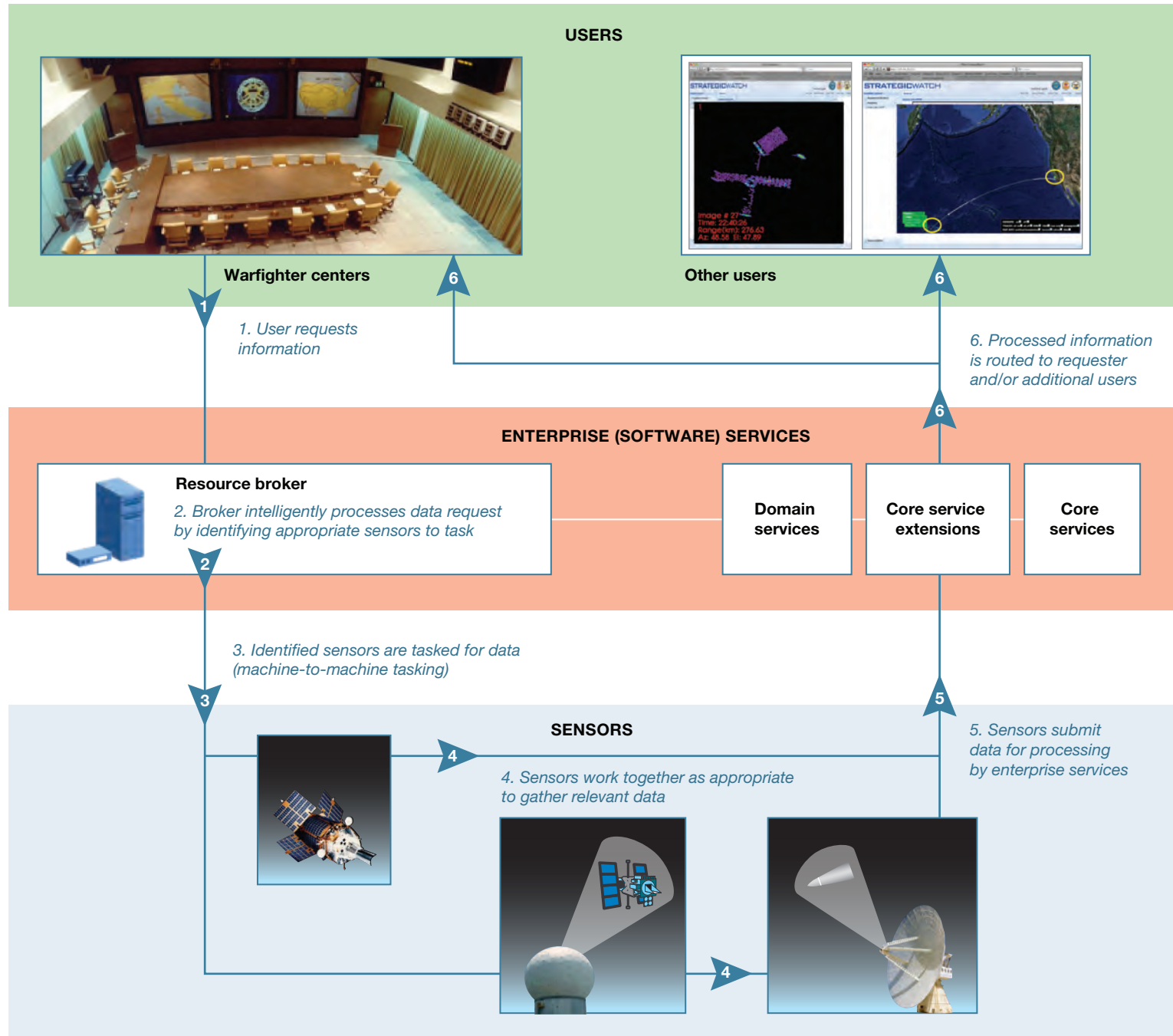
In order to demonstrate this vision, Lincoln Laboratory developed a GIG test bed to enable demonstrations of NCO architectures. Demonstrations are based on specific threat scenarios. A set of software services and sensor data feeds are identified and rapidly interconnected to provide a solution tailored to the specific event.

In 2010, a ballistic missile defense/space situational awareness/cyber “live fly” event served as the scenario. Utilizing services from the Net-Centric Toolkit, the demonstration orchestrated sensors and services between the BMD, SSA, and cyber communities during a live Minuteman III launch. Figure 6-10 illustrates the demonstration. Key highlights of the demonstration included the following:

1. Live-time SSA and imaging feed services
2. Launch prediction, impact prediction, and launch characterization of the Minuteman III launch
3. Machine-to-machine, dynamic tasking of sensors using semantic-based resource broker services
4. Services and processing chains to expose tracks and features, and to provide a track correlation framework
5. Cyber attack and defense
6. Integration with enterprise services on the Secret Internet Protocol Router Network (SIPRNet), including Net-Centric Enterprise Services, Joint User Messaging, and Google Maps
7. Web browser-based User Defined Operational Picture using Strategic Watch

The demonstration highlighted the benefits of orchestrating net-centric services to handle different missions, the process of defending through a cyber attack by switching operating systems in live time, and the capability of dynamically switching a sensor between space and missile defense mission areas.

## 2010 BMD\*\*/SSA\*\*/Cyber NCO\*\*\* Demonstration



\*BMD: ballistic missile defense

\*\*SSA: space situational awareness

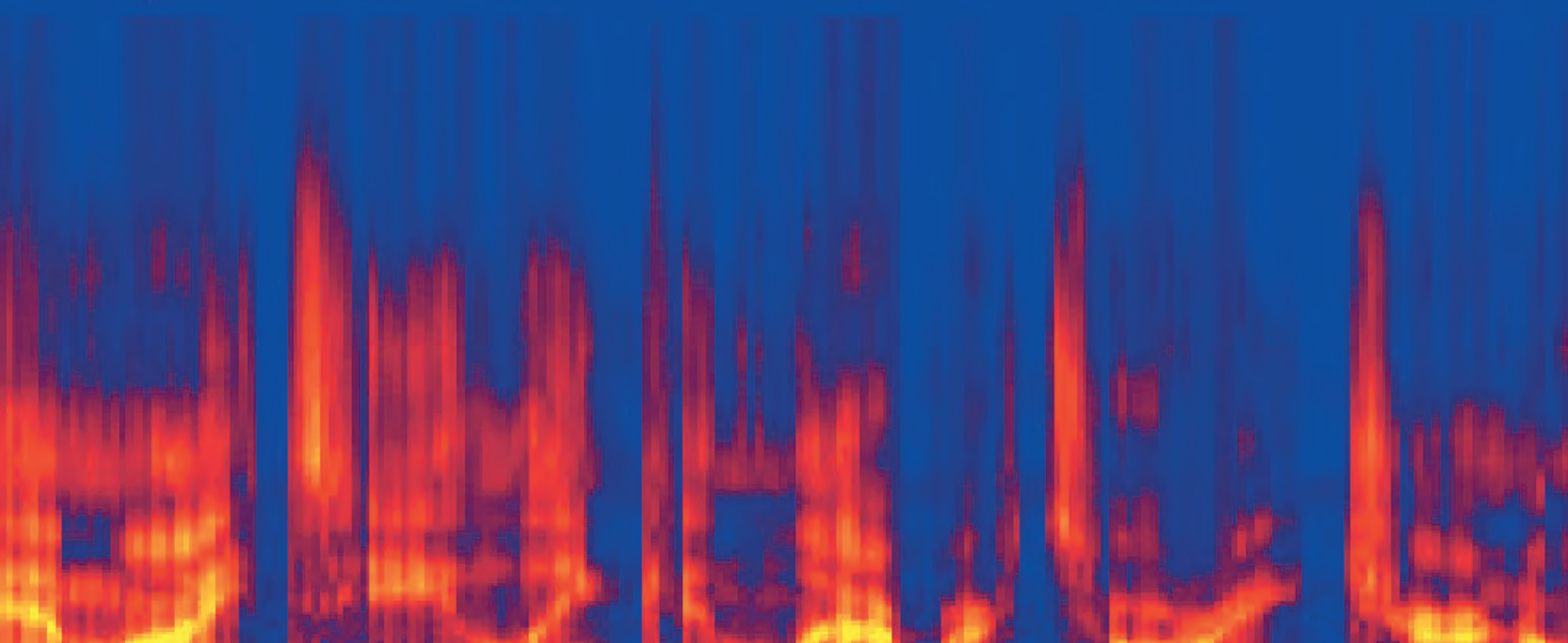
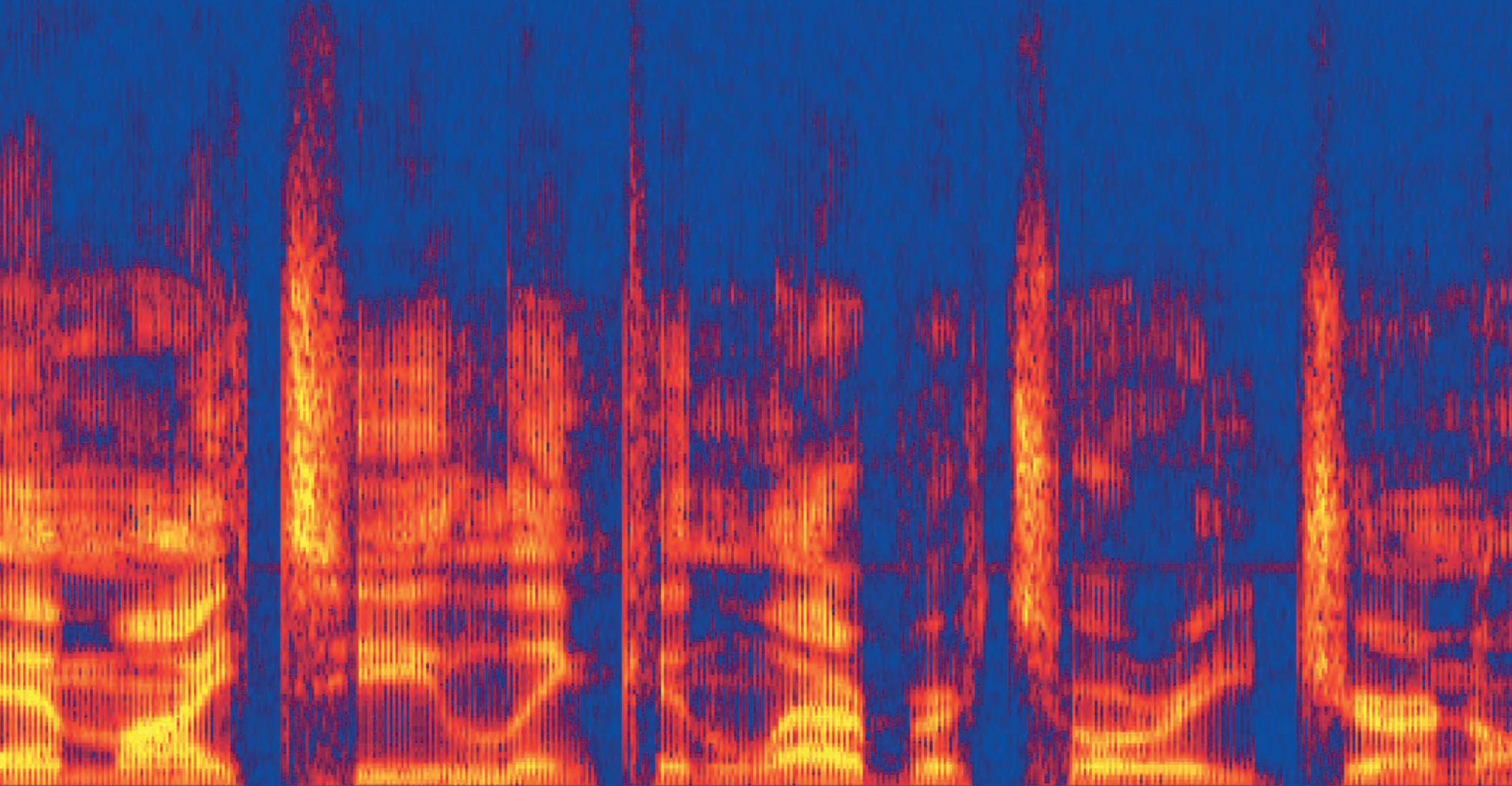
\*\*\*NCO: network-centric (net-centric) operations

**Figure 6-10**

Depiction of the 2010 BMD/SSA/cyber NCO demonstration. Sensor data are communicated and processed by enterprise services to provide situational awareness to command centers via user-defined displays.

The enterprise services enable the command centers and any other users to get the information they need. In addition, components are architected to survive through a cyber attack.







**Starting with pioneering work in speech coding and recognition in the 1950s, Lincoln Laboratory has sustained and expanded a speech and language technology effort that has yielded major contributions in speech coding, networking, and enhancement; speech recognition; speaker, language, and dialect identification; and machine translation of speech and text.**

**Left: The image shows the underlying time-frequency characteristics of speech that are exploited by automatic recognition systems. The white plot in the center is the time-domain waveform of the spoken phrase “MIT Lincoln Laboratory Journal.” Upper and lower plots are high-resolution and lower-resolution spectrographic representations of the same signal. The horizontal time axis represents time (about 4 sec), the vertical axis represents frequency (0 to 16 kHz), and the colors represent energy intensity.**

Lincoln Laboratory’s contributions in speech technology began in the 1950s with the development of pioneering computer-based systems for speech coding, pitch detection, and speech recognition. The early speech work grew out of computer technology, digital signal processing, and communications programs; a speech systems technology group was established in the late 1970s and has been led by Clifford Weinstein since 1979.

Over several decades, the Laboratory has sustained and expanded a speech and language technology effort that has yielded major contributions over a range of technologies (Figure 7-1) both in speech processing (coding, networking, and enhancement) and in information extraction from speech and language (speech-to-text; speaker, language, and dialect identification; and machine translation of speech and text). The program has produced new algorithms that have achieved world-leading performance in international evaluations, innovative hardware/software implementations, and significant Department of Defense (DoD) and government system applications.

Speech research and development at Lincoln Laboratory have also produced technologies that subsequently proved to be important in other areas. For example, speech coding applications were the initial focus for Laboratory work in digital signal processing, and speech-recognition applications were a principal early focus for Lincoln Laboratory work in advanced pattern-classification algorithms, including algorithms based on artificial neural networks.

### Speech Coding and Networking

Lincoln Laboratory has played an important role in the advancement of vocoder technology. The purpose of a vocoder is to analyze and synthesize speech in terms of a set of parameters (characterizing the pitch and spectrum) that can be encrypted and transmitted at a much lower bit rate than the original speech waveform. Vcoders have a rich history. The World War II-era SIGSALY system allowed Presidents Franklin Roosevelt and Harry Truman to converse freely with Prime Minister Winston Churchill over a highly secure transatlantic telephone. The SIGSALY system was massive, comprising a room full of equipment at each side, and the transmitted speech, though reasonably intelligible, was not of very good

quality. Today’s secure telephones provide significantly higher quality than did the SIGSALY system and are the size of a typical telephone deskset or even a handheld cellular phone.

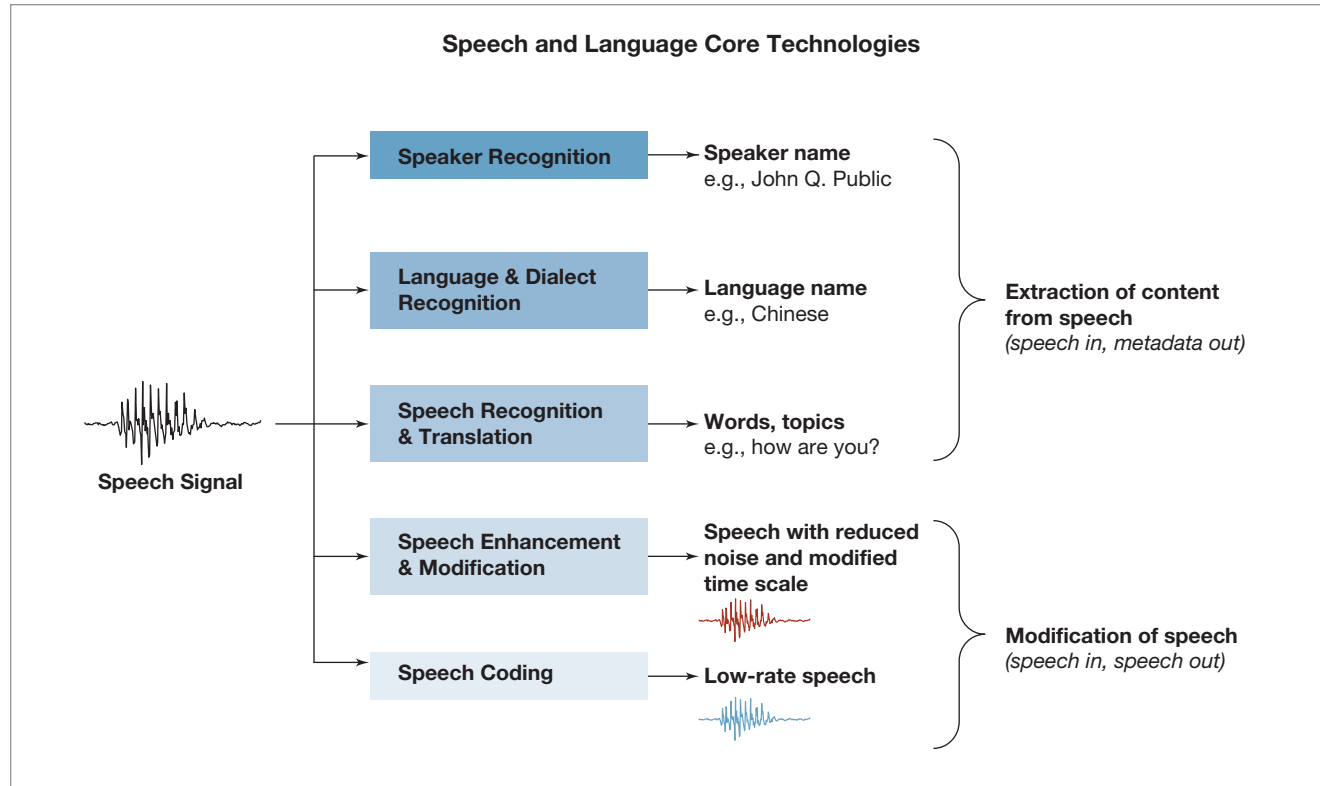
The Laboratory’s entry into the vocoder field was initiated in the early 1960s by Bernard Gold’s development of a computer-based pattern-recognition algorithm for pitch detection on the TX-2 computer. The unreliable performance of pitch detectors had been a limiting factor in vocoder performance, and Gold’s algorithm yielded significant improvements over previous techniques; it was one of the first successful applications of computer technology to an important problem in waveform processing. The algorithm later became a key component of various vocoders developed at Lincoln Laboratory and elsewhere over the next 30 years (Figure 7-2). In the middle to late 1960s, Lincoln Laboratory designed and built channel vocoders (vocoders that perform spectrum analysis and synthesis by using a bank of channel filters) that included a hardware version of the pitch detector and that provided 2400 bps voice coding for the Lincoln Experimental Satellite communication systems.

Although digital simulations were used to help design the filters in the early Lincoln Laboratory vocoders, the actual vocoders used analog filters. But by the late 1960s, advances in digital signal processing and the invention and development of the fast Fourier transform (FFT) began to change both the Laboratory’s vocoder algorithms and their implementations. Alan Oppenheim developed the homomorphic vocoder algorithm, which performed fine-grain spectrum analysis via the FFT, and he used novel techniques for separating the pitch and vocal tract parameters. The Laboratory also developed the first all-digital channel vocoder implementations.<sup>1</sup>

The 1970s were marked by rapid advances in vocoder algorithms and in their implementations in digital processors. An important development occurred around 1970 when Bishnu Atal and Manfred Schroeder of Bell Telephone Laboratories introduced the technique of speech spectrum analysis by linear prediction, known as linear predictive coding (LPC). An LPC vocoder models the speech spectral envelope as an all-pole filter, with the parameters defined by

**Figure 7-1**

**Core technologies that extract information from speech or text and that process speech to produce modified speech signals. The extracted information includes the speaker, the language or dialect, and/or the words (sometimes translated from another language).**



**Notes**

**1** T. Bially and W.M. Anderson, "A Digital Channel Vocoder," *IEEE Trans. Comm. Tech.* **14(4)**, 435–442 (1970).

**2** E.M. Hofstetter, J. Tierney, and O. Wheeler, "Microprocessor Realization of a Linear Predictive Vocoder," *IEEE Trans. Acoust. Speech Signal Process.* **25(5)**, 379–387 (1977).

**3** J.A. Feldman, E.M. Hofstetter, and M.L. Malpass, "A Compact, Flexible LPC Vocoder Based on a Commercial Signal Processing Microcomputer," *IEEE J. Solid-State Circuits* **18(1)**, 4–9 (1983).

**4** R.J. McAulay and T.F. Quatieri, "Speech Analysis-Synthesis Based on a Sinusoidal Representation," *IEEE Trans. Acoust. Speech Signal Process.* **ASSP-34(4)**, 744–754 (1986).

**5** T.F. Quatieri, C.J. Weinstein, K. Brady, W.M. Campbell, D.P. Messing, J.D. Tardelli, P.D. Gatewood, and J.P. Campbell Jr., "Exploiting Nonacoustic Sensors for Speech Encoding," *IEEE Trans. Audio Speech Lang. Process.* **14(2)**, 533–544 (2006).

**6** A. McCree, K. Brady, and T.F. Quatieri, "Multisensor Very Low-Bit-Rate Speech Coding Using Segment Quantization," *Proc. ICASSP 2008*, 3997–4000 (2008).

solving a set of linear equations. Surprisingly, the computation needed for LPC spectrum analysis is significantly less than for a bank of digital filters in a channel vocoder, and this less intensive computation was a primary factor in the selection of LPC as a DoD standard vocoder in 1975.

Lincoln Laboratory played a leading role in the development and practical application of LPC and other vocoders in the 1970s. In 1971, Edward Hofstetter implemented the first real-time 2400 bps LPC algorithm; it ran on the Fast Digital Processor and was implemented with fixed-point arithmetic, which turned out to be crucial in the hardware implementations that followed. In 1974, Peter Blankenship and others developed the Lincoln Digital Voice Terminal (LDVT), the first easily programmable signal processor that could implement a large range of narrowband vocoder algorithms in real time. In 1977, a more capable successor to the LDVT, the Lincoln Digital Signal Processor (LDSP), provided a powerful facility for Lincoln Laboratory speech research through the early

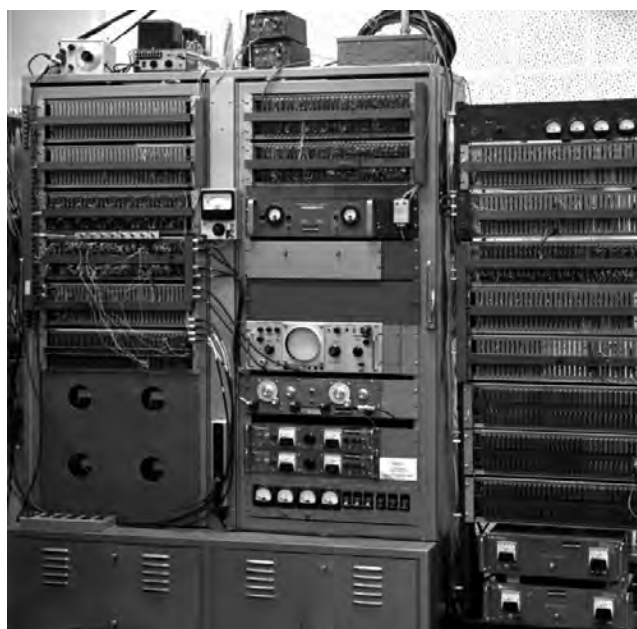
1980s. Also in 1977, Lincoln Laboratory developed the first stand-alone, microprocessor-based LPC vocoder (LPCM), which became a model for a number of subsequent commercial units.<sup>2</sup> The design was later modified to produce a programmable vocoder that was used in F-15 flight tests.

When a new generation of digital signal processing chips became commercially available around 1980, Lincoln Laboratory moved rapidly to exploit these devices and developed the first truly compact LPC vocoder, a single-card design with circuitry occupying 18 sq in and dissipating 5.5 W (Figure 7-3).<sup>3</sup> This single-card compact LPC vocoder was particularly important in the U.S. development of secure voice systems because it demonstrated technical feasibility for the DoD's Secure Telephone Unit (STU-III) program, which was launched soon after the demonstration of the compact LPC vocoder. The STU-III program has provided compact secure telephones to hundreds of thousands of users.



**Figure 7-2**

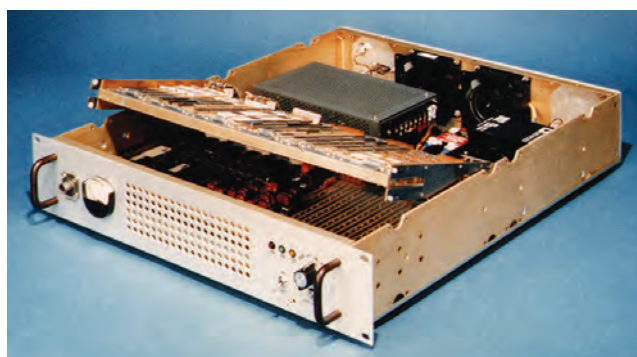
The early channel vocoder built at Lincoln Laboratory included a bank of twenty analog Bessel filters and an implementation of the Gold pitch detector in digital hardware.



A focus of the Laboratory's vocoder work in the 1980s was the development of robustness techniques for speech-coding algorithms to retain high performance in military aircraft environments characterized by high noise and channel errors. Lincoln Laboratory's robust speech processing algorithms included robust LPC analysis techniques and new pitch-detection algorithms specifically designed to combat noise. These algorithms were implemented in real time on the LDSP and tested in simulated aircraft noise with a test bed cooperatively developed by Lincoln Laboratory and the Air Force Medical Research Laboratory. On the basis of this research, the Laboratory implemented a set of robust LPC-based algorithms in compact, flyable hardware to provide 2400 bps voice data for the Joint Tactical Information Distribution System (JTIDS) communication system on F-15 aircraft. The flight tests of the Lincoln Laboratory equipment, conducted over Nellis Air Force Base, Nevada, in 1986, were the first successful U.S. tests of narrowband vocoders in fighter aircraft.

**Figure 7-3**

**Top:** The LPCM of 1977 was the first microprocessor-based linear predictive-coding vocoder. **Bottom:** The compact LPC vocoder of 1982 demonstrated that microprocessor technology would permit construction of a vocoder that was small and inexpensive enough for wide distribution.



In the mid-1980s, Robert McAulay and Thomas Quatieri began work on a new approach to speech analysis/synthesis based on a sinusoidal model.<sup>4</sup> They developed the sinusoidal transform coder (STC), which achieved high quality and robustness in the 4000 to 8000 bit-rate range. The STC was then extended to 2400 bps operation, and it significantly outperformed LPC in quality at that bit rate. The sinusoidal analysis/synthesis model also served as the basis for many significant advancements in speech and audio enhancement and modification, described later in this chapter.



Lincoln Laboratory has also devised techniques to obtain good voice performance at bit rates below 2400 bps. Early work in this area included frame-fill techniques that enabled 1200 bps LPC-based systems to perform almost as well as their 2400 bps counterparts, and adaptive template-matching techniques that produced good performance at 800 bps, with adaptation times of a few seconds for new speakers. More recent work has focused on simultaneously achieving low bit rates and robust performance in noise through a combination of multiple sensors and pattern-recognition techniques.<sup>5,6</sup>

## Notes

7 C.J. Weinstein and J.W. Forgie, "Experience with Speech Communication in Packet Networks," *IEEE J. Selected Areas Commun.* **SAC-1(6)**, 963–980 (1983).

8 T.F. Quatieri, *Discrete-Time Speech Signal Processing: Principles and Practice*. Upper Saddle River, N.J.: Prentice Hall, 2002.

9 R.J. McAulay and M.L. Malpass, "Speech Enhancement Using a Soft-Decision Maximum-Likelihood Noise Suppression Filter," *IEEE Trans. Acoust. Speech Signal Process.* **28(2)**, 137–145 (1980).

The success of packet networks for data communications in the late 1960s and early 1970s sparked interest in integrating voice and data in packet networks. Participating with other research laboratories and working on its own, Lincoln Laboratory conducted pioneering research and development, and subsequent experiments, in packet speech and created systems that were forerunners of the Voice-over-Internet Protocol (VoIP) systems that are now so widely in use.<sup>7</sup>

Using the TX-2 computer, Lincoln Laboratory conducted the earliest packet-speech-related experiments on the Advanced Research Projects Agency Network (ARPAnet) in 1971. The Laboratory subsequently worked with other ARPA-supported laboratories to implement revolutionary packet-speech and packet-speech-conferencing experiments on the ARPAnet, the Atlantic Packet Satellite Network, and an experimental domestic wideband packet satellite network. Lincoln Laboratory developed packet-voice terminals, local-area packet-voice networks, and new stream-oriented protocols for packet voice that were forerunners of current strategies used for voice and video transmission in packet networks. A major milestone was achieved in June 1982, when packet-speech conferencing over the wideband satellite network was demonstrated by linking voice terminals on local-area cable networks at Lincoln Laboratory, a mobile packet radio net at SRI in Palo Alto, California, and the Information Sciences Institute in Marina del Rey, California, where a special interface provided connection to the regular switched telephone network (Figure 7-4). In August 2011, the IEEE Board of Directors approved "First Real-Time Speech Communication on Packet Networks, 1974–1982" as an *IEEE Milestone*, with plaque to be installed at Lincoln Laboratory.

## Speech Enhancement and Modification

Since the late 1970s, Lincoln Laboratory has developed a broad range of speech enhancement and speech modification algorithms and systems that have been applied successfully in DoD and government systems. The goal of speech enhancement is generally to improve the quality of speech that has been degraded by noise, interference, or processing.<sup>8</sup>

Early Lincoln Laboratory work in speech enhancement included the development of a filterbank-based noise-reduction system based on a maximum-likelihood technique.<sup>9</sup> This filterbank-based system was successfully applied to noise reduction in both vocoding and speech recognition.

Later, in an effort led by Quatieri, the sinusoidal analysis/synthesis approach, which was the basis for the STC, was expanded to become a core technology for a number of significant applications in speech enhancement, including noise and tone suppression, suppression of cochannel interference when the interfering signal is speech, and pretransmission enhancement of speech to increase effective AM radio broadcast range for the Voice of America. In addition to algorithms based on sinusoidal analysis/synthesis, the Laboratory has developed novel signal-adaptive approaches for speech enhancement. The Laboratory integrated a suite of these sinusoidal and adaptive-signal-based enhancement algorithms — including wideband noise, tone, pulse, and interference suppression — into a flexible speech enhancement tool kit that has been transitioned to many military and

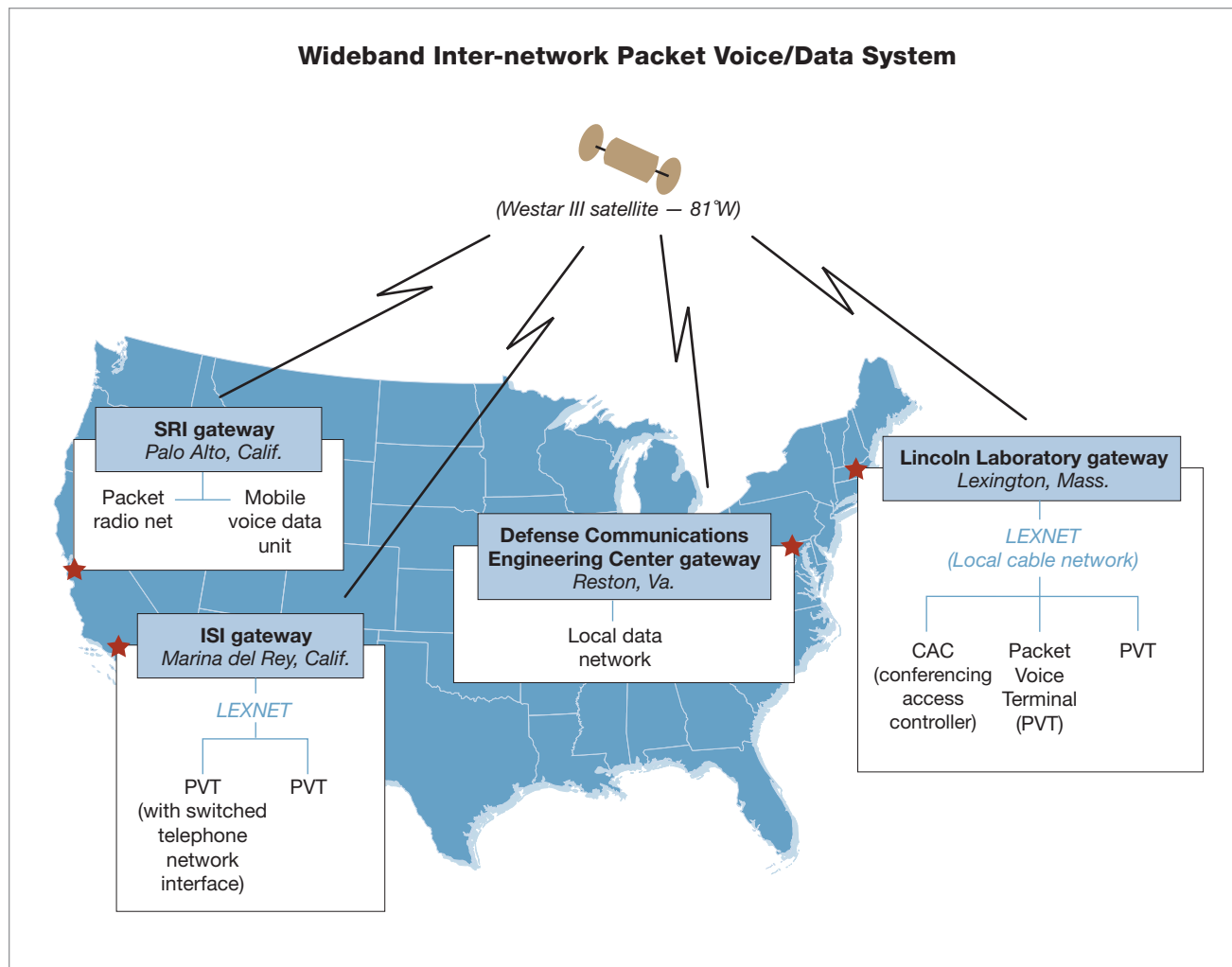
1960



B. Gold



J. Tierney evaluating speech vocoder



**Figure 7-4**  
Lincoln Laboratory developed packet-voice technologies and protocols that were forerunners of current strategies widely used for voice and video transmission in packet networks. A major milestone was achieved in June 1982, when packet-speech conferencing over a wideband satellite packet voice/data network was demonstrated by linking voice terminals on local-area cable networks and a mobile packet radio net, and connecting to the regular telephone network via a switched telephone network interface.

1970



C.J. Weinstein

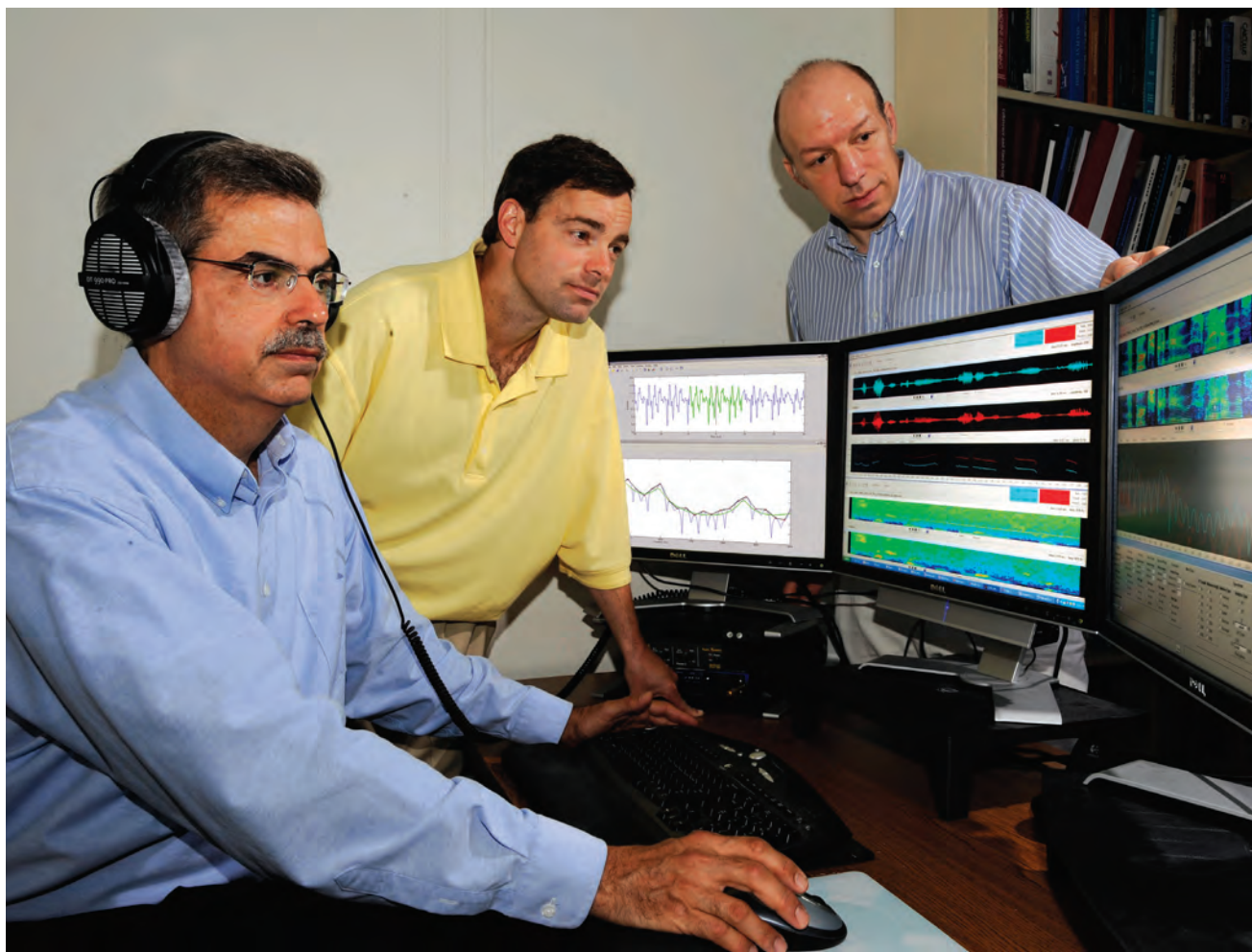


Lincoln Digital Signal Processor



**Figure 7-5**

Lincoln Laboratory has developed and utilizes a variety of powerful, interactive algorithms, systems, and displays for speech technology research and development. Here Thomas Quatieri, Michael Brandstein, and Robert Dunn are working with the Laboratory's speech modification system, which is based on sinusoidal analysis/synthesis and which also supports noise and interference suppression. Displays from left to right show a sinusoidal analysis of a short speech segment, and waveform and spectral displays of processing results.



1980



T.F. Quatieri



G. O'Leary

## Notes

**10** T.F. Quatieri and R.J. McAulay, "Speech Transformations Based on a Sinusoidal Representation," *IEEE Trans. Acoust. Speech Signal Process.* **ASSP-34(6)**, 1449–1464 (1986).

**11** C.J. Weinstein, S.S. McCandless, L.F. Mondschein, and V.W. Zue, "A System for Acoustic-Phonetic Analysis of Continuous Speech," *IEEE Trans. Acoust. Speech, Signal Process.* **ASSP-23(1)**, 54–67 (1975).

government agencies. For example, this tool kit is being applied successfully to aid human listeners by reducing noise and interference in forensic applications at government and military agencies. In addition, Lincoln Laboratory's noise and tone suppression algorithms have been used to make significant improvements in speaker recognition performance under noisy conditions.

The goal in speech modification is to alter the speech signal to have some desired property. Modifications of interest include time-scale, pitch, and spectral changes, many of which have been implemented using sinusoidal analysis/synthesis.<sup>10</sup> Lincoln Laboratory's speech modification systems exhibit high-quality speedup and slowdown of speech for enhanced listening, with pitch and spectral changes to alter the sound of a voice and with both time-scale and pitch changes for concatenative speech synthesis (Figure 7-5). Many of these systems have been transitioned to DoD and law enforcement applications.

### Speech Recognition and Information Extraction

Whereas the output of speech processing (e.g., coding, enhancement) is another speech waveform, the goal of recognition algorithms is to extract information from speech. Speech recognition generally refers to extraction of the words (speech-to-text), but speech information extraction includes identification of speaker, the language, the dialect, or the topic. Lincoln Laboratory has made major contributions in all these areas since the 1960s.

Lincoln Laboratory's work on speech recognition originated in the 1950s and 1960s, when James Forgie and Carma Forgie applied new computer-based pattern-recognition techniques to phoneme recognition and Bernard Gold developed an early computer program for word recognition based on acoustic features.

In the early 1970s, James Forgie led the Laboratory's efforts in the ARPA Speech Understanding Research Program, the first national, multilaboratory effort in speech recognition and understanding. Lincoln Laboratory's contributions included an acoustic/phonetic recognition system that was acknowledged as a leader among the Defense Advanced Research Projects Agency's (DARPA) systems of the time.<sup>11</sup> The Laboratory's full speech-understanding system provided voice control of access and display of a speech database. This system was followed by a phrase recognizer that recognized narrowband speech transmitted over the ARPAnet and demonstrated voice control over access to ARPAnet mail.

The DARPA Strategic Computing Program, initiated in 1984, included a new national program in speech recognition and understanding. Lincoln Laboratory's activities for this effort focused on robust recognition under the stress and noise conditions typical of the fighter aircraft cockpit. The work built upon the hidden Markov model (HMM) approach, a powerful statistical framework for pattern recognition of time-varying



Lincoln Laboratory  
packet-voice terminal



R.P. Lippmann

---

## Notes

**12** D.B. Paul, "Speech Recognition Using Hidden Markov Models," *Linc. Lab. J.* **3(1)**, 41–62 (1990).

**13** R.P. Lippmann, "An Introduction to Computing with Neural Nets," *IEEE ASSP Magazine* **4(2)**, 4–22 (1987).

**14** R.P. Lippmann, L.C. Kukulich, and E. Singer, "LNKnet: Machine Learning and Statistical Software for Pattern Classification," *Linc. Lab. J.* **6(2)**, 249–268 (1993).

**15** D.A. Reynolds, "Automatic Speaker Recognition Using Gaussian Mixture Speaker Models," *Linc. Lab. J.* **8(2)**, 173–192 (1995).

**16** M.A. Zissman, "Automatic Language Identification of Telephone Speech," *Linc. Lab. J.* **8(2)**, 115–144 (1995).

**17** J.P. Campbell, W.D. Andrews, and M.A. Kohler, "Method of and Device for Phone-Based Speaker Recognition," U.S. Patent No. 6,618,702, September 9, 2003.

**18** D.A. Reynolds, W. Andrews, J. Campbell, J. Navratil, B. Peskin, A. Adami, Q. Jin, D. Klusacek, J. Abramson, R. Mihaescu, J. Godfrey, D. Jones, and B. Xiang, "The SuperSID Project: Exploiting High-Level Information for High-Accuracy Speaker Recognition" (lead paper in special session on Exploiting High-Level Information for High-Accuracy Speaker Recognition), *Proc. ICASSP 2003*, IV-784–IV-787 (2003).

**19** W.M. Campbell, J.P. Campbell, D.A. Reynolds, E. Singer, and P. Torres-Carrasquillo, "Support Vector Machines for Speaker and Language Recognition," *Comput. Speech Lang.* **20(2–3)**, 210–229 (2006).

**20** S. Seneff, E. Hurley, R. Lau, C. Pao, P. Schmid, and V. Zue, "GALAXY-II: A Reference Architecture for Conversational System Development," *Proc. ICSLP 98* (1998).

**21** C.J. Weinstein, Y.-S. Lee, S. Seneff, D.R. Tummala, B. Carlson, J.T. Lynch, J.-T. Hwang, and L.C. Kukulich, "Automated English/Korean Translation for Enhanced Coalition Communications," *Linc. Lab. J.* **10(1)**, 35–60 (1997).

signals, which was originally introduced at the Institute for Defense Analyses, Carnegie Mellon University, and IBM in the 1960s and 1970s. By 1987, the Laboratory had developed robust HMM techniques that reduced error rates for recognition of a limited vocabulary (105 words) under stress and noise conditions by an order of magnitude over standard HMM techniques.<sup>12</sup> These techniques also yielded the best results reported to date on a standard, normally spoken, 20-word-vocabulary speech database. From 1988 to 1990, this speech recognition research was extended to include large-vocabulary (up to 20,000 words) continuous-speech recognition systems, and high-performance HMM-based word-spotting techniques. The speech recognition effort during this time also included pioneering work, led by Richard Lippmann, in applications of neural networks and related pattern classifiers.<sup>13</sup> These neural net systems were applied to speech and also were extended to develop a suite of algorithms used by many other applications of pattern classification.<sup>14</sup>

Starting in the early 1990s, Lincoln Laboratory focused its speech information extraction efforts on speaker and language identification. Douglas Reynolds developed pioneering speaker identification algorithms based on Gaussian mixture models (GMM),<sup>15</sup> and Marc Zissman developed new algorithms for language identification based on recognition of phonetic patterns.<sup>16</sup> Building upon these foundations, the Laboratory's speech team became preeminent in speaker and language identification (Figure 7-6). Since 1996, the National Institute of Standards and Technology (NIST) has conducted regular international evaluations of both speaker and language identification systems. At these events, research groups from around the world test their algorithms against common sets of evaluation data prepared by NIST. Lincoln Laboratory has been the perennial world leader in performance for both speaker and language identification algorithms.

In the early 2000s, Joseph Campbell led the development and patenting of new techniques for phone-based speaker-recognition technology.<sup>17</sup> In 2002, the Laboratory led a landmark, multiorganization project which successfully exploited higher-level information, including phonetic, word-level, and

prosodic features to improve speaker recognition,<sup>18</sup> and has built upon this work for ongoing performance improvements. A recent highlight of the Laboratory's algorithm research and development was the application of support vector machines (SVM) to both speaker and language identification. Under this effort, led by William Campbell, the SVM techniques produced enhanced performance at reduced computation and also combined well with GMM and other methods in systems that fuse a set of pattern classifiers to achieve best overall performance.<sup>19</sup>

Especially in the areas of speaker and language identification, Lincoln Laboratory has been the leader in transitioning systems from research to highly effective use in DoD, government, and law enforcement applications. The Laboratory has maintained an extremely successful cycle of research, test and evaluation, and deployment, with each cycle progressing to new improvements in application systems.

## Machine Translation

The U.S. military has a critical need for language translation, and there is a severe shortage of translators. Building on Lincoln Laboratory's work in speech and language processing, and adapting conversational system architecture and natural-language understanding technology developed by the MIT Spoken Language Systems Group, the Laboratory initiated a machine translation research and development effort in 1995.<sup>20</sup> Motivated specifically by the needs for machine translation for the U.S./Republic of Korea (RoK) Combined Forces Command in Korea, Lincoln Laboratory developed systems for two-way, automated, English/Korean translation of text and speech that focused on coalition communications.<sup>21</sup> The systems used an interlingua-based approach to take advantage of the limited context of the military domain and to enable extendability to multiple languages. In two U.S./RoK Combined Forces Command exercises, the Laboratory successfully demonstrated its system for automated English-to-Korean translation of the regular command briefings that must be presented concurrently in English and Korean (Figure 7-7).



Figure 7-6

Lincoln Laboratory algorithms for speaker and language identification have achieved world-leading performance using a framework that extracts speech features at multiple levels (spectral, prosodic, phonetic, lexical) and that applies and fuses the results of multiple pattern classifiers, including Gaussian mixture models (GMM), support vector machines (SVM), and n-gram language models.

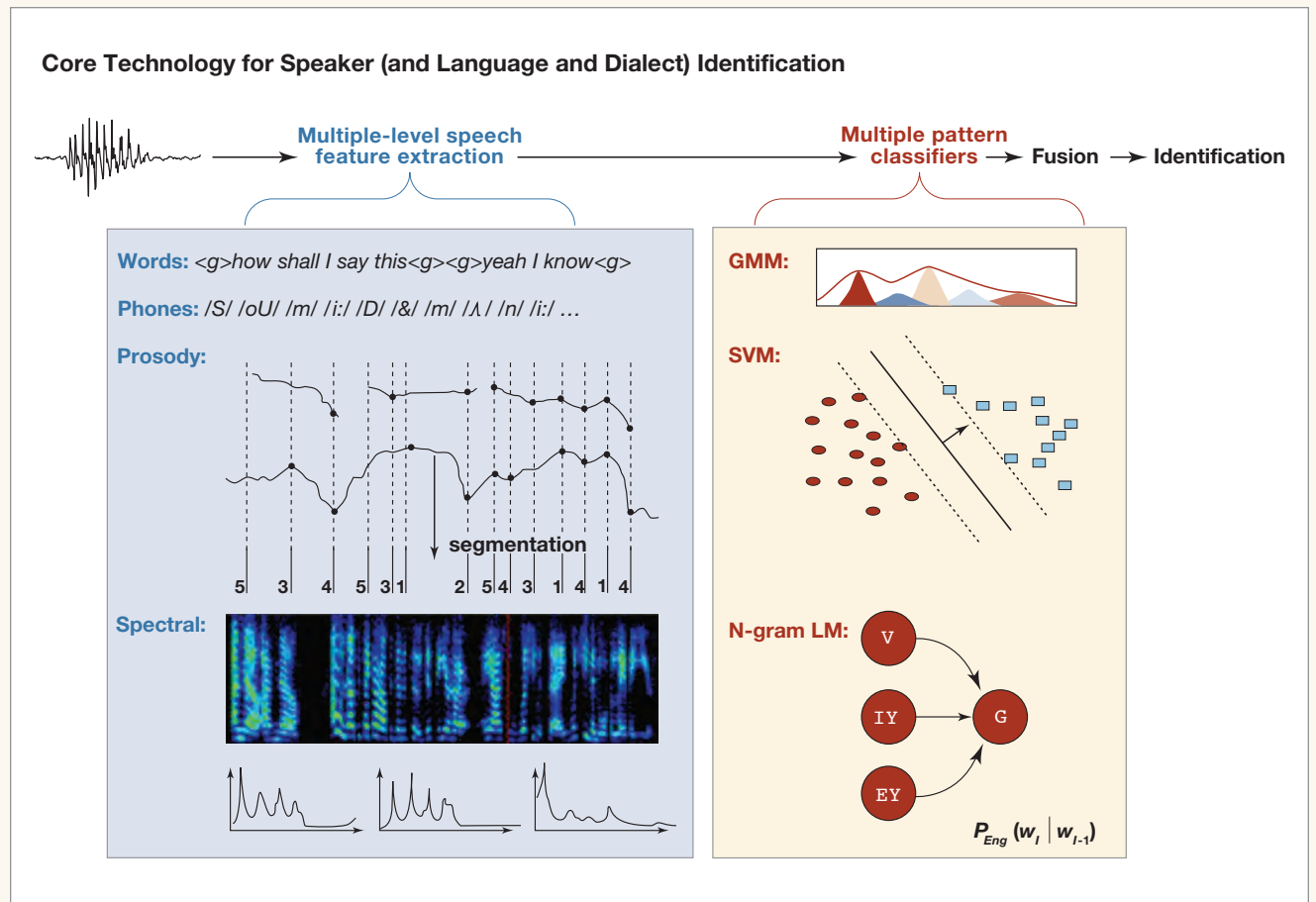


Figure 7-7

Lincoln Laboratory's interlingua-based English-to-Korean machine translation system was used during an exercise in the Republic of Korea in 1997 to assist in translation of operational PowerPoint briefings from English to Korean.

Left: Example of slide from 1997 exercise

Right: Translation produced by Lincoln Laboratory system

UNCLASSIFIED

### AGENDA

- Exercise overview
- Maneuver damage
  - M1 tank damaged road sign
  - Track vehicle damaged bean crop
- DCINC comments and guidance
- CUWTF OPFOR brief

UNCLASSIFIED

### 보고 순서

연습 개요  
 기동부대 대민피해사항  
 M1 탱크는 도로 신호를 파괴했다  
 궤도차는 콩 농작물을 파괴했다  
 부상평관 의견 그리고 지침  
 연륙사 대항군 보고

---

## Notes

**22** D.A. Jones, W. Shen, and C.J. Weinstein, "New Measures of Effectiveness for Human Language Technology," *Linc. Lab. J.* **15(2)**, 341–345 (2005).

**23** W. Shen and B.W. Delaney, "The MITLL/AFRL IWSLT-2006 MT System," *Proc. Int. Wkshp. on Spoken Lang. Trans.*, Kyoto, Japan, 71–75 (2006).

**24** C.J. Weinstein, W.M. Campbell, B.W. Delaney, and G.C. O'Leary, "Modeling and Detection Techniques for Counter-Terror Social Network Analysis and Intent Recognition," *Proc. IEEE Aerospace Conf.* (2009). This paper won Best Paper Award for the conference.

A challenge in machine translation is how to evaluate its effectiveness. Working in conjunction with the Defense Language Institute, Douglas Jones has led a successful project to adapt DoD standard tests for human translators to the evaluation of machine translation.<sup>22</sup> These unique evaluations, which focus on measuring how effective machine translation systems are in helping translators and analysts do their jobs, have provided important information to guide ongoing work in machine translation (Figure 7–8).

Most recently, Lincoln Laboratory's new systems for speech translation have performed very well in international evaluations.<sup>23</sup> These systems use statistical methods that utilize bilingual data to train machine translation systems. The focus of the Laboratory's work has been on how to maximize performance for languages and applications for which training data are limited.

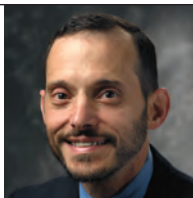
### Future Directions

Work in speech processing is expected to emphasize the application of fundamental speech science to the development of advanced speech analysis/synthesis systems for speech enhancement, modification, and coding. Speech recognition research will focus on the integration of speech recognition and understanding,

speaker and language identification, and topic-spotting algorithms to enhance the overall effectiveness of application systems. The research will extend to combining speech processing with processing of other media; for example, voice and face recognition will be fused in systems that integrate multiple biometrics. Future efforts will also include transitioning of speech algorithms to new platforms to achieve enhanced processing speed and efficiency for key applications. New work in social network analysis and intent recognition for counterterror applications will be expanded, combining the results of analysis of multiple speech and language documents and other sources to "connect the dots."<sup>24</sup>

Overall, Lincoln Laboratory expects to extend its contributions in speech and language research and development, and continue its leadership in the technology transfer and application of algorithms to government and military systems.

1990



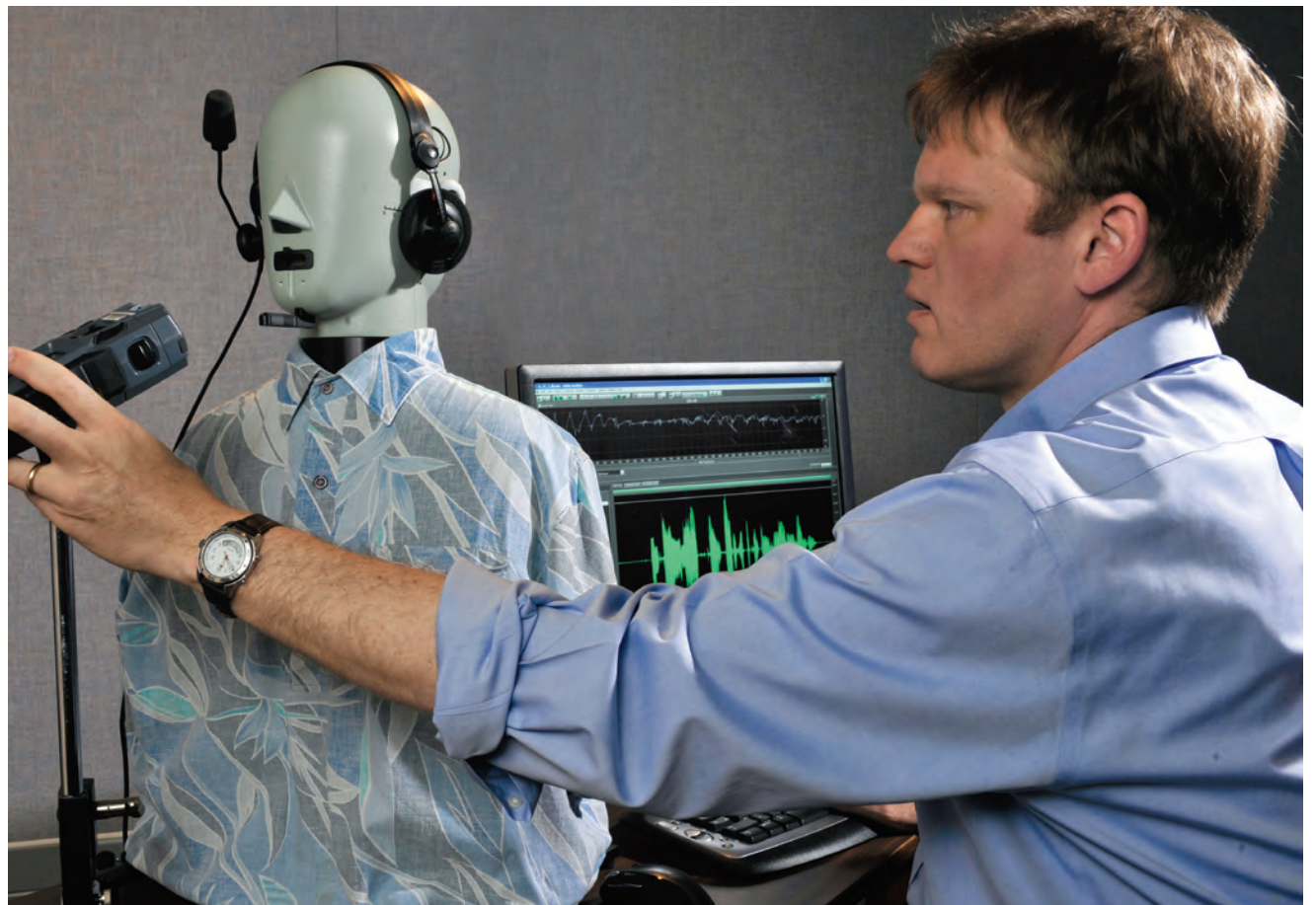
M.A. Zissman



D.A. Reynolds

**Figure 7-8**

Douglas Jones is setting up an automated test of the performance of a speech translation unit (in his left hand) using a physical head-and-torso simulator and measurement and test capabilities that run on standard computer facilities.



2000

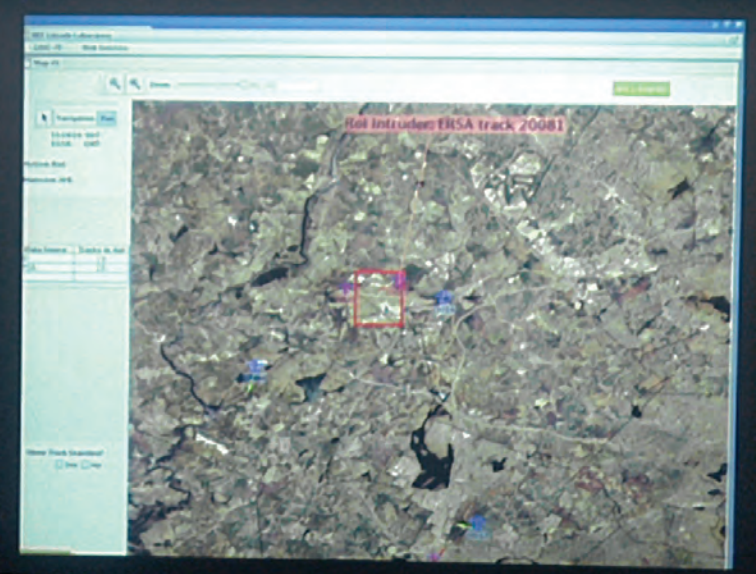
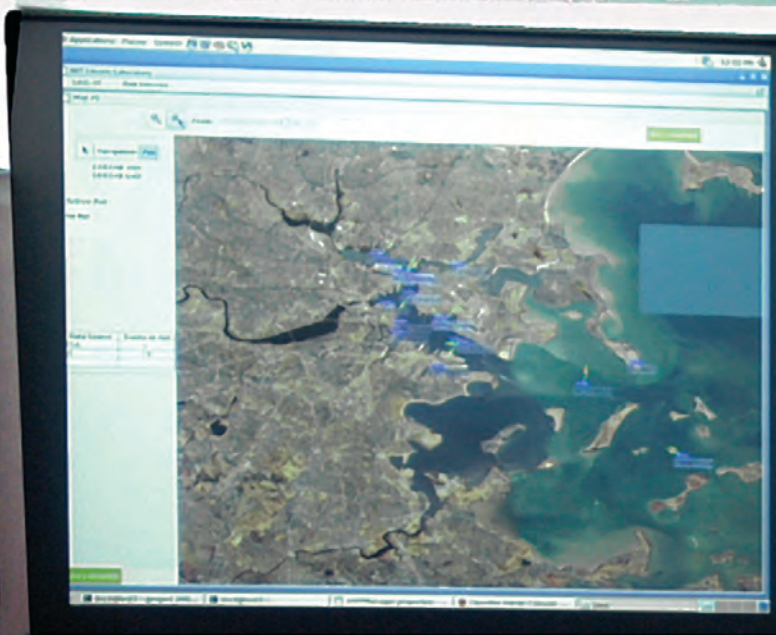


Ultralow-rate  
speech coder



J.P. Campbell





180.125  
120.125  
40.125  
60.125  
MIT Lineator



**Lincoln Laboratory leverages its expertise in systems design, algorithm development, high-performance computing, and data exploitation to provide decision support to a broad range of programs.**

**Left: A multidomain ISR maritime awareness demonstration in 2008 provided automated cueing, tasking, and data sharing, combined with decision support tools for backtracking potential airborne intruders who enter a user-designated “keep out” zone. The displays for the decision support systems in the control center are shown in the figure.**

Decision support has a long history at Lincoln Laboratory, starting with the pioneering work on the Semi-Automatic Ground Environment (SAGE) system begun in 1954 under U.S. Air Force sponsorship (see chapter 2, “The SAGE Air Defense System”). SAGE, one of the first digitally processed radar systems, was conceived to protect the United States against Soviet bomber attacks. The original design foresaw eight sectors, each with a combat center and four direction centers that would process data from more than 100 radar sites and simultaneously track 200 enemy aircraft while providing information to 200 defensive aircraft and missiles.

In the years since SAGE, Lincoln Laboratory has included decision support elements in every research mission. By 2009, the decision support portion of Laboratory research had grown to about 10% of all programs, with nearly a third of the total decision support investment in the civilian mission of air traffic control that is reviewed in chapter 12, “Air Traffic Control.”

In addition to projects such as SAGE, Lincoln Laboratory has built decision support systems for such diverse missions as intelligence, surveillance, and reconnaissance (ISR), antisubmarine warfare, missile defense, homeland protection, and hazardous-weather avoidance for air traffic control. For these missions, the Laboratory has developed sensor-based systems, human-machine interfaces, and analytical tools to support decision making and problem solving. Besides developing and running simulations of these decision support systems, the Laboratory has, in most cases, field-tested the proposed solutions. With advances in information technology, the Laboratory has increased its focus on automating decision support. It has developed new tools that do more than just collect data; these tools are designed to automatically identify and exploit critical information buried in the data.

In 2004, Lincoln Laboratory identified the critical significance of decision support systems across a wide range of defense projects in many divisions and developed an internal investment strategy, focusing initially on ISR missions. Subsequently, the Laboratory began a broad initiative to facilitate developing, simulating, and testing decision support systems, as well as building the infrastructure necessary for supporting them. In 2009, the Laboratory refreshed its overall

decision support strategy by reviewing its capabilities and developing plans for expanding them across all relevant missions. An external advisory board to provide a broad vision and an internal steering panel to provide oversight were established. The Laboratory is currently engaged in a systematic effort to apply and extend tools developed in academia and industry for tasks such as data mining, cognitive fusion, course-of-action evaluation, and human-machine interfaces. In addition, the Laboratory has continued to expand its modeling and test bed capabilities by, for example, testing decision architectures and components online and developing standard online interfaces that enable developers to interact with legacy systems while demonstrating new decision support tools.

### **Decision Support — Historical Perspective**

After World War II, engineers and scientists began working on automated decision support systems. During the 1950s, Herbert Simon at the Carnegie Institute of Technology (later Carnegie Mellon) carried out theoretical work on organizational decision making.<sup>1</sup> At the same time Simon was studying the way individuals solve problems and make decisions, J.C.R. Licklider, an associate professor at MIT, served on the committee that established Lincoln Laboratory. A creative thinker about the future of computer systems, he and other researchers at MIT worked on providing a simple human interface to a computer system.<sup>2</sup> Their concept for an interactive terminal was implemented as part of the SAGE system. Continuing work in interactive computing during the 1960s, Lincoln Laboratory developed the time-sharing TX-2 system, which used Ivan Sutherland’s Sketchpad graphical user interface (see chapter 28, “High-Performance Computing”). Douglas Engelbart at the Stanford Research Institute was influenced by Vannevar Bush’s visionary 1945 paper “As We May Think,” in which Bush described a hypothetical system for storing information based on associations.<sup>3</sup> Using many of Bush’s concepts and some of the Sketchpad ideas, Engelbart led the Stanford team in developing the On-Line System that consisted of computer-interface elements such as bit-mapped screens, the mouse, hypertext, collaborative tools, and precursors to the graphical user interface.<sup>4</sup>

While interactive computing advances were accelerating the deployment of automated decision support, mathematical and statistical algorithms to find solutions to more complex decision problems were

## Notes

1 H.A. Simon and J.G. March, *Organizations*. Hoboken, N.J.: John Wiley and Sons, 1958.

2 J.C.R. Licklider, "Man-Computer Symbiosis," *IRE Trans. Human Factors in Elect.* **HFE(1)**, 4–11 (1960).

3 V. Bush, "As We May Think," *The Atlantic*, 101–108 (July 1945).

4 T. Bardini, *Bootstrapping: Douglas Engelbart, Coevolution, and the Origins of Personal Computing*. Palo Alto, Calif.: Stanford University Press, 2000.

5 T. O'Reilly, "What is Web 2.0?" posted online at O'Reilly website (<http://oreilly.com>), Sept. 2005.

6 "We're going to find ourselves in the not too distant future swimming in sensors and drowning in data... We're going to have to use technology, smart systems that cipher through the intelligence," Lt Gen David A. Deptula, Air Force deputy chief of staff for ISR, in S. Magnuson, "Military 'Swimming in Sensors and Drowning in Data,'" *Nat. Def. Mag.*, 37–38, (2010).

being developed in parallel. During the 1980s, new statistics-based reasoning techniques such as Bayesian networks and hidden Markov models greatly extended the complexity of decision problems that could be addressed. Consequently, the concept of a decision support system expanded to include models to solve ill-structured problems. By the mid-1990s, nonlinear classification and regression models such as the support vector machine were beginning to find applications in decision support systems. These new techniques formed the core of knowledge-driven or model-driven decision support systems. The next section presents examples of applications of these methods in several Lincoln Laboratory missions.

From 1989 to 1991, Tim Berners-Lee and his colleagues at the European Organization for Nuclear Research began work on a hypertext markup language (later called HTML) as well as the client/server software that he called the World Wide Web. As Berners-Lee worked on the web, the Internet, which until the early 1990s had only been used by the government and researchers, became available for commercial applications in 1991. The combination of the ubiquitous Internet and the web browser greatly accelerated the development of decision support tools and capabilities. In 2004, the original definition of the web was expanded to become a "universal, standards-based integration platform."<sup>5</sup> Information architectures based upon emerging networking standards at Lincoln Laboratory have formed the integration platform of open systems (see chapter 30, "Open Systems Architecture") and the decision support automation described in the next section.

Data mining based upon hypertext and metadata has become commonplace since 2000. A large number of companies have developed products that focus on web-based information access and visualization. Inspired in part by commercial developments, Lincoln Laboratory has been developing data-mining systems based on hypertext and metadata since 2005, as described later in the section on the decision support initiative.

## Defense System Trends

Although Lincoln Laboratory has applied decision support to sensor systems for many of its defense projects, the challenges to defense systems are growing dramatically. Defense threats are becoming ever more challenging. In traditional missions such as air and missile defense, the decision urgency has increased. Since the September 11, 2001, terrorist attacks on the Pentagon and the World Trade Center towers in New York City, in missions such as homeland protection and counterterrorism, the target sets are asymmetric and elusive — threats in these missions can "hide in plain sight." Another significant trend is the proliferation of sensor platforms and networks. Persistent surveillance, in particular, introduces a special challenge: sensor data collected have increased exponentially in recent years while the number of analysts available to investigate these data has not changed significantly.<sup>6</sup> Finally, there are increasingly adaptive countermeasures encountered in many missions that make target identification extremely difficult.

Because of these trends, machine automation must be used more and more to complement the analysts' skills and to avoid data overload. Since many of the sensor

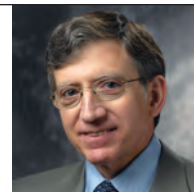
2000



J.A. Tabaczynski



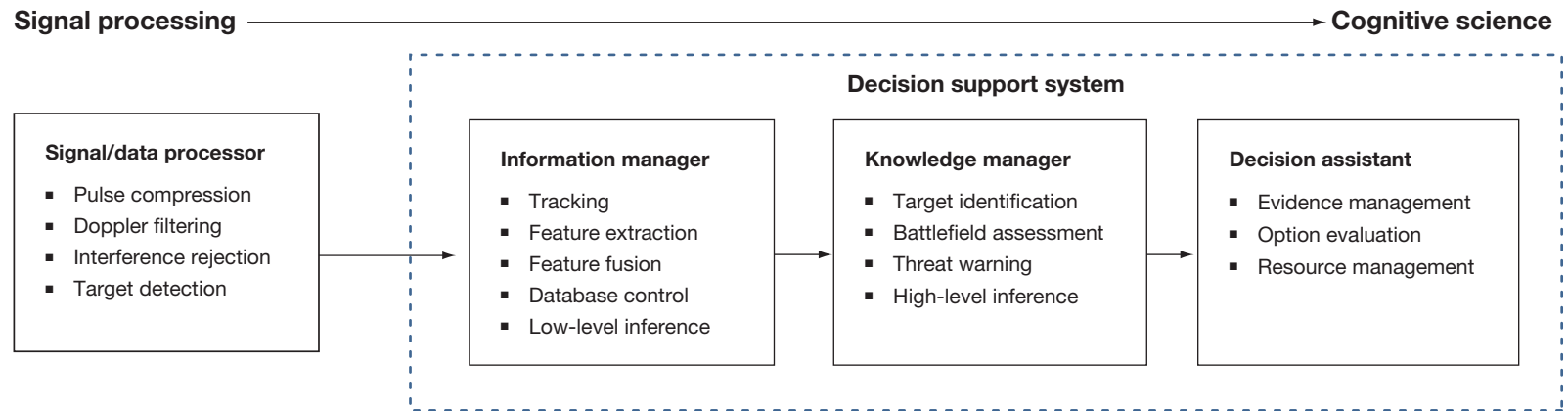
S.R. Bussolari



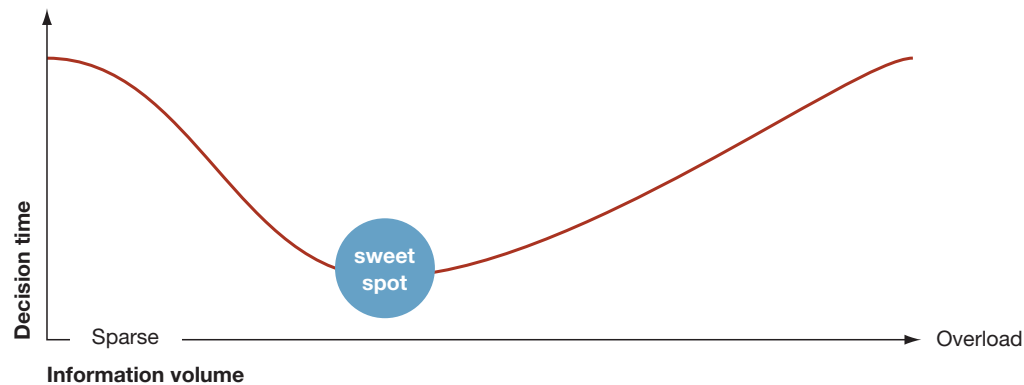
C.W. Davis



## Decision Support Systems Defined



### Decision time versus information volume



**Figure 8-1**

**Decision support systems – a definition.** Top: Decision support processes build on raw sensor-data inputs (detections) and perform successively higher-level analysis, requiring increasing levels of learning and reasoning, which, if automated, require cognitive science approaches. Bottom: Automation of data collection can ensure that all of the relevant data are available. Automating exploitation can provide information compression in order to approach the “sweet spot,” or the minimum relevant information for decision making.



J.E. Evans



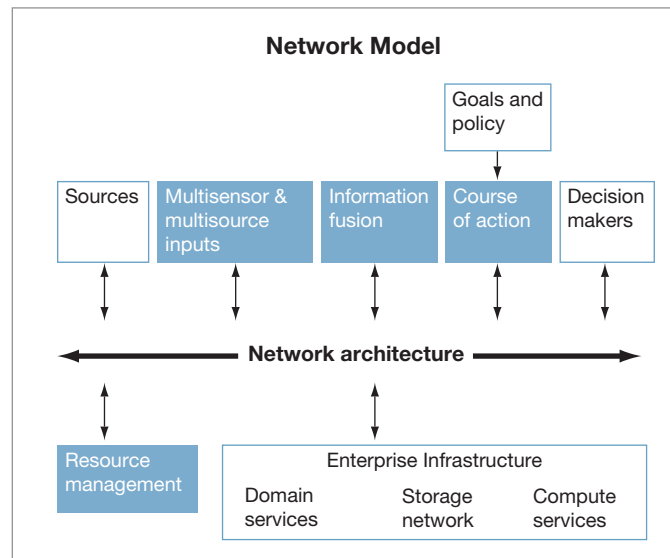
K.D. Senne



D.R. Martinez

**Figure 8-2**

**Decision support network model, showing roles for automation in decision support systems involving multisource data. A decision support network architecture features automated processes that are implemented as services. Some level of automation in the top blue-shaded (exploitation) and the bottom blue-shaded (collection) processes will generally contribute to reducing the time required to make decisions. The levels of work needed in each of the decision support processes, as well as the available courses of action, depend upon the mission and goals.**



systems were initially deployed before the explosion of network-based technologies, any new decision support architecture will need to accommodate these legacy systems while still using modern web-based tools. The Enhanced Regional Situation Awareness (ERSA) system (see chapter 18, “Homeland Protection”) made some progress in this direction, but much work remains.<sup>7</sup>

For the past several years, Lincoln Laboratory has been working on several initiatives to accommodate the challenges to decision support. Decision support systems are enabled by open, networked architectures (an initiative discussed in chapter 30) and by distributed, parallel computing (discussed in chapter 28). In addition, a new initiative in decision support architecture and automation is also under way at Lincoln Laboratory.

### Decision Support Architecture and Automation

Decision support employs automation to collect, manage, and exploit data from one or more sources in order to provide the right information to analysts and decision makers. A sensor decision support system takes the raw sensor products (target detections) and applies successively higher-level analysis until actionable information is available for the operators and decision makers, as illustrated in Figure 8-1. As the bar at the top of the figure suggests, the required automation technology moves from traditional signal and array processing to a more significant dependence on machine learning and reasoning (cognitive science). Automation can reduce decision making time in two basic ways, as illustrated in the graph at the bottom of the figure: decision times can be adversely affected if the available information is too sparse; conversely, information overload can occur when the available data include much extraneous or incomprehensible information. This relationship between information volume and required decision time suggests two important roles for automation: (1) “smart” data collection automation can ensure that the “right” information is available while minimizing the amount of extraneous information, and (2) exploitation automation can compress and represent the available information so as to provide the most intuitive explanation to the analysts, as depicted by the “sweet spot” in the figure.

Decision support type	Emphasis	Examples
Communication-driven	Use of tools that enable collaborative decision making	E-mail, chat, wikis, bulletin boards
Information-driven	Access to local and web-based documents via search engines	Internet search engines, document storage and retrieval
Data-driven	Direct access to large structured data sets	National Imaging and Mapping Agency database, Digital Terrain Elevation Data, threat signatures
Model-driven	Use of feature extractors, system models, and simulations of current state and options	“Rule-based” models, “ends-based” models, war-game simulations
Knowledge-driven	Use of systems that extract higher-level knowledge or relationships	Data mining, expert systems, optimization tools, battle management discovery
Decision-driven	Use of inference engines that suggest decision options with possible automatic execution	Medical diagnosis systems, investment portfolio management systems

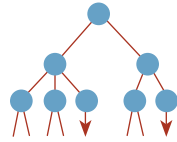
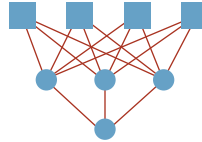
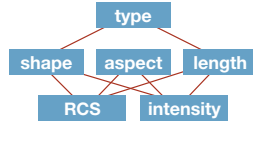
Human-machine interface

**Figure 8-3**

**Decision support system taxonomy, adapted from D.J. Power.<sup>8</sup> The top three types of decision support require database automation and networking. The bottom three types also require machine learning and reasoning.**

Data collection can be automated by using resource management (tasking and scheduling of information sources). Exploitation automation involves database

**Figure 8-4**  
Decision support inference engine technology.

Model	Decision trees	Neural nets	Bayesian nets
			
Strengths	<ul style="list-style-type: none"> <li>■ Rapid training and running times</li> <li>■ Representation is easy to debug</li> </ul>	<ul style="list-style-type: none"> <li>■ Fast run times</li> <li>■ Handles correlated features</li> </ul>	<ul style="list-style-type: none"> <li>■ Representation is easy to debug</li> <li>■ Handles correlated features</li> <li>■ Identifies probabilistic causality</li> </ul>
Weaknesses	<ul style="list-style-type: none"> <li>■ Does not handle correlated inputs</li> <li>■ Requires large training set</li> <li>■ Performance can be suboptimal</li> </ul>	<ul style="list-style-type: none"> <li>■ Requires large training data set</li> <li>■ Representation is difficult to debug</li> </ul>	<ul style="list-style-type: none"> <li>■ Slow run times possible</li> </ul>

#### Notes

7 C.W. Davis, J.M. Flavin, R.E. Boisvert, K.D. Cochran, K.P. Cohen, T.D. Hall, L.M. Hebert, and A.-M.T. Lind, "Enhanced Regional Situation Awareness," *Linc. Lab J.* **16(2)**, 355–380 (2007).

8 D.J. Power, *Decision Support Systems: Concepts and Resources for Managers*. Westport, Conn.: Quorum Books, 2002.

9 M.E. Weber, J.E. Evans, W.R. Moser, and O.J. Newell, "Air Traffic Management Decision Support During Convective Weather," *Linc. Lab. J.* **16(2)**, 263–275 (2007).

functions including multisensor and source data input and tagging, information fusion to extract the actionable information, and evaluation of available courses of action. The courses of action available are constrained by overall mission goals and policy.

Decision support systems are increasingly being implemented in distributed network architectures (Figure 8-2). Such systems are implemented as modular software applications that use enterprise services including databases, computation resources, and web-based domain services. The figure also illustrates the human-machine interface with the system. The design of this interface is critical to the user acceptance and the effectiveness of decision support systems in practice.

Just as the definition of decision support systems has continued to evolve over time as the computing, networking, and data-mining technologies have improved, so have the frameworks that characterize different classes of decision support systems. A taxonomy of decision support systems adapted from Daniel Power is shown in Figure 8-3.<sup>8</sup> The top three types involve very little automation beyond networked communication and database interactions. By contrast, the decision support systems that are driven by models or knowledge extraction provide opportunities for automation in the form of machine inference and simulation.

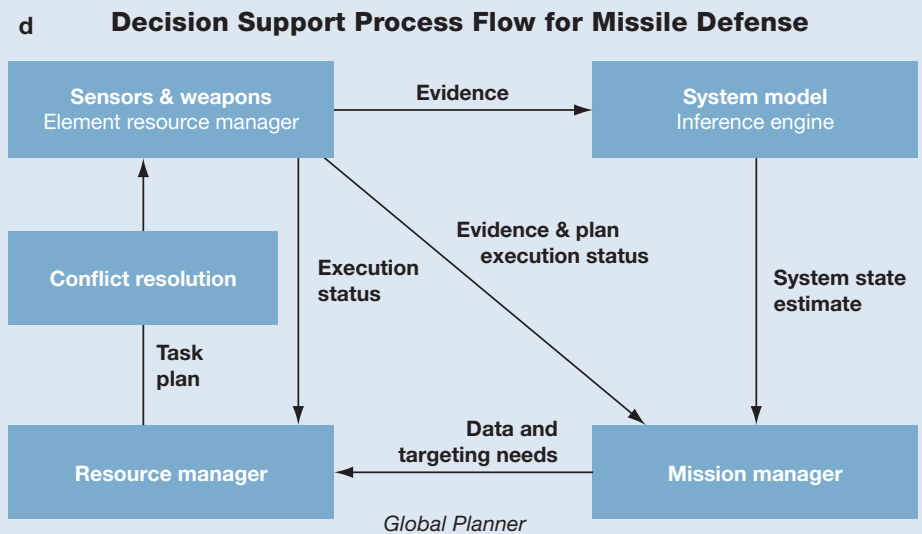
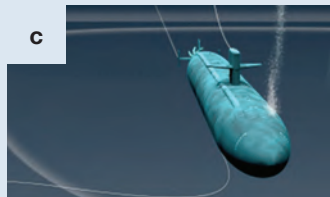
Some examples of automated inference technology are shown in Figure 8-4. For example, decision trees provide the evidence to assess the threat severity for the ERSA

system described in chapter 18, "Homeland Protection."<sup>7</sup> Neural nets can be used to learn and compute functions for which the analytical relationships between inputs and outputs are unknown and/or computationally complex; consequently neural nets are useful for pattern recognition, classification, and function approximation: the hazardous-weather modeling for air traffic control makes use of neural nets.<sup>9</sup> Neural nets are also used in the environmental monitoring mission (see chapter 11, "Environmental Monitoring") and speech processing (see chapter 7, "Speech and Language Processing").

Bayesian techniques, which are another example of automated inference technology, make use of probabilistic inference. A Bayesian network can be constructed to apply to complex problems, in which the nodes represent variables and the edges encode relationships between the variables. Bayesian networks are used in the discrimination logic for the missile defense mission described in chapter 9, "Ballistic Missile Defense." Hidden Markov models, which are the simplest form of dynamic Bayesian networks, have been used for speaker recognition (see chapter 7).

As discussed previously, introducing decision support automation into fielded, operational systems is a challenge because the legacy sensor systems are not prepared for modern, network-enabled automation. Furthermore, if the target system is required for operational use, care must be exercised not to disrupt the existing system while demonstrating new decision support technologies. Instead, the decision support system is implemented using a spiral development process that was used extensively





**Figure 8-5**  
Decision support at Lincoln Laboratory — past and present: (a) console operations at the experimental SAGE subsector direction center at Lincoln Laboratory in 1956, (b) TCAS, (c) antisubmarine warfare, (d) decision support process flow for missile defense.

## Decision Support Applications

### Ballistic Missile Defense

- Providing fire control guidance
- Automating battle management

### Intelligence, Surveillance, and Reconnaissance

- Monitoring and warning of activities
- Modeling and recognizing situations
- Extracting networks from multi-INT data

### Homeland Protection

- Detecting unusual situations
- Detecting chemical, biological, radiological, or nuclear (CBRN) threats
- Managing large-scale incidents
- Automating biometrics

### Antisubmarine Warfare

- Avoiding submarine collisions
- Assessing potential threats

### Environmental Monitoring

- Modeling global temperature and moisture

### Space Situational Awareness

- Resolving uncorrelated target reports
- Avoiding spacecraft collisions

### Counterterrorism/Counterinsurgency

- Recognizing terror networks and attacks
- Rapidly detecting emerging terrorist signatures

### Air Traffic Control

- Avoiding aircraft collisions
- Managing arrival and departure traffic
- Indicating and warning of wind shear
- Avoiding severe weather

### Speaker Recognition

- Extracting metadata

### Computer Network Operations

- Proactively managing computer networks
- Preventing network attacks

**Figure 8-6**  
Decision support applications in selected Lincoln Laboratory missions.

---

## Notes

**10** W.P. Delaney and W.W. Ward, "Radar Development at Lincoln Laboratory: An Overview of the First Fifty Years," *Linc. Lab. J.* **12(2)**, 147–166 (2000).

**11** J.K. Kuchar and A.C. Drumm, "The Traffic Alert and Collision Avoidance System," *Linc. Lab. J.* **16(2)**, 277–295 (2007).

**12** R.P. Lippmann, L. Kukulich, and E. Singer, "LNKnet: Neural Network, Machine-Learning, and Statistical Software for Pattern Classification," *Linc. Lab. J.* **6(2)**, 249–266 (1993).

**13** R.L. Delanoy, "Toolkit for Image Mining: User-Trainable Search Tools," *Linc. Lab. J.* **8(2)**, 145–160 (1995).

in the missile defense mission: first, the new decision support tools are tested in a simulation environment with operators in the loop; then, the new capability is added to the operational sensors via a nondisruptive network interface, referred to as a sidecar. The resulting decision support system can thereby be tested online in real time with the operational system and can provide new displays for the analysts to evaluate without interfering with the target system. This approach takes advantage of an open systems architecture.

### Decision Support Initiative at Lincoln Laboratory

The first large-scale decision support system, implemented by Lincoln Laboratory, was the SAGE system (Figure 8-5a), an automated, networked radar system that provided decision support to multiple human operators. This system, which was a precursor to the modern air traffic control system, ensured air defense readiness against the Soviet long-range bomber threat. The interactive user display system was also an early example of human-computer interfaces in a modern decision support system.<sup>10</sup>

The Traffic Alert and Collision Avoidance System (TCAS) described in chapter 12, "Air Traffic Control," uses beacon transponders in a cooperative separation measurement process among nearby aircraft: the measurements provide the information necessary to display the lines of bearing of nearby traffic (Figure 8-5b). In addition, if the predicted time to closest approach and minimum separation between aircraft pairs is unacceptable, TCAS also provides complementary climb or descend advice to the pilots. The display provides the resulting advice in a clear and intuitive manner. This design resulted from over a decade of experimentation and development of standards.<sup>11</sup>

Antisubmarine warfare requires extensive decision support tools to facilitate threat detection and to protect against possible collisions. Sonar systems on submarines provide the principal surveillance information used for feature detection, tracking, and threat assessment (Figure 8-5c). Since the mid 1990s, Lincoln Laboratory has provided interactive decision support tools to the Navy's annual program build for the submarine fleet. Since the sonar operators have heavy workloads, the decision support approach provides machine automation that prioritizes the sonar contacts for operator attention.

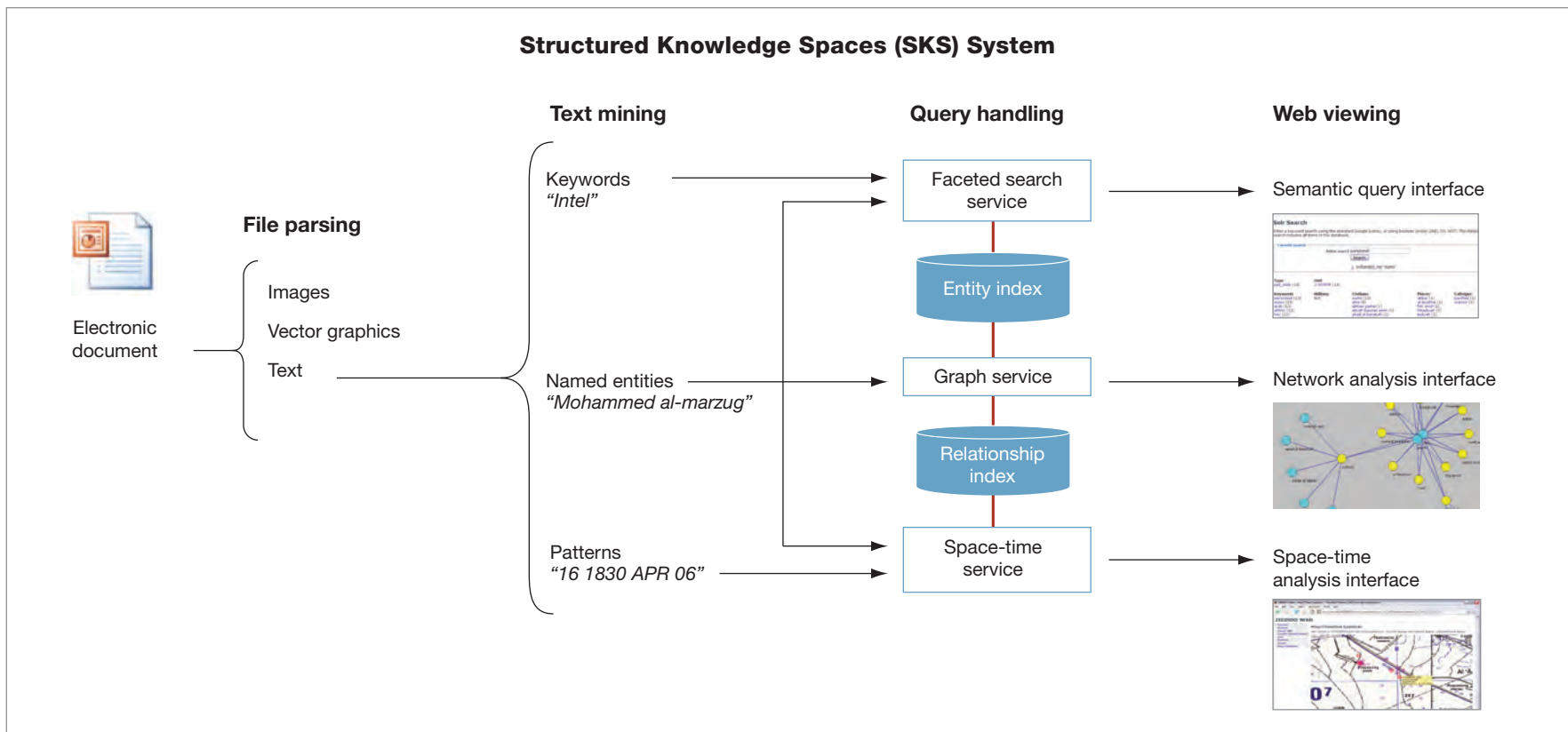
The process flow architecture relevant for missile defense is shown in Figure 8-5d. By employing a ballistic engagement model, the information exploitation is accomplished with an inference engine using a variety of technologies. Since the sensor and weapon resources are potentially needed for multiple simultaneous operations, resource management must resolve conflicts prior to tasking and scheduling.

More decision support functions that have been automated by Lincoln Laboratory are listed in Figure 8-6. There are several themes that involve technologies that span multiple missions. For example, technologies for tracking ballistic or orbiting targets are shared between the ballistic missile defense and space situational awareness missions. In addition, tracking and identifying targets in the air or on the ground are themes in air traffic control, ISR, and some counterterrorism and homeland protection problems.

A number of software tools are required to build decision support systems. Lincoln Laboratory has built several software tool kits to simplify the task of prototyping inference engine algorithms in new areas. The Laboratory developed the tool kit LNKnet over a ten-year period starting in the early 1990s and publicly released it in 2001.<sup>12</sup> This package provides access to more than twenty pattern-classification, clustering, and feature-selection algorithms taken from the fields of neural networks, statistics, machine learning, and artificial intelligence. The LNKnet software package is often used to facilitate collaborative development among organizations. In order to train machine-learning models, the designer can use either supervised (with a human in the loop) or unsupervised training. In order to provide supervised learning for imagery analysis, the Laboratory developed the Toolkit for Image Mining.<sup>13</sup>

During 1996 to 2008, Lincoln Laboratory developed two generations of open architectures for radar systems (see chapter 30, "Open Systems Architecture"). The open-architecture team also standardized the design approach to the sensor network sidecar interfaces that are used in testing decision support tools under development.

Lincoln Laboratory developed a simulation process to use in the spiral development of decision support tools discussed in a previous section. Used extensively in the missile defense mission area, a "red/blue" exercise framework



**Figure 8-7**  
**SKS concept.**

facilitated testing and evaluating several generations of discrimination tool sets before they were used in field tests. The red team is responsible for implementing a threat scenario by simulating the sensor inputs and command-and-control functions. Then the decision support tools under test are provided to multiple blue teams. During the simulated event, researchers keep detailed records of the decision timeline with the new tools. Once the tools have been “hardened” and accepted by the prospective users, the software and displays are transferred to the field for testing.

In 2004, after reviewing decision support developments in several defense missions, a Lincoln Laboratory management panel offered three recommendations for a decision support initiative: (1) establish a Laboratory-wide advisory panel, (2) create a Laboratory decision support modeling and simulation test bed, and (3) connect to academic and commercial developments. Since several missions have an interest in ISR capabilities (homeland protection, counterterrorism, and missile defense, for example), the panel recommended an initial focus on ISR. Beginning later that year, the Laboratory invested in a decision support test bed, external workshops, and seminal research.

The Integrated Sensing and Decision Support (ISDS) Laboratory was developed as a test bed for decision support. The facility includes a simulation laboratory,

which can provide recorded or simulated sensor data to a decision laboratory. In the laboratory, the analysts can test new tools while these tools and the decisions enabled are monitored closely to evaluate the system timeliness and overall effectiveness.

The investment in external workshops resulted in four annual ISDS workshops held at Lincoln Laboratory between 2004 and 2007. The workshops brought together the ISDS community to exchange recent developments and future plans. The Laboratory also began outreach to universities; for example, the Decision Modeling Research Initiative is a collaboration with the MIT Laboratory for Information and Decision Systems and leverages the MIT expertise with representation and extraction of information in complex data and phenomena. This effort has resulted in technical interchanges and advanced machine-automation codes that were initially applied to missile defense discrimination and tracking systems and, in 2009, were extended to include ISR applications.

In late 2004, an internal Lincoln Laboratory team started a research effort in support of ISR. The team was motivated by the immense library of intelligence reports and other documents produced manually by intelligence analysts who carefully tagged sensor products (e.g., imagery, suspect photographs, and maps) and combined



them into briefings. Although these products could not be automatically searched, the text-mining technology previously developed by the team enabled the tags to be indexed by entities and relationships. The research led to a very flexible database system, the Structured Knowledge Spaces (SKS), illustrated in Figure 8-7, which provides services for searching documents, graphing relationships, and analyzing space and time features in large collections of intelligence products. By using SKS to develop an overall understanding of the context from previous analyses, the search for evidence in new data products can be narrowed significantly. After several years of subsequent development, including the addition of new document types, the U. S. intelligence community selected SKS for transition into operational use beginning in 2009.

Providers of automation for decision support face many challenges. As the nation continues to be involved in irregular and asymmetric warfare, for example, it is clear that adding automation to the fusion of information from multiple sources will become extremely important. This multiple-intelligence (multi-INT) fusion, discussed in chapter 15, “Intelligence, Surveillance, and Reconnaissance,” will be needed in many ISR missions for unraveling suspicious networks of individuals and for locating perceived threats in a timely manner. Such networks can be represented as graphs, with the nodes representing people and places and the edges depicting relationships. The SKS capability greatly improves the automation of information exploitation from human intelligence (HUMINT) sources, but does not directly deal with sensor data that has not already been tagged.

In 2008, Lincoln Laboratory began a research effort in multi-INT fusion. Each source of ISR data reveals certain relationships: HUMINT often leads to information about people who know and depend on each other in various ways; imagery intelligence can frequently associate individuals with places at specific times; traffic between locations indicates connections between these places resulting from vehicle movement; and signals intercepted can provide connections between people and places when they are not visible otherwise. The inferences from each of these data sources can be represented as a single intelligence graph — the nodes represent people, places, or events, and the edges show relationships.

If the duplicate entities are taken into account, these smaller graphs can be combined to provide a much more complete, multi-INT picture of the activities and relationships of the network. Given such a fused network, it is possible to estimate the location of specific targets or suspect locations at particular times.

#### **Path Ahead — Future Research**

In 2008, building on the early success of the decision support initiative in ISR, Lincoln Laboratory management commissioned a broad refresh of the 2004 strategy study. The new study expanded the scope to include all Laboratory missions in both defense and non-defense areas. The 2008 study also provided a vision for establishing a coordinated and integrated decision support enterprise across the Laboratory.

The expanded decision support initiative, with recommendations from an external advisory board and oversight from an internal Laboratory-wide panel, provides new decision support capabilities by (1) engaging in cross-mission developments, (2) monitoring and coordinating algorithm technologies, and (3) establishing communities of interest in system performance assessment and human-machine interfaces. More emphasis has been placed on sharing infrastructure and on standardizing software development methods and tools. For example, the Lexington Decision Support Center is serving as a Laboratory-wide test bed for decision support, including red/blue exercises that have been expanded to additional missions such as ISR and space situational awareness.

In conclusion, Lincoln Laboratory is implementing an expanded initiative for decision support systems over the next five to ten years, with a rolling five-year plan that will be updated annually. Specifically, research across the Laboratory will continue to focus on collaboration, both internally and externally, in order to systematically reduce barriers to developing effective decision support systems. In addition, the Laboratory will continue its efforts to increase automation of decision support systems by working on carefully selected challenging problems. The goal is to provide more timely insights into complex situations, both by collecting the “right” data and by rapidly exploiting it.







**The Ballistic Missile Defense mission area at Lincoln Laboratory has as one of its focal points the understanding of the phenomenology associated with ballistic missile targets and their observables. This understanding has been exploited and applied to the critical problem of discriminating threatening targets from an adversary's countermeasures and debris. The Kiernan Reentry Measurement Site complex on Roi-Namur Island in the Kwajalein Atoll has been a key technology demonstration venue and data source for Lincoln Laboratory's programs in missile defense.**

Left: ALTAIR on Roi-Namur Island, Kwajalein Atoll, Marshall Islands.

In the decade following World War II, technology advances in rocket science, electronics, and precision machining led to the development of a revolutionary weapon system that dominated the strategic balance right up to the fall of the Soviet Union. Intercontinental ballistic missiles (ICBM) with their massive destructive power and pinpoint accuracy buttressed the Cold War standoff between the United States and the Soviet Union. In the late 1950s, the Department of Defense (DoD) recognized the looming potential of this technology and approached Lincoln Laboratory to take on a new challenge — ballistic missile defense (BMD).<sup>1</sup> The expertise Lincoln Laboratory had gained during the Semi-Automatic Ground Environment (SAGE) air defense effort provided an excellent starting point for developing BMD techniques. (See chapter 2, “The SAGE Air Defense System,” for a detailed account of the project.) In particular, the concept of computer-controlled sensors and interceptors employed by SAGE was a critical aspect in the design of BMD systems.

In the mid-1950s, Lincoln Laboratory joined with the National Advisory Committee for Aeronautics, the forerunner of the National Aeronautics and Space Administration (NASA), to conduct a reentry measurements program.<sup>2</sup> This laid the groundwork for the establishment of the Advanced Research Projects Agency (ARPA)-sponsored Reentry Physics Program, a measurement and phenomenology modeling effort that began in 1958.

The Lincoln Laboratory BMD program experienced three significant growth periods: the first during the 1960s, again in the 1980s, and most recently in the early 2000s. Currently, the Air and Missile Defense Technology Division exercises the primary management responsibility for the Laboratory's BMD program. BMD projects have utilized significant support from across the Laboratory, involving the Engineering, Aerospace, and Advanced Technology Divisions, as well as the former Optics Division. In a related effort, the Laboratory's Aerospace and Engineering Divisions, under Air Force sponsorship, developed expertise in the design and construction of BMD countermeasures that provided an excellent counterpoint to the missile defense system development work.

Missile defenses and air defenses are similar in that they both must be able to detect, track, identify, intercept, and disable their targets, but they differ in the detail of how they accomplish these functions. Ballistic missile reentry vehicles (RV) are smaller than aircraft, travel much faster, and approach from much higher altitudes. Countermeasures and debris from the deployment of a missile's payload might accompany a warhead on nearby ballistic trajectories. Consequently, missile defense includes the additional function of discrimination — distinguishing real warheads from accompanying decoys and debris. The discrimination function is particularly critical since the cost of a BMD interceptor limits the number of shots the defense can afford to use to negate an individual RV.

Intercepting an ICBM differs from intercepting an aircraft. For example, ballistic missiles, although faster than aircraft, move on predictable trajectories, so it is possible to fly an interceptor to a point within error bounds of a target's ballistic path. On the other hand, an ICBM RV is extremely rugged. Even if the ballistic missile is hit, substantial portions, including the RV, might survive and continue on a ballistic trajectory, rather than crash like an aircraft. Until interceptor guidance technology advanced in the 1980s, it was generally assumed that disabling a ballistic missile would require an interceptor with a nuclear warhead because both a large kill radius and a high-confidence kill mechanism were required. Testing within the last twenty years has demonstrated the viability of so-called “hit-to-kill” interceptors that use the enormous kinetic energy of a high-velocity impact to destroy the warhead without requiring any explosive payload, nuclear or otherwise.

### The National Effort

BMD history can be divided into five phases:

- The city defense era, which began in the 1950s and ended in 1968 with the decision to deploy the Safeguard system
- The silo defense era, with the objective of protecting our strategic deterrent, which lasted from 1968 to 1983
- The initial phase of the Strategic Defense Initiative (SDI) era, intended to defend the homeland against a massive attack from the Soviet Union, which dated from President Reagan's speech of March 23, 1983, to 1991



**Figure 9-1 (opposite)**

**This timeline lists the most significant world events, Lincoln Laboratory programs, and Lincoln Laboratory research projects in BMD from 1951 to 2011.**

**Notes**

**1** Material for this chapter was drawn extensively from E.C. Freeman, ed., *Technology in the National Interest*, Lexington, Mass.: MIT Lincoln Laboratory, 1995; new material was added by John Tabaczynski, Stephen Weiner, and Kenneth Roth.

**2** L.J. Sullivan, "The Early History of Reentry Physics Research at Lincoln Laboratory," *Linc. Lab. J.* **4(2)**, 113–132 (1991).

- The second phase of the SDI era, which dated from 1991 to 2002 and focused on defense of U.S. and allied forces within a theater of combat
- The Missile Defense Agency (MDA) era, which dates from 2002 to the present, with focus on a single integrated ballistic missile defense system capable of defending the United States and its allies from attack at home and abroad

In the city defense era, the emphasis was on protecting population centers against a massive Soviet attack. The mainstream of BMD research concentrated on the development of radar-controlled interceptors carrying nuclear warheads and on the development of the ability to intercept an attacking nuclear warhead, carried on board a ballistic RV, in very late midcourse or in reentry.

In the silo defense era, deterrence became the guiding philosophy of BMD. It was based on the fundamental assumptions that a substantial number of U.S. missiles would survive any attack and therefore the certainty of retaliation would deter attack. Thus, defending missile silos provided the defense of the entire country, and the emphasis of the BMD effort was on the defense of U.S. Minuteman missile silos.

The initial phase of the SDI era brought the emphasis back to population defense, employing multiple layers of defense to protect the United States — with almost no leakage — against a massive Soviet attack. To accomplish this objective, large-scale technology programs in laser and particle-beam weapons, as well as in space-based sensors and interceptors, were initiated.

During the second phase of the SDI era, the objective was modified to focus on defense against a theater missile attack against U.S. forces and allies anywhere in the world, in addition to an accidental or deliberate, but limited, attack against the United States by a minor nuclear power. The technology emphasis shifted to ground-based sensors and interceptors, and the Strategic Defense Initiative Organization (SDIO) became the Ballistic Missile Defense Organization (BMDO).

In the current MDA era, the goal is to develop a single integrated Ballistic Missile Defense System (BMDS) for defense of the United States and its allies. The first phase of the deployed system was initially brought to a state

of readiness from 2004 to 2006 in order to provide a rudimentary capability against an unsophisticated ICBM attack by North Korea. The system has continued to evolve and makes use of multiple sensors, weapons, and an integrated command, control, battle management, and communication (C2BMC) network. Over time, MDA plans to improve the BMDS through a series of capability upgrades. Significant testing is completed to validate new capability. New system components, which may be either sensors or interceptors, and advanced technologies are incorporated into each upgrade. These upgrades are then transitioned to the operational community. In some cases, system components may be assigned to one of the military services for further development or production.

Through the years, a great many national and world events, some technical, others political, have influenced the course of missile defense. Figure 9-1 depicts some of the more significant of these events.

**The Lincoln Laboratory Focus**

While the nation's BMD program has undergone many important changes, the Lincoln Laboratory effort has focused on two key problems: the development of long-range, high-resolution sensors and the design of real-time, robust architectures and their constituent algorithms that provide the capability to identify the threatening targets and control the entire engagement.

The program at Lincoln Laboratory has consistently embraced four basic technical threads. The first is the collection and analysis of high-quality radar and optical data on targets of interest: foreign and U.S. offensive systems as well as U.S.-designed and -fabricated models of potential future threats. The second is the study of the phenomenology of ballistic missile-associated objects in different environments and of measurable differences that might be exploitable via real-time algorithms. The third is the design of defense sensors capable of making sophisticated discrimination measurements and of the real-time algorithms and processors that can handle the realistic threats presented by warheads, decoys, and deployment hardware. The fourth is the integration of multiple sensors and fusion of their measurements into a networked BMD system architecture that includes the associated system-level decision support functions. Each of these technical threads has been maintained

1950s	1960s	1970s	1980s	1990s	2000s	2010s
<b>WORLD EVENTS</b>						
First ICBM (USSR)	First intercept by Nike-Zeus Sentinel System	Anti-Ballistic Missile (ABM) Treaty Safeguard system deployed at Grand Forks, North Dakota Safeguard system deactivated	Reagan's "Strategic Defense" speech Homing Overlay Experiment ICBM hit-to-kill demonstration successful First TBM intercepts	First Gulf War (Operation Desert Storm) Theater Missile Defense (TMD) Taepo Dong missile launch (North Korea) First NMD intercepts	Integrated BMD System (BMDS) Satellite launches by Iran Phased Adaptive Approach (PAA) Satellite shot down with SM-3 Missile tests by North Korea, Iran, India, Pakistan	
<b>MAJOR LINCOLN LABORATORY PROGRAMS</b>						
	Kwajalein-related <i>Project PRESS</i>	<i>Kiernan Reentry Measurements Site (KREMS) scientific director</i>		<i>Reagan Test Site (RTS) scientific advisor (formerly Kwajalein Missile Range, 1991–2000)</i>		
Core BMD	<i>BMD Radar Technology</i>	Optical Aircraft Measurements Program (OAMP) <i>Army BMD program</i>	<i>Sensor developed</i>	<i>Measurements</i>		
		<i>Laser radar development</i>	<i>SDIO program</i>	<i>BMDO program</i>	<i>MDA program</i>	
		<i>Reentry systems program</i>				
		<i>High-energy laser program</i>				
		<i>Intelligence data analysis</i>				
			<i>Optical Discrimination Technology (ODT) program</i>			
			<i>Theater High Altitude Area Defense (THAAD) program</i>			
				<i>Critical measurements program (TCMP/CMP/CMCM)</i>		
				<i>Aegis BMD program</i>		
					<i>Project Hercules</i>	
					<i>National Missile Defense (NMD)</i>	
						<i>OTHR</i>
						<i>Airborne Infrared (ABIR) program</i>
<b>MAJOR LABORATORY TECHNICAL CONTRIBUTIONS</b>						
<i>STUDIES</i>	Sentinel studies	Laser atmospheric propagation Non-nuclear interceptor Single silo defense	Strategic defense concept study Radar discrimination study Optical discrimination study	NMD study Discrimination road map Navy TMD study Navy radar road map	Pan-Pacific Range road map Discrimination and Lethality Enhancement (DALE) study	ABIR Alternative Analysis (AAA)
<i>MICROWAVE AND LASER RADARS</i>	Phased-array development S-Band tracker operational (Wallops Island)	Waveguide ferrite phase shifter TRADEX radar operational (Kwajalein) Laser radar operational (Firepond)	ALTAIR and ALCOR radars operational (Kwajalein) Laser Infrared Tracking Experiment (LITE) laser radar operational (Kwajalein) Design studies for Cobra Judy	Gallium-arsenide (GaAs) Ka-band transmit/receive (T/R) module MMW radar operational (Kwajalein) Ultraviolet and visible angle-angle-range laser radar developed Firepond wideband laser radar	Cobra Gemini radar operational Kwajalein Modernization and Remoting (KMAR) Firepond operation MMW 2 GHz upgrade	THAAD user operational evaluation system radar conversion to TPS-X X-Band Transportable Radar (XTR) operational Angle-Angle-Range Doppler Imaging (AARDI) laser radar Over-the-horizon radar (OTHR) demonstrations Enhanced Track Illuminator Laser (ETILL) radar
<i>VISIBLE AND INFRARED SENSORS</i>	Schmidt cameras (Wallops Island)	Long-wavelength infrared (LWIR) detectors PRESS ground optics (Kwajalein) PRESS airborne optics (KC-135, A-3D)	Indium antimonide photodiodes Avalanche photodiodes Army optical station (Kwajalein)	Cobra Eye sensor operational (Shemya AFB, Alaska) Schottky-barrier platinum silicon detectors	Space-Based Visible sensor (MSX) Sea Lite Beam Director (SLBD), White Sands Missile Range Fly-Away Sensor Package (FASP) flown on TCMP-2A	Captive-carry infrared seeker Airborne infrared sensor experiments Digital focal-plane array (DFPA)
<i>DISCRIMINATION TECHNOLOGY</i>	Reentry phenomenology	Discrimination requirement development Real-time discrimination algorithm development	Phase-derived range demonstrated 3-band infrared discrimination techniques	Discrimination Algorithm Fusion Architecture development	Red-blue exercises Sidecars developed and deployed	Sea-Based X-Band (SBX) radar architecture enhancements Multisensor fusion
<i>DIRECTED ENERGY</i>		First laser thermal-blooming experiments Atmospheric compensation experiments 500J CO <sub>2</sub> laser	Atmospheric compensation experiments (Hawaii, California, Massachusetts) Thermal-blooming correction of Mid-Infrared Advanced Chemical Laser (MIRACL)	Simulation of Airborne Laser (ABL) propagation effects (Firepond)	ABL engagements using Missile Alternative Range Target Instrument (MARTI)	Fiber-laser beam combining and cryo-cooled solid-state laser development
<i>RANGES, FIELD MEASUREMENTS, AND TESTING</i>	Trailblazer tests (Wallops Island)	Reentry simulating range (Lincoln Laboratory) Reentry measurements flight tests (Kwajalein)	Reentry Designation and Discrimination (REDD) system Cobra Dane radar operational (Alaska) HAVE Jeep experiments Bulk filter flight tests	Cobra Judy radar operational Lexington Discrimination System (LDS) Real-time radar imaging Army sounding rocket measurements	First Theater Critical Measurements Program (TCMP) tests (Kwajalein) Red Crow test (Hawaii) TCMP-2 test campaign (Kwajalein) Firefly and Firebird test (Firepond, Wallops Island)	TCMP-3 and Critical Measurements Program tests (Kwajalein) Countermeasure Critical Measurement (CMCM) tests (Hawaii) Clutter experiments (Advanced Systems Flight Test [ASFT])
						RTS Distributed Operations Center operational Cobra Judy replacement operational

and refreshed at Lincoln Laboratory to keep pace with the numerous changes in foreign threats and national objectives that the U.S. BMD program has experienced over five decades. The Laboratory has made a great many technical contributions as a consequence of this sustained and focused effort. The timeline in Figure 9-1 provides an overview of the more significant contributions.

### The City Defense Era (1960s)

Two major DoD organizations supported BMD work during the city defense era: the Army and ARPA. The Army effort was an outgrowth of the Nike-Ajax and nuclear-tipped Nike-Hercules air defense systems that had been deployed in the 1950s around major cities. These systems had separate radars for surveillance, target tracking, and interceptor guidance. The first Army BMD system, Nike-Zeus, was essentially an upgrade of the Nike-Hercules air defense system, but incorporated longer-range radars and interceptors, and exercised a greater degree of automated operation. Nike-Zeus utilized multiple target and interceptor-tracking radars to handle simultaneous attacks by multiple missiles and an additional radar to discriminate enemy warheads from decoys. The second organization, ARPA, focused on understanding the physics of the observables presented by the attacking missiles and on the development of advanced technology to counter the threat.

Two fundamental problems with Nike-Zeus were an inability to handle significant amounts of traffic during an attack and a lack of discrimination capability at the very high altitudes needed to provide coverage for city-defense protection. Project Defender, the ARPA BMD effort, focused on solving these problems. ARPA sponsored two major activities at Lincoln

Laboratory. The first, Project PRESS (Pacific Range Electromagnetic Signature Studies), conducted radar and optical measurements by using sensors at the Kwajalein Atoll in the western Pacific. The second was a radar discrimination technology effort that used the PRESS data to develop discrimination techniques capable of identifying threat objects in the presence of countermeasures and debris.

Another line of research at the Laboratory led to the development of the electronically steered phased-array radar that addressed the traffic problem. A wide-field-of-view phased-array radar has many individual radiating elements, each with phase control of the electromagnetic signal transmitted (or received) by the element. With systematic adjustment of the phase of each element, a radar beam can be formed and pointed in a completely different direction on a pulse-to-pulse basis over a wide field of view without mechanically moving the antenna. Thus, it is possible to track hundreds of widely spaced targets having enough continuity to provide trajectory information with sufficient precision to determine target deceleration caused by the atmosphere, the target impact point, and potential intercept points.

The success of this technology led the Army to incorporate phased-array radars into its BMD program. In the early 1960s, Nike-Zeus was replaced by a new system, initially called Nike-X (and subsequently Sentinel, then Safeguard) that had three phased-array radars: Multifunction Array Radar (MAR), Perimeter Acquisition Radar (PAR), and Missile Site Radar (MSR). Nike-X included a high-acceleration interceptor, the Sprint, which allowed the defense enough time to wait until the atmosphere had filtered

1951



Radars at Laboratory field site, Arbutle Neck, Va.



Optical sensors at Laboratory field site, Arbutle Neck, Va.

1960



J. Freedman



## Notes

**3** J.L. Allen, "Phased Arrays — There is a Future," *Microwave J.* **8(6)**, 110–115 (1965).

**4** W.J. Ince and D.H. Temme, "Phasers and Time Delay Elements," *Advances in Microwaves*, Vol. 4, ed. L. Young. New York: Academic Press, 1969, p. 1.

**5** G.F. Dionne, "A Review of Ferrites for Microwave Applications," *Proc. IEEE* **63**, 777–789 (1975).

**6** P.A. Ingwersen, W.W. Camp, and A.J. Fenn, "Radar Technology for Ballistic Missile Defense," Lexington, Mass.: MIT Lincoln Laboratory (2007).

out the heavy RVs from the lighter decoys before launching an interceptor. Nike-X also utilized the Spartan interceptor (an upgraded version of the Nike-Zeus interceptor), which could intercept and destroy targets outside the atmosphere through the use of a high-yield nuclear warhead.

### *Lincoln Laboratory Technology Efforts*

Lincoln Laboratory contributed significantly to the development of phased-array radars. Early work during the 1960s on electronically steerable agile-beam radars placed the Laboratory at the forefront of a technology that revolutionized the tasks of both threat detection and interceptor guidance control for BMD.<sup>3</sup>

The key component essential for these radars was the phase-shifter device that provided phase control for the individual elements of the antenna array. A Lincoln Laboratory team developed the latching ferrite phase shifter during the late 1960s and early 1970s.<sup>4</sup> The ferrite waveguide phase shifters provided a strong interaction between the microwave signal and the magnetized ferrite within a convenient packaging geometry, and became a standard design configuration for industry.

A critical limitation of the early phase shifters was the ferrite material. Commercially available compositions were both expensive and incapable of maintaining a controlled magnetic state under varying temperature and stress conditions. In the early 1970s, the Laboratory addressed this problem and developed low-cost microwave ferrite materials tailored for temperature and stress sensitivities.<sup>5</sup> Once the developmental work was complete, the Laboratory built a number of experimental arrays and tested these as well as arrays built by other organizations. By the 1970s, the technology had been

successfully transferred to industry. An excellent survey follows Lincoln Laboratory's role in the development of radar technology.<sup>6</sup>

The other major problem that Lincoln Laboratory focused on — discrimination — is intrinsically more difficult than the traffic problem because the attacker can respond to each defense action by changing the design of the RVs and decoys. There is no fundamental solution to this problem. The defense must develop robust discrimination techniques, that is, techniques that perform acceptably regardless of what the adversary does. Thus, in a changing environment, only continuing research on both evolutionary and revolutionary techniques will allow the defense to remain effective against the offense. The Laboratory discrimination program has taken a broad-based approach for more than 50 years. Major elements of the effort have included gaining an understanding of fundamental phenomenology, the collection and exploitation of data on current and potential targets, the improvement of sensor measurement and signal processing capability, the development of automated techniques for discrimination in realistic environments, and the comparison of required performance with achievable capability.

There is a basic trade-off between difficulty of discrimination and the payoff for discrimination. At higher altitudes, the atmosphere is less dense, making discrimination between RVs and decoys more difficult. In order to discriminate between RVs and decoys at higher altitudes, the defense sensors must operate at longer ranges and are, consequently, larger and more expensive. However, the payoff for discrimination at high altitude is the increased time available for interceptor fly-out, resulting in a larger defended footprint.



Early TRADEX radar,  
Roi-Namur



Project PRESS  
KC-135 aircraft



AMRAD radar  
with clutter fence,  
White Sands, N. Mex.

## Notes

**7** The Laboratory tracking and measurement radars at Arbutle Neck became the Joint Air Force–NASA multiwavelength radar facility in 1965.

**8** J. Ruze, F.I. Sheftman, and D.A. Cahlander, "Radar Ground Clutter Shields," *Proc. IEEE* **54(9)**, 1172–1183 (1966).

**9** Material in this section is drawn from K.R. Roth, M.E. Austin, D.J. Frediani, G.H. Knittel, and A.V. Mrstik, "The Kiernan Reentry Measurements System on Kwajalein Atoll," *Linc. Lab. J.* **2(2)**, 247–276 (1989).



**Figure 9-2**

The islands of the Kwajalein Atoll enclose the world's largest lagoon — 1100 sq mi in area. About a hundred small islands with a total land area of 5.6 sq mi circle the lagoon.

As the RV penetrates deeper into the atmosphere, the defense will be able to identify and reject the lightest decoys first, followed by the heavier decoys, until only the heaviest decoys and RVs remain. At any point, the defense has the option of shooting at all remaining credible targets. The longer the defense waits, the fewer interceptors it will waste on decoys, but the resultant defended region will be smaller. The payoff for discrimination at long range is that fewer discrimination sensors are needed to provide area coverage. The trade-off is between the number of sensors needed and the cost of the higher-quality sensor required to perform at the longer ranges. Lincoln Laboratory's goal has been to extend the boundary of high-quality discrimination performance.

### *Lincoln Laboratory Measurement Efforts*

When the BMD effort started, the only information available on target phenomenology at ICBM velocities of 7 km per sec (over 15,000 mi per hr) had been obtained by studying meteors entering the atmosphere. This work had shown that a wake of ionized gas would trail the target and be visible to radar and optical sensors. NASA sponsored the initial target reentry observations that Lincoln Laboratory conducted at Wallops Island, Virginia.

The Laboratory installed radar and optical instrumentation at Arbutle Neck, Virginia, for observation of Trailblazer launches from the NASA Wallops Island facility. In addition to an S-band tracking radar and a multiplexed ultrahigh frequency (UHF) and X-band measurement radar, the Laboratory developed the S-band Space Range Radar for long-range trajectory tracking.<sup>7</sup> Optical instrumentation included Harvard Observatory Schmidt cameras and a smaller Schmidt camera built by the Perkin-Elmer Corporation for the Laboratory. The Laboratory also developed a dual-wavelength spectrometer with a 1.2 m Cassegrain telescope.

Beginning in 1964, the Laboratory, as scientific director, conducted additional tests at the White Sands Missile Range in New Mexico using the 60 ft aperture L-band ARPA Measurements Radar (AMRAD). The 104 ft high, 2000 ft long radar ground clutter shield located 500 ft from the AMRAD was described as "the largest corral in New Mexico."<sup>8</sup>





**Figure 9-3 (above)**  
TRADEX antenna.



**Figure 9-4 (right)**  
Lincoln Laboratory's first site inspection visit to Roi-Namur Island, October 26, 1960. Pictured are Lieutenant Colonel Kenneth Cooper, U.S. Army, and Glen Pippert.

Missiles were flown on short-range trajectories and, as they started to reenter, additional rocket motors were fired to increase the reentry velocity to that of an ICBM. Measurements made on these small targets gave some insight into the physics of reentry at ICBM speeds. Subsequent experiments were conducted at the Reentry Systems Range in Lexington and other ballistic ranges, where light-gas guns were used to accelerate small targets to reentry velocities in a controlled environment.

#### *The Kwajalein BMD Role Begins*

In 1959, ARPA chose Kwajalein Atoll, which was part of the U.S. Trust Territory of the Pacific (now part of the Republic of the Marshall Islands, an independent Micronesian island nation), to be the centerpiece of its BMD research program because of the atoll's geography and its strategic location. Kwajalein Atoll, which rests 9° north of the equator and 3500 km southwest of Hawaii, is a necklace-like strand of palm-studded islands enclosing the world's largest lagoon (Figure 9-2).<sup>9</sup> It was a natural choice for ARPA since the Army's BMD effort (Nike-Zeus, Nike-X) were also located at Kwajalein. ARPA's effort, Project PRESS, was located on the island of Roi-Namur at the northern end of the atoll.

During the early 1960s, when the United States first developed its own ICBMs, flight tests from Vandenberg Air Force Base, California, to Kwajalein Atoll, Marshall

Islands, (a distance of 4300 nautical miles) provided an opportunity for measurements on full-scale RVs, booster tanks, decoys, and related missile hardware. The location and isolation of the atoll made it an ideal target area for ICBMs launched from Vandenberg Air Force Base carrying mock warheads. Lincoln Laboratory observed the ICBM flight tests using the PRESS instrumentation to gain an understanding of the phenomenology of missile systems.

It was recognized early on that additional knowledge of radar observables would be required to build an effective BMD system. The major Lincoln Laboratory BMD data-collection radar during this time was the Target Resolution and Discrimination Experiment (TRADEX). Design of TRADEX began in 1959, and the radar became operational at UHF and L-band frequencies in 1962 (Figure 9-3). Lincoln Laboratory personnel assignments to Kwajalein had begun in 1961 (Figure 9-4). By 1962, the contingent had grown to seventeen staff members and six support personnel. The second radar, the very-high-frequency (VHF) and UHF ARPA Long-range Tracking and Instrumentation Radar (ALTAIR), became operational in 1969; the ARPA Lincoln C-band Observables Radar (ALCOR) came online one year later.

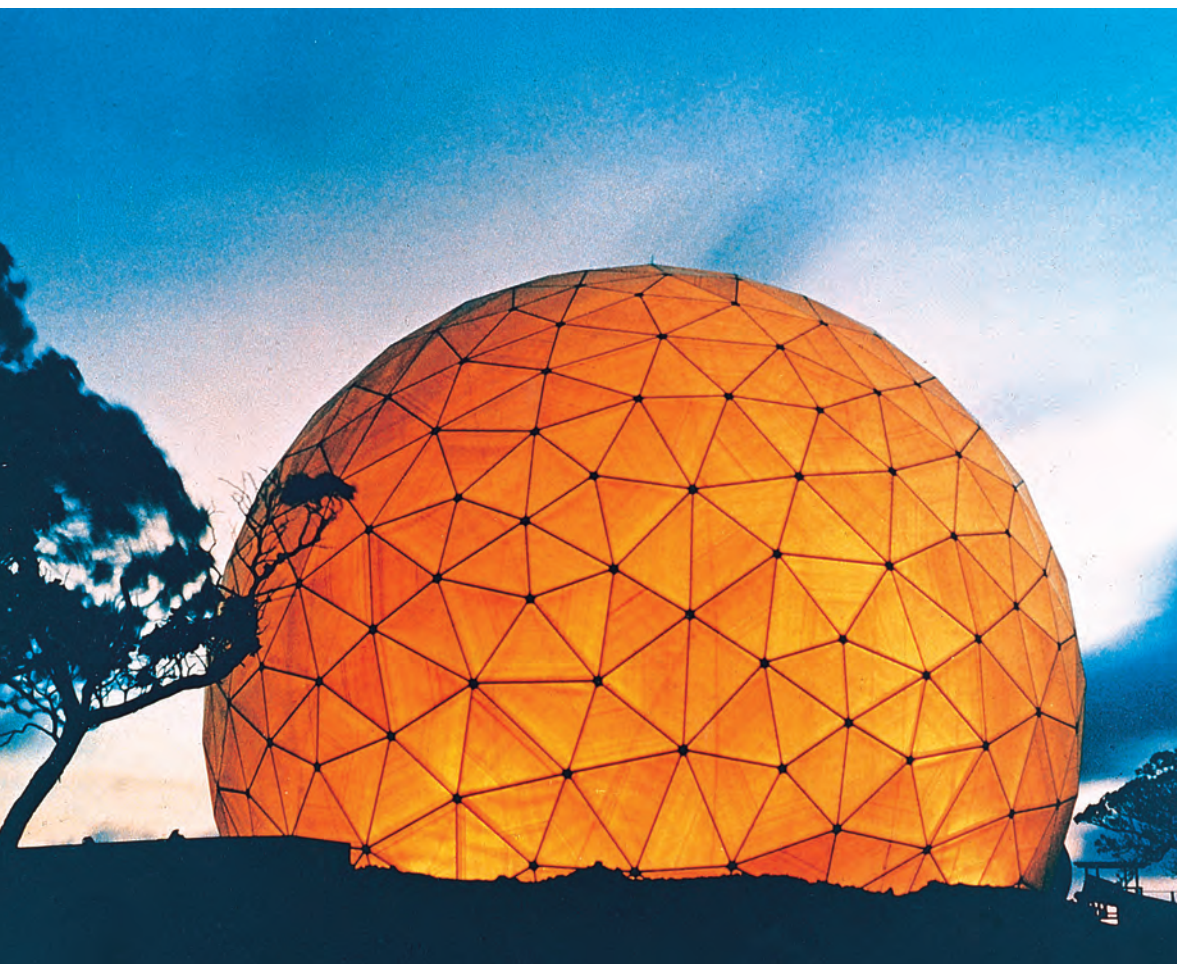


**Figure 9-5 (right)**

**Aerial view of the KREMS sensors. ALCOR is in the front left; TRADEX in the front right. The MMW radar is in the center of the photograph and ALTAIR is in back, closest to the lagoon.**



**Figure 9-6 (below)**  
**ALCOR radome.**



In the early days, TRADEX's greatest asset was its large repertoire of waveforms. The radar was capable of using chirp pulse waveforms to track an RV during reentry while interleaving other waveforms — for example, bursts and pulse pairs — to gather high-resolution Doppler data on the low-velocity, high-electron-density wake that forms behind the vehicle. Today, in addition to tracking U.S.-launched ballistic missiles, TRADEX also tracks new foreign satellite launches and deep-space satellites.

In the early 1960s, ARPA gave Lincoln Laboratory the task of fielding and managing an optical measurements program in the Kwajalein Atoll to gather reentry data on strategic missile system components launched from Vandenberg Air Force Base. Because the reentry phase of the flights was considered to be of prime importance, the focus was on measurements in the visible region of the optical spectrum. Two ground-based optical stations were built, one on Roi-Namur Island near the TRADEX radar and the other on Kwajalein Island.

Because of the concern that cloud cover would at times prevent the stations from gathering data, the Laboratory also developed and fielded an airborne optical system. The aircraft chosen was a KC-135; its sensors included an array of wide- and narrow-field-of-view sensors operating in the visible band. Data collection on the ground at Kwajalein began in late 1962, and the Project PRESS aircraft, unofficially called the Liki-Tiki (since it flew out of Hickam Air Force Base in Honolulu), began flights a year later.

Visible-band reentry data were collected and analyzed to advance the understanding of reentry phenomenology. However, by the mid-1960s, it was recognized that target discrimination would be improved by collecting data at exoatmospheric (outside the atmosphere) altitudes, where the targets would be cooler. This approach required measurements in the long-wavelength infrared (LWIR), and therefore the measurements program adopted a new direction. The program thus required the development of detectors for the LWIR sensors. The detectors had to be extremely sensitive, so they operated at cryogenic temperatures to minimize locally generated thermal noise. The major effort, however, was the conversion of the PRESS aircraft to collect LWIR target data. An open cavity was constructed in the side of the aircraft,



**Figure 9-7**  
Inflatable ballistic missile decoy developed by Lincoln Laboratory.

#### Notes

**10** A detailed history of KREMS is given by M.S. Holtcamp, an Army civilian responsible for oversight of KREMS, in the report *The History of the Kiernan Reentry Measurements Site*. Lexington, Mass: MIT Lincoln Laboratory, 1980.

**11** Material for the Reentry Systems Program (RSP) was provided by Alan Grometstein.

and a telescope and its mount were installed. The optical beam was focused on an LWIR focal-plane array. The sensor system was called the Airborne Infrared Telescope (AIRT) system and its narrow-field-of-view sensor was pointed using radar data. The AIRT, the first LWIR radiometer of its kind, gathered unique and useful data until the city defense era ended with the transfer of Project Defender from ARPA to the Army.

In 1969, the Project PRESS site was named the Kiernan Reentry Measurements Site (KREMS) (Figure 9-5) to memorialize U.S. Army Lieutenant Colonel Joseph Kiernan, who headed Project PRESS during its period of rapid growth. Between 1963 and 1966, Kiernan, while serving at ARPA, initiated the development of the ALTAIR (opening figure) and ALCOR (Figure 9-6) radars on Roi-Namur Island. He later served as Commander of the 1st Engineer Battalion of the 1st Infantry Division in Vietnam, where he was killed in a helicopter crash in 1967.<sup>10</sup>

Lincoln Laboratory has been responsible for the scientific direction of KREMS since its inception as Project PRESS in 1959. The Laboratory has continually maintained the sensor complex at state-of-the-art technology levels, and it has continued to provide high-quality radar and optical measurements on a broad spectrum of missile targets since its inception almost a half century ago.

#### *The Reentry Systems Program*<sup>11</sup>

In addition to the effort to develop discrimination capability for defensive systems, the Laboratory also examined the other side of the coin: designing potential adversary countermeasures or penetration aids (called pen-aids). This activity began as U.S. Air Force-sponsored work to design, test, and evaluate the performance of pen-aids to increase the probability of U.S. strategic missiles penetrating Soviet defense systems.

Countermeasures can potentially place a huge burden on the defense. In the absence of countermeasures, a BMD system need only detect a target, determine its location, and predict its trajectory, and then launch an interceptor. In the presence of pen-aids, however, the decision process must also include the difficult task of detecting a target in a cluttered environment and then discriminating the threatening warheads from decoys. It should be noted that, even in the absence of intentional

countermeasures, a primitive threat will arrive in the presence of booster and deployment debris that requires the defense system developer to incorporate a sufficient degree of mitigation technology.

An offensive countermeasure takes advantage of some aspect of a BMD system to impair its ability to intercept a warhead — the more successful the pen-aid, the larger the number of warheads that reach their targets. The various forms of pen-aids that Lincoln Laboratory worked on included decoys, jammers, and chaff.

Decoys are lightweight objects deployed on threatening trajectories; they are constructed to resemble warheads when viewed by defense sensors (radars, optics). Thus a defense lacking the ability to distinguish between a decoy and a warhead may be forced to fire at each (Figure 9-7).

Decoys come in a variety of forms. Replica decoys resemble warheads in detail and, as a result, tend to be somewhat heavy such that only a few can be deployed per missile. Traffic decoys only crudely resemble warheads but are typically small or lightweight so that each missile can deploy large numbers. For radar, passive decoys depend on the echo they reflect back to a sensor, whereas active decoys transmit a signal that simulates the echo of a warhead to confuse the defense.

Jammers are electronic devices deployed on trajectories near those of the warheads. They are active devices that can emit strong signals. Jammers make detection of the reflected radar signal difficult so that even if the defense does detect the presence of incoming targets, it is extremely difficult to discriminate between real warheads and decoys.

Chaff, originally used during World War II, consists of numerous, very light scatterers that produce a strong echo when viewed by defense sensors, thus hiding the presence of nearby warheads. Depending on the nature of the defense sensor, chaff can consist of long, thin metallic strips or of minute metallic spheres (called aerosols) dispensed in the region of space occupied by the warheads.



Beginning in 1960, the study of pen-aided missiles flying against an enemy defense became one of Lincoln Laboratory's areas of specialization. The program, originally entitled the Penetration Aids Study, had as its goal the development of pen-aid devices suitable for protecting U.S. missiles against an enemy BMD system. The Penetration Aids Study evolved and in 1963 was formally instituted as the Ballistic Missile Reentry Systems Program (RSP). The work was conducted under the sponsorship of the Advanced Ballistic Reentry Systems (ABRES) Office of the Air Force. ABRES was in charge of developing missiles and pen-aids for possible adoption by the Strategic Air Command (SAC).

The first goal for the RSP was to develop models for and estimate performance of a potential adversary's BMD systems. The models included such system elements as search radars; tracking and fire-control radars; interceptor missiles; and command, control, communication, and intelligence. On the basis of these models, the Lincoln Laboratory group then estimated the fraction of ICBMs that might penetrate the defense and reach their targets. Several models of each BMD system were postulated, and pen-aids were proposed to take advantage of the weak points of each. Promising concepts were designed, tested in the laboratory, flight-tested, then modified, and retested. Eventually, the performance of a BMD system against an ICBM incorporating the pen-aids was analyzed to determine how many additional warheads would penetrate the defense because of the action of the pen-aids. The most notable capability of RSP was that it produced pen-aid concepts that had undergone sufficient analysis to quantify their level of protection to warheads. Moreover, the concepts received sufficient testing in the laboratory and in the field so that their

feasibility could be established. Following the completion of an evaluation effort, each pen-aid concept was made available by ABRES for incorporation into the missile force, or more commonly, to be put on the shelf as a proven augmentation to the force whenever a future requirement was established.

The RSP activity was particularly well qualified to develop pen-aids for ABRES because Lincoln Laboratory personnel were well versed in the intricacies of missile offense/defense considerations. Practical limitations on technology, information flow, and decision making were the major factors that determined whether the offense or defense would prevail. Advances in new technologies, particularly in the fields of microelectronics and materials science, often made the difference between a pen-aid concept that was feasible and one that was attractive but impractical. The RSP studied all factors and measured the effect a pen-aid would have on the outcome of an attack. The program's greatest strength was that it supplemented theoretical studies with tests performed in the laboratory and in the field. RSP conducted tests on pen-aid concepts at the facilities in Lexington and at subcontractor sites throughout the United States.

#### **The Silo Defense Era (1970s and early 1980s)**

With the decision to deploy the Safeguard system in 1968, the nation's BMD program underwent a major change in organization and direction. The ARPA Defender program that supported the Lincoln Laboratory BMD effort was merged with the Army Nike-X program to become the Army Ballistic Missile Defense Agency (ABMDA), and subsequently became the Ballistic Missile Defense Advanced Technology Center.

1965



Construction of ALCOR,  
Roi-Namur



S.H. Dodd

1975



Army Optical Station,  
Roi-Namur



The overall Army program consisted of three major thrusts: the Safeguard system for population defense, an advanced silo defense system initially called Site Defense (later Sentry), and the ABMDA advanced technology effort. Lincoln Laboratory worked primarily in the advanced technology area but frequently supported the system development efforts.

The concept of system operation changed with the shift from city defense to silo defense. Silos are more numerous and harder to kill than defense radars, and only a small fraction of the silos need to survive to preserve an effective deterrent. Therefore, the offense can most easily overcome the defense by attacking the silos in two waves — the first wave to destroy the defense radars and the second to destroy the (no longer defended) silos.

The greatest threat to the silos comes from multiple independently targeted reentry vehicles (MIRV) because silo spacing potentially permits one attacking missile to destroy several defended silos. MIRVs also pose a threat to the defense radars because they can send multiple RVs, with accompanying decoys, to arrive at a radar almost simultaneously. MIRVs thus strain the capabilities of the defense system in terms of traffic handling, discrimination, and reliability.

The defense needed a larger battlespace to be able to make multiple near-simultaneous (nuclear) intercepts without the interceptors destroying each other. This battlespace was to be achieved in two ways. The bottom of the battlespace was lowered by hardening the radars to permit intercepts at low altitudes. The phased-array radar was a key element: it had no moving parts and

could thus be hardened to resist nearby nuclear blasts. The ceiling of the battlespace was raised by detecting and discriminating targets at longer ranges, resulting in higher-altitude intercepts.

One problem that had been recognized was that a missile's booster tank could fragment into thousands of pieces at high altitude. Therefore, discrimination techniques had to be developed to identify RVs enveloped by clouds of booster fragments, as well as at low altitudes and in very high traffic levels.

#### *The Lincoln Laboratory Effort*

The Laboratory's BMD effort during the silo defense era focused on four major areas: engineering applications of discrimination techniques, data collection on foreign ballistic missile systems, system analysis, and advanced technology development.

The engineering application of discrimination techniques became a major new effort in this period. Previous discrimination research had involved recording raw sensor data, bringing the data back to the Laboratory, reducing the data to obtain physical signature information, and then manually examining the large database to identify and develop techniques for discriminating RVs from decoys. The new goal of the discrimination engineering effort was to automate these processes and perform them in real time.

The Laboratory began a project known as Designation and Discrimination Engineering to demonstrate real-time signal processing for wideband waveforms and coherent-burst waveforms on the Kwajalein Atoll radars.



G.F. Pippert



MMS remote antenna site,  
Gellinam



Sounding rocket  
for pen-aids test



**Figure 9-8**  
Cobra Judy radars on the USNS  
*Observation Island*.

A high-speed computer was interfaced to the radars to permit real-time processing of metric and signature data. Automated algorithms for performing discrimination were developed and embedded in an overall software system for qualifying and controlling the radar data.

Tens of reentry discrimination algorithms were developed and tested in real time, and many of these were transferred to the Safeguard and Site Defense systems. The process of developing discrimination techniques led to significant insights into the steps required to go from a phenomenology difference between two objects to a proven algorithm that could be automated and that was applicable to a broad class of objects. The statistical performance of the algorithms was measured by testing the algorithms on a large set of targets.

The narrowband UHF PAR of the Safeguard system had only a rudimentary discrimination capability. ALTAIR, a VHF and UHF dish radar at KREMS, was modified to provide the capability to simulate the PAR array. (ALTAIR is discussed later in the KREMS section.) The S-band Site Defense radar had wide bandwidth and coherent waveforms, allowing it to identify a variety of targets. However, the discrimination data available up to that time on foreign missiles had been collected by narrowband UHF radars. To provide any confidence that discrimination would work, intelligence data had to be gathered by a radar of a quality equal to or better than the corresponding defense radar; therefore, wideband intelligence radars were needed. Two phased arrays were constructed by Raytheon during this period: a fixed L-band radar (Cobra Dane) that became operational on Shemya Island in the Aleutians in 1976 and a ship-based S-band radar (Cobra Judy) that became operational on the USNS *Observation*

*Island* in 1981 (Figure 9-8). Both radars had wideband waveforms and provided valuable new information on foreign missile tests.

The Laboratory helped develop these radar designs and, after the radars became operational, was responsible for defining their data-collection plans and reducing and analyzing the data they collected. The analysis used many of the techniques that had been developed for the KREMS radars on the Kwajalein Atoll. At Kwajalein, however, the targets were known; in the case of foreign tests, the radar data were a primary source of discrimination information about the target complexes.

Another area of Laboratory activity that expanded during the silo defense era was system analysis. Lincoln Laboratory carried out a number of studies of concepts for major sensors or defense technologies to evaluate them more fully and see how they fit into the overall system. Some of the concepts studied included applications for active-element, solid-state, phased-array radars; applications of trilateration radar systems; application of LWIR sensors for exoatmospheric discrimination; the requirements for an interceptor with a non-nuclear warhead; application of simple sensors and interceptors for silo defense; approaches to defending the dense-pack basing of Peacekeeper missiles; and applications for laser radars and weapons. In addition to conducting system studies in house, the Laboratory participated in numerous national studies, often in leadership roles. In some cases, the studies led to larger technology programs; other studies were able to determine that the technical approach under consideration was unlikely to offer a significant system advantage.

1980



MMW operational,  
Roi-Namur



Sea Lite Beam Director,  
White Sands Missile Range,  
N. Mex.



W.Z. Lemnios

1990



W.M. Kornegay



**Figure 9-9**  
**Monolithic gallium-arsenide 31 GHz receiver component showing a balanced mixer and metal semiconductor field-effect transistor amplifier on a 2.5 x 5 mm chip developed for an active-element phased-array transceiver.**

**Note**

12 A. Chu, W.E. Courtney, and R.W. Sudbury, "A 31-GHz Monolithic GaAs Mixer/Preamplifier Circuit for Receiver Applications," *IEEE Trans. Electron Devices* **ED-28(2)**, 149–154 (1981).

**Technology**

The need for sophisticated measurement capabilities in both KREMS and operational sensors helped to guide the Laboratory's advanced technology programs. Of particular importance was developing techniques for generating and processing a variety of waveforms, a difficult task before the development of integrated circuits.

Waveform design always involves a compromise between range resolution, Doppler resolution, and ambiguities in range and Doppler, all of which can cause problems in environments containing multiple targets or clutter. For the KREMS radars, a variety of waveforms were needed to permit high-quality data collection on a variety of targets. For defense radars, waveforms had to be designed to balance the needs for real-time processing and for operation against countermeasures. The Laboratory carried out pioneering work in theoretical analysis of waveform performance, in hardware implementation of waveform generation, and in processing under computer control.

The Laboratory developed a number of advances in signal processing for sophisticated radar waveforms. Digital signal processing provided greater flexibility and accuracy than analog processing, and avoided many of the drift and thermal problems of analog components. Furthermore, advances in digital hardware and special-purpose processing architecture during this time enabled digital signal processors to handle all but the widest-bandwidth waveforms for defense radars. Therefore, the Laboratory designed and constructed several large digital signal processing systems for potential defense radar prototypes.

Solid-state technology also played an important role in the advancement of phased-array radar designs. Identified early as a key technology by the Laboratory, as well as by Air Force and Army laboratories, the development of microwave solid-state components for use in an active-element phased array was initiated. These activities served as a pathfinder and provided a basis for educating the microwave engineers across the nation to the advantages of solid-state phased-array radars.

The Laboratory carried out investigations of materials and radiating element designs suitable for nuclear-event hardening of the radiating array face. Lincoln Laboratory pursued the use of ceramic material as the basic substrate for microwave, metallic, photolithographically patterned, integrated circuits, and the development of hybrid circuits on high-dielectric-constant ceramic and ferrite substrates. The Laboratory developed the MSTRIP software code that was used extensively in the design of microstrip and strip-line circuits.

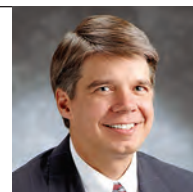
Experience with hybrid microwave integrated circuits involving discrete semiconductor devices preceded early efforts in microwave, monolithic, integrated circuits. A Laboratory team produced landmark achievements in the evolution of monolithic microwave transmit and receive (T/R) modules at microwave and millimeter-wave frequencies (Figure 9-9).<sup>12</sup> The current generation of transportable solid-state radars being built for missile defense is an outgrowth of the achievements of these early T/R module activities, involving wide cooperation between Lincoln Laboratory, the armed services and their laboratories, the Defense Advanced Research Projects Agency (DARPA), ABMDA, and the microwave industry.



Firepond Laser Radar Facility, Westford, Mass.

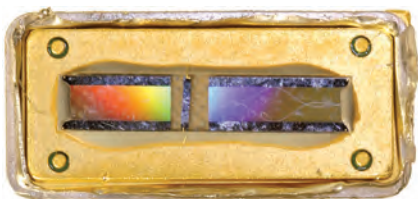


Cobra Gemini radar (large radome)



E.D. Evans





**Figure 9-10**  
**SAW filter. Note the faint white curves (left) that visibly indicate the finite-impulse-response filter coefficients. These coefficients implement a very narrow bandpass filter.**

Lincoln Laboratory also continued its activities in analog signal processing, still, at that time, the only alternative for processing the wide-bandwidth signals used by the ALCOR on Roi-Namur. One highly successful analog signal processor built at Lincoln Laboratory used a surface-acoustic-wave (SAW) device to process the ALCOR wideband pulse. The 512 MHz bandwidth was too great for transistorized signal processors. The pulse had a duration of 10  $\mu\text{sec}$  and a time-bandwidth product of 5120; processing the pulse required delaying the front of the pulse until the back caught up. Although the time delay could be produced electronically, it required several kilometers of transmission line to create the delay. SAW device development activity grew out of radar technology work for BMD and was developed by staff in the Solid State Division. The SAW device was only a few centimeters wide, and it was able to convert the fast-moving electrical signal to a much slower acoustic signal. After processing, the acoustic signal was converted back to an electrical signal. The actual device installed on ALCOR could be held in one hand and replaced seven racks of equipment (Figure 9-10).

#### *Measurements*

With the creation of ABMDA, the Project PRESS aircraft and activity at the Kwajalein Island optical site were discontinued; the optical station on Roi-Namur was renamed the Army Optical Station (AOS) and was used to evaluate a number of optical sensors. Foremost among these were LWIR sensors and a laser radar. These sensors collected data on a broad spectrum of targets, usually from early reentry to near impact. The Wide Angle Sensor was a wide-field-of-view, wideband radiometer operating in the LWIR. Shortly afterward, a second passive LWIR sensor was added to the AOS; it was used for gathering target data with improved multiband spectral resolution. A laser radar, Laser Infrared Tracking Experiment, was added to the AOS to provide an additional source of low-altitude target data. This laser radar used a neodymium-doped yttrium-aluminum-garnet (Nd:YAG) solid-state laser developed by the Laboratory as its transmitter.

#### *The Kiernan Reentry Measurements Site*

ALTAIR, KREMS's second radar, was designed primarily to give the United States a view of how U.S. ICBMs looked to Soviet radars. ALTAIR has the greatest

sensitivity of the KREMS radars. Operating at both UHF and VHF frequencies, the radar can view a target complex shortly after it breaks the horizon, near apogee (the highest point) along its trajectory, at a distance of roughly 4500 km. The radar provides KREMS with its first view and assessment of a reentry-target complex, i.e., the number of objects and their spacing. ALTAIR keeps the range sidelobe levels for the metric waveforms at 40 dB or more below the mainlobe returns. Thus, unlike some other radars, ALTAIR can isolate and track a small target even when the target is in the vicinity of much larger objects.

In 1977, a major system and software effort at KREMS to carry out the Pacific Barrier Trial provided ALTAIR with the capability to search for, detect, and track new foreign space launches as well as maintain track on resident space objects. This test activity was conducted on a round-the-clock basis for several months for the Air Force and provided data to the North American Air Defense Command (NORAD). The design included a system test function that gave the Air Force the capability to delete a single satellite temporarily from the NORAD space-object catalog. Thus, when that satellite entered ALTAIR's field of view, the radar system would successfully detect the "new" satellite, identify it as an uncataloged object, and enter it into track. These tests provided the Air Force with confidence in ALTAIR's capability for the space surveillance mission. ALTAIR also provided data to NORAD on cataloged space objects, as required on a priority basis, to maintain and upgrade the NORAD catalog. Successful completion of the trial resulted in the decision to add ALTAIR to the U.S. Air Force's SPACETRACK network. Subsequent modifications also created a capability for tracking deep-space satellites. Now, in addition to tracking U.S. missile reentries, ALTAIR supports the U.S. Strategic Command by tracking near-earth-orbit and deep-space satellites for 128 hours per week (see chapter 10, "Space Situational Awareness"). Even today, ALTAIR is the only radar in the world able to provide coverage of one-third of the deep-space geosynchronous belt.

The location of Kwajalein Atoll in the western Pacific enables ALTAIR to provide the United States with its first view of Russian and Chinese satellite launches. The radar has successfully acquired and tracked more than 95% of the new foreign launches within its coverage

(approximately 65 per year). ALTAIR also tracks around 1000 deep-space orbiting satellites every week, accounting for the majority of all deep-space radar tracks obtained by the U.S. Space Command.

KREMS's third radar, ALCOR, became operational in 1970 and has a wide bandwidth and narrow-beam antenna that enable it to measure trajectories more precisely than either ALTAIR or TRADEX. The excellent range resolution of ALCOR permits it to observe individual scattering centers on objects. During missions, this capability operates in real time to measure the length of objects within a target complex. ALCOR's coherent high-resolution measurements can be used to generate real-time, two-dimensional range-Doppler images of orbiting and reentering objects. ALCOR holds the distinction of being the first radar to image a reentry vehicle.

With the strong interest in using S-band as a defense frequency, TRADEX was upgraded in the early 1970s to collect S-band signature data. RVs can be tracked at ranges approaching 4000 km. TRADEX is coherent and is capable of measuring the target velocity along the line of sight (Doppler velocity) to an accuracy of a few centimeters per second. It has waveforms that can simultaneously measure range and velocity on different parts of targets and their wakes as they reenter the atmosphere. The Doppler resolution of the radar permits detection of high-velocity targets in a background of lower-velocity clutter. This detection capability is needed when lightweight objects start to strip out in early reentry as atmospheric drag takes effect.

#### *Ballistic Missile Defense Penetration Aids*

The RSP that had started during the early 1960s continued into the 1970s. In this new era, Lincoln Laboratory designed, developed, and tested many new pen-aid technologies. Jammers were developed with a wide range of radiated powers, transmission frequencies, and types of logic. Some jammers radiated continuously, some radiated only when interrogated by a defense radar, and some adapted their transmission to the character of the interrogation pulse. Jammers were even designed to operate during reentry, despite the ionized plasma that forms around bodies reentering the atmosphere.

Heavier decoys were designed that remained credible during the heating and acceleration of reentry. Lighter decoys were developed to provide credibility only in the less stressing environment of exoatmospheric flight. Some were full-size replicas of a warhead; others were much smaller. Since payload capacity was limited, all decoys had to be much lighter than the warhead they accompanied. Most radar decoys were passive, depending for their credibility on the echo characteristics of their shape and material. The RSP developed an active decoy: it sensed receipt of a radar pulse and transmitted a signal that was tailored to resemble a warhead. A novel type of decoy developed by RSP addressed the problem of how to build a body that was the size of a warhead and had similar aerodynamic properties in reentry, but was much lighter. This project involved a thorough investigation of the hypersonic aerodynamic properties of bodies of unusual shape and produced a design that exceeded what had previously been thought feasible.

The RSP also investigated many different chaff designs. One fundamental problem with chaff is the task of dispensing large numbers of small scatterers (often flexible metallic strips) that must be stored for long periods of time, then dispensed in flight so that they separate, forming a large cloud in which to hide a reentry vehicle. The scatterers must provide the maximum possible scattering cross section, and they must not separate with such speed that they fail to obscure the warhead in their midst.

Aerosol chaff was developed to confuse optical sensors. Metalized spheres of a diameter appropriate to the wavelength of the sensor were stored by the billions in a container that, at the proper time, released them at a controlled rate. The mechanical problems inherent in dispensing aerosols were different from those for dispensing radar chaff but were equally challenging.

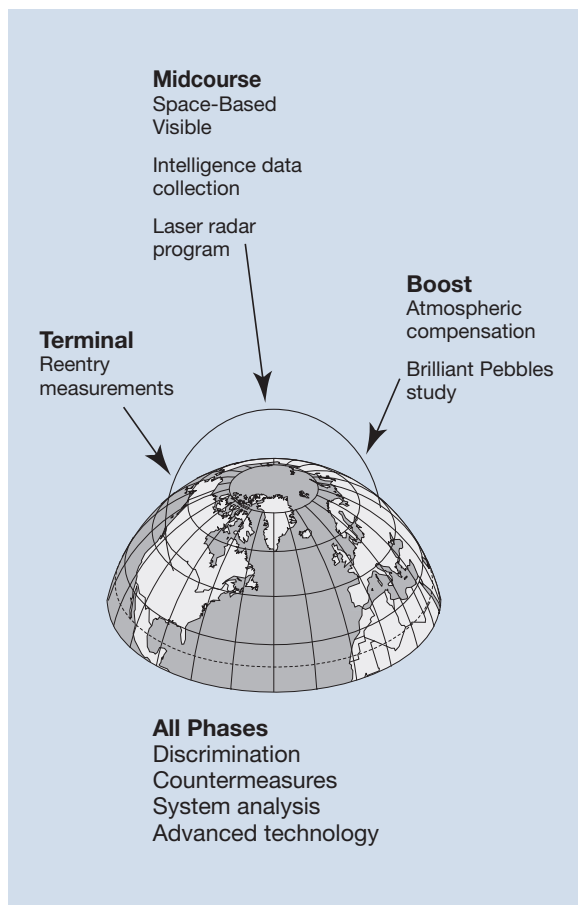
Each of these projects called upon novel technology to produce and authenticate a pen-aid to be added to the arsenal of ABRES in support of SAC's inventory of missiles. The database collected on these targets by Project PRESS and the KREMS sensors constitutes one of the major contributions to the development of U.S. BMD. With the end of the Cold War and the disintegration of the Soviet Union in the late 1980s, the Laboratory RSP activity was brought to an end.

## The Phases of Missile Flight

During the course of a ballistic missile flight, there are distinct phases that defenders may attempt to exploit (Figure 9-11). The initial boost phase occurs when the missile is in powered flight. The missile is moving relatively slowly, accelerating, and then leaving the atmosphere. At this point, it is at its most vulnerable; however, it is still over the adversary's homeland and difficult to reach.

In the midcourse phase, all objects have been deployed and the targets accelerate only under the influence of gravity. This phase is the longest portion of the flight, but typically the most difficult region in which to conduct discrimination because all objects follow essentially the same trajectory. However, the midcourse phase's long duration for long-range missiles gives the defense interceptors plenty of time to fly out to cover a large defended area. Furthermore, the fact that targets are on predictable trajectories makes the interceptor's job of hitting the target easier (if it can identify the correct target).

The final phase, called the terminal phase, is the easiest region in which to discriminate the lethal targets because the drag of the atmosphere significantly slows many of the penetration aids relative to the reentry vehicles. Since the terminal phase of flight is over so quickly, the defense can support only a limited defended area. Late in the terminal phase, the target may undergo large accelerations that further complicate the job of the interceptor, particularly a hit-to-kill interceptor. The need to operate in the atmosphere also imposes design constraints on the interceptor and its seeker that an exoatmospheric interceptor does not face.



**Figure 9-11**  
The three phases of ballistic missile flight.

## The Strategic Defense Initiative – The First Phase (1980s)

President Reagan's speech of March 23, 1983, permanently changed the course of the nation's BMD program. The goal of protecting the nation's deterrent force was replaced by that of developing a near-leakproof defense for the entire country.

The concept of the near-leakproof defense depends on the capability to destroy incoming ICBMs in each of the three phases of missile trajectory: boost, midcourse, and terminal. If the defense could destroy 90% of the attack in each phase and the phases operated independently, then the overall leakage could be expected to be as low as one in one thousand. It is exceedingly difficult for an attacker to develop a single countermeasure that is effective against every layer of the defense. Thus, the overall goal was to combine sensors and weapons operating in all layers to create an effective and robust defense at a reasonable cost. The SDIO was established with overall program responsibility for SDI, but much of the research was supported by the Army BMD programs, the Air Force space-based sensor programs, and the Department of Energy and DARPA directed-energy programs.

In the early part of the SDI era, the emphasis was on directed-energy weapons such as lasers or particle beams for boost-phase kill. These devices posed some extremely difficult technical problems, and as the desire for nearer-term capability emerged, the program emphasis shifted toward hit-to-kill interceptors for both boost- and midcourse-phase kill. As in previous eras, Lincoln Laboratory worked in advanced technology, measurements and data analysis, discrimination engineering, and system analysis. Some of these activities were follow-ons to prior work; others were new.

The Laboratory participated in several studies and analyses of different space-based interceptors. A study of the Brilliant Pebbles concept was conducted that highlighted critical technology issues such as target discrimination, guidance concepts, aim-point selection, and overall interceptor integration.



---

**Note**

**13** W.E. Keicher, W.E. Bicknell, R.M. Marino, W.R. Davis, Jr., S.E. Forman, and T. Stephens, "Laser Radar Technology for Ballistic Missile Defense," Lexington, Mass.: MIT Lincoln Laboratory (2007).

In the critical area of discrimination, particular attention was focused on the early midcourse portion of the trajectory timeline. A sensor observing this section of the trajectory must be space based and must have very good spatial resolution. Lincoln Laboratory led two major national studies to address this problem; one examined laser radar sensors, the other microwave radar sensors.

A laser radar study led to the establishment of the Optical Discrimination Technology Program at the Laboratory, which developed one of the first coherent laser radars in the country, to participate in field measurements of ballistic missile targets in flight. The laser radar approach was selected by SDIO for further development and resulted in a major new Laboratory effort. This work involved the development of lasers, agile beam-steering mirrors, and discrimination concepts, as well as countermeasure flight-test measurements. Laser work included the development and use of a wideband coherent laser at 10.6  $\mu\text{m}$  wavelength for range-Doppler imaging and of a noncoherent frequency-doubled Nd:YAG laser at 0.53  $\mu\text{m}$  wavelength. The beam-steering work concentrated on ultralight, ultrarigid, mechanically steered mirrors (see chapter 25, "Laser Systems"). This effort culminated in the Firebird flight tests, in which targets were launched from Wallops Island and observed by laser and microwave imaging radars in Westford, Massachusetts, and by a variety of passive optical sensors at other locations.<sup>13</sup>

The microwave radar study recommended that the monolithic microwave circuit technology be given national priority. A major DoD technology development program was established with industry and became a significant part of the Army BMD program.

The Laboratory's work in the midcourse-defense layer evolved from the work of previous eras. The principal sensor classes for midcourse discrimination were satellite-, missile-, or aircraft-based LWIR and visible sensors, and ground-based wideband imaging radars. Work on LWIR discrimination included multiple-target tracking and thermal discrimination based on target intensities in several wavelength bands. Radar discrimination used range-Doppler imaging and precise measurements of target dynamics. The radar and LWIR discrimination work was taken through both phenomenology study and laboratory evaluation phases.

### *System Concept Analysis*

During this era, SDIO needed a system engineering capability to guide the deployment of a selected set of BMD concepts. A system engineering and integration (SE&I) contract was awarded to industry to develop system constructs and to define the integration and requirement documents for these concepts. To augment the SE&I effort, SDIO requested that the federally funded research and development centers (FFRDC) and national laboratories provide a technical presence in Washington, D.C., to conduct in-depth technical analysis of difficult problems. Lincoln Laboratory and the other organizations agreed, and the Phase One Engineering Team (POET) was formed in 1988. Lincoln Laboratory provided the POET lead in the areas of radar-sensor engineering and discrimination as well as several staff members resident in Washington, D.C. This office was augmented with significant back-home support. The other laboratories and FFRDCs participated as well, forming a team of approximately 25 resident analysts working directly with SDIO on a daily basis. POET was tasked to do trade-off studies of several proposed system architectures and sensor systems, such as space-based infrared sensor satellites, missile-borne infrared sensors, airborne infrared sensors, ground-based interceptors, and ground-based X-band radars.

### *Algorithm Development*

The shift from hardened silo defense to soft target defense increased the minimum intercept altitude in the reentry phase and, consequently, raised the required discrimination altitude. The Lincoln Laboratory effort in discrimination focused on those techniques that would be most appropriate in the midcourse and high-altitude reentry regime where the atmosphere is very thin. In this region, the techniques relied upon very precise radar measurements to discriminate between the small differences in deceleration exhibited between the massive RV and the lightweight decoys. A second aspect of these discrimination schemes exploited target size measurements to reject the small decoy targets that could mimic the deceleration profiles of the larger, heavier reentry vehicles.

In order to demonstrate the efficacy of high-altitude reentry discrimination, the U.S. Army Ballistic Missile Defense Advanced Technology Center initiated an effort at Lincoln Laboratory in the early 1980s to conduct real-time, image processing experiments on actual flight tests



**Figure 9-12**  
Cobra Eye RC-135 aircraft.

into Kwajalein. The Lexington Imaging System (LIS) implemented at the Laboratory was used as the development site, and algorithms — once mature — were installed at a sister unit, the Kwajalein Imaging System (KIS), attached to the ALCOR radar. The demonstrations convinced a broad user community of the viability of such techniques for field application. As digital technology advanced, the throughput capacity of LIS and KIS increased to the point that the imaging process was augmented with complete discrimination suites. By the end of the decade, the units were upgraded to such a degree that they became known as the Lexington Discrimination System (LDS) and the Kwajalein Discrimination System (KDS).<sup>14</sup> Demonstrations of discrimination technology by these facilities in a field test environment were instrumental in getting many of these discrimination algorithms adopted by the acquisition community for use in actual defense systems.

#### Field Measurements

Several important new sensors were deployed to provide data to develop and test midcourse discrimination. An X-band dish radar was added to the Cobra Judy shipborne sensor suite. This sensor provided high-quality radar measurements at the preferred frequency for SDI radar systems. This and many other sensors were used to gather data on foreign and domestic missile systems, and were used by the Laboratory for developing and testing discriminants.

Interest in an airborne LWIR sensor dated back to the 1978 Minuteman Defense Study III, which had defined the requirements for LWIR exoatmospheric discrimination and investigated the available database for the development and validation of discrimination algorithms. The study found that the database was very limited. Lincoln Laboratory then recommended that the Army develop an airborne LWIR sensor system to gather data for discrimination algorithm development and validation. This suggestion provided the motivation that led to initiation of the Optical Aircraft Measurements Program (OAMP), a joint Army and Air Force program. The OAMP sensor carried aboard the Cobra Eye (RC-135) aircraft collected endoatmospheric and exoatmospheric signature data on missiles deep into reentry flight (Figure 9-12). It monitored ballistic missile tests on the Western Test Range, the Eastern Test Range, and other locations.

The OAMP sensor was a three-band LWIR radiometer with scan capability over a field of view that could be pointed by directing data for acquiring the target prior to track and three-band data collection (Figure 9-13). Lincoln Laboratory developed the sensor; Ball Aerospace was the contractor for the sensor system, Hughes Aircraft Company for the LWIR array, and Itek Corporation for the telescope. The sensor was integrated into an RC-135 aircraft designated Cobra Eye, which had an open cavity similar to the cavity on the earlier PRESS aircraft. Measurement requirements, sensor system procurement, computer system development, mission planning, and data processing and analysis were all conducted under the cognizance of Lincoln Laboratory.<sup>15</sup> The Cobra Eye platform successfully collected data on ballistic missile flight tests from 1989 until 1993.<sup>16</sup>

#### Kwajalein Activities

New sensor development and sensor upgrades continued at Kwajalein during this era. The newest radar, the Millimeter Wave (MMW) radar, went into operation in 1983, the same year that the Multistatic Measurement System (MMS) was added to TRADEX.

Initially, MMW operated in the Ka and W bands. It is unique in its very narrow beamwidth (760  $\mu$ rad at 35 GHz and 280  $\mu$ rad at 95.5 GHz) and very high bandwidth (1 GHz) (Figure 9-14). Both MMW and MMS provided highly precise target position measurements, on the order of less than a meter. These measurements proved extremely important in the early 1980s when the Army began experimenting with hit-to-kill interceptor technology. During 1983 and 1984, four hit-to-kill intercept experiments were conducted at Kwajalein using targets launched from Vandenberg Air Force Base in California. The final test, in June 1984, resulted in a successful intercept and was the first demonstration of an exoatmospheric hit-to-kill intercept of a ballistic missile target. All of the KREMS radars collected data during this series of tests, including the two newest, MMW and MMS. The high-precision data collected during the three unsuccessful tests were analyzed by Laboratory personnel and provided important diagnostic information for the hit-to-kill demonstration team.

#### Notes

**14** S.B. Bowling, R.A. Ford, and F.W. Vote, "Design of a Real-Time Imaging and Discrimination System," *Linc. Lab. J.*, **2(1)**, 95–104 (1989).

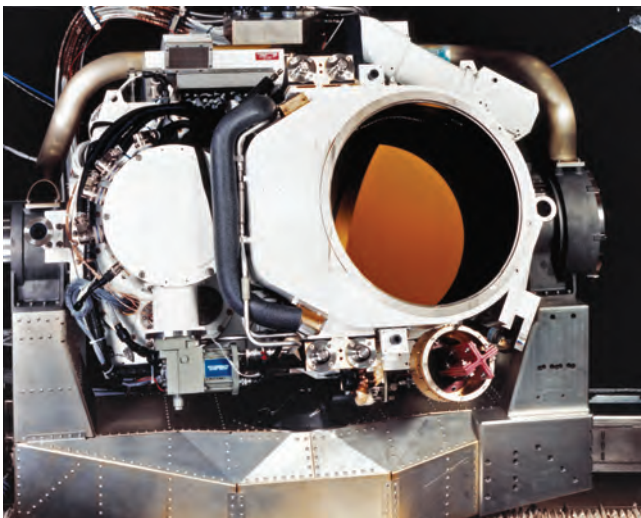
**15** W.E. Bicknell, M.J. Cantella, B.E. Edwards, D.G. Fouche, C.B. Johnson, D.G. Kocher, D.E. Lencioni, and G.H. Stokes, "Passive Optical Systems and Technology for Ballistic Missile Defense," Lexington, Mass.: MIT Lincoln Laboratory (2007).

**16** B.L. Cardon, D.E. Lencioni, and W.W. Camp, "The Optical Aircraft Measurements Program and Cobra Eye," Lexington, Mass.: MIT Lincoln Laboratory (2007).

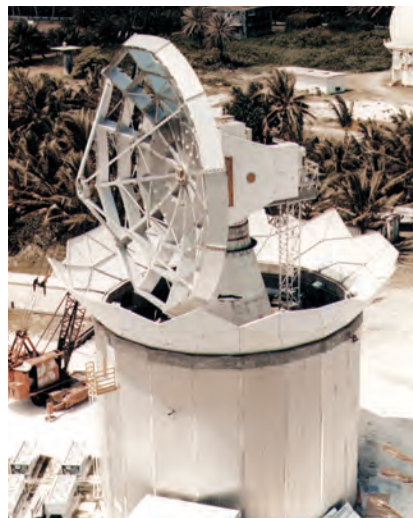
**17** W.D. Fitzgerald, "A 35-GHz Beam Waveguide System for the Millimeter-Wave Radar," *Linc. Lab. J.*, **5(2)**, 245–272 (1992).

**18** G. Zorpette, "Kwajalein's New Role: Radars for SDI," *IEEE Spectrum* **26(3)**, 64–69 (1989).

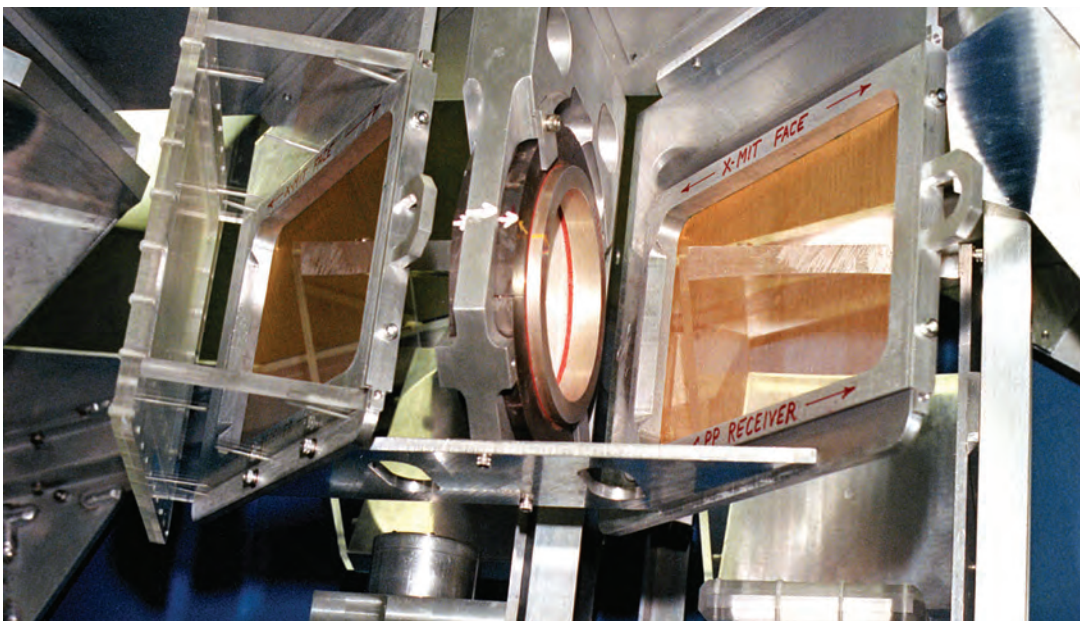




**Figure 9-13**  
OAMP sensor telescope system.



**Figure 9-14**  
MMW radar under construction.



**Figure 9-15**  
Quasi-optical circulator in the reflecting-beam-waveguide system developed for the MMW radar.

The MMW radar was upgraded in the late 1980s with the addition of a quasi-optical beam waveguide system (Figure 9-15). MMW was the first high-power, dual-polarized, angle-tracking radar to use a quasi-optical beam waveguide. The beam waveguide design has lower losses, broader bandwidth, and greater power handling capability compared to conventional waveguide systems.<sup>17</sup>

In the early 1990s, the MMW bandwidth was upgraded to 2 GHz. Consequently, MMW has the best range resolution — approximately 0.12 m after weighting — of the KREMS radars. With its 2 GHz bandwidth, MMW collects data for generating images of orbiting and reentering objects. The radar's high range resolution and short wavelength enable it to provide more detailed images than ALCOR. The radar routinely images about 300 satellites per year in support of the space-object-identification activities of the U.S. Strategic Command. MMW images have been used to determine satellites' size, shape, configuration, and stability/orientation and to assess potential damage.

MMW has four principal applications: precision tracking, high-resolution RV and wake measurements, RV and satellite imaging, and intercept miss-distance and hit-point measurements. These applications are similar to those noted for ALCOR, but MMW's higher bandwidth and narrower beam provide finer-scale measurements than ALCOR.<sup>18</sup>

MMW, because of its ultrahigh range and angle resolution, can accurately measure the miss distances of intercepting objects within its beam, as well as maintain track of selected targets in cluttered environments. During missions in which objects of interest pass through the debris of a disintegrating post-boost vehicle, MMW is the only KREMS radar with enough resolution to maintain continuous track of the objects. The coherent, high-resolution data that MMW recorded allowed the generation of excellent images of satellites. With the introduction of the KDS in 1987, real-time imaging of RVs became a reality. Today, real-time images of RVs and satellites are routinely generated in a sidecar (an auxiliary computer) attached to the radar.



### **The Strategic Defense Initiative – The Second Phase (1990s)**

By the late 1980s, the threat posed by the Soviet Union had diminished, but concerns had increased about the possibility of accidental or unauthorized launches. Ballistic missiles had spread to more countries, heightening the importance of defense against short-range theater missiles. In response to the changed political picture, the emphasis of SDI shifted away from the near-leakproof defense against a massive attack and toward development of a capability known as Global Protection Against Limited Strikes (GPALS). GPALS work focused on systems that could be deployed in a few years to defend against a limited number of attacking missiles. Near-term applications emphasized ground-based radars and interceptors. Research for longer-term GPALS concepts augmented the ground-based system with space-based sensors and interceptors.

Later in the 1990s, interest in National Missile Defense (NMD) revived, particularly against “rogue” nations. In 1996, Congress passed the Defend America Act, which declared that it is our nation’s goal to deploy a treaty-compliant BMD system to defend the country against limited ICBM attacks as soon as technically possible. While there was not universal agreement on the form the NMD system should take, there was agreement that an ICBM threat to the United States would arise in the near future. This became clear in August 1998, when North Korea used a stack-up of ballistic missile boosters to attempt a satellite launch. The satellite did not achieve orbit, but the missile overflew Japan and made impact west of the Hawaiian Islands, stoking fears that North Korea could build an ICBM capable of attacking Hawaii

or Alaska. There was considerable controversy regarding the ability of the planned NMD system to handle potential countermeasures that North Korea or another rogue nation might deploy on its ballistic missiles.

Meanwhile, in January 1991, during Operation Desert Storm, the first successful ballistic missile intercept during combat operations occurred. Following Desert Storm, theater missile defense (TMD) took center stage. To reflect the emphasis on TMD as opposed to NMD, the SDIO was renamed the Ballistic Missile Defense Organization. Theater ballistic missiles (TBM) generally employ relatively unsophisticated technologies and have shorter flight times (particularly the exoatmospheric portion), which limit the types of penetration aids that can be used. Much of the missile trajectory occurs within the view of a ground-based radar in theater, making discrimination easier. The lower speed of TBMs also makes it easier to hit the targets with hit-to-kill interceptors.

Other aspects of TMD, however, are quite difficult. The short time of flight limits the coverage the defense can achieve, particularly in the boost phase, and shortens the midcourse discrimination timeline. In addition, theater missiles can have a variety of warheads: high explosive, chemical, biological, or nuclear. At the start of this era, the Army’s Patriot surface-to-air missile system was the only system in our defense arsenal that had even a limited TBM defense capability. The Navy’s Aegis air defense system was not yet ready to fill the TMD role and the Army’s Theater High Altitude Area Defense (THAAD) system was just entering its demonstration and validation phase. Theater ballistic missile defense



Aegis BMD



K.R. Roth

with the potential of various weapon systems distributed among a spectrum of allied forces presented a new set of problems in terms of interoperability, command, and control. At this time, the Laboratory became more significantly engaged with the theater defense community, particularly THAAD and Aegis, translating many of the ideas developed in strategic defense to the theater problem.

#### *System Concept Analysis*

POET continued to support the new organization during this era. POET had contributed in several key nationwide defense system studies that laid the foundation of GPALS and later became the early framework of the NMD effort in the 2000s. It also addressed several system issues such as the need for a family of X-band radars with application to both NMD and TMD applications, a Critical Measurements Program for TMD, an integrated TBM tracking system to generate a single integrated air picture for a theater region, and a battlefield learning concept to quickly incorporate changes into the fielded systems. Lincoln Laboratory played an important role in developing technology to support all these areas.

Just as the Army had its Patriot system, the Navy had an air defense weapon system, Aegis, consisting of the ship-based AN/SPY-1 radar and the Standard Missile 2 (SM-2). In the early 1990s, the Navy initiated an effort with the Laboratory to examine the feasibility of developing a system to provide BMD capability by incorporating upgrades into the existing Aegis. To support this work, the Laboratory developed an analytical simulation tool, the Lincoln Laboratory Theater Engagement Assessment Model, which was

used to understand the implications of technology insertion on Aegis capability. Two significant results of this work were a sensor system road map for the evolution of Aegis BMD and the development of a debris model that could be used to assess the impact of a cluttered environment on system performance. This debris model has continued to be upgraded and is still in use by the BMD community today.

#### *Sensor Technology*

The system study work sponsored by the Navy spawned a number of technology activities. In the radar area, an initial goal was to provide the AN/SPY-1 radar with wide-bandwidth, high-range-resolution capability. The Laboratory developed a concept to enhance the resolution of the SPY radar by using frequency-jump burst waveforms (that had been developed and demonstrated on the TRADEX radar at Kwajalein years earlier) and advanced signal processing techniques. As part of this effort, the Laboratory designed and built a prototype advanced signal processor, and then tested it with the SPY radar on board the Navy cruiser USS *Lake Erie* during field experiments at the Navy's Pacific Missile Range Facility.

The Navy sensor work extended into the infrared seeker domain as well. The Laboratory had invested in building a Seeker Experimental System (SES) laboratory to measure focal-plane characteristics and test various seeker designs. The core of the SES was a cold chamber to house seekers and a computer-controlled infrared diode array used to simulate target scenes. Some of the first work in this facility focused on the SM-2 Block IVA seeker, to establish the ability of the SPY radar to provide adequate target handover to the seeker.



B.J. Sheeks



G.C. Augeri



M.D. Bernstein



H.K. Burke

---

## Notes

**19** S.L. Borison, S.B. Bowling, and K.M. Cuomo, "Super-Resolution Methods for Wideband Radar," *Linc. Lab. J.* **5(3)**, 441–461 (1992).

**20** K.M. Cuomo, J.E. Piou, and J.T. Mayhan, "Ultrawideband Coherent Processing," *IEEE Trans Antennas Prop* **47(6)**, 1094–1107 (1999).

**21** W.W. Camp, J.T. Mayhan, and R.M. O'Donnell, "Wideband Radar for Ballistic Missile Defense and Range-Doppler Imaging of Satellites," *Linc. Lab. J.* **12(2)**, 267–280 (2000).

During the 1980s, the Laboratory had been doing extensive research in the area of ultrawide bandwidth signal processing. By the early 1990s, this effort produced two powerful processing techniques: extended coherent processing and bandwidth extrapolation. These two approaches allowed a radar analyst to enhance the resolution of the images being studied after a test event, but were too compute-intensive for real-time application at the time. The bandwidth exploitation technique, since it involved the fusion of data from separate sensors, provided a springboard for some of the sensor fusion imaging techniques developed later.<sup>19, 20, 21</sup>

### *Algorithm and Decision Architecture Development*

During the 1990s, algorithm and decision architecture work grew significantly and focused on two major areas: TMD system applications and interoperability, and NMD systems designed to cope with limited attacks from rogue nations. At the time, three TMD systems were under development and test: Patriot, THAAD, and Navy TMD. Aggressive field measurement activities (Laboratory involvement in this thrust is discussed in the following section) focused on these TMD systems. New discrimination algorithms were developed, implemented, and tested on the TMD radars. Some exoatmospheric and high endoatmospheric discrimination algorithms developed for previous SDI systems were applied to the TMD radars.

As part of the Navy effort, Lincoln Laboratory developed the AN/SPY-1 radar discrimination architecture for the Navy area BMD system. The discrimination capability evolved and became a core for the Navy theater-wide BMD architecture. This discrimination capability and many of the algorithms that were developed in this effort were the precursors to discrimination algorithms and architectures that were later further developed and tested under both Navy and Project Hercules sponsorship. As the Navy's BMD capability evolved, it became known as the Aegis BMD program.

Laboratory engineers were involved in many of the field demonstrations and evaluation tests to assess the effectiveness of the algorithms. The sensor-to-sensor correlation problem addressed by the system trade-off studies of the 1980s for the SDI system became a major interoperability issue for TMD to form a single integrated air picture for the theater commander. Several

multitarget tracking algorithms were developed in the Laboratory to deal with dense target environments and sensor biases. The Laboratory developed several algorithms to support the hit-to-kill interceptor functions such as radar-to-seeker handover as well as aimpoint selection for the TMD systems.

In the late 1980s, a shoot-look-shoot strategy was required for the SDI system. This strategy requires that the defense *shoot* at an attacking missile, then *look* to assess damage and the need for a follow-up shot, then *shoot* again, if necessary. To effectively implement this strategy, a kill-assessment algorithm that determines if an intercept is successful became necessary. The Laboratory conducted seminal work in the development of the observable phenomenology for the kill-assessment function. Data gathered during rocket-sled tests conducted at Holloman Air Force Base in New Mexico, in which RVs were struck with high-speed kinetic warheads, were used to generate lethality models. These models were then used to develop algorithms that were later exercised during actual hit-to-kill engagements in live-fire field tests.

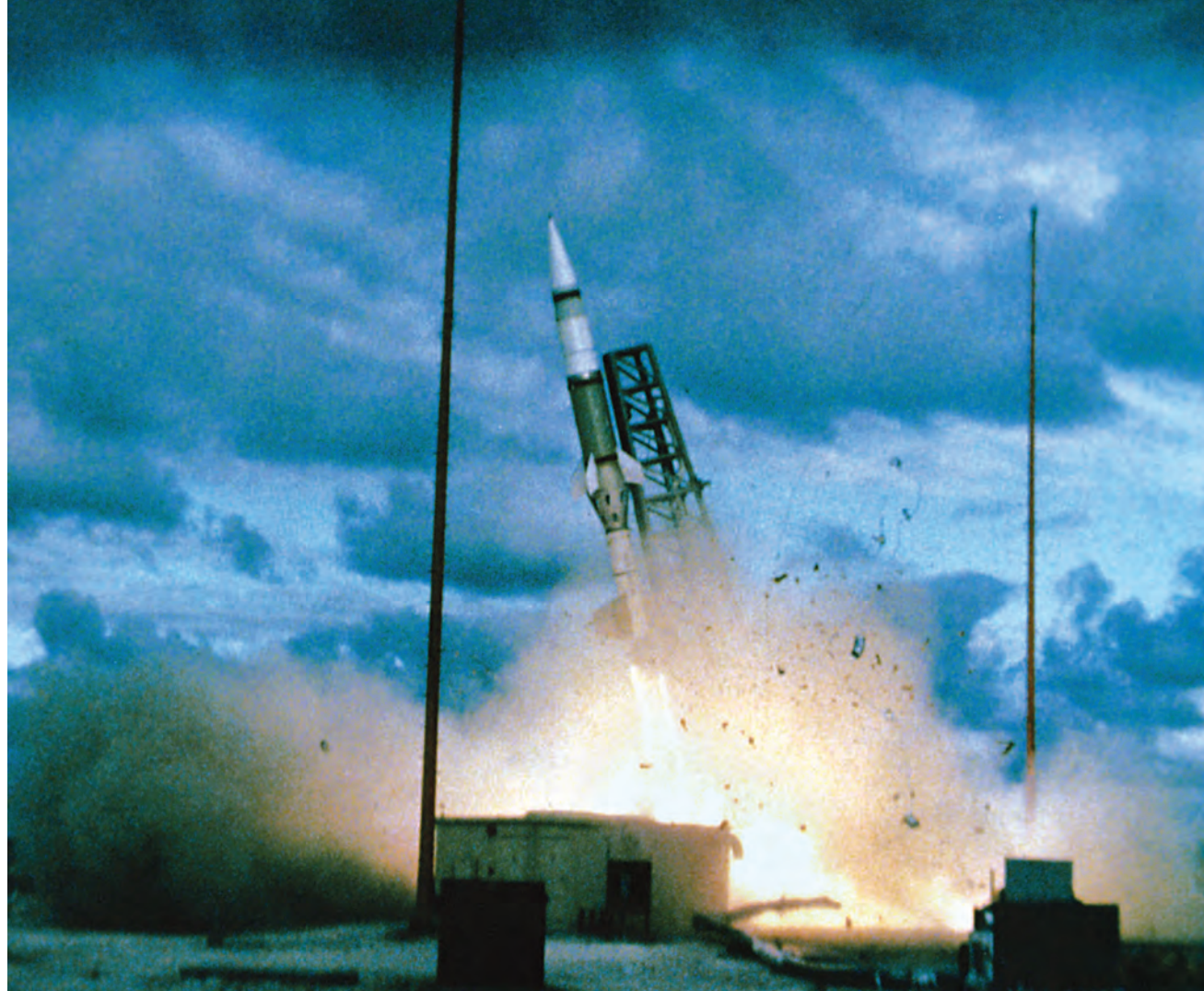
Even though the new threat from rogue nations was smaller and less sophisticated than that of the former Soviet Union, a number of worrisome features made this threat a challenge. The Soviet threat of the 1980s was designed to achieve high accuracy against hardened targets, such as Minuteman missile silos, and was tested extensively to verify that performance. This extensive testing gave the United States a window of opportunity to observe and react to new Soviet developments. Rogue threats need only perform well enough to terrorize soft urban targets. As such, the rogue attacker is less constrained in the design of warheads. Furthermore, a rogue country is not expected to test its missiles extensively; it may even change its payload from one flight to the next. Consequently, we cannot rely on having extensive or reliable *a priori* information on the nature or appearance of rogue payloads.

In order to address the broad diversity of issues facing the BMD community, the director of BMDO established a program at the start of 2000 to bring the nation's leading talent in the area of discrimination and other critical BMD functions under a single umbrella. The effort called Project Hercules grew and lasted until the end of



**Figure 9-16**

**Theater countermeasures missile launch from Wake Island toward the Kwajalein Atoll.**



the decade. Lincoln Laboratory worked closely with the government to develop the effort and played a major role in its leadership. During the first two years, the program was small and focused on developing and testing algorithms for the discrimination problem. Later, during the MDA era, the program expanded significantly and is discussed as part of that time frame.

#### *Field Measurement Effort*

Prior to the 1990s, almost all BMD system flight tests involved strategic targets flown from Vandenberg Air Force Base into the vicinity of the Marshall Islands (a range of 6000 km) and were observed by sensors on Kwajalein. On some of these missions, targets were engaged by using NMD interceptors launched from Kwajalein, e.g., the Homing Overlay Experiment in 1984 and a series of Integrated Flight Tests (IFT-3 to -10) between 1999 and 2002. The later IFTs involved the Ground-Based Radar Prototype (GBR-P) in order to assess its search, track, and discrimination capabilities against realistic targets.

However, during this era, a new concern arose regarding the lack of knowledge that existed with respect to theater missile phenomenology and observables. This concern was brought to the forefront by some of the surprises the Patriot system experienced during the first Gulf War. In order to fill the knowledge gap, the Laboratory, in concert with the POET group at BMDO, defined a program to gather critically lacking field measurement data on theater targets by using appropriate sensors. This program, initiated in 1991, was known as the Theater Critical Measurements Program (TCMP). Lincoln Laboratory worked closely with the government to define the data needs of the TMD systems and set requirements for the field experiments. During the execution phase, the Laboratory played a key role in the design, development, and conduct of these measurement campaigns, which were carried out at the Kwajalein Missile Range (Figure 9-16). Many of the payload sensors and flight-test articles were designed and built at the Laboratory, taking advantage of the experience and talents that were honed during the RSP effort of the previous decade. After nearly two years of planning and



**Figure 9-17**  
**Clockwise from upper left: FASP, Midcourse FASP, FASP ejector module, FASP infrared imagery.**

fabricating the flight-test articles, the initial flight-test campaign (TCMP-1) successfully took place in 1993. On the basis of its early success, the program continued for the next decade. All three U.S. theater missile defense systems — Patriot, Aegis, and THAAD — participated in these tests and incorporated lessons learned to enhance their capability.

The TCMP flight tests flew theater missile payloads from Wake Island to Kwajalein, a distance of about a 1000 km. The Kwajalein radars, along with U.S. theater defense assets, and other radars and infrared sensors, collected data on the flight-test articles. These data were used for a variety of purposes: to test signal processing techniques and algorithms that were in development for TMD sensors, to characterize TMD targets for model development, and to assess feasibility of potential countermeasure concepts and develop techniques to counter them. Data analysis workshops hosted by the Laboratory were conducted approximately six months after each flight test. Participants came from a broad community of TMD system engineers, algorithm developers, system contractors, and simulation model builders. The Laboratory exploited these data to aid in the development of TMD sensor technology and to develop and test discrimination techniques for use by the sensors. A Fly-Away Sensor Package (FASP) was developed and deployed in every test beginning with the second campaign (TCMP-2) in 1996 (Figure 9-17). FASP was deployed with a low relative velocity from the payload module in order to collect resolved infrared and visible data of the flight-test articles. This experiment provided the first optical database suitable for interceptor seeker algorithm development and testing. During the first presentation of the FASP data, the images looked so impossibly clean and detailed that many observers thought they were watching a computer-generated movie. During TCMP-2, an integrated system test was also conducted with all the participating TMD element sensors and their associated command, control, and communication systems. TCMP-2 was the first interoperability experiment conducted with TMD elements during an actual missile flight.

#### *Kwajalein Modernization*

At Kwajalein things were changing as well. The Laboratory's responsibility expanded as it became the Army's technical advisor for all measurement assets at the site. The operational tempo shifted from primarily a strategic missile system test site to a BMD test site.

With the advent of BMD testing, the mission complexity increased significantly. A complicated BMD test can cost more than \$100 million and require detailed advance test planning to ensure that the available sensors can obtain the required data. The actual mission, however, takes only a half hour from Vandenberg Air Force Base liftoff to Kwajalein Atoll splashdown, and the missile is within view and detectable by KREMS for just fifteen minutes. During those fifteen minutes, the KREMS sensors must gather all the appropriate data with precision. Lincoln Laboratory has championed the concept of comprehensive mission test planning in order to maximize the odds of successfully acquiring the needed data. Mission planning is carried out both at the Laboratory in Lexington and at Kwajalein. A control center capable of following the progress of the mission, reviewing and comparing data from all the radars, and providing directing information during the mission ensures site-wide coordination and communication.

The KREMS radars led the state of the art when they were first developed and have been kept at the forefront of technology ever since. Continuous upgrades incorporating the latest appropriate technology have been the Laboratory's guiding principle in its role as technical advisor to the Army at KREMS. KREMS has truly been the remote research laboratory that was originally envisioned by ARPA, but the excellent performance was achieved at a high price. The original systems were extremely complex and required substantial numbers of highly skilled engineering personnel to operate and maintain them. Supporting those personnel and their families at a remote island became too costly in a time of shrinking defense budgets. A major effort, the Kwajalein Modernization and Remoting (KMAR) program, was undertaken in 1997 to alleviate this problem.

---

**Notes**

**22** The Kwajalein Missile Range was officially renamed the Reagan Test Site (RTS) in 1999.

**23** Secretary of Defense, Donald Rumsfeld, memorandum, "Missile Defense Program Direction," January 2, 2002.

KMAR was a five-year program designed to reduce the cost and improve the capability and reliability of these radars by modernizing all hardware and software except the antennas and transmitters. The challenge was to replace aging, complex, one-of-a-kind systems at each of the four radar sites with a single, common design. To this end, the Laboratory developed an architecture and implementation that became known as the Radar Open Systems Architecture (ROSA) (see chapter 30, "Open Systems Architecture"). The ROSA design decomposes the radar system into a number of loosely coupled subsystems consisting primarily of commercial off-the-shelf (COTS) hardware and connected to one another by standard, commercially supported interfaces.

The ROSA architecture was used to modernize the systems and incorporate a higher degree of automated operation. With this capability, the sensors can be remotely controlled. Replacement of special-purpose processors and one-of-a-kind electronics with powerful general-purpose computers and COTS hardware simplified the systems. Coupled with built-in diagnostics to detect and isolate faults down to the circuit-board level, the capabilities of the new technology greatly reduced the required number and skill level of maintenance personnel. Enforcing a common design for all the radars facilitated maintenance by a matrixed operations and maintenance organization, and reduced the implementation costs as well. Remoting the operations and diagnostics from Roi-Namur to the main island of Kwajalein reduced intra-atoll transportation costs.

Software development was carried out in the continental United States, resulting in additional reductions of island personnel. Finally, the systems became more tightly integrated and automated to reduce the demands on operators and increase the capability to handle complex missions. The automated radars are driven by a script that is generated by test planners at Lincoln Laboratory. Extensive high-fidelity simulations allow thorough pre-mission testing of the scripts.

A complete development system, without the transmitter and antenna, but driven by a high-fidelity target simulator, is maintained at the Laboratory and used to develop future upgrades, troubleshoot problems observed at Kwajalein, and test repaired or replacement parts and subsystems.

The first system upgraded, in December 1999, was ALCOR. Four weeks after their arrival at Kwajalein, the ROSA components had been installed and interfaced to the antenna and transmitter, and ALCOR was tracking satellites. The MMW system was upgraded in October 2000 and was able to track satellites in only three weeks. The modularity of ROSA and the realism of the simulations allowed better-than-anticipated system checkout prior to shipment. ALTAIR and TRADEX upgrades followed later and were delivered in 2002 with an equally rapid and successful integration period.<sup>22</sup>

### **The MDA Era (2002–Present)**

In January 2002, the Secretary of Defense redesignated the BMDO as the Missile Defense Agency (MDA) and directed the establishment of "... a Ballistic Missile Defense System (BMDS) that layers defenses to intercept missiles in all phases of their flight (i.e., boost, midcourse, and terminal) against all ranges of threats."<sup>23</sup>

After the United States withdrew from the Anti-Ballistic Missile Treaty in 2001, many of the obstacles and constraints to having defense components operating in all phases of missile flight (boost, midcourse, and terminal) vanished. It became possible to have large numbers of interceptors and sensors, to have mobile and even space-based sensors and interceptors, to integrate theater and strategic defense elements, and to test them against a variety of threats in a variety of locations.

Following the December 2002 decision to deploy an initial BMDS by 2004, MDA's role transitioned from that of developing a research and development system into that of deploying an operational missile defense system for the military. To accommodate such a large shift in objective, the MDA adopted a capability-based, spiral-development acquisition strategy. To accommodate this broader role, the Ballistic Missile Defense National Team (BMDNT) was established. It was a consortium of several hundred people drawn from industry, the national laboratories, and FFRDCs working to evaluate alternative concepts for the comprehensive BMDS and to define its component parts. The Laboratory expanded its work to provide more direct support to the BMDNT, while maintaining its concentration in the areas related to system studies, sensor development, laboratory and field measurements, and data analysis and algorithm development.



Toward the end of the decade, the focus shifted to regional defense with emphasis on the rogue nation threat. As part of this shift, the operational use of optical sensors, airborne as well as space-based, reemerged in order to establish an early intercept phase for the layered defense concept.

#### *System Studies*

The BMDNT was organized into two major branches. One branch, NT-S, was responsible for systems analysis, the other, NT-B, was responsible for the design and implementation of the battle management software and infrastructure. In this new environment, the concept of net-centric operation came to the fore. Multiple integrated sensors, and the fusion of data from individual sensors to provide system-level functionality, introduced a whole new set of challenging problems. The Laboratory became fully engaged in developing the technology for realizing net-centric BMDS capability.

One of the early changes to the BMDS was the introduction of forward-based sensors to enable “birth-to-death” (i.e., launch to impact) tracking of the adversary’s missiles. The Laboratory played a large role in defining a forward-based radar (FBR) concept to operate early in the missile trajectory. This work involved determining the measurements an FBR must make and setting requirements for sensitivity, data rate, measurement accuracy, etc. It also involved studying the siting of these radars to determine their range and angular field-of-view requirements to provide full coverage of the threat volumes. Combining the range, angle, and measurement requirements served to determine the size (and cost) of the radars capable of doing this job.

#### *Sensor Technology Development*

In May 2001, the Missile Defense and Space Technology Center (MDSTC) initiated a national study to explore technology readiness for future-generation radar concepts. Lincoln Laboratory was fully engaged in this Army study and provided its deputy director as well as many of the technical participants. In the year prior to the study, staff members at the Laboratory had been examining the suitability of multistatic and interferometric radar, three-dimensional imaging, and advanced waveform design for BMD application. The recommendation of MDSTC’s study was to initiate

an aggressive radar development effort that would employ sophisticated signal processing techniques to cohere physically separated, independent apertures. This recommendation resulted in an MDA review of the ideas proposed and led to the establishment of a follow-on effort, the Concept Definition Team, to define an MDA program for advanced radar technology development and demonstration. Lincoln Laboratory provided the lead for that effort as well as many of the panel leads and participants. The result of the effort was a road map leading to transportable, scalable, phased-array antennas that could be cohered to provide capability significantly beyond the current generation of traditional radars. A risk-reduction program was established to demonstrate the concept, known as the Next Generation (NexGen) Radar Program, and became the core component of the Radar System Technology Program in MDA’s Advanced Technology Directorate. The idea was to utilize easily transportable radars (THAAD-like in size) that could be brought into a region and, by means of sophisticated signal processing techniques, cohere the separate apertures to yield a radar with significantly longer reach. This aspect was married with a low-power-density antenna aperture that provided larger aperture-per-unit weight and was more efficient in terms of power-generation requirements.

Lincoln Laboratory took on the key technical risk issues associated with cohering separate apertures through the application of sophisticated waveform design and signal processing techniques. The Laboratory conducted a field demonstration as part of a risk-reduction program that gathered critical data and retired the risk associated with every aspect of the concept. The Laboratory pursued the development and demonstrated that semi-independent radars could be operated so that the transmitted pulses added coherently on a target. Cohering on transmit was considered a significant technical risk and a requirement if multiple apertures were to be operated and achieve the equivalent transmit gain of a single large aperture. The difficulty of cohering on transmit is that the different paths between transmit arrays and receive arrays and the differential timing between systems cannot be measured using conventional signal processing. A method was devised to allow the estimation of these different parameters by using mutually orthogonal waveforms transmitted from each of the apertures that are then received and processed by the different receive apertures.



**Figure 9-18**  
**Lincoln Laboratory test team, standing**  
**in front of one of a pair of NextGen**  
**Radar test systems at White Sands**  
**Missile Range, New Mexico.**

The orthogonal waveforms provided the observability of the transmitter–target path, allowing the radars to transition to a fully coherent, nonorthogonal mode in which the primary source of alignment error could be determined and calibrated out by using only the receive signals.

To test the concept, Lincoln Laboratory built a NexGen test bed radar and conducted experiments at the Air Force Research Laboratory’s Ipswich antenna range. The signal processing for this test used a laptop computer to control waveform generators programmed with a large suite of conventional and orthogonal waveforms with different relative delays. The approximately 2 sec update rate for the waveform coherence parameters was sufficient to demonstrate that the full transmit and receive coherent gain could be achieved for relatively stationary targets.

The success of the Ipswich cohere-on-transmit test led to the next phase — to show that a true real-time test capability could be achieved in a field environment. Two ROSA dish-radar systems were built to perform the real-time signal and data processing needed to demonstrate this technology. These radars used 2 kW peak power X-band wideband transmitters and were deployed to the White Sands Missile Range to participate in aircraft and missile tracking tests (Figure 9-18). These tests demonstrated the real-time capability of the technology and the value of the multiple-input, multiple-output signal processing concept applied to radar.

This technology, with further support from the Radar Systems Technology Program at MDA, matured to the point where it became of interest to applications beyond the BMD mission area. In 2004, MDA initiated a collaborative effort with the Australian government focused on ballistic missile defense technology. Six technical areas were considered; one in particular was the application to over-the-horizon radar (OTHR). This joint effort advanced the state of the art significantly to the point that a major effort was spawned at Lincoln Laboratory in OTHR and is reported upon in Chapter 13, “Air Defense and Air Vehicle Survivability.”

Other sensor activities include work on advanced laser radars for use on kill vehicles and standoff sensors such as aircraft or unmanned aerial vehicles. These sensors range from laser rangefinders to wideband coherent lasers that can resolve targets in angle, range, and Doppler. Some of these laser radars incorporate unique technology developed at the Laboratory, such as high-efficiency diode lasers and detector arrays using avalanche photodiodes that are capable of detecting single photons. Two important efforts in the optical sensing area undertaken by Lincoln Laboratory during this period were the Angle-Angle-Range-Doppler Imaging (AARDI) laser radar that incorporated both coherent as well as noncoherent processing and the digital focal-plane array (DFPA) technology, an approach that allowed for on-focal-plane array processing and the fast readout of focal-plane data.

The first of these, AARDI, was a result of interest from the MDA Advanced Technology Directorate and led to the design and test of a laser sensor possessing both coherent and noncoherent processing capability.

The second, DFPA, was a Laboratory-generated initiative with the intent of satisfying the defense community's desire for wider field-of-view infrared sensors with more sophisticated onboard processing. The need for this technology was established by a Laboratory study, the BMD Seeker Roadmap study (2004–2005), and received initial endorsement from the Director of Defense Research and Engineering. BMD infrared seekers demand large-area coverage at high data rates in order to carry out effective target acquisition, tracking, and identification. These requirements, combined with the limited size, weight, and power constraints imposed by the interceptor physical design, led to a desire to combine the infrared sensor and digital processing components into a single device. While some visible-light-sensitive sensors, common in today's high-end, consumer digital cameras, are fabricated using the same complementary metal-oxide semiconductor (CMOS) materials and techniques used to produce microprocessor and memory devices, standard CMOS materials are not sensitive to infrared radiation. Consequently, infrared detectors must be fabricated by using alternative materials with less well-developed fabrication techniques. In addition, integrating the digital processing onto the sensor is more difficult. In 2002, the Laboratory demonstrated the concept of a high-speed digital focal-plane readout.

In 2006, the Laboratory initiated an internally funded effort to mature the technology for a DFPA that would utilize a high-speed readout integrated circuit (ROIC) that could be bonded to any manner of light-sensitive FPA. In 2007, the Laboratory demonstrated LWIR and short-wave infrared (SWIR) FPAs integrated with the ROIC technology. The FPAs employed arrays of 256-by-256 pixels, demonstrated high data rates (5 kHz), and low power consumption (<100 mW). On the basis of these successful early demonstrations, MDA and other sponsors are providing the Laboratory with support to develop a fourth-generation ROIC with even greater capability (see sidebar entitled “Digital Focal-Plane Array Technology” on page 201).

During 2003 to 2005, Aegis BMD and Project Hercules collaborated to demonstrate the viability of open system architectures for seeker application. The effort known as the Captive-Carry Adjunct Signal Processor (CASP) test bed enabled the development of advanced seeker algorithms operating in real time on the next-generation COTS parallel signal processors that were slated for use on board the SM-3 missile. The signal processing software was implemented using object-oriented C++ code and standard signal processing middleware, thereby significantly reducing algorithm insertion time while maintaining real-time performance. In addition to performing two-color SM-3 signal processing, algorithms for innovative detection, localization, discrimination, and tracking were implemented and evaluated. CASP was the first open systems-based processor implemented for use in the BMD seeker community, and it influenced subsequent SM-3 hardware and software architectures as well as real-time processor development approaches.

#### *System-Level Algorithms and Architecture Testing*

By 2002, Project Hercules had been under way for barely two years, yet had become MDA's main thrust for the development of algorithms to solve problems in the area of discrimination and decision making. The program was organized into four teams with member organizations providing support to one or more of these teams. The teams were organized around high-level functions. The red team focused on threats and threat signatures, the blue team was responsible for the development of critical BMD technology, the green team conducted very-high-fidelity independent testing, and the white team interacted with the rest



of MDA, addressed system issues, and adjudicated the appropriateness of continuing specific lines of technology development. The Laboratory played a major role in making this program a success by providing technical leadership to each of these teams and undertaking a principal role in the conduct of all facets of the program.

During the initial phase of the program, much of the focus was on algorithms that processed data obtained by sensors and that exploited the extracted information to make sensor-level decisions. An important part of the effort was concerned with developing a decision architecture that could fuse information from the separate sensors to provide a system-level result. The Laboratory conducted significant work in this area, making important adaptations to Bayesian belief networks that enabled application to the BMD problem.

As the decade progressed, effort shifted to the system-level critical functions. The use of a distributed network of sensors to realize birth-to-death tracking of an adversary's threat complex became a major interest. To accomplish birth-to-death tracking successfully, one must hand over targets from one sensor to another in a dense target environment. Ambiguity can occur at the sensor during track formation as well as in the sensor-to-sensor handover process. How to mitigate these errors to ensure that the target engaged by the interceptor is the same target the system identified as lethal received a great deal of attention. The Laboratory played an important role in both the system architecture studies as well as in the development of the techniques to quantify and mitigate ambiguity.

A major part of the effort involved testing as well as developing the handover algorithms. Work on radar-to-radar and radar-to-optics handover examined various combinations of metric and signature information to enhance performance in a dense target environment. These considerations included sensors with pointing biases and situations in which all targets were not visible to every sensor.

The discrimination and handover work has been generalized to include overall decision architectures that allocate sensor and weapon resources, suitable for inclusion in an overall battle management system. The

Laboratory played an important role in advocating the concept of a common discrimination database, common interface data structures, and consistent track picture for the integrated BMDS system-level architecture.

With the rogue threat as the primary concern, the nation has entered an era in which little *a priori* information on the nature of threat objects and their signatures is expected. Because of this lack of information, the emphasis in discrimination research has shifted toward an ability to exploit physics-based differences in measurable attributes to distinguish between warheads and countermeasures. Discrimination techniques that exploit such differences were developed in Project Hercules. The Laboratory's earlier work on algorithm development expanded to include overall discrimination architectures that combine multiple algorithms for a single sensor. As the program evolved, it addressed the multisensor, system-level algorithms and architectures required to support the BMDS C2BMC decision function.

Given the evolving view of the threat, a collaborative study between Aegis BMD and Project Hercules was conducted, and a new discrimination road map emerged. The Laboratory's Navy program focused its work to enhance the Aegis BMD capability for the new threat requirements and an expanded mission role. As a consequence, Aegis BMD capability has been fielded in the U.S. fleet today, and it includes not only a TMD capability as was originated in the Navy theater-wide era, but also a long-range surveillance and track capability that can provide early track data on intermediate range ballistic missile or ICBM targets (a capability that was only possible after the United States withdrew from the Anti-Ballistic Missile Treaty), as well as a terminal capability similar to that envisioned in the Navy Area program years earlier.

Testing of the more sophisticated techniques being incorporated into the BMDS became more comprehensive. The test effort in Project Hercules was unique and one of the most important aspects of the program. It subjected the developed technology to stresses not conducted anywhere else in the MDA community. The green team tested algorithms to the breaking point in order to characterize their potential operational envelope. At program onset, the test team established the appropriate level of fidelity the data would

need to properly test the various algorithms. There were two aspects to this. First, the targets being represented had to be something a reasonable adversary might be able to implement and fly. Second, the fidelity of the measurement models for each target had to be extremely high since the algorithms that would be under test utilized sensor data to determine the attributes of targets under observation in order to decide if they might be lethal. Thus, the radar and optical signatures had to be of the highest quality. The Laboratory took the lead role in the red team to provide the target engineering details as well as the radar signature models. The engineering detail of the threats and the fidelity of the signature information were unequaled in the MDA community. Many organizations outside Project Hercules used its threat and data packages for their own simulation needs. By the close of the decade, the value of the Project Hercules simulation models were recognized throughout MDA, and the methodology was being incorporated into the MDA simulation infrastructure.

Test results were presented and discussed in a series of capability and transition meetings in which algorithm designers, testers, prime contractors, and MDA National Team members participated. This process helps the algorithm designers to “harden” their technology and demonstrates to the prime contractors and MDA community the advantages and limitations of these algorithms. As the value of this maturation process became familiar to the broader MDA community, a number of algorithms developed by programs external to Project Hercules were brought into the green team for test.

Shortly after the start of Project Hercules, it was recognized that the ability to demonstrate capability in the field would be an essential next step beyond the green team simulation testing if the warfighter was to be convinced of the viability of individual techniques. To address this concern, MDA sponsored a study led by Lincoln Laboratory to determine what type of venue should be used to conduct such demonstrations. The result of this study was the creation of the BMD Fusion Testbed (BFT), which used a networked set of adjunct processors (later to become known as sidecars) that were attached to any sensor that might be participating in a given flight-test exercise. Each of the sensor sidecars would contain a suite of sensor algorithms and decision support techniques. The sensors were networked to a

pair of system-level nodes that existed at the Laboratory in Lexington and at the MDA Joint National Integration Center (JNIC) in Colorado Springs, Colorado. The BFT conducted its first demonstration as part of IFT-10 in December 2002. In this test, radar data from the ALCOR sidecar on Kwajalein, and optical data from the HALO-II instrumentation aircraft utilizing a ground-based sidecar in Hawaii, were transmitted to the nodes at the Laboratory and the JNIC, where the data were fused and used to discriminate the IFT-10 targets. The BFT has been used on more than 23 missions and has served to demonstrate many Project Hercules algorithm and architecture concepts.

A particularly significant demonstration of rapid development and test of new capability took place between 2004 and 2006 during the development of the FBR system. In that demonstration, two sidecars were adjoined to the TPS-X radar and participated in a number of critical measurement tests. TPS-X was one of the developmental prototypes of the THAAD radar, and, when no longer needed by the Army, was placed under MDA and Lincoln Laboratory management to be used in an instrumentation and research and development test role. One of the TPS-X sidecars contained a preprototype suite of algorithms that would evolve into the FBR sensor architecture implemented by the Sensors Directorate of MDA. The second sidecar was used to demonstrate more advanced Hercules algorithms. These techniques, along with the lessons learned during the flight tests, were used by MDA and Raytheon to shorten the development and acquisition cycle of the AN/TPY-2, a forward deployable version of the Army’s THAAD radar.

The sidecar concept has developed significantly since that time. MDA now utilizes a sidecar derivative, called the Communication Network Interface Processor (CNIP), to link all sensors with the battle management node to form the BMDS. Part of the CNIP design architecture is a parallel development capability in which both the latest tactical software and development software are exercised simultaneously on every mission. While the tactical data path controls the mission, the development software operates in a noninterference mode, providing valuable testing opportunities before it becomes the next tactical build. This concept has been so successful that parallel development processors are becoming standard equipment in all ballistic missile data collection and instrumentation radars.

## Lexington Decision Support Center

The Lexington Decision Support Center (LDSC) represents a new approach at Lincoln Laboratory for the development of distributed, sensor-driven decision support systems (Figure 9-19). This facility is used for developing and testing algorithmic solutions for multisensor fusion and system-level decision making. It supports the Laboratory's commitment to sensing "on-the-net" and MDA's need for developing an integrated networked BMDS.

The facility takes its heritage from the Lexington Discrimination System (LDS), which was focused on discrimination of countermeasures for individual systems (e.g., THAAD, Aegis BMD, Sea-Based X-band radar) and expands its scope to an integrated BMDS consisting of a distributed system of sensors and interceptors, all connected by an integrating communication and battle management backbone. LDS was focused on successful engagement of a single ballistic missile threat. LDSC is focused on battle management in a raid scenario with a larger number of launchers and overlapping sensor and weapon coverage, and provides a laboratory environment to develop effective sensor and weapon management solutions.

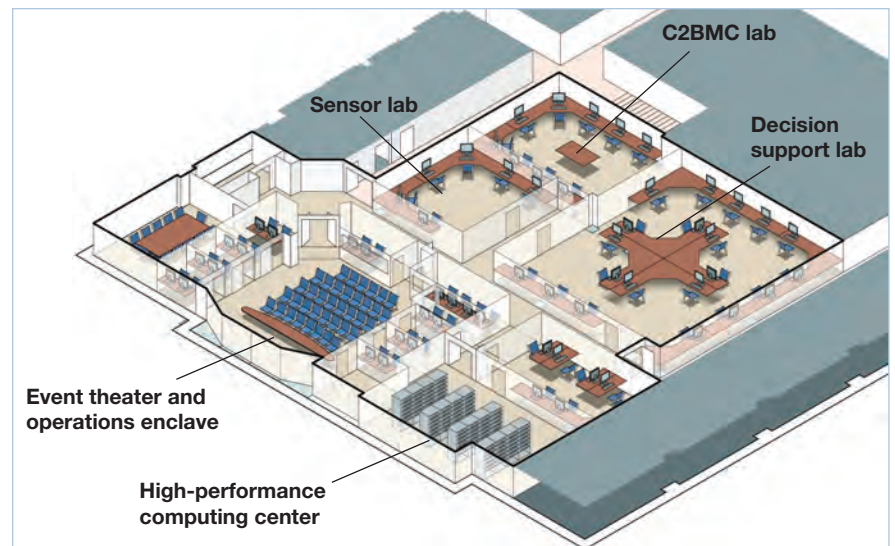
Whereas the discrimination problem can be solved through an automatic data processing algorithm approach, integrated battle management will be conducted by humans using decision support tools. The BMDS battle management decision support approach is similar to other military decision support systems that consist of a signal and data processor layer and an information manager that extracts information to be used by operators to select appropriate courses of action. A unique aspect of BMD decision support is that all these decisions have to be made within very short timelines that stress current algorithm, processing, and network technologies. Developing solutions for these technical challenges requires a laboratory environment that has three major components: high-

fidelity simulation of the BMD battle, including threat and environment; high-fidelity simulation of the sensors and fire-control components; and a plug-and-play environment in which different battle management networks and algorithms can be exercised and evaluated in a timely fashion.

The LDSC consists of four interconnected laboratories, each with a specialized function: sensor simulation, networking, algorithm development, and decision support development.

The sensor simulation laboratory is used to model a variety of threats, a full assortment of sensors, and fire-control elements. The laboratory is used to run high-fidelity models of electro-optical and infrared sensors and radars that are anchored to capabilities of existing systems, and also to quickly implement models of potential new systems. The facility is networked to the Laboratory's high-performance computing facility, bringing to bear a capability powered by distributed supercomputing clusters. Tools in the simulation laboratory are based on both commercial standards, such as the Optical Signatures Code, and Lincoln Laboratory-developed tools such as the Augmented Point Scatterer Model for wideband radar signatures. An important aspect of the simulation laboratory is the use of model characterization tools based on statistical testing that verifies that a model has the fidelity needed to address the problem at hand, such as multitarget tracking, track fusion, or discrimination.

The networking laboratory has connectivity to the MDA research data networks and is used to send and receive data from BMDS sensors through the Missile Defense Integration and Operations Center in Colorado Springs, as well as from research radars at the Reagan Test Site in Kwajalein. Through the networking laboratory, live-time, in-line experimentation is conducted on missile defense flight tests, and



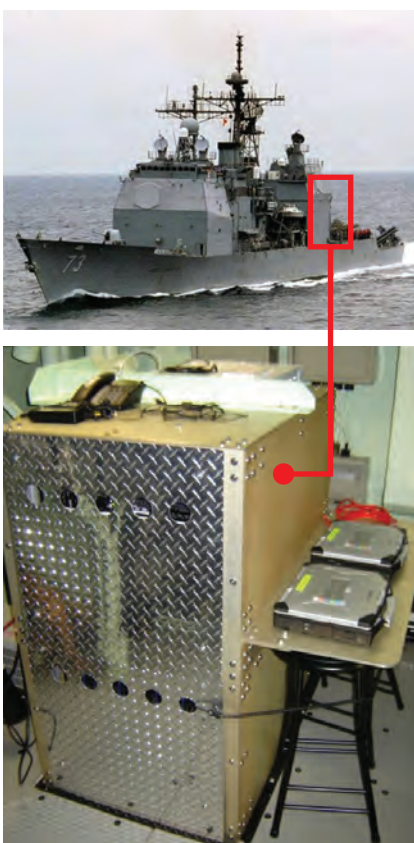
flight data are recorded to support post-mission playback exercises. Work in this laboratory focuses on the transport and middleware layers of the Laboratory's net-centric missile defense development architecture. This laboratory also hosts a variety of quality-of-service tools that assess the capability of networks and data formats to support time-critical BMD applications.

The algorithm development laboratory provides a project-focused collaborative development environment. Central to this laboratory is the use of the Open Architecture Simulation Specification (OASIS) simulation development framework. Individual model components are incorporated into complex architectures through an OASIS simulation environment. This process allows the model developers to see how their components work as part of an integrated system without having to build individual simulation environments. OASIS has the capability to work in digital simulation or real-time mode and can incorporate hardware- and processor-in-the-loop components. The algorithm development laboratory has been used to develop integrated architectures for the MDA Multiple Kill Vehicle program and regional ballistic missile defense systems.

Figure 9-19  
LDSC floor plan.

LDSC provides an environment for distributed BMD red-blue exercises. In these war games, human decision makers operate an interactive simulation, which presents the operator with information through decision support terminals and responds to operator actions. The laboratory is reconfigurable and can be used to study integrated components of the BMDS or individual subsystems. Red-blue exercises have covered a broad spectrum of BMDS scenarios, dealing with multiple threat types, geographical diversity, varied sensor types and configurations, and a host of countermeasures. Exercises have involved single sensor, multiple radar sensors, and multiple radar and infrared sensors. The single-sensor games tend to concentrate on different types of countermeasures or deniability of coverage. Multisensor exercises explore issues related to the correlation and fusing of data. These exercises continue to evolve, with the goal of providing a mechanism for the design and test of BMDS decision architectures and their components.





**Figure 9-20**  
**USS *Port Royal* host ship and Hercules-Aegis sidecar.**

Advances in sidecars as well as modeling and simulation also played an important role in improving the technology transfer process from Project Hercules to the missile defense elements, such as Aegis BMD or the AN/TPY-2 radar. A common problem in technology transfer occurred when new algorithms and architectures successfully completed the Hercules development and test process but did not fit into previously defined element improvement plans. To address the problem, in 2007 Project Hercules initiated a series of technology transfer projects that brought together developers from the research and development community and the element system engineers to accelerate technology insertion.

The first project was the Hercules/Aegis BMD discrimination architecture effort which culminated in an at-sea demonstration of new discrimination capability in an AN/SPY-1 radar sidecar during the FTM-12 Aegis BMD flight-test event. Aegis BMD engineers worked hand-in-hand with the Hercules developers to develop the discrimination and sidecar technology and integrate it with the shipboard equipment, execute the field demonstration during FTM-12, and accept the components for future Aegis BMD software builds. This was the first example of a missile defense sidecar being mated with an actual weapon system, and it resulted in not only a successful technology demonstration but also successful transfer of key Laboratory and Hercules discrimination technology to Aegis BMD. Since then, this technology has been integrated into the tactical baseline. Figure 9-20 shows the Hercules-Aegis sidecar ruggedized and integrated into the test ship, USS *Port Royal*.

A second project was focused on developing counter-countermeasure capability for the AN/TPY-2 radar. In this project, Hercules developers and AN/TPY-2 system engineers used a rapid prototyping process to demonstrate new algorithms at the AN/TPY-2 hardware/software-in-the-loop facility. Results of this demonstration were used to define a number of new radar software builds. On the basis of the success of these projects, Project Hercules instituted element transition projects for all its major algorithm technology initiatives.

At the end of 2009, Project Hercules was brought to a close, having developed many new technologies during its nine-year history. A number of technologies were

transferred to BMDS elements, and some of the core methodologies, such as the green team high-fidelity testing and the use of sidecars, were adopted by the broader BMD community.

In 2009, MDA's Sensors Directorate initiated the development of a sidecar for the Sea-Based X-band (SBX) radar, the long-range midcourse radar for the BMDS. The Laboratory is implementing two systems, the first to be installed at the development center at Raytheon, the second to be installed at the BMDS hardware-in-the-loop test facility in Huntsville, Alabama. These systems, based on the ROSA II standards, allow rapid insertion of new capability. The SBX sidecars will be used to investigate potential capability upgrades for SBX and will have the flexibility to accommodate new algorithms provided by the Laboratory as well as any other member of the BMD community.

During the Project Hercules era, the LDS had become the central Laboratory facility for new concept development and "plug-and-play" BMD algorithm testing. At LDS, a new approach to discrimination architecture development based on war gaming was initiated in 2001. The core of this approach is the use of a computer-assisted human-in-the-loop war game with high-fidelity descriptions of the target scene to allow a human decision maker to allocate sensor and weapon resources, and decide which observed targets should be intercepted. In these red-blue exercises, a red team defines the threat scene and challenges the blue teams with surprising and deceptive scenarios. The blue teams use automatic decision aids to provide the results of tracking, discrimination, and resource allocation algorithms to identify the threatening objects and allocate interceptors. Through analysis of the games, the utility of algorithms as part of the overall BMD engagement are assessed, and "referees" record the reasoning used by each team during the game to suggest new approaches and lead to future algorithm and decision architecture development.

The red-blue exercises evolved in complexity as hardware advances took place and simulation software matured. In 2006, LDS was expanded physically as well as in scope and was renamed the Lexington Decision Support Center (LDSC) to reflect the important role that operator-in-the-loop war gaming plays in BMD

architecture development. The major features of the LDSC are described in the sidebar on page 155. The LDSC and red-blue exercises continue to evolve in order to probe different facets of the BMDS and provide a mechanism for designing and testing decision architectures and their components.

In late 2007, the Laboratory initiated an effort with the MDA Sensors Directorate to validate the radar simulation models MDA used to conduct simulation tests. The Laboratory worked with the government to develop a satisfactory validation methodology along with an appropriate set of metrics and acceptance criteria. During 2008, this new methodology was employed on several field tests as pathfinders. The post-mission analysis was very successful, and the methodology was soon adopted by the broader BMD community to validate sensor simulation models.

#### *Net-Centric Architectures*

Over the past several years, Lincoln Laboratory focused significant attention on the development of net-centric, service-oriented software and hardware architectures for use across multiple mission domains. As a key milestone, the Laboratory carried out a net-centric mission concept demonstration that cut across both the BMD and space situational awareness (SSA) disciplines to showcase technology development and to illustrate how sensors and weapon systems can be integrated in a global context.

Conducted in November 2008 in conjunction with an Air Force Minuteman test flight, the exercise demonstrated the ability to use net-centric services to expose and share data, consistent with the DoD Data Sharing Strategy mandate, and to use this as a baseline to develop software services and frameworks to perform real-time brokering of control of sensors between the BMD and SSA missions via machine-to-machine tasking. The actual experiment used a KREMS sensor that was conducting space surveillance activities, retasked it in real time to collect data on a missile flight test, and then returned it to its original space surveillance task.

To accomplish the above, net-centric software components were used to securely expose a subset of existing sensors, algorithms, and data feeds in a way that higher-level resource broker services could find (discover) and use, without *a priori* knowledge of their

existence. The key enabler of this approach is the paradigm shift in requesting sensors declaratively, that is by describing the data products required instead of naming a particular sensor to collect it. This approach allowed the dynamic brokering service to optimize sensor use across the entire DoD enterprise by finding an appropriate sensor given a declarative need and knowledge of other competing demands.

#### *Laboratory and Field Measurements*

As MDA moved into the first decade of the 21st century, the need to test the BMDS as an integrated system became increasingly important. In the early part of the decade, the tests focused on individual elements or pairs of elements. The Laboratory employed the Project Hercules sidecar concept and the BFT to test capabilities on the KREMS sensors as well as on such MDA assets as the GBR-P. The BFT was also employed to conduct early demonstrations of sensor-data fusion concepts on various BMDS assets and sensor surrogates such as the High-Altitude Observatory airborne infrared platform. The success of the TCMP series of special flight tests of the 1990s led to the formulation of two additional campaigns: the Critical Measurements Program at Kwajalein and the Countermeasures Critical Measurement Program at the Pacific Missile Range Facility, that made these demonstrations possible.

Each campaign contributed significant knowledge to the BMD community, and the measurement requirements and sophistication of the payloads and instrumentation increased over time. To address these needs, the Laboratory designed and built more sophisticated fly-away sensor payloads that carried a variety of passive and active sensors yielding high-quality, high-resolution measurements invaluable for the development of discrimination and homing techniques for BMD seekers. The same Laboratory team that fabricated the RV and some of the countermeasures for TCMP also built the payloads for these subsequent campaigns.

In addition to performing specific payload design and fabrication and executing the field tests, the Laboratory participated significantly in phenomenology data analysis as well as in the development and testing of discrimination and other critical BMD engagement functions.

In order to test a system as complex as the BMDS, it was desirable to exercise multiple sensor and interceptor sites against a variety of potential threat trajectories and engagement scenarios. To this end, MDA set out to develop a pan-Pacific range with additional launch sites at Kodiak, Alaska, and Kauai, Hawaii, and from airborne and sea-based platforms. Interceptors are now launched from Aegis ships at sea, Vandenberg Air Force Base, and the Kwajalein Missile Range. Mobile and transportable sensors now operate throughout the Pacific and record data on targets and interceptors. The Laboratory has been active in design and integration of the pan-Pacific range. Recent field tests have employed Laboratory sidecars attached to the AN/TPY-2, allowing it to be integrated with the BMDS battle management center and the rest of the BMDS.

The primary purpose of field testing the BMDS is to demonstrate that all system elements work harmoniously in an integrated system. Flight tests to achieve this demonstration are expensive and must be primarily devoted to collecting essential information. However, the tests can be such a rich source of information on the characteristics and behavior of the targets and defense elements that the Laboratory made a substantial effort to collect auxiliary data on a noninterfering basis by using sidecars, as described earlier in this chapter.

Key elements of this effort were sensor sidecars, computers that tap into the primary sensor data stream without affecting the sensor operation. Sidecars were also used to run BMD algorithms in real time at the field-test sites and to send results to a fusion center to be combined with data from other sensors as well as to record the data for post-mission analysis. In this way, it was possible to demonstrate the capability of algorithms under development without compromising the primary mission objectives. The use of sensor sidecars during actual field tests has allowed the Laboratory to diagnose problems in the algorithms used in the field, develop fixes in a matter of weeks, and insert a new version in time for a subsequent mission during a flight-test campaign. In no case has the collection of auxiliary data interfered with the primary objective of the test (Figure 9-21).

The Laboratory participated in a number of field tests using sidecars attached to many radars, including the GBR-P radar at Kwajalein as well as the AN/TPY-2 located at various venues around the Pacific. These exercises proved fruitful and allowed the Laboratory to demonstrate a number of capability enhancements and to gather data to support continued technology development.

Near the end of 2008 and in early 2009, MDA conducted a comprehensive multiphase review and restructuring of its test program. This effort was motivated by the need to make sure that the data collected would be appropriate and adequate to validating the extensive array of BMDS component simulations that MDA had developed to replicate and understand the behavior of the full system. The Laboratory with its extensive experience in field-test planning and data analysis for the BMD community provided the leadership for developing the new Integrated Master Test Plan.

#### *A New Era at Kwajalein*

The Reagan Test Site (RTS) continues to be operated by the U.S. Army Space and Missile Defense Command. The primary objective of RTS still remains the collection of high-quality metric and signature data on missiles. The RTS instrumentation system supports five functional areas: missile user requirements and operational testing; space surveillance, tracking, and object identification; BMD system and component tests; discrimination studies; and scientific research. To these ends, the RTS maintains a variety of sensors and flight-test support systems that provide special measurement capabilities for gathering information on missile flight tests and space research programs. The Laboratory's responsibilities have expanded to provide technical oversight for all RTS instrumentation, including long-range strategic planning, determining test range user requirements, planning and executing equipment and system upgrades, performing system engineering, and analyzing and interpreting sensor data. In addition to the KREMS sensors on Roi-Namur, the RTS sensor suite includes two MPS-36 tracking radars located on Kwajalein Island; a variety of visible, MWIR, and ballistic camera optical systems located around the atoll to provide geometric diversity; thirteen telemetry collection systems; a range safety



### BMD Fusion Testbed Network

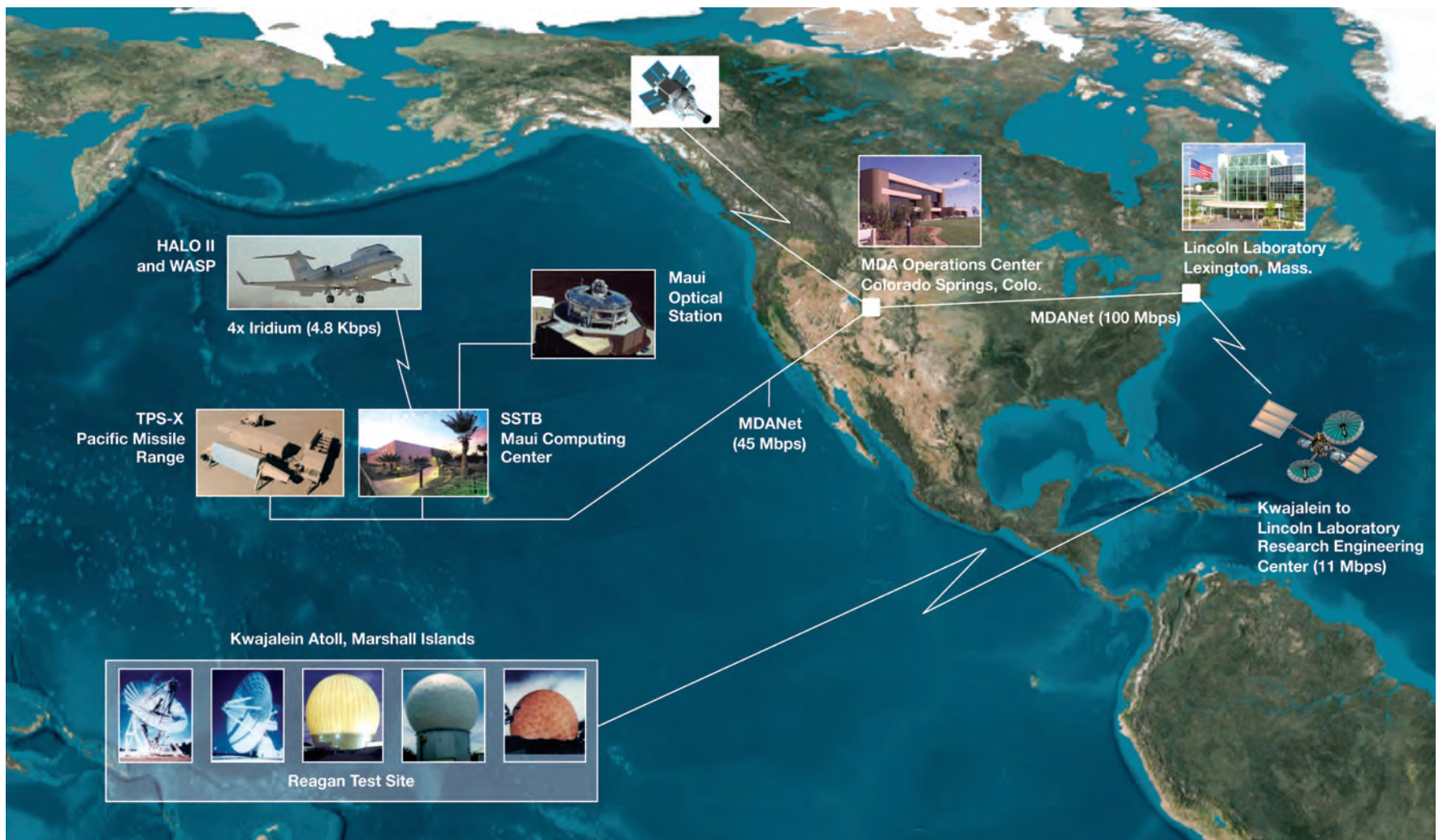


Figure 9-21  
BFT and pan-Pacific range.

## MDA Pioneer Award for the Laboratory TCMP Team

On March 23, 2010, the MDA recognized Lincoln Laboratory for its role in the Theater Critical Measurements Program (TCMP) flight tests by awarding it the MDA Technology Achievement Team Award (Figure 9-22). TCMP was started shortly after the first Gulf War to fill a knowledge gap in the understanding of the behavior of theater ballistic missiles (TBM) and the potential of various mitigation techniques against debris and countermeasures. In 1991, MDA's predecessor organization, SDIO, recognized the need to gather data on TBMs, and, in collaboration with a team from Lincoln Laboratory, developed the constituency and the technical plan for this important measurement program. They assembled and led a strong team to conduct the field-test campaigns. The initial campaign focused on issues that confronted the Patriot system during the Gulf deployment, but were equally important to the broader theater mission area within SDIO. The success of the first campaign (January 1993) led to continuation of the effort with additional dedicated campaigns that extended over the next decade to provide the BMD community with a wealth of data and capability demonstrations. TCMP consisted of three campaigns that included eight individual flight tests, with the final test conducted in 2001. Success of TCMP led to the Critical Measurements Program and the Countermeasure Critical Measurements Program.

The following are key contributions of TCMP:

- Accelerating the PAC-3 radar development and testing with realistic TBM targets and environments
- Providing the first real-time TBM tracking by the Aegis BMD AN/SPY-1 radar and guiding the future development and testing of the Aegis BMD high-range-resolution waveform
- Incorporating the first Fly-Away Sensor Package to collect resolved infrared data for seeker algorithm development and testing against TBM targets and debris
- Conducting a series of interoperability tests between the U.S. TBM defense elements with various TBM targets
- Collecting a spectrum of TBM countermeasure and debris environment data by using element sensors as well as radio-frequency and infrared instrumentation sensors to support model development and algorithm testing. These data are still being used by MDA and its contractors.



Figure 9-22  
Lincoln Laboratory staff receive the Technology Achievement Team Award (right). Above, left to right: Keh-Ping Dunn, Christopher Johnson, LTG Patrick O'Reilly (Director, MDA), David Immerman, Paul Temple, Daniel O'Connor, Donald Coe, and Charles Jenning (U.S. Army Space and Missile Defense Command).



ship equipped with command destruct and telemetry systems; a hydro-acoustic impact scoring array; and a variety of weather sensors. All of the RTS instrumentation is tied together by a control center located on Kwajalein Island.

The ROSA software technology evolved to its next generation, bringing a higher degree of modularity as well as a broadened applicability suitable for optical sensors and internal net-centricity. During 2009 and 2010, the new version of ROSA was installed on the newly refurbished suite of RTS optical sensors. A project to incorporate the new version of ROSA on the radar suite was also under way. Consistent with past practice, the sensors have continued to incorporate state-of-the-art technology. Most noteworthy in this regard is the upgrade of MMW's bandwidth to 4 GHz with an initial operational capability in July 2010.

A resident team of Lincoln Laboratory staff and government subcontractors operate the sensor suite at Kwajalein. About twenty Laboratory personnel are stationed on Kwajalein Atoll at any given time, serving two-to-three-year tours before returning to Lexington. Lincoln Laboratory rotates personnel, instead of maintaining a permanent field-site staff, so that the site will receive the benefit of a steady flow of new ideas, and the sensors will continue to operate at state-of-the-art capability. The experience gained by personnel returning to Lexington has broadened the expertise of staff members throughout the Laboratory.

### **Summary**

Since its start in 1957, the U.S. effort in BMD has evolved significantly. In support of this important national effort, the BMD program at Lincoln Laboratory has maintained a flexible posture in order to address the key technical issues facing the development of a robust Ballistic Missile Defense System. The changes have been driven by three factors: the perceived threat, the technology available to meet the threat, and, above all, the calculus that provides the greatest security for the United States. However, during this same period, the most critical technical issues of BMD have remained much the same. These are discrimination and decision support, architecture design and evaluation, and technology leading to new system elements. The Laboratory program has strived to maintain a balance between technology development and capability demonstration, with a strong commitment to incorporating live-fire field tests and demonstrations. In many cases, the technologies developed under the auspices of the BMD program have found fruitful applications in other mission areas.

As the Laboratory looks to the future, significant technical challenges await the next-generation BMD system, and the Lincoln Laboratory program is gearing up to address these challenges. Primary among these thrusts are developing the knowledge that enables effective sensing on a network that uses advanced sensors, conducting system-level tracking in dense target environments, and effectively applying sensor fusion in support of decision making. As the program moves into its sixth decade, the Laboratory has every confidence that these challenges will be met with great enthusiasm by the Laboratory community and will result in new rounds of significant technical achievement.







**Radars associated with Lincoln Laboratory play a major role in the U.S. Air Force SPACETRACK system, in both satellite tracking and imaging. Radar and electro-optical sensors, both ground- and space-based, have been developed for their application in systems for detecting, tracking, and identifying objects in space.**

**Left: Aerial view of the Millstone Hill complex in Westford, Tyngsboro, and Groton, Massachusetts, 1993.**

The Soviet launch of Sputnik I on October 4, 1957, transformed the military application of space from abstract concept to reality. The threat posed by foreign satellites called for detailed monitoring and evaluation, and thus space situational awareness became a vital component of national security.<sup>1</sup>

Space situational awareness encompasses detecting, tracking, identifying, and cataloging all artificial objects in earth orbit, including payloads, rocket bodies, and debris from launches and fragmentation; it involves sensors, processing, data exploitation, and connectivity. Keeping a catalog of satellites enables the United States to assess, and respond to, the military potential of satellites launched by other countries, whether overtly or surreptitiously.

Developing a robust network of systems to perform the space surveillance mission required significant development for both radar and electro-optical technologies. Radars were the natural choice for tracking low-earth satellites, leveraging systems developed for early warning of intercontinental ballistic missiles. They provided high sensitivity and an all-weather tracking capability. Astronomical telescopes combined with electro-optical sensors were more suited for tracking deep-space satellites. The Laboratory assumed a leading role in the development of the systems and sensor technology, as well as the techniques for both phenomenologies.

#### **Radars for Space Surveillance**

Lincoln Laboratory became involved in space surveillance essentially because of lucky timing. The Millstone radar on Millstone Hill in Westford, Massachusetts, had been designed to explore problems relating to early warning of intercontinental ballistic missile launches, but it would prove to be well suited for satellite tracking. The Laboratory was just bringing the radar on line in the fall of 1957, so it was available, although only at low power and with manual tracking, to take data at the time of the Sputnik launch. Through an intense effort on the part of the staff, the skin return from Sputnik was observed within a few days of the satellite's injection into orbit (Figure 10-1). The Soviet Union launched three more satellites over the next year, and Lincoln Laboratory staff members Gordon Pettengill and Leon Kraft, Jr., were able to report that the Millstone radar had successfully detected each of the four satellites.<sup>2</sup>

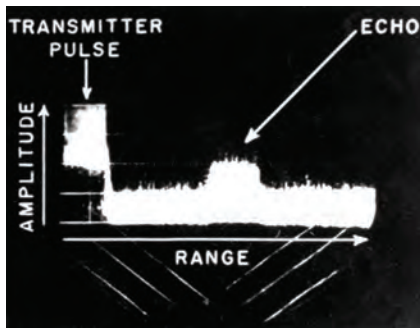
Responsibility for space surveillance was assigned to the Aerospace Defense Command (ADCOM), the Air Force component of the North American Air (now Aerospace) Defense Command (NORAD). Over the next decade, the Millstone radar occasionally tracked satellites for ADCOM; space surveillance, however, did not become a major program effort at Lincoln Laboratory until deep-space satellites were deployed in the late 1960s.

In 1963, the original Millstone antenna was shipped to the Pirinlik early-warning site near Diyarbakir, Turkey, and an 84 ft diameter parabolic reflector with a monopulse feed was installed in Westford (Figure 10-2). The radar wavelength was converted from ultrahigh frequency (UHF, 450 MHz) to L-band (1295 MHz). The shorter wavelength increased the antenna gain by a factor of ten, although at the cost of a narrower beamwidth (about  $0.5^\circ$  instead of  $2^\circ$ ). The average power was increased to 150 kW from a nominal 20 kW. Because of the increased power and antenna gain, as well as a somewhat lower receiver noise figure, the sensitivity increased by a factor of about 60, or about 18 dB, with a corresponding single-pulse detection range on a  $1 \text{ m}^2$  target of approximately 6400 km. The corresponding detection range for the UHF system had been 1800 km.

With the new sensitivity and advances in radar processing, Millstone was able to track SYNCOM II, the first of a series of experimental geostationary satellites orbiting at 40,000 km range. The existing sensors in the SPACETRACK system had been capable of performing space surveillance operations on objects in near-earth orbit. However, they could not see objects in *deep space*, that is, with circular orbits having a period greater than 240 min and an altitude in excess of 5000 km.

Since the mission of the U.S. Air Force SPACETRACK system was to maintain surveillance of all earth-orbiting satellites and to detect newly launched foreign satellites, the Millstone radar became a key component in the system. For many years, the Millstone radar was the only SPACETRACK radar that could acquire and routinely track satellites in deep space.

The first operational geostationary satellite, the Applications Technology Satellite (ATS-1), was launched by the United States in September 1967. After ATS-1 reached a geostationary altitude, a rocket



**Figure 10-1**  
The Millstone Hill UHF radar detected the first Soviet satellite, Sputnik I, in 1957.

burn established a more or less circular orbit above the equator, where the ATS-1 moved in synchronism with the earth's rotation. Millstone tracked the booster stage as it injected ATS-1 into geosynchronous orbit.

A year later, Lincoln Laboratory deployed Lincoln Experimental Satellite (LES)-6 into a geostationary orbit. Baker-Nunn cameras, which employ a modified Schmidt tracking telescope for satellite tracking, were used to detect LES-6 optically, but the reflected sunlight was fainter than could be detected on film.

In summer 1971, Robert Bergemann and Gordon Guernsey, while investigating the Soviet capability to detect U.S. geostationary satellites, persuaded the Haystack planetary-radar team to attempt acquisition of the LES-6 satellite. On the third attempt, the narrow radar beam — only  $0.06^\circ$  — successfully tracked LES-6. Moreover, the team was able to measure the satellite's spin rate and wobble.

The measurement showed that spin-stabilized payloads, which were the principal class of synchronous payloads, yielded coherent radar returns, and that paved the way for exchanging integration time for radar beam power. Not surprisingly, this achievement spurred interest in measuring the radar characteristics of all deep-space satellites.

Two major classes of deep-space communications satellites needed investigation. The most important orbit class was the geostationary, the 24-hour orbit first proposed for global communications in 1944 by the science fiction writer Arthur C. Clarke. Three geostationary satellites equally spaced in longitude over the equator, revolving in synchronism with the earth's rotation, can provide communication between any two points on earth between the latitudes of  $80^\circ\text{N}$  and  $80^\circ\text{S}$  with no more than two relays. Geosynchronous satellites must be located at an altitude of 22,000 mi above the earth.

The other important class of deep-space satellites contains those in the Soviet Molniya ("lightning") orbit. A minimum-energy Hohman transfer from a circular low-earth orbit raises the apogee of the Molniya orbit to approximately 40,000 km. This clever high-eccentricity orbit, with a plane inclined to the equatorial around  $50^\circ$ , requires neither a rocket burn for circularization at

apogee nor a burn for changing the inclination of the plane from the latitude of the launch site. Substantially greater payloads can be deployed in Molniya orbits (with a given booster capacity) than in geostationary orbit. At the high-latitude cities and military bases of the Soviet Union, Molniya satellites loiter, nearly stationary, nearly overhead, for about nine hours, minimizing the tracking antenna requirements at the communication ground sites. Near perigee, the Molniya scoots over the southern hemisphere and rises to apogee over the United States, where it loiters for another nine hours. A constellation of four to eight Molnias in the plane ensures that an operating satellite is always nearly overhead.

The Soviet Union began launching Molniya satellites for military and civilian interrepublic communication in 1965. More than twenty were in orbit by 1972. ADCOM had no deep-space sensors at this time, with the exception of a few Baker-Nunn cameras that did not provide real-time observations to ADCOM. The SPACETRACK system was, however, able to maintain surveillance of the Molniya satellites because the high eccentricity of their orbit meant that about a third of the orbit was inside the near-earth sensor coverage.

Late in 1972, the desirability of deep-space coverage was dramatically demonstrated when what was thought to be a routine Molniya launch was not acquired. The lost payload, Cosmos 520, was the first in a series of Soviet launches having high-apogee, high-eccentricity, 12 hr orbits in which the apogee occurred over  $25^\circ\text{N}$ , approximately, instead of near  $60^\circ\text{N}$ , as in the Molniya class. The possibility that the payload was an antisatellite interceptor caused considerable consternation within the space surveillance community. However, the Cosmos 520 payload was acquired several months later, and soon identified as the Soviet Union's first ballistic missile launch-detection satellite.

Lincoln Laboratory's space surveillance group was asked to stand by for the launch of the second launch-detection satellite the following year. With precious little lead time from the announcement of the launch, Antonio Pensa was able to use the Millstone radar to acquire the new satellite, Cosmos 606, before the first revolution was completed. An initial orbit was determined from the metric data that confirmed Cosmos 606 was indeed the same class as Cosmos 520.

#### Notes

**1** Material for this chapter was provided by Robert Bergemann.

**2** G.H. Pettengill and L.G. Kraft, Jr., "Earth Satellite Observations Made with the Millstone Hill Radar," in *Avionics Research: Satellites and Problems of Long Range Detection and Tracking*. New York: Pergamon Press, 1960, p. 125.





**Figure 10-2**  
**Millstone radar with 84 ft antenna.**



## Tracking a Satellite

Within a few days of the launch of Sputnik I on October 4, 1957, several radars at Lincoln Laboratory and elsewhere in the Western world successfully detected echoes from the satellite. These radars could not, however, track Sputnik; they could observe the satellite only briefly during each orbit.

The sight of a Soviet satellite passing over North American skies every 95 minutes prompted serious concern within the DoD about U.S. strategic defenses. Optical instruments could track the satellite under clear conditions at night, but only radar could track under all weather and light conditions. Therefore, a high priority was assigned to the task of developing a radar that was able to track space objects.

Although the original plans for the Millstone radar had called for a tracking capability, it had not been implemented up to that point. Within a few days of the Sputnik launch, however, the DoD instructed Lincoln Laboratory to build an automatic tracker as soon as possible.

Two Communications Division staff members, Victor Guethlen and Leo Sullivan, were assigned to lead the project. In a sense, it was an engineer's dream — no expense was to be spared — but it was also a nightmare. The work schedule was relentless and the calls from the Director's Office were frequent. But within six months, the team had completely designed and constructed a conical-scan automatic angle-tracking system that permitted the Millstone radar to lock onto and follow a satellite as it traveled across the sky.

Installation of the automatic angle-tracking system was completed on April 11, 1958. During that afternoon, the radar successfully tracked the sun. By sunset, the team was ready to initiate the first automatic track of a satellite. The radar was not yet able to acquire a satellite automatically. The Air Force, however, had supplied the coordinates of Sputnik II (Sputnik I had reentered the earth's atmosphere and disintegrated by that time), so they knew the target could be found easily. There was just one problem. The automatic angle-tracking system used the moon as a reference, and the night was cloudy.

The tracking team could not find the moon. The radar was able to see through clouds, but they had to know where to point it. Not wanting to be forced to explain another delay in the project, the members of the team pulled out their slide rules and an ephemeris table for the moon. And at that point, they began a very brief study in the use of an ephemeris table.

No one there had ever calculated the position of an astronomical object from an ephemeris table before, but by about 9:00 p.m., the group had converged on one set of coordinates. They pointed the radar and, to their astonishment, the moon indeed was there.

With the last crisis behind them, they pointed the radar to the spot on the horizon where they expected the satellite to appear on its next orbit. When Sputnik II rose over the horizon, the Millstone radar locked onto the signal and tracked the satellite from horizon to horizon.

The value of a radar that could track a new foreign launch (NFL) in deep space had already been demonstrated to the surveillance community. By 1975, ADCOM had initiated the Satellite Tracking (SATTRK) program with the Lincoln Laboratory Aerospace Division, and Millstone, which was the only available deep-space radar, had become a contributing sensor in the SPACETRACK system.

SATTRK was initiated by Alexander Nedzel, the first head of the Aerospace Division, and subsequently managed by Jack Slade. The program is currently supervised by Grant Stokes, head of the Aerospace Division.

The Lincoln Laboratory missile defense program had been reoriented as a result of the signing of the Anti-Ballistic Missile Defense Treaty in 1972, and a substantial fraction of Millstone's support was then cut off. However, ADCOM increased SATTRK funding to make up the difference and Millstone became dedicated to space surveillance.<sup>3</sup>

The space surveillance group began to develop the techniques required for Millstone to achieve a high probability of detection, precise tracking, high-accuracy metric measurement, and rapid initial-orbit determination for deep-space satellites. Millstone's 0.6° beamwidth gave the radar a limited but useful search capability, along orbit and transverse to orbit, to aid target acquisition. Nevertheless, unannounced foreign launches, as well as U.S. non-nominal rocket burns, deployed objects that required considerable searching before detection was achieved.

One important addition was the capability for real-time data communication to ADCOM. Initial-orbit observation data determined on a new foreign payload were still being driven by courier from Westford to the Electronic Systems Division (ESD) Communications Center in Lexington, Massachusetts, so that data on punch cards could be transmitted to ADCOM. Millstone's request for an onsite AUTODIN terminal was approved by the NORAD commander-in-chief on his first visit to Millstone.<sup>4</sup>

---

## Notes

**3** When Jack Slade requested that ADCOM replace the Millstone shortfall, the Air Force colonel directing ADCOM's SATTRK program, a chronic gesticulator, accidentally knocked over his coffee cup and drenched Slade. Mortified by his loss of control, the colonel apologized and found a million dollars for Millstone before Slade's clothes had dried. Lincoln Laboratory scientists are used to having cold water thrown on their proposals, but not hot coffee!

**4** Just after he had been listening to a series of complaints about inefficient data communications, the commander of NORAD spotted a horse tethered near the Millstone entrance with a sack thrown over the saddle. The sack strongly resembled the courier's data pouch.

The primary goal of the space surveillance group, therefore, was to transform Millstone into a stand-alone, semiautomatic, interactive, real-time deep-space sensor by developing powerful integrated software programs and databases to run efficiently on the site computers. The CG-24 that had initiated computer tracking in the UHF epoch had been replaced by a Scientific Data Systems SDS-9300 shortly after Millstone came up on L-band, and that computer was then superseded in 1978 by two Harris 24-bit S220/7 machines.

The Millstone radar was able to achieve a detection signal-to-noise ratio of about 13 dB on a 1 m<sup>2</sup> target at 6000 km. However, the signal-to-noise ratio at geostationary distance, reduced by the fourth power of the range ratio, was only -21 dB, requiring a thousandfold gain. This improvement and more was achieved with SATCIT (Satellite Acquisition and Tracking using Coherent Integration Techniques) software, and the breakthrough allowed Millstone to detect and close-loop-track most geostationary satellites within several seconds of real-time processing.

Real-time coherent integration was achieved by running a fast Fourier transform on the site computer to process 256 pulses at a pulse-repetition frequency of 60 Hz. The integration gain of a factor of 256 allowed real-time detection of geostationary satellites as small as 5 m<sup>2</sup>!

Even more impressive was the coherent integration of 60,000 pulses. This task required not only that the satellite be stable (which spin-stabilized cylinders are), but that the coherent radar signal phase be corrected for the mismatch between the true acceleration and the predicted target line-of-sight acceleration (from the element set driving the radar). This error was determined by observing the successive drift in the peak Doppler frequency of sequential FFTs. When the small mismatch of only  $3 \times 10^{-5}$  m/sec<sup>2</sup> was corrected, the gain achieved was 47.3 dB, only 0.5 dB from the theoretical limit. Without acceleration mismatch correction, the same integration yielded 35.8 dB. Thus, the smallest payloads of a few-square-meters radar cross section could be detected in or near the geostationary belt with only a few seconds of coherent integration.

Millstone satellite observations using SATCIT provide positional data that are transmitted to the NORAD Space Surveillance Center in Cheyenne Mountain, near Colorado Springs. Onsite, the observations are stored in the Master Object File and inputted to ANODE (Analytic Orbit Determination), the powerful program that computes an initial orbit for uncataloged objects or differentially corrects an existing orbit.

The Millstone dynamic scheduler (MIDYS) is a major part of the overall satellite tracking system. MIDYS optimizes satellite tracking operations by automatically sequencing objects to be tracked. The program uses tasking category, age-of-element sets, radar cross section, and coherence or noncoherence of objects to prioritize tasks. In contrast with preplanned session scheduling, MIDYS tolerates such interruptions as real-time requests for high-interest tracks, equipment outages, and missed detections. After MIDYS was installed on the Harris computer in mid-1979, the number of tracks increased from about 250 to 450 per week.

The New Foreign Launch Processor (NFLP) program bears some similarity to MIDYS in that a number of orbits are automatically examined sequentially. However, only the high-priority components of an NFL are sought. From a set of several dozen historical foreign-launch patterns, a few are selected for sequential search on the basis of the launch-detection sensor report of launch site, launch direction, if available, and other possible information from intelligence sources. NFLP controls Millstone's search near a satellite's probable orbit, centered on the position computed from the selected historical launch patterns and reported launch time. A detected target initiates tracking; a missed detection during a programmed pattern search initiates a search around the next programmed orbit.

The current surveillance tasks include NFL acquisition, deep-space catalog maintenance, initial-orbit determination, and object identification for orbit and for signature correlation and uncorrelated target resolution.

When a satellite is detected and an initial orbit determined, the problem remains to identify it or at least establish the object class. In many cases, the object defies identification with a known launch or function and is called an uncorrelated target (UCT). Most





**Figure 10-3**  
**The Lincoln Calibration Sphere**  
 prior to launch. Although the sphere  
 was designed to be used for radar  
 calibration, the highly polished surface  
 also allowed its use by optical sensors.

UCTs are believed to be debris from a payload or booster fragments. UCTs also include miscellaneous launch hardware and objects dropped by astronauts: a screwdriver and a Hasselblad camera are cataloged.

At Millstone, the mean radar cross section, polarization, and Doppler spread (components of the signature) are combined with the orbital characteristics to determine the satellite class and, in many cases, the actual satellite.

A notable achievement related to radar networks was the use of Lincoln Calibration Spheres (LCS) to calibrate sensitivity and metric position simultaneously. Each LCS was a polished, hollow, rigid aluminum sphere with a diameter of 1.129 m, an optical cross section of 1 m<sup>2</sup>, and a radar cross section at 1300 MHz of 1 m<sup>2</sup> (Figure 10-3). These passive satellites were designed to be calibration objects for ballistic missile and satellite tracking radars and for optical telescopes.

LCS-1 was placed in a circular orbit of 2800 km on May 6, 1965 — too high to be used by any but the most powerful radars (but where the booster had been scheduled to dispense its prime payload). LCS-2 and -3 were lost to booster failures. LCS-4 was placed in a circular near-polar orbit at an altitude of 850 km on August 7, 1971, and continues to be a useful calibration object.

E. Michael Gaposchkin refined the orbital drag and solar-pressure models for LCS-1 and -4 and, with frequent observations, enabled them to be used as metric standards, secondary to the primary standard, the Laser Geodynamics Satellites (LAGEOS). Because both LCS satellites have an area of exactly 1 m<sup>2</sup> compared to LAGEOS's 0.3 m<sup>2</sup>, the radar signal-to-noise ratio is typically 35 dB greater for LCS-4 and 15 dB greater for LCS-1 than for LAGEOS in a 6000 km orbit.

### High-Resolution Radar Imaging

In the mid-1960s, Lincoln Laboratory researchers discovered that high-range-resolution radars could provide unique discrimination capabilities for ballistic missile defense.<sup>5</sup> The fundamental requirement was to obtain a range resolution smaller than the range extent of a target. Such high-resolution data could provide an estimate of a target's length, isolate individual scattering centers, and therefore distinguish that target from other targets in an incoming missile complex.

Range resolution is inversely proportional to signal bandwidth. For example, a 500 MHz bandwidth provides 0.5 m range resolution. However, new technology for radio-frequency (RF), signal processing, and data processing had to be developed before the wideband radar could be built. Lincoln Laboratory, recognizing the challenging issues, obtained funding from the Advanced Research Projects Agency (ARPA) and began developing these new technologies. The effort led to the construction of the ARPA Lincoln C-band Observables Radar (ALCOR) on Roi-Namur Island in the Kwajalein Atoll. ALCOR, a wideband (500 MHz) C-band radar, began collecting data on U.S. ballistic missile tests late in 1969.

The technology of synthetic-aperture radar (SAR) had been developed and was widely used by this time. SAR systems produce two-dimensional images of terrain by processing the phase of the returned signal. The phase changes as the radar platform moves and rotates with respect to the ground. The cross-range resolution is inversely proportional to the radar platform rotation angle and is directly proportional to the radar wavelength. In the late 1960s, SAR images could be produced with moderate radar range resolution of 5 to 10 m.

1955



Early Millstone radar



G.H. Pettengill

---

**Note**

5 Material for this section was provided by Sidney Borison and Israel Kupiec.

The SAR principle can also be used to image satellites from the ground with a coherent radar if the range resolution is smaller than the range extent of the satellite. The apparent rotation of a satellite about its own center of mass as a low-altitude satellite flies overhead provides the necessary rotation for Doppler processing. The cross-range resolution is achieved by processing (resolving) the fine differential Doppler across the satellite due to its rotation. This technique is called inverse synthetic-aperture radar (ISAR). Matching the cross-range resolution to the range resolution by using microwave radars (e.g., at C-band or X-band) requires coherent processing of data collected over five to ten degrees of target rotation.

Once ALCOR began tracking satellites, Lincoln Laboratory applied these concepts to satellite imaging for the first time. The Laboratory thus played a pioneering role in this field and developed the essential techniques and algorithms for the generation and interpretation of radar images.

When China launched its first orbiting satellite early in 1970, the upper booster stage remained in orbit. This event generated a high level of interest within the Department of Defense (DoD) in estimating the size of the stage and determining its potential use in an intercontinental ballistic missile. The 50 m resolution inherent to the passive optical tracking system was insufficient to provide a meaningful size estimate. Therefore, the DoD asked Lincoln Laboratory to use ALCOR to track the booster and estimate its size and shape.

ALCOR's half-meter range resolution was sufficient for estimating the booster's length along the radar line of sight. Other dimensions were estimated by analyzing the angular lobe width of the radar cross section (RCS) scattering pattern of the target. Analysts at Lincoln Laboratory also studied the fine Doppler of the radar return and applied the ISAR principle to derive a cross-range size estimate that corroborated the estimates from the RCS pattern analysis.

The USSR launched *Salyut-1*, its first space station, in spring 1971. Images produced from ALCOR data were remarkable, even showing such details as solar panels that were not apparent in the photograph released by the USSR and published in *Time* magazine. This success led to the space-object identification program at Lincoln Laboratory. Subsequent images of *Salyut-2* and *Salyut-3* provided the means to monitor their activities. An image of the docked *Soyuz-14* revealed, among other features, the location of the docking site on the space station.

Over the next few years, with ARPA sponsorship, the effort at the Laboratory focused on acquisition and analysis of ALCOR data on many types of Soviet satellites and on development of special techniques for radar image interpretation. During that time, Laboratory staff members routinely reported the latest findings on wideband data analysis at the annual NORAD Space Identification Conference. These findings were superior to the results of narrowband RCS scattering lobe pattern analyses and became the last word on satellite shape and size. Little by little, analysts from other organizations followed Lincoln Laboratory and began to depend heavily on wideband analysis results.

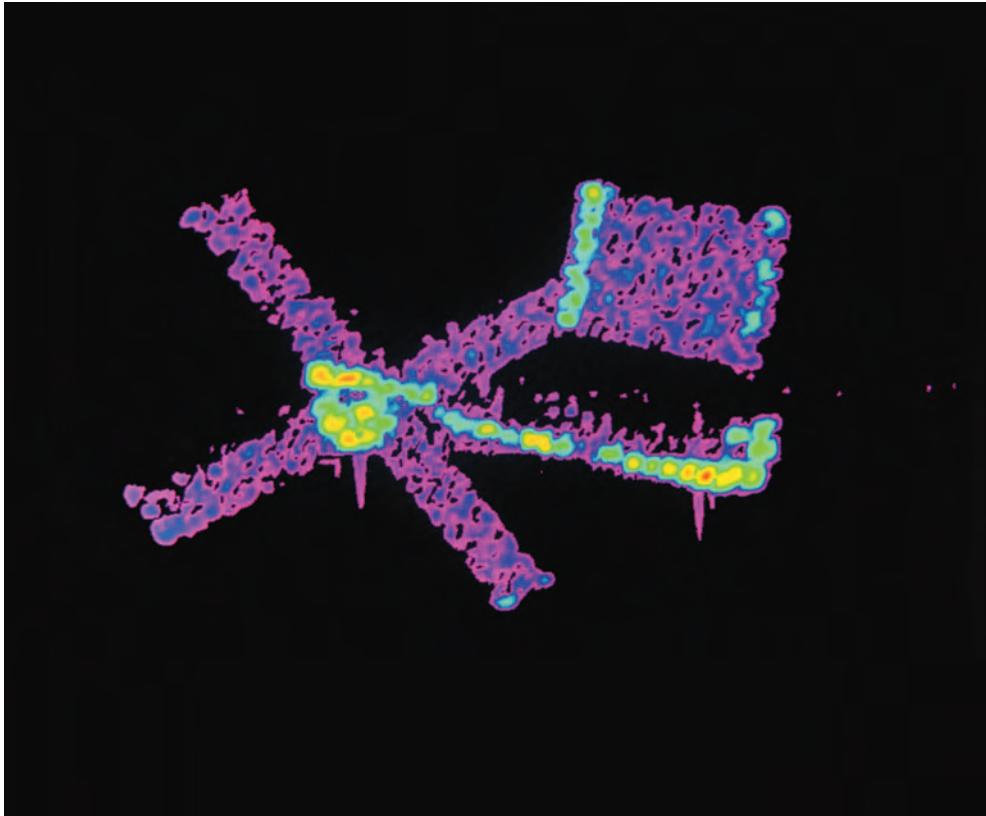
1965



L.G. Kraft, Jr.



ALCOR, Roi-Namur



**Figure 10-4**  
**Above: Computer-generated simulation of a radar image of *Skylab*. Analysis by Lincoln Laboratory of actual radar images of *Skylab* (differing in detail and without the color enhancement) aided in understanding solar array deployment problems.**  
**Left: Photograph of *Skylab* taken after the remaining solar array had been extended and the crew compartment had been covered by a thermal blanket.**

#### Note

<sup>6</sup> This event was the precursor to the development of near-real-time imaging at Haystack discussed later in this section.

The details of wideband radar image analysis of foreign satellites are classified and cannot be discussed here. In general, it can be said that the Lincoln Laboratory effort in this area has been very productive and has provided an independent, all-weather, day/night resource to assess foreign activities in space. Several types of foreign satellites have been analyzed by Lincoln Laboratory staff, in each case generating a detailed model of the satellite components and inferring its mission.

The technique of radar imaging was also applied to U.S. satellites when malfunctions occurred. A case in point is that of the first U.S. space station, *Skylab-1*, launched on May 14, 1973. Shortly after launch, the National Aeronautics and Space Administration (NASA) determined that several problems had developed. It appeared that the micrometeorite (and sun) shield had deployed prematurely and been torn away. Furthermore, the solar panels were improperly deployed. As a result of discussions between ARPA and NASA officials on the day after the launch, Lincoln Laboratory was asked to acquire radar data and use identification techniques to evaluate the satellite (Figure 10-4). Three tracks were taken by ALCOR between May 15 and May 18. Telephone conversations between Lincoln Laboratory staff members on the Kwajalein Atoll and in Lexington identified important sections of the data, which were then sent via satellite to a ground terminal at Boston Hill in North Andover, Massachusetts, and brought to the Laboratory for analysis. The mainframe computer at the Laboratory was dedicated for a night to image analysis, and the next day, May 23, the results were presented to NASA officials in Huntsville, Alabama. The basic conclusions were that the left solar panel was missing, the other solar panel appeared to be only partially deployed, and no bent or protruding sections of the micrometeorite shield were visible.<sup>6</sup> On the basis of this analysis and other information, NASA decided to send up a crew to repair and man the space station. Additional radar data were recorded after the crew properly deployed the right solar panel and rigged a sun shield to protect the space station from overheating, and the results confirmed the corrected configuration.



Another application relates to a U.S. Defense Meteorological Satellite that failed to deploy its solar panel properly and went into an uncontrolled tumble. Lincoln Laboratory explained to Johns Hopkins University Applied Physics Laboratory personnel how wideband radar data could reveal the orientation of the tumble axis and the rate of rotation, and also provide an image of the satellite. The information could then be used to calculate the required correction torques by attitude-control jets. The Applied Physics Laboratory accepted the suggestion and asked Lincoln Laboratory to acquire the data. The Laboratory delivered the detailed tumble motion parameters and a satellite image; over the next several weeks, incremental attitude controls were applied. The satellite assumed a stable and properly oriented orbit, and the solar panels were deployed.

The initial success of satellite imaging with ALCOR data prompted considerable interest in extending the capabilities of the imaging radars. Higher resolutions required more bandwidth, so the radar center frequency had to be shifted up to make it possible to realize wider bandwidth with existing technology. In 1974, after sorting out available options, Lincoln Laboratory proposed the addition of a high-power wideband X-band capability to the Haystack radar. In addition to higher range resolution, the X-band subsystem was designed with enough sensitivity to track and image satellites in deep space. ARPA sponsored construction of this addition to Haystack, the Long Range Imaging Radar (LRIR), and it was completed in 1978.

The 25 cm resolution of the LRIR yielded fine details and more information about imaged satellites. The real challenge, however, turned out to be the imaging of deep-space satellites, particularly for satellites at geosynchronous altitude.

Lincoln Laboratory staff members developed new techniques, including stroboscopic imaging and extended coherent processing, that used coherent integration of a large number of pulses and the knowledge of the precise motion of a satellite to image satellites. Extended coherent processing, which allows coherent integration over a large rotation angle, is still in use and has been shown to be essential in other, newer image analysis techniques.

ARPA was satisfied with the outcome of the program and in 1978 declared that the project had been completed successfully. However, the feeling at Lincoln Laboratory was that the new technology could and should be put to use. Because the intelligence community strongly concurred with the Laboratory viewpoint, ARPA initiated funding through the Air Force Space and Missile System Organization to operate the LRIR for two years. Lincoln Laboratory obtained support for data collection and operations for the radar from ADCOM and the Air Force Foreign Technology Division (FTD).

ADCOM required delivery of satellite images within one hour after track, even though the then prevailing delay between satellite track and image generation was several weeks. The Haystack LRIR radar team met this requirement by developing a near-real-time imaging capability. They simplified and accelerated the various processing stages and successfully imaged satellites within one hour. In less than a year, an operational system was connected to the NORAD Cheyenne Mountain Complex (NCOM) via a high-speed data line. From this point on, Haystack LRIR became a contributing sensor and part of the ADCOM Space Surveillance Network. In 1983, after the Air Force permitted the generation of radar images outside the continental United States, a similar capability was installed at ALCOR.

*Skylab* again played a role in proving the utility of radar images. The orbit of the space station had decayed, and NASA anticipated that it would reenter the atmosphere in July of 1979. To accelerate the reentry of *Skylab*, NASA needed to stabilize it and then put it in a high drag orientation. During June and July of 1979, LRIR was asked to image *Skylab*, determine its motion, and then corroborate the orientation after NASA reoriented it to maximize the drag. The near-real-time imaging capability provided timely data on the motion and orientation that would otherwise have been unavailable. By the mid-1980s, the Haystack X-band and ALCOR C-band radars had become contributing sensors and were helping the NCOM intelligence sector perform its function of mission and payload assessment.

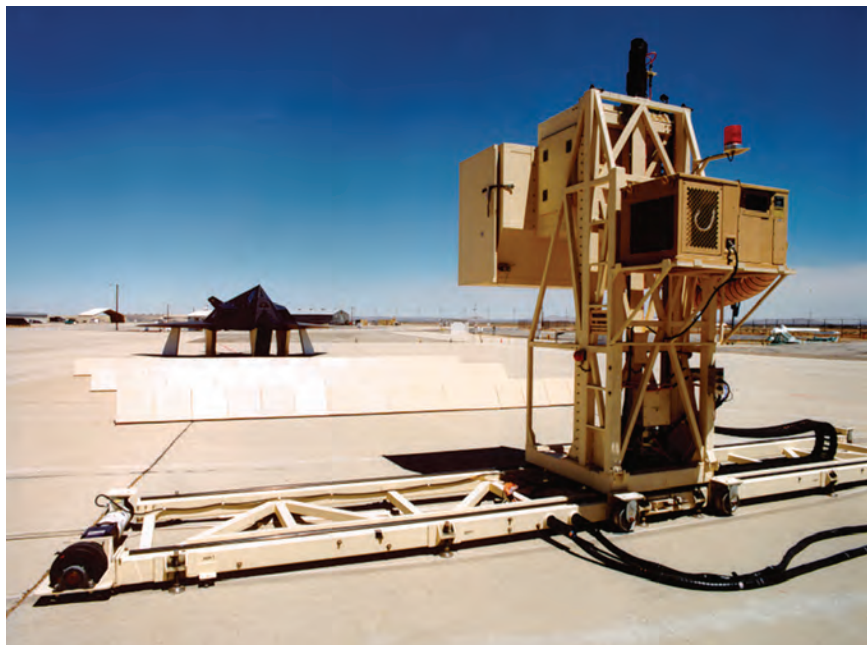
## F-117 Diagnostic Imaging

Wideband radar imaging techniques are applicable to applications other than space surveillance, such as the imaging of aircraft. The F-117 Night Hawk stealth fighter, which was retired in 2008, relied on having a low radar cross section to perform its mission of penetrating enemy defenses. If its stealth capability were compromised in any way, the odds of success were greatly diminished.

A deployable imaging radar to monitor the F-117's stealth condition would be very beneficial. To fulfill this need, a maintenance tool called Diagnostic Imaging Radar (DIR) was developed. The DIR system utilized a wideband rail SAR to generate high-resolution images of the aircraft while it was on the ground (Figure 10-5). The DIR automatically detected anomalous scattering centers associated with particular aircraft parts, thereby allowing appropriate repairs. This program was unusual in that Lincoln Laboratory was partnered with

commercial companies to develop the DIR system. The Laboratory developed the software (Advanced Diagnostic Analysis Package) to generate the images, maintain the images database, and automatically identify parts needing repair.

This program was highly successful in maintaining low radar cross section performance of the F-117 and greatly reduced the maintenance costs. When the system was retired in 2008, Lincoln Laboratory was told that the software system had never failed. The staff members who worked on the DIR were highly motivated and particularly appreciated their involvement in a program that saved the lives of pilots. The back projection and polar formatting imaging routines developed for the DIR were subsequently incorporated into satellite image processing software to improve satellite image quality.



**Figure 10-5**  
Diagnostic Imaging Radar conducting maintenance operations on an F-117 Night Hawk.

The satellite image analysis effort continued in the Laboratory largely in support of FTD. New and better algorithms for radar image interpretation led to an in-depth analysis capability that helped in both modeling and understanding the operational modes of satellites. In several cases, data from this analysis were the first sources used in modeling a new foreign satellite.

In 1984, the development of small computer workstations led to a major effort sponsored by the U.S. Space Command and FTD to package the radar-image analysis software in a workstation. The principal objective was to automate and simplify the process of radar-image analysis and interpretation. The workstation was then to become a vehicle for technology transfer from Lincoln Laboratory to the user community. New computer graphics tools were added to the software package. The delivered workstation software helped both the U.S. Space Command and FTD perform independent routine wideband image analyses, thus freeing Lincoln Laboratory to focus on developing new and better analysis techniques.

Other efforts followed. An electromagnetic scattering prediction software capability was packaged into a workstation and delivered to the same user community. This package, the Lincoln Laboratory RCS prediction software, ToolLLBox, enhanced the ability of an analyst to interpret radar images. Another package, the narrowband workstation, used narrowband satellite radar signature data and modern pattern recognition techniques to monitor and identify satellites.

### The Haystack Auxiliary Radar

Throughout this period, the LRIR had shared its antenna mount with the Northeast Radio Observatory Corporation (NEROC) radio astronomers at the Haystack Observatory. According to the terms of the agreement between Lincoln Laboratory and NEROC, satellite imaging could be conducted for only about eight weeks per year. This arrangement proved unsatisfactory to the U.S. Space Command, which needed continuous availability. The most cost-effective solution proposed was to build a Ku-band auxiliary system with a smaller antenna that could share much of the LRIR signal and data processing equipment. The antenna, transmitter, and receiver of the auxiliary system would be located close to the LRIR and connected to its equipment via underground signal and control cables.



The auxiliary system could then operate whenever the radio astronomers were using the Haystack antenna. The proposal also recommended that the bandwidth be doubled to obtain a range resolution of 12 cm.

The funding for the Haystack Auxiliary (HAX) radar came in a roundabout way. Haystack's high sensitivity and wavelength combination made it ideal for detecting very small objects in space. In the late 1980s, NASA was looking for reliable data to help model the space-debris environment for use in the shielding design of the International Space Station. The only available source for such data was the Haystack LRIR, which could detect orbiting objects as small as one centimeter. Lincoln Laboratory proposed that if NASA would fund HAX construction, it would get Haystack and HAX debris data in return. The proposal was accepted by NASA and the U.S. Space Command, and an agreement to exchange funding for debris data went into effect in 1989. Since then, Haystack has provided NASA with approximately 1000 hours of space-debris measurements per year.

The HAX was completed in fall 1993 (Figure 10-6). HAX wideband data produced finer and sharper images than even the Haystack radar. The detailed information derived from these images is routinely used to refine satellite models. In 1993, the HAX became a contributing sensor, like Haystack and ALCOR, and also began collecting space debris data for NASA.

### Wideband Networked Sensors Program

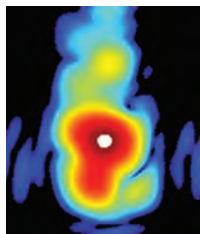
The Wideband Networked Sensors (WNS) program, a follow-on program with the Defense Advanced Research Projects Agency (DARPA), was initiated to demonstrate the value of wideband networks for use in integrating sensors. Wideband radar data from the HAX and Haystack radars were streamed in real time over the Boston South Network (BOSSNET) (see chapter 5, "Satellite Communications") to be processed at a remote location. The WNS project required upgrading the Haystack and HAX radars as "network ready" sensors that could provide processed radar results and raw radar data to be remotely processed in unique ways and combined with other sensor data. A separate processing chain was developed for each of the radars so that both radars could be operated independently and simultaneously. A "dark fiber" was utilized to connect the Lincoln Space Surveillance Complex (LSSC) in



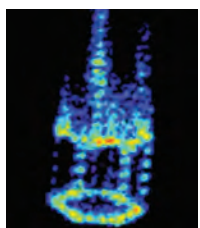
**Figure 10-6**  
Haystack radar site. The LRIR Haystack antenna is in the large radome on the left; the HAX radome and equipment building are on the right. HAX was completed in 1993 to collect satellite-imaging and space-debris data.



### Haystack upgrade: X-band vs. W-band radar



X-band image of  
model



W-band image of  
model



Satellite  
model

Figure 10-7

**Inverse synthetic aperture radar (ISAR) images of a satellite model (above right) using compact range data. The Haystack upgrade to W-band (92–100 GHz) will enable ISAR imaging of satellites in low earth orbits with much higher resolution than possible with the current X-band radar.**

Westford, Massachusetts, to the BOSSNET, allowing for both radars to simultaneously stream high-rate, real-time radar data onto the network.

Lincoln Laboratory developed appropriate software and processing algorithms that combined data from the two radars to synthesize an ultrawideband radar image in real time. Demonstrations of real-time imaging were conducted in Lexington, using data that were routed on BOSSNET from LSSC down to Washington, D.C., and back. Other demonstrations included real-time satellite imaging, conducted at Kwajalein and using data from Haystack and HAX.

The WNS project legacy enabled subsequent program developments, particularly as early demonstrations of network-centric-ready radars. The WNS project was a precursor to several programs, including a U.S. Army Advanced Concept Technology Demonstration and several network-centric space situational awareness programs. The MIT radio astronomers have also taken advantage of the high-rate link to process very-long-baseline interferometry (VLBI) data sets.

#### Lexington Space Situational Awareness Center: Moving Operations to Lexington

In 2001, an internal Lincoln Laboratory study recommended consolidating the control of the Millstone, Haystack, and HAX radars into a single facility, thereby enabling the entire site to work more efficiently. Equally significant was the decision to relocate the control facility at the main Laboratory complex as had recently been done by the Kwajalein Modernization and Remoting project (see chapter 30, “Open Systems Architecture”).

The selection of a Lexington operating location also enhanced staff interaction: Space Surveillance Group personnel then located at Millstone Hill could be relocated to the Lexington campus, where a state-of-the-art control facility, the Lexington Space Situational Awareness Center (LSSAC), was completed in 2003.

At the heart of LSSAC is the set of three Radar Open Systems Architecture (ROSA) radar control consoles (see chapter 30, “Open Systems Architecture”). Each console consists of a set of computers on which the operator can plan collection activities, control the radar remotely in real time, and monitor complete radar and antenna status.

A mission director can now change search strategies, cue one radar with another radar, and modify collection parameters in real time much more rapidly. These new capabilities continue to be crucial to the success of many experiments and missions, including the 2008 Burnt Frost operation in which a U.S. satellite that had fallen out of orbit was successfully destroyed before it could break up in the earth’s atmosphere and release not only heavy debris but its nearly 1000 lb of toxic fuel.

#### Haystack Ultrawideband Satellite Imaging Radar

The advent of microsattellites with significant technical capability greatly stresses existing space surveillance assets, which do not have sufficient imaging resolution capability to characterize objects less than 1 m in dimension. To achieve this resolution would require a radar with sufficient sensitivity to track small satellites but with much greater bandwidth than previously achieved.

In order to realize wide radar bandwidths, transmission at high frequency is desirable. Backscatter from small target features is also enhanced at high frequencies. The atmospheric radio transmission window at W-band and recent advances in high-power gyrotron vacuum devices suggest that the widest practical radar bandwidth could be realized at W band. On the basis of these considerations, Lincoln Laboratory proposed upgrading the Haystack radar to dual-band operation at X (9.5–10.5 GHz) and W (92–100 GHz) bands to address the need for extremely high-resolution imaging of space objects. The Federal Communications Commission radar frequency allocation at W band allows 8 GHz of instantaneous bandwidth corresponding to 3 cm resolution that can be reduced to 1 cm with bandwidth expansion. A comparison of images of a small satellite taken at X (1 GHz bandwidth) and W (8 GHz bandwidth) bands is shown in Figure 10-7. The Air Force accepted the Laboratory’s proposal and initiated the Haystack Ultrawideband Satellite Imaging Radar (HUSIR) program to image satellites in low earth orbits.

The HUSIR program required major advances in at least three key areas: achieving a peak transmitter power of at least 500 W over the 92–100 GHz frequency range; making significant improvements in data processing throughput (100 Mbps) and low-noise, wide-bandwidth waveform generation (275–525 MHz); and building a new dish antenna for Haystack with a surface accurate to 100  $\mu\text{m}$  rms (approximately the width of a human hair)



over its 120 ft diameter. To maintain this accuracy while tracking low-earth-orbit (LEO) satellites, the antenna was designed to be very stiff yet light enough to be supported by the existing Haystack yoke and pedestal.

The stiffness and precision requirements dictated that the components of the new antenna had to be integrated and welded on the ground prior to installation. These assemblies, including the aluminum back-structure and quadrapod, and the steel transition structure were too large for road transport and so were integrated and staged at the Haystack site in Tyngsboro, Massachusetts. Installation of the antenna was executed during summer 2010 in a sequence of critical operations:

- Removal of the radome cap (115,000 lbs, 141 ft diameter)
- Removal of the old antenna back-structure (86,000 lbs) and counterweights
- Modification of the existing yoke to receive the new antenna
- Removal of the temporary building housing the new antenna back-structure
- Installation of the new antenna transition structure (155,000 lbs)
- Installation of the new antenna back-structure (70,000 lbs) (Figure 10-8)
- Reinstallation of the radome cap

These operations required the use of a large-capacity (750 ton) crane assembled at the site. Each lift was backed up with rigorous engineering analysis and detailed procedures and drawings.

With the radome cap reinstalled, the 104 surface panel assemblies were installed on the reflector and are in the process of being aligned to the 100  $\mu\text{m}$  accuracy. The complete HUSIR system will be integrated and tested in 2012 following the checkout of the new antenna control system.

**Figure 10-8**

**Installation of the new antenna back-structure, September 2, 2010. Precise control of the 70,000 lb, 120 ft diameter structure was required to position it on the transition structure with less than 3 inches of clearance available.**

---

**Note**

**7** The magnitude scale is a quantification of stellar brightness. The scale is logarithmic and also reversed: the fainter the star, the larger the magnitude number. The brightest stars are about 0 *M<sub>v</sub>*; the sun is  $-26.8 M_v$ .

**Multistatic Radar**

Lincoln Laboratory pioneered the use of high-power radars for space surveillance, both with the first tracks of Sputnik by the Millstone Hill radar and with the development of wideband radar imaging at ALCOR and Haystack. Over the past decade, the Laboratory has also been exploring the use of multistatic radar for observations of space objects.

Most radars are employed in what is called a “monostatic” configuration, i.e., the transmitter and the receiver are collocated, and typically use the same physical antenna. Such an arrangement can provide great range resolution (depending on the bandwidth of the transmitted radar pulses), but angular resolution is often rather limited; because of the diffraction limit, the angular resolution can be no better than the ratio of the radar wavelength to the physical antenna size.

However, if one could somehow coherently combine radar returns observed at multiple geographically separated locations, then the angular resolution could be improved to that of a virtual antenna the size of the largest separation between physical antennas. With the separation between antennas in tens or hundreds of kilometers, the potential gain in angular resolution is immense. This gain in resolution can be used, for example, to three-dimensionally image low earth-orbiting satellites or to provide unambiguous resolution and precise metrics for the crowded clusters of commercial satellites in the geosynchronous belt.

An arrangement in which the transmitter and receiver are physically separated is called multistatic. During the past decade, Lincoln Laboratory has set out to demonstrate applications of multistatic radars for space surveillance and other related applications. In 2005, the Laboratory started the Sparse Aperture Multistatic Radar Testbed project.

In a sustained effort, Lincoln Laboratory developed a network protocol that harnesses the availability of Global Positioning System (GPS) timing to synchronize wideband radars and provide a means of coherently receiving high-resolution radar pulses with a network of widely separated inexpensive receivers. Researchers refurbished and upgraded a telemetry antenna, located on the roof of the Laboratory’s Building B and originally

used to support LES status downlink, and installed a new full-motion satellite-tracking antenna on the roof of the Laboratory’s flight facility near the Hanscom Field Airport. The separation between the two antennas, about a mile, provides roughly 15 cm interferometric resolution for scatterers on a target at a range of about 1000 km (i.e., typical range to a low-earth-orbit satellite). The first three-dimensional images were obtained with this system in 2007.

As part of the Sparse Aperture Multistatic Radar Testbed project, Lincoln Laboratory developed several compact, transportable bistatic radar receivers based on the ROSA architecture. Transportability of these receivers allowed access to longer baselines necessary for demonstrating precise metrics in geostationary orbit.

The crowding of the geostationary orbit is increasing the risk of conjunctions and collisions, as there are more and more active satellites and debris contending for room in this special orbit. Active orbit control via ion propulsion that continuously applies a small thrust is becoming more common, thus making accurate orbit determination a very formidable challenge.

In 2007, the astronomy department at the University of Massachusetts, Amherst, allowed Lincoln Laboratory to use the Five Colleges Radio Astronomy Observatory radio telescope for bistatic radar experiments. Using this telescope, as well as the 43 m radio telescope at Green Bank Radio Astronomy Observatory, the Laboratory attacked the problem of measuring separations between objects in geostationary clusters. In a series of experiments with the Sparse Aperture Multistatic Radar Testbed, researchers successfully demonstrated a capability to generate nearly instantaneous estimates of three-dimensional separation between satellites in the geostationary belt.

**Electro-Optics for Space Surveillance**

In 1971, Bergemann proposed that the emerging electro-optical technology could support the search and detection of small, distant satellites by their reflected sunlight. An electro-optic low-light-level television (LLTV) camera at the focal plane of a modest 1 m<sup>2</sup> aperture telescope promised a clear advantage over the Air Force’s Baker-Nunn cameras; because the LLTV camera had no film to be developed, it could provide





**Figure 10-9**  
**The 31-inch main telescope of the ETS with an intensified Ebsicon camera at Cassegrain focus. The 14-inch wide-field auxiliary telescope is on the declination axis, helping to counterbalance the main telescope.**

real-time output. Electronic cameras also promised high sensitivity to point-source objects (unresolved stars and unresolved satellites), principally because of the quantum efficiency of the photoemissive detector chemistry. The telescope field of view could be as large as several square degrees, and because of the short exposures required (1/30 sec television rate), that feature promised a high search rate, as much as 1000 square degrees per hour.

Electro-optical detection of distant satellites capitalizes on sun illumination of deep-space satellites with a visible-band flux on the order of  $1000 \text{ W/m}^2$ , which is about  $10^9$  times greater than the Millstone radar flux at geostationary distance. Since, unlike a radar signal, solar illumination is not phase coherent, the net power gain from solar illumination is actually the square root of  $10^9$ . The flux is considerable nevertheless. More importantly, all satellites except those eclipsed by the earth are illuminated simultaneously, greatly aiding object searches.

A system of two telescopes with electro-optical cameras, separated by several kilometers and searching synchronously, was proposed as a means of star subtraction and satellite range detection from the parallax. A goal was set to detect the smallest geostationary payloads having a projected area  $A$  of  $1 \text{ m}^2$ . The reflectivity coefficient  $\rho$  was expected to be about 10%, resulting in an estimated brightness for  $\rho A = 0.1 \text{ m}^2$  at geostationary distance of about 16 stellar magnitudes (Mv).<sup>7</sup>

A search of the geostationary belt viewable from a site in one night seemed a minimum goal: about  $120^\circ \times 20^\circ$  (to allow  $\pm 10^\circ$  inclination spread). Since satellites at geosynchronous distance move relative to the stars at about  $15^\circ$  per hour, the required search rate was  $120^\circ \times 15^\circ$  per hour, or 1800 square degrees per hour.

The sine qua non of the system was the camera tube. Laboratory experiments indicated that the best LLTV tube for this purpose was the Westinghouse Ebsicon. This camera tube was chosen and, for even greater sensitivity, an external image intensifier was mounted between the focal plane and the Ebsicon tube. With this enhancement, the camera noise, referred to the first photocathode, was only a few electrons. The sky background, not the camera noise, limited the detection performance. The external

intensifier soon became available with an 80 mm fiber-optic faceplate to couple to a 32 mm Ebsicon, easing the design of a wide-field telescope.

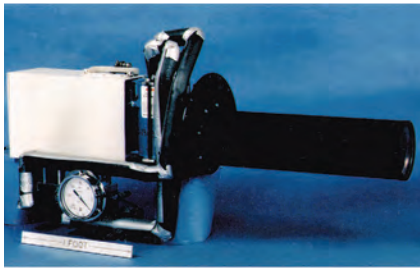
In less than a year, a portable intensified Ebsicon camera was assembled and tested at the focal plane of the 31-inch telescope at Lowell Observatory in Flagstaff, Arizona. Three field trips, concluding in October 1973, produced videotapes of some two dozen satellites in the geosynchronous belt and one about four times farther out.

The television playbacks were spectacular. A satellite appearing as an unresolved star slowly drifted across the screen from west to east, taking two minutes to transit. Some satellites brightened and faded regularly, the result of wobble in their spin stabilization.

Observations of calibrated star fields showed that on dark nights satellites and stars as faint as 16.5 Mv were detectable on the video monitor without an automatic processor. Robert Weber, who constructed the camera and conducted the field tests, quantified the solar flux as having a value of  $5 \times 10^{10}$  photons/sec/ $\text{m}^2$  and the quantum efficiency of the photocathode as 7.2% in the visible-wavelength region.

The results of the camera field tests motivated the construction of the Experimental Test System (ETS) to be located where the nights were predominantly clear. A short study produced the ETS design, which was accepted by the ESD in 1974. The Space Surveillance Group, led by Bergemann, was then established to construct the ETS and develop technology to support the acquisition of an operational Air Force system. A field site on the White Sands Missile Test Range near Socorro, New Mexico, was selected by the Air Force, and construction of the telescope building and dome began. The real-time site software and detailed system design were managed by Donald Batman, the first site manager.

The telescope chosen as the largest affordable aperture was a Boller-Chivens 31-inch Ritchey-Chrétien with a focal ratio of  $f/5$  (155-inch focal length) at the Cassegrain focus (Figure 10-9). With the 80 mm faceplate of the intensified Ebsicon camera, the field of view was  $1.2^\circ$  diagonal,  $0.93^\circ$  horizontal in the television format, and  $0.6^\circ$  with the intensifier zoom. The angular-resolution element with 400 television



**Figure 10-10**  
The 31-inch telescope camera and cold-shield assembly adapted for medium-wavelength infrared (1 to 5  $\mu\text{m}$ ) satellite-tracking experiments.

horizontal half-amplitude picture elements (pixels) was approximately 9 arc sec. On zoom, the 4 arc sec resolution elements were about twice the site's average seeing disk. Subsequent implementation of a prime focus approximately doubled the field of view. A comounted 14-inch  $f/1.7$  folded-Schmidt telescope provided a  $7^\circ$  field of view for rapid search of bright satellites. ETS became operational in the fall of 1975, eighteen months after ESD approval. LES-6 was easily detected electro-optically, without the four-hour search that the Haystack radar had required four years earlier.

During the time that a database on the brightness of existing satellites was being established, site investigators discovered that old spin-stabilized solar-panel-covered satellite cylinders, a major class of inactive payloads, were fainter than expected by about two stellar magnitudes.

Two remedies were found to this problem. In the first approach, 30 television frames were summed with an electronic scan converter (the kind used to hold X-ray images at airport boarding gates). With noncoherent integration, the gain was the square root of 30, about equal to the lost brightness. In the second approach, a later version of the electro-optical camera allowed integration on the silicon target while the read beam was gated off. Either integration technique provided significantly improved sensitivity.

The desire to have a second tracking telescope led to making the ETS a duplex site with two main telescopes, including a second console and a second site computer. Lincoln Laboratory continued to develop electro-optical sensors and techniques, and the second site allowed a military crew from ADCOM to conduct operational

tasks and communicate nightly position measurements to the NORAD Space Surveillance Center. ADCOM used this site for deep-space surveillance for five years, until a permanent site went into operation.

The ETS was used to test a variety of surveillance concepts. One of the most interesting was daylight satellite tracking, called DAYSAT. It had become apparent that a silicon target vidicon, without intensification, could detect and track near-earth satellites in broad daylight. When extended-red-sensitivity vidicons, filters to reduce the bright blue sky, and a Quantex digital-image-storage processor to add the two camera signals were used, a Soviet *Salyut* spacecraft was detected at a distance of about 300 km, with 4-inch lenses, by looking out through a basement laboratory window! Daylight electro-optical observations were carried out on about two dozen satellites; the maximum range was about 2000 km. Experiments on the 31-inch telescopes reached 9.3 Mv in a daylight sky brightness of 4 Mv.

The panoramic sky camera, PANSKY, was developed at Lincoln Laboratory and tested at ETS. An electro-optical camera on a 35 mm fish-eye lens with  $160^\circ$  field of view provided detection of bright stars to compare with those in computer storage. Atmospheric extinction could be estimated, and the ability to report regions of clouds obviated fruitless observations.

Daniel Kostishack and Michael Cantella used Schottky-barrier detectors to initiate an entirely new approach to medium-wavelength infrared satellite surveillance. One ETS 31-inch telescope was modified to investigate a camera intended for space-based surveillance of near-earth satellites (Figure 10-10). Thermoelectrically cooled

1970

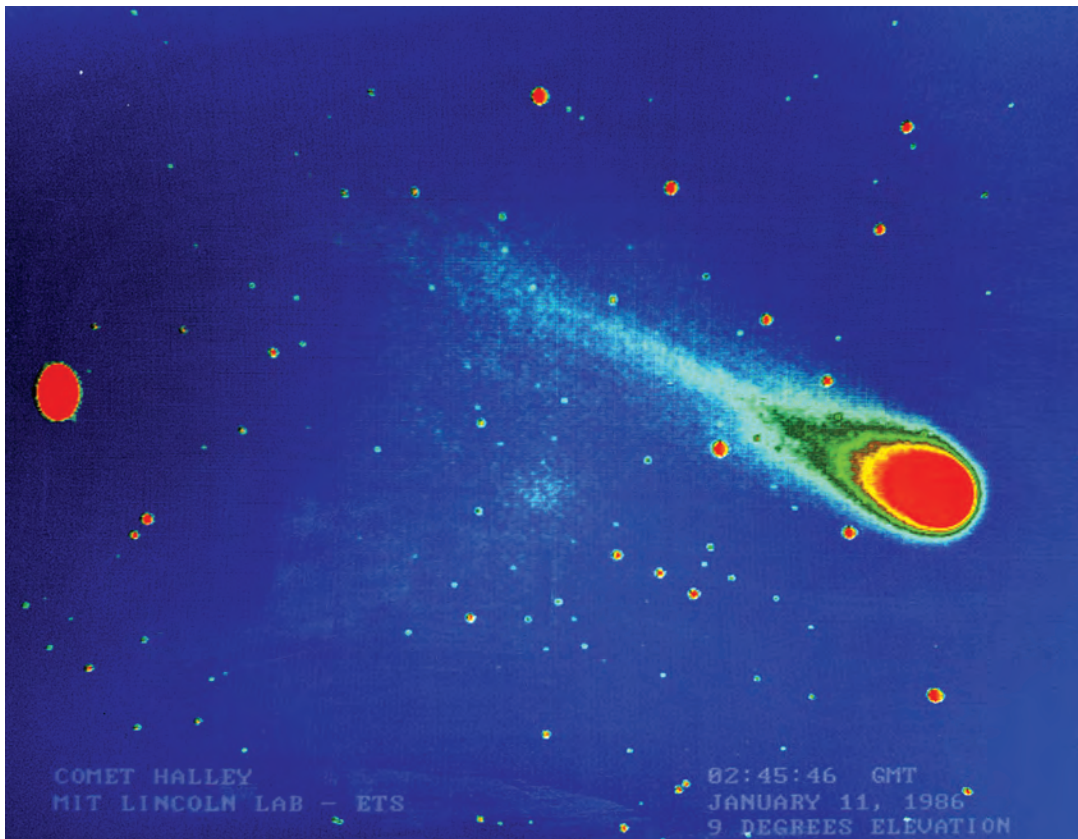


V.A. Nedzel

1980



GEODSS ETS, Socorro, N. Mex.



**Figure 10-11**  
Intensity contours of Halley's comet measured by the ETS during 1986 apparition.

megapixel medium-wavelength infrared (1 to 5  $\mu\text{m}$ ) detector arrays, operated in a stare mode, were shown to provide more effective surveillance of objects in earth shadow than scanning long-wavelength infrared detector arrays. The atmospheric window near 4  $\mu\text{m}$  permitted successful ground-based detection of several large satellites, including the Soviet space station *Mir*.

Perhaps the most important experiment was the first search of the geostationary belt by Larry Taff and John Sorvari during the spring specular season of 1978. (The specular seasons are the periods two weeks before the spring equinox and two weeks after the fall equinox, when geostationary satellites exhibit mirrorlike specular reflections, one hundred times brighter than usual.) Both main telescopes were operating, one to provide a leak-proof fence, the other to record photometric light-curve signatures. After a few observation nights, 30 UCTs had been detected and tracked by dead reckoning and had their initial orbits determined. About one-third of the signatures had measurable periods, one-third had distinctive features, and one-third had constant but distinct brightness levels; this collection of signatures proved adequate to reacquire the ensemble of UCTs even after the specular season ended.

The ETS also participated in astronomical measurements, particularly observations of comets (Figure 10-11). Taff and David Beatty also conducted the first electro-optical search for asteroids, resulting in the discovery of eight new asteroids. The most important function of ETS was that it proved the concept of using electro-optical technology for deep-space surveillance. As a result, ESD used technical specifications developed by Lincoln Laboratory and initiated the procurement of five globally



Modular design of Haystack antenna allows LRIR capability



Deep-space surveillance network, radar (▲) and optical (●)





**Figure 10-12**

**The electro-optical space surveillance site near Socorro, New Mexico. The ETS with its three telescope domes is in the foreground; the operational GEODSS CONUS site is the large building farther back. The operational GEODSS site has one auxiliary and two main telescope domes attached to the building.**

deployed operational sites. Years later, charge-coupled device (CCD) technology would also be applied to a new-generation asteroid-search system at ETS called Lincoln Near-Earth Asteroid Research (LINEAR) (see chapter 23, “LINEAR and Other Programs”), which would prove itself as one of the most prolific search systems for near-earth asteroids ever developed.

### **Operational GEODSS**

On May 15, 1978, ESD awarded TRW and its partner for camera production, Itek, a contract to produce five ground-based electro-optical deep-space surveillance (GEODSS) sites (Figure 10-12). General Robert Marsh, commander of ESD, expressed his thanks to Walter Morrow, director of Lincoln Laboratory, for the technical accomplishments of ETS that made the production contract possible. The concept of electro-optical space surveillance was so well proven that the request for quotation was for a fixed price. The operational system was designated AN/FSQ-114. The Laboratory provided technical support to ESD throughout the procurement and in the selection of operational sites.

Rather than operate at television rates with post-read integration, as had been done at ETS, TRW chose to use an 80 mm faceplate tube without an external intensifier and integrate on the camera tube. Lincoln Laboratory was concerned that this technology posed technical risk. When it was learned that TRW had selected the RCA electro-optical silicon intensified-target (SIT) tube for the operational systems, the tube was quickly ordered and tested.

The worst fears were realized when Lincoln Laboratory bench measurements indicated the sensitivity would suffer a shortfall of more than a factor of two. ESD directed TRW and Itek to design the camera to accept both the RCA SIT tube and the Westinghouse Ebsicon, and asked the Laboratory to manage a manufacturing techniques program at Westinghouse.

Lincoln Laboratory continued to support the GEODSS procurement by guiding TRW’s tests at Newbury Park, California. It soon became apparent that the sensitivity shortfall of the RCA electro-optic tube was at least as great as had been predicted by bench measurements, and greater when skies were bright. The Laboratory initiated a GEODSS upgrade program in anticipation

of replacing the Ebsicon camera tubes with solid-state CCD cameras offering far greater quantum efficiency and long operational life. The Microelectronics Group at Lincoln Laboratory developed visible-band CCDs, and various camera configurations were tested at the ETS during the 1980s. These tests demonstrated the performance advantages that would be gained from CCD camera technology.

Finding locations for the first three of the five GEODSS sites went quickly. The continental U.S. (CONUS) GEODSS site was built adjacent to ETS. The mid-Pacific site was collocated with the DARPA Maui Optical Site (now called the Air Force Maui Optical Station) in Hawaii; the western Pacific site was established near Tague, South Korea.

Siting the remaining two GEODSS installations brought international negotiations into the effort. The U.S. State Department was unable to obtain host country agreements for the eastern Atlantic and Mideast sites. The island of Diego Garcia, located in the Indian Ocean at 7°20'S, 72°25'E, was finally selected to serve as the site for Mideast coverage. Rewriting the telescope-mount software was avoided by aligning the polar axis with the north celestial pole, 7°20' below the northern horizon, rather than following the astronomical convention of south polar alignment for the southern hemisphere. This solution was workable, but limited the zenith distance (elevation) coverage to the south.

The Diego Garcia site became operational in 1984. Existing Baker-Nunn cameras in San Vito, Italy, and Saint Margarets, New Brunswick, Canada, helped to fill the eastern Atlantic gap. The fifth set of GEODSS equipment originally slated for the eastern Atlantic site was installed instead in Socorro as the GEODSS Test Site to aid in the development of GEODSS upgrades.

#### **Morón Optical Space Surveillance System**

Late in 1989, the Air Force asked Lincoln Laboratory to construct a transportable optical system (TOS) to fill in gaps in space surveillance coverage. An available 22-inch Ritchey-Chrétien  $f/2.3$  telescope was provided with a commercially available silicon target vidicon having two stages of image intensification to achieve background-noise-limited sensitivity. The fiber-optic 18 mm faceplate gave a field of view of about 0.3 square degrees.

Under the direction of Weber, the TOS was completed and installed in the Baker-Nunn site in San Vito in nine months. With a signal-to-noise ratio of 6, a sensitivity of 16.7 Mv at the telescope on calibration stars — against a 21 Mv/(arc sec<sup>2</sup>) sky background — was achieved with 2 sec integration in the image processor.

The San Vito site nearly closed the coverage gap on geostationary satellites between the CONUS and the Diego Garcia GEODSS sites. The coverage gap overlapped if both sites operated very close to the horizon, but the astronomical seeing then spoiled the detection sensitivity and the metric accuracy.

In the early 1990s, the TOS was decommissioned and returned to the Experimental Test System in Socorro, where the team there comprehensively upgraded the system and its capabilities. A new generation of CCD cameras, based on the back-illuminated version of the imager developed for the Space-Based Visible sensor, was introduced. Charge-coupled device technology significantly increased both the sensitivity and search rate of the small telescope system. Moreover, the latest generation of space surveillance control system, MIT Optical Space Surveillance System (MITOSS) was employed. This control system increased the level of automation significantly, and most metric data collection was done without any operator intervention.

The TOS was redeployed to a new site in southern Spain on the Morón Air Base south of Seville and renamed MOSS (Morón Optical Space Surveillance). The Laboratory would once again upgrade the control systems, algorithms, and cameras in MOSS in 2006, and ultimately transition the system to the Air Force for operation. As of 2010, the MOSS system continued to operate as the only U.S. optical sensor with visibility of the geosynchronous belt over Western Europe.

#### **GEODSS CCD Upgrade**

In 1991, the Space Surveillance Group at Lincoln Laboratory conducted a survey of the state of the art in imaging technology to seek a replacement for the large Ebsicon vacuum-tube cameras used in GEODSS, which would soon become obsolete. Although CCD imaging technology had advanced and vendors were producing imagers that would meet some of the requirements of GEODSS, none were making fully suitable devices.

However, the Laboratory's Microelectronics Group was fabricating CCD imagers that would meet all the requirements except focal-plane size. In late 1992, the Air Force funded the Laboratory's development of the CCD imager specifically for the purposes of upgrading the GEODSS system.

This imager, called CCID-16, would have the required large (80 mm diagonal) gap-free focal plane with  $2560 \times 1960$  imaging pixels and frame-transfer readout for real-time applications. CCID-16 was so large that one imager completely filled the 4-inch silicon wafer used for fabrication at the time. In fact, the frame transfer regions had to be uniquely tapered to fit within the confines of the wafer. The successful fabrication of this imager was accomplished in 1994 and supplied to Photometrics to build the prototype CCD camera under a Laboratory contract. These prototype cameras were used by TRW as part of the GEODSS Upgrade Prototype System (GUPS) to develop operational image processing software and demonstrate the enhanced performance of CCD cameras in GEODSS. After the successful GUPS demonstration, the prototype cameras were returned to the Laboratory and continue to be used to search for asteroids at the ETS under the LINEAR program.

New CCD technology would finally find its way into the operational GEODSS sites in 2003. The Laboratory, under Air Force sponsorship, transitioned the technology and imager design of the CCID-16 to a contractor team including Sarnoff, TRW, and PRC. Sarnoff adapted the CCID-16 to their own fabrication techniques and designed and fabricated low-noise camera electronics and dewars for the operational GEODSS. TRW, building on the success of the previous GUPS program, and PRC teamed to refresh the computer and control systems technology. Many of the algorithms and techniques employed in the upgrade were originally developed and demonstrated by Lincoln Laboratory, including high-precision astrometric and photometric techniques, dynamic scheduling, and mount modeling.

The Deep-space Surveillance Technology Advancement and Replacement for Ebsicons (Deep STARE) program, which completed in 2005, significantly expanded GEODSS capabilities, increasing sensitivity by 2.6 visual magnitudes and doubling its metric accuracy. The

Deep STARE upgrade is the latest chapter in what has proven to be the most successful ground-based optical space surveillance system ever developed, serving as the backbone of deep-space surveillance for over two decades.

#### **Deep-Space Sensor Networks and Controls**

The GEODSS sites, despite their wide-field search capability and rapid position update capacity, had their limitations. Electro-optical surveillance of a satellite was possible only when a site was in darkness, the sun was illuminating the satellite, and clouds did not obscure the line of sight. By contrast, a radar could detect an NFL injection into geostationary orbit under all weather conditions.

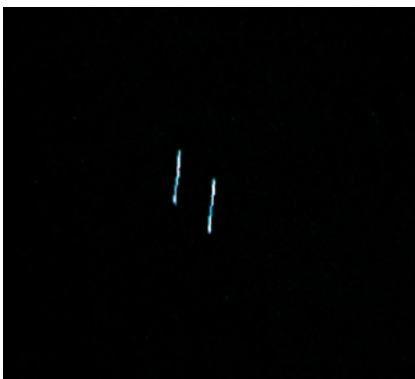
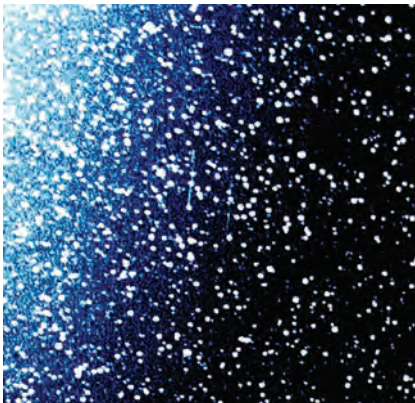
In 1977, the Millstone space surveillance group participated in ADCOM's study of a leak-proof multi-radar fence: a Pacific barrier that could detect all prograde launches from Asia. An experiment using the dual-wavelength (VHF and UHF) ARPA Long-Range Tracking and Instrumentation Radar (ALTAIR) at Kwajalein demonstrated the efficacy of the fence, and the radar was upgraded to provide an operational low-altitude surveillance capability.

At the same time, ADCOM decided to augment Millstone's all-weather radar coverage of about half of the geostationary satellite belt by upgrading both ALTAIR and Pirincliik to a deep-space capability. (The three radars are more or less equidistantly spaced.) Millstone's software provided the technology transfer basis for both ALTAIR and Pirincliik. Since both radars operated in the deep-space mode at UHF, rather than L-band, the upgraded sensitivities achieved were not quite as good as those of Millstone.

Some five years later, Lincoln Laboratory played a major role in upgrading the AN/FPS-85 phased-array surveillance radar at Eglin Air Force Base, Florida, to provide a limited deep-space surveillance fence. In addition to hardware upgrades, the SATCIT integration/tracking program was added to the system.

By 1985, the large number of Air Force Space Command (the organization that succeeded ADCOM) sensors deployed around the world — Millstone, Pirincliik, ALTAIR, the AN/FPS-85 radar at Eglin, the GEODSS sites — gave the Millstone space surveillance





**Figure 10-13**  
**Streak-detection processing of data taken by the SBV sensor allowed star-background-clutter removal with high throughput and high sensitivity. Top: Output display before streak-detection processing. Bottom: Output display after processing.**

group the opportunity to form an integrated deep-space surveillance system: the Deep-Space Network Control Processor (DSNCP). In simplified terms, DSNCP takes the Air Force Space Command deep-space tasking priority list, computes a satellite's pass geometry from each site for several days, and optimally tasks the sites for observations. Equipment availability and weather conditions at optical sensor sites are considered during the scheduling process. DSNCP algorithms scheduled support of catalog maintenance, coordinated search and acquisition of the components of NFLs, and processed data to provide signature data.

From time to time, the value of sensor network coordination was demonstrated by the reacquisition of a missing inactive payload. The element set of LES-5, launched in 1967, was not maintained after the communications transmitter expired in 1970. Because the telemetry transmitter continued to operate, the location of LES-5 was known in a rough sense, but the lack of an element set precluded tracking by the Millstone radar's narrow beam.

On February 6, 1987, during the optical specular season, ETS detected a UCT with an inclination of about  $7.2^\circ$ , drifting eastward at a rate of  $29^\circ$  per day. Millstone acquired the UCT from ETS's rough initial-orbit determination, and the satellite was identified with high confidence as LES-5 by the spin period and low radar cross section.

#### **The Space-Based Visible-Band Sensor**

Lincoln Laboratory came to regard GEODSS as an interim system; the long-term goal should be *space-based* surveillance. A space-based system would always be above the clouds. Perhaps more importantly, it would be above the geopolitics that plagued the siting of the eastern Atlantic and Mideast GEODSS sites. In addition, a sensor in space always sees a dark sky when looking away from the sun, the moon, the zodiacal light, and the earth limb.

A space-based sensor always has a clear line of sight to all satellites except when they are in the earth's shadow. Such eclipses occur for a maximum of about one-third of the orbit period for a near-earth satellite; for geostationary satellites, earth eclipse occurs for only about a week near the equinoxes, a maximum of 70 minutes in a 24-hour period.

The Air Force and the Strategic Defense Initiative Organization supported the development of a space-based space surveillance system, the Midcourse Space Experiment (MSX). This spacecraft, managed by Johns Hopkins University, included long-wavelength infrared, ultraviolet, and visible-band sensors. Lincoln Laboratory's contribution to this effort was in the visible band: the Space-Based Visible (SBV) sensor.

The MSX infrared sensor required cooling to cryogenic temperatures, but because the SBV sensor can take on the tasks of near-earth surveillance when targets are sun illuminated, and deep-space surveillance at all times, the visible-band sensor would reduce cryogen consumption in an operational space surveillance system.

The weight and power allocations to the Lincoln Laboratory SBV package were 172 lb and 98 W. With these restrictions, the space-based telescope was limited to a 6-inch aperture, small compared to GEODSS and TOS. But the CCD imaging devices at the focal plane, with a quantum efficiency of about 20% and a read noise smaller than 10 electrons, allowed the SBV system to detect objects as faint as roughly 14.5 Mv with a 1 sec exposure against a nominal 20 Mv sky background (Figure 10-13).

A critical problem was the non-rejected earth reflectance when the sensor is pointed close to the bright sun-illuminated earth limb. However, high rejection of light from sources outside the field of view was achieved by developing a three-mirror off-axis reimaging telescope design with an intermediate field stop and a diffraction stop. Because mirrors for this design must be exceptionally clean, fabrication and laboratory measurements were conducted in a clean room. The performance met Lincoln Laboratory's specifications.

During surveillance operations, the MSX did not have real-time communication with the ground. Therefore, Lincoln Laboratory set up the SBV processing operations control center, which converted experiments from concept to spacecraft instructions: pointing, sensor settings, and formats, taking into account the constraints of spacecraft power; the position of the sun, moon, earth limb, and zodiacal light; and the geometry between MSX and the target.

About twenty experiments were designed for MSX. Plans included metric measurements to bound the limiting accuracy of angular position measurements from an orbiting spacecraft. Other high-priority experiments included geosynchronous belt search, NFL search acquisition, space-shuttle satellite deployment to deep space, debris search after satellite fragmentation, and tasking observations for catalog maintenance.

The MSX was successfully launched in April 1996 from Vandenberg Air Force Base in California. Over the next year, data were collected on several domestic ballistic missile tests, including one dedicated test that deployed a series of decoys and calibrated spheres. SBV collected data on all these events, providing a wealth of knowledge on the properties of sun-illuminated objects and the capabilities of visible band optics to capture their signatures and estimate their trajectories.

This data collection, leading to a planned series of demonstrations using SBV to collect positional and signature data on manmade satellites, resulted in the establishment of an Advanced Concept Technology Demonstration (ACTD) to incorporate SBV as a contributing sensor in the Space Surveillance Network (SSN). Accommodating this new kind of sensor – the first space-based collector – required much more than collecting data.

Lincoln Laboratory and the Air Force worked together to establish tasking, data processing, and data dissemination. Although SBV had access to virtually every satellite in orbit, geosynchronous satellites were the first priority. Subsequently, Lincoln Laboratory developed and refined several strategies for wide-area

searches of both the geosynchronous belt and other orbital regimes. All this required advanced planning to successfully schedule the sensor. In operation, the Air Force would generate tasking; Lincoln Laboratory would create a schedule to accomplish the tasking as well as conduct search operations, and this plan would be uplinked to the MSX satellite by the Johns Hopkins Applied Physics Laboratory (APL). Lincoln Laboratory automatically processed down-linked data into the metric observations used to establish or update the satellite orbits. The Air Force's use of these observations was the SSN's first instance in incorporating data from a space-based space surveillance sensor.

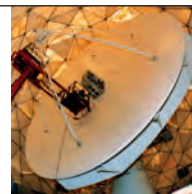
Throughout the three-year duration of the ACTD, Lincoln Laboratory made numerous improvements to increase the operational contribution of the SBV: increased data accuracy by estimating the subpixel location of detected energy; performed calibration to remove biases; and optimized scheduling of tasked objects. As a result, the number of objects tracked per day went from about 100 (which was the ACTD goal) to over 350 a day.

Well beyond the three-year period of the ACTD (and the nominal five-year lifetime of the MSX satellite), Lincoln Laboratory and APL continued operation of the SBV by clever exploitation of the MSX star camera, horizon sensors, and momentum wheels to reorient the satellite for data collection. In June 2008, after more than twelve years of successful operations, the system was shut down.

The SBV effort left a legacy of space-based visible-band space surveillance knowledge. The technology developed and the lessons learned are being applied



H. Kottler



HAX radar antenna



**Figure 10-14**  
Fully assembled SST.

to the Air Force's next-generation system, the Space-Based Space Surveillance (SBSS) satellite. Lincoln Laboratory is transferring its expertise to the Air Force contractor for SBSS as well as building the ground station software for mission planning and data processing.

### Space Surveillance Telescope

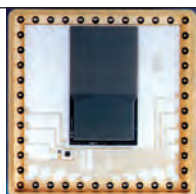
Advances in microsatellite technology and recent worldwide trends in offensive and defensive counterspace capabilities have again raised the bar for a new generation of deep-space optical surveillance systems. In particular, the development of technologically capable microsatellites has significantly stressed the existing Space Surveillance Network. The Space Surveillance Telescope (SST) program is an initiative to develop and demonstrate technology for a new generation of very wide field-of-view, synoptic, space surveillance systems to address future surveillance needs. The SST program began in 2002 under the sponsorship of DARPA and was focused on developing and demonstrating the technology required to perform synoptic space surveillance with very high search rates, while maintaining adequate sensitivity to detect very small microsatellites at geosynchronous distances.

In order to meet these requirements, the SST required a 3.5 m telescope, much larger than the 1-meter-class GEODSS telescopes previously used. However, the optical design also had to maintain a very large field of view — as large as or larger than the 2° field of view GEODSS provided. In order to have the widest field of view possible, an  $f/1$  Mersenne-Schmidt design was selected, employing three mirrors, corrector optics, and a curved focal surface that is centrally located within the telescope structure. The tertiary mirror and corrector optics take the place of the Schmidt plate in a classic Schmidt telescope and allow a wide field of view while

significantly increasing the aperture size beyond what is achievable for Schmidt telescopes. The Mersenne-Schmidt design was first developed theoretically in the 1920s but was unrealizable without the significant technological advances necessary to fabricate the aspheric mirrors and correctors, as well as to populate a curved focal surface with detectors.

To realize that curved focal surface detector, the Laboratory developed a unique, curved CCD imager that consisted of a large-format, full-frame, rapid readout, low-noise imager that was conformally bonded to a curved silicon mandrel. A number of these imagers were then meticulously assembled into a focal-surface mosaic. Because of the extremely fast optical system, conformance of the mosaic of imagers to the ideal focal surface had to be extremely precise, better than 6  $\mu\text{m}$  rms. Full-frame imagers were selected to help maximize the SST field of view; however, that choice necessitates the use of a shutter to control exposure length. The location of the sensor inside the telescope structure required development of a unique high-speed shutter that did not impinge upon the light path while operating. A novel, compact, high-speed shutter similar to a Bonn shutter was designed, tested, and ruggedized for use in the telescope.

The SST telescope was constructed by L3 Communications, Brashear Division. Based on the previous Brashear design used for the Air Force Maui Optical System, the gimbal incorporates unique torque-shaping control-system algorithms, sold commercially and based on research done at MIT, and liquid-cooled motors to rapidly step and settle the telescope as it scans the geosynchronous belt (Figure 10-14). L3 Communications also developed innovative optical metrology techniques to facilitate the fabrication of the highly aspheric optics.



CCD focal plane  
for SBV telescope



SBV telescope package



Morón Optical Space  
Surveillance system





**Figure 10-15**  
**The enclosure for the SST under construction near North Oscura Peak on the White Sands Missile Range. The enclosure incorporates state-of-the-art techniques and cooling to preserve the pristine observing conditions found at the site and to allow SST to achieve its full potential.**

The SST control and data processing systems leverage the legacy of Lincoln Laboratory, using the best algorithms and techniques originally developed for TOS, MOSS, Deep STARE, and the LINEAR programs as well as new algorithms developed under the Optical Processing Architecture at Lincoln effort (discussion of this effort is in the following section). SST takes automated operation to the next level through the extended automation of the enclosure and facility infrastructure so that the SST can be operated safely and reliably from a remote location.

The first SST telescope will be located on the White Sands Missile Range near North Oscura Peak, New Mexico. This mountaintop site provides pristinely dark, high-altitude observing and is near the original Lincoln Laboratory field site. A new observatory

featuring a traditional rotating dome enclosure and an attached control building was constructed in 2010 to house the telescope (Figure 10-15). The telescope assembly on the mountaintop was completed in late 2010, and the mosaic camera was integrated in early 2011. The system achieved first light in February 2011. Following first light, the sensor system and telescope will go through a period of tuning to optimize performance of the imaging system, finalize focus and alignment of the telescope optical assemblies, and optimize the dynamic performance of the entire telescope assembly. These activities will be followed by an extended operational demonstration for DARPA. The SST will then be operated as a contributing sensor to the Space Surveillance Network while Air Force Space Command prepares to transition the

system for dedicated operation in the Network. The Laboratory's multifaceted technology development for SST represents a much needed revitalization of ground-based deep-space surveillance technology to address the new realities of a more hostile environment.

### **Optical Processing for Space Situational Awareness**

The development of next-generation space surveillance sensors like the SST and the SBSS satellite (the operational follow-on to the SBV) burden the Air Force with a significant increase in the number of (and shrinking size of) satellites that can be tracked on a daily basis. Consequently, the resulting demand for increased data throughput stresses data processing and has driven the development of the Optical Processing Architecture at Lincoln (OPAL). OPAL is a flexible, scalable architecture that enables a plug-and-play framework for adding new sensors as they become available. Fundamentally, the imagery data filled with stars, satellites, and asteroids is the same regardless of whether the picture was taken from the ground or in space.

OPAL comprises three major areas of algorithm development: mission planning, signal processing, and mission data processing. Mission planning focuses on how to best utilize and schedule a sensor during its daily routine. Signal processing takes raw images and detects targets such as stars or satellites. Mission data processing takes those detections and attempts to identify that target from a catalog of known objects. These algorithms are based on Lincoln Laboratory's decades of experience. The OPAL project continues to develop next-generation algorithms, e.g., separating closely spaced objects to levels difficult to distinguish with the human eye and increasing detection sensitivity through new approaches for searching target velocities.

The success of the OPAL program led to the addition of new sensors to the system. OPAL was designed to support the Space-Based Surveillance System, which launched in fall 2010. OPAL is also being used at the ETS as part of the LINEAR program, which uses these algorithms to find new asteroids previously unseen with legacy processing.

The main deployment of OPAL is at the Space Operations Center located at Schriever Air Force Base in Colorado Springs, Colorado.

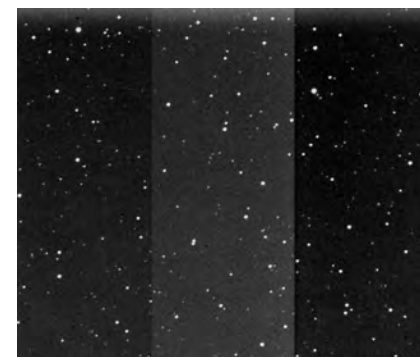
### **Space Surveillance Telescope First Light**

**Often lost to history is the personal side of major program milestones. The Space Surveillance Telescope (SST) first light was the climax of nearly a decade of effort by a dedicated team to develop a truly unique space surveillance system.**

**The team had worked through the weekend of February 12–13, 2011, and many had worked the entire week before, preparing for first light. The camera system had been installed earlier in the week by Donald Johnson and Brian Fandell, a tense and meticulous operation of lowering the components by crane through the telescope and carefully guiding them into position – all while working within inches of the 2.6 m secondary mirror (which took years to make)!**

**By the morning of February 15, cables and plumbing had been integrated, and the telescope was ready to be brought to the vertical position for first light. On all fronts, preparation had run very smoothly. After a mid-day tagup, the team committed to attempt first light on February 15, a day earlier than planned. The air conditioning in the dome was set to begin cooling the telescope and its enclosure to the expected nighttime temperature. By sunset, Steve Mix and the Brashear team were completing final adjustments to the telescope primary mirror support system and preparing to bring the telescope into position. Meanwhile, in the control room, Alexander Szabo and James Sopchak continued to work through minor interface issues.**

**Sunsets from North Oscura Peak are almost without exception spectacular, and the evening of February 15 was no different. In twilight, we could see the brilliant reflection of the setting sun off the Apache Point Observatory, 75 mi to the south in the Sacramento Mountains. I had previously done post-doctoral work at the observatory, one of the first to integrate remote operation into a large observatory. The team was electrified with anticipation and excitement. Although most**



**Figure 10-16**  
Image of the SST first light.

**everyone had already worked a full day, no one wanted to leave the mountain.**

**Shortly before 9:00 p.m., telescope preparations were completed. The telescope was moved to zenith and the shutter doors opened. The night was simply glorious, with a bright moon illuminating thin clouds over the site. By the time we got downstairs, whoops and hollers could be heard from the control room. “You’ve got to get down here, we have doughnuts!” The first images had already been taken, showing tiny out-of-focus stars appearing as doughnuts across the wide field of view. It was 9:12 p.m., and we had first light. A simple focus adjustment based on a hand calculation by James Arendt, the Brashear optical engineer, shrunk the images into spots. Image quality was better than we could have hoped for (Figure 10-16).**

**The e-mail notifications would follow, “First Try, First Light.”**

**— Eric Pearce**



## Support of the Launch of Milstar Flight 3

For the application of satellite anomaly assessment and resolution, radar imaging can provide timely, detailed configuration and motion information to assist satellite operators in rescue operations. One example was Lincoln Laboratory's support of the launch of Milstar Flight 3.

Milstars are military communications satellites developed by the MILSATCOM Joint Program Office (MJPO) of the Air Force Space Command's Space and Missile Systems Center. Between 1995 and 2003, Lincoln Laboratory provided launch support to Milstar Flights 2 through 6 by supplying the satellite operators with precision trajectories, configuration verification, and deployment validation during the launch phase of this system.

On April 30, 1999, soon after the launch of Milstar Flight 3, the Centaur rocket upper stage that was designed to deliver the Milstar payload to the

geosynchronous orbit malfunctioned, causing the payload to separate prematurely from the rocket and go into an uncontrolled tumble. MJPO requested urgent support from the Laboratory. Within 90 minutes of data collection by the Haystack radar, Lincoln Laboratory analysts were able to provide preliminary spacecraft configuration and motion information to the satellite operators on the basis of quick-look radar image analysis.

Subsequently, within 24 hours of the mishap, using the Laboratory's assessment as guidance, the satellite operators succeeded in stabilizing Milstar and deployed its solar arrays, just in time to recharge the onboard batteries before the batteries became completely discharged (Figure 10-17).

Figure 10-17  
Milstar satellite in operational configuration.



## Satellite Assessment

Air Force Space Command through its SSN maintains and updates the orbits of nearly 13,000 manmade space objects in a Space Catalog. Among these objects, over 3300 are active and dead satellite payloads, 1800 are rocket bodies that transported the payloads to orbit, and the rest are space debris.

This Space Catalog contains precision orbit information of space objects that radar and electro-optical sensors can use to acquire and track these objects, update the ephemeris, and record the radar or optical backscattered signals. When properly processed, the backscattered data from a space object provide very useful information about the object's attitude and configuration; the data may be used to deduce satellite stability, orientation, and operational status, and they can also verify deployment events and assess satellite anomalies.

Prior to July 2001, radar images were generated well after data collection had been completed on a given satellite. At that time, Lincoln Laboratory successfully implemented a real-time radar image-generation capability whereby wide-bandwidth radars such as the Laboratory's Haystack and HAX radars could generate satellite images while the satellite is still in track. This capability significantly reduced the timeline for radar image exploitation, which is especially critical for satellite identification during launch and for anomaly resolution, e.g., when, during a satellite launch, the satellite payload is often in close proximity to the rocket upper stage and other space debris.

Other sensors record radar cross-section or optical brightness data on tracked objects. In the late 1990s, Laboratory analysts determined that these narrowband radar and electro-optical signatures could contain valuable information about a satellite's status when compared to a database of similar signatures of an operational satellite over time. Furthermore, the degree of signature mismatch can be used to compute a quantitative confidence measure of the assessment. On the basis of this concept, Lincoln Laboratory in 2000 initiated the development of an automated satellite-status assessment system to provide near-real-time status-change alert on most active spacecraft from near earth to the geosynchronous region.





**Figure 10-18**  
**The new satellite assessment workstation environment.**

The heart of this development is a Bayesian belief network methodology that enables one to combine the individual sensor assessment confidence into a cumulative, more accurate description of the satellite status by using all available signature and metric data collected on the satellite. This system is currently in use operationally at Air Force facilities, supporting space situational awareness by providing analysts with a quick-look, automated satellite-status change-alert capability for the entire active satellite population.

In a parallel development around 1999, Lincoln Laboratory researchers recognized that SSN narrow-bandwidth radar signatures can be used to provide highly accurate identification of objects in a space launch. For example, three-axis stabilized payloads would not have rapid variation in intensity; tumbling rockets exhibit periodic fluctuations; and space debris usually has low radar backscatter. This recognition is particularly important when imaging radars may not be available during a launch.

In 2003, Air Force System Command sponsored Lincoln Laboratory to develop a radar-signature-based near-real-time automatic-launch object-identification system to augment the metric-only launch object-identification process. This development was implemented and successfully tested at the end of February 2004. Since then, this system has been applied to over 50 launches with over 90% correct identification in support of the U.S. Strategic Command's Joint Space Operations Center.

With the advance of many new satellite assessment applications, it became clear that the data processing, data sharing, and information exchange paradigm had to be changed. In 2006, under Air Force sponsorship, the Laboratory initiated an effort to redesign the satellite assessment environment: new application software is rewritten in the Java programming language suitable for many different types of computer platforms; analysis tools and databases are being re-architected and modularized so that they are more conducive to future expansions and information sharing; and application graphical user interfaces are retooled to provide a common look and feel to enhance ease of use and analyst training (Figure 10-18).



**Figure 10-19**  
Conceptual process for assessing threats to U.S. space systems and services.

In the next few years, many of these applications will be further extended to become network-centric, web-based services under the Extended Space Sensors Architecture (ESSA) program so that analysis tools and products are more accessible to various users.

### Emergence of Threats to U.S. Space System Survivability

The end of the Cold War enabled the United States to enjoy more than a decade of unchallenged preeminence in space. While the threat to U.S. satellites from the former USSR receded into history, U.S. reliance on space increased steadily, exemplified by the first Gulf War, termed the first “space war.” Warfighter dependence on space-based communications, the Global Positioning System, and missile warning placed a premium on the availability of space systems. The U.S. and allied air campaign against Serbia (Operation Allied Force) in 1999 further solidified U.S. dependence on space systems. In this conflict, the first use of fully integrated space services was observed: long-range strike aircraft used satellite communications for transfer of near-real-time imagery and targeting information.

As a consequence of the realization that U.S. space systems and services no longer operate in sanctuary, in 2007, the Air Force directed the formation of a Space Red Team, with its technical center at Lincoln Laboratory. The Space Red Team capitalizes on the Laboratory’s more than 30-year-old Air Vehicle Survivability Evaluation (AVSE) program. The approaches developed by the AVSE program for threat assessment and red teaming are being applied to Space Red Team activities. Lincoln Laboratory’s conceptual approach is outlined in Figure 10-19.

Central to Space Red Team activities is the adoption of the system analytical viewpoint, in which a military problem or situation is broken down into its important elements, interactions between elements are identified, and detailed investigations are conducted of the driving elements and interactions. The problem is then reassembled into its entirety in such a way that it is understood both at a big-picture level and at the succeeding levels of detail needed to support this top-level view. This hierarchy of modeling, simulation, and systems approach is augmented and closely coupled to laboratory and field measurements intended to validate the models used in the systems analysis. The intent of this activity is to anticipate evolution in rest-of-world capabilities, to understand how these capabilities might be manifested in improved or newly emergent threats, and to help capability developers identify the most promising responses to these threats.

### Extended Space Sensors Architecture Advanced Concept Technology Demonstration

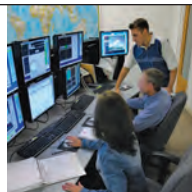
The Space Surveillance Network (SSN) had its genesis in missile early-warning radars that, for more than 50 years, have continuously searched space for potential incoming ballistic missiles. Because typical search ranges extend to altitudes at which many satellites orbit earth, some confusion is possible since satellites and ballistic missiles travel at very similar velocities. The potential for generating a false attack warning is significant unless a highly accurate catalog of all known space objects is available.

A significant consequence of this heritage is that space surveillance is performed within the constraints of the missile-warning network: hardened, low-bandwidth,

2000



A.F. Pensa



Lexington Space Situational Awareness Center



ALTAIR equipped with sidecar is part of ESSA network

point-to-point circuits; zero tolerance for spurious data in the system; new sensors installed only after rigorous, lengthy testing.

However, space situational awareness is much broader than maintaining a catalog of space objects and their positions. It involves processing new space launches, searching for lost objects, predicting collisions between objects such as the International Space Station, determining causes of satellite breakups, and so on. Information other than position data is needed to support these tasks, and often these data are not directly accessible by the warfighter. Providing these data requires sweeping changes to the SSN, but in a way that does not disrupt or degrade current operations.

In 2006, Lincoln Laboratory began the three-year Extended Space Sensors Architecture (ESSA) ACTD to build and demonstrate a network-centric service-oriented architecture (SOA) with operational SSN sensors (see chapter 6, “Communication Networks and Cyber Security”).

An SOA focuses on the loosely coupled relationships between producers of services and consumers of services. This approach provides a natural way to remap the SSN. The providers of data and information are either space surveillance sensors or applications that process data and provide higher-level information. The consumers then are either users or other services that subscribe to the providers.

The ESSA SOA is a collection of nodes and services connected to the Secret Internet Protocol Router Network (SIPRNet) as the common communications

backbone. Use of SIPRNet allows authorized end users, command-and-control nodes, and command centers access to products and services via web-based applications.

To make sensor data available, the ESSA employs sidecar technology. The sidecar is a computer processing workstation that is fed by a data stream in parallel with the sensor’s central processing system. This approach provides a near-real-time, one-way data connection from the sensor to the end user without interfering with the sensor’s primary data and processing architecture. Sidecars expose the sensor mission data and other information in a network-centric manner and will provide services ESSA subscribers can access and utilize.

The ESSA architecture was demonstrated in three phases. In the initial phase, the first sensor sidecar was deployed on the HAX radar to generate and publish real-time space data products, including radar imagery. By publishing these data to SIPRNet, users without prior access could now view the data on their desktop, in real-time as the data were collected in Massachusetts.

The second demonstration deployed sidecars to the ALTAIR and Millimeter Wave radars at the Reagan Test Site and introduced a central data fusion node. This node hosted a set of network-centric services that ingested data from sidecars and produced higher-level, fused information for monitoring deep-space satellites. This demonstration also marked the first use of Net-Centric Enterprise Services for messaging to publish data from ESSA nodes and for consumption through user subscriptions.

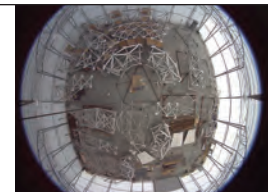
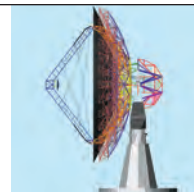
2010



W.M. Brown



G.H. Stokes



HUSIR antenna design

HUSIR antenna  
back-structure



## Geometry Optimized Space-Based Telescope

**Space-based optical telescopes provide the primary means of timely search and track of targets in and around the geostationary belt. Since space payloads are generally mass constrained, they have been restricted to small apertures, which limit their detection sensitivity. The Geometry Optimized Space-based Telescope (GeOST) is a novel concept that exploits sensor-viewing geometry and time-delay-integration charge-coupled-device technology to improve detection sensitivity. The resulting performance is equivalent to increasing the telescope aperture area by a factor of ten. The GeOST concept offers operational capabilities utilizing a microsatellite-class spacecraft and allows substantial cost and schedule saving. Technical advances such as the ones being developed with GeOST are instrumental in providing capabilities that meet national space surveillance objectives.**

The final demonstration utilized the entire architecture to process a new foreign space launch. Key to this demonstration was the addition of an AN/TPY-2 X-band Missile Defense Agency (MDA) radar. Data from this radar, and other provided ESSA sensors, fed an automated object-discrimination service hosted on the fusion node.

The connection of an MDA sensor to space situational awareness sensors was a significant achievement for ESSA because the sharing of sensors across mission boundaries had long been a goal of senior leaders. The use of network-centric sidecars showed that data sharing was technically possible and set the stage for further interactions between the mission communities.

### Summary

Until 1975, the Millstone radar was the only deep-space radar available to the SPACETRACK system. Four radars and four GEODSS sites subsequently became operational within a very short time, with the help of Lincoln Laboratory technology and the close cooperation of the Air Force Space Command (Figure 10-20).

The cataloged space population has grown to well above ten thousand, of which a couple of thousand are in deep-space orbits. Lincoln Laboratory has played a significant role in space surveillance — from the detection of the Sputnik, cataloged as 1957 alpha, through the development and technology transfer of deep-space sensor innovation — at radar and electro-optical wavelengths.

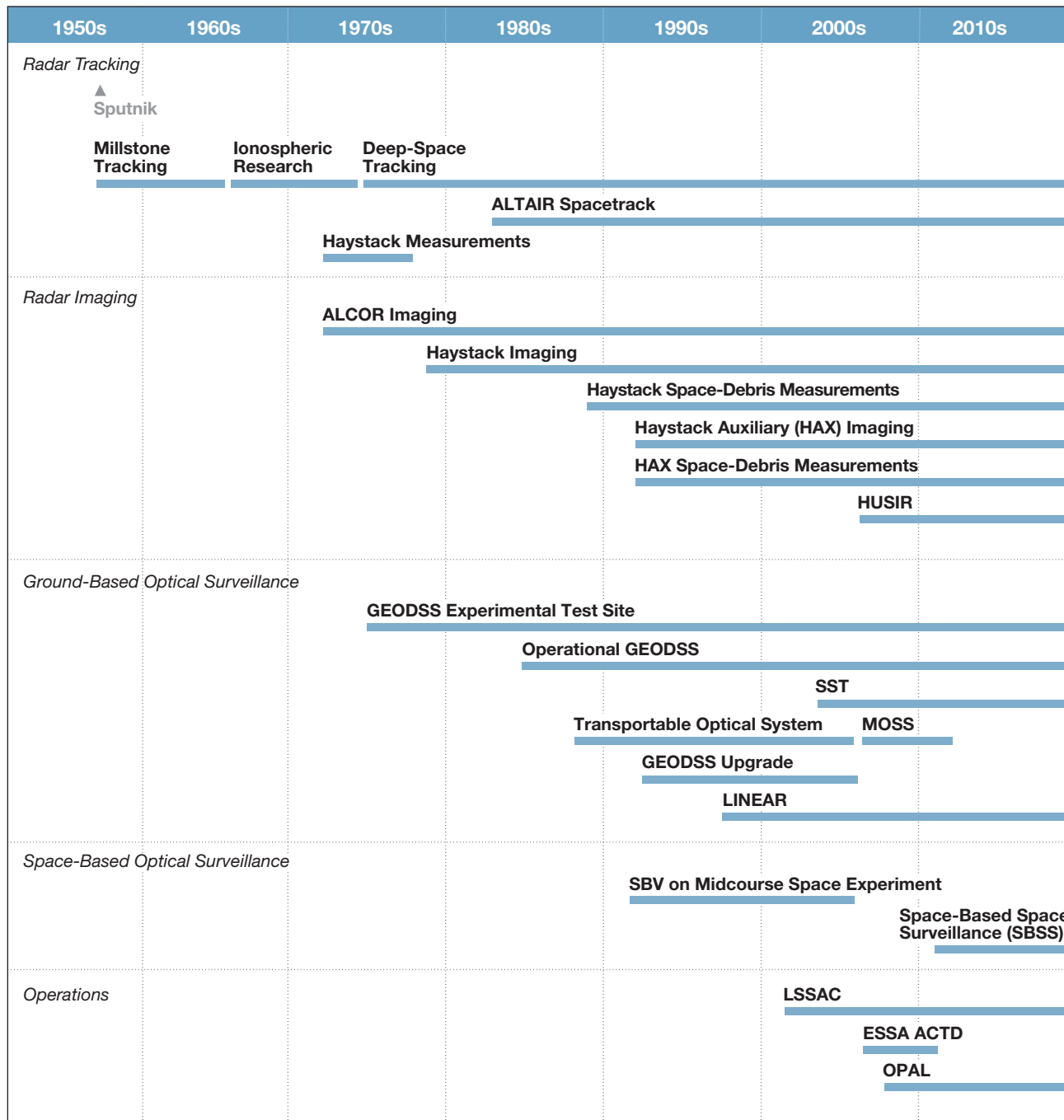
The growth of the deep-space catalog, as more nations develop geosynchronous communications and other systems, has led to the development of significant new sensor systems to search for objects in high-altitude orbits and to characterize the objects once found. Additionally, pollution of space by debris has become an international concern with antisatellite testing by the Chinese, notable on-orbit failures by the Russians and others, and the first payload versus payload collision in early 2009. Furthermore, increased sensor sensitivity and improved wide-area search techniques enable the detection of greater numbers of debris pieces. As space-object identification techniques improve, smaller resident space objects and long-lost large ones are being added to the catalog.

The reemergence of threats to space systems has led to the development of a Space Survivability Red Team, which provides architectural analysis of space systems and space situational awareness systems, and is leading to a methodical approach to increasing the survivability of critical space-provided and space-delivered services. As well, the timelines associated with potential threat events are collapsing to minutes, motivating the development of network-centric, machine-to-machine systems to develop timely space situational awareness based on data from a wide variety of sensor systems and other sources.

The annual Lincoln Laboratory-hosted Space Control Workshop, established in 1980, continues to provide an efficient means for the Laboratory to transfer space situational awareness technology.

National and international interest in space situational awareness is extending to solar-system debris — asteroids and comets smaller than those currently detectable by the astronomical community. Of particular concern is interplanetary debris that could collide with the earth. Search technology and systems developed by Lincoln Laboratory have played a pivotal role in assessing the collision threat and cataloging the populations of asteroids and comets.

**Figure 10-20**  
**Lincoln Laboratory space situational awareness activities.**









**Over the 40-year history of space-based systems used to monitor the earth's meteorological and space-weather environment, the technology employed in these systems evolved to meet demands for increased capabilities. One advancement in capability for the Geostationary Operational Environmental Satellite platforms led to the involvement of Lincoln Laboratory in the development of these systems.**

**Left: Panchromatic-sharpened natural-color image of Boston Harbor. The data are from the April 23, 2001, Advanced Land Imager (ALI) scan of Boston. Runways at Logan International Airport can be clearly seen. The scan was used to test the image quality of the ALI on orbit.**

In 1991, the National Oceanic and Atmospheric Administration (NOAA) and the National Aeronautics and Space Administration (NASA) were developing the next generation of Geostationary Operational Environmental Satellites (GOES), designated GOES I-M. This block of satellites would be the first to be three-axis stabilized, offering opportunity for increased sensitivity and improved update-rate imagery for the system. The on-orbit operational satellites, GOES-6 and GOES-7, were nearing the end of their expected lifetimes, and the development of GOES I-M was delayed for technical reasons. Daniel Goldin, at that time the NASA administrator, contacted Lincoln Laboratory for assistance in reviewing the status of GOES I-M. NASA and NOAA commissioned a study group, led by Herbert Kottler of Lincoln Laboratory and including a host of national experts in the development of space systems, to assess the acquisition process for GOES I-M.

The Kottler Committee, as it came to be known, recommended, among other things, the development of a liaison office between NOAA and NASA to improve communications between the organizations and, most importantly, the development and qualification of an engineering model sensor system to enable understanding of the technical challenges prior to fabrication of the final flight articles. These recommendations were implemented by the government; Lincoln Laboratory participated in the development of the NOAA Liaison Office collocated at the NASA Goddard Space Flight Center (GSFC) with the NASA development team. The Laboratory also contributed design and prototype development assistance in key technical areas. Since that time, the Laboratory has provided independent technical support to NOAA in the development of both the current and next-generation GOES and Polar Operational Environmental Satellite (POES) systems.

#### **The GOES High-Resolution Interferometric Sounder**

As early as 1988, the National Weather Service (NWS) recognized the need for improved atmospheric sounding measurements to enhance initialization of numerical weather-prediction (NWP) codes used to generate mid- and long-range forecasts. Over time, the community settled on a requirement of 1 K absolute temperature accuracy for 1 km thick vertical atmospheric layers that would provide the needed input fidelity to improve model accuracy. This level of temperature accuracy with

such fine vertical resolution implied a significant increase (~500 times) in the spectral resolution of the infrared atmospheric sounders used to make these measurements.

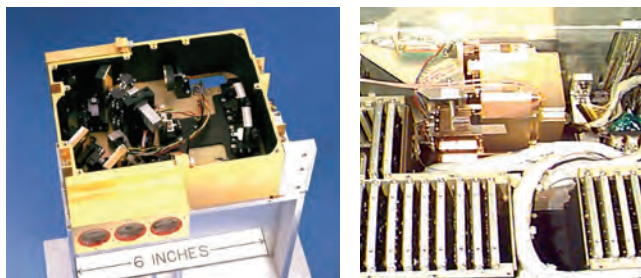
Working closely with NOAA, Lincoln Laboratory undertook a study, starting in 1995, to demonstrate the possibility of upgrading the aft-optics of the GOES I-M sounder to include a Michelson interferometer as a spectrometer. This upgrade, should it prove technically feasible, would enable the inclusion of high-resolution sounders on board the next upgrade of the system, referred to as the GOES N-P series.

This assignment was technically challenging for several reasons. First, the existing GOES I-M sounder system had a limited aperture and limited volume available behind the telescopes to incorporate a complicated system such as a Michelson interferometer. Second, at that time, nobody had demonstrated the ability to fly an interferometer, with the requisite high-performance metrology system, in space for any extended period of time. Metrology laser lifetime, mechanical stability, and component lifetime for the moving pieces were major concerns for the program. Finally, the interferometer needed to be designed to permit alignment to very high tolerance at room temperature and to maintain that alignment as it was cooled to an operational, on-orbit temperature of ~80 K.

With a small team, Lawrence Candell was able to quickly demonstrate a laboratory version capable of meeting the spectral resolution requirements for the system and of maintaining alignment over the required temperature range (Figure 11-1). The athermalized mechanical system was developed by Darryl Weidler with optical engineering support from Danette Ryan-Howard. This first demonstration of capability led to a full protoflight development, including demonstration of long-life capability for some of the critical mechanical parts. David Weitz led the final protoflight development and, in 1997, demonstrated end-to-end system capability after integrating the Lincoln Laboratory hardware into the ITT engineering model sounder in Fort Wayne, Indiana. Using this integrated system, the GOES High-Resolution Interferometric Sounder (GHIS), Weitz demonstrated that all technical system requirements could be met with a retrofitted interferometer system.

**Figure 11-1**

The GHIS system. The left-hand image is the GHIS interferometer designed and built by Lincoln Laboratory. The right image shows the interferometer installed in the GOES sounder flight instrument prior to testing at ITT in Fort Wayne, Indiana.



**Figure 11-2**

NAST installed on the Proteus.



However, because of cost constraints, NOAA decided to forego this upgrade and maintain the baseline 16-channel sounder.

#### **NPOESS Airborne Sounder Testbed**

As the GOES program moved forward without implementing the GHIS system, the next-generation polar system, the National Polar Orbiting Environmental Satellite System (NPOESS), was under development jointly with the U.S. Air Force, NOAA, and NASA. The baseline sounder system for the NPOESS system is a Michelson interferometer. On the basis of the Laboratory's success with the GHIS instrument, the NPOESS Integrated Program Office asked the Laboratory to develop a prototype sounder suite to be flown on board an airborne test platform for risk mitigation and early algorithm development. In response to this request, the Laboratory began the NPOESS Airborne Sounder Testbed (NAST) development.

The baseline sounder suite on board NPOESS is a combination of the Advanced Technology Microwave Sounder (ATMS) and the Cross-track Infrared

Sounder (CrIS). In order to provide a suitable risk mitigation and validation test bed, Lincoln Laboratory needed to develop both an infrared sounder and a microwave sounder to be collocated on a single high-altitude aircraft to collect data simultaneously. In order to complete this challenging task on schedule and within the budget available, the Laboratory teamed with the Remote Sensing and Estimation Group of MIT's Research Laboratory of Electronics (RLE), under the direction of Professor David Staelin. Staelin and his team of graduate students and researchers were responsible for the development of the microwave portion of the system (NAST-M), while Daniel Cousins and his team at the Laboratory were responsible for the development of the infrared portion of the system (NAST-I). NAST has flown on three high-altitude research aircraft — the NASA ER-2, WB-57, and Proteus (Figure 11-2).

The NAST-I instrument is an imaging Fourier transform spectrometer (FTS) that collects data with 7337 spectral channels ( $0.3 \text{ cm}^{-1}$  spectral resolution) spanning the wavelength range from  $3.54 \text{ }\mu\text{m}$  to  $16.13 \text{ }\mu\text{m}$ . Flying at 65,000 feet, the NAST-I has a spatial resolution of 2.6 km (nadir footprint) and an instantaneous field of regard of  $7.5^\circ$  ( $\pm 23 \text{ km}$  field of regard). This system was developed and demonstrated in approximately 24 months (1996 to 1998), and was transitioned to operation at the NASA Langley Space Flight Center, where it remains operational today.

The NAST-M instrument consists of a multichannel microwave sounder system spanning the frequency range of 50 to 425 GHz. NAST-M was designed to match, and in some areas exceed, the performance of the ATMS sensor. Notwithstanding the absence of the low-frequency water-vapor lines and upper-air sounding channels, NAST-M provides higher spatial resolution and wider spectral coverage than does ATMS. There are four spectrometers, and the receiver front ends operate near 53, 118.75, 183.31, and 424.76 GHz. NAST-M has a combined set of 30 channels. The 425 GHz spectrometer demonstrated the first airborne measurements at these frequencies and has provided unique data available for precipitation measurements. All of the spectrometers' antenna footprints are collocated in a cross-track scan pattern and have a nadir spatial resolution of 2.5 km while

## Environmental Monitoring Systems

Environmental monitoring systems employ a variety of sensing modalities, such as satellite-based imagery and broadband radiometry (remote sensing), to achieve forecast accuracy (Figure 11-3).

The optimum system for monitoring the earth from space should provide high spatial and temporal resolution imagery and radiometry for all locations on the earth at all times. A system capable of providing data of this complexity has not been within technological or fiscal reach (though future systems may achieve these goals). The compromise system as it has evolved over the 40 years of the space era includes a constellation of low earth-orbiting (LEO) satellites providing global coverage with temporal resolution of ~6 hours coupled with a group of geostationary orbiting (GEO) satellites providing hemispheric coverage with high temporal resolution (~10s of minutes) (Figure 11-4). The U.S. LEO constellation is the POES system while the GEO constellation is the GOES system.

The different orbital platforms also provide different observing capabilities. For example, passive microwave radiometry of the earth is useful in measuring atmospheric water content even in the presence of clouds. Infrared systems provide atmospheric water vapor profiles but

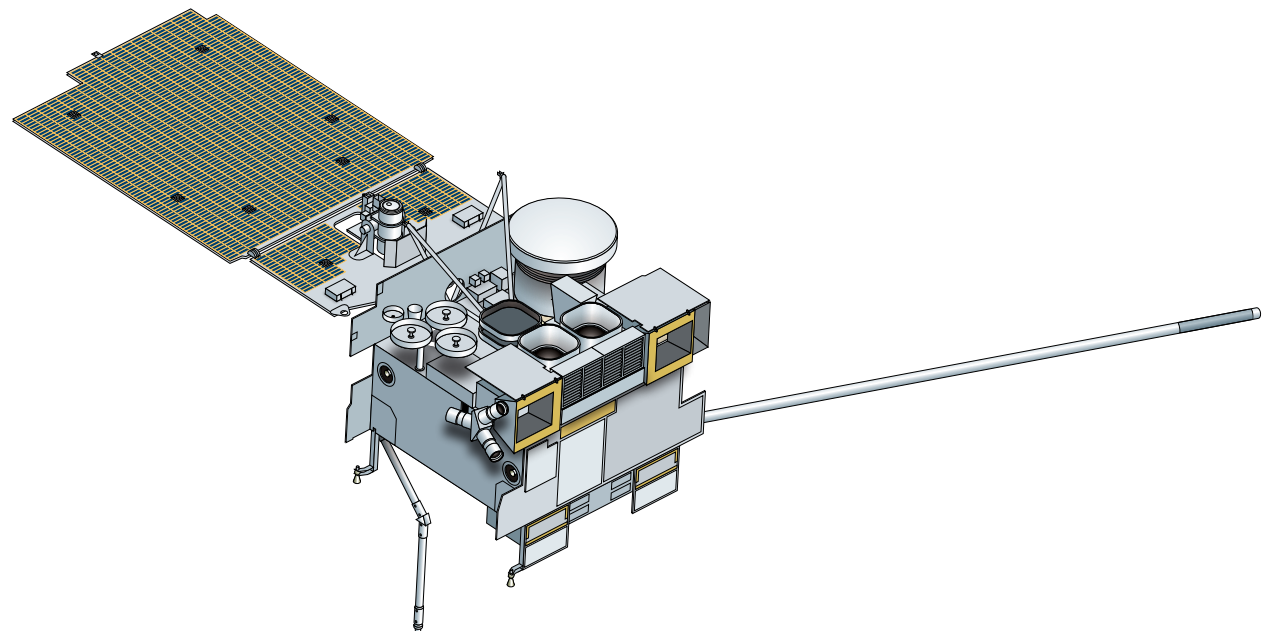
are limited to clear air columns, while microwave systems can penetrate most cloud types. Combining data from infrared systems with data from microwave systems provides optimal atmospheric water vapor sounding. GEO satellites also provide a better capability for observing the sun (the driving force of the space environment, or space weather) than is available from LEO systems. For this reason, the GOES platforms include X-ray and extreme ultraviolet sensors to provide imagery and spectrometry of the sun. Both POES and GOES include in situ charged-particle and magnetic-field sensors for determining the state of the local space environment.

Given the complexity of the space-based portion of the U.S. environmental monitoring infrastructure, it is not surprising that from time to time technological challenges arise in the development of these systems.



Figure 11-3  
GOES image of Hurricane Katrina as she heads toward New Orleans.

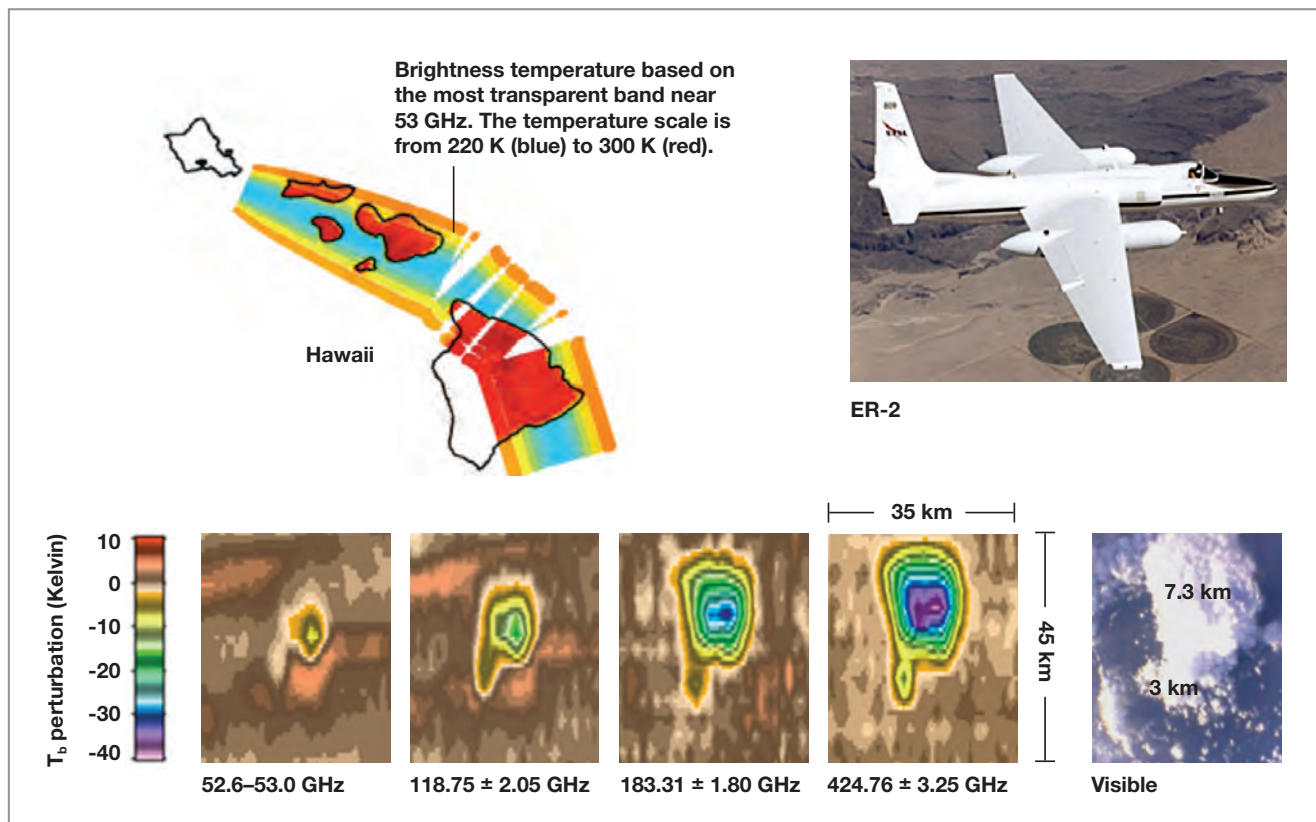
Figure 11-4  
Rendering of the GOES series N-P satellites (below).





**Figure 11-5**

**NAST-M brightness temperature images.** These data were collected during a data collection experiment over the Hawaiian Islands with a flight path shown in the upper left. The NAST system, installed on the NASA ER-2 aircraft (top right), collects data in the microwave regime. The images on the bottom demonstrate the ability of the sensor to see all portions of a cloud from the ground to the top. Four of the images show the structure of the thunderstorm pictured on the right as a function of wavelength; as the frequency increases, higher (and colder) portions of the cloud structure are seen.



flying at an altitude of 20 km. Figure 11-5 shows examples of NAST-M brightness temperature images. The NAST-M sensor has been upgraded several times since its fabrication in 1998 and is currently operated and maintained by Lincoln Laboratory to support NPOESS calibration and validation activities through field campaigns.

#### **From Advanced Baseline Sounder Path to Digital Focal-Plane Array**

As Lincoln Laboratory developed the GHIS and NAST-I interferometers for use as atmospheric sounders, it became clear that the limiting technology in these complex systems was the cooled HgCdTe (mercury cadmium telluride) detector subsystem. The existing analog technology limited the detector's output rate to approximately ten million pixels per second for each analog output. For large-format arrays of  $512 \times 512$  pixels, the analog technology limited the frame rate to approximately 40 frames per second for each output.

To address this problem, Candell and his team developed a conceptual design for a digital focal-plane array (DFPA). The fundamental concept was to digitize the signal from each pixel within the pixel itself (see the sidebar "Digital Focal-Plane Array Technology"). This approach eliminates the need for high-speed analog output circuitry on the array and allows the use of high-speed digital outputs, thus providing several significant system advantages. This simplification has several important system impacts. First, postprocessing electronics needed to receive and prepare the analog signal for digital conversion can be eliminated from the system. Second, the very-high-speed, precise (14 bits) analog-to-digital converters themselves can be eliminated. Third, transmission of digital signals off-chip instead of analog signals reduces noise susceptibility, reduces overall power consumption, and can improve system sensitivity.

Conceptually, the DFPA is quite simple; however, the implementation of these concepts has taken several years to achieve maturity. Michael Kelly took the lead on

the implementation of this device and has developed a component capable of meeting many needs in both imaging and spectroscopy applications of infrared systems. Recently, the DFPA has been integrated into a Michelson interferometer by Juliette Costa, Kristin Clark, Joseph Costa, and Jenna Samra. The performance of the combined system is encouraging and will likely lead to future system demonstrations.

### Algorithm Development

Lincoln Laboratory has further contributed to U.S. environmental monitoring satellite programs by developing and improving the parameter retrieval and radiative transfer algorithms needed to derive geophysical products from the radiometric measurements. A principal challenge presented by the NPOESS generation of atmospheric sounders is the wealth of data that is generated, primarily in the spectral domain, where 1000s of spectral channels are measured in every spatial pixel. William Blackwell has led the development of a new class of efficient and accurate retrieval algorithms based on advanced signal processing techniques, including principal components analysis and neural network estimation. These algorithms have been shown to exceed state-of-the-art performance in profile retrieval accuracy while affording a computational efficiency advantage approaching three orders of magnitude in some cases.

Although the 20-channel Advanced Microwave Sounding Unit (AMSU) was launched in 1998 on the NOAA-15 satellite, and the 2378-channel Advanced InfraRed Sounder (AIRS) was launched in 2002 on the NASA Aqua satellite, intense efforts to maximize their joint sounding performance continue at the Laboratory today because room remains for useful future improvements in both accuracy and yield, particularly in cloudy regions and over problematic terrain. Clouds and terrain remain challenging primarily because their complexity can far exceed the degrees of freedom easily incorporated in physical models. Similar complexity limitations characterize models for surfaces that have varying vegetation, soil moisture, roughness, and solar and wind effects. The Lincoln Laboratory team's retrievals of cloud-cleared radiances or retrieved parameters partly circumvent these challenges by replacing simple surface and cloud models with robust higher-order relations tuned using accurate hyperspectral observations matched to accurate NWP analysis fields.

## The Next-Generation Polar-Orbiting Atmospheric Sounding Suite: ATMS and CrIS

A suite of sensors scheduled to fly on board the NPOESS Preparatory Project satellite in a low-earth sun-synchronous orbit in 2011 will both continue and improve the environmental data records provided by operational and research missions over the last 40 years. The Cross-track Infrared and Microwave Sounding Suite (CrIMSS)—comprising the Cross-track Infrared Sounder (CrIS) and the first space-based, Nyquist-sampled cross-track microwave sounder, the Advanced Technology Microwave Sounder (ATMS)(Figure 11-6)—will provide atmospheric vertical profile information needed to improve numerical weather forecasting and climate modeling. The ability of ATMS to sense temperature and moisture profile information in the presence of nonprecipitating clouds complements the high vertical resolution of CrIS. Furthermore, ATMS observations are sensitive to scattered, cold, cosmic background radiance from precipitating cloud tops, thus enabling the retrieval of precipitation intensities with useful accuracies over most surface conditions.

ATMS, built by Northrop Grumman Electronic Systems, is a cross-track scanning passive microwave spectrometer that measures upwelling thermal emission from the earth's atmosphere and surface in 22 spectral channels from 23.8 GHz to 183.31 GHz. These channels are principally located near atmospheric absorption lines near 60 GHz (due to oxygen) and near 183.31 GHz (due to water vapor). The footprint diameter of the ATMS measurements near nadir ranges from approximately 15 km (1.1° full-width, half-maximum [FWHM] beamwidth at 183.31 GHz) to 75 km (5.2° FWHM beamwidth at 23.8 GHz) and increases by approximately a factor of two (down track) and three (cross track) at the edge of scan ( $\pm 52.8^\circ$ , 2500 km total width). Each of the 96 ATMS footprints



Figure 11-6  
ATMS.

in a single scan is stepped at 1.1° increments, thus providing Nyquist sampling of the 2.2° FWHM beamwidth temperature sounding channels near 60 GHz.

CrIS, built by ITT Space Systems Division, is a cross-track scanning infrared Fourier-transform spectrometer with 1305 spectral channels in three noncontiguous bands spanning 650 to 2550  $\text{cm}^{-1}$ . The spectral resolution of the long-wave, mid-wave, and short-wave bands is 0.625  $\text{cm}^{-1}$ , 1.25  $\text{cm}^{-1}$ , and 2.5  $\text{cm}^{-1}$ , respectively. The CrIS focal plane consists of nine detectors at each of three bands arranged in a 3 × 3 configuration with a 14 km footprint diameter at nadir. CrIS has demonstrated unprecedented radiometric sensitivity in the long-wave and mid-wave bands, and short-wave sensitivity is commensurate with the current state of the art. Global temperature and moisture profiling root-mean-square accuracy with CrIMSS in non-precipitating conditions is expected to approach 1 K/15% in 1 km layers.

Through collaborative work with Marilyn Wolfson and other members of the Weather Sensing Group, the team analyzed future instruments by replacing radiance observations with values simulated using cloud-resolving NWP models; validation has included comparisons of simulations with observations.

Lincoln Laboratory has employed high-resolution NAST-M measurements of precipitation to improve scattering radiative transfer algorithms used in the estimation of precipitation intensities. Advances in cloud-resolving NWP models have allowed detailed and comprehensive comparisons of radiative transfer algorithms with NAST-M observations offering high spatial resolution, accuracy, and frequency coverage. Radiative transfer algorithms calculate simulated sensor radiances using atmospheric profiles by numerically solving the radiative transfer equation. The 1 km resolved NWP models are used to simulate the weather phenomenology overflowed by NAST-M during calibration field campaigns. The Laboratory has exploited this unique opportunity to compare simulated NAST-M radiances with observed NAST-M radiances to improve both the radiative transfer algorithms and the subsequent precipitation retrievals.

An important advantage of the retrieval methods previously described is the computational efficiency, which allows rapid processing of long-term sensor data records, thus facilitating detailed studies of the earth's climate system. The complexity of earth climate models can largely be attributed to nonlinear interactions of a vast number of atmospheric and surface processes. Neither the interactions nor the processes are well understood in many cases, and space-based measurements of outgoing earth radiance over a broad range of wavelengths provide valuable geophysical information to better characterize atmospheric trends and to help facilitate detailed studies of the earth's climate system. The complexity of earth climate models can illuminate and isolate the confounding interactions. Furthermore, a resurgence of wide-scale multidisciplinary technology efforts focused on global energy systems has necessitated a detailed investigation of concomitant long-term environmental impacts.

Lincoln Laboratory's atmospheric retrieval and radiative transfer algorithms are being used to study the earth's climate system in a variety of ways. Long-term records of global temperature and moisture fields are currently being generated from a 30-year record of POES satellite observations to help assess the earth's radiation balance and characterize important climate feedback processes. The methodologies used to retrieve temperature and moisture are also being adapted to retrieve greenhouse gas concentrations from current and future satellite measurements in the infrared and ultraviolet wavebands. The Laboratory continues to collaborate with several groups, including Staelin's group at MIT, to improve the integration of global measurements of rain and snow into climate models forecasting ice-sheet extent, an important influence on the climate system because of its effect on the transport of heat via thermohaline circulation in the North Atlantic and southern oceans.

#### **The Advanced Land Imager on Earth Observing 1**

Under NASA's Landsat program, a series of satellites have provided an archive of multispectral images of the earth. Landsat satellites fly in a polar orbit at about 700 km altitude. The Landsat imagers have relatively few detectors in a linear array that is mechanically scanned in the cross-track direction, covering a ground swath width of 185 km. The typical image is also 185 km long along the flight path. The data acquired by the Landsat satellites provide an extraordinary image resource that has been used for years to meet many important needs of business, government, science, and education.

The Advanced Land Imager (ALI) was developed at Lincoln Laboratory under the sponsorship of NASA's New Millennium Program. The purpose of ALI was to validate in space new technologies that could be utilized in future Landsat satellites to achieve significant economies of mass, size, power consumption, and cost, and improved instrument sensitivity and image resolution. The resolution improvement applied only to the panchromatic band (10 m), while all other bands were at the standard Landsat imager resolution of 30 m to provide data continuity. ALI was designed to produce images directly comparable to those from the imager on Landsat 7.



## Digital Focal-Plane Array Technology

Long-wave infrared (LWIR) imaging enables a variety of applications, including atmospheric imaging and sounding. These LWIR sensing applications not only demand large-area coverage at high data rates but must also be realized in a sensor design consistent with stressing size, weight, and power platform constraints. As with modern digital photography and video recording cameras, the heart of an LWIR imaging sensor is the focal-plane array (FPA)—the device that converts an optical image into an electrical signal that can then be read out and processed and/or stored. While visible-light-sensitive FPAs can be fabricated using the same integrated circuit (IC) materials and techniques used to produce processor and memory devices, standard IC materials are not sensitive to LWIR radiation. In the fabrication of a working LWIR FPA, the detector array must be mated to a readout integrated circuit (ROIC) that accumulates the photocurrent from each detector (pixel) and then transfers the resultant signal charge from each pixel onto output taps for readout. Commercial and Department of Defense communities have been exploring new LWIR detector technologies as a means to enable larger-format, more uniform imagers, but they have given relatively little attention to ROIC improvements.

Lincoln Laboratory has designed, developed, and tested LWIR ROIC technology that overcomes many of the performance and scaling limitations imposed by conventional ROIC technology, such as storing large signal charge and maintaining the signal-to-noise ratio as the signal is digitized. The Laboratory's approach is to digitize the detector current within each pixel by incrementing a counter each time a small charge bucket is filled; the larger the detector current, the quicker the bucket is filled and the counter incremented. Here the total charge is given by the size of the charge bucket (in electrons) times the digital value in the counter. This approach is in stark contrast to the conventional approach whereby the total accumulated charge must be stored on a large capacitor (with

an associated large bias voltage). The counter containing the digital representation of the detector signal is connected through a multiplexor to its four nearest neighbors; high-speed serializers located on the edge of the ROIC transfer the array contents onto a set of high-speed 2.5 Gbps digital output taps for readout.

This up-front digitization of the detector signal has profound implications with regard to device design and fabrication; the in-pixel digital ROIC can leverage low-voltage, deeply scaled (nanometer class) IC processes that enable low-power, high-component-density designs. Low-power, large-format, small-pixel LWIR FPAs with large dynamic, on-chip digital image processing, and high-speed readout are now possible. In addition, the potential to “package” design components (e.g., analog-to-digital conversion, data transfer, high-speed readout) into libraries makes this approach amenable to rapid prototyping of new and alternate sensor concepts.

In 2002, the National Reconnaissance Office sponsored initial risk-reduction activities to demonstrate the viability of in-pixel digital FPA (DFPA) circuits and high-speed digital readout (at the cryogenic temperatures necessary for sensitive LWIR operation).<sup>\*</sup> The relatively large pixel (60 mm square) test structures designed and fabricated by using a 180 nm IC process validated the in-pixel DFPA approach.

A follow-up multiyear Lincoln Laboratory activity to design, fabricate, and demonstrate in-pixel digital FPA technology was initiated in 2006 and sponsored by the Director of Defense Research and Engineering. The goal was to design, develop, and demonstrate full-format (256 × 256, 30 μm pitch) in-pixel DFPA ROIC technology by using a 90 nm fabrication process (Figure 11-7).<sup>\*\*</sup> The in-pixel DFPA ROICs were hybridized to several different detectors with detection bands spanning short-wave infrared to very-long-wave infrared. The program successfully

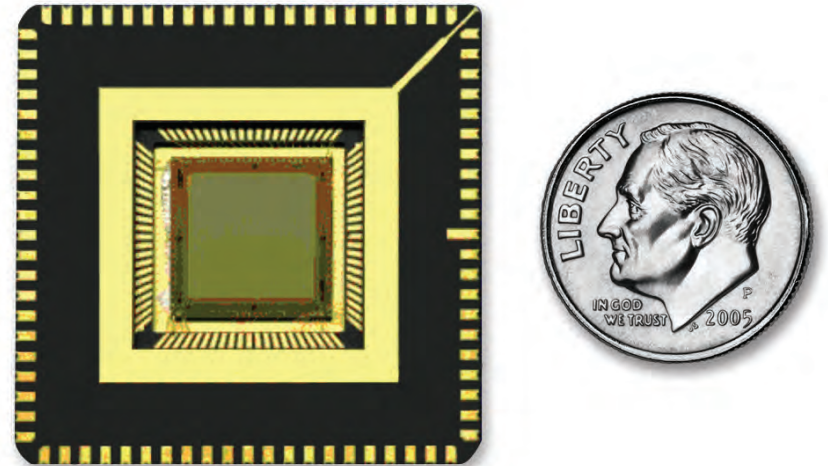


Figure 11-7  
A 256 × 256, 30 μm pitch in-pixel DFPA.

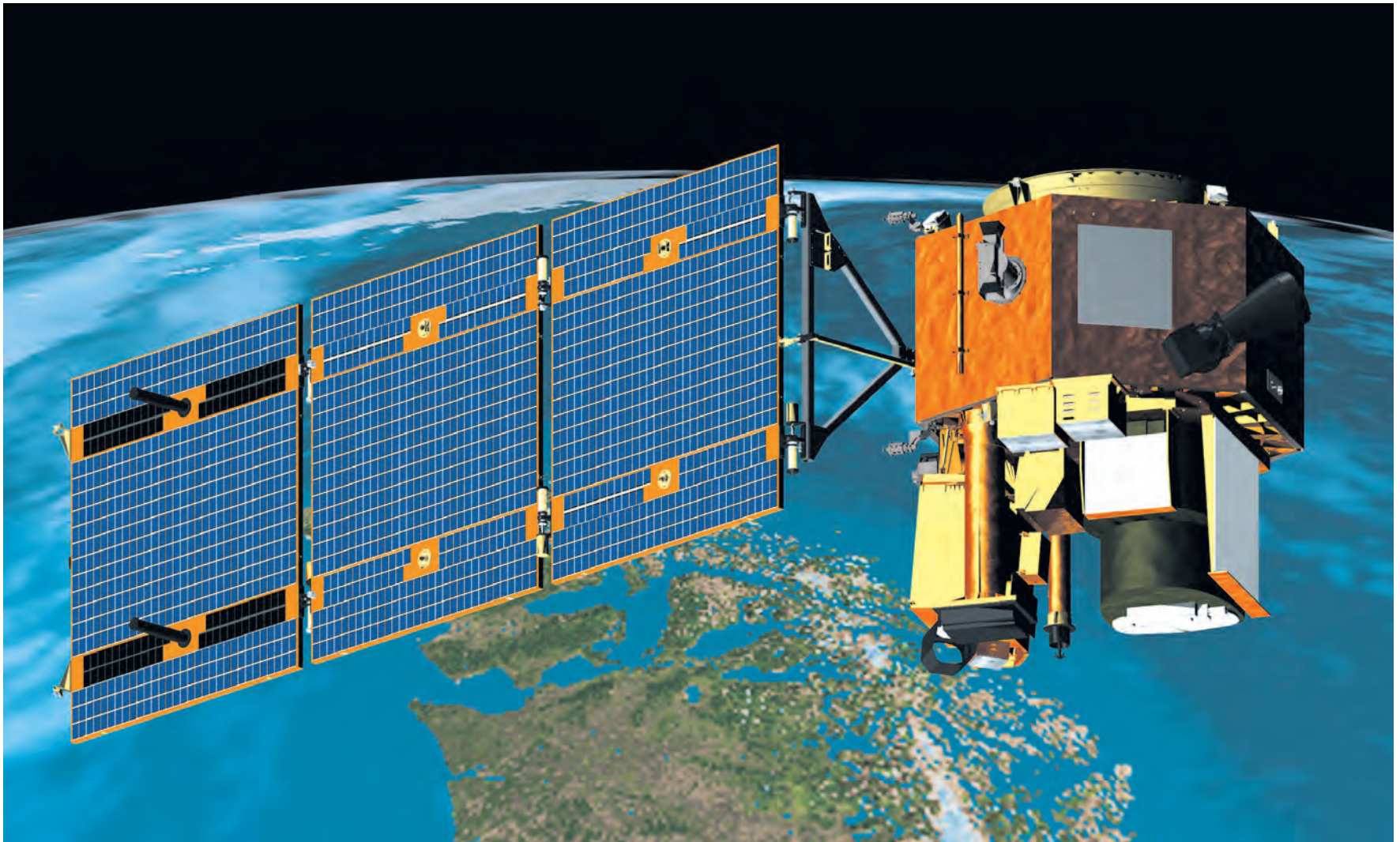
demonstrated wide dynamic range; low read noise; on-chip background suppression; high-speed data rate; on-chip image stabilization, spatial linear filtering, and change detection; on-chip synchronous detection of a pulsed laser in the presence of strong spatial clutter; near background shot-noise limited detection at low input currents; <100 mW power dissipation at 100 Hz frame rate; and successful operation with short-wave infrared through LWIR (up to 14.5 μm cutoff) detector arrays.

The Laboratory is continuing efforts to mature in-pixel DFPA ROIC technology and to develop novel DFPA-based sensors for a variety of applications, including wide-area persistent surveillance and ballistic missile defense. The Missile Defense Agency has funded the development of a pixel capable of supporting bias-switchable, stacked, two-color detector arrays, as well as an effort to mature the DFPA architecture to enable scaling to larger-format devices.

<sup>\*</sup> M.W. Kelly, R. Berger, C.B. Colonero, M.A. Gregg, J. Model, D.L. Mooney, and E.J. Ringdahl, “Design and Testing

of an All-Digital Readout Integrated Circuit for Infrared Focal Plane Arrays,” *Proc. SPIE* 5902 (2005).

<sup>\*\*</sup> B.M. Tyrrell, R. Berger, C.B. Colonero, J.S. Costa, M.W. Kelly, E.J. Ringdahl, K.I. Schultz, and J.R. Wey, “Design Approaches for Digitally Dominated Active Pixel Sensors: Leveraging Moore’s Law Scaling in Focal Plane Readout Design,” *Proc. SPIE* 6900, (2008); M.W. Kelly, C.B. Colonero, B.M. Tyrrell, and K.I. Schultz, “The Digital Focal Plane Array (DFPA) Architecture for Data Processing ‘On-Chip,’” *Mil. Sens. Symp. Detector Spec. Gp.*, Feb. 2007; K.I. Schultz, “Digital Focal Plane Array Technology,” Seminar Series on the MIT Campus — Fall 2008; B.M. Tyrrell, K. Anderson, J.J. Baker, R. Berger, M.G. Brown, C.B. Colonero, J.S. Costa, B. Holford, M.W. Kelly, E.J. Ringdahl, K.I. Schultz, and J.R. Wey, “Time Delay and Integration and In-Pixel Spatiotemporal Filtering Using a Nanoscale Digital CMOS Focal Plane Readout,” *IEEE Trans. Electron Devices*, 56(11), 2516–2523 (2009).



**Figure 11-8**  
Artist's rendering of the EO-1. ALI is on the lower right with the white cover and two radiators (the light-colored rectangles).

ALI achieved a reduction in size by employing a fixed planar array of more than 15,000 detectors operating in push-broom mode, replacing the mechanically scanned linear array of earlier imagers. The planar detector array was coupled to a wide-field-of-view optical system ( $15^\circ$ ) that covered the full swath width of a typical Landsat image (185 km). Lightweight silicon-carbide mirrors were used in ALI to reduce weight. In addition, the HgCdTe detectors were formulated for operation at a higher temperature (220 K) than earlier detectors, making possible passive radiator cooling that also saves weight and power. The focal-plane detector arrays covered a total of ten spectral bands spanning the  $0.4\ \mu\text{m}$  to  $2.5\ \mu\text{m}$  wavelength region. To reduce cost, the focal plane was partially populated, providing  $3^\circ$  cross-track coverage that corresponded to 37 km on the ground. The focal-plane detector array was designed in a modular fashion so that the full  $15^\circ$  coverage could be achieved by simply replicating the current module four more times.

ALI was selected as the main instrument on the Earth Observing 1 (EO-1) satellite. EO-1 was the first of the earth-orbiting missions under the New Millennium Program, which was conceived as a series of lean, less-expensive missions to validate new instrument and spacecraft technologies in flight. NASA's GSFC had overall responsibility for the EO-1 mission. Other imagers on EO-1 are the Linear Etalon Imaging Spectrometer Array atmospheric corrector developed by GSFC and Hyperion, a hyperspectral imager with 220 spectral channels and a 7.6 km swath width, developed by TRW for GSFC. Figure 11-8 shows an artist's rendering of EO-1 in flight, with its protective space cloth removed for illustration.

Under the motto "faster, cheaper, better," NASA allowed some shortcuts in documentation and in the review process, and a reduction in hardware prototype models, in exchange for an increased emphasis on schedule, cost, and performance. The engineering development unit was eliminated, and the qualification and flight units were combined into one, known as the protoflight, unit. Single-point failure modes were allowed in noncritical components. NASA established strict schedules and budgets that were enforced under penalty of mission cancellation.

The development of ALI began in this environment. A small team of unit engineers and scientists was assembled at the Laboratory to carry out the instrument development and testing. The project organization within the Laboratory was as follows: program manager Constantine Digenis; instrument scientist Donald Lencioni; system engineers David Harrison (1996–1997), Ed Bicknell (1997–1999), and Jeffrey Mendenhall (1999–2001); and payload engineering manager Steven Forman.

In addition to the tight schedule and budget, another challenge was the calibration of more than 15,000 detectors in the focal plane. The necessary hardware and software for this calibration phase of the project were developed at Lincoln Laboratory. All the detectors were individually calibrated in a thermal vacuum prior to the launch of EO-1, and their performance has been periodically verified since the launch.

Concurrent with the development of ALI, the necessary ground instrumentation was assembled and software was written to acquire and process the ALI data. This ground-based system was utilized extensively during the ground testing of ALI and also to process the subsequent flight data.

The EO-1 satellite was launched on November 21, 2000, on a Delta II rocket from Vandenberg Air Force Base, California, and inserted into a 705 km circular, sun-synchronous orbit. Within a month, after a series of orbital maneuvers, EO-1 achieved its intended position in formation with Landsat 7. In this position, EO-1 covers the same ground track one minute later than Landsat 7. Images of the same ground areas, at nearly the same time, have been collected by the two satellites for direct comparison.

EO-1 had a primary mission duration of one year but was designed to operate for an additional year. It carried enough consumables for five years. In December 2009, EO-1 and ALI were still functioning nominally and collecting about fifteen images per day. As of July 2011, ALI was still on orbit and collecting images. The total number of ALI scenes currently exceeds 50,000, a 25-fold increase over the original plan for 2000 images.



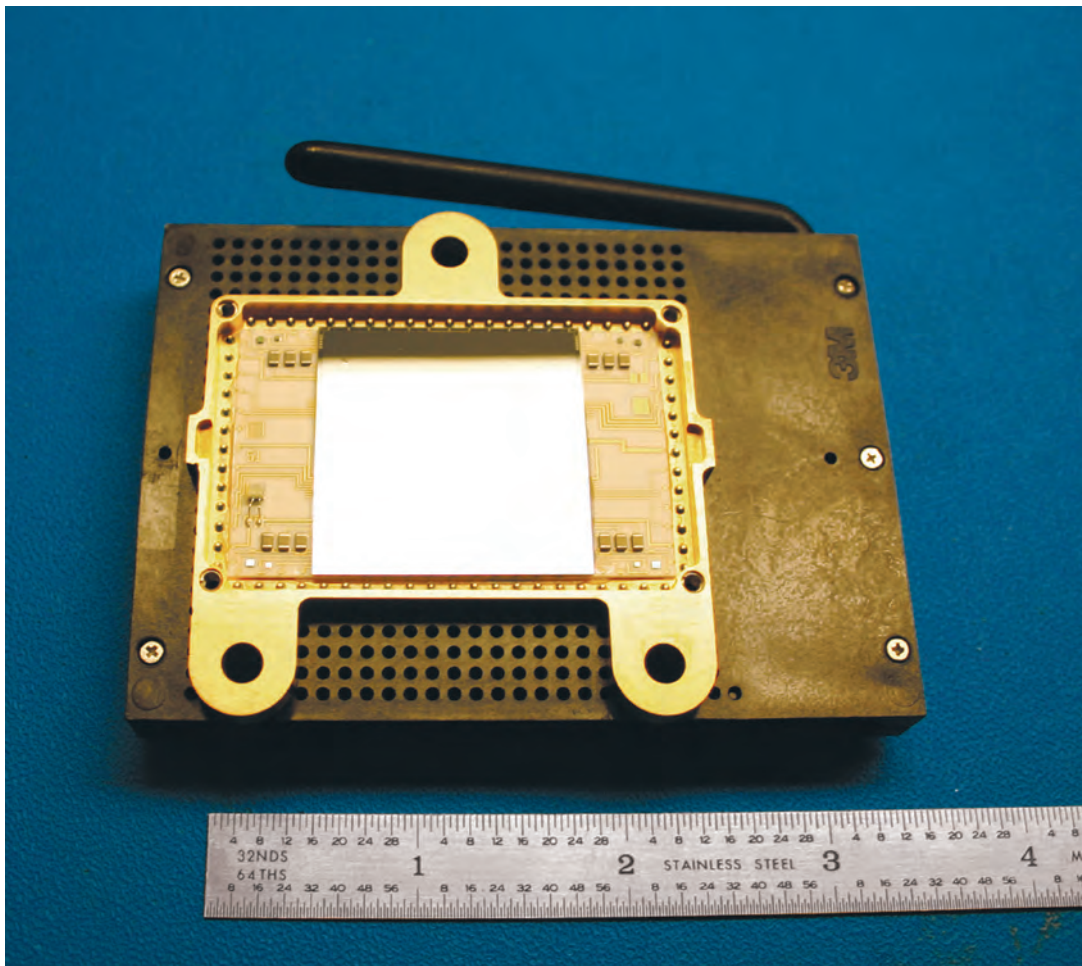
The most serious problem encountered by ALI was the gradual buildup of contaminants on the cold surface of the focal plane. The likely source of the contamination was conjectured to be outgassing products from the black paint on the telescope, caused by insufficient duration of the paint bake-out during ground processing. The problem was first diagnosed during the initial thermal vacuum tests on the ground. It was found that raising the temperature of the focal plane to 0°C for several hours was effective in boiling off the contaminants. As a result, the Laboratory researchers performed a bake-out for several days before shipping the instrument, and it was verified in subsequent testing that there was no evidence of contamination. For good measure, a heater was added to the focal-plane radiator to bring the focal-plane temperature to 0°C while the ALI was on orbit. This heater turned out to be a good feature to implement because contamination reappeared on the focal plane after launch.

It was necessary to conduct periodic bake-outs on orbit to remove the contaminant buildup. Each bake-out cycle lasted about twenty hours. The interval between bake-outs was initially five days, but a gradual decrease in the contaminant buildup rate after the second year on orbit allowed lengthening of the bake-out interval to one month. The cumulative bake-out time over the first year, when most of the reduction in the rate of contamination was observed, was roughly equivalent to a continuous outgassing period of one month. Since focal-plane contamination is not a problem unique to EO-1, a lesson learned is to allow sufficient time after launch for instrument outgassing.

The scientific community has embraced the ALI data; researchers are excited about the greater resolution of the panchromatic band, the greater sensitivity of the multispectral bands, and the overall increased band selection, compared to the imager on Landsat 7. More than 300 scientific publications based on EO-1 data have been generated and many of these are about ALI. An extensive technology-transfer effort has been carried out by NASA and Lincoln Laboratory. This effort consisted of several publications, a number of presentations and workshops in open forums, and many one-on-one interactions with interested instrument vendors. Many of the activities were in support of the Landsat Data Continuity Mission. As of this writing, NASA is pursuing procurement of the Operational Land Imager (OLI), which is expected to bear a strong resemblance to ALI. That event will mark the successful fruition of the EO-1 mission and the continuing contribution of ALI to the science and art of imaging the earth.

#### **Extreme Ultraviolet Variability Experiment**

On the basis of experience gained in support of the solar imaging sensors on board the GOES spacecraft, Lincoln Laboratory began collaborations in 2001 with the NOAA Space Environment Center, the University of Colorado Laboratory for Astronomy and Space Physics (LASP), the University of Southern California (USC), and the Naval Research Laboratory (NRL) to develop the next-generation solar extreme-ultraviolet (EUV) spectrometer for flight on board the NASA Solar Dynamics Observatory (SDO). This collaboration led to the development of the Extreme Ultraviolet Variability Experiment (EVE) beginning in 2002. Lincoln Laboratory contributed unique focal-plane arrays and electronics for use in detecting the EUV solar emission (Figure 11-9), while LASP led the development of the spectrometer instrument, with subsystems provided by USC and theoretical support from NRL.



**Figure 11-9**  
**EVE flight detector. These detectors, the first devices demonstrated to have high, stable quantum efficiency in the EUV regime, provide an enabling technology for the EVE system.**

The purpose of SDO is to study the dynamic behavior of the sun in order to improve both the understanding of the basic physics driving solar dynamics and the ability to forecast future solar activity. The SDO instrument suite includes EVE, measuring high temporal and spectral resolution spectra of the integrated solar EUV irradiance; the Atmospheric Imaging Assembly, measuring high spatial and temporal resolution imagery of the sun in multiple narrowband EUV wavelengths; and the Helioseismic and Magnetic Imager, measuring the three-dimensional solar magnetic field distribution at high spatial and temporal resolution.

The focal-plane arrays developed for EVE are unique in that they have high and stable EUV quantum efficiency even after exposure to substantial EUV radiation. Barry Burke and James Gregory of the Advanced Imaging Technology Group were responsible for the detector development while Gregory Berthiaume from the Sensor Technology and System Applications Group led the overall effort and Brian Languirand of the Fabrication Engineering Group assembled the electronics hardware.

The SDO was launched on February 11, 2010, and a five-year mission is planned, with potential for an additional five years of extended operations.

#### **Summary**

For the past eighteen years, Lincoln Laboratory has provided many technological improvements to the NOAA and NASA environmental monitoring systems. Recent flight programs (EVE, NPOESS, and GOES) provide ample opportunity to continue these contributions to the U.S. environmental monitoring program.







**The Laboratory has been able to apply its surveillance expertise to air traffic control under the sponsorship of the Federal Aviation Administration. Principal technical activities include collision avoidance, hazardous-weather detection, and enhanced safety and efficiency for terminal areas.**

**Left: Takeoff Hold Lights, part of the Runway Status Lights system, in operation at Los Angeles International Airport.**

Lincoln Laboratory's program in civil air traffic control (ATC) began because one man — Herbert Weiss — became exasperated by delays in air travel. Back in the late 1960s, Weiss, as head of the Radar Division, was flying to Washington frequently. As he later recalled, the experience was “horrendous.” Flights were almost invariably late.<sup>1</sup>

Weiss was not alone. In the late 1960s, the U.S. ATC system faced a crisis. The introduction of jet aircraft in the late 1950s had led to a rapid expansion of scheduled air carrier traffic, and the booming economy had stimulated enormous growth in general aviation. Flight delays increased, and the current system appeared to be on the verge of breakdown. Moreover, the projected growth of aviation made substantial improvements in the quality and efficiency of the ATC system imperative.

In the course of waiting for his many delayed flights, Weiss had plenty of time to think about improving ATC. The system needed better radars, computers, and communications — exactly Lincoln Laboratory's areas of expertise. As he considered the problem further, he also realized that the Semi-Automatic Ground Environment (SAGE) program (see chapter 2, “The SAGE Air Defense System”) had essentially been an exercise in ATC — detecting enemy aircraft and vectoring fighters to intercept them. Because the Laboratory's program had broadened substantially over the years beyond air defense, considerable interest and expertise in ATC existed among Lincoln Laboratory personnel.

Lincoln Laboratory had another reason for becoming involved with ATC. By the late 1960s, a sense had developed that the U.S. government was placing too much national research and development talent into defense-related areas and was neglecting important needs in the civilian economy. Therefore, the Department of Defense (DoD) was encouraging its laboratories to demonstrate the applicability of DoD-developed technology and resources to nondefense problems. In particular, the Air Force was willing to permit the Laboratory to use research funds as seed money to develop programs in selected nondefense areas. ATC was particularly appropriate since the Air Force had decided to reduce its own ATC research and development and give the responsibility for joint-use ATC/air defense sensors to the Federal Aviation Administration (FAA).

Weiss began a personal campaign with the FAA. The centerpiece for his crusade was a technical note published in 1968 that proposed a new approach, the “spaghetti tube,” to en route traffic management.<sup>2</sup> Weiss proposed that the FAA create a set of preplanned routes between various American cities, which he called spaghetti tubes, instead of allowing pilots to create their own flight plans. Although pilot objections to the spaghetti tubes ended this proposal, Weiss did succeed in stimulating the FAA's interest in Lincoln Laboratory.

In response to concerns about the growth in air traffic congestion and resulting delays, Lincoln Laboratory formed the Ad Hoc Committee on ATC in 1968. The committee was charged with performing a broad study of the ATC system, examining its problems, and recommending a program for developing solutions. The committee met over several months and, in May 1969, published its report, including a proposal for a Laboratory program in the ATC area.

In September 1969, a study group chaired by Walter Morrow, then an assistant director of Lincoln Laboratory, was convened to further investigate the possibility of new ATC programs. In addition to Lincoln Laboratory personnel, members of this group were drawn from the MIT Flight Transportation Laboratory in the Department of Aeronautics and Astronautics, the Electronic Systems Laboratory, the Measurement Systems Laboratory, and the Draper Laboratory, then part of MIT. Over a three-month period, the study gave its participants a broad education in the various disciplines related to ATC and validated the idea that an ATC program should be pursued. Both the committee and the study group concluded that Lincoln Laboratory had the right mix of capabilities to make a unique contribution to ATC research and development.

To give focus to the development of an ATC program at Lincoln Laboratory, the Laboratory restructured the Radar Division (under the leadership of Weiss) in early 1970 and named it the Air Traffic Control Division. Ongoing defense-related activities were moved to other divisions, and the Air Traffic Control Division became the nucleus for the development of the ATC program. A small number of interested staff members from other parts of the Laboratory joined the Air Traffic Control Division to work with Weiss on the development of an

---

## Notes

**1** This chapter is taken in part from P.R. Drouilhet, “Air Traffic Control Development at Lincoln Laboratory,” *Lincoln Lab. J.* **2(3)**, 331–334, (1989).

**2** H.G. Weiss, “A Concept for Air Traffic Control,” *Lincoln Laboratory Technology Note 1968–29*. Lexington, Mass.: MIT Lincoln Laboratory, 17 October 1968, DTIC AD-678060.

ATC program. Paul Drouilhet was appointed leader of the newly formed Air Traffic Control Group. From this genesis, Lincoln Laboratory’s ATC programs later branched into air traffic surveillance, weather sensing, and decision support domains.

### Surveillance Programs

As Lincoln Laboratory’s ATC programs were being formed, the Department of Transportation created a national committee, the Air Traffic Control Advisory Committee (ATCAC), to examine all aspects of the national air traffic control system, to project the demands on the system for at least the next twenty years, and to recommend a national ATC program. A key element of the ATCAC plan was the upgrade of the existing Air Traffic Control Radar Beacon System (ATCRBS) to allow expanded data communication with individual aircraft and to add an integral data link for two-way communication between ATC facilities and aircraft under control. The principal technologies necessary to bring the concept to reality — radar, signal processing, digital communications, data processing — were well matched to the capabilities and interests of Lincoln Laboratory. Thus, the Discrete Address Beacon System (DABS) became the Laboratory’s initial foray into air traffic control.

### Mode S

In early 1971, the FAA established its first sponsored program at Lincoln Laboratory, a six-month effort to prepare a technical development plan for DABS. The FAA’s key concern with the design of DABS was compatibility: since most aircraft would continue to be equipped with ATCRBS transponders, signals from DABS could not be permitted to interfere with ATCRBS. Lincoln Laboratory’s technical development plan addressed this problem in detail, and the plan convinced the FAA that it was possible to design a new beacon system that would not only be compatible with the old system, but could employ the same aircraft antennas and operate in the same frequency band.

The successful completion of the technical development plan led to a greatly expanded program to develop, test, and demonstrate DABS, including the development of a DABS experimental facility adjacent to the Laboratory and a transportable measurement facility for testing DABS

around the country (Figure 12-1). Several aircraft were outfitted to make airborne measurements, and a number of pilots from the local community, as well as airline flight crews, participated in these flight tests (Figure 12-2).

Lincoln Laboratory completed the basic design of DABS in the mid-1970s. Subsequently, the Laboratory assisted the FAA in developing and testing three commercial prototype DABS sensors. These prototypes were completed on time, performed well, and demonstrated the compatibility of the DABS waveforms with existing ATCRBS equipment.

During prototype testing, Lincoln Laboratory acted as the FAA’s principal technical agent in generating national and international standards for the DABS waveforms and transponder protocols. As a result of this effort, the International Civil Aviation Organization adopted the design and changed the name of the system from DABS to Mode Select, or Mode S. Today, Mode S has been deployed extensively at airports around the globe and at en route surveillance facilities for air traffic surveillance (Figure 12-3).

By the mid-1970s, the Laboratory was well established as one of the FAA’s primary sources for system design and evaluation. After passing the peak of activity on DABS development, Lincoln Laboratory was able to use its growing expertise in ATC surveillance technology to expand into other ATC-related activities, including collision avoidance, advanced surveillance techniques, automation, and weather.

### ATC Radar

Immediately following the initiation of the DABS program, the FAA tasked Lincoln Laboratory with developing an improved airport surveillance radar. The goals were reducing clutter from fixed targets and rain in order to enhance aircraft detection and decreasing the false-alarm rate. “Clean” aircraft target reports were required to support planned improvements to the ATC automation system. In addition, the FAA recognized the need to replace the analog weather displays with concise digitized information that relieved controllers from the need to make meteorological assessments during intense thunderstorm activity. A new digital radar concept, the Moving Target Detector (MTD), was developed to provide a controller’s display free of clutter



**Figure 12-1**  
**DABS/Mode S experimental facility**  
 with two experimental radars in  
 the background.



**Figure 12-2**  
**Aircraft used in early DABS/Mode S**  
**flight tests in front of the Lincoln**  
**Laboratory Flight Facility. The larger**  
**aircraft to the left rear is a Twin**  
**Otter used in the multiple-antenna**  
**surveillance radar program.**



**Figure 12-3**  
**Mode S radars are installed to**  
**support the major U.S.**  
**ATC facilities.**





**Figure 12-4**  
**Airport surveillance radar with Lincoln Laboratory-developed MTD processor in Burlington, Vermont. The surrounding hills provided a high-clutter environment to test and demonstrate the clutter-reduction capability of the radar.**

and a telephone bandwidth data stream for transmitting the information to both en route and terminal ATC facilities. This research and development program led to a field-test program in Burlington, Vermont (Figure 12-4), and the production of the Airport Surveillance Radar Model 9 (ASR-9) by Westinghouse that is deployed at 137 sites nationwide.

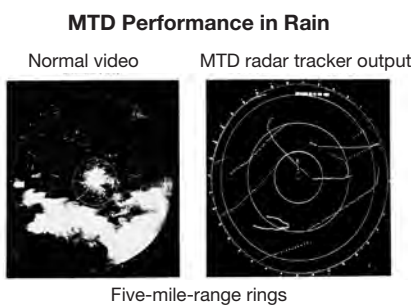
The selection by the FAA in the 1970s of Lincoln Laboratory to develop the improved Airport Surveillance Radar was motivated by the Laboratory's legacy in developing an advanced moving target indicator (MTI) radar, the AN/FPS-18 60 nmi range, gap-filler radar in the 1950s for use in the U.S. Air Force SAGE air defense system (see chapter 2, "The SAGE Air Defense System").

Charles Muehe led the Lincoln Laboratory team that developed the MTD, which features digital signal and data processing, that superseded the World War II-era MTI radar (Figure 12-5). Among the performance improvements attained by the MTD were the reduction of rain and ground clutter and false target reports, a six-level storm-intensity output conforming to the National Weather Service weather-radar standard, and digitization of target and weather data output that enables the FAA to consolidate Terminal Radar Approach Control (TRACON) facilities at sites away from airports.

Following the nationwide installation of 137 ASR-9 radars in the 1990s, the Air Traffic Surveillance Group developed, tested, and refined improvements in radar performance and reliability. The ASR-9 radars were

initially built with 1970s state-of-the-art signal and data processing components that were limited to one million operations per second. Although the MTD met its initial performance objectives, the FAA's need to operate the systems in a variety of challenging environments resulted in the generation of undesirable target reports from moving targets other than aircraft; failure to detect large, low-flying aircraft collocated with intense clutter; and difficulty in sustaining aircraft tracking in regions of dense automobile traffic.

Lincoln Laboratory embarked on the development of an ASR-9 Processor Augmentation Card (9-PAC), which had approximately 100 million operations per second capability that replaced four cards in the production system, and a set of post-detection target processing and tracking algorithms. Extensive in situ characterization of data processing problems, performed by Lincoln Laboratory and William Goodchild of the FAA, led to the development, validation, and certification of new algorithms. Among the improvements were better rejection of false targets and birds, and enhanced detection of low-reflectivity aircraft; the automated generation of multiple layers of selectively higher-resolution clutter maps augmented with automatic, sophisticated selection criteria; diurnal editing of automobile traffic to facilitate aircraft track initiation and maintenance over roads, geo-map-selected interchange of the high and low antenna receiving beams to achieve detection of low-flying aircraft collocated with intense clutter; and improved tracking of targets having acceleration of greater than one g ( $9.8 \text{ m/s}^2$ , the gravitational acceleration at the earth's surface). The 9-PAC hardware and software were manufactured by Northrop Grumman Corporation and installed by the FAA Field Support Group.



**Figure 12-5**  
**Comparison of MTI (left) and MTD (right) on controller's display, observed with the developmental MTD at the FAA Technical Center.**

1970



H.G. Weiss



P.R. Drouilhet



**Figure 12-6**  
**A Lincoln Laboratory test aircraft**  
**in a controlled encounter with an**  
**FAA Boeing 727 aircraft during**  
**TCAS testing.**

#### *Traffic Alert and Collision Avoidance System*

The Laboratory's expertise in ATC beacon surveillance allowed it to address another aviation safety problem — mid-air collisions — for the international aviation community. Interest in development of a collision avoidance system dates back to the 1950s, when a mid-air collision occurred between two U.S. air carrier aircraft over the Grand Canyon. For several decades thereafter, a variety of approaches to collision avoidance were explored, until the 1970s when the FAA narrowed its focus to the Beacon Collision Avoidance System (BCAS), a transponder-based airborne system in which an aircraft desiring protection could carry a special interrogator that would elicit replies from nearby aircraft equipped with the standard ATCRBS or Mode S transponders.

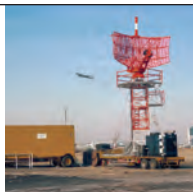
Lincoln Laboratory's involvement in collision avoidance began in 1974, when the FAA tasked the Laboratory to develop the BCAS surveillance subsystem and the MITRE Corporation to develop the collision avoidance algorithms. Shortly thereafter, the system was given its current name, the Traffic Alert and Collision Avoidance System (TCAS).

As with the DABS/Mode S system, Lincoln Laboratory supported BCAS/TCAS development all the way from the basic surveillance concept through the publication of final international standards. This development included initial design and test, technology transfer to industry, and limited implementation program testing (Figure 12-6). The first commercial TCAS systems began flying in 1990. Today, aircraft with more than nineteen passenger

seats or maximum takeoff weight more than 5700 kg are mandated to carry TCAS, resulting in more than 25,000 TCAS-equipped aircraft worldwide.

Starting in the mid-1970s, the Laboratory began TCAS-related monitoring of aircraft in the Boston airspace, using first a Laboratory-developed prototype Mode S sensor and, later, FAA production Mode S sensors. Early monitoring focused on identifying errors in transmitted data that would impact the performance of a collision avoidance system, such as garbled aircraft-reported altitude. Later monitoring focused on assessing the appropriateness of collision-avoidance advisories and the impact of these advisories on airspace operation. Lincoln Laboratory's TCAS monitoring has since expanded into an FAA-led nationwide program involving twenty sites across the United States.

After the introduction of TCAS into the airspace, a mid-air collision near Überlingen, Germany, in 2002 (due in part to one pilot maneuvering opposite to a TCAS resolution advisory) drew new attention to the component of TCAS that determines whether to reverse between climb and descend commands (the so-called sense reversal logic) when conditions continue to deteriorate. Starting in 2004, the FAA reconvened a panel to address proposed improvements to the sense reversal logic. Lincoln Laboratory played a key role in this analysis and safety assessment process, including two major development efforts — creation of a more realistic model describing aircraft behavior during close encounters and a more capable TCAS simulation tool. TCAS analysis tools and expertise are now being extended to the safe management and control of unmanned aerial vehicles.



Transportable  
 measurements  
 facility



Prototype Mode S  
 transponder and  
 pilot display

Between 2005 and 2009, Lincoln Laboratory developed a series of updated and expanded aircraft encounter models based on data from more than 130 radars across the United States. These models allowed for realistic three-dimensional intruder maneuvers and also captured a wide range of aircraft types and encounter situations. In addition to the updated encounter models, Lincoln Laboratory was tasked to perform an independent assessment of the effectiveness of the conflict-resolution component of TCAS. During the initial development of TCAS, Lincoln Laboratory and the FAA William J. Hughes Technical Center had developed simulation and analysis tools to perform specific types of threat-logic assessment in the 1990s. This work was greatly expanded starting in 2004 with the development of the Collision Avoidance System Safety Assessment Tool (CASSATT) at Lincoln Laboratory. CASSATT is a flexible, fast-time Monte Carlo simulation capable of running on the Lincoln Laboratory parallel computing facility, typically involving millions of encounter runs. Analyses conducted using CASSATT and the updated encounter models were key contributions toward the latest version of TCAS, version 7.1, approved in 2009, which resolves the earlier concerns about the sense reversal logic.

#### *Automatic Dependent Surveillance–Broadcast*

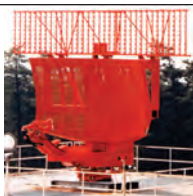
In the late 1970s, the Department of Transportation undertook an examination of the use of satellite-based ATC systems for communications, navigation, and surveillance. Lincoln Laboratory participated in this effort by examining the application of satellites to each of the principal ATC functions. In particular, Automatic Dependent Surveillance–Broadcast (ADS-B) was conceived as a system in which each aircraft broadcasts its aircraft-determined position, intent, and status information once each second. This broadcast position

information can be received by other aircraft and by ground stations, providing robust air-to-ground and air-to-air surveillance. Starting in 2008, the FAA has undertaken a major acquisition of the ADS-B ground environment as a key element of its Next Generation Air Transportation System (NextGen) initiative. Expected benefits from full deployment of ADS-B include positive surveillance coverage in airspace where radar deployment is difficult, improved capability to maintain high-density airport operations in reduced visual conditions, more efficient approach and departure procedures, and, ultimately, reduced separation standards in high-density terminal and en route airspace.

Lincoln Laboratory played a critical role in the conception, development, and testing of ADS-B, and continues to support the FAA's national implementation program. In 1992, the Laboratory proposed to the FAA a technique to leverage the existing Mode S infrastructure for ADS-B. The Mode S transponder spontaneously emits a “squitter” about once per second that contains the unique Mode S address of the transponder. The squitter is used by TCAS to discover the addresses of nearby aircraft. The Laboratory invented the concept of expanding the squitter to include aircraft call sign, Global Positioning System (GPS) position, and flight-plan information as a means of automatic dependent surveillance. The Laboratory obtained a patent on the concept and issued unlimited rights to all users in order to protect the free use of the technology. This concept has evolved into the current ADS-B, allowing aircraft to broadcast and receive ADS-B information by using existing transponder equipment. It has been adopted worldwide as the commercial fleet's standard for ADS-B implementation.



TDWR, Denver



ASR-9



J.C. Fielding



TCAS display indicating traffic conflict





**Figure 12-7**  
**Considered the “Oscar” of aviation, the Collier Trophy was established in 1911. It was named after publisher Robert J. Collier, the first person to purchase a private airplane from the Wright brothers.**

The National Aeronautic Association awarded the 2007 Robert J. Collier Trophy to the Automatic Dependent Surveillance–Broadcast team of public and private-sector groups, which included Lincoln Laboratory (Figure 12-7). The Collier Trophy is awarded annually “for the greatest achievement in aeronautics or astronautics in America, with respect to improving the performance, efficiency, and safety of air or space vehicles.” Past winners include the teams who developed the F-22 Raptor, the Global Hawk unmanned aerial vehicle, and the Space Shuttle.

Implementation of the Mode S extended squitter required several new techniques. Because the new squitter was limited to 128 bits, the Laboratory had to develop a new compression scheme for encoding geographic coordinates, called the compact position reporting format. Since the system was a safety-critical technology, its reliability needed to be established in a high-interference environment. Because the Mode S extended squitter shares the spectrum with other transponders, it was necessary to show that a victim receiver could receive the squitter among as many as 100 other replies per second on 1090 MHz. Lincoln Laboratory also had to show that the system would be robust to other effects (e.g., multipath from low grazing-angle reflections from the sea surface or reflections from structures and aircraft on the surface of a busy airport). The Laboratory conducted key experiments to demonstrate the reliability of the ADS-B extended-squitter surveillance technique and to assess compatibility with other ATC systems operating in the 1090 MHz band. These experiments included tests in the Boston area, the Gulf of Mexico, and high-interference environments such as Los Angeles and Frankfurt, Germany.

The Laboratory’s current support for the FAA’s national ADS-B implementation program includes analysis and modeling of surveillance performance requirements, radar/ADS-B fusion algorithms, 1090 MHz spectrum interference mitigation, and the evaluation of concepts of operation that will exploit ADS-B to enhance future National Airspace System operations. One example of Laboratory support for the ADS-B program is the development of TCAS hybrid surveillance. This concept augments the active TCAS surveillance with passive surveillance of aircraft broadcast position information, thus reducing the active interrogation rate. This technique retains the independence of collision-avoidance functions by using extended-squitter data only when periodically validated by active interrogation, while tracking intruders within the alert boundaries by using active surveillance.

#### **Automation Programs**

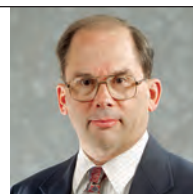
In its early days, the Lincoln Laboratory program for the FAA focused primarily on surveillance. In 1987, the Laboratory broadened its focus to include the development of automation technology to improve the entire air traffic management process (Figure 12-8). At that time, the Laboratory helped the FAA initiate two major automation programs directed at increasing the efficiency and capacity of aircraft operations in the terminal area. These were the Terminal Air Traffic Control Automation (TATCA) program and the Airport Surface Traffic Automation (ASTA) program.

The objective of the TATCA program was to increase airport capacity through the use of controller automation aids as an alternative to the construction of new runways. The TATCA program developed automation tools through rapid prototyping and further refinement

1990



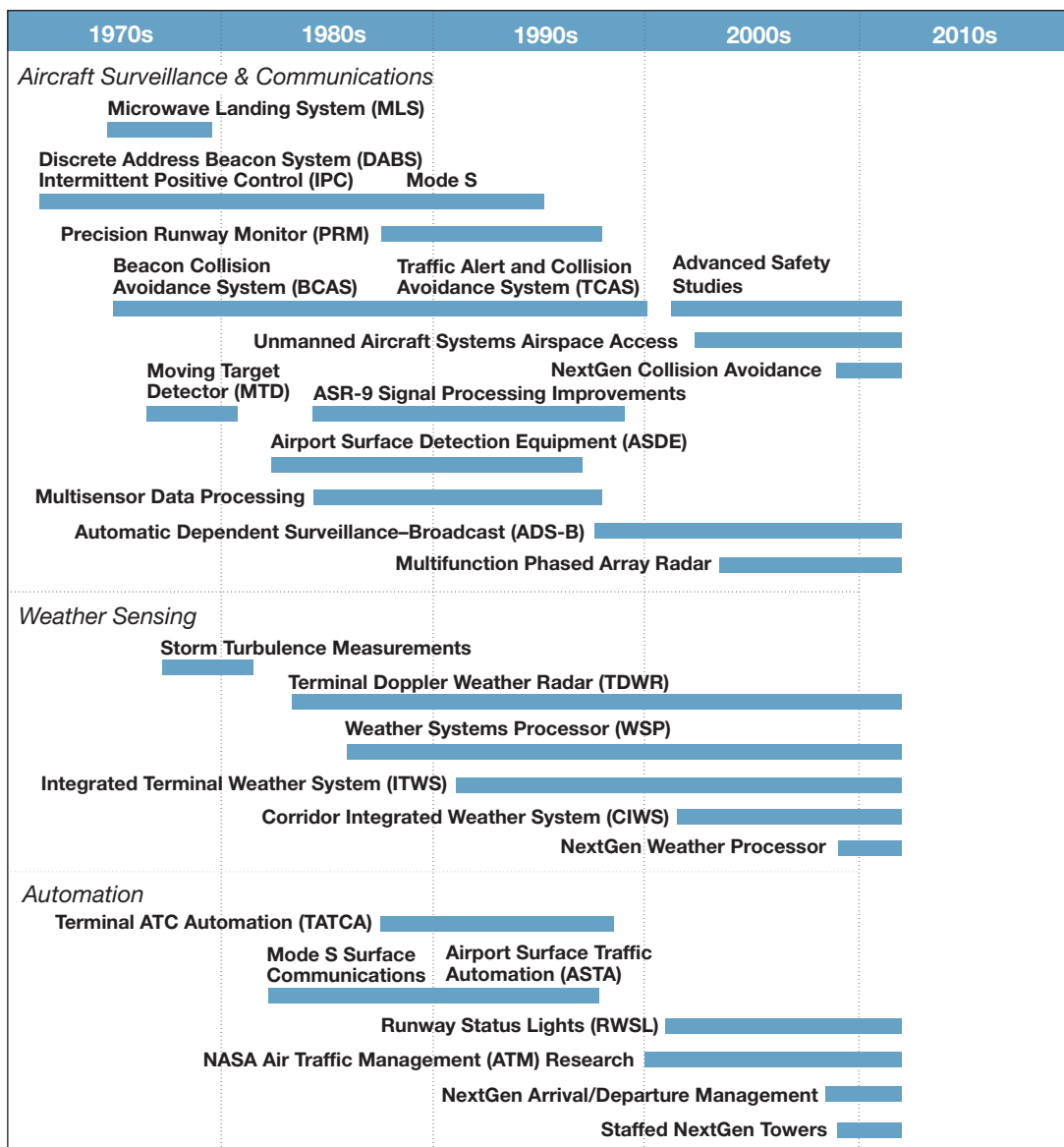
J.E. Evans



R.R. LaFrey



ASTA, Logan Airport model



**Figure 12-8**  
Principal Lincoln Laboratory programs for the FAA from 1971 to the present.

in operational field sites at Denver and Dallas airports. Lincoln Laboratory created the system infrastructure and interfaces needed to tie the experimental workstations to the existing FAA equipment and provided the algorithms essential for precise trajectory-based timing predictions. The Laboratory also performed extensive reengineering of prototype software to improve its modularity, robustness, and maintainability.

Lincoln Laboratory undertook important automation activities to support the FAA's oceanic and en route program offices. The goal of the oceanic program was to develop modern surveillance processing and display capabilities for controllers handling oceanic airspace, where radar surveillance is not available. The Lincoln Laboratory en route program focused on techniques to modernize existing computers and software for displaying surveillance data, processing flight plans, and alerting controllers to conflicts in en route airspace. The Laboratory's work for the en route program office was instrumental in the FAA's decision to proceed with its En Route Automation Modernization program. This major new system, which includes modern computers and completely redesigned en route processing software, is nearing operational deployment in all Air Route Traffic Control Centers.

In the 1980s, Lincoln Laboratory began studying the potential benefit of automation to improve airport surface safety, including demonstration of an ASTA radar-based prototype concept at Boston Logan International Airport (Figure 12-9). However, it was a near-universal conclusion at the time that the existing radar surveillance, which lacked both positive identification of targets and a low false-target reporting rate, was inadequate to support an automation system with reliable performance necessary to be compatible with operations at a complex, busy airport. By 2002, surface surveillance had been improved sufficiently (particularly through the development of the Airport Surface Detection Equipment [ASDE] system in which surface movement radar plots are fused with beacon multilateration position estimates) to justify proceeding with the development of the Runway Status Lights (RWSL) system.

**Figure 12-9**

**Real-time ASTA demonstration at Boston Logan International Airport. The runway status lights were not installed on the airport surface but were displayed on a scale model of the airport, located in the demonstration room in the airport control tower.**



**Figure 12-10**

**Cockpit view at dusk of Takeoff Hold Lights, part of the Runway Status Lights system in operation at Los Angeles International Airport.**



**Figure 12-11**

**Daylight cockpit view of Takeoff Hold Lights in operation at Dallas/Fort Worth International Airport.**



RWSL is an automated, all-weather safety backup for pilots, airport vehicle operators, and air traffic controllers. Surveillance data from ASDE primary radar, ASR, transponder multilateration, and ADS-B sources are combined with airport configuration data to determine when a runway is occupied or about to be occupied by traffic. The time criticality of runway incursions necessitates directly informing pilots of runway occupancy by illuminating new in-pavement red lights visible to pilots about to cross or depart from a runway or by flashing existing approach lights to pilots who are about to land on a runway. Two classes of lights are provided to advise pilots of operations affecting surface movement: Runway Entrance Lights that illuminate in response to high-speed traffic on the runway and Takeoff Hold Lights that illuminate whenever an aircraft is in a departure position and traffic is downfield on the runway or is projected to enter the runway in the next few seconds (Figure 12-10 and Figure 12-11). Pilots use RWSL as another means of maintaining situation awareness of traffic on active runways while continuing to comply with ATC-issued clearances.

Lincoln Laboratory was tasked to execute a multiphase effort to integrate a prototype ASDE-X (Model X) system at Dallas/Fort Worth International Airport (DFW), develop effective algorithms, and demonstrate the system at a limited number of busy intersections on the west side of the airport. Following an engineering test phase at the Laboratory, RWSL was successfully implemented at DFW, starting with shadow operations testing in 2003 through 2004 and culminating in live, operational use beginning in 2005. The system has since been proven to be effective. A 2008 Department of Transportation audit compared 29-month periods prior to and after the installation of RWSL at DFW and determined that the incursion rate had been reduced by 70% on the runway on which it was installed. On the basis of RWSL's successes, the FAA decided to begin deployment of the system to more than twenty airports across the country. As the first steps in this deployment, RWSL has been operating at San Diego International Airport since December 2006, and the system was recently extended to two other runways at DFW.



## Disaster Averted

Certainly one of the most rewarding of the Laboratory's programs has been the Terminal Doppler Weather Radar effort. The TDWR has had a major impact on aviation safety, but never more so than on July 11, 1988, the ninth day of the first operational test of the system's detection capability.

It was a hot and humid afternoon in Denver, Colorado, perfect weather for microbursts. At 4:07, the TDWR reported the presence of microbursts near the approach end of the runway.

Traffic was heavy; five United Airlines aircraft were on the approach. A few days earlier, United had issued a bulletin to its pilots that instructed them to not take off or land if a microburst was reported. But out of the five pilots approaching Denver, only one remembered the portion of the bulletin dealing with microburst advisories.

Within the next six minutes, two of the pilots who attempted to land during the microburst lost altitude in a critical phase of flight. Flight 395 dropped to less than 100 ft above ground level, at a distance of more than a mile from the end of the runway. A second aircraft, Flight 236, lost almost 3000 ft, but remained safely above the airport surface. Only Flight 862, flown by the one pilot who responded correctly to the microburst advisory with an avoidance maneuver, was unaffected.

A transcript of the exchanges between Denver air traffic control and the pilots is given below. The printed word, however, cannot convey either the icy calmness of the air traffic controllers or the fear in the voices of the pilots. It was, as a film produced by the FAA and the National Center for Atmospheric Research was called, *The Day All Hell Broke Loose*.

**862:** Denver tower, United 862 just outside Altur, visual to the right, say your winds please, and we're going to alpha 8.

**ATC:** *United 862, Denver tower. Runway two six right, cleared to land. Microburst alert, center field wind two two zero at niner, a four zero knot loss, one mile final, reported by machine, no pilot report.*

**395:** United 395 inside Altur.

**ATC:** *United 395, Denver tower. Runway two six left, cleared to land. Wind two one zero at five, a four zero knot loss, one mile final. Microburst alert, not substantiated by aircraft.*

**395:** United 395.

**ATC:** *United 395, say your gate.*

**862:** Missed approach. We don't want to make the approach with a microburst alert.

**ATC:** *Who wants to go missed?*

**862:** United 862. We'd like to go to the right here if we can.

**ATC:** *United 862, change to runway to three five right, cleared to land. I do have a microburst alert for that runway. Wind three five zero at fifteen, a four zero knot loss on three mile final.*

**862:** We don't want to make any approach. We'd like to go ahead and hold somewhere until you stop having the microburst alerts.

**395:** United 395, we're missing.

**ATC:** *United 395, fly runway heading, climb, maintain 7000.*

**395:** Seven thousand.

[At this point, United 395 is roughly 20 to 70 feet above ground level. Passengers later report seeing the ground just off the end of the wing. The pilot follows correct microburst avoidance procedure, but his anxiety is evident.]

**ATC:** *United 395, turn right, heading zero one zero, climb, maintain 8000.*

**395:** Okay, say that heading again?

**ATC:** *Turn right, heading zero one zero, climb, maintain 8000, United 395.*

**395:** Zero one zero, 8000, United 395.

**236:** United 236 heavy. Sky Ranch for the left one, we have Buffalo 9 for gate.

**ATC:** *United 236 heavy, Denver tower, microburst alert threshold wind one four zero at five, expect a five zero knot loss, two mile final, runway two six left. Cleared to land.*

**236:** Cleared to land.

**395:** And you say 8000 for United, uh, 395?

**ATC:** *Yeah, 395, affirmative, climb, maintain 8000, heading zero one zero. United 395, fly heading zero three zero for right now, please.*

**395:** Okay, zero three zero, 395.

**ATC:** *United 395, contact Denver Approach, one two eight point zero five.*

**395:** One two eight zero five.

**236:** We're going around, United 236 heavy.

**ATC:** *United 236 heavy, fly runway heading, climb, maintain 7000.*

**236:** Seven thousand.

**949:** Hey, tower, United 949 is marker inbound.

**ATC:** *United 949, caution wake turbulence from the heavy DC-8 going around. Microburst alert, threshold wind zero nine zero at three, expect a seven zero knot loss on a three mile final.*

**305:** United 305.

**949:** United 949, we're going around.

**ATC:** *United 305, microburst alert, threshold wind one six zero at six, expect an eight zero knot loss on a three mile final, say request.*

**305:** Did you say eight zero knots?

**ATC:** *Affirmative, United 305.*

**Unknown:** He's correct.

**Second unknown:** And we can confirm it.

**ATC:** *United 305, what is your request?*

**305:** United 305 is going around.

The plan had been to remove the Lincoln Laboratory TDWR test bed equipment from the Denver airport at the end of the summer so that further tests could be conducted at another site. However, the FAA Air Traffic Service made the decision to continue protection at Denver by operating another experimental radar with the Lincoln Laboratory wind-shear detection software until a production TDWR system became available.

Other early adopters include Los Angeles International Airport, which received RWSL in 2009, and Boston Logan International Airport (BOS) in 2010. The final-approach runway occupancy signal, which flashes precision approach-path indicator lights to warn pilots that the landing runway is currently in use by other traffic, has been tested at DFW. Runway intersection lights, in-pavement lights at runway-runway intersections that indicate that the crossing runway is unsafe to enter or cross because of conflicting traffic, will be first tested at BOS. Design refinements will continue to accommodate special needs imposed by operations, such as the use of RWSL as stop bars to support an active surface movement guidance and control system.

The Laboratory's experience in surveillance, weather, and automation also led it to transition into a lead role in the FAA's Tower Flight Data Manager (TFDM) program in 2008. TFDM is a new terminal automation platform that will provide an integrated tower/user display suite, including an airport-surface traffic display and an extended electronic flight-strip display. The integrated information exchange and processing environment established by TFDM will support a suite of automation-assisted, user support tools collectively designated as the Arrival/Departure Management Tool (A/DMT). A/DMT will develop and manage an integrated plan for arrival, surface, and departure operations at the airport on the basis of four-dimensional-trajectory assignments. A primary concern of A/DMT is the efficient use of the runway complex. In addition, A/DMT seeks to reduce engine emissions on the airport surface, to permit more efficient use of gates and holding areas, and to enhance the safety of surface operations. The above-mentioned development will play a key role in possible future "remote" tower operations.

### **Weather Programs**

The third pillar of Lincoln Laboratory's contributions to air traffic control is based on weather sensing and decision support. The initial weather radar program began in the early 1980s under the leadership of James Evans.

#### *Terminal Doppler Weather Radar and the Integrated Terminal Weather System*

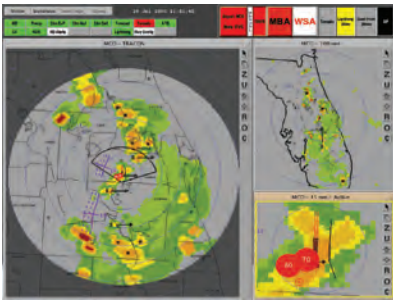
Early work in weather radar focused on Doppler weather radar processing challenges, including ground-

clutter suppression and detection of turbulence based on weather echo spectrum width estimates. In the mid-1980s, a series of commercial aircraft accidents associated with microbursts (powerful, thunderstorm-generated down-drafts and divergent surface wind shear) spurred the FAA to develop a Terminal Doppler Weather Radar (TDWR) to provide wind-shear detection and warning services at large U.S. airports. Lincoln Laboratory was tasked to develop a TDWR prototype and the signal processing and pattern recognition algorithms needed to provide highly reliable, fully automated detection of wind-shear phenomena. The prototype was used for operational TDWR demonstrations at Denver, Colorado; Kansas City, Missouri; and Orlando, Florida. These tests validated the technical and operational viability of the TDWR concept and provided valuable data on regional characteristics of wind shear, supporting detection algorithm optimization for different environments.

New radar capabilities were recognized during the course of developing the TDWR, namely, the ability to detect gust fronts — the wind generated by the outflow of thunderstorms — and to predict the arrival of a front at an airport tens of minutes in advance. This information helps the supervising controller to configure operations in anticipation of the wind shift produced by the gust front, thereby significantly reducing delay in operation and the cost of holding air traffic.

Lincoln Laboratory's TDWR prototype activities resulted in the specification and procurement by the FAA of 47 TDWRs from Raytheon Corporation. The TDWR network was fully deployed during the 1990s, and there has not been a major U.S. wind-shear-related accident since 1994. The Laboratory has continued to support the FAA in optimizing the performance of TDWR wind-shear detection algorithms, modernizing its data processing architecture, and implementing enhancements to its processing algorithms.

The acquisition and life-cycle maintenance costs of TDWR preclude its deployment at medium- and low-density U.S. airports. To provide wind-shear detection services at these smaller airports, Lincoln Laboratory developed a complementary Weather Systems Processor (WSP) augmentation for the ASR-9.



**Figure 12-12**  
**The ITWS showing severe weather**  
**and microburst alerts near Orlando,**  
**Florida.**

The WSP consists of microwave and timing signal interfaces, a high-capacity signal processing computer, innovative signal and image processing algorithms, and ATC displays providing wind-shear warnings for relay to pilots via tower local controllers. The Laboratory developed a WSP prototype and validated its operational performance during field trials at Orlando, Florida; Albuquerque, New Mexico; and Austin, Texas. Northrop Grumman received the FAA contract for WSP implementation and worked closely with Lincoln Laboratory staff to deploy the system at 35 U.S. airports between 2000 and 2003.

During field testing of TDWR and WSP, Laboratory researchers recognized that the broad-area weather surveillance provided by these Doppler radar-based systems allowed terminal controllers to improve tactical decision making relative to weather impacts on arrival and departure operations. For example, controllers identified the value of short-term (0–20 min) thunderstorm motion forecasts in anticipating closures and reopenings of runways and arrival and departure gates. This information allowed them to proactively reroute traffic to reduce ground and airborne holding.

At the TDWR field site in Orlando, an innovative team of air traffic controllers requested that the FAA continue operation of a TDWR prototype at their site. They committed to working collaboratively with researchers from the Laboratory to advance the automated products to meet the FAA's needs. This relationship lasted over sixteen years and led to the creation of a suite of new products that exploited the benefits of multisensor integration, thus extending the scope well beyond what was possible from the TDWR alone. The TDWR still provided basic data for wind-shear detection, but additional sources were used to add a microburst-prediction capability, the extension of high-resolution precipitation coverage beyond the limited terminal domain, and eventually a 1 hr convective weather forecast.

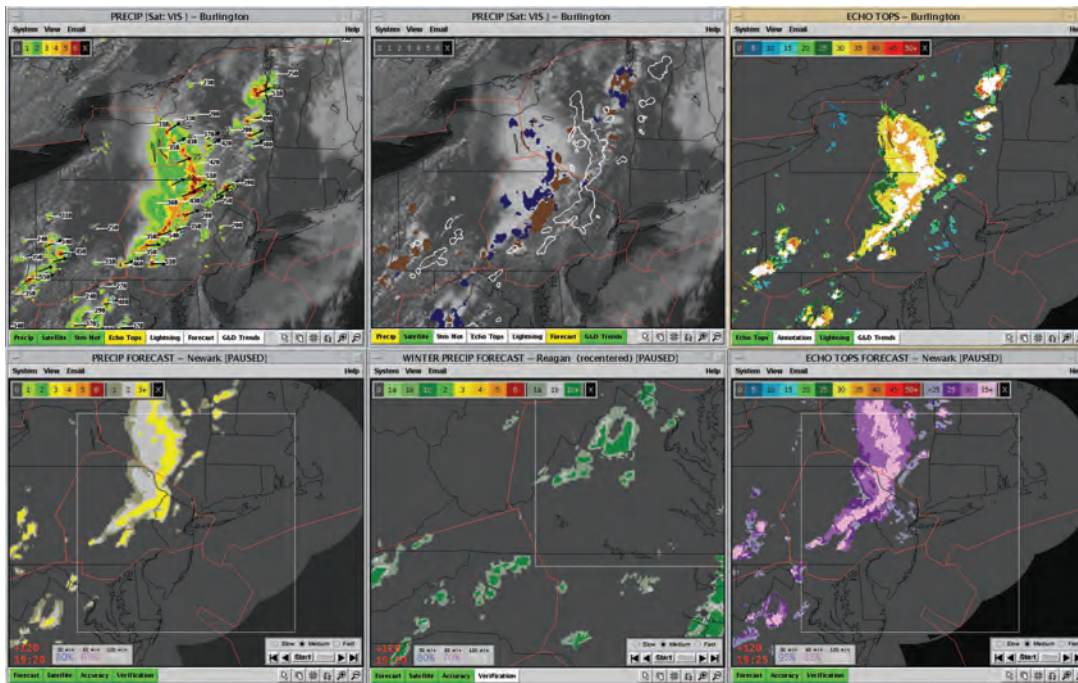
In 1994, the decision was made that most of the algorithms were sufficiently mature to be the basis of a system that could be fielded to every site currently running a TDWR; the forecast capability was to be deferred for the second wave of technology infusion. Thus, the Integrated Terminal Weather System

(ITWS) was born (Figure 12-12). The first step in this process was to establish a second Laboratory prototype in Memphis, Tennessee, to support independent testing at a non-development location. A third site at Dallas/Fort Worth, Texas, was established to represent different climatic and traffic conditions. Operations of these prototypes continued until 2007, when the production ITWS had been through one technology refresh cycle to incorporate the forecast product and could be installed at these locations without loss of capability.

Lincoln Laboratory contributed the high-level specification for ITWS and the detailed specifications for each of the 27 algorithms that were to be part of the initial procurement. Laboratory staff subsequently assisted in the FAA's acquisition through technical involvement with Raytheon. In addition to the role that the Laboratory played in oversight and testing, one of the most interesting outcomes of this process was the evolution of the technology transfer process from one of paper specifications only, to one of paper plus prototype code examples, to finally one in which the code is not only an integral part of the specification but is intended for reuse. This paradigm has continued to evolve to become a lightweight technology transfer mechanism designed to shorten acquisition time and reduce risk to the government.

Additional testing and refinement of the ITWS products and concept of usage were accomplished at the major New York City airports (Newark Liberty, LaGuardia, and John F. Kennedy International) between 1998 and 2004 under a Cooperative Research and Development Agreement between Lincoln Laboratory and the Port Authority of New York and New Jersey. The Laboratory developed and operated a demonstration ITWS with user displays at the towers of the four major airports serving New York City, at TRACON, in the New York Air Route Traffic Control Center, and in the FAA's ATC System Command Center. The functional capability of the system was modified to reflect feedback from the operational users and the results of data analyses by Laboratory staff. Important capabilities developed and refined at New York sites included higher departure rates during Severe Weather Avoidance Plans (including the use of the Route Availability Planning Tool [RAPT] to provide explicit guidance as to when aircraft could safely depart on various departure routes) and also the use of the ITWS high-resolution terminal wind grids





**Figure 12-13**  
CIWS displays.



**Figure 12-14**  
CIWS in operation at the Boston Air  
Route Traffic Control Center.

to increase arrival rates in shared environments and to identify regions of significant wind shear aloft. The New York ITWS also provided the impetus for studies of the extent to which delays at the New York airports were avoidable and highlighted the importance of severe storms at significant distances (e.g., 100 miles) from the airports in causing airport delays. A number of ITWS refinements that were developed and demonstrated at New York (e.g., 1 hr convective forecasts and a mosaic of several Next Generation Weather Radars [NEXRAD]) were incorporated into the production ITWS.

#### *Corridor Integrated Weather System*

The New York ITWS avoidable-delay studies determined that en route traffic congestion caused by severe weather was a significant contributor to delays at major airports (especially those in the northeast quadrant of the United States). Lincoln Laboratory developed a fully automated weather analysis and forecasting system (the Corridor Integrated Weather System [CIWS]) to support the development and execution of tactical (0–2 hr) convective-weather impact-mitigation plans for congested en route airspace. Currently, CIWS combines data from over 100 weather radars in the lower 48 states with satellite data, surface observations, and numerical weather models to dramatically improve the accuracy and timeliness of storm-severity information and to provide state-of-the-art, accurate, automated, high-resolution, animated three-dimensional, 0–2 hr forecasts of storms, including explicit detection of storm growth and decay (Figure 12–13 and Figure 12–14). Real-time observations of the FAA decision-making process during convective weather at Air Route Traffic Control Centers in the Midwest and Northeast have shown that CIWS enables FAA users to achieve more efficient tactical use of the airspace, reduce traffic-manager workload, and significantly reduce delays. Now that transition of CIWS technology is under way, CIWS products will be used on FAA operational traffic-flow-management displays as well as in automated air traffic management (ATM) weather decision support systems.

Operational testing of the New York ITWS and CIWS showed that the determination of ATC impact corresponding to a weather forecast and the development of weather-impact mitigation strategies were very difficult when severe weather was changing rapidly. More effective ATM during adverse weather requires determining





---

**Note**

**3** *Report of the Department of Transportation Air Traffic Control Advisory Committee, Vol. 1, Washington, D.C. (December 1969).*

mapping storm tops accurately for the first time. These products were eventually made part of the national NEXRAD radar system used by the National Weather Service, the FAA, and the DoD.

Lincoln Laboratory achieved a breakthrough in 1 hr convective storm forecasting with the development of large-scale storm “envelope” motion tracking (versus individual cell motion), patented in 1999. This technology has been deployed operationally as part of the FAA CIWS and ITWS systems, and has been licensed to several private vendors, national laboratories, and universities. By using an extension of the 1 hr forecast technology, a 0–2 hr forecast product was deployed for CIWS. Also encouraged by the users were other advancements, such as storm growth and decay trends, and color-coded winter storm forecasts that correctly analyze and forecast the rain-mix-snow precipitation regions.

Achieving a high-quality, short-term forecast capability has enabled traffic-flow managers to do business differently — planning for reroutes and opening closed routes sooner. However, the larger problem of strategic traffic flow management, namely, estimating future storm impact on airspace capacity, requires a longer lead-time forecast. Under the Collaborative Storm Prediction for Aviation, or CoSPA, program, active research is now under way at Lincoln Laboratory to build an aviation-oriented 0–8 hr forecast product, in collaboration with the numerical model developers at the National Oceanic and Atmospheric Administration and other scientists at the National Center for Atmospheric Research, the National Aeronautics and Space Administration, and several universities (MIT, the University of Wisconsin, and the University of Alabama). The planned nationwide 2–8 hr forecast product, with 3 km resolution and new model runs

every hour around the clock, is unprecedented in the United States. The first nationwide demonstration of this technology took place in 2010.

**The Ongoing Program**

Lincoln Laboratory has two groups working on FAA projects. The Surveillance Systems Group focuses on integrated communication, navigation, and surveillance systems for improved air traffic decision support. The Weather Sensing Group focuses on weather phenomena, fusion of data from diverse weather sensors, automatic prediction of hazardous weather events for air traffic controllers and traffic managers, and NextGen tower automation systems. Both groups collaborate closely on integrating these fields of expertise into advanced decision support and automation systems.

For more than 40 years, Lincoln Laboratory has carried out research and development for the FAA.<sup>3</sup> Major outputs of these programs have already played critical roles in supporting the nation’s growing air transportation system. These outputs include systems for the Mode S sensor (for improved surveillance), the Mode S and ADS-B data links (for better communications), TCAS and RWSL (for aviation safety), the ASR-9 radar (for improved detection of aircraft in the presence of clutter), TDWR and WSP (for severe-weather sensing), and ITWS, CIWS, and RAPT (to reduce weather impact on air traffic management).

As current programs are completed, new programs are undertaken. These efforts focus on the use of new technical capabilities to enhance the efficiency and capacity of aircraft operations in the terminal area and on the airport surface. Through these programs, Lincoln Laboratory will continue to play a major role in providing the FAA with critical technology.



M.E. Weber



J.M. Flavin







**In 1977, the Cruise Missile Detection Technology Program was initiated at Lincoln Laboratory to evaluate the survivability of U.S. cruise missiles penetrating enemy air defenses. An advanced air defense effort that complemented the air vehicle survivability investigations was undertaken in the mid-1980s. These programs returned the Laboratory to an important national role in air defense and now rank among the Laboratory's principal activities.**

**Left: The Mountaintop Radar complex at North Oscura Peak on the White Sands Missile Range, New Mexico.**

Air defense has played a prominent role in Lincoln Laboratory's history. The Laboratory was founded in the early 1950s to address the problem of national air defense, but that work diminished significantly with the completion of the Semi-Automatic Ground Environment activity in 1958. By the 1970s, little air defense work remained at the Laboratory.<sup>1</sup> In 1977, however, the U.S. development of the modern cruise missile<sup>2</sup> created a new role for the Laboratory in air defense.

The new assignment was initially not the development of new U.S. air defense capabilities, but the corollary task of developing insights, techniques, models, and experiments that would help to ensure that U.S. cruise missiles could penetrate enemy air defenses. The principal enemy was the Soviet Union, which had built a formidable national air defense system, consisting of thousands of ground radars to guide thousands of aircraft interceptors and about a thousand surface-to-air missile (SAM) batteries at military bases and industrial complexes. The Soviets' modern navy was also equipped with heavy air defenses — mostly of the SAM variety. U.S. cruise missiles were being developed as long-range weapons that allowed U.S. Air Force and Navy aircraft to avoid these intense defenses.

The Laboratory's initial role in 1977 was to characterize these enemy air defenses. In the mid-1980s, the Laboratory took on the additional role of developing air defense technologies against enemy cruise missiles. These two activities, air vehicle survivability and air defense, grew in size so that by 1995 they represented about 25 percent of the Laboratory's total effort.

Although characterizing Soviet weapons and air defenses was the focus of work performed throughout the Cold War, the demise of the Soviet Union did not diminish U.S. interest in air defense and air vehicle survivability. As vividly demonstrated during Operation Desert Storm in 1991, Operation Allied Force in 1999, and Operation Iraqi Freedom in 2003, U.S. cruise missiles and low-observable aircraft continue to play a critical role in regional and theater conflicts.

The Lincoln Laboratory teams working on the air defense and air vehicle survivability programs continue to help the United States maintain a technical advantage by developing future air defense concepts and technologies,

and by assessing the vulnerabilities and threats to U.S. air vehicle operations. These important activities will likely continue for the foreseeable future, providing key insights and material contributions to our national defenses.

#### **Early Controversy over Cruise Missile Survivability**

The introduction of the modern cruise missile caused some controversy, both political and technical. Politically, cruise missiles were worrisome and complicating devices to the arms-control community. Another group, the manned-bomber advocates, also saw them as a threat, and for good reason: in 1977, President Jimmy Carter cancelled the production plan for the original B-1 bomber, partially on the grounds that cruise missiles launched from outside the Soviet Union from the older B-52 bombers would allow weapon delivery into the heavily defended Soviet Union.

There were also technical controversies that surrounded the cruise missile — mainly in the area of their survivability against air defenses. Proponents of cruise missiles thought of them as nearly invisible to surveillance systems, capable of defeating (in a variety of ways) air defense systems designed to handle much larger signature aircraft. The small size and simple shape of cruise missiles made them difficult to detect by radar, electro-optical, and infrared defense sensors. Modern navigation technology allowed them to fly a low-altitude, terrain-hugging flight path and allowed large numbers of cruise missiles to strike with precise timing. Thus, the air defender faced the challenges of detecting a host of low-observable targets and sorting out a complicated air picture.

One Navy proponent of the Tomahawk cruise missile argued:

“Even if you are lucky enough to find it and fire a missile at it and the interceptor missile guides successfully to an intercept, the radar fuze on the interceptor missile won't work because of the low observability of my cruise missile.”

Advocates of SAM systems were far less impressed with cruise missile technology. A proponent of the Improved Hawk SAM system, for example, saw cruise missiles in a very different light:

---

## Notes

**1** Historical material for this chapter was provided by William Delaney.

**2** Cruise missiles were not new in 1977; the Germans had launched over 20,000 V-1 “buzz bombs” against England and Allied forces in Belgium during World War II. However, the modern cruise missile was much more sophisticated: smaller, longer range, more accurate and, with its nuclear warhead option, vastly more lethal.

“This cruise missile looks a lot like the target drones I practice on. It can’t maneuver aggressively, it doesn’t carry electronic countermeasures. It will present my SAM battery with a low-altitude target on a straight and level flight. I will kill it easily — probably a direct hit as in many of my tests.”

### *The 1977 Strategic Penetration Technology Summer Study*

By spring 1977, the controversy over the relative survivability of cruise missiles and penetrating bombers led William Perry, at that time Director of Defense Research and Engineering (DDR&E) and later secretary of defense, to commission a summer study on two topics: cruise missile survivability and B-1 electronic countermeasures. The study was co-chaired by E.C. “Pete” Aldridge of the System Planning Corporation, who later became under secretary and then secretary of the Air Force, and William Delaney of Lincoln Laboratory. A national team of talent was assembled in Washington for the study. Also participating from the Laboratory were Victor Reis, who later became the director of the Defense Advanced Research Projects Agency (DARPA) and then the DDR&E, and David Briggs, who subsequently led the Air Defense Technology Division of Lincoln Laboratory, and eventually became director of the Laboratory.

The cruise missile part of the 1977 summer study concluded that there was substantial justification for controversy over cruise missile survivability. Air defenders and cruise missile designers alike lacked the necessary experience, analytic models, and experimental data to predict the outcome of an adversary’s attempt to engage a low-flying, low-observable cruise missile. Accurate prediction was important: the early cruise missiles had a strategic nuclear deterrent role, and the ability to predict survivability with confidence was paramount.

The list of uncertainties was long and included some basic phenomenological effects, such as the magnitude and statistics of radar ground clutter, the complications of very-low-elevation-angle radar propagation, and the effects of terrain masking. Practical hardware issues of radar sensitivity and clutter rejection, interceptor missile seeker sensitivity and clutter rejection, and fuze performance also frustrated predictions for surface or

airborne defenses. Electro-optical, infrared, and other passive systems had similarly long lists of uncertainties in predictions.

This study convinced the Lincoln Laboratory management that cruise missiles were an important part of future Department of Defense (DoD) weapons capabilities and that the Laboratory had a role to play in their development.

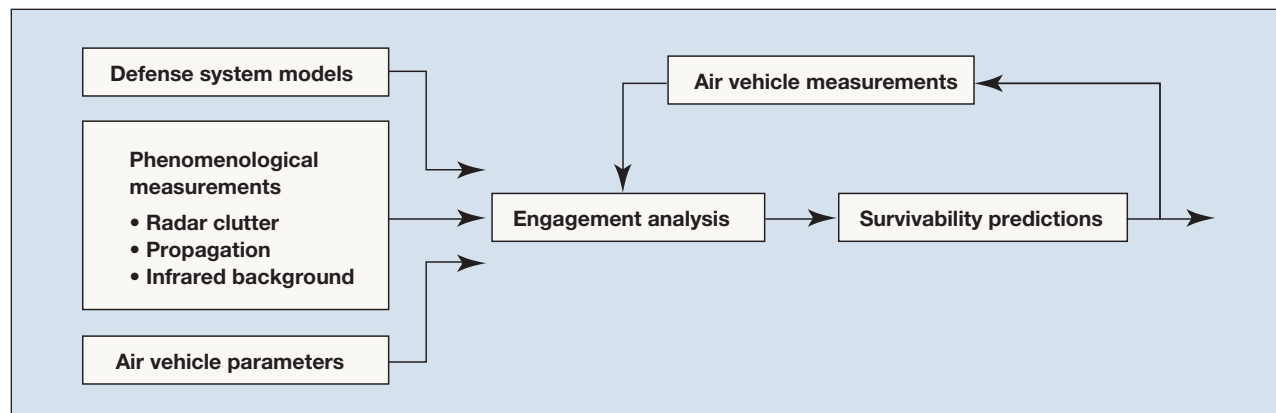
### *The Air Vehicle Survivability Program*

Late in 1977, with encouragement from the office of the DDR&E, the Laboratory proposed that DARPA take the lead in establishing a sound scientific underpinning to cruise missile survivability and air defense against cruise missiles. The Laboratory proposal outlined a basic scientific, phenomenological effort toward those goals. In 1978, DARPA established the Cruise Missile Detection Technology program at Lincoln Laboratory. This effort has evolved because of a variety of sponsorship changes and substantial broadening of the charter, and remains a vital Laboratory program.

The Laboratory’s program began in the Radar Measurements Division in 1978 under Delaney’s leadership; the program and the people supporting it joined the Surveillance and Control Division in 1979. The program grew and expanded in that division over the next thirteen years, led first by Delaney and later by Carl Nielsen. In 1992, the Air Defense Technology Division was established under the leadership of Briggs and later Lee Upton to continue the expanding program in air vehicle survivability and air defense. Lewis Thurman took over leadership of the program as head of the newly reorganized Tactical Systems Technology Division in 2000. Robert Shin took over for Thurman in 2005, and the mission of the program continued to grow and evolve with significant support from the Air and Missile Defense Technology Division and also the Intelligence, Surveillance, and Reconnaissance (ISR) Systems and Technology Division. In 2010, the program transitioned to the reorganized ISR and Tactical Systems Division led by Shin. Over the years, several hundred staff at the Laboratory have dedicated countless hours to the program, under the strong technical leadership of Alan Bernard, Curtis Davis, Dennis Keane, Michael Shatz, Robert Atkins, Jack Fleischman, Eliahu Niewood, Aryeh Feder, David Ebel, and Kevin Cohen.



**Figure 13-1**  
Air vehicle survivability and air defense prediction process.



The program was jointly sponsored by DARPA and the Office of the Assistant Secretary of the Air Force for Acquisition from 1982 to 1985 and became an Air Force–sponsored program in 1986. It has been called the Air Vehicle Survivability Evaluation (AVSE) program since 1983. In 2003, the program sponsorship was taken over by the newly formed Air Force Rapid Capabilities Office.

At the outset, the sponsors' goal for this program was ambitious — establishment of a national community of technical understanding and a scientific prediction capability in air vehicle survivability. This goal required Lincoln Laboratory to ensure that its work would be important to and supportive of industry and government efforts throughout the nation. A variety of approaches have been used to make the Laboratory's work widely available and to capture the interest and support of the defense community. Chief among these approaches are the annual Air Vehicle Survivability Workshops and the Cruise Missile Technology report series.

A process was developed early in the program to provide confident predictions of air vehicle survivability (Figure 13-1). The intelligence community supplied the enemy air defense models; air vehicle models were provided by U.S. industrial developers via their government sponsors. Lincoln Laboratory's role was to build phenomenological models and predictive models, as needed, and to participate in field tests. Predictions were developed in advance of flight tests; experimental results were subsequently compared with predictions; and corrective feedback was given to the modeling process.

The initial focus was on phenomenology and analytic modeling of Soviet defenses; as systems evolved, there was a growing emphasis on missile seekers, electronic warfare, global positioning systems, and passive infrared and radio-frequency systems. Recent years have seen increased focus on digital technology and software, threat prototyping, and integrated air defense systems (IADS). Although the program focus has evolved in response to changing priorities and world events, a constant has been the reliance on instrumentation and field testing to provide a solid foundation for air defense model development. Whether viewed from the perspective of characterizing the threat or supporting U.S. system development — the physics is the same for both — the lessons learned from the rigorous approach have benefited senior leadership decision makers within the Air Force and DoD for more than 30 years.

In the years between 1978 and the present, the air vehicle survivability program has covered an enormous range of issues associated with low-observable vehicles. Much of the work is classified, but even the work that can be described in unclassified terms is too extensive to address in detail. The following sections provide a synopsis of the Laboratory's air defense contributions in five areas: phenomenology; system analysis and modeling; field instrumentation and experimentation; survivability analysis; and advanced technology.



**Figure 13-2**  
**Phase Zero radar equipment in**  
**Dundurn, Saskatchewan, Canada.**

### **Air Defense Phenomenology**

A radar's ability to detect and track low-altitude, low-observable air vehicles is determined predominantly by its ability to find a target within the background clutter from the earth's surface. Radar returns from moving air vehicles present a different Doppler (frequency) shift from nonmoving ground clutter, which can be exploited by the radar to filter out some of the clutter return. This situation was a predominant concern for the understanding of air vehicle survivability — the weak signal of a cruise missile could be easily lost in the clutter residue.

Radar ground clutter is simply electromagnetic scattering from the surface of the earth. Scattering from simple objects can be difficult to calculate; scattering from the infinite variety of complex objects on the earth's surface is impossible to calculate. Confident models are nonetheless needed, and an empirical approach has been pursued.

When the AVSE program began, an intense search of existing radar clutter models indicated many shortcomings: highly variable results from similar situations, inadequate data to yield statistical confidence, and inadequate coverage of many terrain types. The clutter uncertainty was most severe at low grazing angles to the earth — exactly where U.S. cruise missiles intended to fly to frustrate Soviet ground radars!

In 1980, the Laboratory undertook a major empirical effort to characterize low-grazing-angle ground clutter, probably the most intense and coherent effort ever carried out in this phenomenological area. Early analysis and experiments indicated that propagation of the radar signal to and from any particular piece of ground clutter was often as important as the inherent reflectivity of the clutter piece itself. Low-angle radar propagation over the bumpy surface of the earth is a complex phenomenon that, when combined with the complexities of radar scatter off terrain, could explain the highly variable, often inconsistent, clutter models in existence at that time. A dedicated set of propagation measurements was planned in order to develop more reliable clutter models.

The dominant concern, cruise missile survivability against Soviet defenses, determined the radar frequencies of most interest and the types of terrains investigated. Soviet radar frequencies covered a wide range, very high frequency (VHF) to X-band (2 m to 3 cm wavelength).

Because Soviet-type terrains were of principal interest, and the prairie provinces of Canada provided a very good analog, DARPA instituted a joint program with the Canadian government. Multifrequency clutter and propagation experiments were planned for a variety of sites in Canada and the United States.

From the outset, Lincoln Laboratory was committed to making this major experimental venture as scientifically sound and useful to future investigators as possible. Measurement sites would be characterized by extensive ground truth (verification of what really is on the ground), all data would be carefully calibrated and archived, and extensive data and modeling reports would be published.

### *The Phase Zero Clutter Measurement System*

In 1979, plans were being developed for a sophisticated five-frequency clutter measurement instrument. It was clear that the procurement of this instrument would take some time, and both the Laboratory and the sponsor were anxious to get into the complicated business of measuring and characterizing clutter as soon as possible. Lincoln Laboratory quickly built the Phase Zero single-frequency clutter instrument — and it found uses beyond anyone's hopes! It characterized clutter at cruise missile test ranges, it served as a recording and display adjunct to weapons system radars, it helped the DoD plan siting for special electromagnetic backscatter ranges, and it assisted the Federal Aviation Administration in characterizing sites for weather radars.

The Phase Zero system was a small X-band commercial marine radar, mounted on an extendable mast on a medium-size truck (Figure 13-2). Its main use was to characterize a wide variety of sites with respect to their clutter effects and to conduct the initial survey to find suitable sites for the more comprehensive follow-on instrumentation. Overall, the Phase Zero system visited some 150 sites between 1981 and 1991 and, after a distinguished career, it was decommissioned in 1991.

### *The Phase One Clutter Measurement System*

General Electric (GE) in Syracuse, New York, built the Phase One clutter instrument to Lincoln Laboratory specifications and delivered it in October 1981. GE also operated and maintained the system in the field.



**Figure 13-3**  
Phase One radar equipment in Brazeau, Alberta, Canada, a site similar to Ukraine.

#### Notes

**3** The Department of Defense never promoted the idea of invisibility, but the press did, and considerable controversy resulted.

**4** The U-2 aircraft operated by Gary Powers that was lost in 1960 was shot down by an early Soviet surface-to-air missile, the SA-2.

The Phase One system was a transportable five-frequency (VHF, ultrahigh frequency [UHF], L-band, S-band, and X-band) dual-polarization radar clutter instrument. It traveled in three tractor-trailer trucks and featured a 100 ft erectable tower that allowed it to see over trees, which in the Canadian (and Soviet) topography could often be 80 ft tall or higher. Phase One instrumentation collected data in 1983 in Brazeau, Alberta, Canada, a site typical of Ukraine (Figure 13-3). Between 1981 and 1984, the system visited 42 different sites in Canada and the United States, and revisited four sites to check on seasonal variations in clutter.

The Phase One system was the principal source of data (along with propagation measurements) that allowed the Laboratory to uncover the underlying phenomenological basis for the wide variations seen in the amplitude of ground clutter. Parts of the Phase One system instrumentation were used in other experimental programs. The system was decommissioned in 1992.

#### *Airborne Measurements of Ground Clutter*

Higher-grazing-angle ground clutter such as would be seen by Soviet airborne radars was also of interest. In 1979, the Laboratory contracted with the Environmental Research Institute of Michigan to modify an existing airborne L-band and X-band synthetic aperture radar and conduct a limited set of radar clutter measurements of terrain at six specified sites in Manitoba, Saskatchewan, and Alberta. These measurements yielded early insights into the airborne clutter problem. The field instrumentation and experimentation part of this chapter discusses the follow-on Lincoln Laboratory effort addressing the performance of airborne radars in a look-down mode, in which terrain clutter is an important factor.

#### *Low-Angle Propagation Measurements*

A variety of radar propagation experiments were conducted between 1979 and 1990. Initial measurements were performed in Massachusetts, and, in 1980 and 1981, measurements were also made at Grand Forks, North Dakota, and at Port Austin, Michigan, the site of the last U.S. VHF air defense radar.

In 1982, the Laboratory built a propagation measurements package that could be conveniently carried on a helicopter. In a typical experiment, the helicopter

instruments would record the signal strength as a function of height from the radar of interest. These signal-versus-height profiles would be collected at various ranges and azimuths around the radar, thereby providing a variety of terrain for the signal propagation. Measured terrain profiles would then be used in conjunction with reflection and diffraction theory to deduce the relative importance of each effect.

#### **Air Defense System Analysis and Modeling**

The Lincoln Laboratory approach in a major program area is to conduct broad system studies to guide the phenomenological, technological, and experimental work. These studies and concept analyses played an especially prominent role in the air defense and air vehicle survivability program. First, the studies were necessary to guide the design and development of U.S. cruise missiles and aircraft. Second, the concept of low observability was new and much air defense analysis work was needed to assess the impact of low observability on traditional types of air defense and on the design of new defenses. Finally, the prospect of an invisible cruise missile or aircraft piqued the imagination and creative impulses of engineers and scientists throughout the nation.<sup>3</sup> A plethora of ideas to defeat this invisibility flowed forth. Some ideas were conventional, others quite novel. The novel or unconventional air defense approaches also required substantial analysis by the Laboratory.

#### *Conventional Air Defense Analyses*

The 1977 Strategic Penetration Technology Study described earlier focused on surface-to-air defenses. These air defense approaches have continued to receive major attention through the ensuing years of the Lincoln Laboratory program, reflecting the fact that the Soviet Union was the world's most prolific builder, user, and exporter of such systems.<sup>4</sup> The Laboratory's SAM system analyses have looked particularly closely at the system and its follow-on variants because they represent the most capable long-range threat. The Laboratory has issued a substantial number of classified reports on these systems. At the same time, the Laboratory has continued to study and assess the threat posed by shorter-range systems as well as man-portable air defense systems.



## Note

5 J.B. Billingsley, "Ground Clutter Measurements for Surface-Sited Radar," *Lincoln Laboratory Technical Report 786 (Revision 1)*. Lexington, Mass.: MIT Lincoln Laboratory, 1 February 1993, DTIC AD-A262472.

Another conventional air defense approach involved manned interceptors directed by either ground or airborne radar. Airborne defenses have the very important attribute of being potentially capable of providing broad-area defense against low-altitude targets. In the 1980s, the Soviets had significant defenses of this type, with some 3000 manned interceptors supported by several thousand ground radars.

### *Unconventional Air Defense Analyses*

The Laboratory has also studied a wide variety of novel or unconventional defense schemes to characterize the threat they pose to U.S. air vehicles. Many of these schemes could be applicable to the detection of low-observable air vehicles at short range, although a robust air defense capability often requires much more than that. An effective air defense system should detect an air vehicle at relatively long range, track continuously, and guide some kill mechanism into close proximity of the target air vehicle; finally, the interceptor should kill the vehicle. A weakness in any one of these factors can limit the air defense capability.

Many unconventional defense schemes envision solving the detection problem by proliferating a great number of very simple sensors on the landscape. As pointed out in the section on phenomenology, all sensor systems are limited by background effects. One role of the Lincoln Laboratory investigations has been to characterize these background limitations, which have often been the fatal flaw in unconventional approaches against low-observable vehicles.

The Laboratory has analyzed more than 50 unconventional defense schemes. A partial list gives some idea of the wide range of analyses: acoustic detection, infrared

sensor detection, bistatic radar schemes, occultation of natural cosmic rays by the air vehicle, high-frequency surface-wave radar, detection of chemical emissions from aircraft engines, detection of the aerodynamic wake of an aircraft, radiometric detection approaches, space-based radar and space-based infrared sensors, and ultrawideband or impulse radar approaches.

In many cases, a relatively simple analysis demonstrated that a scheme was either unworkable or provided less capability than fielded conventional systems, and was therefore unlikely to be aggressively pursued by an adversary. Other defense schemes required a more substantial investigation, often involving the analysis of existing phenomenological data. A few unconventional defense approaches required substantial dedicated field testing to be characterized with adequate confidence.

### *Modeling Tools for Air Defense Analysis*

The basic process of Lincoln Laboratory's air defense and air vehicle survivability effort, as diagrammed in Figure 13-1, revolves around the development of a scientific understanding of modern air defense and the embodiment of this understanding in computer models that can predict the outcome of air defense scenarios. This process is a significant challenge, as a wide variety of complicated effects must be captured in a computer code that must be easy to use, easy to change, efficient in run time, and transparent to the analyst.

The radar clutter data collection enterprise produced a formidable amount of data. The Phase Zero and Phase One system clutter-data tape libraries contain 4000 high-density computer tapes. A great deal of effort by many investigators was needed to reduce these data to usable models.<sup>5</sup>

1970



W.P. Delaney



C.E. Nielsen

1980



D.L. Briggs

---

**Note**

6 S. Ayasli, "SEKE: A Computer Model for Low Altitude Radar Propagation over Irregular Terrain," *IEEE Trans. Antennas Propag.* **AP-34(8)**, 1013–1023 (1986).

A variety of models of radar clutter have been developed and published. These models offer the user varying degrees of sophistication to suit individual modeling needs. The principal insights of the propagation work have been embodied in the well-known Lincoln Laboratory Spherical Earth with Knife Edges model,<sup>6</sup> which predicts low-angle radar propagation over specified terrain profiles, taking into account multiple combinations of reflection, diffraction, and refraction.

The complexities of the low-altitude air defense engagement precluded the possibility of simple generic, or "cookie-cutter," models. The earth's complicated surface and, in the case of infrared systems, complex atmosphere were heavily enmeshed in the problem. Defense situations had to be analyzed on a site-by-site basis — accumulating statistics from many sites and then finding a way to capture the statistical insight in fast-running computer codes. This process was named *site-specific analysis*. Lincoln Laboratory became its champion and bore the heavy burden of making it work.

An example of this type of site-specific modeling is the TRAJ software program, which calculates a radar's signal-to-interference ratio and can separate the effects of terrain masking, clutter, propagation, and target radar cross section. The TRAJ code was used most often to evaluate cruise missile encounters with Soviet surveillance radars. The model was also important for analyses that supported flight-testing of U.S. cruise missiles on test ranges.

Soviet SAM systems are often characterized by their footprint, the area on the ground surrounding the SAM battery that is defended against a specified model of an attacking cruise missile. Lincoln Laboratory developed

the premier site-specific predictive air defense, or footprint-generator model, the Advanced Surface-to-Air Missile Model (ASAMM).

ASAMM provides the analyst with a tool to examine in detail the performance of each SAM subsystem and gives an overall system coverage footprint. Multiple computer modules with various degrees of complexity are available for each subsystem of the specified SAM. This flexibility allows the analyst to tune the code to the scenario under study, modeling the key subsystems with the highest fidelity. For example, ASAMM has been used to establish the importance of defensive-missile-seeker clutter rejection in SAM performance against low-altitude cruise missiles. ASAMM is also used for high-altitude intercept modeling, which does not call for seeker clutter calculations. Attention in the high-altitude intercept case can be focused on other issues, such as the endgame, where missile miss distance, fuzing, warhead lethality, and endgame countermeasures are important.

In addition to the extensive deployment of SAM batteries, a main line of Soviet air defense comprised numerous manned interceptor aircraft guided by ground radar or Airborne Warning and Control Systems (AWACS). More advanced Soviet interceptors have sophisticated look-down, shoot-down radar fire-control systems. The Laboratory took on the complex problem of characterizing the limits of such radars against low-observable targets.

A computer model of a look-down fire-control radar was developed through a number of evolutions, finally leading to RADAIR, the current software program. This code was constructed with sufficient modularity so that the user could easily model many different



L.O. Upton



L.A. Thurman



A.D. Bernard



**Figure 13-4**  
The L-X radar system in Lexington,  
Massachusetts.

look-down fire-control radars. RADAIR allows the user to predict snapshots of the clutter return seen by the radar in any look-down geometry, and also to “fly” a target through a clutter background and emulate the radar’s detection process. RADAIR has enabled the Laboratory to understand and to model accurately the inherent limitations in the detection of small, low-altitude targets with an airborne look-down fire-control radar.

Over time, the Laboratory has developed detailed models of all major classes of air defense systems. These models are used to calculate not only the intrinsic capabilities of those systems, but also to take into account the impact of a range of electronic countermeasures and counter-countermeasures. These models are very useful in assessing the “1 versus 1” performance of threat defenses versus U.S. air vehicles. However, in order to assist the Air Force in major acquisition decisions, it is often desirable to fold these results into a larger “scenario” context. The key to doing this successfully is to ensure that the scenario-level modeling not only incorporates the key physics of the problem, but remains simple enough to give the analyst insight into which effects are driving the analysis outcomes. The Laboratory has developed a number of tools to help the United States understand the relative benefits of proposed systems against threat surveillance radars, SAMs, air-to-air interceptors, as well as IADS.

#### *Systems Analysis Lessons Learned*

The Lincoln Laboratory philosophy is that people must analyze problems, aided, but never supplanted, by computer models. No air defense model will ever be broad and flexible enough to capture fully the next tough air defense problem. Therefore, accurate modeling and analysis efforts must continue to rely on talented people whose judgments are based on scientific principles, experimental results, and computer models. In addition, it is critical that model parameters, assumptions, and predictions be validated using real-world measurements.

#### **Air Defense Field Instrumentation and Experimentation**

Field experimentation has played a critical role throughout the long history of the air defense and air vehicle survivability programs. It is the element of the validation process that ensures confidence in predictions of air defense or air vehicle survivability performance.

The Laboratory’s philosophy on field experimentation was stated early in the program by Delaney, the first program manager of the Laboratory’s air vehicle survivability activity:

“If you think you understand all the interactions, then plan a substantial-scale experiment and predict the results of the experiment beforehand. God won’t change physics to make you look good.”

Participation in major field tests and the development of critical field instrumentation have been substantial parts of the Laboratory’s air defense effort. Radar, infrared, and acoustic sensing have each been tested. Some instruments were built to the Laboratory’s specifications; others were leased or borrowed for particular experiments. The military services made many weapon systems’ sensors available through cooperative ventures. The complete list of such initiatives is too long to cover in this chapter; only major initiatives and experiments are described here.

#### *L-X Radar*

The dual-frequency L-X radar was a derivative of a Raytheon AN/TPN-19 aircraft-approach guidance radar that had been modified for a proposed artillery location role. Since L-band and X-band were of high interest in cruise missile survivability experiments, the Laboratory contracted with Raytheon in 1980 to modify the radar for a cruise missile testing role. Raytheon delivered the radar in 1982 (Figure 13-4). One of its contributions was early flight data on cruise missile signatures. The radar participated in twelve air-launched and ground-launched cruise missile tests at the Dugway Proving Ground, Utah, test range in 1983 and 1984. It was later used at Nellis Air Force Base, Nevada, and again at Dugway in 1989. The radar was decommissioned in 1990.

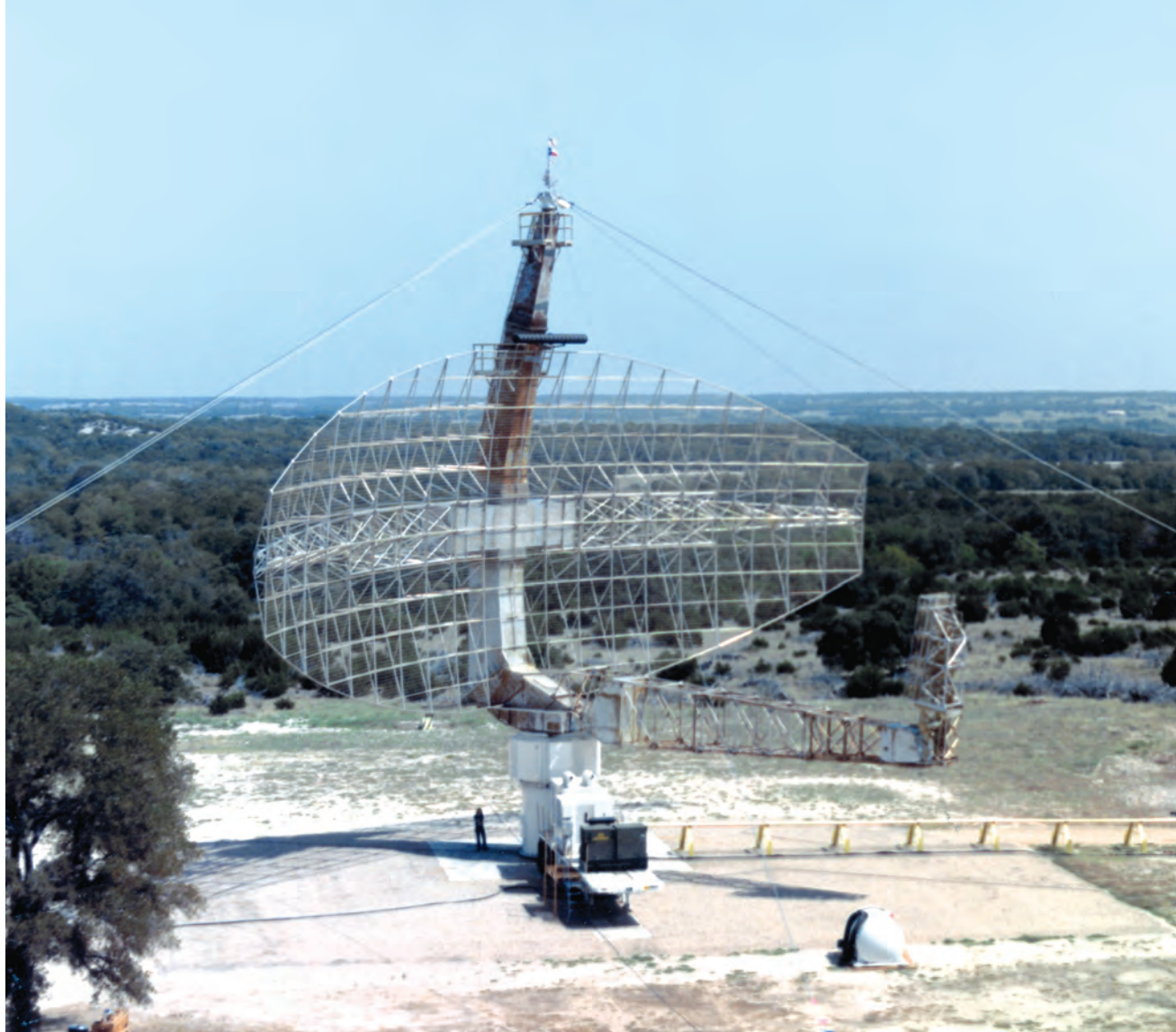
#### *Very-High-Frequency Radar*

Very-high-frequency (VHF) radars are an important element in field tests of the survivability of cruise missiles and other low-observable air vehicles. Even before the development of the modern cruise missile, the Soviets had deployed thousands of VHF ground radars. A particular concern to the United States was characterizing cruise missile vulnerability at VHF frequencies.



**Figure 13-5**

**This VHF instrumentation radar could emulate representative Soviet radars.**



In 1983, the Laboratory initiated a competitive procurement for a VHF test range instrument, which was awarded to General Dynamics of Fort Worth, Texas. This radar, delivered in 1985, is a substantial but transportable radar featuring a 150 ft wide antenna (Figure 13-5). It could emulate representative Soviet-built VHF radars. The radar underwent a number of modifications and upgrades to enhance its usefulness to the test community.

The principal contribution of the VHF instrumentation radar was the development of realistic appraisals of VHF radar capability against advanced U.S. cruise missiles and aircraft. The VHF radar was decommissioned in 1999.

#### *Acoustic Instrumentation and Experiments*

Air vehicles emit relatively loud acoustic signals from their engines and airframes. In the pursuit of low observability to all sensors, the acoustic signal became a concern. In the early 1980s, little information was

available on acoustic sensing systems and on their performance in an air defense mode. However, Lincoln Laboratory's Computer Technology Division had fortuitously developed substantial expertise with distributed arrays of seismic and acoustic instruments in support of DoD tactical battlefield initiatives. The staff had developed automated techniques for collecting signals from networks of sensors and establishing tracks on desired targets while rejecting unwanted noise and interference signals.

Between 1984 and 1988, under air vehicle survivability program sponsorship, the Computer Technology Division conducted and supported a variety of acoustic signature measurements on a wide range of military aircraft and cruise missiles. Processing techniques were developed for tracking such vehicles in backgrounds of natural noise and manmade interference. These experiments provided a realistic assessment of the potential threat of acoustic sensing to U.S. air vehicles.

## Enhanced Insight

**The phenomenological work by Lincoln Laboratory on clutter and propagation confirmed that the Department of Defense can deduce and predict the fundamental effects underlying the success or failure of major weapons systems. The legacy of this critical phenomenological work was best captured by J. Barrie Billingsley, the Lincoln Laboratory principal clutter investigator, at the 1984 Cruise Missile Workshop, when he concluded his talk with an analogy concerning how high-quality, multifrequency, multisite clutter and propagation data enhanced his insight:**

**“We had heard the violins and the horns and the woodwinds before, but now we could understand the whole orchestration — how frequency, terrain, propagation, resolution, and polarization all operated together to produce the complex result we had witnessed but did not understand.”**

**Technical talks seldom get spontaneous applause, but this one did!**

### *FLEXAR Instrumentation*

Essentially all weapons systems' radars are limited in performance against low-altitude, low-observable targets by ground clutter. This limitation engendered a seemingly everlasting argument among U.S. analysts (Central Intelligence Agency, Defense Intelligence Agency, Air Force intelligence, Army intelligence, U.S. industrial contractors for radars or cruise missiles, military sponsors, and government laboratories) on just how good the Soviet radar receivers were. Some postulated immense, others very limited Soviet capabilities.

Of great interest was the advanced air defense SAM. The United States had no direct access to advanced SAMs, yet the fine details of its receiver and processor design had to be known in order to estimate its clutter rejection accurately. The next best thing was to look for existing U.S. systems to evaluate the technology limits.

The Hughes Aircraft Company had developed an experimental fire-control radar, called FLEXAR, for Navy shipboard application. Hughes was one of the world's leading companies in the field of clutter rejection, having pioneered the F-14 and F-15 look-down radars, so FLEXAR had state-of-the-art clutter rejection and a surface radar system based on airborne radar technology.

The Laboratory conducted field experiments with the FLEXAR system from 1983 to 1986. It was first used to characterize the clutter rejection capability of high and medium pulse-repetition-frequency ground radars. It was later used at Eglin Air Force Base, Florida, and the China Lake, California, test range to evaluate U.S. electronic countermeasures against Soviet radars. Although FLEXAR did not settle the clutter rejection arguments, it did add a healthy measure of real-world data to the debate.

### *Fuze Experimentation and Testing*

Another element in the air defense chain is the radio-frequency proximity fuze, which is basically a short-range radar mounted in a guided missile that initiates a warhead detonation sequence when it approaches a target. Because there was no consensus on the performance of existing fuzes against low-observable targets, an experiment was carried out in 1984 at an indoor fuze testing facility. This test was followed in 1987 by a larger measurement program with scaled targets and fuzes. A great number of missile flyby trajectories

were simulated in this program, and the extensive test results were used to validate a model developed at the Laboratory for assessing fuze performance. This model has since been used on a variety of targets.

### *Improved Hawk Live-Firing Experiments*

One approach to cruise missile survivability testing is to fly cruise missiles against U.S. weapons systems and see how well they survive. The Improved Hawk SAM system engagement of cruise-missile-like targets at White Sands Missile Range (WSMR), New Mexico, in 1980 through 1981 and in 1988, turned out to be one of the more interesting sagas in the Lincoln Laboratory air vehicle survivability program. The Navy-led Joint Cruise Missile Project Office flew eleven low-observable cruise missile surrogates (modified MQM-107 target drones) against an Improved Hawk SAM battery built by Raytheon and provided by the Army. This may not have been the annual Army-Navy game, but it is fair to say there was a sense of rivalry.

A fair amount of controversy arose and persisted for years. The Army felt it was being cheated out of a victory; Raytheon analysts defended Hawk. The annual Lincoln Laboratory-Raytheon debate at the Cruise Missile Workshop was held in a packed room during those years.

The controversy had positive benefits for the nation — it illustrated the complexities of air defense, it showed how vigorous technical debate should be conducted, it demonstrated the need for more carefully instrumented tests, and it eventually led to a much better instrumented Hawk live-firing exercise against special drone targets in 1988. The second live-firing series ended the debate, and both sides gained new insights into this complex issue. The tests for the first time also evaluated Improved Hawk missile performance against receding targets, which is an essential question for determining an enemy's capability to defend areas behind a SAM site.

The controversy had another vital impact. It highlighted the extreme importance of defensive missile-seeker performance in survivability assessments and thereby laid the groundwork for the development of the airborne seeker test bed instrumentation — which became a key Lincoln Laboratory field instrument for air vehicle survivability experiments.



**Figure 13-6**  
The IRMS sensor on a portable trailer mount at Point Loma, California, where it was used to characterize ocean surface glint effects.

### *Infrared Measurement System Instrumentation and Experiments*

The ability of radar sensors to provide long-range all-weather operation has made them the primary focus of the air defense and air vehicle survivability programs. Infrared systems, however, have been high priority because they offer a number of advantages that offset their principal disadvantage of poor performance in bad weather. Because they are totally passive in operation, the target air vehicle does not know it is being detected or tracked. Infrared sensors are also compact; they are generally much smaller and lighter than their radar counterparts.

Air vehicle infrared signature control is not an easy task. Infrared systems are inherently more difficult to analyze and characterize than radar systems because weather and environmental conditions strongly influence target signature, background clutter, and signal propagation from a target to an infrared sensor. The Laboratory's effort in infrared sensor systems started in the Optics Division in 1983 with infrared clutter measurements made with existing infrared sensors. Shortly thereafter, specifications for a much more capable infrared measurement system (IRMS) were developed, and Honeywell won a competitive contract for its construction. The instrument was delivered in 1986 (Figure 13-6). The IRMS features high angular resolution in the mid- and long-wavelength infrared bands. It has a wide-field-of-view mode for the rapid collection of large angular fields of clutter data and for the emulation of infrared search and track systems; it also has a narrow-field-of-view mode for collection of target signature data.

Early use of the IRMS focused on collection of infrared clutter data and the infrared signatures of many air vehicles. The IRMS now spends a significant portion of time at various national test ranges across the country, including Nellis Air Force Base, the Dugway Proving Ground, and the WSMR. A wide variety of airborne targets have been viewed to measure their infrared signatures, to assess their detectability at long range against clutter, and to provide highly resolved imagery of targets in flight. An extensive data-collection effort has produced an infrared clutter database from many background sites. These data have been analyzed to characterize infrared background clutter in terms of such factors as terrain type, season, weather conditions, time of day, and waveband.

Because interest in infrared systems has included airborne infrared sensors, the IRMS was brought to a mountaintop a number of times to view infrared clutter from an airborne perspective and to exercise algorithms for detecting and tracking targets in clutter. The IRMS data have been distributed widely to industry and government to support infrared clutter rejection analysis and serve as a basis for new infrared system designs.

### *Airborne Look-Down Fire-Control Radar Characterization*

Look-down capability is the ability of an air defense fighter to fly at high altitude and use its radar to search the airspace below for enemy air vehicles, particularly low-flying air vehicles. Shoot-down capability is the ability of the high-altitude air defense fighter to launch an air-to-air missile against a low-altitude enemy penetrator and kill it.

Look-down, shoot-down capability is an extremely difficult technology to achieve. The problem is radar clutter from the earth's surface. Unlike in the case of ground radar, ground clutter appears to move in a look-down, shoot-down system because the fighter radar is moving. Considerable attention must be given to the radar antenna design to prevent sidelobe clutter from degrading the radar's capability. In fact, for a fighter radar's processor to remove *all* clutter, it needs an electronic filter that can cancel clutter by a factor of about 100 million.

The Air Force sponsor was intensely interested in the clutter processing capability of the newest Soviet air defense fighters, the MiG-29, MiG-31, and the Su-27. This capability was extremely difficult to assess even within broad boundaries because it depended on knowing fine details of Soviet signal processor technology, design capacity, and ingenuity. The Laboratory soon found out that clutter rejection capability was hard to determine even for U.S. look-down radars!

The United States had invented look-down radar and pioneered its first substantial application in the Navy F-14 fighter, followed by the F-15, F-16, and F-18. Beginning in 1984, the Laboratory undertook an experimental investigation of U.S. look-down fighter radars to gain a realistic characterization of their clutter-rejection capability and their ability to



**Figure 13-7**

**Test of the AN/APG-70 radar in an F-15 aircraft at Edwards Air Force Base, California.**



**Figure 13-8**

**Top: The ASTB was originally hosted on a Falcon 20 business jet. Bottom: The technology was transitioned to a larger Gulfstream II business jet to support additional payloads and longer missions. After the transition, the Falcon 20 was converted to an ACTS.**



detect low-observable vehicles in ground clutter. By characterizing U.S. equipment, which was judged to be the best in the world, the Laboratory hoped to acquire some sense of both the fundamental limits and the real-world hardware limits faced by the Soviets.

The Westinghouse AN/APG-68 radar for the F-16 fighter was selected for the first case study. Westinghouse had a well-instrumented prototype of that radar flying on a corporate-size jet aircraft. Lincoln Laboratory built a small target device called the moving target simulator that could sit on the ground, receive the look-down radar signal, and transmit back to the radar a signal that looked like a low-flying, low-observable target. This device immensely simplified the experiments; it could be placed in a wide variety of clutter scenes, from benign clutter (ocean or flat fields) to moderate clutter (farmland or forest) to severe clutter (mountains or cities). The actual size of the simulator's return could be varied from a large target to a quite low observable one. A detailed characterization of the AN/APG-68 radar was developed and compared with the predictions, and the causes of differences were then determined. These results guided general assessments of look-down radars and supported airborne radar computer simulation. The success of this effort led to a similar one on the F-15 radars, the AN/APG-63, and the later version, the AN/APG-70 (Figure 13-7).

The expertise acquired in the look-down radar test program has been shared with other members of the U.S. airborne fire-control radar community. Computer simulation of the look-down fighter capability was distributed to a number of organizations investigating fire-control radar issues.

#### *Airborne Seeker Test Bed*

Successful engagement of cruise missiles by enemy air defenses requires success in three distinct processes: surveillance, for initial detection; fire control, for track of the target; and intercept, for kill of the target. Low-observable techniques attack all three of these processes, and overall enemy air defenses are limited by the weakest link.

In many situations, the kill process is the weakest link. Because guns have very short effective ranges, a guided missile almost always makes the kill of the attacking cruise missile or aircraft. The missile is most often guided



**Figure 13-9**

**The AIRI pod is carried on an inboard wing station of the ASTB. Two high-performance cameras provide “truth” in the medium-wave and long-wave infrared bands. An onboard calibration system enables in-flight calibration and nonuniformity compensation.**

---

**Note**

7 C. Davis, “The Airborne Seeker Test Bed,” *Linc. Lab. J.* **3(2)**, 203–224 (1990).

by a radar or infrared seeker in its nose; thus the seeker must be small to fit in the missile’s streamlined airframe. Therefore, in the interest of small size, low weight, and reasonable cost, the seeker must be restricted to a small antenna (or optics aperture) and a limited amount of onboard electronics — constraints that often conspire to make the seeker the most vulnerable element in engagement of a cruise missile.

Assessing the performance limits of missile seekers and the impact of countermeasures is an important part of the air vehicle survivability program at Lincoln Laboratory. Early in the program, the work was largely analytic, but in 1985, the Laboratory’s efforts in analyzing the Improved Hawk SAM live firings and the Sparrow air-to-air missile live firings against cruise missiles, along with continued advances in countermeasure design, pointed to the need for an experimental mechanism to investigate missile seeker performance. Since firing actual missiles against targets would be an expensive and cumbersome way to gain this insight, the Airborne Seeker Test Bed (ASTB) effort was started.<sup>7</sup>

The concept of the ASTB is to configure a jet aircraft to represent a missile. The nose of the jet houses the seeker sensors, and the fuselage carries processing electronics and other antennas needed to emulate a surface-to-air or air-to-air missile. Many auxiliary sensors and extensive data recording equipment are carried, making the ASTB essentially a flying seeker laboratory. In 1986, Raytheon Missile Systems Division of Bedford, Massachusetts, received the contract to build the first major sensor, an X-band semiactive homing instrumentation head, which was then integrated with the other parts of the system developed at Lincoln Laboratory. The original ASTB was configured on a Falcon 20 aircraft in 1990; in 1994, it was rehoused in a larger Gulfstream II aircraft with increased payload capacity and mission duration (Figure 13-8). The ASTB continues to be a workhorse for the air vehicle survivability program, successfully completing its 800th mission in spring 2009.

The ASTB design was kept as flexible as possible to allow it to collect data pertinent to a wide variety of U.S. and Soviet missiles, e.g., U.S. and Soviet infrared-guided missiles, Improved Hawk, Patriot, Standard Missile, Sparrow, and advanced medium-range air-to-air missiles.

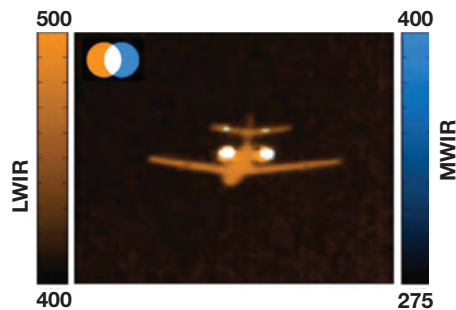
The nose of the aircraft houses the X-band semiactive instrumentation seeker antenna. In wing-mounted pods, the ASTB also carries other sensors, including the Airborne Infrared Imager (AIRI), and various infrared and radio-frequency seekers (Figure 13-9).

The first series of ASTB experiments was conducted in spring 1990. Early experimentation focused on clutter and target-scattering issues of importance in modeling missile seeker capability. These issues included the fluctuations of aircraft radar return strength and its polarization behavior, the characterization of ground clutter, and the signal-propagation effects. These data were used to ensure the accuracy of computer models of missile performance.

The ASTB has also been used to evaluate the vulnerability of a variety of U.S. air vehicles to missile attack. In a typical survivability test, the target aircraft would fly at low altitude while the ASTB dived from above on a proportional navigation collision course. A look angle representative of an actual missile intercept would be maintained until the ASTB pulled out of its dive (prior to the collision point).

On its return from an extensive first measurement campaign in January 1991, the ASTB was able to respond quickly to a unique test opportunity in support of Operation Desert Shield. Eight missions were flown to help the U.S. Air Force prepare its air defense fighter forces for combat with the Iraqi Air Force. Although particulars of these tests are classified, the ASTB provided a unique source of insight for U.S. pilots training to combat potential Iraqi countermeasure tactics.

Countermeasures against missile seekers that operate in the last few seconds before intercept are often called endgame countermeasures. They tend to exploit the inherently poor angular resolution of the seeker caused by its small antenna. Endgame countermeasures are expensive to remedy, often requiring a multiple-mode seeker such as a radar and infrared dual-mode sensors. In the 1990s, the ASTB played a key role in the scientific characterization of endgame countermeasures and the rigorous investigation of countercountermeasure techniques.



**Figure 13-10**

This example shows that AIRI two-color imagery supports calibrated airborne measurements of aircraft infrared signatures and background clutter. Fused MWIR and LWIR measurements of a Falcon 20 aircraft are shown here.



**Figure 13-11**

ACTS 2 on its inaugural flight out of Hanscom Air Force Base, April 2008.

The Army Missile and Space Intelligence Center provides intelligence on foreign missile systems. This agency, along with the Air Force, has contributed significantly to the funding of the ASTB development effort. The ASTB has become a national asset and has found use in programs for all the services and DARPA. Data have been widely distributed in the government and industry.

In 1995, a new sensor was developed by Lincoln Laboratory and added to the ASTB suite to characterize airborne infrared phenomenology. The AIRI is a dual-waveband (medium-wave and long-wave infrared [MWIR/LWIR]) staring focal-plane-array (FPA) sensor mounted in an aircraft pod, and was designed to study a variety of air defense issues. AIRI has been successfully used to provide calibrated measurements of airborne and ground target signatures and infrared clutter phenomenology, and has supported numerous characterizations of airborne infrared search and track systems, seekers, and countermeasures (Figure 13-10).

#### *Airborne Countermeasures Test System*

To assess weapon system performance, it is critical to consider the impact of electronic warfare, including both electronic countermeasures (also known as jamming or electronic attack) and countercountermeasures (also known as electronic protection). All links in a radar-based air defense engagement are potentially susceptible to degradation due to electronic warfare. To investigate these issues, the Laboratory developed and deployed the Airborne Countermeasures Test System (ACTS) on the Falcon 20 aircraft that was the original ASTB. First deployed in 1997 to support radio-frequency missile seeker development, ACTS provided the seeker test community with an instrumented test platform capable of generating several different electronic attack techniques in several different radio-frequency bands. In addition, an electronically generated synthetic target provided a calibrated target radar cross section. Subsequently, ACTS supported testing of fighter radar and ground-based surveillance radar electronic protection capabilities.

In 2007, ACTS was rehoused in a newer Falcon 20 and dubbed ACTS 2 (Figure 13-11). This update provided the opportunity to rebuild the jamming and support infrastructure with a more modern, open

system design architecture and to incorporate more modern, digital radio-frequency memory (DRFM)–based jamming techniques. In its initial test campaigns, ACTS 2 supported assessments of the impact of jamming on VHF ground-based surveillance radars.

#### *Threat Prototyping*

In the mid-2000s, the AVSE program reemphasized the importance of coupling instrumented hardware testing to the systems analysis tools developed over the last ten years. A significant number of new hardware systems were specifically designed to serve as surrogates for advanced threat systems that may have existed already, but about which little was known, or for threat systems that might be developed in the future. A particular emphasis was also placed on threat systems that relied on modalities not previously exploited or that relied on advanced commercial off-the-shelf technologies.

The first of these new threat prototype systems was a European ground-based infrared surveillance sensor. The sensor was obtained by Lincoln Laboratory and modified by working with the manufacturer. The Laboratory wrote new software to enable the sensor to be used in ways different from those for which it had been designed. The system was then tested in the field by using commercial air traffic in the Boston area and dedicated test flights with Laboratory-operated aircraft. When compared with detailed simulation data, results from the tests showed good agreement and pointed out the importance of understanding the background clutter in the infrared and the likelihood of cloud cover between the aircraft and the sensor.

The Laboratory has also used a number of existing U.S. systems and instrumented them to serve as prototype threats. In the infrared area, the ASTB now has the capability to carry both an airborne infrared surveillance sensor and an imaging infrared missile seeker. These sensors can be used in tandem, with one cueing the other, or in separate test efforts. The Laboratory has also used the radar open systems architecture and advanced commercial electronics to develop a surveillance radar sidecar, currently being used to test advanced electronic protection algorithms to assess effectiveness in an operational environment. The ACTS 2 aircraft, with its DRFM system and advanced receiver, is also intended to be used in testing future threat capabilities.



### *Field Instrumentation and Experimentation*

#### *Lessons Learned*

Field experimentation work is difficult, and thousands of hours of hard work, travel, disappointment, argument, frustration, and a few bright moments of success underlie this brief summary. The field workers are the heroes of the Lincoln Laboratory air vehicle survivability program, for it is they who provided the critical element of confidence via experimental verification of the Laboratory's analyses and predictions.

#### **National Leadership in Air Vehicle Survivability**

In 1977, Lincoln Laboratory was challenged by DARPA and the office of the DDR&E to provide a strong scientific basis in survivability analysis to support the design and development of the new air vehicles known as cruise missiles. A corollary challenge was to improve the quality of the survivability analysis work throughout the national community. The approach that quickly evolved was to "raise the ante" on the quality of survivability analyses, predictions, and experiments by setting the example.

A number of factors helped start this process. Cruise missiles were new, interesting, and important to the nation. Many questions and problems needed to be addressed. DARPA was an enlightened sponsor with a reputation for independence and for taking the lead on national technical issues. Moreover, the technical challenges in this area attracted and motivated a cadre of exceptionally talented engineers and scientists from outside Lincoln Laboratory to interact with the Laboratory staff and provide independent and valuable augmentation to, and sometimes argument with, the Laboratory's perspective. More than any other factor, talented individuals contributed to the success of the Laboratory's effort to enhance the national capability in the cruise missile survivability area. Later, the strong leadership of the Air Force sponsor consolidated the program, and its activities became focused on survivability issues in major national efforts.

The Laboratory's goal of increasing quality demanded that the staff find a means to interact with the community and publicize their work. These two initiatives, instituted early in the program and still followed, spawned the Cruise Missile Workshops and the Cruise Missile Technology series of technical reports.

### *The Cruise Missile Workshop*

Lincoln Laboratory conducted its first Cruise Missile Workshop in fall 1979. It became an annual event and was expanded in scope and renamed the Air Vehicle Survivability Workshop in May 1995. For the 30th annual workshop, the original program sponsors, William Perry and Paul Kaminski, returned to the Laboratory to give keynote addresses.

The workshop is an intensive three-day symposium featuring 30 half-hour technical talks by Laboratory staff on key results, ongoing work, and new initiatives. (One visitor described it as a "core dump" of Lincoln Laboratory's work for the past year.) About ten outside speakers also give presentations, generally on such topics of interest as intelligence perspectives or recent cruise missile test results. Attendance is by invitation only, and the sponsors and Lincoln Laboratory invite only the members of the air defense technical community. Prior to the addition of the South Laboratory complex, the Laboratory's largest meeting room had a capacity for only 125 people. Deciding whom to invite was an onerous task. Even with the addition of the 342-seat auditorium, narrowing the selection of potential attendees remains challenging and standing room only is common.

The workshop quickly became *the* national meeting on survivability prediction, helping establish Lincoln Laboratory as a national entity in survivability analysis. There have been a number of testimonies to the success of the Air Vehicle Survivability Workshop approach, the best of which is that each year for 31 years the audience has reported, "This was the best workshop yet."

### *The Cruise Missile Technology Report Series*

The Laboratory's protocol from the start included dissemination of all aspects of its work through technical reports. The Cruise Missile Technology, or CMT, report series was started for this purpose, and more than 220 reports have been published to date. The report series by itself is a national archive on air vehicle survivability and advanced air defense.

---

**Note**

8 Section approved by NAVAIR Public Release 10-144.

**Advanced Air Defense Technology<sup>8</sup>**

The Lincoln Laboratory air vehicle programs between 1977 and 1984 focused almost exclusively on understanding and modeling the survivability of U.S. cruise missiles against existing or possible new Soviet air defenses. These in-depth investigations gave the Laboratory a substantial head start on the complementary question of how to develop advanced air defenses to counter enemy cruise missiles. Beginning in the mid-1980s, the Laboratory began working on a number of projects to improve U.S. air defenses against the emerging cruise missile threat. Over subsequent years, these efforts grew into a substantial effort directed toward improving U.S. air defense capabilities. Leaders for these efforts included Lee Upton, David Kettner, Andrew Gerber, Gary Ahlgren, Chaw-Bing Chang, David Conrad, and Geordi Borsari.

***Radar Surveillance Technology Program***

The Radar Surveillance Technology (RST) program was established at Lincoln Laboratory in 1984 under U.S. Navy sponsorship in order to advance the state of the art in shipboard surveillance radar technology in response to the emerging antiship cruise missile threat. The potential of these dangerous weapons came into the public consciousness with the sinking of the HMS *Sheffield* by an Exocet cruise missile off the Falkland Islands in 1982, and was underscored again in 1987 by the attack on the USS *Stark* in the Persian Gulf by two Exocet missiles fired by an Iraqi Mirage F1 fighter during the Iran-Iraq war.

The RST concept for cruise missile defense centered on a sensitive, high-power shipboard radar that could survey the full airspace around a ship and detect medium- or high-altitude, low-observable cruise missiles. As the Soviets were expected to use intense electronic jamming to help their cruise missiles penetrate, the radar would be designed to provide exceptional jamming resistance. It also needed excellent clutter rejection and lightweight antenna and electronics to minimize its impact on the already heavily loaded surface combatant ships.

The Radar Surveillance Technology Experimental Radar (RSTER), a prototype radar, was developed and tested at Lincoln Laboratory. The RSTER design featured a UHF planar array antenna that was mechanically rotated in azimuth and electronically

scanned in elevation. In the azimuth plane, jammer suppression was achieved by ultralow sidelobes that were realized through advanced numerically controlled manufacturing techniques. In the elevation plane, RSTER featured digital adaptive nulling, exploiting the separation in angle between the standoff jammers on the horizon and the relatively high-angle incoming cruise missile threats. The antenna, developed under contract by Westinghouse in Baltimore, Maryland, comprised fourteen stacked ultralow-sidelobe rows, each of which was brought down via a multichannel rotary coupler which fed fourteen individual receivers and analog-to-digital converters. Lincoln Laboratory developed a state-of-the-art digital processor for RSTER in order to implement real-time digital adaptive elevation beamforming, as well as waveform and data processing. The processor also featured one of the earliest implementations of digital separation of baseband quadrature components from a single analog-to-digital converter at a low intermediate frequency, and employed real-time channel equalization in order to prevent receiver channel transfer function mismatches from limiting achievable nulling performance. RSTER also featured an all-solid-state transmitter, again developed by Westinghouse, in order to achieve the necessary pulse-to-pulse stability to meet the tight clutter cancellation requirement. Another key technical development for RSTER was the development of the advanced multichannel rotary coupler, built by Randtron, which had very tight specifications in order to maintain the excellent amplitude and phase stability required to ensure meeting the clutter-cancellation specification.

In 1991, when the entire radar was completed, it was assembled at Lincoln Laboratory on Katahdin Hill (Figure 13-12a). Tests showed the radar to have extraordinarily low sidelobes and an impressive ability to null jammers near the main beam. In 1992, the radar was moved to a Navy test site at Wallops Island, Virginia, for an extensive series of detection, tracking, and jamming tests (Figure 13-12b). The Wallops Island tests were completely successful, and in 1993 the experimental radar was transferred to the Advanced Research Projects Agency (ARPA) under the Air Defense Initiative program and moved to White Sands Missile Range to begin a new life of advanced airborne radar research and development in the ARPA Mountaintop Program.





**Figure 13-12**

**(a)** RSTER radar on Katahdin Hill in Lexington, Massachusetts;

**(b)** RSTER radar on Wallops Island, Virginia;

**(c)** RSTER radar on North Oscura Peak, New Mexico. The smaller phased-array antenna is an IDPCA used for moving clutter emulation;

**(d)** IDPCA array on North Oscura Peak;

**(e)** RSTER radar on Makaha Ridge, Kauai, Hawaii;

**(f)** RSTER radar with ADS-18 antenna at Kokee Park, Kauai, Hawaii;

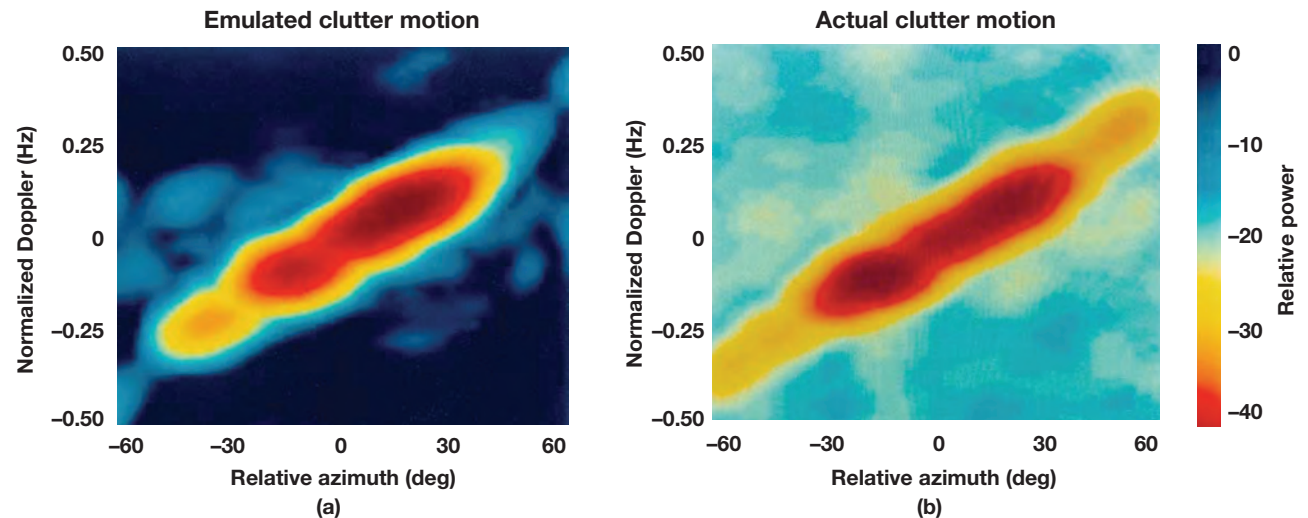
**(g)** UHF electronically scanned antenna radar on Makaha Ridge.





Figure 13-13

Example of (a) emulated ground-clutter motion experienced by the RSTER radar and (b) actual flying clutter observed from an aircraft flying overhead.



**Note**

9 J. Ward. "Space-Time Adaptive Processing for Airborne Radar," *Lincoln Laboratory Technical Report No. 1015*. Lexington, Mass: MIT Lincoln Laboratory, 13 December 1994. DTIC No. ADA 293032.

*The ARPA Mountaintop Program*

While RSTER demonstrated a viable approach to detecting and tracking medium- to high-flying cruise missile threats from surface combatants, detection of low-flying cruise missiles was horizon-limited and necessitated airborne radar assets. This requirement presented a challenge for airborne radars. They needed to look down at an intense clutter background that competed with the target and had to contend with the aircraft motion that spread the clutter in Doppler, making traditional pulse-Doppler clutter mitigation techniques all but useless. Additionally, the potential for energy from sidelobe jammers to reflect off terrain into the radar main beam (known as hot clutter or terrain-scattered jamming) was perceived as a significant challenge. At the time, space-time adaptive processing (STAP) was an emerging technology that showed great promise for facilitating target detection in this difficult environment. The ARPA Mountaintop Program sponsored STAP research and experimentation in order to demonstrate the viability of this approach.

The application of STAP techniques to deployed systems like AWACS and the E-2C was of considerable interest to both the Air Force and the Navy. In 1993, the ARPA Mountaintop Program cosponsored (with the Air Force and Navy) the Joint Airborne Early Warning STAP Requirements Study, which laid a fundamental technical foundation for STAP research in the context of application to airborne early-warning radars. Among the key technical achievements

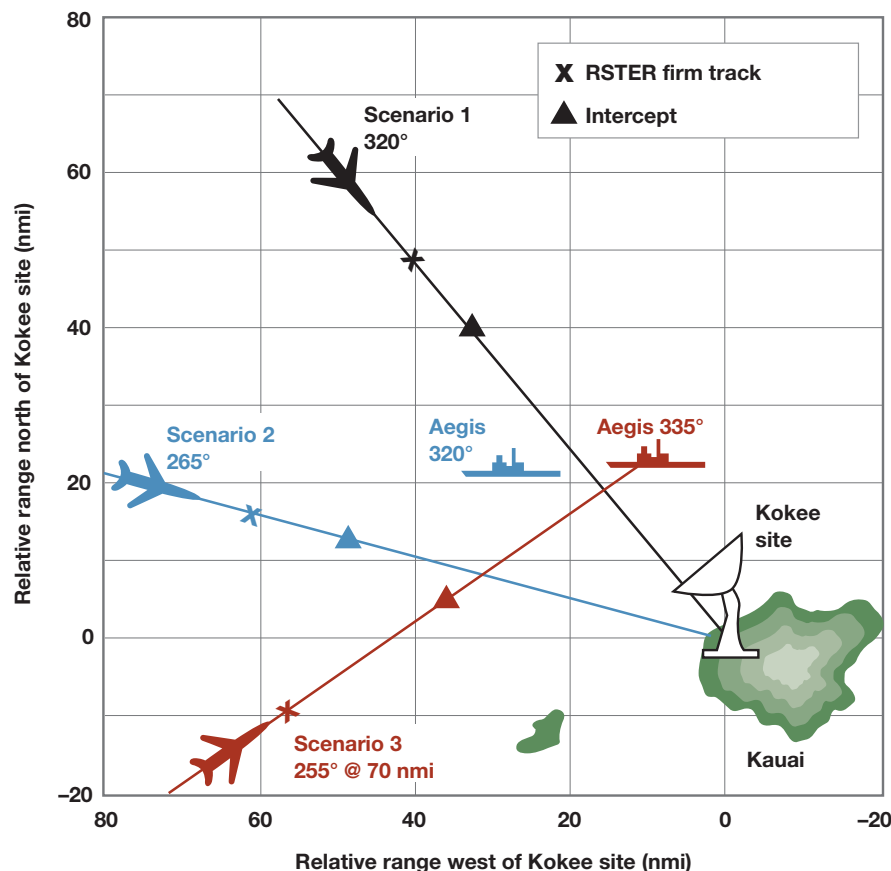
during the course of this study was the development of an overarching taxonomy for classification of STAP techniques<sup>9</sup> and an assessment of suitable technical approaches, as well as potential performance improvements for applying STAP to these platforms.

The Mountaintop Program also looked to augment theory and simulation with experimental results, and toward that end, RSTER moved to North Oscura Peak at WSMR (Figure 13-12c). From that vantage point, on the edge of a sheer cliff looking down 4000 ft to the desert floor below, it was possible to replicate an airborne radar geometry under controlled conditions and at considerably reduced cost. RSTER's planar array was rotated by 90° (a configuration which became known as RSTER-90) to provide adaptive degrees of freedom in the aircraft (azimuthal) plane of motion. The moving clutter background caused by aircraft motion (Figure 13-13) was emulated through the use of a novel inverse displaced-phase-center array (IDPCA) built next to the RSTER system (Figure 13-12d), which transmitted sequentially through successive elements of a linear array at a rate commensurate with the relative motion of a typical aircraft between radar pulses. Experiments with RSTER, RSTER-90, and the IDPCA were conducted throughout 1993 and helped cement the developing theoretical understanding of airborne clutter and terrain-scattered jamming mitigation through STAP.

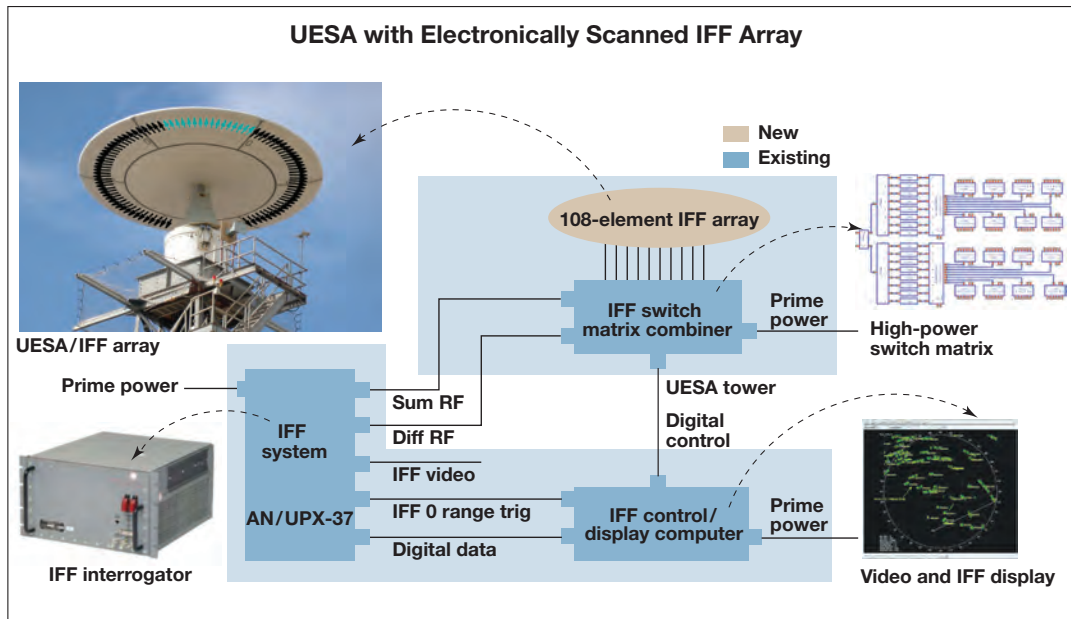
The Mountaintop Program also fostered a broader national discussion on STAP research through its cosponsorship (with the U.S. Navy) of the Adaptive Sensor Array Processing Workshop, held annually at Lincoln Laboratory for sixteen years from 1992 through 2007.

From WSMR, RSTER was moved to Kauai, Hawaii, in 1994 and deployed at Makaha Ridge and Kokee Park (Figure 13-12e and Figure 13-12f), both elevated sites like North Oscura Peak, but looking out over the Pacific Ocean and the Navy's Pacific Missile Range Facility (PMRF). This was an ideal venue for Navy research and development testing activities. The centerpiece of this effort was the successful Navy Cruise Missile Defense Advanced Concept Technology Demonstration, which featured a live-fire over-the-horizon engagement of a cruise missile surrogate in 1996 (Figure 13-14). The concept, known as air-directed surface-to-air missile, would enable surface combatants to engage low-flying cruise missile targets beyond their horizon, aided by an airborne radar system that would detect, track, and illuminate incoming targets. At Kokee Park, 3700 ft above the Pacific Ocean, RSTER served as a surrogate for the airborne surveillance radar. An MK 74 fire-control radar was collocated with RSTER and both tracked and illuminated targets designated by RSTER. These "airborne" radars were netted together as well as to the Aegis Cruiser CG-70 (USS *Lake Erie*) via the Navy's Cooperative Engagement Capability communications system. A BQM-74E drone serving as a surrogate for a low-flying, low-observable cruise missile was launched from PMRF and successfully intercepted by a modified SM-2 interceptor launched from the *Lake Erie* on the basis of data from the radars at Kokee Park. Three successful intercepts in different geometries were carried out.

While in Kauai, Laboratory researchers also worked with the Navy on continued STAP research and technology development focused on upgrades to the Navy's E-2C radar system that would eventually become known as E-2D, now in engineering and manufacturing development. The development of a multichannel antenna that would fit inside the E-2C radome was one of the key enabling technologies, and with RSTER deployed at Makaha Ridge, the Laboratory supported testing of the experimental ADS-18S antenna, an



**Figure 13-14**  
Cruise Missile Defense Advanced  
Concept live-fire demonstration.



**Figure 13-15**  
**Block diagram of UESA with electronically scanned IFF array. The switch matrix permitted a sector of the fixed IFF array to be electronically scanned. An electronically controlled beam-switching matrix allows a sum and difference taper to be applied to the selected sector.**

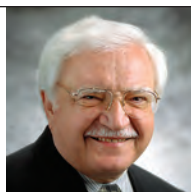
eighteen-channel STAP-capable antenna developed by Northrop Grumman. Testing was accomplished with the ADS-18S connected to RSTER in lieu of the UHF planar array used in the 1997 to 1998 time frame. Following successful testing in this configuration, early prototype radar hardware developed by Northrop Grumman supplanted RSTER, as Makaha Ridge became an early integration and testing site for the Navy. This work eventually led to an airborne radar prototype on board a C-130 test aircraft deployed at the Patuxent River Naval Air Station.

Like the RSTER antenna, the ADS-18S was rotated to achieve full 360° coverage, adding considerably to the mechanical complexity of the design and requiring a multichannel rotary coupler. Under sponsorship of the Office of Naval Research, the Laboratory became involved in research and development of an alternative concept — a UHF electronically scanned antenna (UESA) consisting of a circular array of UHF elements. Technical challenges here included developing STAP algorithms for circular arrays (whereas previous STAP work involved linear array configurations) and techniques for integrating an identification-friend-or-foe (IFF) antenna into the circular UESA concept. During 2006 and 2007, the Laboratory developed a prototype UESA IFF system that was integrated with the UESA developed by Randtron and tested at Makaha Ridge in spring 2008 (Figure 13-12g, Figure 13-15, and Figure 13-16).

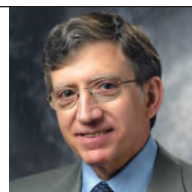
### Surface Navy Radar Technology

Work on the development of a ballistic missile defense capability for the Navy in the 1990s gave the Laboratory a familiarity with the capabilities and limitations of radars on surface ships, in particular, the AN/SPY-1 radar aboard Aegis cruisers and destroyers. In 1996, Lincoln

1990



M. Gruber

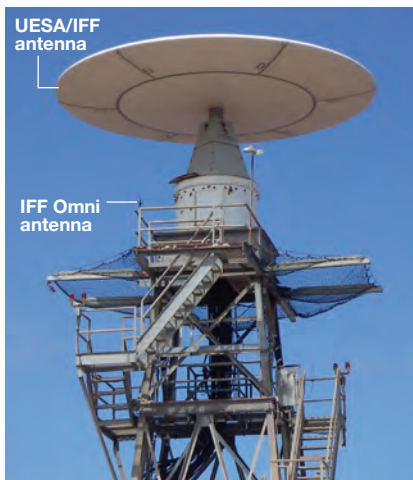


C.W. Davis



E.D. Evans





**Figure 13-16**  
**UESA/IFF circular array.**

Laboratory was asked by the Navy to participate in a radar road map study to help define a path for future shipboard radars. The current generation of radars, including the AN/SPY-1, had been designed in the mid-1960s, and was based on technology of that era. The study defined a family of new radars for future shipboard applications and included an X-band multifunction radar for defense against low-flying cruise missiles, an L-band volume search radar to complement the multifunction radar for air situational awareness and control, and a large S-band air and missile defense radar (AMDR) to enable the Navy to have an active role in ballistic missile defense. Each of these new radars was to be based on active phased-array technology. The results of the study were widely embraced and became the basis for program starts for this new family of radars.

Following the study, the Laboratory began work on a number of programs to prove out the technology needed for this next generation of radars. The first project was the L-band digital array radar (DAR) program, begun under Navy sponsorship in 1997. The objective of the program was to demonstrate the feasibility of an element-level digital architecture for the volume search radar, in which each element of the array would have an analog-to-digital converter and digital receiver behind it. The program ran from 1997 to 2001 and involved the design and fabrication of a fully digital L-band transmit/receive module, and the assembly of a number of these modules into an all-digital L-band array for testing (Figure 13-17).

In 2001, based in part on the success of the L-band DAR effort, the Navy began to consider digital beamforming for its S-band AMDR, which would be a replacement for the AN/SPY-1. The Laboratory co-led a six-month

study with Lockheed Martin, the contractor for the AN/SPY-1, to determine the benefits and feasibility of such an approach. Although skeptical at first, both the Navy and the contractor were won over by the arguments brought forth during the study, and at the conclusion of the study it was agreed that the S-band AMDR would be a subarray-level digital design. Although the Laboratory had worked on designs for digitally beamformed radars in the past, most notably, the ADS-18 for the Navy's E-2D as well as the L-band DAR project, the design needed for the AMDR was more complex in a number of ways. First, the number of digital channels would be in the many hundreds, rather than the tens of channels needed for the E-2D. Second, the bandwidth needed for each digital channel would have to be in the hundreds of megahertz, an order of magnitude greater than that of digital systems built in the past. Finally, the dynamic range and stability of the system had to be exquisite in order to effectively cancel the clutter present in a littoral environment. All of these factors led to the conclusion that, although digital beamforming appeared to be the desired path to pursue, a risk-reduction program was needed to ensure that the technology was well understood before full development of the radar could begin.

One recommendation from the six-month study was that a sixteen-channel test bed be constructed to assess the challenges associated with wideband digital beamforming, to be followed by a larger, 1000-element test array. Lincoln Laboratory built the sixteen-channel S-band DAR test bed beginning in 2002 and used it to develop and test the signal processing chain that would be needed to conduct digital beamforming on the large scale needed for AMDR. The Laboratory also participated in the Advanced Radar Technology



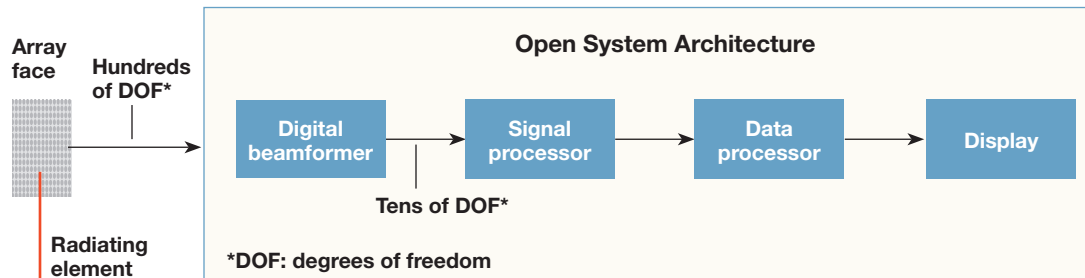
A.D. Gerber



R.T.-I. Shin



D.J. Keane



**Figure 13-17**  
**Top: DAR top-level architecture.**  
**Bottom: 224-element L-band DAR**  
**array in anechoic chamber.**

Integrated System Testbed program conducted jointly between the United States and the United Kingdom, to test prototype digital beamforming arrays at Wallops Island, Virginia.

### **Distributed Antennas for Cooperative Engagement Capability Communications**

The Laboratory's increasing role in Navy air defense programs in the late 1990s and early 2000s led to an involvement not only in radar development, but also in developing new capabilities for the systems used to share radar data between ships to form an integrated air picture. The Navy's main tool for creating an integrated air picture is the Cooperative Engagement Capability (CEC), which consists of C-band communications equipment and data fusion algorithms designed to provide a complete and consistent view of aircraft over the battle group. It supports both ship-based and airborne (E-2) installations.

In 2002, Lincoln Laboratory was asked to support an analysis of alternatives for a next-generation (Block II) version of CEC. This effort focused on identifying and prioritizing new technologies that could substantially improve system performance and extend capabilities to a larger number of participants. Both existing and new technologies were considered, and the Laboratory proposed modifications to the existing communication system that would reduce power, reduce fading, and significantly increase channel capacity. Following the analysis of alternatives, Laboratory researchers performed a low-cost proof-of-concept demonstration to validate this performance improvement.

The proposed system made use of multiple-input, multiple-output (MIMO) array processing and advanced coding techniques to improve throughput by up to 10 dB. Any shipboard communication system must counter the effects of fading due to multipath interference between direct signals and those bouncing off the ocean. The original implementation of CEC budgeted a significant amount of power to overcome the effects of this multipath fading. In a MIMO implementation, multiple antennas are positioned high on the mast with both vertical and lateral displacements. The signals from the various transmit antennas are coded and received in such a way as to minimize interference and create two effective communication paths: one direct and one bounced from the sea.

In 2004, the Laboratory began a two-year effort to demonstrate this technology. Propagation tests were performed between Halibut Point State Park and the Air Force's Ipswich antenna range over Ipswich Bay in Massachusetts to demonstrate fade mitigation afforded by adaptive receive antennas. In 2005, a second series of tests was conducted in the same location to verify the performance of both advanced coding and adaptive antennas. In both cases, the test results verified the theoretical performance predictions.

Following the successful demonstrations, the Navy asked Lincoln Laboratory to work with two contractors to show the feasibility of inserting this new technology into the contractors' hardware configurations. Together, the Laboratory and the contractors performed preliminary designs of the necessary processing boards to fit within existing chassis and support all the advanced functionality. This effort completed the Laboratory's role in identifying, demonstrating, and transitioning this new technology to the Navy for its planned product improvements for CEC.

#### **Combat Identification Technology**

Development of improved radar, missile, and cooperative engagement capabilities in the 1990s and 2000s gave the Navy the potential ability to engage air targets at very long ranges. The Navy coined the term "integrated fire control" to describe such long-range engagements using multiple sensor and shooter assets. One issue with such an integrated fire-control capability was that it required the ability to positively identify targets as hostile at long ranges. The Navy did not have such a capability at the time, and this need led to a set of efforts to improve the Navy's long-range combat identification technology.

Combat identification is similar in many ways to the discrimination problem encountered in ballistic missile defense (see chapter 9, "Ballistic Missile Defense"). Multiple target features can be integrated in computerized decision logic to determine whether an air vehicle is friendly, neutral, or hostile. In the case of combat identification for air vehicles, these features include height, speed, bearing, IFF beacon returns, radio contact, electronic emissions, and multiple features which can be derived using radar returns.

In 1999, the Laboratory began investigating advanced methods for performing combat identification using radar returns. One method used the coherent returns from multiple radars at different aspect angles to form a three-dimensional view of the target. The approach was made possible by the fact that relative phase differences between different scattering centers on a target vary from one radar location to the other, allowing out-of-plane distances of the scattering centers to be inferred. This effort was initiated through the analysis of simulated data in 1999, progressing to the collection of compact range data at the University of Massachusetts, Lowell, range in August 2001. The processed data was encouraging enough that a set of data collections was performed at the Kwajalein Missile Range (KMR) in October 2001. The KMR test included data from the X-band TPS-X radar on Kwajalein and the ARPA Lincoln C-band Observables Radar on the island of Roi-Namur. The combination of radars with different frequencies and different aspect angles to the target made the effort of cohering the data exceedingly challenging. Nonetheless, the effort provided a great deal of insight into the complexities of multiaspect multifrequency imaging that would be utilized on future developmental efforts.

In 2004, the effort was picked up by the Missile Defense Agency for application to ballistic missile targets. Air targets were also flown as part of the effort to verify that multiple radars could operate coherently for ballistic missiles. The final test was in 2006 at WSMR. The effort succeeded in generating a three-dimensional image of a King Air aircraft by using X-band radars at two different aspect angles to the target. The equipment developed for this effort was then used to collect data on space objects, successfully producing extremely sharp three-dimensional images of satellites.

In addition to the multiaspect target imaging work, Lincoln Laboratory has developed combat identification technology for a number of military systems over the years, including fighter radars, airborne surveillance, and shipboard systems.





**Figure 13-18**  
Advanced electronic warfare capabilities are being developed to defend surface ships (above) from anti-ship missiles.

### Electronic Warfare Technology

The Laboratory has historically had a major involvement in the development of electronic protection techniques to protect radars from the detrimental effects of jamming on the part of an adversary. The technology for STAP, which adaptively cancels jammer energy in a radar's receive beam, grew to maturity under the Laboratory's development efforts for the E-2D. In 2009, the Navy commissioned Lincoln Laboratory to look at techniques that could counter the effects of more complex jamming techniques on radar performance. To respond to this need, the Laboratory initiated a multidivisional program involving algorithm development, hardware development, testing, and technology transfer to a number of Navy radar systems.

In 2008, the Navy began to take a strong interest in electronic warfare techniques to counter the threat of advanced antiship missiles. Under the Navy's sponsorship, Lincoln Laboratory started a program to develop a prototype for an enhanced electronic attack capability for use on surface ships to defend against these advanced missile threats (Figure 13-18).

The coordination of the use of missile and electronic attack methods to defend a ship against incoming antiship missiles had traditionally been done by operators in a ship's combat information center, and there was concern on the part of the Navy that, under a large-scale coordinated attack by antiship missiles, the operators would be overwhelmed. In 2010, the Office of Naval Research commissioned Lincoln Laboratory to develop a combat system capability that would calculate in real time the optimal mix and employment timeline for

missile and electronic attack weapons, and apply them in such a way as to defeat the incoming raid while minimizing the use of resources.

The addition of large-scale Navy electronic warfare projects in the Laboratory's air defense portfolio represented a significant new growth direction. Fortunately, a great deal of expertise was leveraged from the Laboratory's prior radio-frequency systems development and air vehicle survivability experience.

### Over-the-Horizon Radar

Over-the-horizon radar (OTHR) employs reflection of radio-frequency transmissions off the ionosphere to detect and track targets at very long ranges — a technology dating back to the 1950s. Systems were installed by the Navy in the late 1980s to provide surveillance off the U.S. coastline for illegal drugs, but little was done in the United States to improve the fundamental capabilities after that.

In 2004, the Missile Defense Agency initiated a collaborative effort with the Australian government to focus on improving the capabilities of OTHR. OTHRs are among the world's most sensitive surveillance radars and have a potentially significant role in long-range air and maritime surveillance, as well as in early warning for ballistic missile defense. However, OTHR system performance can be impaired by environmental effects, in particular, ionospheric-motion-induced spread of ground clutter, which impairs the ability to detect and track slow-moving or crossing targets. As part of the Missile Defense Agency effort, the Laboratory proposed to mitigate this spread clutter using MIMO waveforms

2000



R.G. Atkins



J.G. Fleischman



E.H. Niewood



G.K. Borsari



**Figure 13-19**  
**In collaboration with the Australian DSTO and using the Jindalee Operational Radar Network in Australia, Lincoln Laboratory completed two demonstrations of critical components for a next-generation over-the-horizon surveillance radar. Above: Frank Robey of Lincoln Laboratory and government staff at the Jindalee OTHR site in Australia.**

and a signal processing approach developed for the NexGen missile defense radars (see chapter 9, “Ballistic Missile Defense”). The processing uses antennas with resolution in azimuth and elevation to select the most stable ionospheric propagation path while adaptively suppressing all other paths. This adaptive processing requires the ability to observe the propagation in space of the transmitted signal as it interacts with the environment and then to control the transmitter illumination. This capability is provided by Lincoln Laboratory signal processing. This signal processing mitigation of the spread clutter was untested, and furthermore it was unclear that an OTHR could even be operated in this mode.

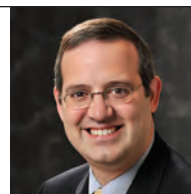
To answer these questions, an effort was proposed in early 2005 to the Australian Defence Science and Technology Organisation (DSTO) under the newly signed U.S.–Australian collaboration Memorandum of Agreement. This collaboration led to U.S. involvement in the Australian High-frequency L-array Orthogonal Waveform trials, in which data were collected using the Laverton OTHR in the Great Victoria Desert of western Australia. This radar consists of two collocated radars with antenna arrays oriented at  $90^\circ$  to each other (hence the name L-array). These arrays were configured for the trials as a single two-dimensional array. Significant instrumentation was deployed across the northern Outback and along the northern Australian coast. These trials showed that MIMO processing with two-dimensional arrays could successfully be used to select stable ionospheric propagation modes and to suppress the undesired modes (Figure 13-19).



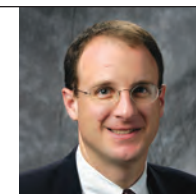
D.J. Ebel



M.G. Choi

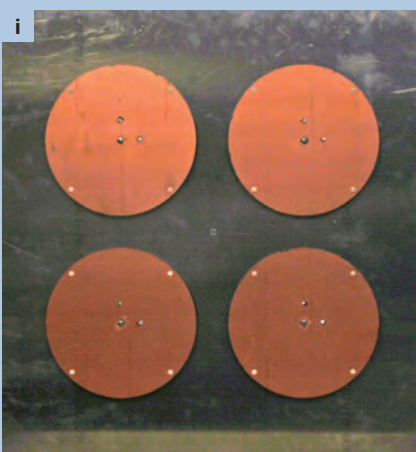
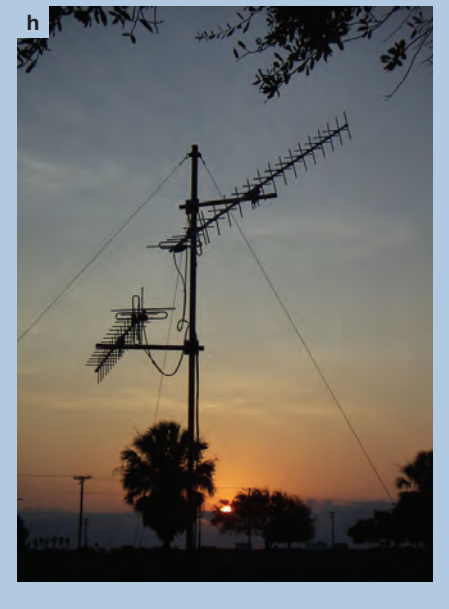


A. Feder



K.P. Cohen







**Figure 13-20**

**Scope of Lincoln Laboratory Advanced Air Defense Technology Program activities.**

- (a) Testing at WSMR, New Mexico (Laboratory staff, foreground; Lincoln Laboratory's Boeing 707, background center);**
- (b) Testing aboard the Navy's E-2D test bed, Patuxent River, Maryland;**
- (c) Flight testing in the National Capital Region, Washington, D.C.;**
- (d) Advanced air defense interceptor test, WSMR;**
- (e) Slotted planar array with monopulse feed network for airborne testing;**
- (f) Large array airborne antenna, flown on the Laboratory's Boeing 707;**
- (g) System integration tower and lab, Katahdin Hill, Lexington, Massachusetts;**
- (h) Test site at Corpus Christi, Texas;**
- (i) 2 × 2 circular patch array for flight testing;**
- (j) Ground-based emitter at North Oscura Peak, WSMR;**
- (k) Equipment for integration onto the airborne test bed;**
- (l) Radar on San Nicolas Island, California.**

Since then, two-dimensional OTHR antenna arrays on transmit and receive, along with MIMO adaptive processing, have been recognized by the U.S. OTHR community as having a significant role in mitigating spread clutter. At the urging of North American Aerospace Defense Command/U.S. Northern Command (NORAD/NORTHCOM), the Office of the Secretary of Defense initiated a Technology Risk Reduction Initiative in 2009 to reduce risks in building a next-generation OTHR. Lincoln Laboratory conducted the key risk-reduction and prototyping activities for this initiative.

**Advanced Air Defense Technology Evolution**

Beginning in the mid-1990s, the Laboratory's involvement in air defense technology grew to include some significant prototyping of advanced air defense system concepts. As a rule, these large projects spanned the gamut of technology development and innovation, and included systems analysis, system design, large-scale hardware development, algorithm development, systems integration, flight testing, test data analysis, and technology transfer to government contractors. These efforts have had a significant impact on a number of major Service acquisition programs, most notably with the Navy and Air Force. A subset of the efforts is depicted in Figure 13-20.

**Summary**

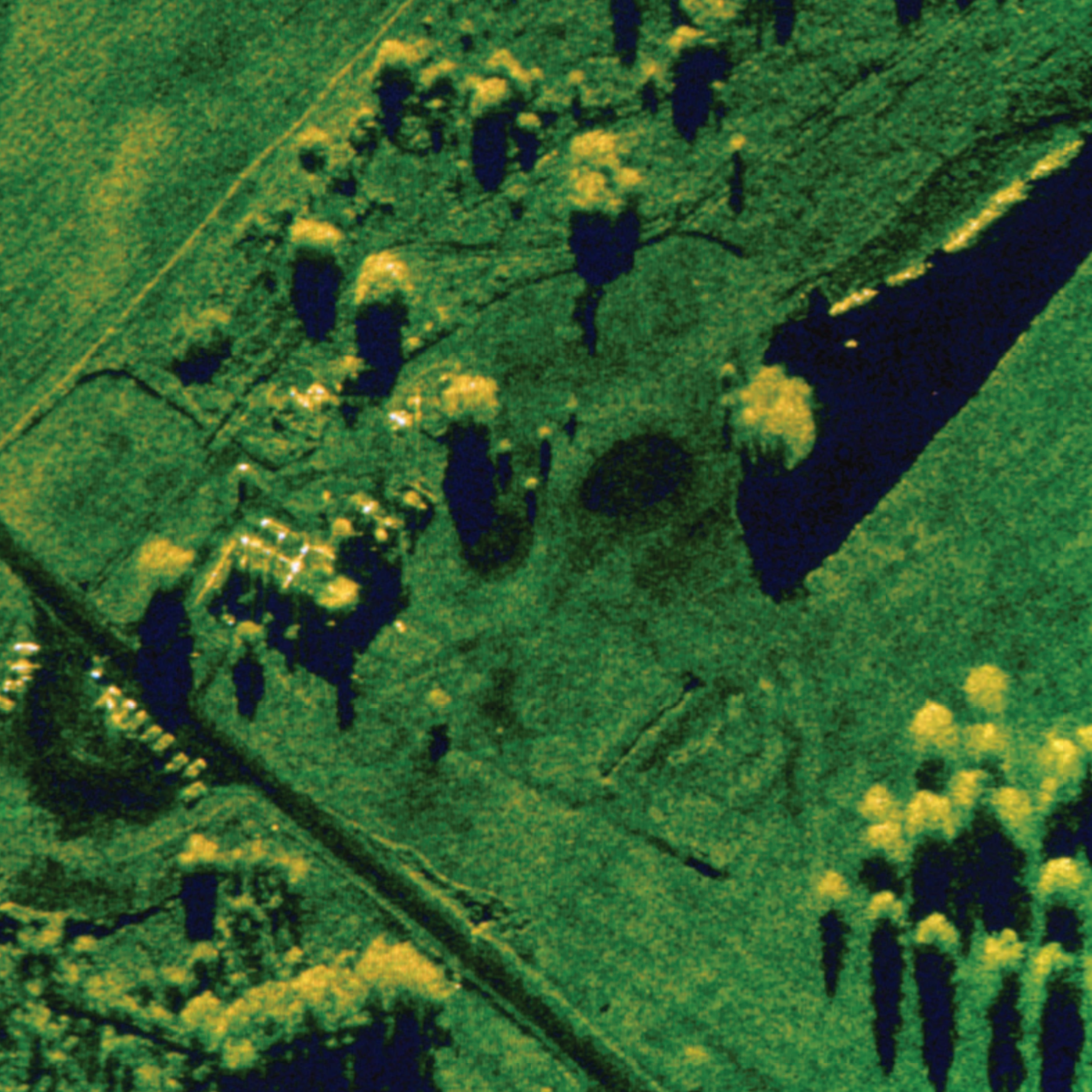
Lincoln Laboratory's initial mission was to develop an air defense system to protect North America from the threat of Soviet bombers bearing nuclear weapons. The Laboratory successfully developed the Semi-Automatic Ground Environment system, a project that required massive innovation, particularly in the domain of real-time digital computers and large-scale system integration (see chapter 2, "The SAGE Air Defense System").

As the intercontinental ballistic missile and other threats displaced the Soviet bomber as a primary security concern, air defense faded into the background, and the Laboratory pursued technologies in support of other more pressing mission areas. However, with the emergence of U.S. cruise missile technology in the late 1970s, a new concern arose: Would U.S. cruise missiles be vulnerable to the formidable air defenses that had been developed by the Soviet Union? Thus was initiated a new chapter in the Lincoln Laboratory air defense history — analyzing and modeling foreign air defense systems to determine the survivability of U.S. air vehicles. The air vehicle survivability program, initiated in 1977, made major contributions to the understanding of these issues throughout the Cold War and continues to do so.

Partly because of the deep understanding of air defense technology that it evolved through the air vehicle survivability effort, the Laboratory began in the mid-1980s to take a role in the development of advanced air defense technology for U.S. air defense systems. From the mid-1990s to the present, the Laboratory has had a key role in major technology prototyping efforts, many of which have transitioned to U.S. air defense systems that are either operational or in development.

It is safe to say that Lincoln Laboratory has had a major impact on the shape and character of modern air defense, in terms of both the capabilities of U.S. systems and the understanding of foreign air defenses and their potential impact on U.S. air vehicles. Since battles of the future are almost certain to require air superiority and a well-defended air space, the need for advances in air defense technology are expected to continue to be a national priority and an important mission area for the Laboratory.







**Tactical battlefield surveillance systems need the ability to survey large areas on the ground to detect and identify surface targets that may be located in ground clutter or protected by countermeasures. In 1967, the Laboratory began to develop both an understanding of the phenomenology of ground-target detection and a wide variety of sensors, processors, and novel algorithms to attack this challenging task. These developments have formed the foundation for important national capabilities such as the JSTARS airborne battlefield surveillance system.**

**Left: Synthetic aperture radar image of a golf course in Stockbridge, New York. This image was constructed from data taken by the 35 GHz Advanced Detection Technology Sensor.**

Lincoln Laboratory's involvement in the tactical battlefield surveillance area began in 1967 with a program to develop a radar to penetrate jungle foliage and detect intruders moving at short range. This early effort was in direct response to a critical problem that arose during the war in Vietnam. Previously, the Laboratory's programs had focused mainly on the strategic arena, but events in Vietnam pressed the major national laboratories into contributing to the solution of tactical battlefield problems as well.<sup>1</sup>

The Laboratory's work in the tactical area soon increased and diversified markedly, and by the mid-1970s, it encompassed a number of significant efforts. Over succeeding years, tactical activities were conducted under a wide variety of project names, including Hostile Weapons Location Systems, Strategic Relocatable Targets, Critical Mobile Targets, Netted Radar Program, and Infrared Airborne Radar. For simplicity, the timeline of surface surveillance efforts (Figure 14-1) refers to these activities generically.

Numerous individuals, too many to be identified here by name, worked individually and as part of Lincoln Laboratory teams, contributing to the great breadth of the activities shown in Figure 14-1. The overall Lincoln Laboratory tactical area was under the direction of assistant director Daniel Dustin until his retirement in 1985, when he was succeeded by assistant director William Delaney. In the formative years of the tactical activities, Herbert Weiss, John Allen, and Larry Lynn played key leadership roles at the division level. The middle years of the program were led by Delaney, Paul Drouilhet, David Briggs, Lee Upton, Kenneth Senne, and David Martinez. Robert Shin currently leads this effort.

Several Laboratory groups conducted radar activities for tactical battlefield surveillance. Leaders of these groups included Aaron Galvin, Edward Muehe, Donald Temme, Melvin Stone, Gerald Morse, Michael Gruber, Paul Monticciolo, and now Stephen Kogon. A number of other groups also carried out tactical technology programs, including the tactical laser and infrared (IR) activity led by Alfred Gschwendtner; the tactical communications activity led by John Beusch; the signal intercept and command, control, and communications (C3) countermeasures activity led

by Irvin Stiglitz; the laser radar group led by Richard Heinrichs; and the seismic-acoustic technology activity led by Richard Lacoss.

Numerous organizations in both industry and government were and are involved in tactical battlefield surveillance research. The Lincoln Laboratory programs recounted here are only a small part of an enormous and diverse national effort, and the Laboratory has benefited greatly from participation in the larger national activity.

Lincoln Laboratory's involvement in the tactical area continues today, centered in a new Intelligence, Surveillance, and Reconnaissance (ISR) and Tactical Systems Division. Key thrusts include airborne ground surveillance radar, airborne laser radar, novel ISR capabilities for counterterrorism and counterinsurgency applications, and ISR sensor data exploitation. Great progress has been made in battlefield surveillance, but as the recent conflicts in Iraq and Afghanistan illustrate, many challenges remain.

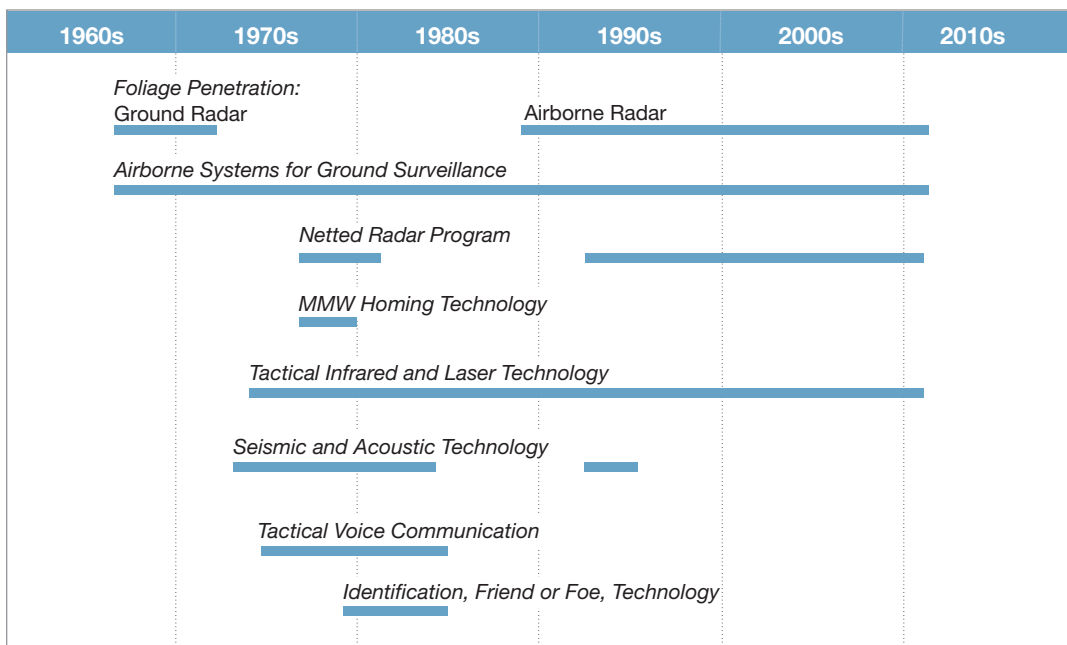
#### **Foliage and Ground Penetration Radar**

Field reports from American troops in Vietnam revealed that foliage played a major role in concealing the enemy in most tactical engagements. Therefore, Lincoln Laboratory took a strong interest in developing a surveillance system that offered a foliage penetration capability. A Laboratory study carried out in November 1966 concluded that radar would be able to detect people and vehicles moving through dense foliage. A small program in ground penetration radar to detect underground tunnels was also conducted to support troops in Vietnam.

#### *The Camp Sentinel Radar*

The foliage penetration radar program, supported originally by the Advanced Research Projects Agency (ARPA) and subsequently by the Air Force, began in January 1967. The objective was the development of two systems: a ground-based radar that could detect intruders into a small encampment and a helicopter-borne radar that could detect moving vehicles along foliage-concealed roads. The ground-based system to detect intruders was named the Camp Sentinel Radar. Deployed in Vietnam after an eighteen-month crash development program, it protected American troops throughout the rest of the war.





**Figure 14-1**  
Timeline of major efforts in the surface surveillance program area.



**Figure 14-2**  
Camp Sentinel Radar installed in Lai Khe, Vietnam.

#### Notes

**1** The tactical battlefield surveillance program has also been known as the surface surveillance program. Organization and editing of this chapter were directed by William Delaney. Contributors included John Beusch, Thomas Bryant, Thomas Goblick, Robert Hull, Herbert Kleiman, Melvin Labitt, Richard Lacoss, Edward Muehe, Edward Schwartz, Jay Sklar, Irvin Stiglitz, Melvin Stone, and Donald Temme.

**2** A summary of the Florida measurements program appears in a 1971 report: M. Labitt, J.H. Teele, and R.D. Yates, "The Lincoln Laboratory Foliage Penetration Radar Measurements Program," *17th Ann. Tri-Service Radar Symp. Record, Vol. 1, 25-27 May 1971*. Fort Monmouth, New Jersey: U.S. Army Electronics Command, AMSEL-CT-DT.

At the program's inception, there was little information on which to base the radar design. The technical literature provided minimal data on electromagnetic attenuation in tropical foliage, but it did suggest that the best operating frequencies were between 20 and 500 MHz. In order to localize any detections to a small azimuth region with an antenna small enough for tactical deployment, a frequency near the upper end, 435 MHz, was chosen.

Three critical questions about the propagation of radar signals within foliage had to be answered: (1) How much does the foliage spread the frequency spectrum of a signal reflected from a target? (2) What is the frequency spectrum of clutter signals reflected from windblown foliage? (3) What is the effect of multipath propagation on range and azimuth resolution and on subclutter visibility?

The Laboratory built two radar systems to answer these questions. The initial system, the Camp Sentinel Radar-I, took measurements locally. It worked well, and it was used in demonstrations to military observers in fall 1967. A second version was mounted in a van and sent to Bisley, Puerto Rico, where foliage closely simulated the conditions in Vietnam. By January 1968, enough measurement data had been accumulated to go ahead with a more advanced radar, the Camp Sentinel Radar-II.

The design of the Camp Sentinel Radar-II incorporated unique and innovative concepts. The antenna was mounted high above the ground on a rapidly deployable tower so the electromagnetic waves could reach a target by propagating over the tops of the trees and then be diffracted to the ground, rather than by propagating directly through the foliage. An electronically scanned cylindrical array sequentially stepped the antenna beam through 32 positions of azimuth to cover 360°. Methods to cancel out moving clutter due to wind were successfully demonstrated.

The radar control was designed to allow an operator to construct two intrusion fences. These fences could be made irregular in shape, matching them to the desired defense perimeter. The operator did not need to monitor the radar unless an alarm sounded. If a detection occurred, the operator simply checked the display to see which range/azimuth sector contained the intruder and to see if the target was incoming or outgoing.

After a short local testing period, the first Laboratory-built Camp Sentinel Radar-II was shipped to Vietnam in August 1968. Leonard Bowles and David Rogers spent two months in Vietnam, introducing the radar to the 3rd Brigade, 1st Infantry Division, and instructing Army personnel in its operation and maintenance. The radar received immediate acceptance, and the Army used it until the end of the war (Figure 14-2).

Additional development work was carried out by the Army's Harry Diamond Laboratory. The improved version, the Camp Sentinel Radar-III, included a more powerful transmitter to increase the detection range and additional display options. Six of these radars were manufactured and sent to Vietnam, where they remained until U.S. combat troops were withdrawn.

#### *The Long Range Demonstration Radar*

The success of the Camp Sentinel radar encouraged the Department of Defense (DoD) to support a program to investigate the feasibility of developing a much longer-range foliage penetration radar. This effort began early in 1969 with the design of equipment that could measure electromagnetic propagation and clutter spectra in foliated areas. Measurements were then carried out in the Florida Everglades between June 1969 and December 1970.<sup>2</sup>

The Florida program collected detailed and precise data on the effect of foliage on radar, including measurements of the spectra and amplitude statistics of signals from wind-blown clutter, the spectra of signals from moving men in the clear and in clutter, and the variation of the signal strength and polarization of the electromagnetic field as a function of height above ground. These measurements at 435 and 1305 MHz verified the lossy dielectric slab model of propagation in foliage, as well as a randomly moving tree model that explained the observed spectra.

The design and construction of the Long Range Demonstration Radar, an electronically scanned radar featuring an 80 ft semicircular antenna, proceeded in parallel with the Florida measurements. The radar was operational from fall 1971 through June 1972. Its antenna was mounted on a 100 ft tower on Katahdin Hill near the Laboratory. Most of the signal processing — the Doppler filter bank and thresholding in each range-azimuth cell — was performed in real time by

## In Vietnam

**Certainly no Lincoln Laboratory assignment has called for greater physical courage than the one given in 1968 to Leonard Bowles and David Rogers. Their task — to install the Camp Sentinel Radar in Vietnam, operate it in the field, and train Army personnel in its use.**

**When Bowles and Rogers arrived in Saigon on August 11, the city was under attack. Five rockets hit nearby parts of the city, one only about 100 ft away. Ironically, Saigon was considered safe.**

**They flew to Lai Khe, about 50 mi northwest of Saigon, where the 3rd Brigade, 1st Infantry Division, had established a large base. The Vietcong had established a route through the village of Lai Khe and were slipping onto the base at night. They had already blown up the officers' club, three helicopters, and four barracks; the commanding officer, Colonel William Patch, was eager to bring the Lincoln Laboratory team on board.**

**The Camp Sentinel Radar had been shipped to South Vietnam in three boxes, all of which were left out on the runway in the tropical weather. When Bowles and Rogers opened the boxes, they found the radar equipment sitting in several inches of water. Working with military personnel in weather that alternated between 100°F and torrential rain, they replaced corroded parts, cleaned circuit boards, dragged equipment through deep mud, and set up the radar.**

**The radar proved its value immediately, detecting targets during each of the first three days. Mortars and M-79 grenades were fired each time moving targets were detected, and each time the targets were then observed moving away. Patrols during the following days found items dropped by the enemy along the trail in hasty retreats.**

**After a month of operations at Lai Khe, Bowles and Rogers moved the radar by helicopter to an even more hazardous site: Bandit Hill, a night defensive**

**position near the village of Tam Binh. Located deep in Vietcong country, Bandit Hill was suffering frequent attacks by mortar, rocket, and ground intrusion. A first sergeant came out to greet the Lincoln Laboratory team; all of the commissioned officers were wounded.\***

**Setting up the radar called for extraordinary courage; while working on the tower, Bowles and Rogers were completely exposed. But once the Camp Sentinel Radar became operational, it was immediately successful in detecting targets under foliage. When the Vietcong realized that their movements were being detected, attacks declined markedly.**

**Over the next month, Bowles and Rogers trained military radar mechanics and operators to detect moving targets. Averaging about five hours of sleep each night throughout their tour, both men were more than glad to leave Vietnam on October 10. But the real proof of the importance the Vietcong assigned to the Camp Sentinel Radar came just two days later.**

**On October 12, Army radar mechanics took the Camp Sentinel Radar antenna down from its tower for routine maintenance. The radar position immediately came under heavy ground and mortar attack, and the radar was damaged and unable to function. The maintenance battalion personnel and enlisted men Bowles and Rogers had trained were able to replace or repair the damaged parts. Three days later they brought the set back into operation. The radar had proved its importance, and the Vietcong stayed away from Bandit Hill.**

---

\* Letter from Leonard Bowles to John Allen, September 23, 1968.

## Note

3 E.M. Hofstetter, C.J. Weinstein, and C.E. Muehe, "A Theory of Multiple Antenna AMTI Radar," *Lincoln Laboratory Technical Note 1971-21*. Lexington, Mass.: MIT Lincoln Laboratory, 8 April 1971, DTIC AD-724076.

the Fast Digital Processor, which had been developed by the Laboratory's computer division as a general-purpose signal processor.

The Long Range Demonstration Radar reliably detected a single walking man at distances greater than 7 km. Sub-clutter visibility varied from 45 to 60 dB, depending on whether the clutter was distributed or from a single large scatterer. Military observers attended demonstrations of the radar in May 1972. Shortly thereafter, the foliage-penetration program at Lincoln Laboratory ended because of the U.S. decision to withdraw from Vietnam.

The foliage penetrating radar program using low-frequency sensors on airborne platforms was initiated in the late 1980s. The research and development focus of the airborne foliage penetration program was on enhancing the detection probability on difficult targets and controlling false alarms (false positives) on objects that were not targets of interest. Coherent change detection techniques and advanced tracking algorithms improved the false-alarm control by orders of magnitude. The Defense Advanced Research Projects Agency (DARPA) was a key sponsor of this effort.

### *Geodar: Ground Penetrating Radar*

American forces operating in Vietnam needed a sensor system that could detect tunnels. In 1966, after discussions with others working on this problem, Robert Lerner of Lincoln Laboratory concluded that a particular form of radar system offered possibilities, and the Geodar program was initiated to investigate his concept under

ARPA sponsorship. The main distinguishing feature of the Geodar concept was that electromagnetic energy was radiated directly into the ground.

Because the soil-penetration properties of radar were not known with any precision, it was decided to use a wide band of frequencies, 50 to 150 MHz, within the generally applicable frequency range. A flat, rectangular-shaped antenna of transmission-line design operating very close to the surface generated electromagnetic energy in compact packets of 3 to 5 nsec duration. The antenna, with an effective area of about  $3/4 \text{ m}^2$ , would be drawn over the ground on a Teflon sled structure.

A first experimental system was quickly assembled late in 1966 and proof-of-concept tests were made at a simple tunnel test range at the Laboratory. The tests proved that voids in the ground could be detected. A formal program was then established to develop a demonstration system for field test. The first system, Geodar Mark I, was completed in early March 1967 and an improved version, Geodar Mark II, a few months later.

The Geodar systems were tested on tunnels at Fort Belvoir, Virginia, and at Raleigh, North Carolina, as well as on voids implanted in a second Laboratory test range constructed on Millstone Hill. The test results indicated that the Geodar systems could locate tunnels of 2 to 3 ft in diameter at depths of 3 to 20 ft (although detection below 12 ft was an extrapolation) in most alluvial, glacial, and loessial soils.

1965



D.E. Dustin



Geodar



Several sets of Geodar Mark II were fabricated by Sylvania West, and Lerner went with them to Vietnam. Demonstrations there corroborated the earlier test data and predictions. For a time, the Geodar system was deployed for perimeter tunnel surveillance around an Army Headquarters installation.

#### **Airborne Systems for Ground Surveillance**

Concurrent with the early activity on ground radars was an effort in airborne radar for detecting trucks. The first program was followed by a near-continuum of airborne ground surveillance efforts that have continued to the present (Figure 14-1).

##### *The Airborne Truck Detector Radar*

Work on the Airborne Truck Detector radar began in early 1967. This system was designed and built to demonstrate that a helicopter moving at 100 knots could survey and detect trucks along foliage-obscured roads. The effort progressed somewhat more slowly than had the Camp Sentinel Radar effort, but by September 1968 the system was ready for flight testing.

A Sikorsky SH-3A helicopter was configured to carry a five-beam antenna, 13.5 feet long by 16 inches high. The five beams provided an overall azimuth surveillance swath about a kilometer wide. An operating frequency of 970 MHz was chosen as a compromise between attenuation through foliage, which increased with frequency, and clutter returns, which increased at lower frequencies. The system was made noncoherent to eliminate the need to compensate for the multiplicity of Doppler shifts that occurred with each clutter patch on the ground.

A limited flight-test program was conducted and results were generally positive. Jeeps moving at 12 mph were easily detected in dense New England foliage although detection capability was lost when the jeep slowed to 8 mph. Men on bicycles moving at 10 mph in the clear were also easily detected. Men on foot were not detected successfully. The inability to see an individual man was attributed to noise, probably coming from the radar itself. Termination of funding prevented further flight testing of the Airborne Truck Detector radar, and the effort was concluded late in 1969 after about six months of successful tests.

##### *Multiple-Antenna Surveillance Radar*

In the late 1960s, Lincoln Laboratory undertook a feasibility study of a radar to perform ground surveillance from a high-altitude, fast-moving aircraft, with the additional requirement that the system operate under all weather conditions. These requirements, and the need to detect slowly moving ground targets, led to the choice of an operational frequency of 1200 MHz.

The feasibility study developed a mathematical analysis<sup>3</sup> of the characteristics of a multiple-antenna surveillance radar (MASR) operating on a fast-moving platform and able to detect slowly moving targets maneuvering in the presence of strong ground clutter. The key to the elimination of ground clutter was the displaced phase-center antenna (DPCA), which processed signals from two or more antennas to cancel the clutter returns. The DPCA employed an ingenious concept. Two antennas, formed sequentially by an array, radiated alternately from a phase center located at the same position along the line



Long Range  
Demonstration Radar



MASR antenna,  
Bedford, Mass.



HOWLS radar in test aircraft



**Figure 14-3**  
**Flight test of the MASR on a Twin Otter aircraft. The displaced phase-center antenna is mounted on the starboard side.**

#### Notes

**4** The PMP development effort was led by Edward Muehe in early 1975 as a second-generation digital processor for air traffic control moving-target detector radars. The PMP was a single-instruction multiple-data-stream processor, a structure that was ideal for radar signal processing because the same algorithm could be processed for numerous range-Doppler cells. As evidenced by the number of radars that employed a PMP, it quickly changed the state of the art in radar technology.

Two FAA radars — the Airport Surveillance Radar and the Air Route Surveillance Radar — and three ground-surveillance radars — MASR,

the Army's AN/PPS-5 radar, and the Advanced Ground Surveillance Radar — were all fitted with PMPs. Another PMP was supplied to the Army's Harry Diamond Laboratory for use on the Camp Sentinel Radar-III, giving that radar large area coverage. In all, eleven PMPs were built between 1975 and 1977, four by Lincoln Laboratory and seven under a contract with Stein Associates.

**5** T.H. Einstein, "Advanced Detection Technology Program," *Monthly Technical Letters*. Lexington, Mass.: MIT Lincoln Laboratory, April 1983–April 1991.

of flight. The two antenna outputs were subtracted, thereby cancelling the nonmoving clutter. A moving target would not cancel. This operation was made possible by precise timing of transmissions with the aid of an inertial navigator. An early form of this concept had been proposed by General Electric in the 1950s, and it was subsequently tested with the monopulse feed of an airborne early-warning radar.

In September 1972, Lincoln Laboratory undertook a development program for the DPCA technique. The goal was to be able to reject at least 40 dB of ground clutter and to detect objects moving at speeds as low as 4 knots; to meet these requirements, the design called for an airborne signal processor that could execute 50 million instructions per second.

The DPCA technique was flight-tested in 1973 on a Twin Otter aircraft to evaluate the basic concept (Figure 14-3). The 1200 MHz antenna array consisted of columns of open waveguide radiators that were connected by phase-matched cables to a diode switching matrix. Two antennas were formed out of subarrays of 32 columns, each with the desired phase center. Favorable results with a nonsteerable antenna led to the assembly of an antenna array with a beam that could be steered electronically by diode phase shifters.

The MASR program produced a number of advances to the state of the art in radar and signal processing. To ensure that the displaced phase-center patterns matched, extreme accuracy of amplitude and phase illumination of the antenna was necessary. The design, fabrication, and testing of this very precise antenna array represented an extraordinary technological achievement in the mid-1970s.

Researchers in the Laboratory's Solid State Division developed a surface-acoustic-wave pulse-compression device to achieve a 1250-to-1 compression ratio of the radar pulses. A parallel microprogrammable processor (PMP) was developed that processed the received signals at a rate of 50 million instructions per second and was able to perform pulse-to-pulse signal subtraction, Doppler filtering, and constant false-alarm rate thresholding. The PMP later was employed on several other ground-surveillance and air traffic control radars.<sup>4</sup>

During 1977 and 1978, extensive flight testing of the MASR was carried out at Fort Devens, Massachusetts, and over public highways in the vicinity of Boston. Clutter cancellation in the range of 40 to 50 dB was achieved. Convoys of National Guard vehicles on a heavily trafficked public highway were automatically detected and tracked. The program culminated with a series of field operations during fall 1978 at the Rome Air Development Center, New York. Military vehicles operating off the road were successfully detected, tracked, and classified.

The successful MASR development at Lincoln Laboratory led to the Pave Mover program sponsored by DARPA and the Air Force. The DPCA clutter cancellation technique was eventually employed in a variant form in the Joint Surveillance Target Attack Radar System (JSTARS) ground surveillance radar that enjoyed a dramatic, successful demonstration in combat in the war with Iraq. In 2005, the seventeenth and final JSTARS aircraft with the descendant of the Lincoln Laboratory MASR technology was delivered to the 116th Air Control Wing at Robins Air Force Base, Georgia.

#### *The Advanced Battlefield Radar*

The Advanced Battlefield Radar (ABR) was an experimental airborne radar built for the joint Army/DARPA program to locate and identify indirect-fire weapons. One goal of this effort was to study the detection and identification of nonmoving military targets.

Construction of the ABR system started in 1975. It consisted of a Ku-band array radar mounted on a twin-engine aircraft, a ground-station recording system in a trailer, and an offline data processing system. Resolution was  $1/2^\circ$  in angle, with a 10 m range resolution — exceptional resolution for that era. Speckle in the output images was minimized by averaging measurements over sixteen frequencies. Real beam (as opposed to synthetic aperture) radar images of an array of tactical targets in Stockbridge, New York, were formed and automatic target detection was explored. Targets could be detected in the open, but the detector suffered from a high false-alarm rate from natural and manmade clutter. The resolution was still insufficient for confident identification of nonmoving military ground targets. This experimentation led to a series of monthly reports on target detection and false alarms in clutter.<sup>5</sup>



**Figure 14-4**  
**Paraboloidal dish antenna mounted in Amber UAV fuselage.**

The ABR was later used in the Netted Radar Program as the airborne moving target indicator (MTI) radar component to detect moving targets. It was given two additional features: a low-resolution (100 m) waveform and a Westinghouse programmable signal processor in the ground station. These modifications allowed the ABR system to detect moving ground vehicles automatically in real time within a 5 to 15 km range swath. The ABR helped demonstrate the value of an airborne radar in a netted battlefield surveillance system. But the ABR was awkward to use in an unmanned air vehicle because it weighed 2000 lb and was linked to a van full of computing and display equipment. Within a decade, however, Lincoln Laboratory succeeded in producing a much smaller airborne system for an unmanned air vehicle.

#### *Moving Target Indication Radar on an Unmanned Aerial Vehicle*

An MTI radar flying on an unmanned aerial vehicle (UAV) can provide much better ground surveillance than can a ground radar. The payload capacity for UAVs was generally less than 150 lb; therefore, a substantially lighter-weight radar was needed. Extensive use of modern solid-state electronics and great attention to weight budgets were, therefore, to be key elements in any MTI radar development.

Lincoln Laboratory was to undertake the MTI radar development, and a memorandum of agreement was signed in 1983 between DARPA and the Army for a new program to build an MTI radar configured for the DARPA-sponsored long-endurance UAV Amber program. An additional challenge was to move all the data processing equipment required to produce the moving target reports aboard the vehicle, thereby reducing the data-link requirements by more than three orders of magnitude. The Laboratory developed the Data Stream Array Processor (DSAP), which combined a custom high-speed programmable signal processor with commercial single-board computers.

Five years later, in 1988, an MTI radar weighing 110 lb, including the Laboratory-built DSAP<sup>6</sup> mounted in an Amber fuselage attached to a manned aircraft, was flown in the Boston area (Figure 14-4). After a few minutes of flight, the system was able to paint a real-time picture of vehicles moving in a 30 × 30 km area on the road network west of Boston.

In spring 1990, the radar was brought to Fort Sill, Oklahoma, to be evaluated by an independent team from the Army's Intelligence School. Flying in the Amber fuselage, the radar was able to supply moving target reports and tracks, which were displayed in real time against a background of the road network in the Fort Sill area. The Intelligence School sent convoys of military vehicles around Fort Sill and asked the radar operator to determine the number of vehicles in the convoy, the convoy's speed, and the mix of tracked and wheeled vehicles. The radar accurately reported location, speed, and composition of convoys out to ranges of 17 km from the airborne platform, even during heavy rain. The program ended with this demonstration, but its legacy was that it convinced Army users of the feasibility and value of a small, but very capable, battlefield radar on a UAV.

During the 2000s, an important transition of the ground MTI hardware and signal processing technology was to the Vehicle and Dismount Exploitation Radar (VADER). The VADER is designed for dismount detection together with high-resolution SAR imaging. This system, in a netted architecture, provides critical situational awareness of ground-based vehicle and individual soldier traffic.

#### *Synthetic Aperture Radar Techniques*

By 1984, the problem of detecting moving objects had become well understood. Under DARPA sponsorship, Lincoln Laboratory moved on to an even greater challenge — an examination of the far more difficult task of finding and identifying stationary objects of military interest in the presence of natural and manmade clutter. Since Doppler measurements cannot discriminate among different stationary objects, the technique of synthetic aperture radar (SAR) must be used. A SAR synthesizes an extremely long antenna aperture (1000 ft or more) as an aircraft flies along its path, achieving angular (or cross-range) resolutions that cannot be obtained with a conventional antenna. High range resolution is achieved with wideband radar pulses.

The impetus for this program at its outset was tactical battlefield surveillance. By the late 1980s, the program had taken on a more strategic flavor as the United States became interested in locating Soviet land and rail mobile intercontinental ballistic missiles (the SS-25 and SS-24). The effort was then called the Strategic

#### **Note**

<sup>6</sup> The Laboratory also supplied five DSAPs to the Army's Harry Diamond Laboratory in 1987 for use in ground-based surveillance radars. One radar spent a year on a mountain in Korea; two others were used in sensor suites mounted on extendable masts on armored personnel carriers.





**Figure 14-5**  
Fully polarimetric, high-resolution SAR mounted below the fuselage of a Grumman Gulfstream G-1 aircraft.

Relocatable Targets program. The demise of the Soviet Union and the increased interest in theater missile defense brought on by the Scud missile's use in the war with Iraq occasioned a name change to the Critical Mobile Targets program. Throughout these changes in name and program focus, the basic problem remained intact: to find the enemy's high-value movable assets, such as missile launchers, tanks, guns, and air defense units, within the confusion of the natural background clutter, the manmade clutter, intentional hiding, and deceptive practices.

A serious problem in 1983 was the lack of a high-resolution SAR database on military targets of interest in interfering clutter backgrounds. DARPA, therefore, implemented a program at Lincoln Laboratory to provide quality data to a wide range of DoD users. The Laboratory contracted with Goodyear (later Loral) Aerospace of Phoenix, Arizona, to build a 1 ft resolution, fully polarimetric, 35 GHz SAR. This system, called the Advanced Detection Technology Sensor (ADTS), was delivered in 1987, mounted in a Grumman Gulfstream G-1 aircraft (Figure 14-5). The system was used to gather data on strategic and tactical targets to determine the feasibility of developing automatic target recognition algorithms for stationary targets. Calibrated data packages on targets and clutter were sent to more than a hundred government, laboratory, and industry investigators.

By 1992, Lincoln Laboratory and other investigators had developed initial algorithms that could with high reliability detect strategic and tactical targets in open areas and close to trees. The algorithms could distinguish between natural clutter and manmade objects and, in most cases, could identify a target as a military vehicle type (e.g., tank versus truck). The ADTS program concluded in the mid-1990s with a legacy of achievement in the detection and identification of strategic, theater, and tactical military targets.

#### **Netted Radar Program**

The DARPA/Army-sponsored Netted Radar Program (NRP) was initiated in 1977 to develop modern radar processing and netting technology and to demonstrate the operational advantages of close-netting battlefield sensors. Lincoln Laboratory conducted a two-phase demonstration of battlefield sensor netting starting in fall 1978 at the Army Field Artillery Center at Fort Sill.

Two standard U.S. Army AN/PPS-5 ground radars were modified to be coherent and integrated with a common signal generator, minicomputer, and display at a central location. Each radar operated in a track-while-scan mode, automatically detecting and tracking moving ground vehicles out to a range of 20 km in a 4 km deep range swath. Algorithms were developed for automatically detecting 155 mm shellbursts, walking people, and moving vehicles.

In a netted radar system, target reports from several overlapping radars are integrated in real time to form a single track for each moving target. Netted radars are more difficult to jam than single radars. Furthermore, by using triangulation, the radar net is able to locate jammers accurately. The Phase I NRP demonstrated the feasibility of the antijamming techniques and the ability of radar to direct artillery fire accurately.

The AN/PPS-5 radar used in the Phase I demonstration had been found previously to have poor survivability on the battlefield because it could be located easily through the use of direction-finding techniques. Therefore, Lincoln Laboratory developed the Advanced Ground Surveillance Radar (AGSR) for the Phase II demonstration. This system overcame the liabilities of the AN/PPS-5 and provided an improved technology for battlefield surveillance.

The AGSR consisted of a cylindrical phased-array antenna integrated with the PMP signal processor (Figure 14-6). Numerous features were incorporated to make the radar difficult to locate on the battlefield and to enhance its surveillance and antijamming capabilities. Agile azimuth-beam-position scheduling, frequency hopping, and low sidelobes enabled the system to overcome all simple direction-finding schemes, which had been used to direct fire on fixed-frequency, mechanically steered radars. Various pulse-compression waveforms were employed to enhance detection, to minimize surveillance coverage time, and to render interception more difficult.

A Phase II NRP demonstration was held at Fort Sill early in 1981 with an airborne ground surveillance radar (the ABR described previously), an AN/TPQ-36 counterfire radar, and the AGSR added to the network of two PPS-5 radars.

The demonstration was a major success. All sensors were successfully netted together, and correlated target data from the wide variety of sensors were presented on common displays. Control from a central command facility was demonstrated. Command and control consoles were operated in the Pentagon to control and direct artillery fire on moving target vehicles at Fort Sill — all in real time. In sum, the value of airborne battlefield sensors to see a large piece of the battlefield and to see around obstructions in terrain was demonstrated. The NRP ended in 1981, by which time it had established the feasibility and value of netting, of real-time digital radar data transmission, and of control for the tactical battlefield.

#### **Millimeter-Wave Homing Technology**

In the late 1970s, Lincoln Laboratory conducted a millimeter-wave (MMW) homing program sponsored by the Air Force Armaments Laboratory at Eglin Air Force Base, Florida. The objective was to provide technical assistance to the Air Force in the development of MMW seekers for air-launched guided missiles. The MMW seekers were small active radar sensors intended to provide the missiles with all-weather homing capability. These missiles were designed to be delivered at low altitude, fly autonomously to the target area, and strike heavy armored vehicles such as tanks or self-propelled guns.

Guided weapons already played an important role in air-to-air combat; radar and infrared missiles had become standard armament for fighter aircraft. But further improvements were needed for air-to-ground guided-missile radar seeker technology to be fully practical. Significant improvements were needed in detection of stationary and moving vehicles in a clutter background and smooth tracking (reduced aimpoint wander due to target glint effects). The MMW radar and advanced digital signal processing offered the potential for realizing such seeker improvements.

A noncoherent, 95 GHz, monopulse missile-seeker radar was built and mounted on the front of a UH-1 helicopter to study the details of target detection, acquisition, and tracking with an MMW homing missile system. This configuration allowed the emulation of missile-like homing trajectories so that seeker performance against real targets could be evaluated realistically. A noncoherent



**Figure 14-6**  
The AGSR, a cylindrical phased-array antenna integrated with a PMP.

Doppler processing capability was implemented in the radar in order to include the detection and tracking of moving vehicles, which were high-priority targets for the missile seeker.

Terminal guidance studies consisted of three basic components: (1) tank signature studies using submillimeter laser scaling techniques with metallized models of various tanks; (2) terminal homing studies, with a complete software simulation of the target and seeker, and a three-degree-of-freedom model of the missile system; and (3) guidance performance demonstrations involving helicopter-borne seeker descent trajectories toward tank targets.

Real target-in-clutter imagery from other Lincoln Laboratory programs was used to develop improved algorithms for stationary-target detection and acquisition. The effect of frequency-diverse pulse averaging was not well understood in 1980, but the Laboratory was able to demonstrate that fundamental limits on stationary-target detection performance existed because of spatial heterogeneity of ground clutter and aspect-angle variability of target radar cross section.

New target and clutter models were developed that incorporated all of these phenomena; theoretical performance predictions that used these models were found to agree quite well with measured results. The implementation of advanced signal processing techniques resulted in modest improvements in stationary-target detection. However, insight gained during this program indicated the need for still higher resolution to meet future performance goals.

Improvements in target tracking during the terminal homing phase were realized. Aimpoint wander was reduced by an angular error estimation technique that used the frequency-averaging characteristics of the Impact Ionization Avalanche Transit Time diode radar transmitter, and beamfill effects were reduced by adaptively modifying the guidance signals sent by the seeker to the missile guidance system as the range to target decreased. These results were initially developed by using the seeker/target/missile simulation with signature data derived from scaled target models and then testing the helicopter-mounted MMW seeker radar in realistic field conditions.

By the end of the program in 1980, significant improvements in guided-missile seeker performance had been achieved, and several defense contractors subsequently adopted these improvements in the design of MMW seeker systems.

### **Tactical Infrared and Laser Technology**

Lincoln Laboratory's first involvement with optical systems for battlefield applications began in 1974 as part of the DARPA-sponsored Hostile Weapons Location Systems (HOWLS) effort. Infrared and other optical wavelength sensor systems also formed a significant component of the Air Vehicle Survivability Evaluation (AVSE) program. AVSE research in infrared systems continues, and a wide variety of techniques, processes, sensor systems, and related experiments have been developed.

#### *Early Infrared Work*

Two major issues needed to be addressed to assess the utility of optical and infrared sensors on the battlefield: the statistical effects of the environment (weather, clouds, obscurants) and the detection of targets, particularly stationary targets, in background clutter. Worldwide databases of IR transmission were translated into statistics of operational utility to resolve the issue of environmental effects. Cloud statistics were combined with weather statistics, yielding complete statistical descriptions of the probable operational utility of a sensor. This effort was one of the first systematic examinations of sensor utility, and the IR community still routinely uses these databases and computer techniques to predict sensor performance.

Two infrared sensors were developed under the HOWLS program. The first was a mortar location system made up of several linear arrays of passive IR staring sensors low on the horizon. As mortar or artillery shells passed through the coverage of the arrays, the arrays would report several angular position points for the projectile trajectory. The uppermost staring array was also coupled to an Nd:YAG laser radar programmed to make a single range measurement. This combination of sensors could measure shell trajectories and backtrack to launch points with high accuracy. The system successfully demonstrated its predicted performance in 1978 at the China Lake Naval Weapons Center, California. After the field tests, responsibility was transferred to the Army Night Vision Laboratory, but the techniques were never carried forward into advanced system development.



The second IR sensor developed during this early effort had a longer-lasting impact. It was a multispectral IR sensor for developing techniques to allow precision guided munitions to detect IR targets in clutter. A number of clutter suppression techniques were explored, particularly those based on spectral and spatial differences between targets and backgrounds. Algorithms for clutter suppression yielded results that were dependent on the (highly variable) statistics of the instantaneous background clutter. A notable achievement was the development of optimized digital filters for both point targets and targets that could be resolved by the IR sensor. These filters were essentially two-dimensional equivalents of the matched filters in radar signal processing.

Infrared sensors mounted in a truck and on a fixed-wing aircraft were used to gather a large, well-calibrated database on background IR clutter. This database became the basis for testing clutter-rejection algorithms, and a generation of heuristic spatial filters with improved performance against various types of backgrounds was developed.

The difficult problem of IR detection of a stationary land target in a cluttered IR background is not yet fully solved. Many of the techniques first developed for the HOWLS program have been carried forward to systems currently under development requiring automatic detection — for example, IR search and track arrays for detecting low observable targets and automatic target recognition for IR imagers. See chapter 13, “Air Defense and Air Vehicle Survivability,” for a discussion of the AVSE program.

#### *Infrared Airborne Radar*

Lincoln Laboratory initiated a program under Air Force sponsorship in 1975 to explore the utility of imaging IR laser radars for tactical applications. The primary impetus for this development was the need for high spatial resolution in an airborne sensor aboard low-altitude air vehicles like the A-10, the F-16, or a cruise missile. The sensor had to provide high-quality images in any of several domains (intensity, range, Doppler, or thermal) for either automated or man-in-the-loop target detection and identification, when applications included navigation with terrain following and obstacle avoidance, fire control, or damage assessment. A combination of active and passive IR sensors was chosen because it provided

day and night operation, high-resolution images with modest-size apertures, and some measure of penetration in bad weather and of many obscurants found on the battlefield (smoke, dust, haze).

A 10.6  $\mu\text{m}$  carbon dioxide ( $\text{CO}_2$ ) laser radar was built to serve as a test bed imaging laser radar. The objective was to provide about 30 cm spatial resolution on a target at a range of 3 km. The laser radar used heterodyne detection and operated in a pulsed mode for ranging applications and in a continuous wave (CW) mode for Doppler measurements. A 1 W laser transmitter gave a sufficient margin for operation in most weather conditions. The laser radar was completed in 1977 and, from its station in one of the Laboratory's penthouses overlooking Hanscom Air Force Base, was able to image a variety of buildings and other structures. Military tanks (U.S. and foreign) were brought onto the base to establish their signatures; images were collected in fog and rain and even through limited amounts of military obscuring smoke.

A truck-transportable version of the laser radar was designed and its fabrication completed in 1980. The sensor was taken to Camp Edwards on Cape Cod for extensive data collection exercises during which a tank, an armored personnel carrier, and a 105 mm howitzer were imaged at ranges between 700 and 2500 m and at various aspect angles. Targets were imaged both dry and soaked by streams of water. In addition, IR-absorbing smokes were used to mask targets being imaged. The measurements showed that 10.6  $\mu\text{m}$  radiation was only minimally attenuated by common visual obscurants and that the range data, displayed as an image, provided reliable identification.

Several DoD programs used the transportable laser radar to support their research. In 1981, the Air Force Armaments Laboratory at Eglin Air Force Base funded the laser radar to collect data on Pershing missiles at Fort Sill. The laser radar also collected transmission measurements on a variety of obscurants during Smoke Week exercises at Redstone Arsenal, Alabama. Measurements were made of the signatures of ships passing through the Cape Cod Canal to establish their signatures at 10.6  $\mu\text{m}$ . Then in 1982, a series of modifications to the transportable system were undertaken to support a chemical-agent detection program managed



**Figure 14-7**  
The IRAR mounted below the fuselage of a Gulfstream G-1 aircraft.

by the Air Force Engineering and Services Center at Tyndall Air Force Base, Florida. Demonstration of the detection of a gaseous chemical released into the atmosphere was carried out in 1985.

An airborne laser radar and passive IR system called the Infrared Airborne Radar (IRAR) was designed and built in 1983 under Air Force sponsorship. The system was patterned after the transportable version, but required a twelve-element detector array for the radar to be useful at typical aircraft speeds. Its platform was a Gulfstream G-1 twin turboprop aircraft (Figure 14-7). The laser radar sensor and the passive IR sensor looked forward from a housing mounted on the bottom of the aircraft just behind the wings. The first images were collected in 1984, and the wide-field-of-view line-scan mode became operational in December 1984.

During the latter half of the 1980s, the IRAR was employed extensively to collect data, demonstrate technology, and test system concepts in support of such DoD programs as the Air Force Avionics Laboratory's Cruise Missile Advanced Guidance Program, DARPA's Smart Weapons Program, DARPA's Strategic Relocatable Targets Program, and the Navy Space and Naval Warfare Systems Command's Radiant Outlaw Program. Various upgrades of and additions to the IRAR sensor on the G-1 aircraft were made during that period. These upgrades included an improvement in the range precision of the basic IRAR CO<sub>2</sub> laser radar from 6 to 1 m, the addition of a passive IR mode in the 8 to 12 μm spectral band, the addition of a real-aperture MMW radar operating at 85 GHz with a range resolution of 0.5 m, the addition of a very-high-resolution (15 cm in each of the three spatial dimensions) down-looking near-IR laser radar integrated with the forward-looking infrared sensors, and a similar high-resolution down-looking CO<sub>2</sub> laser radar.

Lincoln Laboratory's pioneering effort in IR laser technology broke new ground for many subsequent DoD and industry efforts. Underscoring the impact of this early work most vividly is the widely reproduced image of the Bourne Bridge over the Cape Cod Canal in Massachusetts, taken with the IRAR laser radar in 1984 (Figure 14-8).

### Seismic and Acoustic Technology

In 1973, as part of its effort to address the problem of locating hostile indirect-fire weapons, the Laboratory began investigating seismic and acoustic techniques for weapon location, with an emphasis on understanding the basic phenomenology and the use of sensor arrays. This effort continued through 1982.

The hostile-weapons work benefited substantially from the earlier Laboratory involvement in the DARPA VELA UNIFORM program, described in chapter 21, "Seismic Discrimination," which had developed a system for the detection of seismic waves from underground nuclear tests at intercontinental ranges. The array technology and the propagation physics from that program carried over directly to the weapon location problem although the time and space scales were very different and the hostile-weapons problem included the element of air acoustic propagation.

The DARPA Distributed Sensor effort at the Laboratory, which started in 1977, provided additional acoustic phenomenology and array processing technology inputs to the hostile-weapons work. This project involved the use of geographically distributed sensor sites for aircraft surveillance and emphasized the use of small acoustic arrays. The project culminated in 1986 with the successful demonstration of real-time aircraft tracking by using fused data from multiple acoustic arrays and imaging sensors.

Experimental work on the use of acoustic and seismic signals for hostile-weapons location began in earnest in 1975. Sources included firing weapons, ground vehicles, and a weapon surrogate in the form of a modified 4.2-inch mortar. The mortar fired a projectile that consisted of a mass of water equivalent to a real mortar projectile; realistic seismic and acoustic signals could be safely generated where real weapons could not be used. Data were obtained at multiple field sites: Fort Devens, Massachusetts; Eglin Air Force Base, Florida; and Twentynine Palms U.S. Marine Corps Base, California.

Experiments with microphone arrays indicated that multilateration and time-difference-of-arrival source location methods would allow arrays to be effective for weapon location and that the arrays would be effective out to operationally useful ranges.



Figure 14-8  
Laser radar image of the Bourne  
Bridge over the Cape Cod Canal in  
Massachusetts.





**Figure 14-9**

**Extensive use of digital electronics made it possible to fit this jam-resistant tactical voice communication equipment into a fighter aircraft.**

Seismic experiments provided interesting results. As expected, the seismic signals contained many seismic phases in addition to signals generated by the passage of the air acoustic wave. It was concluded that, for a well-calibrated site, the seismic signals could be used for weapon location and probably for distinguishing between weapon firings and shell impacts. However, seismic signal details were geology sensitive, and seismic detection ranges were much shorter than typical acoustic detection ranges.

The VELA, Distributed Sensor, and weapon location work all involved arrays of ground-based mechanical-wave sensors. The VELA program left a legacy of a network of seismic monitoring arrays around the world.

Between 1983 and 1984, the Laboratory briefly investigated the use of an airborne dual-mode RF and acoustic homing weapon for tactical applications. The idea was to develop a system that would allow an airborne platform to home in on RF emissions or acoustic signals from motors on vehicles, electric generators, and other equipment. Acoustic homing was judged to be feasible based on preliminary measurements and analysis, but the program did not proceed to an experimental phase. The Army Brilliant Anti-Tank weapon, which utilizes acoustic target acquisition methods, is similar in general concept.

#### **Tactical Voice Communication**

The objective of the Tactical Voice Communication program was to develop a system design and technology to produce highly jam-resistant voice radios for tactical fighter aircraft and related platforms. The challenge was to develop a design that provided secure (encrypted) communications with high jam resistance and a multiple voice and interrupt (conferencing) capability, yet still satisfied the constraints on electromagnetic compatibility to coexist with other users of the ultrahigh voice frequency band. Additional technology development was also needed to implement radios based on this system design in the small volume available in fighter aircraft.

The program, sponsored by the Air Force and the National Security Agency, began in 1976. The brassboard demonstration model was bench tested in 1980 and flight tested in 1981 (Figure 14-9). The program was

completed in 1984; in the last few years, the focus was on the development of technology to miniaturize the radio for form-fit replacement of existing AM radios and to transfer the technology to an industrial contractor chosen by the Air Force.

The signal waveform employed pseudorandomly phase-modulated pulses that were further spread over the ultrahigh frequency (UHF) band by frequency hopping. In the bench tests, a level of jam resistance very close to the theoretical value was demonstrated against broadband jamming, and the performance was shown to be robust; that is, any strategy of partial-time (pulsed) or partial-band jamming did not give an advantage to the jammer. The flight tests demonstrated successful operation in an aircraft environment.

Equipment miniaturization to permit form-fit replacements for the existing radios using existing antennas in fighter aircraft was an important requirement. By the mid-1980s, rapid advances in digital circuitry had solved the problem of digital miniaturization, but significant challenges remained in the RF and analog circuitry, the charge-coupled device (CCD) matched filters, and the transmitter. Miniaturization of key circuits was demonstrated with volume reductions ranging from factors of 10 to 30. The CCD matched filters for the brassboard model were fabricated in a joint effort between Lincoln Laboratory and industry, and a next-generation device with the proper characteristics was defined. A family of transmitters of various sizes and output powers was designed to provide a pragmatic approach to tailoring the transmitter size (and output power) to the space available in a given aircraft type. Transmitters with efficiencies in excess of 40% were demonstrated. Industry development continued for a time after completion of the Lincoln Laboratory program, but no production resulted from this effort.

#### **Identification-Friend-or-Foe Technology**

Identification friend-or-foe (IFF) describes an electronic password system that identifies friendly units on a battlefield. In the classic question/answer system, potential targets are interrogated, or “challenged,” by an encrypted radio signal before they are fired on. All friendly units carry a transponder that can detect and decrypt the interrogation and can send an encrypted response. The encryption prevents enemies from eliciting responses to

their interrogations and prevents interrogated enemies from sending the proper responses. Thus, a cooperative IFF system reduces fratricide, an important consideration when targets can be engaged beyond visual identification range.

In the late 1970s, the North Atlantic Treaty Organization (NATO) Alliance recognized the need for a common IFF system among the member nations. The United States had the largest amount of IFF equipment in operational use at that time, but the U.S. system design, the Mark XII, was based on 1950s technology, and NATO wanted to develop a new IFF system design that could overcome the shortcomings in the Mark XII.

In 1978, a team of three NATO members (the United States, the United Kingdom, and the Federal Republic of Germany) formed a working group to define a NATO Standardization Agreement (called a STANAG) for an IFF system for NATO-wide use. The new system was referred to as NIS (for NATO IFF System). France and Italy subsequently joined the endeavor.

The NIS team became interested in the use of very wideband pseudonoise-modulated waveforms to provide jamming resistance, low probability of intercept, and security. The U.S. DoD representative on the NIS team, Michael Keller, from the Office of the Secretary of Defense—Command, Control, Communications and Intelligence (OSD—C<sup>3</sup>I), was familiar with the surface-acoustic-wave (SAW) devices that had been developed by Lincoln Laboratory's Solid State Division for use as programmable matched filters for wideband pulses. These devices, called convolvers, could be used to perform matched filtering of pulses modulated at up to 100 MHz or more within a restricted time window. Keller, therefore, approached Lincoln Laboratory and requested assistance in designing the NIS around SAW technology.

The Laboratory began its involvement with the NATO IFF project in 1979, and the program lasted until 1985. It began with funding from OSD—C<sup>3</sup>I, and later from the Mark XV IFF program, a Joint Services development effort with the Air Force as the lead organization. Throughout this program, the Laboratory provided direct technical support to the DoD team involved in the NATO effort and worked with laboratories of all three U.S. military services and with foreign laboratories

as well. Lincoln Laboratory personnel were also active participants in the many tense and sensitive negotiations among the NATO working group members.

Because the Mark XII system operated at L-band, it was unable to match the narrow beamwidths of higher-frequency (X-band and Ku-band) radars. The mismatch in resolution between the radar sensor and the IFF could lead to ambiguous identification of closely spaced targets. Thus, the initial NIS concept was to have multiple interrogation frequency bands that could accommodate target sensors with differing resolutions. Three interrogation modes were proposed: (1) a microwave interrogation and response with wideband direct-sequence pseudonoise (DSPN) modulated waveforms and an S-band operating frequency, distinct from the air traffic control radar beacon system (ATCRBS) band, to relax electromagnetic compatibility constraints (by contrast, ATCRBS and Mark XII operated in the same band); (2) an X-band radar interrogation mode with simple waveforms chosen to provide narrow interrogation beamwidths with a better match to the radar resolution; and (3) an optical interrogation mode for ground combat vehicles chosen to match the resolution of optical sights and forward-looking IR devices.

Lincoln Laboratory's initial work addressed the feasibility of using wideband DSPN modulation for IFF waveform formats in the S-band microwave interrogation and reply modes. The Laboratory played a major role in defining the S-band signals, and designed and built a matched-filter signal processor with SAW convolvers to detect, synchronize, and demodulate messages that consisted of wideband (100 MHz) DSPN-modulated pulses. This processor was demonstrated at the Laboratory in 1981. The wideband approach was shown to be technically feasible but also complex and costly.

Lincoln Laboratory played an instrumental role in persuading the NATO team to reassess the decision to avoid the Mark XII and ATCRBS L-band frequency. The Laboratory conducted detailed electromagnetic compatibility analyses and carried out airborne measurements of the L-band interrogation environment in Europe during NATO exercises in order to bolster the case for switching the proposed S-band mode back to L-band. After these analyses, measurements, and simulations had convinced the NATO working

group that electromagnetic compatibility with the air traffic control system could be achieved, the S-band interrogation was dropped in favor of a new L-band interrogation with a smaller bandwidth that would produce a much more affordable IFF system. In 1985, NATO agreed to a STANAG for NIS that included L-band and X-band interrogations and essentially adopted Lincoln Laboratory's Mark XV signals design for the L-band interrogation and reply modes.

Because of serious concerns about fratricide in a major tank battle in an environment that might include fog, haze, smoke, dust, and night fighting, Germany expressed a strong interest in developing a battlefield IFF mode for NIS. On the basis of the technology then available at Siemens, the German delegation proposed the use of lasers operating at 1  $\mu\text{m}$  wavelength. However, Lincoln Laboratory's work in IR radar technology indicated that the 1  $\mu\text{m}$  wavelength would not penetrate fog, smoke, or dust on the battlefield as effectively as the 10  $\mu\text{m}$  wavelength. A debate ensued within the NATO NIS team; the technical issues were finally addressed by a Lincoln Laboratory program to analyze and verify the performance of 1  $\mu\text{m}$ , 10  $\mu\text{m}$ , and millimeter wavelength interrogations under the conditions of interest. This work, carried out at Cape Cod, Massachusetts, indicated that the 10  $\mu\text{m}$  wavelength was superior to 1  $\mu\text{m}$ , but the millimeter wavelength was the best.

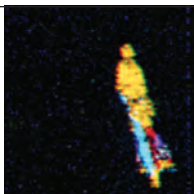
Although the Air Force dropped the Mark XV program in 1990 for lack of funds, the Navy continues to pursue the design of IFF equipment based on the Lincoln Laboratory waveforms. The Army has become increasingly concerned about fratricide on the battlefield, particularly since the war with Iraq.

### Lethal C<sup>3</sup> Countermeasures

The DoD recognized in the mid-1970s that there was considerable leverage for tactical antiradiation weapons employed against command, control, and communications (C<sup>3</sup>). The notion was to employ low-cost weapons to target both C<sup>3</sup> transmitters and jammers threatening friendly communications. Solutions to two major technical challenges were needed: (1) direction-finding seeker antennas with small apertures (less than 1 ft) capable of effective operation at the frequencies of principal interest (UHF and very high frequency [VHF]) and (2) signal processing algorithms capable of homing on a target in an environment consisting of multiple cochannel emitters operating with continuous signals.

The technology base that had been developed for attacking radars under a variety of antiradiation missile programs was unfortunately deficient for this application because of the substantially smaller seeker aperture available (typically between 0.1 and 0.5 wavelength) and because the leading-edge gating direction-finding technique could not be employed against pulsed emitters. The principal focus of Lincoln Laboratory's program, therefore, was the development of the necessary critical technologies and their validation through flight testing.

An effort was begun in 1975 to conduct an initial concept-feasibility assessment. The early work focused on algorithm development, simulation evaluation, and bench testing. The major advance during the first two years was the development of the enhanced interferometer to avoid the centroid homing problem traditionally associated with multiple CW cochannel emitters in the homing sensor's beam. These activities were followed by the design and evaluation of a compact



Transportable laser radar image (bicyclist)



Cylindrical aperture AGSR



W.P. Delaney





**Figure 14-10**  
**Direct impact of an antiradiation drone on the radiating antenna of a simulated tactical target.**

broadband dual-polarized direction-finding antenna, and led to flight-test validation with an airborne seeker test bed against multiple cochannel emitters.

The flight-test program, conducted at Eglin Air Force Base in the summer of 1982, used a miniature UAV platform (XMQM-106). Of the three identical flight-test vehicles built, two were allowed to complete a terminal impact against a low-frequency emitter. The test scenarios represented stressed environments that consisted of three nominally equipowered emitters in the VHF/UHF bands. Of the two impact tests, the first was a near miss, but within the lethal radius of a small warhead, and the second was a direct impact on the radiating antenna of a simulated tactical target (Figure 14-10).

The final phase of the program focused on technology transfer to industry. This activity included formal reporting, inputs to specifications, evaluation of proposed efforts, construction of critical subsystems, and direct interactions with cognizant government agencies and industrial contractors.

#### Signal-Intercept Techniques

In 1982, the Laboratory began an analysis and data collection program to assess the applicability of adaptive antenna array techniques to signal intercept. Signal receivers generally must be able to handle various forms of interference, including that from other signals in the same frequency band and multipath signals due to propagation effects. Such interference is difficult enough when the transmissions are cooperatively generated. In the case of signal intercept, however, the transmitter is noncooperative; as a result, the receiver may be poorly sited and the transmitted signals may incorporate features

that make reception difficult. Signal intercept can thus be an extremely challenging problem. But, through adaptive antenna techniques that use spatial processing to suppress undesired signals, interference can be mitigated.

The Laboratory's work has focused on four areas: (1) mathematical assessments and simulations to develop and analyze appropriate adaptive array algorithms; (2) evaluation of such algorithms with data collected in controlled experiments; (3) development of real-time, preprototype demonstration systems based on adaptive array signal processing; and (4) analysis of operational signal intercept problems to determine the suitability of adaptive array processing techniques.

The greatest challenge to achieving effective spatially based interference suppression comes when the spatial separation between the signal of interest and the interfering sources is small. When the separation is more than an antenna beamwidth, the undesired interfering signal can be largely attenuated by using well-established sidelobe cancellation techniques. In many situations, however, the available antenna aperture is too few wavelengths in diameter for a narrow beam to be formed, and the desired and interfering sources will fall within the same beam. Superresolution techniques are then necessary to suppress the interference.

Superresolution — the ability to place multiple deep nulls closer in angle than the diffraction limit — has been the common thread in most of the Laboratory's work in the signal-intercept area. The techniques were first developed by the geophysics community for spectral frequency estimation processes, but in recent years they have been applied to spatial resolution processing.

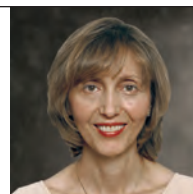
1990



C.E. Nielsen



R.H. Whiting



S. Ayasli



L.O. Upton



Figure 14-11  
Beech 1900 test aircraft with both a  
top- and a bottom-fuselage-mounted  
conformal broadband compact  
multielement array.

---

**Note**

7 R.S. Bucy and L.L. Horowitz, "Maximum Likelihood Direction Estimation for Multiple Emitters with Array Response Vector Distortion and Noisy Observations," *Lincoln Laboratory Technical Memorandum No. 44L-0655*. Lexington, Mass.: MIT Lincoln Laboratory, 1991.

Theoretical analysis and simulation had shown that super-resolution techniques should provide subbeamwidth resolution, but it was unclear whether superresolution could be made to work with real antennas and their associated pattern mismatches and errors. Furthermore, it was unclear whether such propagation effects as multipath would preclude effective interference nulling.

A multiphase program was initiated to cast light on these questions. It was necessary to understand the effects of antenna errors on the performance of high-resolution algorithms and to learn how array and signal characteristics (number of antenna elements, aperture, signal/interferer spacing) affected performance. For these techniques to be practical, moreover, algorithms had to be developed that would be robust despite array errors. A major breakthrough occurred when Lincoln Laboratory developed unique calibration techniques to compensate for array errors, and it became clear that superior interference suppression capabilities were achievable.<sup>7</sup> But this goal had to be verified with field measurements.

In the first set of measurements, three emitters and a line array of antenna elements were deployed at the antenna test range; data collected there confirmed expectations. Next, an airborne flight-test program was begun with a Beech 1900 aircraft as the test platform to prove that superresolution was achievable in practice and to provide an extensive source of data from representative scenarios.

The Beech 1900 was initially fitted with arrays of eleven dipole elements on the top and bottom of the fuselage (Figure 14-11). Later, elements were added on each wing and on the tail. Over 150 flights were carried out with a controlled set of emitters operating in the low VHF band as targets. A network of distance-measuring equipment (DME) transmitters located the aircraft position accurately. The data were processed with a number of algorithms and detailed comparisons were made.

Representative data sets were also distributed to industry so that algorithms and results could be compared. The aircraft was decommissioned in 1991.

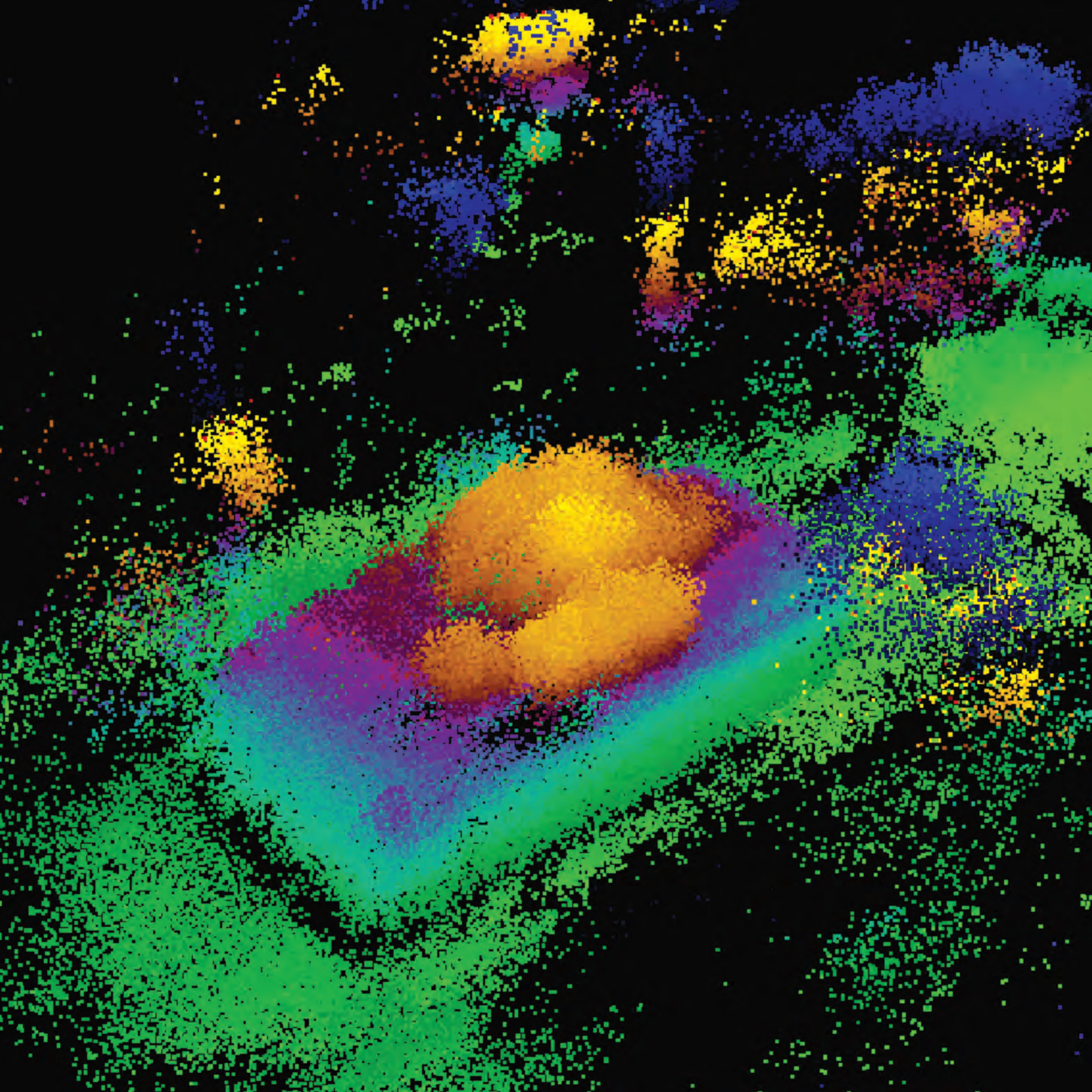
This program was the initial effort in superresolution technology. It spawned several other small programs, however, that continue today: (1) extensions of the technology to the HF band, where sky wave signals propagate via ionospheric refraction; (2) assessment of how the techniques apply to spread-spectrum signals; (3) development of real-time interference cancellation receiver systems for use at VHF/UHF and HF frequencies; (4) application of these techniques to low-frequency radar imaging in foliage penetration situations; and (5) microwave airborne and space-based adaptive systems.

Through the combination of theoretical analyses, simulations, and realistic field experiments, the Laboratory's efforts since 1982 have validated the use of superresolution techniques for difficult signal-intercept situations. Several new and effective algorithms have been developed; these algorithms increase performance and are suitable for real-time implementation.

**Retrospective**

Battlefield technology is of great national importance; the ability to stay ahead of potential adversaries protects the lives of U.S. military forces and U.S. allies. Lincoln Laboratory's accomplishments in MTI radar, laser radar, secure communications, and signal processing have made important contributions to the nation's battlefield systems. Work in stationary-target detection, foliage penetration, and superresolution is forming the basis of future systems. Continuation of the careful attention to scientific analysis and experimentation, and to the development and demonstration of advanced sensor and processing hardware, that has characterized the 44 years of Lincoln Laboratory's activities in this area will provide superior technology for the U.S. forces of the future.







# Intelligence, Surveillance, and Reconnaissance

**Lincoln Laboratory addresses the military's increased reliance on accurate, timely, and multidimensional intelligence by applying its expertise in sensors, data processing and exploitation, and advanced imaging to a variety of challenges—detecting targets under foliage, undersea surveillance, and persistent video surveillance, to name a few.**

**Left: Three-dimensional image of a tank in a forested area was created from laser radar detections. Height is indicated by color, with lighter shades corresponding to greater height above the reference plane in black.**

Lincoln Laboratory is focusing on developing innovative sensor technologies and systems, as well as defining intelligence, surveillance, and reconnaissance (ISR) enterprises that integrate sensing, processing, data analysis and exploitation, and decision support in a net-centric, multiple-intelligences (multi-INT) architecture. Central to this effort is the Laboratory's ISR development approach, which has as its core objective the leveraging of innovative technology to meet user needs, to add new capabilities to the national ISR enterprise, and to validate these capabilities by field tests and demonstrations in environments and with scenarios representative of operational missions.

The three-term designation known as intelligence, surveillance, and reconnaissance refers to the system of data collection (sensors), data analysis, and data dissemination resources used to provide information about persons and targets of interest to decision makers at all levels of government and the military. *Intelligence* in this context represents information and understanding obtained through exploitation of sensor data and through knowledge extraction. *Surveillance* generally means the “systematic” observation of an area, while *reconnaissance* denotes a dedicated mission to obtain specific information about adversaries. ISR sensors are designed to collect data on a variety of “observables” that can be used to gain information about adversaries’ capabilities, assets, organization, actions, and intent. These sensors include devices and systems such as video cameras, radio receivers, radars, and others, and may be satellite based, airborne, or surface based.

## Global Trends in ISR

With the breakup of the Soviet Union and the subsequent emergence of the United States as the lone superpower, the threat of large-scale conventional military conflicts, which had dominated the focus of ISR for most of the 20th century, diminished significantly, although it did not disappear entirely. What evolved in its place was the threat to peace and U.S. interests by smaller nation states and by nonstate actors (e.g., terrorists) motivated by ideological, cultural, and religious dogma. This shift in threat was brought into harsh focus by the terrorist attacks of September 11, 2001.

Emphasis on irregular warfare has had a major impact on the type of intelligence required and, consequently, on the ISR capabilities needed to provide that intelligence. It is no longer sufficient to find, locate, and determine the signature of a target to counter the threat. Terrorists and insurgents, and the means they use to plan and carry out their acts, cannot easily be distinguished from the rest of the population—they “hide in plain sight.” Consider, for example, an urban street; the driver of a vehicle or a pedestrian could be a terrorist. Most likely neither person is a terrorist. However, neither the vehicle's nor the individual's appearance (“signature”) is in itself sufficient to determine whether there is a threat; additional information would be required to make such a determination. This information (i.e., intelligence) may be obtained from a combination of sensors that could link an individual to known terrorists (network discovery), could detect unusual behavior through “patterns of life” analyses, or could discern other indicators. The process of integrating diverse sources of intelligence to accumulate information is referred to as multi-INT exploitation and is a central paradigm for ISR in the new era of irregular warfare.

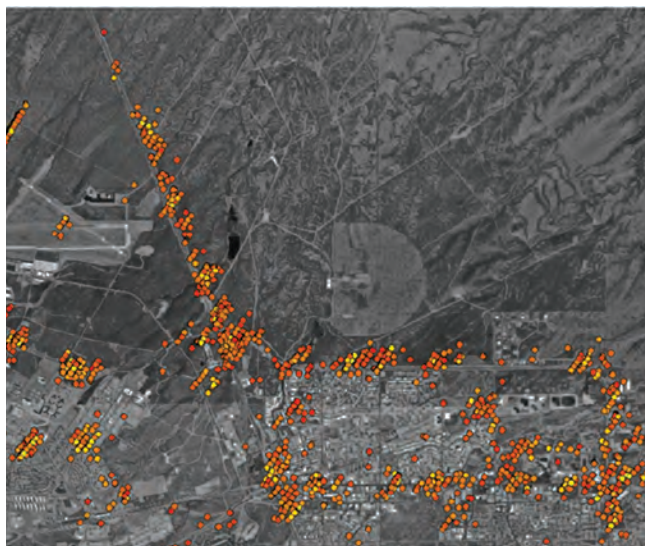
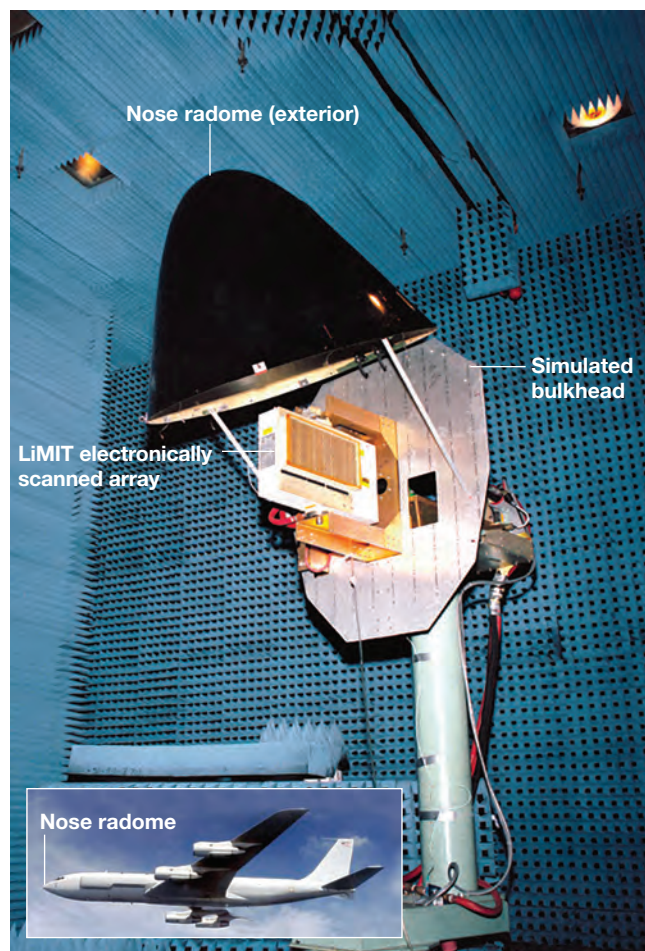
## Overview of ISR at Lincoln Laboratory

The ISR effort at Lincoln Laboratory is dedicated to improving ISR capabilities by leveraging innovative technologies, ISR architectures, and advanced concepts for multi-INT data fusion and decision support (see chapter 8, “Knowledge Extraction and Decision Support”). In addition to counterterrorism and counterinsurgency, which present the most urgent and daunting problems, the key challenge areas for ISR are homeland security, space-based ISR, detection in foliated regions, maritime domain awareness, undersea surveillance, and the continuing threat of major conflicts. The Laboratory is a major participant in the nationwide effort to develop ISR sensors, systems, and concepts of operation to address these problems.

A key objective of counterterrorism is the discovery of terrorist networks, a process of accumulating pieces of evidence over a period of time that can extend over weeks and months. Persistent surveillance of an area or region is required to establish the links that connect individuals, places, and events.

**Figure 15-1**

**Top: LiMIT sensor in anechoic chamber. The sensor is mounted in the nose cone of a Boeing 707 test bed (inset). Bottom: Sample moving vehicle detections indicate the level of activity in different areas of surveilled region.**



Homeland security includes border protection against illegal and clandestine crossings by individuals or vehicles that may be part of a terrorist threat. ISR challenges in this domain are posed by the distances and varied terrains that need to be covered. Additional challenges arise from political and economic considerations that may constrain ISR sensor options and system architectures. (See chapter 18, “Homeland Protection” for more about the Laboratory’s initiatives in this area.)

Although recent conflicts have taken place primarily in regions of mostly open terrain, areas in many other parts of the world are dominated by foliated regions. Foliage penetrating (FOPEN) radars operating at low frequencies (wavelengths of ~1 m or greater) can penetrate foliage to varying degrees, but face the major difficulty of separating target returns from the clutter caused by radar backscatter from leaves and tree trunks. Lincoln Laboratory addressed the problem of detecting targets shielded by dense foliage by conducting field experiments and analyzing field measurements to characterize the phenomenology of FOPEN radar propagation through foliage, developing advanced radar designs, and contributing novel signal processing algorithms.

ISR for maritime domain awareness requires the ability to cover vast areas to detect and prosecute illicit traffic on the open sea. Having appropriate sensors that can detect and track vessels in or near port is essential. Integrating multiple sensors and information from diverse sources in an overall ISR enterprise is key to success. As described later, the Laboratory demonstrated such an approach to counter a maritime threat in a live field exercise.

Undersea surveillance is primarily concerned with the submarine threat. ISR in this domain consists of passive and active acoustic sensors and exploitation of the signals from these sensors. The Laboratory effort in this area leverages advanced signal processing and exploitation techniques to improve the quality of information derived from sensor data and to provide human operators with tools that improve their speed and accuracy in using this information to produce intelligence products.



---

**Note**

<sup>1</sup> J.G. Fleischman, S. Ayasli, E.M. Adams, and D.R. Gosselin, "Part I: Foliage Attenuation and Backscatter Analysis of SAR Imagery," *IEEE Trans. Aerosp. Electron. Syst.* **32(1)**, 135–144 (1996).

In major military conflicts, the ISR emphasis is on strategic intelligence collection to assess enemy strength and force disposition, and to infer intent in preparing for possible conflict. Space-borne ISR assets will play a central role in intelligence gathering and could also counter the denial of airborne ISR. The Laboratory leveraged its expertise in advanced signal processing together with innovative radar design concepts to address this challenge. Advanced algorithms were developed and performance validated with field measurement data obtained with a space-radar surrogate.

### **ISR Enterprise Elements**

The ISR enterprise at Lincoln Laboratory can be divided into a number of broad categories or elements. At the core are the sensors that provide the data that form the basis for the intelligence. Other key elements are processing that converts raw sensor data into information and data exploitation that uses this information to derive intelligence, the basis of decision support. The Laboratory's distinguished history in the field of high-performance processing is discussed in chapter 28, "High-Performance Computing." This chapter presents several examples of sensor exploitation for ISR.

### *Space-Based ISR*

In 1998, the Defense Advanced Research Projects Agency (DARPA), jointly with the Air Force and the National Reconnaissance Office, initiated the Discoverer II space-based radar program that, for the first time, focused on ground moving target indication (GMTI) from space. The Laboratory was selected to define the radar system architecture and to develop the signal processing for GMTI, as well as to develop analytical models for estimating the performance of different design options. GMTI from space brought on challenges beyond those for airborne systems because of the very high velocities of satellites (approximately 40 times that of airplanes). The Laboratory developed and optimized the performance of a set of space-time adaptive processing (STAP) algorithms specifically for space radar. However, without a space-based radar, it was difficult to carry out two key steps in the Laboratory development approach: field testing and demonstration of operational utility. To allow meaningful field testing of algorithms, as well as to get insight into the potential utility of GMTI from space, the Laboratory developed a scaled radar system on a fast airborne platform. By

scaling the length of airborne antenna such that the ratio of antenna size to platform speed closely matched the same ratio for the space-borne radar, GMTI performance could be evaluated. The scaled system consists of a small multichannel antenna, similar to the antenna architecture for the space radar, mounted in the nose of a Boeing 707 aircraft. The integrated system is called the Lincoln Multimission ISR Testbed (LiMIT). Figure 15-1 shows the array antenna that is mounted in the nose of the aircraft. The combination of the antenna length (~0.5 m) and the speed of the 707 (360 kts) allows LiMIT to serve as a space-radar surrogate. In this role, LiMIT has participated in a number of enterprise-level field exercises to demonstrate the ISR potential of space-based radar. Also shown in Figure 15-1 is an example of LiMIT moving target detections collected during one of these exercises.

### *Foliage Penetration ISR*

Airborne GMTI radars typically operate at X-band (10 GHz) or higher frequencies to maximize GMTI performance for the limited-size antennas that can be put on manned aircraft, as well as on unmanned aerial vehicles (UAV). Radars at these frequencies cannot detect targets that hide under trees since the radar signal cannot penetrate through the foliage cover. Lincoln Laboratory conducted a number of field experiments to characterize both the attenuation and reflection of foliage as a function of frequencies, down to as low as very high frequency (VHF) (20–90 MHz).<sup>1</sup> Results of these experiments showed that radars operating in the VHF and ultrahigh frequency (UHF) bands were most suitable for detecting targets under foliage.

Early FOPEN radar ISR, which focused on detecting stationary targets under trees by using synthetic aperture radar (SAR) imaging, was a difficult problem because backscatter from foliage and tree trunks is comparable to that from targets. Conventional radar detection techniques are plagued by a high rate of false alarms. To address this problem, the development approach for FOPEN involved signal processing and exploitation algorithm development, combined with carefully planned and executed field tests and data-collection experiments. Analysis of the data collected in these field tests led to a quantitative understanding of the phenomenology of radar propagation through, and reflection from, foliage for different environments.



**Figure 15-2**

**Top: FOPEN GMTI was demonstrated with radars on two types of platforms, including the A-160 UAV helicopter. The FOPEN radar on the A-160 is housed in a pod that can be rotated. The A-160 is in a hovering position when in GMTI mode to minimize interference from ground clutter for slow-moving targets. Bottom: A test subject was equipped with instrumented devices to provide ground truth for data interpretation.**

#### Notes

**2** R.M. Marino and W.R. Davis, Jr., "Jigsaw: A Foliage-Penetrating 3D Imaging Laser Radar System," *Linc. Lab. J.* **15(1)**, 23–36 (2005).

**3** M. Vaidyanathan et al., "Jigsaw Phase III: A Miniaturized Airborne 3-D Imaging Laser Radar with Photon-Counting Sensitivity for Foliage Penetration," *Proc. SPIE* **6550**, 65500N-1–65500N-12 (2007).

**4** B.F. Aull, A.H. Loomis, D.J. Young, R.M. Heinrichs, B.J. Felton, P.J. Daniels, and D.J. Landers, "Geiger-Mode Avalanche Photodiodes for Three-Dimensional Imaging," *Linc. Lab. J.* **13(2)**, 335–350 (2002).

This understanding was essential to the algorithm development. Test imagery collected during field tests also provided data for algorithm development and evaluation, leading to performance models that served as input to mission-effectiveness analysis. On the basis of the results of the mission-effectiveness analysis, test scenarios selected from real mission scenarios were then used to evaluate system trade-offs. The results of the evaluations guided the design of improved sensors, thereby initiating a new cycle of system development.

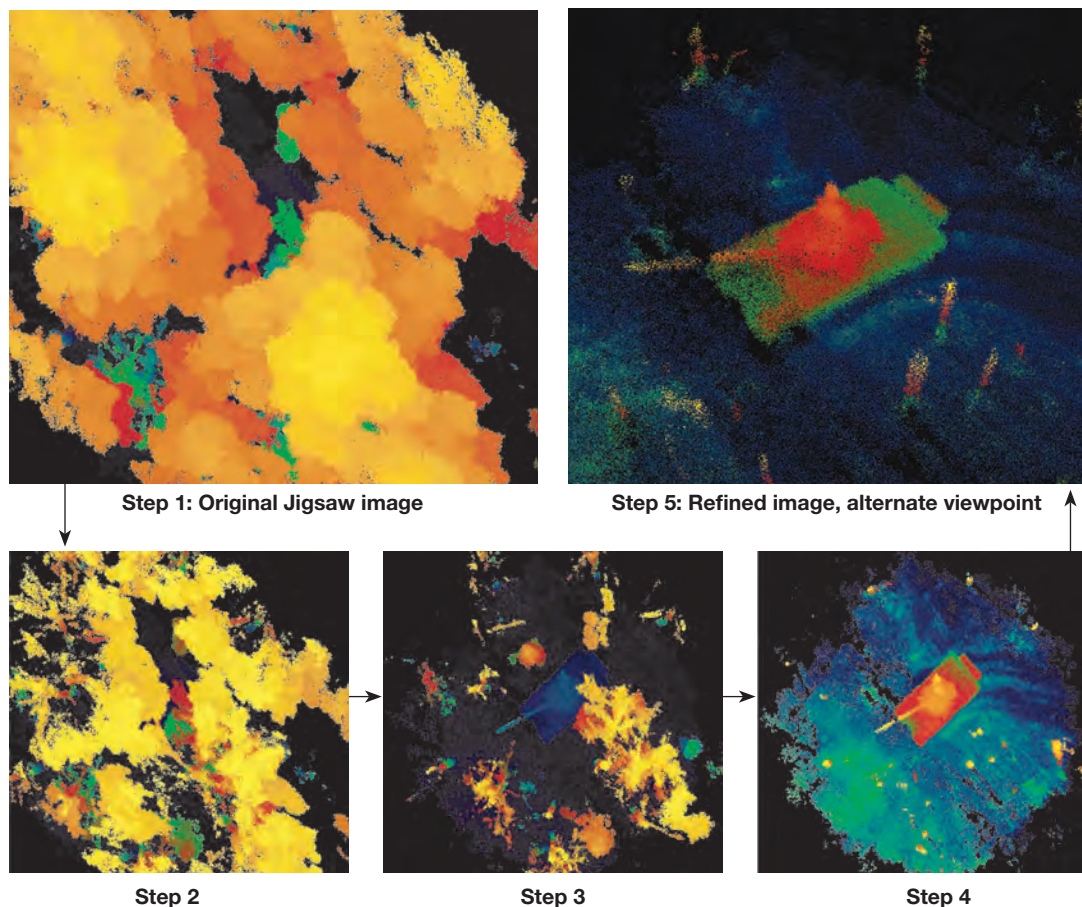
Subsequent developments in FOPEN radar shifted the focus from SAR to detecting slow-moving targets, especially people (dismounts), under foliage by using low-frequency radars on airborne platforms. Platform motion, combined with the very broad beam of radars operating at FOPEN frequencies, causes clutter returns to spread over a large Doppler extent that overlaps and thus interferes with the return from slow-moving targets. The severity of this interference depends on both antenna size and platform speed. One approach to solve this problem is to use a rotary wing (helicopter) platform that can hover and thus reduce platform motion to near zero. Figure 15–2 shows a FOPEN radar mounted on an A-160 Hummingbird UAV, a system known as FOPEN Reconnaissance, Surveillance, Tracking and Engagement Radar, or FORESTER. This system was developed jointly by DARPA and the U.S. Army. Lincoln Laboratory participated in the development and design phase of this radar and is responsible for the dismount detection and feature-based discrimination algorithms and exploitation processing chain. The Laboratory also organized and directed field experiments to collect data for evaluating exploitation techniques and to guide the development process. In these experimental campaigns, establishing accurate "ground truth" was crucial to correlating radar signatures with the phenomenology of target behavior. Test participants serving as the dismounts of interest were instrumented with multiple sensors for this purpose (Figure 15–2).

#### Laser Radar ISR

At the turn of the century, Lincoln Laboratory began to explore the potential of laser radar for tactical intelligence gathering. A laser radar (ladar) operates on the same principle as a conventional microwave radar, but at much shorter (optical) wavelengths. This difference in wavelength enables new capabilities that are not achievable with conventional radars. In particular, the laser beam can be made orders of magnitude smaller than a radar beam by using only modest-diameter lenses (on the order of a few inches). By scanning the laser beam over a scene or an object, a two-dimensional image is obtained from the reflected energy. Measuring the range to the target for each of these beams adds a third dimension, thereby creating a three-dimensional image of the scene and objects in it. The narrow beam can also be used to take advantage of small breaks in foliage cover to reach targets hiding under trees. In 2005, Lincoln Laboratory developed such a ladar system as part of the DARPA Jigsaw program.<sup>2,3</sup> A key enabler for this ladar was a new  $32 \times 32$  pixel Geiger-mode avalanche photodetector developed at the Laboratory.<sup>4</sup> (For more information on laser systems, see chapter 25, "Laser Systems.")

Jigsaw represents a powerful complement to FOPEN for identifying targets under trees by providing high-resolution three-dimensional target-shape information. To image the target under trees, Jigsaw collects angle-angle-range (three-dimensional) data on points on the target by viewing the target from different angles over a  $\pm 30^\circ$  window, taking advantage of small breaks in the foliage cover, i.e., looking "between" the foliage with the narrow laser beam. Figure 15–3 shows the evolution of the imagery made possible by Jigsaw. Height is indicated by color to facilitate interpretation of the two-dimensional image. Projections of the actual three-dimensional image can be displayed on a screen and manipulated by the analyst to view the target and the environment surrounding it from different vantage points.





**Figure 15-3**

The sequence of images from step 1 to step 4 illustrates the ability of Jigsaw to identify targets under trees (in this case a tank) by viewing the same scene from successively lower altitude vantage points, thus eliminating the tree canopy that hides the target. The image in step 5 is a zoomed-in version of the step 4 image with the perspective changed from a direct overhead view to one from the side, illustrating the three-dimensional nature of the Jigsaw image. Shown at right is an aerial view of the area being imaged. The tank is beneath the tree canopy.



#### *Video ISR Data Exploitation*

Achieving significant area coverage, adequate resolution to distinguish closely spaced vehicles, and high revisit rates — all requirements associated with the urban environment — is a considerable challenge for ISR. A video camera, collecting full-motion video, is capable of high resolution and rapid revisits (~30 frames per second) but is limited to small areas. To achieve coverage over much larger areas, the U.S. Army in 2006 developed an airborne optical surveillance system called Constant Hawk. This system uses multiple high-resolution digital cameras capable of taking black and white pictures at two frames per second. Each camera is pointed in a different direction such that their combined field of view covers a large area. It would be very difficult to analyze this (moving) imagery in its raw form. The Laboratory was tasked to develop algorithms and software to equalize and seamlessly stitch together the images from the multiple cameras, as well as to remove the effect of aircraft motion. The final large-composite image not only makes it much easier for human analysts to “track” vehicles (and potentially even individuals), but it is essential to the development of automatic tracking software that is a key enabler for rapid and efficient discovery of networks.

The Laboratory developed and integrated both the hardware and software to process the video signals from the multiple cameras and then transitioned these components to the Army for integration into the current Constant Hawk systems.

Full-motion video (FMV) cameras play a major role in battlefield ISR by providing high-resolution images in a format that is easy to interpret without extensive training. However, an FMV camera is often referred to as a “soda-straw” sensor because of the very limited area covered in its field of view. To extend coverage area while retaining FMV’s high resolution requires a very large total number of pixels. One approach to achieve wide-area coverage is to use multiple cameras and large focal-plane arrays (exceeding 15 megapixels) in each camera. While multi-camera systems are capable of imaging a significantly larger area than FMV, coverage must be extended further to provide true wide-area surveillance. Adding even more cameras is not a practical option if operationally significant improvements are to be achieved. Increasing the number of pixels on the cameras’ imaging chips is also not a viable solution, given current technology





**Figure 15-4**  
**MASIVS mounted on the Cessna aircraft.**

limitations, development time required, and the high cost associated with the design and manufacture of special devices.

To address the challenge of providing wide-area surveillance, Lincoln Laboratory developed an alternate, innovative approach that achieves a significant increase in coverage (by more than an order of magnitude), reduces cost by taking advantage of commercially available digital camera imaging chips, and produces color images. The capability to image in color is important because color adds target features that can be exploited to improve target tracking and identification.

The Laboratory's system uses four cameras. On the focal-plane array for each of the cameras, the imaging chips are mounted in a sparse configuration that allows room for the peripheral circuitry extending beyond the photodetector array. Each individual imaging chip covers only a small section of the total area imaged. To provide persistent wide-area coverage, the location of the multiple imaging chips in the four focal planes is such that when all the subimages are merged by using sophisticated processing techniques, a single large, seamless color image is created. This concept is the foundation for the Multi-Aperture Sparse Imager Video System (MASIVS), which achieves 880 Mpixels at two frames per second in color and demonstrated wide-area persistent imaging capability when mounted on a test aircraft (Figure 15-4). Although the basic concept for MASIVS is deceptively simple, considerable design, engineering, and processing challenges had to be overcome to bring the idea to fruition.

Lincoln Laboratory also developed technology and an integrated imaging system for extending the MASIVS daylight capability to nighttime imaging through the use of advanced infrared detector arrays. A key enabler in achieving the nighttime capability was the digital focal-plane array, which features a unique Lincoln Laboratory-developed silicon readout integrated circuit bonded to a commercially available long-wave infrared focal-plane array (see chapter 11, "Environmental Monitoring" for a discussion of the digital focal-plane array). This array is a key component of an airborne scanning camera system that was able to produce unprecedented, high-resolution, wide-area, infrared nighttime images. An illustration of this capability is shown in Figure 15-5.

### **Net-Centric Multi-INT Architecture**

The Lincoln Laboratory ISR enterprise elements discussed in the previous section focused on sensors and associated exploitation technology. These efforts are essential to understanding capabilities as well as limitations of sensors when formulating net-centric ISR enterprise architectures that address specific mission needs. Lincoln Laboratory is developing a service-oriented architecture test bed that facilitates bringing together airborne and ground-based ISR assets to demonstrate advances in sensing, processing, and decision support technologies in the context of a multi-INT, net-centric architecture. The service-oriented, net-centric architecture backbone provides the framework that links multi-INT sensor systems to command and control, processing, exploitation, and decision support resources.

An example of the type of multi-INT ISR system demonstration such a test bed enables is the ISR mission concept demonstration for a maritime domain awareness scenario. This demonstration focused on using ISR in a maritime threat scenario involving a surrogate cruise missile launched from a boat to a protected facility (e.g., a convention center) in a city. The demonstration included a broad range of Lincoln Laboratory and other assets to emulate an end-to-end semiautomated approach to identifying the perpetrator of the attack and interdict the vessel. This use of multiple Lincoln Laboratory assets, working together in an integrated fashion with sensors from other organizations, is an example of using multi-INT data to demonstrate capabilities critically needed for national security.

### **Future Vision and Technology Transfer**

Irregular warfare will continue to be a high-priority challenge for the nation. By the very nature of irregular warfare, the threat will evolve and change with time. In addition, the adversary will become increasingly more technologically sophisticated, perhaps devising electronic countermeasures to defeat U.S. sensors or employing camouflage, concealment, and deception techniques to make the sensors less effective. This evolution of the threat will require even greater emphasis on multi-INT solutions to mitigate the impact of countermeasures on the U.S. military's ability to collect information. The need for persistent surveillance over a variety of terrains, but particularly in urban areas, will continue. Because



**Figure 15-5**  
**Aerial, winter night, infrared image of downtown Boston collected by a camera using the digital focal-plane array. The inset image of the Massachusetts State House partially illustrates the detail present in the image. Infrared image resolution is less than 1 meter, and the image quality is better than a high-definition television image.**

the focus is increasingly on activities and movements of individuals or groups of individuals, sensors or sensor networks will be required to detect them and their activities. Lincoln Laboratory will continue to investigate a wide variety of techniques to detect dismounts and to derive information about their activity. Part of the challenge is relating signature features to useful attributes of people or their activities.

There will also be a continuing need to improve sensor capabilities by leveraging advanced technologies and innovative designs, together with coordinated sensor tasking that enables more flexible and efficient use of sensor resources. The trend toward UAVs for airborne sensor platforms will persist and, with it, the need for ISR architectures incorporating a potentially large number of networked sensors to achieve wide-area persistent surveillance. In addition to the work on optical sensors described previously, the Laboratory is engaged in advanced technology developments and designs for signals intelligence and radar sensor systems suitable for deployment on a broad range of UAVs.

#### *ISR Technology Transfer*

The principal objective of the ISR mission area at Lincoln Laboratory is to bring the benefits of innovative technologies and ISR enterprise architectures to the user, whether this is a national organization or the soldier in the field. This objective is accomplished by transitioning technology developed at the Laboratory to government agencies or contractors for integration in operational systems. The Laboratory plays an integral and active part in this process, including designing and building systems or critical components of a system, implementing algorithms and software, and assisting in the integration and testing.

The Laboratory has transferred a number of ISR technologies to contractors. For example, the Multi-mode Laser ISR (MLISR) program included the transitioning of ladar technology developed at Lincoln Laboratory. In this program, the Laboratory was responsible for the ladar sensor and processing capabilities of the MLISR system on an aircraft. In the underwater surveillance area, innovative ISR processing and exploitation algorithms have been transitioned to the submarine community. The Laboratory developed and tested advanced

sonar signal processing techniques for acoustic array sensors. The algorithm for processing the array signal was implemented, demonstrated improved performance in an operational system test environment, and was finally transferred for operational use.

The Laboratory has also transitioned its high-performance computing technology. For example, a Laboratory-developed technique greatly increased the dynamic range of analog-to-digital converters (ADC) by compensating for hardware nonlinearities through signal processing. To implement this nonlinear equalization, a processor capable of throughput on the order of a trillion operations per second (teraops) is required. The Laboratory built such a processor on a single card and demonstrated its ability to greatly extend the dynamic range of readily available high-end commercial ADCs to levels not directly achievable with current ADC technology. The nonlinear equalization technology was transferred for application in an electronic support measures program, which benefits significantly from the increased dynamic range capability.

Lincoln Laboratory has developed a number of decision support technologies that have been transitioned for government use. One such technology is software for search and discovery of unstructured data, which is information that is not stored in a conventional, i.e., structured, database format. Examples of unstructured data include text files, PowerPoint slides, and printed reports. The system provides the user interface and services that transparently perform the search and retrieve the data for the user. The software to accomplish these functions was transferred to the National Security Agency. A federated search capability was implemented using software that Lincoln Laboratory developed as part of testing the Distributed Common Ground System Family of Systems (DCGS FoS) architecture. The DCGS FoS forms the core of the Department of Defense net-centric ISR enterprise. A central element of this enterprise is the DCGS Integration Backbone (DIB), which ties together the various members of this family (Navy, Army, Marines, and Air Force). The complexities of the DCGS FoS architecture are beyond the scope of this book, but suffice it to say that the improved performance resulting from the software developed by the Laboratory led the contractor, Raytheon, to incorporate it in an improved version of the DIB.







**Counterterrorism and counterinsurgency require new capabilities to address unconventional and asymmetric threats, as well as an ability to develop those capabilities rapidly. The Laboratory has developed a number of quick-reaction capabilities and pioneered a new paradigm for rapid innovation and prototyping.**

**Left: Twin Otter aircraft carrying a Laboratory-developed quick-reaction capability.**

If the events of September 11, 2001, led to Lincoln Laboratory's involvement in homeland protection, it was the ensuing events in Afghanistan and Iraq that spurred Laboratory efforts to provide technology and capabilities for counterterrorism and counterinsurgency. With daily news headlines reflecting the impact of the asymmetric tactics employed by insurgents, the Laboratory was asked to pursue solutions to the improvised explosive device (IED) threat, as well as a range of other problems faced by deployed forces.

In 2003, that response began modestly with a number of quick studies, as well as one small effort to explore a novel, potentially useful sensor. By 2004, the Laboratory was involved in a first force-protection capability prototyping activity designed to provide a quick field-worthy prototype for in-theater testing. In the years that followed, the Laboratory's efforts expanded considerably. The Laboratory developed both "goal tending" capabilities that sought to provide direct detection or defense of asymmetric attacks, as well as "source tending" capabilities designed to aid in detection and targeting of terrorist networks. By 2009, the Laboratory had developed a series of prototypes and, in parallel, a range of prototyping efforts was ongoing. That same year, the Laboratory transitioned two systems to Iraq for combat evaluations and operational demonstrations.

Key to the expansion of the Laboratory's counterterrorism and counterinsurgency efforts was the development of a new approach to rapid capability development. Driven by urgent needs, the goal of this model was to develop capability rather than technology, and the process often involved a focus on innovation rather than invention. A role emerged for the Laboratory in rapidly advancing a technology perhaps one more step or in adapting it to a new problem, and then quickly developing a first capability. This role leveraged the significant, multidisciplinary expertise of the Laboratory, as well as its ability to respond in an agile manner. The Laboratory filled a role between the "off-the-shelf" solutions immediately in reach, when they existed, and the longer-term solutions eventually available via more conventional research, development, and capability acquisition paths.

The need for rapid innovation gave rise to a "blue-team" model, which used small teams to quickly innovate, assess, and engineer solutions to specific critical problems.

With this approach, concepts were formulated and their efficacy determined on a scale of days to weeks. To support this process, quick measurements were performed to understand critical physical parameters, and rapid demonstrations were undertaken to prove concepts with early laboratory prototypes. Where a viable solution emerged, rapid prototyping then produced first field-capable prototypes for testing and transition to overseas operational demonstrations.

As the counterterrorism and asymmetric warfare problems continue to evolve, it is expected that this blue-team model will remain at the center of the Laboratory's efforts in these areas. Even beyond these problem areas, the pace of threat evolution is increasing; open architectures and greater use of software-defined capabilities permit rapid refresh of foreign defense capabilities and motivate the similar need to shorten reaction cycles for other mission areas. This new rapid development paradigm will likely play a larger, broader role in future Laboratory efforts. The blue-team approach demonstrates innovation of new capabilities on timelines of a few months or even a few weeks, timelines considered short by conventional standards. Coupled with the urgent, challenging nature of the problems addressed, this approach also has enabled the formation of strong coalition teams, bringing experts together from across the Laboratory to innovate in ways otherwise not possible.

### **New Threats and Challenges**

To better understand the urgent problems and key new national needs arising in the past decade from Operation Enduring Freedom, the continuing U.S. military action to combat terrorism in Afghanistan, and Operation Iraqi Freedom, the coalition effort to end the regime of Saddam Hussein and drive out terrorists in Iraq, it is important to first understand the characteristics of the "fourth-generation" warfare faced by U.S. forces in these operations. Unlike adversaries in more conventional, earlier generations of warfare, fourth-generation opponents have no illusion of winning by military supremacy, but instead focus on winning by eroding the U.S. will to fight. In the conflicts in Iraq and Afghanistan, this battle of wills was waged by insurgents through a propaganda campaign, fueled by IED and other attacks, aimed at creating the continual flow of images published to weaken U.S. resolve.

## A First Rapid Capability

Many of the Laboratory's rapid efforts in counterterrorism trace back to a first prototyping activity undertaken over a nine-month period in 2004. This development gave birth to the blue-team process that was used on many subsequent problems and that has become a significant underlying approach in the Laboratory's rapid capability development.

It started with researchers experimenting with some electronics obtained from a local store. After about a week of measurements, they knew they had something, but weren't sure whether it would be practical in a military situation. The researchers took what they had learned, did the systems analysis to model what the performance of the system would be, and then brought everything outside and conducted a real demonstration. The whole experiment was jury-rigged together quickly, but it worked, and the performance was what the analysis had predicted.

This laboratory experimentation, systems analysis, and quick demonstration represented the rapid innovation part of the process. It was conducted quickly over a few weeks and developed a pretty compelling case for prototyping the capability. The Laboratory showed the concept and results to the Air Force, and right away the Air Force said to go do it—and to do it quickly, asking for a prototype in six months. Building the prototype ended up taking nine months, but the process was still much faster than anything like this done under normal circumstances. The Laboratory had a completely new technology and was trying to understand how to make the technology work at the same time as trying to build a field-worthy prototype. There were plenty of days along the way that the researchers said, "That's it; that's the show stopper. We're not going to make this work." But somehow, they always found a way around the problem.

Making this early prototype field-worthy ended up being a significant challenge as well. The prototype had to be designed to survive the heat,



Figure 16-1  
Bullwinkle prototype.

dust, and vibration the device would see deployed in a desert environment. The first prototype wasn't designed for that kind of environment, but the team ended up taking it out to the Arizona desert and testing it there, with the lab equipment strapped to the side of a high mobility multipurpose wheeled vehicle (HMMWV). By noon the first day, the temperature rose so high that equipment started failing. After that, testing was done at night.

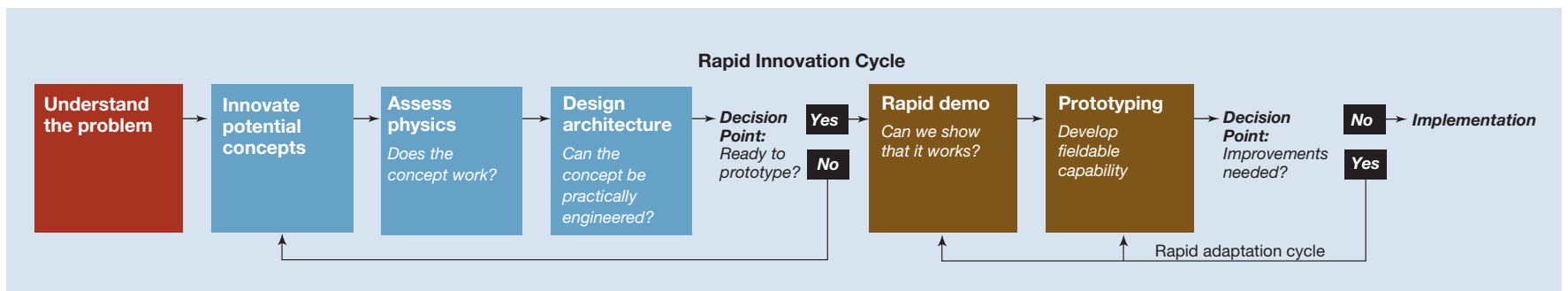
When completed, the field-worthy prototype was a major technical success, representing the only test-proven solution to the problem it addressed. The government engineers who did the testing couldn't believe how well it worked; the Laboratory's system performed nearly perfectly. Unfortunately, developing a viable concept of operations for the system remained challenging. No one liked the way it looked, dubbing it Bullwinkle (Figure 16-1). And it had a few other operational challenges as well. It was very close to being deployed—two days from a C-130 ride at one point. But Bullwinkle never made it overseas. The Laboratory took the technology and went on to better approaches. However, the Laboratory learned a lot about the process, particularly the need to integrate the eventual user in all steps of the development.

Although this type of asymmetric approach was not new, several factors made attention to it more critical. First, the asymmetric methods employed by insurgents were leading to significant casualties incurred by U.S. and coalition forces; the images from these attacks were successfully filling U.S. media. Second, despite overwhelming military force advantage, this type of conflict represented the only type the U.S. had ever lost (e.g., Vietnam, Somalia). Third, there was mounting evidence that the conditions were right for a greater emergence of fourth-generation warfare. The declining standard of living in many regions of the world, coupled with a resurgence of radical religious and ideological groups, provided much of the fuel for such an emergence. The methods of such fourth-generation fighters were further aided by the development of faster and more prolific connectivity methods, such as the Internet, which provided the agile means for adapting attack methods.

The solution to this fourth-generation warfare experienced in Iraq and Afghanistan is not entirely military. Social, political, and economic methods play an even larger role in affecting the final outcome of the conflict. Their prominence is due to the central goal in such conflicts, that of winning over the local population. Support from the population for safe harbor, as well as for personnel and other resources, is needed by the insurgents to effectively wage their battle of wills. Propaganda created by insurgent actions serves not only to attack the U.S. will to fight, but to incite fear or allegiance in the local population in order to obtain needed resources. The military role in such a conflict is to disrupt this cycle sufficiently such that the other mechanisms (social, political, and economic) can take hold.

### Key National Needs

Two top-level military needs arose out of the differences reflected in this new type of warfare. First was the need to develop new sensing and strike capabilities, focused on the very different targets presented by the insurgency enterprise, which is organized to consume various resources while disseminating propaganda, attacking U.S. will, and controlling the local populace. As with a more conventional network, disruption of the enterprise is accomplished by selecting those elements that can be targeted to have maximum disruptive



**Figure 16-2**  
**The rapid innovation process allows quick nomination and evaluation of concepts.**

value. The difference here is that the targets reflected in those choices are very different from those of more conventional warfare and often require a new set of capabilities. For example, one significant target is terrorist or insurgency leadership. Targeting leadership requires capabilities to detect and track individuals within urban and other high-clutter environments. This capability is significantly different and more challenging than, for example, the more conventional goal of detecting and tracking armor formations on the battlefield.

The second top-level national military need stemmed from the pace at which the threat was able to evolve in fourth-generation warfare. In all warfare, there is a natural measure-countermeasure cycle by which one side develops a capability and the other develops a countermeasure against it. In more conventional military problems, that cycle time is often many years since both sides invest significant resources in the development of capabilities and counter-capabilities. By contrast, in the asymmetric warfare faced in Iraq and Afghanistan, the investment by insurgents was very small, and they were therefore able to adapt methods and tactics in a short time frame. The cycle time of measure and countermeasure was reduced from years to months and, in some cases, to even a few weeks. This rapid cycle motivated the capability to react quickly to new threats and to develop and field new capabilities against them.

### Rapid Innovation

Both of these key national needs were central in the Laboratory's response to the challenges arising from Iraq and Afghanistan. The Laboratory played important roles in developing capabilities to defend against specific asymmetric threats and in addressing the broader problem of targeting or disrupting the terrorist enterprise. In all of these activities, however, the urgency of the situation required a different model for development. Where off-the-shelf solutions were

unavailable, innovation was required to develop the appropriate solutions, but this development cycle needed to be fast-paced.

Central to this rapid innovation was the blue-team process, which involved two major stages (Figure 16-2). The first stage, rapid innovation, required sorting through potential approaches and quickly evaluating and identifying a solution. The second stage, rapid prototyping, involved building a first field-worthy capability of the envisioned solution.

Of the two stages, the first was where the real magic of the overall process happened. This stage involved taking a problem, innovating possible solutions, assessing the physics for each to see if that solution was physically possible, and then performing at least a first-order engineering of the solution to determine whether or not it was realizable. For many problems, rapid measurement of critical problem or physical parameters was required, as well as in some cases, quick demonstrations to show in a non-field-worthy way the efficacy of the overall solution.

Several things were key to this rapid innovation step. It was important that the solution developers be technology agnostic so that they would examine a broad set of potential technical solutions rather than settle on the particular tools in their local toolbox. Hence, the rapid innovation team had to maintain broad knowledge of what technology was available to draw upon, both from within the Laboratory as well as from other sources across the nation. It was also important that this be a systems-analysis-led process, done rapidly but with high accuracy. Here the Laboratory drew upon systems-analysis expertise developed over many years in other mission areas such as air defense. The innovation team also had to act as an honest broker, not only for the government, but for themselves. Even when considering technology





**Figure 16-3**  
**Bell Ranger helicopter with novel sensors attached to the landing skids.**



**Figure 16-4**  
**Twin Otter aircraft used as a counterterrorism capability test bed.**

imported from others, the development team needed to maintain objectivity when tempted to develop their own system from that technology. It was also necessary to be brutally honest in evaluating the concept and to look at all possible failure modes and countermeasures, as well as to maintain a clear perspective on the system's concept of operations and the issues a user might have in applying the system.

#### **Rapid Concept Demonstration**

Integral to the blue-team process was the rapid demonstration of novel concepts to prove efficacy before launching the more expensive and time-consuming effort to develop a field-worthy prototype. Many of these demonstrations were initially done in the laboratory, where bench electronics could be rapidly pulled together to take critical measurements or perform a first-demonstration test. These efforts also utilized the Laboratory's anechoic chambers and other test facilities. In addition to allowing small measurements, the chambers allowed entire vehicle-mounted systems to be tested as an early method of proving efficacy or debugging the system.

Since many of the unique concepts the Laboratory explored involved airborne sensing, it also became necessary to perform quick airborne tests and data collections. Much of the early testing was done with a Bell Ranger helicopter (Figure 16-3). The helicopter's capability to fly slowly and at low altitude permitted simulation of the kinematics of small unmanned aerial vehicles (UAV). A variety of sensing concepts were tested from the Bell Ranger, including optical sensors, signals intelligence (SIGINT) systems, and low-frequency radio-frequency (RF) detectors.

A second platform used extensively in these tests was a Twin Otter aircraft (Figure 16-4). The Twin Otter, as an unpressurized vehicle, permitted easy integration of new antennas and sensor apertures. Over several years beginning in 2006, the Twin Otter was used to test a number of capabilities, including radars, SIGINT systems, and other RF geolocation concepts.

#### **Rapid Adaptation Cycle**

Also essential to the blue-team model was the ability to rapidly adapt solutions once introduced to the field. The first operational look at a new capability was often

very revealing. Systems were tested extensively before overseas deployment, but the differences between testing environments and operational environments often led to the need for rapid spirals to perform quick engineering changes or to work with operators to adapt employment methods. It was essential to keep the engineering team in place to work through this adaptation cycle. Open collaboration between operators and engineers was also critical. This ongoing dialogue helped establish the real requirements and concept of operations, and ensured that capabilities met both technical and operational constraints.

#### **Unmanned Vehicles**

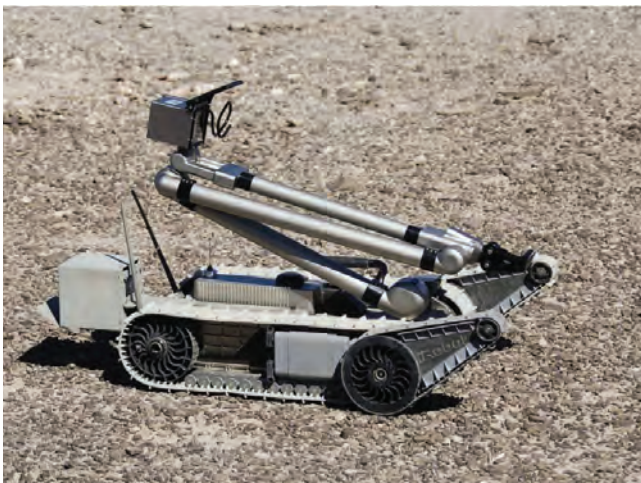
A significant portion of the Laboratory's rapid development activities was focused on prototyping and integrating new capabilities and payloads for unmanned vehicles. The conflicts in Iraq and Afghanistan brought an increase in the use of unmanned systems, both airborne vehicles and ground robotic systems. These unmanned systems reduced the jeopardy to soldiers and airmen by allowing them to apply new capabilities from a safe distance. In some cases, these systems also offered cost advantages over larger manned ones.

The Laboratory developed prototype sensing capabilities for unmanned air vehicles ranging in size from the few-pound, hand-launched RQ-11B Raven UAV to the much larger MQ-1 Predator. One of the first capabilities was developed for the Army Shadow 200 UAV (Figure 16-5), a mid-sized UAV operated at the battalion level. In a joint effort sponsored by the Air Force and the Defense Advanced Research Projects Agency, a team from the Laboratory and the Shadow 200 manufacturer worked closely to integrate and flight-test a novel payload in five months. The effort leveraged a sensor previously developed for ground-based use; rapid modifications to sensor algorithms were made to account for the airborne geometry. A host of other issues were also overcome to integrate the payload and sensor apertures without impacting the flight performance of the vehicle. Tests of the integrated system were very successful, and the payload design was transitioned to the Air Force, which oversaw production of additional payloads.

The Laboratory's capability prototyping also extended to unmanned ground systems. During late 2008 and early 2009, the Laboratory led a team that integrated a novel detection technology on both PackBot (Figure 16-6) and



**Figure 16-5**  
**Shadow 200 UAV.**



**Figure 16-6**  
**PackBot with Laboratory-developed payload.**

Talon robotic systems. The sensor capability, developed over the previous year, leveraged advanced signal processing and antenna concepts to achieve the required high sensitivity. During the integration of the payload onto the robots, small size, weight, and power versions of the sensor were quickly developed. The team also worked to integrate this capability into the existing robotic control interfaces and displays. Tests of the system, both at a continental United States (CONUS) test site and in an outside CONUS operational demonstration, were successful, and the capability was transitioned to production by several industrial partners in an Army-led effort.

#### **Advanced Sensors and Technology**

Many of the Laboratory-developed advanced sensing capabilities involved either entirely new sensor concepts or extensions of existing technology to modify a sensor in a novel way to match it more tightly to the needs of the problem. While the objective was to rapidly field a first capability, significant new technology was also developed as part of this process. That technology spanned a variety of areas, including SIGINT, synthetic aperture radar, ground penetrating radar, low-frequency sensors, radio-frequency tags, optical imagers, and active optical systems.

In the SIGINT area, Lincoln Laboratory developed an advanced multichannel receiver system, unique in its use of adaptive beamforming to suppress interference sources and to preserve receiver sensitivity. A capability leveraging this receiver, as well as Laboratory-developed detection algorithms, and a custom antenna array were flight-tested in an operational demonstration. Ground vehicle-mounted and man-portable versions of the system were also rapidly developed at warfighter request and transitioned to operational use.

The Laboratory developed novel signal processing technology to improve the detection of targets in synthetic aperture radar images. After CONUS testing with several airborne radars, these algorithms were then transitioned for use with an operational radar system. Furthermore, the Laboratory designed and built a synthetic aperture radar, unique in its coverage rate, antenna technology, and target-specific processing. This system, as well as another Laboratory-built payload, was transitioned for use in a quick-reaction intelligence, surveillance, and reconnaissance (ISR) capability.



## A Very Rapid Capability Development

Although many of the Laboratory's counterterrorism capability developments have been rapid by traditional standards, some have been even more fast-paced. One such example occurred in early 2006 when the Laboratory was approached to help with the solution of an important, time-critical problem, one with a timeline measured in weeks.

"We got the call on a Tuesday afternoon," recalls one member of the small team formed to rapidly formulate possible solutions. "Folks wanted something for the following Monday. Not just an idea, but a real capability. It was clear to everyone that that probably wasn't doable, but we started working the problem as hard as we could. In a couple of hours, we had equipment in the anechoic chamber, and one team was taking measurements, looking for something to exploit. We had a second team dreaming up system concepts and doing the modeling to see if they could work. As soon as the first team had measurements, the system team would plug them into the models. It took about a week to get to a system concept that made sense, and another to run down all the details, not quite the timeline that was originally desired, but still very fast."

With the measurements and system concept that emerged from this rapid innovation in hand, the Laboratory was asked to take the lead in rapidly developing the prototype capability. The solution involved a new class of airborne sensor, and, over a period of six weeks, the Laboratory designed, fabricated, integrated, and successfully flight-tested this novel capability.

"When we got told it was a go, we had one day to do the system design; the following day was the design review. A day or so later, the P-3 aircraft we were going to integrate on showed up at the



**Figure 16-7**  
P-3 aircraft used for rapid development and testing.

Laboratory's Flight Facility (Figure 16-7). What made this even harder was that we couldn't get the equipment you would want in this few-week timeline; the lead times were just too long. We had to beg and borrow and piece together what we could get our hands on.

"The team worked day and night those six weeks. People were tired, but the whole team was running on adrenaline. The problem was incredibly motivating, and people were so excited about what we were making happen so fast.

"It was about the third flight test before we got things working and got good data. Lots of things could have gone wrong—quite a few did. But we pulled it off. It was incredibly satisfying to help out with such an important problem, and to develop and prove a new technology in six weeks. It remains one of the proudest moments of my career."

Of the several technologies Lincoln Laboratory developed for geophysical sensing, one involved a new approach to ground-penetrating radar. The system employed a unique antenna array and innovative signal processing to achieve significant performance improvements. After proving the efficacy of this approach in several field tests, the Laboratory was asked to build a prototype for military fielding.

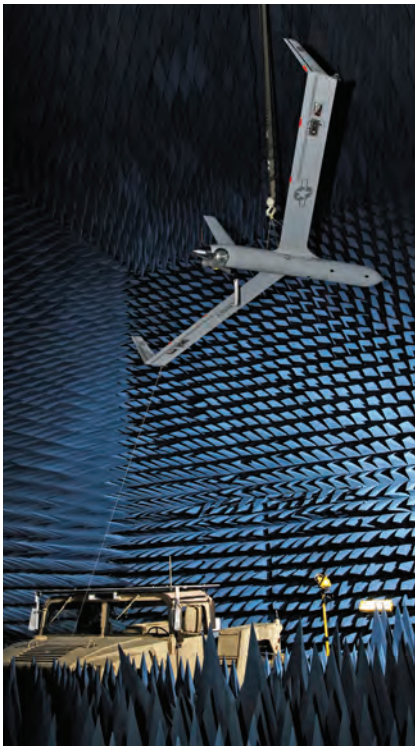
In addition to these sensing technology advancements, the Laboratory also supported development of advanced generations of counter-IED electronic attack systems. Architectures allowing higher-performance systems were developed, and specific key technologies identified. The Laboratory conducted critical risk reduction of many of those needed technologies, including advanced receivers and novel algorithms.

### Red Teaming

Despite the success of the blue-team model in rapidly innovating solutions and prototyping first capabilities, keeping ahead of threat evolution remained challenging. Development times for new capabilities, even with the fastest processes, were often months, and the threat could often evolve in a matter of weeks. Some method of anticipating future threats was needed to allow developers to get ahead of this fast measure-countermeasure cycle.

With this necessary "head start" in mind, Lincoln Laboratory turned to a method that had been used successfully in the air defense and other mission areas: "red teaming," the use of a small team to predict likely threat actions through a capability-based approach. Unlike intelligence-based approaches, which attempted to collect evidence suggesting a specific threat action, this capability-based approach purely examined the most likely threat behavior and could be used to prioritize threats in the absence of any advance warning. This prioritization was critical; the asymmetric opponent often had not only a large number of choices in attack method but also the detailed tactics and materials for that attack. Building defenses against all of these threats was often impractical. Fortunately, all of these threats were generally not equal; often some stood out as attractive options for an insurgent, either because they were easier to employ (e.g., less expensive, less risky, lower technology) or because they would be expected to be more effective against current U.S. defenses.





**Figure 16-8**  
Small UAVs such as the Scan Eagle shown under test will become increasingly important in future distributed ISR solutions.

The Laboratory applied red teaming to the counter-IED problem, using it to identify likely future threats and to prioritize the development of countermeasures against them. In several cases, when the reality of the threat was questioned, the Laboratory further prototyped the threat to demonstrate its credibility.

This threat-prototyping process also aided the development of countermeasures by providing test articles for cases in which the threat had not yet surfaced and threat exemplars did not exist for testing. The process often revealed threat details and phenomenology that lent insight into potential countermeasures.

#### **View Ahead**

Significant challenges remain in developing solutions for the type of fourth-generation warfare problems faced in Iraq and Afghanistan. Because of the wide publicity these conflicts provided for insurgents' activities and goals, it is likely that the United States will face similar asymmetric responses in future conflicts. In addition, the threat from global terrorism, highlighted by the events of September 11, remains a concern, and the desire to find and eliminate this threat continues.

In the attempts to address these unconventional threats, an evolution is under way, both in the technology provided to the battlefield and in the way that technology is brought to the battlefield. Requirements have been turned upside down as what is asked from current and future systems changes, often dramatically, to meet new needs. In some cases, future systems may look much like those today, but with different capabilities buried under the surface. In other cases, a more paradigm-shifting change will be required.

For example, consider the ISR systems built in the Cold War era to support a massed battle. These centralized capabilities are in many cases ill-designed for the distributed fourth-generation warfare. A distributed ISR capability is needed, one which cost-effectively scales to bring ISR support to the widespread tactical fight. Large assets become unaffordable in this distributed fight, and the solution begs for a disruptive innovation that brings advanced sensing to small affordable platforms (Figure 16-8) and ISR capability to the masses.

Equally important is the way new technology is brought to the battlefield. Again, Cold War-era methods are at odds with rapidly changing threats, fueled by a rapidly evolving commercial sector—the free development laboratory for the terrorist and insurgent. Agility and adaptability are vital in this new environment.

Lincoln Laboratory will continue to play a major role in the solution of these issues, both the longer-term challenge of evolving capabilities and the nearer-term problem of rapidly providing critical gap fillers. The Laboratory has begun to shape the vision and architecture for the path ahead; these ongoing efforts will help define the technologies that need to be invented by the Laboratory as well as by others. The blue-team process, developed to rapidly innovate and prototype new capabilities, will enable Lincoln Laboratory to continue providing critical capabilities and advanced technologies. In addition, the Laboratory's blue-team approach demonstrated a new paradigm for rapid development, one that will remain key as long as U.S. forces face rapidly evolving challenges.





**Lincoln Laboratory responded to a national security need to develop improved methods of rapidly and accurately detecting biological and chemical agents. By pulling together technology and expertise developed in various unrelated areas, the Laboratory was able to quickly make a contribution to combating the use and effectiveness of biological and chemical weapons. In seven years, these fledgling programs had grown into a significant research area.**

**Left: The CANARY PANTHER disk prototype is used with fluorescent beads in experiments to select appropriate dry aerosol collection features.**

World events caused Lincoln Laboratory to recognize the growing threat and potential impact of biological and chemical weapons. In 1991, Russian defector Ken Alibek revealed the scope of a Soviet biological weapons program conducted in secret and in violation of the Biological and Toxin Weapons Convention. In 1994, years after the Gulf War, revelations of development, stockpiling, and use of biological and chemical weapons came forth from a highly placed Iraqi defector. Several high-level studies within the Department of Defense (DoD), including some by the influential Defense Science Board, pointed to the growing threat and risk to U.S. forces and civilians. In 1994, the DoD consolidated a set of loosely connected service programs under a joint umbrella, giving the biodefense program identity and a growing budget.

The stage was thus set for Lincoln Laboratory to take steps to see how it could become involved in a field where it had not been previously engaged. While the Laboratory had employed biologists, they were not doing biology and had no biology laboratories. (A notable exception was the Genosensor Consortium, sponsored by the National Institute of Science and Technology, through which the Laboratory had developed advanced DNA sequencing techniques under Mark Hollis as an assistant group leader.) Lincoln Laboratory did employ a few chemists and there were chemistry labs, but they were primarily devoted to the microelectronics enterprise. Despite an apparent lack of capability, in early 1995 the Laboratory decided to study the biodefense problem and to look for areas where it might make immediate contributions, and where not, if and how it might build needed capabilities.

The first such initiative was a study on biological-agent detection led by Charles Primmerman with funding from the Laboratory's Advanced Concepts Committee (ACC). While this study focused primarily on remote detection of biological agents, some laboratory measurements of amino-acid fluorescence were conducted and a new concept for a point biological-agent detector was conceived by Thomas Jeys and Antonio Sanchez-Rubio. At about the same time, Primmerman and Arieh Karger proposed a study on the limits of remote detection of bioagents to Brigadier General Walter Busbee, then head of the Joint Program Office for Biodefense. On the

basis of this proposal, the Laboratory got its first outside funding for biodefense in mid-1995. Primmerman's study group analyzed the potential for detecting agents at a distance as a function of laser technology, sensing modality, atmospheric limitations, and target cross section. The results of the analysis were reported to and well received by General Busbee in September 1995.

Also in 1995, Sanchez-Rubio and Jeys proposed to the Army's Edgewood Chemical and Biological Center (ECBC) a sensor development program based on the concept developed under the ACC project. The proposed approach uses a miniature "microchip" laser unique to Lincoln Laboratory to excite native fluorescence in biological agents and to discriminate agent aerosols from background aerosols on the basis of their characteristic fluorescence data. The passively Q-switched microchip laser was invented and developed in 1993 by John Zayhowski as part of an independent research project. The warm reception of the remote sensing study helped advance the sensor development proposal (which was funded in late January 1996) with an objective to have an operating system at Dugway Proving Ground, Utah, for the Joint Field Trials in September 1996, an objective that was subsequently achieved (Figure 17-1). The sensor technology that ultimately evolved from the ECBC program was a generic biological "trigger" named Biological Agent Warning Sensor (BAWS).

On yet another front, the Aerospace Division pursued biodefense at the system level. Senior staff member Robert Miller conducted the Laboratory's first system study, focused on vulnerabilities to a bioagent attack, that served to merge the energies of the participants as well as to educate. By mid-1996, Darryl Greenwood, just returned from an Intergovernmental Personnel Act assignment at Air Force Rome Laboratory, took on the task of conducting a biothreat assessment. What made this task interesting was the ability to conduct such a broad-based assessment using only open-source materials — texts, papers, and the Internet. Greenwood's report also served to alert the DoD's biological and chemical leadership that Lincoln Laboratory had much to offer.





**Figure 17-1**  
Third-generation BAWs sensors were tested at the Dugway Proving Ground Joint Field Trials in 1999.

Later in 1996, Greenwood and Primmerman approached the Defense Advanced Research Projects Agency (DARPA) with a proposal to conduct aerosol background measurements related to BAWs. Meanwhile, the BAWs system undergoing tests in September 1996 at Dugway Proving Ground got considerable attention because of its excellent performance. On VIP day at the site, the Deputy Assistant Secretary to the Secretary of Defense, Colonel Ellen Pawlikowski, visited Dugway and observed BAWs in action. Soon thereafter, DARPA funded the background measurements proposal and the Laboratory had its first DARPA biodefense support.

The following year, staff member Todd Rider conceived a new approach for bioagent identification. Termed CANARY (for Cellular Analysis and Notification of Antigen Risks and Yields), the invention involved the use of white blood cells genetically engineered both to express antibodies for particular bacteria and to signal recognition for bound bacterial antigens by emitting light. A small grant from the ACC funded an initial study, and Professor Jianzhu Chen on the MIT campus provided laboratory facilities in which Lincoln Laboratory researchers could engineer CANARY cells since the Laboratory did not have biology laboratory space at that time. With MIT's help, the Laboratory took the CANARY proposal to DARPA and, after several meetings, convinced DARPA to fund the project. Now the Laboratory was engaged in research and development of technology for both triggering the presence of a bioagent (BAWS) and identifying it (CANARY).

What both Lincoln Laboratory and the government realized, in a period of just one year, was that Lincoln Laboratory had a lot to offer: various technologies, such as microchip lasers, signal processing, and sensors, and various disciplines of study, such as environmental monitoring, atmospheric, and laser propagation. The Laboratory evinced a solid understanding of system studies and architectures that could be used to better focus the technology developments into useful capability. More importantly, *in a period of just two years*, the Laboratory had become a major player in the biodefense business, from effectively a cold start.

In 1997, the Laboratory's senior management recognized the importance of this emerging new field. Director Walter Morrow and assistant director Herbert Kottler pledged support to build laboratories and to invest resources. The first biolab came on line in 1998. Independently, initial BAWs testing at Lincoln Laboratory took place on the bench and in a test chamber located in the Quantum Electronics Group's space, but by 2000, a well-designed combined electro-optics and biology lab, complete with an aerosol test chamber, was built and made operational. Over the next few years, a number of biology laboratories were built, allowing first-class biotechnology work in spaces where bacteria could be sequestered from viruses and where DNA could be researched without contaminating other areas (Figure 17-2). Ultimately, more than 5000 sq ft of laboratory space was built for researching biological agents.

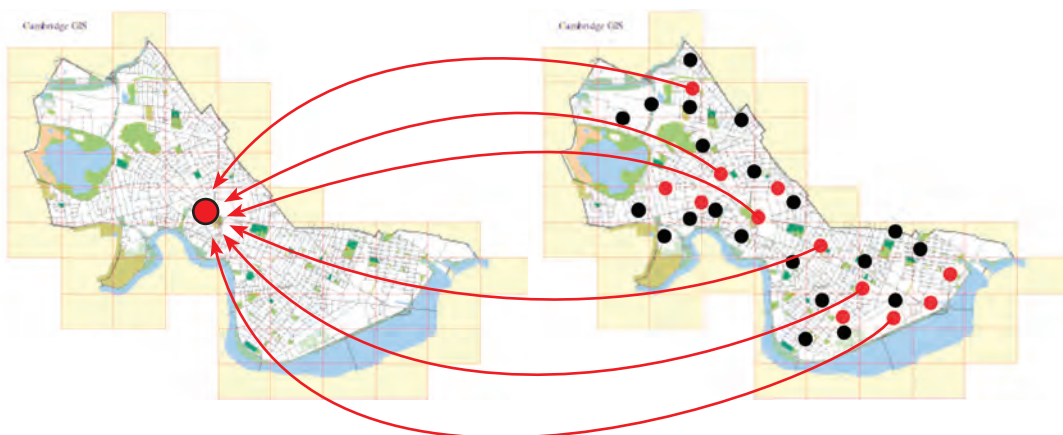
In 1998, assistant director Alan McLaughlin approached the deputy head of the Federal Bureau of Investigation (FBI) Laboratory, Randall Murch, with a spectrum of Lincoln Laboratory technologies, including its biology research, with potential forensic applications. Hollis had experience with a commercially available treated paper that could separate biomatter (particularly DNA) from contaminated backgrounds. The paper had the ability to lyse cells, remove the DNA intact, and leave the background behind. The Laboratory proposed to the FBI that Laboratory researchers perfect these techniques and develop automated means of biopreparation and separation. The FBI provided funding starting in 1999, with other sponsorship following in the forensics area. Numerous technologies spun off from the initial idea of using the treated paper, including Simple Nucleic Acid Protocol (SNAP), later named Recovery, Extraction and Archiving Protocol (REAP) due to naming rights, and Lincoln Nucleic-acid Kit (LiNK). Funding for these innovations continued for a number of years from various sponsors, including the Army.

A year later, Murch headed the Advanced Systems Concepts Office at the Defense Threat Reduction Agency (DTRA). The Defense Science Board had studied and proposed novel means of detecting a biological attack on the military and recommended pursuit of a program called Z-chip. The concept was of interest to the Office of the Secretary of Defense, but at



Figure 17-2  
Biolab facilities.



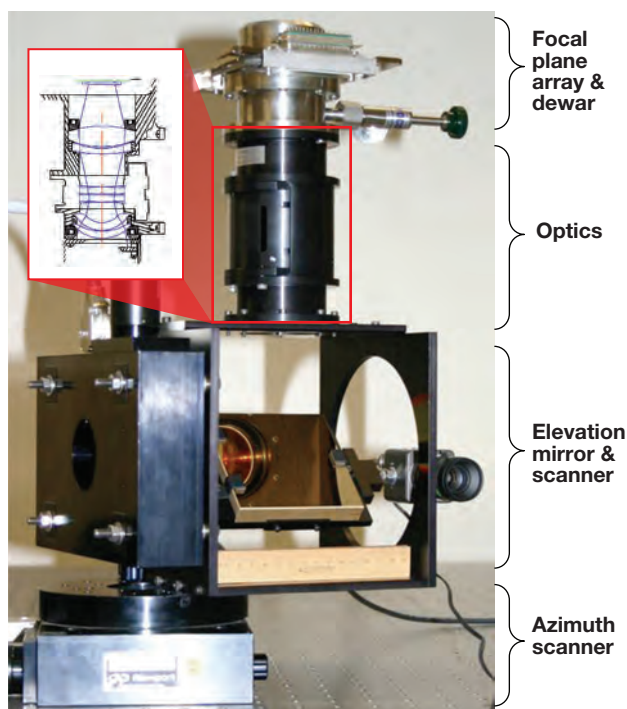


**Figure 17-3, above**

This illustration introduces the concept of BACTrack. The idea is to record the health status and location histories of a volunteer population. These data are used to find regions in the past in which a higher than expected proportion of currently ill people had congregated.

**Figure 17-4, right**

Wide-area chemical sensor.



a suggested buy-in of \$1 billion, this was felt to be too costly and lacked obvious first steps. The task of fleshing out a research program fell to Murch, who asked for Lincoln Laboratory's help. Greenwood proposed, then led, the Health Surveillance and Biodefense Systems (HSBS) study under DTRA sponsorship, starting in early 2001. The study involved an eclectic group of technologists from Lincoln Laboratory, the Naval Research Laboratory (NRL), and Harvard, and also included attorneys and medical doctors. The group was preparing to have its first plenary meeting on September 2, 2001, but it was necessarily postponed because of the attacks on New York and Washington.

Just one month after the infamous aircraft attacks, the nation experienced a biological weapons attack with anthrax-laced letters sent to news media and members of the Senate. Several people died from anthrax infection and, although the fatalities were thankfully few, these attacks, alongside the September attacks, served as wake-up calls. Chemical weapons were also of greater concern following attacks by Aum Shinrikyo on the Tokyo subway and by Saddam Hussein on the Kurds in Iraq. All these events served to underscore the will and intent of terrorist organizations and individuals to cause great harm and loss of life, not just to the military but also to civilians in the homeland. The result at the federal level was increased funding, not just for the DoD, but also for the National Institutes of Health and for the new Department of Homeland Security (DHS). The entire national dynamic had changed; whereas biological and chemical defense research had been more the art of the possible, it was now the necessary.

Internally, the biodefense program area gained momentum. In the 1990s, the work was a collection of projects in groups across the Laboratory. But in 1999, the Biosensor and Molecular Technologies Group was founded under Hollis, and in early 2001, the Biodefense Systems Group was founded under Bernadette Johnson. Other groups with biological and chemical defense emphasis areas were Quantum Electronics, under Sanchez-Rubio; Submicrometer Technology, under Mordechai Rothschild; Advanced Systems Concepts, led by Michael Shatz; and Sensor Technology and Systems Applications (which emphasized algorithm development), led by Gregory Berthiaume. External and internal funding in this period were also increasing.





**Figure 17-5**  
Test bed studies took place at the Boston Esplanade.

New efforts were started in medical tracking of infected individuals. These included the Biological Agent Correlation Tracker (BACTrack) invented by Lawrence Candell and Ronald Hoffeld (Figure 17-3); wide-area chemical sensing (Figure 17-4); DNA tracking based on concepts from the Laboratory's first biologist, Laura Bortolin; homeland security; and a Boston biodefense test bed, developed under Timothy Dasey, a recruit from one of the Laboratory's air traffic control groups. The Boston test bed proved particularly interesting and quite educational to the participants in its two years of existence: Laboratory researchers participated in events that could potentially be terrorist targets (e.g., MBTA subway rides, the Boston Marathon, and Fourth of July on the Esplanade — Figure 17-5). An important concept that had to be resolved was the separation of how things really worked or could be implemented from why or when they would not be practical. During the Boston test bed program, Laboratory researchers made many new contacts, establishing good working relations with various hospitals, the Boston Fire and Police departments, and emergency management for Boston and Massachusetts. Based in part on the understanding gained from the Boston test bed work, the Hanscom-Lincoln Testbed (HaLT) was created to provide protection of the Laboratory's facilities against a chemical or biological attack. (Note that no actual attack was anticipated. The exercise used Laboratory facilities, over which the staff had complete control, as a prototypical office building with conventional 1990s-vintage ventilation systems and perimeter control.)

Increased support led to the development of new Laboratory capabilities to counter biological and chemical weapons. The Army's medical establishment requested assistance with processing samples ("white powders") that were suddenly flooding their laboratory. Large numbers of sample-preparation cartridges were manufactured and sent to Fort Detrick, Maryland, for use in their laboratory. DTRA began funding a "medical CANARY" as well as a program intended to merge CANARY with BAWs. With DTRA funds, the Army ECBC teamed with NRL and Lincoln Laboratory to pursue new modalities and better algorithms for biological early warning. In the meantime, DARPA was entering its final round of biodefense programs before exiting the area in 2006.

In 2003, DHS was created and with it a domestic biological and chemical defense program aimed at countering terrorist activities. Lincoln Laboratory offered its resources to the new department, specifically in studies and architectures. The Laboratory received some of the earliest funding from the DHS Homeland Security Advanced Research Projects Agency. This work has continued, emphasizing requirements assessments, architectures, and system trades, which have enabled DHS to make informed, key investments in technology for biological defense of America.

By 2003, the biological and chemical program area at the Laboratory had grown to the extent that the director designated it an official laboratory mission, alongside Ballistic Missile Defense, Advanced Electronics, Communications, and others. With Greenwood as the lead, the new mission had increased visibility with the Joint Advisory Committee and the Laboratory's Advisory Board. As the program area matured, other dimensions were added, including protection of water systems, investigation of food contamination, and, notably, chemical defense. Point-chemical-sensing technology actually spun off from an existing capability that had been created to investigate trace background contamination in the Laboratory's microelectronics clean rooms. Under Rothschild's leadership, the Laboratory tested fundamental performance of chemical sensors against contaminants and interferents. Understanding false-alarm characteristics is critical to using any type of sensor, since otherwise the alarms may be falsely interpreted or, worse, ignored. The Environmental Sensing Group, under Berthiaume and Edward Wack, employed remote-sensing capabilities to investigate system architectures for chemical remote sensing. A new concept for area sensing (a chemical-agent line sensor) was invented and tested in an intergroup collaboration.

In 2003, the DoD reorganized its biological and chemical defense program, putting all their biological and chemical research funds into DTRA. Lincoln Laboratory was able to propose science and technology programs to the new office starting in late 2005. Activities include advanced sensors, nanotechnology, algorithms, interferent measurements, mission impact modeling, and pathogen preparation signatures. With this change, medical programs were likewise centered within DTRA.



**Figure 17-6**  
**Top: Portable field-data-collection system. Bottom: System used in van.**

Though not a medical lab, Lincoln Laboratory has pursued three medical thrusts. The first adapted sample-preparation technology (SNAP/LiNK) to process medical materials such as blood and sputum. The second emphasized the use of CANARY as a rapid bio-identifier in human and animal forensic samples. The third is not related to sensing at all, but is a therapeutic intended to protect and/or treat intended victims of an attack or infection. The Pharmacological Augmentation of Nonspecific Anti-pathogen Cellular Enzymes and Activities (PANACEA — see sidebar) aims to provide broad-spectrum antimicrobial protection either pre- or post-exposure.

#### Biological Agent Warning Sensor

Since 1996, Lincoln Laboratory has been developing biological-agent trigger systems for early warning of an aerosolized bioattack. Although BAWS does not identify the biological species, it can signal when the biological makeup of the air is suspect. BAWS was designed to take maximum advantage of ultraviolet-radiation-excited fluorescence signatures associated with native biological constituents. BAWS proved to be a success not only because it detects individual particles with good sensitivity, good discrimination, and high speed, but also because of its compact size and quality engineering.

A large part of the BAWS success was due to the Laboratory-developed microchip laser-based ultraviolet (UV) light source. From 1992, microchip lasers have been developed for use in various applications, including environmental monitoring. To get wavelengths in the UV, the passive Q-switched neodymium-yttrium aluminum garnet (Nd-YAG) laser had its fundamental frequency quadrupled in nonlinear crystals. They operated reliably, efficiently, and in a small package.

Here is an example of technology that was developed for one purpose but found several other applications, including biological-agent detection.

The first phase of the BAWS development took just nine months from start of funding to competitive field trials. During this time, the research team from the Quantum Electronics and Laser and Sensor Applications Groups designed, fabricated, and tested the sensor, and then assembled a van-housed data-collection system (Figure 17-6). This system was actually driven to the Dugway Proving Ground Joint Field Trial site before the computer algorithms were finished. That development took place in the bachelor officers' quarters at night by Jeys and Gregory Rowe. The BAWS system outperformed most of the other sensors involved in the field test. As a result, Lincoln Laboratory was asked to refine the design and prepare three self-contained sensors for testing the following year.

The BAWS-II system incorporated the features of BAWS but it was better engineered, enclosed in a 3 cu ft box, and could be powered by lead-acid batteries — a feature required for remote operation. In September 1997, BAWS-II was tested at the Dugway Joint Field Trials. Again, BAWS performed quite well, and Lincoln Laboratory was given more time to further refine the design and build three new sensors with significant improvements.

For BAWS-III, additional measurement channels were added and the detection algorithm was further improved. In addition, the overall package size and weight were reduced to 0.8 cu ft and 17 lb. BAWS-III was very portable and capable of operating unattended for long periods of time. BAWS-III underwent several

1995



Microchip laser



D.P. Greenwood



First BAWS trigger



T.H. Jeys

## PANACEA

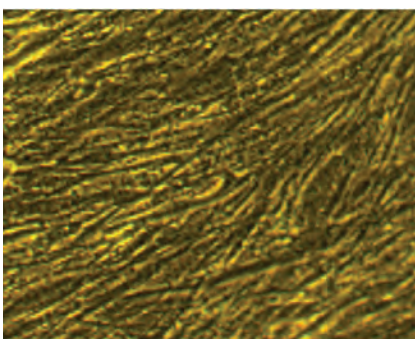
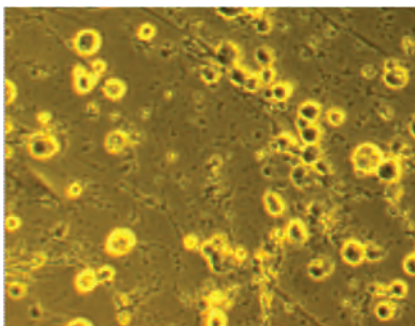


Figure 17-7

Viruses such as rhinovirus rapidly kill human cells (top), but DAC eliminates viral infections and keeps the cells healthy (bottom).

A vast number of pathogens are concerns for biodefense, clinical medicine, and agriculture: bacteria, viruses, pathogenic fungi, protozoa, and prions. Many of these pathogens are currently untreatable. In those cases for which therapeutic drugs do exist, pathogens can become resistant to those drugs either naturally (e.g., multidrug-resistant tuberculosis and HIV) or via human assistance (e.g., the overuse of antibiotics). Thus, there is a great need for new therapeutics, especially ones with efficacy against a broad spectrum of pathogens.

To address this need, in 2000 Todd Rider conceived an entire family of novel therapeutics called the Pharmacological Augmentation of Nonspecific Anti-pathogen Cellular Enzymes and Activities (PANACEA). Although cells have a number of natural internal defenses against pathogens, successful pathogens have become skilled at evading those defenses. Unlike previous therapeutic approaches, the concept for PANACEA is to “rewire” the natural intracellular defenses in safe, simple ways, thereby preventing pathogens from evading them. The result is a family of therapeutics, each of which is intended to make a different modification to the natural defenses and each of which should be effective against one or more broad classes of pathogens.

The first such therapeutic, and the most developed, is a dsRNA (double-stranded RNA) activated caspase (DAC). It selectively induces cellular suicide or apoptosis in cells containing long viral dsRNA, rapidly killing infected cells without harming uninfected cells (Figure 17-7). Since all known viruses make long dsRNA — uninfected cells do not — and must avoid apoptosis

of the host cell in order to replicate, DAC should have broad-spectrum efficacy against virtually all viruses.

With initial internal funding in 2000 and DARPA funding starting in 2001, Lincoln Laboratory began engineering DAC genes. The first major success came in 2002 when researchers showed that permanently adding a DAC gene to cultured human cells made those cells resistant to rhinovirus, the common cold virus. While this first proof-of-concept result was important, the DAC gene was not a form that could be easily delivered to animals or humans. Therefore, the Laboratory undertook an effort to produce DAC protein with an *in vivo* delivery tag to facilitate penetration of cells when administered as a drug.

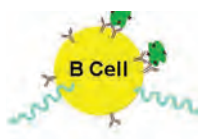
The first tests of the deliverable DAC protein were made in cultured human cells in 2004, and it was found that the DAC protein performed very well. It easily penetrated cells within minutes, persisted for days, was nontoxic to uninfected cells, and was highly effective at eliminating rhinovirus-infected cells. Because this protein form could be administered to cells much more quickly and easily than the earlier gene version, Laboratory scientists were able to test it with a wide variety of cells and viruses. By 2007, the Laboratory had demonstrated that the deliverable DAC protein was nontoxic in all ten human and mouse cell types tested thus far. In these cells, DAC was effective against all ten viruses tested: four rhinovirus strains, human and mouse adenoviruses, two influenza strains, mouse encephalomyelitis, and a stomach virus.

While continuing to pursue further results in cells, Laboratory technical staff began to conduct mouse trials of

the deliverable DAC protein with funding from DTRA. Because Lincoln Laboratory does not have animal facilities, outside laboratory resources were employed. In 2006, the services of a Pennsylvania contract laboratory that does routine drug toxicity trials in animals were enlisted. They found that DAC was nontoxic in mice when administered through a variety of routes, even at very high levels. In 2007, the Laboratory began testing in mice infected with H1N1 influenza at the MIT Division of Comparative Medicine. In 2008, it was demonstrated that DAC can successfully rescue mice that have been infected with a lethal dose of influenza.

While DAC is the first member of the PANACEA family of therapeutics, the Laboratory is developing other members of the family. Other treatment approaches are intended to be efficacious against bacteria and protozoa, complementing DAC, which was designed to be effective against viruses. Experiments are being designed to produce deliverable protein forms of these therapeutics and test them against a variety of pathogens.

In late 2009, Lincoln Laboratory received its first major NIH grant, through NIH’s New England Regional Center of Excellence for Biodefense and Emerging Infectious Diseases. This is a two-year grant that covers testing of DAC against members of the more serious arenavirus, bunyavirus, and flavivirus families in both cells and mice. During 2010, Laboratory researchers successfully demonstrated that DAC is effective against members of all three virus families (Amapari and Tacaribe arenaviruses, Guama bunyavirus strains, and dengue flavivirus) in cultured cells. The Laboratory will be testing and optimizing DAC efficacy against dengue virus in mice during 2011.



CANARY luminometer setup  
CANARY Bio-ID technology



SNAP/REAP sample-preparation protocol



BAWs-III trigger at Dugway Proving Ground



tests at Dugway Proving Ground during summer 1999, and these test results (as well as the previous test results) convinced the program manager for the Joint Biological Point Detection System (JBPDS) to seriously consider integrating BAWs into the JBPDS, which was at that time suffering from a poor trigger sensor. To determine whether BAWs should be integrated into the JBPDS, a series of tests was conducted at Dugway during October and November 1999. These tests were very successful and the JBPDS program manager, Lieutenant Colonel Timothy Moshier, decided to fund Lincoln Laboratory to design and produce fifteen prototype BAWs units that could be inserted into the JBPDS for testing under varied and militarily relevant operating conditions. Ultimately, BAWs-III passed these tests and the design was accepted for limited production by a DoD-chosen contractor. At the request of Colonel Moshier, Lincoln Laboratory transferred the BAWs technology (including previous test results and a build-to-print drawing package) to the contractor.

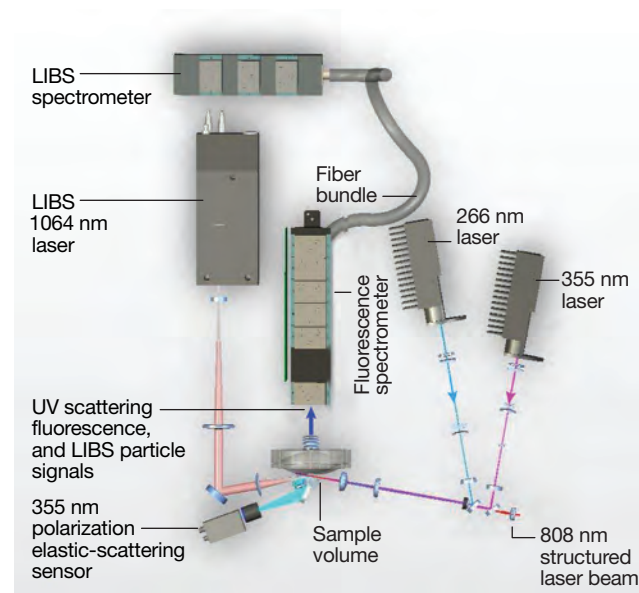
While BAWs was state of the art, much remained to be learned about long-term performance of a system constructed in industry and routinely used by service personnel. From 2000 to 2008, Michael Languirand worked closely with the JBPDS program office and with the JBPDS contractor. During this time, under

the leadership of George Haldeman, an Advanced BAWs (ABAWs) test bed was developed to evaluate potential biotriggers upgrades for the JBPDS. During the course of development and testing, the program investigated fluorescence spectrometer optical systems, low-noise optical and electronic designs, sheath airflow systems, aerosol concentrator applications, alternative algorithm strategies, particle cueing systems, and methods for three-axis particle-position measurement to correct spatial signal dependencies. Numerous performance and reliability upgrades were developed, some of which were transitioned to industry and incorporated into JBPDS.

Though BAWs was the state of the art at the time, Lincoln Laboratory thought it could be improved by making radical changes in its fundamental approach. Starting in 2002, a two-pronged effort explored designs that could improve performance and designs that could cut individual sensor cost (permitting deployment in great numbers). For the high-performance sensor, the Rapid Agent Aerosol Detection (RAAD) program was initiated in partnership with NRL and Army ECBC (Figure 17-8). RAAD incorporates more laser and sensing channels as well as a patented “structured trigger beam,” which accurately locates the interrogated particle. The RAAD program, under William Herzog’s leadership, has indeed performed significantly better than BAWs, and RAAD may eventually replace BAWs in the JBPDS.

On the low-cost end, Lincoln Laboratory pursued two approaches. The Intelligent Particle Analysis Sensor (IPAS), designed by Daniel Cousins, is a particle counter built from inexpensive commercial parts. This sensor works by noting the level of particles in the air and, through its algorithms, determines whether a threat cloud may be present. The Biological Agent Sensor and Trigger (BAST), designed by Jeys, maintained the fluorescence analysis of BAWs but replaced two high-cost components. Light-emitting diodes (approximately \$100 each) developed under DARPA sponsorship replaced the laser (\$10,000), and commercial charge-coupled devices (\$100) replaced the photomultiplier detectors (\$1000). Both IPAS and BAST have exceeded expectations in field tests.

**Figure 17-8**  
RAAD optics breadboard showing all laser sources and sensors.





**Figure 17-9**  
The portable PANTHER uses CANARY technology like the multiposition carousel shown in the top image, with the added advantages of automation, ruggedness, and reliability.

### CANARY

BAWS, RAAD, IPAS, and BAST are all biotrigger sensors: none of them identify the agent. To complete a sensor architecture requires an identifier, for which there are basically three classes: cell culture, DNA-based polymerase chain reaction (PCR), and immunoassay. Of the three, culture is very slow, but for many laboratories, it still remains the “gold standard” largely because it is cheap and accurate. PCR is a highly accurate, sensitive, and specific bio-identifier, with speeds in the tens of minutes. Immunoassay is best epitomized by the pregnancy test kit. However, immunoassays are typically based on antibodies removed from their host cells and placed on substrates, resulting in a reduction in sensitivity and speed.

A variation on the immunoassay scheme is the Laboratory-developed CANARY. CANARY is based on the observation that antibodies function much better when they are still attached to their host cells. The concept for the new identifier was to use B cells, with antibodies attached, that are genetically engineered to recognize individual biological agents (bacteria, viruses, and toxins). In addition, the B cell has to report when it encounters the target bioagent. The cells were genetically engineered to express aequorin, a bioluminescent jellyfish protein, which causes the cells to emit blue-green light when stimulated. During detection, the cells are localized over a detector element. Once the suspect material is brought into close contact with the cells, the specific antigen is recognized and light is emitted and detected.

One CANARY instantiation uses a commercial centrifuge and is suitable for use by laboratory technicians. In addition, several CANARY-based sensors were designed to collect and analyze aerosol samples. These systems, such as the Triggered CANary (TCAN) use cartridges that are preloaded by trained personnel. This approach allows for field-site use, involving fewer trained personnel and unattended operation. The most recent version of CANARY is called the Pathogen ANalyzer for THreatening Environmental Releases (PANTHER) (Figure 17-9), which has been used at a number of field sites and indoor locations, and in concert with field training of the local National Guard unit.

CANARY, in all various manifestations, has met certain needs of the defense community to identify a bioagent at low concentration within 3 min, enough time to effect protective measures. It has also been demonstrated to be effective not only for aerosol interrogations but also for various media including food, plants, water, urine, and blood. CANARY has the honor of being highlighted in *Science* magazine in 2003.<sup>1</sup>

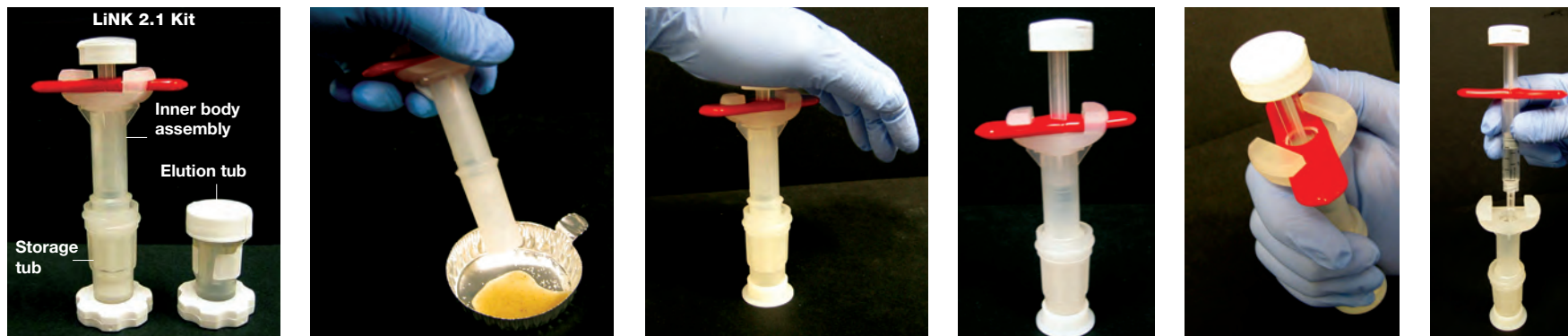
### Sample Preparation

Identification of bioagents using PCR requires input of a clean, noninhibitory sample into (commercially available) instruments. This need is a result of the optically based readout of the signal, easily degraded reagents, and sensitive binding efficiencies of reagents to the nucleic-acid target. Production of a clean sample is not an easy task, given many types of environmental and clinical samples processed (e.g., soil, dry filter unit eluates, blood, nasal secretions, surface wipes). Commercially available kits used to purify samples are labor-intensive, time-consuming, and costly, and are not amenable to field use. Thus, Lincoln Laboratory took on the challenge of adapting and creating new sample preparation methods that minimize required reagents, equipment, and processing steps.

Stemming from a commercially available paper (originally produced by Schleicher and Schuell, now produced by Whatman) designed to bind proteins and inhibitors from blood samples and to elute clean DNA, Lincoln Laboratory optimized the use of the paper to detect *B. anthracis* spores from inhibitory environmental samples in REAP. An added benefit is the ability to archive the extracted DNA on the paper indefinitely. To simplify the sample-preparation process further, the paper was engineered into a small LiNK cartridge, easily meeting the field use requirements of low power, light weight, and easy operability by minimally trained personnel in bulky protective gear. The development of LiNK was initiated in response to an urgent request from the U.S. Army Medical Research Institute of Infectious Diseases in October 2001 because of the recent anthrax letters. LiNK has since been redesigned to better meet the needs of field users and has been shown to work against a wide variety of targets and sample classes, including environmental, clinical, and food (Figure 17-10).

### Note

<sup>1</sup> T.H. Rider, M.S. Petrovick, F.E. Nargi, J.D. Harper, E.D. Schwoebel, R.H. Mathews, D.J. Blanchard, L.T. Bortolin, A.M. Young, J. Chen, and M.A. Hollis, “A B Cell-Based Sensor for Rapid Identification of Pathogens,” *Science* **301**(5630), 213–215 (2003).



**Figure 17-10**  
The latest version of LiNK includes an easy-to-use and easy-to-see twist lock to release the syringe.

To further improve PCR detection of bioagents from samples, including large volumes and samples containing trace levels of nucleic acid, Lincoln Laboratory designed a concentration method named Affinity Magnet Protocol (AMP) that is based on magnetic beads with robust coatings for target capture (Figure 17-11). The AMP has also been engineered into an easy-to-operate device, an Affinity Magnet Cartridge (AMC) (Figure 17-12). Numerous versions of LiNK and AMC have been designed on the basis of the required features for specific field operations and the ability to mate with various commercial laboratory and field PCR instruments. While Lincoln Laboratory continues to develop novel methods and devices, several versions of the described devices have already been transitioned to industry for large-scale production.

The research and development conducted at Lincoln Laboratory for minimizing and simplifying sample preparation has resulted in advancing PCR analysis into a broad range of field applications. The developed protocols integrate easily with many commercially available instruments and thus, without requiring any changes in instrumentation, are amenable to rapid, onsite processing of inhibitory samples. The sample-preparation methods and tools are also compatible with a wide variety of other detection technologies and forensic techniques for analyzing DNA. These sample-preparation tools have enabled a revolutionary ability to detect and identify pathogens without the need for extensive training, costly materials, or long processing times, thus enabling a faster response and treatment.

### Systems Programs

While component technologies such as triggers, identifiers, and sample-preparation cartridges are essential to a defensive system, they do not constitute a complete system unless there is a full end-to-end appreciation for the threats, vulnerabilities, and risks, as well as an integrated means of assembling an effective defensive architecture and assessing its performance. System studies and architecture developments have been a mainstay of the biodefense program since its inception at the Laboratory.

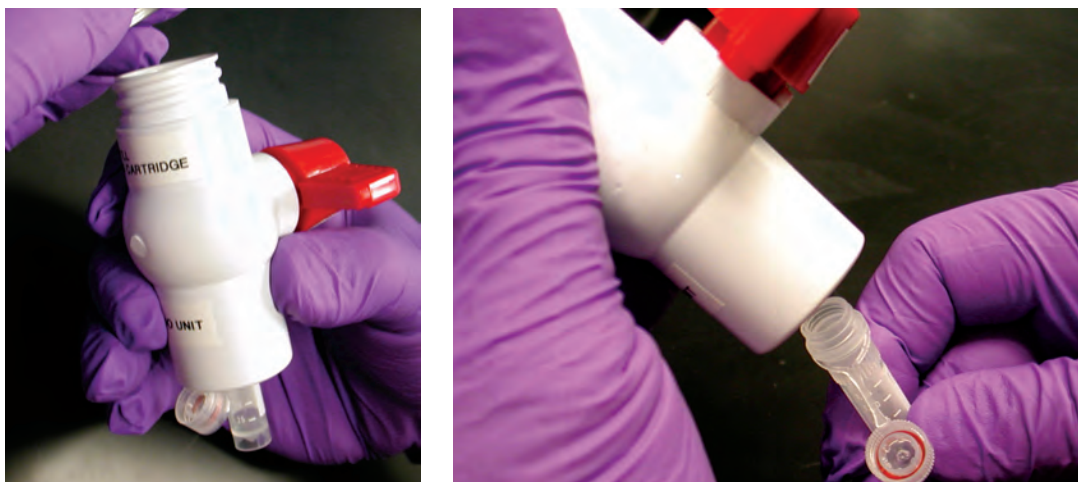
System studies are a major component of focusing requirements and technology directions. Researchers and sponsors must recognize the importance of studies as a first and continuing step in developing an overarching biological and chemical defense capability. As noted earlier, the Laboratory's biodefense program started in 1995 with a study, and the first involvement with the Joint Program Office was in a biological standoff study, which enabled a series of technology programs in a way that no one predicted. From 1995 on, Lincoln Laboratory used studies not only to educate sponsors but also to educate staff. Early analysis by Miller helped to focus thinking.

In 2002, Lincoln Laboratory was asked to develop a biodefense architecture for Fort Leonard Wood, the headquarters of the Chemical School. Under Dasey's leadership, a three-tiered set of architectures was produced that depicted ways in which the capability was proportional to the expenditure. Although recommendations were well received, the biodefense architectures being deployed were still largely collections of individual measurement and collection instruments, rather than the integrated defenses that Lincoln Laboratory strongly advocated.



**Figure 17-11**

**AMP uses magnetic beads with semi-selective coatings to capture and concentrate target from complex sample.**



**Figure 17-12**

**AMC packages the AMP into a fieldable easy-to-use tool.**



The Fort Leonard Wood study was the beginning of a set of analysis and measurement efforts with the Joint Program Executive Office for Chemical and Biological Defense that continues to this day. In addition to its detection system and information-fusion contributions, Lincoln Laboratory is one of the few organizations in the nation that can produce unbiased prototypes and evaluations of end-to-end system concepts.

System analysis of biological and chemical attack and potential defenses must include exploration of the organization and effectiveness of potential responses. This coupling of operational and technical analyses is prominent in an extensive series of analyses conducted for the DHS, beginning shortly after the DHS's formation. Lincoln Laboratory's reputation for in-depth and clear-thinking analysis has resulted in the initial work, under the leadership of Mark Weiner and Dasey, growing to include efforts in facility protection, wide-area urban protection, container screening, and technology evaluation. The reputation the Laboratory has established with DHS Science and Technology (S&T) has led to additional roles in measurements, test and evaluation, and system prototyping. Additionally, since the biodefense studies were the first substantive engagement with DHS, they were helpful in paving the way for broader impact to the department when the Laboratory's Homeland Protection mission was established.

System studies are not done in a vacuum; what is needed is corroborative and supporting data. The Boston subway study was just one such example (see chapter 18, "Homeland Protection"). Other data collections of biological and chemical matter were performed in various buildings and outdoor environments, including Camp Doha in Kuwait and many places across the United States, including the San Francisco airport. Knowledge of how sensors perform against real environments serves to set expectations. Too often operational users are given sensors that have not been tested in the presence of backgrounds. One environment might be very benign (e.g., deserts), while another might be very cluttered (e.g., subways), while others are in between (airports, office buildings). The Laboratory's understanding of sensor performance in realistic environments could be imparted to this new community. Selling the concept of the so-called

ROC (receiver–operating characteristic) curve became almost a crusade. In 2000, a DARPA sponsor, Colonel John Carrano, caught the spirit of the approach and sponsored the Spectral Sensing Biological Agent program, intended to focus DoD sensor efforts, as well as others, on bio–ROC curves. Through these unwavering efforts, ROC curves are now accepted throughout the community.

#### Lessons Learned

Lincoln Laboratory’s successes in developing a biological and chemical mission were not without plan. As in all its programs, success is about people, and the Laboratory had a number of highly qualified, dedicated staff. Recruitment was not difficult for this new and exciting area.

In addition to the studies already emphasized, the development plan involved five elements: education, staffing, infrastructure, collaboration, and funding. Education was needed to enable communication and understanding among various disciplines. A set of classes was established under the Laboratory’s education program from 1997 to 1999, with speakers from universities in the Boston area as well as national leaders in biodefense. Initially, staff were hired with the intent to grow biological talent, but over time it became apparent that cross–disciplinary skills would serve the staff members and the Laboratory better. Biology labs were built, thanks to support from the director. Finally, it was acknowledged that Lincoln Laboratory should not engage in testing human or animal subjects, nor would it go to high levels of biocontainment. Such research could be done at facilities owned and operated by others and had the added bonus of pressing the Laboratory to

establish external collaborations. Funding was garnered largely by a bootstrap process: starting small and achieving success generally attracted attention and, often, sponsorship.

Finally, leadership, vision, and patience (and persistence) were critical factors in the success in this new area. Leadership from the director on down was critical. Particularly valuable was the guidance given by associate director Kottler, who provided the right level and the right kind of guidance and help. Greenwood, who ran the mission, was afforded the time and opportunity to make this area succeed. Finally, and most importantly, were the staff and group leaders who made it all work; without them none of the technology or systems would have been such a success.

#### Looking Forward

Huge problems remain in defending U.S. civilians and military against biological or chemical attack. While the Laboratory has made notable contributions in biological and chemical sensing, much remains to be accomplished (e.g., improved sensitivities, improved specificity, and more rapid response). Arguably though, what the DoD and counterpart civilian agencies need is a systems approach to biological and chemical defense. Today such an integrated capability is lacking. Individual sensors are deployed, often requiring significant human attention, all resulting in high cost and at times inadequate reliability. Future integrated systems will employ sensors but will also integrate ancillary sensors, human response, intelligence, and operations. Lincoln Laboratory should be ready to help develop and integrate the future biological and chemical defense architecture for the country.



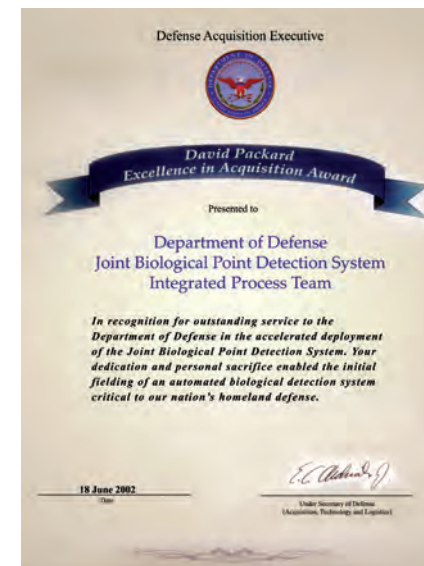
Final BAWS unit developed at Lincoln Laboratory



T.H. Rider



B. Johnson



## 2002 David Packard Award

A 2002 David Packard Award for Excellence in Acquisition was presented June 18, 2002, by the Under Secretary of Defense for Acquisition, Technology and Logistics, Edward “Pete” Aldridge, to the Joint Biological Point Detection System (JBPDS) program, of which Lincoln Laboratory was a member. This prestigious award recognizes teams who have made significant contributions in technical innovation and best practices. The JBPDS team, led by the Joint Program

Executive Office (JPEO) for Chemical and Biological Defense, was selected for “its performance in the accelerated deployment of a biological detection system after September 11.”

Lincoln Laboratory’s role in JBPDS was the introduction of a more advanced, more reliable biotrigger for the system. The transfer of BAWS technology took place under the leadership of Michael Languirand in the Engineering Division. Languirand was on the stage for the

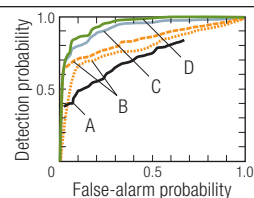
award ceremony in the Pentagon, receiving the award along with the JPEO and the principal contractors, Battelle and General Dynamics. The award correctly recognizes the Laboratory’s contribution to this major technology acquisition program and to the biological defense of the military (Figure 17-13).

Figure 17-13

Left: Under Secretary of Defense Aldridge (fifth from left, front row), presents the award. Lincoln Laboratory’s representative at the ceremony, Michael Languirand, is fourth from left, front row. Center, holding the award in the front row is Timothy Moshier, the program manager of JBPDS. A few years later after he retired from military service, Moshier joined the Laboratory as a staff member. Right: David Packard Award.



Testing at the UK site  
Porton Down



Receiver-operating characteristic curves accepted as standard analysis tool







**Lincoln Laboratory is leveraging the core competencies developed in support of its traditional mission areas for new needs in homeland security.**

**Left: The Enhanced Regional Situation Awareness system has been integrated with other key technologies to provide air defense of the National Capital Region.**

After the terrorist attacks on September 11, 2001, the U.S. government focused increased attention on homeland defense and security. This emphasis was the most recent in a historical pattern of increasing and waning homeland protection activities precipitated by perceived threats, and it resulted in the creation of the Department of Homeland Security (DHS), the establishment of the U.S. Northern Command as the Department of Defense's (DoD) combatant command for homeland defense, and the prioritization of counterterrorism as the key focus area for the Department of Justice.

Current homeland protection activities are driven by unique challenges. One challenge is the rise of radical terrorist groups who have the intention and perhaps the ability to use weapons of mass destruction or launch a significant cyber attack. Another factor is a U.S. citizenry that places strong demands on U.S. leadership to prevent terrorist attacks whose random nature, underlined by persistent and immediate media coverage, evokes a strong emotional reaction. Perhaps of most concern is the significant vulnerability of the nation's critical infrastructure, which is almost completely reliant on information technology.

Lincoln Laboratory has been investigating ways to apply its expertise in systems development to the protection of the United States against terrorist attacks. Among the early efforts were the development of the Enhanced Regional Situation Awareness system to support the air defense of the National Capital Region and the architecting of biodefense systems for homeland security. It also became clear that the Laboratory could contribute in many additional areas: systems for defending the nation's land and maritime borders, the protection of the nation's physical and cyber critical infrastructure, and disaster response. This recognition led in 2008 to the creation of Homeland Protection as a Laboratory mission area and to the subsequent establishment of the Homeland Protection and Air Traffic Control Division.

As Lincoln Laboratory moves to help the nation improve its capability in homeland protection, it is facing the complexities involved — the diverse range of targets presented by the homeland; the need to defend against very significant attacks involving weapons of mass destruction; the extent of U.S. land and maritime borders; a domestic environment that presents concurrent

privacy, political, and economic concerns; and the confusing command-and-control environment caused by the overlapping responsibilities of federal, state, and local entities.

#### **Enhanced Regional Situation Awareness System**

The September 11 air attacks on the Pentagon and the Twin Towers in New York City exposed the need for improved air space situational awareness to more effectively defend important national assets. Under the direction of the U.S. Air Force Rapid Capabilities Office, Lincoln Laboratory assisted in integrating new air defense elements introduced to the National Capital Region (NCR). The result of this effort was the Enhanced Regional Situation Awareness (ERSA) system, which provides an integrated sensing and decision support system for the complex, busy airspace surrounding the NCR.<sup>1</sup>

Identifying aircraft threats is the responsibility of the North American Aerospace Defense Command (NORAD). NORAD operators continually compare the behavior of aircraft flying in the NCR to published airspace restrictions and required practices. Three separate levels of restricted airspace were established after the September 11 attacks. These are the Prohibited Area 56, the Flight Restricted Zone (FRZ), and the Washington Air Defense Identification Zone (ADIZ). Aircraft entering the ADIZ must be equipped with a transponder that reports both identification code and altitude. Pilots must file flight plans before entering the ADIZ and know the password of the day before entering the FRZ. Failure to comply will prompt intercept from nearby fighter aircraft or Coast Guard helicopters (depending on the type of aircraft in violation and its location).

Because of the high volume of commercial aircraft normally entering the NCR, the overall process to assess an aircraft's intent must be extremely reliable. Decision makers must rapidly and continually collaborate and assimilate all information available on targets of interest. False alerts and the unnecessary use of military aircraft must be avoided. To assist operators in meeting these goals, ERSA provides a layered decision support architecture that includes passive monitoring of the airspace while simultaneously providing a means for NORAD operators to visually

---

## Notes

**1** Material for this section was provided by James Flavin.

**2** Material for this section was provided by Timothy Dasey.

warn the pilots of airspace violators and then to monitor their response.

The ERSA architecture has four infrastructure layers connected through a redundant network: sensors, data aggregation and processing, the common air picture, and response. The sensor layer combines existing Federal Aviation Administration (FAA) air traffic control (ATC) radars with new military radars to detect and track aircraft in the region. Sentinel radars provide accurate three-dimensional cues for pointing camera systems, as well as for target identification, through the use of both identification-friend-or-foe equipment and radar-signature measurements. An extensive electro-optical and infrared camera network is deployed across the NCR. These cameras provide the operator with a capability for visual identification of aircraft and comparison of observed features to those expected from the flight-plan database. The control of these cameras includes an autonomous video-tracking capability.

The data aggregation and processing layer performs track processing to fuse the radar data into high-quality metric reports of aircraft positions in the region. The track data are aggregated with weather and other data, and the aggregated data are then processed through software threat-conditioning logic to automatically assess aircraft compliance with airspace restrictions and to detect unusual behavior. Aircraft flagged as possible threats are highlighted through a color change to the aircraft symbol on the display. Any aircraft of interest may be immediately “hooked” through the click of a mouse to cue the camera array toward it.

The common-air-picture display layer distributes aircraft tracks to civilian and military agencies to aid collaborative decision making during the identification and coordination of the response. An information drill-down capability is provided to allow operators to perform passive intent assessment by viewing detailed information on tracks of interest to evaluate inconsistencies and identify reasons for concern. Aircraft approaching high-value assets will be contacted by FAA air traffic controllers through voice radio. Lack of response to this warning may indicate hostile intent or, more likely, pilot confusion. To augment voice radar communication,

ERSA provides a means of visually warning pilots that they are in violation of airspace restrictions.

The ERSA Visual Warning System is a highly directional set of blinking lights that are described in a published Notice to Airmen. The notice instructs pilots that if they see the flashing red-red-green warning light sequence, they must contact ATC and exit the region. Because the warning is highly directional, it is only seen by the intended pilot. Failure to respond to this visible warning, in addition to the lack of radio contact and compliance with airspace restrictions, further informs NORAD that the pilot may have hostile intent, and intercept by military aircraft could ensue if hostility is determined.

The ERSA user interface was designed to support the time-critical mission of the users tasked with the protection of the NCR. The workstation images illustrate ERSA display functionality (Figure 18-1). The common-air-picture radar display is shown in the lower left quadrant and the main video display is shown in the lower right quadrant. A single keyboard and mouse control the displays. Above the radar display and the main video display is the camera mosaic, which consists of two tile displays, each showing the output of up to four cameras. While this is the display configuration used by the NORAD operators, other agencies in the NCR have certain relevant parts of this configuration, depending on their information needs.

### *ERSA Enhancements and Expansion to Other Regions*

Lincoln Laboratory continues to build upon the original capabilities that were deployed through ERSA in 2005. Research and development activities span the broad scope of architecture elements needed for homeland air defense and air security, including advanced radar systems, software architectures for net-centric data exchange, and threat-identification techniques. A critical element has been the adaptation of the ERSA software to integrate advanced ground-based radars for target classification and low-altitude tracking. Efforts are also under way to transition to a service-oriented architecture, which comprises a group of services for subscription by new applications created across the broader air domain. Within this vision, data exchange and service publication will span the government’s multiple enterprise systems, fostering





**Figure 18-1**  
ERSA workstation.

improved collaboration and information sharing during situations of interest. The challenges that lie ahead include defining interface standards and services; determining enterprise service bus technology needs; and integrating sensors, services, and applications.

Improved data exchange across the government enterprise also motivates the development of threat sorting logic for airspace within which pilots operate under greatly reduced airspace restrictions. Recent advancements in machine-learning techniques were designed to draw operator interest to aircraft exhibiting behaviors that are unusual relative to similar aircraft or past activities.

#### **Biological Defense for Urban Areas**

Terrorism is not confined to air attacks — it can take the form of biological attacks. For example, in October 2001, several letters laced with *Bacillus anthracis*, the causative agent of anthrax, were sent to prominent politicians and news outlets. In total, five Americans were killed and seventeen were sickened, but the attack impact went far beyond the immediate deaths. Biological defense experts recognized the potential for even more devastating attacks, so increased attention was aimed at protecting the civilian population against such attacks.<sup>2</sup>

Even before the DHS was established, the predecessor Office of Homeland Security was strongly focused on how to mitigate the impact of a biological attack on urban populations, and that emphasis continued in DHS. Rapidly deployable solutions, such as the BioWatch system of aerosol collectors and laboratory sample analysis, were positioned in many U.S. cities. Lincoln Laboratory was brought in by DHS to assess the future evolution of existing systems such as BioWatch, to analyze gaps in defenses and potential system architectures to bridge those gaps, and eventually to prototype and test the system solutions.

Initial architecture analysis focused on next-generation detect-to-treat systems such as BioWatch. Detect-to-treat defenses signal the presence of pathogens in time for treatments to be given to the potentially infected. The analysis framed the utility of various detect-to-treat options as a function of the detection system characteristics and of the potential responses and their associated timelines. Sensing-architecture performance

---

**Note**

**3** Material for this section was provided by Israel Soibelman.

as a function of sensor density and sensitivity was estimated. However, the initial sensing system does not describe a complete system. Additional evidence is needed to determine whether the detected organism is endemic or manmade, what the scale of potential exposure is, and what treatment options can be employed before a large-scale health-care response is mounted. Lincoln Laboratory studied options for this incident-characterization process and suggested technology development investments.

In addition to treatment-based architectures, the Laboratory investigated the means to reduce the exposure of a released pathogen to a population, particularly an indoor population. As in the detect-to-treat analysis, response utility and feasibility, as well as sensor performance in various placement configurations, were analyzed for various types of urban facilities, including subways, sports arenas, convention centers, and office buildings. Substantial sensor background measurements from operational settings were used in this analysis. Of particular importance was a year-long data set collected from multiple locations in the Boston subway system (Figure 18-2 and Figure 18-3). Measurements were also made in airports, at a postal sorting facility, in a sporting arena, and at large, public gatherings (e.g., July 4th celebration in Boston).

In the final years of the decade, the technologies that DHS had begun investing in when the department was first formed reached maturity. Lincoln Laboratory was asked to demonstrate these technologies in prototypes in operational settings. Using a commercial candidate detect-to-treat sensor called the Microfluidic Bioagent Autonomous Networked Detector, the Laboratory measured the performance of the sensors over a long period of time in a variety of challenging environments. In addition, a prototype detect-to-warn biodefense system was constructed and tested at a major public facility.

Lincoln Laboratory's contributions were not limited to post-attack defenses. Preventing the smuggling of chemical, biological, or explosive (CBE) materials into the country via maritime shipping containers was the objective of the DHS Safe Container (SAFECON) program (Figure 18-4). Because the available detection signatures for such an effort were not well

characterized, the Laboratory performed a series of phenomenological measurements of potential threat-like simulant releases and container backgrounds to understand the feasibility of detecting CBE threats in shipping containers via sampling of the container air.

Urban centers and facilities, with dense populations and open access, may be especially attractive targets for chemical and biological attacks, and the defense against these weapons touches the entire, widely interconnected urban system. In the future, the defense architectures developed for DHS thus far will need to be expanded to incorporate defenses against additional portions of the attack chain and will need to be adaptable to an evolving threat and risk tolerance.

**Seedling Activities**

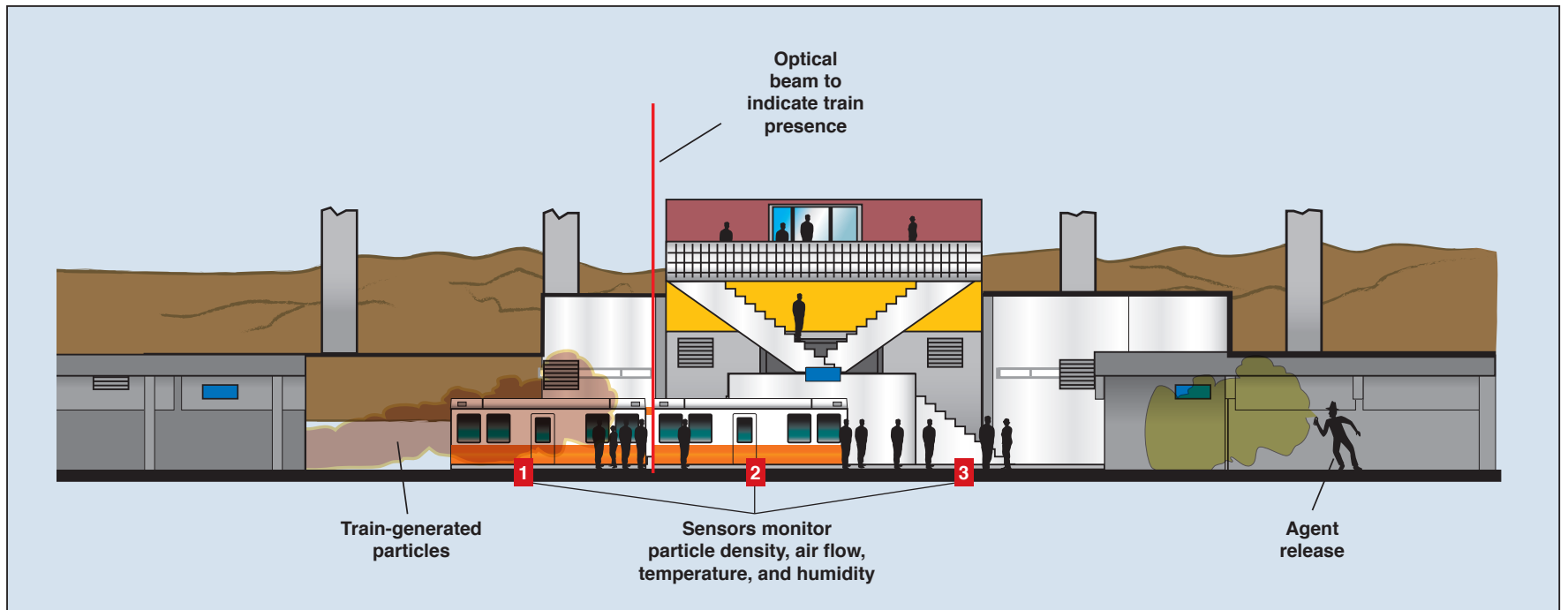
Lincoln Laboratory's expertise in systems analysis and development is being tapped for a variety of innovative efforts in homeland protection.<sup>3</sup>

**Border Security**

Lincoln Laboratory is assisting the DHS Science and Technology Directorate (DHS S&T) in understanding what technologies can provide operational utility and effectively enhance security along the northern border of the United States. The challenges of the northern border are significant: the considerable size of the border (approximately 5500 miles of land and water), the varied terrain ranging from mountains to plains to waterways and forests, the often extreme weather conditions, the lack of infrastructure in remote areas, the "open" culture that disallows fences and other restrictions, the location of heavily populated urban areas at the border, and the presence of semiautonomous indigenous people's reservations spanning both sides of the border. The Laboratory is supporting the DHS S&T-sponsored North-East Testbed program that is evaluating systems and technologies in various regions of the northern border to assess their operational utility.

**Critical Infrastructure Protection**

Seedling activities in support of both physical infrastructure protection and cyber protection are under way (see chapter 6, "Communication Networks and Cyber Security"). Lincoln Laboratory is supporting DHS S&T in architecture studies for various classes of physical infrastructure as well as prototyping an



**Figure 18-2**

A representative illustration of the sensor deployment in the Boston subway test bed. The patterns of activity from train-generated releases at each of the sensing nodes 1, 2, and 3 are expected to differ from the measurement patterns caused by terrorist biological releases.



**Figure 18-3**

Biological Aerosol Warning Sensor and a polyaromatic hydrocarbon sensor collocated with a center node were used in Boston subway field tests.



**Figure 18-4**

Lincoln Laboratory is assessing methods for screening shipping containers for CBE threats.







**Figure 18-5**  
**The ISIS Spiral 1 sensor, shown mounted on the ceiling next to the flag, has been in operational testing since December 2009 at Logan International Airport's Terminal A.**

innovative sensor for surveillance in highly populated urban areas. Specifically, the Laboratory is developing the Imaging System for Immersive Surveillance (ISIS) shown in Figure 18-5. ISIS is a novel, 360° surveillance system that provides hundreds of millions of pixels of video coverage through the integration of commercial imagers and lenses. ISIS includes a parallel real-time processing architecture for disseminating its data over a networked interface. This approach will allow video to be integrated with real-time video analytic techniques, also under development at the Laboratory, for detecting scene changes or identifying and tracking object types determined to be of high interest to the user. Currently, ISIS is undergoing operational testing at Boston's Logan International Airport in collaboration with the Massachusetts Port Authority. A second-generation system called Chandelier will feature twice the video resolution of the first-generation ISIS system.

#### *Disaster Response*

In 2008, Lincoln Laboratory set out to understand how to leverage its DoD core competencies to help in disaster response. Because disaster response represented a new challenge for the Laboratory, an effort funded by the Director of Defense Research and Engineering was initiated to explore this problem space and identify where the Laboratory could contribute. As part of this effort, a partnership was established with California's emergency-response community. Forest fires represented a good study opportunity because they occur annually, can become large-scale events, and have many of the challenges posed in all disasters, including coordination of multiple agencies and the time-critical need for information. The Laboratory reconstructed a significant fire event, identified critical capability gaps, and prototyped a net-centric command-and-control system during experiments executed in conjunction with professionals from different responder organizations.

The prototype system, called the Lincoln Distributed Disaster Response System (LDDRS), combines sensors with communications and visualization technologies to enable robust collaboration and coordination among disparate disaster-response agencies. The system allows information from airborne platforms, distributed weather stations, Global Positioning System (GPS)-enabled devices, and other sources to be shared by personnel at emergency command centers and by responders

equipped with ruggedized laptop computers at the front lines. Imagery and video data from airborne sensors are available in real time. For example, an electro-optical/infrared camera on an aircraft provides full-motion video for real-time incident assessment, and imagery from a wide-area infrared remote-sensing platform is integrated into the system.

The command centers and front-line responders gain access to LDDRS through an Internet-based graphical interface that permits responders from a variety of agencies to collaborate, regardless of computer hardware or software. Through the use of a service-oriented architecture, new sensor systems and data feeds can rapidly be integrated into the system. LDDRS uses a set of chatting and collaboration tools in the form of georeferenced virtual whiteboards and incident report logs that allow responders to quickly form teams, send messages to one another, and remotely share maps and drawings.

During field experiments, the LDDRS prototype successfully enabled personnel to develop and maintain real-time shared situational awareness. Responders could develop a dynamic incident action plan that minimizes the need for face-to-face meetings, reduces travel time, and increases response efficiency and effectiveness.

While initial LDDRS technology demonstrations and operational tests focused on wildland fires, the system has potential to be widely applicable across all natural or manmade disasters in which real-time, shared situational awareness is needed. The California Department of Forestry and Fire Protection (CAL FIRE) in Riverside and San Diego Counties is integrating LDDRS into its day-to-day operations to train personnel and to respond to incidents. In the future, LDDRS capability will be transitioned across California to other regional partners, such as the Pacific Northwest pilot states, and to a national level in coordination with the Federal Emergency Management Agency and the National Guard.







**Fundamental to the success of Lincoln Laboratory is the ability to build hardware systems incorporating advanced technology. These systems are used as platforms for testing new concepts, as prototypes for demonstrating new capabilities, and as operational systems for addressing warfighter needs.**

**Left: Upgrades are under way for the control system and mounts for an optical tracking system.**

At Lincoln Laboratory, development of prototype systems is a fundamental part of the mission. Prototypes can satisfy several needs: providing key data, demonstrating a new capability, and, in some cases, fielding equipment for operational use. Some prototypes remain Laboratory assets while other prototypes or their designs are delivered to the government or government contractors for technology transfer. Central to the development of prototypes is an engineering function within the Laboratory that can apply a wide range of technologies to the design, construction, and testing of hardware. This function is centered within the Laboratory's Engineering Division (known until 1959 as Engineering Design and Technical Services).

Starting in the 1970s, the division's role began evolving from that of a component and service provider to a true partner in the various coalitions formed across the Laboratory for the development of prototype systems. The Engineering Division serves as the center of expertise for mechanical engineering and design, aerodynamics, thermal engineering, control systems, fabrication, systems integration, and environmental testing. For about six years during the late 1970s and early 1980s, an energy systems group operated in support of the nation's push into energy independence. Optical systems engineering became a new thrust with the advent of Strategic Defense Initiative Organization (SDIO) activities in the 1980s, and it has remained an important area of expertise.

Given the broad diversity of technologies involved in the Laboratory's mission areas — be it radar, communications, optics, or lasers, with applications to space, airborne, and ground-based systems — the Engineering Division has met a wide range of challenges. This continual achievement has been an inspiration to staff who are obliged to think broadly and who thrive on the demand for unique and varied solutions. Commonly, these solutions have required developing new technologies and innovative designs. This chapter illustrates, in a historical context, some examples of the division's accomplishments.

#### **Radar Antennas**

The genesis of Lincoln Laboratory system prototyping goes all the way back to the MIT Radiation Laboratory. There, expertise in antenna structures, rotators and tilters, bearing systems, and radomes evolved to satisfy

the needs for the development of military radars during World War II. These capabilities, coupled with close ties to industry to facilitate technology transfer, resulted in rapid production and fielding of operational systems to support the war effort. When the Radiation Laboratory closed in 1946, some of this talent migrated to the MIT Research Laboratory for Electronics and the MIT Physics Department. Subsequently, some of these experienced engineers found their way to the newly established Lincoln Laboratory. In fact, during the Laboratory's earliest years on the MIT campus, the Engineering Division made use of the machine shops and other facilities remaining from the Radiation Laboratory. These facilities served as models for the new facility at Hanscom Field.

As antennas grew larger and more capable, the Engineering Division became a national leader in antenna structures, large bearings, and control systems. Division engineers traveled around the world to help support the design and installation of experimental radar systems. One of the more interesting aspects of this work involved the design and implementation of geodesic radomes, which had to operate in increasingly hostile environments, including the Arctic (see chapter 3, "Early-Warning Systems").

While the Engineering Division broadened its expertise in the late 1950s and early 1960s to support the Laboratory's expanding role in satellite communications and missile defense, it has continued supporting the design and upgrading of radar systems, an important mission to this day. The Millstone Hill radar has been upgraded several times, including a recent overhaul of the drive system and installation of modern control technology. The division led the original mechanical design and erection of the X-band Haystack radar dish in 1964, and the upgrade of the antenna for W-band operation was completed in 2011. The latter required a completely new dish with 100  $\mu\text{m}$  rms surface accuracy across the entire 37 m surface — a first for a dish of this size. Other major Engineering Division efforts include the design and installation of the Gray Star shipborne system, and failure diagnosis for the Federal Aviation Administration's air traffic control radars.



Figure 19-1  
Millstone Hill radar.

## Upgrading a National Asset

The Millstone Hill radar (Figure 19-1) was the first in the world to track a satellite and has been an important space surveillance asset since 1957. Its importance has only increased as more nations have gained the ability to launch satellites. In 2005, it became clear that a major overhaul was needed to keep the radar operational well into the future. Although there have been numerous upgrades over the last 50 years to the radar system and computers, the motors and motor generators were original 1950s-era equipment. They were worn from years of use, well past their end of life, and failing frequently. In addition, the legacy antenna control system and sensors, completed 21 years earlier, included a 286/386-class microprocessor using an outdated programming language for position loop control with dials, knobs, and buttons for a user interface. The venerable system was showing its age.

From software to electronics to heavy and bulky motors and gear boxes, this upgrade required the full spectrum of capabilities of the Engineering Division. Installing and aligning mechanical components were challenging because few design drawings and no computer-aided-design models of the original system existed. Many control functions that were previously implemented in hardware were replaced with embedded real-time software. A new graphical user

interface was provided and the system now records servo and safety data automatically whenever the motors are enabled, giving unparalleled ease of use for maintenance and complete insight into antenna operations.

In addition to the technical aspects of the upgrade, schedule and safety considerations were very important. Since there are only a few radars in the world used to maintain the Deep Space Catalog, the downtime resulting from upgrades needed to be minimized. Having the Millstone radar out of operation for any period of time would have impacted the ability to track objects in the geosynchronous region. The technical design for the upgrade of the motors and controls was done over twelve months by a multidivisional team. The actual downtime from shutdown of the old system to tracking objects with the upgraded system was only three months.

The Millstone antenna upgrade illustrates the application of state-of-the-art drive components and control system technology to enhance system performance and extend system lifetime. This upgrade significantly reduced downtime and maintenance tasks and ensures reliable antenna operation in the future.

---

This section was provided by  
Paula Ward.

1955



Early geodesic radome

1960



LES-4

1970



Reentry decoy

### Satellites and Space Sensors

In 1963, Lincoln Laboratory was designated the lead technology development laboratory for the nation's military communications satellite systems. This assignment thrust the Engineering Division into the whole new realm of spacecraft systems only six years after the launch of Sputnik. To support the development of the Lincoln Experimental Satellite (LES) series and the Fleet Satellite Communications System Extremely High Frequency Packages communications payloads, the division became proficient in addressing the many engineering challenges of satellite design, including lightweight structures, electronic packaging, power systems and solar arrays, thermal control, precision ejection systems, attitude control, and antenna mechanical pointing systems. In the early days, few of the satellite subsystems or components could be purchased from vendors, and the division had to develop original designs. A working relationship was formed with the TRW Corporation, which provided additional expertise and experience in satellite development. Project management evolved from quite informal beginnings to a more structured form with the establishment of a project office overseeing LES-8 and LES-9. The Engineering Division's role evolved as well, from being principally a support operation to becoming a full partner and member of the management team. Starting with LES-1, the division also began investing in test facilities, including large vacuum tanks and vibration exciters that continue to serve the Laboratory.

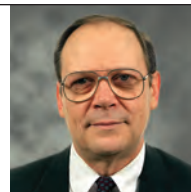
After LES-8 and LES-9, the Laboratory's focus shifted from building complete satellites to developing payloads, including a series of optical payloads

beginning with the Space-Based Visible (SBV), launched in 1996 (see chapter 10, "Space Situational Awareness"). The SBV program required the engineering of a very precise telescope and charge-coupled device (CCD) focal plane, as well as the packaging of a high-performance signal processor. This program was followed by the Advanced Land Imager for the Earth Observer-1 spacecraft, which demonstrated new technologies for the National Aeronautics and Space Administration (NASA) earth-resources imaging mission. The division also developed the mechanical design of the focal plane for MIT's Advanced CCD Imaging Spectrometer instrument on NASA's Chandra X-ray observatory. This effort was an example of applying the division's specialized expertise in focal-plane packaging that has also supported SBV and more recent Lincoln Laboratory space sensors.

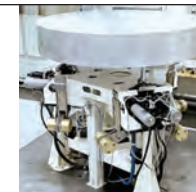
In parallel with imaging sensor work, the Laboratory began the development of fiber-optic technologies for space optical communications. One difficulty was the lack of electro-optical components qualified for space, and the Engineering Division played an important role in qualifying commercial components for this purpose. Lincoln Laboratory's Geosynchronous Lightweight Integrated Technology Experiment (GeoLITE) system, the Department of Defense's first optical communications payload, was launched in 2001. The division made a fundamental contribution in developing optical beam stabilization and pointing techniques needed to close optical links over long distances. This development was particularly important for the Mars Laser Communication Demonstration instrument that required pointing over distances as long as 300 million



Airborne countermeasures testing



M. Vlajinac



2 m agile mirror demonstration for SDIO



## Advanced Technologies in Space

The Advanced Land Imager (ALI) was developed as part of the NASA New Millennium Program (NMP) (Figure 19-2). The intent of the NMP was to fly innovative technologies as part of low-cost demonstration projects to determine the technology readiness for more extensive use in space. The ALI was developed from mid-1996 through early 1999 and was launched in November 2000.

The mechanical engineering of ALI was divided into several subareas: engineering design, optomechanics, control electronics, thermal design, structures and mechanisms, and advanced fabrication, which are all areas of expertise in the Engineering Division. The telescope and focal plane were developed outside the Laboratory at Space Sensors Group (SSG) and Santa Barbara Remote Sensors (SBRS), and were subsequently integrated into an instrument infrastructure, tested, and calibrated at Lincoln Laboratory. The NMP technologies specifically developed for ALI were silicon-carbide mirrors and a multispectral focal plane operating at  $-50^{\circ}\text{C}$  rather than at much lower cryogenic temperatures, a limitation of other sensors. The system fit within one cubic meter volume with a mass of 90 kg.

The original design of the ALI called for an all-silicon-carbide telescope structure supporting the silicon-carbide mirrors. Early on, it was found that silicon carbide, a brittle ceramic, could not be employed as structural elements in the required configuration and size. The Engineering Division developed an alternate three-piece telescope structure using Invar, a special low-thermal-expansion steel (Figure 19-3).

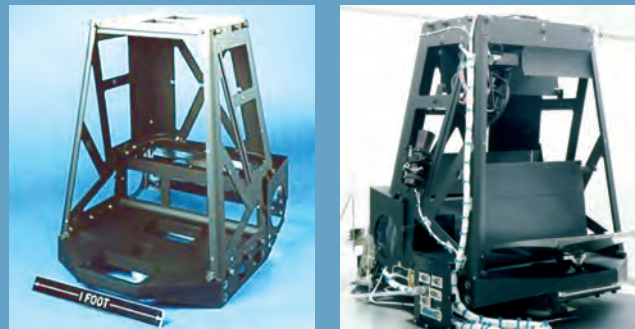
It was fabricated at Lincoln Laboratory and supplied to SSG for optical alignment of the ceramic mirrors.

After delivery of the focal-plane subsystem from SBRS, it became apparent that its thermal control did not work as planned. The Engineering Division quickly accommodated the errant functions in the design of control electronics being developed at the Laboratory, with little impact to the program's schedule.

Since its launch in 2000, ALI has proven to be highly successful. This is a testament to the environmental testing and calibration campaign at Lincoln Laboratory shared between the Engineering and Aerospace Divisions. That campaign provided sufficient time to find and resolve anomalies without compromising the delivery schedule. Integration of space hardware and resolution of anomalies are strengths developed over many Laboratory space projects. Since its launch, ALI has captured over 50,000 images of various earth locations. The technology has been transferred to industry for the creation of the next operational land-imaging instruments.

---

This section was provided by Steven Forman.

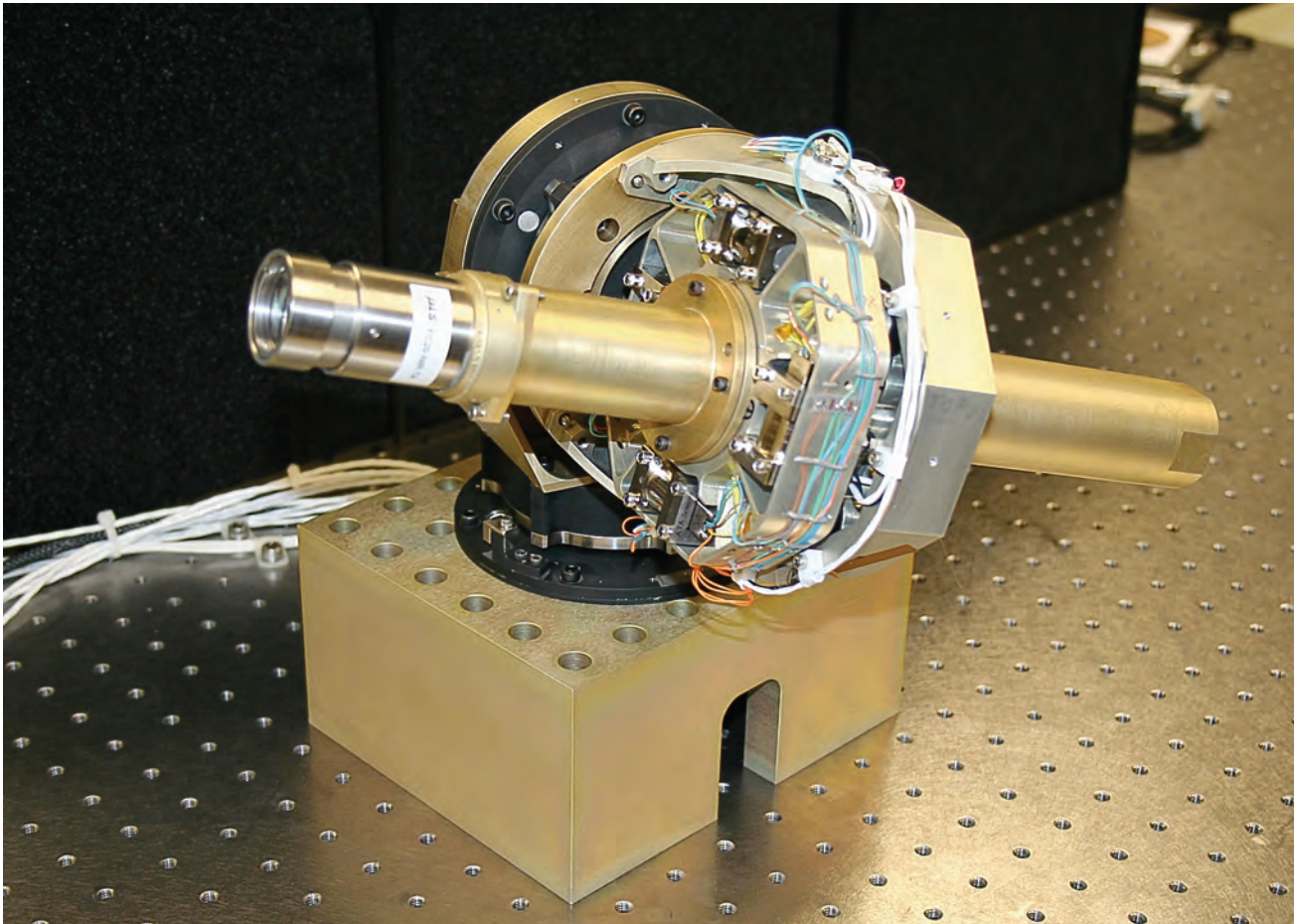


---

Figure 19-2, top  
ALI.

---

Figure 19-3, bottom  
Invar telescope structure.



**Figure 19-4**  
Lunar laser communications pointing and tracking model. The aperture size is 24 mm.

### Pointing Over Great Distances

Free-space optical communications, operating at 1 to 1.5  $\mu\text{m}$ , have the potential to vastly improve the efficiency of satellite communication systems. This increased efficiency may be used to maximize communication rates while imposing modest size, weight, and power impact on the host spacecraft. Conversely, a terminal may be designed to provide more modest data rates while minimizing size, weight, and power requirements. The improved efficiency of optical communications is primarily due to the very narrow beamwidth (i.e., high antenna gain) provided by terminals with apertures typically in the range of 10 to 30 cm. Two important Laboratory developments helped to overcome the challenges associated with implementing optical terminals.

Most optical communication terminals rely on high-bandwidth tracking of the incoming beam to point and stabilize the outgoing beam. Such tracking systems need relatively high optical power and very capable fast steering mirrors. The Lincoln Laboratory Engineering Division developed the technology for these fast steering mirrors at the end of the 1980s, and the mirrors have since been used in multiple optical communication systems deployed on the ground, in aircraft, and in space.

An alternate approach is necessary when it is impracticable to illuminate a terminal with adequate optical power to enable high-bandwidth tracking. This approach employs an inertially

stabilized platform to inject a stable tracking beam into the system. The injected beam is then tracked to reject base motion and the incoming beam is then only needed as a pointing reference. Taking advantage of newly available inertially stabilized platform technology, the Laboratory used this approach to design the NASA Mars Laser Communication Demonstration (MLCD) terminal that was to provide data rates up to 30 Mbps from Mars to earth over distances as great as 300 million km. (Unfortunately, the MLCD program was cancelled before this payload was built.)

For optical systems with relatively small apertures of up to approximately 10 cm, it is possible to mount the

entire optical system on an inertially stabilized platform, thus eliminating the need for a fast tracking system altogether. Lincoln Laboratory's Lunar Laser Communication Demonstration program is developing a terminal of this type that will allow communications from a lunar orbit to an earth ground station at data rates up to 622 Mbps. A pointing and tracking system model of this terminal is shown in Figure 19-4. These small terminals represent an important advancement for future optical communication systems.

This section was provided by Joseph Scozzafava.

kilometers. While this effort was cancelled during the design phase, the key engineering techniques were applied to a lunar optical communications link in development for NASA.

The space systems developed by Lincoln Laboratory have been remarkably reliable, suffering few failures in over 40 years of space systems development. An important lesson was learned early in the development of LES-1. The Air Force decided shortly before launch to require redundancy in the mechanical sequencers involved in separating the satellite from the missile. The engineering team was reluctant to take on the risk of this last-minute revision but finally agreed to implement the change. The change caused an unforeseen malfunction, resulting in the satellite's failure to achieve the correct orbit. Ever since this incident, Lincoln Laboratory has insisted on thorough testing of all designs, allowing no anomaly to go unresolved and demanding personal responsibility from all engineers.

#### **Optics and Laser Systems**

The Engineering Division has a long history of pioneering developments in optics and lasers. Much of the early work was driven by missile defense needs; more recent tactical requirements for intelligence, surveillance, and reconnaissance sensors and biological-agent sensors have led to a wide range of additional challenges.

One of the earliest missile defense applications was the Project PRESS (Pacific Range Electromagnetic Signature Studies) aircraft, which first flew in 1963. It was equipped first with visible sensors and later upgraded with a long-wavelength infrared detector. Similarly, the Cobra Eye aircraft, which first flew in 1989, was equipped with a much larger telescope on a gimbaled mount (see chapter 9, "Ballistic Missile Defense"). The Engineering Division had a major role in acquiring and integrating the sensors and dealing with the complications of large optics housed in open, unpressurized cavities in the sides of these aircraft. The division was also involved in the early development of high-power gas dynamic and chemical lasers, helping to solve the difficult problems of beam pointing, conditioning optical beam paths, cooling high-power mirrors, and building some of the first deformable mirrors for atmospheric distortion compensation (see chapter 25, "Laser Systems"). This work accelerated in

the mid-1980s when the Laboratory began supporting the Strategic Defense Initiative. The division established a new Optical Systems Engineering Group, combining the talents of mechanical and optical engineers. In this period, the division's efforts included building some of the first carbon-epoxy composite mirrors, testing large 2 m class beam-steering systems that could operate in space, addressing the design challenges of large free-electron lasers, and studying large ground-based beam directors for high-power lasers.

More recently, to support the development of the Air Force's Airborne Laser (ABL), the Engineering Division partnered with the Advanced Technology Division to develop an Enhanced Track Illuminator Laser, answering a critical ABL need. This is a highly complex optical system with multiple lasers presenting considerable engineering challenges driven by the aircraft environment. The Engineering Division also developed missile targets for the ABL under the Missile Alternative Range Target Instrument project, which involved building missile segments with thousands of optical detectors to evaluate ABL performance. The large quantity of targets needed required extraordinary efforts in developing industry sources for key components and in assembling and testing the hardware.

The division was also involved in the development of laser radars from the earliest Laboratory efforts in the 1970s. Many of these were for aircraft applications with the associated challenges of designing compact optical systems with precision pointing and navigation, and lasers with stringent temperature controls. One of the earliest laser radars was the highly successful Infrared Airborne Radar, which flew on a Gulfstream G-1 aircraft. More recent laser radars included the Airborne Lidar Research Testbed and Jigsaw, which demonstrated key new capabilities, including miniaturized optics in the case of Jigsaw. The division also supported other optical systems spanning the range from ground-based trackers, to airborne imaging systems such as the Airborne Infrared Imager, to large ground-based telescopes such as the 3.5 m Space Surveillance Telescope designed to track space objects.

Beginning in 1994, another unique challenge for the division was the development of biological-agent warning and identification systems. These optically based instruments required a multidisciplinary approach and



## A Flying Test Bed

In 1988, Lincoln Laboratory needed a large transport aircraft to support a new program. The Boeing 707 platform was chosen because of its size, availability, low purchase cost, and the extensive experience on the part of the Air Force and others in modifying the airframe. Since the Boeing 707 was long out of production and airline service, the question was where to find a suitable candidate. A former Pan American airliner was finally located in an aircraft “bone yard” in Florida. Before being relegated to long-term storage, the aircraft had been flown by several regional carriers, shuttling college students to Daytona Beach for spring break, among other duties; and it was next headed to Africa to haul cattle. With wires dangling at various locations and no engines, the aircraft was purchased by the Laboratory for only a little more than two million dollars. Engines were located, a special flight permit was obtained, and a crew was persuaded to fly it to E-Systems (now L-3 Communications) in Greenville, Texas. There it was refurbished and modified with new power systems and fairings on either side of the forward fuselage, all at many times its purchase cost.

After the original program was successfully completed in 1999, the Laboratory decided to retain the aircraft as a general-purpose test bed. The Air Force, which had management responsibility for the aircraft, turned over operations to the Lincoln Laboratory Flight Facility, which trained its pilots and maintenance crew to fly and care for the aircraft.

Since then, the aircraft has undergone a series of additional modifications, permitting it to host a wide variety of experiments. The Engineering Division played an important role in implementing these changes. An extensive fiber-optic network backbone was installed along with two workstation tables, each capable of hosting six operators with computer access to the network. The power system was further upgraded, several additional radomes were installed to handle communications antennas, and a liquid-cooling system was installed to cool power-hungry electronics. To date, the aircraft has hosted a wide range of radars and communication systems and supported numerous military exercises around the country. Special efforts have been made to facilitate rapid equipment reconfigurations between missions, including “roll-on, roll-off” electronics racks. Also, techniques were developed to host laboratory-type electronics while minimizing the efforts required to qualify them for the flight environment.

Boeing 707, tail number N404PA, has come a long way since it lay forgotten in the bone yard (Figure 19-5). Now retrofitted with a forest of antennas and bulging fairings, it continues to support a wide range of experiments needing a convenient vehicle to carry them aloft.

---

This section was provided by John Sultana.



**Figure 19-5**  
The lifespan of Lincoln Laboratory’s flying test bed: (top to bottom) 1978, 1988, and 2009.

## A Unique Autonomous Observer

For decades, long-range ground-based and airborne sensors observed and measured many of the threat system emulations developed by the Laboratory for missile defense testing. However, nothing had been available to observe these objects at close range as they would be seen by a seeker mounted on an approaching interceptor missile. The interceptor seeker has the challenging requirement, shortly before impact, to discriminate the target among several possible objects while closing at very high speeds. The Laboratory proposed a completely autonomous vehicle that would deploy from the simulated threat system and fly in formation with the emulated warhead, observing the scene at close range with the same sensors planned for the interceptor.

The first Fly Away Sensor Package, or FASP, flew in 1996. It was a small conic reentry vehicle, measuring 0.9 m in length, with a mass of 100 kg (Figure 19-6). The FASP carried optical imagers operating in the visible and in the infrared bands used by the interceptors; image data was sent to the ground via a radio frequency (RF) link. A cold-gas control system, built around an inertial measurement unit and a microprocessor, maintained vehicle stability in the exoatmosphere. Pointing was maintained by tracking an RF beacon from the emulated warhead. The FASP heat shield allowed operation in atmospheric reentry, collecting image data of the reentering warhead surrogate until the imager focal planes became saturated by the FASP reentry wake. Total time of flight was approximately ten minutes. The downlinked images were displayed in real time at the launch range, and the excitement of the viewers was palpable — the images were extraordinary! The reentry version of the FASP flew on seven missions from 1996 to 2004, with major upgrades between each campaign.

The Missile Defense Agency then sponsored a new vehicle with major upgrades for enhanced operation in the midcourse phase of flight. Without the reentry requirement, the conic form factor and heat shield were not needed; the design was modified to a cylinder measuring 0.35 m in diameter by 0.6 m in length, with a mass of 65 kg. The cylindrical form factor afforded volume for a number of significant capability enhancements, including telemetry (with advanced data compression and forward error correction); onboard Global Positioning System (GPS) measurements; extended operating time (up to 30 minutes); space for developmental sensors such as microbolometers, range-finders, and high-speed imagers; and advanced control algorithms to achieve multiple viewing aspects in a given mission. This vehicle became known as the Midcourse Fly Away Sensor Package, or MFASP. Three MFASPs flew in 2005 and 2006, and again, the image sequences were striking.

This section was provided by Bruce Bray.

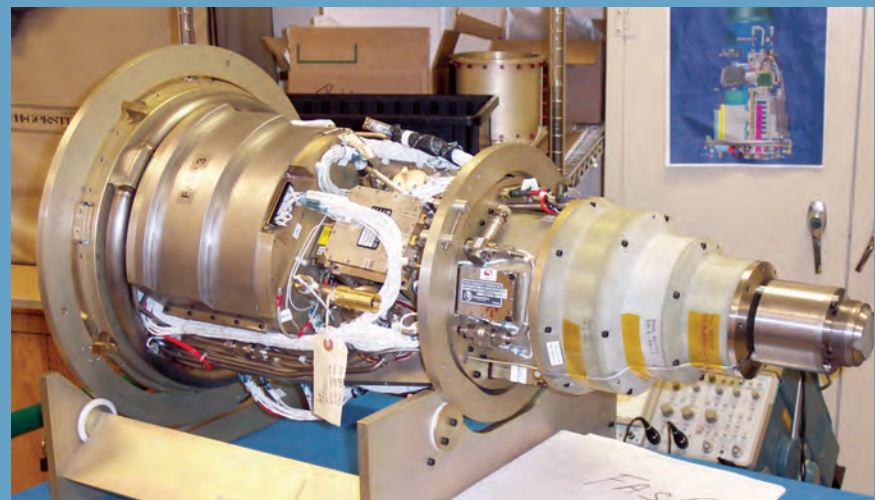


Figure 19-6  
FASP (top and bottom right) and  
sample image (bottom left).



innovative designs that combined air-flow dynamics, optical design, electronic packaging, and, in some cases, protection of living cells, and had to be engineered to operate in a combat environment. A wide variety of systems were developed. One of particular note was the Biological Agent Warning Sensor, whose design was adopted directly by the Army and transferred to industry with Laboratory support. Hundreds of these instruments served in the field.

### Missiles and Countermeasures

During the 1970s and 1980s, the Laboratory made significant contributions to missile defense through the Reentry Systems Program (RSP). The Engineering Division was a major contributor to the effort, building penetration aids for U.S. systems and simulating foreign threats for testing against U.S. radar and optical sensors. The division built a wide range of decoys employing radar cross-section enhancement, tethered wires, chaff, aerosols, and other features. Some of these decoys were designed to survive reentry in the atmosphere and led to experimentation with advanced heat-resistant materials and special aerodynamic features. The division had to gain expertise in these areas and develop new computational tools for hypersonic aerodynamics. The RSP program concluded with the end of the Cold War, but the impact of Scud missiles used in Operation Desert Storm and long-range missile threats from North Korea and other countries brought additional challenges. Lincoln Laboratory addressed these with a series of tests in support of theater and national missile defense. Laboratory engineers had a major role, developing a series of threat system emulations, including reentry vehicles, countermeasures, chaff, and calibration objects. The division provided complex payloads for sixteen missile launches from 1993 to 2006. One of the unique division developments was the Fly Away Sensor Package (FASP), a completely autonomous vehicle deployed to provide optical images of the target complexes.

### Airborne Systems

The Engineering Division has supported diverse airborne experiments conducted by the Laboratory, some of which have already been described. The division worked in partnership with the Lincoln Laboratory Flight Facility on integrating experiments and ensuring that these experiments met strict structural and aerodynamic

### Meeting the Challenges of Airborne Optics

The Airborne Infrared Imager (AIRI) is an example of the many engineering challenges faced in developing a high-precision optical system that had strict pointing accuracy requirements and that must operate in the challenging vibration and temperature environment of a jet aircraft. AIRI was designed to measure the infrared signatures of airborne targets. The sensor was mounted under the wing of a modified Gulfstream II aircraft inside a pod that also housed the sensor electronics and a thermal control system. AIRI possesses two cryogenically cooled infrared cameras (2 to 5  $\mu\text{m}$  mid-wave and 6 to 10  $\mu\text{m}$  long-wave bands) (Figure 19-7). The two cameras, their shared telescope, and an optical bench are mounted inside a two-axis gimbal assembly that looks through an 18-inch clear dome with a field of regard of  $\pm 45^\circ$ . The supporting electronics and a novel infrared calibration reference are mounted in the pod behind the gimbal. With the exception of the cameras and the pod shell, all of these components were designed and built at Lincoln Laboratory.

Numerical optimization techniques guided the design of the optical bench and the gimbal support structure to meet line-of-sight jitter requirements in the operational aircraft vibration environment. The design process included correlating the structural design model of the sensor with vibration test data measured on an engineering development unit in the Laboratory's environmental test facility. Design changes were implemented on the basis of these results, which identified regions to stiffen and areas to remove mass, increasing the structure's natural frequency and enhancing image stability. Final line-of-sight jitter predictions were based on vibration data recorded on a dummy pod mounted to the Gulfstream aircraft. The optimization process and model validation were instrumental in the structural design that allowed the AIRI sensor to record high-resolution infrared imagery.



Figure 19-7  
AIRI optical head including telescope (left) and detectors (right).

AIRI also presented a unique thermal design challenge with temperature control of the optical bench to  $20^\circ\text{C} \pm 5^\circ\text{C}$  required from 1 kft to 35 kft altitude and at variable aircraft speed and orientations. The thermal control design integrated an aircraft-mounted chilled-water system with a combination of pod-mounted liquid-to-air heat exchangers, heaters, temperature sensors, thermostats, and a feedback temperature controller referenced to the gimbal ambient air temperature. A nitrogen purge system was included to prevent condensation on dome surfaces. Thermal design and analysis, followed by thorough thermal testing, was successful in accomplishing this goal. The pod-mounted infrared calibration reference design utilized thermoelectric coolers and ram air, and operated in either a forward- or aft-looking system mounting arrangement.

This design resulted in a system that was operational for over ten years, participating in multiple flight-test campaigns for both air-to-air and air-to-ground testing. It has collected a wealth of phenomenological data and been used for understanding the performance of a variety of operational sensors.

This section was provided by Keith Doyle and David Nathanson.





**Figure 19-8**  
**Model of a three-inch micro aerial vehicle.**

requirements for safe flight. A prime example of this is the wide variety of experiments conducted on the Laboratory's Boeing 707 test bed, which has served the Laboratory since its acquisition in 1988.

Many airborne projects were also conducted with military and other outside flight-test organizations. One example of this is the Airborne Countermeasures Technology program of the early 1980s, which was led by the division. This effort pioneered the use of towed passive reflectors to protect fighter aircraft from threat missiles. The feasibility was proven in a series of flight tests with military aircraft. While the services ultimately decided to employ active towed decoys, the division's efforts were helpful in convincing skeptical fighter pilots that towed systems were practical. To support this and later efforts, including towed infrared countermeasures, the division developed computational tools for towed system dynamics, advancing the nation's capability in this area.

In 1994, the division led the study of a unique aircraft called the micro aerial vehicle. This was the idea of the then Laboratory director, Walter Morrow, who called on the division to conduct a system study on a miniature unmanned aircraft that could provide a soldier on the ground with a hand-launched vehicle capable of seeing threats over the next hill. A team of Laboratory experts in aerodynamics, controls, communications, and imaging determined that a small vehicle with a three-inch wingspan could be feasible. The team built a model (Figure 19-8) and briefed various potential users. Word of this ultimately filtered up to the then vice chairman of the Joint Chiefs of Staff, Admiral William Owens. To the Laboratory's surprise, Owens displayed one of the

Lincoln Laboratory models on the Lehrer News Hour. The ensuing wave of publicity helped inspire the Defense Advanced Research Projects Agency (DARPA) to start a new program to develop such a vehicle. To date, a three-inch vehicle continues to be difficult because of aerodynamic and propulsion constraints; however, in part because of the Laboratory's initiative, larger micro air vehicles are now operational with the services.

#### Future Directions

As in the past, the Engineering Division will evolve to meet the challenges of the future. Some of this evolution is driven by the need to stay abreast of new technologies for design, analysis, and fabrication and to advance the state of the art where needed. Evolution is also driven by the changing needs of sponsors and partners across the Laboratory. In recent years, sponsors have increasingly demanded shorter development cycles. The Laboratory and the division have responded accordingly, and the division has been quite successful in meeting the demands of rapid development. Recent examples span the range from space payloads (under two years), missile payloads (under one year), and biosensors (nine months), to numerous airborne experiments fielded in weeks to several months. Example airborne experiments include the Jigsaw laser radar and the many experiments hosted on the Boeing 707. The organization of the division will continue to evolve as well. In 2008, a new rapid prototyping group was formed, added emphasis was placed on development of space systems engineering expertise, and analysis experts were brought together to strengthen multidisciplinary skills. The division will continue to be shaped by the emergence of robotics, new materials, alternative energy, and other technologies.

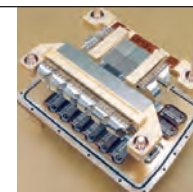
1990



SBV sensor



C.F. Bruce



Chandra focal plane

## When Speed is the Measure of Success

The Laboratory's development of Geiger-mode avalanche photodiodes and short-pulse solid-state lasers enabled a new class of tactical laser radars (see chapter 24, "Solid-State Research"). One of these was the Jigsaw system, a laser radar that could detect objects shrouded under foliage by piecing together many overhead images taken from different viewing angles. It was an ideal sensor for small, low-flying unmanned aerial vehicles. In 2002, DARPA laid down a challenge to fly a prototype sensor in six months. This at first seemed an insurmountable task: design a complex laser optical system from scratch and qualify it for the high-vibration environment of an Army Huey helicopter (Figure 19-9). Given that DARPA funding for future laser radar work depended on meeting this milestone, the Laboratory accepted the risk; a multidivision team set about the task.

For the Engineering Division, this meant utilizing the latest design and analysis tools that permitted rapid cycling through design iterations. For this first prototype, weight was not a significant challenge, so the structure was crafted from Invar steel with low thermal-expansion properties. Maintaining optical alignment was particularly challenging because the laser beam was divided up into an array of spots that had to align exactly with individual pixels in the detector array of pixels. The system's

largest mirror required mechanisms for highly precise adjustments. Initial attempts to fabricate it from titanium proved unsuccessful, leading to a redesign late in the effort. The design process was aided by the use of relatively new machines that could translate digital design databases directly into accurate plastic models.

Ultimately, the system was delivered on time and used to conduct a highly successful flight campaign. DARPA subsequently funded the development of the next phase of Jigsaw: a miniaturized system for a small unmanned helicopter. This system would not have been possible without a small, highly dedicated team, the latest design and analysis tools, and direct access to fabrication and test facilities. This early demonstration of what is now called rapid prototyping is an approach that has been in increasing demand by Laboratory sponsors and has since been applied successfully across several mission areas. For these efforts, both the sponsor and the Laboratory have to be willing to take added risks balanced against the ability to quickly field prototypes and iterate designs. This new way of thinking and organizing has become an important Laboratory capability.

---

This section was provided by William "Bob" Davis.



Figure 19-9  
Jigsaw helicopter test platform.

2010



W.R. Davis



E.H. Niewood



M.T. Languirand



Haystack W-Band antenna under construction







**Lincoln Laboratory's expertise in systems engineering and field testing, materials growth, and device fabrication has been applied to the development of alternative energy solutions. The early work was prompted by the 1970s oil crisis; more recently, the demands for alternative energy sources are in response to the increasing global stresses on oil supplies.**

**Left: Solar-photovoltaic-array test facility on Lincoln Laboratory rooftop.**

When the Yom Kippur War broke out in October 1973, oil-producing Arab nations imposed a total ban on petroleum exports to the United States. In March 1974, exports resumed, but the price of oil had quadrupled. The embargo and the subsequent price hikes took a marked toll on the United States; the economy slumped into a recession and unemployment climbed to eight percent by the mid-1970s. The United States realized that cheap imported oil was no longer a guaranteed commodity, and the government began to encourage the development of alternative sources of energy. At this same time, Lincoln Laboratory was expanding its mission scope into nationally relevant nondefense areas. One such area was energy.

The Laboratory's energy program was two-pronged. One prong was the engineering and fielding of solar photovoltaic (PV) systems. The solar PV program ran from 1976 to 1982 and was largely devoted to the design and test of solar PV systems for residential and remote applications. The National Photovoltaic Program was initially funded by the Energy Research and Development Administration (which became the Department of Energy [DOE] in 1977). The other prong of the energy program was the development of fundamental components of energy systems, ranging from solar PV cells (so-called III-V cells) to thermophotovoltaic (TPV) systems.<sup>1</sup> This work, funded in part by DOE, continues today.

#### **Solar-Photovoltaic Systems and Engineering (1976–1982)**

Lincoln Laboratory's role in the National Photovoltaic Program emphasized its core strengths in engineering and field testing. Both residential and nonresidential applications were addressed, with the first field tests performed on nonresidential systems. The DOE had requested that Lincoln Laboratory delay the study of residential systems until the National Photovoltaic Program as a whole was ready to deal with the relatively large number of experimental systems involved. During the nonresidential phase of the program, the Laboratory designed and constructed systems for a farm, a museum display, a commercial radio station, and a national park.

The first nonresidential field test was carried out on an experimental farm in Nebraska. The test began in the spring of 1977 when Lincoln Laboratory installed a 25 kW photovoltaic system at the University of Nebraska's Agricultural Research Station in Mead, Nebraska. The experiment looked at energy management strategies, monitored system performance, and evaluated the match between the agricultural load and the available solar energy.

The Mead experiment established a concept that Lincoln Laboratory would substantiate in all subsequent PV projects: utility-interactive operation was preferable to stand-alone operation. Stand-alone operation provided the advantage of being able to operate through a utility outage. However, the need for a storage battery in a stand-alone system meant that the system either had a complicated startup sequence or a large inverter and control subsystem. Operation in parallel with the electric utility provided a considerable advantage by eliminating the costly battery-storage subsystem and its attendant system-control functions.

Lincoln Laboratory's second project was a 1.6 kW system to power a display in the Chicago Museum of Science and Industry. System reliability was outstanding — between 1977 and 1983 there were no module failures. No other system at the time demonstrated comparable reliability.

In November 1978, Lincoln Laboratory initiated a project with WBNO, a daytime AM radio station in Bryan, Ohio, to power their transmitter. Nine months later a 15 kW PV system began operation. The system was designed to be economically attractive and to supply power primarily to dc loads requiring minimal energy storage. During two years of operation, the Bryan system provided approximately 19 MW-hr of energy, or about 80% of the total energy required by the transmitter.

---

**Note**

**1** III-V refer to these columns on the Periodic Table of Elements. Examples of III-V devices are gallium arsenide (GaAs) and indium phosphide (InP). Note that germanium (Ge) and silicon (Si) are in column IV. Silicon today dominates the solar PV market.

The final nonresidential project was the most ambitious. The Laboratory worked with the National Park Service to set up a PV power station at a remote site. The project began with a study evaluating 63 sites for their PV potential. Laboratory personnel then visited the ten most promising locations. Because it offered both insolation (the rate of delivery of direct solar radiation per unit of horizontal surface) and isolation, Natural Bridges National Monument in Utah was chosen as the optimum site for a test of the usefulness of photovoltaics for the National Park Service. At the time of its completion in June 1980, the 100 kW Natural Bridges unit was the largest PV system in the world (Figure 20-1). Because the system was located in a remote corner of the Southwest, it had excellent insolation, but connection to the utility grid was not available. Therefore, despite discouraging results in earlier tests of energy storage, the Laboratory included a backup diesel generator and a battery-storage unit in the system. Even though these elements increased system complexity considerably, unattended operation was successful. Notably, the Natural Bridges system was still operational in 2009, providing 90% of the site's electricity needs.

Lincoln Laboratory turned to residential systems in late 1978. The first systems were prototypes in uninhabited structures. Two Residential Experiment Stations were built, one in the northeastern region and one in the southwestern region of the United States. The stations were complete in the technical details of their PV systems and in their integration into a residence-like structure, but only the portion of the structure needed to effect the integration was constructed. The Northeastern Station, located on Virginia Road in Concord, Massachusetts, included five prototype systems; the Southwestern Station, on the grounds of the New Mexico State University campus in Las Cruces, New Mexico, had eight. Each Residential Experiment Station included a rooftop PV array, sized to meet at least 50% of the annual electrical demand of an energy-conserving house, and an enclosed structure for the remainder of the PV equipment, test instrumentation, and work space. Each building was the minimum size that could accommodate the PV system.

Photovoltaic systems for two additional uninhabited residences, one in Florida and the other in Arizona, were constructed in 1980. The Florida system was located at the Florida Solar Energy Center in Cape Canaveral; the Arizona system was installed in a model house built by John F. Long Properties in Phoenix. The annual ac energy output of the Florida residential system was approximately 8000 kWh, with an average system efficiency of 6.4% (considered quite good at the time). Reliability was excellent, with only two of 168 PV modules failing during sixteen months of operation.

Lincoln Laboratory's first test of an inhabited structure was in a grid-connected residential system installed at the University of Texas Solar Energy Research Facility in Arlington. The house featured an integrated solar system that combined solar-PV and solar-heating collectors. The most significant contribution of this project, however, was its success in integrating photovoltaics with the electric utility grid.

Although the Texas house was inhabited, it was still an experimental effort. In the next project, however, Lincoln Laboratory brought photovoltaics into the real world. The Laboratory participated in the design of a fully solar house located on Monroe Hill Road in Carlisle, Massachusetts. Energy-conservation features, passive solar heating, solar hot-water collectors, heat-pump space heating, a wood stove, and a PV power system made this house an energy-self-sufficient residence. Designed by Solar Design Associates of Lincoln, Massachusetts, the house included a living room, dining room, kitchen, family room, and four bedrooms, for a total living area of 3100 sq ft.

For the Carlisle house, Lincoln Laboratory installed the largest residential PV system of its time: a 1000 sq ft array with utility-interactive dc-to-ac power conditioning equipment to eliminate the need for onsite storage. Peak power capacity was 7.3 kW, about ten times larger than that of any previous solar home. The house was completed in May 1981, and a family of four moved into it the following March. Over an average year, the house generated about 9500 kWh, about half the family's annual energy consumption.





**Figure 20-1**  
**Solar-photovoltaic power station at**  
**Natural Bridges National Monument,**  
**Utah.**



1975

Three other PV residential systems were installed in Hawaii, which was ideally suited for photovoltaics. The warm and sunny climate gave abundant insolation, and the cost of electricity was high. Moreover, because it is composed of a group of islands with scattered population centers, Hawaii used isolated utility plants, not a power grid. The Laboratory arranged with the Hawaii Natural Energy Institute to retrofit three occupied residences with PV systems. The three houses were of various types and in different locations. One was a two-story duplex in the Kalihi section of Honolulu, the second was a quadruplex in a public housing area in Pearl City, and the third was a 40-year-old ranch house on the island of Molokai. Because these homes were already occupied, safety was of paramount importance. Each site was checked by an MIT safety officer and by a State of Hawaii safety inspector. Peak power output from the Pearl City and the Molokai houses was 4 kW; the smaller Kalihi residence generated 2 kW. Each system became operational in June 1981.

During the course of the National Photovoltaic Program, Lincoln Laboratory installed more than 11,000 PV modules in 33 field sites. The total power output was 283 kW.

#### Engineering Innovations in the Early Energy Program

Though the emphasis of the energy program of the 1970s through early 1980s was on fielding and demonstrating systems, several notable achievements derived from recognized needs for instruments and

components that simply did not exist at the time. In the course of the program, Laboratory staff invented or advanced pyrheliometers to measure solar radiance, a new current-voltage (I-V) curve tracer, dc-to-ac converters, electrical components for PV systems, and a flywheel storage device. Many of these advances led to the formation of spin-off energy companies, some of which are still in business.

One requirement of the photovoltaic program was a sun-following pyrheliometer for monitoring insolation at unattended sites. Because the pyrheliometer needed to be able to track the sun from unattended locations, an automatic tracking capability was necessary. Lincoln Laboratory was able to provide that capability with a microprocessor-based controller for the pyrheliometer mount, which had a sun-tracking accuracy of less than 1°, compensated for changes in the sun's motion, and also functioned without attendant operators.

A second requirement was for a portable unit for determining the I-V characteristics of a PV module or array in the field. Existing units were not easily portable; therefore, a new I-V curve tracer was developed. Because the Lincoln Laboratory instrument used a capacitive load rather than a resistive load (the existing technology at the time) to measure current as a function of voltage, the curve tracer was far lighter than available instruments and its accuracy was comparable.

1980



Radio station WBNO  
photovoltaic-powered  
transmitter site, Bryan, Ohio



Solar array,  
Natural Bridges, Utah

Solar array testing,  
Laboratory flight facility



**Figure 20-2**  
**Charles Ciacera, Philip Jarvinen,**  
**and Frederick DiGregorio install a**  
**1/10-scale flywheel system to evaluate**  
**the feasibility of a kinetic-energy**  
**storage proposal.**

In an array of many solar cells, the electric current flow can reverse its direction in some cells because of local shadowing, dirt or debris accumulation, cell cracking, or other defects. When this reversal happens, the affected cells act as energy dissipaters, rather than generators, and cause potentially serious local overheating. Any of several means developed to prevent this reversal in direction of current flow are referred to as reverse bypass protection, and Lincoln Laboratory investigated two methods of providing reliable integrated reverse bypass protection for PV cells. Both methods were based on adding a bypass diode around the periphery of the cell and both occupied negligible surface area.

The dc-to-ac inverter in a PV system has to perform three operations: inversion, regulation, and waveshaping. At the start of Lincoln Laboratory's effort in developing residential inverters, only two such products were commercially available, and neither satisfied Laboratory engineers. Therefore, the Laboratory undertook the development of a new waveshaping inverter, and a prototype was fabricated. American Power Conversion of West Kingston, Rhode Island, a Lincoln Laboratory spin-off company, further advanced the concept and produced a 4 kW commercial version with an efficiency of more than 90%. American Power Conversion has grown from this start in 1981 to become a major producer of power electronics equipment.

Because solar power can be generated only during daylight hours, Lincoln Laboratory also worked on energy-storage technology. A solar-PV flywheel storage and conversion system was developed to convert stored mechanical energy to 60 Hz ac power as required. The flywheel acted as a complete interface between the PV array and the ac load, thus performing dc-to-ac inversion in addition to providing storage. Key elements in the design of this system included the use of extremely low-loss magnetic bearings, maximum-power-point tracking of the PV array, integrated motor generator and output power conditioning of the stand-alone cycloconverter or utility-interactive inverter unit, and selection of a configuration tolerant of rotor imbalances.

The Laboratory built a fully operational 1/10-scale prototype energy-storage unit that incorporated a flywheel developed at Sandia Laboratory (Figure 20-2). In-out storage efficiency of the utility-interactive inverter flywheel unit was 80%. For a flywheel equipped with a stand-alone cycloconverter, the efficiency was 65%, almost exactly the same as that of a battery inverter system. The difference in efficiency between the two systems was partly due to the increased complexity of the stand-alone system and partly to design deficiencies in the filter, where most of the losses occurred.

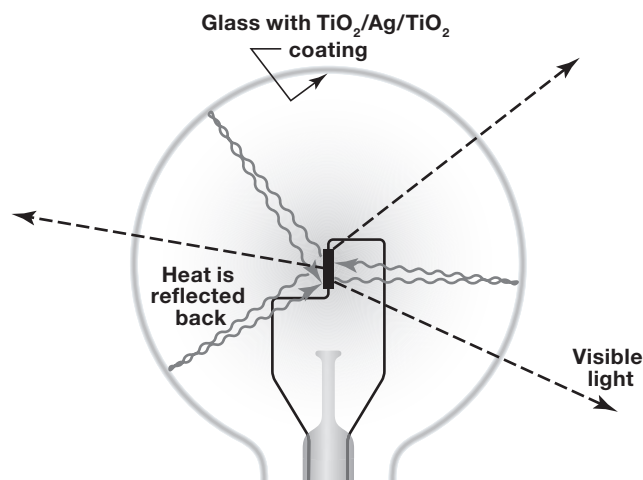


Installing solar panels,  
 Carlisle, Mass.

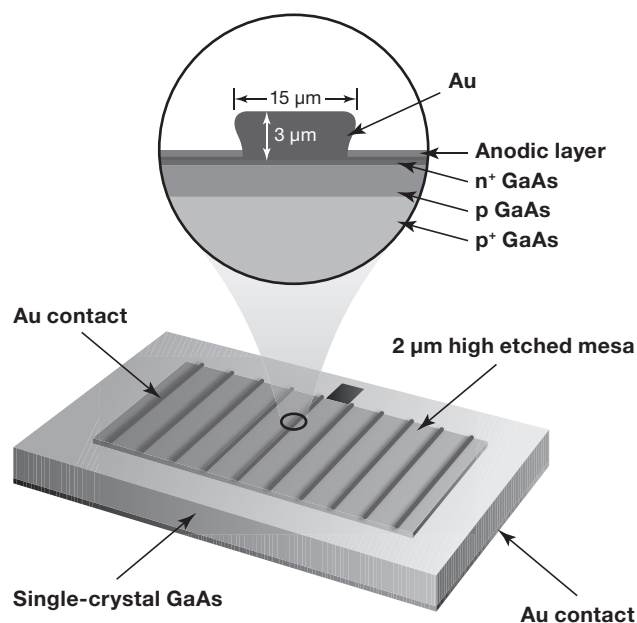


J.C.C. Fan

**Figure 20-3**  
Improved incandescent light bulb developed by John Fan utilizes a  $\text{TiO}_2/\text{Ag}/\text{TiO}_2$  transparent heat mirror.



**Figure 20-4**  
Schematic diagram of 20% efficient,  $1.0 \times 0.5$  cm GaAs shallow-homojunction solar cell with antireflection coating formed by anodic oxidation.



#### Notes

**2** T.B. Reed, "Methanol: A Versatile Fuel for Immediate Use," *Science* **182**, 1299–1304 (1973).

**3** T.C. Harman, *Thermoelectric and Thermomagnetic Effects and Applications*. New York: McGraw-Hill, 1967.

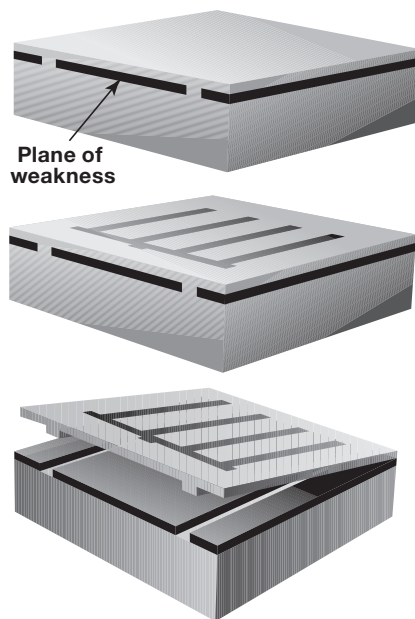
#### Energy Technology in the Advanced Technology Division

Lincoln Laboratory's Advanced Technology (formerly Solid State) Division has a long and productive history of energy-related research. This research often leveraged other ongoing technical activities, especially in materials growth and device fabrication. Most of this work was done at the fundamental materials, device, or component levels, although a number of proof-of-concept experiments were also performed. Sponsors for this research have included DOE, the National Renewable Energy Laboratory (a component of DOE), the Office of Naval Research, and the Army Research Laboratory.

One of the first seminal publications on the proposed utilization of methanol as an automotive fuel supplement, generated from various sources including biomass, was published by Thomas Reed, a staff member in the Solid State Division who was primarily engaged at that time in crystal growth.<sup>2</sup> Additional work was performed in collaboration with the MIT Energy Laboratory, and this work eventually transitioned to the newly formed Solar Energy Research Institute when Reed left MIT in 1977.

During the 1970s, other solar energy conversion techniques also attracted significant interest on a number of alternative technical fronts. One such technique investigated by the Laboratory was the use of spectrally selective thin-film coatings for solar thermal, photovoltaic, and architectural window applications. Sputtered multilayer films that used combinations of metals and dielectrics were developed. This technology enabled the demonstration of transparent heat mirrors, which transmit solar radiation and reflect infrared thermal radiation, as well as selective absorbers, which absorb solar radiation and have a low infrared emissivity. One application of the heat mirror technology was the improved incandescent light bulb developed by John Fan (Figure 20-3). This new light bulb, which recycled infrared radiation back to the filament in order to improve efficiency, was able to save ~50% of electrical input energy while maintaining the same typical filament temperatures and light output. Unfortunately, this light bulb technology could not be produced commercially.





**Figure 20-5**  
**Schematic diagram of the CLEFT process illustrating the concept of epitaxial layer removal from the GaAs substrate.**

Photovoltaic energy conversion — the direct conversion of sunlight into electricity — also gained considerable attention during this period. A number of key advances in high-efficiency gallium arsenide (GaAs) PV cell technology were demonstrated. Carl Bozler and Fan pioneered the development of the shallow-homojunction solar cell device concept. Advantages of this approach included both simplified epitaxial materials growth by chemical vapor deposition, the lack of any vacuum processing steps, and the ability to use anodic oxidation to perform post-epitaxial-growth performance optimization, as well as to directly form the antireflection coating from the anodic oxide. Conversion efficiencies of up to 20% were obtained for these simplified GaAs PV cells by using optimized device fabrication techniques. A schematic of a high-efficiency shallow-homojunction cell is shown in Figure 20-4.

Electrochemical-based PV cells were investigated by John Mavroides and coworkers. In this PV application, sunlight is used to generate hydrogen by the direct electrolysis of water in an electrochemical cell with suitable electrode materials. The significant advantage of this approach is the ability to store the solar energy in the form of the generated hydrogen, which can subsequently be used in fuel cells to regenerate electricity.

Other energy conversion techniques besides solar were researched. Both MIT campus and Lincoln Laboratory have had a long-standing interest in thermophotovoltaic (TPV) energy conversion. TPV energy conversion is the direct conversion of infrared radiation, from a heated source, to electricity through the use of specially designed long-wavelength PV cells and infrared mirrors for photonic recycling. The earliest reported practical demonstration of a TPV generator was performed at Lincoln Laboratory in 1956 by Henry Kolm, who used a Coleman lantern as the infrared source.

Thermoelectric energy conversion — the direct conversion of temperature differences into electricity by means of the Peltier effect and by the reverse process (the use of electricity to generate temperature differences for heating or cooling) — has also had a long history of development at Lincoln Laboratory and MIT. Theodore Harman and coworkers published a number of important works in this area, including a widely cited book.<sup>3</sup> In this period, improved battery technology,

crucial for energy storage in many energy conversion applications, was also studied. Henry Hong explored the use of novel solid electrolytes for battery applications.

Between 1978 and 1985, Lincoln Laboratory was widely viewed as a center of excellence for advanced III-V solar cell technology. The Laboratory contributed many presentations and publications to the field, and Laboratory researchers routinely participated in international meetings that were often the settings for announcements of new technical breakthroughs.

During this time, the basic shallow-homojunction cell design was further refined for both potential terrestrial applications (supported by DOE) and also for potential space applications (supported by NASA). Developments included the reusable GaAs substrate technology by means of the Cleavage of Lateral Epitaxial Films for Transfer (CLEFT) process. In this process, the GaAs epitaxial layers could be removed by cleaving, thus enabling the starting substrate to be recycled for a number of additional cell-growth cycles (Figure 20-5). This process was the forerunner to the now widely used epitaxial lateral overgrowth single-growth process employed in the manufacturing of gallium nitride (GaN)-based optoelectronic devices, enabling devices such as long-lifetime Blue-Ray diode lasers.

Some researchers investigated alternative solar cell junction-formation techniques, including laser photochemical processes, solid-phase epitaxial regrowth, and diffusion from spin-on dopants. Others produced shallow-homojunction solar cells in alternative indium phosphide (InP) and germanium (Ge) substrate materials. In pursuit of potential weight and cost reduction, solar cells were also fabricated on polycrystalline GaAs and Ge/silicon (Si). Tandem cells (solar cells containing multiple stacked junctions) were also made from aluminum GaAs materials and from Ge/Si substrates, with the intent of boosting overall cell conversion efficiency.

For NASA space applications, Laboratory researchers developed GaAs CLEFT cells for high power-to-weight ratio, and concentrator cells for improved efficiency under concentrated solar illumination and increased radiation resistance. GaAs shallow-homojunction cells were subjected to radiation testing and found to be suitably robust for many space applications.

## Note

4 T.C. Harman, P.J. Taylor, M.P. Walsh, and B.E. LaForge, "Quantum Dot Superlattice Thermoelectric Materials and Devices," *Science* **297**, 2229–2232 (2002).

Most of the PV cell development work in the Solid State Division came to an end in 1984, shortly after the successful spin-off of Kopin Corporation and the associated departure of many key staff.

The ongoing thermoelectric materials and device efforts in the Solid State Division were very active from about 1990 to 2007. A program sponsored by the Navy and the Army produced numerous advances in thin-film, lead-salt-based nanostructured thermoelectric materials and devices. The seminal paper on quantum dot superlattice thermoelectric materials and devices by Harman and coauthors has been cited over 375 times in other publications.<sup>4</sup> Significant breakthroughs have been made in thermoelectric device performance and in the power density generated from a device structure working with a modest temperature differential. This materials and device work led to an exploratory industrial interaction with a major thermoelectric device manufacturer. Recently, the Engineering Division has undertaken a proof-of-concept demonstration of a compact thermal generator that utilizes the nanostructured lead-salt materials for the actual power-generation elements.

From approximately 1995 to 2005, the DOE sponsored the investigation of TPV materials and device technology. The goal of this work was to demonstrate the highest-performance TPV cell/optical filter combination for black-body radiator temperatures of around 950°C. For highest efficiency in these

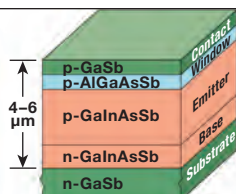
applications, the TPV cell cutoff should be matched to the peak of the black-body spectrum. Initially, lattice-matched, gallium antimonide (GaSb)-based, InGaAsSb TPV cells were developed, with an infrared cutoff wavelength near 2.5  $\mu\text{m}$ . The best system performance obtained with these devices was a power conversion efficiency of  $\sim 19\%$ , with a power density of 0.6  $\text{W}/\text{cm}^2$ . Toward the end, this program demonstrated multicell modules for increased voltage with lattice-mismatched InP-based InGaAs cells, thus achieving better performance.

## Looking Forward

In 2009, the world entered into another energy crisis, but one very different from that of the 1970s. Emerging industries in China, India, and other developing countries were creating a greater global demand for oil, while the United States was facing a much greater dependence on imported oil. Global warming, enhanced by the burning of fossil fuels, is a growing concern. It has become imperative for the United States to consider either energy solutions that do not depend on fossil fuels or means by which fossil fuels can be burned but the emissions sequestered.

In the 1970s, alternative energy solutions were still very much in a research stage; in the current era, many companies are involved in manufacturing products and installing and operating renewable energy systems. At this stage, Lincoln Laboratory can make fresh contributions to energy research and development by addressing the needs of the defense community.

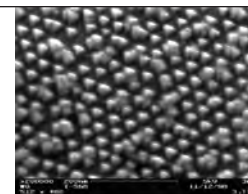
1990



Schematic cross section of GaSb-based thermophotovoltaic cell



T.C. Harman



Field emission scanning electron micrograph of PbTe/PbSeTe quantum-dot superlattice structure

Following a strategy used effectively for its past programs, the Laboratory has chosen to attack the energy problem from the top and from the bottom: that is, as a systems problem and as a technology opportunity.

At the system level, the Laboratory's strength is in excellent systems analysis. This strength is being applied to alternative energy solutions for the military's unique needs, among which are the energy demands of remote sites, forward-deployed units, and continental U.S. facilities. For example, the Laboratory is assisting the U.S. Army Kwajalein Atoll, which has significant energy demands that have been met solely through the importation of diesel fuel, in the exploration of alternative energy sources such as solar, deep ocean, wind, and tidal, all of which have potential benefits in a tropical environment.

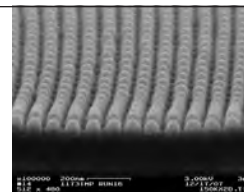
Lincoln Laboratory's Advanced Technology Division continues to utilize its expertise in the solar photovoltaic area, largely centered in organic PV work with MIT campus. The division and MIT are collaboratively exploring new materials and devices for thermoelectrics, with the aim of producing small devices that can be used to recharge batteries in the field or to scavenge energy from available sources. Both the organic PV and the thermoelectric projects have clear implications for the forward-deployed soldier. The Advanced Technology Division is separately researching the bioengineering of algae as a potential new biofuel.

Lincoln Laboratory is also pursuing energy projects with homeland security implications. An ongoing project supported by the Department of Homeland Security is aimed at detecting software faults in process-control software systems for nuclear power plants. This is an example of cross-fertilization among three Laboratory thrusts: homeland protection, cyber security, and energy. In another program, test-bed projects involve a plug-in hybrid vehicle whose battery can be used either to provide energy to a building to shave peak power demands (this requires a fleet of vehicles) or to gain charge from the building in low-demand times. Lincoln Laboratory is advancing and demonstrating this new concept, known as "vehicle to building." Finally, Laboratory researchers are exploring the use of electronics technologies developed for extreme environments (high radiation, high temperature) in new applications of geothermal energy, for which wells are typically very deep and very hot.

The renewed recognition of the importance of energy to national security means an increased support for research into and development of energy technologies. This support will likely lead to projects lasting from years to decades, given the long-term nature of the problem that Lincoln Laboratory has, once again, strategically chosen to address.



Lincoln Laboratory is looking at alternative energy solutions for Kwajalein



Scanning electron micrograph of surface of organic-based PV cell





**Project VELA UNIFORM, a program in seismic monitoring under ARPA sponsorship, aided the United States in monitoring underground nuclear tests and in verifying international compliance with the Limited Test Ban Treaty. Lincoln Laboratory had a major role in the deployment of the Large Aperture Seismic Array.**

**Left: LASA seismometer subarray showing open trenches for cable installation near Miles City, Montana.**

Public concern about nuclear testing in the atmosphere reached a peak in the late 1950s and compelled the nuclear powers — the United States, the Soviet Union, and the United Kingdom — to continue their nuclear testing programs underground. The problem with underground testing, however, was that it made test ban verification difficult. In December 1958, the U.S. government appointed a panel to study seismic monitoring of nuclear testing. In its report, published six months later, the panel argued that seismic methods were capable of detecting only explosions with yields over 20 kton and recommended the initiation of an aggressive program in seismic detection and discrimination. In response to this recommendation, the VELA UNIFORM program was established, and responsibility for the program was assigned to the Advanced Research Projects Agency (ARPA).<sup>1</sup>

Primarily because of its substantial expertise in antenna and wave propagation theory, Lincoln Laboratory became involved with the VELA UNIFORM program in 1962. At the suggestion of director Carl Overhage, a small group was asked to explore possible Laboratory participation. Their report, presented in September 1962, advocated a serious commitment. Overhage accepted the recommendation and started a small effort in December 1962.

Lincoln Laboratory's involvement in VELA UNIFORM began with its participation in the addition of mobile digital recording equipment to the Tonto National Forest array in Arizona. As a result, Lincoln Laboratory was one of the first groups to record seismic data in digital form. Using these data, as well as data from other networks, the group began to develop and apply a variety of propagation theory, statistical, and data processing methods to seismic discrimination.

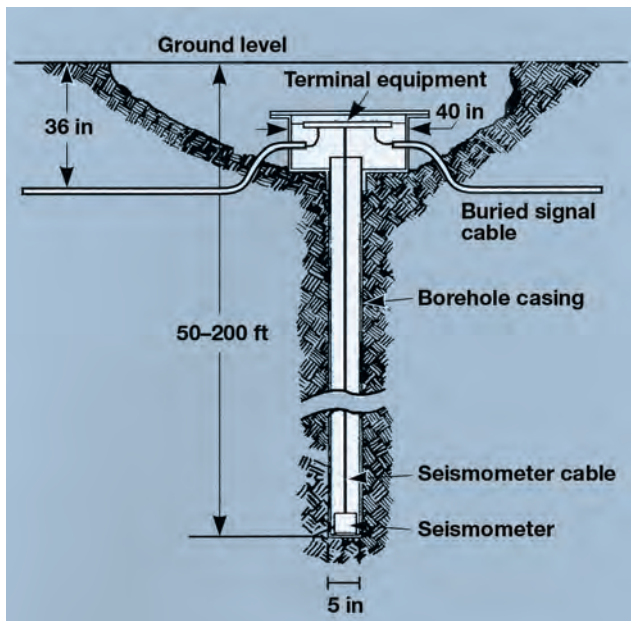
The Lincoln Laboratory team formulated a plan to construct a large seismic array that could be used to study the feasibility of monitoring underground nuclear explosions. The plan was accepted and the ARPA-supported VELA UNIFORM program at the Laboratory was initiated in October 1963.

The Limited Test Ban Treaty was signed by the United States, the United Kingdom, and the USSR in August 1963; it eliminated all future atmospheric testing. The treaty led to a substantial increase in the importance of VELA UNIFORM, and the program became the focus of much activity and new funding. As a result, in late summer 1964, the Lincoln Laboratory effort was enlarged and aimed specifically at the immediate development and deployment of a Large Aperture Seismic Array (LASA).

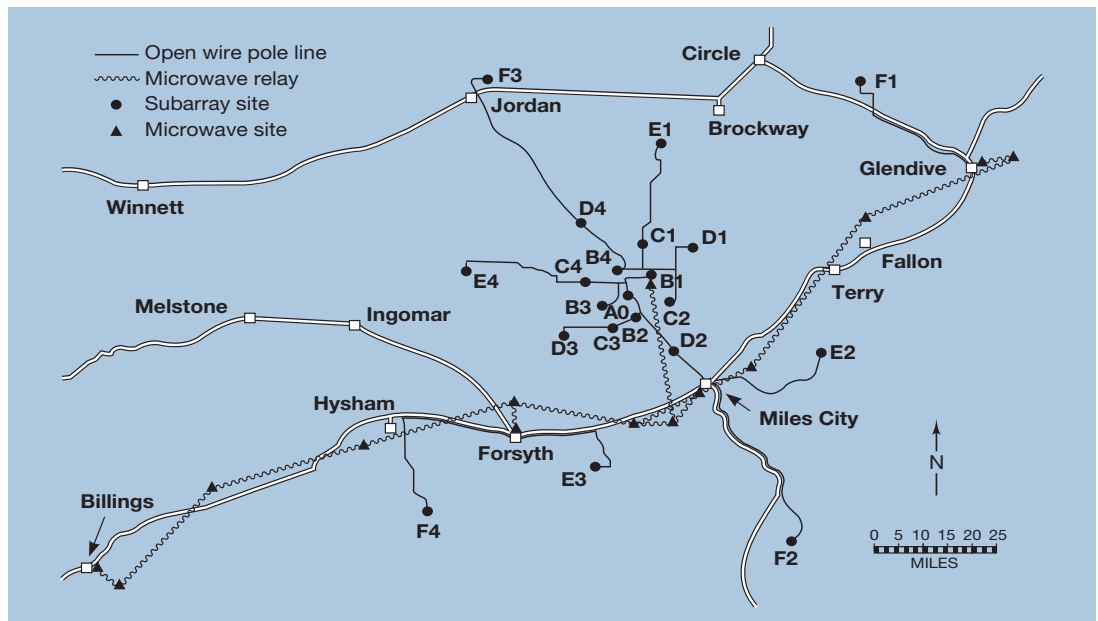
Seismologists were hired and assigned to the problem, and by December 1964, the array design was complete and construction had begun on LASA. The array consisted of 525 seismometers arranged in 21 subarrays, configured with a 200 km aperture and installed near Miles City, Montana (Figure 21-1). The Air Force Tactical Applications Center was assigned responsibility for installation of the seismometers and for communications from the sensors to the subarray vault. Lincoln Laboratory was assigned responsibility for signal transmission beyond that point, for the construction of an array data analysis center, and for all processing functions at that center.<sup>2</sup>

A site for the data center was selected in Billings, Montana, and by the summer of 1965, the seismometers and communication links had been installed, computer equipment was operating at the data center, and testing had begun (Figure 21-2). LASA began operations in October and its technical performance exceeded expectations (Figure 21-3). Within six months, the experimental period ended and routine operations began.

Lincoln Laboratory was then assigned overall system responsibility for control and maintenance of LASA. Operations and maintenance were handled by sub-contract to Philco Corporation. The program became heavily involved in processing the LASA data and applying it to the basic problems of detection and discrimination; the processing of array data dominated the program for the next seven years.



**Figure 21-1**  
LASA seismometer installation.



**Figure 21-2**  
LASA communication network for transmission of seismometer data from subarrays to the LASA data center in Billings, Montana.

#### Notes

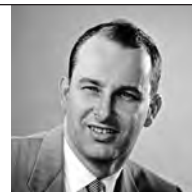
**1** This section is based on a report by M.A. Chinnery: *Seismic Discrimination, Final Report to the Defense Advanced Research Projects Agency*. Lexington, Mass.: MIT Lincoln Laboratory, 1982. Report No. ESD-TR-82-099.

**2** R.V. Wood, Jr., R.G. Enticknap, C.S. Lin, and R.M. Martinson, "Large Aperture Seismic Array Signal Handling System," *Proc. IEEE* **53(12)**, 1844-1851 (1965).

1960



C.F.J. Overhage



P.E. Green, Jr.





**Figure 21-3**  
Laurice Fleck and a Philco employee  
in the LASA data center in Billings,  
Montana.

The Seismic Discrimination Group during this period was at the forefront of the development and exploitation of modern high-resolution array processing and spectral analysis techniques. Major accomplishments included significant developments in digital time-series analysis, the formulation of a frequency-wave-number approach to array analysis, the invention of velocity spectral analysis, the application of sonograms, and considerable work in array calibration both for travel times and for amplitudes. The group developed time and spectral domain versions of the maximum-likelihood method of array processing and was among the first to apply and popularize the Burg maximum-entropy method.

A notable accomplishment in this period was the introduction of interactive computer graphics for the analysis of array waveforms. Using two PDP-7 computers, Lincoln Laboratory constructed a display system called CONSOLE, which advanced the state of the art for the analysis and display of seismic waveforms.

CONSOLE was easy to use. With little preparation, a user could select a tape containing a given event, play it into the computer, and view the waveforms. Facilities were provided for such standard analysis operations as filtering and spectral analysis. The system attracted visitors from all over the world, and many Ph.D. theses were based on LASA data and CONSOLE.

In 1967, an experimental subarray was installed in Norway. Lincoln Laboratory played an active part in the site evaluation.

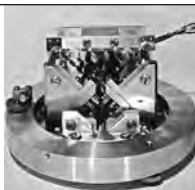
However, the array program, while successful technically, was not successful in seismic detection and discrimination because the earth has a complex seismic environment. Signals arriving at subarrays were more incoherent than had been expected, and this incoherence placed a fundamental limitation on the usefulness of the large aperture of the array. The inferred degree of inhomogeneity in the crustal section beneath LASA became a new standard for the way geophysicists think about the continental crust. As the Norwegian array began to produce data, these effects were observed to an even larger degree.

Clearly, the analysis of seismometer array problems needed the services of geophysicists as well as data processors. The emphasis of the program shifted toward seismological research.

By 1969, LASA had become an operational entity, and the routine operations passed to IBM, leaving Lincoln Laboratory free to focus on the data analysis and seismic issues. Realizing that the LASA data were raising questions at the forefront of academic seismology, the Lincoln Laboratory group moved into new quarters on the MIT campus, where the group could interact closely with academia.

About this time, Paul Green, who had directed the seismology effort from its start, left the Laboratory. Because of the new emphasis, David Davies, who had been reviewing seismic monitoring methods for the Stockholm International Peace Research Institute, joined the Laboratory to lead the research. Richard Lacoss took over responsibility for the computer systems and signal processing aspects.

1965



Seismometer



LASA maintenance  
console

The end of the array era was approaching, however, as it became clear that scattering in the earth provided a natural limitation to the usefulness of seismic arrays. By 1970, interest in array data had diminished considerably, and although LASA was not finally closed until the mid-1970s, it received little attention.

Interest in the overall VELA UNIFORM program was revitalized in 1971, largely as a result of a series of Senate hearings by the Foreign Relations Subcommittee on Disarmament. Several influential senators spoke strongly for an expansion of the U.S. seismic discrimination program.

Since the large-array program had not proven as successful as had been hoped, the program returned to an earlier idea — a global distribution of single stations. Such a network, especially if equipped with low-noise-sensitivity instruments, would lead to a substantial improvement in detection capability and, by providing wide azimuthal coverage, would allow more sophisticated studies of the source mechanism of seismic events.

The VELA UNIFORM program at Lincoln Laboratory became increasingly oriented toward geophysical problems. By the 1970s, most of the staff in the program were professional seismologists, and research was focused on understanding earthquake source mechanisms and path effects.

The emphasis on global networks led the Laboratory to organize an international project to clarify the detection capability of the existing seismic stations. With cooperation from many countries, the seismic records for one month (February 20 to March 19, 1972) were analyzed and the results sent to Lincoln Laboratory, where they were checked and assembled into a list of events. The results of the International Seismic Month project were surprising. Existing organizations that produced global lists of earthquakes were able to identify about 300 events per month; the International Seismic Month event list, however, contained 1000 events. The study showed clearly the need for care in reading and analyzing seismic records.

During 1973, Davies left the Laboratory to become the editor of the scientific journal *Nature*, and Professor Michael Chinnery of Brown University joined the Laboratory, taking over leadership of the program.

The new federal administration in 1977 changed the test ban treaty situation completely. President Jimmy Carter initiated new negotiations with the objective of formulating a comprehensive test ban treaty. Early in these negotiations it became clear that a key element in any potential treaty would be the deployment of sensitive seismic stations that were within the national boundaries of both the United States and the USSR. This plan raised a new issue that changed the Lincoln Laboratory program.

The possibility that internal stations might send continuous densely sampled seismic data raised concerns about data management. The only existing system for handling digital data in an operational way was at the Seismic Data Analysis Center in Alexandria, Virginia. That facility, however, did not have the capacity to handle the new data flow. Lincoln Laboratory had already been considering ways to update the Seismic Data Analysis Center. The Defense Advanced Research Projects Agency (DARPA), as ARPA had been renamed in 1975, asked the Laboratory to design an entirely new system that would be capable of fulfilling whatever requirements might be specified by the test ban treaty.

DARPA's request altered the Lincoln Laboratory program substantially. Research in seismology was reduced, computer scientists were brought into the program, and the program focus changed to computer hardware and software, and database management.

The design for the new Seismic Data Analysis Center was submitted in September 1979, and Lincoln Laboratory completed construction of the system two years later. DARPA moved the hardware and software to the Center for Seismic Studies in Rosslyn, Virginia.

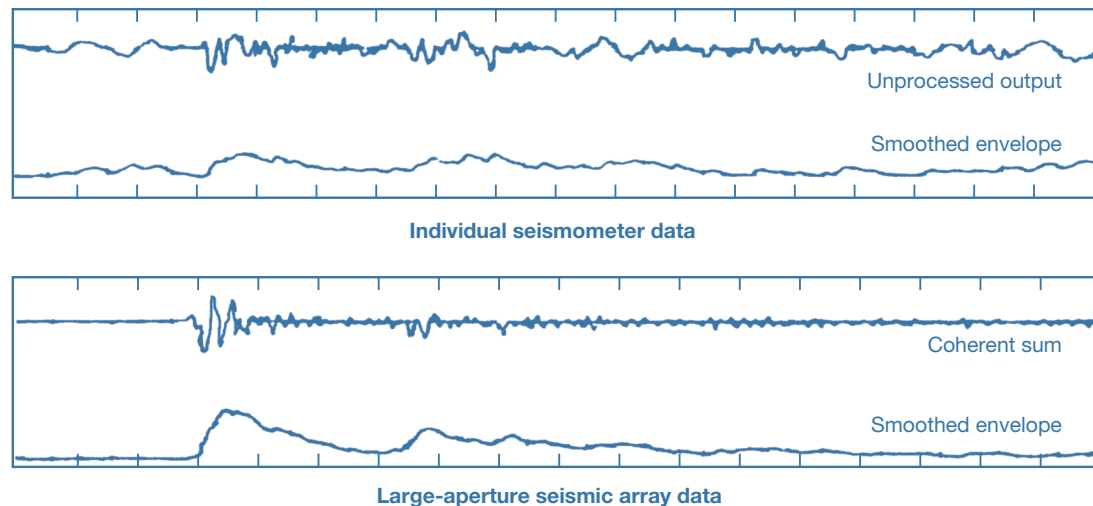
The completion of the new Seismic Data Analysis Center signaled the end of the Lincoln Laboratory VELA UNIFORM program. During its twenty years, the Lincoln Laboratory effort made major contributions to the fields of seismic discrimination and seismic data management and analysis, and it counted some of the foremost seismologists in the country on its staff.

## Seismic Events

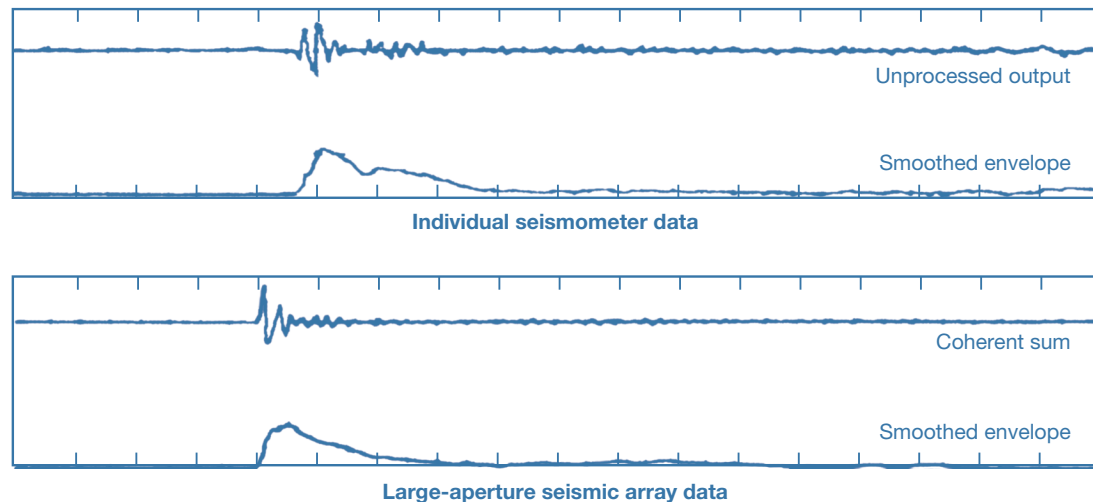
Soon after LASA became operational in 1965, it recorded data on both natural and manmade seismic events.\* Two events of particular note were an earthquake in the Rat Islands (Figure 21-4), a group of islands in the Aleutian chain, and a presumed explosion detected in Kazakhstan (Figure 21-5), a republic within the USSR. By combining all subarray outputs in a central signal processing computer, LASA scientists were able to detect and analyze these events successfully.

The recorded data for these events show the amplitude of the detected signal and smoothed envelope of the signal on the vertical axis with time progressing to the right on the horizontal axis.

\* H.W. Briscoe, J. Capon, P.L. Fleck, Jr., P.E. Green, Jr., R.J. Greenfield, and E.J. Kelly, Jr., "Interim Report on Capabilities of the Experimental Large Aperture Seismic Array," *Lincoln Laboratory Technical Note No. 1966-16*. Lexington, Mass.: MIT Lincoln Laboratory, 24 February 1966, DTIC AD-631285.



**Figure 21-4**  
Earthquake near the Aleutian Rat Islands, November 11, 1965.



**Figure 21-5**  
Presumed explosion in Kazakhstan, USSR.





**A program in radar astronomy led to the mapping of the moon, a refinement in the value of the astronomical unit, and verification of the General Theory of Relativity. Haystack's operation as a radar and as a radio telescope contributed to planetary science and radio astronomy.**

**Left: Haystack's 120 ft diameter antenna inside the radome.**

Radio astronomy is the study of the natural radio-frequency signals emitted by celestial bodies; radar astronomy, by contrast, looks at signals that have been emitted by earthbound transmitters and reflected by objects in the sky. Since manmade transmitters are not nearly as powerful as naturally occurring cosmic transmitters and since the radio wave intensity falls as the square of the distance (hence as the fourth power for radar), radar astronomy can be used only for the study of objects within the solar system. Radio astronomy, on the other hand, can be used to detect objects in other galaxies and even at the very edge of the universe.<sup>1</sup>

For studies within the solar system, optical and radar astronomy complement each other well. Optical astronomy can determine angular separations between objects with precision, but provides little accuracy in the direct measurement of distance. Thus, although precise determinations of the elements of the orbits of the planets were available in the nineteenth century, the sizes of their orbits were known accurately only in astronomical units of length, not in terrestrial units. Radar astronomy has relatively poor angular resolution; however, it offers extraordinary accuracy in the determination of distances and radial velocities. The goal for radar astronomers in the 1960s, therefore, was to determine the size of the astronomical unit (the mean distance between the earth and the sun) and to explore the radio reflection properties of planetary bodies and the sun.

The idea that radar could lead to new insights in astronomy had been discussed since the end of World War II, when researchers in Hungary and the United States transmitted radio signals toward the moon and detected their echoes. The sensitivity of the equipment at that time was poor, however, so it had not been possible to carry out any real science. Lincoln Laboratory was able to make its mark in the field of radar astronomy because it had developed sensitive radars that were available for science, and it had a staff that was interested and knowledgeable.

In the years between 1958 and 1969, Lincoln Laboratory achieved and maintained a position of international prominence in radar and radio astronomy.<sup>2</sup> Under the successive leaderships of John Harrington, James Meyer, and Stephen Dodd, scientists in the Radio Physics

Division mapped the moon, measured the orbits of the terrestrial planets, determined the size of the solar system, verified a prediction of the theory of general relativity, studied the sun's corona, and identified a molecule in interstellar space for the first time.

Although the Millstone radar at the Millstone Hill field site in Westford, Massachusetts, was built for the Ballistic Missile Early Warning System (BMEWS) effort, its first achievement was the detection of radar echoes from Sputnik I, the first artificial satellite, in fall 1957. The radar's success in finding nearby objects in space, combined with its great sensitivity, meant that it could also look at objects farther away. Therefore, researchers in the Radio Physics Division decided to use this instrument for the first radar astronomy measurements beyond the earth-moon system.

The Millstone radar operated at a wavelength of 68 cm and employed a fully steerable 84 ft diameter antenna. It was coupled to a transmitter with a peak output power of 1 MW and an average output power of 60 kW. The radar was later upgraded to operate at 23 cm with greatly improved performance.

Soon after the Millstone radar went into operation, Lincoln Laboratory proposed construction of the Haystack radar in Tyngsboro, Massachusetts (part of the Millstone Hill site), as the next significant step in the development of high-performance microwave systems. Haystack, designed by a team led by Herbert Weiss as an experimental facility for research on space communications and radar, became a true state-of-the-art system. After operations began in 1964, the radar was used in space communications and radio propagation experiments, as a tracking and measurements radar, and as a high-resolution radio telescope.<sup>3</sup> Following the conclusion of Project West Ford (see chapter 5, "Satellite Communications"), the Haystack radar was assigned to basic science. Because its sensitivity was much greater than that of the Millstone radar, Haystack became Lincoln Laboratory's primary planetary astronomy radar for the next decade.

The Haystack radio telescope operated at a wavelength of 3.8 cm; its central element was a fully steerable paraboloidal Cassegrain antenna, 120 ft in diameter. The antenna was fully enclosed in the world's largest space-

## Notes

**1** Material for this chapter was contributed by John Evans and Irwin Shapiro.

**2** Much of Lincoln Laboratory's work is collected in the book *Radar Astronomy*, eds. J.V. Evans and T. Hagfors. New York: McGraw-Hill, 1968.

**3** The main motivation behind the decision to construct the Haystack radar was its intended application as a high-sensitivity ground terminal for the Project West Ford space communications activity. At the time the radar was named, Project West Ford was still known as Project Needles (see chapter 5, "Satellite Communications") — hence the name Haystack.

**4** For a review of Lincoln Laboratory's work on the surfaces of the moon and planets, see J.V. Evans, "Radar Studies of Planetary Surfaces," in *Annual Review of Astronomy and Astrophysics*, Vol. 7, eds. L. Goldberg, D. Layzer, and J.G. Phillips. Palo Alto, Calif.: Annual Reviews, 1969, p. 201.

**5** G.H. Pettengill, "Measurements of Lunar Reflectivity Using the Millstone Radar," *Proc. IRE* **48**, 933–934 (1960).

frame radome, which improved antenna pointing by protecting the antenna from snow, ice, wind loading, and direct radiation from the sun.

Also employed for some experiments were the Camp Parks, California, and Westford systems of the Project West Ford experiment with their radar-mode capability. These systems operated at a wavelength of 3.6 cm and employed 60 ft fully steerable parabolas, together with continuous-wave (CW) transmitters that could be chopped.

### Lunar Studies

In the mid-1950s, scientists in Great Britain and the United States began studies of the radio-wave scattering properties of the moon.<sup>4</sup> Their investigations found that the largest portions of the reflected signals were returned from a region near the center of the lunar disk with a radius about one-third that of the moon, suggesting that the returns were coming from a largely smooth undulating surface, termed *quasi-specular*.

Lunar studies began at Millstone Hill in 1958 with a much more powerful radar than had been used up to that time. These measurements showed that there was a second, weaker component of the reflections that came almost uniformly from the entire surface; it was termed *diffuse*. These weaker signals exhibited considerable depolarization, unlike the quasi-specular returns, suggesting that a very different type of scatterer was responsible.

Measurements were subsequently made at wavelengths shorter than the 68 cm first used at the Millstone radar, including 23 cm at Millstone in 1965 and 3.6 cm at Camp Parks in 1962. These observations demonstrated that the quasi-specular returns were wavelength dependent. The scattering appeared to come from a larger region at the center of the disk as the wavelength was shortened. The strength of the diffuse component increased, suggesting that the reflectors responsible for this component were more numerous and/or better scatterers at shorter wavelengths.

Theoretical studies of the scattering from smooth undulating surfaces were carried out by a number of researchers. Theory could best be matched to the observed results when the correlation between the height of two points on the surface was assumed to fall exponentially with the distance separating them.

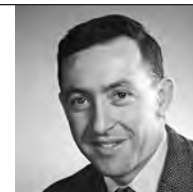
The radar results were of particular significance when the United States undertook the mission to carry out a landing on the moon. The smallest feature on the lunar surface visible from terrestrial telescopes is about 1/2 km in size. Early in the 1960s, little was known about the roughness on the scale of a landing vehicle; the radar results suggested a smooth surface with an average slope of about one part in eight.

This conclusion was subsequently borne out by close-up television pictures taken by the lunar Ranger probes. The pictures also revealed the presence of boulders lying on the surface, presumably ejected

1960



El Campo radar dipoles



S.N.M.N. Weinreb, MIT Professor A.H. Barrett, and M.L. Meeks

I.I. Shapiro



from below during the impact of meteorites. It seemed very likely that these boulders were responsible for the weaker diffuse component. Careful polarization studies made at 23 cm wavelength at the Millstone radar supported this view because they showed that the diffuse component was partially linearly polarized in a direction radial to the center of the visible disk.

The radar studies contributed to the lunar landing in other ways. Prior to the landing, there was concern that the lunar surface could be fine dust many feet deep into which any heavy object would sink. From the strength of the radar reflections, however, it was possible to deduce that the average dielectric constant of the surface was about 2.7 — a value very close to that of terrestrial sand, with corresponding weight-bearing properties. Subsequent in situ measurements confirmed the correctness of this result.

The use of radar to map the surface of the moon became possible when the radar beam was made small enough to discriminate between two points on the surface that would contribute echoes at the same range and Doppler shift. The first application of this technique (originally suggested by Paul Green, leader of the Communication Techniques Group) to a solar system target was made at the Millstone radar by Gordon Pettengill, associate leader of the Surveillance Techniques Group, who published a short description of the results in January 1960.<sup>5</sup> Range-Doppler mapping was used extensively over the following decade, first with the new 23 cm Millstone radar system and later with the 3.8 cm Haystack radar. These studies identified regions of

anomalous scattering such as (newer) rayed craters and older craters with rough rims. Increased reflectivity could be accounted for by increased roughness associated with these features, although increased intrinsic reflectivity may also have been a contributor (Figure 22-1).

Another technical innovation at Lincoln Laboratory — the use of interferometry — later enabled altitude data to be added to the two-dimensional radar reflectivity maps, thereby yielding three-dimensional maps of the moon. By using this technique, the Haystack system was able to produce very-high-resolution topographic maps of parts of the moon.

#### Venus Studies

Although radar echoes from the moon had first been detected in the 1940s, none of the planets had been observed through radar astronomy at the time that Lincoln Laboratory entered the field. The object that came nearest the earth and had the largest radar cross section after the moon was Venus, so the Laboratory initiated an effort to detect its radar echo. The task proved vastly more difficult than was at first expected. In the attempt to observe radar echoes from Venus in February 1958, the group initially believed that Venus had been detected, but subsequent observations proved that the echoes' supposed detection had been caused by noise. The next set of measurements was taken about eighteen months later, but because the data were analyzed with the value of the astronomical unit of length in terrestrial units inferred from the 1958 observations of Venus, no acceptable evidence of an echo was obtained.



P.B. Sebring



J. Evans

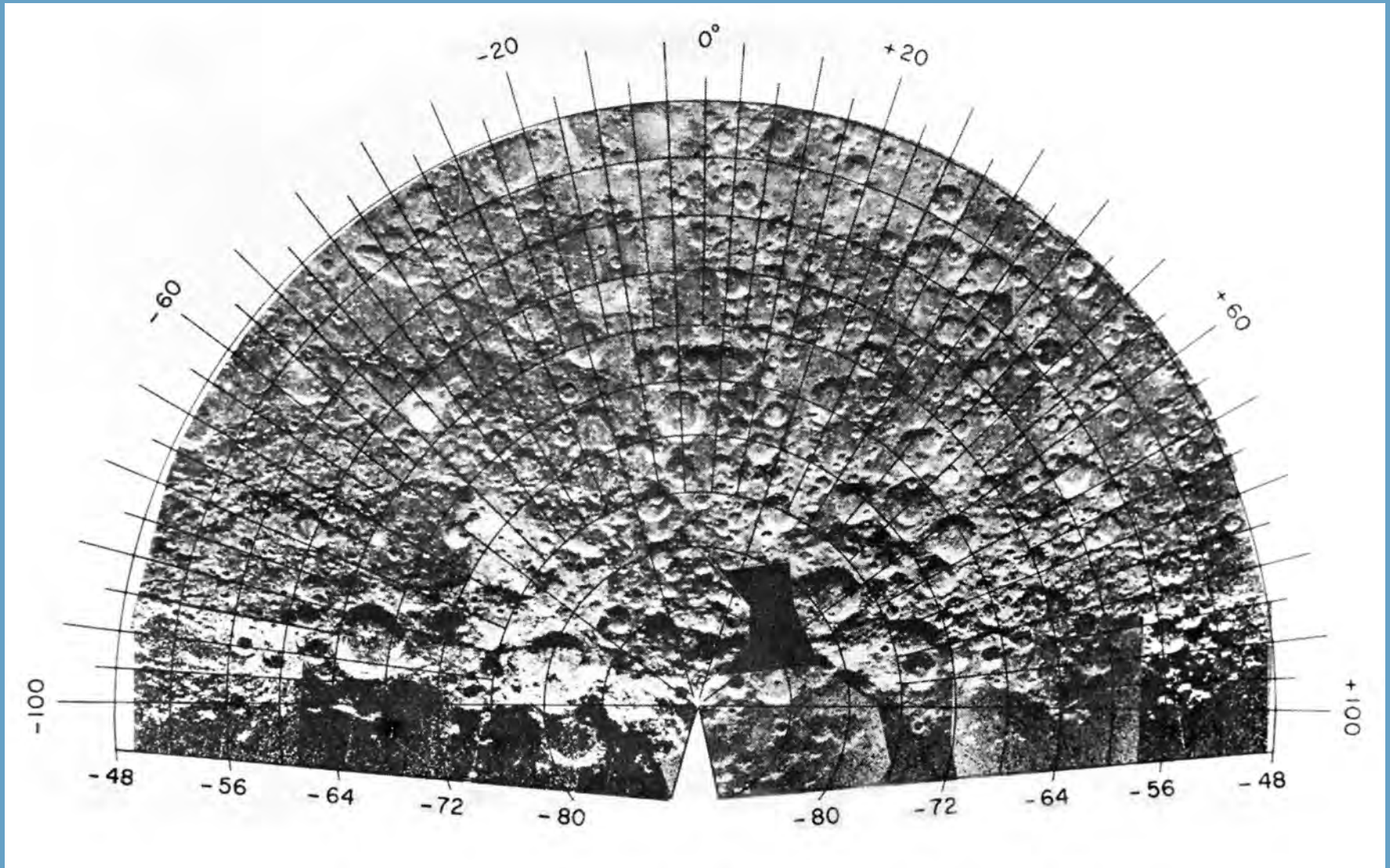


Figure 22-1  
Radar map of the surface of the moon  
from latitude 48°S to 90°S and  
longitude 104°W to 104°E.

---

**Note**

6 M.E. Ash, I.I. Shapiro, and W.B. Smith, "Astronomical Constants and Planetary Ephemerides Deduced from Radar and Optical Observations," *Astronom. J.* **72(3)**, 338–350 (1967).

By 1961, the power of the Millstone transmitter had been increased to 2.5 MW; by this time, the search for radar returns from Venus had become an international race. Four other laboratories were competing to report the first definitive measurement: the Jet Propulsion Laboratory's (JPL) Goldstone facility in California; RCA in Moorestown, New Jersey; Manchester University's Jodrell Bank radar in England; and the Institute for Electronics and Radiotechniques' radar system in the Soviet Union (in what is now Ukraine). On March 10, 1961, the JPL radar obtained unmistakable evidence of a return from Venus.

The principal cause for the difficulty in detecting a radar echo from Venus was the uncertainty in the value of the astronomical unit (the mean distance between the earth and the sun) in terms of a terrestrial unit of length. The astronomical unit was then known only to an accuracy of about 1 part in  $10^3$  in terms of terrestrial units of length, and this uncertainty contributed to the difficulty of integrating a sufficient number of echoes (in a computer) to detect the echo. Lincoln Laboratory attempted a ranging experiment by transmitting pulses of radio energy toward Venus. Although the Laboratory found clear echoes in measurements recorded on March 6, 1961, this fact was not known until March 24, by which time enough data had been collected to resolve an inherent ambiguity in the echo delays due to the uncertainty in the value of the astronomical unit. The British and Soviet groups each reported successful detection of echoes from Venus in April.

The error in the astronomical unit could have caused intolerable errors in planetary space-probe missions. The most significant accomplishment of the Venus race, therefore, was the correction to the astronomical unit. Over the next few years, the value was refined further. Lincoln Laboratory eventually determined a value of 499.004786 light sec — nine significant digits.<sup>6</sup>

With the astronomical unit determined, the Lincoln Laboratory researchers then reanalyzed their 1959 data, which had been preserved on magnetic tape. The results showed clear evidence of echoes and provided the first indication that Venus rotated in a retrograde fashion.

Besides contributing to an improved measurement of the size scale of the solar system, continued radar studies of Venus revealed other unexpected aspects of the planet. Not only does Venus rotate in a direction opposite to the earth's rotation, but the period of its rotation is extremely long: about 243 days. These results were dramatic in two respects. With the exception of Uranus, no other planet in the solar system is known to execute retrograde rotation. Moreover, a period of 243.16 days would cause Venus to present exactly the same face to the earth at successive inferior conjunctions, implying capture of Venus's spin by the earth's gravitational field. More recent measurements show the spin period is significantly less, 243.02 days, ruling out capture. Some form of cosmic collision must be responsible for Venus's slow retrograde rotation.

The average scattering properties of Venus were found to exhibit considerable similarity to those of the moon. The returns could be divided into both a quasi-specular component and a diffuse component, with the diffuse component weaker for Venus than for the moon. The average surface slope deduced from the quasi-specular component was also less than that for the moon; the average surface slope was found to be about one part in twelve. Venus exhibited considerable surface differentiation with regions of intense anomalous scattering. These features were studied by using the Haystack radar at 3.8 cm as the illuminator. For reception, the Haystack and Westford antennas were arranged as an interferometer to resolve the ambiguity between points of equal range and Doppler coordinates.

Lincoln Laboratory found that at meter and decimeter wavelengths Venus had a scattering cross section of about 15% of its physical projected area, in contrast with 7% for the moon. This result suggested that the surface of Venus is less porous than the sandy surface of the moon — possibly solid rock with only a thin soil covering.

Initial attempts to observe Venus at the 3.6 cm wavelength were unsuccessful. These experiments were carried out in 1961 at the Camp Parks, California, site by using the Project West Ford equipment. In 1964, an attempt that used the Westford site yielded weak returns, indicating a radar cross section one-tenth of that observed at decimeter wavelengths. This result was confirmed with the more



---

**Note**

7 J.H. Chisholm and J.C. James, "Radar Evidence of Solar Wind and Coronal Mass Motions," *Astrophys. J.* **140**, 377–379 (1964).

powerful Haystack radar in 1966. Near-simultaneous range measurements at Millstone (23 cm wavelength) and Haystack (3.8 cm wavelength) demonstrated that the centimeter wave reflections were from the solid surface, indicating that the difference must be attributed to absorption in the atmosphere of Venus, and that only 30% of the incident 3.8 cm signal reached the surface.

The round-trip times of the radar echoes from Millstone and Haystack also yielded the first reliable value for Venus's radius, showing it to be about 35 km smaller than had been deduced from the Soviet spacecraft Venera 4, which had been thought to have stopped transmitting when it hit Venus's surface. The radar data showed that the transmission had stopped well above the surface and, hence, that the surface was far hotter and the atmospheric pressure there far higher than had been deduced from the Venera 4 measurements. Radar results obtained at JPL confirmed Lincoln Laboratory's determination of Venus's radius.

These results, along with the surprisingly high temperature of Venus's surface (about 750 K) deduced from radio astronomy observations, supported the view that Venus is blanketed by a very thick atmosphere with a surface pressure perhaps a hundred times that of the earth. This atmosphere gives rise to a powerful greenhouse effect, trapping thermal radiation.

**Mercury Studies**

Radar reflections from Mercury were first reported by the Soviet team in 1962. These were followed by observations reported by the JPL group in 1963 and Millstone and Arecibo Observatory in 1965.

The scattering properties of Mercury were studied by the Arecibo team and later by the Lincoln Laboratory team using the Haystack radar. The total radar cross section of Mercury (about 6%) and the distribution of the returns proved extraordinarily close to those observed for the moon. This result implied that Mercury has a similarly eroded and cratered surface; high-resolution photographs taken in 1974 by the Mariner 10 spacecraft provided confirmation. The limited sensitivity of the radar systems then available and the short interval that Mercury spent close enough to earth to be studied made it impossible to discern regions of anomalous scattering.

**Mars Studies**

Because Mars never approaches the earth as closely as Venus does, and because it is smaller than Venus, detection of Mars is difficult even at favorable oppositions. Moreover, the high rotation rate of Mars (24.6 hr) increases the frequency dispersion of the reflections. Therefore, the apparatus necessary to detect Mars must be a hundred times more sensitive than the apparatus to detect Venus.

The first detections of Mars were made in 1963 by the JPL and the Soviet groups. At subsequent oppositions, measurements were also made by the Arecibo group and Lincoln Laboratory, initially using the Millstone radar (23 cm wavelength) and later the Haystack radar (3.8 cm wavelength). Measurements of Martian topography taken at Haystack revealed surprisingly large variations, up to 12 km from the mean.

Studies of the radar echo intensities showed the average radar cross section of Mars to be about 10%, suggesting that the dielectric constant was slightly larger than the value found for the moon. This fact indicated that the surface of Mars was more compact, though still somewhat unconsolidated.

On the basis of the average distribution of echo power over the disk observed at Haystack, the Lincoln Laboratory team concluded that Mars had the smoothest of the planetary surfaces so far investigated, with average slopes of about one part in twenty. These were average properties, however, and the JPL and Arecibo teams both reported large variations in the reflectivity of the subradar point with Martian longitude, with values in the range of 3 to 15% of the physical area of the disk.

There seemed to be a definite association of increased radar reflectivity with the dark-appearing regions on the surface, for example, Trivium Charontis and Syrtis Major. It was not clear whether these variations were caused by changes in the composition of the surface material, its compactness or its roughness, or a combination of properties.

## The General Relativity Experiment

The possibility of detecting radar echoes from Mercury prompted thoughts about measuring precisely the relativistic advance of Mercury's perihelion; this effect is one of the predictions of Einstein's theory of general relativity. This measurement and two others had been the only known methods for testing Einstein's theory experimentally. The theory also predicted, however, that the speed of a light wave depended on the strength of the gravitational potential along its path, so that a radar pulse passing near the sun would be delayed.

In 1964, Irwin Shapiro published an article suggesting that general relativity could be tested by measuring the round-trip time of radar pulses transmitted toward Mercury or Venus when either was close to superior conjunction, that is, on the opposite side of the sun from the earth. These measurements would provide a fourth test of the theory of general relativity, one that had not been previously considered.

An intensive program was undertaken in 1965 to build a new transmitter and receiver system to provide Haystack with the capability to measure these round-trip delays to an accuracy of about ten microseconds. The improved radar was put into operation in 1966, and tests were carried out over the next year.

The results showed that the sun's gravity did indeed slow the speed of propagation of light. The predicted increase in round-trip delays was confirmed to within about 10%.<sup>\*</sup> The predicted general relativistic advance of Mercury's perihelion was also confirmed, to within about 1%. Lincoln Laboratory had successfully carried out the fourth test of the theory of general relativity.

---

<sup>\*</sup> I.I. Shapiro, G.H. Pettengill, M.E. Ash, M.L. Stone, W.B. Smith, R.P. Ingalls, and R.A. Brockelman, "Fourth Test of General Relativity: Preliminary Results," *Phys. Rev. Lett.* 20(22), 1265–1269 (1968).

### Asteroid, Comet, and Satellite Studies

The improved Haystack radar system was also able to detect small objects that came near the earth. On June 14, 1968, the asteroid Icarus passed the earth at a distance of 6.5 million km and was successfully detected with the Haystack radar. This measurement marked the first such detection of an asteroid. An attempt to detect Comet Kohoutek, however, failed; the radar system had insufficient sensitivity. Only later, in the 1970s and 1980s, when radar systems with greater sensitivities were developed, were echoes from comets detected.

Even in 1968, greater sensitivity was possible by combining the Haystack and Goldstone antennas in a bistatic configuration. The extra performance of this system permitted the detection of Callisto, one of the major satellites of Jupiter.

### Solar Studies

Other than the moon and the terrestrial planets, the only other body that presented a large enough cross section to be detected by radar in the early 1960s was the sun. However, the frequency range over which radar systems could be built to detect echoes from the sun was very limited. For the best signal-to-noise ratio, calculations had predicted the wavelength had to be greater than 6 m. This conclusion was based on the expectations that higher frequencies would penetrate farther into the solar corona and that the physical conditions prevailing there would cause greater absorption losses. The Millstone radar then operated at a wavelength of 68 cm, so its use was ruled out.

Radar reflections from the sun were first reported in 1960 by a group from Stanford University that employed a radar operating at a wavelength of 11.7 m. No systematic scientific studies were carried out, however.

Lincoln Laboratory had built a powerful very-high-frequency (VHF) transmitter in 1955 near El Campo, Texas, to study signal propagation on a path from El Campo to Oakhurst, New Jersey. Four years later, the Laboratory began to build an array of dipoles to use with the El Campo antenna to permit the use of the system for radar astronomy of the sun. This effort was completed in 1960, and, in 1961, the first systematic radar studies of the sun were begun. Over the next three years, the El Campo radar made roughly 600 separate radar observations of the solar corona (Figure 22-2).

Echoes from the sun showed considerable variability from day to day, indicating equivalent solar cross sections between zero and three times the projected area of the solar disk. The bulk of the energy appeared to be returned from solar plasma residing between 0.5 and 1.5 solar radii above the photosphere. Moreover, there was a wide spread in the energy with Doppler frequency, corresponding to returns from reflection points with speeds between 60 and 150 km/sec along the line from the earth to the sun. Also, the shortest delayed echoes tended to exhibit the largest positive Doppler shift.

The reflections seemed to be caused by irregularities in the solar wind — an ionized plasma that flows radially away from the sun as a consequence of being heated to a temperature of about one million degrees centigrade, sufficient for plasma to escape the sun's gravitational field. However, the spread of the velocities observed appeared to be larger than the simple expansion velocity predicted by the theory of the solar wind, suggesting that perhaps some of the reflections arose from shock waves traveling through the plasma. These measurements provided one of the first confirmations of the existence of the solar wind.<sup>7</sup>

Lincoln Laboratory's study of the solar corona ended in 1964 when the El Campo radar was transferred to the MIT Center for Space Research. Measurements continued for a short time and were then concluded.

### Radio Astronomy

Most of the scientific work at Millstone Hill employed radar techniques; there was, however, one program of radio astronomy. Although radio emissions from hydrogen in interstellar space had been observed by 1951, no one had detected the presence of any molecules. Therefore, in a joint effort, MIT and Lincoln Laboratory astronomers set out to see if the Millstone radar could be adapted to detect a radio signal from a molecule. They designed and built a special-purpose digital correlator to look specifically for the hydroxyl (OH) radical.

The digital correlator was completed in 1963, and the Millstone antenna was pointed toward the radio source Cassiopeia A. Careful measurements revealed a decrease in the received power of about 1.6% at the frequency of the OH transition. Over the next few weeks, the line shifted in frequency — a result of the change in





Figure 22-2  
The 38 MHz antenna array for radar astronomy of the sun in El Campo, Texas. The scale of the array can be appreciated by noting the size of the individual in the center of the photograph.





**Figure 22-3**  
**Littleton Meeks, John Henry, and Sander Weinreb examine photographic evidence of electromagnetic radiation emitted by OH radicals in interstellar space.**

**Note**

**8** S. Weinreb, A.H. Barrett, M.L. Meeks, and J.C. Henry, "Radio Observations of OH in the Interstellar Medium," *Nature* **200**, 829–831 (1963).

velocity of the earth toward the source. This effect was caused by the orbital motion of the earth around the sun, and it provided confirmation that the OH being detected was not in the earth's atmosphere. A molecule had been detected in interstellar space for the first time (Figure 22-3).<sup>8</sup>

A much larger radio astronomy effort was eventually undertaken at Haystack and produced many notable achievements. The galactic center was mapped with a resolution of 2 arc min, yielding the highest-resolution radio map then available. Radio studies of interstellar molecules led to the detection of three new sources of water-vapor emission and established the near-coincidence of the positions of eight OH and water-vapor sources. Several new OH sources associated with infrared stars were observed with a very-long-baseline interferometer between Haystack and the National Radio Astronomy Observatory in Greenbank, West Virginia.

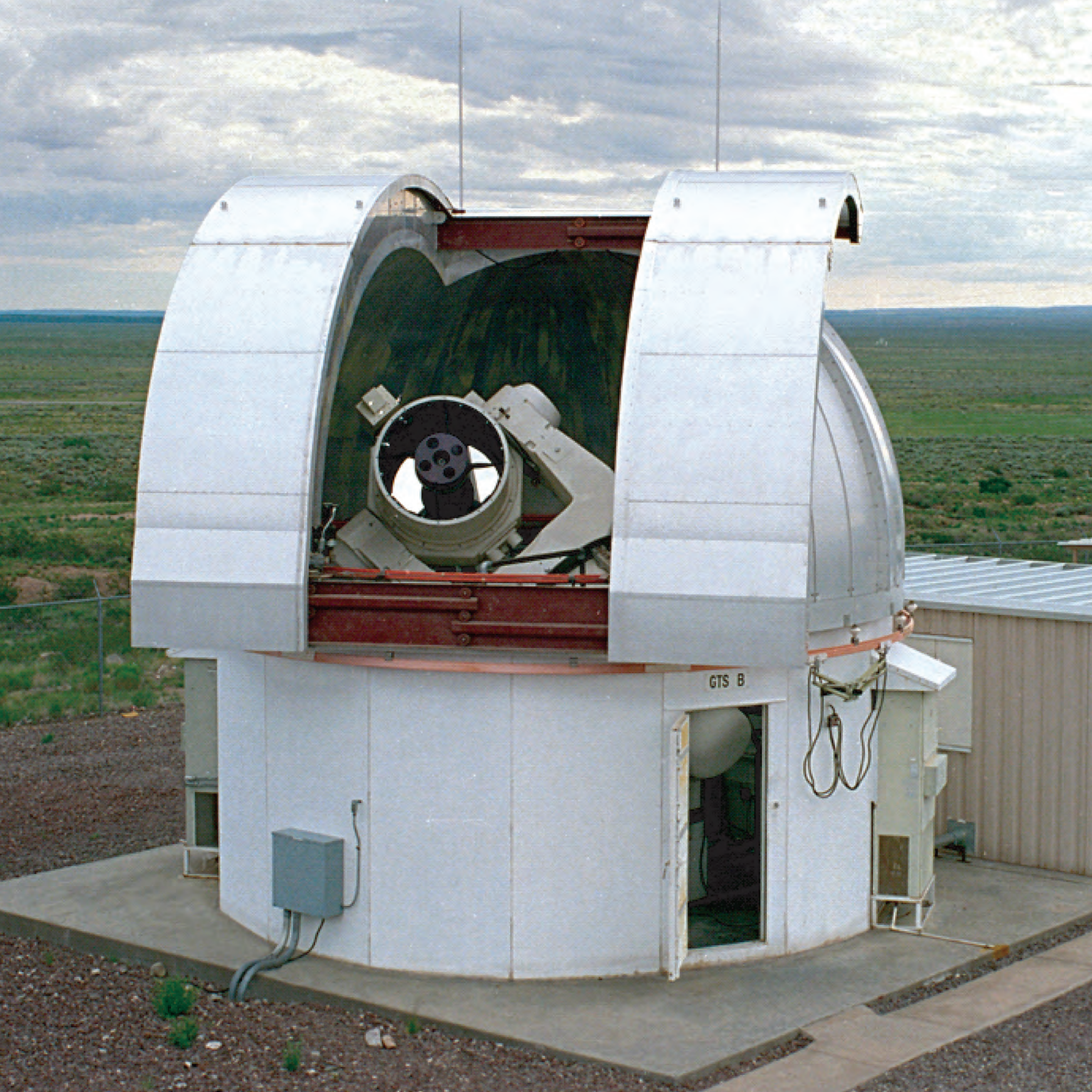
In spring 1965, President Nathan Pusey of Harvard University, President Julius Stratton of MIT, and Secretary Dillon Ripley of the Smithsonian Institution, with funding from the National Science Foundation, established the Cambridge Radio Observatory Committee (CAMROC) to define the goals of a university-led consortium dedicated to radio astronomy. Jerome Wiesner — who earlier had been associate head of the Laboratory's Communications and Components Division, was then provost of MIT and later became president of MIT — and Professor Edward Purcell of Harvard provided additional support for the study. The committee recommended the establishment of a nonprofit corporation for the advancement of radio and radar astronomy research, and the Northeast Radio Observatory Corporation (NEROC), a consortium of thirteen educational institutions, was set up in 1967 for that purpose. Paul Sebring served as its first director and John Evans later served concurrently as NEROC director and as an assistant director of Lincoln Laboratory.

By the end of the 1960s, the Air Force had greatly reduced its need for Haystack, and the radar was declared surplus. On July 1, 1970, ownership of Haystack was transferred to MIT, which has operated the facility since then under agreement with NEROC.

NEROC continues to conduct a radio astronomy program. Scientists working at the Haystack Observatory are studying the processes of star formation, probing the nature of quasars, and monitoring the tectonic motion of the earth's plates. The connection between Lincoln Laboratory and Haystack has not altogether disappeared, however, because the Laboratory continues to use the radar to conduct imaging for satellite surveillance. The Laboratory has continued to use the radar to conduct imaging for satellite surveillance.

In 2003, under U.S. Air Force sponsorship, Lincoln Laboratory began a program to upgrade the Haystack radar to enable inverse synthetic aperture radar imaging of satellites out to geosynchronous altitudes. (See chapter 10, "Space Situational Awareness," for a description of this program.) The enhanced radar, the Haystack Ultrawideband Satellite Imaging Radar, will expand capabilities for satellite imaging applications, and will, via the inclusion of a suite of radio astronomy receivers in the instrumentation box, yield dramatically improved performance for passive astronomy use in cooperation with Haystack Observatory staff. It is now possible to switch from radar to radio astronomy on short time scales, allowing for flexible sharing of time. The extraordinary precision of the antenna surface will enable sensitive observations at wavelengths of 3 mm and, instrumentation permitting, even at 1.3 mm. With these astronomy capabilities, both educational use and frontier research, including astrochemistry and very long baseline interferometry (VLBI), can be supported. At 3 mm wavelength, Haystack will be able to participate in VLBI observations to investigate a wide variety of astrophysical phenomena, from circumstellar masers to relativistic jets powered by supermassive black holes in distant galaxies.





GTS B



**Lincoln Laboratory has responded over the years to changing national needs in nondefense areas. NASA's mission to catalog 90% of large near-earth objects was realized by the Laboratory's space surveillance technology, through the Lincoln Near-Earth Asteroid Research program. Other nondefense projects were in diverse areas, including early manned space flights, health care, and education.**

**Left: One of two 1 m ground-based electro-optical deep-space surveillance search telescopes at the ETS. This telescope, which previously was used for space surveillance, is now a component of the LINEAR program.**

Since the 1970s, national concerns have prompted the Laboratory to expand its efforts into activities outside its core mission areas. The Lincoln Near-Earth Asteroid Research program (LINEAR), which has become the world's leading discoverer of near-earth objects, was undertaken in the late 1990s for the National Aeronautics and Space Administration (NASA). Chapter 12, "Air Traffic Control," discusses what has become the Laboratory's largest non-Department of Defense (DoD) activity. This chapter covers LINEAR and other unique programs.

#### **Lincoln Near-Earth Asteroid Research Program**

Astronomers have been engaged in efforts to find and catalog asteroids for the past two hundred years. Initially, the searches were inspired by scientific curiosity and a desire to understand our solar system. More recently, however, these searches have also been motivated by the desire to understand — and possibly react to — the threat of a potential collision between the earth and certain asteroids near the earth's orbit. In 1998, Congress issued a mandate to NASA requiring that 90% of the near-earth asteroids (NEA) with diameters greater than 1 km be discovered and cataloged by 2008. At the time, the number of known NEAs was 450, of which 223 were 1 km in diameter or larger. The total number of large NEAs was estimated to be near 2200.

Under the leadership of Grant Stokes, the LINEAR program began regular operations in March 1998 and quickly became the most productive asteroid survey program in history. LINEAR is an outgrowth of space surveillance technology developed by Lincoln Laboratory for the U.S. Air Force. Searching large areas of the sky for faint moving objects is common to developing a catalog of earth's orbiting satellites and a catalog of asteroids. Applying the highly refined Air Force space surveillance technology to the asteroid search task has provided an order-of-magnitude increase in capability to the worldwide asteroid search effort.<sup>1</sup>

Since the start of routine operations in March 1998, LINEAR has provided 56% of the worldwide discovery stream for NEAs, and has now discovered more than 40% of the known population of near-earth asteroids larger than 1 km in size. LINEAR has accomplished this productivity by using two 1 m ground-based electro-optical deep-space surveillance (GEODSS) telescopes, located at the Lincoln Laboratory Experimental Test System (ETS) on the White Sands Missile Range near Socorro, New Mexico (Figure 23-1). The telescopes are equipped with charge-coupled device (CCD) focal planes that Lincoln Laboratory developed and fabricated as prototypes for the Air Force program that upgraded the GEODSS cameras to operate using CCD detectors. The CCD focal plane (Figure 23-2) contains an array of  $2560 \times 1960$  pixels and has an intrinsic readout noise of only a few electrons per pixel. The CCDs are constructed with a back-illumination process, which provides peak quantum efficiency exceeding 95% and solar-weighted quantum efficiency of 65%. A frame-transfer feature produces a quick image-transfer time from imaging area into frame buffer of only several milliseconds, thus allowing fields to be acquired as fast as the telescope can step and settle. This advanced CCD, in combination with agile wide-field-of-view GEODSS-type telescopes, rapid processing capability, and sophisticated moving-object detection algorithms, forms a unique and powerful asteroid search system that can survey essentially the entire available sky each month.

All of the LINEAR observations are sent to the Minor Planet Center (MPC) at the Harvard-Smithsonian Center for Astrophysics in Cambridge, Massachusetts. The MPC acts as the central repository chartered by the International Astronomical Union to collect and publish all observations of asteroids. In addition, the MPC maintains the catalog of known minor planets (the formal name for asteroids) and issues formal notification of new discoveries.



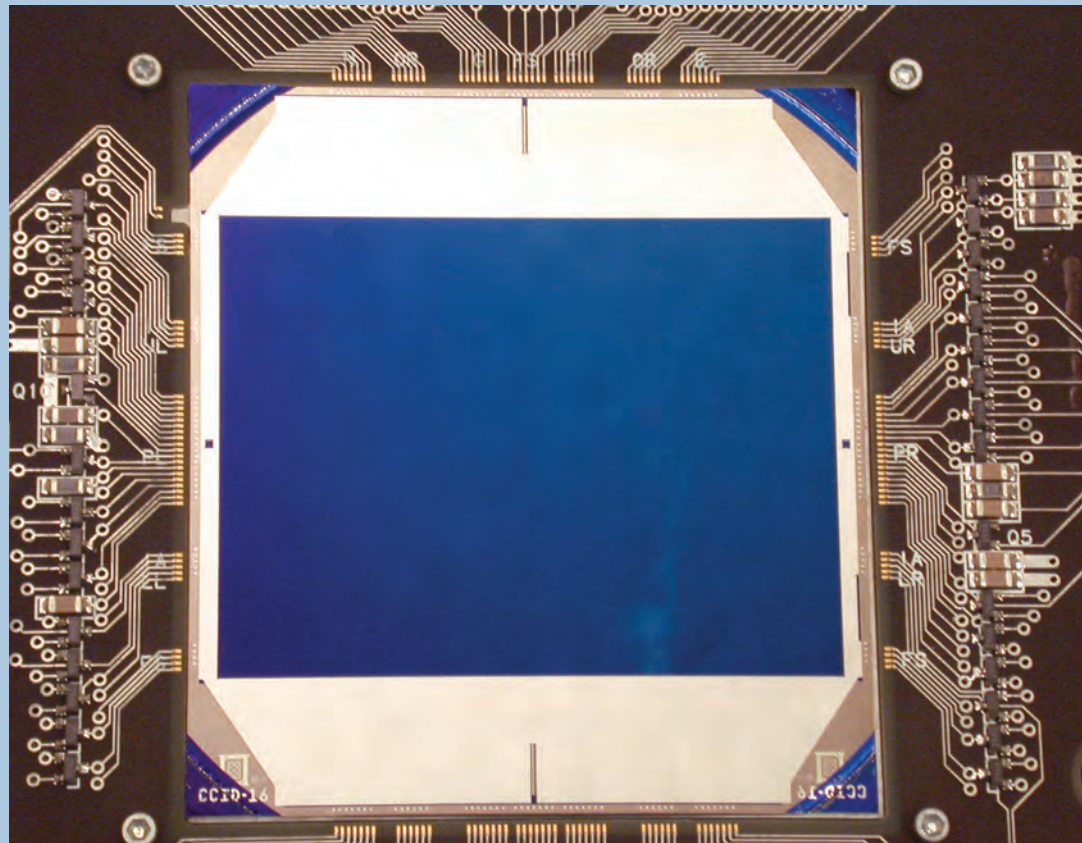
**Figure 23-1**

The ETS adjacent to the U.S. Air Force GEODSS site. The LINEAR program operates two search telescopes, called L1 and L2, and one follow-up telescope, called L3.



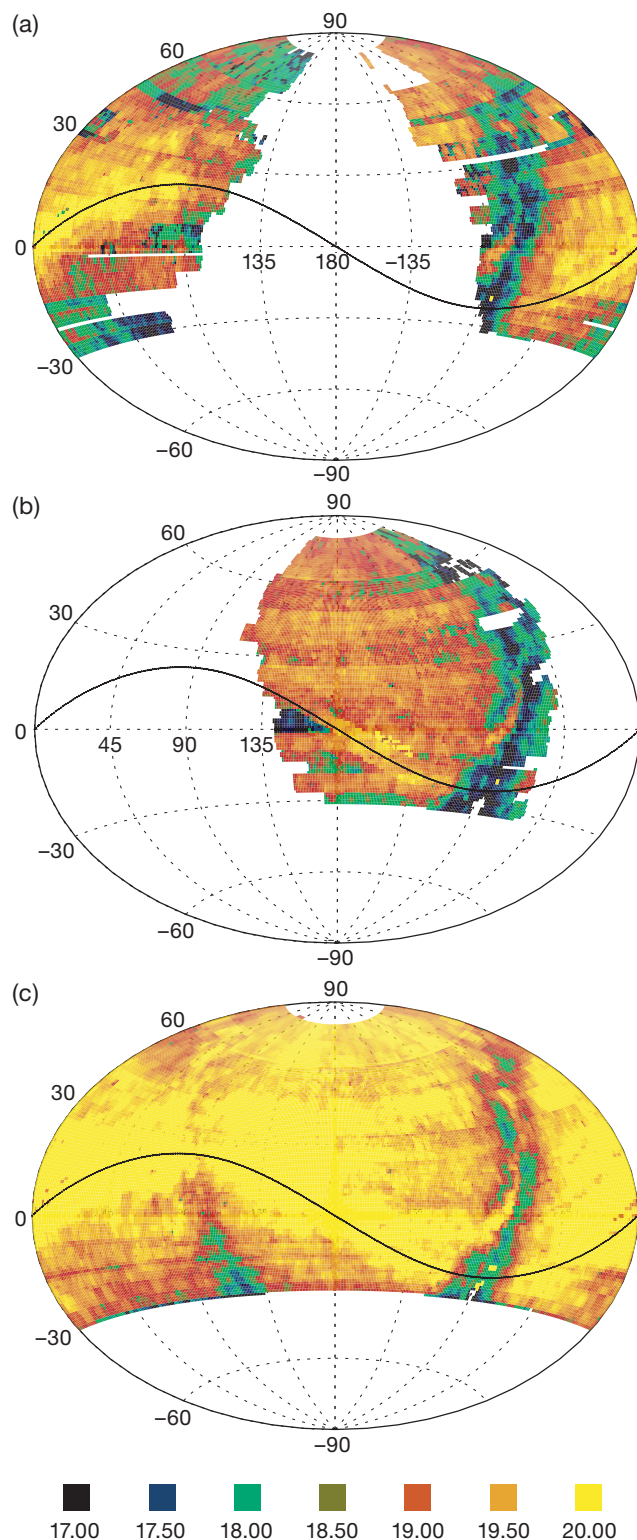
**Figure 23-2**

The CCD developed by Lincoln Laboratory is a large-format, back-illuminated, low-noise, high-quantum-efficiency, fast frame-transfer device.



**Figure 23-3**

The area of sky searched by LINEAR is shown for (a) October 2002, (b) May 2002, and (c) composite coverage from January to December 2002. The depth of search shown is the good-weather, background-corrected, single-frame equivalent limiting magnitude.



**Note**

<sup>1</sup> Material for this section was taken from J.B. Evans, F.C. Shelly, and G.H. Stokes, "Detection and Discovery of Near-Earth Asteroids by the LINEAR Program," *Linc. Lab. J.* **14(2)**, 199–220 (2003).

Figure 23-3 illustrates the sky coverage typically achieved by LINEAR. Normally, the best search experience is during the fall and winter months, when the nights are long and the sky is clear. Figure 23-3a shows typical coverage during a fall or winter month. The oval graph represents the entire sky as seen from the earth. Only about half of the sky is available for search in a given month; the rest is above the horizon only when the sun is up. During the spring and summer time, shown in Figure 23-3b, the nights are not as long, the weather is less conducive to clear skies, and the galactic plane (the Milky Way) is above the horizon. The Milky Way's much larger background of stars increases the sky brightness, thus making it harder to detect asteroids. The areas containing the Milky Way are shown by the darker colors in Figure 23-3b. Figure 23-3c displays the composite coverage of the LINEAR system during the year 2002. These plots have been scaled to show a good-weather, background-corrected, single-frame-equivalent integration time, with the lighter colors displaying increased performance. Note that the LINEAR system is covering nearly the entire sky visible above the site's effective southern declination limit of  $-35^\circ$ .

LINEAR has discovered 40% of all NEA discoveries made during the years of operation from March 1998 through 2008. Responding to the Congressional mandate to discover 90% of all NEAs with diameters larger than 1 km, LINEAR has discovered 326 large NEAs, bringing the total known to 719. In addition to increasing the discovery rate of NEAs, LINEAR has provided significant quantities of search statistics and sky coverage information. This information was used by Scott Stuart, while he was a Lincoln Scholar, to improve the population estimate of large asteroids as part of his thesis research at MIT. Stuart's estimate of the number of large NEAs — about  $1090 \pm 180$  — provided the best statistical estimate of the population of large asteroids available to date and represents a large change from the 2200 thought to exist before LINEAR began searching.

In addition to its discovery of approximately 225,000 asteroids, LINEAR has also discovered more than 200 comets, making it the most prolific ground-based discoverer of comets as well. The sidebar entitled "Contribution of LINEAR to Comet Science" discusses some of the ways LINEAR has fundamentally advanced the study of comets.



## Contribution of LINEAR to Comet Science

In addition to being the world's most productive asteroid search program, LINEAR has profoundly altered the field of comet science. LINEAR's detection algorithm, based on algorithms used to detect earth-orbiting satellites, is fundamentally a moving-object detector. Any object in motion across the fixed star pattern, within the dynamic range of the algorithm (about 0.1 to 10+ deg/day), is duly recorded. Since these rates of motion are characteristic of comets as they enter the inner solar system, LINEAR has discovered more than 200 comets, making it the most prolific ground-based discoverer of comets in history.

Most of the comets discovered by LINEAR are found on their inbound trajectory, as they pass the orbits of Saturn or Jupiter. At this point, the comet starts to brighten as volatile materials are evolved by solar heating, and the comet becomes detectable by LINEAR. Typically, the LINEAR system at this time does not notice any comet-

like trailing feature that would clearly identify the object as cometary. Thus, the comet detection observations are routinely passed to the MPC along with hundreds of thousands of asteroid observations generated each month. At this point, one of two possible actions results in the object being identified as a comet: (1) the orbit of the object is calculated and determined to be comet-like, as opposed to asteroid-like, and the MPC requests an observer with a large telescope to check the object for a tail; (2) if the object is posted on the MPC confirmation page because of its interesting rate of motion, a follow-up observer may detect a tail.

This process of comet discovery is fundamentally different from the process prior to LINEAR operations. In the pre-LINEAR era, amateur observers usually discovered comets by scanning regions close to the sun. By the time a comet is near the sun, it has heated up and formed a characteristic tail, which makes it detectable. The amateur

method has two deficiencies: (1) only comets that travel close enough to the sun and are active enough to develop a large tail are discovered; (2) the comet is discovered only after it has substantially completed its inbound trajectory. Thus, the heating and tail formation process are not observed or recorded. By finding comets far from the sun, LINEAR helps to solve both these issues. Many comets that never form tails large enough to be visible are discovered, and — more importantly — comets are discovered early in their trajectory. This early detection enables comet scientists to gather observations covering the interval in the comets' orbits where they become active, evolve a tail, and break into pieces. In addition, enough warning is provided to allow time to schedule additional observations by other assets such as the Hubble space telescope and the Keck Observatory. These observation opportunities have led to some striking discoveries and have resulted in the dedication of an

entire 2001 issue of *Science* magazine to comets, with a special focus on comet C/1999 S4 LINEAR, which was discovered on September 27, 1999, just inside the orbit of Jupiter (Figure 23-4).

By June 2000, LINEAR S4 had a well-developed tail, as shown in the CCD image in Figure 23-5, and was expected to be visible to the naked eye at a closer approach to the earth (the dark adapted eye at a dark site is sensitive to objects of 5th to 6th magnitude). In reality, LINEAR S4 peaked with an intensity of about 6.5 in late July (visible through binoculars) and then disintegrated from July 21 to 24, 2000. Because of the long time between discovery of LINEAR S4 and its closest approach to earth, the Hubble space telescope was scheduled for observations of LINEAR S4 in July 2000 and recorded the comet's activity and residual cometesimals. These images of comet LINEAR S4 provided a wealth of insight into comet evolution and function (Figure 23-5).

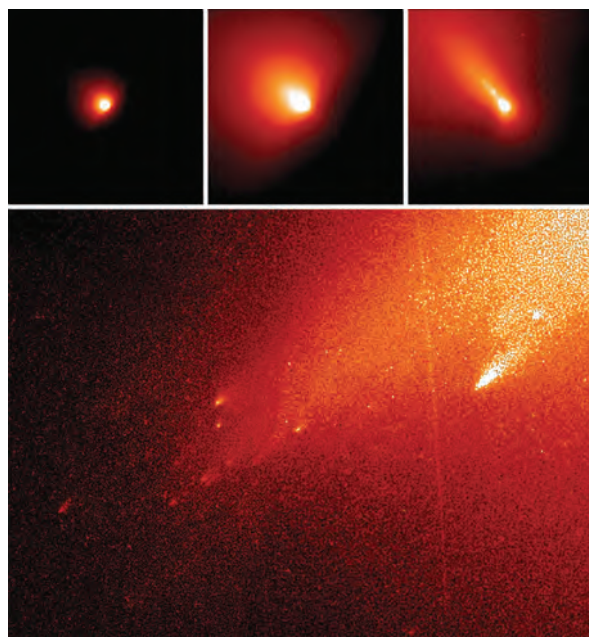
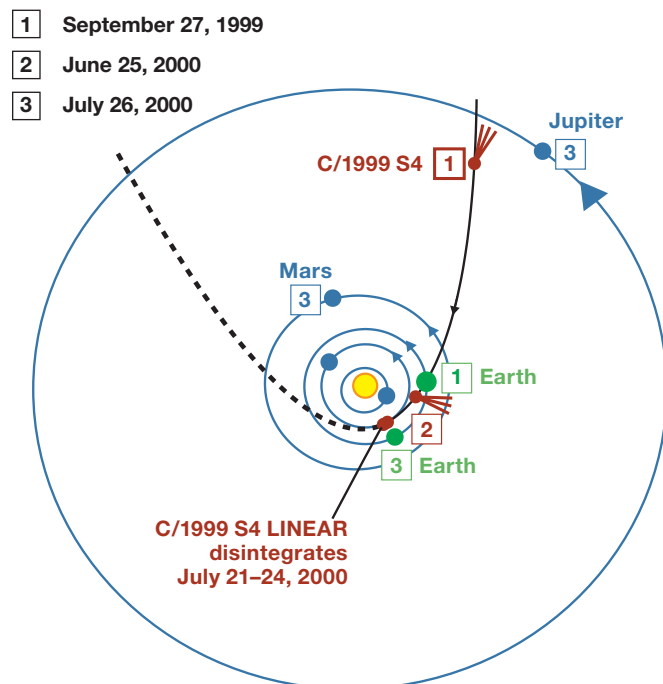


Figure 23-4 (far left)

Path of comet C/1999 S4 LINEAR through the solar system. It was discovered at point 1 and disintegrated near its closest approach to the earth. The position of the earth is shown as a green circle for the discovery epoch (1) and for the disintegration epoch (3).

Figure 23-5 (right)

Top: Hubble space telescope observations showing C/1999 S4 LINEAR flaring up and beginning to disintegrate in early July 2000. Bottom: Later observations show the cometesimals remaining a couple of days after the breakup of LINEAR S4 on July 24, 2000.



### *Interesting Discoveries*

Not surprisingly, among LINEAR's large number of discoveries of asteroids and comets are some interesting and unique objects. The most notable discovery, made in February 2003, is a new class of inner-earth-orbit asteroids: that is, an asteroid — 2003 CP20, which is now numbered and named (163693) Atira — whose orbit is entirely interior to the earth's orbit. The existence of such objects had been theorized for years, but not proven until the discovery of 2003 CP20. LINEAR has also discovered two objects in resonance with the earth, both with unique horseshoe-type orbits, designated 2000 PH5 and 2002 AA29. While 2000 PH5 maintained its horseshoe-type appearance only through the year 2006, 2002 AA29 will likely be the earth's companion for at least another hundred years. In January 2000, LINEAR discovered a sun-grazing asteroid — 2000 BD19 — with the closest known approach to the sun. Even though no cometary activity has been spotted, some astronomers suggest that 2000 BD19 is an extinct comet. In November 2003, LINEAR discovered an object — 2003 WT42 — with the largest known aphelion (distance away from the sun). LINEAR also discovered in June 1999 the first-known retrograde asteroid, which is now numbered and named (20461) Dioretsa.

Besides discovering asteroids with unique orbits, LINEAR has also found a number of asteroids with unique light curves. Radar observations have shown 1999 KW4 and 2000 DP107 to be binary objects, i.e., a pair of asteroids orbiting each other while orbiting the sun. Finally, an early LINEAR discovery — (25143) Itokawa, named at Lincoln Laboratory's request in honor of an early Japanese rocket developer — was chosen by the Japanese as the target destination for the Hayabusa mission to an asteroid. The Hayabusa spacecraft rendezvoused with Itokawa in 2005, and it returned with collected sample in June 2010.

In 2003, members of the LINEAR team participated in a special NASA study to address the feasibility of searching for smaller near-earth asteroids upon the completion of the current NASA goal. The NASA Science Definition Team, composed of a dozen top scientists from around the nation representing the various asteroid search and impact hazard specialties, included Grant Stokes as the chairman and Jenifer Evans as a member. The nine-month study resulted in a report

that recommends the next NASA goal should be to eliminate 90% of the impact hazard risk by detecting 90% of all objects larger than 140 m in diameter. The report also offered a list of technologically feasible asteroid search systems that could accomplish such a goal in a given time period. While the recommended goal is beyond the capability of LINEAR and other current asteroid search systems, it is certainly attainable from space, or from the ground with multiple wide-field-of-view, large-aperture systems. The goal defined by the Science Definition Team has been incorporated into Congressional language directing NASA to engage in the next generation of asteroid search activities.

### **Geosynchronous Satellite Monitoring for Collision Avoidance**

A spacecraft placed in an orbit at an altitude of 35,785 km (22,236 mi) above the earth's surface completes one orbit in exactly one day. Because the orbital velocity matches the spin rate of the earth, a spacecraft in such a circular geosynchronous orbit above the equator appears to hover motionless over a single location on the ground. From this extremely high vantage point, a spacecraft can see effectively about one-third of the earth's surface. This unique advantage of being able to be continuously in direct line of sight with the same large ground area makes this region in space, commonly referred to as the geosynchronous belt, very popular for use for communications, television broadcasting, and weather monitoring.

When a geostationary spacecraft is near the end of its operational life, spacecraft operators typically boost the satellite to a higher disposal graveyard orbit of about 300 km above the geosynchronous altitude so as to minimize any collision threat with other satellites and to reduce congestion. Occasionally, a geostationary satellite unexpectedly fails in its operational location. Because it is no longer under control by ground operators, it tends to drift along the geosynchronous belt. This type of mishap can result in collision between the failed satellite and nearby active geostationary satellites. In order to avoid a collision calamity, high-precision orbits of both the failed spacecraft and its active operational neighbors must be computed and carefully monitored using tracking data from radars and optical sensors. If a potential conjunction is detected, avoidance strategies must be developed to move the active satellite out of harm's way.

## The Ceres Connection: Naming Asteroids in Honor of Excellence in Science

Under the rules of the International Astronomical Union, the discoverer of an asteroid eventually obtains the right to suggest a name for it. In order for an asteroid to be formally numbered, and thus eligible for naming, its orbit must be well determined so that the asteroid will not be lost in the future. Developing a good orbit normally takes a few apparitions, or perhaps five years for a main-belt object. LINEAR has been observing continually since March 1998 and has accrued discovery credit for approximately 225,000 objects, of which more than 100,000 of them have been numbered and are available to be named. Each month several hundred more LINEAR discoveries are numbered, thus continuously adding to the total. By 2001, LINEAR had accrued enough naming rights to precipitate serious thought on how to employ these rights to greatest benefit. Because the International Astronomical Union forbids the use of naming rights for financial gain, operating the search by selling names is not an option. LINEAR was discovering so many asteroids that the team felt an obligation to avoid devaluing the honor of an asteroid name.

After careful consideration, it was decided that the highest and best use of the honor of naming an asteroid was to invest it in promoting science education in the international community. Lincoln Laboratory decided to name LINEAR-discovered asteroids in honor of junior-high-school and high-school students who demonstrated excellence in select science competitions. The name chosen for the asteroid-naming program was Ceres Connection, because Ceres was the first minor planet discovered by Italian astronomer Giuseppe Piazzi in 1801. The Ceres Connection program fits in well with the objectives of Lincoln Laboratory and MIT, and with the educational outreach objectives of NASA. The Ceres Connection was developed in cooperation with Science Service, Inc., (now known as the Society for Science and the Public [SSP]) an organizer and administrator of several national and international competitions. The program was inaugurated on October 23, 2001, with an awards presentation in Washington, D.C., to the 40 finalists and their teachers in the Discovery Science Challenge Competition (now known as the SSP Middle School program). Grant Stokes presented each student and each teacher with a certificate



denoting an officially numbered minor planet named in their honor, along with explanatory material. The minor planet name is either the recipient's last name or, if an asteroid already had that or a similar-sounding name, a name is derived from a combination of the recipient's first and last names.

During the 2001/2002 academic year, the Ceres Connection awarded additional naming honors to the 40 finalists and their teachers in the Intel Science Talent Search, and to 105 student winners at the International Sciences Fair held in Louisville, Kentucky. In addition to rewarding the specific achievements of these

students, the Ceres Connection is intended to promote interest in science education in the broader community by popularizing science. Since the inauguration of the Ceres Connection in October 2001, Stokes, currently head of the Aerospace Division, presents the awards at the Science Talent Search, and Jenifer Evans, a technical staff member in that division's Sensor Technology and System Applications Group, travels to present the awards at the other two ceremonies; more than 2200 top-ranking students and their teachers have returned to the classroom with the message that excellence in science can result in a part of the solar system being officially named in their honor.

1975



The LTS, an interactive teaching tool



A.J. McLaughlin

---

**Note**

**2** A CRDA is a Co-operative Research and Development Agreement legislated by the Federal Technology Transfer Act of 1986. It is a written agreement between a private company and a government agency such as MIT Lincoln Laboratory, a federally funded research and development center (FFRDC), to work together on a project. By entering into a CRDA, the federal government and non-federal partners can optimize their research resources and benefits by cost sharing.

On January 11, 1997, Telstar 401, a television broadcast satellite owned by AT&T, failed on orbit in the geosynchronous belt. The cause of failure was attributed to the occurrence of a geomagnetic storm. Because Telstar 401 was located in a geopotential well of the earth's gravitational field at 97° W longitude when it failed, without station-keeping at its assigned longitude position, Telstar 401 began to drift under natural gravitational forces back and forth about the center of the well at 105.3° W longitude, from 97° to 113°, within approximately a two-and-a-half-year period and became a collision threat to many active satellites along its drift path.

Immediately after the Telstar 401 failure, PanAmSat, which owned several commercial satellites along the drift trajectory of Telstar 401, requested Lincoln Laboratory's support for the provision of conjunction monitoring and warning information to the PanAmSat satellites. Lincoln Laboratory initiated a Cooperative Research and Development Agreement (CRDA)<sup>2</sup> with PanAmSat on Geosynchronous Encounter Analysis. Subsequently, other commercial companies that owned active geostationary satellites along the path of Telstar 401 became CRDA partners with the Laboratory as well. These were GE Americom (now SES Americom), PanAmSat (now owned by Intelsat Global Services), Telesat Canada (now Telesat), and SATMEX. The first close crossing with an active satellite, Galaxy IV, came in June 1997. Lincoln Laboratory analysts estimated that Galaxy IV had a closest approach distance from Telstar 401 of less than 1 km. This information resulted in PanAmSat executing a maneuver strategy that increased the crossing separation with Telstar 401 to a

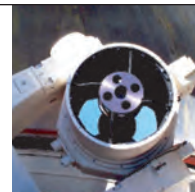
safe distance of 6 km. In that first year, seventeen close crossings of Telstar 401 within 10 km from partner active satellites were detected, resulting in the special maneuvers of six CRDA partners' satellites to increase encounter separation. Because any collision-avoidance maneuver consumes a satellite's propellant, it reduces the operational life span of the satellite and the revenue of the CRDA partner. As a result, these maneuvers are only employed as a last resort.

In order to reduce the number of specific collision-avoidance maneuvers, the Laboratory's orbital analysts, together with CRDA partner operators, began to develop strategies to incorporate these measures into the routine satellite station-keeping maneuvers that are periodically executed to maintain the spacecraft in its geosynchronous operational location. For example, it is often sufficient just by delaying or advancing the date/time of a planned station-keeping maneuver to increase the encounter distance. Since the inception of the CRDA program, the number of end-of-life satellites left in the geosynchronous belt and other space debris, such as apogee kick motors, that this program monitors has increased to close to 500. With the continuous refinement of collision-avoidance strategies, only a handful of dedicated maneuvers per year are now required of the CRDA partners' satellites. In addition, an automated Geosynchronous Monitoring and Warning System, developed and implemented at the Laboratory, incorporates radar and optical sensors tracking data, together with the CRDA partners' satellite downlink ranging data and future maneuver schedules, to produce high-accuracy orbit predictions for use in conjunction assessment and warning.

1990



G.H. Stokes



LINEAR search telescope



---

**Note**

**3** Material for this section was contributed by William Ward. Background material is taken from H. Sherman, "Lincoln Laboratory Participation in the Apollo Program May 1961–May 1963," *Lincoln Laboratory Memorandum 65L-0001*. Lexington, Mass.: MIT Lincoln Laboratory, 22 May 1963.

**Space-Based Radar**

During the 1980s, Lincoln Laboratory conducted a program under the leadership of Vincent Vitto, first in the Aerospace Division and then in the Communications Division, to investigate and demonstrate the technologies necessary for wide-area surveillance space-based radar (SBR) for the detection of moving ground and airborne targets. The basic concept was that a network of phased-array moving target indicator radars in orbit could be used to provide global surveillance of military air activity and furnish warning and cueing information to air defense systems.

Space-based radars are subject to large amounts of interference, both natural and manmade. The problem of suppressing the ground clutter is in itself formidable, because of both the large beam footprint and the wide clutter Doppler spectrum induced by the spacecraft motion. Added to that is the problem of suppressing intentional jamming. The jamming threat was projected to be severe because of the visibility of an SBR to large areas on the ground. Therefore, a substantial part of the effort was devoted to developing the means for dealing with these interference sources.

Goals established for interference suppression were 50 dB of clutter cancellation (with respect to the level that would otherwise have been present in a range-Doppler resolution cell) and 50 dB of sidelobe jammer nulling (with respect to the average sidelobe level). An adaptive-nulling and clutter-cancellation architecture suitable for space implementation was developed, as were techniques for achieving the adaptive cancellation goals. These techniques were demonstrated by using a series of test articles and test beds, including antennas, nulling receivers, and digital signal processing hardware and software. These devices and systems were exercised on the bench and in near- and far-field test ranges. The test articles were not space qualified, but results did confirm the ability to achieve the desired levels of interference suppression.

Also of critical importance to an SBR is the development of appropriate transmit/receive (T/R) modules. In a corporate-fed phased-array radar, one T/R module is associated with each antenna element. The transmit section of the module must provide (typically) several watts of average radio-frequency

(RF) output power with necessarily high efficiency in order to minimize the load on the spacecraft power system. The receive section of the module needs a noise figure on the order of 2 dB or less and a dynamic range on the order of 60 dB, again while minimizing the power dissipation. Finally, interference cancellation techniques demand careful control of variable RF phase shifters and attenuators. Since thousands of T/R modules could be required for each SBR, their weight is a major concern.

Under the Space Radar Technology program, Lincoln Laboratory developed some of the necessary component technologies and sponsored a number of component development efforts in industry. The Laboratory also supported the sponsor in contracting for preliminary versions of T/R modules and in testing and evaluating the resulting T/R modules produced by industry.

Although no operational military SBR surveillance system has been deployed, this program greatly reduced the technological risks should such a system be required in the future. The Space Radar Technology program also demonstrated performance levels and advanced technologies likely to see use in other radar applications.

**Manned Space Flight**

The Soviet launch of Sputnik I on October 4, 1957, prompted the United States to begin a manned-space-flight effort. Just one year later, the creation of NASA and the start of Project Mercury — the program to put an American into space — were concurrently announced.<sup>3</sup>

Project Mercury was carried out in a hurry. The first of two manned suborbital flights took place on May 5, 1961, about two years after NASA assigned the prime contract for the capsule to McDonnell Aircraft. Five manned orbital flights followed in short order.

The several streams of data coming from and going to the capsule had to be integrated on the ground so that the Mercury Control Center at Cape Canaveral, Florida, could make good decisions about the progress of a mission and could implement them reliably. There was also an urgent need for expertise in acquiring and tracking the capsule by radar from various stations in the range and for transmitting the tracking data to the Goddard Space Flight Center in Greenbelt, Maryland.

The overall task of developing the Mercury worldwide ground tracking range was similar in many ways to the tracking problem of the Semi-Automatic Ground Environment (SAGE) system (see chapter 2, “The SAGE Air Defense System”). The Project Mercury task was easier than SAGE because there was only one target. SAGE, however, was designed to detect objects moving much more slowly than the Mercury capsule. Because Lincoln Laboratory certainly had more experience in tracking than any other organization, NASA awarded a contract to the Laboratory to study all phases of tracking and computation for Project Mercury.

Lincoln Laboratory predicted radar-tracking problems for the Mercury capsule long before the first suborbital flight, and a number of remedies were suggested and implemented. Because of the time pressure on the Project Mercury effort, the tracking range was made up of radars that were already available. For the most part, the worldwide ground tracking range comprised C-band AN/FPS-16 radars and S-band very-long-range trackers (VERLORT).

Lincoln Laboratory improved the C-band AN/FPS-16 radar in Bermuda with a larger, higher-gain antenna, a more powerful transmitter, and a more sensitive receiver. The S-band VERLORT located there was given a more sensitive receiver.

Antenna deficiencies in the C-band tracking-radar beacon transponder in the capsule were identified and remedied. In the face of widespread opinion to the contrary, Lincoln Laboratory predicted unacceptably low-quality radar tracking during the crucial period of measuring the orbital insertion parameters. The Laboratory implemented a suggestion made by A.E. Hoffman-Heyden of RCA Service Company and developed a system design for a time-varying ferrite phase shifter, which turned out to be of great importance when the prediction of poor tracking was fulfilled during the first unmanned Mercury-Atlas orbital flight.

The phase shifter was placed in series with the C-band antenna elements, filling in the interference nulls between the main lobes of the elements. The first orbital flight with a chimpanzee on board, November 29, 1961, carried a single RF phase shifter in series with a C-band antenna element. Radar tracking was much improved.

The first manned orbital flight, that of astronaut John Glenn on February 20, 1962, carried the full two RF phase shifters, as did the remaining Mercury missions. Performance was excellent and the phase shifters were also used on the two-man Gemini flights. At Lincoln Laboratory’s recommendation, the orientation of the capsule in flight was changed to give better antenna-pattern performance in the direction of the tracking radars.

Operator performance was another problem area. Because flights were separated by several months, the individuals in charge of tracking and acquisition needed assistance in maintaining their skills between missions. At the urgent request of NASA, and on an extremely short time schedule, Lincoln Laboratory developed and tested the vibroacoustic test (VAT) and RAZEL simulators and installed them at three of the tracking stations in the worldwide ground tracking range.

Lincoln Laboratory accurately predicted that, as a result of ground reflections and end-on capsule antenna patterns, communications at most tracking stations would be inadequate as the capsule came over the horizon. The contractor for this part of the capsule electronics, the Collins Radio Company, changed the antenna design and solved the problem.

The original design of the computation complex had substantial problems. An alternative design was formulated, and it formed the basis for a substantial revision in the unified Goddard computer system.

In May 1961, President John F. Kennedy announced Project Apollo, the mission to land an American on the moon by the end of the decade. A year later, a small Laboratory effort that had been advising NASA on communications problems encountered during atmospheric reentry by the Mercury and Gemini manned orbital space capsules was expanded to study spacecraft telecommunications and associated ground support for Project Apollo. The focus of the Lincoln Laboratory effort was on combining all the telemetry functions, the voice communications, and the ranging code onto a single S-band carrier. This approach was demonstrated to NASA with prototype equipment constructed in the Radar Division and became the basis for the communications approach used in Project Apollo.

---

**Note**

**4** For a further description of this program, see H.E. Sherman and A.L. Komaroff, *Ambulatory Care Project, Final Contract Report 14A, 30 June 1969 to 29 February 1976*. Lexington, Mass.: MIT Lincoln Laboratory, 1976.

As Project Apollo moved into the implementation phase, NASA support for the Lincoln Laboratory activity declined. A gallium arsenide laser radar was developed for possible application on the moon prior to the end of the Laboratory role in Project Apollo in 1964.

**Ambulatory Health Care**

Two Lincoln Laboratory engineers, Herbert Sherman and Barney Reiffen, initiated a program on health care in 1969. The program focused on the delivery of ambulatory health care, that is, caring for nonhospitalized patients.<sup>4</sup>

Ambulatory visits can be classified into two categories: acute and chronic. Sherman and Reiffen observed that most acute-care ambulatory visits were due to a small number of complaints, such as colds, headaches, or abdominal pain. Similarly, most chronic-care ambulatory visits were for a small number of conditions, for example, hypertension or diabetes. These visits were usually straightforward and routine. Sherman and Reiffen proposed that through the use of standardized protocols, one for each of the most common acute complaints and chronic diseases, health practitioners other than physicians could handle the majority of medical visits.

Each protocol was an algorithm that described the appropriate data to be taken during an ambulatory visit for a given problem. These data derived from the history, physical examination, and laboratory tests. Once the data were collected, the protocol gave precise rules for action. The protocols incorporated branching logic, so that the data collected and the medical action recommended could be adapted to each patient's clinical picture. Of course, the protocols always called for physician intervention whenever a patient's condition failed to fit within the standard parameters.

One of the most useful applications for the protocols was in well-child care. For healthy children, a health-care practitioner with only a high-school diploma could use the protocols to provide the same care as a pediatrician — allowing the pediatrician more time to devote to patients whose problems were serious and complex.

In 1969, when the ambulatory care project began, computers and online service were expensive. Therefore, the protocols were not implemented as software; they were printed on paper (Figure 23–6).

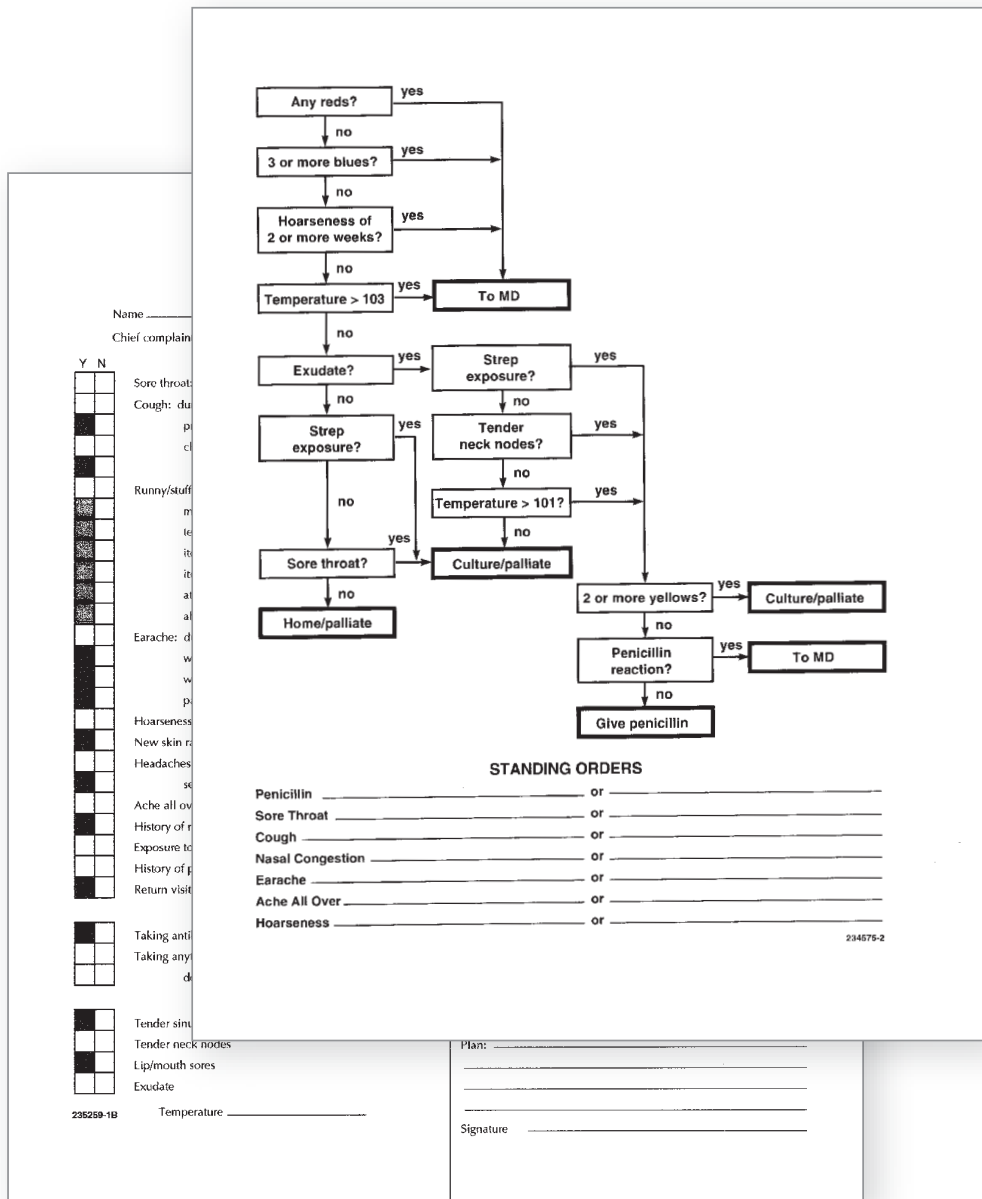
The most attractive feature of the protocols was that their use supported the role of health aides in the effort to address the problem of the maldistribution of physicians. Although the United States as a whole had an ample supply of medical doctors, many parts of the country, particularly in rural areas and inner cities, had severe shortages. The Laboratory-developed protocols gave health aides the tools they needed to increase the availability of medical care to patients in those areas.

The ambulatory care project was conducted by Lincoln Laboratory under a contract with the Department of Health, Education, and Welfare. Beth Israel Hospital of Boston was a full collaborator, its work supported by a subcontract. Lincoln Laboratory staff developed the concepts; the Beth Israel staff provided the medical contents of the protocols and tested their reliability.

The development of each protocol involved an intensive review of the medical literature, consultation with experts on the ailment under study, and interviews with physicians in primary-care practice. When the protocol content and medical logic were finalized, a validation study was performed. Typically, this study involved the random allocation of patients with a particular medical problem into an experimental group in which they were cared for by health aides using the protocols with physician consultation, or into a control group in which they were managed only by physicians. Thoroughness of the recorded evaluation, accuracy of diagnosis, relief of symptoms, expressed patient satisfaction, and the development of unrecognized illnesses were evaluated by medical record review and telephone follow-up.

The ambulatory health care project was a technical success. Follow-up studies evaluated the time spent by the health practitioner, the physician, and the patient in each group. Depending upon the medical problem being addressed, a physician time-saving of 20 to 90% was achieved.





**Figure 23-6**  
**Protocol developed in 1972 for the**  
**diagnosis of upper respiratory**  
**complaints.**

Health aides using the protocols sometimes provided even better care than physicians. In a comparative study of the treatment of patients with high blood pressure, results for the group monitored by health aides were better than for the control group under physician care. The advantage of the protocols was that health aides using them never omitted questions; physicians occasionally either forgot questions or failed to follow up on a patient's response.

Over the course of the ambulatory care program, a library of fourteen protocols was created: five for ongoing conditions, including well-child and prenatal care, and nine for acute complaints. The protocols covered an estimated 50% of all ambulatory visits.

Approximately 15,000 protocols and more than 1600 copies of supporting materials were sold to over 300 private practices, community clinics, hospital outpatient departments, health maintenance organizations, and training programs in 40 states and 12 foreign countries. Four states — California, Massachusetts, Tennessee, and Washington — changed their laws to encourage expanded roles for nurses and physician assistants if they used protocols.

In the end, however, protocol use did not become widely established. The physician shortage of the 1960s led to increased medical school enrollments, which in turn relieved the shortage. Furthermore, there was a large expansion in the use of semiprofessional physician assistants and nurse practitioners, who tended to shun formal protocols because they minimized subjectivity in dealing with patients. The utilization of nonprofessional health aides administering protocols did not find a place in U.S. medical practice.

Lincoln Laboratory's role in the ambulatory health care project ended in 1976, but Beth Israel Hospital continued the work and extended the applicability of protocols.



**Figure 23-7**  
Louis Hallowell using LTS.

### Educational Technology

Lincoln Laboratory initiated a program on educational technology in 1970 with the objective of developing an automated training system for self-paced instruction. The outcome of that effort was the Lincoln Training System (LTS), an interactive teaching machine (Figure 23-7).<sup>5</sup>

Jointly supported by the Air Force and Advanced Research Projects Agency (ARPA), the Lincoln Laboratory educational technology group concentrated on computer-aided instruction for the military environment. By 1975, the usefulness of LTS for civilian applications had become apparent, and the Bureau of Mines began a program that supported development of instructional aids for safety training in the mining community.

The heart of the LTS concept was its use of microfiche (4 × 6-inch film cards) as the storage medium (Figure 23-8). Work carried out at Lincoln Laboratory — principally by teams led by Frederick Frick, William Harris, and David Karp and subsequently by Alan McLaughlin and Robert Butman — made it possible to integrate visual images, voice-quality audio, and control logic on a single microfiche. Therefore, each LTS could provide lesson-specific information at each student's terminal; it was an interactive learning system at a time when interactive computers were complex and expensive.

The first system to undergo testing, LTS-3, consisted of a DEC PDP-8/I computer and five terminals for student instruction. The central computer held lesson material, interpreted student responses, and recorded student performance. Each terminal comprised an Image Systems Model 201 CARD reader (modified to give improved frame registration), a dual video/audio projection system, a solid-state photodiode tracker-reader assembly for the audio, and a keyboard. Audio for each frame was stored on a spirally recorded optical track that could contain up to 28 seconds of speech.

Early in 1972, the 3380th Technical School of the Air Force Training Command conducted a field test of the LTS-3 at Keesler Air Force Base, Mississippi. Course material for the test was developed by a team of Air Force classroom instructors and consisted of 30 hours of material from the Standardized Electronic Principles Course. The authors prepared the visual display, audio script, and specifications for control logic.

The LTS-3 reduced training time by 37% with no loss in student achievement. Students and instructors were uniformly enthusiastic about the system.

The success of the Keesler trial led to an effort to design a more economical system. The LTS-3 random-access microfiche selector could hold 780 microfiches; for the LTS-4, a microfiche selector that could hold only 30 microfiches was chosen, still enough for an hour of learning.

To reduce costs, LTS-4 was designed to be a stand-alone system; the shared PDP-8 was replaced by state-of-the-art microprocessor-based hardware. The use of microprocessors provided another advantage: it permitted individual training at remote locations.

In 1975, at the end of the LTS-4 development period, the DoD ended its support of the educational technology program. The Bureau of Mines funded the program for an additional five years to develop stand-alone systems and instructional materials for training miners in safety procedures.

The last Bureau of Mines task, initiated in 1979, asked Lincoln Laboratory to produce a book to bring stand-alone teaching equipment into the mining community. The next year, Lincoln Laboratory issued the *Guide to Computer-Text Training*, which taught instructors with little or no computer experience how to develop lesson materials.<sup>6</sup>

The commercial availability of the personal computer and video disks changed the computer-aided instruction field. Mass-marketed software became commonplace, and Lincoln Laboratory carried out no further work on educational technology for a decade.

### *The Partners in Manufacturing Education Project*

In 1989, in the interest of enhancing American competitiveness in manufacturing, Lincoln Laboratory, under the leadership of Alan McLaughlin, then head of the Computer Technology Division, and Harold Heggstad, resumed its work on the development of training aids that make use of computer-assisted instruction techniques. The focus of the new Lincoln Laboratory initiative was on educating the workforce to perform well in the flexible, adaptable manufacturing environment of the 1990s.

### Notes

<sup>5</sup> Material for this section is taken from two sources: R.C. Butman and F.C. Frick, *The Lincoln Training System: A Summary Report, Technical Note 1972-26*, 3 October 1972; and R.C. Butman and W.P. Harris, *Educational Technology Program, Final Report*, 28 October 1980.

<sup>6</sup> W.P. Harris, *Guide to Computer-Text Training*, 6 August 1980. Lexington, Mass.: MIT Lincoln Laboratory, 1980.



**Figure 23-8**  
**Audio/graphic fiche for the educational technology program.**

The chosen means to this end was the formation of a partnership, including Lincoln Laboratory, educational institutions, and industry, whose goal was the development of a hands-on laboratory-based manufacturing technology curriculum that would produce graduates who could function efficiently, adapt to changing conditions, solve problems as they occurred, and contribute to the evolution of manufacturing processes in the workplace.<sup>7</sup>

The school selected for this activity was the Minuteman Science and Technology High School in Lexington, Massachusetts. Minuteman Tech provides vocational and technical training to students in sixteen neighboring towns. Its students are typically hands-on, mechanically oriented, and inclined to learn by doing.

On the basis of discussions with Minuteman Tech, the need for early industry involvement in the program was identified. The Partners in Manufacturing Education Working Group was formed, chaired by Heggstad, then associate leader of Lincoln Laboratory's Machine Intelligence Technology Group, and including McLaughlin and representatives from the MIT campus, Harvard University, Digital Equipment Corporation, Raytheon, Polaroid, Vermont Circuits, Minuteman Tech, Middlesex Community College, and the University of Massachusetts at Lowell. These partners committed effort, expertise, personnel, and equipment to the creation of a manufacturing training program at Minuteman Tech.

In 1990, as a result of collaborative proposal efforts by Minuteman Tech and Lincoln Laboratory, the school was awarded a National Science Foundation grant of \$151,000 for a four-year project entitled "Math/Science Enhanced Manufacturing Center." The development effort was directed by Ronald Fitzgerald, Superintendent-Director of Minuteman Tech.

Lincoln Laboratory continued to coordinate industry/school activities. A teacher from the Acton-Boxborough (Massachusetts) Public Schools worked at Lincoln Laboratory on the project. Digital Equipment Corporation and Raytheon provided teams of engineers to assist in designing the manufacturing curriculum and in teaching the students, and these companies also provided modern equipment for a manufacturing line in a laboratory space newly refurbished by Minuteman Tech.

A three-year curriculum was developed; it used a real manufacturing facility and produced real products. The first manufactured output was completed in the spring term of 1993 — nine copies of a Digital Equipment Corporation voice-synthesis subsystem known as MULTIVOICE for use by voice-impaired individuals. Lincoln Laboratory's involvement then evolved to an advisory role to Minuteman Tech.

### Highway Management

The term Intelligent Vehicle/Highway Systems (IVHS) describes a broad range of concepts that apply technology to problems of congestion and safety on road networks. Since Lincoln Laboratory had an ongoing involvement in surveillance and control systems for military applications and air traffic control, it could make contributions to IVHS-related activities. IVHS work at the Laboratory benefited from contact with researchers on campus, and joint projects with the MIT Center for Transportation Studies proved productive.<sup>8</sup>

In 1991, the Laboratory undertook an investigation of emerging IVHS needs and identified items of technology necessary for the demonstration of IVHS capabilities.<sup>9</sup> In 1992, the Laboratory became a partner with the MIT Center for Transportation Studies in a project aimed at verifying and enhancing the sensing and control elements of Boston's Central Artery/Third Harbor Tunnel project. This project involved simulation of traffic flow, a study of efficient use of sensor data, and analysis of the project control system.

In 1993, the Laboratory initiated a project to introduce new capabilities for urban traffic management into the Boston Traffic Control Center (BTCC), located at Boston City Hall. The BTCC was connected via two-way underground cable to more than 325 signalized intersections in Boston, and the Laboratory project concluded with the development of a graphical user interface to the traffic sensor data that demonstrated a limited ability to predict congestion and suggest suitable BTCC responses to problems.

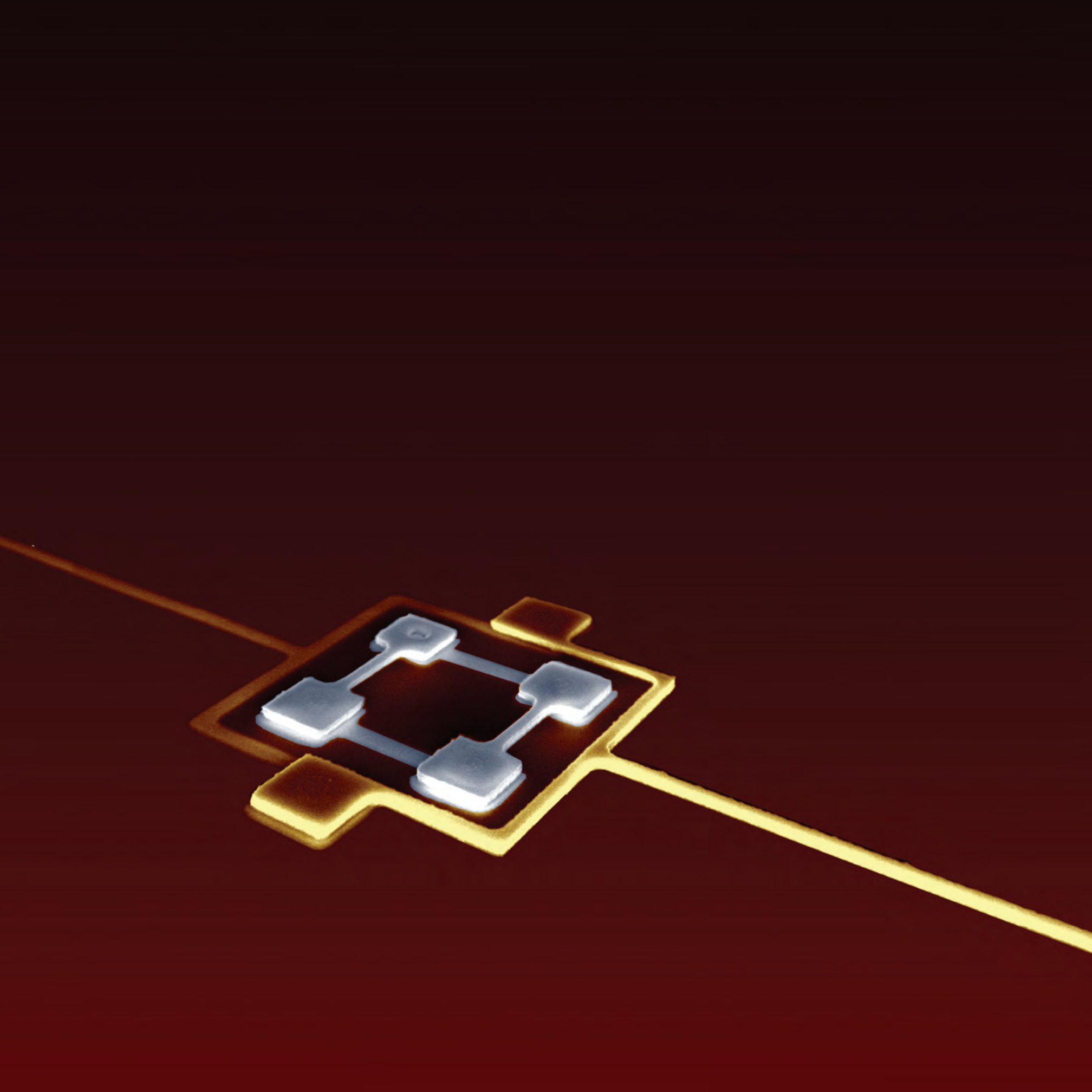
### Notes

<sup>7</sup> This section was contributed by Harold Heggstad.

<sup>8</sup> This section was contributed by John Andrews.

<sup>9</sup> A.F. Hotz, C.H. Much, and T.J. Gobllick, eds., "Advanced Traffic Management Technology Development and Field Demonstration," *Lincoln Laboratory Project Report ACC-1*. Lexington, Mass.: MIT Lincoln Laboratory, 21 February 1992.





**Research in solid-state devices and materials provides an essential foundation for all advanced electronic technologies. Solid-state devices pioneered and developed at the Laboratory have been incorporated into a broad array of applications meeting specialized needs.**

**Left: Superconducting quantum bits (qubits) are being fabricated and manipulated with increasing complexity and precision as artificial atoms. The single qubit is approximately 20  $\mu\text{m}$  on each side. The ultimate goal of this work is to create a quantum computer.**

Solid-state-device and materials research has played an important role at Lincoln Laboratory since the Laboratory's founding. Over the first two decades, a major goal of the solid-state program was to establish an understanding of the physics of a wide range of materials. In the subsequent four decades, research efforts turned to applications, with a strong emphasis on developing devices to meet military needs and the specialized requirements of other Laboratory programs.

The history of research in the solid-state area described in this chapter progressed through three eras: basic research in materials and devices (1951–1971); applied research in materials, devices, and circuits (1972–1992); and advanced technology development in integrated subsystems (1993–2011 and beyond).

Even during the early 1950s, when the work of every staff member was directed toward completing the design of the Semi-Automatic Ground Environment (SAGE) air defense system, basic research in solid-state physics received strong support from Lincoln Laboratory management. Professor Jerrold Zacharias, the first associate director of the Laboratory, was particularly interested in this area because he was among the first to recognize the potential of the transistor for fast, reliable computer operation. Therefore, he decided to create a group to study the physics and applications of semiconductors. Zacharias recruited Richard Adler, then a young professor of electrical engineering at MIT, to head what became the Solid State and Transistor Group. Once Adler was on board, he began to recruit other physicists, engineers, and chemists. In summer 1951, the first staff members joined the group. By the end of the year, the group consisted of about 20 professional staff members, and by the end of 1952, more than 50.

In summer 1953, a group to study ferrites was formed with Benjamin Lax as group leader. Also in 1953, Adler returned to his teaching duties on the campus, and MIT Professor Earl Thomas became leader of the Solid State and Transistor Group, a post he held for two years. Thomas left Lincoln Laboratory in 1955 and Lax was appointed as his successor. The two solid-state groups were then merged into one, the Solid State Group.

By 1958, the growing reputation and size of the Solid State Group made an administrative change imperative. The group, which had been a part of the Communications Division, was set up as a new division, the Solid State Division, with Lax as the head. From this point on, research expanded into a wide range of areas within the general solid-state field, with particular emphasis on quantum electronics and solid-state devices. Lax continued as division head until 1964, when he was succeeded by Harry Gatos. Professor Alan McWhorter was appointed head of the Solid State Division in 1965 and held the position until 1994, when he became the first division fellow and David Shaver became division head.

Examples of the Laboratory's contributions to solid-state science during the 1950s and 1960s include experiments on cyclotron resonance in semiconductors and the development of magneto-optical spectroscopy. The techniques in these experiments provided the data necessary to determine the nature of the band structure and the properties of charge carriers in semiconductors. Studies of ferrites were interwoven with applications of materials in isolators and phase shifters for microwave radar. Experiments in magneto-optics led to the development of Faraday rotation isolators for the Firepond laser radar. Key contributions in the emerging field of quantum electronics included the development of the first three-level solid-state maser amplifier and the experimental confirmation of its extremely low-noise operation. Basic studies of injection luminescence in GaAs led to the invention of the diode laser in 1962, which initiated a highly productive period in quantum electronics research and later led to the development of ionic solid-state, gas, and other semiconductor lasers.

These twenty years of extraordinarily productive research in solid-state physics were funded by the Department of Defense (DoD). In 1971, however, a major change in the nature of the work in the Solid State Division took place. In response to a national reaction against the defense department funding research in a broad range of nonmilitary areas, the U.S. Congress passed the Mansfield Amendment, which instituted the requirement that DoD-sponsored work be directly relevant to DoD needs.

Partly in response to this requirement and partly because of an overall change in the research climate, the basic research activities of the Solid State Division were virtually eliminated and efforts were redirected toward device development and engineering for DoD applications. The Solid State Division had built a strong base in advanced materials and device technology, an in-depth understanding of the underlying physics, and a tradition of technological excellence over the first two decades: it was, thus, well positioned to make contributions at the forefront of device technology.

The applied device research during the 1970s and 1980s covered a broad spectrum, and included electronic and electro-optical devices for sensing, communications, and signal processing. Through a combination of invention, sophisticated design, and innovative fabrication techniques, an advanced analog surface-acoustic-wave (SAW) device technology was pioneered for radar and communications signal processing. Compact SAW reflective array compressor devices were invented at Lincoln Laboratory and engineered for use in the Advanced Research Projects Agency (ARPA) Lincoln C-band Observables Radar (ALCOR) and later for microwave satellite communications systems.

Quaternary lasers operating in the 1.3 to 1.5  $\mu\text{m}$  wavelength range were developed; these are still used throughout the world in fiber communications. Titanium sapphire lasers, invented and developed at the Laboratory, are now in commercial use in applications requiring broad wavelength tunability. HgCdTe wide-band receivers were developed for the Firepond laser radar, and high-performance PtSi Schottky barrier focal-plane arrays were developed for theater missile defense. Highly sensitive large-array charge-coupled-device (CCD) imagers were developed to detect and track space objects at visible wavelengths. Microwave devices explored include impact ionization avalanche transit-time (IMPATT) diodes, planar mixers, permeable-base transistors, and resonant tunneling diodes.

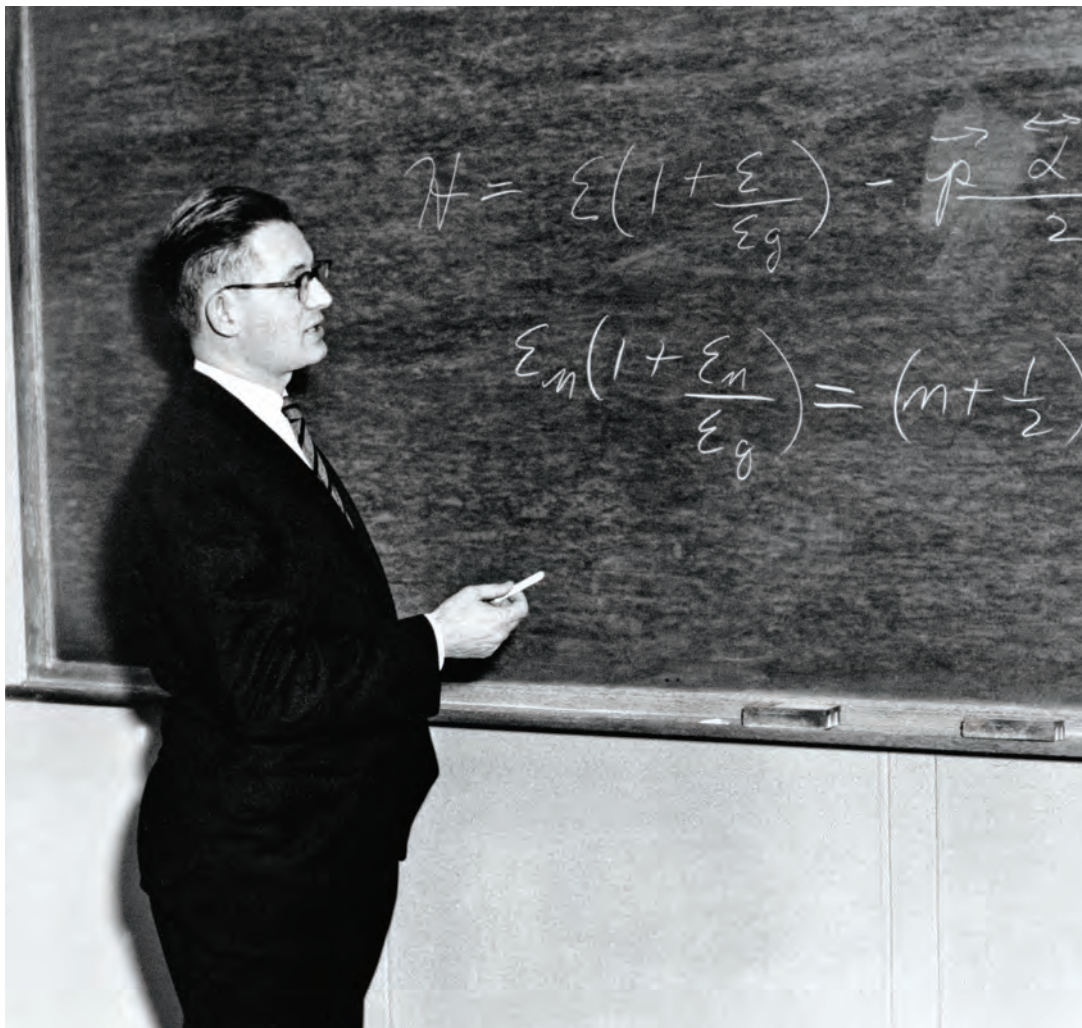
Underlying the device work were strong efforts in materials technology, particularly in bulk crystal growth, molecular-beam, and organometallic-vapor-phase epitaxy techniques, and device and integrated-circuit processing. Examples in the processing area include key contributions in ion implantation, the invention

of X-ray lithography, and the initiation of both laser photochemical processing and excimer laser lithography.

The most recent era of advanced technology development in integrated subsystems began in the early 1990s and continues at the time of this writing. A major enabler for highly integrated electronics and electro-optics was the commissioning in 1992 of a research integrated-circuit fabrication facility, the Microelectronics Laboratory. Biology laboratories were also established, chemistry and circuit-test facilities were upgraded, and computer-aided design for circuits was enhanced. More recently, a facility for cryogenic demonstration of superconductive quantum circuits was established.

Although many new devices continue to be based on solid-state electronic or electro-optical technologies, recent work is now highly multidisciplinary, and devices increasingly exploit biotechnology and innovative chemistry. The division's name was changed to the Advanced Technology Division in May 2010 in recognition of the broad research scope. The Advanced Technology work includes the development of unique high-performance detectors and focal planes, three-dimensional integrated circuits, biological and chemical agent sensors, diode lasers, and photonic devices using compound semiconductors and silicon-based technologies, microelectromechanical devices, radio-frequency (RF) technology, and unique lasers, including high-power fiber and cryogenic lasers. Indeed, it is in large part because of the close vertical integration of device physics with solid-state science, materials and processing technology, and other disciplines that the Advanced Technology Division maintains an international reputation as one of the premier participants in the field. The crucial combination of staff innovation, awareness of DoD application needs, and Laboratory facilities enabled the development of several integrated systems through prototype field demonstration. Examples include the engineering development and transition to industry of 193 nm excimer laser lithography, chirp-filter-based electronic-intercept receivers, trace explosives detection, large-format imagers (see chapter 26, "Charge-Coupled Imagers"), high-power lasers (see chapter 25, "Laser Systems"), photon-counting laser radar (see chapter 27, "Photon-Counting Laser Radar"), and biological-agent detection and identification (see chapter 17, "Biological and Chemical Defense").





**Figure 24-1**  
**Benjamin Lax explains the theory**  
**of cyclotron resonance in indium**  
**antimonide and bismuth.**

### **Basic Solid-State Physics and Device Research (1951–1971)**

By 1952, under Adler, the solid-state programs began to take shape. The physicists and electrical engineers built and acquired equipment for measuring the properties of transistor devices. The chemists assembled equipment for growing crystals and for exploring the chemical and surface properties of semiconductors.

A visit by Lester Hogan of Bell Telephone Laboratories in 1952 excited the interest of Robert Fox and Lax in the potential of ferrites for microwave radar applications. In summer 1953, they were authorized to form the Ferrite Group with Lax as group leader. He soon recognized that the program offered an extraordinary opportunity for basic research: the same microwave techniques that were being used for device development could be exploited to uncover the fundamental properties of ferrites and of semiconductors.

Thus began a highly successful program in resonance spectroscopy of solids. Most notable among the group's achievements were measurements of cyclotron resonance in germanium and silicon. These experiments measured for the first time the values of the tensor masses of electrons and the mass parameters of holes in these materials, and they enabled the first detailed models of the band structures of semiconductors.

The cyclotron resonance work triggered research in the United States, Europe, and elsewhere that led to an understanding of the basic transport and optical properties of semiconductors. As an indication of the respect the international community had developed for Lincoln Laboratory's program, the American Physical Society awarded the 1960 Buckley Prize to Lax for the development of cyclotron resonance and magneto-optical spectroscopy (Figure 24-1).

The year 1954 began a productive period for solid-state research at Lincoln Laboratory. The Ferrite Group presented for the first time complete data about the energy band structures for both electrons and holes in germanium and silicon. The results stirred a great deal of excitement because the understanding of the carrier transport properties saw immediate application in device design. The Ferrite Group also began theoretical and experimental work on ferrite devices for radar applications.

## List of Chemical Symbols Used in Solid-State Research

The symbols listed below may be used in this chapter when explaining Lincoln Laboratory's role in solid-state research.

Symbol	Material	Symbol	Material
Al	Aluminum	Li	Lithium
As	Arsenic	Mg	Magnesium
Ba	Barium	Mn	Manganese
Be	Beryllium	N	Nitrogen
Bi	Bismuth	Na	Sodium
C	Carbon	Nb	Niobium
Ca	Calcium	Nd	Neodymium
Cd	Cadmium	O	Oxygen
Ce	Cerium	P	Phosphorus
Cl	Chlorine	Pb	Lead
Co	Cobalt	Pt	Platinum
Cr	Chromium	S	Sulfur
Cu	Copper	Sb	Antimony
F	Fluorine	Se	Selenium
Fe	Iron	Si	Silicon
Ga	Gallium	Sn	Tin
Gd	Gadolinium	Te	Tellurium
Ge	Germanium	Ti	Titanium
H	Hydrogen	U	Uranium
He	Helium	Y	Yttrium
Hg	Mercury	Zn	Zinc
In	Indium		

The Solid State Group began its work on surfaces, ultimately leading McWhorter to formulate a theory of the  $1/f$  noise in semiconductor devices that tied it to fundamental physical processes at the semiconductor surface, and to publish a paper on the subject that became a classic in the field.<sup>1</sup> The group also developed a theory of the transient response of  $p-n$  junction and related devices that is still cited in the literature.<sup>2</sup>

With the merger of the Ferrite and Solid State Groups in 1955, interest began to broaden into magneto-optics and quantum electronics. In spring 1956, the Solid State Group announced its plan to use the Bitter magnet concept to produce extremely high dc magnetic fields, which would enable scientists to perform various experiments in solid-state transport and spectroscopy that were difficult with pulsed fields. The goal was to produce a field of 250 kG, 2.5 times that achieved by Professor Francis Bitter in the basement of Building 6 at MIT. The results of this effort ultimately led to the creation of the Francis Bitter National Magnet Laboratory at MIT.

### Ferrites

After Hogan visited Lincoln Laboratory and explained how Faraday rotation could be used to make a nonreciprocal device that operated at microwave frequencies,<sup>3</sup> the Solid State Group began a program to study the properties of ferrites and to develop devices for modern radars, including isolators, circulators, and phase shifters. Not long after Hogan initiated the use of ferrites by applying Faraday rotation, a new concept was introduced by a group at the Naval Research Laboratory. They proposed a circulator that utilized a single rectangular slab in a rectangular waveguide; this device also exhibited nonreciprocal behavior.

The rectangular waveguide turned out to provide a seminal problem, and its solution was analytically obtained and numerically analyzed by Lax, Kenneth Button, and Laura Roth.<sup>4</sup> Further analysis led to the invention of the twin-slab configuration, which is still used in phased arrays employing ferrite phase shifters.

Extensive experimental measurements of differential nonreciprocal phase shifts in rectangular waveguides containing ferrite slabs for various different ferrite parameters at a variety of microwave frequencies were

## Notes

**1** A.L. McWhorter, "1/f Noise and Germanium Surface Properties," in *Semiconductor Surface Physics*, R.H. Kingston, ed., Philadelphia: University of Pennsylvania Press, 1957, p. 207.

**2** R.H. Kingston, "Switching Time in Junction Diodes and Junction Transistors," *Proc. IRE* **42**, 829–834 (1954).

**3** C.L. Hogan, "The Ferromagnetic Faraday Effect at Microwave Frequencies and Its Applications: The Microwave Gyrator," *Bell System Tech. J.* **31**, 1–31 (1952).

A nonreciprocal device is one that has different transmission properties in two directions. It can be used to separate signals that would otherwise interfere. In the case of radar, nonreciprocal devices separate the transmitted signal from the received signal so that the received signal goes into the receiver, but the transmitted signal does not. Because transmitted signals are many times more powerful than received signals, nonreciprocal devices are crucial to the operation of radar systems.

**4** B. Lax, K.J. Button, and L.M. Roth, "Ferrite Phase Shifters in Rectangular Wave Guide," *J. Appl. Phys.* **25(11)**, 1413–1421 (1954).

**5** P.E. Tannenwald, "Ferromagnetic Resonance in Manganese Ferrite Single Crystals," *Phys. Rev.* **100(6)**, 1713–1719 (1955).

**6** M.H. Seavey, Jr. and P.E. Tannenwald, "Direct Observation of Spin-Wave Resonance," *Phys. Rev. Lett.* **1(5)**, 168 (1958).

**7** B. Lax and K.J. Button, *Microwave Ferrites and Ferrimagnetics*. New York: McGraw-Hill, 1962.

**8** W. Shockley, "Cyclotron Resonances, Magneto-resistance, and Brillouin Zones in Semiconductors," *Phys. Rev.* **90**, 491 (1953).

In the cyclotron resonance experiment, current carriers (electrons or holes) are accelerated in spiral orbits around the axis of a static magnetic field  $H$ . The angular rotation frequency of the carriers is their cyclotron resonance frequency  $\omega_c$  and, because the effective mass of the current carriers is equal to  $eH/\omega_c c$  (where  $e$  is the electron charge and  $c$  is the speed of light), a measurement of the cyclotron frequency in a material gives the value of the effective mass of its charge carriers. Once the effective mass tensor is known, the band structure of the material under study can be modeled.

**9** B. Lax, H.J. Zeiger, R.N. Dexter, and E.S. Rosenblum, "Directional Properties of the Cyclotron Resonance in Germanium," *Phys. Rev.* **93**, 1418 (1954).

investigated by Fox and compared with the theoretical results. These experiments led directly to the development of devices that could operate at frequencies of 500 MHz to 3 GHz.

A new staff member, Simon Foner, joined the group to concentrate on measuring the magnetic susceptibilities of a variety of ferrites and on developing instruments for such measurements. He invented the Foner magnetometer, which is still used in susceptibility measurements. His paper describing the magnetometer has been cited unusually widely in the technical literature.

On the microwave end, Peter Tannenwald extended the microwave resonant studies from the tensor properties of polycrystalline materials to those of single crystals.<sup>5</sup> From these measurements, the anisotropy parameters of single crystals were deduced; in fact, all necessary microwave properties were made available to the device designers.

By 1956, the device research effort had moved into both lower and higher frequencies. The program now encompassed the electromagnetic spectrum from 600 MHz to 60 GHz.

The behavior of resonant isolators in rectangular waveguides was explored. A unique application that evolved from this investigation was the use of antiferromagnetic materials to fabricate resonant isolators that operated at millimeter frequencies.

During this time, two very important developments took place in the basic measurements program. One of these was the study by Martin Seavey and Tannenwald of ferromagnetic resonance in thin metallic films.<sup>6</sup> They discovered spin-wave exchange resonance in thin ferromagnetic films, thus experimentally demonstrating an effect predicted by Conyers Herring and Charles Kittel at the University of California at Berkeley (UC Berkeley).

The second significant development was Foner's observation of antiferromagnetic resonance in  $\text{MnF}_2$ , in an experiment that called for a unique combination of techniques.  $\text{MnF}_2$  normally exhibits a natural zero-field resonance at 4 K of 1.5 mm. However, since an external magnetic field splits the resonance, it could be

observed at the more accessible wavelengths of 4 and 8 mm. The resultant measurement of antiferromagnetic resonance as a function of temperature demonstrated the fundamental nature of antiferromagnetic resonance.

Various Lincoln Laboratory staff members implemented many of the ferrite devices in radars, and the Solid State Group became generally recognized as a leader in the field. Lax and Button wrote a book, *Microwave Ferrites and Ferrimagnetics*, which is still considered a classic text.<sup>7</sup> As a consequence of the book, they both achieved distinction as authorities in the field.

### Cyclotron Resonance

In the early days of the transistor, the energy bands and effective masses of electrons and holes in silicon and germanium were unknown. Considering the advances that were being made in the development of transistors, this was a potentially disastrous state of affairs.

In May 1953, William Shockley of Bell Telephone Laboratories published an article suggesting that the effective masses of carriers could be studied in an experiment that combined microwave and magnetic fields. He labeled the experiment cyclotron resonance.<sup>8</sup>

On reading Shockley's paper, Lax designed an experiment that entailed freezing out carriers at liquid-helium temperatures and re-exciting them in a controlled way with microwave power. He recruited Herbert Zeiger and Richard Dexter to carry out the experiment, and they began to assemble the required microwave and low-temperature equipment.

The microwave breakdown technique devised for the experiment worked. However, the anisotropy of the breakdown signal as a function of crystal orientation showed a broad spectrum that could not be resolved.

In October 1953, the team rebuilt the microwave system to be more sensitive, and they confirmed the preliminary findings. This time, however, the structure and the anisotropy of the spectra with respect to crystal orientation were resolved. The tensor masses of electrons in germanium were measured for the first time.<sup>9</sup>



## Notes

**10** R.N. Dexter, H.J. Zeiger, and B. Lax, "Anisotropy of Cyclotron Resonance of Holes in Germanium," *Phys. Rev.* **95**, 557 (1954).

**11** (a) B. Lax, H.J. Zeiger, and R.N. Dexter, "Anisotropy of Cyclotron Resonance in Germanium," *Physica* **20(11)**, 818 (1954); (b) C. Kittel, "Experimental Evidence on the Band Structure of Germanium and Silicon," *Physica* **20(11)**, 829 (1954).

**12** (a) R.N. Dexter, B. Lax, A.F. Kip, and G. Dresselhaus, "Effective Masses of Electrons in Silicon," *Phys. Rev.* **96(1)**, 222–223 (1954); (b) R.N. Dexter and B. Lax, "Effective Masses of Holes in Silicon," *Phys. Rev.* **96(1)**, 223–224 (1954).

**13** R.J. Keyes, S. Zwerdling, S. Foner, H.H. Kolm, and B. Lax, "Infrared Cyclotron Resonance in Bi, InSb, and InAs with High Pulsed Magnetic Fields," *Phys. Rev.* **104(6)**, 1804 (1956).

**14** B. Lax and J.G. Mavroides, "Cyclotron Resonance," in *Solid State Physics, Vol. 11*, eds. F. Seitz and D. Turnbull. New York: Academic Press, 1960.

The band structure of germanium was, at last, clearly established. The transport behavior of electrons was explained and, more importantly, the work soon gave rise to the concept of indirect optical transitions. The next challenge was to see if holes in germanium also showed anisotropic behavior. A microwave breakdown experiment on p-type material indicated the likelihood of such an anisotropy but did not prove it because the spectral lines were too broad at X-band.

A change in technique from microwave breakdown to optical excitation yielded narrower spectral lines. Once the resonance peaks were well resolved, the anisotropy of the holes was revealed. The three mass parameters as defined in the theory were measured for the first time by Lincoln Laboratory.<sup>10</sup>

All this work was conducted in the midst of an intense rivalry between Lincoln Laboratory and a group at UC Berkeley. The work at UC Berkeley and the Lincoln Laboratory measurements on germanium were published in adjacent articles in *Physica*.<sup>11</sup> The investigation of electrons in silicon using optical excitation was begun at Lincoln Laboratory and closely followed by the UC Berkeley group. Because the studies were being performed so much in parallel, the two groups decided to publish the results in a joint paper, with Lincoln Laboratory's observation of heavy and light holes in silicon added in the succeeding article.<sup>12</sup> Thus, within a period of six months, the properties of the carriers in the two technologically important single-element semiconductors had been quantitatively established.

Most materials at that time were relatively impure and not suitable for microwave cyclotron resonance. The mean free path of electrons in an impure material is much shorter than in one that is pure; a much higher frequency and a stronger magnetic field must be applied in order to resolve the cyclotron frequency in an impure material. Because the only high magnetic fields available were pulsed, and because the wavelength of microwaves was too long, the decision was made to leapfrog from the microwave to the infrared regime and to use pulsed magnetic fields for cyclotron resonance.

Foner and Henry Kolm were assigned to develop a pulsed-field magnet that used contemporary electronics, and they surpassed previously reported performances. Moreover, the Lincoln Laboratory data produced a surprising result. The effective masses of carriers in indium antimonide and indium arsenide increased by a factor of two with increasing magnetic field.<sup>13</sup>

Because classical theory was inadequate to explain these data, a quantum-mechanical treatment became necessary. Through the use of band theory, a satisfactory interpretation was developed. In fact, the interpretation explained the nonparabolicity not only of the effective mass, but also of the magnetic moment.<sup>14</sup>

Once the group had studied the elemental semiconductors germanium and silicon, a cyclotron resonance experiment on diamond became almost irresistible. A search in the diamond market in New York failed to produce any diamonds with the correct photoluminescence properties, but it did prompt some curious comments about the type of individuals who work for Lincoln Laboratory.

1951



R.B. Adler



A.L. McWhorter



First junction

1960



R.H. Kingston

## Notes

**15** A review of Lincoln Laboratory's programs in magneto-optical spectroscopy was given in an article by B. Lax and S. Zwerdling, "Magneto-Optical Phenomena in Semiconductors," *Prog. Semicond.* **5**, 221 (1961).

**16** W.C. Dash and R. Newman, "Intrinsic Optical Absorption in Single-Crystal Germanium and Silicon at 77°K and 300°K," *Phys. Rev.* **99(4)**, 1151 (1955).

**17** S. Zwerdling and B. Lax, "Oscillatory Magneto-Absorption of the Direct Transition in Germanium," *Phys. Rev.* **106(1)**, 51 (1957).

**18** B. Lax and Y. Nishina, "Interband Faraday Rotation in III-V Compounds," *J. Appl. Phys. Suppl.* **32(10)**, 2128–2131 (1961).

**19** R.J. Keyes, S. Zwerdling, S. Foner, H.H. Kolm, and B. Lax, "Infrared Cyclotron Resonance in Bi, InSb, and InAs with High Pulsed Magnetic Fields," *Phys. Rev.* **104(6)**, 1804 (1956).

**20** B. Lax, J.G. Mavroides, H.J. Zeiger, and R.J. Keyes, "Infrared Magnetoreflexion in Bismuth. I. High Fields," *Phys. Rev. Lett.* **5(6)**, 241 (1960).

**21** R.N. Brown, J.G. Mavroides, and B. Lax, "Magnetoreflexion in Bismuth," *Phys. Rev.* **129(5)**, 2055 (1963).

The Diamond Institute in Johannesburg was contacted next, and they sent a 1 mm specimen of type II-B diamond. In the meantime, a millimeter-wave spectrometer was being developed at Lincoln Laboratory. In 1961, Conrad Rauch used the millimeter-wave apparatus to measure the cyclotron resonance of diamond.

### *Magneto-Optical Spectroscopy*

The work on magneto-optical properties of semiconductors<sup>15</sup> was inspired by a measurement reported by William Dash and Robert Newman of the General Electric Research Laboratory.<sup>16</sup> They observed the direct transmission in germanium through a thin polished crystal. At the request of the Solid State Group, Dash and Newman sent a 10  $\mu\text{m}$  sample of their material to Lincoln Laboratory. The sample was inserted in a magnetic field, and the oscillatory interband transition was observed, which is the infrared quantum analog of cyclotron resonance.<sup>17</sup>

The phenomenon was then investigated in indium antimonide, which led to the discovery of the anomalous magnetic moment of the electron. Roth, who had just joined Lincoln Laboratory, used the theory created by Professor Joaquin Luttinger of the University of Wisconsin to explain the anomaly and developed a formula for it.

The next phase of the work was to study the Zeeman Effect of impurities. The experimental work of Solomon Zwerdling and coworkers, together with theoretical work of Roth and Lax, made further contributions to the quantitative understanding of semiconductors. The spin-orbit splitting in silicon and the effective mass of the previously inaccessible valence band were measured for the first time.

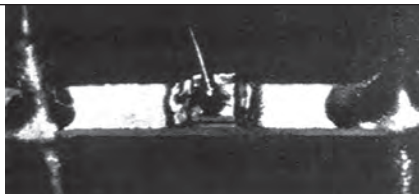
Following this work, studies began on interband Faraday rotation in indium antimonide. Richard Brown, a graduate student at MIT working at Lincoln Laboratory, observed an anomaly as the wavelength approached the energy gap. This discovery, which was later explained theoretically and identified as the interband contribution,<sup>18</sup> led to the development of the interband Faraday rotation isolator, which was later used in the Firepond laser radar (see chapter 25, "Laser Systems").

For his Ph.D. thesis, George Wright looked at the infrared magnetoplasma effect in such low-gap semiconductors as HgSe and InSb. He determined the masses of degenerate electrons in highly doped semiconductors, the densities, and the relaxation times.

Interestingly, the first interband magneto-absorption experiment was performed on the semimetal bismuth with pulsed magnets in 1956.<sup>19</sup> At that time, it was interpreted as cyclotron resonance. It was not until 1960 that Lax and coworkers reanalyzed the data and deduced that an interband phenomenon had been observed.<sup>20</sup> Subsequently, Brown performed much cleaner experiments using magneto-reflection in a Varian magnet at low temperatures, confirming the phenomenon in semimetals.<sup>21</sup>

Mildred Dresselhaus and John Mavroides later extended the studies to alloys of bismuth and antimony and to graphite. These elegant experiments and their interpretation established Dresselhaus as a prominent scientist.

The magneto-optical studies established another important tool for examining the energy band structure of semiconductors. The technique complemented cyclotron resonance when possible and replaced it when the other method was not feasible.



One of the first GaAs diode lasers co-invented at Lincoln Laboratory



C. Freed



P.E. Tannenwald



**Figure 24-2**  
Robert Kingston and Alan McWhorter demonstrate the first maser amplifier.

#### Notes

**22** H.E.D. Scovil, G. Feher, and H. Seidel, "Operation of a Solid State Maser," *Phys. Rev.* **105**(2), 762 (1957).

**23** A.L. McWhorter and J.W. Meyer, "Solid-State Maser Amplifier," *Phys. Rev.* **109**(2), 312–318 (1958).

**24** A.L. McWhorter, J.W. Meyer, and P.D. Strum, "Noise Temperature Measurement on a Solid State Maser," *Phys. Rev.* **108**(6), 1642–1644 (1957).

**25** R.H. Kingston, "A UHF Solid-State Maser," *Proc. IRE* **7**(1), 92–94 (1959).

**26** Two decades later, interest in superconductors was reborn at the Laboratory in an effort conducted by the Analog Device Technology Group.

**27** S. Foner and L.R. Momo, "CW Millimeter Wave Maser Using Fe<sup>3+</sup> in TiO<sub>2</sub>," *J. Appl. Phys.* **31**(4), 742–743 (1960).

**28** This section is taken from an article by I. Melngailis, "Laser Development at Lincoln Laboratory," *Linc. Lab. J.* **3**(3), 347–360 (1990).

**29** T.M. Quist, R.H. Rediker, R.J. Keyes, W.E. Krag, B. Lax, A.L. McWhorter, and H.J. Zeiger, "Semiconductor Maser of GaAs," *Appl. Phys. Lett.* **1**(4), 91–92 (1962).

#### Masers

When Professor Nicolaas Bloembergen of Harvard University conceived of the three-level paramagnetic maser in 1956, he was serving as a consultant to the ferrite program. Since the facilities and equipment then in use for this program happened to be suitable for building a maser, when Bloembergen suggested prior to publishing his concept that Lincoln Laboratory embark on a project to build such a maser, the Solid State Group was in a good position to do so.

James Meyer was immediately assigned to the task of constructing a double-resonant cavity that would provide a pump frequency in the X-band and a signal frequency in the L-band. He was soon joined in the project by McWhorter and Stanley Autler.

In the meantime, a team at Bell Laboratories had demonstrated the operation of a three-level maser oscillator in gadolinium thiosulfate.<sup>22</sup> The race, however, was not yet lost. The Bell Laboratories crystal was not suitable for practical application as an amplifier.

After a search of the literature, McWhorter came up with the fortunate choice of potassium cobalt cyanide doped with chromium for the maser crystal. The crystal was rapidly grown by Harry Gatos, who directed the chemistry work, and it proved to be highly successful.<sup>23</sup> The maser operated both as an amplifier and as an S-band oscillator at a temperature of 1.25 K and a frequency of 2800 MHz. This accomplishment proved for the first time that the maser could meet the objective of providing a low-temperature, low-noise amplifier (Figure 24-2).

The program soon adopted a practical objective: to make the maser into an operational low-noise amplifier. A ferrite circulator was incorporated into the system, and an apparatus was constructed to measure the noise temperature. McWhorter and coworkers established an upper limit of approximately 20 K as its equivalent noise temperature.<sup>24</sup>

Robert Kingston joined the maser team and began work on pushing the frequency range of the maser into the L-band portion of the ultrahigh frequency (UHF).<sup>25</sup> Among other advantages, a maser frequency of 1400 MHz would permit the hydrogen line in space to be observed with greater sensitivity. A unique feature

of the L-band maser was that it incorporated a superconducting loop to provide the resonant circuit inside the microwave cavity.

The maser effort proliferated in several directions, including such projects as the construction of a maser radiometer, an S-band maser radar, and one of the first uses of a ruby crystal for a tunable L-band maser. The ruby-based tunable L-band maser incorporated a novel technique: a superconducting coil of niobium provided a highly stable magnetic field in a persistent mode.<sup>26</sup>

Higher frequencies now beckoned, and the next objective was millimeter-wave spectroscopy. The question of sources was the most difficult, so the group began to investigate techniques of harmonic generation. Staff members looked for harmonics in magnetrons, crystal multipliers, ferrite frequency multipliers, and varactor diodes. They built such components as resonant isolators, three-port circulators, and superheterodyne receivers. Foner and Lynn Momo extended the operation of the maser into the millimeter range. Ferric iron in a TiO<sub>2</sub> dielectric was found to be suitable, and a tunable maser pumped at 75 GHz was operated at frequencies of 26 to 39 GHz.<sup>27</sup>

The millimeter-wave spectrometers were used to study cyclotron, ferromagnetic, and antiferromagnetic resonances in a variety of solids. When these spectrometers were combined with the 50 kG Varian magnet, Lincoln Laboratory had equipment for spectroscopy that was unmatched in the world.

#### Semiconductor Lasers

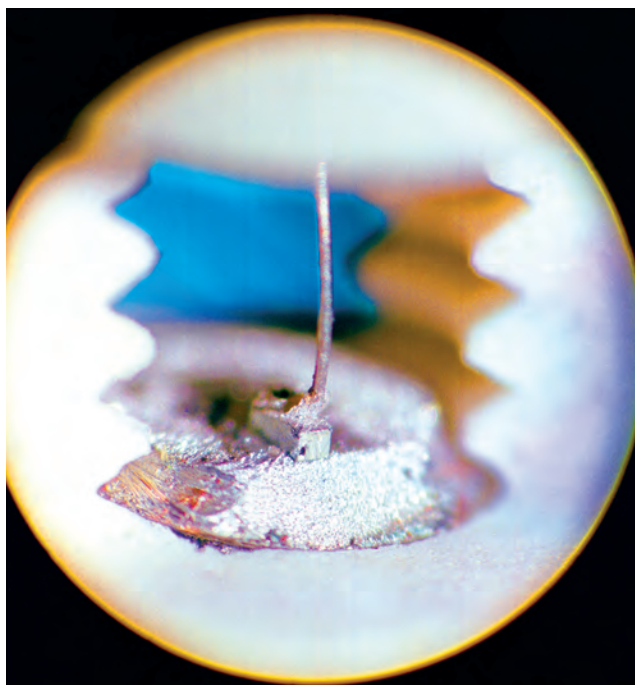
In 1962, Lincoln Laboratory demonstrated its first semiconductor laser, two years after Hughes Research Laboratory's demonstration of the first laser in May 1960.<sup>28</sup> Hughes' first laser was a lamp-pumped ruby, but investigators at the Laboratory had been working on the possibility of laser emission in other media, including semiconductors. The Solid State Division had extensive experience in semiconductor research, putting it in a good position to investigate such materials.

A key factor was Lincoln Laboratory's expertise in GaAs materials and device technology. In 1958, Robert Rediker, leader of the Applied Physics Group, decided to pursue GaAs, rather than silicon technology, which



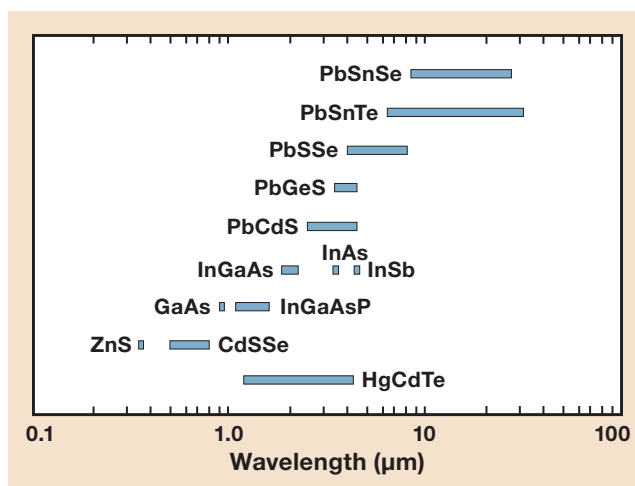
**Figure 24-3**

One of the first GaAs diode lasers fabricated at Lincoln Laboratory. The first Laboratory GaAs diode laser was developed in October 1962. Wire is approximately 0.01 mm in diameter.



**Figure 24-4**

Wavelengths of semiconductor lasers that were developed at Lincoln Laboratory.



at the time was becoming the focus of semiconductor research at most other laboratories. Although the initial work on GaAs was aimed at high-speed electronic devices, it was soon discovered that GaAs diodes, in contrast to silicon and germanium diodes, were efficient light emitters. Thus, early in 1962, Robert Keyes and Theodore Quist observed quantum efficiencies of 85% in spontaneous emission from GaAs diodes at 0.84  $\mu\text{m}$ . This observation set the stage for a race to develop the first diode laser. By that fall, Quist and his coworkers at Lincoln Laboratory had demonstrated a diode laser (Figure 24-3),<sup>29</sup> but groups at General Electric and International Business Machines had independently also developed GaAs diode lasers (see sidebar entitled “From Luminescence to the Diode Laser”). At this same time, McWhorter, Zeiger, and Lax developed a theoretical model of the semiconductor laser that identified some of its unique characteristics.

In the following years, work in the Solid State Division concentrated on developing lasers in other semiconductor materials to cover different parts of the wavelength spectrum (Figure 24-4). Although the motivation for the investigations during the early stage was primarily scientific, lasers fabricated from the different materials subsequently found application in numerous areas, including spectroscopy and fiber communications.

Several milestones are worth noting. In 1963, Ivars Melngailis observed laser emission at 3.1  $\mu\text{m}$  in InAs diodes and in the ternary compound InGaAs at 1.8 and 2.1  $\mu\text{m}$ . Robert Phelan obtained emission in InSb at 5.1  $\mu\text{m}$ . In 1964, Rediker, Jack Butler, and coworkers fabricated lasers in the IV-VI lead salts: PbTe at 6.4  $\mu\text{m}$  and PbSe at 8.3  $\mu\text{m}$ .

In all of the early diode lasers, the current was injected in a direction normal to light emission. However, the use of a longitudinal pumping configuration was expected to reduce beam divergence. Therefore, in 1965, Melngailis used an InSb diode to produce the first longitudinally pumped structure. The difficulty in fabricating high-performance devices of this type, however, prevented their development in other materials until the 1980s, when researchers first in Japan and later in the United States made significant progress in this area. As a result, good-performance arrays of longitudinally pumped lasers can now be made in GaAs

## From Luminescence to the Diode Laser

“The thing that really set it off was going to a device conference and hearing a paper by Keyes and Quist.”  
—Robert Hall\*

“I don’t remember the junction luminescence reports at SSDRC of any group except that of Keyes and Quist. I think the reason for this was the impressive nature of the Keyes and Quist report of GaAs *p-n* junction luminescence, its high efficiency, and the fact that GaAs junctions had already been used to transmit signals.”  
—Nick Holonyak\*\*

On July 9, 1962, at the Solid State Device Research Conference (SSDRC) held at the University of New Hampshire, Robert Keyes presented a paper coauthored with Theodore Quist that reported a luminescence efficiency for GaAs-diffused diodes approaching 100%. This was an extraordinary result; previous estimates of the efficiency of light-emitting diodes had been in the range of 0.01%. The audience was astounded. In the questions following Keyes’s talk, a conference attendee from Bell Laboratories questioned the measurement by arguing that it might violate the second law of thermodynamics. To this challenge, Keyes replied that he was truly very sorry, drawing gales of laughter from the listeners.

A number of researchers immediately recognized that a material this efficient could meet the requirements for a semiconductor laser. Robert Hall, a conference attendee from the General Electric Research and Development Center in Schenectady, New York, began planning an experiment on the train home. Nick Holonyak, then working at the General Electric Laboratory in Syracuse, New York, and also an expert in the field, promptly set out to develop a GaAsP diode that

could emit radiation in the visible. Marshall Nathan, working in the field at the IBM Research Center in Yorktown Heights, New York, had not attended the conference, but his management clipped an article about it from the next day’s *New York Times* and urged him to develop a semiconductor laser as quickly as possible.

The race was on. Each of the researchers knew that someone would develop a semiconductor laser before the year was over, and each was determined to be first. Hall had not been working specifically on semiconductor lasers before the Keyes and Quist talk, yet he was the first to succeed, reporting the development of a semiconductor laser in a paper received on September 24. Nathan’s group at IBM followed closely, reporting their laser on October 6. Holonyak announced a GaAsP semiconductor laser on October 17. At Lincoln Laboratory, lasing of GaAs was demonstrated during the first part of October and results were reported to *Applied Physics Letters* on October 23.

Four groups, each working independently, had produced a semiconductor diode laser within a single month. And all were inspired to action by a report of highly efficient luminescence given at a small conference in New Hampshire.

---

\* R.N. Hall in J. Hecht, ed., *Laser Pioneers*. New York: Academic Press, 1992, p. 181.

\*\* N. Holonyak, Jr., “Semiconductor Lasers—1962,” *IEEE J. Quantum Electron.* 23(6), 684–691 (1987).

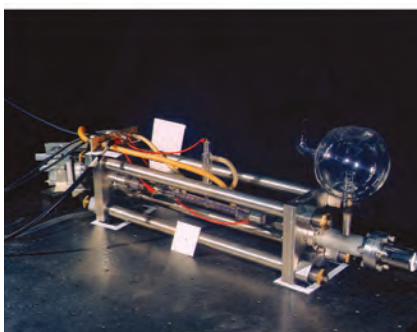
and in InGaAsP. Both materials are of particular interest for optical signal processing and optical interconnects for fiber-optic communications.

During the late 1960s, the semiconductor laser work at Lincoln Laboratory included wavelength tuning of diode lasers by means of optical and electron-beam pumping. Electron-beam pumping was of considerable interest because it permitted emission into the visible and ultraviolet through the use of wide-energy-gap semiconductors for which *p-n* junctions could not be produced. Thus, for the first time, Charles Hurwitz obtained laser radiation in CdSSe in the range of 490 to 690 nm as the ratio of S to Se changed. High efficiencies as well as high powers in CdS were obtained at 490 nm (26% power efficiency, 350 W peak) and ZnS at 330 nm (6.5%, 1.7 W).

Optical pumping with a GaAs diode laser source proved useful for semiconductors that emitted in the infrared (>1  $\mu\text{m}$ ) range, e.g., HgCdTe in which, in 1966, emission was observed near 4  $\mu\text{m}$ . In 1983, through a collaborative effort between Theodore Harman of Lincoln Laboratory and a team from MIT, HgCdTe lasers were also demonstrated at shorter wavelengths (1.2 to 2  $\mu\text{m}$ ) through optical pumping with Nd:YAG lasers at 1.06  $\mu\text{m}$ . Research on lead-salt lasers accelerated after John Dimmock, Alan Strauss, and Melngailis discovered in 1966 that, because the energy bands crossed in the ternary alloys PbSnTe and PbSnSe, the energy gap decreased with increasing Sn content, reached zero at a particular composition, and then increased. This effect allowed coverage of a broad wavelength spectrum from 6.4  $\mu\text{m}$  in PbTe and 8.3  $\mu\text{m}$  in PbSe to greater than 30  $\mu\text{m}$  in both materials.

In PbSnTe diodes, emission was observed at wavelengths as long as 31.2  $\mu\text{m}$ . During the 1970s, Steven Groves, James Walpole, and coworkers introduced considerably more sophistication in lead-salt lasers through the use of double heterostructures to increase the temperature of operation and distributed feedback to achieve single-frequency operation.

In 1969, E. David Hinkley and Charles Freed made heterodyne measurements with 10.5  $\mu\text{m}$  lead-salt lasers that showed that linewidths were determined by phase fluctuations due to spontaneous emission of photons.



**Figure 24-5**  
**The first stable sealed-off CO<sub>2</sub> laser.**  
**Four 1-inch-diameter Invar rods**  
**stabilize the assembly.**

Linewidths as narrow as 54 kHz were observed. In these lasers, it was possible to measure the relation between the linewidth and the output power, and to establish an inverse proportion. (In all previous observations, thermal and acoustic vibrations had masked the phase-noise-limited laser linewidth.)

This measurement thus provided the first experimental verification of the theory of quantum phase noise, which had been developed by Arthur Schawlow and Charles Townes of Bell Laboratories, and was a significant triumph for the theory of quantum mechanics.

The Laboratory's innovations in semiconductor diode lasers continue to be robust. The highlights for the 1972–1992 epoch are described in the section entitled “Semiconductor Diode Lasers.”

#### Gas Lasers

Gas laser development at Lincoln Laboratory was driven by the requirements of laser radar and high-precision spectroscopy. Starting in the mid-1960s, Freed built sealed-off CO<sub>2</sub> lasers for ultrastable operation in the TEM<sub>00</sub> (transverse electromagnetic) mode for use as local oscillators and master oscillators in coherent 10.6 μm radars (Figure 24-5). Single-frequency output powers up to 45 W and a yet-to-be-surpassed short-term frequency stability of  $\Delta f/f \leq 1.5 \times 10^{-13}$  over 0.1 sec were obtained.

Absolute frequency stabilization of a CO<sub>2</sub> laser was achieved by inventing a technique that makes use of saturation resonance on the 4.3 μm wavelength fluorescence of CO<sub>2</sub>.<sup>30</sup> The technique facilitates absolute frequency reproducibilities to within 3 kHz in nine CO<sub>2</sub> isotopic species. Thus, secondary frequency standards in the 8.9 to 12.3 μm wavelength range were calibrated with the Cs atomic clock used as a primary standard.

A modified ultrastable CO<sub>2</sub> laser that could be operated either in a continuous wave (CW) or in an electronically Q-switched mode was built for use in compact imaging radars. Miniature transverse-electric atmospheric-pressure lasers with 10 W average powers (20 mJ at 500 Hz) were designed and built for lidar measurement of atmospheric constituents. In 1970, Lincoln Laboratory was the first to achieve sealed-off operation of CO lasers, which were subsequently used in numerous spectroscopic applications.

In the early 1970s, a team in the Solid State Division made important contributions in the area of submillimeter-wavelength lasers by using a CO<sub>2</sub> laser as a source for pumping gas molecules at frequencies far removed from their vibrational transitions. Nonresonant pumping greatly extended the number of gases that could be used for submillimeter lasers (which concomitantly greatly extended the number of possible wavelengths) and allowed significant wavelength tuning by the application of an electric field. Laser emission at numerous lines in the range of 58 to 755 μm was obtained with methane and other gases. These lasers were instrumental in greatly expanding the applications of submillimeter spectroscopy, which proved useful in the study of impurity levels in semiconductors such as GaAs.

#### Early Infrared Detectors

A good deal of the pioneering work on new infrared detector materials and structures for applications in thermal imaging, laser radar, and optoelectronic detectors has come out of the Solid State Division. Research on devices for all three applications began in the 1960s and continues to the present.

Development efforts on thermal imaging devices took place largely in the late 1960s and early 1970s. In 1966, shortly after Harman, Strauss, and A. Robert Calawa developed lead-tin chalcogenide alloy crystals, Melngailis and Calawa demonstrated, for the first time, near-background-limited photovoltaic long-wavelength infrared (8 to 12 μm) detectors operating at 77 K.<sup>31</sup> A year later, Phelan showed that metal-oxide semiconductor (MOS) structures in InSb could be used for sensitive infrared detection. In 1968, Keyes and Quist demonstrated the very high detection capability in low backgrounds in the long-wavelength infrared of high-purity Cu-doped Ge. Also during this time, Gregory Stillman and Charles Wolfe showed that ultrahigh-purity n-type GaAs made a very sensitive high-speed far-infrared (120 to 500 μm) photoconductor.

A van de Graff accelerator installed in the late 1960s enabled George Foyt, Joseph Donnelly, and Laboratory colleagues to pioneer the field of ion-implanted photovoltaic infrared detectors. They found that proton implantation produced n-type layers, and good infrared detectors, in the small-bandgap PbSnTe, PbSnSe, and

#### Notes

**30** C. Freed and A. Javan, “Standing-Wave Saturation Resonances in the CO<sub>2</sub> 10.6-μ Transitions Observed in a Low-Pressure Room-Temperature Absorber Gas,” *Appl. Phys. Lett.* **17(2)**, 53–56 (1970).

**31** I. Melngailis and T.C. Harman, “Single-Crystal Lead-Tin Chalcogenides,” in *Semiconductors and Semimetals, Vol. 5*, eds. R.K. Willardson and A.C. Beer. New York: Academic Press, 1970, p. 111.



## Notes

**32** M.C. Teich, R.J. Keyes, and R.H. Kingston, "Optimum Heterodyne Detection at 10.6  $\mu\text{m}$  in Photoconductive Ge:Cu," *Appl. Phys. Lett.* **9(10)**, 357–360 (1966).

**33** J.J. Hsieh, J.A. Rossi, and J.P. Donnelly, "Room-Temperature CW Operation of GaInAsP/InP Double-Heterostructure Diode Lasers Emitting at 1.1  $\mu\text{m}$ ," *Appl. Phys. Lett.* **28(12)**, 709–711 (1976).

HgCdTe alloys and in InSb. Background-limited infrared detectors were also made by implanting various dopant ions into Pb salts and InSb. Beryllium implantation produced excellent InSb detectors for the mid-infrared, and the technique became a standard commercial process.

The very high (near ideal) detector sensitivity that Malvin Teich, Keyes, and Kingston demonstrated in 1966 at 10.6  $\mu\text{m}$  with a liquid-helium-cooled Cu-doped Ge detector operating as a photomixer proved that infrared heterodyne detection was both feasible and very sensitive.<sup>32</sup> In fact, the demonstration verified the feasibility of the concept of CO<sub>2</sub> laser radar. Because of the difficulty of liquid-helium operation, Cu-doped Ge detectors never became practical, but Pb-salt diodes operating at 77 K were soon developed and were also found to give good heterodyne performance.

In the 1970s and 1980s, heterodyne detection was driven to new limits as described in the section entitled "Heterodyne Infrared Detectors."

### Applied Research in Materials, Devices, and Circuits (1972–1992)

After the Mansfield amendment was enacted in 1971, the research activities of the Solid State Division beginning in 1972 focused on device development and engineering for DoD needs. The epoch saw substantial progress in diode lasers.

#### Semiconductor Diode Lasers

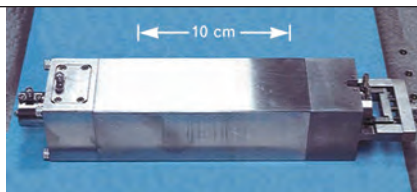
Three characteristics of semiconductor lasers — narrow linewidths, the ability to lase at almost any required wavelength, and the capability for short-range tuning by means of variation of the injection current — opened

up applications for high-resolution spectroscopy and air-pollution monitoring. These applications provided the impetus for Kenneth Nill and Butler to create Laser Analytics in 1974, Lincoln Laboratory's first spin-off company in the laser area.

Possibly one of Lincoln Laboratory's most significant accomplishments in semiconductor lasers was in the development of sources for fiber telecommunications. In the early 1970s, the advent of low-loss optical fibers prompted numerous laboratories to search for appropriate semiconductor lasers to use as transmitters. The wavelength range of 1.3 to 1.6  $\mu\text{m}$  was of particular interest because both minimum absorption losses and minimum frequency dispersion for silica fibers occur in this range.

A number of ternary III-V semiconductor alloy systems, including InGaAs and GaAsSb, had been investigated elsewhere for use at these telecommunications wavelengths, but researchers could not fabricate high-performance, long-lifetime lasers from those materials. The difficulty was attributed to a mismatch in the crystal lattice spacing between the active region of the laser and the substrate material on which the laser structure was epitaxially grown. This mismatch produced a high density of defects that inhibited efficient laser operation and led to rapid degradation. By contrast, the good lattice match of the ternary alloy AlGaAs to GaAs enabled the successful development of AlGaAs/GaAs diode lasers in the wavelength range of 0.68 to 0.86  $\mu\text{m}$ . But AlGaAs/GaAs did not produce radiation in the right wavelength for fiber optics; an indium-based compound was required.

1970



External cavity ultrastable GaAs diode laser



I. Melngailis

Lincoln Laboratory researchers had studied InGaAs/GaAs avalanche photodiodes and had already encountered the problems of lattice mismatch. Partly on the basis of this experience, Strauss and J. Jim Hsieh chose instead to produce the quaternary compound InGaAsP and deposit it on an InP substrate. The development by Soviet researchers of diode lasers operating at 77 K, as well as earlier work on InGaAsP photoemission devices, supported the choice.

In 1976, a Lincoln Laboratory team demonstrated a CW InGaAsP/InP diode laser that operated at room temperature and had a lifetime of 3000 hours.<sup>33</sup> These lasers emitted in the wavelength range of 0.92 to 1.7  $\mu\text{m}$ , just right for fiber-optic communication.

The InGaAsP/InP material system was almost immediately adopted by other laboratories in Japan and later in the United States. Hsieh and Nill helped to bring fiber communications transmitters and receivers into production in 1980 by founding a new company, Lasertron, to fabricate and market these devices. Today, InGaAsP/InP is still the main system used for transmitter sources and detectors in fiber communications.

During the late 1970s and the 1980s, numerous contributions were made in laying the foundation for the fundamental materials and device technology of the InGaAsP system. Detailed studies were performed on the conditions for lattice matching in the liquid-phase epitaxial growth of InGaAsP on InP substrates. Zong-Long Liao developed a mass-transport technique for the fabrication of buried-heterostructure lasers and laser arrays.

Unless they have special designs, semiconductor lasers often operate in multiple spectral and spatial modes. Moreover, because of their low-Q cavities, the linewidths of semiconductor lasers are broad compared to those of gas lasers. Following work published elsewhere in 1969 in the use of external cavities, John Rossi and coworkers at Lincoln Laboratory demonstrated in 1973 that single-mode narrow linewidths and wavelength tuning at high power levels could be obtained by introducing a grating in an external cavity. Very stable external resonators were used with both AlGaAs and InGaAsP diode lasers, and Aram Mooradian and coworkers succeeded in producing linewidths as small as 5 kHz. A stability better than 15 Hz was observed by phase locking two external-cavity lasers.

In 1991, Walpole, Emily Kintzer, and Christine Wang demonstrated a tapered semiconductor laser amplifier that provided a major increase in the laser power available from a single semiconductor laser while maintaining high beam quality (i.e., near-diffraction-limited beams at CW power levels up to 3.5 W, which was approximately an order of magnitude improvement over previous results). However, the tapered structure was still susceptible to mode instabilities and was thus not a robust source. Further developments occurred in the next epoch. These recent advancements are described in the “Laser Beam Combining” section.



D.L. Spears



H.I. Smith



R.C. Williamson

## Notes

**34** P.F. Moulton, "Titanium-Doped Sapphire: A New Tunable Solid-State Laser," in *Physics News in 1982*. P.F. Schewe, ed. New York: American Institute of Physics, 1982, pp. 89–90.

**35** P.F. Moulton, "Spectroscopic and Laser Characteristics of Ti:Al<sub>2</sub>O<sub>3</sub>," *J. Opt. Soc. Am. B*, **3**(1), 125–133 (1986).

**36** S.R. Henion and P.A. Schulz, "Efficient, High-Average-Power, Liquid-Nitrogen-Cooled Ti:Al<sub>2</sub>O<sub>3</sub> Laser," *Adv. Proc. Solid State Lasers*, 36–38 (1988).

**37** (a) P.L. Kelley, "Laser-Related Research at Lincoln Laboratory: A Historical Review—Part 1," *Laser Focus* **18**, 28–30 (1982); "Laser-Related Research at Lincoln Laboratory: A Historical Review—Part 2," *Laser Focus* **18**, 32–36 (1982); (b) R.H. Rediker, I. Melngailis, and A. Mooradian, "Lasers, Their Development, and Applications at M.I.T. Lincoln Laboratory," *IEEE J. Quantum Electron.* **20**(6), 602–615 (1984); (c) "Special Issue on Laser Technology," *Linc. Lab. J.* **3**, 347–500 (1990).

## Ionic Solid-State Lasers

Research on ionic solid-state lasers at Lincoln Laboratory has been aimed at the development of efficient, compact sources with broad wavelength tunability. In 1964, Keyes and Quist were the first to demonstrate the use of diode lasers as pump sources for ionic solid-state lasers by using a bank of GaAs diodes to pump a U<sup>3+</sup>:CaF<sub>2</sub> laser rod. In this first demonstration, both the pumps and gain element were cooled to liquid-helium temperature. Extensive employment of this technique did not take place until two decades later, when diode lasers had achieved the wavelength control, high efficiency, room-temperature operation, and long lifetime that gave such pumping an advantage over lamp pumping.

More examples of optically pumped lasers developed at Lincoln Laboratory include the Co:MgF<sub>2</sub> laser, which operates in the CW mode when pumped with a 1.06 μm Nd:YAG laser, and is tunable from 1.63 to 2.08 μm. Daniel Ehrlich and coworkers demonstrated the first ultraviolet laser in 1979 with Ce-doped YLiF<sub>4</sub> (Ce:YLF), which is tunable from 300 to 325 nm. In 1980, emission at 286 nm was obtained from Ce:LaF<sub>3</sub>. These were also the first observations of laser emission produced by 5d–4f transitions in trivalent rare earths.

A notable accomplishment in solid-state (non-semiconductor) lasers was Peter Moulton and Mooradian's initial demonstration and subsequent development of the Ti:Al<sub>2</sub>O<sub>3</sub> laser, which is broadly tunable between 0.65 and 1.12 μm and can be designed for efficient and stable operation at room temperature.<sup>34</sup> Fundamental materials studies carried out in the 1980s identified and reduced the parasitic defects in Ti:Al<sub>2</sub>O<sub>3</sub> crystals. As a result, CW operation was achieved at room temperature, and slope quantum efficiencies of 86% were measured with a frequency-doubled (0.53 μm) Nd:YAG laser as a pump source. Also important for average-power scaling of solid-state lasers were early experiments by Moulton,<sup>35</sup> Peter Schulz, and Scott Henion,<sup>36</sup> which suggested that cooling ionic lasers to liquid-nitrogen temperature could increase by 100 times the average power of this type of laser. Application of this principle is more fully described in chapter 25 "Laser Systems."

The wide gain bandwidth of a Ti:Al<sub>2</sub>O<sub>3</sub> laser permits the generation of ultrashort light pulses. A joint effort between MIT campus and Lincoln Laboratory

researchers demonstrated pulses as short as 200 fsec in mode-locked operation. Various types of Ti:Al<sub>2</sub>O<sub>3</sub> lasers are commercially available with uses in high-resolution spectroscopy, agile-beam laser radars, spatial illuminators, and laser surgery. Ti:Al<sub>2</sub>O<sub>3</sub> lasers are now manufactured by a number of organizations, including Q-Peak, where ex-Lincoln Laboratory staff played a key role in the laser's commercialization.

The numerous scientific and technological achievements in laser development at Lincoln Laboratory resulted from a close collaboration of physicists, materials scientists, and device engineers. More detailed descriptions of Lincoln Laboratory's early lasers and their applications have appeared in several review articles chronicling the developments from 1963 through 1990.<sup>37</sup>

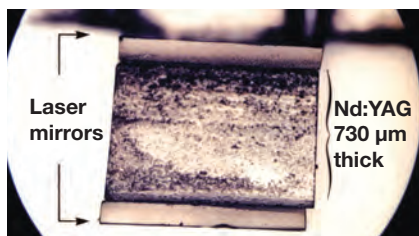
## Nonlinear Optics and Frequency Conversion

Other topics of investigation in the 1970s included harmonic generation and frequency mixing in nonlinear optical materials. High-quality crystals of the chalcopyrites CdGeH<sub>2</sub> and HgGaSe were grown by James Mikkelsen, and the crystals were used to frequency-double the 10.6 μm emission line from CO<sub>2</sub> lasers. A conversion efficiency of nearly 30% was obtained for lidar experiments in the remote sensing of atmospheric constituents.

An important application of frequency conversion resulted from Mooradian's observation that the frequency sum of two Nd:YAG emission lines — one at 1064 nm and the other at 1319 nm — exactly matches the sodium emission line at 589 nm. This precise wavelength match enabled the development of a laser source for the creation of an artificial beacon ("guidestar") in the earth's mesospheric layer. The application of guidestar techniques to astronomy is discussed in chapter 25, "Laser Systems."

In 1985, James Harrison conducted the first experimental demonstration that the Nd:YAG sum-frequency laser source could indeed be tuned to the sodium D2 transition wavelength by observing fluorescence from a sodium cell. In 1986, Thomas Jeys assumed responsibility for developing a sum-frequency source of sodium resonance radiation that could be useful for atmospheric adaptive optics applications. An important early demonstration of the feasibility of the Nd:YAG sum-frequency source for high-power generation of sodium resonance radiation





**Figure 24-6**  
**Photograph of one of the first microchip lasers successfully demonstrated at Lincoln Laboratory. The laser consisted of a 730  $\mu\text{m}$  thick piece of Nd:YAG sandwiched between two discrete mirrors. It produces over 8 mW of single-frequency output at a wavelength of 1.06  $\mu\text{m}$ .**

#### Notes

**38** T.H. Jeys, A.A. Brailove, and A. Mooradian, "Sum Frequency Generation of Sodium Resonance Radiation," *Appl. Opt.* **28(13)**, 2588–2591 (1989).

**39** T.H. Jeys, "Development of a Mesospheric Sodium Laser Beacon for Atmospheric Adaptive Optics," *Linc. Lab. J.* **4(2)**, 133–150 (1991).

**40** T.H. Jeys, R.M. Heinrichs, K.F. Wall, J. Korn, T.C. Hotaling, and E.J. Kibblewhite, "Observation of Optical Pumping of Mesospheric Sodium," *Opt. Lett.* **17(16)**, 1143–1145 (1992).

**41** R.W. Duffner, *The Adaptive Optics Revolution: A History*. Albuquerque, N. Mex.: University of New Mexico Press, 2009.

**42** E.J. Kibblewhite, R. Vuilleumier, B. Carter, J. Wild, and T.H. Jeys, "Implementation of CW and Pulsed Laser Beacons for Astronomical Adaptive

Optics Systems," *Proc. SPIE* **2201**, 272–283 (1994).

**43** C.A. Denman, P.D. Hillman, G.T. Moore, J.M. Telle, J.D. Drummond, and A.L. Tuffli, "20 W CW 589 nm Sodium Beacon Excitation Source for Adaptive Optical Telescope Applications," *Opt. Mater.* **26(4)**, 507–513 (2004).

**44** A.J. Tracy, A.K. Hankla, C.A. Lopez, D. Sadighi, K. Groff, C. d'Orgeville, M. Sheehan, D.J. Bamford, S.J. Sharpe, and D.J. Cook, "High-Power Solid-State Sodium Guidestar Laser for the Gemini North Observatory," *Proc. SPIE* **6100**, 61001H1-12 (2006).

**45** A. Mooradian, "Solid State Micro-laser," U.S. Patent No. 4,860,304, August 22, 1989.

**46** J.J. Zayhowski and A. Mooradian, "Single Frequency Microchip Nd Lasers," *Opt. Lett.* **14(1)**, 24–26 (1989).

was the generation of such radiation with the 1064 and 1319 nm lasers tuned to near the center of their respective tuning ranges.<sup>38</sup> This demonstration showed that a robust laser system could be developed by using the peak gain of these laser transitions. During 1986 to 1995, four sum-frequency laser systems were developed at Lincoln Laboratory.

The first laser system was a low-power demonstration laser which could be operated in both a CW mode and a Q-switched mode. In Q-switched mode, this laser system generated 400 mW (0.4 mJ with 100 ns pulse duration at 1 kHz repetition rate) of sodium-resonance radiation and was used to excite the mesospheric sodium layer. The second laser was designed to generate much-higher-energy pulses but at a lower repetition rate. It operated at a 10 Hz pulse repetition rate and generated up to 0.5 J of sodium-resonance radiation per pulse. Each pulse had a duration of 100  $\mu\text{s}$  and was composed of a train of mode-locked pulses.<sup>39</sup> In order to suppress strong relaxation oscillations, intracavity second harmonic generation crystals were inserted into the 1064 and 1319 nm lasers. This second laser was used for the first optical pumping experiment on mesospheric sodium.<sup>40</sup> The third laser was developed for the Starfire Optical Range at Kirtland Air Force Base, New Mexico, and was delivered to the range in 1991.<sup>41</sup> This laser operated with pulsed energies of up to 23 mJ per pulse at a pulse-repetition rate of 840 Hz and with 100  $\mu\text{s}$  mode-locked macro-pulses. The fourth sum-frequency laser system was developed for the University of Chicago under the sponsorship of the National Science Foundation. In contrast to previous laser systems, this system utilized diode lasers, instead of flashlamps, for pumping of the Nd:YAG gain media. Diode pumping had the advantage of improved optical efficiency and greatly reduced thermal loading of the Nd:YAG crystals. The diode-pumped laser system produced 18 to 25 mJ of sodium-resonance radiation in 150  $\mu\text{s}$  mode-locked pulse train envelopes at a repetition rate of 400 Hz. In December 1995, this laser system was installed at the 3.5 m aperture Astrophysical Research Consortium telescope at Apache Point Observatory, New Mexico, for use by the University of Chicago.<sup>42</sup> Lincoln Laboratory's pioneering development of the sum-frequency source of sodium-resonance radiation was followed by the work of other organizations on several variant designs of the Nd:YAG sum-frequency concept.<sup>43,44</sup>

#### Microchip Lasers

Mooradian developed the original concept for the microchip laser in 1987. Over the next two decades, the microchip laser would evolve in diverse directions and would enable significant new applications, both at Lincoln Laboratory and elsewhere. Mooradian's novel idea was to make the cavity of a solid-state laser sufficiently short (<1 mm) that the frequency spacing of the cavity modes would be comparable to or greater than the gain bandwidth of the laser. As a result, only one cavity mode would see enough gain to reach lasing threshold, and the laser would oscillate on a single frequency.<sup>45</sup> Mooradian submitted an application for the first microchip laser patent on February 2, 1988, and the patent was granted on August 22, 1989.

Initial lab work on microchip lasers focused on placing tiny pieces of stoichiometric Nd-based gain media between two small mirrors, but frustration with the quality of the stoichiometric materials available at the time led John Zayhowski to try the microchip concept with the much more mature Nd:YAG material. Success with Nd:YAG was almost immediate (Figure 24-6). The discrete mirrors used in the initial demonstration were soon abandoned in favor of dielectric mirrors deposited directly onto the gain medium, forming a fully monolithic microchip laser. By summer 1988, single-frequency operation of microchip lasers had been demonstrated using a variety of solid-state gain media, including stoichiometric materials.<sup>46</sup>

In 1988, Lincoln Laboratory collaborated with the Charles Stark Draper Laboratory to develop the first application for a microchip laser — a fiber-optic gyroscope. Lincoln Laboratory developed the microchip laser, and Draper Laboratory used the laser to develop the gyroscope. This application required a modest amount of frequency tunability from the microchip laser, which was achieved by using piezoelectric materials to apply stress to the gain medium, thereby affecting the physical length of the gain medium and its electro-optic properties and, in turn, tuning the frequency of the laser. Following the fiber-optic-gyroscope program, work on tunable CW microchip lasers evolved to include laser tuning via pump-power modulation and electro-optic tuning. In addition, new gain media were explored to extend the wavelength coverage and capabilities of CW microchip lasers.



**Figure 24-7**  
**Photograph of an electro-optically Q-switched microchip laser system packaged for use in airborne light detection and ranging. The system shown contains the microchip laser, the pump diode, and all of the high-speed, high-voltage electronics required to Q-switch the laser. It generates 300 ps duration pulses with a pulse energy of 7  $\mu$ J at a repetition rate of 5 kHz.**

#### Notes

**47** J.J. Zayhowski and A. Mooradian, "Coupled-Cavity Q-Switched Laser," U.S. Patent No. 4,982,405, January 1, 1991.

**48** J.J. Zayhowski and C. Dill III, "Diode-Pumped Microchip Lasers Electro-optically Q Switched at High Pulse Repetition Rates," *Opt. Lett.* **17(17)**, 1201–1203 (1992).

In 1992, Mooradian left Lincoln Laboratory and cofounded Micracor to commercialize CW microchip-laser technology. Micracor licensed Mooradian's microchip-laser patents from MIT. With CW microchip-laser technology transitioned to industry and commercially available, Lincoln Laboratory's work on CW microchip lasers was phased out.

#### Short-Pulse Microchip Lasers

Zayhowski realized that the short length of the microchip-laser cavity provided the potential to produce very short pulses in gain-switched or Q-switched operation. Consequently, in 1989, he began to explore the pulsed operation of microchip lasers. Gain-switched operation was easy to demonstrate with pulsed pump sources but was not very practical. Q-switched operation offered the potential of much more compact and robust devices, provided the Q-switch could be incorporated into the laser cavity in a way that maintained the desirable short cavity length.

The solution was to use two coupled cavities, with a short gain cavity coupled to a second short optical cavity that served as a tunable etalon.<sup>47</sup> In the initial demonstrations of the concept, the length of the second cavity was controlled piezoelectrically. Zayhowski recognized, however, that it was the response time of the piezoelectric material that controlled the duration of the output pulse, and in 1990 he began to pursue an electro-optic version of the device. By 1991, an electro-optically Q-switched microchip laser had been demonstrated and had, in fact, produced the shortest output pulses obtained from a Q-switched solid-state laser (270 ps) up to that date.<sup>48</sup> An electro-optically Q-switched microchip laser was packaged for use in a laser radar (Figure 24-7).

Zayhowski continued to develop increasingly practical and versatile microchip lasers. These later advances are described in the "Passively Q-Switched Microchip Lasers" section.

#### Early Integrated Photonics

Integrated photonics, or guided-wave optics, involves the monolithic or hybrid integration of optoelectronic devices such as semiconductor diode lasers, optical amplifiers, photodiodes, optical modulators, filters, and passive waveguides. Applications of integrated photonics include optical communications (both digital and analog),

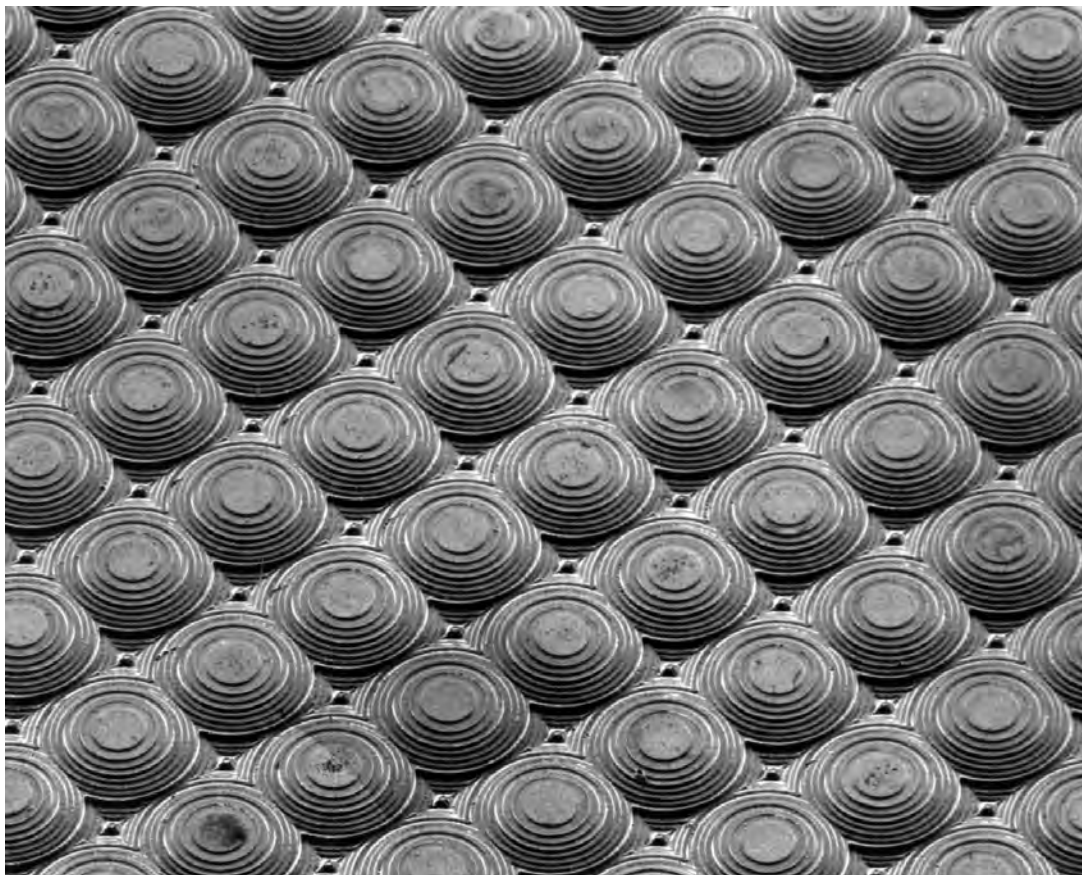
sensing, and signal processing. Much of the research in integrated photonics was driven by the digital fiber-optic communications industry, including leading organizations such as Bell Laboratories in the United States and Nippon Telegraph and Telephone Laboratories in Japan.

The primary applications of integrated photonics pursued at Lincoln Laboratory include microwave photonic links and optical sampling for analog-to-digital conversion. Work was initiated in the early 1970s with funding from the Defense Advanced Research Projects Agency (DARPA). Materials used to realize integrated photonic devices include compound (III-V) semiconductors, LiNbO<sub>3</sub>, and Si.

In the early 1970s, activity in III-V integrated photonics was centered on GaAs technology, principally because of its relative maturity and its compatibility with the 0.9 to 1.15  $\mu$ m wavelength range, where fiber-optic communication research was focused at the time. In one of the first demonstrations of a III-V integrated photonic device, Stillman, Wolfe, and Melngailis incorporated an InGaAs Schottky-barrier photodiode in a GaAs planar waveguide. In the 1980s, building on the development of InGaAsP materials for semiconductor lasers in the 1970s, III-V integrated photonics research shifted to the InP material system. Donnelly fabricated the first optical waveguides in InP-based materials, thereby opening the 1.3 to 1.5  $\mu$ m wavelength region to monolithic photonic integration.

In parallel with the III-V research activities, development of LiNbO<sub>3</sub> integrated photonics started in the late 1970s and grew to a substantial effort by the early 1980s. The early work was driven by signal processing and sensor remoting applications that could exploit the wide modulation bandwidths projected for guided-wave electro-optic devices. The Laboratory activity focused on the development of Mach-Zehnder interferometric modulators. In 1980, Frederick Leonberger demonstrated the first interferometric modulator with bandwidth exceeding 1 GHz. These devices formed the core of the 4-bit 1-GS/s electro-optic analog-digital (A/D) converter discussed below. Work on increasing modulation bandwidth progressed rapidly, with Richard Becker reporting a traveling-wave modulator with 16 GHz bandwidth in 1984. Both Leonberger and Becker left Lincoln Laboratory in the





**Figure 24-8**  
**Scanning electron micrograph of an array of binary optics microlenses fabricated from CdTe. Each f/0.9 microlens has a diameter of 55  $\mu\text{m}$ .**

**Note**

**49** R.A. Becker, C.E. Woodward, F.J. Leonberger, and R.C. Williamson, "Wide-Band Electro-optic Guided-Wave Analog-to-Digital Converters," *Proc. IEEE* **72(7)**, 802–819 (1984).

1980s to lead separate industry efforts to commercialize  $\text{LiNbO}_3$  integrated optical components, and  $\text{LiNbO}_3$  interferometric modulators are now widely employed in fiber-optic telecommunications systems.

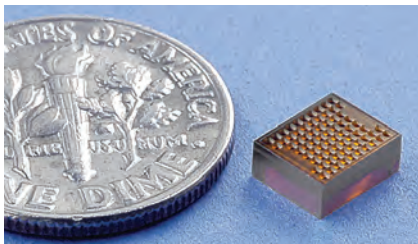
By the early 1980s, it was recognized that  $\text{LiNbO}_3$  integrated photonics could address important needs in a wide range of optics-based DoD sensor systems. Early advances in miniature fiber-optic gyroscopes were enabled by  $\text{LiNbO}_3$  optical phase and frequency modulators. Leonard Johnson and Charles Cox demonstrated serrodyne optical frequency shifters that became a key component of high-accuracy closed-loop fiber gyroscopes. Rediker and colleagues pioneered a class of optical wavefront sensors based on monolithic  $\text{LiNbO}_3$  interferometer arrays for laser-beam atmospheric correction. Early work on advanced beamforming techniques for wideband RF antenna systems was enabled with specialized traveling-wave  $\text{LiNbO}_3$  optical modulators developed by Gary Betts and Johnson.

Another important application of integrated photonics to microwave signal processing is the use of optical sampling for frequency down-conversion and A/D conversion. Initial work on optical sampling at Lincoln Laboratory was performed in the early 1980s by Becker and colleagues. They combined optical sampling with an optoelectronic quantization scheme to realize a 4-bit 1-GS/s A/D converter.<sup>49</sup> The quantization scheme was based on an array of  $\text{LiNbO}_3$  interferometers having half-wave voltages organized in a binary ladder. Although this demonstration was limited in resolution, the results highlighted the benefits provided by the application of optical sampling to the front end of an A/D converter. The Laboratory continued to innovate photonic devices. The more recent achievements are described in the "Integrated Microwave Photonics" section.

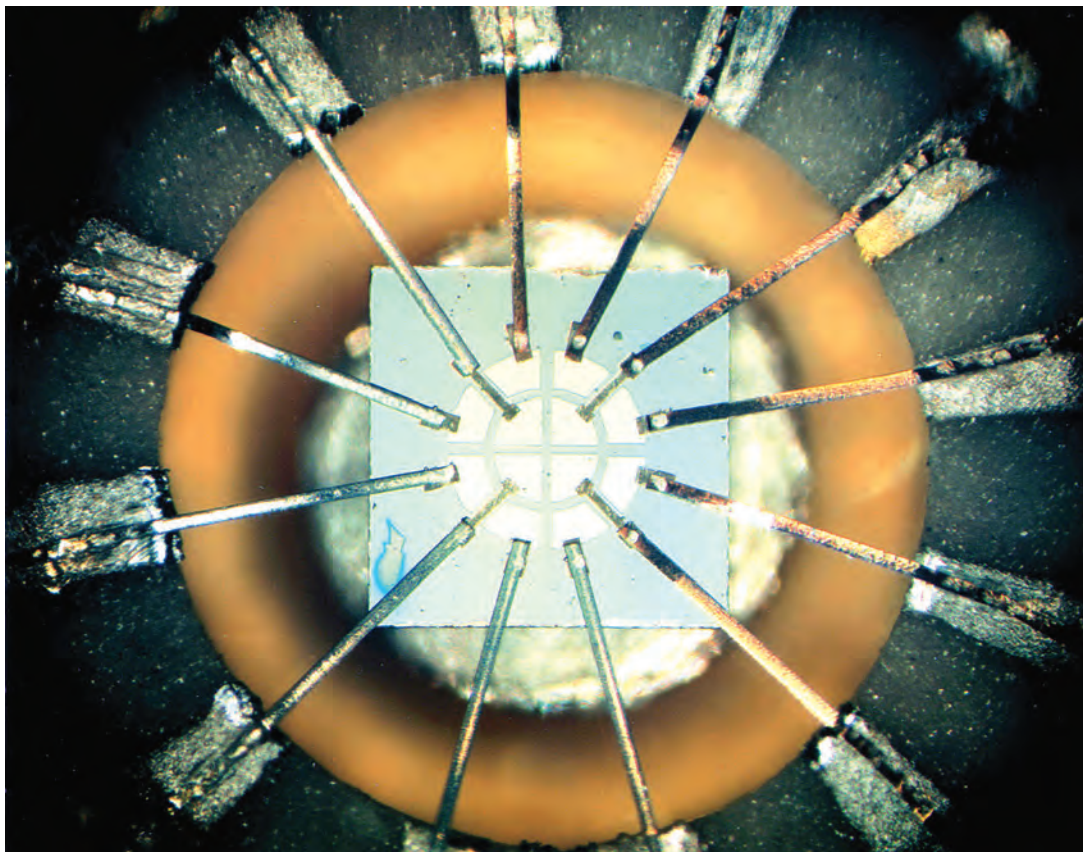
*Micro-Optics*

Micro-optics technology manages light with submicron-scale structures. The technology leverages the photolithographic design and fabrication methodologies developed for integrated-circuit fabrication in order to generate surface-relief features on optical substrates. The surface-relief patterns impose spatial phase modulation on a wavefront via propagation through the optical substrate or by reflection off the optical substrate (Figure 24-8). The computer-designed surface-relief





**Figure 24-9**  
A gallium-phosphide microlens array fabricated for use with a surface-emitting laser array in a free-space optical communication system.



**Figure 24-10**  
Twelve-element array of high-sensitivity 2 GHz bandwidth HgCdTe heterodyne detectors developed in 1977 for the Firepond CO<sub>2</sub> laser radar. The outer segmented contact ring on this chip has a 0.5 mm diameter.

features can be either spatially quantized or continuous; the relief dimensions can range from many wavelengths to less than the wavelength of the light being spatially modulated. Two forms of micro-optics have been developed at the Laboratory: one uses binary (or multi-level) quantized steps in the surface; the other smooths the steps in a digital preform into a desired continuous shape with a final thermal process for mass transport. Micro-optics technology is employed today by the optics industry to provide solutions to a variety of demanding optical design problems.

#### Binary Optics

The Lincoln Laboratory binary optics program grew out of the tactical laser radar program (discussed in chapter 14, “Tactical Battlefield Surveillance”) because the high frame rate required for an airborne laser radar demanded an array of photomixers. In the original 1977 design study for the infrared airborne radar program, Richard Becherer suggested the use of a hologram to generate an array of local-oscillator beams that had the amplitude and phase distributions necessary to ensure efficient photomixing in the array. In 1978, Becherer and Wilfrid Veldkamp successfully reported the development of an analog phase hologram that generated three local-oscillator beams. Difficulties in extending the analog technique to larger arrays led to Veldkamp’s proposing and patenting the use of computer-generated holograms implemented as binary phase patterns to solve the problem of generating multiple local-oscillator beams. Veldkamp met with success in 1979 when he designed and fabricated a binary surface-relief structure for heterodyne detection. By 1980, the Lincoln Laboratory team working on the infrared airborne radar program had developed an efficient binary phase hologram to produce a uniform-intensity elliptical laser beam for the laser radar transmitter.

In 1984, the first of five patents on coherent laser beam combining was disclosed by Veldkamp, James Leger, and Gary Swanson. This technique allowed large numbers of lasers to be combined. A linear array of two hundred semiconductor diode lasers was subsequently combined to end-pump a Nd:YAG solid-state laser rod. The work in coherent laser beam addition led to the development of binary-optic lenslet arrays.

## Notes

**50** Z.L. Liao, V. Diadiuk, J.N. Walpole, and D.E. Mull, "Large-Numerical-Aperture InP Lenslets by Mass Transport," *Appl. Phys. Lett.* **52(22)**, 1859–1861 (1988).

**51** D.L. Spears, "Theory and Status of High Performance Heterodyne Detectors," *Proc. SPIE* **300**, 174 (1981).

**52** Lincoln Laboratory's binary optics program originally evolved from the task of making a holographic grating to form matching CO<sub>2</sub> local oscillator beams to this linear detector array.

## Lenslet Arrays

In parallel to the binary approach, an analog lenslet technology was developed in the mid-1980s by Liao, Walpole, and Richard Williamson for combining diode laser beams<sup>50</sup> and more recently for applications in focal-plane arrays used in laser radars and in free-space optical communications.

This micro-optics fabrication is derived from wafer processing technology, which has been highly developed for the semiconductor industry. A gallium-phosphide or indium-phosphide semiconductor wafer (both of which have desirably high refractive indices greater than 3) is first patterned by using photolithography and then dry-etched by using ion beam and chlorine gas, to produce an accurate preform. The etched wafer is then heat-treated in a protective atmosphere in order to allow the surface atoms to move, to subsequently form a smooth micro-optical surface whose shape is directly related to the shape of the starting preform. Figure 24-9 shows an array of such spherical lenses designed for use with an array of surface-emitting lasers in a free-space optical communication system.

Lenslet arrays are routinely used to increase detection efficiency in Geiger-mode (single-photon sensitive) avalanche photodiode (APD) arrays in laser radar and optical communication receivers.

## Heterodyne Infrared Detectors

In 1970, Melngailis and Harman showed that, because the dielectric constant of HgCdTe is much lower than that of lead-based salts, diode photomixers could be made that operated at very high (0.5 GHz) bandwidths. Later that year, the Société Anonyme de Télécommunications published results indicating bandwidths above 1 GHz in 10  $\mu\text{m}$  HgCdTe photodiodes. When the Optics Division, however, tried to purchase these devices for the Firepond laser radar, the Société responded with a very high price, a year for the delivery time, and no guarantee of sensitivity. Since the Solid State Division had already developed a capability to make these detectors, staff members were asked to stay involved with the technology.

In the early 1970s, work progressed in the Optics Division on the Firepond laser radar. Because of the long lead time and lack of guaranteed performance of

10  $\mu\text{m}$  detectors from the Société Anonyme de Télécommunications in France, David Spears and coworkers produced a number of advances,<sup>51</sup> including high-sensitivity multigigahertz-bandwidth quadrantal arrays and twelve-element arrays. Both types of arrays went into the Firepond monopulse CO<sub>2</sub> laser radar facility (Figure 24-10). Twelve-element linear arrays were also developed for the Infrared Airborne Radar program.<sup>52</sup>

In the course of this work, measurements to determine photodiode heterodyne performance characteristics were developed. The high heterodyne quantum efficiency of the Lincoln Laboratory HgCdTe photodiodes enabled astronomers at the National Aeronautics and Space Administration (NASA) and UC Berkeley to use heterodyne radiometry effectively for numerous astronomical measurements. In the 1980s, Spears developed special p-type HgCdTe photoconductors with good heterodyne performance at temperatures over 200 K, making these detectors compatible with thermoelectric cooling.

## High-Speed Electronic Devices

Optoelectronic detector development began with work on APDs initiated by William Lindley and coworkers, who used the newly developed proton isolation process to eliminate edge breakdown in Schottky-barrier and ion-implanted GaAs devices. Wolfe and Stillman extended their pioneering work on GaAs vapor-phase epitaxy (VPE) and developed InGaAs APDs, the first devices with high gain and high speed at 1.06  $\mu\text{m}$ . They also demonstrated a unique electroabsorption APD with greatly enhanced response near the GaAs absorption edge.

In 1977, following Hsieh's development of liquid-phase epitaxy (LPE) InGaAsP/InP, Hsieh and Hurwitz demonstrated the first APDs in that system. Later, Vicky Diadiuk and coworkers developed a polyimide passivation process that led to higher gains and significantly lower dark currents. Diadiuk and Groves continued to work on InP-based LPE detector technology and developed a unique lateral *p-i-n* detector structure. In the late 1980s, Diadiuk, Groves, and Calawa developed sensitive, ultrawide bandwidth (5 to 10 GHz), 830 nm AlGaAs/GaAs heterodyne detectors and *n<sup>+</sup>-p* InP epitaxial structures that were used in the satellite communications programs in the Communications Division.



**Figure 24-11**  
**Monolithic Ka-band frequency doubler.**  
 A varactor diode is integrated with microstrip transmission lines, radial stub tuners, and bias lines. The length of the structure is ~3 mm.

#### Notes

**53** C.O. Bozler, G.D. Alley, R.A. Murphy, D.C. Flanders, and W.T. Lindley, "Permeable Base Transistor," *Proc. 7th Biennial Cornell Electrical Engineering Conf. on Active Microwave Semiconductor Devices and Circuits*. Ithaca, N.Y.: Cornell University Press, 1979, p. 33.

**54** T.C.L.G. Sollner, W.D. Goodhue, P.E. Tannenwald, C.D. Parker, and D.D. Peck, "Resonant Tunneling through Quantum Wells at Frequencies up to 2.5 THz," *Appl. Phys. Lett.* **43(6)**, 588–590 (1983).

The high-speed electronic device effort grew out of the APD program because successful APD performance demanded that the dimensions of the active device be precisely defined. Lindley instituted the first photolithographic definition of devices at Lincoln Laboratory to achieve this objective. Photolithography and proton isolation were shortly thereafter applied to advantage in the fabrication of GaAs IMPATT diodes, and in 1972, R. Allen Murphy developed high-efficiency Ka-band GaAs IMPATT diodes with long extrapolated lifetimes.

New lithographic processing procedures were developed in the course of the IMPATT diode development effort. The IMPATT effort also made the importance of microwave packaging and characterization abundantly clear. Because of the need for good GaAs material, Carl Bozler designed and built a VPE system for microwave device material.

In the mid-1970s, Brian Clifton developed GaAs mixer diodes for Ka-band operation on the LES-8 and -9 satellites. These Schottky-barrier devices were contacted by exquisitely crafted tungsten whiskers, and conversion losses were less than 4 dB, as was required for the satellites. The mixer technology was extended to a monolithic antenna/mixer circuit that eliminated the fragile whisker contact and provided a conversion loss of 4 dB at 100 GHz. A number of organizations have since used the planar mixer technology for mixer and varactor-diode applications.

A concurrent program to develop components for a monolithic millimeter-wave integrated circuit was set up by Alejandro Chu. Planar mixer technology was combined with selective epitaxy to fabricate a 32 GHz heterodyne receiver that consisted of a planar mixer and a field-effect transistor (FET) intermediate-frequency amplifier. Other millimeter-wave components later fabricated by Chu and Chang-Lee Chen for the Radar Measurement Division's monolithic millimeter-wave transceiver development program included phase shifters, monolithic power distribution networks, and a 16 to 32 GHz doubler (Figure 24-11).

One of the early applications of VPE was a technique in which large regions of epitaxial GaAs films were grown over photoresist and subsequently removed from a reusable substrate. During this development effort, it was

observed that GaAs films of high crystallographic quality could be grown over metallic tungsten gratings. This observation led to the conception of the GaAs permeable-base transistor (PBT) by Bozler and colleagues in 1978.<sup>53</sup>

In contrast to conventional planar FETs, in which the current flow is parallel to the wafer surface, the current flow in PBTs is normal to the wafer surface. Numerical simulations performed in 1980 projected that this feature of the PBT should provide a number of advantages for high-speed operation over the then-current FET technology.

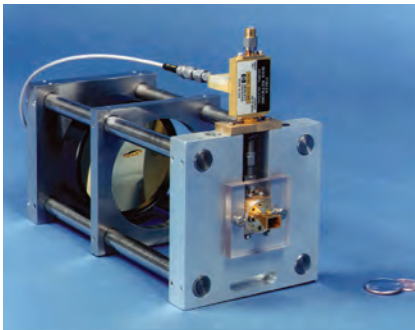
As a result of an extensive research effort, reproducible fabrication of PBTs with extrapolated maximum frequencies of oscillation exceeding 200 GHz was demonstrated in 1985. Later, through careful microwave characterization and power combining of monolithic GaAs PBT cells, Richard Chick and Robert Actis demonstrated PBT power amplifiers that provided 1.8 W with 30% efficiency at 20 GHz. A silicon version of the PBT was developed by Dennis Rathman to provide an alternative high-performance microwave device. The Si PBT demonstrated very low 1/f noise and excellent performance in low-phase-noise oscillators up to 20 GHz.

Resonant-tunneling diodes (RTD) offered the potential for even higher operating speeds. The resonant-tunneling mechanism was proposed by Leo Esaki and Raphael Tsu of IBM Research in 1970, but interest in the field was low until 1983, when William Goodhue, T.C.L. Gerhard Sollner, and Tannenwald collaborated to demonstrate a high-quality GaAs/AlGaAs RTD.<sup>54</sup> Conductance measurements indicated that the devices were capable of operating at frequencies as high as 2.5 THz.

Elliott Brown and Sollner developed models to design a microwave circuit that produced fundamental oscillations as high as 712 GHz. A quasi-optical 200 GHz RTD local oscillator was developed for the superconducting-insulator mixers that the Harvard-Smithsonian Observatory used in a prototype receiver intended for astrophysical measurements (Figure 24-12).

An advance in materials research — the development of low-temperature-grown (LTG) GaAs — led to a significant advance in device performance. In 1983, a series of fundamental molecular-beam epitaxy (MBE)





**Figure 24-12**  
A quasi-optical resonant-tunneling-diode local oscillator constructed for use in 200 GHz radiometric measurements.

#### Note

**55** G.M. Metzke and A.R. Calawa, "Effects of Very Low Growth Rates on GaAs Grown by Molecular Beam Epitaxy at Low Substrate Temperatures," *Appl. Phys. Lett.* **42(9)**, 818–820 (1983).

growth studies by George Metzke and Calawa led to the discovery that MBE at low temperatures ( $<400^{\circ}\text{C}$ ) produced GaAs layers that had high resistivity, showed good crystallographic quality, and were stable at normal MBE temperatures ( $\approx 600^{\circ}\text{C}$ ).<sup>55</sup>

An MIT Ph.D. project carried out at Lincoln Laboratory in 1988 demonstrated that this new material, when used as a buffer, eliminated backgating in GaAs FET integrated circuits. In the early 1990s, Chen demonstrated that when used as a gate insulator, LTG GaAs provided high FET power densities, and when used as a passivation layer, LTG GaAs increased FET operating voltage. Femtosecond time-resolved-reflectance measurements indicated that LTG GaAs has a very short carrier lifetime ( $\approx 150$  fsec), permitting its application as a photoconductive switch and as a photomixer for the generation of signals up to 100 GHz. LTG technology was transferred to numerous industrial organizations for use in a variety of applications, including high-speed analog devices.

A higher breakdown voltage makes InP potentially better than GaAs for microwave devices with high output powers. In the 1980s, Donnelly and John Woodhouse developed InP ion implantation technology and p-channel InP FETs. Chen subsequently fabricated InP metal-insulator semiconductor field-effect transistors (MISFET) with high power densities and analyzed the effect of interface traps on MISFET characteristics.

During the 1980s, the continued planar scaling of metal-oxide semiconductor field-effect transistors (MOSFET) and the commercial emergence of InGaAs high-electron-mobility transistors resulted in a ramp-down of compound semiconductor transistor development at the Laboratory.

#### *Surface-Acoustic-Wave Technology*

When the ALCOR in the Kwajalein Atoll became operational in 1970, existing solid-state signal processing devices were unable to handle all-range processing of the radar's wide bandwidth of 512 MHz and time-bandwidth product of 5120. A huge, unstable bridged-T network housed in seven 7 ft high electronic cabinets was built to process the ALCOR waveform, but the cost — several million dollars — was a major impediment to obtaining a second such system. However, the

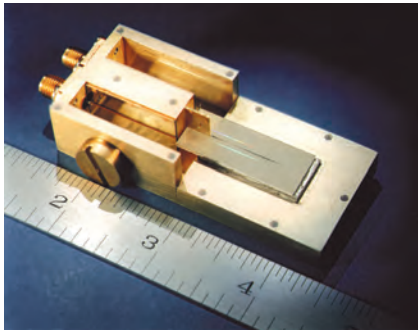
U.S. Army was just then planning a series of missile discrimination tests for which ALCOR needed to have two pulse-compression subsystems.

A team from the newly formed Microsound Group stepped in and made a daring proposal. Group leader Ernest Stern and associates believed that they could develop a SAW device that could perform the wideband signal processing task, and that the device could be small and inexpensive.

Jerome Freedman, then the assistant director responsible for strategic defense efforts, decided to call their bluff. Instead of ordering a second bridged-T pulse-compression subsystem, Freedman helped Stern obtain funding to develop the SAW device, called the reflective array compressor (RAC). With the funding, however, came a warning that the discrimination tests were scheduled to take place in two years and that the Solid State Division would be held responsible if the RACs failed to work properly.

The pressure was intense. The group had only two years to develop all necessary technologies and fabricate an operational device. A team was established that included Williamson for device modeling and design, Henry Smith for fabrication technology development, and Barry Burke for acoustoelectric amplifier research. The SAW wavelength of the ALCOR RAC had to be approximately  $3\ \mu\text{m}$ , which required the fabrication of  $0.8\ \mu\text{m}$  wide metal lines and spaces, and thousands of precisely positioned  $1.25\ \mu\text{m}$  wide grooves with a controlled depth of a few hundred angstroms. Because these requirements were well beyond the state of the art at the time, new fabrication processes and tools had to be invented and developed.

The most difficult part of the program was the requirement for submicron lithography. Smith converted one of the first available scanning electron microscopes into a pattern generator tool. Smith and Andrew Hawryluk, a graduate student, analyzed high-energy electron exposure of resist systems and used that knowledge to develop polymethyl methacrylate (PMMA)-based electron resists and exposure procedures, which are still in use throughout the electronics industry.



**Figure 24-13**  
SAW reflective array compressor for  
ALCOR at KREMS.

Because the photomask for defining the grating pattern could not be obtained from commercial sources, Williamson collaborated with the D.W. Mann Company to develop a laser-controlled pattern generator capable of producing the desired pattern. The pattern generator later became a commercial product. Because no existing tools were capable of transferring this grating pattern to a substrate, Smith devised a conformable mask technique that produced optical contact between a thin glass mask and the photoresist-coated LiNbO<sub>3</sub> substrate. The absence of a gap between mask and substrate controlled diffraction sufficiently to permit replication of the pattern with excellent fidelity.

It was not clear that the submicron transducer pattern could be transferred to the LiNbO<sub>3</sub> substrate with the conformable optical printing process, so a backup technique, X-ray lithography, was conceived by Smith, Spears, and Stern. Spears and Smith developed a soft X-ray source (a modified electron-beam evaporator) and an X-ray mask consisting of a transparent (to soft X-rays), 5 μm thick silicon membrane and a gold absorbing pattern. PMMA was effective as X-ray resist. By early 1973, both the conformable optical and the X-ray lithography concepts worked sufficiently well to produce submicron transducers on LiNbO<sub>3</sub>; conformable printing, however, gave better results for both the transducer and grating patterns and was the method selected for device fabrication.

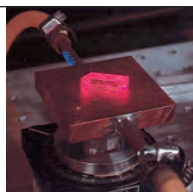
An etching system consisting of a French-designed ion-beam spacecraft thruster mounted on a vacuum chamber was modified by Williamson for etching the groove pattern into the exposed LiNbO<sub>3</sub> surface. A significant modification allowed the gratings to be etched with spatially varying depth.

The phase error of the ALCOR RACs could not be greater than one part in 10<sup>6</sup>, a requirement that exceeded the intrinsic uniformity of LiNbO<sub>3</sub> SAW devices by an order of magnitude. No commercial instrument could perform phase measurement on a device of this type, so Williamson led an effort to develop an automated instrument. The deviation of each RAC from ideal was measured, a compensatory phase-correction pattern was generated and applied to the substrate surface, and a matched pair of RACs was produced in time for the 1973 real-time ALCOR demonstration (Figure 24-13).

When the program started in 1970, losses in RACs could not be predicted with confidence. Therefore, Burke developed a SAW acoustoelectric amplifier (previously conceived and analyzed by Kjell Ingebrigtsen at the Norwegian Institute of Technology) that could double (in dB) the available dynamic range. The amplifier consisted of a strip of silicon immediately adjacent to the LiNbO<sub>3</sub> surface on which the fringing piezoelectric field of the SAW interacted with drifting carriers in the adjacent silicon. By 1972, devices without amplifiers possessed a dynamic range sufficient for ALCOR, causing a shift of emphasis in acoustoelectric device research.

The RACs met all performance goals. They replaced the bridged-T network, and the full development cost of the RACs was less than the projected purchase price of even one bridged-T network. Moreover, the SAW technologies developed during the RAC program received wide acceptance in industry and defense communities. These submicrometer technologies created a separate legacy that led to the formation of the Submicrometer Technology Group.

1980



Titanium-doped  
sapphire laser invented at  
Lincoln Laboratory



E. Stern



Infrared photograph of first  
monolithic 2-D surface-  
emitting diode laser array

## Note

56 J.T. Lynch, A.C. Anderson, R.S. Withers, P.V. Wright, and S.A. Reible, "Passive Superconducting Microwave Circuits for 2–20 GHz Bandwidth Analog Signal Processing," *IEEE MTT-S Int. Microwave Symp. Digest*, 524–526 (1982).

The RACs were installed in several Lincoln Laboratory systems, including the multiple-antenna surveillance radar and the Fleet Satellite Communications EHF Package (FEP), forerunners of the Joint Surveillance Target Attack Radar System and Milstar, respectively. RAC technology was transferred successfully to Texas Instruments, Hughes Aircraft, and TRW. The physics and fabrication of SAW gratings were applied to SAW resonators by Robert Li, and then transferred to industry. These resonators were in common use in analog television receivers and represented one of the highest-volume SAW devices.

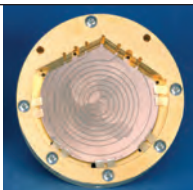
In 1971, Lars Svaasand at the Norwegian Institute of Technology observed a weak second harmonic caused by the nonlinear interaction of two counter-propagating SAWs. This signal was exactly equivalent to the convolution of one signal with respect to the other. The nonlinearity of the acoustoelectric interaction in  $\text{LiNbO}_3$ -Si structures, initially developed by Burke for amplifiers, was orders of magnitude greater than elastic nonlinearity in  $\text{LiNbO}_3$ , and therefore the Lincoln Laboratory group anticipated, and demonstrated, a substantially stronger effect.

John Cafarella used this structure to demonstrate high-performance convolvers. Because Lincoln Laboratory had developed a superior technology for maintaining a uniform, several-centimeters-long,  $0.5\ \mu\text{m}$  gap between Si and  $\text{LiNbO}_3$ , Cafarella and Stanley Reible were able to set a standard of performance for acoustoelectric convolvers with time-bandwidth products of 2000 and bandwidths up to 200 MHz. These stable, uniform, and reproducible devices proved to be suitable for insertion into packet radios and an identify-friend-or-foe system prototype. The technology was successfully transferred to Texas Instruments.

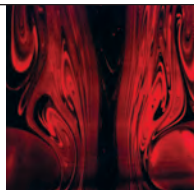
## Superconductive Electronics

Superconductive electronics for ultrawideband signal processing was first proposed as a research activity by Reible, a member of the Surface Acoustic Wave Technology Group, in the late 1970s. At the time, the group was engaged in engineering SAW devices and inserting them in signal processing systems, but even in the midst of this activity, Stern, the group leader, saw the need to explore new technologies, and he encouraged Reible to begin a small effort on developing a Josephson-junction-based convolver. The goal was to integrate the low microwave loss of superconducting transmission lines and the high-speed nonlinearities of superconducting tunnel junctions into analog circuits. The broader expectation was that many of the techniques familiar from SAW technology could get recast at higher bandwidth in superconductive form. The group name was changed to Analog Device Technology Group.

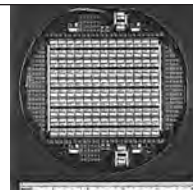
Familiar with the success of the SAW RAC, Jack Lynch proposed a superconducting tapped delay line as a chirp filter, and Peter Wright enhanced the concept by suggesting the device consist of a spiral pair of coupled transmission lines with a cascade of backward-wave couplers. Each backward-wave coupler would act like a grating element to electromagnetic waves the way an etched groove in the surface of  $\text{LiNbO}_3$  acts as a grating element to SAWs, and the pair of transmission lines would provide superior input/output isolation. The low microwave loss of superconducting transmission lines allowed long dispersive delays and compact form factors on small-area substrates.<sup>56</sup> A pair of these chirp filters built using superconducting niobium transmission lines on silicon wafers was operated at 4.2 K and used by Richard Withers and Reible to demonstrate a 2.6 GHz bandwidth analog chirp transform, essentially



Superconductive microstrip delay line



Gas flow in vapor-phase-epitaxy reactor



Wafer-scale laser-restructurable integrated circuit for adaptive nulling



---

**Note**

**57** R.S. Withers and S.A. Reible, "Superconductive Chirp-Transform Spectrum Analyzer," *IEEE Electron Device Lett.* **6(6)**, 261–263 (1985).

the analog front end of a compressive receiver.<sup>57</sup> This work and other accomplishments established the Analog Device Technology Group as a leader in superconductive electronics.

Alfredo Anderson began a study of materials technology to select the best film candidates for extending operation to higher temperatures, and he created high-quality NbN films with good microwave properties operating at up to 10 K. The resonator techniques he developed to characterize the RF properties of the deposited films became an important tool, since extended by Daniel Oates, to probe the quality of the class of superconducting oxides that were discovered in 1986. A variety of film synthesis techniques were evaluated, and from this work emerged a focus by Anderson on the development of sputter deposition of YBaCuO over large areas for microwave applications. This material becomes superconducting at 90 K and provides good device performance at temperatures up to about 77 K; these temperatures can be readily provided by either a closed-cycle refrigerator or liquid nitrogen.

The earlier effort on Nb devices gave the group a lead in the race for practical applications of the new materials; indeed, other researchers in the emerging field of superconductive microwave devices sought to emulate some of the work being carried out at the Laboratory. One individual who was particularly interested in Lincoln Laboratory's work was Ralph Gomory, then IBM senior vice president and director of research, who was chairing a White House Science Council panel examining the formation of consortia to combine government, industry, and academia in the pursuit of practical applications of superconductivity. Soon after issuing the panel report, Gomory approached MIT President Paul Gray and proposed the formation of such a group. Gomory's researchers had specifically recommended that Lincoln Laboratory join the effort. Negotiations were completed in October 1989, and the Consortium for Superconducting Electronics (CSE) was formed by MIT, Lincoln Laboratory, IBM Research, and AT&T Bell Laboratories. Membership grew to include Conductus, a startup company focused on superconductive electronics, in Sunnyvale, California, and CTI-Cryogenics, the world's largest manufacturer of cryocoolers, located in Mansfield, Massachusetts. Richard Ralston, leader of the Analog Device Technology Group, served as principal

director of the CSE. Research costs were shared by industry and ARPA, and the CSE was among the first of such ARPA-supported research consortia.

Working jointly with its industrial partners, the Analog Device Technology Group continued to develop both low- and high-temperature superconducting (HTS) electronics. As an example of some of the work done within the CSE, in 1990, W. Gregory Lyons and collaborators demonstrated the world's first HTS resonator-based filter and the first HTS delay-line-based filter. Eventually, researchers building on this initial CSE work would demonstrate microwave HTS resonator-based filters with more poles and zeroes than any other technology can support. These were successfully applied to the cell-phone base-station market by Conductus and competing startup firms.

The CSE ended in 1995. An important research legacy is found in the Microelectronics Laboratory, which still supports the only submicron-planarized Nb-junction process available anywhere, originally developed by researchers at IBM Research and grafted by Manjul Bhushan, Paul Mankiewich, and others into the Microelectronics Laboratory, ultimately forming a basis for work in superconductive quantum information science.

#### *Submicrometer Technology*

Reducing the size of solid-state devices is unquestionably the best way to improve performance, increase density, reduce costs, and produce new types of devices. In the 1970s, there was no consensus about which of several approaches was the best for fabricating submicron devices. Clearly, however, conventional optical techniques were inadequate for feature sizes well below 1  $\mu\text{m}$ , and advanced techniques had to be developed.

The work carried out in 1972 on high-resolution lithography for SAW grating devices, particularly the patent for the use of X rays to print patterns, initially led Lincoln Laboratory into an effort to develop techniques for submicron device fabrication. However, the official start of the submicron technology effort was in 1977, when Smith was appointed assistant group leader in the Microelectronics Group, with the charter of advancing the state of the art in the fabrication of small device structures.

In 1978, Dale Flanders made an unambiguous demonstration of the resolution capabilities of X-ray lithography when he succeeded in printing 20 nm features. In 1980, when Smith accepted a faculty position at MIT and moved the X-ray lithography research activity to the campus, Lincoln Laboratory's work on X-ray lithography came to an end.

Interest in electron-beam lithography at Lincoln Laboratory had, in any event, already superseded X-ray lithography because X-ray lithography, although it can replicate patterns already on masks, cannot actually pattern a mask. For mask fabrication, therefore, the group turned to focused electron-beam lithography.

This first electron-beam lithography system was a modified microscope used to fabricate submicron SAW structures. A commercial electron-beam lithography system was purchased in 1979, and Shaver used this tool to fabricate diffractive lenses (zone plates) for X-ray imaging applications. Cumbersome holographic techniques requiring custom optics had previously been used to fabricate such lenses, but the electron-beam system proved to be more flexible and more accurate.

The electron-beam system was also used to fabricate GaAs transistor devices and X-ray masks. Shaver and Theodore Lyszczarz used the system to test and customize digital integrated circuits by directly injecting charge on floating-gate devices. In 1986, the electron-beam system was retired when a more capable system was purchased that could fabricate devices 0.1  $\mu\text{m}$  and smaller with good pattern registration and automation.

An independent effort within the group investigated masked ion-beam lithography, which has the advantages of high throughput, robust processing, and high resolution. Techniques for ion-beam etching and reactive-ion etching to transfer the patterns into a semiconductor or metal were developed, and Stella Pang explored the impact of etching on the quality of the semiconductor surface.

Technologies developed within the Solid State Division have permitted the fabrication of numerous electronic devices and optical elements at Lincoln Laboratory. The heart of the permeable-base transistor, for instance,

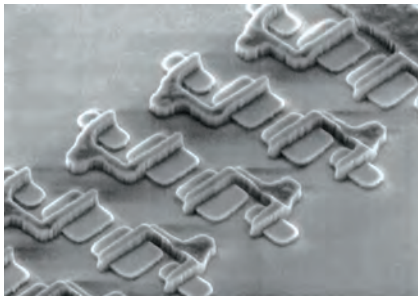
was a 320 nm period-base grating that was patterned with a combination of X-ray lithography, electron-beam lithography, and reactive-ion etching.

While the Microelectronics Group was working on electron-beam and X-ray lithography, several people within the Quantum Electronics Group were laying the foundation for advanced optical lithography techniques. In fall 1979, Thomas Deutsch, Daniel Ehrlich, and Richard Osgood performed the first experiments in high-resolution patterning by laser-induced photochemistry, a technique that soon proved to be a new and exciting area of research. Tightly focused argon-ion lasers (typically at 488 and 514 nm or frequency doubled at 257 nm) were able to deposit thin films selectively or etch materials with submicron definition.

The early pioneering work of Jeffrey Tsao and Ehrlich was followed by more careful applications-oriented studies performed by Ehrlich, Jerry Black, and Mordechai Rothschild. Although conceptually simple, laser photochemistry demanded fine balances in gaseous, adsorbate, and solid-state phases, frequently augmented by photothermal reactions. The applicability of the technique to the prototyping and repair of photomasks, semiconductor devices, and integrated optics drew immediate worldwide attention, and whole symposia were devoted to this topic.

Lithography — the patterning of thin films used in the fabrication of semiconductor devices — has been the key enabler of the continuous reduction in size of microelectronic circuits for over three decades. Among the various lithography methods, optical projection lithography became the dominant technology in the 1980s. It was well known at the time that one approach to reducing the patterned feature size was a shift to shorter wavelengths of the radiation used in lithographic systems. In the early 1980s, the dominant lithography employing mercury discharge lamps in the blue spectral region (at 436 nm) had transitioned to the near-ultraviolet (365 nm).

In the mid-1980s, the semiconductor industry was in the process of changing the lithography wavelength yet again, this time to the deep-ultraviolet 248 nm. Since powerful discharge lamps were difficult to engineer in the deep ultraviolet, this change was enabled by the emergence of a new radiation source — the pulsed excimer laser, which



**Figure 24-14**  
Scanning electron micrograph of the first functional electrical devices (ring oscillators) fabricated with the 193 nm system. The pitch of the inverter chain is 3.65  $\mu\text{m}$ .

emitted at 248 nm. By the late 1980s, excimer lasers were being incorporated into sophisticated optical projection systems, and in parallel, photoresists sensitive at this wavelength were being developed to match the laser output.

The accepted wisdom in the lithography community was that 248 nm lithography was the end of optical lithography: no further reduction in lithographic wavelength was possible because neither high-quality lens materials nor suitable photoresists were feasible at wavelengths shorter than 248 nm. If the lithographic dimensional shrinking was to continue, so it was argued, radically different technologies would have to be developed, such as proximity X-ray lithography. Indeed, significant research and development efforts were expended in new lithographic directions, both by the semiconductor industry worldwide and by DARPA in the United States.

With these trends as a backdrop, in 1988, DARPA started a project at Lincoln Laboratory to explore the feasibility of optical projection lithography at the even deeper ultraviolet wavelength of 193 nm, which corresponded to another wavelength at which excimer lasers could operate, albeit with less efficiency than at 248 nm. Compared to the investments at the time in non-optical lithography, the 193 nm effort at Lincoln Laboratory was quite small. Still, it was significant enough to warrant the establishment of the Submicrometer Technology Group.

Over the next few years, the new group, under the leadership of Shaver and then Rothschild, attacked all the issues raised by skeptics of 193 nm lithography. It identified failure mechanisms of amorphous fused silica and crystalline calcium fluoride, the two most promising lens materials, and then it collaborated with optical-materials companies to improve the quality and laser-damage resistance of the lens materials. The group also

explored a wide range of photoresists that would have the right transparency and photosensitivity at 193 nm, and collaborated with other research groups in demonstrating the first 193 nm photoresists. It constructed a 193 nm microstepper and fabricated the first microelectronic devices using only 193 nm lithography. It also demonstrated the feasibility at 193 nm of photomasks and their protective pellicle membranes.

Significantly, the Lincoln Laboratory program also included the construction by Silicon Valley Group Lithography Systems (SVGL) of a prototype large-field 193 nm step-and-scan projection system, which was built on the platform of a commercial 248 nm tool. The change from 248 to 193 nm necessitated radical reengineering of the laser and all optical elements. When it was completed in 1993, this first-ever 193 nm system was installed in the then recently completed Microelectronics Laboratory at Lincoln Laboratory, and it was subsequently used to develop photoresists and related microfabrication processes, explore the resolution limits of 193 nm lithography, and fabricate microelectronic devices (Figure 24-14). The Laboratory continued to develop deep-ultraviolet lithography; the more recent achievements in nanoscale technology are described in the section entitled “Nanoscale Technology.”

#### *Charge-Coupled Imagers*

The charge-coupled-device (CCD) technology activity within the Microelectronics Group produced major performance improvements for the Laboratory’s systems groups. The first instance of this was providing a solution to the problem of detecting and tracking space objects (satellites and debris) with telescopes equipped with low-light-level imaging devices. This task required large-area imagers with both low noise and high quantum efficiency; in short, CCDs.

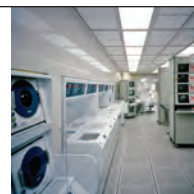
1990



D.C. Shaver



Microelectronics Laboratory  
(dedicated in 1992)



Diffusion area in  
Microelectronics Laboratory  
class-10 clean room



M. Rothschild



## Note

58 A.M. Chiang and B.E. Burke, "A High-Speed Digitally Programmable CCD Transversal Filter," *Gov. Microelectronics Applications Conf. Digest of Papers*, 182 (1980).

The development of CCD imagers is described in chapter 26, "Charge-Coupled Imagers," and DoD applications are expanded in chapter 10, "Space Situational Awareness."

In 1988, a separate activity was initiated to develop large-area infrared focal-plane arrays that combined Schottky-barrier detectors and CCD readout circuitry in support of the Aerospace Division's space surveillance mission. This activity was based on earlier pioneering work conducted at the Rome Air Development Center. Significant efforts were devoted to the development of ultrahigh-vacuum processing for production of high-sensitivity detectors and to the development of improved CCD processing to achieve high-efficiency operation even at cryogenic temperatures. These two major technical advances, accomplished by Bor-Yeu Tsaur and Chenson Chen, led to the demonstration of large two-dimensional PtSi focal-plane arrays with state-of-the-art performance in terms of sensitivity, uniformity, and noise.

In early 1990, the emphasis of the electro-optical surveillance effort shifted toward missile surveillance and interceptor seeker applications to be employed in strategic and theater missile defense. Lincoln Laboratory's advanced PtSi focal-plane arrays played a key role in enabling the first development phase of several advanced ground-based and airborne sensor platforms, and of the Theater High-Altitude Area Defense interceptor seeker.

### *Charge-Coupled Signal Processors*

Charge-coupled-device technology was soon recognized at Lincoln Laboratory and elsewhere as having substantial potential for electronic signal processing, and an active period of exploration of digital, analog, and mixed analog-digital architectures began. In the initial effort at Lincoln Laboratory, the analog tapped-delay-line

techniques that had been successfully implemented in SAW technology by Stern, Williamson, and their group were adapted to the charge domain, and resulted in the 1976 demonstration by Burke and Lindley of a transversal filter with 32 taps and 2-bit programmable weights.

The tapped delay line has been an important element of most architectures throughout the evolution of CCD signal processing at Lincoln Laboratory over nearly two decades. It soon became clear that the promise for CCD signal processors could be realized only by mixing increasingly sophisticated weighting, programming, and support circuits, both analog and digital, onto a monolithic integrated-circuit chip. This combination, though not achieving the bandwidths of either the SAW or superconductive signal processors, yielded far more flexible signal processors in very compact, low-power forms. Alice Chiang and Scott Munroe separately had this early vision. They each invented techniques and circuits that established the Laboratory as the unchallenged leader in charge-domain signal processing. Chiang extended the filter architecture to six parallel tapped lines as a means to implement 6-bit weights, and then invented a far more compact method based on multiplying digital-to-analog converters (MDAC),<sup>58</sup> one for each 8-bit tap weight. Using multiple MDACs, Chiang demonstrated a wide variety of computationally efficient circuits operating at up to ten million samples per second.

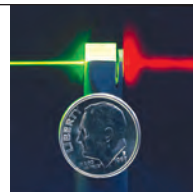
The matrix-matrix-product chip implemented a conventional algorithm for radar waveforms, provided eighteen variable-frequency Doppler bins for each of sixteen range cells, and could resolve multiple simulated targets 42 dB below dc clutter. The image feature extractor chip used a neural network algorithm for  $128 \times 128$  pixel analog images and performed a  $7 \times 7$  pixel correlation with twenty programmable 8-bit feature templates. These



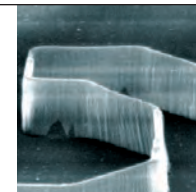
R.W. Ralston



Infrared countermeasures optically pumped 4  $\mu\text{m}$  laser



Laser-frequency doubling of a passively Q-switched microchip laser



Silylation resist with 0.1  $\mu\text{m}$  features

---

## Notes

**59** A class-100 clean room has fewer than 100 dust particles of 0.5  $\mu\text{m}$  diameter or larger per cubic foot of air. By comparison, typical office space has from a quarter of a million to a million dust particles in this size range per cubic foot of air, and a surgical operating room has about 10,000 particles per cubic foot.

**60** A.H. Anderson, J.I. Raffel, and P.W. Wyatt, "Wafer-Scale Integration Using Restructurable VLSI," *Computer* **25(4)**, 41–47 (1992).

chips and others, with their arrays of MDACs, outstripped pure digital approaches and achieved more than  $10^9$  multiply-accumulate operations per second per watt.

As a member of the Laboratory's Tactical Communications Group, Munroe was involved in overseeing Radio Corporation of America's production of a CCD-based programmable matched filter in an effort begun by Freeman Shepherd of the Rome Air Development Center. Shepherd and Munroe were both strong advocates of CCDs and convinced of the usefulness of CCDs for signal processing. The filter was successfully demonstrated within prototype jam-resistant secure-voice aircraft radios developed by the Laboratory. Munroe subsequently joined the Analog Device Technology Group and, working with Duane Arsenault and others, implemented a succession of increasingly integrated analog-signal/binary-reference programmable transversal filters that were easy to interface to standard complementary metal-oxide semiconductor (CMOS) subsystems. Prototype chips with 256 taps in each of two channels were provided to the NASA sponsor and then embedded in receivers by Stanford Telecommunications. These integrated circuits demonstrated synchronization and demodulation functions over a wide range of data rates in the Tracking and Data Relay Satellite System.

The commercial demand for compact and efficient signal processing brought new opportunities for applications. Chiang and Sollner separately created startup companies to exploit the charge domain for signal processing. Chiang formed Teratech Corporation in 1994 and developed a line of portable, ultrasound imaging systems. Sollner formed Kenet in 2002 to create a line of low-power analog-to-digital converters.

### **Advanced Technology Development in Integrated Subsystems (1993–2011)**

#### *Microelectronics Laboratory*

Since the late 1960s, Lincoln Laboratory has operated world-class microelectronics fabrication facilities that engage in research and advanced prototyping activities on new electronic devices, process technologies, and circuits. At their foundation, these activities have targeted the invention of new device concepts, the practical realization of those devices, and their integration into subsystems for system demonstrations. The fabrication

of these unique and often complex microelectronic components requires highly specialized clean-room facilities to minimize the impact of airborne contaminants on microelectronic component yields. These specialized facilities also allow for the safe handling, storage, and disposal of the many hazardous chemicals, materials, and gases used in the fabrication of advanced microelectronic devices.

One of the nation's first class-100 clean rooms<sup>59</sup> was constructed at the Laboratory in 1968 in the Building E complex. This new facility, dedicated to microelectronic fabrication, was quickly put to use exploring the application of the recently discovered CCD for solid-state imaging applications. Around the same time, the Digital Integrated Circuits Group of the Computer Technology Division constructed their own clean room in converted laboratory space in Building B. This facility was used originally for work in large magnetic film memories, and after 1970, for silicon integrated-circuit fabrication. While this facility was not of the same quality as the Building E clean room, it still enabled the group to build the largest-area digital integrated circuits in the world.<sup>60</sup>

By the mid-1980s, the technology of the semiconductor industry had been advancing at an exponential rate for almost two decades. Stern, then associate head of the Solid State Division, realized that if Lincoln Laboratory was to continue in microelectronic fabrication, better facilities would have to be built. Planning for the East Laboratory, as it was initially called, began in 1985. The goal of the new East Laboratory was to consolidate the ongoing silicon-based microelectronics activities of both the Solid State Division and the Computer Technology Division in a state-of-the-art class-10 microelectronics laboratory. Stern believed it was important for Lincoln Laboratory to remain a place that builds things, in contrast to many DoD laboratories whose mission is primarily to study things or to supervise others. Since what the Laboratory builds is electronic systems, and since the heart of all modern electronic systems is integrated circuits, Stern persuaded the Steering Committee to make the necessary investment to stay in that field. A new building would be built (Figure 24-15).

Creating a state-of-the-art clean room is technically complex, and creating any new building to be owned by the U.S. government requires many bureaucratic



**Figure 24-15**

**Lincoln Laboratory's class-10 Microelectronics Laboratory at dusk. This 70,000 ft<sup>2</sup> research and advanced prototyping facility has recently completed a major recapitalization effort. The Microelectronics Laboratory utilizes 200 mm diameter wafers and contains a production-class sub-90 nm process tool set used to support multiple Laboratory programs in the advanced technology area.**



## Inside the Microelectronics Laboratory

The Microelectronics Laboratory is a ~\$100 million state-of-the-art three-story facility with myriad special features designed specifically for the fabrication of microelectronic devices and systems in an ultraclean environment.

Semiconductor processing takes place on the second floor of the Microelectronics Laboratory, which houses an 8100 sq ft class-10 clean room.

The special requirements associated with the clean room are numerous. One routine requirement is suiting up. Staff go through a series of gowning procedures to enter the class-10

area. After changing their shoes and putting on hair nets, gloves, and safety glasses, Microelectronics Laboratory staff pass through an air shower to enter the class-10,000 area surrounding the clean room. They then enter a class-10 gowning area where they go through a special protocol to don Gore-Tex clean-room suits and pass through another air shower before entering the class-10 process level. These clean-room suits are designed to protect the environment from the person. As a person moves and speaks, particles are shed. Just a single particle during the fabrication process can render an integrated circuit inoperable. The clean-room suit and

helmet are designed to prevent these particles from entering the clean-room environment while still allowing water vapor to exit, making it comfortable for a person to work (Figure 24-16).

The clean-room ceiling consists of ultrahigh-purity filters placed everywhere, including behind the fluorescent lights. The air in the clean room is in laminar flow. Particle-free air enters through the ceiling filters and exits through the perforated floor. Even the tabletops are made of wire grates, so there is no flat surface to collect particles. Process tools like the Centura plasma etch system are flush-mounted with the clean-room wall

so as not to disturb the laminar flow (Figure 24-17a). The actual process hardware resides in the clean-room return air chase on the other side of the clean-room wall (Figure 24-17b).

Currently dozens of programs from throughout the Laboratory are supported by the Microelectronics Laboratory, which is staffed by over 65 technicians, engineers, and scientists working two shifts each day, five days each week.



**Figure 24-16**  
Microelectronics Laboratory staff with class-10 clean-room garment performs a bright-light inspection on a 200 mm diameter Si wafer prior to three-dimensional wafer bonding.



**Figure 24-17**  
(a) Cluster plasma-etch system viewed from clean room.  
(b) Physical vapor deposition system viewed from clean-room return air chase.

## Notes

**61** The air in today's Microelectronics Laboratory is considerably better than class-10, which has been redefined to mean not only less than ten particles per cubic foot, but also measuring much smaller particles—0.12  $\mu\text{m}$  instead of the earlier 0.5  $\mu\text{m}$ . Process gases and fluids, vibration, and safety equipment and procedures are all vastly improved.

**62** In the mid-1990s, the Laboratory management concluded that the Computer Technology Division was no longer needed since by that time every technical division was working on computer technology. As part of the reorganization, the Digital Integrated Circuits Group joined the Solid State Division as Group 88. Since that time, the Microelectronics Laboratory has been operated entirely by the Solid State Division, although many of the programs that depend on it for advanced components reside in other divisions.

**63** M.W. Geis, H.I. Smith, B.-Y. Tsaur, J.C.C. Fan, D.J. Silversmith, and R.W. Mountain, "Zone-Melting Recrystallization of Si Films with a Moveable-Strip-Heater Oven," *J. Electrochem. Soc.* **129(12)**, 2812–2818 (1982).

**64** P.C. Karulkar, "A Novel Technique for Fabrication of Fully Depleted CMOS Devices in Ultra-Thin SOI Films," abstract published in *IEEE Trans. Electron. Devices* **36(11)**, 2622 (1989).

steps, so the process was not quick. Ground was broken on the new building in 1989 and the building was structurally complete by late 1991,<sup>61</sup> by which time the political and funding environment had changed considerably. The early decisions were made during Ronald Reagan's Strategic Defense Initiative, when DoD funds flowed profusely. But defense spending peaked in 1989, the Soviet Union was in the process of collapsing, and a war had to be fought in the Persian Gulf while DoD funds were decreasing. Equipment and facility costs had also increased as semiconductor technology had advanced two more generations. A committee headed by Antonio Pensa evaluated the situation and appointed Shaver as director of the new laboratory to lead it through the fit-up of complex systems, such as high-purity water and gases, and the acquisition of semiconductor fabrication equipment.

With a renewed mandate and initially close oversight by other divisions, Shaver and others in the Solid State Division, the Computer Technology Division, and the Administration Division finished the job. The Microelectronics Laboratory completed the installation and startup of 4-inch wafer processing tools during 1992 and finished processing its first silicon microelectronic wafers in spring 1993, eight years after Stern's initial efforts.<sup>62</sup>

The Building B and E clean-room laboratories used 3-inch-diameter wafers, too small for the advanced large imagers and wafer-scale circuits that were of interest. The intent for the Microelectronics Laboratory was always to move up to 6-inch wafers, but 4-inch wafers were used initially in order to save money by utilizing more of the old equipment and to make the initial transition easier. The facility conversion to 6-inch wafers occurred in 1996, driven principally by the fact that for both wafers and fabrication equipment, the most advanced, best quality, and highest-yielding technology was only available for the larger wafer sizes. These same capability and quality issues drove the more recent conversion to 200 mm wafers, which occurred in 2011.

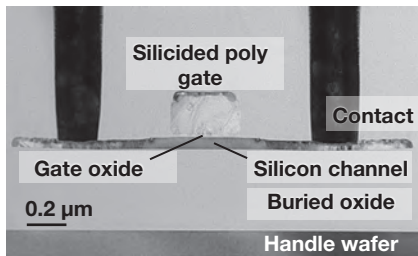
Along with increasing wafer size, dimensions of individual transistors and other devices have decreased substantially over the years. For decades, reducing dimensions of digital integrated circuits was a winning

strategy in all ways. As transistors got smaller, they switched faster, operated at lower voltage, and, hence, they dissipated less power, and more of them fit in each square millimeter. Higher density allowed more functionality on a chip and made the wires shorter, further reducing power and increasing speed. Minimum dimensions on the circuits built in the old laboratories were greater than 1  $\mu\text{m}$ . In the early planning for the Microelectronics Laboratory, the aim was experimentation at 0.5  $\mu\text{m}$ ; in fact, results were much better than that. By 1995, minimum dimensions on CMOS silicon-on-insulator (SOI) circuits were 0.25  $\mu\text{m}$ , or 250 nm, later reduced to 180 nm and then to 150 nm. By using the new equipment acquired during the transition to 200 mm wafers, minimum dimensions were reduced to sub-90 nm in 2011. The scaling trend for switching speed as a function of transistor gate dimension begins to flatten below 90 nm, and this new capability will bring a substantial advantage to custom imagers and other DoD circuits.

### *Silicon-on-Insulator Technology*

Conventional transistors are built in a bulk silicon wafer, with isolation between devices accomplished by reverse-biased diodes. Building each transistor instead in a small island of silicon on top of an insulator, and isolated entirely by insulators, reduces power dissipation, increases both speed and density, enhances radiation hardness, and allows operation at higher temperature.

Lincoln Laboratory began silicon-on-insulator (SOI) work in the 1980s with two complementary projects. John Fan in the Solid State Division developed a method to build SOI wafers, called zone-melt recrystallization (ZMR), and started Kopin Corporation to commercialize it.<sup>63</sup> Using some of this ZMR material, as well as wafers purchased from other sources, the Digital Integrated Circuits Group developed fabrication processes to build and study transistors and circuits.<sup>64</sup> After the move into the Microelectronics Laboratory, design and fabrication of SOI circuits became a principal activity of the renamed Advanced Silicon Technology Group. Craig Keast, leader of that group, succeeded Shaver as director of the Microelectronics Laboratory, and Shaver rose to the position of head of the Solid State Division.



**Figure 24-18**  
A cross-sectional transmission electron micrograph of a fully depleted SOI transistor fabricated in the Microelectronics Laboratory.

Thanks to the cleanliness and equipment of the new laboratory, it was soon possible to build devices with smaller dimensions and circuits with higher performance. Early programs focused on low power, very high and very low temperature, and radiation hardness, areas in which the Laboratory continues to contribute. Most SOI work other than Lincoln Laboratory's has used relatively thick (or highly doped) silicon in which the depletion layer under the transistor channel does not reach the buried insulator when the transistor is turned on — hence, the name partially depleted, or PDSOI. The Laboratory chose to make the silicon thinner (or with lower doping) so that the depletion layer reaches all the way through to the buried insulator — hence, fully depleted silicon-on-insulator, or FDSOI. Full depletion has additional advantages, providing even lower power and higher temperature operation when compared to PDSOI (Figure 24-18).

During the 1990s, a lot of excitement for SOI technology was developing in the integrated-circuit research community and designers everywhere, including Lincoln Laboratory, wanted access to it. In order to satisfy this need, the Laboratory, working with DARPA sponsorship, developed a 0.25 micrometer FDSOI CMOS fabrication process in the Microelectronics Laboratory and made it available to the precompetitive U.S. circuit-design research community. Providing the nation's only open research access to a FDSOI technology, the Microelectronics Laboratory conducted its first multiproject run in 1995. Lincoln Laboratory provided design rules and a process description, and designers at the Laboratory and throughout the country submitted designs that were all fabricated in parallel on a set of SOI wafers. This activity, funded over the years by a variety of DoD sources, continues as an important part of the Microelectronics Laboratory's activities. To date, hundreds of different circuits have been fabricated for more than 100 different organizations, roughly half from universities and one quarter each from industry and government laboratories (Figure 24-19).

Since the goal of the Microelectronics Laboratory is research and development, over the last 15 years, the Laboratory's baseline FDSOI process technology has undergone numerous enhancements and modifications targeted at exploring new device and circuit design

concepts. Each of the greater-than-one-dozen multiproject runs completed to date has been centered on a specific electronics theme. Examples include low-power operation, mixed-signal operation, radio-frequency operation, high-temperature operation, cryogenic operation, high-radiation environment operation, subthreshold operation, and three-dimensional circuit integration. While FDSOI CMOS technologies are now being explored by all the major semiconductor manufacturers, the Laboratory still remains the only U.S.-based organization providing open research access to this versatile and enabling technology.

Design of an integrated circuit depends on the ability to simulate its behavior, one of the necessary tools for which is an accurate simulation program with integrated-circuit emphasis (SPICE) model. SPICE was published as open-source software in 1973 by researchers at UC Berkeley and became an industry standard, improved and extended by many organizations since then. In 1998, UC Berkeley developed a model for SOI transistors, but it did not adequately describe the behavior of Microelectronics Laboratory devices. It soon became apparent that early assumptions in the industry about FDSOI devices were incorrect. Using DARPA funds, the Laboratory initiated a program with UC Berkeley in which equations of their original SOI model were modified. The resulting model was based on transistors fabricated in the Microelectronics Laboratory and included with reasonable accuracy the full range of silicon thickness and channel doping levels used in SOI devices.<sup>65</sup> This enhanced model is now the principal tool for simulating complex SOI circuits throughout the industry.

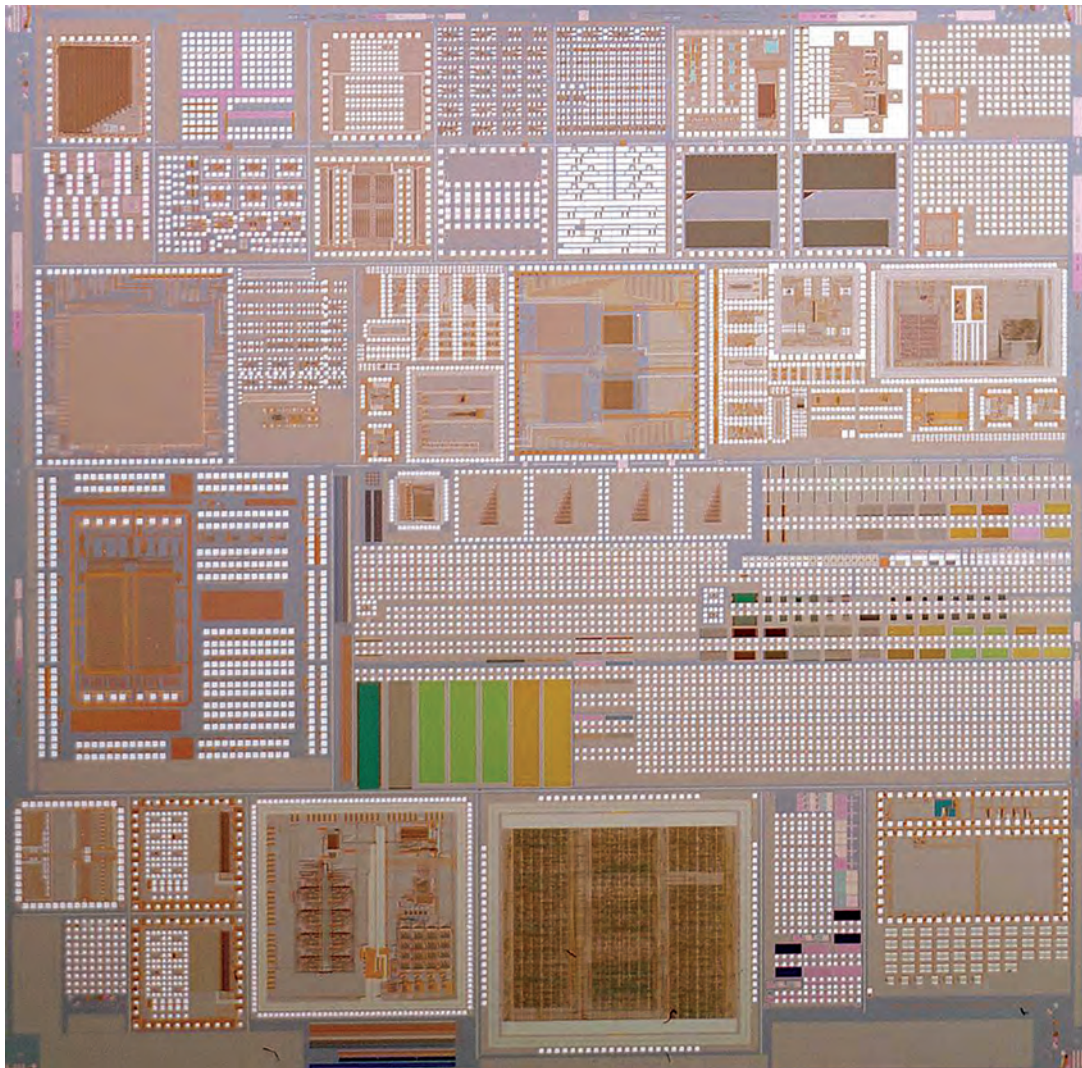
#### *Nanoscale Technology*

By 1994, the progress made under the Lincoln Laboratory program in 193 nm lithography, as described earlier, had convinced the rest of the lithography community to examine this technology more closely. The Semiconductor Manufacturing Technology (SEMATECH) consortium started a series of workshops on 193 nm lithography, and most companies supplying projection systems, photomasks, and photoresists expanded their respective internal development efforts. From 1993 on, several of these companies also entered into Cooperative Research and Development Agreements (CRDA) with the Submicrometer

#### **Note**

**65** P. Su, S.K.H. Fung, P.W. Wyatt, H. Wan, A.M. Niknejad, M. Chan, and C. Hu, "On the Body-Source Built-In Potential Lowering of SOI MOSFETs," *IEEE Electron Device Lett.* **24(2)**, 90–92 (2003).





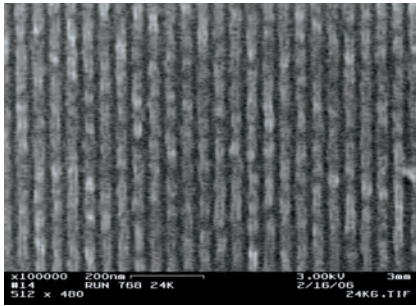
**Figure 24-19**  
Die photo of a FDSOI multiproject run fabricated in the Microelectronics Laboratory. This 22 mm × 22 mm die contains over 30 different circuit designs from the U.S. research community.

Technology Group in order to transfer and expand the technology and know-how developed in this field by the Lincoln Laboratory team. Multiyear CRDAs in optical lithography were established with SEMATECH, Intel, IBM, Shipley, SVGL, DuPont, KLA-Tencor, and others. Today 193 nm lithography is the mainstream lithography used in the semiconductor industry, while X-ray lithography has been largely abandoned for more than a decade. Commercial advanced microelectronic circuits have been fabricated with 193 nm lithography since at least as early as 2002. Thus, despite widespread initial doubts, the pioneering work at Lincoln Laboratory seeded a whole new era in lithography.

As soon as the paradigm change was accepted — that sub-248 nm lithography was indeed technologically feasible — the question arose as to how to extend optical lithography even further, so as to enable patterning at even smaller dimensions. For several years in the late 1990s, the Submicrometer Technology Group, with continued DARPA support, was at the forefront of exploring lithography at wavelengths shorter than 193 nm, in particular at 157 and 121 nm, two wavelengths where lasers or powerful discharge lamps seemed possible. For a while, the 157 nm option appeared to have practical potential, and the lithography community was gearing up to its large-scale implementation.

Nearly all 157 nm lithography programs came to an abrupt halt, however, in 2003. This drastic shift in consensus happened for two complementary reasons. On one hand, there were continuing difficulties on the 157 nm materials front — large-scale growth of the crystalline calcium fluoride lens material, the development of radiation-durable pellicles, and the engineering of chemically stable photoresists. On the other hand, a new lithographic option had recently proven feasible — again by the Lincoln Laboratory group — an option that did not require abandoning the 193 nm wavelength, yet enabled higher resolution. This option was liquid-immersion lithography.

Liquid-immersion lithography is a method whereby a transparent liquid is introduced between the last optical element of the projection system and the photoresist surface. By adding this liquid, the effective wavelength at the photoresist surface is reduced by the refractive index of the liquid without changing the wavelength



**Figure 24-20**  
**Scanning electron micrograph of 22 nm half-pitch gratings patterned with 157 nm immersion interference lithography.**

#### Notes

**66** W.G. Lyons, D.R. Arsenault, A.C. Anderson, T.C.L.G. Sollner, P.G. Murphy, M.M. Seaver, R.R. Boisvert, R.L. Slattery, and R.W. Ralston, "High- $T_c$  Superconductive Wideband Compressive Receivers," *Linc. Lab. J.* **9(1)**, 33–67 (1996).

**67** W.G. Lyons, A.V. Messier, R.A. Stiffler, R.L. Slattery, M.Z. Straayer, P.G. Murphy, D.J. Baker, G.L. Fitch, L.M. Johnson, and M.A. Gouker, "Superwideband Compressive Receiver," *Proc. GOMACTech-09*, 91–94 (2009).

throughout the rest of the lithographic system. Although the underlying concept of improving lithographic resolution by liquid immersion had been known for at least two decades, it was once again the Lincoln Laboratory group that, in 2001, showed liquid immersion at 193 nm was a practical option. One particularly attractive feature demonstrated by Lincoln Laboratory's Michael Switkes and Rothschild was that high-purity water could be used as the immersion fluid at 193 nm, as it had sufficient transparency and radiation durability.

Since 2002, 193 nm liquid-immersion lithography has gained momentum, with Lincoln Laboratory making seminal contributions to its development. Together with an ever-growing array of research, development, and engineering groups in the United States and abroad, the Laboratory has solved difficulties in controlling water purity, eliminating bubble formation, optimizing water-resistant optical coatings, and mitigating the formation of various liquid-induced defects in the photoresist. Liquid-immersion 193 nm lithography has been used in small-volume manufacturing since 2007, and it is widely expected to become the dominant lithography for large-scale device production by 2014.

In the last few years, the lithography efforts of the Submicrometer Technology Group have focused on double-exposure processes, in which one of the exposure steps is performed with interference lithography.

The rationale behind this approach was that, as device designs increasingly had a grid-like geometry, the grid itself could be patterned with the less expensive, and potentially higher-resolution, technique of interfering two beams. Only the second exposure, that of the cutouts, required a complex projection system, but with more relaxed specifications. Lincoln Laboratory's team led by Rothschild and Michael Fritze of the Advanced Silicon Technology Group, therefore, explored interferometric grid formation at the smallest possible dimensions. It achieved a record small half-pitch of 22 nm by combining the short wavelength of 157 nm and immersion at a high refractive index (Figure 24-20). Further lithographic extensions were pursued by the group, especially by Theodore Fedynyshyn in the area of developing novel photoresists. An especially promising method involved lithographically directed self-assembly of diblock copolymers, which form patterns with twice

the spatial frequency of the underlying directing lithography. This method was especially applicable to grid-based geometries, and was therefore synergistic with interference lithography.

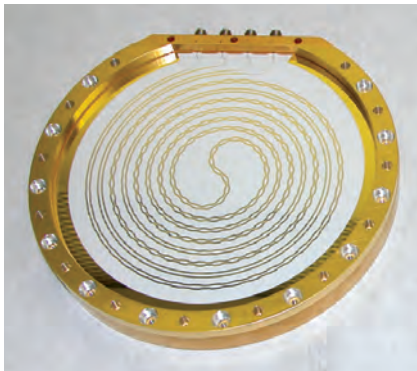
When the Submicrometer Technology Group was formed in 1988, the smallest features patterned with optical lithography (at 248 nm) in commercial devices were 0.5  $\mu\text{m}$  in size. By 2010, the smallest half-pitch used in the semiconductor industry was still patterned with optical lithography (water immersion at 193 nm), and was  $\sim 10$  times smaller, 0.045  $\mu\text{m}$ , and much of this remarkable extension of optical lithography can be traced back to the Submicrometer Technology Group's work.

#### *Superwideband Compressive Receivers*

A compressive receiver implements an analog Fourier transform and thereby maps the frequencies present within each input time window into a series of "time-compressed" pulses, which appear with proportionate delay in each corresponding output time window. The key technology element required to implement a useful analog chirp transform is an accurate chirp filter with sufficient bandwidth and dispersive time delay to provide reasonable signal processing gain. Practical compressive receivers were implemented in Lincoln Laboratory and commercial SAW technology; these analog devices outstripped the bandwidth performance of available digital implementations in the 1970s and 1980s.

It was a natural extension to consider superconductive electromagnetic chirp filters for this purpose, and in the early 1980s a matched pair of Nb-based filters was demonstrated as a front end of a compressive receiver. Subsequently, with HTS films deposited by Anderson, tapped-delay-line chirp filters were fabricated. These enabled Lyons, Sollner, and colleagues to produce a system-level demonstration of the world's first multi-gigahertz instantaneous bandwidth compressive receiver, complete with signal-reporting back end. This HTS-based space-qualified compressive receiver was delivered for the High Temperature Superconducting Space Experiment (HTSSE) II, launched in 1999 aboard the Advanced Research and Global Observation Satellite, and functioned well.<sup>66</sup> Better frequency resolution was desired, necessitating longer chirp delay. Despite new design techniques instituted by Lyons and materials efforts by Anderson to develop a bonded-wafer technique





**Figure 24-21**  
**Electromagnetic tapped-delay-line filter with 40 ns dispersive delay and 4.3 GHz bandwidth, fabricated from high-quality sputtered gold on 6-inch-diameter high-purity polycrystalline alumina.**



**Figure 24-22**  
**Gregory Lyons, Andrew Messier, and Mark Gouker are pictured here with sponsor participants after an all-night test flight. Flight testing provides means to verify receiver performance in a realistic environment.**

compatible with the HTS copper oxides, it proved difficult to produce HTS-based chirp filters with delays approaching 40 ns. Also, the need for cooling the filters, if only to 77 K, loomed as an impediment to field applications.

Through the process of fielding the HTSSE receiver, Lyons came to realize that it might be possible to build chirp filters with dispersive delay sufficient for applications by using more conventional materials, such as high-quality gold transmission lines on high-purity polycrystalline alumina wafers. The effort would include obtaining large-area alumina wafers polished flat to several microns across 4- to 6-inch-diameter wafers, and sputtering high-quality gold with a reproducibly low surface resistance (Figure 24-21). Lyons demonstrated the first such “normal metal” chirp filters through an Advanced Concepts Committee program in 2000. In 2002, an Advanced Concepts Committee program explored using these filters in military systems. The approach was dubbed superwideband compressive receiver (SWCR).

Support from multiple sponsors followed in 2003, leading to a series of demonstrations and flight tests (Figure 24-22). Andrew Messier joined the Analog Device Technology Group in 2003 to bring subsystem digital expertise to “mixed-signal” (analog combined with digital) efforts like SWCR. Lyons, Messier, and colleagues have built several iterations of impressive SWCR hardware.

The SWCR approach has been tested for multiple applications in signal intercept, electronic countermeasures, and electronic support measures. The key attributes of SWCR are a size, weight, and power advantage over wideband digital receivers and an extremely low latency for multiple-signal detection.<sup>67</sup> A developmental second-generation version of SWCR was installed as part of the Airborne Countermeasures Test System II hosted on a Falcon 20 flown for the Air Force by Lincoln Laboratory. Efforts are planned to continue to reduce the size, weight, and power footprint of SWCR for application in a variety of military systems.

#### *Passively Q-Switched Microchip Lasers*

A significant improvement in the microchip laser described earlier was the invention of the passively Q-switched version. This invention was spurred by the requirements of an environmental monitoring application. The passively Q-switched microchip laser has spawned numerous applications, although interestingly, the promise of the original environmental monitoring application has not been realized.

In 1992, Bernadette Johnson led an informal effort to develop new concepts for laser-based or optically based sensors for environmental monitoring. As part of that effort, a core group, comprising Charles Primmerman and Johnson from the Optics Division and Antonio Sanchez-Rubio, Roshan Aggarwal, Jeys, and Zayhowski from the Solid State Division, met regularly to discuss ideas. Late in 1992, the group discussed an idea for measuring pollutants at distances of tens of meters underground. The general concept was to use a short-pulse ultraviolet laser to excite fluorescence underground, to transmit the fluorescent light to the surface by using an optical fiber, and to use fluorescent signatures to identify and quantify the underground pollutants.

At this meeting, Johnson pressed Zayhowski to develop a laser suitable for the proposed application. A quadrupled Nd:YAG (yielding radiation at 266 nm) electro-optically Q-switched microchip laser could meet the performance requirements, but the application-specific implementation was problematic. Transmitting the short-pulse ultraviolet light from the surface through an optical fiber would lead to unacceptable losses. The electro-optically Q-switched microchip laser was too bulky and too fragile to be driven into the ground with a cone penetrometer. Transmitting the high-speed, high-voltage signals to actively Q-switch the microchip laser presented its own set of problems. Consequently, there seemed no practicable solution until, after much discussion, there arose the suggestion: passively Q-switch the microchip laser.

As a result of the environmental monitoring impetus, Zayhowski developed and demonstrated the passively Q-switched microchip laser. In its most common embodiment, this laser consists of a short length of Nd:YAG gain medium diffusion-bonded to a short length of Cr<sup>4+</sup>:YAG saturable absorber. The diffusion-



## Photoinduced Outgassing and Chemical Trace Detection

Within a few months of installing the SVGL 193 nm step-and-scan system in the Microelectronics Laboratory, an unexpected problem arose: the image quality at the wafer plane had degraded considerably. Detailed analysis revealed that some of the optical surfaces were covered with a layer of contaminant, whose chemical composition or source was unknown. The Lincoln Laboratory team led by Roderick Kunz, senior staff in the Submicrometer Technology Group, hypothesized that small amounts of volatile compounds present in the chamber were photodissociated by the short-wavelength 193 nm radiation, leading to a soot-like deposit. Here was a new effect, apparently unique to 193 nm, that could potentially be fatal to 193 nm lithography. It certainly had to be understood and fully resolved.

The team set up a separate test bed, specifically dedicated to studying and analyzing 193 nm photocontamination. The test bed included a state-of-the-art highly sensitive chemical analysis system, coupled to a photo-dissociation chamber into which trace amounts of various compounds could be introduced. It soon became apparent that controlling volatile impurities was not enough to avoid surface deposits. Perfectly nonvolatile materials in the chamber were being dissociated by minute amounts of scattered laser light, yielding volatile fragments that migrated into the laser beam and eventually decomposed and formed the observed deposits.

When the Lincoln Laboratory scientists first reported their findings, they realized that they had hit a raw nerve. Several semiconductor companies that had just started using 248 nm lithography in mass production were encountering serious optics contamination issues, but had kept the information as

highly proprietary. It turned out that photoinduced outgassing was not unique to 193 nm after all. It took place also at 248 nm, and even at longer wavelengths, and it presented a major challenge in manufacturing.

Almost overnight, the test bed became a unique resource for lithographers everywhere. In response to requests from the semiconductor industry, the Lincoln Laboratory group analyzed the photoinduced outgassing at 248 and 193 nm of numerous types of photoresists, adhesives, ceramics, vacuum-sealing materials, even the surface finish of metal tubing. The test bed provided invaluable information to the semiconductor industry. Similar effects have plagued suppliers of ultraviolet lasers, and again the Lincoln Laboratory team was able to identify the cause of optics degradation.

Furthermore, the team used its accumulated knowledge, coupled with the test bed-related infrastructure, as a springboard to expand into new areas of research. In the last few years, it has brought online a specialized chemical-warfare-agent sensor test bed, conducted field measurements of trace explosive residues, and explored the use of ultraviolet lasers for remote detection of these compounds — all because of the degradation of the first 193 nm lithography system.

bonding is done by using an innovative technique developed by John Daneu especially for the microchip laser. Cavity mirrors are deposited directly onto the diffusion-bonded material pair. The optical absorption of the saturable absorber prevents the onset of lasing until there is a large optical gain in the cavity. The onset of lasing at that point bleaches the saturable absorber and Q-switches the cavity, resulting in very short output pulses without the need for any active control of the cavity Q.

The Q-switched microchip laser is extremely compact and robust. The only input required is a low-power optical pump, which can be delivered via an optical fiber (Figure 24-23).<sup>68</sup> Because the gain medium of the passively Q-switched laser can store energy for several hundred microseconds and produce pulses that last only a fraction of a nanosecond, the microchip laser can produce peak output powers that are more than 10,000 times as great as the pump power, making it easy to perform nonlinear optical frequency conversion.

In March 1994, Zayhowski applied for a patent on the passively Q-switched laser, and the patent was granted in February 1995.<sup>69</sup> The patent proved to be highly successful, with eight different companies licensing the technology from MIT (as well as several companies getting sublicenses). For example, Cyra Technologies obtained exclusive rights to use passively Q-switched microchip lasers in their field of interest — three-dimensional imaging for engineering and architectural applications. Under a CRDA, Lincoln Laboratory worked with Cyra Technologies to develop a time-of-flight optical ranging system based on the newly invented passively Q-switched microchip laser. The system would later become the Cyrax imaging system, which went on to be the market leader in its industry.<sup>70</sup>

In contrast to the success of the passively Q-switched microchip laser, results for the environmental monitoring application that had prompted the invention of the laser were decidedly mixed. Under funding from the Department of Energy, Johnson and Jonathan Bloch, in collaboration with researchers from the MIT Department of Civil and Environmental Engineering, demonstrated the monitoring of underground pollutants using the passively Q-switched microchip laser. These measurements, conducted from 1995



**Figure 24-23**

**Photograph of one of the first passively Q-switched microchip lasers. The microchip laser consists of thin pieces of Nd:YAG and Cr<sup>4+</sup>:YAG diffusion-bonded together, with dielectric mirrors deposited directly onto the diffusion-bonded pair. The laser is epoxied to the ferrule of the optical fiber used to pump it. It typically generates 350 ps duration pulses with a pulse energy of 10 μJ at a repetition rate of 10 kHz.**

#### Notes

**68** J.J. Zayhowski and C. Dill III, "Diode Pumped Passively Q-switched Picosecond Microchip Lasers," *Opt. Lett.* **19(18)**, 1427–1429 (1994).

**69** J.J. Zayhowski, "Passively Q-switched Picosecond Micro-laser," U.S. Patent No. 5,394,413, February 28, 1995.

**70** In 1998, MIT Lincoln Laboratory, Cyra Technologies, and Los Alamos National Laboratory won an R&D 100 Award (awarded by *R&D Magazine* to the 100 most technologically significant new products of the year) for their work on the Cyrax portable 3-D laser-mapping and imaging system. In 1999, Cyra was purchased by Leica Geosystems.

**71** J. Bloch, B. Johnson, N. Newbury, J. Germaine, H. Hemond, and J. Sinfield, "Field Test of a Novel Microlaser-Based Probe for *In Situ* Fluorescence Sensing of Soil Contamination," *Appl. Spectrosc.* **52(10)**, 1299–1304 (1998).

**72** B. Johnson and J.J. Zayhowski, "Sensor System for Remote Spectroscopy," U.S. Patent No. 5,483,546, January 9, 1996.

**73** R. Berger, D.D. Rathman, B.M. Tyrrell, E.J. Kohler, M.K. Rose, R.A. Murphy, T.S. Perry, H.F. Robey, F.A. Weber, D.M. Craig, A.M. Soares, S.P. Vernon, and R.K. Reich, "A 64 × 64-Pixel CMOS Test Chip for the Development of Large-Format Ultra-High-Speed Snapshot Imagers," *IEEE J. Solid-State Circuits* **43(9)**, 1940–1950 (2008).

through 1997, were sufficiently novel that they made the cover of *Applied Spectroscopy*,<sup>71</sup> but the Department of Energy lost interest in the general application area. In May 1994, the environmental monitoring application was filed as a continuation of the microchip-laser patent and the continuation was granted in January 1996.<sup>72</sup> This patent continuation attracted no interest from commercial firms, however, and ten years later, MIT allowed it to expire.

Although work on the original environmental monitoring application proved to be short-lived, the microchip laser enabled two other applications that led to significant, long-term Lincoln Laboratory programs. In 1994, Sanchez-Rubio and Richard Marino began using the passively Q-switched microchip laser along with Geiger-mode APDs to explore a new concept for three-dimensional laser radar. The <1 ns microchip laser proved to be an ideal match for the Geiger-mode APDs, and the rugged construction of the microchip laser made it easy to field on airborne platforms. Consequently, the passively Q-switched microchip laser became a key component of several highly successful airborne laser radars (see chapter 27, "Photon-Counting Laser Radar").

In 1995, as part of an exploratory effort led by Primmerman on the detection of biological agents, Jeys and Sanchez-Rubio developed a concept for using an ultraviolet frequency-converted microchip laser to construct a compact sensor for the rapid detection of biological-agent aerosols. This concept led to the highly successful Biological Agent Warning Sensor and to long-term significant Lincoln Laboratory efforts in biodefense (see chapter 17, "Biological and Chemical Defense"). Indeed, it is probably not an exaggeration to state that without the passively Q-switched microchip laser, Lincoln Laboratory would not have developed a biodefense program. Thus, one of the tiniest of inventions — the passively Q-switched microchip laser — led to some of the largest, most significant projects at Lincoln Laboratory in the late 1990s and in the 2000s.

#### Single-Photon Detector Arrays

In 1994, Marino and Sanchez-Rubio demonstrated a novel sensor architecture under Advanced Concepts Committee funding. It used APDs and the short-pulse microchip laser to show that an array of single-photon-

sensitive detectors and a high-repetition-rate laser could enable a flash three-dimensional laser radar with good angle-angle and range resolution. The size of the detector array, sensitivity at different wavelengths, and sophistication of the readout integrated circuit (ROIC) bonded underneath the detector array were all substantially improved in the ensuing fifteen years. In addition, a high-yield process for bump-bonding the array with the readout circuit was established based on early work by Richard Slattery. The photon-counting technology became an enabler for several important sensor platforms. This development, with far-reaching system impacts, is described in chapter 27, "Photon-Counting Laser Radar."

#### Subnanosecond Snapshot CMOS Imager

For extremely high-speed applications, Lincoln Laboratory developed a snapshot imager capable of 100 ps shutter speed for use at the National Ignition Facility. An X-ray source illuminates the target region, and the imager captures the evolution of the density of laser-imploded frozen hydrogen pellets for potential use in initiating controlled fusion.

This imager required fast and adjustable sampling speeds of 100 ps to 10 ns, a large imaging array of a million pixels, sensitivity to 1 to 10 keV X-radiation, and 10-bit dynamic range. These requirements posed severe challenges. To achieve the necessary results, the device approach conceived by Rathman and Robert Berger used a separate CMOS ROIC bump-bonded to a Laboratory-fabricated custom silicon diode array.<sup>73</sup> The CMOS ROIC was designed and fabricated using a standard 0.18 μm foundry process, and benefited from extensive industry development. The design produced less than 30 ps gate delays, with millions of transistors per chip. The device was unusual in that both on-chip and in-pixel signal conditioning were needed to meet the requirements.

The requirement for simultaneous sampling times in all pixels dictated an H-tree clock distribution; it should be noted that the shutter time is comparable to the time of flight of light across the expected size of the imager chip. Also, resources were allocated throughout the device to amplify the clock signals and provide local capacitance to supply transient pulse current; a part of each pixel was dedicated to imaging functions and part to clock

## Notes

**74** J.A. Burns, B.F. Aull, C.K. Chen, C.-L. Chen, C.L. Keast, J.M. Knecht, V. Suntharalingam, K. Warner, P.W. Wyatt, and D.-R.W. Yost, "A Wafer-Scale 3-D Circuit Integration Technology," *IEEE Trans. Electron Dev.* **53(10)**, 2507–2516 (2006).

**75** B. Aull, J. Burns, C. Chen, B. Felton, H. Hanson, C. Keast, J. Knecht, A. Loomis, M. Renzi, A. Soares, V. Suntharalingam, K. Warner, D. Wolfson, D. Yost, and D. Young, "Laser Radar Imager Based on 3D Integration of Geiger-Mode Avalanche Photodiodes with Two SOI Timing Circuit Layers," *IEEE 2006 ISSCC Dig. Tech. Papers*, 2006, pp. 1179–1188.

**76** V. Suntharalingam, R. Berger, J.A. Burns, C.K. Chen, C.L. Keast, J.M. Knecht, R.D. Lambert, K.L. Newcomb, D.M. O'Mara, D.D. Rathman, D.C. Shaver, A.M. Soares, C.N. Stevenson, B.M. Tyrrell, K. Warner, B.D. Wheeler, D.-R.W. Yost, and D.J. Young, "Megapixel CMOS Image Sensor Fabricated in Three-Dimensional Integrated Circuit Technology," *IEEE 2005 ISSCC Dig. Tech. Papers*, Vol. 1, 2005, pp. 356–357.

**77** V. Suntharalingam, R. Berger, S. Clark, J. Knecht, A. Messier, K. Newcomb, D. Rathman, R. Slattery, A. Soares, C. Stevenson, K. Warner, D. Young, L.P. Ang, B. Mansoorian, and D. Shaver, "A Four-Side Tileable, Back Illuminated, Three-Dimensionally Integrated Megapixel CMOS Image Sensor," *IEEE 2009 ISSCC Dig. Tech. Papers*, 2009, pp. 38–39.

regeneration. Because clock regeneration needed to be varied according to the local region of the chip, four different pixel cells were used. On a  $512 \times 512$  readout circuit, clock skew was measured to be less than 3 ps peak to peak, and clock jitter less than 1.2 ps rms.

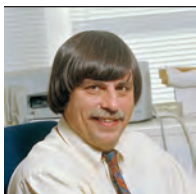
Lincoln Laboratory also developed a back-illuminated photodiode array of a unique design to meet the speed requirements. The pixels were spaced at a 30-micron pitch. Tungsten-filled trenches were designed and fabricated; these trenches through the 20  $\mu\text{m}$  thickness of the detector array reduce internal resistance and increase speed. The array thickness was chosen to optimize X-ray quantum efficiency and speed, while multiple metal layers and built-in capacitance structures provided charge locally to minimize signal and bias line droop caused by expected high peak currents from the transient photoelectron signal. Subnanosecond imaging performance was demonstrated with about 30 ps of jitter, of which most is not inherent to the imager. The bump-bonding process ultimately limits the pixel pitch to an order of 30 microns. The three-dimensional process described below can provide much tighter pixel pitches for increased image resolution.

## Three-Dimensional Integrated Circuits

Present-day work at Lincoln Laboratory is at dimensions much smaller than 250 nm (Figure 24–24). A conventional integrated circuit consists of a single layer of transistors interconnected by many layers of wires. The potentially huge advantages of adding multiple layers of transistors, or other active devices such as photodetectors, had long been recognized. For digital circuits, more layers would allow much shorter wires, which in turn would allow faster transmission of data with less power dissipation. For imagers, multiple layers would allow nearly 100% of the surface area of the chip to be devoted to capturing the image, while each pixel could be backed by substantial processing capability. For all kinds of circuits, the additional layers would allow mixing technologies so that each tier of the circuit could be separately optimized. In 1998, the Laboratory started a series of programs utilizing SOI CMOS as an enabling element to accomplish practical three-dimensional integrated circuits, and became a world leader in the field.<sup>74</sup>

The Microelectronics Laboratory provided the research and development community with three-dimensional integrated-circuit multiproject fabrication runs. The runs allowed designers to test theories of the three-dimensional advantage in the presence of the physical constraints of a specific process, as well as to explore completely new ideas.

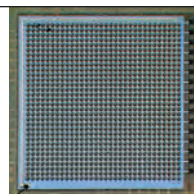
2000



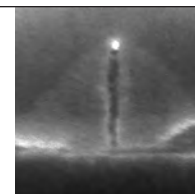
T.H. Fedynshyn



J.J. Zayhowski

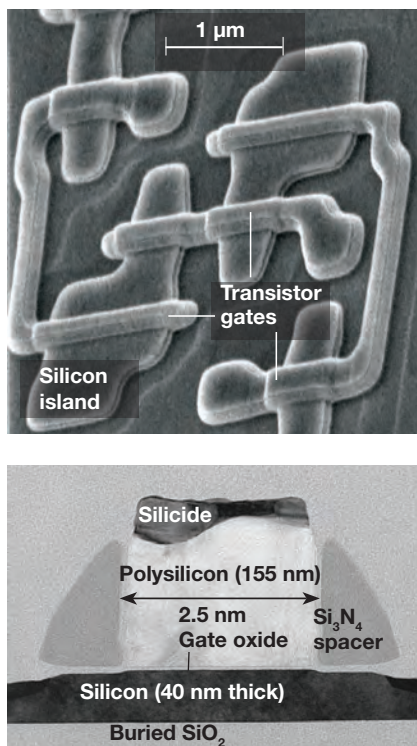


Photomicrograph of APD  $32 \times 32$  array. A CMOS integrated circuit (not visible) is bonded underneath for readout of each pixel for three-dimensional imaging



Cross-sectional electron-microscope image of SOI transistor with 9 nm gate length indicated





**Figure 24-24**

**Top:** Six transistors composing one cell of a static random-access-memory device fabricated in the Microelectronics Laboratory in 150 nm FDSOI CMOS. These will be buried under three layers of metal wiring and glass insulators to complete the integrated circuit. **Bottom:** Cross section of a transistor similar to those in the cell above.

The Laboratory's initial target application of three-dimensional integration technology was toward increasingly larger sizes of image sensors consisting of smart pixels with two or three layers of circuitry. Under the DARPA Vertically Integrated Sensor Array (VISA) program, the Laboratory demonstrated a visible Geiger-mode APD-based lidar imager spanning three circuit layers,<sup>75</sup> each with a specialized process technology. Under the DoD Mosaic program, Lincoln Laboratory demonstrated the largest (1 million pixels in 8 mm × 8 mm) three-dimensional integrated-circuit visible image sensor.<sup>76</sup> That achievement was followed by an image sensor tile that also included a three-dimensional integrated-circuit packaging method to incorporate many parallel channels of analog-to-digital conversion and control functions in the same footprint. Thus, the tiles could be abutted with low image seam loss on all four sides to create a larger imager with easily scaled direct digital output.<sup>77</sup>

The Laboratory continued to push forward in the three-dimensional, integrated-circuit, smart-focal-plane arena, with programs to build larger-format devices to be tiled closely together, to incorporate detector materials that reach beyond silicon into the infrared wavelengths, and to increase the digital image processing and filtering done on the device so that high-quality imagery or feature extraction was transmitted off the chip with little overhead.

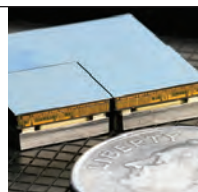
### *Laser Beam Combining*

In semiconductor laser technology, the individual laser output power is often lower than in other laser technologies. Therefore, high-power applications such as laser radar require the proper combination of large arrays of semiconductor lasers. A significant portion of the diode-laser research at Lincoln Laboratory since the 1980s has been devoted to power and brightness scaling and the application of beam-combining techniques to semiconductor lasers. Such combined arrays have been used successfully as pump sources for solid-state and fiber lasers, as diode-array-pumped lasers have been found to be both more reliable and more efficient than the lamp pumps used earlier.

A remaining major challenge in the diode-laser field is the achievement of coherence among a large number of elements of a large ( $\geq 1 \text{ cm}^2$ ) high-power, multielement array. Such coherent combining could produce single-frequency, near-diffraction-limited beams at high ( $\geq 100 \text{ W}$ ) power levels and thereby greatly expand the scope of both military and civilian applications of semiconductor lasers. Research at Lincoln Laboratory helped to realize this goal by developing monolithic diode-laser arrays in which individual elements are fabricated simultaneously on a wafer by lithography and etching. Early work on arrays of this kind showed that they were candidates for establishing coherence when used in external



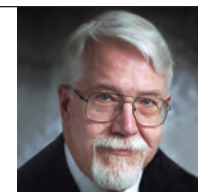
M.A. Gouker



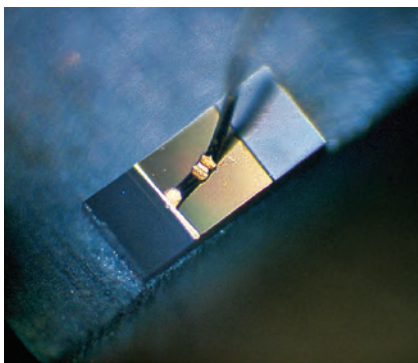
Four abutable imaging tiles with seven-tier vertical integration. Each tile is a 1024 × 1024 array of CMOS 8 μm pixels incorporated with address, readout, control, and digital conversion circuitry



Silicon photonic filter bank showing detail of ring-resonator filter section



J.P. Donnelly



**Figure 24-25**  
**Double-heterostructure diode laser fabricated from GaInAsSb and AlGaAsSb on a GaSb substrate. This laser emits radiation in the infrared at 2.3  $\mu\text{m}$ . The square gold contact is 30  $\mu\text{m}$  square.**

#### Notes

**78** R.K. Huang, B. Chann, L.J. Missaggia, S.J. Augst, M.K. Connors, G.W. Turner, A. Sanchez, J.P. Donnelly, J.L. Hostetler, C. Miester, and F. Dorsch, "Coherent Combination of Slab-Coupled Optical Waveguide Lasers," *Proc. SPIE* **7230**, 72301G1-12 (2009).

**79** H.K. Choi and S.J. Eglash, "Room-Temperature CW Operation at 2.2  $\mu\text{m}$  of GaInAsSb/AlGaAsSb Diode Lasers Grown by Molecular Beam Epitaxy," *Appl. Phys. Lett.* **59**(10), 1165–1166 (1991).

**80** G.W. Turner, H.K. Choi, and M.J. Manfra, "Ultralow-Threshold (50A/cm<sup>2</sup>) Strained Single-Quantum-Well GaInAsSb/AlGaAsSb Lasers Emitting at 2.05  $\mu\text{m}$ ," *Appl. Phys. Lett.* **72**(8), 876–878 (1998).

**81** J. Faist, F. Capasso, D.L. Silvco, C. Sirtori, A.L. Hutchinson, and A.L. Cho, "The Quantum Cascade Laser," *Science* **264**(5158), 553–556 (1994).

**82** C.A. Wang, R.K. Huang, A. Goyal, J.P. Donnelly, D.R. Calawa, S.G. Cann, F. O'Donnell, J.J. Plant, L.J. Missaggia, G.W. Turner, and A. Sanchez, "OMVPE Growth of Highly Strain-Balanced GaInAs/AlInAs/InP for Quantum Cascade Lasers," *J. Cryst. Growth* **310**(23), 5191–5197 (2008).

**83** J.C. Twichell and R. Helkey, "Phase-Encoded Optical Sampling for Analog-to-Digital Converters," *IEEE Photon. Technol. Lett.* **12**(9), 1237–1239 (2000).

cavity configurations in conjunction with matched arrays of microlenses. Significant early demonstrations in the coherent combining of diode lasers in small arrays were performed in 1984 in the now-disbanded Optics Division, where Leger and coworkers obtained a near-diffraction-limited beam at low power. In 2009, Bien Chann, Robin Huang, and coworkers used a ten-element array of 960 nm wavelength lasers in an external cavity to demonstrate a coherent beam at high-power ( $\sim 5$  to 7 W continuous wave).<sup>78</sup> This milestone was enabled by the invention of the slab-coupled optical-waveguide laser (SCOWL). The SCOWL, invented by Walpole, Donnelly, and Stephen Chinn, was patented in 2005. Its special attributes for beam combining are described more fully in chapter 25, "Laser Systems." Chann and Huang left the Laboratory soon after to join TeraDiode with a goal of commercializing the beam-combining techniques.

#### Advanced Semiconductor Lasers

An effort in the 1990s sought to develop high-performance mid-infrared semiconductor lasers for room-temperature operation in the 2 to 10  $\mu\text{m}$  wavelength range. Using GaInAsSb as the active material, Hong Choi and Stephen Eglash in 1991 developed GaSb-based diode lasers near 2  $\mu\text{m}$  with excellent performance at room temperature.<sup>79</sup> (Figure 24-25). In 1998, Choi and George Turner extended this work with GaInAsSb to advanced, strain-balanced quantum-well structures, in which threshold current densities as low as 50 A/cm<sup>2</sup> were observed at room temperature.<sup>80</sup> At longer wavelengths, however, room-temperature operation of diode lasers had fundamental limitations. To overcome these, Han Le and Turner developed an optically pumped GaSb-based laser at 4  $\mu\text{m}$  that generated 0.35 W average power at 80 K, and they implemented a compact laser for infrared countermeasures applications.

More recently, the quantum cascade laser (QCL), which is based on a different physical mechanism for mid-infrared emission, has been investigated for room-temperature operation in the wavelength region from  $\sim 5$  to 8  $\mu\text{m}$ . The QCL was first theorized in the Soviet Union in 1974 and experimentally demonstrated at Bell Laboratories in 1992.<sup>81</sup> The fundamental advantage of the QCL is that it is a unipolar device and uses an interband cascade process to efficiently generate high-power mid-infrared radiation at room temperature.

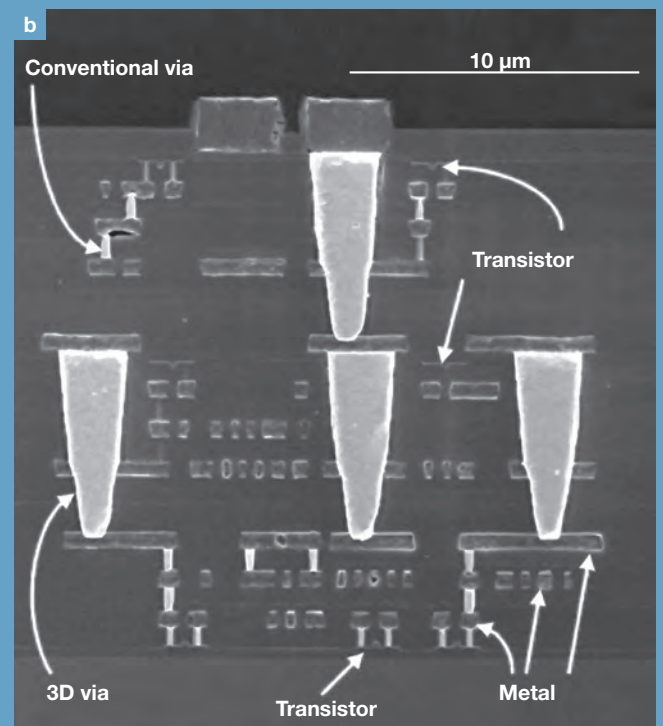
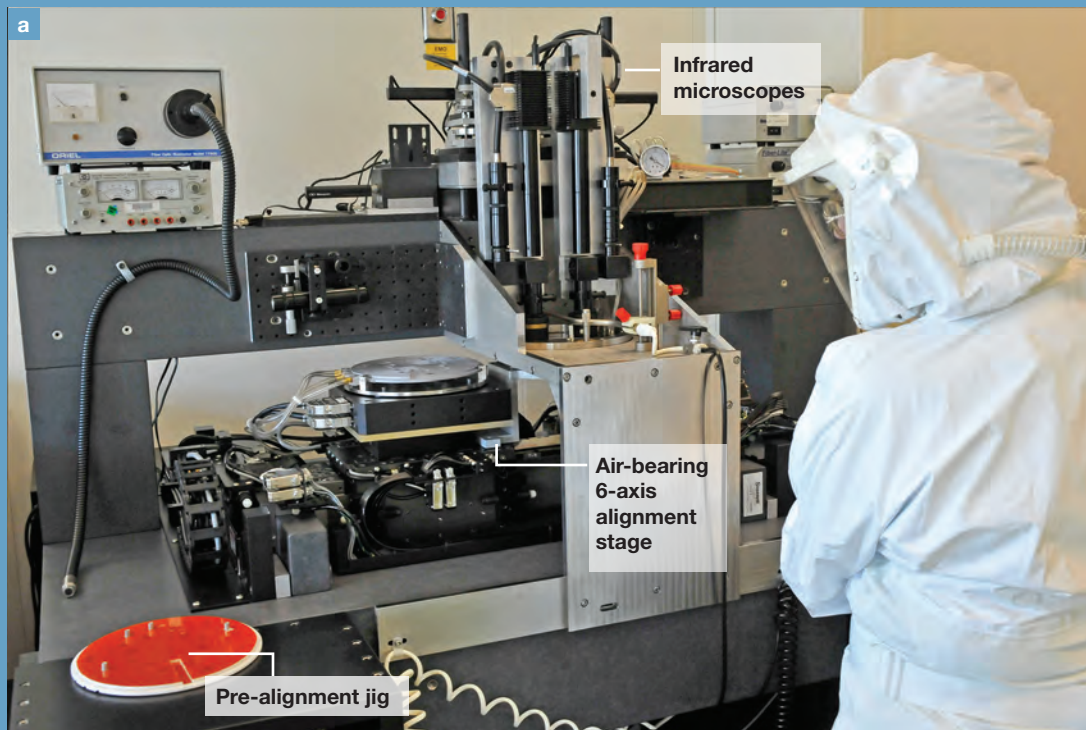
Wang and coworkers demonstrated  $\sim 4.8$   $\mu\text{m}$  QCLs with peak powers  $>3$  W at 280 K<sup>82</sup> and room-temperature QCLs with wavelengths as long as  $\sim 8$   $\mu\text{m}$ .

#### Integrated Microwave Photonics

Research in III-V integrated photonics since 2000 has focused on developing components for microwave photonic systems. Microwave photonics is motivated by the low loss (0.2 dB/km) and wide bandwidth ( $>1$  THz) of optical fibers and has direct applicability to antenna systems and communication links. A principal constituent in these systems is the microwave analog optical link, which transmits a microwave signal between two points using an optical carrier. Such a link consists of a transmitter used to impress the microwave signal onto the optical carrier, a transmission medium such as an optical fiber, and a receiver used to convert the modulated optical signal back to the microwave domain. To make such a link practical, it must provide low RF-to-RF loss or net gain, low noise figure, and high linearity. Work on microwave photonic links at Lincoln Laboratory has included seminal analyses of link metrics and performance, optimization of LiNbO<sub>3</sub> and InGaAsP modulators for improving link performance, and application of links to antenna remoting applications.

Another important application of integrated photonics to microwave signal processing is the use of optical sampling for frequency down-conversion and analog-to-digital conversion. The bandwidth and accuracy by which signals can be sampled are ultimately limited by the temporal width and timing jitter of the sampling aperture. Optical sampling provided significant advantages over electronic sampling because of the ultrashort ( $<1$  ps) pulse width and ultralow ( $<10$  fs) timing jitter of optical pulse trains produced by modern mode-locked lasers.

The field of optical sampling was advanced in the late 1990s by Jonathan Twichell and Roger Helkey, who developed the phase-encoded optical sampling technique.<sup>83</sup> This technique involves processing the complementary outputs of a dual-output LiNbO<sub>3</sub> Mach-Zehnder interferometer to invert the transfer function of the interferometer and access the highly linear electro-optic (phase versus voltage) characteristic in LiNbO<sub>3</sub>,



### Three-Dimensional Integration

The three-dimensional integration program required the development of new technologies and specialized fabrication equipment. To achieve the program goal of multicircuit-tier, tight-pitch electrical interconnects, accurate alignment and bonding of the circuit wafers were needed. After a comprehensive search and evaluation of the commercial wafer aligner/bonder tools, the Laboratory decided that in order to meet the alignment specifications of the program, a precision wafer aligner and bonder would have to be built. Leveraging components from the wafer-scale restructurable VLSI program, the Laboratory designed, assembled, and wrote the control software for this unique process tool. When completed, the tool provided a wafer-to-wafer overlay accuracy of  $\sim 0.25 \mu\text{m}$  — eight times better than what could be achieved on the commercial tools at

the time. Figure 24-26a shows a photo of the Laboratory's second-generation precision wafer aligner/bonder installed in the Microelectronics Laboratory. Using infrared optics and computer controlled alignment algorithms, the system allows the operator to “look through” two silicon wafers, align them, and bond them with high precision. After bonding, the wafer stack is thinned and electrical interconnects are made between the circuit tiers using a specialized three-dimensional-via plasma etch process followed by a conventional, high-reliability tungsten chemical vapor deposition process to form the electrical interconnect between the circuit tiers. Figure 24-26b is a scanning electron micrograph cross section of a completed three-tier, three-dimensional integrated circuit. The three different active device (transistor) layers are visible along with

the eleven levels of interconnect metal. The conventional metal interconnect vias and larger three-dimensional vias are also clearly visible in the photo.

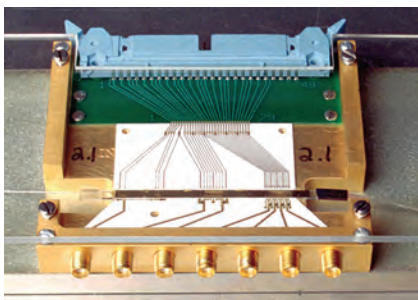
Using these specialized tools and processes, the Laboratory became the first organization in the world to demonstrate a functional, densely integrated, three-dimensional integrated circuit. Almost a decade after this first demonstration, the Laboratory remains active in the three-dimensional integration area and continues to provide access for the research community to this enabling technology through multiproject fabrication runs in the Microelectronics Laboratory.

Figure 24-26

(a) The Laboratory's second-generation precision wafer aligner/bonder system installed in the Microelectronics Laboratory.

(b) Scanning electron micrograph cross section of a completed three-tier, three-dimensional integrated circuit.





**Figure 24-27**  
Lithium niobate ( $\text{LiNbO}_3$ ) 1-to-8 optical time-division demultiplexer used in the 10-bit 505 MS/s optically sampled A/D converter. One input fiber can be seen to the left of the  $\text{LiNbO}_3$ , and eight output fibers are on the right side. The top face of the  $\text{LiNbO}_3$  crystal is 7 cm  $\times$  0.5 cm.

#### Notes

**84** P.W. Juodawlkis, J.C. Twichell, G.E. Betts, J.J. Hargreaves, R.D. Younger, J.L. Wasserman, F.J. O'Donnell, K.G. Ray, and R.C. Williamson, "Optically Sampled Analog-to-Digital Converters," *IEEE Trans. Microwave Theory Tech.* **49(10)**, 1840–1853 (2001).

**85** S.J. Spector, T.M. Lyszczarz, M.W. Geis, D.M. Lennon, J.U. Yoon, M.E. Grein, R.T. Schulein, R. Amatya, J. Birge, J. Chen, H. Byun, F. Gan, C.W. Holzwarth, J.L. Hoyt, E.P. Ippen, F.X. Kaertner, A. Khilo, O.O. Olubuyide, J.S. Orcutt, M. Park, M. Perrott, M.A. Popovic, T. Barwicz, M. Dahlem, R.J. Ram, and H.I. Smith, "Integrated Optical Components in Silicon for High Speed Analog-to-Digital Conversion," *Proc. SPIE* **6477**, 647700-1 (2007).

**86** M.W. Geis, S.J. Spector, M.E. Grein, J.U. Yoon, D.M. Lennon, and T.M. Lyszczarz, "Silicon Waveguide Infrared Photodiodes with >35 GHz Bandwidth and Phototransistors with 50 AW-1 Response," *Opt. Express* **17(7)**, 5193–5204 (2009).

**87** S.J. Spector, M.W. Geis, G.-R. Zhou, M.E. Grein, F. Gan, M.A. Popovic, J.U. Yoon, D.M. Lennon, E.P. Ippen, F.Z. Kärtner, and T.M. Lyszczarz, "CMOS-Compatible Dual-Output Silicon Modulator for Analog Signal Processing," *Opt. Express* **16(15)**, 11027–11031 (2008).

**88** "Existing and Potential Standoff Explosives Detection Techniques," Committee on the Review of Existing and Potential Standoff Techniques, National Research Council, Washington, D.C.: National Academies Press, 2004.

The technique improved sampling linearity by >30 dB at high modulation depth and suppressed laser amplitude noise by 60 dB.

In the early 2000s, Paul Juodawlkis and colleagues employed time-division optical demultiplexing to realize a phase-encoded optically sampled 505 MS/s analog-to-digital converter with 10-bit resolution.<sup>84</sup> At the time of demonstration, this was the highest resolution of any analog-to-digital converter operating at this sampling rate. A key integrated photonic component that enabled this result was a  $\text{LiNbO}_3$  1-to-8 time-division optical demultiplexer with channel-to-channel isolation >40 dB (Figure 24-27). Additional optical sampling achievements during this period included direct down-conversion of wideband microwave signals (1 GHz bandwidth on 10 GHz carrier) and the first demonstration of optical sampling at a field radar site, Haystack Auxiliary radar in Westford, Massachusetts.

Rapid commercial advances in silicon CMOS technology in the early 2000s motivated the Laboratory to look at fabricating silicon photonic devices, operating at the 1.55  $\mu\text{m}$  wavelength. Silicon is transparent at these wavelengths, and the development of a CMOS-compatible process for photonic devices would enable the integration of advanced electronics with the optical components. The initial work focused on low-loss waveguides for optical time-delay applications. Steven Spector demonstrated meter-long optical waveguides that achieved 10 ns of delay in a 1  $\text{cm}^2$  footprint. In addition, optical filters and switches were demonstrated. In 2004, DARPA initiated the Electronic and Photonic Integrated Circuits program, which was dedicated to integrating silicon photonics with silicon electronics. Lincoln Laboratory teamed with Professor Franz Kaertner at MIT to propose an optical-sampling system to DARPA.<sup>85</sup> Under this program, Spector developed a high-speed optical modulator based on silicon diodes.<sup>86</sup> Given the transparency of silicon at 1.55  $\mu\text{m}$ , silicon optical detectors are problematic. Jung Yoon, working with MIT Professor Judy Hoyt, developed a process to integrate germanium into the CMOS process flow and demonstrated germanium photodetectors.<sup>87</sup> Michael Geis persisted with an all-silicon approach and demonstrated that implantation damage could be used to enhance the photoresponse of silicon and thereby

fabricate a successful optical detector in a CMOS process. These efforts culminated in the fabrication of a silicon microchip that integrated the optical modulator, tunable optical filters, and detectors that formed the basis for an optical-sampling system.

#### Trace-Chemical Detection of Explosives

During the Second Gulf War, improvised explosive devices (IED) posed an increasing operational challenge to coalition forces. In response to this challenge, the office of the Director of Defense Research and Engineering (DDR&E) commissioned a study at Lincoln Laboratory to explore possible technical solutions for locating and/or mitigating roadside IEDs. This study, commissioned in 2003 and led by Assistant Director Lee Upton, focused on technologies that were within the core Laboratory expertise, such as sensing and/or mitigation methods that use optical, infrared, microwave, and/or radio-frequency radiation. From this study, Laboratory efforts on optical imaging change detection and persistent surveillance (see chapter 16, "Counterterrorism and Counterinsurgency"), as well as RF jamming methods, were envisioned and demonstrated, with some of these since growing into larger efforts. Absent from the 2003 Upton study was any consideration given to sensing methods based on exploiting IED chemical signatures. This oversight was largely due to the lack of information regarding the composition and magnitude of these signatures. The lack of signature data ran counter to the increasing investment the DoD was beginning to make in chemical-signature-based sensing technologies. In partial response to that, and in the interest of casting a broader net for sensing solutions, the Laboratory commissioned its own internal study in 2004, led by Edward Wack, assistant leader in the Sensor Technology and Systems Applications Group. This second study performed a systems-level analysis of the potential of chemical-signature-based sensing for counter-IED operations and led to the conclusion that chemical-sensing development efforts should not be limited to tactical technologies (i.e., finding the device on the roadside), but should also focus on strategic technologies helpful in identifying the entire IED network. Coincidentally, the results of the 2004 Wack study were available at roughly the same time as a related study commissioned by the National Research Council.<sup>88</sup> Both the Lincoln Laboratory and



**Figure 24-28**  
**Sample environments where Lincoln Laboratory signature studies focused their measurement activities. Top: Surveying the explosive signatures in a facility used to fabricate IEDs. Bottom: Test to determine post-blast residues.**

#### Notes

**89** T. Arusi-Parpar, D. Helfinger, and R. Lavi, "Photodissociation Followed by Laser-Induced Fluorescence at Atmospheric Pressure and 24°C: A Unique Scheme for Remote Detection of Explosives," *Appl. Opt.* **40(36)**, 6677–6681 (2001).

**90** C.M. Wynn, S. Palmacci, R.R. Kunz, and M. Rothschild, "A Novel Method for Remotely Detecting Trace Explosives," *Linc. Lab. J.* **17(2)**, 27–39 (2008).

**91** C.M. Wynn, S. Palmacci, R.R. Kunz, K. Clow, and M. Rothschild, "Detection of Condensed-Phase Explosives via Laser-

Induced Vaporization, Photodissociation, and Resonant Excitation," *Appl. Opt.* **47(31)**, 5767–5776 (2008).

**92** The first of several patents granted was "Electric Display Device," U.S. Patent No. 5,233,459, August 3, 1993. Two additional patents were also granted later, called "Spatial Light Modulator," U.S. Patent Nos. 5,784,189, July 21, 1998, and 5,959,763, February 26, 1998.

**93** J. Muldavin, C.O. Bozler, S. Rabe, P.W. Wyatt, and C.L. Keast, "Wafer-Scale Packaged RF Microelectromechanical Switches," *IEEE Trans. Microwave Theory Tech.* **56(2)**, 522–529 (2008).

the National Research Council studies noted that the dearth of knowledge regarding the magnitude and composition of IED chemical signatures limited the ability to project the potential utility of chemical-based sensors. In response, the Laboratory made the strategic decision to invest experimental resources to begin measuring the chemical signatures of IEDs and to apply the new information to detailed trade studies on different potential sensing options. This "science-based" approach represented a departure of other "requirements-based" sensor development efforts and would ultimately help Lincoln Laboratory become an important contributor to the nation's chemical-sensing counter-IED community.

Experimental work began in 2005 under the leadership of Roderick Kunz, senior staff in the Submicrometer Technology Group, with quantitative measurements of chemical signatures from IEDs and IED-related activities. The effort expanded to include numerous measurement campaigns at ranges in Edgefield, South Carolina; Yuma Proving Ground, Yuma, Arizona; the National Training Center, Fort Irwin, California; and Twentynine Palms Marine Base, Twentynine Palms, California (Figure 24-28). As the work became more widely recognized, support expanded from DDR&E to also include the Joint Improvised Explosive Device Defeat Organization, DARPA, the Army, and the Department of Homeland Security, and led to a close collaboration with the U.S. Army Forensic Analytical Center at Edgewood, Maryland. Collectively, several reports were written on trace explosive signatures created during assembly and deployment of IEDs and of background explosive residues in tactical field environments. This information was disseminated to numerous agencies within both the DoD and the Department of Homeland Security. As of early 2010, the work was still ongoing with the focus shifting from military-grade explosives to homemade explosives, such as those encountered in Afghanistan, threatening the U.S. homeland.

During the course of the IED signature studies, Lincoln Laboratory also observed that explosive residues often occurred on the bomb makers themselves. This information, combined with pharmacokinetic studies on the metabolism of explosive materials performed jointly between Michael Sworin and Professor Steven

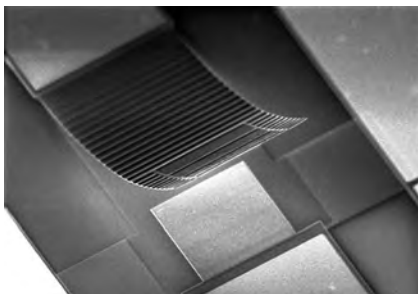
Tannenbaum of MIT's Department of Biological Engineering, suggested new ways of identifying explosive handlers and bomb makers. On the basis of the studies, Sworin initiated an effort to develop new ways of screening personnel to determine their occupational exposure to explosive materials.

With a broad IED signature database then in hand, Lincoln Laboratory was able to evaluate the potential capabilities of the various proposed detection schemes. One detection method, called photodissociation followed by laser-induced fluorescence (PDLIF) and first reported in open literature in 2001,<sup>89</sup> appeared most promising on the basis of analysis. Starting in 2006, a Lincoln Laboratory effort led by Charles Wynn refined and improved the PDLIF detection method.<sup>90</sup> In this technique, a single ultraviolet laser pulse photodissociates the explosive molecule to create vibrationally excited nitrogen oxide (NO), and that same laser pulse also induces a unique fluorescence signal from the vibrationally excited NO.<sup>91</sup> A prototype PDLIF system was successfully field tested at Fort Irwin, California, in April 2009.

Improvised explosive devices will remain a threat to U.S. interests for the foreseeable future. Defense against such a persistent and adaptive threat requires the establishment of a long-term commitment to understand, detect, and counteract it. The effort in explosives trace-chemical signature studies and detection has complemented other in-house counter-IED initiatives and positioned Lincoln Laboratory at the forefront of IED defense technologies.

#### *Microelectromechanical and Microfluidic Circuits*

Microelectromechanical (MEM) systems fabricated with silicon integrated-circuit technology became mass-market products in early automobile air-bag systems. The Advanced Silicon Technology Group, in parallel with industry, explored novel MEM switch configurations for RF applications. The basic invention in 1993 by Bozler was to use a metal cantilever as the moving part of a mechanical switch that had substantially better characteristics than semiconductor equivalents for RF circuits in the tens of gigahertz frequency range.<sup>92</sup> By using these switches, along with a packaging technique developed in the group,<sup>93</sup> several integrated circuits were demonstrated, such as a 4-bit phase-shifter utilizing



**Figure 24-29**  
**A MEM system switch. Corrugated flap is ~150  $\mu\text{m}$  wide.**

#### Notes

**94** J. Kedzierski, P.-L. Hsu, P. Healey, P.W. Wyatt, C.L. Keast, M. Sprinkle, C. Berger, and W.A. de Heer, "Epitaxial Graphene Transistors on SiC Substrates," *IEEE Trans. Electron. Devices* **55(8)**, 2078–2085 (2008).

**95** J. Kedzierski, P.L. Hsu, A. Reina, J. Kong, P. Healey, P. Wyatt, and C.L. Keast, "Graphene-on-Insulator Transistors Made Using C on Ni Chemical-Vapor Deposition," *IEEE Electron Device Lett.* **30(7)**, 745–747 (2009).

many four-throw switches (Figure 24–29). Such devices have the potential to greatly improve the performance of advanced radars and communication systems. This work resulted in the lowest-loss, broadest-band packaged RF switch demonstrated to date. Transfer to industry began in 2010.

The Microelectronics Laboratory silicon facilities were also used by Jakub Kedzierski to develop microfluidic integrated circuits, in which fluids move around in channels on a substrate to accomplish a variety of tasks. Fluids can be pumped and their paths switched using no moving parts and no external pressure. The underlying principle is electrowetting. Potential applications of this new field ranged from chemical lasers to implantable drug delivery systems, to detection of biological or chemical hazards, to DNA analysis.

#### Replacing Silicon Transistors

As has been widely acknowledged since 2005, the 50-year exponential performance scaling of silicon integrated circuits in electronic systems has approached barriers that appear to be fundamental. Dimensions became so small that the discrete nature of atoms began to matter, and electrons no longer stayed reliably inside the conductors because of quantum mechanical tunneling. The search was on for new materials that could allow rapid improvements to continue.

One of the few promising materials was graphene, which comprises a single layer of graphite. Like carbon nanotubes, graphene has mobility that is at least ten times higher than that of silicon. Unlike nanotubes, graphene has the potential to be made in large sheets and could be

the starting material for processes very similar to those now used for silicon. If this approach worked, it would allow reuse not only of fabrication facilities, but also of many familiar circuit design concepts, enabling quick and economic adoption of the new technology.

Lincoln Laboratory made some of the world's first graphene transistors and has demonstrated their high mobility.<sup>94</sup> In 2009, researchers in the Microelectronics Laboratory, in collaboration with researchers at MIT, also reported on transistors fabricated on novel graphene-on-insulator material. This pioneering work resulted in the Laboratory being honored by the IEEE Electron Devices Society 2009 George E. Smith Award as the best paper published in 2009 in the *IEEE Electron Device Letters*.<sup>95</sup> Many questions remain to be answered before it becomes clear whether this new material, or any other material, can replace silicon.

#### Quantum Information Science

Quantum information science (QIS) is the investigation and application of quantum mechanical phenomena for metrology and for computing, storing, and communicating information. Significant national interest exists in long-term applications of QIS, including cryptanalysis, high-performance computing, and provably secure quantum key distribution. Although QIS is still in a precompetitive stage, Lincoln Laboratory and the broader MIT community are at the forefront of QIS research and development. The Laboratory's work in quantum computation is discussed in this section; its quantum communications work is discussed in chapter 5, "Satellite Communications."



G.W. Turner



C.A. Wang



J.C. Twichell



R.R. Kunz

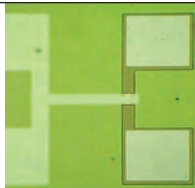


Richard Feynman, among many others in the 1960s and 1970s, considered what would happen if computation were performed by smaller and smaller objects, where classical physics gives way to quantum physics. As a research field, quantum computation began to take shape in the 1980s with the concept of quantum parallelism by David Deutsch and the conjecture by Feynman that quantum computers may be able to outperform classical Turing computers.

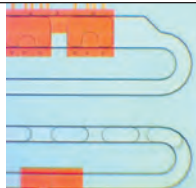
In 1994, Peter Shor (then at AT&T, now at MIT) presented the first quantum algorithm to utilize quantum parallelism to achieve an exponential performance enhancement over a classical computer. His work addressed a particular problem in the national interest, prime factorization, which underlies the public-key infrastructure for data encryption. In 1995, Shor and Andrew Steane developed the first quantum error-correction code, which demonstrated how seemingly uncorrectable errors of delicate quantum mechanical superposition states could indeed be corrected — an absolutely remarkable result — provided an error threshold could be reached. Seth Lloyd at MIT soon thereafter showed that quantum computers could more generally outperform classical computers with regard to simulations of quantum systems, thereby proving the Feynman conjecture.

Atoms, ions, nuclear spins, and photons were among the first candidates for use as elemental quantum bits of information, or qubits, because the quantum control of these systems was already rather mature by the 1990s, as evidenced by atomic clocks for precision timing and nuclear magnetic resonance for magnetic resonance imaging. In 1999, Yasunobu Nakamura, Yuri Pashkin, and Jaw-Shen Tsai at NEC (formerly Nippon Electric Company) demonstrated quantum oscillations in a micron-scale superconducting circuit comprising Josephson junctions. Soon thereafter, numerous groups worldwide demonstrated several other solid-state “artificial atoms” built from semiconducting and superconducting circuits, holding the promise of lithographic scalability. Nonetheless, as of this writing, each qubit modality has its own strengths and weaknesses, and no clear winner has yet been identified.

Lincoln Laboratory began investigating QIS using superconductivity in 2000. In 1999, Professors Terry Orlando at MIT and Johan Mooij at Delft University of Technology had proposed a flux-based qubit comprising a superconducting circuit with Josephson junctions, which, when cooled to milliKelvin temperatures, exhibits quantized energy levels addressable at microwave frequencies. Orlando was awarded in 2000 a Defense University Research Initiative on NanoTechnology



Graphene transistor with  
5  $\mu\text{m}$  gate



Microfluidic pump with  
50  $\mu\text{m}$  channel width



W.D. Oliver



C.L. Keast

---

**Note**

**96** The Advanced Research and Development Activity was an intelligence community center for conducting advanced research and development related to information technology. This center eventually morphed into the Intelligence Advanced Research Projects Activity, under the Office of the Director of National Intelligence's Director of Science and Technology.

program between MIT, Harvard, and the University of Rochester to explore single and coupled flux qubits. In conjunction, Karl Berggren in the Analog Device Technology Group was funded by the Advanced Research and Development Activity and the Air Force Office of Scientific Research to provide qubit fabrication to these efforts.<sup>96</sup> The qubits were fabricated in the Microelectronics Laboratory using niobium trilayers, i-line (365 nm wavelength emission from mercury lamp) lithography and the planarized all-refractory technology for a low superconducting transition temperature ( $T_c$ ) process, a junction fabrication approach first developed in the early 1990s at Lincoln Laboratory and IBM for classical rapid single-flux quantum computing. By 2003, four fabrication runs were completed, and numerous qubits were sent to MIT, Harvard, the University of Rochester, and elsewhere for testing.

William Oliver joined Lincoln Laboratory in 2003 to initiate an experimental superconducting qubit effort and to collaborate with the groups of Orlando at MIT and Professor Michael Tinkham at Harvard to assist their experimental efforts. Coaxial cables were installed in the MIT and Harvard dilution refrigerators, and testing of the i-line qubits was initiated.

The Lincoln Laboratory–fabricated qubits behaved beautifully as artificial atoms. During 2004 to 2008, these were used in three significant demonstrations of atomic physics with superconducting circuits. All three experiments center on manipulating the energy level of the qubit at very low temperatures between the allowed quantum mechanical states by adjusting the magnetic field surrounding the qubit and/or illuminating the qubit with microwave photons (photons with energy levels corresponding to frequencies in the 1 to 100 GHz range). In three experiments, the degree of manipulation achieved was greater than that observed with natural atoms, demonstrating an elegance of the superconducting artificial atoms not previously appreciated.

The first experiment demonstrated that the wave function that described the qubit quantum mechanical state can be split between two allowed energy levels and, with coherent manipulation of the local magnetic field, can be made to interfere with itself, producing uniform and predictable oscillations of the qubit state between these two energy levels. This phenomenon

is well understood in atomic physics as Stueckelberg oscillations, but they had never been observed in superconducting qubits.

The second experiment demonstrated that it was possible to illuminate the qubit with microwave photons and place it in an energy state well below the ambient thermal energy level. This practice is well established in the manipulation of isolated atoms or ions held in electromagnetic traps and is known as optical cooling. But again, it had never been demonstrated in superconducting qubits. The observed temperature was between the theoretical lower limit of 0.03 mK and an upper bound of 0.3 mK determined from the experimental conditions. This temperature is a factor of 10 to 100 times lower than the 3 mK ambient temperature in the He dilution refrigerator.

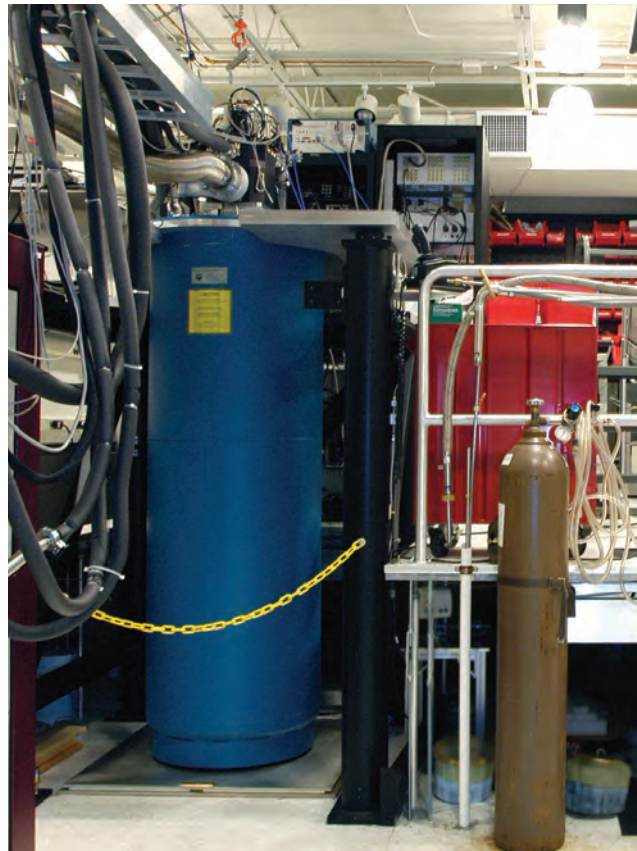
The third experiment demonstrated that it was possible to characterize the values of the allowed energy levels (as a function of local magnetic field) of the qubit by probing with an external field of varying amplitude rather than the more conventional approach of varying the frequency. In this remarkable experiment, the “spectroscopy” of the qubit up to 120 GHz was determined by probing the qubit with a single 160 MHz signal of varying amplitude.

The superconducting qubit effort has grown significantly. In 2007, the Laboratory built a superconducting qubit testing facility including dilution refrigerators and measurement equipment (Figure 24–30). Experimental demonstrations at the Laboratory included dispersive readout, Rabi oscillations, Ramsey interferometry, spin-echo pulse sequences, and high-Q resonator measurements in the single-photon, low-temperature limit.

Despite exciting experimental results, it was soon clear that the minimum yielding junction size in the i-line process, about 0.5  $\mu\text{m}$ , was not small enough for quantum computing applications. Therefore, in parallel with the experimental effort mentioned above, a multiyear effort was initiated to develop the deep-submicron fabrication process using 248 nm lithography, which has since led to reliably yielding junctions with critical dimension to 200 nm appropriate for quantum computing. These junctions can also be used for rapid single-flux quantum classical logic circuits.

**Figure 24-30**

**Helium dilution refrigerator in qubit testing laboratory.** The view on the left shows the closed vessel, about 3 m high. The view on the right shows the outer vessel lowered through the floor with the cryoprobe exposed. The bottom tip of the cryoprobe can reach 25 mK with qubit circuitry attached.



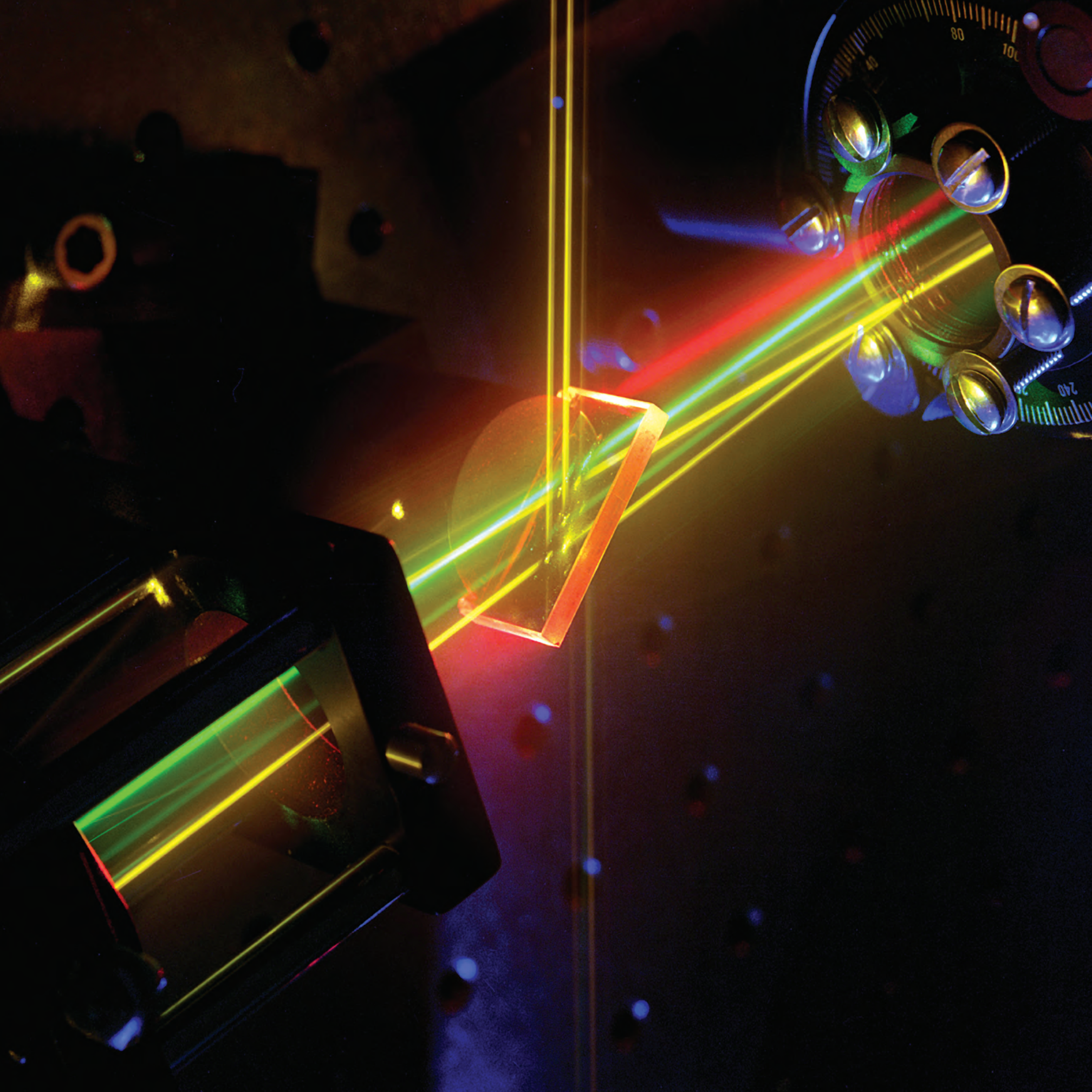
The result of this fabrication effort has been extraordinary. At this writing, the Lincoln Laboratory deep-submicron process is the only fully planarized Josephson junction process worldwide that can regularly achieve 200 nm junctions. The coherence times of the Laboratory's niobium-based qubits are ten times longer than those of other research groups, and the aluminum-based qubits are among the world's best at 4 microseconds. Many years of effort remain to be invested in this quest for a practical quantum computer. It is a goal for which Lincoln Laboratory resources are well suited, as it requires materials science, physics, electrical engineering, and integrated-circuit fabrication across a broad front with keen multidisciplinary teamwork.

#### **Looking Ahead**

With the transition of the Microelectronics Laboratory to 90 nm CMOS technology, Lincoln Laboratory is well positioned to exploit FDSOI CMOS technology for both lower-power and harsh-environment operation.

When thinned and three-dimensionally integrated with other semiconductor circuit tiers, many specialty sensor circuits will uniquely meet needs in the DoD. The Microelectronics Laboratory also facilitates development of micromechanical, microfluidic, superconductive, and integrated photonic circuits. The scope of applications for Geiger-mode photon-counting detection technology will continue to expand. Higher-energy lasers will be developed with techniques ranging from cryo-cooled or slab-coupled gain media to scaled beam combining. Chemical and biological sensing will be further advanced for detection of explosives, toxins, and bioagents. Because of the broad span of research and development topics and disciplines integrated with the research enterprise, the division was renamed the Advanced Technology Division in May 2010.







**Lincoln Laboratory played a major role in developing technologies for military laser systems, particularly in laser radar, in adaptive optics for the transmission of high-energy-laser beams through the atmosphere, and in solid-state lasers.**

**Left: Laser beam of 589 nm yellow light generated by summing 1.06 and 1.32  $\mu\text{m}$  wavelength Nd:YAG lasers.**

The first laser — a solid-state ruby laser — was demonstrated in May 1960 by Theodore Maiman at the Hughes Research Laboratory. At that time, Lincoln Laboratory researchers had already been working to develop other solid-state lasers. After the first laser had been demonstrated, Lincoln Laboratory work accelerated (see chapter 24, “Solid-State Research” for the story of the first Laboratory-developed laser).

With the laser a reality, Lincoln Laboratory also began to develop laser systems for particular applications. Given the Laboratory’s expertise in radar systems, it was natural to explore laser radar (ladar) and to exploit the high precision enabled by operating radar at optical wavelengths. To perform long-range ladar experiments, the Laboratory built the Firepond optical research facility in Westford, Massachusetts; this facility began operations in 1968.

As the power of lasers increased, the Advanced Research Projects Agency (ARPA; later it became the Defense Advanced Research Projects Agency, or DARPA) identified the potential of high-energy lasers to destroy missiles and other targets, and asked Lincoln Laboratory to participate in a high-energy-laser effort. Thus, in the late 1960s, Lincoln Laboratory initiated an activity, under Seymour Edelberg and Louis Marquet, to understand the propagation of high-energy lasers in the atmosphere.

By the end of the 1960s, there was significant laser-systems work at the Laboratory. This fact prompted Lincoln Laboratory Director Milton Clauser to form the Optics Division in 1969, under the leadership of Alan McWhorter. Throughout the 1970s and into the 1980s, the Optics Division conducted large-scale experiments with ladar systems and high-energy-laser systems. The atmospheric-propagation efforts evolved into seminal efforts in adaptive optics for compensating atmospheric effects and controlling high-energy-laser beams.

In 1984, the Strategic Defense Initiative Organization (SDIO) was formed to implement President Reagan’s vision for a defensive system against nuclear-armed ballistic missiles. Initially, SDIO had a strong focus on laser systems, both for sensing applications and for destroying missiles in boost phase. The formation of SDIO led to major changes and substantial growth in the Optics Division. Charles Niessen became the head

of the division and the program manager for the Optical Discrimination Technology program, which was aimed at developing and demonstrating technology for a proposed orbiting ladar sensor for discrimination. Darryl Greenwood became associate head of the division and leader of significantly increased high-energy-laser efforts, aimed principally at atmospheric compensation for SDIO’s ground-based-laser program. For the remainder of the decade and into the early 1990s, the Laboratory’s laser-systems work flourished under funding from SDIO.

With the fall of the Berlin Wall in 1989 and the demise of the Soviet Union in 1991, however, SDIO’s focus began to change from large-scale laser systems for strategic defense to more modest, theater missile defense systems. This change in focus led to the cancellation of the ground-based-laser program in 1991 and to the cancellation of the Optical Discrimination Technology program in 1993. Thus, in 1993, the Optics Division was disestablished, and its remaining efforts were transferred to other divisions.

Since 1993, Lincoln Laboratory has developed a whole new class of photon-counting ladar systems for various applications (see chapter 27, “Photon-Counting Laser Radar”). In high-energy-laser beam control, the mid-1990s brought interesting new efforts in atmospheric compensation for the Airborne Laser (ABL), discussed later in the chapter, and 2000 saw a revival of interest in high-energy lasers for tactical applications. As for solid-state lasers, the first decade of the 2000s saw a flowering of new kinds of laser systems at the Laboratory — cryogenically cooled lasers, beam-combined fiber lasers, new types of diode lasers — and a push to higher and higher powers from solid-state lasers.

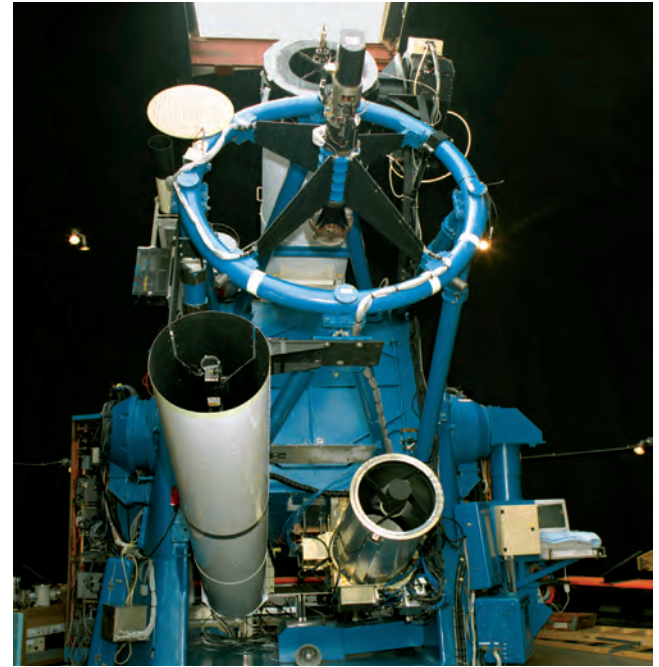
### **Strategic Ladar**

In May 1962, only two years after the demonstration of the first laser, a team of researchers from the MIT campus and Lincoln Laboratory used a liquid-nitrogen-cooled, photon-counting, direct-detection laser receiver to perform the first ladar range measurements to the moon. These experiments, titled Project Luna See, were performed with a visible 50 J/pulse ruby laser located in the Laboratory’s Annex 4. This demonstration was a historical first, but ladar research at Lincoln Laboratory did not take on major significance until after the invention of the carbon-dioxide ( $\text{CO}_2$ ) laser in 1964.<sup>1</sup>



**Figure 25-1 (left)**  
Firepond infrared radar complex in 1992.

**Figure 25-2 (right)**  
Front view of the Firepond 1.2 m Cassegrain telescope. The three auxiliary telescopes collect radiant energy for a variety of other sensors.



The CO<sub>2</sub> laser was at once a temporally coherent signal source and a high-power source of infrared radiation. Earlier collaborations among Professors Ali Javan and Hermann Haus of MIT and Charles Freed at Lincoln Laboratory had led to fundamental measurements of the photon-counting statistics of frequency-stable helium-neon lasers. In 1966, at the suggestion of Robert Kingston, Javan's laser-construction techniques were applied to CO<sub>2</sub> lasers to produce the first frequency-stable CO<sub>2</sub> laser at Lincoln Laboratory; its stability was at least a hundred times greater than that previously reported.

In 1967, the first coherent CO<sub>2</sub> ladar was demonstrated at the Laboratory. This continuous-wave (CW) Doppler ladar employed the stable laser and used a conical-scan system for tracking target angles. Additional radar components had to be developed to take full advantage of the new signal source. The first indium antimonide (InSb) 10.6 μm optical isolator, a device necessary to maintain master-oscillator and laser-transmitter stability, was also built in 1966. Experiments with laser amplifiers during 1968 led to master-oscillator/power-amplifier (MOPA) combinations that produced 100 W. High-speed photomixers were developed to accommodate the large Doppler frequency shifts

produced by satellites. By 1968, researchers in the Solid State Division had developed a high-speed (1.25 GHz) copper-doped germanium photoconductor that could operate as a photomixer in an optical heterodyne circuit.

In parallel with the ladar developments at Lincoln Laboratory, ARPA and the Office of Naval Research were funding the development of a 1000 W CW CO<sub>2</sub> laser oscillator at the Raytheon Corporation. After Raytheon had evaluated the oscillator, it was given to the Laboratory for ladar experiments.

In late 1968, the Laboratory completed the Firepond Optical Research Facility, located near the Millstone Hill radar in Westford, Massachusetts, to provide a facility for performing ladar measurements on aircraft and satellites (Figure 25-1). Within a few months, members of the newly formed Optics Division had modified the Raytheon laser oscillator, turning it into a 1 kW CW laser amplifier with an optical gain of 33. Initial ladar measurements were made at a power of 200 W on a corner-cube retroreflector placed on the Groton Fire Tower, located on a hill 5.4 km from Firepond. Additional measurements were made on buildings, trees, and calibration spheres, and on an aircraft at a range of 10 km.

#### Note

**1** Material for this section was provided by Leo Sullivan and William Keicher.



The first lidar images of several different stationary objects were collected with a flying-spot scanning system in 1971. The year closed with the installation of a 1.2 m telescope at the Firepond site (Figure 25-2).

Coherent wideband radar offers an approach to imaging that circumvents the conventional *angular* resolution limits associated with diffraction and atmospheric turbulence. A range-Doppler radar can use the aspect changes of a target, such as a satellite, as it moves along its orbit, to form an image that has resolution in *range* and in *Doppler frequency*. Moreover, the resolution of the range-Doppler image is independent of the range to the target.

In 1972, a Lincoln Laboratory study under the direction of Robert Cooper examined the feasibility and role of a wideband, very-high-power range-Doppler lidar for space-object surveillance and identification. The study group concluded that development of a lidar was feasible and that Lincoln Laboratory should undertake the task.

Accordingly, in 1973, the Laboratory developed specifications for a high-power CO<sub>2</sub> lidar capable of imaging unenhanced satellite targets in low earth orbit at slant ranges out to approximately 1000 km, with downrange and cross-range resolutions of less than 30 cm. To obtain the necessary Doppler resolution, the waveform had to have a duration of 4 msec in a wideband mode. The long-range specification meant that the output power amplifier had to generate a high-energy pulse with a wide bandwidth, which required that the CO<sub>2</sub> laser amplifier had to operate at close to atmospheric pressure.

The radar system required a laser oscillator, a wideband waveform generator, a wideband laser preamplifier, and a wideband laser power amplifier arranged in a MOPA configuration. Leo Sullivan was responsible for the lidar receiver, the angle- and frequency-tracking systems, and the optics. The wideband waveguide CO<sub>2</sub> laser preamplifier and the high-power CW electron-beam sustained-discharge laser power amplifier were subcontracted to an outside vendor. Shen Shey led the effort to install and modify the high-power laser amplifier.

Advances continued during this period in lidar components. David Spears of the Solid State Division built single- and quad-array, wideband mercury cadmium telluride (HgCdTe) photodiode photomixers

for monopulse laser tracking. W. Edward Bicknell and Louis Tomasetta constructed high-power optical isolators. Freed's research in laser physics produced a catalog of the lasing frequencies of nine out of a possible eighteen different CO<sub>2</sub> laser isotopic combinations. Optical modulators were required to impress the wideband frequency-modulated waveform on the laser beam, and in 1976 Gary Carter and Hermann Haus developed a wideband double-sideband gallium arsenide (GaAs) electro-optic modulator that was used to form the first CO<sub>2</sub> lidar range-Doppler images of a pair of moving retroreflectors on a ground range. Analytical developments led to the development and testing of an efficient narrowband single-sideband CdTe electro-optic modulator in 1978.

The laser signal produced by the double-sideband modulator required significant amplification prior to injection into the wideband laser amplifier. Unfortunately, the wideband preamplifier was not successfully completed by the outside contractor. Although the radar peak-power goal of 200 kW was not achieved, the laser power amplifier still was among the most powerful in the world, with maximum peak pulse power close to 11 kW (44 J/pulse) when driven by the original 1000 W narrowband laser amplifier. Without an efficient wideband electro-optic modulator or a wideband laser preamplifier, however, the power was available only in the narrowband mode.

Prior to the completion of the high-power laser amplifier, several lidar measurements were obtained with the Raytheon kilowatt narrowband laser amplifier. These measurements included scanned real-aperture images of various buildings and most of the church steeples within line of sight of the Firepond site, as well as images of helicopters at ranges of 15 km. This work eventually led to the tactical Infrared Airborne Radar program, sometimes referred to as "Firepond in a shoe box" (see chapter 14, "Tactical Battlefield Surveillance").

In 1977, monopulse laser tracking was demonstrated in experiments performed by Rein Teoste on aircraft and satellites. The monopulse experiments resulted in tracking errors of approximately 1  $\mu$ rad rms for targets equipped with retroreflectors. Other experiments included the lidar (light detection and ranging) measurement of high-altitude winds in 1978.

## Note

2 I. Melngailis, W.E. Keicher, C. Freed, S. Marcus, B.E. Edwards, A. Sanchez, T.Y. Fan, and D. Spears, "Laser Radar Component Technology," *Proc. IEEE* **84(2)**, 227–262 (1996).

The high-power lidar amplifier system was installed in the Firepond Optical Research Facility, and the lidar power amplifier (LRPA) alone filled an entire room. Many modifications were required to achieve reliable operation at typical peak powers of 4 to 5 kW in 4 msec pulses (16 to 20 J/pulse). Operating at a wavelength of 10.59  $\mu\text{m}$  with an aperture of 1.2 m yielded a beamwidth of about 10  $\mu\text{rad}$ .

Because the Doppler-frequency resolution was high, it was possible to collect Doppler-time-intensity (DTI) measurements of satellites. In 1981, a detailed DTI measurement of a slowly tumbling space object — an Agena D rocket body — at a slant range of 1350 km was generated successfully. The lidar demonstrated a capability for acquiring and monopulse-angle-tracking unenhanced targets in low- and medium-altitude earth orbits. Space objects were automatically tracked in frequency while Doppler data were recorded, and DTI plots were generated on a wide variety of targets. However, the failure to produce high-resolution range-Doppler images and to meet the average-power goal led to the termination of the lidar program in the early 1980s.

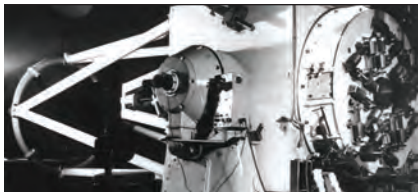
With the advent of the Strategic Defense Initiative, a major national study was launched in summer 1984. The Fletcher Summer Study recommended investigating the use of an orbiting lidar sensor to discriminate nuclear warheads from decoys during the post-boost phase of an intercontinental ballistic missile's flight. The Laboratory

responded with a DARPA-funded study led by John Rheinstein that further detailed the requirements for lidars for ballistic missile defense. The optical discrimination study was completed in January 1985 and led to the initiation of the Optical Discrimination Technology program in February 1985.

Lincoln Laboratory resumed the high-power lidar effort with a reinforced emphasis on high-resolution range-Doppler imaging. Niessen, head of the Optics Division, became program manager of the largest lidar technology and measurements effort that had ever been attempted. The scope of the SDIO laser-technology program was enormous. In addition to the efforts in the Optics Division, the Radar Measurements Division was involved with systems-effectiveness analysis and discrimination engineering, the Solid State Division was involved with the development of tunable diode-pumped titanium aluminum oxide ( $\text{Ti:Al}_2\text{O}_3$ ) and neodymium:yttrium aluminum garnet (Nd:YAG) laser transmitters,<sup>2</sup> the Aerospace Division developed lidar countermeasures, and the Engineering Division built countermeasure systems and decoys (and was also responsible for the Firebird rocket system and payload).

In the Optics Division, William Keicher and Leo Sullivan were tasked with reconstituting the high-power lidar effort, developing both ultraviolet and infrared lidar ground ranges, and conducting the Firefly sounding-rocket experiment.

1960



Project Luna See



500 J  
single-pulse  
 $\text{CO}_2$  lasers



1000 W CW laser  
amplifier, Firepond

At Keicher's suggestion, Robert Knowlden and Alan Kachelmyer analytically investigated the effects of atmospheric absorption and dispersion on wideband ladar signals propagating through the atmosphere. Because atmospheric CO<sub>2</sub> (principally the common isotope, <sup>12</sup>C<sup>16</sup>O<sub>2</sub>) has some narrowband absorption at 10.59 μm, models of atmospheric propagation predicted significant nonlinear frequency dispersion and, therefore, a distortion of the wideband ladar signal. In the new ladar, all of the lasers used <sup>13</sup>C<sup>16</sup>O<sub>2</sub>, a rare isotope of CO<sub>2</sub>, and therefore had to operate in a sealed-off mode to conserve the gas. The resultant output wavelength, 11.15 μm, was not significantly absorbed or distorted by propagation through the atmosphere.

Once again, a MOPA configuration was chosen for the wideband ladar; however, a short-pulse design was chosen to maximize the laser-amplifier gain. A contract was let to Rockwell Corporation and to Spectra Technology for the design and construction of a high-power, wideband, sealed-off, electron-beam sustained-discharge pulsed-laser amplifier. Freed produced a collection of documents that instructed laser contractors on “how not to build a laser amplifier.” Brian Edwards, who led the effort to build the wideband amplifier, played a significant role in ensuring that Rockwell did not repeat the mistakes made by earlier laser-amplifier contractors. The emphasis was on developing a conservative design with a significant performance margin.

A separate program to measure the gain of the isotopic CO<sub>2</sub> laser was initiated in March 1986 to provide the contractors with information necessary to build the laser amplifiers.

The narrowband preamplifier was designed by a small laser manufacturer. The gain and output energy of the modular narrowband laser preamplifier were more than sufficient to drive the modulator and high-power laser amplifier, but because of major difficulties with the pulsed-power supply and mechanical construction of this laser, Freed heavily modified its original design.

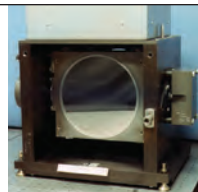
Lincoln Laboratory developed several major components: the programmable wideband waveform generator, which generated the wideband linear FM multiple-chirp waveform, and the wideband laser receiver and analog stretch processor, which were designed and built by David Kocher. Neville Harris spent more than four years developing a wideband, efficient, single-sideband electro-optic modulator. Alan Stein was responsible for the wideband digital data processor used to create real-time, movie-like range-Doppler images.

In early December 1989, the wideband ladar effort narrowly avoided a major setback when a power failure at the Firepond facility destroyed the four unique Raytheon traveling-wave tube amplifiers (TWTAs) that were used to drive the four-section single-sideband laser modulator.

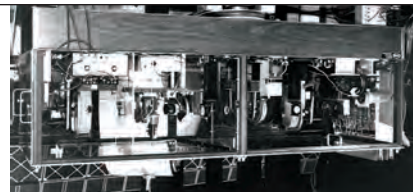
1970



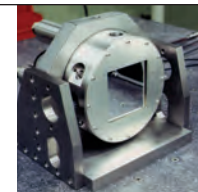
L.C. Marquet



Cooled 69-channel deformable mirror



OCULAR



TRAPAF mirror



---

**Note**

3 Material for this section was provided by Dennis Hall and William Keicher.

Within six weeks, Harris had rebuilt the four-section modulator into a two-section modulator, and the Navy sponsor, Commander Frederick Marcell, had located two Navy Litton TWTAs that were compatible with the electronics used with the Raytheon TWTAs. These efforts allowed the launch of the Firefly sounding rocket before the end of the launch window in April 1990.

The wideband imaging lidar had a pulse-repetition frequency of 8 Hz with a pulse duration of 32  $\mu$ sec. The laser waveform consisted of multiple linear frequency-modulated chirps, each with a bandwidth of 1 GHz. The maximum output energy achieved with the wideband coherent optical radar amplifier (CORA) was 100 J/pulse (3.1 MW peak power). Initial operation was at an energy of 24 J/pulse; typical operation during imaging experiments was 40 to 60 J/pulse.

On March 4, 1990, the wideband lidar successfully collected the first range-Doppler images of an orbiting satellite. Lidar images of SEASAT were collected at ranges of 800 to 1000 km; precision angle tracking was performed with a visible-light tracker. Only 25 days after the lidar first began imaging operations, the SDIO Firefly sounding-rocket experiment was successfully completed. For the next two years, wideband range-Doppler images of many satellites at ranges as great as 1500 km were collected. Thus, the plan originating in the 1972 study to build a lidar for space-object surveillance was fulfilled eighteen years later.

After the first Firefly experiment, satellite measurements continued with the Raytheon narrowband, kilowatt CO<sub>2</sub> lidar. These experiments focused on the

measurement of vibrations of the boom structure of the Low-Power Atmospheric-Compensation Experiment (LACE) satellite for the Naval Research Laboratory. Lincoln Laboratory researchers were able to measure the extremely low-frequency vibrations of this retroreflector-equipped satellite.

#### *Firefly and Firebird*

During the middle of 1986, Lincoln Laboratory embarked on a sounding-rocket flight-test program, designated Firefly, to demonstrate the performance of the Firepond lidar.<sup>3</sup> David Klick and Jeffrey Parker were responsible for the design of the Firefly experiment. Sandia developed the Terrier-Malemute rocket and payload section, and L'Garde developed, tested, and flight-qualified the Firefly inflatable replica-decoy balloons. After a tracking data communications link had been established among the radars on Millstone Hill, joint satellite-tracking exercises began in September 1988. An active argon-ion-laser tracking capability, installed by James Daley, was demonstrated at Firepond on retroreflector-equipped satellites in February 1989. The tracking data link was extended to the National Aeronautics and Space Administration (NASA) Wallops Island C-band radar soon afterward, and NASA and Lincoln Laboratory teams conducted joint exercises in preparation for the sounding-rocket launches.

The Firefly sounding-rocket experiment, a part of the field-measurements effort in the Optical Discrimination Technology program, included sounding-rocket launches from the NASA Wallops Island Space Flight Facility in Virginia on March 29, 1990, and on October 20, 1990. Klick was the mission director

1980



D.P. Greenwood



LRPA gas laser



C.A. Primmerman

## Notes

**4** A.B. Gschwendtner and W.E. Keicher, "Development of Coherent Laser Radar at Lincoln Laboratory," *Linc. Lab. J.* **12(2)**, 383–396 (2000).

**5** This section is taken from an article by D.P. Greenwood and C.A. Primmerman, "Adaptive Optics Research at Lincoln Laboratory," *Linc. Lab. J.* **5(1)**, 3–24 (1992). The entire spring 1992 issue of the *Lincoln Laboratory Journal* was devoted to adaptive optics.

for both launches. Each flight path was oriented in an easterly direction and reached an apogee of 460 km, at a range of 760 km and an elevation of  $36^\circ$  from Millstone Hill. Utilizing angle-tracking data for initial acquisition from the NASA C-band and Haystack X-band radars, the Firepond ladar angle-tracked the deployed target to submicroradian precision. The ladar collected real-time, high-resolution range-Doppler images of the ejection and inflation of the replica decoy.

On the basis of the success of the Firefly experiments, the U.S. Air Force Brilliant Eyes program office wanted to investigate the use of a very-low-power diode-pumped Nd:YAG ladar for ranging on rocket boosters and post-boost vehicles. The concept, proposed by Niessen, involved the use of a receiver that could detect single photons returning from the target. Antonio Sanchez-Rubio of the Solid State Division led the development of a 30 mJ/pulse diode-laser-pumped Nd:YAG laser transmitter. Sullivan, assisted by Steven Davidson, led the development of the proof-of-principle (PoP) ladar tracker. Kocher designed and built the photon-counting receiver and visible-angle tracker. The PoP ladar tracker was successfully utilized in the Firebird 1B experiment.

A second series of flight tests, designated Firebird, was conducted to demonstrate sophisticated ladar discrimination techniques and ladar countermeasures. These experiments were conceived by Donald Coe and David Immerman of the Engineering Division. In these tests, the Millstone and Haystack radars were operated to support the Firepond ladar in acquiring and tracking the targets.<sup>4</sup> Once again, Klick was the mission

director with Dennis Hall as the NASA liaison during both Firebird experiments. The Firebird experiments used a high-performance Talos-Minuteman I Stage II guided booster to deploy a dozen targets to be acquired by the Millstone Hill sensors and other airborne and ground-based sensors scattered along the East Coast. The Firebird 1B test added countermeasure-complex surface signatures, photon-counting Nd:YAG ladar bus tracking, and passive stereo tracking.

The Firebird 1 rocket was launched on April 12, 1991 (Figure 25-3). The Firepond, Haystack, and Millstone radars, and the Cobra Eye aircraft sensor and infrared sensors at NASA Goddard Space Flight Center collected data during the Firebird 1 experiment.

Firebird 1B was launched on April 13, 1992. In addition to the sensors participating in the Firebird 1 experiment, Utah State University's infrared sensor located at Firepond and the SDIO Airborne Surveillance Testbed infrared sensor aircraft, the Pave Paws UHF radars in Massachusetts and Georgia, and optical sensors at Malabar, Florida, collected data during the flight. The flight tests were carried out as planned, gave excellent results, and completed the experimental investigation of the ladar discrimination techniques described in the 1984 studies.

### Adaptive Optics

The adaptive-optics effort at Lincoln Laboratory was started by Louis Marquet in the early 1970s as an outgrowth of an investigation of high-energy-laser beam propagation.<sup>5</sup> Over the subsequent two decades, Lincoln Laboratory became a leader in adaptive optics.



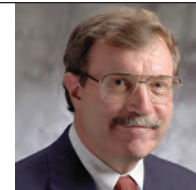
MIRACL compensation,  
White Sands Missile Range



C.W. Niessen



CORA gas laser



W.E. Keicher



**Figure 25-3**  
Launch of Firebird sounding rocket  
from Wallops Island, Virginia.

It conducted a broad program of research, including theoretical analysis, laboratory experiments, hardware development, and field experiments. Among the highlights of the research program were seminal experiments in atmospheric compensation, including the first thermal-blooming compensation of a high-energy laser, the first compensation of a laser beam propagating from ground to space, and the first compensation with a laser-guidestar beacon.

#### *Adaptive Optics Techniques*

Adaptive optics is a technique for real-time measurement and correction of optical aberrations such as laser-device aberrations, thermally induced aberrations in telescopes, and aberrations resulting from optical-fabrication errors. But the most common use for adaptive optics is in correction of atmospheric distortions. The Department of Defense (DoD) interest has principally been in the use of adaptive optics for high-energy-laser beam propagation through the atmosphere.

Two mechanisms distort high-energy-laser beams propagating through the atmosphere: turbulence and thermal blooming. Turbulence-induced aberration is an easily observed, everyday phenomenon. It is what causes objects to appear distorted when viewed across a black-topped runway on a hot, sunny day; it is what causes stars to twinkle and dance. Thermal blooming is the spreading of a laser beam that results when the beam heats the medium through which it is propagating. As the laser beam passes through the atmosphere, some energy is absorbed, heating

1990



Firefly



D.V. Murphy



A. Sanchez-Rubio



## Notes

6 L.C. Bradley and J. Herrmann, "Phase Compensation for Thermal Blooming," *Appl. Opt.* **13(2)**, 331–334 (1974).

7 C.A. Primmerman and D.G. Fouche, "Thermal-Blooming Compensation: Experimental Observations Using a Deformable-Mirror System," *Appl. Opt.* **15(4)**, 990–995 (1976).

the atmosphere. The heated region is less dense and, consequently, has a lower index of refraction. Since the hottest regions are normally in the center of the beam, a negative lens develops in the atmosphere, and this lens diverges the beam.

Turbulence-induced distortions are independent of laser-beam power. Thermal blooming, on the other hand, becomes increasingly important as the laser-beam power increases. For many high-power scenarios of interest to the DoD, the magnitude of the beam spreading caused by thermal blooming is comparable to or exceeds that from turbulence.

Adaptive optics can be used to correct a laser beam for both turbulence and thermal blooming. The basic technique is as follows. A beacon is formed at or near a target. Light from the beacon passes through the atmosphere, where it picks up atmospheric aberrations. The aberrated beacon light is reflected from a deformable mirror and then is measured by a wavefront sensor. Signals from the wavefront sensor are used in a multichannel servo loop to drive the deformable mirror so as to flatten the incoming wavefront. The high-energy-laser beam is then inserted into the optical train by an aperture-sharing element and reflected from the deformable mirror, which precorrects the beam for the distortions it will experience in the atmosphere. Thus, as the laser beam propagates through the atmosphere, the atmospheric distortions cancel the phase that the deformable mirror applied, and the laser beam reaches the target as an undistorted beam.

## Origins of Adaptive Optics Research at Lincoln Laboratory

Lincoln Laboratory started work on high-energy-laser beam propagation in the late 1960s and began investigating adaptive optics in the early 1970s. The initial emphasis was on compensating 10.6  $\mu\text{m}$  CO<sub>2</sub> laser beams that would be used in tactical scenarios and, hence, would be focused in the atmosphere. (The benefit of more than three decades' hindsight clearly shows that the most difficult problem was addressed first.) Lincoln Laboratory's initial effort in adaptive optics was a set of computer calculations by Lee Bradley and Jan Herrmann demonstrating that thermal blooming could be at least partially corrected by phase compensation.<sup>6</sup> Several years later Charles Primmerman and Daniel Fouche conducted laboratory experiments that verified the calculations.<sup>7</sup> These early thermal-blooming-compensation experiments used a 69-channel deformable mirror that was manually adjusted according to the computer predictions to maximize the intensity of the laser beam on the target. In a subsequent experiment, named Closed Loop Adaptive Single Parameter (CLASP), the shape of the deformable-mirror correction was fixed, but the amplitude was adjusted automatically to maximize the far-field intensity.

In the mid-1970s, Lincoln Laboratory carried out a long series of field experiments with the Pratt and Whitney XLD — a 10.6  $\mu\text{m}$  CO<sub>2</sub> gas-dynamic laser that was, at the time, the most powerful laser in the nation — at the Pratt and Whitney high-energy-laser beam propagation range in West Palm Beach, Florida. This propagation range is fondly remembered by the researchers for its location in the middle of Florida



Laser diode array for first wavelength beam combining



T.Y. Fan

**Figure 25-4**

Pratt and Whitney high-energy-laser propagation range in West Palm Beach, Florida, site of thermal-blooming tests. An alligator is just visible at the bottom center of the photograph.



**Figure 25-5**

Air Force Maui Optical Site on top of Mount Haleakala on the island of Maui, Hawaii.





swampland and for its resident alligators (Figure 25-4). The experiments were conducted with a cooled 52-channel deformable mirror, the first deformable mirror to be used with a high-power laser. The XLD laser beam was expanded to 1.2 m and propagated over a 2 km horizontal path to an instrumented vehicle (affectionately known as the Everglaser) that ran on a short stretch of railroad track. This arrangement enabled the Lincoln Laboratory team to produce the first thermal-blooming compensation with a high-energy laser. CLASP tests were also completed successfully — the first closed-loop thermal-blooming compensation of a high-energy-laser beam.

The 52-channel deformable mirror was used in several experiments to correct for aberrations on the XLD laser beam itself. The most successful of these experiments was the Optical Compensation of Uniphase Laser Radiation (OCULAR), which used a multidither technique that had been pioneered several years earlier by Hughes researchers. OCULAR demonstrated the first-ever compensation for device aberrations in a high-energy laser. A second atmospheric-compensation experiment performed with the XLD was the Target Return Adaptive Pointing and Focus (TRAPAF). To explore the efficacy of simple, low-order adaptive-optics systems, TRAPAF used, instead of the 52-channel deformable mirror, a mirror that could correct only for tilt and focus. Successful high-power and low-power tests were conducted along the 2 km path, although the lack of a fully deformable mirror limited the correction achieved.

#### *Atmospheric-Compensation Experiment*

In the late 1970s, the DoD emphasis on lasers shifted from tactical to strategic applications that involved ground-to-space propagation. As a result, Lincoln Laboratory began to develop the Atmospheric-Compensation Experiment (ACE) system to explore ground-to-space compensation.

The ACE system was a complete 69-channel adaptive-optics system; it used a deformable mirror and a shearing interferometer built by Itek Corporation. The sensor had photomultipliers for low-light operation, and the system had a correction bandwidth of 600 Hz. The ACE system was built on the technology of the pioneering 21-channel real-time atmospheric-compensation system developed

by Itek in the mid-1970s, and utilized technology similar to that of the 168-channel compensated-imaging system Itek researchers used to perform the first star-imaging-compensation experiments in 1982.

Tests of the ACE system began in 1981 with turbulence simulated by rotating phase screens. During the following year, the system was shipped and installed on the 60 cm laser-beam director at the Air Force Maui Optical Site on the top of Mount Haleakala on the island of Maui in Hawaii (Figure 25-5). Thus began a decade of adaptive-optics experiments at the Maui field site. Most people think of Maui as a warm-weather paradise, but Lincoln Laboratory researchers mostly remember the arduous three-hour round-trip commute to the top of the 10,023 ft Mount Haleakala. The mountaintop is always cold and occasionally snowy.

From 1982 through 1985, Lincoln Laboratory conducted an extensive three-phase field test of ACE under the overall direction of Greenwood. In phase 1, completed in 1982, atmospheric compensation was demonstrated for a beam propagating along a 150 m horizontal path (with integrated turbulence equal to that for vertical propagation through the entire atmosphere). In phase 2, conducted from 1983 to 1984, atmospheric compensation was demonstrated for a laser beam propagating to a small aircraft flying above the site. The aircraft tests demonstrated compensation to a dynamic target.

The third and culminating phase of the ACE tests was a demonstration of compensation from ground to space. In the first experiment of this phase, a laser beam was bounced off a retroreflector carried by the space shuttle *Discovery*, and the return signal was used as a beacon to perform atmospheric compensation. This was the first SDIO space experiment and, as such, received considerable publicity (see sidebar next page).

The experiment with the space shuttle did not involve compensating an outgoing beam; that was subsequently demonstrated in experiments with four instrumented sounding rockets. These rockets, developed for Lincoln Laboratory by Sandia National Laboratory, were launched from Barking Sands on the island of Kauai in Hawaii and reached altitudes of about 600 km as they went by Maui. Each rocket carried a retroreflector,



## The First SDI Experiment in Space

In the early days of SDIO, the basic concepts behind the Strategic Defense Initiative were provoking passionate debate over their feasibility. Therefore, when the SDIO revealed that it was about to conduct its first experiment in space, the announcement became front-page news. Whether fortunately or not, that experiment was Lincoln Laboratory's test of the use of adaptive optics for atmospheric compensation.

The plan was to propagate a 4 W 488 nm argon-ion laser beam from the Air Force Maui Optical Site, retroreflect it from the space shuttle, and correct it on the ground. NASA installed an 8.5-inch-diameter laser retroreflector on the left mid-deck side-hatch window of the space shuttle orbiter *Discovery* and described the test at a press briefing. By the time of the shuttle's launch on June 17, 1985, intense media coverage was focused on the atmospheric-compensation experiment.

The test began on June 19. With reporters present, NASA transmitted the altitude of the ground station to the orbiter computer in units of feet, rather than in the nautical miles the computer was expecting. The shuttle flipped around, searching for a 10,023 nautical-mile-high mountain.

About seven minutes before reaching Maui, as the orbiter passed over Guam, Mission Commander Daniel Brandenstein informed mission control in Houston that the orbiter was oriented with its left side — the one with the retroreflector — pointing toward space. Because it was impossible to reorient the orbiter within the time left before reaching Maui, the atmospheric-compensation test could not be conducted. The Lincoln Laboratory team did illuminate the shuttle with the laser, and the shuttle crew reported seeing a blue light. But with the shuttle facing the wrong way, none of the test objectives could be achieved.

The mistake was immediately reported worldwide by network television and numerous newspapers. Opponents of SDI used the opportunity to advance their arguments against the program, and the Lincoln Laboratory staff on Maui

received a message relayed from high levels within the DoD that the next test had to succeed.

NASA juggled the shuttle schedule to permit a test opportunity on June 21. As tensions mounted, the day of the test arrived with gale-force winds. Gusts reached 55 mph; winds were steady at 40 mph. Normally, astronomical domes are kept shut under such conditions. For this experiment, the high winds also meant increased difficulty in compensating for atmospheric turbulence.

The NASA mission director asked Charles Primmerman, who was heading the Lincoln Laboratory effort, if he wanted to conduct the experiment on the next pass. In an agonizing decision, Primmerman declined. NASA, however, made the decision to turn the shuttle around anyway, just to test that part of the experiment. Deciding it was a no-lose proposition, the Lincoln Laboratory team opened the domes and illuminated the space shuttle. If they failed, they could report that it was only an engineering test. But if it succeeded,...

It was night when the space shuttle passed over Maui, so the crew ignited a one-million-candlepower docking light in the left flight-deck window for optical acquisition. The orbiter was also acquired by radar, with the laser-beam director slaved to the radar.

The experiment worked precisely as planned. The argon-ion laser beam bounced from the retroreflector, was measured by detectors at the observatory, and then was corrected by the deformable mirror of the adaptive-optics system. The active tracking sequence lasted two minutes, thirty seconds.\*

The news flashed around the world, from the front page of the *New York Times* to the evening news. The SDIO had conducted its first successful experiment in space.

---

\*E.H. Kolcum, "Discovery Crew Tests Laser Tracker, Surpasses Mission Goals," *Aviat. Week Space Technol.* 123, 19 (1985).

which was illuminated to serve as a beacon, and a linear array of detectors to detect the outgoing beam. The beam detected at the rocket clearly showed a dramatic increase in irradiance when atmospheric compensation was applied. The ACE sounding-rocket tests were the first to demonstrate atmospheric compensation of a beam propagating from the ground to space.

### Short-Wavelength Adaptive Techniques

In the principal high-energy laser scenario of interest to SDIO, the laser beam was to be sent from the ground to a relay mirror in space. The relay mirror may be regarded as a cooperative target; that is, it can provide a beacon source suitable for the adaptive-optics system. Many targets, however, are uncooperative in that they do not come equipped with a beacon suitable for the adaptive-optics system. For short-range tactical targets, optical energy emitted by or reflected from the target can be used as a beacon. For long-range targets like satellites, such a beacon is usually too dim and, more importantly, will not lead the aim point by the correct angle.

A solution to the uncooperative-target problem is to generate a laser guidestar (also called an artificial beacon or a synthetic beacon) by atmospheric backscatter from a ground-based illuminator laser. In this concept, the ground-based laser beam is sent skyward in the proper direction (Figure 25-6). The beam generates a laser guidestar either by backscatter from atmospheric oxygen and nitrogen or by backscatter from atomic sodium in the mesosphere at approximately 90 km altitude. Once the laser-guidestar beacon is generated, the atmospheric compensation is performed in much the same manner as in the cooperative-beacon scenario.

At the same time that Lincoln Laboratory was conducting the ACE cooperative-compensation program, a new program — called Short-Wavelength Adaptive Techniques (SWAT) — was initiated to explore uncooperative atmospheric compensation. This program, under the overall direction of Primmerman, comprised a variety of theoretical, hardware-development, and experimental efforts.

Lincoln Laboratory researchers, including Jan Herrmann, Ronald Parenti, and Richard Sasiela, performed original theoretical analyses and computer simulations to put



**Figure 25-6**  
**Sodium-beacon experiment at White Sands Missile Range, New Mexico. A 589 nm wavelength laser beam is sent skyward to generate a synthetic beacon in the sodium layer at an altitude of 90 km.**

#### Notes

**8** R.J. Sasiela, *Electromagnetic Wave Propagation in Turbulence: Evaluation and Application of Mellin Transforms*, New York: Springer Verlag, 1994. Revised edition published by SPIE in 2007.

**9** E.H. Kolcum, "SDI Laser Test Satellites Placed in Precise Orbits," *Aviat. Week Space Technol.* **132**, 24 (1990).

uncooperative atmospheric compensation on a sound theoretical foundation. Sasiela eventually published much of his original analysis work in a book on propagation through turbulence.<sup>8</sup>

Ronald Humphreys conducted the first SWAT experiment at the White Sands Missile Range in New Mexico in 1984 and 1985. This was a phase-measurement, not a phase-compensation, experiment. A laser guidestar was generated in the mesospheric sodium layer, and the phase measured from the laser guidestar was compared to the phase measured from a real star in the same direction. The experiment was the first to show that atmospheric phase distortions could be measured with a laser guidestar in the mesospheric sodium layer.

Following completion of the initial tests, the main SWAT system — a 241-channel adaptive-optics system — was constructed. The system's deformable mirror, built by Itek, used discrete lead-magnesium-niobate actuators. The phase sensor was a Hartmann design developed by the Laboratory; it included advanced charge-coupled-device (CCD) focal planes developed by the Laboratory. The wavefront reconstructor, also developed by the Laboratory, was based on an all-digital matrix-multiplication technique.

The entire SWAT system was designed to operate in many different modes. It could operate in an astronomical-imaging mode or compensate an outgoing laser beam propagated to a satellite. The system could operate in a cooperative or an uncooperative mode with either a single laser-guidestar beacon or multiple laser-guidestar beacons. In the laser-guidestar mode, the system could, in less than 1 msec, make a single phase measurement and drive the deformable mirror to correct for the measured phase error.

In February 1988, the SWAT system was shipped to Maui and installed on the same 60 cm beam director that had been used for ACE. Over the next three years, the SWAT experiments achieved four major milestones in atmospheric compensation. Lincoln Laboratory used the SWAT system in August 1988 to perform the first-ever atmospheric-compensation experiment with a laser guidestar. This experiment used a single laser-guidestar beacon generated by a dye laser and imaged a bright star to diagnose the degree of correction. The next phase of

the SWAT program began on Valentine's Day, February 1990, when the LACE instrumented satellite, developed by the Naval Research Laboratory primarily for SWAT experiments, was launched.<sup>9</sup> Over the next fifteen months, a team of researchers headed by Daniel Murphy conducted an extensive series of tests with the LACE satellite. In the summer of 1990, Lincoln Laboratory demonstrated the first cooperative atmospheric compensation of a laser beam propagating to a satellite target. A short time later, Lincoln Laboratory successfully performed the first uncooperative, laser-guidestar atmospheric compensation of a laser beam propagating to a satellite target. The final major SWAT milestone occurred in October 1990 — the first multiple laser-guidestar experiment. In this experiment, measurements from two laser guidestars were stitched together to compensate the image of a star.

#### *Compensation of High-Energy Lasers*

The ACE and SWAT experiments convincingly demonstrated atmospheric compensation for the distortions introduced by turbulence, but because only low-power beams were used, the experiments did not address high-power effects. Therefore, to complement the ACE and SWAT experiments, in the mid-1980s, Lincoln Laboratory began several high-power efforts, one to address laser-device correction and the other to address thermal blooming.

From 1986 through 1987, Lincoln Laboratory developed and tested a local-loop compensation system to correct device aberrations for the Mid-Infrared Advanced Chemical Laser (MIRACL), a high-energy 3.6 to 4.2  $\mu\text{m}$  deuterium-fluoride laser installed at the White Sands Missile Range. The adaptive-optics system was based on a cooled 69-channel deformable mirror and incorporated a multidither sensing technique. By using this system, the Lincoln Laboratory team was able to demonstrate a significant improvement in the beam brightness of the MIRACL. Although local-loop compensation had been accomplished earlier, these tests clearly demonstrated that compensation could be done at power levels of interest to the military.

With the formation of SDIO in 1984, Lincoln Laboratory had returned to research on thermal blooming. The new objective was to determine whether the ultrahigh powers required for ballistic missile defense

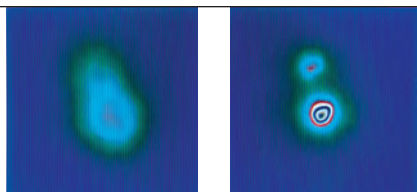
could be successfully propagated through the atmosphere. From the mid-1980s through 1991, Lincoln Laboratory conducted a multistage thermal-blooming research program that involved propagation-code development and laboratory and field experiments.

Although thermal blooming and turbulence are nominally corrected in the same way by the same adaptive-optics system, there are fundamental physical limits to the ability of an adaptive-optics system to correct for thermal blooming. Turbulence distortions are completely independent of the phase-compensation process; thermal blooming, by contrast, is induced by the same laser beam that is being corrected. Thus, phase corrections to the laser beam can cause changes in the heating pattern of the beam, and such changes can alter the atmospheric phase that needs to be corrected. The feedback path from phase correction to changed phase distortion can even cause the adaptive-optics correction for thermal blooming to become unstable. This instability, called phase-compensation instability (PCI), limits the energy that can be propagated through the atmosphere with good phase correction.

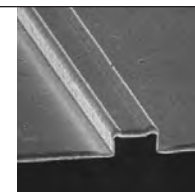
A new four-dimensional (three spatial dimensions and time) propagation code named MOLLY was developed by Jonathan Schonfeld and Gregory Rowe to simulate the combined effects of turbulence and thermal blooming and to give a realistic treatment of adaptive-optics hardware. MOLLY was able to simulate scenarios involving full ballistic missile defense power levels and

to watch for the development of PCI. A two-phase laboratory experiment was then conducted to verify MOLLY predictions and examine PCI further. Phase 1 used the ACE 69-channel adaptive-optics system, which had been returned from Maui, and by seeding PCI with an initial intensity perturbation, Bernadette Johnson obtained the first experimental evidence of the instability. Phase 2 used a new optics system, with 241 channels; these experiments obtained the first experimental evidence of PCI growing spontaneously from noise.

Although the laboratory experiments verified the prediction of PCI and benchmarked MOLLY, they did not include atmospheric effects such as fluctuations in wind velocity. Thus, the next step was to perform a field experiment to address thermal-blooming compensation in the real atmosphere. Daniel Fouche and Charles Higgs developed an experiment called the Scaled Atmospheric Blooming Experiment (SABLE) in which a 10 kW 2.7  $\mu\text{m}$  hydrogen fluoride (HF) chemical laser was propagated over a 400 m horizontal path at a TRW test site in San Juan Capistrano, California. Because 2.7  $\mu\text{m}$  radiation is strongly absorbed by the atmosphere, the laser beam simulated the thermal blooming of a much more powerful laser tuned to an atmospheric transmission window. The adaptive-optics system for SABLE used two cooled deformable mirrors, one with 69 actuators and the other with 241 actuators, in a woofer-tweeter arrangement. The results of SABLE demonstrated that real-world atmospheric effects such as wind shear and wind fluctuations can considerably mitigate PCI.



Double-star  
Castor image  
After compensation



SCOWL micrograph



## Notes

**10** Material for this section and the remainder of the sections in this chapter was provided by Charles Primmerman.

**11** C.A. Primmerman, D.V. Murphy, D.A. Page, B.G. Zollars, and H.T. Barclay, "Compensation of Atmospheric Optical Distortion Using a Synthetic Beacon," *Nature* **353**, 141–143 (1991).

**12** R.A. Humphreys, C.A. Primmerman, L.C. Bradley, and J. Herrmann, "Atmospheric-Turbulence Measurements Using a Synthetic Beacon in the Mesospheric Sodium Layer," *Opt. Lett.* **16(18)**, 1367–1369 (1991).

**13** D.V. Murphy, C.A. Primmerman, B.G. Zollars, and H.T. Barclay, "Experimental Demonstration of Atmospheric Compensation Using Multiple Synthetic Beacons," *Opt. Lett.* **16(22)**, 1797–1799 (1991).

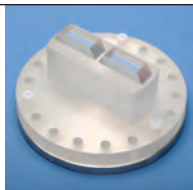
## Adaptive Optics for Astronomy

Until 1991, much of Lincoln Laboratory's adaptive-optics work — most notably, all of the laser-guidestar work — had been classified.<sup>10</sup> In spring 1991, the laser-guidestar work was declassified so that, in May 1991, Primmerman was able to give the first public briefing on Lincoln Laboratory laser-guidestar atmospheric-compensation efforts at a meeting of the American Astronomical Society. This briefing was quickly followed with an article in *Nature*<sup>11</sup> and several other seminal publications.<sup>12,13</sup> The declassified results caused considerable excitement within the astronomy community, and the potential of laser-guidestar adaptive optics to revolutionize ground-based astronomy was widely recognized.

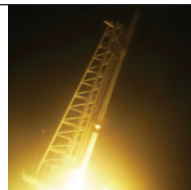
In late 1991, the SWAT adaptive-optics system was moved from Maui and installed on the Firepond telescope, and in 1992 it was used for some imaging of double stars. In the same time period, Lincoln Laboratory refurbished the ACE adaptive-optics system and installed it at the Mt. Wilson observatory in California, where it was used in some of the first adaptive-optics experiments at an astronomical observatory. In the past two decades, adaptive-optics techniques, which were pioneered by Lincoln Laboratory, have been adopted by the astronomy community to enable near-diffraction-limited imaging from large (8–10 m) ground-based telescopes. In fact, no significant ground-based telescope would be built today without adaptive optics.

## The End of the Optics Division

In 1991, SDIO cancelled its ground-based-laser program. The program cancellation was unrelated to the atmospheric-compensation results; the Lincoln Laboratory research had convincingly demonstrated that the required compensation was feasible for the SDIO ground-based-laser scenario. In early 1993, following the successful completion of the Firebird lidar tests in 1992, SDIO also cancelled the optical-discrimination-technology program. With two major programs cancelled, there was no longer sufficient laser-systems funding to support a whole division. Thus, on September 30, 1993, the Optics Division was disestablished, and the remaining efforts were distributed among the other divisions. The end of the Optics Division did not mean, however, the end of high-energy-laser research or lidar research at Lincoln Laboratory. As described in the remainder of this chapter, adaptive-optics research continued for different applications, new work in high-energy-laser diagnostics was conducted, and solid-state-laser research actually increased to support several high-energy-laser concepts. As for lidar, there was a major resurgence with the development of photon-counting lidar, as described in chapter 27, "Photon-Counting Laser Radar."



Grazing incidence disk for cryogenic laser



MARTI launch



COCHISE

**Figure 25-7**

**Arrangement for atmospheric-compensation experiment in support of the ABL program. The laser beam was propagated from the Firepond telescope to a diagnostic target located on the Groton fire tower 5.4 km away. The images on the right show beam images at the target without adaptive-optics (AO) correction (top right) and with AO correction (bottom right).**



### **The Airborne Laser**

In 1991, SDIO and the Air Force began planning for an Airborne Laser (ABL) system to shoot down theater-class ballistic missiles in boost phase. Impetus for an ABL was provided by the Iraqi launching of Scud missiles during Operation Desert Storm in January and February 1991. In 1992, SDIO initiated an ABL program. In 1993, the program was transferred to the Air Force, which set up a Systems Program Office (SPO) to develop a demonstration ABL system. In 1996, following a competitive procurement, the ABL SPO selected a contractor team comprising Boeing, Lockheed Martin, and TRW to design, fabricate, and field test the ABL demonstration system. When the Missile Defense Agency (MDA) was established in January 2002, the ABL program was transferred from the Air Force to the MDA (essentially back to its roots in SDIO).

The ABL system consists of a megawatt-class chemical oxygen-iodine laser (COIL), two solid-state illuminator lasers for tracking and atmospheric compensation, a 1.5 m nose-mounted beam director, and a sophisticated beam-control/fire-control system, all installed in a Boeing 747 aircraft. On February 11, 2010, after a long development period, the ABL succeeded in shooting down a representative ballistic missile in boost phase on its first attempt.

Primmerman, Greenwood, and others at Lincoln Laboratory were involved in the earliest planning discussions for the ABL. Throughout the ABL program, Lincoln Laboratory provided critical technical support in a variety of areas, as discussed in the following sections.

### *Atmospheric Compensation for the ABL*

The ABL is designed to loiter at an altitude of about 40,000 ft and engage boosting missiles along predominantly horizontal paths. At this altitude, the atmosphere is thin, and turbulence is weak; but because the engagement ranges are very long (~100s of km), turbulence-induced phase aberrations cause strong intensity fluctuations in laser beams — the same phenomenon that causes stars to twinkle strongly when viewed near the horizon. Under these conditions, it was not clear that adaptive optics could be used successfully to compensate for the atmosphere as it had been in ground-to-space scenarios.

Primmerman suggested that atmospheric compensation in the ABL scenario could be ground tested by using the SWAT adaptive-optics system installed on the Firepond telescope. To properly mimic the physics of the ABL scenario, the wavelength of the beam and the beam diameter were scaled down, and a target was set up on a fire tower 5.4 km from the telescope (Figure 25-7).



**Figure 25-8**

**The ABL, at left in the image, flying along with the Big Crow diagnostic aircraft. The painted missile outline on the Big Crow was illuminated by low-power beams from the ABL.**

#### Notes

**14** C.A. Primmerman, R.A. Humphreys, T.H. Price, H.T. Barclay, B.G. Zollars, and J. Herrmann, "Atmospheric-Compensation Experiments in Strong-Scintillation Conditions," *Appl. Opt.* **34(12)**, 2081–2088 (1995).

**15** Proteus is a unique high-altitude aircraft developed by Scaled Composites, LLC, Mojave, Calif. Scaled Composites, founded by Elbert "Burt" Rutan, has been involved in a variety of novel aerospace systems, including SpaceShipOne, which in 2004 won the Ansari X PRIZE, established by the X PRIZE Foundation, for a commercial space-flight system.

Experiments were done during times of day when the integrated turbulence along the 5.4 km path was equivalent to that expected for ABL scenarios. These experiments began in April 1992 and continued through fall 1997, first under the direction of Thomas Price, later under Byron Zollars, and then under Higgs. The experiments demonstrated that atmospheric compensation was possible in ABL scenarios and quantified the expected performance under various atmospheric conditions and hardware configurations.<sup>14</sup>

Although the Firepond experiments demonstrated that atmospheric compensation was possible in ABL scenarios, the compensation was far from perfect. Thus, in 1997, the Air Force initiated a major effort to explore ways to improve the compensation. A centerpiece of this effort was the Atmospheric Compensation Laboratory (ACL) assembled by Lincoln Laboratory. As with Firepond, the ACL mimicked ABL scenarios, but since turbulence was simulated by rotating phase screens, conditions could be carefully controlled and repeated to test various schemes for improving atmospheric compensation and tracking. Under the direction of Mitch Fields and later Jan Kansky and Steven Michael, the ACL was used through 2004 to test concepts developed both by Lincoln Laboratory and by others in the optics community.

The atmospheric compensation that can be achieved depends on the strength of turbulence. Yet, when the ABL program started, knowledge of turbulence strength at ABL altitudes was scant. Critics of the ABL program, both inside and outside the government, seized on this paucity of turbulence data to argue that the performance of the ABL could not be adequately predicted. As a result, between 1996 and 1997, the Air Force conducted a major worldwide campaign to measure turbulence strengths at appropriate altitudes in representative ABL operating locations. Lincoln Laboratory researchers, including Jan Herrmann and Jonathan Bloch, led the effort to analyze the various turbulence measurements and put them in a form suitable for ABL performance predictions. The Lincoln Laboratory effort was vital to achieving an ABL authority-to-proceed milestone.

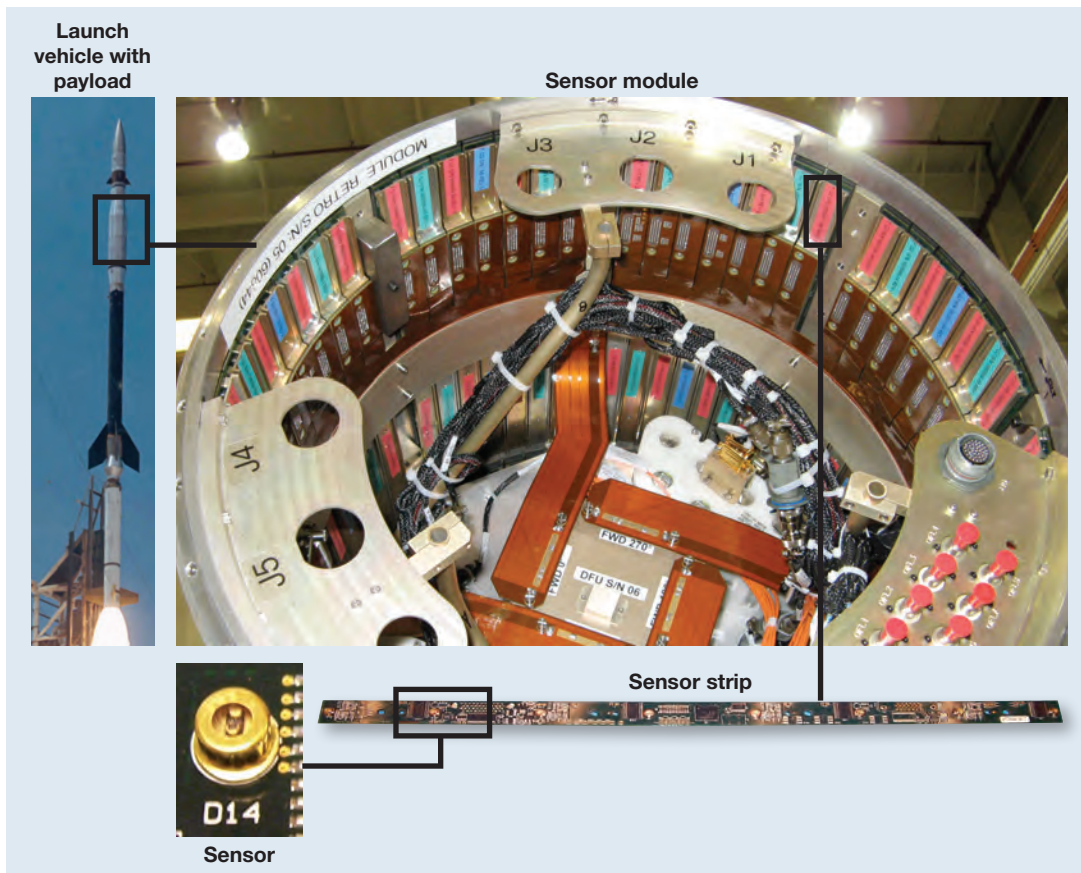
#### *Diagnostic Targets for the ABL*

Diagnosing the performance of the ABL is challenging, particularly under realistic in-flight conditions. Lincoln Laboratory designed and fielded several sophisticated diagnostic targets for both low-power and high-power ABL beams.

The first diagnostic target that Lincoln Laboratory developed specifically for the ABL was for low-power surrogate high-energy-laser measurements of beam-control performance. Higgs conceived the idea of hanging an array of detectors under the Proteus aircraft.<sup>15</sup> Since Proteus is a long-endurance, high-altitude (60,000 ft) aircraft, having it carry a target board would permit extended ABL tests along propagation paths appropriate to missile engagements. The Proteus target board was designed and fabricated from 2001 to 2003 and was flight-tested on the Proteus in 2003 and 2004. Unfortunately, in 2005, as the time for ABL tests neared, it became clear that the Proteus, which is a one-of-a-kind airplane, would not be available to support ABL tests. Thus, Lincoln Laboratory rapidly developed a backup diagnostic target. A crude outline of a missile silhouette was painted on a Big Crow (Boeing 707) airplane, and three cameras were mounted on the wing tip to diagnose the beams reflecting from the missile silhouette (Figure 25-8). An array of lamps was added to simulate a missile plume. This diagnostic system was used successfully for low-power tests of the ABL beam-control system in 2007. For further low-power testing in 2009, the cameras and other associated equipment were remounted on a Gulfstream G5 aircraft.

Aircraft-mounted target boards permit extensive experiments with low-power beams, but they do not have the right dynamics, and they do not allow for high-power tests. To satisfy these requirements, Lincoln Laboratory developed the Missile Alternative Range Target Instrument (MARTI) diagnostic targets. The first concept for the MARTI target was that it would be carried aloft and dropped from a high-altitude balloon at about 100,000 ft altitude. The ABL engagement would take place at altitudes of 70,000 to 40,000 ft as the MARTI target dropped, and then the target would parachute to the ground. This scenario would allow for the right dynamics, albeit with the target accelerating downward instead of upward, and would allow for





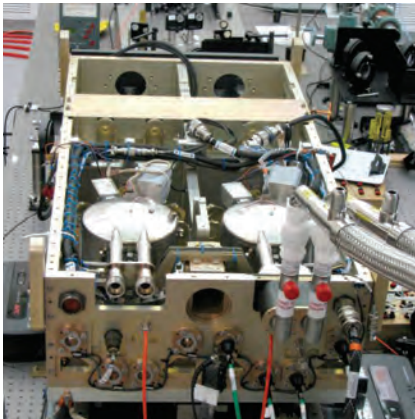
**Figure 25-9**  
**The MARTI missile diagnostic target for the ABL.**

recovery and reuse of the target. Unfortunately, in a June 2003 test flight with a dummy payload, the MARTI recovery system failed to deploy, and the payload crashed. In addition, concept-of-operations analysis suggested that the balloon trajectories could not be predicted accurately enough to satisfy safety and other requirements for an ABL engagement. As a result, the dropped, recoverable MARTI targets were abandoned in favor of launched, single-use MARTI targets.

Under Kenneth Chadwick's direction, beginning in 2003, Lincoln Laboratory developed a launched version of the MARTI target. As shown in Figure 25-9, each low-power MARTI target consists of three 1 m optical sensor modules, each with 512 detectors sensitive to the low-power surrogate high-energy laser, as well as some detectors sensitive to the illuminator lasers. A telemetry unit sends data to the ground during an engagement. The payload is launched on a two-stage Terrier/Black Brant rocket. In late 2006, a high-power variant of the MARTI was developed. The high-power MARTI is essentially the same as the low-power model, except that it has different filters in front of the detectors to measure the high-power beam and does not have detectors for the illuminator beams. On August 10, 2009, the first low-power MARTI target was launched from San Nicolas Island, California, and was successfully engaged by the ABL over the Pacific Ocean. The first high-power MARTI was successfully launched and engaged by the ABL on January 10, 2010.

#### **Cryogenically Cooled Solid-State Lasers**

As described in chapter 24, "Solid-State Research," some of the first solid-state lasers were cryogenically cooled. Cooling the laser material can make the laser work better, but it also makes the laser more cumbersome, thereby reducing its utility for many applications. Thus, in the solid-state-laser field, much effort has been devoted to making lasers work efficiently at room temperature. For example, in 1990, Tso Yee Fan demonstrated the first operation of a Yb:YAG laser at room temperature. Nevertheless, despite the simplicity of room-temperature operation, there are definite advantages to cryogenic cooling. The main limitation to high-power solid-state lasers arises from thermal distortion of the lasing crystals, which in turn distorts the output laser beam. Cryogenically cooling the laser crystal dramatically improves the thermal properties.



**Figure 25-10**  
**Cryogenically cooled ETILL developed for the ABL.**

#### Notes

**16** D.J. Ripin, T.Y. Fan, A.K. Goyal, and J. Hybl, "Grazing-Incidence-Disk Laser Element," U.S. patent application 12389975, February 20, 2009.

**18** *Department of Defense High-Energy Laser Science and Technology Investment Strategy*, report to Congress, December 2001.

**17** Primmerman was lent to the DoD under the terms of the Intergovernmental Personnel Act (IPA). This act permits Lincoln Laboratory employees, and the employees of other nonprofit organizations, to take temporary IPA positions acting as government employees.

For instance, cooling Yb:YAG to liquid-nitrogen temperature (77 K) decreases the thermally induced distortion by more than an order of magnitude and also increases the laser efficiency.

Throughout the 1990s, Fan continued to develop both room-temperature and cryogenically cooled Yb:YAG lasers. The cryogenically cooled versions always outperformed the room-temperature ones, but no compelling application justified the cryogenic cooling. That situation changed in 2002 when the ABL program began experiencing distortion and reliability problems with its Track Illuminator Laser (TILL). The TILL is a high-repetition-rate (~5 kHz) laser used to illuminate the nose of a missile. Backscatter from the missile nose is then used for fine tracking of the missile. Interestingly, the TILL was based on room-temperature Yb:YAG technology that Lincoln Laboratory had transitioned to industry about a decade earlier. Fan suggested that the solution for the TILL problems was to develop a cryogenically cooled TILL, and as a result, the ABL program office funded Lincoln Laboratory to conduct a proof-of-principle demonstration. Working under Fan's direction, Daniel Ripin, a new staff member fresh from MIT, developed a 250 W, 5 kHz laser in only 24 months. This laser met or exceeded all performance goals.

On the basis of excellent results from the proof-of-principle laser, in September 2005, Lincoln Laboratory was asked to develop the Enhanced Track Illuminator Laser (ETILL) as an upgraded replacement for the TILL. Ripin and Dennis Burianek led the ETILL development effort. Because the ABL system was densely packed in the 747 aircraft, the ETILL laser needed to be engineered to fit in exactly the same size box as the previous TILL, and the auxiliary electronics to fit in the same size rack. The ETILL system is shown in Figure 25-10. The ETILL demonstrated an output power greater than 2.5 times that of the TILL and a beam quality improvement of a factor of about 5, giving a brightness improvement of a factor of about 70. Yet, the ETILL's electrical efficiency was so much better than the TILL's that, even with the significant performance improvement, ETILL actually used less electrical power than did the TILL.

To continue to push cryogenically cooled lasers to higher output powers, in 2006, a team of researchers at Lincoln Laboratory invented a new crystal geometry called the Grazing Incidence Disk (GRID).<sup>16</sup> On the basis of this invention, MDA funded Lincoln Laboratory to design and develop a 6 kW illuminator laser. By the end of 2008, John Hybl had demonstrated 1 kW output from a single GRID, and no impediment had been found to achieving the 6 kW goal. Indeed, it would seem possible to scale cryogenically cooled Yb:YAG lasers to greater than 100 kW.

#### **The High Energy Laser Joint Technology Office and a Return to Tactical Applications for High-Energy Lasers**

Throughout the 1980s and 1990s, most high-energy-laser research had been focused on long-range, strategic applications (e.g., shooting down ballistic missiles in boost phase), but in 2000 a significant change in emphasis occurred. Congress directed the Office of the Secretary of Defense to create a new organization, called the High Energy Laser Joint Technology Office (HEL JTO). The mission of HEL JTO was to reinvigorate science and technology efforts for high-energy lasers, with a particular emphasis on tactical applications (e.g., Navy ship defense or Army defense against rockets and mortars). Lincoln Laboratory played a key part in the early days of HEL JTO, in that Primmerman was asked to serve as the first HEL JTO director.<sup>17</sup> As the first director, Primmerman established the operating procedures for HEL JTO and developed the overall DoD investment strategy for high-energy lasers.<sup>18</sup>

With the renewed emphasis on tactical high-energy lasers, Lincoln Laboratory initiated a number of efforts to explore atmospheric compensation and tracking in tactical scenarios. The ACL, which had been set up to simulate ABL scenarios, was reconfigured to also support tactical scenarios. In addition, during 2002 to 2003, under Brian Edwards' direction, a new laboratory was set up to simulate thermal blooming in tactical scenarios.

To improve atmospheric compensation in strong-turbulence conditions, a multiconjugate adaptive-optics (MCAO) system — a system with multiple deformable mirrors and wavefront sensors — was developed. From 2003 through 2004, Seth Trotz conducted MCAO experiments in the ACL, and Sandip Bhatt developed advanced algorithms for the MCAO approach.



**Figure 25-11**  
**Three-dimensional ladar installed on the Sea-Lite Beam Director at the High Energy Laser Systems Test Facility at the White Sands Missile Range in New Mexico.**

To improve aim point selection and precision pointing in stressing tactical scenarios, Lincoln Laboratory developed, under John Shelton's direction, a three-dimensional ladar designed for high-energy-laser applications (see chapter 27, "Photon-Counting Laser Radar"). In July 2004, Edwards fielded this ladar at the High Energy Laser Systems Test Facility at the White Sands Missile Range in New Mexico and used it to collect three-dimensional images of a variety of static targets (Figure 25-11). In early 2007, as part of some tracking tests being conducted by Herbert Barclay, the ladar was used to collect images of flying targets. Scot Shaw and Steven Michael developed advanced algorithms enabling the three-dimensional ladar measurements to provide better pointing accuracy than would be possible with two-dimensional imagery.

The return to tactical applications prompted a revival of target-in-the-loop, multidither adaptive-optics techniques. Lincoln Laboratory had successfully demonstrated these techniques in the 1970s, but they largely lay dormant for two decades because the finite speed of light makes the achievable correction rates too low for long-range strategic scenarios. For short-range tactical scenarios, however, with ranges less than 15 km, the round-trip time for light is less than 100  $\mu$ s, which allows for high-bandwidth correction. Beginning in summer 2004 and continuing into spring 2007, Lincoln Laboratory conducted a series of experiments, first under the direction of Ryan Lawrence and later under Kansky and Michael. These experiments explored compensation for turbulence (in the ACL) and thermal blooming (in the thermal-blooming lab). It was found that for strong atmospheric aberrations characteristic of tactical scenarios target-in-the-loop, multidither algorithms often outperformed the phase-conjugate adaptive optics used for strategic scenarios. One particular multidither algorithm tested was the stochastic parallel gradient descent (SPGD) technique, which was investigated in collaboration with its inventor, Mikhail Vorontsov from the Army Research Laboratory. The SPGD algorithm proved effective in a conventional adaptive-optics system and, as described in the following section, was later adapted for coherent combining of laser beams.

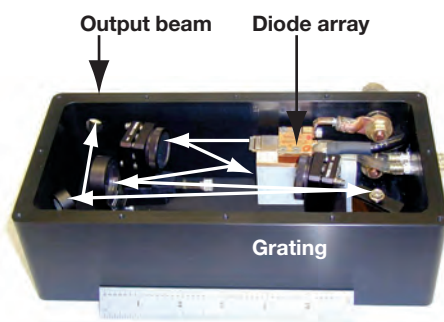
#### *Laser Beam Combining*

Two approaches are possible to produce a high-energy laser: (1) build a monolithic high-energy laser, or (2) build many lower-energy lasers and combine their outputs to form a single diffraction-limited beam. The former approach has principally been used with chemical lasers; the latter approach has principally been used with solid-state and fiber lasers, for which it is possible to produce efficient low-power lasers, but difficult (or physically impossible) to produce monolithic high-energy lasers. Lincoln Laboratory has done pioneering work in laser beam combining.

The initiation of Lincoln Laboratory work in wavelength beam combining can be precisely dated to April 4, 1995, when Antonio Sanchez-Rubio was at a meeting on infrared countermeasures. At that time, lamps were used as sources to spoof infrared seekers, but there was a stated need for broadband, diffraction-limited lasers in the mid-infrared (3–5  $\mu$ m). As he listened to this need statement, Sanchez-Rubio conceived the idea of wavelength beam combining. As with many good inventions, wavelength beam combining is based on a clever implementation of a simple idea. At its simplest, wavelength beam combining may be regarded as a prism run in reverse. As is well known, a prism divides white light into a rainbow of colors. If different colored (i.e., different wavelength) beams are injected into the prism in the reverse direction, they will be combined to make a single beam.

At first, Sanchez-Rubio had difficulty getting both his colleagues at Lincoln Laboratory and his government sponsors to understand the power of the wavelength-beam-combining concept. Thus, for several years, the concept was discussed internally and elaborated theoretically but was not demonstrated. Finally, in December 1997, Sanchez-Rubio took a reject array comprising twelve 2  $\mu$ m diode lasers (only some of which were working correctly) that had been developed for another program and performed the first demonstration of wavelength beam combining.





**Figure 25-12**  
**Compact, high-brightness 100-diode laser array implemented using wavelength beam combining.**

In the mid 1990s, worldwide development of fiber lasers accelerated to support the telecommunications industry. One company involved in fiber-laser development, Aculight, visited Lincoln Laboratory in December 1997 and was briefed on Sanchez-Rubio's recent demonstration of wavelength beam combining. Aculight expressed interest in commercializing this technology. With that impetus, a patent on wavelength beam combining was filed in September 1998. The patent was granted,<sup>19</sup> and Aculight eventually licensed the technology.

In this same time period, Christopher Cook, a Lincoln Laboratory employee, was working on his master's degree, and Fan suggested that for his research project he should wavelength combine two fiber lasers. Cook did so and presented his results in winter 1999 — the first external presentation of wavelength beam combining.<sup>20</sup> In spring 1999, Sanchez-Rubio published the first results on spectral beam combining of diode lasers.

In the early 2000s, Lincoln Laboratory work in wavelength beam combining concentrated on using Slab-Coupled Optical Waveguide Laser (SCOWL) diode arrays (see the sidebar on “The SCOWL Diode Laser”) to generate high-brightness pumps for fiber lasers. This work culminated in September 2005 with the demonstration of a compact, high-brightness pump module (Figure 25-12). Using a 100-element, 980 nm linear SCOWL array, Bien Chann obtained 50 W beam-combined output in a nearly diffraction-limited beam. The brightness of this system was 3.7 GW/cm<sup>2</sup>-sr, which remains a record high brightness for a diode laser system.

In 2001, Fan led a study to explore how to scale fiber-laser systems up to very high power levels. This study developed a new technique, called hybrid beam combining, that used both wavelength beam combining and coherent beam combining. As an example of this technique, consider 100 fibers per wavelength, combined coherently, and 100 different wavelengths, combined using wavelength beam combining. If each of the 10,000 fiber lasers had an output of 100 W, the hybrid beam combining would result in a total output of 1 MW.

To support the hybrid-beam-combining concept, Lincoln Laboratory began working on coherent combining as well as wavelength combining. In October 2002, Steven Augst coherently combined two 10 W fibers. At the time, the 20 W output was the highest for a coherently combined fiber system, but as fiber technology rapidly improved, the result was soon surpassed.

Coherently combining a large number of fiber lasers opens the possibility that, rather than constraining all the fiber phases to be the same, the fiber phases can be adjusted to correct for atmospheric turbulence, in a manner analogous to using a deformable mirror. In 2005 and 2006, under Murphy's direction, Lincoln Laboratory conducted the first experiment to explore this concept. The output of a single fiber laser was split into 48 passive fibers, and the 48 outputs were propagated through phase screens in the ACL. The 48 fiber phases were controlled using fiber stretchers, and the SPGD multidither approach was used to compensate for the aberrations. As shown in Figure 25-13, this experiment successfully demonstrated the ability to use a large array of fibers to perform atmospheric correction.

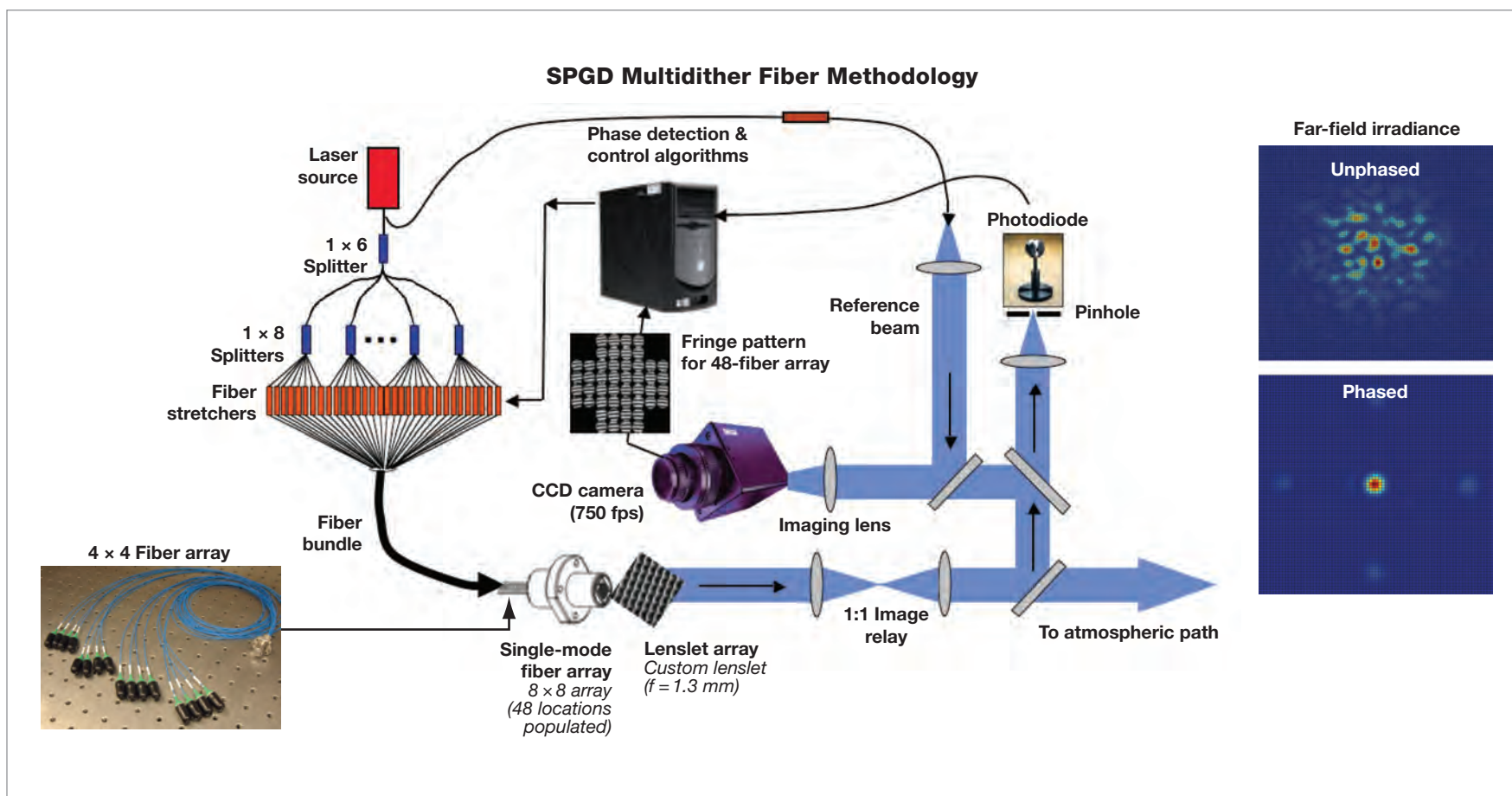
After separate demonstrations of wavelength beam combining and coherent combining, in 2008, Lincoln Laboratory began the first demonstration of hybrid beam combining. This effort, led by Charles Yu, will combine twenty-four 500 W fibers (three wavelengths and eight coherently combined fibers at each wavelength) for a total beam combined power of 12 kW. As a first step, in 2010, three fibers were coherently combined yielding a power of 1.2 kW — a world record to that date.

It appears that combining fiber lasers provides a path to high-energy solid-state lasers, but there is an alternative path — coherently combining arrays of diode lasers. Since fiber lasers are pumped by diode lasers, directly combining diode lasers would eliminate a step and, potentially, lead to a more efficient laser system. Consequently, for decades, coherent combining of diode lasers has been a goal of the laser community, one that was pursued by many researchers but with little success. Beginning in 2005, however, three separate events led Lincoln Laboratory to make dramatic progress in coherent combining of diode lasers.

#### Notes

**19** A. Sanchez-Rubio and T.Y. Fan, “Beam Combining of Diode Laser Array Elements for High Brightness and Power,” U.S. Patent No. 6,192,062, February 20, 2001.

**20** C.C. Cook and T.Y. Fan, “Spectral Beam Combining of Yb-doped Fiber Lasers in an External Cavity,” *OSA Trends in Optics and Photonics Series*, vol. 26, *Advanced Solid State Lasers*, M.M. Fejer, H. Injeyan, and U. Keller, eds., Washington, D.C.: Optical Society of America, pp. 163–166 (1999).



**Figure 25-13**  
**Outline of experiment to perform atmospheric compensation with an array of 48 fibers. Images on the right show overall far-field beam images with the fibers not phase controlled (top right) and with all 48 fibers correctly phased (bottom right).**

**Note**

**21** The Talbot effect is a near-field diffraction phenomenon discovered by Henry Fox Talbot in 1836. In rediscovering the effect, Chann was in good company, as Lord Rayleigh had rediscovered the effect in 1881.

The first event was a completely serendipitous discovery by Chann. In January 2005, while Chann was adjusting a volume Bragg grating as part of an experiment in wavelength combining of SCOWLs, he noticed stable fringes, indicating that the SCOWLs were being combined coherently. Excited by the discovery, Chann reported it to Sanchez-Rubio, who quickly realized that Chann had rediscovered the Talbot effect.<sup>21</sup> More importantly, Sanchez-Rubio realized that the stability of the fringes implied that large arrays of SCOWLs could be coherently combined. The second event was the decision by George Turner to develop SCOWL arrays with individually addressable elements; that is, each laser diode had its own current driver to provide power. The individual addressability allows the phase of each element to be adjusted by making tiny changes in each drive current. The third event, described above, was the successful application of the SPGD multidither algorithm to phasing of fiber lasers. That technique could now be applied to phasing of diode lasers.

In 2006, Lincoln Laboratory began the Coherently Combined, High-Power Intelligent Semiconductor Emitters (COCHISE) program to demonstrate the coherent combining of diode lasers. Robin Huang and Leo Missaggia developed the first ten-element array of independently addressable SCOWL lasers. Subsequently, they developed arrays 21-elements wide that were stackable to 11-elements high. Chann and Kansky took these arrays and used them in coherent-beam-combining experiments. In early 2009, a single 21-element linear array was phased using the SPGD multidither technique to provide 7 W of coherently combined output. In December 2009, a six-bar stack of 21-element arrays was phased to produce 46 W of coherently combined output — at that time a record for diode-laser systems. It is expected that the techniques demonstrated in COCHISE can be scaled to produce much higher-power coherent output from diode lasers.

## The SCOWL Diode Laser

In 1998, James Walpole and Joseph Donnelly were exploring ways to make a >1 W, single-mode diode laser for pumping a fiber laser. In doing so, they reached back to work done at Bell Laboratories a quarter century before on passive slab-coupled waveguides.\* The Bell Laboratories work had shown that a passive waveguide could be designed to support only a single mode because of coupling of the higher-order modes into the slab modes of the waveguide structure. Walpole and Donnelly wondered if a similar waveguide structure could be used to make a laser. It took many months of discussion to convince themselves that it might work. Eventually, they concluded that if they could make the gain small enough (to avoid gain guiding of higher-order modes) and the losses low enough (to permit relatively long laser-gain regions), they could build such a waveguide laser. They designed and fabricated a test device, and amazingly, in early 2000, the very first device actually lased. Walpole and Donnelly named their new laser SCOWL (for Slab-Coupled Optical Waveguide Laser) and filed a patent application in July 2000 (Figure 25-14).\*\* The SCOWL device has satisfied all of Walpole and Donnelly's initial goals, and more. It has produced greater than 1 W output in a large, circular, single-mode beam. It has been implemented in various semiconductor materials to produce different wavelengths. And it has been a key enabling component for the beam-combining experiments described elsewhere in this chapter.

\* E.A.J. Marcatili, "Slab-Coupled Waveguides," *Bell Syst. Tech. J.* 53(4), 645–674 (1974).

\*\*J.N. Walpole, J.P. Donnelly, and S.R. Chinn, U.S. Patent No. 6,928,223, August 9, 2005. Interestingly, because of a clerical error, the patent erroneously renders the name of the laser as "Stab-Coupled Optical Waveguide Laser."

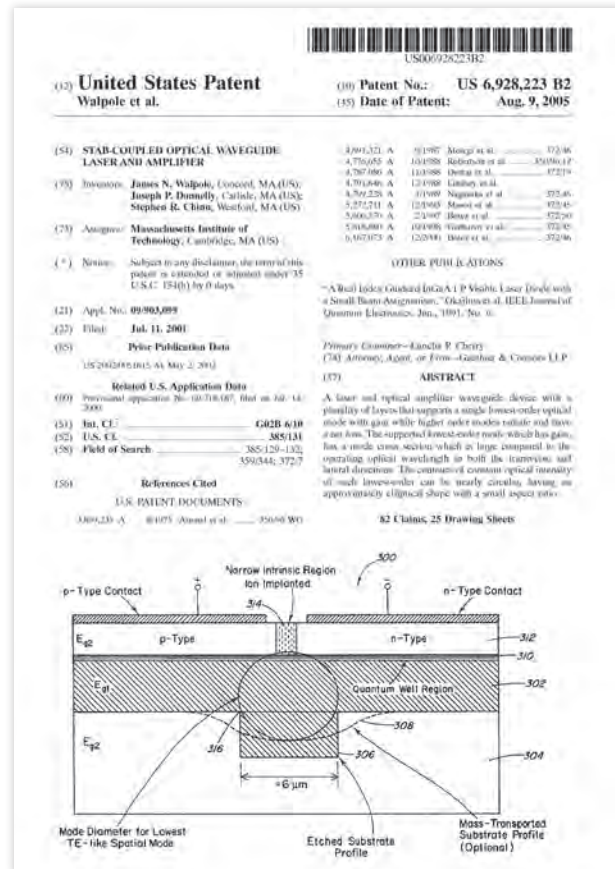


Figure 25-14  
Original drawing of SCOWL from the patent application.

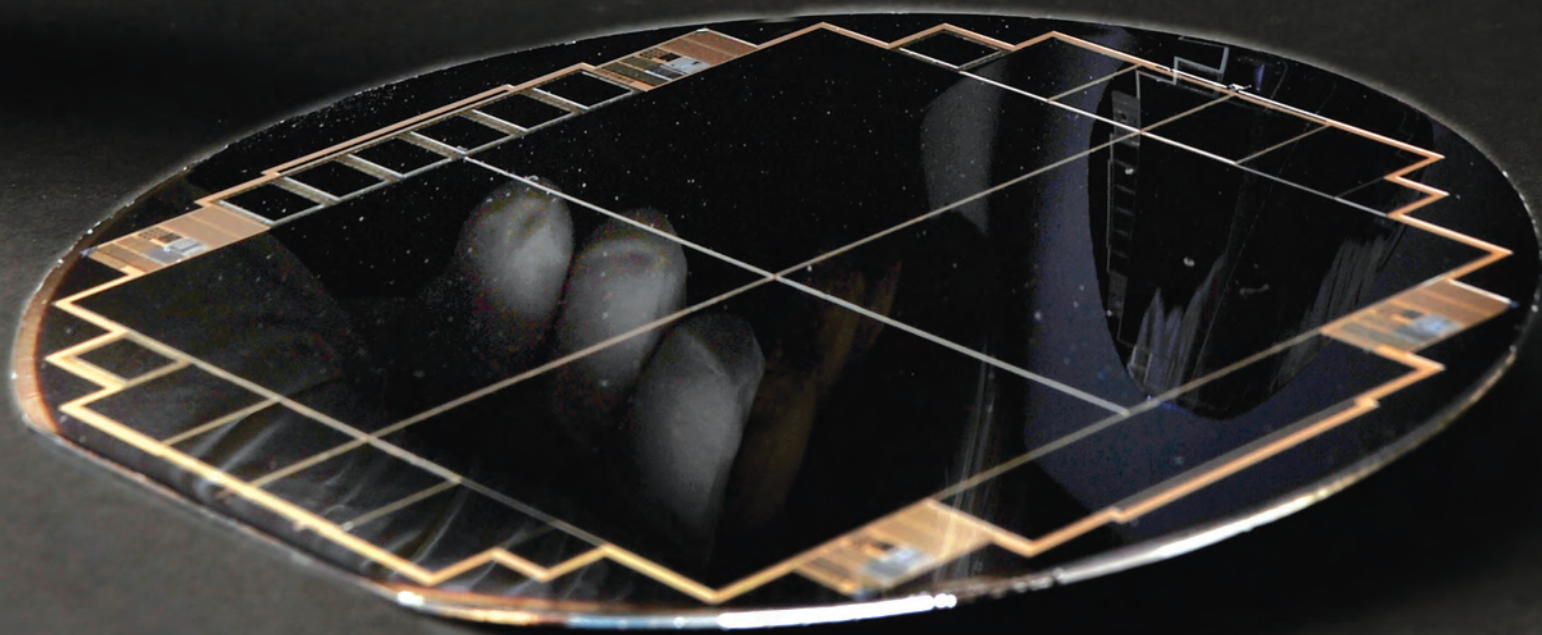
## Epilog

For the past five decades — since shortly after the invention of the laser in 1960 — Lincoln Laboratory has been a recognized leader in research and development for large-scale laser systems. The Laboratory did much of the nation's pioneering work in adaptive optics for high-energy lasers. In strategic laser radar, the Laboratory's work was sufficiently advanced that the results of the Firefly and Firebird experiments in the early 1990s have not been surpassed by anyone else in the ensuing two decades.

In some cases, the Laboratory's research has contributed to a flowering of practical systems. For example, adaptive-optics systems are now widely used on astronomical telescopes. Contradistinctively, in the case of one of the original motivations — developing high-energy lasers for destroying missiles and other targets — success has been elusive. As of this writing, the DoD has yet to field a practical high-energy-laser system.

Currently, Lincoln Laboratory research in high-energy lasers concentrates on fiber lasers, cryogenically cooled solid-state lasers, and diode lasers. In some sense, this concentration represents a return to the roots of lasers: the first laser was a solid-state laser, and the first Lincoln Laboratory laser was a cryogenically cooled diode laser. The new generation of Laboratory lasers is, however, supported by 50 years of laser-materials development and informed by 50 years' understanding of the physics of lasers. It is hoped that one of these new-generation lasers can be lightweight, affordable, supportable, and efficient enough to enable a practical high-energy-laser system.





**Imaging technology was significantly altered, and advanced, by charge-coupled devices. Lincoln Laboratory's Solid State Division developed devices as solutions to complex imaging problems.**

**Left: A silicon membrane formed by thinning a silicon wafer. The process is used in making back-illuminated charge-coupled devices (CCD). The membrane can be thinned to less than 10  $\mu\text{m}$  in thickness and can be very flexible, allowing construction of non-flat imaging devices. Reflected in the membrane is a back-illuminated wafer containing four large CCD imagers.**

The charge-coupled device (CCD) was invented by George Smith and Willard Boyle at Bell Telephone Laboratories in 1969. Soon afterwards, it was obvious that this technology would enable large improvements in sensitivity and other capabilities of electronic imaging devices, which were mostly vacuum-tube-based at that time. Decades later, CCD imagers had proven to be the device of choice for challenging imaging applications, and the overwhelming importance of this technology to the field of electronic imaging was recognized in 2009 by the award of a Nobel prize in physics to the original inventors.

Knowing that high-performance imaging sensors had been critical components of many military systems, Lincoln Laboratory began a period of development of the CCD technology in the early 1970s, shortly after the CCD's invention (see sidebar "Charge-Coupled-Device Operation"). This development effort, continuing in 2011, has been aimed at military and scientific advanced imaging applications and has led to many exciting innovations. The contributions from Lincoln Laboratory included record low-read-noise devices, nearly perfect quantum efficiency in the visible wavelength range, and extensions of high quantum efficiency into the ultraviolet, X-ray, and near-infrared. In addition, Lincoln Laboratory researchers have invented many important extensions to basic CCD imaging operation, such as the orthogonal-transfer CCD, the electronic shutter, unique anti-blooming processes, very-large-size CCDs with practical yields, and curved-surface devices. Since the early 1990s, Lincoln Laboratory has been considered by many to be the world leader in advanced military and scientific imaging technology. This chapter describes the history of these and other Lincoln Laboratory innovations that enhanced and expanded the application of CCD technology to imaging.

Since its beginnings, the Advanced Imaging Technology (AIT) program at Lincoln Laboratory addressed a broad range of complex imaging problems by using a wide variety of silicon-based imager technologies, including CCDs and active-pixel complementary metal-oxide semiconductor (CMOS) sensors (the latter are described in chapter 24, "Solid-State Research"). Military and scientific imaging CCD design and fabrication were driven primarily by performance, unlike commercial applications for which the importance of cost

constrained the effort that could be spent on improving performance. Because scientific and surveillance CCDs often were used to detect images from large optical systems, the need was for very-large-area imagers able to cover the large optical focal-plane area. To produce these large CCDs, a process capable of very-low-defect density was required.

From the start of this effort and over the next fifteen years, the Microelectronics Group developed increasingly sophisticated silicon-wafer processing technology, built its first clean room, and developed a robust CCD technology. A series of successes then contributed to the planning and construction of the much more capable Microelectronics Laboratory, dedicated in 1992, that would enable development of significantly larger and more complex imaging devices. The Microelectronics Laboratory comprises 8000 sq ft of clean room with a cleanliness level better than class 10, equivalent to the quality of large industrial silicon integrated-circuit fabrication facilities. It is also equipped with a set of processing tools that are periodically upgraded. The facility continues to enable the fabrication of uniquely capable CCD imaging devices, as well as advanced CMOS devices (see chapter 24, "Solid-State Research").

Lincoln Laboratory, with the resources of the Microelectronics Laboratory, was soon routinely fabricating devices similar in size to the 1994 Ground-based Electro-Optical Deep-Space Surveillance (GEODSS) device, and many of these very large devices also had additional specialized features to enhance performance, such as an electronic shutter or an orthogonal-transfer CCD cell structure, both Lincoln Laboratory CCD inventions described later in this chapter.

### Space Surveillance

The early Lincoln Laboratory CCD imaging program was motivated by the need for a robust, sensitive, and stable imager for ground-based surveillance of satellites in space. Under a separate program, the Laboratory had just completed development of the GEODSS system that was designed to enable the Air Force to track satellites using visible imagery (see chapter 10, "Space Situational Awareness," for a discussion of the GEODSS system). While this system worked well, its weak link was the Ebsicon tube imaging device that was constructed



---

**Note**

**1** B.E. Burke, R.W. Mountain, P.J. Daniels, and D.C. Harrison, "420 × 420 Charge-Coupled-Device Imager and Four-Chip Hybrid Focal Plane," *Opt. Eng.* **26**, 890–896 (1987); D.C. Harrison and B.E. Burke, "Large Area Focal Plane Comprising Charge-Coupled Devices and Fiber Optics," *Opt. Eng.* **26**, 897–901 (1987).

using vacuum-tube technology and had the undesirable traits of modest sensitivity, large size, and susceptibility to damage when exposed to bright light. In the mid-1970s, Robert Bergemann, who had been involved in the original GEODSS system design, approached Barry Burke of the Microelectronics Group with the question of whether it would be possible to use the infant CCD technology to develop over the long term a replacement for the Ebsicon imaging tube that would be more robust and stable and have greater sensitivity.

By 1978, the Microelectronics Group, led by William Lindley, had produced  $100 \times 400$ -pixel CCD devices and had assembled a precisely positioned array of six such chips on a ceramic board. The performance of these early devices confirmed the sensitivity superiority of CCDs over the Ebsicon sensors then being used in the GEODSS system. Although then-current CCD device sizes were well below the system requirements, the clear trend toward larger chips and improved performance prompted a long-range Laboratory investment in the technology. By 1984, a  $420 \times 420$ -pixel imager had been demonstrated. This device was the first designed to be closely abutted on two sides of the imaging area. A  $2 \times 2$  array of chips was mounted on a common substrate and positioned to an accuracy of a few micrometers to show the feasibility of larger-scale arrays.

In a demonstration of the technology in 1986, arrays were mounted on fiber bundles that were tapered to compress the 80 mm diagonal GEODSS focal-plane size to match the smaller area of the CCD array. The devices set a new record for low noise; researchers at the Jet Propulsion Laboratory measured 1.6-electron rms read noise at a 50 kHz data rate. Figure 26-1 shows the first GEODSS chips assembled and mounted to a fiber-optic bundle in a prototype all-solid-state version of a GEODSS sensor. The package in the upper left corner of the fiber-optic bundle comprises four CCD devices mounted tightly abutted.<sup>1</sup>

Although this fiber-optic bundle/CCD assembly was not practical for use in operational GEODSS sites, it showed the promise of CCD technology. In 1991, the technology had progressed further, and Robert Weber of the Space Surveillance Group at Lincoln Laboratory conducted a survey of state-of-the-art imaging technology to see if an industry-sourced solid-state replacement for the Ebsicon

vacuum-tube cameras was feasible. There was some urgency to this search since manufacture of the Ebsicon tube was about to be discontinued. However, although CCD imaging technology had advanced considerably by then, vendors were producing imagers that would meet only some of the requirements of GEODSS; none were fully suitable.

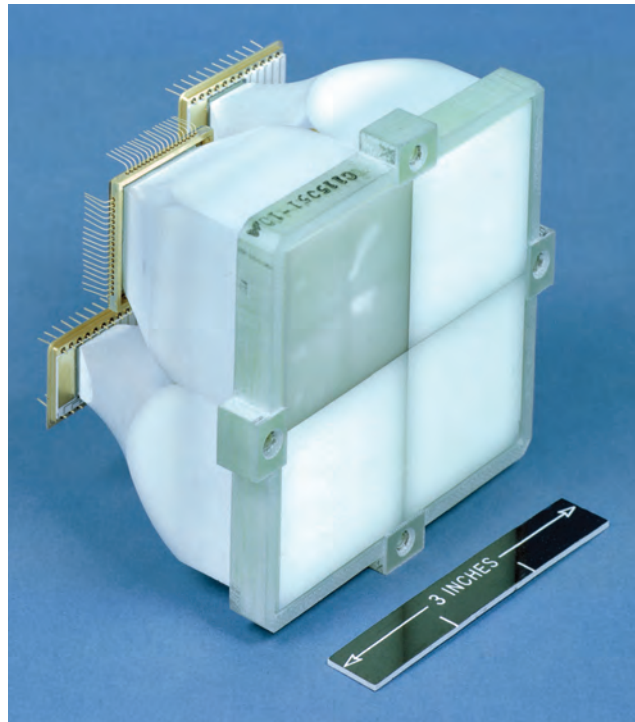
At that same time, the Microelectronics Group was fabricating CCD imagers that would meet all the GEODSS requirements except focal-plane size. Thus, in late 1992, the Air Force funded the Laboratory's development of a CCD imager for the GEODSS Upgrade Prototype System program. The imager proposed by Lincoln Laboratory comprised a large (80 mm diagonal that matched the GEODSS focal-plane size) gap-free focal plane with  $2560 \times 1960$  imaging pixels and the same size storage array to support output transfer of the previous image frame for real-time application. The Laboratory successfully fabricated this device in 1994 in the new Microelectronics Laboratory. Figure 26-2 shows the progression in size of CCDs fabricated at Lincoln Laboratory over the early years; the 10-megapixel device shown at the right in this figure is the GEODSS Upgrade Prototype device, which at that time was the largest CCD imager fabricated. These prototype CCDs were tested in GEODSS telescopes, leading to critical advances in tracking satellites, and later enabled the most prolific system for discovering near-earth asteroids — the system for the Lincoln Near-Earth Asteroid Research (LINEAR) program (see chapter 23, "LINEAR and Other Programs").

In addition to its large size, the GEODSS device also used high-quantum-efficiency back-illuminated technology, which had been demonstrated on small-area CCDs at Lincoln Laboratory and elsewhere, but was very challenging to reliably produce over larger areas (see sidebar "Back-Illuminated Technology"). Previously, this technology had been used at the Laboratory only on small-size adaptive-optics wavefront-sensor devices, which are described below. Beginning in 1988 and continuing to 2009, James Gregory, Jamie Huang, and Richard Westhoff developed several different technologies for producing robust, stable, high-quantum-efficiency, back-illuminated devices in different wavelength ranges. The GEODSS device was the first very large Lincoln Laboratory CCD to use back-



**Figure 26-1**

**The early GEODSS all-solid-state experimental sensor with CCD arrays bonded to a fiber-optic bundle.**

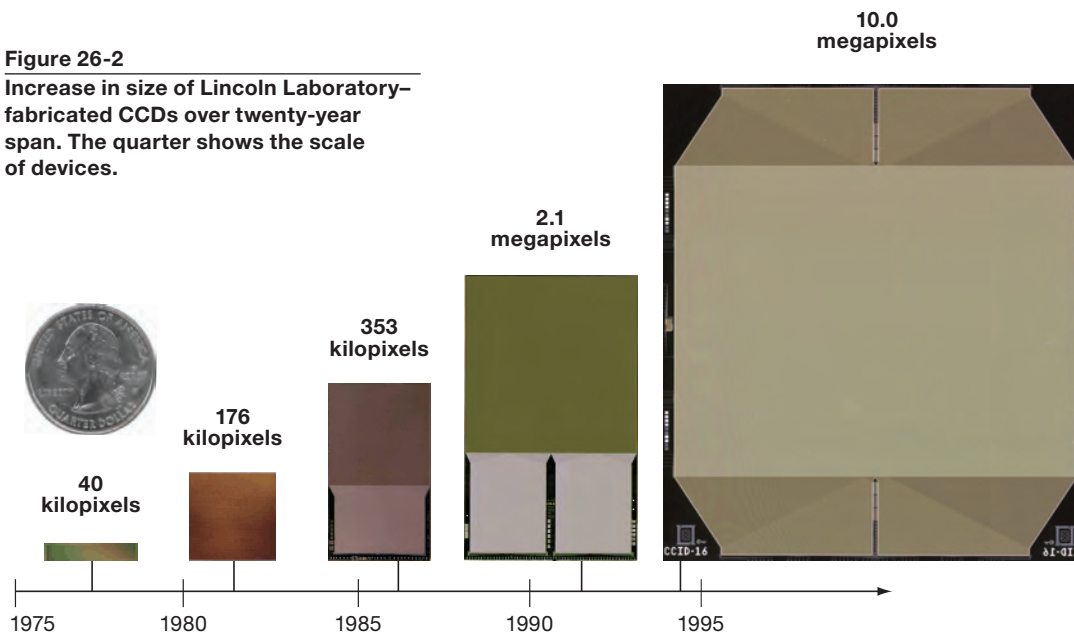


illumination technology. The GEODSS experience in scaling back-illuminated technology to a wafer scale was so successful that today most CCDs developed at the Laboratory use this feature to improve the quantum efficiency of the device and also to extend its wavelength range, especially toward the ultraviolet and into the X-ray regime.

To produce back-illuminated devices, technicians at Lincoln Laboratory mechanically and chemically thin the silicon wafer to about 20  $\mu\text{m}$  in thickness so that radiation can be directed into the back surface of the device, but photoelectrons generated by that light can still be collected by the front-surface circuitry. In most commercial devices, light is directed onto the front (or circuit) side of the device, and the substrate is not thinned. The commercial device is less costly to produce, but is considerably less sensitive because some of the light is obstructed by circuitry on the front side, photoelectrons absorbed deep in the silicon substrate cannot be collected, and it is not practical to produce an effective antireflection film on the rough, nonplanar front side.

**Figure 26-2**

**Increase in size of Lincoln Laboratory-fabricated CCDs over twenty-year span. The quarter shows the scale of devices.**



Smaller devices shown in Figure 26-2 were also put to good use. Four of the 353-kilopixel chips were packaged as a  $4 \times 1$  array and launched in 1996 as a Space-Based Visible (SBV) experiment (see chapter 10, “Space Situational Awareness”). SBV was the first successful space-based space surveillance system, which was designed to evaluate the observation of satellites from a space-based rather than a ground-based platform. Work began on this program in 1988, and the CCDs and sensor package were completed in 1992. The SBV CCDs used were not back-illuminated and did not contain radiation-hardening features found on later Lincoln Laboratory space-based CCD missions. Despite these limitations, the imaging devices, with a quantum efficiency of about 20% and a read noise smaller than 4 electrons, were designed to detect faint objects, comparable in size to a golf ball at 1000 km distance, against faint stellar backgrounds. The SBV instrument was launched in 1996 as part of a larger Midcourse Space Experiment satellite and continued operations for twelve years until being shut down in 2008.

## Charge-Coupled-Device Operation

A CCD can be understood as a series of closely spaced metal-oxide semiconductor (MOS) capacitors. Figure 26-3a shows a single MOS capacitor, consisting of a biased gate electrode, an oxide insulating layer, and a p-type silicon substrate. With the gate biased to a positive voltage, a potential well is formed below the gate and a packet of electrons can be collected and held at the silicon/oxide interface.

The basis of CCD operation is for two or more MOS devices to be located very close to each other, as in the bottom figure. Figure 26-3b illustrates that if the left gate is biased to a high positive voltage and the right gate is biased to a much less positive (or zero) voltage, a charge packet located under the left gate will be maintained there. However, if the high positive voltage on the left gate is reduced toward zero, and the voltage on the right gate is simultaneously increased to a large positive value, as suggested by the voltage diagram above these gates, then the packet of electrons will move from under the left electrode to under the right electrode.

A practical CCD will typically have many thousands of closely spaced electrodes, and charge may be transferred a distance of many centimeters from where it is formed by a light image to an output amplifier, where the charge is converted to voltage and sent off chip to the camera electronics.

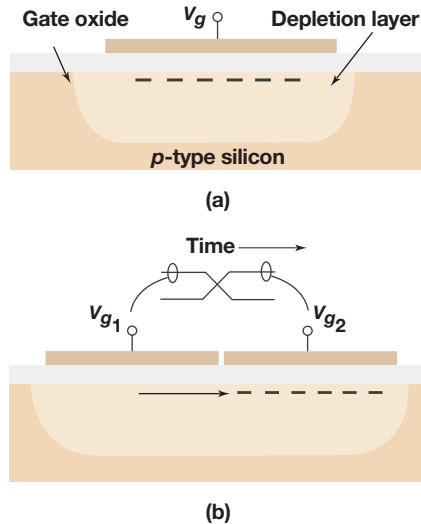


Figure 26-3  
Illustration of CCD operation.

### Notes

**2** G.H. Stokes, F. Shelly, H.E.M. Vigg, M.S. Blythe, and J.S. Stuart, "The Lincoln Near-Earth Asteroid Research (LINEAR) Program," *Linc. Lab. J.* **11(1)**, 27–40 (1998).

**3** J.A. Gregory, B.E. Burke, M.J. Cooper, R.W. Mountain, and B.B. Kosicki, "Fabrication of Large-Area CCD Detectors on High-Purity, Float-Zone Silicon," *Nucl. Instrum. Methods Phys. Res. A* **377A(2-3)**, 325–333 (1996).

An important requirement of most military and scientific imagers is high sensitivity, which implies high (~100%) quantum efficiency and low read noise. Since read noise increases with output data rate for each output amplifier on the device, Lincoln Laboratory researchers developed devices with multiple outputs to simultaneously satisfy requirements of low noise and high device data rate. For the GEODSS device, the need for high search rate and low noise dictated the use of eight outputs. This device was well suited for rapidly searching the sky for very faint objects; the primary application was to search for small satellites in near-earth orbit, but it has also been used very successfully to search for asteroids in the LINEAR program.<sup>2</sup> The Air Force adopted this device design as the solid-state replacement for the original Ebsicon vacuum-tube sensors. In 1999, Lincoln Laboratory successfully transferred its design to an Air Force contractor for production of these replacement parts, and insertion of these CCDs into operational systems began in 2003.

In addition to greatly improved sensitivity, the back-illumination process produced sensors that are thin (down to 20  $\mu\text{m}$ ) and flexible, features that found application in systems in which a curved detector markedly improves overall system performance. The full-page photograph at the beginning of this chapter shows the flexibility of a thinned silicon membrane. In 1999, Gregory demonstrated, in a program supported by the Defense Advanced Research Projects Agency (DARPA), the practicality of fabricating curved sensors in this way. In 2002, Lincoln Laboratory began work on

1970



B.E. Burke



W.T. Lindley

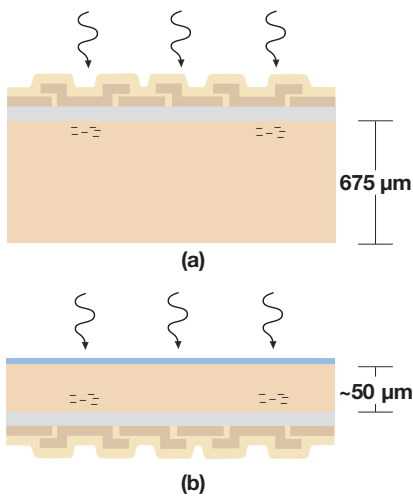
1980



GEODSS fiber bundle with 4 × 4 CCD array aligned to upper right quadrant

## Back-Illuminated Technology

When the light passes through the front surface of a conventional front-illuminated CCD, as in most commercial devices, part is lost to blockage or absorption caused by various films on the front surface (26-4a). When the back surface of the device is thinned and light introduced into the back surface as in view 26-4b (back-illuminated), these losses are avoided. Note the blue back-surface treatment, which is needed to prevent charges on this surface from affecting the operation of the device.



**Figure 26-4**  
Illustration in cross section of (a) conventional front-illuminated CCD imager and (b) a back-illuminated one.

a very wide field-of-view experimental successor to the GEODSS system that, the Laboratory proposed, would be based on this technology. The Space Surveillance Telescope's 3.5 m diameter optics required a large-area focal surface that was spherical (with a 5.4 m radius) in order to fully utilize its excellent optical qualities. Using experience gained in the previous program, the Advanced Imaging Technology Group developed in 2004 a spherical-surface CCD for use as the sensor of this telescope system. (See chapter 10, "Space Situational Awareness," for a description of the Space Surveillance Telescope system.)

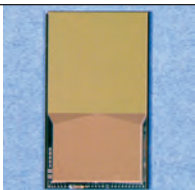
During the 1980s, Burke made two other fundamental contributions to CCD technology that were important for surveillance imagers. One of these was dynamic clocking, which involved suppression of surface-generated dark current by using appropriately timed back-and-forth movement of charge from two neighboring CCD charge wells during image integration. The other was using avalanche multiplication of signal charge by high electric fields as charge was moved from one well to the next in order to increase signal charge during the transfer toward the output. Both of these innovations became general practice in the CCD industry.

### Space-Based Astronomy

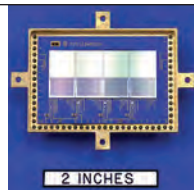
In 1986, George Ricker of MIT's Center for Space Research (now the MIT Kavli Institute for Astrophysics and Space Research [MKI]) was searching for a laboratory that was both capable and willing to develop CCDs fabricated on high-resistivity silicon for use as X-ray sensors. Lincoln Laboratory agreed to collaborate with him on this mission and began development of this challenging technology.

In order to improve the quantum efficiency from moderately energetic X-rays (up to 10 keV), Gregory developed the ability to fabricate CCDs from high-resistivity (5000 ohm-cm) silicon.<sup>3</sup> The use of high-resistivity silicon allowed silicon photocharge detection thickness to be increased from 20  $\mu\text{m}$  to about 45  $\mu\text{m}$ . The thicker substrates absorbed more X-ray photons that otherwise would pass through the device undetected. Slip and dislocation defects were very easily generated during high-temperature processing in highly pure, high-resistivity silicon, so new processing techniques were developed to make high-quality (low-defect density) CCDs with this material.

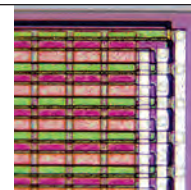
The new high-resistivity CCD capability resulted in many scientific space-based programs being conducted by Burke and Bernard Kosicki of the Microelectronics Group in partnership with Ricker and Mark Bautz, as well as other MIT colleagues at MKI. The first of these was the Advanced Satellite for Cosmology and Astrophysics mission launched in 1993, a joint National Aeronautics and Space Administration (NASA) and Japanese Institute for Space and Astronautical Science (ISAS) effort aimed at improvement of space-based X-ray astronomy. For this mission, the Laboratory developed arrays of solid-state imaging spectrometer (SIS) CCDs. Each SIS array comprised four 420  $\times$  420-pixel CCDs positioned accurately with respect to each other on a hybrid ceramic board. Each column in the CCD was furnished with a narrow trough to guide small charge packets away from many of the radiation-induced traps expected to be formed from space radiation over the life of the mission. This was one of the first space deployments of this radiation-



CCD imager chip with 353k pixels; four chips used for SBV

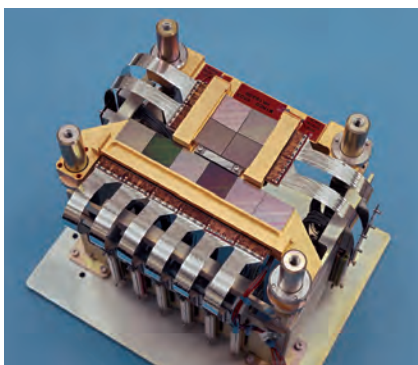


SBV focal plane



Corner of a CCD imager showing three (horizontal) gate levels per pixel and (vertical) aluminum clock busses





**Figure 26-5**  
Chandra ACIS focal-plane assembly.

mitigation strategy in CCD devices. It was also one of the first space-based devices to use high-resistivity silicon substrates. The SIS devices also contained a unique n<sup>+</sup> diode on the back surface of the devices to remove unwanted photoelectrons created too deep in the silicon to be controlled by the CCD gates. Removal of these extraneous electrons allowed much more accurate reconstruction and identification of a true X-ray event.

The Chandra X-Ray Observatory is one of the NASA Great Observatories, with the purpose of high-resolution imaging of X-ray astronomical targets from space. Lincoln Laboratory developed and provided the Advanced CCD Imaging Spectrometer (ACIS) for Chandra (Figure 26-5). The observatory was launched in July 1999 and continues to operate and make important contributions to astrophysics as of this writing in 2010, more than five years after its planned end of life.

The ACIS instrument comprises ten 1k × 1k deep-depletion CCDs arranged in two arrays, a 1 × 6 linear array for dispersive spectroscopy and a 2 × 2 area array, both canted piecewise to approximate a spherical surface. The bench on which these devices were assembled was fabricated from beryllium to exacting tolerances. Allen Pillsbury designed the bench and the methodology for inserting and removing devices, on the basis of the concept suggested by Kosicki, and managed the fabrication of the bench and precise insertion of devices for the flight array.

Each of the ten CCD imaging arrays of the ACIS instrument,<sup>4</sup> shown in Figure 26-5, are about one square inch; the squares are visible in the photo. Two of the ten CCDs are back-illuminated devices, fabricated using a new high-temperature oxidation and annealing technology developed by Gregory to treat the back surface. This new process resulted in a very thin back-surface passivation layer and therefore allowed high quantum efficiency for very-low-energy (down to 100 eV) X-ray photons, which have a very short absorption depth in silicon. The two back-illuminated devices are the dark squares in the 1 × 6 spectrometer array shown in Figure 26-5.

Charge-coupled devices are sensitive to environmental radiation found in space and, in particular, to damage from high-energy protons that cause displacement damage in the silicon near the spot where they are absorbed. The high-resistivity silicon needed for deep-depletion X-ray imagers was especially sensitive to proton radiation damage. Mitigation of this damage built on experience gained from the SIS mission and involved implantation of a narrow (2 μm) potential trough in the bottom of all pixels. On the ACIS array, a second strategy involved operation of the device at an appropriately low temperature so that charge traps, once filled, remained filled and are therefore not able to absorb more signal photoelectrons during the imaging cycle. For the Chandra devices and operational conditions, this optimum temperature was close to −100°C. Both of these strategies were implemented in Chandra, and resulted in an approximately 50-times-longer device lifetime compared to a normal CCD operated at −40°C.<sup>5</sup>

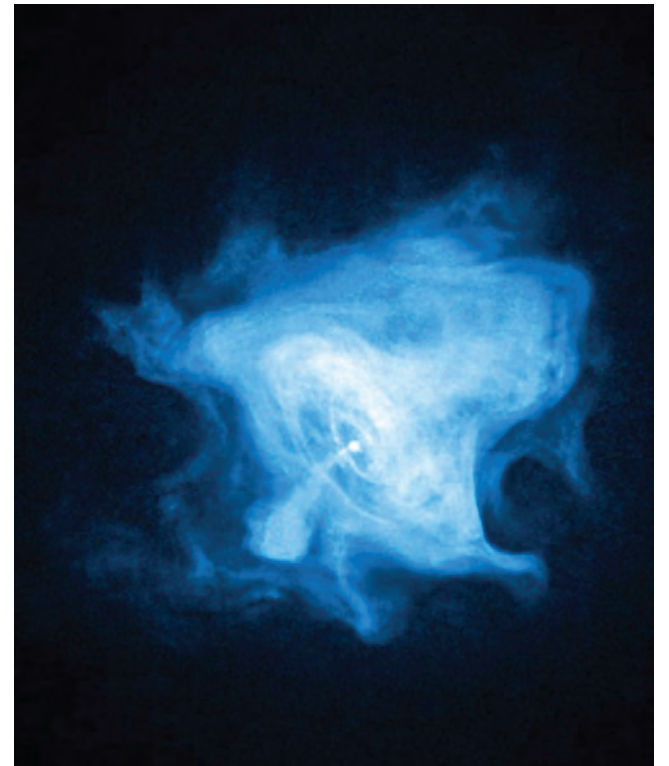
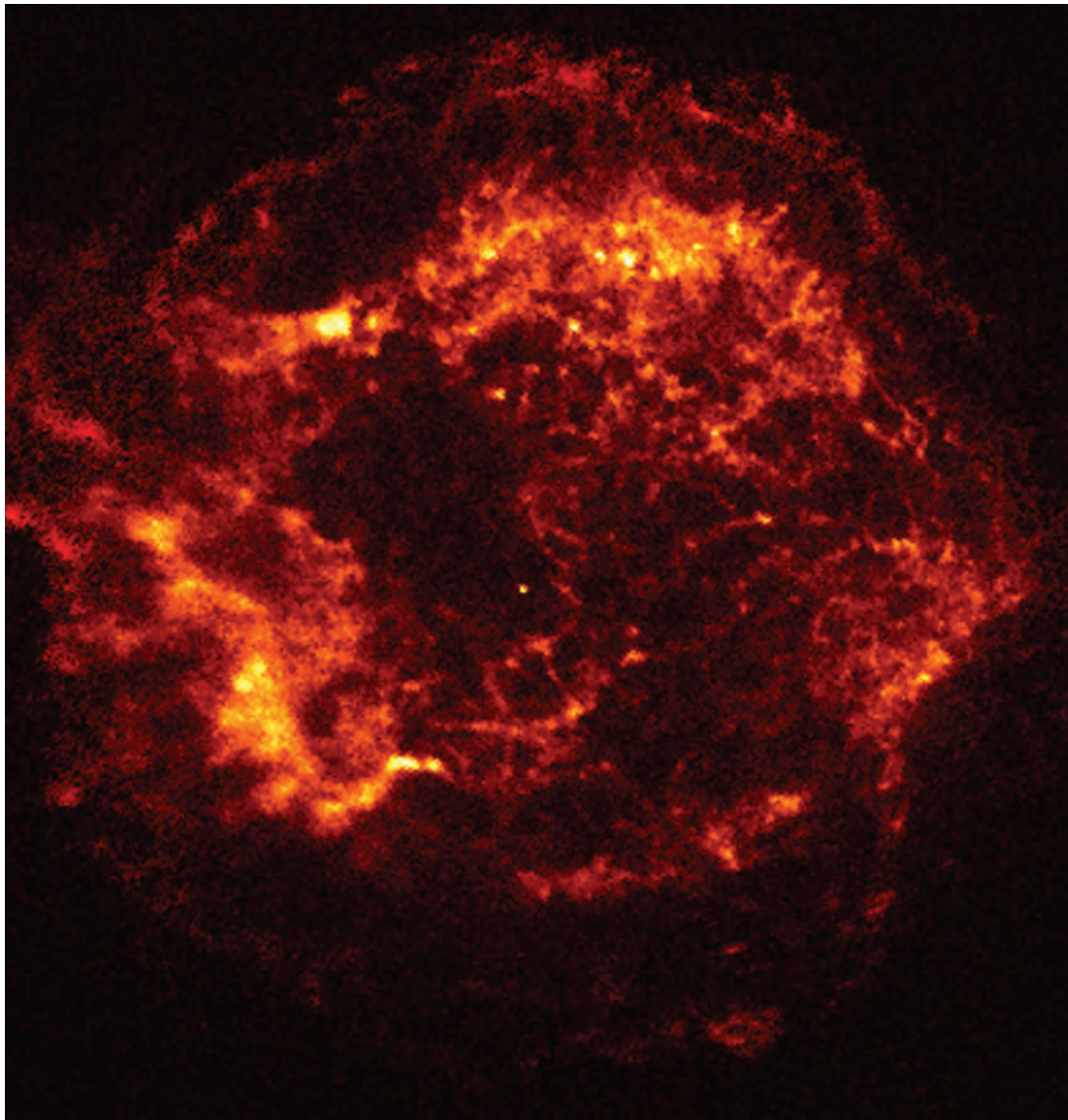
Unfortunately, very early in the mission, Chandra experienced a large unexpected dose of radiation caused by relatively modest energy protons (~100 keV) scattered onto the focal plane by the X-ray mirror assembly. While this radiation caused significant damage to the front-illuminated devices, the sensitive CCD charge-transfer channels (near the front surface) of the two back-illuminated devices were shielded by the 45 μm thick substrate silicon and escaped relatively unaffected. Although the eight front-illuminated CCDs received almost an end-of-life dose of radiation during this event, the Chandra operational team led by Bautz of MIT found a way to recover useful operation. Their method was to reduce the operation temperature to −120°C and to use an onboard radiation source to calibrate and carefully measure the radiation-induced charge-transfer inefficiency of each column in the CCD. They then applied corrections in ground data processing software.<sup>6</sup> Using this technique, the Chandra observatory continues to rely on the ACIS array for 95% of its science imagery and has been able to achieve an estimated 90% of its original mission science. The mission continues to be so valuable that NASA has planned for a ten-year extension to 2019. Figure 26-6 shows two high-resolution X-ray images from Chandra that were acquired after the early high-radiation-exposure event.

#### Notes

**4** J.A. Gregory, B.E. Burke, B.B. Kosicki, and R.K. Reich, "Developments in X-ray and Astronomical CCD Imagers," *Nucl. Instrum. Methods Phys. Res. A* **436(1-2)**, 1-8 (1999).

**5** B.E. Burke, J.A. Gregory, M.W. Bautz, G.Y. Prigozhin, S.E. Kissel, B.B. Kosicki, A.H. Loomis, and D.J. Young, "Soft-X-Ray CCD Imagers for AXAF," *IEEE Trans. Electron Devices* **44(10)**, 1633-1642 (1997).

**6** G.Y. Prigozhin, S.E. Kissel, M.W. Bautz, C. Grant, B. LaMarr, R.F. Foster, and G.R. Ricker, "Characterization of the Radiation Damage in the Chandra X-ray CCDs," *Proc. SPIE* **4140**, 123-134 (2000).



**Figure 26-6**  
Images captured by Chandra Observatory. Left: An X-ray image of Cassiopeia A. This is the youngest (about 300 years old) known supernova remnant in the Milky Way galaxy. This 1999 image showed for the first time a hot point-like source close to the center of the remnant, which is thought to be a neutron star or black hole. Right: The Crab Nebula, a remnant of a supernova explosion seen on earth in 1054 A.D.

## Notes

**7** B.E. Burke, R.K. Reich, J.A. Gregory, W.H. McGonagle, A.M. Waxman, E.D. Savoye, and B.B. Kosicki, "640 × 480 Back-Illuminated CCD Imager with Improved Blooming Control for Night Vision," *Int. Electron Devices Mtg. Tech. Dig.*, 33–36 (1998).

**8** B.E. Burke, J.A. Gregory, A.H. Loomis, M. Lesser, M.W. Bautz, S.E. Kissel, D.D. Rathman, R.M. Osgood III, M.J. Cooper, T.A. Lind, and G.R. Ricker, "CCD Soft-X-Ray Detectors with Improved High- and Low-Energy Performance," *IEEE Trans. Nucl. Sci.* **51(5)**, 2322–2327 (2004).

**9** R.C. Westhoff, B.E. Burke, H.R. Clark, A.H. Loomis, D.J. Young, J.A. Gregory, and R.K. Reich, "Low-Dark-Current, Back-Illuminated Charge-Coupled-Devices," *Proc. SPIE* **7249**, 72490J (2009); R.C. Westhoff, M.K. Rose, J.A. Gregory, G.D. Berthiaume, J.F. Seely, T.N. Woods, and G. Ucker, "Radiation-Hard, Charge-Coupled Charges for the Extreme Ultraviolet Variability Experiment," *Proc. SPIE* **6686**, 668604 (2007).

**10** B.M. Starr, G.A. Luppino, J.-C. Cuillandre, and S. Isani, "CFH12k: 12k × 8k CCD Mosaic Camera for the CFHT Prime Focus," *Proc. SPIE* **3965**, 58–69 (2000).

The Chandra program, with its requirement for high quantum efficiency for 10 keV X-rays, provided the impetus to develop a robust process for fabricating CCDs on very-high-resistivity silicon, which became a key to many other CCD imaging innovations. High-resistivity silicon substrates enabled electronic shutter technology for back-illuminated CCDs, an invention of Robert Reich, and also a number of innovations by Burke, including incorporation of logic and control circuitry on devices such as orthogonal-transfer arrays (described below). Other innovations include new designs for a very-low-noise output amplifier that used a junction field-effect transistor (JFET) instead of a metal-oxide semiconductor field-effect transistor (MOSFET), blooming control for back-illuminated CCDs,<sup>7</sup> and a method to extend the depletion region in CCDs by using an external bias to enable a much thicker (75 μm compared with 45 μm) very-deep-depletion device.<sup>8</sup> This very-deep-depletion technology significantly increased near-infrared and X-ray quantum efficiency while retaining a charge point-spread function that was small compared to a 10 μm pixel. The quantum efficiency in the near-infrared reached nearly 100% at 800 nm, thereby enhancing the sensitivity for night-vision devices. Thick-substrate CCD imagers were also important for improved X-ray sensors.

The Suzaku mission, a cooperative venture between the Japan Aerospace Exploration Agency and NASA, was launched in July 2005. The goal was imaging and spectroscopy of astrophysical targets in the X-ray wavelength band. The strengths of Suzaku over previous X-ray satellites are the very low background and excellent spectral resolution of its CCD instrument and its very broad spectral band, extending from below 0.5 keV to above 500 keV. Suzaku has been used to study a range of celestial objects, including neutron stars and

supernova remnants in our own galaxy, massive black holes at the centers of other galaxies, and entire clusters of galaxies.

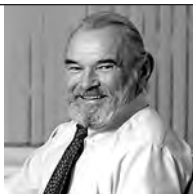
One of the spacecraft's three instruments was CCD-based, constructed by MKI and using devices designed and fabricated by Lincoln Laboratory. On the basis of lessons learned from the Chandra experience, these CCD imagers incorporated a novel charge-injection register at the top of the pixel array. The register injected a precisely measured amount of charge to fill radiation-induced traps, a convenient means to compensate radiation-induced performance degradation on orbit. This technique has resulted in a three- to five-times reduction in the charge-transfer inefficiency (the major deleterious effect of proton radiation on CCD), which is equivalent to about five years of in-orbit exposure. This method has been so successful that Bautz considers it mandatory for future X-ray space-based missions.

The Extreme Ultraviolet Variability Experiment (EVE), launched in February 2010, was designed to study extreme-ultraviolet radiation from the sun to better understand and predict solar behavior. (See chapter 11, "Environmental Monitoring," for a description of EVE.) The EVE CCDs developed at Lincoln Laboratory were back-illuminated devices using a novel, extremely thin, back-surface passivation layer deposited by molecular beam evaporation that enables very high quantum-efficiency imaging of ultraviolet photons, which have very short absorption depth in silicon. This back-surface treatment, developed by Westhoff,<sup>9</sup> was found to be surprisingly robust and stable even for substantial doses of ultraviolet radiation and was a considerable improvement over the high-temperature back-surface treatment developed earlier for Chandra.

1990



SBV camera



E.D. Savoye



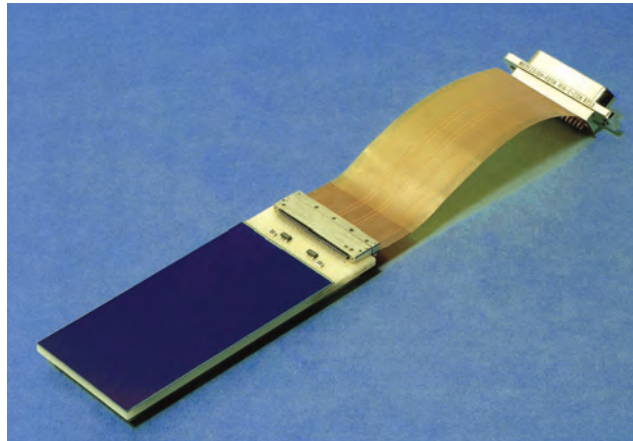
Microelectronics Laboratory  
(dedicated in 1992)



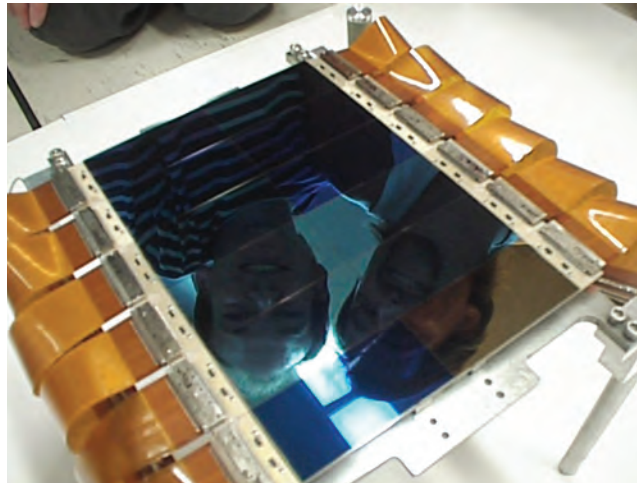
R.K. Reich



**Figure 26-7**  
Eight-megapixel astronomy CCD.



**Figure 26-8**  
A 101-megapixel CCD focal plane  
fabricated in 1998 for the CFHT on  
Mauna Kea, Hawaii.

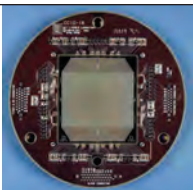


### Ground-Based Astronomy

Astronomy telescopes, which are used to look at dim deep-space objects, have large optics that create large prime image areas, requirements similar to those of defense surveillance CCDs. In 1994, Lincoln Laboratory entered a cooperative agreement with Gerald Luppino of the Institute for Astronomy at the University of Hawaii to apply the sensitive and large-scale CCD technology that the Laboratory had developed for the Department of Defense to sensors for ground-based astronomy. The Laboratory-developed technology that allowed abutting devices on three sides enabled the construction of very large image arrays suitable for astronomy. Figure 26-7 shows a  $2048 \times 4096$  (8.4 megapixel) CCD imager, designed for astronomy use, mounted on a three-side-abuttable ceramic substrate with an attached flexprint for the input/output signals.

The array shown in Figure 26-8 was constructed for the University of Hawaii-operated Canada-France-Hawaii Telescope (CFHT) on Mauna Kea, Hawaii, in 1998.<sup>10</sup> It comprised twelve 8.4-megapixel imagers, for a total focal-plane size of 101 megapixels. The physical size of this image array was about  $12 \times 18$  cm, at that time probably the largest CCD focal plane in existence.

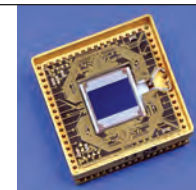
Astronomy imaging from ground-based telescopes is degraded by atmospheric distortion. A large part of this distortion can be described as translational — the image dances back and forth across a small part of the imager. John Tonry of MIT pointed to this problem in astronomical observations and asked if it were possible to design a special CCD whose pixels could be shifted in an arbitrary direction to compensate for this motion.



Full-wafer GEODSS  
2560 × 1960-pixel imager  
on printed circuit board



B.B. Kosicki



Night-vision CCD camera  
with associated electronics

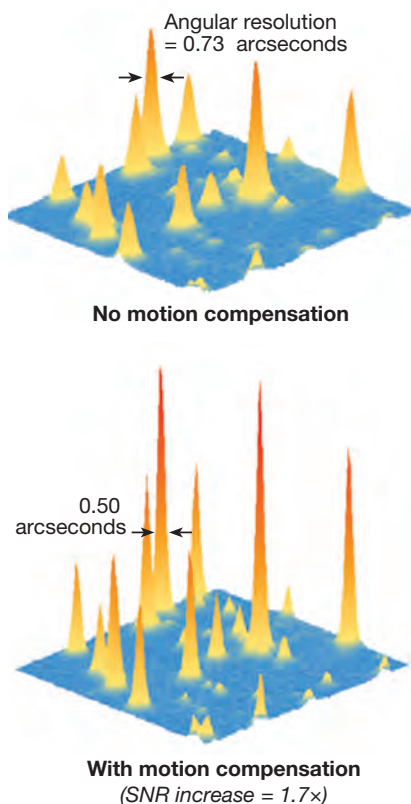


**Figure 26-9**

**Left: Image obtained with OTCCD feature disabled. Right: Image obtained with OTCCD enabled.**

**Figure 26-10 (below)**

**Surface plots of imagery from a portion of a star cluster. Imagery was taken by the MDM telescope.**



The orthogonal-transfer CCD (OTCCD) was conceived by Burke and Eugene “Dick” Savoye to provide this new capability and enable removal of the motion blur by shifting the previously collected charge in unison with the dancing image during the image integration period.<sup>11</sup> Initially, these devices proved challenging to fabricate, and the concept required considerable development before becoming practical for use in large devices.

In 1994, Lincoln Laboratory designed, fabricated, and successfully demonstrated the first moderately large ( $512 \times 512$  pixels) OTCCD. To demonstrate the improvement of imagery, Tonry mounted a camera with the OTCCD on a spring and imaged a stationary picture on the wall with the camera bouncing. A point source of light on the wall was used to determine the motion of this spring-mounted camera. The image on the left of Figure 26-9 was obtained with the OTCCD feature disabled and shows blurring caused by the motion of the image across the device during the image integration period. The image on the right of Figure 26-9 was captured by the same camera, again mounted on a spring and bouncing, but this time, with the OTCCD enabled. In this case, the charge moved in synchronization with the motion across the imager; the improvement was obvious.

Tonry later applied this OTCCD in ground-based astronomy to remove the translational component of the jitter caused by atmospheric turbulence.<sup>12</sup> Figure 26-10 shows two surface plots of imagery from a portion of the star cluster M71 taken by the Michigan-Dartmouth-MIT (MDM) telescope located on Kitt Peak in Arizona. The data in the top image were taken with no compensation shifting of the OTCCD pixels; that is, the OTCCD was operating as a normal CCD. The data in the bottom image were taken with the imager operating as an OTCCD, using a bright guide star to measure jitter. The compensated star image has an improved signal-to-noise ratio of 1.7 times that of the standard image.

### Orthogonal-Transfer Arrays

The OTCCD concept was extended in 2002. In collaboration with Tonry, Lincoln Laboratory incorporated many relatively small OTCCDs in an array with on-chip controls. Called an orthogonal-transfer-CCD array (OTA), this large-scale device, designed to be abutted on all four sides, could be assembled into

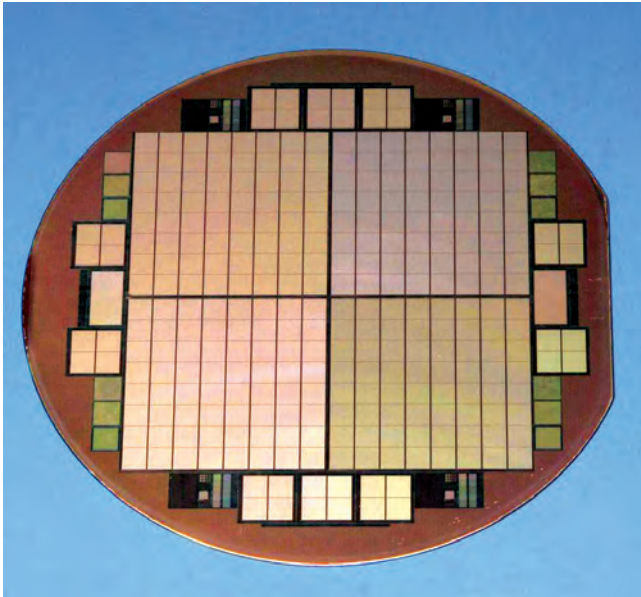
very large focal-plane arrays (FPA) for ground-based astronomy. The device is highly effective for ground-based telescopes with a wide field of view when the translational component of wavefront atmospheric distortion varies even over one OTA device.

The OTA consisted of an  $8 \times 8$  array of individual OTCCDs on a single silicon substrate with circuitry so that the translational charge movement of each OTCCD cell may be controlled independently.<sup>13</sup> Each OTCCD is approximately  $600 \times 600$  pixels, resulting in  $\sim 23$  million pixels for a single OTA. This large-scale device became practical because of dramatic improvements in the OTCCD fabrication process yields at Lincoln Laboratory since the original invention and demonstration of the device in 1994. The novel Lincoln Laboratory OTA design allowed independent operation of each of its constituent 64 OTCCDs by including on-chip cell-control circuitry located in the lanes between the closely spaced OTCCDs. This unique design also enabled rapid readout of imaging charge with only a modest number of pad connections to the package.

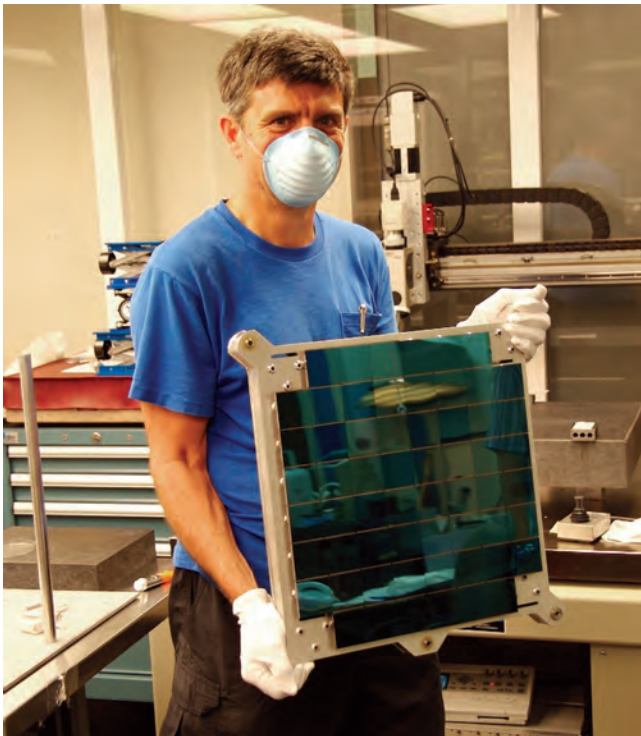
A processed 150 mm diameter silicon wafer containing four OTAs was first produced in 2004 (Figure 26-11). The Laboratory designed and fabricated these  $50 \text{ mm}^2$  devices for the Panoramic Survey Telescope and Rapid Response System (Pan-STARRS) program, managed by Tonry, which assembled a focal plane containing 60 of these high-quantum-efficiency back-illuminated devices with approximately 1.4 billion pixels (Figure 26-12).<sup>14</sup> This was the largest CCD focal plane reported to be produced as of 2007. The variation of atmospheric compensation required over a wide field of view necessitates independent control of the individual OTCCD cells in the OTA. The objective of the Pan-STARRS system is to use four co-aligned telescopes to survey the entire sky, viewable from Hawaii, several times each month with sensitivity down to 24 visual magnitude and a resolution of 0.3 arc sec. As of 2010, Lincoln Laboratory was on track to provide devices for the second telescope during 2011.

Although the OTA was developed for use in astronomy, a number of its features could also be used to greatly improve performance for large FPAs used in surveillance applications. For example, the partitioning of the imager into 64 smaller blocks enabled more rapid read rate and





**Figure 26-11**  
A 150 mm silicon wafer containing four orthogonal-transfer-CCD array devices.



#### Notes

**11** B.E. Burke, R.K. Reich, E.D. Savoye, and J. Tonry, "An Orthogonal-Transfer CCD Imager," *IEEE Trans. Electron Devices* **41(12)**, 2482–2484 (1994).

**12** J.L. Tonry, B.E. Burke, and P.L. Schechter, "The Orthogonal Transfer CCD," *Publ. Astron. Soc. Pac.* **109**, 1154–1164 (1997).

**13** B.E. Burke, J. Tonry, M. Cooper, G. Luppino, G. Jacoby, R. Bredthauer, K. Boggs, M. Lesser, P. Onaka, D. Young, P. Doherty, and D. Craig, "The Orthogonal-Transfer Array: A New CCD Architecture for Astronomy," *Proc. SPIE* **5499**, 185–192 (2004).

**14** N. Kaiser, H. Aussel, B.E. Burke, H. Boesgaard, K. Chambers, M.R. Chun, J.N. Heasley, K. Hodapp, B. Hunt, R. Jedicke, D. Jewitt, R. Kudritzki, G.A. Luppino, M. Maberry, E. Magnier, D.G. Monet, P.M. Onaka, A.J. Pickles, P.H.H. Rhoads, T. Simon, A. Szalay, I. Szapudi, D.J. Tholen, J.L. Tonry, M. Waterson, and J. Wick, "Pan-STARRS: A Large Synoptic Survey Telescope Array," *Proc. SPIE* **4836**, 154–164 (2002); J.L. Tonry, P.M. Onaka, B. Burke, and G.A. Luppino, "Pan-STARRS and Gigapixel Cameras," in *Scientific Detectors for Astronomy 2005*, Vol. 336 of Astrophysics and Space Science Library, J.E. Beletic, J.W. Beletic, and P. Amico, eds. New York: Springer, 2006, pp. 53–62.

with lower noise than conventional CCDs, yet needed only a few output circuits; for all 23 million pixels at a 1 megapixel/sec low-noise rate, readout time was about 4 sec. The Laboratory is experimenting with a next-generation OTA incorporating JFET-based charge-sensing amplifiers, which offer faster read rates for a given noise level.

#### Adaptive Optics Imagers

In the early 1980s, Lincoln Laboratory conducted the first experiments for the Short-Wavelength Adaptive Techniques (SWAT) program (see chapter 25, "Laser Systems," for a discussion of SWAT). The first wavefront sensor used a five-stage image-intensified commercial CCD that was then the state of the art. In 1986, Jonathan Twichell and Herbert Barclay initiated a program with the Microelectronics Group to develop a highly sensitive CCD that would be used as the scoring device for this SWAT system.

High-speed imaging for adaptive optics needed fast frame rates (typically about 4000 frames per second), short latency time before data is available for processing (since this is a real-time application), and very high sensitivity (since there are typically few photons available during the image integration time). These requirements placed a premium on very-low-noise readout amplifiers and high quantum efficiency. In 1987, when Reich joined Lincoln Laboratory, he began development of a  $64 \times 64$ -pixel high-speed imager, equipped with an equal-size frame-store array originally planned for the scoring device. This device was furnished with four output amplifiers, both to improve read noise (since each amplifier would operate more slowly and therefore with less noise than if equipped with a single amplifier) and also to reduce latency. This device was the first of the adaptive-optics family of CCDs and had about 80 electrons noise at 4000 frames/sec, including the noise of the electronics used to operate the device. Over the next few years in successive CCDs and electronics sets, Reich's team reduced the effective noise to about 30 electrons, which was far below the approximately 100-electron noise of the intensified CCDs in the original wavefront sensor and which made the CCD a serious contender for the intensified CCD wavefront sensor.

**Figure 26-12**

John Tonny holds the Pan-STARRS focal plane with 60 OTA devices, comprising about 1.4 billion pixels in the 16-square-inch area.





**Figure 26-13**  
**High-speed camera, using extensions of the SWAT technology, with a 128 × 128-pixel sixteen-output-port device mounted in a low-noise camera system.**

#### Note

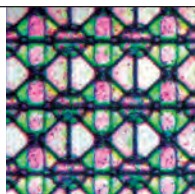
15 R.K. Reich, R.W. Mountain, W.H. McGonagle, J.C.-M. Huang, J.C. Twichell, B.B. Kosicki, and E.D. Savoye, "Integrated Electronic Shutter for Back-Illuminated Charge-Coupled Devices," *IEEE Trans. Electron Devices* **40(7)**, 1231–1237 (1993).

To further improve quantum efficiency, a back-illuminated process was developed by Huang specifically for adaptive-optics CCDs. In the Laboratory's back-illuminated process, the entire wafer containing many devices was thinned at once. This approach was in contrast to approaches taken by several other laboratories also conducting development of back-illuminated processes at this time. In addition to being thinned, the back surface had to be passivated in order to prevent the ions and charges that would collect there from affecting operation of the device. The process Huang developed involved implanting the back surface with low-energy boron, and then activating this implant with a carefully engineered laser melting and recrystallization of this surface. This adaptive-optics sensor was the first operational device produced by Lincoln Laboratory to use high-quantum-efficiency back-illuminated processing. This same back-illuminated process would later prove successful not only for small adaptive-optics devices, but also for many very-large-scale surveillance and scientific devices.

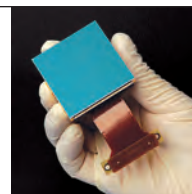
The high quantum efficiency achieved with the back-illumination process enabled these CCDs to perform wavefront sensing without needing an intensifier. So a new version of the SWAT Hartmann phase sensor was built and used the sensitive and fast back-illuminated CCD both for the scoring device and for the wavefront sensor. This nonintensified CCD-based adaptive-optics system was field-tested at the Air Force Maui Optical Site for two years, from 1989 to 1990, and represented the first successful use of CCDs for adaptive optics.

In 1992, the Air Force declassified its secret adaptive-optics program at a conference for the astronomical community held in Albuquerque, New Mexico. At that meeting, Kosicki met with Robert Fugate, the Air Force chief scientist directing the adaptive-optics program, and the AIT Group entered into a long-term relationship with Air Force Research Laboratory's Starfire Optical Range (SOR) to develop solid-state sensors for Air Force adaptive-optics systems. The primary mission of SOR was (and is) to develop optical sensing, imaging, and atmospheric propagation technologies to support Air Force aerospace missions. The SOR housed a 3.5 m telescope (one of the largest telescopes in the world equipped with adaptive optics designed for satellite tracking). From then and continuing to 2010, Lincoln Laboratory developed a series of moderate-format ( $64 \times 64$ ,  $128 \times 128$ , and  $160 \times 160$  pixel) CCDs, carried out exploratory development of several different types of ultra-low-noise readout amplifiers, and also developed unique pixel architectures specifically optimized for wavefront sensor use. The effective noise of these high-speed adaptive-optics sensors has been continuously reduced from 30 electrons in the SWAT system to less than 5 electrons in 2010. This trend continues, driven by the recent development of an innovative two-stage pJFET charge amplifier with noise performance improved by more than 50%, to only a few electrons.

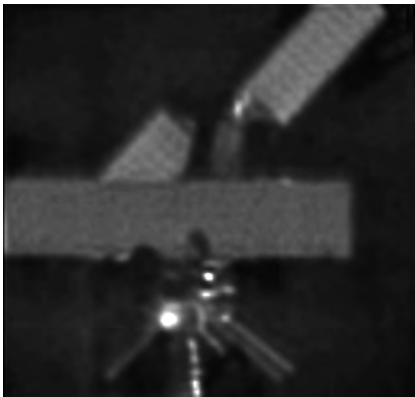
2000



OTCCD 4-pixel gate pattern



Backside-illuminated packaged single-chip  $8 \times 8$  OTA CCD; 60 such chips are assembled in the Pan-STARRS focal plane



**Figure 26-14**  
**Images obtained at Kirtland Air Force Base, Albuquerque, New Mexico, with the Starfire Optical Range telescope. Top: The satellite Seasat at a range of ~600 miles; resolution is 10 inches. Bottom: Agena rocket body at a range of ~500 miles.**

A low-noise high-speed camera and the  $128 \times 128$ -pixel sixteen-port device it uses were both developed at Lincoln Laboratory specifically for use in adaptive optics (Figure 26-13). The two images of space objects shown in Figure 26-14 were obtained with the 3.5 m SOR telescope, using 941-channel adaptive optics with this high-speed camera as the wavefront sensor.

When the Air Force declassified its adaptive-optics programs in 1992, virtually every large astronomical telescope in the world began to incorporate the technology. Lincoln Laboratory collaborated with a majority of these observatories, including the Keck Observatory on Mauna Kea, Hawaii; Lick Observatory on Mount Hamilton, California; La Palma Observatory, Canary Islands; Steward Observatory at the University of Arizona, Tucson; Calar Alto Observatory in Almeria, Spain; Canada-France Hawaii Observatory at Mauna Kea; Apache Point Observatory, Sunspot, New Mexico; Palomar Observatory, Palomar Mountain, California; and Mount Wilson Observatory, California.

In early 1993, Lincoln Laboratory was directed by the Air Force to apply its newly developed high-frame-rate CCD technology for the Advanced Electro-Optical System (AEOS) that had been recently built at the Maui Space Surveillance Complex in Hawaii. AEOS has a 3.67 m telescope located on the rim of the dormant Haleakala volcano — a site chosen because of clear visibility and proximity to the equator. AEOS was designed to improve both the means of collecting and the quality of space surveillance data. The Air Force

was trying to develop a ground-based antisatellite surveillance capability that required an adaptive-optics system. The Laboratory provided Hughes Danbury Optical Systems (the wavefront sensor system integrator) four government-furnished  $128 \times 128$  CCDs and electronics, as well as a  $64 \times 64$  CCD camera for integration into the wavefront sensor and tracker, respectively. The wavefront sensor with Lincoln Laboratory CCDs enabled diffraction-limited imaging on the AEOS telescope.

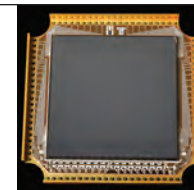
In response to SOR needs for a very fast, lossless, and noiseless shutter for Raleigh beacon use, in 1995 Reich invented and developed an electronic shutter specifically designed for back-illuminated devices.<sup>15</sup> A potential barrier layer was implanted deep below the surface of a CCD gate. Photoelectrons were either collected into the CCD well or repelled into a drain by controlling these two voltages. The electronic shutter made it possible to shelter previously collected and stored charge from unwanted additional photoelectrons when the integration period of the imager had ended. The Lincoln Laboratory high-resistivity CCD technology enabled the development of the electronic shutter technology. The electronic shutter was designed to have opening and closing speeds of less than a microsecond and therefore was able to be used with a Raleigh beacon to accept only that part of the beam that was sufficiently high in the atmosphere to sample all the relevant atmospheric disturbances. This shutter was incorporated into a number of  $128 \times 128$ -pixel cameras and deployed to SOR for testing beginning in 1996.



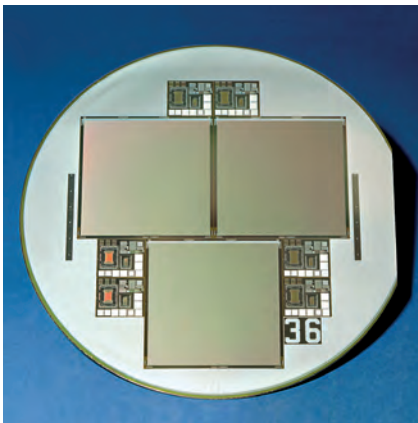
V. Suntharalingam



First Pan-STARRS telescope on Haleakala



$448 \times 448$  array 50-frame high-speed imager



**Figure 26-15**  
**A 150 mm diameter silicon wafer containing three 512 × 512-pixel array CCDs. Each imager can take four snapshots in a very rapid sequence.**

#### Note

**16** R.K. Reich, D.M. O'Mara, D.J. Young, A.H. Loomis, D.D. Rathman, D.M. Craig, S.A. Watson, M.D. Ulibarri, and B.B. Kosicki, "High-Fill-Factor, Burst-Frame-Rate Charge-Coupled Device," *Int. Electron Devices Mtg. Tech. Dig.*, 24.6.1–24.6.4 (2001).

### High-Speed Sampling Enabled by an Electronic Shutter

Although the original motivation for the electronic shutter was adaptive-optics applications, the shutter development led to devices for sampling imagery at high speed, such as a four-sample, high-burst-rate imager and a 50-sample, high-rate imager. Both of these operate with effective sampling rates well above 1 MHz.

In some applications, the goal is to record several snapshots during the evolution of a single event, and the image data are not needed immediately for real-time use. In that case, after obtaining a number of exposure images of the scene during the fast event, the data may be read off the device slowly (thereby enjoying lower read noise). The image sampling can be noiseless if carried out in the charge domain, whereas conversion of charge into voltage during the readout process incurred a noise penalty. Therefore, fast sampling in the charge domain followed by slow readout was a high-sensitivity strategy for either a single image or short bursts of imagery.

Taking sample images at high speed required a fast shutter technology. Standard commercial imagers introduce light through the front surface of the device and accomplish a shutter function by moving the sampled photoelectrons behind an opaque metal line in the pixel to block further accumulation of charge. The back-illuminated CCD greatly improves sensitivity over commercial imagers by bringing light into the device through the back surface, unobstructed by the structures on the front surface. The normal commercial method of producing a shutter function, however, cannot be used in a back-illuminated CCD. The electronic shutter invented by Lincoln Laboratory has been invaluable in addressing a number of fast image-sampling applications and is used in the two examples described below.

#### *Four-Sample, High-Burst-Rate, Charge-Coupled Imager*

A multisample high-speed imaging device using the electronic shutter, developed by Reich for the Los Alamos National Laboratory's Dual-Axis Radiographic Hydrodynamic Test (DARHT) facility, was designed to image rapidly changing explosive phenomena. The high-speed imagery was to be used to validate a sophisticated software code that is being developed at Los Alamos to predict the aging characteristics of the nuclear stockpile. Los Alamos required this device to capture four rapid

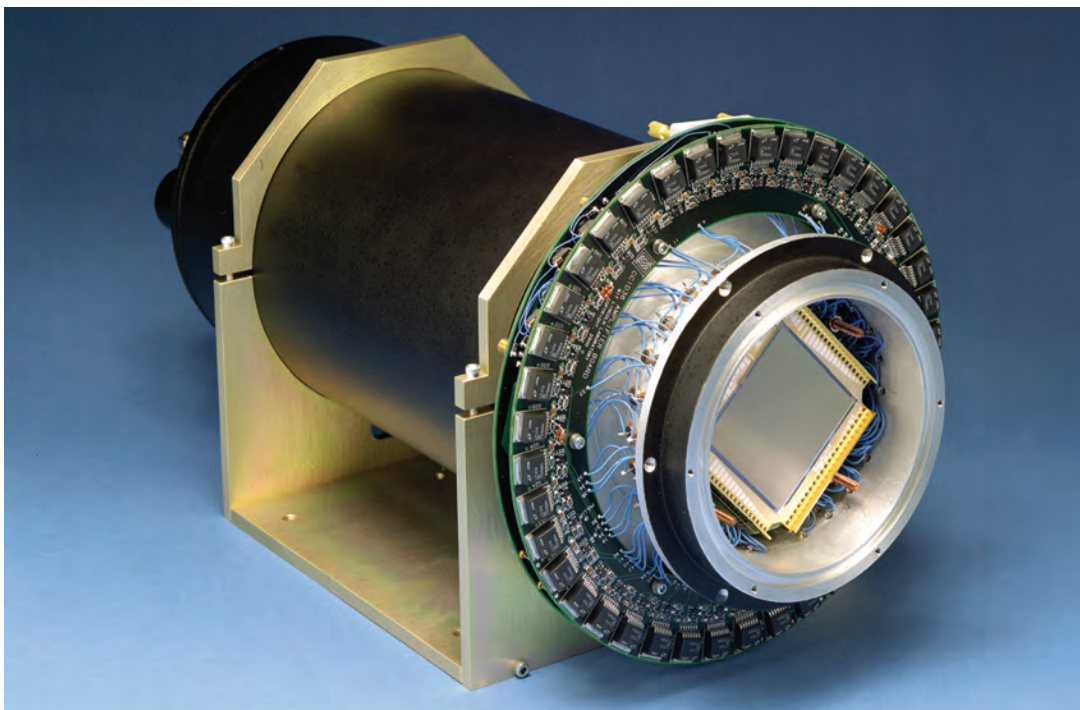
sequential frames (one frame every ~650 ns) with high isolation between frames (factor of at least 2000). Since the signal strength of the light was limited, high quantum efficiency (40% to 60% at ~450 nm) was also needed. To satisfy this sensitivity requirement, the device had ~100% fill factor, even while the pixel was divided into four separate parts to store each of the four frames. The device was structured so that photoelectrons were collected from every part of each pixel. Accomplishing this required using the high-resistivity silicon deep-depletion process, together with extensive three-dimensional modeling and measurements, to confirm that photoelectrons from the entire pixel area were captured with high efficiency for each of the frames. A picture of a wafer with a 150 mm diameter and with three four-sample devices is shown in Figure 26-15.<sup>16</sup>

The camera electronics driving the shutter needed to be designed carefully to achieve the speed inherent to the device. A cryostat-based camera was built that met the required performance; the cold head of this camera is shown in Figure 26-16. The multiple feed-throughs near the device were necessary to enable high transient currents by limiting the resistance. The first use of the camera at DARHT was successful in late 2009.

#### *Fifty-Sample, Wide-Dynamic-Range Imager*

Dennis Rathman developed a 50-sample, 448 × 448-pixel CCD imager for operation at approximately 15 kiloframes per second for the Midcourse Fly-Away Sensor Package (M-FASP) project at Lincoln Laboratory (see chapter 19, "Engineering Advanced Technology"). While the sensor was never flown on the M-FASP, Lawrence Livermore National Laboratory (LLNL) funded an effort to increase the operating frame rate to up to 2 megaframes per second, with high sensitivity and wide dynamic range. As with the four-sample imager, a primary application for the LLNL high-frame-rate imager was high-energy-explosive shock-front analysis (Figure 26-17). This device had several attributes that made it unique among CCDs that can store many consecutive frames. First, it was back-surface illuminated, giving it high sensitivity. Second, it had excellent optical isolation between successive images. The back surface contained a metal mask with an aperture at each photosite. Should a very bright event happen at the target, this mask, used together with an electronic shutter, yielded excellent optical isolation from previous





**Figure 26-16**  
Side view of cold head of four-sample high-speed camera, showing the multiple vacuum electrical feed-through posts for driving the electronic shutter.

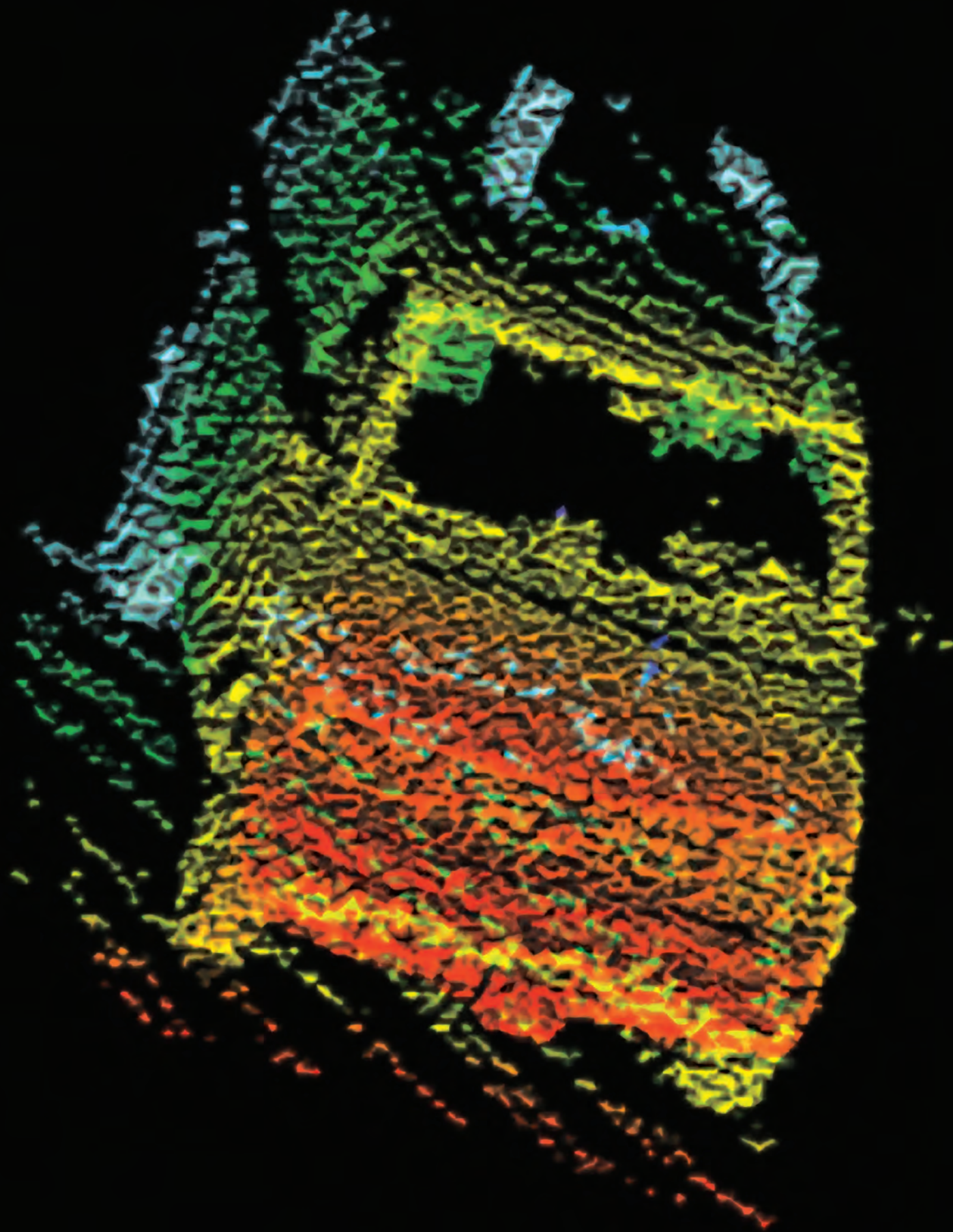


**Figure 26-17**  
A plate of metal was coated with high-explosive material on the bottom and then discharged. The image, which shows the rapidly rising column of debris approximately 20–25  $\mu\text{s}$  after discharge, was extracted from a 50-picture high-speed movie taken using the 50-sample imager. The diagonal strut in the foreground was part of the fixture.

samples (up to a million-fold barrier to leakage). This level of isolation would have been extremely difficult to achieve on a front-illuminated device because of probable light-piping laterally in dielectric layers. Third, it had very fast response. Because the device was back-surface illuminated, there was no need for space to be reserved on the front of the device for light reception. Therefore, very dense metal coverage of the front surface was used, together with a metal plane on the back surface, to provide for very fast signal propagation, and therefore fast shutter speeds.

#### **Current and Future Trends**

Over the past 40 years, Lincoln Laboratory has developed CCD imaging technology ranging from very sensitive CCDs designed for very-large-scale FPAs for both ground-based and space-based astronomy, to specialized high-speed devices used by Department of Energy laboratories for materials studies and U.S. nuclear stockpile stewardship, and to real-time high-speed imagers that made adaptive-optics astronomy feasible. Work in Laboratory programs led to rapid improvements in the physical size and pixel count of CCD arrays. It also led to the integration of special features, such as electronic shutters, orthogonal-transfer capability, and anti-blooming for back-illuminated imagers. Because of these accomplishments, the state of the art in high-speed imaging technology was vastly improved. The advanced imaging technology area at the Laboratory is expected to continue to expand the limits of imagers; future directions include the development of lower-noise output amplifiers and the incorporation of single-photon-counting capability into output circuits in a way that will further improve both the sensitivity and the dynamic range of imaging devices.





**The ability of photon-counting lidar receivers to achieve extremely high sensitivity and, by extension, long range was demonstrated in the Firebird experiments. While these experiments demonstrated tracking with a photon-counting lidar, there was growing interest in imaging with a lidar system.**

**Left: A single two-dimensional projection of three-dimensional spatial image data collected with a photon-counting laser radar. The colors represent relative distance, or range, from the sensor.**

In the early 1990s, the Department of Defense (DoD) had interest in technologies that could provide long-range sensing and characterization of targets. The sensors under consideration would need to be mounted on small, lightweight platforms and consume little power. Optical systems were considered — in particular, three-dimensional (3-D) imaging laser radars (lidars). In 1992, Richard Marino recommended that a new type of lidar receiver be developed: one that would be composed of an array of detectors in which each pixel could measure the time of arrival of a single photon. This novel sensor architecture was proposed as part of lidar-sensor-system studies for the DoD. A lidar with this capability could meet the requirements for a long-range, yet compact, sensor to help meet target detection and characterization challenges.

In July 1994, Marino and Antonio Sanchez-Rubio proposed the development of a laboratory demonstration of photon-counting 3-D lidar. This initial demonstration, with contributions from Juan Ochoa, utilized commercial (EG&G, Inc.) single-element photon-counting avalanche photodiodes (APD), whose field of view was scanned across the imaged target to emulate the performance of an array. This experiment was later upgraded to employ  $4 \times 4$  silicon photon-counting arrays developed by Radiation Monitoring Devices. A key technology element that enabled the development of 3-D lidars was the passively Q-switched microchip laser discussed in chapter 24, “Solid-State Research.” The subnanosecond pulses from these lasers are key to the high range resolution required for 3-D imaging, and the high-repetition rate enables high 3-D frame rates. Also in 1994, Marino submitted an application for a patent on arrays of photon-counting detectors used for 3-D lidar. This was granted as U.S. Patent No. 5,892,575 and was issued on April 6, 1999.

In 1996, Charles Primmerman succeeded in initiating an effort for the development of photon-counting-array technology. This effort also initiated a design study for the development of a  $32 \times 32$  photon-counting array led by Bernard Kosicki. This work included three parts: design the readout circuitry for the APD arrays, fabricate the detector arrays themselves, and develop technologies for bonding the two together. Brian Aull headed up this research work.

Another part of the nascent project included the development of a portable photon-counting 3-D lidar brassboard system. This first fieldable lidar employed a  $4 \times 4$  array photon-counting receiver.

#### **4 × 4 Brassboard System Development**

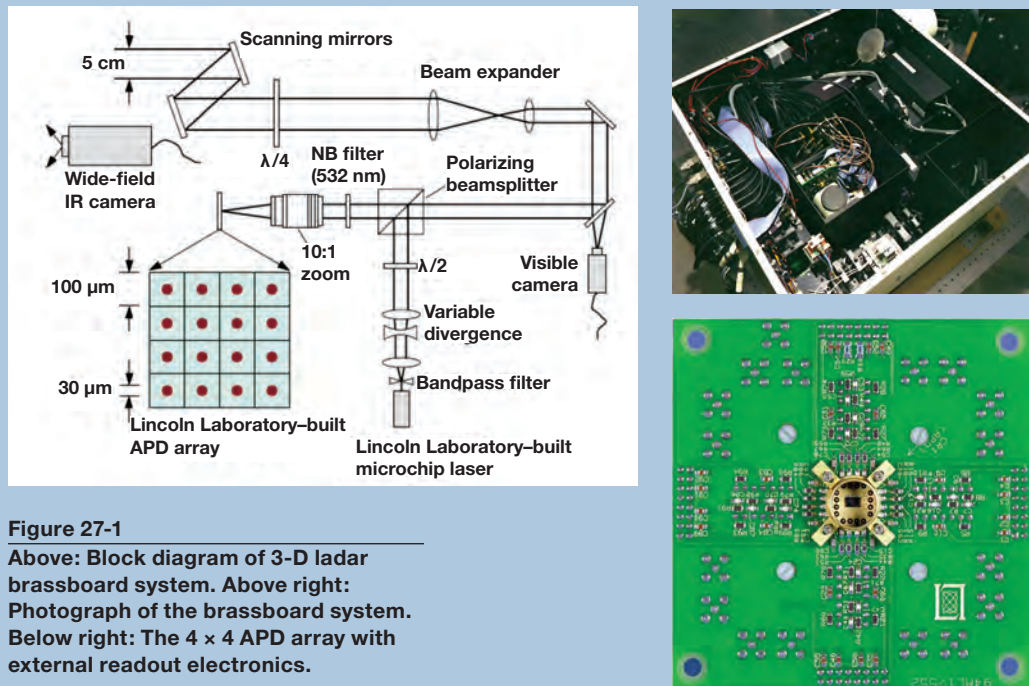
Richard Heinrichs led the development of the brassboard lidar. This system employed a  $4 \times 4$  array of Geiger-mode APDs with external timing electronics. The electronics were designed by David Kocher and built by Brian Player. The detector array was developed by Aull. Three-dimensional images were collected with this system by scanning the field of view of the detector array to generate either  $32 \times 32$ - or  $128 \times 128$ -pixel images (see photo in Figure 27-1). This system was the first fieldable lidar to employ photon-counting-array technology.

At this time, there was considerable skepticism in the lidar community that a single-photon-sensitive lidar could ever be used for tactical applications. In particular, there was doubt that these systems could ever operate in daylight because of the high background. The brassboard lidar was critical to addressing these concerns. Daniel Fouche, working with Marius Albota, used the brassboard system to collect 3-D images in broad daylight to alleviate these concerns. One particular image, shown in Figure 27-2, was seminal in convincing skeptics. This image of a Chevrolet van not only shows the utility of 3-D imagery — the detail of both the inside and the outside of the van are discerned from a single viewing angle — but also shows that this imagery can be collected near noon on a summer day.

Fouche and Albota then proceeded to compare 3-D imagery with intensity imagery. In a well-crafted set of measurements, they compared two-dimensional (2-D) intensity images with 3-D images, keeping both the range to target and the number of pixels on the target the same for both modalities. Figure 27-3 shows the results of one of their comparisons. In this case, a 2-D image of a pair of sports utility vehicles (SUV), one behind a camouflage net, is compared with a 3-D image of the same scene. The figure shows that from the 2-D intensity images, even at high signal levels, one cannot discern the SUV behind the net. However, the 3-D image collected at only a fraction of a measured photon per pixel per frame clearly showed the camouflaged SUV. This imagery successfully demonstrated the utility of photon-counting 3-D imagery.



### 3-D Ladar Brassboard System



**Figure 27-1**  
**Above: Block diagram of 3-D ladar brassboard system. Above right: Photograph of the brassboard system. Below right: The 4 × 4 APD array with external readout electronics.**

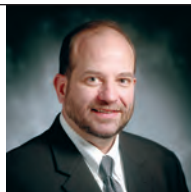
### 32 × 32 Silicon APD Development

In parallel with the efforts to demonstrate the efficacy of 3-D imaging, Aull was developing the first 32 × 32 APD arrays. The basic concept involved bonding an array of detectors to an array of complementary metal-oxide semiconductor (CMOS) counters. The hybrid array would then function by introducing a voltage across the detectors above their breakdown voltage and at the same time starting the counters. The returning photons from the target cause the APD detectors to break down, generating a voltage pulse that stops the associated counter, and thus recording the time of arrival of the photons. Aull fabricated the detectors in silicon since that material system was well understood.

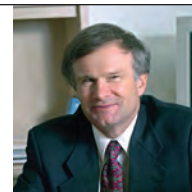
Aull proceeded with the development of the 32 × 32 arrays in stages. First, he developed 4 × 4 arrays of detectors. These could be individually connected to external circuitry and, thereby, their performance could be individually measured. In the next step, Aull fabricated sixteen timing counters surrounding a region where a 4 × 4 detector array could be mounted so that the individual detectors could be wire-bonded to individual counters. This device allowed the testing of the APD detectors with CMOS counters. The final step was to bond a 32 × 32 array of detectors with a 32 × 32 array of CMOS counters by using a specially developed technique in which the detector-to-counter connections were made by etching through the silicon substrate next to each detector to expose the counter layer.

In 2000, the first fully integrated 32 × 32 Geiger-mode APD arrays were developed as shown in Figure 27-4. This figure shows photographs of the individual detector and CMOS counter layers as well as a photograph of the integrated structure. As can be seen in the figure, the detector layer is epoxy-bonded to the CMOS

1990



R.M. Marino



C.A. Primmerman

Figure 27-2

3-D image of a Chevrolet van collected at a range of 60 m with the brassboard system. The far left shows a surface image. The three images to the right show the 3-D point cloud in various rotated geometries.

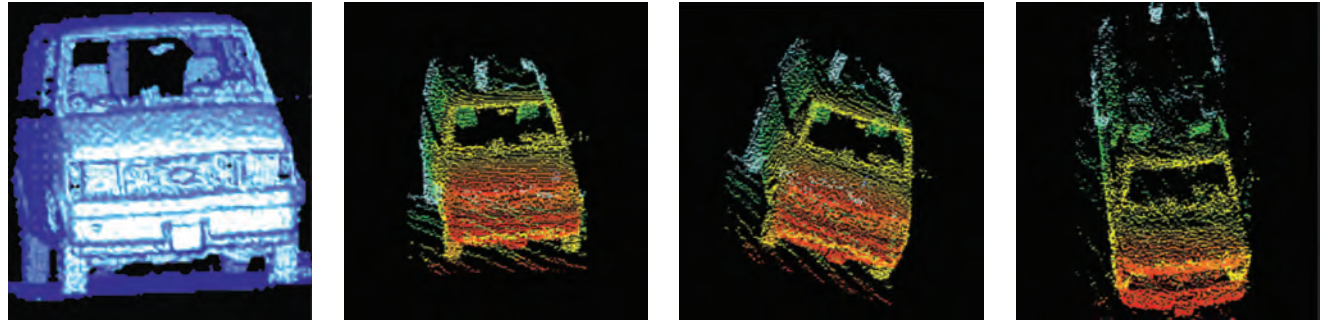
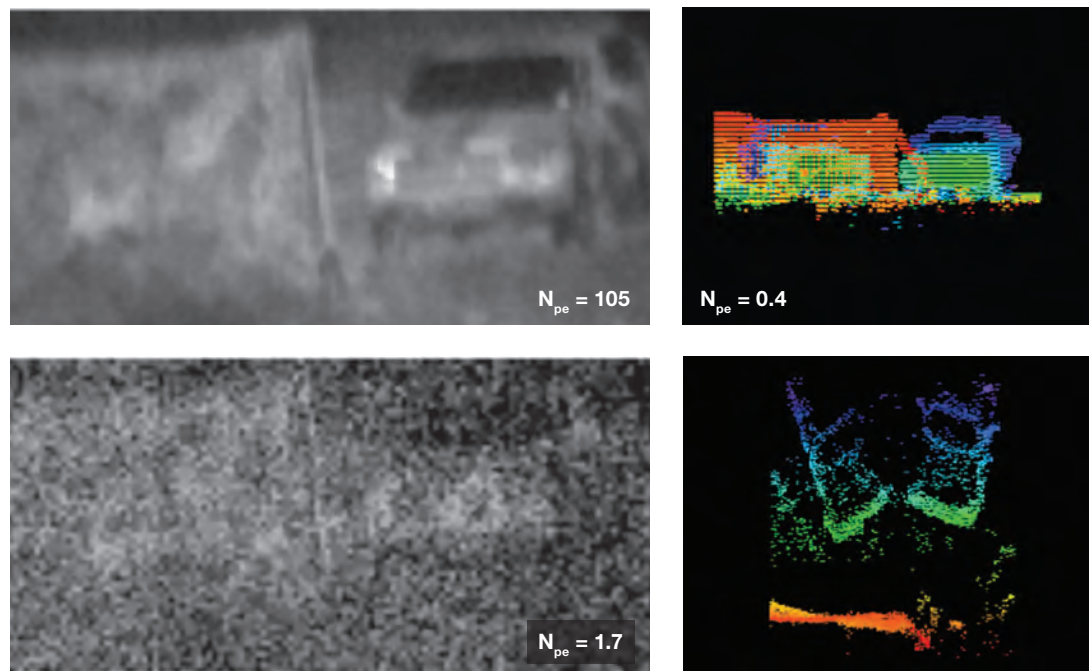
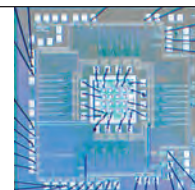


Figure 27-3

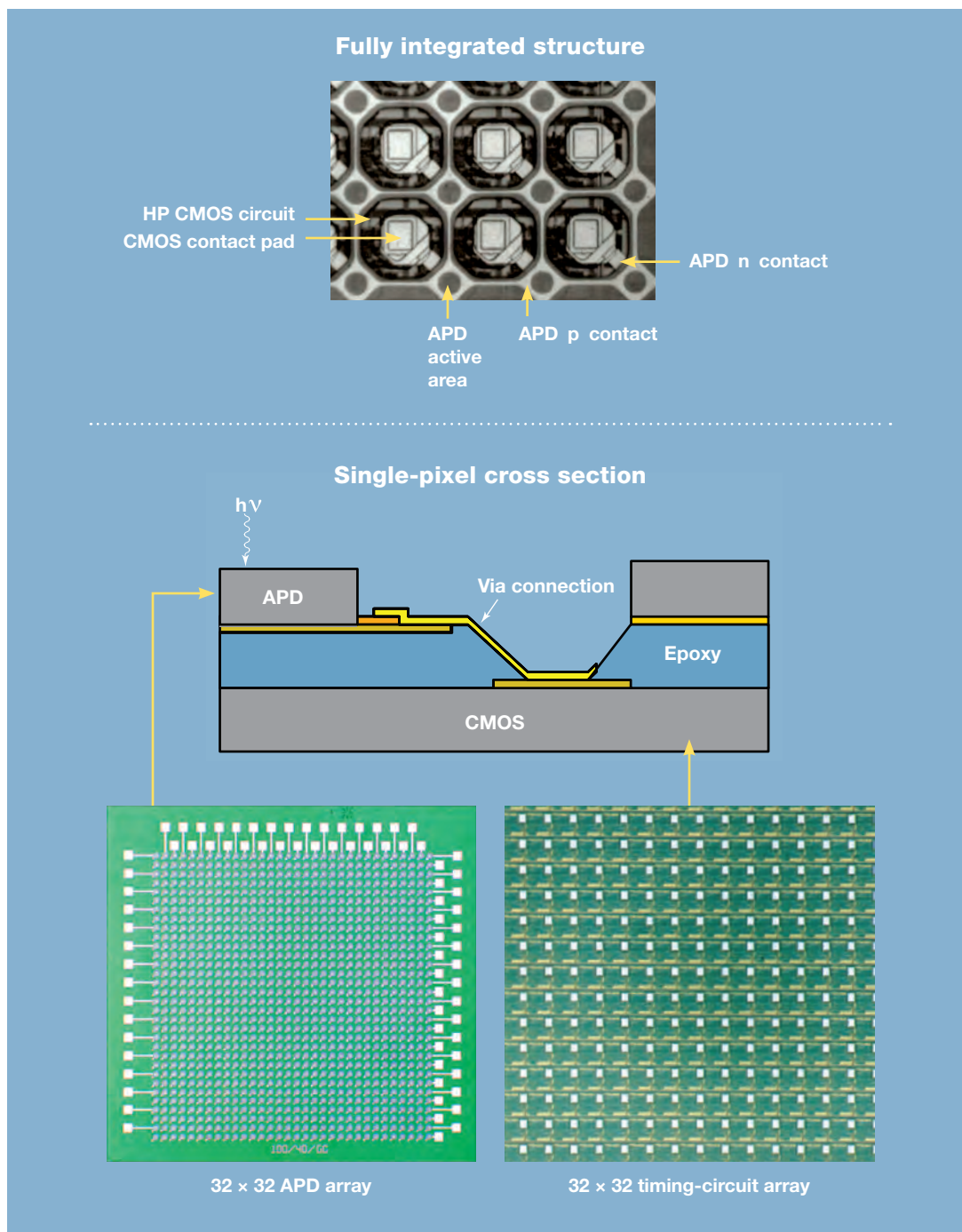
Comparison of 2-D intensity and 3-D images. The imaged region contains a pair of SUVs, one behind a camouflage net. On the left are two intensity images collected from a range of 500 m. Both images are the result of averaging 200 frames with an average signal on the top image of 105 photoelectrons/pixel/frame, and 1.7 photoelectrons/pixel/frame on the bottom image. Only the SUV in the clear is visible at the high signal level. At low signal level, the image is difficult to interpret. On the right are two renditions of a single 3-D image of the same objects at the same range with the same number of pixels and the same number of frames averaged. In this case, the signal is 0.4 photoelectrons/pixel/frame. As can be seen from the 3-D images, not only is the SUV in the clear visible but the SUV behind the camouflage net is also clearly distinguishable even though the signal level is significantly lower than for the intensity images.



Single-element commercial APD



4 x 4 Geiger-mode APD array



**Figure 27-4**  
**Bridge-bonded silicon 32 x 32**  
**Geiger-mode APD arrays.**

timing-circuit layer. Holes are then etched between the detectors, exposing the CMOS underneath. This created the “Swiss cheese” configuration of the detector layer, which allowed metal pads to be laid down to electrically connect each detector with the timing circuit underneath. These arrays represented the culmination of efforts over five years and became the backbone of several 3-D lidar systems that followed.

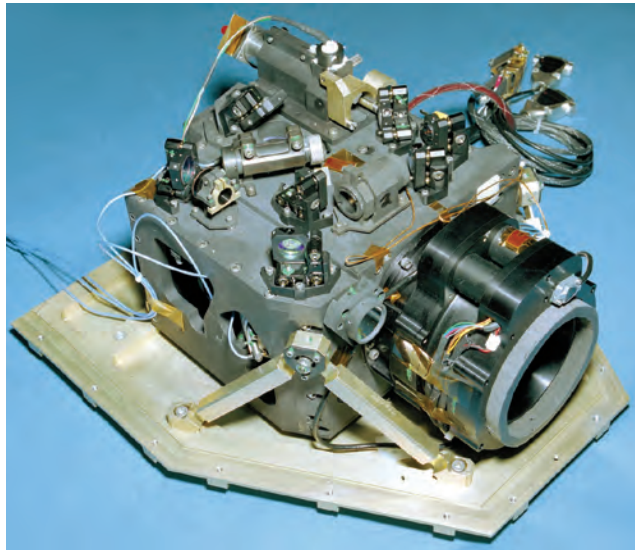
### Jigsaw

In 2001, the Defense Advanced Research Projects Agency (DARPA) began a program to develop 3-D lidar systems for imaging through tree canopies. This program was named Jigsaw in recognition of the fact that the lidar would need to look through the trees at multiple angles and then piece the images back together. The first phase of this program consisted of a design study to determine whether a 3-D lidar could be built small enough to be mounted on one of the ducted-fan unmanned aerial vehicles (UAV) envisioned for the Army Future Combat Systems program. At the suggestion of the DARPA program manager, Lincoln Laboratory and Harris Corporation formed one of the teams to conduct this study. The Laboratory effort was led by Heinrichs and Marino and had strong contributions from Aull, W. Robert Davis, Gary Rich, and Jamie Burnside. The study predicted that a 3-D lidar the size of a can of tomatoes could be built that would meet the imaging requirements.

As a result of the Phase 1 study, DARPA down-selected from six to two teams, one being the Lincoln Laboratory/Harris Corp. team, to develop a prototype system and fly it in six months. The Jigsaw Phase 2 then began. The prototype 3-D lidar did not have to meet the size, weight, and power requirements of the final system. However, it did need to demonstrate the functional performance of the final system, which included the ability to collect a full image during a 6 sec overflight of a target. After the data collection, the system was required to fully process the image and transmit it within 10 min to a viewing station on the ground, where a ground operator would identify the target. These targets could be both under the trees and covered with camouflage nets and could not be seen, much less identified, from the air.



**Figure 27-5**  
**Jigsaw Phase 2 system.**



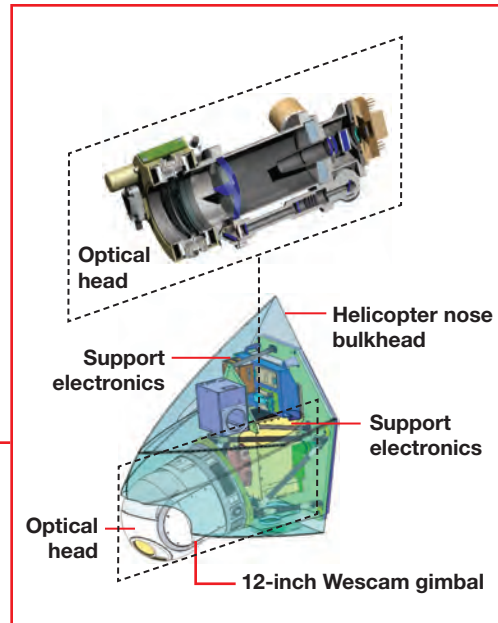
**Figure 27-6**  
**Jigsaw Phase 2 system installed in UH-1 helicopter.**



The short 6-month time frame for Jigsaw Phase 2, along with the strict performance requirements, was extremely challenging. Marino and Davis were the leaders on this project, which represented a classic case of rapid prototyping. Gregory Rowe headed up the electronics design effort and Joseph McLaughlin headed up the optical design. The completed system is shown in Figure 27-5, and the system integrated onto a UH-1 helicopter is shown in Figure 27-6. Of the two teams funded under the Phase 2 Jigsaw program, only the Lincoln Laboratory/Harris Corp. team successfully accomplished the field tests. All requirements were met with this system, including the ability to image and identify all the targets.

Because of the success of the Jigsaw Phase 2 program, DARPA funded the team to build and test the next-generation system. This Phase 3 ladar was mounted onto a 12-inch gimbal and nominally was to be able to fly on a UAV helicopter with a 10 ft rotor. Marino continued to lead this effort. Although the design of the system still did not need to meet the weight requirements of the ducted-fan version, the optical head was very close to the final system configuration (Figure 27-7).

The concept of operations for the Phase 3 Jigsaw system was very similar to that of the Phase 2 system in that it involved flying once over a cued location above the trees. The real challenges to this system, however, were the integration onto a much smaller gimbal and the requirement that the image formation, downlink, and display occur in less than 90 sec. These constraints required a complete redesign of not only the optical head but also the processing chain. Rather than doing the processing on rack-mounted computers, the image formation had to be migrated to field-programmable gate arrays and digital signal processors. John Drover, working with Harris Corp., was responsible for the development of this processing capability, which was successfully demonstrated to DARPA in field trials at Fort A.P. Hill in 2007.



**Figure 27-7**  
Phase 3 Jigsaw system. Above: The system is shown mounted on the helicopter. Right: A drawing of the system configuration and a cut-away view of the ladar optical head.



**Figure 27-8**  
ALIRT system Sabreliner-40 jet platform.

### Airborne Ladar Imaging Research Testbed

In 2001, Heinrichs succeeded in introducing the Airborne Ladar Imaging Research Testbed (ALIRT) program to Lincoln Laboratory. This effort was the result of two government studies, in which Heinrichs participated, dedicated to the investigation of technologies for wide-area 3-D mapping. The studies concluded that the use of high-sensitivity photon-counting receivers was crucial for obtaining high-area-rate collections of 3-D maps from airborne platforms. The ALIRT system was conceived as a demonstration of this capability: a 3-D ladar designed to demonstrate the efficacy of wide-area 3-D mapping with photon-counting APD arrays. The ALIRT program was headed up by Robert Knowlton with the system electronics designed by Rowe, the optics by Berton Willard, and the mechanical design by Robert Carlson and Vincent Cerrati.

The platform chosen for the ALIRT system was a Sabreliner-40 jet (Figure 27-8). This small, fast aircraft did not allow a large amount of volume for the system. The aircraft had an escape hatch at the bottom of the fuselage that was modified to contain a window through which the system could direct the scan.

The ALIRT system employed one of Aull's  $32 \times 32$  silicon APD arrays as the receiver. However, because the Air Force sponsor preferred not to have a visible laser beam propagating from the bottom of the aircraft, the wavelength chosen for operation was  $0.78 \mu\text{m}$ . This wavelength is just off the visible spectrum and can still be detected with silicon-based APDs. John Zayhowski developed the laser transmitter for the ALIRT system. This consisted of one of Zayhowski's microchip lasers (discussed in chapter 24, "Solid-State Research"), which was frequency-doubled to the green end of the spectrum and then used to pump a titanium-sapphire laser that generated the  $0.78 \mu\text{m}$  radiation.

The final system integration and initial flight measurements occurred in early 2003, with Joseph Adams as the lead system engineer. The system recorded the first airborne imagery in February of that year.

### Direct and Coherent Detection

Although arrays of Geiger-mode APDs are near optimal for direct detection, they can also be used for coherent detection (see the sidebar entitled “Coherent Detection with Photon Counting”). In fact, APD arrays can be employed as coherent receivers simply by turning a local oscillator on or off. This concept was employed in a study conducted by Primmerman and Heinrichs in 2003, with contributions from Kenneth Schultz and Sumanth Kaushik. The result of this study was a system architecture that could change measurement modes to adapt to the changing signal levels as the range to a target varied.

The results of this study were briefed to the DoD in 2004 and resulted in a program to demonstrate the capability in a laboratory environment. This three-year effort led to the demonstration of a single laser and receiver that could switch between multiple coherent-detection and direct-detection lidar modes. Leaf Jiang, with the assistance of Jane Luu, successfully carried out this task, achieving all the goals.

The requirements for the direct and coherent detection program included the development of a multimode laser and Geiger-mode APD receiver that could shift between direct-detection and several coherent-detection modes. Jiang and Luu performed this task in the recently developed active laboratory part of the Optical Systems Test Facility (OSTF). This laboratory housed a 1 m primary mirror, which could simulate very long ranges, and a 100 W laser amplifier. Jiang and Luu demonstrated this capability in fall 2006.

### Processing of 3-D Imagery

The development and fielding of various 3-D lidar systems necessitated the development of algorithms and software for 3-D data processing, image simulation, and exploitation. Some of the first progress along these lines can be attributed to the efforts of Michael O’Brien working with Fouche. Fouche developed the first algorithms to convert pixel-firing times to angle-angle-range to points in 3-D space. O’Brien implemented these algorithms, generating some of the first imagery collected with these systems, which included the  $4 \times 4$  brassboard, the early ALIRT collections, and the Phase 2

### Coherent Detection with Photon Counting

Photon-counting arrays can be used as coherent-detection receivers. Optical coherent detection involves “mixing” or spatially combining the light backscattered from a target with light from a reference laser on a detector. If these two light sources are suitably matched in frequency and direction, then they will interfere and the detector will measure the Doppler shift of the backscattered light as a beat note at the difference frequency  $\Delta\nu$  between the backscattered light and the reference laser light. Figure 27-9 shows two examples of mixing light and the resulting interference.

On the left part of the figure, light from a single coherent source, such as a laser, is incident on a pair of slits. The light passing through each slit interferes with light passing through the other slit. The result is a set of bands, or fringes, which define the locations where the light from each of the slits either interfere constructively or destructively, as shown in the varying intensity pattern on the middle left. On the right part of the figure, light from two lasers operating at slightly different frequencies is combined on a single detector. If the frequency difference between the

two lasers is  $\Delta\nu$ , then the detector will register a signal at this difference frequency as the two lasers come into and out of phase with each other as shown in the middle on the right.

As it turns out, both of these interference effects are preserved even if the light sources produce only one photon at a time. In the case of the two slits, because of the wave-particle duality of photons, a single photon passes through both slits and effectively interferes with itself. Thus, if the laser only sends out a single photon at a time, it will land on the target preferentially on the locations where the light fringes are located and less preferentially on the locations of the dark fringes. Likewise, if the two lasers separated by frequency  $\Delta\nu$  only put out single photons each, and usually not at the same instant, then the detector will measure the combined signal as photons occurring more often during the intense portions of the beat note and less often during the less intense portions. This interference, like Schrödinger’s cat, is only preserved as long as no effort is made to determine which slit the photon traversed or from which laser it emanated.

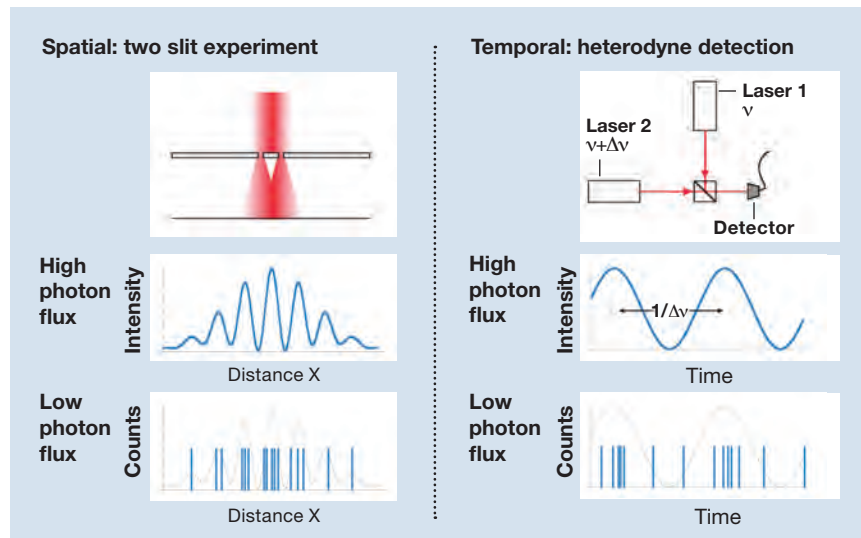
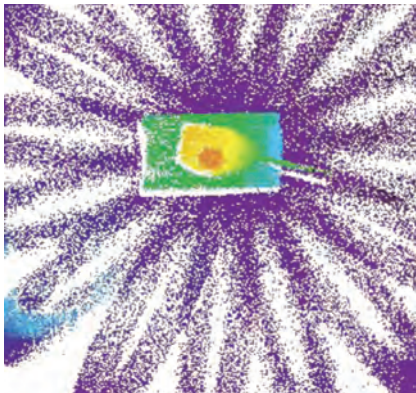


Figure 27-9  
Photon-counting coherent detection.





**Figure 27-10**  
**Example of a simulated 3-D ladar image of a tank, employing the parameters of the Jigsaw system.**

**Note**

**1** D.G. Fouche, "Detection and False-Alarm Probabilities for Laser Radars That Use Geiger-Mode Detectors," *Appl. Opt.* **42(27)**, 5388–5398 (2003).

Jigsaw system. These algorithms were the basis for all later processing. O'Brien developed the first simulation capability for 3-D imagery in 2000. This capability formed the basis of future simulation efforts in support of multiple programs and studies (Figure 27–10). Fouche subsequently developed the first theory on the statistical performance of Geiger-mode imaging systems and published this in 2003.<sup>1</sup> The simulation efforts initiated by O'Brien and Fouche have also been extended over time by Frederick Waugh in a 2005 analysis of 3-D ladar for improvised-explosive-device detection.

One area of data processing that is unique to Geiger-mode 3-D ladar data is range estimation from multiple measurements or so-called "coincidence processing." O'Brien and Fouche developed early estimators. However, it was due to the efforts of Alexandru Vasile that the highest performance was achieved. Vasile developed some of the best-performing coincidence processors for the Jigsaw program, and a version of his range-estimation algorithm has been widely used by the ALIRT program.

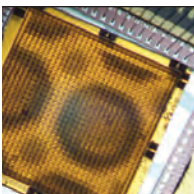
Another area of development is visualization. This is critical, since the utility of 3-D ladar data is often dominated by the ability of the human eye to interpret the information. In 2002, Luke Skelly developed one of the first 3-D visualization tools that allowed the user to rotate and fly through the imagery. This work was later extended by Ross Anderson, who developed a sophisticated visualization tool, called Eyeglass, that is tuned to Geiger-mode data and is comparable to some of the best commercially available tools today.

Finally, in the area of ladar-data exploitation, the efforts of Vasile and Peter Cho stand out in particular. Vasile's master's thesis involved the development of "spin" image techniques for automated identification of 3-D ladar images. His algorithms, which basically projected 3-D images onto a set of 2-D spin images, were able to identify 3-D images of tanks and trucks from a wide confusion matrix. Subsequent efforts by Cho, begun in 2005, have shown an increasing ability to associate standard photographic images with 3-D ladar data. Cho's work has been aimed at using 3-D ladar imagery as the foundation upon which to organize 2-D intensity imagery as well as other geographically referenced information.

**ALIRT System Evolution**

Concurrent with these technology developments, the ALIRT program continued to make progress through the early adoption and demonstration of new Geiger-mode APD technologies. One of the key enablers of high efficiency, and the resultant high 3-D mapping rates, was an APD array that was sensitive at optical wavelengths near 1  $\mu\text{m}$ . This array enabled the direct use of the neodymium yttrium-aluminum-garnet (Nd:YAG) microchip lasers developed by Zayhowski. These lasers are highly developed and some of the most power efficient. The 0.5  $\mu\text{m}$  and 0.78  $\mu\text{m}$  wavelength lasers employed for the Jigsaw and early ALIRT systems, for example, utilized Nd:YAG microchip lasers as their cores. These lasers have a primary output wavelength at 1.06  $\mu\text{m}$  and are tailor-made for the requirements of the ALIRT system.

2000



32  $\times$  32 APD array with (misaligned) lenslets



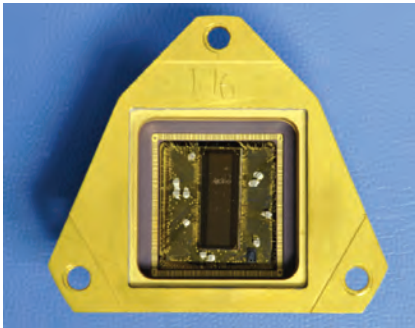
R.M. Heinrichs



First collected imagery with a 1  $\mu\text{m}$  sensitive APD array



B.F. Aull



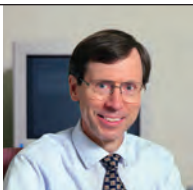
**Figure 27-11**  
64 × 256 receiver.

In 2005, the ALIRT system was upgraded with one of the first  $32 \times 32$  APD arrays sensitive at  $1 \mu\text{m}$  and promptly destroyed it. These detector arrays, unlike the earlier arrays that were fabricated in silicon and bridge-bonded to the CMOS timing circuitry, were fabricated in the indium-gallium-aluminum-phosphide-material system and were the results of the combined efforts of Simon Verghese, K. Alexander McIntosh, and Joseph Donnelly. Since the indium-phosphide substrate used for these arrays is transparent to the laser radiation, these arrays could be bump-bonded to the readout circuitry, thus enabling the use of a more standard fabrication to allow greater reliability of the arrays. However, when one of these arrays was installed in the ALIRT system, the first flight contained a 3-inch corner cube as one of the targets, which produced enough return light to immediately destroy the array. This quickly pointed out the sensitivity problems of the arrays and resulted in efforts to significantly increase the threshold for optical damage.

Eventually, the ALIRT system was upgraded with a  $1 \mu\text{m}$  sensitive array that was not immediately destroyed. Other upgrades to the ALIRT system at this time included mounting the system onto a stiffer optical bench fabricated from Invar. The upgrade to a new, high-performance scan mirror, however, had the greatest impact on data quality. For several years, the quality of the data produced by ALIRT was limited by the fact that the mirror used to scan the field of regard did not provide the absolute pointing knowledge required. This lack of absolute pointing knowledge was equivalent to having a high-precision digital

camera with the pixels in the focal plane stretched or squeezed in unknown and constantly changing ways. Knowlton convinced the sponsor of the need for the new mirror, and he worked with John Shelton and Dale Fried to find a company to build it. When the mirror became available in 2006, it was Fried who oversaw its integration into the system and Brandon Call who worked with Fried to develop and institute the calibration. The result was the ability to pinpoint the absolute geolocation of the images collected with the system down to the size of a coffee cup.

Simultaneous to these upgrades, the development of APD arrays with a greater number of smaller pixels was under way. Building larger detector arrays required more precise control of the fabrication parameters, and McIntosh pushed the fabrication in this direction. Larger detector arrays also required new CMOS readout electronics. In 2005, Brian Tyrrell developed the first in a new generation of readouts that, rather than having counters behind each pixel as in the designs developed by Aull, had a single counter that broadcast just the count to each of the pixels. The advantage of this new design is that each of the pixels did not have to actively count clock pulses with fast-switching circuitry. Instead, each pixel only had to save the current count when the associated APD fired. This capability allowed significantly less heat dissipation, which was critical for scaling up the array size. Tyrrell developed the readout architecture for the first generation of a  $32 \times 128$  APD array. This architecture served as the foundation for scaling up the size of the focal plane and also led to the development of receivers with dual  $32 \times 128$  arrays and  $64 \times 256$  APD arrays (Figure 27-11).



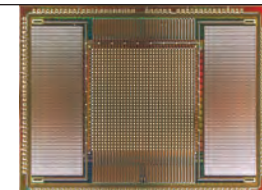
W.R. Davis



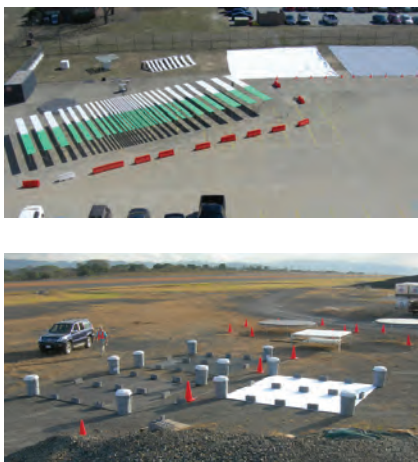
3-D ladar operating at  $1.5 \mu\text{m}$  wavelength



3-D ladar with scanning telescope, APD array, and transmit laser before integration into 12-inch gimbal for Jigsaw program



$32 \times 32$  APD array with continuous-readout integrated circuit



**Figure 27-12**  
**Calibration targets used for flight campaigns local to Lincoln Laboratory (top) and at remote field sites (bottom). The bar target at top quantifies the system resolution, and the large tarpaulins quantify the system radiometry. The bar target at top can be seen on Google Earth.**

Another capability that was added to the ALIRT system was a second 3-D lidar operating at a wavelength of  $1.5\ \mu\text{m}$ . This added capability came out of the sponsor's desire to determine if operating at  $1.5\ \mu\text{m}$  would offer advantages to operating near  $1\ \mu\text{m}$ , as well as McIntosh's push for developing APD arrays that were sensitive out to longer wavelengths. Therefore, a second lidar system was developed and integrated onto the Sabreliner (Figure 27-8). The mechanical design for this dual-wavelength system was performed by Cerrati with the optical design by McLaughlin. Fried completed the integration, and many of the dual-wavelength results were analyzed by O'Brien.

Besides the phenomenology comparison, the development of lidar systems that operate at  $1.5\ \mu\text{m}$  opens up many new applications (e.g., where higher laser powers are required for tactical applications) because the threshold for eye damage is significantly greater for exposure to  $1.5\ \mu\text{m}$  laser light versus  $1\ \mu\text{m}$  light. Therefore, a lidar operating at  $1.5\ \mu\text{m}$  can transmit significantly more power and still remain eye safe.

Between upgrades, the ALIRT system continued to participate in several major field campaigns. In spring 2006, responding to a request for assistance from the Costa Rican government, the ALIRT system conducted a field campaign in Costa Rica in search of an aircraft that had crashed in 1965. The downed aircraft, a C-54 four-engine propeller plane, had 68 people on board, including half the senior class of the Argentine Air Force Academy. The aircraft has never been found and is still the worst air disaster in Costa Rican history. Since the ALIRT 3-D lidar was the only system capable of imaging under trees over a potentially wide area, the system was employed over a three-week period to search for the downed aircraft. From the outset, it was known that this search amounted to looking for the tip of a needle in a haystack. However, the Costa Rican government was pleased at the attempt, and for the ALIRT program, this was an opportunity to quantify the system performance through rainforest foliage.

Toward this end, multiple "test" targets were deployed at the La Selva biological research station and were subsequently imaged by ALIRT.

From its inception through 2010, the ALIRT system has conducted multiple field campaigns, imaging both local and remote targets. Several major cities have been imaged by ALIRT, including New York; San Francisco; Boston (on three occasions); Rochester, New York; and Lowell, Massachusetts. ALIRT has imaged various regions of interest, including Yosemite National Park, the Millstone Hill radar facility in Massachusetts, and the western part of the U.S.-Mexican border. ALIRT has also flown over multiple military facilities including Fort Devens and Hanscom Air Force Base in Massachusetts, Fort A.P. Hill in Virginia, Camp Roberts in California, and the Yuma Proving Ground in Arizona. Recently, the ALIRT system was deployed to Key West, Florida, to demonstrate the ability of 3-D lidar to detect low-profile boats in the ocean. In this case, not only could ALIRT detect the boat but it could also detect the waves created by the boat as it passed through the water. In support of field campaigns local to Lincoln Laboratory, a set of calibration targets that includes a large angular resolution target, which can be seen on Google Earth, has been erected near the Flight Facility at Hanscom Air Force Base (Figure 27-12). Other targets have been deployed along with the system when it has conducted remote field campaigns.

The ALIRT system has demonstrated the ability of 3-D lidar to provide unique information in the form of 3-D maps as well as imaging through foliage and finding targets over water. In 2010, the ALIRT system was under preparation to be deployed on a nine-month overseas field campaign.



## ALIRT Participation in Operation Unified Response over Haiti

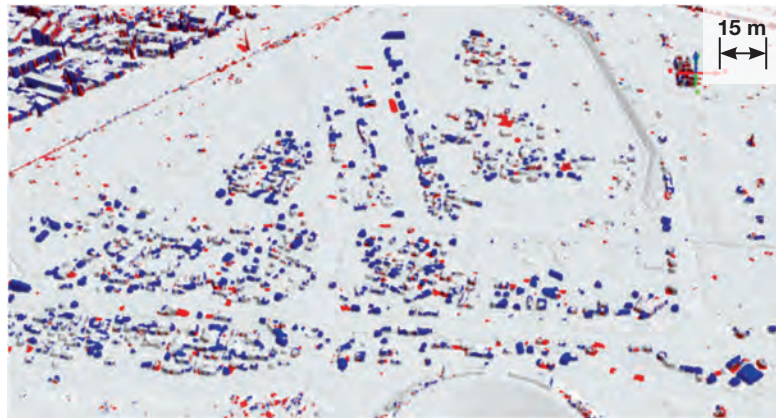
During an ALIRT planning meeting for an upcoming deployment on the Friday after the January 12, 2010, earthquake in Haiti, Richard Heinrichs received a phone call from a representative of U.S. Southern Command (SOUTHCOM), whom he and Dale Fried had visited the previous week. The SOUTHCOM representative requested that the ALIRT system be deployed “as soon as possible” to collect 3-D imagery over Port-au-Prince and the surrounding area in support of relief operations.

The ALIRT system, which had just undergone avionics upgrades, was deployed along with a full operations and processing team 48 hours later. The ALIRT system was collecting imagery over Haiti 60 hours after the phone call. This imagery was processed within hours of the aircraft landing, and image products were made available to SOUTHCOM personnel.

One example of a 3-D image product that was produced is shown in Figure 27-13. This is a change-

detection map in which two 3-D images, collected on subsequent days, are subtracted from one another. Objects that appear in the more recent map but not in the earlier one are colored blue, and objects that appear in the earlier map but not the more recent one are colored red (“blue new, red fled”). Change-detection maps such as the one shown in the figure of a tent encampment were used to trace the flow of displaced persons into and out of the various food distribution centers. This information was used to help determine the optimal distribution of relief supplies in the two-week period after the earthquake.

The ALIRT system also collected a 2000 km<sup>2</sup> 3-D map of the region surrounding Port-au-Prince. This map will help determine the location of the flood plains in anticipation of the rainy season. The map will also help guide the reconstruction effort and map out the regions of greatest destruction.



**Figure 27-13**  
Sample change-detection product showing increase in number of tents at Dessalines in Haiti.

## Summary and Conclusions

Photon-counting lidar is an example of a capability developed at Lincoln Laboratory that brings together technologies from across multiple divisions. The core technologies include the Geiger-mode APD array detectors and the microchip lasers developed in the Advanced Technology Division. These technologies have been integrated into lidar systems by the Laser and Sensor Applications Group, now named the Active Optical Systems Group in the Intelligence, Surveillance, and Reconnaissance (ISR) and Tactical Systems Division. Integrating these systems onto airborne platforms was then enabled with the engineering capabilities of the Optical Systems Engineering and Control Systems Engineering Groups in the Engineering Division. Two of these airborne systems, Jigsaw and ALIRT, have generated 3-D imagery that has caught the attention of many in the user community.

Photon-counting technology has also enabled the demonstration of an advanced lidar sensor that can adapt to the range and nature of the target. The extreme sensitivity of photon counting along with the precision timing and multiple pixels of the APD arrays provides a generic receiver that can be adapted to almost any active optical-imaging task.

Along with these demonstrated technologies, Lincoln Laboratory has been developing novel ways to process the information that these lidars collect. This work has brought together statistical-estimation techniques and signal processing theory. Lincoln Laboratory continues to develop new algorithms that generate 3-D imagery, display the imagery in ways that allow the eye to perceive the content and make sense of the imagery, and combine it with other information.

**Blue** objects have been added.

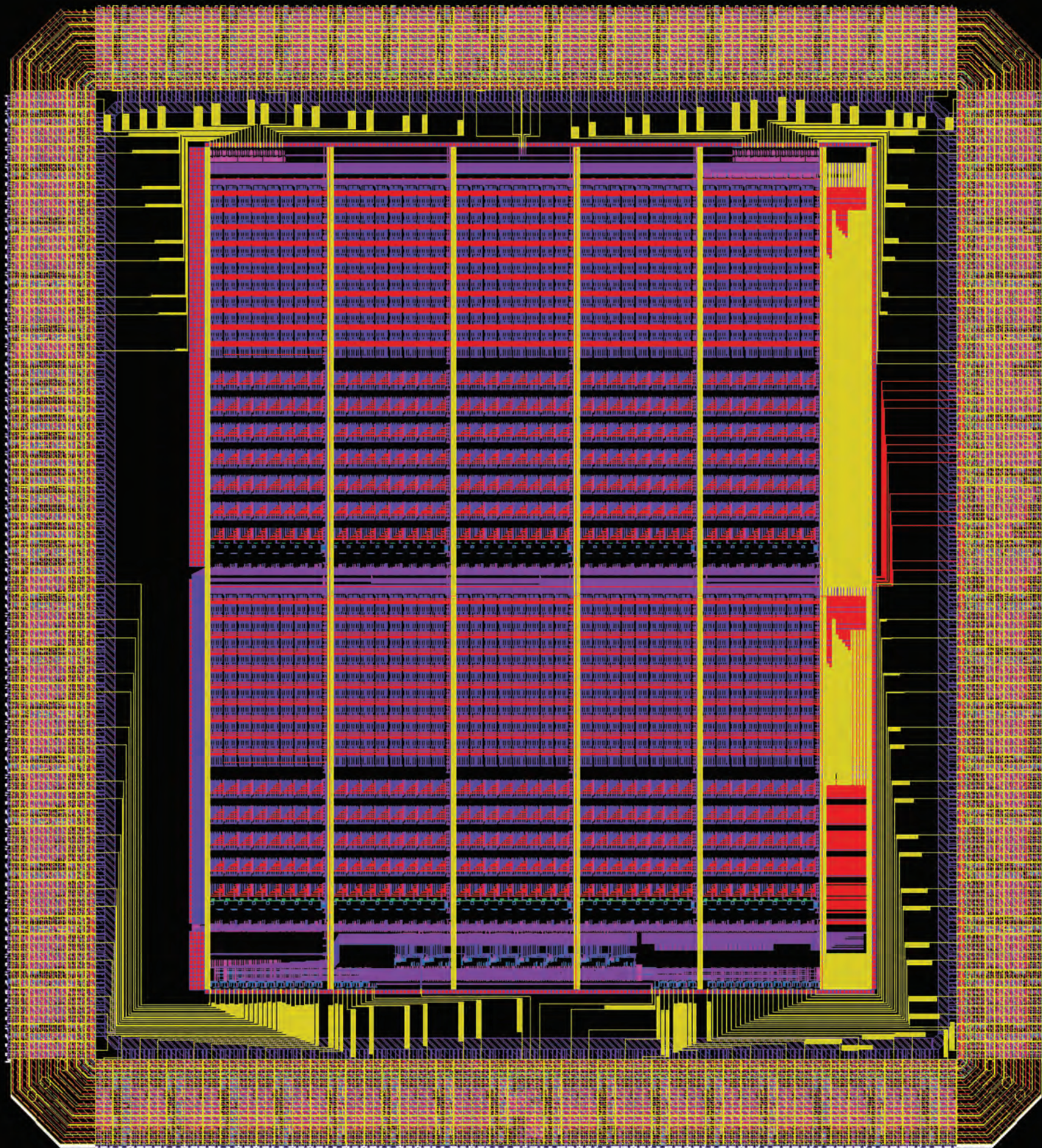
**Red** objects have departed.

**18 Jan 2010**  
**0531Z / 0031L**  
**24,900 m<sup>3</sup> of tents**

**19 Jan 2010**  
**0212Z / 2112L**  
**34,700 m<sup>3</sup> of tents**

**39% increase**  
**in tents**







**Lincoln Laboratory has had a vital role in inventing and using high-performance computing technology for national defense applications. The lineage of the Whirlwind and TX series computers of the 1950s led to today's embedded parallel processors, advanced very-large-scale integrated circuits, and interactive grid computing.**

**Left: Shown here is a computer-aided-design drawing of Lincoln Laboratory's nonlinear equalization (NLEQ) VLSI integrated circuit. NLEQ technology is being used to improve the dynamic range and bandwidth of electronic warfare systems.**

High-performance computing has occupied a central role in Lincoln Laboratory's history since its earliest days. The success of the Laboratory's first major endeavor, the Semi-Automatic Ground Environment (SAGE) national air defense system, hinged on the development of the Whirlwind computer. Whirlwind incorporated the world's first magnetic-core memory, one of the key components that allowed the computer to keep up with the arrival of data, respond quickly to commands from its operators, and provide timely calculations of enemy aircraft trajectories to the SAGE system. The ability to produce results in real time, which is taken for granted in today's highly interactive computer age, was a revolutionary development for its time. Whirlwind and its successors, the TX series of computers, incorporated other important advances, such as one of the first program compilers that made the job of writing complex computer codes significantly easier. Since Whirlwind, Lincoln Laboratory has continued to provide innovative, cutting-edge computer technologies, both hardware and software, in support of crucial U.S. military systems.

Numerous contributions and spin-off companies from Lincoln Laboratory have helped to create and shape the modern computer and digital signal processing industries. Examples of Laboratory spin-off companies include Digital Equipment Corporation, which invented the minicomputer, and Applicon, which developed software for computer-aided design of integrated circuits. Other influential developments include interactive computing; computer graphics; wafer-scale restructurable very-large-scale integration (VLSI); secure digital voice communications; voice communication in packet networks; robust speech recognition for Department of Defense (DoD) applications; and artificial neural network technology. In fact, the emergence of Massachusetts as a center of the computer industry derives in large part directly from the Lincoln Laboratory computer technology program, its spin-off companies, and their descendants.

Today, the Laboratory remains a national leader in high-performance computing in support of national defense. The Laboratory continues to develop some of the nation's highest-performing embedded programmable parallel processors and custom VLSI signal processors, pioneering such areas as nonlinear

signal processing, open system architectures, networked systems of systems, grid supercomputing, and automated software mapping technologies.<sup>1</sup>

#### **From Whirlwind to TX-2**

The Whirlwind computer was developed initially in the 1940s in the MIT Servomechanisms Laboratory, and subsequently during the 1950s in the MIT Digital Computer Laboratory and Lincoln Laboratory, to perform real-time tasks, originally as a flight simulator and later as part of the SAGE system. Real-time performance was obtained by building the computer as a 16-bit parallel system and employing a random-access memory.<sup>2</sup> The replacement of Whirlwind's small and unreliable storage-tube memory by a magnetic-core memory in 1953 was an epochal event in the history of computers. Equally important was the linking of computer and man through displays and light pens. The story of Whirlwind and magnetic-core memory and its importance for the SAGE system and the early history of Lincoln Laboratory are found in chapter 1, "Beginnings," and chapter 2, "The SAGE Air Defense System."

The early emphasis on real-time applications, memory systems and man-computer interaction continued through the development of several generations of new computer technologies and systems at the Laboratory.

Whirlwind in 1952 had about 5000 vacuum tubes and 11,000 diodes in its logic circuits. A preliminary design for a transistorized computer for SAGE, the TX-1, was developed but not implemented because the transistor was too immature. The AN/FSQ-7, the first SAGE computer, used about 25,000 tubes in each computer of the duplexed system. Transistor circuit development was pursued, however, and in 1955 a double-rank shift register of eight stages was built with 100 surface-barrier transistors manufactured by Philco. Later that year, an 8-bit multiplier with about 600 transistors was produced.

During this time, Lincoln Laboratory built a 64k-word ( $256 \times 256$ ) magnetic-switch-driven core-memory array. The memory drive currents were generated by vacuum tubes, 425 in total, but it also used 625 transistors. To test both the memory and the transistor logic circuits, Lincoln Laboratory built the TX-0 computer.<sup>3</sup>



---

## Notes

**1** Material in the chapter was provided by Allan Anderson and James Forgie (early computers), Charles Rader (digital signal processing), William Song (VLSI technology), Jeremy Kepner (grid computing), and Robert Bond (STAP computing).

**2** K.C. Redmond and T.M. Smith, *Project Whirlwind*, Bedford, Mass.: Digital Press, 1980, p. 237. This book provides a fascinating history of the technological and the political issues surrounding the development of Whirlwind.

**3** J.L. Mitchell and K.H. Olsen, "TX-0, a Transistor Computer with a 256 by 256 Memory," *Proc. 1955 Eastern Joint Computer Conf.*, 93–101 (1956).

**4** A set of articles describes the TX-2 computer in detail in *Proc. 1957 Western Joint Computer Conf.*

The TX-0 was an 18-bit machine built with about 3600 transistors. Gates and flip-flops were packaged as individual plug-in units. Each flip-flop was composed of ten transistors and operated at 5 MHz; the instruction rate was 80,000 instructions per second. Sixteen address bits were required in each single-address instruction word, leaving only two bits for instructions. Three of the four instructions — add, store, and conditional jump — used an address; the fourth used the address bits for controlling such functions as clearing and complementing the accumulator, transfers between registers, and input/output (I/O) operations. Input/output was provided by a Flexowriter, a paper-tape reader, and a cathode-ray tube (CRT) display system. Marginal checking was implemented by varying a positive bias voltage on the base of the *p-n-p* transistors.

The next computer to be constructed was the TX-2 (Figure 28-1), which was a much more complete implementation of transistor technology than TX-0. Many of the concepts in the design of TX-2 came from the TX-1 design; the core memory, however, came from TX-0. The TX-2 was a constantly evolving machine; each week, one day was devoted to maintenance, improvements, and changes.<sup>4</sup> In what would turn out to be a highly successful innovation, all circuits for TX-2 were packaged in a single type of standard pluggable module.

In 1957, Kenneth Olsen and Harlan Anderson, who had worked on the matrix core switch for core memories, the AN/FSQ-7 design, and the circuit design for the TX-0 and TX-2 computers, left Lincoln Laboratory to found Digital Equipment Corporation (DEC). Their first product was a line of pluggable logic modules based on TX-2 circuits. The first DEC computer, the PDP-1, was introduced in 1960 and was oriented to the type of interactive computing that Whirlwind, TX-0, and TX-2 had pioneered. The minicomputers developed by DEC soon revolutionized the computer industry.

By 1958, TX-2 had three core memories: the large 64k-word system, a transistor-driven 4k-word memory, and a fast 64-word index memory (Figure 28-2). Many additional registers, including the arithmetic registers, were addressable in the memory address space. The separate memory units could operate in parallel so that faster operation was possible if instructions and data were

in separate memories. The TX-2 implemented a single-instruction architecture with an 18-bit address and 6 bits to specify an address index from the index memory.

The arithmetic element could be reconfigured on each instruction into one 36-bit, two 18-bit, or four 9-bit sections, all executing the same instruction. All data in and out of the arithmetic element flowed through an exchange element where data could be shuffled among the four 9-bit registers. The configuration was specified by five instruction bits that accessed a set of 32 9-bit registers, 28 fixed, and 4 settable; later the configuration registers were implemented in a small read-write magnetic-film memory.

All I/O processing was handled by the central computer through a multiple-program sequence technique. There were 32 sequences, each of which had its own program counter, organized by priority. Three were assigned to main programs and the others to alarm conditions and I/O devices. Each instruction had control over whether it would allow switching to another sequence at its completion. Therefore, each I/O device could be controlled with the full power of the computer, even though several slow devices could be operating at the same time. Multisequence architecture was more efficient for programmed I/O than the widely used interrupt-vector approach. Direct-memory-access hardware was added to the TX-2 later. Almost twenty years later, Xerox's Alto computer used a similar multiple-sequence technique.

New I/O devices were relatively easy to interface to TX-2 and many were connected, including standard tape drives, a very large magnetic drum, a Stromberg-Carlson Charactron-driven xerographic-process printer, an *x-y* plotter, light pens, several different tablets, a three-dimensional wand input device, two keyboard workstations, and several different display devices. There was a plan for building a tape library system for TX-2 with 100 transports with a total capacity of 1010 bits and an access time of 30 sec. Although only one such transport was ever built, the scheme illustrates the innovative thinking that characterized the engineering of TX-2.

**Figure 28-1**

The TX-2 computer was often used in a time-sharing mode. Carma Forgie is working at a dual-storage scope station with a custom color-coded keyboard; Alan Nemeth is using a graphics display. On the left is a small part of the logic frame.



**Figure 28-2**

Don Ellis removes one bit plane from the 64k-word memory that was used first with TX-0 and later with TX-2. Each bit plane was a  $256 \times 256$  array of ferrite cores.



**Figure 28-3**

**Ivan Sutherland using the Sketchpad graphics program at the TX-2 console. On the display is part of a bridge, with numbers calculated by Sketchpad that show the forces in the structural members.**



**Note**

5 I.E. Sutherland, "Sketchpad: A Man-Machine Graphical Communication System," *Proc. 1963 Spring Joint Computer Conf.*, 329 (1963).

Address transformation hardware to provide both segmentation and paging was added when operation moved to a time-sharing mode. In 1966, the tube-driven 64k-word memory was replaced by commercial core memories; both magnetic-film and semiconductor memories were added later. By the end of the program, TX-2 had evolved to about the size and power of the DEC PDP-10. The TX-2 computer was retired in 1975.

**Hands-On Computing and Interactive Graphics**

Batch operations were standard for most computers of the 1960s, but TX-2 was designed for hands-on use from its inception. The accessibility and convenience of interactive computing eventually made the batch mode obsolete, and TX-2 had a major impact on the rapid acceptance of interactive operation. Two sponsored programs, one from the Air Force and the other from the Advanced Research Projects Agency (ARPA), facilitated the development and rapid evolution of the tools of hands-on operation.

The Air Force asked Lincoln Laboratory to develop software that enabled hands-on use of the computer for performing a variety of frequently required computations without the need to master the details of a programming language. This effort produced a time-sharing system for TX-2 called APEX that supported multiple concurrent users. It also led to the development of a software system called Reckoner that operated in a coherent environment so the output of one program could serve as the input to another program. Files of data used by Reckoner had descriptors, allowing the programs to interpret input data appropriately.

In the early 1960s, Ivan Sutherland developed the Sketchpad system,<sup>5</sup> often called the first interactive graphics program (Figure 28-3). Although the Sketchpad user could create drawings on a display with a light pen, the emphasis was not so much on drawing as on serving as a tool for education and design. Sketchpad included a subpicture capability for including arbitrary symbols on a drawing, a constraint capability for relating the parts of a drawing in any computable way, and a definition-copying capability for building complex relationships from combinations of simple constraints. The topology of a drawing was described in a ring structure that permitted rearrangement of the data-storage structure during editing of pictures with a minimum of file searching and rapid constraint satisfaction and display file generation. Example applications included moving mechanical linkages, loaded truss bridges with display of computed forces, and various artistic pictures.

1950



Memory Test Computer



TX-0 computer with TX-2 in background



In this same time period, Lawrence Roberts used TX-2 in his research on machine perception of three-dimensional solids and introduced the use of homogeneous matrix representations and manipulation to computer graphics, a technique now universally employed.

The second sponsored effort, the ARPA Graphics program, was aimed at enhancing the state of the art of interactive graphics in a time-sharing environment. This program was started in 1965 to support the development of successively more sophisticated display hardware, the enhancement of APEX to provide operating-system support for display outputs, the demonstration of a variety of input devices, and the creation of new languages to facilitate the writing of application programs that could take advantage of the interactive graphics capabilities.

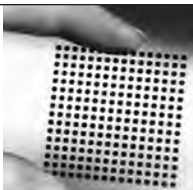
Hardware development for the ARPA program took display generators from early point-by-point capabilities through straight-line vectors to conic sections. Because the desire was to time-share a single generator among a number of displays while maintaining an acceptable flicker rate, speed was a major objective. It became clear that this objective could not be achieved with the available technology, so storage scopes were added to the system to handle applications such as text editing that did not require the full performance of the refreshed displays.

Much attention was given to the input side of interactive graphics. Light pens were used, and some work was done with an ultrasonic acoustic wand as a three-dimensional input device, but the principal graphics input device under study was the tablet. Both commercial tablets and Laboratory-built units were connected to TX-2.

One useful capability based on the tablet was a simple and very fast stroke-following character recognizer that operated as part of APEX. It allowed the user with a simple hand motion to point to an object on the screen and specify an operation to be performed on that object. A trainer program was provided so that the user could customize the alphabet of characters. Modern technology uses the mouse and its buttons for this function, but the tablet and recognizer provided a wider range of choices for the action to be taken with respect to an object selected by pointing.

The ARPA program supported the development of a compiler-compiler called VITAL that was used to create a number of other languages. The most widely used language was one known as LEAP, a high-level language based on ALGOL that also had associative data structuring operations, reserved procedure forms for display, and input manipulation and real-time variables. A RECOGNIZE statement was available to retrieve a character from the tablet recognizer. LEAP was used to create a number of application programs, including the Mask Maker.

The Mask Maker program was written in the late 1960s to perform computer-assisted layout of photomasks for the fabrication of integrated circuits. In this program, the user could call up predefined components from a library or define new components from smaller parts, instead of working with individual rectangles on the different layers of the integrated circuit. A unique aspect of Mask Maker was its user input of commands through characters drawn on the tablet. The program was used to lay out a number of integrated circuits that were fabricated both at Lincoln Laboratory and



Magnetic thin-film array



J.M. Frankovich and  
O.C. Wheeler with  
TX-2 computer

---

## Notes

**6** Wesley Clark gave a history of the development of LINC, with additional notes on the TX-0, TX-2, and ARC, in his article, "The LINC was Early and Small," in A. Goldberg, ed., *A History of Personal Workstations*. New York: ACM Press, 1988, p. 347.

**7** I.S. Reed, "Symbolic Design of Digital Computers," *Lincoln Laboratory Technical Memorandum No. 23*. Lexington, Mass.: MIT Lincoln Laboratory, 19 January 1953.

**8** J.I. Raffel, "Operating Characteristics of a Thin Film Memory," *J. Appl. Phys.* **30**(4), 60S-61S (1959).

by a subcontractor. The designers of Mask Maker — Harry Lee, Gary Hornbuckle, Richard Spann, and Fontaine Richardson — left Lincoln Laboratory to found Applicon, an early and highly successful manufacturer of computer-aided-design equipment.

Between the late 1950s and the early 1970s, TX-2 was used in a wide range of applications. The computer processed image and audio data (including Caruso recordings), simulated neuronlike nets, and evaluated graphical design in mechanical engineering. Professor Amar Bose of MIT, who later founded Bose Corporation, used TX-2 to process data taken in a sound chamber and to develop a novel type of loudspeaker. The TX-2 was used in early experiments on packet switching between computers and was an early host on the ARPAnet. Other applications that made use of TX-2 included simulations of air traffic control problems at dual-runway airports, analysis of speech processing techniques, and modeling of logic circuits.

### ARC and LINC

Wesley Clark was a user of Whirlwind and the Memory Test Computer and one of the principal architects of TX-0 and TX-2.<sup>6</sup> As a proponent of the idea that computers are tools and that convenience of use is the most important single design factor, he believed that computers should be affordable and compact. Whirlwind, of course, was neither. Clark's Laboratory Instrument Computer (LINC) was both; in fact, it prefigured the workstation computer revolution of the 1980s.

Working with Belmont Farley, also a Laboratory staff member, Clark began a collaboration on the use of computers in biomedical research with the MIT Communications Biophysics Laboratory. The Average Response Computer (ARC), built in 1958, was an 18-bit machine with TX-2 circuit modules and a 256-word memory. It had an analog-to-digital converter (ADC) so that computations could be performed in real time on analog signals. The ARC was hardwired to perform in any of three modes: response averaging, amplitude histogram compilation, and compilation of time histograms of single-neuron activity. The success of ARC and the conviction that a programmable machine would be even more useful led to the design of LINC.

Since LINC was to be an affordable laboratory tool, a driving force in its design was a \$25,000 cost goal. (The team came close to its goal; the first machines actually cost \$32,000.) LINC was a 12-bit parallel machine with a 1k-word memory, an ADC, and a small CRT display made from a modified laboratory oscilloscope. It had two block-addressable tape drives that were miniature versions of the experimental tape drive that had been built for TX-2. The tape reels were small enough to put in a pocket. The logic sections were built with DEC logic modules; the computer filled one relay rack plus a separate console box and was quite easily moved. The LINC architecture was simulated on TX-2 and the first assemblers were also written on TX-2.

The first machine was demonstrated at the National Academy of Sciences Conference on Engineering and the Life Sciences in Washington in April 1962. After the conference, LINC was moved to a National Institutes of Health laboratory, where its analog-to-digital (A/D) input channel was connected to a multiple-electrode array implanted in the brain of a cat; the average responses were computed and displayed.

In January 1963, the LINC effort moved from Lincoln Laboratory to a new center at MIT and then in 1964 to Washington University in St. Louis. Twenty LINCs were built for biomedical researchers in 1963, and more than 1200 LINC or LINC variants were manufactured commercially. DEC sold about 150 copies of the LINC-8, a combination of the LINC and the PDP-8, and about 1000 PDP-12s, which incorporated a modified LINC design. A small startup company called Spear subsequently produced an integrated-circuit version of the LINC, called the micro-LINC.

### CG-24 Computer

The CG-24 computer was being built in the Laboratory's Data Processing Group (Group 24; the name, CG-24, stands for Computer Group 24) at the same time that the Advanced Development Group was building TX-2. The CG-24 was a 25-bit parallel machine with an 8k-word core memory driven by transistor circuits (Figure 28-4). It was the first all-transistor machine; TX-0 and TX-2 had vacuum-tube-driven memories.

**Figure 28-4**  
**CG-24, the first all-transistor computer.**



The transistor and diode circuitry was capable of operation at clock rates up to about 0.5 MHz, and the computer operated with a 0.33 MHz clock. Considerable parallelism was employed to improve the computation rate. The addition time was 24  $\mu$ sec and multiplication time was 84  $\mu$ sec, both including the access time of the 12  $\mu$ sec cycle time memory. Its I/O included three input registers for transfer of real-time data, a Flexowriter, and two CRTs for display of alphanumeric data. The CG-24 was packaged quite compactly in a three-quarter circle arrangement of low cabinets.

Perhaps the greatest innovation in the design of the CG-24 was Irving Reed's development of a register-transfer language, which enabled the designers to simulate the logic design of CG-24 before the machine was built; this technique achieved wide acceptance within the computer industry.<sup>7</sup> The register-transfer description of the machine was simulated on TX-0, and a CG-24 program was executed by the simulation. The control element was implemented as a read-only diode memory, but the concept of a read-write control memory was recognized and described.

The CG-24 computer was built in 1956 and 1957 and moved to Millstone in 1958. The Millstone staff used the machine to process radar data in real time until it was replaced by a commercial computer in 1966.

### **Magnetic-Film Memory**

Lincoln Laboratory mounted a large effort in the 1950s in the development of methods of ferrite-materials preparation with the objective of building smaller and faster memory systems. Engineering efforts were made to reduce the cost of testing and construction, and the results of all these development activities had a major influence in the industry. Magnetic-core memory had become a very big business; by 1970, IBM was producing more than twenty billion each year. However, as transistor circuitry and higher levels of integration permitted the construction of faster and cheaper computers, two drawbacks of ferrite-core memories became apparent: switching speeds were too slow and the production costs of threading three wires through each core were too high.

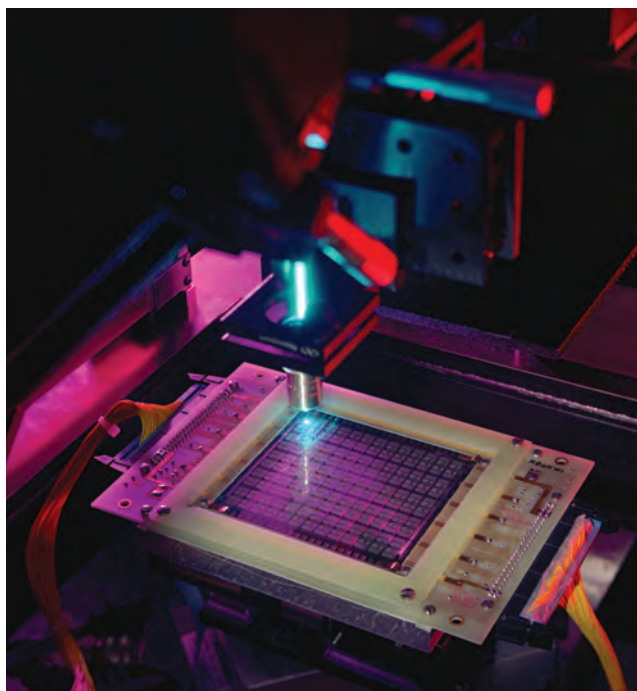
John Goodenough led an extensive program in the physics of magnetic materials, and under Donald Smith's leadership, this activity was extended to magnetic thin films in 1956. Magnetic films have much shorter switching times than do ferrite cores and are suitable for batch fabrication. For a while, it seemed that magnetic films might replace ferrite cores, and a film memory project was started.

In 1959, a 32-word  $\times$  10-bit film memory was installed in TX-2 to store configuration control words.<sup>8</sup> It used two  $16 \times 16$  arrays of magnetic film spots and had a cycle time of 0.8  $\mu$ sec. A small 50-megapulse computer, the FX-1, was constructed with transistor circuitry to conduct a realistic exercise of film memory with a 0.3  $\mu$ sec cycle time. A film memory was also installed in TX-2 as a Page Address Memory, and in 1968, a million-bit film memory was installed as part of the main memory.

For the million-bit memory, magnetic film and copper were evaporated onto  $10 \times 1.6$ -inch glass substrates and then etched into continuous word lines in the long dimension. Digital lines were formed as long copper lines on flexible substrates that were pressed onto the glass pieces. A storage element was formed at the intersection of a word line and two digit lines. Each substrate had 100,000 bits, and spare word lines were wired in to replace lines with defective bits. The memory had the unusual feature of reading or writing 352 bits per cycle; this, potentially, gave a very high data rate, though TX-2



**Figure 28-5**  
**Computer-controlled laser in the process of manufacturing a wafer-scale adaptive-nulling system using restructurable VLSI.**



#### Notes

**9** C.T. Kirk, Jr., "A Theory of Transistor Cutoff Frequency (f<sub>T</sub>) Falloff at High Current Densities," *IRE Trans. Electron Devices* **9(2)**, 164–174 (1962).

**10** A.H. Anderson, J.I. Raffel, and P.W. Wyatt, "Wafer-Scale Integration Using Restructurable VLSI," *Computer* **25(4)**, 41–47 (1992).

could not take advantage of it. The memory was bench tested at a 1.2  $\mu\text{sec}$  cycle time, but it was limited to a slower speed by the computer. A cross section of a tenfold larger memory was built, but, by that time, advances in integrated-circuit memory devices had outstripped all other technologies for computer storage in speed, packing density, and cost.

#### Integrated Circuits and Wafer-Scale Integration

In cooperation with the research division of Philco, a program in the design and characterization of switching transistors was pursued in parallel with the design of transistor circuits for TX-0 and TX-2. In 1962, Charles Kirk, Jr., published a paper that explained why high collector current limited the frequency response of bipolar transistors.<sup>9</sup> This mechanism, the spreading of the base layer into the collector region at high current density, was thereafter known as the "Kirk effect."

Fabrication of digital integrated circuits at Lincoln Laboratory began in 1970 with equipment that had been used in the magnetic-film program. Over succeeding years, research was conducted in materials, circuits, systems, and design methods in support of general research and specific projects.

In the mid-1970s, a monolithic circuit to perform 3-bit A/D conversion was built. It comprised an array of eight comparators with a bias network and output encoders. Eight of the devices were used to build an experimental 6-bit ADC with a sampling rate of  $200 \times 106$  samples per second. A version of this circuit was also built by Westinghouse.

The ultrahigh-density memory project attempted to make a semiconductor memory that was comparable in cost to such bulk memories as magnetic disk, yet provided higher speed and reliability. The storage element was made as simple as possible; it was a capacitor formed by the crossing of a metal line over a silicon line with a silicon-nitride/silicon-dioxide sandwich as an insulator to achieve the highest bit density. Information was stored in the metal-nitride-oxide semiconductor (MNOS) device by storing a charge in the nitride and was maintained even without an applied voltage.

A 64k-bit chip with partial on-chip decoding and off-chip sensing was built; writing and reading in several microseconds was demonstrated. A megabit chip was designed but not built because ultimate density was more likely to be limited by material properties than by lithography.

The Lincoln Laboratory project in restructurable VLSI, headed by Jack Raffel, took circuit integration to the wafer level through the use of defect avoidance and customization. In this scheme, wafers were fabricated with arrays of circuits and uncommitted wiring. After testing of the circuits, interconnections were modified or restructured to connect only the good circuits into the system. It was proposed initially to use MNOS transistors for the restructuring, but laser restructuring proved to be the more area-efficient method.

Restructurable VLSI technology was demonstrated by the construction of nine different wafer-scale systems (Figure 28-5).<sup>10</sup> The most ambitious system was the Matrix Update Systolic Experiment (MUSE), built in 1991. It was an array of 32 processors on one wafer, and it performed real-time adaptive antenna nulling computations with 64 degrees of freedom. The device executed about 1.4 billion real operations per second.

The technology and computer-aided-design programs were transferred to the National Security Agency and the University of South Florida. Restructurable VLSI technology was also used to build a 4000-gate logic array that was customizable after fabrication for use in rapid application-specific integrated-circuit prototype development.

### Digital Signal Processing

Analog processing of a waveform can be simulated by using a computer to process the digital sequence that represents the waveform; this procedure is called digital signal processing. Many of the key advances in the development of digital signal processing began at Lincoln Laboratory, and staff members played an important role in spreading the basic concepts throughout the technical community.

The vocoder (voice coder) research in the Laboratory's Speech Systems Technology Group, for example, took sampled-data signal representations of speech and developed algorithms to determine voiced pitch, and then used the resulting pitch to excite an experimental vocoder. The bulk of the vocoder hardware was in the narrowband bandpass and low-pass filters, so digital signal processing offered the potential of producing a more effective vocoder design by simulating the filters. In 1960, however, digital filtering involved discrete convolution of a filter's sampled input with its sampled impulse response and required hundreds of multiplications and additions to simulate just one filter accurately.

In 1962, Charles Rader and Bernard Gold came up with the idea of using recursive digital filters, and they increased the speed of computation of filter outputs by two orders of magnitude. This result led them to develop many techniques for the design of recursive digital filters with prescribed frequency responses and to analyze the effects of finite word-length arithmetic for digital filters.

Even the recursive filter designs of that era required about ten seconds of computer time to simulate vocoder processing of one second of speech. During the 1960s, however, circuit speeds increased and circuit costs decreased, so real-time digital simulation became possible. In fact, the digital signal processing implementation was simply an alternative realization of the system, and mathematical simulations of vocoder designs eventually replaced the analog hardware.

### From Radar to Rachmaninoff

A solution developed in the 1950s for correcting errors that crept into radar data transmitted over noisy communications links eventually enabled the production of music CDs whose digitally recorded sound would be unaffected by scratches on the disk's surface. How did early radar requirements make possible the digital age of music? Here's the story.

Lincoln Laboratory's first initiative, the Semi-Automatic Ground Environment (SAGE) air defense system, required reliable transmission of digital data among radars, command centers, and interceptors. This system would work only if the data could be made reliable; errors in transmission had to be found and fixed. Claude Shannon at Bell Laboratories had proved in 1947 that near-perfect error correction techniques were possible, but his proof did not show how to make them practical. Shannon's work led to research at Lincoln Laboratory (and elsewhere) to find a better, more efficient way to remove errors than to just send the message multiple times and "take a vote." It was known that error-correction codes should incorporate in the digital message additional "redundancy" bits that are derived from the data bits by some particular formula. But what formula? And how to invert it at the receiver to correct the errors? The few codes known then worked only on binary digits (0 and 1) and were very limited in error-correction performance.

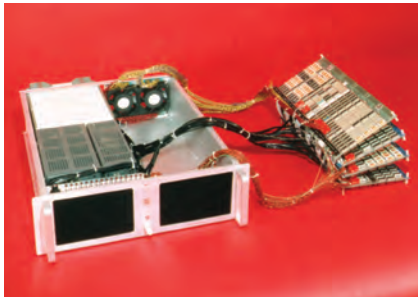
Fortunately, two researchers at the Laboratory worked on this problem for SAGE: Irving Reed and Gustave Solomon. Together, in 1960, they published a breakthrough method for constructing a class of efficient, capable, error-detection and correction codes, now known as the Reed-Solomon codes. Their new idea was to construct a code based not on individual binary data bits, but rather on groups of  $N$  bits. ( $N = 8$  is very common since it is one byte of data.) In groups of 8 bits, there are 256 possible combinations; these are the 256 symbols in the "alphabet" used in

modern finite-field linear algebra to define encoding and decoding rules and to calculate error-correction performance. According to Reed and Solomon's formula, the number of symbol errors that can be found and corrected is equal to half the number of redundancy symbols that have been added to the data symbols. If one symbol represents  $N$  adjacent data bits, it is easy to see that the code is capable of fixing multiple erroneous bits in a symbol by processing these bits as a single symbol error. The code is thus exceptionally well suited to correcting bit errors that occur in bursts.

The decoding algorithm described by Reed and Solomon was computationally challenging at a time when computers were in their infancy. It was not until the late 1960s that new, simpler decoding algorithms were found, allowing tens of symbol errors to be corrected in one code word. These algorithms, running on modern very-large-scale integrated processing chips, now allow Reed-Solomon decoding at 100s of megabits per second.

The Reed-Solomon codes are so powerful and flexible that they have been applied to many purposes beyond the original one at Lincoln Laboratory. The codes have been used by the National Aeronautics and Space Administration on deep-space probes and on the Hubble telescope. They have been combined (concatenated) with other codes (e.g., convolutional codes) for better performance. They are embedded in several standards for transmission of data over radio and fiber links. And, the Reed-Solomon codes are ideally suited to correcting errors such as the bursts of bits in error caused by a simple scratch on a CD.

Reed and Solomon received the 1995 IEEE Masaru Ibuka Consumer Electronics Award "for contributions to basic error-correcting codes, specifically the Reed-Solomon Codes, which led to the compaction of data and made possible a generation of consumer compact optical disk products."



**Figure 28-6**  
**Development of Lincoln Laboratory's**  
**programmable signal processors.**  
**Top: The Fast Digital Processor, 1968.**  
**Middle: The Lincoln Digital Voice**  
**Terminal, 1974. Bottom: The Lincoln**  
**Digital Signal Processor, 1977.**

Computers were also being used for spectrum analysis of speech signals, but the computations ran slowly until 1965, when two mathematicians, James Cooley of IBM and John Tukey of Princeton University, developed an algorithm for the fast Fourier transform (FFT). Rader, Norman Brenner, and Thomas Stockham took the concept of the FFT, improved the algorithm, implemented it on a computer, and used it to accelerate vastly the computation of correlations and convolutions.

With the availability of the FFT technique, digital signal processing was ready to make the transition to a practical technology. Numerous tutorial publications by Lincoln Laboratory authors introduced digital signal processing to the electrical engineering community.<sup>11</sup>

The FFT was of major importance, but its use was initially limited to computing discrete Fourier transforms for the relatively few data sequence lengths that were highly composite numbers and preferably powers of two. Then, in 1968, Lincoln Laboratory developed the chirp z-transform algorithm, which allowed the FFT to be applied to sequences of any length. At the same time, a second scheme, employing permutations based on number theoretic principles, allowed the FFT to be used on sequence lengths that were prime numbers. In addition, an analogy to the FFT algorithm called the Fermat number transform was developed to compute convolutions and correlations without any errors from numerical round-off. Research at the Laboratory also developed fundamental analyses of the performance limitations resulting from finite word-length computations in digital filtering and the FFT.<sup>12</sup>

The requirement for high-speed computation led to the development of specialized parallel computing systems that were optimized for digital signal processing. The Fast Digital Processor (FDP), completed in 1970, carried out signal processing tasks about a hundred times faster than the general-purpose computers of that time.<sup>13</sup> Approximately a tenfold increase in computing speed came from using the fastest available circuits; another tenfold speedup came from the FDP architecture. The FDP could simultaneously perform four instructions and compute the addresses of data to be used in subsequent instructions.

Subsequent processors built on the ideas about specialized hardware that came out of the FDP effort (Figure 28-6). The Lincoln Digital Voice Terminal, for example, was a flexible signal processor that was programmed to realize any of a wide variety of speech compression systems in real time; modern integrated-circuit digital signal processor designs are architectural descendants of this system.<sup>14</sup>

The Laboratory made use of digital signal processing techniques in a number of applications besides speech processing, most notably in radar. The high bandwidths common in radar introduced some challenging requirements; huge rates of arithmetic operations per second were necessary for real-time processing.

The pipelined FFT, a highly parallel organization of processing elements for FFT computation, was developed at several laboratories during the early 1970s. Lincoln Laboratory researchers then generalized the pipeline concept to apply to the most efficient FFT algorithms of the era. A high-speed FFT pipelined processor built in the late 1970s for radar applications was able to compute a 16,384-point transform of complex data every 136  $\mu$ sec.

Lincoln Laboratory had been developing a large radar digital signal processor, known as the Advanced Digital Signal Processor (ADSP), that was intended to be integrated with the System Technology Radar, a phased-array radar located on Meck Island in the Kwajalein Atoll. The installation of the ADSP was cancelled when the System Technology Radar operation was discontinued in late 1980. Work to evaluate the technology continued and a major ADSP subsystem, the Digital Convolver System, was tested at the Laboratory. The Digital Convolver System used approximately 27,000 integrated emitter-coupled logic 10K series circuits with a large multiplexed metal-oxide semiconductor memory to achieve a high throughput data rate for the FFT.

In many ways, radar is the perfect application area for digital signal processing, and Lincoln Laboratory has been preeminent in both proving and applying this technology to radar. In a periodically pulsed radar, the gated returns from each range (after digitally filtering for pulse compression) comprise sampled signals that can be digitally processed to extract information about the objects under study. This analysis can be carried out in



## Notes

**11** See, for example, B. Gold and C.M. Rader, *Digital Processing of Signals*. New York: McGraw-Hill, 1969.

**12** C.J. Weinstein, "Quantization Effects in Digital Filters," *Lincoln Laboratory Technical Report No. 468*. Lexington, Mass.: MIT Lincoln Laboratory, 1969.

**13** B. Gold, I.L. Lebow, P.G. McHugh, and C.M. Rader, "The FDP, a Fast Programmable Signal Processor," *IEEE Trans. Comput.* **C-20(1)**, 33–38 (1971).

**14** P.E. Blankenship, "LDVT: High Performance Minicomputer for Real-Time Speech Processing," *EASCON '75 Record*. IEEE Publication 75CH0998-5 ECON. New York: IEEE, 1975, p. 214-A.

**15** C.M. Rader, "Wafer-Scale Integration of a Large Systolic Array for Adaptive Nulling," *Lin. Lab. J.* **4(1)**, 3–30 (1991).

many creative ways. First, clutter can be eliminated by digital filtering, leaving only the reflections of moving targets. Second, a Fourier analysis can give the distribution of velocities of scatterers at any range. Finally, the radar returns from objects with known rotational motion can be analyzed in both range and Doppler to give two-dimensional images because the cross-range displacement of a scatterer is proportional to its Doppler frequency. Alternatively, the known motion of a radar can be used to produce a synthetic aperture, enabling all-weather mapping of any area with high resolution.

Digital signal processing is finding a new application in phased-array radar. The antenna pattern of a phased-array radar can be redirected in microseconds, giving this type of radar a significant advantage over mechanically steered conventional antennas. Analysis of data from a phased array, however, requires the ability to weight and sum the received signals, a process that could not be done digitally at the necessary data rates until recently. Digital phased-array radars, such as the Radar Surveillance Technology Experimental Radar (RSTER), have now been demonstrated successfully, and many more are proposed.

Sometimes the optimum signal processing for a given signal is not known when the system is designed or programmed. Adaptive systems solve this problem by using statistical properties of a signal to create a digital filter. A dramatic example of such an adaptive system was Lincoln Laboratory's multiple-antenna surveillance radar, which used an adaptive spatial-temporal digital filter to suppress clutter with the same Doppler frequency as the target under study.

The MUSE system,<sup>15</sup> completed in 1991, can compute optimum adapted weights for a 64-antenna phased array in the presence of as many as 63 jamming sources impinging on the antenna sidelobes. The entire MUSE design was realized as a single wafer-scale integrated circuit.

Digital signal processing is now well established as an important tool for electrical engineering. Hundreds of companies manufacture products that make use of the techniques of digital signal processing. Within Lincoln Laboratory, the concepts of digital signal processing continue to be refined and to be incorporated in a wide range of applications.

## The Synchronous Processor for Signal Processing

At the same time that the MUSE system was being developed, Ira Gilbert and his team were in the midst of creating the Synchronous Processor (SP). Built entirely of readily available, off-the-shelf components, the first SP computer achieved a throughput of nearly 400 million instructions per second (MIPS). The SP2, a later version of the processor, delivered 760 MIPS. The SP is a parallel-architecture computer designed to make extensive use of concurrency in control, computation, internal communication, and input/output. It had its own special programming language, called SPL, that provided the programmer with effective support for the concurrent operation of the processor. The language also enhanced processing efficiency by giving the programmer control of individual hardware registers. The SPL extended the FORTRAN programming language while providing intimate register control similar to what is available in assembler languages. A feature that is particularly important for signal processing applications is the language's capability of treating data arrays as objects, thus eliminating the need to keep track of the physical addresses of the data in the arrays.

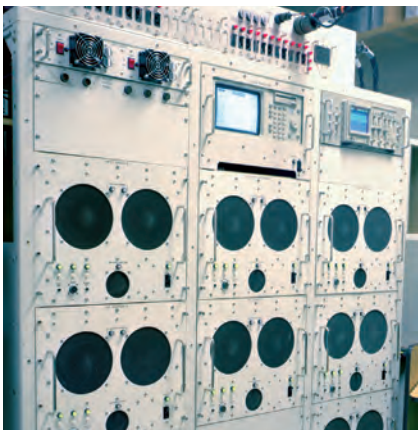
The SP was designed to handle high-throughput signal and image processing applications. The design team chose to use a single-instruction, multiple-data-stream (SIMD) processor architecture, which is especially well suited for regular and predictable computations. A SIMD computer consists of an array of identical processing elements that operate in lockstep under the control of one master processor. The slave processing elements synchronously execute the instruction stream broadcast to them by the master.

## High-Performance Embedded Computing for Adaptive Radars

The rapidly increasing performance of digital processor semiconductor technologies enabled Lincoln Laboratory to pioneer a new generation of phased-array radar systems that employed powerful adaptive beamforming techniques. To make these systems possible, the Laboratory needed to develop high-performance digital computers that exploited Moore's Law to the fullest extent. Two systems in particular emerged in the early 1990s to serve as advanced processing architectures that would become models for the U.S. radar communities



**Figure 28-7**  
RSTER processor.



**Figure 28-8**  
APT.

for years to come: the RSTER adaptive processor (Figure 28-7) and the space-time adaptive processing (STAP) Adaptive Processing Testbed (APT). The technology approaches of these two processors were later combined and extended in the late 1990s to produce the nation's most capable programmable airborne processor for STAP computers, the Reconfigurable Adaptive Processing Testbed for Onboard Radars (RAPTOR).

In the 1980s, the RSTER program (see chapter 29, “Adaptive Sensor Array Processing”) was initiated to address the threat of missiles that could rapidly descend on a naval vessel with little warning because a standoff jammer near the horizon could jam the sidelobes of its radar. RSTER was one of the very earliest examples of an adaptive beamforming radar, and its success depended on several novel computation techniques and technologies developed at Lincoln Laboratory. Later, RSTER became known as the Mountaintop System and was used in numerous Navy experiments requiring adaptive beamforming and low-sidelobe antenna performance. The system served as a prototype for Navy adaptive radars.

The RSTER processor introduced several innovations in radar processor technology, e.g., digital I/Q sampling of each antenna channel received signal. By resolving the signal directly into in-phase (I) and quadrature (Q) components in the digital domain, highly accurate measurements of phase and precise control over signal filtering could be accomplished. Digital filtering required,

for each channel, processing-element (PE) boards performing 100s of millions of operations per second. Today, digital I/Q sampling is common in radar systems, but in the 1980s this represented a significant improvement. The PEs were followed in the processing chain by the world's first fully programmable radar adaptive systolic beamformer that computed adaptive weights and applied them in real time to the incoming data streams.

The rest of the RSTER processor comprised ten single-board computers that combined to perform real-time detection, target position and velocity estimation, scan-to-scan tracking, and display processing. The modular design of the system allowed it to be upgraded several times, and its programmability allowed it to be adapted for new missions as the radar was deployed and reconfigured numerous times over the next fifteen years.

The RSTER processor was not the only high-performance embedded computing (HPEC) system to emerge from Lincoln Laboratory in the late 1980s. In fact, it was not even the most capable. A few buildings away, another radar processor, APT, was also being developed to implement a similarly sophisticated suite of radar signal processing algorithms (Figure 28-8). The APT processor, designed for airborne surveillance radars, was an enormously powerful system, capable of over 22 billion operations per second (GOPs).

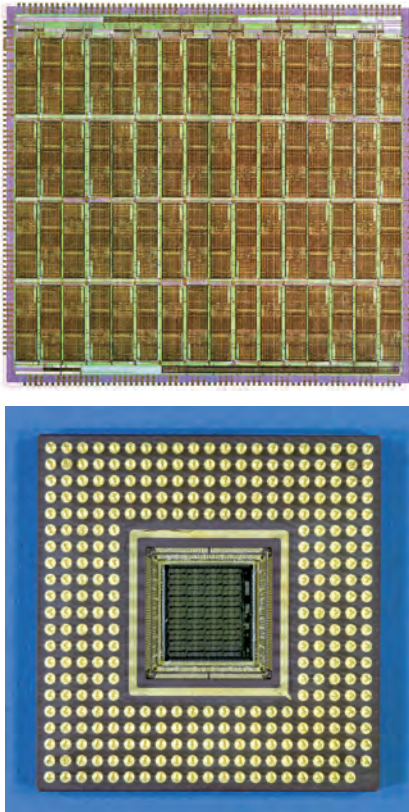
1960



J.E. Laynor with FX-1



W.A. Clark, Jr., with LINC computer



**Figure 28-9**  
**RAPTOR chip technology.**  
**Top: Die level. Bottom: Ball-grid package.**

While RSTER performed adaptive beamforming by spatially steering nulls toward adaptively detected sources of interference, APT was one of the world's first processors to demonstrate beamforming that used STAP. Airborne military radars not only had to contend with jamming sources; ground clutter was also a major concern since small targets can be masked by antenna sidelobe clutter returns. STAP was invented to deal with this problem. By adaptively sensing not only the spatial distribution of energy but also the temporal distribution, a two-dimensional adaptive filter can be designed that nulls both the sidelobe clutter and jamming energy while preserving a high-gain in the direction and at the relative velocity where the target can be found. Usually STAP requires more processing than spatial adaptive processing. APT had two adaptive stages: the first stage performed spatial adaptation (similar to the processing done in the RSTER) to remove jammer energy, and the second stage used space-time adaptation to mitigate unwanted clutter. The design and development of the APT was a prodigious achievement; the processor used over 25,000 LSI and VLSI integrated circuits.

#### **RAPTOR and the Rise of Commercial Off-the-Shelf Technology**

The successes of the APT and RSTER processors led to an even more ambitious undertaking: RAPTOR. While the APT and RSTER processors had been uniquely Lincoln Laboratory endeavors, the Laboratory teamed with industry partners Mercury Computer Systems and Northrop Grumman Corporation to develop

RAPTOR. The goal of RAPTOR was to demonstrate new levels of STAP for airborne systems. RAPTOR ended up being one of the nation's largest and most capable real-time radar processors. The algorithms researched and prototyped using RAPTOR fueled the introduction of STAP into modern radars, and RAPTOR itself served as a blueprint for modern STAP real-time computing architectures.

RAPTOR consisted of a special-purpose front-end digital signal processor and a back-end programmable signal processor that together delivered 200 GOPS of processing power in a rugged, airborne form factor. The front-end digital processor accepted data right after they were converted to digital format. The hardware was built to be modular and could scale to support 96 ultrahigh-frequency (UHF) radar receiver channels. The half-scale, 48-channel system that was prototyped had an aggregate throughput of 120 GOPS. To achieve this enormous throughput, the Laboratory designed a custom filtering chip called the A1000 to provide the principal computation capability because the technical risk in applying commercial technology was quite significant (Figure 28-9).

To design and develop the programmable processor, the Laboratory first initiated a nationwide study to assess the feasibility of the project. Phase 1 of the study showed that the current commercial off-the-shelf (COTS) technologies could handle the most stressing computations needed to do STAP in real time; phase 2

1965



B. Gold



C.M. Rader



RSTER as originally deployed at Lincoln Laboratory

1980





**Figure 28-10**  
**RAPTOR four-chassis signal processor.**

produced several viable designs. It appeared that a system with the required size, weight, and power was, indeed, feasible using commercial technologies.

Northrop Grumman Corporation, teamed with Mercury Computer Systems, provided a processor that was remarkable in several respects. It consisted of 948 SHARC digital signal processors and 24 PowerPCs. (The SHARC was an advanced processor whose initial architecture had been created by the Laboratory's Ira Gilbert and transitioned to Analog Devices for commercialization.) These SHARC processors provided the compute power needed to handle the 48 channels of input from the RAPTOR front end. The power-efficient PowerPCs were responsible for coordinating the actions of the processor. At the software level, a new operating system was created that spanned the entire ensemble of processors and treated them as a single, large, parallel processor. The result was the largest and most capable programmable embedded signal processor in the nation.

Lincoln Laboratory's job was to program this processor with a set of configurable radar STAP modes, integrate it with the front-end hardware, and demonstrate the potential of STAP and STAP processors. This was a daunting task. The RSTER and APT processors were a fraction of the size and complexity of the RAPTOR programmable signal processor (PSP) (Figure 28-10). At the same time that RSTER and APT were being developed, industry was introducing parallel processors with thousands of nodes that were programmed as SIMD computers. The RAPTOR processor, however, was a multiple-program, multiple-data parallel processor. Each computer node had its own unique program and data. The advantage of this architecture is its flexibility in handling multiple radar modes, each of which had a complex, multistage STAP algorithm. But its flexibility was also an extreme programming challenge. The software engineers had to write dozens of distinct programs that worked together in real time to explicitly control the hundreds of processors.

To handle the complexity, the development team built a middleware library that could hide some of the machine's complexity while providing the ability to map the code and data onto the processor. Thus, Lincoln Laboratory began the development of

the STAP Library (STAPL). STAPL had two main innovations that were employed and extended by later middleware systems. As with all signal processing software libraries, STAPL provided a set of commonly used signal processing functions; however, STAPL was unique for its day in that the library components could be provided with maps that specified how the data and computations were to be spread out over the processor. STAPL took care of the low-level details of hardware synchronization and data communication so that the developer could focus on the complex signal processing functionality of the radar. Scalability was the second STAPL innovation. By embedding scalability into the map, the application code could be written once; then, by simply changing the maps, the application could be scaled from an early, smaller processor to the full-scale processor.

Within about one year of the acceptance of the PSP hardware, a full set of STAP radar modes was demonstrated running in real time and integrated with the front-end processor. The various modes demonstrated the ability of STAP radars to perform moving-target detection from airborne platforms, tuned to various environmental conditions. In the end, the programmable processor delivered an impressive 27% efficiency, which was on the high end of what had been predicted by the benchmarking studies done three years earlier. The RAPTOR system pushed the state of the art in so many dimensions it would not be fair to highlight efficiency as the single most impressive achievement. The processor provided nearly 200 GOPS of throughput. It handled 48 channels of digitized UHF radar signals in real time with built-in scalability to 96 channels. The STAP application itself consisted of over 75,000 lines of code and over 100 complex parallel signal processing steps for each mode or operation. The STAPL and other libraries comprised an additional 85,000 lines of code. The front-end processor advanced VLSI circuitry for digital filtering. The back-end PSP was the largest of its kind, containing nearly 1000 individually programmable processors. The four-chassis configuration operated as a single system and was one of the first demonstrations of high-speed chassis interconnection.



**Figure 28-11**  
**32-channel UHF-band digital receiver subsystems implemented using custom VLSI circuitry.**

### From RSTER to Digital Receivers

The RSTER receiver system was state of the art for its day. It used sophisticated three-stage down-conversion analog receivers, one per channel, to convert the signals received at the antenna to intermediate frequency signals presented to the ADCs. The components had to be carefully chosen to provide the sensitivity and low noise figure required for adaptive beamforming. Although the performance specifications of the receivers were impressive, the analog hardware was bulky and expensive.

Once RSTER was deployed, a team of engineers led by William Song began to investigate how the form factor and performance of a UHF receiver could be further improved by using digital techniques. Over the next few years, in the mid 1990s, they developed the world's first fully digital UHF receiver.

By converting the received signals to the digital domain early in the receiver path, reliable and inexpensive digital circuitry can be employed. Digital hardware enables the size, weight, and power of the receivers to be dramatically improved, opening up a range of potential applications. The designs demonstrated in the early Lincoln Laboratory prototypes were transitioned to industry, and today all-digital receivers are found in many applications.

The original research of the Lincoln Laboratory team focused on digital receivers for military aircraft that used UHF radars for surveillance, such as the Navy's E2-C Hawkeye. By using digital receivers, these platforms could upgrade their radars to STAP systems with multichannel antennas. Also, it was envisioned that smaller platforms such as unmanned aerial vehicles could exploit the technology.

The basic ideas behind the digital receiver were simple, but the implementation required high-performance computing and advanced packaging. The first digital receiver directly oversampled a 4 MHz instantaneous bandwidth UHF radar signal with an 8-bit ADC at 3 billion samples per second. Once the oversampled signal was in the digital domain, the 4 MHz bandwidth of interest was digitally filtered with a band-pass filter. In this manner, the out-of-band noise spread throughout the rest of the band is removed, improving the signal-to-noise ratio (SNR) by more than 25 dB. Hence, the 8-bit

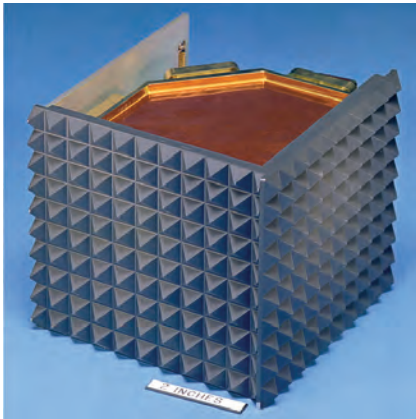
ADC, which nominally had a dynamic range of 48 dB, could actually be used to detect a signal that was 25 dB smaller, thereby supporting a receiver SNR of nearly 73 dB.

To provide the computing power needed to digitally process the signals, Lincoln Laboratory developed a new VLSI chip set. The chip set used the same systolic processing principle used by the RSTER beamformer, but applied at the transistor and bit level. By using this technique, the data could be pipelined through the chips, achieving extremely high throughput. In fact, a single chip set operated at 3 billion samples per second and executed 65 GOPS, or more than ten times the total throughput of the entire RSTER processor.

The next steps in the development were to incorporate a more capable ADC and to miniaturize the digital circuitry in an advanced packaging approach. These steps required the careful segregation and isolation of radio-frequency (RF) analog components from the digital components since the digital circuitry could easily interfere with the 450 MHz RF signal in the analog circuitry. The prototype worked perfectly, and a 32-channel packaging concept was developed that occupied less than 3 liters volume and consumed less than 300 watts (Figure 28-11). In contrast, the RSTER receiver and digital I/Q subsystems together occupied 90 liters and consumed several kilowatts of power.

### Advanced VLSI Circuits for Space-Based Radar

In the 1990s, the Defense Advanced Research Projects Agency (DARPA) began to explore the use of advanced radar processing techniques for space-based radar systems. With advances in phased-array antennas and transmit/receive modules, multifunction space radars with synthetic aperture radar (SAR) processing and surface moving target indication (SMTI) processing were becoming feasible. Such systems, deployed in sufficient numbers, could give the United States the capability to conduct around-the-clock global surveillance missions. Lincoln Laboratory became involved in early risk-mitigation developments in this area, undertaking research into the algorithms, processor architectures, and key digital technologies that would be needed for such systems.



**Figure 28-12**  
**Mock-up of a space-qualified high-performance embedded computer developed in 2002 for a space radar system.**

One of the major challenges for the space-based radar was the need for unprecedented onboard digital processing capabilities. The communication data rates that could be supported between the host satellite and the ground station dictated what processing needed to be done on board and what could be done on the ground. Various signal processing architectures were explored, leading to the conclusion that the SMTI mode dominated the onboard throughput, requiring more than one trillion operations per second for a fully capable system. Several of the SAR mode variants were not that much behind, needing about 800 GOPS.

A processor that could switch between two or more of these high-throughput modes and still deliver the needed performance required a careful co-design between the signal processing algorithms and the digital technology. The team came up with an onboard signal processing architecture that provided 1100 GOPS in a ruggedized, compact form factor. The packaged system was projected to consume about 50 W and to be less than 12 kg while occupying a mere 1/8th of a cubic foot. A mock-up of the full system in a space-qualified enclosure is shown in Figure 28-12.

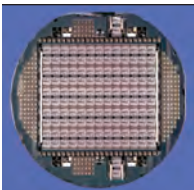
To achieve such staggering performance, the design extended the full-custom VLSI techniques that were developed for the UHF digital receiver described earlier. The bit-level systolic processing minimized long data paths, making the circuitry scalable to smaller semiconductor fabrication processes. Furthermore, the systolic designs reused a small set of highly optimized PEs that were replicated throughout the chips. Hence, the chips designs were made very efficient by dedicating

a small, expert team of VLSI designers who took great care optimizing the design of each PE. Unlike in most VLSI designs, the chips employed dynamic-logic transistors. Conventional static logic, although easier to design, uses more silicon and consumes more power than dynamic-logic circuits of equivalent function.

A significant processing challenge was supporting the 180 MHz bandwidth waveform needed to achieve the desired range resolution. Since the waveform was a significant fraction of the operational frequency band, the amount of dispersion experienced by signals arriving non-broadside would often be more than the wavelength as it traversed the antenna. The conventional way to handle dispersion was to use time-delay circuitry built into each channel. To avoid this complicated circuitry, the team came up with an approach whereby the signals from each channel were filtered into a set of subbands that together spanned the overall bandwidth of the signal. The bandwidth of each subband was set so that dispersion was minimized.

The processing architectures and technologies that Lincoln Laboratory prototyped in its risk-reduction initiatives were crucial in demonstrating the feasibility of multifunction phased-array radars for space applications. Although the form-factor challenges of space radar required VLSI solutions, the advent of highly capable field-programmable gate arrays (FPGA) and standard cell application-specific integrated circuits (ASIC) have enabled both the commercial and military industries to apply the subband filtering and systolic processing techniques pioneered by the Laboratory to many communication and signal processing applications.

1990



MUSE system array of 130 CORDIC cells on a 5-inch wafer



W.S. Song



D.R. Martinez



RAPTOR front-end signal processor chassis



### Nonlinear Signal Processing

As the sensitivity of receivers has improved, nonlinear receiver effects have become a major limiting factor in signal detection. Analog circuits and ADCs tend to exhibit nonlinear effects, so that two or more injected tones create intermodulation products (called intermods) that are sums and differences of these tones, raised to integer powers. Although the energy in these products is usually small, some of these intermods will fall into the receiver band. In fact, the nonlinear intermods can appear above the noise level, thus masking detection of very small signals of interest.

In principle, nonlinear filters such as polynomial filters can remove the nonlinear effects of the analog receivers and ADCs, essentially equalizing the channels to a reference linear transfer function. The basic idea is to characterize the receiver channel to develop a compact representation of the nonlinear response of the system. Then, the terms in the polynomial filter that do not contribute appreciably to the filter performance can be pruned from the filter, reducing its complexity. Moreover, by rearranging the order of indexing in the filters, redundant computations can be removed, further reducing computational complexity.

The nonlinear algorithmic techniques developed at Lincoln Laboratory brought real-time nonlinear signal processing within reach of custom VLSI implementation. The Laboratory applied the same bit-level systolic processing techniques it had developed for the UHF digital receiver and the space-radar signal processor to the development of a high-performance nonlinear equalization (NLEQ) chip set. The first chip developed

was capable of 500 million samples per second (MSPS). It was designed to handle the ground moving target indication (GMTI) radar bandwidths with better than 1 ft range resolution, a capability unmatched by all but the most capable deployed GMTI radars.

One of the ultimate goals of NLEQ technology is to couple it with digital receivers to enable high-dynamic-range phased-array radars. The idea of placing a digital chip behind every element in an active array with thousands of elements necessitated very-low-power electronics. The chip was designed with low-power dynamic transistor logic and consumed only 243 mW.

An even more impressive achievement was the 20 dB dynamic range that the nonlinear processing added to the system. Historically, A/D conversion technology at the high end tends to improve about 1 dB each year, so the NLEQ circuitry was equivalent to advancing the ADC state of the art by twenty years.

A second NLEQ chip surpassed the first in bandwidth while preserving equalization performance. Its specifications were intended to meet the needs of an electronic warfare system that required a chip capable of 1500 MSPS. The first set of chips was capable of 4000 MSPS. At the 1500 MSPS rate, each chip consumed only 831 mW, providing more than 1400 GOPS/W.

To ensure that the NLEQ system — which included the nonlinear filter design, the chip implementation, and the receiver channel characterization approach — was not just a point design for one ADC, a whole



K.D. Senne



Digital receiver



Aegis cruiser



R.A. Bond

## Vector, Signal, and Image Processing Library

**At the same time that the PVL was being developed, the DoD was sponsoring the standardization of a high-performance middleware for embedded processing, called the Vector, Signal, and Image Processing Library (VSIPL). VSIPL is a C-based standard targeted at radar, sonar, electro-optical, and other sensor applications. Lincoln Laboratory approached the Director of Defense Research and Engineering (DDR&E) with the idea that object-oriented techniques could be applied to VSIPL and that a DoD-wide C++ standard could be created that would greatly benefit the community. The DDR&E sponsored the creation of the High Performance Embedded Computing Software Initiative (HPEC-SI) to pursue this goal.**

**Both the Laboratory and Lockheed Martin participated in the HPEC-SI program, and the VSIPL standards group began working closely with the HPEC-SI. Through this process, the best ideas from the Lincoln Laboratory–Lockheed Martin team, as well as techniques and technologies from similar developments nationwide, were combined to create a C++ variant of VSIPL, called VSIPL++. One of the important aspects of VSIPL++ is that it is an open standard with a reference C++ implementation freely available to the DoD or any organization working on DoD programs. Commercial versions optimized for specific platforms also exist. One of VSIPL++'s unique characteristics is that it is “parallel ready” — by merely changing its maps (the same construct developed in STAPL), it can be applied to parallel embedded processors, yet it can also be used as a serial library in a more conventional programming approach. Lockheed Martin and other DoD contractors now use VSIPL and VSIPL++ in several DoD sensor applications.**

range of state-of-the-art ADCs were tested. All showed significant linear dynamic range improvements (14 dB to 21 dB). Lincoln Laboratory's work in NLEQ has already had a profound effect on system architecture design. NLEQ techniques are finding their way into many sensor receiver systems, especially those that are wideband or high dynamic range (or both). The future in this area, and in the overall area of nonlinear signal processing, promises to be one of the most important frontiers in signal processing.

### From RAPTOR to Industry-Standard Signal Processing Middleware

RAPTOR proved that large-scale processors based on commercial technology, instead of on expensive military computers, could successfully serve as high-performance radar processors. STAPL demonstrated that portable and scalable radar applications could be developed by using high-performance middleware. In 1998, around the time when RAPTOR was enjoying its first successes, the Navy's Aegis AN/SPY-1 radar system was ready to undergo a major technology upgrade. In 1999, the Navy enlisted the Laboratory to work with the Aegis prime contractor, Lockheed Martin Corporation, to transfer the lessons learned from RAPTOR to this new development.

One of the most notable achievements of this partnership was the development of new middleware for parallel embedded signal processors. The lessons learned from RAPTOR and STAPL made it clear that middleware could significantly simplify the job of programming complex signal processing applications while at the same time providing portability. STAPL had its limitations, however, since it was written in the low-level C programming language.

The Lincoln Laboratory–Lockheed Martin team carefully reviewed the STAPL implementation to see which aspects were appropriate to a C++ programming language library. The map construct used by STAPL to specify how to lay out data and computations onto the parallel computer was quickly identified as the key innovation that would be migrated to the new library. From the very outset, performance was a major concern with the use of C++. The more features packed into the library, the higher was the risk that the library would not deliver the throughput needed by the AN/SPY-1B signal processor. The team decided to create two variants of the library,

one having more features and one focused more on lower-level performance. The Laboratory undertook the higher-level middleware task, and the resultant library became known as the Parallel Vector Library (PVL). The Lockheed Martin variant shared the basic mapping capability and object-oriented interface, and was a very good match to the commercial signal processing platforms being evaluated for the AN/SPY-1 radar.

The PVL proved to be a very powerful library for rapidly prototyping sensor systems, delivering performance comparable to or better than C code. The PVL overhead compared to special-purpose, custom libraries turned out to be no more than about 5%, which was well worth the three-fold increase in productivity that accompanied the use of the library.

To evaluate PVL on Aegis signal processing, a Cray Research T3E supercomputer and a Mercury Computer Systems embedded multicomputer were procured (Figure 28-13). By using two radically different processor types, the Lincoln Laboratory–Lockheed Martin team was able to showcase the portability benefits of using middleware. The Laboratory first ported PVL to both processors and then showed that, with less than 10% code changes from the workstation version, the new AN/SPY-1B high-range-resolution mode could be hosted on each platform. Both systems achieved real-time performance and demonstrated over 50 billion floating-point operations per second of throughput on the application.

Lockheed Martin applied the lessons learned from these demonstrations to develop the Aegis BMD Signal Processor, which is scheduled to begin fleet deployment on Aegis BMD-capable cruisers and destroyers in 2011. The PVL was also used to demonstrate that the Navy Standard Missile 3 missile seeker could use commercial computer technology in a manner that would permit effective, periodic refresh of the processor technology. Early variants of PVL were designed to use a lower-level standard for communication called the Message Passing Interface (MPI) library. By using MPI, PVL was, in turn, portable to the wide range of processors that used MPI.

**Figure 28-13**

The Cray T3E (left) and the embedded multicomputer (right) were used to evaluate the PVL on Aegis signal processing.



**Figure 28-14**

LLGrid.



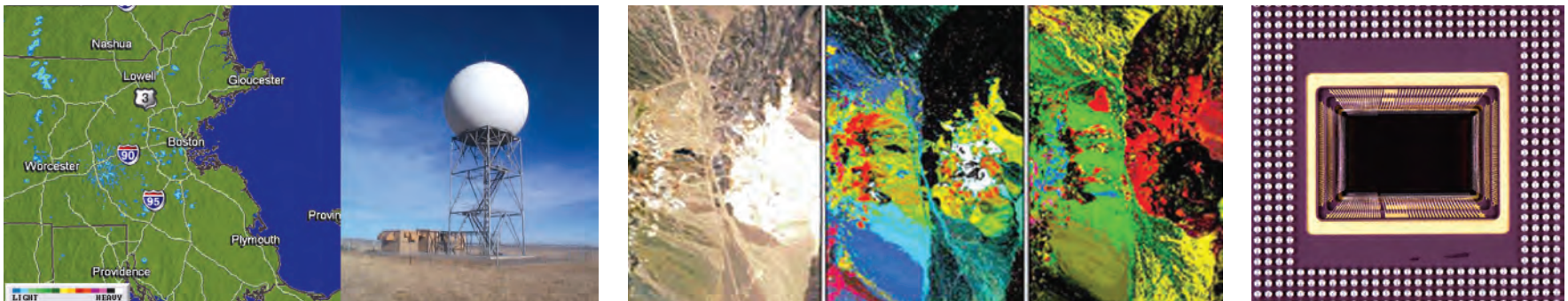
### The TX-2500 Grid Computer

Lincoln Laboratory's innovations in computing were always focused on making computers more effective and easier to use. In 2004, following in this tradition, the Laboratory developed the Lincoln Laboratory Grid (LLGrid) computing system to help make high-performance computing as accessible and user-friendly as today's personal computers (Figure 28-14). The LLGrid hardware follows the Beowulf cluster model of the 1990s: inexpensive personal computer hardware and open-source software are used to economically deliver high computational performance. The notion of grid computing followed quickly on the success of the Beowulf model. A grid computer is envisioned as a corporate-wide computing infrastructure in which the computing capabilities are as available and easy to use as electricity is from the electric grid. The LLGrid actually consists of several computing clusters that together comprise hundreds of commercially available computing nodes. Each node is similar to a desktop personal computer, and the entire grid is accessible to every Laboratory researcher over the Lincoln Laboratory local-area network (LAN) system. Access to grid supercomputing has proven to be a boon for the Laboratory's new research initiatives. LLGrid has enabled large-scale simulations, algorithm prototyping, and data analyses tasks that, because of their sheer size and complexity, cannot be carried out on desktop computers.

A major portion of the LLGrid hardware was provided by the DoD High Performance Computing Modernization Office (HPCMO) in 2005 to augment the Laboratory's research and development focused on the global threat of weapons of mass destruction. The research focused in two areas: (1) simulations for ballistic missile defense that needed large-scale cluster computing and interactive programming capabilities, and (2) NLEQ chip development, an important technology for highly sensitive electronic intelligence systems, that required enormous amounts of computer power for circuit-design simulations and algorithm development.

The HPCMO provided Lincoln Laboratory with a dual-node 750 Dell computer cluster that had a peak performance of nearly ten trillion floating-point operations per second. It also contained 2500 disks that together provide nearly 800 terabytes of storage. In honor of its predecessors, this flagship system was named TX-2500.





**Figure 28-15**  
**Examples of Lincoln Laboratory programs benefiting from the LLGrid. Among the wide variety of applications on which Laboratory engineers and scientists work are radar algorithm development for weather sensing (left), hyperspectral imaging (middle), and application-specific integrated-circuit simulation (right).**

Several smaller-scale variants of TX-2500, called satellite clusters, have also been deployed by research and development programs requiring dedicated use of high-performance computing resources. Classified LLGrid systems have been created, the most notable being the TX-3D cluster provided by the HPCMO to conduct research in ballistic missile defense. All of these systems use the same basic hardware, and all rely on the software innovations that have enabled new levels of interactive, on-demand use of supercomputing-scale computing. By 2008, LLGrid technology had become a staple of Laboratory computing, providing dozens of programs and over 400 users with flexible, on-demand computing right at the desktop (Figure 28-15). Recently, the success of LLGrid has begun to attract collaborations with MIT campus researchers and other universities nationwide.

From the very start, usability was a principal concern of the Lincoln Laboratory grid team. Using a cluster in an on-demand manner should be as much as possible like using a dedicated personal computer. The only difference should be that much greater computational power and storage are available. The LLGrid development team recognized that Laboratory researchers already had a very effective development environment at their desktops: MATLAB. Bridging the gap between the Laboratory's MATLAB community and grid computing turned out to be the key enabler of high-performance scientific computing at the Laboratory.

In 2002, Jeremy Kepner developed the MatlabMPI toolbox, which provided MATLAB users with a way to parallelize their codes by using message passing based on the Message Passing Interface (MPI) standard. MatlabMPI was highly portable and easy to install. The

toolbox was quickly adopted both inside and outside the Laboratory. For MATLAB programmers willing to write explicit parallel codes, MatlabMPI proved to be a powerful tool.

In 2003, Nadya Bliss and Kepner began the development of pMatlab, a parallel MATLAB toolbox to convert serial MATLAB programs into parallel programs. MatlabMPI required explicit message-based parallel code, whereas pMatlab used a form of implicit parallelism borrowed from the PVL. A MATLAB programmer can learn how to use the basic pMatlab toolbox library in a few hours. After that, converting a MATLAB code to a parallel code typically takes, at most, a few days.

MATLAB programmers were very willing to invest a day or two to be able to speed up their codes by factors of ten or more. However, to make parallel MATLAB codes easy to run on a grid, a further innovation was needed. Albert Reuther and Andrew McCabe, who were exploring the various scheduling mechanisms available for grid computing, realized that on-demand grid scheduling software could be combined with the interactive capabilities of pMatlab. The fundamental innovation was enabling users' personal computing to become part of the overall LLGrid environment. Once this was done, a user's computation space was seamlessly expanded into the entire grid, and he or she had access to the grid right from the desktop. The new software system was dubbed gridMatlab.

In the 1960s, TX-2 experimented with time-shared operation, whereby the users were given slices of time to execute their codes without interference by other users who were getting a share of time to run their codes as

## Grid Computing for Research

**Research directions in grid computing have followed several exciting paths. For example, as data sets continue to become larger and larger, a major limitation on the throughput that can be achieved on any computer is how much of the problem can be placed in main memory at any one time. The complexity of a computer program grows considerably when the program must explicitly control data access to and from files distributed throughout hundreds of disks.**

**Lincoln Laboratory devised a novel hierarchical array approach to this problem. The pMatlab tool kit already provided a nice abstraction layer that allowed a MATLAB user to specify parallelism. To this was added another level of mapping so that the disks at each node could be used as virtual main memory, with any excess data that could not fit on the node spilling automatically into the disk. The pMatlab library hid the details of the disk interactions so that a code would work regardless of main memory and data set sizes (provided the disks were big enough).**

**The idea of virtual memory is not new, but the coupling of virtual memory to computations in such a fine-grained manner maximized the performance for large data sets. Once this capability was put into place, it was demonstrated on an array nearly one petabyte in size; this represented the world's largest operation applied to a single data object. The hierarchical array construct also allowed Bradley Kuszmaul of MIT to develop the world's fastest algorithm for sorting data. Kuszmaul demonstrated his sort algorithm on the TX-2500, outperforming the largest supercomputers in the world.**

well. Today's TX-2500 provides a form of space-shared operation: users are given dedicated nodes (space) on the parallel machine without interference by other users who are also given their own sets of nodes.

Although MatlabMPI made parallel MATLAB programming possible, and pMatlab made it easier, the user still had to work out the best maps of the data and program code onto the cluster. To help make this task easier, Bliss and Henry Hoffman, in 2004, began research into technology that could automatically determine efficient maps for an algorithm on a distributed or parallel computing system. They developed a novel mapping technology and architecture that they named pMapper. The pMapper system takes as input a MATLAB code and a model specifying the computer that will run the MATLAB code. One of the novel aspects of pMapper is that, in creating the program parse tree, which is basically a specification of the flow of control and the operation order of the program, pMapper only attempts to find the best maps when results need to be output from the program. In this way, pMapper is able to use information about actual program execution that is not available to a compiler, thus allowing for better optimization over much larger code fragments.

In the near future, Lincoln Laboratory is looking to expand LLGrid and to exploit containerized grid computing technology. Two significant considerations with a large computing grid are the tremendous amount of electrical power it consumes and the need to provide adequate cooling for the hardware. Thus, an initiative is under way to relocate the LLGrid to western Massachusetts, where inexpensive hydro-electric power will be available.

### **The Programming Challenge of Multicore Processors**

The seemingly relentless march of Moore's Law has run into a speed barrier that is causing computer architects to rethink chip-level design approaches. It has become harder and harder to increase microprocessor clock rates. Chip designers are compelled to abandon performance improvements through clock rate increases and pursue other avenues. They have begun to place multiple copies of miniaturized processor cores onto single chips.

The DARPA Polymorphous Computing Architectures (PCA) program was one of the first initiatives to explore this important trend. The program's goal was to develop microprocessor technologies that could be reconfigured more efficiently ("polymorphed") to meet different application needs. A team led by Anant Agarwal from the MIT Computer Science and Artificial Intelligence Laboratory (CSAIL) developed the Raw microprocessor, which consisted of 64 cores and two high-speed networks on a chip. The prototype Raw chip was capable of 16 GOPS. Lincoln Laboratory's role in the program was to assess the new processor's suitability for DoD embedded applications. The Laboratory worked with several national teams to define the HPEC Challenge Benchmark Suite, a set of key benchmarks that have since become standards for evaluating high-performance embedded computing processors.

Researchers at Lincoln Laboratory and MIT campus collaborated to demonstrate that the prototype Raw system outperformed state-of-the-art processors in overall throughput and in throughput per watt on embedded applications. The power efficiency of the Raw was especially important for military embedded applications, but has also become increasingly important for many commercial applications as computing needs have continued to grow in the past decade. The MIT team formed the Tiler Corporation and developed the Tiler processor family based on the Raw microprocessor. Tiler chips are now being used in wireless, multimedia, and networking systems.

Essentially, multicore processors are parallel processors on a chip. Programming a high-performance processor containing several multicore processors is tantamount to programming a parallel processor of parallel processors — a formidable task. To address the programming challenge, Lincoln Laboratory began the development of the Parallel Vector Tile Optimizing Library (PVTOL) research middleware. The PVTOL combined the lessons learned from PVL with the idea that the programming challenge could be attacked using a hierarchical approach. The hierarchical data-parallel mapping technique developed for the LLGrid was combined with the task-parallel constructs pioneered by PVL. By building these constructs into the middleware, PVTOL gave the application developer a standard way to specify and

implement parallel computations on multicore processors. The PVL task-parallel constructs enabled signal and image processing programs to be divided into parallel computation tasks that consume data from previous tasks, perform computations on the data, and pass them on to the next parallel task for further processing.

An early prototype of PVTOL was targeted at the Intel/Sony Cell processor and an advanced airborne camera application. High-resolution cameras flown over urban territory provided persistent video surveillance. But limited downlink data rates required onboard storage disks that were removed from the aircraft for processing after each mission. The cycle could take a week or more. Real-time image processing and detection on the aircraft and immediate downlinking of images around areas of interest significantly sped up forensic analysis tasks. This capability would also serve as a precursor to predictive analysis, in which suspicious areas could be monitored and analyzed in real time for potentially threatening situations.

When it was decided to quadruple the capabilities of the cameras, it became clear that the only program-mable processing solutions were multicore-based systems. A version of the image processing chain was developed on a set of Cell processors that fit into a few card slots and delivered over 200 GOPS. A prototype version of the PVTOL library was used to architect the overall processing task. The full system was successfully flown in November 2008 and became the first demonstration of the use of Cell processors in an embedded HPEC application. The PVTOL middleware allowed the system to be developed in less than a year.

#### **Rapid and Open Development of High-Performance Computers**

In the building of a military sensor, the embedded computer is usually the last component integrated into the overall system. Thus, if the computer can be developed more efficiently, prototypes can be fielded faster. Middleware libraries such as PVL, VSIPL (see sidebar entitled “Vector, Signal, and Image Processing Library”), and PVTOL allow developers to write less code to get the same level of functionality. But most sensor computers also have custom hardware components. Thus, to enable end-to-end rapid prototyping of high-performance embedded computers, techniques for quickly developing hardware are also essential.

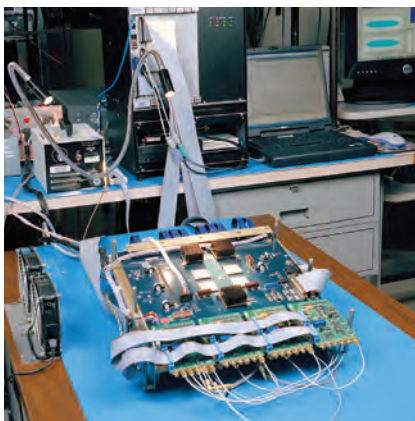
In 2002, Lincoln Laboratory developed the Intelligence, Surveillance, and Reconnaissance (ISR) Processing and Array Technology (IPAT) processor for phased-array radars (Figure 28-16). It was first used for the Lincoln Multimission ISR Testbed (LiMIT) radar system that was installed on the Laboratory’s Boeing 707 aircraft. LiMIT was used to demonstrate new radar processing algorithms, and it needed a high-performance, flexible processor. The IPAT combined VLSI supercomputing filter chips with a modular and scalable design. To provide high performance, the IPAT processor chips used the same architectures prototyped for space-based radar research. A single IPAT board provided more than one trillion operations per second on radar-signal filtering functions and was capable of handling the four-channel 180 MHz bandwidth of the LiMIT receiver subsystem. Additional beams and channels could be added to an IPAT processor by adding boards and using a board-to-board systolic beamformer based on the beamforming chip designs for the space radar.

The IPAT processor technology was reused in several high-performance computing applications. For example, the DARPA Symbiotic Communications program needed a high-performance digital correlator for sets of high-bandwidth signals. Some proposed solutions required dozens of boards and could not readily fit on the unmanned aerial vehicle that was the target platform. Using IPAT technology, Lincoln Laboratory was able to demonstrate a solution that reduced the processor to a set of two boards, a factor of ten improvement.

Following the lessons learned in the development and use of IPAT technology, the Laboratory in 2006 began a new program called Rapid Advanced Processors in Development (RAPID). The IPAT technology had demonstrated its flexibility, but it also had some limitations. The capabilities and cost of an IPAT board were often more than were needed for a particular application, yet other than using FPGAs instead of VLSI processors, there was no economical way to scale the boards to accommodate the less-demanding applications.

The RAPID design team recognized that compositional flexibility was a key enabler. Instead of starting from a sophisticated board-level platform, as had been done with IPAT, the RAPID approach was to allow the developer to compose a board quickly from standard





**Figure 28-16**  
IPAT processor.

building blocks. These building blocks provided templates into which custom and reusable intellectual property (IP) circuits could be inserted. Each building block standardizes the data and control paths used by the IP circuits. The building block designs are captured in software representations and can be retargeted to different types of boards. In this manner, for example, an advanced FFT design can be inserted into a standard template targeted for a Peripheral Component Interconnect Express (PCI-E) board (a common board standard for personal computers) and the same FFT could be quickly retargeted for a microTCA board (a popular standard in the communications industry).

Although a relatively new initiative, RAPID is already finding use in several high-performance embedded applications, including sonar, electronic intelligence, radar, and electronic countermeasures systems. It has allowed the Laboratory to prototype custom signal processors twice as fast as the industry average.

Lincoln Laboratory also participated in the submarine sonar advanced processor build that employed a middleware-based open architecture to allow sonar processors to be upgraded independently of sonar application development. Since the application was decoupled from the hardware through middleware, the Navy was able to rapidly develop new algorithm technology and insert it into many related but distinct sonar systems that used the same middleware. The Laboratory participated in the earliest algorithm development cycles, and today is one of the major developers of submarine sonar algorithms, especially in the areas of beamforming and detection.

The Navy's Common Broadband Advanced Sonar System program to upgrade the U.S. MK 48 heavy-weight torpedo processing has been another beneficiary of Lincoln Laboratory's expertise in sonar and radar high-performance open architectures. The Laboratory, working with the Naval Undersea Warfare Center in Newport, Rhode Island, helped to prototype an open signal processing architecture.

The Radar Open Systems Architecture (ROSA) was a revolutionary technology for its day (see chapter 30, "Open Systems Architecture"), but Lincoln Laboratory recognized that it needed to continue to extend its reach to a wider class of radars. In 2005, the Laboratory

conducted a study to develop a future road map for ROSA. The study recommended that the architecture be modified to make the software more modular and be extended to support phased-array airborne radars. At the same time, the study recognized that network-centric operation was an important emerging requirement for all sensor systems and recommended an approach that would readily permit new radars to connect to a network. The resulting architecture was named ROSA II.

A key enabler for all three major recommendations was a new high-performance communication middleware based on publish and subscribe semantics. In this type of communication system, software components publish data as topics. Components that require data subscribe to the relevant topics. Whenever a topic is refreshed with data, the subscribers are notified by the communication system, and each subscriber can then read the new contents. This form of communication is very flexible since publishers and subscribers do not require any knowledge of each other. They are only required to create data products and publish the data in topics or subscribe to topics and consume the data contained therein.

To make the publish/subscribe system suitable to high-performance radars, Lincoln Laboratory researchers created a real-time communication layer (RTCL). RTCL provided a publish/subscribe interface into which other communication systems could be inserted at a lower level. In this way, a very-high-performance front-end processor can use RTCL with special features designed for maximum performance while a more general-purpose radar component can use a more full-featured underlying system, such as the industry-standard Data Distribution System.

The flexibility of RTCL allowed next-generation ROSA II systems to incorporate the very-high-performance front-end processors needed by multichannel phased-array radars. In 2008, ROSA II technology was combined with a phased-array front-end processor developed using the RAPID techniques discussed earlier. Both ROSA II and RAPID are being used for future-generation Lincoln Laboratory phased-array radars being developed to explore advanced antenna technologies and signal processing techniques.



**Figure 28-17**  
**KASSPER computer system.**

### Processors for Knowledge-Aided STAP

Space-time adaptive processing algorithms and applications have continued to grow in sophistication. In the mid-2000s, Lincoln Laboratory became involved in the DARPA Knowledge-Aided Sensor Signal Processing and Expert Reasoning (KASSPER) program. The KASSPER program recognized that STAP could be improved by taking advantage of nonconventional additional information about the environment. In a typical adaptive operation, small subsets of the data (called training data sets) are extracted from the data stream to estimate interference statistics. These statistics are used to compute beamforming weights that reject the interference while maintaining high gain in the directions of interest. Usually, the training data sets are gathered by sampling the environment in regions surrounding where the radar is looking for detections. If the regions that are sampled differ in their interference statistics from the area where the radar is looking for detections, the radar forms beams that are not optimal. To acquire better training sets, Lincoln Laboratory developed an advanced processor that extrapolated the aircraft position ahead in time, and used map and terrain data to predict the kind and location of training samples needed to allow the radar to operate at peak performance (Figure 28-17).

The processor needed to be both a high-performance signal processor and a highly capable reasoning machine that could deal with real-time databases. To carry out the knowledge computation in real time, Lincoln Laboratory developed a novel look-ahead scheduling architecture. The processing system used Inertial Navigation System and Global Positioning System (INS/GPS) data, predicted the future position of the aircraft, accessed and interpreted previously stored terrain and map data, determined the best set of training regions, scheduled the radar, collected the training data, and then performed traditional STAP. The processing architecture was implemented using the latest Mercury Computer Systems multicomputer, the MP-510.

### Graph Computations in Three Dimensions

As sensor systems have become networked together and as these sensors have continued to improve, the amount of data collected has grown enormously. Modern radar, lidar, optical systems, infrared sensors, communication systems, and sonar have increased their data processing capabilities to keep pace with Moore's Law digital processing improvements. The output of these systems (images, detections, audio, video, tracks) along with all of their metadata (location, time, user identifications, and so on) need to be further analyzed by people or computer programs. The user interface and computational challenges that are emerging because of this glut of data, especially in today's networked systems, are leading to the emergence of new software technologies and high-performance computing architectures.

The image and signal processing that goes inside most of today's sensors or communication systems is based on high-throughput matrix and vector operations. The algorithms that are needed to analyze the data products produced by the imaging and sensing system, on the other hand, are far more irregular and difficult to process efficiently. They become even less efficient when they need to scale to large data sets. However, most of the algorithms are either based on graph algorithms or else they can be recast as graph algorithms. As Lincoln Laboratory began to tackle the problem of computations over very large graph structures, a key observation emerged: graphs and graph computations could be recast as arrays and array computations. In sensor processing, the arrays are dense, meaning that there are relatively few zeros in the data. Graphs can be represented by adjacency matrices and arrays, however, which tend to be very sparse, especially as the dimension of the array increases. So, a major distinction arises: sensors today do dense-array mathematics; post-sensor processing performs sparse-array mathematics. The initial investigations into sparse-array computing have inspired several computer innovations that together promise to deliver orders of magnitude more efficient processing on large graph-intensive algorithms.

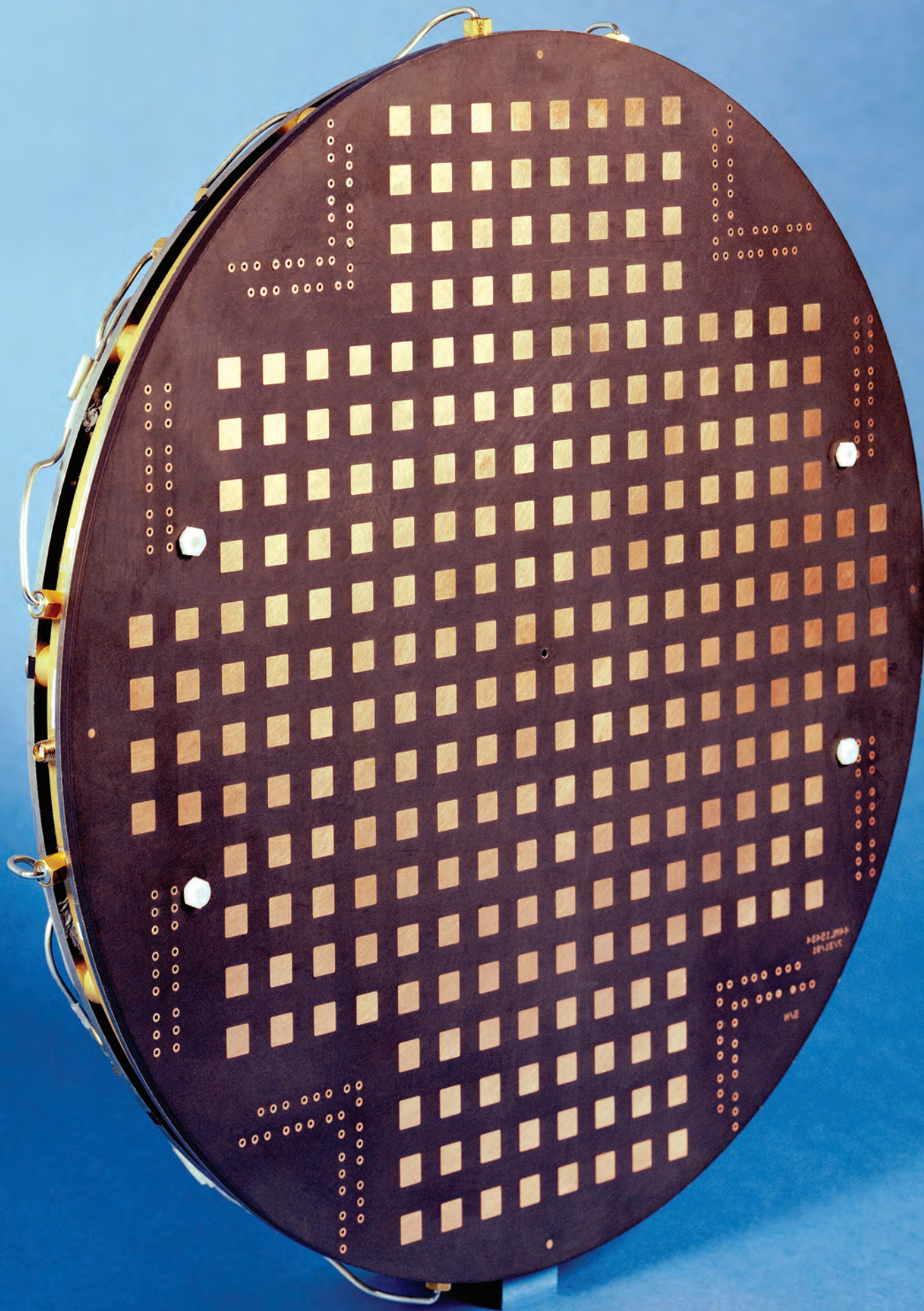
Irregular and high-volume movement of the data over the array motivated the development of a novel, stacked three-dimensional design. The communication network uses inductive coupling in the vertical dimension to increase the number of paths between computing nodes. A three-dimensional connection of sparse-array computation nodes is thereby established to support very large computations. With the added third dimension, the system performance is able to scale as the data sets scale.

Initial simulation results indicate that three-dimensional graph processing systems will outperform conventional architectures by one or two orders of magnitude on large data sets. The innovations being explored in the three-dimensional graph processor promise to enable the embedded high-performance decision support systems of the future. These systems can dramatically improve the military's ability to analyze complex urban environments, terrorist social networks, and network intrusion attacks. Tomorrow's sensors will be able to incorporate in situ many of the fusion, discrimination, and identification tasks that are done today at large operations centers. Soldiers will have data mining and decision support systems deployed at forward bases or built into their communication devices and vehicles, thereby enhancing situational awareness and increasing their combat effectiveness.

### **The Future**

To meet the national defense needs of the next decade, Lincoln Laboratory is well positioned to provide the high-performance computing solutions that will enable new levels of capability, faster response to threats, and more economical systems. The work on advanced middleware, real-time algorithms, and rapid processor development methods makes the Laboratory one of the premier rapid-prototyping centers in the nation. The application of open-system principles allows the Laboratory to develop systems that are affordable and that can be readily upgraded as technology evolves. The novel processor technologies under development at Lincoln Laboratory, such as custom VLSI processors for nonlinear processing and three-dimensional graph processors for large-scale decision support, place the Laboratory at the vanguard of military computer research and development.







**The Laboratory has been a national leader in the development of adaptive sensor array processing and its application to national defense problems. The impetus for many of the Laboratory's advances in antennas, receiver technology, and high-performance computing was the requirement to implement adaptive processing algorithms and to achieve significant sensor performance benefits.**

**Left: Sampled aperture sensor was developed to support two-dimensional planar array direction-finding techniques. The polarized array utilizes patch antenna technology. The patch elements are grouped to allow a wide range of aperture and array configuration trade studies.**

Throughout its history, Lincoln Laboratory has developed advanced sensors. Earlier chapters have provided examples, including radar for air and missile defense, radar for ground and space surveillance, and radio-frequency geolocation systems for direction finding and battlefield surveillance. All these systems have a “front end” that consists of the antenna and receiver electronics, and a “back-end” processor subsystem that implements mathematical algorithms to convert the signals received at the sensor to useful products. The processor subsystem is a digital computer, and the algorithms are referred to collectively as the signal and data processing.

Antenna size drives sensor detection and geolocation performance. For many applications, an effective means to construct a large antenna is to form an array of individual smaller elements. Antenna arrays, or phased arrays as they are sometimes referred to, offer the potential for significant performance benefits such as rapid beam steering for search radars and flexible multifunction search and track capability.

Early in the development of phased-array antennas it was realized that having a receiver and analog-to-digital converter at each element can enable a computer to control the individual antenna responses. This flexibility enables much more control of the response of the antenna and the capability to change it dynamically in response to changes in the external signal environment. This observation resulted in the name *adaptive antenna processing*, which refers to the sensor automatically “adapting” the antenna response to the signals that are received by the array. The term adaptive sensor array processing has emerged within the Laboratory to include the application of these techniques to other sensor arrays such as imaging and acoustic sensors.

In the late 1960s, the initial theory of adaptive antenna processing was developed. Under the technical leadership of Jack Capon, the Laboratory was working on optimal array processing of data from large arrays of seismic sensors for nuclear test applications. As the capability of digital computers and the technology of phased-array antennas and receiver electronics progressed, the Laboratory became significantly involved in this new field of adaptive sensor array processing for radar and other applications.

Lincoln Laboratory adaptive sensor array processing algorithms have been enablers for significant new radar capabilities. These approaches are now a key component of making modern radars robust to electronic attack. The Laboratory has applied its expertise in adaptive processing to enhance direction-finding sensors, to improve the resolution and target classification ability of imaging radars, and to make Global Positioning System (GPS) receivers more robust. More recently, the Laboratory's experience in this area has led to new program thrusts in improving the performance of undersea surveillance systems with acoustic arrays and making very-high-performance radio-frequency communications systems.

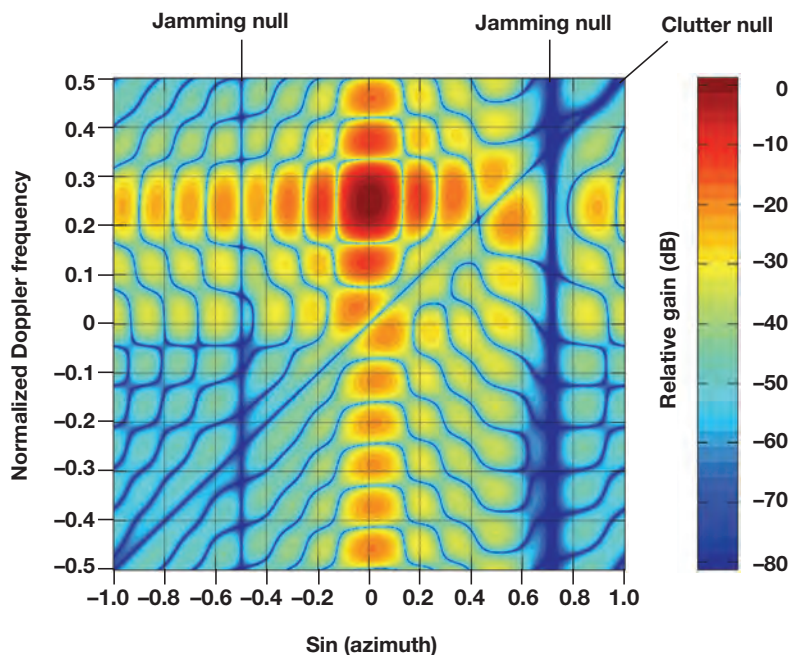
#### **Development of Adaptive Array Radar**

The problems of jamming and clutter suppression have interested radar engineers, including many Lincoln Laboratory staff, since the early days of radar. During the late 1980s, Laboratory researchers were charged with the task of improving air defense radars to better detect low cross-section targets in the presence of radio-frequency interference. The Radar Surveillance Technology Experimental Radar (RSTER) program developed a prototype for an advanced Navy air defense radar to demonstrate the phased-array antenna, multichannel radio-frequency receiver, and signal processing algorithm technologies, as well as the system-level performance necessary for future adaptive radars.

The RSTER adaptive radar utilized a large planar array that was decomposed into a vertical array of fourteen rows that formed the elements of an adaptive array.<sup>1</sup> Each row antenna element had its own receiver and analog-to-digital converter. The system's digital processor implemented the adaptive beamforming algorithms to steer the radar beam in elevation and to place deep receive pattern nulls at the elevation angles (typically low angle, near horizon, for faraway interference) of interfering signals. The signal processing team developed efficient methods for rapidly solving linear systems of equations for the adaptive weights and new techniques for maintaining good beam-pattern sidelobes to preserve accurate target angle estimation. To achieve high levels of interference suppression also required new methods of calibration, including receiver channel equalization. For adaptive radar, channel equalization matches the receiver frequency responses so that after the adaptive beamforming weights are applied, the residual from any channel mismatch over



**Figure 29-1**  
RSTER Wallops Island field site.



**Figure 29-2**  
STAP filter response.

**Note**

1 B. Carlson, L. Goodman, J. Austin, M.W. Ganz, and L.O. Upton, "An Ultralow Sidelobe Adaptive Array Antenna," *Linc. Lab. J.* **3(2)**, 291–310 (1990).

the radar waveform bandwidth was kept to below the system noise floor. In summer 1992, the RSTER program conducted experimental tests at Wallops Island, Virginia, that demonstrated the technical feasibility of real-time adaptive beamforming for achieving unprecedented levels of interference suppression capability (Figure 29-1).

Lessons learned from the RSTER program were applied to Navy shipboard radars. When the RSTER program ended, the Laboratory became involved in the technology development and system design for next-generation airborne early-warning radars. Studies were conducted for the Navy and Air Force.

In an airborne surveillance radar, the desired target signals compete with a large ground clutter return and any jamming that is present. The techniques demonstrated with RSTER needed to be extended to handle this airborne radar clutter problem. Since the largest portion of the ground clutter comes from the same mainbeam sector as the targets, adaptive beamforming alone is insufficient. For this problem, adaptive sensor array processing techniques were extended to filter both the spatial dimension comprising the antenna array elements and the temporal dimension consisting of the radar echoes from the sequence of transmitted radar pulses. The resulting family of techniques was termed STAP, for space-time adaptive processing.

Two key functions in the airborne radar processing chain are the receive beamforming that combines the signals across the array for gain and angle estimation and the Doppler filtering that combines the echoes from a coherent pulse sequence for gain and velocity determination. STAP can be thought of as the joint adaptive optimization of these two functions. Two challenges were inherent in the Laboratory's STAP development. First, the dimension of the problem is significantly larger. An optimal STAP approach computes a weight vector of length equal to the product of the number of antenna elements and the number of pulses. Thus, the size of the linear systems that need to be solved is potentially very large, requiring substantially more computation throughput.

The second issue is more subtle. An estimate of the background signals from the data must be derived. As the weight-vector size increases, so does the number of background data samples needed to get a background estimate sufficient to support deep nulls (Figure 29-2)



## Adaptive Array Processing Concepts

The architecture of an adaptive array processing system is displayed in Figure 29-3. Each antenna element has a receiver and analog-to-digital converter. The sampled signals from each antenna are the inputs to the adaptive algorithm. The algorithm correlates the signals from each element to, in effect, sense the environment and determine the number, location, and strength of any interfering signals. Based on this estimate of the signal environment, a set of amplitude and phase weights is computed that maximizes the signal-to-interference-plus-noise ratio (SINR) from the desired search direction. These weighted signals are summed to produce the receive beam output that is then passed to subsequent filtering and detector portions of the processing.

Figure 29-4 shows a comparison between conventional and adaptive beam responses. With conventional beamforming, the strong interfering signals are not sufficiently attenuated by the antenna sidelobes; they mask the target return and thereby reduce the radar detection range. With adaptive processing, the beam response automatically adjusts to place deep nulls in the directions of interferers, essentially preventing them from leaking into the target beam.

The output of a radar target receive beam for conventional and adaptive processing is shown in Figure 29-5.

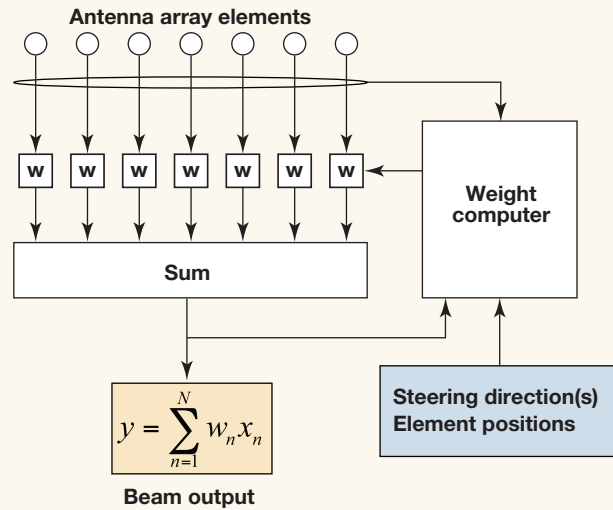


Figure 29-3  
Adaptive beamformer architecture.

Without adaptive processing, the interference significantly raises the noise floor and overwhelms all but very large targets. Adaptive processing mitigates the interference and restores radar performance to very nearly that in the absence of any interference. The adaptive algorithm must recompute the weights for every search direction and update them rapidly to track changes in the signal environment.

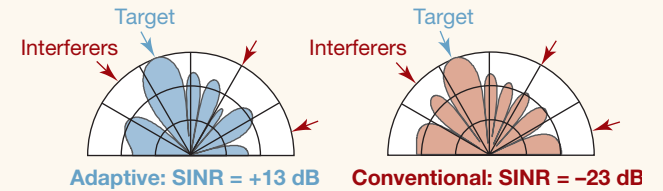


Figure 29-4  
Receive beam responses as a function of signal arrival angle.

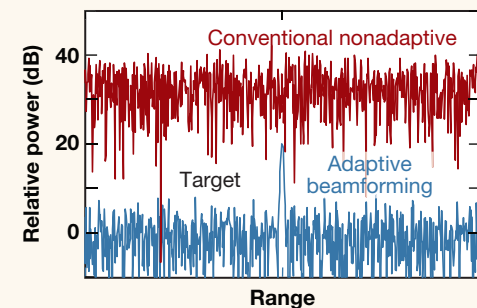


Figure 29-5  
Radar receive beam output.

**Figure 29-6**

**Mountaintop Program field sites.**

**Top: White Sands Missile Range, North Oscura Peak, New Mexico.**

**Bottom: Pacific Missile Range Facility, Makaha Ridge, Kauai, Hawaii.**



**Notes**

**2** J. Ward, "Space-Time Adaptive Processing for Airborne Radar," *Lincoln Laboratory Technical Report 1015*. Lexington, Mass.: MIT Lincoln Laboratory, 13 December 1994, DTIC ADA 293032.

**3** G. Benitz, "High-Definition Vector Imaging," *Linc. Lab. J.* **10(2)**, 147–170 (1997).

for high amounts of clutter and jamming reduction. As real-world signal environments can change quickly because of platform motion and jamming signal changes, this estimation requirement is often the driving factor. These issues drove a team of Laboratory researchers, led by Kenneth Senne and Steven Krich, to develop the theory and techniques of partially adaptive, or reduced-dimension STAP. The basic concept was to do some nonadaptive beamforming and Doppler filtering initially, and then to select a small set of beams and Doppler filters to adaptively combine for the final output. These approaches were shown to provide near-optimal performance but with a small fraction of the training data, and much less computational resources, than originally thought necessary.

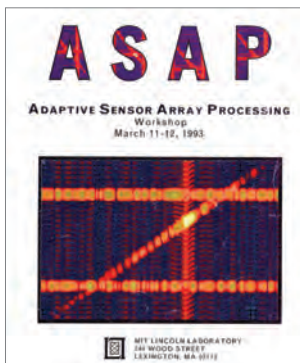
Much of the initial STAP work was performed under the sponsorship of the Defense Advanced Research Projects Agency (DARPA) in the 1990s. A comprehensive report that described and compared various approaches to STAP for airborne surveillance radar was published by James Ward in 1994.<sup>2</sup> From 1993 to 1996, the Laboratory led the DARPA Mountaintop Program in which an airborne radar was emulated at fixed sites at White Sands Missile Range, New Mexico, and then on Kauai, Hawaii (Figure 29-6).

The RSTER radar was used as a surrogate radar and augmented with auxiliary transmitter capabilities to collect data representative of airborne radar with heavy clutter. The data collected by the Mountaintop systems were used both by the Laboratory and a broad academic and government community to advance the understanding of radar adaptive processing. As part of the Mountaintop Program, the Adaptive Sensor Array Processing (ASAP) Workshop was initiated to provide a forum for the presentation and discussion of adaptive processing technology relevant to the military sensor

1965



J. Capon



**Figure 29-7**  
Program booklet for the first ASAP Workshop in 1993.



**Figure 29-8**  
Radar antenna array for E-2C modernization program.

1985

community. The ASAP Workshop, conducted by the Laboratory and coordinated by Senne, was held annually for fifteen years beginning in 1993 and running through 2007 (Figure 29-7). It served to educate the national community and was an excellent forum to guide Laboratory expertise into new areas.

The Laboratory's work in STAP was applied to the modernization of the Navy's E-2C airborne early-warning radar (Figure 29-8). In the early 2000s, the Laboratory leveraged its STAP experience to design a new foliage-penetration radar for unmanned vehicles; this work grew into the DARPA Foliage Penetration Reconnaissance, Surveillance, Tracking, and Engagement Radar (FORESTER) program.

Work on adaptive processing for radar also applied to synthetic aperture radar (SAR) for ground imaging. Typically, a SAR synthesizes a very long aperture with an airborne moving platform and the coherent processing of many radar pulses accumulated over an appropriate segment of the aircraft track.

Gerald Benitz applied adaptive processing techniques for SAR to enable higher resolution imagery.<sup>3</sup> Traditional SAR processing uses fixed filters that trade off effective coherent integration time for good sidelobe performance needed to prevent large scatterers from leaking across an image. Benitz recognized that the adaptive processing could be used to manage the sidelobes without the typical resolution loss seen with conventional processing. His resultant techniques, called high-definition vector imaging, were shown to be an effective means to increase the resolution of SAR imagery and also to enable enhanced automatic target classification. Additionally, for SAR systems that have multiple antenna elements, adaptive processing can provide some robustness to jamming.

The Laboratory's leadership in adaptive processing for radar has resulted both in new radar concepts and significant new generations of military radar systems. To this day, the Laboratory remains involved in extending and applying adaptive processing technology to new radar concepts. The first decade of the 21st century saw additional emphasis on surface surveillance radar. Under DARPA and Army sponsorship, the STAP techniques first developed for low-frequency airborne early warning are being evolved for a new generation of precision ground moving target indicator (MTI) radar for unmanned aerial vehicles. These techniques are also being extended and combined with novel waveforms for improved over-the-horizon radar detection of air and maritime targets.

#### **Superresolution Direction Finding and Geolocation**

Another important dimension to the field of adaptive sensor array processing is the estimation of signal direction of arrival, or more simply, direction finding. Typically, direction finding is accomplished by using models and measurements of how the antenna outputs should look relative to each other (i.e., their cross correlation) in response to a signal coming from a given direction. Direction-finding applications include signal intercept and copy for battlefield awareness, electronic intelligence gathering, and radar.

During the late 1970s, Lincoln Laboratory began developing algorithms to estimate the radio signal direction of arrival in the presence of interfering signals that occupy the same frequency band at the same time as the desired signal. The presence of interference not only inhibits the detection of a desired signal but also makes signal direction finding much more difficult.



L.L. Horowitz



S.I. Krich



J.R. Sklar





**Figure 29-9**  
**This Beechcraft 1900 aided the superresolution test bed program in obtaining data for source direction-finding estimations.**

Direction finding in the presence of interference is particularly difficult when an interfering signal and a desired signal are close together. Typically in this situation, conventional direction-finding systems and algorithms are unable to resolve the separate emitters. An analogous situation occurs when you attempt to look at two lights in the distance through a pinhole aperture — if the lights are too close, they look like one blur. Fortunately, in the case of adaptive arrays, there exist techniques that allow the estimation of the directions of the sources even when conventional processing would result in a blurred estimate. Lincoln Laboratory began a pioneering program to understand and refine this class of adaptive array estimation approaches, called superresolution direction-finding algorithms, that can be used to separately estimate the directions of multiple emitters even when they are spaced closer together than the antenna array beamwidth of the direction-finding equipment.

Using an antenna array mounted on a Beechcraft 1900, Lincoln Laboratory captured data sets allowing the development and evaluation of a wide class of superresolution algorithms (Figure 29-9). This pioneering work provided data not only for development of algorithms at the Laboratory, but also for dissemination throughout the defense community to spur development of algorithms elsewhere. The antennas in the array were intentionally designed to be matched in pattern and polarization as closely as possible. A necessary portion of the algorithm development effort was the development of calibration methods to allow more precise direction estimation.

Array calibration can be thought of as developing a map from the cross correlation of the antenna array outputs to a signal direction. When the calibration algorithms were implemented, there seemed to be some irreducible mismatch between the actual calibration measurements and the models developed to represent the measured calibration data points. This error was larger than expected, assuming all of the antenna elements were matched in polarization and pattern.

After some investigation, Larry Horowitz determined that a large fraction of the calibration error was due to modeling the array as having identically polarized antenna elements (a unipolar array). An array that is not

unipolar will have a response that depends not only on source direction but on source polarization as well. With this insight, a new calibration routine was developed that treated the antenna array as having elements of unknown, and potentially dissimilar, polarization. This routine resulted in a calibration map ten times more accurate than previous efforts. More importantly, when the new array calibration was used with direction-finding algorithms that assumed a polarization-diverse array and unknown signal-polarization state, the resulting direction-finding accuracy was markedly superior to what was achieved when the unipolar calibration and direction-finding algorithms were used.

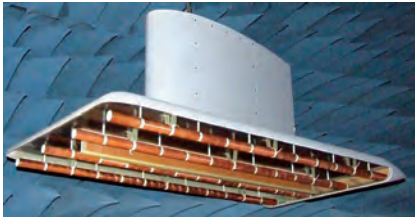
This performance improvement was most significant when there were cochannel sources separated by angles much less than the beamwidth of the array. The new approaches utilize an additional discriminant, the signal-polarization state, that helps separate multiple signals more effectively than prior techniques that exploit direction of arrival alone. This new antenna calibration routine has evolved and has been applied to multiple antenna array systems in the years since its initial development.

Laboratory researchers learned that signal features such as polarization, when properly exploited, can greatly aid direction-finding capability. In many applications, some aspect or feature of the desired signals is known, such as frequency, bandwidth, or modulation type. Building upon the polarization-based direction-finding techniques, the Laboratory began investigating adaptive waveform-based direction-finding techniques. These techniques exploited partial knowledge of the transmitted signal characteristics to improve direction-finding performance, particularly in the presence of interference. A variety of adaptive approaches were developed, including the constant modulus algorithm, which exploits the fact that many communications systems transmit waveforms with approximately the same amplitude over time. The Laboratory team was the first to successfully demonstrate these approaches and understand the performance dependence on important system parameters such as aperture size and signal strength.

#### Notes

**4** G.F. Hatke and K.W. Forsythe, "A Class of Polynomial Rooting Algorithms for Joint Azimuth/Elevation Estimation Using Multidimensional Arrays," *Conf. Rec. 28th Asilomar Conf. on Signals, Syst. and Computers* **1**, 694–699 (1994).

**5** G.F. Hatke, "Super-resolution Source Location with Planar Arrays," *Linc. Lab. J.* **10(2)**, 127–146 (1997).



**Figure 29-10**  
Geolocation antenna array.

Lincoln Laboratory has made other significant advances in adaptive array direction finding. In the early 1990s, the Laboratory began working on a program to apply superresolution algorithms to the problem of two-dimensional direction (both azimuth and elevation) estimation with compact planar arrays. At the time, superresolution algorithms for multidimensional arrays were computationally complex and could not resolve closely spaced sources as well as the state-of-the-art algorithms developed for linear antenna arrays. These issues limited the applicability of two-dimensional superresolution algorithms. Lincoln Laboratory staff member Gary Hatke developed a new class of algorithms that could be formulated as polynomial rooting problems. These new approaches provided increased resolution but were much more computationally efficient than prior techniques. Two variations of these algorithms were called PRIME,<sup>4</sup> developed for estimating all of the cochannel signals in the environment, and GAMMA,<sup>5</sup> which applied to those situations in which only one signal is desired and the remaining signals can be considered interference.

In practice, these algorithms have decreased the computational complexity of real-time direction finding by an order of magnitude for many antenna system types, such as the antenna shown at the beginning of this chapter. These algorithms have proven useful in areas where multidimensional parameter estimation is required, such as the target angle and velocity estimation in airborne radars employing STAP. The algorithms have also been generalized to allow estimation of an arbitrary number of parameters, such as polarization, azimuth, and elevation, for an incoming signal measured with a polarization-diverse antenna array.

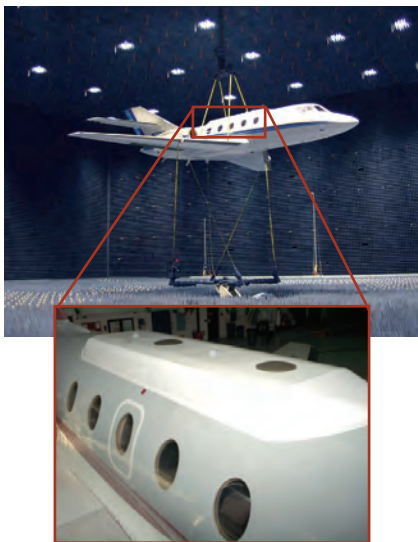
Since the attacks of September 11, 2001, precision direction-finding and geolocation systems have received significant renewed interest for sensing applications in support of counterterrorism and counterinsurgency missions (Figure 29-10). Lincoln Laboratory has been able to leverage its accrued expertise in adaptive array processing to develop new sensor concepts aimed at addressing new surveillance needs, including the detection of signatures associated with improvised explosive devices. By maintaining active research in these areas, the Laboratory will continue to be in the forefront of this important national security technology.

### **Making GPS Navigation Robust**

The 1980s brought a new technology to bear on the problem of precisely knowing one's position anywhere on (or above) the surface of the earth. The Navstar GPS allowed users to know to within a few meters exactly where they were, how fast (and in what direction) they were moving, and precisely what time it was. This technology quickly became embedded in myriad applications from navigation devices to jam-resistant radios. The world has benefited immensely from the adoption of GPS by the civil sector for automobile navigation systems and for cellular telephones, which rely on GPS for their timing.

Unfortunately, from a military standpoint, the GPS system has a weakness — the signals transmitted by the orbiting satellites to allow users to calculate their positions are extremely weak and thus very susceptible to jamming. This disadvantage was recognized early in the Navstar GPS program, and a number of different techniques were proposed to increase the ability of a GPS device to withstand interference, both intentional and unintentional. One prominent technique involved the use of multiple GPS receive antennas that can be adaptively combined to cancel the signals coming from potential jamming threats while maintaining sufficient gain on the satellite signals to enable the application to calculate time, position, and velocity. The challenges in implementing adaptive processing for the GPS application were (1) minimizing the size of the required antenna array necessary to cancel the interference signals, and (2) developing processing algorithms that provided maximal rejection of the jamming signals while not biasing the GPS position and timing solution.

Working with DARPA and the GPS Joint Program Office (eventually known as the GPS Wing), Jay Sklar led a Laboratory team that began to develop approaches to increase the robustness of GPS receivers by leveraging expertise in two areas: polarization-diverse antenna array processing to develop smaller antenna arrays and adaptive processing to develop the processing algorithm. The resulting system design utilized a seven-element controlled-radiation pattern antenna (CRPA). A STAP architecture consisting of five time delays for each of the seven antenna elements was chosen to enable both jamming mitigation and multipath equalization. The system formed four simultaneous adaptive beams, each



**Figure 29-11**  
**The Falcon 20 (top) used for demonstration of GPS antijam capability was tested inside an anechoic chamber at Patuxent River Naval Air Station. A seven-element GPS antenna array (bottom) is integrated into the rooftop cupola on the aircraft.**

#### Note

**6** In fact, countering the German U-boat threat was a driving factor in the development of microwave radar during World War II; the MIT Radiation Laboratory, of course, played a key role in this development.

1990

steered to a different GPS satellite. The required adaptive weights were computed using a novel approach that constrained the output signal to have a common time bias across each of the four adaptive beams.

As a proof of concept, the Laboratory equipped a Falcon 20 test aircraft with the compact CRPA antenna, and a real-time processor implemented the team's STAP algorithm (Figure 29-11). This prototype system, called Multipath-Adaptive Multi-Beam Array (MAMBA), was developed and built at Lincoln Laboratory in conjunction with Rockwell Collins. The MAMBA system was tested in the laboratory, then on the aircraft in a large anechoic chamber, and finally, in an extensive experimental campaign at White Sands Missile Range in 2002. During these tests, the Falcon 20 repeatedly flew directly over high-power jamming sources, and the system did not show any degradation in GPS performance. The MAMBA system and processor were the first GPS space-time adaptive antenna array processor to demonstrate the effectiveness of this technique in a rigorous evaluation program. The Laboratory antenna and adaptive processing technology dramatically increased the antijam performance for the airborne GPS receiver, while allowing the use of smaller antennas. The results of these experiments were used to guide the procurement of a new class of adaptive antenna and electronics modules for military GPS systems.

#### Upgrading Undersea Surveillance

Undersea surveillance and antisubmarine warfare have been critical national defense capabilities since the advent of the submarine.<sup>6</sup> Because sound propagates well in the ocean, sonar has become the primary means of detecting and locating submerged submarines and is a key component of providing defense for Navy surface ships. Passive sonar systems use arrays of hydrophones to listen

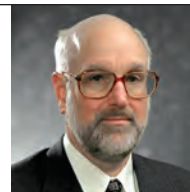
for sounds emanating in the ocean. Active sonar systems are the acoustic equivalent to radar; an acoustic source transmits pulses and a receiving array and processor detect echoes reflected off target objects.

Lincoln Laboratory has contributed significantly to the modernization and improvement of U.S. Navy sonar since the mid-1990s. At that time, three factors motivated the Navy to change their model for developing submarine sonar systems. First, the acoustic signatures of the threats were decreasing, both in foreign nuclear submarines and in a proliferating class of quiet diesel-electric submarines. Second, post-Cold War budgets had declined rapidly, and the government could no longer afford legacy business practices. Finally, commercial off-the-shelf (COTS) computing technology had advanced to meet system needs at much lower cost and was continuing to advance rapidly. These factors contributed to the Navy's starting a submarine sonar modernization effort called the Advanced Processing Build and Acoustic Rapid COTS Insertion program, or APB/A-RCI.

The objectives of this program were to utilize COTS computing as the basis for the submarine sonar processors, to open up the development to a broader research and development community, and to develop and insert new signal processing software on a yearly basis. The idea was to make use of the computing gains predicted by Moore's Law and to institute a rigorous build-test-build development process with peer review on which to base decisions about inserting new capability. Because of the Laboratory's expertise in demonstrating adaptive signal processing for advanced radars and bringing the military sensor community together through ASAP Workshops, the Navy asked the Laboratory to contribute to the submarine sonar modernization effort.

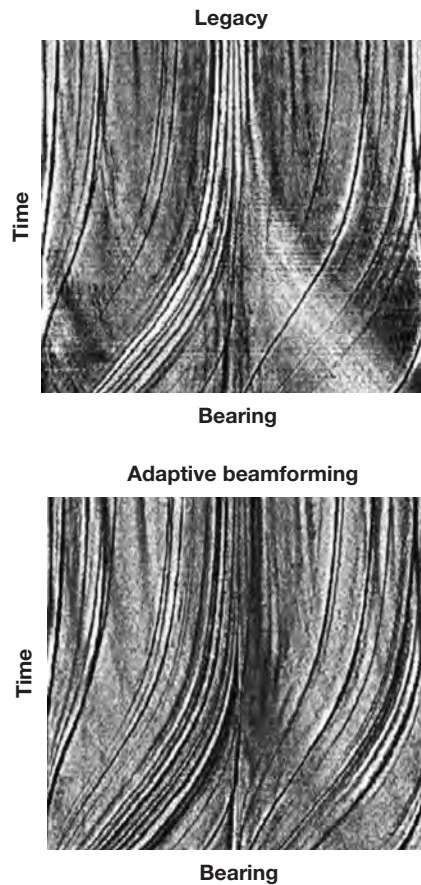


RSTER adaptive radar



K.D. Senne





**Figure 29-12**  
Towed-array performance comparison.

William Payne and Stephen Kogon began an effort to improve the beamforming on the towed arrays employed by U.S. Navy attack submarines. These arrays can have many hundreds of individual elements and operate over the large frequency ranges of potential submarine signals. Additionally, towed arrays form an aperture whose shape is changing as the submarine moves and maneuvers in the ocean. A sonar laboratory was established to store and process archived raw hydrophone data from operational sonar arrays. These data were used to develop and test new algorithm concepts and compare their performance to legacy processing techniques.

The challenge of using a dynamic sensor to improve detection of weak submarine signatures against a growing noise and interference background of surface-ship noise was well suited to the adaptive processing expertise of the Laboratory. While some of the theoretical fundamentals were common to the adaptive radar work, most aspects of the passive sonar problem required algorithm design and development unique to the sonar problem. The adaptive processing algorithm requires a good estimate of the array shape so that its model for the spatial signature of a target is good; otherwise, the adaptive algorithm can mistake a target signal for an interference source and suppress it. Additional algorithm emphasis was placed on enabling rapid adaptation to handle both own-ship motion and that of interfering surface-ship noise sources. Particularly for the larger arrays, algorithm development drove research into partially adaptive beamspace algorithms and frequency averaging that enabled sufficient estimates of background signal environment with a shorter observation time.

A primary display that passive sonars use for initial detection is called a bearing-time record (BTR), which maps the sound energy received as a function of look direction and time history. Sound sources such as surface ships or target submarines are detected when their strength is sufficiently above the background ocean ambient noise. The BTR display time history shows the bearing tracks caused by the motion between the sources and the sonar system platform. In cluttered ocean environments with many ships, these BTRs display many contacts. Surface ships have relatively high radiated noise, which sometimes masks weaker submarine signatures. Analogies to both the radar problem of operating in the presence of jamming and the direction-finding problem of resolving closely spaced sources were recognized. New variants of adaptive processing techniques for these passive sonar systems were developed and implemented to enhance the suppression of loud surface ships and improve the detection of both strong and weak sound sources.

Figure 29-12 shows a comparison of submarine towed-array sonar BTR displays with and without adaptive beamforming. The adaptive processing provides improved resolution and detection of closely spaced sources, improved detection of weak signals, and, because the array shape is accounted for in the beamforming, improved ability to resolve the left/right ambiguity that is inherent to line arrays.

Since 2000, the Laboratory has provided adaptive beamforming algorithm innovations and software that have been transitioned to the Navy for all of its submarine towed-array types. Through the APB/A-RCI program, these algorithms are now operational on the majority of the Navy's fleet of nuclear-powered attack submarines.



J. Ward



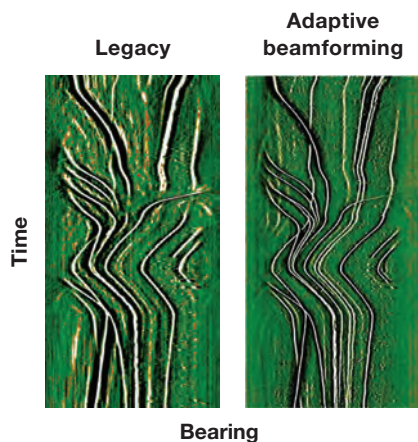
G.F. Hatke



**Figure 29-13**  
Virginia-class attack submarine.

Once improvements were inserted into the towed arrays that are used for longer-range search in deeper-water environments, development emphasis during 2007 to 2010 shifted to additional submarine sensors and to those sensors on the newest submarine class, the Virginia-class (Figure 29-13). The bow sphere array is a large-diameter, three-dimensional sonar array with hundreds of transducers (transmit and receive elements). Installed in the bow compartment of the submarine, the sphere array is the primary sensor responsible for situational awareness and also plays a strong part in navigation in shallow-water environments.

Nicholas Pulsone led an effort to develop several improvements to sphere-array processing. First, it was observed that with newer processor engines many of the legacy algorithm compromises could be revisited. Then, lessons learned with towed arrays were applied and adapted to the three-dimensional sphere array. The design team developed a novel beamspace adaptive formulation that exploits array oversampling for the lower frequencies to save computations. The additional processor capacity was applied to enable beamforming with finer granularity, improving operator displays. The Laboratory has conducted many tests of the new approaches, and there have been independent Navy sea tests.



**Figure 29-14**  
Sphere-array performance comparison.

Figure 29-14 shows sphere-sonar-array comparisons between legacy and new adaptive beamforming. These are BTR displays that are the primary operator displays for initial detection. The adaptive beamforming approach demonstrates significantly better angular resolution and enhanced detection performance. One can easily see that more signals are detected, and those that are common to both have narrower traces in the adaptive beamformer, which translates into improved bearing measurement accuracy. These improved beamforming algorithms have also transitioned into the operational submarine fleet.

Another program benefiting from the Laboratory's expertise in adaptive array processing is the MK 48 Heavyweight Torpedo. First operational in 1972, the MK 48 is the primary weapon on U.S. submarines for antisubmarine and antiship defense. In 2001, the Navy began a modernization of the MK 48 torpedo through the Common Broadband Advanced Sonar System (CBASS) program in a joint development effort with the Australian navy. The objectives of the

MK 48 CBASS torpedo development were to enhance its capabilities in both deep and coastal waters and to provide advanced counter-countermeasure capabilities. These objectives were achieved with improvements to the active/passive sonar guidance system and include a wider operating band and improved adaptive signal processing. The torpedo is guided by a 52-element dual-mode active/passive sonar array installed in the front end of the weapon.

Lincoln Laboratory was invited to be part of the CBASS upgrade program in 2001. With the Naval Undersea Warfare Center, the Laboratory developed and tested a new adaptive array processing chain. The new processing chain addresses challenges in a dynamic, shallow-water noise environment and contends with strong interfering sources. Moreover, the processing is limited to implementation on hardware with significant constraints on size, weight, and power. To meet these challenges, an efficient adaptive array processing chain was developed and tested that includes advanced decision logic to accurately detect and localize sonar contacts. The Laboratory also aided in selecting COTS processing hardware and developing open-systems real-time software for the torpedo.

The Laboratory's work in sonar adaptive array processing has grown to include research in advanced sonars for autonomous undersea vehicles. In 2009, Lincoln Laboratory partnered with MIT, Woods Hole Oceanographic Institution, and the U.S. Navy to demonstrate a prototype system. Laboratory engineers developed a complete processing chain for adaptive beamforming, detection, and classification. These algorithms were implemented in a form-factored processor for autonomous operation. The system had successful initial at-sea testing. Although this work is in the early developmental stages, it is likely that the sensors and associated processing technology will be key components of future generations of undersea surveillance systems.

#### **Adaptive Wireless Communications**

Lincoln Laboratory has been developing adaptive processing technology applicable to wireless communications since its beginnings. In 1958, the Laboratory developed the Rake receiver. Over time, this idea has evolved into the modern adaptive equalizer, which has

## Notes

**7** K.W. Forsythe, D.W. Bliss, and C.M. Keller, "Multichannel Adaptive Beamforming and Interference Mitigation in Multiuser CDMA Systems," *Conf. Rec. 33rd Asilomar Conf. on Signals, Syst. and Computers* **1**, 506–510 (1999).

**8** G.J. Foschini, "Layered Space-Time Architecture for Wireless Communication in a Fading Environment When Using Multi-Element Antennas," *Bell Labs Tech. J.* **1**, 41–59 (1996).

**9** D.W. Bliss, K.W. Forsythe, A.O. Hero, and A.F. Yegulalp, "Environmental issues for MIMO Capacity," *IEEE Trans. Signal Process.* **50(9)**, 2128–2142 (2002).

**10** D.W. Bliss, A.M. Chan, and N.B. Chang, "MIMO Wireless Communication Channel Phenomenology," *IEEE Trans. Antennas Propag.* **52(8)**, 2073–2082 (2004).

**11** D.W. Bliss, K.W. Forsythe, and A.M. Chan, "MIMO Wireless Communication," *Linc. Lab. J.* **15(1)**, 97–126 (2005).

become one of the essential tools in communications. Many of the same factors that have motivated the use of adaptive sensor array processing for military sensors have also contributed to an explosion of adaptive processing in the wireless communications area. The Laboratory has made significant contributions in developing this technology.

The adaptive communication research at Lincoln Laboratory can be differentiated from communication research performed by commercial interests by its focus on link robustness. Because of this focus, the sophistication and computational complexity of the implemented algorithms exceed those employed by commercial interests, which are strongly driven to minimize costs. Military links must operate in difficult and complicated environments. A dropped call is an annoyance for the typical cellular phone user; a broken military communication link can be disastrous. A common thread through the research at the Laboratory is the use of adaptive techniques to provide robust, high-performance communication links. This research has included development of both theory and demonstration systems exploiting the advantages of multiple-antenna systems and the associated adaptive processing. The level of work in adaptive wireless communications began to grow in the late 1990s, building upon prior work in superresolution direction finding and adaptive interference suppression.

Beginning in 1996, the Laboratory participated in the DARPA Novel Antenna Program to develop new classes of high-performance wireless communications systems that utilize multiple-access waveforms and a variety of antenna array configurations. As part of this program, Keith Forsythe and Daniel Bliss developed the multichannel multiuser detector (MCMUD).<sup>7</sup> The function of this multiple-antenna receiver algorithm is to decode multiple code-division multiple-access (CDMA) signals in a complicated multipath environment with large power variations. CDMA is a common modulation approach used by modern third-generation cellular phone systems. In CDMA, multiple communication signals are transmitted at the same time and in the same frequency band. The signal from each radio is given a different code, enabling the receiver to disentangle the multiple transmitted signals. MCMUD provided a significant improvement over traditional receiver

algorithm approaches. The iterative receiver employed a combination of demodulation-based time-domain interference cancellation (sometimes called multiuser detection or MUD) and a form of STAP. To be clear, the technical details of STAP in this application are somewhat different than those of STAP for airborne MTI radar mentioned earlier. The MCMUD algorithm was demonstrated in field experiments performed on and near the MIT campus during 1998. In 2004, MIT was awarded a patent for MCMUD.

The concept of using multiple transmit and receive antennas to perform communication had been considered by a variety of authors, but the clearest introduction was provided by Gerard Foschini of Bell Laboratories in 1996.<sup>8</sup> In multiple-input multiple-output (MIMO) communications, a transmit node has multiple transmit antennas, and a receive node has multiple receive antennas. A single stream of information is encoded across the multiple transmit antennas by a space-time code. MIMO communication links have the advantage of providing higher data rates than those of traditional single-input single-output communication links. There are two reasons for this improvement. The first is that a single data stream can be split across multiple antennas. The second is that coding across streams provides diversity. As an extreme example of this diversity advantage, a particular transmit antenna could be removed, and a strong space-time coding approach would enable the recovery of the original signal at the receiver. In 2007, the draft MIMO standard, Institute of Electrical and Electronics Engineers (IEEE) 802.11n, was accepted, and this has become a common implementation for commercial WiFi communications.

Because of Lincoln Laboratory's work on multiuser communication, it was natural to extend this research to MIMO communications.<sup>9,10,11</sup> Of particular interest were robust versions of MIMO communication. Under funding from Lincoln Laboratory's New Technology Initiatives Program during 2001 and 2002, MIMO communication concepts, algorithms, and techniques were developed and experimentally demonstrated. A space-time turbo code and extended MCMUD receiver were conceived. While most MIMO systems, such as most implementations of IEEE 802.11n, fail in the presence of interference or jamming, the MCMUD





**Figure 29-15**  
**In this experiment conducted at Fort Dix, New Jersey, mobile transmit arrays and fixed receive arrays were used to test different waveforms and coding strategies.**

receiver suffered little degradation in the presence of jamming. For the use of MIMO in the test environment, the MCMUD receiver was extended in two important ways. First, the MCMUD receiver was modified to compensate for Doppler spread, so that MCMUD combined space-time-frequency adaptive processing with multiuser detection. In this case, the multiuser detection did not disentangle multiple users. Rather, it unraveled the multiple transmit antennas of a single user. Second, MCMUD was embedded in an outer iterative turbo decoder for the space-time turbo code. In the presence of multiple jammers, the nested-iterative receiver demonstrated performance more than 20 dB better than that of an ideal single-input single-output link. These results were demonstrated experimentally in 2005 in Fort Dix, New Jersey. Images of the experiment are depicted in Figure 29-15. The collected data were used to develop the adaptive processing algorithms for channel equalization, interference suppression, signal demodulation, and decoding.

In order to decrease the performance gap between theoretical predictions and potential implementations, new space-time codes were needed. During 2006, Lincoln Laboratory developed high-performance space-time codes that came closer to the theoretical limits than any available in the literature (Figure 29-16). These codes were based on low-density parity-check codes (LDPC) that operated using higher-dimension symbols rather than the binary symbols often used. Laboratory researchers observed that these symbols could be matched directly to the set of signals sent from the transmit antennas. This direct space-time LDPC modulation more tightly coupled the coding and the modulation,<sup>12</sup> improving coding performance. The

2000



Navy E-2D Radar  
 Modernization Program



K.W. Forsythe

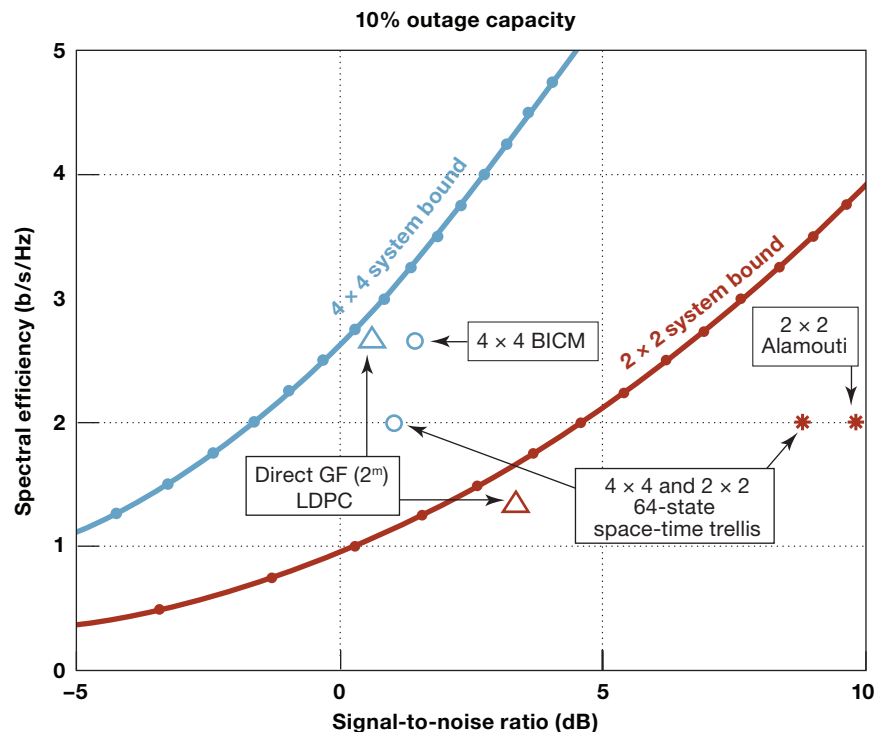


Figure 29-16

The information capacity of space-time codes for MIMO adaptive wireless communication links is shown here. Laboratory-developed LDPCs are much closer to the theoretical bounds than any prior codes and enable higher-performance communication links for stressing military applications.

#### Note

12 A.R. Margetts, K.W. Forsythe, and D.W. Bliss, "Direct Space-Time GF(q) LDPC Modulation," *Conf. Rec. 40th Asilomar Conf. on Signals, Syst. and Computers*, 1264–1268 (2006).

receiver for this space-time code naturally mitigated the effects of interference by taking the interference into account when estimating symbol likelihoods — a coding approach used by multiple Laboratory programs.

As the computation capabilities of embedded systems increase, the implementation of these more sophisticated approaches will certainly become more widespread. Multiple programs at the Laboratory are developing implementations and further theoretical and algorithmic technologies for adaptive wireless communications.

#### Future

Lincoln Laboratory has become a national leader in the field of adaptive sensor array processing, from its theoretical basis through experimental demonstration and operational system implementations. Future national security needs will require sensing systems that provide effective wide-area surveillance against new threats and in challenging environments where interference or intentional jamming is present. There will be increased demand for effective air, ground, and undersea surveillance capabilities on unmanned systems on which size, weight, and power are limited. To meet these needs, adaptive sensor array processing will be an integral part of future military sensor systems. In combination with the Laboratory's research in novel sensors, receiver electronics, and high-performance computing, the Laboratory is well positioned to continue its national leadership in the development of next-generation military sensor systems.

2005

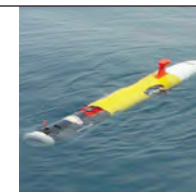


W.H. Payne



S.M. Kogon

2010



Autonomous undersea vehicle adaptive sonar processing demonstrated





RECORDING

MAIN COMPUTER  
ORIGIN 2000

ORIGIN 2000

ORIGIN 2000

Microsoft  
ORIGIN 2000

Elite Graphics

ORIGIN 2000

6500  
EnergySmart

6500  
EnergySmart



**Lincoln Laboratory has been defining, engineering, and building open systems for many years. The open systems concept has significantly decreased development time frames, cut development and maintenance costs, and enabled the use of innovative components from the commercial sector.**

Left: The complete system for ALCOR.

Sensor and similar device control systems have traditionally been developed from the ground up, using proprietary hardware and software architectures. This development model is expensive and requires long design times. Furthermore, because each device or system employs unique architectures and technology, it is difficult and expensive to maintain and upgrade the potentially vast assortment of fielded systems that require substantial computational backing to operate.<sup>1</sup>

Acquisition reform and the proliferation of open systems and commercial off-the-shelf (COTS) technologies have paved the way for major changes and cost reductions in the development process of defense acquisition programs. But open systems and COTS are about more than saving money. Open systems facilitate the use of common architectures, multiple alternate vendors, and a vastly more competitive acquisition model. A standard open architecture applied to sensors and similar systems streamlines the development process and greatly improves future technology-insertion opportunities.

Lincoln Laboratory has been heavily involved with developing open systems architectures (OSA) for a variety of applications, including ballistic missile defense (BMD), naval systems, high-performance embedded computing, and tools for data and systems analysis, to name a few. In the BMD mission area, the open systems approach has been used to upgrade radar and optical systems at missile defense test ranges, as well as at launch support sites and for mobile data-gathering assets. Open systems have also been used to provide for adjunct test processing for functional BMD sensors and test beds through the use of “sidecars.” The Laboratory has developed the Radar Open Systems Architecture (ROSA) and extended it to a second phase to support a wider variety of sensors and devices. The latter is called the Real-time Open Systems Architecture (ROSA II).

What is meant by an open system? Such a system has several salient characteristics. It is a potentially complex system that is made more manageable by breaking it down into subsystems, and then further into components and modules. The smaller parts of the open system interact with each other in a predictable fashion that involves interpart interfaces that are well defined and published without reservation. This approach allows individual parts, i.e., subsystems,

modules or components, to be sourced from different vendors or other entities while still allowing the system to be integrated and to function in accordance with specifications. This decomposition of complex problems has major benefits. The subproblems associated with the development of the parts become more manageable as fewer engineers and developers need to work on any given part. The parts are more easily tested, and multilevel testing (unit, component, integration, validation) is more easily carried out. Individual parts may be replaced by other like-function parts that share the proper behavior and interfaces. This approach, which allows the integrator of an open system to be different from the developer of the individual parts, breaks down barriers to competition within a system development project and also enables participation by potentially lower-cost sources such as small business.

The openness of a system is determined largely by the level to which parts are described with respect to their interfaces. It is quite possible that an open system may contain some closed or proprietary parts as long as their functions are well known and understood and they obey the common system-interface definitions. It is important to allow for proprietary technology as long as it is segmented appropriately, since this approach will provide a smooth transition path from completely closed and vertically integrated technology to the final goal of open and horizontally integrated (across projects and programs) technology. As a case in point, a proprietary building block that is key to open systems is the highly integrated electronic circuit — for example, the central processing unit (CPU) chip. The behavior of these chips is well understood publicly because the interface rules as well as the programming model are made public knowledge by the vendor. Although the details of the chip design are often held as a trade secret, nondisclosure of the details does not inhibit the use of the chip in an open system and allows vendors to profit from designing, forging, and selling the chips while still making the chips useful in systems that were not foreseen.

#### **Lincoln Laboratory Open Systems Historical Overview**

Lincoln Laboratory’s ROSA has been used successfully in building a mobile instrumentation radar and a shipborne instrumentation radar, and in modernizing six unique signature radars at the Reagan Test Site (RTS) on the Kwajalein Atoll in the Marshall Islands and

---

## Notes

**1** This chapter was written and edited by John Nelson, using material from Stephan Rejto; S. Rejto, "Radar Open Systems Architecture and Applications," *Rec. of IEEE Int. Radar Conf.*, 654–659 (2000); J.T. Mayhan, R.M. O'Donnell, and D. Willner, "COBRA GEMINI Radar," *Proc. 1996 IEEE Nat. Radar Conf.*, 380–385 (1996); and W.W. Camp, J.T. Mayhan, and R.M. O'Donnell, "Wideband Radar for Ballistic Missile Defense and Range-Doppler Imaging of Satellites," *Linc. Lab. J.*, **12(2)**, 267–280 (2000).

**2** The four radars, usually referred to by their acronyms, are the ARPA Long-range Tracking and Identification Radar (ALTAIR), the Target Resolution and Discrimination Experiment (TRADEX) radar, the ARPA Lincoln C-band Observables Radar (ALCOR), and the Millimeter Wave (MMW) radar.

three unique radars at the Lincoln Space Surveillance Complex in Westford, Massachusetts. Radars at the Eastern and Western ranges, along with systems at the Pacific Missile Range Facility on Kauai, Hawaii, have also been modernized using the ROSA approach. ROSA embraces the Modular Open System Approach (MOSA) by decomposing a radar processing and control system into functional building blocks constructed using COTS hardware and modular embedded software. This decomposition provides loosely coupled operational subsystem components that, when tied together using well-defined interfaces, form a complete radar processing and control system. Building blocks can be added or modified to allow new technology insertion, with minimal impact on the other elements of the radar system. More importantly, existing radar building blocks can be shared and used to create new radars or to modernize existing systems. MOSA has led to improvements in time to operation, reduced cost, and increased commonality.

The ROSA technology refresh, ROSA II, is designed to extend the reach of open systems work at the Laboratory to include support for other sensors, devices, and more complex sensors such as phased-array radars, heterogeneous networks of compute platforms, and a highly configurable net-centric architecture. ROSA II consists of a layered structure that isolates the application modules, or components, from the lower-level details of the structure. These common components are written to a specific application interface that isolates the application layer from the middleware in use and from the hardware the system is running on, be it a cluster of computers or a single symmetric multiprocessor computer. This interface allows the hardware and communications fabric in the system to be changed or upgraded without affecting the software at the application layer, a dramatic advantage in portability and openness.

### *Example Laboratory Efforts in Open Systems*

With the end of the Cold War, measurement and signature intelligence (MASINT) data collection requirements had changed. Formerly, the primary MASINT task had been to collect information on foreign strategic missile systems. By the mid-1990s, the data-collection problem had changed to that of collecting information on proliferating and emerging tactical ballistic missile capabilities of a number

of countries. In particular, after the Gulf War, it became apparent that theater-style ballistic missiles, which are available to many nations, are a political and military force to be considered. These missiles could be equipped with chemical, bacteriological, conventional, or nuclear weapons, with all the potential devastation that such weapons bring with them.

In 1996, Lincoln Laboratory, with sponsorship from the Air Force Electronic Systems Center and in collaboration with the MITRE Corporation, developed and fielded a dual-band radar using the ROSA approach for a mobile instrumentation radar. The purpose of the system was to collect metric and signature data on theater ballistic missile targets. Key studies had recommended developing a small transportable radar that could be deployed on land or at sea. A radar design and development approach using open systems principles and techniques was crucial to meeting the low cost and short development schedule of this program. The back-end processing system of the radar was the first implementation of the Lincoln Laboratory ROSA approach that was put into practice. The system completed its ground-based testing in summer 1998 and had first operational capability in winter 1999.

The ROSA approach as implemented in the mobile instrumentation radar was an approach that could be handed off to industry to commercialize, thereby allowing any number of these radars to be developed. The mobile instrumentation radar was a major milestone in Lincoln Laboratory's engagement of radar open systems approaches. Shortly before the work on the mobile instrumentation radar was completed, work began on extending ROSA to test-range applications.

During the period of the late 1990s to the early 2000s, RTS, Lincoln Laboratory, and Raytheon Range Systems Engineering fully modernized the RTS radar suite as part of the Kwajalein Modernization and Remoting (KMAR) program. The radar suite included four unique state-of-the-art signature instrumentation radars<sup>2</sup> located on the island of Roi-Namur of the Kwajalein Atoll (Figure 30-1), and two metric tracking radars located on Kwajalein Island. These radars are world-class systems supporting six frequencies from very high frequency (VHF) to Ka-band. They are used for metric and signature data collection on





**Figure 30-1**  
RTS instrumentation radars: ALCOR  
(front left), TRADEX (front right),  
MMW (center), and ALTAIR (back,  
near lagoon).





**Figure 30-2**  
Haystack and Haystack Auxiliary radars on the Millstone Hill site.

operational missile tests, in ballistic missile defense experiments, and for space surveillance. The radars also play an important role as surrogates for testing new technology that may be appropriate for new weapon-system radars. Examples of such technology are wide-bandwidth waveforms (512 MHz and 1 and 2 GHz) and frequency-jump burst waveforms.

The RTS radars, each uniquely developed with specialized hardware and software running on different types and brands of computer equipment, represented an environment that was ripe for the application of the ROSA approach. ROSA would allow, after the upgrades at RTS were complete, the radar operations and maintenance staffing to be reduced substantially and would permit the radar systems to be run remotely from the RTS headquarters building on Kwajalein Island, some 80 km from the actual location of the majority of the radar sites, which are on Roi-Namur Island. This remote operation was enabled both by the network-friendly architecture of the ROSA system components, as well as the existence of a redundant fiber-optic ring network linking a number of the islands around the Kwajalein Atoll, including Kwajalein and Roi-Namur. The number of workers traveling every day from Kwajalein Island to Roi-Namur and back was therefore greatly lowered, thereby saving range resources.

The RTS operational objectives were obtained by decomposing each radar system into ROSA building blocks. A high degree of commonality (greater than 75%) was achieved among the five radar types. Each ROSA component was designed to work as a generic radar subsystem, thus allowing a subsystem to be moved from one radar to another with minimal

impact. As subsystems were used to abstract unique hardware components, the main computer real-time program was also shared among the individual radars. Each rack represented an individual radar subsystem. The ALCOR system was received at RTS in December 1999; within only two weeks, it was up and running the radar, tracking space objects.

As part of the KMAR program, similar open technology offered the potential for effective use in the support roles of planning and analysis for the radars and other range sensors. For the RTS radars, it is crucial that missions be planned out in detail to ensure that the dwell is placed on the correct targets at the correct times to collect the data that will help determine or verify the behavior of the mission flight vehicles. Setup for the sensors must be done in a coordinated fashion, taking into account the capabilities of each and the desire for the most effective mission coverage. Undertaken with a manual approach, the planning effort can be daunting. For this reason, a Mission Planning Workstation, developed using an open software development approach, was created. This planning tool is suitable for use with any radar or collection of radar systems to efficiently lay out a mission timeline based upon the details of sensor capabilities and mission data requirements.

The data collected by the ROSA radars is stored in a common signature and metric data format, regardless of the source. This common analysis data format is the input to the Laboratory-developed Advanced Analysis Workstation data-analysis toolset, which was also created as part of the KMAR program. The workstation suite has since been extended to accept data from a wide variety of other non-RTS radars by

1990



S.B. Rejto



Millstone radar

---

**Note**

**3** Material for this section is from J. Kepner and J. Lebak, "Software Technologies for High-Performance Parallel Signal Processing," *Linc. Lab. J.* **14(2)**, 181–198 (2003).

providing a suite of programs that convert the many data formats native to individual radar recordings into the standard open analysis format. Therefore, all the intellectual property built into the Advanced Analysis Workstation — such as metric analysis, pulse signature analysis, Doppler processing, and inverse synthetic aperture radar imaging — may be used for all relevant radars and their data sets.

During the RTS radar modernization, the Millstone Hill radars in Westford, Massachusetts (Haystack, Haystack Auxiliary, and Millstone), which perform space surveillance functions for the U.S. Air Force, were selected for an upgrade very similar to that of the RTS program (Figure 30-2). After evaluating the RTS effort, the Millstone Hill engineers realized that they could leverage many of the recently developed ROSA building blocks. The open systems architecture, available subsystems, and generic radar software have drastically reduced the cost of modernizing the radars at Millstone Hill.

ROSA has also been used to upgrade radars at the Pacific Missile Range Facility through a technology-sharing agreement with industry, and at the Eastern and Western ranges as well. As a result, a large number of instrumentation radars at test ranges around the globe are now utilizing ROSA software and hardware. Lincoln Laboratory's ROSA technology has proven to be much more common, simple, and inexpensive to develop and install, and with lower overall life-cycle costs, than traditional radar development methodologies of vertically integrated architectures.

***Open, Portable Software for Signal Processing***

Another significant area of open systems activity for Lincoln Laboratory is the development of open and portable software technologies for high-performance signal processing and high-performance embedded computing applications.<sup>3</sup> Real-time signal processing consumes the majority of the global computing power. Signal processing-capable hardware capacity has increased vastly in the last decade, and the state of the art in computing hardware continues to expand at a rapid rate. The biggest challenge with respect to signal processing remains the mapping of parallel algorithms onto a compute fabric in such a way that performance is preserved while at the same time the software remains portable to future platforms with higher performance potential. A number of tools and approaches have been developed at Lincoln Laboratory to allow for this software portability. These include the Parallel Vector Library (PVL), which is an open, layered software approach that allows high-level code to be internally downcast to specific hardware platforms without requiring the application engineer to have full, detailed understanding of the underlying platforms themselves.

The development of the PVL library and approach had the following major goals: (1) ease the development of parallel signal processing software, (2) make the application-level code as portable as possible, (3) separate the tasks of signal processing design and development from the tasks of data mapping and management, and (4) achieve respectably high performance on many different target platforms. To reach these goals, the PVL approach had to be open, that is, the component layers of the system needed well-defined interfaces that should



R.A. Bond



**Figure 30-3**  
**Sidecar for BMD forward-based test bed.**

not vary from platform to platform. Another requirement was the mapping of data onto the hardware platform. The mapping may necessarily change as the details of the hardware platform change, for example, the number of CPUs involved or the number of machines networked in a cluster computing environment. To mitigate mapping changes, PVL uses the same object reference for computational data and memory areas that contain the data, thereby unifying the tags that data are calculated with and communicated through.

The PVL library supports advanced features of object-oriented programming languages (for example, C++) to provide for data and task parallelism without being tied to the details of the underlying compute hardware. Thus, PVL provides an open, platform-independent software approach while offering performance on par with more traditional hard-coded approaches.

#### *Sensor Sidecars for Advanced Ballistic Missile Defense Testing*

Developers of a general missile defense system face a number of significant challenges. System upgrades and improvements are necessarily incremental and must be carried out on short time schedules, often when the system is operational and “on alert.” The system must have a robust capability that matches the requirements. This capability is often based upon advanced algorithms that make the best use of information gathered by sensors and processed potentially in other system components. Individual sensors will employ algorithms to ensure that their data-collection capability is used most effectively, and the system itself will employ algorithms to fuse the data from multiple sensor sources to most effectively mine and utilize the available information. Finally, these advanced algorithms must be emplaced in sensors and system components and therefore tested concurrently with the operational system activities. Sensor or other system component adjunct processors, or sidecars, have been and are being developed to help meet these challenges in building BMD systems.

A sidecar is an adjunct information processing system that may be attached to a sensor or other data-gathering or processing component of a system. The purpose of this symbiosis is to provide for an additional processing environment, which generally is not part of the operational system but which has the capability to run

algorithms and other processes that can augment the system or provide an upgrade path for the sensor or system component.

Lincoln Laboratory has been involved in sidecar specification, design, and development since the early 2000s. Laboratory-developed sidecars that are based upon ROSA have been emplaced at the sensors at RTS, the Missile Defense Agency’s (MDA) fusion algorithm development sites, space assets, and operational mobile shipborne platforms. A new suite of sidecars is being developed and deployed onto the MDA’s most important assets so that new technology can be inserted into these assets in an expedient yet controlled fashion.

Sidecars may also be used for sensor surrogate activities. Because of the evolutionary nature of large-scale system development, the situation in which an available sensor does not match completely the requirements of the system interface will often occur. This situation can be mitigated by the use of a sidecar that can interface with a sensor to make it operate with the target system. The Laboratory has also developed surrogate sensor test beds based upon the construct of sidecars. For example, the Laboratory developed, while working in collaboration with Raytheon, a missile defense forward-based sensing test bed that allowed advanced algorithms to be tested and hardened in a live-fire test environment (Figure 30-3).

#### **ROSA II Development**

The initial ROSA data processing computer systems running the ROSA real-time processor are based on the SGI IRIX symmetric multiprocessing platform. At the time of the original ROSA development effort, the SGI platform was the most robust real-time UNIX platform available. Since the original ROSA efforts, the code base has been revised and expanded to support a variety of other dish-type instrumentation radars. ROSA has also been modified for sidecar development by making significant adaptations and add-ons, some of which have aided the development of the next wave of Lincoln Laboratory sensor processing — ROSA II.

ROSA II has become the next real-time signal and data processing framework. Because ROSA II technology is applicable on a diverse set of sensors, it was initially undertaken as an internal research and development



effort at the Laboratory. Specific implementations of sensor systems using the ROSA II framework have been funded by individual program development funding lines.

ROSA II adds more flexibility, scalability, modularity, portability, and maintainability than is offered by the original version of ROSA. ROSA II focuses on enhancing these features, as well as providing a robust infrastructure for sidecar and other test bed development. A key enabler for ROSA II is abstraction, by which interfaces among components are well separated and closely defined. With abstraction in the software codes, new developers do not need to understand or modify complexities in the core code in order to add features or make changes for a new application or mission area. This approach decreases the amount of code that needs to be maintained and increases the integration of codes among applications.

Abstraction of specific details of hardware and operating systems allows ROSA II to more easily use different types of machines for control and signal processing. System designers are able to use inexpensive commodity computers, rugged space- and power-efficient computers, or the traditional high-performance symmetric multiprocessing computers as appropriate for their application.

The ROSA II system adds the capability to easily and directly support phased-array radars. The phased array is very important for the future of Lincoln Laboratory's system, radar, and algorithm development. In a phased-array system, closed-loop tracking components need to be more robust. Furthermore, the signal processing requirements of a phased-array system can be very substantial and may require dedicated signal processing hardware subsystems. These requirements may be accommodated by using specialized parallel computers, without affecting the general-purpose computers used to service other aspects of the system. An abstracted communications layer in the system called the ROSA Thin Communication Layer (RTCL) allows the connecting of disparate subsystems without the need for each subsystem to have knowledge of the internal workings of the others. RTCL also allows the software components of the system to be location-transparent with respect to computing platform and network

infrastructure. For example, a system may be based upon a symmetric multiprocessing platform or a networked cluster of computers, or both. The ROSA II software components may be placed within these architectures without making changes to the components themselves.

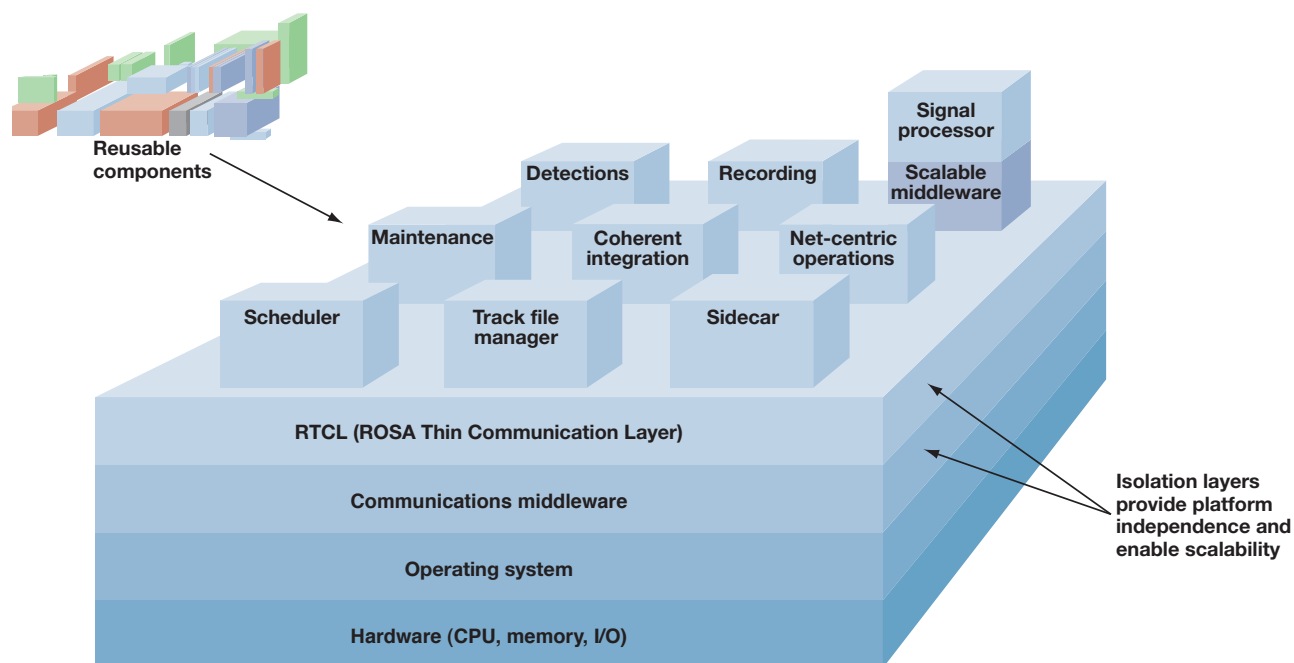
The approach for ROSA II development has been a combination of evolution and revolution. The effort resulted in a much more portable and platform-independent solution that includes the ability to use both symmetric multiprocessor systems and distributed computing clusters. The computational platform choice depends upon the specific application that is contemplated. The ROSA II architecture has been designed to run on multiple platforms to accommodate the anticipated increased importance and availability of high-performance multiprocessor clusters using multicore chips.

The use of a communications infrastructure, or middleware, represents a revolutionary aspect of the architecture. Also, in order to support a phased array, the system needs a new set of control messages as well as a new beam-steering subsystem. A new mechanism for handling state vectors suitable for use with phased-array systems that can track many tens of objects simultaneously has been developed.

Components (e.g., loggers, data recorders, trackers) are scalable and portable themselves. With very limited exceptions (interfaces to the radar hardware, for example), the modules subscribe to input data and control information through the communications middleware, and make outputs available by publishing on the same middleware. With a consistent and well-defined interface for each module, swapping modules is a simple matter. In the same way, a well-defined isolation layer above the communications infrastructure provides a straightforward way to upgrade the middleware if the need should arise in the future (Figure 30-4).

RTCL isolates the components from the specific aspects of the middleware(s) in use. This approach allows the components to be used with any middleware supported by RTCL and to be used with multiple middlewares at the same time if that is required by the system design. This layer switching is done without any changes

**Figure 30-4**  
**Modern ROSA model.**



**Note**

4 In late 2008 and early 2009, John Young, Under Secretary of Defense for Acquisition, Technology and Logistics, issued directives pertaining to the use of open systems architecture. The first directive called for the creation of a Joint Analysis Team (JAT) to examine the use of open systems in radar development efforts. As a result of the activities of the JAT, Young issued a directive in February 2009 establishing a Radar Open Systems Architecture (ROSA) Defense Support Team. The charter for the team was to coordinate all interested parties in the area of ROSA and recommend open architecture options that can meet radar development requirements. The Laboratory was and is a key participant in these activities.

necessary to the application code of the components, just with configuration changes. For example, a system that runs on a shared-memory platform needs a shared-memory transport that allows transfer of data between components without any data copying; this transport, without the delay of data copying, is important for ultimate throughput. For a system that runs on a network, a good middleware is the Data Distribution Service object-messaging approach defined by the Object Management Group. For a system with components on both shared-memory and clustered machines, both middlewares are simultaneously usable with no software changes.

The components are contained in a component library. The system itself is built up by using an appropriate collection of the existing components or new components that the system developer generates. System developers can maintain their own selection of components, as necessary and appropriate. Well-engineered components are loosely coupled and rely upon well-defined inputs and outputs defined by machine-readable Interface Control Documents. The ROSA II component model contains support for a common component object model that supports

common code for data input and output as well as component control and status-logging functionalities. The common component model also supports a component state machine, as well as timing and time-control functionality. These functionalities are provided in a component base class that all ROSA II components inherit from and thereby obtain by default. Application code needing to use these functionalities can inherit and populate the relevant parts of the base class in the finished component code.

The time-control functionality is used to support the system from the view of time budgeting. The system engineer may determine that a particular component has to respond with a result or action within a certain period of time in order to be viable. This strict timing control can and should be avoided in most components; however, some time-critical components in a system have to respond reliably with respect to a time budget. This need is supported in the component base class and can be used in components with a time-criticality requirement. Structure is provided in the form of timing routines, including callbacks that can be executed as a preset time-budget limitation is approached. The application programmer can provide the code to handle

## Government Policy for Open Systems: Open Systems Joint Task Force

In 1994, the Under Secretary of Defense for Acquisition and Technology, Paul Kaminski, directed acquisition executives in the DoD to use open systems specifications and standards for acquisition of all weapon systems to the greatest extent possible. As a result of this directive, the Open Systems Joint Task Force (OSJTF) was chartered as a cooperative effort of the Army, Navy, Air Force, and the Under Secretary of Defense for Acquisition and Technology.\* The OSJTF charter was to use the opportunity that exists in open systems to make a significant impact on the cost, interoperability, modularity, technology transparency, and supportability of technology in future systems and system upgrades.

Key aspects of the OSJTF mission were to establish a Modular Open Systems Approach (MOSA) that could be used in the acquisition and upgrade process, to ensure MOSA use by all relevant DoD acquisition programs, and to collaborate with industry to allow the emplacement of a viable open standards technology base and approach. MOSA is both a business strategy and technical approach for developing new systems, as well as modernizing or upgrading existing systems. MOSA

seeks to implement open standards (industry standards where available and appropriate; specific standards which are open and published when industry standards do not exist or are not appropriate) to design and develop systems. Lincoln Laboratory's ROSA is one example of an open system that is MOSA compliant.

Throughout the 1990s, the Under Secretary of Defense for Acquisition, Technology and Logistics continued to issue directives guiding the requirements for development and deployment of open systems.\*\* These included a memo issued in 1996 extending the reach of open systems approaches to command, control, communications, and intelligence (C3I) systems with inclusion of Special Operations Command, Defense Airborne Reconnaissance Office, and the Ballistic Missile Defense Organization, later recast as the Missile Defense Agency.

---

\*Open Systems Joint Task Force website, <http://www.acq.osd.mil/osjtf/>.

\*\*Under Secretary of Defense for Acquisition, Technology and Logistics website, <http://www.acq.osd.mil/>.

time-out exceptions as necessary. An example would be a component that refines estimates of target position based upon available time and information. When the component's time budget for a new target report runs out, it will be able to provide its best estimate available.

With the completion of the basic ROSA II development effort, Lincoln Laboratory has the architecture, design, and reference implementations for the system, the middleware, and components suitable for use in radar systems, optical control systems, and other device-control domains. A number of programs are making use of ROSA II.

### Open Systems Development Summary

Acquisition reform, open systems approaches, and the use of industry-standard technology have paved the way for major changes in the development process of DoD acquisition programs. The open systems approach can provide cost reductions, simplify new technology insertion, promote the use of alternate vendors, and streamline the development process.

Weapons systems or system components traditionally developed using proprietary architectures, hardware, and software are very expensive to build and maintain. By embracing the open systems approach, developers decompose a system into functional subsystems, each built with either standard commercial parts or open software modules. Lincoln Laboratory has been and remains on the forefront of open systems technology development. A series of directives from John Young, then the Under Secretary of Defense for Acquisition, Technology, and Logistics, emphasized the DoD's interest in using open systems in radar and other device development.<sup>4</sup> The Laboratory is well positioned to provide government and industry with the benefit of its experience and expertise in these important technical areas.





MASSACHUSETTS INSTITUTE OF TECHNOLOGY  
LINCOLN LABORATORY



**Lincoln Laboratory applies a consistent philosophy to each design effort. Highly qualified technical personnel are assigned, necessary support is provided, and each project is followed systematically from concept development, through simulation and analysis, to the demonstration of an integrated system, and finally to technology transfer.**

**Left: The main entrance to Lincoln Laboratory is in Building S, completed in 1994.**

The preceding chapters recount the diverse technical achievements of Lincoln Laboratory. But what is the source of this substantial, continuing productivity? The answer lies in the Laboratory's style — an approach to the management of research and technology development that encompasses every aspect of its operations.

The basic style of operation of Lincoln Laboratory can be traced to the World War II–era MIT Radiation Laboratory.<sup>1</sup> The Radiation Laboratory, known as the Rad Lab, was successful both in developing microwave radars for the war effort and in laying the groundwork to establish continuing relationships between the government and the nation's research universities. The Rad Lab had enormous independence: it maintained close working relationships with industry and the armed services, including forces in the field, and it was permitted intimate access to classified information in the United States and Great Britain. By the end of World War II, the Rad Lab had 3500 employees, and they took their experience with them to influence the development of multidisciplinary research efforts at universities across the nation.

The Rad Lab ceased work at the end of World War II, but many of the individuals who served there went on to participate in the Project Charles study and in Project Lincoln, bringing with them their ideas about how a laboratory should be run. Much has changed in Lincoln Laboratory's operations since 1951, but the heritage from the MIT Rad Lab remains strong.

#### **Personnel, Organization, and Infrastructure**

The key ingredients in a successful research and development laboratory are its personnel, its organizational structure, and its infrastructure. Lincoln Laboratory has long recognized the importance of these factors: its excellence derives from its advanced technical facilities; its supportive organizational structure and administrative staff; its skilled technical support personnel; and its highly motivated, intelligent, and creative technical staff.

#### *Personnel*

The association of Lincoln Laboratory with MIT, the nation's leading technical university, is an essential element in attracting the best scientific and engineering expertise. This affiliation gives assurance of quality research and technology development while providing access to the university's unique facilities and outstanding faculty.

The determining factor in maintaining excellence at Lincoln Laboratory is the quality and creativity of the approximately 1500 professional technical staff members. The Laboratory recruits top graduates of the leading technical universities in the country. Emphasis is placed on hiring candidates with advanced graduate training in physics, electrical engineering, mathematics, and computer science. Currently, more than 70% of the staff hold advanced degrees and over 40% have doctorates (Figure 31-1).

Because of the rapid pace of advances in science and technology, technical staff members need ongoing opportunities to maximize their capabilities through technical courses, self-education, professional contacts, and peer reviews. The Laboratory environment respects and encourages cooperation among colleagues and free exchange of information. The contributions of each technical staff member are evaluated regularly in writing to assess performance on current assignments and guide staff members in planning their future at the Laboratory. Reviews based on these assessments, coupled with regular merit-based turnover, result in continual renewal of the technical staff. Recognizing the critical importance of retaining a superior technical staff, management devotes considerable time to staff development and evaluation of staff quality.

#### *Organizational Structure*

As the largest research laboratory of MIT, Lincoln Laboratory is accountable to the senior management of the Institute (Figure 31-2). The director of the Laboratory reports to the MIT provost, who has an advisory committee of academic and industrial leaders to assist in evaluating and guiding the operation of the Laboratory. This committee serves a function similar to that of a visiting committee to an academic department.

---

**Note**

The Radiation Laboratory was established by the National Defense Research Council (NDRC), which was conceived in 1940 by Vannevar Bush as an independent civilian agency to coordinate and extend military research. Bush put his ideas for the NDRC on a single sheet of paper and, after a fifteen-minute meeting with President Roosevelt, received the approval "OK, FDR." No additional paperwork, meetings, or studies were necessary. The Microwave Committee of the NDRC, headed by Alfred Loomis, then set up the Radiation Laboratory to develop radar systems. Lee DuBridge was chosen as the director, and MIT, with the approval of its president Karl Compton, was chosen as the location for the new laboratory.

All research and development programs undertaken at the Laboratory must be approved by the Department of Defense (DoD) Joint Advisory Committee (JAC). The JAC is chaired by the Assistant Secretary of Defense for Research and Engineering. The Laboratory was created as and remains a joint-service DoD facility with close ties to its sponsoring organizations. In its oversight role, the JAC ensures that the Laboratory adheres to federal policies for DoD Federally Funded Research and Development Centers and annually reviews the Laboratory's proposal for programs to be undertaken in the subsequent fiscal year. The JAC is advised in its oversight of the Laboratory by the Joint Advisory Committee Executive Group, which includes sponsors who review individual programs and a contracting administrative office that monitors overall Laboratory activities and ensures compliance.

The Laboratory's advanced technology efforts are supported by a Congressional budget line. In 2010, this budget line accounted for approximately 3% of the total DoD funding of Laboratory projects. Most Laboratory programs are funded by individual government sponsors, and programs are regularly reviewed to ensure they are closely tied to the sponsors' requirements. Sponsors have many choices in deciding where work is to be accomplished and are required to establish that the Laboratory is the most effective source.

Since Lincoln Laboratory's productivity depends on the creativity of its technical staff, it has always avoided multiple middle management levels in its internal organizational structure and encourages the interchange of ideas between staff members and senior management. The Laboratory organization includes just three primary management levels: the Director's Office, the division heads, and the group leaders.

The director of the Laboratory is aided by an associate director, an assistant director for operations, and the Steering Committee, which comprises the associate director, assistant director for operations, other key staff in the Director's Office, division heads, and associate division heads. Assistant division heads are invited to attend meetings as well. The Steering Committee meets biweekly to listen to technical presentations, review Laboratory strategic plans, and approve and discuss general Laboratory issues. The Steering Committee

provides technical leadership and supports the efficient utilization of resources across Laboratory programs. It also provides a forum for information exchange and for discussion of management and policy issues.

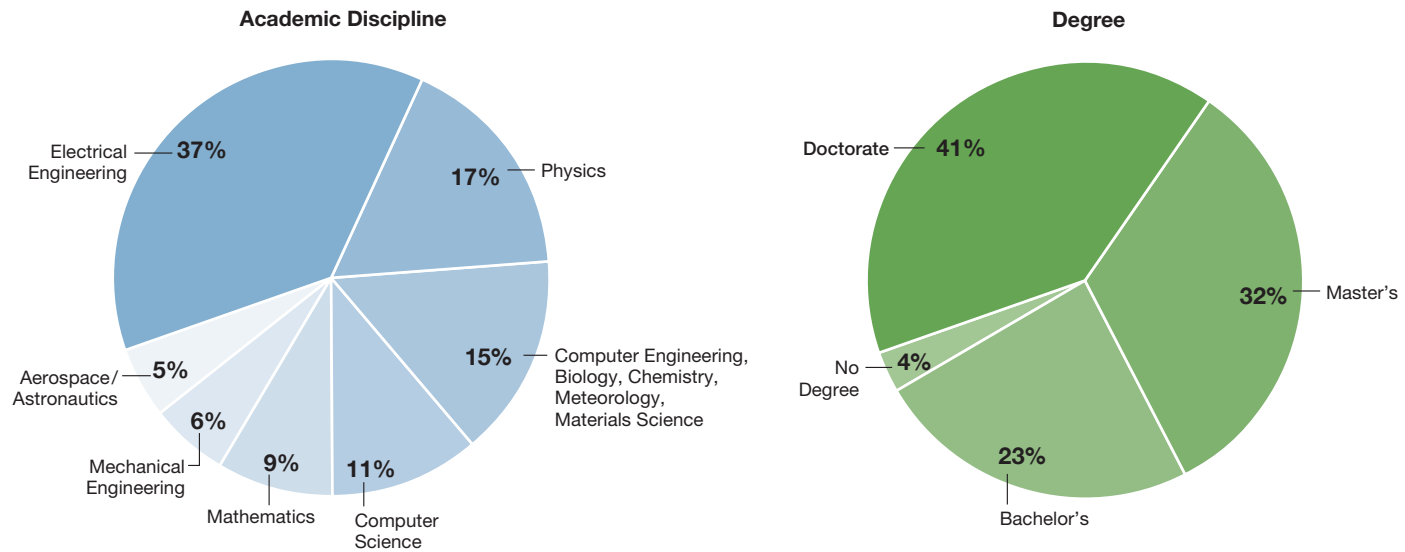
In 2006, the Laboratory added two key technical staff functions: the chief technology officer and the Mission Assurance Office. The chief technology officer coordinates the Laboratory's technical investment portfolio for both research projects and technical infrastructure. The Technology Office fosters technical relationships with university campuses and outside research organizations. With the advent of more complex system integration, and flight and space programs, the Laboratory created the Mission Assurance Office to ensure programs meet sponsors' expectations for quality and reliability. This office balances the need for rapid development of high-risk technologies with quality assurance by tailoring standard practices for the Laboratory's advanced development environment.

The Laboratory has seven technical divisions and six administrative departments; the Engineering Division also provides engineering support services. Each division has between four and nine groups (Figure 31-3). The typical technical group has 20 to 25 technical staff members and approximately as many technical and nontechnical support personnel. Management at all levels consists almost entirely of individuals with technical backgrounds who usually have been promoted from within. Technical leaders are assisted by their own group members in determining the direction of projects and in onsite supervision of activities. The ratio of technical supervisory personnel to technical staff and support personnel is thus relatively low.

Laboratory projects are executed by the line organization of divisions and groups, rather than by a matrix organization, thereby minimizing the number of personnel required. On a large project requiring expertise from several divisions, a lead division may create a project management team to coordinate work with supporting divisions. Formal and informal internal technical presentations are also used to promote the exchange of information and ideas among colleagues across divisions.



### Composition of Professional Technical Staff



**Figure 31-1**  
Composition of Lincoln Laboratory technical staff in 2011 by highest degree earned and by discipline.

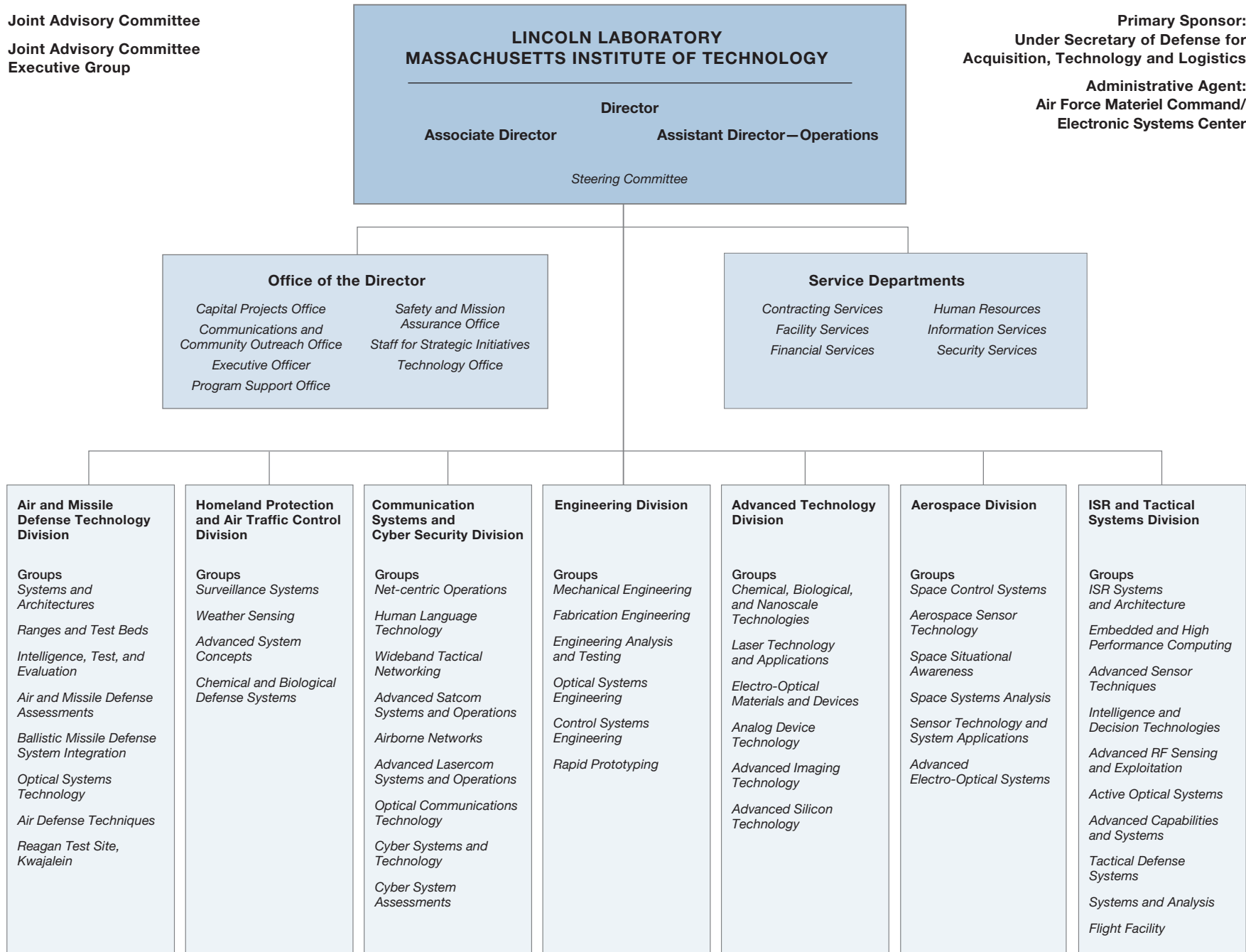


**Figure 31-2**  
The organization for MIT's management of Lincoln Laboratory in 2011.

Joint Advisory Committee  
 Joint Advisory Committee  
 Executive Group

Primary Sponsor:  
 Under Secretary of Defense for  
 Acquisition, Technology and Logistics

Administrative Agent:  
 Air Force Materiel Command/  
 Electronic Systems Center



**Figure 31-3**  
 Lincoln Laboratory organization chart  
 in 2011.

Lincoln Laboratory operates with a ceiling on the total number of professional technical staff members and with a ceiling on the annual funding the Laboratory can receive. The ceilings have been beneficial in that they have compelled the Laboratory to emphasize staff quality, organizational efficiency, the selective undertaking of new tasks, and the transfer of technologies.

The productivity of technical staff members is maximized through the use of technical services from engineering assistants, specialists, and technicians who construct and operate equipment, develop software, and assist in engineering efforts. An average of one technical support person assists each principal technical staff member; provision of substantially less technical support than this has been found to lower productivity.

The technical staff also receive considerable administrative and resource support. From 2005 to 2006, the Laboratory transitioned from a single administrative division to six administrative service departments reporting to the assistant director for operations. These departments — financial, information, contracting, security, facilities, and human resources — provide a full range of administrative and management services to technical divisions and special projects. The internal operating budget is managed in the Director's Office by the assistant director for operations and is built collaboratively by the service departments, Technology Office, and technical divisions.

The optimal level of administrative services has been found to be about the same as for technical support services, approximately one person for each principal technical staff member.

#### *Infrastructure*

Certainly, a critical factor in Lincoln Laboratory's achievements is its world-class technical infrastructure. Laboratory resources include microelectronics research and fabrication laboratories; advanced radars in Lexington and at field sites; flight facilities and aircraft for testing advanced sensor systems; optics, laser, chemical, and biology laboratories; high-speed grid computation capabilities; and antenna test ranges and chambers. A variety of mechanical and electronics fabrication facilities support engineering activities. Additional facilities, such as electron microscopes

capable of resolving features as small as individual atoms, are available on the MIT campus and are utilized by Laboratory staff members.

In 1994, the Laboratory opened its main building complex; over the ensuing years, technical capabilities such as optical test ranges, operations centers, and decision support facilities were added to the building. In 2001, an expanded health and wellness facility opened, and in 2005, new engineering and prototyping spaces were added on the Katahdin Hill campus. Currently, the Laboratory is embarking on a major recapitalization phase to modernize the microelectronics laboratories, update the engineering shops, and refresh the 1950s-era buildings.

#### **Approach to Research and Development**

The Lincoln Laboratory approach to research and development incorporates seven basic steps: systems study; measurement of relevant phenomenology; development of required device technologies; design and prototyping of equipment; field tests with operational personnel; technical review of research by peers; and technology transfer to industry. Repeated successful implementations of Lincoln Laboratory system designs have demonstrated the soundness of this methodology.

When Lincoln Laboratory initiates an investigation of a significant technical issue affecting national security, the undertaking generally begins with a system definition study, carried out either internally or with external participation. The study defines the problem to be addressed, reviews possible solutions with known technologies, identifies needed phenomenological information, evaluates new technical approaches, outlines possible system designs, and delineates a plan of attack. A defining study often reveals the need to gather specific environmental data such as radar clutter, noise backgrounds, electromagnetic propagation, infrared emission, or acoustic levels. A study may also call for a characterization of the properties of the system itself. Measuring and understanding the relevant phenomenologies provide information vital to the successful creation of new technical approaches and allow verification of the concepts underlying development efforts. Experience has shown that proceeding with system development without such studies can bring unfortunate surprises.



Figure 31-4

Lincoln Laboratory's publications present its technical accomplishments to a wide audience.



Quite often, technical challenges can be met through the development of new electronic or optical devices. Devices developed in the past include the core memory, the laser diode, surface-acoustic-wave devices, electro-optic devices, and high-sensitivity optical and infrared sensors — and these are just a few examples of devices developed at Lincoln Laboratory. The Laboratory continues to have a strong commitment to the development and utilization of advanced electronic, optical, chemical, and biological devices to improve system capabilities.

Once a system has been designed, constructed, and characterized, it is thoroughly tested, frequently in the field. Such tests may be preceded by preliminary analyses, including intensive computer-based modeling and simulations. However, simulations cannot take the place of actual field trials. In fact, field tests often provide the data necessary to extrapolate a simulation to reflect a more complex environment. The Laboratory considers a system design incomplete until its soundness has been verified by carefully planned and executed tests in the field.

Throughout the initial system study, device development, design, and testing, the Laboratory requests reviews of program progress by technically qualified personnel from within the Laboratory, outside, or both. Small review groups composed of individuals with a

high degree of technical competence have been found to provide the most useful reviews. This technical input by peers serves as a check on the soundness of a system design and ensures that alternative approaches are considered. Both formal and informal technical reviews by Laboratory colleagues are also held whenever a staff member is planning to make a technical presentation. These reviews are highly informative, thought-provoking, and critical to ensuring that the Laboratory presents high-quality work to the technical community.

The transfer of new technologies to outside institutions and industries is a key process throughout a project. Technology transfers can be accomplished by publications, seminars, and field demonstrations; by Laboratory personnel temporarily or permanently transferring to outside organizations; or by industry personnel residing at the Laboratory. In addition, the Laboratory helps shape the capability of the industrial base by subcontracting the fabrication of specialty components using Lincoln Laboratory-developed designs and processes. The Laboratory hosts technical workshops, seminars on special topics, and an annual series of JAC seminars covering each of the Laboratory's mission areas. Individual technical staff members also speak at symposia sponsored by professional societies, contribute to professional journals, write detailed descriptions of their research activities in technical reports, and present their work

to scientists and engineers in a wide range of technical disciplines through the *Lincoln Laboratory Journal*, *Lab Notes*, *Tech Notes* (Figure 31-4), and news releases on its external website, all coordinated and produced by the Communications and Community Outreach Office.

Unlike private industry, Lincoln Laboratory does not manufacture and sell products; therefore, it must measure the success of its work by the extent to which new technologies find applications elsewhere. The transfer of technologies for either government or commercial use is a vital Laboratory objective and is strongly encouraged. The Laboratory frequently transfers technologies to companies serving the defense sector. Mechanisms such as patent licenses, technology transfer agreements, and cooperative research and development agreements now also permit the transfer of advanced technologies to nondefense commercial industries. Before a cooperative agreement is signed, it is reviewed by the Laboratory for any possible conflict of interest and by the Air Force to ensure its appropriateness.

Lincoln Laboratory provides an exceptionally supportive environment for research and development, where scientists and engineers are free to think, experiment, and solve problems of national importance. Because of the quality of its technical staff and an organizational structure that fosters innovation, the Laboratory has produced research of the highest quality for 60 years, and it will maintain this excellence as it faces new challenges.

### The Lincoln Laboratory Logo



The MIT Lincoln Laboratory logo, which first appeared in February 1958 in the *Lincoln Laboratory Bulletin*, was conceived by Carl Overhage, the Laboratory's fourth director. Overhage drew a Lissajous figure\* based on the superposition of two simple harmonic vibrations and commissioned retired Brigadier General Robert Steinle and the firm Advertising Designers of Los Angeles to transform the Lissajous figure into an artistic image.

The two L's rotated 180° with respect to each other stand for Lincoln Laboratory. They form a rectangle enclosing the Lissajous figure generated by the parametric equations  $x = 3 \sin(8\pi t/T)$  and  $y = 4 \sin(6\pi t/T)$ . The figure is traced along the horizontal axis  $x$  and the vertical axis  $y$  as the variable  $t$  progresses from  $t = 0$  to  $T$ .

The Lissajous figure, familiar to most physical scientists and engineers, connotes harmony, order, and stability.

The Lincoln Laboratory logo is an identifying symbol on Laboratory reports, presentation materials, badges, and signs. Because of its distinctive and striking appearance, it was included in *The Book of American Trademarks*, a compilation of the nation's most significant trademarks, logos, and corporate symbols.\*\*

---

\* Lissajous figures, named for the French mathematician Jules-Antoine Lissajous, are also known as Bowditch curves after their discoverer, Nathaniel Bowditch, the mathematician from Salem, Massachusetts.

\*\* D.E. Carter, *The Book of American Trademarks*. Ashland, Ky.: Century Communications Unlimited, 1972.







**Lincoln Laboratory maintains technical excellence by recruiting high-caliber technical professionals and by encouraging professional development, innovative ideas, and community involvement.**

**Left: The first slate of officers of the Lincoln Laboratory New Employee Network. Pictured left to right: Bryan Reid, Kevin Carter, Cathy Ho, Ngairé Underhill, Sara James, Jessica Olszta, Jessica Brooks, Melissa May, and Rodolfo Cuevas.**

Because Lincoln Laboratory is at the forefront of urgent and compelling problems for national security and pursues cutting-edge solutions from the drawing board to fielded demonstrations, it has regularly attracted some of the best technical talent in the country. The Laboratory strives to retain staff by providing fulfilling work, enabling professional and personal growth, and facilitating access to resources that can lend balance between work and home life.

The technical work of the Laboratory has often received recognition from the Secretary of Defense, the Department of the Navy, the Department of the Air Force, the National Oceanic and Atmospheric Administration, the National Aeronautics and Space Administration (NASA), and the National Aeronautic Association. Most notably, on its 25th and 50th anniversaries, the Laboratory received the Secretary of Defense Medal for Outstanding Public Service in recognition of its distinguished technical innovation and scientific discoveries.

Accomplished members of the technical staff have received alumni awards from universities for distinguished work in their fields. Many staff members have been named fellows and board members of professional societies, such as the Institute of Electrical and Electronics Engineers (IEEE) and the Optical Society of America. Such honors are testament to the caliber of work achieved by these individuals.

The Technical Excellence Awards, instituted on the occasion of Lincoln Laboratory's 50th anniversary in 2001, have recognized eighteen staff members for sustained excellence in their respective fields. Each year since the 2001 inception of the MIT Excellence Awards, a component of the Institute's Rewards and Recognition Program, at least three Laboratory individuals or teams received awards acknowledging their efforts toward fulfilling the goals, values, and mission of MIT.

The Laboratory encourages staff to be involved in more than just their official work assignments. The Human Resources Department's College Recruiting Program includes technical staff as integral participants on recruiting teams. Staff members volunteer to recruit at their alma maters, taking advantage of their associations with professors and department heads to identify and

interview students who have demonstrated excellent academic preparation and motivation. These teams have an active recruiting presence at as many as 65 colleges and universities.

### **Professional Educational Development**

A commitment to the professional development of staff is founded on the recognition that Lincoln Laboratory's extensive research and development contributions are made possible through the staff's continuing excellence and accomplishments. Significant effort has gone into developing resources and services to enable employees to earn advanced degrees or acquire new skills.

After working at the Laboratory for a year, employees who wish to enroll in work-related courses or a degree program are eligible for the MIT tuition assistance plan. Staff members may pursue master's degrees while continuing to work full time by participating in distance-learning programs offered by Carnegie Mellon University and the Pennsylvania State University, and coordinated by the Graduate Education Committee. In addition, staff members interested in resident graduate studies at the master's or doctoral level may apply for admission to the competitive Lincoln Scholars Program. The distinctive feature of this program is that it allows participants to complete full-time technical graduate work at a Boston-area university while remaining a contributing Laboratory staff member (Figure 32-1).

The internal Technical Education Program helps all levels of staff expand their technical knowledge and acquaints newer personnel with major advanced technical themes of the Laboratory. Under the direction of the Technical Education Committee, in-house technical courses are continually being developed in areas as diverse as radar systems, electro-optical systems, communications technology, solid-state science, and design and analysis methods. Special "hot topic" courses are offered to support programmatic needs. Teaching is provided by senior technical staff or by outside experts as needed for courses related to the development of new technical capabilities.

## Encouraging Innovative Thinking

**Two key mechanisms for fostering innovation and experimentation are Lincoln Laboratory's Advanced Concepts Committee (ACC) and New Technology Initiatives Program.**

**The ACC supports the development of concepts that address important technical problems of national interest by providing programmatic support to investigators with new technology ideas. These ideas are typically high risk, but offer the potential to significantly impact national needs by enabling new systems or improving existing capabilities, and are scoped to demonstrate concept feasibility. Collaborative efforts between Lincoln Laboratory and MIT campus are encouraged. Among the novel developments the ACC has supported are technologies for detecting genotoxins and other harmful agents, a quantum-limited charge-coupled-device imager that enables wide dynamic range day/night imaging, and a three-dimensional organic solar cell for portable low-cost power.**

**The New Technology Initiatives Program seeks to extend the application of new technologies and approaches to the Department of Defense's current and anticipated problems. Potential new technologies include social/cultural modeling and automated language processing; close-in sensor and tagging systems and soldiers-as-sensors; situation-dependent information extraction; and consequence-modeled decision making.**

While Lincoln Laboratory has offered onsite technical courses for quite some time, two of these courses became available to the public in early 2009 through the Laboratory's external website. The courses were developed for a wide audience that includes not only staff but also sponsors, nontechnical employees of corporations (such as accountants or lawyers), and university students. The instructors for the video courses, Introduction to Radar Systems and Adaptive Antennas and Phased Arrays, are resident experts who developed the courses over their careers at the Laboratory.

The Professional Training and Development program offers courses in computer software, interpersonal skills, and management techniques such as increasing productivity or managing time effectively. These courses are typically taught by outside contractors or representatives from software firms. Staff can also take advantage of web-based software and management training. Laboratory offices and departments also conduct sessions to keep employees apprised of new rules or operating procedures; environmental, health, and safety training and security refreshers are among these offerings.

Learning opportunities are continually provided to the technical staff through live broadcasts and streaming videos of selected seminars given by faculty and researchers from a variety of MIT departments and centers, such as the Microsystems Technology Laboratories and Research Laboratory of Electronics, as well as universities such as Northeastern or Tufts.

In fall 2007, the Laboratory initiated the Leadership Development Program for Contracting to prepare future contracting management specialists. This highly competitive program includes both academic and workplace assignments to prepare participants to support research programs. The three-to-four-year program develops a career path from an entry-level position to an administrative staff role.

The onsite library offers a highly focused and comprehensive collection of technical books, reports, and electronic journals and databases in all Laboratory technology areas. Information specialists with degrees in physics, mathematics, aerospace engineering, and computer science are available to provide training and



**Figure 32-1**

**Scott VanBroekhoven (left), now in the Rapid Prototyping Group, began his Laboratory career as a Lincoln Scholar, mentored by Ronald Efromson (right).**

research support. The library provides multiple online resources and desktop access to its catalog and many journal databases. In addition, all the resources of the main MIT library system are available to staff.

The Laboratory's status as a research and development center of MIT promotes research collaborations, knowledge exchange, and staff development. The MIT Office of the Provost and the Laboratory Director's Office strongly support the Campus Interaction Committee. As a large interdisciplinary system laboratory, Lincoln Laboratory is able to offer a breadth of expertise to campus researchers, both faculty and students. The synergy between the campus focus on basic research and the Laboratory knowledge of defense applications has benefited both communities.

Through the comprehensive range of professional education opportunities, the Laboratory's technical versatility and perspective continue to grow. In 2010, Lincoln Laboratory received the IEEE Educational Activities Board Employer Professional Development Award for "exemplary leadership in providing programs for its employees, IEEE members, and other professionals for continuing education and professional development."

### **Commitment to Diversity**

Lincoln Laboratory works to create a more diverse work force. In 1973, under the leadership of the then director, Gerald Dinneen, an internship program was initiated to provide summer employment to science and engineering students from historically black colleges and universities. By the late 1980s, the internships had evolved into the Summer Minority Program. The interns also attended summer classes at the MIT campus in Cambridge, where they were housed. The program afforded minority students the opportunity to obtain direct technical work experience and training that channeled many students to graduate studies and technical employment throughout the United States. By the late 1990s, close to 300 minority students had participated in this professional development program, which then became part of the all-inclusive Summer Research Program for college students.

### **A Great Place for Military Research and Development**

**Lincoln Laboratory is dedicated to the development, demonstration, and transfer of technology to promote the national security of the United States. As is true of similar organizations, the Laboratory has evolved its own particular research culture, one in which a principal goal is to develop sophisticated technology for systems that positively affect the United States. This culture has its roots in the Laboratory's predecessor, the MIT Radiation Laboratory of World War II fame.**

**The Laboratory develops very broad insight into important problems. Laboratory technical staff are often called upon to serve in advisory positions to high-level government sponsors. As advisors, these staff members help ensure that the Laboratory, as it sets its technical directions, focuses its research programs on key national issues — a fact that provides great satisfaction to the employees of the Laboratory.**

**A hallmark of the research culture is an exceptional freedom to pursue new system architectures and constructs. While there are real constraints associated with operation as a federally funded research and development center, new ideas and innovative approaches are highly regarded and strongly encouraged (see sidebar, "Encouraging Innovative Thinking"). In part, this freedom can be attributed to the Laboratory's unusually flat management structure. Managers at all levels are technically competent and are current with the state of the art in relevant technical disciplines. Moreover, the Laboratory operates as a true meritocracy in which individuals are assessed on their accomplishments. As a whole, the Laboratory possesses an enormous range of expertise, enabling the totality of a system solution to be addressed in house and encouraging**

**a confident attitude to address the full measure of a problem.**

**To facilitate the work of its researchers, Lincoln Laboratory provides excellent support (facilities, equipment, and personnel) in a milieu of broad technical expertise that covers a wide range of scientific and engineering disciplines. Typically, Laboratory staff members are working on the most advanced technologies in almost any given technical field.**

**The Laboratory prides itself on effective dissemination of its findings. Staff regularly present and publish work that is carefully reviewed and critiqued by their peers. Often, Lincoln Laboratory researchers will evolve new technical interests that lead them to unexpected career paths. Such career flexibility allows many to develop expertise in several different technical fields and is highly prized.**

**Especially gratifying for the technical staff is the experience of seeing a project through from initial inception to final delivery of a fielded operational system. This has been true from the Laboratory's inception when it was charged with establishing the Semi-Automatic Ground Environment (SAGE) System (see chapter 2, "The SAGE Air Defense System"). SAGE, the world's first fully integrated air defense system, spawned many of the digital communications and processing technologies that have led to today's information technology. Since SAGE, many more technologies and operational systems in the air, in space, at sea, and on the ground have followed, as Lincoln Laboratory continued its long tradition of developing technology that supports the security of the nation.**



## The Professional and Community Enhancement Committee

The Professional and Community Enhancement (PACE) Committee assists the Director in oversight of professional training, career development, matters related to quality of life within the workplace, and policy modifications (Figure 32-2). PACE subcommittees evaluate child care, education, health and wellness, new employee orientation, and outreach to ensure that the Laboratory provides a productive workplace and a supportive, diverse environment.



Figure 32-2  
The 2009 PACE Committee.

Efforts continued to make the Laboratory a more desirable workplace for women, minorities, and people with disabilities. The establishment of a day-care center in the mid-1990s, a Professional Women's Network, a Health and Wellness Center, and the Professional and Community Enhancement Committee contributed to attracting and retaining a more diverse workforce.

In 2008, Lincoln Laboratory created the position of Manager of Diversity and Inclusion. This role was filled by William Kindred, who implemented new efforts to increase the representation of women and minorities. Sixteen additional colleges and universities (those with higher concentrations of women and minorities pursuing technical degrees) were added to the College Recruiting Program to support this goal. The Laboratory also established affiliations with minority organizations such as the Society of Hispanic Professional Engineers, the National Society of Black Engineers, the Society of Women Engineers, and the Society of Mexican-American Engineers and Scientists.

Kindred also helped promote the establishment of two support groups: the Lincoln Laboratory New Employees Network, which assists new employees in transitioning to the Laboratory and the local area, and the Lincoln Laboratory Technical Women's Network, a forum for promoting the professional development and achievement of technical women employees (Figure 32-3). Groups such as these sustain the commitment to diversity and inclusion as core values. As Director Eric Evans has said, "The Laboratory's continued success is achieved through the appreciation and support of the diverse talents, ideas, cultures, and experiences of its employees."

### Work-Life Balance

Lincoln Laboratory understands that a balance between work and personal life is essential for employees' success. Through the diligence and hard work of committees formed entirely of staff and administrative employees, as well as through initiatives developed by the Director's Office and MIT campus, the Laboratory is able to offer an array of services and activities that help employees achieve a satisfying balance.

Employees have access to various resources administered by MIT. MIT's flexible work arrangements program provides employees and supervisors with options — alternative work schedules, telecommuting, job sharing, and part-time work — that align with job requirements and individual needs. Laboratory staff may take advantage of MIT's courses, seminars, cultural events, and facilities. Some MIT facilities are located at the Laboratory, such as a medical facility operated by MIT Medical and a fitness center run by the MIT Athletic Department. The medical center offers primary care services for members of the MIT Health Plan and brief medical assistance for employees. The Fitness Center, which all employees may join, features weight training facilities, a free-weight area, and a variety of cardiovascular equipment, including treadmills, steppers, and lifecycles. The Fitness Center also offers classes in aerobics, weight training, and yoga. The MIT Activities Committee, which has an office at Lincoln Laboratory, arranges discounted tickets to Boston-area cultural and recreational activities, as well as weekend excursions to regional activities.

A number of services assist employees with parental responsibilities. The Technology Children's Center in Lexington, just 1.3 miles from the Laboratory, provides developmentally based infant, toddler, and preschool programs for children from eight weeks to six years old. The Technology Children's Center is managed by Bright Horizons and overseen by the MIT Work-Life Center, which also manages backup childcare and adult-care referral programs. MIT offers adoption assistance, reimbursing parents for a portion of adoption expenses.

Employees seeking impartial advice on work-related issues may consult the volunteers of the Laboratory's Ombudspersons Program. The ombudspersons are employees who have been appointed by the Director to help resolve employee concerns. Ombudspersons supply informal assistance that may facilitate fair and equitable resolutions of problems or disputes. Ombudspersons do not represent anyone; they act as neutral parties and respect the rights of privacy of individuals they are helping.



**Figure 32-3**  
**The Lincoln Laboratory Technical Women's Network Planning Committee was the recipient of a 2010 MIT Excellence Award. The committee is seen here at the 2010 MIT Excellence Awards Ceremony with, in the back row from left to right, Eric Evans, Director, Lincoln Laboratory; Theresa Stone, Executive Vice President and Treasurer, MIT; L. Rafael Reif, Provost, MIT; and Kirk Kolenbrander, Vice President for Institute Affairs & Secretary of the Corporation, MIT. The committee includes (middle row left to right) Aimee D'Onofrio, Hsiao-hua Burke, Leslie Alger, Ellen Johnson, Vyshnavi Suntharalingam, Melissa Choi; (front row) Elizabeth Champagne, Christine Wang, Anne Vogel, Nadya Bliss, Tamara Yu, Emily Anesta.**

To help people obtain information necessary to handling their non-work-related concerns, the Laboratory's Human Resources Department regularly offers seminars given by community experts on subjects such as parenting, elder care, goal-setting, and managing finances.

The Laboratory encourages employee-driven activities that bring together people with similar interests. Sports leagues, such as golf, bowling, tennis, even Frisbee, and special-interest groups contribute to a supportive environment. Members of the Laboratory's chapter of Toastmasters International meet onsite during lunchtime to hone their public speaking skills. Since the mid-1990s, the Lincoln Laboratory Concert Committee has arranged noontime performances that introduce employees to a range of musical genres and performers.

Several programs managed by the Travel Office aim to reduce employees' commuting frustrations and expenses. The Hitch-a-Ride matching service, Rideshare program, Guaranteed Ride Home program, and discounted passes for the Massachusetts Bay Transportation Authority

system all encourage use of shared transportation and public transportation. In 2008, bicycle enthusiasts at the Laboratory organized to promote bike riding to work and participation in a national Bike-to-Work Week event in the spring. Lincoln Laboratory's teams enrolled in the Bay State Bike-to-Work Week events have been recognized for their high percentage of participation.

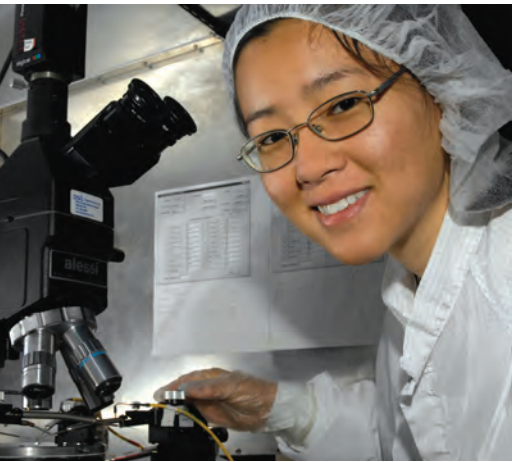
### **Educational Programs for University Students**

Lincoln Laboratory has supported educational opportunities for university students through three primary programs: MIT's VI-A Master of Engineering (M.Eng.) Thesis program, Worcester Polytechnic Institute's (WPI) Major Qualifying Project (MQP) program, and the university cooperative education (co-op) and summer intern program. These programs provide hands-on learning for students and enrich the Laboratory's base of highly qualified scientists and engineers. Often, these programs lead to post-graduation employment for the participants.

Laboratory researchers have long partnered with MIT's VI-A M.Eng. Thesis program, mentoring students in applying the principles learned in the classroom to current engineering problems while they develop their theses (Figure 32-4). In the collaboration with WPI, the Laboratory serves as a host organization for students as they develop a thesis-like MQP that demonstrates the application of skills and knowledge to the solution of a problem representative of the type encountered in industry. The Laboratory has consistently employed university co-op students and summer interns with mutual benefit. Interns, typically totaling more than 100 in a summer, work full time with scientists in ongoing programs. Each year, approximately 50 co-op students work full time during their nonacademic terms; some students continue to work part time when they return to classes.

The Laboratory has developed two programs to reach out to universities at which it is less well-known, thus expanding the recruitment program. The Graduate Fellowship Program offers grants to science and engineering students pursuing M.S. or Ph.D. degrees at any of the partner universities (University of Michigan, Brigham Young University, Clemson University, Washington University in St. Louis, Colorado University, Ohio State University, North Carolina State University, New Mexico State University, University of Washington,





**Figure 32-4**  
**Pei-Lan Hsu, an MIT VI-A student, probes graphene transistors for her master's degree work during her internship.**

and University of Illinois) and subsidizes direct research opportunities in the final phases of the student's thesis research. Somewhat similar is the Undergraduate Diversity Award Program, which enhances opportunities for women and minorities pursuing bachelor's degrees in engineering and science. The awards offer tuition assistance, support technical paper presentations, and fund independent research projects for typically three to four students per year from the participating schools, which include Bryn Mawr College, Howard University, Mount Holyoke College, New Mexico State University, North Carolina Agricultural and Technical University, Smith College, Spelman College, Stevens Institute of Technology, the University of Puerto Rico, and Wellesley College.

### **Community Outreach**

Community outreach is widely recognized as an important component of Lincoln Laboratory's mission. Educational outreach programs for students from kindergarten to high-school age integrate service with education and research, and have been both well received and successful. Employees have been supportive of the many charitable efforts available at the Laboratory, providing "care packages" to soldiers overseas, warm winter coats to local children, clothing and food needed by shelters, and funds for medical research.

Laboratory staff volunteer regularly to serve as judges for local and state science fairs, such as the Lexington High School Science and Engineering Fair and the Massachusetts State Science and Engineering Fair, sometimes providing up to ten judges per event. In 2010, the Laboratory also began hosting booths at science festivals, such as the nine-day Cambridge Science Festival, at which three booths were hosted for three different age groups, and the first-ever national science festival, the USA Science and Engineering Festival, in Washington, D.C.

### *Educational Programs for K-12 Students*

After many years of offering educational outreach to college students, the Laboratory found a new audience in 2006: students in elementary through high schools. This new focus contributed to the formation of the Lincoln Laboratory Community Outreach (LLCO) committee, which includes in its mission the promotion of programs to motivate student interest in science, technology, engineering, and math (STEM).

At the request of local educators, technical staff present in-class science demonstrations for elementary through high-school students on subjects as diverse as heat and thermodynamics, minerals, computers, enzymes, archaeology and ancient artifacts, and effects of liquid nitrogen. Todd Rider coordinates these science demonstrations, presenting many of them himself. In an average year, Laboratory volunteers make presentations to more than 6000 students in local schools from Rockport, Maine, to Fitchburg, Massachusetts.

Science on Saturday interactive science presentations are given onsite by Laboratory scientists and engineers during the school year (Figure 32-5). Local students, their parents, and teachers have enjoyed presentations on the principles of cryogenics, magnetism, sound waves, optics, rocketry, robotics, archaeology, weather, and rheology. The Science on Saturday series, also coordinated by Rider, is very well attended, often filling all 342 seats in the auditorium. More than 3500 people attend these events each year.

Science on Saturday demonstrations spawned questions from curious children. To address these questions, the Communications and Community Outreach Office established an "Ask the Scientist" web page, fielding questions from all over the world on science and technology. All questions submitted on the web page are answered by experts in the field; however, one question per week is highlighted with examples, experiment ideas, and web links to promote a fuller understanding of the topic.

In March 2011, Lincoln Laboratory hosted the highly successful "Wow! That's Engineering!" event, offering hands-on engineering activities for 100 sixth- through eighth-grade girls. The event, coordinated by Damaris Sarria of the Engineering Analysis and Testing Group and cosponsored by the Society of Women Engineers, Boston chapter, had girls mixing lip gloss (Figure 32-6), assembling toy solar cars, programming a Lego Mindstorms robot, making an electrical circuit, and disassembling various electrical devices. The success and rapid sellout of the event warranted future girls-only events.

The Laboratory's Ceres Connection program partners with the Society for Science and the Public (SSP) to promote science education. This program names minor planets in honor of students in fifth through twelfth





**Figure 32-5**  
**Roderick Kunz demonstrates surprising reactions in his “Chemistry Magic” Science on Saturday demonstration.**



**Figure 32-6**  
**Gabriela Galaviz of the Mission Assurance Office helped the girls create their own lip gloss, applying materials engineering and chemistry skills during the “Wow! That’s Engineering!” event.**

grades and their teachers. Recipients are selected through SSP-sponsored science competitions. The minor planets named through the Ceres Connection were discovered by the Lincoln Near-Earth Asteroid Research (LINEAR) program (see chapter 23, “LINEAR and Other Programs”).

Lincoln Laboratory is affiliated with three internship programs: the Armed Forces Communications and Electronics Association (AFCEA) International program for students, internships for students from local technical high schools, and the Leadership Initiatives for Teaching and Technology (LIFT<sup>2</sup>) program for teachers. Through a program coordinated by the local chapter of AFCEA, the Laboratory offers up to three summer internships for graduating high-school seniors planning careers in science or engineering. Based on the rewarding partnership resulting from the AFCEA program, Lincoln Laboratory began hosting internships for vocational students in 2010. Two students from Minuteman Career and Technical High School in Lexington, Massachusetts, and one student from Shawsheen Valley Regional Technical High School in Billerica, Massachusetts, are hired during the school year (Figure 32-7). Students get hands-on experience in a real-world setting while learning from experts. Under the LIFT<sup>2</sup> program, middle- and high-school science and math teachers engage in summer internships that help them develop an understanding of the skills needed in modern technological workplaces. Back in the classroom, the teachers enrich their curriculum with insights gained through their seven-week apprenticeship.

Considerable strides are being made toward inspiring would-be scientists through a robotics outreach program initiated in 2008. Robotics Outreach at Lincoln Laboratory (ROLL) hosts full-immersion weekend robotics workshops for ninth and tenth graders, some of whom continue their interest in robotics by joining a ROLL-sponsored competitive robotics team. Since 2008, ROLL has also mentored teams in regional and statewide robotics competitions sponsored by the Lego company and the For Inspiration and Recognition of Science and Technology (FIRST) organization. ROLL introduces the children to building and programming a robot, and helps them plan the robot’s task order to complete a challenge course in the most efficient manner possible.

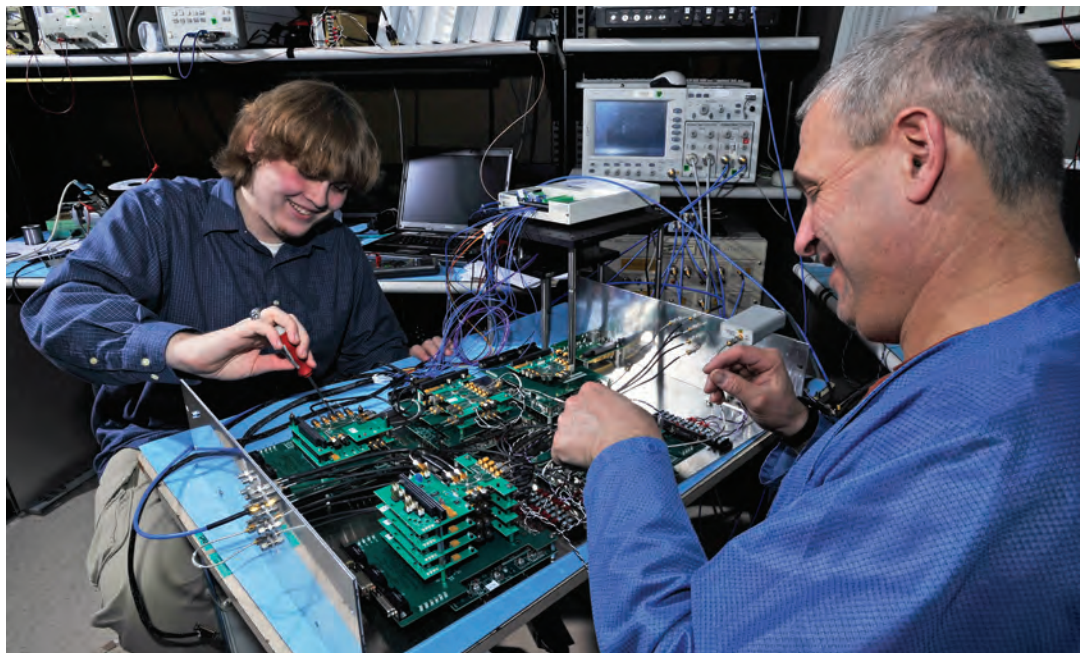


Interest in ROLL robotics competitions has increased every year. What started with four teams in 2008 grew to 17 teams in 2011. Other Laboratory employees, although not members of ROLL, have helped their local robotics teams by sharing their knowledge and organizational skills. Ideal venues for children's robotics are continually sought. For example, ROLL mentors introduced students to the requirements of underwater robotics in the Navy's SeaPerch competition in 2010 (Figure 32-8).

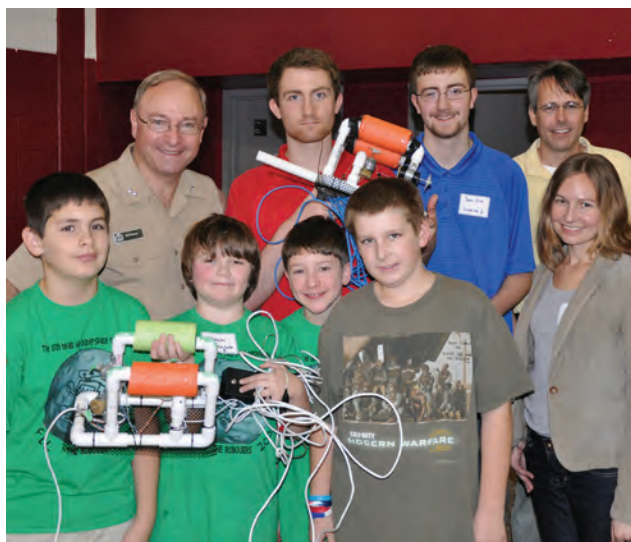
In an effort to deepen the children's knowledge gained in the competitive arena, ROLL developed its own Roboworkshops to focus on particular aspects of building and programming robots. The workshops promoted significant progress in programming abilities. Workshop activities included designing a robot that can go anywhere, equipping robots with the right tools for the mission, introducing students to robotic intelligence, and using sensors for smart orientation. Each workshop ends in a competition so that programming skills can be tested, and new students can better understand what a FIRST robotic competition entails.

New to robotics outreach activities in 2011 was the Laboratory's involvement in the debut of the Boy Scout Robotics Merit Badge, released during National Robotics Week. Lincoln Laboratory volunteers provided twelve robotic kits for a "Robot Block Party" at Boston's Museum of Science and volunteered to serve as merit-badge counselors for this event. The Laboratory also supported scouting by conducting a workshop to earn the Invention Merit Badge, created in conjunction with the Lemelson-MIT program in MIT's School of Engineering. Laboratory volunteers hosted an Aviation Merit Badge workshop for local Boy Scouts at the Hanscom Air Force Base Aero Club. This hands-on workshop taught scouts about aircraft and flight, inspection of a plane, aeronautics, map reading, forces on a plane, wind tunnel effects, and careers in aviation.

Twice each year, approximately twenty students from the John D. O'Bryant School of Mathematics and Science in Roxbury, Massachusetts, tour Laboratory facilities. While here, the students attend sessions with staff members who discuss careers in engineering and science. In 2010, the Laboratory increased outreach to the John D. O'Bryant School to include sponsorship of a team in the FIRST robotics competition.



**Figure 32-7**  
An intern from Shawsheen Technical Vocational High School works with Barry Romkey of the Optical Communications Technology Group.



**Figure 32-8**  
Jonathan Williams (back right) and Jennifer Eisenman (front right) volunteered to mentor the two student teams participating in the SeaPerch Derby at New Bedford High School. The teams are pictured here with RADM Phil Wisecup (back left), current Naval Inspector General and former president of the U.S. Naval War College, the sponsor of the derby.

In 2009, Lincoln Laboratory began a collaboration with the MIT Department of Engineering's Office of Engineering Outreach Programs, which runs four educational programs for middle- and high-school students: the Science, Technology, Engineering, and Mathematics Program, a year-round academic enrichment program that develops mathematical thinking and problem solving; the Saturday Engineering and Enrichment Discovery Academy, a career-exploration program for promising but traditionally underserved high-school students; the Minority Introduction to Engineering and Science Program, an academically rigorous six-week residential summer program for high-school juniors interested in science and engineering; and the MIT Science of Baseball Program, a summer program that builds on eighth-grade boys' interest in baseball to teach physics and math. All four programs are designed to prepare students for postsecondary study and to encourage them to consider careers in STEM. The Laboratory sponsors students in each of these programs, provides group tours of its unique facilities, and offers presentations given by members of the technical staff.

Most of the Laboratory's educational outreach is aimed at Boston area communities, although in-class presentations have been given in communities ranging from eastern and central Massachusetts to southeastern New Hampshire. Two programs reach much farther. One is the Ask a Scientist web page described earlier, and the other is the Marshallese Islands Outreach Program.

Lincoln Laboratory operates a field site at the U.S. Army Kwajalein Atoll installation. Twenty staff members, accompanied by their families, work at this site, serving two-to three-year tours of duty. The amiable relationship enjoyed by the Laboratory staff and the local community prompted the initiation of this outreach program, developed to enrich educational and life experiences of the Marshallese people. Each summer, two Marshallese college students are supported as interns at a Laboratory facility. Each fall, a scholarship is awarded to a local student choosing a STEM career path. Laboratory staff at Kwajalein contribute to the student lunch program for the local elementary school and assist resident artisans by displaying and selling Marshallese handcrafts at the Laboratory facility in Lexington.

### Lincoln Laboratory Robotics Team Goes to World Championship

Lincoln Laboratory's For Inspiration and Recognition of Science and Technology (FIRST) Technical Challenge (FTC) team, MITiBOT, finished its debut season by placing 24th out of 100 teams at the World Championship in Atlanta, Georgia, in April 2009. The team, made up of fifteen- to eighteen-year-old children of Laboratory employees, qualified to compete in Atlanta by performing well in regional tournaments throughout the winter (Figure 32-9).

Coached by ROLL mentors John Peabody and Brian Shucker, pictured above in the top row, this team met every weekend throughout the fall to build and program a robot from a kit of parts that included gaming controllers, a metal building kit, ten sensors, eleven motors, and three software packages. The team programmed its robot to perform a robotic challenge dictated by FIRST to meet specifications, traverse

various surfaces, and perform precise loading, carrying, and unloading programs, yet also play defensively.

In March 2009, the team received special recognition from the judges for technical strength and professionalism. This win led to the World Competition, at which their performance was outstanding for a rookie team.

Because of the enthusiasm engendered by the Laboratory's premiere FTC team, the robotics outreach program has grown each year, totaling eight teams in 2010 and seventeen teams in 2011.

Figure 32-9  
Lincoln Laboratory's FTC team, MITiBOT, placed in the semifinals in the World Competition in their rookie year.







**Figure 32-10**  
Laboratory employees and Hanscom personnel participated in the 5K Fun Run hosted by the MIT Lincoln Laboratory Fitness Center. The event supported the Veterans Administration Hospital in Bedford, Massachusetts.

**Figure 32-11**  
Alicia LaDuke of the Communications and Community Outreach Office counts the number of sock donations made by the Laboratory community for a charity called Hannah's Socks. A total of 565 high-demand items were collected and given to the Veterans' Administration Hospital in 2010.



### *Community Giving*

Lincoln Laboratory supports the local community through civic programs. Charitable giving continues to increase because of the dedicated volunteer work of staff members who organize, promote, and manage a variety of programs. Annual support to the United Way, Toys for Tots, and Red Cross Blood Drive Campaigns has been unflinching. Donations to several new programs — Support Our Troops, Holiday Giving Tree, clothing drives, used-book drive, and food drives — have become significant.

In 2006, LLCO facilitated the Laboratory's entry into the National Multiple Sclerosis (MS) Society's annual "Bike and Hike the Berkshires" charity event. The LLCO Bike and Hike teams have consistently surpassed their fund-raising goals for MS research. In 2009, LLCO began supporting the Greater Boston Memory Walk sponsored by the Alzheimer's Association, raising funds to provide critical programs and services for Massachusetts and New Hampshire residents with Alzheimer's disease and related disorders.

Other athletes in the Laboratory have supported the annual Fitness Center 5K Fun Run (Figure 32-10), benefiting a different charity each year, including the United Way, MIT Community Service Fund, Special Olympics Massachusetts, and Food for Free.

In 2011, volunteers supported the Great Strides for Cystic Fibrosis Walk and the Lowell General Hospital's TeamWalk for CancerCare by forming fund-raising teams and donating to these causes. Individuals throughout the Laboratory also support the Pan Mass Challenge, raising funds for cancer research.

The Laboratory community has been extremely supportive of new giving programs emerging in 2009 and after. LLCO participates in Coats for Kids each winter, typically donating 500 coats to children and adults in the greater Boston area. Through a national program called Hannah's Socks, named for a 4-year old girl who gave a man her socks because he had none, Lincoln Laboratory donates more than 500 socks and other needed items to local shelters (Figure 32-11).

**Figure 32-12**

The Lincoln Laboratory Troop Support team prepares boxes for a troop in Afghanistan. Left to right, Carmen Caballero, Mike Chaplin, Dave Myers, and Joanne Knoll, who manages the troop support program.



The number of LLCO-sponsored initiatives has rapidly grown throughout the years to include multiple food drives, blanket donations, book sales, holiday wish trees, personal-care products collection, and home construction help. Many charities benefit from the Laboratory's helping hands; among them are Massachusetts Coalition for the Homeless, Habitat for Humanity, Bikes Not Bombs, Catie's Closet, Veterans Administration Hospital, Burlington Food Pantry, Somebody Cares, and the American Red Cross.

Since 2007, the Laboratory has run an ongoing campaign of support for deployed U.S. troops. Donations of food, books, games, and personal-care items are collected, boxed, and mailed weekly to military personnel serving in Iraq and Afghanistan (Figure 32-12). Each box includes a handwritten note and a description of Lincoln Laboratory. LLCO Troop Support mails more than 200 care packages

every year, showing pride in American soldiers, sending encouragement, and expressing gratitude for their work. The Troop Support team has received many letters of thanks, certificates, and U.S. flags flown overseas in recognition of the kindness and generosity of the Laboratory community.

#### **Summary**

Lincoln Laboratory's reputation has been built on the strength of its technical staff, and significant time and resources are allocated to recruiting, staff development, and continuing education. The commitment to employees also includes amenities and services that enable a healthy work-life balance. In addition, the Laboratory makes substantial contributions to the community — inspiring the scientists and mathematicians of tomorrow and helping those in need.







**The Laboratory has always recognized the value of making its technology available where possible to the entire scientific and technical community. For this reason, technology transfer has been encouraged and supported since the Laboratory's establishment.**

**Left: The world's largest and most advanced digital camera captures images (like that of the Rosette Nebula, shown here) to create the most comprehensive catalog of stars and galaxies ever produced. The silicon chips developed by Lincoln Laboratory and the Institute for Astronomy are at the heart of the camera and contain advanced circuitry that makes instantaneous corrections for any image shake caused by the earth's atmosphere.**

The regular transfer of Lincoln Laboratory's technological advances to the industrial and technical communities has benefited the nation in defense as well as nondefense industries. New uses in the commercial industrial sector for Lincoln Laboratory–developed concepts, devices, and systems have proven there is a place for Laboratory innovation in promoting national economic development. Work in every mission area from radar systems to advanced electronic components has produced enabling technologies for the nation's defense, has improved capabilities in the scientific and technical communities, and has promoted new enterprises in the commercial sector. The transfer of technology to new industries has provided a foundation for the creation of large numbers of jobs, as evidenced by the many spin-off companies founded by Lincoln Laboratory staff.

Significant contributions to the nation's commercial industrial base have resulted from technologies developed for national defense in the areas of computers, communications and signal processing, radars, optics, solid-state devices, and biology. This section provides examples of just a few of the Laboratory's contributions resulting from commercial-sector applications of Laboratory developments beyond the initial intended objectives.

The Semi-Automatic Ground Environment (SAGE) air defense program at Lincoln Laboratory (see chapter 2, "The SAGE Air Defense System") demonstrated real-time digital computer control of a large, geographically dispersed system for the first time. Many nondefense applications have been based on this technology, including the national air traffic control system, industrial process controllers, and business inventory systems. In addition, the Laboratory's work with Bell Laboratories on the transmission of digital data over telephone circuits for remote radars in the SAGE system led to the development of the modem and contributed to worldwide computer data networks.

The Laboratory also pioneered some of the earliest digital signal processors; the SAGE system was capable of processing radar outputs for automatic target detection so as to transmit only target reports to the central computers. One of the earliest books on digital signal processing was written by two Laboratory staff

members,<sup>1</sup> who also taught some of the first courses on the subject. Digital signal processing techniques are now used extensively not only in military radars, but also in air traffic control radars and numerous other applications, including oil prospecting, medical imaging, high-definition television, and cell phones.

Lincoln Laboratory's work with International Business Machines (IBM) as a contractor for the SAGE computer strongly influenced the development of the mainframe computer and the growth of the business computer industry.<sup>2</sup> The initial concepts for the first minicomputer were based on work in the development of transistorized computers carried out at the Laboratory and led to the formation of Digital Equipment Corporation (DEC) as an early spin-off from Lincoln Laboratory. The success of the first minicomputer spawned an entirely new industry and led to the emergence of Massachusetts and neighboring states as a center of high technology. The Laboratory Instrument Computer, built in the late 1950s, was the first small computer, and the concepts behind this system established the foundation for the much later development of the personal computer. Computer graphics systems have a historical basis in the TX-2 interactive graphics interface demonstrated at the Laboratory in the early 1960s.

The Laboratory played a leading role in the development of computer algorithms, including efficient techniques for coding. The Reed-Solomon error-correction code, developed in the early years of the Laboratory, is widely used in a variety of commercial as well as military communications systems and is employed almost universally in such familiar applications as compact-disc players. In the 1980s, the Laboratory developed the first truly compact speech-coding device implementing a linear predictive coder algorithm. The speech-recognition work subsequently led to the development of the high-performance hidden-Markov-model algorithms gaining increasing importance in numerous industrial applications.

MIT, Bell Laboratories, and Lincoln Laboratory pioneered early radio propagation studies of tropospheric scatter communications for long-distance use. Satellite communications have now largely supplanted scatter communications, but tropospheric scatter continues to be used for communications circuits of a few hundred

## Notes

1 B. Gold and C.M. Rader, *Digital Processing of Signals*. New York: McGraw-Hill, 1969.

2 E.W. Pugh, L.R. Johnson, and J.H. Palmer, *IBM's 360 and Early 370 Systems*. Cambridge, Mass.: MIT Press, 1991, pp. 178–182.

kilometers. Bell Laboratories pioneered satellite communications with Telstar while Lincoln Laboratory performed unique military satellite communication demonstrations, including the geosynchronous Lincoln Experimental Satellites (LES)-8 and LES-9. Fiber-optic communications has largely supplanted satellite communications for long-haul, wideband digital transmission, but the military still has unique requirements for wideband satellite communications.

As discussed in chapter 6, “Communication Networks and Cyber Security,” an all-optical networking consortium was formed by Lincoln Laboratory, Bell Laboratories, and DEC. The success of the all-optical networking consortium program spread in multiple dimensions. Over 60 professional papers describing the various architectures, technologies, and experiments were published in ten or more professional forums. The wavelength-division-multiplexed technologies adopted via architecture or technology transfer gave rise to a new generation of telecommunication companies, including Ciena, Sycamore, and PhotonEx — companies whose joint peak market valuations were measured in tens of billions of dollars. Wavelength-division-multiplexed offerings began strongly affecting the optical networking capabilities of existing telecommunications companies such as Lucent and Nortel, router companies such as Cisco, and numerous component vendors. Fiber providers also began to lay tens of thousands of miles of fiber-optic cable in the continental United States. Lincoln Laboratory staff became founders, principals, or key contributors in several of the startup companies.

International standards bodies have since standardized data rates, frequencies, control, power levels, connectors, and other optical networking mechanisms.

Radar developments at Lincoln Laboratory also have been used for nondefense purposes. The difficulty of detecting air vehicles in the presence of severe ground clutter was evident even in the first stages of work on the SAGE system. Early systems were able to suppress performance-limiting ground-clutter returns by, at best, only a factor of 100. The development of coherent radar transmitters at the Laboratory, coupled with the development of powerful digital signal processors, made it possible to overcome the problem of severe ground clutter. These techniques were first demonstrated in the 1970s in a radar developed for air traffic control, and the technology has been used in numerous radars by the Federal Aviation Administration (FAA) and military radars. Weather radar technology was pioneered at the Laboratory. Adaptive beamforming techniques originally developed for reducing the effects of radar jammers led to multiple-input, multiple-output techniques for communication systems. These multiple-input, multiple-output techniques are now found in many wireless network routers to reduce multipath effects in home wireless computer networks.

Lincoln Laboratory's optics activity developed a holographic technique popularly known as binary optics. A binary phase plate was employed in a laser radar application to generate multiple optical laser beams to drive multiple heterodyne detectors. Binary optics technology

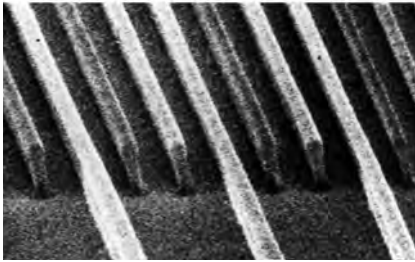
1950



DEC founder K. Olsen



MITRE founder  
R.R. Everett



**Figure 33-1**  
The sub-0.25  $\mu\text{m}$  feature sizes in this scanning electron micrograph were defined in a 193 nm laser lithographic process.

makes use of integrated-circuit microlithographic fabrication techniques and is now widely used by industrial organizations throughout the world. Adaptive optics, developed at the Laboratory to aid in high-energy laser beam propagation through the atmosphere for ballistic missile defense, have found application in reducing the effects of atmospheric turbulence for infrared and visible astronomy. Recent astronomical applications of adaptive optics include observations of stars orbiting the central black hole in the Milky Way galaxy. This application led to the determination of the mass of the black hole at the center of our galaxy.

Advances in solid-state devices at Lincoln Laboratory have produced several commercial applications. In the early 1960s, Laboratory research on spontaneous emission of light from gallium-arsenide diodes led to the demonstration of the first laser diode at General Electric (GE), followed by near-simultaneous demonstrations of the laser diode at Lincoln Laboratory and IBM. Since then, the Laboratory has demonstrated laser-diode power amplifiers with a gain factor greater than 30 and several watts of output power. The Laboratory has played a major role in the development of solid-state lasers, and laser diodes have become critical components in a wide variety of products.

Among the various solid-state lasers that have been developed at the Laboratory over the years, perhaps the most notable is the titanium sapphire laser amplifier. First demonstrated in the 1980s, this laser amplifies over the wavelength range of 0.65 to 1.12  $\mu\text{m}$  — the widest bandwidth ever achieved. It is used in applications

ranging from spectroscopy to medicine. In recent years, the Laboratory has developed laser-diode power amplifiers at telecommunications wavelengths that have demonstrated 500 mW of output power. The successful development of the microchip laser, a semiconductor laser-pumped solid-state laser, has led to widespread use of these miniature lasers in green, yellow, and blue laser pointers; they also have potential military applications in lightweight imaging laser radars.

Solid-state device research in the 1970s and 1980s at Lincoln Laboratory resulted in the development of a number of high-speed electro-optic modulators based on optical integrated-circuit interferometers. These devices have become an important enabling component for commercial as well as military optical communications system applications. They have also become an important enabling component for ultrahigh-speed optical switches used in laboratory demonstrations of all-optical logic. The all-optical logic has been used to demonstrate novel optical communication packet routing.

Also in the 1970s, X-ray lithography was invented at Lincoln Laboratory to fabricate electronic devices with increasingly smaller dimensions, a technology of critical importance in increasing the speed of digital processors and the size of digital memories. The Laboratory worked with industry to develop ultraviolet laser lithography at the 193 nm wavelength. Ultraviolet lithography can be used to fabricate integrated circuits with 0.25  $\mu\text{m}$  feature sizes, and an ultimate resolution of 0.1  $\mu\text{m}$  or less is possible (Figure 33-1).

1960



Electronic Space  
Systems Corporation  
co-founders A. Cohen  
and J.A. Vitale

1970



U.S. Windpower,  
founded by H. Weiss,  
S. Charren, and  
N. Moore



## Technical Excellence Awards

Lincoln Laboratory places a high priority on its technological leadership and rewards two staff members each year with Technical Excellence Awards. This award is the Laboratory's highest honor and recognizes exceptional and sustained individual technical excellence resulting in significant impact on a Laboratory mission area.

The Technical Excellence Awards were initiated by the Director's Office for the Laboratory's fiftieth anniversary in 2001. In addition to individual recognition and a monetary reward, recipients are given authority over a Laboratory account to enhance their research environment for three years.

### *Past award recipients*

#### **2010**

**Dr. David J. Ebel**, for his nationally recognized leadership in systems analysis to support the Department of Defense and for his use of detailed modeling, test data analysis, and a broad system perspective to provide superb analysis for air vehicle survivability, electronic warfare, and intelligence, surveillance, and reconnaissance systems.

**Dr. William D. Ross**, for critical contributions in the development of advanced imaging systems with applications in wide-area persistent surveillance, remote sensing, and homeland security, and in the development of enabling video sensor, processing, and data exploitation technologies.

#### **2009**

**Dr. T.Y. Fan**, for innovation in the solid-state laser field by demonstrating the first diode-pumped Yb laser and by pioneering both the use of cryogenics for scaling solid-state lasers to high power with excellent efficiency and techniques for laser beam combining.

**Dr. David R. McElroy**, for sustained contributions to the DoD's Military Satellite Communications program, for critical contributions to the nation's communications priority, and for perfecting a method to transition Lincoln Laboratory technology to industry through the use of "gold standard" test instruments.

#### **2008**

**Allen D. Pillsbury**, for his innovation in the mechanical design of space-based sensors and optical communication systems, and his introduction of new technologies that demonstrate revolutionary performance gains for space systems.

**Dr. Benny J. Sheeks**, for his analysis of radar observations of foreign and domestic ballistic missiles, his expertise in the utilization and interpretation of real-world ballistic missile radar data, and his techniques and results that have formed a critical cornerstone for the development of the Ballistic Missile Defense System.

#### **2007**

**Dr. Don M. Boroson**, for his contributions to the field of modulation and coding techniques as applied to optical communications systems.

**Dr. Bernadette Johnson**, for her system-level architecting, technical innovation, and prototype demonstration in multiple areas and, in particular, nontraditional problems.

#### **2006**

**Dr. Robert G. Atkins**, for his leadership in developing advanced system architectures and his unique ability to develop new architectures for addressing complex, nontraditional problems.

**Lawrence M. Candell**, for his contribution to developing new optical and radar sensors for communications and surveillance systems.

#### **2005**

**Dr. John J. Zayhowski**, for his sustained technical contributions, both research and engineering, in the area of microchip lasers for advanced sensing applications.

**Dr. William S. Song**, for his technical excellence in pushing the boundaries of radar systems by developing new components and processes to exploit digital technologies.

#### **2004**

**Dr. Stephen D. Weiner**, for his creative insights, technical depth, and systems perspectives that have yielded significant contributions to the many phases of missile defense development.

**Dr. Marilyn M. Wolfson**, for her work in the application of meteorology and, in particular, convective weather forecasts to the problem of improving air traffic control at the national level.

#### **2003**

**Robert A. Bond**, for his technical vision and leadership in the application of high-performance embedded processing architectures to real-time digital signal processing systems.

**Dr. Richard M. Heinrichs**, in recognition of his individual contributions and technical leadership in the development and application of experimental laser detection and ranging systems with significant new capabilities.

#### **2002**

**James E. Evans**, for his work with hazardous-weather warning systems for aviation.

**Stephan B. Rejto**, for his work on Open Systems Architectures for Radar.

#### **2001**

**Dr. Barry E. Burke**, for his work with charge-coupled-device imagers.

**Dr. James Ward**, for his work in adaptive array processing.

1980

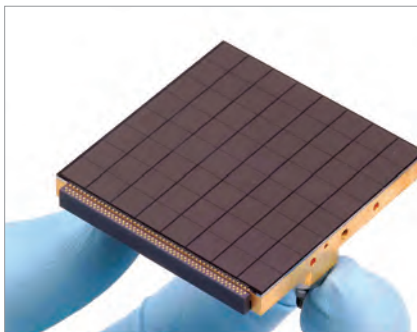


E.E. Landsman, E.F. Lyon, and N.E. Rasmussen (l to r), founders of the American Power Conversion Corporation

1990



Teratech founder  
A.M. Chiang



**Figure 33-2**

**Packaged orthogonal-transfer array showing device top and side. The device measures 5 × 5 cm, and the package enables close abutting to other devices on all four sides.**

### Technological Leadership

The Laboratory's strong record of technical innovation is exemplified by its technological leadership in surveillance, identification, and recognition; in communications for the Department of Defense (DoD); and in air traffic control for the FAA. This section briefly summarizes examples of key advances in the Laboratory's areas of technological leadership, many of which have benefited both the sponsors that supported the technology and small but significant segments of the scientific community.

#### *Surveillance*

In the late 1950s, the Laboratory developed the Millstone radar — the first high-power, long-range radar that could track ballistic missiles and satellites. The Air Force made wide use of this technology in both ballistic missile early-warning radars and low-altitude (a few thousand kilometers) satellite-tracking radars. In the 1970s, the Laboratory developed advanced signal processing techniques permitting Millstone-type radars to track satellites out to synchronous orbit and beyond, to ranges of 60,000 km. Today, the Laboratory operates long-range radars that provide primary tracking of geosynchronous satellites for the nation's space surveillance system. These radars are also used by the National Aeronautics and Space Administration (NASA) to investigate the amount of space debris in near-earth orbits.

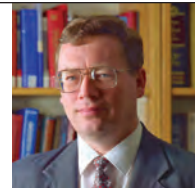
Events during the Vietnam War clearly established the value of airborne radars that could detect slowly moving ground targets, but the Doppler spread of ground clutter returns caused by the motion of the airborne radar itself made this task difficult. In the 1970s, Lincoln Laboratory began to develop the airborne multiple-antenna surveillance radar based on the displaced-phase-center antenna concept conceived at GE in the 1950s. The multiple-antenna surveillance radar was able to detect slowly moving ground targets from an airborne platform. This system was the first to demonstrate the technology that was eventually applied to the Joint Surveillance Target Attack Radar System, which proved successful in Operation Desert Storm.

The Laboratory also conducted research on the leading edge of electro-optics technology development. In the 1970s, the Laboratory used 70 cm diameter telescopes equipped with sensitive electro-optic imagers to detect high-altitude satellites. More recently, the Laboratory developed charge-coupled-device (CCD) arrays with millions of detectors and near-quantum-limited sensitivity. With these devices in the focal plane, telescopes with apertures as small as 15 cm could detect distant satellites. The astronomy community has found that this technology is making dramatic improvements in the sensitivity of deep-space telescopes. Performance improvements in spectral response, number of pixels, and sensitivity led to the installation of more than 100 Lincoln Laboratory-built imagers in astronomical observatories. Novel CCD imager architectures, such as the orthogonal-transfer array (OTA) (Figure 33-2), are being used to reduce the effects of atmospheric turbulence. The largest OTA CCD array of

2000



E.A. Swanson, founder of Sycamore Networks and LightLab Imaging



L.G. Shirley, founder of Dimensional Photonics



**Figure 33-3**  
Image of the M81 galaxy from the Pan-STARRS telescope. The Pan-STARRS camera uses a 1.4-gigapixel focal-plane array developed at Lincoln Laboratory.

1.4 gigapixels was assembled from 64 Lincoln Laboratory-supplied OTA CCD wafers. This focal plane was installed in the first Panoramic Survey Telescope and Rapid Response System (Pan-STARRS) camera, PS1, in Hawaii, and was fully operational in May 2010. The camera, which employs a 1.8 m telescope, will be joined by three additional Pan-STARRS cameras. These four cameras will be used to search for near-earth asteroids and comets. An early Pan-STARRS image of the M81 galaxy is shown in Figure 33-3.

#### *Identification and Recognition*

Lincoln Laboratory's tradition of leadership in identification and recognition techniques began in the 1950s, when Millstone and other Laboratory long-range radars were being used for range measurements to the moon and nearby planets. It became evident that crude images of lunar and planetary surfaces could be formed by combining the range resolution and the Doppler shift of radar returns. In the late 1960s, work on range-Doppler radar imaging led to high-resolution inverse synthetic aperture radars for space surveillance and for surveillance of discrete ground targets.

Additional research at the Laboratory led to the development of imaging radars. The range resolution of imaging radars is normally determined by the bandwidth of the radar transmission and the cross-range resolution by the length of integration time used to measure the Doppler frequency shift. In recent years, mathematical techniques derived from superresolution angle-of-arrival antenna systems have been applied to imaging radars, and these techniques have increased radar imaging resolution by almost a factor of three without an increase in the radar bandwidth.

Although a microwave imaging radar can detect fixed ground objects in the open, it cannot detect objects hidden by foliage. Ultrahigh-frequency signals can penetrate foliage, but it was thought that the phase disturbances created by foliage would make it impossible to form radar images at such long wavelengths. Lincoln Laboratory demonstrated, however, that objects can be detected through foliage with relatively high resolution. The Laboratory also developed a variety of recognition techniques for ballistic missile defense, ship recognition, and ground-target recognition. Neural network concepts were also applied to recognition problems.

#### *Communications*

Lincoln Laboratory was the first organization to employ ultrahigh-frequency, superhigh-frequency, and extremely high-frequency bands for military satellite communications. Numerous current military satellites, including the Defense Satellite Communications System, Fleet Satellite, and the Military Strategic and Tactical Relay System, now employ these frequency bands, as do international civil satellite communications systems. The Laboratory continues to develop lightweight equipment for space-based communications applications. Lightweight, robust, extremely high-frequency ground terminals developed at the Laboratory have seen service in the field.

#### *Air Traffic Control*

Through ongoing technology development and transition to industry, the Laboratory's air traffic control (ATC) program has resulted in major enhancements to the nation's ATC infrastructure. Primary and secondary ATC radars, airport wind-shear detection radars, aircraft collision-avoidance systems, and integrated weather sensing and decision support systems are examples of Laboratory-developed technologies that are now integral parts of the National Airspace System. Ongoing work in support of the FAA's Next Generation Air Transportation System (NextGen) initiative will lead to the introduction in coming years of significant new operational capabilities based on Laboratory programs.

In an effort to improve runway safety, Lincoln Laboratory is developing and testing the Runway Status Lights (RWSL) system. RWSL, a system of surveillance-driven status lights on the airport surface, provides aircraft flight crews and vehicle operators with an indication that a runway is occupied or in use by a high-speed aircraft. The system receives information from not only airport surveillance radars, but also the Laboratory-developed Airport Surface Detection Equipment, which collects data and provides air traffic controllers with color map displays showing the location of all aircraft and vehicles on the runways and taxiways. RWSL has shown the potential to substantially reduce the risk of a collision by increasing the situation awareness of pilots. Between 2005 and 2009, status lights were installed at Dallas/Fort Worth International Airport, Los Angeles International Airport, San Diego International Airport, and Boston Logan International Airport. With



## R&D 100 Awards

The R&D 100 Awards, widely recognized as the “Oscars of Innovation,” identify and celebrate the best high-technology products of the year, such as sophisticated testing equipment, innovative new materials, chemistry breakthroughs, biomedical products, and consumer items. The R&D 100 Award winners, chosen by *R&D Magazine*, represent a broad range of technologies developed by industrial enterprises, government laboratories, and university research facilities from around the world. Lincoln Laboratory won five R&D 100 Awards in 2010.

### **Geiger-Mode Avalanche Photodiode Focal-Plane Array**

The Geiger-mode avalanche photodiode focal-plane array is a two-dimensional array of ultrasensitive solid-state photodetectors, each of which can measure the arrival time of single photons.

*Developers: Simon Verghese, Richard M. Marino, Brian F. Aull, Bernard B. Kosicki, Robert K. Reich, Bradley J. Felton, David C. Shaver, Andrew H. Loomis, Douglas J. Young, K. Alexander McIntosh, David C. Chapman, Joseph P. Donnelly, Douglas C. Oakley, Antonio Napoleone, Erik K. Duerr, Jonathan P. Frechette, Joseph M. Mahan, Joseph E. Funk, Brian M. Tyrrell, Pablo I. Hopman, Eric A. Dauler, Peter J. Grossmann, and Leonard J. Mahoney.*

### **Digital-Pixel Focal-Plane Array**

The digital-pixel focal-plane array revolutionizes infrared imaging by providing novel, real-time, in-pixel processing, permitting an extreme dynamic range and wide-area coverage from a minimally sized, low-powered package.

*Developers: Michael W. Kelly, Kenneth I. Schultz, Lawrence M. Candell, Daniel L. Mooney, Curtis B. Colonero, Robert Berger, Brian M. Tyrrell, James R. Wey, Christopher L. David, Stephanie Hsu, Andrew M. Siegel, Joseph S. Costa, Eric J. Ringdahl, Matthew G. Brown, Justin J. Baker, and Thomas D. Gardner.*



**Figure 33–4**  
A view of the in-pavement Runway Status Lights at the Los Angeles International Airport.

**Runway Status Lights**  
Runway Status Lights help prevent runway incursions by integrating airport surveillance to control in-pavement lights that directly alert pilots to runway hazards (Figure 33–4).

*Developers: James R. Eggert, Eric M. Shank, Walter L. Brown, Richard W. Bush, Jeffrey L. Gertz, Daniel C. Herring, Leo Javits, Daniel A. Komisar, Maria Picardi Kuffner, Jessica E. Olszta, and Harald Wilhelmson.*

**Miniaturized Radio-Frequency Four-Channel Receiver**  
The miniaturized radio-frequency four-channel receiver detects low-level signals across a wide frequency range in the presence of many interferers while requiring minimal space and power.

*Developers: Helen H. Kim, Matthew D. Cross, Merlin R. Green, Daniel D. Santiago, and Sabino Pietrangelo.*

**Sub-wavelength-Separated Superconducting Nanowire Single-Photon Detector Array**  
The nanowire photodetector array enables broadband single-photon detection with high efficiency and low noise at record rates exceeding one billion photons per second.

*Developers: Eric A. Dauler and Andrew J. Kerman (Lincoln Laboratory), Karl K. Berggren (MIT), and Vikas Anant and Joel K.W. Yang (former MIT graduate students).*

continued support from Lincoln Laboratory, the FAA has extended operational evaluations of RWSL at these test airports indefinitely.

The critical need for improved departure management during inclement weather in highly congested airspace was addressed by the Route Availability Planning Tool (RAPT), an automated decision support tool intended to help air traffic controllers and airline dispatchers quickly determine which departure routes will be affected by convective weather up to 90 minutes into the future. RAPT assigns a departure route status to future departures by combining precipitation and echo tops forecasts with a model for local-area departure operations. A prototype of the system has been operationally effective for about four years at locations in the New York City region, including LaGuardia, John F. Kennedy, and Newark airports; several regional air traffic control centers; and commercial airline dispatch operations.

Both RWSL and RAPT are designed to be compatible with existing FAA procedures and can greatly benefit airline operations by reducing flight delays and the potential for on-ground collisions.

#### **Commercialization of Laboratory Technology**

Lincoln Laboratory does not compete with the private sector; instead, it places a high priority on working with and encouraging technology transfer to the commercial industrial base through individuals and organizations. In some cases, employees who leave the Laboratory to set up their own firms are given advice and encouragement from the MIT Technology Licensing Office during the transition. In other cases, the Laboratory transfers new technologies to the private sector through government-sponsored arrangements, licenses, or cooperative agreements.

Public Law 96-517, popularly known as the Bayh-Dole Act of 1980, has particular importance for MIT and Lincoln Laboratory. Because of this law, universities and

small businesses can acquire the title to patents arising out of federally funded research. The Bayh-Dole Act allows universities to grant licenses and receive royalties, and encourages the commercialization of federally funded research. The government retains the right to royalty-free use of the patents.

MIT's extensive technology licensing program has expanded Lincoln Laboratory's technology-transfer activities. Companies that have obtained Laboratory-licensed technology through the MIT Technology Licensing Office now also receive technical support from Lincoln Laboratory personnel to facilitate the transfer of technologies.

#### ***Patents and Licensing***

Application for the first patent originating from work at Lincoln Laboratory, the "saturable switch," was filed in 1953 by Kenneth Olsen, who later founded DEC, the developer of the minicomputer. Among the most significant patents stemming from Laboratory work is the 1966 patent on the semiconductor infrared maser, invented by Herbert Zeiger, Robert Keyes, William Krag, Benjamin Lax, Alan McWhorter, Theodore Quist, and Robert Rediker. This patent was the culmination of the race to build the first semiconductor laser. (At about the same time, teams at GE and IBM also were issued patents on this important idea.) Additional solid-state electronics research led to a patent on the semiconductor heterojunction diode, the process for making mercury cadmium telluride, and multiple patents on the microchip laser. Optical research led to several inventions based on diffractive optics, including several patents for coherently adding laser beams, and multiple patents on high-efficiency, multilevel, diffractive optical elements; diffractive optics used for efficient illumination of color displays; and combinations of diffractive and refractive optical elements for optical chromatic dispersion correction. More recent inventions include several patents on nanostructure and quantum-dot thermoelectric materials and devices, and rapid, sensitive identification of biological agents with unique instruments that use the Cellular Analysis and Notification of Antigen Risks and Yields (CANARY) technology.

---

## Notes

**3** E.B. Roberts, "Technological Entrepreneurship: Birth, Growth, and Success" *MIT Management*, Winter 1991, p.21.

**4** *MITRE: The First Twenty Years*. Bedford, Mass.: The MITRE Corporation, 1979.

From 1991 to 1998, under funding from the Department of Commerce and National Institute of Standards and Technology, Lincoln Laboratory partnered with six companies, the Baylor College of Medicine, and the Houston Advanced Research Center to form the Genosensor Consortium, which developed some of the seminal technology for DNA analysis that is now commonly used in the biomedical and life science communities. Methods were developed to synthesize and print short segments of DNA onto inexpensive plastic substrates in large arrays. In DNA tests, samples of unknown target DNA are washed across these arrays and bind to the printed DNA in specific patterns that reveal their coding sequence. The Laboratory also developed means for reading the binding patterns rapidly and reliably. The technology was transferred to the original six industrial licensees and subsequently has been sublicensed to seven additional companies, some of which are currently selling these arrays and the instruments that process and measure them. The patent royalties on the genosensor patents have been more than \$1.2 million.

As of July 2010, MIT held a total of 945 patents derived from work at Lincoln Laboratory. Of those, 548 had been licensed to industry for commercial applications. Successful patents often lead to spin-off companies that license these patents. Two examples of very successful MIT licenses that originated with Lincoln Laboratory inventors are the patents on optical-coherence tomography licensed to Zeiss Meditec and LightLab Imaging, and the accordion-fringe interferometry patents licensed to Dimensional Photonics International and Faro Technologies. Other important licenses include the picosecond microchip laser licensed to multiple companies; advanced weather-prediction software licensed to multiple companies, including Weather Services International and MySky; longitudinally pumped solid-state-laser technology licensed to Tessera; antigen-detection technology licensed to Innovative Biosensors; and medical X-ray technology licensed to Sectra Mamea.

## *Spin-off Companies*

Spin-off companies are a powerful vehicle for technology transfer from the Laboratory to the commercial sector. Studies show that the success rate of high-technology companies in their first five years is roughly 70 to 85%, a figure far higher than for nontechnology companies.<sup>3</sup> Lincoln Laboratory's impact on U.S. industrial development is evident from the number of high-technology enterprises started by former staff members. The businesses that have spun off from the Laboratory range from small consulting firms to midsize manufacturers to large corporations, and these companies have created more than 195,000 jobs. A few of the technology-based commercial ventures created by former Laboratory employees are described here to indicate the breadth of technological expertise at the Laboratory and the range of companies spawned.

*Digital Equipment Corporation:* Kenneth Olsen and Harlan Anderson founded DEC in 1957 to manufacture transistorized circuit boards and computers for engineers. Three years later, DEC introduced the PDP-1, the first computer to offer interactive operation, and the company was on its way to becoming the world's second largest computer manufacturer. DEC was purchased by Compaq Computer Corporation in 1998, which then merged with Hewlett Packard in 2001.

*MITRE Corporation:* MITRE was established by Robert Everett, John Jacobs, and others in 1958 to complete the system engineering of the Lincoln Laboratory-developed SAGE system. It is a nonprofit corporation that provides systems engineering support in air traffic control, information systems, telecommunications, and command, control, communication and intelligence.<sup>4</sup> MITRE Corporation employs more than 7000 people around the world.

*Electronic Space Systems Corporation:* Founded by Albert Cohen and Joseph Vitale in 1961, Electronic Space Systems Corporation manufactures precision antenna systems and space-frame and composite radomes. It is currently a division of L-3 Communications.



## Spin-off Companies

One direct measure of the Laboratory's contribution to the nation's economy is its success in transferring technology to spin-off companies. More than 90 spin-off companies have been started by Lincoln Laboratory staff since 1951. While some of the companies, such as DEC, may no longer exist, each of these spin-off companies has had or continues to have a significant impact on the national economy through the creation of jobs and new technologies. The partial list of spin-off companies that follows indicates the range of industrial activities that have been generated and supported by ideas and techniques developed at the Laboratory.

Air Traffic Software Architecture  
American Aviation  
American Power Conversion Corporation  
Amtron Corporation  
Applicon  
Arcon Corporation  
Ascension Technology  
Atlantic Aerospace Electronics  
Axsun Technologies  
Broadcloud Communications  
Carl Blake Associates  
Catalyst  
Centocor  
Clark Rockoff and Associates  
Computer Corporation of America  
Corporate-Tech Planning  
Delta Sciences  
Digital Computer Controls  
Digital Equipment Corporation  
Dimensional Photonics  
Electronic Space Systems Corporation  
Electro-Optical Technology  
F.W.S. Engineering  
Genometrix Genomics  
Gulf Coast Audio Design  
Hermes Electronics  
HH Controls Company  
HighPoint Systems  
Information International  
Integrated Computing Engines  
Janis Research Company  
Jumpjot  
Kenet  
Kolodzy Consulting  
Kopin Corporation  
Kulite Semiconductor Products  
Laser Analytics  
Lasertron  
LightLab Imaging, LLC  
Louis Sutro Associates  
Mann VLSI Research  
M.D. Field Company  
Meeks Associates  
Message Secure Corporation  
Metric Systems Corporation  
Micracor  
Micrilor

MicroBit Corporation  
MicroGlyph Systems  
MIT Francis Bitter Magnet Laboratory  
MITRE Corporation  
Morris Consulting  
Netexpress  
Nichols Research Corporation (Wakefield Branch)  
Novalux  
Object Systems  
Okena  
Optim Microwave  
Photon  
PhotonEx  
Pugh-Roberts Associates  
QEI  
RN Communications  
Sandial Systems  
Saxenian Hrand Associates  
Schwartz Electro-Optics, Research Division  
Sensors Signal Systems  
Signatron  
sound/IMAGE Multimedia  
Sparta (Lexington Branch)  
Spiral Software Company  
Stanford Telecommunications (Lowell Office)  
Sycamore Networks  
Synkinetics  
Tau-Tron  
Technology Transfer Institute  
TeK Associates  
Telebyte Technology  
Telenet Communications  
Terason Corporation  
Teratech Corporation  
Torch Concepts  
Transducer Products  
Tyco Laboratories  
U.S. Windpower  
UTP  
Viewlogic Systems  
VVimaging  
Wolf Research & Development  
XonTech  
Zeopower  
ZTEK Corporation

*Signatron Acquisition Corporation:* Formerly a subsidiary of Sundstrand Corporation, Signatron was founded in 1962 by Julian Bussgang. This company manufactures systems and components for defense and industrial electronics communications.

*Applicon:* Applicon was founded by Harry Lee, Gary Hornbuckle, Richard Spann, and Fontaine Richardson in 1969. Applicon was one of the first organizations to develop computer-aided-design/computer-aided-manufacturing (CAD/CAM) software for commercial applications. Applicon was acquired in 1999 by Unigraphics Solutions, which was later acquired by Siemens Corporation in 2007.

*U.S. Windpower:* Founded in 1979 by Herbert Weiss, Stanley Charren, and Norman Moore,<sup>5</sup> U.S. Windpower is the world's largest wind-energy company. Now known as Kenetech Windpower, a division of Kenetech, it works closely with utility companies on technology and wind-farm development projects.

*Lasertron:* Founded by J. Jim Hsieh and Kenneth Nill in 1980, Lasertron manufactures fiber-optic telecommunications systems and components. The company has supplied tens of thousands of 1.3 and 1.55  $\mu\text{m}$  lasers, detectors, and light-emitting diodes for optical fiber communications. The company is now Corning Lasertron, a division of Corning, Inc.

*American Power Conversion Corporation:* Emanuel Landsman, Ervin Lyon, and Neil Rasmussen founded American Power Conversion Corporation in 1981. The company designs and manufactures electronic uninterruptible-power-supply products for personal computers, engineering workstations, file servers, communications equipment, and other sensitive devices that depend on electric utility power. The company's products provide automatic, virtually instantaneous backup power in the event of a utility power failure.

*Kopin Corporation:* Founded by John Fan in 1984, Kopin was created to develop, manufacture, and market advanced composite semiconductor wafers for the next generation of high-performance integrated circuits. Kopin's wafer engineering techniques have produced high-quality thin films of advanced materials, including gallium arsenide on silicon and silicon on insulator.

---

## Notes

**5** Stanley Charren and Norman Moore were not Lincoln Laboratory employees.

**6** Jess Belser was not a Lincoln Laboratory employee.

*Micracor*: Founded by Aram Mooradian and Jess Belser<sup>6</sup> in 1990, Micracor manufactured advanced solid-state lasers, including the microchip laser, a miniature single-frequency solid-state laser capable of optical pulses as short as 300 psec. Micracor was sold to Coherent, Inc. in 1997.

*LightLab Imaging*: Originally founded by Eric Swanson, Mark Brezinski, and James Fujimoto as Advanced Ophthalmic Devices in 1997, the company was renamed LightLab in 1998. LightLab Imaging, which licenses key Lincoln Laboratory–developed patents in optical coherence imaging, is a pioneer in using optical-coherence tomography for medical imaging. This technology can be used to create real-time images with a resolution of 15  $\mu\text{m}$ . Optical-coherence imaging has had a major impact in ophthalmology and is poised to have a major impact in studying heart disease. In 2010, LightLab Imaging was acquired by St. Jude Medical.

*Sycamore Networks, Inc.*: Founded by Swanson, Richard Barry, and Gururaj Deshpande in 1998, Sycamore Networks provides fiber-optic, edge-to-core switching products, service and support, and network access products, design services, and support for the telecommunications industry.

*Axsun Technologies, Inc.*: Founded by Dale Flanders in 1999, Axsun Technologies manufactures near-infrared spectrometers for the pharmaceutical industry; accurate optical power, frequency, and signal-to-noise ratio measurement equipment for the fiber-optic telecommunications industry; and near-infrared materials monitors to identify polymers for the recycling industry.

*Dimensional Photonics, Inc.*: Founded by Lyle Shirley in 2000 and reemerged as Dimensional Photonics International (DPI) in 2003, DPI has licensed the Lincoln Laboratory–developed accordion-fringe interferometry patents for noncontact surface measurements. DPI designs and produces three-dimensional shape scanners that create a three-dimensional data representation of an object accurate to within micrometers. These scanners are used for creating three-dimensional CAD drawings of an object for reverse engineering as well as for quality control for manufactured objects. The many other applications of this technology include use as an aid in criminal forensics.

## Cooperative Activities with Commercial Industries

The synergistic relationship between Lincoln Laboratory and industry results in a transfer of technology, initiated by the U.S. government, from Lincoln Laboratory research and technology development to a commercial industrial production environment. In addition to the licensing of MIT patents to companies and spin-off companies, several mechanisms are used for transferring Laboratory–developed technology to industry, academia, and government. These include briefings and technical publications; delivery of hardware, software, algorithms, or advanced architecture concepts to government contractors under the auspices of a government sponsor; Cooperative Research and Development Agreements (CRDA), which are privately funded by businesses to transfer Laboratory–developed technology; and Small Business Technology Transfer (STTR) projects, which are joint research partnerships with small businesses.

Recent deliveries of hardware, software, algorithms, or advanced architecture concepts transferred to government contractors under the auspices of a government sponsor are listed below:

- For several years, Lincoln Laboratory has been the only U.S. organization providing research access to a fully depleted silicon-on-insulator (FDSOI) complementary metal-oxide semiconductor (CMOS) process technology. Through Defense Advanced Research Projects Agency (DARPA) sponsorship, the FDSOI CMOS technology has been used by over 80 different U.S. industrial, university, and government laboratories to fabricate more than 300 different circuits as part of 13 multiproject runs performed in the Microelectronics Laboratory at Lincoln Laboratory. These multiproject runs exploit some of the unique attributes of the Laboratory’s FDSOI CMOS technology, including low-power operation, high-quality radio-frequency (RF) performance, and three-dimensional circuit integration capabilities. In 2010, the Laboratory completed its third multiproject run targeted at three-dimensional circuit integration, or 3DM3. The 3DM3 run allowed researchers from twenty different organizations to explore three-dimensional circuits for high-performance computing, imaging, and RF applications.

- Lincoln Laboratory's silicon and indium phosphide Geiger-mode avalanche photodiode (APD) technologies were used in DARPA and DoD prototype systems. Boeing, British Aerospace Engineering, Lockheed Martin, and Northrop Grumman are among the industries using Laboratory-developed APD arrays.
- A 1.4 billion pixel, ultralow-noise, OTA, silicon CCD imager was delivered to the Pan-STARRS camera operated by the University of Hawaii's Institute for Astronomy. The OTA CCD helps overcome the blurring effects of the atmosphere on ground-based telescopes.
- Spherically curved silicon CCD imager tiles used in the focal arrays for DARPA's Space Surveillance Telescope enable fast ( $f/1$ ) optics.
- A low-cost bioaerosol sensor technology and micro-electromechanical systems RF switch technology were recently transferred to industries such as Innovative Micro Technology, Northrop Grumman, and ICX Mesosystems.
- The Laboratory developed and transferred to industry the weather-sensing algorithms for the Terminal Doppler Weather Radar, which is used by air traffic controllers nationwide.

#### *Cooperative Research and Development Agreements*

The Stevenson-Wydler Technology Innovation Act of 1980, as amended by the Federal Technology Transfer Act of 1986, has given federally funded research and development centers new mechanisms for technology transfer to industry on a precompetitive basis. In recent years, the Laboratory has been working extensively with industrial organizations to take advantage of these new opportunities for enhancing the nation's economic vitality and promoting job growth. For example, a CRDA now allows Lincoln Laboratory to develop technologies with, and transfer technologies to, industry through cooperative arrangements.

In such industry-funded activities as CRDAs, a research agreement between Lincoln Laboratory and an outside company protects the confidentiality of proprietary information that the company shares with the Laboratory as well as proprietary information developed under the CRDA. Title to any intellectual property developed is negotiated as part of the CRDA, with Lincoln Laboratory rights retained by MIT, just as for government-sponsored research.

Lincoln Laboratory receives no government funding for CRDA activities, and CRDA work at the Laboratory must be completely supported by the companies involved. Between 1992 and 2010, Lincoln Laboratory participated in 81 CRDAs with 74 businesses, universities, and local government organizations.

#### *Small Business Technology Transfer Programs*

Title II of the Small Business Research and Development Enhancement Act of 1992 (P.L. 102-564) established the STTR program. The purpose of the STTR program is to promote innovation by bringing together the private and public sectors through joint ventures between small, entrepreneurial businesses and the nation's premier nonprofit research institutions. Each year, all federal agencies or departments that have more than one billion dollars in extramural research and development funds must spend 0.3% of that budget on STTR awards. These federal agencies include the DoD, Department of Energy, and the Department of Health and Human Services, as well as NASA and the National Science Foundation. Under STTR contract rules, only a small business can serve as a prime contractor, while the nonprofit research institution serves as a subcontractor. Lincoln Laboratory qualifies as a subcontractor.

There are two phases in the STTR program. Phase 1 is the startup phase, during which the collaborative team explores the scientific, engineering, and commercial feasibility of an idea. Upon successful completion of phase 1, teams may continue into phase 2 to further develop the commercial potential of the idea. After the completion of phase 2, the innovation must move from the Laboratory to the commercial marketplace without the benefit of STTR funding. Between 1995 and 2010, Lincoln Laboratory completed 40 STTRs with a total Laboratory funding of approximately \$3.3 million.



## Cooperative Research at Lincoln Laboratory

CRDAs promote the transfer of technology developed for government sponsors to the commercial and local government sectors. Since the first CRDA at Lincoln Laboratory was sponsored by Texas Instruments in 1992, 74 businesses, local government agencies, and universities have funded 81 CRDAs worth more than \$144 million. The long list of organizations that have funded CRDAs at Lincoln Laboratory indicates the reach of this successful technology-transfer mechanism.

Actel	Lasertron
Air Products	Lockheed Martin
Airtron Litton	Lockheed Martin Coherent Technologies
AmberWave	Loral
American Xtal Technology	Loral Skynet
Amray	Lucent Technologies
Anro Engineering	LuxNet
Applied Materials	Maxion
Arch Chemicals	MCI
Axsun	MediSpectra
Beckman	Modetek
BSST, LLC	Motorola
Chromaplex	National Photoresist Development
Clariant	New York City Transit Authority
Confluent Photonics Corporation	New York Port Authority
Cyra	Northeastern University
Delco Electronics	NPC Trials
Digital LightCircuits	Orbital Science
DMC	Radiant Images
DRS Technologies	Recon Optical
E.I. Dupont	Reflexite
Environmental Optical Sensors	Satmex
ETEC	SEMATECH
Ford	SES Americom
GE Global	Shiple Company
Global Atmospheric	Sparta
Hughes	Spinnaker Semiconductor
Ibis Tech Corporation	SS-Loral
IBM	SVGL
Innovative Biosensors	Telephotonics
Innovative Photonics	Telesat Canada
Intel Corporation	Texas Instruments
Intelsat	University of Arizona
ITT	Visa
Kenet	Visidyne Corporation
KLA-Tencor	Xradia
Kopin Corporation	

The Laboratory has also participated in the formation of university-industry consortia for the development of advanced technologies. Working with MIT campus groups, Lincoln Laboratory played a central role in the establishment of two major consortia: the Consortium for Superconducting Electronics and the All-Optical Network Consortium.

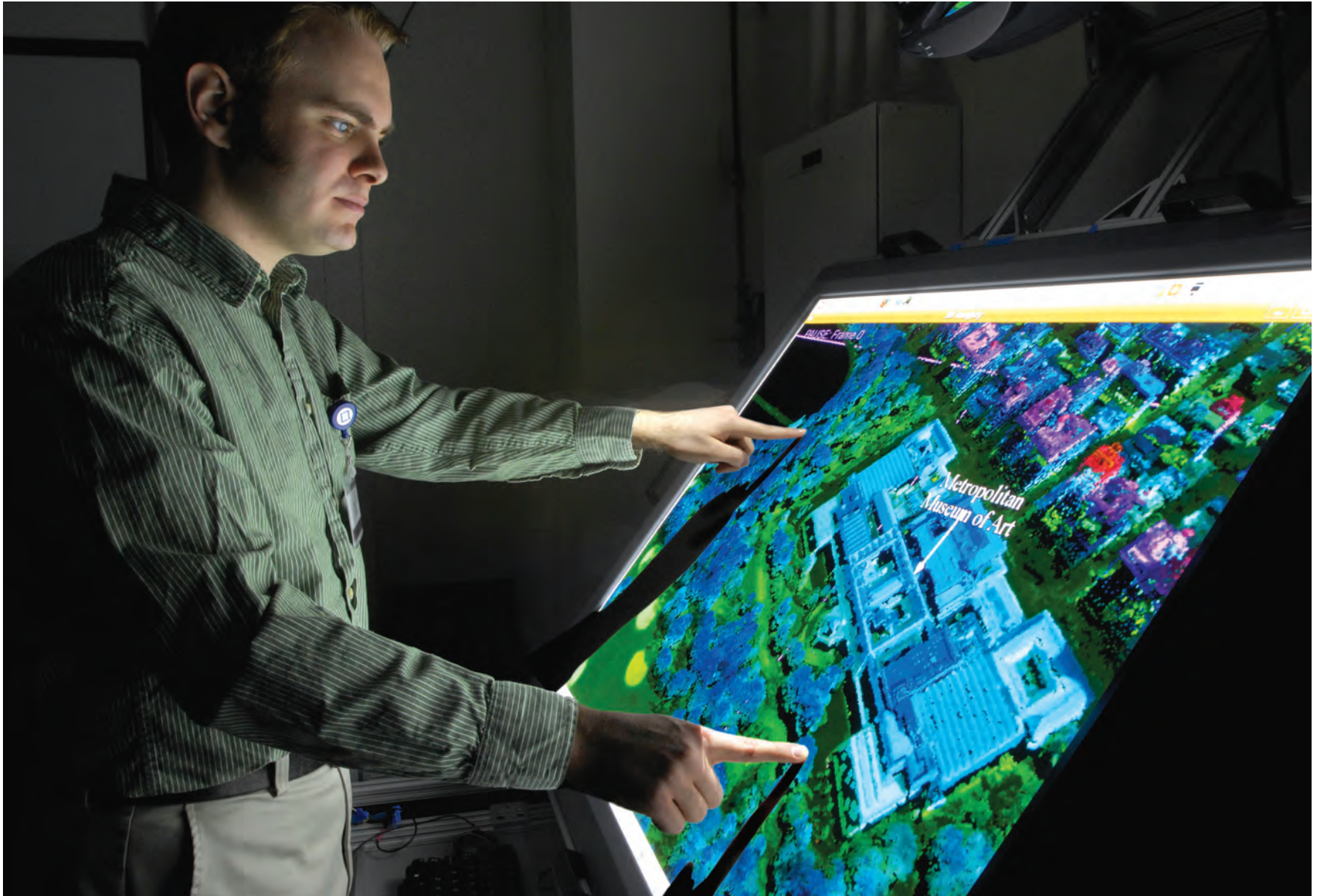
Other partnerships include relationships with universities and with both large and small businesses in the defense and commercial sectors. The Laboratory issues subcontracts for goods and services with values exceeding \$300 million on an annual basis.

Small businesses — which supply construction, maintenance, fabrication, and professional technical services in addition to commercial equipment and material — have been the primary beneficiaries of the Laboratory's outside procurement program. The Laboratory's Small Business Office is committed to an aggressive program designed to afford small business concerns the maximum opportunity to compete for purchase orders.

### A Continuing Commitment

The flow of enabling technologies as interacting technical innovations leading to new commercial products can be difficult to trace. Researchers may develop similar ideas nearly simultaneously, and several organizations working in the same area may advance a technology rapidly by building on each other's earlier work. Even if a technical advance occurs with astonishing speed, the widespread application of the new idea or technology can take a long time. The evolution of technology from innovation to application is impossible without the nation's most important resource — its technical talent. The nation's economic security, which depends on its technical competitiveness, requires the effective use of all sources of technical innovation in both the defense and commercial sectors. Engineering laboratories continue to play an essential role in producing and demonstrating the usefulness of technical innovations.

The Laboratory continues to develop technologies that support the nation's security, many times resulting in innovations ripe for application in a variety of markets. Consider the Laboratory's touch technology research.



**Figure 33-5**

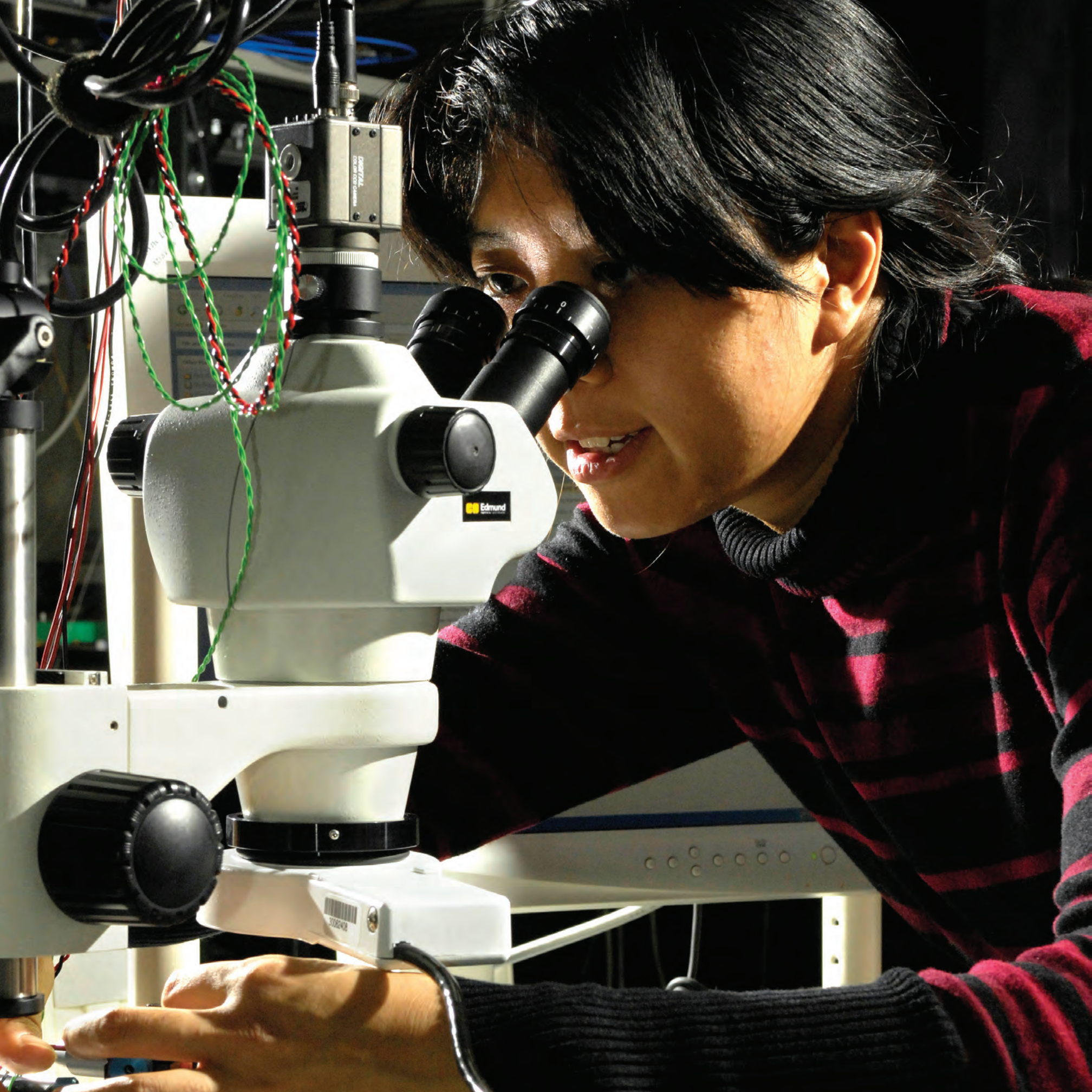
**A Laboratory staff member demonstrates the utility of touch technology in retrieving detailed information about a location.**

The Mitsubishi Electronics Research Laboratory multi-touch table displayed in Figure 33-5 was originally purchased in 2007 for an internal program and later used for a sponsor-funded program in 2008. In this picture, a staff member is shown manipulating a three-dimensional laser radar image of New York City. The touch table interface allows users to navigate through massive data sets by using intuitive hand gestures. Human analysts can consequently utilize this novel technology to rapidly scan through large volumes of two-dimensional and three-dimensional imagery and zero in on anomalies or other items of interest within the data.

Touch-technology has clearly become ubiquitous in the commercial world of handheld devices such as touch iPods, iPhones, and iPads. As part of the Laboratory's touch-technology research, the Active Optical Systems Group linked output similar to that shown in Figure 33-5 with a touch iPod. The link between the large touch table and the small touch iPod was part of a prototype demonstration of transporting intelligence between warfighters in the field and commanders in centralized headquarters.

Lincoln Laboratory's ongoing technological leadership will ensure that it remains a source of innovative technology for the nation. In carrying out its primary mission of developing technology in support of national security, the Laboratory will continue to provide other benefits to the technical community and the nation. The Laboratory has demonstrated its commitment to the widest dissemination and application of technology advances. It has provided enabling technologies for major new enterprises and fostered thriving companies. Today, global economic competition and national policy promoting dual-use technology compel the Laboratory to continue increasing its support for commercialization of technical advances. The Laboratory has been involved in the transfer of innovative technology to industry since its establishment in the early 1950s, and it will continue performing this essential task.







**For six decades, Lincoln Laboratory has strengthened the nation's security and its economy through its technological leadership and innovation. Motivating the Laboratory's ability to meet this national challenge is a sustained commitment to working on relevant, difficult technologies and to improving the effectiveness of our technical execution for programs of all scales.**

—E.D. Evans

**Left: Central to the Laboratory's sustained technical excellence is its high-caliber scientists and engineers.**

Before World War II, very few members of the national security establishment had identified the critical relationship between the nation's security and its technological leadership. The role of technology development in strengthening the national economy has been understood for an even briefer time. In the 21st century, these facts seem self-evident: technology development is vital to both the nation's security and its economic strength. The question for the future is, "How will U.S. leadership in technology development best be maintained?" For Lincoln Laboratory, the ancillary question is, "How can Lincoln Laboratory help sustain U.S. technical predominance?"

#### **Core Values of Lincoln Laboratory**

The core values of Lincoln Laboratory have remained constant since its inception in 1951. These values — technical excellence, innovation, integrity, collaboration, and open communication — applied to every facet of the enterprise will continue to guide the Laboratory and assure its future vitality and usefulness to the nation.

Technical excellence begins with the quality of the staff. Researchers and engineers are drawn from the top universities in the nation and are provided with strong mentorship for individual advancement and with support talent matched to the tasks. Collaborative execution is stressed in a team-oriented atmosphere of advancement based on meritocracy. The culture — one of risk tolerance, creative exploration, and technical community openness, to the extent allowed by national security considerations — continues to promote innovative solutions to critical problems.

Lincoln Laboratory is governed by a strong adherence to the roles and responsibilities established for federally funded research and development centers (FFRDC) and by a Joint Advisory Committee led by the Assistant Secretary of Defense for Research and Engineering. This governance promotes continuity in management while providing strategic direction for future initiatives.

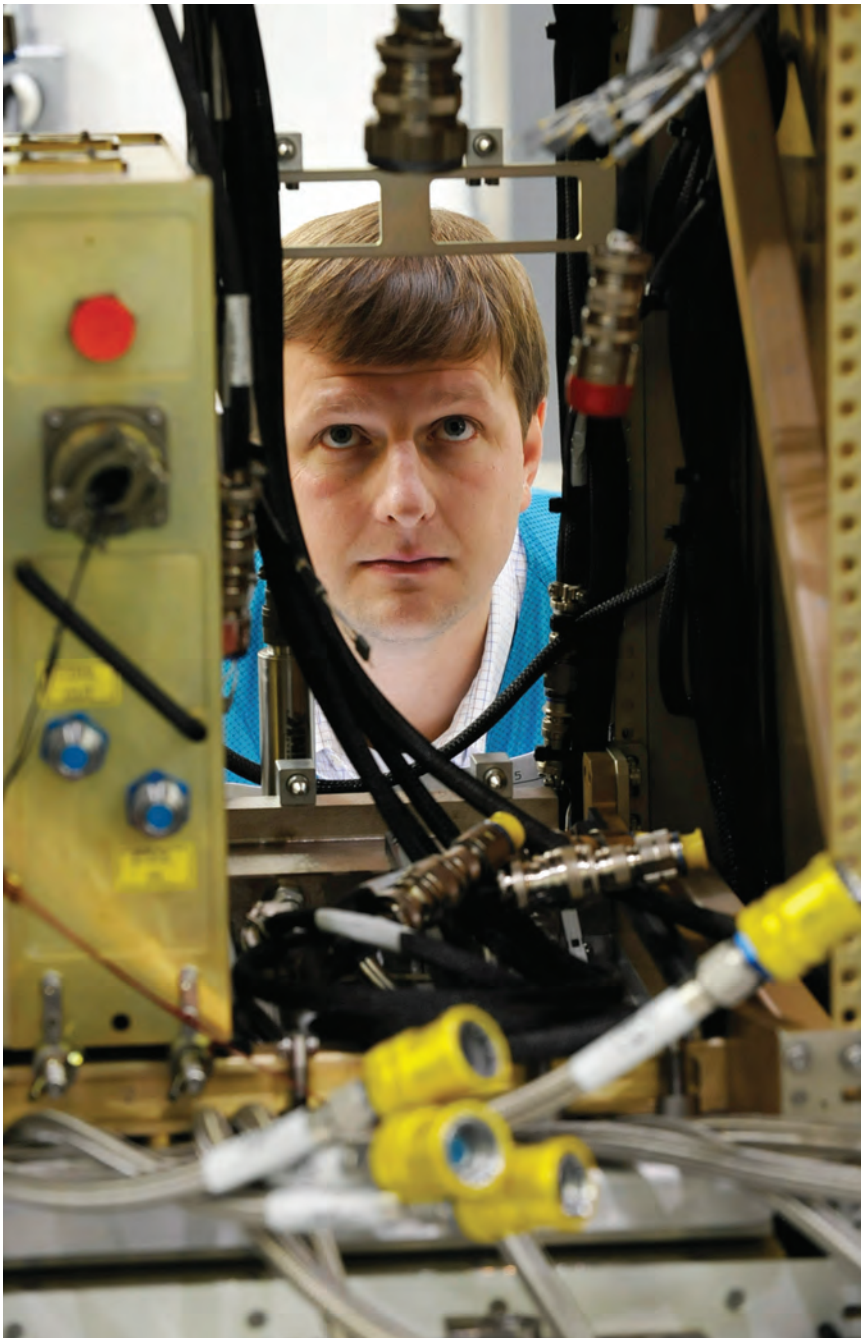
The governance relationship with MIT is vital to the Laboratory's mission. Laboratories such as Lincoln Laboratory that are affiliated with major universities provide very favorable settings for undertaking long-term, large-scale science and technology challenges. Their research priorities, unlike those of industrial

organizations, can be exclusively in the national interest. Such university-affiliated laboratories can also undertake complex projects that would be impossible in small faculty laboratories, and they can utilize the resources of the parent universities.

Since its first project, Lincoln Laboratory has fostered enduring partnerships with sponsoring agencies. The trust and respect engendered through these partnerships have had significant impacts on the continued success of programs. Most of the approximately 500 programs in progress at the Laboratory result from direct and continuous associations between Laboratory members and sponsors with pressing technical needs in areas relevant to the goals and expertise of the Laboratory. For a need to become a program requires a well-posed problem with minimal programmatic constraints to achieving technical solutions. User connectivity is essential to solving the "right problem," and is intimately associated with the well-posed problem. Lincoln Laboratory believes that prototyping and field experimentation are essential to validate or disprove "otherwise perfectly good theories" (Figure 34-1). The concluding, and often a very difficult, step in a successful program is an effective technology transfer to the user community.

#### **The Challenges to National and International Security**

Since the end of the Cold War era, the specific challenges facing the United States have changed dramatically, and the need for advanced technology to solve problems affecting national and international security has grown even greater. The Laboratory periodically conducts internal strategic studies to address the following four questions: (1) What are the current and future major national security challenges? (2) What overarching capabilities and key enabling technologies are required to meet these challenges? (3) Which of these capabilities should the Laboratory emphasize? (4) What investments in facilities, test beds, staffing, and other resources are needed to develop the technologies and demonstrate the capabilities? The approach taken by the Laboratory's strategic systems analysis team is to review national studies sponsored by the Department of Defense (DoD) and other nondefense organizations, to compare the top priorities with existing and emergent Lincoln Laboratory areas of expertise, and then to synthesize a strategic plan.



**Figure 34-1**  
The Laboratory's focus on prototyping and field demonstration of technologies is supported by state-of-the-art fabrication and test facilities.

A synopsis of the Laboratory's 2011 strategic plan envisions several challenges for national security and suggests areas in which Lincoln Laboratory can make significant contributions. These focus areas are not necessarily intended to replace current mission areas in an evolutionary way but rather are offered to establish a strategic vision for the Laboratory through balancing current and future national security requirements with Laboratory capabilities and resources.

#### *Space System Vulnerability*

Current and planned space systems are critically important to military, commercial, scientific, and other aspects of the U.S. presence in the world community. Denial of surveillance, communications, navigation, and intelligence capabilities would have far-reaching consequences. Space control requires space situational awareness derived from sensors such as the Haystack and Kwajalein radar systems, telescopes, and space satellites.

#### *Cyber System Vulnerability*

The Laboratory recognizes the importance of the cyber systems that relate the physical domain to the cognitive domain (decisions). An increased emphasis is being placed upon ensuring both situational awareness and command and control in the cyber domain, with the goal of preventing adversaries from influencing U.S. capabilities. Key technologies include sensing, data fusion, decision support, and resilient infrastructures.

#### *Violent Extremism*

The tragedy of September 11, 2001, and the rise of terrorist activities around the world have ushered in a need for entirely new concepts to provide for the nation's security. Large-force engagements have, in part, been replaced by activities designed by small nation states, terrorist organizations, and dogmatic individuals to inflict massive destruction upon governments and their citizens. Lincoln Laboratory's architecture for addressing the problem of irregular warfare involves the development of tactically distributed, cost-effective intelligence, surveillance, and reconnaissance (ISR) systems. The goal is to detect and interdict insurgent activity, both at home and abroad, with a high degree of probability and a low false-alarm rate.



## Assessment

E.D. Evans, Director  
MIT Lincoln Laboratory

**In my vision statement at the opening to this chapter, I cited relevance and effectiveness as two of the most essential constituents of our strategic plan for the future. We can define and we are adhering to the fundamental core principles upon which the Laboratory was created in 1951. The national, and indeed the global, security picture is volatile, but we are addressing this picture, and we have a plan for where and how we can effect a significant contribution in a timeline that makes a difference. I conclude that we are relevant, we are effective, and we can look forward to a very bright future for MIT Lincoln Laboratory.**

### *Disruptive Commercial Technologies*

Commercial industries provide highly sophisticated technologies, such as high-performance computing engines, communication systems, and sensors, to the world. Thus, actual and potential adversaries have access to these technologies that are enabling global disruption. A number of rapid-reaction capability offices have evolved within the DoD and other agencies to anticipate and reduce the effectiveness of these devices and systems in terrorist hands. Lincoln Laboratory is developing prototypes involving commercial equipment and software in a rapid development, “skunk works” approach to fighting terrorism.

### *Weapons of Mass Destruction*

Nuclear, chemical, biological, and radiological weapons of mass destruction remain the greatest threat to international security. The primary means to counter the spread of these weapons is to develop intelligence and surveillance capabilities that can detect weapons-development programs and the weapons themselves. Lincoln Laboratory is committed to ISR sensor research and systems analyses to determine effective application architectures.

### *Natural Disasters*

Efforts to manage military campaigns and natural disasters, such as fires, earthquakes, and floods, share common elements in sensing, communicating, analyzing data, decision making, and bringing counter forces to bear on the problem. The Laboratory is pursuing research to counter natural disasters by applying the intellectual property, hardware, and interagency associations developed over decades of defense programs.

### **The Challenge for Lincoln Laboratory**

Lincoln Laboratory is prepared to address the problems identified above, and it will play a critical role in maintaining the nation’s strong base in advanced technologies. The technological directions are difficult to precisely predict because important advancements often involve complex interactions between discoveries in several fields and because the best technical solution is not usually apparent when an investigation begins. The areas in which significant contributions are now being sought include advanced sensing systems, improved data processing, automatic recognition techniques, and decision support. Innovative technologies will be

applied to legacy and advanced sensors, and to netted communications technologies that interactively tie together sensing, data processing, distribution, and user-defined responsive systems.

New or improved sensor systems will be able to acquire data sufficient to detect and identify objects of interest that have been concealed or have had their observables reduced. These systems will operate in all natural and manmade environments, and be nearly impossible to detect and disrupt. The signal processing and recognition equipment of the future, which will be many orders of magnitude more capable than current equipment, will require completely new types of devices.

Other likely future developments include advanced signal processing and recognition algorithms that can identify objects with a high degree of reliability, and advanced communications technologies that permit compact equipment to support very-high-capacity circuits. The information age has introduced an entirely new virtual world where bits and packets have replaced objects that can be seen and touched, but where consequences to national security are very real and potentially catastrophic. Decision support tools address the ever-increasing volume of information available to a user and the need to present only relevant data and potential options for action.

The Laboratory’s six decades have witnessed a transition from the Semi-Automatic Ground Environment (SAGE) system, with its limited sensing and computational capabilities, to the enormously powerful data processors and sensors that form key components in the defense systems of today. By any measure — speed of processing, volume of data manipulated, range and data rate of sensing, subtlety and depth of data interpretation, reliability of performance — the newer systems have improved by orders of magnitude; this is as it must be, because the security of our nation depends upon those systems.

Foreseeing technological threats to the nation and providing responses to those threats are tasks no easier to carry out today than when the Laboratory began. Yet they are vital tasks if the nation is to remain secure and free. Anticipating technological threats and responding to them will continue to be the mission of Lincoln Laboratory.



# Lincoln Laboratory Directors



**F. Wheeler Loomis**  
July 26, 1951 – July 9, 1952



**Albert G. Hill**  
July 9, 1952 – May 5, 1955



**Marshall G. Holloway**  
May 5, 1955 – February 1, 1957



**Carl F.J. Overhage**  
February 1, 1957 – February 1, 1964



**William H. Radford**  
February 1, 1964 – May 9, 1966



**C. Robert Wieser, Acting Director**  
May 10, 1966 – January 1, 1967



**Milton U. Clauser**  
January 1, 1967 – June 1, 1970



**Gerald P. Dinneen**  
June 1, 1970 – April 1, 1977



**Walter E. Morrow, Jr.**  
April 1, 1977 – June 30, 1998



**David L. Briggs**  
July 1, 1998 – June 30, 2006



**Eric D. Evans**  
July 1, 2006 – Present



# Steering Committee Members 1951–2011

## Notes

**1** Director

**2** Acting Director  
and Deputy Director

**3** Associate Director

**4** Assistant Director

Allen, J.L. 1969–1971	Davenport, W.B., Jr. <sup>4</sup> 1956–1960	Grometstein, A.A. 1987–1989	MacLellan, D.C. <sup>4</sup> 1972–1996	Ralston, R.W. 1996–2008	Stokes, G.H. 2001–
Anderson, L.B. 1972–1991	1963–1965 Delaney, W.P. <sup>4</sup> 1976–1998	Harrington, J.V. 1956–1963	Marquet, L. 1980–1982	Rauschenbach, K.A. 1998–1999	Sudbury, R.W. 1993–2003
Benn, B.J. 1974–1976	Dinneen, G.P. <sup>1,4</sup> 1960–1977	Herlin, M.A. 1963–1987	Martinez, D.R. 1999–2010	Rediker, R.H. 1970–1979	Tabaczynski, J.A. 1984–2004
Bernard, A.D. 2000–2004	Dodd, S.H., Jr. 1957–1983	Hill, A.G. <sup>1,4</sup> 1951–1955	McCook, J.A. <sup>4</sup> 1983–1996	Reiffen, B. 1976–1988	Tannenwald, P.E. 1965–1974
Bernstein, M.D. <sup>3</sup> 2007–	Drouilhet, P.R., Jr. <sup>4</sup> 1972–1993	Holloway, M.G. <sup>1</sup> 1955–1957	McCormick, J., Jr. 1957–1959	Rheinstein, J. 1983–1984	Taylor, E.G. 1999–2006
Bially, T. 1979–1984	Dustin, D.E. <sup>4</sup> 1960–1984	Hubbard, M.M. <sup>4</sup> 1951–1955	McLaughlin, A.J. <sup>4</sup> 1975–2001	Richmond, A.S. 1957–1968	Taylor, N.H. 1956–1958
Blankenship, P.E. 1984–1998 2000–2006	Evans, E.D. <sup>1</sup> 1999–	Hutzenlaub, J.F. 1963–1980	McWhorter, A.L. 1963–1994	Rogers, F.A. 1956–1958	Thurman, L.A. 1998–2005
Bondurant, R.S. 1999–	Evans, J.V. <sup>4</sup> 1975–1983	Jacobs, J.F. 1958–1958	Melngailis, I. 1975–1996	Rogers, T.F. 1959–1963	Upton, L.O. <sup>4</sup> 1992–2009
Briggs, D.L. <sup>1,4</sup> 1987–2006	Everett, R.R. 1952–1958	Jacobus, D.D. 1961–1962	Meyer, J.W. 1960–1965	Rollefson, R. 1951–1952	Valley, G.E. <sup>3,4</sup> 1951–1957
Brown, G.S. 1951–1973	Fahnestock, H. 1953–1961	Johnson, B. 2009–	Mindel, J. 1969–1975	Rosen, P. 1966–1976	VanVoorhis, S.N. 1953–1958
Brown, W.M. 1996–2009	Fielding, J.C. 1987–1996	Keast, C.L. 2009–	Morrow, W.E., Jr. <sup>1,3,4</sup> 1964–1998	1980–1983 Roth, K.R. 1993–2007	Vitale, J.A. 1952–1961 Vitto, V. <sup>4</sup> 1984–1997
Bruce, C.F. 1986–2008	Fitzpatrick, H.W. <sup>4</sup> 1956–1984	Kingston, R.H. 1969–1972	Mott-Smith, H.M. 1951–1953	Sack, B.P. 1988–1998	Vlajinac, M. 1980–2004
Burke, H.K. 2007–	Floe, C.F. 1958–1969	Kleiman, H. 1983–1993	Nedzel, V.A. 1965–1984	Sage, N. McL. 1952–1956	Waldron, P. 1976–1996
Bussolari, S.R. 2005–	Floyd, F.W., Jr. 1985–1988	Kornegay, W.M. 1986–2001	Nielsen, C.E., Jr. <sup>4</sup> 1984–2001	Schimmoller, F.D. 1995–2006	Weiss, H.G. 1960–1979
Canizares, C.R. 2004–	Ford, H. 1953–1955	Kottler, H. <sup>3,4</sup> 1980–2002	Niessen, C.W. 1977–2005	Senne, K.D. 1994–2003	Wells, W.I. 1989–1993
Carroll, F.L. 1976–1991	Forrester, J.W. 1952–1956	Kuconis, J.E. 2009–	Niewood, E.H. 2009–	Sharon, A.P. <sup>4</sup> 2003–	Wieser, C.R. <sup>2,4</sup> 1956–1970
Chan, V.W.S. 1988–1998	Freedman, J. <sup>4</sup> 1955–1987	LaFrey, R.R. 1999–2001	Oppenheim, A.V. 1978–1980	Shaver, D.C. 1994–	Wiesner, J.B. 1951–1960
Clauser, M.U. <sup>1</sup> 1967–1970	Frick, F.C. 1959–1971	Lax, B. <sup>3</sup> 1957–1965	Overhage, C.F.J. <sup>1</sup> 1951–1952, 1955–1964	Shin, R.T-I. 2005–	Willard, B.K. 1996–1996
Cochrane, E.L. 1954–1957	1975–1979 Gatos, H.C. 1959–1962	Lebow, I.L. 1970–1975	Pensa, A.F. <sup>4</sup> 1988–2008	Smullin, L.D. 1952–1955	Woodbury, D.G., Sr. 1991–2003
Colucci, K.F. 2001–2008	1964–1965 Lemnios, W.Z. 1970–1993	Lemnios, Z.J. 2005–2008	Pippert, G.F. 1976–1985	Soibelman, I. 2009–	Wozencraft, J.M. 1969–1972
Creel, B.M. IV 1996–2003	Gerber, A.D. 2002–	Loomis, F.W. <sup>1</sup> 1951–1952	Primmerman, C.A. 2004–	Stadler, J.S. 2007–	Yaffee, J.D. 1995–2008
Cusick, P.V. 1952–1954	Greenwood, D.P. 1985–1994 2002–2008	Lynn, V.L. 1975–1980	Rader, R.E. 1962–1974	Staelin, D.H. <sup>4</sup> 1990–2002	Zacharias, J.R. <sup>3</sup> 1951–1955
			Radford, W.H. <sup>1,3</sup> 1952–1966	Stern, E. 1983–1994	

# Acronyms

3DM2	three-dimensional circuit integration	ASR	Airport Surveillance Radar
AARDI	angle-angle range Doppler imaging	ASTA	Airport Surface Traffic Automation
ABL	Airborne Laser	ASTB	Airborne Seeker Test Bed
ABM	anti-ballistic missile	ATC	air traffic control
ABMDA	Army Ballistic Missile Defense Agency	ATCAC	Air Traffic Control Advisory Committee
ABRES	Advanced Ballistic Reentry Systems	ATCRBS	Air Traffic Control Radar Beacon System
ACAS	Airborne Collision Avoidance System	ATM	air traffic management
ACC	Advanced Concepts Committee	ATMS	Advanced Technology Microwave Sounder
ACE	Atmospheric-Compensation Experiment	AUST-T	AEHF Universal System Test Terminal
ACIS	Advanced CCD Imaging Spectrometer	AUV	autonomous undersea vehicle
ACL	Atmospheric Compensation Laboratory	AVSE	Air Vehicle Survivability Evaluation
ACTD	Advanced Concept Technology Demonstration	AWACS	Airborne Warning and Control System
ACTS	Advanced Communications Technology Satellite, Airborne Countermeasures Test System	AWIPS	Advanced Weather Interactive Processing System
A/D	analog to digital	BACTrack	Biological-Agent Correlation Tracker
A/DMT	Arrival/Departure Management Tool	BAST	Biological-Agent Sensor and Trigger (formerly Biological-Agent Sensor Test bed)
ADC	Air Defense Command	BAWS	Biological Agent Warning Sensor
ADC	analog-to-digital converter	BCAS	Beacon Collision Avoidance System
ADCOM	Aerospace Defense Command	BFT	BMD Fusion Toolbox
ADES	Air Defense Engineering Services	BMD	ballistic missile defense
ADIS	Air Defense Integrated System	BMDNT	Ballistic Missile Defense National Team
ADS-B	Automatic Dependent Surveillance-Broadcast	BMDO	Ballistic Missile Defense Organization
ADSEC	Air Defense Systems Engineering Committee	BMEWS	Ballistic Missile Early Warning System
ADSP	Advanced Digital Signal Processor	BOSS	BMEWS Operational Simulation System
ADTS	Advanced Detection Technology Sensor	BOSSNET	Boston South Network
AEHF	advanced EHF	C2BMC	command, control, battle management, and communication
AESA	active electronically steered array	C3	command, control, and communications
AEW	airborne early warning	C3I	command, control, communications, and intelligence
AFCRL	Air Force Cambridge Research Laboratory	CANARY	Cellular Analysis and Notification of Antigen Risks and Yields
AFOAT	Air Force Office of Atomic Testing	CASSATT	Collision Avoidance System Safety Assessment Tool
AFOSR	Air Force Office of Scientific Research	CBASS	Common Broadband Advanced Sonar System
AGSR	Advanced Ground Surveillance Radar	CCD	charge-coupled device
AIRI	Airborne Infrared Imager	CDMA	code-division multiple-access
AIRT	Airborne Infrared Telescope	CCM	counter-countermeasure
ALCOR	ARPA-Lincoln C-Band Observables Radar	CIWS	Corridor Integrated Weather System
ALEX	Airborne Laser Communications Experiment	CLASP	Closed Loop Adaptive Single Parameter
ALI	Advanced Land Imager	CLEFT	cleavage of lateral epitaxial films for transfer
ALIRT	Airborne Ladar Imaging Research Testbed	CMCM	Critical Measurements and Countermeasures
ALTAIR	ARPA Long-Range Tracking and Instrumentation Radar	CMOS	complementary metal-oxide semiconductor
AMC	Affinity Magnet Cartridge	CMP	Critical Measurements Program
AMP	Affinity Magnet Protocol	COCHISE	Coherently Combined, High-Power Intelligent Semiconductor Emitters
AMOS	Air Force Maui Optical System	CONOPS	concept of operations
AMRAD	ARPA Measurements Radar	CONUS	continental United States
AMSU	Advanced Microwave Sounding Unit	CoSPA	Collaborative Storm Prediction for Aviation
AMTI	airborne moving target indicator	CNO	computer network operations
APD	avalanche photodiode	COTS	commercial off-the-shelf
APT	Adaptive Processing Testbed	CRDA	Cooperative Research and Development Agreement
ARPA	Advanced Research Projects Agency	CrIS	Cross-track Infrared Sounder
ASAMM	advanced surface-to-air missile model	CRT	cathode ray tube
ASAP	Adaptive Sensor Array Processing	CSAIL	(MIT) Computer Science and Artificial Intelligence Laboratory
ASCA	Airplane Stability and Control Analyzer		
ASDE	Airport Surface Detection Equipment		
ASIC	application-specific integrated circuit		

CW	continuous wave	GOES	Geostationary Operational Experimental Satellite
DABS	Discrete Address Beacon System	GOPS	billion operations per second
DAC	double-stranded RNA activated caspase	GPALS	Global Protection Against Limited Strikes
DARPA	Defense Advanced Research Projects Agency	GPS	Global Positioning System
DCGS	Distributed Common Ground System	GTS	GEODSS Test Site
DDR&E	Director of Defense Research and Engineering	HaLT	Hanscom-Lincoln Testbed
DEW	Distant Early Warning	HAX	Haystack Auxiliary
DFPA	digital focal-plane array	HEL	high-energy laser
DHS	Department of Homeland Security	HELJTO	High-Energy Laser Joint Technology Office
DIR	Diagnostic Imaging Radar	HELSTF	High-Energy Laser Systems Test Facility
DNA	deoxyribonucleic acid	HF	high frequency
DoD	Department of Defense	HMM	hidden Markov model
DOE	Department of Energy	HOWLS	Hostile Weapons Location Systems
DPCA	displaced-phase-center antenna	HPEC	high-performance embedded computing
DRFM	digital radio-frequency memory	HUMINT	human intelligence
DSCS	Defense Satellite Communications System	HUSIR	Haystack Ultrawideband Satellite Imaging Radar
DSNCP	Deep Space Network Control Processor	IADS	integrated air defense systems
DSP	digital signal processor	IC	integrated circuit
DSPN	direct-sequence pseudonoise	ICBM	intercontinental ballistic missile
DTI	Doppler-time-intensity	IDPCA	inverse displaced-phase-center array
DTRA	Defense Threat Reduction Agency	IDS	intrusion detection systems
ECBC	Edgewood Chemical and Biological Center	IED	improvised explosive device
EHF	extremely high frequency	IF	intermediate frequency
ERSA	Enhanced Regional Situation Awareness	IFF	identification, friend or foe
ESD	Electronic Systems Division	IMINT	imagery intelligence
ESM	electronic support measures	IMPATT	impact ionization avalanche transit time
ESS	Experimental SAGE Subsector	I/O	input/output
ESSA	Extended Space Sensors Architecture	IPAS	Intelligent Particle Analysis Sensor
ETILL	Enhanced Track Illuminator Laser	IPAT	ISR Processing and Array Technology
ETS	Experimental Test System	IPC	intermittent positive control
EUV	extreme ultraviolet	I/Q	in-phase/quadrature
EVE	EUV Variability Experiment	IRAR	Infrared Airborne Radar
FAA	Federal Aviation Administration	IRCM	infrared countermeasures
FASP	Fly-Away Sensor Package	IRMS	infrared measurement system
FBR	forward-based radar	ISAR	inverse synthetic aperture radar
FEP	FLTSAT EHF Package	ISDS	integrated sensing and decision support
FET	field-effect transistor, Fusion Exploitation Tools	ISIS	Imaging System for Immersive Surveillance
FDSOI	fully depleted silicon on insulator	ISR	intelligence, surveillance, and reconnaissance
FFRDC	federally funded research and development center	ITWS	Integrated Terminal Weather System
FFT	fast Fourier transform	JAC	Joint Advisory Committee
FIR	finite-impulse-response	JBPDS	Joint Biological Point Detection System
FLIR	forward-looking infrared	JFET	junction field-effect transistor
FLTSAT	Fleet satellite communications	JNIC	Joint National Integration Center
FM	frequency modulation	JSTARS	Joint Surveillance Target Attack Radar System
FOPEN	foliage penetration	KASSPER	Knowledge-Aided Sensor Signal Processing and Expert Reasoning
FPA	focal-plane array		
FPGA	field-programmable gate array	KDS	Kwajalein Discrimination System
FSK	frequency-shift keying	KIS	Kwajalein Imaging System
GEO	geostationary orbit	KMAR	Kwajalein Modernization and Remoting
GEODSS	Ground-based Electro-Optical Deep-Space Surveillance	KMR	Kwajalein Missile Range
GHIS	GOES High-Resolution Interferometric Sounder	KREMS	Kiernan Reentry Measurements Site
GIG	Global Information Grid	KV	kill vehicle
GMM	Gaussian mixture model	LACE	Low-Power Atmospheric-Compensation Experiment
GMTI	ground moving target indicator (indication)	LADAR	laser detection and ranging, laser radar



LARIAT	Lincoln Adaptable Real-time Information Assurance Testbed	MTI	moving target indicator
LASA	large-aperture seismic array	MUSE	Matrix Update Systolic Experiment
LCS	Lincoln Calibration Sphere	MWIR	medium-wave infrared
LDSC	Lexington Decision Support Center	NASA	National Aeronautics and Space Administration
LDSP	Lincoln Digital Signal Processor	NAST	NPOESS Airborne Sounder Testbed
LDVT	Lincoln Digital Voice Terminal	NATO	North Atlantic Treaty Organization
LEO	low earth orbit	NCES	Net-Centric Enterprise Services
LES	Lincoln Experimental Satellite	NCMC	NORAD Cheyenne Mountain Complex
LESOC	Lincoln Experimental Satellite Operations Center	NCO	network-centric (net-centric) operations
LET	Lincoln Experimental Terminal	NCR	National Capital Region
LIDAR	light detection and ranging	NCW	net-centric warfare
LIMIT	Lincoln Multimission ISR Testbed	Nd:YAG	neodymium-yttrium aluminum garnet
LINC	Laboratory Instrument Computer	NEROC	Northeast Radio Observatory Corporation
LINC-IT	Lincoln Integrated Net-Centric Infrastructure Testbed	NFL	new foreign launch
LINEAR	Lincoln Near-Earth Asteroid Research	NFLP	New Foreign Launch Processor
LiNK	Lincoln Nucleic-Acid Kit	NGA	National Geospatial-Intelligence Agency
LIS	Lexington Imaging System	NIS	NATO IFF System
LLCO	Lincoln Laboratory Community Outreach	NIST	National Institute of Standards and Technology
LLNEN	Lincoln Laboratory New Employee Network	NLEQ	nonlinear equalization
LPC	linear predictive coding	NMD	national missile defense
LPE	liquid-phase epitaxy	NOAA	National Oceanic and Atmospheric Administration
LRIR	Long-Range Imaging Radar	NOMAC	noise modulation and correlation
LRPA	laser-radar power amplifier	NORAD	North American Aerospace Defense Command
LSSAC	Lexington Space Situational Awareness Center	NPOESS	National Polar Orbiting Environmental Satellite System
LSSC	Lincoln Space Surveillance Complex	NRL	Naval Research Laboratory
LTS	Lincoln Training System	NRP	Netted Radar Program
LWIR	long-wavelength infrared	NWP	numerical weather prediction
MAMBA	Multipath-Adaptive Multi-Beam Array	OAMP	Optical Aircraft Measurements Program
MARTI	Missile Alternative Range Target Instrument	OCULAR	Optical Compensation of Uniphase Laser Radiation
MASIVS	Multi-Aperture Sparse Imager Video System	ONR	Office of Naval Research
MASR	Multiple Antenna Surveillance Radar	OPAL	Optical Processing Architecture at Lincoln
MBA	multiple-beam antenna	OSD	Office of the Secretary of Defense
MBE	molecular beam epitaxy	OTA	orthogonal-transfer array
MCAO	multiconjugate adaptive optics	OTCCD	orthogonal-transfer CCD
MCMUD	multichannel multiuser detector	OTHR	over-the-horizon radar
MDA	Missile Defense Agency	PANACEA	Pharmacological Augmentation of Nonspecific Anti-pathogen Cellular Enzymes and Activities
MEM	microelectromechanical	Pan-STARRS	Panoramic Survey Telescope and Rapid Response System
MFSK	multiple-frequency shift keying	PANTHER	Pathogen Analyzer for Threatening Environmental Releases
MIDYS	Millstone Dynamic Scheduler	PAR	perimeter acquisition radar
MILSATCOM	military satellite communications	PBT	permeable base transistor
MIMO	multiple-input, multiple-output	PCI	phase-compensation instability
MIRACL	Mid-Infrared Advanced Chemical Laser	PCR	polymerase chain reaction
MIRV	multiple independently targeted reentry vehicles	PDSOI	partially depleted silicon on insulator
MLS	Microwave Landing System	PMP	parallel microprogrammable processor
MMS	Multistatic Measurement System	POES	Polar Operational Environmental Satellite
MMW	Millimeter Wave (radar on Kwajalein)	POET	Phase One Engineering Team
MNOS	metal-nitride-oxide semiconductor	PPI	plan position indicator
MOSS	Morón Optical Space Surveillance	PRESS	Pacific Range Electromagnetic Signature Studies
MPI	message passing interface	PRM	Precision Runway Monitor
MSR	missile site radar	PV	photovoltaic
MSX	Midcourse Space Experiment	PVL	Parallel Vector Library
MT	machine translation	PVTOL	Parallel Vector Tile Optimizing Library
MTD	moving target detector		

QCL	quantum cascade laser		target indicator
QE	quantum efficiency	SNAP	Simple Nucleic Acid Protocol
QIS	quantum information science	SOA	service-oriented architecture
RAAD	Rapid Agent Aerosol Detection	SOI	space-object identification, silicon on insulator
RAC	reflective array compressor	SOT	system operation test
RAPID	Rapid Advanced Processors in Development	SOUTHCOM	U.S. Southern Command
RAPT	Route Availability Planning Tool	SPGD	stochastic parallel gradient descent
RAPTOR	Reconfigurable Adaptive Processing Testbed for Onboard Radars	SSA	space situational awareness
		SSB	single sideband
REAP	Recovery, Extraction, and Archiving Protocol	SSGN	ship, submersible, guided, nuclear
RCS	radar cross section	SSN	Space Surveillance Network
RDO	RTS Distributed Operations	SST	Space Surveillance Telescope
RLE	Research Laboratory of Electronics	STANAG	Standardization Agreement
RF	radio frequency	STAP	space-time adaptive processing
RNA	ribonucleic acid	STC	Sinusoidal Transform Coder
ROC	receiver operating characteristic	STTR	Small Business Technology Transfer
ROIC	readout integrated circuit	SVM	support vector machine
ROLL	Robotics Outreach at Lincoln Laboratory	SWaP	size, weight, and power
ROSA	Radar Open Systems Architecture	SWAT	Short-Wavelength Adaptive Techniques
RSP	Reentry Systems Program	SWCR	superwideband compressive receiver
RSTER	Radar Surveillance Technology Experimental Radar	TACCAR	Time-Averaged Clutter-Coherent Airborne Radar
RTCL	real-time communication layer	TATCA	Terminal Air Traffic Control Automation
RTD	resonant-tunneling diode	TATS	Tactical Transmission System
RTS	Reagan Test Site	TCAS	Traffic Alert and Collision Avoidance System
RV	reentry vehicle	TCMP	Theater Critical Measurements Program
RWSL	Runway Status Lights	TDWR	Terminal Doppler Weather Radar
SAB	Scientific Advisory Board	TFDM	Tower Flight Data Manager
SABLE	Scaled Atmospheric Blooming Experiment	THAAD	Theater High-Altitude Area Defense
SAC	Strategic Air Command	TILL	Track Illuminator Laser
SAGE	Semi-Automatic Ground Environment	TMD	theater missile defense
SAM	surface-to-air missile	TPV	thermophotovoltaic
SAR	synthetic aperture radar	TRACON	Terminal Radar Approach Control
SATCIT	Satellite Acquisition and Tracking using Coherent Integration Techniques	TRADEX	Target Resolution and Discrimination Experiment
		TRSB	time-reference scanning-beam
SATCOM	satellite communications	TSAT	Transformational Communications Satellite
SATTRK	satellite tracking	TWTA	traveling-wave tube amplifier
SAW	surface acoustic wave	UAV	unmanned aerial vehicle
SBR	Space-Based Radar	UCT	uncorrelated target
SBV	Space-Based Visible	UESA	UHF electronically scanned antenna
SBX	sea-based X-band	UHF	ultrahigh frequency
SCAMP	Single-Channel Anti-jam Man-Portable	USJFCOM	U.S. Joint Forces Command
SCOTT	Single-Channel Objective Tactical Terminal	VERLORT	Very Long Range Tracker
SCOWL	Slab-Coupled Optical Waveguide Laser	VHF	very high frequency
SDI	Strategic Defense Initiative	VLSI	very-large-scale integration
SDIO	Strategic Defense Initiative Organization	VPE	vapor-phase epitaxy
SHF	superhigh frequency	VSIPL	Vector, Signal, and Image Processing Library
SIAP	single integrated air picture	WNS	Wideband Networked Sensors
SIGINT	signals intelligence	WSMR	White Sands Missile Range
SIMD	single instruction, multiple data stream	WSP	Weather Systems Processor
SIPRNet	Secret Internet Protocol Router Network	XDR	extended data rate
SIT	silicon-intensified target		
SKS	Structured Knowledge Spaces		
SMTI	shipboard moving target indicator, surface moving		

# Index

---

## Note

**Bold** indicates a chapter or section on the topic; *italic* indicates a figure.

- Adaptive array processing **489**
- Adaptive array radar **487**
- Adaptive optics **415, 423, 434, 443**
  - for astronomy 423
  - imagers 443
- Adaptive Sensor Array Processing (ASAP) 241, **487**
  - array calibration 492
  - cochannel interference 492–493
  - controlled-radiation pattern antenna (CRPA) 493
  - direction finding/geolocation 491
  - global positioning system 487, **493**
  - multichannel multiuser detector (MCMUD) 497–498
  - Multipath-Adaptive Multi-Beam Array (MAMBA) 494
  - Radar Surveillance Technology Experimental Radar (RSTER) 487–490
  - space-time adaptive processing (STAP) 488–494, 497
  - submarine sonar 494
  - workshop 490–491, 494
  - Adaptive wireless communications **496**
- Advanced CCD Imaging Spectrometer (ACIS) 438
- Advanced Concept Technology Demonstration (ACTD) 184, **190**
- Advanced Detection Technology Sensor (ADTS) 250, 258
- Advanced Digital Signal Processor (ADSP) 470
- Advanced extremely high frequency (AEHF) systems 77–78, 85, 89, 94
  - networking test bed 86
- Advanced Ground Surveillance Radar (AGSR) 258, 259
- Advanced imaging technology (AIT) 433
- Advanced Land Imager (ALI) **200, 312**
- Advanced Microwave Sounding Unit (AMSU) 199
- Advanced Research Projects Agency (ARPA) 125, 168–171, 251, 384, 409, 464–465
  - ARPA Lincoln C-band Observables Radar (ALCOR) 381–382
  - ARPA Long-Range Tracking and Instrumentation Radar (ALTAIR) 124, 131
  - ARPA Measurements Radar (AMRAD) 130
  - Mountaintop program **240**
- Advanced Research Projects Agency Network (ARPANet) 106, 107
- Advanced surface-to-air missile model (ASAMM) 229
- Advanced technology engineering **309**
  - Advanced Land Imager (ALI) **312**
  - airborne systems **317**
  - Enhanced Track Illuminator Laser (ETILL) 314
  - Fly Along Sensor Package (FASP) **316**
  - flying test bed **315**
  - Lincoln Experimental Satellite (LES) 311
  - missiles and countermeasures **317**
  - optics and laser systems **314**
- Advanced Technology Microwave Sounder (ATMS) 196, 199
- Aerospace Defense Command (ADCOM) 163, 164, 178
- Air and missile defense radar (AMDR) 242–244
- Air defense 3, **223**
  - 1977 Strategic Penetration study **224**
  - acoustic instrumentation 231
  - airborne look-down radar 233
  - airborne surveillance radar **237**
  - combat identification **245**
  - cruise missile survivability **223**
  - cruise missile workshop/report series 237–238
  - electronic warfare **246**
  - evolution 248, 249
  - field measurements **230**
  - FLEXAR shipboard radar 232
  - low-angle propagation 227
  - L-X radars 230
  - modeling tools 228
  - phenomenology **226, 236**
  - radar ground clutter **226**
  - Spherical Earth with Knife Edges (SEKE) model 229
  - surface Navy radar **242**
  - systems analysis and modeling **227**
  - Ultrahigh frequency Electronically Scanned Antenna (UESA) 242
  - very-high-frequency (VHF) radar 230
- Air Defense Identification Zone (ADIZ) 28
- Air Defense Integration System (ADIS) 25
- Air Defense Systems Engineering Committee (ADSEC) 2–5
- Air Defense Technology Division 224
- Air Force Cambridge Research Laboratory (AFCRL) 3–4, 13, 21, 25
- Air Force Maui Optical System (AMOS) 185
- Air Force Office of Atomic Testing (AFOAT) 1
- Air Force Research Laboratory (AFRL) 151
- Air traffic control (ATC) **207**
  - ASR-9 radars 210, 212
  - Automatic Dependent Surveillance–Broadcast (ADS-B) 212–214
  - Beacon Collision Avoidance System (BCAS) 211
  - Collier Trophy 213
  - Corridor Integrated Weather System (CIWS) **219**
  - Discrete Address Beacon System (DABS) 208, 209
  - Integrated Terminal Weather System (ITWS) 218–219
  - Mode S radar 209, 212–214, 221
  - Route Availability Planning Tool (RAPT) 219–220
  - Runway Status Lights (RWSL) 206, 214–216
  - Semi-Automatic Ground Environment (SAGE) system 210
  - Terminal Doppler Weather Radar (TDWR) 212, **216**
  - Tower Flight Data Manager (TFDM) 217
  - Traffic Alert and Collision Avoidance System (TCAS) **211**
  - weather programs **217**
  - wind shear 217–218
- Air Traffic Control Advisory Committee (ATCAC) **208**
- Air Traffic Control Radar Beacon System (ATCRBS) 208
- Air vehicle survivability (AVS) **223**
- Air Vehicle Survivability Evaluation (AVSE) 190, 224–225, 236
- Airborne Countermeasures Test System (ACTS) **236**
- Airborne early warning (AEW) **37, 40**
  - E-2C Navy radar 240–242
  - Navy blimp 36, 37–38
  - radars 488, 491



- Airborne ground surveillance **255**
  - displaced phase-center antenna (DPCA) 255–256
  - multiple-antenna surveillance radar (MASR) **255**, 256
  - truck detection 255
- Airborne Infrared Imager (AIRI) 235, 236, 314, **317**
- Airborne Infrared Telescope (AIRT) 133
- Airborne Ladar Imaging Research Testbed (ALIRT) **454**
  - Operation Unified Response over Haiti **459**
  - system evolution 456
- Airborne Laser (ABL) 409, **424**
  - atmospheric compensation **424**
  - diagnostic targets **425**
- Airborne moving target indicator (AMTI) 39–40
- Airborne Seeker Test Bed (ASTB) **234**
- Airborne Warning and Control System (AWACS) 40
- Aircraft control and warning (AC&W) 25
- Airport Surface Detection Equipment (ASDE) 214
  - Dallas/Fort Worth prototype 215
- Airport Surface Traffic Automation (ASTA) 213
- Ambulatory health care **356**
- AN/FPS radars 18, 36–46
  - coded-pulse radar 45–47
- AN/FRC 61
- AN/FSQ 22–25, 30–32
- AN/FST 22
- Angle-angle range-Doppler imaging (AARDI) 152
- Anti-Ballistic Missile (ABM) Treaty 149
- Applications Technology Satellite (ATS) 163
- Army Ballistic Missile Defense Agency (AMBDA) 134
- Army Missile and Space Intelligence Center 236
- Army Optical Station (AOS) 138
- ARPA Lincoln C-band Observables Radar (ALCOR)
  - 131, 138–139, 168–171, 381–382, 504
- ARPA Long-Range Tracking and Instrumentation Radar (ALTAIR) 131, 138, 182, 191, 503
- ARPA Mountaintop program **240**
- ASR-9 radars 210, 212
- Atmospheric-Compensation Experiment (ACE) **419**, 430
- Atmospheric sounding 195, **199**
- Automatic Dependent Surveillance-Broadcast (ADS-B) **212**
- Avalanche photodiode (APD) 449
  
- Ballistic missile defense (BMD) 97, **125**
  - algorithm development **141**
  - Army Ballistic Missile Defense Agency (ABMDA) 134
  - ARPA Reentry Physics Program 125
  - city defense era 125, **128**
  - Cobra Dane/Cobra Judy 136
  - discrimination 129, 135–136
  - foreign ballistic missile systems 135
  - fusion testbed (BFT) 159
  - Kwajalein Atoll **131**
  - Missile Defense Agency (MDA) 126, **149**
  - Missile Site Radar (MSR) 128
  - Multifunction Array Radar (MAR) 128
  - Nike-Zeus/Nike-X 128
  - penetration aids **139**
  - Perimeter Acquisition Radar (PAR) 128
  - reentry systems: chaff/countermeasures/decoys/jammers 133
  - silos defense era 125, **134**
  - site defense (Sentry) 135
  - Strategic Defense Initiative (SDI) 125, **140**
  - system concept analysis **141**
  - timeline 127
- Ballistic Missile Defense Advanced Technology Center (BMDATC) 134, 141
- Ballistic Missile Early Warning System (BMEWS) 34, **47**, 51, 337
- Battlefield surveillance **251**
  - acoustic technology **262**
  - advanced battlefield radar (ABR) 256
  - battlefield identification, friend or foe 264–266
  - laser technology **260**
  - moving target indicator (MTI) 257
  - seismic technology **262**
  - surface surveillance timeline 252
  - synthetic aperture radar (SAR) 257–258
  - tactical voice communication **264**
  - Vietnam **253**
- Bayesian networks 116, 119
- Beacon Collision Avoidance System (BCAS) 211
- Biological Agent Correlation Tracker (BACTrack) 290, 291
- Biological Agent Warning Sensor (BAWS) 287–288, **292**
  - Q-switch neodymium-yttrium aluminum garnet (Nd-YAG) laser 287, 292
- Biological and chemical defense **287**
  - Biological Agent Correlation Tracker (BACTrack) 290, 291
  - Biological Agent Warning Sensor (BAWS) 287–288, **292**
  - David Packard Award **299**
  - Lincoln Nucleic-acid Kit (LiNK) 288, 296
  - Pharmacological Augmentation of Nonspecific Anti-pathogen Cellular Enzymes and Activities (PANACEA) 292, **293**
  - Recovery, Extraction and Archiving Protocol (REAP) 288
  - sample preparation **295**
  - Simple Nucleic Acid Protocol (SNAP) 288
  - urban protection **303**
- Border security 304
- Boston Hill radar **42**, 43
- Boston South Network (BOSSNET) **91**, 173–174
- Brilliant Eyes 415
- Building 22 10, 11

- Cambridge Radio Observatory Committee (CAMROC) 345
- Camp Sentinel Radar 251–253
- Cape Cod system 14, 15, **17**, 27–30
- Cellular Analysis and Notification of Antigen Risks and Yields (CANARY) **295**
  - Pathogen Analyzer for Threatening Environmental Releases (PANTHER) 286, 295
- Ceres Connection **352**, 524
  - International Sciences Fair 352
  - Science Talent Search 352
- Chandra X-Ray Observatory 438–440
- Charge-coupled device (CCD) 180–181, **192**, **433**
  - adaptive optics 421
  - anti-blooming 433, 447
  - back-surface illumination 438–440, 446
  - curved/spherical-surface devices 433, 436, 437
  - electronic shutter 440, 445, **446**
  - fabrication 438, 442
  - high-speed sampling/electronic shutter **446**
  - low read-noise 433
  - orthogonal-transfer arrays (OTA) 433, **442**
  - signal processors **387**
  - Space-Based Visible (SBV) experiment 435, **437**
  - X-ray quantum efficiency 433–434
  - X-ray sensors 437–440
- Charge-coupled-device (CCD) imagers 362, **386**
  - abutting components 441
  - high-burst-rate imager **446**
  - quantum efficiency 434–440
  - radiation-hardening 435
- Chemical defense **287**
  - sample preparation **295**
- Cleavage of Lateral Epitaxial Films for Transfer (CLEFT) 327
- Cobra Dane/Cobra Judy 136
- Cobra Eye 142
- Cochannel interference 492–493
- Collier Trophy 213
- Command, control, communications (C3) countermeasures **266**
- Commercial off-the-shelf technology **473**
- Communication network interface processor (CNIP) 154
  - Hercules-Aegis sidecar 156
- Communication networks **85**
  - policy shifts **85**
- Community outreach **524**
- Computer network attack/defense (CNA/CND) 91
- Computer network exploitation (CNE) 91
- Computer Science and Artificial Intelligence Laboratory (MIT/CSAIL) 99
- Constant Hawk 275
- Cooperative Engagement Capability (CEC) 244
- Cooperative Research and Development Agreement (CRDA) 353, **541**
- Corridor Integrated Weather System (CIWS) **219**
- Counterterrorism and counterintelligence **279**
  - advanced sensors **283**
  - blue-team model 279
  - improvised explosive device (IED) 279
  - rapid innovation 280, **281**, **284**
  - red teaming **284**
  - signals intelligence (SIGINT) 282–283
  - unmanned aerial vehicles (UAV) **282**
- Critical Mobile Targets 251
- Cruise missile defense **237**, 241
- Cryogenically cooled solid-state lasers **426**
- Cyber security **85**, **91**
  - government systems **94**
  - intrusion detection systems **92**
  - LARIAT 93
- Cyclotron resonance spectroscopy 363, **365**
- Dallas/Fort Worth International Airport 215, 218
- David Packard Award **299**
- Decision Modeling Research Initiative (DMRI) 122
- Decision support **115**
  - antisubmarine warfare 120, 121
  - applications **120**
  - architecture **118**
  - automation **118**
  - data exploitation **115**
  - decision trees 119
  - Enhanced Regional Situation Awareness (ERSA) 118
  - human intelligence (HUMINT) 123
  - human-machine interface 118
  - LNKnet tool kit 121
  - machine automation 116, 121, 122
  - maritime awareness demonstration 114
  - multiple-intelligence (multi-INT) fusion 123
  - network model 118
  - Semi-Automatic Ground Environment (SAGE) 115, 120
  - sweet spot 117
  - taxonomy 118
  - Traffic Alert and Collision Avoidance System (TCAS) 121
- Deep STARE 182, 186
- Deep-space radar coverage 166, **182**
- Defense Advanced Research Projects Agency (DARPA) 90, 137, 224, 262, 386, 392–393, 402–403, 409
  - distributed sensors 262
  - FORESTER program 274
  - VELA UNIFORM program 262–264
- Defense Satellite Communication System (DSCS) 69
- Defense Science Board (DSB) 85
- Defense Threat Reduction Agency (DTRA) 288
- Demand-assigned multiple-access (DAMA) system 72
- Department of Homeland Security (DHS) 290, 297
  - Safe Container (SAFECON) 304, 305
- Digital Array Radar (DAR) 243–244, 243
- Digital focal-plane array (DFPA) 152
- Digital radar relay 21–22

- Digital signal processing **469**, 531
- Diode lasers 369, **370**
- Direction finding **491**
- Disaster response 307
- Discrete Address Beacon System (DABS) 208, 209
- Distant Early Warning (DEW) Line **35**, 51
- Distributed antennas **244**
- Distributed sensors 262
  
- E-2C Navy radar 240–242
- Early warning systems **35**
- Earth Observing 1 (EO-1) satellite **200**, 202
- Edgewood Chemical and Biological Center (ECBC) 287
- Educational technology **358**
  - Lincoln Training System (LTS) 358
- Electronic shutter high-speed sampling **446**
- Electronic warfare **246**
- Energy technology **321**
  - Cleavage of Lateral Epitaxial Films for Transfer (CLEFT) 327
  - early Laboratory programs **324**
  - electrochemical-based photovoltaics 327
  - kinetic-energy storage 325
  - solid-state technology **326**
  - thermoelectric/thermovoltaic energy conversion 327
- Engineering Advanced Technology **309**
- Enhanced Regional Situation Awareness (ERSA) 118, **301**, 303
  - National Capital Region (NCR) 301
- Enhanced Track Illuminator Laser (ETILL) 314, 427
- Environmental monitoring 195, 197
  - digital focal-plane array (DFPA) **198**, **201**
  - Landsat 200, 203–204
  - microwave sounding 196, 199
  - solar imaging sensors 204–205
- Experimental Test System (ETS) 346, 347, 348
- Extended data rate (XDR) communication waveforms 77
- Extended Space Sensors Architecture (ESSA) **190**
- Extreme Ultraviolet Variability Experiment (EVE) **204**, 440
- Extremely low-frequency (ELF) communications **62**
  
- F-117 Stealth imaging **172**
- Fast Digital Processor (FDP) **470**
- Fast Fourier transform (FFT) **470**
- Federal Aviation Administration (FAA) Lincoln Laboratory programs 214
- Federally funded research and development center (FFRDC) 141
- Ferrites 363, **364**
- Fiber-laser systems 429, **431**
- field-effect transistor (FET) 380–381
- Firebird/Firefly tests **414**, 416
- Firepond Optical Research Facility 410–412
  
- Fleet Satellite Communications (FLTSAT) 75, 311
  - extremely high frequency package (FEP) 75
- Flight Restricted Zone (FRZ, Washington, D.C.) 301
- Fly-Away Sensor Package (FASP) 148, **316**
- Foliage penetration (FOPEN) radar **251**, **273**
  - FOPEN Reconnaissance, Surveillance, Tracking, and Engagement Radar (FORESTER) 274
- Fourth-generation warfare 279–281
  
- Gallium arsenide lasers 369, **370**
- Geolocation **491**
- Geostationary Operational Environmental Satellite (GOES) **195**
  - high-resolution interferometric sounder **195**
- Geosynchronous Monitoring and Warning System **351**
- Geosynchronous satellite monitoring for collision avoidance **351**
- Global Positioning System **487**, **493**
  - robust navigation **493**
- Global Protection Against Limited Strikes (GPALS) 144
- GOES High-Resolution Interferometric Sounder (GHIS) **195**, 197
- Graph computations **484**
- Grid computing **481**
- Ground-based astronomy **441**
- Ground-based electro-optical deep-space surveillance (GEODSS) telescopes **180**, **183**, 185, 347, 348, 433–437
  - charge-coupled-device (CCD) upgrade **181**
- Ground control of intercept (GCI) 1
- Ground moving target indication (GMTI) 273, 274
- Ground penetration radar **251**
  - Geodar 254
  
- Halley's comet 179
- HALO-II instrumentation 154
- Hanscom Field 8, 10
- Harvard-Smithsonian Center for Astrophysics in Cambridge 347
- Haystack Auxiliary (HAX) radar **172**, 173
- Haystack observatory 37
- Haystack Ultrawideband Satellite Imaging Radar (HUSIR) 173, **174**
- High Energy Laser Joint Technology Office (HELJTO) 427
- High Performance Computing Modernization Office (HPCMO) 479–480
- High-performance embedded computing **461**, **471**
  - adaptive radars **471**, 476
  - Average Response Computer (ARC) **466**
  - commercial off-the-shelf technology **473**
  - digital signal processing **469**
  - fast Fourier transform (FFT) processing **470**
  - graph computations **484**
  - grid computing **481**
  - image processing library **478**
  - industry-standard signal processing **478**



- interactive graphics/hands-on computing **464**
- Knowledge-Aided Sensor Signal Processing and Expert Reasoning (KASSPER) 484
- Laboratory Instrument Computer (LINC) **466**
- magnetic-film memory **467**
- Matrix Update Systolic Experiment (MUSE) 468, 471
- nonlinear signal processing **477**
- Parallel Vector Tile Optimizing Library (PVTOL) 481–482
- Rapid Advanced Processors in Development (RAPID) 482–483
- RAPTOR 472, **473**
- Semi-Automatic Ground Environment (SAGE) 461
- space-time adaptive processing (STAP) 472–473
- synchronous processor (SP) signal processing **471**
- very-large-scale integration (VLSI) **475**
- Whirlwind to TX-2 **461**
- High-resolution imaging **172**
- High-speed electronics **379**
- High-speed sampling electronic shutter **446**
- High Temperature Superconducting Space Experiment (HTSSE) 394–395
- Highway management **359**
  - Boston Traffic Control Center (BTCC) 359
  - Intelligent Vehicle/Highway Systems (IVHS) 359
- Homeland protection **301**
  - biological defense **303**
  - border security **304**
  - disaster response 307
  - Enhanced Regional Situation Awareness (ERSA) **301**
  - Flight Restricted Zone (FRZ, Washington, D.C.) 301
  - Imaging System for Immersive Surveillance (ISIS) 306, 307
  - National Capital Region (NCR) 301
  - North American Aerospace Defense Command (NORAD) 301
  - Washington Air Defense Identification Zone (ADIZ) 301
- Hostile Weapons Location Systems (HOWLS) 251, 260
- Human intelligence (HUMINT) 123
- Human-machine interface 115, 118, 121
  
- Identification, friend or foe (IFF) **264**
- Image mining tool kit 121
- Image processing library **455, 478**
- Imaging System for Immersive Surveillance (ISIS) 306, 307
- Impact ionization avalanche transit-time (IMPATT) 260, 380
- Infrared Airborne Radar (IRAR) 251, 261–262, 411
- Infrared measurement system (IRMA) 233
- Integrated air defense system (IADS) 225
- Integrated sensing and decision support (ISDS) 122
- Integrated Terminal Weather System (ITWS) 214, 218–219
- Intelligence, surveillance, and reconnaissance (ISR) 115, **271**
  - global trends **271**
  - Jigsaw 275
  - laser radar 274
  - space-based ISR 273
  - technology transfer **276**
  - video ISR **275**
- Intelligent Vehicle/Highway Systems (IVHS) **359**
- Interactive graphics/hands-on computing **464**
- International Sciences Fair 352
- Inverse displaced-phase-center array (IDPCA) 240
- Inverse synthetic aperture radar (ISAR) 169, 174
  
- Japanese Institute for Space and Astronautical Science (ISAS) 437
- Jigsaw 275
  - optics 319
  - tree penetration 448, **452, 453**
- Joint Tactical Information Distribution System (JTIDS) 105
  
- Katahdin Hill 13, 57
- Kiernan Reentry Measurements Site (KREMS) 132, 133, 136, **138**
- Knowledge-Aided Sensor Signal Processing and Expert Reasoning (KASSPER) 484
- Knowledge extraction **115**
- Kwajalein Atoll 130
  - Roi-Namur island 133
- Kwajalein Discrimination System (KDS) 142
- Kwajalein Imaging System (KIS) 142
- Kwajalein Missile Range (KMR) 245
- Kwajalein Modernization and Remoting (KMAR) 148, 149, 502
  
- L-band digital array radar (DAR) 243–244
- Laboratory Instrument Computer (LINC) **466**
- Landsat 200, 203–204
- Language/Speech processing **103**
- Large-aperture seismic array (LASA) 330, 331–333
- Laser beam combining **399, 428**
- Laser communications 86
  - Airborne Infrared Imager (AIRI) 314, **317**
  - Airborne Laser (ABL) 314
  - Enhanced Track Illuminator Laser (ETILL) 314
  - Fly-Away Sensor Package (FASP) **316**
  - pointing and tracking **313**
- Laser guidestar 416, 420–421
- Laser Intersatellite Transmission Experiment (LITE) 80
- Laser radar (ladar) **449**
  - Airborne Ladar Imaging Research Testbed (ALIRT) **454**
  - brassboard development **449, 450**
  - calibration targets 458
  - Jigsaw tree penetration 448, **452**
  - silicon avalanche photodiodes (APD) **450, 452**
  - three-dimensional (3-D) imaging 448, 449, 451, 456

- Laser systems **409**
  - adaptive optics **415, 423, 434, 443**
  - Airborne Laser (ABL) 409, **424**
  - beam combining **399, 428**
  - cryogenically cooled solid-state lasers **426**
  - Doppler-time-intensity (DTI) measurements 412
  - Enhanced Track Illuminator Laser (ETILL) 427
  - high-energy-laser compensation **421**
  - infrared (IR) airborne radar 411
  - laser radar power amplifier (LRPA) 412
  - Low-Power Atmospheric-Compensation Experiment (LACE) satellite 414, 421
  - Mid-Infrared Advanced Chemical Laser (MIRACL) 421
  - Missile Alternative Range Target Instrumentation (MARTI) 425–426, **426**
  - Optical Compensation of Uniphase Laser Radiation (OCULAR) 419
  - Scaled Atmospheric Blooming Experiment (SABLE) 422
  - Short-Wavelength Adaptive Techniques (SWAT) **420**
  - Slab-Coupled Optical Waveguide Laser (SCOWL) 429–430, **431**
  - Target Return Adaptive Pointing and Focus (TRAPAF) 419
  - thermal-blooming tests 416–422
  - traveling-wave tube amplifiers (TWTA) 413
- Lenslets 377, **379**
- Lexington Decision Support Center (LDSC) 123, **155**
- Lexington Discrimination System (LDS) 142, 155
- Lexington Imaging System (LIS) 142
- Lexington Space Situational Awareness Center (LSSAC) **174**
- Lincoln Adaptable Real-time Information Assurance Testbed (LARIAT) **93**
- Lincoln Calibration Sphere (LCS) 168
- Lincoln Digital Signal Processor (LDSP) 104
- Lincoln Digital Voice Terminal (LDVT) 104
- Lincoln Distributed Optical Receive Array (L-DORA) 82
- Lincoln Experimental Satellite (LES) 67–76, 164, 311
  - Space-Based Visible (SBV) 311
- Lincoln Experimental Satellite Operations Center (LESOC) 74
- Lincoln Experimental Terminal (LET) 67
- Lincoln Laboratory
  - Advanced Concepts Committee (ACC) **520**
  - commercial industry cooperation **541**
  - commitment to diversity **521**
  - community giving 528
  - Community Outreach (LLCO) **524**
  - composition 513
  - core values 547
  - For Inspiration and Recognition of Science and Technology (FIRST) organization 525
  - formation 1
  - infrastructure **515**
  - Laboratory innovation benefits **531**
  - Leadership Initiative for Teaching and Technology (LIFT<sup>2</sup>) 525
  - logo **517**
  - New Employee Network 518, 522
  - New Technology Initiatives Program **520**
  - organizational structure **511, 514**
  - personnel **511**
  - Professional and Community Enhancement (PACE) Committee **522**
  - professional development **519**
  - research and development approach **515**
  - Robotics Outreach at Lincoln Laboratory (ROLL) **525, 527**
  - science, technology, engineering, and math (STEM) program 524
  - spin-off companies **539, 540**
  - style of operation **511**
  - Technical Excellence Awards 519, **534**
  - Technical Women's Network 522, 523
  - technology commercialization **538**
  - university student education programs 523
  - work-life balance **522**
- Lincoln Laboratory Grid (LLGrid) **479**
- Lincoln Laboratory Theater Engagement Assessment Model (LLTEAM) 145
- Lincoln Multimission ISR Testbed (LiMIT) 272, 273
- Lincoln Near-Earth Asteroid Research (LINEAR) 180, 182, 186, **347, 434, 436**
  - Ceres Connection **352, 524**
  - charge-coupled devices 347, **348**
  - comet science **350**
  - geosynchronous satellite monitoring **351**
  - Harvard-Smithsonian Center for Astrophysics 347
  - Minor Planet Center (MPC) 347, 350
  - space-based radar **354**
- Lincoln Space Surveillance Complex (LSSC) 174
- Lincoln Training System (LTS) 358
- LNKnet tool kit 121
- Long Range Demonstration Radar 253
- Long Range Imaging Radar (LRIR) 171–173
- Long-range scatter communications 55
- Los Alamos National Laboratory 446
  - Dual-Axis Radiographic Hydrodynamic Test (DARHT) 446
- Low-Power Atmospheric-Compensation Experiment (LACE) satellite 414
- Luminescence **370**
- Lunar Laser Communication Demonstration (LLCD) 82
- Machine translation **110**
- Magnetic memory 15–17
- Magneto-optical spectroscopy **367**
- Manned space flight **354**
- Mark-X identification 18
- Mars Laser Communications Demonstration (MLCD) 82, 313
- Masers **368**

- Matrix Update Systolic Experiment (MUSE) 468, 471  
Maui Optical Site 418  
Microchip lasers **375, 396**  
Microelectromechanical (MEM) systems **403**  
Microelectronics Laboratory **388, 389, 433–434**  
Microfluidic circuits **403**  
Micro-optics **377**  
Microwave sounding 196, 199  
Midcourse Fly-Away Sensor Package (M-FASP) 446  
Mid-Infrared Advanced Chemical Laser (MIRACL) 421  
Military satellite communications (MILSATCOM) 70, 72, 78, 85, 86  
Millimeter Wave (MMW) radar 142–143, 503  
    homing technology **259**  
Millstone antenna 162, 164–168, 165  
Millstone dynamic scheduler (MIDYS) 167  
Millstone Hill radar **310, 337, 345, 410**  
Milstar flight number 3 **188**  
Minor Planet Center (MPC) 347, 350  
Missile Alternative Range Target Instrument (MARTI) 425–426, 426  
Missile Defense Agency (MDA) **149, 192**  
    architecture testing **152**  
    field testing **157**  
    Kwajalein activities **158**  
    net-centric architecture **157**  
    Pioneer Award **160**  
    sensor development **149**  
Missile Defense and Space Technology Center (MDSTC) 150  
Missile flight phases 140  
MIT optical space surveillance (MITOSS) 181  
MITRE Corporation 32  
Mobile satellite communications 86  
Mode S radar **208, 212–214, 221**  
Morón Optical Space Surveillance (MOSS) **181**  
Moving target detector (MTD) 208, 210  
Moving target indicator (MTI) 3, 210  
Multichannel multiuser detector (MCMUD) 497–498  
Multicore processors programming **481**  
Multi-mode Laser ISR (MLISR) 277  
Multipath-Adaptive Multi-Beam Array (MAMBA) 494  
Multiple-frequency-shift keying (MFSK) 70–75  
Multiple-input, multiple-output (MIMO) communications 244–247, 497–498  
Multistatic radar **176**  
Multiwavelength Optical Networking (MONET) 91  
  
Nanoscale technology **392**  
National Aeronautics and Space Administration (NASA) 66, 80, **82, 125, 437, 438, 440**  
    Advanced Communications Technology Satellite 80  
    Advanced Satellite for Cosmology and Astrophysics (ASCA) 437  
    Chandra X-Ray Observatory 438–440  
    Echo 1 satellite 66  
National Capital Region (NCR) 301  
National Institute of Standards and Technology (NIST) 110  
National/international security challenges 547  
National Oceanic and Atmospheric Administration (NOAA) 195  
National Polar Orbiting Environmental Satellite System (NPOESS) **196**  
National Weather Service (NWS) 195, 221  
Naval Research Laboratory (NRL) 204  
Navy Cruise Missile Defense Advanced Concept Technology Demonstration 237–238, 241  
Neodymium:yttrium aluminum garnet (Nd:YAG) laser 412, 415  
Net-Centric Enterprise Services (NCES) **99**  
Netted Radar Program (NRP) 251, **258**  
Network-centric (net-centric) demonstrations **100**  
Network-centric (net-centric) multiple intelligences 271  
Network-centric (net-centric) operations (NCO) **96**  
Network-centric (net-centric) research **97**  
Network-centric (net-centric) tool kit 98, **99**  
Networking **89**  
    air-to-air **89**  
    airborne-to-ground **89**  
    all-optical networks **91**  
    BOSSNET **91**  
    MONET 91  
    Net-Centric Enterprise Services (NCES) **99**  
    ONRAMP **91**  
    optical terrestrial networks **90**  
    Paul Revere airborne test bed **90**  
    sidecars **99**  
Neural networks 119–121  
New Foreign Launch Processor (NFLP) 166–167  
Noise modulation and correlation (NOMAC) 51–54  
    Rake 54–55  
Nonlinear equalization (NLEQ) chip set 477–478  
Nonlinear equalization (NLEQ) VLSI circuitry 460  
Nonlinear signal processing **477**  
North American Aerospace Defense Command (NORAD) 138, 163, 171, 249, 301  
Northeast Radio Observatory Corporation (NEROC) 172, 345  
Northern Lights **41**  
NPOESS Airborne Sounder Testbed (NAST) 196, 198, **199**  
  
Ocean radar **42, 44**  
Open systems architecture **501**  
    advanced ballistic missile defense testing **506**  
    Kwajalein Modernization and Remoting (KMAR) program 502, 504  
    measurement and signature intelligence (MASINT) 502  
    Parallel Vector Library (PVL) layered software 505–506  
    sensor sidecars **506**  
Open Systems Joint Task Force **509**



- Operation Unified Response over Haiti **459**
- Optical Aircraft Measurement Program (OAMP) 142
- Optical communications **79**
- Optical Compensation of Uniphase Laser Radiation (OCULAR) 419
- Optical Discrimination Technology (OTD) program 141, 409, 412, 414
- Optical Network for Regional Access using Multiwavelength Protocols (ONRAMP) **91**
- Optical Processing Architecture at Lincoln (OPAL) **187**
- Orthogonal-transfer arrays (OTA) **442**
- Over-the-horizon radar (OTHR) **246**
  
- Pacific Missile Range Facility (PMRF) 145, 157
- Packet-voice protocols 107
- Panoramic Survey Telescope and Rapid Response System (Pan-STARRS) 442, 536
- Parallel Vector Tile Optimizing Library (PVTOL) 481–482
- Passive Q-switched laser 287, 292
- Pathogen Analyzer for Threatening Environmental Releases (PANTHER) 286, 295
- Phase One Engineering Team (POET) 141
- Phase Zero/Phase One Measurement Systems **226**
- Phased-array antennas 258
- Phases of missile flight 140, 149
- Photodissociation followed by laser-induced fluorescence (PDLIF) 396, 403
- Photon-counting laser radar **449**
  - Airborne Ladar Imaging Research Testbed (ALIRT) **454**
  - brassboard development **449, 450**
  - calibration targets 458
  - coherent detection **455**
  - Jigsaw tree penetration 448, **452**
  - silicon avalanche photodiode (APD) development **450, 452**
  - three-dimensional (3-D) imaging 448, 449, 451, 456
- Pine Tree 58
- Pioneer Award **160**
- Polevault 58
- Polymerase chain reaction (PCR) 295
  - receiver operating characteristic (ROC) curves 298
- Process control system defense **95**
- Project Apollo 355
- Project Charles 1, 6–8, 17
- Project Hercules 152–156
- Project Lincoln 8–13, 16
- Project Lincoln Charter **9**
- Project PRESS 128–132, 138, 314
- Project Sanguine 62
- Project VELA UNIFORM 330, 331, 334
- Project West Ford **65**, 337–338
  - HARDTACK 65
  
- Quantum bits (qubits) 360, 405–406
- Quantum electronics 361, 364
- Quantum Information Science (QIS) **404**
  
- R&D 100 Awards **537**
- Radar antennas **309**
- Radar data transmission **21**
- Radar Open Systems Architecture (ROSA) 174, 176, 501–507, 508
  - ROSA II development **506**
- Radar Surveillance Technology (RST) **238**
  - Experimental Radar (RSTER) 238–242, 239, 240, 471–475, 487–490
  - digital receivers **475**
- Radio astronomy 336, 337, **343, 344**
- Rapid Advanced Processors in Development (RAPID) 482–483
- Rapid Agent Aerosol Detection (RAAD) 294
- Rapid innovation 280, **281, 284**
- RAPTOR 472, **473**
- Reagan Test Site **158**
- Recovery, Extraction and Archiving Protocol (REAP) 288, 295
- Red/blue exercise 121, 123, 156
- Resonance spectroscopy 363
- Robotics Outreach at Lincoln Laboratory (ROLL) **525**
- Round Hill Field Station 56, 57
- Route Availability Planning Tool (RAPT) 219–220
- Runway Status Lights (RWSL) 206, 214–216
  
- Sample preparation **295**
  - Affinity Magnet Cartridge (AMC) 296, 297
  - Affinity Magnet Protocol (AMP) 296, 297
  - Lincoln Nucleic-acid Kit (LiNK) 288, 295, 296
- Satellite Acquisition and Tracking using Coherent Integration Techniques (SATCIT) 167, 182
- Satellite assessment **188**
- Satellite collision avoidance **351**
- Satellite communications (SATCOM) **65, 86**
  - fiber optics **81**
  - Laser Intersatellite Transmission Experiment (LITE) 80
  - Lincoln Distributed Optical Receive Array (L-DORA) 82
  - link blockage 88
  - Lunar Laser Communication Demonstration (LLCD) 82
  - National Aeronautics and Space Administration (NASA) **82**
  - Operation Desert Storm support 76
  - optical communications **79**
  - protected communications **76**
  - SATCOM-on-the-move 84
  - space communications 83
  - transformational communications (TSAT) **81**
- Satellite tracking (SATTRK) **166**
- S-Band Space Range Radar 130
- Scaled Atmospheric Blooming Experiment (SABLE) 422

- Scientific Advisory Board 2
- Secret Internet Protocol Router Network (SIPRNet) 100, 191
- Seismic discrimination **331**
  - Large Aperture Seismic Array (LASA) 331–333
  - Project VELA UNIFORM 330, 331, 334
- Semi-Automatic Ground Environment (SAGE) **15, 20, 33, 51, 58, 96, 115, 121, 207, 531**
  - air defense **15**
- Sentinel 128
- Short-Wavelength Adaptive Techniques (SWAT) **420, 443, 444**
- Sidecars 98, 99
- Signal-intercept techniques **267**
  - superresolution 269
- Silicon: high-resistivity 437–440
- Silicon: radiation-induced traps 437–440
- Silicon-on-insulator (SOI) technology **391**
- Silo Defense era **134**
- Simple Nucleic Acid Protocol (SNAP) 288
- Single-Channel Anti-jam Man-Portable (SCAMP) 79
- Single-Channel Objective Tactical Terminal (SCOTT) 78, 79
- Single-photon detectors **397**
- Sinusoidal transform coder (STC) 105
- Skylab 170, 171
- Slab-Coupled Optical Waveguide Laser (SCOWL) 400, 429, **431**
- Small Business Technology Transfer (STTR) **542**
- Socorro, New Mexico 177, 180, 181
- Solar imaging sensors 204–205
- Solar-voltaic systems 320, **321**
- Solid-state research **361**
  - binary optics **378**
  - charge-coupled device (CCD) 362, **386, 387**
  - CMOS imager **397**
  - CMOS readout integrated circuit (ROIC) 397
  - device research **363**
  - ferrites 363, **364**
  - focal-plane arrays 362, 379, 387
  - frequency conversion **374**
  - gas lasers **371**
  - high-speed electronics **379**
  - impact ionization avalanche transit-time (IMPATT) 380
  - infrared detectors **371, 379**
  - integrated photonics **376**
  - lenslets 377, **379**
  - liquid-immersion lithography 393–394
  - luminescence **370**
  - magneto-optical spectroscopy **367**
  - masers **368**
  - microchip lasers **376**
  - microelectromechanical (MEM) systems **403**
  - Nd:YAG lasers 370, 374–375
  - nonlinear optics **374**
  - quantum bits (qubits) 360, 405–406
  - quantum cascade laser (QCL) 400
  - resonance spectroscopy 363
  - semiconductor laser technology **399**
  - semiconductor laser wavelengths 369
  - simulation program with integrated circuit emphasis (SPICE) 392
  - single-photon detectors **397**
  - trace chemical detection **396, 402**
- South Truro, Massachusetts 18, 57
- Soviet Salyut/Soyuz launches 169
- Soviet Union 1
  - air attack 35
  - ICBM attack warning 47
  - Sputnik 1 launch 46
- Space and Missile System Organization (SAMSO) 171, 188
- Space-based astronomy **437**
- Space-based radar **354**
- Space-Based Visible (SBV) experiment 181, **183, 435**
- Space catalog 167, 188
- Space Command 173, 182–183
- Space communication 67–74
- Space science **337**
  - asteroid, comets, and satellite studies **343**
  - Ballistic Missile Early Warning System (BMEWS) 337
  - Cambridge Radio Observatory Committee (CAMROC) 345
  - general relativity experiment **343**
  - lunar studies **338**
  - Mars studies **342**
  - Mercury studies **342**
  - Northeast Radio Observatory Corporation (NEROC) 345
  - radio astronomy 336, 337, **343, 344**
  - solar studies **343**
  - Venus studies **339**
- Space sensors **311**
- Space situational awareness (SSA) **163**
  - Advanced Concept Technology Demonstration (ACTD) 184, **190**
  - Aerospace Defense Command (ADCOM) 163, 164, 178
  - Air Force Maui Optical System (AMOS) 185
  - Air Vehicle Survivability Evaluation (AVSE) 190
  - AN/FPS-85 phased-array surveillances radar 182–183
  - ARPA Lincoln C-band Observables Radar (ALCOR) 168–171
  - ARPA Long-Range Tracking and Instrumentation Radar (ALTAIR) 182, 191
  - Baker-Nunn camera 164, 176, 181
  - charge-coupled device 180–181, **192**
  - deep-space sensor network 166, **182**
  - Deep STARE 182, 186
  - electro-optical technology 163, **176**
  - emerging threats **190**
  - Extended Space Sensors Architecture (ESSA) **190**
  - geostationary satellites 163–164, 167, 176–177
  - ground-based electro-optical deep-space surveillance (GEODSS) **180, 183**

- Haystack Auxiliary (HAX) radar **172**
- Haystack Ultrawideband Satellite Imaging Radar (HUSIR) *173*, **174**
- high-resolution imaging **172**
- inverse synthetic aperture radar (ISAR) *169*, *174*
- Lexington Space Situational Awareness Center (LSSAC) *174*
- Lincoln Calibration Sphere (LCS) *168*
- Lincoln Experimental Satellite (LES) *164*
- Lincoln Near-Earth Asteroid Research (LINEAR) *180*, *182*, *186–187*, *193*
- Lincoln Space Surveillance Complex (LSSC) *173*, *174*
- Long Range Imaging Radar (LRIR) *171–173*
- low-light-level television (LLTV) camera *176–177*
- Millstone dynamic scheduler (MIDYS) *167*
- Millstone Hill radar *162*, *163*, *165*, *174*, *176*
- Milstar **188**
- Morón Optical Space Surveillance (MOSS) System **181**
- Multistatic radar **176**
- New Foreign Launch Processor (NFLP) *166–167*
- North American Aerospace Defense Command (NORAD) *163*, *166*, *167*, *171*
- Optical Processing Architecture at Lincoln (OPAL) **187**
- radar imaging **168**, **188**
- Radar Open Systems Architecture (ROSA) *174*, *176*
- radars **163**
- Salyut satellites *169*
- satellite assessment **188**
- satellite tracking (SATTRK) **166**
- Secret Internet Protocol Router Network (SIPRNet) *191*
- space red team *190*
- SPACETRACK *163*, *164*, *167*, *192*
- threat assessment **190**
- timeline *193*
- transportable optical system (TOS) *181*, *183*
- uncorrelated target (UCT) *167–168*, *179*
- very-long-baseline interferometry (VLBI) *174*
- Wideband Network Sensors (WNS) **173**
- wideband radar *168–171*, **172**
- Space surveillance **163**, **433**, *445*
- Space Surveillance Network (SSN) *184*, *191–192*
- Space Surveillance Telescope (SST) **185**, *186*, **187**
- Space-time adaptive processing (STAP) *240–242*, *273*, *472–473*, *497*
- Space-time coding *497–498*
- SPACETRACK *138*, *163–166*
- Speaker recognition *104*
- Speech coding *104*
- Speech enhancement *104*, **106**
- Speech information extraction **109**
- Speech/Language processing **103**
  - core technologies **104**
  - Interlingua-based translation **111**
  - linear predictive coding (LPC) **103**
  - machine translation **110**
  - voice encoder (vocoder) *103*
- Speech modification **106**
- Speech recognition **109**
- Speech translation *104*
- Speech Understanding Research Program *109*
- Spin-off companies **539**, *540*
- Sputnik launch *163*, *164*, **166**
- Starfire Optical Range (SOR) *444–445*
- Strategic Defense Initiative (SDI) **140**, **144**
  - field measurements **142**, **147**
  - Kwajalein activities **142**, **148**
- Strategic Defense Initiative Organization (SDIO) *309*, *409*, **420**
  - Ballistic Missile Defense Organization (BMDO) *126*
  - space experiments **420**
- Strategic ladar **409**
- Strategic relocatable targets (SRT) *251*
- Structured Knowledge Spaces (SKS) *122*, *123*
- Submarine sonar **494**
- Submicrometer technology **384**
- Superconductive electronics **383**
- Superresolution direction finding **491**, *497*
- Superwideband compressive receiver (SWCR) **394**
- Surface-acoustic-wave (SAW) chirp *75*
- Surface acoustic wave (SAW) devices *362*, *381–385*
- Surface Navy radar **242**
- Surface-to-air missile (SAM) system *227*, *235*, *241*
- Switchboard in the sky **74**
  - antijam communications *74*
- Synthetic aperture radar (SAR) *257–258*, *273*, *491*
- Tactical battlefield surveillance **251**
- Tactical Systems Technology Division *224*
- Tactical voice communication **264**
- Tactical warfighter communications **85**
  - network on the move **86**
- Target Resolution and Discrimination Experiment (TRADEX) *131–133*, *139*, *503*
- Target return adaptive pointing and focus (TRAPAF) *419*
- Technical Excellence Awards **534**
- Technological leadership **535**
  - air traffic control *536*
  - communications *536*
  - identification and recognition *536*
  - surveillance *535*
- Technology commercialization, patents and licensing **538**
- Technology transfer *531*, **538**, **543**
- Television transmission **66**, *67*
- Telstar-401 television satellite *353*
- Terminal Air Traffic Control Automation (TATCA) *213*
- Terminal Doppler Weather Radar (TDWR) *212*, **216**



Terminal Radar Approach Control (TRACON) 210  
 Terrestrial communications **51**  
     high-frequency communications **51**  
 Theater Critical Measurements Program (TCMP) 147–148, 160  
 Theater High-Altitude Area Defense (THAAD) 144, 145  
 Theater missile defense (TMD) 144–146, 148  
 Three-dimensional (3-D) image processing **455**  
 Three-dimensional (3-D) integrated circuits **398, 401**  
 Time-Averaged Clutter-Coherent Airborne Radar (TACCAR) 39–41  
 TM-20 proposal for air defense 26  
 Tower Flight Data Manager (TFDM) 217  
 Traffic Alert and Collision Avoidance System (TCAS) 121, **211**  
 Transformational communications architecture (TCA) 86  
 Transformational Communications Satellite (TSAT) 78, **86**  
 Tropospheric scatter 55–61  
     Pine Tree 58  
     Polevault 58  
     White Alice 58  
 TX-2 system 115, **461**

Ultrahigh-frequency Electronically Scanned Antenna (UESA) 242  
 Unconventional air defense analyses **228**  
 Undersea surveillance submarine sonar **494**  
 Unmanned aerial vehicle (UAV) **282**

VELA UNIFORM 262–264  
 Very high frequency (VHF) 35  
 Very-large-scale integration (VLSI) **475**  
     space-based radar 475  
 Very-long-range trackers (VERLORT) 355  
 Visual Warning System (VWS) 302  
     Notice to Airmen (NOTAM) 302  
 Voice encoder (vocoder) 103  
     SIGSALY 103  
 Voice-over-Internet protocol (VoIP) 106

Wafer-scale integration **468**  
 Wallops Island field site 488  
 Washington Air Defense Identification Zone (ADIZ) 301  
 Weather programs 195, **197, 199, 217**  
 Westford, Massachusetts 163, 174  
 Whirlwind 4–5, 15, 16, 22–25, 26, **461**  
 White Alice 58  
 White Sands Missile Range 151, 222, 232  
 Wideband Networked Sensors (WNS) **173**  
 Wind shear 217–218

X-ray quantum efficiency 433–443

# Image Credits

The photographs in this book have been supplied by Lincoln Laboratory's Technical Communications sector except as noted.

## Page xii

Photograph of the Experimental SAGE Subsector plotting board courtesy of the MITRE Corporation.

## Chapter 1

**Figures 1-4 and 1-5:** Killian and Loomis photographs courtesy of the MIT Museum

**Figures 1-6 and 1-7:** Building 22 and Barta Building photographs courtesy of the MIT Museum.

**Timeline:** Wiesner photograph courtesy of the MIT Museum; Building 20, Sloan Building, and Whittemore Building photographs courtesy of the MIT Museum.

## Chapter 2

**Introductory photograph:** Cape Cod System direction center courtesy of the MITRE Corporation Archives.

## Chapter 3

**Timeline:** Zacharias and Hubbard photographs courtesy of the MIT Museum.

## Chapter 4

**Timeline:** Texas Tower antenna photograph courtesy of the *New York Times*.

## Chapter 5

**Introductory photograph:** Atlas/Centaur launch courtesy of NASA.

## Chapter 9

**Figure 9-4:** Roi-Namur photograph courtesy of William Ward.

**Figure 9-5:** Aerial photograph courtesy of the U.S. Army.

**Figure 9-8:** Cobra Judy photograph courtesy of the U.S. Air Force.

**Figure 9-12:** Cobra Eye photograph courtesy of the U.S. Air Force.

**Figure 9-16:** Wake Island launch photograph courtesy of the U.S. Army.

**Timeline:** Gellinam photograph courtesy of the U.S. Army.

## Chapter 10

**Figure 10-3:** Lincoln Calibration Sphere photograph courtesy of the ROHR Corporation.

**Figure 10-4:** Skylab photograph courtesy of NASA.

**Figure 10-5:** Diagnostic Imaging Radar photograph courtesy of Systems Planning Corporation; photograph taken by SSgt Andy Dunaway, U.S. Air Force.

## Chapter 11

**Figure 11-3:** GOES image of Hurricane Katrina courtesy of NASA.

**Figure 11-8:** Artist's rendering of the EO-1 courtesy of NASA Goddard Space Flight Center.

## Chapter 12

**Introductory photograph:** Los Angeles International Airport photograph courtesy of FAA.

**Figure 12-9:** Logan International Airport photograph courtesy of Massachusetts Port Authority.

## Chapter 13

**Introductory photograph:** Mountaintop radar photograph courtesy of Jim Davis.

**Figure 13-7:** AN/APG-70 radar photograph courtesy of the U.S. Air Force.

**Figure 13-12:** ADS-18 and IDPCA photographs courtesy of Jim Davis; UHF radar in Kauai photograph courtesy of the U.S. Navy.

## Chapter 15

**Figure 15-2, top:** Helicopter photograph courtesy of the Defense Advanced Research Projects Agency.

## Chapter 19

**Figure 19-5, top:** Boeing 707 photograph courtesy of Fred de Ruiter Collection, The Netherlands, and Airliners.net.

## Chapter 20

**Figure 20-3:** From J.C.C. Fan, "Sputtered Films for Wavelength-Selective Applications," *Thin Solid Films* **80(1-3)**, 125-136 (1981). With permission, © Elsevier 1981.

**Figure 20-4:** From J.C.C. Fan, C.O. Bozler, and R.L. Chapman, "Simplified Fabrication of GaAs Homo Junction Solar Cells with Increased Conversion Efficiencies," *Appl. Phys. Lett.* **32**, 391 (1978). With permission, © American Institute of Physics, 1978.

**Figure 20-5:** From J.C.C. Fan, R.W. McClelland, and B.D. King, "GaAs CLEFT Solar Cells for Space Applications," Proc. 17th IEE PV Spec. Conf. 31-35 (1984). With permission, © IEEE, 1995.

## Chapter 23

**Figure 23-5:** Hubble images courtesy of H.A. Weaver (Johns Hopkins University), NASA, and the Space Telescope Science Institute.

## Chapter 24

**Timeline:** Adler photograph courtesy of the MIT Museum.

## Chapter 25

**Figure 25-3:** Firebird launch photograph courtesy of NASA.

**Figure 25-4:** High-energy-laser propagation range photograph courtesy of Pratt and Whitney.

**Figure 25-5:** Air Force Maui Optical Site photograph courtesy of AVCO.

**Figure 25-6:** Sodium-beacon photograph courtesy of the U.S. Army.

**Figure 25-8:** Airborne laser and Big Crow photograph courtesy of Air Force Flight Test Center.

**Figure 25-9:** MARTI missile diagnostic photographs courtesy of Naval Sea Systems Command (NAVSEA).

**Timeline:** Luna Sea photograph courtesy of Louis Smullin; MARTI launch photograph courtesy of NAVSEA and NASA Sounding Rocket Operations Contract (NSROC).

## Chapter 26

**Figure 26-6:** Images taken by Chandra Observatory courtesy of NASA.

**Figure 26-8:** Focal plane photograph courtesy of Pan-STARRS Project, Institute for Astronomy, University of Hawaii.

**Figure 26-12:** Pan-STARRS focal plane photograph courtesy of Pan-STARRS Project, Institute for Astronomy, University of Hawaii, Richard Wainscoat.

**Figure 26-14:** Seasat and rocket body images courtesy of the Starfire Optical Range.

**Figure 26-17:** Image of explosive debris courtesy of Lawrence Livermore National Laboratory.

**Timeline:** Photograph of first Pan-STARRS telescope, courtesy of Pan-STARRS Project, Institute for Astronomy, University of Hawaii, Brett Simpson.

## Chapter 27

**Introductory photograph:** Three-dimensional image data courtesy of National Geospatial-Intelligence Agency (NGA).

**Figure 27-2:** Three-dimensional images courtesy of NGA.

**Figure 27-3:** Two- and three-dimensional images courtesy of NGA.

**Figure 27-12:** Calibration target photographs courtesy of NGA.

**Figure 27-13:** ALIRT image courtesy of NGA.

## Chapter 33

**Introductory photograph:** Rosette Nebula, courtesy of Pan-STARRS Project, Institute for Astronomy, University of Hawaii.

**Figure 33-2:** Orthogonal-transfer array photograph courtesy of Pan-STARRS Project, Institute for Astronomy, University of Hawaii.

**Figure 33-3:** Image of M81 galaxy courtesy of Pan-STARRS Project, Institute for Astronomy, University of Hawaii.

**Timeline:** Olsen photograph courtesy of Digital Equipment Corporation; Windfarm photograph courtesy of U.S. Windpower, Inc.; Landsman, Lyon, and Rasmussen photograph courtesy of American Power Conversion Corp.

## Lincoln Laboratory Directors

Loomis photograph courtesy of University Archives, University of Illinois at Urbana-Champaign; Wieser photograph courtesy of the MIT Museum; Hill photograph courtesy of the MIT News Office; Radford, Clauser, Dinneen, Morrow, and Evans photographs taken by the Fabian Bachrach Studio.



# Colophon

Editing by Alan Grometstein.

Project management by David Granchelli.

Copyediting by Dorothy Ryan, Barbra Gottschalk, and Gregory Hamill.

Art direction by Heather Clark.

Design by Heather Clark and Susan Hersey.

Photography by MIT Lincoln Laboratory Technical Communications sector except as noted.

Text composed in Bembo and Helvetica Neue.

Printed by Kirkwood Printing, Wilmington, Massachusetts, on Chorus Art silk finish and Cougar uncoated papers.

Binding by Acme Bookbinding, Charlestown, Massachusetts.

## **Distribution Statement**

This document was prepared as an account of U.S. Government sponsored research and development work performed at the Massachusetts Institute of Technology's Lincoln Laboratory, a Federally Funded Research and Development Center under contract to the U.S. Air Force. Neither the Massachusetts Institute of Technology nor the U.S. Government makes any warranty, express or implied, nor assumes any legal liability or responsibility for the accuracy of any information disclosed, nor represents that its use would not infringe upon privately owned rights. Reference to any specific commercial product, trade name, trademark or manufacturer, or otherwise does not constitute or imply endorsement.

The view, opinions, interpretations, conclusions, and recommendations expressed herein are those of the authors and are not necessarily endorsed by, nor do they necessarily state or reflect those of, the U.S. Air Force, the Department of Defense, the U.S. Government, or any of its agencies.

Approved for public release; distribution is unlimited.  
The work described in this document is performed under the prime contract with the U.S. Air Force, FA8721-05-C-0002.











LINCOLN LABORATORY



STRUCTURE  
RADIAL RIBS ← → HONEYCOMB

Building 22 at MIT, constructed to house the Radiation Laboratory during World War II, was the site of early work on Project Lincoln.



*“The air defense problem which faces the Air Force is of great importance to the people of this country. The problem is technically complicated and difficult. The Air Force must urgently increase its research and development effort in this area and in this we ask your help. I sincerely hope that you will be able to give the matter serious consideration.”*

—General Hoyt Vandenberg, Air Force Chief of Staff  
1950 letter to James Killian, MIT president