

(a)

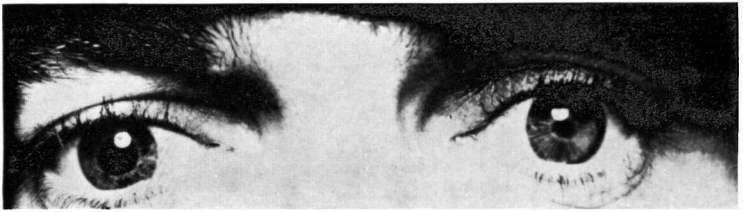

(b)

Pupil sizes. Left eye exposed to di-*isopropyl* phosphorofluoridate (0.008 mg./l.; 2 min. exposure): (a) 3 hr. after exposure; (b) 24 hr. after exposure.

(*Frontispiece*)

SOME ASPECTS OF THE
CHEMISTRY AND TOXIC ACTION
OF ORGANIC COMPOUNDS
CONTAINING PHOSPHORUS
AND FLUORINE

BY

BERNARD CHARLES SAUNDERS

M.A., PH.D., Sc.D., D.Sc., F.R.I.C.

*Fellow and Charles Kingsley Lecturer in
Natural Sciences, Magdalene College,
University Lecturer in Chemistry,
Cambridge*

WITH A FOREWORD BY

PROFESSOR SIR ALEXANDER TODD

M.A., D.Sc., LL.D., F.R.S.

*Professor of Organic Chemistry,
Cambridge*

CAMBRIDGE
AT THE UNIVERSITY PRESS

1957

63092

PUBLISHED BY
THE SYNDICS OF THE CAMBRIDGE UNIVERSITY PRESS

Bentley House, 200 Euston Road, London, N.W. 1
American Branch: 32 East 57th Street, New York 22, N.Y.

By the same author

NOTES ON QUALITATIVE ANALYSIS

*Printed in Great Britain at the University Press, Cambridge
(Brooke Crutchley, University Printer)*

CONTENTS

| | |
|---|------------------|
| FOREWORD | <i>page</i> xiii |
| PREFACE | xv |
| CHAPTER I. INTRODUCTION AND GENERAL SURVEY | 1 |
| Phosphorofluoridates | 1 |
| Production on a technical scale | 6 |
| Phosphorodiamidic fluorides | 7 |
| Fluoroacetates | 10 |
| 2-Fluoroethyl fluoroacetate | 12 |
| Other compounds | 15 |
| Fluoro-aspirin, <i>p.</i> 15. Di-2-fluoroethylphosphorofluoridate, <i>p.</i> 15. Triethyl-lead fluoroacetate, <i>p.</i> 16. 'Sesquifluoro-H', <i>p.</i> 16. Fluorine-containing ammonium salts, <i>p.</i> 17 | |
| Particular applications | 18 |
| CHAPTER II. NOMENCLATURE OF ESTERS CONTAINING PHOSPHORUS | 21 |
| Early nomenclature | 21 |
| Notes | 23 |
| Accepted nomenclature | 25 |
| Notes on the agreed system for compounds containing only one phosphorus atom | 27 |
| CHAPTER III. NOTES ON THE MAMMALIAN NERVOUS SYSTEM | 28 |
| The transmission of nervous effects | 28 |
| The autonomic nervous system | 31 |
| The sympathetic nervous system, <i>p.</i> 31. The parasympathetic nervous system, <i>p.</i> 33. The physiology of the autonomic nervous system, <i>p.</i> 33. Diagrammatic representation of acetylcholine action, <i>p.</i> 36 | |

CONTENTS

| | |
|--|----------------|
| The eye | <i>page</i> 37 |
| Accommodation, <i>p.</i> 38. Intraocular pressure, <i>p.</i> 39 | |
| Autonomic inhibitor drugs | 40 |
| Spasmolytics, <i>p.</i> 40. Sympatholytics, <i>p.</i> 41. | |
| CHAPTER IV. THE PHOSPHOROFLUORIDATES | 42 |
| Synthetic methods | 43 |
| Preparation of di- <i>isopropyl</i> phosphorofluoridate (D.F.P.) | 46 |
| Some properties of D.F.P. | 47 |
| Hydrolysis of D.F.P. by alkali, <i>p.</i> 48. Hydrolysis by $N/2$ sodium hydroxide at room temperature, <i>p.</i> 48. Hydrolysis of D.F.P. by water, <i>p.</i> 49. D.F.P. and mustard gas, <i>p.</i> 49 | |
| Preparation of esters of phosphorofluoridic acid by means of phosphorus oxydichlorofluoride | 50 |
| Phosphorus oxydichlorofluoride | 54 |
| Apparatus, <i>p.</i> 54. Procedure, <i>p.</i> 55. Diethyl phosphorofluoridate, <i>p.</i> 55. Di- <i>isopropyl</i> phosphorofluoridate, <i>p.</i> 55. <i>Dicyclohexyl</i> phosphorofluoridate, <i>p.</i> 56 | |
| Alternative 'one-stage' process for the preparation of esters of phosphorofluoridic acid | 56 |
| Di- <i>isopropyl</i> phosphorochloridate, <i>p.</i> 57. Esters of phosphorofluoridic acid, <i>p.</i> 57. (i) General procedure, <i>p.</i> 58. (ii) <i>Dicyclohexyl</i> phosphorofluoridate, <i>p.</i> 58 | |
| Anticholinesterases | 59 |
| Inhibition of cholinesterase by D.F.P. | 61 |
| Results, <i>p.</i> 62 | |
| Inhibition of cholinesterase by D.F.P.: alternative technique | 62 |
| Poisons, <i>p.</i> 63. Results, <i>p.</i> 63. Reversibility, <i>p.</i> 64. Effect of substrate concentration, <i>p.</i> 64. True and pseudo-cholinesterase, <i>p.</i> 66. Assessment of inhibitory power, <i>p.</i> 66 | |

CONTENTS

| | |
|---|----------------|
| Toxic effects of D.F.P. | <i>page</i> 68 |
| Detailed pharmacological studies | 70 |
| Effect on the eye, <i>p.</i> 72. Further observations, <i>p.</i> 73 | |
| Enzymic destruction of D.F.P. | 74 |
| Radioactive D.F.P. | 75 |
| Apparatus, <i>p.</i> 76. Preparation of phosphorus tri- chloride, <i>p.</i> 76. Di- <i>isopropyl</i> phosphorofluoridate, <i>p.</i> 77. Results, <i>p.</i> 77 | |
| Reaction of esterases with radioactive di- <i>isopropyl</i> phosphorofluoridate | 78 |
| Structural requirements for high toxicity and myotic action of esters of phosphorofluoridic acid | 79 |
| Discussion, <i>p.</i> 81 | |
| Other compounds related to the phosphorofluoridates | 82 |
| Dialkyl phosphorofluoridites | 85 |
| CHAPTER V. I. PHOSPHORODIAMIC FLUORIDES. | |
| II. TABUN AND SARIN | 87 |
| I. Phosphorodiamic fluorides | 87 |
| Alkyl phosphoramidofluoridates | 90 |
| II. Tabun | 91 |
| Sarin | 92 |
| CHAPTER VI. SELECTED REACTIONS OF ESTERS CONTAINING PHOSPHORUS | |
| The Arbusov reaction | 95 |
| Formation of esters of phosphorous and phosphoric acids | 98 |
| Anhydrides | 100 |
| Alkylation by means of phosphorus-containing esters | 100 |
| Some further reactions of phosphorus trichloride | 101 |
| The interaction of phosphorus pentachloride and alcohols | 102 |

CONTENTS

| | |
|---|-----------------|
| Esters of metaphosphoric acid | <i>page</i> 103 |
| Esters of pyrophosphoric acid | 103 |
| Methods of phosphorylation | 106 |
| Dialkyl phosphoroiodidates | 108 |
| Dialkyl phosphorobromidates | 108 |
| Preparation of alkyl- and acylphosphonic acids | 108 |
| Carbon-phosphorus bonds | 109 |
| Polyphosphorus compounds | 111 |
| CHAPTER VII. THE FLUOROACETATES | 114 |
| Methyl fluoroacetate (M.F.A.) and related compounds | 114 |
| 2-Fluoroethanol (F.E.A.) and its derivatives | 122 |
| Fluoroacetamide and related compounds | 125 |
| 2-Fluoroethyl fluoroacetate and related compounds | 129 |
| 2:2'-Difluorodiethyl ethylene dithioglycol | 130 |
| Fluorine-containing ammonium salts | 131 |
| Relationship between physiological action and chemical constitution in the fluoroacetate series | 133 |
| More detailed consideration of toxic action of 'fluoroacetates' | 136 |
| Action of sodium fluoroacetate on enzymes | 139 |
| Cause of fluoroacetate poisoning | 140 |
| Naturally occurring potassium fluoroacetate | 145 |
| Stability of the C—F link | 146 |
| Enzymic rupture of a C—F bond | 148 |
| CHAPTER VIII. OTHER COMPOUNDS CONTAINING THE C—F LINK | 149 |
| ω -Fluorocarboxylic acids and derivatives | 149 |
| Synthetic methods employed in this series of compounds | 155 |

CONTENTS

| | |
|---|----------|
| Further evidence for the β -oxidation of ω -fluoro-carboxylic acids <i>in vivo</i> | page 157 |
| Synthetic methods, p. 158 | |
| ω -Fluorocarboxylic acids and derivatives containing an oxygen atom as a chain member | 160 |
| Pharmacological examination | 162 |
| Other examples of alternating toxicities | 163 |
| Antagonisms of ω -fluorocarboxylic acids | 165 |
| Fluorocarbons | 168 |
| Fluorochlorocarbons, p. 169 | |
| CHAPTER IX. INSECTICIDES | 170 |
| Systemic insecticides | 170 |
| Octamethylpyrophosphoramidate (O.M.P.A.) | 172 |
| Oxidation of O.M.P.A. | 173 |
| Radioactive O.M.P.A. | 175 |
| Tetramethylphosphorodiamidic fluoride | 177 |
| Diethyl <i>p</i> -nitrophenyl phosphate (paroxan) | 177 |
| <i>OO'</i> -Diethyl <i>O''-p</i> -nitrophenyl phosphorothionate (parathion) | 178 |
| Systox | 179 |
| <i>OO'</i> -Diethyl- <i>S</i> - β -diethylaminoethyl phosphorothiolate | 180 |
| Tetraethyl pyrophosphate (T.E.P.P.) | 181 |
| Sodium fluoroacetate | 182 |
| Comparison of the action of organo-phosphorus compounds on mammals and insects | 183 |
| Organo-phosphorus compounds and fly control, p. 185 | |
| CHAPTER X. ESTERASE ACTIVITY AND MEDICAL ASPECTS | 186 |
| Further consideration of esterase activity | 186 |
| Structural requirements for anticholinesterase activity | 187 |

CONTENTS

| | |
|--|-----------------|
| Theoretical considerations | <i>page</i> 188 |
| Active centre in chymotrypsin | 193 |
| An irreversible cholinesterase inhibitor in white clover | 193 |
| Anticholinesterases containing quaternary N groups | 194 |
| Medical aspects of D.F.P. and related compounds | 195 |
| The use of D.F.P. in post-operative paralytic ileus | 196 |
| D.F.P. and myasthenia gravis | 197 |
| Protection <i>in vitro</i> of cholinesterase against organo-phosphorus compounds | 198 |
| Protection against benzoylcholine by the injection of pseudo-cholinesterase | 199 |
| Demyelination of nerve fibres | 199 |
| Permeability of nerve fibres | 200 |
| D.F.P. and cell growth | 200 |
| Cholinesterase in the retina | 201 |
| Organic phosphates as radiosensitizers in the radio-therapy of malignant tumours | 202 |
| EPILOGUE | 203 |
| APPENDICES | |
| A. DETERMINATION OF FLUORINE IN ORGANIC COMPOUNDS | 205 |
| Determination of fluorine in phosphorofluoridates | 206 |
| Breakdown of the phosphorofluoridate | 206 |
| The lead chlorofluoride method | 207 |
| Specimen determination of fluorine in di- <i>isopropyl</i> phosphorofluoridate | 207 |
| Determination of fluorine in fluoroacetates | 208 |
| Fluoroacetamide standard | 208 |
| Specimen determination of fluorine in methyl fluoroacetate by fusion with sodium | 209 |
| Standardization of the 'sodium peroxide bomb' method with pure fluoroacetamide | 210 |

CONTENTS

| | |
|--|-----------------|
| Fluorine determination of radioactive D.F.P. by thorium nitrate | <i>page</i> 210 |
| Reagents | 210 |
| Method | 211 |
| Standardization of thorium nitrate solution using A.R. sodium fluoride | 211 |
| Standardization, <i>p.</i> 211. Results, <i>p.</i> 211 | |
| Determination of fluorine in D.F.P. | 211 |
| Method, <i>p.</i> 211. Results with a sample of radioactive D.F.P., <i>p.</i> 215 | |
| B. TABLE OF PROPERTIES OF TYPICAL FLUORO COMPOUNDS | 212-13 |
| C. FIRST-AID TREATMENT FOR NERVE-GAS POISONING | 215 |
| GENERAL BIBLIOGRAPHY | 216 |
| INDEX | 219 |

FOREWORD

During the first world war intensive research on toxic chemical compounds was carried out in all the belligerent countries. Much of this research had, and still has, a rather restricted interest, but the studies on organic compounds containing phosphorus and fluorine, initiated in this country by Dr Saunders and his colleagues, have had wide repercussions. Not only have they influenced studies in enzymology and even clinical medicine, but they have achieved industrial importance in the general field of pest control. The development of modern systemic insecticides, which stems from the independent war-time studies of Dr Saunders in England and Dr Schrader in Germany, is indeed a fascinating story and one which is less well-known than it should be. The veil of secrecy covering the early work and the rather piecemeal uncovering of it in the years following the war have caused many chemists and biologists to remain very ill-informed about the development of knowledge in the field of organic phosphorus and fluorine compounds.

The present monograph should do much to remedy this state of affairs. Although intended primarily for chemists, the book contains much information on the pharmacology of the compounds discussed; this is particularly valuable since a proper appreciation of the biological background is essential to the chemist who wishes to see the work in proper perspective. As one who has had the privilege of following the work of Dr Saunders and his colleagues closely from its beginnings in 1939, I am particularly pleased that he has now written this authoritative account of it and I commend the monograph to chemists and biologists as a mine of information on one of the most interesting chemical developments which originated in work begun under the stress of war.

A. R. TODD

CAMBRIDGE
August, 1956

PREFACE

This monograph arose as a result of a series of lectures given at Delft and Leiden in 1950 to the Chemical and Medical Staffs of the Netherlands Defence Council, Rijksverdedigingsorganisatie. Some of those attending the course suggested that the lectures should be written in the form of a monograph, a task which has now been undertaken.

The chemistry and the biological applications of organic compounds containing phosphorus and fluorine have advanced so rapidly and in so many directions in recent years that all I can hope to do in a monograph of this size is to select certain aspects for special treatment. Even these selected topics are not treated exhaustively, and the original lectures are written up as a series of essays. It is hoped thereby that sufficient information will be given to enable the general reader to follow the development of those aspects of the subject with which the author has been personally connected since 1939.

Chapter I gives a broad general historical survey of the work, and the more precise details of nomenclature, experimental procedures and theoretical considerations are reserved for later chapters.

In a monograph of this kind it has not been possible, nor indeed is it desirable, to segregate completely synthetic chemical methods from biological action. Such a separation would inevitably lead to a catalogue of entirely unrelated facts. Nevertheless, some effort has been made to concentrate particular aspects of the subject in different sections or chapters; but the interrelationships of chemical constitution with biological activity, have always been kept in mind.

As the monograph is intended primarily for chemists, some attempt has been made to indicate certain of the underlying physiological and anatomical considerations involved (Chapter III and elsewhere). It is hoped that this clarification of some of the fundamental biological aspects will enable the organic chemist to appreciate the applications of the compounds

PREFACE

that he synthesizes, and in fact it may indicate to him the lines along which future work could be most profitably conducted.

It has occurred to the author, in his role of Senior Scientific Adviser for the Eastern Region (Home Office), that some of the chapters might prove of interest to Technical Reconnaissance Officers and to those whom they instruct.

I wish to express my deepest appreciation to Dr J. van Ormondt of the Chemisch Laboratorium, Delft, and Professor Dr G. J. Sizoo, President of the National Defence Research Council at the Hague for arranging the original course of lectures. I also wish to record the kindness and encouragement received on a lecture tour given on these topics in the United States and Canada during 1954, more particularly to the Ohio State University; Purdue University; the University of Chicago; the University of Michigan; Cornell University; the University of Rochester Medical School, Rochester, N.Y.; E.I. du Pont de Nemours & Co., Dayton, Ohio; Dow Chemical Co., Midland, Michigan; and the University of Western Ontario.

My thanks are due to Dr R. F. Webb and Dr H. Goldwhite for kindly reading the book in proof. The author's grateful thanks are tendered to the numerous British and Foreign scientific and medical journals to which references have been made and from which material has been selected. Similarly the author's thanks are due to the Ministry of Supply for permission to publish certain results.

I am most grateful for the unfailing help and courtesy of the staff of the Cambridge University Press.

Finally, I am greatly indebted to my research colleagues at Cambridge who have made this monograph possible, and to those biochemists, physiologists, pharmacologists and pathologists in Cambridge and elsewhere with whom I have had the privilege of working.

B. C. SAUNDERS

December, 1955

Chapter I

INTRODUCTION AND GENERAL SURVEY

A great deal of the work described in this series of lectures arose as a consequence of investigations carried out by the author and his colleagues at Cambridge during World War II. The original purpose of the researches was the production and examination of toxic materials, but it must be emphasized at the outset that, because of their remarkable physiological properties, many of these compounds are now finding wide application in the investigation of enzyme systems, as insecticides and rodenticides and in clinical medicine. The general reader may therefore be assured at once that toxicity is by no means the sole measure of the importance of the compounds now about to be described.

The monograph is concerned mainly with two types of organic fluorine-containing compounds: (a) those containing the >POF group and belonging largely to the class of *phosphorofluoridates* (fluorophosphonates) and (b) a large class of compounds containing the FCH_2 group and designated somewhat loosely as *fluoroacetates*.

Work on these compounds was undertaken by the author and his colleagues in 1939, and before that date no very detailed information had been published regarding either their chemistry or their physiology.

Phosphorofluoridates (Fluorophosphonates)

At the beginning of the war we synthesized, by methods described below and also in Chapter IV, a series of dialkyl phosphorofluoridates (I). In general, these compounds were colourless, stable and almost odourless liquids. With them we carried out tests (a) on ourselves, (b) on animals, (c) on enzyme systems. The very close collaboration of the Departments of Chemistry, Physiology, Biochemistry and Pathology at Cambridge permitted of the initial screening of a compound often within a few

INTRODUCTION AND GENERAL SURVEY

hours of its synthesis. This enabled the work to proceed very rapidly and quick estimates to be made of the lines most likely to give fruitful results.

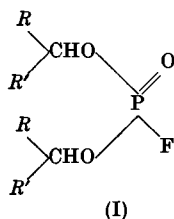

One of the most interesting compounds of the series which was synthesized in 1941¹ was di-*isopropyl* phosphorofluoridate (di-*isopropyl* fluorophosphonate) (I, $R = R' = \text{CH}_3$), now often referred to as D.F.P. (Chapter IV). The compound could be stored in glass vessels and it was hydrolysed only very slowly by water. In order to examine the effects of these 'gases' on ourselves we employed a 10 cu.m. glass testing chamber fitted with an air-lock. We entered the testing chamber,² in which D.F.P. was sprayed so as to give a concentration of 1 part in 1,000,000 (i.e. 0.0082 mg./l.), and remained in the chamber for 5 min. No effects were detected while we were in the chamber nor until some 5 min. afterwards. Intense myosis (pupil constriction, etc.) then set in and often persisted for as long as 7 days, and there was usually little relaxation of symptoms until after 72 hr. This myotic or eye effect may be summarized as follows:

(a) pupil constriction, often down to pin-point size (see frontispiece). The amount of light entering the eye was greatly reduced. Incapacitation was naturally greater in a poor light;

(b) powers of accommodation were reduced;

(c) photophobia and headaches, and pain experienced when changing from a bright to a dull light.

At higher concentrations the toxicity was such as to cause a quick 'knock-out' action. For these observations small animals were used and standard techniques employed. Inhalation

¹ B. C. Saunders, Ministry of Supply Meeting, London, 11 December 1941; McCombie and Saunders, *Nature, Lond.*, 1946, **157**, 287; Saunders and Stacey, *J. Chem. Soc.* 1948, p. 695; Saunders *et al.* B.P. 601,210.

² Without respirators. All the gases mentioned in this monograph are held back by service and civilian respirators.

PHOSPHOROFUORIDATES

experiments showed that the L.C. 50 for 10 min. exposures¹ was 0.36 mg./l. for rats and 0.44 mg./l. for mice. This means that the compound is more toxic than cyanogen chloride, CNCl, or chloropicrin, C(NO₂)Cl₃, and comparable with hydrogen cyanide. The symptoms were muscular weakness, gasping and finally cessation of respiration.

The compound is also toxic by injection;² thus for intravenous injection into rabbits the L.D. 50 in normal saline was about 0.5 mg./kg. Pupil constriction began 2 min. after injection, followed by loss of muscular co-ordination and then by respiratory collapse.

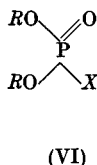
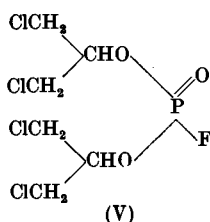
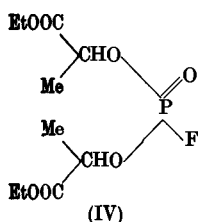
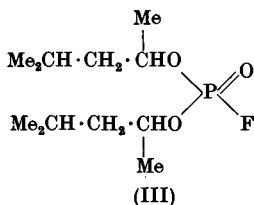
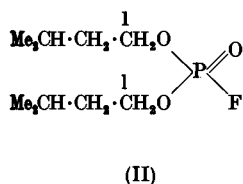

We carried out a great deal of work on the relationship between the above physiological effects and chemical constitution, and it was shown conclusively that the more potent compounds were those derived from secondary alcohols.³ Thus, for example, di-isopropyl phosphorofluoridate is very much more potent than diethyl phosphorofluoridate or di-n-propyl phosphorofluoridate and the toxicity of the dicyclohexyl ester is of a high order (L.C. 50 for mice, rats and rabbits was 0.11 mg./l.). Di-n-butyl phosphorofluoridate had low toxicity and produced only feeble

¹ L.C. = lethal concentration. Toxicity by inhalation (L.C. 50) is expressed as the concentration in mg./l. required to kill 50 per cent of the animals exposed.

² L.D. = lethal dose. Toxicity by injection (L.D. 50) is expressed as the dose in mg./kg. body weight required to kill 50 per cent of the animals treated.

³ McCombie and Saunders, *Nature, Lond.*, 1946, 157, 287; Cook, Saunders and Smith, *J. Chem. Soc.* 1949, p. 635.

INTRODUCTION AND GENERAL SURVEY

myosis, whereas di-*sec.*-butyl phosphorofluoridate (I, $R = \text{Me}$, $R' = \text{Et}$) was comparable with D.F.P. itself. These results led us to determine whether the branching of the chain adjacent to the oxygen atom was a necessary requirement for high toxicity or whether a branching at the end of the chain would do equally well. Accordingly, we prepared di-*iso*amyl phosphorofluoridate (II) and found it to be only slightly toxic and almost devoid of myotic properties. A most striking result was obtained on examining the compound derived by branching the chain in (II) by a methyl group on carbon atom 1. This new compound (III) was found to be very toxic and to possess strong myotic action. Thus a secondary grouping does seem to be necessary for the production of high toxicity. This is true, however, only if the secondary groupings are unsubstituted; for toxicity and myotic action disappeared almost entirely in compounds (IV) and (V).

Furthermore, in the particular type of phosphate molecule under discussion (VI) we showed that when X is fluorine, compounds of high toxicity result; whereas myotic effect is absent and toxicity of a low order if $X = \text{H}$, Et, OH, OEt, $\text{OCH}_2\text{CH}_2\text{Cl}$, $\text{OCH}_2\text{CH}_2\text{F}$, Cl, NH_2 , NMe, NPh, $\text{CH}_2\text{CH}_2\text{F}$, CN, SCN, etc.¹ In Chapters IV and VI, however, we consider in more detail cases where X is not fluorine, but nevertheless toxicity results. Toxicity is also of a low order in the aromatic series; for example, diphenyl phosphorofluoridate is relatively non-toxic and devoid of myotic properties. We also showed that ethyl phosphorodifluoridate, $(\text{C}_2\text{H}_5\text{O})\text{POF}_2$, had neither myotic nor toxic action.²

Concurrently with experiments on animals, the action of the phosphorofluoridates on enzymes was investigated in Cambridge.³ It was shown in 1942 that esters of phosphorofluoric acid inhibit⁴ the action of the enzyme cholinesterase, which is present in tissue fluids and hydrolyses acetylcholine to the much less active choline.

In order to understand the implications of this inhibition, some knowledge of the mammalian nervous system is necessary.

¹ Cook, Saunders and Smith, *J. Chem. Soc.* 1949, p. 635.

² Saunders, Stacey, Wild and Wilding, *J. Chem. Soc.* 1948, p. 695.

³ Adrian, Feldberg and Kilby, *Brit. J. Pharmacol.* 1947, 2, 56; Macworth and Webb, *Biochem. J.* 1948, 42, 91.

⁴ Full details are given on pp. 61-8.

PHOSPHOROFUORIDATES

This matter is given some consideration in Chapter III. In passing we may note here that it is because of the parasymphathomimetic action of D.F.P. and related compounds that the term 'nerve gas' has been applied.

Di-*i*sopropyl phosphorofluoridate is active against the enzyme cholinesterase in extremely low concentrations (for example, of the order of 10^{-10} M). This effect was not due to the fluoride ion (produced by subsequent hydrolysis), as sodium fluoride required a high concentration (10^{-2} M) to give a 50 per cent inhibition of cholinesterase activity. Similarly, a 10^{-2} M solution of ammonium phosphorofluoridate was also necessary to give a 50 per cent inhibition of the enzyme. The drug eserine has been known for a long time as a strong inhibitor of cholinesterase, but even here a concentration of 10^{-8} M is required; moreover, its action is reversible, whereas that of D.F.P. is irreversible. Saunders and Worthy,¹ by using special techniques, prepared D.F.P. containing radioactive phosphorus, ³²P. This enabled Bournsnel and Webb² to show that approximately one molecule of D.F.P. combines with one molecule of the enzyme under conditions which produce complete inactivation.

Acetylcholine is antagonized by atropine. It is not surprising therefore that atropine was suggested at a very early stage by the Cambridge physiologists as a therapeutic agent for the treatment of D.F.P. poisoning.

More recent attempts, using other compounds, to reverse the poisoning action by D.F.P. are described below (p. 191).

As regards methods of synthesis, one of our early attempts consisted in preparing the trialkyl phosphite, $(RO)_3P$, by the action of phosphorus trichloride on an alcohol in the presence of a tertiary base such as pyridine or dimethylaniline:

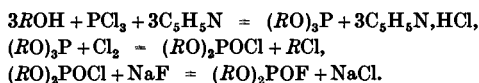

Chlorine reacted with the trialkyl phosphite to give the phosphorochloridate³ which on being heated with an inorganic

¹ Saunders and Worthy, *J. Chem. Soc.* 1950, p. 1320.

² Bournsnel and Webb, *Nature, Lond.*, 1949, **164**, 875.

³ Gerrard, *J. Chem. Soc.* 1940, p. 1464.

fluoride gave the required phosphorofluoridate. The method, however, was not sufficiently cheap for large-scale work, and so it was decided to try the effect of eliminating the rather expensive tertiary base altogether. The result of the action of phosphorus trichloride on ethyl alcohol was *diethyl hydrogen phosphite* in high yield. It seemed at first that this modification was useless, as the required triethyl phosphite was not produced. We decided, nevertheless, to examine the effect of chlorine on the hydrogen phosphite and found that the essential phosphorochloridate was indeed produced in 80 per cent yield.¹

As subsequent work showed, this discovery had a marked effect on the course of phosphorofluoridate chemistry. It now became possible to prepare phosphorofluoridates in excellent yield and from cheap and readily accessible materials; in particular, no tertiary base was required.

The synthesis is represented in outline by the following equations:

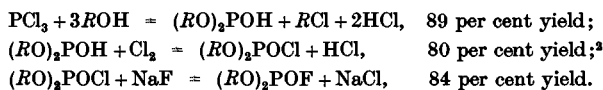

Production on a technical scale

Further modifications were then made in this 'hydrogen phosphite' method of preparing di-*isopropyl* phosphorofluoridate in order to put it on an industrial scale.

After a large number of experiments, we found that the preparation could be run virtually as a one-stage process. The whole process consists simply in adding phosphorus trichloride to *isopropyl* alcohol, dissolved in a solvent such as carbon tetrachloride, without external cooling. The crude product (still in the solvent) is chlorinated and then heated with an inorganic fluoride, e.g. sodium fluoride. After filtration, the solvent is distilled off and the pure di-*isopropyl* phosphorofluoridate distilled.³

¹ McCombie, Saunders and Stacey, *J. Chem. Soc.* 1945, p. 380.

² For small-scale work the chlorination is also conveniently carried out by *N*-chlorosuccinimide (Kenner, Todd and Weymouth, *J. Chem. Soc.* 1952, p. 3575). In this case no acid by-product is obtained. This modification is discussed in Chapter iv.

³ McCombie and Saunders, *Nature, Lond.*, 1946, 157, 287; Saunders and Stacey, *J. Chem. Soc.* 1948, p. 695; Saunders *et al.*, B.P. 601,210.

PHOSPHOROFLUORIDATES

This process is very easily carried out by efficient workers and yields are of the order of 70 per cent. It has formed the basis of the method in general use for the production not only of this substance but also of related compounds. An American patent¹ gives closely similar details.

A distinctly different method of synthesizing the esters of phosphorofluoric acid consisted in the partial fluorination of phosphorus oxychloride with antimony trifluoride (using a specially designed apparatus and phosphorus pentachloride as catalyst) to give phosphorus oxydichlorofluoride, POCl_2F . In the latter compound the chlorine atoms proved to be much more reactive than the fluorine atom, and with an alcohol the dialkyl phosphorofluoridate was readily obtained in high yield.²

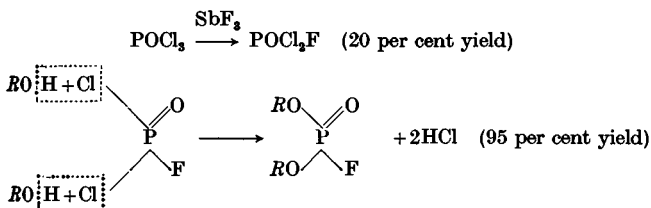

Although the action of POCl_2F on an alcohol cannot compete with the 'hydrogen phosphite' method for large-scale work, the former was found extremely valuable for exploratory purposes. In particular, it was found possible to prepare diaryl phosphorofluoridates (e.g. $(\text{C}_6\text{H}_5\text{O})_2\text{POF}$) and diethyl phosphorofluorido-dithiolate (diethyl dithiofluorophosphonate, $(\text{C}_2\text{H}_5\text{S})_2\text{POF}$) by the action of phosphorus oxydichlorofluoride on the appropriate phenol or mercaptan.

Phosphorodiamidic Fluorides

(Diamino fluorophosphine oxides)

In 1942 we reported the preparation of a new type of phosphorus-fluorine compound, obtained by the action of POCl_2F

¹ U.S.P. 2,409,039.

² Chapman and Saunders, *J. Chem. Soc.* 1948, p. 1010; Saunders *et al.* B.P. 602,446.

INTRODUCTION AND GENERAL SURVEY

on an amine.¹ The condensation was clear cut, and only the chlorine atoms were replaced:

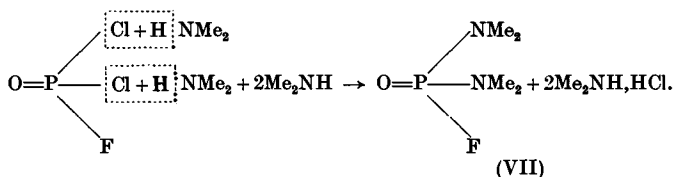

The reaction was found to be general and was extended to the preparation of a large range of phosphorodiamidic fluorides, e.g. from diethylamine, butylamine, methylaniline, benzylamine, cyclohexylamine, morpholine and piperidine. The method was patented.

Many of these compounds were toxic; for example, tetramethyl phosphorodiamidic fluoride (dimethylaminofluorophosphine oxide (VII)) had a L.C. 50 of 0.1 mg./l. Unlike the phosphorofluoridate esters, however, they were devoid of myotic action.

About this time² we also worked out the conditions for an alternative method for preparing phosphorodiamidic fluorides from phosphorus oxychloride. The principle of the method is given by the following equations:

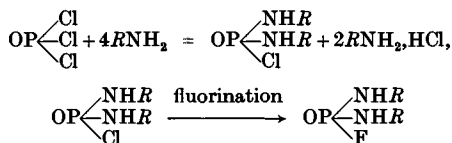

We then decided to 'combine' the toxicities of a phosphorofluoric ester with that of a phosphorodiamidic fluoride in a 'hybrid' molecule, and carried out the following synthesis in 1943:³

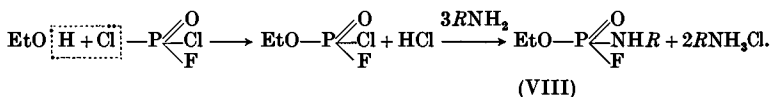

¹ Saunders *et al.* B.P. 602,446; Heap and Saunders, *J. Chem. Soc.* 1948, p. 1313.

² Saunders *et al.* *J. Chem. Soc.* 1949, p. 2921; McCombie and Saunders, *Nature, Lond.*, 1946, 157, 776.

³ McCombie and Saunders, *Nature, Lond.*, 1946, 157, 776.

PHOSPHORODIAMIDIC FLUORIDES

This new type of compound, an ethyl *N*-substituted phosphoramidofluoridate (VIII), had a high toxicity.

As a matter of interest, we obtained a compound, diethyl phosphorofluoridite (IX), of a lower state of oxidation than the corresponding phosphorofluoridate by the action of phosphorus dichlorofluoride on ethyl alcohol. The new compound, unlike the phosphorofluoridate, was readily hydrolysed by water, was relatively non-toxic and did not produce myosis.¹

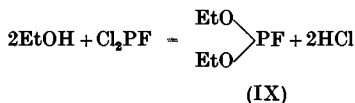

Among other reactions which are described in detail later are the following: (1) A novel method for the introduction of the CN group is given in Chapter VI. Thus diethyl phosphorocyanidate (X) was prepared² according to the equation:

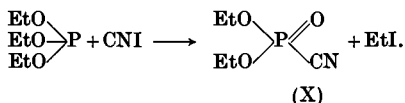

(2) In Chapter VI the introduction of the 2-fluoroethyl group by the action of 1-bromo-2-fluoroethane on triethyl phosphite,³ giving diethyl 2-fluoroethylphosphonate (XI), is considered:

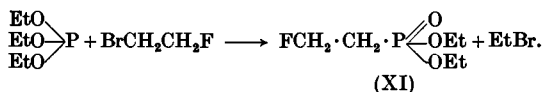

It should be emphasized that the physiological properties of D.F.P. and related compounds are very similar to those of other highly toxic nerve gases, such as, for example, the German 'tabun' and 'sarin' (pp. 91-4). In fact, the fundamental chemical and physiological investigations carried out in Cambridge during the years 1939-45 have proved of very great value in dealing generally with a wide variety of toxic compounds containing phosphorus. Both tabun and sarin produce intense myosis and have powerful anti-cholinesterase properties. The

¹ Saunders *et al.* *J. Chem. Soc.* 1949, p. 2921.

² Saunders, Stacey, Wild and Wilding, *J. Chem. Soc.* 1948, p. 695.

³ *Ibid.*

physiological action on animals is similar to that described for D.F.P., but lower concentrations are effective. All three compounds are destroyed by alkali (pp. 48, 92 and 93).

Fluoroacetates

These compounds contain, in general, the CH_2F group. Until work was undertaken at Cambridge at the beginning of the war little serious attention had been paid to these compounds or to their systematic physiological examination.

The first compound to be investigated in detail was methyl fluoroacetate (M.F.A.), and extensive work was carried out to select the best conditions for its preparation. It was found¹ that if methyl chloroacetate and potassium fluoride were heated together in an inclined rotating autoclave, a 54 per cent yield of methyl fluoroacetate was obtained, or 60 per cent allowing for recovery of methyl chloroacetate. This method formed the basis of its production and that of many related substances on a large scale. Methods not involving the use of an autoclave have been suggested, but in general the yields are much lower (p. 125).

Methyl fluoroacetate, a mobile liquid, has an extremely faint odour. Animals did not usually exhibit any symptoms while being exposed to lethal concentrations of this vapour, and no obvious effects were noted until some 30–60 min. (depending upon the concentration) after exposure. Violent convulsions then took place and death usually followed within a few hours. For rabbits and guinea-pigs the lethal concentration (L.C. 50) for a 10 min. exposure was of the order of 0.1 mg./l. Mice were rather more resistant. Intravenous injection produced symptoms similar to those displayed after exposure to the vapour. Even with large doses a delayed action was observed. The L.D. 50 for rabbits (intravenously) was found to be about 0.25 mg./kg.

Ethyl, *n*-propyl and *isopropyl* fluoroacetates were also readily prepared by heating the corresponding esters of chloroacetic acid with potassium fluoride in the rotating autoclave. Their toxicities were similar to that of methyl fluoroacetate. (It

¹ McCombie and Saunders, *Nature, Lond.*, 1946, 158, 382; Saunders and Stacey, *J. Chem. Soc.* 1948, p. 1773.

should be noted in passing that in the phosphorofluoridate series the intensity of toxic action depended upon the nature of the alcohol grouping.) On the other hand, methyl α -fluoropropionate, $\text{CH}_3 \cdot \text{CHF} \cdot \text{COOCH}_3$, and methyl α -fluoroisobutyrate, $(\text{CH}_3)_2\text{CF} \cdot \text{COOCH}_3$, showed negligible toxicity. It is interesting to note that these compounds do not contain the CH_2F group. Difluoroacetic acid and trifluoroacetic acid and their esters also proved to be non-toxic.

Sodium fluoroacetate was prepared with the idea of obtaining a stable water-soluble compound containing the FCH_2CO group, suitable for feeding experiments with animals. This salt is now finding application to some extent as a rodenticide, but if used in this way, very great care must be taken to keep it away from human beings and domestic animals. The method of obtaining the salt consisted in treating methyl fluoroacetate with sodium hydroxide solution in the cold.¹

The following three acyl halides were prepared and their toxicities examined:

| | | |
|-----------------------|----------------------------------|--|
| fluoroacetyl chloride | $\text{FCH}_2 \cdot \text{COCl}$ | toxicity similar to that of methyl fluoroacetate |
| chloroacetyl fluoride | $\text{ClCH}_2 \cdot \text{COF}$ | non-toxic |
| fluoroacetyl fluoride | $\text{FCH}_2 \cdot \text{COF}$ | toxicity similar to that of methyl fluoroacetate |

These findings were in accordance with expectation, and it was now obvious that the toxicity was bound up with the FCH_2CO group, whereas the FCO group was ineffective. Further confirmation of this point was provided by the observation that ethyl fluoroformate, FCOOEt , was non-toxic. Fluoroacetic anhydride was slightly more toxic (by inhalation) than methyl fluoroacetate.

Fluoroacetamide, $\text{FCH}_2\text{CONH}_2$, and many new substituted amides of the type FCH_2CONHR , were all convulsant poisons with delayed action. The magnitude of their toxicities suggested that they were hydrolysed in the animal body to fluoroacetic acid.² In short, the effective part of the molecule was the FCH_2CO grouping.³ Swarts⁴ was unable to obtain fluoroethyl

¹ Saunders and Stacey, *J. Chem. Soc.* 1948, p. 1773.

² Buckle, Heap and Saunders, *J. Chem. Soc.* 1949, p. 912.

³ Fluoropyruvic acid, $\text{FCH}_2\text{COCOOH}$, is less toxic than expected and does not seem to be metabolized *in vivo* via fluoroacetic acid; Avi-Dor and Mayer, *Biochem. J.* 1956, 63, 813.

⁴ Swarts, *Chem. Zbl.* 1914, 1, 1551.

alcohol ($\text{FCH}_2\text{CH}_2\text{OH}$) by the action of silver fluoride or mercuric fluoride on ethylene chlorohydrin. We found¹ that, by using a rotating autoclave, ethylene chlorohydrin could be fluorinated by heating with potassium fluoride at 130–135° for 4 hr. Thus fluoroethyl alcohol (F.E.A.) became readily accessible and was prepared in quantity using a 10 gal. autoclave. With sodium fluoride (in place of potassium fluoride) yields were small.

Fluoroethyl alcohol is a stable, mobile, colourless liquid of b.p. 101°, completely miscible with water and practically odourless. The compound was a convulsant poison like methyl fluoroacetate, and was about equally potent. As in methyl fluoroacetate, the fluorine atom in fluoroethyl alcohol is firmly bound; in the former the fluorine atom is not removed to any extent by boiling 10 per cent sodium hydroxide solution (boiling 30 per cent aqueous alkali is required to effect removal). This chemical unreactivity of the fluorine atom of the FCH_2 group is shared by the majority of the simple 'fluoroacetates'. This renders decontamination difficult where this class of toxic substance is concerned. For the same reason it is difficult to detect their presence quickly by simple chemical means, and lack of odour enhances the insidious nature of the compounds. It may be added that early biochemical work failed to reveal a single enzyme which was inhibited to any extent by methyl fluoroacetate or sodium fluoroacetate. Sir R. A. Peters and his colleagues at Oxford,² however, have shown that poisoning by fluoroacetate is brought about by its conversion into fluorocitrate and subsequent blocking of the 'tricarboxylic acid cycle' *in vivo* (Chapter VII).

We have recently, by special techniques,³ prepared sodium fluoroacetate labelled with ^{14}C in the methylene group, $\text{F}^{14}\text{CH}_2\text{COONa}$, which may be of use in ascertaining the fate of fluoroacetate in animals.

2-Fluoroethyl fluoroacetate

In view of the fact that fluoroethyl alcohol produced a toxic effect comparable with that of fluoroacetic acid, it seemed worth

¹ Saunders, Stacey and Wilding, *J. Chem. Soc.* 1949, p. 773.

² Buffa, Peters and Wakelin, *Biochem. J.* 1951, 48, 467.

³ Saunders and Worthy, *Nature, Lond.*, 1952, 169, 38.

while to synthesize a compound in which the 'active' parts of these molecules were combined, in the hope of obtaining a substance of increased potency. We prepared¹ 2-fluoroethyl fluoroacetate, $\text{FCH}_2 \cdot \text{COOCH}_2 \cdot \text{CH}_2\text{F}$, in 1943, by the action of fluoroacetyl chloride on fluoroethyl alcohol. In accordance with expectation, the compound possessed greatly enhanced toxic properties, and it was shown that for a 10 min. exposure the L.C. 50 for rabbits by inhalation was 0.05 mg./l. In short, the compound was about twice as toxic as methyl fluoroacetate (weight for weight). This may indicate that the 2-fluoroethyl fluoroacetate molecule can exert a toxic action *per se*, independently of any subsequent hydrolysis. In general, however, it seems that the toxic compounds are those that can give rise to fluoroacetic acid either by oxidation and/or by hydrolysis.²

The writer was able to demonstrate a most striking alternation in the toxic properties of ω -fluorocarboxylic acids;³ it was found that, in compounds of the type $\text{F}(\text{CH}_2)_n\text{COOH}$, if n was odd the compound was very toxic, whereas if n was even the compound was non-toxic.

This interesting phenomenon is discussed in detail in Chapter VIII, but we may note in passing that Knoop in 1906 suggested that fatty acids were oxidized in the animal body by the loss of two carbon atoms at a time, owing to oxidation occurring at the carbon atom which was in the β -position with respect to the carboxyl group. It will be readily seen in our series $\text{F}(\text{CH}_2)_n\text{COOH}$, that, when n is odd, this process of β -oxidation will yield the toxic fluoroacetic acid, whereas when n is even the compound will be oxidized only as far as the non-toxic β -fluoropropionic acid, $\text{FCH}_2 \cdot \text{CH}_2 \cdot \text{COOH}$. Our results are in complete accord with this hypothesis and provide confirmation of a new kind, of the process of β -oxidation in the living animal body.

If our theory of alternating toxicities is right, then, if the β -position in the chain is 'blocked' so that oxidation cannot take place, the compound should be devoid of toxic properties.

¹ McCombie and Saunders, *Nature, Lond.*, 1946, 158, 382; Saunders and Stacey, *J. Chem. Soc.* 1949, p. 916.

² Saunders, *J. Chem. Soc.* 1949, p. 1279.

³ Saunders, *Nature, Lond.*, 1947, 159, 491; Buckle, Pattison and Saunders, *J. Chem. Soc.* 1949, p. 1471.

INTRODUCTION AND GENERAL SURVEY

For this purpose we synthesized ethyl 2:2-dimethyl-3-fluorobutyrate

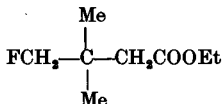

and showed that it was indeed non-toxic. Another way of testing the theory was to build on the α - and β -carbon atoms a carbon ring so that the animal body could not oxidize the compound down to fluoroacetic acid. Accordingly, we synthesized methyl 2-fluoromethyl-4:5-dimethylhexahydrobenzoate (XII) and three related compounds and showed that they were completely non-toxic,¹ whereas the parent compound (XIII) is extremely toxic.

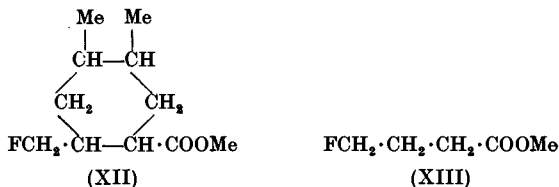

Among other compounds which we studied in this connexion (Chapter VIII, p. 158) was *p*-fluorophenylacetic acid (XIV), which has the carbon skeleton of the highly toxic 5-fluoropentanecarboxylic acid, $\text{F}[\text{CH}_2]_5\text{COOH}$ (XV). The compound (XIV) was shown to be non-toxic, and cannot of course be oxidized to fluoroacetic acid. We also employed another method² which threw some light on the phenomenon of alternating toxicities and the possible connexion with β -oxidation. The principle was to replace a CH_2 group at some appropriate point in the chain by an oxygen atom and then to compare the toxic action of the new compound with that of the parent ω -fluorocarboxylic acid. Thus whereas 5-fluoropentanecarboxylic acid (XV) and its derivatives are highly toxic the corresponding oxygen compound $\text{FCH}_2 \cdot \text{CH}_2 \cdot \text{O} \cdot \text{CH}_2 \cdot \text{CH}_2 \cdot \text{COOH}$ had L.D. 50 for injection into mice of only 70 mg./kg.

Several compounds of this type have been prepared by a novel synthesis depending upon the cyanoethylation of the appro-

¹ Pattison and Saunders, *J. Chem. Soc.* 1949, p. 2745.

² Saunders and Stacey, *J. Chem. Soc.* 1948, p. 1773; Buckle and Saunders, *J. Chem. Soc.* 1949, p. 2774.

FLUOROACETATES

prate fluoroalcohol. Thus fluoroethyl alcohol gave 2-fluoro-2'-cyanodiethyl ether (XVI) in good yield:

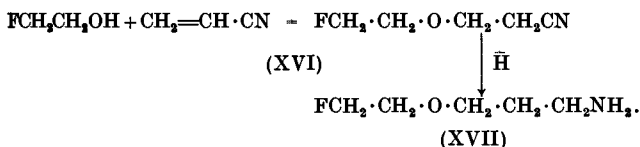

It was found possible to reduce the ether (XVI) to the primary amine (XVII) by means of hydrogen and Raney nickel, without removing the fluorine atom. This permitted the lengthening of the chain at one end of the molecule, while lengthening at the other end was achieved by cyanoethylation of a higher ω -fluoroalcohol.

Utilizing the cyanoethylation process the following new compounds were prepared:

- (i) $\text{FCH}_2\cdot\text{CH}_2\cdot\text{CH}_2\cdot\text{O}\cdot\text{CH}_2\cdot\text{CH}_2\text{CN}$,
- (ii) $\text{FCH}_2\cdot\text{CH}_2\cdot\text{CH}_2\cdot\text{O}\cdot\text{CH}_2\cdot\text{CH}_2\cdot\text{COOH}$,
- (iii) $\text{FCH}_2\cdot\text{CH}_2\cdot\text{CH}_2\cdot\text{O}\cdot\text{CH}_2\cdot\text{CH}_2\cdot\text{COCl}$.

Acid chlorides were converted into the esters of higher acids by the Arndt-Eistert reaction:

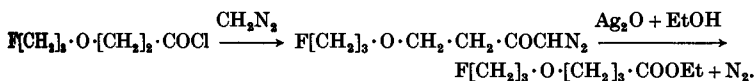

These fluoroethers are discussed in greater detail in Chapter VIII.

Other compounds

Finally, of the numerous 'fluoroacetates' we prepared in Cambridge, reference will be made here only to some compounds of peculiar interest. Further details are given in later chapters.

Fluoro-aspirin (fluoroacetyl salicylic acid) caused initial stupor without convulsions in mice.

Di-2-fluoroethyl phosphorofluoridate (XVIII) was prepared with the idea of combining the 'toxic principles' of the fluoroacetates and of the phosphorofluoridates. It was readily obtained by the action of phosphorus oxydichlorofluoride on

INTRODUCTION AND GENERAL SURVEY

fluoroethyl alcohol.¹ The compound did, indeed, cause myosis, but the toxicity was rather lower than that anticipated. At a concentration of 0.5 mg./l. (10 minutes' exposure) it did, however, produce in rats a remarkable state of 'hyperactivity' followed by convulsions of an unusual type leading to coma and death.

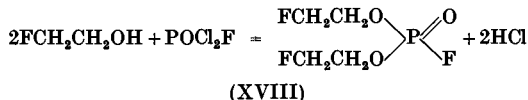

Triethyl-lead fluoroacetate, $\text{FCH}_2 \cdot \text{COOPbEt}_3$. A systematic study of the sternutatory properties (irritation of nose, throat and chest) of organo-lead salts has been carried out in Cambridge.² We showed that salts of the type $R_3\text{PbX}$ (R = aliphatic hydrocarbon radical, X = acid radical) produced sternutation. The toxic effect increased in the order $\text{Me} < \text{Et} < n\text{Pr}$ and more potent compounds were obtained where X was an organic acid radical. Triethyl-lead fluoroacetate³ is a most interesting compound, in that it effectively combines the sternutatory properties associated with the trialkyl-lead salts on one hand and (by injection) the convulsant action of the fluoroacetates on the other hand.

'*Sesqui-fluoro-H*.' The properties of

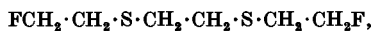

the fluorine analogue of 'sesqui-H' (2:2'-dichloroethylethylene dithioglycol), had for many years remained a matter of speculation, for all attempts to prepare this compound had failed. 'Sesqui-H', a compound of considerable interest, is a strong vesicant. In 1943 we prepared 2:2'-difluoroethylethylene dithioglycol ('sesqui-fluoro-H') as follows:⁴

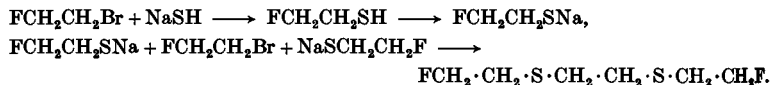

¹ We have recently prepared this compound by a simple modified 'one-stage' process (p. 58).

² McCombie and Saunders, *Nature, Lond.*, 1947, 159, 491; Saunders and Stacey, *J. Chem. Soc.* 1949, p. 919; Heap and Saunders, *J. Chem. Soc.* 1949, p. 2983; Saunders, *J. Chem. Soc.* 1950, p. 684; Heap, Saunders and Stacey, *J. Chem. Soc.* 1951, p. 658.

³ Saunders and Stacey, *J. Chem. Soc.* 1948, p. 1773.

⁴ Saunders and Stacey, *J. Chem. Soc.* 1949, p. 916.

The above reaction is rather remarkable in view of the unreactivity of the fluorine atom in fluorobromoethane towards many reagents. In order to establish the identity of 'sesqui-fluoro-H', it was synthesized by an alternative unambiguous method (p. 130). 'Sesqui-fluoro-H' is a mobile liquid, devoid of vesicant properties and non-toxic. The lack of toxicity is understandable since the animal body is probably unable to rupture this C—S link, and hence the compound cannot easily give rise to fluoroacetic acid.

Fluorine-containing ammonium salts. As amino compounds often have marked physiological action, it seemed worth while to prepare compounds containing both fluorine and a quaternary amino grouping.

Advantage was taken of the fact that of the two halogens in fluorobromoethane, FCH_2CH_2Br , the bromine atom is the more reactive. When, for example, trimethylamine and fluorobromoethane were allowed to react at room temperature, addition took place and 2-fluoroethyl trimethyl ammonium bromide was produced (XIX):¹

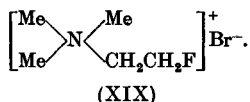

Pyridine gave 2-fluoroethyl pyridinium bromide on being refluxed with fluorobromoethane:



These fluoro quaternary bromides proved to be not very toxic. Triethyl 2-fluoroethyl ammonium bromide, for example, had a L.D. 50 for subcutaneous injection into mice of about 300 mg./kg. The low toxicity of these compounds may again provide useful evidence regarding their probable fate in the body. It seems that the bond connecting the 2-fluoroethyl group with the rest of the molecule is not readily ruptured. In this connexion, however, the possibility of increased lability of the fluorine atom in these less toxic compounds must not be overlooked.

¹ Saunders, *J. Chem. Soc.* 1949, p. 1279.

INTRODUCTION AND GENERAL SURVEY

The study of these fluorine-containing salts was then extended, and we prepared other new compounds in this series, e.g. 2-fluoroethyl glycine hydrochloride and 2-fluoroethyl betaine hydrochloride (that is, carbofluoroethoxy-methyl trimethyl ammonium chloride). The first of these was readily prepared by the Fischer-Speier esterification of glycine with fluoroethyl alcohol:

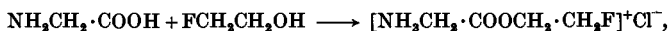

Using similar conditions with betaine and fluoroethyl alcohol, none of the expected ester was obtained, the betaine remaining unchanged. The reaction between anhydrous trimethylamine and fluoroethyl chloroacetate, however, gave fluoroethyl betaine hydrochloride in excellent yield:

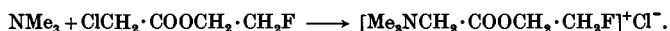

The 2-fluoroethyl glycine hydrochloride was found to have a L.D. 50 of about 10 mg./kg. by subcutaneous injection into mice. The corresponding figure for 2-fluoroethyl betaine hydrochloride was 45 mg./kg.

Particular Applications

In a secret patent taken out during the war,¹ we claimed that some of these compounds might be useful as insecticides and might be capable of general clinical application. It is interesting to note that D.F.P. has been used in the treatment of glaucoma and paralytic ileus.² Quilliam and Quilliam³ state that 'as a result of its powerful viscerostimulant action, D.F.P. is more effective than either prostigmine or pituitary (posterior lobe) extract in the treatment of post-operative paralytic ileus'. Investigations have also been carried out in connexion with myasthenia gravis. Compound (VII) (p. 8) and related substances are finding application as insecticides.

While our investigations on phosphorus and fluorine were proceeding in England during the war, German chemists, particularly Schrader,⁴ were working (independently of course) on

¹ Saunders *et al.* B.P. 602,446.

² (Sir) L. Whitby, *Practitioner*, 1947, 159, 243.

³ Quilliam and Quilliam, *Med. Pr.* 1947, 22 October.

⁴ Schrader, *B.I.O.S. Final Rep.*

problems that were similar in some respects. Among the many compounds recommended by Schrader as insecticides, the following will be mentioned later:¹ parathion (or *OO'*-diethyl *O'*-*p*-nitrophenyl phosphorothionate), paroxan (or diethyl *p*-nitrophenyl phosphate) and T.E.P.P. (or tetraethyl pyrophosphate).

Toxic compounds that can be absorbed to a marked degree by a living plant either through its roots or its leaves have been called *systemic insecticides* by British investigators.

The following systemic insecticide (XX) has been used in England to control aphids on hops:

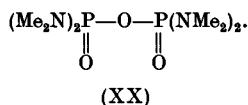

This compound has been prepared by Schrader² and by Pest Control, Ltd.³ Its translocation in the plant has been studied⁴ using the compound containing radioactive phosphorus.⁵ Compound (XX) is further discussed on p. 172.

It is interesting to note that the toxic sodium fluoroacetate (above, p. 11) occurs in the poisonous South African plant 'gifblaar' (*Dichapetalum cymosum*, Pl. I). It has recently been shown that sodium fluoroacetate is a highly effective systemic insecticide, but it is difficult to say exactly how this substance will be applied on a large scale.⁶ There are many other insecticides containing fluorine and phosphorus, and special precautions must be taken when handling these toxic compounds.

Finally, it may be noted that the fluorocarbons (C_xF_y), which have great stability, are in general non-toxic.

In this monograph it is possible to make only passing reference to the fundamental work on the process of phosphorylation by Sir A. R. Todd and his colleagues⁷ (p. 106) and of the

¹ See pp. 177-8, 181-2.

² Schrader, *B.I.O.S. Final Rep.*

³ Pest Control, Ltd., Pound and Saunders, B.P. 631,549.

⁴ W. A. L. David, *Nature, Lond.*, 1950, 166, 72.

⁵ Gardiner and Kilby, *J. Chem. Soc.* 1950, p. 1769.

⁶ W. A. L. David, *Nature, Lond.*, 1950, 165, 493.

⁷ Atherton, Openshaw and Todd, *J. Chem. Soc.* 1945, p. 382.

INTRODUCTION AND GENERAL SURVEY

phosphorus-containing compounds of biological importance which are consequently now being synthesized.¹

From this brief review it will be realized that a new organic chemistry of phosphorus and fluorine arose during the war. Interest in these compounds now spreads far beyond the domain of chemistry, and the applications in agriculture and medicine have been particularly gratifying to those of us who worked on these substances initially as chemical warfare agents. Fortunately, they have not been used for the purpose for which they were originally designed.

¹ Kenner, *Fortschr. Chem. org. Naturst.* 1952, 8, 97.

Chapter II

NOMENCLATURE OF ESTERS CONTAINING PHOSPHORUS

In view of the rapid growth of the organic chemistry of phosphorus since 1939, considerable attention has been paid to nomenclature. It has not always been easy to achieve agreement among workers in different parts of the world as to the most logical, convenient and simple system. It may not be out of place therefore to trace the inner history of some of the changes and developments that have taken place. However, the reader who is interested only in the details of the nomenclature as now accepted should turn at once to p. 25.

Early Nomenclature

Before 1940, compound (I) would have been called diethyl chlorophosphate without any good reason. One of the fundamental rules

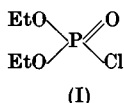

to be followed in deriving a formula is that substitution should take place at a hydrogen atom, e.g. $\text{C}_6\text{H}_5\text{Cl}$ is chlorobenzene, not chlorophenol:

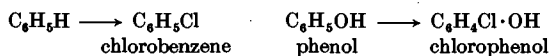

The 'chlorophosphate' is derived from the phosphate (II) by the replacement of OH, not H, by chlorine, hence the designation chloro-

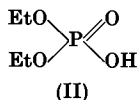

phosphate is illogical. Note that when we replace the OH by chlorine in acetic acid we get not chloroacetic acid but acetyl chloride.

This difficulty was overcome by describing (I) as diethyl chlorophosphate, and the use of this term was later endorsed by the

NOMENCLATURE OF ESTERS CONTAINING PHOSPHORUS

Nomenclature Committee¹ of the Publication Committee of the Chemical Society.

Analogy with sulphur chemistry is useful here. If one OH group in sulphuric acid is replaced by a H atom, the hypothetical sulphonic acid (IV) is obtained.

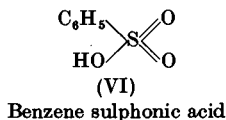
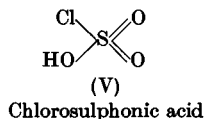
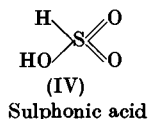
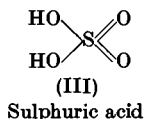

From (IV), chlorosulphonic acid (V) and benzene sulphonic acid (VI) are obtained by the replacement of H by Cl and C₆H₅ respectively.²

Arguing along similar lines, (VIII) is phosphonic acid and (IX) is fluorophosphonic acid, hence (I) is diethyl chlorophosphonate. The

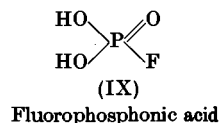
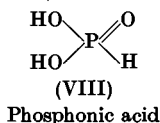
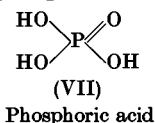

recommended names of certain esters of phosphorus were therefore as follows:

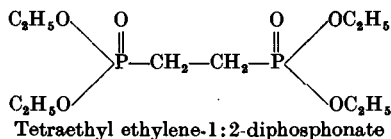
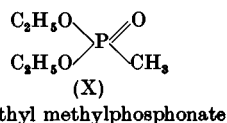
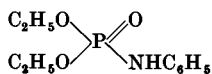
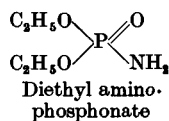
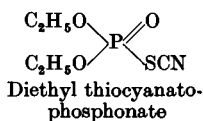
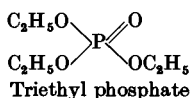

¹ In 1946: (the late) C. S. Gibson, G. M. Bennett, H. Burton, C. K. Ingold, B. C. Saunders and J. E. Driver. Sir A. R. Todd and (the late) Clarence Smith had also previously used the phosphonate nomenclature.

² Compound (VI) is usually described as benzene sulphonic acid, but it is probably more correctly described as phenylsulphonic acid. Accordingly (X) is described as diethyl methylphosphonate.

NOMENCLATURE

If (VIII) is phosphonic acid, then (XI) would be phosphinic acid and (XII) and (XIII) would be phosphonous acid and phosphinous acid respectively. (See Note 1 below.)

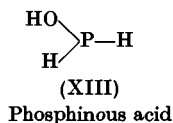
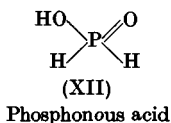
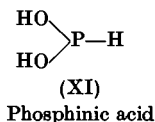
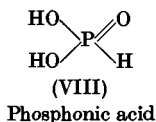

Thus we had the following :

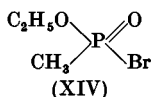
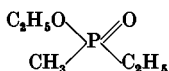
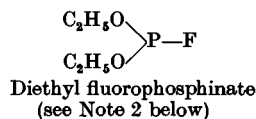
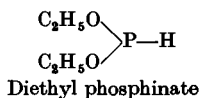
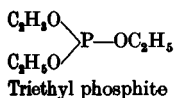

Ethyl methylethylphosphonite
(see Note 2 below)

Ethyl methylbromophosphonite¹

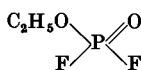
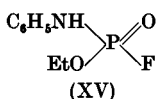

Ethyl anilino fluorophosphonite

Ethyl difluorophosphonite

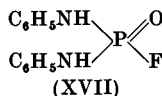
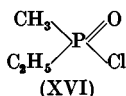

Methylethylchlorophosphine oxide
(see Note 3 below)

Dianilino fluorophosphine oxide
(see Note 4 below)

Notes

(1) In support of the above formulae for phosphonous acid (XII) and phosphinic acid (XI) Professor Ingold² kindly supplied the following note:

'The relationship between the names proposed for phosphorus acids and established names of sulphur acids may be explained as follows:

'If we remove a protonic charge from the sulphur atom of

¹ In (XIV) 'methyl' is placed before 'bromo' to avoid confusion with the BrCH_2 group.

² Private communication, 1946.

NOMENCLATURE OF ESTERS CONTAINING PHOSPHORUS

sulphuric acid and associate the removed proton with one of the oxygen atoms, we obtain the isoelectronic phosphoric acid

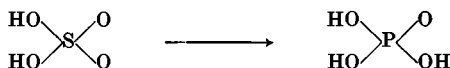

'The same process applied to sulphurous acid forms phosphorous acid



'We should therefore wish an application of the same process to sulphonic and sulphinic acids to give phosphonic and phosphinic acids respectively:

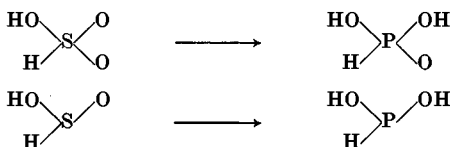

'The proposed nomenclature furnishes this regularity.

'Sulphuric and sulphurous acids are dibasic. Sulphonic and sulphinic acids are monobasic. With them we are at the end of the series of *acids* generated by replacing OH by H. In the phosphorus series the basicity is always one unit higher, so that having passed from phosphoric and phosphorous acids, which are tribasic, to phosphonic and phosphinic acids, which are dibasic, we can proceed a further step to two monobasic acids, for which the recommended names are very naturally phosphonous and phosphinous acids:

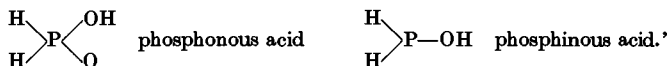

(2) The proposed nomenclature leads to the following stems which appear to be satisfactory:

(a) *Phospon-* (for P^v compounds).

(b) *Phosphin-* (for Pⁱⁱⁱ compounds).

Thus all the quinivalent esters are *phosponic* or *phosponous* according to the basicity (2 or 1 respectively). All the trivalent esters are *phosphinic* or *phosphinous* according to the basicity (2 or 1 respectively).

Generically *phosphin-* fits in with the parent *phosphine*, and *phospon-* with *phosphine oxide* or *phosphone* (cf. sulphone).

(3) Compound (XVI) was best considered as a straight derivative of phosphine and not derived from the acid. Compare diphenyl chloroarsine.

NOMENCLATURE

(4) The most unambiguous description of amino compounds of the type (XVII) was in terms of the parent phosphine oxide.

It will be seen that the above system of nomenclature has the virtue of simplicity and is easy to memorize. All that one has to keep in mind is *phosphon-* for quinquivalent phosphorus compounds and *phosphin-* for trivalent phosphorus compounds. In fact, the above system was successfully used in Britain until 1950 and may be summarized thus:



An objection sometimes raised against the above system was that *phosphonous acid* contains quinquivalent phosphorus, whereas *phosphinic acid* contains trivalent phosphorus, and it was argued that this contravened the usual -IC for the higher valency state and -OUS for the lower valency state (cf. *ferric* Fe^{3+} and *ferrous* Fe^{2+}). For this reason the formulae for phosphonous acid and phosphinic acid were interchanged and with these amendments the system continued to be used for a further period in this country.

Accepted Nomenclature

In spite of its simplicity, the British system was not found to be universally acceptable. Workers in the field everywhere agreed to the acceptance of phosphonic, phosphinic, phosphonous and phosphinous acids and to derivatives of these provided a P—C link was present, e.g.

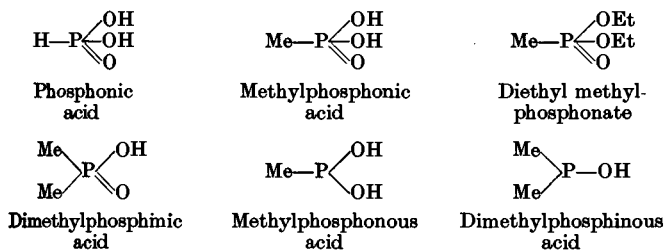

If, however, the H of the P—H bond is replaced by a group which would not result in a P—C link, then it was considered that the terms *phosphonic*, etc., were not desirable. In other words, compound (I) containing the P—Cl link should not be called *diethyl chlorophosphonate*. For the reasons already given

NOMENCLATURE OF ESTERS CONTAINING PHOSPHORUS

the designation diethyl chlorophosphate is also most undesirable as it contravenes the recognized rules of substitution in organic compounds.

Accordingly, at a joint meeting¹ of representatives of the British sub-committee on organo-phosphorus nomenclature and of the American Chemical Societies' advisory sub-committee on organo-phosphorus nomenclature it was considered desirable to introduce an entirely new terminology for the P—Cl, P—NH₂, etc., type of ester so as to overcome strong differences of opinion.

Under the *agreed system*, (XVIII) now becomes phosphorochloridic acid and (XIX) is phosphoramidic acid. The contro-

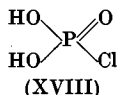

Phosphorochloridic acid

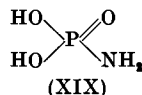

Phosphoramidic acid

versy on the replacement of H or OH is thus completely bypassed. Other examples based on the agreed system are:

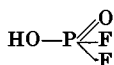

Phosphorodifluoridic acid

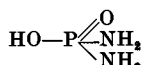

Phosphorodiamidic acid

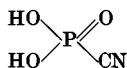

Phosphorocyanidic acid

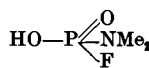

N-Dimethylphosphoramidofluoridic acid

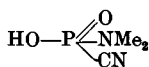

N-Dimethylphosphoramidocyanidic acid

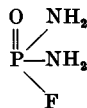

Phosphorodiamidic fluoride

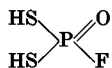

Phosphorofluorodithiolic acid

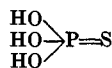

Phosphorothionic acid

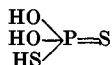

Phosphorothiolothionic acid

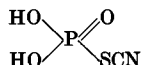

Phosphorothiocyanatic acid

¹ New York, 1951; among those present were (Sir) A. R. Todd, F. G. Mann and R. S. Cahn. Decisions were ratified in 1952.

ACCEPTED NOMENCLATURE

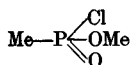
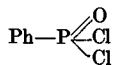
Methyl *P*-methylphosphonochloridate

Phenylphosphonic dichloride

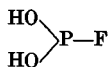

Phosphorofluoridous acid

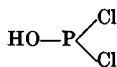

Phosphorodichloridous acid

Notes on the agreed system for compounds containing only one phosphorus atom

(1) Indexing of such compounds is under *phosph-*.

(2) The convention usually adopted in writing a formula is that when H or *R* (hydrocarbon, heterocyclic, etc., radical) are present, these are written to the left and other substituents to the right of the P atom. When neither H nor *R* is present OH or OR is written to the left and other substituents to the right of the P atom.

In conclusion, it may be said that the *agreed* system seems to be entirely logical, although it often results in a certain degree of cacophony. It may be noted that two workers¹ independently at a very early stage found it convenient to describe all these compounds as derivatives of either phosphine oxide or phosphine; for example

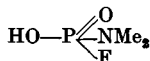

would be described as hydroxydimethylaminofluorophosphine oxide. Such a system is extremely simple, but it was soon realized that the chemical character of the compound was not always adequately revealed by such a name.

¹ F. G. Mann, 1943; B. C. Saunders, Ministry of Supply Reports, 1943.

Chapter III

NOTES ON THE MAMMALIAN NERVOUS SYSTEM

The Transmission of Nervous Effects

On the surface of a resting living excitable cell such as muscle or nerve fibre there is a potential of the order of 100 mV., i.e. the outside is electropositive compared with the inside. Thus the surface of the intact unstimulated nerve is everywhere equipotential (fig. 1a). It may be worth while for a moment to try

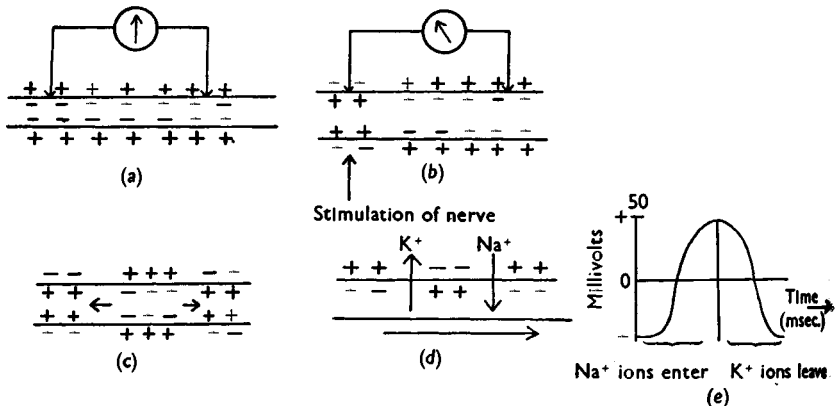

Fig. 1. Nerve fibre. (a) Before stimulation. (b) Initial electrical disturbance at point of stimulation. (c) The passage of electrical disturbance is shown in both directions. In the body, however, the fibres are stimulated at only one end and hence conduction is in only one direction.

to get a picture (instructive, even if not accurate) of the cause of this double layer. If a potassium proteinate at pH 7.4 is placed in a collodion sac and the latter immersed in water, the potassium ions will tend to pass through the membrane, but because the larger proteinate molecules cannot do so, the potassium ions will be held back by the attraction of the anions. The two types of ion will therefore tend to arrange themselves at the surface of the membrane with the negative proteinate ions

inside and the positive potassium ions towards the outside, thus forming a double layer and a potential difference between the outside and inside. Any disturbance of this condition, for example, an increase in the permeability of the membrane which might diminish the segregation of positive and negative ions, will cause a depolarization to take place.

When a wave of excitation starts at a specified point on the fibre this potential difference is abolished and reversed and the surface becomes electronegative with regard to the unexcited portions of the fibre (fig. 1 *b*). ('Depolarization' coincides with a change in the surface of the membrane of the cell which first allows Na^+ ions from the tissue fluids to pass into the cell and K^+ ions to pass outwards. In the undisturbed state, the cell membrane is relatively impermeable to the Na^+ ions which are kept outside and the concentration of K^+ ions inside the cell is greater than in the external fluids.) This induced negativity at the excited spot causes local electrical circuits to arise and so new points of excitation are caused (Fig. 1 *c*). The passage of electrical disturbance is shown in both directions. In the body, however, the fibres are stimulated at only one end, and hence induction is in one direction.

Fig. 1 *d* represents the ionic changes and reversal of polarity of the membrane when the nerve is stimulated. Na^+ ions enter the membrane ahead of the electrical charge and K^+ ions pass out at the peak of the potential reversal.¹ Fig. 1 *e* shows how the ionic interchange is related to the 'action potential' (or magnitude of polarity change). It must be stressed that the actual percentage changes of concentration are very small indeed. The exact nature of the restoration of the original concentration of ions is not completely known. Obviously a source of energy is required, and this is considered to be derived from the metabolism of the cell.

This wave of excitation travels at about 120 m./sec. in the nerve of man at 37°. It should be noted that this value is much less than that of an electric current through a moist conductor. The temperature coefficient of the velocity of conduction in nerve is about 1.8 for a rise of 10°, and is of the same order as

¹ Hodgkin, *Biol. Rev.* 1951, 26, 379.

NOTES ON THE MAMMALIAN NERVOUS SYSTEM

that of the velocity of chemical change, and is far greater than that of electrical conductions. At 0° conduction is usually completely abolished. Complete nerve block can also result by subjecting the nerve to the action of air containing anaesthetic vapours. On removal of the vapour the conductivity is restored.

We must now consider what happens when a nerve impulse reaches the end of a nerve fibre. The single nerve cell, together

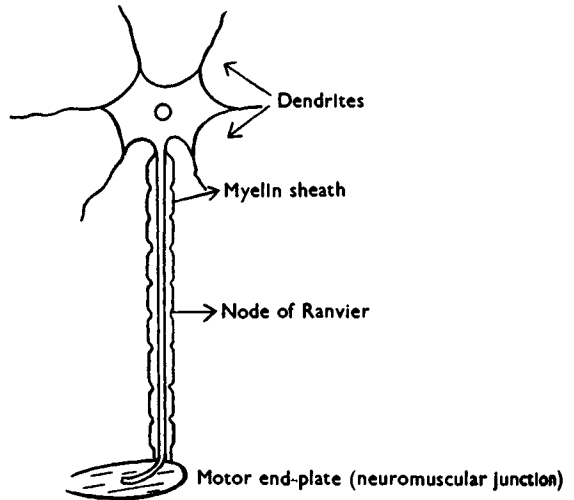

Fig. 2. Diagram of a nerve cell.

with its long process, is known as the neurone, and the long process or fibre is the axon. A typical nerve cell is shown in fig. 2. By means of its dendrites (short branched processes) the nerve cell makes contact with the axons of other nerve cells. There is, however, no protoplasmic continuity across the point of contact or 'synapse', the excitatory process being transmitted by chemical means. Nerve fibres may also end on (1) striated, i.e. skeletal or voluntary muscle, (2) cardiac muscle, (3) smooth muscle, which enters into the structure of a viscus such as the digestive canal, (4) a gland (see figs. 2 and 3).

It should be noted that at a neuromuscular junction or at a ganglionic synapse there is a delay in the transmission of the excitatory process of about 2 msec. As stated above, the im-

pulse in the nerve itself can be propagated in both directions (Fig. 1c); at a synaptic junction, however, transmission is unidirectional.

The autonomic nervous system

The autonomic nervous system is by definition that part of the nervous system that innervates smooth muscle, cardiac muscle and glands. It is thus a motor system. Perception arising from the viscera involves pathways similar to those arising from the body surface and skeletal muscle. Thus there are visceral afferent fibres that pass from the viscera to the central nervous system. Such impulses then ascend the spinal cord to the thalamus and are thence relayed to the post-central gyrus of the brain (or sensory cortex). Visceral reflex arcs use visceral afferent fibres to convey impulses to the cord, but the efferent limb of such a visceral reflex is the autonomic nervous system. Although visceral reflexes are under higher central control, it is usually impossible to bring them under the control of the will.

The chief anatomical difference between the autonomic nervous system and the somatic motor system is that fibres of the former that originate in the spinal cord do not directly innervate a smooth muscle or gland. Actually the fibre makes a synapse with a second neurone which innervates the muscle or gland. (A somatic fibre connects the spinal cord directly with an effector organ.) Thus in the autonomic nervous system the *preganglionic* fibre terminates in a ganglion of cell bodies from which the *postganglionic* fibres take origin. It is the latter fibres that innervate smooth muscles and glands. The autonomic nervous system consists of two parts, the *sympathetic* and the *parasympathetic* divisions which differ anatomically and physiologically (see fig. 3).

The sympathetic nervous system. This is represented by an orderly arrangement of preganglionic fibres arising from the lateral horns of the thoracolumbar segments of the cord. These fibres may end in the sympathetic ganglion at the same segmental level, or pass through the ganglion upwards or downwards to terminate in another ganglion, or they might pass right through the ganglion to terminate in a more distal ganglion. It

NOTES ON THE MAMMALIAN NERVOUS SYSTEM

is in one of these ganglia that the preganglionic fibre makes a synapse with the postganglionic fibre. In every case the synapse is at a distance from the effector organ (figs. 3 and 4).

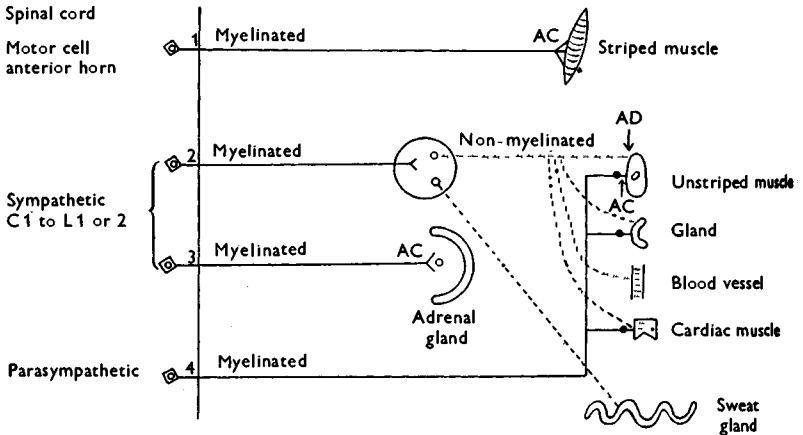

[Only sympathetic but AC]

Fig. 3. Diagram of the working of the autonomic nervous system. AC, liberation of acetylcholine; AD, liberation of adrenaline or noradrenaline.

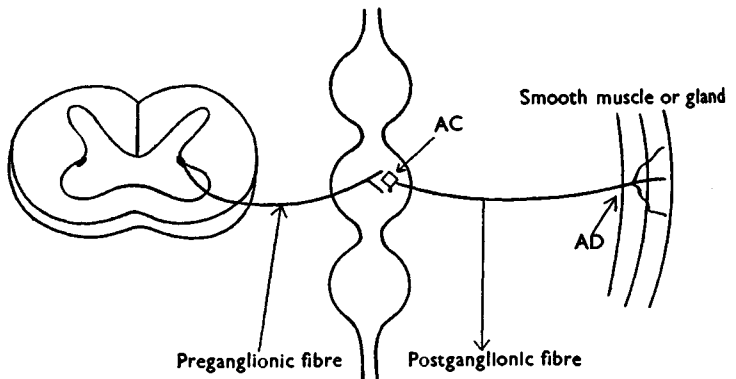

Fig. 4. Diagram of an element of the sympathetic nervous system. AC, liberation of acetylcholine; AD, liberation of adrenaline or noradrenaline.

It should be noted, as an apparent exception, that preganglionic fibres pass through the sympathetic chain, and without synapse, innervate the adrenal medulla. The cells of the latter may, however, be considered as modified postganglionic tissue.

The parasympathetic nervous system. Here the postganglionic fibres are always short. The preganglionic fibres are long and pass almost up to the muscle or gland to be innervated. The preganglionic fibres arise from the brain stem (cranial nerves VII, IX and X), from the tectal region (cranial nerve III which supplies the eye, p. 38), and from the sacral region.

The physiology of the autonomic nervous system. Most viscera are innervated by both divisions of the autonomic nervous system. In a sense they are antagonistic and as such are concerned with important homeostatic mechanisms.

Some of the actions of the two systems are as follows. It is interesting to compare this list with the known physiological actions of D.F.P. as detailed on p. 71. Fig. 5 will also make the relationship clearer to the non-biologist.

Pupil: sympathetic dilates, parasympathetic constricts.

Lacrimal and salivary glands: parasympathetic produces secretion, sympathetic stops it.

Heart: sympathetic accelerates, parasympathetic slows.

Bronchioles: sympathetic dilates, parasympathetic constricts.

Alimentary canal: sympathetic dilates, parasympathetic constricts, especially the rectum (see effect of D.F.P. in treatment of post-operative paralytic ileus, p. 196). Furthermore, parasympathetic stimulates glandular secretion.

Urinary bladder: sympathetic dilates, parasympathetic contracts.

Penis: erection by parasympathetic. This action gave rise to the name 'nervi erigentes' for the pelvic nerves.

Only the sympathetic system supplies the ureters, uterus, uterine tubes, vasa deferentia, blood vessels (which are constricted), sweat glands (actually cholinergic, however, fig. 3) and the arrectores pilorum which are contracted.

Thus we see that most viscera (but not all) are innervated by both sympathetic and parasympathetic fibres. Stimulation of one division normally produces a response opposite to that produced by the other division. The hypothalamus is the centre of integration.

Most of the postganglionic sympathetic fibres when stimu-

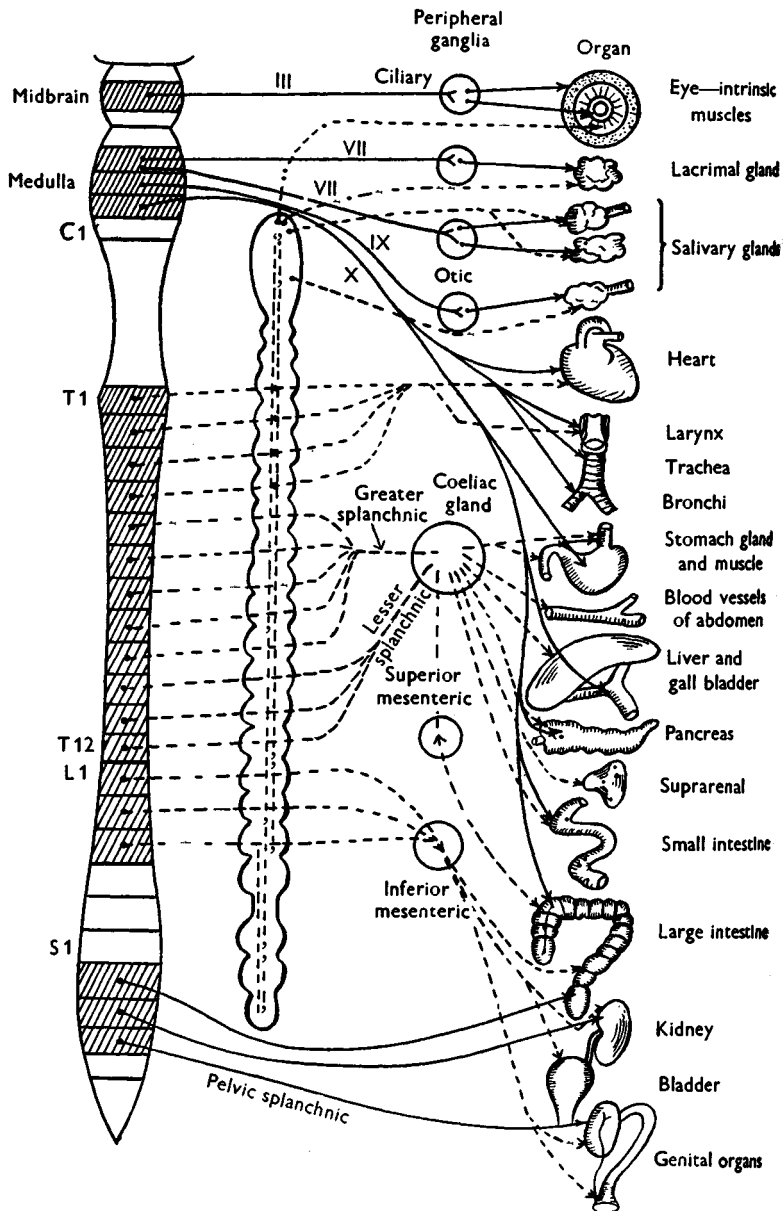

Fig. 5. Plan of the autonomic nervous system (after Gray).

between a motor nerve and skeletal muscle and at the junction between preganglionic and postganglionic fibres. Muscarine resembles the action of acetylcholine at the termination of a postganglionic parasympathetic junction.

Diagrammatic representation of acetylcholine action. Let us now turn our attention for a moment and try to picture in general terms what happens, for instance, at the junction of the nerve ending of a motor fibre and a striated muscle. On stimulating the nerve, acetylcholine is liberated as represented diagrammatically in fig. 6. The acetylcholine then alights on the 'receptor patches' within the tissue of the striated muscle (fig. 6) thus causing the contraction. The 'receptor patches' may be assumed to be such as to accommodate¹ snugly the acetylcholine molecules; see representation on fig. 7. Cholinesterase converts acetylcholine into choline (incorrect shape for 'receptor patches' and therefore almost ineffective) and acetic acid. This is done by first forming a complex between the enzyme and acetylcholine, and this complex itself could also be of such a shape as not to fit into the 'receptor patches'. It can be concluded that curare (tubocurarine) which paralyzes the motor endplate fits into the 'receptor patches' and thereby excludes the entry of acetylcholine (figs. 6 and 7). It may be noted that curare (see fig. 6) has itself no action on the muscle.

Similar considerations would apply at the synapse between the preganglionic fibre and the nerve cell of the postganglionic fibre of the sympathetic and parasympathetic systems and curare is the blocking agent (fig. 7 A).

With regard to the junction of the postganglionic fibre of the parasympathetic system and the effector organ such as smooth muscle, heart or gland, a blocking agent is atropine (fig. 7C). The latter compound may be considered as sitting in the receptor patches and thus excluding acetylcholine. It thus antagonizes the muscarine-like effect of acetylcholine, and produces mydriasis (dilatation of the pupil of the eye); but it must be borne in mind that atropine has its own pharmacological actions, e.g. on the central nervous system, etc.

¹ An attempt to provide a more precise representation of these changes is given on p. 188.

ACETYLCHOLINE ACTION

Although organo-phosphorus compounds are not directly concerned with the peripheral endings of sympathetic fibres we may complete the picture by noting that here adrenaline or noradrenaline are liberated and that their 'receptor patches' are blocked by prisol and dibenamine (for formulae, see p. 41).

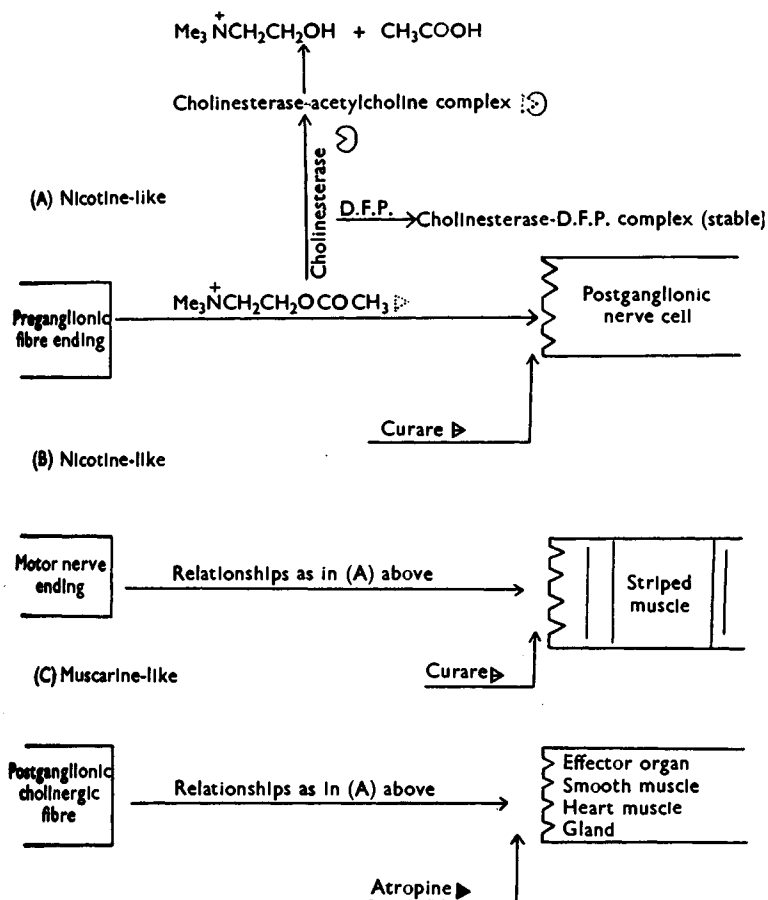

Fig. 7

The Eye

The first effect that we ever observed with very small concentrations of the vapour of D.F.P. was the constriction of the pupil of the eye (see p. 2). As all the intrinsic muscles of the eye

NOTES ON THE MAMMALIAN NERVOUS SYSTEM

are controlled by the autonomic nervous system, this organ is convenient for the study of the action of drugs that affect the autonomic system.

The pupil is supplied with constrictor fibres from the parasympathetic system (via the IIIrd or oculomotor nerve and the ciliary ganglion) and with dilator fibres from the sympathetic system (the upper thoracic nerves to the sympathetic and to the inferior and superior cervical ganglia; fig. 8).

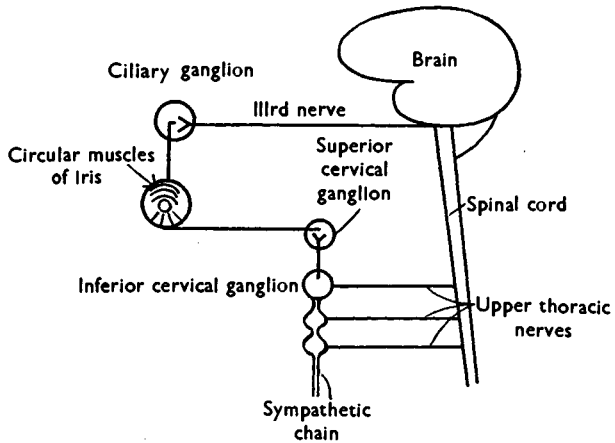

Fig. 8

It may be noted that the oculomotor centre in the brain is also controlled by impulses passing from the higher centres. If these are inhibited, constriction of the pupil occurs, e.g. during sleep and surgical anaesthesia. The higher centres can be directly stimulated by morphine, thus causing pin-point pupil.

Fear and excitement causes dilatation of the pupil as does adrenaline. Ergotoxine paralyses the sympathetic and causes constriction.

Accommodation (fig. 9). The lens of the eye is suspended by the zonula (suspensory ligament) consisting of delicate transparent fibres attached on the one hand to the ciliary body and on the other to the elastic capsule covering the lens. At rest, this zonula is under tension and in consequence the lens assumes a flattened form. When the ciliary muscle contracts it pulls the

ciliary body towards the lens and relaxes the zonula and the lens assumes a more convex form.

The muscle fibres of the ciliary bodies are innervated by the IIIrd or oculomotor nerve. As explained above, when these fibres contract they allow the lens to take up its natural shape. Direct stimulation of the IIIrd nerve therefore produces accommodation for near objects. Parasympathomimetic drugs have a similar action, whereas atropine paralyses this effect and so accommodates the lens for seeing distant objects.

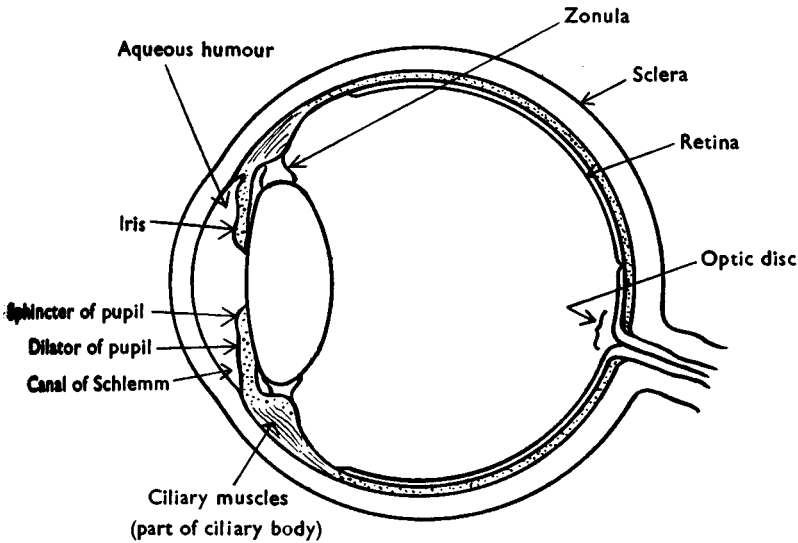

Fig. 9

Intraocular pressure. The fixed distances of the refractive surfaces from the retina are maintained because the inelastic sclera is under a constant intraocular pressure of 20-25 mm. Hg. This pressure is maintained by a balance between the production and escape of the intraocular fluid. The mechanism appears to be as follows. All the constituents of the serum are found in the aqueous humour, although proteins are present only in traces. The total osmotic pressure is above that of blood. The material of the aqueous humour is indeed derived from the blood chiefly in the ciliary body, partly by secretion and partly by diffusion.

The fluid escapes into the canal of Schlemm at a rate of about 6 ml./day.¹

A marked increase in intraocular pressure is known as *glaucoma* and results in hardness of the eye, atrophy of the retina, cupping of the optic disk and ultimate blindness. Atropine will cause a rise of intraocular pressure and D.F.P. will reduce intraocular pressure (see p. 195).

Autonomic Inhibitor Drugs

We will conclude this chapter by referring to a term often used for those symptomatic drugs inhibiting the action of the autonomic nervous system by interfering with the effect of the chemical mediators involved. There are two groups. (1) *Parasympatholytic* drugs block the action of acetylcholine. These are included within the wider class of *spasmolytics* which, as the name suggests, check or eliminate spasms. (2) *Sympatholytics* inhibit the action of adrenaline, noradrenaline and the sympathetic nervous system.

Spasmolytics. These include atropine (III), which as already explained dilates the pupil of the eye and finds use as a mydriatic in ophthalmology and for the relief of visceral spasm (see also p. 36 and fig. 7). In addition, it has a direct action on the blood vessels causing vasodilatation. It reduces secretions of the salivary, bronchial and sweat glands. Atropine has a peculiar action on the lower motor centres and diminishes the tremor and muscular rigidity of the disease known as Parkinsonism.

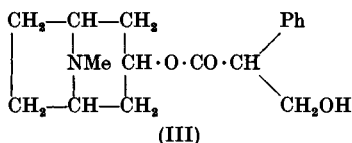

Early synthetic spasmolytics resembled atropine closely, e.g. homatropine (the ester of mandelic acid and tropine (IV)). It may be noted that acetylcholine itself is an ester of a quaternary aminoalcohol and a short-chain organic acid. If the length of the chain is increased, acetylcholine activity decreases and com-

¹ Kinsey and Grant, *Brit. J. Ophthal.* 1944. 28, 355.

AUTONOMIC INHIBITOR DRUGS

pounds which act like atropine are produced, being acetylcholine antagonists. The benzilic ester of choline (V) and lachesine (VI) are about as active as atropine with respect to their peripheral action.

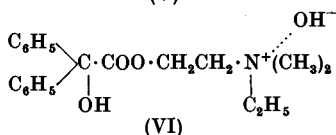
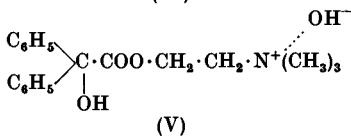
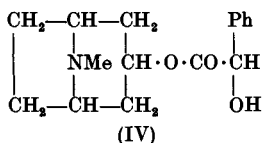

Artane (VII) is a spasmolytic¹ of a rather different type of structure:

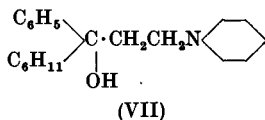

Sympatholytics. Sympatholytic activity was first detected in the ergot alkaloids. Synthetic substitutes of various kinds have been made with a view to alleviating conditions dependent upon hypertension.

Tests are made by examining the inhibition caused by the substance on the sympathomimetic effects of injected adrenaline and of sympathetic nerve stimulation. Among the recently recommended anti-adrenaline drugs are iminazole derivatives (e.g. prisol (VIII))² and β -haloalkylamines (e.g. dibenamine (IX)). The action of dibenamine is almost certainly that of destroying the receptor patches in the effector organ (p. 37).

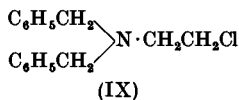
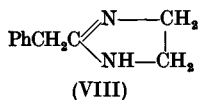

¹ Cunningham *et al.* *J. Pharmacol.* 1949, 96, 151.

² Oxley and Short, *J. Chem. Soc.* 1947, p. 497.

Chapter IV

THE PHOSPHOROFUORIDATES

In Chapter I a brief description was given of D.F.P. and some related compounds, and in this chapter a more detailed account is given of the work initiated and carried out on the toxic phosphorofluoridates during World War II at Cambridge by an extramural Ministry of Supply research team working with the author.

For security reasons, during the war the work was not published at the time, though secret reports (which were also made available to American workers almost from the inception of the investigations) were regularly submitted to the Ministry of Supply.

Until this work began in Cambridge at the beginning of the war, the alkyl phosphorofluoridates had received practically no attention. Lange¹ had given a tedious and laborious method for preparing dimethyl and diethyl phosphorofluoridates in very poor yield as follows.

Phosphorus pentoxide was fused with ammonium fluoride, a mixture of di-ammonium phosphorofluoridate and ammonium phosphorodifluoridate being produced. The monofluoridate was converted into the silver salt which was then heated with the alkyl iodide, the overall yield being less than 4 per cent. Only a passing reference was made to an effect on the vision, but no record was made of the remarkable general toxic effects of these two compounds. No other phosphorofluoridates were recorded. During the early part of the war we prepared, by methods described below (p. 44; see also p. 50), a large number of new alkyl phosphorofluoridates, R_2PO_3F ($R = n\text{-Pr}$, $iso\text{-Pr}$ and $n\text{-Bu}$, etc.), and in 1941 the author made a preliminary report² to the following effect:

(a) These substances had high toxicity as lethal inhalants.³

¹ Lange, *Ber. dtsh. chem. Ges.* 1932, **65**, 1598.

² B. C. Saunders, Ministry of Supply Meeting, London, 11 December 1941.

³ McCombie and Saunders, *Nature, Lond.*, 1946, **157**, 287.

PHOSPHOROFLUORIDATES

Death took place rapidly (for example, a concentration of 1:10,000 of the di-*isopropyl* ester killed 6/6 rats, 10/10 mice and 2/3 rabbits within 25 min. from the beginning of exposure of 10 min.). Such rapid effect and quick knock-out action was shown by few other gases or vapours.

(b) At lower and non-fatal concentrations, a peculiar effect was produced on the eyes, quite distinct from lacrimation. The material caused the pupils to become acutely constricted, and the effect might last for several days. In addition there was interference with visual accommodation. There was no tear formation and little or no irritation produced in the eyes. Reading was rendered difficult and vision at night was seriously affected.

These initial observations encouraged us to search for new and simple methods of preparation. It is convenient therefore to defer a more detailed discussion of the physiological action of these compounds until we have indicated the methods of preparation.

Synthetic Methods

It was quite obvious that the fusion of phosphoric anhydride and ammonium bifluoride would not form the basis of a practicable method. We accordingly paid attention to entirely different methods of preparation. Brief reference has already been made to two new general methods (pp. 5, 7). The first and more important of these new methods depended upon the conversion of a dialkyl phosphorochloridate into the corresponding dialkyl phosphorofluoridate by means of an inorganic fluoride. Consideration therefore had to be given to the most convenient method for preparation of the intermediate phosphorochloridate.¹ In the first instance three methods for the preparation of chloro compounds (I) were considered:

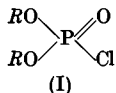

(i) Phosphorus oxychloride on treatment with 3 mol. of an alcohol and 3 mol. of pyridine gives the trialkyl phosphate; this

¹ McCombie, Saunders and Stacey, *J. Chem. Soc.* 1945, p. 380.

THE PHOSPHOROFLUORIDATES

on further treatment with phosphorus oxychloride gives a mixture¹ of dialkyl phosphorochloridate (I) and alkyl phosphorodichloridate (II):

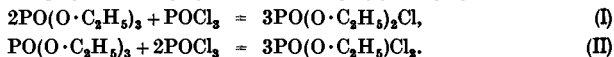
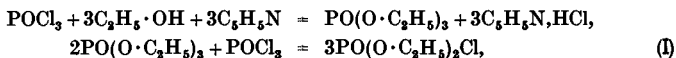

The disadvantage of this method, especially for large-scale work, lies in the utilization of large quantities of pyridine. Furthermore, with ethyl alcohol some ethyl phosphorodichloridate (II) is usually produced even under conditions favourable to the production of diethyl phosphorochloridate.

(ii) The action of ethyl alcohol on phosphorus oxychloride gives a mixture of diethyl phosphorochloridate, ethyl phosphorodichloridate, ethyl metaphosphate and other products. The diethyl phosphorochloridate is obtained impure and in poor yield.² Under favourable conditions the method is essentially one for preparing the alkyl phosphorodichloridate.

(iii) Phosphorus trichloride on treatment with 3 mol. of an alcohol and 3 mol. of pyridine gives the trialkyl phosphite.³ We found that the latter on chlorination readily gave the dialkyl phosphorochloridate:

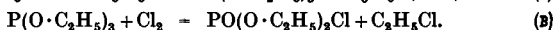
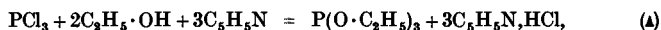

Here again the disadvantage was the pyridine requirement in equation (A). The more readily accessible dimethylaniline can be used in place of pyridine in reaction (A), thus effecting a considerable economy for large-scale work.⁴ We found also that the production of a faint yellow coloration, due to a slight excess of chlorine, is probably a better indication of the end-point of the reaction (B) than is the determination of the increase in weight of the reactants.

A still more economical method for large-scale work was then sought, since a further drawback of methods (i) and (iii) is that

¹ Cf. Gerrard, *J. Chem. Soc.* 1940, p. 1464, who had worked, however, only with *n*-butyl alcohol.

² Walczynska, *Roczn. Chem.* 1926, 6, 110.

³ Milobedski and Sachnowski, *Chem. Zbl.* 1918, 1, 911.

⁴ McCombie, Saunders and Stacey, *J. Chem. Soc.* 1945, p. 380.

the complete removal of the tertiary base is sometimes difficult, particularly the elimination of traces of pyridine from triethyl phosphite. We therefore carried out the reaction between phosphorus trichloride and ethyl alcohol in the absence of a tertiary base¹ and obtained a 90 per cent yield of pure diethyl hydrogen phosphite (III):

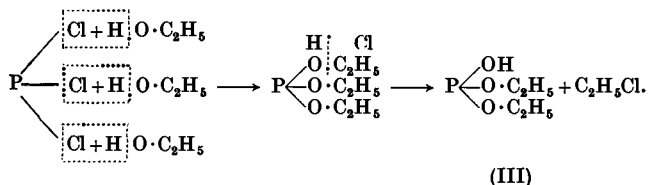

Milobedski² had previously made this compound, but he had 2 mol. of pyridine present during the addition of the alcohol. The compound was probably first made by Thorpe and North³ by the action of phosphoric anhydride on ethyl alcohol. Sachs and Levitsky⁴ and other workers had mentioned the action of phosphorus trichloride on alcohol, but details were generally incomplete and yields low. Nylen,⁵ however, obtained fair yields, but his method necessitated the use of an atmosphere of carbon dioxide.

We found that diethyl hydrogen phosphite (almost certainly as the tautomeric diethyl phosphonate (IV)), reacted very readily with chlorine to give the required diethyl phosphorochloridate (V) in 87 per cent yield:

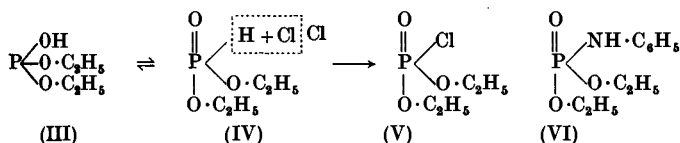

The diethyl phosphorochloridate was characterized by the crystalline *diethyl phenylphosphoramidate* (VI) formed by the action of aniline.

¹ McCombie, Saunders and Stacey, *J. Chem. Soc.* 1945, p. 380.

² *Chem. Polski*, 1917, 15, 34, 48.

³ *J. Chem. Soc.* 1890, 57, 634.

⁴ *J. Soc. phys.-chim. russe*, 1903, 35, 211.

⁵ *Ber. deutsch. chem. Ges.* 1924, 57, 1029.

Preparation of Di-*isopropyl* Phosphorofluoridate (D.F.P.)

A similar reaction was carried out in the *isopropyl* series. On account of the demand for very large quantities of di-*isopropyl* phosphorochloridate, the preparation of this compound and the intermediate di-*isopropyl* hydrogen phosphite were examined in great detail. In the preparation of the hydrogen phosphite the temperature of the reaction could be controlled by the presence of a solvent (ether or carbon tetrachloride). The hydrogen chloride produced in the reaction was removed from the ethereal solution as far as possible by drawing first air through the reaction mixture, and then ammonia; a considerable excess of the latter did not affect the yield. With carbon tetrachloride, however, the passage of ammonia could be omitted.

The three stages may therefore be summarized as follows.¹ Using carbon tetrachloride as solvent, *isopropyl* alcohol was converted into pure di-*isopropyl* hydrogen phosphite (stage I) in 89 per cent yield. Without a solvent the yield was 86.4 per cent. Chlorination of the hydrogen phosphite gave 76 per cent of pure di-*isopropyl* phosphorochloridate (stage II). (Yields of 80–90 per cent of slightly less pure phosphorochloridate could, however, be easily obtained.) By heating the phosphorochloridate, dissolved in a solvent such as dry benzene, with an inorganic fluoride such as dry sodium fluoride (stage III), pure di-*isopropyl* phosphorofluoridate was obtained in 90 per cent yield. Thus the phosphorofluoridate was obtainable in a pure condition by a three-stage process from phosphorus trichloride and *isopropyl* alcohol, and the overall yield was *ca.* 60–70 per cent. The compound so obtained was identical with that obtained by heating an authentic specimen of dry silver phosphorofluoridate with *isopropyl* iodide. In the ethyl series the yields of the products at stages I, II and III were 93, 87 and 91 per cent respectively.

The individual stages having been established, the whole process was then re-examined with a view to preparing di-*isopropyl* phosphorofluoridate on a technical scale. As a result of many

¹ Saunders and Stacey, *J. Chem. Soc.* 1948, p. 695.

experiments it was found that the process could be run virtually as a 'one-stage' process by adding phosphorus trichloride to *iso*-propyl alcohol dissolved in a solvent such as carbon tetrachloride without external cooling. The hydrogen phosphite was not isolated but the crude product (still in the solvent) was chlorinated, and the solution of crude phosphorochloridate thus obtained was heated with the inorganic fluoride, e.g. sodium fluoride. After filtration and removal of carbon tetrachloride, the residue was distilled giving pure di-*iso*propyl phosphorofluoridate. The overall yield was *ca.* 75 per cent. The method was patented.¹

An important feature of the above process was that it could be carried out in an all-glass apparatus as no fluorine or hydrogen fluoride was produced.

The process is very easy to work in competent hands; care, however, must be taken to prevent ingress of moisture and to ensure efficient stirring.

Some properties of D.F.P.

Di-*iso*propyl phosphorofluoridate is a practically odourless, mobile liquid, b.p. 183°/760 mm. (by extrapolation), f.p. *ca.* -82°. This wide range of temperature over which the compound is liquid adds to its usefulness. A specimen of the pure liquid has remained unchanged in a glass vessel for several years. Whereas the phosphorochloridate was readily hydrolysed by water, hydrolysis of the phosphorofluoridate was slow and took 72 hr. for completion at 15° and then only in the presence of a large excess of water (1 per cent solution; solubility 1.5 per cent):



Dimethyl and diethyl phosphorofluoridate were hydrolysed much more quickly, the order being Me > Et > Prⁱ; complete hydrolysis of the ethyl ester took about 4 hr. Small quantities of the di-*iso*propyl, but not the diethyl ester, could be steam-distilled. Di-*iso*propyl phosphorochloridate can be readily identified by allowing it to react with aniline to give the crystalline phenylphosphoramidate:

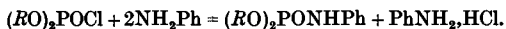

¹ Saunders *et al.* B.P. 601,210.

THE PHOSPHOROFUORIDATES

Di-*isopropyl* phosphorofluoridate does not, like the phosphorochloridate, give the anilinophosphonate on treatment with aniline.

*Hydrolysis of D.F.P. by alkali.*¹ When D.F.P. was heated under reflux with an excess of N/2 sodium hydroxide solution for 30 min., and then back-titrated with N/2 sulphuric acid (phenolphthalein as indicator), it was found that 1 mol. of the phosphorofluoridate required 2.0 mol. of sodium hydroxide.

Now 4 mol. are required to effect complete hydrolysis to sodium orthophosphate according to equation (c), but only 2 mol. are required either for the removal of fluorine alone and conversion into sodium di-*isopropyl* phosphate (D) or for conversion into disodium fluorophosphonate (E). To decide between these reactions, half of the above hydrolysis product was rendered acid to bromophenol blue

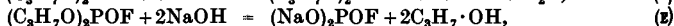
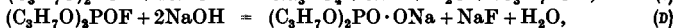
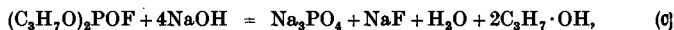

with dilute nitric acid, and the sodium fluoride determined as PbClF; it corresponded to 41.1 g. (0.98 mol.) per mol. of di-*isopropyl* phosphorofluoridate. The hydrolysis is therefore in accordance with equation (D).

A small portion of the hydrolysis solution was strongly acidified with concentrated nitric acid, and warm ammonium molybdate solution added. No visible change took place, and it was only after some minutes' boiling that a yellow coloration was produced. This is good evidence against equation (c). Presumably sodium di-*isopropyl* phosphate requires to be broken down with boiling nitric acid before phosphoric acid is produced.

Hydrolysis by N/2 sodium hydroxide at room temperature. (a) Di-*isopropyl* phosphorofluoridate (2.0532 g.) was shaken with 100 ml. of 0.49N sodium hydroxide at 17°. The oily drops disappeared after about 5 min. The shaking was continued for a total of 30 min., and then 25 ml. were withdrawn and required 13.35 ml. of 0.5N sulphuric acid for neutralization (phenolphthalein). Therefore 1 mol. of the phosphorofluoridate had reacted with 1.994 mol. of alkali.

(b) Di-*isopropyl* phosphorofluoridate (2.3355 g.) was allowed to stand in contact with 100 ml. of 0.49N sodium hydroxide without shaking. After 30 min. a considerable amount of unchanged oil still remained, and titration showed that hydrolysis had proceeded to an extent of about 16 per cent. This result is important in indicating that decontamination by cold dilute alkali is effective only when

¹ Saunders and Stacey, *J. Chem. Soc.* 1948, p. 695.

accompanied by vigorous agitation. This point should be borne in mind when dealing with apparatus contaminated by di-isopropyl phosphorofluoridate.

Hydrolysis of D.F.P. by water. Waters and de Worms¹ made a kinetic study of the hydrolysis of D.F.P. in neutral aqueous solution and in acid solution. They found that the hydrolysis in water was autocatalytic and catalysed by hydrogen ions for the initial rate of hydrolysis (0.6 per cent./hr.) was independent of the initial concentration of D.F.P. The rate-determining stage is not the direct heterolysis of the P—F link, but rather as suggested in schemes (a) or (b):

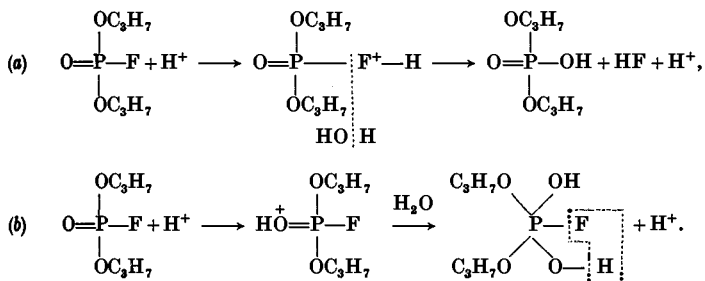

D.F.P. and mustard gas. The powerful vesicant mustard gas, dichlorodiethyl sulphide, 'H', has m.p. 11.5°, and its tendency to crystallize can be very troublesome. From time to time inert diluents have been suggested. The very low melting-point of di-isopropyl phosphorofluoridate suggested to us that it might prove to be a useful active diluent for mustard gas. Thus mixtures possessing at the same time the vesicant properties of mustard gas and the nerve-gas properties of D.F.P. were obtained.² The freezing-points of these mixtures were determined. Cooling agents used were ice, a mixture of ice and salt, a mixture of acetone and solid carbon dioxide, and liquid air. The 'H' used had d 1.275 g./c.c., and the D.F.P. had d 1.067 g./c.c. at 19° (see p. 50).

Thus a mixture of 87 per cent D.F.P. and 13 per cent 'H' with m.p. -36° could be used over a wide range of climatic

¹ *J. Chem. Soc.* 1949, p. 926.

² Saunders and Stacey, *J. Chem. Soc.* 1948, p. 695.

THE PHOSPHOROFUORIDATES

conditions, and it need hardly be remarked that it would be a very 'unwholesome' mixture.

| 'H' (per cent) | D.F.P. (per cent) | M.p. (deg.) | 'H' (per cent) | D.F.P. (per cent) | M.p. (deg.) | 'H' (per cent) | D.F.P. (per cent) | M.p. (deg.) |
|----------------------|-------------------------|----------------|----------------------|-------------------------|----------------|----------------------|-------------------------|----------------|
| 100 | 0 | 11.5 | 61.44 | 38.56 | 0.4 | 37.42 | 62.58 | -11 |
| 90.54 | 9.46 | 8.9 | 54.46 | 45.54 | -3.3 | 42.76 | 57.24 | -7.5 |
| 82.73 | 17.27 | 6.3 | 0 | 100 | ca. -82 | 47.27 | 52.73 | -5.4 |
| 76.11 | 23.89 | 4.8 | 13.00 | 87.00 | -36 | 51.11 | 48.89 | -4.2 |
| 68.21 | 31.79 | 2.8 | 22.99 | 77.01 | -22 | 54.46 | 45.54 | -3.3 |
| 65.66 | 34.34 | 2.1 | 30.94 | 69.06 | -15 | | | |

Preparation of Esters of Phosphorofluoric Acid by means of Phosphorus Oxydichlorofluoride

In a Report to the Ministry of Supply (27 February 1942) we proposed a method for synthesizing esters of phosphorofluoric acid by the reaction between phosphorus oxydichlorofluoride and the appropriate alcohol:

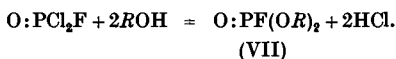

The reaction depended upon the marked difference in reactivity between the chlorine atoms and the fluorine atom in phosphorus oxydichlorofluoride. In general, the reaction with alcohols was clear-cut, and most of the phosphorofluoric esters were obtained in excellent yield and uncontaminated with the phosphoric triester. For example, when ethyl alcohol and phosphorus oxydichlorofluoride were allowed to react in the cold, diethyl phosphorofluoridate (VII, $R = \text{Et}$) was obtained in 93 per cent yield. No tertiary base was necessary to remove the hydrogen chloride produced in the reaction. The general process was patented during the war.¹

The method depended upon the availability of phosphorus oxydichlorofluoride, a compound described by Booth and Dutton,² who devised an elaborate apparatus for the preparation of the compound in a pure condition for physicochemical measurements. We modified their process to suit the particular needs of this work. The 'generator' which we developed for this step-

¹ B.P. 602,446 (Ministry of Supply, McCombie, Saunders, Chapman and Heap, 17 April 1944).

² *J. Amer. Chem. Soc.* 1939, **61**, 2937.

ESTERS OF PHOSPHOROFLUORIDIC ACID

wise fluorination of phosphorus oxytrichloride by antimony trifluoride (and pentachloride as catalyst) is shown in fig. 10. On a kilogram scale the yield of pure phosphorus oxydichlorofluoride was *ca.* 20 per cent.

Among many esters, di-*n*-propyl and di-*isopropyl* phosphorofluoridate were prepared by the action of phosphorus oxydichlorofluoride on *n*-propyl and *isopropyl* alcohol respectively. The *n*-ester was less toxic and possessed only feeble myotic

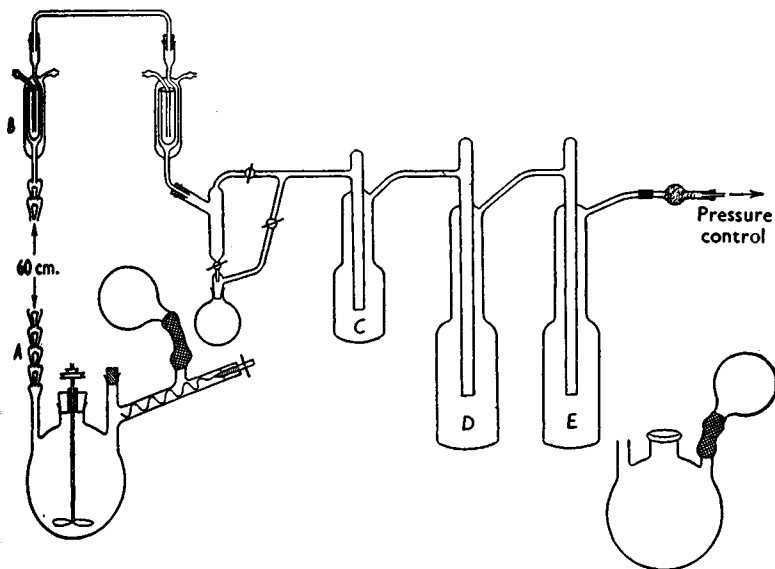

Fig. 10

action compared with the ethyl and the *isopropyl* esters, the order of potency being $Pr^i > Et > Pr$. The ethyl and *isopropyl* esters were identical with the compounds obtained by the 'hydrogen phosphite' method described by Saunders and Stacey (p. 46).

In order to determine whether other secondary alcohols would give phosphorofluoridic esters of high potency, dicyclohexyl phosphorofluoridate (VIII) was prepared by the action of phosphorus oxydichlorofluoride on *cyclohexanol*. In this preparation it was essential to remove all the hydrogen chloride before distillation, otherwise decomposition took place. The

THE PHOSPHOROFUORIDATES

compound was a colourless, mobile liquid, b.p. $116^{\circ}/0.3$ mm., insoluble in water, and formed a 'persistent gas'. It was extremely toxic;¹ at a nominal concentration of 1/12,500, the following died after a 10 min. exposure: 3/3 rabbits, 3/4 guinea-pigs, 6/6 rats, 10/10 mice. The pupils of the animals' eyes contracted to pin-point size and there were the usual phosphorofluoridate-like convulsions before death. More precise toxicity experiments showed that the approximate L.C. 50 for a 10 min. exposure for mice, rats and rabbits was 0.11-0.14 mg./l. (guinea-pigs appeared to be more resistant). This means that *dicyclohexyl* phosphorofluoridate was more toxic than *di-isopropyl* phosphorofluoridate (pp. 3 and 69).

Whereas *diethyl* phosphorofluoridate was hydrolysed in aqueous solution in about 4 hr., the *di-isopropyl* ester required 72 hr. for complete hydrolysis, and small quantities could be steam-distilled. *Dicyclohexyl* phosphorofluoridate was very stable, and vigorous shaking with water did not produce any appreciable hydrolysis. It was hydrolysed by boiling water only after several hours. When stirred vigorously with 2 per cent sodium hydroxide solution at 28.5° , the time taken to bring about hydrolysis according to the equation

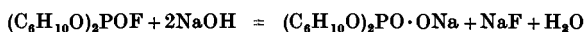

was of the order of 90 min. On prolonged shaking, hydrolysis proceeded beyond the stage represented above. With occasional shaking (i.e. under conditions comparable with those employed in decontamination) in the presence of 2 per cent sodium hydroxide solution at 20° , hydrolysis proceeded to an extent of only 64 per cent after 220 min.

In view of the greater toxicity often observed with derivatives of *o*-cresol compared with derivatives of phenol itself, it seemed worth while to prepare *di(o-methylcyclohexyl)* phosphorofluoridate. At a concentration of 0.65 mg./l. only three out of a batch of twenty-three animals (rabbits, guinea-pigs, rats and mice) were killed. The animals which died (the rabbits) exhibited muscular twitchings, but myosis was not very marked.

¹ Report no. 9 to Ministry of Supply by McCombie and Saunders, 10 April 1943.

ESTERS OF PHOSPHOROFLUORIDIC ACID

The compound was therefore much less toxic than the corresponding unsubstituted *dicyclohexyl* phosphorofluoridate.

Di-2-chloroethyl phosphorofluoridate was obtained from phosphorus oxydichlorofluoride and chlorohydrin, and in a testing chamber at a concentration of 1/10,000 (1.0 mg./l.) caused some irritation of the eyes and nose of the animals. After exposure, the irritant effects rapidly subsided, and no other effects were observed. A small number of animals died as follows: 0/3 rabbits, 1/4 guinea-pigs (12 hr.), 1/6 rats (4½ days), 3/10 mice (12 hr., 5½ days, 7½ days). The compound was therefore relatively non-toxic. In Chapter VII it is recorded that 2-fluoroethyl alcohol is highly toxic,¹ and that 2-fluoroethyl fluoroacetate is markedly more toxic than either fluoroethyl alcohol or fluoroacetic acid (weight for weight). In view of this enhanced toxicity it seemed desirable to investigate the effect of introducing the 2-fluoroethyl group into the phosphorofluoridate molecule. Accordingly, di-(2-fluoroethyl)phosphorofluoridate (IX) was prepared from phosphorus oxydichlorofluoride and fluoroethyl alcohol. The compound, a mobile liquid, exhibited lower toxicity than either fluoroethyl alcohol or diethyl phosphorofluoridate. At a concentration of 0.5 mg./l. (10 min. exposure), however, it produced a remarkable effect on rats. An hour or so after exposure some of the rats became extremely violent, rushed about the cage and exhibited a type of hyperactivity which caused them to bite the legs of their companions. The rats died of convulsions that appeared to be of an unusual type.² The phenomenon was repeatable. The compound also caused myosis.

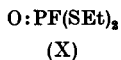
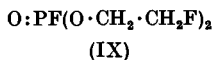
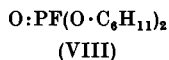

Diphenyl phosphorofluoridate was prepared in 60 per cent yield by the action of phosphorus oxydichlorofluoride on phenol in the presence of dimethylaniline to take up the hydrogen chloride formed. Gottlieb³ claimed to have prepared this

¹ See also McCombie and Saunders, *Nature, Lond.*, 1946, 158, 382.

² It is possible that this compound (and perhaps related compounds) acts by direct entry into the diencephalon.

³ *J. Amer. Chem. Soc.* 1936, 58, 532.

compound in 7 per cent yield by the action of potassium fluoride on the corresponding phosphorochloridate. His compound was rapidly decomposed by water, whereas ours was stable (in accordance with expectation); furthermore, he gave no fluorine analysis. We showed that diphenyl phosphorofluoridate was relatively non-toxic and possessed negligible myotic action.

There appeared to be no appreciable reaction between ethylthiol and phosphorus oxydichlorofluoride, whereas the sodium thioethoxide reacted with all three halogen atoms producing triethyl phosphorotrithiolate, $OP(SET)_3$. It was found, however, that if dimethylaniline were used as the condensing agent then the two chlorine atoms were removed while the fluorine atoms remained unaffected. Diethyl phosphorofluoridodithiolate (X) thus obtained was a liquid, and unlike the corresponding oxygen analogue (VII, $R = Et$) was relatively non-toxic and devoid of myotic properties.

It should be emphasized that the phosphorus oxydichlorofluoride method for preparing esters of phosphorofluoric acid cannot compare in speed with the 'hydrogen phosphite' method already described (p. 46). Furthermore, it is not very suitable for very large-scale work. On the other hand, once the apparatus is set up and a supply of $POCl_2F$ is obtained, one has a simple, clear-cut, method for producing a large variety of phosphorus compounds, not only esters but amino compounds (p. 87) and 'mixed' compounds (p. 90). In other words, the method is extremely valuable for exploratory purposes and where an unequivocal synthesis is required.

*Phosphorus oxydichlorofluoride*¹

Apparatus. The generator employed is shown in fig. 10. There are six important points. (1) The column *A* is designed so that throttling is avoided; it is at least 2 ft. long and surmounted by a reflux double-surface water-condenser *B*. (2) A Perkin triangle (air-cooled), inserted between the down-condenser and the traps, enables any phosphorus oxychloride which distils to be removed. (3) It is convenient to have three traps, viz. *C*, ice and salt; *D*, acetone and carbon dioxide; *E*, liquid air. (4) The intermittent addition of the solid antimony trifluoride presents a problem. The mechanical 'solid' feed

¹ Chapman and Saunders, *J. Chem. Soc.* 1948, p. 1010.

PHOSPHORUS OXYDICHLOROFLUORIDE

shown in the diagram proves satisfactory over short periods of working; there is a tendency, however, for the wire screw-feed to become jammed as the antimony fluoride becomes damp during the experiment. A less elegant but more reliable device for long periods of working is shown in the small diagram; it consists of a round-bottom flask attached directly to the reaction vessel by means of a flexible, corrosion-resisting, rubber hose. (5) The stirrer is made of stainless steel; the stirrer gland is packed freshly before each run, and is filled as full as possible. (6) Silicone grease is used on all joints. Ground-glass joints are used where possible, but some rubber connections (strong pressure tubing) are employed at certain points to provide flexibility. Considerable vibration is caused by vigorous stirring. The necessary reduced pressure (200 mm.) is maintained by a steel water-pump and moving-bell type of manostat.

Procedure. Finely powdered antimony trifluoride is placed in the reservoir of the feed. Phosphorus oxychloride and then antimony pentachloride are placed in the reaction vessel. The temperature of the bath is maintained, thermostatically, at 75° and the pressure kept at 190–200 mm., and the antimony trifluoride is then added slowly from the feed. The distillates in the traps are united and fractionated. The distillate, up to b.p. 90°/760 mm., is collected and carefully re-fractionated, giving pure phosphorus oxydichlorofluoride, b.p. 54° (20 per cent yield).

*Diethyl phosphorofluoridate.*¹ Phosphorus oxydichlorofluoride (5.5 g.) is placed in a Claisen flask (possessing a fractionating column) and fitted with a calcium chloride tube. Ethyl alcohol (4 g., 10 per cent excess) is slowly run in, the temperature not being allowed to rise above 5°. The hydrogen chloride is removed by suction at room temperature, and the residue heated to remove excess of alcohol and hydrogen chloride. When the residue is distilled under reduced pressure, almost the entire liquid comes over at 70–72°/18 mm.; yield 5.8 g. (93 per cent); b.p. 171°/760 mm.; 1 mol. of the compound requires 2 mol. of sodium hydroxide (N/2 solution) for hydrolysis in the cold or on being gently heated under reflux for 30 min.; this is in accordance with the equation

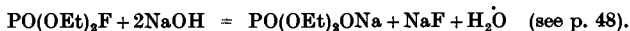

Di-isopropyl phosphorofluoridate. Phosphorus oxydichlorofluoride (50 g.) is dissolved in dry ether (100 c.c.), isopropyl alcohol (dried over calcium oxide; 50 g., 15 per cent excess) in dry ether (100 c.c.) is added slowly with cooling, and the mixture kept for 1 hr. Dry ammonia is then passed through the liquid, with cooling. The liquid

¹ Chapman and Saunders, *J. Chem. Soc.* 1948, p. 1010.

THE PHOSPHOROFUORIDATES

is then filtered, and the excess of ammonia and ether taken off at room temperature. The residue is distilled, and the fraction, b.p. 37–47°/0.5 mm., collected. This redistills at 84–85°/25 mm.; yield 60 g. (45 per cent).

Dicyclohexyl phosphorofluoridate. Phosphorus oxydichlorofluoride (68.5 g., 0.5 mol.) is dissolved in dry ether (150 c.c.) and cooled in ice and salt. *Cyclohexanol* (100 g., 1.0 mol.) in dry ether (150 c.c.) is slowly dropped in and the mixture kept overnight. In order to remove hydrogen chloride, dry air is drawn through the resultant liquid for about 5 hr. More dry ether is then added, and dry ammonia passed through the liquid until no more ammonium chloride is precipitated. The ammonium chloride is filtered off, and the filtrate kept over lead carbonate for some time, filtered, and the filtrate dried (Na_2SO_4). After distillation of the ether, the residue is distilled in a 'semi-molecular' still, without air leak, glass wool being used to prevent splashing. The fraction of b.p. 90–96°/0.02 mm. is collected. The liquid can also be distilled at slightly higher pressures in an atmosphere of nitrogen. After the 'initial' distillation the above precautions are usually not necessary for further distillation. Yield 126 g. (70 per cent).

Alternative 'One-stage' Process for the Preparation of Esters of Phosphorofluoric Acid

Although the 'one-stage' process for production of D.F.P. and related compounds given on p. 46 is undoubtedly the best method available, particularly for large-scale work, chlorination on the small scale can conveniently be carried out by *N*-chlorosuccinimide. This method has the advantage that none of the products of the reaction is acidic.¹ We have recently shown that pure di-*isopropyl* phosphorochloridate can be obtained from di-*isopropyl* hydrogen phosphite in 82 per cent yield by this method. It is also possible to prepare di-*isopropyl* phosphorofluoridate without isolating the corresponding phosphorochloridate, and thus the preparation can be run virtually as a 'one-stage' process.²

Although the pharmacologically important *dicyclohexyl* phosphorofluoridate is readily obtained by the action of phosphorus oxydichlorofluoride mentioned just above, it is not

¹ Kenner, Todd and Weymouth, *J. Chem. Soc.* 1952, p. 3675.

² Goldwhite and Saunders, *J. Chem. Soc.* 1955, p. 2040.

ESTERS OF PHOSPHOROFUORIDIC ACID

very readily obtained by the standard one-stage process using chlorine. We have recently shown,¹ however, that the action of *N*-chlorosuccinimide on dicyclohexyl hydrogen phosphite followed by fluorination provides a very convenient alternative preparation, and dicyclohexyl phosphorofluoridate now becomes a readily available compound for the first time.

Most of the esters of phosphorofluoridic acid hitherto described in this monograph can be readily prepared on a small scale in this way. It may be emphasized that chlorination by *N*-chlorosuccinimide is for this purpose more satisfactory than by sulphuryl chloride,² as with the latter reagent an acid medium is produced:

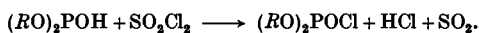

By the new process it is thus possible to prepare phosphorofluoridates which contain unsaturated side chains, e.g. diallyl phosphorofluoridate. In particular, compounds which on distillation decompose in the presence of acid are now easily obtained. The usefulness of the process is shown by the examples given below.

*Di-isopropyl phosphorochloridate.*³ *Di-isopropyl* hydrogen phosphite (0.1 mol.) is dissolved in dry carbon tetrachloride, and to the solution *N*-chlorosuccinimide (0.1 mol.) is added in portions of 0.5 g., with shaking and occasional cooling. After the addition, the solution is cooled to -5° and the precipitated succinimide filtered off. Carbon tetrachloride is removed from the filtrate by warming under reduced pressure, and the residual liquid is fractionated. Practically the whole of it boils at $94-95^\circ/14$ mm. Yield 17.5 g., 82 per cent.

Other preparations of (RO)₂POCl

| <i>R</i> | Yield (from the hydrogen phosphite) (per cent) | B.p. ($^\circ$ C./mm. pressure) |
|---------------------------------------|--|----------------------------------|
| Me | 85 | 54.5/2 |
| Et | 87.5 | 93/18 |
| CH ₂ =CH·CH ₂ — | 38 | 89-90/0.9 |
| Me·CH—CO ₂ Et | 75 | 158-160/1 |

Esters of phosphorofluoridic acid. Two procedures for the preparation of the esters of phosphorofluoridic acid were developed, a general one applicable to most alcohols and a special one for *cyclohexanol*.

¹ *Ibid.*

² Atherton, Howard and Todd, *J. Chem. Soc.* 1948, p. 1106.

³ Goldwhite and Saunders, *J. Chem. Soc.* 1955, p. 2040.

THE PHOSPHOROFLUORIDATES

(i) *General procedure.* To a vigorously stirred solution of the dry redistilled alcohol (0.3 mol.) in dry carbon tetrachloride (30 ml.) a solution of redistilled phosphorus trichloride (0.1 mol.) in carbon tetrachloride (20 ml.) is slowly added. Hydrogen chloride is expelled from the solution by heating under reflux for 1 hr. and then by drawing dry air under reduced pressure through the solution for 2 hr. Solvent is added to replace that lost by evaporation and the hydrogen phosphite is chlorinated by the addition in small portions of *N*-chlorosuccinimide (0.1 mol.) with vigorous shaking and occasional cooling. The solution is then cooled to 5° and the succinimide filtered off and washed with cold carbon tetrachloride. To the filtrate is added dry sodium fluoride (0.5 mol.) and the mixture heated under reflux with vigorous stirring for 3 hr. The solids are filtered off and the filtrate dried (Na₂SO₄). Low-boiling liquids are removed by warming under reduced pressure. The residue is fractionated at low pressure in dry nitrogen to yield pure phosphorofluoridate.

Phosphorofluoridates, (RO₂)₂POF, prepared as above

| R | Yield (from PCl ₃ used) (per cent) | B.p. (° C./mm. pressure) |
|--|--|-----------------------------|
| Me- | 25 | 149-50/760 |
| Et- | 42 | 74.5-75.5/20 |
| FCH ₂ CH ₂ - | 70 | 101-2/0.8 |
| ClCH ₂ CH ₂ - | 82 | 159-60/23 |
| Pr ^t - | 76 | 83/22 |
| CH ₂ =CH·CH ₂ - | 37 | 99-100/23 |
| MeCH(CO ₂ Et) | 47 | 128-30/1.0 |
| | | |
| Me ₂ CH·CH ₂ ·CHMe | 54.5 | 105-6/1.0 |
| | | |

(ii) *Dicyclohexyl phosphorofluoridate.* Phosphorus trichloride (13.75 g.) in carbon tetrachloride (20 ml.) is slowly added to dry cyclohexanol (30 g.). A stream of dry air is drawn through the solution during the addition to ensure thorough mixing and removal of hydrogen chloride. The solution is then heated under reflux for 1½ hr. and solvent and other low-boiling liquids are removed by warming on a water-bath under reduced pressure and then at 100°/0.5 mm. The residual crude hydrogen phosphite is then dissolved in dry benzene (50 ml.) and chlorinated by the addition of *N*-chlorosuccinimide (13.35 g.) in portions as described in the previous experiment. After cooling, and filtering off the succinimide, the filtrate is heated to 60-70° with dry ammonium fluoride (18 g.) for 4 hr., with vigorous stirring. The product is then shaken with water (100 ml.) to extract ammonium salts and then twice with aqueous sodium hydroxide (50 ml., 10 per cent) to hydrolyse and remove any unchanged phosphorochloridate. The benzene solution is finally washed with water

DICYCLOHEXYL PHOSPHOROFUORIDATE

to ensure removal of alkali, and dried (Na_2SO_4). The benzene is removed by warming under reduced pressure and the residue fractionated in dry nitrogen giving the pure dicyclohexyl phosphorofluoridate, b.p. 125–8/0.6 mm. Yield 14 g., 52 per cent.

Anticholinesterases

There is some confusion in the literature regarding the substances designated as anti-choline-esterases (usually shortened to anticholinesterases). The term 'cholinesterase' was first used¹ in connexion with an enzyme present in the blood serum of the horse which catalysed the hydrolysis of acetylcholine and of butyrylcholine, but exhibited little activity towards methyl butyrate,

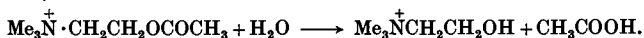

Thus a distinction was provided between simple esterases, such as liver esterase, which catalysed the hydrolysis of simple aliphatic esters but were ineffective towards choline esters. The term 'cholinesterase' was extended to other enzymes, present in blood sera and erythrocytes of other animals, including man, and in nervous tissue, which catalysed the hydrolysis of acetylcholine. It was assumed that only one enzyme was involved until Alles and Hawes² found that the enzyme present in human erythrocytes readily catalysed the hydrolysis of acetylcholine, but was inactive towards butyrylcholine. Human-serum enzyme, on the other hand, hydrolyses butyrylcholine more rapidly than acetylcholine. The erythrocyte enzyme is sometimes called 'true' cholinesterase, whereas the serum enzyme is sometimes called *pseudo*-cholinesterase. Stedman,³ however, prefers the names α -cholinesterase for the enzyme more active towards acetylcholine, and β -cholinesterase for the one preferentially hydrolysing butyrylcholine. Enzymes of the first type play a fundamental part in acetylcholine metabolism *in vivo*. The function of the second type *in vivo* is obscure. Not everyone agrees with the designation suggested by Stedman. It must also be stressed that enzymes of one type from different species are not always identical in every respect.⁴ Furthermore,

¹ Stedman, Stedman and Eason, *Biochem. J.* 1932, **26**, 2056.

² *J. Biol. Chem.* 1940, **133**, 375; *Science*, 1944, **100**, 75.

³ E. Stedman, *Chem. & Ind. (Rev.)*, 1954, p. 414.

⁴ Baudansky, *Ann. N.Y. Acad. Sci.* 1946, **47**, 521.

the difficulty in obtaining pure enzymes has sometimes confused the general picture.

We may now consider in a little more detail the interaction of true (or α -) cholinesterase with acetylcholine. Wilson and Bergmann¹ suggest that there are two active sites in the enzyme, known as *anionic site* and *esteratic site* respectively. These sites (represented diagrammatically in fig. 11)² are not to be considered independent. The mode of attachment will be seen to depend upon (a) the quaternary nitrogen atom ($N^+ \leftarrow$) and (b) a positive carbon at the ester end of the acetylcholine. This positive carbon will give rise to a covalent link on the esteratic site and so produce the acetylated enzyme and choline. The

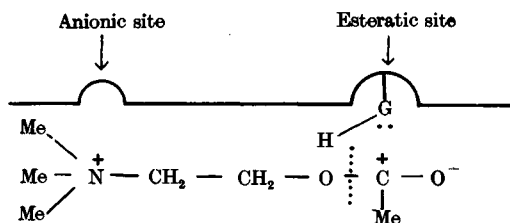

Fig. 11

acetylated enzyme is then readily hydrolysed back to the original enzyme and acetic acid. Substances which interfere with this reaction between the enzyme and acetylcholine are known as anticholinesterases.

Depending upon the part of the enzyme with which the anticholinesterases react, the latter can be readily classified. In the first place there are a few compounds (e.g. mercuric chloride) that combine with the enzyme at sites other than those mentioned, thus providing a type of inhibition which is non-competitive with the substrate. The vast majority of inhibitions, however, compete with the substrate for positions on the enzyme. Depending upon the point of attachment, competitive inhibitors have been classified thus:³

(1) inhibitors that attach themselves to the anionic site, e.g. choline, quaternary ammonium salts generally;

¹ *J. Biol. Chem.* 1950, 185, 479.

² This figure represents a modified version of Wilson and Bergmann's views.

³ Hobbiger, *Chem. & Ind. (Rev.)*, 1954, p. 415.

(2) inhibitors that attach themselves to the esteratic site, e.g. di-*isopropyl* phosphorofluoridate;

(3) inhibitors that are regarded by some as attaching themselves to both sites on the enzyme, e.g. neostigmine, physostigmine (eserine).

It may be noted that many of the anticholinesterases of the competitive type are equally potent as inhibitors of α - and β -cholinesterases. We should add, however, that the existence of an anionic site in β -cholinesterases has been questioned.¹

Inhibition of cholinesterase by D.F.P.

In view of the immense amount of work that has been carried out on the anticholinesterase activity of organo-phosphorus compounds, it is perhaps apposite to record in some detail the pioneer enzyme work carried out in Cambridge as early as 1941. In view of the long-lasting myosis and spasm of accommodation which we noted by exposure to *very low* concentrations of D.F.P., it seemed unlikely that the effects were due to a central action. Lord Adrian, Feldberg and Kilby² suggested instead a local effect on the eye by absorption through the mucous membrane, and this was proved by the fact that if one eye was protected from the vapour (at low concentrations), the pupil of that eye did not constrict (frontispiece). A peripherally produced myosis of such long duration at once suggested the possibility that these compounds might not act directly on the smooth muscles in the eye, but indirectly, like eserine, by inhibiting the action of cholinesterase.

To test this possibility, they first examined the effect of phosphorofluoridates on isolated rabbit's intestine. On such a preparation the action of drugs, like acetylcholine, which act directly on the muscle differs characteristically from the action of those, like eserine, which act by inhibition of cholinesterase activity. The directly acting drugs produce an immediate contraction which proceeds rapidly to a maximum, and after the drug has been washed out the muscle again quickly relaxes. The contraction produced by cholinesterase-inhibiting drugs, such as

¹ Whitaker, *Physiol. Rev.* 1951, **31**, 312.

² *Brit. J. Pharmacol.* 1947, **2**, 56; also Report to Ministry of Supply, November 1942.

eserine, is characterized by latency, slow development and very gradual disappearance when the drug is washed out. The phosphorofluoridates when tested on the isolated rabbit's intestine produced a contraction resembling that produced by eserine and not that produced by acetylcholine. The contraction produced by di-*isopropyl* ester, for instance, persisted for hours after washing out the drug. They then tested the effects of these compounds on the activity of plasma cholinesterase as follows.

The cholinesterase-inhibiting activity of the phosphorofluoridates was compared quantitatively with that of eserine sulphate thus. To 0.2 ml. of heparinized human plasma was added 0.5 ml. of a solution containing either eserine or the phosphorofluoridate in varying concentrations; then the mixture was kept at room temperature for 10 min. before 1 μ g. of acetylcholine in 1 c.c. saline solution was added. After 5 min. at room temperature, the mixture was made up to 10 ml. with frog saline containing eserine 1/100,000, which at once stopped the action of any cholinesterase not yet inactivated. The solution was then assayed for acetylcholine on the frog rectus-muscle preparation.

Results. Both the dimethyl and di-*isopropyl* ester were found to inhibit the cholinesterase activity of human plasma, and their action was stronger than that of eserine. Of the two esters, the di-*isopropyl* had a more powerful cholinesterase-inhibiting action than the dimethyl ester. An accurate quantitative comparison was made of the action of the di-*isopropyl* ester with that of eserine sulphate. Under the conditions of Adrian's experiment, the ester at 1/80 million had about the same cholinesterase-inhibiting action as eserine sulphate at 1/14½ million, i.e. the di-*isopropyl* ester was about 5½ times as active as eserine sulphate when compared weight for weight, and about 3 times as active when compared in molar solution.

Inhibition of cholinesterase by D.F.P.: alternative technique

As the work on cholinesterase activity by Adrian and his co-workers went on concurrently in Cambridge with that of Dixon, Mackworth and Webb, the investigations of the latter will also be described in some detail.¹

¹ Dixon and Mackworth, Report no. 13 to Ministry of Supply, 'Mode of action of fluorophosphonate esters', April 1942; Dixon and Webb, Report no. 27 to Ministry of Supply, May 1944.

ANTICHOLINESTERASES

Their specimen of cholinesterase was prepared from horse serum by the method of Stedman and Stedman,¹ and the method of estimation was that of Ammon.² The enzyme solution was placed in the right-hand flask of a Barcroft manometer, in a total volume of 3 ml. of 0.2 per cent NaHCO_3 solution; the gas phase was 5 per cent CO_2 in N_2 . The reaction, carried out at 20° , was started by adding a solution containing 2 mg. of acetylcholine chloride. The CO_2 output was usually linear until about $100 \mu\text{l.}$ had been produced.

Poisons. These were the phosphorofluoridates prepared by the Cambridge team of chemists (pp. 2-7), and eserine. Since the phosphorofluoridates slowly hydrolyse in water, stock solutions of these and of eserine were prepared in ethylene glycol monoethyl ether, and

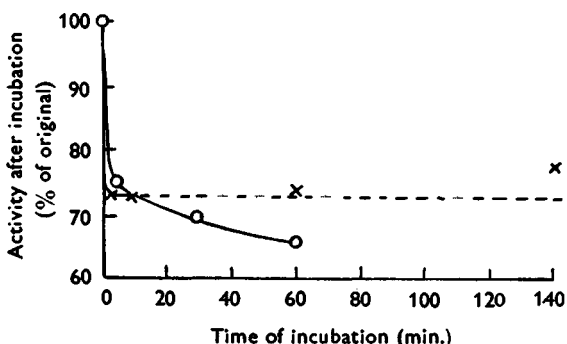

Fig. 12. Progress curve³ of inhibition of horse-serum cholinesterase by eserine and by di-isopropyl phosphorofluoridate in the absence of a substrate at pH 7.4 and 20° . x---x, 5×10^{-8} M eserine; O—O, ca. 3×10^{-10} M di-isopropyl phosphorofluoridate.

diluted with the same solvent so that an addition of 0.01–0.03 ml. to the 3 ml. of enzyme buffer solution in the manometer vessel gave the required final concentration of poison. The enzyme, buffer and poison were incubated in the manometer vessel for the required time (15 min. in the standard test mentioned below) at 20° before adding the substrate.

It was found that the enzyme was unaffected by the solvent, or by incubation at 20° without substrate for a period of some hours.

*Results.*³ In preliminary experiments with di-isopropyl phosphorofluoridate, it was found that concentrations above 10^{-7} M completely inhibited cholinesterase almost instantaneously.

¹ *Biochem. J.* 1935, 29, 2563.

² *Pflüg. Arch. ges. Physiol.* 1933, 233, 486.

³ Mackworth and Webb, *Biochem. J.* 1948, 42, 91.

THE PHOSPHOROFUORIDATES

With lower concentrations, the inhibition produced varied with the time of incubation. Fig. 12 shows the inhibition of cholinesterase by di-*isopropyl* phosphorofluoridate, and by a comparable amount of eserine, after varying times. The action of eserine reaches a maximum within 5 min., while the inhibition by phosphorofluoridate is initially less rapid, but is progressive and ultimately more complete. The latter effect suggests an irreversible inactivation of the enzyme rather than an equilibrium.

Reversibility. It is known that the effect of eserine on cholinesterase can be completely reversed by prolonged dialysis against water. On the other hand, it proved impossible to obtain any reversal of the poisoning by the phosphorofluoridate esters (see table below). The enzyme solution (5 ml.) was treated with the inhibitor for 15 min. at 38°; 1 ml. was used at once for activity estimation, and the remainder dialysed against running water for 24 hr. in the case of the eserine experiment, 36 hr. in the others. It was clear that the combination between the phosphorofluoridate esters and the enzyme is much firmer than that between eserine and the enzyme.

Effect of dialysis against water on activity of cholinesterase poisoned with eserine and phosphorofluoridate

| Inhibitor | Concentration (M) | Inhibition (per cent) | |
|--|----------------------|-----------------------|---------------------------------|
| | | Before dialysis | After dialysis for 24-36 hr. |
| Eserine | 10^{-6} | 100 | 35 |
| Diethyl phosphorofluoridate | 4×10^{-9} | 70 | 76 |
| Diethyl phosphorofluoridate | 10^{-8} | 90 | 85 |
| Di- <i>isopropyl</i> phosphorofluoridate | 10^{-9} | 50 | 50 |

Effect of substrate concentration. In the following experiments the cholinesterase activities were measured by a continuous titration method. The digest of acetylcholine and horse-serum cholinesterase (total vol. 10 ml.), containing bromothymol blue and 0.0002 M phosphate, was titrated with 0.01 N NaOH to maintain the pH at 7.4. The titrations, which were carried out at 20°, were linear over a period of 10-15 min. The velocity was expressed as ml. 0.01 N NaOH/5 min.; under the conditions used, it was proportional to the enzyme concentration. When an inhibitor was added, this was equilibrated with the enzyme, etc., for 5 min. at 20° before adding the substrate contained in a volume of 1 ml.

ANTICHOLINESTERASES

Under the conditions used, the enzyme was less sensitive to phosphorofluoridate than in the manometric experiments. With an acetylcholine concentration of 0.0045M, 50 per cent inhibition was produced by 2×10^{-7} M eserine or 3.5×10^{-8} M di-isopropyl phosphorofluoridate. When the substrate concentration was varied over the range 0.0004–0.06M, the percentage inhibition by the phosphorofluoridate (compared with a standard having a similar substrate concentration but no inhibitor) remained more or less constant. On the other hand, the inhibition due to eserine decreased when the acetylcholine concentration was raised. The difference in the behaviour of

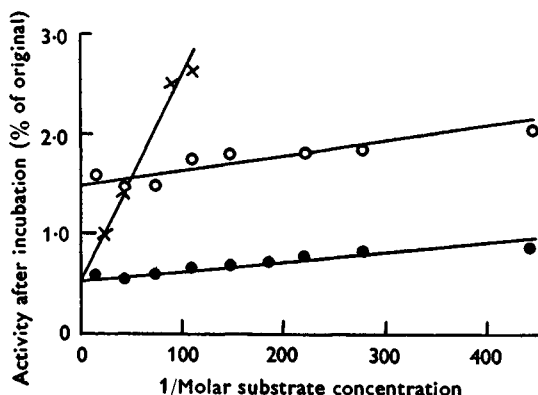

Fig. 13. Effect of substrate concentration on inhibition of horse-serum cholinesterase.¹ Enzyme activity was estimated by titration with 0.01 N NaOH at pH 7.4 and 20°. ●—●, control, no inhibitor; ×—×, 2×10^{-7} M eserine; ○—○, 5×10^{-8} M di-isopropyl phosphorofluoridate.

the two inhibitors is shown when the results are examined by the method of Lineweaver.² The relationship between enzyme reaction velocity v and substrate concentration S is given by

$$\frac{1}{v} = \frac{1}{V} + \frac{K_p}{VS},$$

where V is the limiting velocity and K_p is the effective Michaelis constant. In the presence of a 'competitive' reversible inhibitor, V is unchanged but K_p is increased, i.e. the apparent affinity of the enzyme for its substrate is lowered. If there is no competition between inhibitor and substrate for the enzyme, $K_p = K_M$, but V is lowered.

Fig. 13 shows the results obtained with 2×10^{-7} M eserine and 5×10^{-8} M di-isopropyl phosphorofluoridate. Eserine behaves like a

¹ Mackworth and Webb, *Biochem. J.*, 1948, 42, 91.

² *J. Amer. Chem. Soc.* 1934, 56, 658.

THE PHOSPHOROFUORIDATES

typical competitive inhibitor, with V unchanged, but the phosphorofluoridate gives no indication of competition with the substrate.

True and pseudo-cholinesterase. The above serum preparations contained both the 'true' and 'pseudo-' cholinesterases of Mendel and Rudney.¹ The effect of di-*isopropyl* phosphorofluoridate on these components was examined separately by means of the specific substrates described by Mendel, Mundel and Rudney,² using the titration method described above. Phosphorofluoridate (5×10^{-8} M) gave an inhibition of 57 per cent of the activity towards 0.0045 M acetylcholine, 30 per cent of the activity towards 0.0005 M acetyl- β -methylcholine, and 40 per cent of that towards 0.005 M benzoylcholine, after incubating the enzyme with the poison for 5 min. Thus in these experiments there appeared to be no appreciable difference in sensitivity of the true and pseudo-cholinesterases of horse serum to phosphorofluoridates.

Assessment of inhibitory power. In order to compare the inhibitory power of the different compounds, conditions for a standard manometric test were defined. A fixed amount of enzyme was incubated at 20° with varying concentrations of the inhibitor for 15 min. before adding the acetylcholine. The CO₂ production in the first 10 min. was used for estimating the activity, and by comparison with a control, the percentage inhibition. Curves showing the percentage inhibition produced under the standard conditions plotted against the logarithm of the inhibitor concentration for eserine and a number of alkyl phosphorofluoridates are shown in fig. 14. They are, in general, sigmoid in shape, but are not all similar; in particular, those for *isopropyl* and *sec.*-butyl phosphorofluoridate are considerably flatter than the others, so that in the range of inhibitions below 50 per cent these esters are relatively more effective than would be indicated by the pI_{50} values (see below).

To obtain a numerical value for inhibitory power, the concentration of poison producing 50 per cent inhibition in the standard test was read off from the inhibition-log (concentration) curve. This value is conveniently expressed as the pI_{50} , which is the negative logarithm of the concentration producing 50 per cent inhibition. Values for the poisons examined are given in the Table below.³ Di-*isopropyl* phosphorofluoridate is the most active of these compounds, being thirty times more potent than eserine. Other branched-chain esters, e.g. *sec.*-butyl and 1-methyl*isoamyl*, although less active than the *iso*-propyl derivative, are more active than the straight-chain *n*-propyl

¹ *Biochem. J.* 1943, **37**, 59.

² *Biochem. J.* 1943, **37**, 473.

³ See p. 68.

ANTICHOLINESTERASES

ethyl and methyl esters. Replacement of oxygen in diethyl phosphorofluoridate by sulphur reduces the activity to 1/400 of the original. The phosphorofluoridate ion and the fluoride ion are virtually inactive. They are also relatively non-toxic.

The above proof of the extremely high affinity for cholinesterase of the phosphorofluoridates, especially those with branched-chain alkyl groups, suggested that the toxic and myotic power was due to inhibition of cholinesterase *in vivo*. Bloch¹ showed

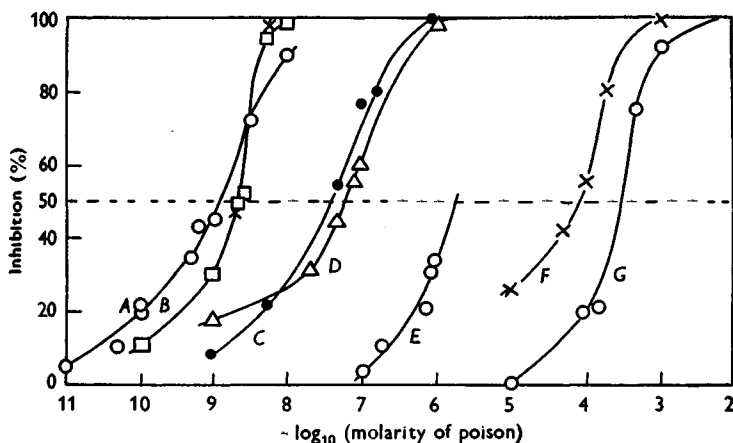

Fig. 14. Inhibition of horse-serum cholinesterase by various compounds. Incubated for 15 min. at 20° before addition of 2 mg. of acetylcholine chloride. A, di-*isopropyl* phosphorofluoridate; B, di-*sec.*-butyl phosphorofluoridate; C, eserine; D, diphenyl phosphorofluoridate; E, dithioethyl phosphorofluoridate; F, tetramethylphosphorodiamidic fluoride; G, diethyl *N*-methylphosphoramidate.

that the parasympathomimetic symptoms of poisoning by cresyl phosphate, which is also an inhibitor of cholinesterase *in vitro*, were paralleled by a fall of serum cholinesterase and serum lipase activities *in vivo*. Similarly, Mazur and Bodansky² observed a correlation between fall in serum cholinesterase and poisoning by phosphorofluoridates. The values obtained in this work for inhibitory power towards serum cholinesterase corresponded to the effect on the rabbit eye, although there was not always a strict quantitative agreement.

¹ *Helv. chim. Acta*, 1943, 26, 733.

² *J. Biol. Chem.* 1946, 163, 261.

THE PHOSPHOROFUORIDATES

Inhibitory power of eserine, phosphorofluoridates and related compounds on horse-serum cholinesterase

(Standard test conditions; 15 min. incubation at 20° in bicarbonate buffer, pH 7.4, in absence of substrate.)

| | Molarity producing 50 per cent inhibition | pI_{50} ($-\log_{10} M$) |
|--|--|------------------------------|
| $\left(\begin{array}{l} \text{CH}_3 \\ \diagdown \\ \text{CHO} \\ \diagup \\ \text{CH}_3 \end{array} \right)_2 \text{PO} \cdot \text{F}$ | 1.3×10^{-9} | 8.9 |
| $\left(\begin{array}{l} \text{C}_2\text{H}_5 \\ \diagdown \\ \text{CHO} \\ \diagup \\ \text{CH}_3 \end{array} \right)_2 \text{PO} \cdot \text{F}$ | 2.0×10^{-9} | 8.7 |
| $\left(\begin{array}{l} (\text{CH}_3)_2\text{CH} \cdot \text{CH}_2 \\ \diagdown \\ \text{CHO} \\ \diagup \\ \text{CH}_3 \end{array} \right)_2 \text{PO} \cdot \text{F}$ | 2.0×10^{-9} | 8.7 |
| $(\text{CH}_3 \cdot \text{CH}_2 \cdot \text{CH}_2\text{O})_2 \text{PO} \cdot \text{F}$ | 5.5×10^{-9} | 8.25 |
| $(\text{C}_2\text{H}_5\text{O})_2 \text{PO} \cdot \text{F}$ | 8.0×10^{-9} | 8.1 |
| Eserine* | 4.0×10^{-8} | 7.4 |
| $(\text{C}_6\text{H}_5\text{O})_2 \text{PO} \cdot \text{F}$ | 6.3×10^{-8} | 7.2 |
| $(\text{CH}_3\text{O})_2 \text{PO} \cdot \text{F}$ | 1.0×10^{-7} | 7.0 |
| $(\text{C}_2\text{H}_5\text{S})_2 \text{PO} \cdot \text{F}$ | 2.0×10^{-6} | 5.7 |
| $(\text{C}_2\text{H}_5\text{O})_2 \text{PO} \cdot \text{NHCH}_3$ | 3.0×10^{-4} | 3.5 |
| $(\text{CH}_3)_3 \text{PO}_4$ | 1.0×10^{-3} | 3.0 |
| Vitamin B ₁ | 1.7×10^{-3} | 2.8 |
| $(\text{NH}_4\text{O})_2 \text{PO} \cdot \text{F}$ | 1.0×10^{-2} | 2.0 |
| NaF | 1.0×10^{-2} | 2.0 |

* Eserine (physostigmine) has the structure

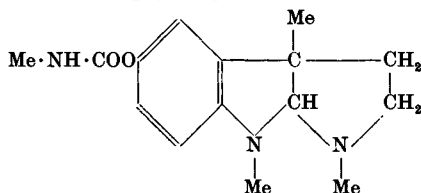

Toxic Effects of D.F.P.

On pp. 2 and 43 reference was made to the intense myosis that we experienced when exposed to low concentrations of D.F.P. In fact, appreciable myosis is brought about by concentrations very much lower than that mentioned on p. 2. The author has frequently noted that, after dealing with D.F.P. and related compounds even under carefully controlled laboratory conditions (e.g. using fume cupboards, respirators, etc.), minute traces of material have adhered to clothing and some hours later gradually vaporized and were sufficient to cause myosis with its

attendant painful syndromes. Besides headaches and pains behind the eyes, the pupil reflexes are absent and the near point moves inwards. Some 24 hr. after exposure to a concentration of 50 mg./cu.m. for 5 min., conjunctival hyperaemia often ensues, and with this dosage congestive iritis usually develops. Permanent ocular lesions are extremely rare.

Repeated doses of atropine or homatropine are required to maintain relaxation of the pupil. Although congestive symptoms are thereby relieved, the writer has repeatedly noted paralysis of accommodation with resultant blurred vision. In short, in spite of the instillation of a mydriatic, one's vision is still impaired as the pupil is now usually dilated.

It is some 15 years since the writer first experienced myosis with D.F.P. and related compounds, and one difference now noted during myosis is that white surfaces appear yellow. This phenomenon may well be due to changes in lens structure in the region of the optic axis.

With higher concentrations than those mentioned above, animals exhibit, in addition to myosis, the following symptoms: salivation, muscular weakness, loss of muscular co-ordination, gasping, diarrhoea and finally cessation of respiration. There is intense constriction of the bronchioles and the immediate cause of death is asphyxia. Respiration ceases before the heart stops beating. The L.C. 50's for rats and for mice for a 10 min. exposure are respectively 0.36 and 0.44 mg./l. Air saturated with D.F.P. at ordinary temperatures contains about 8 mg./l. and this will kill mice within 1 min. During exposures for a limited time (e.g. 5 min.), rabbits appear to be more resistant to the inhaled vapour of D.F.P. than are other animals. It appears that the peculiar nasal structure of the rabbit is responsible for its great resistance.

Symptoms produced by injection by various routes resemble those produced by inhalation. The L.D. 50 by intravenous injection into rabbits is 0.5 mg./kg. The L.D. 50 by subcutaneous injection into mice is 5 mg./kg. It should be noted that myosis can occur after injection, and that 1.4 mg./kg. (body weight) applied to a rabbit's eye is immediately fatal.

Detailed pharmacological studies

Following the original British work, other investigators have confirmed and elaborated pharmacological studies. The work of Grob, Lilienthal, Harvey and Jones may be quoted in this connexion.¹ A single dose of D.F.P. administered to human subjects, either intramuscularly (10.5 to 3.0 mg. of 0.1 per cent solution in arachis oil)² or intra-arterially (0.5-2.0 mg. of 0.1 per cent aqueous solution),³ caused a marked depression of plasma cholinesterase to between 5 and 35 per cent of the

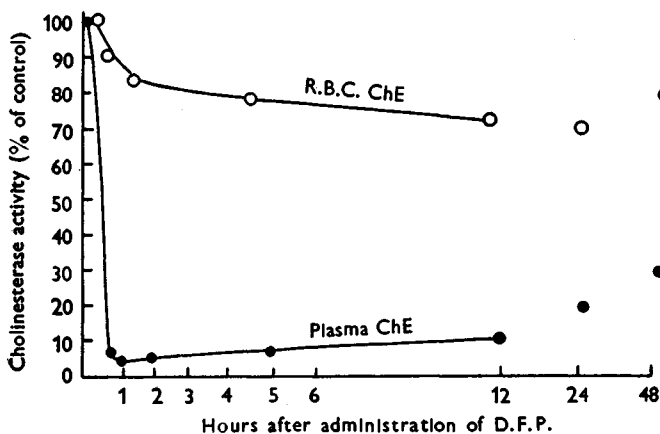

Fig. 15

original activity. Red blood cell cholinesterase dropped to between 95 and 65 per cent of the original activity. The maximum depression of plasma cholinesterase activity approaching zero occurred within 1 hr. after administration, while red blood cell cholinesterase activity declined more slowly, maximum depression occurring 24 hr. after administration (fig. 15).

The daily intramuscular administration of 0.5-2.3 mg. of D.F.P. caused a sustained fall in plasma cholinesterase to 5-20 per cent of original activity. A slower progressive decline of red blood cell cholinesterase took place.

¹ *Bulletin of the Johns Hopkins Hospital, Baltimore, Maryland, 1947, 81, 217.*

² Stable for one year.

³ Half hydrolysed after about 16 hr.

After the administration of D.F.P. was stopped, the plasma cholinesterase soon began to increase, e.g. within 4 hr., whereas red cell cholinesterase activity did not begin until after 24 hr. and then at a much slower rate. This latter rate of regeneration was remarkably uniform at approximately 1-2 per cent of the original activity per day. This figure is similar to the replacement rate of red blood cells and indicates that the limiting factor in the regeneration of red blood cell cholinesterase is the rate of replacement of the red blood cells themselves. It is interesting to note that in patients with low reticulocyte counts there was a correspondingly low rate of regeneration of red blood cell cholinesterase and conversely.

The rate of regeneration of plasma cholinesterase in man after its depression by D.F.P. was found to resemble the rate of regeneration of serum albumin in experimental animals that have been depleted by plasmaphoresis.¹

The symptoms that followed the daily intramuscular administration of D.F.P. for 5 days mimicked most of the muscarine-like and nicotine-like effects (see p. 37) of cholinergic drugs. There were also effects on the central nervous system.

Among the muscarine-like effects were gastro-intestinal symptoms, e.g. anorexia-nausea, abdominal cramps, vomiting, diarrhoea. Other effector organs involved were sweat glands (increased sweating), salivary glands (increased salivation), pupils (myosis, p. 38), ciliary body (difficulty of distant vision), lungs (constriction of bronchioles), bladder (urinary frequency), heart (slight bradycardia).

Among nicotine-like effects on skeletal muscle were fasciculations (non-myasthenics² only), increased strength (myasthenics only), decreased strength (non-myasthenics only), muscular cramps.

Among the effects on the central nervous system the following symptoms were pronounced: excessive dreaming, insomnia, nightmares and headaches.

According to Grob *et al.*, atropine given by any route has a marked inhibiting effect on the muscarinic symptoms due to

¹ Kerr, Hurwitz and Whipple, *Amer. J. Physiol.* 1918, 47, 356; Stanbury, Warweg and Amberson, *ibid.* 1946, 117, 230.

² For the effect of D.F.P. on myasthenia gravis, see p. 197.

D.F.P., a moderately inhibiting effect on the symptoms in the central nervous system, and no effect on the nicotinic symptoms.

The above workers summarized the activity of D.F.P. by saying that the symptoms caused by it are explicable in terms of the inhibition of the cholinesterase enzymes of the tissues themselves and are not related immediately to the cholinesterase activity of the plasma or red blood cells.

The symptoms produced by D.F.P. (2-3 mg. intramuscularly) in man have also been studied by Comroe, Todd and Koelle.¹ Gastro-intestinal disturbances are most common, and the symptoms in order of frequency of occurrence are: nausea, epigastric 'discomfort', indigestion or belching, anorexia and occasionally diarrhoea, vomiting or abdominal cramps. Less frequently, patients complained of symptoms referable to the central nervous system, viz. dizziness, 'shakiness', weakness and frequent dreams or nightmares. In some cases there was a slight flow of urine undoubtedly arising from parasympathetic stimulation.

Compared with neostigmine,² D.F.P. produced side effects more commonly and these arose in spite of administration of atropine (0.01 gr.) in an attempt to control the gut symptoms. There were no changes in liver, kidney or haemopoietic function ascribed to D.F.P. Asthma was considered a contra-indication to the use of D.F.P. It can thus be seen that D.F.P. in therapeutic dosage is a safe medicament.³

Effect on the eye. Leopold and Comroe⁴ recorded the actions of D.F.P. on the normal eye, expanding the earlier British work (pp. 2, 43). They confirmed the prolonged myosis lasting up to 3 weeks with a spasm of the ciliary muscle for 3-7 days. There is usually a decrease in the intra-ocular tension, although occasionally there may be a slight rise before a fall in pressure. The action outlasts that of common myotics, and a 0.1 per

¹ *J. Pharmacol.* 1946, 87, 281.

² Neostigmine methosulphate has the formula

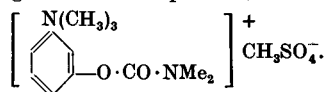

³ Quilliam, *Post Grad. Med. J.* June 1947.

⁴ *J. Arch. Ophthal.* New York, 1946, 36, 17.

cent solution of D.F.P. produces an effect greater than that of 1 per cent eserine or 5 per cent neostigmine bromide solution, and outlasts them both. After the removal of the ciliary ganglion, no myosis with D.F.P. was observed as might have been expected from a drug inhibiting only the cholinesterase and also showing that D.F.P. had no direct effect on the iris musculature. Anderson¹ had previously shown that there was an absence of response of the iris to eserine after the removal of the ciliary ganglion. Pupil dilatations caused by atropine have been easily counteracted by ocular administration of D.F.P.

Leopold and Comroe² studied the use of 0.05, 0.1 and 0.2 per cent D.F.P. in arachis oil in glaucoma, and found that cases unrelieved by eserine responded readily to 0.1 per cent D.F.P. instilled into the conjunctival sac. However, the action of D.F.P. in the glaucomatous eye lasts for about 12 hr. compared to an action of about 12 days in the normal eye. The short-lived action of D.F.P. in cases of raised intra-ocular tension lends evidence to the suggestion that there may be an upset of the acetylcholine-cholinesterase mechanism in glaucoma. There are certain side effects such as ciliary spasm and headache which may prove troublesome during treatment.

Further observations. Wilson³ studied the effect of D.F.P. in myasthenia gravis and found on prolonged administration in one case there was a marked diminution of the prostigmine requirements (a fall from 2 to 0.2 mg. after 3 weeks of daily D.F.P.). Another case was able to perform muscular movements without undue fatigue after a course of D.F.P. alone.

Rowntree, Nevin and Wilson have also examined the effects of D.F.P. in schizophrenia and manic depressive psychosis.⁴ D.F.P. dissolved in peanut oil was administered by intramuscular injection to seventeen cases of schizophrenia and nine cases of manic depressive psychosis. Their findings suggest that D.F.P. may be of therapeutic value in some manic patients if given in repeated small doses and gradually cut down after improvement has been obtained.

¹ *J. Physiol.* 1905, **33**, 156, 414.

² *J. Arch. Ophthal.* New York, 1946, **36**, 1.

³ Quoted by Quilliam, *Post-grad. Med. J.* June 1947.

⁴ *J. Neurol. Psychiat.* 1950, **13**, 47.

THE PHOSPHOROFUORIDATES

The rate of regeneration of serum cholinesterase in normal subjects after the administration of D.F.P. by intramuscular injection has been determined.¹ The regeneration rate of serum cholinesterase after the administration of D.F.P. to patients with liver damage has also been determined and is found to be significantly lower than normal.

It will be shown below that D.F.P. is rapidly destroyed *in vitro* and *in vivo*.² Therefore, the recovery of serum cholinesterase activity is not representative of a reversal of enzyme inhibition, but is indicative of synthesis of new enzyme proteins. Since the regeneration rate of serum cholinesterase in patients with liver damage is significantly depressed as contrasted with that in the normal patient, it is concluded that the ability of such patients to synthesize this particular enzyme protein is decreased. This constitutes evidence for the view that the liver is a primary locus for the formation of serum cholinesterase.

Further details of the applications of D.F.P. are mentioned more conveniently later (pp. 195–202), when certain related compounds have been considered.

Enzymic Destruction of D.F.P.

D.F.P. is hydrolysed by a heat-labile, non-dialysable substance, present in plasma and various tissues of the rabbit and man as follows:

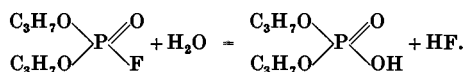

The enzyme responsible for the reaction is insensitive to fluoride, and it is not related to phosphatase, cholinesterase or esterase.²

The reaction is important in detoxication in the liver, which contains a relatively high proportion of the enzyme, and plays an important part in the destruction of D.F.P. in the intact animal.

Mounter and his co-workers³ designate this enzyme responsible for the hydrolysis of D.F.P. as *dialkylfluorophosphatase* (D.F.P.-ase). They have shown that D.F.P.-ase from hog kidney is activated by cobalt and manganese ions. In the presence of

¹ Wescoe, Hunt, Riker and Litt, *Amer. J. Physiol.* 1947, **149**, 549.

² Mazur, *J. Biol. Chem.* 1946, **164**, 271.

³ Mounter, Floyd and Chanutin, *J. Biol. Chem.* 1953, **204**, 221.

Mn^{2+} , D.F.P.-ase is further activated by cysteine, histidine, thiolhistidine, and serine, histamine and 2:2'-dipyridyl. Reagents reacting with metal ions, SH groups and carbonyl groups inhibit D.F.P.-ase activity. Work is proceeding on the further elucidation of such mechanisms.¹ In a somewhat similar connexion attention is called to the fact that the non-enzymic hydrolysis of D.F.P. is accelerated by heavy metals and their complexes, in particular by copper chelates of ethylene diamine, *o*-phenanthroline, 2:2'-dipyridyl and histidine.²

Radioactive D.F.P.

Reference has repeatedly been made to the powerful anticholinesterase activity of D.F.P. (p. 61). Towards pseudocholinesterase, for example, it is effective in concentration as low as 10^{-11} M. In order to throw light on its mode of action with esterases,³ radioactive D.F.P. containing ^{32}P was prepared.⁴ An account of its production on what may be conveniently called the 'one-gram scale', directly from phosphorus, is given below.

It is considered that the direct method of preparing radioactive di-*isopropyl* phosphorofluoridate possesses advantages compared to the method of B. Witten and J. I. Miller, which starts with radioactive potassium dihydrogen phosphate.⁵

Phosphorus containing ^{32}P (of the order of 1 g.) was converted into the trichloride. This small-scale conversion presented considerable and unexpected difficulties, the most serious feature being the very ready production of phosphorus pentachloride. (All the reliable descriptions of the preparation of phosphorus trichloride are on a basis of *ca.* 200 g. of phosphorus.)⁶ This tendency to pentachloride formation was checked by the correct geometry of the apparatus and by the method of manipulation.

The active trichloride was converted into di-*isopropyl* hydrogen phosphite and thence through the phosphorochloridate into the phosphorofluoridate essentially according to the scheme

¹ Mounter and Chanutin, *J. Biol. Chem.* 1954, **210**, 224.

² Wagner-Jauregg, Hackley, Proper and Owens, *Fed. Proc.* 1953, **12**, 284.

³ Boursnell and Webb, *Nature, Lond.*, 1949, **164**, 875.

⁴ Saunders and Worthy, *Nature, Lond.*, 1949, **163**, 797; also Saunders and Worthy, *J. Chem. Soc.* 1950, p. 1320.

⁵ *J. Amer. Chem. Soc.* 1948, **70**, 3886.

⁶ Cf. *Inorg. Synth.* **2**, 145.

THE PHOSPHOROFLUORIDATES

shown on p. 6, although a modified apparatus and techniques were essential (*a*) because of the small scale of the operations, and (*b*) on account of the volatility of the radioactive intermediates and final product.

Apparatus. This is shown in fig. 16. The apparatus was erected in a fume cupboard equipped with a powerful fan.

(i) The tube *A* was connected to supplies of dry chlorine and dry nitrogen.

(ii) The vessel *B* contained phosphorus and phosphorus trichloride.

(iii) The lower extremity of *A* just touched the top of the P-PCl₃ mixture.

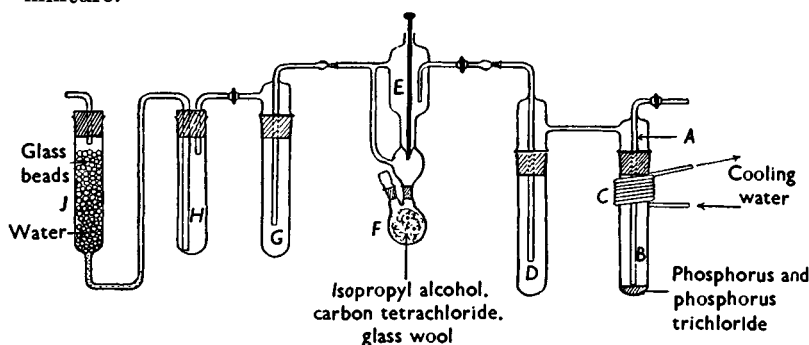

Fig. 16

(iv) The coil condenser *C* was constructed of lead tubing.

(v) *E* was a specially designed graduated collecting vessel. By opening the needle valve, phosphorus trichloride could be dropped into the reaction flask *F*.

(vi) The trap *G* was cooled in liquid air throughout the experiment. Its purpose was to prevent phosphorus compounds escaping from the apparatus.

(vii) *H* was used to prevent water from *J* being sucked back into *G*.

(viii) Escaping gas was washed free from phosphorus compounds by water contained in *J*.

Preparation of phosphorus trichloride. The following were placed in the flask *F*: isopropyl alcohol (10 ml.), carbon tetrachloride (5 ml.) and glass wool. The taps between *D* and *E* and between *G* and *H* were opened, and *G* and *D* were cooled in liquid air. Radioactive phosphorus (1 g.) was placed in the vessel *B*, and non-radioactive phosphorus trichloride (1 ml.) then added. *B* was then fixed in position and the bottom of the vessel heated so that the phosphorus tri-

chloride refluxed gently. A stream of dry chlorine was slowly admitted through the inlet tube *A* until nearly all the phosphorus had reacted. If the rate of ingress of the chlorine was too high, the phosphorus began to glow and phosphorus pentachloride was produced. If, on the other hand, the rate was too slow, the reaction time was unduly long.

The water passing through the condenser *C* was then cut off, and a stream of nitrogen substituted for the chlorine. This swept the phosphorus trichloride into *D*, where it was trapped. The next stage of the operation was to sweep the phosphorus trichloride from *D* into the graduated vessel *E*, the latter being cooled in liquid air while *D* was gently warmed. When the transference was complete, the temperature of *E* was allowed to rise to room temperature and the volume of phosphorus trichloride produced measured on the scale. Yield, *ca.* 90 per cent.

Di-isopropyl phosphorofluoridate. The rod in *E* was raised and the phosphorus trichloride allowed to drop slowly into the flask *F*, which was then detached from the apparatus. The central neck of *F* was fitted to a gas-inlet tube, and a reflux water condenser attached to the side arm. The top of the condenser was then connected to a gas-washing system similar in construction to *H* and *J*. Nitrogen was passed through the liquid, followed by a stream of chlorine, *F* being cooled in ice water while the chlorine was passed. At this stage the liquid was yellowish green. Nitrogen was again passed through the liquid in order to remove hydrogen chloride and excess of chlorine. The gas-inlet tube was replaced by a mercury-sealed stirrer, and dry sodium fluoride (15 g.) was placed in the flask *F*. The mixture was then heated under reflux, with vigorous stirring. After cooling, the carbon tetrachloride was removed under reduced pressure and the residual *di-isopropyl phosphorofluoridate* distilled; it had b.p. 63–66°/14 mm.

Results. Phosphorus (1 g.) and phosphorus trichloride (1 ml.) were used. The weight of *di-isopropyl phosphorofluoridate* obtained was 5.5 g. (62 per cent). The purity, determined by fluorine analysis¹ on 50 mg. of the active product, was 98.5 per cent.

(N.B. With inefficient stirring the product contained less *di-isopropyl phosphorofluoridate*.)

The radioactive phosphorus used had an activity of 28,000 counts/min./mg. (counter efficiency, *ca.* 1 per cent, *i.e.* specific activity *ca.* 1 mc./g.), whilst the radioactive *di-isopropyl phosphorofluoridate* had an activity of 2200 counts/min./mg. (corrected to zero time).

¹ See p. 210 for this method of analysis.

THE PHOSPHOROFUORIDATES

Reaction of esterases with radioactive di-isopropyl phosphorofluoridate

It was suggested,¹ on the basis of kinetic measurements, that the phosphorofluoridates inhibit esterases by virtue of a highly specific affinity for the active centres of this group of enzymes. Preliminary experiments by Bournsnel and Webb² with di-isopropyl phosphorofluoridate containing ³²P gave results which were in accordance with this view.

The enzymes used by these workers were cholinesterase, prepared from horse serum, and horse-liver esterase. Parallel experiments were carried out with twice crystallized ovalbumin, and with an aged, dialysed specimen of horse serum with negligible esterase activity.

The reactions were carried out in each case with a 0.1 per cent protein solution in phosphate buffer (pH 6.8), to which the radioactive phosphorofluoridate was added as a concentrated solution in dry ethanol. At the end of the reaction time, the product was dialysed for 20 hr. against running water, and precipitated at 0° by addition of two volumes of acetone. The precipitate was spun off and washed at -5° with ethanol and ether, and dried in air or over sulphuric acid. Samples of 25-50 mg. of dry powder were used for radioactivity determinations, and compared with a standard prepared by hydrolysing a weighed amount (*ca.* 1 mg.) of the phosphorofluoridate in N sodium hydroxide, neutralizing and drying.

| Protein | Final molarity of active phosphorofluoridate | Time of reaction at 18° C. | Radiophosphorus (g.atoms) fixed per 10 ⁶ g. protein |
|-----------------------------|--|----------------------------|--|
| Horse-serum cholinesterase | 2×10^{-6} | 30 min. | 0.5 |
| Aged dialysed horse serum | 2×10^{-6} | 30 min. | 0.0 |
| Ovalbumin | 2×10^{-6} | 30 min. | 0.0 |
| Horse-liver esterase | 10^{-4} | 2 hr. | 0.8 |
| Heat-treated liver esterase | 10^{-4} | 2 hr. | 0.0 |
| Aged dialysed horse serum | 10^{-4} | 2 hr. | 0.0 |
| Ovalbumin | 10^{-4} | 2 hr. | 0.0 |

The reaction conditions with cholinesterase and the esterase were in each case sufficient to produce a reduction in enzyme activity greater than 98 per cent.

No reaction occurred with the esterase which had been previously denatured by maintaining at 85° for 10 min. There was no loss of radioactivity by denaturation of esterase which had been treated with

¹ Mackworth and Webb, *Biochem. J.* 1948, **42**, 91; Webb, *Biochem. Soc. Symp.* 1948, no. 2, p. 50.

² *Nature, Lond.*, 1949, **164**, 875.

radioactive phosphorofluoridate under these conditions, nor by prolonged extraction of the dry treated enzyme with organic solvents at 0°.

Stoichiometric deductions from these results are difficult, owing to the inhomogeneity of the enzyme preparations; but if the figure of 80 per cent for the purity of the esterase is used, the results show that 1 g. molecule of the phosphorofluoridate combines with 96,000 g. esterase under conditions which produce complete inactivation. This low figure is consistent with the value obtained by Jansen, Nutting and Balls¹ for crystalline chymotrypsin.²

Structural Requirements for High Toxicity and Myotic Action of Esters of Phosphorofluoridic Acid

We found that the toxicity and myotic activity of di-*isopropyl* phosphorofluoridate (XI) were far greater than that of di-*n*-propyl phosphorofluoridate. In Report no. 6 on fluorophosphonates to the Ministry of Supply³ we described the preparation of di-*sec*.-butyl phosphorofluoridate (XII) by the 'hydrogen phosphite method' (p. 6). The compound was found to be very toxic and to produce severe myosis in man and animals. The symptoms displayed during and after exposure were identical with those produced by di-*isopropyl* phosphorofluoridate. The L.C. 50 for di-*sec*.-butyl phosphorofluoridate for mice for deaths within 2 hr. was 0.6 mg./l., and that for deaths within 48 hr. was 0.54 mg./l.

Four of us were exposed to a concentration of 1 part in 10⁶ for 5 min. A tightness across the chest was noticed.⁴ Some 5 min. after leaving the chamber, myosis set in, and became intense and caused severe incapacitation which lasted for 5 days. One observer suffered from sickness and diarrhoea in addition to the myotic effect.⁵

We then examined the preparation of the compound from the

¹ *J. Biol. Chem.* 1949, 179, 201.

² For nature of chymotrypsin, see p. 186.

³ McCombie and Saunders, 30 September 1942.

⁴ Negligible sensory irritation was caused by di-*isopropyl* phosphorofluoridate at a concentration of 1 part in 10⁶. This, coupled with the fact that the odour was practically undetectable, means that sufficient warning is not usually given at this concentration to suggest the use of respirators. Exposures at this concentration cause severe myosis which persists for several days and causes considerable incapacitation (Report no. 12 by McCombie and Saunders to Ministry of Supply, 4 August 1943).

⁵ Cook, Saunders and Smith, *J. Chem. Soc.* 1949, p. 635.

THE PHOSPHOROFUORIDATES

technical standpoint, and found that it could be prepared by a 'one-stage' process from phosphorus trichloride and *sec.*-butyl alcohol in a 72 per cent yield (see p. 47).

We had previously stated¹ that *di-n-butyl phosphorofluoridate* was a compound of low toxicity and produced a negligible myotic effect. It seemed of interest then to determine whether the branching of the chain adjacent to the oxygen atom was a necessary requirement for high toxicity or whether a branching at the end of the chain would do equally well. Accordingly *di-isoamyl phosphorofluoridate* (XIII) was prepared by the hydrogen phosphite method and shown to be almost non-toxic and devoid of myotic properties. A most striking result was obtained on examining the compound derived, by branching the chain in (XIII) by a methyl group on carbon atom 1. This new compound, *di-(1:3-dimethyl-n-butyl) phosphorofluoridate* (XIV), was found to be very toxic and to possess strong myotic action. A 10 min. exposure to a concentration of 1.2 mg./l. killed 3/3 rats, 0/4 guinea-pigs and 10/10 mice.

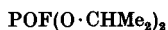

(XI)

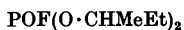

(XII)

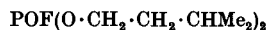

(XIII)

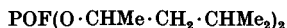

(XIV)

Di-(1-carbethoxyethyl) phosphorofluoridate (XV) was readily produced by the action of sodium fluoride on the corresponding phosphorochloridate obtained from *di-(1-carbethoxyethyl) hydrogen phosphite*, which in turn was obtained by the action of phosphorus trichloride on ethyl lactate. Although (XV) contained secondary groupings, it was found to be relatively non-toxic and to produce only slight myosis in the pupils of the eyes of rabbits and guinea-pigs.

In view of the high toxicity and very pronounced myotic effect of *di-isopropyl phosphorofluoridate*, *di-(1:3-dichloroisopropyl) phosphorofluoridate* (XVI) was of special interest. It was prepared from 1:3-dichlorohydrin and phosphorus trichloride. It did not have any appreciable myotic effect and the toxicity was of a low order. *Di-(1-ethylpropyl) phosphorofluoridate* (XVII),

¹ Report to Ministry of Supply, 18 December 1941.

STRUCTURAL REQUIREMENTS FOR TOXICITY

prepared from phosphorus trichloride and the corresponding alcohol, caused constriction of the pupils of the eyes of rabbits and guinea-pigs at a concentration of 1/10,000 (1.07 mg./l.). The material (b.p. 98°/2 mm.) formed a fine fog on atomization. In spite of the secondary groupings the toxicity was not of a high order and only 13/23 of a batch of small animals died when exposed to the above concentration. Thus it becomes apparent that there is a falling-off of toxicity as methyl groups are replaced by ethyl groups, the potencies of compounds of this class being in the order, (XI), (XII), (XVII).

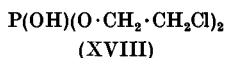
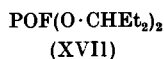
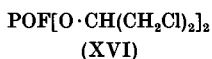
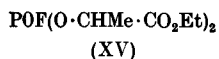

As previously stated (p. 53) di-(2-chloroethyl) phosphorofluoridate can be prepared by the action of phosphorus oxydichlorofluoride on ethylene chlorohydrin. The compound can also be prepared by the fluorination of di-(2-chloroethyl) phosphorochloridate, prepared from di-(2-chloroethyl) hydrogen phosphite (XVIII), obtained by the action of phosphorus trichloride on ethylene chlorohydrin. This partial fluorination was effected by means of sodium fluoride, although the yield was not high. The chlorine atoms of the 2-chloroethyl groups were not affected by this procedure, a fact which falls into line with the observations of Saunders and Stacey (p. 12) that ethylene chlorohydrin is not readily fluorinated by sodium fluoride, but only by potassium fluoride under pressure in a rotating autoclave.¹

Discussion. From the investigations of the compounds described so far, it is evident that the myotic effect and toxicity of the molecule $\text{POX(O}\cdot\text{CHRR')}_2$ depend upon the nature of X, R and R'. In this *particular type*² of molecule if X is fluorine, then high toxicity and myotic properties result. Myotic effect is absent and toxicity is of a low order if X = H, Et,

¹ Cf. McCombie and Saunders, *Nature, Lond.*, 1946, 158, 382.

² We shall see later (p. 188) that toxicity seems to be dependent, to some extent at least, on the presence of an anhydride structure, e.g. P—F, P—O—P, P—O—C₆H₄NO₂, etc. Nevertheless, P—Cl compounds are non-toxic.

THE PHOSPHOROFLUORIDATES

$O \cdot CH_2 \cdot CH_2Cl$, $O \cdot CH_2 \cdot CH_2F$, Cl , NH_2 , $NHMe$, $NHPh$, CH_2F , $CH_2 \cdot CH_2F$, CN , SCN , or morpholino. (Further details are given below, p. 83.)

In the molecule ($X = F$), the pupil-constricting action and toxicity are increased by a secondary grouping (e.g. $R = R' = Me$; $R = Me$, $R' = Et$; $RR' = cyclohexyl$; $R = Me$, $R' = CH_2 \cdot CHMe_2$). Furthermore, it appears that for non-cyclic compounds both R and R' , for the best results, must be unsubstituted hydrocarbon radicals (e.g. if $R = Me$ and $R' = CO_2Et$ the compound is scarcely toxic). Similarly, if $R = R' = CH_2Cl$, both the myotic effect and toxicity are of a low order. Among unsubstituted (non-cyclic) secondary radicals, the best results seem to be obtained when one group, at least, is Me ; for example, if $R = R' = Et$, the toxicity is considerably reduced.

Turning again to primary phosphorofluoridates ($R' = H$), if R is substituted, e.g. in di-(2-chloroethyl) phosphorofluoridates, the toxicity and myotic effect are greatly inferior to those shown by the unsubstituted diethyl phosphorofluoridates. Toxicity is also very low in the aromatic series; for example, diphenyl phosphorofluoridate is non-toxic and devoid of myotic properties. Similar remarks apply to certain sulphur analogues, e.g. diethyl phosphorofluoridodithiolate, $POF(SEt)_2$ (preparation, p. 54).

Other Compounds related to the Phosphorofluoridates

Reference has already been made to some of these compounds in the previous section and a description of these and of other related substances is now given.

Potassium thiocyanate reacted readily with diethyl phosphorochloridate giving diethyl phosphorothiocyanidate,



The compound proved to be relatively non-toxic.¹

Gaseous ammonia reacted with the phosphorochloridate at 0° producing solid diethyl phosphoramidate in accordance with the equation: $Et_2PO_2Cl + 2NH_3 = Et_2PO_2NH_2 + NH_4Cl$.

In a similar manner, gaseous methylamine gave diethyl methylphosphoramidate, Et_2PO_2NHMe , which was, however,

¹ Saunders, Stacey, Wild and Wilding, *J. Chem. Soc.* 1948, p. 699.

RELATED COMPOUNDS

a liquid. The compound could not be acetylated with a mixture of acetic acid and acetic anhydride, and it did not react with either *p*-toluenesulphonyl chloride or ethylene oxide. Diethyl phenylphosphoramidate is described on p. 45; diethyl phosphoromorpholidate has been prepared by a similar method. The phosphoramidate, the methylphosphoramidate, and the phenylphosphoramidate were non-toxic and devoid of myotic properties.

It was important to determine whether the fluorine atom must be attached directly to the phosphorus atom in order to produce 'phosphorofluoridate-like' activity. For this purpose we treated the toxic di-*sec.*-butyl phosphorofluoridate¹ with diazomethane and obtained a compound which was undoubtedly di-*sec.*-butyl fluoromethylphosphonate (XIX). Unlike the parent phosphorofluoridate, the fluoromethylphosphonate was only slightly toxic and produced negligible myosis. (It may be mentioned here that thionyl chloride and carbonyl chloride were converted by means of diazomethane into bis-(chloromethyl)-sulphoxide and *S*-dichloroacetone respectively.)

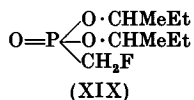

Compounds containing the $\text{>P}(\text{O})\text{CH}_2\text{CH}_2\text{F}$ group are referred to later under the Arbusov reaction (p. 96).

The 2-chloroethyl group, which is often an effective toxophore, was then attached to phosphorus through oxygen. No reaction appeared to take place between ethylene chlorohydrin and diethyl phosphorochloridate in the absence of a tertiary base. In the presence of pyridine, however, which removed the hydrogen chloride formed, a smooth reaction took place at 0° with the formation of diethyl 2-chloroethyl phosphate,

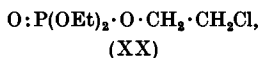

¹ The best results were obtained with slightly impure ester, no doubt because of some catalytic effect (cf. p. 161).

THE PHOSPHOROFUORIDATES

in good yield. The compound was non-toxic and devoid of myotic action. The fluorine analogue of (XX), diethyl 2-fluoroethyl phosphate, was prepared in an analogous manner from 2-fluoroethyl alcohol.

Ethyl phosphorodifluoridate (XXI) was obtained by the action of sodium fluoride on the corresponding phosphorodichloridate; unlike diethyl phosphorofluoridate, it was rapidly attacked by cold water. Alcohol converted (XXI) into the phosphorofluoridate:

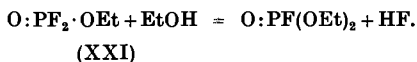

When mice, rats, rabbits and guinea-pigs were exposed to a concentration of 0.88 mg./l. (i.e. 1/5000) of ethyl phosphorodifluoridate for 10 min. there was irritation of the eyes and nose with nasal discharge, lacrimation and salivation. Four minutes after exposure the mice and some of the rats developed dyspnoea, but all the animals recovered. When animals were exposed to a corresponding concentration of ethyl phosphorodichloridate (1.46 mg. l.; 1/5000), similar symptoms were observed and no deaths resulted.

It has been shown¹ that triethyl-lead salts are, in general, sternutators. Accordingly bistriethyl-lead phosphorofluoridate, $\text{O}=\text{PF}(\text{O} \cdot \text{PbEt}_3)_2$, was prepared in an attempt to combine sternutatory properties and myotic action. A solid with powerful sternutatory properties, it produced an irrespirable atmosphere at a concentration of 1 part in 10^6 . At 1 part in 10^8 the sternutatory properties were still marked. No myotic effect was produced in human beings at a concentration of 1 part in 10^6 . Tests at higher concentrations were not carried out on human beings owing to the overwhelming sternutatory effects.

Diethyl *p*-dimethylaminophenylphosphoramidate was readily obtained as a colourless crystalline solid by the action of *NN'*-dimethyl-*p*-phenylenediamine on diethyl phosphorochloridate.²

¹ McCombie and Saunders, *Nature, Lond.*, 1947, **159**, 491.

² Cook, Ilett, Saunders, Stacey, Watson, Wilding and Woodcock, *J. Chem. Soc.* 1949, p. 2921.

The parent phenylphosphoramidic acid, $\text{PO}(\text{NHPH})(\text{OH})_2$, was obtained by a method¹ which consisted in the ready hydrogenolysis of dibenzyl phenylphosphoramidate.² An attempt to prepare dibenzyl *p*-dimethylaminophenylphosphoramidate by the action of *NN'*-dimethyl-*p*-phenylenediamine on dibenzyl phosphorochloridate gave only an oil. When, however, a mixture of the amine, dibenzyl hydrogen phosphite, and trichlorobromomethane was used,³ a good yield of the dibenzyl *p*-dimethylaminophenylphosphoramidate was obtained. It is a crystalline solid which causes severe dermatitis; the irritation develops slowly and with some individuals persists for weeks.

Dialkyl phosphorofluoridites

The myotic, toxic and other physiological properties of the dialkyl phosphorofluoridates, $\text{POF}(\text{OR})_2$, have been fully described on pp. 42, 68 *et seq.* In 1944⁴ we described an analogous compound of the phosphorofluoridite series, namely, *diethyl phosphorofluoridite*, $\text{PF}(\text{OEt})_2$. This could not be prepared by the action of sodium fluoride on the corresponding diethyl phosphorochloridite (the preparation of which is considered below). We obtained it, however, by the action of ethyl alcohol on phosphorus dichlorofluoride,

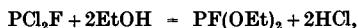

under the following conditions: (a) in ether, cooled by ice and salt; (b) in ether, in the presence of a tertiary amine to remove hydrogen chloride, cooled by ice and salt; (c) without a solvent, cooled by a mixture of carbon dioxide and ether; or (d) in ether, cooled by a mixture of carbon dioxide and ether. Condition (a) gave the best results, although some of the ester was obtained in each of the above experiments.⁵

Diethyl phosphorofluoridite is readily hydrolysed by water. It is only feebly toxic in comparison with the corresponding phosphorofluoridate. Exposure to a concentration of 1 mg./l.

¹ Cf. Atherton and Todd, *J. Chem. Soc.* 1947, p. 649.

² Cf. Atherton and Todd, *J. Chem. Soc.* 1947, p. 674. See also below, p. 107.

³ Cook, Ilett, Saunders, Stacey, Watson, Wilding and Woodcock, *loc. cit.*

⁴ Report no. 18 to Ministry of Supply, McCombie and Saunders, 4 July 1944.

⁵ Cook, Ilett, Saunders, Stacey, Watson, Wilding and Woodcock, *loc. cit.*

THE PHOSPHOROFLUORIDATES

for 10 min. caused no deaths among a batch of small animals, although some myosis was produced, but all the eyes returned to normal within 24 hr.

The phosphorus dichlorofluoride required for the above condensation was prepared by the fluorination of phosphorus trichloride by a modification of the method of Booth and Bozarth.¹

We prepared diethyl phosphorochloridite, $\text{PCl}(\text{OEt})_2$, (a) by the action of phosphorus trichloride on triethyl phosphite, $2\text{P}(\text{OEt})_2 + \text{PCl}_3 \longrightarrow 3\text{PCl}(\text{OEt})_2$, or (b) by the action of phosphorus trichloride (1 mol.) on ethyl alcohol (2 mol.) in the presence of diethylaniline (2 mol.),

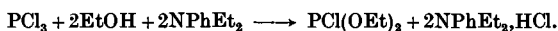

Although diethyl phosphorochloridite is hydrolysed by water it did not react readily with sodium fluoride (referred to above) or potassium cyanide, but it gave derivatives with aniline and β -naphthylamine, viz. diethyl phenylphosphoramidite, $(\text{EtO})_2\text{P}\cdot\text{NHC}_6\text{H}_5$, and diethyl β -naphthylphosphoramidite, $(\text{EtO})_2\text{P}\cdot\text{NHC}_{10}\text{H}_7$.

Ethyl phosphorodichloridite was first prepared by Menchutkin,² but he did not give precise details. We found that it could be isolated from the reaction product formed by adding ethyl alcohol (1 mol.) to phosphorus trichloride in ether in the absence of a tertiary base. By this means the phosphorus trichloride is always in excess. Thus the interaction of phosphorus trichloride and ethyl alcohol under a wide variety of conditions has been recorded and may conveniently be summarized as follows:

| PCl_3 (mol.) | EtOH (mol.) | Addendum | Product | Ref. |
|--------------------------|-------------------------|-------------------------|--|--|
| 1 | 3 | 3 mol. of tertiary base | $\text{P}(\text{OEt})_3$ | <i>J. Chem. Soc.</i> 1945, p. 380. |
| 1 | 3 | No tertiary base | $\text{P}(\text{OEt})_2\cdot\text{OH}$ | <i>Ibid.</i> |
| 1 | 2 | 2 mol. of tertiary base | $\text{PCl}(\text{OEt})_2$ | <i>J. Chem. Soc.</i> 1949, p. 2921. |
| 1 | 1 | No tertiary base | $\text{PCl}_2(\text{OEt})$ (mainly) | <i>Ibid.</i> |

¹ *J. Amer. Chem. Soc.* 1939, **61**, 2927.

² *Liebigs Ann.* 1866, **139**, 343.

Chapter V

I. PHOSPHORODIAMIC FLUORIDES

II. TABUN AND SARIN

I. Phosphorodiamic Fluorides

As we have seen (pp. 50 *et seq.*) the reaction between phosphorus oxydichlorofluoride and alcohols, phenols and thiols, affords dialkyl, *dicycloalkyl*, diaryl phosphorofluoridates and dialkyl phosphorodithiolates. In a Report¹ to the Ministry of Supply on fluorophosphonates a description was given of a new type of 'nitrogen fluorophosphonate' formed by the action of 4 mol. of aniline on 1 mol. of phosphorus oxydichlorofluoride, the fluorine atom being unaffected:

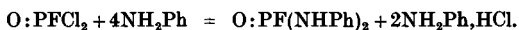

(I)

The compound (I) was a highly crystalline, stable substance, and at that time was named dianilino fluorophosphine oxide. This compound is now called diphenylphosphorodiamidic fluoride. A solution in propylene glycol was injected into mice, and the L.D. 50 found to be about 90 mg./kg.

Later, American workers² described the preparation of this type of compound by a method which necessitated the loss of two-thirds of the fluorine concerned in the reaction. They prepared tetramethylphosphorodiamidic fluoride (bisdimethylaminofluorophosphine oxide) (II) by the action of phosphorus oxyfluoride on the calculated quantity of dimethylamine. In addition, it should be emphasized that phosphorus oxyfluoride is a gas and is more difficult than the liquid phosphorus oxydichlorofluoride to manipulate. In Report no. 14 on fluorophosphonates to the Ministry of Supply³ it was shown that our reaction could also be applied to the preparation of tetramethyl-

¹ 30 September 1942.

² Burg, private communications of 19 February and 15 March 1943.

³ 30 September 1943.

PHOSPHORODIAMIC FLUORIDES

phosphorodiamidic fluoride, and was of very general application.¹

It was found that tetramethylphosphorodiamidic fluoride (bisdimethylaminofluorophosphine oxide) was very toxic and had a L.D. 50 of the order of 1.0 mg./kg. for subcutaneous injection into mice; the concentration for rabbits was higher at 3.0 mg./kg. (intravenously). The Cambridge figure for toxicity by inhalation agreed with that found by American workers, the L.C. 50 for mice being 0.095 mg./l. for a 10 min. exposure. We also carried out experiments with four human observers exposed to a concentration of one part in a million for 5 min. No effects of any kind were noted; in particular, myotic action was absent. In this report, therefore, the highly toxic compound (II) differed markedly from the toxic di-*isopropyl* phosphorofluoridate (IV), in that the latter showed powerful myotic action. It is to be noted also that, whereas (IV) caused 50 per cent inhibition of cholinesterase activity at a concentration of the order of 10^{-10} M, a concentration of *ca.* 8×10^{-5} M of (II) was necessary to produce the same percentage inhibition.²

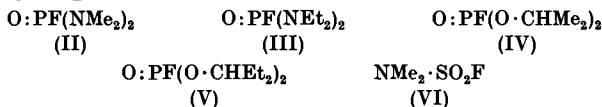

Nevertheless, there is some similarity of structure between compounds (II) and (IV). It is known that with *gem.*-diethyl groups in the phosphorofluoridate molecule, e.g. di-(1-ethyl-*n*-propyl) phosphorofluoridate (V), the toxicity is less than with *gem.*-dimethyl groups (di-*isopropyl* phosphorofluoridate (IV)). We found that similarly tetraethylphosphorodiamidic fluoride (III) was very much less toxic than (II). This applied to subcutaneous as well as to inhalation experiments. By subcutaneous injection the L.D. 50 of (III) for mice was *ca.* 160 mg./kg. This close analogy between the two types of compound cannot, however, be pressed too far. The toxicities by subcutaneous injection into mice of other hitherto undescribed substituted phosphorodiamidic fluorides, are given on p. 89.

¹ B.P. 602,446. Ministry of Supply, McCombie, Saunders, Chapman and Heap, 17 April 1944.

² Dixon and Mackworth, Report to Ministry of Supply, 23 April 1942; also Dixon and Webb, 8 May 1944. See also p. 62.

PHOSPHORODIAMIC FLUORIDES

In the British Patents¹ we claimed the use of this type of compounds as insecticides,² bactericides and fungicides, and indicated their general clinical application.

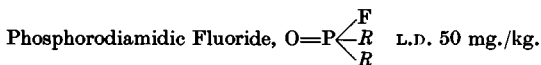

| | |
|-------------------------------|-----|
| <i>R</i> | |
| Di-(<i>n</i> -butylamino) | 16 |
| Di-(benzylamino) | 10 |
| Di-(cyclohexylamino) | 9 |
| Dimorpholino | 400 |
| Dipiperidino | 320 |
| Di-(<i>N</i> -methylanilino) | 160 |

The compounds are, in general, stable and fairly resistant to hydrolysis in spite of the >POF grouping. We showed, for example, that diphenylphosphorodiamidic fluoride could be recrystallized from aqueous alcohol. Tetramethylphosphorodiamidic fluoride was not affected to any extent by contact with water at 18° for 6 hr. The reaction between $N/2$ aqueous sodium hydroxide solution and the compound was studied. The extent of hydrolysis (removal of fluorine) after 30 min. was about 8.9 per cent, and even after 500 hr. it was only 29.9 per cent. The compound is also affected by acid.

In Report no. 16 on fluorophosphonates to the Ministry of Supply,³ we gave an account of a very useful alternative method of preparation. The method consisted in treating an amine with the calculated quantity of phosphorus oxychloride in ethereal solution:

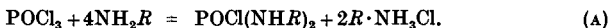

The phosphorodiamidic chloride thus obtained was then fluorinated. For example, diphenylphosphorodiamidic chloride was readily fluorinated by heating it with potassium fluoride in benzene,



With some compounds, e.g. tetramethylphosphorodiamidic chloride, $POCl(NMe_2)_2$, certain other salts were also effective fluorinating agents.

¹ B.P. 602,446. Ministry of Supply, McCombie, Saunders, Chapman and Heap, 17 April 1944.

² The use of tetramethylphosphorodiamidic fluoride as an insecticide is described on p. 177.

³ December 1943; see also McCombie and Saunders, *Nature, Lond.*, 1946, 157, 776.

PHOSPHORODIAMIC FLUORIDES

The preparation of diphenylphosphorodiamidic chloride was first mentioned by Michaelis,¹ who heated 2 mol. of aniline hydrochloride with 1 mol. of phosphorus oxychloride for 48 hr. He did not give a yield and we found the method long and tedious. We showed, however, that this compound is much more simply prepared by allowing 4 mol. of aniline to react with phosphorus oxychloride in cold ethereal solution, in accordance with equation (A).

In view of the high toxicity of (II), it seemed that the sulphur analogue, dimethylaminosulphonyl fluoride (VI), might be of some interest. We therefore studied the fluorination of dimethylaminosulphonyl chloride. The reaction with potassium fluoride was incomplete, and that with zinc fluoride unsatisfactory, but that with antimony trifluoride using benzene as a solvent proved to be very satisfactory, and an 80 per cent yield of (VI) was obtained. Physiological examination showed that (VI) caused no irritation when small animals were exposed to a concentration of 1 mg./l. for 10 min., and no deaths took place. With the sulphonyl chloride at the same concentration, lacrimation and nasal irritation were caused; no deaths were recorded, and all the animals recovered almost immediately on being removed from the chamber.

Alkyl Phosphoramidofluoridates

In view of the rapid toxic action and myotic effect of the dialkyl phosphorofluoridates and of the high toxicity of some of the phosphorodiamidic fluorides, we prepared² and examined a 'hybrid' molecule containing the essential features of each type of compound. The first to be examined was ethyl phenylphosphoramidofluoridate (VII). One mol. of phosphorus oxydichlorofluoride was added to 1 mol. of ethyl alcohol, and the resulting ethyl phosphorofluoridochloridate (which it was not necessary to isolate) was treated with aniline.

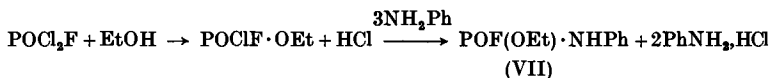

¹ *Ber. deutsch. chem. Ges.* 1894, **27**, 2574.

² Report no. 15 on fluorophosphonates to Ministry of Supply, by McCombie and Saunders, 9 December 1943.

On subcutaneous injection into mice, (VII) had a L.D. 50 of 10 mg./kg., which was unexpectedly high in view of the reduction of toxicity caused by the phenyl group on both the phosphorofluoridates (p. 54) and the phosphorodiamidic fluorides (p. 87).

Ethyl dimethylphosphoramidofluoridate (VIII) was prepared by a similar method and proved to be a very toxic liquid. Its L.D. 50, on intravenous injection into rabbits and also on subcutaneous injection into mice, was 2.5 mg./kg. Toxicity was also determined by inhalation and a *Ct* (*C* = concentration, *t* = 10 min.) of 200 mg./min./cu.m. killed seven out of a batch of eleven rabbits, guinea-pigs, rats and mice; a *Ct* of 100 mg./min./cu.m. killed four out of eleven. The compound also possessed myotic properties. Other compounds that we made in this series were much more toxic; and it will be seen that they bear some resemblance to tabun and sarin now about to be described.

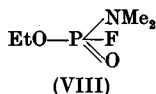

II. Tabun

This compound, ethyl *N*-dimethylphosphoramidocyanidate (IX), has been prepared in a variety of ways. One published method used phosphorus oxychloride¹ thus:

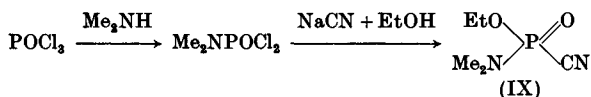

A large-scale plant for the production of 100 tons a month was known to be in operation in Germany at the end of World War II. It was also prepared on a laboratory scale by Saunders and Stacey² before German reports were available, by the novel reaction:

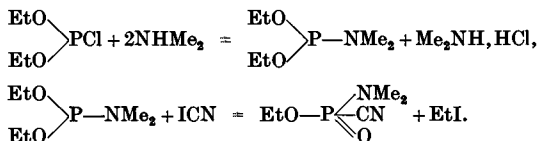

¹ Gordon, 'Information on poison gas manufacture in Germany', Report no. 12; U.S. Department of Commerce, Washington, D.C., 1945.

² B. C. Saunders, Report to Ministry of Supply, no. 19, 1945.

B. O. Holmstead¹ has carried out investigations on the rate of hydrolysis of cyano-phosphorus compounds. First of all, mention may be made of the hydrolysis of diethyl phosphorocyanidate² which proceeds rapidly in a buffer solution at pH 7.2 giving rise to the CN ion. Some 90 per cent hydrolysis takes place at this pH in 1 hr. Under similar conditions tabun is also hydrolysed to cyanide to the extent of about 80 per cent in 12 hr. There is a concurrent diminution of toxicity as the hydrolysis proceeds. Even in distilled water 50 per cent of the cyanide is split off in 9 hr. This instability would seem to render this compound ineffective as a toxic agent for use on a large scale.

In acid solution, it hydrolyses rapidly to dimethylamine thus:

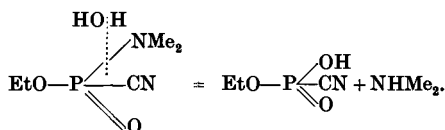

There is, of course, a concurrent breaking of the P—CN link because of the aqueous medium alone.

Bleaching powder destroys tabun, but it gives rise to cyanogen chloride, CNCl, which is also toxic.

Sarin

This ester, *isopropyl methylphosphonofluoridate* (X), is a colourless liquid. It is more toxic than D.F.P., but shows very similar physiological properties, intense myosis, respiratory collapse, powerful anticholinesterase activity, etc. The liquid passes rapidly through the skin. At the end of World War II, two plants were under construction in Germany for the production of the material on a large scale.

It is an odourless, colourless, hygroscopic liquid, completely miscible with water in which it is hydrolysed at an appreciable rate with the loss of fluorine and loss of toxicity. It is about three times as toxic as tabun to most animal species. Its boiling-point, 147° with decomposition, classifies it as a semi-persistent gas. It is hydrolysed extremely rapidly by dilute aqueous

¹ *Acta physiol. scand.* 1951, **25**, suppl. 90.

² For preparation see p. 97 below, and Saunders, Stacey, Wild and Wilding, *J. Chem. Soc.* 1948, p. 699.

sodium hydroxide or sodium carbonate to non-toxic products. The first stage of decomposition can be represented thus:¹

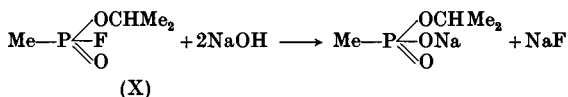

The ester group is then hydrolysed, and the hydrolysis normally stops at the $\text{MePO}(\text{OH})_2$ stage. More vigorous conditions are required to rupture the $\text{Me}-\text{P}$ bond. Thus the normal hydrolysis product of D.F.P. and of tabun, namely, phosphoric acid, will give a positive test with ammonium molybdate, whereas the product from sarin, namely, methylphosphonic acid, will not respond to this test. Vigorous reagents such as hot nitric acid and ammonium persulphate will break the $\text{C}-\text{P}$ link and then a positive test for phosphate is obtained with ammonium molybdate. Sarin can be prepared in a variety of ways. Three methods² are outlined below:

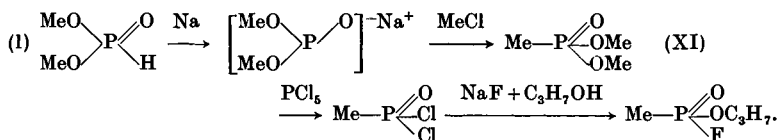

The dimethyl methylphosphonate (XI) can also be readily prepared by the Arbusov rearrangement of trimethyl phosphite:³

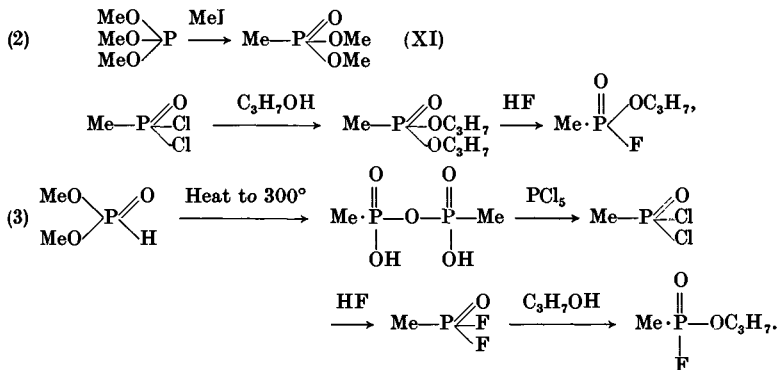

¹ Water also rapidly removes the F atom producing the non-toxic acid $\text{MePO}(\text{OCHMe}_2)\text{OH}$.

² Schrader, *B.I.O.S.* 1947, 714, 41.

³ Cf. Saunders, Stacey, Wild and Wilding, *J. Chem. Soc.* 1948, p. 702; see also p. 95, below.

TABUN AND SARIN

A compound related to sarin is *soman* (XII) which is pinacolyl methylphosphonofluoridate. It is more toxic than sarin:

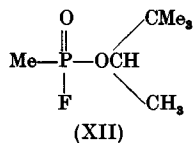

Chapter VI

SELECTED REACTIONS OF ESTERS CONTAINING PHOSPHORUS

In this chapter no attempt is made to present an exhaustive compilation of the reactions of esters containing phosphorus. For a more extensive survey the references on p. 216 should be consulted.

Most of our examples are chosen because they have, or may have, some bearing directly or indirectly on the main theme of the monograph, namely, the study of certain compounds of phosphorus and fluorine noted for their striking toxic action.

The Arbusov Reaction

The Arbusov reaction¹ was discovered in 1906, and has found many applications. If an alkyl halide is heated with a trialkyl phosphite, the following change takes place:

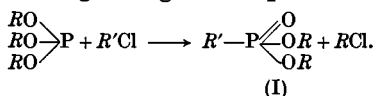

If $R = R'$ the reaction appears to be catalytic, as a small quantity of $R'\text{Cl}$ will suffice to convert a considerable quantity of the phosphite into the alkylphosphonate² (I). As little as 0.01 ml. of methyl iodide will isomerize trimethyl phosphite.³ Methyl iodide can be replaced satisfactorily by dimethyl sulphate.

Arbusov and later Kosolapoff⁴ suggested that the reaction took a course now represented thus:

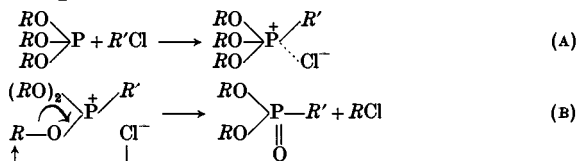

¹ Arbusov, *J. Soc. phys.-chim. russe*, 1906, **38**, 687.

² Arbusov and Razumov, *Bull. Acad. Sci. U.R.S.S., Cl. Sci. Chim.*, 1945, no. 167.

³ Landauer and Rydon, *J. Chem. Soc.* 1953, p. 2224.

⁴ *J. Amer. Chem. Soc.* 1944, **66**, 109.

REACTIONS OF ESTERS CONTAINING PHOSPHORUS

In this reaction the evidence indicates that (B) is the rate-determining step.

Arbusov reactions have been observed with many different types of reactive halogeno compounds, e.g. with polyhalogenoalkanes,¹ esters of halogenocarboxylic acids,² alkylaryl halides³ and certain heterocyclic halides.⁴ Acetyl chloride and benzoyl chloride react at room temperature to give esters of the corresponding acetyl and benzoyl phosphonic esters.⁵

It is interesting to note that Saunders, Stacey, Wild and Wilding⁶ have brought about the reaction between triethyl phosphite and bromofluoroethane (II), giving diethyl 2-fluoroethylphosphonate (III), thus providing the first recorded example of the 2-fluoroalkyl group attached to phosphorus:

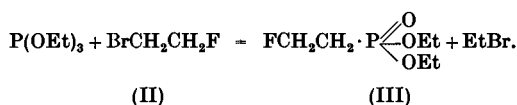

This reaction depends upon the great difference in reactivity between the bromine atom and the fluorine atom in bromofluoroethane. The relative firmness of the C—F link is again referred to in Chapter VII.

We similarly prepared diethyl benzylphosphonate, $\text{C}_6\text{H}_5\text{CH}_2 \cdot \text{PO(OEt)}_2$ (IV), using benzyl chloride in place of bromofluoroethane.

In passing, it may be noted that we prepared diethyl 2-fluoroethylphosphonate (III) and diethyl benzylphosphonate (IV) by an alternative route from sodium diethyl phosphite and the corresponding halides.⁶

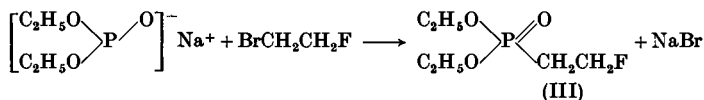

¹ Kosolapoff, *J. Amer. Chem. Soc.* 1947, **69**, 1002; Arbusov and Kuschkowa, *J. Gen. Chem., Moscow*, 1936, **6**, 283.

² Arbusov and Danin, *J. Soc. phys.-chim. russe*, 1914, **46**, 295.

³ Kosolapoff, *J. Amer. Chem. Soc.* 1945, **67**, 2259.

⁴ Kosolapoff, *J. Amer. Chem. Soc.* 1947, **69**, 1002.

⁵ Kabachnick and Rossiiskaya, *Bull. Acad. Sci. U.R.S.S., Cl. Sci. Chim.*, 1945, p. 364.

⁶ *J. Chem. Soc.* 1948, p. 699.

This type of reaction was originally carried out with ethyl iodide¹ and has been extended to other alkyl halides,² halogeno-carboxylic esters³ and to substituted arsine halides.⁴ Incidentally when *p*-toluene sulphonyl chloride and naphthalene-2-sulphonyl chloride were allowed to react with sodium diethyl phosphite, the corresponding disulphones were obtained in small yield.⁵

We obtained diethyl phosphorocyanidate (V) in only small yield by the action of potassium cyanide on the corresponding phosphorochloridate. We were able to prepare it,⁶ however, by the action of cyanogen iodide on the phosphite. This is apparently a modified Arbusov reaction:

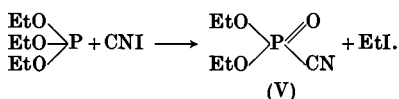

Kosolapoff⁷ carried out a modified Arbusov reaction between triethyl phosphite and trimethylene dibromide and obtained tetraethyl trimethylenediphosphonate (VII, *n* = 3) and diethyl 3-bromopropylphosphonate (VI, *n* = 3).

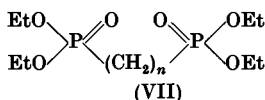
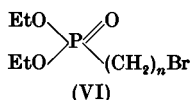

Similar compounds (VI, *n* = 2) and (VII, *n* = 2) were also made by Ford-Moore and Williams⁸ who also showed that (VI, *n* = 2) with triethylamine reacted thus:

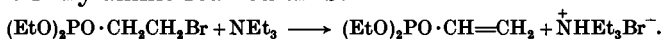

This reaction is similar of course to the corresponding elimination of hydrogen chloride from 'H' sulphone⁹ to give divinyl sulphone:

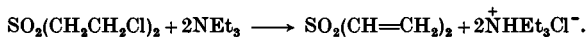

¹ Michaelis and Bedser, *Ber. dtsh. chem. Ges.* 1897, **30**, 1003.

² Kosolapoff, *J. Amer. Chem. Soc.* 1945, **67**, 1180, 2259.

³ Nylen, *Ber. dtsh. chem. Ges.* 1924, **57**, 1023; 1926, **59**, 1119.

⁴ Kamai and Belorossova, *Bull. Acad. Sci. U.R.S.S., Cl. Sci. Chim.*, 1947, p. 141.

⁵ Saunders, Stacey, Wild and Wilding, *J. Chem. Soc.* 1948, p. 699.

⁶ *Ibid.*

⁷ *J. Amer. Chem. Soc.* 1944, **66**, 1511.

⁸ *J. Chem. Soc.* 1947, p. 1465.

⁹ Alexander and McCombie, *J. Chem. Soc.* 1931, p. 1913.

REACTIONS OF ESTERS CONTAINING PHOSPHORUS

In the Arbusov reaction using a triaryl phosphite both the stages (A) and (B) (above, p. 95) are slow, and it is possible to isolate the intermediate 'phosphonium' compound.¹

By the use of triphenyl phosphite methiodide, Rydon² has obtained alkyl iodides according to the equation

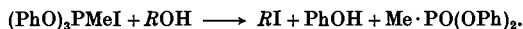

Using this method it is easy to convert ethyl lactate into ethyl α -iodopropionate. It is not necessary to isolate the 'phosphonium compound', and the general reaction can be thus represented:

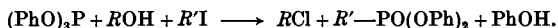

A definite conclusion as to the mechanism has not yet been reached, but Rydon³ has made some suggestions.

Formation of Esters of Phosphorous and Phosphoric Acids

The direct esterification of phosphorous acids with alcohols has been known for a long time, but the method is not successful.

Diazomethane and substituted diazomethanes react smoothly to give the corresponding esters. Thus Atherton, Howard and Todd⁴ have obtained diesters of phosphorous acid (which contains only two acid groups) thus:

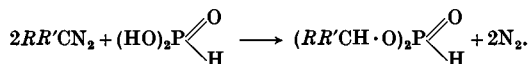

Phosphoric acid is preferentially monosubstituted.⁵

A glycol monophosphate has been synthesized by opening up the appropriate olefin oxide with disodium hydrogen phosphate⁶

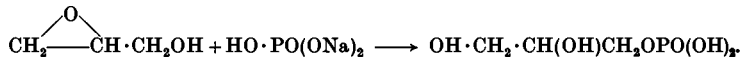

¹ Michaelis and Kähne, *Ber. dtsh. chem. Ges.* 1898, **31**, 1048.

² *J. Chem. Soc.* 1953, p. 224.

³ *Ibid.*

⁴ *J. Chem. Soc.* 1948, p. 1106. See also Pallazo and Maggiacomo, *Gazzetta*, 1908, **38**, II, 115.

⁵ Rechstein and Schindler, *Helv. chim. acta*, 1940, **23**, 669.

⁶ Bailly, *Ann. Chim.* 1916, **6**, 133.

PHOSPHOROUS AND PHOSPHORIC ESTERS

This is a general reaction. Thus ethylene oxide with phosphoric acid gives partial or complete esterification. Phosphorous acid, even when 'completely' esterified, gives only the di-ester:¹

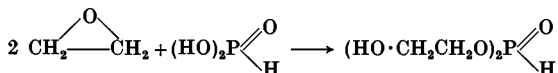

Phosphorus trichloride (but not the pentachloride) also reacts smoothly with ethylene oxide stepwise² thus:

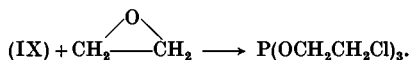
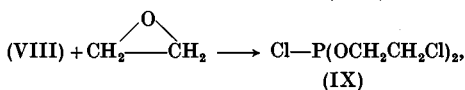
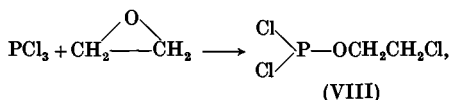

Triaryl esters can be prepared by a variety of methods. For example, by allowing 3 mol. of the phenol to react with 1 mol. of phosphorus oxychloride for several hours. Organic bases such as aniline, dimethylaniline and pyridine have been used to neutralize the hydrogen chloride formed in the reaction.³ Alternatively, the phenols may be converted into the sodium phenoxides⁴ and then allowed to react with phosphorus oxychloride.

A mixed ester such as diethyl *p*-chlorophenyl phosphate is readily prepared by the dropwise addition of diethyl phosphorochloridate to sodium *p*-chlorophenoxide.⁵

Triphenyl phosphite can be prepared by the gradual addition of phosphorus trichloride to a mixture of phenol and pyridine.⁶ It is claimed that magnesium chloride can be used in place of pyridine.⁷

¹ Adams and Shoemaker, U.S.P. 2,372,244.

² Kabnchnik and Rossiiskaya, *Bull. Acad. Sci. U.S.S.R., Cl. Sci. Chim.*, 1946, p. 295.

³ B.P. 322,036.

⁴ German Patent 246,871.

⁵ U.S. Patent 2,504,121.

⁶ Milobendski and Szulgin, *Chem. Polski*, 1917, 15, 66-75.

⁷ Russian Patent 34,555, 28 February 1934.

Anhydrides

Monosilver phosphate reacts readily with acyl chlorides to give a mixed anhydride:¹

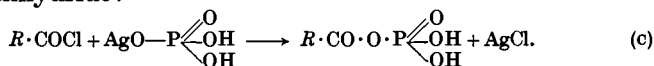

Keten in phosphoric acid gives a similar result:

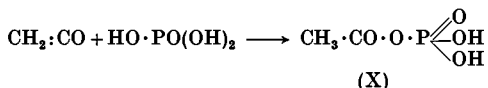

Dibenzyl esters of (X) are obtained by the action of keten on dibenzyl hydrogen phosphate.²

True 'phosphoric' anhydrides are prepared by a method strictly analogous to reaction (c), viz. by the action of a dialkyl phosphorochloridate (p. 43) on the silver dialkyl phosphate:

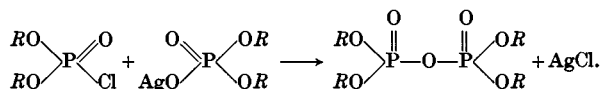

In this way a tetra-alkyl pyrophosphate can be readily obtained.³ This process can be readily extended to give a tri-phosphate⁴ as follows:

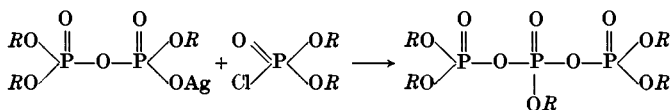

Alkylation by means of Phosphorus-containing Esters

It has been known for a long time⁵ that when triphenyl phosphate is heated with sodium ethoxide, phenetole results. It is possible that there is initially an interchange between the aryl phosphate and the ethoxide giving triethyl phosphate and that

¹ Lipmann and Tuttle, *J. Biol. Chem.* 1944, **153**, 571; Lehainger, *ibid.* 146; 1946, **162**, 333.

² Bentley, *J. Amer. Chem. Soc.* 1948, **70**, 2183; Lynen, *Ber. dtsh. chem. Ges.* 1940, **73**, 367.

³ Baddiley and Todd, *J. Chem. Soc.* 1947, p. 648.

⁴ Baddiley, Michelson and Todd, *Nature, Lond.*, 1948, **161**, 761.

⁵ Morel, *C.R. Acad. Sci., Paris*, 1899, **128**, 507.

ALKYLATION

the latter alkylates the phenol. At all events the overall change is represented by the equation

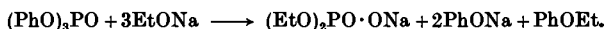

It is now known¹ that trialkyl phosphates will indeed alkylate phenols. The idea has been extended² to the production of methyl ethers from alcohols and trimethyl phosphate, and of a butyl ether according to the equation

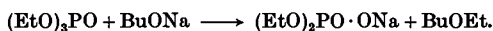

Tertiary amines can often be formed by the reaction between a trialkyl phosphate on an amine³ at a high temperature:

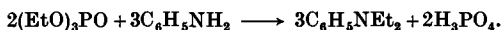

Tribenzyl phosphate and tetrabenzyl pyrophosphate are 'hyperalkylating' agents and produce quaternary amine salts, e.g.

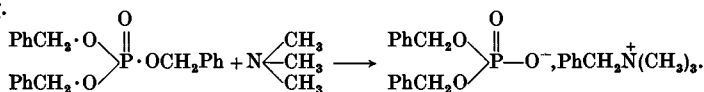

Reference may be made to the great value of this reaction in the synthesis of adenosine triphosphate.⁴

Some further Reactions of Phosphorus Trichloride⁵

In addition to the all-important reaction between phosphorus trichloride and alcohols (p. 45), attention is drawn to the following reactions of phosphorus.

Phosphorus trichloride reacts with benzaldehyde according to the equation⁶

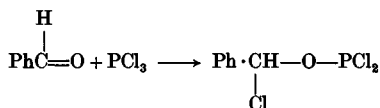

Phosphorus trichloride combines with olefins in the presence of diacetyl peroxide:⁷

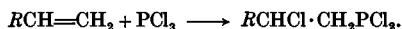

¹ Noller and Dutton, *J. Amer. Chem. Soc.* 1933, **55**, 424.

² Toy, *J. Amer. Chem. Soc.* 1944, **66**, 499.

³ Billman, Radike and Mundy, *J. Amer. Chem. Soc.* 1942, **64**, 2977.

⁴ Baddiley, Michelson and Todd, *Nature, Lond.*, 1948, **161**, 761.

⁵ See above, p. 99.

⁶ Atherton, Clark and Todd, *Rec. Trav. chim. Pays-Bas*, 1950, **69**, 295.

⁷ Kharasch, Jenson and Urry, *J. Amer. Chem. Soc.* 1945, **67**, 1862.

REACTIONS OF ESTERS CONTAINING PHOSPHORUS

This provides an extension of Kharasch's work on free radical reactions, and Kharasch puts forward a free radical mechanism to explain the above.

As already mentioned (p. 99) ethylene oxide reacts with phosphorus trichloride to give ultimately tri-(2-chloroethyl) phosphite, $P(OCH_2CH_2Cl)_3$.¹ In a similar manner $C_6H_5OPCl_2$ and $(C_6H_5O)_2PCl$ will give the corresponding mixed phosphite esters.

By a corresponding reaction with phosphorus oxychloride² in the presence of aluminium chloride and other catalysts such as ferric chloride, iodine, etc., trichloroethyl phosphate can be prepared in a stepwise fashion. This and related compounds possess the property of reducing the inflammability of organic materials and are recommended for special clothing.

It may be noted that triaryl phosphates already referred to are also used as fire-resisters and as plasticizers for cellulose esters and for synthetic resins such as polystyrene and polyvinyl esters.³

The Interaction of Phosphorus Pentachloride and Alcohols

The usual equation given for this reaction is



Under certain controlled conditions Gerrard,⁴ with primary alcohols, has obtained the chloroesters $RO \cdot P(O)Cl_2$ and $(RO)_2POCl$ as well as the alkyl chloride. He therefore postulates the following mechanism employing the hypothetical $ROPCl_4$:

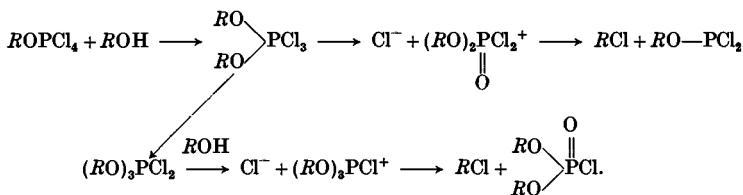

¹ Kharasch, Jenson and Urry, *J. Amer. Chem. Soc.* 1945, **67**, 1862.

² B.P. 473,523.

³ Dow Chemical Co., B.P. 497,174.

⁴ Gerrard and Phillips, *Chem. & Ind. (Rev.)*, 1952, p. 540.

PHOSPHORUS PENTACHLORIDE AND ALCOHOLS

Owing to the greater electron release in derivatives from secondary alcohols, olefins would be produced by a mechanism such as the following:

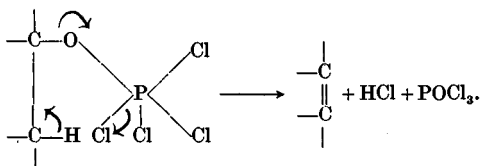

Esters of Metaphosphoric Acid

Metaphosphates have been prepared by the action of phosphoric anhydride on dry ether and also by metathesis:¹



Phosphoric anhydride will also convert a neutral phosphate ester into the metaphosphate ester:²

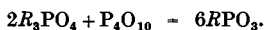

Metaphosphates are unstable liquids and have been used to remove water or ammonia in organic syntheses. For example, acetone may be dehydrated to mesityl oxide at room temperature.³

Esters of Pyrophosphoric Acid

These esters have been prepared by a number of reactions of which the following may be mentioned:

(1) The reaction between silver pyrophosphate⁴ and an alkyl halide gives the ester⁵



(2) Esters of orthophosphoric acid react with phosphoric anhydride thus:⁶

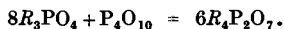

¹ Adler and Woodstock, *Chem. Ind.* 1942, 51, 516, 657.

² *Ibid.*; and see U.S. Patent 2,402,703.

³ Langheld, *Ber. deutsch. chem. Ges.* 1910, 43, 1857.

⁴ Mellor, *A Comprehensive Treatise on Inorganic and Theoretical Chemistry*, 8, 911.

⁵ Adler and Woodstock, *Chem. Ind.* 1942, 51, 516, 657.

⁶ *Ibid.*; and see U.S. Patent 2,402,703.

REACTIONS OF ESTERS CONTAINING PHOSPHORUS

(3) Tetraethyl pyrophosphate (T.E.P.P.) was prepared by Toy¹ in 73 per cent yield by the controlled hydrolysis of diethyl phosphorochloridate in the presence of a tertiary base:

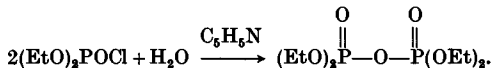

(4) Kosolapoff² has prepared T.E.P.P. by the action of chlorine on a mixture of sodium diethyl phosphate and diethyl phosphorochloridate followed by the addition of an excess of alcohol.

(5) The reaction between a dialkyl phosphorochloridate and a silver dialkyl phosphate has already been referred to (p. 100).

(6) Tetramethyl and tetraethyl pyrophosphate can be prepared in good yield by the following reaction:³



These pyrophosphates are not stable to water.

T.E.P.P. is classed as a systemic insecticide, unstable to water, and is referred to in Chapter IX.

(7) Dibenzyl hydrogen phosphate when warmed with oxalyl chloride evolves hydrogen chloride and gives bisdibenzylphosphoryl oxalate (XI), which when heated to its melting-point yields tetrabenzyl pyrophosphate.⁴

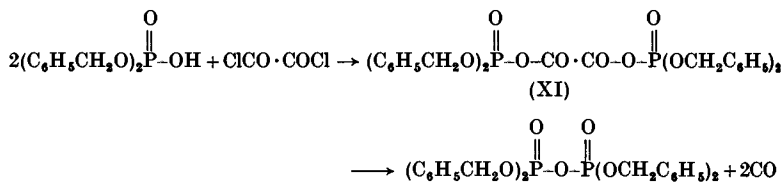

Dibenzyl hydrogen phosphate and thionyl chloride give a small yield of the pyrophosphate.

(8) The same pyrophosphate⁵ can be prepared in high yield from dibenzyl hydrogen phosphate by reaction for a short time with tetraphenyl pyrophosphate at room temperature in an

¹ U.S. Patent 2,504,165.

² U.S. Patent 2,503,204.

³ Toy, *J. Amer. Chem. Soc.* 1949, **71**, 2268; also *Nature, Lond.*, 1949, **163**, 379.

⁴ Mason and Todd, *J. Chem. Soc.* 1951, p. 2267.

⁵ Corby, Kenner and Todd, *J. Chem. Soc.* 1952, p. 1234.

PYROPHOSPHATES

hydrous polar solvents in presence of a tertiary base. It may be noted that such conditions are ideal for work in the nucleotide field. The mechanism of this 'exchange' reaction depends upon the disproportionation of tetraphenyl pyrophosphate by the dibenzyl phosphate.

(9) An effective reagent for the preparation¹ of certain pyrophosphates from the hydrogen phosphates is trifluoroacetic anhydride.²

(10) It has been known for some time³ that carbodi-imides react with carboxylic acids (*a*) giving acid anhydrides and ureas, or (*b*) *N*-acylureas. Khorana and Todd⁴ have been successful in converting dibenzyl hydrogen phosphate into the pyrophosphate by the following reaction with *dicyclohexyl*carbodi-imide:

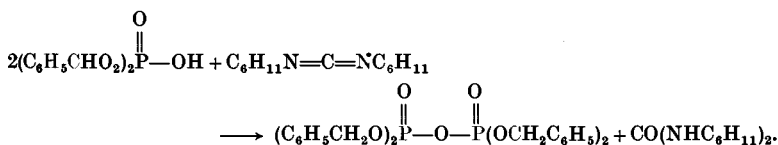

The reaction, which is instantaneous, takes place at room temperature in an inert solvent and excellent yields are obtained.

Recently Sir A. R. Todd and his co-workers have shown that pyrophosphates are obtained by the action of an imidoyl phosphate⁵ on a hydrogen phosphate

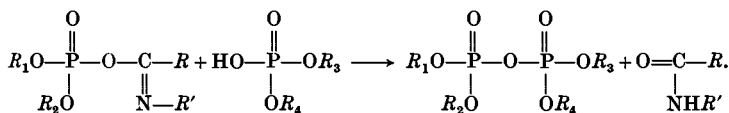

The imidoyl phosphate can be obtained from the imidoyl chloride and the silver or organic salts of a phosphate:

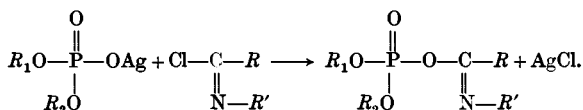

¹ *Ibid.*

² Bonne, Stacey, Tatlow and Tedder, *J. Chem. Soc.* 1949, p. 2976.

³ Zetche, *Ber. dtsh. chem. Ges.* 1938, **71**, 1088.

⁴ *J. Chem. Soc.* 1953, p. 2257.

⁵ Atherton, Morrison, Cremlyn, Kenner, Todd and Webb, *Chem. & Ind.* 1955, p. 1183.

Methods of Phosphorylation

On pp. 45 and 57 we referred to the action of chlorine¹ and of *N*-chlorosuccinimide² on dialkyl phosphites producing dialkyl phosphorochloridates. We have made use of the latter in producing a variety of esters of orthophosphoric acid and of phosphoramidates, and reference has already been made to many such reactions (p. 82). These processes are, in a sense, phosphorylations of the alcohols or of the amines respectively.

In synthetic work in the phosphorus field, particularly in the realm of nucleotide chemistry, it becomes necessary to remove with ease, from the product (XII), the original *R* groups so as to produce a *true* phosphorylation of *R'*OH thus:

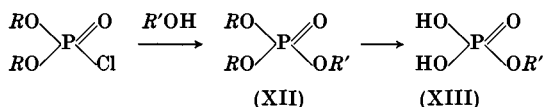

Sir A. R. Todd³ and his colleagues have exploited these phosphorylation processes with great success. It may be added parenthetically that the direct esterification of *R'*OH with phosphoric acid would, in general, be a far too crude process for the production of (XIII).

From phosphorus trichloride, benzyl alcohol and 2 mol. of a tertiary base, dibenzyl hydrogen phosphite (XIV), is obtained which on treatment with chlorine or a chlorinating agent (e.g. sulphuryl chloride)⁴ gives the phosphorochloridate (XV). Although not isolated, (XV) is almost certainly obtained by treatment of (XIV) with a polyhalogen hydrocarbon because reaction in the presence of an alcohol or of a primary or secondary amine gives a triester (XVI) or a phosphoramidate.

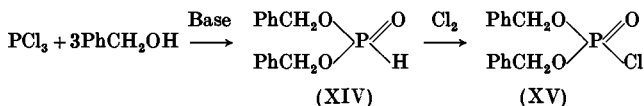

¹ McCombie, Saunders and Stacey, *J. Chem. Soc.* 1945, p. 380.

² Goldwhite and Saunders, *J. Chem. Soc.* 1955, p. 2040.

³ Atherton, Openshaw and Todd, *J. Chem. Soc.* 1945, p. 382.

⁴ Atherton, Howard and Todd, *J. Chem. Soc.* 1948, p. 1106.

PHOSPHORYLATION

Both benzyl groups are removed from (XVI) by hydrogenolysis with palladium catalysts.

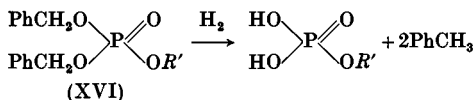

One benzyl group may be removed from (XVI) by two methods: (1) 'quaternization' in which a tertiary base attacks one benzyl group yielding the quaternary benzylammonium salt of the di-phosphate¹ (XVII) (see also p. 101); or (2) the use of a salt (e.g. lithium chloride).² In both (1) and (2) the mono-debenzylated ester produced is an anion, and would therefore tend to resist a second debenzylation process which requires the formation of a doubly-charged anion.

These very important discoveries may be indicated in the following scheme:

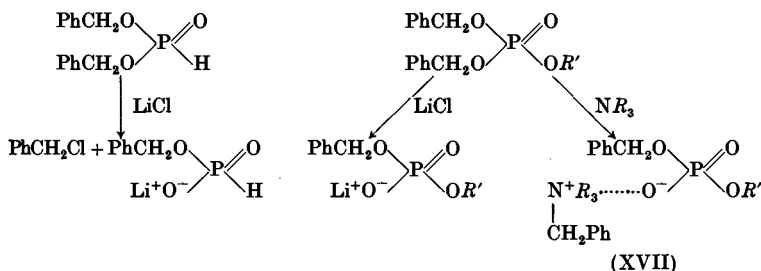

Very recently we have shown that di-*tert.*-butyl phenylphosphoramidate decomposes as follows:³

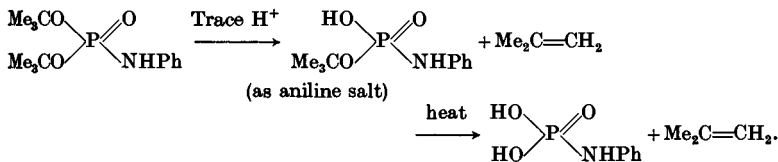

In this way a novel phosphorylation of aniline is achieved, and the method may have other applications.

¹ Baddiley, Clark, Michalski and Todd, *J. Chem. Soc.* 1949, p. 815; Clark and Todd, *J. Chem. Soc.* 1950, p. 2023.

² Clark and Todd, *J. Chem. Soc.* 1950, p. 2031.

³ Goldwhite and Saunders, *Chem. & Ind.* (in the press).

Dialkyl Phosphoriodidates

When an ethereal solution of iodine is added to triethyl phosphite a rapid reaction ensues, the iodine being taken up quantitatively in accordance with the equation¹

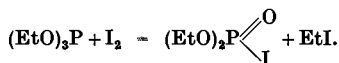

The phosphoriodidate decomposes on distillation, but evidence for its quantitative production in ethereal solution is obtained by its conversion in theoretical yield into the stable crystalline diethyl *N*-phenyl phosphoramidate and aniline hydriodide by means of aniline:

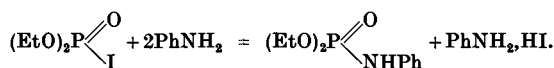

In this way a variety of dialkyl phosphoramidates can be prepared.

Dialkyl Phosphorobromidates

These compounds can be prepared by the action of bromine on a trialkyl phosphite,² but a more satisfactory method recently worked out by Goldwhite and Saunders³ consists in treating the dialkyl hydrogen phosphite with *N*-bromosuccinimide. In this way dimethyl, diethyl *n*-propyl and *isopropyl* phosphorobromidates have been obtained as pure liquids by distillation at very low temperature. When kept at ordinary temperatures, they gradually decompose with the evolution of the corresponding alkyl bromide.

Preparation of Alkyl- and Acylphosphonic Acids

For the hydrolysis of dialkyl alkylphosphonates to alkylphosphonic acids Kosolapoff⁴ used hot concentrated hydrochloric acid, and for more stubborn cases, 48 per cent hydrobromic

¹ McCombie, Saunders and Stacey, *J. Chem. Soc.* 1954, p. 921.

² Gerrard and Jeacocke, *J. Chem. Soc.* 1954, p. 3647.

³ *J. Chem. Soc.* 1955, p. 3564.

⁴ *J. Amer. Chem. Soc.* 1945, 67, 1180; *Organophosphorus Compounds*, 1950 (New York, Wiley).

ALKYL- AND ACYLPHOSPHONIC ACIDS

acid. This process removed also the *acyl* group from dialkyl acylphosphonates. An alternative procedure for removing alkyl groups from alkyl esters of phosphorous and phosphoric acids is by interaction with dry halides, which give the alkyl halides. The rates of dealkylation are in the order $\text{HI} > \text{HBr} > \text{HCl}$, and advantage may be taken of higher temperatures at least to 100° to increase the rate. Cooke, Gerrard and Green¹ have used this procedure for the preparation of alkyl- and acylphosphonic acids:

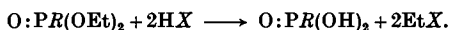

Dry hydrogen halide was passed into the ester. The ethyl halide was trapped at -78° , and the weight of it served to indicate the progress of dealkylation. Dealkylation being completed, volatile matter was removed from the residue at low pressure. Crude acids were thus obtained in absence of water. Similar results to those obtained at 100° were obtained at 25° , but of course longer reaction time was required.

Carbon-Phosphorus Bonds

The Arbusov reaction is of course a method *par excellence* for producing C—P links (p. 95). Among other methods, the following also may be mentioned:

(a) Carbon-phosphorus bonds can be formed by the addition of dialkyl hydrogen phosphites or alkyl hydrogen phosphinates to activated ethylenic compounds.²

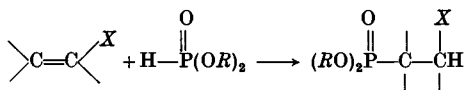

X can be COOR or $\text{C}\equiv\text{N}$, and the reaction takes place against Markownikov's rule.

(b) *Ethylphosphonic dichloride*. Of convenient methods for preparing ethylphosphonic dichloride ($\text{Et}-\overset{\text{O}}{\parallel}{\text{P}}\begin{array}{l} \swarrow \text{Cl} \\ \searrow \text{Cl} \end{array}$, very valuable

¹ *Chem. & Ind. (Rev.)*, 1953, p. 351.

² Bochwic and Michalski, *Nature, Lond.*, 1951, **167**, 1935.

REACTIONS OF ESTERS CONTAINING PHOSPHORUS

indeed for obtaining esters of ethylphosphonic acid) two may be considered. (1) Phosphorus trichloride, ethyl chloride and aluminium chloride form the complex $\text{EtCl} \cdot \text{PCl}_3 \cdot \text{AlCl}_3$, which is then decomposed by hydrochloric acid.¹ (2) Tetraethyl-lead converts phosphorus trichloride into ethylphosphonous dichloride (ethyldichlorophosphine),² which is then oxidized by sulphuryl chloride to the phosphonic dichloride.³

The first method is quicker, but the filtration entailed in this reaction presents a hazard because of the danger of inhalation. If it is desired to employ volatile radioactive materials, e.g. to introduce ^{32}P into the molecule, the second method is recommended. Further, the first method involves some danger because of the pressure developed in an enclosed reaction vessel containing ethyl chloride. It is considered essential that operations with the more volatile radioactive compounds (up to b.p. $150^\circ/760$ mm.) should be carried out in a completely enclosed system. This is possible with the second method, and the extra time of operation involves a decrease in the radioactivity of only 15 per cent compared with the first method.⁴

The volatility of phosphorus trichloride, ethylphosphonous dichloride and sulphuryl chloride, permit of their quantitative transfer in a high-vacuum system. The conversion of the phosphonous into the phosphonic dichloride can also be carried out in an enclosed system.⁵

This second method of obtaining radioactive EtPOCl_2 (and hence a variety of radioactive compounds containing the C—P link) has therefore much to commend it. Accordingly a brief outline of the technique is now given.

The probable impurities in radioactive phosphorus trichloride are hydrogen chloride and phosphorous acid; the trichloride is, therefore, purified by fractional evaporation and fractional condensation in the high-vacuum system. Pure ethylphosphonous dichloride is prepared according to the equation:



¹ Clay, *J. Org. Chem.* 1951, **16**, 1892; Kinnear and Perren, *J. Chem. Soc.* 1952, p. 343.

² Kharasch, Janson and Weinhouse, *J. Org. Chem.* 1949, **15**, 429.

³ Kharasch, personal communication.

⁴ Saunders and Worthy, *J. Chem. Soc.* 1953, p. 2115.

⁵ *Ibid.*

REACTIONS OF ESTERS CONTAINING PHOSPHORUS

Using similar techniques, isomeric dodecamethylphosphoramides were prepared as follows:

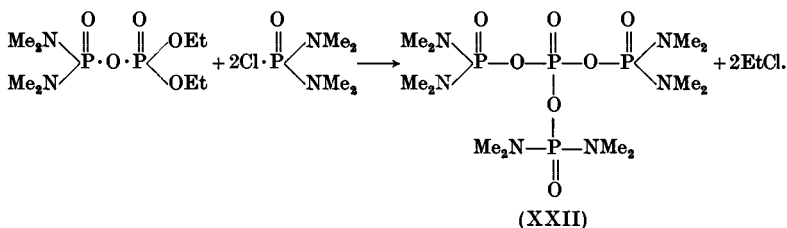
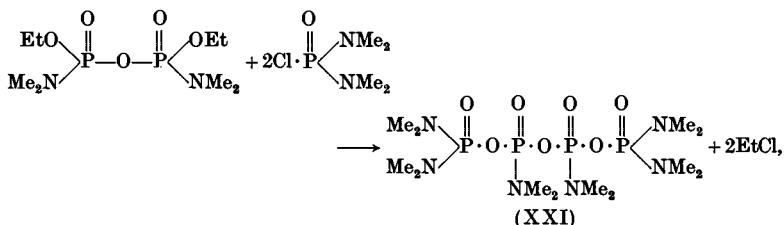

The 'linear' compound (XXI) is twice as active as the 'pyramidal' compound (XXII) against *Aphis fabae*.

As is pointed out later (p. 172), O.M.P.A. or the octamethylamide of pyrophosphoric acid (XXIII) has been developed, more particularly in England, as a selective systemic insecticide which does not kill predatory insects.¹ Furthermore, it has a rather greater safety margin than other cholinergic organo-phosphorus insecticides.² A satisfactory method³ for the large-scale preparation of O.M.P.A. is given on p. 172.

A different kind of synthesis of organic pyrophosphoramides was suggested by transphosphorylation reactions of organic polyphosphoramides:⁴

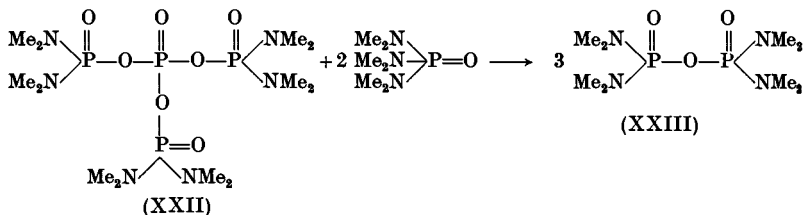

¹ Ripper, Greenslade and Hartley, *Bull. Ent. Res.* 1950, **40**, 481.

² Dubois, Doull and Coon, *J. Pharmacol.* 1950, **99**, 376.

³ Pound and Saunders, B.P. 631,549.

⁴ Tolkmith, *J. Amer. Chem. Soc.* 1953, **75**, 5273.

The above ingenious reaction was brought about by heating the mixture to 150° for 1.5 hr., the yield of (XXIII) being 49 per cent. Thus there is a redistribution of energy-rich phosphate bonds.

Compound (XXII) can be obtained quantitatively by the reaction

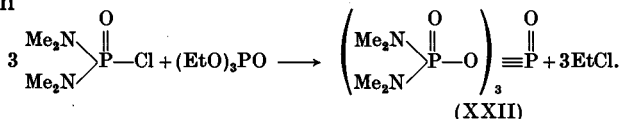

Therefore Tolkmith¹ combined the above two reactions thus:

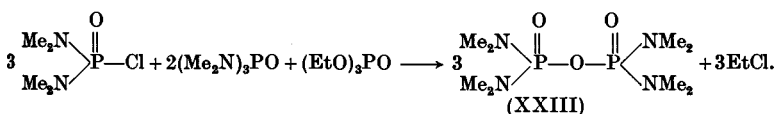

By this very clever device he obtained a 67 per cent yield of (XXIII) (O.M.P.A.).

Finally, to conclude this chapter, passing reference may be made to certain perfluoro derivatives of organo-phosphorus compounds that have recently been prepared.² The starting point is trifluoroiodomethane, CF_3I , prepared from trifluoroacetic acid and iodine. The interaction of phosphorus and trifluoroiodomethane at about 200° gives $\text{P}(\text{CF}_3)_3$, $\text{P}(\text{CF}_3)_2\text{I}$ and $\text{P}(\text{CF}_3)\text{I}_2$. The first of these compounds is a spontaneously inflammable liquid which reacts smoothly at -40° to give $(\text{CF}_3)_3\text{PCl}_2$ in quantitative yield. When $\text{P}(\text{CF}_3)\text{I}_2$ is oxidatively hydrolysed³ trifluoromethylphosphonic acid, $\text{CF}_3 \cdot \text{PO}(\text{OH})_2$, is obtained:

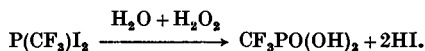

The properties of these and related compounds are now being systematically studied.⁴

¹ *J. Amer. Chem. Soc.* 1953, **75**, 5276.

² Bennett, Emel us and Haszeldine, *J. Chem. Soc.* 1953, p. 1565.

³ Bennett, Emel us and Haszeldine, *J. Chem. Soc.* 1954, p. 3598.

⁴ Bennett, Emel us and Haszeldine, *J. Chem. Soc.* 1954, p. 3898.

Chapter VII

THE FLUOROACETATES

Methyl Fluoroacetate (M.F.A.) and Related Compounds

The work described in this section was carried out in Cambridge during the war, and was originally submitted by us to the Ministry of Supply in communications entitled 'Fluoroacetates and related compounds'. These communications were made available to American workers from the inception of the work. The present section is concerned mainly with a description of methyl fluoroacetate, $\text{CH}_2\text{F}\cdot\text{CO}_2\text{Me}$, and of certain other derivatives of fluoroacetic acid.

In Chapter IV we have described toxic fluorine¹ compounds containing the >POF grouping. Such compounds possessed quick knock-out action, and many of them were powerful myotics. Compounds of the 'fluoroacetate' series are characterized by the $\text{CH}_2\text{F}\cdot$ group. Many of them are highly toxic with delayed action, but are completely devoid of myotic activity. The action is, broadly speaking, that of a convulsant poison (but see p. 136).

Methyl fluoroacetate was first prepared by Swarts² in small yield by the action of silver or mercurous fluoride on methyl iodoacetate. The method is impracticable for large-scale work and therefore the preparation³ was reinvestigated in detail.⁴ Methyl chloroacetate was used in place of the expensive iodoacetate, and a variety of fluorinating agents was tried. It was found that fluorination could be effected by heating methyl chloroacetate in a rotating autoclave with potassium fluoride at 220° for 4 hr. Sodium fluoride, on the other hand, was almost without action.

¹ See also McCombie and Saunders, *Nature, Lond.*, 1946, 157, 287, 776.

² *Bull. Soc. chim. Belg.* 1896, 15, 1134.

³ Some of the early work in connexion with this particular ester was carried out in collaboration with F. O. Sporzynski, Professor Briscoe and Professor Emeléus.

⁴ Saunders and Stacey, *J. Chem. Soc.* 1948, p. 1773.

METHYL FLUOROACETATE

Other methods are available for the preparation of M.F.A. without the use of an autoclave, but it is doubtful whether they possess advantages over the autoclave method having regard to quality of product and yield.

Methyl fluoroacetate (M.F.A.) is a liquid of b.p. 104° and f.p. ca. -32° and is almost odourless. During a 10 min. exposure to a lethal concentration of the vapour, small animals did not appear to be affected in any way. After exposure, no very obvious symptoms developed until some 30–60 min. later (depending upon the concentration). The symptoms then shown depended to some extent upon the species, but all animals suffered convulsions, from which a partial recovery was sometimes made. Finally, however, a recurrence of the convulsions would cause death.

The L.C. 50 for rabbits, rats and guinea-pigs was of the order of 0.1 mg./l. Mice were more resistant. By intravenous injection into rabbits the L.D. 50 was 0.25 mg./kg. The L.D. 50 for subcutaneous injection into mice was found to be of the order of 6–10 mg./kg. M.F.A. was also found to be toxic by absorption through the skin, but less so than by other routes. When placed on the clipped backs of rabbits the L.D. 50 was about 20 mg./kg. Free evaporation of the drops was permitted. The animals showed the usual symptoms.

It is noteworthy that a massive concentration of the vapour of methyl chloroacetate (1/1000; 4.85 mg./l.) did not kill any animals.

M.F.A. is practically odourless. When four of us were exposed to a concentration of 1/1,000,000 in a 10 cu.m. chamber, we were unable to detect the compound. Even at 1/100,000 (30 sec. for reasons of safety) the compound was found to possess only a faint fruit-like odour indistinguishable from that of many harmless esters not containing fluorine.

The fluorine atom in methyl fluoroacetate (and in many other compounds containing the CH_2F group) is quite firmly bound. When M.F.A. was boiled with 10 per cent aqueous potassium hydroxide for 1 hr., no free fluoride was formed.

From the inception of this work we have found the most satisfactory sensitive qualitative test for fluorine in the 'fluoro-

THE FLUOROACETATES

acetates' and in the phosphorofluoridates to consist in the formation of 'oily droplets' when the compound is heated with a mixture of concentrated sulphuric acid and potassium dichromate.¹

It was obviously of interest to determine whether other esters of fluoroacetic acid would prove to be more or less toxic than the methyl ester. In the phosphorofluoridate series, for example, we found that esters of secondary alcohols were far more potent than those of primary alcohols; for instance, di-*isopropyl* fluorophosphonate (I) was a compound of considerable activity. Accordingly ethyl, *n*-propyl and *isopropyl* fluoroacetates were prepared by heating the corresponding esters of chloroacetic acid in the rotating autoclave with potassium fluoride. The toxicity figures of these esters were very similar to those of methyl fluoroacetate.

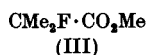
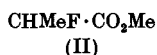
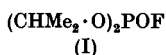

In the phosphorofluoridate series, we found that the diphenyl ester (p. 53) was relatively non-toxic. *Phenyl fluoroacetate*, however, was toxic with an L.D. 50 of 6-10 mg./kg. for subcutaneous injection into mice. The symptoms were similar to those displayed by methyl fluoroacetate.

It was next important to determine the effect of altering the groups adjacent to the fluorine atom. Thus *methyl α -fluoropropionate* (II) and *α -fluoroisobutyrate* (III) were prepared. Both these compounds were relatively non-toxic. The first, for example, at a concentration of 1/20,000 (0.24 mg./l.) killed 0/23 of a batch of 3 rabbits, 4 guinea-pigs, 6 rats and 10 mice. The second at the same concentration killed only 2/23.

In Report no. 5 on fluoroacetates to the Ministry of Supply² we described the preparation of *methyl 1:3-difluoroacetoacetate*, $\text{CH}_2\text{F} \cdot \text{CO} \cdot \text{CHF} \cdot \text{CO}_2\text{Me}$, in 10 per cent yield by the action of sodium on methyl fluoroacetate. Later we reported that if the condensation were carried out in the presence of methyl alcohol, the yield of methyl difluoroacetoacetate could be increased to 23 per cent, and allowing for recovered methyl fluoroacetate the overall yield was 35 per cent.

¹ See also Appendix, p. 213.

² 30 May 1943.

FLUOROACETATES

Fluoroacetyl chloride, $\text{CH}_2\text{F}\cdot\text{COCl}$, was prepared by the action of phosphorus pentachloride on the free fluoroacetic acid (p. 121).¹ It is extremely useful as fluoroacetylating agent in synthetic work. Because of its importance we have recently re-investigated other methods of preparation.² These may be summarized as follows: (1) direct from fluoroacetamide (p. 125) by the action of phosphorus oxychloride and water; (2) the action of phosphorus oxychloride on either sodium fluoroacetate (p. 121) or on barium fluoroacetate (p. 121). Good yields are obtained in both (1) and (2), and in each case the starting materials are more easily available than fluoroacetic acid itself.

It is interesting to compare the toxicity of fluoroacetyl chloride with the isomeric chloroacetyl fluoride. The former possessed a toxicity comparable to that of methyl fluoroacetate, whereas the latter was relatively non-toxic. This is readily understandable in that fluoroacetyl chloride gives the toxic fluoroacetic acid, whereas chloroacetyl fluoride hydrolyses to chloroacetic acid and the relatively non-toxic (at the concentrations employed) hydrogen fluoride. Fluoroacetyl fluoride also possessed a toxicity comparable with that of fluoroacetyl chloride or of methyl fluoroacetate, again showing that the $\cdot\text{COF}$ group contributed practically nothing. Acetyl fluoride was also non-toxic.

Goswami and Sarkar³ claimed to have prepared methyl and ethyl fluoroformates by the action of thallium fluoride on the corresponding chloroformates. These fluoroformates were described as powerful lacrimators. We found that no appreciable reaction took place between potassium fluoride and ethyl chloroformate in boiling carbon tetrachloride or nitrobenzene. Ethyl fluoroformate could, however, be readily produced by the action of potassium fluoride on ethyl chloroformate by using the autoclave technique. It was found not to have the lacrimatory properties claimed for it, and was non-toxic in comparison with M.F.A. This non-toxicity was to be expected, as the fluoroformate contains the $\cdot\text{COF}$ and not the $\text{CH}_2\text{F}\cdot$ group.

¹ Saunders and Stacey, *J. Chem. Soc.* 1948, p. 1773.

² Mirosevic-Sorgo and Saunders, *J. Chem. Soc.* 1957 (in the press).

³ *J. Indian Chem. Soc.* 1933, p. 537.

THE FLUOROACETATES

Chloromethyl esters are obtained quite readily by the action of paraformaldehyde on the appropriate acid chloride in the presence of a small quantity of zinc chloride as catalyst.¹ It therefore seemed worth while to try the action of paraformaldehyde on fluoroacetyl fluoride, but the only product which could be isolated was a low-melting solid which appeared from its reactions to be *methylene bisfluoroacetate*, $\text{CH}_2(\text{O}\cdot\text{CO}\cdot\text{CH}_2\text{F})_2$. The compound was submitted for physiological tests, and it was shown that the L.D. 50 subcutaneous injection into mice was about 10 mg./kg. Subcutaneous injection into rats with doses of 2.5, 5 and 10 mg./kg. all killed 1/1.

*Sodium fluoroacetate*² was prepared with the idea of obtaining a stable water-soluble compound containing the $\text{CH}_2\text{F}\cdot\text{CO}\cdot$ group, suitable for feeding experiments. The method of obtaining this salt is described in detail below. It consists essentially in adding cold aqueous sodium hydroxide to methyl fluoroacetate and evaporating the solution. Subsequent to our initial work, sodium fluoroacetate has been recommended and used as a rodenticide.

Fluoroacetic anhydride, which was readily prepared by the action of fluoroacetyl chloride on sodium fluoroacetate, is a mobile liquid of b.p. $89^\circ/12$ mm. It is a useful fluoroacetylating substance. It was rather more toxic by inhalation than M.F.A. (weight for weight).

It has been shown that trialkyl-lead salts have marked sternutatory action³ when dispersed as a particulate cloud.⁴ *Triethyl-lead fluoroacetate*, $\text{CH}_2\text{F}\cdot\text{CO}_2\text{PbEt}_3$, was therefore prepared with the idea of combining sternutatory action with 'fluoroacetate-like' activity. The compound, a stable, highly crystalline material, was readily prepared by the action of fluoroacetic acid on tetraethyl-lead in the presence of silica gel. As a sternutator it proved to be similar in action to that of the

¹ Ulich and Adams, *J. Amer. Chem. Soc.* 1921, **43**, 662.

² Reports to Ministry of Supply, 1943.

³ Affecting the nose, throat and chest and producing a difficulty in respirable atmosphere.

⁴ McCombie and Saunders, *Nature, Lond.*, 1949, **159**, 491; Saunders and Stacey, *J. Chem. Soc.* 1949, p. 919; Heap and Saunders, *J. Chem. Soc.* 1949, p. 2983; Saunders, *J. Chem. Soc.* 1950, p. 684; Heap, Saunders and Stacey, *J. Chem. Soc.* 1951, p. 684.

FLUOROACETATES

majority of other triethyl-lead salts of organic acids. Eight of us were exposed for 10 min. to a nominal concentration of 1 part in 10,000,000 (i.e. 1.7 mg./cu.m.) obtained by spraying an ether-alcoholic solution of the material. We all suffered from intense irritation of the nose and throat within the first minute, and five reported pains in the chest. Subcutaneous injection into mice gave an L.D. 50 of about 15 mg./kg. and produced the usual 'fluoroacetate-like' symptoms.

Glycol bis-fluoroacetate was prepared with a view to obtaining a toxic fluorine compound (containing the $\text{CH}_2\text{F}\cdot\text{CO}$ group) which would have a high boiling point and be soluble in oils and fats. When it was sprayed into a chamber 4/13 animals (rats, guinea-pigs and rabbits) were killed at 1/40,000 for 10 min. and exhibited the convulsions characteristic of M.F.A. This low toxicity may be due to low volatility. The compound was found to be quite soluble in hot olive oil and to form in the cold a solution of sufficient concentration for animal-feeding experiments. Injection of the solution (5 mg./c.c.) into the stomach with a catheter showed that the L.D. 50 for rats was about 2.2 mg./kg.

Cholesteryl fluoroacetate was made in an attempt to discover whether a combination of fluoroacetic acid and some biologically important compound might give a product of increased toxicity. This compound, however, placed considerable limitations upon injection experiments owing to its low solubility in non-toxic solvents. It appeared, however, to be considerably less toxic than M.F.A.

In view of the well-known pharmacological action of aspirin, it was thought that the fluorine analogue, *O*-(*fluoroacetyl*)-*salicylic acid*, might be of considerable interest. The compound was readily made by acylation of salicylic acid by fluoroacetyl chloride in the presence of pyridine. The L.D. 50 for subcutaneous injection into mice was approximately 15 mg./kg. After injection the mice went into a drugged sleep, and died overnight.

Methyl fluoroacetate.¹ Methyl chloroacetate (108.5 g., 1 mol.) and neutral anhydrous potassium fluoride (70 g., 1.2 mol.) are mixed and heated (with glass marbles) in an inclined rotating autoclave at a

¹ Saunders and Stacey, *J. Chem. Soc.* 1948, p. 1773. See also p. 114, n. 3.

THE FLUOROACETATES

constant temperature. A speed of about 280 r.p.m., together with the glass marbles, ensures thorough mixing. At the end of a specified time the autoclave is allowed to cool and the contents broken up and washed out with ether, and the inorganic salts filtered off. The filtrate is then placed in a flask with an efficient fractionating column 80 cm. long. The ether is distilled off slowly. The temperature rises rapidly to 104°, and the fraction, b.p. 104–110°, is collected (methyl fluoroacetate). The temperature again rises rapidly to 125° and the fraction, b.p. 125–132°, is collected (unchanged methyl chloroacetate). Below are tabulated the results of experiments employing different temperatures and times. The conditions of experiment no. 5 are recommended for routine operations.

The fraction, b.p. 104–110°, on refractionation comes over almost entirely at 104.5°. (Found: F, 20.65. Calc. for C₃H₅O₂F: F, 20.65 per cent.)¹ Methyl fluoroacetate is a mobile liquid of f.p. –32°, *d*₄²⁰: 1.1744, *n*_D²⁰ 1.3679, soluble in water to the extent of about 15 per cent. Hydrolysis, according to the equation

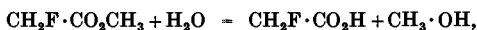

was found to be 50 per cent complete at room temperature in about 14 days. The ester is completely miscible with alcohol, ether, acetone, light petroleum (b.p. 40–60°), carbon tetrachloride, benzene, glacial acetic acid and 2:2'-dichlorodiethyl sulphide, and partly soluble in carbon disulphide.

| Exp. | Temp. (deg.) | Dura- tion (hr.) | B. p. 104–110° (g.) | B. p. 125–132° (g.) | Resi- due, b. p. >132° (g.) | Wt. of in- organic salts filtered off (g.) | Yield (actual) (%) | Yield (net)* (%) | Remarks |
|------|--------------|------------------|---------------------|---------------------|-----------------------------|--|--------------------|------------------|--|
| 1 | 140 | 24 | 1.2 | 85.3 | 5.6 | 70 | 1.3 | 6.1 | — |
| 2 | 150 | 20 | 3.6 | 81.3 | 7.7 | 72 | 3.9 | 15.6 | — |
| 3 | 160 | 15 | 5.6 | 78.7 | 6.7 | 73 | 6.1 | 22.0 | Press. ca. 2 atm. |
| 4 | 190 | 10 | 35 | 40.5 | 9.1 | 86 | 38.0 | 60.7 | Press. ca. 10 atm. |
| 5 | 220 | 4 | 50.1 | 4.5 | 9.4 | 99 | 54.5 | 59.6 | Press. ca. 12 atm.; about 1 atm. in cold at end of run |
| 6 | 250 | 2 | 43.8 | 4.8 | 9.6 | 98 | 37.8 | 39.6 | Press. ca. 30 atm.; 4 atm. in cold at end of run |

* Allowing for recovery of methyl chloroacetate.

Highest actual yield at 220°.

Highest net yield at 190° (but of course more KF required per g. of M.F.A.).

N.B. Because of the non-detectability of M.F.A. by smell, respirators should be used when cleaning out the autoclave after a run.

¹ For method and analysis see Chapman, Heap and Saunders, *Analyst*, 1948, 73, 869; and also Appendix, p. 208.

FLUOROACETIC ACID

*Fluoroacetic acid.*¹ A few drops of phenolphthalein solution are added to a mixture of methyl fluoroacetate (46.0 g., 0.5 mol.) and water (100 c.c.) and then powdered barium hydroxide octahydrate (78.9 g., 0.25 mol.) is added in small portions, the mixture being mechanically stirred after each addition until the alkaline reaction has disappeared. The resultant liquid is then made acid, if necessary by the addition of a few drops of methyl fluoroacetate, filtered and the filtrate concentrated to about 100 c.c. on a water-bath. The liquid is cooled and methylated spirit (500 c.c.) added in order to precipitate the barium fluoroacetate, which is filtered off, drained and dried, but not recrystallized; yield 69.0 g. (95.0 per cent).

Dry barium fluoroacetate (58 g., 0.2 mol.) is slowly added to 100 per cent sulphuric acid (122.5 g., 1.25 mol.). On distillation under reduced pressure, using a wide air-condenser, the fluoroacetic acid comes over between 83 and 100°/17 mm., and crystallizes immediately. It can be redistilled at atmospheric pressure and comes over at 167-168.5°; yield 29.5 g. (94.2 per cent); colourless needles, m.p. 31-32°. (Found: F, 24.3. Calc. for C₂H₃O₂F: F, 24.4 per cent.) These yields are considerably higher than those obtainable by Swarts's original method.

*Sodium fluoroacetate.*¹ To methyl fluoroacetate (46.0 g., 0.5 mol.) suspended in water (100 c.c. containing a few drops of phenolphthalein) sodium hydroxide (0.5 mol., 20 g. in 100 c.c. water) is added slowly. The mixture is kept well stirred, and the rate of addition governed by the disappearance of the red coloration. When the addition of sodium hydroxide is complete, a few more drops of M.F.A. are added to render the solution acid. It is then evaporated on the water-bath until crystallization starts, cooled and the solid filtered off. More solid is obtained from the filtrate by the addition of alcohol; total yield 45.5 g. (91.0 per cent). (Found: F, 19.0. Calc. for C₂H₂O₂FNa: F, 19.0 per cent.) This is characterized as *p*-nitrobenzyl fluoroacetate as follows. *p*-Nitrobenzyl bromide (0.9 g.), dissolved in alcohol (10 c.c.), is added to a solution of sodium fluoroacetate (0.3 g.) in the minimum amount of water. The mixture is heated under a reflux condenser for 2 hr. and allowed to cool; the solid is collected by filtration, and crystallized from ethanol as long needles, m.p. 76°.

¹ Saunders and Stacey, *J. Chem. Soc.* 1948, p. 1773.

2-Fluoroethanol (F.E.A.) and its Derivatives

In this work on compounds containing the C—F link, it was obviously desirable to prepare 2-fluoroethanol, both for toxicity tests on the compound itself, and as a starting material for the production of other fluorine compounds. Swarts¹ was unable to obtain 2-fluoroethanol by the action of silver fluoride or mercuric fluoride on either ethylene chlorohydrin or ethylene bromohydrin. He obtained acetaldehyde in each case. He ultimately obtained fluoroethanol in very poor yield by the indirect method of hydrolysing fluoroacetin (from bromoacetin and mercuric fluoride) for 80 hr. with dilute mineral acid.

In Report no. 3 on fluoroacetates and allied compounds to the Ministry of Supply² we described a very simple and efficient preparation of fluoroethanol (F.E.A.) by heating together ethylene chlorohydrin and potassium fluoride in a rotating autoclave at 135° for 4 hr.³

Fluoroethyl alcohol has also been prepared without the use of an autoclave,⁴ but in this case the product is not so easily obtained pure.

Fluoroethanol is soluble in water and stable to moisture. As a lethal inhalant it produces convulsions in animals similar to those produced by methyl fluoroacetate (M.F.A.). A concentration of 0.29 mg./l. (10 min. exposure) killed 62 per cent of a batch of rabbits, guinea-pigs and rats, and a concentration of 0.14 mg./l. killed 38 per cent, all the deaths occurring within 12 hr. Mice were much more resistant, the L.C. 50 being about 1.1 mg./l.

1-Chloro-2-fluoroethane, easily obtained³ from fluoroethanol, was found to be non-toxic. A concentration of 0.184 mg./l. failed to kill any animals, whereas a similar concentration of fluoroethanol or of methyl fluoroacetate would have killed some 50 per cent of a batch of rabbits, guinea-pigs or rats. The chlorine atom in chlorofluoroethane was found to be unreactive towards a variety of reagents, and this fact no doubt

¹ *Chem. Zbl.* 1914, I, 1551.

² 31 March 1943.

³ Saunders, Stacey and Wilding, *J. Chem. Soc.* 1949, p. 773.

⁴ Hofmann, *J. Amer. Chem. Soc.* 1948, 70, 2596.

accounts for its non-toxic nature since it is unlikely that the animal body is able to hydrolyse it readily to the toxic fluoroethanol.

Under the conditions employed in our experiments no reaction occurred between chlorofluoroethane and potassium phthalimide or potassium thiocyanate. Magnesium (in ethereal suspension) did not react in the normal manner to give a Grignard reagent, although on prolonged heating a certain amount of metal did go into solution to give a product which, on the addition of water, set to a jelly-like mass.

Attempts to prepare 2:2'-difluorodiethyl sulphide by the action of sodium sulphide on chlorofluoroethane resulted in the production of dithian together with other polymeric substances. Aniline either did not react at all or, under drastic conditions, gave *NN'*-diphenylpiperazine and *NN'*-diphenylethylenediamine.

Sodium phenoxide, however, reacted with chlorofluoroethane when they were heated together in alcoholic solution and gave *phenyl 2-fluoroethyl ether*, a solid which proved to be less toxic than M.F.A.

An attempt to prepare 1-bromo-2-fluoroethane by the partial fluorination of ethylene dibromide by means of antimony trifluoride was not very successful. The compound was best prepared by the action of phosphorus tribromide on F.E.A. The compound was relatively non-toxic and the bromine atom rather unreactive, but considerably more reactive than the chlorine atom in chlorofluoroethane. For example, bromofluoroethane was readily converted by means of potassium thiocyanate into *2-fluoroethyl thiocyanate*. As a lethal inhalant the toxicity of the thiocyanate was inferior to that of M.F.A. Toxicity by injection, however, appeared to be higher.

By employing the method similar to that of Johnson and Douglass¹ for converting SCN into SO₂Cl, fluoroethyl thiocyanate was readily converted by the action of chlorine water into *2-fluoroethylsulphonyl chloride*, a stable liquid. When small animals were exposed to the vapour at a concentration of 0.5 mg./l. for 10 min., irritation and lacrimation were caused, but there were no deaths and all the animals recovered.

¹ *J. Amer. Chem. Soc.* 1939, **61**, 381.

THE FLUOROACETATES

2-Fluoroethyl xanthate, $F \cdot CH_2 \cdot CH_2 \cdot S \cdot CS \cdot OEt$, was a yellow oil formed by the action of sodium xanthate on bromo-fluoroethane. The compound has a L.D. 50 of 50 mg./kg. for subcutaneous injection into mice, thus showing it to be considerably less toxic than M.F.A.

The action of sulphuryl chloride on F.E.A. was investigated, chiefly with a view to preparing *2:2'-difluorodiethyl sulphate*, a compound which was expected to have applications analogous to those of diethyl sulphate. 2-Fluoroethanol was added slowly to an excess of cooled sulphuryl chloride, the only product isolated being, however, *2-fluoroethyl chlorosulphonate*, $Cl \cdot SO_2 \cdot O \cdot CH_2 \cdot CH_2F$. In the second experiment, conditions were reversed and sulphuryl chloride was added to slightly more than the theoretical quantity of F.E.A. The difluorodiethyl sulphate was obtained this time, but not in large yield.

On exposing animals for 10 min. to 0.327 g./cu.m. of the chlorosulphonate, irritation was observed and rats showed the same type of convulsions as with M.F.A. However, only 2/13 of a batch of rabbits, guinea-pigs and rats died within 24 hr. The difluorodiethyl sulphate was non-irritant and less toxic. It proved to be a good fluoroethylating agent.

2-Naphthyl 2-fluoroethyl ether was readily prepared by warming an alkaline solution of 2-naphthol with 2:2'-difluorodiethyl sulphate. Subcutaneous injection into mice of the propylene glycol solution showed that the compound had a L.D. 50 of approximately 60 mg./kg. and was therefore much less toxic than M.F.A.

The reaction between F.E.A. and manganese dioxide and sulphuric acid was investigated initially with a view to preparing the corresponding fluorinated acetal. It soon became apparent that the isolation of the hitherto undescribed *fluoroacetaldehyde* might be possible in this experiment, and accordingly attention was directed to that end.

By analogy with chloral and monochloroacetaldehyde it is to be expected that fluoroacetaldehyde might readily form a hydrate, and it was in this form that the fluoroacetaldehyde was obtained in small yields by the above-mentioned oxidation of F.E.A.

Toxicity determinations by subcutaneous injection into mice of

a sample containing 80 per cent of the aldehyde gave a L.D. 50 of 6 mg./kg. As the L.D. 50 for M.F.A. is also 6 mg./kg. the two compounds are equally toxic, molecule for molecule, allowance being made for the presence of 20 per cent water in the aldehyde. This degree of toxicity is thus exactly in accordance with expectation.

Fluoroacetamide and Related Compounds

Fluoroacetamide was first mentioned by Swarts,¹ but he gave no exact details for its preparation. In 1943 we prepared this compound in high yield by the action of ammonia on methyl fluoroacetate. It is a highly crystalline stable compound of sharp melting-point, and it has proved useful for the identification of methyl fluoroacetate (M.F.A.). Because of its stability and the fact that it can be obtained in a highly purified condition, it has proved to be of great value as an analytical standard for organic compounds containing fluorine.² It has the advantage, too, that it contains nitrogen which can be determined independently. Being a solid, it was not possible to assess its toxicity by inhalation in comparison with M.F.A., but intravenous injection into rabbits showed that the two compounds were about equally toxic and produced the same type of convulsions.

Fluoroacetamide has also been prepared by heating a mixture of potassium fluoride and chloroacetamide at 135° under reduced pressure when fluoroacetamide and unchanged chloroacetamide distil over.³ The reaction can also be carried out in xylene solution at ordinary pressure,⁴ but the yield is only 55 per cent. However, the method has been improved lately, although the product still contains unchanged chloroacetamide.⁵

By distilling the amide with phosphoric oxide at ordinary pressure, fluoromethyl cyanide was obtained as a colourless, mobile liquid. This compound had been obtained by Swarts,⁶ who claimed that it was necessary to distil the amide with

¹ *Bull. Soc. chim. Belg.* 1896, **15**, 1134.

² Chapman, Heap and Saunders, *Analyst*, 1948, p. 869. See also p. 208.

³ Bacon, Bradley, Hoeberg, Tarrant and Cassady, *J. Amer. Chem. Soc.* 1948, **70**, 2653.

⁴ U.S. Patent, 2,403,576.

⁵ Phillips, *Industr. Chem.* 1954, p. 122.

⁶ *Bull. Soc. chim. Belg.* 1922, **31**, 364.

DERIVATIVES OF FLUOROACETAMIDE

N-2-Chloroethylfluoroacetamide was also prepared by the direct action of 2 mol. of fluoroacetyl chloride on ethanolamine, although we carried out this reaction with the intention of preparing 2-(fluoroacetamide)ethyl fluoroacetate,



Injection of (V) into mice showed that the L.D. 50 was similar to that of fluoroacetamide or of fluoroacetic acid, and the symptoms produced appeared to be similar in each case; (V), however, showed no vesicant action. It is probable then that hydrolysis of the molecule occurs *in vivo*, resulting in the formation of fluoroacetic acid and the relatively harmless 2-chloroethylamine.

By reactions similar to the above we also prepared NN-*di*-(2-hydroxyethyl)fluoroacetamide and NN-*di*-(2-chloroethyl)fluoroacetamide.

The action of bromine and potassium hydroxide solution on fluoroacetamide might be expected to give fluoromethylamine. Under certain conditions, however, no fluoromethylamine was obtained, but a crystalline solid containing both fluorine and nitrogen was produced.¹ Analysis and general reactions showed that it was *N*-fluoroacetyl-*N'*-fluoromethylurea,



This reaction then is exactly analogous to Hofmann's preparation of the corresponding chloro compound from chloroacetamide.² Toxicity by injection into mice showed a L.D. 50 of about 60 mg./kg.

We then directed our attention to the properties of fluoromethyl cyanide, as it seemed likely, on theoretical grounds, that it would undergo certain addition reactions very readily. Alcohol and dry hydrogen chloride readily converted it into *fluoroacetimino ethyl ether hydrochloride* (VI), which was converted into the *amidine* (VII) by means of alcoholic ammonia. Similar condensation of the cyanide with 2-fluoroethanol and phenol yielded *fluoroacetimino 2-fluoroethyl ether hydrochloride* (VIII; $R = \text{CH}_2 \cdot \text{CH}_2\text{F}$) and the corresponding *phenyl imino ether hydrochloride* (VIII; $R = \text{Ph}$) respectively. Analogous experi-

¹ Buckle, Heap and Saunders, *J. Chem. Soc.* 1949, p. 912.

² *Ber. dtsh. chem. Ges.* 1885, 18, 2735.

THE FLUOROACETATES

ments were carried out with methyl cyanide, and it was established that the rate of formation of the imino ether hydrochlorides was much slower with this than with the fluoro-substituted analogue. This difference in reactivity was even more noticeable in the condensations with phenol.

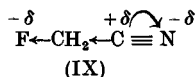
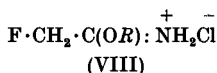
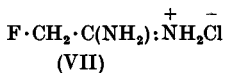
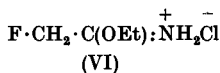

This enhanced reactivity of fluoromethyl cyanide is undoubtedly due to the inductive effect of the fluorine atom which produces an electron deficit on the carbon atom linked to the nitrogen, and presumably increases still further the polarity of the carbon-nitrogen bond, so that the electron displacements can be pictured as (IX). The increased polarity of the carbon-nitrogen bond will obviously facilitate polar addition of hydrogen chloride and alcohols (or phenols).

Compounds (VI), (VII) and (VIII; $R = \text{CH}_2\cdot\text{CH}_2\text{F}$ and $R = \text{Ph}$) were tested pharmacologically by subcutaneous injection into mice. Results obtained are shown in the accompanying table:

| Compound | Toxicity towards mice |
|--|---|
| (VI) | Comparable to that of methyl fluoroacetate |
| (VIII; $R = \text{Ph}$) | Comparable to that of methyl fluoroacetate |
| (VII) | Comparable to that of methyl fluoroacetate |
| (VIII; $R = \text{CH}_2\cdot\text{CH}_2\text{F}$) | Comparable to that of 2-fluoroethyl fluoroacetate |

It was to be expected that the imino ether hydrochlorides would be hydrolysed in the animal body to give the corresponding fluoroacetate and ammonium chloride, and the toxicities should be roughly the same as those of the fluoroacetates. The results show this to be the case. The compound (VIII; $R = \text{CH}_2\cdot\text{CH}_2\text{F}$) was expectedly more toxic than the other compounds, as this would be hydrolysed to 2-fluoroethyl fluoroacetate which is known to be twice as toxic as methyl or ethyl fluoroacetate,¹ as indicated below.

¹ McCombie and Saunders, *Nature, Lond.*, 1946, 158, 382.

2-Fluoroethyl Fluoroacetate and Related Compounds

In view of the fact that fluoroethanol is as toxic as methyl fluoroacetate (or as fluoroacetic acid), it seemed worth while preparing a compound in which the 'active' parts of these molecules were combined, in the hope of obtaining a compound of increased potency. Such a compound is *2-fluoroethyl fluoroacetate*, first prepared and described by us in 1943.¹ This ester was readily prepared by the action of fluoroacetyl chloride on fluoroethanol. It is a stable, mobile liquid possessing an extremely faint odour.

2-Fluoroethyl fluoroacetate was found to possess rather enhanced toxic properties. The L.C. 50 by inhalation for rabbits was 0.05 mg./l. This shows that it is about twice as toxic (weight for weight) as fluoroethanol or methyl fluoroacetate. This seems to indicate that the toxicity of 2-fluoroethyl fluoroacetate cannot be due entirely to that of its hydrolysis products according to the equation

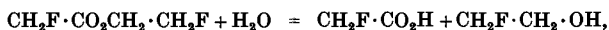

for if this were the case the L.C. 50 would be approximately equal to that of either fluoroethanol or methyl fluoroacetate. 2-Fluoroethyl fluoroacetate seems, therefore, to possess toxic properties *per se*, and this may be connected with the two 'active' ends of the molecule. Subcutaneous injection into mice also showed the compound to be about twice as toxic as methyl fluoroacetate. With other animals this difference was not always so apparent.

| Ester | Formula | Toxicity compared to that of methyl fluoroacetate |
|----------------------------------|---|--|
| Ethyl fluoroacetate | $\text{CH}_2\text{F}\cdot\text{CO}_2\text{Et}$ | Similar |
| 2-Chloroethyl fluoroacetate | $\text{CH}_2\text{F}\cdot\text{CO}_2\text{CH}_2\cdot\text{CH}_2\text{Cl}$ | Rather higher |
| 2-Fluoroethyl acetate | $\text{CH}_3\cdot\text{CO}_2\text{CH}_2\cdot\text{CH}_2\text{F}$ | Less |
| 2-Fluoroethyl chloroacetate | $\text{CH}_2\text{Cl}\cdot\text{CO}_2\text{CH}_2\cdot\text{CH}_2\text{F}$ | Rather higher |
| 2-Fluoroethyl fluoroacetate | $\text{CH}_2\text{F}\cdot\text{CO}_2\text{CH}_2\cdot\text{CH}_2\text{F}$ | Twice |
| Phenyl fluorothiolacetate | $\text{CH}_2\text{F}\cdot\text{CO}\cdot\text{SPh}$ | Low |
| 2-Chloroethyl fluorothiolacetate | $\text{CH}_2\text{F}\cdot\text{CO}\cdot\text{S}\cdot\text{CH}_2\cdot\text{CH}_2\text{Cl}$ | Lower by injection; considerably lower by inhalation |
| Allyl fluoroacetate | $\text{CH}_2\text{F}\cdot\text{CO}_2\text{C}_3\text{H}_5$ | Very slightly less |

¹ Report no. 4 on fluoroacetates to the Ministry of Supply, 15 April 1943.

In order to determine whether this increase in toxicity was necessarily bound up with the presence of two fluorine atoms in the molecule, a series of structurally related esters was prepared and examined.¹

The results obtained may be conveniently summarized in the table on p. 129.

2:2'-Difluorodiethyl Ethylene Dithioglycol

In view of the powerful vesicant action of 2:2'-dichlorodiethyl ethylene dithioglycol ('sesqui-H'), we decided in 1943 to prepare the corresponding fluorine analogue.² Earlier workers had failed to achieve the synthesis of this compound. Our preparation consisted in treating bromofluoroethane with sodium hydrogen sulphide. The resulting fluoroethanethiol (IX) was not isolated, but was converted directly into the sodium mercaptide (X). This was heated under reflux with an alcoholic solution of bromofluoroethane, and 2:2'-difluorodiethyl ethylene dithioglycol (1:8-difluoro-3:6-dithiaoctane) (XI) thus obtained.

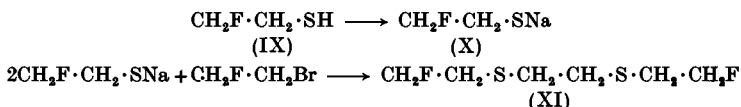

This reaction is very interesting in view of the unreactivity of the halogen atoms in bromofluoroethane towards many reagents. It may well be, however, that the reaction is not as simple as that represented above.

In order to prove the identity of (XI), it was synthesized in a different manner. Ethylene dibromide was converted into ethylene dithiol, which was then heated with bromofluoroethane in the presence of sodium hydroxide. The yield by this method was small. The compound (XI), otherwise called 'sesquifluoro-H', is a liquid. It is neither a vesicant nor does it produce fluoroacetate-like symptoms in the animal body.

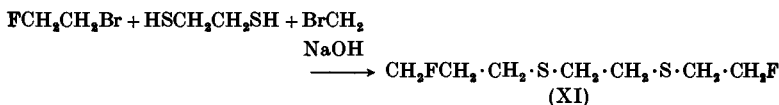

¹ Saunders and Stacey, *J. Chem. Soc.* 1949, p. 916.

² Report no. 8 on fluoroacetates to the Ministry of Supply.

Fluorine-containing Ammonium Salts

It is well known that the amino and acetamido group and quaternary ammonium groups often render compounds physiologically active. Particular reference may be made to the work of Haworth and his collaborators on the toxic action associated with quaternary ammonium salts.¹

In view of these facts and of the known toxic action of 'fluoroacetates' it seemed worth while investigating compounds containing both fluorine and the above-mentioned groups. We prepared the first of a series of nitrogen compounds in 1943,² namely, *ethyl fluoroacetamidoacetate*, $\text{CH}_2\text{F}\cdot\text{CO}\cdot\text{NH}\cdot\text{CH}_2\cdot\text{CO}_2\text{Et}$ (XII). It was a colourless crystalline solid which, when injected into mice, had a L.D. 50 of 20 mg./kg. The corresponding figure for methyl fluoroacetate is 6 mg./kg. The symptoms were similar in each case (delayed convulsant action).

2-Fluoroethyl aminoacetate hydrochloride (XIII) was readily prepared by esterifying glycine with fluoroethanol (F.E.A.) according to the Fischer-Speier method:

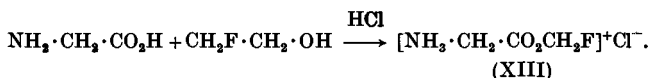

Using similar conditions with betaine and F.E.A. none of the expected ester was obtained, the betaine remaining unchanged. The reaction between anhydrous trimethylamine and fluoroethyl chloroacetate, however, gave *2-fluoroethyl betaine hydrochloride* (XIV) in excellent yield:

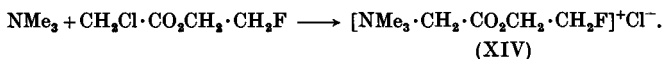

The hydrochloride (XIII) had a L.D. 50 of *ca.* 10 mg./kg. by subcutaneous injection into mice. The corresponding figure for 2-fluoroethyl betaine hydrochloride was 45 mg./kg. Both (XIII) and (XIV) produced fluoroacetate-like symptoms.

In preparing other compounds containing fluorine and quaternary ammonium groups, advantage was taken of the fact that of

¹ *J. Chem. Soc.* 1946, pp. 176, 182.

² Report no. 6 on fluoroacetates to the Ministry of Supply, 30 September 1943; Saunders, *J. Chem. Soc.* 1949, p. 1279.

THE FLUOROACETATES

the two halogens in 1-bromo-2-fluoroethane, the bromine atom is the more reactive (see pp. 96 and 123). When, for example, trimethylamine and bromofluoroethane were allowed to react at room temperature, addition took place and *trimethyl-2-fluoroethylammonium bromide* (XV) was produced. Similarly, triethylamine gave *2-fluorotetraethylammonium bromide* on being heated with bromofluoroethane.

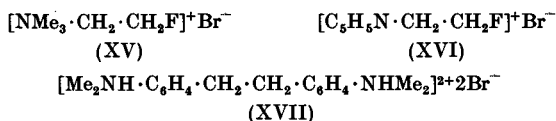

Pyridine gave *2-fluoroethylpyridinium bromide* (XVI) on being heated under reflux with bromofluoroethane.

Dimethylaniline did not give the expected phenyldimethyl-2-fluoroethylammonium bromide, but gave the compound (XVII) in small yield, the point of attack being the *para*-hydrogens of the dimethylaniline. This seems surprising in view of the relative unreactivity of the fluorine in bromofluoroethane. A possible explanation is that (XVIII) is first formed and that in this compound

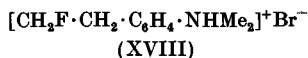

the fluorine atom is much more reactive than in the original bromofluoroethane. The fluorine atom of (XVIII) would then react with the *p*-hydrogen atom of a second molecule of dimethylaniline. These fluoro-quaternary bromides were relatively non-toxic and had L.D. 50's of the order of 300 mg./kg.

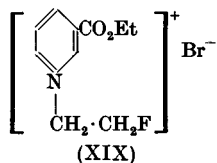

In view of the biological importance of nicotinic acid, it was decided to prepare a quaternary salt from the acid or ester and bromofluoroethane. *3-Carboxy-N-2-fluoroethylpyridinium bromide* (XIX) was therefore prepared and examined. The L.D. 50 for subcutaneous injection into mice was 200 mg./kg., i.e. it was relatively non-toxic compared with methyl fluoroacetate.

It seems possible to draw certain deductions from the above toxicities. It is to be noted that ethyl fluoroacetamidoacetate (XII) would almost certainly be hydrolysable in the animal body to free fluoroacetic acid, and that (XIII) and (XIV) would similarly give 2-fluoroethanol (oxidizable *in vivo* to fluoroacetic acid). These three compounds do, in fact, show toxicities of the same order as that of methyl fluoroacetate (or of fluoroacetic acid); (XIV) is, however, rather less toxic than might be expected.

The inactivity of the quaternary bromides is probably due to the inability of the body to rupture the C—N link in the $\text{CH}_2\text{F}\cdot\text{CH}_2\cdot\text{N}^+\text{<}$ grouping. The toxicity figures nevertheless reveal an interesting feature. For example, a saline solution of 2-fluorotetraethylammonium bromide injected subcutaneously into mice gave the following results: 500 mg./kg. killed 1/1 in 10 min.; 400 mg./kg. killed 4/4 within 90 min.; 300 mg./kg. killed 2/4 within $2\frac{1}{2}$ hr.; and 200 and 100 mg./kg. killed 0/4 and 0/1 respectively. These figures show a very *rapid* action at the higher concentrations, and the toxicity was therefore probably due to the quaternary ammonium ion rather than to the 2-fluoroethyl group.

Relationship between Physiological Action and Chemical Constitution in the Fluoroacetate Series¹

A wide variety of compounds containing the C—F link has been described in this Chapter, and it is now convenient to classify them according to their physiological activity. In general, two types of assessment of animal toxicity have been made: (a) by inhalation (liquids) and given as L.C. 50 in mg./l.; (b) by injection (liquids and solids) and given as L.D. in mg./kg. of body weight.

Methyl fluoroacetate (M.F.A.) has a L.C. 50 of 0.1 mg./l. for rabbits, guinea-pigs and rats. The figure for fluoroethanol (F.E.A.) is similar. For intravenous injection into rabbits, M.F.A., F.E.A. and free fluoroacetate acid (a solid) have L.D. 50's of the order of 0.25 mg./kg., and for subcutaneous injection

¹ Saunders, *J. Chem. Soc.* 1949, p. 1279.

into mice the figure is about 6 mg./kg. for each substance. Thus any one of these substances can be conveniently taken as a reference standard. The symptoms are the same in each case, the action being that of a convulsant poison with delayed action. In these compounds the fluorine is unreactive chemically towards many reagents; for example, the fluorine atom in fluoroacetic acid is unaffected by water and boiling 10 per cent aqueous sodium hydroxide solution removes the fluorine very slowly.

For purposes of comparison the magnitude of the toxicity of fluoroacetic acid is represented as *B*; *A* indicates higher toxicity (up to a factor of 2) and *C* indicates a lower toxicity (down to about 1/4 of that of fluoroacetic acid); *D* represents very low or negligible toxicity of the 'fluoroacetate' type.

In class *B* are placed all simple esters, $\text{CH}_2\text{F}\cdot\text{CO}_2R$, of fluoroacetic acid, where $R = \text{Me, Et, Pr}^n, \text{Pr}^i, \text{Ph, etc.}$ When substitution takes place in the α -hydrogen atoms, e.g. in methyl α -fluoropropionate or α -fluoroisobutyrate, then the compound is devoid of toxicity. This indicates the importance of the unsubstituted fluoromethyl group. On pp. 125 *et seq.* it was shown that fluoroacetamide and a variety of substituted amides such as $\text{CH}_2\text{F}\cdot\text{CO}\cdot\text{NH}\cdot\text{CH}_2\cdot\text{CH}_2\text{Cl}$ were, molecule for molecule, equally toxic with fluoroacetic acid and produced the same symptoms. The 2-chloroethyl group therefore contributed nothing appreciable to the toxicity of the molecule. The majority of the esters of fluoroethanol showed the toxicity of the parent alcohol, e.g. 2-fluoroethyl chlorosulphonate, $\text{CH}_2\text{F}\cdot\text{CH}_2\cdot\text{O}\cdot\text{SO}_2\text{Cl}$, di-(2-fluoroethyl) sulphate and 2-fluoroethylglycine hydrochloride.

Fluoroacetaldehyde was as toxic as fluoroacetic acid.

All the toxic compounds mentioned above are either hydrolysable or oxidizable to fluoroacetic acid.¹ In this connexion it should be noted that 1-chloro-2-fluoroethane was relatively non-toxic. The chlorine atom in this compound was shown to be rather unreactive chemically, hence hydrolysis to the toxic fluoroethanol in the animal body would be unlikely.

Compounds in which the fluorine atom is very loosely bound are relatively non-toxic. Thus the COF group is not toxophoric

¹ See, however, work on fluorocitrate to which fluoroacetate gives rise in the animal body (p. 142).

STRUCTURAL REQUIREMENTS FOR TOXICITY

as shown by the inactivity of acetyl fluoride, chloroacetyl fluoride and ethyl fluoroformate. Also in the non-toxic class are the quaternary ammonium salts described on p. 132. 'Sesqui-fluoro-H', $\text{CH}_2\text{F}\cdot\text{CH}_2\cdot\text{S}\cdot\text{CH}_2\cdot\text{CH}_2\cdot\text{S}\cdot\text{CH}_2\cdot\text{CH}_2\text{F}$ (see p. 130), was non-vesicant as well as non-toxic, whereas the corresponding chloro compound is potent in both these respects. 2-Fluoroethyl sulphonyl chloride, $\text{CH}_2\text{F}\cdot\text{CH}_2\cdot\text{SO}_2\text{Cl}$, was also relatively non-toxic by inhalation. These facts suggest that the body is unable to rupture these carbon-nitrogen and carbon-sulphur bonds easily, and so the facile formation of fluoroethanol is prevented.

There is, however, another factor which must not be overlooked. In the highly toxic compounds the fluorine atom is firmly bound, and the toxic action may in some way be connected with this. In the compounds containing N or S in the 2-position to the F atom, the latter may not be so firmly attached. There is some qualitative evidence to support this, but the matter requires further investigation.

The compounds in class *C* definitely show 'fluoroacetate-like' activity, but are rather less potent than members of the standard class *B*.

2-Fluoroethyl fluoroacetate is a compound of considerable toxicity. Its L.C. 50 for rabbits (inhalation) is 0.05 mg./l., i.e. about half as great as for M.F.A. It is therefore placed in class *A*. Other factors apart from hydrolysis to fluoroethanol and fluoroacetic acid appear to be operative, and it seems that the molecule is toxic *per se*. The related fluoroacetylmino-2-fluoroethyl ether hydrochloride, $[\text{CH}_2\text{F}\cdot\text{C}(\text{:NH}_2)\cdot\text{O}\cdot\text{CH}_2\cdot\text{CH}_2\text{F}]^+\text{Cl}^-$, is also placed in class *A*. This is understandable as it is readily hydrolysed by water to 2-fluoroethyl fluoroacetate. Other fluoroacetylmino ether hydrochlorides containing, however, only one fluorine atom fall into class *B*, as does also fluoroacetamidine hydrochloride itself.

Combination of 'fluoroacetate' activity and certain other recognizable physiological effects have been successfully combined in fluoroaspirin (drugged sleep), triethyl-lead fluoroacetate (sternutation), difluoroethyl phosphorofluoridate (myosis, but not powerful). In general, quaternary ammonium

THE FLUOROACETATES

groups and the $S \cdot CH_2 \cdot CH_2Cl$ and $N \cdot CH_2 \cdot CH_2Cl$ groups have not contributed anything really significant to the potency of molecules containing them. Occasionally the $CH_2 \cdot CH_2Cl$ group seems to have had some slight effect as in 2-chloroethyl fluoroacetate.

Apart from chemical considerations, purely physical phenomena, such as rate of diffusion through the cell membrane, must also play their part in determining the toxic action of a compound.

The following summarizes the more important features of the above classification. The list is not exhaustive.

Class *A*: 2-Fluoroethyl fluoroacetate.

Class *B'*: 2-Chloroethyl fluoroacetate.

Class *B*: Fluoroacetic acid and salts, e.g. sodium fluoroacetate, triethyl-lead fluoroacetate; all simple esters of fluoroacetic acid; fluoroacetamide and substituted amides; fluoroacetamide hydrochloride; fluoroacetyl chloride and fluoride; fluoroethanol and its simple esters; fluoroacetaldehyde.

Class *C*: Fluoromethyl cyanide (but more toxic to rabbits); certain 2-fluoroethyl ethers; phenyl fluorothioloacetate, $CH_2F \cdot CO \cdot SEt$.

Class *D*: Alkyl fluoroformates; quaternary ammonium salts, $CH_2F \cdot CH_2 \cdot \overset{+}{N}R_3\bar{X}$, chlorofluoroethane; sulphur-containing compounds, e.g. $CH_2F \cdot CH_2 \cdot SR$; esters of 1-alkylated fluoroacetic acids, $CHR'F \cdot CO_2R$ and $CR'R''F \cdot CO_2R$; acetyl and chloroacetyl fluoride.

In the next chapter a description will be given of the synthesis of further highly toxic compounds containing the C—F link, which lend support to the views expressed above.

More Detailed Consideration of Toxic Action of 'Fluoroacetates'

The L.D. of a typical fluoroacetate varies considerably from species to species; moreover, the pharmacodynamic action of the material is very varied. The main point of attack may be the central nervous system or the heart or sometimes both. Death can result from (i) respiratory arrest after convulsions, (ii) cardiac failure or ventricular fibrillation, or (iii) gradual depression

TOXIC ACTION OF FLUOROACETATES

of the central nervous system followed by either respiratory or cardiac failure.¹ Death is always delayed.

Broadly speaking herbivorous animals (guinea-pig excepted) show cardiac symptoms and carnivores develop central nervous system convulsions or depression; with omnivores both heart and central nervous system may be affected. Cold-blooded vertebrates are usually less sensitive to fluoroacetate, but frogs are more sensitive in summer than in winter.² Fish appear to be insensitive to fluoroacetate dissolved in water.³ Insects are easily killed by fluoroacetate, and the use of sodium fluoroacetate as a systemic insecticide is described on p. 182.

In the accompanying table a number of toxicity figures⁴ are given for M.F.A. by intravenous injection. The wide variation in toxicity and the two types of action, nervous and cardiac, will be noted.

| Animal | L.D. 50 | Cardiac response | Response of central nervous system |
|---------------|-----------------------------------|---------------------------------|------------------------------------|
| Rabbit | 0.20-0.24 | Ventricular fibrillation | None |
| Goat | 0.6 | Ventricular fibrillation | None |
| Spider monkey | 14.0 | Ventricular fibrillation | None |
| Cat | 0.5 | Slight ventricular fibrillation | Marked |
| Rhesus monkey | 4.0 | Ventricular fibrillation | Slight |
| Dog | 0.06 | None | Marked convulsions |
| Rat (albino) | 5.0 | Ventricular fibrillation | Convulsion |
| Guinea-pig | (intra-musc.) 0.30 | None | Marked convulsions |
| Frog | (intra-per.) 150 (sub-cut.) | None | Convulsions |

In Chapter VIII (p. 149) we discuss our suggestion that β -oxidation of ω -fluorocarboxylic acids takes place in the animal body. Nevertheless, there is some indication that γ -fluorobutyrate (but not γ -fluorocrotonate), even if it does undergo β -oxidation, also acts *per se*. For example, progressive cardiac failure without ventricular fibrillation is noted in Rhesus monkeys poisoned with fluorobutyrate. Rabbits poisoned with fluorobutyrate do indeed show ventricular fibrillations and weak convulsions, but in addition appear to manifest a para-

¹ Chenoweth, *J. Pharmacol.* 1949, **97**, 383.

² Boyarski, Rosenblatt, Pistel and Gerrard, *Amer. J. Physiol.* 1949, **157**, 291.

³ Deonier, Jones and Incho, *J. Econ. Ent.* 1946, **39**, 459.

⁴ Taken mainly from Chenoweth and Gilman, *J. Pharmacol.* 1946, **87**, 90; and Chenoweth, *J. Pharmacol.* 1949, **97**, 383.

THE FLUOROACETATES

sympathetic stimulation. In the opinion of the writer this atypical result would appear to demand further detailed examination.

All the available evidence indicates that fluoroacetate is probably excreted in the urine as such. Tolerance to increasing doses (below the lethal dose) has been detected in the mouse and rat.¹ The resistance appears to be of a temporary nature.

With all 'fluoroacetates' there is a latent period before response. Even with massive doses a latent period is observed. Prior administration of large amounts of sodium bicarbonate, fumarate or chloride reduce the time required for the onset of ventricular fibrillation, but the latent period cannot be eliminated.²

Large doses of sodium fluoroacetate injected intravenously into the lateral ventricles of the brain of cats produced increases in the electrical activity of the thalamus and hypothalamus.³ Rises in blood glucose to 400 mg./100 ml. have been reported.

The oxidation of acetate by baker's yeast is 95 per cent inhibited by 0.001 M fluoroacetate,⁴ but not by chloroacetate, iodoacetate, fluorobutyrate and fluorocrotonate.

Sodium fluoroacetate (but not methyl fluoroacetate) is practically without action on frog nerve or brain *in vitro*. The ester decreases the action potential of frog sciatic nerve and reduces the conduction velocity.⁵ The inactivity of the salt may be related partly to its inability to penetrate cells.

Lethal concentrations of sodium or methyl fluoroacetate perfusing through isolated rabbit hearts caused failure of myocardial contractile power, but rarely fibrillation.⁶ (In this connexion it may be noted that fluoroethanol is without action on the isolated perfused heart, presumably because this organ cannot oxidize fluoroethanol to fluoroacetate.) The addition of sodium acetate to the perfused heart gives a great deal of protection against M.F.A., although it appears to give no protection in the intact rabbit. In mice, however, it has been claimed that sodium acetate (2-3 g./kg.) will give some protection

¹ Quin and Clark, *Onderstepoort J. Vet. Sci.* 1947, **22**, 77.

² Chenoweth *et al.* *Fed. Proc.* 1949, **8**, 280.

³ Ward, *J. Neurophysiol.* 1947, **10**, 105.

⁴ Kalnitsky and Barron, *J. Biol. Chem.* 1947, **170**, 83.

⁵ Boyarski, Pistel and Rosenblatt, *Fed. Proc.* 1948, **7**, 11.

⁶ Chenoweth and Gilman, *Fed. Proc.* 1946, **5**, 171.

against fluoroacetate.¹ Ethanol and acetate together are more than twice as effective as either alone, suggesting a synergistic effect. This has led to a search for other protecting C₂ compounds, and among the many substances tried by many different workers in England and the United States glyceryl monoacetate shows considerable promise.²

Fluoroethanol itself is innocuous towards a variety of tissue constituents, a series of enzymes in rat-liver mince, and the respiration and metabolism in liver, kidney, heart and brain slice.³ After a period of incubation in those tissues known to contain alcohol dehydrogenase, e.g. liver and kidney, the respiration and pyruvate oxidation were strongly inhibited. Likewise, following a period of incubation with yeast, acetate oxidation was blocked. These inhibitions were similar to those produced by fluoroacetate, and the facts can best be explained by the oxidation of fluoroethanol to fluoroacetic acid by alcohol dehydrogenase.

Fluoroethanol, in contrast to ethanol, is only weakly oxidized by purified alcohol dehydrogenases, the rate being one-tenth to one-twentieth. Nevertheless, this rate appears sufficient to produce a typical fluoroacetate poisoning. A fairly long lag period in the development of the fluoroacetate symptoms possibly masks the time required for oxidation of fluoroethanol.

Action of Sodium Fluoroacetate on Enzymes

In the Croonian Lecture⁴ in 1951, (Sir) R. A. Peters remarked: 'Extensive experiments by several investigators, including ourselves, have not revealed any isolated individual enzyme which is inhibited *in vitro* by this poison.' The following figures were given for the pyruvate oxidase system (pigeon brain homogenate), using sodium pyruvate and sodium fumarate as substrates:

| | O ₂ uptake (μ l. in 30 min.) |
|--------------------------------|--|
| No addition | 426 |
| NaF (24 mM) | 262 (38 per cent inhibition) |
| FCH ₂ COONa (75 mM) | 439 (no inhibition) |

¹ Tourtellote and Coon, *Fed. Proc.* 1949, 8, 339.

² Chenoweth, Scott and Sebi, *Fed. Proc.* 1949, 8, 250.

³ Bartlett, *Report to Office of Naval Research*, 1952.

⁴ *Proc. Roy. Soc. B*, 1952, 139, 143.

THE FLUOROACETATES

Cause of fluoroacetate poisoning

In 1947 Bartlett and Barron,¹ using tissue slice, showed that fluoroacetate blocked the oxidation of acetate competitively, and that this accounted for the toxic effect, namely, the body was deprived of acetate. Liebig and Peters then found that fluoroacetate blocked the oxidation of fumarate in a guinea-pig's kidney homogenate without accumulation of acetate; hence Bartlett and Barron's hypothesis could not be the whole story.

The results of Liebig and Peters² are shown in the accompanying table from which it is also obvious that there is an accumulation of citrate:

Effect of FCH₂COONa (3.3 mM) on kidney homogenate respiring in presence of sodium fumarate (Mg and A.T.P. added)

| | O ₂ Uptake (μ l.) | Inhibition (%) | Acetic acid (mg.) | Citric acid (mg.) |
|------------------------|--------------------------------------|-------------------|----------------------|----------------------|
| No addition | 436 | 0 | 0.11 | 0.18 |
| FCH ₂ COONa | 246 | 4 | 0.13 | 0.75 |

Buffa and Peters³ then demonstrated the accumulation of citrate *in vivo*. The rat was injected with a lethal dose of sodium fluoroacetate and the following results obtained:

Citric acid, μ g./g. wet tissue

| | Control rat | Poisoned rat |
|-----------------|-------------|--------------|
| Kidney | 14 | 1036 |
| Heart | 25 | 677 |
| Spleen | 0 | 413 |
| Stomach | 37 | 386 |
| Small intestine | 36 | 368 |
| Large intestine | 21 | 248 |
| Lung | 9 | 257 |
| Brain | 21 | 166 |
| Blood | 3 | 50 |
| Liver | 0.8 | 31 |
| Diaphragm | 0 | 400 |
| Uterus (virgin) | 217 | 207 |

Other workers (Potter and Bush)⁴ have confirmed this citrate accumulation, and, in addition, have demonstrated that cancer tissue does not show the increase.

¹ *J. Biol. Chem.* 1947, **170**, 67.

² *Biochim. biophys. Acta*, 1949, **3**, 215.

³ *J. Physiol.* 1949, **110**, 488.

⁴ *Cancer Res.* 1950, **10**, 353.

SODIUM FLUOROACETATE AND ENZYMES

We will now draw attention to the Krebs cycle otherwise called the tricarboxylic acid cycle (fig. 17). It is now known that carbohydrate metabolism and fatty acid metabolism as well as acetate proceed via changes indicated in the cycle. The essential

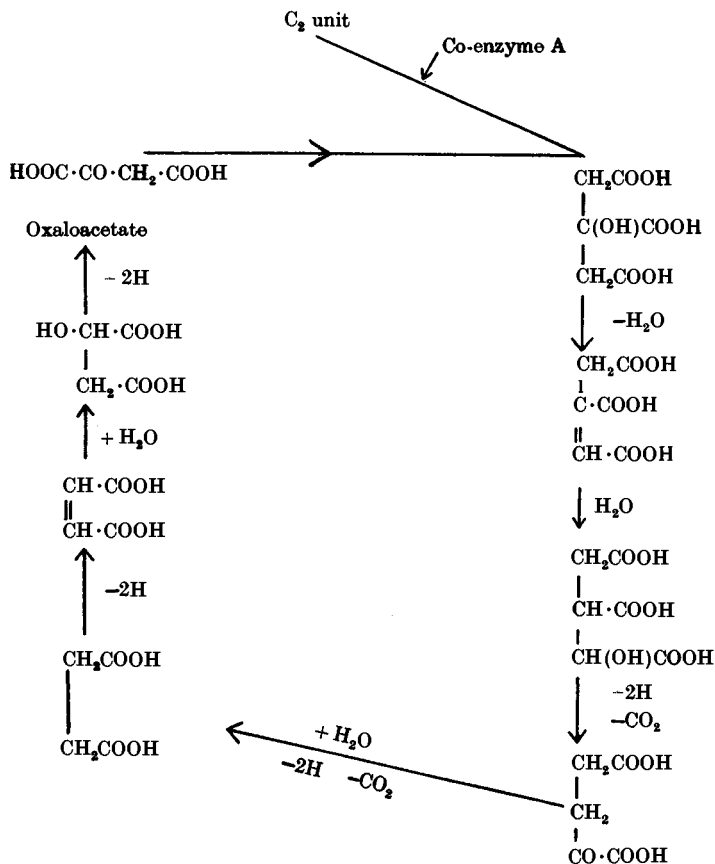

Fig. 17. Krebs's tricarboxylic acid cycle.

features of the reactions involved are shown in the simplified version outlined in fig. 17.

The pyruvate oxidase system (p. 139) should now be interpreted as pyruvate dihydrogenase together with the enzymes of the tricarboxylic acid cycle. The fact that sodium fluoroacetate itself did not poison the tricarboxylic acid cycle enzymes in

THE FLUOROACETATES

brain (p. 139), led Liebig and Peters to suggest that fluoroacetate entered the tricarboxylic acid cycle by synthesis and somehow jammed the further oxidation of citrate. Martius¹ independently arrived at the same conclusion. Considerable credit must be given to Kalnitsky and Barron,² who as early as 1948 had indeed observed accumulation of citrate *in vitro*. Initially they thought that this was due to increased production and not due to inhibition by fluoroacetate.

The view of Liebig and Peters is consistent with our work³ mentioned later (p. 149), because only compounds capable of being oxidized by β -oxidation to a C₂-containing fluoro fragment would be built up into the tricarboxylic acid system. Also Peters believes that the brain homogenate pyruvate oxidase system was not poisoned because the tissue was incapable of oxidizing acetate and hence might not synthesize the 'jamming' compound.

Working with kidney homogenates from guinea-pigs, Peters has isolated an inhibitor containing a C—F link as the result of the enzymic action of kidney upon fumarate and fluoroacetate. This inhibitor is almost certainly fluorocitrate because

(1) the inhibitor migrates with tricarboxylic acid on a paper chromatogram;

(2) fluoroacetate itself is much less inhibiting in the test system.

Aconitase, an unstable enzyme,⁴ is concerned with the reversible conversion of *cis*-aconitate to either citric acid or *isocitric* acid. It may be noted that the entire system of tricarboxylic cycle enzymes are present in the mitochondria separated from cells, and, furthermore, it has been found that the mitochondrial enzymes differ from the isolated enzymes in that the former require no addition of D.P.N. (co-enzyme I) or T.P.N. (co-enzyme II) for activity. Peters suggests that the citrate accumulation is caused by the competitive reaction of the fluorocitrate with aconitase required for the conversion of citrate to *isocitrate*. This interference with the tricarboxylic acid

¹ *Liebigs Ann.* 1949, **561**, 227.

² *Arch. Biochem.* 1948, **19**, 75.

³ Saunders, *Nature, Lond.*, 1947, **160**, 179.

⁴ Aconitase can be stabilized by citric acid; and Fe²⁺ and cysteine incite it to full activity.

cycle must contribute to the malfunctioning of cells, and we may add that citrate accumulations precede the development of toxic symptoms. The injection of citrate into the blood stream has long been known to have a toxic effect.¹

Chenoweth,² on the other hand, has observed no increase in the citrate content of brain in animals suffering a convulsive death after poisoning with methyl fluorobutyrate.

Where accumulation of citrate does occur, this may well react with calcium ions and cause consequent physiological disturbance in nerve and muscle. In this connexion it is interesting to note that fluoroacetate is relatively non-phytotoxic (for its use as systemic insecticide, see p. 182).

We may add that, although the enzymically prepared fluorocitrate³ is a competitive inhibitor of a very highly purified aconitase,⁴ synthetic fluorocitrate⁵ (see below) behaves differently; for example, it is more toxic to soluble aconitase. There is no very satisfactory explanation of this difference, although stereochemical differences have been suggested.

The proof that fluorocitrate is indeed the toxic substance is shown by injecting 30 mg. of enzymically produced fluorocitrate within the skull of an anaesthetized pigeon. Some 10 min. after the bird came round, convulsions and death followed. On the other hand, an intracranial injection of fluoroacetate in larger amounts produces no convulsions. This fact indicates that brain tissue does not synthesize fluorocitrate from fluoroacetate, and suggests that convulsions occurring after intraperitoneal injections by fluoroacetate are due to penetration to the brain by fluorocitrate synthesized elsewhere.

The above observations, taken together with the facts set out on pp. 133-6, support the view that 'fluoroacetate' poisoning is brought about by the building up of FCH_2COOH into fluorocitrate by enzymes *in vivo*.

The protective effect against 'fluoroacetate' poisoning by C_2 -containing compounds (see Chenoweth's work, pp. 132 and

¹ Solant and van Hecht, *Amer. J. Physiol.* 1915, **36**, 126.

² Kandel, Johnson and Chenoweth, *Fed. Proc.* 1951, **10**, 312.

³ Peters *et al.* *Proc. Roy. Soc. B*, 1953, **140**, 457.

⁴ Morrison, *Biochem. J.* 1954, **56**, 99.

⁵ Rivett, *J. Chem. Soc.* 1953, p. 3710.

THE FLUOROACETATES

165) is thus explained as being due to the interference of the conversion of fluoroacetate into fluorocitrate.

The synthesis of a lethal or toxic substance from a less toxic or non-toxic substance *in vivo* is also observed among esters of phosphorus (see p. 173).

Finally, we may add that fluorocitrate interferes with fat metabolism *in vivo*, because it leads to rapid and marked urinary appearance of ketone bodies.¹ Unlike fluoroacetate, intraperitoneal fluorocitrate (20 mg./kg.) (synthetic), though increasing the citrate in the brain, produces no convulsions in 2 hr.

Sherwood-Jones *et al.*² have demonstrated the presence of the tricarboxylic acid cycle in mammalian reticulocytes by observing citrate accumulation in the presence of sodium fluoroacetate. They also demonstrated a substantial inhibition of respiration by fluorocitrate.

Rat reticulocytes incubated in presence of
FCH₂COONa (0.02 M)

| Oxygen uptake in μM | | |
|--------------------------------|----------------------|--------------------------------------|
| Fluoroacetate present | Fluoroacetate absent | Citrate accumulations* in micromols. |
| 5.9 | 17.3 | 3.0 |
| 6.7 | 18.2 | 2.5 |
| 5.4 | 13.4 | 2.9 |

* Citrate accumulation = citrate in flasks containing fluoroacetate less citrate in control flasks.

The *synthetic fluorocitric acid*, to which reference has been made in the foregoing pages, has been prepared³ in low yield (12 per cent) by the following method from ethyl fluoroacetate:⁴

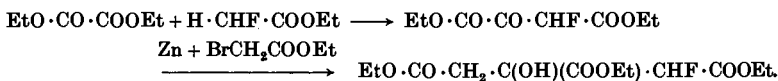

Synthetic fluoropyruvate,⁵ FCH₂COCOONa is much less toxic than fluoroacetic acid and surprisingly does not affect the tricarboxylic acid cycle.

¹ Gal, Peters and Wakelin, *Biochem. J.* 1954, 58, xlii.

² *Ann. Trop. Med. Parasit.* 1953, 47, 431.

³ Rivett, *J. Chem. Soc.* 1953, p. 3710.

⁴ For preparation of ethyl fluoroacetate, see Saunders and Stacey, *J. Chem. Soc.* 1948, p. 1773.

⁵ Mager and Blank, *Nature, Lond.*, 1954, 173, 126.

Naturally Occurring Potassium Fluoroacetate

In South Africa, mainly in the Pretoria region, a poisonous plant called 'gifblaar' grows (Pl. I (a) and (b)). Gifblaar (*Dichapetalum cymosum*) is a deep-rooted plant, its root system penetrating into the soil to a depth of 60 ft. For this reason the plant sprouts early in summer before the first rains have fallen. It is said that green patches of gifblaar are very attractive to stock grazing on the dry veld.

D. G. Steyn describes the symptoms in animals caused by gifblaar as follows:¹

Gifblaar is a heart poison, ranking amongst the most poisonous plants in the world. The younger the leaves, the greater their toxicity; this is one of the reasons why large numbers of stock die during spring every year (from August to November) as a result of the ingestion of gifblaar. One seldom sees animals showing symptoms of gifblaar poisoning, as most of them die suddenly after having ingested the plant, especially if they drink water soon afterwards. It is only in isolated cases that illness is detected in the animals. The disease is, as a rule, attended by muscular twitching, laboured breathing and weakness of the heart. Oxen which have ingested gifblaar may collapse while under the yoke.

Steyn then goes on to say that there are no specific post-mortem lesions. It is stated that less than an ounce of fresh leaves is enough to kill a sheep.

A larger plant (*D. toxicarium*) which grows in West Africa also gives rise to a toxic principle² which is known to cause paralysis of the lower extremities and abolition of tendon reflexes in human beings.

An interesting letter,³ passed on to the author from the High Commissioner of South Africa, states that *D. cymosum* grows in the Transvaal, north of Pretoria (i.e. in frost-free areas). In the spring, because of the depth of its roots and its access to deep water supplies, it is practically the first thing to turn green on the parched veld. The poor half-starved cattle, which do not

¹ D. G. Steyn, *Fmg in S. Afr.* July 1939.

² W. Renner, *Brit. Med. J.* 1904, 1, 1314.

³ Correspondence (December 1953) from Sir John le Rougetel, High Commissioner, Pretoria, containing a letter from Mr Snelling, Office of the High Commissioner, Pretoria.

eat it normally, then turn to it in desperation. Far from being non-poisonous to animals, it is so poisonous that half of one leaf is enough to kill an ox. It grows in sandy country with boulders; its roots are entwined round these boulders and it cannot be removed except by using dynamite. '... Pole Evans once tried to get one out. He dug a quarry 100 ft. deep and even then couldn't get the thing disentangled. He advised farmers that the only thing to do was to fence in the areas where it grows. What interested him particularly was Saunders's statement that the toxic principle is a fluorine compound. For he says that it grows best precisely where the water has an abnormally high fluorine content, and especially around Warmbaths where there is so much fluorine in the water that it rots the teeth of the inhabitants and the whole town chews on its gums or dentures.'

Mr Pole Evans also offers the following information:¹ 'In the Bechuanaland Protectorate, especially in the neighbourhood of the Hunters' Road near the Southern Rhodesian Border a larger growing species *D. veneatum* is found. This plant is well known to the natives of this area as *Makow*, and is reported to be just as poisonous as *D. cymosum*.'

The toxic principle of *D. cymosum* has been isolated by Marais and proved to be potassium fluoroacetate.² It is evident that this is indeed the heart poison referred to by Steyn in his vivid account given above.

Fluoroacetate can also be detected in extracts from the seeds of *D. toxicarium* (ratsbane). Unlike the South African *D. cymosum*, the main toxicity of ratsbane seems, however, to be due to a long-chain fluoro acid, which has not yet been thoroughly characterized.³

Stability of the C—F Link

The formation of fluoroacetate in the plant is of very great interest and the question arises how the plant enzymes build up the C—F link. Equally interesting is the mechanism by which fluoroacetate is destroyed. Throughout the aeons of time, in which the plant has built up fluoroacetic acid, the accumulation

¹ Letter from Mr I. B. Pole Evans (December 1953), Irene, Transvaal.

² *Onderstepoort J. Vet. Sci. An.* 1943, 18, 203; 1944, 20, 67.

³ Peters *et al.* *Biochem. J.* 1954, 58, xl.

PLATE I

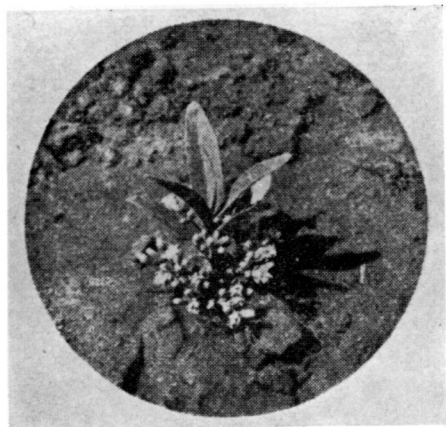

(a)

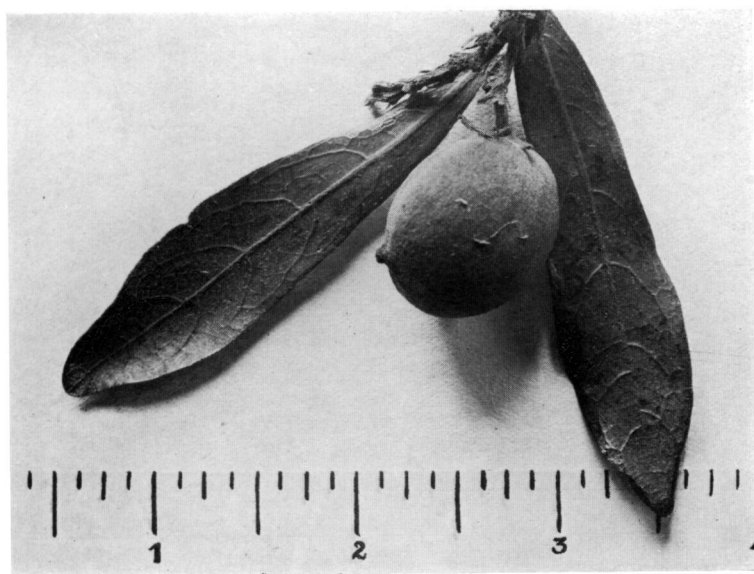

(b)

Dichapetalum cymosum (gifblaar): (a) whole plant; (b) fruit and leaves.
Leaves are alternate and finely veined.

(Facing p. 146)

of the latter in the surrounding terrain would most probably be greater than it in fact is. Two suggestions may be made. One is that the toxic fluoroacetic acid is decarboxylated by some plant (or, more probably, soil) enzyme system to the volatile and non-toxic fluoromethane:



A second suggestion is that the C—F link is actually broken by some enzyme system and the toxic principle thereby removed. So far no enzyme system has been discovered which will bring about this cleavage, and we have repeatedly stressed the unreactivity of the fluorine atom in many compounds containing the C—F link. Nevertheless, there are several instances, in some cases unexpected, of the apparent lability of the fluorine atoms towards certain reagents. We may quote a few such reactions, and their further study might give a clue to a probable means of rupturing C—F links in 'fluoroacetates' in general.

(a) The action of a Grignard reagent, e.g. phenyl magnesium bromide, on methyl fluoroacetate gives among other products $\text{Ph}_2\text{CH} \cdot \text{CH}(\text{OH})\text{Ph}$ and desoxybenzoin.¹

(b) The action of phenyl magnesium bromide on ethyl 2-fluoroethoxypropionate gave, not the expected diphenyl-2-2'-fluoroethoxyethylcarbinol, but rather surprisingly the corresponding bromo compound (p. 160).²

(c) Fluorobromoethane reacts with dimethylaniline giving

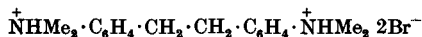

in small yield (p. 132).³

(d) Fluorobromoethane reacts with triethyl phosphite giving

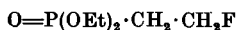

and also⁴ some (p. 96)

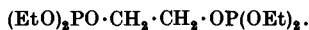

(e) Fluorobromoethane reacts with sodium fluoroethyl mercaptide giving 'sesqui-fluoro-H',⁵

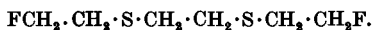

¹ Mirosevic-Sorgo and Saunders, *J. Chem. Soc.* (in the press).

² Buckle and Saunders, *J. Chem. Soc.* 1949, p. 2774.

³ Saunders and Wilding, *J. Chem. Soc.* 1949, p. 1279.

⁴ Saunders, Stacey, Wild and Wilding, *J. Chem. Soc.* 1948, p. 699.

⁵ Saunders and Stacey, *J. Chem. Soc.* 1949, p. 916.

THE FLUOROACETATES

(f) The fluorine atom in fluoroacetic acid is removed only very slowly by 10 per cent aqueous sodium hydroxide solution (p. 12). It has, however, recently been shown that when fluoroacetic acid is boiled with 30 per cent aqueous sodium hydroxide solution, the fluorine atom is quantitatively removed within 30 min.² This observation may have many applications, particularly in analytical procedures (see also p. 208).

(g) Phenyl magnesium bromide eliminates the fluorine atom from methyl γ -fluorobutyrate (p. 149).¹

Enzymic rupture of a C—F bond

There is as yet no known enzyme that breaks the C—F bond in fluoroacetic acid, FCH_2COOH , or in related compounds. It is interesting to note, however, that in the course of our investigations² on peroxidase-catalysed oxidations, we have effected an enzymic cleavage of the C—F bond in *p*-fluoroaniline.³ In acetate buffer (pH 4.5) and at room temperature, the amine was oxidized by hydrogen peroxide and peroxidase to give mainly the red crystalline 2-amino-5-*p*-fluoroanilinobenzoquinone di-*p*-fluoroanil (XX).

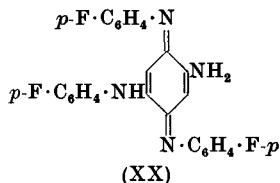

The formation of (XX) requires the elimination of one fluorine atom per four molecules of amine. The fluorine was expelled as F^- , and since the enzyme reaction is retarded by F^- , the process is self-poisoning. As might have been expected the reaction was not complete; it stopped at 30 per cent completion and F^- was detected on the walls of the containing vessel.

It is believed that the oxidation of *p*-fluoroaniline is the first recorded case of an enzymic cleavage of a C—F bond.

¹ Mirosevic-Sorgo and Saunders, *J. Chem. Soc.* (in the press).

² Daniells and Saunders, *J. Chem. Soc.* 1953, p. 822.

³ Hughes and Saunders, *Chem. & Ind. (Rev.)*, 1954 p. 1265; Hughes and Saunders, *J. Chem. Soc.* 1954, p. 4630.

Chapter VIII

OTHER COMPOUNDS CONTAINING THE C—F LINK

ω -Fluorocarboxylic Acids and Derivatives

From a study of the 'fluoroacetates' so far mentioned, it appears that any compound which can give rise to fluoroacetic acid (or the fluoroacetate ion), either by hydrolysis or by oxidation (or both), is toxic. The toxic grouping is thus $F \cdot CH_2 \cdot CO$, and any substitution in this radical destroys the toxicity as far as relatively simple compounds are concerned. We had reached this conclusion by May 1943.¹ We subsequently showed that esters of β -fluoropropionic acid were non-toxic, whereas esters of γ -fluorobutyric acid were shown by American workers to be toxic. In 1944² we reported the synthesis of ethyl 5-fluoropentanecarboxylate, $F \cdot [CH_2]_5 \cdot CO_2Et$ (I). This is a stable, colourless liquid and we showed that it possessed very potent toxic properties of the 'fluoroacetate' type. By subcutaneous injection of the propylene glycol solution into mice the L.D. 50 was 4 mg./kg. Methyl fluoroacetate (II) may be taken as a convenient standard (p. 115) and has a L.D. 50 of about 6 mg./kg. for saline solutions, and 15 mg./kg. for propylene glycol solution.³ Therefore ethyl 5-fluoropentanecarboxylate was about 7 times as toxic as methyl fluoroacetate (molecule for molecule).⁴

On p. 129 it was shown that 2-fluoroethyl fluoroacetate was about twice as toxic as methyl fluoroacetate (M.F.A.) by inhalation. By analogy then it seemed that 2-fluoroethyl-5-fluoropentanecarboxylate (III) might be a compound of exceptionally high toxicity. This proved to be correct, for its L.D. 50

¹ Report no. 5 on fluoroacetates to the Ministry of Supply, 30 May 1943; also Carpenter, Kilby, McCombie and Saunders, Report to the Ministry of Supply, 8 January 1944.

² Saunders, Ministry of Supply Meeting, London, 1 June 1944, and Report no. 11 on fluoroacetates to the Ministry of Supply, 8 August 1944. See Saunders, *Nature, Lond.*, 1947, **160**, 179.

³ This difference in toxicities when using saline and propylene glycol should be noted when comparing potencies.

⁴ Buckle, Pattison and Saunders, *J. Chem. Soc.* 1949, p. 1471.

OTHER COMPOUNDS CONTAINING THE C-F LINK

for subcutaneous injection into mice was 2.5 mg./kg., i.e. it is about 11 times as toxic as M.F.A. (per molecule) by this route and in propylene glycol as solvent.

The comparison of the toxicities of compounds (I), (II) and (III) by intravenous injection into rabbits also revealed a similar gradation, as shown herewith:

| | L.D. 50 (mg./kg.) |
|--|----------------------|
| methyl fluoroacetate (II) | 0.25 |
| ethyl 5-fluoropentanecarboxylate (I) | 0.2-0.5 |
| 2-fluoroethyl 5-fluoropentanecarboxylate (III) | 0.1-0.2 |

The very high toxicity of ethyl 5-fluoropentanecarboxylate and its derivatives and the 'fluoroacetate-like' symptoms produced seemed to us to be of particular interest, since by a process of β -oxidation in the animal body 5-fluoropentanecarboxylic acid would readily give rise to the toxic fluoroacetic acid. Similar remarks apply to γ -fluorobutyric acid and its derivatives prepared independently by American workers. The non-toxicity of β -fluoropropionic acid and its derivatives may, on the other hand, be due to the inability of this acid to give the toxic fluoroacetic acid by a process of β -oxidation.

In order to prove that fluorine was responsible for the lethal action in (I) and (II), the intermediate bromo esters were examined physiologically. Ethyl 5-bromopentanecarboxylate was found to be entirely without toxic action, and the toxicity of its 2-fluoroethyl ester was also of a low order, the L.D. 50 being about 75 mg./kg.

We then set out to determine whether this remarkable alternation in toxic properties could be observed among other ω -fluorocarboxylic acids.

Ethyl δ -fluorovalerate (IV) was found to be completely non-toxic, a subcutaneous injection of 160 mg./kg. failed to kill mice, and there was complete absence of any symptoms of poisoning. Intramuscular injection of 40 mg./kg. into rats similarly produced no toxic symptoms.¹

In striking contrast to this we showed that ethyl 7-fluoroheptanecarboxylate (V) was highly toxic and that the 2-fluoroethyl ester (VI) was slightly more toxic.

¹ See also Ott, Piller and Schmidt, *Helv. Chim. Acta*, 1956, **39**, 682; and Ott, *Chimica*, 1956, **10**, 112.

ω -FLUOROCARBOXYLIC ACIDS

Ethyl 9-fluorononancarboxylate (VII) was found to be even more toxic than ethyl 5-fluoropentancarboxylate by injection into rabbits, the L.D. 50 for a propylene glycol solution of (VII) being 0.2 mg./kg.¹ Mice and rats were slightly more resistant, but exhibited convulsions of the general fluoroacetate type. On account of the high boiling-point of the material, no inhalation experiments were attempted. 2-Fluoroethyl 9-fluorononancarboxylate (VIII) was found to be no more toxic than the corresponding ethyl ester by injection into mice. Each had a L.D. 50 of about 10 mg./kg. This anomaly is discussed later.

Ethyl 10-fluorodecanancarboxylate (IX) when injected into mice caused no deaths at a concentration of 100 mg./kg., and no symptoms of any kind. Therefore it was non-toxic. In accordance with expectation ethyl 11-fluoroundecanancarboxylate (X) proved to be toxic.

The results obtained for injection into mice of propylene glycol are summarized in the following table:

| Value of n in acid $F \cdot (CH_2)_n \cdot CO_2H$ | L.D. 50 (mg./kg.) (propylene glycol as solvent) Me or Et ester | Conclusion | L.D. 50 (mg./kg.) (propylene glycol as solvent) 2-Fluoroethyl ester |
|--|--|------------|---|
| 1 | 15 (Me) | Toxic | 8.5 |
| 2 | >200 (Et) | Non-toxic | — |
| 3 | (Me)* | Toxic | — |
| 4 | >160 (Et) | Non-toxic | — |
| 5 | 4 (Et) | Toxic | 2.5 |
| 7 | 9 (Et) | Toxic | 7 |
| 9 | 10 (Et) | Toxic | 10 |
| 10 | >100 (Et) | Non-toxic | — |
| 11 | 20 (Et) | Toxic | — |

* American workers.

It is thus apparent that, in this series of ω -fluorocarboxylic esters, if n is odd the compound is highly toxic, whereas if n is even it is non-toxic. This striking alternation in toxicity provides a useful verification of the theory of β -oxidation of fatty acids in the animal body.

The theory of β -oxidation was first put forward by Knoop²

¹ The ester (VII) would probably be even more toxic in saline solution.

² *Beitr. chem. Physiol. Path.* 1904, 6, 150; 1906, 11, 411.

OTHER COMPOUNDS CONTAINING THE C-F LINK

and was based essentially on the following evidence. The ω -phenyl derivatives of the fatty acids containing from one to five carbon atoms were administered to dogs, and the urine was subsequently analysed for the presence of derivatives of these acids. In all cases the final acid produced by breakdown was excreted as its glycine derivative. Those fatty acids containing an odd number of carbon atoms were excreted as hippuric acid, and those with an even number as phenylaceturic acid, $\text{CH}_2\text{Ph}\cdot\text{CO}\cdot\text{NH}\cdot\text{CH}_2\cdot\text{CO}_2\text{H}$. These results led Knoop to postulate that fatty acids were oxidized by a route which involved the loss of two carbon atoms at each stage, owing to oxidation occurring at the β -carbon atom. He suggested, but without evidence, that the β -oxidation took place by the following steps:

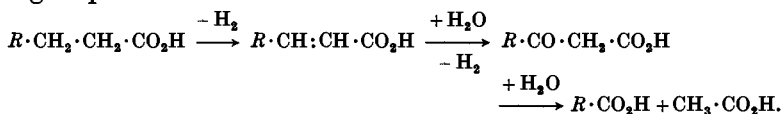

It will readily be seen in our series of ω -fluorocarboxylic acids, that when n is odd, β -oxidation would yield the toxic fluoroacetic acid, whereas when n is even, the compound would presumably be oxidized only as far as the non-toxic β -fluoropropionic acid.¹ The pharmacological results obtained are in complete accord with this hypothesis, and provide verification, of a kind not hitherto achieved, of the process of β -oxidation in the living animal body. However, Weinhouse, Medes and Floyd² have inoculated rat-liver slices with one or two fatty acids containing isotopic carbon, and have obtained some evidence for a process of β -oxidation.

Certain aspects of our results, however, while not invalidating the β -oxidation theory of the ω -fluorocarboxylic acids, do indicate that β -oxidation is not the only factor concerned with the alternation of toxic properties.

Ethyl 9-fluorononancarboxylate is toxic in accordance with expectation, but the magnitude of the toxicity (L.D. 50 for injec-

¹ Further β -oxidation of this acid would give the unknown fluoroformic acid, $\text{F}\cdot\text{COOH}$, which would of course immediately decompose to give CO and HF, which would be non-toxic at the concentrations employed.

² *J. Biol. Chem.* 1944, **153**, 689.

tion into rabbits 0.2 mg./kg.) is greater (molecule for molecule) than that of methyl fluoroacetate (L.D. 50, 0.25 mg./kg.). On the basis of the β -oxidation theory alone, toxicity of the former ester should be less than that of the latter, because of the long chain of CH_2 groups which must be burned away in the body before fluoroacetic acid is produced. It may be, however, that because of its long chain, the higher ester would have a higher fat:water partition coefficient and therefore would pass more readily than the lower ester through the cell membranes, and there break down giving a higher intracellular concentration of fluoroacetic acid.

Reference has already been made to the fact that 2-fluoroethyl 9-fluorononancarboxylate proved no more toxic than the corresponding ethyl ester by injection into mice. This was contrary to expectation, and was investigated in the following manner. One set of mice was injected with ethyl 9-fluorononancarboxylate in the usual way; a second set of mice had exactly the same injections of this ester and then, almost simultaneously, injections of fluoroethyl alcohol were made corresponding to the amount which would have been liberated had 2-fluoroethyl 9-fluorononancarboxylate been injected instead. The mice of the second set therefore contained the same amount of fluorine as if they had been injected with the latter ester. The results are tabulated as follows:

| | Wt. of nonancarboxylic alone (mg./kg.) | | |
|--|---|------------|------------|
| | 20 | 8 | 6 |
| Ethyl 9-fluorononancarboxylate alone | 6/6 killed | 4/6 killed | 4/6 killed |
| Ethyl 9-fluorononancarboxylate + fluoroethyl alcohol | 6/6 killed | 5/6 killed | 1/6 killed |

This showed the fluoroethyl alcohol had no very marked effect, and this observation was in line with the fact that the ethyl and the 2-fluoroethyl ester of this particular acid had the same toxicity.

Two points were tentatively put forward at the time¹ to account for this similarity of toxicity. (1) As the homologous series of ω -fluoro esters is ascended, the proportion of fluoro-

¹ Buckle, Pattison and Saunders, *J. Chem. Soc.* 1949, p. 1471.

ethyl alcohol obtainable from the 2-fluoroethyl esters must decrease. It was suggested that a point would be reached when the amount of fluoroethyl alcohol derived from the 2-fluoroethyl ester would be too small to make any apparent difference in the toxicity. The L.D. 50 of 2-fluoro 9-fluorononancarboxylate liberates only about 0.05 mg. of fluoroethyl alcohol in the mouse. This, if injected alone, would have no action. (2) 2-Fluoroethyl 5-fluoropentancarboxylate was found to be nearly twice as toxic as the corresponding ethyl ester, weight for weight; but if its action were due solely to hydrolysis *in vivo* the toxicity should be the same. Similar remarks apply to 2-fluoroethyl fluoroacetate. It thus seems possible that the molecule may exert some action *per se*, independently of any subsequent degradation. It might further be suggested that if the toxic action of these 2-fluoroethyl esters is indeed dependent primarily upon the molecule as a whole (as distinct from its hydrolysis products) then the action may be related to the terminal fluorine atoms of the molecule. If this is so, there may be an optimum stereochemical distance apart of the fluorine atoms for the maximum action of the molecule in this way. It is significant that the difference in activity between the ethyl and the 2-fluoroethyl esters is greater with the shorter chains. With the fluoroheptancarboxylates the difference is slight, and it disappears entirely with the nonancarboxylates.

Although our results support the β -oxidation theory, one point must not be overlooked, namely, that fluoroacetic acid is not the actual toxic agent and has to be converted into fluorocitrate before exerting its activity (see p. 142). It should also be noted that American workers¹ showed that both methyl γ -fluorobutyrate and methyl δ -fluorocrotonate,

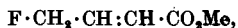

were highly toxic; moreover, we showed that the crotonate was much more rapid in its lethal action than fluoroacetate at equivalent concentrations.

¹ Private communication.

Synthetic methods employed in this series of compounds

As direct chlorination or bromination of a carboxylic acid usually gives the α-substituted acid, such methods are useless for the preparation of the ω-substituted acids; *ad hoc* methods therefore had to be found for the preparation of each individual ω-fluorocarboxylic acid and its derivatives.

Ethyl δ-fluorovalerate (IV) was prepared in an impure state from ethyl δ-bromovalerate, and in a pure condition from ethyl δ-iodovalerate by fluorination with silver fluoride. It may be noted that difficulty was experienced in converting allylacetic acid into δ-bromovaleric acid. The conditions of the experiment were varied between wide limits in the presence and the absence of peroxides. Conflicting results had previously been obtained by other workers in this field.¹ δ-Iodovaleric acid was prepared by Carter's method,² who converted it into the ethyl ester using a solution of dry hydrogen chloride in alcohol. We found that under these conditions a large part of the iodo acid was converted into the chloro ester. We therefore carried out the esterification using sulphuric acid, and showed that if the correct molar ratios of sulphuric acid, iodo acid and ethyl alcohol were used, negligible interchange took place. The fluorination of the iodo ester was achieved by the use of pure dry silver fluoride in the absence of a solvent.

The starting point for the 5-fluoropentanecarboxylic esters was *cyclohexanone*, which was oxidized to 5-hydroxypentanecarboxylic acid by a modification of Robinson and Smith's method.³ This was then converted into the bromo acid by means of hydrogen bromide and sulphuric acid.⁴

5-Bromopentanecarboxylic acid was converted into the appropriate esters as follows:

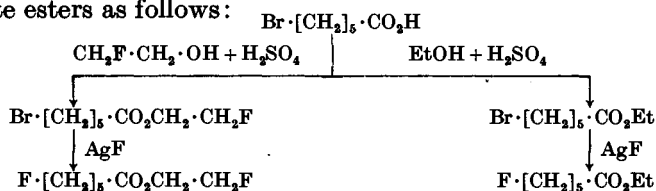

¹ Boorman, Linstead and Rydon, *J. Chem. Soc.* 1933, pp. 568, 1974; Kharasch and McNab, *Chem. & Ind. (Rev.)*, 1935, 54, 98.

² *J. Amer. Chem. Soc.* 1928, 50, 1968. ³ *J. Chem. Soc.* 1937, p. 373.

⁴ Barger, Robinson and Smith, *J. Chem. Soc.* 1937, p. 718.

OTHER COMPOUNDS CONTAINING THE C-F LINK

The 7-fluoroheptanecarboxylates were synthesized from hexamethylene dibromide according to the following scheme:

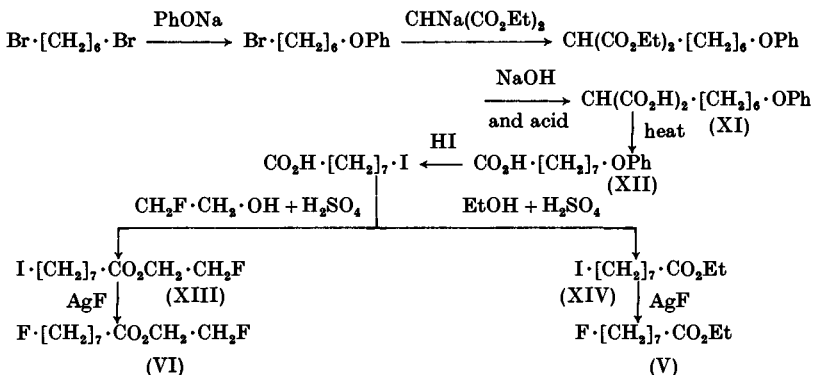

The splitting of (XII) took place smoothly with constant-boiling hydriodic acid to give the pure iodo acid. The fluorination of (XIII) was more facile than that of (XIV). In fact, with the latter acid, hydrogen iodide was eliminated to some extent with the production of ethyl hept-6-enecarboxylate, which was effectively removed by conversion into the dibromide with bromine, followed by distillation.

Ethyl and 2-fluoroethyl 9-bromononancarboxylate and ethyl and 2-fluoroethyl 9-fluorononancarboxylate were all prepared from 9-bromononancarboxylic acid, made by the action of hydrogen bromide and sulphuric acid on 9-acetoxynonancarboxylic acid, which in turn was obtained by a four-stage synthesis from sebacic acid.

Ethyl 10-fluorodecanecarboxylate was readily prepared by the fluorination of the corresponding bromo ester prepared by esterifying the acid with ethyl alcohol and sulphuric acid.

Ethyl 11-fluorodecanecarboxylate was synthesized from 10-bromodecanecarboxylic acid as follows:

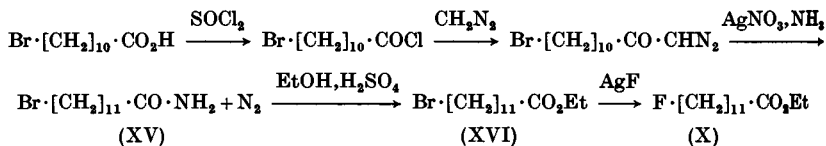

β -OXIDATION OF ω -FLUOROCARBOXYLIC ACIDS

The alcoholysis of (XV)-(XVI) was effected by boiling with absolute alcohol and sulphuric acid. The standard technique was adopted for the fluorination.

Further evidence for the β -oxidation of ω -fluorocarboxylic acids in vivo

We see from the above that there is a striking alternation in the physiological properties of ω -fluorocarboxylic esters of the general formula of $F \cdot [CH_2]_n \cdot CO_2R$. Thus when n is an odd number the compound is highly toxic to animals, whereas when n is even the compound is non-toxic. All the toxic compounds are powerful convulsant poisons and showed symptoms of the 'fluoroacetate' type.

We then sought an independent method of proving the β -oxidation theory.¹ This consisted in synthesizing ω -fluoro compounds which contained the 'skeleton' of the toxic members, but which could not undergo β -oxidation in the body. If these new compounds had been toxic, the β -oxidation theory would have had to be abandoned. Actually they were non-toxic compared with the 'parent acid', and so excellent support, of a kind hitherto not considered, was obtained.

Structurally, the prevention of β -oxidation was achieved by two means: (a) side-chain inhibition and (b) ring inhibition. (a) The β -oxidation of the highly toxic ethyl γ -fluorobutyrate could presumably be stopped by effectively 'blocking' the β -position in the chain. A simple compound satisfying this condition was *ethyl γ -fluoro- $\beta\beta$ -dimethylbutyrate*,

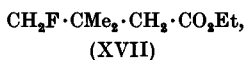

which was found to be entirely devoid of toxic properties. (b) The α - and β -carbon atoms of methyl γ -fluorobutyrate were 'fixed' by making them part of a ring system. It was considered most unlikely that the animal body could degrade such compounds by a process of β -oxidation. The following compounds in this class were synthesized and found to be non-toxic: *methyl 2-fluoromethyl-4:5-dimethyl- Δ^4 -tetrahydrobenzoate*

¹ Saunders, Ministry of Supply Meeting, London, 1 June 1944, and Report no. 11 on fluoroacetates to the Ministry of Supply, 8 August 1944; Pattison and Saunders, *J. Chem. Soc.* 1949, p. 2745.

(XVIII), methyl 2-fluoromethyl-4:5-dimethylhexahydrobenzoate (XIX), methyl 2-fluoromethyl-3:6-endomethylene- Δ^4 -tetrahydrobenzoate (XX) and methyl 2-fluoromethyl-3:6-endomethylene hexahydrobenzoate (XXI).

One further compound should be mentioned in this connexion, namely, *p*-fluorophenylacetic acid (XXII), which has the carbon 'skeleton' of the highly toxic 5-fluoropentanecarboxylic acid (XXIII). It seemed unlikely that (XXII) could be broken down *in vivo* to fluoroacetic acid, and as expected it was non-toxic. It should be mentioned, however, that aromatic compounds are capable of certain types of oxidative breakdown in the animal body. Jaffe,¹ for example, isolated small quantities of muconic acid from the urine of dogs and rabbits which had received considerable quantities of benzene.

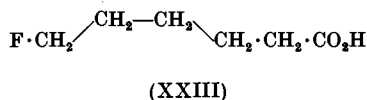
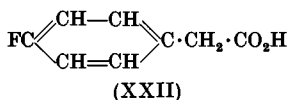

Synthetic methods. $\beta\beta$ -Dimethylglutaric acid (prepared from mesityl oxide) was converted into the di-silver salt, which, by an improvement of the method of Windaus and Klanhardt,² was converted into $\beta\beta$ -dimethyl- γ -butyrolactone. The latter on treatment with constant-boiling hydrobromic and sulphuric acid gave γ -bromo- $\beta\beta$ -dimethylbutyric acid which readily gave its ethyl ester. The pure fluoro ester was obtained from this by heating with silver fluoride, although the yield was low.

The synthesis of (XVIII), (XIX), (XX) and (XXI) from methyl fluorocrotonate was accomplished according to the annexed scheme. Methyl γ -fluorocrotonate had previously been prepared, and was reported by Kharasch and his co-workers³ to be a highly toxic compound. It possesses the carbon structure of methyl γ -fluorobutyrate, and the double bond in the $\alpha\beta$ -position would undoubtedly facilitate oxidation. The American workers prepared methyl γ -fluorocrotonate by an ingenious five-stage process from epifluorohydrin. For the above syntheses we

¹ *Hoppe-Seyl Z.* 1909, **62**, 58.

² *Ber. dtsch. chem. Ges.* 1921, **54**, B, 581.

³ Private communication.

REACTIONS OF METHYL γ -FLUOROCROTONATE

prepared it by the direct fluorination of methyl γ -bromocrotonate using silver fluoride. The bromo ester was obtained (1) from methyl crotonate by means of *N*-bromosuccinimide¹ and (2) by the addition of bromine to methyl vinylacetate and the subsequent removal of hydrogen bromide with sodium ethoxide.²

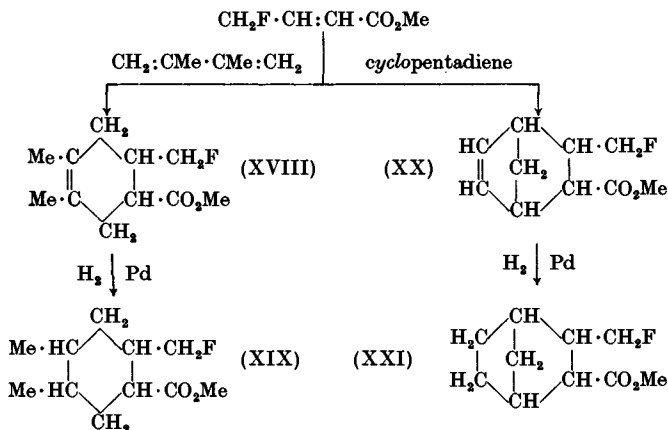

The Diels-Alder additions of methyl γ -fluorocrotonate to 2:3-dimethylbuta-1:3-diene and *cyclopentadiene* were effected by heating the reactants in sealed tubes at 110–120° for about 3 hr. The reduction of the unsaturated products, (XVIII) and (XX), was carried out at room temperature with palladium as catalyst. In both cases the theoretical quantity of hydrogen was absorbed, although the hydrogenation of the dimethyl derivative was much slower than that of the *endomethylene* compound.

p-Fluorophenylacetic acid had been obtained by Dippy and Williams³ by a rather long process. We prepared it by an alternative route from *p*-fluorotoluene. This was treated with sulphuryl chloride and a trace of peroxide giving *p*-fluorobenzyl chloride, thus providing a further example of the free-radical chlorination process first described by Karasch and Brown.⁴ The chloride was then converted into the cyanide and thence into the free acid.

¹ Zeigler, *Liebigs Ann.* 1942, 551, 103.

² Glattfeld and Rietz, *J. Amer. Chem. Soc.* 1940, 62, 976.

³ *J. Chem. Soc.* 1934, p. 1466.

⁴ *J. Amer. Chem. Soc.* 1939, 61, 2142.

ω -Fluorocarboxylic Acids and Derivatives containing an Oxygen Atom as a Chain Member

In view of the strong evidence for the β -oxidation of ω -fluorocarboxylic acids (p. 151) *in vivo* and for the inhibition of β -oxidation when such compounds were 'blocked' in the α - and in the β -position (p. 157), it was decided to investigate the effect of introducing an oxygen atom as a chain member at some appropriate point. For this purpose eleven compounds were synthesized and examined pharmacologically.¹

When 2-fluoroethyl alcohol was treated with 1 mol. of vinyl cyanide and aqueous potassium hydroxide, 2-2'-fluoroethoxyethyl cyanide, $F \cdot [CH_2]_2 \cdot O \cdot [CH_2]_2 \cdot CN$, was obtained in good yield. This was readily hydrolysed by hydrochloric acid to β -2-fluoroethoxypropionic acid, the acid chloride of which on treatment with a large excess of diazomethane gave diazomethyl-2-2'-fluoroethoxyethyl ketone, $F \cdot [CH_2]_2 \cdot O \cdot [CH_2]_2 \cdot CO \cdot CHN_2$. This substance was a yellow oil which was stable up to about 60° and could be handled with safety. When distillation was attempted, however, it often decomposed explosively. It was therefore converted immediately into ethyl γ -2-fluoroethoxybutyrate, $F \cdot [CH_2]_2 \cdot O \cdot [CH_2]_3 \cdot CO_2Et$, by warming it with absolute alcohol and dry silver oxide. Esterification of the fluoroethoxypropionic acid gave ethyl β -2-fluoroethoxypropionate, which reacted with phenylmagnesium bromide to give, not the expected diphenyl-2-2'-fluoroethoxyethylcarbinol, but the corresponding bromo compound,

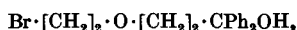

as the result of halogen interchange.

The formation of the bromoethoxycarbinol was unexpected, as there seems to be no previous record in the literature of the substitution of one halogen for another by a Grignard reagent. Even with a deficiency of the reagent, the only product which could again be isolated was the bromoethoxycarbinol. The replacement of an unreactive fluorine atom² by the more active bromine is worthy of further investigation.

¹ Buckle and Saunders, *J. Chem. Soc.* 1949, p. 2774.

² For recent work on the elimination of the fluorine atom from M.F.A., see p. 147.

The reduction of 2-2'-fluoroethoxyethyl cyanide, using Raney nickel and hydrogen, was examined under a variety of conditions. Defluorination readily took place, but finally conditions were found which permitted the conversion of CN to CH₂·NH₂ without the removal of the fluorine atom, giving 3-2'-fluoroethoxypropylamine as a stable distillable liquid.

Ethyl 2-fluoroethoxyacetate, F·[CH₂]₂·O·CH₂·CO₂Et, could not be prepared by the action of ethyl diazoacetate on pure redistilled 2-fluoroethyl alcohol, and the addition of a small quantity of concentrated hydrochloric acid had no effect, which is rather surprising in view of the known catalytic action of acids on the decomposition of the diazoacetic ester. However, fluoroethyl alcohol which had not been specially dried reacted immediately with ethyl diazoacetate with a vigorous evolution of nitrogen and the simultaneous disappearance of the yellow colour of the diazo ester.

The reaction between 2-fluoroethyl alcohol and ethyl chloroformate at 100° for 10 hr. gave pure ethyl 2-fluoroethyl carbonate, F·[CH₂]₂·O·CO₂Et.

By warming together 2.5 mol. of 2-fluoroethyl alcohol and 1 mol. of ethylene oxide in the presence of concentrated sulphuric acid, 2-2'-fluoroethoxyethanol (2-fluoro-2'-hydroxydiethyl ether), F[CH₂]₂O[CH₂]₂OH, was obtained in 25 per cent yield, but there was no indication of the formation of any higher condensation product. When, however, a much larger excess of the alcohol (5 mol.) was used and the mixture heated in an autoclave at 140° for 4 hr. with anhydrous sodium sulphate as catalyst, the yield of 2-2'-fluoroethoxyethanol increased to 70 per cent and there was, in addition, a 15 per cent conversion into 2-hydroxy-2'-2''-fluoroethoxydiethyl ether (XXIV),

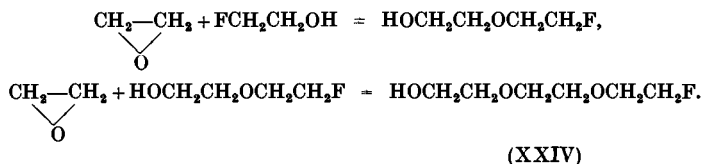

The following homologues were prepared from 3-fluoropropanol by suitable modifications of technique: 2-3'-fluoroprop-

OTHER COMPOUNDS CONTAINING THE C-F LINK

oxyethyl cyanide, $F \cdot [CH_2]_3 \cdot O \cdot [CH_2]_2 \cdot CN$, β -3-fluoropropoxypropionic acid, the acid chloride thereof, diazomethyl 2-3'-fluoropropoxyethyl ketone, and ethyl 3-fluoropropoxybutyrate.

Pharmacological examination

The compounds in a suitable solvent were subcutaneously injected into mice. Methyl fluoroacetate was always injected, under the same conditions, into a batch of mice as a control. The β -carbon atom in β -2-fluoroethoxypropionic acid and in β -3-fluoropropoxypropionic acid is linked to the ether oxygen atom, and if β -oxidation of these compounds takes place *in vivo*, the hydrogen carbonate of the fluoro alcohol is formed. One would expect this to have approximately the same toxicity as the alcohol itself, since the latter would be produced either by hydrolysis or by elimination of carbon dioxide:

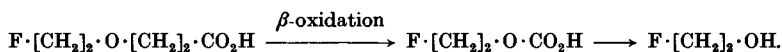

This was verified by showing that ethyl 2-fluoroethyl carbonate was as toxic as 2-fluoroethyl alcohol. Furthermore, we found that β -2-fluoroethoxypropionic acid was indeed toxic, whereas β -3-fluoropropoxypropionic acid was non-toxic.¹ (3-Fluoropropanol is itself non-toxic.)

The actual L.D. 50 for β -2-fluoroethoxypropionic acid, however, was about 70 mg./kg. and was therefore considerably less than that for fluoroethyl alcohol, whereas the nitrile of the acid showed a toxicity (L.D. 50, 10–20 mg./kg.) of the same order as that of the alcohol. The cause of this difference may be due to different rates of absorption. 2-3'-Fluoropropoxyethyl cyanide was non-toxic in accordance with expectation.

In this connexion ethyl 2-cyanoethyl ether, $EtO \cdot [CH_2]_2 \cdot CN$, was tested and found to be relatively non-toxic, showing that the toxicity of the fluorine analogue was caused ultimately by the presence of the fluorine atom (as fluoroethoxyl) and not to any extent by another part of the molecule.

β -Oxidation of ethyl γ -2-fluoroethoxybutyrate and γ -3-

¹ The term 'non-toxic' is used relatively to the highly toxic methyl fluoroacetate. At high concentrations (e.g. several hundred mg./kg.) it is probable that some symptoms would be observed even with the 'non-toxic' materials.

fluoropropoxybutyrate will not lead to the formation of a hydrogen carbonate, but to a fluoroalkoxyacetic acid. It was for this reason that ethyl 2-fluoroethoxyacetate was prepared and examined. It was found to be non-toxic, and (as expected) the two butyric esters were also non-toxic.

2-Fluoro- and 2-hydroxy-2'-2''-fluoroethoxydiethyl ether were both toxic; the former had a L.D. 50 of 15-20 mg./kg. and the latter of 30-40 mg./kg. If the former is readily oxidized to the corresponding acid in the animal body, then we should expect it to be non-toxic in view of the non-toxicity of ethyl 2-fluoroethoxyacetate referred to above. It must be concluded then that the ether alcohols exert some toxic action *per se*. Ethylene glycol monoethyl ether, was examined physiologically but was found to be non-toxic,¹ showing that the activity of 2-fluoro-2'-hydroxydiethyl ether was again closely associated with the 2-fluoroethoxy group in the molecule.

The L.D. 50 of 3-2'-fluoroethoxypropylamine was about 50 mg./kg.

Further evidence is thus obtained for the process of β -oxidation of acids, but not in such a clear-cut manner as with the compounds described on pp. 149-59. Several additional factors, apart from β -oxidation, appear to be operating, presumably owing to the presence of the ether linkage.

Other Examples of Alternating Toxicities

Our findings with regard to the alternating toxicities of ω -fluorocarboxylic acids and derivatives have recently been confirmed by the examination of further members² of the series, $F[CH_2]_nCOOR$ ($n = 6$ or 8 , non-toxic; $n = 15$ or 17 , toxic). No new features were revealed. Indeed, it would be surprising now to discover a *simple* compound which contravened the 'alternation of toxicity' rule. According to expectation the corresponding ω -fluoro alcohols, $F[CH_2]_nOH$, are toxic when n is even, and non-toxic when n is odd. It appears that nitriles *in vivo* are metabolized thus:

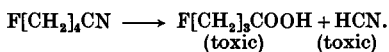

¹ See above, p. 162, n. 1.

² Pattison, *Nature, Lond.*, 1953, 172, 1139.

OTHER COMPOUNDS CONTAINING THE C-F LINK

Amines, as might be expected, take the following course:

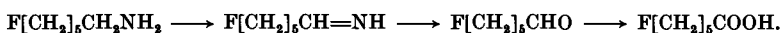

Only a few aliphatic fluoro-nitro compounds have been examined, and if n is odd the material is toxic. Having regard, however, to the known relaxation of smooth muscle, irrespective of the type of innervation, by the nitrite ion, the writer feels that caution is required in drawing conclusions regarding the toxic action of fluoro-nitro compounds.

On p. 123 we described¹ the preparation of 2-fluoroethyl thiocyanate by the reaction

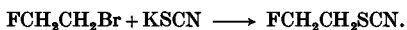

The L.D. 50 for mice of this compound was 15 mg./kg. Some of the higher members of this series show an alternation of toxicity, as do also the mercaptans produced by reduction of the thiocyanates by lithium aluminium hydride. Thus $F(CH_2)_nSH$ was toxic when n was even.

On p. 123 an account was given of our preparation of 2-fluorosulphonyl chloride by the reaction

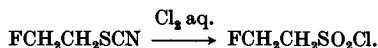

Using a similar method, higher members of this series have been prepared,² as well as the corresponding sulphonyl fluorides. Toxicity figures present a somewhat confused picture at the moment. One must be careful in drawing too definite conclusions from gross toxicity figures in compounds where more than one biologically 'active' centre exists and where the lability of the fluorine cannot be ruled out under *in vivo* conditions.

Although not containing fluorine, certain acids examined by Wain³ also showed an interesting alternation of biological activity. When the growth-regulating activity of compounds of the type



was assessed, an alternation of activity was usually shown with regard to wheat-cylinder elongation, pea curvature and tomato-

¹ Saunders, Stacey and Wilding, *J. Chem. Soc.* 1949, p. 773.

² Pattison, *Nature, Lond.*, 1954, 174, 737.

³ *Selective Weed Control: some new developments at Wye* (M.I.M.E.O. Report), 1954.

leaf epinasty tests. When n is odd the compound was active and when n was even no activity was shown. Such an alternation is fully consistent with the breakdown of the side chain by a β -oxidation process, similar to that which we demonstrated above for the ω -fluorocarboxylic acids.

However, it has recently been shown that when the substituents in the benzene ring of the phenoxy acid are changed, then alternation in activity is exhibited in the wheat-cylinder test, whereas in the pea curvature and leaf epinasty tests, only the first member of the series was active. This means that the β -oxidizing system present in pea and tomato tissue is incapable of degrading the side chain of these particular substituted phenoxy acids. This approach¹ opens up the possibility of selectively controlling weeds in a wide range of crops.

Antagonisms of ω -Fluorocarboxylic Acids

It has been established that intestinal motility is supported by specific fatty acids.² This has provided the basis for the very important work of Chenoweth,³ who has examined the effects of sodium fluoroacetate, sodium γ -fluorobutyrate and sodium ϵ -fluorohexanoate in the presence of acetate, butyrate and hexanoate as sources of energy. The method consists in suspending a strip of rabbit small intestine in a suitable solution at 38° through which a mixture of 95 per cent oxygen and 5 per cent carbon dioxide is bubbled. The contractions are recorded on a smoked-paper kymograph. The substrate (e.g. sodium acetate) is added to the medium before the experiment begins, and the inhibitor (i.e. the fluoro compound) added after a suitable control period. The time required for the amplitude of contraction to decrease to 50 per cent of its control value is taken as the criterion of the comparative inhibitory potency of a given fluoro acid (as its sodium salt).

It is found that acetate is superior to either butyrate or hexanoate in antagonizing fluoroacetate, but that it is inferior to either butyrate or hexanoate in antagonizing fluorobutyrate or

¹ Wain and Wightman, *Proc. Roy. Soc. B*, 1954, **142**, 525.

² Furchgott and Shorr, *Proc. Soc. Exp. Biol., N.Y.*, 1946, **61**, 280.

³ Hendershot and Chenoweth, *J. Pharmacol.* 1934, **110**, 344.

fluorohexanoate. Butyrate or hexanoate are equally effective in weakly antagonizing fluoroacetate, but hexanoate is superior to butyrate as an antagonist to either fluorobutyrate or fluorohexanoate (see fig. 18).

Any one substrate antagonizes fluorobutyrate and fluorohexanoate equally. Further, hexanoate will antagonize fluorobutyrate and fluorohexanoate much better than it antagonizes fluoroacetate, while the acetate is just the reverse from the hexanoate in this respect. Butyrate may or may not antagonize fluorobutyrate and fluorohexanoate better than fluoroacetate, depending upon the concentration of the inhibitor used.

Other workers have demonstrated the specificity of antagonisms among the fluoro acids. Kalnitsky and Barron¹ found the inhibition of butyrate oxidation to be more profound with fluorobutyrate than with fluoroacetate. Kandel and Chenoweth² could prevent or reverse the toxic manifestations of fluoroacetate with glyceryl monoacetate and those of fluorobutyrate with glyceryl monobutyrate *in vivo*, but they could not demonstrate cross protections with these compounds.

Such high selectivity is interesting, for it does not appear to be explainable solely on the basis of the incorporation of a fluorinated 2-carbon radical into fluorocitrate (see p. 141).

Chenoweth believes that an explanation of the above results may lie in the reactions occurring before the entrance of fatty acid metabolites into the citric acid cycle. Activated acetate, i.e. acetyl coenzyme A (AcCoA) is the end-product of fatty acid metabolism prior to its condensation with oxalacetate to form citrate. Possibly fluoro-fatty acids behave like non-fluorinated fatty acids. The end-product before the oxalacetate condensation could be the same for all three fluorinated inhibitors, viz. fluoroacetyl coenzyme A (FACoA). Fluorocitrate could then be formed by the condensation of oxalacetate with FACoA, thereby blocking the citric acid cycle. The specificity of antagonisms must therefore occur before entrance of the metabolites into the citric acid cycle.

¹ *Arch. Biochem.* 1948, 19, 75.

² *Pharmacol. Rev.* 1949, 1, 383.

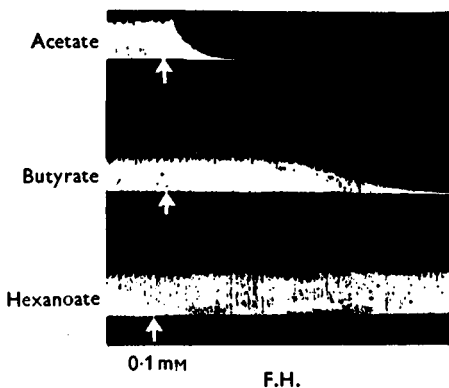
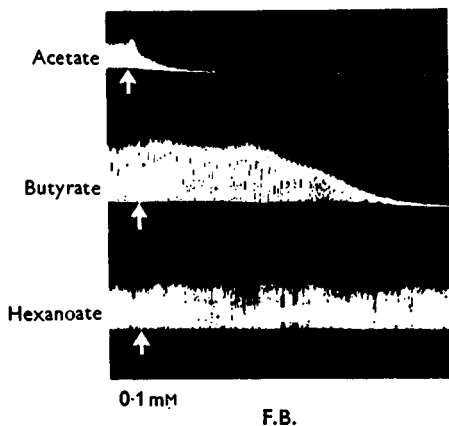
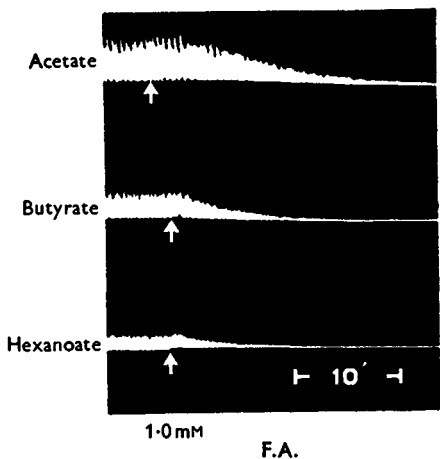

Fig. 18. Typical recordings of the effect of 1.0 mM fluoroacetate (F.A.) and 0.1 mM fluorobutyrate (F.B.) and fluoro-hexanoate (F.H.) upon isolated rabbit intestinal strips in the presence of acetate, butyrate and hexanoate. (Taken from Hendershot and Chenoweth, *J. Pharmacol.* 1934, 110.)

Fluorocarbons

It is not the writer's intention to describe these compounds in any detail as they have not figured to any significant extent in the study of toxic fluorine compounds. We may note that these compounds are the analogues of the hydrocarbons and are of interest both because of their physical properties and because of their increasing industrial importance.

The lower members, e.g. CF_4 and C_2F_6 , are colourless, odourless gases of very low toxicity. By comparison with the 'fluoroacetates' they may be said in general to be non-toxic. This is understandable, particularly with regard to the simple saturated fluorocarbons, as they do not contain the FCH_2CO group and are not likely to give rise to it in the animal body. Recently, however, perfluoroisobutylene, $\begin{matrix} \text{CF}_3 \\ \diagdown \\ \text{C} \\ \diagup \\ \text{CF}_3 \end{matrix} = \text{CF}_2$, has been shown to be toxic, but it is quite likely that its pharmacological action does not resemble that of the fluoroacetates.

The fluorocarbons have relatively low boiling-points, i.e. there is abnormally low attraction between the molecules, with little tendency to association, which makes their physical properties similar to those of the rare gases.

| Fluorocarbons | | | Hydrocarbons | | |
|---------------------------|----------|------------------------------|---------------------------|----------|------------------------------|
| | Mol. wt. | B.p. ($^{\circ}\text{C}$.) | | Mol. wt. | B.p. ($^{\circ}\text{C}$.) |
| CF_4 | 88 | - 128 | CH_4 | 16 | - 161 |
| C_2F_6 | 138 | - 78 | C_2H_6 | 30 | - 88 |
| C_3F_8 | 188 | - 38 | C_3H_8 | 44 | - 42 |
| C_4F_{10} | 238 | - 5 | C_4H_{10} | 58 | - 0.5 |
| C_7F_{16} | 388 | 82 | C_7H_{16} | 100 | 98 |

The lower fluorocarbons (C_5F_{12} , etc.) are colourless liquids of high density (sp.gr. 1.5-2.0) and of very low refractive index, while the higher members are colourless solids.

Chemically they are extremely inert, being much more unreactive even than the fluoroacetates. The inertness of the fluorocarbons and their nearly 'perfect' physical properties arise from the strength of the F—C linkage and from their compact structure. The effective atomic radius of covalently bound fluorine is 0.64 Å., which although greater than hydrogen (0.30) is smaller than other elements, e.g. Cl 0.99 Å., Br 1.14 Å.

FLUOROCARBONS

The fluorocarbons are resistant to the action of strong acids and aqueous alkalis; they are non-inflammable and attacked only by such reagents as fused caustic alkalis. The plastic 'teflon' is polymerized C_2F_4 (cf. polythene which is polymerized C_2H_4) and is made into tubing, or into sheets to act as linings for vessels required to withstand corrosion. The liquid fluorocarbons ('fluorolubes') are used where hydrocarbon oils would be attacked, and their non-inflammability makes them particularly useful.

Fluorochlorocarbons. These are compounds in which the hydrogen atoms of methane, ethane, etc., are replaced partly by chlorine and partly by fluorine. They are known as 'freons' in the United States and as 'arctons' in Britain. Their boiling-points are lower than the fully chlorinated compounds, and the derivatives of methane provide a group of non-inflammable compounds in the boiling range from -81° ($CClF_3$) to 25° (CCl_3F). The compound, CCl_2F_2 , boils at -29° . These are useful as refrigerants on account of their chemical inertness and non-toxic nature.

It is interesting to note that some difluorohydrocarbons of the type $F[CH_2]_nF$ are moderately toxic.¹ The compounds so far examined have $n=4, 5$ and 18 , and so alternation is not apparent, but a larger selection should be examined before any attempt is made to discuss the theoretical implication. What may be said is that mobility of the fluorine atom is probably operative here.

¹ Pattison, *Nature, Lond.*, 1954, 174, 737.

Chapter IX

INSECTICIDES

Systemic Insecticides

While carrying out early experiments with D.F.P. and related compounds on small animals, we frequently noticed that extremely small quantities of these materials caused the death of flies in the room. It was this observation that led us during the war¹ to claim the use of certain phosphorus compounds as insecticides. Schrader² describes phosphorus-containing compounds made by the I.G. Farbenindustrie in Germany. Many similar compounds were also made (independently) by British and German research workers. It turned out, however, that 'systemic' insecticides based on organo-phosphorus compounds were first commercially produced in England.³

The term 'systemic' insecticide was introduced⁴ in connexion with compounds that are absorbed by the plant and 'translocated' to other parts of the plant in such quantities that they have insecticidal action.

Ripper⁵ classifies systemic insecticides in three categories according to their rate of decomposition in the plant:

(1) *Stable*, e.g. selenium compounds.⁶ The selenate ion exerts a toxic effect, but does not undergo any further chemical change in the plant.

(2) *Endolytic*. After absorption in the plant and translocation the compounds are present to at least 98 per cent in their original form, and act in this form as insecticides until they are ultimately decomposed by the plant.

(3) *Endometatotoxic*, e.g. systox (p. 179). The insecticide is ab-

¹ B.P. 602,446.

² B.I.O.S. Final Report.

³ Ripper, *Third International Congress on Crop Protection*, Paris, 17 September 1952.

⁴ Martin, 'Important new discoveries in plant protection', *Grower*, 26 April 1947.

⁵ *Third International Congress on Crop Protection*, Paris, 17 September 1952.

⁶ Hurd Karrer, *J. Agric. Res.* 1937, 54, 601.

SYSTEMIC INSECTICIDES

sorbed, 'translocated' and then undergoes transformation within the plant into a new toxic compound or compounds which also act as insecticides. These newly formed insecticides will then be ultimately decomposed by the plant fluids.

Systemic insecticides are superior to contact insecticides in many ways. On account of their absorption and transfer in the plant they can deal with insects which might normally remain hidden or protected from the direct spray of a contact insecticide. Many systemic insecticides are specific to certain pests. For example, owing to the insecticide being contained within the plant, parasitic non-phytophagous insects are less likely than the pests to absorb the insecticide. And so ecological selectivity¹ comes into play.

G. S. Hartley² has studied, from the standpoint of physical chemistry, the following requirements for efficient systemic insecticidal action:

(1) The insecticide must be soluble in plant sap, hence in water.

(2) It must be fairly stable in aqueous solution over the plant pH range (4.5-6.5).

(3) It must be able to enter the sap by diffusion through the leaf or root cuticle. Hence some degree of lipid solubility is desirable. Larger molecular size will be disadvantageous.

(4) The insecticide if used on food crops should be non-toxic to mammals or broken down at such a rate as to be innocuous when the crop is harvested.

Since selenium and all its compounds are toxic in some degree they are of no use as systemic insecticides because condition (4) is not realized. Parathion,³ however, has a low water-solubility and tetraethyl pyrophosphate (T.E.P.P.)⁴ is very readily hydrolysed by water. Therefore, although they have powerful insecticidal action, they are not considered by some workers as successful *systemic* insecticides.

¹ Ripper, Greenslade and Hartley, *J. Econ. Ent.* 1951, 44, 448.

² *XVth International Chemical Congress*, New York, 1951.

³ See p. 178.

⁴ See p. 181.

Octamethylpyrophosphoramidate (O.M.P.A.)¹

One of the most important systemic insecticides is octamethylpyrophosphoramidate (O.M.P.A. or schradan or pestox III) (I).

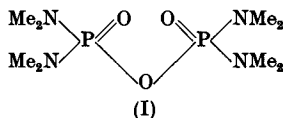

This compound was made by Schrader by the following reaction:

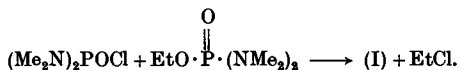

An industrial process worked out by Pest Control Ltd. consisted in a direct synthesis. This general reaction can be represented thus:

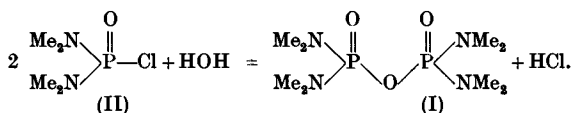

The hydrochloric acid is removed by the strong tertiary base, methyl dibutylamine, which has a soluble hydrochloride. In B.P.'s 631,549 and 652,981 it was shown that compound (II) could be prepared by the action of dimethylamine on POCl_3 in chloroform containing an excess of methylbutylamine. The further reaction with water is very conveniently carried out in the same system by adding an excess of aqueous sodium hydroxide solution. The chloroform layer contains the tertiary amine and (I). The solvent and amine are stripped off leaving the product. Side reactions take place, and the commercial product also contains some triphosphoric pentadimethylamide (I A) and smaller amounts of other phosphoric amides. The compound (I A) is itself also a valuable systemic insecticide.

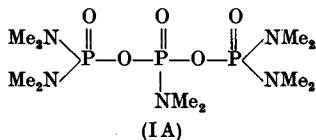

An important aspect of the use of systemic insecticides is the safety of the crop for human or animal consumption. Systemic

¹ Otherwise called tetramethylphosphorodiamic anhydride.

OCTAMETHYLPYROPHOSPHORAMIDE

insecticides must enter the plant and remain toxic for a period. O.M.P.A. is slowly broken down in the plant by enzymic reactions, and a period of 6 weeks in the active growing period suffices for almost complete decomposition. This has been ascertained by insecticidal tests and by radio-tracer methods (p. 175).

A. David *et al.*¹ draw attention to the fact that the L.D. 50 for O.M.P.A. is between 8 and 22 mg./kg. body weight, i.e. a dangerous ingestion for man (70 kg.) would be of the order of 560 mg.

Human subjects suffering from myasthenia gravis have received daily doses of 25 mg. for 3 months with beneficial results and no toxic symptoms. Under neutral conditions it is estimated² that the half-life in water is some 100 years. Hydrolysis is catalysed by acids with fission of a N—P link and the half-life in normal acid is 200 min. Hydrolysis is catalysed by alkali with fission of the POP link: the half-life in N sodium hydroxide is 70 days. At biological pH it would appear that it should be indefinitely stable, but as we shall see, other factors besides pH must be taken into account in biological systems.

As stated previously (pp. 62 *et seq.*) there is often correlation between anticholinesterase activity *in vitro* and gross mammalian toxicity. The toxicity of O.M.P.A. is not very much less than that of tabun, D.F.P. and T.E.P.P., yet the anti-cholinesterase activity of O.M.P.A. *in vitro* is negligible (50 per cent inhibition, 4.5×10^{-2} M). On the other hand, O.M.P.A. produces all the symptoms of acetylcholine poisoning when administered to animals. Moreover, the serum cholinesterase of such animals is almost completely inhibited. Another anomaly of O.M.P.A. is that toxic action is slower than that of D.F.P. or tabun, an hour's delay being usual compared to the very quick knock-out action of D.F.P., etc. (see p. 2).

Oxidation of O.M.P.A.

These facts suggested that O.M.P.A. is converted in some body tissue into another substance which is the real toxic

¹ David, Hartley, Heath and Pound, *J. Sci. Fd Agric.* 1951, 7, 310.

² Du Bois, *et al.* *J. Pharmacol.* 1950, 99, 376.

INSECTICIDES

material with esterase-inhibiting properties. In support of this theory it has been shown that O.M.P.A. in the presence of liver slices and oxygen produces a cholinesterase-inhibiting substance.¹ The use of a radioactive O.M.P.A. containing ³²P confirmed this enhancement of activity² in rabbit blood.

Certain workers³ believed that enhanced activity in the animal body was due to the formation of the amine oxide (IB).

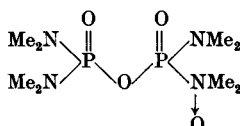

(IB)

Hartley⁴ has shown that chemical oxidation of O.M.P.A. using potassium permanganate leads to the transfer of one oxygen atom per molecule of O.M.P.A. An alkali-labile substance of increased anticholinesterase activity was thereby produced.

Octamethylpyrophosphoramidate is also enzymically oxidized *in vivo*, as well as chemically by permanganate, to a highly effective anti-esterase.⁵

The oxidation has also been effected with dichromate, hypochlorite, bromine water and peracetic acid to form products which yield formaldehyde on treatment with acid.⁶ The products from hypochlorite and peracetic acid oxidation were separated by column chromatography and shown to be different. The biologically oxidized schradan and the material from hypochlorite oxidation were more polar than schradan and inhibited cholinesterase, 50 per cent at 7×10^{-6} M. The material from peracetic acid oxidation was less polar than schradan and inhibited at 5×10^{-4} M. A transformation of the highly unstable product from biological, permanganate or hypochlorite oxidation was suggested by the solubility changes on purification by column chromatography. Differences in infra-red absorption spectra,

¹ Aldridge and Davidson, *Biochem. J.* 1952, **52**, 663; Du Bois, Doull and Coon, *J. Pharmacol.* 1950, **99**, 376; Gardiner and Kilby, *Biochem. J.* 1950, **46**, xxxii.

² Gardiner and Kilby, *Biochem. J.* 1952, **51**, 78.

³ Casida, Allen and Stahmann, *J. Amer. Chem. Soc.* 1952, **74**, 5548.

⁴ *XVth International Congress for Pure and Applied Chem.*, Abstr., 1951.

⁵ *Ibid.* Casida, Allen and Stahmann, *Nature, Lond.*, 1953, **170**, 243; *J. Biol. Chem.* 1954, **210**, 607.

⁶ Tsuyuki, Stahmann and Casida, *Biochem. J.* 1954, **59**, iv.

OXIDATION OF O.M.P.A.

anti-esterase activity, solubility and mode of chemical decomposition also indicated a structural difference between the initial highly unstable oxidation product and the less reactive transformed product.

The chemical and physical properties of the biological oxidation product indicate that it is the same as that produced by permanganate and is probably the mono-*N*-oxide of octamethylpyrophosphoramidate, in which the oxidized amide group represented by (IB).¹ The phosphoramidate *N*-oxide readily undergoes a rearrangement similar to that shown by amine oxides to produce the substituted hydroxylamine represented by (III). This rearrangement occurs rapidly in aqueous solutions under slightly alkaline conditions, or in anhydrous chloroform on heating, or in the presence of acetic acid. This explains why peracetic acid oxidation produces the substituted hydroxylamine. The rearranged product (III) is more stable and a less active anti-esterase than the phosphoramidate *N*-oxide (IB), and can be decomposed to formaldehyde and a hepta-methylpyrophosphoramidate (IV).

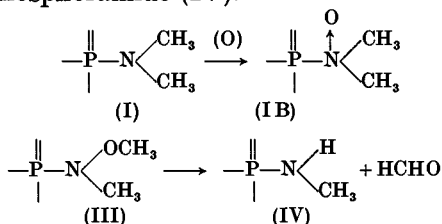

This rearrangement may clarify some of the experimental difficulties encountered in studies of phosphoramidates. A rearrangement of the *N*-oxide after reaction with the enzyme might also contribute to the prolonged cholinesterase inhibition *in vivo* often occurring with phosphoramidate poisoning in animals.

Radioactive O.M.P.A.

W. A. L. David,² using radio-tracer methods, has determined the concentration of ('undecomposed') O.M.P.A. necessary to give a complete kill of *Aphis fabae* on beans. He gives a figure

¹ Alternative primary oxidation products are possible, e.g. structures containing the CH₂OH group.

² *Ann. Appl. Biol.* 1951, 38, 508.

of 50 mg./kg. of plant. When O.M.P.A. was sprayed on insects other than aphids, e.g. ladybirds and bees, they were not killed at concentrations¹ that would have killed aphids.

The phenomenon of translocation within the plant has been widely studied and W. A. L. David, using ³²P O.M.P.A. on broad beans, cabbage, hops, peas and strawberries has shown that the insecticide passes preferentially into the young parts of the plants, and upwards rather than downwards, although translocation in the downward direction does exist. Thus translocation of systemic insecticides has been attempted for the control of root aphid (e.g. lettuce root aphid).

We may add two further interesting observations² noted with radioactive O.M.P.A. The first is that examination of the transpired material from plants, the roots of which had absorbed the insecticide, failed to show that any radioactive material had been given off. The second observation is that aphids killed by feeding on such plants, and also the honey dew which they produced, were found to be radioactive.

As far as fruit and vegetables are concerned Ripper proposes the following *tolerances*. At these dosage rates no detectable response or injury is manifested since the detoxicating mechanisms of the human body are able to inactivate the insecticide:

| | |
|---------------------|--------------------------------|
| O.M.P.A. | Less than 3 parts per million |
| Hanane ³ | Less than 0.2 part per million |

A 'forbidden' period is also recommended for each systemic insecticide. During this period natural processes of detoxication are going on within the plant. This is different for each plant and depends upon the climate. Broadly speaking, for strawberries in the northern hemisphere during the summer, the recommended interval between spraying and harvesting of strawberries, brussels sprouts, fruit trees and hops is about 5 weeks.

The use of systemic insecticides has also opened up the possibility of combating virus diseases by controlling disease-carrying insects (cf. p. 171). Contact insecticides are again less efficient here as the insects are usually in hidden positions.

¹ Greenslade, *Grower*, December 1951, p. 1948.

² W. A. L. David, *Nature, Lond.*, 1950, **166**, 72.

³ See p. 177.

TETRAMETHYLPHOSPHORODIAMIDIC FLUORIDE

Pestox III has been effectively used by Pest Control Ltd. to arrest transmission of the strawberry viruses by virtue of the 100 per cent kill of the strawberry aphid.

Tetramethylphosphorodiamidic Fluoride

Compound (V) (see p. 88) is a less active inhibitor *in vitro* than its toxicity¹ might suggest. As has already been pointed out it is a quick-acting poison. Oxidation by permanganate in this case is very slow, but here also an alkali-labile material of increased inhibiting power is produced, but in small yield.

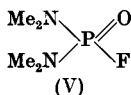

Compound (V) is used as an insecticide and is marketed as a 50 per cent solution under the name of hanane, which also contains 5 per cent of O.M.P.A. Hanane properly placed at the roots of cocoa trees kills mealy-bugs in the crown of the tree without harming beneficial insects such as ants which effect pollination. Five hundred trees infested with mealy-bugs were treated;² 10 per cent of the trees, chosen at random, were cut down before treatment and after treatment, and the number of mealy-bugs counted under a binocular microscope. After 6 weeks only thirty-five mealy-bugs were present on the treated trees as opposed to 42,971 counted before treatment in the untreated portion, a reduction of 99.9 per cent. It is well known that several species of mealy-bug, especially *Pseudococcus ujalensis*, transmit strains of swollen shoot virus, which kill the cocoa tree in 2-4 years. Thus the spread of the disease can be effectively controlled by this systemic insecticide (see also p. 171).

Diethyl *p*-Nitrophenyl Phosphate (Paroxan)

This compound was designated E-600 by Schrader,³ who prepared it by the reaction of sodium *p*-nitrophenate on diethyl phosphorochloridate in xylene:

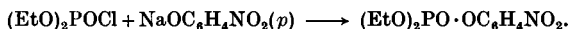

¹ Heap and Saunders, *J. Chem. Soc.* 1948, p. 1313.

² Hanna, Heatherington and Jaderko, *Nature, Lond.*, 1952, **169**, 334.

³ *B.I.O.S. Final Report*, p. 714.

INSECTICIDES

It can also be made by nitrating diethyl phenyl phosphate below 0°. It is a red oil, almost insoluble in water, and Schrader found it effective against aphids, while Ball and Allen¹ proved it active against the housefly, milkweed bug and cockroach. Later work showed it active against the two-spotted spider mite.

OO'-Diethyl O'-p-Nitrophenyl Phosphorothionate (Parathion)

This is a reasonably stable substance (VI); Schrader called it E-605 and prepared it as follows:

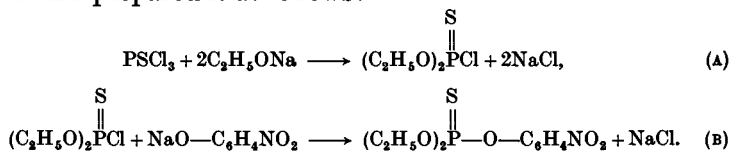

Chlorobenzene was the solvent preferred by the Germans for carrying out the reaction in step (B).

The pure compound is a pale yellow, nearly odourless oil, soluble in organic solvents, but almost insoluble in water. Averell and Norris² describe the detection of minute quantities of parathion (20 μg .) in spray and dust, by reduction with zinc, diazotization and coupling with an amine to give an intense magenta colour. It is effective (at concentrations of 25-600 p.p.m.) against many insect species, but of course, like the majority of organo-phosphorus insecticides, it is toxic to man and to animals.

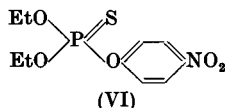

Parathion when highly purified has low anti-cholinesterase activity *in vitro* compared to its activity *in vivo*. Diggle and Gage³ considered this to be due to isomerization to the *S*-ethyl ester, but it may also be due to the formation⁴ of paroxan itself

$$\text{O}$$

$$\parallel$$

$$[(\text{EtO})_2\text{P}-\text{O}-\text{C}_6\text{H}_4\text{NO}_2].$$

The pattern of inhibition produced by parathion resembles that produced by paroxan.

¹ *J. Econ. Ent.* 1949, 42, 394.

² *Analyt. Chem.* 1948, 20, 753.

³ Diggle and Gage, *Biochem. J.* 1951, 49, 491.

⁴ Gersmann *et al.* *Nature, Lond.*, 1952, 170, 805.

SYSTOX

Systox

Among other insecticides may be mentioned systox, first synthesized by Schrader.¹ Ripper calls for caution in its use on food crops until more is known about the toxic metabolites.

The active constituent of this insecticide is stated to be *OO'*-diethyl *O'*-ethylmercaptoethyl phosphorothionate,

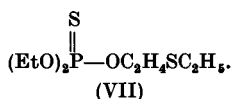

Parathion (*OO'*-diethyl *O'*-*p*-nitrophenyl phosphorothionate) is known to isomerize to *OS*-diethyl *O'*-*p*-nitrophenyl thiophosphate on heating,² and the reaction $\text{S}=\text{P}-\text{O}- \rightarrow \text{O}=\text{P}-\text{S}-$ appears to be fairly general. Parathion normally contains a small percentage of the *S*-ethyl isomer, which is more toxic to mammals than the parent compound and is a much more potent inhibitor of cholinesterase. Consequently, much of the early work on the toxicity and cholinesterase-inhibiting power of parathion has been proved incorrect.³ By analogy it was natural to suggest that systox contained either or both of the two isomers, (VIII) and (IX).⁴

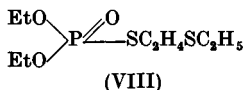

OO'-Diethyl *S*-ethylmercaptoethyl phosphorothiolate

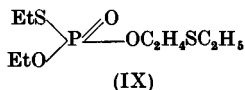

OS-Diethyl *O'*-ethylmercaptoethyl phosphorothiolate

A thorough examination of the whole problem was carried out by Gardner and Heath. Using diethyl phosphorochloridate containing ³²P, they prepared compound (VIII) thus:

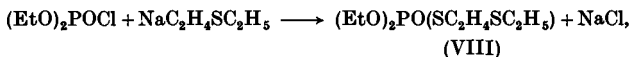

¹ Schrader, *Die Entwicklung neuer Insektizide u.s.w.* (Berlin, Verlag Chemie), 1952.

² Topley, *Chem. & Ind.* 1950, p. 5859.

³ Aldridge and Davidson, *Biochem. J.* 1952, **52**, 663; Diggle and Gage, *Biochem. J.* 1952, **49**, 491.

⁴ Gardner and Heath, *Analyt. Chem.* 1953, **25**, 1849.

and proved its structure by alkaline hydrolysis to 2-mercapto-ethylethyl sulphide, which neither (VII) nor (IX) could liberate. The liberation of the mercapto compound is thus positive proof of structure, and incidentally shows which bond is broken.

Compound (VII) containing ^{32}P was prepared thus:

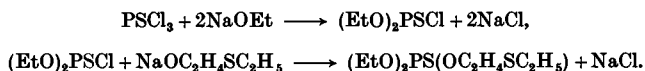

An infra-red spectrograph showed absorption in the wavelength band expected for $\text{P}=\text{S}$.

When compound (VII) was heated to 130° for 2.5 hr. it isomerized to *OO'*-diethyl *S*-ethylmercaptoethyl phosphorothiolate (VIII). This was shown by successive partitioning of the heated product between suitable solvents, the partition ratios of the radioactive phosphorus being determined after each extraction. If only one compound is present all the ratios would be the same; if two or more compounds are present, the observed over-all partition ratios would change in systematic fashion.

It was shown that systox indeed consisted of *OO'*-diethyl *S*-ethylmercaptoethyl phosphorothiolate (VIII) and *OO'*-diethyl *O''*-ethylmercaptoethyl phosphorothionate (VII). (Compound (IX) was not present, and in any case it does not seem to have been fully characterized.) It seems that at room temperature (VII) isomerizes to (VIII), the half-life being about 3 years. Furthermore, the $\text{P}=\text{S}$ compound is much less effective than the $\text{P}=\text{O}$ compound as an insecticide.

OO'-Diethyl-*S*- β -diethylaminoethyl Phosphorothiolate

Among phosphorus insecticides containing also nitrogen and sulphur we may mention *OO'*-diethyl-*S*- β -diethylaminoethyl phosphorothiolate (X). It was prepared (i) from diethyl phosphorochloridate¹ and sodium β -diethylaminoethyl mercaptide, (ii) from sodium diethyl phosphite and β -diethylaminoethyl thiocyanate, (iii) by the isomerization of *OO'*-diethyl-*O''*- β -diethylaminoethyl phosphorothionate (XI) obtained from β -diethylaminoethoxide and diethyl phosphorochloridothionate.

¹ See p 45 for its preparation.

OTHER SYSTEMIC INSECTICIDES

Compound (X) and its salts are effective systemic insecticides for various species of red spider mites. Absorption by foliage seems to be rapid and different toxicities to different groups of insects and mites is claimed.¹ The L.D. 50 for rats is 1.5 mg./kg.

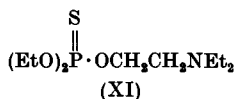
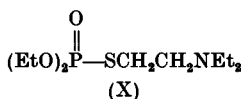

The American Cyanamid Company market *OO'*-diethyl *S*-(ethylthiomethyl)phosphorodithioate under the name of 'Thimet'. Its L.D. 50 for rats is 1.5 mg./kg. This product is promising as a seed treatment substance into which plants are dipped before transplanted from the seed bed to the field.

Italian workers have made progress with a substance of the formula

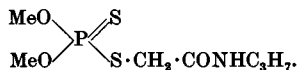

This substance kills the olive fly which bores into olives. The compound is metabolized in the plant and seems to leave little in the way of toxic residues.

Just as O.M.P.A. is oxidized enzymically to a cholinesterase inhibitor of greatly enhanced activity (p. 173), so also are systox (p. 179), thimet and certain related sulphur organo-phosphorus compounds.

A product of the Shell Company under the code O.S. 2046 (*OO'*-dimethyl-2-carbomethoxy-1-methylvinyl phosphate) is a water soluble insecticide which does not appear to be metabolized. Its oral toxicity to rats is 4 mg./kg.

Tetraethyl Pyrophosphate (T.E.P.P.)

Toy² prepared this ester³ (as well as related esters) by the controlled hydrolysis of 2 mol. of diethyl phosphorochloridate:

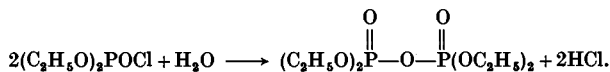

¹ Ghosh and Newman, *Chem. & Ind.* 1955, p. 118.

² *J. Amer. Chem. Soc.* 1948, **70**, 3882.

³ For other preparations of tetraethyl pyrophosphate, see p. 103.

INSECTICIDES

The hydrogen chloride is removed either by reduced pressure or by salt formation with pyridine or sodium bicarbonate; the latter procedure gave high yields of the pure ester. Toy also measured the hydrolysis rates and compared the toxicities of a series of tetra-alkyl pyrophosphates.

T.E.P.P. is a colourless, odourless, water-soluble toxic liquid, more toxic than parathion and rapidly absorbed through the skin. It is quickly hydrolysed, even in the absence of alkali, to the non-toxic diethyl hydrogen phosphate. It has found use as an aerosol to control pests on greenhouse vegetables and flowers, and is relatively free from residual toxicity hazards.

Schrader,¹ by the action of 3 mol. of triethyl phosphate on 1 mol. of phosphorus oxychloride, obtained what he considered to be 'hexaethyl tetraphosphate' (H.E.T.P.):

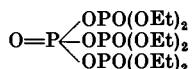

The product was undoubtedly a mixture and contained some T.E.P.P. It may be noted that we showed that one of the primary actions² of triethyl phosphate on phosphorus oxychloride is to give $\text{EtO} \cdot \text{POCl}_2$ and $(\text{EtO})_2\text{POCl}$, hence a complex mixture is likely to result from the further splitting out of ethyl chloride between the primary product and the original ethyl phosphate.

Sodium Fluoroacetate

During our experiments on the toxicity of sodium fluoroacetate, feeding experiments were carried out on rats and its possible use as a rodenticide was recorded.³ Similar observations, not surprisingly, have been made elsewhere.⁴ The dangers attaching to the use of sodium fluoroacetate as a rodenticide cannot be over-emphasized owing to the stability of the compound.

It is worth recording in some detail some of the findings of W. A. L. David⁵ on the use of sodium fluoroacetate both as a

¹ German Patent 720,577. U.S. Patent 2,336,302.

² McCombie, Saunders and Stacey, *J. Chem. Soc.* 1945, p. 380-2.

³ Reports to the Ministry of Supply, 1943.

⁴ Schrader, Rep. 714; *Brit. Intell. Obj. Subcomm.* 1948; Dicke and Richter, *Pub. Hlth Rep.* 1946, 61, 672.

⁵ *Nature, Lond.*, 1950, 165, 493.

systemic and a contact insecticide. Biological tests were carried out at 15-25°, and the test insects were *Aphis fabae* on broad beans. The lowest concentration giving a complete kill was 0.001 per cent w/v, which was effective in 2 days. By the fifth day the plants had lost their toxicity. Sodium fluoroacetate was found to be a highly effective systemic insecticide. As little as 1 mg. added to 400 g. of soil freed the plant from aphids in 5 days.

In culture solutions complete kills of aphids were obtained on plants supplied with 100 c.c. of 0.00005 per cent w/v solution, or 0.005 mg./g. of plant.

It appears that sodium fluoroacetate is more toxic than O.M.P.A. towards *A. fabae*.

It should be stressed that we are not yet aware of all the hazards in connexion with the use of sodium fluoroacetate, or indeed of any compounds containing the FCH₂CO group, as insecticides.

Comparison of the Action of Organo-phosphorus Compounds on Mammals and Insects

Lord and Potter¹ have claimed that it is important not to generalize the known anti-cholinesterase activity of organo-phosphorus insecticides in mammals to account for their action in insects. They could find no specific cholinesterase in two species of insect, but there was a general esterase inhibited by the insecticides.

Hopf² concludes that although insect nerve tissues produce 'substances' that simulate acetylcholine and a cholinesterase which is inhibited by organo-phosphorus insecticides, these 'substances' (in locusts at any rate) are not antagonized by atropine. Furthermore, tubocurarine does not poison insects, although it is active in warm-blooded animals and affects the neuromuscular junctions (see pp. 36, 37). In short, different physiological mechanisms appear to be at work in insects. In particular, it seems that acetylcholine, when injected into a variety of insects, has no marked toxic action. It seems then that, in some

¹ *Ann. Appl. Biol.* 1951, 38, 495.

² *Ibid.* 1952, 39, 193.

insects, choline-esters do not act as synaptic mediators and that the enzyme that is inhibited by T.E.P.P., D.F.P., etc., is a 'general esterase'.

In this connexion we will stress again that, although there is often a correspondence between toxic action of organo-phosphorus insecticides and anti-cholinesterase activity (p. 67), the relationship is not always simple. Thus parathion (p. 178), not itself an esterase inhibitor, is converted *in vivo* into an enzyme inhibitor.¹ On the other hand, Aldridge² has shown that the inhibitor paroxan can be hydrolysed enzymically to produce non-inhibitory substances.

As mentioned above, to apply to insects a conclusion drawn directly from tests on mammals may sometimes be misleading.³ For instance, American cockroaches have a remarkably high tolerance for acetylcholine,⁴ but, on the other hand, a substance showing some of the pharmacological properties of acetylcholine does accumulate in flies and cockroaches poisoned with D.D.T. Similarly, Hopf, working with locusts, was unable to demonstrate any increase in toxicity of eserine or T.E.P.P. resulting from the subsequent injection of acetylcholine. From this, Lord and Potter infer that acetylcholine may not be directly involved in the insecticidal action of organo-phosphorus compounds, either because the enzymes which hydrolyse acetylcholine are not inhibited to any considerable extent *in vivo* or because the functions performed by acetylcholine in mammals are performed by another substance in insects.

These authors claim, therefore, that it cannot safely be assumed that the toxic action of organo-phosphorus insecticides to insects is due to the inhibition of cholinesterase, although in the case of some insect species there is considerable evidence that an enzyme capable of hydrolysing acetylcholine may be important in the toxic action of the organo-phosphorus compounds.⁵ Further evidence on this point⁶ showed that with

¹ Gage, *Biochem. J.* 1953, **54**, 426.

² *Biochem. J.* 1953, **53**, 117.

³ Lord and Potter, *Chem. & Ind. (Rev.)*, 1954, p. 1214.

⁴ Tobias, Kollros and Savitt, *J. Cell. Comp. Physiol.* 1946, **28**, 159.

⁵ Metcalf and March, *J. Econ. Ent.* 1949, **42**, 721; Chamberlain and Hoskins, *ibid.* 1951, **44**, 177; Dubois and Mangun, *Proc. Soc. Exp. Biol., N.Y.*, 1947, **64**, 137.

⁶ Chadwick and Hill, *J. Neurophysiol.* 1947, **10**, 235.

di-isopropyl phosphorofluoridate (D.F.P.), H.E.T.P. and physostigmine, inhibition of the hydrolysis of acetylcholine by American roach nerve cords is closely paralleled by toxicity. Insects treated with these substances died when 90 per cent or more of the 'cholinesterase' activity was inhibited. This points to the importance of the inhibition of cholinesterase activity, but the situation is very confused by the fact that the same workers¹ found that neither acetylcholine nor acetyl- β -methylcholine had any effects on the insects whether they were poisoned with cholinesterase inhibitors or not.

Organo-phosphorus compounds and fly control. Certain organo-phosphorus compounds have been used as fly-controlling agents, where fly populations have become resistant to chlorinated hydrocarbons such as D.D.T.² The compounds are applied in the form of sugar baits which attract the flies and so increase the effectiveness of the poisons.

¹ *Ibid.*

² Robson and Milne, *Vet. Rec.* 1954, 66, 415.

Chapter X

ESTERASE ACTIVITY AND MEDICAL ASPECTS

Further Consideration of Esterase Activity

Having reviewed the properties of a variety of organo-phosphorus compounds, we are now in a position to consider in greater detail their action towards enzymes and to utilize the information given on pp. 35 *et seq.* and 61 *et seq.*

We must stress that organo-phosphorus compounds are not specific inhibitors for the cholinesterases, but are rather inhibitors for enzymes possessing carboxylic esterase activity. All the enzymes mentioned below will hydrolyse carboxylic esters. However, not all esterases are inhibited, for example, *A*-esterase which hydrolyses phenyl acetate is not inhibited by organo-phosphorus compounds.

| Enzyme | Inhibitors |
|-----------------------------------|-------------------------------|
| Chymotrypsin* | D.F.P., T.E.P.P., E-600, etc. |
| Trypsin | D.F.P., T.E.P.P., E-600, etc. |
| Cholinesterase (true and pseudo-) | D.F.P., T.E.P.P., etc. |
| Liver esterase | D.F.P. |
| Milk esterase | D.F.P. |

* Chymotrypsin is a proteolytic and milk-curdling enzyme of the pancreatic secretion. It is a protein endopeptidase which catalyses the hydrolysis of native proteins to peptones, polypeptides and amino acids, by breaking the peptide linkages of the carboxyl groups of tyrosine and phenylalanine.

Thus using inhibitors such as D.F.P. containing ^{32}P , it has been shown that the inhibited cholinesterase contains phosphorus which is very tightly bound.

Using erythrocyte cholinesterase, Aldridge¹ has studied the kinetics of its reaction with inhibitors. With one compound in excess, he has shown that the reaction is bimolecular, and the energy of activation is 10-11 kcal./mol. Such a value is not in agreement with a simple absorptive process, and it is assumed that a chemical change has taken place, e.g. phosphorylation of the enzyme.

¹ *Chem. & Ind. (Rev.)*, 1954, p. 473.

ESTERASE ACTIVITY

Aldridge has shown that the addition of eserine to intact erythrocytes causes a fall of cholinesterase activity to 20 per cent, and that the activity returns when the cells are washed at 0°. With dimethyl *p*-nitrophenyl phosphate there is a similar fall of activity, but washing at 0° does not restore the activity. Washing at 37°, however, is effective.

Many workers in the organo-phosphorus field have from time to time suggested theories to explain anti-cholinesterase activity.¹ These theories differ in certain respects, but some features are common to them all. Nothing, however, can be at all certain until pure cholinesterase has been obtained.

Structural requirements for anti-cholinesterase activity

In these speculations we must take cognizance of the following points:

(1) The phosphorus compounds are always esters (or ester derivatives, e.g. amides). It was shown² among many examples, that whereas D.F.P. (I) is a powerful anti-cholinesterase material, the diammonium salt (II) is virtually inactive.

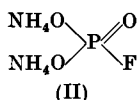
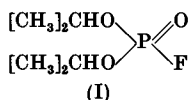

(2) The ester must in addition contain some group which will 'initiate' the approach of the ester to the surface of the enzyme. In this connexion it should be noted that di-*isopropyl* phosphorochloridate (III, X = Cl), in which the chlorine atom is chemically very reactive,³ has no toxic properties, is devoid of myotic and anti-cholinesterase activity. In this compound, the chlorine is hydrolysed very quickly in water and would probably be destroyed extremely quickly *in vivo*. We have shown, quite conclusively, that in non-polar solvents the phosphorochloridate

¹ Saunders, Ministry of Supply Meetings, London, 1941-50; Aldridge, *Chem. & Ind. (Rev.)*, 1954, p. 473; Kilby, *Chem. & Ind. (Rev.)*, 1953, p. 856; Nachmansohn and Wilson, *Advanc. Enzymol.* 1951, 12, 290.

² McCombie and Saunders, *Nature, Lond.*, 1946, 157, 776.

³ McCombie and Saunders, *Nature, Lond.*, 1946, 157, 287.

will readily phosphorylate alcohols and amines,¹ whereas the phosphorofluoridate will not. Therefore something more than a simple acylation is involved in biological processes.

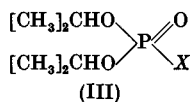

(3) We have shown² in a large range of compounds that, if $X = \text{H, Et, OEt, OCH}_2\text{CH}_2\text{Cl, OCH}_2\text{CH}_2\text{F, NH}_2, \text{NHMe, NPh, CH}_2\text{F, CH}_2\text{CH}_2\text{F, CN, SCN,}$ or morpholino, then the toxicity of the 'phosphate' is small or negligible.

(4) Besides compounds in which $X = \text{F}$, toxicity and anticholinesterase activity are observed in compounds in which X represents an 'anhydride', e.g. alkyl pyrophosphates (T.E.P.P.), *p*-nitrophenyl esters.

Theoretical considerations

Keeping items (1) to (4) in mind we may next envisage a potentially negative centre on the enzyme and also a closely located centre containing a reactive hydrogen (perhaps an OH or a NH group) (see fig. 19 (a)).

In Fig. 19 (b) the formation of a hydrogen bond is envisaged followed by the attachment of the positive P atom to the negative site and elimination of HF (fig. 19 (c)). Reversal, when possible,³ is represented in fig. 19 (d). The inhibitor is of course hydrolysed at the end of the reaction. It may well be that $(\text{RO})_2\text{PO}(\text{OH})$ is not actually recoverable, but that the regeneration process involves, first of all, a dealkylation which then facilitates the removal of the phosphate moiety from the enzyme.⁴

It is not wise to assert categorically that the initiating reaction is actually the hydrogen bonding between the fluorine atom (or oxygen atom in T.E.P.P., see below) of the phosphorus compound and the 'active' hydrogen. It should be noted in support,

¹ McCombie, Saunders and Stacey, *J. Chem. Soc.* 1945, p. 380; Cook, McCombie and Saunders, *J. Chem. Soc.* 1945, p. 873.

² Cook, Saunders and Smith, *J. Chem. Soc.* 1949, p. 635.

³ Possible with T.E.P.P. and dimethyl *p*-nitrophenyl phosphate.

⁴ Todd and Webb (private communication, 1955).

THEORETICAL CONSIDERATIONS

however, that phosphorochloridic esters are *not toxic*, and here hydrogen bonding is not possible. It can be argued of course that the P—Cl link is so quickly hydrolysed that the compound

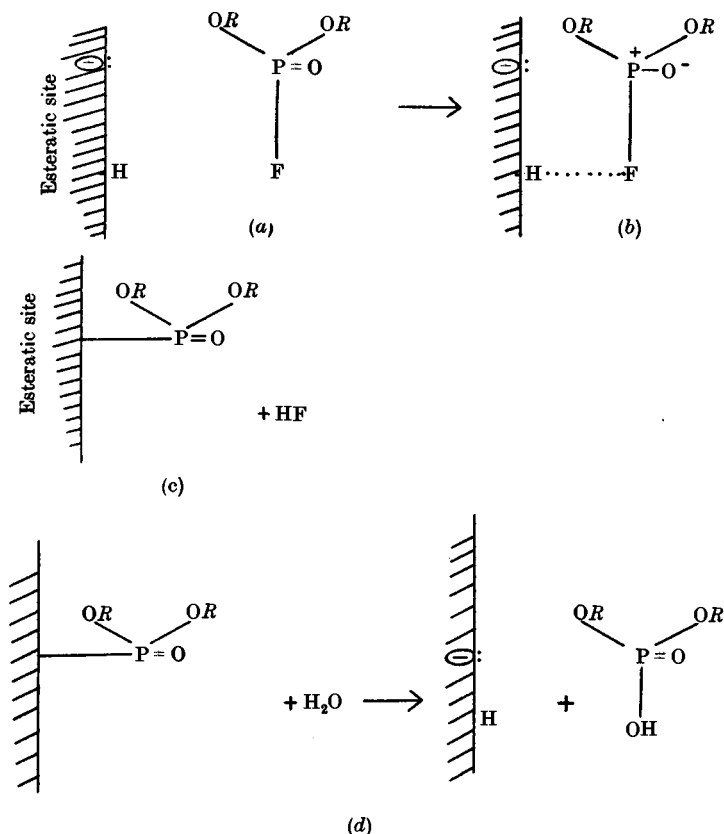

Fig. 19

never reaches the site of reaction. It would be interesting therefore to examine a phosphorochloridate with a P—Cl link very resistant to hydrolysis. It should be noted that dimethyl phosphorofluoridate has a readily hydrolysable P—F link and yet is very toxic.

As an acceptable alternative to the direct formation of a hydrogen bond $\text{F} \cdots \text{H}$, we can envisage that the very positive

ESTERASE ACTIVITY AND MEDICAL ASPECTS

phosphorus atom attaches itself directly to the 'basic group G' of the esteratic site, followed by elimination of HF (fig. 20 (b)).

Perhaps both these mechanisms are operative simultaneously as shown in the diagram (fig. 20 (a)).

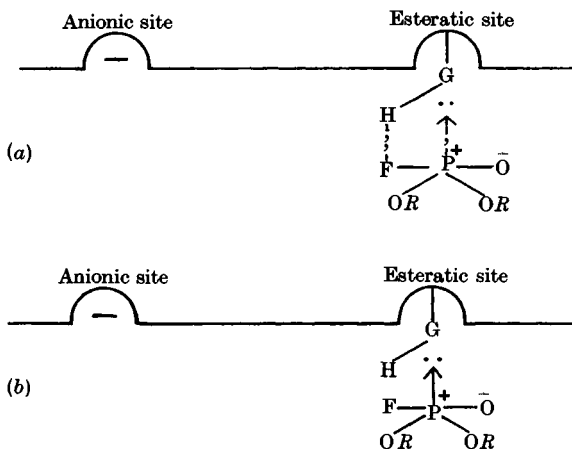

Fig. 20

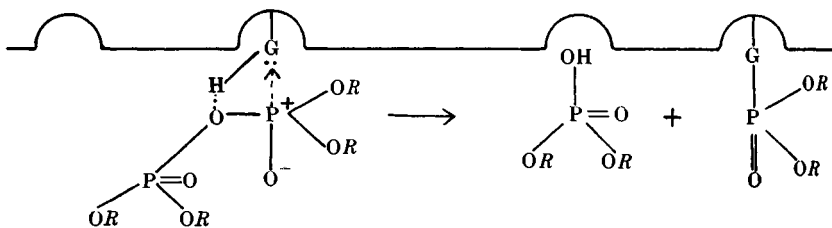

Fig. 21

It is possible to speculate on a situation analogous to that shown in fig. 19 (b) or fig. 20 (a) for certain anticholinesterases such as T.E.P.P. or *p*-nitrophenyl esters (fig. 21). Here a $H \cdots O$ bonding may perhaps be envisaged in place of the $H \cdots F$ bonding. Whatever the precise mechanism of attack by the phosphorus compound on the enzyme, the fact is that the latter is phosphorylated in contradistinction to normal acetylation. Whereas the acetyl group is readily removed by hydrolysis under normal conditions, the 'phosphoryl' group is usually firmly attached.

THEORETICAL CONSIDERATIONS

Any rational approach to the study of antidotes for nerve-gas poisoning must take this firm attachment into account. It has been observed that, in experiments *in vitro*, the D.F.P.-poisoned heart recovers to an appreciable extent in the presence of hydroxylamine. With this experiment in mind I. B. Wilson¹ has examined the action of hydroxylamine derivatives and has had considerable success with nictonic hydroxamic acid methiodide (IV). The reaction envisaged here is a nucleophilic attack

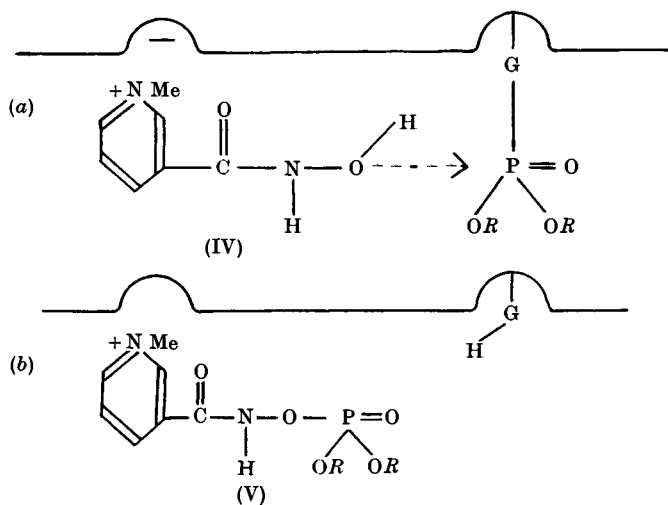

Fig. 22

by (IV) on the phosphorus atom of the phosphorylated enzyme (fig. 22 (a)). The result is the regeneration of the enzyme in its natural condition as shown in fig. 22 (b). If the hydroxylamine compound reacts as clearly as indicated in the diagram and if the phosphorylated hydroxamic acid (V) is itself devoid of toxic action, then indeed a reversal of the poisoning effect of D.F.P. can be expected.

Wilson's work in this connexion is of considerable importance, and it is worth recording his earlier observations. In 1951 he showed that enzyme inhibited by T.E.P.P. could be reactivated rapidly by choline or hydroxylamine (and even very slowly by

¹ *Chem. and Eng. News*, 1955, p. 136.

water).¹ In 1953 he observed that a variety of nucleophilic reagents would dephosphorylate the enzyme poisoned with T.E.P.P. and diethyl phosphorofluoridate. Such dephosphorylating agents included compounds containing amino, hydroxyl, thiol, guanidino, amidino and pyridyl groups.² With hydroxylamine the reaction proceeds somewhat as follows:

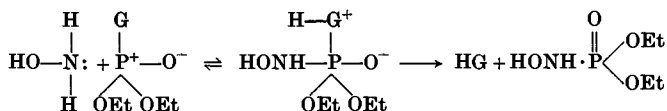

With D.F.P., the reaction was far more difficult and this led Wilson to combine the hydroxylamino group with a suitably placed N structure in the same molecule. Oximes will also restore activity of poisoned cholinesterase.³

Other workers⁴ have recently shown that hydroxamic acid, $R \cdot \text{CONHOH}$, at pH 7.7 accelerates the hydrolysis of D.F.P. and sarin. They envisage the following reaction, although compound (I) has not been isolated.

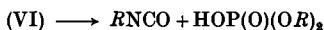
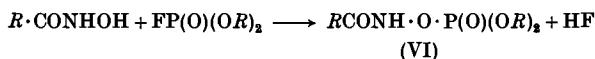

They have reduced the half-hydrolysis time of D.F.P. from 3000 min. to 30 min., and of sarin from 300 min. to 5 min.

It is relevant here to quote from Whittaker:⁵

The binding of enzyme and substrate may involve many different types of interaction ranging from normal electrovalent and covalent links through hydrogen bonds to the various types of intermolecular exchange forces such as the van der Waals's dispersion forces. Pauling has pointed out that van der Waals's forces may make a significant contribution to the total binding energy when the contact area of substrate and enzyme is large. Stereospecificity may be thought

¹ Wilson, *J. Biol. Chem.* 1951, **190**, 111.

² Wilson and Meislich, *J. Amer. Chem. Soc.* 1953, **75**, 4629.

³ Childs, Davies, Green and Rutland, *Brit. J. Pharmacol.* 1955, **10**, 462.

⁴ Hackley, Plapinger, Stolberg and Wagner-Jauregg, *J. Amer. Chem. Soc.* 1955, **77**, 3651.

⁵ 'Stereospecificity of enzyme reactions', in *Progress in Stereochemistry* (Butterworths Scientific Publications, London), 1954, p. 318.

of as arising from the need for accurate spatial correspondence between the combining groups on the enzyme and those in the substrate. Incorrect orientation may operate against enzyme activity both by failing to bring interacting groups together and also by introducing steric hindrance or ionic repulsion so preventing the close approach of substrate and enzyme.

Active centre in chymotrypsin.

Chymotrypsin, in addition to its proteolytic activity, can also function as an esterase.¹ It is inactivated by D.F.P., etc. (p. 186). The esterases firmly bind the phosphorus of D.F.P., and in the case of chymotrypsin the reaction is bimolecular, yielding a crystalline derivative containing two *isopropoxy* groups and one atom of phosphorus per protein molecule, but no fluorine.²

Recently the compound of chymotrypsin and labelled D.F.P. has been hydrolysed and the hydrolysate shown to contain L-serine phosphoric acid.³ The latter is known to be phosphorylated on its hydroxyl group.⁴

It should be noted that 1 mol. of chymotrypsin contains about twenty-seven residues and that most proteins regardless of their serine content do not react with D.F.P. Hence D.F.P. must act at one very special active centre, and other functions must be involved. It has, however, been suggested recently that the D.F.P. attacks at a histidine or tyrosine unit rather than at a serine unit.⁵ The suggestion is that a phosphorylated histidine residue might be unstable and give rise ultimately to a product phosphorylated on the hydroxyl group of one of the serine residues. A migration might also take place during the actual acid hydrolysis.

An irreversible cholinesterase inhibitor in white clover

In the course of a study of the decomposition products of radioactive octamethylpyrophosphoramidate in white clover (*Trifolium repens*, strain S100), it was found quite incidentally by Heath and Park,⁶ that extracts from clover, whether

¹ Kaufmann, Schwert and Neurath, *Arch. Biochem.* 1948, **17**, 203.

² Jansen *et al.* *J. Biol. Chem.* 1950, **185**, 209.

³ Schaffer, May and Summerson, *J. Biol. Chem.* 1953, **202**, 67.

⁴ Levene and Schormüller, *J. Biol. Chem.* 1944, **105**, 547.

⁵ Wagner-Jauregg and Hackley, *J. Amer. Chem. Soc.* 1953, **75**, 2125.

⁶ *Nature, Lond.*, 1953, **172**, 206.

previously treated with this compound or not, inhibited cholinesterase *in vitro*.

These workers isolated from untreated clover a 'substance' that did indeed inhibit cholinesterase. If this 'compound' can be absorbed by animals eating large quantities of clover, it might be expected that they would show some ill effects. Bloat in sheep and cattle is attributed to cyanogenetic compounds produced by several varieties of clover.¹ It is certain that the 'substance' that Heath and Park have discovered does not inhibit cholinesterase by producing cyanide, as M/100 potassium cyanide induces only 20 per cent inhibition in plasma cholinesterase under their experimental conditions; but this does not rule out the possibility that the cholinesterase inhibitor is identical with one of the cyanogenetic compounds. Thus clover may in some cases produce signs of anti-cholinesterase poisoning as well as cyanide poisoning. It is thought, therefore, that these observations may have some relevance to bloat.

Anticholinesterases containing Quaternary N Groups

A valuable contribution to the study of the relation between structure and activity of anticholinesterases containing quaternary nitrogen groups has been made by A. W. D. Avison. However, in a monograph of this size concerned mainly with phosphorus and fluorine compounds, space does not permit an appreciation of Avison's work² on nitrogen compounds and the deductions drawn therefrom; but attention may be drawn to certain compounds containing both phosphorus and quaternary ammonium groups.³ Some of these are shown in the appended table, and compared with tetramethyl pyrophosphate. Figures in parentheses are the potencies of the corresponding tertiary bases for comparison. This emphasizes the influence of a quaternary ammonium group in the molecule, since in all cases the tertiary base is only of the order of one-hundredth of the activity of the quaternary salt. However, this applies equally to their action

¹ Melvill and Doak, *N.Z. J. Sci. Tech.* 1944, 22B, 674; Evans and Rees Evans, *Nature, Lond.*, 1949, 163, 373.

² A good review is given in *Chem. & Ind. (Rev.)*, 1954, p. 288.

³ Andrews, Atherton, Bergel and Morrison, *J. Chem. Soc.* 1952, p. 780.

OTHER ANTICHOLINESTERASES

against pseudo-cholinesterase in which the absence of an anionic group has been postulated by some workers. Avison says that this is not quite so disastrous for the theory as might appear at first sight, for the presence of a positively charged group in the benzene nucleus would be expected to enhance the electrophilic character of the phosphorus atom. This means that interaction with the ester-binding site of the enzyme and subsequent hydrolysis or phosphorylation would be facilitated.

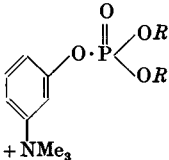
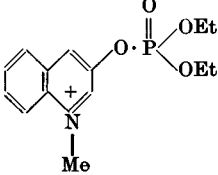
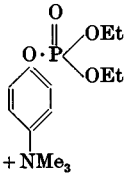
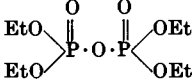
| Compound | <i>R</i> | Potency relative to prostigmine (= 1) | |
|--|---|--|---|
| | | True ChE | Pseudo-ChE |
|  + NMe ₃ | Me Et <i>iso</i> -Pr <i>sec.</i> -Bu | 1.5 (0.014) 1.4 (0.015) 0.5 (0.085) 0.7 | 110 (2.0) 575 (1.1) 230 (3.3) 77 |
|  Me | | 290 (1.4) | 575 (180) |
|  + NMe ₃ | | 1.6 | 1100 |
|  (Tetraethyl pyrophosphate) | | 9.2 | 870 |

Medical Aspects of D.F.P. and Related Compounds

Passing reference has already been made to experiments with D.F.P. in cases of glaucoma, post-operative paralytic ileus and myasthenia gravis. The intra-ocular tension in glaucoma appears

to be satisfactorily reduced by the direct administration of D.F.P. solution in arachis oil to the affected eye (p. 40). This use of D.F.P. is recommended in some quarters.

More will now be said about the conditions of paralytic ileus and myasthenia gravis.

*The use of D.F.P. in post-operative paralytic ileus*¹

The treatment of the clinical condition known as paralytic ileus has long been the subject of controversy, the reasons being at least threefold: (1) the degree of paralysis of the peristaltic movement of the gut may vary in intensity and extent; (2) the condition may arise as a complication of a number of very different diseases and procedures; (3) there are few who agree that any one drug or any single treatment is uniformly successful in all cases, even though they may all have a closely similar origin.

One definition of post-operative paralytic ileus is 'the failure of the patient to pass faeces or flatus within 60 hr. of the termination of a surgical abdominal operation'. A somewhat similar condition may arise in cases of gross mechanical obstruction of the gut. It is well known also that operations involving handling of the gut or the peritoneum are especially liable to cause paralytic ileus. Peritonitis and post-operative pain, inadequately treated with morphia, also precipitate paralytic ileus. Pneumonia, meningitis and typhoid predispose to paralytic ileus, whilst severe hypothyroidism can also be complicated by a paralytic ileus.

Drugs which facilitate peristalsis thus have a definite place in the treatment of the fully developed paralytic ileus, and are of great value in the developing ileus. In this work D.F.P. was selected as a potentially useful drug on pharmacological grounds.² D.F.P. was used in a short series of cases of paralytic ileus developing during the post-operative period in persons suffering from widely differing pathological conditions.

The treatment consisted of intramuscular injection of 1.5 ml. of 0.1 per cent solution of D.F.P. in sterile arachis oil, thus

¹ Quilliam and Quilliam, *Med. Pr.* 1947, ccxviii, no. 5659.

² *Ibid.*

causing a powerful viscerostimulant effect. According to Quilliam and Quilliam, D.F.P. appeared to be more effective than prostigmine or pituitary (posterior lobe) extract.

D.F.P. and myasthenia gravis

One of the features of myasthenia gravis is the dramatic, though transient, relief of symptoms, produced in patients with this disease by an injection of neostigmine. The action of neostigmine is usually attributed to its inhibition of cholinesterase activity; if this is a true explanation, then di-isopropyl phosphorofluoridate (D.F.P.), a potent and irreversible inhibitor, might also be expected to produce prolonged clinical effects. Wilson, Maw and Geoghegan¹ have compared the inhibitory effects on blood cholinesterase produced by D.F.P. and by neostigmine in patients with myasthenia gravis, and have attempted to establish what relationship, if any, exists between these effects and the clinical response to the two drugs. Three types of observation were made:

(1) The immediate clinical effects and simultaneous changes in blood-cholinesterase activity produced by an intramuscular injection of neostigmine were compared with those which resulted from an intramuscular injection of D.F.P.

(2) The immediate effects on the action potential² of the small muscles of the hand, and the ensuing changes in blood-cholinesterase activity, produced by an injection of neostigmine into the brachial artery were compared with those obtained with a similar injection of D.F.P.

(3) D.F.P. in small doses was administered for prolonged periods, and the clinical effects and concomitant changes in blood-cholinesterase activity were studied.

Some of the results obtained by these workers may be summarized as follows:

(1) Action potentials of the small muscles of the hands were recorded. The muscles were fatigued by electrical stimulation of the nerves, and the effects of D.F.P. and of neostigmine,

¹ *Quart. J. Med.* (n.s.), 20, no. 77, January 1951, p. 21.

² The changes in the electric potential of an active cell or tissue: see Chapter III, p. 29. See also Bibliography, below, p. 217.

injected into the artery of one arm, were observed in both hands. D.F.P. restored the action potentials to the pre-fatigue state, but only on the injected side; the true cholinesterase activity of the venous blood from both arms was inhibited by about 20 per cent. The effect on the muscle action potential could be demonstrated for as long as 4 days after the injection. Neostigmine restored the muscle action potentials on both hands, but the effect lasted for about 80 min.; the true cholinesterase activity of the venous blood was inhibited by about 3 per cent.

(2) D.F.P. was administered intramuscularly in small doses to ten patients for periods varying from 2 weeks to 2½ years. It was concluded that D.F.P. was not a very suitable drug for the routine treatment of myasthenia gravis, since it did not relieve signs and symptoms as effectively and consistently as neostigmine.

(3) When a single dose of neostigmine was given either by mouth or parenterally during D.F.P. treatment, the patient always showed a clinical improvement which was more intense than that attained by D.F.P. alone. This applied particularly to the relief of oculo-bulbar symptoms where these had not been affected by D.F.P. A marked increase in muscle strength occurred, with relief of ptosis, but there was no significant change in the red-cell cholinesterase activity.

The writer would point out that the above conclusions were reached only with D.F.P., and it may well be that the physical properties of some other phosphorofluoridate might render it more suitable for this type of investigation. It may be noted, for example, that dicyclohexyl phosphorofluoridate, which is stable to hydrolysis (p. 52), has not yet been tried clinically.

Protection in vitro of cholinesterases against organo-phosphorus compounds

Work has been carried out to discover compounds which would protect cholinesterases against inhibition by tabun, sarin and D.F.P.¹ Sixteen amino acids were examined for this purpose in connexion with sarin and only D.O.P.A. (3:4-dihydroxy

¹ Berry, Fellowes, Fraser, Rutland and Todrick, *Biochem. J.* 1955, **59**, 1.

phenylalanine) in high concentration was able to abolish the inhibition *in vitro*.

It was found that catechol derivatives in general were able to protect cholinesterases *in vitro*. Both horse-serum and rat-brain cholinesterases were protected against the above inhibitors. It is thought that the basis of the protection is a reaction between catechol and the inhibitor.

It has been suggested by Augustinsson¹ that adrenaline and noradrenaline can protect cholinesterase. However, adrenaline cannot protect below a concentration of 0.1 mM, and it is therefore unlikely that mobilization of adrenaline *in vivo* could influence the inhibition of cholinesterase.

Protection against benzoylcholine by injection of pseudo-cholinesterase

Benzoylcholine is a substrate of pseudo-cholinesterase but not of the true cholinesterase. It inhibits the true cholinesterase of man (laked red cells centrifuged and the supernatant liquid diluted 1/150, acetylcholine substrate 0.005 M) from 30 per cent at a concentration of 0.1 M to 85 per cent at a concentration of 0.3 M. Benzoylcholine injected intravenously into rabbits will, at a dose of 8–14 mg./kg. body weight, produce a head drop lasting 40–120 sec.

Immediately following the injection of pseudo-cholinesterase, rabbits were protected against the effect of benzoylcholine and were unaffected by a dose of it which would normally have paralysed them.

Further interesting observations along these lines² are awaited especially in connexion with poisoning by organo-phosphorus compounds.

Demyelination of nerve fibres

In Chapter III we drew attention to the fact that some nerve fibres are myelinated. It has been suggested that the pseudo-cholinesterase of the central nervous system may be concerned in myelin metabolism and that inhibition of pseudo-cholinesterase

¹ *Acta Chem. Scand.* 1952, 6, 959.

² Lehmann and Silk, *Biochem. J.* 1955, 59, vii.

may therefore cause demyelination with subsequent paralysis.¹ D.F.P. and 'isopestox' (VII) produce demyelination and paralysis in the chicken.² Nevertheless, the precise relationship between inhibition of pseudo-cholinesterase and demyelination remains obscure.³

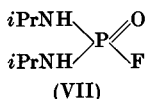

Permeability of nerve fibres

It has been reported⁴ that cholinesterase inhibitors (such as di-isopropyl phosphorofluoridate) increase the permeability of squid giant axons towards sodium and potassium. There is also an indication that the erythrocyte requires, among other factors, an adequate acetylcholine-cholinesterase system to prevent a gain of sodium or a loss of potassium.⁵ The conclusion that permeability is dependent on cholinesterase activity, however, seems to be contested by Strickland and Thompson.⁶

D.F.P. and cell growth

Mendel and colleagues have made some notable observations with D.F.P. They have observed that the germination and growth of seeds are inhibited by esterases such as D.F.P. and also by diethyl *p*-nitrophenyl phosphate (E 600), and diethyl *p*-nitrophenyl thiophosphate (E 605).⁷ A close relationship exists between the degree of esterase inhibition and the degree of growth inhibition. They also observed that the growth of human tubercle bacilli is inhibited by D.F.P. in a concentration of 10 mg./ml.

In addition, they noted that in tissue cultures the growth of the malignant cells (lymphoblasts) of a mouse lymphosarcoma is inhibited by E 600 in a concentration which inhibits the esterase

¹ Earl and Thompson, *Brit. J. Pharmacol.* 1952, 7, 261, 685.

² Barnes and Denz, *J. Path. Bact.* 1953, 65, 597.

³ Davison, *Chem. & Ind. (Rev.)*, 1954, p. 985.

⁴ Rothenberg, *Biochim. biophys. Acta*, 1940, 4, 96.

⁵ Lindvig, Greig and Peterson, *Arch. Biochem. Biophys.* 1951, 30, 241.

⁶ *Biochem. J.* 1954, 58, xx.

⁷ Mendel, Myers, Uyldert, Ruys and de Bruyn, *Brit. J. Pharmacol.* 1953, 8, 217.

CHOLINESTERASE IN THE RETINA

activity. The non-malignant fibroblasts in the same lymphosarcoma, the lymphoid cells and fibroblasts of normal lymph glands, and a non-malignant variation of the lymphoblasts originating from the mouse lymphosarcoma, all grow normally in the presence of the concentration of E600 by which the growth of the malignant cells is inhibited.

These results may well provide a basis for a new approach towards a rational chemotherapy of tuberculosis and neoplastic disease.

Cholinesterase in the retina

Francis¹ has successfully used D.F.P. in the histological localization of cholinesterases in the retina of the eye.

It may be noted that the retina represents an outlying portion of the brain itself. It arises as a protrusion from the prosencephalon (anterior portion of the cerebrum), and, being a constituent part of the brain, presents the same anatomical and physiological problems as does the central nervous system elsewhere. The more or less complete spatial separation of the synapses from the cell bodies makes the retina eminently suitable for finding out whether a known biochemical constituent is located in the cell bodies, axons, dendrites or at the synapses, and the information so obtained may perhaps be applicable to other parts of the nervous system, where the cell bodies and the synapses are all too intimately mingled for a proper analysis.

Francis placed strips of the retina from different animals in sodium sulphate to precipitate the cholinesterase *in situ*. Some strips were then incubated with acetylthiocholine, while others were kept in D.F.P. solution before the incubation. The tissues after preliminary washings were then treated with appropriate reagents so as to precipitate the copper derivative of thiocholine. The sections ultimately obtained showed dark deposits at those points where the enzyme was present, and deposits were absent if D.F.P. had destroyed the enzyme. As a result of the application of this technique, Francis was able to establish that for all the animals examined, except the frog, true cholinesterase was present only at the inner synaptic layer.

¹ *J. Physiol.* 1953, 120, 435.

Organic phosphates as radiosensitizers in the radiotherapy of malignant tumours

Pioneer work in this field has been carried out by J. S. Mitchell.¹ The idea is to select a radiosensitizing compound which blocks entry of cells into mitosis and also provides chromosome breakage. The compound itself must also be of low toxicity.

Among the many phosphorus compounds selected by Mitchell and his collaborators may be mentioned tetrasodium 2-methyl 1:4-naphthohydroquinone diphosphate (VIII). A concentration of 4×10^{-6} M of (VIII) produced a 50 per cent mitotic inhibition using chick fibroblasts in tissue culture. It is thought that the inhibition of the entry of cells into mitosis depends on the blockage of cellular synthetic processes involving phosphorylation.

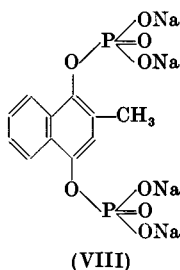

It should be noted that the compound alone has no therapeutic effect in malignant tumours. Cases of inoperable carcinoma of the bronchus have been treated² by a combination of X-ray therapy and compound (VIII). In such cases and also in connexion with malignant tumours of other types, there are indications from preliminary clinical studies, that the intravenous administration of compound (VIII) has a small but useful effect as a clinical radiosensitizer.

¹ Mitchell and Simon-Reuss, *Brit. J. Cancer*, 1952, 6, 317.

² Mitchell, *Brit. J. Cancer*, 1953, 7, 313.

EPILOGUE

In the foregoing chapters an attempt has been made to give some account of the chemistry and pharmacology of certain compounds containing phosphorus and fluorine. As pointed out in Chapter 1, many of these compounds were prepared initially in Cambridge during the years 1939-45 as chemical warfare agents. As such they were not used, and it soon became apparent that, because of their remarkable biological properties, they would find use as valuable tools in the investigations of enzyme systems, as insecticides, as rodenticides and in clinical medicine. Such anticipation has in fact been realized. The progress of the work provides a wonderful example of the beating of the proverbial swords into ploughshares.

The original work in Cambridge in 1941-2 established that the organo-phosphorus compounds¹ were powerful inhibitors of cholinesterase, and this accounts for many of the parasympathomimetic and other actions of these compounds. These original findings have been confirmed and extended in other parts of the world, notably in the United States, where most valuable contributions have been made. The writer would like to stress that, although many of the symptoms of organo-phosphorus poisoning are accounted for remarkably well by disturbance of the normal functioning of the peripheral nervous system, we must be prepared to look for dysfunctioning centrally where cholinergic centres may also be involved. It would be a mistake also to think only in terms of known and probable cholinergic centres; direct entry into the diencephalon² and other parts of the brain might well be involved.

Similarly with regard to the fluoroacetate story, other factors in addition to the jamming of the Krebs cycle may be looked for. One profitable line may well be the examination of the mobility, by chemical and enzyme methods, of the 'firmly

¹ It need hardly be mentioned that during the war years British and German work on the chemistry and toxic action of chemical warfare agents proceeded on completely independent lines!

² See p. 16.

EPILOGUE

bound' fluorine atom in these C—F compounds. The plant, indeed, can synthesize this link, and presumably the secret of this and the reverse process¹ cannot be very far off. Much remains to be done; but even so far, a study of organo-phosphorus and organo-fluorine compounds has helped to reveal, confirm and establish several vital biological mechanisms.

The writer, indeed, considers himself fortunate that the alighting upon certain poisonous compounds in 1939 should have provided him with an interest which extends far beyond the confines of a single discipline.

¹ The C—F link in certain aromatic amines has been broken by peroxidase, p. 148

Appendices

A. DETERMINATION OF FLUORINE IN ORGANIC COMPOUNDS

For our investigations on organic compounds containing fluorine, it was of vital importance to have trustworthy methods of determining the fluorine contents of the compounds. In a report to the Ministry of Supply¹ we described the macro-methods that we had found satisfactory for the types of compounds under investigation.

The two types of fluorine compounds are (a) compounds containing the P—F link, e.g. the phosphorofluoridates; (b) compounds containing the C—F link and known collectively as fluoroacetates.

In each class the problem may be resolved into two essential parts: (i) the breakdown of the organic compound under appropriate conditions to give a quantitative yield of fluoride ions in aqueous solution, and (ii) the determination of the concentration of these fluoride ions. Methods of breaking down the organic compounds were examined and the procedure adopted for the phosphorofluoridate was different from that used for the fluoroacetate series. From both, however, sodium fluoride was obtained as the breakdown product containing all the fluorine present. After numerous preliminary experiments we came to the conclusion that on the macro-scale a very convenient method of determining the quantity of fluoride ions in the products was by precipitation as lead chlorofluoride,² PbClF, which was then dissolved in dilute nitric acid and the chloride was determined by the Volhard method and calculated to the equivalent amount of fluorine. We determined carefully the conditions for the quantitative precipitation of lead chlorofluoride.

It must be emphasized at the outset that we are dealing with highly toxic compounds here, and that rigid precautions must be taken to ensure that no traces of volatile toxic material can escape into the atmosphere. Therefore any method that depends upon fusion, or a reaction in an open crucible, is at once ruled out.

¹ Report to the Ministry of Supply, 31 December 1943.

² Stark, *Z. anorg. Chem.* 1911, **70**, 173.

Determination of Fluorine in Phosphorofluoridates

Diethyl phosphorofluoridate, $\begin{array}{c} \text{O} \\ \parallel \\ \text{EtO} \rangle \text{P} \text{—F} \end{array}$, is a typical phosphorofluoridate. The problem was to find (a) an efficient method of breaking down the phosphorofluoridate so as to liberate fluoride ions quantitatively, and (b) a method of determining the fluoride ions in the presence of phosphorus-containing compounds.

Breakdown of the phosphorofluoridate

The equation for the hydrolysis of alkyl phosphorofluoridate by dilute aqueous sodium hydroxide is

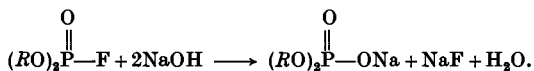

Although this hydrolysis is usually fairly rapid it is desirable to obtain conditions of a general nature that would be likely (a) to effect the complete hydrolysis of the more resistant phosphorofluoridates, (b) to ensure homogeneity of the reaction mixture so as to avoid possible mechanical losses of oily material, and (c) to ensure that the hydrolysis does not proceed so far as to cause an accumulation of phosphate ions, which might interfere with the subsequent determination.

These conditions were realized by treating the phosphorofluoridate ester, dissolved in alcohol, with five times the quantity of sodium required by the equation

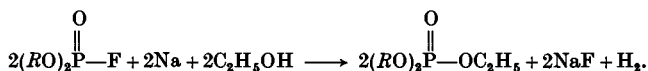

Further action of sodium ethoxide would convert the phosphate ester into a compound of the type $\text{OP}(\text{OEt})_2\text{ONa}$, but this is known not to be attacked by sodium ethoxide in anhydrous alcohol, and so the production of PO_4^{3-} is unlikely to occur to any extent.

It is not impossible that the sodium in the initial reaction may have a reducing action:

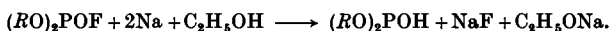

A hydrogen phosphite might therefore be produced, but here again this compound is not likely to be broken down to any extent by the sodium ethoxide. The concentration of phosphate ions will therefore presumably be small.

LEAD CHLOROFLUORIDE METHOD

The above method (of which details are given in the example below) requires at most 45 min. heating; with pure di-isopropyl phosphorofluoridate 5 min. heating was found sufficient.

After the treatment with sodium, the reaction mixture was washed with water into a beaker and brought to the correct pH for the determination of fluoride.

The lead chlorofluoride method

The estimation of fluoride as lead chlorofluoride, $PbClF$, was first described by Stark¹ and developed by Hoffman and Lundell,² Hawley,³ Fischer and Peisker⁴ and Kapfenberger.⁵ Hoffman and Lundell determined the correct pH and chloride-ion concentration for the precipitation. The time for complete precipitation and the effect of varying amounts of fluoride on the composition of the precipitate were examined by Hawley, and these factors were re-examined by us in greater detail.

The particular variable factors investigated were:

- (a) the concentration of fluoride at the time of precipitation;
- (b) the length of time during which the precipitate is heated and then allowed to remain in contact with the supernatant liquid before filtration.

Specimen determination of fluorine in di-isopropyl phosphorofluoridate

A weight of compound, containing about 0.05 g. of fluorine, was dissolved in 10 ml. of dry alcohol and metallic sodium (about 0.5 g., i.e. at least 5 equivalents) was added. After the sodium had dissolved, the mixture was gently heated under reflux for 5 min.,⁶ and then washed out with about 100 ml. of water into a beaker, made acid to bromophenol blue with dilute nitric acid and then just alkaline with 10 per cent sodium hydroxide solution. Three ml. of 10 per cent sodium chloride solution were added and the solution was diluted to 250 ml. One ml. of concentrated hydrochloric acid was added, and the solution heated on a water-bath to about 80°. Then 5.0 g. of finely powdered A.R. lead nitrate were added with stirring (still at 80°). As soon as all the lead nitrate had dissolved, 5.0 g. of crystalline sodium acetate were added, with vigorous stirring. The product was then heated on the water-bath for 15 min. and cooled in ice, and the precipitate was filtered off on a Swedish filter paper. It was washed once with water, four times with saturated $PbClF$ solution

¹ *Z. anorg. Chem.* 1911, **70**, 173.

² *Bur. Stand. J. Res., Wash.*, 1929, **3**, 581.

³ *Industr. Engng Chem.* 1926, **18**, 573.

⁴ *Z. anal. Chem.* 1933, **95**, 225.

⁵ *Aluminium*, 1942, **24**, 428; *Chem. Abstr.* 1943, no. 5333.

⁶ In general, with a phosphorofluoridate of unknown composition, 45 min. should be allowed.

APPENDICES

and finally once with water. It was then transferred to the beaker in which the precipitation had been carried out, 100 ml. of 5 per cent nitric acid were added and the paper was macerated. A measured excess of 0.1N silver nitrate solution was added, and the mixture was heated on the water-bath for 30 min. and cooled in the dark. It was then filtered through a no. 4 sintered Gooch crucible and the filtrate titrated with 0.1N potassium thiocyanate in presence of 10 ml. of a saturated ferric alum solution as indicator (the indicator solution being rendered clear by addition of nitric acid).

Weights of sample taken: 0.8459 and 0.8166 g.

Fluorine found, uncorrected: 10.43 and 10.58 per cent.

Mean: 10.5 ± 0.1 per cent.

Corrected¹ mean: 10.3 ± 0.15 per cent.

Calculated for $(C_3H_7O)_2POF$: F = 10.32 per cent.

Determination of Fluorine in Fluoroacetates

Here again the fluorine was determined ultimately by precipitation as lead chlorofluoride, but the breakdown of the organic compound is more difficult than with the phosphorofluoridates. The two² methods recommended are

(i) fusion with metallic sodium in an evacuated tube at 400° (cf. Elvin and Ligett;³

(ii) fusion in a stainless-steel bomb with sodium peroxide as recommended by Briscoe and Emelús,⁴ and described earlier by Finger and Meed.⁵

Details of both these methods as used by us are given below in specimen analyses. With regard to the bomb method, the lead washer supplied by the manufacturers was useless; the lead melted and disintegrated at the temperature of the reaction. Copper was also found to be attacked and was otherwise unsatisfactory. Gold, on the other hand, was found to be most suitable. It is soft, will withstand the required temperature without melting or disintegrating, and is not attacked by fluorine, fluoride or alkali.

Fluoroacetamide standard

For standardizing the estimation of fluorine in fluoroacetates, a compound of undisputed purity containing the CH_2F group is re-

¹ For method of determining 'correction factor' see 'Determination of fluorine in organic compounds', Chapman, Heap and Saunders, *Analyst*, 1948, 73, 869.

² The recent observation of Mirosevic-Sorgo and Saunders that fluoroacetic acid and related compounds are decomposed rapidly by boiling with 30 per cent aqueous sodium hydroxide (p. 148), provides the basis for a third method.

³ *Industr. Engng Chem. (Anal. ed.)*, 1942, 14, 452.

⁴ Reports to the Ministry of Supply, 7 June 1943.

⁵ *Trans. Ill. Acad. Sci.* 1936, 29, [ii], 89.

PURE FLUOROACETAMIDE

quired. It is important to select a stable compound that has some other element capable of independent determination. Fluoroacetamide was found to satisfy these conditions. It could be obtained pure, and ammonia determination provided a rigid cross-check.

A pure specimen was prepared as follows.¹ Methyl fluoroacetate (39 g.) was shaken with 30 ml. of ammonia solution (sp. gr. = 0.89). Heat was evolved, and on standing overnight the first crop of almost pure crystals was deposited. These were filtered off and dried (yield, 16 g.). By concentrating the filtrate *in vacuo* a second crop of crystals was obtained (yield, 5 g.). The two crops were united and could be recrystallized from chloroform (fine needles) or acetone (prisms). We used dry chloroform and each recrystallization gave about 75 per cent yield. After recrystallizing three times, the final yield of pure substance was 8.7 g., m.p. 108°. The amide can also be purified by sublimation.

The determination of nitrogen in the pure product was performed by the usual method of slow distillation with excess of dilute sodium hydroxide solution, the evolved ammonia being collected, during 4 hr. distillation, in standard acid, and determined by titration as usual, with methyl orange as indicator. The yield of ammonia corresponded to 18.19 per cent of nitrogen in this sample. Calculated for $\text{FCH}_2\text{CONH}_2$: N = 18.18 per cent. The standard fluoroacetamide was therefore 100 per cent pure.

Specimen determination of fluorine in methyl fluoroacetate by fusion with sodium

A specimen of methyl fluoroacetate, b.p. 104.5°, was analysed for fluorine as follows (cf. Elving and Ligett).² The liquid (0.25 g.) was weighed in a small closed glass ampoule which was then introduced into a thick-walled glass tube containing 0.4 g. of sodium in 5 ml. of ether. The tube was then evacuated and, after the ether had been removed, sealed off while still connected to the water pump. It was then heated to 400° for 1 hr. in a Carius oven. After cooling, the tube was opened and the contents treated with alcohol and washed out with water. After removal of the excess of alcohol by evaporation to small bulk, the liquid was diluted to about 100 ml., filtered and made up to 250 ml. The fluorine in it was then determined by the PbClF method given above.

Found: F = 20.80 per cent (uncorr.) = 20.65 per cent (corrected).

Calculated for $\text{CH}_2\text{F}\cdot\text{COOCH}_3$: F = 20.64 per cent.

¹ McCombie and Saunders, Report no. 2 on fluoroacetates to the Ministry of Supply, 17 February 1943; Buckle, Heap and Saunders, *J. Chem. Soc.* 1949, p. 912.

² Elving and Ligett, *Industr. Engng Chem.* (Anal. ed.), 1942, 14, 452.

APPENDICES

Standardization of the 'sodium peroxide bomb' method with pure fluoroacetamide

For this determination a quantity of the fluorine-containing sample containing approximately 0.06 g. of fluorine was in general used. For fluoroacetamide, therefore, the quantity weighed out was 0.24 g. This was enclosed in the bomb with about 2.5 g. of sodium peroxide and 0.05 g. of cane sugar (which may sometimes be omitted). The bomb was heated gently to start the combustion. The reaction products (after cooling) were dissolved out in about 200 ml. of hot water and boiled to destroy hydrogen peroxide. The fluorine was then determined by the PbClF method with Volhard finish, using the correction curve obtained previously. The PbClF precipitate was allowed to stand for $\frac{1}{4}$ hr. and cooled immediately in ice:

Weight of sample taken = 0.2380 g.

Volume of 0.1 N silver nitrate required = 31.20 ml.

Apparent fluorine content = 24.91 per cent.

Correction factor = 0.991.

Hence corrected fluorine content = 24.69 per cent.

Calculated for $\text{FCH}_2\text{CONH}_2$: F = 24.68 per cent.

Fluorine Determination of Radioactive D.F.P. by Thorium Nitrate¹

The yield of radioactive D.F.P. from ^{32}P is necessarily small on the semi-micro scale (p. 75); it is better therefore to titrate the fluoride (obtained after the decomposition of D.F.P.) with thorium nitrate, sodium alizarin sulphonate being used as indicator.² It is necessary, however, first of all, to remove the fluoride by distillation (p. 211). This method gives an accuracy of ± 1 per cent with 50 mg. of D.F.P. This degree of accuracy on a semi-micro scale³ may be considered fairly satisfactory.

Reagents

(i) *Thorium nitrate solution*, 13.80 g. $\text{Th}(\text{NO}_3)_4 \cdot 4\text{H}_2\text{O}$ dissolved in 500 ml. of water and made up to 1 l.

(ii) *Sodium alizarin sulphonate solution*, 0.1 g. of sodium alizarin sulphonate shaken with 200 ml. of water and filtered.

(iii) *Monochloroacetate buffer solution*, 9.45 of chloroacetic acid and 2.00 g. of sodium hydroxide dissolved in 100 ml. of water.

(iv) *Hydrochloric acid*. A 1/200 solution in a dropping-bottle.

(v) *Sodium hydroxide*. A 2 per cent solution in a dropping-bottle.

(vi) *Pyrex powder*.

¹ Based on Report to Ministry of Supply by Saunders, 21 October 1949.

² Willard and Winters, *Industr. Engng Chem.* (Anal. ed.), 1933, 5, 7.

³ For a recent determination of fluorine on a *micro-scale* (3 μg .), see Gillieson and Newcombe, *Biochem. J.* 1952, 50, xiv.

DETERMINATION BY THORIUM NITRATE

Method

The fluoride solution is diluted to 100 ml. with water, 8 drops of the indicator are added and the pink coloration just removed with 1/200 hydrochloric acid solution. Then 1 ml. of the monochloroacetate buffer solution is added and the solution is titrated with the thorium nitrate solution to a faint pink coloration. This may be seen more easily by allowing the precipitate of thorium fluoride to settle, when the pink coloration collects at the bottom of the beaker. It is essential to use either bright sunlight or mercury vapour illumination, otherwise the end-point is indistinct.

A control reaction with the indicator must be carried out using the reagents as above, but with no fluoride present. This titration must be subtracted from subsequent titrations using fluoride solutions, thus giving the 'corrected titration'.

It is found that, after the eye has become accustomed to the end-point change in the titration, an accuracy of ± 1 per cent is obtainable with 5-10 mg. F.

Standardization of thorium nitrate solution using A.R. sodium fluoride

To A.R. sodium carbonate (2 g.), contained in a platinum dish, is added hydrofluoric acid solution (10 ml. 10 per cent A.R.). This is evaporated to dryness and a further quantity of hydrofluoric acid solution (3 ml.) is added. After evaporating to dryness the dish is heated to 500° to drive off excess of hydrofluoric acid.

Standardization. A.R. sodium fluoride (25 mg.) was dissolved in water and the solution titrated with thorium nitrate.

Results

| | | |
|---|-------------|-------------|
| Wt. of sodium fluoride | 32.62 mg. | 16.04 mg. |
| Thorium nitrate titration corrected | 8.292 ml. | 4.095 ml. |
| Thorium nitrate solution, 1 ml., is equivalent to | 1.782 mg. F | 1.774 mg. F |

Average = 1.778 mg. F.

Determination of fluorine in D.F.P.

It is essential to remove all interfering elements. This is done by first decomposing the D.F.P. with sodium and alcohol, the fluoride is then distilled as H_2SiF_6 .

Method. D.F.P. (ca. 50 mg.) is weighed in an ampoule, the top of which is closed by a rubber sleeve and glass rod. The ampoule is transferred to a small flask containing alcohol (10 ml.) and then broken by forcing a tapered glass rod down the neck of the ampoule. Sodium (0.5 g.) is added and the mixture heated under reflux for $\frac{1}{2}$ hr. after the sodium has dissolved. The solution is then transferred quantitatively to a two-necked flask. A small quantity of Pyrex powder is added followed by concentrated sulphuric acid (15 ml.). The mixture is heated and steam is passed in to avoid excessive 'bumping'. The rate of heating and of passing steam are varied to keep the temperature at 135-140°. The distillation

B. TABLE OF PROPERTIES OF

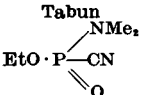
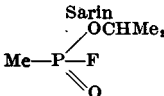
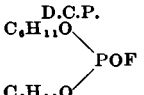
| | (1) | (2) | (3) | (4) | (5) | (6) |
|--|----------------------------|---------------|--------------------|---|----------------------------------|---|
| D.F.P. $(\text{Me}_2\text{CHO})_2\text{POF}$ | B.p. 180° 75°/17 mm. | F.p. - 80° | d_4^{20} 1.07 | Water Solubility 1.5% only very slowly hydrolysed | Odour Nil | Effect of 10% NaOH aq. F ⁻ |
| Tabun  | 240° 120°/10 mm. | - 50° | 1.08 | Miscible and quickly hydrolysed | Odour of cyanide 'almonds' | CN ⁻ |
| Sarin  | 147° 56°/16 mm. | - 57° | 1.10 | Miscible and hydrolysed | Nil | F ⁻ |
| M.F.A. | 104° | - 32° | 1.174 | Solubility 15% | Extremely faint ester | No liberation of F ⁻ . Gives FCH ₂ COONa still toxic |
| F.E.A. FCH ₂ CH ₂ OH | 104° | - 43° | 1.1095 | Miscible stable | Nil | Nil |
| D.C.P.  | 127°/0.6 mm. | | | Insoluble stable | Nil | Gives F ⁻ extremely slowly |

(1) By working through the items described in the table it should be possible to obtain some idea of the class of compound under investigation.

Columns (1), (2) and (3) give information which could be used only on the reasonably pure compounds. The determination of the boiling-point on the micro-scale using one drop of material is often useful.

(2) Ideally the effect of sodium hydroxide solution, column (6), is best observed by heating a small quantity of the substance with 10% aqueous sodium hydroxide under reflux and then carrying out tests on the product remembering that the solution is alkaline. Fluoroacetates will give F⁻ when boiled with 30 per cent sodium hydroxide solution for some time.

(3) The test in column (7) is also carried out best with the original material and hot potassium dichromate and sulphuric acid.

The test can also be carried out by the 'air-flow' method as suggested in column (11). This may be carried out as follows. Air is purified by drawing it through a tower *A* containing activated charcoal and calcium chloride (fig. 23 (a)). The clean air then passes through the sample tube *B* (about 8 × 2.5 cm.) containing the material to be tested. The sample may be used as such or placed on glass wool. *B*, which may be heated to increase the volatility of the sample under test, is connected to the bubbler *C* (fig. 23 (b)) containing the *required reagent*. Air leaves the system through the tower *D* containing charcoal.

The *required reagent* in this particular test is concentrated sulphuric acid and pure powdered potassium dichromate. After aspiration, the bubbler is heated and rotated in order to observe the non-wettability on the glass (p. 116). The test is given even by fluoroacetates, but rather more heating may be required than with easily decomposed compounds such as sarin and D.F.P.

(4) Test 8 is of significance only when carried out on the pure compound.

(5) In test 9 material is heated with ammonium molybdate and concentrated nitric acid. With *strong* heating, even the P—C link of sarin is broken, and the yellow ammonium phosphoromolybdate is produced.

TYPICAL FLUORO COMPOUNDS

| (7) | (8) | (9) | (10) | (11) | (12) | (13) |
|---|----------------|--|--|---|-------------------------|-------------------------------------|
| $\text{H}_2\text{SO}_4 + \text{K}_2\text{Cr}_2\text{O}_7$ 'Oily drops' | Na fusion F | $\text{HNO}_3 + \text{ammonium molybdate}$ Yellow ppt. on heating | Air flow into ammonium molybdate + slow | Air flow into $\text{K}_2\text{Cr}_2\text{O}_7 + \text{K}_2\text{SO}_4$ + slow | N.G. test + | Pharmacology Parasympathomimetic |
| Nil | N | Yellow ppt. on heating | + | - | + but HCN interferes | Parasympathomimetic |
| 'Oily drops' | F | Yellow ppt. on very strong heating | - | + | + | Parasympathomimetic |
| 'Oily drops' | F | Nil | - | + | - | Blocks tri-carboxylic acid cycle |
| 'Oily drops' | F | Nil | - | + | - | Blocks tri-carboxylic acid cycle |
| 'Oily drops' | F | Yellow ppt. on strong heating | - | - | + | Parasympathomimetic |

(6) Column (10) indicates that volatile material is aspirated into the bubbler *C* containing a 10 per cent aqueous solution of ammonium molybdate mixed with an equal volume of benzidine solution (made by dissolving 0.05 g. of benzidine in 10 ml. of glacial acetic acid and making up to 100 ml. with water). D.F.P. and tabun are hydrolysed to phosphate and a typical green or green-blue coloration is produced.¹

Sarin, which is hydrolysed only to methylphosphonic acid, will not give this colour. If, however, the sarin is first volatilized into ammonium persulphate, and then heated, rupture of the C—P bond takes place at an appreciable rate, and a positive reaction is then usually given.

(7) Column (11) refers to the 'non-wettability test' using the air-flow technique.

(8) Column (12) refers to the standard nerve gas or N.G. test obtainable with the vapour detector kit supplied by the Home Office.

Using the pump provided in the kit the contaminated air is drawn through a test-paper moistened with a suspension or solution of two 'substances' *A*, and *Z*. The nature of these substances has not yet been disclosed to the general public. It may be noted, however, that as little as 0.1 μg . of nerve gas will give a pink-brown coloration. Unfortunately, many other substances, particularly oxidizing agents such as chlorine or bromine vapour, will give the reaction. Hydrogen cyanide inhibits the reaction.

(9) Tabun may be detected by the air-flow method, by aspirating into ferrous sulphate solution to which a few drops of 10 per cent sodium hydroxide has been added. The mixture is then boiled and acidified with dilute sulphuric acid and filtered to observe the blue 'specks' of prussian blue on the filter paper.

Other sensitive tests for cyanide may be used, e.g. the pink colour produced with a mixture of chloramine-T, barbituric acid solution and γ -benzyl pyridine in acetone.

¹ For a suggested theory to explain this colour change in the presence of benzidine, see (Fenton's *Notes on Qualitative Analysis*, B. C. Saunders (Cambridge University Press, 1953).

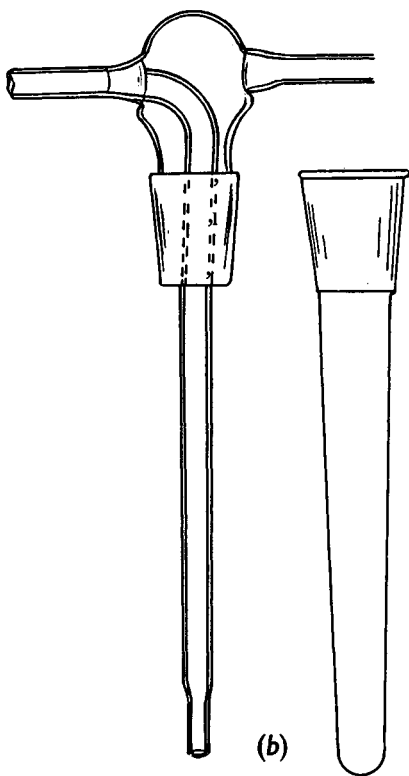
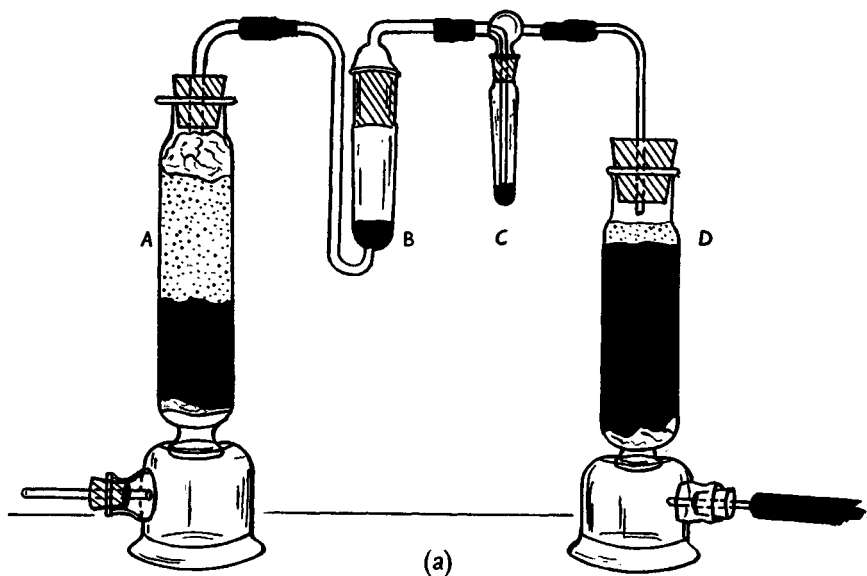

Fig. 23. (a) Air-flow apparatus; (b) air-flow bubbler.

DETERMINATION BY THORIUM NITRATE

is continued for 2 hr., or until 250 ml. of distillate have collected, whichever is the shorter. The distillate is then titrated with standard thorium nitrate solution, and since some sulphuric acid may have been swept over during the distillation, a few drops of 2 per cent sodium hydroxide solution are added after the addition of the indicator until the latter turns pink. Hydrochloric acid is then added so that the pink colour is just discharged. The method is then identical with that given previously (p. 211).

Results with a sample of radioactive D.F.P. The radioactive D.F.P. used had been prepared from 1 g. of radioactive phosphorus and once distilled (p. 75).

| | 1 | 2 |
|--|-----------|-----------|
| Weight of D.F.P. | 53.13 mg. | 55.74 mg. |
| Thorium nitrate titration corrected | 3.058 ml. | 3.157 ml. |
| Thorium nitrate solution, 1 ml. \equiv mg. D.F.P. sample | 17.4 mg. | 17.7 mg. |

Average = 17.55 mg.

1 ml. thorium nitrate solution = 17.25 mg. pure D.F.P.

∴ Purity of sample of radioactive D.F.P. = 98.5 per cent.

C. FIRST-AID TREATMENT FOR NERVE-GAS POISONING

The symptoms produced by D.F.P., etc., have been described in detail. However it is convenient to give a concise summary of the main effects here.

(a) Muscarine-like action causing bronchospasm: atropine and ephedrine are antagonists. Other parasympathetic effects include constriction of the pupil and of the ciliary muscles of the eye: both effects are antagonized by atropine.

(b) Nicotine-like action causing paralysis of respiratory muscles.

(c) Central effects: these are antagonized to some extent by atropine.

The suggested treatment is therefore as follows:

Serious symptoms can often be relieved by injection of atropine (2 mg.) repeated at intervals, and by artificial respiration preferably by the Nielson 'arm-lift back-pressure' method.

Mild symptoms are relieved by 0.5 per cent atropine ointment in the eye, aspirin as a mild analgesic for pains in the ciliary muscles and headache, ephedrine to deal with bronchospasm.

Liquid nerve gas on the skin should be washed off immediately with a large volume of water. The skin should not be wiped.

N.B. Fluoroacetate poisoning. Nothing satisfactory has so far been officially recommended, but note may be taken of the use of glyceryl monoacetate.

GENERAL BIBLIOGRAPHY

CHAPTER I

- SARTORI, M. G. (1951). New developments in the chemistry of war gases. *Chem. Rev.* **48**, 225.
- SAUNDERS, B. C. (1947). Toxic fluorophosphonates and related compounds. *Chem. & Ind. (Rev.)*, p. 117.
- SAUNDERS, B. C. (1947). *Toxic Organic Compounds containing Fluorine*. Lecture to XIth International Congress of Pure and Applied Chemistry.
- SAUNDERS, B. C. (1952). Some aspects of the organic chemistry of fluorine and phosphorus. *Sch. Sci. Rev.* p. 320.
- SAUNDERS, B. C. (1953). *Chemistry and Toxicology of Organic Fluorine and Phosphorus Compounds*. Lecture given to the Royal Institute of Chemistry, no. 1.

CHAPTER II

- Nomenclature of Compounds containing one Phosphorus Atom*. September 1952. London: The Chemical Society.

CHAPTER III

- DALE, Sir HENRY (1953). A chemical phase in the transmission of nervous effects. *Endeavour*, **47**, 117.
- GADDUM, J. H. (1953). *Pharmacology*. Oxford Medical Publications.
- RANSON, S. W. and CLARK, S. L. (1953). *Anatomy of the Nervous System*. W. B. Saunders Co.
- WILSON, A. and SCHILD, H. O. (1952). *Applied Pharmacology*. J. and A. Churchill Ltd.

CHAPTER VI

- ATHERTON, F. R. (1949). Some aspects of the organic chemistry of derivatives of phosphorus oxyacids. *Quart. Rev. Chem. Soc.* **111**, 146.
- FRIEND, NEWTON (ed.) (1929). *Text-book of Inorganic Chemistry*. Vol. 6, part II, Phosphorus. Vol. 11, part III, Derivatives of phosphorus. C. Griffin and Co.
- KOSOLAPOFF, G. M. (1950). *Organo Phosphorus Compounds*. Wiley and Sons.
- MANN, F. G. (1950). *Heterocyclic Derivatives of Phosphorus*. Interscience Publishers Inc.
- SIDGWICK, N. V. (1950). *Chemical Elements and their Compounds*, 1, 725, Phosphorus. Oxford: Clarendon Press.
- TODD, Sir A. R. (1956). Phosphates in vital processes. *Chem. & Ind. (Rev.)*, p. 802.

BIBLIOGRAPHY

CHAPTERS VII AND VIII

- CHENOWETH, M. B. (1949). Review of *Monofluoroacetic Acid and Related Compounds*, in *Pharmacol.* **97**, 383.
- GILMAN, H. (1944). *Organic Chemistry*. Vol. 1, Aliphatic Fluorides, by A. L. Henne. John Wiley and Sons.
- HASZELDINE, R. N. (1955). Perfluoroalkyl compounds. *Ann. Rep. Chem. Soc.* p. 279.
- HASZELDINE, R. N. and SHARPE, A. G. (1951). *Fluorine and its Compounds*. Methuen and Co.
- MUSGRAVE, W. K. R. (1954). Reactions of organic fluorine compounds. *Quart. Rev. Chem. Soc.* **8**, 331.
- PETERS, Sir R. A. (1954). Biochemical light upon an ancient poison: a lethal synthesis. *Endeavour*, **51**, 115.
- SIDGWICK, N. V. (1950). *Chemical Elements and their Compounds*. Vol. 2, p. 1097, Fluorine. Oxford: Clarendon Press.
- SIMMONDS, J. H. (1950, 1954). *Fluorine Chemistry*. Vols. 1 and 2. Academic Press.

CHAPTER IX

- FINGER, G. C., REED, F. H. and TEHON, L. R. (1955). *Aromatic Fluorine Compounds as Fungicides*. Illinois State Geological Survey.

CHAPTER X

- FELD, E. A., GRUNDFEST, H., NACHMANSOHN, D. and ROTHENBERG, M. A. (1948). Effect of D.F.P. on action potential and cholinesterase of nerve. IV. *J. Neurophysiol.* **11**, 125.
- MARTIN, HUBERT (1949). Review of *Organo-phosphorus Insecticides*, in *Mfg Chem.* **20**, 158.
- METCALF, R. L. (1955). *Organic Insecticides*. Interscience Publishers Inc.
- RIPPER, W. E. (1952). *Systemic Insecticides*. Lecture to IIIrd International Congress of Crop Protection. Paris.
- SCHRADER, G. (1947). *Development of New Insecticides*. Final Report. British Intelligence Objectives Sub-Committee. H.M. Stationery Office.
- SCHRADER, G. (1952). *Die Entwicklung neuer Insektizide auf Grundlage organischer Fluor- und Phosphor-Verbindungen*. G.M.B.H. Weinheim: Verlag Chemie.

APPENDICES

- ALLEN, R. J. L. (1940). Micro-determination of phosphorus. (Colorimetric estimation: molybdate blue.) *Biochem. J.* **34**, 858.
- BELLAMY, L. J. (1954). *Infra-red Spectra of Complex Molecules*. Methuen and Co.

BIBLIOGRAPHY

- BELLAMY, L. J. and BEECHER, L. (1952). Infra-red data. *J. Chem. Soc.* pp. 475, 1701.
- BELLAMY, L. J. and BEECHER, L. (1953). Infra-red data. *J. Chem. Soc.* p. 728.
- BERGMANN, F. and SÉGAL, R. (1956). The separation and determination of microquantities of lower aliphatic acids, including fluoroacetic acid. *Biochem. J.* **62**, 542.
- CHAPMAN, N. B., HEAP, R. and SAUNDERS, B. C. (1948). Determination of fluorine in organic compounds. *Analyst*, **73**, 434.
- DUPÉE, L. F., HEATH, D. F. and OTTER, I. K. H. (1956). Determining traces of tetramethylphosphorodiamidic fluoride (dimefox) in crops. *Agric. and Food Chem.* **4**, 233.
- GODFREY, P. R. and SHREWSBURY, C. L. (1945). Determination of fluorine in minerals and bones. *J. Ass. Off. Agric. Chem.* **28**, 335.
- HEATH, D. F., CLEUGH, J., OTTER, I. K. H. and PARK, P. O. (1956). Determining traces of octamethylpyrophosphoramidate (O.M.P.A., shradan) in crops. *Agric. and Food Chem.* **4**, 230.
- HOLMSTEAD, B. and LARSON, L. (1951). Infra-red spectra of some organic phosphoryl compounds. *Acta Chem. Scand.* **5**, 1179.
- LAMAR, W. (1945). Determination of F^- in water. A modified zirconium-alizarin method. *Industr. Engng Chem. (Anal. ed.)*, **17**, 148.
- Medical Manual of Chemical Warfare 1955*. London: Her Majesty's Stationery Office.
- MEYRICK, C. J. and THOMSON, H. W. (1950). Infra-red data. *J. Chem. Soc.* p. 225.
- SIMMONS, W. R. and ROBERTSON, J. H. (1950). Spectrophotometric determination of phosphorus in organic phosphates. *Analyt. Chem.* **22**, 1177.
- SIMONS, J. H. (1954). *Fluorine Chemistry*. Vol. 2. *Analytical Chemistry of Fluorine*. Academic Press.
- WALKER, P. J. and GAINER, G. C. (1945). Determination of fluorides in water by means of a photoelectric colorimeter. *Canad. J. Res.* **23B**, 275.
- WILLARD, H. H. and WINTER, O. B. (1953). Volumetric method for determination of fluorine using thorium nitrate. *Industr. Engng Chem. (Anal. ed.)*, **5**, 7.

INDEX

- Accommodation of eye, 38
 effect of D.F.P. on, 2, 43
- acetoacetic methyl ester, difluoro-, 116
- acetylcholine, 32, 35, 36, 37, 59
 in insects, 183
- acetylcholine-cholinesterase complex, 35
- acetyl- β -methylcholine, 66, 185
- acetyl fluoride, 117, 135, 136
- acetylphosphoric esters, preparation, 96
- acids, fluoro, 121
 ω -fluoro, 149
 phenoxycarboxylic, 164
 phenylphosphoramidic, 107
 of phosphorus, nomenclature, 21-7
- aconitase, 142
 toxicity of fluorocitrate towards, 143
- action potential, 29, 197
- acylphosphoric acids, 108
- adrenaline, 32, 35
- adrenal medulla, 32
- adrenergic nerve fibres, 32, 35
- air-flow, 213
 apparatus, 214
- alimentary canal, 33
- alkylation, by means of phosphorus-
 containing esters, 100
- alkyl fluoroformates, 136
- alkylphosphonates, 95
- alkylphosphonic acids, 108
- alkyl phosphoramidofluoridates
 preparation, 90
 toxicity of, 91
- apparatus
 for preparation of D.F.P. contain-
 ing ^{32}P , 76
 for preparation of POCl_2F , 51, 54
- amine oxide. cause of enhanced
 activity, in O.M.P.A., 174
- 2-amino-5-*p*-fluoroanilino benzoquin-
 one di-*p*-fluoroanil, 148
- ammonium molybdate, test with
 nerve gases, 93, 213
- analysis
 of fluoroacetate, 208
 of phosphorofluoridates, 206
- anhydride
 structure and anticholinesterase
 activity, 188
 structure and toxicity, 81
- anhydrides, containing phosphorus,
 100
- anionic site of cholinesterase, 60
- antagonism
 of atropine and D.F.P., 39
 of ω -fluorocarboxylic acids, 165
- anticholinesterase, 5, 59, 92
 activity and myasthenia gravis,
 197
 activity and structure, 187, 188
 activity, theoretical considerations,
 188-93
 containing quaternary N groups,
 194
- Aphis fabae*, 112, 175, 183
- Arbusov reaction, 95, 96
- artane, 41
- atropine, 5, 40, 69, 71, 72
 accommodates lens for distant
 objects, 39
 as blocking agent in parasympa-
 thetic system, 36
 injection of, for nerve-gas poisoning
 215
- autonomic inhibitor drugs, 40
- autonomic nervous system, 31, 32, 33
 plan of, 34
- Bees, action of insecticides on, 176
- benzoylcholine, as substrate of
 pseudo-cholinesterase, 66, 199
- benzoylphosphonic esters, prepara-
 tion, 96
- bis-[chloromethyl]-sulphoxide, pre-
 paration, 83
- bis-dibenzylphosphoryl oxalate, pre-
 paration, 104
- bistriethyl-lead phosphorofluoridate,
 84
- blocking agents in nerve action, 36
- bomb, stainless steel, for fluoridic
 analysis, 208
- 1-bromo-2-fluoroethane, 9, 16, 17,
 132, 147

INDEX

- 9-bromononancarboxylic acid, preparation and conversion into fluoro compound, 156
- 5-bromopentane carboxylic acid, 155, 158
ethyl ester, 150
2-fluoroethyl ester, 150
- bronchioles, 33, 69, 71
- butyrylcholine, 59
- C—F link, 12
relative firmness of, 96, 123, 132
rupture of, 115, 146, 212; by enzymes, 148
- C—P link
methods of producing, 96, 97, 109
rupture of, in sarin, 93, 213
- 3-carbethoxy-*N*-2-fluoroethylpyridinium bromide, preparation and toxicity, 132
- carbodi-imide, use of, in preparing pyrophosphates, 105
- cell growth, inhibition by D.F.P., etc., 200
- Chapman-Saunders, synthesis of phosphorofluoridates, 7, 55
- chloroacetyl fluoride, 11, 117, 135, 136
- N*-2-chloroethylfluoroacetamide, 126
- 2-chloroethyl fluorothiolacetate, 129
- 1-chloro-2-fluoroethane, 122, 134, 136
- chloropicrin, 3
- N*-chlorosuccinimide, use in preparing phosphorochloridates, 57, 58
- choline
benzilic ester of, 41
esters of, 66
- cholinergic nerve fibres, 32, 35
- cholinesterase, 4, 36, 59, 66
cresyl phosphate as inhibitor of, 67
detailed discussion, 186 *et seq.*
in insects, 185
in retina, 200
inhibitor in clover, 193
protection by D.O.P.A., 198
pseudo-, 59, 186, 199
red blood cell, 70
reversibility of activity of, 64
serum, 68, 70, 74
true, 59, 186
- α -cholinesterase, 59
 β -cholinesterase, 59
- chromosome breakage by phosphate radiosensitizers, 202
- chymotrypsin, 186
active centre in, 193
- ciliary muscle, 38, 72
spasm of, 73
- citrate
accumulation of, in fluoroacetate poisoning, 140–41, 142
in mammalian reticulocytes, 144
- isocitric acid, in tricarboxylic acid cycle, 142
- clinical applications, 18, 40, 73, 195, 196
- convulsions
caused by fluoroacetate, 10, 136, 137
caused by fluorocitrate, 143
- cresyl phosphate, as inhibitor of cholinesterase, 67
- curare, 35–7
- cyanide, tests for, in tabun, 213
- cyanoethylation, 14, 160
- cyanogen chloride, 3, 92
- cyanogen iodide, use in producing P—CN link, 91, 97
- cyanogenetic compounds, in clover, 194
- D.D.T.-resistant flies, 185
- D.F.P., *see* di-*isopropyl* phosphorofluoridate
- D.F.P.-ase, *see* dialkylfluorophosphatase
- D.O.P.A., *see* 3:4-dihydroxyphenylalanine
- dealkylation
of organo-phosphorus compounds, 45, 108, 109
of poisoned enzyme, 188
- debenzylation of phosphate esters, 107
- decamethyltriphosphoramidate, 111
- dehydrogenase, action on fluoroethanol, 139
- demyelination
by D.F.P., 199–200
by isopestox, 199–200
- dephosphorylation, 192
- dermatitis, 85
- determination of fluorine in organic compounds, 205–11
- detoxication
of D.F.P., 74
of insecticides, 176

INDEX

- dialkylfluorophosphatase, 74
- diamino fluorophosphine oxides, *see*
phosphorodiamidic fluorides
- diazomethyl-2:2'-fluoroethoxyethyl
ketone, 160
- diazomethyl-2:3'-fluoropropoxyethyl
ketone, 162
- dibenamine, 41
- dibenzyl *p*-dimethylaminophenyl-
phosphoramidate
dermatitis from, 85
preparation, 85
- dibenzyl phenylphosphoramidate, 85
- di-*sec*-.butyl fluoromethylphosphon-
ate, 83
- di-*tert*-.butyl phenylphosphoramidate
use in phosphorylation, 107
- Dichapetalum cymosum*, *see* gifblaar
- di-*isopropyl* phosphorofluoridate
(D.F.P.)
action on enzymes, 4
action of D.F.P.-ase on, 75
anticholinesterase activity of, 5, 62
and cell growth, 200
compound with chymotrypsin,
193
and demyelination, 200
determination of fluorine in, 207
effect in central nervous system
71
and glaucoma, 195
and myasthenia gravis, 197
and paralytic ileus, 196
and permeability of nerve fibre,
200
general properties, 46
hydrolysis by alkali, 48; by
hydroxamic acid, 192; by water,
49
mechanism of anticholinesterase
activity of, 190
mixtures of with mustard gas, 49
muscarine-like effect, 71
nicotine-like action, 13
preparation from phosphorochlor-
idate, 6, 46; from phosphorus
oxychloride, 55; using *N*-chloro-
succinimide, 57, 58
production on a technical scale, 6,
46
radioactive, 2, 75; determination
of fluorine in, 210; reaction with
esterases, 78
recovery from by poisoning by,
191
summary of properties of, 210
synthesis of, 6, 7, 46, 55, 57, 58
toxic action on animals, 2, 68, 72;
on man, 2, 69
D. toxicarium, 145
D. venecatum, 146
S-dichloroacetone, preparation, 83
NN-di-[2-chloroethyl]fluoroacet-
amide, 127
- Diels-Alder reaction, applied to
methyl fluorocrotonate, 159
- dienecephalon
entry of nerve gas into, 53
- diethyl benzylphosphonate, 96
- diethyl 3-bromopropylphosphonate,
97
- diethyl 2-chloroethyl phosphate,
83
- OO'*-diethyl-*S*- β -diethylaminoethyl
phosphorothiolate, 180
- diethyl *p*-dimethylaminophenyl-
phosphoramidate, 84
- OO'*-diethyl-*S*-ethylmercaptoethyl
phosphorothiolate, 179
- OS*-diethyl *O'*-ethylmercaptoethyl
phosphorothiolate, 179
- OO'*-diethyl *O''*-ethylmercaptoethyl
phosphorothionate, 179
- OO'*-diethyl *S*-[ethylthiomethyl]-
phosphorodithiolate, 181
- diethyl 2-fluoroethyl phosphate, 84
- diethyl 2-fluoroethylphosphonate, 9,
96
- diethyl hydrogen phosphite
preparation, 6, 44
reaction with chlorine, 45
sodium derivative, use in synthesis,
96
as tautomeric diethyl phosphonate,
45
- diethyl *N*-methylphosphoramidate,
82
- diethyl β -naphthylphosphoramidate
preparation, 86
- diethyl *p*-nitrophenyl phosphate, *see*
paroxan
- OO'*-diethyl *O''*-*p*-nitrophenyl phos-
phorothionate, *see* parathion
- diethyl *N*-phenylphosphoramidate,
45
- diethyl phosphoramidate, 82

INDEX

- diethyl phosphoramidate, preparation, 86
- diethyl phosphorochloridate preparation, 45
uses of, 82, 84, 100, 177, 179, 180, 181
- diethyl phosphorochloridite, 86
- diethyl phosphorocyanidate, 9, 97
hydrolysis of, 92
- diethyl phosphorofluoridite, 9, 85
- diethyl phosphorofluoridodithiolate, 7, 54, 82
- diethyl phosphoromorpholidate, 83
- diethyl phosphorothiocyanidate, 82
- diethyl vinylphosphonate, preparation, 97
- 2:2'-difluorodiethyl ethylene dithioglycol, 130
- 2-2'-difluorodiethyl sulphate, 124
- 1:8-difluoro-3:6-dithiaoctane, 130
- di-2-fluoroethyl phosphorofluoridate, *see under* phosphorofluoridate
- di-(2-fluoroethyl)sulphate, 134
- 2-2'-difluoroethylene dithioglycol, *see* 'sesqui-fluoro-H'
- difluorohydrocarbons, 169
- N,N*-di-(2-hydroxyethyl)fluoroacetamide, 127
- 3:4-dihydroxyphenylalanine (D.O.P.A.), protection of cholinesterases by, 198
- dimethylaminosulphonyl fluoride, 90
- OO'*-dimethyl-2-carbomethoxy-1-methylvinyl phosphate, 181
- dimethyl methylphosphonate, preparation, 93
- N*-dimethylphosphoramidocyanidate, preparation, 91
properties, 92
- diphenylphosphorodiamidic chloride, 90
- di-*isopropyl* fluorophosphonate, *see* di-*isopropyl* phosphorofluoridate
- di-*isopropyl* hydrogen phosphite, 46
action of chlorine on, 46
action of *N*-chlorosuccinimide on, 57
as part of 'one-stage' preparation of D.F.P., 47
containing ³²P, 75
- di-*isopropyl N*-phenylphosphoramidate, 47
- di-*isopropyl* phosphorochloridate, 6, 46, 47
containing ³²P, 75
non-toxic nature of, 185
preparation of, using *N*-chlorosuccinimide, 57
- divinyl sulphone, preparation, 97
- dodecamethylphosphoramidate, 112
- E-600, 177; *and see* paroxan
- E-605, 178; *and see* parathion enzyme
see under particular enzyme
- rupture of C—F link by, 148
- synthesis of lethal substance by, 144, 148, 174, 181
- ephedrine, relief of bronchospasm, 215
- ergotoxin, paralysis of sympathetic system by, 38
- eserine (physostigmine), 5, 61, 62, 68
in cases of glaucoma unrelieved by, 73
- esterase, 186
insect, 183
liver, 186
milk, 186
reaction of, with radioactive D.F.P., 78
- esteratic site of cholinesterase, 60
- ethyl 2:2-dimethyl-3-fluorobutyrate, 14
- ethyl dimethylphosphoramidofluoridate, 91
- ethylene oxide
reaction with fluoroethanol, 161
use in synthesizing esters containing phosphorus, 98, 102
- ethyl fluoroacetamidoacetate, 131
- ethyl γ -fluoro- $\beta\beta$ -dimethylbutyrate, 157, 158
see also ethyl 2:2-dimethyl-3-fluorobutyrate
- ethyl 2-fluoroethoxyacetate, 161, 163
- ethyl γ -2-fluoroethoxybutyrate, 160, 162
- ethyl 2-fluoroethoxypropionate, 147
- ethyl 2-fluoroethyl carbonate, 161, 162
- ethyl fluoroformate, 11, 117, 135
- ethyl 5-fluoropentancarboxylate, 149
- ethyl γ -3-fluoropropoxybutyrate, 162, 163

INDEX

- ethyl phenylphosphoramidofluoride, 90
- ethylphosphonic dichloride, 109, 110
- ethylphosphonous dichloride, 110
- ethyl phosphoramidofluoride, 9
- ethyl phosphorodichloridate, 44, 84
- ethyl phosphorodifluoridate, 4, 84
- ethyl phosphorofluoridochloridate, 90
- eye
 anatomy of, 37
 effect of D.F.P. on, 2, 43, 72
see also pupil
- Fibrillation, ventricular caused by fluoroacetates, 137
- fire-resisters, phosphate esters as, 102
- first-aid treatment for nerve-gas poisoning, 215
- fluorine
 atom, removal from fluoroacetates, 12, 17, 115, 147, 148, 160
 atom and toxicity, 134, 135, 188-93
 determination of, in fluoroacetates, 208; in organic compounds, 205-15; in phosphorofluoridates, 206, 211; using lead chlorofluoride, 207; using thorium nitrate, 210
 enzymic removal of atom, 148
 test for, in compounds, 115, 212
- fluorine-containing ammonium salts, 17, 131, 135
- fluoro compounds, table of properties, 212
- fluoroacetaldehyde, 124, 134, 136
- fluoroacetamide, 11, 125, 134, 136
 standard for analysis, 208, 209, 210
- fluoroacetamidine hydrochloride, 135, 136
- fluoroacetate
 allyl, 129
 barium, 121
 2-chloroethyl, 129, 136
 cholesteryl, 119
 ethyl, 10, 116, 129
 2-fluoroethyl, *see under* 2-fluoroethyl fluoroacetate
 methyl, *see under* methyl fluoroacetate
p-nitrobenzyl, 121
 phenyl, 116
 poisoning by, cause of, 140; relief of, 215
 potassium, naturally recurring, 145
- isopropyl, 10, 116
n-propyl, 10, 116
 sodium, *see under* sodium fluoroacetate
 triethyl-lead, 16, 118, 135, 136
- fluoroacetates
 detailed toxic action of, 136-8
 determination of fluorine in, 208
 esters, 116
 general, 10, 114
 latent period of, 138
 physiological action and chemical constitution of, 133-6
- fluoroacetic acid, 121, 126, 133, 134, 136
 esters of 1-alkylated, 136
 fluoroacetic anhydride, 118
 fluoroacetimino ethyl ether hydrochloride, 127, 135
 fluoroacetimino 2-fluoroethyl ether hydrochloride, 127
- fluoroacetyl chloride
 preparation, 117
 toxicity, 11, 117, 136
 use, 13, 117
- fluoroacetyl fluoride, 11, 117, 136
N-fluoroacetyl-*N'*-fluoromethylurea, 127
- ω -fluoro alcohol, 15, 163
- fluoro-aspirin, 15, 119, 135
- p*-fluorobenzyl chloride, 159
- fluorobromethane, *see* bromofluoroethane
- γ -fluorobutyrate, 137
 methyl, 143, 151, 154
 sodium, 165
- γ -fluorobutyric acid, 150
- fluorocarbons, 19, 166
- ω -fluorocarboxylic acids, 13, 14, 149, 151-9
 antagonism of, 165
 containing oxygen, 160-1
- fluoro-chlorocarbons, 169
- fluorocitrate, 12, 142, 143, 166
 and fat metabolism, 144
 synthetic ethyl, 144
- γ -fluorocrotonate, 137
 methyl, 154
 preparation of methyl, 158
 use in synthesis of, 159
- 2-fluoro-2'-cyanodiethyl ether, 15
- 10-fluorodecane carboxylic acid
 ethyl ester, 151, 156

INDEX

- fluoroethane betaine hydrochloride, 18
 fluoroethanethiol, 130
 fluoroethanol, 11, 12
 action on isolated heart, 138
 cyanoethylation of, 15, 160
 detailed action in tissues, 139
 preparation of, 12, 122
 reaction with ethyl chloroformate, 161
 reaction with ethylene oxide, 161
 summary of properties of, 212
 toxicity of, 122, 133, 134, 136
 fluoroethers, 14, 15, 161
 2:2'-fluoroethoxyethanol, 161
 2:2'-fluoroethoxyethyl cyanide, 160
 β -2-fluoroethoxypropionic acid, 160, 162
 ethyl ester, 160
 3:2'fluoroethoxypropylamine, 161, 163
 2-fluoroethyl acetate, 129
 2-fluoroethyl aminoacetate hydrochloride, 131
 2-fluoroethyl betaine hydrochloride, 131
 2-fluoroethyl chloroacetate, 129
 2-fluoroethyl chlorosulphonate, 124, 134
 2-fluoroethyl ethers, 136
 2-fluoroethyl fluoroacetate, 12, 128, 129, 135, 136
 high toxicity of, 129
 preparation of, 129
 2-fluoroethyl glycine hydrochloride, 18, 134
 2-fluoroethyl pyridinium bromide, 17, 132
 2-fluoroethylsulphonyl chloride, 123, 135
 2-fluoroethyl thiocyanate, 123
 2-fluoroethyl trimethyl ammonium bromide, 17
 2-fluoroethyl xanthate, 124
 7-fluoroheptanecarboxylic acid esters, 156
 ethyl ester, 150, 151
 2-fluoroethyl ester, 150, 151
 ϵ -fluorohexanoate (5-fluoropentane carboxylate) sodium, 165
 ω -fluoromercaptans, 164
 fluoromethyl cyanide, 125
 additive reactions of, 128, 136
 ω -fluoronitro compounds, 164
 9-fluorononanecarboxylic acid ethyl ester, 151, 152, 156
 2-fluoroethyl, 151, 153, 156
 5-fluoropentane carboxylic acid, 14
 ethyl ester, 149, 150, 155
 2-fluoroethyl ester, 149, 150, 154, 155
 p -fluorophenylacetic acid, 14, 158, 159
 fluorophosphonic acid, old nomenclature, 22
 3-fluoropropanol, 161, 162
 β -3-fluoropropionic acid, 13, 149, 150, 152
 ethyl ester, 151
 2-3'-fluoropropoxyethyl cyanide, 162
 β -3-fluoropropoxypropionic acid, 162
 β -3-fluoropropoxypropionyl chloride, 162
 fluoropyruvate, 11, 144
 2-fluorotetraethylammonium bromide, 132
 11-fluoroundecanecarboxylic acid ethyl ester, 151, 156
 δ -fluorovaleric acid ethyl ester, 150, 151, 155
 fly control, by organo-phosphorus compounds, 184
 fruit and insecticides, 176
 fumaric acid, in tricarboxylic acid cycle, 141

 Giffblaar, 19, 145, Plate I
 glaucoma, 18, 40, 73, 195
 glyceryl monoacetate, as protecting agent against fluoroacetate poisoning, 139, 166
 glyceryl monobutyrate, as protecting agent, 166
 glycol bis-fluoroacetate, 119
 Goldwhite-Saunders
 alternative synthesis of phosphorofluoridates, 56
 synthesis of phosphorobromidates, 108
 Grignard reagents, action on fluoro compounds, 146, 147, 148
 growth-regulating compounds, alternation of toxication, 164

 Hanane, 176, 177
 see also tetramethylphosphorodiamidic fluoride

INDEX

- heart
 action of D.F.P. on, 71
 action of fluoroacetates on, 136-9
 parasympathetic innervation of, 33
 sympathetic innervation of, 33
- hexaethyl tetraphosphate, 182
- histidine unit in chymotrypsin, attack of D.F.P. on, 193
- homatropine, 40, 69
- hydrogen bond, suggestion in formation of enzyme complex, 188-90, 192
- hydrogen cyanide, 3
- hydrolysis
 of D.F.P., 47; of alkali, 48; of enzymes, 74; increased by heavy metals, 75
 of di-cyclohexyl phosphorofluoridate, 52
 of fluoroacetic acid, 12, 115, 212
 of fluoroethanol, 12
 of nerve gases, 192
 of sarin, 93
 of tabun, 92
- hydroxamic acid, hydrolysis of nerve gases by, 192
- N*-2-hydroxyethylfluoroacetamide, 126
- 2:2'-hydroxy-2'-*fluoroethoxydiethyl ether*, 161, 163
- hydroxylamine
 use against D.F.P. poisoning, 191
- hyperactivity, 16, 53
- hypothalamus
 action of sodium fluoroacetate on, 138
 centre of integration, 33
- Inhibition of cholinesterase, *see* anti-cholinesterase
- insecticides, 18
 contact, 171
 endolytic, 170
 endometotoxic, 170
 'forbidden' period of, 176
 general discussion of, 170-1
 requirements for, 171
 systemic, 19, 111, 112, 170-1
 translocation of, 176
see also decamethyltriphosphoramide, *OO'*-diethyl-*S*- β -diethylaminoethyl phosphorothiolate, *OO'*-dimethyl-2-carbomethoxy-1-methylvinyl phosphate, dodecamethylphosphoramidate, hanane, isopestox, octamethylpyrophosphoramidate, parathion, paroxan, sodium fluoroacetate, systox, tetramethyl pyrophosphate, and thimet
- insects, action of organo-phosphorus compounds, 183
- intraocular pressure, 39
 reduction of, by D.F.P., 40, 73
see also glaucoma
- iodine cyanide, use in producing —P—CN link, 91, 97
- δ -iodovaleric acid, 155
- iris of eye, 39, 73
- isopestox, 200
- Juncton, neuromuscular, 30, 32, 35, 37
- Keten, use in synthesizing organo-phosphoric anhydrides, 100
- kidney
 dehydrogenase in, 139
 isolation of fluorocitrate from, 142
 kinetics of hydrolysis of D.F.P., 49
 Knoop's β -oxidation rule, 151-2
 Krebs's cycle, *see* tricarboxylic acid cycle
- L.C. 50
 definition, 2
- L.D. 50
 definition, 3
- lachesine, 41
- ladybirds, action of insecticides on, 176
- lead chlorofluoride, determination of fluorine using, 205-11
- lead compounds, 16, 84, 118
- lens of eye, 38
 action of drugs on, 39
- linear polyphosphorus compounds, 112
- lithium chloride, use in debenzylolation 107
- M.F.A., *see* methyl fluoroacetate
- manic depressive psychosis, action of D.F.P. on, 73
- metaphosphoric acid
 esters of, 103

INDEX

- methyl 1:3-difluoroacetate, 116
 methylene bisfluoroacetate, 118
N-methylfluoroacetamide, 126
 methyl fluoroacetate (M.F.A.)
 action of Grignard reagent on, 147
 action on isolated frog heart, 138
 determination of fluorine in, 208
 preparation, 10, 114, 119
 summary of properties of, 212
 toxicity, 10, 115, 128, 133
 methyl α -fluoroisobutyrate, 11, 116
 methyl 2-fluoromethyl-4:5-dimethyl-
 hexahydrobenzoate, 14, 158, 159
 methyl 2-fluoromethyl-4:5-dimethyl-
 Δ^4 -tetrahydrobenzoate, 157, 159
 methyl 2-fluoromethyl-3:6-*endo*-
 methylene hexahydrobenzoate,
 158, 159
 methyl 2-fluoromethyl-3:6-*endo*-
 methylene- Δ^4 -tetrahydrobenzo-
 ate, 158, 159
 methyl α -fluoropropionate, 11, 116
 mitochondria, 142
 mitosis, action of phosphate radio-
 sensitizers on, 202
 muscarine, 35, 71
 muscarine-like action, 215
 muscle
 circular, of iris, 38
 skeletal, 35, 37
 smooth, 31, 37
 mustard gas, mixtures with D.F.P.,
 49
 myasthenia gravis, 18, 73, 197
 mydriasis, 36, 40
 myosis, 2, 33, 51, 61, 68, 69, 72, 79,
 92; *see also frontispiece*

 N.G. test, 213
 2-naphthyl 2-fluoroethyl ether, 124
 neostigmine (prostigmine), 61, 72, 73
 compared with D.F.P., 197
 nerve
 anatomy of, 30
 depolarization of, 29
 double layer on, 28
 frog sciatic, action of M.F.A. on, 138
 oculomotor, 38
 stimulation of, 29
 velocity of conduction in, 29
 nerve fibres
 demyelination of, 199
 permeability of, 200

 nerve gases
 antidotes for, mechanism of, 191
 definition, 5
 parasympathetic action of, 33
 table of properties of, 212
 test for (N.G. test), 213
 treatment of, poisoning by, 215
 see also insecticides, phosphoro-
 fluoridates (di-*sec.*-butyl, di-*cyclo*-
 hexyl and di-*isopropyl*), sarin and
 tabun
 nerve tissue of insects, 183
 nervous system, 28
 autonomic, 31, 33, 34
 central, effect of D.F.P. on, 71;
 effect of fluoroacetates on, 137
 parasympathetic, 31, 33
 sympathetic, 31-2
 neurone, 30
 nicotine, 35, 71
 nicotine-like action, 215
 nicotinic hydroxamic acid methiodide
 used against D.F.P.-poisoning,
 191
 nomenclature
 of esters containing phosphorus,
 21-7
 of sulphur acids, 22
 noradrenaline, 32, 35

 O.M.P.A.
 see octamethylpyrophosphoramidate
 octamethylpyrophosphoramidate
 (O.M.P.A. or schradan), 111, 112,
 113
 anticholinesterase activity of, 173
 containing ^{32}P , 174, 175
 oxidation, 173-5
 preparation, 172
 toxicity, 173
 odour of fluoro compounds, 212
 olive fly, action of organo-phos-
 phorus insecticide on, 181
 one-stage process for producing phos-
 phorofluoridate, 6, 47
 alternative, 56
 organo-lead compounds, *see* lead
 compounds
 organo-phosphorus compounds
 general properties, 2
 nomenclature, 21
 oxaloacetic acid in tricarboxylic acid
 cycle, 141

INDEX

- β -oxidation, 13, 150, 151, 157, 160, 163
of non-fluorine compounds, 164
oximes, poisoned cholinesterase re-
stored by, 192
- ³²P
O.M.P.A. containing, 174
diethyl phosphorochloridate con-
taining, 77, 179
ethylphosphonic dichloride con-
taining, 110
ethylphosphonous dichloride con-
taining, 110
synthesis of D.F.P. containing, 5,
75
- paralytic ileus, 18, 196
parasympathetic nervous system, 33
parasympathetic, innervation of eye,
38
parasympathomimetic action of
D.F.P., 4, 71
on eye, 39
parathion, 19, 171, 178, 184, 200
Parkinsonism, treatment by atro-
pine, 40
paroxan, 19, 177, 184, 200
perfluoroisobutylene, 168
peroxidase
action of, on *p*-fluoroaniline, 148
phenyl 2-fluoroethyl ether, 123
phenyl fluorothioloacetate, 129, 136
phenylphosphoramidic acid, 85
phosphate
dibenzyl hydrogen, 101
diethyl *p*-chlorophenyl, 99
imidoyl, used in preparing pyro-
phosphates, 105
silver dialkyl, 100
test for, 213
triaryl, 99, 102
tribenzyl, 101
trichloroethyl, 102
triphenyl, 100
- phosphite
dibenzyl hydrogen, 106
dicyclohexyl hydrogen, 57, 58
diethyl hydrogen, *see* diethylhydro-
gen phosphite
di-*isopropyl* hydrogen, *see* di-*iso*-
propyl hydrogen phosphite
di-(hydroxyethyl) hydrogen, 99
mixed, 102
- trialkyl, 6, 44, 95
triethyl, 9, 96, 97, 147
tri-(2-chloroethyl), 99, 102
trimethyl, 93
triphenyl, 99
phosphonic acid
nomenclature, 25
phosphonium compound, 95, 98
phosphoramidate, 106
phosphoramidic acid, nomenclature,
26
phosphorobromidates, 108
phosphorochloridate
diallyl, 57
di-(carboethoxy)ethyl, 57
di-ethyl, *see* diethyl phosphoro-
chloridate
dimethyl, 57
di-*isopropyl*, *see* di-*isopropyl* phos-
phorochloridate
preparation of, 5, 43, 44, 45, 57,
189
phosphorochloridates
dialkyl, 5, 6, 43, 44
preparation using *N*-chlorosuccin-
imide, 57
phosphorodiamidic chlorides
preparation and use, 89
use, 111
phosphorodiamidic fluoride
di-(benzylamino), 89
di-(*n*-butylamino), 89
di-(cyclohexylamino), 89
di-(*N*-methylanilino), 89
di-morpholino, 89
dipiperidino, 89
diphenyl, 89
tetramethyl, 87; as insecticide,
89 n. 2, 177
phosphorodiamidic fluorides, 7, 8, 87
phosphorofluoridate
ammonium, anticholinesterase
activity of, 5
diallyl, 58
di-*iso*-amyl, 4, 80
di-*n*-butyl, 3
di-*sec*-butyl, 3, 79
di-(1-carbethoxyethyl), 58, 80
di-(2-chloroethyl), 53, 58, 81, 82
di-(1:3-dichloro-*isopropyl*), 80
diethyl, 42, 47, 51, 55, 58; action of
alkali on, 55
di-(1-ethylpropyl), 80

INDEX

- phosphorofluoridate (*cont.*)
 di-2-fluorethyl, 15, 53, 58, 135
 dicyclohexyl, 3, 51, 52, 56, 58;
 summary of properties of, 212
 dimethyl, 42, 47, 58, 62
 di-(*o*-methylcyclohexyl), 52
 diphenyl, 53, 82
 di-*isopropyl*, *see* di-*isopropyl* phos-
 phorofluoridate
 di-*n*-propyl, 3, 51
 phosphorofluoridate ion, inactivity
 towards cholinesterase, 67
 phosphorofluoridates
 anticholinesterase activity of, 5,
 61-8
 determination of fluorine in, 207
 diaryl, 7
 general, 1, 42
 nomenclature, 21-7
 requirements for high toxicity and
 myosis, 4, 79, 81
 synthesis of, 5, 6, 7, 43, 56, 57
 toxicity of, 2, 3, 4, 42, 79, 81
 phosphorofluoridic acid, nomencla-
 ture, 21-2, 26
 phosphoric acid, esters of, 98
 phosphoroiodidates, 108
 phosphorous acid, esters of, 98
 phosphorus, test for, in nerve gases,
 48, 93
 phosphorus dichlorofluoride, 85
 phosphorus oxychloride, 7, 43, 44, 55,
 182
 phosphorus oxydichlorofluoride
 preparation, 7, 50, 54
 use in synthesis, 7, 50, 87, 90
 phosphorus pentachloride, 102
 phosphorus trichloride
 radioactive, 75
 uses, 5, 6, 44, 86, 99, 101, 110
 phosphorylation
 methods of, 106-7
 photophobia, caused by D.F.P., 2
 physiological action
 of D.F.P., 2-5, 42, 68
 of fluoroacetates, 10, 136
 of ω -fluorocarboxylic acids, 13,
 149, 162
 of fluorocitric acid, 143
 of fluoropyruvic acid, 11, 144
 of M.F.A., 10, 136
 of organo-lead compounds, 16, 84,
 118, 136
 of phosphorofluoridates, 2, 42, 68
 of sarin, 92
 of tabun, 92
 physiology of autonomic nervous
 system, 33
 pinacolyl methylphosphonofluorid-
 ate, 94
 pituitary extract, compared with
 D.F.P., 197
 plasticizers, organic phosphates as,
 102
 poisoning
 by fluoroacetates, cause of, 143
 by nerve gases, cause of, 37, 188-
 93; first aid, 215
 polyphosphoramides, 112
 polyphosphorus compounds, 111
 postganglionic fibre, 31, 33, 37
 preganglionic fibre, 31, 33, 37
 prisol, 41
iso-propyl methylphosphonofluorid-
 ate, 92
 physostigmine (neostigmine), 61, 68
 Prostigmine, *see* neostigmine
 protection
 against benzoylcholine, 199
 against fluoroacetate poisoning,
 144
 of cholinesterase against D.F.P.
 etc., 198
 pupil
 constriction of, by D.F.P., 2; by
 parasympathetic system, 33
 dilatation of atropine, 36
 innervation of, 38
 pyramidal polyphosphorus com-
 pounds, 112
 pyrophosphate
 alkyl, and anticholinesterase activ-
 ity, 188, 190
 esters, 103
 silver, 103
 tetralkyl, 100
 tetrabenzyl, 100
 tetraethyl, 104
 tetramethyl, 104
 pyruvate oxidase, 139, 141

 Qualitative detection
 of fluorine, 115, 212
 of fluoroacetates, 116, 212
 of nerve gases, 212
 of phosphorus, 212

INDEX

- quaternary ammonium salts containing fluorine, 17, 132, 135, 136
- quaternary *N* groups and anticholinesterase activity, 194
- 'quaternization', 107
- Radiosensitizers, organic phosphates as, 202
- ratsbane, *see* *Dichapetalum toxicarium*
- receptor patches
destruction by drugs, 41
on muscle, 35, 36
- reduction of fluoro compounds, 15, 161
- relationship between physiological action and chemical constitution
fluoroacetate series, 133
organo-phosphorus compounds, 187
phosphorofluoridate series, 4, 79
- respiration
artificial, for nerve-gas poisoning, 215
effect of D.F.P. on, 3, 69
- respirators
effectiveness against organo-phosphorus compounds and fluoroacetates, 2
insufficient warning to suggest use of, 79 n.
- reticulocytes, action of sodium fluoroacetate on, 144
- retina, cholinesterase in, 201
- Rydon, syntheses using 'phosphonium compound', 98
- Salivary gland
effect of D.F.P. on, 71
innervation of, 33
- sarin, 9, 91, 92, 94
hydrolysis of, by hydroxamic acid, 192
summary of properties of, 212
- Saunders, symptoms from toxic compounds, 2, 68, 79, 115, 119
- Saunders-Stacey
'hydrogen phosphite' synthesis of D.F.P., 6, 46; of M.F.A., 114; of di-*sec*-.butyl phosphorofluoridate, 79; phosphorofluoridate, 80; diisocamyl phosphorofluoridate, 80
- one-stage process for D.F.P., 6, 46
synthesis of M.F.A., 114, 119
synthesis of PCN compounds, 91
- Saunders-Worthy
synthesis of radioactive D.F.P., 75
synthesis of radioactive M.F.A., 12
- schizophrenia, 73
- schradan, *see* octamethylpyrophosphoramidate
- Schrader, 18, 172, 177, 178, 179
- selenium compounds
as insecticides, 170
- 'sesqui-fluoro-H', 16, 130, 135, 148
- 'sesqui-H', 130
- sodium alizarin sulphonate, indicator for fluoride analysis, 210
- sodium fluoride
pure, for analysis, 211
anticholinesterase activity of, 5
- sodium fluoroacetate, 11, 118, 121, 136
action on enzymes, 139
action on frog brain, 138
action on isolated frog heart, 138
action on external ventricles, 138
action on reticulocytes, 144
action on tissues, 140
containing ¹⁴C, 12
as inhibitor, 165
as insecticide, 182
as rodenticide, 182
- soman, 94
- spasmolytics, 40
- stereospecificity of enzymes, 192
- sternutation, 16, 84, 119
definition of, 118
- structure
and anticholinesterase activity, 187
and fluoroacetate activity, 133
and phosphorofluoridate activity, 4, 79
- succinic acid, in tricarboxylic acid cycle, 141
- sweat glands, 32, 35, 40, 71
- sympathetic innervation of eye, 38
- sympathetic nervous system, 31-2
- sympatholytics, 41
- synapse
action at, 35
definition, 30
in sympathetic system, 31
- systemic insecticides, 9, 111, 112, 170-1
- systox, 170, 179

INDEX

- T.E.P.P., *see* tetraethyl pyrophosphate
- tables
- anticholinesterase containing quaternary N groups, 195
 - boiling-points of fluorocarbons, 168
 - cardiac responses to M.F.A., 137
 - citrate accumulation in tissues, 140
 - classification of toxic action of fluoroacetates, 136
 - conditions for preparation of M.F.A., 120
 - effects of dialysis on poisoned anticholinesterase, 64
 - enzyme inhibitors, 186
 - incubation of reticulocytes in presence of FCH_2COONa , 144
 - inhibiting power of anticholinesterases, 68
 - L.D. 50's of phosphorodiamidic fluorides, 89
 - melting-points of mixtures of H and D.F.P., 50
 - phosphorochloridates from *N*-chlorosuccinimide, 57
 - phosphorofluoridates via *N*-chlorosuccinimide, 58
 - properties of fluoro compounds, 212
 - reactions between PCl_3 and alcohols, 86
 - toxicities of acid chlorides, 11
 - toxicities of fluoroacetic esters, 128, 129
 - toxicities of ω -fluorocarboxylates, 151
- tabun, 9, 91
- summary of properties of, 212
- testing chamber for gases, 2, 43, 68, 79, 84, 115
- tetraethyl-lead
- in preparation of EtPCl_2 , 110
 - in preparation of trialkyl-lead fluoroacetate, 118
- tetraethyl pyrophosphate, 19, 171
- general properties, 182
- tetraethyl trimethylenediphosphate, 97
- tetramethylphosphorodiamidic anhydride, *see* octamethylpyrophosphoramidate
- tetramethylphosphorodiamidic fluoride, 8, 87
- as insecticide, 177
- tetrasodium 2-methyl 1:4-naphthohydroquinone diphosphate, 202
- thalamus, 31
- action of sodium fluoroacetate on, 138
- theory of fluoroacetate poisoning, 140-4
- theory of organo-phosphorus poisoning, 188
- thimet, 181
- thorium nitrate, titration of fluoride with, 210
- Todd (Sir A. R.), methods of phosphorylation, 106
- toxicity
- by absorption, M.F.A., 115; sarin, 92
 - alternating, 11, 151, 163
 - by inhalation, D.F.P., 2, 42, 69; dicyclohexylphosphorofluoridate, 52; fluoroacetates, 116-19; fluoroethanol, 122; M.F.A., 10, 115-16; phosphorodiamidic fluorides, 88-90; phosphorofluoridates, 53, 79-80
 - by intracranial injection, fluoro-citrate, 143
 - by intramuscular injection, D.F.P., 70, 72
 - by intravenous injection, D.F.P., 3, 69; M.F.A., 10, 115
 - by subcutaneous injection, D.F.P., 69; ω -fluoroacetates, 149-50; M.F.A., 115; phosphorodiamidic fluorides, 88-90
 - relationship between, and chemical constitutes, 4, 79, 81, 133
 - testing, on human beings, 2, 43, 60, 79, 84, 115
- transphosphorylation, 112
- trialkyl phosphate, 43, 101
- trialkyl phosphite, 5, 44, 95
- tricarboxylic acid cycle, 12, 141
- entry of fluoroacetate into, 142
 - on reticulocytes, 144
- tri-(2-chloroethyl) phosphite, 99
- triethyl-lead fluoroacetate, 16, 118, 136
- triethyl phosphite, 9, 96, 97, 147
- trifluoroacetic anhydride, use of, 105
- trifluoroiodomethane, 113
- trifluoromethylphosphonic acid, 113
- trimethyl-2-fluoroethyl ammonium bromide, 132

INDEX

- trimethyl phosphite, 93
 triphosphoric pentadimethylamide, 172
 trypsin, action of D.F.P. on, 186
 tubercle bacilli, inhibition by D.F.P., 200
 tumours, malignant, treatment by organo-phosphorus compounds, 200, 202

 Unsaturated phosphonates, 97
 unsaturated phosphorochloridates, 57
 unsaturated phosphorofluoridates, 57
 urea, substituted, containing fluorine, 127
 uterus, innervation of, 33

 Vacuum line for preparation of radioactive ^{32}P compounds, 110
 van der Waals's forces in formation of enzyme complex, 192
 vegetables and insecticides, 176
 ventricle, lateral, of brain of cat, action of sodium fluoroacetate on, 138
 ventricular fibrillation caused by fluoroacetates, 137
 vinyl cyanide, use in preparing O-containing fluoro compounds, 14, 160
 virus, control by insecticides, 176, 177

 vision, affected by D.F.P. etc., 2, 43
 volatility of D.F.P., 69

 Water
 action on diethyl phosphorofluoridate, 47
 action on D.F.P., 47
 action on dicyclohexyl phosphorofluoridate, 52
 action on dimethyl phosphorofluoridate, 47
 action on di-isopropyl phosphorochloridate, 47, 189
 action on sarin, 93
 action on T.E.P.P., 171
 action on tabun, 92
 in treatment of nerve-gas poisoning, 215
 solubility of fluoro compounds in, 212
 solubility of insecticides in, 171
 weed-killers, selective, 164
 white clover, cholinesterase in, 193

 X-ray therapy and organic phosphates, 202
 xanthate, 2-fluoroethyl, 124

 Yeast
 action of fluoroacetate on, 138
 action of fluoroethanol on, 139

 Zonula of eye, 38