

# 16 S 2330 TD ZF-Ecosplit (Truck)

Synchromesh transmission for heavy trucks

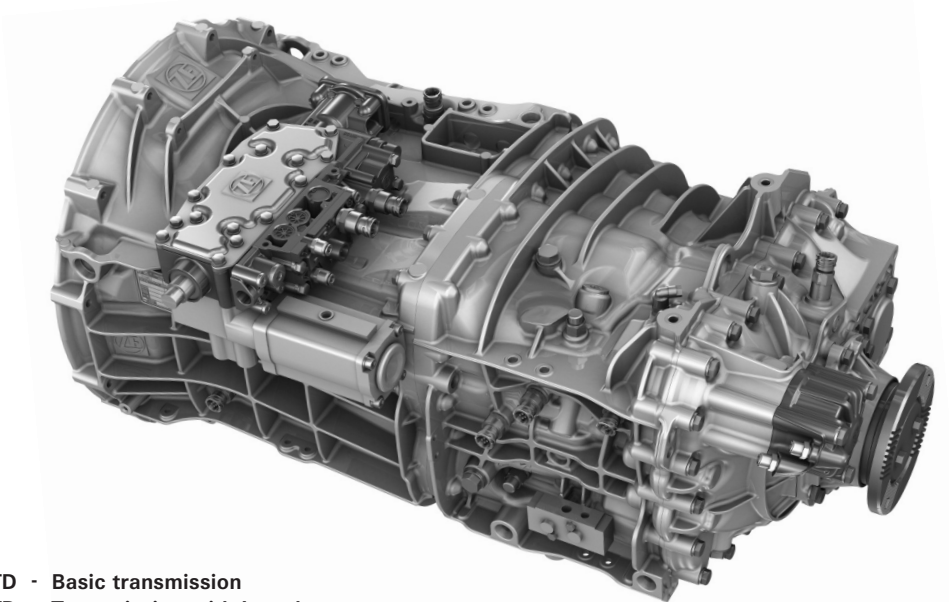

- 16 S 2330 TD - Basic transmission
- 16 S 2331 TD - Transmission with Intarder
- 16 S 2333 TD - Transmission designed for 100% coasting torque
- 16 S 2335 TD - Transmission with clutch-dependent PTO

SERVOSHIFT is the standard shift system in all transmission versions.

Transmission type	16 S 2330 TD
Input torque	max. 2350 Nm
Weight without auxiliaries	≈ 314 kg
Additional weight for ZF-Intarder	≈ 70 kg
Oil capacity for standard installation	≈ 15.4 dm <sup>3</sup>
Oil capacity for transmission with ZF-Intarder	≈ 26.0 dm <sup>3</sup>
Oil grade	as specified in ZF List of Lubricants TE-ML 01 or TE-ML 02
Installation	horizontal left, with integrated clutch bell

Standard ratios in gears (L = splitter low; H = splitter high)

1		2		3		4		5		6		7		8		R	
L	H	L	H	L	H	L	H	L	H	L	H	L	H	L	H	L	H
16.41	13.80	11.28	9.49	7.76	6.53	5.43	4.57	3.59	3.02	2.47	2.08	1.70	1.43	1.19	1.00	15.36	12.92

➔ see also Data Sheet for Intarder: IT\_Ecosplit\_EN

# 16 S 2330 TD

## Installation dimensions

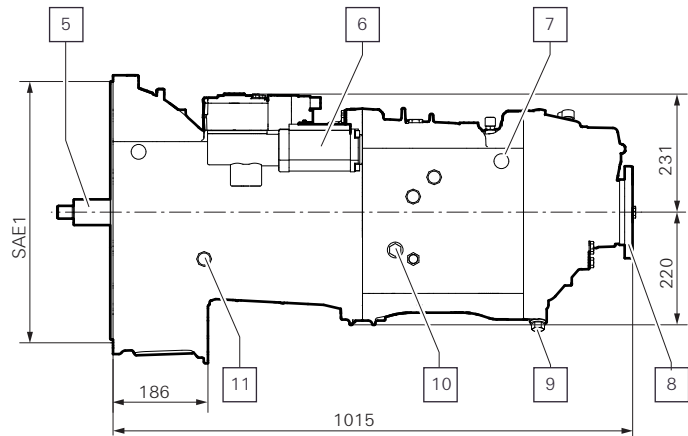
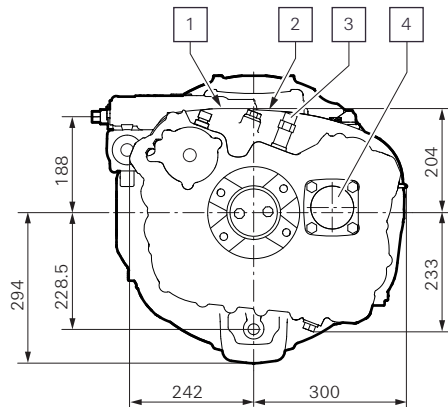

- 1 "Neutral" signal transmitter
- 2 "Reverse gear" signal transmitter
- 3 Speedometer connection, electronic (optional)
- 4 Connection point for clutch-dependent ZF-PTOs
- 5 Input

- 6 Servoshift
- 7 "Range change" signal transmitter
- 8 Output
- 9 Oil drain
- 10 Oil fill and oil overflow check
- 11 "Splitter" signal transmitter

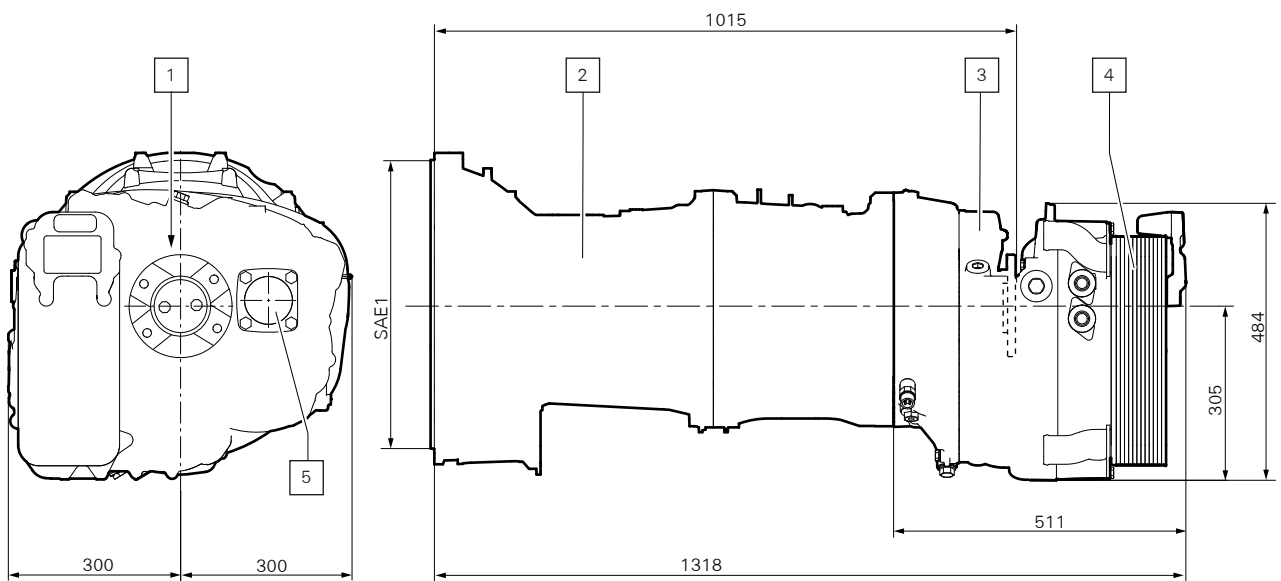

- 1 Option to fit steering pump drive
- 2 ZF-Ecosplit transmission
- 3 ZF-Intarder unit

- 4 Oil/water heat exchanger
- 5 Connection for PTO