

16 S 2530 TO ZF-Ecosplit (Truck)

Synchromesh transmission for heavy trucks

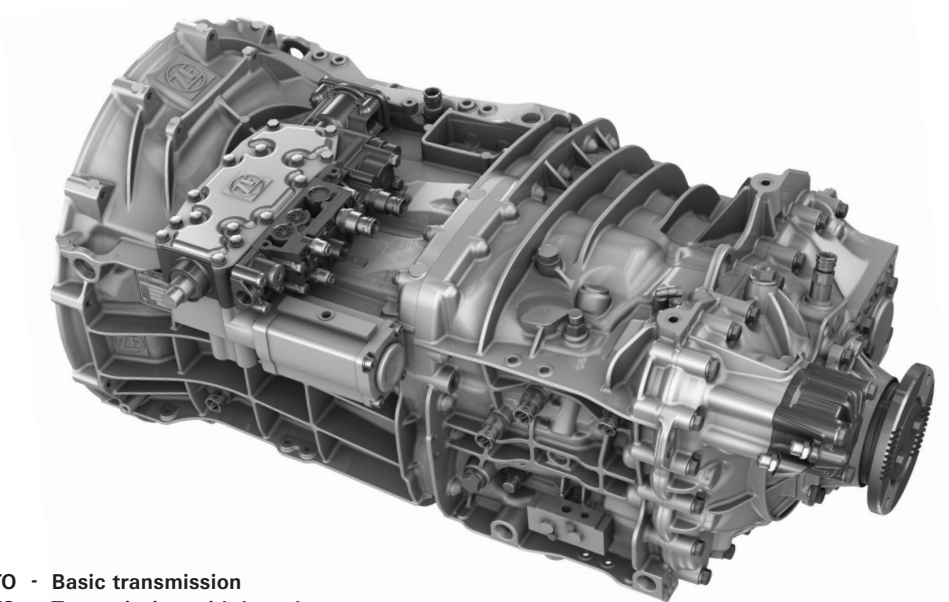

- 16 S 2530 TO - Basic transmission
- 16 S 2531 TO - Transmission with Intarder
- 16 S 2533 TO - Transmission designed for 100% coasting torque
- 16 S 2535 TO - Transmission with clutch-dependent PTO

SERVOSHIFT is the standard shift system in all transmission versions.

Transmission type	16 S 2530 TO
Input torque	max. 2500 Nm
Weight without auxiliaries	≈ 314 kg
Additional weight for ZF-Intarder	≈ 70 kg
Oil capacity for standard installation	≈ 15.4 dm ³
Oil capacity for transmission with ZF-Intarder	≈ 26.0 dm ³
Oil grade	as specified in ZF List of Lubricants TE-ML 01 or TE-ML 02
Installation	horizontal left, with integrated clutch bell

Standard ratios in gears (L = splitter low; H = splitter high)

1		2		3		4		5		6		7		8		R	
L	H	L	H	L	H	L	H	L	H	L	H	L	H	L	H	L	H
13.80	11.54	9.49	7.93	6.53	5.46	4.57	3.82	3.02	2.53	2.08	1.74	1.43	1.20	1.00	0.84	12.92	10.80

➔ see also Data Sheet for Intarder: IT_Ecosplit_EN

16 S 2530 TO

Installation dimensions

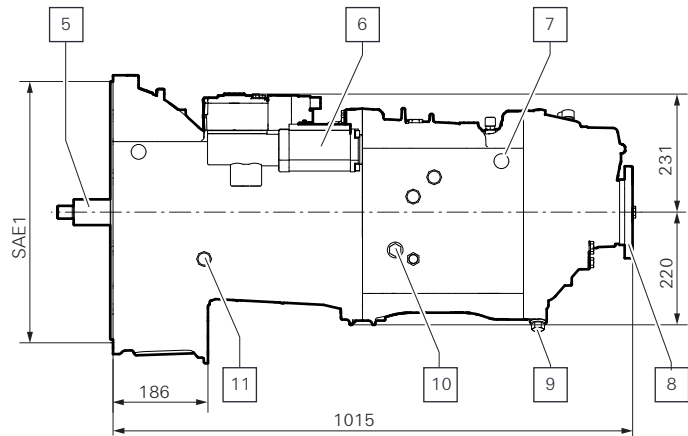
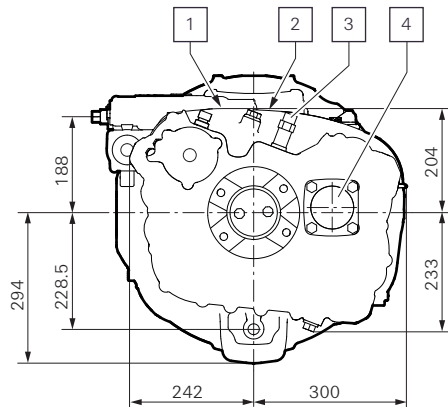

- 1 "Neutral" signal transmitter
- 2 "Reverse gear" signal transmitter
- 3 Speedometer connection, electronic (optional)
- 4 Connection point for clutch-dependent ZF-PTOs
- 5 Input

- 6 Servoshift
- 7 "Range change" signal transmitter
- 8 Output
- 9 Oil drain
- 10 Oil fill and oil overflow check
- 11 "Splitter" signal transmitter

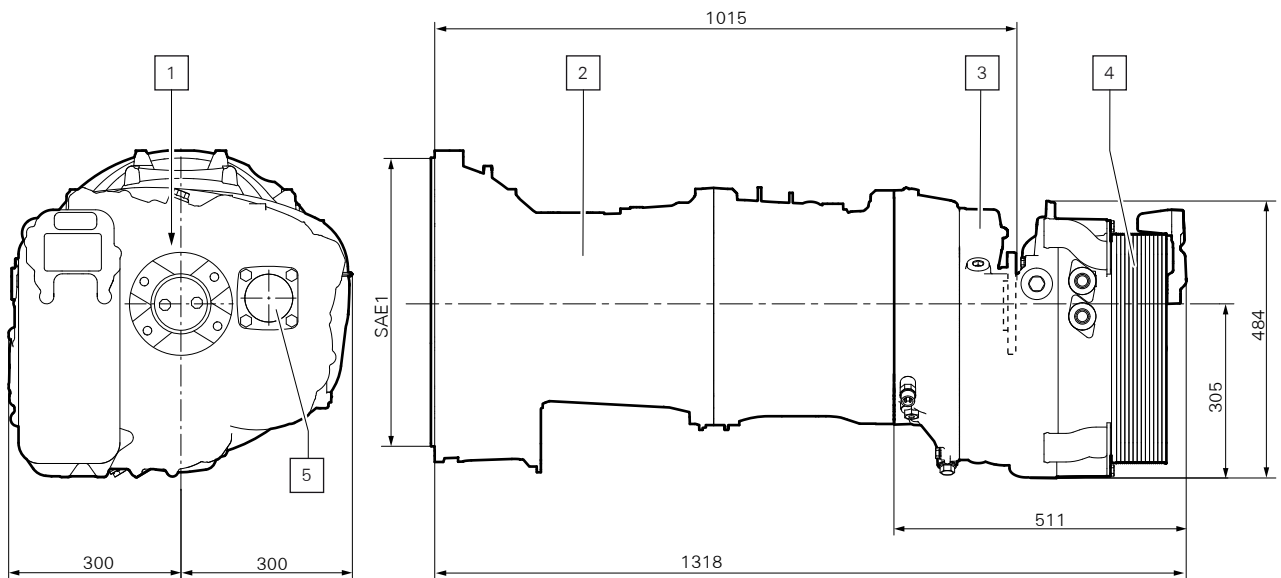

- 1 Option to fit steering pump drive
- 2 ZF-Ecosplit transmission
- 3 ZF-Intarder unit

- 4 Oil/water heat exchanger
- 5 Connection for PTO