



Introduction to the Battlefield Surveillance Brigade (BFSB)

142nd BFSB, AL-ARNG

Decatur, AL

MAJ Ethan Allen

NMIA – July 28, 2011

UNCLASSIFIED



BFSB – What's in an Acronym?



- B – Battle
- F – Field
- S – Surveillance
- B – Brigade

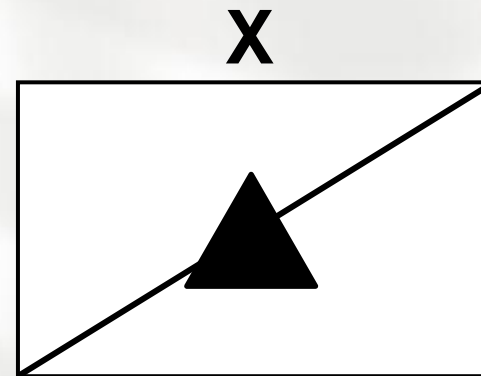



Origins of the BFSB



- **DoD Transformation Initiatives**
 - Army Modularity
 - NOT an Army of Excellence MI Brigade
 - NOT an Armored Cavalry Regiment
 - Army Military Intelligence Rebalancing
- **Afghanistan and Iraq: GWOT**
 - Gap: tactical ISR at brigade level and operational/strategic above division
 - Evolving Operational Environment
 - Evolving Threat

UNCLASSIFIED



BFSB Operational Principles



- **Primary purpose: ISR to satisfy Division, Corps, JTF Priority Intelligence Requirements**
- **Lightly armed organization**
- **Modular: designed to accept augmentation**
- **Dual focus: ISR and collection capability reinforcement**
- **Will perform the same mission set across the spectrum of conflict**

UNCLASSIFIED



Organizational Design

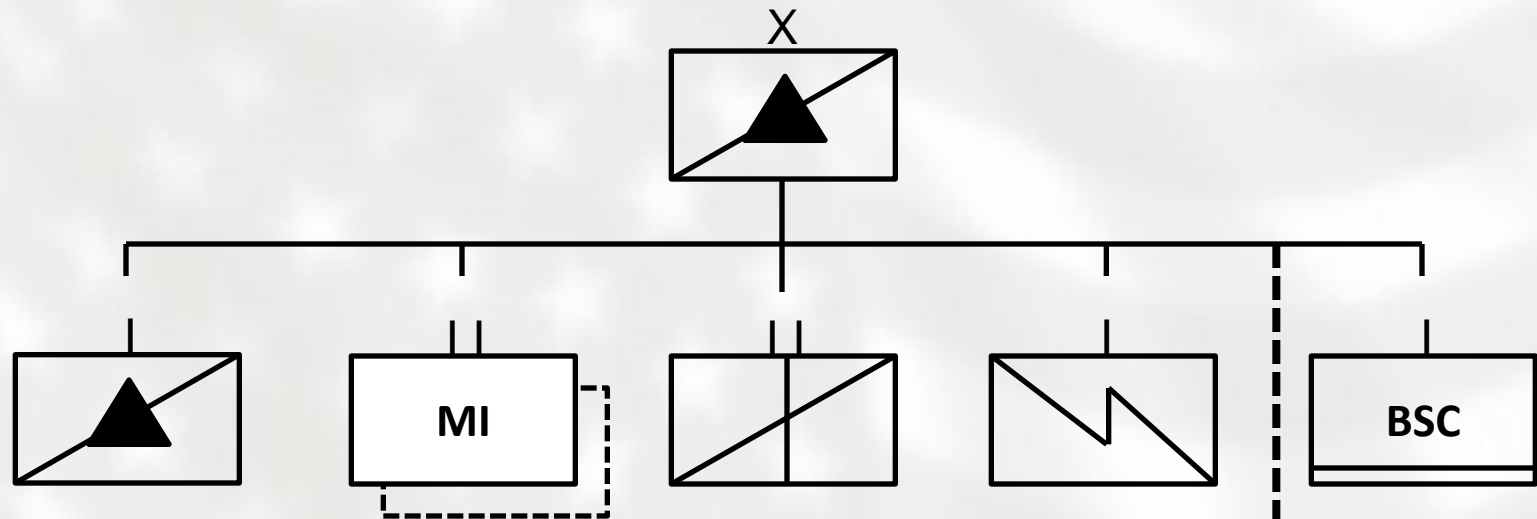

Note: Active component BFSB's have one organic and one assigned MI battalion



UNCLASSIFIED



What We Do



Wartime Mission:

On order, conducts multi-disciplined intelligence, surveillance, reconnaissance (ISR), target acquisition, and analysis operations to answer Division, Corps, or JTF headquarters priority intelligence requirements and focus combat power to achieve desired effects.

UNCLASSIFIED



(What Else We Do)



Civil Support Mission:

On order, JTF-North, provides military assistance to State, County, and Municipal Agencies within the boundaries of assigned AOR, to mitigate, and alleviate the effects of natural or man-made disasters. JTF-North will function as a force and resource provider to other JTFs operating either inside or outside Alabama.

UNCLASSIFIED



Headquarters and Staff

- 175 Authorized
- 33 MI Positions (20%)

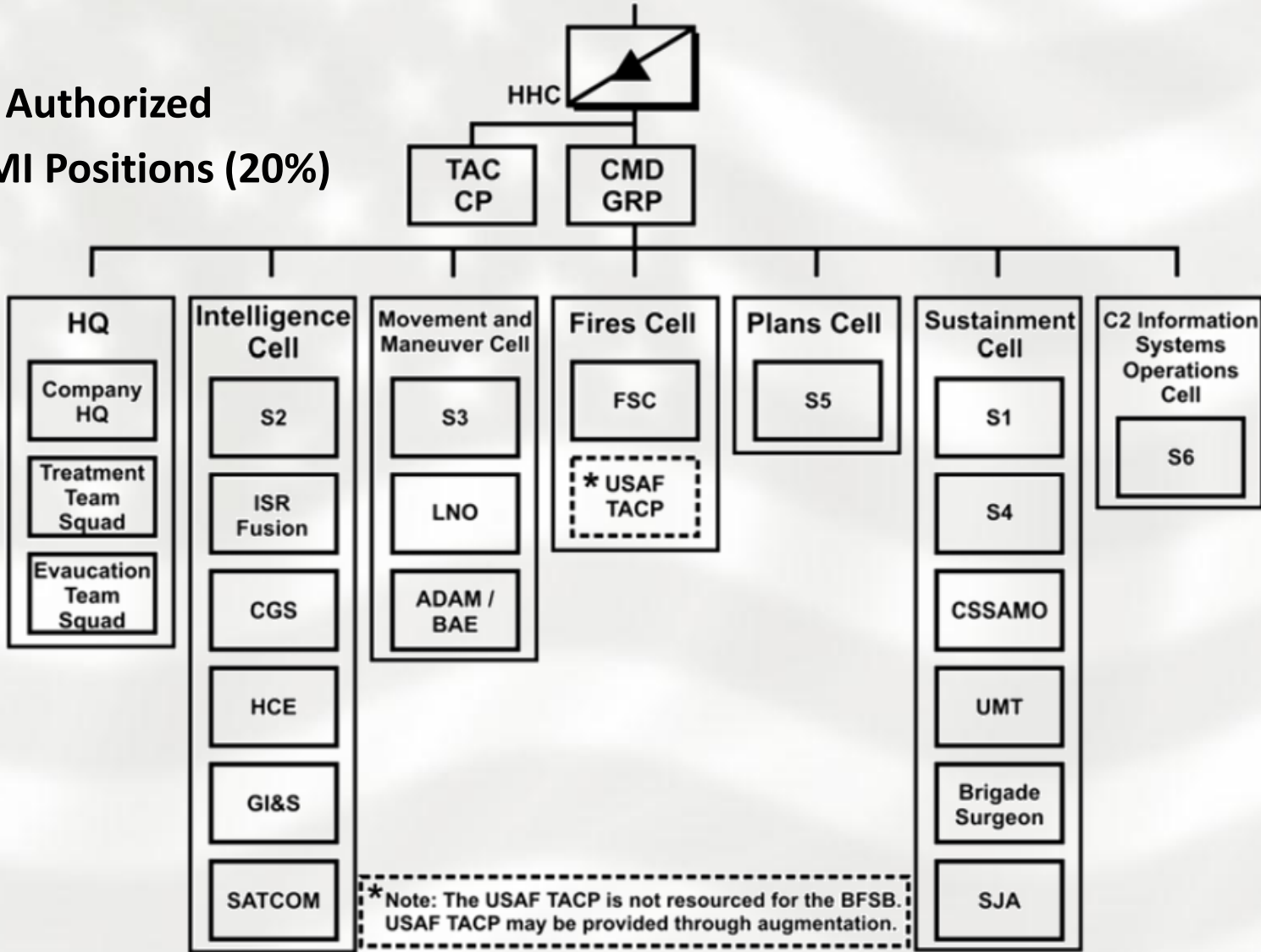

UNCLASSIFIED



MI Battalion

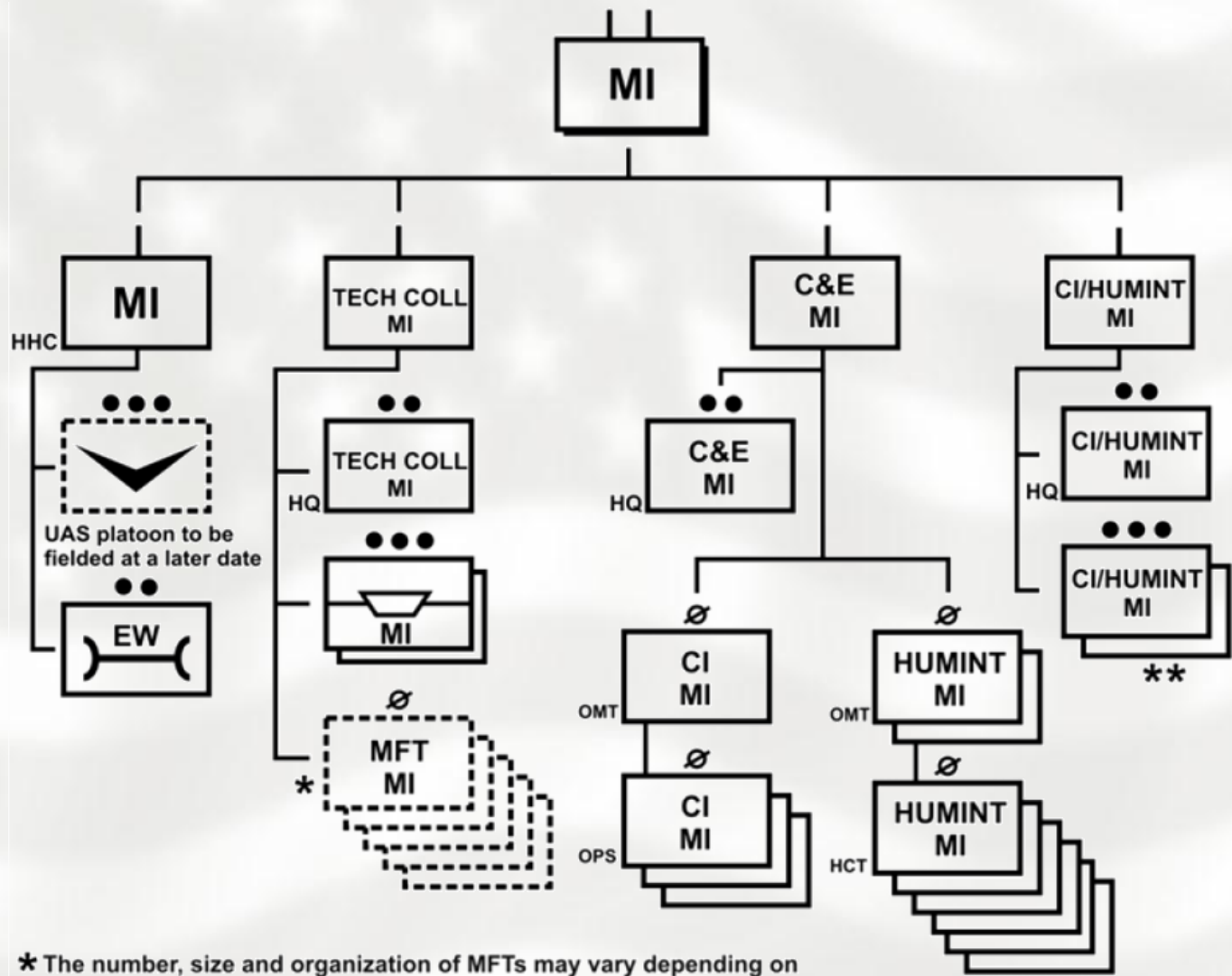

* The number, size and organization of MFTs may vary depending on METT-TC and commander's priorities.

** Each CI/HUMINT MI platoon has 2 OMTs and 6 HCTs

UNCLASSIFIED



Reconnaissance Squadron

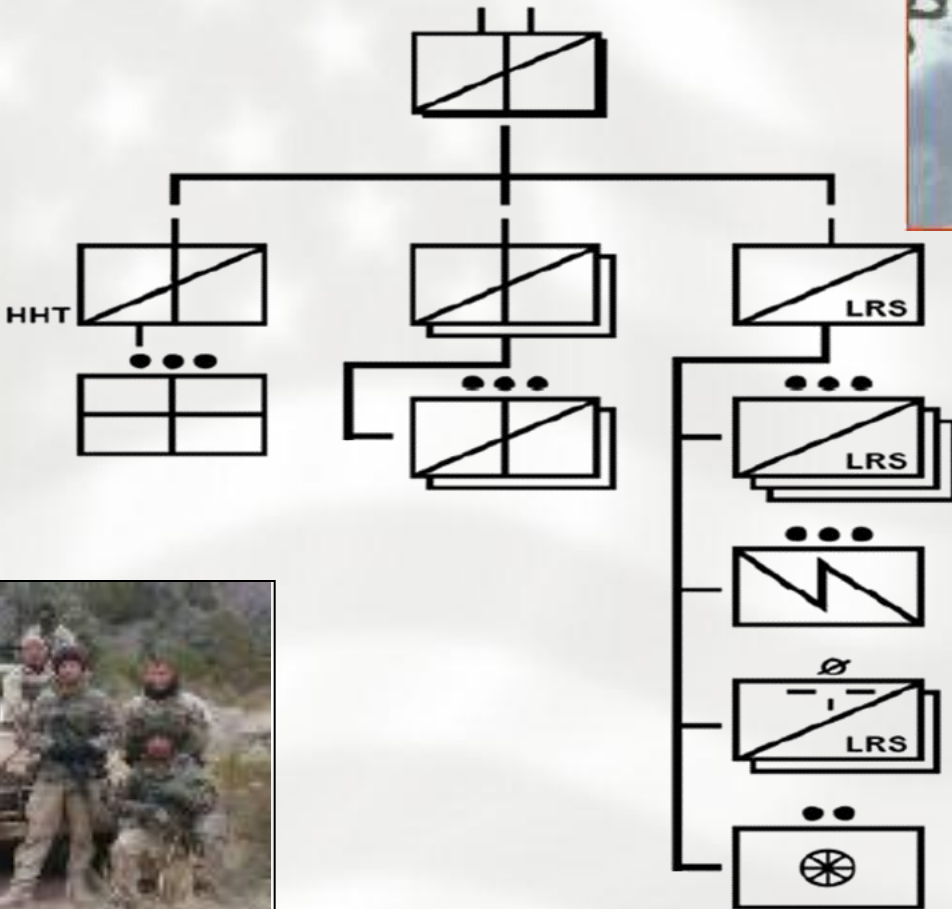

UNCLASSIFIED



Network Support Company

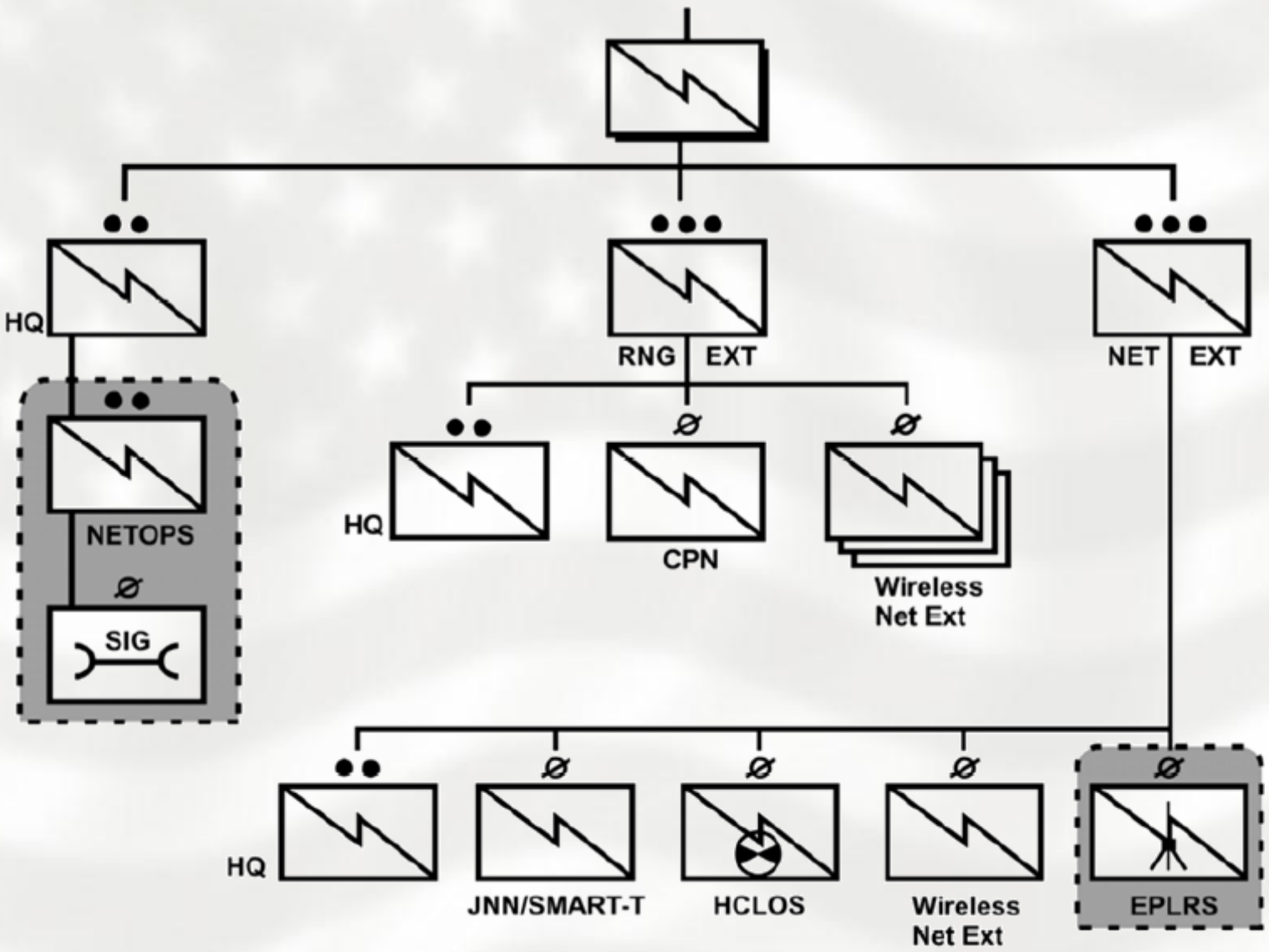

UNCLASSIFIED



Brigade Support Company

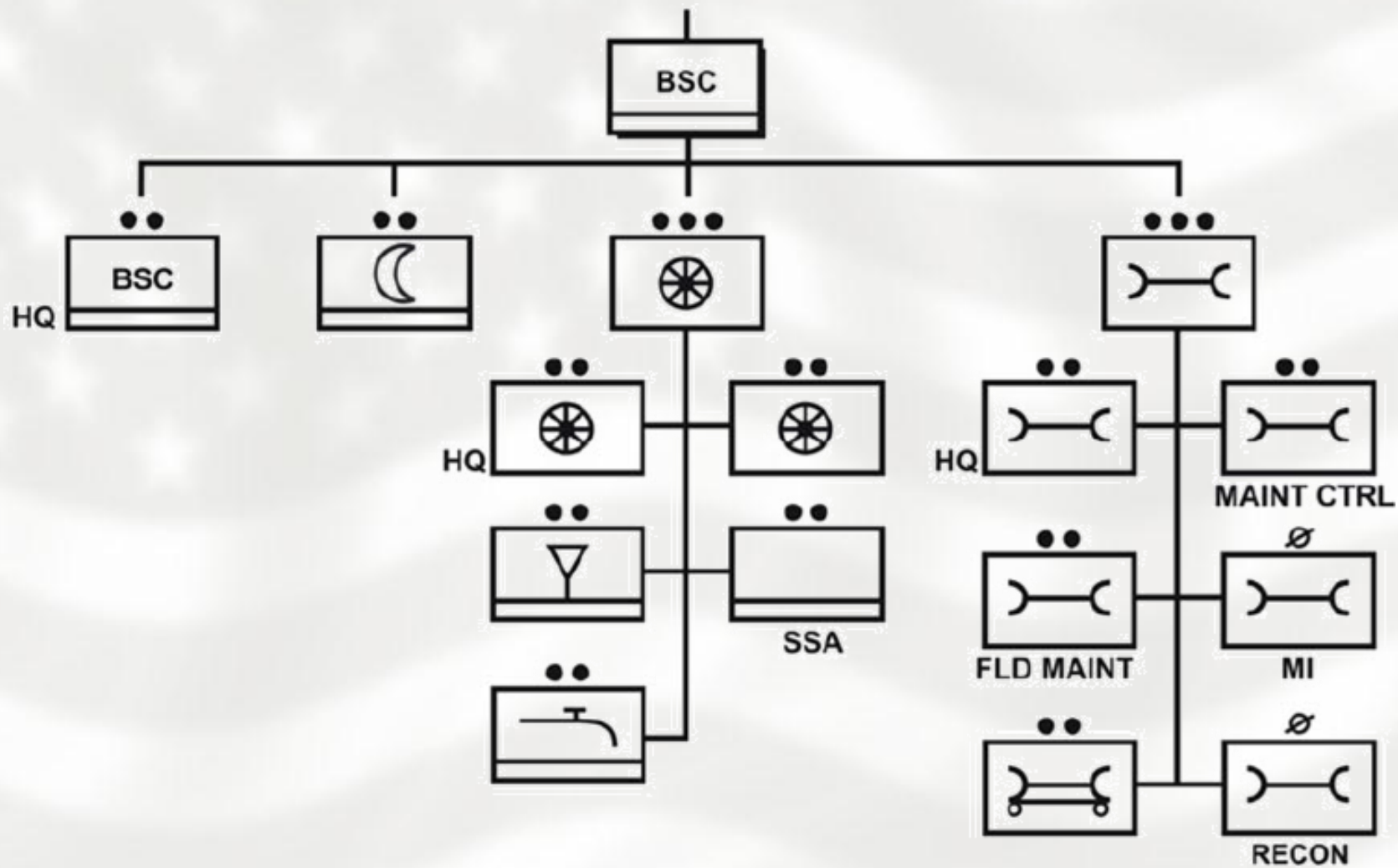

UNCLASSIFIED



BFSB Location Break-out

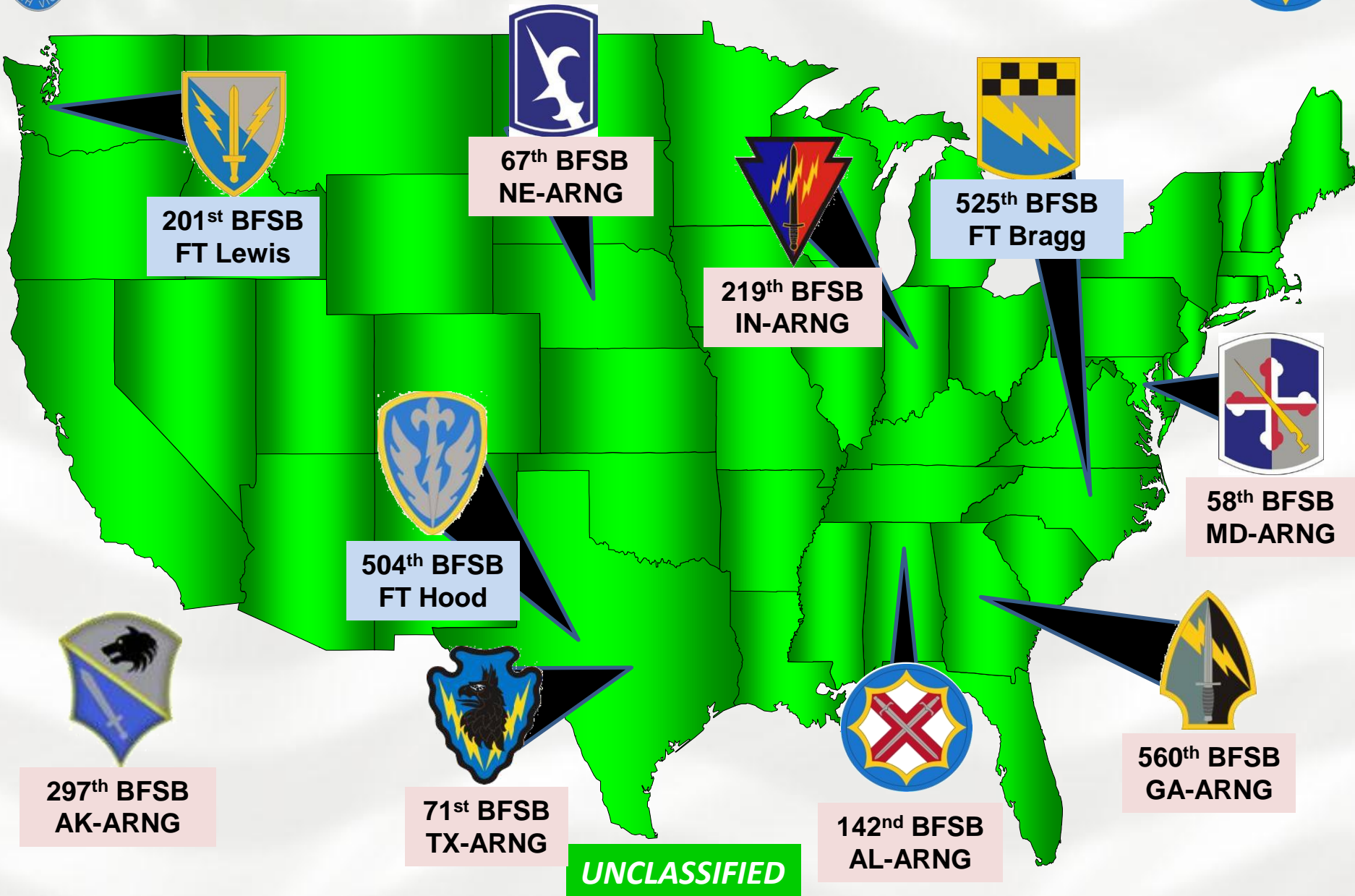

UNCLASSIFIED



142nd Location Break-out

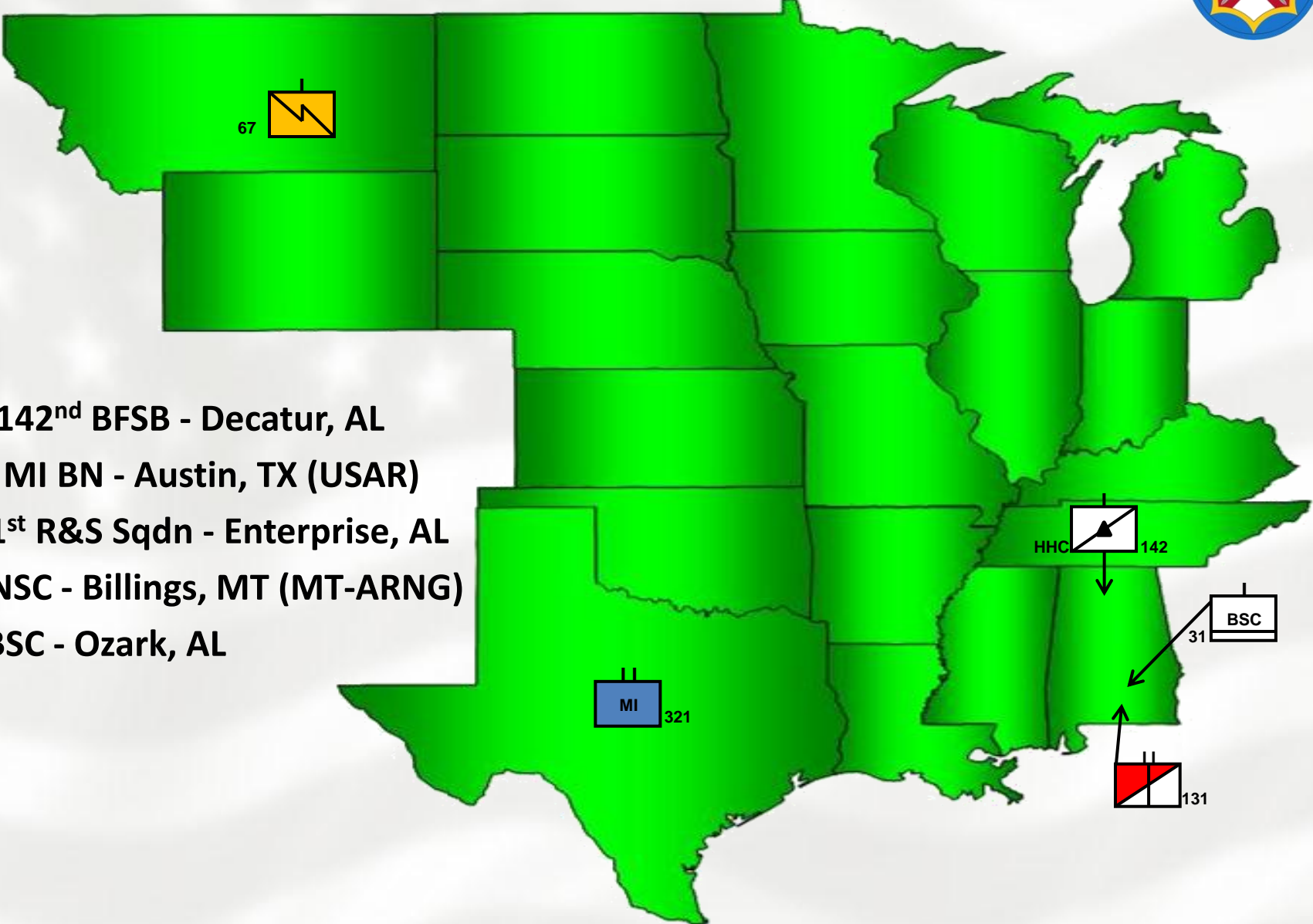

- ❖ HHC 142nd BFSB - Decatur, AL
- ❖ 321st MI BN - Austin, TX (USAR)
- ❖ 1-131st R&S Sqdn - Enterprise, AL
- ❖ 67th NSC - Billings, MT (MT-ARNG)
- ❖ 31st BSC - Ozark, AL

UNCLASSIFIED



Future Operations



Challenges:

- MI Density
- Coordination
- SCIF
- Sustainment Training

Way-Ahead:

- FOUNDRY
- MOA with SMDC
- SCIF Construction
- Equipment Fieldings



Bottom Line

- **BFBSB construct continually evolving**
- **Discovery learning**
- **Bridges the gap between tactical ISR at the brigade level and the operational / strategic ISR executed at division and above**
- **Leverages traditional reconnaissance with integrated intelligence expertise**
- **Relevant, current and timely**

UNCLASSIFIED



Additional Information

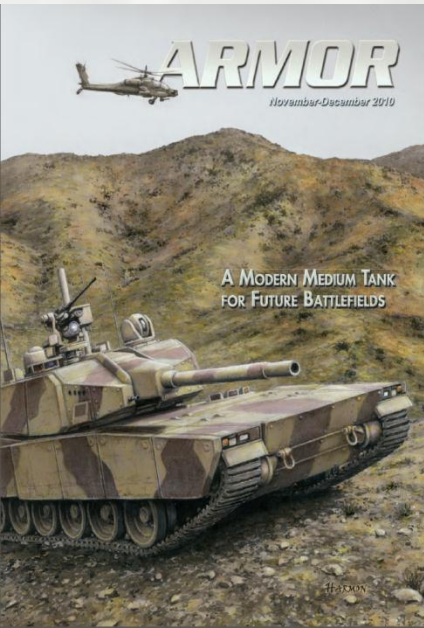

Nov/Dec 2010



BFSB 101: A Brief Introduction to the Battlefield Surveillance Brigade

by Lieutenant Colonel (Retired) Shane E. Lee, Lieutenant Colonel (Retired) Edward G. Miller, and Major (Retired) Michael A. Thomas

Although the battlefield surveillance brigade (BFSB) has been in the force since September 2006, its mission, organization, and capabilities are not fully understood across the Army. Additionally, with the impending decisions on military intelligence (MI) rebalance and the emergence of new Army concepts, the future role of this organization is not clearly defined. This article addresses both of these issues and identifies near-term required capabilities.

The BFSB is an established modular support brigade. Currently, there are three Active Component (AC) and seven Reserve Component (RC) BFSBs in the Army. All three AC BFSBs have served, or are serving, in Iraq. Two BFSBs (one AC and one RC) deployed this summer in support of Operation Enduring Free-

dom (OEF) and Operation New Dawn, respectively. These units have successfully answered division, corps, and joint task force (JTF) commander's priority intelligence requirements (PIR) and they will continue to do so for the foreseeable future. The Army has committed resources for more than 6 years to BFSB development and has recently approved U.S. Army Field Manual (FM) 3-55.1, *The Battlefield Surveillance Brigade*.

Background

Recent U.S. Army concept documents describe future threats capable of quickly adapting their strengths to our weaknesses. Like the enemies we face today, they will conduct decentralized, asymmetric operations, using small elements to achieve strategic objectives. They will

be located in complex terrain, dispersed among the population and highly networked. They will be skilled at information warfare and will often use commercially available technology to their advantage. Successfully defeating these threats will challenge the modular force, the Army as a whole, and homeland security. Of all the modular brigades in the Army, the BFSB is uniquely templated against these threats. The unit is employed as a network of combat information collection systems, both manned and unmanned, directly interfacing with the populace from which threat networks emerge.¹ It is a full spectrum, combined arms unit that has the capability to disrupt threat networks and operate inside their decision cycle by quickly adapting its strengths to the enemy's weaknesses.

FM 3-55.1

Battlefield Surveillance Brigade (BFSB)

June 2010

Headquarters, Department of the Army

DISTRIBUTION RESTRICTION: Distribution authorized to U.S. government agencies and their contractors only to protect technical or operational information that is for official government use. This determination was made on 30 March 2009. Other requests for this document will be referred to Commandant, U.S. Army Armor School, ATTN: ATZK-TDD-C, Building 1002, 204 1st Cavalry Regiment Road, Fort Knox, Kentucky 40121-5123. After February 2011, this address will change to Commander, Maneuver Center of Excellence, ATTN: ATZB-TDD, Building 4, 6751 Constitution Loop, Fort Benning, Georgia, 31905-5593.

DESTRUCTION NOTICE: Destroy by any method that will prevent disclosure of contents or reconstruction of the document.

<http://www.benning.army.mil/Armor/ArmorMagazine/index.htm>

Army Field Manual 3-55.1

UNCLASSIFIED



Contact Us



MAJ Ethan Allen	Human Resource Officer	256-308-3425
MAJ Sean Sawyer	Brigade Plans Officer	256-308-3431
CPT Broderick Pickett	Logistics Officer	256-308-3426
SGM Ed Stasiak	Operations Sergeant Major	256-308-3429
MSG Tim Jones	Chief Intelligence NCO	256-308-3423

UNCLASSIFIED