



Principles of Electrosurgery



Introduction

The Covidien Energy-based Professional Education, Department of Clinical Education is pleased to provide you with this educational booklet on electrosurgery. Designed to explain the essential principles of one of the most widely utilized technologies available to surgeons, it emphasizes clinical efficacy and patient safety.

This information represents Covidien's ongoing commitment to meet the educational needs of the surgical team. As partners in the delivery of perioperative care, we must work together to achieve the highest standards in patient care and optimal patient outcomes.

This booklet contains excerpts from the many educational programs available from Valleylab, an accredited provider of nursing continuing education. To schedule programming or for additional information call 800-255-8522, ext. 6240. Please contact us if we may be of assistance.

Clinical Information Hotline

To answer clinical questions of a more immediate nature, Covidien has established a Clinical Information Hotline. You may access this valuable service 24 hours a day by calling 800-255-8522, ext. 2005.

www.valleylab.com

www.valleylabeducation.org

www.ligasure.com

www.cool-tipRF.com

www.forcetriad.com

Educational Offerings from Covidien Energy-based Professional Education, Department of Clinical Education

Advanced Energy-Based Applications and Technology	Program hours vary
The Art and Science of Electrosurgery: Principles, Applications and Risks	Program hours vary to meet the needs of the audience.
The Art and Science of Minimally Invasive Surgery: Principles, Applications and Risks	Program hours vary
Best Practices for Electrosurgery	1 or 2 contact hours
Electrosurgical Best Practices for Minimally Invasive Procedures	1 contact hour
Electrosurgery Continuing Education Module (online at www.valleylabeducation.org)	2 contact hours
Electrosurgery: Perioperative Liability Issues	1 contact hour
Electrosurgery Self-Study Guide	2 contact hours
Fire Prevention and Safety During Surgical Procedures (also available on CD-ROM and online)	1 contact hour
Innovations in Electrosurgery: High Force Controlled RF Vessel Fusion (also available on CD-ROM)	1 contact hour
Recommended Practices for Electrosurgery	1 contact hour
Surgical Smoke: Hazards and Controls	2 contact hours
Surgical Smoke Self-Study Guide	1 contact hour
Zap Facts	4.5 contact hours

Accreditation Statement

The Covidien Energy-based Professional Education is approved as a provider of continuing education in nursing by the Colorado Nurses' Association, an accredited approver by the American Nurses Credentialing Center's Commission on Accreditation.

CNA "approved" refers to recognition of educational offerings only and does not imply approval or endorsement of any product of Covidien.

Covidien Energy-based Professional Education provider numbers are available upon request by calling the Clinical Education Department at 800-255-8522, ext. 6240.

Table of Contents

Properties of Electricity	2
Principles of Electrosurgery	2
Bipolar Electrosurgery	4
Monopolar Electrosurgery	4
Tissue Effects Change as You Modify the Waveform	5
Electrosurgical Tissue Effects	6
Grounded Electrosurgical Systems	7
Isolated Electrosurgical Systems	8
Patient Return Electrodes	9
Patient Return Electrode Monitoring Technology	11
Adaptive Technologies	12
Radio Frequency Ablation	14
Electrosurgery Safety Concerns During MIS	16
Capacitive Coupling During Endoscopy	17
Recommendations to Avoid Electrosurgical Patient Complications in MIS	18
Coated Electrodes	18
Argon-Enhanced Electrosurgery	19
Surgical Smoke	20
OR Safety Precautions	21
Key Terms	22
Bibliography	24

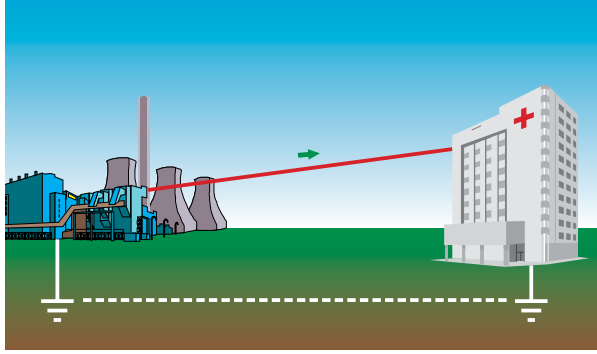

PROPERTIES OF ELECTRICITY

Several properties of electricity must be understood in order to understand electrosurgery. Electrons orbit the nuclei of atoms. Current flow occurs when electrons flow from one atom to the orbit of an adjacent atom. Voltage is the “force” or “push” that provides electrons with the ability to travel from atom to atom. If electrons encounter resistance, heat can be produced. The resistance to electron flow is called impedance.

A completed circuit must be present in order for electrons to flow. A completed circuit is an intact pathway through which electrons can travel. In this diagram, voltage is generated by the power plant, providing the force to push electrons through the circuit. The original source of these electrons is the earth (ground). To complete the circuit the electrons must return to ground. Any grounded object can complete the circuit, allowing the electrons to flow to ground.

Current = Flow of electrons during a period of time, measured in amperes

Circuit = Pathway for the uninterrupted flow of electrons

Voltage = Force pushing current through the resistance, measured in volts

Impedance/ Resistance = Obstacle to the flow of current, measured in ohms (impedance = resistance)

PRINCIPLES OF ELECTROSURGERY

Electrocautery

Often “electrocautery” is used to describe electrosurgery. This is incorrect. Electrocautery refers to direct current (electrons flowing in one direction) whereas electrosurgery uses alternating current. During electrocautery, current does not enter the patient’s body. Only the heated wire comes in contact with tissue. In electrosurgery, the patient is included in the circuit and current enters the patient’s body.

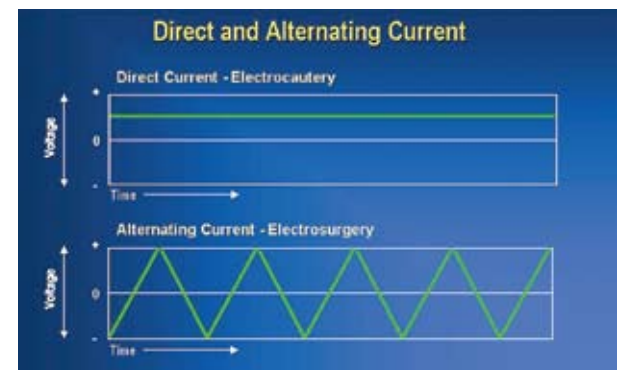
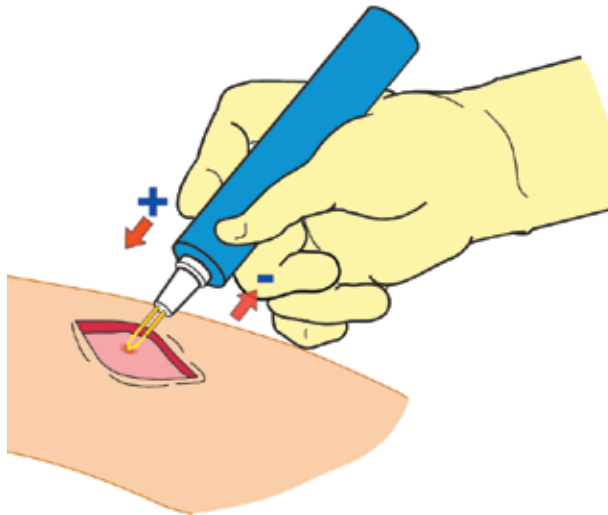

Principles of Electrosurgery in the O.R.

Principles of electricity are relevant in the operating room. The electrosurgical generator is the source of the electron flow and voltage. The circuit is composed of the generator, active electrode, patient and patient return electrode. Pathways to ground are numerous but may include the O.R. table, stirrups, staff members and equipment. The patient's tissue provides the impedance, producing heat as the electrons overcome the impedance.

**The circuit for the alternating current is depicted by arrows in opposite directions.*

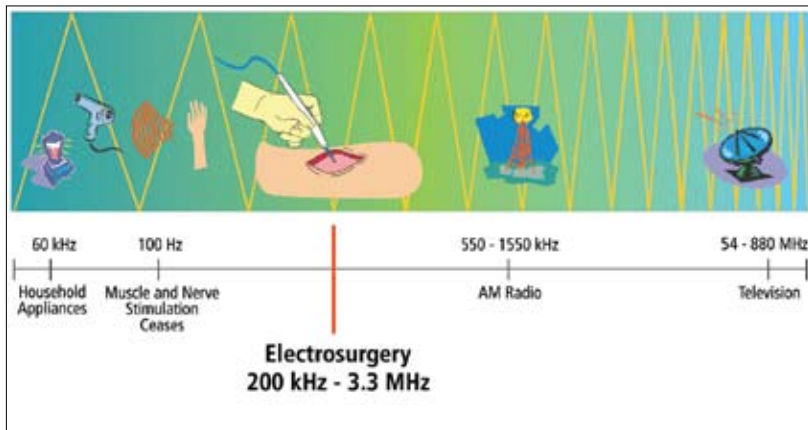
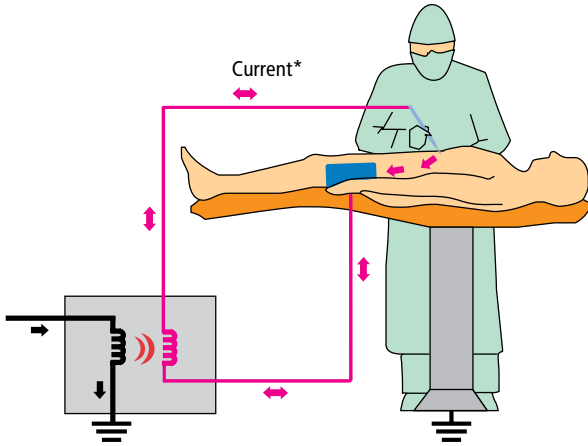

Frequency Spectrum

Standard electrical current alternates at a frequency of 60 cycles per second (Hz). Electrosurgical systems could function at this frequency, but because current would be transmitted through body tissue at 60 cycles, excessive neuromuscular stimulation and perhaps electrocution would result.

Because nerve and muscle stimulation cease at 100,000 cycles/second (100 kHz), electrosurgery can be performed safely at "radio" frequencies above 100 kHz. An electrosurgical generator takes 60 cycle current and increases the frequency to over 200,000 cycles per second. At this frequency electrosurgical energy can pass through the patient with minimal neuromuscular stimulation and no risk of electrocution.

- Active output and patient return functions are both accomplished at the site of surgery.
- Current path is confined to tissue grasped between forceps tines.
- Patient return electrode should not be applied for bipolar only procedures.

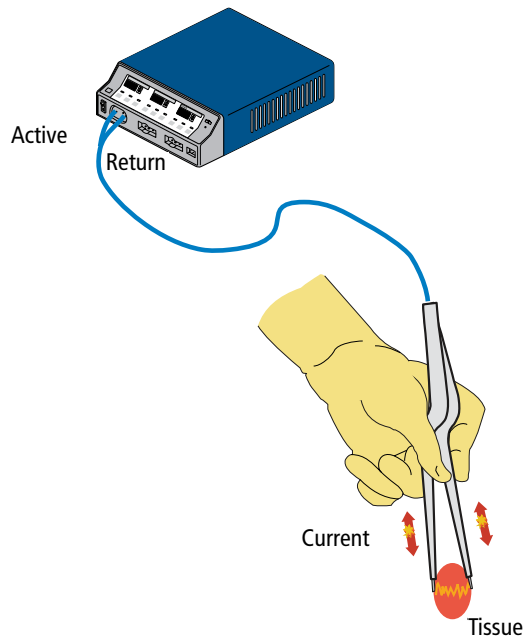

- The active electrode is in the wound.
- The patient return electrode is attached somewhere else on the patient.
- The current must flow through the patient to the patient return electrode.

BIPOLAR ELECTROSURGERY

Bipolar

In bipolar electrosurgery, both the active electrode and return electrode functions are performed at the site of surgery. The two tines of the forceps perform the active and return electrode functions. Only the tissue grasped is included in the electrical circuit. Because the return function is performed by one tine of the forceps, no patient return electrode is needed.

Bipolar Circuit

This picture represents a typical bipolar circuit.

MONOPOLAR ELECTROSURGERY

Monopolar

Monopolar is the most commonly used electrosurgical modality. This is due to its versatility and clinical effectiveness. In monopolar electrosurgery, the active electrode is in the surgical site. The patient return electrode is somewhere else on the patient's body. The current passes through the patient as it completes the circuit from the active electrode to the patient return electrode.

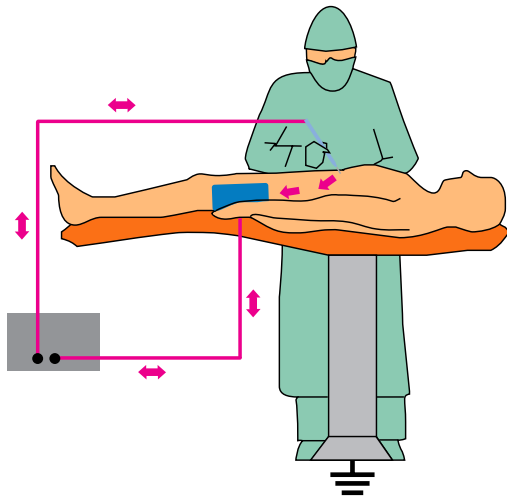

Monopolar Circuit

This picture represents a common monopolar circuit. There are four components to the monopolar circuit:

- Generator
- Active Electrode
- Patient
- Patient Return Electrode

TISSUE EFFECTS CHANGE AS YOU MODIFY THE WAVEFORM

Electrosurgical generators are able to produce a variety of electrical waveforms. As waveforms change, so will the corresponding tissue effects. Using a constant waveform, like "cut," the surgeon is able to vaporize or cut tissue. This waveform produces heat very rapidly.

Using an intermittent waveform, like "coagulation," causes the generator to modify the waveform so that the duty cycle ("on" time) is reduced. This interrupted waveform will produce less heat. Instead of tissue vaporization, a coagulum is produced.

A "blended current" is not a mixture of both cutting and coagulation current but rather a modification of the duty cycle. As you go from Blend 1 to Blend 3 the duty cycle is progressively reduced. A lower duty cycle produces less heat. Consequently, Blend 1 is able to vaporize tissue with minimal hemostasis whereas Blend 3 is less effective at cutting but has maximum hemostasis.

The only variable that determines whether one waveform vaporizes tissue and another produces a coagulum is the rate at which heat is produced. High heat produced rapidly causes vaporization. Low heat produced more slowly creates a coagulum. Any one of the five waveforms can accomplish both tasks by modifying the variables that impact tissue effect.

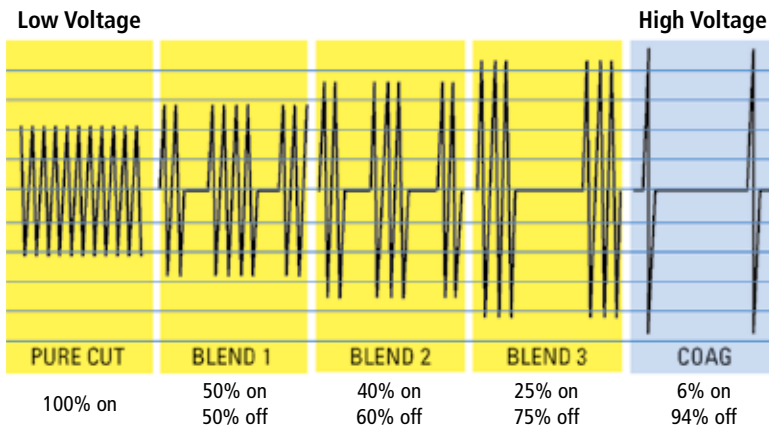

Typical Example

ELECTROSURGICAL TISSUE EFFECTS

Electrosurgical Cutting

Electrosurgical cutting divides tissue with electric sparks that focus intense heat at the surgical site. By sparking to tissue, the surgeon produces maximum current concentration. To create this spark the surgeon should hold the electrode slightly away from the tissue. This will produce the greatest amount of heat over a very short period of time, which results in vaporization of tissue.

Fulguration

Electrosurgical fulguration (sparking with the coagulation waveform) coagulates and chars the tissue over a wide area. Since the duty cycle (on time) is only about 6 percent, less heat is produced. The result is the creation of a coagulum rather than cellular vaporization. In order to overcome the high impedance of air, the coagulation waveform has significantly higher voltage than the cutting current. Use of high voltage coagulation current has implications during minimally invasive surgery.

Desiccation

Electrosurgical desiccation occurs when the electrode is in direct contact with the tissue. Desiccation is achieved most efficiently with the "cutting" current. By touching the tissue with the electrode, the current concentration is reduced. Less heat is generated and no cutting action occurs. The cells dry out and form a coagulum rather than vaporize and explode.

Many surgeons routinely "cut" with the coagulation current. Likewise, you can coagulate with the cutting current by holding the electrode in direct contact with tissue. It may be necessary to adjust power settings and electrode size to achieve the desired surgical effect. The benefit of coagulating with the cutting current is that you will be using far less voltage. Likewise, cutting with the cut current will also accomplish the task with less voltage. This is an important consideration during minimally invasive procedures.

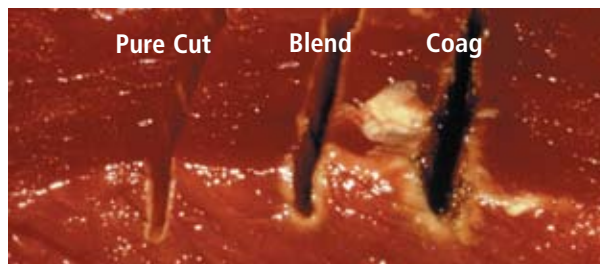
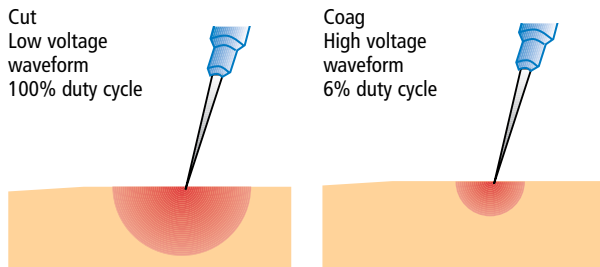
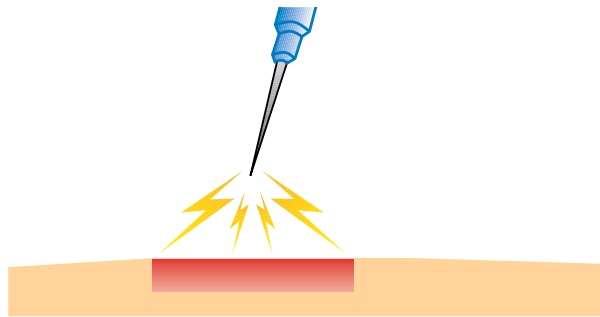
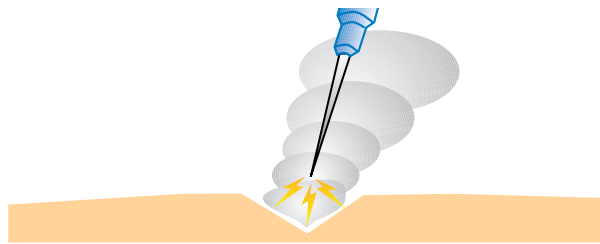

Low Thermal Spread/Charring High
←————— Voltage —————→
Low High

- **Waveform**
- **Power Setting**
- **Size of Electrode**
- **Time**
- **Manipulation of Electrode**
- **Type of Tissue**
- **Eschar**

Variables Impacting Tissue Effect

In addition to waveform and power setting, other variables impact tissue effect. They include:

Size of the electrode: The smaller the electrode, the higher the current concentration. Consequently, the same tissue effect can be achieved with a smaller electrode, even though the power setting is reduced.

Time: At any given setting, the longer the generator is activated, the more heat is produced. And the greater the heat, the farther it will travel to adjacent tissue (thermal spread).

Manipulation of the electrode: This can determine whether vaporization or coagulation occurs. This is a function of current density and the resultant heat produced while sparking to tissue versus holding the electrode in direct contact with tissue.

Type of Tissue: Tissues vary widely in resistance.

Eschar: Eschar is relatively high in resistance to current. Keeping electrodes clean and free of eschar will enhance performance by maintaining lower resistance within the surgical circuit.

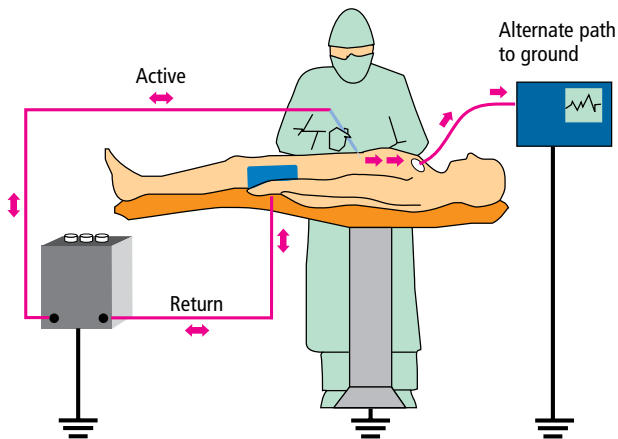

GROUNDING ELECTROSURGICAL SYSTEMS

Electrosurgical technology has changed dramatically since its introduction in the 1920s. Generators operate by taking alternating current and increasing its frequency from 50 or 60 cycles/second to over 200,000 cycles/second. Originally, generators used grounded current from a wall outlet. It was assumed that once the current entered the patient's body, it would return to ground through the patient return electrode. But electricity will always seek the path of least resistance. When there are many conductive objects touching the patient and leading to ground, the current will select as its pathway to ground the most conductive object – which may not be the patient return electrode. Current concentration at this point may lead to an alternate site burn.

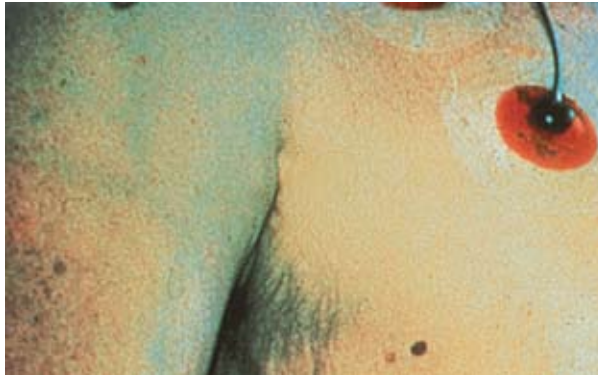

Alternate site burn

RF Current Division

With the phenomenon called current division, the current may split (or divide) and follow more than one path to ground. The circuit to ground is completed whether it travels the intended electro-surgical circuit to the patient return electrode or to an alternate ground referenced site. Patients are thereby exposed to the risk of alternate site burns because (1) current follows the easiest, most conductive path; (2) any grounded object, not just the generator, can complete the circuit; (3) the surgical environment offers many alternative routes to ground; (4) if the resistance of the alternate path is low enough and the current flowing to ground in that path is sufficiently concentrated, an unintended burn may be produced at the alternate grounding site.

This picture shows an alternate site burn that occurred when a grounded electro-surgical generator was used with a ground-referenced ECG device. The ECG electrode provided the path of least resistance to ground. However, it did not disperse the current over a large enough area. The heat produced an alternate site burn under the ECG electrode due to current concentration.

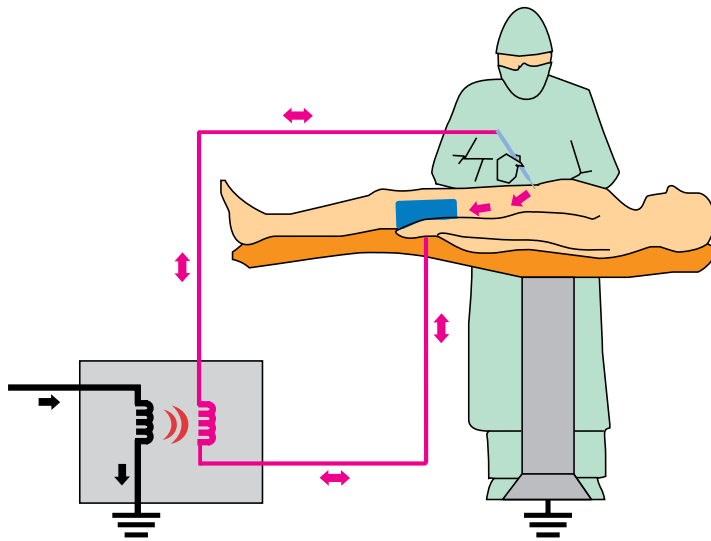

ISOLATED ELECTROSURGICAL SYSTEMS

Isolated System

In 1968, electro-surgery was revolutionized by isolated generator technology. The isolated generator isolates the therapeutic current from ground by referencing it within the generator circuitry. In other words, in an isolated electro-surgical system, the circuit is completed not by the ground but by the generator. Even though grounded objects remain in the operating room, electro-surgical current from isolated generators will not recognize grounded objects as pathways to complete the circuit. Isolated electro-surgical energy recognizes the patient return electrode as the preferred pathway back to the generator.

By removing ground as a reference for the current, the isolated generator eliminates many of the hazards inherent in grounded systems, most importantly current division and alternate site burns.



Pad site burn

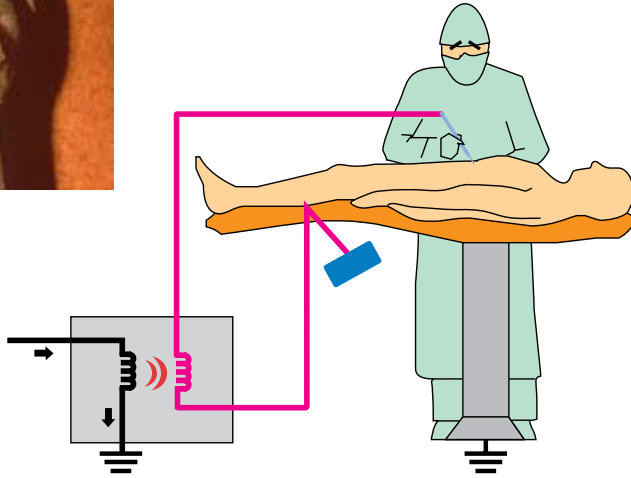

Deactivated Isolated System

If the circuit to the patient return electrode is broken, an isolated generator will deactivate the system because the current cannot return to its source.

Generators with isolated circuits mitigate the hazard of alternate site burns but do not protect the patient from return electrode burns, such as the one shown at left.

Historically, patient return electrode burns have accounted for 70 percent of the injuries reported during the use of electrosurgery. Patient return electrodes are not "inactive" or "passive." The only difference between the "active" electrode and the patient return electrode is their size and relative conductivity. The quality of the conductivity and contact area at the pad/patient interface must be maintained to prevent a return electrode site injury.

$$\text{BURN} = \frac{\text{CURRENT X TIME}}{\text{AREA}}$$

PATIENT RETURN ELECTRODES

Function of the Patient Return Electrode

The function of the patient return electrode is to remove current from the patient safely.

A return electrode burn occurs when the heat produced, over time, is not safely dissipated by the size or conductivity of the patient return electrode.

Ideal Return Electrode Contact with Current Dispersion

The ideal patient return electrode safely collects current delivered to the patient during electrosurgery and carries that current away. To eliminate the risk of current concentration, the pad should present a large low impedance contact area to the patient. Placement should be on conductive tissue that is close to the operative site.

Again, the only difference between the "active" electrode and the patient return electrode is their relative size and conductivity. Concentrate the electrons at the active electrode and high heat is produced. Disperse this same current over a comparatively large patient return electrode and little heat is produced.

Dangerous Return Electrode Contact with Current Concentration

If the surface area contact between the patient and the return electrode is reduced, or if the impedance of that contact is increased, a dangerous condition can develop. In the case of reduced contact area, the current flow is concentrated in a smaller area. As the current concentration increases, the temperature at the return electrode increases. If the temperature at the return electrode site increases enough, a patient burn may result. Surface area impedance can be compromised by excessive hair, adipose tissue, bony prominences, fluid invasion, adhesive failure, scar tissue and many other variables.

Assess Pad Site Location

Choose: Well-vascularized muscle mass

Avoid: Vascular insufficiency
Irregular body contours
Bony prominences

Consider: Incision site/prep area
Patient position
Other equipment on patient

Current Concentration/Density

The more concentrated the energy the greater the thermodynamic effect.

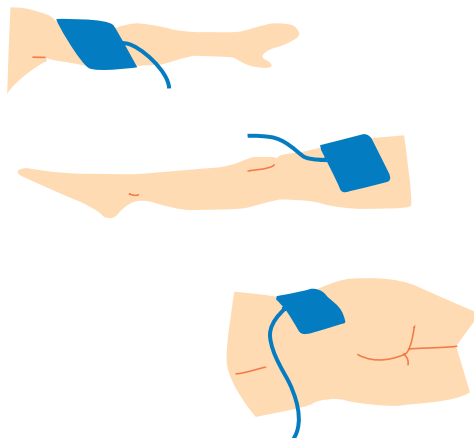
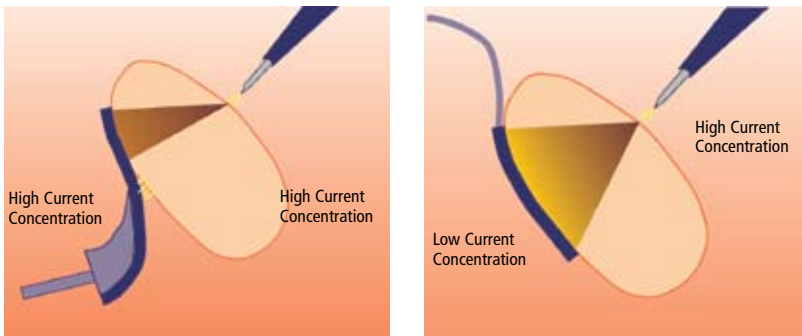

PATIENT RETURN ELECTRODE MONITORING TECHNOLOGY

Return Electrode Monitoring

REM™ contact quality monitoring was developed to protect patients from burns due to inadequate contact of the return electrode. Pad site burns are caused by decreased contact area at the return electrode site. REM™-equipped generators actively monitor the amount of impedance at the patient/pad interface because there is a direct relationship between this impedance and the contact area. The system is designed to deactivate the generator before an injury can occur if it detects a dangerously high level of impedance at the patient/pad interface.

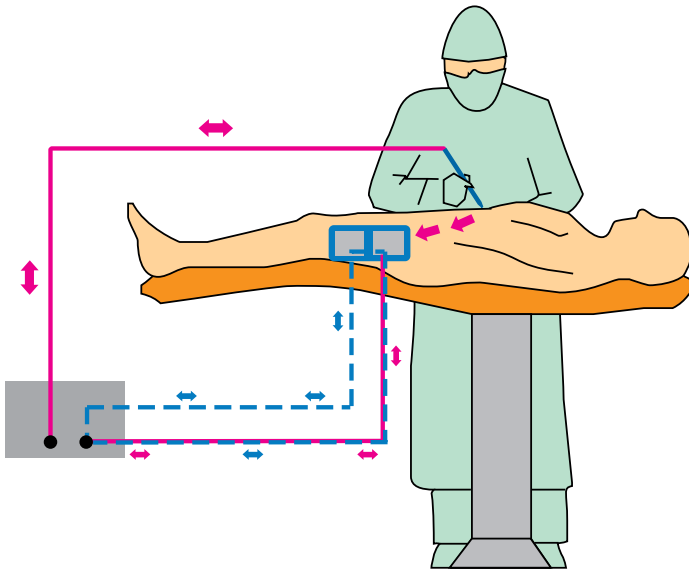

In order to work properly, REM™-equipped generators must use a patient return electrode that is compatible, as depicted in the photo at right. Such an electrode can be identified by its “split” appearance – that is, it has two separate areas – and a special plug with a center pin. REM™ technology has been proven safe in over 100 million procedures.

ADAPTIVE TECHNOLOGIES

Instant Response™ Technology

Computer-controlled output is automatically adjusted

- Measures tissue impedance/resistance at the electrode contact site
- Provides instant response to changes in tissue impedance/resistance
- Produces consistent tissue effect as demonstrated by a high Power Efficiency Rating (PER)* of approximately 98 (Force FX™-C) out of a possible 100
- Controls maximum output voltage
 - Reduces capacitive coupling and video interference
 - Minimizes sparking

* Power Efficiency Rating (PER) is a measure of the ability of an electrosurgical generator to accurately deliver the selected power into a wide range of tissue types.

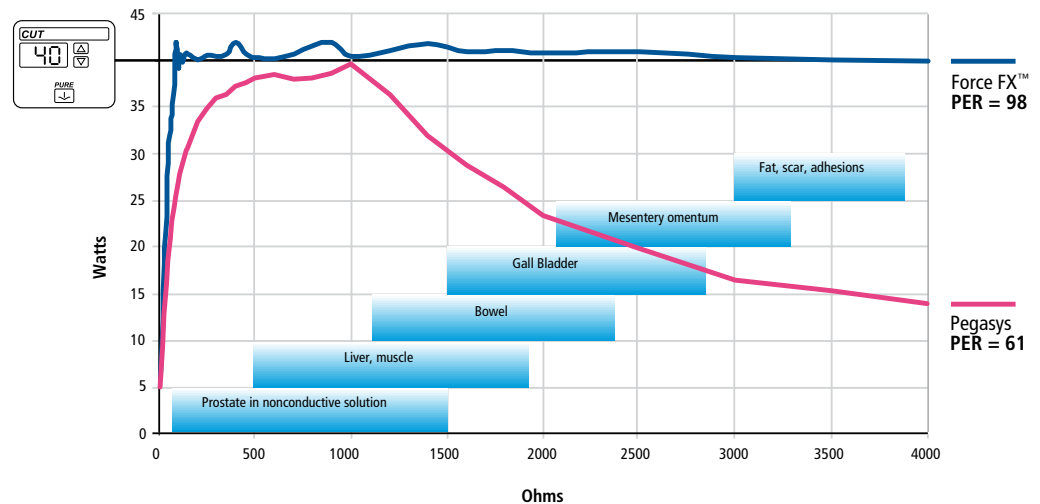

Comparison in Pure Cut mode of an Instant Response™ generator and a conventional generator.

Vessel Sealing Technology™

An electrosurgical technology that combines pressure and energy to create a seal.

- **Reliable, consistent permanent vessel wall fusion**
- **Minimal thermal spread**
- **Reduced sticking and charring**
- **Seal strength higher than other energy-based techniques**
- **Seal strengths comparable to existing mechanical-based techniques**

A specialized generator/instrument system has been developed that is designed to reliably seal vessels and tissue bundles for surgical ligation both in laparoscopic and open surgery applications. It applies a unique form of bipolar electrosurgery in combination with optimal pressure delivery by the instruments in order to fuse the vessel walls and create a permanent seal.

The output is feedback-controlled so that a reliable seal is achieved in minimal time independent of the type or amount of tissue in the jaws. The result is reliable seals on vessels up to and including 7 mm in diameter or tissue bundles with a single activation. The thermal spread is significantly reduced compared to traditional bipolar systems and is comparable to ultrasonic coagulation. The seal site is often translucent, allowing evaluation of hemostasis prior to cutting. Seal strengths are comparable to mechanical ligation techniques such as sutures and clips and are significantly stronger than other energy-based techniques such as standard bipolar or ultrasonic coagulation. The seals have been proven to withstand more than three times normal systolic blood pressure.

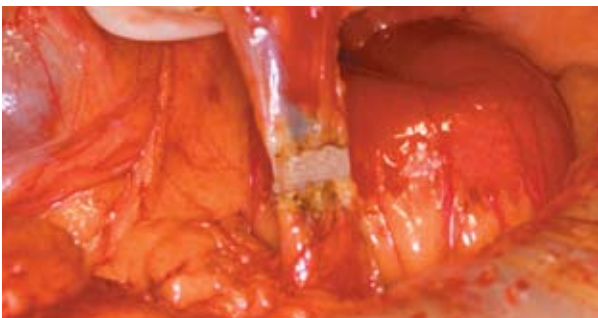

Bipolar-type Generator

- **Low Voltage — 180V**
- **High Amperage — 4A**
- **Tissue Response**

Instruments

- **Precisely calibrated**
- **High pressure**
- **Open/laparoscopic**

System Operation

- **Applies optimal pressure to vessel/tissue bundle**
- **Energy delivery cycle:**
 - Measures initial resistance of tissue and chooses appropriate energy settings
 - Delivers pulsed energy with continuous feedback control
 - » Pulses adapt as the cycle progresses
 - Senses that tissue response is complete and stops the cycle

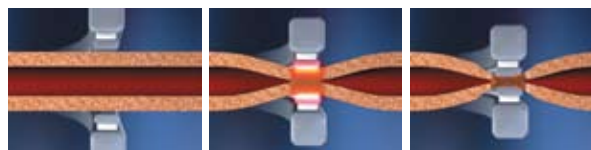

Step 1

Step 2

Step 3



Radiofrequency Ablation System

Alternating current through the tissue creates friction on a molecular level. Increased intracellular temperature generates localized interstitial heating. At temperatures above 60 degrees centigrade, cellular proteins rapidly denature and coagulate, resulting in a lesion.

How it works

The Valleylab™ RF Ablation System with Cool-tip™ Technology generator's feedback algorithm senses tissue impedance and automatically delivers the optimum amount of radiofrequency energy. A unique electrode design eliminates tissue charring and allows for maximum current delivery, resulting in a larger ablation zone in less time.



Pretreatment*

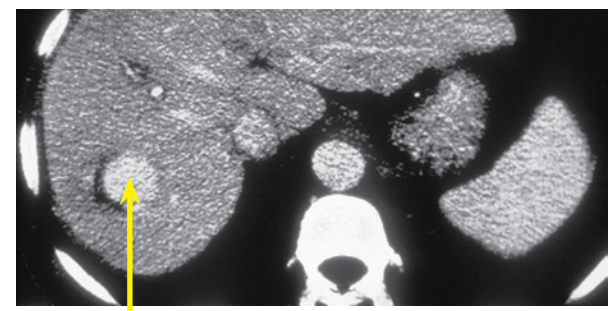

CT scan of 4 cm hepatoma

Post-treatment with Valleylab™ RFA System*

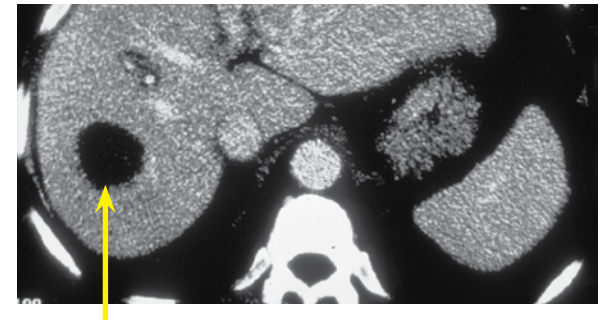

CT scan on six-month follow-up

* See S N Goldberg in Bibliography

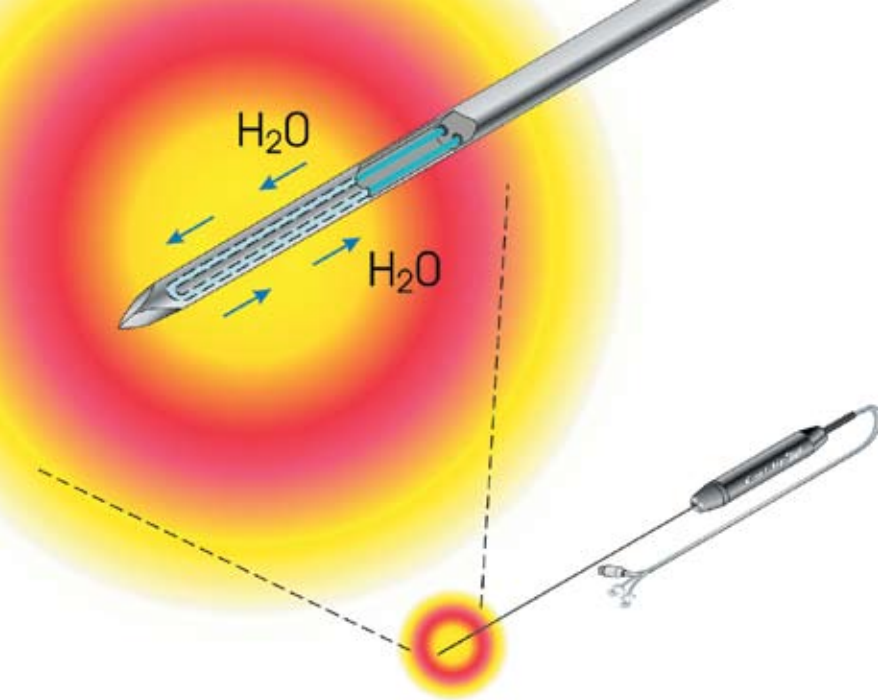

Cool-tip™ Ablation

The system's generator software monitors tissue impedance and adjusts the output accordingly. Pulsed energy delivery allows the target tissue to stabilize, reducing tissue impedance increases that could limit RF output. Typical treatments are completed in a 12-minute cycle.

The Cooling Effect

The electrode's internal circulation of water cools the tissue adjacent to the exposed electrode, maintaining low impedance during the treatment cycle. Low impedance permits maximum energy deposition for a larger ablation volume.

- Direct Coupling
- Insulation Failure
- Capacitive Coupling

ELECTROSURGERY SAFETY CONSIDERATIONS DURING MIS

When electrosurgery is used in the context of minimally invasive surgery, it raises a new set of safety concerns. Some of these are: insulation failure, direct coupling of current and capacitively coupled current.

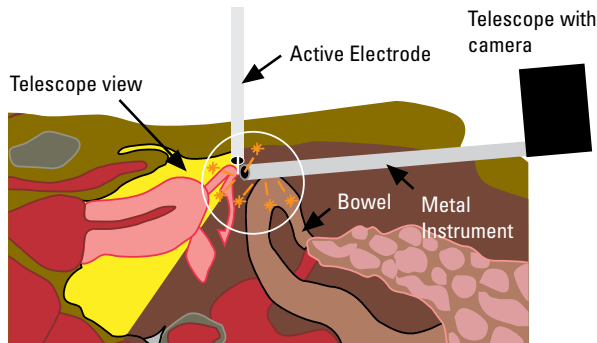

Direct Coupling

Direct coupling occurs when the user accidentally activates the generator while the active electrode is near another metal instrument. The secondary instrument will become energized. This energy will seek a pathway to complete the circuit to the patient return electrode. There is potential for significant patient injury.

Do not activate the generator while the active electrode is touching or in close proximity to another metal object.

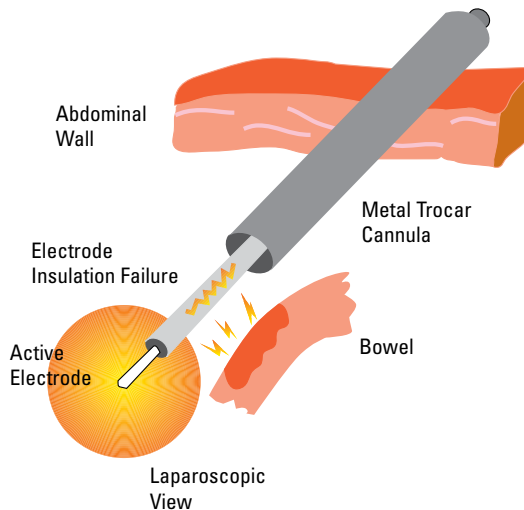

Insulation Failure

Many surgeons routinely use the coagulation waveform. This waveform is comparatively high in voltage. This voltage or “push” can spark through compromised insulation. Also, high voltage can “blow holes” in weak insulation. Breaks in insulation can create an alternate route for the current to flow. If this current is concentrated, it can cause significant injury.

You can get the desired coagulation effect without high voltage, simply by using the “cutting” current while holding the electrode in direct contact with tissue. This technique will reduce the likelihood of insulation failure. Remember, you can coagulate with the cutting current by holding the electrode in direct contact with tissue, thereby lowering the current concentration. By lowering current concentration you will reduce the rate at which heat is produced and rather than vaporize tissue you will coagulate - even though you are activating the “cutting” current.

CAPACITIVE COUPLING DURING ENDOSCOPY

Metal Cannula System

A capacitor is not a part labeled “capacitor” in an electrical device. It occurs whenever a nonconductor separates two conductors.

During MIS procedures, an “inadvertent capacitor” may be created by the surgical instruments. The conductive active electrode is surrounded by nonconductive insulation. This in turn is surrounded by a conductive metal cannula.

A capacitor creates an electrostatic field between the two conductors and, as a result a current in one conductor can, through the electrostatic field, induce a current in the second conductor.

In the case of the “inadvertent capacitor” in an MIS procedure, a capacitor may be created by the surgical instruments’ composition and placement.

Plastic Cannula System

Capacitance cannot be entirely eliminated with an all plastic cannula. The patient’s conductive tissue completes the definition of a capacitor. Capacitance is reduced, but is not eliminated.

Hybrid Cannula System

The worst case occurs when a metal cannula is held in place by a plastic anchor (hybrid cannula system). The metal cannula still creates a capacitor with the active electrode. However, the plastic abdominal wall anchor prevents the current from dissipating through the abdominal wall. The capacitively coupled current may exit to adjacent tissue on its way to the patient return electrode. This can cause significant injury.

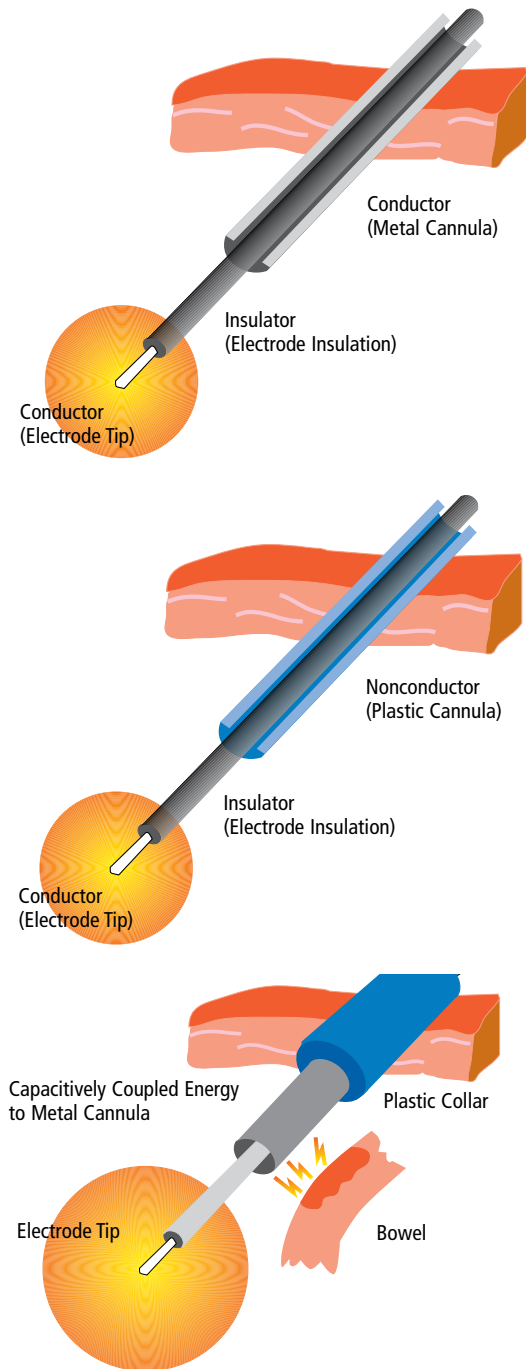

RECOMMENDATIONS TO AVOID ELECTROSURGICAL PATIENT COMPLICATIONS IN MIS

Most potential problems can be avoided by following these simple guidelines:

- Inspect insulation carefully
- Use lowest possible power setting
- Use a low voltage waveform (cut)
- Use brief intermittent activation vs. prolonged activation
- Do not activate in open circuit
- Do not activate in close proximity or direct contact with another instrument
- Use bipolar electrosurgery when appropriate
- Select an all metal cannula system as the safest choice. Do not use hybrid cannula systems that mix metal with plastic.
- Utilize available technology, such as a tissue response generator to reduce capacitive coupling or an active electrode monitoring system, to eliminate concerns about insulation failure and capacitive coupling.

NOTE: Any cannula system may be used if an active electrode monitor is utilized.

Teflon® (PTFE) Coating and Elastomeric Silicone Coating

- Use of a coated blade facilitates removal of eschar but does not eliminate need for frequent cleaning
 - Prevent eschar buildup, which increases resistance and contributes to arcing
 - Eschar can ignite and cause a fire
- Wipes clean with a sponge, eliminating the use of a scratch pad
- Scratch pad creates grooves on stainless blades
- Grooves contribute to eschar buildup

COATED ELECTRODES

Elastomeric Silicone Coated Electrode

- Bendable
- Retains cleaning properties longer
- Coating will not crack or flake
- Cutting edge performance similar to stainless steel electrode
- Enables surgeon to use lower power settings
 - Reduces potential for thermal spread.



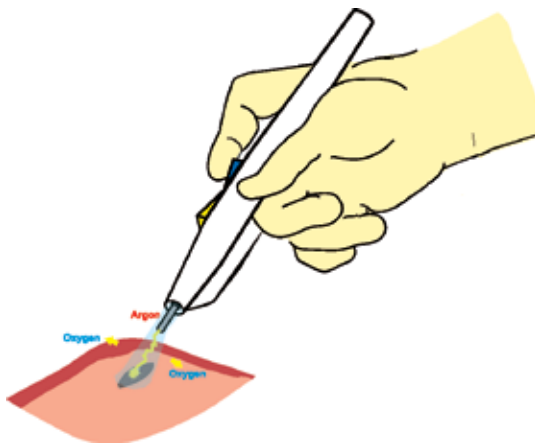

- **Inert**
- **Noncombustible**
- **Easily ionized by RF energy**
- **Creates bridge between electrode and tissue**
- **Heavier than air**
- **Displaces nitrogen and oxygen**



- **Decreased smoke, odor**
- **Noncontact in coagulation mode**
- **Decreased blood loss, rebleeding**
- **Decreased tissue damage**
- **Flexible eschar**

ARGON-ENHANCED ELECTROSURGERY

Argon Flow

Argon-enhanced electrocautery incorporates a stream of argon gas to improve the surgical effectiveness of the electrocautery current.

Properties of Argon Gas

Argon gas is inert and noncombustible, making it a safe medium through which to pass electrocautery current. Electrocautery current easily ionizes argon gas, making it more conductive than air. This highly conductive stream of ionized gas provides the electrical current an efficient pathway.



Argon-Enhanced Coagulation and Cut

There are many advantages to argon-enhanced electrocautery cutting and coagulation.

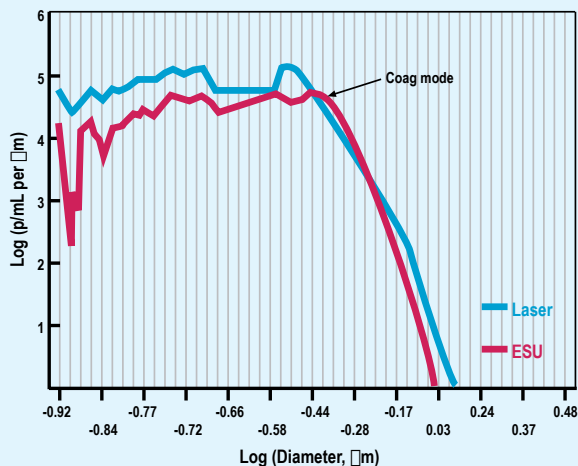

“The smoke plume generated from electrosurgery contains chemical byproducts. The Occupational Safety and Health Administration recommends that smoke evacuation systems be used to reduce potential acute and chronic health risks to patients and personnel.”

AORN Recommended Practices for Electrosurgery 2003

SURGICAL SMOKE

Spectral Content of Surgical Smoke

Surgical smoke is created when tissue is heated and cellular fluid is vaporized by the thermal action of an energy source.

Research has shown that smoke from electrosurgery is similar in content to that produced by a surgical laser. If you currently evacuate the plume from a laser, you should do likewise for smoke created by electrosurgical generators. Viral DNA, bacteria, carcinogens and irritants are known to be present in electrosurgical smoke. Universal precautions indicate a smoke evacuation system should be used.

The National Institute of Occupational Safety and Health (NIOSH) and the Center for Disease Control (CDC) have also studied electrosurgical smoke at length. The organizations concluded:

“Research studies have confirmed that this smoke plume can contain toxic gases and vapors such as benzene, hydrogen cyanide, and formaldehyde, bioaerosols, dead and live cellular material (including blood fragments) and viruses.”

Smoke Evacuation Devices

New products have been introduced to make smoke evacuation easier and more effective. Smoke evacuation devices can now be attached directly to a standard electrosurgical pencil.

AORN Recommended Practices for Electrosurgery

The Association of Operating Room Nurses revised the Recommended Practices for Electrosurgery in the 1994 AORN Standards and Recommended Practices for Perioperative Nursing. AORN included a recommendation for evacuation of all surgical smoke at that time and updated this recommendation in 1998.

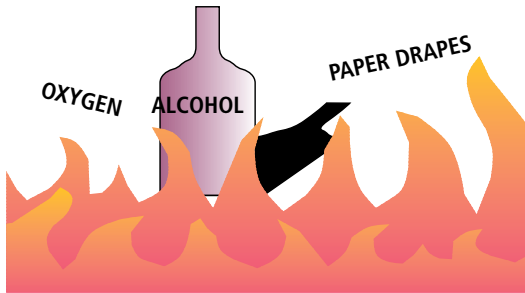

O.R. SAFETY PRECAUTIONS

- “The ESU should not be used in the presence of flammable agents (i.e., alcohol and/or tincture-based agents)”

AORN Recommended Practices for Electrosurgery 2003

- Avoid oxygen-enriched environments

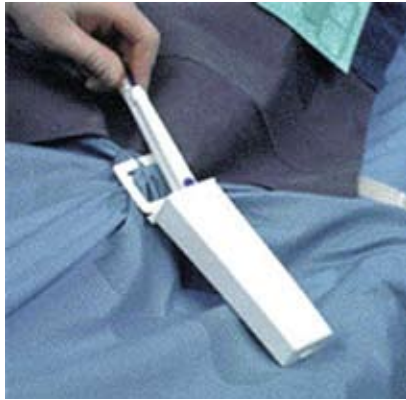

- Use of a nonconductive holster is recommended by:
 - ECRI, Los Angeles Fire Marshall, AORN
 - [Cutting Your Legal Risks of Electrosurgery in OBG Management](#)

“The active electrode(s) should be placed in a clean, dry, well-insulated safety holster when not in use.”

AORN Recommended Practices for Electrosurgery 2003

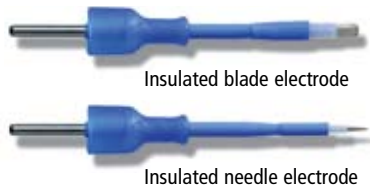

- Do not use red rubber catheters or other materials as a sheath on active electrodes
 - Red rubber and other plastic materials may ignite with high power settings and in the presence of an oxygen-enriched environment
 - Use manufacturer-approved insulated tips



Radiofrequency is not always confined by insulation. Current leakage does occur.

- It is recommended that:
 - Cords not be wrapped around metal instruments
 - Cords not be bundled together

KEY TERMS

Active Electrode	An electrosurgical instrument or accessory that concentrates the electric (therapeutic) current at the surgical site.
Active Electrode Monitoring	A system that continuously conducts stray current from the laparoscopic electrode shaft back to the generator and away from patient tissue. It also monitors the level of stray current and interrupts the power should a dangerous level of leakage occur.
Bipolar Electrosurgery	Electrosurgery where current flows between two bipolar electrodes that are positioned around tissue to create a surgical effect (usually desiccation). Current passes from one electrode, through the desired tissue, to another electrode, thus completing the circuit without entering any other part of the patient's body.
Capacitive Coupling	The condition that occurs when electrical current is transferred from one conductor (the active electrode), through intact insulation, into adjacent conductive materials (tissue, trocars, etc.).
Circuit	The path along which electricity flows.
Current	The number of electrons moving past a given point per second, measured in amperes (A).
Current Division	Electrical current leaving the intended electrosurgical circuit and following alternate paths to ground; typically the cause of alternate site burns when using a grounded generator.
Cutting	The electrosurgical effect that results from high current density in the tissue causing cellular fluid to burst into steam and disrupt the structure. Voltage is low and current flow is high.
Desiccation	The electrosurgical effect of tissue dehydration and protein denaturation caused by direct contact between the electrosurgical electrode and tissue. Lower current density than sparking (cut).
Direct Coupling	The condition that occurs when one electrical conductor (the active electrode) comes into direct contact with another secondary conductor (scopes, graspers). Electrical current will flow from the first conductor into the secondary one and energize it.
Electrosurgery	The passage of high frequency electrical current through tissue to create a desired clinical effect.
Frequency	The rate at which a cycle repeats itself; in electrosurgery, the number of cycles per second that current alternates.
Fulguration	Using electrical arcs (sparks) to coagulate tissue. The sparks jump from the electrode across an air gap to the tissue.

Instant Response™ Technology	An electrosurgical generator technology that continuously measures the impedance presented by target tissue to the active electrode, and, in response to changes in that impedance, makes corresponding adjustments in the voltage delivered in the cut modes.
Insulation Failure	The condition that occurs when the insulation barrier around an electrical conductor is breached. As a result, current will travel outside the intended circuit.
Isolated Output	The output of an electrosurgical generator that is not referenced to earth (ground).
Monopolar Electrosurgery	A surgical procedure in which only the active electrode is in the surgical wound; electrosurgery that directs current through the patient's body and requires the use of a patient return electrode.
Patient Return Electrode	A conductive plate or pad (dispersive electrode) that recovers the therapeutic current from the patient during electrosurgery, dispersing it over a wide surface area, and returns it to the electrosurgical generator. Plates are usually rigid and made of metal or foil-covered cardboard; pads are usually flexible.
Power Efficiency Rating (PER)	A measure of the ability of an electrosurgical generator to accurately deliver the selected power into a wide range of tissue types.
Radiofrequency Ablation System	A system that uses radiofrequency energy to effectively heat and coagulate target tissue for ablation.
Resistance	The lack of conductivity or the opposition to the flow of electric current, measured in ohms. Also called impedance.
Return Electrode Monitoring	A system that actively monitors tissue impedance (resistance) at the contact between the patient's body and the patient return electrode and interrupts the power if the quality of the contact is compromised.
RF/Radiofrequency	Frequencies above 100 kHz that transmits radio signals, the high-frequency current used in electrosurgery.
Vessel Sealing Technology™	A method of ligating vessels that combines thermal effects of a specially modified bipolar electrosurgical output with high compression force to alter the collagen and fuse/obliterate the vessel lumen.
Voltage	The force that pushes electric current through resistance; electromotive force or potential difference expressed in volts.
Watt	The unit of measurement for power.

BIBLIOGRAPHY

- AAGL Technical Bulletin Committee. Electrosurgical safety. AAGL Technical Bulletin. January, 1995;1:1-7.
- Dodd GD, Soulen MC, Kane RA, et al. Minimally invasive treatment of malignant hepatic tumors: at the threshold of a major breakthrough. *Radiogr.* 2000; 20:9-27.
- Dupuy DE. Radiofrequency ablation: an outpatient percutaneous treatment. *Med Health RI.* 1999;82(6):213-216.
- Fortunato NM. Biotechnology: specialized surgical equipment. In: Berry & Kohn's *Operating Room Technique*. 9th ed. Mosby-Yearbook; 2000:313-318.
- Giordano BP. Don't be a victim of surgical smoke. *AORN J.*1996;63(3).
- Gruendemann BJ, Billie Fernsebner B. Technology management: Electrosurgery. In: *Comprehensive Perioperative Nursing, Vol. 1 Principles*. Jones and Bartlett Publishers; 1995:315-323.
- Goldberg SN, Gazelle GS, Mueller PR. Thermal ablation therapy for focal malignancy: a unified approach to underlying principles, techniques, and diagnostic imaging guidance. *AJR.* February 2000:174.
- Iannitti D, Dupuy D. Invasive management of hepatic metastases. *Semin Laparosc Surg.* 2000;7(2):118-28.
- Kennedy JS, Stranahan PL, Taylor K D, Chandler JG. High-burst-strength, feedback-controlled bipolar vessel sealing. *Surg Endosc.* 1998;12(6):876-878.
- Kennedy JS, Stranahan PL, Taylor KD, Chandler JG. High-burst strength, servoregulated, bipolar vessel sealing. Presented at: Joint Euro Asian Congress of Endoscopic Surgery; June 1997.
- Phippen ML, Wells MP. Providing hemostasis. In: *Patient Care During Operative and Invasive Procedures*. WB Saunders Co; 1999:222-224.
- Monopolar electrosurgical safety during laparoscopy. *ECRI Health Devices.* January 1995; 24(1):6-27.
- Recommended practices for endoscopic minimally invasive surgery. *AORN Standards and Recommended Practices for Perioperative Nursing*. Denver, Colo.: Association of Operating Room Nurses;2003:251-255.
- Recommended Practices for Electrosurgery, *AORN Standards and Recommended Practices for Perioperative Nursing*. Denver, Colo.: Association of Operating Room Nurses;2003:237-244.
- Rothrock JC. Patient and environmental safety. In: *Surgical Modalities, Alexander's Care of the Patient in Surgery*. 11th ed. Mosby-Yearbook 2003:19-20, 86-93.
- Tucker RD, Voyles CR. Laparoscopic electrosurgery: complications and prevention. *AORN J.* July 1995;62 (1):49-78.
- Update: controlling the risks of electrosurgery. *ECRI Health Devices.* December 1989;18(12):430-432.
- Vancallie TG. *Electrosurgery: Principles and Risks*. Center for Gynecologic Endoscopy. San Antonio, Texas:1994.
- Control of smoke from laser/electric surgical procedures. *NIOSH Hazard Controls, DHHS (NIOSH) Publication*. September 1996; 96-128.
- Yeh CR. Surgical smoke plume principles and function of smoke, aerosol, gases, and smoke evacuators. *Surg Serv Manage.* April 1997;3(4.):41-44.

COVIDIEN, COVIDIEN with Logo and ™ marked brands are
trademarks of Covidien AG or its affiliate.
© 2008 Covidien AG or its affiliate. All rights reserved.

reorder no: LBES 1009567 Rev. 2008/03



5920 LONGBOW DRIVE
BOULDER, CO
80301

800-255-8522 [MAIN]

WWW.COVIDIEN.COM