

# The Story of Self-Repairing Flight Control Systems

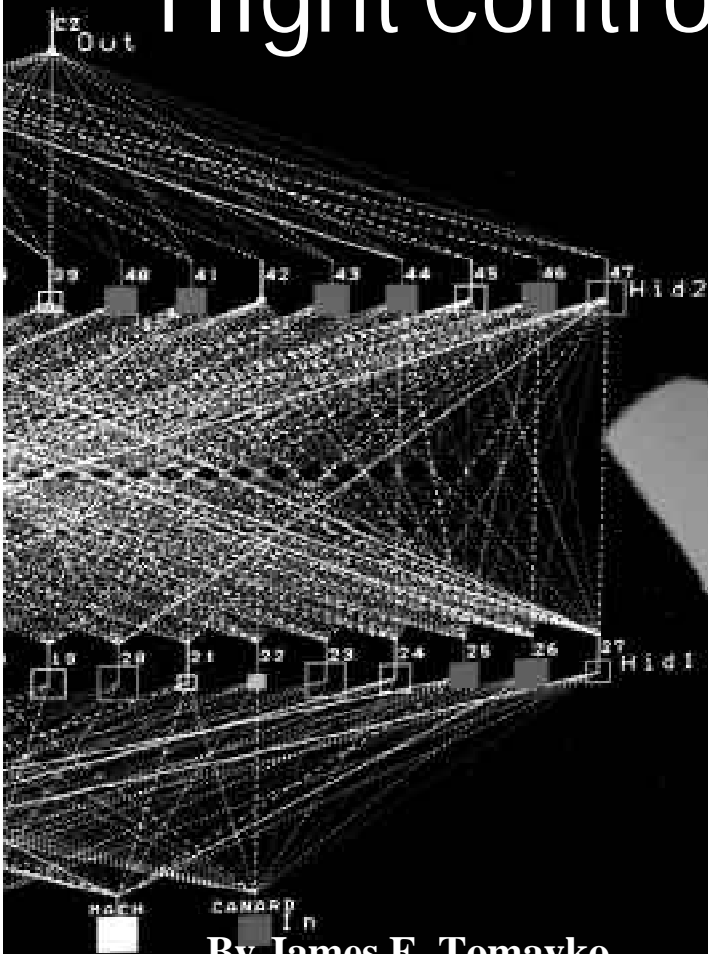

By James E. Tomayko  
Edited by Christian Gelzer

Dryden Historical Study No. 1



# The Story of Self-Repairing Flight Control Systems

**By James E. Tomayko  
Edited by Christian Gelzer**

**Dryden Historical Study No. 1**



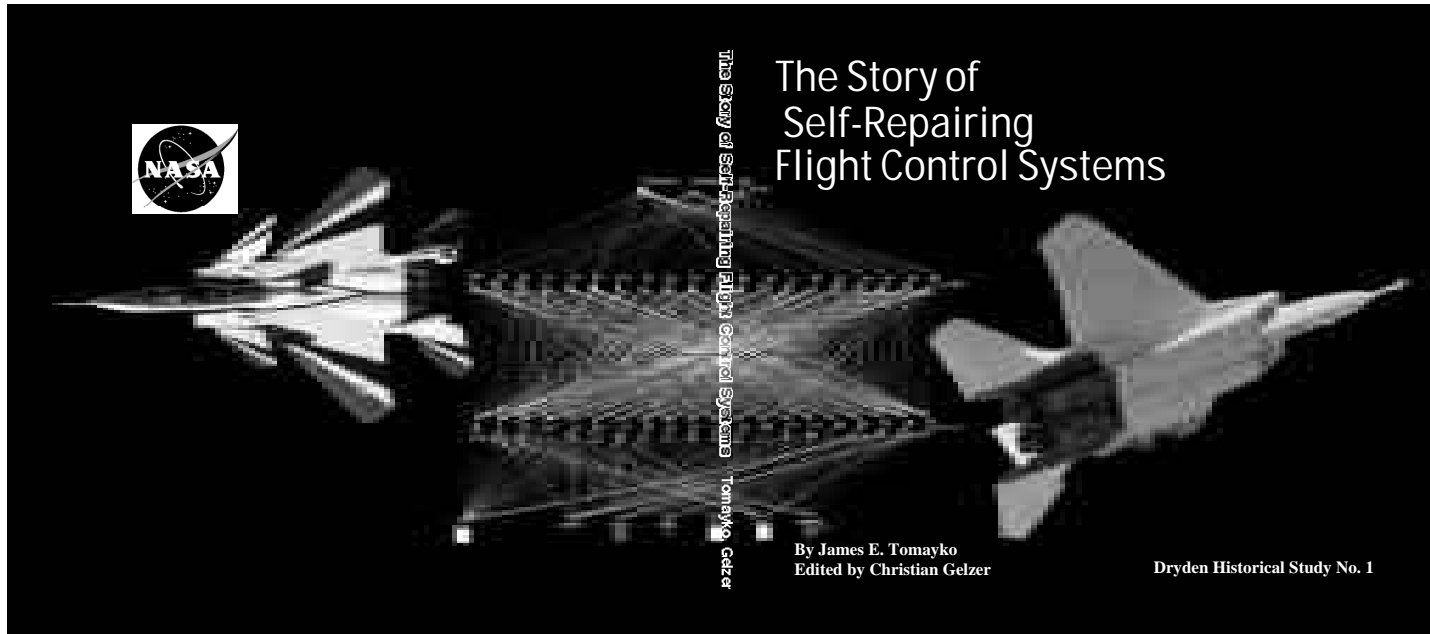

## On the Cover:

On the front cover is a NASA photo (EC 88203-6), which shows an Air Force F-15 flying despite the absence of one of its wings. The image was modified to illustrate why self-repairing flight control systems might play a vital role in aircraft control.

Between the front and rear covers, the lattice pattern represents an electronic model of a neural net, essential to the development of self-repairing aircraft.

On the back cover is the F-15 Advanced Control Technology for Integrated Vehicles, or ACTIVE, (EC96 43780-1), which was the primary testbed for self-repairing flight control systems.

Book and cover design by Jay Levine, NASA Dryden Flight Research Center

# Table of Contents

<b>Acknowledgments</b> .....	VI
<b>Sections</b>	
Section 1: A Brief History of Flight Control and Previous Self-Repairing Systems.....	1
Section 2: The Self-Repairing Flight Control System.....	12
Section 3: The Intelligent Flight Control System .....	29
<b>Epilogue: The Future of Intelligent Flight Control</b> .....	45
<b>Glossary</b> .....	52
<b>Abbreviations</b> .....	54
<b>Bibliography</b> .....	55
<b>Appendices</b>	
Appendix A: SRFCFS Flight Log.....	60
Appendix B: Flight Test Summary, SRFCFS F-15A No. 8 RTO: NASA Ames-Dryden .....	61
Appendix C: SRFCR Progress Report, April 5, 1990 .....	72

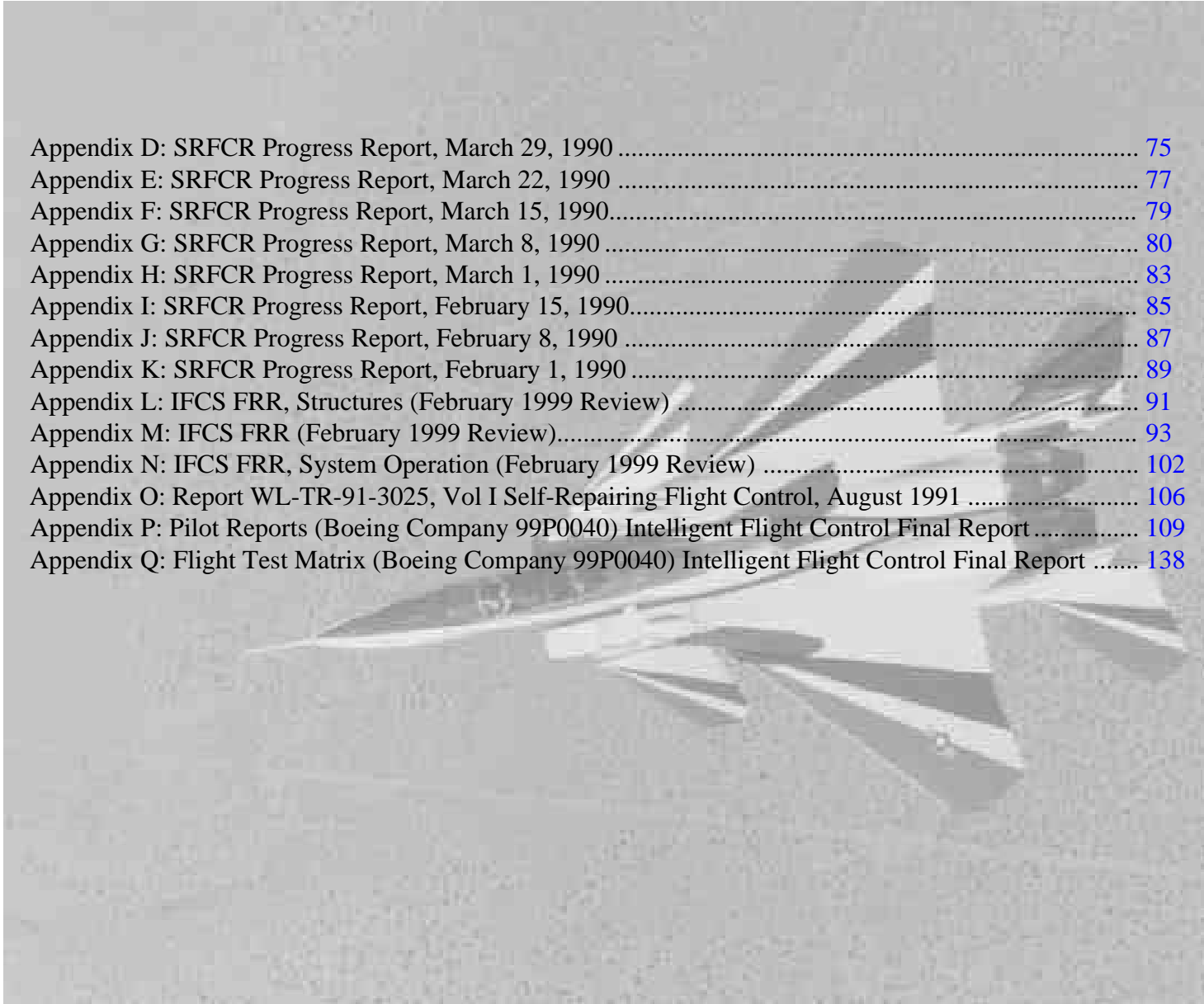

Appendix D: SRFCR Progress Report, March 29, 1990 .....	75
Appendix E: SRFCR Progress Report, March 22, 1990 .....	77
Appendix F: SRFCR Progress Report, March 15, 1990.....	79
Appendix G: SRFCR Progress Report, March 8, 1990 .....	80
Appendix H: SRFCR Progress Report, March 1, 1990 .....	83
Appendix I: SRFCR Progress Report, February 15, 1990.....	85
Appendix J: SRFCR Progress Report, February 8, 1990 .....	87
Appendix K: SRFCR Progress Report, February 1, 1990 .....	89
Appendix L: IFCS FRR, Structures (February 1999 Review) .....	91
Appendix M: IFCS FRR (February 1999 Review).....	93
Appendix N: IFCS FRR, System Operation (February 1999 Review) .....	102
Appendix O: Report WL-TR-91-3025, Vol I Self-Repairing Flight Control, August 1991 .....	106
Appendix P: Pilot Reports (Boeing Company 99P0040) Intelligent Flight Control Final Report .....	109
Appendix Q: Flight Test Matrix (Boeing Company 99P0040) Intelligent Flight Control Final Report .....	138

# Acknowledgments

My deepest thanks to J. D. “Dill” Hunley, who was the chief historian at Dryden while I was writing this monograph. He is one of the best historians, inside or outside the government, with whom I have had the pleasure to work. Michael Gorn, who succeeded Dill when this manuscript was between preparation and publishing, has my thanks for his revisions of the manuscript and other efforts. Also, an important thank you to Jim Stewart, who sponsored this history of the continuing Intelligent Flight Control System. He has a keen awareness of the value of history.

I would also like to express my appreciation to those who shared precious time for an interview or patiently answered extensive questions. Their information and insights led to a more accurate publication. From NASA Ames Research Center: Chuck Jorgenson, John Kaneshige and Joe Totah. From NASA Dryden Flight Research Center: Bill Burcham, John Carter, Jerry Henry, Wilt Lock, Gerard Schkolnik, Jim Smolka, and, of course, Jim Stewart. From NASA Langley Research Center: Aaron Ostroff. From the Boeing Phantom Works: Jim Urnes, Sr. Lastly, from the U. S. Air Force’s Wright Laboratory: Bob Quaglieri.

I would have been lost without my student assistant, Sara Lechleitner, whose word processing skills are almost frightening. She also has a work ethic that enables her to play intercollegiate volleyball, pursue a mechanical engineering degree with an outstanding academic record, and (incidentally) help me. She did much of the glossary, acronym list, footnotes, as well as some insightful editing.

Thanks to my wife, Laura Lallement Tomayko, who scanned the line drawings, and to Dryden’s Carla Thomas, for scanning the photographs. Also thanks to Dryden layout wizard Jay Levine.

Finally, to Allison Xingbi Tomayko, whose adoption focused my efforts on telling this story, I gratefully dedicate it.

– **James E. Tomayko**  
**April 2003**

# Section 1: A Brief History of Flight Control and Previous Self-Repairing Systems

## Introduction

The ochre desert floor was a blur beneath the streaking Israeli Air Force F-15. From 12,000 feet, the pilot and his back-seat instructor could barely make out the haze of the Mediterranean to the west, and the teeming cities to the north. The two-ship formation was simulating the defense of his air base against two pairs of agile A-4s. Even though his plane represented technology 20 years newer than the A-4s, he had great respect for the small, maneuverable jet (which later earned notice by the public as the Navy's aggressor plane of choice at the Top Gun School, in the movie of the same name). The pilot came up from behind the trailing pair of A-4s, looking for the classic Sidewinder missile shot.

The F-15s ran with their radars off so as not to radiate electronic emissions and give away their position to the "enemy", only now-and-again turning them on for a sweep. The subsequent snapshot of their adversaries' position was all the F-15s had to go on, since the relatively tiny, camouflaged A-4s were difficult to acquire visually from more than a few hundred meters away. The A-4s, meanwhile, ran in on the deck, hoping to be invisible against the ground clutter from the lookdown radar of the F-15s.

Suddenly one of the A-4s started a "pop-up" maneuver in which it quickly gained altitude to unmask the radar hunting it. As he climbed, the pilot of the A-4 rolled his plane inverted, allowing him to see clearly beneath him; this also meant his wings blocked any upward view. Assuming his "adversary" was now beneath him, the A-4 driver did not see the F-15 that was now, in fact, right above him, and he collided with the F-15's right wing, destroying his own airplane. The A-4 pilot ejected as his plane exploded into a ball of fire.

After the F-15 pilot recovered from the sudden and literal shock, he saw from his instruments that his jet was venting fuel at an alarming rate, emptying one entire wing tank in no time at all. The F-15 then entered a slow roll to the right at about 350 knots, and began to lose altitude, heading into a spiraling dive. The Israeli pilot had the fleeting notion of ejecting, (his back-seat instructor was telling him to do just that) but he added power instead and stomped hard left rudder in order to pull out. He managed to arrest the spin and then to regain altitude, meanwhile calling for vectors to the nearby F-16 base at Ramon.

Declaring an emergency, he began reducing the big plane's airspeed and losing altitude for landing. When the F-15 approached 260 knots, roughly twice its usual approach speed, it went into another spin. Again the



pilot successfully fought the urge to eject, and again he managed to stop the spin using control surface inputs and resorting to the afterburners.

Approaching the runway, the F-15 touched down at 250 knots—the pilot dared go no slower for fear of losing control again. The runway at Ramon was equipped with arresting gear like that found on aircraft carriers, put there for use in emergencies. The F-15 caught an arresting wire with its tailhook, which promptly ripped away from the plane due to its excessive speed. But now slowed to 150 knot, the pilot stood on the brakes and brought the plane to a stop a mere 10 meters from the emergency recovery net erected at the other end of the runway. Less than five minutes elapsed between collision and touchdown.

With a great sigh of relief, the pilot removed the helmet from his heavily perspiring head, stood up and turned toward his back-seater for a congratulatory handshake. Only then did he see the real damage to his aircraft. The entire right wing had been sheared off. The incredulous pilot spent a long time looking at where the wing had been. An F-16 pilot walked up to the crippled plane from the left side, came around the nose, saw the damage, and purportedly asked the pilot, “Where do I sign up for F-15s?”<sup>1</sup>

At McDonnell Douglas Corporation, the plane’s maker, engineers marveled at how this F-15 managed to stay right side up, to say nothing of how the pilot managed to control the approach. Though curious about the whole affair, the engineers had no data for such extensive damage, and so they placed an F-15 wind tunnel model in MDC’s high-speed wind tunnel, sawing off successive sections of the right wing between tests. In the end, calculations done by controls engineers discovered that the margin to maintain controllable flight for this extent of wing damage was only  $\pm 20$  knots and  $\pm 20$  degree angle of attack variation from trim. The engineers were amazed that the IAF pilot found and maintained this very narrow margin of control. And the revelation that there *was* a stable flight condition for such serious damage triggered a much higher interest in reconfigurable controls technology.

These events occurred in May 1983, and the F-15 was subsequently repaired and returned to service. The story spread far and wide, leading some to ask if this was simply another case of ‘even a brick can fly if you hang a big enough engine on it?’ The answer was yes, at least in part.

MDC engineers concluded that the damaged F-15 stayed aloft because at high speeds its fuselage generated just enough lift to compensate for the missing wing. Bleeding off speed brought on a spin, while maintaining high speed kept the plane in the air. The question begged itself: could a plane’s flight controls be reconfigured automatically by special control software so that in case of such damage the pilot could fly a

---

<sup>1</sup> News accounts say the pilot was on a training mission with an instructor in the back seat. Some of these reports further add that the pilot was subsequently demoted one rank for disobeying orders to eject, and promoted two ranks for safely recovering the aircraft.



*NASA Photo*

*EC89 232-1*

*An Israeli Air Force F-15 involved in a midair collision during a training mission in 1983. In spite of losing virtually the entire starboard wing, the pilot successfully landed the jet.*

crippled airplane slowly enough to land safely? The U.S. Air Force decided to find out. In partnership with NASA, and using NASA's HIDEDEC F-15 test-bed, the two agencies tested the Self-Repairing Flight Control System (SRFCS) between 1989-90. To further advance this damage adaptive technology, in 1995 NASA and McDonnell Douglas cooperated in developing a new system to install in a special research F-15 equipped with a fly-by-wire control system. The newer system is called the Intelligent Flight Control System (IFCS) largely because it uses artificial neural networks to "learn" how to fly a partly failed or battle-damaged airplane. Aside from the obvious safety advantages, a neural net may result in a cheaper, faster-to-build flight control system because it can "learn" to fly a new aircraft more quickly and cheaply than a flight control system can be designed.

### **Flight Control Surfaces**

An understanding of conventional flight controls clarifies how the SRFCS and the IFCS perform their jobs. The concept of controlling an aircraft in flight originated with Sir George Cayley, who, in 1799, became the first person to design a prototype airplane. Cayley's design included a recognizable fuselage, wings, and a cruciform tail. Steering came through a conventional boat's rudder.<sup>2</sup> What appeared in Cayley's drawings and subsequent models (he built and purportedly tested at least one model large enough to carry a human) were aircraft with the essential elements found in modern aircraft, including lifting surfaces and rudimentary control surfaces in the tail. (There were no control surfaces on the wings, however.) Although his work influenced many early aeronauts regarding such things as lift and control, as late as the nineteenth century some designers continued to ignore control surfaces on airplanes. Otto Lilienthal, the first human to die in a heavier-than-air craft, is one example. In the last decade of the nineteenth century Lilienthal flew elegant hang gliders of his own design in a series of flight experiments. He controlled his gliders strictly through weight-shift, which worked well until he could not recover from a gust of wind on his last flight.

Not all aeronauts relied on weight-shift for control, of course. Some glider-builders in the nineteenth century employed wing warping as a primitive tool to achieve roll motion. As a result of their own experimentation, the Wright brothers concluded that control in all three axes was essential if an airplane was to be truly useful, a philosophy harking back to Cayley. The brothers settled on two parallel planes mounted horizontally in front of their wings for pitch control; another pair mounted vertically behind the wings for yaw control; roll control came from warping the trailing edge of the wings through wires attached to a hip cradle on which the pilot lay. In flight the pilot could control all three, as they were linked.

---

<sup>2</sup> C.H. Gibbs-Smith. *Sir George Cayley's Aeronautics*. London: Her Majesty's Stationery Office, 1962. 3-10.



*NASA Photo Illustration EC88 203-6*

*A NASA F-15 banking over Edwards Air Force Base. The image has been modified to illustrate the loss of a wing, in order to demonstrate the IFCS's ability to reconfigure an aircraft and retain controllability. Dr. James Stewart used this image in an early briefing with the Air Force in explaining the potential advantages of self-repairing flight control systems.*

Capable though it was, wing warping in airplanes did not give the fastest control response possible. Furthermore, the Wrights maintained that they owned a patent on this aircraft control method, embroiling subsequent designers in real and potential litigation. Some, such as the team lead by Alexander Graham Bell and Glenn Curtiss, shifted to surfaces either positioned between the wings of a biplane, or located on the trailing edge of the wing itself – known as ailerons. By the First World War, most airplanes integrated ailerons into the wings for roll control; elevators embedded in the horizontal stabilizer producing pitch, and a rudder in the vertical stabilizer-generating yaw. The latter two surfaces could even make use of the prop blast acting on the cruciform tail to increase control authority.

But as airplanes became faster and more maneuverable, control surfaces had increasing difficulty keeping up with the common needs of desired flight control. For one thing, the prop wash was no longer a sure control augmentator. And so, over time control surfaces grew in size to meet these needs. Newer fighter jets with conventional control systems often incorporated all-moving stabilators (ironically, like the Wrights) and big ailerons in order to achieve desired control and response. The enlarged control surfaces were a compromise, for even if they were too large for normal control, they enabled more authority during maneuvers.

In time, and given the “excess” flight surface area, some wondered whether a fighter could be reconfigured to fly with a reduced number of surfaces and yet maintain control authority. An advanced aircraft with technologies such as thrust vectoring, canards, and variable-geometry inlets presented even greater possibilities. NASA engineers working on a commercial version of these smart control systems realized that on large aircraft similar to the new Boeing C-17, nearly 30 individual surfaces might contribute to control.<sup>3</sup> But they also recognized that a human would have great difficulty controlling all 30 individual surfaces simultaneously because of the complexity. How then accomplish this?

### **The Evolution of Flight Controllers**

At first, when airplanes were unstable, the brain of the pilot constituted the active control system that received and transmitted impulses to move an aircraft’s surfaces. During the 1920s, and for many of the decades that followed, most airplanes were designed to be statically stable to capitalize on the advances in the ranges and cruising speeds of both civilian and military types. The advantage of a statically stable aircraft is that it is reluctant to depart from its flight path, sometimes requiring considerable force to do so. Yet static stability can be a drawback in aircraft *meant* to suddenly depart a given attitude – a fighter, for example.

By the 1950s, and with the increasing complexity and speed of aircraft, designers realized that one way to achieve greater maneuverability was the use of what came to be called a “fly-by-wire” system of flight

---

<sup>3</sup> Jerry Henry. Interviewed at Dryden Flight Research Center, 10 April 2001.

control. This entailed using computers—either analog or digital—as the heart of a flight control system. In this scenario a computer receives data from sensors as well as the pilot, compares the two streams of data, and commands the control surfaces to move so as to make the airplane meet the pilot’s desires.<sup>4</sup>

The important nugget here is that with this new computer-controlled flight system an airplane could be purposefully unstable, yet safe and flyable, because it remained under the active control of a computer in the loop, rather than just the much-slower-to-react pilot. The designers then realized that reducing aircraft stability requirements could bring with it a reduction in the size of control surfaces, saving weight. Now, for instance, the horizontal stabilizer no longer had to be canted in such a way that it provided a downward force to balance the airplane around its center of gravity: it could be a lifting surface, and so, much smaller.

Fly-by-wire technology is important for understanding the two projects discussed in this book, for neither project would have been possible without a fly-by-wire system, and in particular, a digital one. The engineers in this story accomplished all their goals through software, which requires a digital computer and its associated memory for storage and execution.

For the groups that wanted to experiment with reconfiguration schemes, the few candidates for experimentation were airplanes initially designed as statically stable, and were only later modified to use a fly-by-wire system. The first of these built was the Canadian CF-105 *Arrow*, a large interceptor with delta wings and fitted with analog computers at the beginning of its test program. But it was unavailable, as well as unusable to Americans because of the type of computer, on top of which the *Arrow* program itself was cancelled in 1959 after only five aircraft had been built and sixty-six flights made.<sup>5</sup>

The U. S. Air Force and NASA eventually turned to domestic aircraft, retrofitting configured test fighter aircraft with fly-by-wire systems. The Air Force used analog processors in an F-4 while NASA installed digital computers in an F-8.<sup>6</sup> Both first flew with a fly-by-wire control system in spring of 1972.<sup>7</sup> In the late 1970s, NASA’s Langley Research Center used its aircraft to conduct a series of experiments on reconfiguring the sensor suite after simulated failures.<sup>8</sup>

---

<sup>4</sup> James E. Tomayko. *Computers Take Flight*. Washington, D.C.: NASA History Office, NASA-SP-2000-4224.

<sup>5</sup> Richard Organ, et al. *Avro Arrow* (Erin, Ontario: The Boston Mills Press, 1980).

<sup>6</sup> James E. Tomayko. “Blind Faith: The United States Air Force and the Development of Fly-By-Wire Technology,” *Technology and the Air Force*. Washington DC: U. S. Air Force, 1997.

<sup>7</sup> Tomayko. *Computers Take Flight*.

<sup>8</sup> *Ibid.*, 118-120.

The presence of digital (thus reprogrammable) computers on a NASA F-15 made it an ideal platform to test reconfiguration control concepts. For future aircraft, the use of neural networks and a more benign operating environment may be acceptable for experiments with a designed-from-the-start fly-by-wire system, such as that on the C-17. This marriage would take advantage of size and weight savings. But the type of reconfiguration that eventually became the SRFCS required that high acceleration maneuvering be maintained even with damage. This was necessary to preserve the maximum ability to continue the fight and complete a mission even with part of the controls disabled. Such high performance needed excess command authority to maintain the maneuver margin.<sup>9</sup>

### **Previous Self-Repairing Systems**

As early as the 1960s NASA initiated research on self-repairing digital systems. While most of the work in recent years has been directed at solving the problems of battle or natural damage as it affects reliability, previous research addressed the problem of reliability from the viewpoint of a given system's longevity. System reliability and longevity remain an issue, but an airplane has only to be able to return to base or an emergency field without crashing to achieve the goal. NASA, by contrast, also needed to consider the possibility of decades-long space missions with no chance of return for repair. With this concern in mind, NASA's Jet Propulsion Laboratory (JPL) funded Algirdas Avizienis of the University of California at Los Angeles (UCLA) to study digital equipment capable of extended systems reliability and longevity.

Avizienis approached the matter from the perspective of the period. In 1961, when he began working on the project, the most frequent source of systems failure lay in hardware, not software. Furthermore, studies of piloted programs up to that time suggested that the most common source of future failures would be in the avionics systems of the computers. Then as now, the chief measure of hardware reliability is Mean Time Between Failure (MTBF). Avizienis and others working on the problem reasoned that the MTBF "clock" did not start until the hardware powered up. Therefore, electrical power could be saved and life expectancy extended among redundant components by only using the minimum hardware necessary for guidance, navigation, and attitude control, and shedding failed components from the power source while turning on quiescent ones. He called this assembly of components the Self-Testing and Repair computer, or STAR.<sup>10</sup>

---

<sup>9</sup> James F. Stewart and Thomas L. Shuck. "Flight-Testing of the Self-Repairing Flight Control System Using the F-15 Highly Integrated Digital Electronic Control Flight Research Facility," Technical Memorandum, NASA-TM-101725. Edwards, CA: NASA Dryden Flight Research Center, 1990.

<sup>10</sup> Avizienis, et al. "The STAR (Self-Testing and Repairing) Computer: An Investigation of the Theory and Practice of Fault-Tolerant Computer Design," *IEEE Trans. Comput.*, 1971, 1314-1320.

The STAR never actually flew, perhaps because critics commented on the single-point failure characteristics inherent in each component's switch. However, the concepts of turning off an unneeded redundancy, then turning it on during critical mission phases, and of cross strapping components, did make their way onto JPL's deep space probes.

IBM performed its own analysis of self-repair in the 1960s. Through mathematical modeling it found that the use of spare components was not optimal. Instead, said IBM, it would be more effective to use redundant circuits and status registers. In that way switches could be made of Triple Modular Redundant (TMR) circuits, like those eventually used in IBM's Saturn Launch Vehicle computer. This system matched the model posited by the eminent mathematician John von Neumann, in "Probabilistic Logic and the Synthesis of Reliable Organs from Unreliable Components."<sup>11</sup> In this paper von Neumann suggested that unreliable components could be made reliable by constructing them with redundant wires, and using a "majority organ" at regular intervals to vote on the correctness of the circuits. Nevertheless, JPL rejected this model for its spacecraft, possibly because such redundancies are powered continuously, and draw precious energy from the supply source.

As electronic components improved in reliability and longevity through the 1960s and early 1970s, both the Air Force and NASA continued to explore digital fly-by-wire aircraft control. A digital flight control system, such as that developed and tested by NASA on a converted Navy F-8, provided the flexibility to conduct several experiments simply by changing the software. Indeed, some of the experiments would have been impossible without digital flight controls. In all of this, airplanes share with spacecraft issues of size, power, and weight. Both are limited by their propulsion systems. Airplanes, however, are more easily fitted with bigger engines to accommodate fully powered redundancies. And by the 1970s full redundancy (all components powered up) seemed to many a likely trend in new, sophisticated aircraft.

In 1976 the Dryden Flight Research Center acquired a unique F-15 from the Air Force. Most F-15s at the time had a mechanical flight control system, supplemented by an analog Control Augmentation System (CAS). On this particular airplane a digital CAS, which could be reprogrammed, replaced the analog CAS. An analog flight computer requires physically modifying the hardware to achieve new control parameters, whereas the digital flight computer merely needs to be reprogrammed. In addition to fly-by-wire in the CAS mode, this airplane served as a test-bed for digital engine controllers. Named HIDEDEC (Highly Integrated

---

<sup>11</sup> John Von Neumann, "Probabilistic Logics and the Synthesis of Reliable Organisms from Unreliable Components," in William Aspray and Arthur Burks, *Papers of John von Neumann on Computers and Computing Theory* (Cambridge, MA: Charles Babbage Institute Reprint Series for the History of Computing, V. 1, The MIT Press, 1987), 553-576.





*NASA Photo*

*ECN 3276*

*NASA number 802, an ex-Navy F-8, was the dedicated test bed for the digital flight control experiments. Using the on-board computer from the Apollo 15 command module, this aircraft demonstrated the possibility of digital fly-by-wire, an essential step in the process of developing IFCS. The aircraft is now on display at NASA Dryden Flight Research Center at Edwards Air Force Base.*

Digital Electronic Control), the F-15 performed numerous integrated flight propulsion control projects. Its digital engine controls had the capability to share information with the flight control computers and the inlet controller, improving both response and efficiency. Ultimately, this versatile aircraft set the stage for experimenting with the concept of self-repairing capabilities on airplanes.

## Section 2: The Self-Repairing Flight Control System

Early in the 1980s, the U. S. Air Force's Wright Aeronautical Laboratory (at Wright-Patterson Air Force Base in Dayton, Ohio), apportioned some of its "63" (advanced development) funding to investigate the problems of automatic maintenance and the self-repair of aircraft flight control systems.<sup>12</sup> It also designated some of this money to fund projects of a professor at Wright State University, and some master's degree students at the Air Force Institute of Technology.<sup>13</sup> Some of them even built and flew an unpiloted version of a self-repairing system using the computer language Ada.<sup>14</sup> But the bulk of the money went to what was then General Electric's Aircraft Control Systems Development operation, a division with a long track record in the flight control business. The overall objective was to explore the feasibility of self-repair through the software on a digital computer, and the Air Force gave the project the acronym SR/DFCS, for the Self-Repairing Digital Flight Control System.<sup>15</sup>

The Air Force had two major interests in the project: maintenance diagnostics, and self-repairing flight control. Up to half of the squawks (flight anomalies) reported by tactical pilots were "not repeatable," or transient in nature, dubbed CND, or "could not duplicate," by Air Force maintenance crews. Attempts to duplicate them on the ground often failed, sapping time and money from maintenance programs, yet their potential importance meant these squawks could not be ignored. Inability to duplicate these anomalies on the

---

<sup>12</sup> Robert Quaglieri. Interviewed via telephone from Air Force Research Laboratory, Air Vehicle Directorate, Wright-Patterson Air Force Base, OH, by the author, 16 May 2001.

<sup>13</sup> Kuldip S. Rattan. "Evaluation of Control Mixer Concept for Reconfiguration of Flight Control System," IEEE NAECON Proceedings, May 1985, 560 – 569.

<sup>14</sup> S. Pruet Mears and J. Houtz. "URV Flight Test of an Ada Implemented Self-Repairing Flight Control System." Dayton, OH: Wright Laboratory, August 1992, WL-TTR-92-3101.

<sup>15</sup> J.M. Stifel, C. J. Dittmar, and M.F. Zampi. "Self-Repairing Digital Flight Control System Study," Final Report for Period January 1980-October 1987, AFWAL-TR-88-3007, May 1988, 1.

ground is, in retrospect, no real surprise, since a test run at one G (acceleration equal to the force of gravity at sea level) differs considerably from operations at six Gs in the air. Fixing these deficiencies and the maintenance diagnostics system was thought of as an experience-leveler. The Air Force hoped, among other things, that the SR/DFCS program would lead to a reduction of false alarms when fielding the next generation Advanced Tactical Fighter (ATF). Additionally, the automatic diagnostic system would allow reports of the anomalies to be sent ahead, enabling ground crews to address them shortly after landing. This idea became closely allied with the concept of in-flight self-repair, since the Air Force hoped the self-repair capability would function in response to a malfunction or battle damage. The Air Force decided early in the program that its approach would be a robust form of reconfiguration. For instance, if an aircraft lost a stabilator, control would not fall to just one or two other surfaces operating at brute force to compensate. Rather, the system would configure the remaining flight control surfaces to behave in a blended fashion, enabling the airplane to continue flying, albeit with reduced capability. Further, if a surface retained even partial capability, it, too, would be utilized rather than deleting it from the control suite.

GE realized the problem had two parts: detection and reconfiguration. For the former, GE engineers developed a System Impairment Detection and Classification (SIDC) box. The SIDC used differential accelerations to determine if a computer model of the airplane was acting strangely: variations in aircraft accelerations were judged to result from failed or missing control surfaces. Once the SIDC did its work, the Effectors Gain Estimation (EGE) part of the system calculated the differences in the electrical gains commanding the various surfaces. Finally, these gains were fed into the Reconfigurable Control Mixer (RCM), or “mixer,” where they were combined with, and then adjusted, the commands to the control surfaces. Additionally, the SYSDYN (SYStem DYNamics) module contained a mathematical model of the unimpaired aircraft. The performance models of both the unimpaired and impaired aircraft were used as inputs to the other modules.<sup>16</sup> This system’s architecture remained essentially the same, allowing GE to adapt it to various aircraft.

The Air Force initially targeted the AFTI (Advanced Fighter Technology Integration) F-16 as the aircraft on which to experiment. The AFTI F-16 had the normal stabilators, rudders, and ailerons of most tactical aircraft, but it also had a set of canards. The RCM could then command various combinations of these surfaces.<sup>17</sup> For example, the AFTI might use a combination of the stabilators, flaps, and canards for pitch

---

<sup>16</sup> John H. Corvin, William J. Havern, Stephen E. Hoy, Kevin F. Norat, James M. Urnes, and Edward A. Wells. “Self-Repairing Flight Control System, Volume I: Flight Test Evaluation on an F-15 Aircraft,” Final Report for Period October 1987 – December 1990, WL-TR-91-3025, Volume I, Part I, August 1991, 3-11.

control; the same surfaces applied differentially, plus the rudder to achieve roll; or the rudder plus differential canards to generate yaw.<sup>18</sup> But when the AFTI aircraft was not immediately available, they adapted the system instead to the Large Amplitude Multimode Aerospace Research Simulator (LAMARS) at Wright-Patterson. LAMARS is a full motion simulator with pilot-in-the-loop capability, used to simulate the characteristics of the AFTI F-16. The Air Force ran the tests in November 1986, during which the SRFCS performed quite well in the LAMARS, encouraging continuation of the program.<sup>19</sup>

The project managers at Wright-Patterson thought that actual flight tests would be required to achieve sufficient levels of proof-of-concept.<sup>20</sup> Accordingly, Air Force Wright Aeronautical Laboratories named Robert Quaglieri as project leader. As early as 1985 some of the spin-off work generated under the Air Force funding became available in the form of papers, theses, and the personal knowledge of students. Aware of this, GE brought in Alphatech to help design the software for the project.<sup>21</sup> Now all the program lacked was a suitable aircraft. Quaglieri and the other Air Force personnel (Lt. Robert Eslinger, Phillip Chandler and John Davison) formulated an approach for flight test of the SRFCS following discussions with James Stewart at NASA Dryden. The plan was to deploy the SRFCS on a NASA research aircraft managed by Stewart.

In 1976, NASA acquired use of airplane 71-0287, the eighth pre-production F-15, and designated it NASA 835. Based at Dryden Flight Research Center, it differed from production F-15s in its control system arrangement. Line aircraft had mechanical controls with an analog Control Augmentation System (CAS). NASA replaced the CAS in 835 with a digital flight controller programmed in about 28,000 words of Pascal.<sup>22</sup>

---

<sup>17</sup> Quaglieri, interview.

<sup>18</sup> Stifel, Dittmar, and Zampi. "Self-Repairing Digital Flight Control System Study", 20.

<sup>19</sup> Ibid. , 81.

<sup>20</sup> Quaglieri, interview.

<sup>21</sup> Corvin, William J. Havern, Stephen E. Hoy, Kevin F. Norat, James M. Urnes, and Edward A. Wells. "Self-Repairing Flight Control System, Volume I: Flight Test Evaluation on an F-15 Aircraft," Part II, p. 3. Thanks to Dr. James F. Aldridge of the Aeronautical Systems Center History Office for explaining the designations of the Air Force Wright Aeronautical Laboratories over the last quarter century.

<sup>22</sup> Corvin et al, "Self-Repairing Flight Control System, Volume I Flight Test Evaluation on an F-15 Aircraft," Volume I, Part I, August 1991, Part I, 5-22.

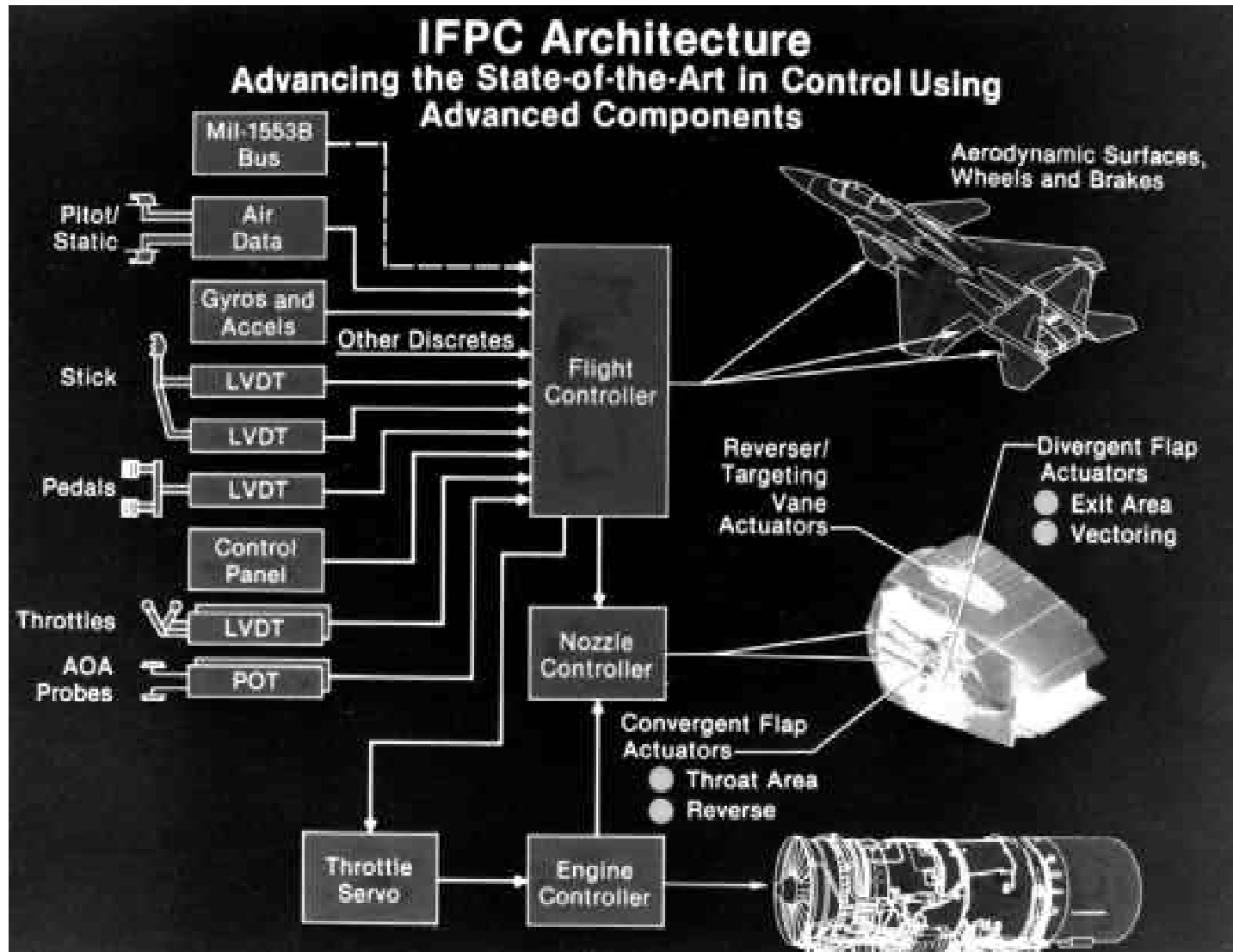

NASA

EC89-117-9

*A diagram of the Intelligent Flight Control System designed to make a partially stricken aircraft flyable .*

By the 1980's this F-15, with its unique capabilities, became the platform for digital engine control and integrated flight propulsion control research. Overall research activities were led by NASA and partnered to various degrees with the Air Force.

Stewart, the F-15 HIDECA project manager, had been in close contact with the Air Force regarding both the current NASA research and the proposed performance seeking control (PSC) flight propulsion research; he had also briefed the Air Force on the F-15 HIDECA capabilities. And so the Air Force contacted him about the availability of the F-15 HIDECA aircraft, with tests of the SRFCS in mind. After several meetings to evaluate the capabilities of the aircraft and determine how to integrate the multiple research activities on the aircraft, the Air Force selected the F-15 testbed to prove the new technology. NASA then assumed the role of "prime contractor," obtaining the flight control hardware from General Electric, the software from McDonnell Douglas Corporation in St. Louis, (which had 12 engineers on the project, led by James Urnes Sr.), and the maintenance diagnostics from the Air Force. Stewart of Dryden became the project manager for the SRFCS project at NASA, while at the same time continuing to be project manager for all of NASA F-15 HIDECA research activities.<sup>23</sup>

In addition to control computers, engineers added a Rolm Hawk computer to make the airplane a more robust test-bed. With the addition of the Hawk and its added capability, Stewart initiated the Performance Seeking Control (PSC) project, a NASA investigation that developed in parallel with the SRFCS. The PSC project was an adaptive on-board optimization of the total propulsion system. The single engine phase was completed in 1990 and the Dual Engine Phase completed by Oct. 1993.

The Hawk could execute 2.5 million instructions per second and had a memory of two million words, making it both faster and larger than any air- or space-borne machine. Even so, the SRFCS and maintenance diagnostics stretched its speed capabilities. The computer's memory, though comparatively large, limited the SRFCS software, which resided almost entirely on the Hawk. The software suffered from such failures as locked trim and some other locked control surfaces, but only one surface—the right stabilator—could simulate losses, and then only at increments of 50, 80, and 100 percent, depending on the circumstances.

So that the on-going ATF program might benefit from the results of SRFCS flight research, managers began the SRFCS flight test earlier than planned. As a consequence, there was a Phase 0 flown in March 1989, in which the maintenance diagnostics were successfully tested in flight. The maintenance diagnostics and the SRFCS occupied 312,000 bytes in the Hawk, very spare by current standards, leaving about 28 kilobytes

---

<sup>23</sup> Most of the integrated flight propulsion control research performance with the F-15 HIDECA aircraft, including the SRFCS, is summarized in NASA Technical Memorandum 4394 (1992) by James F. Stewart entitled *Integrated Flight Propulsion Control Research Results using the NASA F-15 HIDECA Flight Research Facility*.

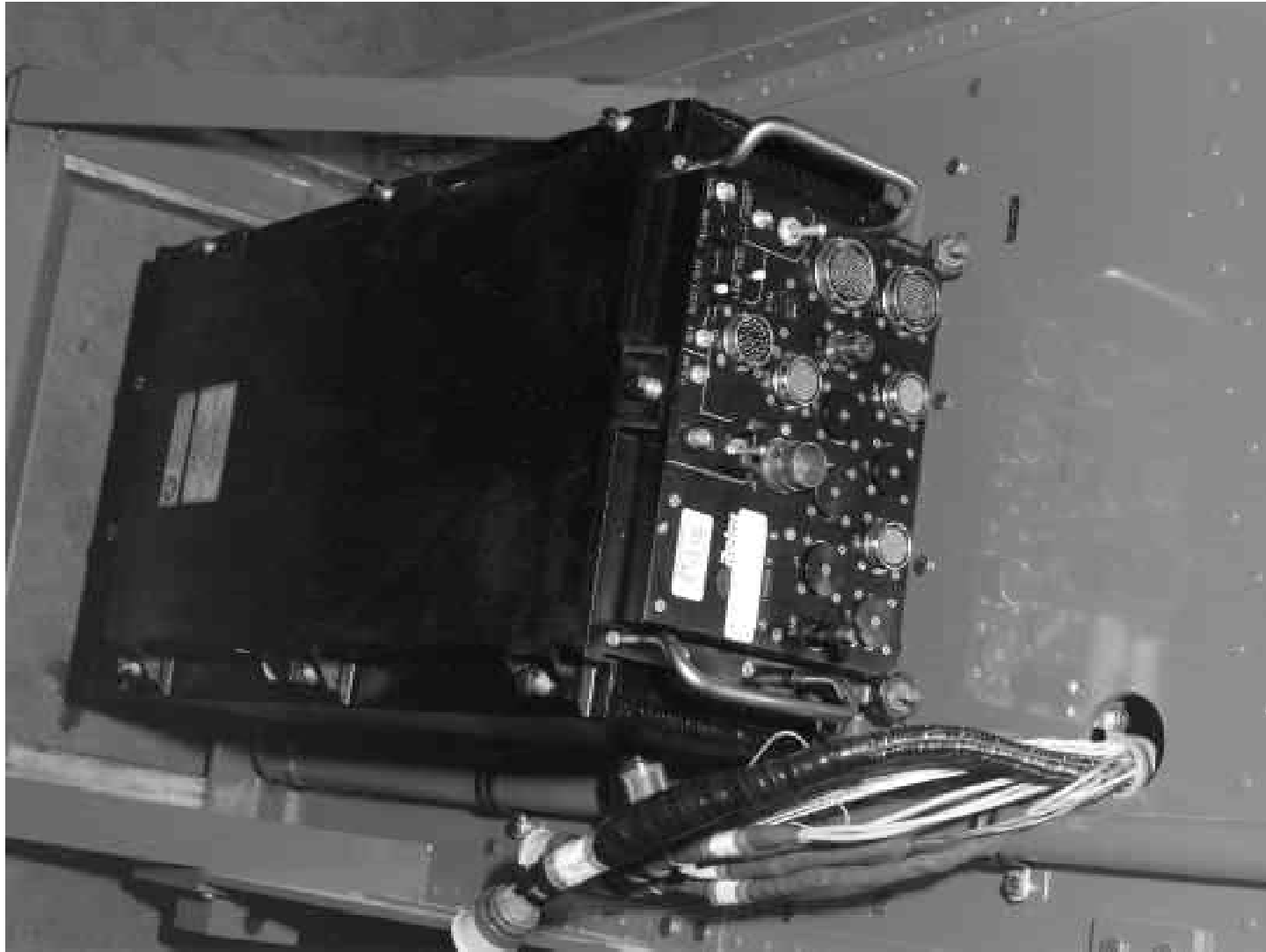

*NASA Photo*

*EC88 018-9*

*The Rolm Hawk computer which served initially as the primary on-board computer on the F-15 HIDEC flying test bed. Capable of 2.5 million instructions per second it was the most advanced airborne computer of its time.*



of flight control software available. Lear Siegler and Alphatech performed some modifications to the software in 1989 following on the Phase 0 testing. So adaptable was the Rolm Hawk in this arrangement that other projects used the same F-15, since its programmable computers permitted a great amount of flexibility. Indeed, within a decade, when the Air Force began converting the F-15 to test-fly the maintenance diagnostics and the self-repairing system, it had already undertaken nearly 500 flights for NASA and been involved in some 25 projects.

NASA 835 required modifications before it could be fully useful to the Air Force for control reconfiguration. The ailerons, for instance, retained a fully mechanical set of actuators. For the SRFCS 's tests NASA Dryden's Wilton Lock and his team replaced them with a set of electrical actuators usable by the new system.<sup>24</sup> McDonnell Douglas designed and built the electronics to control these surfaces, and in the end NASA 835 became the only F-15 to have electronic roll control.

During LAMARS-simulator testing of the self-repairing system, engineers discovered that if pilots were not given visual cues of the new maneuver limits following reconfiguration, they would stray from controlled flight. They found that the system was optimal at 0.7 Mach and 20,000 feet altitude, and so NASA installed the Positive Pilot Alert system. This display projected information in such a way that the pilot could see it without tilting his head and losing sight of what was happening outside the cockpit. It drew a rectangle on the head-up display showing the pilot the new limited maneuvering envelope after self-repair. All would be fine, provided the pilot stayed within the new parameters.

The Air Force took a novel approach to this program. Essentially, it treated NASA as the lead, allowing NASA to manage the project and provide a flight test program. In turn, NASA contracted the electronic systems integration and systems test task to McDonnell Douglas Corporation in St. Louis. MDC had the flight simulator and avionics laboratories that would prove critical to the success of this very complex control system. It also had controls engineers experienced in the flight dynamics and control software so necessary to fly the system in NASA's F-15. To accomplish its share of the program MDC formed a team of 12 for the SRFCS project.

This arrangement enabled programmatic flexibility. When delays in other programs caused engines to be delivered late, NASA research pilots simply flew another self-repairing flight. By this expedient, NASA provided more flights and flight hours than initially promised, with no cost overrun. In fact, Stewart finished the project \$4,000 under budget, and for a multi-million dollar project to be on budget, it was an outstanding accomplishment.

---

<sup>24</sup> Wilt Lock. Interviewed by author, Dryden Flight Research Center, 6 April 2001.

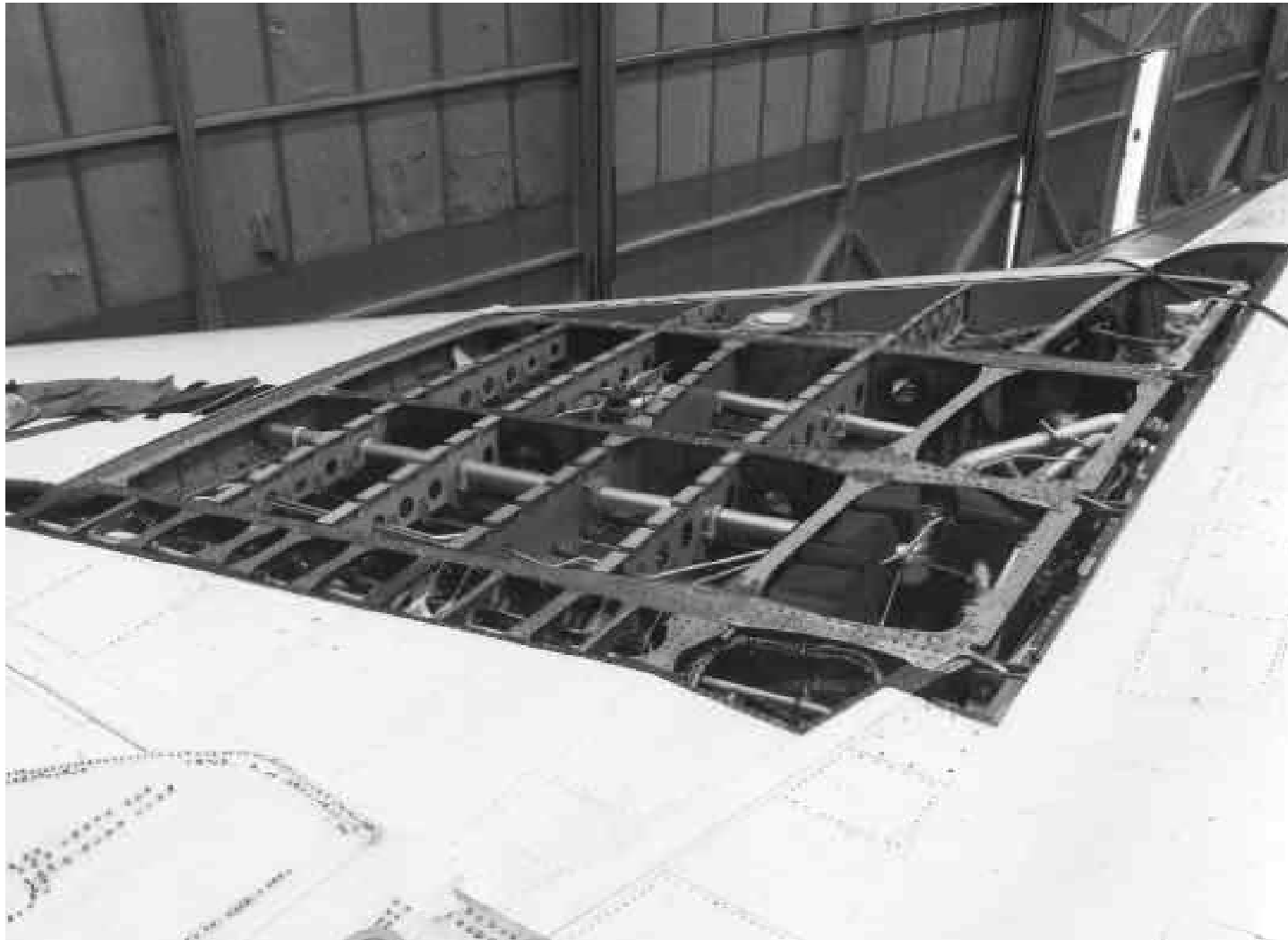

*NASA Photo*

*EC88 249-5*

*The port wing of the F-15 HIDEC, opened so that technicians could replace mechanical actuators with electric servos. This was part of the process of fully integrating the Rolm Hawk computer en route to making the first IFCS flight.*

The SRFCS activity fell under a broad memorandum of understanding between Wright Aeronautical Laboratories and Dryden Flight Research Center signed in 1985.<sup>25</sup> It represented an extraordinary example of two of the government's leading research centers cooperating to test a revolutionary concept, and it proved for both to be one of their closest collaborations. By 1989, the Wright Laboratory team consisted of John M. Perdsock, Program Manager; Robert Yeager, Flight Test Director; and Capt. Barry Migyanko, the project engineer. NASA's Wilt Lock was the operations/systems engineer, Thomas Shuck of NASA the test engineer, and Stewart led the team as project manager. NASA assumed the role of Responsible Test Organization (RTO).<sup>26</sup>

As the flight research approached, the Air Force side expressed a sense of urgency. The demonstration deadline for new technologies set for inclusion in the ATF stood near the end of 1989. Still harboring some hope of incorporating the SRFCS into the ATF, the Air Force pressured NASA to fly before year's end.<sup>27</sup>

Flight number 555 of NASA's F-15, tail number 835, became the first flight of the SRFCS, taking place on 12 December 1989. During the 1.7-hour flight in a bright blue high-desert sky over Edwards, pilot Jim Smolka ran the SRFCS off-line to check its operation. He then refueled from a tanker and brought the SRFCS on-line and locked it at an impairment of the trim. The envelope limitations for the SRFCS were 15,000 to 25,000 feet altitude, -5 to +15 degrees angle of attack, and a speed of 0.5 to 0.9 Mach, and the SRFCS handled the trim failure quite well within those limits.

The next day Smolka again flew the F-15, this time to test battle damage. The SRFCS handled satisfactorily with no impairments, even when subjected to a 50-percent right stabilator loss, followed by an 80-percent right stabilator loss. Toward the end of the 1.2-hour flight the system uncoupled with an incorrect SIDC detection. Engineers later determined the probable cause to have been incorrect weight figures programmed into the Hawk, accompanied by sideslip angles and roll rates outside the operating range.

On 18 December, the problem persisted. When research pilot Bill Dana activated the SRFCS, it once again handled stabilator impairments, including locking at an angle, but the system uncoupled at high roll rates. Engineers again found an improper weight/mass calculation, and corrected it before the

---

<sup>25</sup> Monthly Project Status Reports, to the Director of Flight Operations from Chief, Aeronautics Projects Office, February 1988.

<sup>26</sup> Stifel, Dittmar, and Zampi. "Self-Repairing Digital Flight Control System Study," Final Report for Period January 1980-October 1987, AFWAL-TR-88-3007, May 1988.

<sup>27</sup> Quaglieri, interview.



*NASA Photo*

*EC90 245-2*

*NASA F-15 tail number 835, the aircraft dedicated to the HIDECS program, preparing for its first flight in 1989. Used early in the IFCS and SRFCS project, this aircraft was eventually replaced by the F-15B acquired from the Air Force, an airframe that itself had been extensively modified.*

next flight. To the satisfaction of many, five maintenance diagnostic scenarios run during the 1.3-hour flight that day produced the correct messages on the Positive Pilot Alerts display on the Head-Up Display (HUD).

Up to this point flights had only tried to check out the SIDC. The fourth flight involved maintenance diagnostics and all the components of the SRFCS architecture: the SIDC, the EGE, and the Mixer. Once again the maintenance diagnostics scenarios worked perfectly, giving correct warnings to pilot Tom McMurtry on the HUD. The SIDC also repeated its past performance, doing well on partial stabilator losses, yet faltering on lateral maneuvers. The Mixer worked well with partial surface losses and locked trim, while the EGE transmitted values of only 0 and 100 percent. This last flight of 1989 lasted 1.2 hours, totaling 5.4 hours of test flights for the month. The EGE transmitted values of only 0 and 100 percent. In the end it is difficult to tell whether the results influenced the ATF program, especially considering the mixed results, for the ATF does not include a full SRFCS and maintenance diagnostics system. The fundamental principles from both systems did eventually find their way into the ATF.

Three NASA research pilots flew the F-15 during the SRFCS series. They were: Jim Smolka, then new to NASA and eventually the Chief Pilot at Dryden (after 31 July 2000); Tom McMurtry, the principal pilot of the F-8 supercritical wing, who later went on to become Chief Pilot, and then Director of Flight Operations; and Bill Dana, an X-15 pilot who flew the hypersonic plane's 199<sup>th</sup> and last mission as well as the lifting bodies, and who eventually became Dryden's Chief Pilot, Assistant Chief of Flight Operations, and Chief Engineer.

The first flight of the new year, on 10 January 1990, was meant to be a further checkout of the Mixer. An engine had been swapped during the three-week down time, meaning that it, too, had to be tested. The engine performed well in the 1.5-hour flight, and Smolka tested the Mixer by checking its performance with the aircraft unreconfigured, and with a surface locked or missing. The Mixer performed well with the control surface locked at two- and four-degrees but tended to balk when set at six degrees.

Flight six of the SRFCS came two days later. The maintenance diagnostics, already a success, had another flawless performance on the two-hour flight. There were two sets of maneuvers planned to test the Mixer. The first set, Block A, included some partially missing surfaces and stick doublets of various kinds. Block B, the second set, included wind-up turns, sideslips, pitch capture and tracking. In this instance, the performance of the Mixer proved to be spotty. The system showed handling improvement during some maneuvers between this flight and previous ones, while some worsened. Yet, Dana reported improved performance over the un-reconfigured aircraft.

The program managers planned three missions to further test the gain adjustment component, the EGE, but the first ended after only half an hour because of uncommanded fuel venting. The second flight, with

McMurtry at the controls again, lasted only an hour of the planned 1.5 hours, due to unsatisfactory SIDC performance and an out-of-tune EGE. The final flight of this set, with Dana in the cockpit, lasted the full 1.5 hours, but again the EGE showed no improvement, and the SIDC was less than perfect. This flight had also been delayed by software errors, which crashed the Rolm Hawk computer.

The following flight on 31 January, the 10<sup>th</sup> of the SRFCS program and the 564<sup>th</sup> of NASA 835, lasted only 1.3 hours. Intended just for evaluation of general flying qualities, the flight experienced a takeoff delay due to the corruption of the non-volatile memory on power up. This, in turn, made the airplane miss the rendezvous with the tanker, and so Smolka flew a shortened flight plan with just a few impairments. Even so, the SIDC and Mixer worked well together. (Many of the test flights at Edwards required aerial refueling in order to extend the relatively short flying time of the test aircraft, which is usually a fighter.)

The next two flights made up for the previous abbreviated one. On 2 February, McMurtry flew 2.7 hours, the longest flight of the F-15 in five years, during which he tested the SIDC and EGE. The former showed no improvement over the baseline, which analysis attributed to pilot error, but the latter showed some improvement. Five days later flight 12 (number 566), with Dana in the cockpit, broke the recent longevity record. He tested all three components of the General Electric architecture during the 2.8-hour flight. The SIDC and EGE continued their abysmal performance, neither matching even the baseline, while he also tested the Mixer on large maneuvers.

On 9 February, during flight number 14 with Smolka in command, the SIDC and EGE worked together well on the first series of simulated impairments. Engineers later hypothesized that the EGE worked simply because, when he activated it the residual data was at its best. A large amount of Mixer data was collected on the 1.4-hour flight. When the SIDC alone was tested, it returned passable results only once in three tries.

Program managers scheduled a two-hour flight, with McMurtry at the controls, for 12 February 1990, allowing enough time to run another maintenance diagnostics scenario. The test failed, even while several reconfigurations with surfaces locked at various angles performed correctly. The next day, Smolka repeated the maintenance diagnostics scenario, this time successfully. The EGE used the SIDC to detect failures and transmitted a couple of gain sets, which did not, however, work. The remainder of Smolka's 1.9-hour flight included tests at off-nominal points within the edge of the envelope.

During the 23 February test flight lasting 1.9 hours, the SIDC detected only 25 percent of the simulated failures. Dana flew both Block A and Block B maneuvers during which there was excessive pitching motion; but he had opened the speed brake during some maneuvers, which was not part of the model.

On 28 February, McMurtry tried acceleration and decelerations with impairments. The 1.8-hour flight also tested the edge of the envelope at 16,000 and 24,000 feet. In addition, McDonnell Douglas, the

manufacturer, wanted some cross-coupling data, which McMurtry obtained by trimming the aircraft in a turn, and then increasing Gs. The flight on 2 March aborted because of a failure to align the inertial navigation system (INS). By the time the INS was ready, clouds had moved into the box marking the edge of the envelope.

On 6 March 1990, Dana tested the system for general flying qualities. His only complaint during the 1.7-hour flight: some pitch bobbing caused by the Mixer during tracking. Engineers traced the pitch bobbing to the very small time delay in the reconfiguration feedback correction commands coming from the Hawk flight processor. This small delay caused the motion of the plane to trail the pilot's command, bracketing the intended tracking error, and making it extremely difficult to center the sight exactly on the target airplane. Due to the size of the SRFCS software, the Hawk could only operate at 20 Hz or 20 updates per second, whereas the preferred rate for precision flight control is updates at 80 times per second. The next day, a 2.3 hour flight by McMurtry again resulted in pitch bobbing, and McMurtry adjusted to it. This series ended with a 2.4-hour flight in which he ran cross-coupling tests, and attempts to expand the SIDC and EGE envelope. But the flight was halted, even though fuel remained in the tanks, when Smolka became ill from too many 360-degree rolls.

One fact emerged during these flights, vividly demonstrating the trust that the pilots had in the SRFCS flight controller, as well as its performance. When the pilot rolled the reconfigured aircraft more than 200 degrees/second, the system disengaged and returned control back to the F-15's normal flight controller, with no false damage imposed on the controls. The roll disengage limit was purposely programmed into the SFRCS software by McDonnell Douglas; and at the request of safety engineers, placed in the software as a permanent value that could not be changed. Both McDonnell Douglas and NASA firmly believed that no pilot would ever try to roll a damaged aircraft at 200 degrees/sec, a value on the maximum edge of performance of the F-15, and something comparable to driving a family sedan over 100 mph. Yet the pilots complained loudly to McDonnell Douglas about this limit, wanting an even higher roll rate set in the system. This demand by the NASA pilots astounded the engineers, and illustrated the confidence the pilots had in the SRFCS.

Two weeks passed before the next test, an ambitious 1.3-hour flight that tried pitch doublets at both one and four Gs, and several maneuvers aimed at cross-coupling the controls. With the SIDC and EGE stubbed out, a maintenance diagnostic scenario ran with Mixer only. Dana finished the day's test plan with some large amplitude maneuvers, including 360-degree rolls.

The flight two days later was supposed to test most of the same items with a different pilot, but Dana flew both missions since no one else was available. He put another 1.3 hours on the aircraft and tried all

five maintenance diagnostic scenarios. Although the SIDC did not pick up on the 50-percent surface loss in one of the failure scenarios, everything else was a success. Dana flew some propulsion-only maneuvers as preliminary work on a later program. The tanker aborted its flight, missing the rendezvous, so he cut the test short, and returned to base.

About this time, Stewart and Bill Burcham of NASA both suggested using the two engines of the F-15 for propulsion-only control in a project entirely separate from SRFCS. This was partly inspired by a United Airlines flight in 1989 that lost hydraulics in the tail after an uncontained compressor failure in the tail-mounted engine of a DC-10. As the crew struggled to maintain control of the stricken aircraft, a deadheading pilot came to the cockpit and assisted the crew by using the throttles to control the plane with differential thrust of the wing-mounted engines. In spite of the resulting crash on landing at the Sioux City, Iowa, airport, nearly two thirds of those on board survived. Burcham and Stewart felt that even though the F-15 had its two engines much closer together than the DC-10, the jet's excess power would still generate sufficient differential thrust for experimentation. The engineers traveled to St. Louis to discuss with McDonnell Douglas such a development using NASA 837, another F-15 in the inventory, as a test vehicle. On the way, Burcham drew a diagram of his idea on a TWA paper napkin. At McDonnell Douglas they met with controls engineer Urnes Sr. Urnes himself had experience with Navy carrier landings using an experimental autopilot that employed thrust changes to control landing approach attitude, and McDonnell Douglas agreed to study the concept, conducting a feasibility study using their F-15 simulator. Most senior flight controls engineers at McDonnell Douglas doubted that a highly responsive fighter like the F-15 could ever be landed without any active flight control, since in modern fighters the control system stabilizing feedbacks are dominant for every maneuver the pilot desires to make. Thrust changes without controls would be very slow, leading to uncontrollable pilot induced oscillations (PIO), according to all the available data on pilot handling qualities requirements. Roll and yaw control would be even more difficult, with no rudder force to dampen yaw motion, resulting in a slow spiral to the ground.

Despite the contractor's misgivings, Stewart, Burcham, and Urnes Sr., instructed the engineers to develop control feedback software for the digitally controlled engines to be used on 835, and to install the design on the large visual display F-15 flight simulator at McDonnell Douglas. Then they invited NASA test pilot Gordon Fullerton to St. Louis to test it. Fullerton did not like the control stick method of command, recommending instead two thumbwheel controllers for pitch and roll. McDonnell Douglas initially rejected his idea, but reconsidered when the Air Force found a quad redundant thumbwheel panel that could be installed in the F-15. They discovered it in the same McDonnell F-4 test plane that pioneered



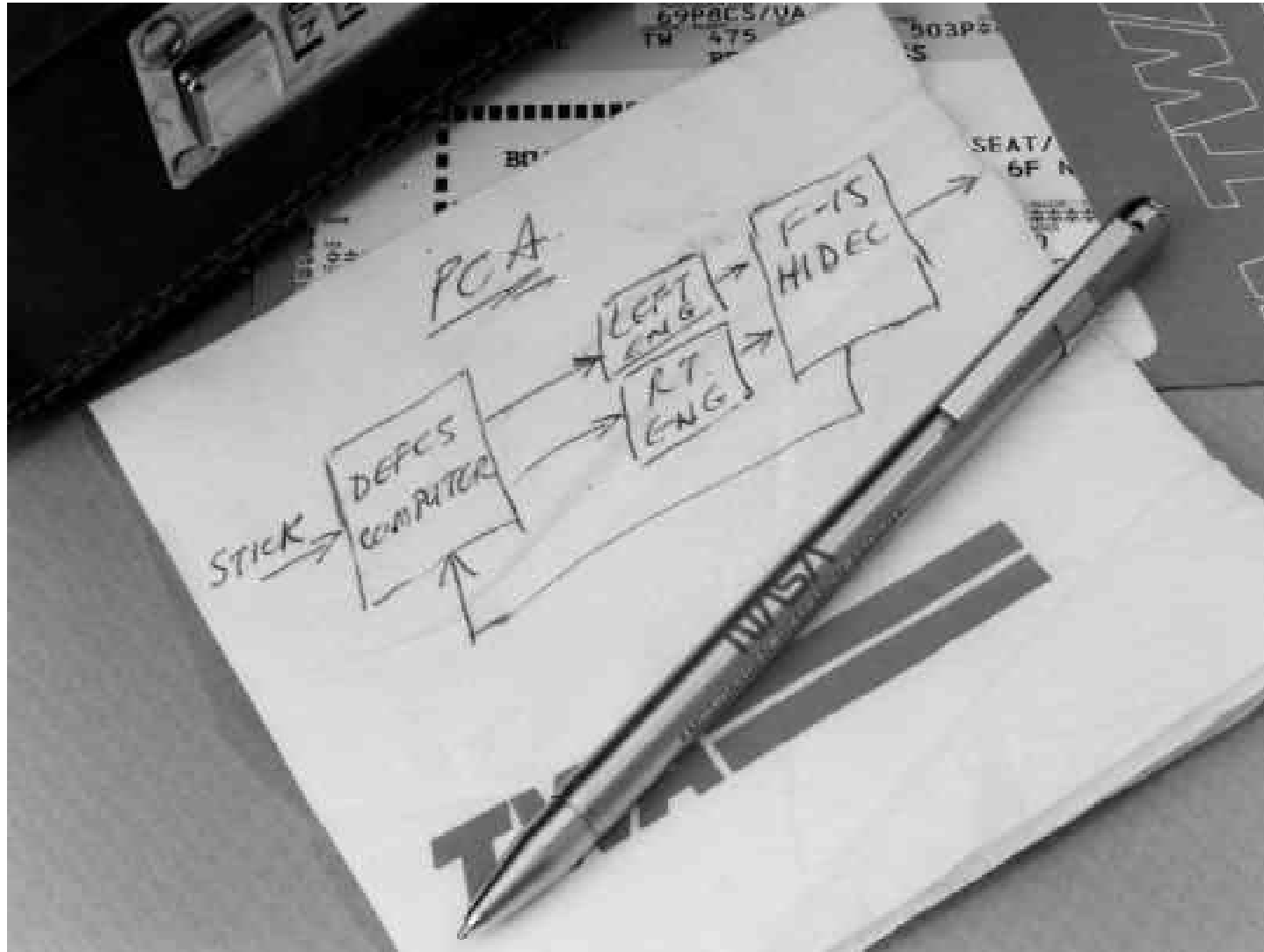

NASA Photo

EC94 42805-1

*The legendary “design on a napkin” sketched by Bill Burcham while flying to visit McDonnell Douglas in St. Louis. Here the Propulsion Control System is laid out with a planned installation on the NASA F-15 HIDEC.*

fly-by-wire control for the USAF, now located in the Air Museum at Wright Patterson. After much discussion with USAF Wright Labs test engineer Bob Yeager, the director at the museum agreed to part with the panel for the test program. Fullerton's suggestion became the key to success, completely eliminating any pilot induced oscillation from the system.

Meanwhile, at Dryden the test flights continued. During NASA 835's flight number 579, McMurtry tried the maintenance diagnostic scenarios again, which failed at the same place as before. He also performed numerous SRFCS maneuvers in the 2.3-hour flight, including wake turbulence assessments using the chase plane's vortex. The tests also included a simulated landing approach at 10,000 feet and 0.35 Mach, rolling through 30 and 45 degrees with the trim locked. Two days later, on 28 March 1990, Smolka tried inputting some new gains to the EGE developed by McDonnell Douglas in St. Louis. The SIDC failed with surface loss at 80 percent, rendering these new values useless. The 1.9-hour flight ended with another attempt at propulsion-only control. But the flight ended early for lack of fuel. Although Smolka was scheduled for the final flight of the program on 30 March, it was aborted because the roll and yaw CAS would not engage. Analysis revealed several corrupted non-volatile memory locations, although they would have been inconsequential to the flight. In the end, the ground crew was unable to reproduce the problem, which was, ironically, one of the very reasons for developing the maintenance diagnostic system.

The final, 1.9 hour flight on 3 April had one of the longest sets of test cards of any SRFCS mission. First, the video crew tried to get a shot of a longitudinal doublet. Then the pilot tried the 50 percent surface loss that had stymied the SIDC before. It took four tries, but it finally worked, although the fourth attempt occurred only because the video team in the chase plane had temporarily run out of tape and asked the pilot to repeat the maneuver. Later he exercised the SIDC/EGE/Mixer at various fuel weights, altitudes, and speeds. The final segment tested propulsion-only control again. Laterally, the response was promising, but slow. Longitudinally, the nose to rose and fell, but once down, the pilot could not raise it. Pitching up and reducing airspeed caused a sink rate, but the pitch angle did not decrease: instead, the angle of attack increased. Under these conditions pitch was not reversible in either direction.

The 25 flights of the SFRCS and maintenance diagnostics ended with general success on the maintenance side, understandable but frequent failures on the SRFCS side, and with early success of propulsion-only control. Yet, some uncertainties persisted about the results of the SRFCS investigation. The maintenance diagnostics project seemed the most successful. It had only one fault in the several flights in which it was

---

<sup>28</sup> Corvin, et al, "Self-Repairing Flight Control System, Volume I: Flight Test Evaluation on an F-15 Aircraft," Volume I, Part I, August 1991, p. 6-28.

exercised. In the SRFCS, the SIDC was right every time it sensed a control surface failure, but it sensed this only 61 percent of the time.<sup>28</sup> The Cooper-Harper ratings by the pilots averaged 2 for the aircraft unimpaired, 4-7 impaired, and 4-5 reconfigured.<sup>29</sup> Nevertheless, NASA proved the concept of the Self-Repairing Flight Control system, while engine-only control emerged as a viable project.

Moreover, NASA eventually demonstrated a successful, if not uneventful, landing of the F-15 using only the engines. Despite the difficulties of the flight, the technology developed by the NASA team enabled its pilots to fare better than the United Airlines crew had at Sioux City. Propulsion-only control eventually became a full-fledged Ames-Dryden initiative using an MD-11, an aircraft with the same engine layout as the DC-10. It also had the additional advantage of being primarily a commercial aircraft, rather than a military fighter jet. Follow-on versions of the landing system would use artificial neural nets, which were a central part of the Intelligent Flight Control System flown on the F-15 flight program, for repair in flight. In 1995 research pilot Gordon Fullerton successfully landed the MD-11 using propulsion-only control.

Both the maintenance diagnostics and self-repairing flight control systems were researched off and on for another decade.<sup>30</sup> The program remained active principally because all U.S. fighters, bombers, and transports after 1990 were controlled by fly-by-wire systems with digital computers. Wright Laboratory's Robert Quaglieri predicted that greater possibilities existed for the application of self-repairing concepts of aircraft layouts, given the potential for reconfiguration and engine-only-control early in their design cycle, because by relying on self-repairing and engine-only-control, the redundancy levels inherent in today's designs might then be reduced.

Stewart, the NASA program manager, placed much of the credit for the program's success on the F-15 itself. It was one of the few tactical aircraft available for tests that had a research computer, in addition to digital flight controls. NASA retired the aircraft in 1992, replacing it with an F-15 that is not only completely fly-by-wire, but also has canards made out of the horizontal tails of an F-18. This airplane, F-15B number 837, still serves as the test bed for on-going IFCS experiments.

The SRFCS was mostly conventional, inasmuch as it used the controllers in expected ways. It took several flights to work the bugs out of the system, but the concept was proved without much "out of the box" innovation. "Innovation" came to the forefront in the follow-on program, which used artificial neural networks.

---

<sup>29</sup> Ibid., 6-112.

<sup>30</sup> Quaglieri, interview.

## Section 3: The Intelligent Flight Control System

After the Air Force discontinued its funding of SRFCS, Stewart and other NASA researchers continued to pursue their interest in self-repairing systems.<sup>31</sup> Moreover, while the F-15 used for the SRFCS tests was retired by the mid 1990's, its replacement – another F-15 – had some of the same characteristics of the first airplane, making it an ideal platform for further research on the concept. Stewart had planned advanced control research using multi axis thrust vectoring, advanced reconfigurable control technologies, as well as a battery of new tests on this new vehicle.

Since Stewart obtained and equipped this unique F-15 for advanced control technologies research, he named the project F-15 ACTIVE (Active Control Technology for Integrated Vehicles). NASA number 837 was equipped with a full authority digital fly-by-wire system, not just a replacement for the CAS. It also incorporated canards, wings forward of the standard F-15 wings, which could make the aircraft unstable. In this case, these canards were actually F-18 horizontal stabilizers, and the control system was largely off-the shelf, and also from the F-18. Moving the canards with angle of attack enabled pilots to re-stabilize the basic airframe. A Vehicle Management System Computer (VMSC), a Motorola 88100 series processor, augmented the regular flight computers. The VMSC provided additional fast computing power and, with some two million words, a larger memory than had been available for previous tests. In addition, a research 68040 processor was added to each of the four-channel primary flight control computers, giving this research airplane the highest control processing capability in the industry.

The project obtained support from two other NASA centers (Langley and Glenn) and received assistance from the USAF, as well as from McDonnell Douglas and Pratt and Whitney. These partners contributed to the first ACTIVE experiment by integrating Flight Research and Demonstration of Thrust Vectoring Nozzles with advanced NASA techniques that were later used with the neural networks. Stewart negotiated with USAF for the aircraft, with P&W for the multi-axis nozzles, and with McDonnell Douglas for the vehicle management system computer. These contributions cost NASA nothing, and consequently leveraged NASA's own

---

<sup>31</sup> Stewart, interviewed by the author, 4 April 2001.



*NASA Photo*

*EC96 43780-1*

*A top-down view of the F-15B ACTIVE as it flies over the Mojave Desert. This perspective highlights the canards – not found on production F-15s – which were integral to the SFRCS/IFCS experiments. The canards were in fact stabilizers from an F-18. The jet's speed brake, just aft of the canopy, has been deployed in this photograph casting a shadow on the fuselage.*

contributions, making the project possible. This aircraft remains one of the most heavily instrumented in all of flight research and, as such, represents an improvement over the HIDECA F-15 NASA test bed.

Following the SRFCS program, Boeing experimented with broadening the reconfiguration process that would address both “A matrix” and “B matrix” failures so successfully demonstrated on the F-15. “B matrix” refers to the control surfaces, one of which, the right stabilator, failed during SRFCS flights. Boeing was interested in the “A matrix” or aircraft airframe damage (such as the loss of a wing, as experienced in the Israeli F-15 mid-air collision). Boeing had the wind tunnel data from the partly missing right wing, and attempted to use the SRFCS process in simulation to restore control, but their attempt did not succeed. SRFCS used a dynamic inverse method to track and correct damage conditions twenty times a second, using the “B matrix” inverse in this computation, but this inverse process could not be expanded to fit the more complex “A matrix” type failures.

Still, Boeing sought a process that would deal with “A matrix” and “B matrix” damage situations. It found that the best way was to continually calculate all the important stability derivatives contained in both the A and B matrix aircraft definitions, and then, having found these derivatives, apply an advanced adaptive flight controller to provide the control surface commands. This flight controller would continually solve the control system gains for the best control response obtainable under the operating conditions of the aircraft, whether damaged or undamaged. Solving the control gains during flight implied use of a real time Riccati solver (linear algebraic equations) while finding the critical stability derivatives implied use of self-learning neural networks, both very challenging tasks. Both Stewart and Urnes Sr. recognized that future IFCS techniques using Neural Networks would require greater computer capability than existed on the ACTIVE aircraft.

One other program was key to the success of neural network flight control demonstrations. DARPA sought a more advanced control concept in which to show off the benefits of fly-by-light. Stewart worked with DARPA to successfully fund a two-year program through McDonnell Douglas to investigate fly-by-light aircraft control in a program titled Fly-by-Light Advanced Systems Hardware (FLASH), begun in 1994. McDonnell Douglas proposed that a neural network Intelligent Control project would be an ideal showcase, blending highly advanced controls technology into the fly-by-light system. Thus, a subtask was added to the FLASH program for flight hardware demonstration of such a system. DARPA designated Dan Thompson at the Air Force’s AFRL to lead the program.

Under the FLASH program, General Electric’s controls division worked to increase computer capacity in order to match the needs of the IFCS. GE turned to its 68040 processor and supplied subsystems that were successfully integrated into the testbed. Without the 68040, IFCS flight tests would not have been possible, and the later NASA programs benefited greatly from DARPA and AFRL’s support during the FLASH program.



*NASA Photo*

*EC96 43415-1*

*NASA F-15B ACTIVE in flight. Notable in this photo are the canards that were added to the airframe by the Air Force, from whom NASA acquired the aircraft. Able to pivot, thereby changing the angle of attack, the canards were used to blank airflow over a wing, simulating loss of that wing in flight. The SRFCS/IFCS could then reconfigure control without actually sacrificing an aircraft.*

## **Artificial Neural Networks Introduced**

Stewart decided almost from the outset to investigate the efficacy of neural networks in creating the Intelligent Flight Control System (IFCS). In fact, the same McDonnell Douglas Corporation group that had worked on the SRFCS, still led by Urnes Sr., had already figured out an approach and started work on a pre-trained artificial neural net.<sup>32</sup> MDC established a neural network laboratory in 1991, and staffed it with young, innovative engineers with academic backgrounds in artificial intelligence technologies. In 1991, Urnes Sr., directed a company funded research project to rework the F-15 SRFCS damage adaptive software incorporating the new neural technology. To the surprise of the MDC researchers, the neural network version not only provided better accuracy in modeling the F-15 stability properties, it also performed this task with nearly a 40:1 reduction in software (primarily by eliminating the massive table look-ups required in the SRFCS). MDC officials then approached NASA with a proposal for flight evaluation of the neural network software, leading to meetings with Stewart and Terry Putnam. Representing the NASA Headquarters, Putnam was instrumental in locating funds for the flight research program. NASA Headquarters, which typically encourages inter-center collaboration, suggested that Stewart contact researchers at NASA Ames already involved in neural networks.<sup>33</sup>

During 1992, Stewart – who earned his Ph.D. in both Engineering (Digital Optimal and Adaptive Control) and Business – met Charles (Chuck) Jorgensen, a NASA scientist and branch chief who came to the agency from a position with Thomson-CSF, the French avionics firm. Jorgensen earned his doctorate in mathematical psychology from the University of Colorado in 1973, and his dissertation included some work with neural networks (See the sidebar for how these nets function on page 35-36). He kept working on them part-time until arriving at NASA in 1989. There he started the “neuro” laboratory at the Ames Research Center. During one of Stewart’s visits to Ames, Jorgensen showed him the lab. Stewart was already thinking of neural nets that could learn in real time as the next logical technology beyond both the SRFCS and the pre-trained neural nets of the IFCS; Jorgensen was looking for a suitable aeronautics application, and the two joined forces.

Stewart and Jorgensen were enthusiastic about neural networks since the technology itself seemed capable of learning new patterns of behavior. This capability made it possible to reduce the time needed to develop and test new flight control systems. It also meant that every contingency did not need to be thoroughly defined ahead of time, making it possible to reduce the number of high cost tests, including wind

---

<sup>32</sup> Urnes. Sr., interviewed by the author, St. Louis, 20 April 2001.

<sup>33</sup> Ibid.



tunnel runs and even some test flights. A dynamic neural network could adapt to new circumstances. Jorgensen wanted to use a dynamic learning network, but he understood Stewart's desire to fly an already trained network first. It was only in 2001 that Jorgensen's ideas finally began to be implemented.

When the IFCS made its first flight, it flew with the neural net software operating "open loop," that is, without linking to the aircraft control system. The ACTIVE F-15 made these "Phase I" flights in 1996 solely to compare the output of a pre-trained neural net to the stability properties, or derivatives, of the F-15. Five "Phase 0" pre-learning neural net flights were flown in order to generate simulator data, with the conventional flight control software in the foreground and the neural net software as a background.<sup>34</sup>

The IFCS controller software consisted of the Stochastic Optimal Feedforward and Feedback Technique (SOFFT) developed by Nesin Halyo and his colleagues at Information Control Inc. They produced this under contract to NASA's Langley Research Center, and the program was implemented by McDonnell Douglas' Phantom Works in St. Louis.<sup>35</sup> There, Urnes Sr., the chief of the SRFCS project for McDonnell Douglas, assumed the same role for the IFCS as he had on the previous program. Prior control systems used only feedback to do their jobs. The SOFFT algorithm, however, used a unique method to provide *feed-forward* as well as feedback to the flight controls, and Stewart had worked with the control branch at NASA's Langley Research Center to enable the use of SOFFT in the development of the F-15 ACTIVE project. Langley itself wanted to demonstrate the SOFFT on an aircraft that had a large number of interactive control effectors and the F-15 ACTIVE, with its canards and thrust vectoring nozzles, was the ideal candidate

An upgraded neural network design was developed during Phase I, and then test flown in 1996. Using the Levenberg-Marquardt feed-forward learning algorithm, this net performed within one percent of the desired flight computations, doubling the accuracy over the networks flown in Phase 0. Meanwhile, McDonnell Douglas had enlisted Tennessee State University to help explore the use of Adaptive Network-based Fuzzy-Interference System, or ANFIS.<sup>36</sup> Fuzzy logic involves the employment of algorithms to arrive at a decision instead of working from linear paths of calculation. The concept was attractive because of its speed, and it better represented the ACTIVE's non-linear stability and control derivatives. But it was too large and resource-hungry to be used on a production airplane featuring IFCS capabilities.<sup>37</sup> NASA

---

<sup>34</sup> Annual Report, 3/95-7/96, p. 2-1

<sup>35</sup> Annual report 3/95—7/96,1-1.

<sup>36</sup> Annual Report, 3/94-7/96, p. 3-3.

<sup>37</sup> Annual Report, 3/95-7/96, p.3-5.

evaluated a competitor algorithm, called Active Selection, along with Levenberg-Marquart. Active Selection functioned differently, picking the case with the largest error, then learning within the limits of that error. But in the end NASA chose the Levenberg-Marquart for further development since it demonstrated an overall error rate lower than that of Active Selection.

The Phase II on-line learning neural networks were developed using the NASA Ames Dynamic Cell Structure (DCS) neural network format. Pilots flew a combination of Phases I and III in order to generate flight data for the Phase II on-line learning. A baseline pretrained neural net sent signals to the flight controller, with the online net calculating the differences between the outputs for the actual system versus the predicted results. The differences were added to the derivatives and also sent to the flight controller. The test flights of Phase I and III took place in March and April of 1999. The Phase II on-line learning software required more development however, and was not flight-tested. Nevertheless, inserting flight data into the algorithm showed good promise for the design.

### **Validating Non-Deterministic Software**

The problem that faced NASA engineers (and will continue so long as they use neural networks) involved verifying and validating non-deterministic software.<sup>38</sup> Real-time embedded

---

<sup>38</sup> John Carter, interviewed by the author, Dryden Flight Research Center, 9 April 2001.

## **Artificial Neural Networks (ANNs): How They Work**

John von Neumann, an early computer pioneer, compared many of the functions of a digital machine with those of the neural network in the brain. Research showed a close relationship between computers and the human brain, an important insight for aeronautical researchers concerned with the interface in the cockpit between machine and human. It also showed the similarity between artificial neural nets (ANNs) and computers.<sup>1</sup> Others have made analogies between the human brain and computers as well, including Norbert Weiner, in his classic *Cybernetic, or: Control and Communication in the Animal and the Machine*.<sup>2</sup>

ANNs function much like the human brain. Most learning in the mind occurs by natural neural networks, made up of cells, called neurons, which act on each other through electrical pulses. Since the early days of artificial intelligence (AI), artificial neural networks have held great promise because they could

---

### **See ANN, page 36**

---

<sup>1</sup> The writings of John von Neumann contain frequent references to the similarities between the human brain and computers. See *Computer and the Brain* (New Haven: Yale University Press, 1958).

<sup>2</sup> Norbert Weiner, *Cybernetic, or: Control and Communication in the Animal and the Machine* (Boston: MIT Press, 1948).

## ANN ... from page 35

---

model how a natural brain is organized and how it works. Marvin Minsky, the well-known AI specialist from the Massachusetts Institute of Technology (MIT) began work on ANNs in the late 1960s. He called the nodes “perceptrons,” a term still occasionally used today. Further work has been done on applications of neural nets in many domains. In situations where learning is required, they are indispensable. At first, processors were too slow and memories too small to adequately support work on ANNs, but even in the case of control applications that is no longer the case.

A neural net hosted by a computer usually consists of several layers of nodes, typically an input layer, a hidden layer or layers, and an output layer. Invariably there are fewer output nodes than input nodes. For instance, in a flight control system, there might be an input layer for each of two-dozen parameters in each axis. These would be combined into a smaller hidden layer, and probably multiplied by a weight. The hidden layers then come together in an output layer of one node per axis that sends a signal to the actuators.

Take an LED display in a bedside clock, for example, with seven light segments which, in combinations, are used to represent the numbers 0 through 9. A “1” would have two segments lit, while an “8,” would have all seven segments lit, and so on. If some segments receive a relatively large signal while others little or no signal, the ones with large signals light up. Recognizing this, the net tries to adjust the weights in the hidden layer in order to light the desired segments by balancing the signals. Preprogrammed to “see” these circumstances and adjust to them, the hidden layers remain invisible to the user who is unaware of any imbalance in the clock.

ANNs are “taught” by rapidly running thousands of cases. Pre-trained neural nets “know” the appropriate weights, having seen them in a simulator. Neural nets that learn on the fly are more flexible, but are also more difficult to implement, since they are limited by computer power. The VMSC, like the Hawk before it, could barely handle the processing needs identified for what was to be called the Intelligent Flight Control System (IFCS).

software is difficult, if not impossible, for a computer to verify under normal circumstances.<sup>39</sup> As a result, the computer will arrive at deterministic answers during non-deterministic times. For instance, if the system is supposed to calculate a seven, a correct program will result in a seven. But that seven may come at an unexpected time, depending on the operating system, information from the environment, previous inputs, and other demands on the computer. A neural net, by contrast, can seldom calculate a specific value. For example, if a neural net inputs 26 values to calculate the command output in one axis, the output may not always be the same – even if the inputs are all the same. The construction of the hidden layers may result in a different value, although it may be in acceptable range. NASA and Boeing combined some test principles from the real-time world with ones intended for neural nets, to form a fairly sophisticated test series.

The open loop nature of the flight controller in Phase I of the IFCS enabled it to be piggy-backed on the regular flight test program of the F-15 ACTIVE. The system received sensor data as though it was connected, but the output remained unconnected to the main flight controller. Instead, this data was compared to what the generic fly-by-wire system commanded, which in turn was telemetered to the ground for later analysis; at this stage it did not control the aircraft in real time. The ANNs ran on the VMSC and verification was, accordingly, less formal. Phase III of the program used the outputs of Phase I's software to control the ACTIVE aircraft and this had to be verified and validated more stringently. During the IFCS testing, Boeing purchased McDonnell Douglas and adapted the principle of “you fly what you test,” to the flight research program, meaning that the flight version is used for all verification and validation activities.<sup>40</sup> NASA itself adopted this principle in verifying the flight software.

The pre-trained neural nets of Phase I were entirely resident on the VMSC. Written in the Ada language, the ANN originally fit into channel C of the computer. For the combined Phase I- Phase III flight program, it resided in Channels A and B, achieving redundancy. Only 512K of Electrically Programmable Read Only Memory, and 256K of Random Access Memory, were needed out of two million words of storage.<sup>41</sup> Output signals to the flight computers could be checked across the channels. The controller resident in the flight control computers was the SOFFT algorithm, which was largely hand-coded and also in the Ada language,

---

<sup>39</sup> Chapter three in James E. Tomayko, *Computers Take Flight* (Washington, D.C.: NASA-SP-2000-4224, 2000) is devoted to verification.

<sup>40</sup> *Testing Philosophy*, p. 8.

<sup>41</sup> Annual Report, 3/95/ - 7/96, p. 3-1.

though some parts were automatically generated using the Matrix-X system build environment. Matrix-X was a software development tool that aided engineers producing the flight program.

Part of the feedback portion of the algorithm required the solution of a complex matrix equation called a Riccati Equation. A non-linear equation, it is the foundation of optimum control such as that used in the IFCS, and is used to continuously calculate the IFCS feedback gains that are critical to the safety and performance of the aircraft. Normally, a Riccati solution determines the control system gains during the design. Since damage necessitates continually new design “on the fly”, the Riccati Equation becomes critical to the IFCS process. Stewart had himself developed a multi-rate digital Riccati Equation as part of his doctoral dissertation, and the test aircraft carried the only Riccati Equation solver known to be in flight at that time, a milestone in the opinion of the project managers.<sup>42</sup> Hand-coded in the C language for ease of expression, the operating system accommodated the Riccati solver as a background job. In the foreground ran the SOFFT controller at 80 hertz. Time left after the execution of the controller was spent solving the Riccati equation. In this way, and even though unscheduled, the Riccati outputs were updated every few cycles while the controller gathered updates from the sensors at the rate of 80 hertz.

The developer of the Riccati solver used in the IFCS was a group at Washington University of St. Louis. Dr. Massoud Amin led development of dynamic neural network software and, most important, on-line computation of the Riccati Equation to be installed on the F-15 IFCS software. The Washington University team faced a difficult design challenge in solving the Riccati Equation on-line, for it would be the first time this had been accomplished in any aircraft control system. Solving this equation onboard, in real time, gave the system the vital ability to adjust to *any* change in aircraft stability, such as that caused by failures or damage to the controls. Their success paid large dividends.

Using the “what you test is what you fly” principle, the controller software would go through many dissimilar software and hardware environments before being installed in the airplane. Building functionally equivalent code with dissimilar software was an essential part of verification, for building software twice – but differently each time – gives assurance that its designers understand it. In fact, functionally identical but dissimilar software is the basis of the backup on an Airbus fly-by-wire commercial transport.<sup>43</sup>

---

<sup>42</sup> Stewart, interviewed by the author, 10 April 2001.

<sup>43</sup> Tomayko, *Computers Take Flight*, p. 128.

The basic process of verification and validation of flight control laws, still used today, is iterative, and proceeds through a number of steps.<sup>44</sup> In this instance, linear and non-linear engineering analysis was applied to the design. The flight software code was then generated by a combination of hand-coding and automatic generation. The code was module-tested, and then the software underwent trials in a simulator with a pilot or engineer in the loop. The codes were next placed under configuration control to curtail frequent changes to the requirements and the integrity of the design. The sub-systems then were integrated, and the software loaded on duplicates of the actual hardware in a high-fidelity simulator. By the time the software was finally loaded on the real aircraft, whatever could be tested on the ground was checked.

This process differed from that used on the HIDEDEC F-15. The software tested at that stage was functionally equivalent (but not line-for-line equivalent) to the flight load.<sup>45</sup> For the IFCS, the Matrix-X tool allowed automatic generation of Ada code based on the graphical representation of the design. The SOFFT modules were relatively easier to verify because almost all of the software ran on each pass through the control system, so the software was executed frequently. Nevertheless, all logic paths were tested in each module. Test scripts were generated by Matrix-X exercise software “super blocks,” a major output of the software tool.

Another, admittedly expensive, way to test the software, was to implement the functional requirements in dissimilar ways and reconcile any discrepancies in output. The results of the hand-coded controller were replicated in a dissimilar fashion by giving the SOFFT and Riccati solver algorithms to a knowledgeable engineer and having the engineer replicate the functions.

The defects in the IFCS system were categorized in four groups: compiler/linker problems, auto coder problems, hand-coded defects, and design and Matrix-X problems. Nearly all discrepancies were compiler/linker problems, something expected in an environment new to the software engineers. The few auto-code and hand-code errors originated with misuse of tools rather than misunderstood requirements. The piloted flight simulation gathered inputs from the Boeing and NASA pilots into the dissimilar SOFFT implementations. Tests run in June 1997 revealed only a couple of design errors, which were quickly fixed and re-tested. This phase completed the testing conducted before the software was loaded onto the airplane. Since the same software was used for each step of verification, the entire verification and validation process was relatively inexpensive.

---

<sup>44</sup> Testing Philosophy, p. 8.

<sup>45</sup> Ibid., 10.

Configuration control was an important part of the SOFFT development. At first, the file protections of the UNIX operating system were used.<sup>46</sup> But only one engineer had full privileges, and he would have to make manual permissions changes. And so the project eventually adopted the Rational Apex Ada development environment, with its configuration manager, source code development editor, and debugger.

The software was then mounted on the airplane in order to run on the Motorola 68040 processor in the flight control computer and the 88100 processor in the VMSC. Both processors had mature compilers and linkers for both Ada and C languages, built by Tartan Laboratories in Pittsburgh, Pennsylvania. Both had been used on other programs and had operated previously on the ACTIVE. Whatever could be tested on the F-15 simulator, such as pilot handling quality evaluations, was then tested with the software installed.

### **The IFCS Test Flight Series**

The first flight of the IFCS actually occurred on the 126<sup>th</sup> flight of the F-15 ACTIVE modified with the highly advanced control system. As he had in the SRFCS program, Jim Smolka won the honor of flying the initial mission on 19 March 1999.<sup>47</sup> Gerard Schkolnik took the rear seat of the airplane on that flight. An engineer, Schkolnik had been in charge of the software verification, and had invented the ADAPT (Adaptive Aircraft Performance Technology) mode, a way of modifying the frequencies of the commands to filter out undesirable characteristics.<sup>48</sup> On this first flight, Smolka performed several maneuvers, including doublets in all axes, aileron rolls, and tracking. The 1.2-hour flight ended by flying different Dial-a-Gain (DAG) settings, which were adjustable by the pilot.

The afternoon of the same day Smolka flew again, this time with Capt. Dawn Dunlop in the rear seat. They did an hour of accelerations and deceleration tests. Dunlop took a few minutes to get used to the F-15's handling, which felt more like that of an F-18 than a normal F-15.

These flights took place with the neural net now activated. But in this instance, it did not have to determine what had failed—as had the System Impairment Detection and Classification module in the Self-

---

<sup>46</sup> Ibid., 19.

<sup>47</sup> James Smolka, interviewed by the author, Dryden Flight Research Center, 6 April 2001.

<sup>48</sup> Gerard Schkolnik interviewed by the author, Dryden Flight Research Center, 9 April 2001.



*NASA Photo*

*EC99 44997-7*

*NASA pilot Marty Trout and U.S. Air Force Captain Dawn Dunlop in front of the F-15B ACTIVE.*



Repairing Flight Control System—it simply compensated for any deviation from the model. Skipping the identification step gave these tests the feeling of success right from the beginning.

Early in the flight test program, NASA wanted to check off the milestone achievements for IFCS, which required test flying throughout the envelope. Normally, this would require numerous flights; in this case however, the program managers decided to accomplish the envelope expansion in one flight by flying only the perimeter of the envelope, involving Mach .5 and Mach 1.3. Smolka flew the test and the IFCS performed magnificently. Tests included a high performance split-S (rapid roll to inverted flight, followed by a 5-6g downward arc until reaching level flight). These maneuvers gave the Dryden engineers – and especially Smolka – confidence that this system would prove worthwhile.

NASA research pilot Dana Purifoy, who flew chase on the first two flights, took the controls on number 3 the morning of March 23<sup>rd</sup> while Schkolnik sat in the back. They tested the ADAPT in other situations and did several engage/disengage cycles, simulating transients. That afternoon, Dunlop and Purifoy flew some more tracking, rolls, and Dial-a-Gain (DAG) settings. The F-15 carried on the rapid pace of the tests a week later as Dunlop commanded, and Smolka crewed flight number 5. Again, doublets, rolls, tracking, and other envelope expansions were on the flight card. On 1 April 1999, Purifoy and Schkolnik flew more Dial-a-Gain settings, as well as some formation flying and tracking. Later in the day Dunlop flew with Schkolnik in the back seat on yet more DAG maneuvers, such as rolls and more tracking. The next day, Smolka flew while Schkolnik took the rear seat, conducting formation flying and tracking with various DAG settings. They scrubbed a second flight that day before the ANN control system was engaged because of a shutdown in one of the research channels.

It took nearly two weeks to fix this problem, and the ACTIVE returned to flying status on the 14 April with two missions. Purifoy flew both, and Larry Walker – Boeing’s chief experimental test pilot – replaced Schkolnik in the back seat on the second flight. The aircraft maneuvered at 1.2 Mach and 32,000 ft. on both flights. NASA tried to make up for lost time on the 16<sup>th</sup> by inserting three flights on the schedule. For the first flight Walker and Purifoy switched positions from two days earlier. Dunlop commanded the second and third flights, with Schkolnik taking back seat; all three flights stretched the DAG envelope. The two flights on 23 April concluded the test program, with Purifoy and Dunlop in the cockpit.

Only a little over a month elapsed between the first and fifteenth – and final – flight of the program. It is a testament to the newly loaded software on the airplane that so many missions were flown in so short a time. These flights of the pre-trained neural net steadily expanded the flight envelope from 0.5 to 1.3 Mach and from 15,000 to 35,000 feet. It is significant that throughout this program the pilot reports sounded more routine than had those of the SRFCS flights, for there seemed to be fewer problems to overcome.



*NASA Photo*

*EC93 42284-13*

*Dr. James Stewart, project manager for the IFCS experiments, pilot Jim Smolka, and Ken Szalai, Director of NASA DFRC.*

These flights completed the initial testing of an ANN system built on top of the SOFFT controller (a process which Chuck Jorgensen and his team watched closely). Now, the next technological step will entail a neural net that learns in real time. Such flights are planned on both the former ACTIVE aircraft and on a C-17 transport.

# Epilogue: The Future of Intelligent Flight Control

At the start of the twenty-first century, dynamic neural networks were on the verge of trials aboard actual aircraft. Chuck Jorgensen and his associates at Ames waited in anticipation during the earlier, pre-trained neural net flown by NASA, hoping for the chance to apply dynamic cell structure neural nets to the task of learning to fly the F-15.<sup>49</sup> Although these kinds of algorithms took much of the power of the VMSC, there were plans to augment that computer with a processor called the Super Harvard Architecture Computer, or SHARC. But these plans did not come to fruition before the 1999 flights were complete.<sup>50</sup>

While NASA and Boeing tested the learning ANN offline, events elsewhere came to bear on the program. As far back as 1994, B.S. Kim, a doctoral student at Georgia Institute of Technology, and his advisor Anthony J. Calise, suggested a new F-18 flight controller concept that linearized feedback, making control computationally difficult, yet possible.<sup>51</sup> An on-line neural net transformed the outer control loop from non-linear to linear, rendering it controllable.<sup>52</sup> Calise, a specialist in this field, eventually conducted research on a helicopter controlled by neural nets. Joe Totah of NASA Ames knew of Kim and Calise's proposal, and ultimately adapted it so as to control an F-15 simulator.<sup>53</sup> The total number of training pairs – 4,275 in Kim's thesis – represented a relatively small number for such applications<sup>54</sup>.

---

<sup>49</sup> Charles C. Jorgenson. "Feedback Linearized Aircraft Control Using Dynamic Cell Structures," ISSCI Paper. Albuquerque: TSI Press, 1998: 050.1 - 050.6

<sup>50</sup> Boeing. "Intelligent Flight Control: Advanced Concept Program," MDC 98P0026, Annual Report Period: 1 April 1997 to 31 March 1998, The Boeing Company.

<sup>51</sup> Byoung S. Kim, and Anthony J. Calise. "Nonlinear Flight Control Using Neural Networks," in *Journal of Guidance, Control, and Dynamics*, Vol. 20, No. 1, January-February 1997.

<sup>52</sup> Kim. "Nonlinear Flight Control Using Neural Networks," Ph.D. Thesis, Georgia Institute of Technology, School of Aerospace Engineering, December 1993, p. 26

<sup>53</sup> Joseph J Totah. "Simulation Evaluation of a Neural-Based Flight Controller," *AAIA Conference Paper* 96-3503-CP, 1996, pp. 259 – 266.

<sup>54</sup> Kim. "Nonlinear Flight Control," p.78.

Even though NASA planned to fly its F-15 with an ANN that learned dynamically, it recognized that the tactical aircraft's performance and usage differed considerably from a commercial airliner; it also understood that this new technology would not be considered a success unless it was adaptable to this second environment. Thus, the next step in planning was the application of the system to a C-17 transport. Aside from having an operating envelope much closer to that of a commercial plane than the F-15, the C-17 came with an organic digital flight control system, enabling a more effective adaptation to self-repair. Moreover, it had 30 surfaces that could be controlled.<sup>55</sup>

But why should NASA contemplate two neural network projects? To begin with, dynamic learning has yet to be proven. The ACTIVE F-15 provides an initial step in this direction, but its narrow purpose as an aircraft yields data with limited applications. The C-17 is a much more suitable vehicle to test the adaptation of this technology more broadly, and with commercial uses in mind.

Additionally, the technology remains anything but routine, though there has been a great increase in other commercial neural net projects even while the NASA projects were proceeding. Indeed, the technological dispersion of neural nets in control systems resembles the rapid expansion of digital fly-by-wire technology, which itself began while NASA was still in the midst of the F-8 fly-by-wire program. But for the foreseeable future, the simplest use of the IFCS will probably be as a backup on standard fly-by-wire aircraft. In this way, the IFCS interfaces will not be overly complicated, and the ANN will not assume primary responsibility for flight control, but serve instead, only as a redundant system.

Perhaps a sign of confidence in this project, Boeing began deploying complete digital fly-by-wire controls in the newer model F-18 E/F. F-18s prior to this had a mechanical back-up system as a redundancy to the digital FWB, reflecting the conservative approach to aircraft control. The newer EF model is controlled entirely with fly-by-wire technology, with no mechanical back up. An active part of the aircraft is the automatically reconfigurable intelligent flight control system, following the developments at NASA, McDonnell Douglas/Boeing and the Air Force. In a recent incident, a test pilot flying the new model F-18/EF in a low altitude-high speed pass at the Navy's Patuxent River test site, experienced stabilator control failure. The stabilator on the F-18 aircraft is the most critical control surface, providing virtually all the maneuverability at high speeds. This F-18 was saved from a near-certain crash, however, by the back up, reconfigurable intelligent flight control system, which rendered the aircraft controllable, and allowed the pilot to land safely.<sup>56</sup>

---

<sup>55</sup> Jerry Henry, interviewed, Dryden Flight Research Center, 10 April 2001.

<sup>56</sup> Interview with James Urnes, Sr. of Boeing Phantom Works, by Christian Gelzer, 11 October, 2002.

Yet, the most advanced use of ANN technology will likely enjoy continued support from NASA. This line of research has the potential to accelerate certain kinds of design, for an analog control computer essentially must be rebuilt in order to command hardware different from the original design. By contrast, a digital computer-based flight control system needs only to have the software changed in order to reconfigure an aircraft. NASA has amply demonstrated this with the former F-15B ACTIVE, an aircraft with high capacity digital computers and new software as the heart of its control system. Thus, although the software may take a great deal of time to develop, and may be expensive, the advantages are evident: ease of development and production, and aircraft versatility.

An ANN can “learn” how to fly new hardware dynamically, allowing a new flight control system to be sorted out and flown without any prior design. This speeds aircraft production, since a portion of software can learn how to fly a particular aircraft, and then all such software can be alike. Even if minute differences exist within a group of aircraft, the differences would be neutralized, and the aircraft optimized, by the control system. Chuck Jorgenson has already used this method to define the control system of a Mars flying aircraft. He has also incorporated this technology into a sleeve embedded with sensors that “read” the human arm’s grabbing and motion impulses, translating these into a control system. Such a system presents the possibility of true hands-off flying. In 1995 his Ames colleague John Kaneshige used neural nets in the final version of the Propulsion Controlled Aircraft software on a MD-11 successfully landed by Gordon Fullerton.<sup>57</sup>

The importance of the In-flight Flight Control demonstration of the F-15 self-learning ANN cannot be over-stated. If flight-critical stability derivative coefficients can be calculated during flight, even with unanticipated damage to the aircraft, it will alter the course of control system design. It will also reduce design cost, and at the same time increase the ability of control systems to adapt to conditions that would cause a crash of aircraft using today’s control system design.

Meanwhile, the average traveler may well encounter ANNs for the first time on automobiles. The General Motors Corporation is experimenting with neural nets as the heart of a controller to provide default values when sensors and actuators fail. This might enable motorists to get to a repair shop before the car stops completely and strands them.

The use of neural networks is likely to blossom in today’s convergence of faster computer processors, larger memories, and more efficient algorithms. As a consequence of NASA’s continuing concern with safety, and its foray into systems of aircraft self-repair, neural networks promise to yield dividends for any industry using a controller. The cars we own, the trains we ride to work, and the planes we fly, all stand to benefit from

---

<sup>57</sup> John Kaneshige, interviewed, Ames Research Center, 12 January 2001.

this advanced technology. More importantly, the success of the real-time learning processes used in NASA's F-15B ACTIVE established a design paradigm for *all* engineering systems. Now the design process no longer needs to analyze the effects of system failures, and can instead use the F-15 Intelligent Systems process to continually maximize system performance under all operating conditions. This intelligent design process, with its similarities to human learning and adaptation, will affect products ranging from washing machines to nuclear reactors, from lawn mowers to electric power plants. What NASA, Boeing and other industries are undertaking in the development of intelligent aircraft systems will have a profound impact on tomorrow's products and systems.



*NASA Photo*

*EC95 43247-2*

*The MD-11 commercial airliner was configured to employ the IFCS for differential engine control. With Gordon Fullerton as captain the jet is seen landing on Rogers Dry Lakebed using only engine thrust for flight control. Not yet earmarked for customer delivery, the jet sports a plain metallic finish rather than airline livery. Tests of the Propulsion Controlled Aircraft (PCA) stemmed from the crash of a United Airlines DC-10, which had lost its flight control surfaces. The DC-10 crew managed to achieve moderate control by adjusting the engine thrust but the jet cartwheeled and broke up on landing.*



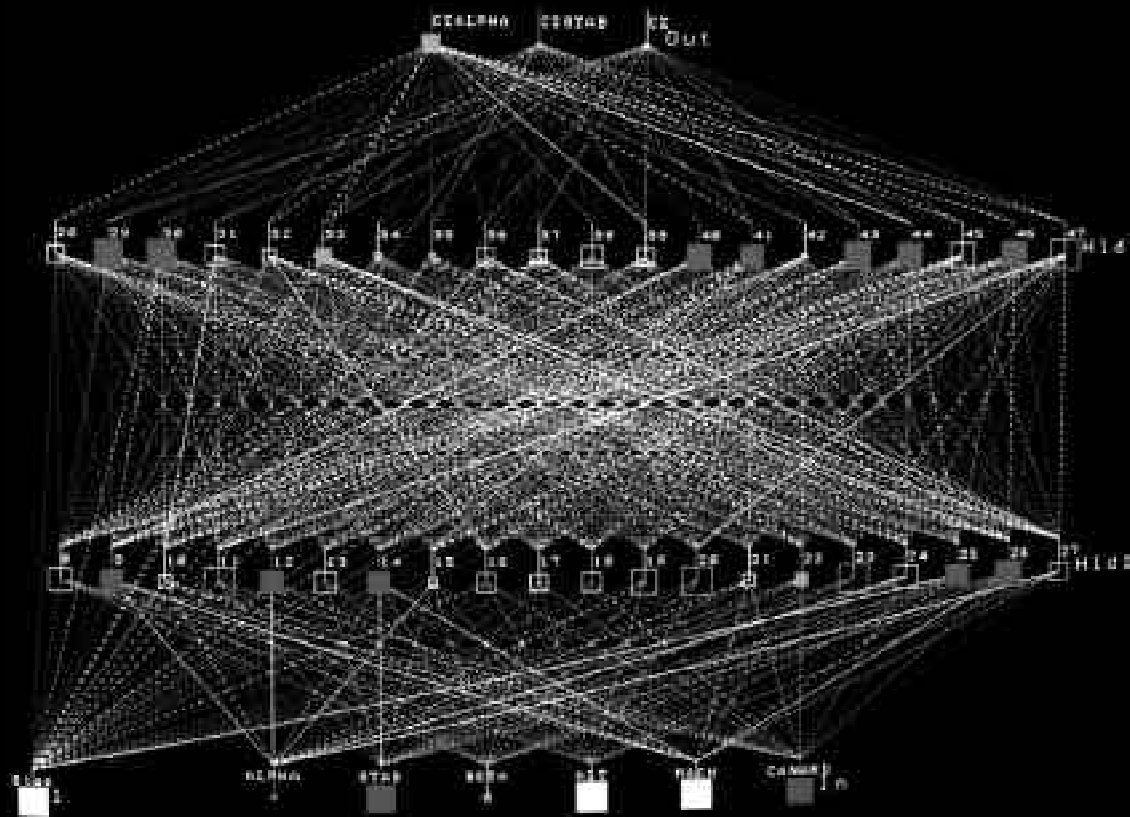

## Generation Next

**The next generation IFCS program is being conducted, appropriately enough, on the former ACTIVE test bed, an F-15B which flew the original tests. The aircraft is undergoing modifications and updates for the upcoming flight program.**



# Glossary

**63 funding** – a nickname for a type of Air Force discretionary funding.

**Ada** – a computer language related to Pascal, and at one time selected by the Department of Defense as the official language for all programs DoD used.

**Ailerons** – a movable hinged section in or near the trailing edge of an airplane wing for controlling the roll movements of the airplane.

**Angle of attack** – the angle of the airplane’s lifting surfaces relative to the motion of the air.

**Attitude** – the position of an aircraft or spacecraft in relation to a given line or plane, like the horizon.

**Bleeding edge** – beyond the leading edge of technology.

**Canard** – the horizontal stabilizer of an aircraft when located forward of the wing or wings, illustrated by the NASA F-15B number 837.

**Control surfaces** – the moving part of wings, horizontal stabilizers, and vertical stabilizers that control the direction of an airplane.

**Cooper-Harper scale** – a scale from one to ten by which research pilots can indicate their subjective judgment of the handling qualities of an airplane, one being the best. 1-3 means “meets desirable criteria (Level 1), 4-6 means “meets acceptable criteria,” (Level 2), and 7-9 are “unacceptable” (Level 3). A rating of 10 represents loss of control.

**Deadheading pilot** – a pilot commuting as a passenger to the next flight that he or she is scheduled to fly.

**Doublets** – a maneuver in which the nose of the aircraft is raised above the horizon and then lowered by equal amounts.

**Envelope** – the altitude and speed limits of an airplane in a specific configuration.

**Fuel venting** – dumping fuel overboard, with or without intent.

**Pilot-in-the-loop** – a human being in the aircraft’s control path.

**Gains** – the ratio of control inputs by a pilot to the movement of the control surfaces.

**Pitch capture** – a method of rating handling qualities by having the pilot try to pull down or up into a target pitch angle and match it without much of an overshoot.

**Prop blast/wash** – the wind caused by a rotating propeller.

**Roll rate** – the speed at which the airplane rotates around its longitudinal axis, typically measured in degrees per second.

**Sideslip angles** – the attitude of an airplane in a skidding turn.

**Stabilator** – a horizontal surface that is all-moving and controls the pitch of an aircraft. The term derived from combining horizontal “stabilizer” and “elevator”, neither of which describes an all-moving surface.

**Squawks** – discrepancies and failed components noticed in flight.

Two-ship formation: two aircraft flying together in such a way that one pilot can tell the other is “lead.”

Research flights are almost always conducted with a chase plane for outside visual feedback, creating a two-ship formation.

**Windup turns** – maneuvers in a level turn that include a linear progression of one parameter, such as “0.5 g per second” or “3 degrees per second.”

**Wing warping** – the twisting of the outer part of the wings’ trailing edges in equal-but-opposite directions for controlling the roll.

# Abbreviations

**ACTIVE** – Advanced Controls Technology for Integrated Vehicles

**ADAPT** – Adaptive Aircraft Performance Technology

**AFIT** – Air Force Institute of Technology

**AFTI** – Advanced Fighter Technology Integration

**ANFIS** – Adaptive Network-based Fuzzy-Interference System

**ANNs** – Artificial Neural Networks

**ATF** – Advanced Tactical Fighter

**CAS** – Control Augmentation System

**DAG** – Dial-a-Gain

**EGE** – Effectors Gain Estimation

**EPROM** – Electrically Programmable Read-Only Memory

**GE** – General Electric

**HIDEC** – Highly Integrated Digital Electronic Control

**HUD** – Heads Up Display

**IFCS** – Intelligent Flight Control System

**INS** – Inertial Navigation System

**JPL** – Jet Propulsion Laboratory

**LAMARS** – Large Amplitude Multimode Aerospace Research Simulator

**LED** – Light Emitting Diode

**MTBF** – Mean Time Between Failure

**NASA** – National Aeronautics and Space Administration

**RCM** – Reconfigurable Control Mixer

**SHARC** - Super Harvard Architecture Computer

**SIDC** – System Impairment Detection and Classification

**SOFFT** – Stochastic Optimal Feedforward and Feedback Technique

**SRFCS** – Self-Repairing Flight Control System

**STAR** – Self-Testing and Repair computer

**SYSDYN** — SYStem DYNAmics

**TMR** – Triple Modular Redundant circuits

**VMSC** – Vehicle Management System Computer

# Bibliography

Most of the information about self-repairing and intelligent flight control is available in NASA technical reports. The second greatest amount of information was gained by interviewing the participants. In this case I was lucky that two men: Jim Stewart of NASA and Jim Urnes of Boeing served as project managers in these endeavors. But a number of other important contributors (listed below) shared their insights:

## Interviews

John Carter, Dryden Flight Research Center, 9 April 2001.

Jerry Henry, Dryden Flight Research Center, 10 April 2001.

Chuck Jorgenson, Ames Research Center, 9 January 2001

John Kaneshige, Ames Research Center, 12 January 2001

Wilton Lock, Dryden Flight Research Center, 6 April 2001.

Aaron Ostroff, via telephone from Langley Research Center, 5 April 2001.

Robert Quaglieri, via telephone from Wright Aeronautical Laboratory, Dayton, OH, 16 May 2001.

Gerard Schkolnik, Dryden Flight Research Center, 9 April 2001.

Jim Smolka, Dryden Flight Research Center, 6 April 2001.

Jim Stewart, Dryden Flight Research Center, 4, 6, 10 April 2001.

Joe Totah, Ames Research Center, 12 January 2001

Jim Urnes, via telephone from Boeing, St. Louis, MO, 20 April 2001.

## Published Sources

Avizienis et al., "The STAR (Self-Testing and Repairing) Computer: An Investigation of the Theory and Practice of Fault-Tolerant Computer Design," IEEE Transactions on Computers (1971), 1314-1321.

Boeing. "Intelligent Flight Control: Advanced Concept Program," STL 99P0040, Final Report, 15 May 1999, The Boeing Company.

Boeing. "Intelligent Flight Control: Advanced Concept Program," MDC 98P0026, Annual Report Period: 1 April 1997 to 31 March 1998, The Boeing Company.

Boeing. "Intelligent Flight Control: Advanced Concept Program," MDC 97M0004, Annual Report Period: 31 July 1996 to 31 March 1997, McDonnell Douglas Aerospace.

Boeing. "Intelligent Flight Control: Advanced Concept Program," Annual Report Period: 1 March 1995 to 31 July 1996, McDonnell Douglas Aerospace.

Burske, J., and G. Sommer. "Dynamic Cell Structures," Neural Information Processing System, 1996.

Corvin, John H., William J. Havern, Stephen E. Hoy, Kevin F. Norat, James M. Urnes, and Edward A. Wells. "Self-Repairing Flight Control System, Volume I: Flight Test Evaluation on an F-

15 Aircraft,” Final Report for Period October 1987 – December 1990, WL-TR-91-3025, Volume I, Part I, August 1991.

Eslinger, Capt. Robert A., and Phillip R. Chandler. “Self-Repairing Flight Control System Program Overview,” IEEE National Aerospace Electronics Conference, Dayton, OH., 1989.

Fritzke, Bernd. “Growing Cell Structures – A Self-Organizing Neural Network for Unsupervised and Supervised Learning,” in *Neural Networks*, Vol. 7, No. 9, 1994.

Gibbs-Smith, C.H. *Sir George Cayley’s Aeronautics*. London: Her Majesty’s Stationery Office, 1962.

Hunt, K.J., D. Sbarbaro, R. Zbikowski, and P.J. Gawthrop. “Neural Networks for Control Systems – A Survey,” in *Automatica*, Vol. 28, No. 6, 1992.

Jorgensen, Charles C. “Direct Adaptive Aircraft Control Using Dynamic Cell Structure Neural Networks,” NASA Technical Memorandum 112198, May 1997.

Jorgensen, Charles C. “Feedback Linearized Aircraft Control Using Dynamic Cell Structures,” ISSCI Paper. Albuquerque: TSI Press, 1998: 050.1 - 050.6

Jorgensen, Charles C. and C. Schley. “A Neural Network Baseline Problem for Control of Aircraft Flare and Touchdown,” in *Neural Networks for Control*. Edited by W. Thomas Miller, III, Richard S. Sutton, and Paul J. Werbos. Cambridge: MIT Press, 1990.

Jorgensen, Charles, Kevin Wheeler, and Slawomir Stepniewski. *Bioelectric Flight Control of a 757 class High Fidelity Aircraft Simulation*. Manuscript, 2000.

Kaneshige, John, John Bull, and Joseph J. Totah. “Generic Neural Flight Control and Autopilot System,” AIAA Paper 2000-4281, 2000.

Kim, Byoung S., and Anthony J. Calise. “Nonlinear Flight Control Using Neural Networks,” in *Journal of Guidance, Control, and Dynamics*, Vol. 20, No. 1, January-February 1997.

Kim, Byoung Soo. “Nonlinear Flight Control Using Neural Networks,” Ph.D. Thesis, Georgia Institute of Technology, School of Aerospace Engineering, December 1993.

Kinney, Dr. David J., and Joseph J. Totah. “Simulating Conceptual And Developmental Aircraft,” AIAA Paper 98-4161, 1998.

Kohonen, Teuvo. “Self-Organized Formation of Topologically Correct Feature Maps,” in *Biological Cybernetics*, 43, 1982.

Laine, Andrew. “Neural Networks,” in *Encyclopedia of Computer Science*, 4th Ed. Edited by Anthony Ralston, Edwin D. Reilly, and David Hemmendinger. Nature Publishing Group. New York: Grove’s Dictionaries, Inc., 2000.

Martinetz, Thomas and Schulten, Klaus. “Topology Representing Networks,” in *Neural Networks*, Vol. 7, No. 3, 1994.

Miller, T., Sitton, R. and Werbos, P. *Neural Networks for Control*. MIT Press, Cambridge, MA, 1990.

Neumann, John von. "Probabilistic Logics and the Synthesis of Reliable Organisms from Unreliable Components," in William Aspray and Arthur Burks, *Papers of John von Neumann on Computers and Computer Theory*. Cambridge, MA: Charles Babbage Institute Reprint Series for the History of Computing, v. 12. The MIT Press, 1987.

Noor, Ahmed K. *Computational Intelligence and Its Impact on Future High-Performance Engineering Systems*. NASA Conference Proceedings Publication 3323. Hampton, VA: June 27-28, 1995. Published January 1996.

Organ, Richard, et al, *Avro Arrow*. Erin, Ontario: The Boston Mills Press, 1980.

Rattan, Kuldip S. "Evaluation of Control Mixer Concept for Reconfiguration of Flight Control System," IEEE National Aerospace Electronics Conference Proceedings, May 1985.

Reed, Russell D. and Robert J. Marks, II. *Neural Smithing: Supervised Learning in Feedforward Artificial Neural Networks*. Cambridge: MIT Press, 1999.

Stifel, J.M., C. J. Dittmar, and M.F. Zampi. "Self-Repairing Digital Flight Control System Study," Final Report for Period January 1980-October 1987, AFWAL-TR-88-3007, May 1988.

Stewart, James F. "Integrated Flight Propulsion Control Research Results using the NASA F-15 HIDEDEC Flight Research Facility," Technical Memorandum, NASA-TM-4394, NASA Dryden Flight Research Center, Edwards, CA, 1992.

Stewart, James F, and Thomas L. Shuck. "Flight-Testing of the Self-Repairing Flight Control System Using the F-15 Highly Integrated Digital Electronic Control Flight Research Facility," Technical Memorandum, NASA-TM-101725, NASA Dryden Flight Research Center, Edwards, CA, 1990.

Tomayko, James E. "Blind Faith: The United States Air Force and the Development of Fly-By-Wire Technology," Technology and the Air Force. Washington D.C.: U. S. Air Force, 1997.

Tomayko, James E. *Computers Take Flight* (Washington, D.C.: NASA History Office, NASA-SP-2000-4224.

Total, Joseph J. "Simulation Evaluation of a Neural-Based Flight Controller," AIAA Conference Paper 96-3503-CP, 1996.

Weiner, Norbert. *Cybernetics: Or Control and Communication in the Animal and in the Machine*. Boston: MIT Press, 1948.

Weinstein, Warren, Walter Posingies, Lt. Robert A. Eslinger, and Lt. Harry N. Gross. "Control Reconfigurable Combat Aircraft Flight Control System Development," AIAA Guidance, Navigation and Control Conference, Williamsburg, VA, 1986.





# Appendices



## Appendix A – SRFCS Flight Log

<u>SRFCS FLIGHT LOG</u>			
<u>NO.</u>	<u>FLT. DATE</u>	<u>FLT. NO.</u>	<u>FLT. TIME</u>
1.	12/12/89	555	1.7
2.	12/13/89	556	1.2
3.	12/18/89	557	1.3
4.	12/20/89	558	1.2
5.	1/10/90	559	1.5
6.	1/12/90	560	2.0 *
	1/22/90	561	0.5
	1/24/90	562	1.0
8.	1/29/90	563	1.5
9.	1/31/90	564	1.3
10.	2/2/90	565	2.7 *
11.	2/7/90	566	2.9 *
12.	2/9/90	567	1.4
13.	2/12/90	568	2.0 *
14.	2/13/90	569	2.0 *
15.	2/23/90	570	1.8 *
16.	2/28/90	571	1.8 *
17.	3/2/90	572	0.6
	3/2/90	573	0.6
	3/6/90	574	1.7 *
19.	3/7/90	575	2.3 *
20.	3/8/90	576	2.4 *
21.	3/21/90	577	1.3
22.	3/23/90	578	1.3
23.	3/26/90	579	2.1 *
24.	3/28/90	580	1.9 *
25.	4/3/90	581	2.0 *
			Aborted - Fuel venting
			Aborted - Weather
			* Tanker Flight
Total:	Flights	25	
	Flt. Time (hrs)	42.9	
	Tanker Flt.'s		13

## Appendix B – Flight Test Summary, SRFCS F-15A No. 8 RTO: NASA Ames-Dryden

FLIGHT TEST SUMMARY - SRFCS F-15A NO. 8 RTO: NASA AMES-DRYDEN		As of 4 April 1990 Subject to Change	
DATE	EVENT	REMARKS	CUMULATIVE HRS ACTUAL (PLANNED)
12 DEC FLT 555	Functional Check System Safety Check SRFCS Impairment Modeling/ SIDC Checkout	SRFCS Performed Well - Uncoupled Locked at Trim Impairment Worked Well for Range of Maneuvers Tested A/C Successfully Refueled In-Flight	1.7 (1.5)
13 DEC FLT 556	SRFCS Impairment Modeling/ SIDC Checkout	Performed Following Cases: No Impairment 50% Partial Right Stab Loss 80% Partial Right Stab Loss Uncouples on Full Stick Rolls and NL Sideslip Resulting From Incorrect SIDC Detection - Probable Causes: Incorrect Weight States in Hawk Sideslip Angles and Roll Rates Outside Operating Range	1.2 (1.5)
18 DEC FLT 557	Maintenance Diagnostic Scenarios SRFCS Impairment Modeling/ SIDC Checkout	Five MD Scenarios Produced Correct HUD Messages Performed Following Cases: No Impairment 80% Partial Right Stab Loss Locked Rt Stab ( 2deg LED) Locked Rt Stab ( 4deg LED) Uncouples During High Roll Rates As Before Discover Incorrect Weight/Mass Calculation in SIDC / Correct Afterward for Next Flight	1.3 (1.5)

PAGE 1

20 DEC FLT 558	Maintenance Diagnostic Scenarios SIDC Checkout EGE Checkout Mixer Checkout	Three (4,5,3) MD Scenarios Produced Correct HUD Messages 80% Partial Right Stab Loss Flown for SIDC and EGE - Neither Performed Very Well SIDC Give Wrong Answer for Lateral Maneuvers EGE Only Gives 0 or 100%- Nothing Between Tested Mixer for Following: Locked @trim 80% Partial Loss Locked (2deg LED) No Objectionable Comments about Mixer from Pilot	1.2 (1.5)
10 JAN FLT 559	Engine Checkout Off-Trim Impairment Checkout Mixer Checkout	Replacement engine checkout with not problems Tested mixer and unreconfigured A/C for following: Locked (6deg LED) Locked (2deg LEU) Locked (4deg LEU) Locked (6deg LEU) 100% surface loss 50% surface loss Pilot very uncomfortable with unreconfigured off-trim cases Mixer showed improvement -but pilot still dislikes 6deg cases	1.5 (1.5)
12 JAN FLT 560	Flying Qualities Maintenance Diagnostic Scenarios	Flew Block A maneuvers w/ unreconfigured A/C for following: Locked @ trim 80% partial surface loss Locked (6deg LED) Locked (6deg LEU) Locked (4deg LEU) Block A maneuvers include: Longitudiinal stick doublets - at steady state 1&4g Laeral Stick doublets - at 1g Rudder doublets - at 1&4g 360 degree Rolls - left and right at 1g Dropped back to 4deg LEU since CAS drops off during 4g turn Pilot uncomfortable with unreconfigured off-trim cases CONT	2.0 (2.0)

12 JAN FLT 560	Flying Qualities Maintenance Diagnostic Scenarios	Continued Flew Block B maneuvers comparing mixer to unreconfigured for following: <table border="0"> <tr> <td></td> <td>unrec</td> <td>mixer</td> </tr> <tr> <td>Locked @ trim</td> <td>4/4</td> <td>3/5</td> </tr> <tr> <td>80% partial surface loss</td> <td>2/3</td> <td>3/4</td> </tr> </table> Block B maneuvers include: Wind up turns (WUT) - left and right (where appropriate) Steady Heading Sideslip - left and right Pitch Capture - 5 and 10 degree Formation Flight - 1g Tracking - 3g maneuvers ( unload during reversals ) Mixer had mixed reviews - some improvement & some worse Unreconfigured 80% missing got better CH than basic A/C (4/4) MD Scenarios worked as expected		unrec	mixer	Locked @ trim	4/4	3/5	80% partial surface loss	2/3	3/4	2.0 (2.0)
	unrec	mixer										
Locked @ trim	4/4	3/5										
80% partial surface loss	2/3	3/4										
22 Jan FLT 561	SIDC Checkout EGE Checkout	Flight aborted shortly after t/o due to fuel venting FOD held open overflow valve	0.5 (1.5)									
24 JAN FLT 562	SIDC Checkout EGE Checkout	Flew two sets of SIDC Thresholds - neither performed desired results Flew two sets of mixer gains with new mixer software - still needs tuning	1.0 (1.5)									
29 JAN FLT 563	SIDC Checkout EGE Checkout	Mission delayed due to several HAWK crashes resulting from software error One EGE case flown - no improvement over baseline Three SIDC cases flown - one 70% correct - 20% incorrect another 50% correct - 0% incorrect	1.5 (1.5)									

31 JAN FLT 564	Flying Qualities	Flight delayed due to NVM and CC corruption - NVM on powerup and CC on powerdown - Missed tanker Flew Block A maneuvers w/ reconfigured A/C for following: Locked @ trim 80% partial surface loss Flew entire CRS for locked at trim - SIDC and Mixer worked well together for local failure during various maneuvers Flew Block B maneuvers only for unimpaired and unreconfigured 6deg LED case	1.3 (2.0)
2 FEB FLT 565	Flying Qualities SIDC Checkout EGE Checkout	Flight delayed due to loss of photo chase - replaced but no photos Flew Block A maneuvers w/ unreconfigured A/C for following: Locked @ trim 80% partial surface loss Locked (6deg LED) Locked (4deg LEU) Good timing between maneuvers CAS dropped off during loaded turns during 4deg LEU Tested three SIDC cases - no great improvement over baseline - baseline did not perform as expected - probable pilot error Tested four cases for EGE - some improvement Longest flight in five years	2.7 (2.0)
7 FEB FLT 566	SIDC Checkout EGE Checkout Mixer Data Collection	9 SIDC cases tested - not one produced good results, not even baseline 7 EGE cases tested - not one produced good results Collected data on Mixer performance for large maneuvers (4/0.2g) POPU for the following failures: Locked @ trim 80% partial surface loss Beta calculated by DFCC does not match boom beta - true cause unknown - possibly bad CC inflight Flew through visible moisture - caused pitot to freeze up a couple of times - does not directly correspond with bad beta Longest flight in five years	2.8 (2.0)

9 FEB FLT 567	Full System CRS Checkout Mixer Data Collection SIDC Checkout	<p>Engaged Following Failures during tracking task with full system working:  80% partial surface loss  Locked @ trim  Locked (6deg LED)  Locked (4deg LEU)</p> <p>SIDC and EGE performed well during task - SIDC worked well for maneuver before - Hypothesis is that EGE works well because it is being engaged when the residuals are best for detection, and not just when the pilot feels like engaging it as in the open loop tests</p> <p>Local failures worked well as expected  Collected large scale input data for Mixer cases for following failures:  80% partial surface loss  Locked @ trim</p> <p>Three SIDC only cases were tested - one produced decent results  Will retry and modify on next flight</p>	1.4 (1.5)
12 FEB FLT 568	Flying Qualities Maintenance Diagnostics Scenario #2	<p>Flew Block A maneuvers w/ reconfigured A/C for following:  Locked (6deg LED)  Locked (4deg LEU)</p> <p>Flew Block B maneuvers w/o &amp; w/ reconfigured A/C for following:  Locked (6deg LED) 7-7 5-5  Locked (4deg LEU) 6-7 5-5</p> <p>Pilot commented on "cross talk" was evident during reconfigured cases but not during unreconfigured - found disturbing  Tried MD Scenario 2 - SIDC/EGE did not respond properly - will retry with other sets of gains on Flt569</p>	2.0 (2.0)



13 FEB FLT 569	SIDC Gains Evaluation EGE Gains Evaluation Maintenance Diagnostics Scenario #2 CRS Evaluation @Off-Nominal Points	<p>Evaluated the performance of baseline and one new set of gains  Baseline detected correctly ~60% and did not false alarm  The other set did not show any improvement  Baseline did not false detect with no impairment  Tested two sets of EGE gains - used SIDC to detect failure  Neither set produced results within the desired range  Tried MD Scenario 2 - Worked well for 100% missing  SIDC did not detect 50% missing at all  Tested the Stuck @Trim case at the corners of the box  Varied fuel weight amount in model - tested at correct weight  and +/- 2000 lbs  No comments @ 25K/0.6 M  pilot said squirrely laterally @ 15K/0.8M</p>	1.9 (2.0)
23 FEB FLT 570	Flying Qualities SIDC Gains Evaluation Video Shots	<p>Flew Block A maneuvers w/ reconfigured A/C for following:  Locked (6deg LED)  Locked (4deg LEU)  Flew Block B maneuvers w/o &amp; w/ reconfigured A/C for following:  Locked (6deg LED)    2/2-3/4            2/2-7/3  Locked (4deg LEU)    5/2-5/5(1g flt)    2/3-7/4(1g)  Baseline                    2/2-3/3  Pilot commented extensively on the "nonlinearity" of the  reconfigured cases - He lost all predictability of a/c  performance and lead to bobble in pitch  No bad comment was made concerning the excessive forces  he had hold during nonreconfigured cases - he liked it  better than recon since once he established the new  "trim", the a/c moved as he predicted it would  The pilot extended the speedbrake during tracking during  both recon runs - the speedbrake is not modelled in the  system and could have caused the additional pitch  degradation  Will rely Block B maneuvers on Flt 572 with Smolka  Tested SIDC baseline gains for both healthy and impaired a/c  No false alarms but detection rate was only 25%  Spent time setting up for good video shots using NASA  photographer</p>	1.9 (2.0)

28 FEB FLT 571	Accel-Decel Tests McAir Cross-Coupling Data Collection SIDC/EGE Checkout	Perform Accel-Decel tests from 0.8M to 0.6M for following cases: Unimpaired 80% PSL Locked 4 deg LEU Straight & level deceleration very slow - threw in 3g WUT System performed as expected - PSL did not detect Tested cross-coupling according to McAir's criteria - trim a/c into 1.2g turn, induce failure, and ask pilot to maintain same bank angle then increase load stepping in 1g increments to 4g - measure lateral stick force to determine force required to cancel cross-coupling Tested SIDC/EGE at corners of envelope Detection rate lower at corners than center of envelope Actually flew at 24K' and 16K' to maintain envelope during maneuvers	1.8 (2.0)															
2 MAR FLT 572	Flying Qualities Cross - Coupling Tests Split Engine Test Turbulence Tests	Flew Block A maneuvers only for 6deg LED case - performed at 19.5K' since cloud cover at 20K' IFIM from invalid INS resulted in RTB - cannot realign F-15 INS inflight - landed to realign at "last chance"	0.5 (2.0)															
2 MAR FLT 573	Flying Qualities Cross - Coupling Tests Split Engine Test Turbulence Tests	Flight aborted because unable to find clear air within the box	0.6 (2.0)															
6 MAR FLT 574	Flying Qualities	Flew Block A maneuvers for following reconfigured cases: Locked at trim 80% PSL No impairment Pilot did not comment on the Block A maneuvers Flew tracking task for following maneuvers: <table border="0" style="margin-left: 20px;"> <thead> <tr> <th></th> <th>unrec</th> <th>rec</th> </tr> </thead> <tbody> <tr> <td>No impairment</td> <td>4/2</td> <td></td> </tr> <tr> <td>Locked 6° LED</td> <td>6/5</td> <td>7/7</td> </tr> <tr> <td>Locked 4° LEU</td> <td>7/7</td> <td>7/3-4</td> </tr> <tr> <td>Locked @ Trim</td> <td>5/3</td> <td>7/7</td> </tr> </tbody> </table> Pitch bobbling was the biggest complaint about mixer during tracking - had little coupling into roll/yaw axis Bobble also seen in the basic CAS system - pilot seems to excite when he lets go of stick, oscillations go away		unrec	rec	No impairment	4/2		Locked 6° LED	6/5	7/7	Locked 4° LEU	7/7	7/3-4	Locked @ Trim	5/3	7/7	1.7 (2.0)
	unrec	rec																
No impairment	4/2																	
Locked 6° LED	6/5	7/7																
Locked 4° LEU	7/7	7/3-4																
Locked @ Trim	5/3	7/7																

7 MAR FLT 575	Flying Qualities Bad EGE/Mixer Evaluation Cross-Coupling Tests Split Engine Test SIDC/EGE Envelope Expansion	<p>Flew Block A maneuvers for following reconfigured cases: 2.3 (2.0)</p> <p>Locked at trim 80% PSL No impairment Pilot did not comment on the Block A maneuvers</p> <p>Flew tracking task for following maneuvers:</p> <table border="0"> <thead> <tr> <th></th> <th>unrec</th> <th>rec</th> </tr> </thead> <tbody> <tr> <td>No impairment</td> <td>3/2</td> <td></td> </tr> <tr> <td>No impairment (CAS Off)</td> <td>2/2</td> <td></td> </tr> <tr> <td>Locked 6° LED</td> <td>7/5</td> <td>5/3</td> </tr> </tbody> </table> <p>Ratings include force required to hold stick (unlike Dana's) Pitch bobbling looked the same to us on the ground - pilot commented that mixer bobble bad at first but he could adapt to it Bobble in basic CAS system worse than without CAS During stick raps, oscillations damped out During cross-coupling tests, very difficult for pilot not to compensate laterally (tried three times) - puts in about 5lbs w/o recon and only 2lbs with Split engine test did not cause any false alarms Flew SIDC with unimpaired and 80% PSL at 20k/0.7M and 24k/0.65 at various fuel readings (errors) - going off nominal seems to reduce detection but does not cause false alarms</p>		unrec	rec	No impairment	3/2		No impairment (CAS Off)	2/2		Locked 6° LED	7/5	5/3
	unrec	rec												
No impairment	3/2													
No impairment (CAS Off)	2/2													
Locked 6° LED	7/5	5/3												
8 MAR FLT 576	Flying Qualities Cross-Coupling Tests SIDC/EGE Envelope Expansion Video Shots	<p>Flew tracking task for following maneuvers: (gross acquisition) 2.4 (2.0)</p> <table border="0"> <thead> <tr> <th></th> <th>unrec</th> <th>rec</th> </tr> </thead> <tbody> <tr> <td>No impairment</td> <td>3/3</td> <td></td> </tr> <tr> <td>Locked 6° LED</td> <td>4/5 (5/8)</td> <td>8/? (5/5)</td> </tr> <tr> <td>Locked 4° LEU</td> <td>5/6 (8/7)</td> <td>8/4 (4/4)</td> </tr> </tbody> </table> <p>Pitch bobbling looked the same during the Mixer runs Took some additional close up shots of airplane from chase During cross-coupling tests, pilot was to dive and then pull up Measure cc by amount of lateral stick to hold wings level Flew SIDC with unimpaired and 80% PSL at 20k/0.7M and 16k/0.75 at various fuel readings (errors) - increasing dynamic pressure seems to increase detection but does not cause false alarms - Detecting without any maneuver Got pilot sick from too many 360° rolls - RTB with fuel remaining</p>		unrec	rec	No impairment	3/3		Locked 6° LED	4/5 (5/8)	8/? (5/5)	Locked 4° LEU	5/6 (8/7)	8/4 (4/4)
	unrec	rec												
No impairment	3/3													
Locked 6° LED	4/5 (5/8)	8/? (5/5)												
Locked 4° LEU	5/6 (8/7)	8/4 (4/4)												

21 MAR FLT 577	Flying Qualities Turbulence (Wake) Test Cross-Coupling Tests Impairment Model Data Collection Frequency Sweeps Maintenance Diagnostic Scenario #2 Mixer Data Collection	<p>Flew pitch doublets for all cases at both 1&amp;4g - with pushover first</p> <p>Flew a/c thru chase wake about 1500ft back with SIDC enabled - entering from both top and bottom - no false alarms</p> <p>During cross-coupling tests, pilot was to dive and then pull up</p> <p>Measure cc by amount of lateral stick to hold wings level</p> <p>Flew several maneuvers with 80%PSL with SIDC running but not able to detect to collect more info on impairment to compare with offline sim</p> <p>Performed both longitudinal and lateral freq sweeps (~0.3-3.0Hz) for basic CAS, no CAS, and Locked @trim w/ &amp; w/o Mixer</p> <p>McAir has not evaluated data yet</p> <p>Ran MD Scenario #2 with Mixer only (SIDC-EGE stubbed) for both 50&amp;100% cases - Worked well - will try complete system on next flight</p> <p>Did large amplitude PUPU, POPU, and 360° rolls to compare Mixer performance to basic CAS</p> <p>Scheduled to try most items of this flight on next flight to evaluate with different pilot techniques, however same pilot flew</p>	1.3 (1.5)
23 MAR FLT 578	Maintenance Diagnostic Scenarios Propulsion Only Control	<p>Dana flew this flight as well as Flt 577 since no other pilot was available</p> <p>Tested all five MD Scenarios - SIDC did not detect 50% PSL part of #2 - others worked as expected</p> <p>Tried to run GSRS but Compact would not boot</p> <p>Flew propulsion only maneuvers for future F-15 work</p> <p>Tanker aborted in flight - F-15 binged during Propulsion only stuff</p> <p>Will retry most items on this flight on next flight to evaluate with different pilot techniques</p>	1.3 (1.5)

26 MAR FLT 579	Maintenance Diagnostic Scenarios Flying Qualities - Longitude Doublets Mixer Data Collection Frequency Sweeps Turbulence Tests - Chase Wake Simulated Landing Task	Tried 5 MD Scenarios - all but #2 (50% PSL) worked correctly SIDC did not detect 50% PSL Repeated Longitudinal Doublets, both at 1g and 4g, for all failures Did large amplitude maneuvers comparing baseline to locked @ trim case - did PUPO(POPU) ~5.0/0.5g and 360° rolls at ~180°/s Performed long and lat frequency sweeps for baseline CAS, CAS off, and Locked @ trim, without and with Mixer - difficult for pilot to maintain constant amplitude at frequency increases Ran a/c through chase wake with SIDC on - detected but did not isolate Flew a/c down to 10K/0.35M and compared baseline to locked @ trim with Mixer case for 30° and 45° bank to bank turn - used to simulate a landing task except using clean a/c configuration - pilot did not have any particular problems with the task	2.1 (2.0)
28 MAR FLT 580	Flying Qualities - Longitude Doublets PSL Residual Data Collection SIDC/EGE Tests Flight Envelope Expansion 27k/0.5M Propulsion Only Flight Control	Repeated Longitudinal Doublets, both at 1g and 4g, for all failures Performed several maneuvers with 80%PSL with SYSDYN calculating residuals, but SIDC rendered impotent - collecting more information on the true signature of the impairment Changed some parameters in EGE based upon research at St. Louis However, SIDC did not detect most cases so unable to evaluate EGE properly Compared the baseline to the reconfigured Locked at Trim case at 27k/0.5M condition for large input maneuvers - The only pilot comment was that when he pulled back with the Mixer, he did not feel like he had precise control Flew propulsion only maneuvers - maneuvers well laterally using throttles, but sluggish - did not try longitudinal maneuvers due to time	1.9 (2.0)
30 MAR FLT 581	Flight Envelope Expansion 13k/0.9M & 27k/0.5M MD Scenarios #1-5 SIDC/EGE Tests Flight Envelope Expansion + Offset Fuel Entries for PSL and baseline Final CRS Check for all 4 Failures Propulsion Only Flight Control	Flight aborted during pre-taxi checks when Roll-Yaw CAS would not engage - Upon examining problem, saw bad NVM locations, which neither would have caused nor been affected by the CAS problem Inspection the next day was not able to reproduce the problem, so not certain it will not repeat - one possibility is Roll/Yaw computer beginning to go bad - but have not investigated further	0.0 (2.0)

3 APR FLT 581	Flight Envelope Expansion 13k/0.9M & 27k/0.5M MD Scenarios #2&4 SIDC/EGE Tests Flight Envelope Expansion + Offset Fuel Entries for PSL and baseline Final CRS Check for all 4 Failures Propulsion Only Flight Control	<p>Started with video shot of long doublet (comparable to ABICS shot) 1.9 (2.0)</p> <p>Flew large amplitude maneuvers at 13k/0.9M</p> <p>Pilot commented that he felt cross-coupling during long maneuvers</p> <p>Tried MD Scenarios #2&amp;4 at 16k/0.75M</p> <p>Finally got SIDC to detect 50% PSL - tried several maneuvers</p> <p>Winner was 3g bank-to-bank roll - pilot unloaded and reversed very rapidly trying to get it to detect - still took 4 tries</p> <p>Tried #4 because last flight ran out of tape before #4 could be saved</p> <p>It worked as expected</p> <p>Tried several sets of parameters for EGE - Steve Hoy picked one, but difficult since three had similar results</p> <p>Note that fuel wt was +2000lbs because that seems to increase SIDC detection rate - uncertain of the affect on EGE</p> <p>Tried SIDC/EGE at several fuel settings at 20k/0.7M</p> <p>SIDC works well at normal fuel wt (~50%) and EGE had good answers within +/-0.15</p> <p>At +2000lbs, SIDC detected more often, but the EGE estimates had a larger range - Steve Hoy/Ed Wells will be looking into this</p> <p>Skipped repeating SIDC/EGE tests at 16k/0.75M due to time constraints</p> <p>Compared Impairment only vs the full CRS for all the failures @20k/0.7M doing a POPU (0.3/3.0g)</p> <p>Locked @ trim and 80% PSL worked well - no pilot comments</p> <p>Locked @ 6° LED kept causing the pitch CAS to drop off - the stab rides the CAS limit flying S/L so the maneuver onset causes CAS to drop</p> <p>Worked for pull of PUPO but dropped during push</p> <p>Did not try 4° LEU</p> <p>Next flew large maneuvers at 27k/0.5M - no pilot comment</p> <p>Then flew Propulsion only maneuvers at 20k/0.7M - lateral good, but slow</p> <p>Can cause pitch up and down from trim - however can not "reverse" pitch angle once established - once down, could not recover</p> <p>When nose up, slowing down will cause a sink rate, but pitch angle does not decrease (AOA increases)</p>
------------------	--	---

## Appendix C – SRFCS Progress Report, April 5, 1990

From: Capt. Barry S Migyanko, WRDC/FIGL 5 Apr 90

Subj: Progress Report of SRFCS Flight Test Program

To: Mr. Calvin Dyer, WRDC/FIGX

1. Progress accomplished for the period 30 Mar 90 through 5 Apr 90:

A. On Friday, 30 Mar, attempted to fly Fit 581. The flight was initially delayed when the pilot could not set the yaw CAS. Upon first examination, there seemed to be some corrupted NVM locations in two of the channels. However, this mysteriously went away while they were trying to track it down. They then guessed that it was a CC problem, so they took it to McAir and reloaded it. When they brought it back, everything seemed to work, but just before pilot climbed in, the CAS would not reset again. By 14:30, Jim Stewart was able to reschedule the flight till Tuesday, 3 Apr. We quickly videoed the mechanics working with the GSRS on the ramp before the fuel truck arrived. With Lock, Don Warren, Steve Hoy, and the mechanics came in on Saturday to troubleshoot the problem, but they were unable to reproduce it in the hanger. Once, the CAS would not engage, but it corrected itself before they could track down the problem. They also tried on Monday, but the problem still did not appear.

B. Fit 581 finally flew on 3 Apr. Bill Dana was the pilot since the other two pilots were in the PEGASUS crew brief. The first item of the mission was to shoot a video shot of the airplane doing a pitch doublet similar to the one seen in the ABICS video. The aircraft only had basic CAS engaged during the maneuver since a failure was not important for the shot. Several were shot, but I feel the first one was the one to use. Next, the pilot flew some large amplitude maneuvers at 1.3k/0.9M for both the basic CAS and a reconfigured locked at trim case. This is the lower left corner of the envelope that McAir claimed the mixer was safe to fly. The maneuvers included push/pulls and pull/pushes with approximately 5.0/0.5g amplitudes and 360° rolls with half stick inputs (~150°/s) due to the high Qbar condition. The pilot commented on noticeable coupling during the longitudinal maneuvers. Next, the pilot tested the OES Scenarios #2 with 50% PSL and #4. The pilot was told to enhance the maneuvers to try to get SIDC to detect. The maneuvers tried were 3g bank-to-bank turns, both unloaded and loaded during the reversals, a 4g wind-up-turn, and a rapid 10° pitch capture from a 20° dive. The bank-to-bank, unloading between, set the rudder once, and the rest did not detect at all. Each maneuver was tried several times. The pilot tried the 3g bank-to-bank, unloading between, again, rapidly unloading and reversing, and SIDC detected. The harsh maneuver was run twice since on the first attempt EGE came up with an answer of less than 15% remaining which the OES interprets as total surface loss. The next try produced a satisfactory estimate. Next, the pilot flew Scenario #4 again, because on a previous flight, we ran out of tape before #4 could be recorded. Only 10 "faults" can be saved on a tape, and every time there is an IFIM while the HAWK is booted, OES inferences on it. Next, the pilot tested several sets of new EGE parameters. He flew the same bank of maneuvers for each and Steve Hoy

selected the set with the best performance. This was difficult since three sets produced had large, overlapping variations. This test were flown with the HAWK fuel weight offset by +2000 lbs to increase the SIDC detection rate, but Steve Hoy was uncertain how this would affect EGE. Next, the pilot flew several maneuvers ( PUPU, POPU, left and right 3g WUT, 3g bank-to-bank turns starting both ways, and left and right 360° rolls @ half stick) at 20k/0.7M with several HAWK fuel entries. Correct weight, +2000 lbs and +4000 lbs were tested. SIDC detected well, about 50%, with the correct weight. It worked for the bank-to-banks and the 360° rolls. The EGE estimates were very good, the bank-to-banks were within +/-0.05 and the rolls +/-0.15. Now, by increasing the fuel weight +2000 lbs, the SIDC detected during some of the other maneuvers, but the EGE estimates had a much larger range, i.e. +0.45 for 360° roll. McAir will be studying this more at depth in St. Louis. Due to time constraints, the pilot did not repeat the off weight tests at 16k/0.75M. Next, he compared the response of a POPU for each of the failure cases, both impairment only and with CRS engaged. The locked at trim and 80% PSL cases worked well. The pilot had difficulty doing a POPU with the 6° LED impairment only case because the pitch CAS would drop off whenever he would initiate the maneuver. The stabilator was riding just under the CAS authority limits in order to hold the wings level. When the pilot started the maneuver, the limit was exceeded and the CAS dropped. To work around this, the pilot did a PUPU, which worked well until he sustained the push over for more than a few seconds. The CRS test was done the same way and the 4° LEU case was skipped altogether. Next, the pilot tried the large amplitude maneuvers at 27k/0.5M, the upper right corner of the "safe to fly" envelope. The pilot did not comment on the performance. Finally, the pilot tried flying the Propulsion Only maneuvers again, this time at a slower airspeed, 20k/200KCAS. The simulator indicated that the aircraft should have some pitch authority at the slower speed. The lateral maneuvers worked well, but a bit sluggish response. Longitudinally, the pilot could establish a pitch angle change, both up and down, from a trim condition. But, once commanded, he could reverse the direction. He could not pull the nose up at all to cancel a nose down maneuver, and when he slowed down to drop the nose from a nose up condition, his sink rate increased but the pitch angle never decreased. The flight ended quietly, 5 minutes late, on the winds of a large sigh of relief. At the crew brief on Wednesday, Bill Dana complimented the program as an excellent example of a joint program. He also said that it has been many years since he has been on a program that flew. The program he referenced, considered a big success, flew 28 missions over a one and a half year time span. We had 25 data flights, most of which were longer than the typical NASA mission, in just over 3 months.

2. On Thursday, 5 Apr, finally got airplane back to download GSRS. The plane was scheduled for some tests at an Air Force facility on Wednesday. It took a while to download because the PASCOT had been pulled for some tests for PSC, but once it was returned, everything worked fine. OES Scenario #2 was on twice, with both a 100% and 50% estimate, and #4 was recorded as well. Steve Hoy reported that he had problems reading the floppy diskette he took to St. Louis. Wilt Lock and myself tried to reproduce the problem here on the IBM machine in the F-15 Office. We also had trouble reading a diskette, but it was an intermittent problem, probably resulting from a bad diskette. We transferred the data onto another one and will be mailing that to him.



2. Projected Accomplishments for the period 6 Apr 90 through 12 Apr 90:

- A. I will make data tapes of all the information I think I will need to write the NAECON paper. I will also collect the remaining video tapes and ship all of them back to Dayton. I currently plan to fly back on 13 Apr.

BARRY S. MIGYANKO, CAPT, USAF  
SRFCS Systems Integration

## Appendix D – SRFCS Progress Report, March 29, 1990

From: Capt. Barry S Migyanko, WRDC/FIGL

29 Mar 90

Subj: Progress Report of SRFCS Flight Test Program

To: Mr. Calvin Dyer, WRDC/FIGX

1. Progress accomplished for the period 23 Mar 90 through 29 Mar 90:

A. On 23 Mar, Bill Dana flew Fit 578 since no other F-15 pilot was available that day. The flight started with all five OES scenarios, using the full CRS system for scenario #2. However, SIDC could not detect 50%PSL. All the other scenarios worked well. Next, the pilot began flying the Propulsion Only maneuvers. During these tests, the tanker aborted and the F-15 binged. No more data was collected that day. When they tried to down load the OES information to the ground station, they discovered that the battery in the Compact was dead. Normally, it would have stayed charged by just having the computer plugged into a powered outlet, but procedures in the hanger require that all electrical equipment be unplugged when not in use. After searching most of the day, Compact bootup software was found and they were able to successfully down load the information on Monday, 26 Mar.

B. Fit 579 flew on 26 Mar. The flight started with all five OES scenarios, using the full CRS system for scenario #2. Once again, SIDC could not detect 50%PSL. All the other scenarios worked well. Next, the pilot, Tom McMurtry, flew the longitudinal doublets, since he had not flown them with the nose down first. No comment was made about the tests. Next, he flew some large amplitude maneuvers (PUPO/POPU with  $-5.0/0.5g$  and  $360^\circ$  rolls at  $\sim 180^\circ/s$ ), comparing the response of the baseline system to the reconfigured locked at trim case. Steve Hoy hopes to use this information back at St. Louis to improve his sim work. Next, the pilot did frequency stick sweeps, both longitudinally and lateral. The sweeps were performed for the following cases: basic CAS, no CAS, unreconfigured locked at trim, and reconfigured locked at trim. It was difficult to see an increase in amplitude as we expected to see for the mixer case because the pilot had a difficult time maintaining a constant amplitude in his inputs. Next, the pilot flew through the wake of the chase pilot. SIDC did "detect", but did not "verify" that there was a failure, concluding with a net result of no false alarms. Then the pilot flew down to 10K/0.35M to try some "landing" maneuvers. The pilot performed lateral doublets and a flight path capture at rates representative of landing conditions, even though the aircraft was in a "clean" configuration (no flaps or landing gear). The pilot commented that he had no problems with the tasks, even though the surface was locked at trim with mixer engaged. The mixer, unlike the SIDC/EGE which only works within 15K-25K, 0.6-0.8M, works rather well throughout most of the subsonic flight envelope.

C. Fit 580 flew on 28 Mar. The pilot, Jim Smolka, started with the longitudinal doublets, nose down first, since he had not done them before. Next, he flew some maneuvers with 80% PSL with SYSDYN working, but SIDC rendered impotent. This was done because Ed Wells wanted to see the residuals of the

impairment in the real airplane, without being affected by SIDC. Next, he tried to test some parameter changes made to EGE, based upon Ed Wells research in St. Louis, but SIDC did not detect most of the cases. We may retry this on the last flight, stubbing SIDC if necessary. Next, the pilot flew some maneuvers comparing the baseline CAS to the reconfigured locked at trim case at 27k/0.5M. This is the corner of the larger box that McAir claimed would be safe to fly the mixer only cases. The only comment that the pilot made was, during a pull up/push over, while pulling back, he did not feel that he had precise control. This once again could be a reflection of the time delay in the reconfigured system. Next, the pilot tried flying the propulsion only maneuvers. He was able to do the lateral maneuvers using the throttles, but he commented that the response was sluggish. Due to time constraints, he was unable to try the longitudinal maneuvers before returning to base.

D. On 29 Mar, we videotaped the computer displays for the GSRS system. The one example taped involved a bad connector between the dynamic pressure sensor and the roll yaw computer. I thought this would be a good example since it is a CND. If there is another that may be a better example, please let me know. We shot about 15-30 seconds of each screen, which is probably more than needed, but can always be edited out.

Projected Accomplishments for the period 30 Mar 90 through 5 Apr 90:

A. Fly Fit 5B1, the final mission, on 30 Mar. The flight will include retrying MD Scenario #2 with 50% PSL, trying some larger maneuvers hoping to get it to detect. Also, the pilot will test the mixer response at 13k/0.9M, the other corner of McAir's safe to fly box. And, the pilot will try all four failures one last time with the full system engaged.

B. I will begin wrapping up all the paperwork out here and begin sending it, along with data and video tapes, back to the Lab.

BARRY S. MIGYANKO, CAPT, USAF  
SRECS Systems Integration

## Appendix E – SRFCS Progress Report, March 22, 1990

From: Capt. Barry S Migyanko, WRDC/FIGL 22 Mar 90

Subj: Progress Report of SRFCS Flight Test Program

To: Mr. Calvin Dyer, WRDC/FIGX

1. Progress accomplished for the period 16 Mar 90 through 22 Mar 90:
  - A. Continued reviewing control room video tapes and updating maneuver log.
  - B. Bill Dana Flt 577 flew on 21 Mar. The flight started by repeating the longitudinal doublets at both 1&4g, with a pushover first, as requested by Bob Yeager. All but the 4° LEU case were flown before the plane had less than 8000 lbs of fuel. Due to the short length of the mission, the last case was postponed till the next flight. Next, the pilot tried flying the airplane through the wake of the chase plane with the SIDC enabled. The chase started at 1g level flight, but then increased to ~3g's to increase the turbulence level. The system "detected" a great deal, but never "verified", hence there were no false alarms. The pilot next flew some large PUPO's to test the cross coupling effects of lacked at trim and some other maneuvers with 80%PSL, but SIDC rendered impotent; to collect the residuals for the impairment. Next, the pilot performed longitudinal and lateral frequency sweeps for the basic CAS, CAS disengaged, the right stab locked at trim without and with mixer. It seemed difficult for the pilot to maintain a constant amplitude as he increased frequency, so it was also difficult to make any real time assessment of the test. We will repeat the test with a different pilot. Next, tried Maintenance Diagnostic Scenario #2 with the mixer only and it worked well. Will try with full system on next flight. The pilot then flew some large amplitude maneuvers( 5.0/0.5g PUPO/POPU and 180°/s 360° rolls) to evaluate the mixer performance with the surface locked at trim compared to that of the basic CAS. We plan to rely most of these test points with a different pilot to ascertain the repeatability of the results.
2. Projected Accomplishments for the period 23 Mar 90 through 29 Mar 90:
  - A. Bill Dana, who flew Flt 577, will also fly Flt 578, currently scheduled for 23 Mar, since no other F-15 test pilot is available on that day. The mission will include the five MD scenarios, with the full CRS system operating for Scenario #2; a set of maneuvers evaluating the aircraft's response using only the propulsion system to collect data for a future NASA program; and, repeat of several of the test points from Flt 577, including the longitudinal doublets and frequency sweeps.
  - B. Flt 579 is currently scheduled for Monday, 26 Mar and Flt 580 for Wednesday, 28 Mar. We also have time on Tuesday, 27 Mar, reserved in case one of these flights is aborted. The missions for these flights will be determined upon reviewing the data from the previous flights.

C. Bob Yeager is scheduled to arrive at NASA on 27 Mar. Along with reviewing data and video tapes, I am sure there will be lots of things happening.

BARRY S. MIGYANKO, CAPT, USAF  
SRFCS Systems Integration

## Appendix F – SRFCS Progress Report, March 15, 1990

From: Capt. Barry S Migyanko, WRDC/FIGL

15 Mar 90

Subj: Progress Report of SRFCS Flight Test Program

To: Mr. Calvin Dyer, WRDC/FIGX

1. Progress accomplished for the period 9 Mar 90 through 15 Mar 90:

A. On 9 Mar, two data tapes were sent to Phil Chandler. Each tape contained one file, written such that it can just be "COPY"ed onto the VAX. Each file consisted of the same 18 minute period from Flt 570, but written in different formats. The first on the tape labeled BARRY, was written in an ASCII format and takes about 85 Mbytes of memory. The second, on tape BARRY2, is written in CMP2 format, and only requires 6 Mbytes. I sent both because I am uncertain of the format of the first tape that I sent to Curtis Jefferson/Cal Dyer, with which they wrote a translation program. I hope that it was the CMP2 format, since it requires much less memory to store.

B. Spent most of the week working on three administrative tasks. First, I had the data from all the flights transferred onto my own tapes so I could have easier access to the data. Next, I began reviewing the control room video tapes from flights 562 through 568, looking for good footage. All tapes prior to flt 562 had been degaused already, since normal procedure to clean the tapes after 30 days. I am uncertain about using the Long Range Optics(LRO) color footage. The camera is on the roof of the building, and must use significant magnification, which also enhances all disconcerting motions caused by winds and electrosvos. I will send some the footage to WPAFB to review. Also, I began a log, categorized by maneuver, and started by reviewing the original flights for entries.

2. Projected Accomplishments for the period 16 Mar 90 through 22 Mar 90:

A. Flt 577 is currently scheduled for Wednesday, 21 Mar. This was moved from the previously scheduled date of 20 Mar due to a DARPA meeting happening here on that date. The meeting will discuss a future project for the aircraft and they want to look at the aircraft in the hanger. Steve Hoy will be the McAir representative on site for the remainder of the testing. He will arrive from St. Louis on 20 Mar.

B. I will continue working on the tasks outlined in Section B above.

BARRY S. MIGYANKO, CAPT, USAF  
SRFCS Systems Integration

## Appendix G – SRFCS Progress Report, March 8, 1990

8 Mar 90

From: Capt. Barry S Migyanko, WRDC/FIGL

Subj: Progress Report of SRFCS Flight Test Program

To: Mr. Calvin Dyer, WRDC/FIGX

1. Progress accomplished for the period 2 Mar 90 through 8 Mar 90:

A. On 2 March, two flights, Flt 572 and 573 occurred. On the first flight, shortly after the first test point, the INS failed. Unable to realign in flight, the pilot, Jim Smolka, landed, realigned the INS at "Last Chance", and took off again. The day had been overcast and when Smolka went back up for the second flight, he was unable to find a sizable hole on condition. The mission, mostly McAir data runs, was postponed to the following week. The INS was replaced with a unit borrowed from the Air Force.

B. Bill Dana flew Flt 574 on 6 March. The flight emphasized the handling qualities of the system during tracking for the locked off trim cases. His Cooper-Harper ratings remained about the same, but he spent more time giving comments. The pitch bobble is the main reason why his ratings were below what we had expected; he did not include the stick force required to hold trim as a factor for the rating. The bobble is present in the basic aircraft tracking. It is about the same, if not slightly better the impaired only cases. With the Mixer, the bobble gets worse and even couples into the roll/yaw axis. On the ground, we could see the pipper making a "lazy eight". A sine wave, about 1Hz, was also very present in all the CAS commands on the strip charts. The system was tried at stuck at trim to see if the impairment modeling at the off trim cases was to blame, but the oscillation shows up there as well, with about the same frequency and amplitude. The Cooper-Harper ratings were:

	untrec	rec
No impairment	4/2	
Locked 6° LED	6/5	7/7
Locked 4° LEU	7/7	7/3-4 (2g tracking)
Locked @ Trim	5/3	7/7

The +4° case had to flown at 2g instead of 3g since the system would exceed its stabilator authority limits if the pilot commanded 3g and SRFCS would drop off. The pilot seems to fly all the cases with about a 1Hz oscillation in his pitch command, but it is unknown as of now if that is cause or a result of the system. Another possible source is a time delay, due to the system implementation, that varies from 150-200ms. An abbreviated set of tests will be run will the other pilots.

C. Tom McMurtry flew Flt 575 on 7 March. This flight was flown on Wednesday to collect all the required McAir data before the week stand down. The tracking task was flown for the -6° locked case. The airplane flew about the same as it did for Dana, but the C-H ratings were more like we expected because they did include the required stick force. The airplane was also flown without the pitch

CAS and the pitch bobble, inherent in the basic aircraft, was reduced. This bobble in the basic system has been noted repeatedly at NASA. I wonder if there is an inherent increased gain in the Mixer which is amplifying this signal already in the CAS. The Cooper-Harper ratings for the flight were:

unrec	rec
No impairment	3/2
No impairment (CAS Off)	2/2
Locked 6° LED	7/5
	5/3

The pilot tried a couple of stick raps, during which the oscillations damped out quickly. Next, the pilot tried some pitch/roll coupling tests for the locked at trim cases. First, he tried a straight longitudinal pull. Even though he tried several times, he always gave some lateral command. One comment that could be made is that, with no reconfiguration, he instinctively put in ~5lbs of lateral force and, for the reconfigured case, he only used ~2lbs to compensate. Next, the pilot tries the split engine test, alternating engines, and with and without a PSL impairment. SIDC did not detect anything during the test, neither detected the real failure nor false alarmed. Next, the pilot flew some cases to expand the envelope. He varied the fuel entry in the Hawk +/-2500lbs at both 20k/0.7M and 24k/0.65M. 24k/0.65M was used instead of the actual corner since maneuvering can cause variations in altitude or speed, and if the airplane goes outside of the box, SIDC has an automatic shutoff. Not much seemed to happen except that the detection rate went down, but there were no false alarms.

D. On 8 March, Jim Smolka flew Ft 576. The mission started with tracking maneuvers for both -6° and +4° cases. Smolka's comments were similar to the other pilots. The C-H ratings were:

Tracking:		unrec (acquisition)	rec
No impairment		3/3	
Locked 6° LED		4/5 (5/8)	8/? (5/5)
Locked 4° LEU		5/6 (8/7)	8/4 (4/4)
Formation:		unrec	rec
No impairment		2/3	
Locked 6° LED		?/7	4/5

The '?' means the pilot did not feel able to rate that axis. An example of this is the reconfigured -6° case. The pitch bobble was so bad and required so much of his attention that he was unable to focus on the lateral axis. During the tracking, the pilot rated both fine tracking and gross acquisition. Looking at the numbers and listen to his comments, during the reconfigured cases, the pilot felt he had more control than during the unreconfigured cases, even though the fine tracking performance needs to be improved. Overall, he says that a pilot would prefer the reconfigured to the unreconfigured aircraft, basically since he felt he had better control of the aircraft.

Since the original first chase aircraft was not ready for takeoff at the scheduled time (the Air Force refueling truck had not arrived yet) and the tanker would only be airborne till 1300, the second chase, the two seat F-18 used to videotape the



mission, had to go up first. Due to this rescheduling, the video shots were taken early in the flight. Several shots that were shot on Flt 570 were retaken, under Bob Yeager's direction. Also, an incorrect data entry after refueling took some time to correct. I made the choice to skip the second formation run and jump to the McAir test cases. The cross coupling tests for the stab locked at trim, both unreconfigured and reconfigured, consisted of a slight dive for speed and then a wings level pull up. Several g levels were tried, using the amount of pilot lateral compensation as the measure of cross coupling. An interesting note is that the pilot had to put in positive stick during the unreconfigured case, and negative stick, about half the amount steady state but oscillatory with a peak to peak value equal to the unreconfigured amount. Next, the pilot went down to 16k/0.75 to test SIDC. The system seemed more sensitive at this condition; it would detect shortly after coupling with no real input. This could be a good fact, however, we have seen this phenomenon with this pilot before at the nominal flight condition. We had to stop the mission prior to completing the cards because Ed asked for several 360° rolls in a row, and after a few runs, the pilot began to feel ill.

2. Projected Accomplishments for the period 9 Mar 90 through 15 Mar 90:

- A. The airplane will stand down from 9-19 March. Ed Wells is going to return to St. Louis to work on the SIDC/EGE back at the McAir facility. I will stay out here and try to get information organized to be processed. I will send some data along as soon as I can.
- B. The next flight is currently scheduled to occur on 20 March. The F-15 may fly on 16 March to collect some data for a future program, and it may be an opportunity to take some more dedicated video shots. More concerning that flight will be known next week.
- C. The PASCOT will be removed 13-15 March for testing for the Intermediated Case Study. This should not interfere with our schedule, but anytime they touch hardware is a potential for a problem to occur.

BARRY S. MIGYANKO, CAPT, USAF  
SRFCS Systems Integration

## Appendix H – SRFCS Progress Report, March 1, 1990

From: Capt. Barry S Migyanko, WRDC/FIGL 1 Mar 90

Subj: Progress Report of SRFCS Flight Test Program

To: Mr. Calvin Dyer, WRDC/FIGX

1. Progress accomplished for the period 16 Feb 90 through 1 Mar 90:

- A. The period 14-22 Feb, I was not at NASA Ames Dryden. The aircraft was down for a phase inspection. No major problems were discovered and flying resumed on 23 Feb. More tests need to be run on the aircraft, however, there is no rush at the moment. They can be performed if the aircraft goes down for any period of time.
- B. Flight 570 flew flying qualities tests on 23 Feb. The tests consisted of flying the Block A maneuvers for 6° LED and 4° LEU reconfigured cases and the Block B maneuvers for the same failures, unreconfigured and reconfigured. The pilot, Bill Dana, rated the pitch during the tracking worse for the reconfigured case than for the unreconfigured. His comment was that the mixer response was "nonlinear", that simple pull commands all axes, and that it was not as predictable as the basic airplane. He claims that even though he has to hold a significant amount of force to stabilize the unreconfigured cases, the response once "trimmed" is more like the basic aircraft, hence predictable. No one is quite sure what to make of his comments at this time. Jim Urnes, Bob Yeager, and Dana are trying to schedule a conference call to discuss his comments, but no definite time is currently set up. Also on the flight, we tested SIDC for no impairment and 80% PSL to collect more data using a different pilot. No false alarms were detected, but the detection rate was less. about 20% correct answers. At the end of the flight, the pilot flew the 6° LED case, unreconfigured and reconfigured, with the photographer directing position and coupling/ maneuver time to get good shots for promotional video. A copy of that tape was sent to WRDC/FIGX for review.
- C. Several phone discussions between WRDC/FIGX, NASA, and McAir occurred this week concerning the flight schedule for the rest of the program. McAir would like to stand down for three flights so they can continue work at St. Louis instead of testing in flight. Jim Stewart is concerned about delaying any tests, considering it risky to postpone testing till the end of the schedule when an unforeseen occurrence could delay the schedule and thus cancel the possibility of the test happening. However, Stewart does not want to dedicate an entire flight to flying qualities or photo taking at this time.
- D. On 28 Feb, Flight 571 flew accel-decel tests, expanded envelope evaluation of SIDC/EGE, and McAir cross-coupling tests. The accel-decel tests were very boring. By limiting the pilot to not using the speedbrake, since it is not modeled in SYSDYN, deceleration was very slow. Nothing happened during the test, SIDC didn't detect the 80% PSL when inserted. Next, the pilot tried to collect

cross-coupling data using the McAir technique; establish a steady state 1.2g turn, induce failure, and load the aircraft while maintaining the same bank angle. By holding the same angle, McAir will equate the lateral stick force required to the amount of lateral cross-coupling resulting from the failure. No additional comments can be made at this time. Then, the pilot tested the SIDC/EGE at the corners of the box. The SIDC detection rate decreased at the corners, about 10%, however, this is not unexpected since the gains were only "optimized" for the center of the box. Another reason why detection rate may have been lower is that once the pilot is outside of the box, SIDC is blocked. Sometimes, when performing maneuvers, the pilot did exceed the box, either altitude or speed.

2. Projected Accomplishments for the period 2 Mar 90 through 8 Mar 90:

- A. Flt 572 is scheduled to fly on 8 Mar, however, the weather forecast is not favorable. Smolka is the pilot. The mission includes some more flying qualities, cross-coupling analysis, split engine test, and turbulence test.
- B. Dana should fly the next mission, Flt 573, on 6 Mar. He begin the mission reflying the tracking tasks of Flt 570 to give more detailed about the mixer performance. Bob Yeager will travel to NASA to speak to Dana personally before, during, and after the flight. Upon completion of the tracking tasks, the mission will continue the tests not completed on Flt 572.

BARRY S. MIGYANKO, CAPT, USAF  
SRFCS Systems Integration

## Appendix I – SRFCS Progress Report, February 15, 1990

From: Capt. Barry S Migyanko, WRDC/FIGL

15 Feb 90

Sub: Progress Report of SRFCS Flight Test Program

To: Mr. Calvin Dyer, WRDC/FIGX

1. Progress accomplished for the period 9 Feb 90 through 15 Feb 90:

- A. On 9 Feb, Fit 567 flew a full system checkout for all failures, collected some large amplitude maneuver Mixer data, and tested SIDC further. The full CRS system was tested during a tracking maneuver. The local failures worked very well as expected, and the SIDC/EGE surprising produced good results. The hypothesis for EGE performing well, unlike previous tests, is that this is the first time it was tested on the aircraft with SIDC. Before it was engaged whenever the pilot hit the couple button, which did not guarantee that the residuals were best for estimation. On this test, SIDC engaged the EGE, thus when the residuals in the system were at a state appropriate for detection and estimation. This will be tested on further flights. Next, the pilot did some large amplitude pushover/pullup maneuvers to evaluate the performance of the Mixer for the stuck at trim and 80% PSL cases back at St Louis. Three more SIDC sets were tested, of which one set produced decent results. This set will be retested on the following flights to evaluate its performance for different pilots.
- B. Fit 568 flew flying qualities runs on 12 Feb. The pilot flew the Block A & B maneuvers for the locked off trim cases. He did not have any memorable comments about the reconfigured a/c flying the Block A maneuvers. During the Block B, he comments demonstrated an improvement using reconfiguration. The tracking tasks went from a 7/7 to 5/5 by adding the reconfiguration. However, one comment that could be construed as negative is that the pilot experienced "cross-talk", a blending of axis commands, during the reconfigured cases. He stated that it was disturbing. Also, the Maintenance Diagnostics Scenario 2 was tried, but was never fully tested since SIDC was not able to detect and start the sequence.
- C. Fit 569 flew on 13 Feb. SIDC was tested again will about 60% accuracy and no false alarms. Another variation was tested, but with no improvement. Two more sets of EGE gains were tested, but spread of values is still outside +/-20%, dipping many times into the negative region. MD Scenario 2 was retried, working well for the 100% PSL case, but SIDC was unable to detect the 50% case and start the inferencing. Also, evaluated the full system for the stuck at trim impairment at the corners of the box with offsets in the fuel state in the SYSDYN model. The fuel weight was varied +/-2000 lbs at all three conditions, but did not seem to have any noticeable effect on the performance. The pilot did not make any notable comments on the aircraft at 25k/0.6M, but he said the aircraft was "squirrely" in the lateral axis at 15k/0.8M.
- D. On 14 Feb, I returned to Dayton to hold some meetings with SRFCS staff and to prepare for the upcoming IG inspection.

2. Projected Accomplishments for the period 16 Feb 90 through 22 Feb 90:

A. Several meetings will be held during the week that I am in Dayton. Some of the topics include the NAECON paper, the project video, the projected schedule for the flight test, and the future direction of the SRFCS Program.

B. I will return to NASA on 20 Feb to prepare for Fit 570 which is currently scheduled for 21 Feb.

BARRY S. MIGYANKO, CAPT, USAF  
SRFCS Systems Integration

## Appendix J – SRFCS Progress Report, February 8, 1990

From: Capt. Barry S Migyanko, WRDC/FIGL

8 FEB 90

Subj: Progress Report of SRFCS Flight Test Program

To: Mr. Calvin Dyer, WRDC/FIGX

1. Progress accomplished for the period 2 Feb 90 through 8 Feb 90:

- A. Flight 565 flew on 2 Feb 90. The mission included both flying qualities and SIDC/EGE tuning. The flight was delayed on the ground 30 minutes due to the first chase, the two seat F-18 photo chase, aborted before takeoff. A one seat F-18 took its place, so no chase photos were taken of the flight. With two tanker refuelings, the four non-reconfigured FQ Block A maneuver cases were flown, with emphasis placed on time between maneuvers to determine settling time. The 4g loaded turns with 4° LEU kept causing the CAS to drop off, so the pilot backed off to 3g turns. The rudder doublet still caused the CAS to drop off, so the pilot continued on without performing that maneuver. The 360° rolls always caused an uncouple because of the high roll rate. Three SIDC cases were tested. None of them produced any improvements of the baseline performance, however, the baseline case did not perform as it did on flt 563. We believe that the pilot did not enter the data correctly. He told us in the debrief that he may not have hit the "ENTER DATA" every time. We will start a practice of having the pilot hold the "ENTER DATA" until we confirm that we see it in the control room. Four EGE cases were tested, none of them produced results above the baseline. We began some tracking tasks, but after 2.5 hours of flying, the longest flight in fives for the HIDEC, the pilot began to get tired and and his performance began to degrade. Everyone here at NASA, including myself and McAir, was very pleased with the flight.
- B. On 2 Feb 90, we held a conference call with McAir concerning the NVM correction on engine startup. McAir agreed that NASA's suggested step of pulling CAS circuit breakers before engine start is sufficient until other problems occur.
- C. The SMDC initiator was due to be replaced, so the airplane was down on 5&6 Feb. Originally, they were to begin the work on Friday, 2 Feb, but with the delayed takeoff and the extended flight, combined with the difficulty to get a fuel truck in any reasonable time, the crew could not start until Monday. This delay caused us to cancel the flight on Tuesday.
- D. On 7 Feb 90, Flight 565 flew several SIDC, EGE and Mixer cases. Nine different SIDC sets were flown, but none came close to the desired responses. Seven EGE test were flown, but once again, not one set produced good results. In addition, several Mixer data collection runs were made. The pilot did a straight pull 4.0g/0.2g pullup-pushover, with no lateral compensation, for both the locked at trim and 80% missing cases.

Unlike previous flights, we are certain that all the data is valid, with respect to pilot entries. The control room verified every NCI and 'Enter Data' entry.

When examining the data later, it was discovered that the sideslip angle calculated by the DFCC did not match the nose boom beta. An error in the calculated sideslip angle can corrupt the model and affect all portions of the system performance. No reason for this error has been verified yet, but the best hypothesis is incorrect airdata being passed to the DFCC. During the preflight on 8 Feb, the CC load was discovered to be corrupted. The crew were able to couple the system on the ground, without being in ground test mode, even though the INS was putting out invalid data. The system should not be able to couple on the ground, and even if it could, the invalid INS should have caused an IFIM. No one is certain right now, but if the CC was corrupted on fit 565, it could be the source of most of the problems on the flight. We have had such a large number of CC corruptions that NASA is beginning to suspect that the CC itself could be going bad. There are supposed to be a couple of spares here at NASA, but no action has been taken yet to replace the one onboard. Another probable source of error was flying through 'visible moisture', which caused the pitot tubes to freeze up occasionally. This is probably a minor problem since it only occurred a few times.

E. On 8 Feb, Bob Yeager, Jim Urnes, and the people at Edwards had a phone conference concerning the programs progress. It was officially decided at that meeting that there would be no demonstration flight.

2. Projected Accomplishments for the period 9 Feb 90 through 15 Feb 90:

A. Three flights will be flown over this period, 9, 12, & 13 Feb. Flight 567, scheduled for 9 Feb, will test the entire system during maneuvers, including tracking, for PSL and locked off trim cases and repeat the mixer test items flown on fit 566. No tanker is available at this time. Flight 568, on 12 Feb, will complete the flying qualities tests and flight 569, on 13 Feb, will repeat the test items on fit 566.

B. The WATR test range facility will not be operational on 14 Feb so no flight can occur on that date. The crew will take advantage of this down time to complete a required phase inspection on the airplane. The inspection should take three days to complete. With the holiday on 19 Feb, the next scheduled flight after the inspection will be in the morning on 21 Feb, allowing one day to prepare the airplane. I will take advantage of this down time to return to WRDC in order to make further arrangements to transfer flight data and to prepare for the upcoming IG inspection. I will return to NASA on 20 Feb.

BARRY S. MIGYANKO, CAPT, USAF  
SRFCS Systems Integration

## Appendix K – SRFCS Progress Report, February 1, 1990

From: Capt. Barry S Migyanko, WRDC/FIGL

1 FEB 90

Subj: Progress Report of SRFCS Flight Test Program

To: Mr. Calvin Dyer, WRDC/FIGX

1. Progress accomplished for the period 26 Jan 90 through 1 Feb 90:

A. Two flights were flown during this time period. Flt 563 on 29 Jan 90 and Flt 564 on 31 Jan 90. The flight scheduled for 26 Jan 90 was aborted on the ground when the pilot shut down the left engine after going to onboard power. The resulting transient corrupted both the NVM and the CC. Since the flight was in the afternoon, the flight had to be postponed till Monday.

B. Flight 563 consisted of SIDC and EGE test runs. Some time was lost at the beginning of the flight investigating fuel venting from the chase aircraft. The chase, a F-18 with an external tank, compensated for the faulty automatic shutoff valve by manually controlling the transfer from the external tank. Using the F-18 with the external tank is a great asset to the program since the tank extends the flying time by about an hour. Our biggest time constraint in the program so far has been the short flying duration of the chase aircraft. The external tank can relieve some of the tension of having two chases to cover the flight.

More time was lost by the several HAWK crashes that occurred when the pilot tried to enter the first SIDC test point. The pilot rebooted the HAWK three times, requiring approximately 6 minutes per retry, before going on to try the first EGE case. Investigation on the ground after the flight revealed that a software error was made that caused the rudder SIDC to look at the wrong residual. This residual was zero and caused a divided by zero error in the software. This crash was repeated several times on the ground afterwards and, once the correct residual was selected, the HAWK operated as expected.

One EGE case was flown which did not result in any improvement over the basic system before we reverted back to the SIDC runs. Three more cases were flown. The baseline set had few detections. Another set which had improved noise characteristics detected correctly about 50% of the time and did not detect the other times. The next iteration lengthen the window of the last set from .25s to .75s. This set detected correctly 75% of the time but incorrectly 20%.

C. Flight 564 consisted of flying qualities tests. The flight was delayed about an hour and a half due to corrupted NVM and CC load. The control room noticed the NVM flag after the transition from ground to onboard power. When the pilot shut down the engines so the crew could work on the airplane, he did not follow the proper procedures about turning off the PASCOT before shutting down an engine. The resulting power transient corrupted the CC. The pilot finally took off at 1140. Since the takeoff was delayed, we missed the tanker. Only two



Block A sets were performed before we were below the fuel weight, locked at trim and 80% missing, both with reconfiguration on. Nothing particularly exciting happened in either case. Then we flew on set of maneuvers that demonstrated the entire system, SIDC and Mixer together, for a locked at trim case. The system worked as expected. Then, the pilot flew the Block B maneuvers for the unimpaired aircraft and the unreconfigured 6 deg LED case before he BINGOed fuel. The few cases flown can be attributed to lack of tanker, extended ground time, and pilot conservatism in performing maneuvers. I will encourage the pilots in the future to work at a quicker speed.

D. On 31 Jan 90, we had a conference call with McAir concerning the NVM corruption. McAir would like to investigate the problem further. But Wilt Lock, NASA Test Engineer, believes the problem is inherent to our particular DFCC and not some new problem with the engines. He proposes that the pilot pull the CAS circuit breakers before transitioning from ground to onboard power, thus preventing a surge to corrupt the DFCC. This has been incorporated into the pilot's checklist and will be used unless another problem arises.

2. Projected Accomplishments for the period 2 Feb 90 through 8 Feb 90:

- A. Flight 565 should be flown on 2 Feb 90. If the flight is aborted, it will be flown on 6 Feb 90. The flight will consist of both flying qualities tests and SIDC/EGE runs. Four heavy weight conditions will be flown first and then proceed with the SIDC and EGE tests. If a tanker is not available, the FQ Block A maneuvers will be flown until there is less than 8000lbs of fuel. The SIDC will consist of four tests: repeat of the 50/50 case, two perturbations about that point, and the original set selected by Gerry Weiss but incorrectly entered on Fit 563. Five EGE sets will be run and if time and fuel remain, the rest of the FQ Block B maneuver cases will be flown.
- B. The aircraft will undergo a required hardware replacement starting after the flight on 2 Feb 90. Since the seat must be removed, the procedure should take two days to complete, thus canceling the flight on Monday as well. If Flight 565 is scrubbed, they will begin the work on Friday and reschedule the flight for the following Tuesday.
- C. Flight 566, currently scheduled for 7 Feb 90, is not at this time a dedicated flight. Possible tests included more FQ runs, SIDC/EGE tests based on fit 565 data, or other items off McAir's priority list.

BARRY S. MIGYANKO, CAPT, USAF  
SRFCS Systems Integration

## Appendix L – IFCS FRR, Structures (February 1999 Review)



# ***IFCS FRR - Structures***



- **Modest maneuvering requirements for IFCS**
  - End points match initial build-up points for ILTV
  - 4g Symmetric, 3g Asymmetric
  - NO thrust vectoring
- **Piloted Sim / Loads model tool will be used to check airframe loadings**
  - ITB2 maneuvers at 3 flight conditions
    - Steady heading sideslips to 10° or full pedal
    - Full stick 360° rolls at 1g
    - Wind-Up-Turns to 4g
    - Turn Reversals at 3g to cover tracking tests
- **Expect to show that critical airframe loadings less than ~ 60% DLL**
  - Flight Test Requirements (if any) will be determined by Simulation Structural Analysis
- **Existing hazard related to use of model will be downgraded to IIE**
  - No longer an accepted risk

2

### F-15 ACTIVE - Loads Model Stations

Canard Root - Shear, Bending, Torsion  
 Wing Root - Bending  
 Horizontal Tail Root - Shear, Bending, Torsion  
 Vertical Tail Root - Shear, Bending  
 Aileron and Rudder - Hinge Moment  
 Forward Fuselage 400 - Vert. and Lat. Bending - SE  
 - Vert. and Lat. Shear  
 Aft Fuselage 627 - Vert. and Lat. Bending - SE  
 - Lat. Shear and Torsion  
 Aft Fuselage 749 - Vert. Shear, Torsion - SE  
 Tail Boom - Strength Envelope

**Not Shown :**  
 Forward Fuselage 425 - Torsion  
 Engine Main Mounts - Vertical, Thrust - SE  
 Engine Forward and Side Links - Axial

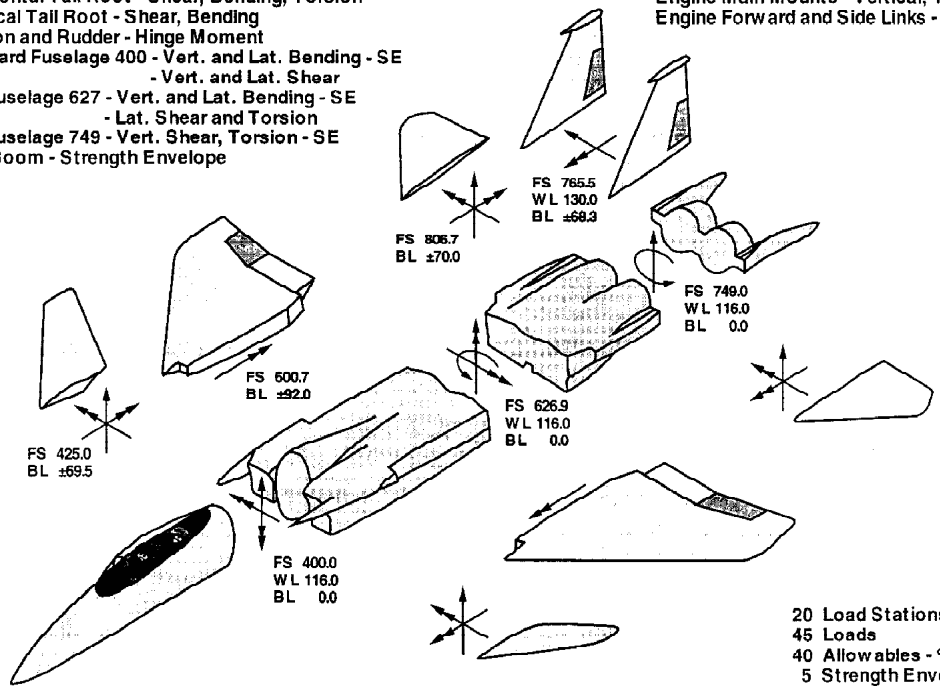

Positive Forces and Moments Shown



## *Flight Test Objectives*



- **Primary / Program Milestone**
  - Demonstrate that a pre-trained NN can supply real-time S&C derivatives to a closed-loop flight controller over a range of subsonic and supersonic flight conditions
- **Secondary**
  - Demonstrate level 1 flying qualities using a pre-trained NN and real-time control law optimization
  - Demonstrate flying qualities different from nominal design by specifying new new target parameters using ACTIVE DAG sets and real-time control law optimization
  - Collect data for Phase II post flight analysis using AdAPT excitation



## ***Flight Test Approach***



- **Real time clearance by discipline**
  - ASE-no ringing during raps and sweeps
  - Controls
    - No ringing in states or surfaces
    - Steady state surface positions and states match simulation
    - Dynamic surface positions resemble simulation trends
- **No real time analysis required due to reversion capability**
- **Flight between test points in IFCS**
  - Controllability checks during transition
  - 3g maneuvering limit
  - 1/2 stick inputs



## ***IFCS Integrated Test Blocks***



- **ITB1: 1g clearance**
  - 1g disengage transient check at selected flight conditions
  - 3-axis raps
  - 3-axis doublets
  - 60 deg bank to bank rolls
  - Pitch attitude captures
- **Post flight analysis**
  - Attenuation at structural mode frequencies
  - Time history comparisons with simulation



## ***IFCS Integrated Test Blocks cont...***

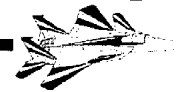

- **ITB2: Basic maneuvering**
  - **Steady heading side slips in both directions**
    - 10 deg test limit or max pedal
    - Abrupt release
  - **Full stick 360 deg rolls in both directions**
  - **Slow onset wind up turn to 4g**
    - Disengage transients check at selected flight conditions
  - **HQ Evaluation - Gross acquisition and fine tracking**
    - Formation
    - 3g target tracking
- **Post flight analysis**
  - Time history comparisons with simulation
  - Handling qualities database



## ***IFCS ADAPT***



- **Provide estimates of aerodynamic derivatives to within 10% of range of the values obtained using standard post-flight data reduction**
  - Stacked Frequency Sweeps
  - collective stab, dif stab, dif aileron, collective rudder, collective canard, dif canard
  - 0.2, 0.4 or 0.8 deg (DAG 25, 28, 31)
- **FTT - maintain straight and level flight or perform doublets, attitude captures, and pedal step inputs for a specified flight condition and AdAPT selection**
- **Flight Data will be used Post Flight to test the Phase II online estimation system**





# IFCS DAG Sets



- DAG sets only effect handling qualities by modifying the forward control path
- No expansion required for DAG 21, 22 and 23

Parameter Description	DAG Set 0	DAG Set 21	DAG Set 22	DAG Set 23
<b>Longitudinal FQ's</b>				
CAP_subsonic	0.564	0.8	0.8	0.564
CAP_supersonic	0.8	0.8	0.8	0.8
zsp	0.8	0.8	0.8	0.8
lalpha_BA_mult	1.67	1.67	1.67	1.67
<b>Lateral FQ's</b>				
taur_low_p	0.3	0.3	1.0	0.3
taur_high_p	0.3	0.3	1.0	0.3
<b>Directional FQ's</b>				
wdr	3	3	1.5	3
zdr	0.7	0.7	0.5	0.7
<b>Lat Stick Shaping Ratio</b>				
latsk_shaping_ratio	2	2	2	1
<b>Adapt Surf Excitation</b>				
coltal_amp_adapt_deg	0	0	0	0
difal_amp_adapt_deg	0	0	0	0
difall_amp_adapt_deg	0	0	0	0
colrud_amp_adapt_deg	0	0	0	0
colcan_amp_adapt_deg	0	0	0	0
difean_amp_adapt_deg	0	0	0	0
max_time_adapt_sec	-1	-1	-1	-1
<b>Checksum Thresh Mult</b>				
chksum_threshol_mult	1	1	1	1
<b>Ground Testing</b>				
Ground_Test	0	0	0	0
<b>SMI Ground Testing</b>				
SMI_LG_fb_mult_x10	10	10	10	10
SMI_LG_fb_mult_x10	10	10	10	10
	Default	High CAP	Alternate FQ's	Lateral Stick Shaping Off



## ***Test Point Sequence***



- ITB1 and freq sweeps at .75/20K - Req for milestone
- Doublets on the IFCS envelope boundary - Req for milestone
- ITB2 at .75/20K
- ITB1, freq sweeps and ITB2 at .9/25K
- ITB1, freq sweeps and ITB2 at 1.2/32K (no acq/track eval)
- ADAPT excitation at .75/20K, .9/25K, 1.2/32K
- ITB1, freq sweeps and ITB2
  - DAG 22, 21, 23
  - .75/20K, .9/25K
  - 1.2/32K (no acq/track eval)



# FLIGHT TEST ENVELOPE



- **Flight Envelope**
  - Airspeed: 300 KCAS to 500 KCAS
  - Altitude: 15k to 35k
- **Heart of the ACTIVE conventional flight controls envelope**
- **Flight conditions evaluated at HILS**

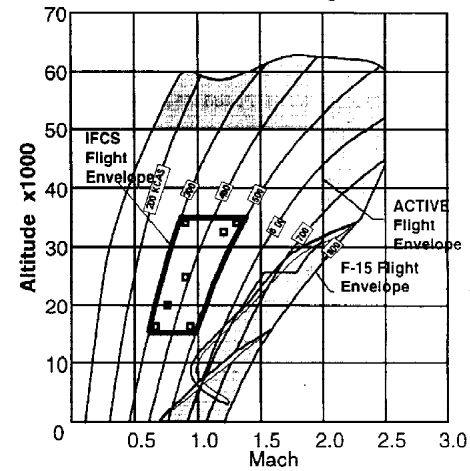

- IFCS Expansion Start, ITB 1, 2, Freq Sweeps
- ITB 1, 2, Freq Sweeps
- Doublets



## ***Flight Test Summary***

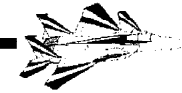

- **One primary and Three secondary flight test objectives**
- **Flight test point sequence designed to meet program milestone, before proceeding to secondary objectives**
- **IFCS is a reversionary flight controls system tested in the heart of the ACTIVE conventional flight envelope**

## Appendix N – IFCS FRR, System Operation (February 1999 Review)



### **System Operation - Reversion OFF**

#### **Flight Control Mode Operation**

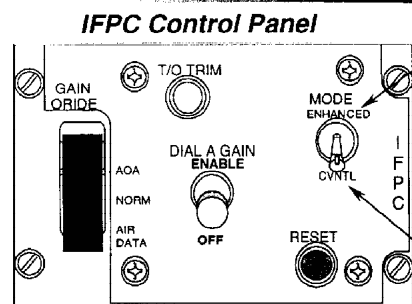

#### **Two - Step Engagement**

1. Select ENHAN Mode
2. Depress Trigger Sw

#### **One - Step Disengagement**

- Select CONV Mode
- Depress Trigger Sw
- Depress Paddle Sw



#### **Automatic Reversion: ENHAN to CONV**

1. Exceed Envelope Boundary { CONFIG-ENVEL  
Master Caution
2. Detect IFPC System Failure { CONFIG-FAIL  
IFPC RESET  
Master Caution



## System Operation - Reversion OFP



### Pick - A - Limit (PAL) Operation

Select PAL Set from Menu

**CONV Mode Must Be Engaged**  
**Box Indicates Selection**  
**Number Appears in 'Ready' Position**

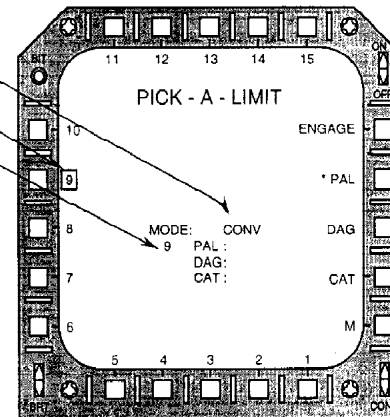
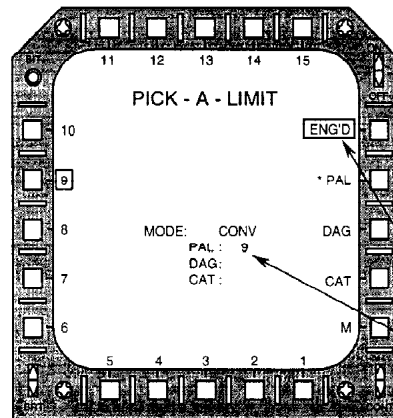

Engage PAL Set from Menu

**Press Bezel Button to Engage**  
**Number Moves to 'Engaged' Position**



## System Operation - Reversion OFF



### Dial - A - Gain (DAG) Operation

#### Select DAG Set from Menu

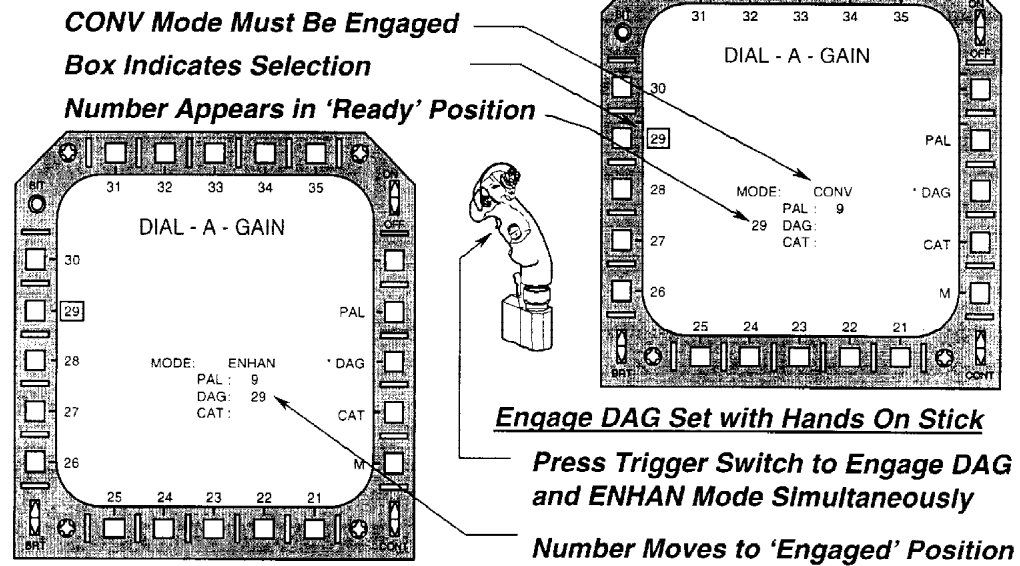



# IFPC System Description

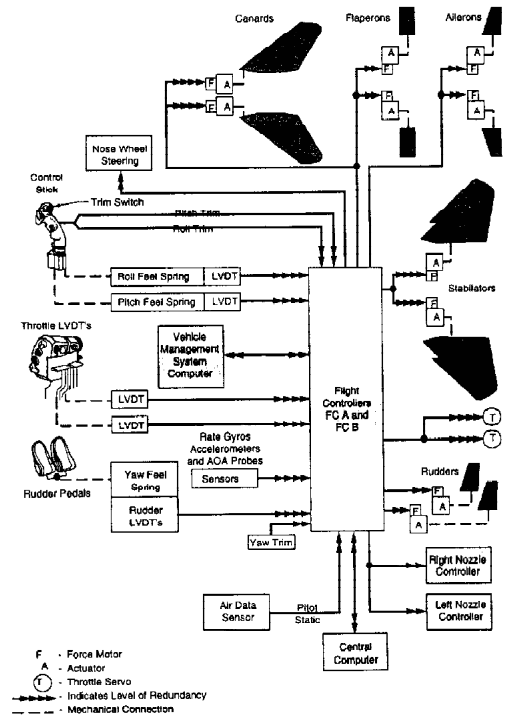

CCS4-0277-12-1



## Appendix O – Report WL-TR-91-3025 Vol. I Self-Repairing Flight Control, Aug. 91

### 6.0 FLIGHT TEST RESULTS AND PERFORMANCE ANALYSIS

#### 6.1 SYSTEM FLIGHT PERFORMANCE

Twenty five flights were flown in the NASA F-15 test aircraft to evaluate the performance of the Self-Repairing Flight Control System. Results were excellent, with high praise from the three NASA test pilots on the ability of the SRFCs to restore control and increase pilot awareness of the flight capabilities of the impaired and reconfigured aircraft.

The situation that was the most difficult to control occurred when the 6° stabilator offset from trim impairment was activated. This impairment produced a sudden pitch and roll transient and required a large control stick displacement just to maintain level flight. During the initial flight activation of this 6° stabilator failure, the pilot reported an extremely difficult control situation, and did not want to proceed with maneuvering sequences with this failure present. His comments included:

"Six degrees leading edge down very uncomfortable, 3/4 left stick, 1/2 forward stick to hold aircraft level, hit forward stop countering transient." "Six degrees leading edge up requires large stick offset to maintain level."

At this point in the initial test of the 6° stabilator failure, the pilot was directed to activate the reconfiguration mode. Results were excellent; the pilot immediately commented on the major increase in controllability, and proceeded to fly the flight plan sequence of pitch, roll and tracking maneuvers with the reconfigured control system. His comments included:

"Five seconds after failure, can go hands off."  
"Certainly think airplane could be flown to a safe place with any of the impairments."

One illustration of the difficulties encountered by the pilot during the 6° stabilator offset failure is shown by the flight test records of the lateral stick force required to maintain level flight in Figure 6-1. With the

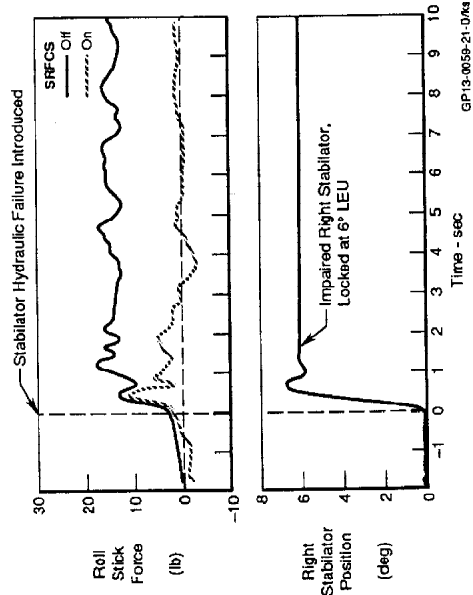

**Figure 6-1. Pilot Roll Input Required to Maintain the Aircraft Wings-Level: With and Without Reconfiguration During the 6° LEU Locked Right Stabilator Impairment**

SRFCS reconfiguration activated, the stick force returned to normal levels; this provided a much more controllable aircraft to the test pilot.

Flight test results of the Fault Detection, Isolation and Estimation function of the SRFCS were acceptable. All locked stabilator failures were correctly identified and about 60% of the partially missing right stabilator impairments were detected and estimated correctly. A very important result was that only one failure was incorrectly identified and no false detections occurred. This was verified during flight maneuvers with the SIDC active and the F-15 in both the impaired and the unimpaired configuration. This was accomplished by carefully designing the fault detection thresholds. The threshold values resulted from a trade-off between false or incorrect detections and the ability to detect small signature failures. Thus, while these threshold values were responsible for the highly desirable result of no

false and one incorrect failure identification, they were also a factor in not achieving a success rate better than 60%. Because great importance was placed on minimizing false and incorrect failure identifications, it was not worth the risk of increasing these false and incorrect identifications in order to increase the success rate above 60%.

The Maintenance Diagnostic System accurately identified the six failures that were emulated in the flight systems of the test F-15. This success of isolating maneuver related intermittent faults is an important milestone in the development of embedded onboard diagnostics and will lead to greater success and accuracy in diagnosing aircraft system failures.

## Appendix P – Pilot Reports (Boeing Company 99P0040) Intelligent Flight Control Final Report

### IFCS ACTIVE Flights 126 and 127

Date: 19 March 1999

#### **First Flight (126):**

Takeoff Time: 0905

Duration: 1.2 hours

Crew: Jim Smolka/Gerard Schkolnik

Chase: F-18A, NASA 851 (Dana Purifoy)

Weather: Light winds, Broken to overcast clouds at FL220.

Control Room: NASA 2, Will Lock

#### **Second Flight (127):**

Takeoff Time: 1315

Duration: 1.0 hours

Crew: Jim Smolka/USAF Capt. Dawn Dunlop

Chase: F-18A, NASA 851 (Dana Purifoy)

Weather: 10 knot winds from the south, Scattered clouds below FL 350.

Control Room: NASA 2, Will Lock

#### **Maneuvers Flown:**

##### **First Flight (126):**

1. Wing fuel pump transfer switch operation and fuel transfer rate determination.
2. Engagement and disengagement of ENHAN mode, 20,000 feet, 0.75 Mach, PAL 3.
3. Pitch, roll, and yaw raps at 20,000 feet, 0.75 Mach in ENHAN mode, PAL 3.
4. Pitch, roll, and yaw doublets at 20,000 feet, 0.75 Mach in ENHAN mode, PAL 3.
5. 60 to 60 degree bank to bank rolls and roll captures, 20,000 feet, 0.75 Mach, PAL 0, ENHAN mode.
6. 5, 10 and 15 degree pitch captures, 20,000 feet, 0.75 Mach, PAL 0, ENHAN mode.
7. Steady heading sideslips to max rudder deflection, left and right, 20,000 feet, 0.75 Mach, PAL 0, ENHAN mode.
8. Half and full stick 360 degree rolls, left and right, 20,000 feet, 0.75 Mach, PAL 0, ENHAN mode.
9. 4g wind-up turn to the left, 20,000 feet, 0.75 Mach, PAL 0, ENHAN mode.
10. Close formation, 1g wings level, 20,000 feet, 0.75 Mach, PAL 0, CONV and ENHAN mode.
11. Longitudinal and lateral-directional tracking, 3g target, 20,000 feet, 0.75 Mach, PAL 0, CONV and ENHAN mode.
12. DAG 25, 28, and 31 AdAPT excitations, 20,000 feet, 0.75 Mach, PAL 0, ENHAN mode.

##### **Second Flight (127):**

1. Deceleration from 20,000 feet, 0.75 Mach (350 KCAS) to 310 KCAS, PAL 3, ENHAN mode, with pitch, roll and yaw doublets every 20 knots.

C-2

2. Descent from 20,000 feet to 16,000 feet, 310 KCAS, PAL 3, ENHAN mode, with pitch, roll and yaw doublets at 18,000 feet and 16,000 feet.
3. Climb from 16,000 feet to 34,000 feet, 310 KCAS, PAL 3, ENHAN mode, with pitch, roll and yaw doublets at 2000 foot increments.
4. Acceleration from 310 KCAS to 460 KCAS (1.25 Mach), 34,000 feet, PAL 3, ENHAN mode, with pitch, roll and yaw doublets every 25 knots.
5. Descent from 34,000 feet to 16,000 feet, 460 KCAS, PAL 3, ENHAN mode, with pitch, roll and yaw doublets at 2000 foot increments.
6. Deceleration from 460 KCAS to 310 KCAS, 16,000 feet, PAL 3, ENHAN mode, with pitch, roll and yaw doublets every 25 knots.
7. DAG 24 and DAG 27 AdAPT excitations, 20,000 feet, 0.75 Mach, PAL 0, ENHAN mode, with 90 seconds of Pitch, roll and yaw doublets superimposed and then 90 seconds of two degree pitch and 10 degree bank angle captures superimposed.

**Pilot Observations and Comments:**

**First Flight (126):**

1. During the initial engagement of the ENHAN mode, no transient was noted in any axis. However, a small amplitude low frequency oscillation in pitch was noted, which resulted in load factor excursions of 0.1 to 0.2 g's about 1.0 g's with no pilot inputs. Also noted was a slight right roll that was easily controlled with three or four clicks of left trim. Disengagement of ENHAN resulted in no transient.
2. Pitch, roll, and yaw doublets showed a fairly solid feel to the aircraft in both the roll and yaw axes, but a looseness in the pitch axis.
3. Bank to bank rolls and roll captures of up to 60 degrees yielded good aircraft response in the lateral axis.
4. Pitch attitude captures yielded some sensitivity, with typically two overshoots before capturing the desired pitch attitude during a moderately aggressive five degree pitch attitude change. The load factor excursions noted previously detracted slightly from the pilot's ability to precisely control the pitch attitude.
5. Steady heading sideslips yielded about 5 degrees of sideslip and 25 degrees of bank. Abrupt release of the sideslip yielded a deadbeat response. The directional axis appears to be very nicely behaved.
6. During the initial roll testing, there was some concern with disengagements due to Dryden simulation predictions. Initial roll inputs were ramped in rather than being abruptly applied. However, when no disengagement problems were noted, an abrupt input was applied, and no disengagement problems were noted in the aircraft. The roll rate appeared to be greater in the ENHAN mode than in the CONV mode. The roll axis appeared to be well behaved.
7. The 4g wind-up turn was accomplished with no problems noted. It did appear that the load factor excursions noted at 1g were less apparent or absent at increased load factors near 4g. However, during steady turns at up to about 1.5g, the load factor hunting was noted.
8. The wing fuel transfer modification worked very well to keep wing fuel balanced, and is an enhancement for flight tests.
9. During close formation flight in the CONV mode as a build up for accomplishing the task in ENHAN, the aircraft was well behaved, with no noted PIO tendency. The aircraft could be

flown within the desired criterion with no problems. During moderately aggressive gross acquisition from a point well below the desired criterion (the tip of the target missile rail about two canopy widths high), the aircraft typically overshoot the desired tracking point, but remained within the desired criterion and was returned to the desired tracking point with only one overshoot. No unique pilot compensation techniques were required. Lower piloting gains in terms of being less aggressive resulted in less overshoot. Performance was desired. No coupling of the axes was noted. Feel system dynamics were acceptable. Gross acquisition Cooper-Harper (CH) rating 3. Gross acquisition PIO rating 1.5. Fine tracking CH rating 2, PIO rating 1.

10. During close formation in ENHAN, a careful buildup in aggressiveness and in how close the aircraft was positioned to the target was accomplished. The aircraft flying qualities were acceptable enough to allow an evaluation using the same position as that used for CONV mode. During moderately aggressive gross acquisition there was a sensitivity in the pitch axis that caused two or three overshoots before the aircraft could be settled down into the normal desired tracking position. The initial overshoot was large enough that the aircraft was outside the desired region, such that only adequate performance was achieved. Special pilot compensation, consisting of consciously trying to lead the control inputs to stop the initial gross acquisition maneuver, improved the aircraft's ability to remain within the desired criterion, however this had to be learned and was not totally natural. Being less aggressive during the gross acquisition maneuver also resulted in less overshoot. Once the aircraft settled into the desired close formation position, it was easy to maintain the position, and aircraft response was comparable with that noted in CONV mode. No coupling of axes was noted. No feel system problems were noted. Gross acquisition CH 6, PIO 3.5. Fine tracking CH 2, PIO 1.5.

11. Air-to-air tracking was performed using a target in a steady 3g turn and a 55 MIL fixed piper in CONV mode. Gross acquisition was accomplished from an initial 50 to 100 MIL piper displacement from the target followed by a moderately aggressive movement of the piper to the centroid of the target aircraft. The pitch axis was well behaved, with the piper settling onto the desired tracking position with only one relatively small overshoot within the desired criterion. Predictability was good. No special compensation techniques were required. No sensitivity was noted. No feel system problems were noted. Pitch axis gross acquisition CH 2, fine tracking CH 2, PIO 1. Lateral gross acquisition was characterized by poor predictability in terms of being able to place the piper on the desired tracking point on the target in a timely manner. This resulted in increased pilot compensation to achieve desired performance. No overshoot problems were noted. Performance generally met the desired criterion. No feel system effects noted. Lateral axis gross acquisition CH 4, fine tracking CH 2, PIO 1.

12. Based on my initial impressions of the aircraft in the ENHAN mode in the formation task, I was skeptical of what to expect in the tracking task. However, I was pleasantly surprised. The aircraft behaved well in both longitudinal and lateral gross acquisition and fine tracking. In the pitch axis, tracking performance was comparable with the CONV mode. Pitch axis gross acquisition CH 2, fine tracking CH 2, PIO 1. The lateral axis was more predictable than in the CONV mode, resulting in better flying qualities. It was easier to move the piper from the initial offset to the desired tracking point on the target. Lateral axis gross acquisition CH 2, fine tracking CH 2, PIO 1. Overall, the flying qualities were desirable in ENHAN mode during tracking of the 3g target.

13. The AdAPT excitations were accomplished without any problems noted. The AdAPT inputs using DAG 31 resulted in a relatively rough ride, with load factor excursions to about 0.1 g. Some lateral and directional inputs were also noted.
14. Overall, the first flight was very successful in demonstrating the ENHAN mode, and all flight objectives were met.

**Second Flight (127):**

1. During the deceleration, descent, and climb to 310 KCAS at 34,000 feet, no anomalies were noted and the aircraft was well behaved during all doublets. The pitch axis response in ENHAN mode was characterized by the previously noted load factor excursion oscillation. The size of the oscillation did not appear to be flight condition dependent.
2. During the acceleration at 34,000 feet from 310 KCAS to 460 KCAS (about 0.9 Mach to 1.25 Mach), an uncommanded aircraft down-mode from ENHAN to CONV was experienced at about 1.05 Mach. The technique during the acceleration was to hold the flight path marker on the zero pitch line rather than to chase the altimeter in the transonic flight region where significant altimeter errors occur due to pitot static system characteristics. The down-mode was due to the altitude exceeding the system limit of 35,000 feet. The problem was well understood, and the acceleration was repeated in ENHAN at 32,000 feet from 310 KCAS to 460 KCAS. The acceleration was accomplished using the same piloting technique without incident. Upon reaching 460 KCAS, the aircraft was flown to 33,000 feet prior to initiating the descent to 16,000 feet. The aircraft appeared to be stiffer in pitch while the aircraft was supersonic. The descent to 16,000 feet and the subsequent declaration from 460 KCAS to 310 KCAS at 16,000 feet yielded no anomalous behavior. The 1.5g turn at 460 KCAS required to reorient the aircraft for the deceleration revealed that the small load factor oscillation in the pitch axis that was previously noted was in fact present at that flight condition.
3. The rest of the flight was spent accomplishing the DAG 24 and DAG 27 AdAPT maneuvers with pilot pitch, roll, and yaw doublets superimposed for 90 seconds, followed by pitch and roll attitude captures superimposed for an additional 90 seconds. No anomalies were noted. There was a tendency to get some load factor excursions to less than zero g on some of the pitch doublets if the doublet were in the proper phase with the AdAPT input, which could be a factor for the DAG 30 points.
4. The aircraft was flown through an overhead pattern with Captain Dunlop flying as an initial orientation for her checkout program. Other than her unfamiliarity with the on-speed cues which are not F-15E standard, but more like an F-18, she had no problems adapting to the aircraft.
5. Overall, the second flight was highly successful, and the Level One milestone for Langley was accomplished.

**Recommendations:**

Continue envelope expansion and data gathering

James W. Smolka  
Project Pilot

### IFCS ACTIVE Flight 128

IFCS Flight: 3 (ACTIVE Flight: 128)  
Date: 23 March 1999

Takeoff Time: 0851  
Duration: 1.1 hours  
Crew: Dana Purifoy/Gerard Schkolnik  
Chase: F-18A, NASA 851 (Jim Smolka)  
Weather: Light winds, clear  
Control Room: NASA 2, Wilt Lock

#### Maneuvers Flown:

1. At 20,000 ft MSL and Mach = 0.75
  - a. Dag 30 Adapt excitation B
  - b. Dag 29 Adapt excitation C with climb and accel maneuvers between test conditions
  - c. Enhanced doublet and frequency sweeps, 360 rolls
  - d. Climb to 25,000 ft MSL and accel to  $M = 0.9$  with doublets, disengage/re-engage transients
2. At 25,000 ft MSL and Mach = 0.9
  - a. Roll and pitch captures
  - b. SHSS, 360 rolls and 4g WUT

#### Pilot Observations and Comments:

1. During engagement of the enhanced mode there was a slight right roll noticed. Approximately 3 trim "clicks" were required to null this input.
2. The aircraft felt less well damped in pitch in enhanced than in conventional mode. This was seen as a very small pitch oscillation which did not damp out with fixed stick. This motion was considered an annoyance.
3. The 360 degree rolls were initially different between left and right. This seems to have been caused by the pitch stick being slightly out of neutral.
4. All the other maneuvers were flown without any special comments.

#### Recommendations:

Continue envelope expansion and data gathering.

Dana Purifoy  
Project Pilot



### IFCS ACTIVE Flight 129

**Program:** F-15 ACTIVE

**Flight Number:** 129

**Date:** 23 Mar 99

**Aircrew:** Dunlop/ Purifoy

**Test Conductor:** Schkolnik

**Chase:** F-18A, NASA 851 (R. Smith)

#### GROUND OPERATIONS:

- With the primary frequency on CH 7 (268.1) the radios did not have any of the radio interference apparent on previous sorties.
- The RDRU was left off intentionally until after the planned engine shutdown in flight in order to prevent any resulting recording malfunctions.

#### INFLIGHT:

- Just following takeoff an IFPC fault was caused as a result of trim rate. An IFPC reset corrected the problem. On departure the front MPD and the left aft MPCD reverted to standby mode, and the right aft MPD went blank. An MPDP reset corrected the malfunction.
- Card 2: Phasing maneuvers were uneventful.
- Card 3 (15K 350 KCAS): Pilot fam doublets, SHSS, pitch/roll captures, 360-degree rolls and wind-up-turn were all accomplished.
- Card 4 (30K, 0.6M): Pilot fam for the PW100-229 SEC ENG CONTR mode. Engine performance was as expected per Dash-1 guidance.
- Card 5 (30K, 0.8M): Pilot fam for throttle transients. No overspeeds, overtemps, stalls or bangs were experienced.
- Card 6 (25K, 300 KCAS): Pilot fam for throttle quadrant and engine shutdown/restart. The throttle was brought from off to midrange at 50% rpm, and engine start was apparent after approximately 45 seconds. After restart the ENG CONTR was returned to PRI and the RDRU was turned on.
- Card 10 (25K, 0.9M): Following the engagement of the ENHAN mode the aircraft had a tendency to roll right. Several clicks of left aileron trim was required to bring the aircraft back to wings level trimmed flight. Pitch, roll, and yaw doublets and raps were accomplished. No undesirable motions were noted.
- Card 11 (25K, 0.9M): Pitch and roll captures in ENHAN mode. Roll captures (20, 30, and 60/60) were accomplished using up to half stick. Aircraft was crisp and responsive in roll, with

no undesirable motions. Feel and roll rate was similar to conventional mode. Five to ten degree pitch captures resulted in one or two slight overshoots, and yielded the initial impression of the aircraft being slightly sluggish, or soft, in the pitch axis.

- Card 12 (25K, 0.9M): SHSS, 360-degree rolls and a wind-up-turn were accomplished in ENHAN mode. Slightly more bank angle was required (approximately 25 degrees) to maintain heading during the full rudder (approximately 4.6 Beta) SHSS than was required in the CONV mode. The SHSS abrupt release yielded a deadbeat response. The rolls were characterized by good rate and predictability, however full stick left roll rate appeared to be faster than full stick right roll rate. In addition, during the full stick left roll a very slight airframe buffet was apparent in the region where the maximum roll rate was achieved. The aircraft was stable and predictable during the WUT, and a constant 4g was easily held with no apparent g-excursions.

- Card 13 (25K, 0.9M): Formation tracking in CONV mode. For the defined task initial response was crisp and predictable with no undesirable motions. Performance and sensitivity was satisfactory, and there was no apparent coupling of axes. Control motion, forces, harmony were all satisfactory, with no nonlinearities noted. Friction and breakout forces were negligible. During low gain gross acquisition desired performance was achieved with no overshoots. As the gain was increased the tendency to overshoot, and amplitude of the overshoot, increased accordingly. In all cases the overshoot was predictable and desired performance was quickly achieved. Pilot compensation was minimal and involved leading the capture point to prevent or minimize the overshoot. During low gain fine tracking desired performance was achieved with no pilot compensation. The task ratings were as follows: Gross Acquisition HQR - 3, Gross PIO rating - 1, Fine Tracking HQR - 2, Fine PIO Rating - 1, Confidence Rating - A.

- Card 14 (25K, 0.9M): Formation tracking in ENHAN mode. During gross acquisition the aircraft response was slightly soft, or sluggish. Initial aircraft response was satisfactory however the capture position and overshoot magnitude were not very predictable, with the initial attempt overshoot placing the aircraft near the edge of the adequate region. This unpredictability of the longitudinal response was apparent during both low and higher gain captures. Pilot compensation technique of using additional lead time for the capture allowed the desired performance, but still resulted in one or two overshoots. The amount of compensation was not initially intuitive, and it was not as easily accomplished or as accurate, as in the CONV mode. Once learned, the compensation required was considered minimal. Fine tracking was very smooth, and desired performance was easily achieved with no pilot compensation. No high gain fine tracking was accomplished. The task ratings were as follows: Gross Acquisition HQR - 3, Gross PIO Rating - 3, Fine Tracking HQR - 1, Fine PIO Rating - 1, Confidence Rating - A.

-Card 26 and 27 (10K, 300 KCAS): Pilot fan cards for target tracking and gain override options. Initial impression of tracking qualities in CONV mode was that the aircraft was responsive, stable, and predictable, with desired performance achieved in both gross and fine tracking. Following the tracking exercises pitch, roll, and yaw doublets, and bank-to-bank rolls were accomplished in both Air Data and AOA gain override. Air Data appeared to be more coupled in roll and yaw than either Norm or AOA modes, however pilot control throughout the simulated landing phase in both gain override modes was satisfactory.

- The wing fuel transfer function was utilized during RTB with a 400 pound fuel imbalance. System performance was good and efficient with the imbalance corrected in less than a few minutes.

- Multiple overheads and landings were accomplished with the only notable comment being the higher stick force in pitch the landing configuration. While noticeable, the higher stick force did not present any difficulties even in the overhead pattern.

**POSTFLIGHT:**

- Uneventful

**RECOMMENDATIONS:**

- None

C-9

### **IFCS ACTIVE Flight 130**

**Program:** F-15 ACTIVE

**Flight Number:** 130

**Date:** 30 Mar 99

**Aircrew:** Dunlop/Smolka

**Control Room:** NASA 1, Thomson

**Chase:** F-18B, NASA 846 (Fullerton)

**Weather:** Moderate winds from the Southwest, Clear

#### **GROUND OPERATIONS:**

- Radio 1 preset function was inoperative and IFPC bit required multiple attempts before passing.

#### **INFLIGHT:**

Maneuvers accomplished at 25K/0.9M

- Card 7 (Pitch, roll, and yaw doublets and frequency sweeps, and full stick 360-degree rolls in ENHAN mode): Yaw doublet was deadbeat. The initial low-frequency portion of the roll sweep was slightly non-linear in application due to the apparent deadband in roll. The first 360-degree full stick roll resulted in a single channel blin failure. IFPC reset and mode switch cycling reset the failure.

- Cards 3&4 (Longitudinal and lateral tracking in CONV mode): During longitudinal gross acquisition slight overshoots were experienced as the task gain was increased. The overshoots were predictable and controlled, and could be reduced and/or eliminated as the gain was reduced. During fine tracking desired criteria was achieved with no specific pilot compensation required. Lateral gross acquisition desired performance was achieved easily with low gain. As the gain was increased slight undershoots/overshoots were experienced based on aggressiveness of the pull, and roll our technique. As with the gross acquisition, these overshoots were always controlled. Lateral fine tracking was stable, again with no specific pilot compensation required to maintain desired criteria. The Handling Qualities Ratings were: Longitudinal gross acquisition - 3, PIO rating - 2, Longitudinal fine tracking - 3, PIO rating - 1, Lateral gross acquisition - 3, PIO rating - 1, Lateral fine tracking - 2, PIO rating - 1, Confidence rating -A.

- Cards 5&6 (Longitudinal and lateral tracking in ENHAN mode): During longitudinal gross acquisition slight overshoots were experienced as the task gain was increased. The overshoot amplitude was less predictable than in the CONV mode, with one of the initial increased gain captures resulting in a 25-50 mil overshoot. Again, the overshoots were controlled and could be minimized and/or eliminated as the gain was reduced. During fine tracking low gain tracking required no specific pilot compensation to achieve desired tracking criteria. However, as the gain was increased there was a tendency to get slightly out of phase with the aircraft resulting in reduced tracking accuracy and only adequate criteria could be achieved. These out-of-phase

motions were very small and bounded but did compromise the task performance. Reducing pilot gain eliminated the oscillations and allowed desired tracking to be achieved. During lateral gross acquisition only slight overshoot/undershoots were noted as the gain was increased, based on aggressiveness and roll out technique. As with the longitudinal gross acquisition, these over/undershoots were controlled and were typically in the 25 mil range. Fine tracking was smooth with no noticeable negative tendencies. Overall performance during the tracking tasks was better than expected based on previous experience with the 1-g tracking performance. The Handling Qualities Ratings were: Longitudinal gross acquisition - 3, PIO rating - 2. Longitudinal fine tracking - 4, PIO rating - 3, Lateral gross acquisition - 3, PIO rating - 1, Lateral fine tracking - 2, PIO rating - 1, Confidence rating - A.

Maneuvers accomplished at 20K/0.75M

- Card 8 (DAG 22 raps, doublets, bank-to-bank rolls and pitch captures): Roll doublets revealed a sluggish initial roll rate, and yaw doublets were deadbeat. Sixty-degree half stick bank-to-bank rolls were sluggish with upwards of 10-degree overshoots on the captures. Pitch captures were solid, with only very slight (<1/2 degree) overshoots.

POSTFLIGHT:

- Uneventful

RECOMMENDATIONS:

- None

## IFCS ACTIVE Flight 131

Active Flight: 131  
Date: 1 April 1999

Takeoff Time: 0853  
Duration: 1.2 hours  
Crew: Dana Purifoy/Gerard Schkolnik  
Chase: F-18A, NASA 851 (Gordon Fullerton)  
Weather: Light winds, clear  
Control Room: NASA 1, Mike Thomson

### Maneuvers Flown:

At 20,000 ft MSL and Mach = 0.75

- e. Dag 22 Eval (SHSS, 360 degree rolls, 4g WUT)
- f. Dag 22 HQID (doublets and freq sweeps)
- g. Dag 21 Eval (raps, doublets, pitch captures, 4g WUT)
- h. Dag 21 HQID (doublet, freq sweep)
- i. Dag 23 Eval/HQID
- j. Wingtip formation task in Conv, Enhanced, DAG 21
- k. Tracking task in Conv, Enhanced, DAG 21

### Pilot Observations and Comments:

1. The open loop maneuvers were accomplished without any difficulty. Several cases of airframe excitation were seen during the frequency sweeps.
2. The wing formation tasks showed some differences between the various modes:
  - a. Conventional mode provided a solid, responsive aircraft regardless of the aggressiveness used. Minor pilot workload was needed to obtain desired performance. This was the same rating given during the previous ILTV testing. Gross Acq: 3 Fine Track: 2 No PIO
  - b. Enhanced mode had showed some lightly damped pitching motion about neutral for the open loop maneuvers and this characteristic was noted during this task. During gross acq a large amount of lead was required by the pilot to arrest the upward or downward movement of the aircraft. For low to moderate aggressiveness adequate performance was obtainable with considerable pilot compensation and no PIO was noted. At the highest level of aggressiveness adequate performance required extreme compensation and there was the appearance of a small PIO. Fine tracking was accomplished to the desired criteria with considerable pilot compensation. Increased aggressiveness did not cause any change in performance. Gross Acq (low to moderate aggressiveness) 6 and PIO 1; Gross Acq (high aggressiveness) 7 and PIO 3; Fine Tracking 4.
  - c. DAG 21 improved the aircraft's flying qualities by reducing the amount of lead compensation required to perform the task. Gross acquisition to the desired criteria was

C-12

possible with considerable compensation and fine tracking was similar to Conv. Gross Acq 4 and PIO 2; Fine Tracking 3 and PIO 1.

3. Air-to-air tracking showed some differences between the different modes:

a. Conventional mode is a good tracking mode. My comments were the same as during ILTV. Longitudinal Gross Acq 2; Fine tracking 2; Lateral Gross Acq 3; Fine tracking 2. No PIO tendencies seen.

b. Enhance mode seemed less effected by the problems seen during the wing formation task. Longitudinally the desired criteria were obtainable for both gross acquisition and fine tracking with considerable pilot compensation. Lateral gross acquisition seemed to be effected more than the longitudinal axis by the "looseness" described above- resulting in more overshoots and a down grade rating. The fine tracking was characterized by pipper wander which caused a small (5-8 mil) oval pattern to be seen around the desired pipper location. The pilot was unable to dampen this motion, however, it did meet desired criteria. Longitudinal gross acq and fine tracking 4; Lateral gross acq 5 and fine tracking 4. No PIO tendencies were seen.

c. DAG 21 showed a slight improvement over the DAG 0 primarily in the gross acquisition phase. It was easier to stop the pipper at the desired point. Again this seems related to the reduced amount of lead required by the pilot during the final portion of the acq. The fine tracking still showed some of the pipper wander described above, but it was slightly smaller in size. Longitudinal gross acq 3 and fine tracking 4; Lateral gross acq 4 and fine tracking 4. No PIO tendencies were seen.

**Recommendations:**

Continue envelope expansion and data gathering. Attempt to characterize the lightly damped motion about neutral for the Enhanced mode.

Dana Purifoy  
Project Pilot

### IFCS ACTIVE Flight 132

**Program:** F-15 ACTIVE

**Flight Number:** 132

**Date:** 1 Apr 99

**Aircrew:** Dunlop/ Schkolnik

**Control Room:** NASA 1, Thomson

**Chase:** F-18B, NASA 850 (Smolka)

**Weather:** Light winds, Scattered 120

#### GROUND OPERATIONS:

- IFPC bit required multiple attempts before passing.

#### INFLIGHT:

Maneuvers accomplished at 25K/0.9M

- Card 34 (DAG 22 raps, doublets, half stick bank-to-bank rolls, and pitch captures): The roll performance was sluggish and resulted in approximately 10-degree overshoots during the bank-to-bank rolls.

- Card 35 (DAG 22 Abrupt release SHSS, 360-degree rolls at half and full stick, and a 4G WUT): The full rudder SHSS produced 4-degrees of beta and required approximately 28 degrees of bank. Release was abrupt in yaw and noticeably slower in roll. The half and full stick deflection rolls were noticeably slow to start and stop, but with good roll rate at the max roll rate. The 4G WUT resulted in some medium frequency aircraft buffet. This buffet is well-documented for the F-15 airframe, and occurred during each of the wind-up turns. The small g-excursions on the HUD were not noticeable in the cockpit and likely just display jitter.

- Card 36 (DAG 22 roll and yaw doublets and frequency sweeps): No comments

- Card 37&38 (DAG 21 pitch raps, doublets, captures, frequency sweep, and a 4G WUT): Pitch captures had very slight overshoots, hardly noticeable, and were likely less than in the basic ENHAN mode.

- Card 39 (DAG 23 raps, doublets, half stick bank-to-bank rolls, half and full stick 360-degree rolls, roll frequency sweep, and a 4G WUT): The roll performance was very quick and responsive, to the point of being oversensitive and somewhat jittery. During the 4G WUT there was much less lateral stick force required to roll, than at stick required to change G. Throughout the maneuver I found myself making constant adjustments to the bank angle as a result of the roll sensitivity.

- Cards 40&41 (DAG 21 tracking exercises). Longitudinal gross acquisition was similar to baseline with the only notable difference being that the increased gain overshoots were slightly



smaller resulting in a quicker gross acquisition. Longitudinal fine tracking was more difficult to accomplish than baseline with a noticeable hunting occurring during medium or high gain tracking that made desired performance impossible to attain. The hunting was well bounded and just outside of the desired performance criteria. Adequate performance was easily achieved with minimal compensation. Lateral gross acquisition and fine tracking were the same as the baseline ENHAN mode. The Handling Qualities Ratings were: Longitudinal gross acquisition – 2.5, PIO rating – 2, Longitudinal fine tracking – 4.5, PIO rating – 3, Lateral gross acquisition – 3, PIO rating – 2, Lateral fine tracking – 3, PIO rating – 2, Confidence rating –A.

– Cards 42&43 (DAG 22 tracking exercises). With the noticeably slow roll rate, it was difficult to completely isolate the lateral influences from the longitudinal tracking task. Longitudinal gross acquisition and fine tracking was comparable to the baseline enhanced mode, however there appeared to be more of an effort required to achieve the desired criteria for fine tracking than in the basic ENHAN mode. Lateral gross acquisition was easily accomplished low gain. However, as the gain was increased, the compensation required to overcome the slow initial roll response was considerable, and the result was typically a larger overshoot with one to two oscillations before the target was captured. During fine tracking the desired performance was met, but the workload/compensation was very dependent on the magnitude of the correction needed. During very small (i.e. 2 mil) corrections the workload was low in that the slow initial roll response was not a hindrance to making this type of small correction. For the larger (i.e. 5-10 mil) corrections the slow roll response was more noticeable, contributed to some overshoots, and required added compensation for predicting a roll-out point. The Handling Qualities Ratings were: Longitudinal gross acquisition – 3, PIO rating – 2, Longitudinal fine tracking – 4, PIO rating – 2, Lateral gross acquisition – 5, PIO rating – 3, Lateral fine tracking – 3, PIO rating – 2, Confidence rating –A.

**POSTFLIGHT:**

- Uneventful

**RECOMMENDATIONS:**

- None

### IFCS ACTIVE Flight 133

Date: 2 April 1999

ACTIVE Flight: 133

Crew: Jim Smolka/Gerard Schkolnik

Chase: NASA 850 (Ed Schneider)

Controller: NASA 1 (Mike Thomson)

Weather: Mostly clear with widely scattered clouds, 10 knot winds from the WSW.

#### Maneuvers Flown:

1. Formation flight, 0.9 Mach, 25,000 feet, 1g, in the following modes:
  - a. CONV
  - b. ENHAN, DAG 0
  - c. ENHAN, DAG 21
2. Air-to-air tracking, 0.9 Mach, 25,000 feet, 3g target, in the following modes:
  - a. CONV
  - b. ENHAN, DAG 0
3. Formation flight, 0.75 Mach, 20,000 feet, 1g, in the following modes:
  - a. ENHAN, DAG 0
  - b. ENHAN, DAG 21

#### Observations:

1. These maneuvers were flown using moderate to high piloting gains and aggressive gross acquisition and fine tracking piloting techniques. Therefore they represent the near worst flying qualities that a pilot might expect to encounter during operational use. If lower gains and less aggressive piloting techniques are used, better flying qualities can be expected. However, for the purpose of uncovering qualitative differences between flight control modes and configurations, more aggressive piloting techniques are deemed appropriate.
2. During 1g formation flight in CONV mode at 0.9 Mach, 25,000 feet, gross acquisition maneuvers, the aircraft generally overshot in pitch once, remaining within adequate criterion, and then was quickly placed in the desired fine tracking position. Occasional second overshoots were encountered, but were on the boundary of the desired and adequate regions. The aircraft response was generally what a pilot would expect, but predictability was somewhat degraded during gross acquisition, resulting in the overshoots mentioned above. If aggressiveness is reduced, the sizes of the overshoots are lessened, as one might expect. No coupling of axes was noted. Sensitivity is not an issue, nor are feel system characteristics. Gross acquisition CH 5, PIO 2. Fine tracking CH 4, PIO 1.
3. During 1g formation flight in ENHAN mode, DAG 0, at 0.9 Mach, 25,000 feet, gross acquisition is degraded from the CONV mode, resulting in overshoots in excess of the adequate criterion in pitch. Predictability is poor due to an initial lag in the aircraft pitch response, and then an abruptness in the response. Pilot compensation requires a lead technique to be used to obtain the desired response, which is not always possible in a consistent way. Lower pilot aggressiveness lessens the effect of the lag in the initial

response and the amount of overshoot experienced in acquiring the desired formation position. No coupling of axes was noted. The pitch axis is overly sensitive in that it is too abrupt in the pitch response. During fine tracking, it is difficult to precisely track the desired position, but it is easy to stay within the desired tracking criterion. However, the 0.2g oscillation noted in 1g flight causes spurious inputs to the pitch axis, adversely affecting the pilot's ability to precisely track a point. Pilot gain does not have a significant effect on this spurious input. It is like flying with mild turbulence on the aircraft, reducing pitch axis predictability. No feel system issues were noted. Gross acquisition CH 7, PIO 3. Fine tracking CH 4.5, PIO 2. As indicated by the ratings, this mode is significantly degraded from the CONV mode for aggressive gross acquisition, but is only slightly degraded for fine tracking. The degradation in gross acquisition is due to the lag and sensitivity in the pitch response. The degradation in the fine tracking is due to the spurious inputs caused by the 0.2g residual oscillation noted in 1g flight. Without this residual oscillation, fine tracking would probably be comparable with the CONV mode.

4. During 1g formation flight in ENHAN mode, DAG 21, at 0.9 Mach, 25,000 feet, handling qualities were comparable or improved over the CONV mode and improved over the ENHAN, DAG 0, mode. The aircraft response was more sensitive than CONV mode, and, whereas sensitivity was similar to that noted in the DAG 0 mode, the lag was absent. This resulted in an aircraft that displayed predictability in its response that was similar to the CONV mode. Overshoots were generally within the adequate region. With less aggressive inputs, the aircraft predictability was good. The increased sensitivity in terms of higher natural frequency in the response provided improved fine tracking. It was generally quite easy to maintain the desired tracking position, and the spurious inputs noted above were easy to suppress, not causing any notable problems. No feel system effects were noted. Gross acquisition CH 5, PIO 2. Fine tracking CH 2, PIO 1.
5. During air-to-air tracking at 0.9 Mach, 25,000 feet, CONV mode, the aircraft displays desirable flying qualities in the pitch axis with no objectionable characteristics noted. Gross acquisition in the pitch axis is predictable, with no objectionable overshoot tendency—generally remaining within the desired criterion. Fine tracking is precise. Pitch gross acquisition CH 2, PIO 1. Pitch fine tracking CH 2, PIO 1. The lateral-directional axis suffers from poor predictability in the gross acquisition, with a sluggish roll response being the primary objectionable characteristic. It is difficult to move the pipper from a 50 to 100 MIL error to the target aggressively. No overshoot tendency is noted—the principle problem is a tendency to undershoot the target. Fine tracking yielded desirable characteristics in the lateral-directional axis, although precision is slightly reduced when compared to the pitch axis. No coupling of axes was noted, and feel system characteristics do not appear to affect aircraft response. Lateral gross acquisition CH 7, PIO 1. Lateral fine tracking CH 3, PIO 1. During air-to-air tracking at 0.9 Mach, 25,000 feet, ENHAN mode, DAG 0, the aircraft displays generally desirable flying qualities in the pitch axis with no significant objectionable characteristics noted. Gross acquisition in the pitch axis was slightly degraded from the CONV mode due to the increased sensitivity of the response. Lag effects noted during formation flight did not appear to pose a significant problem, but may add slightly to the degraded flying qualities. The most significant effect noticed was an increase in the stiffness of the aircraft, which appeared to the pilot as an apparent increase in the pitch axis stick forces. Overshoots were within the desired criterion, but were slightly larger than those noted in CONV mode. Pitch gross acquisition CH 4, PIO 1. Pitch fine tracking CH 2, PIO 1.

The lateral-directional axes response was improved over the CONV mode, with much improved predictability during gross acquisition as compared to the CONV mode. Fine tracking was comparable to the CONV mode. Lateral gross acquisition CH 4, PIO 1. Lateral fine tracking CH 3, PIO 1.

7. During 1g formation flight in ENHAN mode, DAG 0, at 0.75 Mach, 20,000 feet, a moderate PIO tendency was noted due to an initial lag in the pitch response followed by an overly sensitive response. This resulted in poor predictability during gross acquisition maneuvers, resulting in three or more overshoots. The pilot could compensate for the lag with a lead technique, but results were not consistent and this is deemed more than desirable compensation since it requires a certain consciousness by the pilot to achieve desired response. Lower pilot control gains also resulted in less overshoot. Fine tracking was similar to that noted at 0.9 Mach, 25,000 feet, ENHAN mode, DAG 0. Gross acquisition CH 6, PIO 4. Fine tracking CH 4, PIO 2.
8. During 1g formation flight in ENHAN mode, DAG 21, at 0.75 Mach, 20,000 feet, an overly sensitive pitch response was noted, resulting in two or three overshoots of the desired tracking position. The response was characterized by a quick response with similar sensitivity as the DAG 0 configuration. No lag was noted. Pilot compensation strategy was difficult to determine other than to lessen pilot aggressiveness and control gain. However, fine tracking in this mode resulted in desirable handling qualities, with good precision of control within the desired region. Gross acquisition CH 6, PIO 3. Fine tracking CH 2, PIO 1.

**Overall Comments:**

In general, the DAG 21 configuration appeared to be an improvement over the DAG 0 configuration in the ENHAN mode at both flight conditions tested during formation flight. Slight improvements were noted during gross acquisition, but significant improvements were noted in fine tracking tasks. During gross acquisition, some tendency to get larger than desired overshoots followed by a couple of oscillations were noted before the aircraft settled into the desired position. During fine tracking, the DAG 21 configuration was clearly more precise. DAG 0 was comparable to CONV mode for fine tracking in the formation task, whereas DAG 21 was a significant improvement over CONV. During air-to-air tracking, the lateral-directional axis in the ENHAN mode, DAG 0, was clearly superior to the CONV mode. Longitudinal tracking in the air-to-air task was comparable, with the ENHAN mode more prone to overshoots during gross acquisition due to increased sensitivity, which degraded gross acquisition slightly.

**Recommendations:**

None.

James W. Smolka  
Project Pilot

**IFCS ACTIVE Flight 134**

ACTIVE Flight: 134

Return to base was required prior to engaging the enhanced control mode due a shutdown in one of the research flight control processor channels.

### IFCS ACTIVE Flights 135 and 136

IFCS Flight: ACTIVE Flight: 135 and 136  
Date: 14 Apr 99

**First Flight:**

Takeoff Time: 0935  
Duration: 0.6 hours  
Crew: Dana Purifoy/Gerard Schkolnik  
Chase: F-18A, NASA 851  
Weather: Clear, light winds.  
Control Room: NASA 1 Marty Trout

**Second Flight:**

Takeoff Time: 1404  
Duration: 0.6 hours  
Crew: Dana Purifoy/Larry Walker  
Chase: F-18A, NASA 851  
Weather: Clear, light winds.  
Control Room: NASA 1, Mike Thomson

**Maneuvers Flown:**

**First Flight:**

1. Clearance to 32,000 ft MSL and M = 1.2
2. ITB #1 at 32,000 ft MSL and M = 1.2
3. ITB #2 at this condition
4. HQID pitch and roll maneuvers

**Second Flight:**

8. HQID roll and yaw maneuvers (all maneuvers at 32,000 ft MSL and M = 1.2)
9. AdAPT Dag 25, 28, 31
10. AdAPT Dag 27 and conventional mode with 180 secs of P/R/Y doublets
11. Dag 22 ITB #1 and ITB #2 and HQID roll and yaw maneuvers

**Pilot Observations and Comments:**

All the maneuvers were flown without any difficulty.

Dana Purifoy  
ACTIVE project pilot

### IFCS ACTIVE Flight 137

Date: 16 April 1999  
ACTIVE Flight: 137; 1.0 hour  
Crew: Larry Walker/Dana Purifoy  
Chase: NASA 843 (Tom McMurtry)  
Controller: NASA 1 (Marty Trout)  
Weather: Mostly clear with scattered stratus

#### Maneuvers Flown:

4. Air-to-air tracking, 0.75 Mach, 20,000 feet, 3g target, in the following modes:
  - c. CONV
  - d. ENHAN, DAG 0
  - e. ENHAN, DAG 23
  - f. ENHAN, DAG 22
5. Formation flight, 0.75 Mach, 20,000 feet, 1g, in the following modes:
  - d. CONV
  - e. ENHAN, DAG 0
  - f. ENHAN, DAG 22
3. Air-to-air tracking, 0.9 Mach, 25,000 feet, 3g, in the following modes:
  - c. ENHAN, DAG 0
  - d. ENHAN, DAG 23
  - e. ENHAN, DAG 22

#### Observations:

9. Air-to-air tracking at 0.75 M at 20,000 ft produced the following:
  - a. CONV - good results as seen previously. Average error of about 2 mils. Solid Level 1; Cooper Harper Ratings (CHR) of 2 in lateral and longitudinal without any PIO tendency.
  - b. DAG 0 - Low frequency pitch disturbances at about 0.5 hz, perhaps caused by a low frequency oscillation of the right canard which disturbed any fine tracking solution. Some loss of predictability was noticed. Fine tracking had about a 4 mil error, although I could improve the accuracy by raising my gain and flying more aggressively. Longitudinal- CHR-4 for capture; and CHR-5 for fine, but CHR-3 with aggressive inputs. Laterally, the response was ok at CHR-2.
  - c. DAG-23 - Was not as good as DAG-0; lateral was acceptable. Long: CHR 3/3, PIO 1. Lateral: CHR-2.

d. DAG-22 - Although flown at the end of the mission, this version had a slight pitch bobble and overshoot, but didn't tend to diverge. I tried to use increased aggressiveness to improve accuracy, but did not see any help like I had with DAG-0. The lateral axis was significantly degraded by sluggishness and a long roll mode time constant. Ratings: Long - CHR 6/6, PIO 3. Lateral - CHR 7/5; PIO 1.

10. Formation flight at .75 Mach at 20,000 ft was rated as follows:

a. CONV - There were no problems, handling was very nice. Right canard motion was transparent in CONV and did not upset the trimmability or hands-off stability. Ratings: Long: CHR 2/2, PIO 1; Lateral: 2.

b. DAG-0 - Pitch axis was very PIO prone. Without compensation I was very soon in a 0 to 2 g oscillation. I did not like this response at all and had to reduce my gain. However, without the hands off stability (due to the low frequency right canard oscillation?), I had to enter the loop and was in a mild PIO even with compensation. Ratings - Long: CHR 8/8 (gross/fine, respectively); PIO 4 or 5; Lateral: CHR-2.

c. DAG-22 - Pitch was still the worst axis and was still very PIO prone, but lateral was now very sluggish with a slow response. I didn't want to go as close as I had been in CONV mode. Ratings - Long: CHR 8/8; PIO 4; Lateral: 6.

3. Air-to-air tracking at .9 Mach at 25,000 ft was rated as follows:

a. DAG-0 - A dramatic improvement in response was noted here as the longitudinal response was satisfactory at CHR-2/2. No PIO proneness was noted. Lateral was also acceptable.

b. DAG- 23 - This mode also looked good and was acceptable with the same mid Level 1 ratings.

**DAG Control Values Legend (post flight debrief):**

Approximate values:	Control Anticipation Parameter	Roll Mode (sec)
CONV		.4
DAG 0	.58	.3
DAG 21	.8	.3
DAG 22	.8	1.0
DAG 23	.58	.3 (linear lat. stick)

**Overall Comments:**

Although much of the flight was devoted to show how the IFCS can achieve a variety of handling qualities, it must be understood that these variations are not necessarily the desired goal, but that it is intended to demonstrate how the IFCS can achieve these goals. Accordingly, the Intelligent Flight Control System represents a significant advance in techniques used for flight control system design. With the embedded neural net, the IFCS has the potential to improve flight safety when confronted with unknown configurations, which might be caused by a hardover, or loss of control of one or more control surfaces. Additionally, such a neural net



might also be used to shorten flight test development time by homing in on the best set of gains to be used to achieve the best flying qualities.

Although today we examined several variations in end state, the capabilities demonstrated by the IFCS will advance our capability for expeditious control law design well into the 21st century.

**Larry**

Laurence A. Walker  
Chief Experimental Test Pilot  
Boeing - McDonnell Aircraft and Missiles Systems

**IFCS ACTIVE Flight 138**

**Program:** F-15 ACTIVE

**Flight Number:** 138

**Date:** 16 Apr 99

**Aircrew:** Dunlop/ Schkolnik

**Control Room:** NASA 1, Trout

**Chase:** F-18A, NASA 843 (Stucky)

**Weather:** Light winds, Overcast 290-320

**GROUND OPERATIONS:**

- No comments

**INFLIGHT:**

Maneuvers accomplished at 32K/1.2M ( Due to weather at FL320 the maneuvers were actually accomplished between FL320 and approximately FL335)

-Cards 4&5 (ENHAN raps, doublets, half stick bank-to-bank rolls, and pitch captures); Pitch and roll doublets were responsive and well damped. Yaw doublets were deadbeat. Roll acceleration, and roll rate were very good and predictable with 60-to-60 captures easily accomplished. Five and 10-degree pitch captures were easily accomplished with a very small (less than 1-degree) overshoot when trying to maintain the pitch capture attitude.

- Cards 10,11, &12 (DAG 22 raps, doublets, half stick bank-to-bank rolls, and pitch captures, 360-degree rolls, and R/Y frequency sweeps): Pitch response was similar to baseline ENHAN mode. The roll acceleration was noticeably slower than baseline, and bank captures were difficult to precisely accomplish (overshoots of approximately 10 degrees). During the 360-degree rolls, the steady state roll rate appeared comparable to the baseline roll rate, however the slower roll acceleration again made the rollout difficult to predict with any precision.

- Card 13 (DAG 21 pitch doublet and frequency sweep): No comments.

- Cards 14&15 (DAG 23 roll raps and doublets, half stick bank-to-bank rolls, half and full stick 360-degree rolls): Roll performance was very quick and responsive, but a little too sensitive. Holding full stick deflection during the full stick 360-degree aileron roll was difficult due to the quick roll acceleration.

**POSTFLIGHT:**

- Uneventful

**RECOMMENDATIONS:**

- None

C-25

**IFCS ACTIVE Flight 139**

**Program:** F-15 ACTIVE

**Flight Number:** 139

**Date:** 16 Apr 99

**Aircrew:** Dunlop/Meyer

**Control Room:** NASA 1, Schkolnik

**Chase:** F-18B, NASA 852 (Schneider)

**Weather:** Light winds, Broken 260

**GROUND OPERATIONS:**

- IFPC bit required in excess of ten attempts before passing.

**INFLIGHT:**

Maneuvers accomplished at 20K/0.7M

- Card CRR (CONV and ENHAN raps, doublets, half stick bank-to-bank rolls, pitch captures and a 4G WUT): General comments were that the pitch captures were similar in both modes, however the roll rate and predictability may have been better in the ENHAN mode.
  - Cards 35&36 (Formation Flight tasks in CONV and ENHAN modes): Desired performance was met in each of the capture tasks, with all tasks accomplished at a low gain level. General comments were that there was a slight "gallup" during fine tracking in the ENHAN mode. Gross acquisitions were accomplished at very low gain, and there was no comment as to the difference in the capture tasks between CONV and ENHAN. A quick look at DAG 22 was accomplished with the only comment being that the "gallup" in fine tracking was less.
- Maneuvers accomplished at 25K/0.9M
- Card 24 (DAG 25, DAG 28, and DAG 31 with AdAPT excitations): No comments
  - Card 25 (DAG 24, DAG 27 with AdAPT excitations): Pitch, roll, and yaw doublets were accomplished during the first 90 seconds of the excitation period, with pitch and roll captures accomplished during the second 90 second period of the excitation.
  - Card 26 (DAG 30 with AdAPT excitations): Pitch, roll, and yaw doublets were accomplished during the first 90 seconds of the excitation period, with pitch and roll captures accomplished during the second 90 second period of the excitation.

**POSTFLIGHT:**

- Uneventful

C-26

**RECOMMENDATIONS:**

- None

C-27

### IFCS ACTIVE Flight 140

IFCS Flight: ACTIVE Flight: 140  
Date: 23 Apr 99

Takeoff Time: 0850

Duration: 1.1 hours

Crew: Dana Purifoy/Marty Trout

Chase: F-18A, NASA 851

Weather: Clear, light winds.

Control Room: NASA 1 Witt Lock

#### Maneuvers Flown:

1. Clearance maneuvers for 16,000 ft MSL and  $M = 0.85$
2. ITB #1 at this condition
3. ITB #2
4. Accel at 32,000 ft MSL from  $M = 0.85$  to 1.2 with 4g decel turn
5. Split-S maneuver from 32,000 ft MSL and  $M = 0.85$  using 11 deg AOA to 4 g
6. Hands off trim at 20,000 ft MSL and  $M = 0.6, 0.75$  (conv and enhanced)
7. Gibson Dropback maneuvers at 20,000 ft MSL and  $M = 0.75$  (conv, enhanced, Dag21)
8. Tracking task in enhanced at 25,000 ft MSL and  $M = 0.9$

#### Pilot Observations and Comments:

1. The clearance to 16,000 ft and 0.85 showed an increase in the amplitude of the pitch oscillation seen at the previous flight conditions. This increased motion was evident from about 19,000 ft and increased slightly until level off. The frequency of the motion seemed about the same as the other flight conditions. Aircraft control was not an issue, but fine pitch tracking was not possible. The remainder of the clearance maneuvers were accomplished without difficulty.
2. The accel from 0.85 to 1.2 and the decel was uneventful until the very end when 4g's, 11 AOA and some airframe buffet occurred at about the same time. There may have been a very slight pitch up tendency seen at this moment.
3. The split-s maneuver was accomplished twice. The first was aborted when the "normal" slight pitch oscillation coupled into the pull down and caused an overshoot of the target AOA (11 deg). The system downmoded at that time. The second attempt was successful with an initial target AOA of 10 deg until 4g's were seen. This resulted in a slightly higher airspeed and slightly larger altitude loss than was predicted in the sim. The aircraft did not demonstrate any handling qualities problems.
4. A very quick tracking maneuver was accomplished. The aircraft exhibited the previously seen small oscillation about neutral in pitch. Gross acq and fine tracking were level 2 (?). The lateral axis seemed to show a slight hesitation during the gross acq maneuver. Fine tracking was smooth and precise.

Dana Purifoy, ACTIVE project pilot

## IFCS ACTIVE Flight 141

**Program:** F-15 ACTIVE

**Flight Number:** 141

**Date:** 23 Apr 99

**Aircrew:** Dunlop/ Stout

**Control Room:** NASA 1, Thomson

**Chase:** F-18B, NASA 843 (Purifoy)

**Weather:** Light winds, Overcast 150-190

### GROUND OPERATIONS:

- No comments

### INFLIGHT:

Maneuvers accomplished at 25K, 0.9M

Card 14 (CONV and ENHAN trim shots): The aircraft felt smooth and stable in the longitudinal axis during the conventional trim shot. When initially triggering to the ENHAN mode the slight pitch oscillations were apparent, and during the trim shot the oscillations were approximately +/- .1 to .2 g's in magnitude. During both trim shots the aircraft had a tendency to roll to the right. The roll may have been a result of rushing the start of the maneuver (only longitudinal trim inputs were made prior to the conventional mode trim shot, and the T/O trim may not have been true), but the tendency was still present after trimming out the right roll tendency following the ENHAN engagement.

Card 19 (DAG 23 tracking exercise) Longitudinal acquisition and tracking was similar to baseline enhanced, with predictable overshoots present as gain increased in gross acquisition, and a small longitudinal oscillation which prevented achieving the fine tracking desired performance. Lateral gross acquisition was similar to the 20K/0.75 DAG 23 point where there was a tendency to start the roll out early and then step over to the desired capture point. Desired fine tracking was achieved only with very low gain, and as the gain was increased the roll response was easy to over-control. The Cooper-Harper Ratings were: Longitudinal Gross Acquisition - 3, PIO Rating - 2, Fine Tracking - 5, PIO Rating - 3, Lateral Gross Acquisition - 3, PIO rating - 2, Fine Tracking - 5, PIO rating - 3, Confidence Rating - A.

Maneuvers accomplished at 20K, .75M

Cards 24&25 (CONV mode tracking exercise): The aircraft tracking was solid in both gross acquisition and fine tracking. With increased gain in the longitudinal gross acquisition, the task was easily accomplished with only a barely noticeable increase in overshoot tendency. The lateral gross acquisition was smooth, however there was a small tendency to undershoot the desired rollout (less than 25 mil undershoot), resulting in the some minimal additional compensation to achieve the desired rollout point. The Cooper-Harper Ratings were:

Longitudinal Gross Acquisition - 2, PIO Rating - 1, Fine Tracking - 2, PIO Rating - 1, Lateral Gross Acquisition - 3, PIO rating - 1, Fine Tracking - 3, PIO rating - 2, Confidence Rating - A.

Cards 26&27 (ENHAN mode tracking exercise): In the ENHAN mode there was a small but noticeable longitudinal oscillation that resulted in larger overshoots in the longitudinal gross acquisition task than were found in the conventional mode. As with previous comments in this mode, the overshoots appeared to be linear with gain increase, and were predictable. The small oscillations did however prevent the desired fine tracking criteria from being met, even with moderate compensation attempted. Lateral gross acquisition was similar to the conventional mode. The Cooper-Harper Ratings were: Longitudinal Gross Acquisition - 3, PIO Rating - 2, Fine Tracking - 5, PIO Rating - 3, Lateral Gross Acquisition - 3, PIO rating - 2, Fine Tracking - 4, PIO rating - 2, Confidence Rating - A.

Cards 28&29 (DAG 22 tracking exercise): The longitudinal gross acquisition and fine tracking appeared the same as baseline enhanced. In the lateral axis the aircraft felt slow to roll, making gross acquisition more difficult to predict and compensate for. Lateral fine tracking capability was actually slightly improved over baseline enhanced mode because the slower roll response was sufficient for fine tracking and mitigated any overshoot tendencies. Cooper-Harper Ratings were: Longitudinal Gross Acquisition - 3, PIO Rating - 2, Fine Tracking - 5, PIO Rating - 3, Lateral Gross Acquisition - 4, PIO rating - 2, Fine Tracking - 3, PIO rating - 1, Confidence Rating - A.

Cards 30&31 (DAG 23 tracking exercise): Longitudinal acquisition and tracking comments are the same as for baseline, except that desired performance was achieved this time in longitudinal fine tracking. No differences were noted in aircraft longitudinal characteristics, but the compensation was just enough to allow the oscillations that are usually just outside the desired criteria, to fall within the desired criteria. The lateral gross acquisition was characterized by a tendency to start the rollout early, and stair-step to the desired criteria. While only requiring only minimal compensation to achieve the desired criteria, the "ratchety" capture felt unnatural. Lateral fine tracking required no increased compensation. Cooper-Harper Ratings were: Longitudinal Gross Acquisition - 3, PIO Rating - 2, Fine Tracking - 4, PIO Rating - 2, Lateral Gross Acquisition - 3, PIO rating - 1, Fine Tracking - 2, PIO rating - 1, Confidence Rating - A.

Card 32 (CONV mode formation flight): Good, responsive and predictable performance. Slight tendency to overshoot gross acquisition captures as gain increased, however overshoots were minimal and predictable. During fine tracking it was possible to maintain the missile rail in the inner half of the pilots helmet with normal pilot compensation. Cooper-Harper Ratings were: Gross Acquisition - 3, PIO Rating - 2, Fine Tracking - 2, PIO Rating - 1, Confidence Rating - A.

Card 33 (ENHAN mode formation flight): Tendency to overshoot gross acquisition captures was slightly less than in CONV mode. Fine tracking accuracy was better than conventional mode and tracking of a single point on the helmet was achieved with little additional compensation. Cooper-Harper Ratings were: Gross Acquisition - 3, PIO Rating - 1, Fine Tracking - 2, PIO Rating - 1, Confidence Rating - A.



Card 34 (DAG 21 mode formation flight): Gross acquisition capture performance was similar to the conventional mode, however it felt like there was more stick deflection required to capture and then stabilize at the desired point. Fine tracking accuracy was not as good as in than conventional mode, with the missile rail contained within the target helmet but not as precisely controlled. Cooper-Harper Ratings were: Gross Acquisition - 3, PIO Rating - 2, Fine Tracking - 3, PIO Rating - 2, Confidence Rating - A.

Just prior to the descent for RTB a "Tone Off" was displayed in the HUD, and remained for the duration of the flight.

POSTFLIGHT

- No comments

RECOMMENDATIONS

- None

## Appendix Q – Flight Test Matrix (Boeing Company 99P0040) Intelligent Flight Control Final Report

### Intelligent Flight Control System Flight Test Points

Test point Number	Test Description	Flight Conditions			Alpha	PAL	DAG	Comment
		Altitude	Mach	PLA				
IFC 1	1 g system disengage checks	20,000	0.75	PLF	Trim	3	0	ITB #1
IFC 2	Pitch Rap	20,000	0.75	PLF	Trim	3	0	ITB #1
IFC 3	Roll Rap	20,000	0.75	PLF	Trim	3	0	ITB #1
IFC 4	Yaw Kick	20,000	0.75	PLF	Trim	3	0	ITB #1
IFC 5	Pitch Doublet	20,000	0.75	PLF	Trim	3	0	ITB #1
IFC 6	Roll Doublet	20,000	0.75	PLF	Trim	3	0	ITB #1
IFC 7	Yaw Doublet	20,000	0.75	PLF	Trim	3	0	ITB #1
IFC 8	60/60 Bank Roll	20,000	0.75	PLF	Trim	0	0	ITB #1
IFC 9	Pitch Capture	20,000	0.75	PLF	Trim	0	0	ITB #1
IFC 10	Pitch Doublet	16,000	310 KCAS	PLF	Trim	3	0	Envelope Boundary
IFC 11	Roll Doublet	16,000	310 KCAS	PLF	Trim	3	0	Envelope Boundary
IFC 12	Yaw Doublet	16,000	310 KCAS	PLF	Trim	3	0	Envelope Boundary
IFC 13	Climb	16K - 34K	310 KCAS	A/R	Trim	3	0	Envelope Boundary; 3-axis doublets every 2k ft
IFC 14	Accel	34,000	310 - 460 KCAS	A/R	Trim	3	0	Envelope Boundary; 3-axis doublets every 50 kts
IFC 15	Descent	34K - 16K	460 KCAS	A/R	Trim	3	0	Envelope Boundary; 3-axis doublets every 2k ft
IFC 16	Decel	16,000	460 - 310 KCAS	A/R	Trim	3	0	Envelope Boundary; 3-axis doublets every 50 kts
IFC 17	Lt SHSS w/Abrupt Release	20,000	0.75	PLF	Trim	0	0	ITB #2 To 10 Deg BETA or MAX Pedal
IFC 18	Rt SHSS w/Abrupt Release	20,000	0.75	PLF	Trim	0	0	ITB #2 To 10 Deg BETA or MAX Pedal
IFC 19	360 deg Left Roll	20,000	0.75	PLF	Trim	0	0	ITB #2
IFC 20	360 deg Right Roll	20,000	0.75	PLF	Trim	0	0	ITB #2
IFC 21	Wind-up Turn to 4.0g	20,000	0.75	A/R	Trim	0	0	ITB #2
IFC 22	Gross Acquisition	20,000	0.75	A/R	12 Max	0	0	ITB #2 To 3.0g
IFC 23	Fine Tracking	20,000	0.75	A/R	12 Max	0	0	ITB #2 To 3.0g
IFC 24	Formation Acquisition	20,000	0.75	A/R	Trim	0	0	ITB #2
IFC 25	Formation Tracking	20,000	0.75	A/R	Trim	0	0	ITB #2
IFC 26	ADAPT Excitation A	20,000	0.75	PLF	Trim	0	25	15 Sec/ .2 Deg
IFC 27	ADAPT Excitation A	20,000	0.75	PLF	Trim	0	28	15 Sec/ .4 Deg
IFC 28	ADAPT Excitation A	20,000	0.75	PLF	Trim	0	31	15 Sec/ .8 Deg
IFC 29	ADAPT Excitation B	20,000	0.75	PLF	Trim	0	24	P & R Doublets & Captures, Y Doublets, 180 Sec/2 Deg
IFC 30	ADAPT Excitation B	20,000	0.75	PLF	Trim	0	0	P & R Doublets & Captures, Y Doublets, 180 Sec/2 Deg; CVNTL
IFC 31	ADAPT Excitation B	20,000	0.75	PLF	Trim	0	27	P & R Doublets & Captures, Y Doublets, 180 Sec/4 Deg

Test point Number	Test Description	Flight Conditions			Alpha	PAL	DAG	Comment
		Altitude	Mach	PLA				
IFC 32	ADAPT Excitation B	20,000	0.75	PLF	Trim	0	30	P & R Doublets & Captures, Y Doublets, 180 Sec/.8 Deg
IFC 33	ADAPT Excitation C	20,000	0.75	PLF	Trim	0	0	
IFC 34	ADAPT Excitation C	20,000	0.75	PLF	Trim	0	29	30 Sec/.4 Deg
IFC 35	ADAPT Excitation C	20K - 32K	0.75 - 1.2	A/R	Trim	0	0	Climb; CVNTL
IFC 36	ADAPT Excitation C	32K - 20K	1.2 - 0.75	A/R	Trim	0	0	Decent; CVNTL
IFC 37	ADAPT Excitation C	20,000	0.75	PLF	Trim	0	0	30 Sec; CVNTL
IFC 38	ADAPT Excitation C	20,000	0.75	PLF	Trim	0	29	30 Sec/.4 Deg
IFC 39	Pitch Doublet	20,000	0.75	PLF	Trim	0	0	Long HQ Maneuver
IFC 40	Pilot Pitch Frequency Sweep	20,000	0.75	PLF	Trim	0	0	Long HQ Maneuver
IFC 41	Roll Doublet	20,000	0.75	PLF	Trim	0	0	Lat-Dir HQ Maneuver
IFC 42	Yaw Doublet	20,000	0.75	PLF	Trim	0	0	Lat-Dir HQ Maneuver
IFC 43	Pilot Roll Frequency Sweep	20,000	0.75	PLF	Trim	0	0	Lat-Dir HQ Maneuver
IFC 44	Pilot Yaw Frequency Sweep	20,000	0.75	PLF	Trim	0	0	Lat-Dir HQ Maneuver
IFC 45	360 deg Left Roll	20,000	0.75	PLF	Trim	0	0	Lat-Dir HQ Maneuver
IFC 46	360 deg Right Roll	20,000	0.75	PLF	Trim	0	0	Lat-Dir HQ Maneuver
IFC 47	1 g system disengage checks	25,000	0.90	PLF	Trim	0	0	ITB #1
IFC 48	Pitch Rap	25,000	0.90	PLF	Trim	0	0	ITB #1
IFC 49	Roll Rap	25,000	0.90	PLF	Trim	0	0	ITB #1
IFC 50	Yaw Kick	25,000	0.90	PLF	Trim	0	0	ITB #1
IFC 51	Pitch Doublet	25,000	0.90	PLF	Trim	0	0	ITB #1
IFC 52	Roll Doublet	25,000	0.90	PLF	Trim	0	0	ITB #1
IFC 53	Yaw Doublet	25,000	0.90	PLF	Trim	0	0	ITB #1
IFC 54	60/60 Bank Roll	25,000	0.90	PLF	Trim	0	0	ITB #1
IFC 55	Pitch Capture	25,000	0.90	PLF	Trim	0	0	ITB #1
IFC 56	Lt SHSS w/Abrupt Release	25,000	0.90	PLF	Trim	0	0	ITB #2 To 10 Deg BETA or MAX Pedal
IFC 57	Rt SHSS w/Abrupt Release	25,000	0.90	PLF	Trim	0	0	ITB #2 To 10 Deg BETA or MAX Pedal
IFC 58	360 deg Left Roll	25,000	0.90	PLF	Trim	0	0	ITB #2
IFC 59	360 deg Right Roll	25,000	0.90	PLF	Trim	0	0	ITB #2
IFC 60	Wind-up Turn to 4.0g	25,000	0.90	A/R	Trim	0	0	ITB #2
IFC 61	Gross Acquisition	25,000	0.90	A/R	12 Max	0	0	ITB #2 To 3.0g

Test point Number	Test Description	Flight Conditions						Comment
		Altitude	Mach	PLA	Alpha	PAL	DAG	
IFC 62	Fine Tracking	25,000	0.90	A/R	12 Max	0	0	ITB #2 To 3.0g
IFC 63	Formation Acquisition	25,000	0.90	A/R	Trim	0	0	ITB #2
IFC 64	Formation Tracking	25,000	0.90	A/R	Trim	0	0	ITB #2
IFC 65	Pitch Doublet	25,000	0.90	PLF	Trim	0	0	Long HQ Maneuver
IFC 66	Pilot Pitch Frequency Sweep	25,000	0.90	PLF	Trim	0	0	Long HQ Maneuver
IFC 67	Roll Doublet	25,000	0.90	PLF	Trim	0	0	Lat-Dir HQ Maneuver
IFC 68	Yaw Doublet	25,000	0.90	PLF	Trim	0	0	Lat-Dir HQ Maneuver
IFC 69	Pilot Roll Frequency Sweep	25,000	0.90	PLF	Trim	0	0	Lat-Dir HQ Maneuver
IFC 70	Pilot Yaw Frequency Sweep	25,000	0.90	PLF	Trim	0	0	Lat-Dir HQ Maneuver
IFC 71	360 deg Left Roll	25,000	0.90	PLF	Trim	0	0	Lat-Dir HQ Maneuver
IFC 72	360 deg Right Roll	25,000	0.90	PLF	Trim	0	0	Lat-Dir HQ Maneuver
IFC 73	Pitch Rap	20,000	0.75	PLF	Trim	0	22	ITB #1
IFC 74	Roll Rap	20,000	0.75	PLF	Trim	0	22	ITB #1
IFC 75	Yaw Kick	20,000	0.75	PLF	Trim	0	22	ITB #1
IFC 76	Pitch Doublet	20,000	0.75	PLF	Trim	0	22	ITB #1
IFC 77	Roll Doublet	20,000	0.75	PLF	Trim	0	22	ITB #1
IFC 78	Yaw Doublet	20,000	0.75	PLF	Trim	0	22	ITB #1
IFC 79	60/60 Bank Roll	20,000	0.75	PLF	Trim	0	22	ITB #1
IFC 80	Pitch Capture	20,000	0.75	PLF	Trim	0	22	ITB #1
IFC 81	Lt SHSS w/Abrupt Release	20,000	0.75	PLF	Trim	0	22	ITB #2 To 10 Deg BETA or MAX Pedal
IFC 82	Rt SHSS w/Abrupt Release	20,000	0.75	PLF	Trim	0	22	ITB #2 To 10 Deg BETA or MAX Pedal
IFC 83	360 deg Left Roll	20,000	0.75	PLF	Trim	0	22	ITB #2
IFC 84	360 deg Right Roll	20,000	0.75	PLF	Trim	0	22	ITB #2
IFC 85	Wind-up Turn to 4.0g	20,000	0.75	PLF	Trim	0	22	ITB #2
IFC 86	Roll Doublet	20,000	0.75	PLF	Trim	0	22	Lat-Dir HQ Maneuver
IFC 87	Yaw Doublet	20,000	0.75	PLF	Trim	0	22	Lat-Dir HQ Maneuver
IFC 88	Pilot Roll Frequency Sweep	20,000	0.75	PLF	Trim	0	22	Lat-Dir HQ Maneuver
IFC 89	Pilot Yaw Frequency Sweep	20,000	0.75	PLF	Trim	0	22	Lat-Dir HQ Maneuver
IFC 90	360 deg Left Roll	20,000	0.75	PLF	Trim	0	22	Lat-Dir HQ Maneuver
IFC 91	360 deg Right Roll	20,000	0.75	PLF	Trim	0	22	Lat-Dir HQ Maneuver

Test point Number	Test Description	Flight Conditions			Alpha	PAL	DAG	Comment
		Altitude	Mach	PLA				
IFC 92	Pitch Rap	20,000	0.75	PLF	Trim	0	21	ITB #1
IFC 93	Pitch Doublet	20,000	0.75	PLF	Trim	0	21	ITB #1
IFC 94	Pitch Capture	20,000	0.75	PLF	Trim	0	21	ITB #1
IFC 95	Wind-up Turn to 4.0g	20,000	0.75	PLF	Trim	0	21	ITB #2
IFC 96	Gross Acquisition	20,000	0.75	A/R	12 Max	0	21	ITB #2 To 3.0g
IFC 97	Fine Tracking	20,000	0.75	A/R	12 Max	0	21	ITB #2 To 3.0g
IFC 98	Formation Acquisition	20,000	0.75	A/R	Trim	0	21	ITB #2
IFC 99	Formation Tracking	20,000	0.75	A/R	Trim	0	21	ITB #2
IFC 100	Pitch Doublet	20,000	0.75	PLF	Trim	0	21	Long HQ Maneuver
IFC 101	Pilot Pitch Frequency Sweep	20,000	0.75	PLF	Trim	0	21	Long HQ Maneuver
IFC 102	Roll Rap	20,000	0.75	PLF	Trim	0	23	ITB #1
IFC 103	Roll Doublet	20,000	0.75	PLF	Trim	0	23	ITB #1
IFC 104	60/60 Bank Roll	20,000	0.75	PLF	Trim	0	23	ITB #1
IFC 105	360 deg Left Roll	20,000	0.75	PLF	Trim	0	23	ITB #2
IFC 106	360 deg Right Roll	20,000	0.75	PLF	Trim	0	23	ITB #2
IFC 107	Wind-up Turn to 4.0g	20,000	0.75	PLF	Trim	0	23	ITB #2
IFC 108	Gross Acquisition	20,000	0.75	A/R	12 Max	0	23	ITB #2 To 3.0g
IFC 109	Fine Tracking	20,000	0.75	A/R	12 Max	0	23	ITB #2 To 3.0g
IFC 110	Formation Acquisition	20,000	0.75	A/R	Trim	0	23	ITB #2
IFC 111	Formation Tracking	20,000	0.75	A/R	Trim	0	23	ITB #2
IFC 112	Pitch Rap	25,000	0.90	PLF	Trim	0	22	ITB #1
IFC 113	Roll Rap	25,000	0.90	PLF	Trim	0	22	ITB #1
IFC 114	Yaw Kick	25,000	0.90	PLF	Trim	0	22	ITB #1
IFC 115	Pitch Doublet	25,000	0.90	PLF	Trim	0	22	ITB #1
IFC 116	Roll Doublet	25,000	0.90	PLF	Trim	0	22	ITB #1
IFC 117	Yaw Doublet	25,000	0.90	PLF	Trim	0	22	ITB #1
IFC 118	60/60 Bank Roll	25,000	0.90	PLF	Trim	0	22	ITB #1
IFC 119	Pitch Capture	25,000	0.90	PLF	Trim	0	22	ITB #1
IFC 120	Lt SHSS w/Abrupt Release	25,000	0.90	PLF	Trim	0	22	ITB #2 To 10 Deg BETA or MAX Pedal
IFC 121	Rt SHSS w/Abrupt Release	25,000	0.90	PLF	Trim	0	22	ITB #2 To 10 Deg BETA or MAX Pedal

Test point Number	Test Description	Flight Conditions						Comment
		Altitude	Mach	PLA	Alpha	PAL	DAG	
IFC 122	360 deg Left Roll	25,000	0.90	PLF	Trim	0	22	ITB #2
IFC 123	360 deg Right Roll	25,000	0.90	PLF	Trim	0	22	ITB #2
IFC 124	Wind-up Turn to 4.0g	25,000	0.90	PLF	Trim	0	22	ITB #2
IFC 125	Roll Doublet	25,000	0.90	PLF	Trim	0	22	Lat-Dir HQ Maneuver
IFC 126	Yaw Doublet	25,000	0.90	PLF	Trim	0	22	Lat-Dir HQ Maneuver
IFC 127	Pilot Roll Frequency Sweep	25,000	0.90	PLF	Trim	0	22	Lat-Dir HQ Maneuver
IFC 128	Pilot Yaw Frequency Sweep	25,000	0.90	PLF	Trim	0	22	Lat-Dir HQ Maneuver
IFC 129	360 deg Left Roll	25,000	0.90	PLF	Trim	0	22	Lat-Dir HQ Maneuver
IFC 130	360 deg Right Roll	25,000	0.90	PLF	Trim	0	22	Lat-Dir HQ Maneuver
IFC 131	Pitch Rap	25,000	0.90	PLF	Trim	0	21	ITB #1
IFC 132	Pitch Doublet	25,000	0.90	PLF	Trim	0	21	ITB #1
IFC 133	Pitch Capture	25,000	0.90	PLF	Trim	0	21	ITB #1
IFC 134	Wind-up Turn to 4.0g	25,000	0.90	PLF	Trim	0	21	ITB #2
IFC 135	Gross Acquisition	25,000	0.90	A/R	12 Max	0	21	ITB #2 To 3.0g
IFC 136	Fine Tracking	25,000	0.90	A/R	12 Max	0	21	ITB #2 To 3.0g
IFC 137	Formation Acquisition	25,000	0.90	A/R	Trim	0	21	ITB #2
IFC 138	Formation Tracking	25,000	0.90	A/R	Trim	0	21	ITB #2
IFC 139	Pitch Doublet	25,000	0.90	PLF	Trim	0	21	Long HQ Maneuver
IFC 140	Pilot Pitch Frequency Sweep	25,000	0.90	PLF	Trim	0	21	Long HQ Maneuver
IFC 141	Roll Rap	25,000	0.90	PLF	Trim	0	23	ITB #1
IFC 142	Roll Doublet	25,000	0.90	PLF	Trim	0	23	ITB #1
IFC 143	60/60 Bank Roll	25,000	0.90	PLF	Trim	0	23	ITB #1
IFC 144	360 deg Left Roll	25,000	0.90	PLF	Trim	0	23	ITB #2
IFC 145	360 deg Right Roll	25,000	0.90	PLF	Trim	0	23	ITB #2
IFC 146	Wind-up Turn to 4.0g	25,000	0.90	PLF	Trim	0	23	ITB #2
IFC 147	Gross Acquisition	25,000	0.90	A/R	Trim	0	23	ITB #2 To 3.0g
IFC 148	Fine Tracking	25,000	0.90	A/R	Trim	0	23	ITB #2 To 3.0g
IFC 149	Formation Acquisition	25,000	0.90	A/R	Trim	0	23	ITB #2
IFC 150	Formation Tracking	25,000	0.90	A/R	Trim	0	23	ITB #2
IFC 151	1 g system disengage checks	32,000	1.20	PLF	Trim	0	0	ITB #1

Test point Number	Test Description	Flight Conditions			Alpha	PAL	DAG	Comment
		Altitude	Mach	PLA				
IFC 152	Pitch Rap	32,000	1.20	PLF	Trim	0	0	ITB #1
IFC 153	Roll Rap	32,000	1.20	PLF	Trim	0	0	ITB #1
IFC 154	Yaw Kick	32,000	1.20	PLF	Trim	0	0	ITB #1
IFC 155	Pitch Doublet	32,000	1.20	PLF	Trim	0	0	ITB #1
IFC 156	Roll Doublet	32,000	1.20	PLF	Trim	0	0	ITB #1
IFC 157	Yaw Doublet	32,000	1.20	PLF	Trim	0	0	ITB #1
IFC 158	60/60 Bank Roll	32,000	1.20	PLF	Trim	0	0	ITB #1
IFC 159	Pitch Capture	32,000	1.20	PLF	Trim	0	0	ITB #1
IFC 160	Lt SHSS w/Abrupt Release	32,000	1.20	PLF	Trim	0	0	ITB #2 To 10 Deg BETA or MAX Pedal
IFC 161	Rt SHSS w/Abrupt Release	32,000	1.20	PLF	Trim	0	0	ITB #2 To 10 Deg BETA or MAX Pedal
IFC 162	360 deg Left Roll	32,000	1.20	PLF	Trim	0	0	ITB #2
IFC 163	360 deg Right Roll	32,000	1.20	PLF	Trim	0	0	ITB #2
IFC 164	Wind-up Turn to 4.0g	32,000	1.20	A/R	Trim	0	0	ITB #2
IFC 165	Pitch Doublet	32,000	1.20	PLF	Trim	0	0	Long HQ Maneuver
IFC 166	Pilot Pitch Frequency Sweep	32,000	1.20	PLF	Trim	0	0	Long HQ Maneuver
IFC 167	Roll Doublet	32,000	1.20	PLF	Trim	0	0	Lat-Dir HQ Maneuver
IFC 168	Yaw Doublet	32,000	1.20	PLF	Trim	0	0	Lat-Dir HQ Maneuver
IFC 169	Pilot Roll Frequency Sweep	32,000	1.20	PLF	Trim	0	0	Lat-Dir HQ Maneuver
IFC 170	Pilot Yaw Frequency Sweep	32,000	1.20	PLF	Trim	0	0	Lat-Dir HQ Maneuver
IFC 171	360 deg Left Roll	32,000	1.20	PLF	Trim	0	0	Lat-Dir HQ Maneuver
IFC 172	360 deg Right Roll	32,000	1.20	PLF	Trim	0	0	Lat-Dir HQ Maneuver
IFC 173	ADAPT Excitation A	32,000	1.20	PLF	Trim	0	25	15 Sec/.2 Deg
IFC 174	ADAPT Excitation A	32,000	1.20	PLF	Trim	0	28	15 Sec/ .4 Deg
IFC 175	ADAPT Excitation A	32,000	1.20	PLF	Trim	0	31	15 Sec/ .8 Deg
IFC 176	ADAPT Excitation B	32,000	1.20	PLF	Trim	0	27	P, R & Y Doublets, 180 Sec/.4 Deg
IFC 177	ADAPT Excitation B	32,000	1.20	PLF	Trim	0	0	P, R & Y Doublets, 180 Sec; CVNTL
IFC 178	ADAPT Excitation A	25,000	0.90	PLF	Trim	0	25	15 Sec/.2 Deg
IFC 179	ADAPT Excitation A	25,000	0.90	PLF	Trim	0	28	15 Sec/ .4 Deg
IFC 180	ADAPT Excitation A	25,000	0.90	PLF	Trim	0	31	15 Sec/ .8 Deg
IFC 181	ADAPT Excitation B	25,000	0.90	PLF	Trim	0	24	P & R Doublets & Captures, Y Doublets, 180 Sec/.2 Deg

Test point Number	Test Description	Flight Conditions			Alpha	PAL	DAG	Comment
		Altitude	Mach	PLA				
IFC 182	ADAPT Excitation B	25,000	0.90	PLF	Trim	0	0	P & R Doublets & Captures, Y Doublets, 180 Sec; CVNTL
IFC 183	ADAPT Excitation B	25,000	0.90	PLF	Trim	0	27	P & R Doublets & Captures, Y Doublets, 180 Sec/4 Deg
IFC 184	ADAPT Excitation B	25,000	0.90	PLF	Trim	0	30	P & R Doublets & Captures, Y Doublets, 180 Sec/8 Deg
IFC 185	Pitch Rap	32,000	1.20	PLF	Trim	0	22	ITB #1
IFC 186	Roll Rap	32,000	1.20	PLF	Trim	0	22	ITB #1
IFC 187	Yaw Kick	32,000	1.20	PLF	Trim	0	22	ITB #1
IFC 188	Pitch Doublet	32,000	1.20	PLF	Trim	0	22	ITB #1
IFC 189	Roll Doublet	32,000	1.20	PLF	Trim	0	22	ITB #1
IFC 190	Yaw Doublet	32,000	1.20	PLF	Trim	0	22	ITB #1
IFC 191	60/60 Bank Roll	32,000	1.20	PLF	Trim	0	22	ITB #1
IFC 192	Pitch Capture	32,000	1.20	PLF	Trim	0	22	ITB #1
IFC 193	Lt SHSS w/Abrupt Release	32,000	1.20	PLF	Trim	0	22	ITB #2 To 10 Deg BETA or MAX Pedal
IFC 194	Rt SHSS w/Abrupt Release	32,000	1.20	PLF	Trim	0	22	ITB #2 To 10 Deg BETA or MAX Pedal
IFC 195	360 deg Left Roll	32,000	1.20	PLF	Trim	0	22	ITB #2
IFC 196	360 deg Right Roll	32,000	1.20	PLF	Trim	0	22	ITB #2
IFC 197	Wind-up Turn to 4.0g	32,000	1.20	PLF	Trim	0	22	ITB #2
IFC 198	Roll Doublet	32,000	1.20	PLF	Trim	0	22	Lat-Dir HQ Maneuver
IFC 199	Yaw Doublet	32,000	1.20	PLF	Trim	0	22	Lat-Dir HQ Maneuver
IFC 200	Pilot Roll Frequency Sweep	32,000	1.20	PLF	Trim	0	22	Lat-Dir HQ Maneuver
IFC 201	Pilot Yaw Frequency Sweep	32,000	1.20	PLF	Trim	0	22	Lat-Dir HQ Maneuver
IFC 202	360 deg Left Roll	32,000	1.20	PLF	Trim	0	22	Lat-Dir HQ Maneuver
IFC 203	360 deg Right Roll	32,000	1.20	PLF	Trim	0	22	Lat-Dir HQ Maneuver
IFC 204	Pitch Rap	32,000	1.20	PLF	Trim	0	21	ITB #1
IFC 205	Pitch Doublet	32,000	1.20	PLF	Trim	0	21	ITB #1
IFC 206	Pitch Capture	32,000	1.20	PLF	Trim	0	21	ITB #1
IFC 207	Wind-up Turn to 4.0g	32,000	1.20	PLF	Trim	0	21	ITB #2
IFC 208	Pitch Doublet	32,000	1.20	PLF	Trim	0	21	Long HQ Maneuver
IFC 209	Pilot Pitch Frequency Sweep	32,000	1.20	PLF	Trim	0	21	Long HQ Maneuver
IFC 210	Roll Rap	32,000	1.20	PLF	Trim	0	23	ITB #1
IFC 211	Roll Doublet	32,000	1.20	PLF	Trim	0	23	ITB #1



IFC 212	60/60 Bank Roll	32,000	1.20	PLF	Trim	0	23	ITB #1
IFC 213	360 deg Left Roll	32,000	1.20	PLF	Trim	0	23	ITB #2
IFC 214	360 deg Right Roll	32,000	1.20	PLF	Trim	0	23	ITB #2
IFC 215	Wind-up Turn to 4.0g	32,000	1.20	PLF	Trim	0	23	ITB #2
IFC 216	Gross Acquisition	25,000	0.90	A/R	12 Max	0	22	ITB #2 To 3.0g
IFC 217	Fine Tracking	25,000	0.90	A/R	12 Max	0	22	ITB #2 To 3.0g
IFC 218	Formation Acquisition	25,000	0.90	A/R	Trim	0	22	ITB #2
IFC 219	Formation Tracking	25,000	0.90	A/R	Trim	0	22	ITB #2
IFC 220	Gross Acquisition	20,000	0.75	A/R	12 Max	0	22	ITB #2 To 3.0g
IFC 221	Fine Tracking	20,000	0.75	A/R	12 Max	0	22	ITB #2 To 3.0g
IFC 222	Formation Acquisition	20,000	0.75	A/R	Trim	0	22	ITB #2
IFC 223	Formation Tracking	20,000	0.75	A/R	Trim	0	22	ITB #2
IFC	Max Acceleration	32,000	0.85 - 1.2	Max	Trim	0	0	Max Acceleration
IFC	Max Deceleration, 4g turn	32,000	1.2 - 0.85	Idle	Trim	0	0	Max Deceleration, 4g turn
IFC	Split-S	32K - 18K	0.85	Idle	Trim	0	0	Split-S, Max AOA=11 deg, Max NL=4g

