

# TIAKINA KIA ORA – PROTECTING OUR FRESHWATER MUSSELS

by

HANNAH JANE RAINFORTH

A thesis submitted to Victoria University of Wellington in fulfilment of the requirements for the degree of Masters in Ecological Restoration

VICTORIA UNIVERSITY OF WELLINGTON

2008



## ACKNOWLEDGEMENTS

To all those kaumātua who gave their time and opened their kete to me: Kevin Amohia, Wahi Teki, Te Wheturere Poope Gray, Mike Potaka, Charlie Potaka Osborne, Ben Potaka, Wiremu (Bill) Potaka Osborne, Pete Potaka Osborne, and Piki and George Waretini, tēnā rawa atu koutou, ngā puke tuku kōrero.

To my ever-patient supervisors, Murray Williams and Russell Death, thank you for all your encouragement, admonishments, ideas and free lunches. Thanks for believing in me. Murray, next time I'll study ducks.

Thank you to the Foundation for Research, Science and Technology for their provision of a Te Tipu Pūtaiao Fellowship, and to Victoria University for support through the Tū Horomata scholarship.

To the river rats, field assistants and holders of the wisdom: Wai Wiari Southen, Mike Poa, Hemi Gray, Nicola Atkinson, Racquel McKenzie, Nyree Nikora, Coner Gawith, Logan Brown, Kasey Gordon, and Natasha Petrove. Especially to those who have encouraged me through the harder times, and been a rock in turbulent waters, nei te mihi!

Thanks to my fantastic brother Ben and his quicker-than-a-speeding-bullet, sharper-than-a-thumb-tack illustration services. Thanks too to Jet Lawrence who lent me the kākahi in his stream, to Ngairi Phillips who answered my odd questions, and offered much appreciated advice, and to the technicians at Massey, Paul Barrett and Cleland Wallace, who put up with endless requests from this Victoria interloper. Also to the workers at Horizons, Kate McArthur, Maree Clark and Brent Watson, who provided data and enough books to make my backpack extra heavy.

And last but certainly not least, Aunty Maureen – provider of a place to roost and write, supplier of everything from flash drives to flash meals – thank you times infinity billion (as Chey once said).

E tika ana te kōrero, ehara taku toa i te toa takitahi, engari he toa takatini.

## CONTENTS

Acknowledgements	2
Contents	3
List of figures	4
Abstract	6
1. Ngā puke tuku kōrero – the hills that talk. Iwi knowledge of kākahi ( <i>Echyridella menziesii</i> ) in the Whanganui River	7
2. Kākahi ( <i>Echyridella menziesii</i> ) in the Whanganui River – going, going, gone?	31
3. Effect of suspended sediment on kākahi ( <i>Echyridella menziesii</i> ) feeding physiology and behaviour	60
4. Bringing them back – restoration of kākahi ( <i>Echyridella menziesii</i> ) in the Whanganui River	88
Glossary	106
Appendix 1: Suggested procedures for contacting iwi and hapū	107
Appendix 2: Propagation of juvenile kākahi in captivity	109
Appendix 3: Support available for restoration	114

## LIST OF TABLES AND FIGURES

### 1 – NGĀ PUKE TUKU KŌRERO – THE HILLS THAT TALK. IWI KNOWLEDGE OF KĀKAHI (*ECHYRIDELLA MENZIESII*) IN THE WHANGANUI RIVER

Fig. 1.	Map of the Whanganui River catchment.	9
Fig. 2.	Iwi member and river user Mike Poa knee deep in mud near Pūtiki.	16
Fig. 3.	The whakapapa of rocks, seaweed, gravel and sand, the guardians and companions of mussels.	21

### 2 – KĀKAHI (*ECHYRIDELLA MENZIESII*) IN THE WHANGANUI RIVER – GOING, GOING, GONE?

Table 1.	Characteristics of sites in the Whanganui River catchment searched for kākahi.	34
Fig. 1.	Delineation and examples of shell erosion categories.	36
Fig. 2.	Catch per unit effort.	39
Table 2.	Linear relationships between site variables and catch per unit effort (CPUE), median shell length and median shell erosion extent.	40
Fig. 3.	Length-frequency distributions of kākahi at sites in the Whanganui River catchment.	41
Fig. 4.	Bray-Curtis similarity for size class distributions of kākahi at sites in the Whanganui River where $n \geq 10$ .	42
Table 3.	Linear relationships between habitat variables and axis scores from Bray-Curtis analysis of resemblance of length class frequency distribution of kākahi at sites in the Whanganui River where $n \geq 10$ .	42
Table 4.	Abundance and status of kākahi at sites in the Whanganui River catchment.	43
Table 5.	Shell length (mm) for sites where $n < 20$ .	44
Table 6.	Median shell length and median erosion extent in the Whanganui River catchment at sites where $n \geq 10$ , and mean shell length at sites where $n \geq 20$ .	44
Fig. 5.	Extent of shell erosion.	45
Table 7.	Health of kākahi populations in the Whanganui River.	46

3 – EFFECT OF SUSPENDED SEDIMENT ON KĀKAHI (*ECHYRIDELLA MENZIESII*) FEEDING  
PHYSIOLOGY AND BEHAVIOUR

Fig. 1.	Experimental system.	62
Table 1.	Composition of treatment water supplied to kākahi.	66
Fig. 2.	Physiological and behavioural responses of kākahi as a function of total particulate matter concentration.	67
Table 2.	Equations, f, p and $r^2$ values for regression analyses.	68
Fig. 3.	Clearance rate as a function of particulate organic matter (POM); filtration rate (FR) as a function of POM; and FR as a function of organic fraction (%).	70
Fig. 4.	Kākahi rejection rate as a function of filtration rate.	71
Fig. 5.	Organic content (%) of treatment water, pseudofaeces and faeces and organic content (%) as a function of total particulate matter.	72
Fig. 6.	Kākahi selection efficiency.	73

4 – BRINGING THEM BACK – RESTORATION OF KĀKAHI (*ECHYRIDELLA MENZIESII*) IN THE  
WHANGANUI RIVER

Fig. 1.	A model of adaptive management.	90
Fig. 2.	Fig. 2. An example of how adaptive management might be used to facilitate restoration of kākahi in the Whanganui River.	94
Fig. 3.	An example of how results from management experiments could be fed back into further adaptive management responses.	96

## ABSTRACT

Mātauranga (traditional ecological knowledge) built up by Whanganui iwi during their long association with the Whanganui River provides information on local biota and anthropological changes to the river. This mātauranga records a decline in one local species, the kākahi (*Echyridella menziesii* (Gray, 1843)). Reasons suggested for this decline include alterations to flow and desiccation following a hydropower scheme, sedimentation, domestic and agricultural pollution, gravel extraction and channel modification.

Decline was confirmed by a survey of historic kākahi beds: decline was evident at 16 (73%) of 22 sites. Of those 16 sites, there were 7 sites where decline was so severe that the population had been extirpated. Of the 15 historic beds where kākahi are still extant, four (27%) were remnant populations. Evidence of recruitment was found at only four (27%) of the 15 extant populations, or 18% of the total number of sites searched.

Effect of suspended sediment concentrations ranging from 5.5 to 1212 mg.L<sup>-1</sup> on kākahi feeding behaviour and physiology was explored. Both filtration rate and rejection rate increased with increased sediment load (from 1.62 mg.h<sup>-1</sup> to 190.88 mg.h<sup>-1</sup> and from 0.62 to 201.53 mg.h<sup>-1</sup> respectively) but clearance rate decreased with sediment increase (from 0.42 to 0.20 L.h<sup>-1</sup>). Behaviour was unaffected, with kākahi filtering on average 78% of the time. As particulate organic matter increased, clearance rate decreased and filtration rate increased. Filtration rate declined with increasing % organic matter. Kākahi can continue feeding under very high sediment loads for short periods.

Much remains uncertain about kākahi, from their early biology to reasons for decline. Restoration options were explored using an adaptive management framework within which different hypotheses can be trialled in an experimental manner. This proved difficult due to confounding factors. However, given the established link between vegetation clearance and sedimentation, an initial restoration focus which evaluates catchment revegetation and its impact on kakahi survival and growth is suggested.

# 1. NGĀ PUKE TUKU KŌRERO – THE HILLS THAT TALK. IWI KNOWLEDGE OF KĀKAHI (*ECHYRIDELLA MENZIESII*) IN THE WHANGANUI RIVER<sup>1</sup>

## INTRODUCTION

### PERSONAL POSITION STATEMENT

“E rere kau ana te awa mai i te kāhui maunga ki Tangaroa.

Ko au te awa, ko te awa ko au.”

*The river flows from the mountains to the sea.*

*I am the river, the river is me.*

I am of Te Āti Haunui-a-Pāpārangī and Ngāti Hauiti descent. I hail from two rivers which traverse the central region of the North Island of Aotearoa New Zealand: the Whanganui (Fig. 1) and the Rangitīkei. On my Whanganui side, I am from Ngā Paerangi, a hapū which has its home at Kaiwhaiki, about 25 kilometres upstream of the river mouth. Whanganui iwi have inhabited the river since Paerangi came from Hawaiiki, well before Turi and Rongorongo arrived 750 years ago on the Aotea waka. The saying quoted above comes from my Whanganui people. It is an often-used phrase and speaks of our connection with our river; we belong to it, it belongs to us, it is us.

The research presented in this section arises out of a desire to document the knowledge of my people regarding our river and one of its species, the kākahi (*Echyridella menziesii* (Gray, 1843)). Interest in this species was sparked by one of our kaumātua, Phil Firmin, who spoke of its decline in an oral archive housed in the Whanganui Regional Museum (see Firmin 1994).

To achieve this aim, I interviewed kaumātua and iwi river users about kākahi, and about the river in general. Some were formally interviewed and recorded, others preferred for information to be retained only by memory. Written records in archives, court documents and published works were also accessed. As well as discussing specific aspects of the river, kaumātua often talked about values regarding the river and what it meant to

---

<sup>1</sup> Notes on style: As much as possible, this thesis was written as stand alone papers. I ask the reader to excuse any repetition between papers necessitated by this format. There are a number of Māori terms used in the text. A glossary is provided at the end of the thesis for those unfamiliar with these words.

them. The main elements regarding kākahi, the river and Māori values are discussed in this section, and constitute some of the knowledge held by Whanganui iwi.

#### INDIGENOUS KNOWLEDGE, MĀTAURANGA MĀORI, AND TRADITIONAL ECOLOGICAL KNOWLEDGE

Traditionally, Western science has not recognised knowledge that is not repeatable, empirical, and evidence-based (Durie 2004). However, in more recent times, the value of indigenous knowledge is increasingly being recognised by Western scientists (Berkes 1999). In Aotearoa New Zealand, indigenous knowledge is known as mātauranga (or more recently as mātauranga Māori, ‘Māori knowledge’ (Royal 1999)). Each iwi has its own set of knowledge, held in its own wānanga and handed down from generation to generation (Williams 2001). Mātauranga is based in iwi world views, beliefs and paradigms, and covers all aspects of the Māori experience, from knowledge of the environment, to the mathematics of construction, to the metaphors of song, to the intricacies of navigation, to the protocols of ritual ceremonies (Kapua 1997, Royal 1998, Mead 2003, Waikato 2005).

One key concept that differs from Western ideas on knowledge is that iwi mātauranga is not open to everybody – there is mātauranga that remains the select domain of certain tohunga, certain hapū, or certain iwi (Waikato 2005). Mātauranga is intergenerational – it is built up by past generations, cared for by the present generation, and is to be handed on to the coming generations – ngā uri whakatupu – and it is constantly being created (Mead 2003). Many Māori see the protection of this mātauranga as crucial (Williams 2001, Johansen 2003, Waikato 2005), and they are not alone – indigenous peoples across the world are anxious to protect their intellectual property (Dutfield 2000, Usher 2000, Van Overwalle 2005). The knowledge presented here is delivered with a recognition that it comes with responsibilities attached – responsibility to use it with respect, to share only what is open to be shared, to pass it on to those to come, and to not divorce the Māori values inherent in mātauranga from the practical aspects of that knowledge.

Internationally, in Western scientific literature, indigenous knowledge is often referred to as traditional ecological knowledge, or TEK (Berkes 1999). Berkes defines traditional ecological knowledge as:

a cumulative body of knowledge, practice, and belief, evolving by adaptive processes and handed down through generations by cultural transmission, about the relationship of living beings (including humans) with one another and their environment (Berkes 1999).



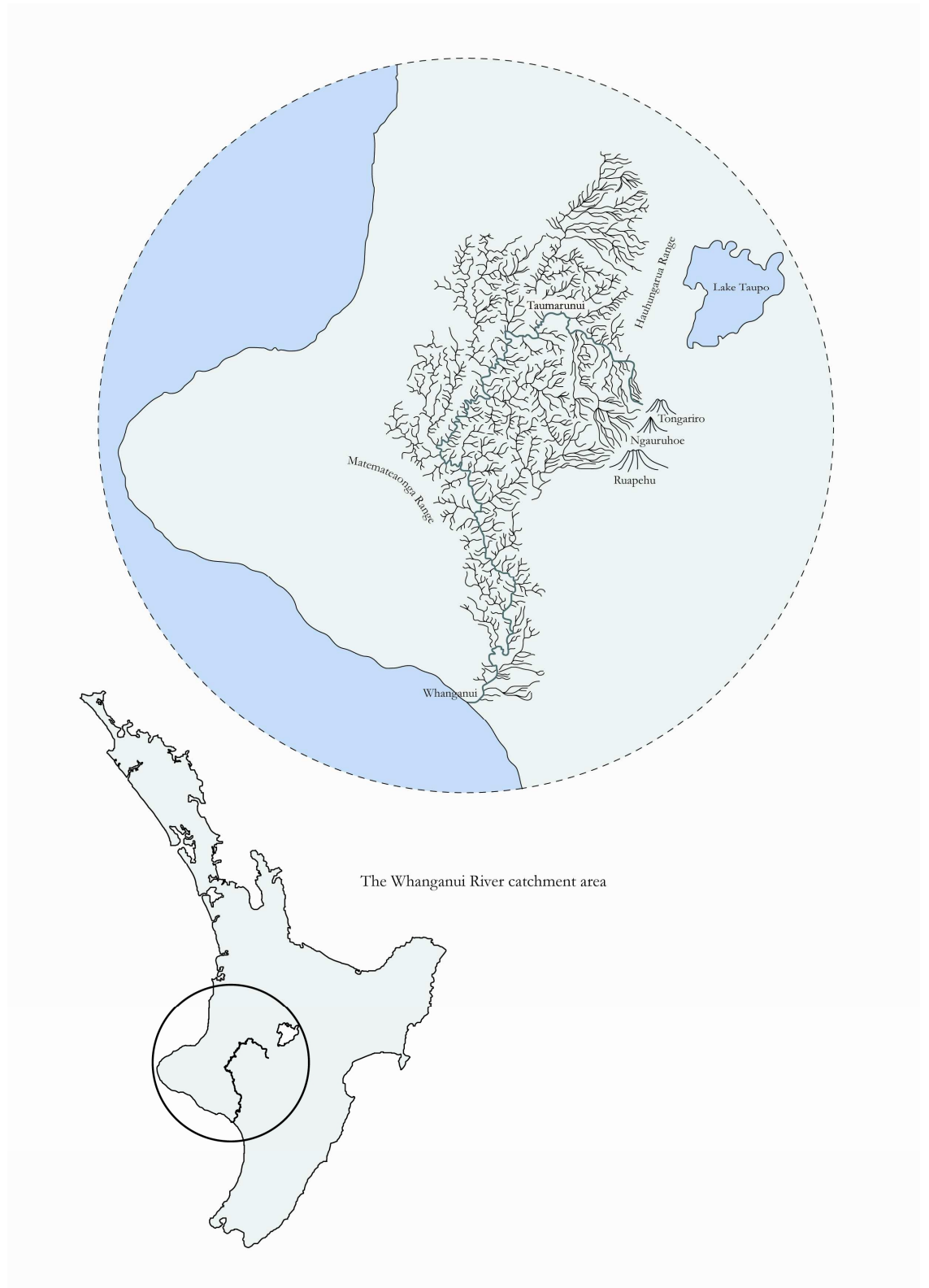

Fig. 1. Map of the Whanganui River catchment.

Those taking the time to engage with TEK, whether in Aotearoa New Zealand or overseas, have come to recognise that indigenous peoples hold not only a great deal of knowledge about their local environments, but also offer an opportunity to Westerners, and especially Western science practitioners, to learn a new way of interacting with the environment (Berkes 1999, Pierotti and Wildcat 2000, Dudgeon and Berkes 2003). Modern Western science is grounded on mainstream Western thinking and philosophies. This thinking developed since the Enlightenment and is based on Cartesian dualism; it values reductionism, and places man as autonomous from and dominant over nature, rather than as a part of it (Berkes 1999, Pierotti and Wildcat 2000). It stems from a wider anthropocentric thinking that reduces nature into either a resource for consumer use, or something separate from man which is in need of our protection and must not be touched (Sessions 1995, Pierotti and Wildcat 2000). Māori, like many indigenous groups worldwide, tend to view themselves as connected to and a part of the natural world (Kapua 1997, Durie 2004, Selby and Moore 2006). We are related to all things through whakapapa (genealogical links) (Williams 2001). A holistic approach tends to dominate Māori thinking – we do not separate the spiritual, intellectual and physical into compartmentalised realms (Kapua 1997, Durie 2004, Waikato 2005). As with the TEK of other indigenous peoples, the values and cultural practices found within mātauranga offer Western scientists an alternative approach to thinking about and interacting with the natural world (Cruikshank 2001, Kimmerer 2002) – a move away from reductionist thinking with man as dominant, and into an integrated approach with humanity as a community member in nature (Berkes 1999, Pierotti and Wildcat 2000).

Those working with TEK also recognise that indigenous peoples across the world have inhabited their lands for thousands of years, and have spent generations interacting with its geography and biota (Drew 2005, Parlee and Manseau 2005). As such they build up a vast amount of knowledge about their regional environment. As well as alternative value systems, holders of TEK can provide valuable practical information about human impacts on local biota and ecosystems, and are often the first to notice the detrimental effects of anthropological changes in their local area. Many TEK researches have pointed out the need for Western science practitioners and resources managers to pay more heed to information provided by local TEK (Roue and Nakashima 2002, Drew 2005, Gilchrist et al. 2005, Parlee and Manseau 2005). Therefore, as well as discussing Māori values, information on kākahi and about the river, the following section also documents

Whanganui mātauranga on the anthropological changes to the river which may have affected kākahi.

While TEK is often discussed in juxtaposition to Western science, it must be remembered that there are many Western elders who have much traditional knowledge to offer. Berkes' definition (Berkes 1999, Berkes et al. 2000) is inclusive of such Western elders, and rightly so. When mātauranga is discussed in this paper in apposition to 'Western values', or 'Western science', it is referring not to Western elders who possess knowledge and values consistent with mātauranga (or values found in TEK worldwide), but to mainstream Western thinking which views humanity as separate from and in control of nature (Pierotti and Wildcat 2000).

## **MĀTAURANGA WHANGANUI**

### **KĀKAHI HABITAT PREFERENCES**

Kaumātua noted that kākahi prefer slow moving water in muddy areas. There was no differentiation made between sandy and muddy areas, with one kaumātua commenting that "mud's mud!" (B. Potaka pers. comm. 2007). Kākahi were not usually found in gravelly areas, primarily because the water in these spots is faster flowing. Nor were they found in areas with papa rock on the bottom, as the kākahi do not "stick like a sea mussel" (C. Osborne pers. comm. 2007). It was also noted that kākahi were often found at the edges of the river, but one kaumātua commented that this was "probably because that's where we were looking for them", with the deeper areas being less accessible. Tributary streams and mouths were also popular spots, and this probably relates to the type of habitat in these areas, which are often sandy or muddy spots with slow moving water. One kaumātua noted you could find the little ones, "smaller than your fingernail", attached to logs (K. Amohia pers. comm. 2008).

### **KĀKAHI ASSOCIATIONS WITH OTHER SPECIES**

Kākahi are often found in association with eels (*Anguilla australis* and *A. dieffenbachii*). Pungarehu kaumātua Ben Potaka, Mike Potaka and Charlie Osborne used the signs of kākahi presence as an indication of a good eeling spot. Charlie comments that eels always "seemed to be hanging around the place where kākahi were". As fishermen, they would look for kākahi shells or the siphon holes in amongst the mud, note that spot, then return there when they wanted to fish.

Birds were used as an indication of both the presence of kākahi and the timing for kākahi collection. Kaumātua in the middle reaches of the Whanganui River waited for the return of sea birds (possibly the pied stilt (*Himantopus himantopus leucocephalus*) or oyster catcher (*Haematopus unicolour*)) to signal the beginning of the kākahi collection season (W. Wiari-Southern pers. comm. 2008). This coincided with the warmer times of the year, when the river was low, and the birds would come inland to feed on the kākahi.

#### KĀKAHI USE FOR KAI

Although most people expressed the opinion that kākahi were somewhat “tasteless”, a number of different modern and traditional cooking methods were identified. These included currying them, making them into a stew, creating a type of chowder with a little milk and making a boil-up with them. One traditional method was to thread them onto muka (flax fibre) strings and hang them to dry (Firmin 1994, W. Wiari-Southern pers. comm. 2008). This provided a store for winter, when food was less plentiful.

No-one talked of eating kākahi on its own in modern times, probably due to the disagreeable taste. In pre-European times, however, they were considered a delicacy (Hiroa 1921, Firmin 1994). In Rotorua, there were three separate words for the various traditional ways of consuming them: tioka, when they are split open and eaten raw; whakakōpupu, when they were dipped in boiling water for a few seconds to open the shell very slightly; and kōwha, to cook and open them (Hiroa 1921). One kuia stated that immersing live kākahi in slightly salty water overnight improves the flavour. This helps them to expel some of the sediment from their system, and also adds a salty tang.

#### USE OF KĀKAHI SHELLS

In historical writings from other areas, kākahi shells were said to be used to cut hair and to sever the umbilical chord of a newborn child (Hiroa 1921). In Whanganui, shells were often returned to the river as a way of giving back to the river (W. Wiari-Southern pers. comm. 2008). It was considered that because the river had nourished you, you needed to offer it something in return. This practice follows a general Māori tikanga of respecting and caring for the environment which nourishes you, and of reciprocity in general. It is seen as unacceptable to take without giving back, whether this is from the land, the waterways or other people. The kākahi shell was also rather useful as a potato peeler (Te Wheturere Gray pers. comm. 2007).

#### DECLINE OF AQUATIC SPECIES IN WHANGANUI

In Whanganui, it was the iwi who first noticed and drew attention to decline of local aquatic species (Planning Tribunal 1990, Firmin 1994). Kāinga on the Whanganui follow the river like a ribbon and Whanganui iwi depended on the waters for survival (Waitangi Tribunal 1999). The river was the life-blood of our people, our ancestor. In the words of one of our kuia, the river was at once a water supply, a food basket, a baptismal font, a place of cleansing and a highway (W. Teki pers. comm. 2007). Apart from seasonal trips to fishing grounds at the coast, kāinga depended on food found in the river such piharau (*Geotria australis*), a Whanganui delicacy, tuna (*A. australis* and *A. dieffenbachii*), ngaore (*Galaxias maculatus* and other *Galaxias spp.*), kōura (*Paranephrops planifrons*), and, of course, the kākahi (Waitangi Tribunal 1999).

The arrival of Europeans obviously brought many changes, both in lifestyle and in diet. A number of traditional foods, including kākahi, dropped out of the diet. Some might say this was merely a by-product of urbanisation and changing palates: the coast and kaimoana became far more accessible, the supermarket was easier to get to than the river, and marine mussels were tastier than freshwater ones. Some kaumātua, however, contend that the change in diet resulted not from differences in lifestyle, but from a growing scarcity of traditional foods available in the river (Waitangi Tribunal 1999, Environment Court 2004). We are losing the kai that sustained us.

#### DECLINE OF THE KĀKAHI

Kākahi decline was formally noted by Whanganui iwi within the European legal system almost two decades ago when, in 1989-90, submissions regarding minimum flows were given at a Planning Tribunal hearing (Planning Tribunal 1990). As part of this hearing, a group of scientists contracted by Electricorp (the Electricity Corporation of New Zealand) spent five days combing the river looking for kākahi, but found none (Firmin 1994). In frustration, they contacted Phil Firmin, an iwi fisherman noted for his skills in both traditional and modern methods. Firmin managed to locate three specimens for them, and then later another two (Firmin 1994). Phil Firmin commented on the decline, saying that where there were once extensive kākahi beds near his home marae, the kākahi had now disappeared (Firmin 1994). Likewise the iwi again expressed concern for the kākahi when the Whanganui River Claim (Wai 167) was heard by the Waitangi Tribunal in the 1990s (Waitangi Tribunal 1999), and more recently when submissions on minimum flows were taken to the Environment Court (2004).

Talk of kākahi decline was a common theme in discussions I had with kaumātua and river users, with most people interviewed noting a severe loss of kākahi populations. Many once abundant populations are now either extirpated, or very low in numbers (K. Amohia, T. Ranginui, W. Wiari-Southern pers. comm. 2008, E. Mahu, B. Potaka, C. Osborne, P. Potaka Osborne, W. Potaka Osborne, M. Potaka, T.W. Gray, G. and P. Waretini pers. comm. 2007). Ben Potaka and Charlie Osborne tell a story of once collecting an entire canoe-load from a bed in order to start a new bed closer to their house. They wanted a nearby population so they would not have to paddle as far to get a kai (pers. comm. 2007). That same source site cannot now provide enough kākahi to half-fill a bucket, let alone a canoe. Terrence Ranginui says they used to fill up a bucket in half an hour at his local beds (pers. comm. 2008); now it takes over an hour to find just 10. George Waretini points out that kākahi were only ever found in “pockets” along the river, but that even these have gone now (pers. comm, 2007).

Kaumātua contend the river has lost its ability to sustain the iwi and to support the kākahi. As a people connected to our awa and its biota, this loss affects not only the kākahi, but our very selves. Niko Tangaroa (senior) pointed out that, “The river and the land and its people are inseparable. And so if one is affected, the other is affected also,” (Waitangi Tribunal 1999). Wai Wiari-Southern comments further that the health of the kākahi shows the health of the river and the health of the people, and the health of the people shows the health of the kākahi (pers. comm. 2008). This view of the health of the people being connected to the wellbeing of the environment is not unique to Whanganui – it is a view shared by Māori around the country (Durie 2004).

### **Timing of the decline**

George Waretini states that decline in kākahi numbers began in the 1950s (pers. comm. 2007). This is in agreement with reports from other kaumātua on the river, most of whom state that in the 1940s kākahi were still abundant. Exact timing of when decline in kākahi numbers began is difficult to ascertain – kākahi can live for over 50 years (Grimmond 1968) and are slow growing, like most unionids (Sethi et al. 2004). Decline in unionids through steady adult die-offs and failure to reproduce may not be noticed for long periods (Sethi et al. 2004). Losses in kākahi populations are likely to have begun some years before the full extent became apparent.

### **Possible factors in decline**

Kaumātua identified a number of factors possibly influencing kākahi decline. Most of these factors were ascertained through observing changes in the river within their lifetimes.

### *Land clearance, siltation and temperature*

Early European settlement brought with it an ethic of converting ‘unproductive’ land into green pastures (Park 1995), and Whanganui was by no means immune. As land passed into Pākehā hands and the river was opened up, more and more forest was turned to farmland (Young 1998). The river became unpredictable: lack of bush cover meant lower levels in dry periods and rapid flooding when it rained (Young 1998). The effects are still noted by river users today, who say the waters rise without warning, quickly foul with silt, and take weeks to clear.

Further bush clearance came with the allocation of land to returned World War I and II soldiers through the government’s ‘rehabilitation scheme’ (McLintock 1966, Bates 1994). Whanganui’s steep hill country is comprised of highly erodible soft papa stone; soil loss off these lands is approximately ten times higher from cleared pastoral areas than in forested lands (Phillips 2001). George Waretini noticed the river began to silt up coinciding with more land being cleared for farming through the rehabilitation scheme (pers. comm. 2007). In rainy conditions nowadays, many side streams and tributaries run brown with silt. “The only water coming into the river,” says Charlie Osborne, “is the muddy stuff from the farms up in the subsidiaries” (pers. comm. 2007).

Consequently the Whanganui now carries far more silt than it did in pre-European times. In 1881, the river was described by Europeans as a “paradise for salmon and trout” with “gravelly reaches interspersed with rapids and deep dark pools” (Young 1998). One kuia stated that when she was a child, Pūtiki had a substrate of large stones and that “you couldn’t possibly go down the river and be up to your knees in silt,” (Young 1998). Now, this area is covered with a layer of mud knee-deep, as this photograph of one local iwi member aptly illustrates (Fig. 2). This vast increase in silt level may have contributed to kākahi decline. Charlie Osborne states his hypothesis that such silt “would have choked [kākahi]” (pers. comm. 2007).

Clearing the land also removed shade cover from streams in the Whanganui area, leading to higher water temperatures. In January 2008, temperatures in the mainstem of the Whanganui River rose above 24°C for more than a week running (data supplied by Horizons Regional Council). During this time iwi and other river users observed a number of eel and fish deaths, and it is likely these deaths are temperature-related (iwi observation, K. McArthur, N. Peet pers. comm. 2008).



Fig. 2. Iwi member and river user Mike Poa knee deep in mud near Pūtiki.



General water quality has also been affected with the advent of farming in the region. Te Wheturere Gray discusses the changes to the river:

When we were young and in our prime, we used to drink the water from the river just anytime. Now we're getting old and grey we dare not eat it, drink it at all any day. [...] Now, one wouldn't want to drink it at all. It's bad enough swimming in it. But drinking, no no. You can't do it anymore. At one time, when we were short of water at our houses, we'd go down with our big drums on sledges to fill up with water and come back. We'd use that water for drinking, cooking, washing, and cleaning. Nowadays we don't even use it for cleaning. But we're not going to get any change to that, simply because it's called 'progress'. Farms have been developed up river and round here ... there's more run-off from farms ... the pollution is huge.

#### *Water diversions*

Whanganui iwi see the Tongariro Power Development scheme (TPD) as a prime cause of kākahi decline (B. Potaka pers. comm. 2007), and have long noted its negative environmental impacts on the river (eg Planning Tribunal 1990, Firmin 1994). One section of the TPD, the Western Diversion, takes water from the Whanganui headwaters and its tributaries, the Whakapapa, Okupata, Taurewa, Tawhitikuri and Mangatepopo (Chapple 1987, Genesis Power Limited 2000).

The diversions led to direct kākahi mortalities. Kākahi beds at Paetawa were once over 100 m long. However, they were only about 18 inches wide, indicating that natural kākahi habitat in the area was limited to a thin strip. After the diversions, water level in the area dropped about 6 inches (observation by local kaumātua M. Potaka noted in Waitangi Tribunal 1999). The drop was enough to expose this entire strip, removing habitat in the area, and desiccating kākahi. Says Mike Potaka, "That mud got left high and dry," (pers. comm. 2007) and "the kākahi have dried out and died," (Environment Court 2004). Kuia Julie Ranginui describes other parts of the river: "The beds are high and dry, and holes in the banks of the river, once home for kākahi, are now exposed for long periods and contain nothing but empty shells," (Ranginui 1990).

While kākahi are highly motile and can move towards water when levels drop, reaching the water requires an obstacle-free path. Kākahi in the Whanganui are often found amongst log jams (personal observation) – the chances of becoming stranded after a sudden drop in water level are rather high. Dewatering overseas has caused mussel losses of 95% (Sethi et al. 2004). Although exact numbers of kākahi mortalities at Paetawa are not known, kaumātua accounts indicate almost a complete loss of the population there after the area was dewatered by commissioning of the TPD.

Iwi noted an increase in fine silt load under the TPD. As Te Wheturere Gray puts it, “it’s all muddied up” (pers. comm. 2007). One river user discussed how the reduced flow left the river with less capacity to flush the silt out of its system. Te Wheturere Gray concurs: “our river just leaves silt lying around. It doesn’t leave sands lying around,” (pers. comm. 2007). Indeed, the Western Diversion of the TPD diverts 25,900 m<sup>3</sup> of sediment away from the Whanganui every year (Genesis Power Limited 2000). Most of this diverted matter is coarse sediment, which settles in Lake Te Whaiiau and Otamangākau Canal. Some of the finer sediments which do not settle out in Lake Te Whaiiau carry on through to the Whanganui River (Genesis Power Limited 2000), resulting in a disproportionate amount of fines to coarse sediment entering the Whanganui than would be the case in natural conditions.

River users also believe that fluctuation in flow from activity in the TPD results in destabilised banks, which in turn exacerbates problems with silt, as large chunks of sediment are washed from banks and transported downstream:

I always believed that when they released the water from the dam, [that] helped to loosen the banks, because they gouged all the banks from way up the river right down to here. [I]t was noticeable that all the banks were cleaned right out (P. Potaka Osborne pers. comm. 2007).

Freshwater mussels often only have limited available habitat in rivers, as they generally require low flow velocity and stable substrate (Morales et al. 2006). The destabilised banks may have contributed to loss in kākahi populations. Downstream kaumātua have linked kākahi survival to bank stability, stating that the few kākahi left in their area only remained where the banks were held together by willows. Pete Potaka Osborne continues: “the roots of the trees helped to hold the soil that helped to retain the kākahi in there, in the beds.”

#### *Sewage and pollution*

From 1956, Taumarunui township deposited municipal sewage into the Whanganui River, and from 1993 onwards it has discharged tertiary treated effluent into the river. Similarly, for many years Whanganui township discharged its sewage straight into the Whanganui River. Piki Waretini identified pollution as one of the potential factors leading to kākahi decline (pers. comm. 2007), as did other kaumātua (Environment Court 2004). She also noted other sources of pollution, such as meatworks discharge and run-off from farms, and saw these as contributing to kākahi decline, and a general drop in the health of the river. Her comments were supported by other kaumātua who presented evidence to both the Waitangi Tribunal (1999) and the Environment Court (2004), with one of our kuia

commenting that the discharge of sewage means that our river “looks dead” – “there’s been a deterioration in the river. Its spirit is dying,” (D. Metekingi in Waitangi Tribunal Waitangi Tribunal 1999).

#### *Channel modification*

In lower Whanganui, within the township itself, channel modification may also have affected kākahi (P. Waretini pers. comm. 2007). Stopbanks and flood protection work mean some banks in the area are concreted and channelised. This can make life difficult for a burrowing shellfish.

#### *Gravel extraction*

Like many rivers, the Whanganui has been used as a source of gravel (Waitangi Tribunal 1999). Wai Wiari-Southen noted gravel extraction as a further impact on kākahi in the Whanganui area (pers. comm. 2008). Metal extraction alters channel morphology and flow, reduces stability and coarsens the bed (Kondolf 1994). For a burrowing species like the kākahi, bed coarsening reduces available habitat in the area. At one particular area on the Whanganui subject to metal extraction, the site of the previous kākahi bed is now papa rock, with no suitable substrate for kākahi to burrow into (pers. obs. on site with W. Wiari Southen, 2008). Kākahi in the Whanganui have been caught up in the extracted material and removed to land, leading to direct mortalities and machinery entering the river has added pollutants to the area (W. Wiari-Southen pers. comm. 2008).

#### *Pesticides, herbicides, and farm sprays*

Wai Wiari-Southen expressed a particular concern about sprays, dips and toxic chemicals which were part of everyday use on farms in Aotearoa New Zealand in the past (pers. comm. 2008, Boul 1995), most notably DDT and 2.4.5.T. She considers such substances to have had the greatest impact on kākahi in the river. She tells a story of one particular station where the dip structure was built directly over a tributary creek to the Whanganui, and all excess dip went directly into the water.

Te Wheturere Gray concurs:

“All the other kinds of pollution from fertiliser and chemicals used to spray plants and pastures and to inject animals and all those sorts of things just adds to pollution of the river. One day the Whanganui River will be as dead as any other of those North American rivers where they’ve just polluted every darn thing.”

Overall, kaumātua have identified a number of factors that may have contributed to kākahi decline in the Whanganui River. Land clearance has increased total particulate matter in the river. The TPD has modified flows, habitat and bank stability, and possibly exacerbates the fine sediment load, while some beds were desiccated at its commissioning. The water has

been polluted with human sewage, farm run-off and chemicals, and some beds have been affected by gravel extraction, with direct mortalities from desiccation resulting.

#### KĀKAHI, WHAKAPAPA AND ECOLOGICAL VALUES

Within the Māori world, whakapapa acts as a defining mechanism. It classifies the relational place of an object, organism or person in the world. Māori definitions of family groups and genus can be found within whakapapa; whakapapa is our nomenclature (Williams 2001, Haami and Roberts 2002). It provides information into the ecological connections we observe within the environment.

It is difficult to find information on the whakapapa of the kākahi; many of those who possessed it have passed on, taking it with them. Best (1982, 1986) records the Māori nomenclature of shellfish in general, but does not differentiate between freshwater and marine mussels. In one version recorded by Best, the mussel family are the offspring of Kāukau (the personification of swimming) and Te Rōpūwai (the gathering of waters) (Best 1986). Hine-moana (the ocean) gave birth to shellfish in general (Best 1982) and it seems Hine-moana's descendant Hunga-terewai produced various univalves, some whelks and limpets, and oysters, while Te Arawaru and Kaumaihi were the progenitors of the pipi (cockle) family.

Best (1982, 1986) does not give the full whakapapa of Kāukau and Te Rōpūwai and how they connect to Hine-moana, but does illuminate the whakapapa of rocks, gravel, sand and seaweed (Fig. 3). The connection in whakapapa between rocks, gravel, sand, seaweed and mussels comes through a story of fostering and care. Hine-moana produced seaweed in all its forms (Wharerimu). She then took Wharerimu and placed this family with Rakahore and Tuamatua (personifications of rock and stones). She did this so that her offspring, the mussel family, might have shelter and protection amongst both the seaweed and the rocks. The mussels were also said to be placed there to be companions for Hine-tū-ā-kiri (gravel) and Hine-one (sand). So we see that whakapapa provides information on the habitat needs of mussels and shellfish, and the interconnections between different elements in the environment.

Whakapapa also reminds us of our own human connections to other species. While Māori ideas and beliefs are as diverse as those found within any society, and there is no such thing as 'a Māori world view' (Durie 1995), there are many Māori who believe that

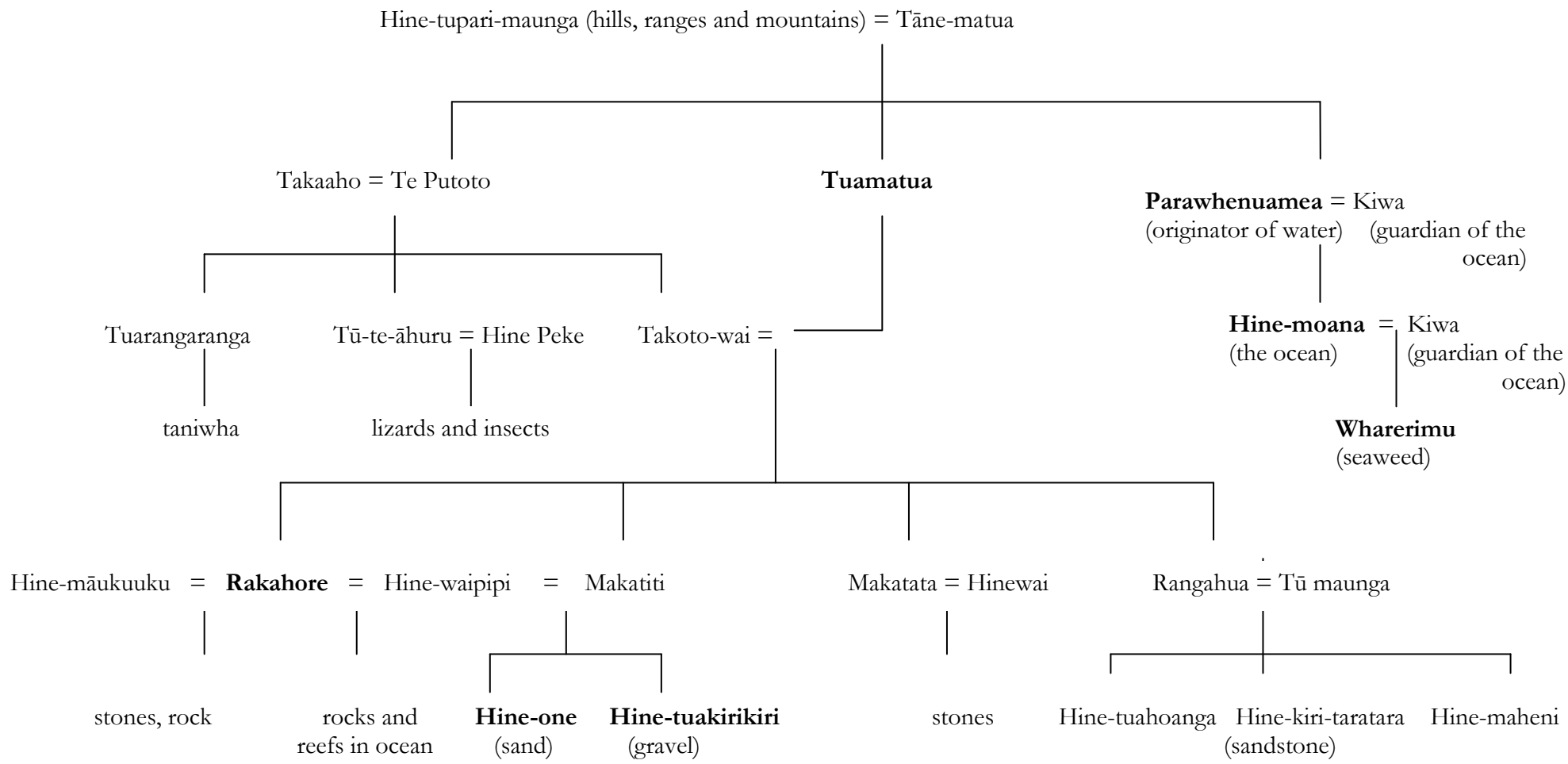

Fig. 3. The whakapapa of rocks, seaweed, gravel and sand, the guardians and companions of mussels. Names discussed in the text are in bold. Adapted from Best (1982, 1986). = denotes marriage or union.

whakapapa shows that humans are not only intimately related to creatures and features of the natural world, but that we are their teina, or younger siblings. The concept of teina and tuakana (older sibling) relationships denotes that teina have a duty to respect their tuakana, and that tuakana have a form of primacy (as well as care and responsibility) over their teina (Mead 2003). Within these concepts of connection and relationship between humans and the world, there are also connections between all species (including humans) and atua, or gods, who had both a role in creation and an ongoing role in ensuring the safety and protection of their offspring.

The result is that many Māori view the world around them differently from how many Westerners, and particularly Western science practitioners, view the world. To many Māori, humans are neither the pinnacle of creation nor the ultimate in evolutionary success; we are not here to dominate over nature (Durie 2004). Rather we are one of many entities, animate and inanimate, that are interconnected (Environment Court 2004). We do not have a right to take more than we need, to kill without giving thanks to the atua whose offspring we are harvesting, or to disrespect our tuakana in any way (see for example the famous story of Rata, recorded in Alpers 1996). If any plant matter is to be taken, respect and acknowledgment must be given to the appropriate atua, often Tāne, Rongo, Maru or Haumietiketike. Likewise for aquatic species, permission from Tangaroa must be sought before fishing or collection begins.

This can be challenging for those walking in both the Western scientific and the Māori worlds. Holding on to the values our kaumātua teach while designing experiments is not always easy. At times it means standard Western methods are not an option for us. An example of this can be found in my own work. The questions I explore in later chapters include the effect of sediment on kākahi, and the status of kākahi in the Whanganui River. As I did not believe it ethical to sacrifice an animal to satisfy a quest for knowledge, standard determinations of condition such as the ratio of ash free dry weight to shell weight were out of the question for me, as were tests for lethal concentrations of sediment. I restricted my methods to those that fitted within the values of respect for our whanaunga. I believe holding on to these values will, in the future, challenge and motivate us to develop new methods which allow science to be practiced in line with Māori ethics, such as more precise ways of measuring wet weight, or using behavioural responses and choice experiments to measure effects of deposited sediment.

However, not all Western science practitioners utilise invasive or sacrificial methods (see for example Rodland et al. 2006) and there is a strong move within Western

science for ethical paradigms (eg Farnsworth and Rosovsky 1993, Rolston 2000, Mather and Anderson 2007). Similarly, Māori in turn have had an adverse effect on the environment in Aotearoa New Zealand (Harada and Glasby 2000). And not every Māori believes there is a relational duty for humans to respect other species. Nevertheless, at a fundamental values level, it remains that there are concepts of connection, care and respect contained within traditional Māori knowledge which, if heeded, could provide Western culture with a much needed path to restoring our natural world to health.

#### VALUES AROUND WATER AND THE RIVER

One major idea within Māori tikanga is the concept that the dead gather together and the living gather together. This is reflected in the often-heard phrase: “Āpiti hono, tātai hono rātou te hunga mate ki a rātou. Āpiti hono, tātai hono tātou te hunga ora ki a tātou anō.” Literally this translates as: “May those who have passed on gather to themselves. Let us who live gather to ourselves.” It illustrates one of the main tenets of kawa Māori: that everything to do with death remains in the area designated for the dead, and that things in the living world are to be kept separate, and in the living realm. This includes mattresses and linen that are used at tangihanga; often marae have a separate set of these to be used for the tūpāpaku (corpse) and these are not slept on by the living. Food, belonging in the living realm, is not eaten near the tūpāpaku. Upon leaving the tūpāpaku, water is utilised to cleanse oneself to allow the shift from the tapu area of the dead to the noa area of the living.

Water, then, is considered to be in the realm of the living. For Māori, the idea of discharging anything to do with death, or bodily wastes, to water is abhorrent (Waitangi Tribunal 1999). The Whanganui River particularly has strong notions of life attached to it. This can be viewed in the statements used about the river in our waiata, karanga and whaikōrero, for example these excerpts from a waiata by Morvin Simon:

“te wai kaukau	<i>our bathing waters</i>
he puna roimata tapu ...	<i>a wellspring of tears</i>
he wai ū, wai ora nui”	<i>a water of sustenance, a water of much life.</i>

The Whanganui is also considered a being in itself, and as such has a life essence of its own. In waiata, karanga and whaikōrero, the awa is often addressed in the first person, for example, “i haere mai rā koe i runga i Tongariro” (you came down from Tongariro), or as a living being, as in te awa tupua, the ancestral river. Whanganui iwi speak of talking to our river, not about it, and very much have a sense of it being alive, of it being part of us.

Bodily discharges are, on the other hand, considered to be dead matter and therefore part of the realm of the dead. The idea of discharging these wastes into a living force such as the river goes against the very fundamentals of Māori tikanga. Wai Wiari-Southern summed it up by saying, “The river is alive. You keep the living stuff with the living and that dead stuff stays with the dead. You don’t put it into the living river,” (pers. comm. 2008).

Furthermore, the river is a mahinga kai, a place to gather food. Both on land and in the water, there are concepts that protect mahinga kai from contamination. For example, a menstruating woman is considered tapu and is restricted from entering mahinga kai in order to safeguard both the food and her state of tapu. The idea of discharging bodily wastes to the river also violates the principles safeguarding our mahinga kai.

Sewage discharges and farm run-off to the Whanganui have meant that for many years the river has had problems with bacterial contamination (Phillips 2001). While major point source discharges of raw human waste have ceased, faecal matter from stock still enters the river through farm run-off (Phillips 2001), as do discharges from septic tanks and tertiary treated human wastes (Ausseil et al. 2005, Horizons Regional Council list of resource consents 2008). Such contamination has led to a degraded waterway on all fronts – from cultural and amenity values to life-supporting ability – and threatens the river and its communities, both human and non-human.

Māori cultural values around the need to keep water clean and protected from degrading substances such as human discharges have often been written off and dismissed as unimportant or too ethereal when considering management decisions. Yet such values could have offered, and indeed do still offer, an alternative route for those making decisions about resource use and how to dispose of human-produced waste. Perhaps heeding such values could have prevented difficult, lengthy, and costly restoration measures now being undertaken in many waterways.

#### INTERCONNECTEDNESS OF LAND AND WATER

As different aspects of the environment are connected by whakapapa, so land and water are connected. This is epitomised in the whakataukī, “E kore a Parawhenua e haere, ki te kore a Rakahore,” which can be translated as “Parawhenua (water) would not flow if it were not for Rakahore (rock),” (Mead and Grove 2003). For Whanganui, this is manifest in how we view the river – it is not a separate entity from the land around it, or the people who belong to it (Waitangi Tribunal 1999). What happens to the land affects the river, and what happens to the river affects the land, and its people.



This idea is not unique to Whanganui and can be found in other indigenous cultures (Burger 1990, Berkes 1999, Johansen 2003, Durie 2004), as well as in Western literature on landscape ecology, integrated catchment management, deep ecology, and land ethics (eg Naveh and Lieberman 1984, Sessions 1995, Forbes et al. 1999, Mance et al. 2002, Payne and Newman 2005, Diadovski and Atanassova 2007, Warner 2007). However, it is a central tenet of Whanganui beliefs, and forms the impetus for restoration efforts – we need to restore the river not just for the sake of a better aesthetic, or safer swimming holes, or cleaner stock water, but because it affects our lands, our health, our selves, because it is our very self.

#### IMPORTANCE OF RESTORING KĀKAHI IN ORDER TO RESTORE THE RIVER

In iwi terms, the health of the river is linked to its biota (Waitangi Tribunal 1999, W. Wiari-Southen pers. comm. 2008). Restoring the kākahi to abundance in the Whanganui River stems from a wider desire to restore the river (Whanganui River Māori Trust Board 2002). Furthermore, kaumātua from Pungarehu believe it is important to restore kākahi to the river as a food source for eels. Eels have become scarce on the river (Waitangi Tribunal 1999); whānau at Pungarehu are currently developing methods of restocking the river with eels, and believe the return of kākahi to be important to the success of this project (M. Potaka pers. comm. 2007).

#### SUMMARY

Kaumātua have noticed a decline in kākahi numbers in the past century, and have offered ideas as to what may have contributed to this decline, based on observations of the Whanganui River in their own lifetimes. These factors include: reduced flow, desiccation, increased sedimentation, domestic and agricultural pollution, gravel extraction and channel modification. Restoring kākahi to abundance in the catchment is seen as a necessary part of the overall restoration of the river, as kākahi health is linked to both river health, and human health. Māori values regarding freshwater and the relatedness of all things through whakapapa offer an alternative framework of respect and interconnectedness to Western science practitioners and resource managers.

#### REFERENCES

Alpers, A. 1996. Maori myths and tribal legends. Second edition. Addison Wesley Longman New Zealand Limited Auckland.

- Ausseil, O., H. Barnett, A. Beveridge, L. Fung, B. Gilliland, F. Gordon, H. Janssen, C. McCarron, J. Roygard, M. Todd, and H. Zarour. 2005. State of the environment report of the Manawatu-Wanganui region 2005. Horizons Regional Council, Palmerston North.
- Bates, A. P. 1994. The Whanganui River today ... A personal photographic journey. Footprints Press, Wanganui.
- Berkes, F. 1999. Sacred ecology: traditional ecological knowledge and resource management. Taylor & Francis, Philadelphia.
- Berkes, F., J. Colding, and C. Folke. 2000. Rediscovery of traditional ecological knowledge as adaptive management. *Ecological Applications* **10**:1251-1262.
- Best, E. 1982. Maori religion and mythology: being an account of the cosmology, anthropogeny, religious beliefs and rites, magic and folk lore of the Maori folk of New Zealand Part 2. Government Printer, Wellington.
- Best, E. 1986. Fishing methods and devices of the Maori. Government Printer, Wellington.
- Boul, H. L. 1995. DDT residues in the environment – a review with a New Zealand perspective. *New Zealand Journal of Agricultural Research* **38**:257-277.
- Burger, J. 1990. The Gaia atlas of first peoples: a future for the indigenous world. Gaia Books Ltd, London.
- Chapple, K. 1987. The rape of the Whanganui River. C&S Publications, Taumarunui.
- Cruikshank, J. 2001. Glaciers and climate change: perspectives from oral tradition. *Arctic* **54**:377-393.
- Diadovski, I. K., and M. P. Atanassova. 2007. Water quality management based on the integral approach. *Chemical and Biochemical Engineering Quarterly* **21**:189-194.
- Drew, J. A. 2005. Use of traditional ecological knowledge in marine conservation. *Conservation Biology* **19**:1286-1293.
- Dudgeon, R., and F. Berkes. 2003. Local understandings of the land: traditional ecological knowledge and indigenous knowledge. Pages 75-96 *in* H. Selin, editor. *Nature across cultures: views of nature and the environment in non-Western cultures*. Kluwer Academic Publishers, Great Britain.
- Durie, M. 1995. Ngā matatini Māori: diverse Māori realities. The wānanga pūrongo kōrerorero: Māori health framework seminar, Tūranga-wāwae Marae, Ngāruawahia.
- Durie, M. 2004. Understanding health and illness: research at the interface between science and indigenous knowledge. *International Journal of Epidemiology* **33**:1138-1143.

- Dutfield, G. 2000. The public and private domains – intellectual property rights in traditional knowledge. *Science Communication* **21**:274-295.
- Environment Court. 2004. Ngati Rangi Trust (RMA 874/01), Tamahaki Inc Society (RMA 875/01), Whanganui River Maori Trust Board, Hinengakau Development Trust, Ngati Hikairo Hapu Forum, Ngati Tama o Ngati Haua Trust, Pungarehu Marae Incorporated Society on behalf of Ngati Tuera Hapu and Ngati Rangi Trust (RMA 877/01) Appellents v The Manawatu-Wanganui Regional Council Respondent and Genesis Power Limited Applicant. Decision no: A 067/2004. Environment Court.
- Farnsworth, E. J., and J. Rosovsky. 1993. The ethics of ecological field experimentation. *Conservation Biology* **7**:463-472.
- Firmin, P. 1994. Oral archives. Whanganui Regional Museum, Whanganui
- Forbes, P., A. A. Forbes, and H. Whybrow, editors. 1999. Our land, ourselves: readings on people and place. Second edition. The Trust for Public Land, San Francisco.
- Genesis Power Limited. 2000. Tongariro Power Development: resource consent applications and assessment of environmental effects. Genesis Power Limited.
- Gilchrist, G., M. Mallory, and F. Merkel. 2005. Can local ecological knowledge contribute to wildlife management? Case studies of migratory birds. *Ecology and Society* **10**:20.
- Grimmond, N. M. 1968. Observations on growth and age in *Hyridella menziesi* (Mollusca, Bivalva) in a freshwater tidal lake. Unpublished Master of Science thesis, University of Otago, Dunedin.
- Haami, B., and M. Roberts. 2002. Genealogy as taxonomy. *International Social Science Journal* **54**:403-412.
- Harada, K., and G. P. Glasby. 2000. Human impact on the environment in Japan and New Zealand: a comparison. *Science of the Total Environment* **263**:79-90.
- Hiroa, T. R. 1921. Maori food-supplies of Lake Rotorua, with methods of obtaining them, and usages and customs appertaining thereto. *Transactions of the Royal Society of New Zealand* **53**:433-451.
- Johansen, B. E. 2003. Indigenous peoples and environmental issues: an encyclopedia. Greenwood Press, Westport, Connecticut.
- Kapua, T. 1997. Defining Maori science. *Historical review* **45**:91-98.
- Kimmerer, R. W. 2002. Weaving traditional ecological knowledge into biological education: a call to action. *Bioscience* **52**:432-438.

- Kondolf, G. M. 1994. Geomorphic and environmental effects of instream gravel mining. *Landscape and Urban Planning* **28**:225-243.
- Mance, G., P. J. Raven, and M. E. Bramley. 2002. Integrated river basin management in England and Wales: a policy perspective. *Aquatic Conservation: Marine and Freshwater Ecosystems* **12**:339-346.
- Mather, J. A., and R. C. Anderson. 2007. Ethics and invertebrates: a cephalopod perspective. *Diseases of Aquatic Organisms* **75**:119-129.
- McLintock, A. H. 1966. Land settlement. *in* A. H. McIntock, editor. *An Encyclopaedia of New Zealand*. Government Printer, Wellington.
- Mead, H. M. 2003. *Tikanga Māori*. Huia Publishers, Wellington.
- Mead, H. M., and N. Grove. 2003. *Ngā pēpeha a ngā tīpuna*. Second edition. Victoria University Press, Wellington.
- Morales, Y., L. J. Weber, A. E. Mynett, and T. J. Newton. 2006. Mussel dynamics model: a hydroinformatics tool for analyzing the effects of different stressors on the dynamics of freshwater mussel communities. *Ecological Modelling* **197**:448-460.
- Naveh, Z., and A. Lieberman. 1984. *Landscape ecology: theory and application*. Second edition. Springer-Verlag, New York.
- Park, G. 1995. *Ngā uruora (the groves of life): ecology and history in a New Zealand landscape*. Victoria University Press, Wellington.
- Parlee, B., and M. Manseau. 2005. Using traditional knowledge to adapt to ecological change: Denesoline monitoring of Caribou movements. *Arctic* **58**:26-37.
- Payne, D. G., and R. S. Newman. 2005. *The Palgrave environmental reader*. Palgrave Macmillan, New York.
- Phillips, J. 2001. *Whanganui catchment water quality: a study on clarity and microbiological water quality in the Whanganui River and its tributaries*. Horizons Regional Council, Palmerston North.
- Pierotti, R., and D. Wildcat. 2000. Traditional ecological knowledge: the third alternative (commentary). *Ecological Applications* **10**:1333-1340.
- Planning Tribunal. 1990. *In the matter of the Water and Soil Conservation Act 1967 and in the matter of two appeals under section 25 of the Act between Electricity Corporation of New Zealand Limited (Appeal 781/88) and Whanganui River Maori Trust Board (Appeal 840/88) Appelants and the Manawatu-Wanganui Regional Council (as successor to the Rangitikei-Wanganui Catchment Board) Respondent*. Decision no W. 70/90. Planning Tribunal.

- Ranginui, J. 1990. "The fish we were able to catch formed the major part of our diet".  
Pages 34-35 Whanganui River Annual. Friends of the Whanganui River, Wanganui.
- Rodland, D. L., B. R. Schone, S. Helama, J. K. Nielsen, and S. Baier. 2006. A clockwork mollusc: ultradian rhythms in bivalve activity revealed by digital photography. *Journal of Experimental Marine Biology and Ecology* **334**:316-323.
- Rolston, H. 2000. The land ethic at the turn of the millennium. *Biodiversity and Conservation* **9**:1045-1058.
- Roue, M., and D. Nakashima. 2002. Knowledge and foresight: the predictive capacity of traditional knowledge applied to environmental assessment. *International Social Science Journal* **54**:337-347.
- Royal, C. 1998. Mātauranga Māori: paradigms and politics – a paper presented to the Ministry for Research, Science and Technology, 13 January 1998. [www.charles-royal.com/assets/mm,paradigms%20politics.pdf](http://www.charles-royal.com/assets/mm,paradigms%20politics.pdf). Date accessed: 23 June 2008.
- Royal, C. 1999. He whakaaro mō te mātauranga Māori. [www.charles-royal.com/assets/matauranga.pdf](http://www.charles-royal.com/assets/matauranga.pdf). Date accessed: 23 June 2008.
- Selby, R., and P. Moore. 2006. Guardians of the land: a Māori community's environmental battles. *in* S. H. Washington, P. C. Rosier, and H. Goodall, editors. *Echoes from the poisoned well: global memories of environmental injustice*. Lexington Books, Oxford.
- Sessions, G., editor. 1995. *Deep ecology for the 21st century: readings on the philosophy and practice of the new environmentalism*. Shambhala Publications Inc., Boston.
- Sethi, S. A., A. R. Selle, M. W. Doyle, E. H. Stanley, and H. E. Kitchel. 2004. Response of unionid mussels to dam removal in Koshkonong Creek, Wisconsin (USA). *Hydrobiologia* **525**:157-165.
- Usher, P. J. 2000. Traditional ecological knowledge in environmental assessment and management. *Arctic* **53**:183-193.
- Van Overwalle, G. 2005. Protecting and sharing biodiversity and traditional knowledge: holder and user tools. *Ecological Economics* **53**:585-607.
- Waikato, T. 2005. He kaitiaki mātauranga: building a protection regime for Māori traditional knowledge. *Yearbook of New Zealand jurisprudence* **8**:344-410.
- Waitangi Tribunal. 1999. *The Whanganui River Report*. Waitangi Tribunal, Wellington.
- Warner, J., editor. 2007. *Multi-stakeholder platforms for integrated catchment management*. Ashgate Publishing Limited, Aldershot, Hampshire.

Whanganui River Māori Trust Board. 2002. Draft Mission Statement. Whanganui River Māori Trust Board.

Williams, D. 2001. Mātauranga Māori and taonga: the nature and extent of Treaty rights held by iwi and hapū in indigenous flora and fauna, cultural heritage objects, valued traditional knowledge. Waitangi Tribunal, Wellington.

Young, D. 1998. Woven by water: histories from the Whanganui River. Huia Publishers, Wellington.

## 2. KĀKAHI (*ECHYRIDELLA MENZIESII*) IN THE WHANGANUI RIVER – GOING, GOING, GONE?

### INTRODUCTION

Freshwater mussels are among the world's most threatened taxa (Lydeard et al. 2004). In the United States 72% of freshwater mussels are listed as endangered, threatened or of special concern (Williams et al. 1993), Europe's aquatic molluscs are declining (Frank and Gerstmann 2007), and species losses have been recorded in places such as Canada and Australia (Metcalf-Smith et al. 1998, Brainwood et al. 2006). Freshwater mussel decline has been attributed to sedimentation (Brim Box and Mossa 1999), eutrophication (Bauer et al. 1991), exposure to toxic metals (Naimo 1995), channel modification (Williams et al. 1993), introduced molluscs (Williams et al. 1993), and decline numbers of in host fish required by the parasitic larvae, the glochidia, to metamorphose into juveniles (Watters 1996).

The freshwater mussel of Aotearoa New Zealand, the kākahi (*Echyridella menziesii* (Gray, 1843)), is thought to be in decline (Firmin 1994, Waitangi Tribunal 1999, McDowall 2004), and has been included in the 'Gradual Decline' category of the Department of Conservation's Threat Classification System (Hitchmough et al. 2005). Reasons for this decline have not been extensively tested, but it is not unreasonable to assume that they may be similar to factors affecting freshwater molluscs worldwide.

In Whanganui, the iwi have long expressed concern over the status of kākahi populations, with local mātauranga evidencing a pronounced decline (chapter one, Planning Tribunal 1990, Firmin 1994, Waitangi Tribunal 1999, Environment Court 2004). Kākahi were once abundant enough throughout the Whanganui River as to provide a food source for local hapū. Now, numbers are so low it is difficult to locate them (Firmin 1994, Horrox 1998, Waitangi Tribunal 1999, T.W. Gray pers. comm. 2007). Iwi suspect that a number of factors may have contributed to kākahi decline in Whanganui, including alterations to flow and desiccation through the implementation of the Tongariro Power Development Scheme (TPD), increased erosion, bank instability and silt load through land clearance and the TPD, and pollutants such as domestic sewage, farm run-off and pesticides (Planning Tribunal 1990, Firmin 1994, Waitangi Tribunal 1999, Environment Court 2004, M. Potaka, P. Potaka Osborne, C. Osborne pers. comm. 2007, W. Wiari-Southern pers. comm. 2008).

As part of a wider desire for restoration of the Whanganui River, iwi wish to see kākahi once again abundant and thriving in the river and its tributaries. Restoration requires baseline data so that programmes can be effectively designed. In the Whanganui River, this requires a survey of the current status and distribution of kākahi.

Kākahi can live for over 50 years (Grimmond 1968). As with other long-lived mussel species, decline through steady adult die-offs and failure to reproduce may not be noticed for long periods (Sethi et al. 2004). Determining the status of Whanganui kākahi will therefore need to include assessments of whether populations are recruiting, or whether the kākahi found at a site are all older individuals representing a remnant, aging group. Condition indices can also be used to provide information on the status of particular populations.

The aim of this study was to provide information on current kākahi status and distribution for use in restoration initiatives by examining the following questions.

1. Have kākahi populations declined in the Whanganui area in living memory? (See below for definitions of decline.)
2. Are kākahi in Whanganui:
  - × lacking recruitment (no individuals < 30 mm); and/or
  - × in poor condition (> 20% of shell area eroded)?

## **METHODS**

### **SITES**

Search sites were areas identified by kaumātua and river users as having once supported kākahi populations. Searches were also made in areas where archival records in Te Papa Tongarewa (the Museum of New Zealand) and other literature (eg Horrox 1998, Young 1998) noted kākahi presence.

At each site, habitat variables were recorded (Table 1). Percent of riparian vegetation cover was assessed visually and vegetation type noted. Channel width was measured with a measuring tape, the trip odometer on a Garmin etrex GPS, or the distance estimator on Google Earth. Flow was defined as slow (no surface ripples, macrophytes upright), medium (some surface disturbance, macrophytes at an angle to river bed) or rapid (white water, periphyton flat against substrate). A visual assessment was made of sediment particle size and of the percentage cover of fine sediment on the substrate. When searches were conducted by snorkelling (see below), vertical visibility was estimated. Macrophyte



presence or absence was noted. Additionally, geographical information system (GIS) data from Horizon Regional Council's local adaptation of the River Environment Classification (REC; Snelder and Biggs 2002) for each site was retrieved using the geoprocessing extension in ARCVIEW. Relevant variables are included in Table 1.

Iwi are concerned that publishing new data on kākahi locations in the Whanganui River opens these populations up to exploitation by Western scientists. Divulging of site information in 1996-7 led to all kākahi found at some sites being taken and sacrificed (Horrox 1998). Some iwi sites were identified to me on the condition that I not make their locations publicly known. Therefore maps and information on locations are not provided in this thesis. Those wishing to access site data may contact Whanganui iwi for permission. Details on how to do this are given in Appendix One.

#### SURVEY METHODS

Each site was searched by myself and one of a number of field assistants who were trained on site. Sites were searched by snorkelling or wading for at least 1 hour between January and March 2008, when vertical visibility was up to 4 m and water levels were low (mean flow at the bottom of the catchment ( $41.35 \text{ m}^3/\text{sec}$ ) was equal to mean annual low flow ( $41.25 \text{ m}^3/\text{sec}$ ; data supplied by Horizons Regional Council)). A measure of catch per unit effort (CPUE) was taken, and is defined as the number of mussels encountered per person hour of search effort.

Timed searches were chosen for Whanganui because indications from iwi and an earlier survey (Horrox 1998) indicated densities would be very low. When determining population structure or abundance for freshwater mussel beds with densities below 0.01 per  $\text{m}^2$ , timed searches are more effective than quantitative searches (eg a one hour timed search has detection probabilities of 0.4, whereas a 10 hour search using  $148 \times 0.25 \text{ m}^2$  quadrats has a detection probability of  $< 0.05$ ; Strayer et al. 1997).

Table 1. Characteristics of sites in the Whanganui River catchment searched for kākahi. Listed in order from river mouth going upstream; sites with kākahi present are numbered, remaining sites labelled with letters. n/a = not applicable.

Site	Tributary (T) or mainstem (M)	Area searched (m <sup>2</sup> )	Visibility (m)	Channel width (m)	Flow	Substrate description	% of substrate covered by fine sediment	Macrophytes present	Distance to sea (m)	Catchment rainfall (mm)	% riparian coverage	% of catchment in native forest	% of catchment farmed
A	M	900	0.2	50	slow	sand, mud, pebbles	100	no	4219	1773	10	39	39
1	T	450	n/a	5	slow	mud, sand, gravel	95	yes	9533	1016	60	1	88
2	M	630	n/a	150	med-slow	mud, sand	100	no	10780	1786	100	39	39
C	T	100	0.3	0.75	med-slow	sand, mud	50	yes	11534	1022	100	1	90
3	M	240	0.3	120	slow	mud, sand	100	yes	16306	1793	90	40	38
4	M	837	1.5	80	slow	mud, sand	100	no	27230	1810	20	41	38
B	T	100	0.5	1.5	med-slow	sand, mud, papa rock	30	yes	32083	1164	80	0	0
5	M	850	1.5	75	slow	mud, logs, sand, papa	100	yes	42411	1819	0	41	38
6	M	320	3.0	80	med-slow	clay and mud	100	yes	45458	1821	0	41	38
7	M	1330	3.0	70	med-slow	logs, pebbles, sand, mud, clay, papa	80	yes	55224	1824	20	41	38
D	M	260	2.0	65	med	sand, mud	60	yes	69008	1833	30	41	39
E	M	1600	1.5	70	med-slow	sand, papa, pebbles	20	no	76060	1838	50	41	39
F	M	800	2.0	70	slow	mud, sand, papa, logs	100	yes	79107	1839	10	42	39

Table 1 (cont). Characteristics of sites in the Whanganui River catchment searched for kākahi. Listed in order from river mouth going upstream; sites with kākahi present are numbered, remaining sites labelled with letters. n/a = not applicable.

Site	Tributary (I) or mainstem (M)	Area searched (m <sup>2</sup> )	Visibility (m)	Channel width (m)	Flow	Substrate description	% of substrate covered by fine sediment	Macrophytes present	Distance to sea (m)	Catchment rainfall (mm)	% riparian coverage	% of catchment in native forest	% of catchment farmed
8	M	540	1.5	110	slow	mud, sand, rocks, pebbles, logs, papa	100	yes	83221	1842	0	42	39
9	M	380	1	140	med-slow	sand, mud, pebbles, papa	100	yes	87063	1843	80	42	39
10	M	1050	4	70	slow	rocks, pebbles, mud, papa, sand	70	yes	98122	1851	50	42	39
12	T	12	1	7	slow	coarse sand, pebbles, mud, papa shelves	80	yes	240537	1795	100	15	84
G	T	600	1	1.75	slow	sand, papa, some fine mud	40	no	245144	1774	100	20	77
15	T	100	2	25	slow	papa, rock, sand, mud	90	no	249089	1602	40	34	47
11	T	20	1	5	slow	rocks, sand, mud	50	no	268751	1793	100	3	97
14	T	1040	1.5	20	slow	sand, mud	80	yes	274534	1636	50	40	35
13	T	210	1	1.5	slow	gravel, sand, mud	30	yes	285998	1921	80	45	50

All mussels found in an area were measured with vernier callipers (anterior to posterior length), photographed and returned to the site. Length data was used to graph size class distributions (at sites with  $n \geq 20$ ) and to compare body size means between sites (when  $n \geq 10$ ). Similarities between population structures were calculated using Bray-Curtis analysis of resemblance (ANOSIM) on the software programme Primer 6 (Clarke and Gorley 2006). Non-metric multi-dimensional scaling (MDS) was used to plot populations according to similarity. Axis scores from ANOSIM were tested for linear relationships with habitat variables and median length using Statistix 8.1 (Analytical Software 2006). Median length (at sites with  $n \geq 10$ ) was compared against habitat variables.

#### DECLINE, RECRUITMENT AND CPUE

Decline was considered to have occurred when kākahi had been extirpated from a site identified by kaumātua or historical records as once housing kākahi beds, or if catch per unit effort (CPUE; number caught per hour searching) was less than 10. Given that sites searched once had enough kākahi to be considered as a regular food source by local iwi, a current CPUE of  $< 10$  is assumed to be a sufficiently conservative estimate of decline, as no site with  $CPUE < 10$  could feasibly be considered to currently support harvestable stock.

Recruitment to a population was considered to be occurring when individuals of less than 30 mm in length were recorded. Kākahi  $< 30$  mm are likely to be younger than two years, although they can be up to four (James 1985, Payne et al. 1997). Populations lacking recruitment and with a CPUE of less than 4 were considered to be ‘remnant’. Large areas can be searched when CPUE is low, and generally a CPUE of 4 would equate to densities well below the 10 mussels per  $m^2$  required by some Unionids to facilitate

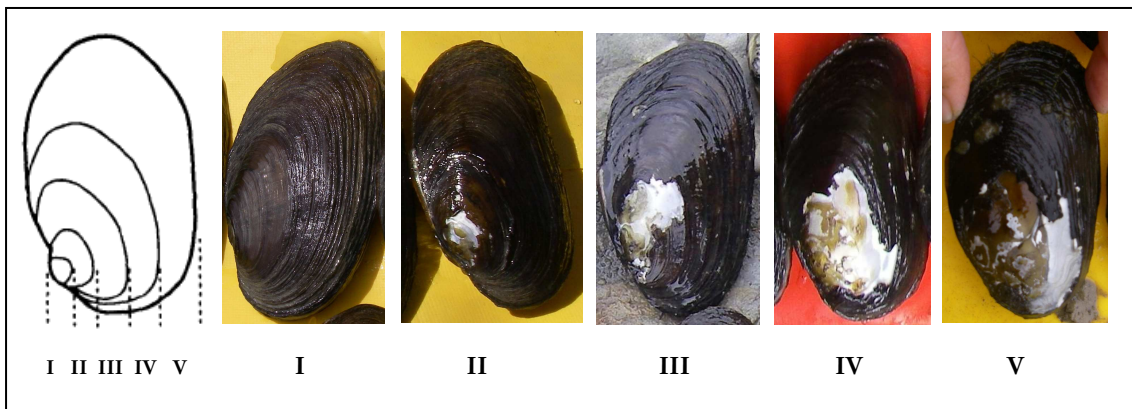

Fig. 1. Delineation and examples of shell erosion categories. Extent of surface area affected by some degree of shell erosion: I  $< 1\%$ ; II  $1-5\%$ ; III  $5-20\%$ ; IV  $20-50\%$ ; V  $> 50\%$ .

reproduction (Weber 2005). CPUE was examined against channel width and distance to the sea (Table 2); comparisons with other habitat variables were not made as the requirement for normality was not met and standard transformations could not be applied. The data was tested for outliers using a box and whisker plot using Statistix 8.1; a 'probable outlier' was defined as being outside the box boundary by more than 3 times the box size.

#### SHELL EROSION

From photographs taken on site, the left valve of each kākahi was examined to determine the amount of periostracum (outer skin) erosion (Roper and Hickey 1994). Each kākahi was assigned to a category depending on the percentage of shell area affected by some degree of erosion: I < 1%; II 1-5%; III 5-20%; IV 20-50%; V > 50% (Fig. 1). At sites where more than 10 kākahi were found, median values were examined against longitudinal position, channel width and median shell length (Table 2). Data could not be examined against other habitat variables as they did not meet the requirement for normality.

#### ASSESSMENT OF THE 'HEALTH' OF A POPULATION

The 'health' of populations was assessed following classifications developed for *Margaritifera margaritifera* (Bauer 1988). Populations were assigned to one of four groups:

- Group one: healthy; > 25% of the population are juveniles. Kākahi can be considered 'juvenile' if they are younger than 5 years, or  $\leq 38$  mm (Roper and Hickey 1994).
- Group two: decreased recruitment;  $\leq 25\%$  of the population are juveniles.
- Group three: recruitment ceased; population has no individuals  $\leq 38$  mm.
- Group four: aging; smallest specimens are 55 mm (corresponds to around 8 years or older (James 1985)).

Categories for groups one and two differ from those in Bauer; his thresholds were 30% and 20% respectively. I have used 25% because the 30% and 20% thresholds leave several populations assigned to no particular category. I labelled this assessment 'health method one' (HM<sub>1</sub>).

#### 'HEALTH' OF KĀKAHI IN THE WHANGANUI RIVER FROM AN IWI PERSPECTIVE

Iwi assess 'health' from a different perspective: whether there are sufficient numbers of large kākahi at a site to supply the hapū with food. For iwi, the decreased availability of kākahi is an indication of a loss of the ability of the river to sustain life (Waitangi Tribunal

1999). A value indicating sufficient supply of large kākahi was calculated by removing all individuals less than 60 mm from the data set and recalculating CPUE. A population was deemed 'healthy' if CPUE exceeded 50. With two collectors, this would fill half a 20 L bucket in an hour, and is about what you might need to feed a small hui. This has been labelled health method two (HM<sub>II</sub>).

## RESULTS

### SITES, KĀKAHI LOCATED AND CATCH PER UNIT EFFORT

A mix of tributary and main stem sites were searched, with channel width ranging from 0.75-150 m and flow ranging from slow to medium (Table 1). At some sites there were isolated areas of faster flow which were also searched, but kākahi were never found in these areas. Definition of flow at a site was taken from areas where kākahi were immediately located. Sites ranged in riparian vegetation coverage from 0 to 100% and fine sediment covering the substrate ranged from 30 to 100%. Kākahi were found in areas of slow flow, which generally had more fine sediment, logs and/or macrophytes. Kākahi were often found in the lee of logs, rocks or other shelter, and at one site juveniles were found nestled on the stems of macrophytes, rather than in the sediment. Site G was unique in that only empty shells were found.

Throughout the river, CPUE ranged from 0 to 93, with a median catch of 3 and a mean of 11 (Fig. 2). Catch per unit effort increased with distance from the sea ( $F_{1,19} = 7.48$ ,  $P = 0.01$ ,  $r^2 = 0.28$ ; Table 2, Fig. 2). Catch per unit effort was not related to channel width ( $F_{1,19} = 1.86$ ,  $P = 0.19$ ,  $r^2 = 0.09$ ; Table 2). Site 11 was excluded from comparison with site variables as it was a probable outlier.

### DECLINE, RECRUITMENT AND REMNANT POPULATIONS

Of the 22 sites surveyed, kākahi have declined at 16 (73%; Table 4). Of those sites, there were 7 sites where decline was so severe that the population had been extirpated. Of the 15 historic beds where kākahi are still extant, four (27%) were remnant populations. Evidence of recruitment (individuals below 30 mm) was found at only four (27%) of the 15 extant populations, or 18% of the total number of sites searched (sites 3, 4, 8 and 12).

### LENGTH

Size class distributions (at sites where  $n \geq 20$ ) showed two differing patterns: unimodal with a skew towards larger size classes; and an even distribution across a range of size

classes (Fig. 3). Juveniles (< 38 mm) were found at five sites, and at three of these sites (3, 4 and 8) small individuals were found in equal proportion to the larger individuals. Of the sites with more than 20 individuals, juveniles were absent from three (1, 6 and 11).

Across all sites, length ranged from 18 to 101 mm (Fig. 3, Table 5). The range in length at each site extended from 23 mm (site 7) to 62 mm (site 4). Range in length was not related to number of kākahi collected ( $F_{1,13} = 0.79$ ,  $P = 0.39$ ,  $r^2 = 0.06$ ); site 11 had the greatest number found (185), but the second smallest size range (26 mm).

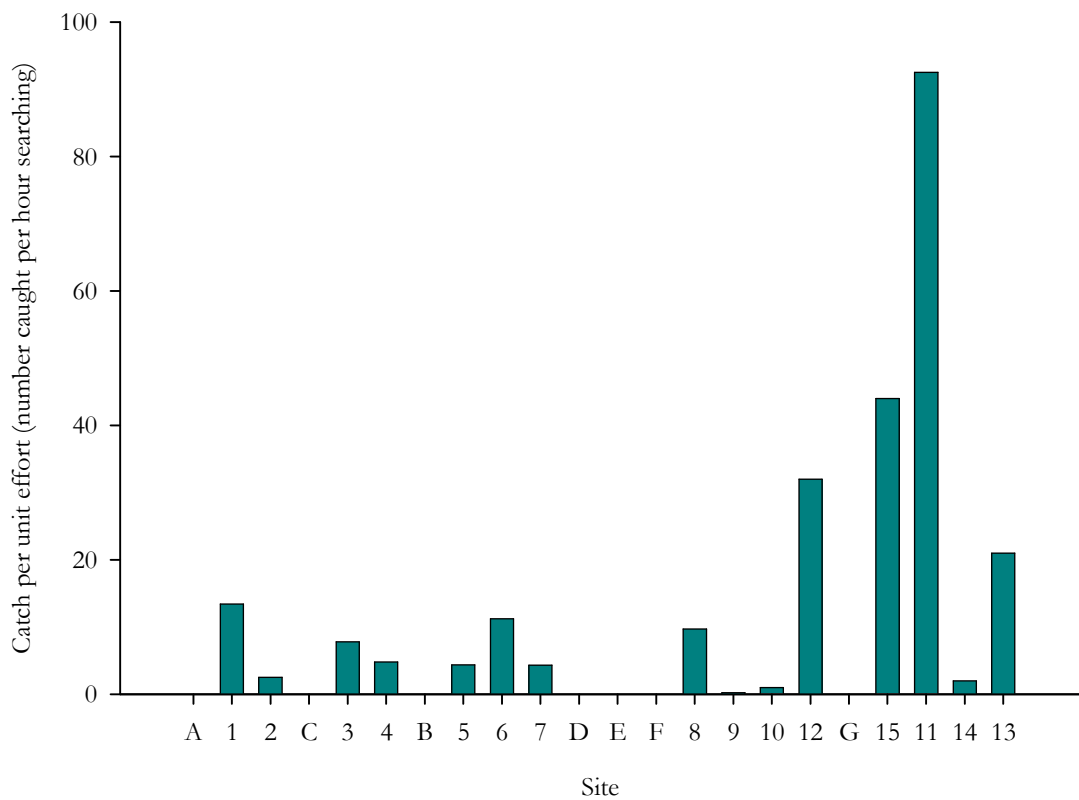

Fig. 2. Catch per unit effort (number caught per hour searching) for kākahi at sites along the Whanganui River. Sites where no kākahi were found are labelled with letters; sites with kākahi are numbered. Sites listed in order of distance from the sea.

Table 2. Linear relationships between site variables and catch per unit effort (CPUE), median shell length and median shell erosion extent. Site 11 is excluded from analysis of CPUE as it is an outlier. Relationships with no values shown failed to meet requirements for normality or constant variance. ns: not significant; \* significant at  $\alpha = 0.05$ ; \*\* significant at  $\alpha = 0.01$ .

Variable	CPUE				Median shell length				Median shell erosion extent			
	Significance and relationship type	F <sub>1,19</sub>	P	r <sup>2</sup>	Significance and relationship type	F <sub>1,9</sub>	P	r <sup>2</sup>	Significance and relationship type	F <sub>1,9</sub>	P	r <sup>2</sup>
Distance to sea (m)	* positive	7.48	0.01	0.28	ns	0.19	0.68	0.02	** positive	17.26	0.00	0.66
% of catchment in native forest	-	-	-	-	ns	0.49	0.50	0.05	-	-	-	-
% of catchment farmed	-	-	-	-	ns	0.42	0.53	0.05	-	-	-	-
% of catchment urban	-	-	-	-	ns	1.12	0.32	0.11	-	-	-	-
% of catchment in exotic forest	-	-	-	-	ns	0.00	0.98	0.00	-	-	-	-
Channel width (m)	ns	1.86	0.19	0.09	ns	1.61	0.24	0.15	* inverse	5.37	0.05	0.37
% sediment on substrate	-	-	-	-	ns	1.45	0.26	0.14	-	-	-	-
Catchment rainfall (mm/year)	-	-	-	-	ns	0.71	0.42	0.07	-	-	-	-
Median shell length	-	-	-	-	-	-	-	-	ns	1.60	0.24	0.15



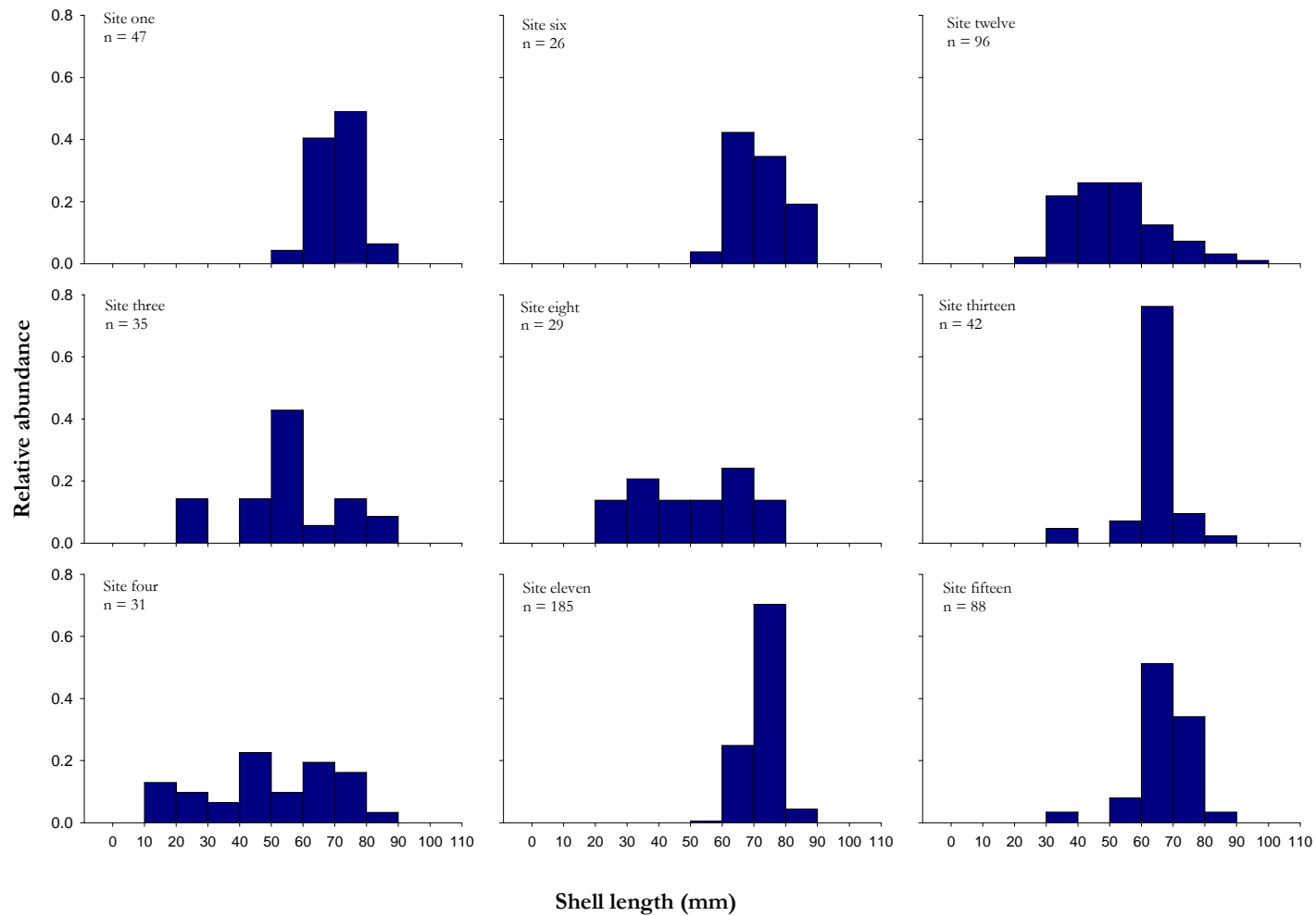

Fig. 3. Length-frequency distributions of kākahi at sites in the Whanganui River catchment. Data for sites where  $n < 20$  is not graphed, but is presented in Table 5.

Median shell length was not related to any variable tested (Table 2 & 6). Mean shell length (Table 6) differed between sites (tested for the 11 sites where  $n \geq 10$ ;  $F_{10, 591} = 43.30$ ,  $P < 0.001$ ). Axis scores from Bray-Curtis analysis of similarity were not related to any habitat variables, but were related to median size ( $F_{1,9} = 32.56$ ,  $P < 0.001$ ,  $r^2 = 0.78$ ; Table 3). Populations fell into two distinct groups using Bray-Curtis analysis ( $R = 0.95$ ,  $P < 0.01$ ): those with a median below 60 mm and those with a median above 60 mm (Fig. 4).

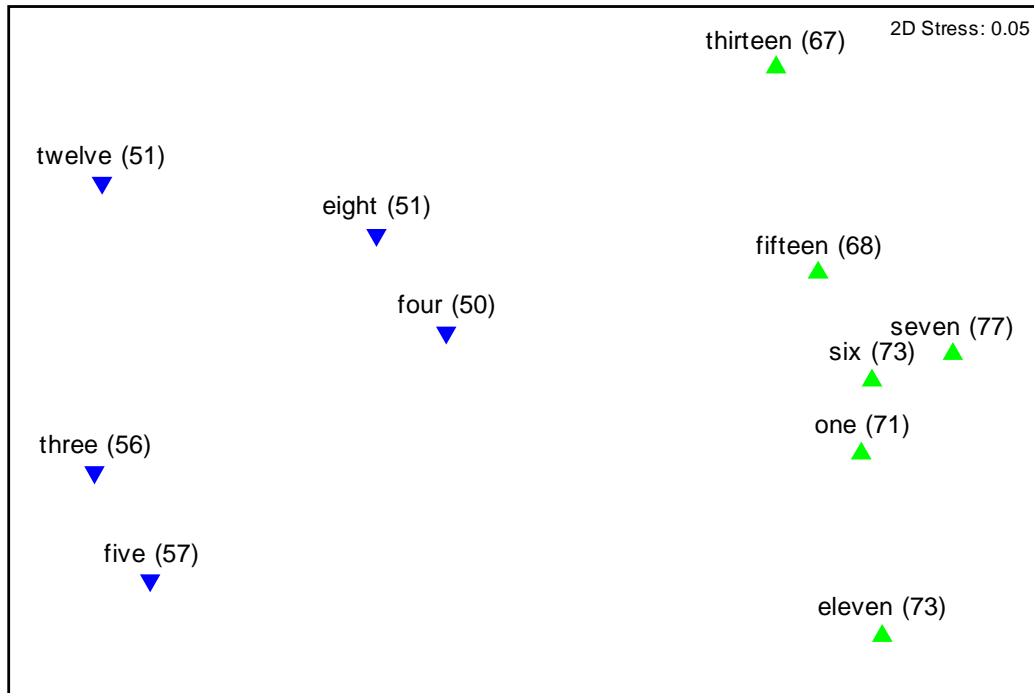

Fig. 4. Bray-Curtis similarity for size class distributions of kākahi at sites in the Whanganui River where  $n \geq 10$ ; labeled by site number and median length (in brackets). ▼ group 1 (median below 60 mm) ▲ group 2 (median above 60 mm).

Table 3. Linear relationships between habitat variables and axis scores from Bray-Curtis analysis of resemblance of length class frequency distribution of kākahi at sites in the Whanganui River where  $n \geq 10$ .

Variable	Axis 1 score (x axis)			Axis 2 score (y axis)		
	$F_{1,9}$	P	$r^2$	$F_{1,9}$	P	$r^2$
Channel width (m)	1.97	0.19	0.18	0.27	0.62	0.03
Sediment coverage of substrate (%)	1.56	0.24	0.15	0.72	0.42	0.07
Distance to sea (m)	0.36	0.56	0.04	1.51	0.25	0.14
Catchment rainfall (mm)	0.80	0.39	0.08	0.47	0.51	0.05
Riparian coverage (%)	0.07	0.80	0.01	0.01	0.92	0.00
% catchment native vegetation	0.37	0.56	0.04	1.41	0.27	0.14
% catchment farmed	0.32	0.59	0.03	0.41	0.54	0.04
Median length	32.56	0.00	0.78	0.48	0.51	0.05

SHELL EROSION

Median shell erosion at the 11 sites containing more than 10 kākahi ranged from category I (less than 1% of the shell area eroded) to category III (up to 20% of shell area affected; Table 6). The two sites (11 and 13) exhibiting the greatest erosion had many shells with up to 50% of their surface affected by erosion (categories III and IV; Fig. 5). Shell erosion increased with distance upstream ( $F_{1,9} = 17.26$ ,  $P < 0.01$ ,  $r^2 = 0.66$ ) and decreased with channel width ( $F_{1,9} = 5.37$ ,  $P < 0.05$ ,  $r^2 = 0.37$ ; Table 2). Shell erosion was not related to median shell length.

Table 4. Abundance and status of kākahi at sites in the Whanganui River catchment. Sites are listed in order from the river mouth heading upstream.

Site	n	CPUE	Declined (CPUE < 10)	Recruitment occurring	Remnant population	Locally extirpated	
A	0	0	yes	-	-	yes	
1	47	13	no	no	no	no	
2	5	3	yes	no	yes	no	
C	0	0	yes	-	-	yes	
3	35	8	yes	yes	no	no	
4	31	5	yes	yes	no	no	
B	0	0	yes	-	-	yes	
5	13	4	yes	no	no	no	
6	26	11	no	no	no	no	
7	10	4	yes	no	no	no	
D	0	0	yes	-	-	yes	
E	0	0	yes	-	-	yes	
F	0	0	yes	-	-	yes	
8	29	10	yes	yes	no	no	
9	1	0	yes	-	yes	no	
10	2	1	yes	no	yes	no	
12	96	32	no	yes	no	no	
G	0	0	yes	-	-	yes	
15	88	44	no	no	no	no	
11	185	93	no	no	no	no	
14	3	2	yes	no	yes	no	
13	42	21	no	no	no	no	
<b>total</b>	<b>22</b>	<b>613</b>	<b>-</b>	<b>16</b>	<b>4</b>	<b>4</b>	<b>7</b>
<b>%</b>	<b>-</b>	<b>-</b>	<b>-</b>	<b>73% (16/22)</b>	<b>27% (4/15)</b>	<b>27% (4/15)</b>	<b>32% (7/22)</b>

## HEALTH OF POPULATIONS

Under  $HM_I$ , only 2 (13%) of the kākahi populations encountered could be classified as 'healthy' (Table 7). Four (26%) sites evidenced reduced recruitment (group 2), whereas at the remaining 9 sites there were no juveniles at all. Of those nine sites, six were comprised entirely of large (aging) individuals, with none smaller than 55 mm. Under  $HM_{II}$ , only one of the 22 sites searched (site 11) would now be considered healthy from an iwi perspective (Table 7).

Table 5. Shell length (mm) for sites where  $n < 20$ .

Site 2	Site 5	Site 7	Site 9	Site 10	Site 14
74	50	62	55	46	50
82	52	68		75	51
85	53	68			56
86	53	69			
101	55	76			
	55	77			
	57	78			
	58	82.5			
	60	83			
	61	85			
	70				
	72				
	85				

Table 6. Median shell length and shell erosion in the Whanganui River catchment at sites where number of kākahi caught ( $n$ )  $\geq 10$ . Mean shell length at sites where  $n \geq 20$ .

Site	n	Median shell length	Mean shell length	Median erosion extent
1	47	71	71	1
3	35	56	56	1
4	31	50	51	1
5	13	57	-	1
6	26	73	73	1
7	10	77	-	1
8	29	51	52	1
12	96	51	52	1
15	88	68	68	2
11	185	73	73	3
13	42	67	66	3

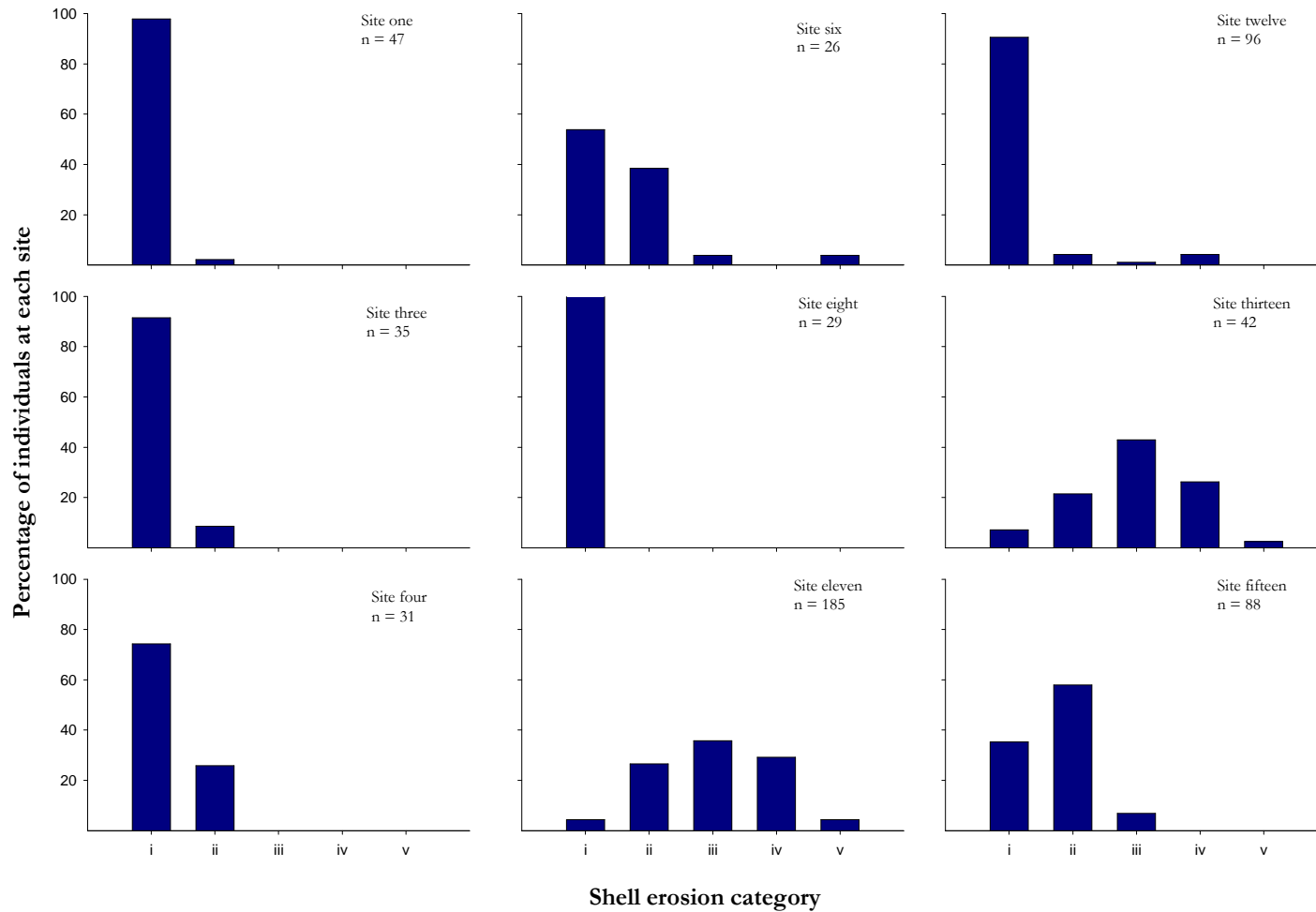

Fig. 5. Extent of shell erosion for sites where  $n \geq 20$ . Categories reflect shell area affected by erosion. I < 1%; II 1-5%; III 5-20%; IV 20-50%; V > 50%.

Table 7. Health of kākahi populations in the Whanganui River. HM<sub>I</sub>: Health method 1, HM<sub>II</sub>: Health method 2. Sites are listed in order from the river mouth heading upstream.

Site	n	Group (HM <sub>I</sub> ) <sup>a</sup>	Recalculated CPUE (all individuals > 60 mm)	'Healthy' according to an iwi perspective (HM <sub>II</sub> ) <sup>b</sup>
A	0	-	0	no
1	47	4	13	no
2	5	4	3	no
C	0	-	0	no
3	35	2	2	no
4	31	1	2	no
B	0	-	0	no
5	13	3	2	no
6	26	3	11	no
7	10	4	5	no
D	0	-	0	no
E	0	-	0	no
F	0	-	0	no
8	29	1	4	no
9	1	4	0	no
10	2	4	1	no
12	96	2	8	no
G	0	-	0	no
15	88	2	39	no
11	185	4	92	yes
14	3	3	0	no
13	42	2	19	no

<sup>a</sup> Groups: 1 – healthy; 2 – decreased recruitment; 3 – recruitment ceased; 4 – aging. See methods for further definitions of groups.

<sup>b</sup> Site has CPUE  $\geq$  50 for individuals larger than 60 mm.

## DISCUSSION

### STATUS OF KĀKAHI AT SITES ON THE WHANGANUI RIVER

Kākahi have declined in the Whanganui catchment in living memory. Decline is ongoing: evidence of recent recruitment was only found at four of 22 sites surveyed, and of the 15 populations found, 27% were remnants and likely to disappear in the near future. Very few populations can be considered healthy by either Western or Māori measures. Concerns raised about kākahi health (Planning Tribunal 1990, Firmin 1994, Waitangi Tribunal 1999, Environment Court 2004, chapter one) are well-justified.

These findings are in line with trends overseas, where freshwater mussels are declining in both abundance and range (Naimo 1995, Lydeard et al. 2004). *Margaritifera margaritifera* declined in abundance by 90% in Europe last century (Bauer 1988), half of North America's 297 species are in decline (Augsburger et al. 2003), species loss and change in community composition to sediment- and pollution-tolerant species have been

documented in Canada (Metcalf-Smith et al. 1998), and freshwater mussel species are now absent from many human modified areas in Australia (Brainwood et al. 2006).

#### SKEWED DISTRIBUTION – INDICATIVE OF DECLINE?

Few juveniles were detected in the Whanganui, but it is difficult to discern from population structure alone whether this is indicative of decline. Kākahi juvenile numbers are often low, and individuals below 20 mm are rarely found (Grimmond 1968, James 1985, Roper and Hickey 1994). The same is also true for freshwater mussel populations overseas, where size class distributions are often unimodal, dominated by one size class, and skewed to the right (Kat 1982). Very small juveniles are rarely found, and numbers in the smaller size classes are often lower than those in larger size classes, whether or not a species is in decline (Kat 1982, Beasley et al. 1998, Johnson and Brown 1998, Strayer and Fetterman 1999, Aldridge 2000, Alvarez-Claudio et al. 2000).

In this study skewed distribution did not necessarily indicate lack of recruitment. However, all three populations lacking juveniles below 38 mm were unimodal, skewed to older individuals and likely to become extirpated in the near future. Juveniles were never found at sites with fewer than 20 individuals, again indicating these populations are likely to be remnants. The threshold of presence/absence of individuals below 38 mm is therefore a more useful indicator of decline than a skewed distribution.

ANOSIM showed population structures were split into two groups: those where the population had a median below 60 mm, and those with a median above 60 mm. Generally, the populations with a median below 60 mm had a more even distribution of length class and higher numbers of small specimens than populations with a median above 60 mm. This would suggest that populations can be split into recruiting and non-recruiting groups, marked by aging (non-recruiting) populations having medians above 60 mm, and populations with some replacement occurring having medians below 60 mm. However, as size structure did not relate to any habitat variables, these findings throw little light on causes of differences in population structure, or possible factors influencing recruitment.

#### JUVENILE HABITAT

A great mystery remains around where the smallest juveniles (< 20 mm) reside. They may have different habitat needs than their older counterparts (Kat 1982, Roper and Hickey 1994) and there is a suggestion that these smallest individuals may live attached to hard substrate (K. Amohia, pers. comm. 2008). Juveniles of some species have a single byssal thread which dissolves as the juvenile grows and is absent in the adult (Carriker 1961,

Chang et al. 1996). Juvenile zebra mussels (*Dreissena polymorpha*) are able to dissolve their byssal threads in order to move along the substrate (Nichols 1996). Photographs of kākahi glochidia show a long thread (Nobes 1980), which Nobes proposed was used to attach to host fish. It is not known if such threads also develop in post-glochidial kākahi and could be used to attach to the substrate, and then dissolve as the juvenile develops into its burrowing phase. If so, this would mean very small juveniles are likely to be found in entirely different habitats than adults and explain the lack of detection with current sampling techniques.

James (1985) noted that juveniles (larger than 20 mm) in Lake Taupō were only found in areas with clean coarse sand (699-2000 µm in diameter). This differs from my study, where juveniles were found at sites with a layer of fine silt often up to 15 cm deep.

#### LACK OF RECRUITMENT

What has caused lack of recruitment in the majority of populations? Recruitment is not limited to either the lower or upper reaches and still occurs in areas which are high in sediment and/or nutrients, suggesting that water quality may not be the primary inhibiting factor (see Phillips 2001, Ausseil et al. 2005, McArthur and Clark 2007 for details on sediment and nutrient loads). Perhaps it is the lack of host fish that is a key limitation (Haag and Warren 1997, Johnson and Brown 1998, McDowall 2004, Brainwood et al. 2006). Fertility in *M. margaritifera* is unaffected by water chemistry factors (Bauer 1987), and mussels in an Australian catchment reproduced every year, but were unlikely to be able to complete their lifecycles for lack of hosts (Byrne 1998). If the same is true for kākahi, adults may still be producing viable glochidia which are unable to metamorphose into juveniles through lack of host fish, and which therefore subsequently perish.

Known hosts for kākahi glochidia are kōaro (*Galaxias brevipinnis*), the giant and common bullies (*Gobiomorphus gobioides* and *G. cotidianus*), and eels (*Anguilla spp.*; Percival 1931, Hine 1978, Phillips 2006). Kōaro make up the second greatest part of the whitebait catch in Aotearoa New Zealand (McDowall 2001). Whanganui iwi formerly recorded shoals of whitebait in the river so large they turned the waters black. Now, however, whitebait numbers in Whanganui are very low (W. Teki, pers. comm. 2007, Waitangi Tribunal 1999), and kōaro decline has been noted in many other waterways in Aotearoa New Zealand (Rowe et al. 2002, McDowall 2006).

Of the other hosts, eel numbers have also dropped in the Whanganui River following heavy pressure from commercial eelers (Environment Court 2004). While common bullies can still be found high abundance in some lakes (Rowe and Chisnall 1997,



Rowe 1999, Rowe and Taumoepeau 2004), information on their present abundance in the Whanganui River is lacking. Likewise, giant bullies are regarded as ‘not uncommon’ in some areas (Rowe 1999), but current abundance in the Whanganui River is unknown. Giant bully distribution is, however, generally limited to estuarine areas (McDowall 1997), limiting their usefulness as a kākahi host. Overall, numbers of fish available to host glochidia are down and this is likely to affect kākahi recruitment (see also McDowall 2004).

#### SURVIVAL AND POSSIBLE CAUSES OF DECLINE

While recruitment is occurring throughout the river (at a limited number of sites), it is not certain that survival is uniform throughout. CPUE increased with distance upstream, suggesting that survival may be higher in the upper regions. According to Horizons Regional Council assessments, water quality is ‘excellent to good’ in the upper reaches, but deteriorates with distance downstream, with sediment being the main contaminant (Ausseil et al. 2005). Soluble inorganic nitrogen (SIN) showed a differing trend: it is high in the upper reaches (at Ngāhuinga), often breaching proposed ‘One Plan’ water quality standards, and decreases with distance downstream until Pipiriki, increasing again in the coastal regions (Horizons Regional Council 2007, McArthur and Clark 2007). Dissolved reactive phosphorus (DRP) only occasionally breached proposed standards anywhere in the river (McArthur and Clark 2007). This suggests that sediment may be the main parameter affecting survival.

However, effects of nutrient enrichment cannot be ruled out completely: the water quality guidelines for ammonia in the United States are set at levels which do not protect freshwater mussels, which are more sensitive than other species (Augsburger et al. 2003). Effect of ammonia on kākahi has not been tested; therefore it remains unknown whether ammonia levels in the Whanganui River have influenced decline.

Further, current kākahi populations may be exhibiting historic effects not captured by analyses linked to current habitat variables. For example, iwi evidence states that some populations were desiccated when the Tongariro Power Development scheme was established (Environment Court 2004). The drop in water was enough to expose the entire bed at Paetawa; this is one site where CPUE is now low and juveniles are not found.

Historic use of pesticides may also have contributed to decline. Pesticide contamination in bivalves has led to increased immune responses, reduced condition, reduced reproductive fitness, and brittle shells (Hickey et al. 1997, Binelli et al. 2001, Oliver et al. 2001, Ruessler et al. 2006, Frank and Gerstmann 2007). Pesticides such as DDT were widely used in Aotearoa New Zealand until 1970 (Boul 1995) and organochlorines have

been found in waterways and in kākahi tissues (Hickey et al. 1997). Pesticide use may even continue to be a factor in decline at some sites. In areas where kākahi are extant, it is usual to find expended shells on the banks or in the stream itself; for a searcher, the discovery of an empty shell is usually a good indication that there are live kākahi nearby. However, at Site G, where seven empty shells were found and an extensive search was made for live kākahi, none were located. Most of the expended shells were upright in the substrate, indicating that kākahi deaths were not a result of predation, and were likely to be recent. They were small (47-58 mm), extremely brittle and highly eroded. It was noted that scrub in the area had recently been sprayed. It seems possible that there is a connection between the spray event and kākahi deaths in the stream; this hypothesis needs further investigation.

Kākahi at individual sites may be influenced by localised factors – for example gravel extraction at site 9, water traffic disturbance (and associated pollutants) at site 10, and urbanisation at sites 1 and 2. Taking of specimens for scientific study may have been the last ‘nail in the coffin’ for kākahi at sites nine and ten – all 11 and 23 found at these sites in 1996-7 were taken (Horrox 1998), and numbers found at these sites in the current study were the lowest of all sites with kākahi present, at 1 and 2 respectively.

It should be noted that while over-harvesting has caused freshwater mussel declines overseas (Alvarez-Claudio et al. 2000), it is unlikely to be a factor in the Whanganui area. Urbanisation has meant there are less iwi members living beside and off the river than in the past, and most no longer eat kākahi (Waitangi Tribunal 1999); harvest pressure has declined rather than increased in the last century.

Overall there is no one clear factor that stands out as contributing to decline. For any restoration measures to be implemented in Whanganui, research will need to be conducted to determine what has caused, and continues to cause, kākahi to decline in the river.

#### SHELL EROSION

Shell erosion was once thought to be a chemical process, where acidic waters wear away the calcium-carbonate layer of the mussel shell (Coker et al. 1921). However, studies have now shown shell erosion is more attributable to physical abrasion through turbulence (Hinch and Green 1988, Kaehler 1999, Griffiths and Cyr 2006). Bivalves have an outer skin, the periostracum, which protects the inner nacreous layer. Once the periostracum is damaged, the underneath layer is exposed to erosion. Mussels are able to repair their shells (Hinch and Green 1988), but the process is energetically costly (Kaehler and McQuaid 1999). Mussels with eroded shells expend more energy on replacing the shell, and put less

into reproduction, leading to reduced gonad development (Kaehler and McQuaid 1999). Furthermore, marine mussels with eroded periostracum had a far higher rate of endolith infestation than intact mussels, leading to additional shell erosion and mortality (Kaehler and McQuaid 1999).

The two sites with the most extensive shell erosion (11 and 13) had coarser substrate than the other sites, which probably contributed to shell erosion through abrasion. The population at site 11 is considered to be aging (group 4 of HM<sub>I</sub>) and lacked any individuals below 59 mm. It may be that the increased costs of shell repair at this site are inhibiting reproduction. Site 13, exhibiting the second highest amount of shell erosion, was rated as group two (reduced recruitment) under HM<sub>I</sub>. It is not clear if shell erosion at this site has led to reduced reproductive output.

Because erosion was not related to shell length in this or other studies (Hinch and Green 1988, Kaehler 1999, Griffiths and Cyr 2006), age is not a factor in the extent of visible shell erosion. It is not clear why distance to the sea is a factor in shell erosion, although it may be that streams nearer the coast in Whanganui have a lower gradient, and kākahi in the lower reaches are therefore subjected to less turbulence. In this study, channel width had an inverse relationship with shell erosion. This differs from Horrox (1998) who found shell erosion increased with channel width. Reasons why erosion decreases with channel width are not clear, although it may be because most kākahi found in wide channel areas were also located downstream, in the lower gradient regions, and usually in very silty spots where shells would not be subject to much abrasion with coarse sediment.

Overall, however, populations in the Whanganui River catchment were not rated as being in 'poor' condition (> 20% of shell area eroded) using the shell erosion condition index. Given that the low CPUEs, decline in abundance and general lack of recruitment indicate that kākahi are indeed in a poor state, the erosion index seems not to provide a particularly reliable assessment of condition.

#### UTILISING HISTORIC AND IWI SITE INFORMATION

Freshwater mussels are aggregated but generally patchily distributed in rivers (Morales et al. 2006). As a consequence, searching in areas once known to house populations of the target species can be a useful way to appraise historic population trends. However, Strayer and Fetterman (1999) have argued that such an approach can lead to erroneous conclusions, and that the difference between historic and current presence/absence data at particular sites cannot be used to calculate total decline, as species may have migrated to other sites or formed new beds. They suggest adding new sites to the historic data set and comparing

total increase or decrease in presence or absence across a number of sites. This, however, overlooks one major consideration: historic data rarely records sites searched where a species of interest was *not* found, but where habitat was suitable. Individuals present in newly documented sites may actually be part of a historic, but undocumented, bed. Their discovery does not necessarily constitute an increase in species presence – only an increase in detection. Furthermore, other historic, undocumented beds may have disappeared unnoticed. Therefore total decline in presence can only be compared at sites where the species is known to have occurred, as was calculated in this study. In Aotearoa New Zealand, where freshwater mussels are not used commercially, often the few people who know of kākahi beds are local iwi. Linking in with iwi helps provide more information on previous to present kākahi distribution.

#### DIFFERENCES IN WESTERN AND MĀORI APPROACHES TO HEALTH

Western and Māori conclusions as to the health of individual populations varied dramatically, primarily because Western approaches focused on recruitment and the ability of a population to replace itself, whereas Māori approaches focused on abundance of larger individuals, especially compared with known historical abundance according to traditional knowledge. Both approaches have limitations in terms of kākahi conservation. Using a Western approach, a population might mistakenly be considered safe because it is recruiting at a certain rate, but this may ignore evidence that total abundance is much lower than it once was, and than what it probably should be. This approach overlooks evidence that the river is not supporting the abundance of life it once did. Conversely, Māori methods, which focus on larger individuals, may not notice the lack of replacement juveniles until abundance declines, some years after the population has begun to decline. The most effective kākahi conservation would therefore utilize both Western science and Māori approaches.

#### PROTECTING SITE INFORMATION

It is standard protocol within Western science to publish site information. This allows replication of results, and ensures scientific rigour. However, in Aotearoa New Zealand, there are wider political issues to consider, one being the disputed ownership of the Whanganui River itself. In 1999, the Waitangi Tribunal published findings on a Treaty of Waitangi claim by Whanganui iwi on the river, accepting that Whanganui iwi had never

freely or willingly relinquished ownership, management and control of the river (Waitangi Tribunal 1999).

In this position of connection with and responsibility for the river, Whanganui iwi wish to protect both the river and its biota from exploitation. Many Māori believe that if sites such as fishing grounds, spawning areas or shellfish beds are disclosed, that information will be exploited by Western science practitioners, resource managers or members of the general public. This belief is often well-justified, and lies in first-hand experiences, of which Horrox's (1998) take of kākahi from the river is one example.

Horrox utilised iwi information to determine search sites. He searched 50 sites and found kākahi at only six of these locations, often in low numbers, noting himself that kākahi are "becoming scarcer in the Whanganui River" (Horrox 1998). This did not deter him from taking those specimens to determine age and condition, a practice many Māori would see as wasteful and disrespectful but which is standard protocol in Western bivalve research (Nobes 1980, James 1985, Roper and Hickey 1994, Diggins 2001, Maire et al. 2007). Actions such as this have led to a widespread reticence amongst Whanganui iwi in sharing information, and, for many, a general mistrust of science practitioners.

I am a Whanganui iwi member, but even my own access to some sites was not allowed until assurance was given that information would not be disclosed. It is for these reasons, and out of my own desire to see kākahi protected on the Whanganui, that site information is withheld.

## **CONCLUSION**

Surveys were conducted to examine whether kākahi abundance in the Whanganui River has declined in living memory, and if kākahi populations are in poor condition and lacking recruitment. Results show that many sites which once provided a plentiful and sustainable harvest of kākahi now support only very low densities, that abundance has declined, and that very few populations are recruiting. Recruitment is likely to be limited by lack of host fish; populations are unlikely to increase until this recruitment pathway is restored. Health in general is low; an intervention to restore the kākahi to abundance in the Whanganui River is required. Interventions which improve water quality and habitat for both kākahi and their host fish (for example, catchment and riparian planting, improved land management practices and better controls on whitebait fishing) are likely to be most effective in facilitating an increase in kākahi numbers in Whanganui.

## REFERENCES

- Aldridge, D. C. 2000. The impacts of dredging and weed cutting on a population of freshwater mussels (Bivalvia: Unionidae). *Biological Conservation* **95**:247-257.
- Alvarez-Claudio, C., P. Garcia-Roves, R. Ocharan, J. A. Cabal, F. J. Ocharan, and M. A. Alvarez. 2000. A new record of the freshwater pearl mussel *Margaritifera margaritifera* L. (Bivalvia, Unionoida) from the River Narcea (Asturias, north-western Spain). *Aquatic Conservation: Marine and Freshwater Ecosystems* **10**:93-102.
- Analytical Software. 2006. Statistix 8 user guide, version 1.0. Tallahassee.
- Augspurger, T., A. E. Keller, M. C. Black, W. G. Cope, and F. J. Dwyer. 2003. Water quality guidance for protection of freshwater mussels (Unionidae) from ammonia exposure. *Environmental Toxicology and Chemistry* **22**:2569-2575.
- Ausseil, O., H. Barnett, A. Beveridge, L. Fung, B. Gilliland, F. Gordon, H. Janssen, C. McCarron, J. Roygard, M. Todd, and H. Zarour. 2005. State of the environment report of the Manawatu-Wanganui region 2005. Horizons Regional Council, Palmerston North.
- Bauer, G. 1987. Reproductive strategy of the freshwater pearl mussel *Margaritifera margaritifera*. *The Journal of Animal Ecology* **56**:691-704.
- Bauer, G. 1988. Threats to the freshwater pearl mussel *Margaritifera margaritifera* L in Central Europe. *Biological Conservation* **45**:239-253.
- Bauer, G., S. Hochwald, and W. Silkenat. 1991. Spatial distribution of freshwater mussels: the role of host fish and metabolic rate. *Freshwater Biology* **26**:377-386.
- Beasley, C. R., D. Roberts, and T. G. Mackie. 1998. Does the freshwater pearl mussel, *Margaritifera margaritifera* L., face extinction in Northern? *Aquatic Conservation: Marine and Freshwater Ecosystems* **8**:265-272.
- Binelli, A., R. Bacchetta, G. Vailati, S. Galassi, and A. Provini. 2001. DDT contamination in Lake Maggiore (N. Italy) and effects on zebra mussel spawning. *Chemosphere* **45**:409-415.
- Boul, H. L. 1995. DDT residues in the environment – a review with a New Zealand perspective. *New Zealand Journal of Agricultural Research* **38**:257-277.
- Brainwood, M., S. Burgin, and M. Byrne. 2006. Is the decline of freshwater mussel populations in a regulated coastal river in south-eastern Australia linked with human modification of habitat? *Aquatic Conservation: Marine and Freshwater Ecosystems* **16**:501-516.

- Brim Box, J. B., and J. Mossa. 1999. Sediment, land use, and freshwater mussels: prospects and problems. *Journal of the North American Benthological Society* **18**:99-117.
- Byrne, M. 1998. Reproduction of river and lake populations of *Hyridella depressa* (Unionacea: Hyriidae) in New South Wales: implications for their conservation. *Hydrobiologia* **389**:29-43.
- Carriker, M. R. 1961. Interrelation of functional morphology, behavior, and autecology in early stages of the bivalve *Mercenaria mercenaria*. *Journal of the Elisha Mitchell Scientific Society* **77**:168-241.
- Chang, T. J., M. A. Hoover, and T. A. Bartrand. 1996. Optimization of a vacuum device for zebra mussel control. Pages 389-398 in F. M. D'itri, editor. *Zebra mussels and other aquatic nuisance species*. Ann Arbor Press, Ann Arbor.
- Clarke, K., and R. Gorley. 2006. PRIMER v6: User Manual/Tutorial. PRIMER-E, Plymouth.
- Coker, R. E., A. F. Shira, H. W. Clark, and A. D. Howard. 1921. Natural history and propagation of freshwater mussels. *Bulletin of the United States Bureau of Fisheries* **37**:75-181.
- Diggins, T. P. 2001. A seasonal comparison of suspended sediment filtration by quagga (*Dreissena bugensis*) and zebra (*D. polymorpha*) mussels. *Journal of Great Lakes Research* **27**:457-466.
- Environment Court. 2004. Ngati Rangi Trust (RMA 874/01), Tamahaki Inc Society (RMA 875/01), Whanganui River Maori Trust Board, Hinengakau Development Trust, Ngati Hikairo Hapu Forum, Ngati Tama o Ngati Haua Trust, Pungarehu Marae Incorporated Society on behalf of Ngati Tuera Hapu and Ngati Rangi Trust (RMA 877/01) Appellents v The Manawatu-Wanganui Regional Council Respondent and Genesis Power Limited Applicant. Decision no: A 067/2004. Environment Court.
- Firmin, P. 1994. Oral archives. Whanganui Regional Museum, Whanganui
- Frank, H., and S. Gerstmann. 2007. Declining populations of freshwater pearl mussels (*Margaritifera margaritifera*) are burdened with heavy metals and DDT/DDE. *Ambio* **36**:571-574.
- Griffiths, N. A., and H. Cyr. 2006. Are there hot spots for *Elliptio complanata* in the shallow littoral zone of a large Canadian Shield lake? *Canadian Journal of Fisheries and Aquatic Sciences* **63**:2137-2147.

- Grimmond, N. M. 1968. Observations on growth and age in *Hyridella menziesi* (Mollusca, Bivalva) in a freshwater tidal lake. Unpublished Master of Science thesis, University of Otago, Dunedin.
- Haag, W. R., and M. L. J. Warren. 1997. Host fishes and reproductive biology of 6 freshwater mussel species from the Mobile Basin, USA. *Journal of the North American Benthological Society* **16**:576-585.
- Hickey, C. W., S. J. Buckland, D. J. Hannah, D. S. Roper, and K. Stuben. 1997. Polychlorinated biphenyls and organochlorine pesticides in the freshwater mussel *Hyridella menziesi* from the Waikato River, New Zealand. *Bulletin of Environmental Contamination and Toxicology* **59**:106-112.
- Hinch, S. G., and R. H. Green. 1988. Shell etching on clams from low-alkalinity Ontario lakes: a physical or chemical process? *Canadian Journal of Fisheries and Aquatic Sciences* **45**:2110-2113.
- Hine, P. M. 1978. Distribution of some parasites of freshwater eels in New Zealand. *New Zealand Journal of Marine and Freshwater Research* **12**:179-187.
- Hitchmough, R., L. Bull, and P. Cromarty. 2005. New Zealand threat classification system lists. Science & Technical Publishing, Department of Conservation, Wellington.
- Horizons Regional Council. 2007. The proposed One Plan – the consolidated resource policy statement, regional plan and regional coastal plan for the Manawatu-Wanganui region. Horizons Regional Council, Palmerston North.
- Horrox, J. V. 1998. Benthic communities of the Whanganui River catchment: the effects of land use and geology. Unpublished Master of Science thesis, Massey University, Palmerston.
- James, M. R. 1985. Distribution, biomass and production of the fresh-water mussel, *Hyridella-menziesi* (Gray), in Lake Taupo, New-Zealand. *Freshwater Biology* **15**:307-314.
- Johnson, P. D., and K. M. Brown. 1998. Intraspecific life history variation in the threatened Louisiana pearlshell mussel, *Margaritifera hembeli*. *Freshwater Biology* **40**:317-329.
- Kaehler, S. 1999. Incidence and distribution of phototrophic shell-degrading endoliths of the brown mussel *Perna perna*. *Marine Biology* **135**:505-514.
- Kaehler, S., and C. D. McQuaid. 1999. Lethal and sub-lethal effects of phototrophic endoliths attacking the shell of the intertidal mussel *Perna perna*. *Marine Biology* **135**:497-503.



- Kat, P. W. 1982. Effects of population density and substratum type on growth and migration of *Elliptio complanata* (Bivalvia: Unionidae). *Malacological Review* **15**:119-127.
- Lydeard, C., R. H. Cowie, W. F. Ponder, A. E. Bogan, P. Bouchet, S. A. Clark, K. S. Cummings, T. J. Frest, O. Gargominy, D. G. Herbert, R. Hershler, K. E. Perez, B. Roth, M. Seddon, E. E. Strong, and F. G. Thompson. 2004. The global decline of nonmarine mollusks. *Bioscience* **54**:321-330.
- Maire, O., J. M. Amouroux, J. C. Duchêne, and A. Grémare. 2007. Relationship between filtration activity and food availability in the Mediterranean mussel *Mytilus galloprovincialis*. *Marine Biology* **152**:1293-1307.
- McArthur, K., and M. Clark. 2007. Nitrogen and phosphorus loads to rivers in the Manawatu-Wanganui Region: An analysis of low flow state: Technical report to support policy development. Horizons Regional Council, Palmerston North.
- McDowall, B. 2004. Decline of the kakahi – identifying cause and effect. *Water and Atmosphere* **10**:8-9.
- McDowall, R. M. 1997. Note on the conservation status of the giant bully, *Gobiomorphus gobioides* (Teleostei: Eleotridae). *Journal of the Royal Society of New Zealand* **27**:163-172.
- McDowall, R. M. 2001. *Freshwater fishes of New Zealand*. Reed Publishing (NZ) Ltd, Auckland.
- McDowall, R. M. 2006. Crying wolf, crying foul, or crying shame: alien salmonids and a biodiversity crisis in the southern cool-temperate galaxioid fishes? *Review of Fish Biology Fisheries* **16**:233 -422.
- Metcalf-Smith, J. L., S. K. Staton, G. L. Mackie, and N. M. Lane. 1998. Changes in the biodiversity of freshwater mussels in the Canadian waters of the lower Great Lakes drainage basin over the past 140 years. *Journal of Great Lakes Research* **24**:845-858.
- Morales, Y., L. J. Weber, A. E. Mynett, and T. J. Newton. 2006. Mussel dynamics model: A hydroinformatics tool for analyzing the effects of different stressors on the dynamics of freshwater mussel communities. *Ecological Modelling* **197**:448-460.
- Naimo, T. J. 1995. A review of the effects of heavy metals on fresh water mussels. *Ecotoxicology* **4**:341-362.
- Nichols, S. J. 1996. Variations in the reproductive cycle of *Dreissena polymorpha* in Europe, Russia, and North America. *American Zoologist* **36**:311-325.

- Nobes, R. G. 1980. Energetics of the freshwater mussel *Hyridella menziesi* Gray. Unpublished Master of Science thesis, Waikato University, Hamilton.
- Oliver, L. M., W. S. Fisher, J. T. Winstead, B. L. Hemmer, and E. R. Long. 2001. Relationships between tissue contaminants and defense-related characteristics of oysters (*Crassostrea virginica*) from five Florida bays. *Aquatic Toxicology* **55**:203-222.
- Payne, B. S., A. C. Miller, and R. Whiting. 1997. Designing a riverine mussel survey. Pages 150-156 in *Conservation and management of freshwater mussels II: proceedings of a UMRCC symposium*. Upper Mississippi River Conservation Committee.
- Percival, E. 1931. A note on the life history of *Diplodon lutulentus* Gould. *Transactions and Proceedings of the New Zealand Institute* **62**:86-91.
- Phillips, J. 2001. Whanganui catchment water quality: A study on clarity and microbiological water quality in the Whanganui River and its tributaries. Horizons Regional Council, Palmerston North.
- Phillips, N. 2006. Review of the potential for biomanipulation of phytoplankton abundance by freshwater mussels (kakahī) in the Rotorua lakes. National Institute of Water & Atmospheric Research Ltd, Hamilton.
- Planning Tribunal. 1990. In the matter of the Water and Soil Conservation Act 1967 and in the matter of two appeals under section 25 of the Act between Electricity Corporation of New Zealand Limited (Appeal 781/88) and Whanganui River Maori Trust Board (Appeal 840/88) Appellants and the Manawatu-Wanganui Regional Council (as successor to the Rangitikei-Wanganui Catchment Board) Respondent. Decision no W. 70/90. Planning Tribunal.
- Roper, D. S., and C. W. Hickey. 1994. Population structure, shell morphology, age and condition of the freshwater mussel *Hyridella menziesi* (Unionacea: Hyriidae) from seven lake and river sites in the Waikato River system. *Hydrobiologia* **284**:205-217.
- Rowe, D. 1999. Factors influencing the abundance of the common bully, *Gobiomorphus cotidianus* McDowall, in small, North Island, New Zealand, lakes. *Fisheries Management and Ecology* **6**:377-386.
- Rowe, D., and B. Chisnall. 1997. Environmental factors associated with the decline of dwarf inanga *Galaxias gracilis* McDowall in New Zealand dune lakes. *Aquatic Conservation: Marine and Freshwater Ecosystems* **7**:277-286.
- Rowe, D. K., G. Konui, and K. D. Christie. 2002. Population structure, distribution, reproduction, diet, and relative abundance of koaro (*Galaxias brevipinnis*) in a New Zealand lake. *Journal of the Royal Society of New Zealand* **32**:275-291.

- Rowe, D. K., and A. Taumoepeau. 2004. Decline of common smelt (*Retropinna retropinna*) in turbid, eutrophic lakes in the North Island of New Zealand. *Hydrobiologia* **523**:149-158.
- Ruessler, D. S., N. J. Kernaghan, C. M. Wieser, J. J. Wiebe, and T. S. Gross. 2006. An assessment of potential contaminant effects on freshwater mussels in the South Florida ecosystem. U.S. Geological Survey.
- Sethi, S. A., A. R. Selle, M. W. Doyle, E. H. Stanley, and H. E. Kitchel. 2004. Response of unionid mussels to dam removal in Koshkonong Creek, Wisconsin (USA). *Hydrobiologia* **525**:157-165.
- Snelder, T. B., and B. J. F. Biggs. 2002. Multi-scale river environment classification for water resources management. *Journal of the American Water Resources Association* **38**:1225-1239.
- Strayer, D. L., S. Claypool, and S. J. Sprague. 1997. Assessing unionid populations with quadrats and timed searches. Pages 163-169 *in* Conservation and management of freshwater mussels II: proceedings of a UMRCC symposium. Upper Mississippi River Conservation Committee.
- Strayer, D. L., and A. R. Fetterman. 1999. Changes in the distribution of freshwater mussels (Unionidae) in the upper Susquehanna River basin, 1955-1965 to 1996-1997. *American Midland Naturalist* **142**:328-339.
- Waitangi Tribunal. 1999. The Whanganui River Report. Waitangi Tribunal, Wellington.
- Watters, G. T. 1996. Small dams as barriers to freshwater mussels (*Bivalvia*, *Unionoida*) and their hosts. *Biological Conservation* **75**:79-85.
- Weber, E. 2005. Population size and structure of three mussel species (*Bivalvia*: *Unionidae*) in a northeastern German river with special regard to influences of environmental factors. *Hydrobiologia* **537**:169-183.
- Williams, J. D., M. L. Warren, K. S. Cummings, J. L. Harris, and R. J. Neves. 1993. Conservation status of fresh-water mussels of the United States and Canada. *Fisheries* **18**:6-22.
- Young, D. 1998. Woven by water: histories from the Whanganui River. Huia Publishers, Wellington.

### **3. EFFECT OF SUSPENDED SEDIMENT ON KĀKAHI (*ECHYRIDELLA MENZIESII*) FEEDING PHYSIOLOGY AND BEHAVIOUR**

#### **INTRODUCTION**

Iwi in Whanganui have contended for almost two decades that the freshwater mussel, kākahi (*Echyridella menziesii* (Gray, 1843)), has declined in the region since European settlement began in the 19<sup>th</sup> century (Planning Tribunal 1990, Firmin 1994, Waitangi Tribunal 1999, Environment Court 2004, chapter one), a fact confirmed by recent surveys (chapter two). Kākahi have also apparently declined in other areas of New Zealand (McDowall 2004), and freshwater mussels are one of the most threatened taxa worldwide (Lydeard et al. 2004), with 72% of freshwater mussels in the United States listed as endangered, threatened or of special concern (Williams et al. 1993).

One key factor in freshwater mussel decline is sedimentation (Bogan 1993, Williams et al. 1993, Brim Box and Mossa 1999). Sediment is the primary pollutant in United States waterways, affecting over 40% of river miles (Waters 1995). Increased sediment load raises turbidity, causing a reduction in light penetration and primary production, increases the retention of organic matter on the substrate, and reduces dissolved oxygen levels at the sediment-water interface and in interstitial spaces (Ellis 1936, Ryan 1991, Quinn et al. 1992, Hemming et al. 2006). Higher turbidity limits visual feeders and reduces invertebrate densities, and fine material smothering the stream bottom reduces habitat for benthic organisms (Quinn et al. 1992, Wood and Armitage 1997). Deposition of fine material in aquatic environments can defaunate an area (Norkko et al. 2006), and as little as a quarter of an inch of sediment can cause high mortality of freshwater mussels (Ellis 1936). Suspended sediment can clog bivalve filtering mechanisms (Kat 1982, Hawkins et al. 1999), has long-term effects on physiology (Norkko et al. 2006), and can reduce growth rates (Bricelj et al. 1984).

Land clearance in Aotearoa New Zealand hill country areas has led to a 2.5- to 7-fold increase in sedimentation (Quinn and Stroud 2002), and sediment has been identified as a key pollutant in the Whanganui River by both local kaumātua and river managers (see

chapter one; Phillips 2001). It is thought that the increase in suspended sediment load in the Whanganui River catchment may have contributed to kākahi decline in the area.

Bivalves generally increase their filtration rates under increasing suspended sediment concentrations until they reach a maximal filtration rate, at which point filtration rates decline as the particulate concentration continues to increase. For *Cerastoderma edule* this point is around 300 mg.L<sup>-1</sup> (Navarro and Widdows 1997), while filtration rates of a 7 cm *Mytilus edulis* declined above concentrations of 190 mg.L<sup>-1</sup> (Widdows et al. 1979). In contrast, *Perna canaliculus* will keep filtering up to particulate concentrations as high as 1000 mg.L<sup>-1</sup> (Hawkins et al. 1999).

Clearance rates tend to show the opposite pattern, decreasing with increased particulate load. For example, the clearance rate of the hard clam *Mercenaria mercenaria* declined by 0.08 L.h<sup>-1</sup>.g<sup>-1</sup> for every 1 mg.L<sup>-1</sup> increase in sediment (Bricelj and Malouf 1984).

Filtering behaviour also changes with varying particulate concentrations. At higher concentrations, siphon diameter may be reduced (Bricelj and Malouf 1984), and some bivalves may cease filtering altogether and close their valves.

The purpose of this research is to explore the effects of suspended sediment concentration on the physiological and behavioural responses of a freshwater mussel from Aotearoa New Zealand, the kākahi, to determine whether increased sedimentation in the Whanganui catchment has contributed to kākahi decline in the area.

## **METHODS**

### EXPERIMENTAL PROTOCOL

Kākahi were tested under a range of randomly ordered sediment loads, ranging in total particulate matter (TPM) concentration from 5.5 to 1212 mg.L<sup>-1</sup> (Table 1). The lowest concentration consisted of pure river water with no added sediment and was the minimum load testable. The highest concentration was the maximum testable load before the experimental system clogged, and was considered sufficient to test kākahi well beyond concentrations experienced in the natural environment (for example, the 50<sup>th</sup> percentile for suspended sediment at median flow at Pipiriki on the Whanganui River was 4.5 mg.L<sup>-1</sup>, and the 95<sup>th</sup> percentile in all flows was 253 mg.L<sup>-1</sup> (Anon. 2006)).

River water, with pre-added algae, flowed into a mixing tank where sediment was added to make up the required turbidity for each treatment (Fig. 1). Sediment in the mixing tank was kept in suspension by a magnetic stirrer. Six 1.5 L chambers containing a 2 cm

substrate of river sand washed through a 1 mm sieve to remove fines were connected to the mixing tank using 5 mm tubing. Three of these chambers were used as controls for settling out rates, and five kākahi were placed into each of the remaining three chambers. Water exiting the chambers ran out to waste.

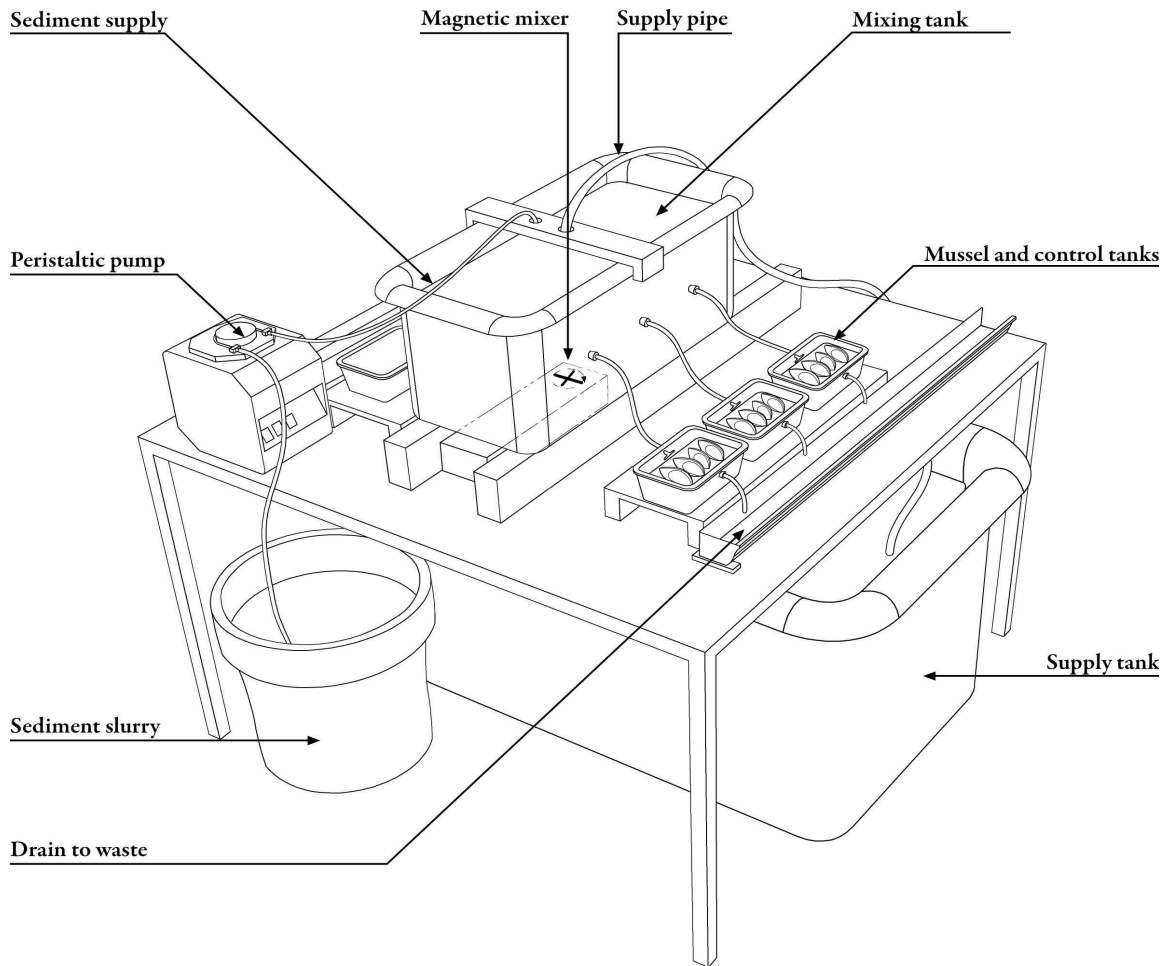

Fig. 1. Experimental system.

Surficial sediment to a depth of 2 cm was collected from the Whanganui River at Kōwhai Park (E2685532, N6141307). Particle size composition of collected sediment was: 64.0% silt/clay (< 63  $\mu\text{m}$  diameter); 35.4% fine sand (63–125  $\mu\text{m}$ ); and 0.6% medium sand (0.125–0.5 mm). Sediment was homogenized by vigorous stirring with a paint mixer attached to an electric drill, wet sieved through a 250  $\mu\text{m}$  mesh sieve and added to filtered tap water to make a stock slurry. The slurry was stored in the dark at 4°C until required, and kept for no longer than four weeks. A bilge pump kept particles in suspension during experimental runs to prevent settling out, and the slurry mix was fed to the mixing tank at a constant rate using a peristaltic pump.

Water for the experiments was collected from the Kahuterawa Stream, Palmerston North, and stored in a supply tank. Wild-caught algae from a local farm were cultivated and added directly to the river water. Algae cells ranged from  $< 5 \mu\text{m}$  to  $12 \mu\text{m}$  in diameter, and were a mix of *Scenedesmus* sp. and other unidentified unicellular species. Counts were conducted using a hemocytometer slide. Background algal concentrations in the river water were determined using the hemocytometer slide and cultivated algae cells were added to make up the desired concentration of roughly  $63200 \text{ cells.L}^{-1}$ .

#### COLLECTION SITE AND ANIMALS USED

Kākahi 65-80 mm in anterior to posterior length were collected from Mangaraupiu Stream, Wairarapa (E2735140, N6066117) where there is a large population. Mangaraupiu drains a mixed dairy farm/bush catchment; the substrate is a mix of fine sand, sand, gravel and pebbles, with around 15% coverage by fines. Kākahi were kept in aquaria in a controlled temperature room at  $12^{\circ}\text{C}$  on a 12:12 hour light-dark scheme for the duration of the experiments and were fed the same cultivated algae as used in the experimental runs. Individual kākahi were used only once. All kākahi were returned to Mangaraupiu Stream at the conclusion of the experiment.

Prior to experimental runs, fifteen visibly filtering kākahi were selected from the tanks and depurated overnight in filtered water. Experimental animals were then transferred to a bucket of treatment water for one hour to acclimatise before being placed into experimental chambers.

After acclimatisation, kākahi were scrubbed clean, measured and randomly assigned to the experimental chambers. Empty kākahi shells were placed in the control chambers to allow for the physical effect of the shell on settling out rates. Kākahi and control chambers were randomised throughout treatments. Data collection began after kākahi had been in the chambers for at least one hour. The average size of kākahi in each chamber ranged from 70-75mm. All experiments were conducted at  $12^{\circ}\text{C}$  and ran for 5-8.5 hours.

#### TURBIDITY MEASUREMENTS

Six water samples per treatment run were taken from each chamber and from the inflow at intervals of roughly an hour. Total particulate matter was determined by filtering samples through a Buchner funnel onto pre-combusted and pre-weighed 47 mm Whatman GF/C glass microfibre filters. Samples were then dried in an oven at  $95^{\circ}\text{C}$  for 24 hours and re-weighed. All equipment was rinsed at least once with deionised water between each sample measurement to prevent contamination.

## FLOW

Flow was measured six times throughout each experimental run simultaneously with water samples by collecting and measuring the outflow from each chamber over a one minute period. Flow was designed to run at a rate slow enough to detect a difference between TPM concentration in the in- and outflows. Average flow across treatments ranged from 145 to 235 mL.min<sup>-1</sup> with a mean of 185 mL.min<sup>-1</sup>.

## BEHAVIOUR

Behaviour was assessed visually ten times during every treatment period. At high turbidities, when visibility was poor, a glass beaker was held over the mussels and a torch was used to illuminate them. Preliminary work showed no effect of the beaker or the spotlight on kākahi filtering behaviour. Siphon activity was assigned into one of four categories (Ogilvie and Mitchell 1995):

- × valves open and filtering
- × valves open but not filtering
- × valves closed
- × indeterminable.

Indeterminable readings resulted when mussels shifted position and siphons could not be seen.

## COLLECTION OF FAECES AND PSEUDOFaecES

### **Faeces**

Kākahi faecal pellets are small, ejected out the exhalant siphon, and generally lost in the flow of water. Therefore only qualitative samples were collected, using a micro pipette. These were used to determine organic content in the faeces.

### **Pseudofaeces**

Pseudofaeces is material which is filtered and sorted by the mussel and rejected before it enters the digestive system. Kākahi pseudofaeces are slowly expelled out the inhalant siphon and generally form a discrete pile on the substrate, distinguishable by texture and colour. At the end of experimental runs, flow of treatment water was stopped and kākahi were left undisturbed for 30 minutes. This allowed time for the water to clear so that pseudofaeces could be collected. Pseudofaeces were collected with a micro pipette and sieved through a 1 mm sieve to remove any substrate that inadvertently entered the sample. Smaller amounts were filtered onto 47 mm Whatman GF/C glass microfibre filters; larger amounts were placed into crucibles. Samples were dried to constant weight at 95°C for at



least 36 hours. Rejection rate was calculated by dividing the average amount of pseudofaeces produced/mussel/replicate by the number of hours each treatment ran for.

It should be noted that at high TPM concentrations, it was difficult to discern where the pseudofaeces piles ended and settled-out substrate began, meaning settled out particles may have been collected with the pseudofaeces. Estimates of rejection rate at higher turbidities may be slightly exaggerated.

#### CLEARANCE RATES

Clearance rate is the amount of water cleared of particles per hour (Sobral and Widdows 2000). Clearance rate was calculated as per Navarro and Widdows (1997) as:

$$\text{flow} \times (C_1 - C_2)/C_1$$

where  $C_1$  is the particle concentration at the outflow of the control chamber and  $C_2$  is the particle concentration at the outflow of the treatment chamber. Six calculations of clearance rate were made in each experimental run from the TPM water samples taken.

#### FILTRATION RATES

Filtration rate is the amount of particulate matter filtered from the water. It was calculated as per Navarro and Widdows (1997) as:

$$\text{clearance rate} \times \text{particle concentration.}$$

#### ORGANIC CONTENT OF SESTON, FAECES AND PSEUDOFaecES

Seston is defined as all particulate matter in suspension. Organic content of the seston, faeces and pseudofaeces was determined by calculating the difference between dry and ash-free dry weights after combustion at 450°C for three hours.

#### SELECTION EFFICIENCY

Selection efficiency is the efficiency with which a bivalve selects organic matter from the inflowing seston. Selection efficiency ( $SE_1$ ) was calculated according to Bayne and Hawkins (1990) as

$$SE_1 = 1 - (\text{OPF}/\text{OTW})$$

where OTW is the organic portion of the treatment water and OPF is the organic portion of the pseudofaeces. An  $SE_1$  of 0 = no selection; an  $SE_1$  of 1 = complete selection. As a comparison, selection efficiency was also calculated following Hatton et al. (2005):

$$SE_2 = ((\text{NOIR}/\text{IRTOT}) - \text{OTW})/\text{OTW}$$

$$\text{where NOIR} = (\text{FR} \times \text{OCF}) - (\text{RR} \times \text{OPF})$$

$$\text{IRTOT} = \text{total ingestion rate (FR} - \text{RR)}$$

OTW = organic fraction of the treatment water

OPF = organic fraction of pseudofaeces

FR = filtration rate

RR = rejection rate

OCF = (organic matter in inflowing treatment water ( $\text{mg.L}^{-1}$ ) – organic matter ( $\text{mg.L}^{-1}$ ) in outflowing water) / (TPM ( $\text{mg.L}^{-1}$ ) in inflowing treatment water – TPM ( $\text{mg.L}^{-1}$ ) in outflowing water).

#### FILTRATION AND CLEARANCE RATES OVER TIME

Filtration and clearance rates for each replicate were plotted against time to determine if rates changed during the experimental run. Data for seston concentrations of 21 and 928  $\text{mg.L}^{-1}$  were not plotted; at 21  $\text{mg.L}^{-1}$  five of the six samples were contaminated in the oven, and samples from the 928  $\text{mg.L}^{-1}$  run were taken in a shorter time period than, and thus are not comparable to, the other runs.

## RESULTS

#### CLEARANCE RATES

Clearance rates declined with increasing TPM concentration ( $F_{1,31} = 7.89$ ,  $P < 0.01$ ,  $r^2 = 0.20$ ; Fig. 2A), from 0.42  $\text{L.h}^{-1}$  at the lowest TPM concentration of 5.5  $\text{mg.L}^{-1}$  to 0.20  $\text{L.h}^{-1}$  at the highest TPM concentration of 1212  $\text{mg.L}^{-1}$ . Clearance rate was related to the amount of particulate organic matter (POM ( $\text{mg.L}^{-1}$ );  $F_{1,31} = 7.52$ ,  $P = 0.01$ ,  $r^2 = 0.20$ ; Fig. 3A). Clearance rate was not related to organic fraction (%) of the treatment water ( $F_{1,31} = 1.01$ ,  $P = 0.32$ ,  $r^2 = 0.03$ ; data log transformed).

Table 1. Composition of treatment water supplied to kākahi. TPM: total particulate matter; POM: particulate organic matter.

TPM ( $\text{mg.L}^{-1}$ )	POM ( $\text{mg.L}^{-1}$ )	Organic content (%)
5.5	5.0	90.2
21	7.1	33.8
70	15.5	22.1
122	18.1	14.8
208	24.7	11.9
238	33.0	13.9
552	62.4	11.3
621	78.6	12.7
928	104.9	11.3
1121	151.7	13.5
1212	138.6	11.4

#### FILTRATION RATES

Filtration rates increased with increasing TPM concentration ( $F_{1,31} = 561.15$ ,  $P < 0.0001$ ,  $r^2 = 0.95$ ; data log transformed; Fig. 2B), from 1.62  $\text{mg.h}^{-1}$  at the lowest seston concentration to 190.88  $\text{mg.h}^{-1}$  at the highest tested concentration. Variation in filtration rates across the

replicates increased with increasing turbidity, especially above 600  $\text{mg.L}^{-1}$ , however there was no high seston concentration at which kākahi in all replicates began to reduce their filtration rate. Filtration rate increased with increasing POM ( $F_{1,31} = 133.11$ ,  $P < 0.0001$ ,  $r^2$

= 0.81), and decreased with increasing percent organic content ( $F_{1,31} = 238.01$ ,  $P < 0.0001$ ,  $r^2 = 0.88$ ; data log transformed; Fig. 3B & C).

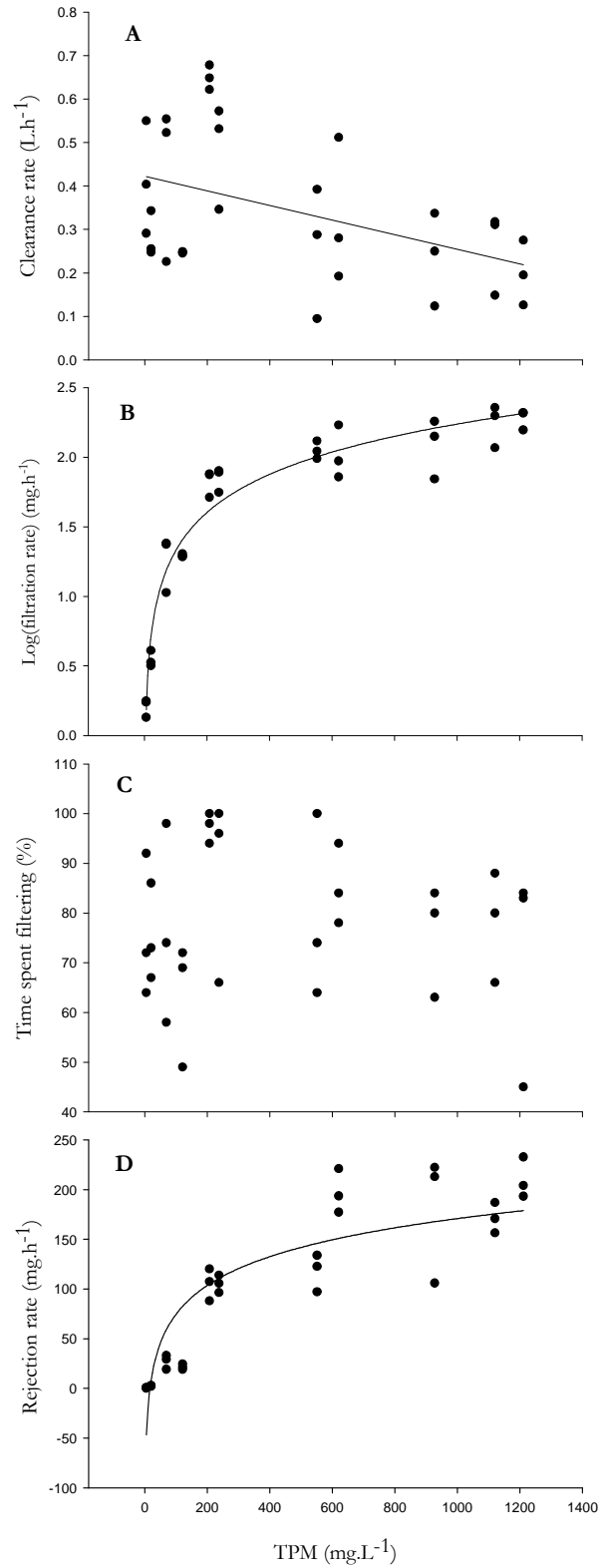

Fig. 2. Physiological and behavioural responses of kākahi as a function of total particulate matter (TPM) concentration (mg.L<sup>-1</sup>). **A:** Clearance rate (L.h<sup>-1</sup>). **B:** Filtration rate (mg.h<sup>-1</sup>). **C:** Percent time kākahi were observed filtering. **D:** Rejection rate (mg.h<sup>-1</sup>). See Table 2 for equations,  $f$ ,  $p$  and  $r^2$  values.

Table 2. Equations,  $f$ ,  $p$  and  $r^2$  values for regression analyses. TPM: total particulate matter; POM: particulate organic matter; CR: clearance rate; FR: filtration rate; RR: rejection rate; OTW: organic portion treatment water; OPF: organic portion pseudofaeces; OF: organic portion faeces; SE<sub>1</sub> selection efficiency method 1; SE<sub>2</sub> selection efficiency method two.

Relationship tested	Degrees of freedom	F value	P value	Equation	$r^2$
Clearance rate vs. TPM	1,31	7.89	< 0.01	CR = 0.42 + 0.0002x x: TPM	0.20
Filtration rate vs. TPM. Data log transformed.	1,31	561.15	< 0.0001	FR = 0.395ln(x) – 0.49 x: TPM	0.95
% time filtering vs. TPM	1,31	0.14	0.71	–	0.005
Rejection rate vs. TPM	1,31	98.97	< 0.001	RR = 41.83ln(x) – 118.11 x: TPM	0.78
Clearance rate vs. POM	1,31	7.52	0.010	CR = 0.43 – 0.0014x x: POM	0.20
Filtration rate vs. POM	1,31	133.11	< 0.0001	FR = 10.84 + 1.24x x: POM	0.81
Filtration rate vs. organic fraction (%). Data log transformed.	1,31	238.01	< 0.0001	FR = 29.84x <sup>-1.07</sup> x: organic fraction	0.88
Rejection rate vs. filtration rate. Data log transformed.	1,31	590.11	< 0.0001	RR = 2.21(1 – e <sup>-0.05x</sup> ) x: FR	0.95
Organic content (%) of treatment water vs. TPM. Data log transformed.	1,9	81.57	< 0.0001	OTW = 2.24x <sup>-0.12</sup> x: TPM	0.90
Organic content (%) of pseudofaeces vs. TPM. Data log transformed.	1,31	320.33	< 0.0001	OPF = 2.16x <sup>-0.12</sup> x: TPM	0.92
Organic content (%) of faeces vs. TPM. Data log transformed.	1,8	2.23	0.17	OF = 1.88x <sup>-0.03</sup> x: TPM	0.22
SE <sub>1</sub> vs. TPM	1,31	1.96	0.17	–	0.06
SE <sub>1</sub> vs. POM	1,31	2.29	0.14	–	0.07
SE <sub>1</sub> vs. organic content	1,31	1.43	0.24	–	0.04
SE <sub>2</sub> vs. TPM	1,31	45.57	< 0.0001	SE <sub>2</sub> = 3.28x <sup>-0.62</sup> x: TPM	0.60
SE <sub>2</sub> vs. POM	1,31	41.31	< 0.0001	SE <sub>2</sub> = 13.65x <sup>-1.58</sup> x: POM	0.57
SE <sub>2</sub> vs. organic content	1,31	46.65	< 0.0001	SE <sub>2</sub> = -0.09 + 0.014x x: organic content (%)	0.60

#### FEEDING BEHAVIOUR

Feeding behaviour was unaffected by increasing seston concentration, with kākahi filtering for an average of 78.6% of the time across all replicates and treatments ( $F_{1,31} = 0.14$ ,  $P = 0.71$ ,  $r^2 = 0.01$ ; Fig. 2C). Although not directly measured, observed siphon diameter was notably smaller at higher TPM concentrations. At the highest turbidities, when even locating kākahi in the chambers was difficult, plumes of clear water were observed issuing from the kākahi exhalent siphons, confirming that they were indeed still filtering.

#### PSEUDOFaecES PRODUCTION

Pseudofaeces production (rejection rate) increased with TPM from 0.62 to 201.53 mg.h<sup>-1</sup> ( $F_{1,31} = 107.94$ ,  $P < 0.0001$ ,  $r^2 = 0.78$ ; Fig. 2D). There was a sharp increase from 0-200 mg.L<sup>-1</sup> TPM and only a gradual increase after this point. Rejection rate increased as filtration rate increased ( $F_{1,31} = 101.76$ ,  $P < 0.0001$ ,  $r^2 = 0.95$ ; Fig. 4, Table 2).

#### ORGANIC PORTION OF PSEUDOFaecES, SESTON AND FAECES.

The organic portion of the seston was highest (90.2%) when TPM concentration was lowest (5.5 mg.L<sup>-1</sup>; Table 1, Fig. 5A & B). The organic portion then decreased with increasing TPM ( $F_{1,9} = 81.57$ ,  $P < 0.0001$ ,  $r^2 = 0.90$ ), levelling off at approximately 12% at around 200 mg.L<sup>-1</sup> TPM. The organic portion of the pseudofaeces followed this same pattern ( $F_{1,31} = 320.33$ ,  $P < 0.0001$ ,  $r^2 = 0.92$ ; Fig. 5A & B), but was lower than the organic fraction in the inflowing treatment water ( $t_{32} = -3.15$ ,  $P < 0.01$ ; Fig. 5A & B), showing that kākahi were actively selecting out organic matter and rejecting unwanted matter as pseudofaeces. The organic fraction of the faeces also declined with increasing seston load, but the relationship was not significant ( $F_{1,8} = 2.23$ ,  $P = 0.17$ ,  $r^2 = 0.22$ ). Faeces had a significantly higher organic portion than both the treatment water ( $t_9 = 3.61$ ,  $P < 0.01$ ) and the pseudofaeces ( $t_9 = -5.02$ ,  $P < 0.001$ ; Fig. 5A & B), again indicating active selection of organic matter.

#### SELECTION EFFICIENCY

Selection efficiency values for method one ( $SE_1$ ) ranged from -0.10 to 0.36 (Fig. 6). There was no relationship between  $SE_1$  and TPM, POM (mg.L<sup>-1</sup>) or organic portion (%; Table 2). Selection efficiency values for method two ( $SE_2$ ) ranged from -1.59 to 1.50, decreasing with increasing TPM and POM concentrations ( $F_{1,31} = 45.57$ ,  $P < 0.0001$ ,  $r^2 = 0.60$ ;  $F_{1,31} = 41.31$ ,  $P < 0.0001$ ,  $r^2 = 0.57$  respectively), and increasing as organic portion increased ( $F_{1,31} = 46.65$ ,  $P < 0.0001$ ,  $r^2 = 0.60$ ; Fig. 6, Table 2).

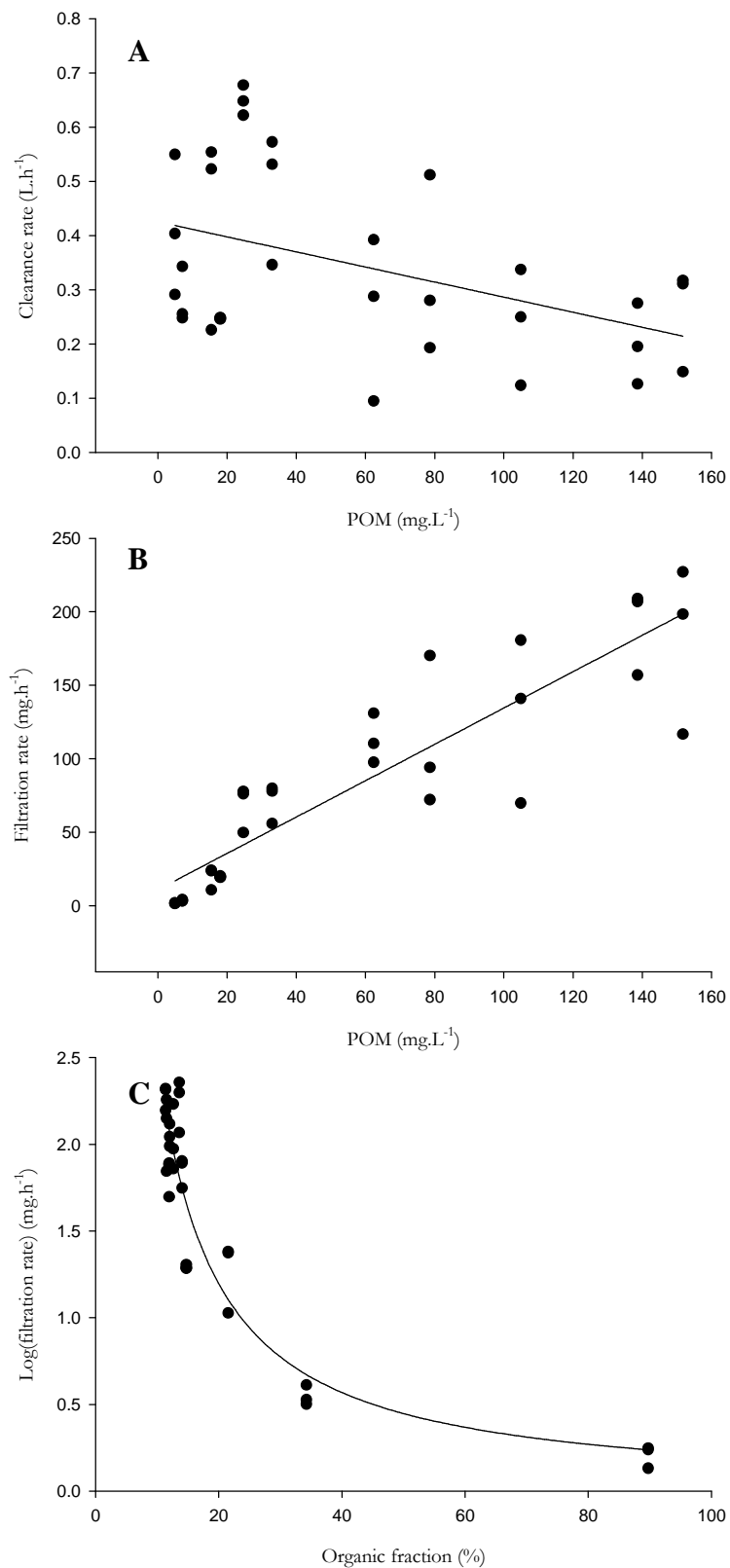

Fig. 3. **A** Clearance rate ( $L \cdot h^{-1}$ ) as a function of particulate organic matter (POM;  $mg \cdot L^{-1}$ ) **B** Filtration rate (FR;  $mg \cdot h^{-1}$ ) as a function of POM and **C** FR as a function of organic fraction (%; data log transformed). See Table 2 for equations,  $f$ ,  $p$  and  $r^2$  values.

## FILTRATION AND CLEARANCE RATES OVER TIME

Time did not affect filtration rate: there was no significant relationship between time and filtration rate in any replicate across all treatments. Likewise, clearance rates showed no strong pattern across the replicates when plotted against time. Only three (11%) of the 27 replicates showed a significant relationship (clearance rate increased over time in two replicates at TPM of 208 mg.L<sup>-1</sup> ( $F_{1,31} = 28.05$ ,  $P < 0.01$ ,  $r^2 = 0.69$  and  $F_{1,31} = 26.65$ ,  $P < 0.01$ ,  $r^2 = 0.64$ ) and in one replicate at TPM of 70 mg.L<sup>-1</sup> ( $F_{1,31} = 50.01$ ,  $P < 0.01$ ,  $r^2 = 0.53$ )).

## DISCUSSION

### CLEARANCE RATES

The clearance rates of kākahi declined significantly with increasing seston concentrations. This is consistent with the recorded responses of other marine and freshwater bivalves eg, *Ruditapes decussatus* (Sobral and Widdows 2000), *M. mercenaria* (Bricelj and Malouf 1984), *M. edulis* (Widdows et al. 1979), *Quadrula pustolosa*, *Fusconaia cerina* and *Pleurobema beadlennum* (Aldridge et al. 1987).

Reduction in clearance rate is a coping strategy used by some filter-feeding bivalves in response to high seston levels (Bricelj and Malouf 1984). However, a reduced clearance rate lowers water flow across the gills and consequently lowers oxygen availability. Oxygen extraction must be increased to compensate (Widdows et al. 1979). *Mytilus edulis* has been shown to increase its oxygen extraction efficiency from 6% at 0 mg.L<sup>-1</sup> to 25% at 280 mg.L<sup>-1</sup>; after this point extraction efficiency would need to increase exponentially with increasing TPM in order to maintain a constant metabolic rate (Widdows et al. 1979). It is not known, however, whether such exponential increases are possible. If not, a continued reduction in clearance rate would result in a reduction of oxygen supplied to the body, leading to detrimental effects on the mussel. Clearance rate is therefore an important consideration in the relationship between suspended sediment concentration and bivalve survival.

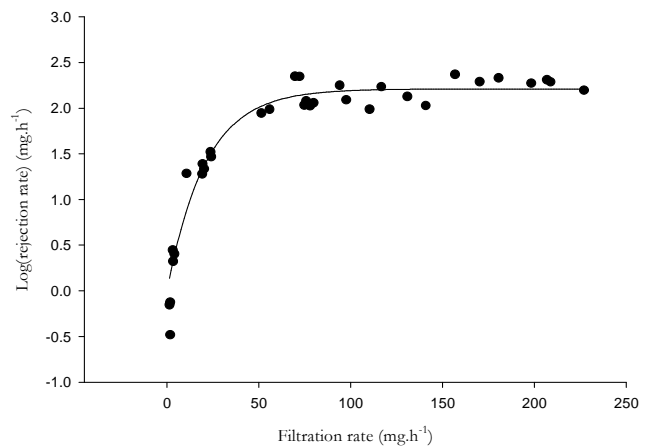

Fig. 4. Kākahi rejection rate as a function of filtration rate (mg.h<sup>-1</sup>; data log transformed). See Table 2 for equations,  $f$ ,  $p$  and  $r^2$  values.

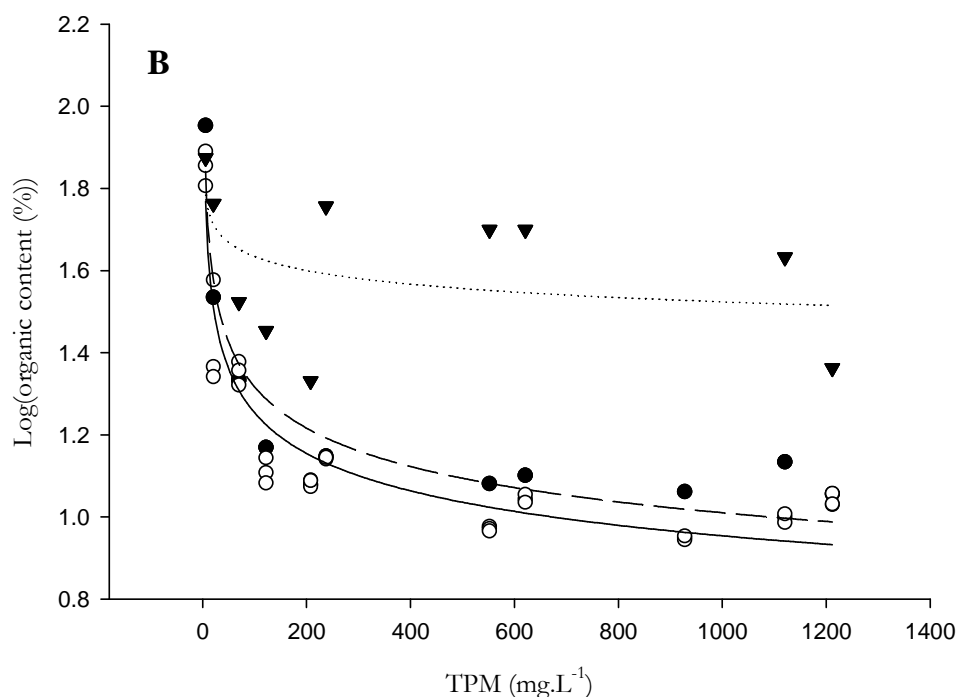
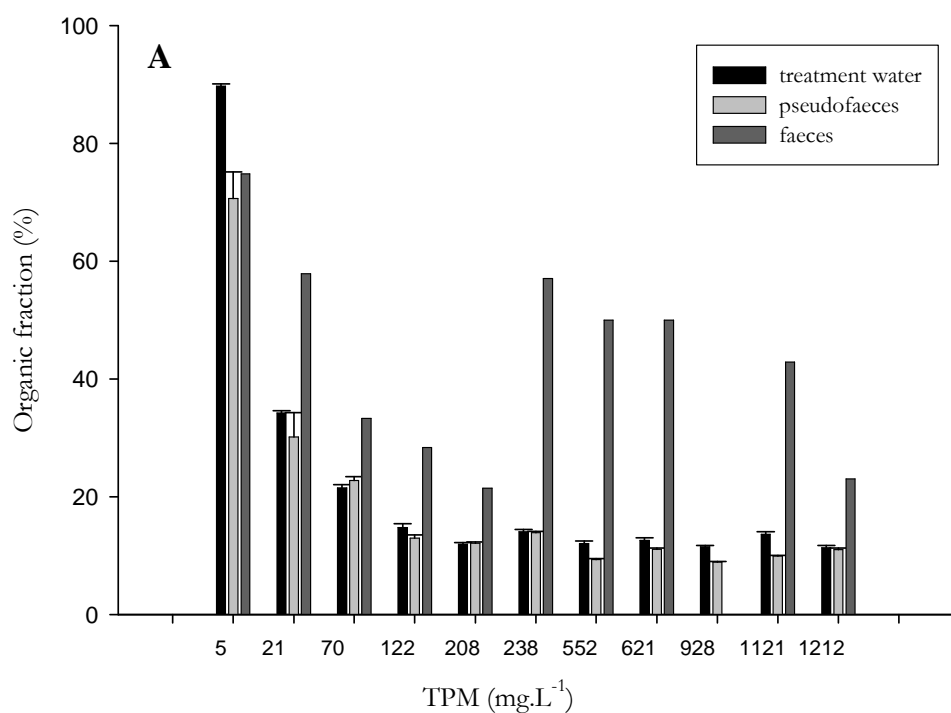

Fig. 5. **A** Organic content (%) of treatment water, pseudofaeces and faeces. Error bars are standard error. Faeces shows no error bars as only one sample was taken per run. There was no sample taken from the treatment of 928 mg.L<sup>-1</sup>. **B** Organic content (%) as a function of total particulate matter (TPM; mg.L<sup>-1</sup>) concentration. See Table 2 for equations,  $f$ ,  $p$  and  $r^2$  values. Data log transformed.



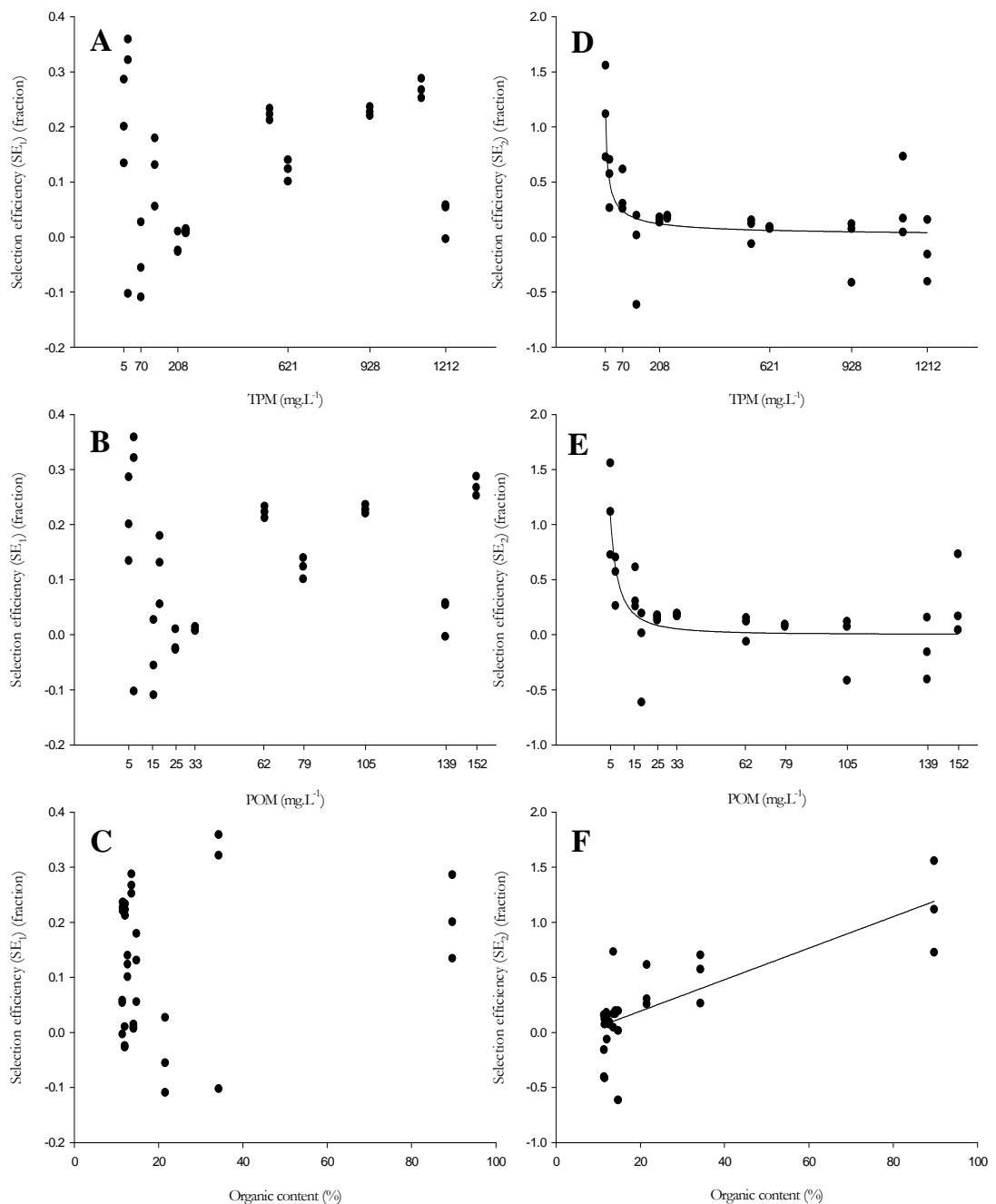

Fig. 6. Kākahi selection efficiency. Selection efficiency (method one) as a function of **A** total particulate matter (TPM; mg.L<sup>-1</sup>) concentration, **B** particulate organic matter (POM; mg.L<sup>-1</sup>) and **C** organic content (%). For **A**, **B** and **C**, 1 = total selection, 0 = no selection. Selection efficiency (method two) as a function of **D** TPM concentration, **E** POM and **F** organic fraction (%). See Table 2 for equations, *f*, *p* and *r*<sup>2</sup> values.

In wild conditions, settling out of suspended sediment may also affect oxygen availability on the river bottom. Fine material blanketing the substrate traps organic matter, which, as it decomposes, creates a higher oxygen demand at the sediment-water interface

(Ellis 1936, Norkko et al. 2006). Furthermore, as it settles, sediment drags organic matter to the river bottom, increasing the organic fraction of the substrate and subsequent oxygen demand at the river bottom (Ellis 1936). In turbid conditions, low dissolved oxygen coupled with a low clearance rate could make respiration very difficult for burrowing bivalves.

Clearance rate changes with food availability (Roper and Hickey 1995, Iglesias et al. 1996). Respiration rates of kākahi in low silt treatments increased with increasing food concentrations, and respiration rates of those kept in low food treatments increased with increasing silt concentration (Roper and Hickey 1995; 'respiration rate' in Roper and Hickey's study (1995) can be considered analogous with clearance rates in my study). Food-dependent filtration and clearance rates have been observed in a number of other species, such as *Mytilus galloprovincialis* (Maire et al. 2007), *P. canaliculus* (Hatton et al. 2005), and *Paphia rhomboïdes* (Savina and Pouvreau 2004). Furthermore, the type of food supplied can affect clearance rates. Kākahi fed on *Gymnodinium* sp. filtered at only about 35% the rate at which they filtered *Choricystis coccoïdes* (Ogilvie and Mitchell 1995) and monocultures of different algae species significantly altered clearance rates in *M. margaritifera* and *Pyganodon cataracta*, with mussels fed on the cyanobacterium *Microcystis aeruginosa* having significantly higher clearance rates than when fed on other diets (Baker and Levinton 2003).

Food levels in the ambient water in the current experiment were kept at a constant level. However, organic matter was present in the sediment. Consequently, even though percent organic matter declined with increasing TPM, the amount of POM increased as silt load increased. This amounts to an increase in the amount of potential food available per litre. The observed decline in clearance rate with POM may be linked to mussels reacting to food content in the water.

#### FILTRATION RATES

Kākahi filtration rate increased significantly with increasing seston concentration. Roper and Hickey (1995) tested kākahi filtration rates under TPM concentrations of 0-35 mg.L<sup>-1</sup> but did not find any relationship. However, the range of turbidities tested was considerably smaller than those tested in my study, and may have been too limited to detect effects. Alternatively, as Roper and Hickey (1995) themselves note, it may be due to the large variability between individual filtration rates. High individual variability in feeding processes is common amongst bivalves (Widdows et al. 1979, Baker and Levinton 2003, Hatton et al. 2005) and kākahi filtration rates have likewise been shown to be variable (Nobes 1980, this study).

The increase in kākahi filtration rate with increased silt load is consistent with other recorded responses for bivalves – *Spisula subtruncata*, *C. edule*, and *P. canaliculus* filtration rates increased with increasing seston concentrations up to 30, 300 and 1000 mg.L<sup>-1</sup> respectively (Navarro and Widdows 1997, Hawkins et al. 1999, Rueda and Smaal 2002). Unlike kākahi in this study, most other bivalves reach a maximal filtration rate at a certain seston concentration, after which point their filtration rates drop off again; for example *Mytilus chilensis* and *Mulinia edulis* filtration rates decreased after seston concentrations reached 665 mg.L<sup>-1</sup> in the wild (Velasco and Navarro 2005). This upper limit varies from species to species, with some species having a far greater tolerance to high particulate load than others. Variability in filtration rate between replicates in my study increased above 600 mg.L<sup>-1</sup>; this may be due to individuals displaying different responses to the stress of high sediment load, with less tolerant individuals beginning to decrease filtration rates.

A reduction in filtration rate at high TPM concentrations would be an expected response as the bivalve attempts to prevent its gills from clogging (Iglesias et al. 1996). However, this was not observed in my study – kākahi continued to filter at a very high seston load of beyond 1200 mg.L<sup>-1</sup> (a concentration three times higher than the 95<sup>th</sup> percentile of all flows in 1996 in the Whanganui River (Anon. 2006), one of the more turbid rivers in Aotearoa New Zealand). No maximum tolerance was determined, as the tubing in the experimental system began clogging at high TPM concentrations, before any consistent drop in kākahi filtration rate was recorded. Filtration activity at high seston loads was confirmed by both the behavioural data and the pseudofaeces production data. Navarro and Widdows (1997) found that when filtration rates of *C. edule* began to drop off, pseudofaeces production also declined. However, large amounts of pseudofaeces were still being produced by kākahi at the highest seston concentrations tested. Similarly, open exhalent siphons and plumes of clear water emitting from the kākahi also provided confirmation that the kākahi were still filtering at these very high turbidities. It seems that kākahi are able to continue filtering at TPM concentrations higher than any so far recorded in the literature regarding bivalve filtration rates.

However, two points are worthy of consideration. Firstly, the tested kākahi were only subjected to high TPM concentrations for eight hours. Length of the experimental period can be crucial: *Austrovenus stutchburyi* and *Paphies australis* showed no change in condition when subjected to short-term (14 day) increases in suspended sediment, but were affected by long-term (3 months) increases (Norkko et al. 2006). In wild conditions, floods create conditions of high silt load for periods of days or weeks, and land clearance brings a

permanent change in silt load. In Whanganui between 1999 and 2001, suspended sediment was consistently above  $100 \text{ mg.L}^{-1}$  for more than a week on eight separate occasions (data supplied by Horizons Regional Council 2008). Although kākahi may be able to continue filtering at  $1200 \text{ mg.L}^{-1}$  in the short-term, the long-term effects of living in such conditions remain unknown.

Secondly, the effects on juveniles are unknown. Filtration rate varies with size (Hatton et al. 2005), with larger mussels exhibiting higher filtration rates across a range of TPM concentrations. For example, the filtration rate of a 3 cm *M. edulis* declined at a TPM concentration of approximately  $125 \text{ mg.L}^{-1}$ , whereas the filtration rate of a 7 cm *M. edulis* did not begin to decline until  $190 \text{ mg.L}^{-1}$  (Widdows et al. 1979). It may be that while adult kākahi in the size class 65-80 mm are able to continue filtering despite high seston concentrations, juveniles lack this ability. Indeed, a TPM of only  $44 \text{ mg.L}^{-1}$  had a negative effect on *M. mercenaria* juveniles, reducing growth by 16% compared with controls (Bricelj et al. 1984). Suspended sediment may therefore affect juvenile growth, survival and recruitment into a population.

As with clearance rate, filtration rate is influenced by food content in the diet (Bayne et al. 1993, Hatton et al. 2005). However, the nature of the influence seems to be variable. Kākahi filtration rates in my study declined with increasing organic content (%), but increased with the total amount of organic matter ( $\text{mg.L}^{-1}$ ). *Perma canaliculus* and *M. edulis* filtration rates show varying responses to food content, at times declining with increased organic fraction (Bayne et al. 1993, Hawkins et al. 1999), and at times increasing (Hawkins et al. 1998, Hatton et al. 2005). Filtration rates of *C. edule* declined with increasing organic fraction, while those of *Crassostrea gigas* rates were unaffected (Hawkins et al. 1998). Given such a variable response to food content, and the relationship between food (organic) content and TPM, it is likely that the response observed in my study was more an effect of TPM than food content.

#### FEEDING BEHAVIOUR

Feeding behaviour was based on observations of siphon activity and valve state, and therefore includes both clearance and filtration activities. Feeding behaviour remained uniform across the range of seston concentrations tested. Mussels may keep valves slightly open in order to maintain a minimum water flow over their gills and, therefore, an adequate oxygen supply (Widdows et al. 1979). Kākahi in my study may have continued feeding behaviour in order to meet oxygen demands. The alternative would be to switch to

anaerobic metabolism, which then draws on lipids and carbohydrate stored in the body (Aldridge et al. 1987). Such a shift is, obviously, not maintainable on a long-term basis.

Siphon diameter of kākahi at higher turbidities was noticeably less than in clearer waters. Reduction in clearance rates of the hard clam *M. mercenaria* is accompanied by a reduction in the diameter of the exhalent siphon (Bricelj and Malouf 1984). The observed reduction in kākahi siphon diameter is consistent with the decreased clearance rate recorded in this experiment.

#### PSEUDOFaecES PRODUCTION

Pseudofaeces production rose with increasing seston loads, with no substantial decrease in pseudofaeces production at any stage, unlike rejection rates of other bivalves subjected to increasing TPM concentrations (eg, Widdows et al. 1979, Navarro and Widdows 1997). This is not surprising given that rejection rate and filtration rate are related, and that filtration rates also showed no decrease with increasing TPM.

Overall, rejection rates for kākahi seem comparable with other bivalves: at TPM concentrations of 10-90 mg.L<sup>-1</sup>, *C. gigas* had rejection rates of 0-130 mg.hr<sup>-1</sup> (Hawkins et al. 1998); at TPM of 30 mg.L<sup>-1</sup>, rejection rates of *S. subtruncata* were roughly 3-8 mg.hr<sup>-1</sup>, depending on organic content (Rueda and Smaal 2002), and *C. edule* rejection rates ranged from 0 to around 230 mg.hr<sup>-1</sup> under TPM concentrations of 0-200 mg.L<sup>-1</sup> (Widdows et al. 1979).

Some bivalves utilise a strategy of increased pseudofaeces production to cope with high seston loads (Bricelj and Malouf 1984). It has been suggested that species utilising this strategy may be better suited to surviving in turbid environments than species which respond by lowering their clearance rates (Bricelj and Malouf 1984). Although kākahi did also lower their clearance rates, they continued to pump water and to filter, and the copious amounts of pseudofaeces they produced suggests that they may be able to withstand highly turbid conditions, a hypothesis in agreement with that suggested by Roper and Hickey (1995).

Pseudofaeces production requires the mussel to manufacture mucous. This mucous is used to bind unwanted particles together before they are rejected out the inhalent siphon. An increase in pseudofaeces production necessitates an increase in mucous production. Sobral and Widdows (2000) have suggested that excessive mucous production may be detrimental, and have noted that it is accompanied by a low clearance rate. Similarly, cockles subjected to extreme organic dilution demonstrated an energetic cost to high pseudofaeces production, with negative absorption rates (Prins and Smaal 1989). While

kākahi may have been able to maintain high pseudofaeces production and a low clearance rate for the short experimental period (5-8 hrs), their ability to do so over a longer period of time is untested, and the long-term effects are unknown. High pseudofaeces production could have a long-term, sub-lethal effect.

Evidence that the recorded rate of pseudofaeces production may be slightly higher than actual rates comes from a comparison of filtration rate to rejection rate within each replicate. At times, the rejection rate is higher than the filtration rate, a physical impossibility, as mussels are unable to reject more material than they are actually filtering. Mucus included in the pseudofaeces weight is unlikely to have contributed substantially to the total weight (Kiørboe and Møhlenberg 1981, Urrutia et al. 2001). The most likely explanation is that settled out material was inadvertently included in the pseudofaeces samples.

This highlights the importance of precise collection methods and good experimental design. Pipettes have been successfully used to collect pseudofaeces in other studies (eg, Kiørboe and Møhlenberg 1981, Rueda and Smaal 2002), but it seems in this study, when other substrate was present and long experimental periods (> 1 hr) allowed suspended matter to settle into the pseudofaeces pile, the method may have been less than perfect. It may have been more effective to measure pseudofaeces production over a shorter time period, perhaps at the beginning of the experimental runs, to separate the substrate with a covering, or to remove substrate altogether and collect pseudofaeces into containers beneath the mussel. It is still unclear how other studies using similar methods, formulas and TPM concentrations (eg Hawkins et al. 1999) successfully collected pseudofaeces without contamination from settled-out material.

#### ORGANIC PORTION OF TREATMENT WATER, PSEUDOFaecES AND FAECES.

Organic content was generally lower in the pseudofaeces than in the surrounding treatment water, showing active selection of organic material by kākahi. The ability to actively select organic matter and enrich the ingested diet is a strategy used by a number of bivalves to compensate for a reduction in food quality of the filtered seston (Vaughn and Hakenkamp 2001).

Degradation of food quality occurs with increased silt load, with shading by suspended sediment reducing primary productivity by up to 50% (Ryan 1991). It has also been suggested that increased silt loads act to reduce the quality of food available to filter-feeders through 'dilution' of the organic content (Widdows et al. 1979). While this holds true for species lacking the ability to actively select out organic material, this dilution effect may not be so important for species that actively enrich their diets (Kiørboe and

Møhlenberg 1981, Iglesias et al. 1996, Navarro and Widdows 1997, Hawkins et al. 1999). It remains to be seen if increased silt load in the Whanganui catchment has affected kākahi through degradation in food quality.

An energy budget calculated for kākahi in the Waikato River found that in winter algal cell concentrations fell below maintenance requirements for all but the smallest individuals (< 0.5 g dry weight; Nobes 1980). However, this calculation does not take other food sources, such as detritus and bacteria, into account. Given that erosion silt can contribute terrestrial organic detritus into the river system, and that kākahi can actively select out edible material, it may be that decreases in primary production and dilution of algal content are compensated through increased organic material from terrestrial sources. However, the cost of sorting this material may outweigh the benefits. Overall, there are many factors interacting in the provision of food to kākahi and the implications of silt load on their diet remain unknown.

There were a few occasions when organic content in the pseudofaeces was higher than in the treatment water. This may be due to organic input from the pseudofaecal mucous. Mucous was previously thought to constitute a negligible amount of the organic content of pseudofaeces (Urrutia et al. 2001). It now seems that as the organic portion of the seston decreases, the organic content contributed by the mucous becomes increasingly important (Urrutia et al. 2001). When organic content of the inflowing water is low, the organic fraction contributed by the mucous can be over 40% (Urrutia et al. 2001). It is likely that mucous from the kākahi contributed to the organic content in the pseudofaeces, again illustrating a potential cost to the kākahi of high pseudofaeces production.

#### SELECTION EFFICIENCY

As noted above, when the seston has a low organic content, the fraction contributed by pseudofaecal mucous increases; this affects selection efficiency values that are based on organic content. Values are particularly affected when the organic portion of the seston drops below 15% (Urrutia et al. 2001), which is the case here. In such instances, selection efficiencies may be underestimated, and a correction factor is needed (Urrutia et al. 2001). If no correction factor is calculable, values should be considered net values, rather than gross values (Iglesias et al. 1992). No correction value for the organic contribution from mucous was able to be calculated in my study, so selection efficiencies for both methods should be considered net values.

At times, kākahi selection efficiency values dropped below 0. Negative selection efficiency values have been observed in a number of other studies (Iglesias et al. 1996,

Urrutia et al. 1996, Suplicy et al. 2003, Hatton et al. 2005) and probably indicate the contribution of organic matter from mucous, and therefore negative energy costs to the bivalve.

Selection efficiencies values for method two declined with increasing TPM and POM, and increased with increasing organic portion (%). A decline in selection efficiency with increasing TPM may indicate an overloading of sorting mechanisms; the decline at high POM loads is likely a reflection of the accompanying high total seston load. However, given these values are net values and may underestimate gross selection efficiency, we cannot conclude that a true reduction in selection efficiency has occurred. The palps may still be sorting to a high capacity even though net values do not indicate this (Iglesias et al. 1992).

Selection efficiency does not seem to follow one particular pattern across all bivalves: some species' selection efficiency values increased with increasing TPM (Hawkins et al. 1998), some declined (Hawkins et al. 1998), some increased with organic fraction (Urrutia et al. 1996, Rueda and Smaal 2002), others declined (Hatton et al. 2005); still others increased when organic fraction was low, reached a maximal point, then declined again as the fraction rose (Iglesias et al. 1992, Iglesias et al. 1996, Urrutia et al. 2001). Others showed no relationship at all (Velasco and Navarro 2005). Overall, the true effect of high silt load on selection efficiency remains unknown.

Kākahi selection efficiency values are comparable with other species, with reported values ranging from 0-0.8 (Iglesias et al. 1996) and 0.17-0.5 (Rueda and Smaal 2002) for method one and from -2 to > 0 (Hatton et al. 2005) and 0.2-0.35 (Hawkins et al. 1998) for method two. Against method one, kākahi values seem a little low, but against method two, kākahi values are somewhat higher.

#### LOCAL ADAPTATIONS TO SILT LEVELS

Mussels can adapt to sediment loads in their local environment through changing the size of their palps relative to their gills (Kjørboe and Møhlenberg 1981, Payne et al. 1995). Mussels in this experiment were taken from only one source population, and these would have been adapted to local silt levels. Therefore, some care needs to be taken in extrapolating findings from this experiment to kākahi in all rivers. However, the silt load in the source river was far less than in the Whanganui, so experimental mussels can be taken to be less silt-adapted than those in the Whanganui, and the high tolerance of experimental



mussels to TPM can be read as indicative that Whanganui kākahi would be at least as silt-tolerant, if not more so.

#### FILTRATION AND CLEARANCE RATES OVER TIME

Filtration and clearance rates over the time period tested remained consistent. However, compared with the natural environment when periods of increased turbidity may last days or weeks, the current experiments are somewhat limited and almost certainly miss any effects of exposure time on filtration and clearance rate. When exposed to sediment over an eleven-day period, the horse mussel *Atrina zelandica* showed a decline in clearance rate, with some treatments resulting in an almost 50% reduction (Ellis et al. 2002). This suggests a longer time period for the current experiments would have been preferable. However, time was constrained by the availability of water for each run as there is limited capacity in the storage tank.

#### CONCLUSIONS

The kākahi tested in this study increased their filtration rates as sediment load increased, demonstrating an ability to adjust to local environmental conditions, and continued filtering even at very high sediment loads. This suggests that, relative to other freshwater bivalves, kākahi are better able to cope with high sediment concentrations in the short-term, and adults may be considered ‘sediment tolerant’.

Clearance rate dropped as TPM increased, probably to prevent an overloading of gills and palps. As oxygen supply to the gills is dependent on water flow, a drop in clearance rate will result in a decrease of oxygen supply, and may make respiration difficult at high sediment loads. Therefore the long-term effects of the high sediment loads tested in this study remain unknown.

Time spent filtering was unaffected by seston concentration. Many other bivalves cease filtering as seston increases beyond ability to cope with the particle load in the water. This again suggests kākahi are tolerant of high sediment loads in the short-term relative to other freshwater bivalve. Further research may be needed to uncover both the upper tolerance of kākahi to suspended sediment load in the short-term, and their long-term reaction to high sediment loads.

Further testament to kākahi tolerance to high seston concentration in the short-term is the increase in pseudofaeces production with increasing TPM. Species which

increase pseudofaeces production in response to increases in seston are thought to be better suited to turbid environments than species which respond solely with a reduction in clearance rate. Overall this study has shown that adult kākahi are tolerant of short-term exposure to high sediment loads relative to other freshwater bivalves, but further research is needed to explore the long-term effects and the impact of TPM on juvenile kākahi.

## REFERENCES

- Aldridge, D. W., B. S. Payne, and A. C. Miller. 1987. The effects of intermittent exposure to suspended solids and turbulence on three species of freshwater mussels. *Environmental Pollution* **45**:17-28.
- Anon. 2006. Water quality data: percentiles based on flow. *in* horizons.mw, editor. Horizons Regional Council.
- Baker, S. M., and J. S. Levinton. 2003. Selective feeding by three native North American freshwater mussels implies food competition with zebra mussels. *Hydrobiologia* **505**:97-105.
- Bayne, B. L., and A. J. S. Hawkins. 1990. Filter feeding in bivalve molluscs: controls on energy balance. Pages 70-83 *in* J. Mellinger, J. P. Truchot, and B. Lahlou, editors. *Animal nutrition and transport processes*. Karger, Basel.
- Bayne, B. L., J. I. P. Iglesias, A. J. S. Hawkins, E. Navarro, M. Heral, and J. M. Deslouspaoli. 1993. Feeding behavior of the mussel, *Mytilus edulis*: responses to variations in quantity and organic content of the seston. *Journal of the Marine Biological Association of the United Kingdom* **73**:813-829.
- Bogan, A. E. 1993. Freshwater bivalve extinctions. *American Zoologist* **33**:599-609.
- Bricelj, V. M., and R. E. Malouf. 1984. Influence of algal and suspended sediment concentrations on the feeding physiology of the hard clam *Mercenaria mercenaria*. *Marine Biology* **84**:155-165.
- Bricelj, V. M., R. E. Malouf, and C. de Quilfeldt. 1984. Growth of juvenile *Mercenaria mercenaria* and the effect of resuspended bottom sediments. *Marine Biology* **84**:167-173.
- Brim Box, J. B., and J. Mossa. 1999. Sediment, land use, and freshwater mussels: prospects and problems. *Journal of the North American Benthological Society* **18**:99-117.
- Ellis, J., V. Cummings, J. Hewitt, S. Thrush, and A. Norkko. 2002. Determining effects of suspended sediment on condition of a suspension feeding bivalve (*Atrina zelandica*): results from a survey, a laboratory experiment and a field transplant experiment. *Journal of Experimental Marine Biology and Ecology* **267**:147-174.
- Ellis, M. M. 1936. Erosion silt as a factor in aquatic environments. *Ecology* **17**:29-42.
- Environment Court. 2004. Ngati Rangi Trust (RMA 874/01), Tamahaki Inc Society (RMA 875/01), Whanganui River Maori Trust Board, Hinengakau Development Trust, Ngati Hikairo Hapu Forum, Ngati Tama o Ngati Haua Trust, Pungarehu Marae Incorporated Society on behalf of Ngati Tuera Hapu and Ngati Rangi Trust (RMA

- 877/01) Appellants v The Manawatu-Wanganui Regional Council Respondent and Genesis Power Limited Applicant. Decision no: A 067/2004. Environment Court.
- Firmin, P. 1994. *in oral archives*. Whanganui Regional Museum, Whanganui
- Hatton, S., B. J. Hayden, and M. R. James. 2005. The effects of food concentration and quality on the feeding rates of three size classes of the Greenshell™ mussel, *Perna canaliculus*. *Hydrobiologia* **548**:23-32.
- Hawkins, A. J. S., B. L. Bayne, S. Bougrier, M. Heral, J. I. P. Iglesias, E. Navarro, R. F. M. Smith, and M. B. Urrutia. 1998. Some general relationships in comparing the feeding physiology of suspension-feeding bivalve molluscs. *Journal of Experimental Marine Biology and Ecology* **219**:87-103.
- Hawkins, A. J. S., M. R. James, R. W. Hickman, S. Hatton, and M. Weatherhead. 1999. Modelling of suspension-feeding and growth in the green-lipped mussel *Perna canaliculus* exposed to natural and experimental variations of seston availability in the Marlborough Sounds, New Zealand. *Marine Ecology Progress Series* **191**:217-232.
- Hemming, J. M., P. V. Winger, S. J. Herrington, W. Gierhart, H. Herod, and J. Ziewitz. 2006. Water and sediment quality at mussel (Unionidae) habitats in the Ochlockonee River of Florida and Georgia. *Endangered Species Research* **2**:37-49.
- Iglesias, J. I. P., E. Navarro, P. Alvarez Jorna, and I. Armentina. 1992. Feeding, particle selection and absorption in cockles *Cerastoderma edule* (L.) exposed to variable conditions of food concentration and quality. *Journal of Experimental Marine Biology and Ecology* **162**:177-198.
- Iglesias, J. I. P., M. B. Urrutia, E. Navarro, P. Alvarez-Jorna, X. Larretxea, S. Bougrier, and M. Heral. 1996. Variability of feeding processes in the cockle *Cerastoderma edule* (L.) in response to changes in seston concentration and composition. *Journal of Experimental Marine Biology and Ecology* **197**:121-143.
- Kat, P. W. 1982. Effects of population density and substratum type on growth and migration of *Elliptio complanata* (Bivalvia: Unionidae). *Malacological Review* **15**:119-127.
- Kjørboe, T., and F. Møhlenberg. 1981. Particle selection in suspension-feeding bivalves. *Marine Ecology Progress Series* **5**:291-296.
- Lydeard, C., R. H. Cowie, W. F. Ponder, A. E. Bogan, P. Bouchet, S. A. Clark, K. S. Cummings, T. J. Frest, O. Gargominy, D. G. Herbert, R. Hershler, K. E. Perez, B.

- Roth, M. Seddon, E. E. Strong, and F. G. Thompson. 2004. The global decline of nonmarine mollusks. *Bioscience* **54**:321-330.
- Maire, O., J. M. Amouroux, J. C. Duchêne, and A. Grémare. 2007. Relationship between filtration activity and food availability in the Mediterranean mussel *Mytilus galloprovincialis*. *Marine Biology* **152**:1293-1307.
- McDowall, B. 2004. Decline of the kakahi – identifying cause and effect. *Water and Atmosphere* **10**:8-9.
- Navarro, J. M., and J. Widdows. 1997. Feeding physiology of *Cerastoderma edule* in response to a wide range of seston concentrations. *Marine Ecology Progress Series* **152**:175-186.
- Nobes, R. G. 1980. Energetics of the freshwater mussel *Hyridella menziesi* Gray. Unpublished Master of Science thesis, Waikato University, Hamilton.
- Norkko, J., J. E. Hewitt, and S. F. Thrush. 2006. Effects of increased sedimentation on the physiology of two estuarine soft-sediment bivalves, *Austrovenus stutchburyi* and *Paphies australis*. *Journal of Experimental Marine Biology and Ecology* **333**:12-26.
- Ogilvie, S. C., and S. F. Mitchell. 1995. A model of mussel filtration in a shallow New Zealand lake, with reference to eutrophication control. *Archiv fur hydrobiologie* **133**:471-482.
- Payne, B. S., J. Lei, A. C. Miller, and E. D. Hubertz. 1995. Adaptive variation in palp and gill size of the zebra mussel (*Dreissena polymorpha*) and Asian clam (*Corbicula fluminea*). *Canadian Journal of Fisheries and Aquatic Sciences* **52**:1130-1134.
- Phillips, J. 2001. Whanganui catchment water quality: a study on clarity and microbiological water quality in the Whanganui River and its tributaries. Horizons Regional Council, Palmerston North.
- Planning Tribunal. 1990. In the matter of the Water and Soil Conservation Act 1967 and in the matter of two appeals under section 25 of the Act between Electricity Corporation of New Zealand Limited (Appeal 781/88) and Whanganui River Maori Trust Board (Appeal 840/88) Appellants and the Manawatu-Wanganui Regional Council (as successor to the Rangitikei-Wanganui Catchment Board) Respondent. Decision no W. 70/90. Planning Tribunal.
- Prins, T. C., and A. C. Smaal. 1989. Carbon and nitrogen budgets of the mussel *Mytilus edulis* L. and the cockle *Cerastoderma edule* (L.). *Scientia Marina* **53**:477-482.
- Quinn, J. M., R. J. Daviescolley, C. W. Hickey, M. L. Vickers, and P. A. Ryan. 1992. Effects of clay discharges on streams. 2. benthic invertebrates. *Hydrobiologia* **248**:235-247.

- Quinn, J. M., and M. J. Stroud. 2002. Water quality and sediment and nutrient export from New Zealand hill-land catchments of contrasting land use. *New Zealand Journal of Marine and Freshwater Research* **36**:409-429.
- Roper, D. S., and C. W. Hickey. 1995. Effects of food and silt on filtration, respiration and condition of the freshwater mussel *Hyridella menziesi* (Unionacea: Hyriidae): implications for bioaccumulation. *Hydrobiologia* **312**:17-25.
- Rueda, J. L., and A. C. Smaal. 2002. Physiological response of *Spisula subtruncata* (da Costa, 1778) to different seston quantity and quality. *Hydrobiologia* **475**:505-511.
- Ryan, P. A. 1991. Environmental effects of sediment on New Zealand streams: a review. *New Zealand Journal of Marine and Freshwater Research* **25**:207-221.
- Savina, M., and S. Pouvreau. 2004. A comparative ecophysiological study of two infaunal filter-feeding bivalves: *Paphia rhomboides* and *Glycymeris glycymeris*. *Aquaculture* **239**:289-306.
- Sobral, P., and J. Widdows. 2000. Effects of increasing current velocity, turbidity and particle-size selection on the feeding activity and scope for growth of *Ruditapes decussatus* from Ria Formosa, southern Portugal. *Journal of Experimental Marine Biology and Ecology* **245**:111-125.
- Suplicy, F. M., J. F. Schmitt, N. A. Moltschaniwskyj, and J. F. Ferreira. 2003. Modeling of filter-feeding behavior in the brown mussel, *Perna perna* (L.), exposed to natural variations of seston availability in Santa Catarina, Brazil. *Journal of Shellfish Research* **22**:125-134.
- Urrutia, M. B., J. I. P. Iglesias, E. Navarro, and J. Prou. 1996. Feeding and absorption in *Cerastoderma edule* under environmental conditions in the Bay of Marennes-Oleron (western France). *Journal of the Marine Biological Association of the United Kingdom* **76**:431-450.
- Urrutia, M. B., E. Navarro, I. Ibarrola, and I. P. Iglesias. 2001. Preingestive selection processes in the cockle *Cerastoderma edule*: mucus production related to rejection of pseudofaeces. *Marine Ecology Progress Series* **209**:177-187.
- Vaughn, C. C., and C. C. Hakenkamp. 2001. The functional role of burrowing bivalves in freshwater ecosystems. *Freshwater Biology* **46**:1431-1446.
- Velasco, L. A., and J. M. Navarro. 2005. Feeding physiology of two bivalves under laboratory and field conditions in response to variable food concentrations. *Marine Ecology Progress Series* **291**:115-124.
- Waitangi Tribunal. 1999. The Whanganui River Report. Waitangi Tribunal, Wellington.

- Waters, T. F. 1995. Sediment in streams: sources, biological effects and control. American Fisheries Monograph 7. American Fisheries Society, Bethesda, Maryland.
- Widdows, J., P. Fieth, and C. M. Worrall. 1979. Relationships between seston, available food and feeding activity in the common mussel *Mytilus edulis*. Marine Biology **50**:195-207.
- Williams, J. D., M. L. Warren, K. S. Cummings, J. L. Harris, and R. J. Neves. 1993. Conservation status of fresh-water mussels of the United States and Canada. Fisheries **18**:6-22.
- Wood, P. J., and P. D. Armitage. 1997. Biological effects of fine sediment in the lotic environment. Environmental Management **21**:203-217.

## **4. BRINGING THEM BACK – RESTORATION OF KĀKAHI (*ECHYRIDELLA MENZIESII*) IN THE WHANGANUI RIVER**

### **INTRODUCTION**

Kākahi (*Echyridella menziesii* (Gray, 1843)) in the Whanganui River are in a poor state: of 22 historic beds surveyed in 2008, 16 (73%) had been extirpated or showed a decline in abundance (chapter 2). Recruitment is low, having occurred recently at only 4 (27%) of 15 sites at which kākahi remain (chapter 2).

Kākahi is a culturally significant species, and its decline is of concern to Whanganui iwi (Firmin 1994, Waitangi Tribunal 1999, Environment Court 2004, chapter 1).

Restoration of the Whanganui River is a goal of the Whanganui River Māori Trust Board, who seek, “a healthy freshwater habitat that enables the tribe to exercise customary use according to ngā tikanga o Whanganui,” (Whanganui River Māori Trust Board 2002). The health of the river, its biota, its land, and its people are interconnected (Waitangi Tribunal 1999). Restoring kākahi to be abundant and self-sustaining in the Whanganui River is one aspect of the restoration of the river and its people. In this context, a restoration goal for kākahi is: “To restore kākahi to abundance and wide distribution in the Whanganui River.”

However, the ecology of kākahi is poorly understood, particularly that of the early life stages. For example, where do the smallest juveniles reside? What are their habitat and food needs? What are their risks of predation? Above all, why are kākahi in decline? Restoration requires an answer to these questions, and many others besides.

Threats to freshwater mussel species in general include sedimentation (Brim Box and Mossa 1999), eutrophication (Bauer et al. 1991), pollution (Naimo 1995), channel modification (Williams et al. 1993), introduced molluscs (Williams et al. 1993), and decline in numbers of host fish required by the parasitic larvae, the glochidia, to metamorphose into juveniles (Watters 1996). Which of these factors has contributed most to the decline of kākahi in the Whanganui River? A method is needed to proceed in the face of vast uncertainty.

### **ADAPTIVE MANAGEMENT – A WAY FORWARD FOR RESTORATION IN WHANGANUI**

Adaptive management (AM) is a formalised process that permits management in the face of uncertainty and the opportunity of ‘learning by doing’ (Walters and Holling 1990). Hypotheses regarding ‘best practice’ are tested by implementing, monitoring and evaluating either one or several management strategies in an experimental manner (Gehrke 2003,



Allan and Curtis 2005). Scientific principles of replication are applied and controls are used (Fig. 1).

The strength of AM is that it is an iterative process. If the hypothesis tested does not achieve the desired outcome, the hypothesis is modified and then re-tested until the management implemented produces the desired outcome (Gehrke 2003).

The difference between simple management and adaptive management is the deliberate testing of a hypothesis (McNab 1983, Wilhere 2002, Allan and Curtis 2005). Simple management will implement what is believed to be the best option (Wilhere 2002). If, however, the strategy fails to deliver the desired outcome, managers are none the wiser (McNab 1983). Another guess at another method follows. Adaptive management allows the use of management strategies while testing their effectiveness. The difference between adaptive management and 'pure research' is that the findings are fed back into on-the-ground management practices, rather than being studied simply to enhance knowledge (Gehrke 2003).

#### CHOOSING A HYPOTHESIS

Many hypotheses to explain freshwater mussel decline have been suggested in the literature. Two likely to be of special relevance in the Whanganui River are sedimentation and lack of host fish. High sediment loading is a key issue in Whanganui River management (Ausseil et al. 2005), and fish have declined in the catchment (Waitangi Tribunal 1999). Two hypotheses can be formulated.

*Hypothesis 1: Sediment reduces kākahi growth and survival.*

Catch per unit effort was higher in the upper reaches of the Whanganui River (chapter two), where sediment levels were lower (Ausseil et al. 2005). However, recruitment still occurred in the lower reaches (chapter two). Survival (but not recruitment) in the lower river may be reduced by sediment load. Adult kākahi can continue feeding for short periods under high ( $> 1200 \text{ mg.L}^{-1}$ ) sediment loads (chapter three), but may not withstand longer periods of increased sedimentation (Ellis et al. 2002, Norkko et al. 2006). Juveniles are likely to have a lower tolerance to sediment than adults (Widdows et al. 1979). Overall, sediment may be reducing growth and survival.

*Hypothesis 2: Lack of host fish prevents recruitment*

The failure of juveniles to recruit into existing populations has been identified as a likely contributor to kākahi decline (chapter 2). Kākahi larvae (glochidia) are brooded in the female's gills, released into the water and must then attach to a host fish, usually on the gills, mouth or fins. Once attached, the glochidia metamorphoses into a juvenile mussel.

After a period, the juvenile drops off its host and developments independently. Host fish, therefore, are an essential element of the kākahi life cycle; decline of fish numbers in Whanganui may have influenced kākahi recruitment rates.

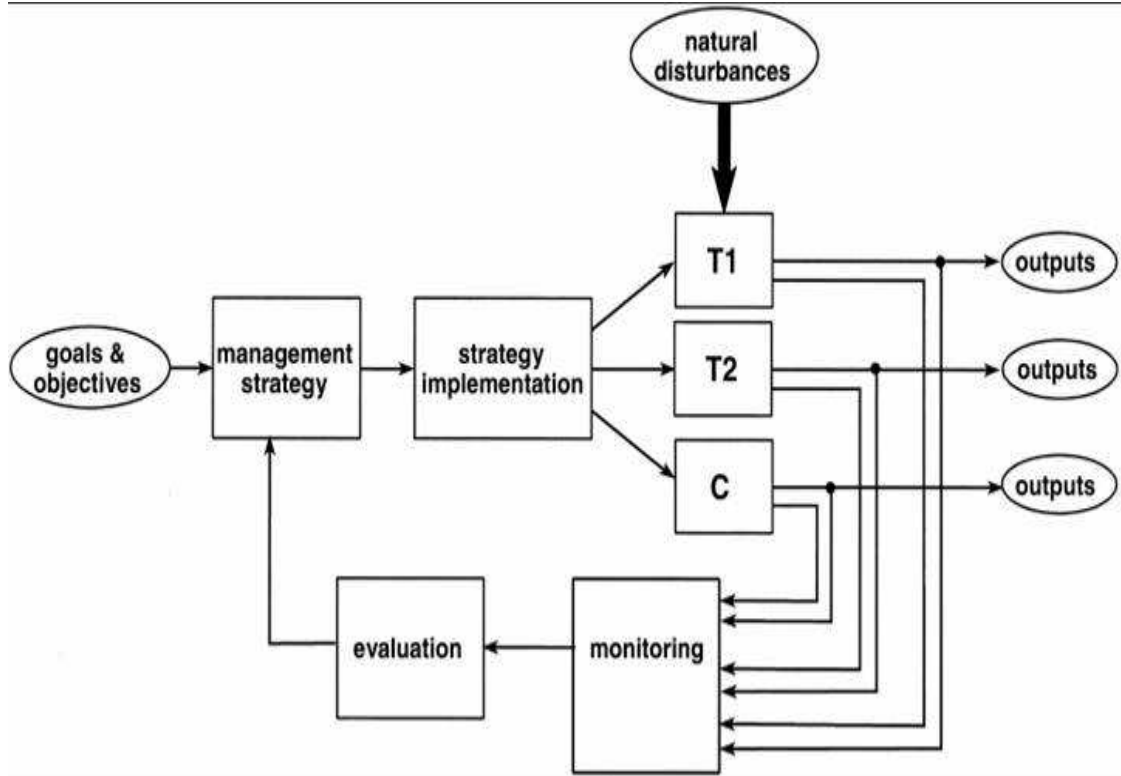

Fig. 1. A model of adaptive management (Wilhere 2002). Cause and effect are established through an active experimental approach. Treatments (T1 and T2) and the control (C) are replicated and assigned randomly. Natural disturbances affect T1, T2, and C. Monitoring and evaluation are fed back into decisions on management strategies. Treatments not only deliver outputs, but also provide information for monitoring; likewise, the actual output provides information for evaluation.

#### IMPLEMENTATION

Actual implementation of an adaptive management project needs to be worked out by groups of stakeholders, managers and scientists together (Walters and Holling 1990).

Hypothesis 1 is used here as an example to depict the use of the adaptive management framework for advancing kākahi restoration (Fig. 2). Hypothesis 2 is not developed in this thesis, but remains an equally valid hypothesis to test, and could be explored by groups of stakeholders using the adaptive management model developed for hypothesis 1.

Sediment can affect molluscs and their habitat in numerous ways – through clogging feeding mechanisms, diluting food, reducing primary production, burying them, reducing dissolved oxygen (DO) in pore water and at the sediment-water interface and carrying pollutants (Ellis 1936, Widdows et al. 1979, Kat 1982, Belanger 1991, Ryan 1991, Quinn et

al. 1992, Ministry for the Environment 2001, Weber 2005). As these factors all interact in the natural environment, it is difficult to test their separate effects with AM. The greatest resolution possible is only between turbid and clear streams.

Further, clear streams are likely to have more vegetation, as soil loss is greater off non-vegetated land (Quinn and Stroud 2002). Streams with more catchment and riparian vegetation have lower temperatures, fewer nutrients, higher dissolved oxygen and less faecal matter than streams without vegetation (Ministry for the Environment 2001, Quinn and Stroud 2002). These factors are not separable using adaptive management. The true experiment then is between vegetated and non-vegetated streams and the hypothesis must be rewritten as: *Stream vegetation positively influences kākahi growth and survival*. Here, two approaches are applicable, with two slightly different hypotheses:

Approach 1: Vegetation restoration (long term option) *Hypothesis: Vegetation planted for erosion control increases kākahi growth and survival.*

Approach 2: Direct translocations (short term option) *Hypothesis: Kākahi growth and survival is higher in vegetated catchments.*

### **Approach 1: Vegetation restoration**

Restoring vegetation is encouraged in restoration literature as it is thought to reduce sedimentation by increasing soil stability and trapping run-off (Ministry of Agriculture and Fisheries, Ministry for the Environment 2001). Stream temperatures are lowered, dissolved oxygen is raised and nutrients are prevented from entering the waterway (Ministry for the Environment 2001).

A management experiment for revegetation would take streams with extant kākahi populations, determine initial length and current survival rates through mark and recapture, and revegetate some of those streams, leaving others as controls. Pre-treatment monitoring of habitat variables (eg turbidity, trophic status, DO in the pore water, at the sediment interface, and in the water column, substrate composition, temperature and pH) would be required. Other habitat variables (catchment vegetation, geology, catchment rainfall) could be obtained through existing geographical information system files.

Once vegetation has become established, growth and survival rates in treated and untreated groups of streams would be assessed, and change between pre- and post-treatment growth and survival rate in treatment and control streams would be determined. If there is no difference in kākahi growth and survival between treatment and control streams, some other factor would need testing. Monitoring of turbidity, trophic status, DO,

substrate composition, and temperature would reveal if revegetation as a management strategy achieves the outcomes suggested in literature (eg less sediment, fewer nutrients).

Because of the large number of complicating factors, a high number of sites are needed to provide statistical power. Sites chosen as controls need to be as similar to treatment sites as possible, and extant differences need to be understood (Roni 2005).

At the end of the experiment, we will not know which aspects of vegetation help kākahi survive (eg, higher DO, lower temperatures, lower nutrients), but we will know whether revegetating streams increases survival and is a useful restoration tool for kākahi. Because vegetation needs time to establish and sediment stored in-stream will take time to clear, it may be at least 10 years before results from this experiment are known.

### **Approach 2: Direct translocations**

Translocation into streams provides a more immediate answer on kākahi survival and growth constraints and has the added benefit of simultaneously increasing kākahi numbers in the wild. A management experiment with this approach would locate streams in the Whanganui River catchment with vegetated and cleared catchments and re-introduce kākahi. A percentage threshold for ‘vegetated’ and ‘cleared’ catchments would need to be determined. Growth and survival in translocated groups would be compared between stream types.<sup>2</sup>

Cohorts of juveniles and adults could be translocated to differentiate effects of stream type on different age groups. Individuals would need to be marked. Adults can be individually marked to determine growth, but juveniles are likely to be too small and fragile for individual tags – growth would be measured by cohort. Some type of shell stain would be needed to distinguish translocated juveniles from naturally occurring juveniles.

Again, a large number of replicates would be needed. Recapture rates are likely to be low, and mussels may have moved a fair distance – monitoring will need to cover around 2 km downstream (Morgan et al. 1997). Sites chosen need to be independent, and translocated kākahi should be placed in the sediment, not broadcast as this reduces recapture rates (Morgan et al. 1997).

If it were possible to find turbid streams with vegetation, and clear streams without vegetation, one could tease out the issue of sediment (separate from vegetation) through controlled re-introductions to these sites. However, I think it unlikely that enough locations of this type would exist for such a study.

---

<sup>2</sup> This approach presents a risk to translocated individuals: if the hypothesis is correct, mussels translocated to non-vegetated sites will have a reduced chance of survival. The ethics need consideration.

Kākahi monitoring would focus on numbers recovered and growth of the cohorts. In initial phases, monitoring should be frequent to capture translocation survival rates and early dispersal. Kākahi monitoring should search micro-habitats other than the sediment to determine if juveniles inhabit different areas than adults (Roper and Hickey 1994). Monitoring should be over a few years; if juveniles are making secondary migrations into adult beds (Roper and Hickey 1994), they will be detected through long-term observations. Stream monitoring should again cover turbidity, trophic status, DO, substrate composition, and temperature. For further analysis, streams could be classified as clear (total particulate matter (TPM)  $>120 \text{ mg.L}^{-1}$  for  $< 10\%$  of the time) or turbid (TPM  $> 120 \text{ mg.L}^{-1}$  for  $> 20\%$  of the time; Rowe et al. 2000).

The reintroduction experiment would inform whether survival in different environments is an issue (and by default shed a little light on whether habitat or lack of host fish is a primary factor), and whether different stressors affect juveniles more than adults. It would inform us where to proceed with translocations, and may begin to illuminate whether translocations are the best restoration option for kākahi. It would not reveal which aspects of vegetation are affecting the kākahi. For example, do they need clean water, clean substrate, the higher DO that comes with unclogged interstices, or lower temperatures? These would need to be explored in a manipulative experiment.

This experiment is useful in that it can determine vegetation effect on juveniles, whereas the generally poor juvenile detection rates in the wild means the use of extant populations would only show vegetation effect on adults, which may be very different to the effects on juveniles. The reintroduction experiment could be altered for use with the first approach, so that translocations are made to deliberately revegetated streams and untreated control streams, rather than streams with naturally occurring vegetation which may have less ground-cover and a less well-designed filter strip (Ministry for the Environment 2001).

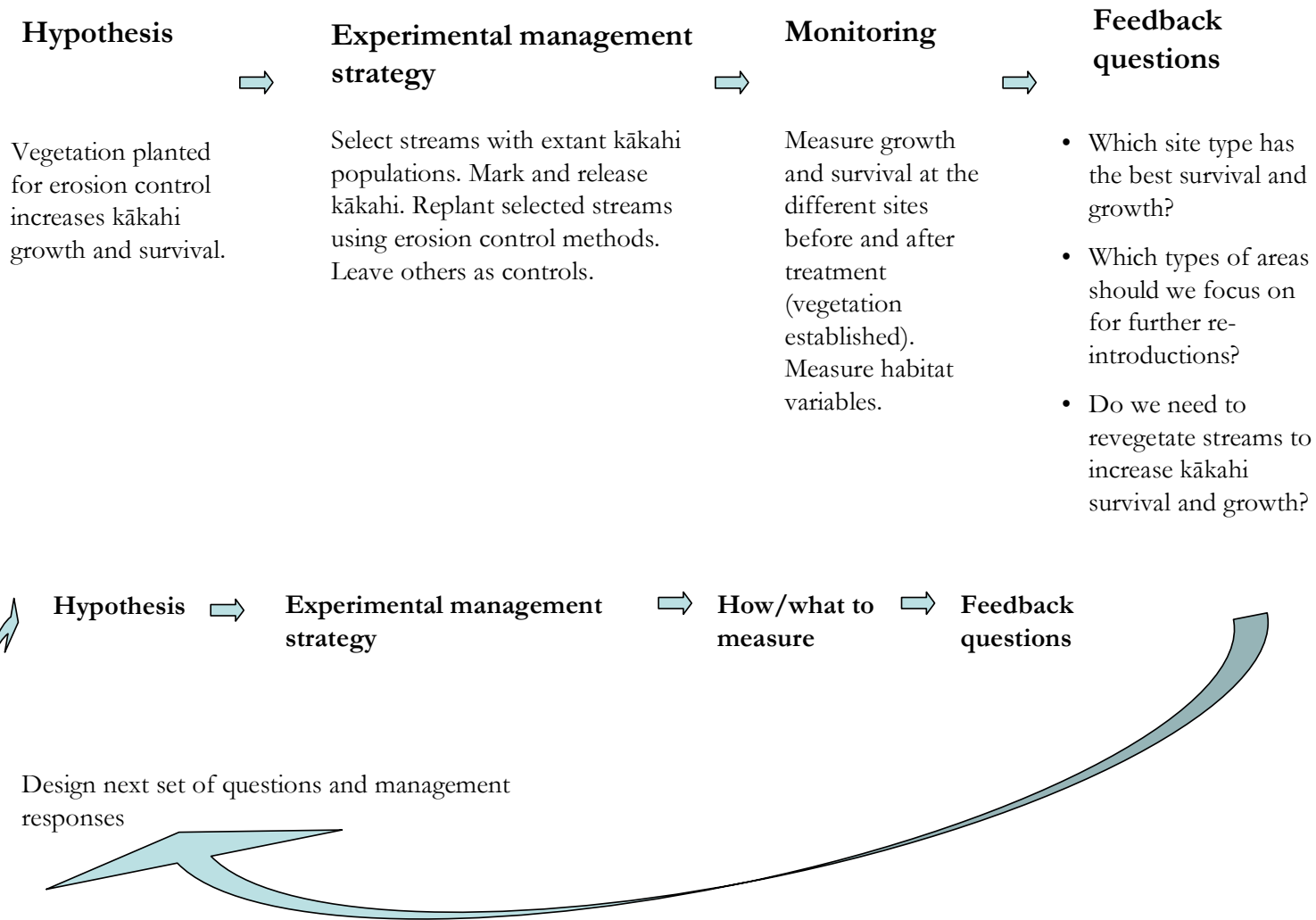

Fig. 2. An example of how adaptive management might be used to facilitate restoration of kākahi in the Whanganui River.

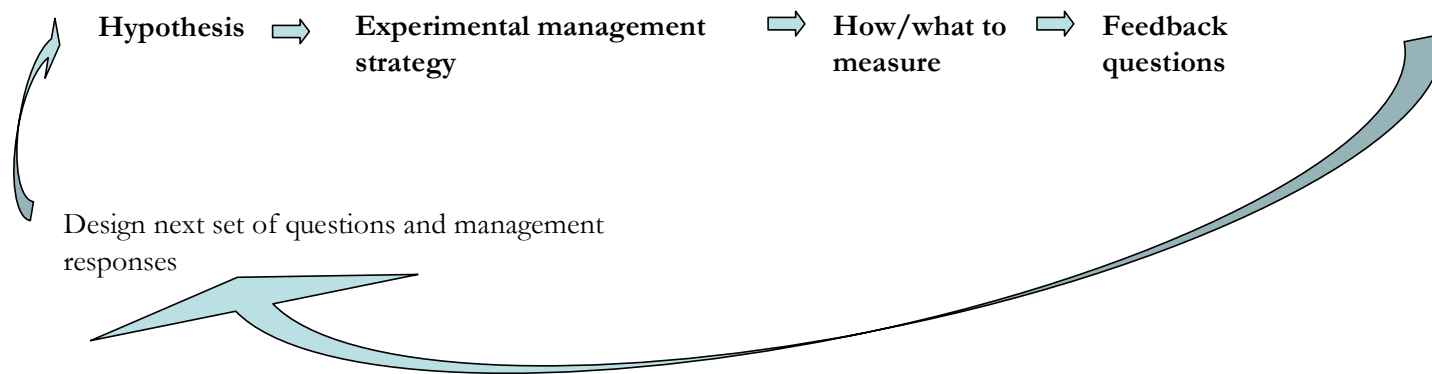
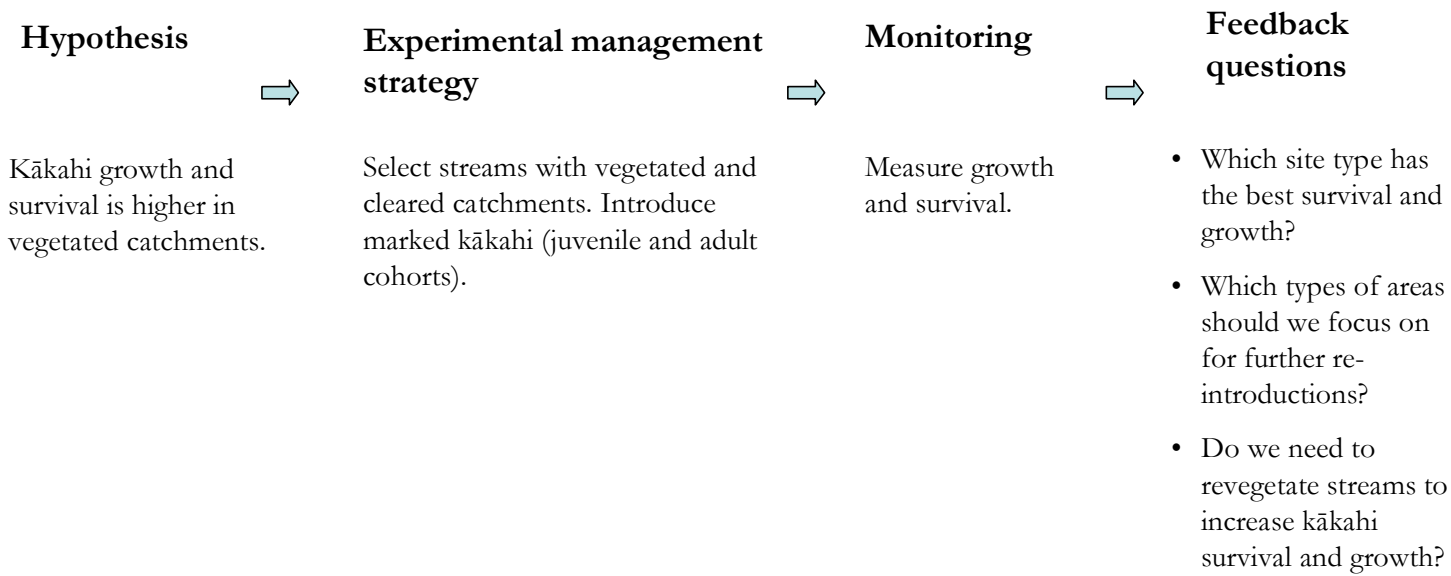

Fig. 2. Continued

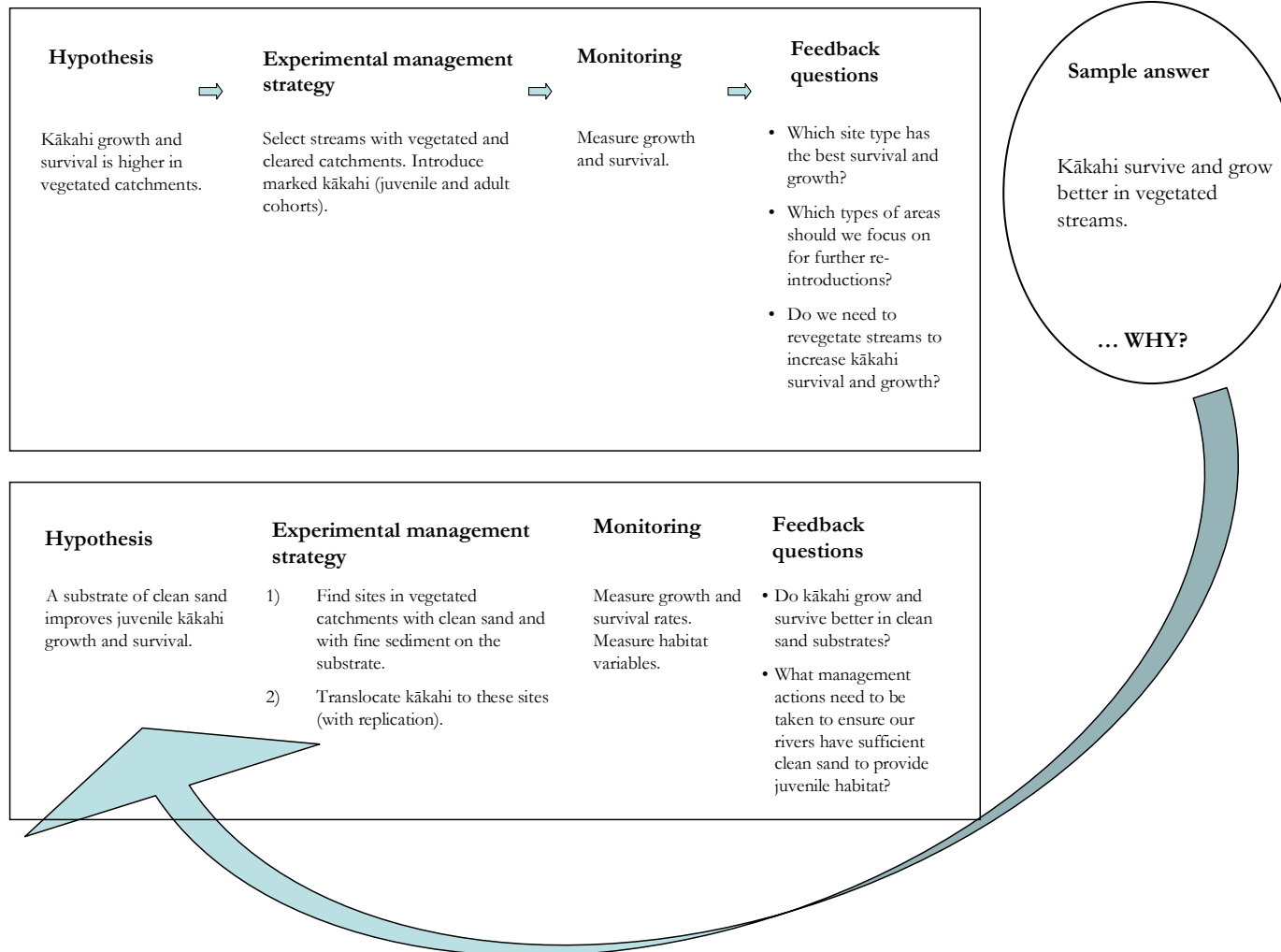

Fig. 3. An example of how results from management experiments could be fed back into further adaptive management responses.



Feedback is crucial in adaptive management – the results must be incorporated back into the restoration or management project. Results would determine which management experiments to proceed with, and which management actions to trial next. For an example of how a possible answer might be fed back in to the kākahi project, see Fig. 3, which lays out an example of a second round of management questions and experiments.

#### EVALUATION AND CRITIQUE OF THIS ADAPTIVE MANAGEMENT FRAMEWORK

An attempt was made to use adaptive management to assess the effect of sediment on kākahi survival. However, given the link between vegetation and sediment load, effects could not be separated from other confounding factors, such as temperature, DO and nutrient input. Consequently, even though AM is lauded as a means to determine causal factors while allowing management action, on application it fails to answer questions with sufficient resolution to conduct restoration expeditiously.

#### PURE RESEARCH QUESTIONS

There is a plethora of information needed to support management interventions, most of which may need to be explored through directed research rather than through any AM framework. The most pertinent of these are:

**Juvenile habitat needs.** Kākahi less than 20 mm are rarely found in the wild (Roper and Hickey 1994) implying that juveniles may settle in different habitats from that of their larger counterparts (Grimmond 1968, Kat 1982, Roper and Hickey 1994). Determining juvenile habitat needs will help ascertain whether juvenile habitat restoration is required.

**Ammonia toxicity.** Mussels are highly sensitive to ammonia (Augspurger et al. 2003, Newton et al. 2003, Cherry et al. 2005, Hemming et al. 2006), and ammonia concentrations are high in waters draining predominantly pastoral catchments (Quinn and Stroud 2002). Delineation of ammonia toxicity to kākahi will determine restoration targets on ammonia in the waterways.

#### **Nutrient enrichment and breeding**

Nutrient enrichment can increase breeding success in some species (Byrne 1998). Evidence from surveys in the Whanganui River evaluated against nutrient data for sub-catchments (Ausseil et al. 2005, McArthur and Clark 2007) was equivocal. Nutrient influence on kākahi breeding could be investigated to determine if restoration initiatives aimed at reducing nutrient concentrations to very low levels are counterproductive.

**Dissolved oxygen.** Molluscs are affected by low levels of DO. Densities of *Corbicula fluminea* were reduced in areas with low DO, and growth was significantly impaired when DO was  $< 3.0 \text{ mg.L}^{-1}$  at the sediment-water interface (Belanger 1991). A concentration of  $6.2 \text{ mg.L}^{-1}$  in overlying water has been given as a threshold for *Unio tumidus* (Weber 2005). For kākahi, this threshold may be around  $5 \text{ mg.L}^{-1}$  (James et al. 1998) but this needs confirmation. Research is currently underway which may help address this knowledge gap (J. Butterworth, unpublished research) and provide restoration targets.

**Triggers for glochidial release.** Percival (1931) suggested that kākahi released glochidia in response to sudden movement (he used a plankton net), but subsequent studies indicate the importance of temperature change (Jones et al. 1986, Dunn and Layzer 1997, Byrne 1998, Jones et al. 2005). We need to know the effect of human-influenced alterations to stream temperatures on glochidial release and whether there are temperature targets to aim for in restoration.

#### **PROPAGATION OF JUVENILES IN CAPTIVITY**

Juvenile mussels will need to be propagated to provide stock for restoration, reintroductions, and for pure research needs. Parents of these mussels will need to be from the Whanganui River to meet iwi requirements of keeping whakapapa pure (B. Potaka pers. comm. 2007). Freshwater mussels have been propagated in the United States with varying success (eg Hove et al. 1998, Zimmerman 2003, Beaty and Neves 2004). Methods have now been developed which increase the successful encystment, metamorphosis and survival of freshwater mussels in captivity (Hove et al. 1998). General principles of those methods are listed in Appendix 2.

#### **GETTING THERE**

##### WHERE TO CONCENTRATE EFFORTS

Generally restoration efforts are best concentrated in first and second order streams (Ministry for the Environment 2001). Revegetating these streams makes a far greater impact on water quality than replanting sections downstream (Ministry for the Environment 2001), with shading to 1 km of first order stream returning substantially more benefit than 1 km of fifth order stream (Rutherford 1998). Also, if middle sections are replanted before upper sections, they remain prone to regular and aggressive flood flows and plants get torn out as a result (Ministry for the Environment 2001).

Horizons Regional Council has identified the Ōhura River as the main sediment polluter (~25% of all sediment input) in the Whanganui River (Phillips 2001, Horizons Regional Council 2006). The Hikumutu and Retaruke catchments are also priority subcatchments (Phillips 2001). These areas should be the initial focus of revegetation adaptive management experiments.

#### STAKEHOLDERS

The Whanganui is a long river with a large catchment and numerous stakeholders. The main stakeholders are iwi, farmers, forestry companies, private landowners, the Department of Conservation, district councils (Ruapehu and Wanganui), and regional councils (Horizons Regional Council and Environment Waikato). To be successful, Whanganui restoration programmes will need to involve as many of these stakeholders as possible (Gippel and Collier 1998, Ministry for the Environment 2001).

A few organisations, including Horizons Regional Council and the Whanganui River Enhancement Trust (WRET), are currently working to improve water quality in the Whanganui region (Horizons Regional Council 2006), however, according to information from the New Zealand Ecological Restoration Network (2007), community and iwi care groups in Whanganui are sadly lacking. There is a need for community groups to be developed to execute restoration programmes.

#### SUPPORT AVAILABLE FOR RESTORATION

Restoration costs money. Securing funding will help programmes succeed (Ministry for the Environment 2001). Ensuring restoration practitioners have expert advice is also essential. Appendix 3 lists organisations offering advice and financial support.

#### MEASURING SUCCESS

The overarching goal, 'To restore kākahi to abundance and wide distribution in the Whanganui River,' is not measurable; it needs quantifiable targets. Targets could be that 30 sites in the upper and lower Whanganui have kākahi populations where:

- × catch per unit effort is greater than 50;
- × recruitment is occurring (juveniles < 30 mm are present); and
- × more than 25% of the population are juvenile (less than 38 mm in shell length).

These are long term targets and would be supplemented by shorter-term targets for management experiments. However, it is useful to hold an overarching restoration vision

(such as above), and have a means to assess when that vision is reached. Measuring this target could be conducted once every five years using timed searches (see chapter two).

## **CONCLUSIONS**

Kākahi have declined in the Whanganui River, evidenced by both kaumātua testimony and recent surveys. This remains a concern to iwi, who note the depletion of traditional food sources, and the mauri of the river. High concentrations of suspended sediment do not seem to be causing decline through reduced feeding activity in the short-term, but the long-term effects of sediment may still be contributing to decline. Sediment may also be affecting juvenile survival in the lower reaches. Further, the impacts of a decline in host fish numbers on kākahi recruitment in the Whanganui River remain unexplored, and are likely to be a major factor influencing kākahi decline in the catchment.

It is obvious that restoration initiatives are needed to aid the return of kākahi to its former abundance. Given the knowledge gaps, adaptive management can be used to trial revegetation as a restoration option. Revegetation would likely aid kākahi directly, as well as indirectly through improving habitat for and therefore numbers of host fish. Direct translocations could also be used as a restoration measure and can be designed to help answer questions on kākahi habitat needs and impacts on growth and survival. Care groups are lacking in the Whanganui catchment and will need to be established to conduct restoration activities. Working with other agencies and accessing support is likely to bring greater success to restoration efforts in the Whanganui River. Nā reira e te iwi, tiakina kia ora!

## REFERENCES

- Allan, C., and A. Curtis. 2005. Nipped in the bud: why regional scale adaptive management is not blooming. *Environmental Management* **36**:414-425.
- Augspurger, T., A. E. Keller, M. C. Black, W. G. Cope, and F. J. Dwyer. 2003. Water quality guidance for protection of freshwater mussels (Unionidae) from ammonia exposure. *Environmental Toxicology and Chemistry* **22**:2569-2575.
- Ausseil, O., H. Barnett, A. Beveridge, L. Fung, B. Gilliland, F. Gordon, H. Janssen, C. McCarron, J. Roygard, M. Todd, and H. Zarour. 2005. State of the environment report of the Manawatu-Wanganui region 2005. Horizons Regional Council, Palmerston North.
- Bauer, G., S. Hochwald, and W. Silkenat. 1991. Spatial distribution of freshwater mussels: the role of host fish and metabolic rate. *Freshwater Biology* **26**:377-386.
- Beaty, B. B., and R. J. Neves. 2004. Use of a natural river water flow-through culture system for rearing juvenile freshwater mussels (Bivalvia: Unionidae) and evaluation of the effects of substrate size, temperature, and stocking density. *American Malacological Bulletin* **19**:15-23.
- Belanger, S. E. 1991. The effect of dissolved oxygen, sediment, and sewage treatment plant discharges upon growth, survival and density of Asiatic clams. *Hydrobiologia* **218**:113-126.
- Brim Box, J. B., and J. Mossa. 1999. Sediment, land use, and freshwater mussels: prospects and problems. *Journal of the North American Benthological Society* **18**:99-117.
- Byrne, M. 1998. Reproduction of river and lake populations of *Hyridella depressa* (Unionacea: Hyriidae) in New South Wales: implications for their conservation. *Hydrobiologia* **389**:29-43.
- Cherry, D. S., J. L. Scheller, N. L. Cooper, and J. R. Bidwell. 2005. Potential effects of Asian clam (*Corbicula fluminea*) die-offs on native freshwater mussels (Unionidae) I: water-column ammonia levels and ammonia toxicity. *Journal of the North American Benthological Society* **24**:369-380.
- Dunn, C. S., and J. B. Layzer. 1997. Evaluation of various holding facilities for maintaining freshwater mussels in captivity. Pages 205-213 *in* K. Cummings, editor. Conservation and management of freshwater mussels II: proceedings of a UMRCC symposium. Upper Mississippi River Conservation Committee.
- Ellis, J., V. Cummings, J. Hewitt, S. Thrush, and A. Norkko. 2002. Determining effects of suspended sediment on condition of a suspension feeding bivalve (*Atrina zelandica*):

- results from a survey, a laboratory experiment and a field transplant experiment. *Journal of Experimental Marine Biology and Ecology* **267**:147-174.
- Ellis, M. M. 1936. Erosion silt as a factor in aquatic environments. *Ecology* **17**:29-42.
- Environment Court. 2004. Ngati Rangi Trust (RMA 874/01), Tamahaki Inc Society (RMA 875/01), Whanganui River Maori Trust Board, Hinengakau Development Trust, Ngati Hikairo Hapu Forum, Ngati Tama o Ngati Haua Trust, Pungarehu Marae Incorporated Society on behalf of Ngati Tuera Hapu and Ngati Rangi Trust (RMA 877/01) Appellents v The Manawatu-Wanganui Regional Council Respondent and Genesis Power Limited Applicant. Decision no: A 067/2004. Environment Court.
- Firmin, P. 1994. *in* oral archives. Whanganui Regional Museum, Whanganui
- Gehrke, P. C. 2003. Assessing the effectiveness of pest fish management. Pages 85-94 *in* Managing invasive freshwater fish in New Zealand. Proceedings of a workshop, 2001. Department of Conservation, Hamilton.
- Gippel, C. S., and K. Collier. 1998. Degradation and rehabilitation of waterways in Australia and New Zealand. Pages 269-300 *in* L. C. de Waal, A. R. G. Large, and P. M. Wade, editors. Rehabilitation of rivers: principles and implementation. John Wiley & Sons Ltd, Chichester.
- Grimmond, N. M. 1968. Observations on growth and age in *Hyridella menziesi* (Mollusca, Bivalva) in a freshwater tidal lake. Unpublished Master of Science thesis, University of Otago, Dunedin.
- Hemming, J. M., P. V. Winger, S. J. Herrington, W. Gierhart, H. Herod, and J. Ziewitz. 2006. Water and sediment quality at mussel (Unionidae) habitats in the Ochlockonee River of Florida and Georgia. *Endangered Species Research* **2**:37-49.
- Horizons Regional Council. 2006. Teaming up for our river. Across the region:4.
- Hove, M. C., K. R. Hillegass, J. E. Kurth, V. E. Pepi, C. J. Lee, K. A. Knudsen, A. R. Kapuscinski, P. A. Mahoney, and M. M. Bomier. 1998. Considerations for conducting host suitability studies. Pages 27-34 *in* Proceedings of the conservation, captive care, and propagation of freshwater mussels symposium. Ohio Biological Survey.
- James, M. R., S. C. Ogilvie, and R. Henderson. 1998. Ecology and potential use in biomanipulation of the freshwater mussel *Hyridella menziesi* (Gray) in Lake Rotorua. NIWA Client Report: HCC90210/1. National Institute of Water and Atmospheric Research.

- Jones, H. A., R. D. Simpson, and C. L. Humphrey. 1986. The reproductive cycles and glochidia of fresh-water mussels (*Bivalvia: Hyriidae*) of the Macleay River, Northern New South Wales, Australia. *Malacologia* **27**:185-202.
- Jones, J. W., R. A. Mair, and R. J. Neves. 2005. Factors affecting survival and growth of juvenile freshwater mussels cultured in recirculating aquaculture systems. *North American Journal of Aquaculture* **67**:210-220.
- Kat, P. W. 1982. Effects of population density and substratum type on growth and migration of *Elliptio complanata* (*Bivalvia: Unionidae*). *Malacological Review* **15**:119-127.
- McArthur, K., and M. Clark. 2007. Nitrogen and phosphorus loads to rivers in the Manawatu-Wanganui Region: an analysis of low flow state: technical report to support policy development. Horizons Regional Council, Palmerston North.
- McNab, J. 1983. Wildlife management as scientific experimentation. *Wildlife Society Bulletin* **11**:397-401.
- Ministry for the Environment. 2001. Managing waterways on farms: a guide to sustainable water and riparian management in rural New Zealand. Ministry for the Environment, Wellington.
- Ministry of Agriculture and Fisheries. Practices which minimise damage to watercourses. *in* <http://www.maf.govt.nz/mafnet/rural-nz/sustainable-resource-use/land-management/erosion-risks/erowater.htm>. Date accessed June 11 2008.
- Morgan, A., N. J. Welker, and J. B. Layzer. 1997. Feasibility of reintroducing threatened and endangered mussels into Shoal Creek in Alabama and Tennessee. Pages 196-204 *in* K. Cummings, editor. Conservation and management of freshwater mussels II: proceedings of a UMRCC symposium. Upper Mississippi River Conservation Committee.
- Naimo, T. J. 1995. A review of the effects of heavy metals on fresh water mussels. *Ecotoxicology* **4**:341-362.
- New Zealand Ecological Restoration Network. 2007. Manawatu-Wanganui ecological restoration directory: restoration sites, organisations, native plant nurseries. Bush Telly Trust, Christchurch.
- Newton, T. J., J. W. Allran, J. A. O'Donnell, M. R. Bartsch, and W. B. Richardson. 2003. Effects of ammonia on juvenile unionid mussels (*Lampsilis cardium*) in laboratory sediment toxicity tests. *Environmental Toxicology and Chemistry* **22**:2554-2560.

- Norkko, J., J. E. Hewitt, and S. F. Thrush. 2006. Effects of increased sedimentation on the physiology of two estuarine soft-sediment bivalves, *Austrovenus stutchburyi* and *Paphies australis*. *Journal of Experimental Marine Biology and Ecology* **333**:12-26.
- Phillips, J. 2001. Whanganui catchment water quality: a study on clarity and microbiological water quality in the Whanganui River and its tributaries. Horizons Regional Council, Palmerston North.
- Quinn, J. M., R. J. Daviescolley, C. W. Hickey, M. L. Vickers, and P. A. Ryan. 1992. Effects of clay discharges on streams. 2. benthic invertebrates. *Hydrobiologia* **248**:235-247.
- Quinn, J. M., and M. J. Stroud. 2002. Water quality and sediment and nutrient export from New Zealand hill-land catchments of contrasting land use. *New Zealand Journal of Marine and Freshwater Research* **36**:409-429.
- Roni, P., editor. 2005. Monitoring stream and watershed restoration. American Fisheries Society, Bethesda, Maryland.
- Roper, D. S., and C. W. Hickey. 1994. Population structure, shell morphology, age and condition of the freshwater mussel *Hyridella menziesi* (Unionacea: Hyriidae) from seven lake and river sites in the Waikato River system. *Hydrobiologia* **284**:205-217.
- Rowe, D., M. Hicks, and J. Richardson. 2000. Reduced abundance of banded kokopu (*Galaxias fasciatus*) and other native fish in turbid rivers of the North Island of New Zealand. *New Zealand Journal of Marine and Freshwater Research* **34**:545-556.
- Rutherford, K. 1998. Can shade reduce stream temperature? Pages 56 in J. M. Quinn and B. S. Thorrold, editors. Hill-country stream management: proceedings of a workshop, April 1998. NIWA Technical Report 46. The National Institute of Water and Atmospheric Research, Wellington.
- Ryan, P. A. 1991. Environmental effects of sediment on New Zealand streams: a review. *New Zealand Journal of Marine and Freshwater Research* **25**:207-221.
- Waitangi Tribunal. 1999. The Whanganui River Report. Waitangi Tribunal, Wellington.
- Walters, C. J., and C. S. Holling. 1990. Large-scale management experiments and learning by doing. *Ecology* **71**:2060-2068.
- Watters, G. T. 1996. Small dams as barriers to freshwater mussels (Bivalvia, Unionoida) and their hosts. *Biological Conservation* **75**:79-85.
- Weber, E. 2005. Population size and structure of three mussel species (Bivalvia: Unionidae) in a northeastern German river with special regard to influences of environmental factors. *Hydrobiologia* **537**:169-183.



- Whanganui River Māori Trust Board. 2002. Draft Mission Statement. *in*. Whanganui River Māori Trust Board.
- Widdows, J., P. Fieth, and C. M. Worrall. 1979. Relationships between seston, available food and feeding activity in the common mussel *Mytilus edulis*. *Marine Biology* **50**:195-207.
- Wilhere, G. F. 2002. Adaptive management in habitat conservation plans. *Conservation Biology* **16**:20-29.
- Williams, J. D., M. L. Warren, K. S. Cummings, J. L. Harris, and R. J. Neves. 1993. Conservation status of fresh-water mussels of the United States and Canada. *Fisheries* **18**:6-22.
- Zimmerman, L. L. 2003. Propagation of juvenile freshwater mussels (Bivalvia: Unionidae) and assessment of habitat suitability for restoration of mussels in the Clinch River, Virginia. Unpublished thesis. Virginia Polytechnic Institute and State University Blacksburg.

## GLOSSARY

iwi	tribe, those you belong to and are connected with
kāinga	home, settlement
karanga	the formal oratory of a woman. Used (mostly) in outside areas to welcome people, invite guests to dine, farewell the dead, acknowledge landmarks, carvings etc. An important aspect of Māori tikanga and kawa
kawa	protocols, formal ways of doing things. Kawa is based on Māori worldviews and incorporates concepts of tapu and noa
kōrero	talk, information
marae	a community building and the surrounds, serving as a place to meet and sleep
noa	things of an everyday nature, unrestricted matters
tangihanga	funeral ceremony
tapu	tapu and noa are key concepts within the Māori world. Tapu things are things of a restricted nature – often special things like intricate cloaks, formal meeting houses, or our bodies. There are protocols governing how tapu things are approached and handled. Things of a tapu nature are not to be brought into contact with things of a noa nature; they are kept separate. An example of this is that you do not bring food into the formal meeting house – it is kept to the eating area
tikanga	usual way of doing things. Tikanga is based on observed norms
tūpuna	ancestors
waiata	song
waka	canoe
wānanga	a school of learning, often held by selected individuals and passed on under restricted circumstances
whaikōrero	formal oratory used to welcome people, discuss issues, recount important kōrero, farewell the dead etc. An important aspect of Māori tikanga and kawa

## APPENDIX 1

### SUGGESTED PROCEDURES FOR CONTACTING IWI AND HAPŪ

Depending on where your research is, you will need to contact either the local marae or hapū, the over-arching rūnanga for the area, or the iwi rūngana, Te Awa Tupua. Most marae are listed in the phone book. The area rūnanga are listed below, and you can probably find out when Te Awa Tupua is meeting by contacting the Whanganui River Māori Trust Board (see below).

Ring the rūnanga or marae committee and set up a time to discuss your idea with them. You may like to send a letter to the committee beforehand – this can be distributed to committee members so they have some idea of what you will be speaking about before you arrive. Either way, discussions are best done in person, and not solely with a letter. The committee is likely to want time to discuss your proposal, so leave space for them to do so. You will need to present your findings back to the hapū or iwi involved. Build this into your time plan – it is an essential part of relations.

At hui you attend to present your proposal, there may or not be a formal welcome. At the very least, there is likely to be a speech given. It is polite to return this. If unfamiliar with tikanga you may like to consider taking someone to guide you.

#### USEFUL CONTACT DETAILS

Whanganui River Māori Trust Board  
61 Taupō Quay  
PO Box 323  
Whanganui  
06 345 8160

*Lower reaches of the river*  
Te Rūnanga o Tūpoho  
42 Mitchell Street  
Whanganui  
06 348 0395  
John Maihi

*Middle reaches of the river*  
Tamahaki Inc Society  
PO Box 55  
Raetihi  
06 385 4686  
Boy Cribb

Te Rūnanga o Tamaupoko  
PO Box 690  
Whanganui  
06 343 2967

*Upper reaches of the river*  
Ngāti Rangi Trust  
PO Box 195  
Ohakune

Hinengākau Development Trust  
PO Box 125  
Taumarunui  
07 896 6726  
Piki Taiaoroa

## APPENDIX 2

### PROPAGATION OF JUVENILE KĀKAHI IN CAPTIVITY

Freshwater mussels have been propagated in the United States for some time with varying success (eg Hove et al. 1998, Zimmerman 2003, Beaty and Neves 2004). Methods have now been developed which increase the successful encystment, metamorphosis and survival of freshwater mussels in captivity (Hove et al. 1998). General principles of those methods are listed below.

#### PROPAGATION, HOST FISH INFESTATION AND GLOCHIDIAL COLLECTION

Collect gravid females from the field (Hove et al. 1998, Jones et al. 2005). Handle individuals carefully as stressed females can abort glochidia (Jones et al. 1986). Glochidia can be obtained by gently flushing water through the female's gills using a pipette (Beaty and Neves 2004), or by leaving females in an aquarium and carefully watching for natural release (Hove et al. 1998). Glochidial maturity can be determined by exposure to a dilute salt solution (0.05-0.10 mg NaCl/L); if valves snap shut, glochidia are mature – those that are slow to respond or fail to close are under-developed (Jones et al. 2005). Do not use these to infest host fish.

Hosts can be infested in two ways. One option is to add glochidia to a tank or small container, aerate to keep in suspension, and introduce host fish for a set time (can be between 15 minutes and 24 hours) (Hove et al. 1998, Beaty and Neves 2004). A number of fish can be exposed in a short time using this method, but infestation may be low or nil (Hove et al. 1998). Alternatively, you can anaesthetise the fish and pipette glochidia directly onto the gills (Hove et al. 1998). This method ensures infestation, but is time consuming, and stressful for the fish (Hove et al. 1998).

While waiting for glochidia to metamorphose and excyst, fish can be kept in well aerated aquaria, or in recirculating or flow-through systems with mesh to prevent loss of glochidia in out-going water (Barnhart and Roberts 1997, Hove et al. 1998). Small host fish will need to be kept in suspended nets to prevent predation on newly-excysted glochidia. (Hove et al. 1998). Glochidia can be collected by siphoning the tank bottom and sieving the siphonate (Hove et al. 1998).

Follow fish husbandry principles – handle fish as little as possible and avoid over-infesting with glochidia (Hove et al. 1998). Feed fish sufficiently, and clean tanks after

feeding to avoid fungal growth on uneaten food (Hove et al. 1998). When transferring fish from one aquaria to another, ensure temperatures are equal (Hove et al. 1998).

#### REARING

Various flow-through and recirculating facilities have been developed for freshwater mussels in captivity, including ponds, cages, aquaria, raceways, aerated culture dishes, single and multi-staged recirculating systems, and systems with many mini-tanks attached to a feeder (O'Beirn et al. 1998, Henley et al. 2001, Zimmerman 2003, Beaty and Neves 2004, Jones et al. 2005). Recirculating systems require regular manual cleaning and higher maintenance (Zimmerman 2003, Jones et al. 2005). Recirculating systems do allow greater control of inputs and predators, but this does not necessary equate to greater survival (Zimmerman 2003). In rearing facilities, using the following principles can increase growth and survival.

**Use natural water supplies.** This increases chances for success, and provides a wide range of food types (Beaty and Neves 2004). Variety in diet increases growth and ensures nutritional requirements are met (Beaty and Neves 2004, Jones et al. 2005). Systems using natural water supplies are also easier to maintain (Beaty and Neves 2004).

**Provide substrate.** Some species survive and grow better in fine sediment (Jones et al. 2005), others perform equally in fine or coarse sediment (Beaty and Neves 2004), but generally all need substrate of some form (O'Beirn et al. 1998). Newly metamorphosed juveniles often go through a pedal-feeding stage (Gatenby et al. 1996, O'Beirn et al. 1998). Sediment may act as a substratum for pedal-feeders to collect food particles, provide bacteria for food and particle breakdown, aid digestion by providing substrate to grind particles, give protection from predators, aid vertical orientation for feeding, and keep shells clean of fungi and epiphytes (Gatenby et al. 1996, O'Beirn et al. 1998, Jones et al. 2005).

**Reduce predation.** Predation from flatworms, dipteran larvae and fish has been observed in some rearing facilities (Hove et al. 1998, Zimmerman 2003, Jones et al. 2005). Fish can be excluded with mesh or nets (Hove et al. 1998, Zimmerman 2003). In systems using treated water, flatworms can be eradicated by autoclaving sediment (Jones et al. 2005). In systems using natural water, predators can be reduced by filtering incoming water, but cannot be eliminated altogether (Beaty and Neves 2004).

**Follow natural seasonal patterns.** Take glochidia from the female in line with natural release times, when they are mature (Jones et al. 2005). Out-of-season glochidia are slower to close when exposed to salt, have less developed tissue, and have poor survival and

growth rates (Jones et al. 2005). Juveniles need to be a good size to survive winter – glochidia propagated too late in the season do not reach a sufficient size and perish (Beatty and Neves 2004).

**Prepare juveniles for the receiving environment.** Mussels develop gills and palps to cope with the silt load in their microhabitat, with mussels in more heavily sedimented environments having larger palps and smaller gills than those in clearer waters (Kjørboe and Møhlenberg 1981, Payne et al. 1995). Before release into the Whanganui River, and while juveniles are developing, it would be useful to expose them to suspended sediment to encourage gill and palp development suitable to their receiving environment.

**Take care in transfer to the wild.** Release juveniles when temperature is moderate – extremes of hot or cold can cause higher mortalities (Dunn and Sietman 1997). Ensure the temperature of the ambient water is equal to the receiving water. Keep mussels moist or in water, and minimise periods out of the water to reduce stress (Dunn and Sietman 1997). Avoid overcrowding mussels in transfer containers, and use personnel who are familiar with mussels to reduce mortalities (Dunn and Sietman 1997). Mussels should be placed in the sediment, not broadcast, as this helps them to burrow and settle more quickly, and ensures greater recovery (Morgan et al. 1997).

## REFERENCES

- Barnhart, M. C., and A. Roberts. 1997. Reproduction and fish hosts of unionids from the Ozark Uplifts. Pages 16-20 *in* K. Cummings, editor. Conservation and management of freshwater mussels II: proceedings of a UMRCC symposium. Upper Mississippi River Conservation Committee.
- Beatty, B. B., and R. J. Neves. 2004. Use of a natural river water flow-through culture system for rearing juvenile freshwater mussels (*Bivalvia: Unionidae*) and evaluation of the effects of substrate size, temperature, and stocking density. *American Malacological Bulletin* **19**:15-23.
- Dunn, H. L., and B. E. Sietman. 1997. Guidelines used in four geographically diverse Unionid relocations. Pages 176-185 *in* K. Cummings, editor. Conservation and management of freshwater mussels II: proceedings of a UMRCC symposium. Upper Mississippi River Conservation Committee.
- Gatenby, C. M., R. J. Neves, and B. C. Parker. 1996. Influence of sediment and algal food on cultured juvenile freshwater mussels. *Journal of the North American Benthological Society* **15**:597-609.
- Henley, W. F., L. L. Zimmerman, R. J. Neves, and M. R. Kidd. 2001. Design and evaluation of recirculating water systems for maintenance and propagation of freshwater mussels. *North American Journal of Aquaculture* **63**:144-155.
- Hove, M. C., K. R. Hillegass, J. E. Kurth, V. E. Pepi, C. J. Lee, K. A. Knudsen, A. R. Kapuscinski, P. A. Mahoney, and M. M. Bomier. 1998. Considerations for conducting host suitability studies. Pages 27-34 *in* Proceedings of the conservation, captive care, and propagation of freshwater mussels symposium. Ohio Biological Survey.
- Jones, H. A., R. D. Simpson, and C. L. Humphrey. 1986. The reproductive cycles and glochidia of fresh-water mussels (*Bivalvia: Hyriidae*) of the Macleay River, Northern New South Wales, Australia. *Malacologia* **27**:185-202.
- Jones, J. W., R. A. Mair, and R. J. Neves. 2005. Factors affecting survival and growth of juvenile freshwater mussels cultured in recirculating aquaculture systems. *North American Journal of Aquaculture* **67**:210-220.
- Kjørboe, T., and F. Møhlenberg. 1981. Particle selection in suspension-feeding bivalves. *Marine Ecology Progress Series* **5**:291-296.



- Ministry for the Environment. 2001. Managing waterways on farms: a guide to sustainable water and riparian management in rural New Zealand. Ministry for the Environment, Wellington.
- Morgan, A., N. J. Welker, and J. B. Layzer. 1997. Feasibility of reintroducing threatened and endangered mussels into Shoal Creek in Alabama and Tennessee. Pages 196-204 *in* K. Cummings, editor. Conservation and management of freshwater mussels II: proceedings of a UMRCC symposium. Upper Mississippi River Conservation Committee.
- O'Beirn, F. X., R. J. Neves, and M. B. Steg. 1998. Survival and growth of juvenile freshwater mussels (Unionidae) in a recirculating aquaculture system. *American Malacological Bulletin* **14**:165-171.
- Payne, B. S., J. Lei, A. C. Miller, and E. D. Hubertz. 1995. Adaptive variation in palp and gill size of the zebra mussel (*Dreissena polymorpha*) and Asian clam (*Corbicula fluminea*). *Canadian Journal of Fisheries and Aquatic Sciences* **52**:1130-1134.
- Zimmerman, L. L. 2003. Propagation of juvenile freshwater mussels (Bivalvia: Unionidae) and assessment of habitat suitability for restoration of mussels in the Clinch River, Virginia. Unpublished thesis. Virginia Polytechnic Institute and State University Blacksburg.

## APPENDIX 3

### SUPPORT AVAILABLE FOR RESTORATION

Restoration costs money. Securing funding will help the programme succeed (Ministry for the Environment 2001). Ensuring restoration practitioners have expert advice is also essential. Financial support and advice is available from the following sources:

✧ **Queen Elizabeth II Trust** provides advice on legal protections for your land and conservation management advice, and may provide some funding (eg for fencing costs).

See: <http://www.openspace.org.nz/> or contact QEII National Trust, PO Box 3341, Wellington 6140. Phone 04 472 6626.

✧ **Ngā Whenua Rāhui** provides funding for conservation on Māori-owned land.

The fund provides legal protection to these lands and finances programmes such as pest control and fencing. See: <http://www.doc.govt.nz/templates/page.aspx?id=43144> or contact the kaitakawaenga on 0800 112 771. Email [kaitakawaenga@doc.govt.nz](mailto:kaitakawaenga@doc.govt.nz)

✧ Funding is available through the **Mātauranga Kura Taiao Fund** to help iwi initiatives to revitalise, use and maintain mātauranga Māori regarding the environment. See: <http://www.doc.govt.nz/templates/page.aspx?id=43160> or contact the kaitakawaenga on 0800 112 771. Email [kaitakawaenga@doc.govt.nz](mailto:kaitakawaenga@doc.govt.nz).

✧ The Horizons Regional Council **Sustainable Land Use Initiative** helps farmers develop Whole Farm Plans to assess how to best use their land in a sustainable and profitable manner. Costs of implementing works in the Whole Farm Plan are shared with Horizons and the landowner. See: <http://www.horizons.govt.nz/Images/Publications/SLUI/SLUI%20v4.pdf> or contact the SLUI Manager on 0508 800 800. Email [SLUI@horizons.govt.nz](mailto:SLUI@horizons.govt.nz).

✧ The **Whanganui River Enhancement Trust** funds social, economic and environmental enhancement projects in the Whanganui catchment.

See: <http://www.genesisenergy.co.nz/genesis/index.cfm?4934F27A-7E95-D748-0D76-FF896D5E2234> or contact Michelle Caird, c/o Tokaanu Power Station, Private Bag 36, Turangi. Phone 07 384 7242.

✧ The **Biodiversity Condition Fund** and the **Biodiversity Advice Fund** are available to private landowners and community groups. Up to \$60,000 is available to each project annually. The Advice Fund provides resources for information and advice; the Condition Fund provides resources for programme implementation. See:

<http://www.biodiversity.govt.nz/land/nzbs/pvtland/condition.html> or contact Biodiversity Funds, Department of Conservation, PO Box 10-420, Wellington, Phone 0800 862020. Email [biofunds@doc.govt.nz](mailto:biofunds@doc.govt.nz).

✘ The **Natural Heritage Fund** provides funding to protect, purchase, or manage private land for conservation purposes.

See: <http://www.doc.govt.nz/templates/page.aspx?id=39023> or contact The Executive Officer, Nature Heritage Fund, PO Box 10-420, Wellington. Phone 04 471 0726. Email [NHF-Admin@doc.govt.nz](mailto:NHF-Admin@doc.govt.nz).

✘ Funding for groups is available through the **Lottery Environment and Heritage** grants. See: [http://www.cdgo.govt.nz/available-grants/downloads.aspx#ApplicationType\\_7](http://www.cdgo.govt.nz/available-grants/downloads.aspx#ApplicationType_7).

✘ The **Sustainable Management Fund** is available from the Ministry for the Environment to fund community groups, iwi and businesses. See: <http://www.mfe.govt.nz/withyou/funding/smf/> or contact Projects and Partnerships, Ministry for the Environment, PO Box 10-362, Wellington 6143. Phone 04 439 7400. Email [funds@mfe.govt.nz](mailto:funds@mfe.govt.nz).

✘ The **MAF Sustainable Farming Fund** is available to groups of farmers, growers or foresters to improve the financial and environmental performance and solve problems or take up opportunities for sustainable resource use. See: <http://www.maf.govt.nz/sff/climate-change/index.htm> or contact the Fund Administrator, Sustainable Farming Fund, Ministry of Agriculture and Forestry, PO Box 2526, Wellington. Phone 0800 100 087.

All text and images © H J Rainforth 2008, except Fig. 1 page 90.