

ENERGIZER L91
Ultimate Lithium

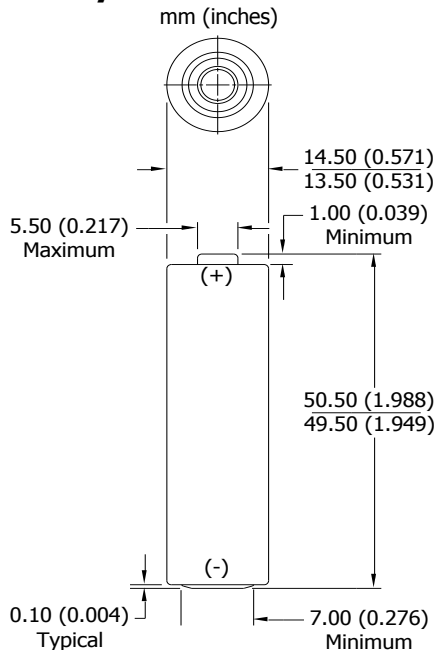



AA

Industry Standard Dimensions



Specifications

Classification:	"Cylindrical Lithium"
Chemical System:	Lithium/Iron Disulfide (Li/FeS ₂)
Designation:	ANSI 15-LF, IEC-FR6
Nominal Voltage:	1.5 Volts
Compatible With:	EA91 , E91 , NH15 , 1215
Storage Temp:	-40°C to 60°C (-40°F to 140°F)
Operating Temp:	-40°C to 60°C (-40°F to 140°F)*
Typical Weight:	14.5 grams (0.5 oz.)
Typical Volume:	8.0 cubic centimeters (0.49 cubic inch)
Max Discharge:	3.0 Amps Continuous 5.0 Amps Pulse (2 sec on / 8 sec off)
Max Rev Current:	2 uA
Lithium Content:	Less than 1 gram
Typical IR:	60 to 210 milliohms (depending on method)
Shelf Life:	20 years at 21°C
Shipping:	Please refer to PSDS Document
Certifications:	 This battery has Underwriters Laboratories component recognition (MH29980)  Certified for intrinsic safety 710024

***All data shown tested at 21°C unless otherwise stated.**

Milliamp-Hours Capacity

Constant Current Discharge to 0.8 Volts

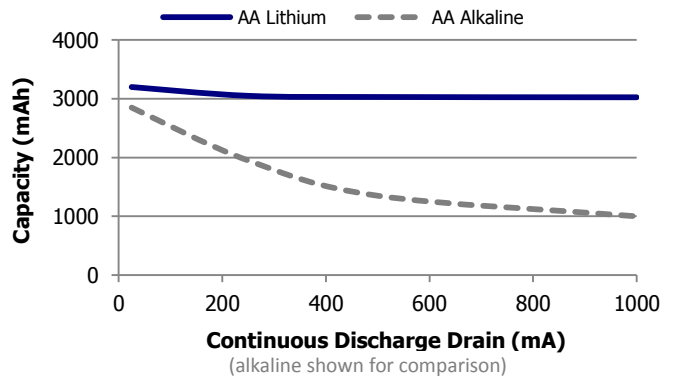

Discharge Profile

Constant Current Discharge

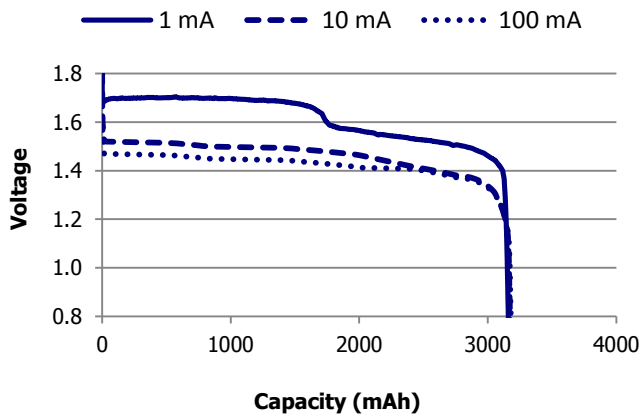

Temperature Effects on Capacity

Constant Current Discharge

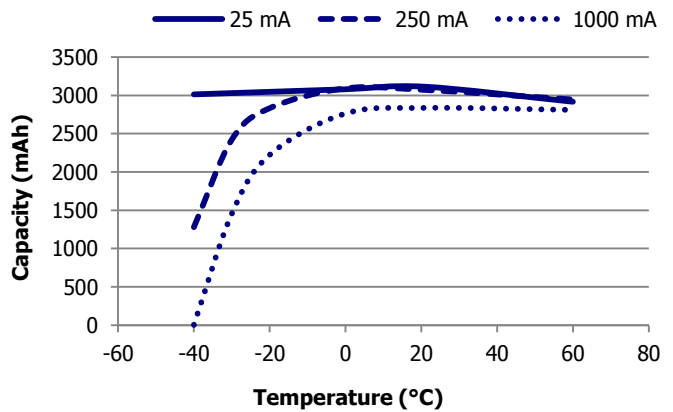

Important Notice

This datasheet contains typical information specific to products manufactured at the time of its publication.
©Energizer Holdings, Inc. - Contents herein do not constitute a warranty.

ENERGIZER L91

AA

Internal Resistance Profile

Cell Ohmic Resistance - Dual Pulse Method

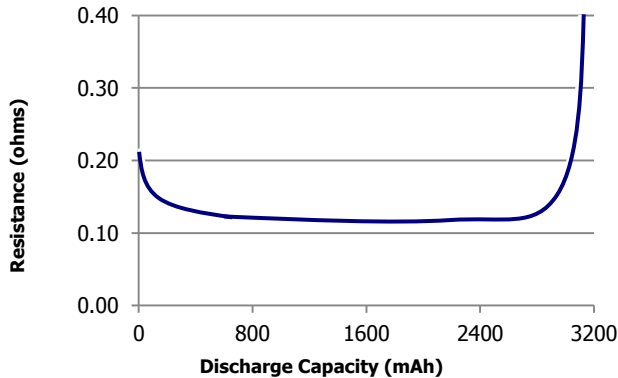

Pulse Response

Open Circuit Voltage - 100/500/1k mA Pulse

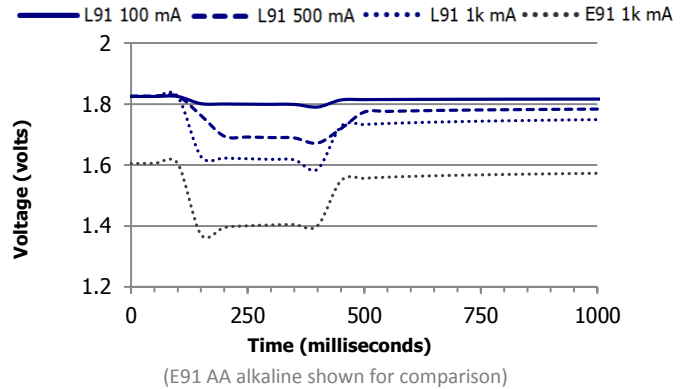

Constant Power Performance

Typical Characteristics to 0.8 Volts

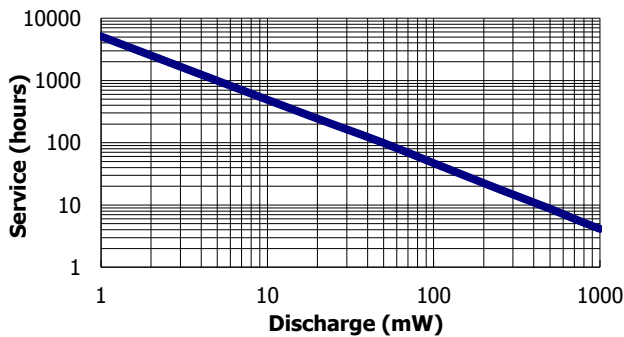

Constant Current Performance

Typical Characteristics to 0.8 Volts

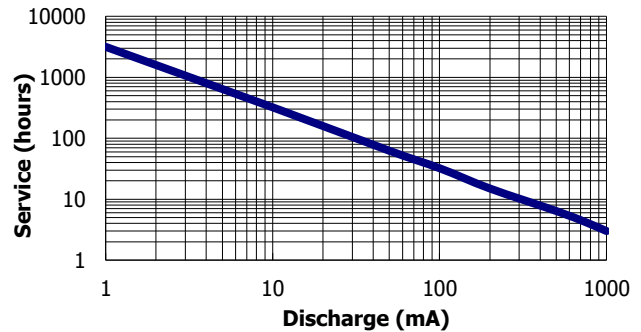

Application Tests

REMOTE 24 ohm 15 sec/min 8 hrs/day
RADIO 43 ohm 4 hrs/day

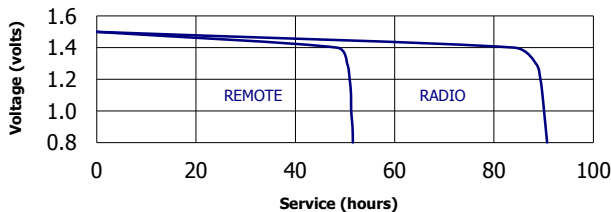

Application Tests

CD/GAMES 250 mA 1 hr/day
DIGITAL AUDIO 100 mA 1 hr/day

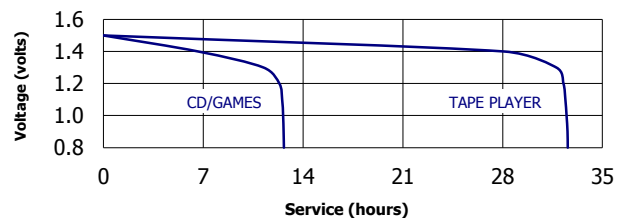

Application Tests

TOOTHBRUSH 500 mA 2/13 min 24 hrs/day
PORTABLE LIGHTING 3.3 ohm LIF
TOY 3.9 ohm 1 hr/day

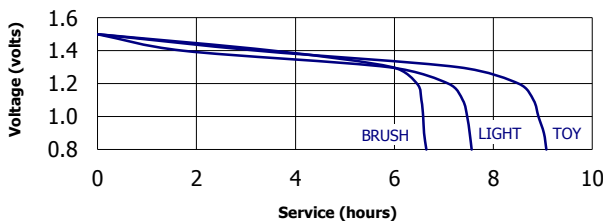

Industry Standard Tests

PHOTOFLASH 1K mA 10 sec/min 1 hr/day
DIGITAL CAMERA 1.5/.65K mW 2/.1/27.9s 10X

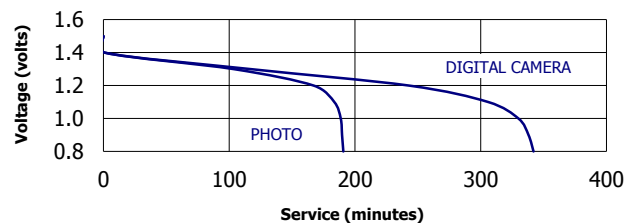

Important Notice

This datasheet contains typical information specific to products manufactured at the time of its publication.
©Energizer Holdings, Inc. - Contents herein do not constitute a warranty.