

FRONT SHOCK ABSORBER WITH COIL SPRING (for 4WD and Pre-Runner)

COMPONENTS

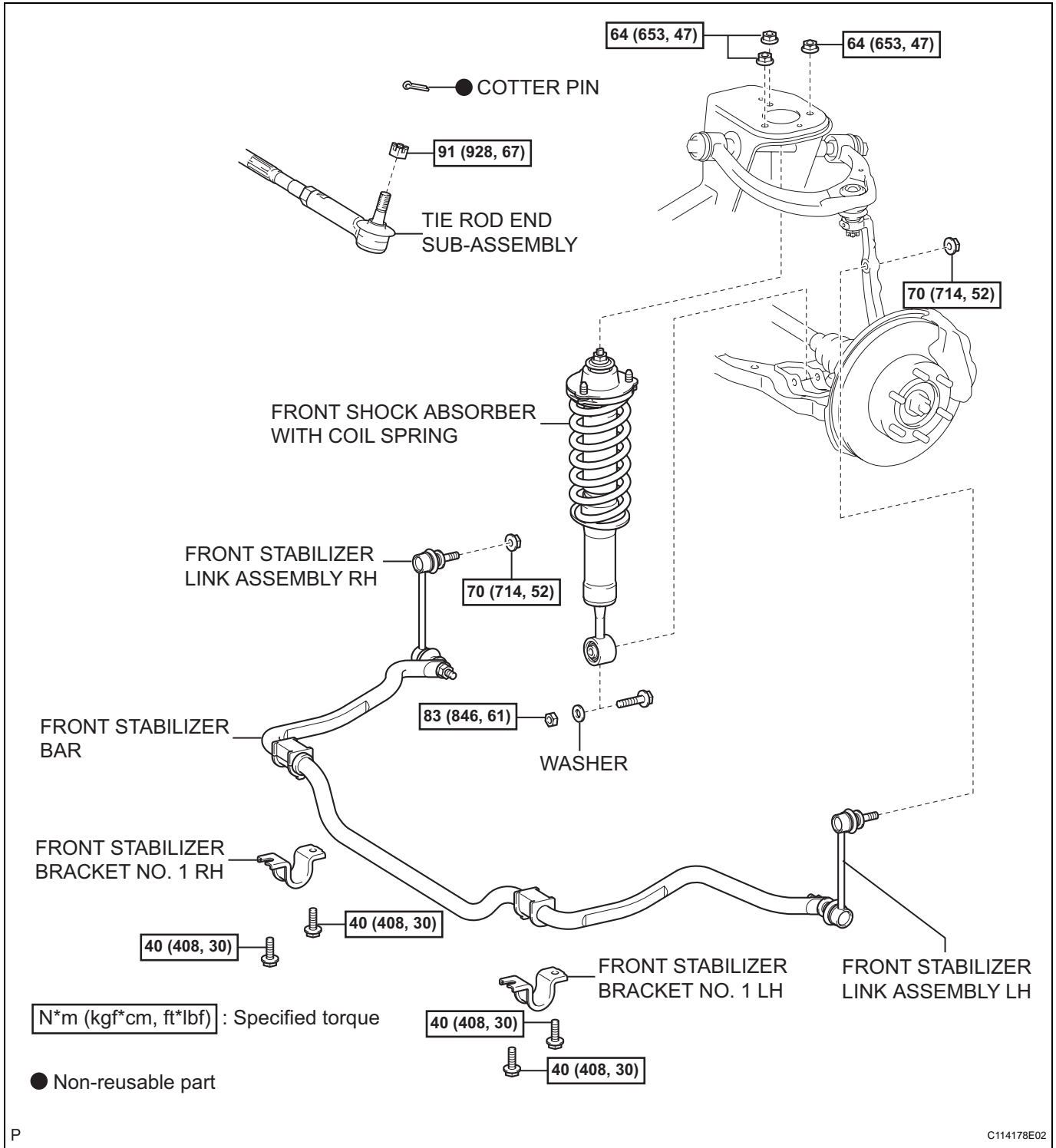

SP

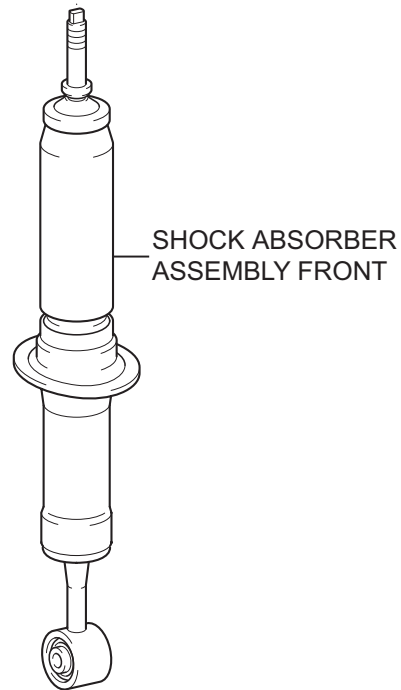
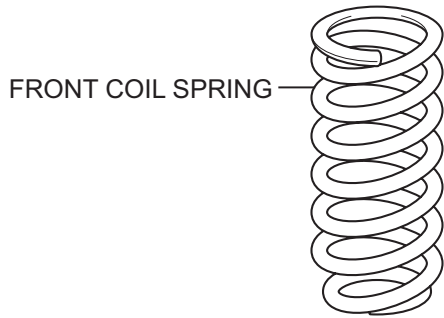
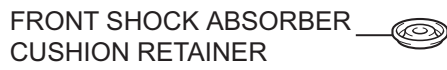
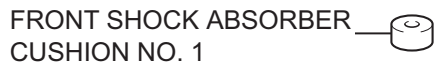
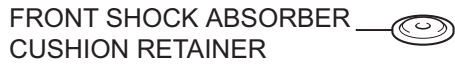
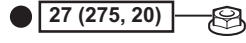

N*m (kgf*cm, ft*lbf) : Specified torque

● Non-reusable part

SP