

FRONT SEAT ASSEMBLY (for Separate Seat Type Driver Side)

COMPONENTS

SE

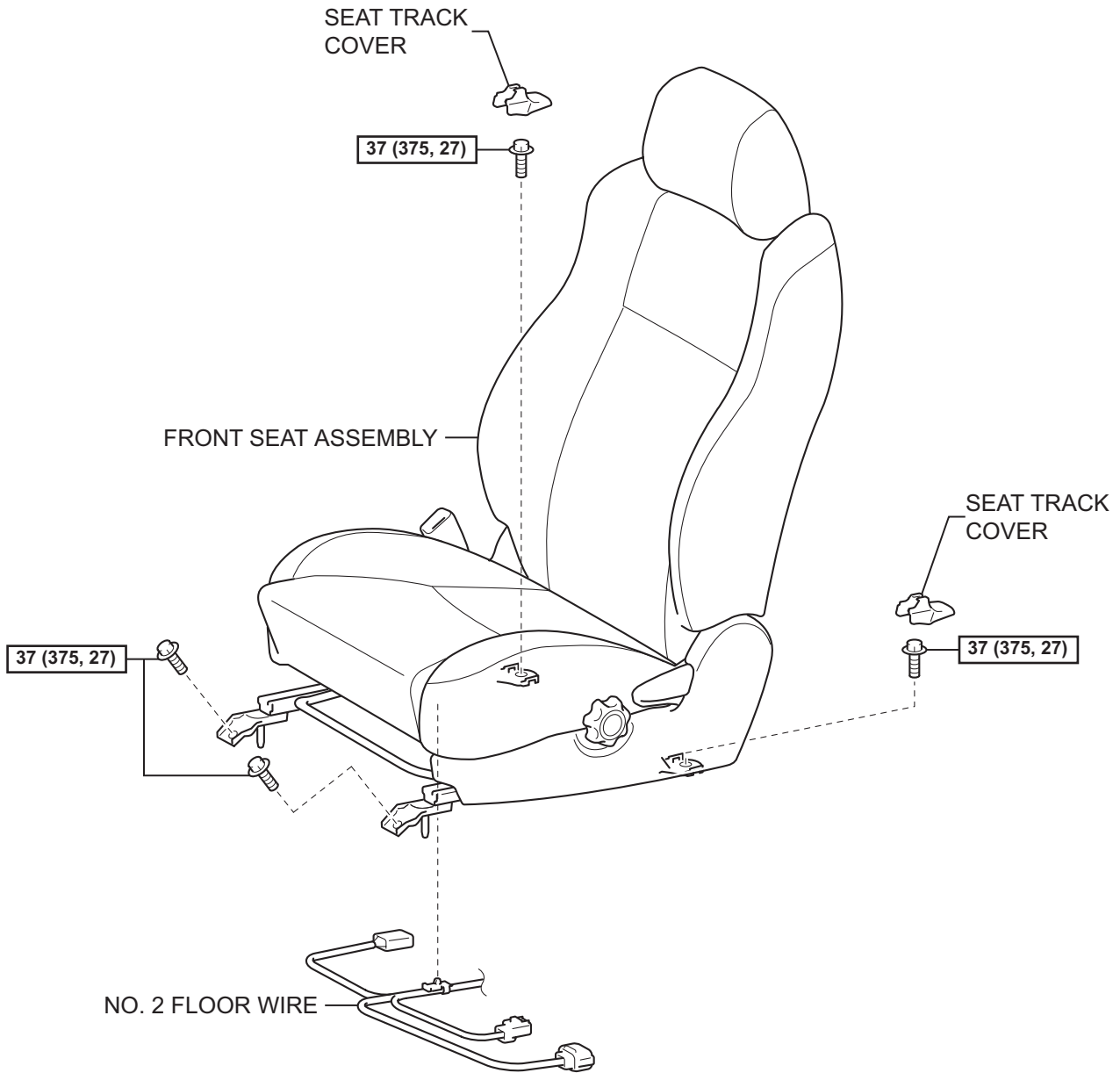

N*m (kgf*cm, ft*lbf) : Specified torque

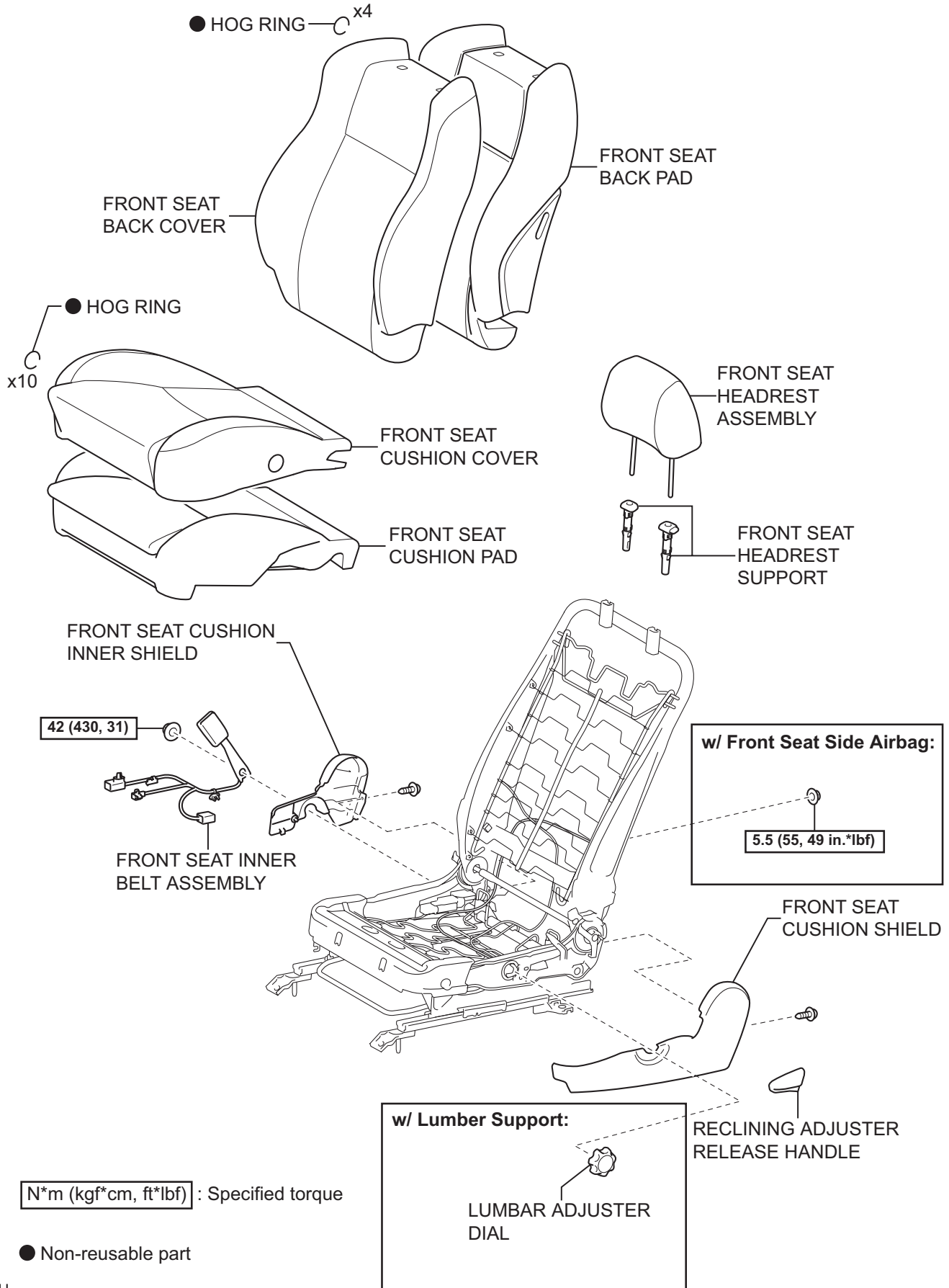

w/ Lumber Support:

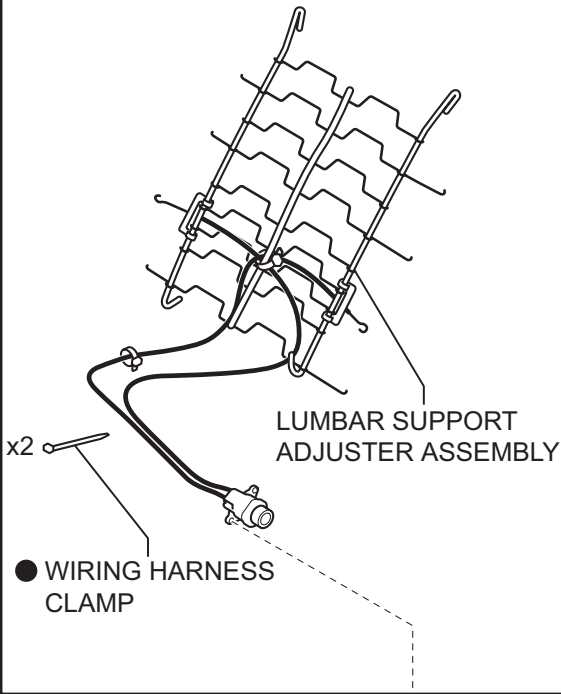

RECLINING ADJUSTER
OUTSIDE COVER RH



RECLINING ADJUSTER
INSIDE COVER RH

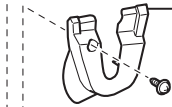

FRONT SEAT FRAME
ADJUSTER ASSEMBLY

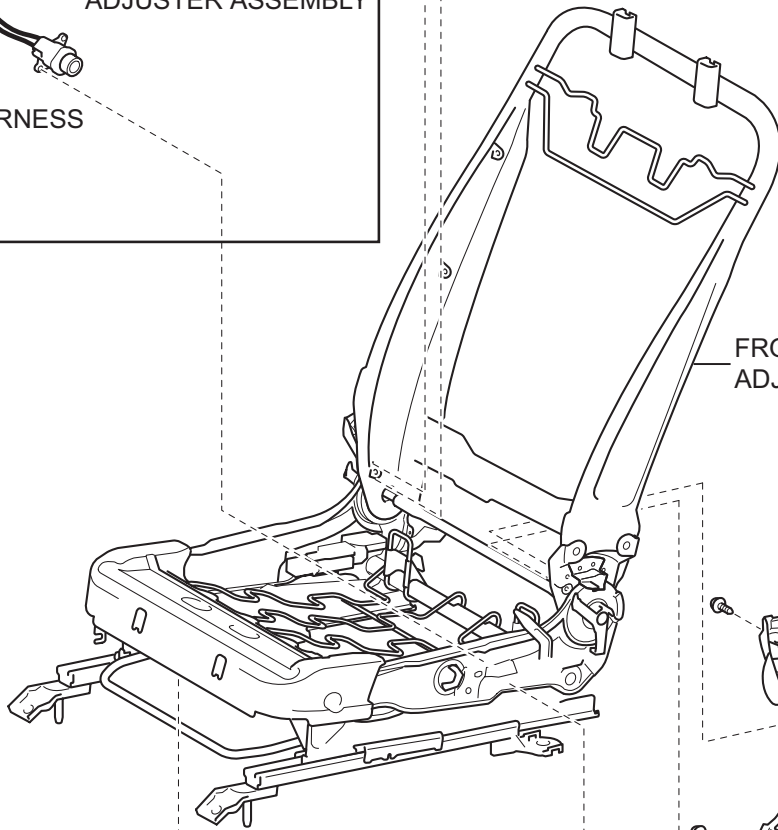

RECLINING
ADJUSTER INSIDE
COVER LH



RECLINING ADJUSTER
OUTSIDE COVER LH

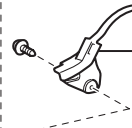

SEAT POSITION
SENSOR



8.0 (80, 71 in.*lbf)

w/ Lumber Support:

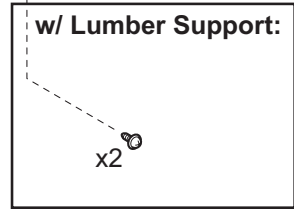

N*m (kgf*cm, ft*lbf) : Specified torque

● Non-reusable part

SE