

# NATIONAL SEARCH & RESCUE MANUAL

JUNE 2014 EDITION



Australian Government

Australian Maritime Safety Authority



---

Published by the Australian Maritime Safety Authority (AMSA) on behalf of the Australian National Search and Rescue Council

© This publication is copyright. The reproduction of this work in whole or in part is invited for search and rescue purposes other than commercial purposes provided due acknowledgment is given to the Australian National Search and Rescue Council.

For further information contact the Council Secretary at:

Secretary  
National Search and Rescue Council  
GPO Box 2181  
Canberra ACT 2601

2014 EDITION Version 1 – 1 June 2014



---

## Foreword

Search and Rescue (SAR) is the search for and provision of lifesaving assistance to people in distress and imminent danger of loss of life. Australian SAR arrangements are intended to complement other emergency services (police, fire, ambulance) in circumstances where those services are unable to operate effectively. Such circumstances could include, for example, remote area operations, rescues at sea, and the need for specialist SAR facilities not normally available to emergency services.

Depending upon the extent and complexity of the incident and on the available staff and facilities, SAR may take many forms in response to a distress situation. Unless the action is indivisible from that of safeguarding life, a SAR operation does not, however, include salvage or the saving of property.

The Australian search and rescue region covers the Australian continent and large areas of the Indian, Pacific and Southern Oceans as well the Australian Antarctic territories. This is an area of about 52.8 million square kilometres, or about one tenth of the earth's surface. Dedicated SAR assets are limited in Australia and other government, private and commercial assets may be diverted from their primary function by charter, arrangement and request.

In practice, many SAR operations are conducted jointly by Commonwealth and State / Territory authorities. It is, therefore, essential that the available resources and operational techniques are standardised and coordinated across the Australian region.

All SAR authorities in Australia: Australian Maritime Safety Authority, Australian Defence Force and State, Territory and Federal Police must be able to act cooperatively.

In 2012, the Commonwealth, State and Territory Ministers responsible for search and rescue response in Australia updated the Intergovernmental Agreement (IGA) on National Search and Rescue Response Arrangements. The IGA (Appendix C of this Manual) confirmed the National Search and Rescue Council's role as the national coordinating body for search and rescue procedures with a function, among others, of sponsoring this National Search and Rescue Manual.

Documenting standardised techniques and procedures, the National Search and Rescue manual enables SAR authorities to cooperate and coordinate to best effect. By establishing and standardising procedures, the manual seeks to promote effective saving of lives.

**John Young**

Chairman

National Search Rescue Council

---

## Introduction

The National Search and Rescue Manual is the standard reference document for use by all Australian Search and Rescue (SAR) authorities. It is promulgated by the National SAR Council operating under direction from relevant Commonwealth, State and Territory Ministers. The Manual promulgates SAR coordination procedures for SAR operations conducted within Australia and the Australian SAR Region (SRR).

The manual is consistent with the relevant International Conventions to which Australia is a party and is supplemented by various legal, informative and instructional documents used within, and between, organisations concerned with search and rescue. It has been developed with due regard to the International Aviation and Maritime Search and Rescue Manual (IAMSAR). For more detailed information on the conduct of land SAR operations, readers should refer to the National Land Search Operations Manual.

The National SAR Manual meets the requirements of international conventions for an Australian Search and Rescue Plan, and includes material covering:

- a) **Abbreviations, terminology and definitions relevant to SAR practitioners**
- b) **The elements and functions of the Australian SAR system**
- c) **Details of communications, assets and procedures for coordination**
- d) **SAR planning and techniques including worksheets**

In providing a search and rescue response, nothing in the content of the manual precludes properly qualified officers from using their initiative in providing a SAR response in circumstances not covered by these procedures. In short, the Manual is a body of guidance rather than an operational straitjacket. In so doing, however, officers' actions should conform as closely as possible to the instructions contained in the manual that are most closely pertinent to the circumstances, and keep all other involved parties informed. Officers should be prepared to justify their actions if necessary.

When developing Standard Operating Procedures (SOP) at the organisational level, care should be taken to ensure that procedures are written consistent with the National SAR Manual. Should an SOP be identified that may be of benefit to the wider SAR community, it is recommended that the issue be raised with the National SAR Council so that inclusion of the procedure into the National SAR Manual can be considered.

This manual is under continual review and will be updated as necessary. The National SAR Manual is promulgated online for the use of all search and rescue practitioners. **The Internet version is the controlled document and is the latest version of this manual. The online version should always be referred to as it contains the most up to date information.**

Suggestions and questions regarding this Manual should be forwarded to:

The Secretary of the National SAR Council

Australian Maritime Safety Authority  
GPO Box 2181  
Canberra ACT 2601



## CHIEF OF JOINT OPERATIONS HEADQUARTERS JOINT OPERATIONS COMMAND


AM169740

### NATIONAL SEARCH AND RESCUE MANUAL – LETTER OF PROMULGATION

1. The National Search and Rescue Manual (NATSAR Manual) is sponsored by the Australian National Search and Rescue Council (NATSAR Council), comprising Commonwealth, State and Department of Defence representatives. The National Search and Rescue Manual is published by the Australian Maritime Safety Authority (AMSA).

2. The National Search and Rescue Manual shall be accepted by the Australian Defence Force as the Australian standard procedural guide for coordinating peacetime search and rescue activities within the Australian Search and Rescue Region (SRR). Attention is drawn to the ADF's unique responsibility to coordinate SAR for all military assets and personnel in the Australian SRR including visiting foreign military forces. Neither AMSA nor the civil Rescue Coordination Centre (RCC) will intervene or assume responsibility for any part of a military SAR response, unless formally requested to do so by Headquarters Joint Operations Command (HQJOC).

3. The ADF recognises Joint Personnel Recovery (JPR) as the mechanism for recovering all isolated personnel from all environments at all levels of hostility. As a part of JPR, SAR Operations are those operations executed in a permissive environment, while Recovery Operations are those executed in an uncertain or hostile environment. The NATSAR Manual exclusively covers interdepartmental responsibilities and provides procedural guidance for SAR Operations, but does not provide guidance or procedures for operations in an uncertain

  
M. EVANS, AO, DSC  
Lieutenant General  
Chief of Joint Operations

*15<sup>th</sup> December*  
15 November 2010



# Table of Contents

<b>FOREWORD</b> .....	<b>1</b>
<b>INTRODUCTION</b> .....	<b>2</b>
<b>TABLE OF CONTENTS</b> .....	<b>5</b>
<b>ABBREVIATIONS AND ACRONYMS</b> .....	<b>16</b>
<b>GLOSSARY</b> .....	<b>20</b>
<b>CHAPTER 1: SEARCH AND RESCUE IN AUSTRALIA</b> .....	<b>26</b>
PART A: ORGANISATION AND COORDINATION - THE NATIONAL SAR PLAN .....	26
1.1 SAR SYSTEM ORGANISATION.....	26
<i>Global SAR System Organisation</i> .....	26
<i>National and Regional SAR System Organisation</i> .....	26
Australian Maritime Safety Authority (AMSA) .....	27
State and Territory Governments.....	28
Australian Defence Force – Military SAR.....	29
Headquarters Joint Operations Command.....	29
Airservices Australia .....	29
<i>Other Commonwealth Agencies/Authorities</i> .....	29
Bureau of Meteorology .....	29
Emergency Management Australia .....	30
Border Protection Command .....	30
Australian Communications and Media Authority .....	30
Australian Transport Safety Bureau (ATSB).....	30
Civil Aviation Safety Authority (CASA).....	30
Volunteer Organisations .....	31
<i>Commercial and Private Organisations</i> .....	31
1.2 SAR COORDINATION.....	31
<i>Overview</i> .....	31
<i>Determination of SAR Authority Responsible for Overall Coordination</i> .....	32
Initial Response .....	32
SAR Authority Best Placed to Coordinate.....	32
Effective Consultation and Coordination .....	33
Coordination of Police Land Search.....	33
<i>Cooperation with Foreign Rescue Coordination Centres</i> .....	33
Provision for Entry of Foreign Aircraft during SAR Operations.....	34
Requests for Assistance from Foreign RCCs .....	34
<i>Distress Beacons</i> .....	34
<i>Transfer of Coordination</i> .....	35
Reasons for Transfer of Coordination .....	35
Transferring Overall Coordination.....	36
Accepting Overall Coordination from another SAR Authority.....	36
Accepting Coordination for a Component of the SAR Event from another SAR Authority .....	37
Guidance in Support of Transferring Coordination of a Component of a SAR Operation .....	37
Transfer of Coordination after Suspension of SAR Action.....	38
<i>JRCC Australia Assistance to Other SAR Authorities</i> .....	39
Provision of Subject Matter Expertise and Advice .....	39
Briefing for SAR Units .....	39
Sourcing of Aircraft.....	39
Tasking of Aircraft .....	40

Coordination of an Air Search .....	40
<i>Civil Requests for Defence SAR Assistance</i> .....	41
Localised Emergency Assistance to Save Life .....	41
All Other Requests for Defence SAR Assistance .....	41
<i>Military Requests for Civil Assistance</i> .....	41
PART B: MANAGEMENT AND SUPPORT .....	42
1.3 OVERVIEW .....	42
<i>SAR Authorities</i> .....	42
<i>RCC Staff</i> .....	43
SAR Mission Coordinator.....	43
Assistant SAR Mission Coordinator (A/SMC) .....	46
Allocator .....	47
Recorder .....	47
Briefing Officer .....	47
Intelligence Officer .....	47
Rescue Planner .....	47
Liaison Officer.....	48
<i>On Scene Coordinator</i> .....	48
<i>Forward Command Post</i> .....	48
1.4 SEARCH AND RESCUE RESOURCES .....	50
<i>Overview</i> .....	50
<i>Personnel</i> .....	51
Dropmasters, Dispatchers and Observers .....	51
<i>Rescue Preparation</i> .....	52
1.5 PUBLIC RELATIONS.....	52
<i>Overview</i> .....	52
<i>Operations involving two or more SAR Authorities</i> .....	53
Public Relations Officers (PRO's) .....	53
<i>Press Releases</i> .....	54
Requesting Public Assistance .....	55
<i>Liaison with Relatives</i> .....	55
Notification of Next of Kin.....	56
<i>Casualties</i> .....	56
<b>CHAPTER 2: COMMUNICATIONS .....</b>	<b>57</b>
2.1 OVERVIEW .....	57
2.2 DISTRESS AND EMERGENCY SIGNALS .....	57
<i>Marine Radio Alarm Signal</i> .....	58
<i>RTF Distress Signal</i> .....	58
<i>RTF Urgency Signal</i> .....	58
<i>RTF Safety Signal</i> .....	58
<i>Radiotelephony Distress/Emergency Frequencies</i> .....	58
GMDSS Distress, Urgency, Safety and Calling Frequencies .....	58
2182 kHz.....	59
4125, 6215, 8291, 12290 and 16420 kHz .....	59
121.5 MHz .....	59
156.8 MHz (Marine VHF Channel 16).....	59
243 MHz .....	59
Safety Frequencies .....	60
2.3 GLOBAL MARITIME DISTRESS AND SAFETY SYSTEM .....	60
2.4 EMERGENCY SIGNALLING DEVICES .....	60
<i>Daylight Devices</i> .....	60



<i>Night-time Devices</i> .....	61
<i>RADAR/IFF/SSR</i> .....	61
<i>Radio and Distress Beacons</i> .....	62
2.5 COSPAS-SARSAT DISTRESS BEACON DETECTION SYSTEM.....	62
<i>Overview</i> .....	62
<i>Purpose</i> .....	62
<i>Satellites</i> .....	63
<i>Beacon Detection</i> .....	63
<i>Beacons</i> .....	64
2.6 OTHER TYPES OF DISTRESS ALERTING DEVICES .....	64
SPOT Personal Satellite Messenger device (SPOT).....	64
AIS-SART .....	65
Maritime Survivor Locating Systems. VHF DSC Maritime Survivor Locating Devices (MSLD). .....	65
Thuraya Satellite Devices .....	65
2.7 SAR RADAR TRANSPONDER (SART) .....	66
<i>Overview</i> .....	66
2.8 COMMUNICATIONS IN SUPPORT OF SAR OPERATIONS .....	67
<i>Overview</i> .....	67
<i>SAR Frequencies</i> .....	67
<i>SAR Call Signs</i> .....	67
2.9 COMMUNICATIONS FACILITIES .....	68
<i>Overview</i> .....	68
<i>Communications Capabilities Australian Defence Force Ships and Aircraft</i> .....	69
International Distress Frequencies - Guarded by Royal Australian Naval Ships.....	69
Lines of Communications - NAVY .....	70
<i>Search and Rescue Visual Signals</i> .....	70
<i>Merchant Shipping and GMDSS</i> .....	70
<i>Limited Coast Radio Stations</i> .....	71
<i>Ship Stations</i> .....	71
<i>Fishing Vessels</i> .....	72
<i>Pleasure Craft</i> .....	72
<i>Volunteer Organisations</i> .....	72
<i>Communication Capabilities of State &amp; Territory SAR Authorities</i> .....	73
Command/Communications Caravans .....	73
Marine .....	73
Air Wings .....	73
<i>Communications Aircraft</i> .....	73
<i>Inmarsat Aero</i> .....	73
<b>CHAPTER 3: AWARENESS AND INITIAL ACTION</b> .....	<b>75</b>
3.1 AWARENESS AND NOTIFICATION.....	75
<i>Introduction</i> .....	75
3.2 SAR STAGES.....	75
3.3 SAR INCIDENTS.....	76
<i>Maritime SAR Incident</i> .....	76
<i>Aviation SAR Incident</i> .....	77
<i>Land SAR Incident</i> .....	77
3.4 EMERGENCY PHASES .....	78
<i>Uncertainty Phase</i> .....	78
<i>Alert Phase</i> .....	79

<i>Distress Phase</i> .....	80
3.5 AWARENESS STAGE.....	81
<i>Evaluation of Reports</i> .....	81
<i>Distress Alerts</i> .....	82
<i>Notification by Airservices Australia</i> .....	82
<i>SAR Incident Information</i> .....	82
Air, Marine or Land Incident Information .....	83
Person Overboard Incident Information .....	83
<i>Notification to States of Foreign Persons in Distress</i> .....	84
<i>Recording of Events</i> .....	84
3.6 SEQUENCE OF SAR EVENTS .....	85
<i>Overview</i> .....	85
<i>Uncertainty Phase Initial Action</i> .....	85
Communication Search .....	86
Phase Transition .....	87
<i>Alert Phase Procedures</i> .....	87
Phase Transition .....	88
<i>Distress Phase Procedures</i> .....	89
Phase Transition .....	90
3.7 COMMUNICATION CHECKS .....	90
<i>General</i> .....	90
<i>Communication Checks for Marine Craft</i> .....	91
<i>Communications Checks for Aircraft</i> .....	92
Actions by JRCC Australia .....	92
<i>Crashed Aircraft</i> .....	92
Health Hazards - Aircraft Accidents.....	93
3.8 INTELLIGENCE GATHERING AND ASSESSMENT .....	93
<i>Overview</i> .....	93
<i>Sighting and Hearing Reports</i> .....	93
Assessing Reports .....	94
Interviewing Witnesses .....	94
<i>Coordination with the Police</i> .....	95
<i>Examination of Recorded Communications</i> .....	95
<i>Flight Path Analysis - Aircraft</i> .....	96
<i>Weather Analysis</i> .....	96
<i>Logistical Information</i> .....	96
<i>General Considerations for the SMC</i> .....	96
Urgency of Response.....	97
General Time Factors .....	98
Daylight Factor .....	98
Night Factor.....	98
Weather/Oceanographic Factors .....	98
Weather Reports by Survivors.....	100
Survival Environment Factors.....	100
Hypothermia .....	101
Survivor Stress Factors .....	105
Terrain Factors .....	106
Available Search Asset Factors .....	107
Survival Equipment Factors .....	107
Risks v Gain Factors .....	107
<b>CHAPTER 4: SEARCH PLANNING AND EVALUATION .....</b>	<b>109</b>

4.1 OVERVIEW .....	109
4.2 SEARCH PLANNING STEPS.....	109
<i>Evaluating the Situation</i> .....	110
<i>Estimating the Distress Incident Location</i> .....	110
4.3 DATUM DEFINITION .....	111
<i>Datum Point Definition</i> .....	111
<i>Datum Line Definition</i> .....	111
<i>Datum Area Definition</i> .....	112
<i>Drift Definitions</i> .....	112
<i>Drift Corrections</i> .....	112
<i>Datum Search Planning</i> .....	112
<i>Recomputed Datum</i> .....	112
4.4 SEARCH STAGES .....	113
4.5 FACTORS AFFECTING INITIAL SAR RESPONSE.....	114
<i>Overview</i> .....	114
<i>Location of a Distressed Craft</i> .....	114
<i>Parachute Drift</i> .....	115
<i>Initial Search Procedures</i> .....	115
<i>Aircraft Incident</i> .....	116
4.6 BASIC SEARCH PLANNING .....	116
<i>Overview</i> .....	116
<i>Controlling Factors</i> .....	117
<i>Search Effort Expenditure Rate</i> .....	118
<i>Maximum Search Effort</i> .....	118
<i>Search Sequence</i> .....	119
4.7 DETERMINATION OF SEARCH AREAS .....	120
<i>Planning</i> .....	120
<i>Possibility Area</i> .....	121
<i>Probability Area</i> .....	122
<i>Calculation of Circles of Probability</i> .....	124
<i>Probable Errors of Position</i> .....	125
<i>Search Radius (R)</i> .....	125
<i>Drift Error for Waterborne Targets</i> .....	125
<i>Sea Current</i> .....	126
<i>Tidal Streams</i> .....	126
<i>River Current</i> .....	127
<i>Long Shore Current</i> .....	127
<i>Swell/Wave Current</i> .....	128
<i>Surf Current</i> .....	128
<i>Rip Current</i> .....	128
<i>Local Wind Current</i> .....	128
<i>Leeway</i> .....	129
<i>Divergence</i> .....	129
<i>Calculating Leeway</i> .....	129
<i>Plotting Drift</i> .....	131
<i>Datum Plot</i> .....	131
<i>Drift Error (De)</i> .....	132
<i>Search Area Based on Non-Moving Datum</i> .....	133
<i>Search Based on Moving Datum</i> .....	133
<i>Labelling the Datum</i> .....	134
<i>Modification of the Probability Area</i> .....	135

Modification Suggested by Intelligence Information .....	135
Modification Resulting from a Shortage of Search Aircraft .....	135
Modification of Areas Incorporating $D_e$ and Increased Safety Factors .....	136
Modification for the Allocation of Areas to Search Units Other than Aircraft .....	136
<i>Consideration of Possible Courses of Action by the Captain of the Distress Craft</i> .....	136
4.8 COASTAL SEARCH PLANNING .....	137
<i>Search Area</i> .....	137
<i>Time Uncertainty</i> .....	139
<i>Position Uncertainty</i> .....	139
<i>Track Line Overdue Incident</i> .....	140
<i>Recomputed Datum</i> .....	141
<i>Track Spacing</i> .....	142
Good Search Conditions .....	142
Poor Search Conditions .....	142
Person in Water .....	142
<i>General</i> .....	142
<b>CHAPTER 5: SEARCH TECHNIQUES AND OPERATIONS .....</b>	<b>144</b>
5.1 OVERVIEW .....	144
5.2 GENERAL GUIDELINES FOR SEARCHES .....	144
<i>Overview</i> .....	144
<i>Stage One Search. Immediate response</i> .....	144
<i>Stage Two Search. Nominated Area Either Side of Track</i> .....	145
<i>Stage Three Search. Mathematically Derived Area</i> .....	146
5.3 SEARCH AREA COVERAGE .....	147
<i>General</i> .....	147
<i>Sweep Width (W)</i> .....	148
Factors affecting Sweep Width .....	148
Type of Target .....	148
Meteorological Visibility .....	149
Type of Terrain/Conditions of the Sea .....	149
Search Aircraft Speed .....	150
Fatigue Factor .....	150
Search Aircraft Height .....	150
Cloud Cover .....	151
Position of the Sun .....	151
Day and Night Factors .....	152
First Search Light/Last Search Light .....	152
Miscellaneous Factors .....	153
Sweep Width Calculations (W) .....	153
<i>Track Spacing (S)</i> .....	154
<i>Coverage Factor (C)</i> .....	154
<i>Probability of Detection (POD)</i> .....	155
Accuracy of Navigation by Search Units .....	157
5.4 SEARCH PATTERNS .....	157
<i>General</i> .....	157
<i>Navigation of SAR Units</i> .....	159
<i>Parallel Track Search Patterns</i> .....	160
<i>Parallel Track Pattern Single Unit</i> .....	160
<i>Parallel Track Pattern Multi-Unit</i> .....	160
<i>Creeping Line Patterns</i> .....	160
<i>Night Time Consideration Multi-Unit Searches</i> .....	161

5.5 VISUAL SEARCH .....	161
<i>Track Line Search</i> .....	161
<i>Parallel Track Pattern</i> .....	162
Drift Compensation .....	163
<i>Expanding Square Search</i> .....	163
<i>Sector Search</i> .....	165
Sector Search Pattern for a Vessel .....	167
<i>Aural Search by Surface Craft</i> .....	168
<i>Searching Coastal Islands and their Foreshores</i> .....	168
<i>Contour Search</i> .....	169
<i>Searches in Mountainous or Rugged Terrain</i> .....	172
<i>Line Abreast Helicopter Searches</i> .....	172
<i>Irregularly Shaped Areas</i> .....	173
5.6 FLARE SEARCHES .....	173
<i>General</i> .....	173
5.7 ELECTRONIC SEARCHES .....	174
<i>General</i> .....	174
<i>Beacon Types</i> .....	174
<i>Beacon Transmission Characteristics</i> .....	175
<i>Beacon Search Procedures</i> .....	176
Locating a Beacon Signal Source by Homing Devices .....	177
Aural Location of Beacons.....	177
Maximum Radio Signal Range Calculations.....	178
Signal Heard, Signal Fade Plotting Method .....	178
De-tuning Method.....	179
Hill Shading.....	179
Locating a Signal from the Ground.....	179
<i>Search by RADAR</i> .....	180
<i>Search by Infrared (IR) Devices</i> .....	180
<i>Night Vision Goggles</i> .....	180
5.8 SAR UNIT SELECTION AND CHARACTERISTICS.....	181
<i>Overview</i> .....	181
<i>Air Assets</i> .....	182
ADF Air Assets .....	185
Customs Aircraft.....	186
<i>Maritime Assets</i> .....	186
Naval Vessels.....	188
Customs Vessels .....	188
Use of Merchant Shipping.....	188
Equipment for Marine Craft .....	188
<i>Land Search Facilities</i> .....	189
5.9 SEARCH UNIT ALLOCATION.....	189
<i>Introduction</i> .....	189
<i>Aircraft Capability</i> .....	190
<i>Calculation of Search Time Required</i> .....	190
<i>Calculation of Search Time Available</i> .....	191
<i>Investigation Time</i> .....	192
<i>Effective Search Time</i> .....	192
<i>Comparison of Search Time Required and Time Available for Search Aircraft</i> .....	193
Sufficient Search Time for Search Aircraft.....	193
Over Sufficiency of Search Time .....	195

Insufficient Search Time .....	195
<i>Allocation Variations to Suit Particular Aircraft</i> .....	196
<i>Allocation Chart Presentation</i> .....	196
5.10 SAR CREW BRIEFING .....	197
<i>General</i> .....	197
<i>Search Briefing</i> .....	197
Search Area Description .....	198
Geographical Coordinates .....	198
Universal Grid Reference.....	198
<i>Track Line</i> .....	198
<i>Landmarks</i> .....	198
<i>Search Pattern Abbreviations</i> .....	199
<i>Search Aircrew Briefing</i> .....	199
<i>Search Aircraft Operations</i> .....	200
<i>Communications Relay Aircraft</i> .....	201
<i>Top Cover Aircraft</i> .....	202
<i>Maritime Search Crews</i> .....	202
<i>Land Assets Employed in the Search of an Aircraft</i> .....	203
5.11 SAR CREW DEBRIEFING.....	204
<i>Overview</i> .....	204
<b>CHAPTER 6: RESCUE PLANNING OPERATIONS .....</b>	<b>206</b>
6.1 GENERAL.....	206
6.2 PREPARATION .....	206
6.3 MEDICAL ASSISTANCE .....	207
6.4 CRASHED AIRCRAFT .....	207
<i>Overview</i> .....	207
<i>Health Hazards - Aircraft Accidents</i> .....	207
6.5 RESCUE ON LAND .....	208
6.6 RESCUE AT SEA .....	209
<i>Use of Rescue Boats and Vessels</i> .....	210
<i>Use of Aircraft for Rescue</i> .....	210
<i>Use of Helicopters for Rescue</i> .....	211
Use of Top Cover Aircraft with Rescue and MEDEVAC Helicopters.....	212
6.7 SUPPLY DROPPING AND DELIVERY OF SURVIVAL EQUIPMENT .....	213
<i>General</i> .....	213
<i>Civil SAR Equipment</i> .....	213
<i>Marking Targets</i> .....	214
<i>Supply Drop from Aircraft over Sea</i> .....	215
<i>Supply Drop from Helicopter over Sea</i> .....	215
<i>Supply Drop from Aircraft over Land</i> .....	215
<b>CHAPTER 7: CONCLUSION OF SAR OPERATIONS .....</b>	<b>216</b>
7.1 GENERAL .....	216
7.2 CONCLUSION OF A SUCCESSFUL SAR ACTION .....	216
7.3 SUSPENSION OF A SEARCH WHEN THE TARGET IS NOT FOUND .....	217
7.4 REOPENING A SUSPENDED SEARCH .....	219
7.5 RECORDS AND REPORTS.....	219
7.6 INCIDENT DEBRIEFS .....	219
7.7 CASE STUDIES.....	220

7.8 PERFORMANCE IMPROVEMENT .....	221
<b>CHAPTER 8: TRAINING AND EXERCISES.....</b>	<b>222</b>
8.1 GENERAL.....	222
<i>Training</i> .....	222
Who to Train .....	222
Requirement for Training.....	222
8.2 NATIONAL TRAINING FRAMEWORK .....	223
<i>Public Safety Training Package</i> .....	223
<i>National Search and Rescue School</i> .....	223
<i>State/Territory SAR Authority Training</i> .....	224
8.3 SEARCH AND RESCUE EXERCISES .....	224
8.4 TRAINING OF SEARCH AND RESCUE UNITS.....	225
<i>Land SAR Training</i> .....	225
<i>Aircrew Training</i> .....	225
<i>Dropmaster and Dispatchers</i> .....	225
<i>Air Observer Training</i> .....	225
<i>Aviation Search and Rescue Units (SRU)</i> .....	226
8.5 PHOTOGRAPHIC RECORDS.....	226
8.6 LIAISON VISITS.....	226
<b>CHAPTER 9: OTHER EMERGENCY ASSISTANCE AND SERVICES AVAILABLE FROM JRCC AUSTRALIA .....</b>	<b>227</b>
9.1 GENERAL.....	227
9.2 SAFETY INFORMATION.....	227
9.3 UNLAWFUL ACTS .....	227
9.4 MEDICAL ASSISTANCE TO VESSELS AT SEA.....	228
9.5 EMERGENCIES .....	228
<b>APPENDICES.....</b>	<b>230</b>
APPENDIX A: AUSTRALIAN SEARCH AND RESCUE REGION .....	231
<i>Coordinates of the SRR are as follows:</i> .....	232
APPENDIX B: NATIONAL SEARCH AND RESCUE (SAR) RESPONSIBILITIES AND FUNCTIONS.....	233
APPENDIX C: INTER-GOVERNMENTAL AGREEMENT (IGA) ON NATIONAL SEARCH AND RESCUE RESPONSE ARRANGEMENTS ....	235
APPENDIX D: TRANSFER OF OVERALL COORDINATION OR REQUEST FOR JRCC AUSTRALIA ASSISTANCE .....	246
<i>Overview</i> .....	246
<i>D.1 Transfer of SAR Coordination Form</i> .....	247
<i>D.2 Request for Assistance from JRCC Australia</i> .....	248
<i>D3 Supplementary Information</i> .....	249
APPENDIX E: DISTRESS AND EMERGENCY SIGNALS.....	251
<i>Overview</i> .....	251
<i>International Distress Signals</i> .....	251
<i>Search and Rescue Signals – Australian Area</i> .....	251
Signals with Surface Craft.....	251
Civil Air-Ground Code.....	252
International SAR Signals.....	253
APPENDIX F: MARITIME SAR RECOGNITION CODE (MAREC).....	254
<i>Overview</i> .....	254
<i>Part 1 – Merchant Vessels</i> .....	255
Merchant Vessels MAREC Messages.....	255
Complete example Merchant Ship.....	260

Part 2 – Small Craft .....	261
Small Craft MAREC Message .....	261
APPENDIX G: PLOTTING SYMBOLS.....	271
APPENDIX H: SIGHTING & HEARING (SHR) TECHNIQUES .....	272
Instructions for Completing Sighting and Hearing Reports.....	273
Sighting and/or Hearing Report for Missing Aircraft .....	274
Sighting and Hearing Report - Generic .....	275
Sighting and/or Hearing Log.....	276
APPENDIX I: TABLES AND GRAPHS.....	277
Local Wind Current.....	278
Leeway Tables.....	279
Taxonomy Class Definitions/Descriptions .....	280
Probability of Detection .....	287
Sweep Width Tables for Visual Search over Water.....	288
Sweep Width Tables for Visual Search Over Land.....	293
APPENDIX J: PROBABLE ERRORS OF POSITION .....	294
Probable Navigation Error of the Distressed Craft (x).....	294
Probable Navigation error of the Search Craft (y) .....	295
APPENDIX K: WORKSHEETS .....	296
Overview .....	296
Worksheet 1 – Maritime Planning .....	297
Worksheet 2 – Maritime Search By Aircraft.....	298
Worksheet 3 – Land Search By Aircraft.....	299
Worksheet 4 – Search Radius.....	300
Worksheet 5 – Sector Search .....	301
Worksheet 6 – Aircraft Allocation .....	302
Worksheet 7 – Asset Allocation .....	303
Worksheet 8 – Maritime Search By Vessel.....	304
APPENDIX L: AIRCRAFT ACCIDENT SITE PRECAUTIONS .....	305
Safety Precautions and Procedures at Aircraft Accidents.....	305
APPENDIX M: CIVIL AIRCRAFT SEARCH AND RESCUE UNITS (SRUs) .....	306
AMSA Aircraft .....	306
Tier SRU Capability Definitions.....	306
Tier 1 SRUs .....	306
Opportunity Based SAR Services – Multi-Use List (MUL).....	307
Current T4 Aircraft and Police Fixed-Wing Operators.....	307
Air Search Observer Programme.....	307
Air Search Equipment.....	308
Customs Aircraft .....	308
Locations of Assets.....	308
APPENDIX N: RAAF SAR EQUIPMENT AND AIRCRAFT CAPABILITIES .....	310
Minimum Requirements for Holdings of Search and Rescue .....	310
Equipment at RAAF Bases .....	310
Aircraft Drop Capabilities .....	310
APPENDIX O: ROYAL AUSTRALIAN NAVY RESPONSE.....	311
HMA SHIP RESPONSIBILITY ON RECEIVING AN ALERTING OR DISTRESS MESSAGE .....	311
RAN Assistance to Local Authorities .....	312



---

This page intentionally blank

## Abbreviations and Acronyms

Abbreviation	Acronym
A	area or search area
ACMA	Australian Communications and Media Authority
ACFT	aircraft
AFTN	aeronautical fixed telecommunications network
ADF	Australian Defence Force
AIP	Aeronautical Information Publication
ALRS	Admiralty List of Radio Signals
AM	amplitude modulation
AMVER	Automated Mutual-assistance Vessel Rescue
AMSA	Australian Maritime Safety Authority
ASRK	Air Sea Rescue Kit (RAAF)
ATA	actual time of arrival
ATC	Air Traffic Control
ATD	actual time of departure
ATS	Air Traffic Services
ATSB	Australian Transport Safety Bureau
AUMCC	Australian Mission Control Centre
AULUTE	Australian Local User Terminal East
AULUTW	Australian Local User Terminal West
BPC	Border Protection Command
C	Coverage Factor
CAO	Civil Aviation Order
CAR	Civil Aviation Regulations
CASR	Civil Aviation Safety Regulations
C/C	cabin cruiser
CRS	coast radio station
CSS	coordinator surface search (maritime)
D	datum
D	diameter
De	total drift error
DCJOPS	Deputy Chief Joint Operations
DF	direction finding
DR	dead-reckoning
DGPS	Differential GPS
DSC	digital selective calling
dwt	dead weight tonnes
E	East longitude
E	total probable error of position
ELR	extra long range aircraft
ELT	emergency locator transmitter
EMA	Emergency Management Australia
EPIRB	emergency position indicating radio beacon
ETA	estimated time of arrival
ETD	estimate time of departure
FCP	Forward Command Post
FFB	Forward Field Base

Abbreviation	Acronym
F/V	fishing vessel
Fig	figure
FIR	flight information region
FLIR	forward looking infrared
FM	frequency modulation
GHz	Gigahertz
GMDSS	Global Maritime Distress and Safety System
GPS	Global positioning system
GS	Ground speed
gt	Gross tonnes
h	hours
HDG	heading
HPA	Hectopascals
HEL-H	heavy helicopter
HEL-L	light helicopter
HEL-M	medium helicopter
HF	high frequency
HQAC	Headquarters Air Command (Air Force)
HQJOC	Headquarters Joint Operations Command
I/B	inboard motor
ICAO	International Civil Aviation Organization
IFR	Instrument Flight Rules
IGA	The Inter-Governmental Agreement (IGA) on National Search and Rescue Response Arrangements
IMO	International Maritime Organization
Inmarsat	International Maritime Satellite Organisation
INTERCO	International Code of SIGNALS
JRCC	Joint (aeronautical and maritime) Rescue Coordination Centre
KHz	kilohertz
kt	knot (nautical mile per hour)
L or l	length
LCRS	Limited Coast Radio Station
LES	land earth station
LHQ	Land Headquarters (Army)
LKP	last known position
LRG	long range
LUT	local user terminal
LW	leeway
m	metres
M	degrees magnetic
MHQ	Maritime Headquarters (Navy)
MAREC	Maritime SAR recognition code
MASTREP	Modernised Australian Ship Tracking and Reporting System
MAX	maximum
MCS	Maritime Communications Station
MIN	Minimum
MPD	miles per day
MPP	most probable position

Abbreviation	Acronym
MSC	marine supply container (RAAF)
M/V	merchant vessel
MCC	mission control centre
MEDEVAC	medical evacuation
MF	medium frequency
MHz	megahertz
MMSI	Maritime mobile service identity
MRG	Medium range
MSI	Maritime safety information
MTS	Mean track spacing (sector search)
n	number of required track spacings
N	North Latitude
NAVAREA X	Navigational warning area Navigation warning area X (Ten)
NM	nautical mile
NOTAM	notice to airmen
NTES	Northern Territory Emergency Service
NVG	night vision goggles
O/B	outboard motor
OSC	on-scene coordinator
PAW	Police Air Wing
P/C	pleasure craft
PIW	person in water
PLB	personal locator beacon
POB	persons on board
POD	probability of detection
PR	public relations
R	radius
RAAF	Royal Australian Air Force
RADAR	Radio detection and ranging
RAN	Royal Australian Navy
RA-Aus	Recreational Aviation Australia
RB	rescue boat
RC	river current
RCC	Rescue Coordination Centre
RFDS	Royal Flying Doctor Service
S	track spacing
S	South latitude
S/V	sailing vessel
SAR	search and rescue
SART	search and rescue transponder
SC	Sea current
SDB	SAR Datum Buoys
SES	State Emergency Service
SITREP	situation report
SMC	Search and rescue mission coordinator
SOLAS	International Convention for the Safety of Life at Sea
SOPs	Standard Operating Procedures
SP	splash point

Abbreviation	Acronym
SPOC	search and rescue point of contact
SRG	short range
SRR	search and rescue region
SRS	single raft system
SRU	Search and Rescue Unit
SURPIC	surface picture
T	degrees True
T	search time available
TAS	true air speed
TC	tidal current
TCA	time of closest approach
TELEX	teletype
TWC	total water current
u	wind speed
UHF	Ultra high frequency
ULR	ultra long range
UTC	coordinated universal time
v	speed of search object
V	SAR unit ground speed or aircraft true air speed
VFR	visual flight rules
VHF	very high frequency
VLR	very long range
VMC	visual meteorological conditions
w	width
W	sweep width
W	west longitude
W/C	wind current
W/V	wind velocity
Wu	uncorrected sweep width
X	Search target position error
Y	Search unit position error

## Glossary

Term	Definition
Aircraft Coordinator (ACO)	A person who coordinates the involvement of multiple aircraft in SAR operations.
Aeronautical drift (Da)	Drift caused by bailout trajectory or aircraft gliding distance.
Aeronautical position	Initial position of a distressed aircraft at the time of re-entry, engine failure, aircrew ejection or bailout.
Aircraft glide	Maximum ground distance an aircraft could cover during descent.
Alert Phase	A situation wherein apprehension exists as to the safety of an aircraft or marine vessel, and of the persons on board.
Alerting post	Any facility intended to serve as an intermediary between a person reporting an emergency and a rescue coordination centre or rescue sub-centre.
ARGOS	A satellite-based location and data collection system.
AusSAR	Australian Search and Rescue: a functional description of the Australian Maritime Safety Authority's role in maritime and aviation SAR coordination, communications, and the provision of SAR units. AusSAR does not exist a discrete entity inside AMSA. Whilst the description "AusSAR" is readily understood by other participants in SAR, the term JRCC Australia is preferred.
Awareness range	Distance at which a search scanner can first detect something different from its surroundings but not yet recognise it.
Awareness stage	A period during which the SAR system becomes aware of an actual or potential incident.
Captain	Master of a ship or pilot-in-command of an aircraft, commanding officer of a warship or an operator of any other vessel.
Checksum digit	A digit that is appended to a numeric data element and used to verify its accuracy. Checksum digits are computed by adding the digits of the data element.
Coast earth station (CES)	Maritime name for an Inmarsat shore-based station linking ship earth stations with terrestrial communications networks.
Conclusion stage	A period during a SAR incident when SAR facilities return to their regular location and prepare for another mission.
Coordination	The bringing together of organisations and elements to ensure effective search and rescue response. One SAR authority must always have <a href="#">overall coordination</a> responsibility and other organisations are to cooperate with this agency to produce the best response possible within available resources.
Coordinated search pattern	Multi-unit pattern using vessel(s) and aircraft.
Coordinated universal time (UTC)	International term for time at the prime meridian.
Cospas-Sarsat System	An international satellite system designed to provide distress alert and location data from 406MHz distress beacon signals.
Course	The intended horizontal direction of travel of a craft.
Coverage factor (C)	For parallel sweep searches, Coverage Factor (C) is computed as the ratio of sweep width (W) to track spacing (S). $C = W/S$ .
Craft	Any air or sea-surface vehicle, or submersible of any kind or size.
Datum	A geographic point, line, or area used as a reference in search planning.
Datum area	Area where it is estimated that the search object is most likely to be located.
Datum line	A line, such as the distressed craft's intended track line or a line of bearing, which defines the centre of the area where it is estimated that the search object is most likely to be located.
Datum point	A point, such as a reported or estimated position, at the centre of the area where it is estimated that the search object is most likely to be located.

Term	Definition
Dead reckoning (DR)	Determination of position of a craft by adding to the last fix the craft's course and speed for a given time.
Digital selective calling (DSC)	A technique using digital codes which enables a radio station to establish contact with, and transfer information to, another station or group of stations.
Direction of current	Direction toward which a current is flowing. Also called set.
Direction of waves, swell or seas	Direction from which the waves, swells, or seas are moving.
Direction of wind	Direction from which the wind is blowing.
Distress Phase	A situation wherein there is reasonable certainty that a vessel or other craft, including an aircraft or a person, is threatened by grave and imminent danger and requires immediate assistance.
Ditching	The forced landing of an aircraft on water.
Drift	The movement of a search object caused by environmental forces.
Drift error (De )	See Total drift error.
Emergency Phase	Emergency phases are based on the level of concern for the safety of persons or craft that may be in danger. The three levels of emergency are classified as Uncertainty, Alert, and Distress.
False alarm	Distress alert initiated for other than an appropriate test, by communications equipment intended for alerting, when no distress situation actually exists.
False alert	Distress alert received from any source, including communications equipment intended for alerting, when no distress situation actually exists, and a notification of distress should not have resulted.
Fetch	The distance over which the wind blows in a constant direction, without obstruction.
Field Search Coordinator	Term for SMC who coordinates land searches only.
First RCC	RCC affiliated with the shore station that first acknowledges a distress alert, and which will accept responsibility for all subsequent SAR coordination unless and until coordination is transferred to another RCC.
Fix	A geographical position determined by visual reference to the surface, referencing to one or more radio navigation aids, celestial plotting, or other navigation device.
Forward Looking Infrared (FLIR)	An imaging system, mounted on board surface vessels or aircraft, designed to detect thermal energy (heat) emitted by targets and convert it into a visual display.
General communications	Operational and public correspondence traffic other than distress, urgency and safety messages, transmitted or received by radio.
Global Maritime Distress and Safety System (GMDSS)	A global communications service based upon automated systems, both satellite-based and terrestrial, to provide distress alerting and promulgation of maritime safety information for mariners.
Global Navigation Satellite System (GNSS)	Worldwide position and time determination system that includes one or more satellite constellations and receivers.
Great Circle Route	The shortest course between two points on the surface of a sphere. It lies in a plane that intersects the sphere's centre.
Ground speed (GS)	The speed an aircraft is making relative to the earth's surface.
Heading	The horizontal direction in degrees magnetic in which a craft is pointed.
Hypothermia	Abnormal lowering of internal body temperature (heat loss) from exposure to cold air, wind or water.
Indicated air speed (IAS)	The aircraft speed shown on the air speed indicator gauge. IAS corrected for instrument error and atmospheric density equals true air speed.
Initial position error (X)	The estimated probable error of the initially reported position of a SAR incident.
International Maritime Satellite Organisation (Inmarsat)	A system of geostationary satellites for worldwide mobile communications services, and which support the Global Maritime Distress and Safety System and other emergency communications systems.

Term	Definition
Instrument flight rules (IFR)	Rules governing the procedures for conducting instrument flight. Also a term used by pilots and controllers to indicate type of flight plan.
Instrument meteorological conditions (IMC)	Meteorological conditions expressed in terms of visibility, distance from cloud, and ceiling less than the minima specified for visual meteorological conditions.
Joint rescue coordination centre (JRCC)	A rescue coordination centre responsible for both aeronautical and maritime search and rescue incidents.
Knot (kt)	A unit of speed equal to one nautical mile per hour.
Last known position (LKP)	Last witnessed, reported, or computed DR position of a distressed craft.
Leeway (LW)	The movement of a search object through water caused by winds blowing against exposed surfaces.
Local user terminal (LUT)	An earth receiving station that receives beacon signals relayed by Cospas-Sarsat satellites, processes them to determine the location of the beacons, and forwards the signals.
MAYDAY	The international radiotelephony distress signal, repeated three times.
MEDEVAC	Evacuation of a person for medical reasons.
Meteorological visibility	The maximum range at which a large object, such as landmasses or mountains, can be seen. Also referred to as Meteorological Range.
Mission control centre (MCC)	Part of the Cospas-Sarsat system that accepts alert messages from the local user terminal(s) and other mission control centres to distribute to the appropriate rescue coordination centres or other search and rescue points of contact.
Narrow-Band Direct Printing (NBDP)	Automated telegraphy, as used by the NAVTEX system and telex-over-radio.
NAVAREA	One of 16 areas into which the International Maritime Organization divides the world's oceans for dissemination of navigation and meteorological warnings.
NAVTEX	Telegraphy system for transmission of maritime safety information, navigation and meteorological warnings and urgent information to ships. NAVTEX is not supported by Australia - see <a href="#">SafetyNet</a> .
On-scene	The search area or the actual distress site.
On-scene coordinator (OSC)	A person designated to coordinate search and rescue operations within a specified area
On-scene endurance	The amount of time a facility may spend at the scene engaged in search and rescue activities.
Overall Coordination	The responsibility of the SAR authority to prosecute a SAR operation for a given target in accordance with Chapter 1 Section 1.2, Appendix B or the SAR authority best placed to coordinate efforts of the response agencies that may become involved in a SAR action.
Overdue	A situation where a craft has failed to arrive at its intended destination when expected and remains missing.
PAN-PAN	The international radiotelephony urgency signal. When repeated three times, indicates uncertainty or alert, followed by nature of urgency.
Personal Locator Beacon (PLB)	Personal radio distress beacon for alerting and transmitting homing signals.
Pilot-in-command	The pilot responsible for the operation and safety of the aircraft during flight time.
Planning stage	A period during a SAR incident when an effective plan of operations is developed.
Position	A geographical location normally expressed in degrees and minutes of latitude and longitude.
Positioning	Process of determining a position that can serve as a geographical reference for conducting a search.
Possibility area	(1) The smallest area containing all possible survivor or search object locations. (2) For a scenario, the possibility area is the smallest area containing all possible survivor or search object locations that are consistent with the



Term	Definition
	facts and assumptions used to form the scenario.
Primary swell	The swell system having the greatest height from trough to crest.
Probability Area	The area in which a missing craft and/or survivors are most likely to be found taking into account possible errors in the navigation of the missing craft and of the search craft.
Probability of detection (POD)	The probability of the search object being detected, assuming it was in the areas that were searched. POD is a function of coverage factor, sensor, search conditions and the accuracy with which the search facility navigates its assigned search pattern. Measures sensor effectiveness under the prevailing search conditions.
Rescue	An operation to retrieve persons in distress, provide for their initial medical or other needs, and deliver them to a place of safety.
Rescue coordination centre (RCC)	The centre from which a SAR incident is controlled and coordinated. The Centre is known by various terms such as the Rescue Coordination Centre, Major Incident Room, Operations Room or Base Station. For the purposes of this manual these centres will be known generically as the Rescue Coordination Centre or RCC.
Rhumb line	A line of constant bearing that cuts meridians at the same angle. It is a straight line between two points on a Mercator projection chart.
SafetyNET	Communications service provided via Inmarsat for promulgation of maritime safety information, including shore-to-ship relays of distress alerts and communications for search and rescue coordination.
SAR Datum Buoy	Droppable floating beacon used to determine actual sea current, or to serve as a location reference.
Scenario	A consistent set of known facts and assumptions describing what may have happened to the survivors and/or craft.
Sea	Condition of the surface resulting from waves and swells.
Sea Current (SC)	The residual current when currents caused by tides and local winds are subtracted from local current. It is the main, large-scale flow of ocean waters.
Search	An operation, normally coordinated by a rescue coordination centre, using available personnel and facilities to locate persons in distress.
Search and rescue authority	The authority within an Administration with overall responsibility for establishing and providing SAR services and ensuring that planning for those services is properly coordinated. The national SAR authority in Australia is the Australian Maritime Safety Authority with each of the States and Territories Polices services and the Department of Defence being the SAR Authorities within their jurisdictions. In Australia, the SAR Authority takes on the roles of the SAR Coordinator as described in the IAMSAR Manual.
Search action plan	Message, normally developed by the SMC, for passing instructions to SAR facilities and agencies participating in a SAR mission.
Search and rescue briefing officer	An officer appointed, usually by the SMC, to brief departing SAR facilities and debrief returning SAR facilities.
Search and rescue case	Any potential or actual distress about which a facility opens a documentary file, whether or not SAR resources are dispatched.
Search and rescue coordinating communications	Communications necessary for the coordination of facilities participating in a search and rescue operation.
Search and rescue facility	Any mobile resource, including designated search and rescue units, used to conduct search and rescue operations.  The terms unit and asset maybe interchangeable with facility.
Search and rescue incident	Any situation requiring notification and alerting of the SAR system and which may require SAR operations.
Search and rescue liaison officer	An officer assigned to promote coordination during a SAR mission.
Search and rescue mission coordinator (SMC)	The suitably trained or qualified official temporarily assigned to coordinate a response to an actual or apparent distress situation. In Australia, the acronym SARMC is also used in some jurisdictions. Throughout this

Term	Definition
	manual, the terms SMC and SARMC are synonymous. Some jurisdictions also use the term A/SARMC to describe the SMC's assistants.
Search and rescue plan	A general term used to describe documents which exist at all levels of the national and international search and rescue structure to describe goals, arrangements, and procedures which support the provision of search and rescue services.
Search and rescue point of contact (SPOC)	Rescue coordination centres and other established and recognised national points of contact that can accept responsibility to receive Cospas-Sarsat alert data to enable the rescue of persons in distress.
Search and rescue region (SRR)	An area of defined dimensions, associated with the national rescue coordination centre (JRCC Australia), within which search and rescue services are provided.
Search and rescue service	The performance of distress monitoring, communication, coordination and search and rescue functions, including provision of medical advice, initial medical assistance, or medical evacuation, through the use of public and private resources, including cooperating aircraft, vessels and other craft and installations.
Search and rescue stage	Typical steps in the orderly progression of SAR missions. These are normally Awareness, Initial Action, Planning, Operations, and Mission Conclusion.
Search and rescue unit (SRU)	A unit composed of trained personnel and provided with equipment suitable for the expeditious conduct of search and rescue operations.
Search area	The area determined by the search planner to be searched. This area may be sub-divided into search sub-areas for the purpose of assigning specific responsibilities to the available search facilities.
Search endurance (T)	The amount of "productive" search time available at the scene also known as Available Search Hours (ASH).  This figure is usually taken to be 85% of the on-scene endurance, leaving a 15% allowance for investigating sightings and navigating turns at the ends of search legs.
Search facility position error (Y)	Probable error in a search craft's position, based on its navigational capabilities.
Search object	A ship, aircraft, or other craft missing or in distress or survivors or related search objects or evidence for which a search is being conducted.
Search pattern	A procedure assigned to an SRU for searching a specified area.
Search radius	The actual search radius used to plan the search and to assign search facilities. It is usually based on adjustments to the optimal search radius that are needed for operational reasons.
Secondary swells	Swell systems of less height than the primary swell.
Sensors	Human senses (sight, hearing, touch, etc.), those of specially trained animals (such as dogs), or electronic devices used to detect the object of a search.
Set	Direction towards which a current flows
Situation report (SITREP)	Reports, from the OSC to the SMC or the SMC to interested agencies, to keep them informed of on-scene conditions and mission progress.
Splash Point	See Last known position
Surface drift	Vector sum of total water current and leeway. Sometimes called Total Drift.
Surface picture (SURPIC)	A list or graphic display from a ship reporting system of information about vessels in the vicinity of a distress situation that may be called upon to render assistance.
Surface position	The position of the search object on the earth's surface at the time of initial distress, or its first contact with the earth's surface.
Sweep width (W)	A measure of the effectiveness with which a particular sensor can detect a particular object under specific environmental conditions.
Swell	Condition of the surface caused by a distant wind system. The individual swell appears to be regular and smooth with considerable distance between rounded crests.

Term	Definition
Swell direction	The direction from which a swell is moving. The direction toward which a swell is moving is called the down swell direction.
Swell face	The side of the swell toward the observer. The backside is the side away from the observer. These definitions apply regardless of the direction of swell movement.
Swell velocity	Velocity with which the swells advance with relation to a fixed reference point, measured in knots.
Time of closest approach (TCA)	Time during a satellite pass when the satellite is closest to a signal source.
Total drift error (De )	Sum of the individual drift errors from the time of the incident until datum. Used when determining Total Probable Error (E).
Total probable error (E)	The estimated error in the datum position. It is the square root of the sum of the squares of the total drift error, initial position error, and search facility position error.
Total water current (TWC)	The vector sum of currents affecting search objects.
Track spacing (S)	The distance between adjacent parallel search tracks.
Triage	The process of sorting survivors according to medical condition and assigning them priorities for emergency care, treatment, and evacuation.
True air speed (TAS)	The speed an aircraft is travelling through the air mass. TAS corrected for wind equals ground speed.
Uncertainty Phase	A situation wherein doubt exists as to the safety of an aircraft or a marine vessel, and of the persons on board.
Unreported	A situation where a craft has failed to report its location or status when expected and remains missing.
Vector	A graphic representation of a physical quantity or measurement, such as wind velocity, having both magnitude and direction.
Visual flight rules (VFR)	Rules governing procedures for conducting flight under visual meteorological conditions. In addition, used by pilots and controllers to indicate type of flight plan.
Visual meteorological conditions (VMC)	Meteorological conditions expressed in terms of visibility, distance from cloud, and ceiling equal to or better than specified minima.
Wave (or Chop)	The condition of the surface caused by local wind and characterised by irregularity, short distance between crests, whitecaps, and breaking motion.
Wind-corrected heading	The actual heading an aircraft is required to fly to make good an intended course.
Wind current (WC)	The water current generated by wind acting upon the surface of water over a period of time.

---

# Chapter 1: Search and Rescue in Australia

## Part A: Organisation and Coordination - The National SAR Plan

### 1.1 SAR System Organisation

#### Global SAR System Organisation

- 1.1.1 The International Civil Aviation Organization (ICAO) and the International Maritime Organization (IMO) coordinate, on a global basis, member States' efforts to provide search and rescue (SAR) services. Briefly, the goal of ICAO and IMO is to provide an effective worldwide system, so that wherever people may be in danger, in the air or at sea, SAR services, as referenced in the International Aeronautical and Maritime Search and Rescue Manual, will be available if needed. The overall approach a State takes in establishing, providing and improving SAR services is affected by the fact that these efforts are an integral part of a global SAR system.
- 1.1.2 Search and rescue services are defined as the performance of distress monitoring, communication, coordination and search and rescue functions, including provision of medical advice, initial medical assistance, or medical evacuation, through the use of public and private resources, including cooperating aircraft, vessels and other craft and installations.
- 1.1.3 In providing assistance to persons in distress and to survivors of SAR incidents, member States shall do so regardless of the nationality or status of such a person or the circumstances in which that person is found.
- 1.1.4 Under this global approach, Australia has taken responsibility for the coordination of SAR in the Australian Search and Rescue Region (SRR) as shown in Appendix A. JRCC Australia in Canberra is the Joint Rescue Coordination Centre (JRCC) responsible for the SRR. There are no designated rescue sub-centres (RSC) within the Australian SRR.

#### National and Regional SAR System Organisation

- 1.1.5 Australia, by being party to the Safety of Life at Sea (SOLAS) Convention, the International Convention on Maritime Search and Rescue, and the Convention on International Civil Aviation, has accepted the obligation to provide aeronautical and maritime SAR coordination and services for its territories, territorial seas, and the high seas within its SRR.
- 1.1.6 Australia, in acceding to the International Convention on Maritime Search and Rescue, 1979, noted that the implementation of the Treaty throughout Australia would be effected by the Commonwealth, State and Territory authorities having regard to their respective constitutional powers and arrangements concerning the exercise of their legislative, executive and judicial powers. The responsibilities of the authorities are set out in the relevant following paragraphs.

- 
- 1.1.7 Australia has established a national SAR service that involves Commonwealth, State and Territory authorities and organisations: The Australian Maritime Safety Authority and the Australian Defence Force at the Commonwealth level; and the relevant police service or force at the State and Territory level, are the relevant SAR Authorities within Australia.
- 1.1.8 The Inter-Governmental Agreement (IGA) on National Search and Rescue Response Arrangements as signed by the responsible Commonwealth, State and Territory Ministers is at Appendix C in accordance with the IGA Commonwealth and the State and Territory search and rescue authorities shall each provide without charge unless otherwise agreed, such assistance or facilities as may reasonably be requested by the SAR authority with overall co-ordination of a SAR operation.
- 1.1.9 A SAR authority that hires or requisitions privately owned facilities for a SAR operation will, unless otherwise agreed between the SAR Authorities, bear any costs of hiring or payment of compensation for such requisitioning.
- 1.1.10 The costs of a SAR response to an activated distress beacon will be borne by the SAR Authority that tasks the SAR Facility.
- 1.1.11 Where the resources required to respond to a SAR incident exceed those available to any SAR Authority, or where the circumstances require significant coordination across Party agencies, a SAR incident may develop into an emergency management response. Where a SAR incident results in State, Territory or national emergency plans or arrangements being activated, they are to be activated in support of national SAR response arrangements established through the IGA.
- 1.1.12 Chapter 1, Part A “Organisation and Coordination-The National SAR Plan” of the National Search and Rescue Manual constitutes the National Search and Rescue Plan for Australia.

### **Australian Maritime Safety Authority (AMSA)**

- 1.1.13 In accordance with Annex 12 of the Convention of International Civil Aviation, the Commonwealth Government, through the Australian Maritime Safety Authority (AMSA), accepts responsibility for the provision of Search and Rescue Services for civil and internationally registered aircraft in Australia’s SRR. The meaning of civil registered is taken to include those aircraft on the VH register managed by the Civil Aviation Safety Authority (CASA) and on the Recreational Aviation Australia (RA-Aus) register which the RA-Aus manages on behalf of the CASA. The responsibilities for the coordination of Aviation SAR response is exercised by JRCC Australia on behalf of AMSA.
- 1.1.14 The Commonwealth Government through AMSA, in accordance with of the Safety of Life at Sea (SOLAS) Convention and the International Convention on Maritime Search and Rescue, accepts responsibility for the coordination of maritime SAR for persons on or from a vessel at sea. These responsibilities are exercised through JRCC Australia on behalf of AMSA.

- 1.1.15 JRCC Australia is staffed continuously and is responsible for:
- a) Coordinating SAR in respect of civil registered aircraft;
  - b) Coordinating SAR for persons on or from a vessel at sea;
  - c) Managing the Australian Mission Control Centre (AUMCC) for the COSPAS - SARSAT distress beacon locating system;
  - d) Operation of the Modernised Australian Ship Tracking and Reporting System (MASTREP);
  - e) Promulgation of Maritime Safety Information (MSI);
  - f) Provision of information on maritime activities such as oil pollution, offshore mineral exploration and dumping at sea;
  - g) Providing assistance to other Australian and emergency response authorities to enable them to meet their obligations in regard to SAR.
- 1.1.16 AMSA is the regulatory authority for maritime safety standards for SOLAS compliant shipping. AMSA also manages the National Plan for marine pollution response.

### State and Territory Governments

- 1.1.17 Police are the SAR Authorities in each State and Territory. The Australian Federal Police is the SAR Authority for the Australian Capital Territory, the Jervis Bay Territory and other populated Commonwealth territories. State and Territory Police Services are responsible for coordinating SAR in respect of:
- a) Persons and vehicles on land;
  - b) Persons and vessels on inland waterways and in waters within the limits of the ports of the relevant State or Territory;
  - c) Persons on or from a vessel at sea;
  - d) Aircraft not included on the CASA and RA-Aus registers including ultra-lights, para-gliders and gyrocopters;
  - e) Coordinating land searches for missing registered civil aircraft in support of the Australian SAR Authority (JRCC Australia); and
  - f) Coordinating the operations of volunteer rescue organisations within their respective jurisdictions.
- 1.1.18 Further information on land SAR operations additional to the generic information within Chapter 1 is available in the National Land Search Operations Manual.

---

## Australian Defence Force – Military SAR

1.1.19 The Commonwealth Government, through the Australian Defence Force (ADF) is responsible for the provision of SAR for all ADF and visiting military ships, personnel and aircraft. This responsibility is exercised through Chief of Joint Operations (CJOPS) located at Headquarters Joint Operations Command (HQJOC).

## Headquarters Joint Operations Command

1.1.20 CJOPS is responsible for managing and coordinating the ADF's operations on behalf of the Chief of the Defence Force (CDF). The Current Operations Commander within HQJOC is JRCC Australia's principal point of contact with Defence on SAR matters.

1.1.21 If a SAR for an ADF asset is required, the Current Operations Commander in consultation with the HQJOC Joint Personnel Recovery Officer (JPRO)/Search and Rescue Officer (SARO) will coordinate any available assets from the respective services and recommend an appropriate ADF SAR Commander and SMC be appointed to coordinate the SAR operation. The HQJOC JPRO/SARO will remain involved as the SMC or as a conduit for information flow to government and civil SAR authorities.

## Airservices Australia

1.1.22 All Air Traffic Services (ATS) units, as a function of their alerting service responsibilities, have a responsibility for the declaration of SAR phases for aircraft, to classify the severity of emergencies and alert JRCC Australia.

1.1.23 In addition, all ATS units are required to act as intermediaries between persons reporting an aircraft in need of assistance and JRCC Australia.

1.1.24 ATS units are responsible for providing in-flight emergency response (IFER) services. ATS units are required to refer incidents likely to culminate in a forced landing, ditching or crash to JRCC Australia at the earliest opportunity.

1.1.25 To the extent that their traffic responsibilities allow, ATS units are required to provide communications between the search aircraft and the responsible SAR Authority. This normally involves the relay of requests, instructions and information between the responsible RCC and aircraft.

## Other Commonwealth Agencies/Authorities

1.1.26 A number of Commonwealth organisations have a special interest in emergency operations; they provide helpful ancillary services, or have SAR facilities that may be of assistance in special cases.

## Bureau of Meteorology

1.1.27 Provides routine or special weather forecasts, wind history and a description of past and present weather reports.

---

## Emergency Management Australia

- 1.1.28 The Commonwealth Government, through Emergency Management Australia (EMA), is responsible for coordinating any Commonwealth assistance to States/Territories following natural or technological disaster. The National Emergency Operations Centre (NEOC) in Canberra exercises this responsibility.
- 1.1.29 State/Territory Governments have constitutional responsibility, within their borders, for coordinating and planning for the response to natural or technological disasters and civil emergencies. When the total resources (government, community and commercial) of an affected State/Territory cannot reasonably cope with the needs of the situation, the State/Territory Government can seek assistance from the Commonwealth Government through EMA.

## Border Protection Command

- 1.1.30 Border Protection Command (BPC) is a joint ADF and Australian Customs agency that coordinates and manages the Australian Civil Surveillance Program and may provide assets to assist during SAR incidents.
- 1.1.31 In accordance with IMO directive MSC/Circ. 1073, BPC is the Australian Security Forces Authority with the responsibility for providing the response to acts of violence against ships.

## Australian Communications and Media Authority

- 1.1.32 The Australian Communications and Media Authority (ACMA) regulate the use of radio frequencies and may assist with direction finding services. ACMA also issues and maintains a database of maritime call sign allocations to Australian holders of maritime radio licenses.

## Australian Transport Safety Bureau (ATSB)

- 1.1.33 The ATSB is responsible for investigating accidents and incidents involving certain transport services in Australia. Australian SAR Authorities have responsibility for notifying ATSB of accidents or incidents. ATSB can provide SAR Authorities with information about the location of past aircraft crash sites, which can be useful in identifying wreckage located during search actions.

## Civil Aviation Safety Authority (CASA)

- 1.1.34 CASA sets aviation safety regulatory standards affecting the civil aviation industry. CASA can provide advice on aircraft and pilot performance, safety matters and maintain the Aircraft Register.
- 1.1.35 CASA through the Office of Airspace Regulation (OAR) is responsible for the declaration of Restricted or Danger Areas during search and rescue operations when appropriate.



---

## Volunteer Organisations

1.1.36 Volunteer rescue organisations are located throughout the country and their focus is primarily one of promoting safety and carrying out local rescues. The State or Territory SAR authority is responsible for the coordination and control of operations conducted by the volunteer organisations during search and rescue operations.

## Commercial and Private Organisations

1.1.37 There are certain commercial and private organisations that are capable of providing assistance during SAR incidents.

1.1.38 Some of these organisations have facilities that are immediately suitable for use as SAR units; others have facilities that have been adapted by way of providing them with extra equipment or training.

1.1.39 Civil units considered suitable for the provision of SAR services are described as Search and Rescue Units (SRUs). The crews of these units are trained in search and rescue techniques.

1.1.40 Aircraft and marine craft in transit may be able to assist in cases of distress within their area of operations. Commercial towing and salvage companies may provide vessels to take over the towing or salvage of a vessel that is no longer in immediate danger. The owner or agent of the disabled vessel usually makes arrangements for these services. SAR units should not interfere with this form of private enterprise providing the commercial facilities are capable of completing the operation safely.

1.1.41 Other organisations that might volunteer to assist in a SAR operation include commercial airlines, general aviation operators, oil companies, fishing companies, aero clubs and other community groups and organisations.

## 1.2 SAR Coordination

### Overview

1.2.1 There are two levels of SAR response in Australia:

- a) The Commonwealth level through AMSA (JRCC Australia) and the ADF; and
- b) The State/Territory level through the Police.

1.2.2 Volunteer organisations work in close liaison with State and Territory Police and the Police retain overall coordination of those organisations within their jurisdiction.

1.2.3 It is common for a number of SAR Authorities to contribute to one SAR operation. Therefore it is vital that one SAR Authority is responsible for the overall coordination of the SAR operation and the other Authorities involved will cooperate to produce the best response possible within available resources.

---

## Determination of SAR Authority Responsible for Overall Coordination

- 1.2.4 The fundamental aim of a SAR system is to provide assistance to persons in distress. To achieve this aim the SAR system has to locate, support and rescue persons in distress in the shortest possible time. The success of the SAR response therefore depends on the speed with which the SAR situation is evaluated and the SAR operation is planned and carried out.
- 1.2.5 To ensure the SAR response is successful there are certain principles of SAR coordination that must be observed.

### Initial Response

- 1.2.6 The first SAR Authority to become aware of a SAR incident is obliged to respond until overall coordination can be transferred to the SAR authority best placed to coordinate.

### SAR Authority Best Placed to Coordinate

- 1.2.7 Normally the SAR Authority best placed to be the Overall Coordinator of a SAR incident will be the SAR Authority identified in Appendix B as responsible for the target type.
- 1.2.8 Appendix B identifies the responsibilities and functions to a SAR Authority based on the type of target that requires assistance from the SAR service and then additionally, in some circumstances, by the location of the SAR incident.
- 1.2.9 Appendix B also identifies the type of support the various Authorities are expected to provide in a SAR operation. However in certain circumstances, when it becomes apparent, following consultation between the authorities involved in the incident, that a SAR authority other than the one specified in Appendix B is more favourably placed to assume responsibility, then by mutual agreement the best placed SAR Authority will assume or maintain overall coordination responsibility.
- 1.2.10 The circumstances may include better communications, closer proximity to the area of search, better access to sources of intelligence, expertise in specialised areas or more readily available facilities.
- 1.2.11 For example, JRCC Australia is normally best placed to coordinate wide area air searches and coordinate search and rescue operations at sea at long range. These operations may also involve requests for ADF assistance. Police forces are normally best placed to coordinate local ground searches or inshore boat searches.
- 1.2.12 A SAR Authority may not be better placed if it is already engaged in responding to another SAR incident/s or it does not have sufficient resources to be able to coordinate effectively.

- 
- 1.2.13 The SAR authority with overall coordination may request assistance from another SAR authority. In such circumstances the Overall Coordinator may delegate to another SAR Authority responsibility for a specific part of the SAR operation.
- 1.2.14 From time to time, a SAR operation may be commenced independent of a SAR authority. Once a SAR authority is alerted to the incident it is their responsibility to coordinate the activities of the responding assets in order that the integrity of the search is maintained until such time as the SAR Authority best placed to coordinate the incident has been determined under this plan or the incident concludes.

### Effective Consultation and Coordination

- 1.2.15 In order to ensure the successful prosecution of a SAR incident involving more than one SAR authority, the SMC with overall coordination shall initiate consultation with all participating SAR Authorities at the commencement of an incident. The SMC should conduct frequent reviews of the progress of the incident and produce a SITREP at regular intervals. This should not preclude all participants offering advice and suggestions.
- 1.2.16 All SAR authorities have specialised knowledge within their specific area of expertise and operation, therefore the SMC should consult with other authorities to establish what assistance is available.

### Coordination of Police Land Search

- 1.2.17 The coordination of a police land-based search cannot be transferred to JRCC Australia. However, JRCC Australia may provide support on request in accordance with the procedures stated below in “JRCC Australia Assistance to Other SAR Authorities”.

### Cooperation with Foreign Rescue Coordination Centres

- 1.2.18 When the area of SAR operations is near or straddles the boundaries between international search and rescue regions (SRR), JRCC Australia is to be informed and will take overall coordination, except for SAR involving military forces as previously discussed. JRCC Australia will liaise with neighbouring foreign RCCs in accordance with the relevant International SAR Arrangements. In general, the following procedures reflect the SAR Arrangements in place.
- 1.2.19 When the position of a party in distress is known, the responsibility for initiation of SAR action will be that of the International RCC in whose SRR the party is located.
- 1.2.20 The International RCC to assume responsibility for conduct of a SAR action when the distressed craft’s position is unknown shall be the RCC responsible for:
- a) The SRR in which the craft was operating according to its last reported position;
- or

- b) The SRR to which the craft was proceeding if the last reported position was at the boundary of two SRRs; or
  - c) The SRR to which the craft was destined if it was not equipped with suitable two-way radio communication equipment or not under obligation to maintain radio communication.
- 1.2.21 If, after a SAR action has been initiated, it is determined that the area of probability lies across the boundaries of two or more adjoining SRRs, the initiating RCC shall normally remain the responsible SAR Authority.
- 1.2.22 Alternatively, where search areas are extensive, it may be agreed that JRCC Australia coordinates search efforts in the Australian SRR and the adjacent International RCC coordinates search efforts in the foreign SRR. Should this be considered the preferable strategy, JRCC Australia may initiate the proposal to its foreign counterpart.

### Provision for Entry of Foreign Aircraft during SAR Operations

- 1.2.23 JRCC Australia shall take responsibility for organising the entry into and departure from the Australian region of foreign aircraft engaged in SAR operations. If another SAR authority becomes aware of a foreign aircraft being tasked to conduct SAR operations in the Australian region, they should inform JRCC Australia immediately who will organise approvals and diplomatic clearances as necessary.

### Requests for Assistance from Foreign RCCs

- 1.2.24 JRCC Australia or the Department of Foreign Affairs and Trade (DFAT) may receive requests from foreign RCCs for Australian assistance in SAR operations. If requests are received via DFAT, JRCC Australia shall immediately establish communications with the RCC responsible for the area to establish and arrange any assistance that may be required.

## Distress Beacons

- 1.2.25 As the COSPAS-SARSAT Mission Control Centre for Australia, JRCC Australia will normally receive distress beacon alerts first. JRCC Australia will advise other relevant SAR Authorities of an alert as soon as practicable because they may be:
- a) Coordinating a response already and have more information;
  - b) The responsible authority in accordance with Appendix B; or
  - c) In a position to assist in a SAR response.
- 1.2.26 In accordance with the principles of SAR coordination set out in paragraph 1.2.6 (above), JRCC Australia will initiate a SAR response and retain coordination responsibilities until intelligence has established the location of the distress beacon, the nature of distress and agreement has been reached on the best placed SAR Authority to assume overall coordination.

- 
- 1.2.27 Distress beacon alerts will be prosecuted until the beacon is deactivated to prevent interference with other incidents on the distress frequency.

## Transfer of Coordination

### Reasons for Transfer of Coordination

- 1.2.28 The SAR authority with overall coordination should evaluate all available information and intelligence and make an initial assessment of the probable search area and assets required. If the required response is assessed as being beyond the capacity of the authority then that authority should request assistance at an early stage. Delaying requests for assistance, may lead to reduced chances of survival and/or significant increase in the size of the search area.

- 1.2.29 Overall coordination responsibility may be transferred from one SAR authority to another within Australia's SRR in the following circumstances:

- a) Where a SAR authority has activated a SAR operation in response to a distress or other emergency situation that is found to be outside their responsibility.

For example, a SAR operation is mounted by JRCC Australia in response to a distress beacon activation that is, having established the nature and location, found to be a land environment incident or a pleasure craft/fishing vessel in distress where Police are better placed to respond. In such a case JRCC Australia, depending on the operational circumstances of the SAR response, may transfer overall coordination of the SAR operation to the responsible State or Territory Police Service or Force.

- b) When an RCC is fully committed, overall coordination of a further incident in that region may be transferred to an adjacent RCC.

**Note:** JRCC Australia is considered to be an adjacent RCC to State and Territory RCCs.

- c) Whenever more accurate knowledge of the distressed craft's position or movements comes to hand.
- d) When it becomes apparent that a SAR authority other than the one initiating the action is more favourably placed to assume responsibility.
- e) Where a SAR operation is beyond the State/Territory's capabilities. This might include situations where vessels are well to sea or along a remote part of the Australian coastline and beyond the capabilities of the SAR facilities available to the State/Territory agencies.
- f) Where the circumstances of the SAR operation requires the implementation of the State or Territory's disaster plan or the declaration of a State or Territory Emergency. For example, an aircraft incident where there are many fatalities and/or injured. In these cases, once appropriate State/Territory resources are on

---

site, the appropriate State/Territory authority will assume overall coordination of the operation.

- g) For a major search where JRCC Australia has assumed overall coordination from a State/Territory SAR authority and the air search has been completed but local land and inshore operations may continue, overall coordination may be transferred back to the appropriate State/Territory authority.

### **Transferring Overall Coordination**

- 1.2.30 Any transfer of responsibility of overall coordination for a SAR operation between SAR Authorities will be by mutual agreement. Following a transfer of overall coordination, the initial authority will continue to provide support as it is able within its capabilities.
- 1.2.31 A transfer of responsibility between SAR authorities may be effected either by the initiating SAR authority inviting another SAR authority to take over or by another SAR authority offering to take over. In either case, the following procedure shall apply:
- a) Consultation shall take place between the SMCs of both SAR authorities concerned;
  - b) Full details of all known information relating to the incident and actions taken or contemplated by the initiating centre shall be passed. If verbally, confirmation will be sent in a message;
  - c) If overall coordination cannot be accepted immediately, the initiating SAR authority shall retain responsibility until a mutually agreed time of transfer;
  - d) The formal handover/take-over shall be recorded in writing by both SMCs using the Transfer of SAR Coordination form (Appendix D); and
  - e) Any other assets or authorities concerned shall be advised of the takeover.

### **Accepting Overall Coordination from another SAR Authority**

- 1.2.32 Where a SAR Authority wishes/requires to transfer overall coordination, the accepting SMC shall ascertain from that SAR Authority the reasons for seeking to transfer overall coordination.
- 1.2.33 In taking coordination for the SAR event, it is essential that the accepting SMC is aware that SAR assistance from the (current) Coordinating SAR Authority may not be available depending on the reasons for the transfer of overall coordination.
- 1.2.34 Where a SAR Authority accepts overall coordination of an incident, the SMC shall ensure that full responsibility for the event is accepted, in which case:
- a) The accepting SMC shall ensure that all aspects, including air and surface search, are coordinated by their RCC.

- 
- b) A Transfer of Coordination form shall be completed and exchanged.
  - c) If an aspect of the search (e.g. surface search) is to be coordinated by, or remain with another SAR Authority, then the terms for the coordination shall be made clear and that Authority shall be required to report progress and keep the SMC with overall coordination informed as to developments.

1.2.35 On completion of the SAR event, if it is appropriate to consider transferring the event back to the original coordinating SAR Authority, the SMC shall establish that the operational limitations for the earlier transfer of coordination no longer exist.

### **Accepting Coordination for a Component of the SAR Event from another SAR Authority**

- 1.2.36 Where an Authority decides to accept coordination for a component of an event (e.g. air search) from another SAR Authority, the accepting SMC shall ensure that responsibility for specific functions (e.g. air search) is accepted, in which case:
- a) The accepting SMC shall operate within the terms of the agreed responsibility and report progress to the SAR Authority with overall coordination; and
  - b) Conduct the specific functions in accordance with accepted standards, procedures and practices.

### **Guidance in Support of Transferring Coordination of a Component of a SAR Operation**

- 1.2.37 Where the overall coordinator needs or requires another cooperating SAR Authority to take responsibility for a component of a SAR event or a specific activity in the SAR event the cooperating Authority must be provided with:
- a) Clear objectives, scope and scale of the delegated responsibility and service required;
  - b) Full briefing on the SAR event to the extent that it will affect the service to be provided;
  - c) Conditions and constraints on use of assets;
  - d) Time requirements and constraints; and
  - e) Tactical intelligence, information and data as it becomes available that may affect the progress of the support service provided.
- 1.2.38 The cooperating Authority must:
- a) Accept, or reject the proposed delegation. If the action is other than to accept the delegation then the coordinating Authority must be informed of the operational reasons;
  - b) Operate within the terms of reference for the supporting service;

- c) Inform the coordinating Authority of any circumstances, if they arise where the specified service cannot be provided or needs to be varied, together with reasons;
- d) Exchange with the coordinating Authority, tactical intelligence, information and data as it becomes available that may affect the progress of the SAR event; and
- e) Report progress of the support activity to the coordinating Authority.

### Transfer of Coordination after Suspension of SAR Action

- 1.2.39 When a SAR action is suspended, the authority with overall coordination at the time shall inform all authorities, units and facilities that have been activated and/or alerted.
- 1.2.40 If, at the time of suspension, the search is under the overall coordination of the Authority responsible for the target type, as identified in Appendix B; overall coordination shall not be transferred to another SAR authority. Rather, the Police, and other agencies involved in the SAR operation, should be informed that the search has been suspended pending the availability of further intelligence. The Police may then instigate further Police (non-SAR) actions as appropriate.
- 1.2.41 Where a search is suspended for a target that another SAR authority has responsibility for under the terms of Appendix B, overall coordination shall be transferred to that authority. The expectation would be that if further intelligence is received that indicates the search should be re-commenced, the SAR authority that has normal responsibility for the target will consider its capability to coordinate the search at that time and either retain coordination, seek assistance or transfer coordination. Also, it may be necessary for that authority to fulfil their coronial or missing person responsibilities.
- 1.2.42 On occasions, after the suspension of a search, it may be necessary for State/Territory Police to continue to search for bodies or aircraft/vessel wreckage. In such cases JRCC Australia may:
  - a) Provide briefings on flight path or vessel track prior to disappearance, splash/crash point, area searched and related intelligence;
  - b) Review intelligence to assist search;
  - c) Source aircraft for transport or search purposes;
  - d) Brief search crews on (a) above; and
  - e) Provide drift information.
- 1.2.43 JRCC Australia will not fund air or surface assets for the search for bodies or aircraft/vessel wreckage once the search has been suspended.



- 
- 1.2.44 Should any other organisation, e.g. the operating company, wish to continue an independent search, the SAR Authority with overall coordination should ascertain whether there is any new intelligence that indicates that the search should be continued. If there is:
- a) New intelligence then this should be evaluated and, if considered valid, the search should be continued/re-initiated; or
  - b) No new intelligence then the RCC may assist the requesting organisation with:
    - i. Briefings on path prior to disappearance, splash/crash point, area searched and related intelligence; and/or
    - ii. Drift information.
- 1.2.45 JRCC Australia will neither fund nor provide air or surface assets for continuation of the search unless the request is supported by new intelligence.

### **JRCC Australia Assistance to Other SAR Authorities**

- 1.2.46 Australian SAR authorities may, and should not hesitate to seek assistance from JRCC Australia during a SAR operation. Where resources are available, JRCC Australia can deliver a range of services as follows.

#### **Provision of Subject Matter Expertise and Advice**

- 1.2.47 JRCC Australia personnel are experienced SAR operators who can assist with the provision of advice on the prosecution of a SAR operation. JRCC Australia has a range of SAR planning, prediction and management tools, including drift calculations that can be utilised at any stage of the search.

#### **Briefing for SAR Units**

- 1.2.48 A coordinating SAR Authority can request JRCC Australia to prepare a briefing for a SAR unit. JRCC Australia will:
- a) Prepare the briefing and fax it to the coordinating SAR Authority for the crew; or
  - b) Prepare the briefing and fax it direct to the crew, copied to the coordinating SAR Authority.

#### **Sourcing of Aircraft**

- 1.2.49 JRCC Australia can identify suitable aircraft to conduct a search on request from a coordinating SAR authority and pass the details to the Authority.
- 1.2.50 If the aircraft are tasked by the coordinating SAR Authority that Authority will bear the costs of the aircraft.

---

## Tasking of Aircraft

- 1.2.51 If the coordinating SAR Authority is coordinating a search, and requests JRCC Australia to identify and brief an air asset or air assets, the coordinating SAR Authority will nominate the search area and JRCC Australia will then arrange suitable aircraft and brief them. Briefings will be copied to the coordinating SAR Authority.
- 1.2.52 All subsequent activities that are related to monitoring progress of the air search, reaction to intelligence and re-allocation of aircraft to modified search allocations would remain with the coordinating SAR Authority.
- 1.2.53 If the coordinating SAR Authority uses the aircraft, that Authority bears the costs for the aircraft.

## Coordination of an Air Search

- 1.2.54 On request, JRCC Australia can take responsibility for an air search in support of a SAR operation under the overall coordination of another SAR Authority. The following procedures will apply:
- a) The search area will be determined by mutual agreement between the coordinating SAR Authority and JRCC Australia;
  - b) When additional intelligence is received that may entail changes to the search area, the revised search area will be determined by mutual agreement between the coordinating Authority and JRCC Australia;
  - c) JRCC Australia will conduct the complete air search including aircraft allocation, crew briefing and de-briefing, air asset performance monitoring and intelligence analysis;
  - d) All aircraft allocation details will be copied to the coordinating SAR Authority;
  - e) The coordinating Authority and JRCC Australia will exchange search area information and intelligence to ensure that coordination of the event is effectively achieved;
  - f) When the air search has been completed and there is high confidence that if the target was in the search area it would have been found, and the probability of survival has been exceeded, the air search will be suspended pending the availability of new intelligence; and
  - g) Requests to extend or continue the air search must be supported by the presence of new intelligence. If the air search is continued for other reasons, the costs of that continuation will be borne by the coordinating Authority and not JRCC Australia.
- 1.2.55 AMSA will pay all the costs for the air search.

- 
- 1.2.56 A completed Request for Assistance from JRCC Australia form available at Appendix D shall be used to support all requests for assistance from JRCC Australia.

## **Civil Requests for Defence SAR Assistance**

### **Localised Emergency Assistance to Save Life**

- 1.2.57 In localised emergency situations when immediate action is necessary to save human life, the RCC/local SAR Authority may request assistance directly from the commander of an ADF unit on scene or in the area. In these circumstances ADF commanders are authorised to provide assistance from within their unit's resources to civil Authorities. Within Defence this type of localised assistance is categorised Defence Assistance to the Civil Community (DACC) Category 1.
- 1.2.58 Whenever this action is taken the SMC/OSC shall advise JRCC Australia as soon as possible, and the commander of the ADF unit will advise their superior Headquarters as soon as possible. JRCC Australia is to follow up with a courtesy call to Headquarters Joint Operations Command (HQJOC).

### **All Other Requests for Defence SAR Assistance**

- 1.2.59 In other than the circumstances described above, civilian SAR Authorities/SMC shall pass requests for ADF assistance to JRCC Australia who will liaise with Headquarters Joint Operations Command (HQJOC). Once a military asset has been assigned, further contact can be with the Service concerned. JRCC Australia will contact the appropriate military unit to discuss with the mission commander/crew an appropriate search tasking for the asset
- 1.2.60 All requests for ADF assistance are to include as much detail as possible about the search target, where assets are required, how long assets are likely to be required, what other search assets are in the area, who is the coordinating SAR Authority, what logistic support can be provided to the ADF and the relevant points of contact.
- 1.2.61 Any verbal request will be followed by a hard copy message.

## **Military Requests for Civil Assistance**

- 1.2.62 In localised emergency situations when immediate action is necessary to save human life, ADF authorities will liaise directly with local SAR authorities/providers for the provision of civil support to ADF SAR operations.
- 1.2.63 In other than immediate, life threatening circumstances, the ADF will pass requests for civil SAR assistance in support of military SAR operations to JRCC Australia for on forwarding to the appropriate civilian SAR Authorities/SMC and the facilitation of the provision of support.

---

## Part B: Management and Support

### 1.3 Overview

- 1.3.1 There are three levels of management within the SAR system.
- a) Overall management of SAR responsibilities by SAR Authorities;
  - b) Management of individual SAR incidents by SAR mission coordinators (SMCs); and
  - c) Direction of SAR activities at an incident by on-scene coordinators (OSCs) specifically designated by the SMC.

This section outlines, in general terms, the management and coordination actions required when a decision is made to implement procedures in prosecuting a SAR.

- 1.3.2 Once it is decided to proceed with the action, plans should be enacted for the commencement of search activity with a minimum of delay. Coincident with progressing search activity, is the development of a rescue plan and obtaining and deploying rescue resources to minimise time between survivors' location and their recovery to a place of safety.

#### SAR Authorities

- 1.3.3 A SAR Authority shall ensure that a SAR operation can be promptly initiated and prosecuted with the efficient use of available SAR resources, until rescue has been completed or until chance of success is no longer a reasonable possibility.
- 1.3.4 SAR Authorities have responsibility for establishing, staffing, equipping and managing the SAR system, including providing appropriate legal and funding support, establishing RCCs, providing or arranging for SAR assets, coordinating SAR training and developing SAR policies, as listed at Appendix B. SAR Authorities will focus upon resources to conduct SAR operations for which they are the Responsible Authority (Appendix B). The SAR authority, where applicable, shall:
- a) Establish a Rescue coordination Centre (RCC) to coordinate all participating search and rescue assets and facilities;
  - b) Ensure that the RCC conforms to the SAR procedures contained in this manual or local SOPs and manuals;
  - c) Establish close liaison and formulate agreements with other authorities and organisations having SAR potential;
  - d) Establish liaison with SAR Authorities of adjacent areas to ensure mutual cooperation and coordination in combined operations;
  - e) Ensure that a comprehensive and current SAR plan is prepared and distributed;

- 
- f) Establish and supervise communication facilities and assign SAR frequencies from those authorised to assets designated for SAR tasks;
  - g) Establish communications with adjoining RCCs and appropriate organisations to ensure two-way alerting and dissemination of SAR information;
  - h) Ensure immediate action is taken to provide assistance, advising the appropriate SAR Authorities and passing all information received concerning the distress incident and any action taken;
  - i) Ensure that the operating authority or agency of any craft, aviation asset or land party in need of assistance has been advised of initial actions taken, and they are kept informed of all pertinent developments;
  - j) Designate an SMC for a specific SAR incident;
  - k) Ensure that each incident is prosecuted until assistance is no longer necessary, rescue has been completed or chance of success is no longer a reasonable possibility;
  - l) Ensure that if the scope of the operation exceeds the authority's capacity to plan and execute the operation, it shall seek advice and assistance from, or by mutual agreement, hand over coordination, to an appropriate authority;
  - m) Maintain and preserve adequate records; and
  - n) Develop new and improved techniques and procedures.

## RCC Staff

- 1.3.5 RCC staff perform duties in the prosecution of search and rescue events. In addition they have responsibility for maintaining the RCC in a continuous state of preparedness. RCC staff shall consist of personnel who are experienced and trained in SAR operations. When a period of heavy activity is anticipated or during major SAR incidents, the regular staff may be supplemented as required.
- 1.3.6 Authorities and agencies that may be involved in providing services to an RCC in the event of an incident e.g. JRCC Australia, State and Territory Police, Airservices Australia, ADF, Bureau of Meteorology (BOM) and ACMA are to be alerted as early as practicable so that staffing can be managed.

## SAR Mission Coordinator

- 1.3.7 Each SAR operation is carried out under the coordination of a SAR Mission Coordinator (SMC) designated for the purpose by the appropriate SAR Authority. The role of the SMC may vary between SAR Authorities depending on their command arrangements. They must understand the extent of their authority and responsibility and must be capable of taking immediate and adequate action, basing their decisions on knowledge, logic and good judgement.

---

### Qualifications

- 1.3.8 The SMC must have completed appropriate SAR training and must review and maintain proficiency as per the organisational procedures. The SMC must be capable of performing all SAR functions required by the SAR Authority.
- 1.3.9 To fulfil the foregoing requirements, the SMC must have a good knowledge of the communications available, the geographical features of the region, and the capabilities and limitations of SAR assets. The SMC must use initiative and be inquisitive in the search for information, cross-checking the sources in doubtful cases.

### Responsibility

- 1.3.10 The SMC is responsible for efficiently prosecuting a SAR incident using the assets available. The SMC is responsible for all stages of the SAR operation. Their responsibilities include the prompt dispatch of appropriate and adequate SAR assets and the prosecution of SAR operations until rescue has been completed, or chance of success is no longer a reasonable possibility.
- 1.3.11 The SMC is responsible for ensuring that the following duties are carried out depending on the SAR incident and local circumstances:
- a) Obtaining and evaluating all information pertaining to the incident, including emergency equipment carried by the person or craft in distress;
  - b) Classifying the SAR incident into the appropriate emergency phase (Uncertainty, Alert/Urgency, or Distress);
  - c) Alerting appropriate SAR assets and SAR organisations that may be of assistance during the incident;
  - d) In consultation with other SAR Authorities, confirming which Authority will exercise overall coordination in accordance with Appendix B;
  - e) Conducting a risk assessment;
  - f) Dispatching SRUs immediately, if situation warrants;
  - g) Conducting initial communications checks. If unsuccessful, making an extended communications search to obtain additional information on the incident, personnel involved and equipment carried by the vessel, aircraft or party in distress;
  - h) Calculating the search area. Preparing optimum plans and promulgating attainable plans;
  - i) Obtaining past/present/forecast weather, drift information and oceanographic conditions if applicable;
  - j) Providing for SAR crew briefing, dispatching of appropriate SRUs, or other assets;

- 
- k) Organising logistical support for all SAR assets including fuel, food and accommodation, through to the completion of the incident;
  - l) Making arrangements for appropriate communications;
  - m) Maintaining a continuous, chronological plot showing, for example sighting and hearing reports, DF bearings, air plot, RADAR plot, fixes, reports of debris, areas searched or not searched and other intelligence;
  - n) Maintaining a continuous, chronological record or log of the search effort, including actions taken in relation to intelligence, SRUs employed, sorties, hours flown/underway, sightings, leads, results obtained, message traffic, briefing notes, telephone calls, daily evaluation of progress and probability of detection;
  - o) Initiating maritime distress broadcasts or maritime information broadcasts and initiating the alerting of enroute aircraft. Consideration should be given to arranging for announcements to be made over radio and TV networks;
  - p) Arranging communication schedules when and if needed;
  - q) Requesting additional SAR assets, as required;
  - r) Exercising overall coordination of SAR assets;
  - s) Maintaining liaison with the next of kin, owner, agent or management of the missing craft or persons;
  - t) Keeping all authorities involved fully advised of SAR incident progress with timely and regular situation reports (SITREPs). SITREPs should be sent in a numbered sequence;
  - u) Making recommendations in relation to the continuation or suspension of searches;
  - v) Issuing news media releases on the progress of incidents in accordance with the local SAR organisational procedures and policies;
  - w) Providing debriefs of SRUs, cancel alerts, release SAR assets and organisations involved, and issuing the final SITREP to all concerned; and
  - x) Acting as required to cope with unique, unusual or changing circumstances of the emergency.

1.3.12 Where a SAR Authority has overall coordination of a SAR operation, the SMC shall give particular attention to the following matters as relevant to the search:

- a) In conjunction with the meteorological office, keeping a watch on weather conditions in the probability area, routes used by SAR units in transit to and from the search area and at aerodromes used as bases or alternate aerodromes for search aircraft;

- b) Coordination of search aircraft in the light of operational conditions by diverting or recalling aircraft or reassigning search areas as conditions dictate;
- c) Planning so as to minimise conflict between search aircraft in adjoining areas;
- d) Attending to logistical requirements, in particular, accommodation, fuel, availability of relief crews and observers and all necessary ground facilities at aerodromes to be used by SAR units;
- e) Coordination of the use of maritime resources and facilities and efficient distribution of message traffic regarding sea state and weather conditions which may affect marine craft engaged in search activities;
- f) Provision of regular information to those agencies responsible for land search units about actual and forecast weather conditions which may affect their operations;
- g) Ensure that all search units are kept informed about actions and developments affecting their operations;
- h) Make effective use of personnel from other SAR authorities, medical agencies, public relations, company representatives and maritime authorities; and
- i) Keeping other authorities, which have been given coordination of search assets, informed of overall search progress and strategy.

1.3.13 The SMC may have access to other SAR qualified personnel. Some functions may be shared where there are insufficient numbers of staff to allocate individual tasks to a staff member. The following roles are listed for completeness.

#### **Assistant SAR Mission Coordinator (A/SMC)**

1.3.14 As the title implies, the A/SMC assists, and is subordinate to, the SMC assigned to a particular SAR mission. The term is used by some Australian jurisdictions to describe officers with SAR qualifications that allow them to provide significant support to the SMC.

#### **Qualifications**

1.3.15 Officers performing A/SMC duties should, as a rule, hold SMC qualifications, but requirements vary within the structure of the SAR organisation. Generally, the title A/SMC refers to the SAR qualifications held by a particular officer, e.g. an officer rated as A/SMC may serve in any capacity within the SAR organisation, except in the position of SMC. Officers rated as SMC may, on the other hand, be allocated A/SMC duties. As a general guide, the objective of any SAR organisation should be to ensure that staff employed in the management of SAR operations should be qualified to perform the highest level of duties i.e. SMC.



---

## Authority

1.3.16 The A/SMC is under the direct supervision of the SMC and therefore has the full operational authority of the SMC when carrying out specific duties assigned.

## Responsibilities and Duties

1.3.17 The A/SMC is responsible for routine documentation, allocation of SRUs and presentation of the search plan under the direction of the SMC. Each SAR Authority will recognise specific duties applicable to the A/SMC function.

## Allocator

1.3.18 An Allocator is responsible to the SMC for the determination of a probability area, allocation of appropriate air or surface search units to specific areas, and when required brief and debrief search crews.

## Recorder

1.3.19 A Recorder, if required, shall maintain an accurate and up-to-date chronological record of the SAR action, together with other necessary records, messages and details of telephone calls and radio logs.

## Briefing Officer

1.3.20 A Briefing Officer shall be responsible for briefing and debriefing search units.

## Intelligence Officer

1.3.21 An Intelligence Officer shall be responsible for:

- a) Liaison with the duty meteorological officer for the supply of planning forecasts and periodic updates of weather information;
- b) Plotting, assessing and filing of sighting and hearing reports;
- c) Interrogating witnesses and assessing other reports;
- d) Obtaining data about the missing persons and/or craft;
- e) Obtaining logistical data relating to the search area; and
- f) Supervising the personnel employed in gathering intelligence.

1.3.22 The Intelligence Officer shall immediately advise the SMC of any information that is considered to be significant.

## Rescue Planner

1.3.23 A Rescue Planner shall be responsible for devising and coordinating a rescue plan. The rescue plan shall include the pre-positioning of supplies for an airdrop to survivors, the positioning of suitable rescue facilities at appropriate locations and the pre-hospital medical needs of survivors.

---

## Liaison Officer

- 1.3.24 Liaison Officers or advisers from other authorities/interested parties, when required, may be sought from or provided by JRCC Australia, the aircraft operator, police, military authorities etc. and shall liaise between the RCC and their parent organisations on matters of their specialisation. The use of liaison officers is encouraged during SAR operations that may become protracted.

## On Scene Coordinator

- 1.3.25 When a number of SAR assets are working together on the same SAR mission in the same location, there may be an advantage if one unit is assigned to coordinate the activities of all participating assets. The SMC will designate this role to an On Scene Coordinator (OSC), who may be the person in charge of a ship or aircraft participating in the search or someone at another nearby facility in a position to handle OSC duties. The OSC should be the most capable person available, taking into consideration SAR training; communications capabilities of the asset; and the length of time that the asset the OSC is aboard can stay in the search area. Frequent changes in the OSC should be avoided. Duties that the SMC may assign to the OSC, depending on needs and qualifications include:

- a) Assuming operational coordination of all SAR facilities on scene;
- b) Receiving the search action plan from the SMC;
- c) Modifying the search action plan based on prevailing environmental conditions and keeping the SMC advised of any changes to the plan (in consultation with the SMC when practicable);
- d) Providing relevant information to the other SAR assets;
- e) Implementing the search and rescue plan where required;
- f) Monitoring the performance of other assets participating in the search;
- g) Implementing the rescue plan (as required); and
- h) Providing regular SITREPS to the SMC.

## Forward Command Post

- 1.3.26 It may be desirable to establish a Forward Command Post or a Forward Field Base at a suitable location. The feasibility of FCP/FFB establishment will be a matter for consideration by the SAR Authority.
- 1.3.27 As the name suggests a Forward Field Base (FFB) differs from a Forward Command Post (FCP) in that a Forward Field Base does not involve transfer of any coordination responsibilities from the parent RCC.

- 
- 1.3.28 JRCC Australia will commonly establish a FFB at an aerodrome being used by several search aircraft for the purpose of managing tasking, allocation of personnel and equipment and conducting briefings and debriefings. A FFB may be also set up in conjunction with a Police headquarters or Police FCP to facilitate liaison between Authorities and agencies involved in a search and rescue operation.
- 1.3.29 The degree of delegation attributed to the FCP/FFB and its actual responsibilities shall be at SMC discretion, bearing in mind the need for:
- a) A clear understanding of respective responsibilities; and
  - b) An optimum response to the operational and administrative features of the current situation e.g.: location of search area and availability of staff.
- 1.3.30 After considering how best to exercise control over SAR assets in remote sectors of an SRR or where communications, administrative or political factors impact on operational efficiency, an SMC may recommend to management to establish a FCP/FFB close to the incident.

The responsibilities of the OIC of an FCP/FFB throughout a particular SAR action shall be delegated by the SMC and may include:

- a) Briefing and debriefing members of search teams during a land search operation;
- b) Briefing and debriefing search crews operating aircraft from an aerodrome close to the search area;
- c) Establishment of a base for helicopter operations, not at an aerodrome;
- d) Coordinating, as required, the provision of safety, survival and SAR equipment to participating SAR aircraft and helicopters;
- e) Collation of intelligence information and provision of logistical support;
- f) Liaison between JRCC Australia, police and emergency services;
- g) Supervising the allocation of observers, and ensuring they obtain adequate rest; and
- h) Making arrangements for food, accommodation and transport for search crews and observers when required.

**Notes:**

- i. Where an aerodrome is to be used for a FCP/FFB; the aerodrome operator/owner should be consulted prior to the final decision being made to establish an FCP/FFB at the location.
- ii. For the broader responsibilities given to a Field Search Controller by a Police Search Commander, see the Land Search Operations Manual.

- 
- 1.3.31 In considering the establishment of a FCP/FFB, the Search Commander/SMC shall consider communications requirements and existing facilities including terrestrial networks, satellite communication links, mobile phones, facsimile machines and facilities available through other agencies, e.g. JRCC Australia, Police, Defence assets and State/Territory Emergency Services.
- 1.3.32 When selecting a location for a FCP/FFB the Search Commander/SMC shall consider:
- a) Navigation aids;
  - b) Geographical limitations;
  - c) Aerodrome or landing area suitability and proximity to the search area;
  - d) Apron capacity;
  - e) Refuelling capabilities;
  - f) Maintenance and logistical support;
  - g) Crew briefing facilities; and
  - h) Availability of accommodation in the vicinity.

## 1.4 Search and Rescue Resources

### Overview

- 1.4.1 Search and Rescue within the Australian SRR is based on the use of aircraft, marine craft and land facilities which are normally used for other purposes but which can be made available to form part of the SAR effort.
- 1.4.2 The SMC shall arrange for the provision of suitable search units. The terms SAR unit or SAR facility are used to describe one or more types of air, maritime and/or land-based facility.
- 1.4.3 Some of these facilities are immediately suitable for SAR use; others have been adapted by way of providing them with extra equipment or training. A number of units considered suitable for the provision of SAR services have been designated as specialised SAR units with trained personnel and are described as Search and Rescue Units (SRUs).
- 1.4.4 AMSA has developed a tiered hierarchy for civil aviation SRUs in Australia that is further explained in Appendix M.
- 1.4.5 Every endeavour should be made to obtain sufficient search assets to search the determined area at a satisfactory coverage factor in the shortest possible time. However certain factors, such as inclement weather or darkness, may make an optimum air search impractical and the use of surface assets should be considered. Search by land facilities alone is usually impractical for large search areas but it can

---

be conducted in most weather conditions and can provide complete coverage of a confined area that cannot be thoroughly searched from the air. Land parties are also critical in operations where the search is carried out from the air and rescue by land facilities.

- 1.4.6 Identification and deployment of rescue units shall commence at the time of the initial SAR response and a review of requirements shall continue through the action. Assistance with selection of search units is given in Section 5.8.

## Personnel

- 1.4.7 While a SAR unit will conduct a SAR operation under the general direction of the SMC, the person in charge of the unit will retain the responsibility for carrying out the operation assigned to it.
- 1.4.8 Medical personnel should be alerted in a timely manner if it is anticipated that they may be required.
- 1.4.9 SAR Authorities should ensure that regular training is undertaken by SRUs in their jurisdictions.

## Dropmasters, Dispatchers and Observers

- 1.4.10 Dropmasters, dispatchers and observers are an integral part of the SAR team and its effective operation.
- 1.4.11 Dropmasters will be required if an aerial delivery of stores is to be made to survivors. The Dropmaster shall be responsible for the preparation of the equipment for delivery and for briefing the drop team and aircrew on dropping techniques. During the drop mission, the Dropmaster will take charge of the aircraft cabin and control the dropping operation. Dispatchers should be available to assist the Dropmaster in the delivery of supplies when required.
- 1.4.12 Whenever possible, trained Observer Leaders and Observers shall be used in all search aircraft. Where it is inevitable that some untrained Observers must be used, the SMC shall make every effort to have at least one trained Observer Leader or Observer in each search aircraft.
- 1.4.13 Sufficient Observers should be assigned to large aircraft to enable the Observer Leader to arrange relief periods. Ideally, search sorties should be approximately of two hours duration.
- 1.4.14 An Observer Leader allocated to an aircraft shall attend the briefing with the pilot or obtain a copy of the briefing, and will then be responsible for briefing Observers allocated to that aircraft. Observer Leaders may be issued with binoculars where available.

1.4.15 Should a prolonged search be foreseen, Observer Leaders and Observers should be rostered to avoid fatigue. If there are insufficient Observers available locally, additional Observers should be obtained and taken to the area.

1.4.16 It is an SMC responsibility, either directly or by delegation from the SAR Authority, to make reasonable provision for and to monitor the welfare of Observers. This includes the provision of refreshments, accommodation and rest breaks. Local State and Territory Emergency Service assets and aero clubs, especially those from which a number of search aircraft may be deployed, may be of assistance in this regard and should be invited to cooperate in making appropriate arrangements.

## Rescue Preparation

1.4.17 Planning for rescue shall commence at the time of the initial SAR response and continue throughout the action. Plans shall be appropriately updated, as the circumstances require and at all times consider the pre-hospital medical needs of survivors.

1.4.18 For further considerations in rescue planning refer to Chapter 6.

## 1.5 Public Relations

### Overview

1.5.1 Search and Rescue operations for missing aircraft and vessels generate considerable publicity. By virtue of its nature, an RCC is a source of news and this is especially true during SAR incidents. The public should be informed during SAR operations, within the limits of confidentiality, of SAR actions. The potential benefits of early release of information include:

- a) Additional information from the public, leading to more effective use of SAR resources;
- b) Fewer time-consuming requests from the news media; and
- c) Reduction of inaccurate public speculation about the SAR mission.

1.5.2 RCC staff should be governed by their parent authority's public relations procedures when dealing with the media. It is important that a relationship between the media and an RCC is established such that:

- a) The media's legitimate interest in an incident of concern and the public's "right to know" is respected;
- b) Information reaching the public is factual and as complete as possible;
- c) The operational functioning of an RCC is not prejudiced; and

- 
- d) Benefit is derived from publicity of an incident and from media broadcasts for information made at the request of SAR staff.

## **Operations involving two or more SAR Authorities**

- 1.5.3 To avoid confusion in public information it is essential that the overall coordinating authority responsible for the particular SAR action make any news release.
- 1.5.4 The following guidelines are recommended for releasing information on operations involving vessels, aircraft or other facilities during joint operations:
  - a) Inquiries from the public made to one authority concerning the activities of another authority shall be directed or referred to the authority in overall coordination of the incident;
  - b) Where the ADF is the SAR Authority, the ADF is responsible for issuing information to the public. The ADF is to be consulted before any information is released to the public/media; and
  - c) Where ADF assets are involved in supporting a civil SAR, information on the activities of those ADF units is not to be released to the public/media without Defence approval. The appropriate authority to consult in Defence is the Public Relations Officer at HQJOC.

### **Public Relations Officers (PRO's)**

- 1.5.5 SAR Authorities usually have a designated PRO. The PRO, or the officer nominated, should have knowledge of search and rescue and the techniques of disseminating information to the public.
- 1.5.6 The authority of the PRO will be covered by organisational policies and procedures. The commercial distribution of news is highly competitive and therefore news releases must be impartial. Specifically, the PRO will perform the following duties:
  - a) Receive briefings from the SMC, RCC personnel, SITREPs, SAR log and interviews with rescued personnel if available;
  - b) Make proper and full use of existing news media such as press, radio, television and wire services to disseminate information;
  - c) Establish liaison with media sources early in the mission in order to prevent the SMC from being flooded with requests for information as the mission progresses;
  - d) Keep well informed on the procedures and techniques being used in the search and in which stage the SAR system is functioning at any particular time; and
  - e) Process and review for news-worthiness all photographs taken of mission activities.

---

## Press Releases

- 1.5.7 The early release of information will frequently aid in preventing time-consuming requests from news media concerning the operation. In cases where extensive searches are being conducted release of information to the public may bring important leads to the SMC.
- 1.5.8 News releases should be written following the time-proved format of who, what, where, when, why and how. In drafting a release all six of these items should be covered in paragraph one. Subsequent paragraphs can provide additional detailed information concerning one or more of these questions. By drafting releases in this fashion the news media will be able to chop portions of the release in order to meet their space requirements without damaging the overall story. The release of names can be a sensitive issue and organisational policies and procedures should be established in accordance with privacy guidelines.
- 1.5.9 A good news release will be well written, factual and newsworthy. It should not contain personal opinion, judgements, elaboration, colouring or any classified material. Asking the following questions may test news-worthiness:
- a) Is story still timely?
  - b) Are the people involved known?
  - c) Is the story unusual?
  - d) Is locality within the range of the news media's interest?
  - e) Does the story have general interest?
  - f) Has the story a personal or human-interest appeal?
- 1.5.10 SAR officers shall not disclose to the media:
- a) The names of any crew or other missing persons;
  - b) Any personal judgments pertaining to any persons involved in the incident;
  - c) Any comments on the judgment, experience or training of persons involved in the incident;
  - d) Degrading opinions on the conduct of the SAR operation or personalities involved;
  - e) Personal opinions and theories;
  - f) Names of those associated with the search; and
  - g) Names of persons who have given information relating to the incident.
- 1.5.11 SAR Officers shall not comment on behalf of other SAR Authorities or organisations.



---

1.5.12 Media releases may include the following information:

- a) Type of aircraft, factual detail of the flight, details of the vessel;
- b) Reason for the SAR operation, e.g. aircraft/vessel overdue, report of impending crash landing; weather situation; beacon activation;
- c) Owner of the aircraft/vessel (subject to consent);
- d) Number of missing persons;
- e) Area being searched;
- f) Number and types of assets engaged in the search;
- g) Arrangements for the search;
- h) Details of other authorities participating in the search; and/or
- i) Reinforce the positive aspects relating to safety and survival.

1.5.13 As the operation progresses, releases should be made periodically to keep the public updated on the progress that is being made. A final release should be made when the mission is concluded. This release should summarise the activities conducted during the operation, giving full particulars on the efforts expended to locate and rescue the distressed persons. The final release should be a complete summary of the incident and detail:

- a) The number of aircraft missions, total hours flown and use of vessels;
- b) Auxiliary land or maritime search, if applicable;
- c) The reasons for termination or suspension; and
- d) Any other information relevant to the incident that should be made public.

### **Requesting Public Assistance**

1.5.14 The SMC may enlist the news media to access information from the general public. In sparsely populated areas, information from the general public may be sought through the media, requesting members of the public to contact the RCC. An RCC telephone number should be included as part of the release.

### **Liaison with Relatives**

1.5.15 Information that may significantly affect the conduct of a search may be obtained from relatives and friends of missing persons. Information relating to the personal history and possible courses of action taken by the missing persons should be collected by officers trained in investigation methods and competent to describe the current and proposed search plan in a reassuring manner.

---

## Notification of Next of Kin

- 1.5.16 The SMC should be aware of the concerns of the relatives of the missing persons. During a search, it is recommended that one staff member should maintain regular contact with the relatives to provide information and outline plans. If appropriate, relatives should be encouraged to visit the RCC to enable them to see the search effort. Next of kin/relatives should be advised at an early stage of any SAR operation, to ensure where possible that the timing of associated media releases does not cause them undue concern.
- 1.5.17 Where available, police liaison officers should be utilised to give initial advice to relatives and particularly when providing advice that a death or deaths have occurred. It is preferable that this information can be passed personally rather than by telephone, so as to ensure that appropriate support services are provided.
- 1.5.18 In any event, before a search is suspended or terminated SAR management should ensure that the next of kin are consulted as far as possible. They should be fully briefed on the complete search effort, conditions in the search area, and the reasons for proposing the suspension or termination of the search. Relatives are more able to accept the SMC's decision to suspend or conclude search operations if they are privy to the processes.
- 1.5.19 Whenever foreign nationals are the subjects of a search and rescue action, the Department of Foreign Affairs and Trade should be informed.
- 1.5.20 The ADF is the sole authority for releasing any information to next of kin of ADF members.

## Casualties

- 1.5.21 State SAR Authorities (Police) will be responsible for the releasing the names of civilian casualties. The names of military casualties of a SAR Incident are only to be released by the ADF or the appropriate national authority for visiting military units.
- 1.5.22 The names and addresses of survivors shall not be released until a positive check and identification has been accomplished. Generally, survivor information should not be released prior to the release of casualty information, although circumstances may dictate some departure from this procedure. Survivors shall be encouraged to contact their own families as soon as possible and all reasonable assistance towards accomplishing this shall be provided. Controlling the dissemination of information by survivors is difficult and requires tactful briefing. Whenever possible the PRO should brief survivors on what information may be released. Information on survivors who are ADF members or members of foreign military units is only to be released by the ADF or the appropriate national military authority.

---

## Chapter 2: Communications

### 2.1 Overview

- 2.1.1 Distress traffic includes all messages relating to immediate assistance required by persons, aircraft, or marine craft in distress, including medical assistance. Distress traffic may also include SAR communications and on-scene communications. Distress calls take absolute priority over all other transmissions; anyone receiving a distress call must immediately cease any transmissions that may interfere with the call and listen on the frequency used for the call.
- 2.1.2 Distress and safety communications require the highest possible integrity and protection from harmful interference. Any interference that puts at risk the operation of safety services degrades obstructs or interrupts any radio communications, is harmful. Some frequencies are protected, in that they have no authorised uses other than for distress and safety. SAR personnel should be particularly careful not to cause harmful interference, and should co-operate with authorities to report and stop incidents of interference.
- 2.1.3 The object of search and rescue (SAR) communications is to make possible the conduct of SAR operations. As per Regulation 7 of Chapter V of SOLAS, arrangements have been established to facilitate distress communication and co-ordination within the Australian SRR. Such communications must allow for:
- a) Rapid transmission of distress messages from aircraft, ships and small craft, including for medical assistance;
  - b) Rapid communication of distress information to the authorities responsible for organising and effecting rescue;
  - c) Coordination of the operation of the various SAR units; and
  - d) Liaison between controlling/coordinating authorities and SAR units.

### 2.2 Distress and Emergency Signals

- 2.2.1 There are many signals that can be used to indicate a distress or other emergency.
- 2.2.2 Personnel involved in SAR operations must be familiar with the types of signals they can expect to encounter in order to evaluate their meaning correctly and take appropriate action.
- 2.2.3 These emergency signals may be made by radio, satellite, RADAR (e.g. transponders), flags, pyrotechnics, flashing light, smoke, sounds, shapes and ground panels. (Appendix E lists the more common signals and terminology in use.)

## Marine Radio Alarm Signal

- 2.2.4 With the full implementation of the Global Maritime Distress and Safety System (GMDSS) in February 1999 the automatic alarm devices used on 2182 kHz are no longer required. However, some maritime communications stations may still use the voice alarm signal consisting of two sinusoidal audio frequency tones, one of 2200 Hz and the other of 1300 Hz, producing a distinct warbling sound to draw attention to a distress broadcast. Merchant shipping complying with the SOLAS Convention now guard the Digital Selective Calling (DSC) distress frequencies.

## RTF Distress Signal

- 2.2.5 The distress signal “MAYDAY” is used to indicate that a craft or person is threatened by grave and imminent danger and requires immediate assistance. It has precedence over all other communications. The distress message is preceded by the word MAYDAY spoken three times.

## RTF Urgency Signal

- 2.2.6 The urgency signal “PAN PAN” is used to indicate that the calling station has a very urgent message to transmit covering the safety of a ship, aircraft or person. It has precedence over all other communications, except distress traffic. The urgency message is preceded by the words ‘PAN PAN’ spoken three times.

## RTF Safety Signal

- 2.2.7 The safety signal “SECURITÉ” indicates that the station is about to transmit a message concerning the safety of navigation or providing an important meteorological warning. The safety message is preceded by the word ‘SECURITÉ’ spoken three times.
- 2.2.8 All stations hearing a distress, urgency or safety signal shall not make any transmissions that might interfere with those signals and be ready to copy any message that follows.

## Radiotelephony Distress/Emergency Frequencies

- 2.2.9 The following frequencies have been designated as distress or emergency frequencies.

### GMDSS Distress, Urgency, Safety and Calling Frequencies

Radio Telephone	DSC	NBDP
2182	2187.5	2174.5
4125	4207.5	4177.5
6215	6312.0	6268.0
8291	8414.5	8376.5
12 290*	12 577.0	12 520.0
16 420*	16 804.5	16 695.0
VHF: Ch 16	VHF: Ch 70	VHF not used

---

**Note:** None of the MF/HF DSC or NBDP frequencies are used when calling. The AMSA HF DSC network monitors DSC in the 4 – 16 MHz bands.

\* 12 290 kHz and 16 420 kHz are to be used only by RCCs.

### **2182 kHz**

2.2.10 The international MF voice distress frequency primarily for ship-to-ship communications, the upper side band 2182 kHz is used for follow-on communications after an initial DSC distress alert on 2187.5 kHz for GMDSS shipping. In Australia 2182 is monitored by a number of Limited Coast Radio Stations operated by Volunteer Marine Groups around the coast. The two-tone alarm may still be used on 2182 kHz to draw attention but auto alarms are no longer a part of the Radio Regulations.

### **4125, 6215, 8291, 12290 and 16420 kHz**

2.2.11 These frequencies have been authorised for common use by ships and coast stations using the HF frequencies for upper sideband radiotelephony on a simplex basis for calling, reply and safety purposes. The frequencies quoted are the carrier frequencies. The State and Territory Coast Radio Stations monitor the distress and safety frequencies in the 4, 6 and 8 kHz bands.

### **121.5 MHz**

2.2.12 The international aeronautical emergency frequency for aircraft and those aeronautical stations primarily concerned with the safety and regularity of flight and having equipment in the 118-136 MHz VHF band.

2.2.13 Ships fitted with the capability are authorised to communicate on this frequency with aircraft for safety purposes.

### **156.8 MHz (Marine VHF Channel 16)**

2.2.14 The international distress, safety and calling frequency for radiotelephony stations of the maritime mobile service, when using frequencies in the Marine VHF bands 156 to 174 MHz.

2.2.15 State and Territory limited coast radio stations, port authorities, merchant ships, fishing craft and pleasure craft use VHF Ch 16. Merchant ships maintain a continuous bridge listening watch on VHF channel 16 to the maximum extent practicable when at sea.

2.2.16 156.3 MHz (Marine VHF Channel 6) is used for coordination at the scene of an incident.

### **243 MHz**

2.2.17 243 MHz is the international military aeronautical emergency frequency.

## Safety Frequencies

2.2.18 The following table indicates Safety frequencies in use in Australia.

156.375 MHz	VHF FM RTF (Marine channel 67)	Marine safety: Australia only (supplementary to Channel 16 and used to broadcast weather and warnings from State/Territory limited coast stations)
27.88 MHz (Channel 88)	HF (Marine) RTF	27 MHz band, pleasure craft safety frequency (in Australia)
2524 kHz	MF (Marine) RTF	Pleasure boat safety, volunteer SAR organisations (in Australia)

## 2.3 Global Maritime Distress and Safety System

- 2.3.1 Ships subject to the Safety of Life at Sea (SOLAS) Convention are obliged to be outfitted with certain communications equipment to participate in the Global Maritime Distress and a Safety System (GMDSS). Fishing vessels and small craft around Australia, if carrying compatible GMDSS equipment can also participate.
- 2.3.2 AMSA is responsible for the provision of shore facilities for the GMDSS and all distress and safety traffic through the GMDSS shore infrastructure in the Australian SRR will be handled by JRCC Australia.
- 2.3.3 Ships operating under GMDSS requirements in the Australian SRR can be expected to carry:
- MF DSC;
  - VHF radiotelephone (Channels 6, 13, 16 and 67);
  - VHF DSC (Channel 70);
  - Inmarsat-C or HF DSC;
  - An AIS-SART or RADAR SART; and
  - An EPIRB.

## 2.4 Emergency Signalling Devices

- 2.4.1 People in a craft in distress may use any possible means of alerting others to their situation. These devices range from emergency radio beacons to mirrors.

### Daylight Devices

- 2.4.2 Reflective mirrors, used by survivors to reflect the sun's rays towards a SAR unit, are an effective daylight device. Mirrors have been detected as far away as 45 miles and from as high as 10000 feet, although the average distance is about 10 miles. Fluorescent material (known as retro-reflective tape) that reflects a large percentage of sunlight is usually sewn on one side of lifesaving craft coverings and has been detected as far away as five (5) miles with an average of 3.5 miles.

- 
- 2.4.3 Fluorescent sea dye marker, which stains the water a green or red colour, has been sighted as far away as 10 miles, with an average of three (3) miles. However, sea dye is not visible when searching up-sun because of surface glare.
  - 2.4.4 Orange smoke generating signals have been sighted as far away as 12 miles with an average of eight (8) miles. Smoke signals are most effective in calm wind conditions and open terrain. The effectiveness of smoke signals decreases rapidly with an increase of wind speed above 15 knots.
  - 2.4.5 Pyrotechnic flares may be used in daylight; however their detectable range is only about 10 per cent of the night-time range.

### Night-time Devices

- 2.4.6 On land, fires are arguably the most effective night time signal that survivors may use. Fires have been sighted as far as 50 miles away, with the average range varying with the size of the fire and the absence of other light sources on the earth's surface.
- 2.4.7 Flashing strobe lights are an effective compact night signalling device available for individual survivors. Strobe lights have been sighted as far as 20 miles away with an average of 3.5 miles.
- 2.4.8 Incandescent lights that are used on some individual lifejackets have a much smaller detectable range than strobe lights, generally about 0.5 mile.
- 2.4.9 Flares, star shells and rockets have been detected as far away as 35 miles, with an average of 25 miles.

### RADAR/IFF/SSR

- 2.4.10 Besides the obvious RADAR target of the distressed craft itself, IFF (Identification Friend or Foe) may be used not only to indicate distress but also to increase the detectable range by RADAR.
- 2.4.11 The basic equipment consists of an interrogator and a transponder. The interrogator, which is usually incorporated into air search RADAR systems, transmits electronic challenges, and if any replies are received will display them on the Radarscope. The transponder, which is usually installed in aircraft, ships and boats, is triggered into operation by the interrogator's challenge and transmits a series of pulses. The reply is displayed as small bars slightly beyond the RADAR target of the transponder-equipped craft. Since interrogators usually use the same antenna as the air search RADAR, replies are only received as the search RADAR beam sweeps across the transponder-equipped craft. In addition, transponder replies will be detected at much greater ranges than the RADAR return from the craft itself.
- 2.4.12 Secondary Surveillance RADAR (SSR) is the name used to describe similar equipment in use by Airservices Australia and civil aircraft. Military mode 3 is the same as civil mode A and thus the systems are compatible for air traffic control and emergency purposes. Military mode 3, code 7700 and civil mode A, code 7700 transmits an

---

emergency signal and, unless amplified by additional information, will be considered as a distress signal.

## Radio and Distress Beacons

2.4.13 In addition to the obvious uses of standard radio for transmitting emergency signals and messages, there are a variety of types of emergency equipment designed for use by survivors or carried in the vessel's wheelhouse. These include:

- a) Hand held VHF transmitters found in life rafts;
- b) 406 MHz distress beacons (GMDSS approved); An AIS-SART; and
- c) 9 GHz SAR Transponders.

## 2.5 COSPAS-SARSAT Distress Beacon Detection System

### Overview

- 2.5.1 COSPAS-SARSAT is a satellite system designed to provide distress alert and location data to assist SAR operations, using spacecraft and ground facilities to detect and locate the signals of distress beacons operating on 406 MHz. The responsible Cospas-Sarsat Mission Control Centre (MCC) forwards the position of the distress and other related information to the appropriate SAR authorities. Its objective is to support all organisations in the world with responsibility for SAR operations, whether at sea, in the air or on land.
- 2.5.2 The Cospas-Sarsat System provides distress alert and location data to RCCs for 406 MHz beacons activated anywhere in the world. In the Australia/New Zealand region, the Australian Mission Control Centre (AUMCC) is located in JRCC Australia and controls the three LUTs located at Albany, Western Australia, Bundaberg, Queensland and Wellington, New Zealand.

### Purpose

- 2.5.3 The primary purpose of this system is to detect, positively identify and provide the positions of 406 MHz EPIRBs, ELTs and PLBs anywhere in the world.
- 2.5.4 The worldwide system comprises:
- a) Low orbiting satellites in near polar orbits;
  - b) Satellites in geostationary orbit;
  - c) Local User Terminals (LUTs), which are ground stations that receive and initially process the raw distress signal data relayed by a satellite;
  - d) Mission Control Centres (MCCs) which are responsible for the final processing and appropriate distribution of beacon detections; and
  - e) Frequency stable 406 MHz beacons, each with a unique identification code and capable of transmitting for 24 or 48 hours depending on their use.



---

## Satellites

- 2.5.5 The satellite constellation is made up of search and rescue satellites in low earth orbit (LEOSAR) and geostationary orbit (GEOSAR).
- 2.5.6 Each LEOSAR satellite makes a complete orbit of the earth around the poles in about 100 – 105 minutes. The satellite views a "swath" of the earth of approximately 4000 km wide as it circles the globe, giving an instantaneous "field of view" about the size of a continent. When viewed from the earth, the satellite crosses the sky in about 15 minutes, depending on the maximum elevation angle of the particular pass.
- 2.5.7 Satellites are not equally spaced and hence do not pass over a particular place at regular intervals. In view of this, pass schedules are computed for each LUT every day. On average a satellite will pass over continental Australia every 90 minutes but, because of the irregularity of passes, there could be up to five (5) hours between passes.
- 2.5.8 The current GEOSAR constellation is composed of five satellites provided by the USA, GOES 11 and GOES 12, and satellites provided by India (INSAT-3A) and Europe (MSG 1 and MSG 2.). These satellites provide continuous global coverage for 406 MHz beacons with the exception of the Polar Regions. To take full advantage of the real-time alerting capability the beacon must be designed to transmit, in its distress message, position data derived from a satellite navigation system such as GPS.
- 2.5.9 GOES-11 covers Australia's area of interest in the Pacific while INSAT-3A provides coverage over the Indian Ocean region as far as the east coast of Australia. Continental Australia is on the edge of coverage for the GOES-11 satellite and detection of 406 MHz beacons on land depends very much on the terrain and how the beacon is positioned.

## Beacon Detection

- 2.5.10 With the exception of the GEOSAR, the position of a distress beacon is calculated by using Doppler shift, which is caused by the relative movement between a satellite and a beacon. As a satellite approaches a beacon there is an apparent rise in the beacon frequency and as the satellite moves away the frequency appears to fall. When a satellite is at its closest point to a beacon the received frequency is the same as the transmitted frequency (the point of inflection) and provides the "Time of Closest Approach" (TCA).
- 2.5.11 This method of calculation produces two possible positions for each beacon (labelled A and B), either side of the satellite's ground track; one is the true position and the other is its mirror image. The ambiguity is due to the equipment only being able to determine the distance between a satellite and a beacon and not the direction. Position ambiguity is subsequently resolved by using:
- a) Data obtained by the same LUT from the next satellite pass which "sees" the beacon; or

- b) Data from another satellite pass observed by a different LUT.

## Beacons

- 2.5.12 There are three types of Cospas-Sarsat distress beacons:
- a) Emergency Locator Transmitters (ELT) used by aviators;
  - b) Emergency Position Indicating Radio Beacons (EPIRB) used by mariners; and
  - c) Personal Locator Beacons (PLB) used on land.
- 2.5.13 Aviators and mariners often carry PLBs as personal back up devices to ELTs and EPIRBs.
- 2.5.14 Because 406 MHz beacons transmit an extremely stable frequency, positions calculated by the LUT usually fall within a radius of 5km from the actual beacon position. All 406 MHz beacons sold in the Australian region are required to transmit on 121.5 MHz to facilitate homing.
- 2.5.15 406 MHz beacons use digital technology that allows an identifier to be sent when the beacon is activated. This identifier correlates to a registration database held at the MCC and allows additional information to be gained about the target. 406 MHz beacons should be coded with a country code and registered in the country that maintains the database for that country code. It is therefore important that all Australian 406 MHz beacons are registered with JRCC Australia.
- 2.5.16 If an Australian beacon is detected overseas, the overseas SAR authority may contact JRCC Australia for appropriate details. Similarly, if a foreign-registered 406 MHz beacon is detected in the Australian SAR area, the Australian RCC contacts the appropriate overseas registration authority to obtain further relevant SAR data.
- 2.5.17 Satellite processing of 121.5 MHz alerts ceased on 1 February 2009, from 1 February 2010, it became illegal to operate the older analogue distress beacon transmitting on 121.5 MHz or 243MHz.

## 2.6 Other Types of Distress Alerting Devices

- 2.6.1 Advances in technology have seen the development of satellite tracking devices.

### SPOT Personal Satellite Messenger device (SPOT)

- 2.6.2 The SPOT device and its associated service originate from a USA company called SPOT LLC. SPOT is primarily a tracking device which can also send preformatted messages indicating that a person is safe or that they require non-emergency assistance. In addition the user is able to alert an Alerting Post that they are in distress. SPOT LLC has contracted for the provision of 24-hour emergency monitoring and response to SPOT users through the International Emergency Response Coordination Centre (IERCC), an Alerting Post located in the United States of America. These devices operate on cellular or satellite telephone networks and are therefore vulnerable to coverage limitations. The devices offer a range of functions

---

which may be more attractive to a hiker or bushwalker than a Cospas-Sarsat approved device but there are limitations to the devices that could hamper a search and rescue effort.

**Note**

A Memorandum of Understanding has been reached between AMSA and the IERCC regarding the handling of SPOT-initiated distress alerts. The IERCC will notify JRCC Australia of any distress alerts within the Australian SRR. JRCC Australia will then coordinate any SAR response required or transfer coordination to another Australian SAR authority where appropriate.

**AIS-SART**

- 2.6.3 The AIS-SART derives position and time synchronization from a built in GNSS receiver and transmits its position with an update rate of one (1) minute. Every minute the position is sent as a series of eight (8) equal position reports, this is to maintain a high probability that at least one of the position reports is sent on the highest point of a wave.
- 2.6.4 Shipboard Global Maritime Distress Safety System (GMDSS) installations include one or more search and rescue locating devices. These devices may be either an AIS-(AIS Search and Rescue Transmitter SART) (from 1 January 2010), or a RADAR-SART (Search and Rescue Transponder). The AIS-SART is used to locate a survival craft or distressed vessel by sending updated position reports using a standard AIS class A position report. The position and time synchronization of the AIS-SART is derived from a built in Global Navigation Satellite Systems GNSS receiver.

**Maritime Survivor Locating Systems. VHF DSC Maritime Survivor Locating Devices (MSLD).**

- 2.6.5 The VHF DSC MSLD, such as the Mobilarm Crewsafe series of beacons, transmit a MAYDAY using a synthesised voice on VHF Channel 16 and a distress alert on DSC (VHF Channel 70) immediately a man overboard incident occurs (or when the unit is manually activated), this is repeated once the MSLD obtains a GPS position (within 1 minute) and is updated every 5 minutes for the first 30 minutes, and then every 10 minutes for the life of the battery (24 hrs). The MSLD includes the MMSI for identification; some MSLD may also transmit on AIS and a 121.5 MHz homing signal.

**Thuraya Satellite Devices**

- 2.6.6 The Thuraya Telecommunications Company (“Thuraya”) runs and operates the Thuraya Satellite Network to provide telecommunications products and services in the coverage area of the Thuraya Satellite System. Thuraya devices have the capability to provide a distress alerting function to subscribers. The Thuraya subscriber will initiate an emergency call by pressing and holding a “special button” or activating a special function on the Thuraya device. The device will then obtain a GPS fix and send the location and event request via the Thuraya satellite system.

- 
- 2.6.7 For the Australian SRR, Thuraya is responsible for immediately notifying JRCC Australia of the emergency assistance request (distress alert) for necessary support and action. JRCC Australia is the sole Australian point of contact for Thuraya unless agreed by the Parties for the distress alert to be sent to another location. Furthermore, the subscriber may program their unit to send the same alert to other destinations in addition to JRCC Australia.
- 2.6.8 In accordance with the Australian National SAR Plan, overall coordination of a SAR operation may be transferred from JRCC Australia to an Australian State or Territory Police force or service. In such circumstances, JRCC Australia will inform Thuraya of the transfer of overall coordination.

#### Note

There is an MOU in place between AMSA (JRCC Australia) and Thuraya Telecommunications Company regarding the above.

## 2.7 SAR RADAR Transponder (SART)

### Overview

- 2.7.1 Satellites can detect and provide the positions of the latest distress beacons to an accuracy of a few miles/kilometres. Though this is extremely good, in poor visibility it may not be sufficient to permit a searching craft to quickly locate survivors. To overcome this problem, a SAR transponder (SART) has been developed which will respond to the normal 3cm X-band (9 GHz) RADAR fitted to merchant ships. It will NOT respond to 10cm S-band (3 GHz) RADAR. It is a short-range homing device, which enables ships and other suitably equipped craft to home on the source of the signal. This facility is in accordance with IMO Resolution A. 530(13) - Use of RADAR transponders for search and rescue purposes.
- 2.7.2 The SART can be either a stand-alone item of equipment or built into an EPIRB.
- 2.7.3 When within RADAR range, the SART will respond to 3cm RADAR pulses by painting a line of blips extending outwards from the SART's position along its line of bearing on the RADAR screen. When within about one (1) mile of the SART, the blips may change to wide arcs or even complete circles thus giving an indication of the close proximity of the SART, but masking its bearing. Decreasing the GAIN on the search craft's RADAR should restore the blips to view.
- 2.7.4 Since the RADAR detection range depends primarily upon the height of the RADAR scanner and the height of the beacon, it is probably not realistic to expect a detection range of much more than 30 miles for an aircraft flying at 3000 ft equipped with 3cm (9 GHz) RADAR and about 10 miles for a ship's RADAR and a few miles for a motor launch. However, bearing in mind that it is a short-range homing device, this should be adequate for final location.
- 2.7.5 Tests have shown that the operation of a SART inside the canopy of a life raft will significantly decrease its detection range, so every effort should be made to operate

---

it from outside the canopy and as high as possible. Battery life in the "standby" mode is 96 hours and about eight (8) hours during RADAR interrogation.

## 2.8 Communications in Support of SAR Operations

### Overview

- 2.8.1 The SMC is responsible for designating specific frequencies for on-scene use during SAR operations, and for establishing reliable communications with adjacent operations centres. When appointed, the Coordinator Surface Search (CSS) or the On Scene Coordinator (OSC) is responsible for establishing reliable communications between all participating search units and the RCC.
- 2.8.2 The SMC is responsible for informing all SAR participants of the specific frequencies selected for an operation. The SMC should designate a primary and secondary frequency in the appropriate frequency bands (HF, VHF and UHF) for use as on-scene channels.

### SAR Frequencies

- 2.8.3 The following frequencies have been authorised for use in SAR operations:
  - a) **2182, 3023, 4125, 5680 kHz.** These frequencies may be used for communications between mobile stations when employed in coordinated search and rescue operations, including communications between these stations and participating land stations;
  - b) **123.1 MHz.** The international SAR on-scene frequency for use in coordinated SAR operations. Ships with this capability are authorised to communicate on this frequency with aircraft for safety purposes;
  - c) **123.2 MHz.** For supplementary continental use in on-scene coordination within the Australian SRR; and
  - d) **282.8 MHz.** Used by military ships and aircraft for communications during coordinated SAR operations.
- 2.8.4 The aeronautical mobile service uses amplitude modulation (AM) for VHF telephony while the maritime mobile service uses frequency modulation (FM). These services are incompatible.

### SAR Call Signs

- 2.8.5 While it was traditional for aircraft to only use 'RESCUE' call signs when engaged on actual SAR operations, the growth of the Emergency Medical Service sector has seen call signs prefixed with 'RESCUE' being used on a day-to-day basis. The authority for the use of 'RESCUE' call signs rests with Airservices Australia, which has accepted this practice. The call signs being used are either in the Army aircraft block or the civil aircraft block (see below). The only organisation routinely using 'RESCUE' call signs

---

for SAR tasks is the RAAF. The RAAF has sub- divided its block and allocated specific call signs to various bases.

2.8.6 With the exception of the RAAF, the normal practice is for aircraft engaged in SAR operations to continue to use their existing civil or military call sign. In exceptional circumstances, search aircraft may be allocated a 'RESCUE' call sign followed by a three-digit number that is drawn from the following bands:

- a) **Army Aircraft - 001-100;**
- b) **RAAF aircraft - 101-310;**
- c) **Civil aircraft - 311-799;**
- d) **Naval aircraft - 800-930; and**
- e) **Foreign aircraft - 931-999.**

2.8.7 If allocation of call signs for surface units is required, the following may be used:

- a) **Marine craft: 'SAR LAUNCH ... (number)'; and**
- b) **Land units: 'LAND RESCUE ... (number)'.**

2.8.8 Ships of the Australian Defence Force will use their names as call signs when employed on SAR operations.

## 2.9 Communications Facilities

### Overview

2.9.1 There are many communication facilities available for use in SAR operations. It is important that personnel employed in SAR learn what facilities and services are available at their specific location and throughout their area of operations. Some of the more extensive and readily available facilities are:

- a) The AMSA HF DSC network operating two maritime communications stations (Wiluna and Charleville). The network Coordination Centre is collocated with JRCC Australia that allows direct communications between JRCC Australia and SAR units on scene when working HF frequencies;
- b) The State and Territory authorities have in place a network of nine limited coast radio stations around Australia monitoring 4, 6 and 8 MHz distress frequencies in the HF voice band (see Para 2.6.5). These authorities also operate VHF sites covering channel 16 and 67;
- c) Each State/Territory has an extensive volunteer marine radio network. Many of these stations do not operate 24 hours but do operate in the 27 MHz, VHF and MF bands;

- d) Discon - this is an extensive secure network linking all Defence authorities. It interfaces with the Naval Broadcast System for ships at sea and the RAAF ground-to-air communication system;
- e) Aeronautical Fixed Telecommunications Network (AFTN) - an international teleprinter network based on ICAO requirements for air navigation services, including SAR. Details of the network can be found in the communications section of the various ICAO Regional Air Navigation Plans. The AFTN in Australia is operated by Airservices Australia;
- f) Satellite communications offering voice, FAX and data;
- g) Mobile phone and fax communications; and
- h) SKYCOMS - Communication with airborne aircraft may be established by telephone through SKYCOMS, Sydney, who have the ability to establish two way contact with suitably equipped aircraft on a discrete frequency. The RCC should advise the aircraft's call sign, position, the time contact is desired and a designated RCC telephone number to SKYCOMS who will establish contact with the aircraft through the Telstra supervisor and "patch" the aircraft to the RCC on the designated telephone number.

## Communications Capabilities Australian Defence Force Ships and Aircraft

- 2.9.2 Ships and aircraft of the Australian Defence Force are fitted with communications equipment which allows for coverage of many of the emergency and SAR frequencies. Table 2-1 shows the communications capabilities of ships of the defence force by type.

Frequency Band Unit/Type	2 to 30 MHz	118 to 136 MHz	156 to 174 MHz	225 to 400 MHz
Frigates and larger	X		(1)	X
Small ships and	X		(1)	X

Table 2-1 Communication Capability Ships of the RAN

**Note:** Frequency coverage in this band depends on the type of equipment fitted. However, all ships can monitor 156.8 MHz FM.

- 2.9.3 The RAN is in the process of equipping its warships with a full suite of GMDSS communications comprising Inmarsat C and VHF/HF DSC. Military units are generally fitted with 406 MHz distress beacons.

### International Distress Frequencies - Guarded by Royal Australian Naval Ships

- 2.9.4 A distress watch is maintained as follows by naval ships at sea:

Major warships (Frigates and above)	HF/VHF DSC, VHF Channel 16	Listening watch will be maintained on Channel 16 until further notice.
Minor warships (Patrol boats and mine-hunters)	VHF Channel 16	Continuous loudspeaker watch.

**Table 2-2 Distress frequencies guarded by RAN**

### Lines of Communications - NAVY

2.9.5 When a SAR operation is in progress and RAN resources are allocated, the RCC would normally liaise with HQJOC JCC MAROPS (MAROPS). However, in some situations, MAROPS may authorise the RCC to communicate directly (DIRLAUTH) with the RAN resource involved. HQJOC and the appropriate involved units are to be included as information addressees on all relevant signal traffic.

### Search and Rescue Visual Signals

2.9.6 Appendix E lists some of the international visual signals that can be used for Search and Rescue purposes. The appendix also contains other visual signals that maybe used by ships or aircraft of other nations when in the Australian SRR.

### Merchant Shipping and GMDSS

2.9.7 Communications between merchant vessels in distress and SAR organisations are achieved by a satellite and radio watch system known as the Global Maritime Distress and Safety System (GMDSS). The GMDSS enables a distress alert to be transmitted and received automatically over short and long distances. The system allows SAR authorities as well as shipping in the vicinity of the distress to be rapidly alerted so that a coordinated search and rescue operation can be commenced with the minimum of delay.

2.9.8 Additionally the GMDSS provides for urgency and safety communications, and the dissemination of Maritime Safety Information (MSI). Certain fishing vessels and other marine craft may also carry GMDSS equipment. RCC personnel may seek advice from JRCC Australia staff who are familiar with the SOLAS GMDSS provisions and associated IMO documents. GMDSS equipped vessels can be expected to perform the following functions wherever they operate:

- a) Transmit ship-to-shore distress alerts by two independent means;
- b) Receive shore-to-ship alerts (usually relayed by International RCCs);
- c) Transmit and receive;
- d) Ship-to-shore alerts;
- e) SAR coordinating communications;
- f) On-scene communications;



- 
- g) Locating signals;
  - h) Maritime safety information;
  - i) General radio communications to and from shore; and
  - j) Bridge to bridge communications.

## Limited Coast Radio Stations

- 2.9.9 In Australia, Limited Coast Radio Stations (LCRS) are located in nine locations: Sydney, Gladstone, Cairns, Darwin, Port Hedland, Fremantle, Adelaide, Melbourne and Hobart and maintain a continuous radio watch by monitoring the following distress frequencies:
- a) 4125, 6215, and 8291 kHz with 8176 kHz used to broadcast weather and warnings at regular times;
  - b) 156.8 MHz (VHF CH16). Channel 16 is monitored in various other locations in each State/Territory;
  - c) Channel 67 is used to broadcast weather and warnings.
- 2.9.10 The State/Territory LCRS use the common call sign of “Coast Radio” preceded by the site. For example: Hedland Coast Radio or Hobart Coast Radio.
- 2.9.11 In addition to the State/Territory LCRS, the SAR net is extended by Limited Coast Stations operated by fishing cooperatives and volunteer SAR organisations. Each Limited station caters for a group or groups of marine craft in its local area. Depending on the capability of its equipment, a Limited station may monitor 2182/2524 kHz, VHF CH16 and 27.88 MHz for pleasure craft, and 2182/2112/4535/4620 kHz and VHF CH16 for fishing craft.

## Ship Stations

- 2.9.12 There are three distinct categories of vessels to be catered for by the marine SAR system; these are:
- a) Deep sea vessels (SOLAS);
  - b) Fishing vessels; and
  - c) Pleasure craft.
- 2.9.13 Most deep-sea vessels will carry communications equipment compatible with the GMDSS. Other vessels, most of which use satellite communications, may extend this coverage. A continuous bridge listening watch is kept on VHF Ch16, as far as is practicable.

---

## Fishing Vessels

- 2.9.14 Some fishing vessels will carry GMDSS equipment; however the majority of fishing vessels carry a variety of radio equipment and do not maintain regular watches. Frequencies allocated to fishing vessels are normally not compatible with large ships.
- 2.9.15 Some fishing vessel operators are members of cooperatives and their normal procedure whilst fishing is to maintain daily radio schedules with the cooperative base station.
- 2.9.16 AFMA and some State Fisheries Authorities use Vessel Monitoring Systems utilising Inmarsat-C polling to track fishing vessels in their fisheries for regulatory reasons. These authorities may be able to assist an RCC in contacting or locating fishing vessels.

## Pleasure Craft

- 2.9.17 These craft are under state control and hence the regulations concerning the carriage of radio and other SAR equipment vary from state to state, and within the state, depending upon the type and size of craft and its area of operations.
- 2.9.18 There is a general acceptance by the boating community of the need to carry some type of radio and the 27 MHz marine radio is most popular. 27.88 MHz has been designated as the primary distress, safety and calling frequency, with 27.86 MHz as the secondary.
- 2.9.19 These frequencies are often referred to as channels 88 and 86 respectively and care must be taken not to confuse them with the VHF Marine FM frequencies that are always referred to as channels. VHF Marine FM radio is increasingly being used by pleasure craft.

## Volunteer Organisations

- 2.9.20 Clubs and other interested groups have set up base radio stations, mainly in popular sea recreational areas around Australia. Each station is normally staffed on an “as required” or “considered necessary” basis. Some offer continuous coverage, but most offer only casual coverage.
- 2.9.21 The majority of voluntary organisations equipped with HF SSB equipment are capable of responding to calls on the 2 MHz, 4 MHz and 6 MHz marine bands.
- 2.9.22 2182 kHz is normally monitored continuously as the internationally recognised primary Distress frequency on HF. However, 2524 kHz as the calling and working frequency for shore stations and pleasure craft, is still traditionally preferred and monitored by many operators since in the past informal communications on this frequency were not subject to operational controls by the ACA.
- 2.9.23 In addition to HF, the use of VHF Maritime Mobile FM (156-174 MHz) service equipment and 27MHz Inshore Boating Radio Communication service equipment is

---

gaining popularity with small craft owners. The recognised Distress/Emergency frequencies respectively are VHF Ch16 and 27 MHz Channel 88.

2.9.24 The use of the 27MHz band is uncontrolled and not guarded on an official basis.

### **Communication Capabilities of State & Territory SAR Authorities**

2.9.25 State SAR authorities maintain extensive communications networks both interstate and intrastate. Arrangements for the use of these communications facilities are in accordance with Commonwealth-State SAR plans.

#### **Command/Communications Caravans**

2.9.26 There are a number of Police and emergency services communications caravans around Australia and these are equipped to utilise available communications facilities and may be deployed to a Forward Field Base.

#### **Marine**

2.9.27 Each State/Territory SAR authority maintains radio-equipped vessels with in-shore SAR capabilities.

#### **Air Wings**

2.9.28 States and Territories have air units with appropriate communications equipment.

### **Communications Aircraft**

2.9.29 A dedicated communications aircraft should be used when communications are expected to be poor in the search area and:

- a) HF is the only means of communication;
- b) It is a large scale search;
- c) It is necessary to improve information feedback into the RCC;
- d) It is necessary to improve information flow to SAR units;
- e) Search aircraft are operating without contact with a ground station; or
- f) It is the best method of maintaining communications with survivors/ground search units and ground rescue units.

2.9.30 A communications aircraft will normally be a suitably equipped SAR Unit aircraft or a Military aircraft, have a minimum crew of pilot and radio operator, and have good on scene endurance.

### **Inmarsat Aero**

2.9.31 Subscribers to the INTERNATIONAL MARITIME SATELLITE (INMARSAT) Aeronautical System may make telephone and facsimile calls while airborne by way of this system. Similarly, terrestrial subscribers may initiate communication with airborne aircraft fitted with INMARSAT aeronautical satellite communication (SATCOM) equipment.

- 
- 2.9.32 Not all countries have arrangements to route ground originated calls to the INMARSAT Aeronautical System.
- 2.9.33 The INMARSAT Aeronautical System offers a capability for communication of distress calls from airborne aircraft via a Land Earth Station (LES) to nominated SAR centres. The Perth LES provides ground-to-air and air-to-ground voice and data facilities for aircraft operations throughout the Indian and Pacific Oceans. It is conceivable that the Perth LES could receive distress calls originating from two thirds of the globe.
- 2.9.34 Perth LES has a standing procedure to relay all distress calls received via this system to the Australian RCC. Voice calls are directed automatically to the designated RCC telephone number, an alarm will be generated indicating a distress call is being processed and a hard copy print out will be produced detailing a LES-specific aircraft identification. LES staff will contact the RCC as a matter of urgency to ensure SAR staff have received the message. If required, the LES staff can access station files to determine the aircraft registration from the LES-specific identification provided in the original message. The RCC will then be enabled to begin checks to ascertain the status of the aircraft. The RCC will only consider a distress situation exists after voice contact with the subject aircraft has been established and the situation evaluated.
- 2.9.35 No international agreements for coordinated handling of distress calls outside Australian airspace are yet in place. However, in keeping with fundamental RCC procedures, the RCC when made aware of an aircraft in distress through this system shall initiate action to confirm the circumstances and location of the aircraft. Then render all possible assistance and work to establish those ground units best placed to provide an on-going SAR service. Checks should be made through ATS units and RCCs with responsibilities in airspace in which the distressed aircraft is thought to be operating.

---

## Chapter 3: Awareness and Initial Action

### 3.1 Awareness and Notification

#### Introduction

3.1.1 When the SAR system first becomes aware of an actual or potential emergency, the information collected and the initial action taken are often critical to successful SAR operations. It must be assumed that in each incident there are survivors who will need assistance and whose chances of survival are reduced by the passage of time. The success of a SAR operation depends on the speed with which the operation is planned and carried out. Information must be gathered and evaluated to determine the nature of the distress, the appropriate emergency phase, and what action should be taken. Prompt receipt of all available information by the RCC is necessary for thorough evaluation, immediate decision on the best course of action and a timely activation of SAR assets to make it possible to achieve the following:

- a) Locate, support and rescue persons in distress in the shortest possible time.
- b) Use any contribution survivors may still be able to make towards their own rescue while they are still capable of doing so.

3.1.2 Experience has shown that the chances for survival of injured persons decrease by as much as 80% during the first 24 hours, and those for uninjured persons diminish rapidly after the first three days. Following an accident, even uninjured persons who are apparently able-bodied and capable of rational thought are often unable to accomplish simple tasks and are known to have hindered, delayed or even prevented their own rescue.

### 3.2 SAR Stages

3.2.1 The response to a SAR incident usually proceeds through a sequence of five stages. These stages are groups of activities typically performed by the SAR system in responding to a SAR incident from the time the system becomes aware of the incident until its response to the incident is concluded. The response to a particular SAR incident may not require the performance of every stage. For some incidents, the activities of one stage may overlap the activities of another stage such that the portions of two or more stages are being performed simultaneously. The five SAR stages are:

- a) **Awareness.** Knowledge by any person or agency in the SAR system that an emergency situation exists or may exist.
- b) **Initial Action.** Preliminary action taken to alert SAR assets and obtain more information. The stage may include evaluation and classification of the information, alerting of SAR assets, communication checks and, in urgent situations, immediate performance of appropriate activities from other stages.

- 
- c) **Planning.** The development of operational plans including plans for search, rescue and final delivery of survivors to medical facilities or other places of safety as appropriate.
  - d) **Operations.** Dispatching SAR assets to the scene, conducting searches, rescuing survivors, assisting distressed craft, providing necessary emergency care for survivors and delivering casualties to medical facilities.
  - e) **Conclusion.** Return of SRUs to a location where they are debriefed, refuelled, replenished and prepared for other missions, return of SAR assets to their normal activities and completion of all required documentation.

### 3.3 SAR Incidents

- 3.3.1 There are many different types of incidents reported to the SAR system that must be evaluated and resolved. Most of these incidents may be grouped by the type of craft involved, the environment, and in the case of individuals, by the type of difficulty being encountered.
- 3.3.2 In general a SAR incident is considered imminent or actual when it is apparent that persons are, or may be, in distress or when a request for assistance has been received.

#### Maritime SAR Incident

- 3.3.3 A maritime SAR incident is considered imminent or actual when any of the following conditions exist:
  - a) A surface vessel or craft has requested assistance.
  - b) A surface vessel or craft has transmitted a distress signal.
  - c) It is apparent that a surface vessel or craft is in distress.
  - d) A surface vessel or craft is reported to be sinking or to have sunk.
  - e) The crew is reported to have abandoned ship or is about to do so.
  - f) Reports indicate that the operating efficiency of the craft is so impaired that the craft may sink or the crew may be forced to abandon.
  - g) The surface vessel or craft is overdue or unreported.
  - h) Persons are in the water and require assistance.
  - i) A distress beacon has been activated.
  - j) A MEDEVAC is required on medical advice.

---

## Aviation SAR Incident

3.3.4 SAR alerting action is based upon the type of notification and flight procedures adopted by an aircraft, for example:

- a) Aircraft that comply with full reporting procedures where a continuous communications SAR watch is maintained fails to report at the next scheduled time.
- b) Aircraft that have nominated a SARTIME where alerting action commences at the time of expiration of the SARTIME.
- c) Aircraft that have not submitted flight notification where alerting action is commenced on the receipt of incidental information from any source which leads to doubt as to the aircraft's safety. This includes notification from a person or organisation holding a Flight Note.

3.3.5 An aircraft SAR incident is considered imminent or actual when:

- a) A SARTIME for an aircraft has not been cancelled.
- b) An aircraft fails to report arrival or if it has failed to report position,
- c) ATS declare a SAR phase (INCERFA, ALERFA or DETRESFA),
- d) Information is received that an aircraft on which no flight notification has been lodged is missing, including notification from a person or organisation holding a Flight Note.
- e) An aircraft, which has been given approach or landing instructions, fails to land. Fuel on board is considered to be exhausted or to be insufficient to enable an aircraft to reach safety.
- f) Information is received which indicates that an aircraft is about to make or has made a forced landing, or has ditched or crashed.
- g) Information is received which indicates that the operating efficiency of an aircraft has been impaired to the extent that a forced landing is likely.
- h) A distress beacon is reported to be transmitting. (Aircraft required to carry a distress beacon normally have an ELT and/or PLB but may also carry EPIRBs, for example in life rafts).

## Land SAR Incident

3.3.6 A land SAR incident is considered imminent or actual when:

- a) a request for assistance is received;
- b) a vehicle or person is reported overdue;

- 
- c) it is apparent that a vehicle or person is in distress;
  - d) a distress beacon has been activated; and/or
  - e) a MEDEVAC is required.
- 3.3.7 The official reference document for Land SAR operations is the National Land Search Operations Manual.

## 3.4 Emergency Phases

- 3.4.1 Emergency phases are based on the level of concern for the safety of persons, vessels or aircraft. Upon initial notification the notified SAR authority or ATS unit classifies the SAR incident as being in one of the three following emergency phases:
- a) **Uncertainty Phase (INCERFA).**
  - b) **Alert Phase (ALERFA).**
  - c) **Distress Phase (DETRESFA).**
- 3.4.2 The emergency phase may be reclassified by the SMC as the situation develops. The current emergency phase should be used in all communications about the SAR incident as a means of informing all interested parties of the current level of concern for the safety of persons or craft which may be in need of assistance.
- 3.4.3 Maritime search and rescue in Australia is based on the GMDSS and although there are three forms of messages from a ship to the SAR authority, there is no mention of emergency phases in GMDSS documentation or IAMSAR Volume 3, the SAR manual carried by ships. However emergency phases are referred to in IAMSAR Volume 1 and 2 and SAR officers do escalate incidents as information is received that indicates a heightened level of concern for the safety of a vessel or aircraft. Therefore emergency phases should be used internally among maritime SAR authorities to indicate the level of concern and as criteria for escalating a SAR action. An uncertainty phase relates to a safety broadcast, the alert phase to an urgency broadcast and a distress phase to the distress broadcast.

### Uncertainty Phase

- 3.4.4 The uncertainty phase is assigned any time doubt exists as to the safety of a craft or person because of knowledge of possible difficulties, or because of lack of information concerning progress or position. **The keyword is DOUBT.**
- 3.4.5 An Uncertainty Phase is said to exist when there is knowledge of a situation that may need to be monitored, or to have more information gathered, but that does not require dispatching of resources. When there is doubt about the safety of an aircraft, ship, other craft or people, the situation should be investigated and information gathered. For aircraft, an INCERFA is declared when:



- 
- a) No communication has been received from an aircraft within a period of fifteen (15) minutes after the time a communication should have been received, or from the time an unsuccessful attempt to establish communication with such aircraft was first made, whichever is the earlier.
  - b) An aircraft fails to report departure from a Mandatory Broadcast Zone (MBZ) or non-standard Common Traffic Advisory Frequency (CTAF) area after a call notifying readiness to taxi or take-off or after an airborne call from within a MBZ or CTAF area, within five (5) minutes after estimate for the boundary.
  - c) An aircraft fails to arrive within 15 minutes of the last estimated time of arrival last notified to or estimated by ATS units; whichever is the later, except when no doubt exists as to the safety of the aircraft and its occupants.
- 3.4.6 For ships or other craft or missing persons, an Uncertainty Phase is declared where the craft or persons have:
- a) been reported overdue at the intended destination;
  - b) failed to make an expected position safety report; or
  - c) there has been no immediate request for assistance received but the possibility exists that a situation could escalate.

### Alert Phase

- 3.4.7 The alert phase is assigned any time apprehension exists for the safety of a craft or person because of definite information that serious difficulty exists which does not amount to a distress or because of a continued lack of information concerning progress or position. **The key word is APPREHENSION.**
- 3.4.8 An Alert Phase exists when an aircraft, ship or other craft, or persons are having some difficulty and may need assistance, but are not in immediate danger.
- 3.4.9 Apprehension is usually associated with the Alert Phase, but there is no known threat requiring immediate action. SRUs may be dispatched or other SAR assets diverted to provide assistance if it is believed that conditions might worsen or that SAR assets might not be available or able to provide assistance if conditions did worsen at a later time.
- 3.4.10 For overdue craft, the Alert Phase is considered when there is a continued lack of information concerning the progress or position of a craft. SAR resources should begin or continue communications searches, and the dispatch of SRUs to investigate high-probability location or overfly the craft's intended route should be considered. Vessels and aircraft passing through areas where the concerned craft might be located should be asked to maintain a sharp lookout, report all sightings and render assistance if needed.
- 3.4.11 An Alert Phase is declared when:

- 
- a) Following the Uncertainty Phase, subsequent attempts to establish communication with the aircraft, ship or craft or missing persons have failed or inquiries to other relevant sources have failed to reveal any news.
  - b) An aircraft has been cleared to land and fails to land within five (5) minutes of the estimated time of landing and communication has not been re-established with the aircraft.
  - c) Information has been received which indicates that the operating efficiency of the aircraft, ship or other craft has been impaired but no to the extent that a forced landing or distress situation is likely, except when evidence exists that would allay apprehension as to the safety of that craft and its occupants.
  - d) An aircraft is known or believed to be the subject of unlawful interference.

## Distress Phase

- 3.4.12 The distress phase is assigned whenever immediate assistance is required by a craft or person threatened by grave or imminent danger or because of continued lack or information concerning progress or position. **The key words are GRAVE or IMMINENT DANGER and IMMEDIATE ASSISTANCE.**
- 3.4.13 The Distress Phase exists when there is reasonable certainty that an aircraft, ship or craft of persons are in imminent danger and require immediate assistance. For overdue craft, a distress exists when communications searches and other forms of investigation have not succeeded in locating the craft or revising its ETA so that it is no longer considered overdue. If there is sufficient concern for the safety of a craft and the persons aboard to justify search operations, the incident should be classified as being in the Distress Phase.
- 3.4.14 For aircraft, a Distress Phase is declared when:
  - a) Following the Alert Phase, the further unsuccessful attempts to establish communication with the aircraft and more widespread unsuccessful inquiries point to the probability that the aircraft is in distress.
  - b) The fuel on board is considered to be exhausted, or to be insufficient to enable the aircraft to reach safety.
  - c) Information is received which indicates that the operating efficiency of the aircraft has been impaired to the extent that a forced landing is likely.
  - d) Information is received or it is reasonably certain that the aircraft is about to make or has made a forced landing, except when there is reasonable certainty that the aircraft and its occupants do not require immediate assistance.
  - e) A report is received that a radio distress beacon has been activated or other visual distress signals have been observed.

- 
- 3.4.15 For ships, other craft or people, a Distress Phase is declared when:
- a) positive information is received that a ship or other craft or people are in danger and need immediate assistance; or
  - b) information is received which indicates that the operating efficiency of the ship or other craft has been impaired to the extent that a distress situation is likely.

### 3.5 Awareness Stage

- 3.5.1 When a SAR authority becomes aware of a possible SAR incident the SAR system is activated. The information is assessed and coordination is assumed or passed to the appropriate SAR authority for coordination.
- 3.5.2 Members of the public are encouraged to report any abnormal occurrence they have witnessed or heard about. Notification of an event may reach the RCC from any source including a member of the public, an ATS Unit or through a designated alerting post such as a police station.
- 3.5.3 For almost all emergency situations, action can be started as soon as the nature and general position of the emergency is known. Additional information, which might be helpful to the resolution of the incident, should be obtained after the initial action has been taken. Communications should be maintained with a craft or person reporting an emergency situation and they should be kept advised of the action being taken.

### Evaluation of Reports

- 3.5.4 All reports relating to a SAR operation must be carefully evaluated to determine their validity, the urgency for action and the extent of the response.
- 3.5.5 While evaluation of reports might be difficult and time-consuming, decisions must be made and action taken as quickly as possible. If confirmation of uncertain information cannot be obtained without undue delay, the RCC should act on a doubtful message rather than wait for verification.
- 3.5.6 The evaluation of reports on overdue or missing craft/persons should take account of:
  - a) Communication delays:

In some areas of the SRR, communication delays may prevent timely reporting. This should be kept in mind when evaluating the significance of a report in order to prevent unnecessary activation of the SAR system while ensuring that the SAR response is appropriate should the circumstance be real.
  - b) Weather conditions:

Adverse weather may contribute to communication delays or deviations from flight plan.

c) Habits of the individual:

Some individuals, including pilots, masters and hikers are known to react or may have been briefed to react in a certain manner in certain circumstances. Knowledge of these habits/company procedures may provide guidance in the evaluation of an incident and the subsequent planning and execution of search operations.

## Distress Alerts

3.5.7 Distress alerts may be received by the RCC from various sources. The following are typical examples:

- a) Aural reception of a distress beacon by an aircraft.
- b) Detection by the Cospas – Sarsat satellite system.
- c) Receipt through Airservices Australia. Receipt by the Inmarsat system, aeronautical or maritime.
- d) Receipt through a coast radio station.
- e) Receipt through other alerting systems, e.g. ARGOS.
- f) Direct communications from the public or the distressed craft.
- g) Another RCC or SAR authority.

## Notification by Airservices Australia

3.5.8 For aircraft communicating with Airservices Australia, the ATS unit responsible will declare the appropriate phase and transfer the phase to JRCC Australia in accordance with the agreed Memorandum Of Understanding (MOU).

3.5.9 JRCC Australia receives notification of aircraft emergencies through ATS units in most instances as they are in receipt of information on most flights within their areas of responsibility and are periodically in contact with the aircraft. Each ATS unit has a responsibility to provide an alerting service to all flights known to it.

3.5.10 Air traffic controllers are responsible for providing in-flight-emergency response (IFER) to distressed aircraft with which they are in contact. Alerting procedures for emergency facilities requested by a pilot are an Airservices Australia responsibility.

3.5.11 JRCC Australia will be alerted to problems affecting a flight that could seriously jeopardise its safety while en-route through Airservices Australia.

## SAR Incident Information

3.5.12 The following information, or as much of it as is required to address an emergency situation, should be obtained from the craft or the individual reporting the actual or potential emergency situation or incident. As many of the items should be obtained as circumstances permit.

---

### Air, Marine or Land Incident Information

- a) Name, address, and telephone number or contact point of person reporting.
- b) Distressed craft (name/type/callsign/registration) or identification.
- c) Position of emergency (latitude/longitude or bearing/distance) from a known point or the last reported position and the next reporting position).
- d) Nature of emergency (fire, collision, person overboard, disabled, overdue, crash or missing hiker etc.).
- e) Date/time of emergency occurrence.
- f) Date/time of notification.
- g) For aircraft, altitude, attitude, heading, speed and endurance.
- h) Craft description (size, type, markings, hull, colour of cabin, deck, rigging, fuselage colour, tail colour, wingtip colour, unusual features).
- i) Details of persons on board, persons involved (POB) including number of people involved, ages, state of health, injuries, and intentions.
- j) Date, time and departure point, planned route, speed, ETA and destination.
- k) Radio frequencies currently in use monitored or scheduled.
- l) Emergency radio equipment and frequencies, EPIRB, ELT, or flares.
- m) Actual weather/sea conditions.
- n) Local action being taken or assistance required.
- o) Owner/agent of distressed craft and contact method.
- p) Possible route deviations.
- q) Navigation capabilities.
- r) Survival equipment including quantity of food/water and signalling devices. Other information sources, e.g. friends, relatives, associates, yacht clubs, and aero clubs.
- s) Mobile phone numbers of any person.

### Person Overboard Incident Information

- a) Name and callsign of ship with man overboard.
- b) Position, course and speed of the ship.
- c) Date, time and position when the person went overboard.

- d) If time of person overboard unknown, when last seen.
- e) Weather conditions (include water temperature.
- f) Person's name, age and gender.
- g) Person's height and weight to determine survivability.
- h) Person's physical/mental condition and swimming ability.
- i) Person's clothing (amount and colour).
- j) Height of fall from ship to water.
- k) Lifejacket (worn, missing).
- l) Has the ship been completely searched?
- m) Will the ship search for the person overboard and, if so, for how long.
- n) Radio frequencies in use monitored or scheduled.
- o) Whether an urgency broadcast is requested.
- p) Assistance desired.
- q) Assistance being received.
- r) Initial reporter (parent agency, radio station, name/callsign of ship).
- s) Other pertinent information.

3.5.13 After evaluating all available information in every case, the RCC should declare the appropriate emergency phase (if not already declared), or review phase as appropriate.

### **Notification to States of Foreign Persons in Distress**

3.5.14 If a foreign registered aircraft is subject to a Distress Phase, that is found not to be a false alarm or is involved in an accident or a foreign national is killed or injured in a SAR related incident, the relevant foreign State is to be notified through the Department of Foreign Affairs and Trade (DFAT). SMC advice should be directed to the DFAT Communications Duty Officer or the Desk Officer for the State concerned.

### **Recording of Events**

3.5.15 The RCC shall maintain records for each incident in which all information should be recorded as it is received, either in full or by reference to other permanent records such as flight plans, forms, charts, hard copy messages, recorded RADAR data etc. Details of all phases notified to the RCC and all information relating to action initiated by the RCC shall be recorded in chronological order.

- 
- 3.5.16 Where information is contained in other records, (messages, forms etc.), these shall be held in such a way that reference to them may be easily made throughout the operation. All hard copy information shall be retained for filing.
- 3.5.17 Each day's search activity shall be plotted. The total search area shall be subdivided into sections assigned to each SAR unit showing individual search patterns, heights and other relevant details. A plot shall be kept of areas searched as well as those not searched.
- 3.5.18 Records may be kept of the actual hours of operation of search craft, showing individual transit times and times engaged in search and/or rescue activity. These records may be used for assessment of financial claims received from operators.
- 3.5.19 Records shall be kept of names of all volunteers used in SAR operations on assets tasked by the RCC usually in the form of a manifest.
- 3.5.20 When a search has been terminated without locating a missing aircraft or its occupants, all records, charts etc. shall be retained and be accessible to SAR staff to allow easy resumption of search activity should further intelligence be received.
- 3.5.21 Records relating to search and rescue operations, including air searches, on behalf of other organisations shall be retained.
- 3.5.22 Records should be retained for coroner's court/civil proceedings and for the possible access of other authorities.

## 3.6 Sequence of SAR Events

### Overview

- 3.6.1 Since no two SAR operations follow the same pattern, it is not possible to develop comprehensive procedures to apply to all situations. The actions described in the following paragraphs should be interpreted with flexibility as many of the activities described may be performed simultaneously or in a different order to suit specific circumstances.

### Uncertainty Phase Initial Action

- 3.6.2 When a SAR authority has declared an uncertainty phase, the RCC should take the following action:
- a) Designate an appropriately qualified officer as SMC for that action.
  - b) Verify the information received, considering the need to extend inquiries to:
    - i. JRCC Australia, ATS units, Police, or the Master of a vessel.
    - ii. Landing areas including the aerodrome of departure and other locations close to the route where a subject aircraft might have landed (inquiries

- 
- maybe made of groundsmen, refuellers, police and aerodrome operators etc.).
- iii. Aircraft, including the subject aircraft, known to be on the same route, in the same area or within communication range, by way of ATS units, or radio contacts calling or listening out, including monitoring emergency frequencies.
  - iv. Family, friends, operator of the aircraft, marinas, etc.
- c) When no flight plan has been filed, or in the case of ships or other craft, no information is available on the intentions of the captain, attempt to obtain information from which the route and departure, flight and arrival times of the aircraft, ship or other craft may be determined.
- d) Establish close liaison with alerting units to ensure that the following occurs:
- i. New information, (e.g.: obtained through widespread communication checks, requests to the public, review of weather factors, etc.), will be made immediately available to the RCC for evaluation, plotting, decision making etc.
  - ii. Duplication of action will be avoided.
- e) Plot the route of the subject craft, making use of all available intelligence.
- f) Conduct a communications search.
- g) Determine actual weather conditions along the route and at the destination.
- h) Record all incoming information and progress reports, details of action as described below, subsequent developments and decisions.

### Communication Search

- 3.6.3 The communication search can be conducted by the following two primary methods:
- a) Attempting to communicate with the aircraft, ship or other craft by all means of electronic communications through various paths.
  - b) Determining the target craft's most probable location by:
    - i. Making inquiries at aerodromes (including the aerodrome of departure) and other locations where an aircraft might have landed or at locations where a ship or other craft might have stopped or called (including the point or port of departure).
    - ii. Contacting other appropriate sources including persons who may have knowledge of the intentions of the pilot in command or ship's captain.



---

## Phase Transition

- 3.6.4 When the communications search or other information received indicates that the aircraft, ship or other craft is not in distress, the SAR authority will close the incident and immediately inform the operating agency, the reporting source and any alerted authorities, centres, or services. However, if apprehension regarding the safety of the aircraft, ship or other craft and its occupants continues, the Uncertainty Phase should progress to the Alert Phase.

## Alert Phase Procedures

- 3.6.5 When an Alert Phase has been declared by the RCC or transferred from Airservices, another RCC or SAR authority, the RCC should:
- a) Initiate or continue any appropriate actions normally performed during the Uncertainty Phase and in particular, ensure a SMC has been appointed and that all interested parties have been informed of the incident.
  - b) Record all incoming information and progress reports, details of action as described below, subsequent developments and decisions.
  - c) Verify the information received.
  - d) Obtain information about the aircraft, ship or other craft from other sources not previously contacted, such as:
    - i. Communications stations associated with radio navigation aids, RADAR facilities, direction-finding stations any may other communication stations that might have received transmissions from the craft.
    - ii. All possible landing or stopping points along the intended route and other agencies and assets included in the flight or voyage plan that may be capable of providing additional information or verifying information.
  - e) Maintain close liaison with relevant ATS units and, as appropriate, request that they:
    - i. pass information to aircraft involved in the emergency;
    - ii. inform aircraft operating in the vicinity of the subject aircraft of the nature of the emergency; and
    - iii. monitor and keep the RCC informed of progress of any aircraft whose operating efficiency is impaired.
  - f) Plot relevant details obtained through the actions described above on an appropriate map or chart to determine the probable position of the craft and its maximum range of action from its last known position and plot the positions of any craft known to be operating in the vicinity.

- 
- g) Consider initiating enroute diversions of other craft to attempt to locate or confirm the safety of the target craft subject to the agreement of the pilot in command/operator or master and there being no hazard due to weather or other factors including:
    - i. the diverted craft's operator shall be advised whenever a diversion is undertaken, and
    - ii. the capabilities of the aircraft considered for diversion including its navigation integrity and range, terrain, weather conditions and any other salient operational factors.
  - h) Thoroughly evaluate the plan, weather, terrain, possible communication aberrations, last known position, last radio communication and operator's qualifications and experience.
  - i) Estimate time of fuel exhaustion and research the craft's performance under possibly adverse conditions.
  - j) Determine and plot the most probable position of the craft and, if relevant, its maximum range of operation from its last known position.
  - k) Alert SAR units to the possible need for search and rescue action, obtaining relevant details of asset availability; if necessary placing assets on a higher level of readiness.
  - l) Notify other SAR authorities, shipping authorities, etc. as soon as possible where they are likely to be called upon to conduct search activity.
  - m) Consider the need for military assistance where the situation is judged likely to be beyond the capacity of available civil resources.
  - n) Ensure that the procedures for notification of next of kin of the occupants are implemented.

### Phase Transition

- 3.6.6 When information received indicates that the craft is not in distress, the RCC will close the incident and immediately inform the operating agency, the reporting source and any alerted authorities, centres or services.
- 3.6.7 If the craft has not been located when all efforts have been completed; if apprehension regarding the safety of the aircraft and its occupants continues, or if the time of an aircraft's fuel exhaustion has been reached, whichever occurs first, the craft and its occupants should be considered to be in grave and imminent danger. The Alert Phase should then progress to the Distress Phase. The decision to declare the Distress Phase should be taken without undue delay and on the basis of past experience with similar situations.

---

## Distress Phase Procedures

- 3.6.8 When a distress phase has been declared by a SAR authority or transferred by Airservices, another RCC or SAR authority, the SAR authority should:
- a) Initiate or continue any appropriate actions normally performed during the Uncertainty and Alert Phases.
  - b) Ensure an SMC has been appointed and that all interested parties have been informed of the incident.
  - c) Examine the detailed plans of operation for the conduct of SAR operations in the area.
  - d) Determine the availability of SAR assets to conduct SAR operations and attempt to obtain more assets if a need for them is anticipated.
  - e) Estimate the position of the distressed craft, estimate the degree of uncertainty of this position and determine the extent of the area to be searched and if a significant search effort is anticipated, use search planning techniques to maximise the chances of finding the survivors.
  - f) Develop a search action plan or rescue planning as appropriate for the conduct of the SAR operation and communicate the plan to the appropriate authorities.
  - g) Initiate action, activating SAR assets as appropriate such as:
    - i. Craft may be dispatched from their bases in accordance with the search plan.
    - ii. Craft may be diverted in-flight or en-route.
    - iii. Whenever practicable, aircraft dispatched early should carry droppable supplies (suitable for the environment in which the incident is occurring) unless these aircraft are unsuitable for dropping and/or an unacceptable delay would result to their departure on account of loading.
    - iv. In the latter case, droppable supplies should be loaded on a suitable aircraft as soon as possible. Aircraft carrying droppable supplies must be configured in conformance with JRCC Australia documentation.
  - h) Amend the plan as the operation develops.
  - i) Notify the State of registry of the target craft.
  - j) Notify JRCC Australia, ADF, State or Territory Police, Maritime Authorities, ATSB and/or CASA, Media as appropriate.
  - k) At an early stage, request aircraft, vessels, coastal radio stations and other relevant services to:

- i. maintain a listening watch for transmissions from the target craft, by voice, survival radio equipment and from an emergency beacon (ELT/EPIRB/PLB);
  - ii. assist the target craft as far as practicable if found; and
  - iii. inform the RCC of any developments.
- l) Maintain close liaison with the following:
- i. Appropriate agencies for onward transmission to the target craft (if possible) and for traffic coordination.
  - ii. Other RCCs along the planned route of the target craft as well as those whose SRRs are within the target craft's maximum radius of action as determined from its last known position (i.e. the possibility area), ensuring that any information they receive regarding the incident is conveyed to the coordinating RCC.
- m) Inform community groups by way of radio and television broadcasts requesting sighting and hearing reports and any other intelligence regarding the whereabouts of the subject craft using established procedures for contacting designated personnel at broadcasting stations and specifying messages in precise form.

### Phase Transition

- 3.6.9 When the distressed craft has been located and the survivors rescued, the RCC will terminate the SAR operation, close the case and immediately advise the operating agency, the reporting source and any alerted authorities, centres and services. To ensure that search assets remain under some type of flight or vessel following system, the SMC should not terminate activities until all SAR assets have established alternative following plans, where they apply.

## 3.7 Communication Checks

### General

- 3.7.1 Communication checks are conducted by the SMC when information, in addition to the initial report, is required. A most common situation is where the craft is overdue or unreported. It is the time when detective work is required of the SMC. Communication checks may be conducted prior to, during or after dispatching search units, depending upon the urgency of the incident.
- 3.7.2 Communication checks involve not only extensive use of various networks to provide additional information, but also may involve physical checks of areas where the craft may be located. Generally the purpose of communication checks is to continue efforts to contact the craft, to determine if the craft is overdue or unreported, to localise the search area, and to get more factual data for evaluation of subsequent SAR action.

- 
- 3.7.3 Initial communication checks may consist of contacting and checking major facilities within the areas where the craft might be or might have been seen, and is normally conducted during the uncertainty phase. These checks should have a reasonably effective probability of locating the missing craft within a short period of time, if the craft is merely unreported rather than actually missing.
- 3.7.4 Where initial checks fail to locate the craft, communication checks are to be expanded to check a wider variety of possible sources of information on the missing craft, including physically checking possible locations, such as harbours, marinas and airports.

### Communication Checks for Marine Craft

- 3.7.5 Communications checks for marine craft may include the following:
- a) Satellite and radio communications.
  - b) Inquiries should be made to the facilities in locations that will give reasonably thorough and rapid coverage of the area such as:
    - i. Port authorities.
    - ii. Marinas, yacht clubs and other water-side facilities.
    - iii. Fishing cooperatives.
    - iv. Harbour masters.
    - v. Volunteer organisations.
    - vi. If the missing craft is known to have a radio aboard, contact by Coast Radio Station.
    - vii. Vessel/boat owners or agents.
    - viii. Police.
      - **Note:** Marine checks should be forwarded through the closest Water Police as they have extensive contact list for Marine facilities. Contact and requests should be noted in running logs.
    - ix. Customs, Immigration (if applicable).
    - x. Relatives, neighbours and associates.
  - c) Check and confirm departure and reported non-arrival and request the RCC be notified immediately if it does arrive.

---

## Communications Checks for Aircraft

- 3.7.6 When an aircraft subject to a SAR watch fails to report by a prescribed time, or if an aircraft fails to report, the responsible ATS unit shall:
- a) Attempt to contact the aircraft direct by calling on normal and alternative frequencies.
  - b) Attempt to contact the aircraft via another aircraft.
  - c) Ascertain whether another unit has received the report.
  - d) Arrange for other ground units to call the aircraft on normal or alternative frequencies.

### Actions by JRCC Australia

- 3.7.7 JRCC Australia will conduct checks by:
- a) Contacting the aircraft operator and destination and alternative airports to confirm that the aircraft has not arrived.
  - b) Having physical checks of aircraft parking areas and hangars conducted at uncontrolled airports and airfields.
  - c) Thoroughly evaluating the flight plan, weather, terrain, possible communication delays, last known position, text of radio calls, pilot's qualifications, and the performance of the aircraft under favourable conditions.
  - d) Compute the time of fuel exhaustion if not done earlier.
  - e) Notify the operating agency of the aircraft.

## Crashed Aircraft

- 3.7.8 When it is known that an aircraft will crash or has crashed and the crash position is incidentally reported or known with reasonable certainty, the RCC is required to confirm the crash site and ensure the provision of medical assistance and rescue of the survivors.
- 3.7.9 Pending assumption of the responsibility for the wreckage by ATSB or the relevant military authority, the RCC shall endeavour to arrange a guard at the crash site to prevent interference with the wreckage or with marks made by the aircraft in landing. State/Territory police customarily act as guards. Aircraft crashes that involve fatalities are to be treated as crime scenes from the outset and once survivors have been checked with minimal disruption to the scene, the RCC's responsibility ceases and the scene is then subject to investigation by State/Territory police under the State/Territory coronial legislation and/or ATSB.

---

## Health Hazards - Aircraft Accidents

- 3.7.10 Movement in the vicinity of crash sites can be extremely hazardous for ground parties. Details of these hazards can be found in Chapter 6 and Appendix L.

## 3.8 Intelligence Gathering and Assessment

### Overview

- 3.8.1 Information relating to a missing craft may be gathered from a variety of sources, in particular from the owner or operator, Airservices and general maintenance records and from the public at large.
- 3.8.2 A SAR rated officer shall be appointed as the RCC Intelligence Officer and given the task of seeking information and assessing and verifying information received.
- 3.8.3 Careful and accurate assessment of intelligence information is a vital part of search action and may be instrumental in modifying probability areas, reprioritising search activities and adopting revised search strategies.
- 3.8.4 Symbols for use in plotting intelligence information are as depicted in Appendix G.

### Sighting and Hearing Reports

- 3.8.5 When even an approximate position of a missing craft is not known, it is usual to arrange for media broadcasts to be made requesting information from members of the public who may have seen or heard the craft.
- 3.8.6 In composing a message for broadcasting, some significant feature of the craft should be omitted from the description, thus enabling a better assessment to be made of the validity of reports received. Care should be taken in specifying the call-in telephone number to avoid engaging vital RCC lines. Having available a dedicated intelligence telephone number is recommended.
- 3.8.7 The aim of a broadcast is to promote the best reception of Sighting and Hearing reports from a defined area. The SMC, or delegate, will contact the Police headquarters or operations centre in the relevant State or Territory capital and discuss an intention to request public assistance.
- 3.8.8 The SMC will discuss the area to be covered by the broadcast, the frequency of the broadcast and its duration. The SMC should be very specific about the area to be covered by the broadcast. Radio provides the quickest local coverage. Television may be very complicated and difficult to handle. Copies of all broadcasts are to be provided to the relevant police centre.
- 3.8.9 The SAR authority should be informed when a broadcast is issued. When the Media/PR officer is present in the RCC, it may be more advantageous and expeditious to have them request a broadcast to a local station. If this occurs the police shall be advised.

- 
- 3.8.10 If appropriate, a sighting/hearing cell will be established to receive, plot and assess the information.
  - 3.8.11 RCC staff should be prepared to receive a large number of reports in the period immediately following a broadcast. A Sighting and Hearing Report should be completed for each call taken. Each report should be immediately entered in the Sighting and Hearing Log and the position and details plotted on the relevant map or chart.
  - 3.8.12 Sighting or Hearing Report Forms should always be used to record reports of craft being seen or heard to ensure that vital information is not omitted. All sighting and hearing reports are to be assessed by an experienced SAR officer. Guidance on sighting and hearing reports is at Appendix H.

### Assessing Reports

- 3.8.13 To assist in the assessment of reports and to eliminate those that relate to other craft, every effort should be made to establish the movements of all craft that would have been operating in the same general area as the missing craft in the same time period. A general description of such other craft, including their colour schemes, is necessary to assist the process of evaluation.
- 3.8.14 In addition to seeking reports on the missing craft, it may be necessary to broadcast a request for information about, and descriptions of craft that were flying/sailing in the subject area at the appropriate time and for which flight/voyage details had not been lodged.
- 3.8.15 Reports that cannot be related to a known movement of craft other than the distressed craft shall be individually assessed and categorised as reliable, unreliable or doubtful.
- 3.8.16 A plot should be made of all reports. Those considered to relate to the missing craft shall be highlighted.
- 3.8.17 It may be good procedure to interview the originators of some reports a second time, either to confirm the original details, or to gain additional information.

### Interviewing Witnesses

- 3.8.18 Care must be taken in the selection of a person to interview witnesses. Consideration should be given to the use of specially trained officers, e.g. the police.
- 3.8.19 When interviewing witnesses, the following points should be kept in mind:
  - a) The interview should be conducted as soon as practicable after the event. Many people forget important facts quickly and are influenced by other opinions, press reports.



- 
- b) The interviewer should know the subject, be aware of the details reported previously, and have questions prepared in advance to clarify points on which further information is required.
  - c) After identifying himself, the interviewer should explain the purpose of the Interview clearly.
  - d) Persons being interviewed should be asked to give a personal account of events without coercion or suggestion. They may then be asked questions designed to solicit other facts.
  - e) When possible, statements should be tested by related occurrences, e.g. the distance of the craft from the observer by weather phenomena such as visibility and cloud base; the time of observation by the extent of daylight, position of the sun or radio program.
  - f) If witnesses are not clear about particular aspects, they may be left to consider the incident further and be given opportunity to contact the RCC should additional information subsequently come to mind.

3.8.20 Reports assessed as reliable may form a basis for modifying or extending the probability area. SMCs should, however, guard against neglecting the search of previously established search areas merely on the basis of such reports. Many compelling reports from the public have proven insubstantial.

### **Coordination with the Police**

3.8.21 It is possible that the police will receive incidental reports from the public that may be of value to the search effort. It is essential that the police in the search area are made fully aware of the search activity and the need to pass all relevant reports and information to the RCC as soon as possible.

### **Examination of Recorded Communications**

3.8.22 At an early stage in the search action, communication records shall be examined for any data relating to the missing craft.

3.8.23 RADAR and recordings of frequencies used or possibly used by the missing craft shall be replayed.

3.8.24 A discrete recording should be made of exchanges between the subject craft and other craft and ground stations during the time of flight/voyage. The recording should then be made available to the RCC.

3.8.25 When a craft disappears without a distress call having been received on the communication channels in primary use, requests should be made to other units to have recordings and written records examined to determine if transmissions were recorded from the missing craft on any other channels.

- 
- 3.8.26 The assistance of specialist communication staff may be sought for transcription of dialogue from recordings.

### **Flight Path Analysis - Aircraft**

- 3.8.27 In addition to information reported by the public, it is often possible to reconstruct a probable flight path from information contained in the flight plan and reports to ATS units of the subject flight's progress.
- 3.8.28 A detailed study of all available navigational data should be made. Particular attention should be directed to the pilot's application of variation and calculation of headings and speeds.
- 3.8.29 Mistakes have also commonly resulted from differences between forecast and actual weather.

### **Weather Analysis**

- 3.8.30 An analysis of the weather existing at the time the craft encountered difficulty and the interaction of weather and terrain (for aircraft) should be made. The opinion of meteorologists should be sought in this respect, as should the views of suitably experienced qualified mariners and pilots.
- 3.8.31 Effort should be made to obtain reports of at sea or in-flight conditions from mariners or pilots who were in the area at the time the craft encountered difficulty.
- 3.8.32 It is conceivable that a likely plan of action adopted by the distressed master, pilot, skipper, etc. can be deduced from these data of intelligence; decisions regarding priority of search effort may follow.

### **Logistical Information**

- 3.8.33 Depending on the target, the Intelligence Cell may consider obtaining data on the following resources:
- a) Suitable landing and anchorage areas.
  - b) Fuel and other craft replenishment supplies.
  - c) Aircraft, vehicles and marine craft suitable as rescue units.
  - d) Shipping resources and facilities, should the search be over water.

### **General Considerations for the SMC**

- 3.8.34 SMC duties can be demanding. The gathering of information, evaluation of this information and initiation of action all require concentrated effort on many details. The SMC will find the various forms, checklists, worksheets, tables and graphs provided in the appendices to be very helpful. The following paragraphs provide

---

some general guidance for the early stages of a SAR operation, including information gathering and preparation for the possible need to plan searches.

- 3.8.35 Several factors will influence the extent and manner of an initial SAR response. In general these are:
- a) Extent and reliability of information about the location of the distressed craft and its occupants.
  - b) Availability of aircraft, marine craft and land parties for searching.
  - c) Actual and forecast weather conditions.
  - d) Times of daylight/darkness.
  - e) Nature of terrain.
  - f) Availability of survival supplies and supply dropping teams.
  - g) Sea currents.
  - h) Time delay in notification.

### Urgency of Response

- 3.8.36 Evaluating incidents to determine the urgency and the extent of required SAR response, or the termination of response is a function requiring information, judgement and experience. In emergency situations requiring immediate assistance, the action taken must be accomplished quickly and positively. Where uncertainty exists, evaluation is usually more difficult and time consuming because of the many factors involved.
- 3.8.37 Perhaps the most difficult task the SMC undertakes is the evaluation of these factors. They usually become apparent between the time the incident is reported and the execution of the search. This is a time when speed and reliability will be most important, however it is also a time when incident reports may be incomplete or confused.
- 3.8.38 The most serious limitation is time. When persons are injured or are subjected to adverse climatic or water conditions, the chances of survival decrease rapidly. Time limitation also may be dictated by the number of hours left for a daylight search, although the SMC should not arbitrarily rule out night search, especially in unpopulated areas, over the ocean, and over flat terrain or deserts.
- 3.8.39 The facilities available to conduct a search may be limited by lack of available personnel and search assets. The SMC must be aware of availability of SAR facilities within their region.
- 3.8.40 Terrain, weather and oceanographic conditions can affect all areas in SAR planning and operations. Search visibility, aircraft limitations, search effectiveness, safety of

---

flight and time available to complete the search are some of the factors that will affect search capability.

- 3.8.41 Whenever practicable, pertinent data should be plotted on a chart to aid in evaluating related factors.
- 3.8.42 Normally the SMC determines the urgency and extent of SAR services required for an incident. A rapid but systematic approach is essential since prompt response to emergency incidents is the essence of the SAR system.

### General Time Factors

- 3.8.43 The probability of finding survivors and their chances of survival diminish with each minute after an incident occurs. Prompt positive action is required so that no life will be lost or jeopardised through wasted or misdirected effort. Individual incidents will vary with local conditions such as terrain, climatic conditions, ability and endurance of survivors, emergency equipment available and SAR units available to the SAR system.
- 3.8.44 In the case of seriously injured survivors or survivors in a hostile environment, the reaction time of the SAR system must be measured in minutes. Critically injured survivors of any accident usually die within the first 24 hours if not given emergency medical care.

### Daylight Factor

- 3.8.45 For survivors not equipped with any type of detection aids daylight visual search is usually the only search method available to the SMC. If darkness were approaching this would be another limiting factor for the SMC to consider.

### Night Factor

- 3.8.46 If it is known or suspected that the survivors have detection aids such as pyrotechnic flares or other night signalling devices or can display other lights, night searches should always be conducted. Night searches, visual and electronic are particularly effective at sea, over sparsely populated areas, flat terrain and deserts.
- 3.8.47 Night aural and visual search should be considered. Modern electronic detection methods may be effective in locating targets. The capability of these devices should be discussed with the operators of the equipment.

### Weather/Oceanographic Factors

- 3.8.48 Adverse weather prevailing in or approaching an area where survivors are located may also limit the time available to conduct a SAR operation. Not only are survivors of a distressed craft more difficult to detect under adverse weather conditions, but also SAR units themselves operate at lower efficiency due to the added turbulence, rough seas and higher stresses on both the search personnel and their craft.

- 
- 3.8.49 Accurate knowledge of weather conditions and the prudent judgment based on it will enhance the likelihood of a successful mission. Knowledge of the prevailing weather conditions will also play an important role in the safety of the search units.
- 3.8.50 If weather will not allow for a search operation to be mounted without endangering additional lives, the search effort should be deferred. If weather is currently good but forecast to deteriorate in a short time, more rapid action is required and detailed planning may suffer due to the time available. If weather is good and forecast to remain so, more extensive planning may be accomplished.
- 3.8.51 Wind, visibility and cloud cover influences the search track spacing. Therefore, the better the weather information, the more realistic will be the derived track spacing. Maintaining accurate search patterns is difficult in adverse weather. Aerial units are particularly vulnerable. For this reason the patterns selected should allow for more precise navigational accuracy.
- 3.8.52 Safety may sometimes be prejudiced by actual weather conditions, which must, therefore, be monitored continuously by the SMC. Low cloud base and restricted visibility are particularly hazardous during searches that cover large areas where many aircraft are employed. Should air search be conducted under adverse weather conditions that deteriorate below the required flight conditions, then air search may have to be suspended.
- 3.8.53 In situations where survivors are adrift in regions of high velocity water current, searches should be mounted without delay. The probability of locating survivors is high during the early stages of survival craft drift as the drift factor allowed for in search calculations will be of reasonable accuracy over a short time period.
- 3.8.54 When missions involve overdue craft, the weather situation should be evaluated to determine what effect it may have had upon the craft's operating capabilities and/or the actions of the craft's operator prior to SAR system activation. To obtain an overall weather picture an attempt should be made to complete the following questionnaire:
- a) What was the weather at the departure point, destination and along the planned track at the time the overdue craft should have been in those areas? If no established weather facilities are available, the information should be obtained from local reliable sources in the areas concerned, such as police or marine volunteers, if possible.
  - b) What was the en route and forecast weather briefing given to the crew of the missing craft, and what was the operator's reaction to the weather briefing?
  - c) What was the weather in the area where the missing craft is presumed to be and if the time of emergency is known, what were the actual weather conditions at the craft's estimated position?

- 
- d) Were there any marked changes in wind or sea currents that might have resulted in navigation errors?
  - e) Were there any areas of low ceiling, poor visibility, precipitation, thunderstorms, frontal activity, turbulence, icing, that may have caused the craft to attempt circumnavigation, or that could have exceeded either the crafts or operator's capability?
  - f) Were there any areas of marked pressure changes that may have caused aircraft altimeter errors?

### Weather Reports by Survivors

- 3.8.55 Occasionally missions will occur during which radio contact can be established with survivors who do not know their exact position. If survivors can report sufficient weather information, the SMC and meteorological personnel may be able to develop an approximation of the survivor's position by fitting the survivor's weather into the current synoptic picture.
- 3.8.56 The following weather information should be requested immediately, and on a scheduled basis thereafter, if possible:
  - a) Percentage of cloud cover.
  - b) Estimated height of clouds.
  - c) Type of description of cloud.
  - d) Estimated surface wind velocity.
  - e) Winds aloft direction, if discernible by cloud movement.
  - f) Prevailing weather phenomena such as snow, rain, fog, sea state, etc.
  - g) The times of sudden changes in wind or weather such as rapid clearing, quick deterioration, sudden changes in wind direction, noticeable change in temperature, blowing dust or any other condition that might indicate frontal passage.
  - h) Outside air temperature.
  - i) Pressure reading of barometer or altitude reading of altimeter set for 1013 HPA.
  - j) Pressure trends from altimeter or barometer.
  - k) Observed times of sunset and/or sunrise.

### Survival Environment Factors

- 3.8.57 The environment in which the survivor is exposed is another factor that limits the time available to complete their rescue. In some cases, environment will be the most time critical of all. Climatic atlases are useful to evaluate probable climatic conditions in regions where few or no weather reporting facilities are available.

- 
- 3.8.58 The relation of survival time to water temperature, air temperature, humidity and wind velocity is not a simple one. These and other factors often exist in combination to complicate the problem of estimating life expectancy of survivors. Individuals will vary in their reaction to cold and heat stresses.
- 3.8.59 Additional factors which will vary a survivor's life expectancy include the type of clothing worn, the clothing's wetness, the survivor's activity during their exposure, initial body temperature, physical conditions, thirst, exhaustion, hunger, and various psychological stresses such as isolation, loneliness and remoteness, and the all-important individual will to live.
- 3.8.60 The graphs at Figures 3.1 and 3.2 are provided to assist the SMC in determining the urgency required to remove survivors from the environment, and to assist in evaluating the practicality of terminating a search. These graphs are based upon case histories, field tests, laboratory experiments and analysis of all known data. However, the SMC must understand that some individuals will exceed the life expectancy or tolerance times indicated in these figures, and therefore should consider these figures as helpful guidelines rather than absolute controlling factors.
- 3.8.61 SMC's should seek advice from medical specialists, preferably experienced in search and rescue and cold water survival, to assist in determining a time-frame-for-survival of individuals subject of a search and rescue operation.

### Hypothermia

- 3.8.62 Hypothermia is the abnormal lowering of internal body temperature (heat loss) and results from exposure to the chilling effects of cold air, wind or water. Death from hypothermia may occur in both land survival and water survival situations. Hypothermia is the leading cause of death for survivors of maritime disasters.
- 3.8.63 Internal core body temperature is the critical factor in hypothermia. If the body core temperature is depressed to only 35°C, most persons will survive. If the body core temperature is depressed to approximately 33°C, most persons will return to useful activity.

At about 32°C, the level of consciousness becomes clouded and unconsciousness occurs at 30°C. Only 30 per cent would be expected to survive these temperatures. Survivors immersed in water would drown at this stage as they would become unable to protect their airway.

At a body core temperature of 26°C and below, the average individual will die and ventricular fibrillation (heart attack) will usually occur as the final event.

- 3.8.64 The warmest ocean water that can be expected at any time of the year is 29°C. About one third of the earth's ocean surface has water temperatures above 19°C.

### Water Hypothermia

- 3.8.65 The body will cool when immersed in water having a temperature of less than 33°C. The warmest temperature that ocean water can be at any time of year is 29°C.

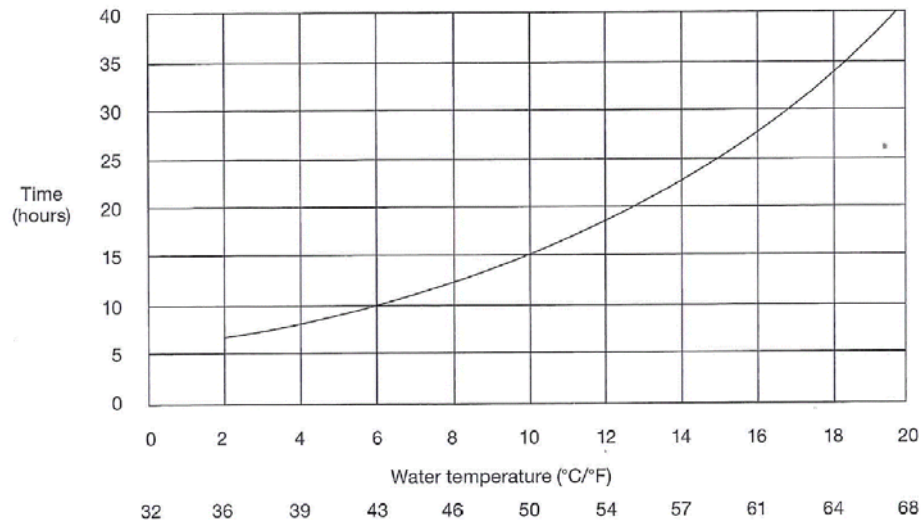
---

Approximately one-third of the earth's oceans have water temperatures of 19°C or above.

- 3.8.66 The rate of body heat loss increases as the temperature of air and water decreases. If a survivor is immersed in water, hypothermia will occur very rapidly due to the decreased insulating quality of wet clothing and the fact that water will displace the layer of still air that normally surrounds the body. Water allows a rate of heat exchange approximately twenty five times greater than that of air at the same temperature.
- 3.8.67 In water temperatures above 21°C survival time depends solely upon the fatigue factor of the individual, some individuals having survived in excess of 80 hours at these temperatures. Staying afloat and fighting off sharks are the major problems at these temperatures.
- 3.8.68 At 15°C skin temperatures will decrease to near water temperature within 10 minutes of entry and shivering and discomfort is experienced immediately upon immersion. Dunking and submersion difficulties become increasingly distressful to the survivor.
- 3.8.69 Faintness and disorientation occur at water temperatures of 10°C and below. Violent shivering and muscle cramps will be present almost from the time of entering the water and intense pain will be experienced in the hands and feet. This very painful experience will continue until numbness sets in.
- 3.8.70 All skin temperatures decrease to that of the surrounding water temperature in about 10 minutes. In the temperature range from 4°C to 10°C, only about 50 per cent of a group can be expected to survive longer than 1 hour. In water temperatures of 2°C and below the survivor suffers a severe shock and intense pain on entering the water. This shock in some instances may be fatal owing to loss of consciousness and subsequent drowning.
- 3.8.71 Water survivors who die within 10 to 15 minutes after entry into frigid water apparently do not succumb because of reduced body temperature, but rather from the shock of rapid entry into cold water. Fifteen minutes is too short a time for the internal body temperature to fall to a fatal level, even though the outer skin temperatures are at the same temperature as the water. In addition, the temperatures of the hands and feet fall so rapidly that such immersions are frequently less painful than those in 4°C to 10°C water.



3.8.72 Figure 3.1 shows the realistic upper limit of survival time for people wearing normal clothing in water at various temperatures. The graph is based on the analysis of known survival cases and laboratory experimentation, and shows a reasonable upper limit for search duration. The search planner must remember that this graph can only be indicative and that a number of uncertainty factors can improve or reduce survival time.



**Figure 3.1 Realistic upper limit of survival time for people wearing normal clothing in water at various temperatures.**

3.8.73 Guidelines based on analysis of accidents, together with laboratory-based experimental evidence, show a clear correlation between water temperature, body cooling and survival times. However, it is also apparent that, because of the vast array of personal factors that can influence survival time in cold water, this time can vary from seconds to days. Factors that slow the loss of body heat are:

- a) High body fat;
- b) Heavy clothing
- c) Survival clothing; and
- d) The use of a protective behaviour.

3.8.74 Factors that make a person lose body heat faster are:

- a) Age (children and the elderly are more prone to hypothermia);
- b) Low body fat;
- c) Light clothing;
- d) Exercising (such as situations where persons without lifejackets have to swim); and

e) Seasickness.

3.8.75 Thus, in water at 5°C, the 50% survival time for a normally-clothed individual is estimated to be about one hour, with a recommended search time of six hours. The corresponding times for 10°C are two hours and 12 hours. While in water at 15°C the 50% survival time is about six hours, with the recommended search time of 18 hours. Between 20°C and 30°C search times exceeding 24 hours should be considered and searching for several days should be considered for water temperatures at the upper end of this temperature scale.

3.8.76 As there are many factors to consider, this model cannot be used for all situations. SOLAS survival suits are meant to keep a person alive for 24 hours in extremely cold water and a person may be able to keep himself out of the water by climbing onto wreckage, for example. It should be kept in mind that factors working positively on survival times are often unknown to the SMC. Some of these factors include, but are not limited to, the following:

- a) Near-naked swimmers would be at the lower ranges of these times. In calm water there may be an exceptional individual (someone who is very fat and fit, for example) who will exceed expectations. If it is known that the victim is such an individual, consideration should, exceptionally, be given to extending the search times from 3-6 to 10 times the predicted 50% survival time.
- b) For inshore incidents, survival times may be less because of breaking water and adverse currents. However, consideration must be given to the possibility that the inshore survivor managed to get ashore. Consequently, the limiting effects of cold water cooling will no longer be the only consideration and the search must be continued until the shore has been thoroughly searched.
- c) For offshore incidents, it is reasonable to expect that individuals may be better equipped to survive and have access to appropriate protective clothing, such as lifejackets and possible life rafts. Consequently, search times for them should be at the upper limits of those expected (10 times predicted 50% survival time), unless obviously adverse conditions prevail, and should exceed them if it is possible that survivors may have been able to get out of the water.
- d) Survival time is shortened by physical activity (such as swimming) and increased by wearing heavy clothing and, if wearing a lifejacket, adopting protective behaviours (such as huddling with other survivors or adopting a foetal position in the water). Specialised insulated protective clothing (such as immersion suits or wet suits) is capable of increasing survival time from two to 10 times. The SMC should bear in mind that ingress of as little as half a litre of water into an immersion/survival suit can reduce its insulation value by 30% and that wave height of one metre can reduce it by an additional 15%.

3.8.77 Predicting survival times for immersion victims is not a precise science; there is no formula to determine exactly how long someone will survive or how long a search

should continue. The SMC must make some difficult decisions based on the best information available and a number of assumptions and should extend the search time beyond that which they can reasonably expect anyone to survive.

### Wind Hypothermia

3.8.78 Although the body will lose heat approximately twenty-five times slower in calm air than when immersed in water, the body heat loss will be accelerated with increasing wind velocities. This is an additional factor to consider for exposed survivors.

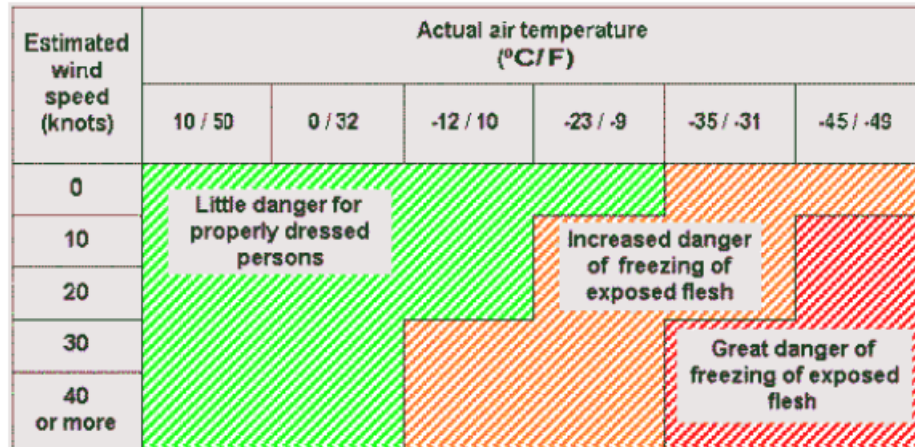


Figure 3.2 Wind Chill and Hypothermia

3.8.79 Figure 3.2 depicts the effects of various wind speed and air temperature combinations. The straight-line relationship between air temperature and the logarithm of D wind speed allows simple interpolation of the intermediate temperatures. The shaded areas represent wind speed and temperature combinations that would cause freezing of any exposed skin.

### Hyperthermia, Heat Stress and Dehydration

3.8.80 Hyperthermia, heat stress and dehydration are dangers in hot climates, particularly in desert areas. The most severe form of heat stress is heatstroke, during which the body temperature rises due to the collapse of the temperature control mechanism of the body. If the body temperature rises above 42°C, the average person will die. Milder forms of heat stress are heat cramps and heat exhaustion. Another limiting factor both in hot climates and in survival situations at sea is dehydration. A person totally without water can die in a few days, although some have survived for a week or more.

### Survivor Stress Factors

3.8.81 Two basic assumptions are to be made concerning survivors of a distress incident:

- a) there are always survivors who require emergency medical care therefore every search and rescue mission is a medical emergency until survivors have been located and their medical needs have been assessed by an appropriately qualified person, and

- 
- b) survivors are under a condition of great stress and experiencing psychological shock.
- 3.8.82 It may also be assumed that not even able-bodied, logical-thinking survivors will be able to help themselves.
- 3.8.83 Records include numerous accounts where supposedly able-bodied, logical thinking survivors failed to accomplish extremely simple tasks in a logical order, and thus hindered, delayed or even prevented their own rescue.
- 3.8.84 This is due to psychological shock that, following an accident, is often so great that even those of strong mind think and act illogically. All survivors will be in some degree of psychological shock. Some may be calm and somewhat rational, some may be hysterical and in panic, while the remainder will be temporarily stunned and bewildered.
- 3.8.85 This last group will generally have passive attitude and can be easily led during the first 24 hours after the incident. As the psychological shock wears off, most of them will develop active attitudes. Those that do not develop active attitudes will die unless rescued quickly.
- 3.8.86 Individuals who observe an emergency situation and reporting it to the SAR system should also be considered as being under stress. Many times it will be necessary for SAR personnel to specifically request essential information from an individual reporting an emergency. This situation should be expected and SAR personnel should be prepared to cope with it.

### Terrain Factors

- 3.8.87 Terrain may be a major factor in evaluating an incident. Terrain may dictate the type of search pattern required, and may limit the selection of search aircraft that can be used. Aircraft that are highly manoeuvrable and will be effective at moderately high altitudes may be required in rugged mountain areas. High performance or large transport aircraft may be unusable in confined areas and helicopters may not be able to operate in the thin air and turbulence associated with mountains and contour searches.
- 3.8.88 Terrain may also limit the time available for search. For example low-level searches in mountain areas are normally limited to daylight only. The type of survival kit carried by the distressed craft and the equipment, such as the type of hoist device used by available helicopters will also be influencing factors. Dense foliage may hamper both visual and electronic searches and require increased numbers of aircraft and closer search track spacing.
- 3.8.89 Man-made additions to the terrain such as power-lines, towers and bridges must also be considered when planning search areas and the altitudes of search aircraft.
- 3.8.90 The type of rescue team used after the distress site has been located is also dependent upon terrain. When there is doubt about survivors or the area is inaccessible, time is a factor. Should other help not be readily available, airdrops or

---

parachutists may be required. Before deploying parachutists, the ability for them to land, to be resupplied and recovered must be considered.

### Available Search Asset Factors

- 3.8.91 During the prosecution of any SAR mission the SMC will have assets at their disposal whose primary mission is not SAR but who have SAR capabilities.
- 3.8.92 It is of primary importance that the SMC fully understands the limitations of all facilities available in their region if they are to be effectively used. The number, types, equipment and experience of available search units will limit the courses of action available to the SMC.
- 3.8.93 In addition there may be instances when all available crews are either committed to other operations, in the case of flight crews or have expended their maximum authorised crew duty time.
- 3.8.94 Some time is usually required for a suitable search unit to arrive on-scene, therefore search unit maximum speed for short distances or normal cruising speed for long distances is a factor. The search unit's range will determine both the maximum distance it can proceed from its operating base and its on-scene endurance. The search unit's communication capability for working with the SMC, other search units and the distressed craft must be considered.
- 3.8.95 The search units' navigation capability will influence the areas to which it can be assigned, since accurate navigation in search areas is essential for effective coverage.
- 3.8.96 The search unit may carry detection sensors and its ability to carry equipment that may be required on-scene should be considered. However, operating limitations of the search unit will override all other factors. These include such things as turbulence, icing and instrumentation for aircraft, and sea-keeping qualities for vessels and small craft.

### Survival Equipment Factors

- 3.8.97 The amount and type of survival and signalling equipment available to the survivor will influence not only the urgency of the SAR system's response, but also the methods and procedures employed in various SAR stages.
- 3.8.98 The SMC may concurrently conduct a high level electronic search and a visual search. The SMC must use their common sense, good judgment and background experience to evaluate the appropriate response for taking advantage of the survivor's capability to signal and survive.

### Risks v Gain Factors

- 3.8.99 SAR facilities are responsible for taking whatever action they can to save life at any time and place where their facilities are available and can be effectively used. Nevertheless, there may be a point beyond which SAR services are not expected and

---

cannot be justified. Known and inherent risk must be carefully weighed against the mission's chances for success and the gains to be realised.

- 3.8.100 SAR personnel and equipment shall not be placed at risk, nor the mission attempted, unless lives are known to be at stake and the chances for saving lives are within the capability of the personnel and equipment available.
- 3.8.101 All reasonable action shall be taken to locate distressed personnel, determine their status and bring about their rescue. Prolonged SAR operations after all probability of survival has been exhausted are uneconomical and not warranted. The decision to conduct such operations must be based on probability of detection.
- 3.8.102 Studies have shown that the period within 12 to 24 hours of a distress incident is the most critical for recovery of survivors. The best chance of successful recovery occurs during this time period. Within 48 hours, chances are still good, but after that time the chance of successful recovery decreases rapidly.

---

## Chapter 4: Search Planning and Evaluation

### 4.1 Overview

- 4.1.1 The wellbeing of survivors is critically dependent on early location and support. It is vital that as soon as possible after becoming aware of an incident, SAR authorities quickly implement procedures for a rapid search of the most likely area of distress. In general, the initial SAR response requires ready application of simple procedures to quickly cover the most likely area of distress. The search area described will be of rudimentary construction, e.g. a circle, square or rectangle depending on the nature of the distressed craft's operation. The area will be of sufficient proportions to cover all reasonable alternative tracks of the distressed craft and will incorporate areas highlighted by intelligence information. This strategy precedes the more complex calculations that will give rise to a more precise area which, failing the success of stage one search will form the basis for a formally planned and executed action at a later time. The stage one search may be undertaken in relatively short time and allow ready allocation and briefing of the few necessary resources.
- 4.1.2 All of the basic search theory concepts are described in this chapter. Practical examples are provided for each concept, showing how it may be applied to the search-planning problem. These examples require only basic arithmetic skills and an understanding of the basic probability concepts encountered in everyday life. Although search planning may be perceived to be complex, each step is relatively simple.
- 4.1.3 **Note:** It is essential when planning commences for search operations that rescue planning is commenced as outlined in Chapter Six. This is to occur as a concurrent action. Rescue planning forms an integral part of the Search Planning.

### 4.2 Search Planning Steps

- 4.2.1 Search planning involves the following steps:
- a) Evaluating the situation, including the results of any previous searching;
  - b) Estimating the distress incident location and probable error of that location;
  - c) Estimating the survivors' post-distress movements and probable error of that estimate;
  - d) Using these results to estimate the most probable location (datum<sup>1</sup>) of survivors and the uncertainty (probable error of position) about that location;
  - e) Determining the best way to use the available search assets so the chances of finding the survivors are maximised (optimal search effort allocation);
  - f) Defining search sub-areas and search patterns for assignment to specific search assets; and

- 
- g) Providing a search plan that includes a current description of the situation, search object description(s), specific search responsibilities to search facilities, on-scene coordination instructions and search asset reporting requirements.

4.2.2 These steps are repeated until either the survivors are located or evaluation of the situation shows that further searching would be futile.

### **Evaluating the Situation**

4.2.3 Searching is the most expensive, risky and complex aspect of the SAR system. Often it is also the only way survivors may be located and assisted. All information received about the incident must be carefully analysed and evaluated before a search is undertaken and at frequent intervals during its progress. In the early stages of a SAR incident, it is almost certain that the SMC will need to make some assumptions about the nature, time or place of the incident. It is very important that such assumptions be kept separate from the known facts. It is important to distinguish conclusions based on known facts from those based partially on assumptions. It is also important to re-evaluate all assumptions regularly and as new information becomes available. Any assumption, which is allowed to go unquestioned for too long a period, begins to falsely assume the appearance of fact, and can compromise the search effort.

4.2.4 Some of the clues that may indicate the survivors' location or situation include:

- a) Intentions;
- b) Last known position;
- c) Hazards;
- d) Condition and capabilities;
- e) Crew behaviour;
- f) On scene environmental conditions; and
- g) Results of previous searching.

### **Estimating the Distress Incident Location**

4.2.5 The first step in either marine or land search planning is to determine the limits of the area containing all possible survivor locations. This is usually done by determining the maximum distance the survivors could have travelled between the time of their last known position (LKP) and the known or assumed time the distress incident and drawing a circle of that radius around the LKP. Knowing the extreme limits of possible locations allows the search planner to determine where to seek further information related to the missing craft or persons and whether an incoming report might apply to the incident. However, systematic search of such a large area is normally not practical. Therefore, the next step is to develop one or more



---

scenario/s or sets of known facts plus some carefully considered assumptions, describing what may have happened to the survivors since they were last known to be safe. Each scenario must be consistent with the known facts of the case, have a high likelihood of being true and allow the search planner to establish a corresponding geographic reference or datum for the survivors' most probable position (MPP).

- 4.2.6 Three possible situations may exist with respect to the location of a distress incident when it is reported.
- 4.2.7 Approximate Position Known. The incident may have been witnessed: reported as a navigational fix by another craft or the craft in distress; or computed by the SMC as a dead reckoning position from a previously reported and reliable position of the craft in distress.
- 4.2.8 Approximate Track Known. The craft in distress may have filed a trip or voyage plan prior to departure that included the intended track or route but the craft's actual position along the track is unknown. A single line of position, such as a flare sighting or DF, should be treated the same as a track known situation.
- 4.2.9 Approximate Area Known. When neither the position nor the intended track is known, at least an area that the craft in distress was probably within can usually be determined. The SMC should try to reduce this area to an area of high probability that can be used as the initial search area or, if the area is small enough, use it.

### 4.3 Datum Definition

- 4.3.1 The datum is the geographic point, line or area used as a reference in search planning. A datum for the initial distress incident is first estimated from the known facts of the case and possibly some assumptions that have a high likelihood of being true. This datum for the distress incident is then adjusted to account for estimates of post-distress survivor motion, either through effects of drift or possible movement of survivor over land, at any particular moment during the incident. Finally, the level of uncertainty about the new datum is evaluated and limits are estimated for the smallest area containing all possible locations consistent with the scenario on which the new datum is based. This area is called the possibility area for that scenario.

#### Datum Point Definition

- 4.3.2 A datum point is the datum developed at a specific time when the initial position of the search object is known.

#### Datum Line Definition

- 4.3.3 A datum line is the line connecting two or more datum points computed for the same specified time, along which the search object is assumed to be located with equal probability. The most common instance when a datum line is developed is when the

---

initial location reported of the search object falls within the trackline- known category.

### Datum Area Definition

- 4.3.4 A datum area is an area in which the search object is assumed to be located with equal probability throughout the area. A datum area is most often necessary in those incidents in which there is no initial position or trackline known.

### Drift Definitions

- 4.3.5 Drift is vectorial movement, (direction and distance), of the search object caused by momentum, drag, wind, water and other external forces. Drift may be spoken of as individual drift ( $d$ ), which is the drift occurring in a specified time interval ( $t$ ); or may be spoken of as a total drift ( $D$ ), for a specified clock time or total elapsed time since the incident occurred ( $T$ ). Total Drift ( $D$ ) of a search object is the vectorial sum of all the individual drifts accumulated during an incident, for the elapsed time since the search object was first exposed to any external forces which cause drift movement, to the time of the latest computed datum.
- 4.3.6 Both total drift and individual drifts may be given subscripts to indicate their specified time or time intervals e.g.:  $d_s$  is sinking drift.
- 4.3.7 Drifts caused by wind and water currents must be continually recomputed during an incident to correct the datum as the errors become greater with the passage of time.

### Drift Corrections

- 4.3.8 External forces may move a distressed craft or distressed person away from the initial position of distress. These include such things as water current drifts, leeway, etc.

### Datum Search Planning

- 4.3.9 The first step in search planning is to determine Datum. Datum calculations begin with the reported position of the SAR incident. The initially reported location may be a position, a line or an area. The 'position known' category are the reported positions of vessels sinking, boat's engine breakdown, sailboat's dismasting, man overboard, etc.

### Recomputed Datum

- 4.3.10 Datum is computed periodically during a search incident when drift forces continue to affect the position of the search target. Updated datum are usually labelled sequentially: - Datum1, Datum2, Datum3, etc.

---

## 4.4 Search Stages

- 4.4.1 A search typically involves three stages:
- a) **Stage 1** Immediate response. An initial visual and/or electronic search along the missing craft's planned route.
  - b) **Stage 2** Nominated area either side of track.  
Normally a search conducted in an area 10 nautical miles either side of track but this can be varied depending on circumstances.
  - c) **Stage 3** Mathematically derived area. An expanded search of a probability area calculated using the navigational tolerances of the missing and search craft, allowing for drift if applicable and the application of a safety factor.
- 4.4.2 Stage 1 and 2 searches can be run concurrently. By way of example, if a distress incident occurs at the end of daylight or during the night, when the first visual search cannot be undertaken until the following day, then it may be appropriate to conduct both stages simultaneously.
- 4.4.3 Note that an essential part of any search stage will be the establishment of a rescue plan, coordination with the Police and consideration of the early dropping of SAR datum buoys.
- 4.4.4 Some emergency situations will suggest a still more spontaneous reaction. Where a craft reports encountering a distress situation, the location is reasonably well known and there are other craft in the near vicinity, it may be possible to divert an asset to the area or intercept the distressed craft's track with instructions to undertake a track crawl search along the known route.
- 4.4.5 If circumstances allow, the diverted asset may be instructed to proceed parallel to the distressed craft's track at an appropriate off-set distance and to return at the same off-set distance on a reciprocal heading. Such a procedure can provide coverage of the distressed craft's track and the most likely lateral area either side of it. Whether this is practicable will be dependent on such factors as endurance of the diverted craft, its suitability for the task, weather, daylight and terrain. The pertinent factors should be discussed with the crew of the diverted craft prior to tasking.
- 4.4.6 In other types of situations, a similarly rapid response may be made by tasking an airborne aircraft or one ready for departure at a nearby aerodrome or a vessel to undertake a square or sector search around a known distress position. In any case, the imperatives of this response are:
- a) Rapid assessment of the type of emergency circumstance;
  - b) Early assessment of the most likely position of distress;
  - c) A quick appraisal of readily available assets;

- d) Rapid determination of achievable effort in the prevailing circumstances;
- e) Consultation with crew well placed to assist;
- f) Dispatch or diversion of SAR unit asset(s) without delay; and
- g) Deployment of rescue platform(s).

## 4.5 Factors Affecting Initial SAR Response

### Overview

4.5.1 As discussed in Chapter 3 there is a wide spectrum of factors that may influence the extent and manner of an initial SAR response. To summarise some of the more important ones:

- a) Extent and reliability of information about the location of the distressed craft and its occupants;
- b) Availability of aircraft, marine craft and land parties for searching;
- c) Actual and forecast weather conditions;
- d) Times of daylight/darkness;
- e) Nature of terrain; and
- f) Availability of survival supplies and rescue assets.

### Location of a Distressed Craft

4.5.2 If the craft is in radio communication, or reports have been received from other sources, the problem of where to search is simplified and may only require the calculation of a DR position. However, should a craft disappear without a distress call being received, the following assumptions are made:

- a) That the craft is probably between the last reported position and its destination; and
- b) That the craft is most likely to be found on the section of the planned track between the last reported position and the position where the next report was due.

4.5.3 The possibility of a communications failure, and a subsequent diversion should not be overlooked. The operating agency should be questioned concerning policy as to diversion.

4.5.4 New intelligence information may cause the SMC to re-evaluate the assumptions made during the initial planning phase. The possibility of these evolutionary changes to search strategy should not, however, dissuade a SMC from basing initial search

---

procedures on the above assumptions as long as there is, at that time, no indication of contrary tracking by the distressed craft.

- 4.5.5 When conducting an initial response, it is not necessary to draw up a probability area accurately based on the navigational history of the distressed craft's route, nor is it normally necessary to take water movement into account, unless the interval between the Last Known Position Time and the estimated time of arrival of search units at the scene is longer than four hours. This will vary in high drift areas and the SMC may make an arbitrary allowance in the first instance, which may be applied until an accurate probability area is calculated in readiness for a more intensive search.
- 4.5.6 The terms "Last Known Position" and "Last Known Position Time" are used when referring to last known position and associated times. For simplicity, they are used to describe both land and water positions.

### Parachute Drift

- 4.5.7 When an aircraft has been abandoned in flight, consideration must be given to drift when determining the probable location of survivors who have descended by parachute. The displacement from the point at which the aircraft was abandoned can be significant. Advice should be obtained from the military or sporting organisations to assess the drift factor.

### Initial Search Procedures

- 4.5.8 When the distress position is not known with certainty, the procedure most frequently used first is to search along the intended track of the missing craft. If not already completed, inspection of possible landing places should continue. It may be necessary to allocate one or more aircraft to the task of examining those possible landing areas that have not been inspected during the landing site and communications checks. The size of the area to be considered for this purpose will be at the discretion of the SMC, however, he should be guided in determining final limits to landing site checks by the size of the probability area, modified by any pertinent intelligence information.
- 4.5.9 Unless it is positively determined that the missing craft does not have an emergency beacon, information should be obtained from the MCC on the satellite pass schedule and an aircraft should be quickly allocated to an electronic search. It may be possible to arrange for an electronic search to be flown either before or after some other task but it should be noted that it is not practicable for an aircraft to be tasked for a combined electronic and visual search. All aircraft on visual searches however, as on other tasks, should be briefed to keep a listening watch on 121.5 MHz and 406.0 MHz, but the maintenance of a listening watch will be supplementary to the primary task. Likewise, an aircraft assigned to an electronic search should be briefed to keep a general look out for visual signals if possible.

- 
- 4.5.10 In addition to aircraft being tasked to conduct an electronic search, a general request should be promulgated through Air Traffic Services (ATS) for other non-search aircraft to monitor 121.5 MHz.
- 4.5.11 In a situation where a craft has been reported missing, the time of the next programmed COSPAS-SARSAT satellite pass from which an ELT/EPIRB/PLB signal radiating from the subject area may be received should be established. Otherwise obtain a history of satellite passes for the period the craft was known to be in transit.

## Aircraft Incident

- 4.5.12 Studies of SAR incident data confirm that in a majority of situations in which VFR aircraft have crashed without warning, the distress site has been located within a reasonable lateral distance of the intended track.
- 4.5.13 More precisely, an extensive foreign study<sup>1</sup> has found that 77% of crashed VFR aircraft flying random tracks, e.g. through mountain valleys and over gaps, were located within five (5) NM either side of track and 87% within 10 NM.
- 4.5.14 With respect to VFR aircraft flying straight line tracks, 79% of crashes were located within 10 NM either side of track and 83% within 15 NM.
- 4.5.15 These statistics may assist in an SMC's decision about the width of the area to be initially searched. In the first instance, the width of area may be dependent upon the number of search hours available from SAR units. If achievable, a common strategy is to initially search for missing VFR aircraft within 10 NM either side of planned track.

**Note**<sup>1</sup> - Based on empirical data collected on Canadian inland SAR incidents from 1981 to 1986.

## 4.6 Basic Search Planning

### Overview

4.6.1 A search plan is required for every mission. It may be a very abbreviated plan for a single search unit, or it may be a complex plan involving a large number of units. In any case, a search plan should always be developed by the SMC, as many lives may depend upon the care with which the search is planned and conducted. When a search mission is required, four factors are of immediate importance to the search unit for conducting their search:

- a) An adequate description of the search target;
- b) The search area, including weather conditions and any possible risks or dangers;
- c) The best search pattern; and
- d) The appropriate track spacing.

- 
- 4.6.2 The SMC will most likely provide much more detailed information to the first search unit to be dispatched to the search area, but the above four items comprise a minimum. The SMC develops the original or optimum search plan on the assumption that sufficient and suitable search units will be available for conducting the operation. Once the optimum plan is developed, the SMC must make every effort to obtain the services of the search units he needs.

### Controlling Factors

- 4.6.3 When developing a search plan, the SMC must carefully weigh the limitations of time, terrain, weather, navigational aids, search target detect ability, suitability of available search units, search area size, distance between search area and SAR unit staging bases, and the particular POD desired under the circumstances.
- 4.6.4 As the ability to survive after an emergency is limited, time is of paramount importance, and any delay or misdirected effort will greatly diminish the chances of locating survivors. While thorough mission planning and good conditions for search are desirable, positive and immediate action is also required. The SMC should exercise best judgement and initiate search with a minimum of information and few SAR units while additional data are obtained and more extensive search operations are planned.
- 4.6.5 Of all the factors involved in search planning, one or more may prove so important in a particular situation that the others can generally be regarded as secondary or even disregarded entirely. These important factors are referred to as the controlling factors, and are the ones given the most consideration when developing the attainable search plan. For example, when only a limited number of SAR units are available, the following relationships might exist between datum, search area, time available and probability of detection (POD):
- a) Inaccurate datum requires a larger search area at the expense of time or POD;
  - b) Limited time available for the search requires a rapid search rate at the expense of the POD; and
  - c) High POD requires close track spacing at the expense of area searched or time.
- 4.6.6 The preceding paragraph illustrates a few of the factors that the particular circumstances may dictate as controlling factors. In any of the above circumstances additional SAR units would alleviate the situation, but (apart from SAR units availability) there is a practical limit to the number of search units that can be safely used within a given area. With the realisation that emphasis on any factor will usually be at the expense of others, the SMC must decide which factors are the most important. Once this is decided, the search effort is planned to meet the requirements of the controlling factors, while at the same time satisfying the other factors as much as possible.

- 
- 4.6.7 A controlling factor peculiar to most maritime areas is the drift rate. In situations where a high drift rate is encountered, the SMC must allow for sufficient extension of the search area in the direction of drift in order to prevent the target from slipping out of the area during the search.
- 4.6.8 Search legs must be planned so that the target cannot slip out of the search craft's track spacing during successive sweeps. The simplest and most effective way of accomplishing the latter is to orientate the search legs with the drift direction.
- 4.6.9 If the search leg must be oriented across the drift direction, then the search craft should take no longer than 30 minutes to complete each search leg.
- 4.6.10 To ascertain if the drift rate presents a problem, compare the target's drift rate to the rate of creep of the search aircraft. If the target's drift rate exceeds the aircraft's rate of creep, remedial action is necessary. This may take the form of a barrier search at the end of the search area.

### **Search Effort Expenditure Rate**

- 4.6.11 Some situations, such as a declared distress or overdue craft, call for an initial maximum search effort over wide areas. However, a maximum search effort cannot be mounted every time a fishing boat or aircraft is first reported overdue. The great majority of overdue aircraft and small boat missions can be effectively handled by a planned build-up of the search effort. By using the repeated expansion concept with a small coverage factor, a reasonable build-up of search effort is possible. This build-up of search effort is combined with an expansion of the search area, and reaches the maximum effort and largest area on the last search. At that time, if no contact has been made with the target, the POD will have been strongly established that the target is not visible in the area searched.

### **Maximum Search Effort**

- 4.6.12 When a situation of actual distress is either known or strongly suspected to exist, the time available for search will usually be limited. A maximum search effort must be completed within this time. Quite often a large search area is also involved, further compounding the SMC's problems. The following method has proved successful in approaching this situation:
- a) Determine a search area that gives a high POD of successfully finding the search object;
  - b) Use a track spacing equal to sweep width ( $C = 1.0$ , or at least 0.5);
  - c) Decide the time by which the search must be completed;
  - d) Select the number of SAR units hours required to complete one search of the area within the allocated time;



- e) Dispatch sufficient SAR units to complete one search of the area within the allocated time; and
- f) If unsuccessful, expand and/or repeat in accordance with the repeated expansion concept.

4.6.13 Do not re-orientate the search or change SAR unit assignments whilst on task if it can be avoided.

4.6.14 Once a large-scale search is ordered and SAR Units are dispatched, reorientation of the search area for that particular search is both difficult and wasteful. Planning should therefore be thorough and then adhered to. The SMC must also resist the temptation to re-deploy units whenever new intelligence or doubtful hearing or sighting reports are received. New intelligence should be evaluated with the possibility that the information needs immediate action. Additional units should be dispatched to investigate leads that come to light after the assigned units have commenced searching.

## Search Sequence

4.6.15 There is no single sequence of search types, search patterns, etc. which can be suggested as standard procedures. The matrix in Table 4-1 shows one search sequence employing various factors and search parameters. Such a sequence could be used where large areas must be searched initially and search craft are limited. Each incident will require its own specific sequence and parameters should be recalculated for each search.

Search No	Type	Period	Target	Speed (Kt)	Track Spacing (NM)	Altitude AGL/ AMSL (FT)
Initial	Track line	Day/ Night	Active target	100/200	5	Below 5000
1	Electronic Beacons	Day/ Night	Electronic	150/500	20	High as practicable
2	Visual (aids)	Night	Fires, flares, torch, etc.	100/150	10	1500-3000
3	Visual (aids)	Day	Mirrors, dye, smoke, etc.	100/150	10	1500-2000
4	Visual (rafts)	Day	Life rafts	100/150	1.5	300-1500
5	Visual (wreckage)	Day	Wreckage, survivors	75/130	0.5	200-2000

Table 4-1 Search Sequence

### Notes:

- Some specialist aircraft may be able to provide RADAR and or electronic sensor searches. This type of search must be considered when conditions are favourable.
- Searches *Initial*, *1 and 2* could take place simultaneously at night and *3, 4 and 5* during the ensuing daylight hours; hence all five searches could be completed by the end of a 24 or 36 hour period. Search number is not to be confused with Day number.

- 4.6.16 The most effective search, by far, is an electronic search for a beacon. Electronic searches cover larger areas very rapidly with a high POD. After a beacon search, and given that it is known that the survivors from a maritime incident have distress flares, the next most effective detection aids are luminous types used at night. The SMC therefore plans to use a search unit on a night track line search during the first darkness period following the ditching. This pattern is also expanded laterally, but at a track spacing of 20 miles. Since the survivors will be in better physical and mental condition during the early stages of their ordeal, the SMC takes advantage of this by deploying a night search at the first opportunity. This minimises the possibility of the detection aids being lost prior to their use, or of the survivors becoming too weak to use them effectively.
- 4.6.17 The third most effective group of detection aids are the daylight aids such as mirrors, smoke and sea dye marker. The first daylight visual search is therefore based on this group of detection aids. A larger area can be covered initially by using 10-mile track spacing. In addition, the SMC is taking advantage of the probable better physical and mental condition of the survivors, in the same manner as when the early night search for the luminous detection aids was commenced.
- 4.6.18 If in a maritime incident, the electronic search, the night visual search and the day visual search for detection aids are unsuccessful; the SMC must next plan to search for life rafts. Just as the SMC assumed that the survivors were able to use their beacon, luminous detection aids and daylight detection aids in previous searches, he now assumes that the survivors were able to board their life rafts after ditching or abandoning their vessel. Therefore the SMC uses slower aircraft at close track spacing to search visually for life rafts.
- 4.6.19 If these raft searches were also unsuccessful, the SMC must then use extremely small track spacing and search for survivors in the water, wreckage and debris. From the second search on, the SMC should have also directed that all SAR Units maintain RADAR search, where RADAR available, even though the search was planned on the more tangible effective detection aids available to the survivors.

## 4.7 Determination of Search Areas

### Planning

- 4.7.1 Should an initial response fail to locate either the distressed craft or its occupants, it will be necessary to plan and execute an intensive search. The planning of a search may be considered under six broad headings:
- a) Determination of the most probable position of the distressed craft and/or its occupants;
  - b) Delineation of an area large enough to ensure that the survivors are within the area;
  - c) Selection of facilities and equipment to be employed;

- 
- d) Selection of the search procedures to be used;
  - e) Allocation of search resources; and
  - f) Preparation for rescue.
- 4.7.2 Additionally, it must be decided what is desirable in terms of search coverage and what may be achievable using available resources.
- 4.7.3 The most probable position (MPP) of a distress incident may be determined from a position reported at the time of the incident, or by the calculation of a DR position.
- 4.7.4 The extent of a search area is based on the accuracy with which the position of the occurrence is known. The SMC should take into account such factors as the possible navigation error of the distressed craft and the search craft, meteorological conditions, and drift of the distressed craft or survivors if in the water.
- 4.7.5 When the location of a craft is not known, a reconstruction of the probable route and some estimation of the most likely position of the incident must be made by the RCC.
- 4.7.6 Two concepts of value in SAR Planning are the Possibility Area, and the Probability Area.

### **Possibility Area**

- 4.7.7 The possibility area is the area in which a missing craft could be located. Usually the area is too big to be considered the search area but knowledge of its extent and boundaries may be of use when assessing intelligence information, in particular sighting or hearing reports.
- 4.7.8 The possibility area is displayed as a circle drawn around the last known position (LKP) of the craft. The radius of this circle should equal the endurance at the time of the LKP expressed in terms of distance and taking into account wind velocity for aircraft or drift for vessels. It is assumed that the craft may have proceeded in any direction until its fuel was exhausted.
- 4.7.9 The possibility area may be determined by:
- a) For aircraft, drawing a wind vector downwind from the LKP to a scale representing a distance equal to the wind speed multiplied by the known or estimated remaining fuel endurance time, while for vessels, drawing the drift for the time period since the LKP; then
  - b) Drawing a circle from the end of the wind vector or drift, of a radius (using the same scale) representing a distance equal to the aircraft TAS or vessel speed multiplied by the known or estimated remaining fuel endurance.
- 4.7.10 Figure 4.1 shows the possibility area for an aircraft with a last known position of A. Position B is the aircraft's datum once the wind vector has been applied. The circle is

derived using a radius, centred on B, of the aircrafts remaining endurance, which in this example is 150 NM.

Where: A = LKP, TAS = 100 kt, W/V +180/15, Endurance remaining at A = 90 minutes.  
Therefore A-B = 22.5 NM and radius B-C = 150 NM

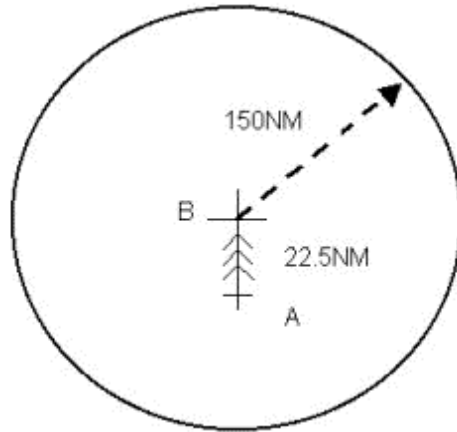


Figure 4.1 Possibility Area

## Probability Area

- 4.7.11 The probability area is the area in which a missing craft and/or survivors are most likely to be found, taking into account possible errors in the navigation of the missing craft and of the search craft, together with an allowance for any water movement (should the incident occur on or over water) and a safety factor.
- 4.7.12 When the position of an incident is reported by a witness, or reported as a navigational fix determined by RADAR or another craft or by the distressed craft itself, or calculated by the RCC in the form of DR position, the probability area is enclosed by a circle of probability centred on that position, taking into account the applicable above mentioned factors.
- 4.7.13 In the case of a downed aircraft (see Figure 4.2), joining lines 10 NM either side of the aircraft's known, planned or suspected route will normally form the initial probability area for an aircraft search. The 10 NM may be adjusted to allow for the type of flight, e.g. a transiting helicopter may be 5 NM either side of track where as a turbo prop or jet aircraft may be 15 NM or more. This is referred to as a Stage 2 search.

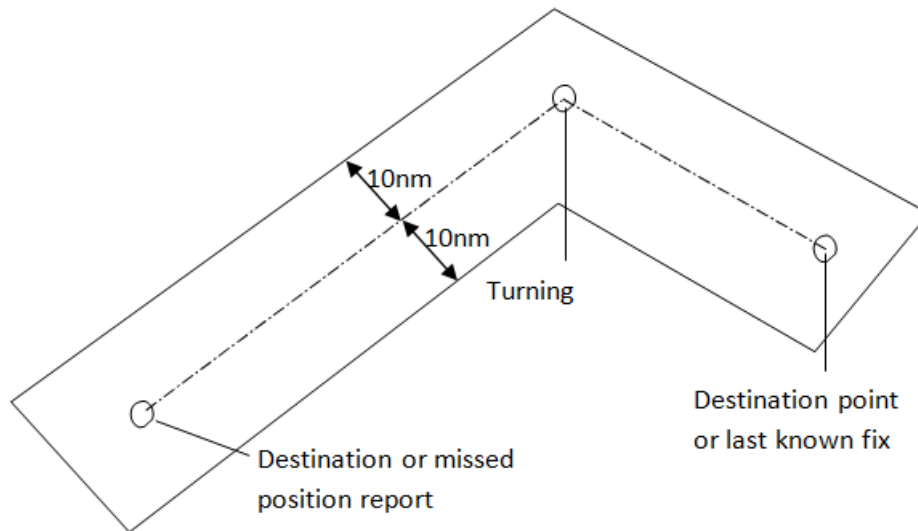


Figure 4.2 Stage 2 Search Area

- 4.7.14 When Stage 1 and Stage 2 search actions fail to locate the target, the probability area should be determined by drawing circles of probability around the last known position, the first missed report position, and any turning points along the planned track. Tangents to the circles then enclose the intervening area. This is referred to as a Stage 3 search and is shown in Figure 4.3. Planning for the Stage 3 search should commence when it is apparent the target cannot be located by the Stage 2 search.

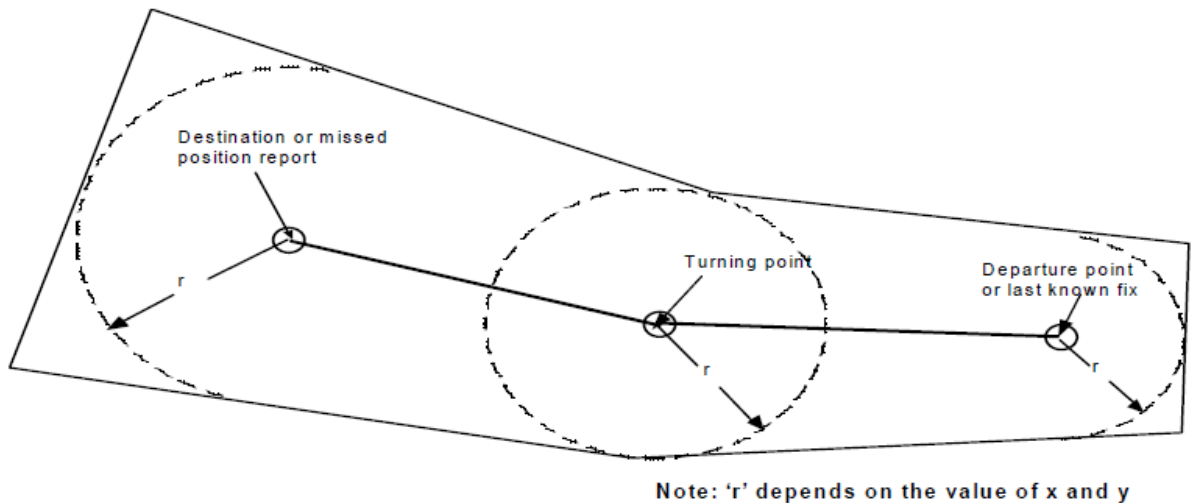


Figure 4.3 Stage 3 Search Area (Mathematically Derived)

- 4.7.15 When a route had been planned to cross the sea, or a large expanse of inland water, or the search involves a marine craft, allowance must be made for movement of survivors in or on the water, brought about by currents and wind.

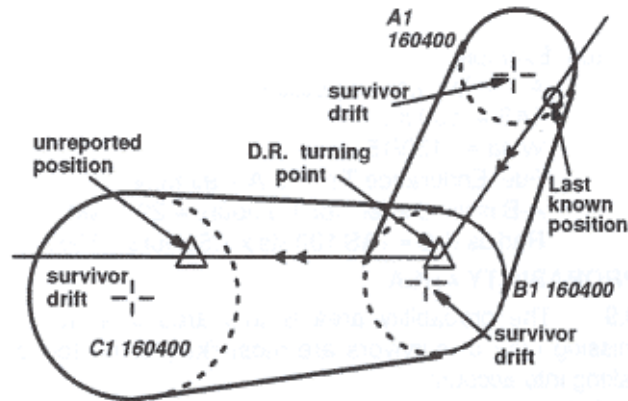


Figure 4.4 Probability Area for an over water Flight or Marine Craft Incident when Track is Known

- 4.7.16 The assumption is made that unless otherwise known, or indicated, the pilot/captain would follow their planned track as closely as possible. Use of information indicating otherwise would be at the discretion of the SMC.
- 4.7.17 When neither the position nor the intended track of a missing aircraft is known, a probability area must be determined by assessing likely pilot decisions in the light of intelligence information received, e.g. the disposition of a township, recent weather conditions; geographical features etc.
- 4.7.18 The examples illustrated in Figures 4.3 and 4.4 are representative of a situation where nothing has been heard from the pilot since departure and the pilot's route was known. Subsequent intelligence information that is gathered from witnesses and observers near the intended route might allow for the elimination of some route segments.

### Calculation of Circles of Probability

- 4.7.19 The Total Probable Error of Position (**E**) is found from the formula:

$$E = \sqrt{x^2 + y^2 + De^2}$$

where:

**x** is the probable navigation error of the distressed craft (initial position error);

**y** is the probable navigation error of a search craft (search craft error); and

**De** is the probable error of the calculated drift of a target in water (total error).

- 4.7.20 In an environment where drift is not available, or does not exist (e.g. coastal or land), the value for **de** should be zero.

## Probable Errors of Position

- 4.7.21 Initial Position Error (x) of the distressed craft and Search Craft Position Error (y) are the estimated errors of position based on navigational accuracy of the distressed craft and of the search assets. These errors of position for the calculation of e can be found in Appendix J.

## Search Radius (R)

- 4.7.22 This is defined as the radius of a circle, centred at the most probable position of the target at any given time (the Datum), equal in length to the Total Probable Error of Position (E) in nautical miles, increased by a safety factor. For successive searches of the probability area the safety factor is increased progressively.
- 4.7.23 The safety factors applied to the Total Probable Error of Position to obtain a Search Radius (R) are shown in Table 4-2.

Search Effort	Safety Factor
Initial Probability Area	1.1c
First Expansion	1.6c
Second Expansion	2.0c
Third Expansion	2.3c
Final Expansion	2.5c

Table 4-2 Safety Factors

- 4.7.24 Worksheet 4 (Appendix K) is available to assist with calculations.
- 4.7.25 JRCC Australia does not use the above safety factors in its programs for computer generating search planning. However, they can be applied to Coastal Search Planning, see Section 4.8.

## Drift Error for Waterborne Targets

- 4.7.26 Over land, the Datum is the last known position; however when survivors are known or thought to be in or on the water an allowance must be made for movement of the water resulting from the effects of wind and current. The degree of displacement of the Datum from the last known position assumes increasing importance with the passing of time, and MUST be allowed for in search planning. This displacement is a function of:
- The average sea current;
  - The average wind current; and
  - Leeway.
- 4.7.27 The deployment of electronic SAR Datum Buoys should be considered as a means of measuring the movement (direction and speed) of the total water column in which the search target is believed to be immersed. Other sources of information include

---

data held in the RCC, vessels passing through the search area, and individuals with local knowledge.

- 4.7.28 The direction and speed of these factors is referred to as 'SET'. Contrary to the convention of expressing wind velocity, the direction component indicates the direction of movement. The speed component is usually quoted in knots. Care must be taken to ensure that the speed unit is both stated, and interpreted, correctly.
- 4.7.29 To determine a value for Drift Error (De) it is necessary to complete a Datum Plot. A Datum Plot provides information both to calculate De and to measure the displacement of the Datum from the Last known Position (LKP) for the period under consideration. Drift error is derived by the resolution of the three factors (average sea current, average wind current, leeway), by way of vector addition.

### Sea Current

- 4.7.30 Sea current data can be obtained from JRCC Australia, which has access to various sources of information and computer drift modelling software to provide up to date information.
- 4.7.31 Tidal and local geographic features may affect sea currents near the coast. When areas near the coast are to be searched, the water movement for the area should be discussed more fully with local experts.

### Tidal Streams

- 4.7.32 Tides are caused by the gravitational pull of the moon and sun, modified by the depth and shape of the sea basin along the coastal areas. Currents in coastal waters are usually be effected by tides, changing in predictable velocity as the state of the tide changes. In some locations tidal streams are of the reversing type, abruptly changing direction 180 degrees at about the time of high and low water. In other places the direction will change in small increments so as to create a constant rotary movement. Variations of these tidal effects may also be found.
- 4.7.33 The exact effect of the tide on currents in any specific area may be found by consulting tide tables or local charts. Local knowledge is again of great value in dealing with movements of tidal streams. While the changes in direction of tidal streams have a tendency to nullify the cumulative effect, they must nevertheless be considered in computing drift for the following reasons:
- a) Often, with reversing streams, the effect in one direction is greater than in the other so that, over a period of time, the resultant effect is more in one direction than in the other; and
  - b) Even over short periods of time the flow of tidal streams will cause significant changes in the probable position of a search object.
- 4.7.34 Since most areas affected by tidal streams will be close to landmasses, wind current will usually not be a factor in determining drift. Because of this, drift occurring in in-



shore waters over short periods will be more greatly affected by tidal streams than current or leeway. However, if the cumulative effect of tidal streams and coastal currents thrusts the target into areas where sea current takes effect then drift considerations will need to be revised.

### River Current

4.7.35 River current will affect SAR incidents that occur in offshore areas near river mouths. Tidal streams affect the river current speeds near the mouths of the rivers. In large rivers this affect may be noticed several kilometres upstream from the mouth. Published current tables often give values which are combinations of tidal and river flow effects. These are among areas where reversing streams will be greater in one direction than the other.

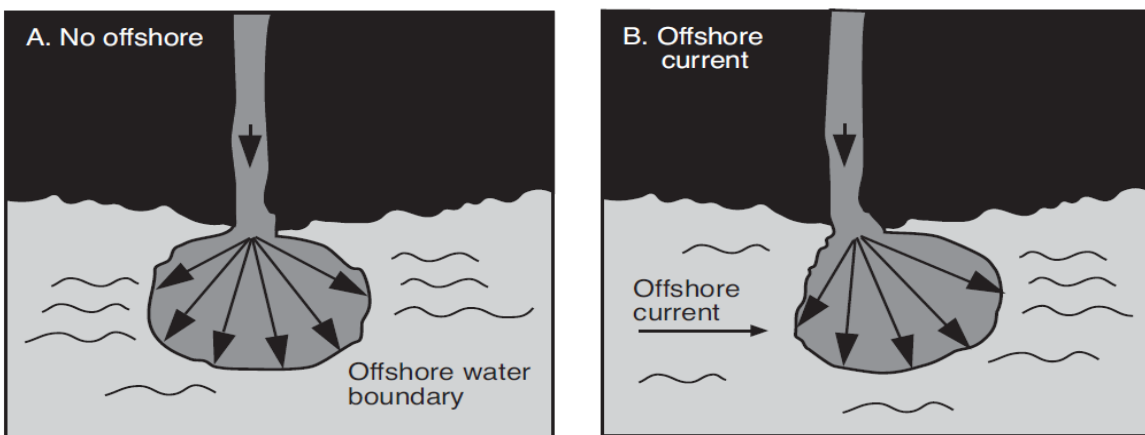


Figure 4.5 River Discharge

4.7.36 On the other hand, river current affects both total current and sea current at its mouth. Some major rivers extend their influence quite significantly off shore. Seasonal variations in water volume and velocity should be considered.

4.7.37 When estimating river current in the discharge area an assumption that the current direction is a straight line from the river mouth to the discharge boundary and the river current speed decreases linearly from the river mouth to the discharge boundary should be made. The river current speed at the mouth can usually be obtained from local knowledge or by direct observation.

4.7.38 If any type of offshore current is present, the SMC should expect that the river discharge will not fan out symmetrically, but will be displaced in the direction of the offshore current.

### Long Shore Current

4.7.39 Longshore currents are caused by incoming swells striking the shore at an angle. Longshore current information must be obtained from direct observation or local knowledge.

---

### Swell/Wave Current

4.7.40 In calm conditions, swells and waves may affect rafts and other small marine search targets. The effect is similar to leeway in that the raft is being moved through the water. However swell/wave current speed is so small, under 0.1 knot, that the drift force is usually ignored in determining general search areas. It is useful however for determining probable direction of target movement in some cases.

### Surf Current

4.7.41 Surf current is only considered for incidents occurring in coastal surf areas. It is more of a rescue or salvage factor than a search planning factor. Surf currents will move a drifting object after it enters the surf zone. If no longshore current is present, the surf current will move the object towards the shore perpendicular to the line of breakers. If a long shore current is present, the object will be displaced in the direction of the long shore current.

### Rip Current

4.7.42 Rip current is a special type of surf current. It is a narrow band of current flowing seaward through the surf line as a result of the long shore current building up a large volume of water along the beach line, and then bursting through the incoming surf on its way back to sea. Rip currents are only a few metres wide through the surf line, but they fan out and slow down when in smoother water. Rip currents occur when longshore currents are present, and in places where some form of bottom trough, bottom rise or shoreline feature assists in deflecting the long shore current build up in a seaward direction.

### Local Wind Current

4.7.43 Local wind current is the current generated by wind acting on the surface of the water. The current changes with variations of the wind pattern.

4.7.44 Near the coast, wind current can be affected by various factors and consideration should be given to omitting the wind current vector from search areas close to the coast. Offshore, consideration should also be given to omitting the wind current vector, if it is considered to be an area of consistent winds. The velocity of a wind current is calculated from:

- a) Wind data for the 48 hours preceding splash time;
- b) Actual and forecast winds between splash time and Datum time; and
- c) The application of coefficients taken from tables held in RCCs.

4.7.45 Wind current is calculated for 6-hour periods, the periods being coincident with the meteorological synoptic periods. The current for any given synoptic period is the cumulative effect of the wind in the area for the 48 hours prior to the end of the synoptic period being considered. The direction and speed coefficients obtained

---

from the tables allow for the effect of coriolis, and the reversal of wind direction, to express the result as 'SET'.

## Leeway

- 4.7.46 Leeway is the movement of a search object caused by it being pushed through the water by local winds blowing against its exposed surfaces. A boat, raft or any other type of marine craft has a certain proportion of its hull and superstructure exposed above the surface of the water at all times. This exposed area is blown against by local winds, which in turn have the effect of pushing the marine craft through the water. The more surface area the wind has to blow against, the greater will be the wind's effect on drift. If the silhouette of a boat were projected onto a flat plane, which was perpendicular to the wind direction, the area enclosed by the silhouette would be called the exposed flat-plane area. As the boat's heading changes relative to the wind, its flat-plane area also changes, usually becoming least when the boat is heading directly into the wind or downwind.
- 4.7.47 The pushing force of the wind is countered by the water drag on the underwater hull. The drag varies with the volume, shape, depth and orientation of the underwater hull. When a marine craft is parallel to the wind direction the least amount of underwater drag will exist since the craft will be pushed through the water in the direction its hull is designed to move. Almost the same conditions exist when the boat is pointed directly into the wind and is being pushed backwards through the water longitudinally. When the boat's heading is perpendicular to the local wind, however, the greatest amount of underwater drag will exist since the boat must now be pushed sideways through the water. Between these extremes the amount of underwater drag will vary depending on the heading of the boat.

## Divergence

- 4.7.48 When a search object first begins to drift, the wind will push the object in a downwind direction. As the search object continues to drift, the wind will cause the search object to deflect (or diverge) to either the left or to the right of the downwind direction. The amount of divergence is dependent upon the shape of the exposed flat-plane area of the search object. Divergence is caused by the lack of symmetry of the drift object.

## Calculating Leeway

- 4.7.49 A search object's leeway speed is measured as a percentage of the of the wind speed. The Multiplier value listed in the Taxonomy (Appendix I Table I-1 and Table I-2) provides the leeway speed percentage. In some cases, it is necessary to add or subtract a Modifier to further refine the search object's leeway speed.
- 4.7.50 The formula to determine leeway speed is:

$$\text{Leeway Speed (knots)} = \text{Multiplier} \times \text{Wind Speed (knots)} + \text{Modifier}$$

**Note:** By international agreement, wind direction is reported in most places based on the direction the wind is blowing from. For search planning we are interested in the direction the wind is blowing to. When using downwind leeway, the leeway direction is equal to the reciprocal of the wind direction (Wind direction + or – 180°).

- 4.7.51 When directional uncertainty applies, the divergence angle is both added and subtracted to the downwind direction to account for the search object’s divergence to the left or right of the downwind direction. Thus, the formula to determine the direction of the divergence is:

Wind Direction +/- 180° = Downwind Direction

Downwind Direction + Divergence Angle = Angle to right of Downwind Direction

Downwind Direction – Divergence Angle = Angle to left of Downwind Direction

The following example illustrates how the Taxonomy is used to determine directional uncertainty leeway. Refer to the Leeway Taxonomy to obtain the appropriate multiplier, modifier, and divergence angle for specific target types.

- 4.7.52 A search is being conducted for a missing scuba diver. The winds are blowing from 270° True at 15 knots.

Leeway Speed = Multiplier (Table I-1 or I-2) x Wind Speed (knots) + Modifier

Leeway Speed = (0.007 x 15 knots) + 0.08

Leeway Speed = 0.185 knots

Leeway Drift distance (NM) = Leeway Speed (knots) x hours of drift

Vector length (NM) @ Divergence Right (270° - 180°) + 30° = 120° T

Vector length (NM) @ Divergence Left (270° - 180° DEG) – 30° = 060° T

- 4.7.53 The leeway speed would be multiplied by the number of hours of drift to determine the leeway vector’s length. The two leeway vectors would be added to the end of the total water current vector to determine the Right and Left Datum.

- 4.7.54 The magnitude of leeway speed in relation to wind speed (u) and leeway divergence for persons in water and various types of marine craft can be found in Appendix I (Tables I-1 and I-2). The tables have been adapted from Allen and Plourde 1999 Review of Leeway: Field Experiments and Implementation, USCG Research and Development Centre Report No CG-D-08-99. Appendix I also contains the Taxonomy Class Definitions/Descriptions.

**Note:** Prior to the publication of the data the USCG Research and Development Centre made the decision that the only data published would be data that was based on actual results derived from documented research and observation during controlled field experiments. However it has been recognised that some anomalies exist in the data pertaining to maritime life rafts with no ballast systems. There has

been significant time elapse between the initial research done by Hufford and Broida in 1974 and later research by Nash and Willcox in 1991 and it is probable that the make of life raft used for the experiments may no longer be in use. SAR Mission Coordinators should evaluate the calculated results obtained from using the tables, compare the results with actual known conditions and, if required, adjust leeway values as appropriate.

## Plotting Drift

4.7.55 Using the vector values determined for average sea current, wind current and leeway it is possible to plot a simple vector diagram and obtain a datum point. However as the leeway data is generally uncertain it is necessary to plot both a left and right drift, and to calculate drift error ( $D_e$ ). Whenever possible the owner or operating agency should be contacted to verify the type of life raft carried and its equipment.

4.7.56 Any change to surface wind conditions has an immediate effect on a craft's leeway, and a recalculation of vectors is required.

### Datum Plot

4.7.57 The bearing and distance of a Datum from its associated Last known position is found by combining four vectors as shown in figure 4.6:

- the sea current;
- the wind current; and
- two leeway vectors, one each for left and right divergence.

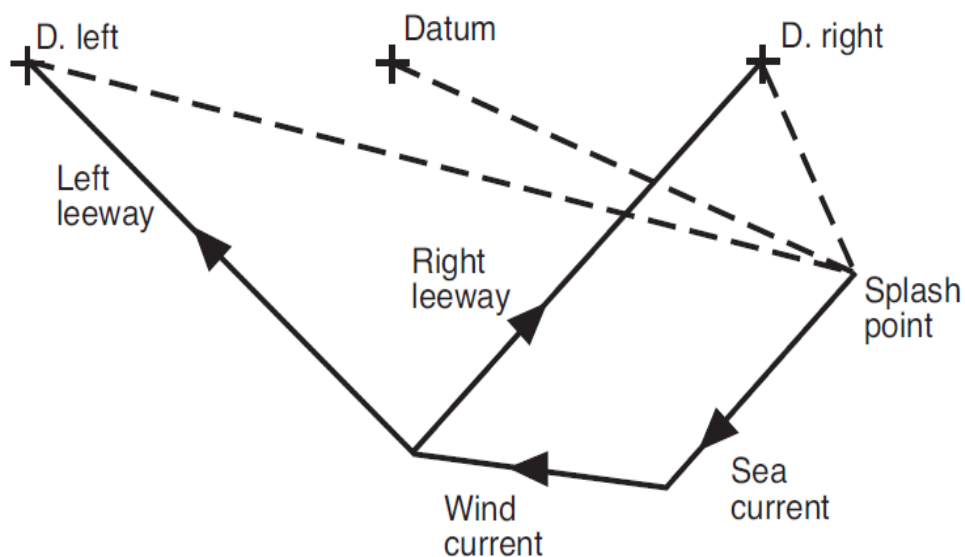


Figure 4.6 Datum Plot

- 4.7.58 The value of the vectors may change with time; therefore it is necessary to calculate a mean value for each vector for the period between splash time and datum time. All calculations are related to meteorological synoptic periods, or part thereof. The objective being to calculate the movement attributable to each factor during the period under consideration, with a vector summation for the whole period and then to combine the individual effects to establish a most probable position for the target. When the most probable position has been established, an allowance is made for possible errors, which is then combined with the navigation error allowances in the Total Probable Error (E) of Position formula.
- 4.7.59 A Datum Plot should be drawn on the appropriate Chart. To construct the plot, draw the sea current vector from the last known position, add the wind current vector, and then from the end of the wind current vector draw the two leeway vectors. Although not quite correct mathematically, the mid-point between the ends of the leeway vectors may be taken as the Datum.

### Drift Error (De)

- 4.7.60 Drift Error ( $D_e$ ) is the radius of a circle of probability around the Datum. The circle is externally tangential to two circles of probability drawn around the end of each leeway vector, the radius of each circle being equal to 12.5% of the distance from Last Known Position (LKP) to the end of the appropriate leeway vector. The value of  $D_e$  therefore, is the sum of the radii of the two leeway probability circles and the distance between the ends of the leeway vector [Distance Left-Right (LR)] divided by two, i.e.

$$D_e = \frac{d_e (L) + d_e (R) + \text{Distance LR}}{2}$$

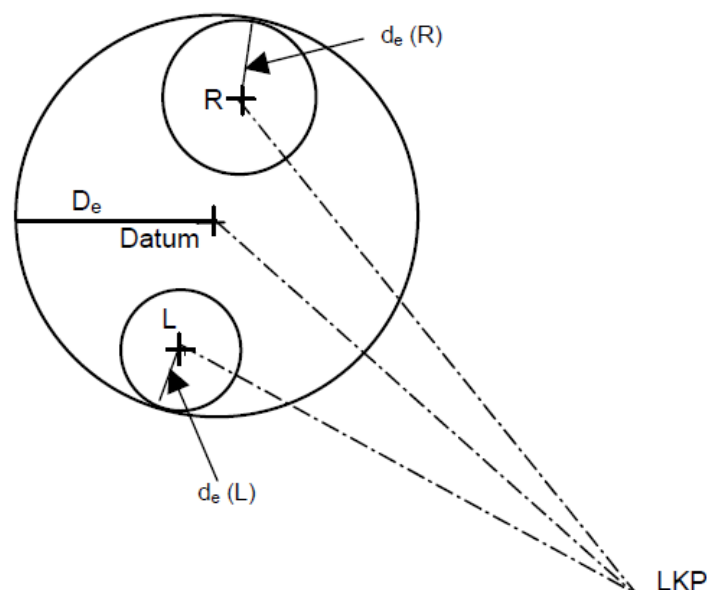


Figure 4.7 Plotting Drift Error

## Search Area Based on Non-Moving Datum

- 4.7.61 For a typical last report/missed report situation, where the track between positions is a straight line, the probability area may be modified as in Figure 4.8 to form a trapezium. The area of the trapezium may be found from the formula:

$$A = \frac{L(D + d)}{2}$$

Where L is the distance between datum A and datum B plus the two radii of the circles of probability, and D and d are the measured distances across the ends of the trapezium. It will be readily apparent that this modification will result in a larger area than the original probability area. An estimate of the excess area can be made and taken into account in planning calculations necessary.

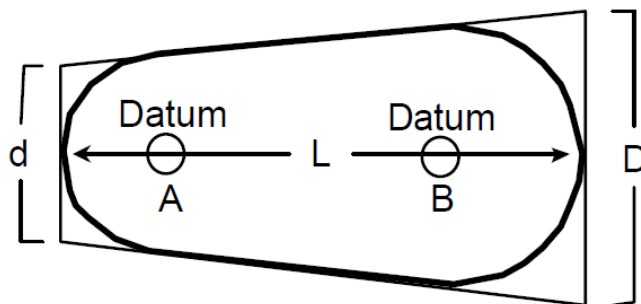


Figure 4.8 Search Area (Non Moving Datum)

## Search Based on Moving Datum

- 4.7.62 To calculate the area of an irregularly shaped probability or search area, it will be necessary to sub-divide the area into squares, rectangles or triangles, calculate the size of the smaller area, and sum the results. Use may be made of a surveyor's grid to determine the size of the irregularly shaped areas. In a maritime situation the datum point is moving and areas will move on the chart as depicted in Figure 4.9.

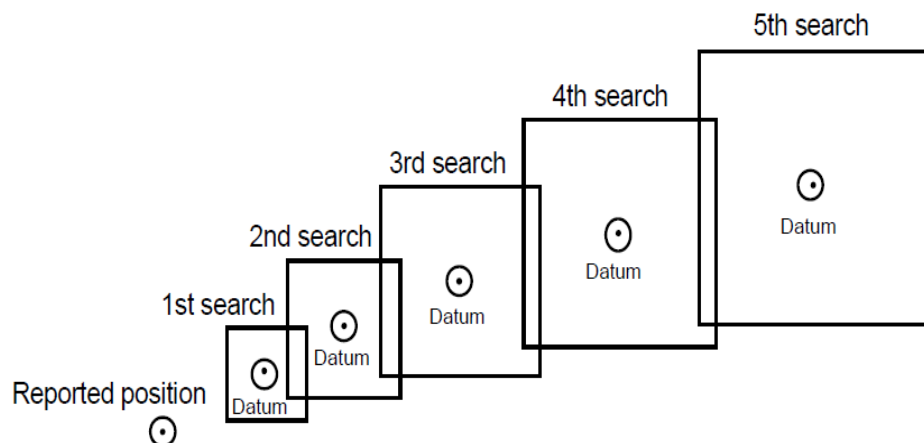


Figure 4.9 Search Areas (Moving Datum Point)

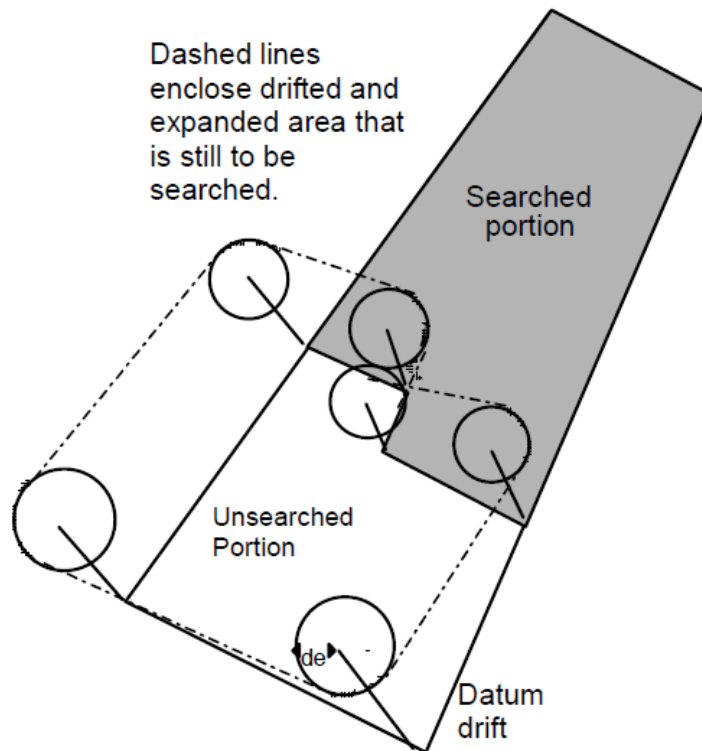


Figure 4.10 Area being Searched at Significantly Different Times

- 4.7.63 It may be necessary to redefine a search area, which is either an unsearched portion of an area, or one derived from intelligence information but located wholly, or partly, over water. In such cases one, or more points on the boundary of the area should be selected, which may then be treated in the same way as any other last known position from which a Datum may be determined.

That is, drift vectors and drift error should be applied to them to give new boundary positions that will compensate for drift effect over the intervening period. The area may then be reconstructed relative to these Data and expanded in proportion to the Search Radii. In doing this it is necessary to draw circles of probability around the Data with Radii equal to "de" and joined by tangents.

- 4.7.64 The appropriate safety factor will have been included in the calculations to determine the original area (See Figure 4.10).

### Labelling the Datum

- 4.7.65 During an extended over water search involving several Datum Points it may be necessary to calculate a series of Data. To avoid confusion when referring to Data, a standard system shall be used. The Datum referring to the distress position or last known position shall be identified as 'A', with subsequent positions along a path identified in alphabetical order. Data referring to a particular Datum Point shall be



numbered consecutively, and in addition, shall be annotated with a date/time group when depicted on a chart as shown in Figure 4.11.

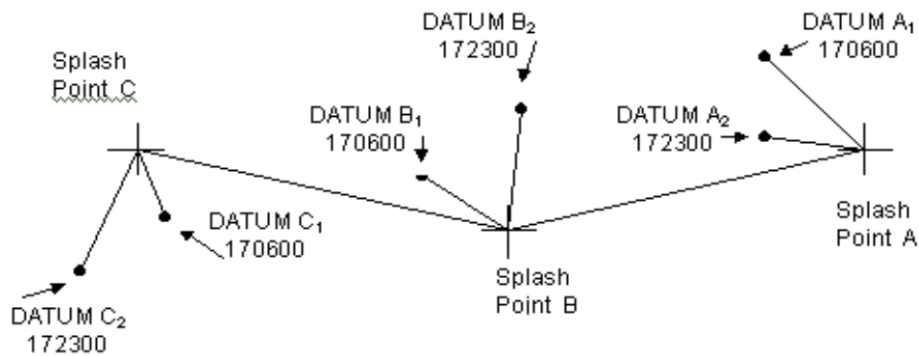


Figure 4.11 Labelling of Data

## Modification of the Probability Area

- 4.7.66 Modification of a calculated probability area may be suggested from an assessment of intelligence information received in the RCC, limitations imposed by search unit availability or for other reasons.
- 4.7.67 It should always be understood that SAR calculations are intended to be a guide to search planning, and may be modified to suit any particular situation as suggested by the accumulated SAR experience within the RCC.
- 4.7.68 Any member of the RCC team who considers that a modification would be to advantage shall make the SMC aware of the suggestion. When offering such suggestions, every attempt should be made to present viable alternatives, together with a summary of the advantages, and disadvantages of each. The authority to make any such modification rests solely with the SMC.

### Modification Suggested by Intelligence Information

- 4.7.69 During the course of a SAR action, reports and information may be received from a variety of sources claiming that the missing craft had been seen or heard. Detailed analysis of these reports, and comparison with data about known flights, may lead the SMC to delineate a modified, or totally different, search area. Discussion with owners or operators of a missing craft may bring forth information concerning the course of action that would be followed in particular circumstances. Similar information may be gathered from relatives, friends and colleagues.

### Modification Resulting from a Shortage of Search Aircraft

- 4.7.70 When it is not possible to search the whole of the probability area in the course of a single sortie by each available aircraft, a number of factors may be changed to facilitate modification of the area. For example: track spacing, aircraft speed, search

---

height or the size of the probability area. After consideration of these factors, the SMC will make a decision which section of a probability area should be searched first.

4.7.71 Worksheets 2 (Maritime) and 3 (Land) have been developed to assist in determining the extent of the probability area that can be searched with available resources. It is designed to present the SMC with a statement in numerical terms of:

- a) The desirable intensity of the search, that is, the optimum coverage factor;
- b) The amount of area which can be searched at the desired coverage factor, and, if this is less than the area described; and
- c) The quality of search that can be obtained by covering the whole area with the search aircraft available.

#### **Modification of Areas Incorporating $D_e$ and Increased Safety Factors**

4.7.72 Care must be taken not to waste search effort on the section of the probability area that encompasses land areas as a result of incorporating allowance for water movement. To avoid this, reference should be made to the fundamental probability area, calculated by using only the 'x' factor. A search of any coastline included in a drifted area should always be made.

4.7.73 Similar consideration should be made when an area that is predominantly over land is expanded, and subsequently includes an area of water. This situation is not so simple and clear cut, and may require reference to intelligence information to justify the inclusion, or exclusion, of the over-water area. Should it be decided to search the over-water part of an expanded probability area, movement of the now included over-water part must be taken into account for the period between Splash Time and Datum Time.

#### **Modification for the Allocation of Areas to Search Units Other than Aircraft**

4.7.74 When drawing up a probability area the allowance for search craft navigation is usually that specified for aircraft. When using other types of search unit, i.e. land or marine, it will be advantageous to recalculate the probability area using the appropriate value for 'y'.

### **Consideration of Possible Courses of Action by the Captain of the Distress Craft**

4.7.75 Through an analysis of intelligence information, or because of the failure to locate a missing craft in the probability area, even after the expansion to the 2.5c safety factor, it may be considered necessary to search other areas or tracks. All decisions of this nature are the responsibility of the SMC. The general guidelines for determination or probability areas should be applied.

## 4.8 Coastal Search Planning

### Search Area

- 4.8.1 A great number of maritime search and rescue incidents occur within 25 NM of the coast, in under 300 metres of water. The coastal search-planning model is to assist with a rapid response and should ideally be used when the report of a craft in distress is notified to a SAR authority within six (6) hours of the actual distress situation arising.
- 4.8.2 This section is aimed at simplifying the search planning methods when this situation arises. If time and unit availability allows, the oceanic model should be used. The principles in other sections under search planning should be referred to. If this model is used and overall coordination of the incident is handed to another SAR authority that SAR authority should be made aware of the situation and model used.
- 4.8.3 In most cases, considering the short response time to coastal SAR incidents, if the search unit proceeds to the last known position (LKP) of the craft in distress it will be found. However, the craft in distress may not be in sight because of inaccuracies in the initial position reported; inherent errors associated with drift factors; and/or errors in navigation of the search unit.
- 4.8.4 If the time since the craft became distressed is less than four (4) hours and it is not located at the LKP draw a 6 NM radius centred at the LKP. Then draw a square search area with the sides tangential to the circle. This will give a search area of 144 NM<sup>2</sup> (as shown in Figure 4.12).

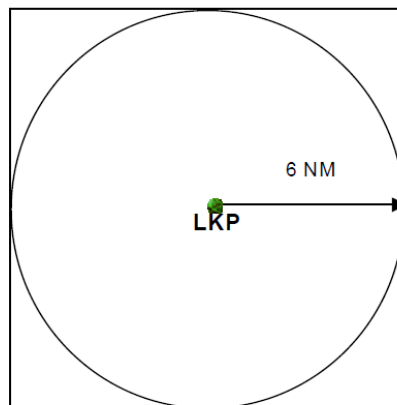


Figure 4.12 Circle of Probability using Coastal Method

- 4.8.5 The purpose of drawing a radius around the datum is to describe the geographical area most likely to contain the search object. The formula uses the Total Probable Error (E), which includes the Initial Position Error (X) of the distressed craft and the Navigation Error of the SRU (Y), but does not include Drift Error (De).

$$E = \sqrt{X^2 + Y^2}$$

- 4.8.6 For coastal SAR cases when an SRU arrives on scene and the search object is not seen, a five (5) NM position error for the distressed craft and a one (1) NM navigation error for the SRU may be assumed. Using the formula, when  $X = 5$  and  $Y = 1$  then:

$$E = \sqrt{(25 + 1)}$$

$$E = \sqrt{26}$$

$$E = 5.099 \text{ NM}$$

- 4.8.7 Applying the safety factor for the first search ( $f_s = 1.1$ ), then:

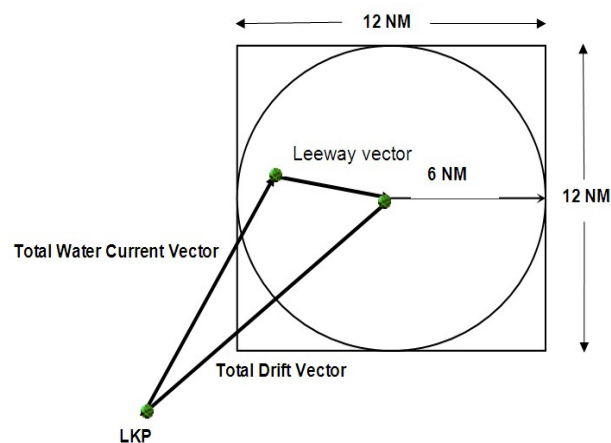
$$\text{Radius} = (E)(f_s)$$

$$\text{Radius} = (5.099)(1.1)$$

$$\text{Radius} = 5.6 \text{ NM.}$$

This is rounded up to six (6) NM.

- 4.8.8 If the time is greater than four (4) hours but less than six (6) hours, and/or the drift, based on local knowledge and/or on scene conditions, is considered to be significant, the search objects drift should be established, and the six (6) NM radius applied to the drift datum position.
- 4.8.9 In coastal SAR, the initial datum is determined by calculating drift using the object's LKP and the effects of water current and leeway speed and direction without considering leeway divergence (leeway direction is considered to be directly downwind). Time of datum must take the underway transit time for the SRU into consideration (Figure 4.13).



**Figure 4.13 Circle of Probability Using Coastal Method and Allowing for Drift**

- 4.8.10 If the craft in distress reports a position in shallow water there is always the possibility that the vessel may attempt to anchor. Therefore, particular attention should be paid to the situation when the LKP is outside the established search area. In many cases, it should be possible to search along the drift line from the LKP to the

datum during the initial search. However, it may be necessary to search the drift line after the search area has been completed.

## Time Uncertainty

- 4.8.11 If the time of the incident is uncertain, calculate a datum for the shortest possible time the vessel could be adrift, and calculate a second datum for the longest possible time the vessel could be adrift. Draw a circle of six (6) NM around each datum point and then enclose the circles in a rectangle (Figure 4.14). To determine the size of the area, multiply the length in miles by the width in miles.

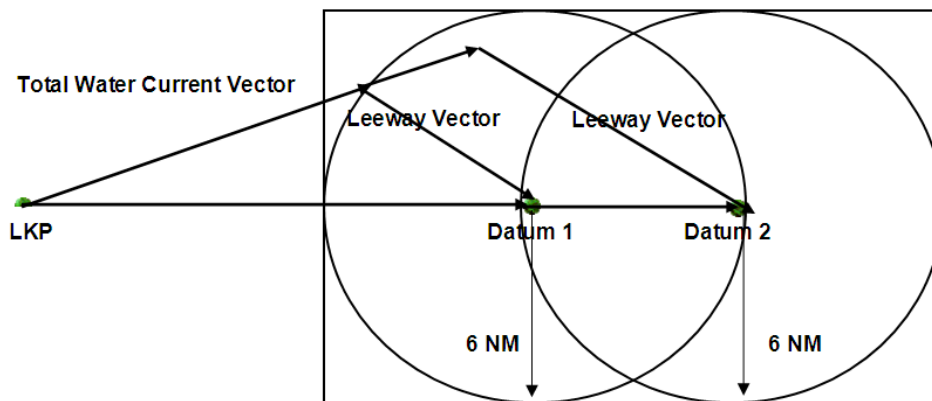


Figure 4.14 Circles of Probability when Time Uncertain

## Position Uncertainty

- 4.8.12 If the position of the craft in distress is in question, calculate a datum for each position (LKP 1 and LKP 2) and draw a six (6) NM circle around each and enclose the circles (Figure 4.15). The search Datum can be assumed as a point midway between the two individually calculated Data. If extreme distances separate the positions in doubt, consideration should be given to treating them as separate vessel adrift incidents (Figure 4.16).

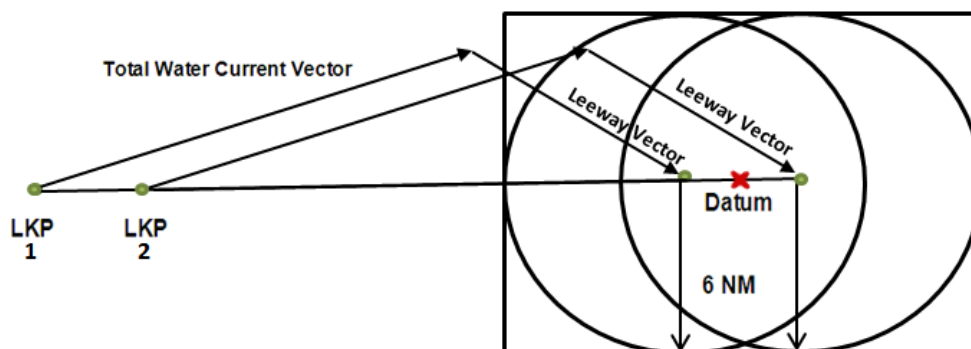


Figure 4.15 Circles of Probability when Position Uncertain

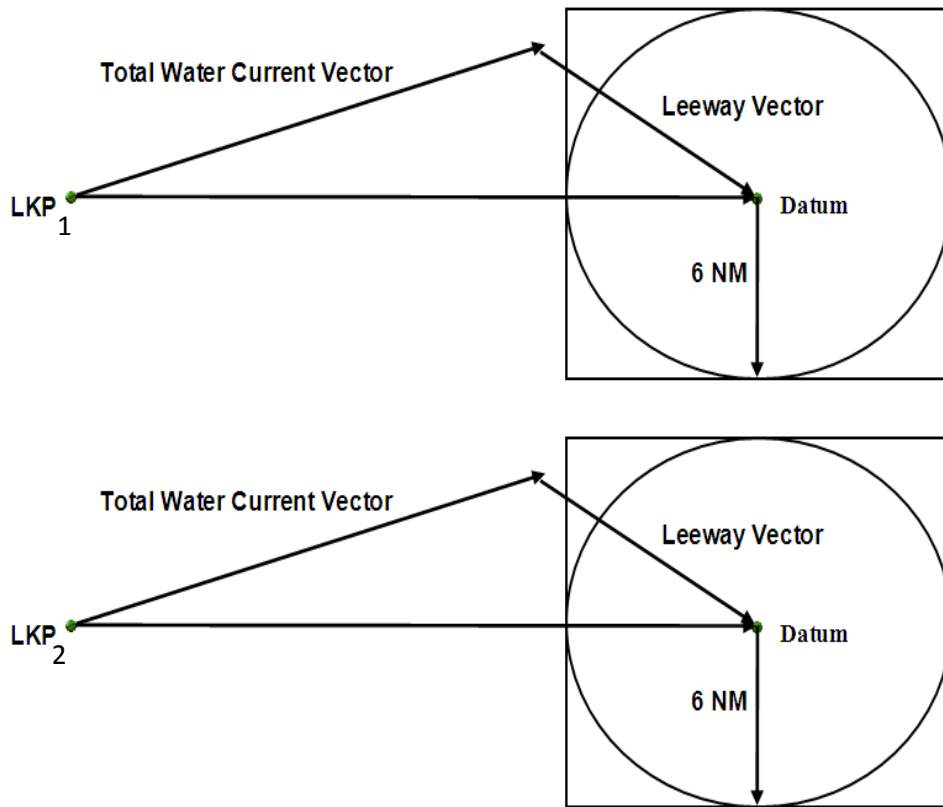


Figure 4.16 Circles of Probability when position Uncertain and Extreme Distances Separate Positions

### Track Line Overdue Incident

4.8.13 If a craft in distress is overdue along a track line, determine a datum near the beginning of the track, another near the end of track and one at each turning point. The datum line is the line joining each datum. Draw a six (6) NM circle around each datum and enclose the circles in rectangles with sides drawn tangentially to the datum circles (Figure 4.17).

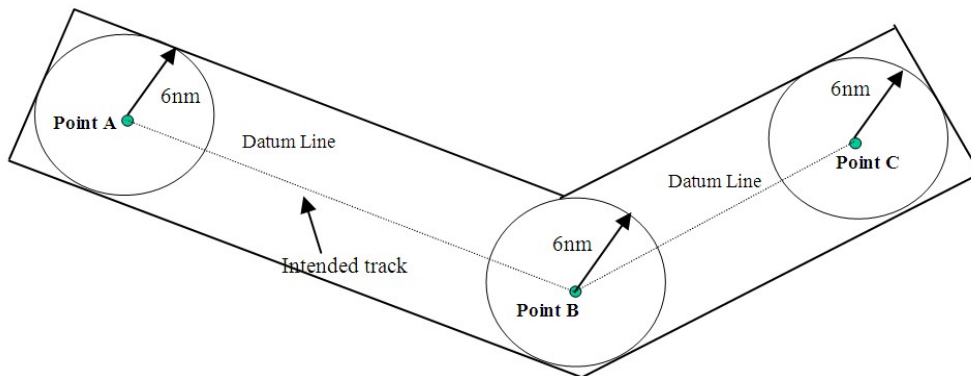


Figure 4.17 Track Line Overdue Incident  $\leq 4$  Hours

4.8.14 If time late to datum is more than four (4) hours allow for drift of starting, ending and turning points as seen in Figure 4.18.

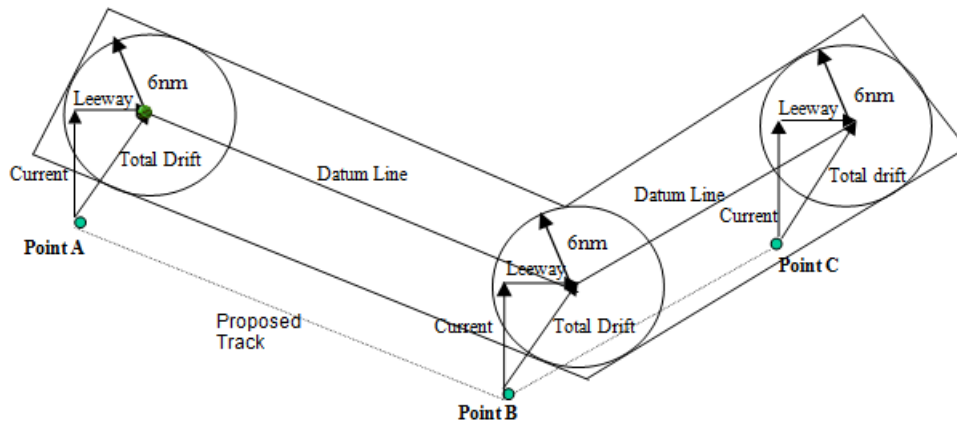


Figure 4.18 Track Line Overdue Incident > 4 Hours

## Recomputed Datum

4.8.15 As a general rule in coastal situations, the datum is recomputed every two (2) to four (4) hours.

4.8.16 When recomputing a datum that was initially established using the coastal model the drift error ( $d_e$ ) of the target must be calculated. As with the case in oceanic search planning, drift error rate estimates usually fall between 1/8 and 1/3 of the total distance drifted. The search planner, depending on the confidence or lack thereof in the relevant drift data, would use a value between 1/8 and 1/3, increasing in size as the confidence in the data decreases. The higher the confidence in the data the smaller the value used to estimate drift error. The search planner may also use values outside this range.

4.8.17 In addition, the total drift error for two or more successive drift updates is the sum of all the individual drift errors up to that point therefore, drift error always increases with the passage of time.

4.8.18 In this model, the distance from datum<sub>1</sub> to the recomputed datum<sub>2</sub> is measured. The  $d_e$  of the position is established, generally using 1/8th of the drifted distance as error, and then adding this distance to the 6 NM assumed error (E) used to establish the initial search area.

## Example

4.8.19 The target is drifted from its LKP to datum<sub>1</sub> and an E = 6 NM is plotted. The targets drift is recalculated some time later and its drift is established as eight (8) NM from datum<sub>1</sub>. Using 1/8th of the targets drift as error, one (1) NM is added to the initial six (6) NM error used for the first datum. Therefore the error used for datum<sub>2</sub> is 6 NM + 1 NM = 7 NM. See Figure 4.19.

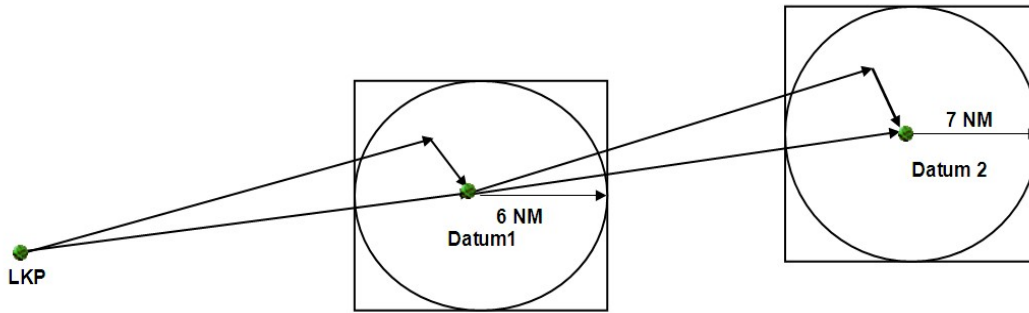


Figure 4.19 Recomputing Datum

## Track Spacing

4.8.20 For the coastal search model, the following standard track spacings are recommended on search objects less than 30 feet high.

### Good Search Conditions

4.8.21 In conditions where the wind speed is less than 15 knots and/or visibility is greater than three (3) NM, use a track spacing of up to three (3) NM by day or night but reduce the separation depending on the size of the search target. After dark, the effect of the search light should be considered.

### Poor Search Conditions

4.8.22 Where winds are greater than 15 knots and /or visibility is less than three (3) NM but greater than one (1) NM, a track spacing of 1 NM should be considered by day or night but reduced depending on the size of the search target. After dark, the effect of the search light should be considered.

### Person in Water

4.8.23 When searching for a person in the water, it should be assumed that the person is not wearing a floatation device and will therefore be more difficult to detect. For good search conditions a track spacing of a 0.25 nautical mile should be considered. For poor search conditions, the track spacing should be reduced as appropriate, taking into account the visibility and the navigational and operational capabilities of the search units.

4.8.24 Note that the track spacings suggested are given as a guide only. The track spacings used in any one (1) search will be decided by the SMC in consultation with the OSC taking into consideration all the available information at the time.

## General

4.8.25 As outlined earlier, the coastal SAR planning model described here is used to facilitate ease of determining a search area and a rapid deployment of search assets into a search area.



- 
- 4.8.26 Although it is ideally used when the response is mounted less than six (6) hours from the time of distress the principles can also be applied for up to 24 hours after this time by drifting the datum as described in the section headed Recomputed Datum. This provides the SMC with a tool to rapidly determine a search area.
- 4.8.27 The oceanic model incorporating leeway divergence and solving for total probable error should be used for all situations in excess of 24 hours or when time and unit availability allows.

---

## Chapter 5: Search Techniques and Operations

### 5.1 Overview

- 5.1.1 Chapter 4 described how to determine the optimal area where the available search effort should be deployed. Once the optimal search area has been determined, a systematic search for the search object should be planned. Before a search operation takes place, the search planner should provide a detailed search action plan to all involved, specifying when, where and how individual search assets are to conduct their search operations. Coordination instructions, communications frequency assignments, reporting requirements, and any other details required for the safe, efficient and effective conduct of the search must also be included in the search action plan.
- 5.1.2 As a minimum, developing a search action plan consists of the following steps:
- a) Selecting search assets and equipment to be used;
  - b) Assessing search conditions;
  - c) Selecting search patterns to cover the optimal search area as nearly as may be practical;
  - d) Dividing the search area into appropriate sub-areas for assignment to individual search assets; and
  - e) Planning on-scene coordination.

**Note:** JRCC Australia uses a computer-based program to design search areas, assign search patterns, allocate assets to a search area and create briefings for search assets. The program uses the same data as is provided in this Manual.

### 5.2 General Guidelines for Searches

#### Overview

- 5.2.1 As discussed in the previous chapter, a search typically involves three stages including the immediate response, a search based on a nominated area either side of track, and a search based on a mathematically derived search area. This applies equally to aviation searches as well as maritime searches, whether using oceanic principles or those of the coastal search plan. The following sections describe these stages in further depth.

#### Stage One Search. Immediate response

- 5.2.2 The stage one or initial search normally consists of:
- a) A visual search along, and possibly also parallel to, the track of the missing craft;
  - b) Action to detect a signal from an emergency beacon;
  - c) Formulation of a rescue plan;

- 
- d) Coordination with Police, Airservices Australia and other agencies as appropriate; and
  - e) For over water searches, dropping of SAR datum buoys to establish drift.

5.2.3 The stage one search may comprise of:

- a) single or multiple track line searches:
- b) Implementing procedures to detect a signal from an emergency beacon, such as monitoring by aircraft flying over the area; tasking a dedicated search unit; monitoring by aircraft or vessel on a visual Track Line search; monitoring by passes of the satellite system;
- c) Developing a rescue plan to return survivors to a place of safety;
- d) Preparing aircraft with SAR droppable supplies;
- e) Arranging observers; and
- f) Gathering intelligence relevant to the search.

5.2.4 The SMC should consider:

- a) Diverting aircraft or ships if they are available;
- b) Tasking aircraft from an SRU or local resources where the urgency of the situation and the locality will determine the assets to be used;
- c) That a surface response for search or rescue may be required;
- d) That the height and track spacing of search aircraft can be higher than book values as there is an expectation that an active target may be available to assist;
- e) That the coverage factor should generally not be less than 0.5; and
- f) The use of electronic or thermal imagery equipment.

### **Stage Two Search. Nominated Area Either Side of Track**

5.2.5 A stage two search is normally not required for a maritime incident. During stage two, the search area is normally 10 NM either side of the missing craft's track.

5.2.6 It may be reduced or extended either side of the track after consideration of the following factors, as applicable:

- a) The height and speed of the missing aircraft;
- b) Possible actions of the missing craft during an emergency, e.g. an aircraft searching for a suitable area to land or attempting to reach land if flying over water;
- c) A ferry flight using GPS;

- d) A scenic flight; and
- e) Drift, if applicable.

5.2.7 A Stage Two search may comprise:

- a) A number of aircraft and surface units assigned an area (normally ten legs) to conduct a visual search;
- b) Helicopters assigned a specific area to conduct a visual contour search;
- c) Arranging observers;
- d) Provision of a dedicated communications aircraft;
- e) Preparing and deploying aircraft with SAR droppable supplies;
- f) Provision of a surface search and or rescue response;
- g) Establishment of a Forward Command Post or Forward Field Base;
- h) Implementing a structured rescue plan;
- i) The use of thermal imagery to locate the target; and
- j) Establishing an intelligence cell.

5.2.8 The SMC should consider:

- a) Drift if the search is over water and it begins more than four hours after Splash Time;
- b) Location of deployed SAR Datum Buoys to establish water movement;
- c) Exercising caution in using aircraft with an endurance of less than four hours;
- d) Increasing the distance either side of track following an unsuccessful search or searches;
- e) Ensuring the search area includes the possible departure path and the approach pattern areas at both the departure and destination aerodromes; and
- f) Increasing detection time over rugged terrain or rough seas.

### **Stage Three Search. Mathematically Derived Area**

5.2.9 A Stage Three search is a further development of Stage Two, where the search area is expanded to cover the probability area calculated by reference to the missing craft's and search aircraft's navigation errors, modified by intelligence and any allowance for drift. This probability area will be expanded after each successive search, thus increasing the total area being searched and incrementally increasing the POD over the centre of the search area.

---

5.2.10 The SMC should consider:

- a) The on-going availability of search aircraft;
- b) Provision of a suitable surface response;
- c) The on-going availability of search crews, including pilots and observers;
- d) Accommodation and financial arrangements for observers if operating away from home base;
- e) Logistical support including availability of fuel for search aircraft if operating from more remote airfields;
- f) Refining rescue plans including deployment of rescue units to the area if considered beneficial;
- g) Location of deployed SAR Datum Buoys to establish water movement;
- h) Further deployment of supply dropping aircraft; and
- i) Any further avenues to obtain intelligence.

## 5.3 Search Area Coverage

### General

5.3.1 Once the search area has been determined, a systematic search for the target should be planned. Factors such as the weather conditions, time available for search, aircraft speed, search altitude, sighting range, size of target, etc., should be taken into account. These factors are related but some may be more important than others. In planning a search operation, the SMC should endeavour to meet the requirements of the more important factors while satisfying the requirements of the others as far as practicable.

5.3.2 Search Area coverage is the systematic search of selected areas of land, or water, to ensure the optimum probability of detecting the object being sought. The factors affecting detection capability have been reduced to four inter-related expressions. The terms and their symbols are:

- a) Sweep Width (W)
- b) Probability of Detection (POD)
- c) Track spacing (S)
- d) Coverage Factor (C)

- 5.3.3 The type and number of available search aircraft will be a factor in determining search area coverage. More time will be required to search a large area thoroughly when there are limited numbers of search aircraft available unless the distance between successive sweeps of the area is increased. This is not desirable since it would reduce the probability of detecting the target. It may, therefore, be necessary to seek additional search aircraft from other sources. It is usually preferable to cover a search area from the beginning with an adequate number of search aircraft.
- 5.3.4 When the aircraft operate far from their home base, consideration should be given to them being redeployed at an advance base so that more time will be available for the search and less time will be spent on flights to and from the search area.
- 5.3.5 An adequate number of well-placed, trained observers as well as altitude and speed of the search aircraft are important factors determining the POD of a target. A slow aircraft will increase the chance of detection of the target.

### Sweep Width (W)

- 5.3.6 Sweep Width, "W", is a function of Search Visibility. It is the ideal width of the area that should be scanned after the appropriate correction factors have been applied.

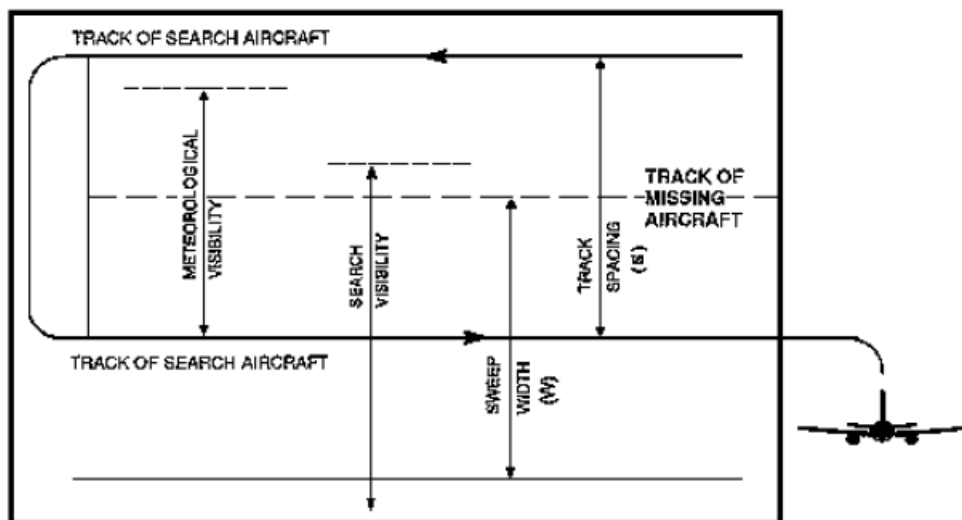


Figure 5.1 Sweep Width

#### Factors affecting Sweep Width

- 5.3.7 Search visibility and sweep width are equally split across the search track of a searching unit (refer Figure 5.1). Search visibility is the range within which a particular search target has a reasonable probability of being detected. Search visibility as affected by the numerous factors discussed below will constitute sweep width.

#### Type of Target

- 5.3.8 The sweep width will depend on the type, size, colour and shape of the target, its colour contrast with the surrounding medium, amount of freeboard, and whether or

---

not the target is moving. Targets may vary from wreckage of an aircraft on land to a person in the water. All targets should be sought from a direction in which they receive the best illumination, colour brightness or contrast. Over water, this is usually the direction in which whitecaps can be seen at the farthest distance.

### Meteorological Visibility

- 5.3.9 If visibility conditions are poor, the subsequent reduction in sweep width and POD may cause an interruption or necessitate a suspension of search effort, e.g.:
- a) Fog makes visual search ineffective if not impossible. Only an electronic search to determine the approximate position of the target, or, perhaps, a ground search, may normally be an appropriate option;
  - b) Smog and haze may reduce the effectiveness of daylight search and, to a lesser extent, night signals;
  - c) Low clouds may render search ineffective or impossible;
  - d) Precipitation reduces visibility; and
  - e) Terrain or Sea Condition.

### Type of Terrain/Conditions of the Sea

- 5.3.10 The type of terrain to be searched obviously affects the ease with which the search target will be detected. The more level the terrain the more effective will be the search. Not only can the search aircraft maintain a constant search altitude, but also there is less likelihood that undulations or irregularities on the terrain surface will hide the distressed craft, wreckage or survivors. Thus calm water areas and flat deserts are easier to search than rough seas or rolling hills, while rugged mountain areas are the most difficult. The more trees, vegetation, rock outcroppings and other surface irregularities that exist on land, the more difficult will be the search. Likewise the more whitecaps, wind streaks, foam streaks, breaking seas, swell systems, salt spray and sun reflections, the more difficult will be a search over water.
- 5.3.11 In addition, patches of seaweed, oil slicks and flotsam may be mistaken for life rafts, or worse, a life raft may be mistakenly identified as seaweed or flotsam. On a glassy sea any object, or disturbance, will probably attract the attention of the eye. On a glassy or smooth sea accompanied by a swell system, chance of detection is also good, being lessened primarily by the intervals in which the object is in the trough between swells. During such intervals, the object may be hidden from the observers of a low-flying search aircraft or the lookouts of a ship. With small targets on glassy seas, however, difficulty will be experienced in detection due to the reflections of sun, sky and clouds on the sea surface.
- 5.3.12 The presence of whitecaps and foam streaks on the water breaks the uniformity of the surface and markedly reduces lookout effectiveness. As the whitecaps become more numerous, the probability of detecting a small object becomes less. With

---

numerous whitecaps and foam streaks in a heavy, breaking sea, even very large objects are difficult to detect, and small objects are unlikely to be detected at all.

- 5.3.13 With high winds, which accompany rough seas, visual aids are rendered less effective. Dye marker tends to dissipate rapidly and smoke signals cling close to the surface and cannot be differentiated from the foam streaks. The reflection of the sun off the breaking seas and whitecaps tends to dull the perception of lookouts to visual signals. With high winds, the wind-driven salt spray constitutes a very real visual obscuration due to both a reduction in visibility and the accumulation of salt on the search craft's windows.
- 5.3.14 Rough seas also adversely affect RADAR detection due to the large amount of sea return on the scope, and the fact that small targets in the trough of a sea cannot be detected.

#### Search Aircraft Speed

- 5.3.15 At low search altitudes the speed of the aircraft will affect the sweep width due to the angular velocity of targets moving through the RADAR scanner's field of view, blurring of targets at very close ranges, and decreasing the exposure time of targets to the scanner. Generally, higher speeds will increase the adverse influence of these factors at search altitudes below 500 feet.

#### Fatigue Factor

- 5.3.16 The effectiveness of observers depends on the number available, their experience, alertness, physical condition, incentive and the suitability of observing positions. The speed at which the search unit moves also has a direct relationship to the effectiveness of the observers' overall performance.
- 5.3.17 If feedback from the search unit indicates that search crews were excessively fatigued, use a correction figure for fatigue and reduce the sweep width by 10 per cent (multiply the uncorrected sweep width by 0.9).

#### Search Aircraft Height

- 5.3.18 Several factors; the prime ones being the size and nature of the target being sought, and the surface conditions surrounding the probable location of the target dictate the selection of the search height. Recommended search heights for particular targets are listed in Table 5-1.



Over Water	Recommended Height
Survivor without raft or dye marker	Below 500FT
Survivor in raft without dye marker, or signalling equipment	800-1500FT
Survivors with dye marker	1000-2000FT
Survivors with signalling equipment and/or RADAR reflector	1000-3000FT
Over Land	Recommended Height
Level terrain with little or no foliage	1000FT
Level terrain with heavy foliage	500FT
Mountainous terrain (height selection governed by turbulence and foliage density)	500-1000FT

**Table 5-1 Recommended Search Heights**

- 5.3.19 Meteorological conditions must be taken into account when selecting search heights. Turbulence, cloud base, and visibility, are the chief considerations.
- 5.3.20 For reasons mostly related to the apparent movement of the surface below a search aircraft, certain minimum heights are recommended according to an aircraft's speed. They are:
- a) **2000 FT, where the speed exceeds 200 kt;** and
  - b) **1000 FT, where the speed is between 150-200 kt.**
- 5.3.21 Advantage should be taken of the characteristics of helicopters to search at low level, possibly in conjunction with fixed wing aircraft operating at higher levels above. This practice is supported by IMO Resolutions A.225 (VII) - Homing Capability of search and rescue aircraft and A.616 (15) – Search and rescue homing capability.
- 5.3.22 Search heights will be quoted as height above ground level (AGL) or above mean sea level (AMSL).

### Cloud Cover

- 5.3.23 The greater the amount of cloud cover, the less will be the ambient light in the search area. This has a detrimental effect on the sweep widths of surface targets. In addition the variable surface shadows caused by scattered or broken clouds make it more difficult to visually detect targets due to the constant dulling effect of the shadows and the mottled appearance of the surface. Although a high, solid overcast will eliminate glare, shadows and reflection from the surface, this advantage is not as large as the detrimental effect of less ambient lighting.

### Position of the Sun

- 5.3.24 Objects are seen at a greater distance when looking down-sun as opposed to up- sun particularly when the sun is in a position to reflect from water. With a clear sky and a bright sun, search conditions are at an optimum between mid-morning and mid-

---

afternoon when the sun is high. Waterborne objects that have a high free board may sometimes be seen even in the sun's glare. Bright sunlight is especially detrimental when haze is present, due to the diffusion of light. Colour contrast is lost when looking up sun, with the result that small objects merge into a confused pattern of glaring light and shadow. Down-sun the sea appears much darker, glare is absent, haze is more transparent, and coloured objects show a marked contrast to their background. Observers forced to look into the sun suffer loss of visual acuity, and may fail to detect an object. When possible, search legs should be orientated to prevent observers having to look directly into the sun. If this is not possible observers should be equipped with sunglasses.

### Day and Night Factors

5.3.25 In some conditions of wind and sea, daylight visual aids may be ineffective. The heliograph is an exception, but sunlight cannot always be expected. Sea conditions and wind have little effect on a night flare search, or on lights. When high winds and seas prevail, night search techniques usually offer the best POD. The quantity of pyrotechnics available to survivors is usually limited, and survivors are unlikely to fire pyrotechnic signals until sighting the lights of the search unit. For this reason sweep width for a night search should be based, not on the expected sighting range of the pyrotechnic aids, but on the range at which survivors may see the navigation lights of the search unit. On entering a search area, search units should turn on all possible lights, and from time to time display searchlights, or landing lights, to facilitate sighting of the search unit by survivors; however observer night vision needs must be taken into account. Ships in a search area should be asked to make smoke at intervals, during daylight hours.

### First Search Light/Last Search Light

- 5.3.26 Times of first and last light at the departure and destination points may limit the time available in a search area when all or part of a flight is governed by Visual Flight Rules.
- 5.3.27 Any limitations to visual searching indicated in a search forecast must be allowed for at the planning stage.
- 5.3.28 The 45-minute periods after sunrise and before sunset are considered unsuitable for daylight visual searching due to visibility restrictions produced by the low elevation of the sun, causing lengthy shadows.
- 5.3.29 These periods are therefore commonly discounted for visual search at the planning stage. The periods may, however, be varied at the SMC's discretion to accommodate local conditions. There may be other factors arise that impact upon search planning with greater moment thus indicating the relative suitability of visual search during some or all of these periods.

- 
- 5.3.30 Within proximity of the equator, where the apparent movement of the sun is at a greater angle to the earth's horizon and its rising and setting phases more rapid, these periods are less critical.
- 5.3.31 Examples of local factors that may need to be considered in the context of available search light are:
- a) A search over tropical rain forest may best be started at dawn in consideration of a likely deterioration in local weather conditions later in the day;
  - b) A search of the western slopes of steep sided valleys may best be delayed until mid-morning; and
  - c) A search of steep eastern slopes may best be abandoned earlier than 45 minutes before sunset.
- 5.3.32 Time available to aircraft outside the periods suitable for visual search may be utilised in other ways, for example, beacon homing, RADAR search or FLIR search.

### Miscellaneous Factors

- 5.3.33 Among the miscellaneous factors affecting sighting are shadows cast by clouds, rain showers, large patches of seaweed, and pure chance. Shadows cast by scattered and broken clouds are a distracting influence on the observers. Rain showers can result in areas not being searched effectively, as the object of search may be hidden by a squall. Despite all other factors, some sightings are made as a result of pure chance. An observer may just look at the right spot at the right time, conversely a momentary lapse on the part of the observer may allow the object of search to be passed unseen. The only safeguard against this possibility is to make repeated searches of an area if sufficient search units are available, and the use of the maximum number of observers.
- 5.3.34 Searches begun early in the day, or extending late in the day have reduced chance of success in wooded terrain due to the shadows cast by the trees and the oblique angle of the sun. These areas are preferably searched when the sun is higher in the sky. Likewise because of the sun, mountainsides may be better searched in the early or late in the day depending on the direction the particular slope faces.
- 5.3.35 Different search heights will produce different sweep width values. It is good practice to calculate sweep widths for several search heights, enabling the search planner to select a sweep width to suit a search height dictated either by the target, or one best suited to the search aircraft to be used.

### Sweep Width Calculations (W)

- 5.3.36 Tables of uncorrected sweep width values and correction factors are provided in Appendix I Tables I-3 to I-6. The sweep width used in planning and evaluating the search is computed as the product of the uncorrected sweep width and all the correction factors that apply. When using Table I-7 of the Appendix for weather

correction factors use the worst case. Therefore if the wind is 10 knots but the sea is 5 ft, use the figures in the second row.

## Track Spacing (S)

5.3.37 Track Spacing (S) is the distance in nautical miles between adjacent search legs. The desired track spacing is a function of detection capability. The more difficult the target to detect, the closer the search legs should be. Decreasing the track spacing increases the POD, but at the expense of reducing the area searched in a given time. There is a limit to which S may be reduced due to the limits of search unit navigation ability and accuracy. The optimum track spacing is one, which permits the maximum expectation of target detection in the available time, or is consistent with the economic employment of search units. Whenever possible Track Spacing (S) should be used that is equal to the Sweep Width (W).

**Note:** For the coastal search model, the following standard track spacings are recommended on search objects less than 30 feet high.

- 5.3.38 Good Search Conditions. In conditions where the wind speed is less than 15 knots and/or visibility is greater than three (3) NM, use a track spacing of up to three (3) NM by day or night but reduce the separation depending on the size of the search target. After dark, the effect of the searchlight should be considered.
- 5.3.39 Poor Search Conditions. Where winds are greater than 15 knots and /or visibility is less than three (3) NM but greater than one (1) NM, a track spacing of one (1) NM should be considered by day or night but reduced depending on the size of the search target. After dark, the effect of the searchlight should be considered.
- 5.3.40 Person in Water. When searching for a person in the water it should be assumed that the person is not wearing a floatation device and will therefore be more difficult to detect. For good search conditions a track spacing of 0.25 NM should be considered. For poor search conditions, the track spacing should be reduced as appropriate, taking into account the visibility and the navigational and operational capabilities of the search units.

**Note:** The track spacing suggested is given as a guide only. The track spacing used in any one search will be decided by the SMC in consultation with the OSC taking into consideration all the available information at the time.

## Coverage Factor (C)

5.3.41 The quality of coverage for any sweep depends on the relationship between Sweep Width and Track Spacing. The relationship is termed Coverage Factor.

$$\text{Coverage Factor (C)} = \frac{\text{Sweep Width (W)}}{\text{Track Spacing (S)}}$$

- 
- 5.3.42 The relationship between Sweep Width and Track Spacing determines the Probability of Detection (POD).
- 5.3.43 Higher coverage factors indicate a more thorough coverage. Higher values of C offer a higher probability of target detection; however the higher POD is not proportional to the extra search effort required.
- 5.3.44 Whilst a coverage factor of 1.0 is most desirable there are occasions when terrain, time limitations, large search area, or shortage of search craft, prevent its attainment. For such occasions an alternative approach must be used that balances the factors of available search hours, size of area and C.
- 5.3.45 A coverage factor of less than 0.5 is unsatisfactory in itself.

### Probability of Detection (POD)

- 5.3.46 Probability of detection (POD) is the statistical measure of search sensor detection performance. It is a function of sweep width and track spacing. It is a conditional probability meaning that search planners assume the search target is in the search area.
- 5.3.47 A definite POD exists for each scan made by a search observer or piece of detection equipment. The probability that a contact will be made in a single scan of a point on the surface is called the instantaneous POD. The instantaneous POD, repeated by successive scans as the search unit moves along the track, develops the probability pattern of a given search. The POD is not uniform over the swept area. In general, it is highest near the search unit and decreases with distance from the search unit.
- 5.3.48 POD is a function of the coverage factor (c), which itself is derived from the relationship of sweep width to track spacing; and the total number of searches in an area. For repeated searches of the same area, the cumulative POD is obtained by making use of the average coverage factor. The application of this concept results in a progressive increase in the POD of a target in the most likely sector of the search area by repeatedly searching the original area within progressively larger areas, a part of each overlaying the original. Thus there results an aggregate POD after successive searches of part of a probability area. For each successive search, the safety factor is increased, and, as a result, the size of the probability area is enlarged. It is not to be thought that early search effort should be restricted in anticipation of the benefits of the expanded search technique; these will take time to accrue, and time, in the rescue of survivors, is of the essence. Neither should a particular search be prolonged unnecessarily in similar anticipation. Still, the concept of expanded search does allow flexibility in search planning in as much as the desired quality of search, if unattainable on account of limitations in the availability of search units, may be attained by repeated effort, while ensuring that the most likely area is rapidly and repeatedly covered.

	Coverage Factor 1	Coverage Factor 0.5
Initial Search (R1)	78% POD	47% POD
First Expansion (R2)	95.6	71.9
Second Expansion (R3)	98.9	85.1
Third Expansion (R4)	99.7	92.1
Final Expansion (R5)	99.9	95.8

Table 5-2 Coverage Data Example

- 5.3.49 The data in Table 5-2 confirms that by making five searches of the initial probability area, each to a coverage factor of 0.5, the cumulative POD (95.8%) is only slightly less than if the same five searches had each been made at a coverage factor of 1.0, (99.9%). The search effort in the former case would have been considerably less in terms of aircraft hours than in the latter. Further, a significantly larger area surrounding the initial probability area would have been searched, albeit at a progressively diminished level of intensity.
- 5.3.50 From the foregoing, it is apparent that for prolonged and repeated searches when aircraft numbers are limited, a coverage factor of 0.5 offers a reasonable coverage of an expanded area resulting, over time, in a good POD. Search of areas at a coverage factor less than 0.5 is not recommended.

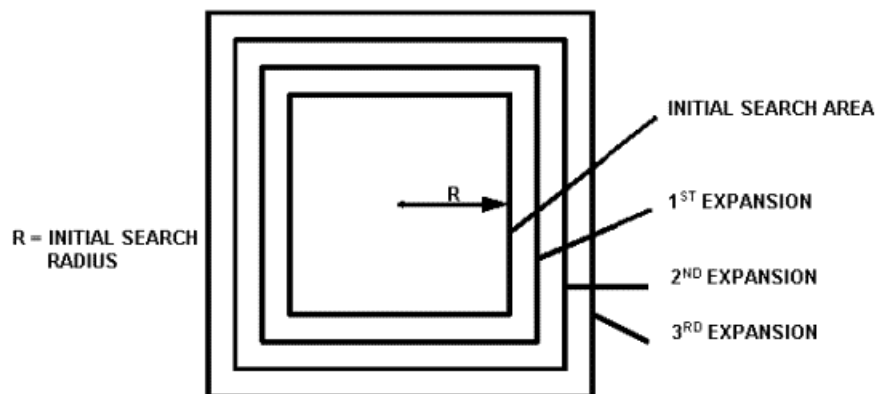


Figure 5.2 Search Area Expansion (Not to Scale)

- 5.3.51 Statistically, the target is more likely to be nearer the last known position, or datum, than in the outer reaches of the expanded search area. Application of the expanded search concept ensures that the greatest search effort is concentrated over the most probable position of the target where the POD is highest. Clearly, the expanding search procedure is best suited to situations where the approximate position or, at least, the planned track of the distressed craft is known.
- 5.3.52 When using the POD Graph in Appendix I, the POD for any particular search is obtained by reference to the appropriate Search graph line depending on the search conditions apparent. For repeated searches of the same area, enter the graph with

the average coverage factor and refer to the graph line relevant to the overall number of searches to obtain cumulative POD. The results are shown as:

1st Search	Coverage Factor	0.5
2nd Search	Coverage Factor	0.7
3rd Search	Coverage Factor	0.3
4th Search	Coverage Factor	0.2
5th Search	Coverage Factor	0.3
		2.0
<b>Over 5 searches, the average coverage factor =</b>		<b>0.4</b>

- 5.3.53 In entering Graph 2 with an average coverage factor 0.4, the cumulative POD after five searches may be read off from fifth search graph line as 92%.
- 5.3.54 The projected value of the POD may be used by an SMC in deliberation of track spacing. Use of POD may also be conveniently made in describing the results of a search, or part of a search, to interested persons not familiar with search planning techniques.
- 5.3.55 Should the target not be located within the fully expanded probability area, the SMC must decide whether to continue searching it, recalculate the probability area using alternative data, or recommend the termination of search effort.

#### Accuracy of Navigation by Search Units

- 5.3.56 The navigational accuracy with which a search aircraft is able to reach a search area and fly a search pattern has an important bearing on the coverage of the area and the POD. Dead reckoning navigation alone generally produces poor results. Map reading can be effective but normally only over land or coastal areas in visual meteorological conditions. In areas where navigation aids are limited, search patterns should be selected so that greatest possible use is made of them. Aircraft with area navigation capabilities can be used for all search patterns in all areas. Alternatively, patterns providing a reference point or a visual navigation aid, e.g. a vessel or a smoke float should be considered.

## 5.4 Search Patterns

### General

- 5.4.1 The selection of a search pattern is very important and should only be made after all factors have been considered. The search pattern selected should meet the following criteria:
- Suitability:** It should permit the search to be completed within the time limits;
  - Feasibility:** It should be within the operational capability of the available search units;

- 
- c) **Acceptability:** The expected result should be worth the estimated time and effort;
  - d) **Safety of the search units:** Close attention should be paid to air traffic in the area of the search. Normally more than one aircraft should not be assigned to a search area segment at the same time. Multiple aircraft operating in the same search area distracts aircrew attention from the search and decreases the flexibility to respond to sightings and drop markers or flares, if required. This does not preclude an electronic search from taking place at high altitude while a visual search is done at a lower level.
- 5.4.2 To assist with the pilot's responsibility of maintaining separation from other aircraft, the SMC may consider assigning aircraft in adjacent search area segments different search heights, the same creep direction and different start times.
- 5.4.3 Non-search aircraft can be informed about the search by the issue of a NOTAM.
- 5.4.4 Non-search aircraft can be excluded from the search area, or informed about the search activity by the issue of a NOTAM.
- 5.4.5 The choice of search pattern is the prerogative of the SMC, who may elect to use only one pattern or several patterns simultaneously but in different areas. A series of search patterns may be used in sequence for the same area, e.g. track crawls, sector search. The following factors will influence the SMC's selection of search pattern:
- a) The accuracy of the distress position;
  - b) The size and shape of the search area;
  - c) The number and type of SRUs available;
  - d) The enroute and on-scene weather;
  - e) The distance between search area and SRU base;
  - f) The availability of navigation aids in the search area;
  - g) The size and detectability of the search object;
  - h) The desired probability of detection;
  - i) The limitations of time; and
  - j) The terrain of the area where the search will be conducted.
- 5.4.6 Careful thought is essential when considering search pattern selection and the allocation of specific SAR units to execute these patterns. Once a large-scale search has been commenced, redeployment of search units or changing assigned patterns



---

becomes complex and should be avoided unless new intelligence indicates such change is mandatory.

5.4.7 There are six main groups of search patterns:

- a) Track line;
- b) Parallel track (search legs are aligned with the major axis of an individual search area);
- c) Creeping line (search legs are aligned parallel with the minor axis of an individual search area);
- d) Expanding square;
- e) Sector; and
- f) Contour.

5.4.8 When it is known, or likely, that an emergency radio beacon may be available in the target vessel or aircraft or to the survivors, an electronic search using an appropriate pattern, (e.g. track line search), should be carried out by aircraft flying at a high level. This may occur at the same time as a visual search is carried out at a lower altitude or on the surface. In planning this search the coverage and possibility of detection by the Cospas–Sarsat system may be considered. It is also valuable to consider the location of the incident and the possibility of overflying aircraft detecting a signal.

5.4.9 Maritime units may search relatively small areas. This type of search is generally very thorough and provides a greater chance that the target will be detected.

### **Navigation of SAR Units**

5.4.10 The navigational accuracy of available search units is a primary consideration for selecting the types of patterns to be used, particularly if the available search units are aircraft. While the accuracy of navigation of surface craft is generally not too great a problem, aircraft present a more difficult picture due to drift from prevailing winds.

5.4.11 The probability of detection curve is valid only when the search pattern tracks are accurately followed.

5.4.12 Significant errors will result from accumulated errors in turns and from wind forecast errors, especially for high-speed aircraft. Consideration must be given to selecting the type of pattern, which gives minimum turns and maximum search leg lengths in order to reduce turning errors and to make it easier for navigation, observations and corrective action. However, there may be a limit to the maximum search leg lengths when the search area covers water surfaces with strong currents or with high survivor drift rates. In these circumstances aircraft search legs are usually limited to

---

30 minutes or less of flying time if the legs are oriented across the drift direction. This is to avoid the possibility of the survivors drifting from one side of a track to beyond the next search track by the time the search aircraft returns to that same general area. A more satisfactory solution to this problem is to orientate the search legs with the drift direction.

- 5.4.13 Greater search accuracy is obtained when visual, RADAR or radio navigational aids are within reception range of search units or when aircraft are equipped with area type navigation equipment (RNAV) e.g. GPS or Inertial Navigational Systems (INS).
- 5.4.14 When dividing up the total search area into areas for assignment to individual SAR units it should be kept in mind that elongated search areas are covered better navigationally than small square areas. When two or more search aircraft are available, elongated search areas are preferred.

### **Parallel Track Search Patterns**

- 5.4.15 Parallel track search patterns can be used for searches involving one or a group of search units and are the simplest patterns available. The coxswain of a search vessel steers straight courses or legs, each leg being one track spacing from the other. The legs are parallel to the long side of the search area.

### **Parallel Track Pattern Single Unit**

- 5.4.16 This pattern is conducted by a single unit. The SMC will detail the area to be searched by giving depth and distance, visual reference points or latitude, longitude if the Search Unit is so capable.

### **Parallel Track Pattern Multi-Unit**

- 5.4.17 This is based on the same principle as the single unit search, except that more than one boat is searching in line abreast, one track spacing apart. It is particularly useful when a number of search units, fishing boats or pleasure craft are available for searching an area and can be instructed what to do by radio. The OSC will direct the search from his position with all turns and distances taken from the OSC's vessel.

### **Creeping Line Patterns**

- 5.4.18 These are the same type of searches but the legs are parallel to the short side of the search area. These patterns would be used when there is a stronger probability of the craft in distress being closer to one end of the search area.
- 5.4.19 The search unit begins the pattern at the end of the search area where the target is most likely to be. These patterns can also be used both in single and multi-unit searches.
- 5.4.20 The multi-unit creeping line pattern is used when there are five or more search units available in a search of a high probability area for small size targets, such a person in

---

the water. This pattern concentrates the search units in the datum area and is structured to avoid gaps developing at the end of each sweep.

- 5.4.21 Search units pivot on the second search unit. By the time the first, second and third vessels take up their allotted positions, the fourth and fifth search units will have moved with the prevailing drift to position them at the top of the next sweep. This method will ensure total coverage of the search area, however, it must be borne in mind that this pattern is slower than other patterns and requires a greater degree of coordination by the OSC.

### **Night Time Consideration Multi-Unit Searches**

- 5.4.22 Extreme care should be taken during multi-unit searches to maintain the observers' night vision whilst working in close proximity to search lights. The operators of searchlights should always remain aware of this concern and direct the search light from a bearing right ahead to a bearing of approximately 45° to port or starboard.
- 5.4.23 For small targets such as a person in the water, search unit track spacing must be adjusted so that the beams of the searchlights maintain a good overlap at all times.

## **5.5 Visual Search**

### **Track Line Search**

- 5.5.1 This procedure is normally employed when an aircraft or vessel has disappeared without a trace. It is based on the assumption that the target has crashed, made a forced landing or ditched on or near the intended route and will be easily seen, or that there are survivors capable of signalling their position by a flashing lamp or other means. It consists of a rapid and reasonably thorough search on either side of the intended route of the target, normally at a height of 1000 to 2000 FT during day or at 2000 to 3000 FT at night. A track line pattern is often used as an initial reaction to a distress situation, the second, intensive phase being introduced on the failure of the track line search.
- 5.5.2 Aircraft and ships following the same route as that of the missing aircraft or ship should be asked if they are available to divert to assist in the search for the target. For ships, this will mean diverting to intercept the most probable track line of the target. For aircraft, this type of search should be regarded as additional to searches by SAR units, as an enroute aircraft may not be entirely suitable as a search platform due to its performance, configuration, endurance, navigational capabilities or lack of observers.

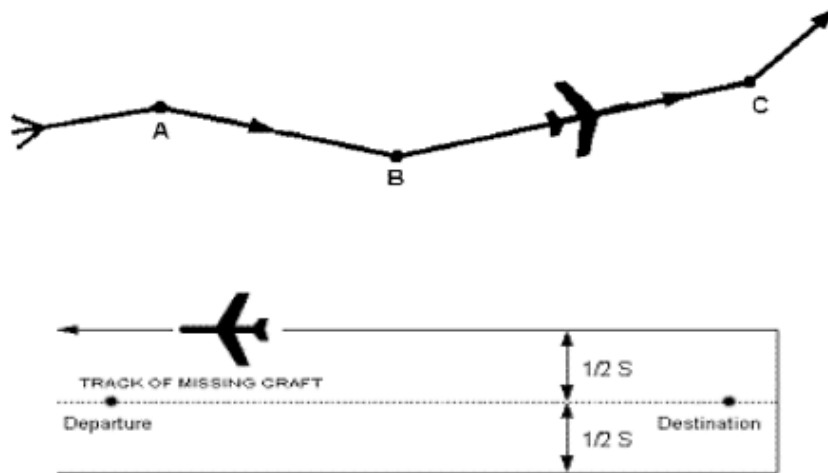


Figure 5.3a Track Line Search where aircraft is returning back along track.

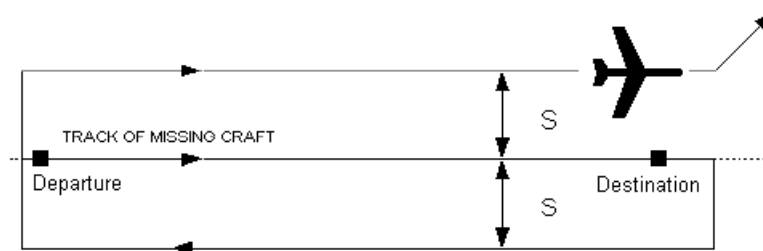


Figure 5.3 b Track Line Search where aircraft is not returning back along track.

## Parallel Track Pattern

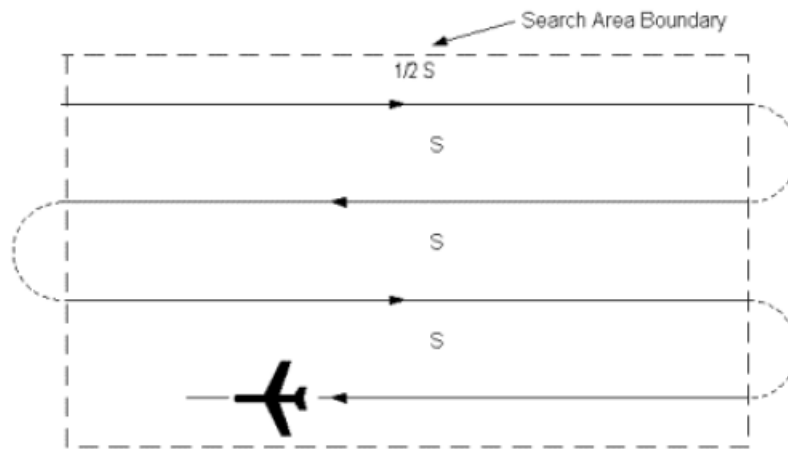
5.5.3 Parallel track patterns are normally used when:

- a) The search area is large and the terrain is relatively level, e.g. desert and maritime areas;
- b) Uniform coverage is required; and
- c) The location of the target is not known with any precision.

5.5.4 Search legs are aligned parallel to the major axis of the individual search area.

5.5.5 The pattern is best used in rectangular or square areas. It is a very suitable pattern for a search conducted over water. The search aircraft proceeds from one corner of the search area maintaining parallel tracks, the first of which is at a distance equal to one-half the track spacing from a side of the area. Successive tracks are maintained parallel to each other and one track spacing apart. This type of search may be carried out by one aircraft or by several aircraft following parallel tracks or each searching smaller rectangular areas separately.

- 5.5.6 When aircraft search hours and adjacent traffic permits, turns will be conducted outside the search area boundaries as shown in Figure 5.4. This allows observer rest and crew position changes.



**Note: First leg may be displaced  $\frac{1}{2} S$  into Search Area. Turns should be made outside Search Area Boundary.**

Figure 5.4 Parallel Track Search Pattern

### Drift Compensation

- 5.5.7 In maritime areas where there is a high drift rate, care must be taken to ensure the target does not drift out of a SAR unit's area. This problem occurs when the rate of creep of the SAR unit is less than the rate of drift of the target.
- 5.5.8 When this condition exists some methods of resolving the problem are to:
- Align the SAR units search legs with the drift vector;
  - Use shorter legs for the SAR unit to increase the rate of creep; and
  - Increase the SAR unit's speed.

### Expanding Square Search

- 5.5.9 This procedure is referred to as an expanding square search as it begins at the reported position or most probable location and expands outwards in concentric squares. It is a very precise pattern and requires accurate navigation. To minimise navigational errors, the first leg is usually oriented directly into the wind.
- 5.5.10 The square search pattern is used when the target is known to be in a relatively small area, no more than 15-20 NM from the start point.
- 5.5.11 The first two legs are held to a distance equal to the track spacing and every succeeding two legs are increased by another track spacing. Turns may be to the left or right, depending upon the observer positions.

- 5.5.12 For successive searches, the direction of the search legs should be changed by 45 degrees. The final track should be the same as the initial search track from the start point. The number of search legs may be 5, or, increasing by increments of 4, 9, 13, 17 etc.
- 5.5.13 Scanning should start at a distance of "S" before reaching the most probable position to avoid leaving an area not scanned near the start point. Observers should be briefed to pay particular attention to the areas outwards of each turn to avoid leaving areas not scanned.
- 5.5.14 The search should be planned so that, whenever possible, the approach to the most probable position, and the first leg, is made into wind as shown in Figure 5.5.

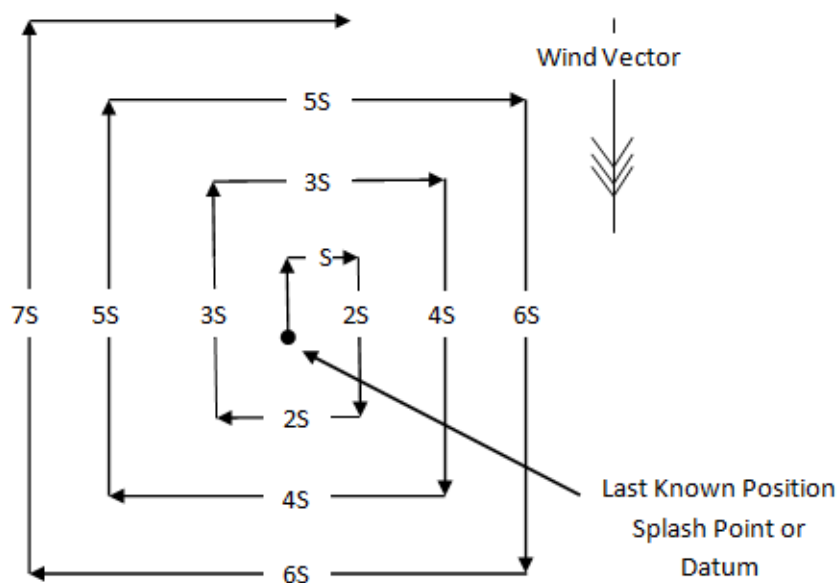


Figure 5.5 Expanding Square Search Pattern

- 5.5.15 Table 5-3 may be used to determine the number of search legs (N) and total track distance (D), given a particular radius (R) and selected practical track spacing (S), e.g.

if  $R = 10\text{NM}$  and practical  $S = 2\text{NM}$ , then  $N = 21$  and  $D = 240\text{NM}$ . The total track distance can then be used to determine whether a suitable SAR aircraft has sufficient endurance to effectively complete the task.

**Note:** The total track miles that an asset has available on search can be calculated by multiplying the effective time available on search (from Worksheet 6: actual search hours (ASH) – 15%) by asset search speed.

RADIUS (NM)	S=0.5		S=1		S=2		S=3		S=4		S=5		S=10	
	N	D	N	D	N	D	N	D	N	D	N	D	N	D
1	9	12	5	8										
2	17	40	9	24										
3	25	84	13	48	5	16								
4	33	144	17	80	9	48	5	24						
5	41	220	21	120	9	48	9	72						
6	49	312	25	168	13	96	9	72	5	32				
7	57	420	29	224	13	96	9	72	9	36	5	40		
8	65	544	33	288	17	160	13	144	9	36	9	120		
9	73	684	37	360	17	160	13	144	9	36	9	120		
10	81	840	41	440	21	240	13	144	9	36	9	120		
11			45	528	21	240	17	240	13	192	9	120		
12			49	624	25	336	17	240	13	192	9	120		
13			53	728	25	336	17	240	13	192	13	240		
14			57	840	29	448	21	360	13	192	13	240		
15					29	448	21	360	17	320	13	240	5	80
16					33	576	21	360	17	320	13	240	9	240
17					33	576	25	504	17	320	13	240	9	240
18					37	720	25	504	17	320	17	400	9	240
19					37	720	25	504	21	480	17	400	9	240
20					41	880	29	672	21	480	17	400	9	240

Table 5-3 Number of Search Legs in Expanding Square Search given Radius

**Table Notes:**

1. Do not interpolate.
2. Tabular values of D are based on the search aircraft completing the search at the boundary of the square area. To achieve this, the final 3 search legs of a square search pattern are of equal length.

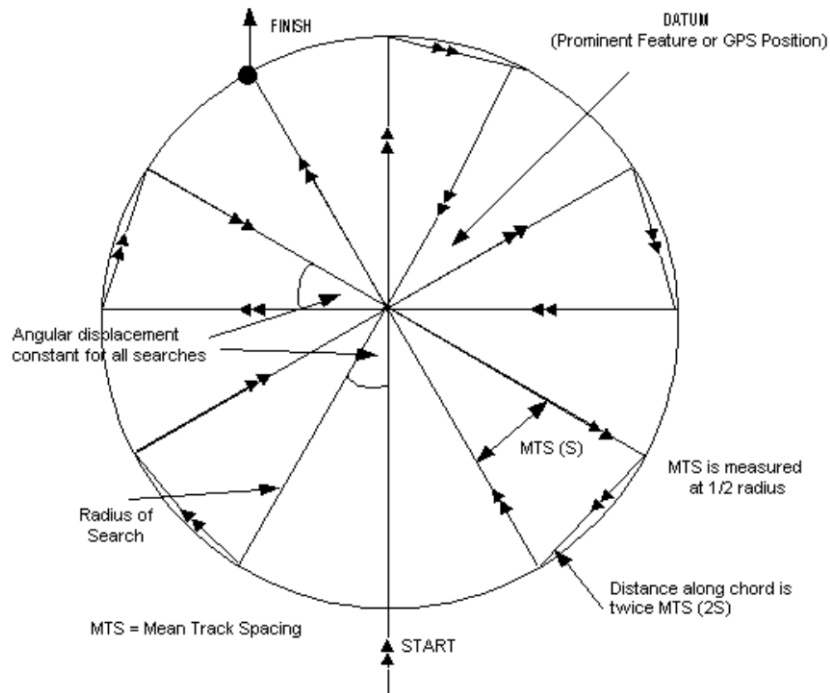
5.5.16 Maritime surface SAR units are not normally assigned a radius in excess of five miles.

## Sector Search

5.5.17 This pattern may be employed when the position of distress is known within close limits and the area to be searched is not extensive. It is simple to execute, is likely to provide greater navigational accuracy than a square search and, because the track spacing is very small near the centre, it ensures a high probability of detection in the area where the target is most likely to be located.

5.5.18 A suitable marker is chosen as a datum and navigation aid on each search leg. For practical purposes, the datum may be moved a mile or two, either at the planning stage or on scene, to take advantage of a prominent landmark well suited as a navigation reference. When using the pattern over water, it is useful to drop either a visual or electronic beacon to mark the datum. Adjustment for total water current is automatic and only leeway need be separately considered.

5.5.19 Trained crews using an aircraft with capable electronic navigational equipment should only be used to fly this search.



**Figure 5.6 Sector Search Pattern - Aircraft**

- 5.5.20 Each search leg is separated by an angle based on the maximum track spacing at the end of the legs and the search radius. For convenience, the angular displacement between each search leg and the distance required to fly the pattern for various track spacings and search radii may be extracted from Table 5-4 Sector Search Calculations.
- 5.5.21 The table makes use of Mean Track Spacing (MTS) as a basis for deriving angular displacement and distance to be flown. MTS is the track spacing at a distance of half the radius of the search area from the datum. The table may also be used to determine the track spacing that can be used for a given track distance and search radius.
- 5.5.22 The search start point may be either on the perimeter of the pattern or over the datum depending on the approach track of the search aircraft and the orientation of the first leg. To keep track computation simple, the first leg may be oriented to the north but this is not essential. Successive tracks may be calculated by adding 90 degrees plus half the angular displacement to the previous track, and so on. The length of the cross leg is twice the mean track spacing.
- 5.5.23 The coverage factor, obtained using sweep width information and mean track spacing, may be used to determine the POD.
- 5.5.24 If a further sector search is necessary, it should be carried out on tracks plotted halfway between the tracks of the pattern followed during the first search:



SECTOR SEARCH CALCULATIONS (This table must not be interpolated)								
S	1		2		3		4	
R	Deg.	D	Deg.	D	Deg.	D	Deg.	D
5	24	90	48	45	72	30	100	30
10	12	330	24	180	36	120	48	90
15	8	720	16	375	24	270	32	210

Table 5- 4 Sector Search Calculations

**Table Notes:**

1. Deg = number of degrees between successive legs  
D = total track distance (NM) to complete the search pattern  
R = Sector Search Radius  
S = mean track spacing (MTS)
2. The total track miles that an asset has available on search can be calculated by multiplying the effective time available on search (from Worksheet 6: actual search hours (ASH) – 15%) by asset search speed.

**Example:**

An area 10 miles radius is to be searched at a mean track spacing of 3NM. From the table, the angle between tracks is 36 degrees and the total time at 120 knots is 1 hour.

**Sector Search Pattern for a Vessel**

- 5.5.25 For vessels search pattern radius is normally between 2NM and 5NM and each turn is 120 degrees. The length of each chord is the same of the radius (R), therefore the total track miles to complete the search area is 9R.

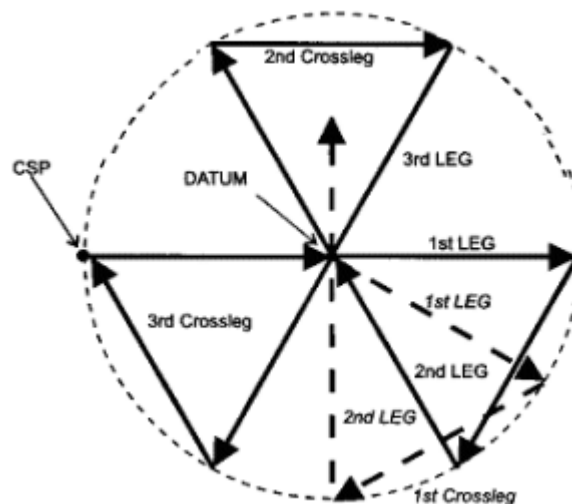


Figure 5.7 Sector Search Pattern - Vessel

**Note:** CSP = Commence Search Point

---

## Aural Search by Surface Craft

5.5.26 An aural search by search vessels may also be required at night for person in water situations. Such a search is accomplished by periodically stopping all engines of the search vessel and listening for the calls for help from survivors. The sounding of a ship's horn should precede an aural search in an attempt to attract the attention of survivors.

**Note:** The conduct of an aural search may be hazardous under certain conditions and will only be conducted at the direction of OSC, after consultation with the SMC. However, serious consideration must always be given to conducting this search at night for person in water situations, especially where it is thought the survivors may not have any detection aids.

## Searching Coastal Islands and their Foreshores

5.5.27 The searching of coastal islands and their foreshores must always be considered when they are located within the search area, or near to it. Uninjured survivors in sight of land may attempt to make landfall, however they often overestimate their physical capabilities or underestimate the distances involved. Island foreshores may provide evidence of flotsam or debris that may further aid in SMC's search planning.

5.5.28 In situations where a coastal island lies directly within a search unit's track, it may be necessary to interrupt the progress of the search unit to search the island and its foreshores. Alternatively, a second search using additional search units should be considered.

5.5.29 Surface craft engaged to perform this search must be suitably equipped with adequate depth sounding equipment and remain constantly aware of the dangers involved from operating near to land. If conditions allow, an aural search should be conducted in case survivors are asleep or have secreted themselves to obtain shelter. In these cases the sounding of a ship's horn or other form of noise making may alert survivors to the search unit's presence.

5.5.30 Should an island fall within a high probability area or there is evidence available that may suggest survivors have reached that point, serious consideration should be given to conducting a land search.

5.5.31 When only a visual foreshore search is considered necessary, it is important that the entry and exit points the search units take when approaching and leaving the island overlap to avoid blind spots developing. Small vessels, or aircraft, especially helicopters, capable of safely flying at low altitudes and speeds, can be used to pass close enough to the shoreline to permit careful inspection and are ideally suited to conduct island and foreshore searches. At night, an aircraft fitted with FLIR would be an advantage. Vessels engaged in shoreline searches must be aware of navigational constraints and any limitations imposed by sea conditions. The SMC should consider the possibility of survivors clinging to buoys or rocks offshore.

## Contour Search

- 5.5.32 Contour search is used to examine mountain slopes and valleys when sharp changes in elevation make other types of search impractical.
- 5.5.33 The procedure requires that the search aircraft be flown at a selected contour level adjacent to the side of steep terrain, starting at the highest selected level. The search is started above the highest peak with the search aircraft completely circling the mountain at that level. Then the search aircraft descends a planned vertical distance while making an orbit in the direction opposite to the search (forming a figure eight), then it makes another circuit of the mountain, and so on. When there is not enough space to make an orbit opposite to the direction of the search, the search aircraft may spiral downwards around the mountain. If the mountain cannot be circled, successive sweeps at the same intervals should be flown along its side. Valleys are searched in circles, moving the centre of the circuit one track spacing after each completed circuit.

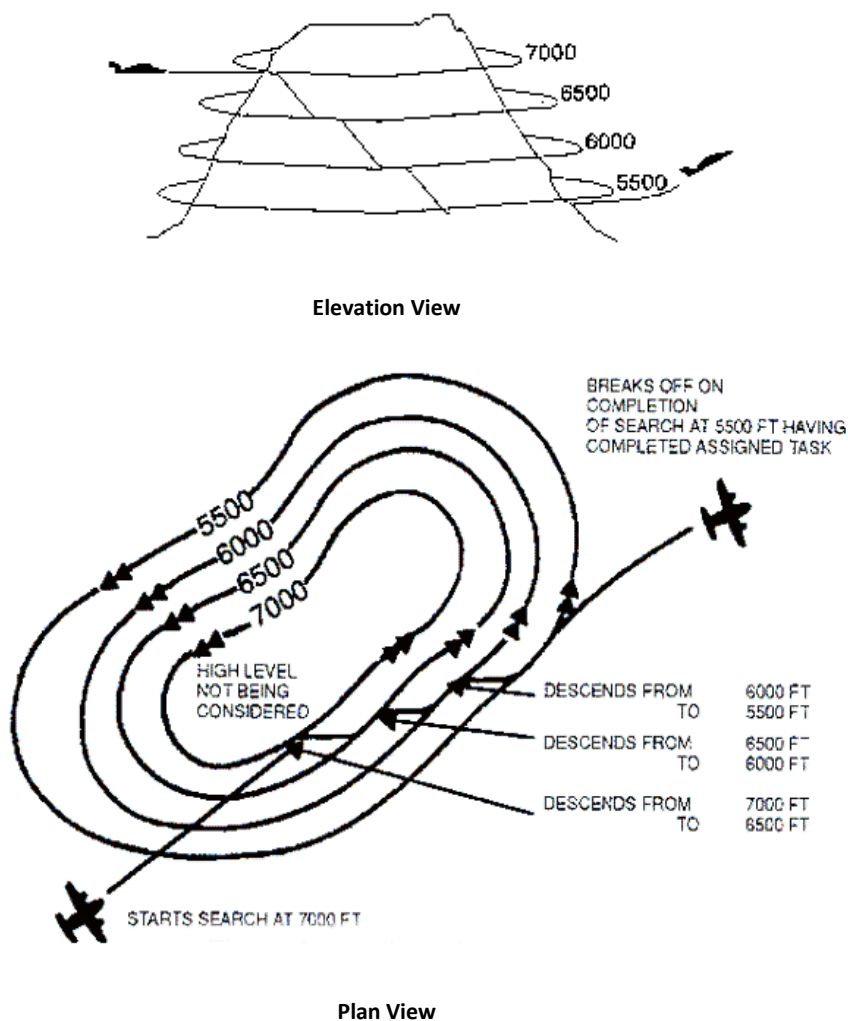


Figure 5.8 Contour Search Pattern

- 
- 5.5.34 It is common to plan for search aircraft to descend a particular vertical distance between successive sweeps. The vertical distance between contours may be selected on a case-by-case basis after consideration of factors similar to those governing the determination of track spacing, i.e. visibility, nature of terrain, type of target etc.
- 5.5.35 A contour search may be very dangerous. Extreme caution should therefore be exercised when searching mountains and valleys. The following safety matters should be considered:
- a) The crew must be very experienced and well briefed and possess accurate large scale maps (1: 100,000 scale maps are recommended);
  - b) Mountainous search areas should be assigned to multi-engine aircraft whenever possible;
  - c) During the search, the entire pilot's attention will be devoted to flying the aircraft. The pilot must evaluate forward terrain to avoid any hazard such as power lines, cables etc. When searching valleys, the pilot must plan ahead to ensure that the aircraft can either climb out of a difficulty or turn around, knowing at all times which way to turn in case of an emergency;
  - d) The weather conditions in the search area must be good, including both good visibility and lack of turbulence, and must be constantly checked. Flights in mountainous areas should be avoided when winds exceed 30 knots because downdraughts can exceed 2000 feet per minute;
  - e) Aircraft should not enter any valley that is too narrow to permit a 180 degree turn at the altitude flown. Searches should be flown close to one side of a canyon or valley so that the entire width may be used if a 180 degree turn becomes necessary. A similar method should be applied when making a contour search of a mountain; and
  - f) The aircraft should be highly manoeuvrable and have a high rate of climb and a small turning radius.
- 5.5.36 Orographic turbulence may be found as updraughts on the upwind side of slopes and ridges and on the downwind side as downdraughts. The extent of the effect depends on the wind speed and the steepness of the slope. Orographic turbulence will be more intense over a rough surface.
- 5.5.37 The safest crossing of mountain peaks and ridges at low altitude under windy or turbulent conditions is downwind, where any downdraughts will be encountered after the terrain is crossed. If this is not practical, altitude should be increased before crossing these areas. Best procedure in transiting a mountain pass is to fly close to that side of the pass where there is an upwind. This will provide additional lift in case of an emergency. Maximum turning space is available and a turn into wind will be

towards lower terrain. Flying through the middle of a pass may be dangerous as this allows the least turning space and is often the area of greatest turbulence.

5.5.38 Should it not be practical to search the entire surface of a mountainous area, a SMC may initiate plans on the basis of certain assumptions, e.g., if limited to VMC, the pilot would neither willingly enter cloud nor descend below the lowest height at which a valley or a gap could be safely traversed. There may, on the other hand, be intelligence information to hand indicating that the pilot did enter cloud, in which case the aircraft may be found at an elevation within the extent of the then existing cloud layer. These possibilities should be examined carefully if it is known that a pilot was flying, or intended to fly, through a valley or gap in the proximity of cloud.

5.5.39 To determine a probability area in such circumstances, a SMC may proceed as follows:

- a) Mark the contour line at a level 500 FT higher than the highest level it is considered that the aircraft would have been flown, and colour all areas above this height in RED;
- b) Mark the contour line at a level 500 FT lower than the height at which the area could be safely traversed, and colour all areas below this height in GREEN; and
- c) The uncoloured area will be the probability area, and, on an appropriate map, may be used as a three dimensional representation of ridges, gullies, etc. Figure 5.9 demonstrates a resultant diagram after using this procedure.

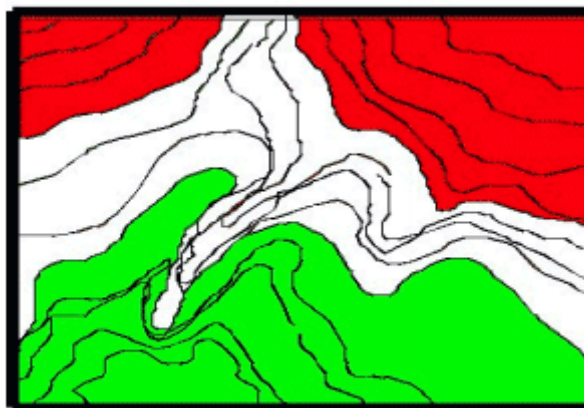


Figure 5.9 Example of Probability Area of Contour Search

5.5.40 Crews must be well briefed and possess accurate, large-scale maps showing the contour lines. (1:100,000 is the smallest practical scale). Crews shall be reminded to make all positioning turns away from the mountainside and to exercise extreme caution when searching valleys where climb-out or turn-around is difficult or impossible.

5.5.41 As with other forms of search, an accurate account of the areas actually searched is required by the RCC. The search crews should plot actual areas covered as the flight

progresses. Areas that have been searched should be shaded in on a large-scale topographical map, leaving the unsearched area outlined.

5.5.42 Only one aircraft shall be assigned to an area at any one time.

### Searches in Mountainous or Rugged Terrain

5.5.43 Searches by fixed wing aircraft become ineffective over certain types of terrain. Helicopters should be tasked for these areas. Individual areas may be defined by using:

- a) Squares or rectangles; or
- b) Geographical areas, referenced to geographical, topographical or man-made features.

5.5.44 Points to note:

- a) An area of approximately 20 – 30 square nautical miles is a good size, depending on the type of helicopters available and the transit distance;
- b) A number of sorties will normally be required to complete each area;
- c) The closer a refuelling point can be established to the area the better; an oval or open area in town is suitable;
- d) A Forward Command Post or Forward Field Base is very desirable; and
- e) If using non-geographical areas, i.e. squares or rectangles, GPS is required.

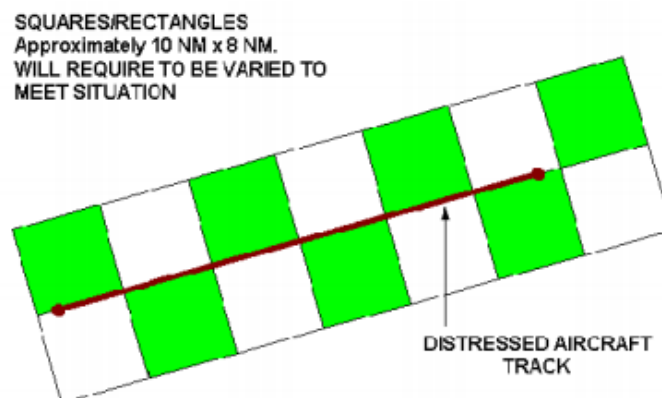


Figure 5.10 Helicopter Search Area

### Line Abreast Helicopter Searches

5.5.45 Where a small area requires a saturated visual search the use of helicopters on an “emu-hop” or line abreast search is an effective search method.

- 
- 5.5.46 This search is best achieved by assembling all search units at one location for briefing by Forward Command Post/Forward Field Base personnel or the assigned On Scene Coordinator.
  - 5.5.47 When on task, the assigned coordinator should ensure all search units keep their position, and care is exercised with any target inspections.

### **Irregularly Shaped Areas**

- 5.5.48 The foregoing method of allocating aircraft assumes a regularly shaped search area. At times it is more practical to define search area boundaries by geographical features. In these situations, it is frequently impossible to set out geometrically aligned, regularly spaced search tracks. Pilots should be briefed to make every effort to conform to the standard patterns but it may be necessary, at times, to leave the execution of the search pattern to the discretion of the pilots.
- 5.5.49 Some difficulty may be encountered in determining the extent of an irregular area to be allocated to any one aircraft.
- 5.5.50 Search effort should be calculated on Worksheet 6 in the prescribed manner and a process of estimation, based on the worksheet calculations, and, if necessary, trial and error, adopted to fit aircraft into suitable areas.
- 5.5.51 When allocating irregular sectors, it is good practice to allocate somewhat smaller areas than were they regular to make allowance for positioning turns and additional manoeuvres.

## **5.6 Flare Searches**

### **General**

- 5.6.1 Military aircraft may be capable of conducting a Flare Search at night. The procedure is appropriate to night time operations when it is known that survivors are equipped with distress signal flares. The military authority concerned will decide the practicality of such a search.
- 5.6.2 The search is flown at 5000 feet or below the cloud base, if lower. The crew fires a green flare every 3-5 minutes after entering the search area and at each turning point of the search pattern.
- 5.6.3 The frequency with which flares are fired from the aircraft should ensure that survivors could sight at least two successive flares. The survivors are expected to respond to green flares by firing their own red flares. The crew will acknowledge the sighting of the distress flares by firing a succession of green flares and switching on the aircraft's landing lights.

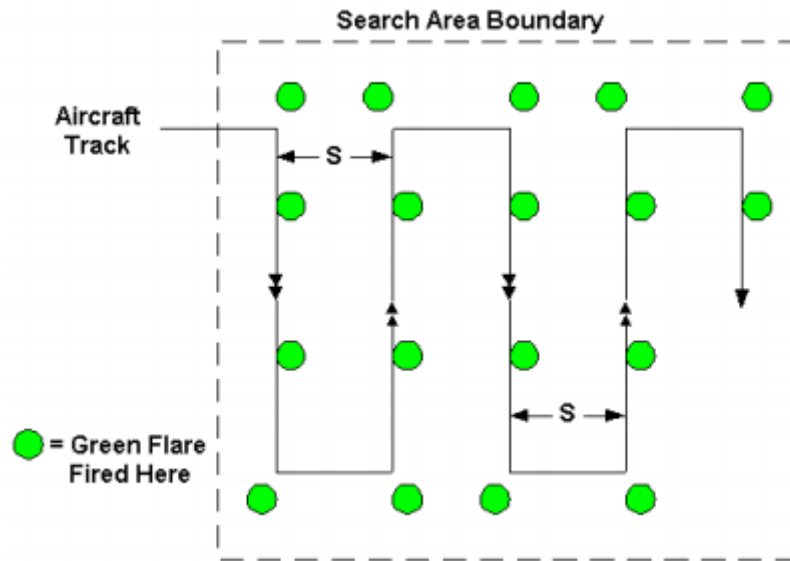


Figure 5.11 Flare Search Pattern

- 5.6.4 The spacing between adjacent tracks ( $S$ ) will depend upon visibility. The quality of pyrotechnics available to survivors is usually limited and survivors are unlikely to fire flares until sighting the lights of or flares from a search aircraft. For this reason, sweep width for a flare search should be based on the range at which survivors may see the search unit. On entering a search area, search units may turn on all possible lights and from time to time display search lights or landing lights to facilitate sighting of the search unit by survivors. However, night vision of on-board observers needs to be taken into account.

## 5.7 Electronic Searches

### General

- 5.7.1 Distress beacons are carried by ships, aircraft and land parties and operate on one or more of the international distress, safety and calling frequencies. When activated to indicate a distress situation, they emit a characteristic signal. The signal serves, in the first instance, to alert to a distress situation and, during an ensuing electronic search, as a homing beacon. The equipment can be activated either manually or automatically as a result of immersion in water or on impact.
- 5.7.2 The RCC shall use whatever resources are required to locate a distress beacon even if it is believed to be an inadvertent activation.
- 5.7.3 Another authority, (e.g. ACMA or the police) is not to be given a large area in which to locate a beacon. SMCs should use aircraft to isolate an area as precisely as possible, then request determination of exact location by a cooperating authority.

### Beacon Types

- 5.7.4 Today's technology takes most of the 'search' out of search and rescue through the utilisation of satellites and evolved radio distress beacons. There are three types of



---

beacons that are carried, and in some cases, are mandated by law, that can be detected by satellite.

- 5.7.5 ELT (Emergency Locator Transmitter) is the name given to an aviation distress beacon carried by aircraft, these operate on 406 MHz, with some transmitting on 121.5 MHz for final stage homing.
- 5.7.6 EPIRB (Emergency Position Indicator Radio Beacon) is the name for a maritime beacon. A specific feature of an EPIRB is that it should be able to float upright. An EPIRB operates on 406 MHz with some transmitting on 121.5 MHz for final stage homing.
- 5.7.7 PLB (Personal Locator Beacon) is a beacon designed for land use and also operates on 406 MHz, with some transmitting on 121.5 MHz for final stage homing.
- 5.7.8 Beacons operating on 406 MHz have no audio signal but transmit in microbursts. Transmitted data, generally, cannot be monitored or interrogated by aircraft as the signal is generated by chip as a discrete data-package. Homing on 406 MHz beacons can be achieved by using specialised airborne equipment or by homing on the beacons' supplementary low-powered 121.5 MHz transmitters. The Australian Standard for 406MHz beacons requires that beacons manufactured for use in Australia be fitted with a 121.5 MHz transmitter to provide a homing signal. AMSA Dornier aircraft and several civil SAR aircraft can home and decode 406 signals.

### Beacon Transmission Characteristics

- 5.7.9 The range at which a beacon may be detected varies considerably, being dependent on a number of factors:
  - a) Surrounding terrain - the range will be extended if the transmitter is located on the top of a mountain or hill and reduced if located in a valley, on a hill-side or mountain-side, amongst trees or bushes, or in a rain forest;
  - b) Power output of the transmitter;
  - c) Condition of the beacon - if a transmitter's aerial or aerial lead has been broken or disconnected, it will, if the unit is otherwise serviceable, still transmit but its range may be reduced to 1 km or less;
  - d) Nature of surrounding surface - the range will be reduced if the transmitter is operated in dry, sandy country unless placed on a good earth mat, e.g. a space blanket, aircraft wing, or similar reflective surface; and
  - e) Presence of interference - interference sources can cause beacon-like transmissions, e.g. strobe and navigational lights.
- 5.7.10 A transmitter operating over water or relatively flat country will emit a radiation pattern approximately circular in horizontal cross section. However, if activated in rough country, between trees or amongst wreckage, its radiation pattern will be

---

interrupted by obstructions and shaped as a series of irregular lobes. Flying a track that cuts these lobes, a pilot will hear the signal while within their coverage but receive only noise or hash between them.

- 5.7.11 Depending on the aircraft's distance from the transmitter and the particular pattern of the lobes, the period during which the signal is heard will vary from a few seconds to several minutes.
- 5.7.12 It should be noted that when a beacon is placed above a water surface, lobes are formed in the vertical plane, one additional lobe for each 112 cm that the beacon is located above the water level. The presence of vertical lobes will be indicated by variations in the received signal. Regardless of aircraft heading, the signal will fluctuate, and may disappear completely, for a distance of several miles.
- 5.7.13 When a buoyant beacon is radiating in rough seas, its aerial may dip into the waves. This results in the swept tone missing a beat or two without any increase in hash. There is little discernible effect on the radiation pattern should an aerial be bent or otherwise distorted, provided it is clear of the water.

### **Beacon Search Procedures**

- 5.7.14 Searches to identify and locate signals from emergency beacons will normally be initiated immediately following the confirmation of the receipt of a beacon signal. Electronic searches may be supplementary to visual searches. Rescue planning must be commenced with all beacon activations.
- 5.7.15 When it is known or believed that an aircraft or persons in distress are equipped with a beacon, an electronic search at a high level should be initiated immediately. In addition to beacons designed for operation by survivors, many aircraft carry ELTs that start operating automatically when G forces reach a certain level, such as in a crash.
- 5.7.16 The electronic search should not preclude the initiation of a visual search at lower levels since the success of an electronic search depends on a beacon actually radiating a signal.
- 5.7.17 When tasking aircraft to search for a beacon signal, it may be necessary to select a search pattern from one of those already described. The most commonly employed are the track line and parallel track patterns. Track spacing should take into account terrain and the height of the aircraft and Table 5-5 lists suggested maximum track spacings.

ALTITUDE AGL/AMSL FT	MOUNTAINOUS DENSE TIMBER NM	PLAINS or DESERT NM	MARITIME NM
1000	2	10	20
5000	10	20	50
8000	15	25	60
10000	20	30	70
15000	30	60	100
20000	40	80	150
30000	50	100	180

**Table 5-5 Suggested Maximum Track Spacing for Aircraft Conducting Beacon Searches**

**Table Note:** Beacon search altitude should, initially, be as high as possible for the aircraft tasked, subject to air traffic and meteorological conditions.

- 5.7.18 Pilots should be briefed to disable the receiver squelch, if fitted, and to leave it disabled throughout the search for a beacon signal. On modern receivers not fitted with squelch control, it may be possible to use the test switch to achieve the same end.
- 5.7.19 When searching for beacon signals on 243.0 MHz over water, the track spacing quoted in Table 5-5 should be reduced by 20%.
- 5.7.20 When searching over mountainous terrain, it is recommended that the track spacing approximates the lesser of that listed for "heavy timber, jungle or mountainous terrain" and the distance between ridges. The search pattern tracks should, as far as possible, be oriented parallel with the ridges.

#### Locating a Beacon Signal Source by Homing Devices

- 5.7.21 A number of civil and military aircraft are fitted with direction finding equipment that enables a pilot to home onto the source of a beacon signal and fix its position.
- 5.7.22 RCC staff are not required to be familiar with the equipment or to brief pilots for in-flight operation. Procedures have been developed to localise the position of a radiating beacon when homing devices are not available and the only information available are reports of beacon signals being heard.
- 5.7.23 A number of agencies and volunteer organisations also have hand held homing devices.

#### Aural Location of Beacons

- 5.7.24 Aural procedures are based on the assumption that an undistorted radiation pattern is very nearly circular.

- 5.7.25 Some guidance on the flying of aural searches for beacons is given in AIP/ERSA. Whenever possible, JRCC Australia shall individually brief pilots unfamiliar with the procedure.

### Maximum Radio Signal Range Calculations

- 5.7.26 By using the following formula:

$$\text{Maximum Range (in NM)} = 1.2 \times \sqrt{h}$$

(Where: h = height/altitude of the receiving antenna in feet)

The theoretical maximum range of the transmitter may be calculated, or for search purposes, the theoretical maximum distance at which a beacon signal may be received given the receiving antenna's height above ground level.

**Note:** The transmitting antenna is assumed to be at ground level.

- 5.7.27 The area in which the transmitter is located may be determined by plotting a circle, with radius equal to the calculated range, from the position at which the beacon was heard. The intersection of circles plotted from two or more hearing positions will result in a fix of the probable position of the transmitter.

### Signal Heard, Signal Fade Plotting Method

- 5.7.28 From reports of "signal heard" (SH) and "signal fade" (SF) positions received from aircraft flying at a constant level, it is possible to determine the limits of a beacon radiation pattern.
- 5.7.29 En-route aircraft may be very helpful in this respect. They should be asked to monitor 121.5 MHz and report the positions where the signal was first heard and where it faded. Lines joining the positions at which the signal was first heard (SH) and the positions at which it faded (SF) form chords of a circle, the perpendicular bisectors of which should intersect at the location of the transmitter. When three or more position lines are obtained in this fashion and plotted, it is most likely that a "cocked hat" will be formed, the centre of which should be taken as the MPP of the beacon. An example of a two position line fix is shown in Figure 5.12.

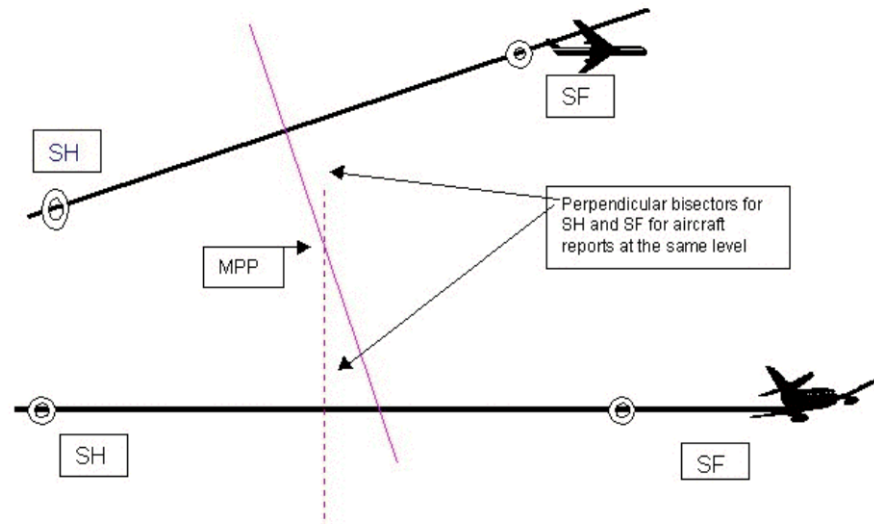


Figure 5.12 Signal Heard and Signal Fade Plotting

- 5.7.30 It is not recommended to join SH and SF positions from different aircraft due to variations in the aircraft's receiver sensitivity, and variations in altitude between different aircraft. Both these factors will alter the effective radiation pattern of the beacon.

#### De-tuning Method

- 5.7.31 Detailed instructions for the use of the De-tuning Method are set out at AIP/ERSA and in the SAR Manual for SAR Unit Pilots and Dropmasters.

#### Hill Shading

- 5.7.32 When a beacon has been localised to a general area of mountainous terrain, it is possible to eliminate smaller specific areas by flying the search aircraft over specific sectors. For example, along valleys, around isolated hills etc., noting those areas where the signal is not heard or where it cuts out sharply as a result of shading.
- 5.7.33 When a more precise target area has been isolated in this way, the de-tuning method or visual search may be employed to pinpoint the exact site.

#### Locating a Signal from the Ground

- 5.7.34 Ground parties may be able to locate the source of a signal using a portable Aviation Band Multi-channel AM VHF Radio. If the radio is tuned to 121.55 or 121.45 MHz and a signal is heard, it is likely that the source of the signal is within 100 metres. Progressive detuning whilst retaining the signal will locate the source of the signal.
- 5.7.35 If a beacon signal can only be heard on 121.5 MHz, the beacon is some distance away. Using a building or obstruction as a shield, if the signal is lost the building or obstruction is between the receiver and the beacon. It is also possible to use the body as a shield by holding the receiver to the chest. The signal should be weakest with the back to the signal.

- 5.7.36 To check individual craft as the source of a signal, a domestic FM or AM radio is likely to receive the signal if placed within a few metres of the source. Also the aerial may be removed from an Aviation VHF radio if the signal is still received the source is very close.

### **Search by RADAR**

- 5.7.37 RADAR may be primarily used for maritime searches. Most available airborne RADAR would be unlikely to detect typical search objects on land except for metal wreckage in open areas such as desert.
- 5.7.38 The sweep width and track spacing to employ will depend on the type of RADAR, height, environmental clutter and noise, RADAR cross-section of the target, RADAR beam refraction due to atmospheric and operator ability. W and S should be agreed between SMC and operator.
- 5.7.39 It should be noted that when the wave height increases to above one to two metres, the probability of detecting a small object rapidly decreases for most RADAR and consequently so does the sweep width. The probability of detection of a small target rapidly decreases.
- 5.7.40 The altitude used should normally be between 2,500 and 4,000 ft for small search objects and a maximum of 8,000 ft for large search objects.

### **Search by Infrared (IR) Devices**

- 5.7.41 Infrared (IR) devices such as IR TV cameras or Forward Looking Infrared (FLIR) are passive detection systems used to detect thermal radiation. They operate on the principle of detecting temperature differences to produce a video picture. Therefore, IR devices may detect survivors by their body heat.
- 5.7.42 IR devices are normally preferred for night use. Search height should normally be 200 to 500 FT for small targets such as persons in the water, and up to a maximum of approximately 1,500 FT for larger targets or those having a larger heat signature. The track spacing can be based on consultation with the operating crew and taking into consideration the effective detection range as provided by the manufacturer.

### **Night Vision Goggles**

- 5.7.43 Use of night vision goggles (NVGs) can be effective in search carried out by various types of search units.
- 5.7.44 The following factors may influence the effectiveness of NVGs for searching:
- a) NVG quality;
  - b) Crew training and experience;
  - c) Environmental conditions, visibility, moonlight, cloud coverage, rain;

- 
- d) Level and glare effects of ambient light, natural and artificial;
  - e) SAR unit speed;
  - f) Height of the observer above the surface;
  - g) Surface conditions (like snow), and sea state;
  - h) Size, illumination, and reflectivity of the search object. The presence of reflective tape greatly enhances detectability; and
  - i) Types of survival equipment or light sources used by the survivors.
- 5.7.45 Glare should be minimised as much as possible within the facility where the NVG users are stationed. This may involve opening or removing windows where practicable. Also proper scanning techniques are important for reducing the adverse effects of moonlight or artificial light sources like, lighthouses, offshore rigs, ships, navigation and strobe lights.
- 5.7.46 Visible moonlight can significantly improve detection of unlighted search objects when using NVGs. Search object light sources, like strobe or similar lights, or even cigarettes, can greatly improve detection even in poor visibility conditions.
- 5.7.47 RCC staff should be aware that sweep width needs to be discussed with the crew conducting the mission and modified according to the conditions encountered in the search area.

## 5.8 SAR Unit Selection and Characteristics

### Overview

- 5.8.1 The selection by SAR staff of available SAR units to be used in SAR operations should take into account the following considerations:
- a) The need to reach the distress scene quickly; and
  - b) Suitability for at least one of the following operations:
    - i) Provision of assistance to prevent or lessen the severity of accidents;
    - ii) Conduct of a search, primarily by air but with the assistance of marine or land units as required;
    - iii) Carriage of supplies to the scene of an accident and, if necessary, delivery of supplies; or
    - iv) Execution of a rescue, (by marine and land units or by helicopters; and as required fixed wing aircraft to provide guidance to units or to relay communications).

- 
- 5.8.2 In coordinating a search, the SMC, as guided by local procedures, may charter, arrange or request the provision of suitable aircraft or resources. JRCC Australia can assist with advice on suitable aircraft for SAR operations (see Chapter 1.2.47 JRCC Australia Assistance to Other SAR Agencies).

### **Air Assets**

- 5.8.3 Many types of aircraft will be suitable as SAR Units with little or no modification.
- 5.8.4 However, care should be taken to ensure that, even in an emergency, safety of flight is the primary consideration and should never be compromised. The normal operational and technical limitations of an aircraft, as well as the qualifications of the crew, should be carefully noted by the SMC. SMCs must ensure they are cognisant of the factors relating to the aircraft and crew that may compromise the conduct of the SAR mission.
- 5.8.5 Some specialist SRUs that have undergone training from JRCC Australia are organised in Tiers and can be fixed wing aircraft or helicopters. The tiers relate to the capabilities and training of the aircraft and crews. Aircraft should be used where the tier relates to the capability required for the task with due regard to responsiveness and availability. Tier capabilities are detailed in Table M-1 in Appendix M. SRUs are strategically located around Australia as shown in Appendix M to ensure the best coverage of the area of responsibility.
- 5.8.6 When chartering aircraft for use as SAR Units, SAR staff shall, whenever practical and effective, select aircraft from trained SAR/Emergency operators including;
- a) Search and Rescue Units (SRUs); and
  - b) Police and State Emergency Service aircraft.
- 5.8.7 Advice on suitable aircraft can be obtained from JRCC Australia (see Chapter 1.2.47 JRCC Australia Assistance to Other SAR Agencies).
- 5.8.8 If additional aircraft are required, call out could be made according to the following priority bearing in mind suitability, location and availability:
- a) Domestic commercial aircraft,
  - b) Customs aircraft,
  - c) ADF aircraft,
  - d) Scheduled Regular Public Transport (RPT) aircraft, and
  - e) Private aircraft.
- 5.8.9 When the circumstances are appropriate, SAR staff may seek assistance from foreign aircraft.



---

5.8.10 Private aircraft may be used when so situated as to more readily effect the saving of life, operated by crew having particularly valuable local knowledge of the area to be searched, or when no other commercial aircraft are available.

5.8.11 As a general rule, slow aircraft or aircraft capable of reducing speed to 100 - 150 knots are most efficient for visual searches. Small and partially hidden targets are easily missed at higher speeds and faster aircraft may be subject to operational limitations making them unsuitable for low-level flights.

Nevertheless, fast and or highflying aircraft also play an important role in search operations, for instance when these aircraft carry out:

- a) An electronic (radio) search to home on distress signals; and
- b) An exploratory sweep of a large search area simultaneously with a search by a slower aircraft flying at lower levels, a method that is particularly effective in maritime or other flat and unobstructed areas.

5.8.12 The suitability and efficiency of an aircraft for search, support and rescue operations will depend on which and how many of the following desirable features it possesses:

a) Operational characteristics:

- i) Safe low-speed and low-level flight capability;
- ii) Short take-off and landing (STOL) capability;
- iii) Sufficient range to cover the area, with due regard to the location of redeployment bases;
- iv) Manoeuvrability, especially for searches in mountainous areas; and
- v) Payload capacity.

b) Equipment:

- i) Suitable navigation and instrument flying aids;
- ii) radio equipment capable of receiving and homing on emergency radio signals; and
- iii) adequate communications equipment;

c) Availability of good observation posts;

d) Suitability for the delivery of supplies, emergency equipment and personnel; and

e) Facilities for the treatment and carriage of survivors.

5.8.13 The SMC shall select aircraft for use as SAR Units after consideration of the following factors:

- 
- a) Type of search necessary;
  - b) Type of terrain;
  - c) Type of navigation involved;
  - d) Need for dropping supplies;
  - e) Disposition of aircraft with respect to search area;
  - f) Crew experience and familiarity with the area;
  - g) Weather conditions at and en route to search area; and
  - h) Rescue considerations.
- 5.8.14 Aircraft not equipped with radios should not be used on SAR operations except as a last resort.
- 5.8.15 Fast, high flying aircraft equipped with homing and or direction finding equipment that have the operational flexibility to descend to low level for final search are recommended for beacon searches.
- 5.8.16 Seaplanes and amphibians are useful for search or for carrying supplies and personnel over water. Their use as rescue units or carriers of personnel is limited to operations in lakes and river areas, or sheltered waters and bays. Under favourable weather and sea conditions, suitable seaplanes may also be used for rescue operations in protected waters, e.g. large lakes, bays, shore areas etc. Rescue operations on open water or at sea are generally only feasible for large seaplanes designed for rough-water work.
- 5.8.17 Helicopters are particularly useful SAR units as their slow speed and ability to hover make them suitable for search as well as rescue operations, particularly where small targets are sought or close scrutiny of terrain or sea is required. They also have the ability to land in a confined area and, in some instances, to operate from some vessels.
- 5.8.18 Some helicopters are fitted with winches, floats or equipped for flight in instrument meteorological conditions (IMC) and at night giving them an added advantage for search and rescue response. Turbulence, gusting winds and icing are conditions that the SMC should consider when determining helicopters as appropriate SAR units.
- 5.8.19 Ship based aircraft operate with great flexibility at sea because they have the advantage of a well-equipped and mobile base.
- 5.8.20 Where terrain and vegetation is such that a contour search is necessary, preference should be given to:
- a) Helicopters;

- 
- b) High-performance short take-off and landing (STOL) aircraft; or
  - c) Light, manoeuvrable twin engine aircraft.
- 5.8.21 Where possible, single engine aircraft should be restricted to areas where the terrain would permit forced landings.
- 5.8.22 When possible, consideration should be given to engaging aircraft capable of carrying at least four observers in order to permit rotation and rest.
- 5.8.23 Where possible, landing sites should be as close to the distress scene as possible. The landing area selected should be clear of loose articles that may be blown into the air by the rotor downwash. On beaches, it is best to use the water's edge to form one side of the landing area. Communications should be established with the aircraft before its arrival and the pilot briefed on the landing site. If the pilot is unfamiliar with the location, a description of the area using large geographical features may need to be passed. If possible, a number of people should be deployed to secure the area before the aircraft arrives so that no one enters the landing area until the rotors of the aircraft have stopped or the pilot indicates that it is safe to do so. If the landing area is in a populated area, extreme care should be taken to ensure that no children run toward the aircraft once it has landed. When communicating with the aircraft, it is important to inform the pilot of any obstacles in the immediate area. This is especially applicable to wire strung between trees and power lines as these types of obstacles are difficult to see from the air and present a danger to the safe operation of the aircraft.
- 5.8.24 Fixed wing aircraft that can land close to a distress site can speed up the evacuation of survivors rescued by helicopter, rescue party or other means.
- 5.8.25 All flights for search and rescue purposes are to be planned and undertaken in compliance with Civil Aviation Regulations (CARs) and Civil Aviation Safety Regulations (CASRs). In the case of a SAR event where safety of life is at stake and exemptions from regulatory requirements maybe necessary and appropriate for the pilot to undertake the mission, the SMC shall review with the pilot all possible risk factors. It is the pilot's responsibility to ensure that dispensations are obtained from those officers holding the power to delegate under CARs and CASRs.
- 5.8.26 It is the SMC's responsibility to provide a complete brief of the situation, including any hazards such as adverse weather or conditions, to the pilot so that a pilot can make an independent decision to become involved in the incident dependent on aircraft capabilities and their own competence.

### ADF Air Assets

- 5.8.27 The RAAF maintain one aircraft on SAR standby for support to any ADF SAR event that may occur. This asset can be requested for DACC 2 tasking through JRCC Australia and HQJOC. The SMC should plan on a minimum response time from receipt of orders to take off of three hours and a maximum of twelve. Response

---

times will vary due to the availability of SAR qualified crews and the location of the SAR stand-by aircraft. Often the response will prove more rapid than indicated by these guidelines but planning should be predicated upon these times.

- 5.8.28 Aircraft on SAR standby at RAAF bases are a C130H or C130J Hercules or an AP3C Orion. The standby role can be transferred from one aircraft to the other at short notice due to operational or maintenance requirements. The Joint Control Centre (JCC) will act as the POC for information regarding the RAAF standby aircraft through the AOC.
- 5.8.29 Other military aircraft suited to civil SAR operations may be available subject to HQJOC approval.
- 5.8.30 Stocks of droppable supplies are held at various RAAF aerodromes, details of equipment held and aircraft capabilities can be found in Appendix N.

#### Control of ADF Aircraft

- 5.8.31 RAAF aircraft assigned to SAR operations coordinated by the RCC will always remain under ADF Operational control. In addition to normal service channels, ADF authorities may exercise operational control of SAR aircraft through the Defence Communications Station Australia (DCSA). DCSA is located in Canberra but has transmit and receive nodes in Exmouth, Darwin Townsville, and Riverina. DCSA provides Voice Contact Nets (VCN), discrete nets and telephone patch facilities on HF radio voice channels. Control of ADF aircraft may also be exercised using SATCOM, or Satellite phone, depending on the aircraft fit.

#### Customs Aircraft

- 5.8.32 An SMC may seek assistance from Customs aircraft through JRCC Australia. JRCC Australia will request assistance in sourcing aircraft through Customs Operations Centre. Where a specific type of search is required, e.g. RADAR or night, JRCC Australia will consult with Customs and the contracted provider to ascertain the best response.

#### Maritime Assets

- 5.8.33 Search operations are generally best carried out by aircraft while rescue is best carried out by helicopter, marine craft or land assets. However, it will sometimes be necessary to use marine craft or land assets for some search efforts, particularly when weather conditions prevent or hamper air search, when the location of the distress scene is known with reasonable accuracy, or the location is remote and non-aviation assets are best placed to render assistance.
- 5.8.34 The speed of marine craft is usually their maximum speed possible under the prevailing sea conditions. Generally, small boats search at 15–40 kt and larger vessels search at 10–30 kt. At these speeds, excellent coverage for small targets is possible. However, the area that can be searched is limited due to the low level of the vessel and the earth's curvature. Tables 1-3 and 1-4 at Appendix I provide

uncorrected visual sweep widths for visual search over water at eye heights of eight and fourteen feet and from the height of a merchantman's bridge.

Category	Abbreviation
Rescue boat - short-range coastal and/or river craft	RB
Rescue vessel - long-range seagoing craft	RV

**Note:** The boat/vessel's speed may be inserted, e.g. RB(14) or RV(10).

- 5.8.35 The abbreviations listed in the table above may be used when referring to vessels made available for SAR purposes.
- 5.8.36 Rescue vessels can participate in operations at considerable distance from their base. Their main design requirements are good manoeuvrability, seaworthiness, long range, relatively high speed and sufficient size to accommodate survivors and equipment. Naval vessels, offshore lifeboats, seagoing tugs, customs and pilot launches and patrol boats are of particular value because of their special equipment, including communications equipment, and trained personnel.
- 5.8.37 Generally, the strategy for sustenance and rescue of survivors of accidents in oceanic areas will depend upon aerial supply drops and or deployment of parachute rescue personnel pending rescue by ship or helicopter.
- 5.8.38 Rescue boats such as lifeboats, patrol boats and crash boats are short-range vessels capable of operating a limited distance off shore in good sea conditions. Pleasure craft, yachts or rigid inflatable boats fitted with an outboard motor could also be used provided they carry appropriate equipment.
- 5.8.39 Other sources of maritime assistance may include:
- a) Naval vessels;
  - b) Customs vessels;
  - c) Merchant vessels;
  - d) Fishing vessels;
  - e) Police vessels;
  - f) Volunteer marine rescue groups e.g. Volunteer Coast Guard;
  - g) Harbour craft, ferries, pilot launches and tugs;
  - h) Oil drilling rigs; and
  - i) Offshore oil industry support vessels.

---

## Naval Vessels

- 5.8.40 When available, it is usually preferable to use naval vessels for SAR operations. The training and discipline of naval crews, communications fits and other specialised equipment with which the ships are fitted makes naval vessels eminently suitable for SAR operations. Some naval vessels can also be more freely used for combined aircraft surface vessel search operations than merchant vessels. In the event of a major operation a navy vessel may be appointed Coordinator Surface Search and coordinate the activities of other vessels.
- 5.8.41 HMA Ship responsibilities on receiving an Alerting or Distress message are contained at Appendix O.

## Customs Vessels

- 5.8.42 Customs vessels are also patrolling the approaches to Australia and, where available, can be used to assist with SAR. In a similar way to Customs aircraft, an SMC may request the assistance from Customs vessels through JRCC Australia.

## Use of Merchant Shipping

- 5.8.43 Some ships do not maintain a continuous communications watch and consequently must be alerted by means of an automatic alarm system. As this system is traditionally employed only for emergencies involving the safety of human life, the decision to request its use must be made advisedly and responsibly. Actual requests for use of the automatic alarm shall be limited to genuine emergencies.
- 5.8.44 Knowledge of the positions of merchant ships is of considerable value in SAR operations as merchant ships are often the nearest means of rescue during an incident off shore. The International Convention for the Safety of Life at Sea (SOLAS) contains an obligatory provision for the captain of a vessel to proceed with all speed to the assistance of persons in distress at sea, provided the safety of his ship or crew is not compromised. At all times the safety of the vessel and crew is the responsibility of the master and RCCs should ensure this responsibility is not compromised. In a distress situation, where doubt exists as to a vessel's intentions, the master should be requested to advise his intentions and confirm that he is responding. Given that a master is not obliged to respond to situations that are not distress, during these situations the master should be requested to divert and assist if practicable. When vessels are known to be proceeding to assist, it is incumbent on the RCC to ensure that only the most suitable vessel or vessels are used and to release other responding vessels as soon as possible.

## Equipment for Marine Craft

- 5.8.45 In the case of oceanic SAR operations, it is desirable that the ship(s) used are fitted with basic equipment appropriate to the task: navigation aids, communication equipment and life-saving and rescue items, (e.g.: inflatable life rafts, signalling devices, line-throwing apparatus, non-sparking boat hooks, rescue baskets, litters, boarding ladders and scrambling nets).

- 
- 5.8.46 Some larger merchant vessels and all service ships will possess equipment for rescue operations. However, additional assistance and supplies, particularly medical, may be required to sustain survivors until they can be landed at a point of safety or transferred to an evacuation vehicle.
- 5.8.47 Depending on the distance from the coast, inshore rescue craft may be available to assist and will be coordinated through the State or Territory Police.

### **Land Search Facilities**

- 5.8.48 Search by land facilities alone is usually impractical for large search areas but it can be conducted in most weather conditions and can provide complete coverage of a confined area that cannot be thoroughly searched from the air. Land parties are also critical in operations where the search is carried out from the air and rescue by land facilities.
- 5.8.49 Police authorities undertake the responsibility for coordination of land search.
- 5.8.50 The need for coordination between land rescue units and search aircraft should be considered, and plans should cater for the need for two-way radio communication. There may also be a need in remote areas to keep land units supplied with fuel, water and food by means of airdrops.
- 5.8.51 When the survivors are located, the SMC should liaise with the police commander with a view to expediting the return of survivors to a place of safety. Consideration should be given to aircraft relay and the use of suitable motor transport: ambulances, four-wheel drive vehicles, buses, etc.
- 5.8.52 Specialist police and military land parties are equipped with material useful to the SAR role. It is desirable that land SAR units be equipped with basic navigation aids, two-way communication equipment, sufficient clothing, medical supplies and rations to reduce the need for air drops and specialist equipment appropriate to the unit's particular role.
- 5.8.53 The National Land Operations Manual should be referred to for procedures with regard to land search techniques, planning and conduct.

## **5.9 Search Unit Allocation**

### **Introduction**

- 5.9.1 Before committing resources to an intensive search, an evaluation should be made of the total search effort required and the contribution that may reasonably be expected from each search unit.
- 5.9.2 When assessing available search capacity, care must be taken not to over-estimate either the time that a particular aircraft and its crew can spend in a search area or the capability of the observers to remain effective over long periods of flight time.

- 5.9.3 Failure to make a sound estimation of these factors may result in one or more of the search units being unable to complete its allocated task and the efficiency of the entire effort being seriously compromised.

### Aircraft Capability

- 5.9.4 Search aircraft are expected to comply with the rules for navigation as stipulated in AIP or the appropriate military documents, including limitations on crew times and navigation.
- 5.9.5 Guidance on the limitations on search time for defence crews should be sought from the relevant controlling authorities. CARs, CASRs and CAOs govern civil operations.
- 5.9.6 As a general principle, search aircraft of the smaller variety should be planned in such a way that a rest period on the ground is possible after about two hours of searching.

### Calculation of Search Time Required

- 5.9.7 There is a simple but important formula that should be used to quickly calculate “search ability” and thus gives practical answers to these typical questions:
- How long will it take to search the whole area?
  - I’ve got 6 hours, how much of the area can I search?
  - We’ve got 5 hours and 4 boats, what track spacing must I use?
  - We’ve got to cover the area by 1600 hrs, how many craft will I need?
- 5.9.8 The factors to be considered are:
- The area to be searched in square nautical miles
  - Time in hours
  - Velocity, the speed(s) of the unit(s) (added together)
  - Track spacing in nautical miles

Note: If any three are known then the fourth can be calculated using the formula:

$$A = TVS \quad (\text{A TV Station})$$

Example 1: How long will it take to search an area 25 NM by 10 NM using a track spacing of 5 NM in a craft with a speed of 10 Knots.

$$\text{Time (T)} = \frac{\text{Area (A)}}{\text{Velocity (V) x Spacing (S)}}$$



$$\text{Time (T)} = \frac{\text{Area (A)}}{\text{Velocity (V)} \times \text{Spacing (S)}}$$

$$T = \frac{A}{VS}$$

$$T = \frac{25\text{nm} \times 10\text{nm}}{10 \text{ kts} \times 5 \text{ nm}}$$

$$T = \frac{250}{50}$$

$$T = 5 \text{ hours}$$

- 5.9.9 If diverting from the assigned pattern track to investigate a sighting, the search unit must fix its position with care. This is to ensure if the sighting is not the target, the search unit can return to and resume the assigned search from the position at which it diverted.

### Calculation of Search Time Available

- 5.9.10 When evaluating the search time available from search assets, certain factors must be taken into account, where applicable:
- a) Total endurance;
  - b) Transit time;
  - c) Necessary fuel reserves at final destination;
  - d) First and last light at departure and destination aerodromes, unless flight:
    - i) Is permissible and practical under Instrument Flight Rules (IFR); or
    - ii) Night Visual Flight Rules (VFR) operation is possible;
  - e) Weather conditions in the search area, and destination points, and any requirement for holding fuel or alternate aerodrome for aircraft.
  - f) Any other operational limitations; and
  - g) Investigation time while on search provides an allowance for investigating sightings and navigating turns at the end of search legs. It is normally 15% of the time available but may be increased where terrain or conditions dictates.
- 5.9.11 In most cases, time in transit to the search area may be calculated using speed and the distance between the points of departure and destination and the mid- point of a search area.
- 5.9.12 For aircraft, when wind speeds are high, it may be advisable to compute a ground speed for use in transit-time calculations. This is especially appropriate for aircraft with low TAS. In a situation where an aircraft will depart from an aerodrome on one

side of its allotted area, conduct its search, then recover to an aerodrome on the other side of the area, if the tracks are aligned with or against the wind direction, calculation of ground speeds is proper.

- 5.9.13 Fuel reserves shall comply with current regulations for the category of flight. The variable reserve allowance for IFR operations is not applied to the time spent in a search area (i.e.: it is only applied to the transit times).
- 5.9.14 Operational factors may limit the search time available from a specific aircraft, examples being the time at which an aircraft will become available, distance from mandatory servicing facilities, and other commitments of the operator that may require the return of an aircraft at a particular time.

### Investigation Time

- 5.9.15 A search asset may sight objects that require investigation; therefore an allowance for the time taken to investigate must be made. The basic allowance is 15% of total time available in the search area, but the SMC may decide to increase this figure. The number of sightings investigated by previous search crews will influence any such decision. These, in turn, will be influenced by the nature of the terrain, the amount of flotsam on the sea etc. Over heavily timbered, mountainous terrain, the allowance may need to be as high as 50% of total search time.

### Effective Search Time

- 5.9.16 Effective search time is the resultant of the actual search hours (ASH) available minus the investigation time.
- 5.9.17 After making allowance for "investigation time", it may be convenient to convert the effective search time to an equivalent time at 120 kt before calculating the size of the area to be allocated to any given aircraft.

The conversion is made by using the formula:

$$T \text{ (hours at 120 kt)} = \frac{\text{Search TAS} \times \text{Effective Search Time}}{120}$$

**Example:** If an aircraft can be in the search area for a total time (ASH) of six (6) hours at a TAS of 180 kt and 15% is allowed for target investigations, then 5.1 (6 hrs - 15%) hours may be planned for actual searching. The equivalent time at 120 kt would be:

$$\begin{aligned} \text{Hours at 120 kt} &= \frac{180 \times 5.1}{120} \\ &= 7.65 \text{ Hours} \end{aligned}$$

- 
- 5.9.18 When obtaining data about aircraft availability, special consideration should be given to the speed at which the aircraft will be flown whilst on search. In general, to provide for optimum scanning by observers, search aircraft should fly as slowly as possible. There are, however, other aspects to be considered, particularly the time available for search and the need to cover the area expeditiously. It may be beneficial to discuss these interacting considerations with operators. Some aircraft operate in excess of 120 kt when on search; although this is less than optimum, logistic considerations may dictate the use of these speeds.
- 5.9.19 When the track spacing to be assigned to each aircraft has been decided, the area each aircraft can cover may then be calculated from the formula:  $A = TVS$ .

### **Comparison of Search Time Required and Time Available for Search Aircraft**

- 5.9.20 Comparison of the search time required with that available, (both denominated at 120 kt), will reveal whether the aircraft resources available are enough, too much or too little.
- 5.9.21 At this point, a critical decision related to aircraft allocation may be made. The time required for search is directly related to track spacing; track spacing, in turn, is directly related to search height. It is feasible, therefore, that despite first indications that insufficient resources are to hand, timely coverage of the whole search area could be achieved by the available aircraft for the sake of a higher-than-optimum search height.

#### **Sufficient Search Time for Search Aircraft**

- 5.9.22 Having calculated the time available from each search aircraft and converted it to time at 120 kt, it is possible to calculate the area that each aircraft can cover, and to allocate a specific sector of the area to each aircraft.
- 5.9.23 Various factors may influence the positioning of search aircraft in the area. These include:
- a) The type of aircraft;
  - b) Time of arrival in the search area;
  - c) Supply dropping capability;
  - d) Navigation capability;
  - e) Suitability to a particular type of search;
  - f) Search height, or speed limitations; and
  - g) Location of recovery aerodrome.

- 5.9.24 When the search area is shaped as a trapezium, (as it usually is in a "last report/missed report" SAR situation), it is simplest to start allocation from the wider end of the area, as follows:
- The distance  $D1$  should be measured;
  - Consider the area that can be searched by the first aircraft to be allocated;
  - Divide this by the distance  $D1$ , and thereby determine the width of the resulting rectangular search area. This width may then need to be adjusted so that the number of legs to be flown will be complete;
  - Consideration should also be given to the location of the departure and recovery aerodromes relative to the search area. If they are on opposite sides of the search area, the number of legs should be odd, if on the same, even. In any case, this relationship may require a further adjustment to the number of legs to be flown; and
  - By multiplying the number of legs by the track spacing, the width of the area to be assigned may be deduced. Repeat the procedure for areas A, B, C

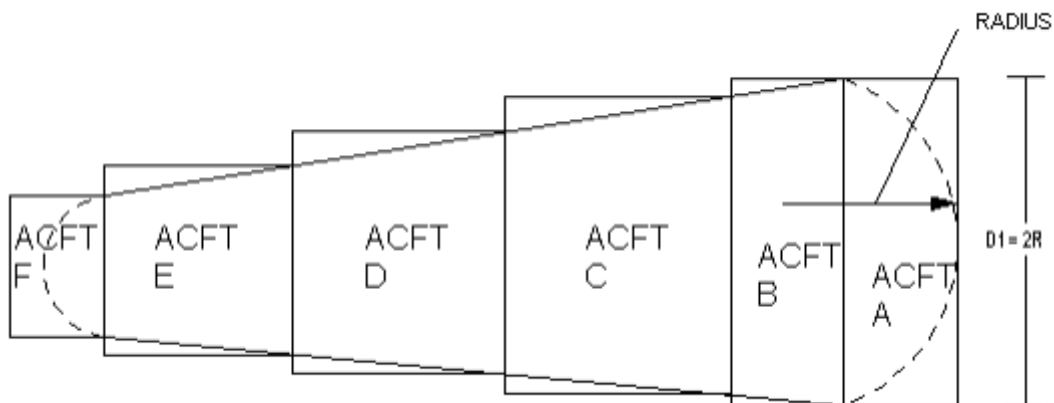


Figure 5.13 Allocation when Sufficient Search Time is Available

5.9.25 It is apparent from Figure 5.13 that this method of allocation results in small areas of individual search areas extending beyond the limits of the original search area. To reduce the incidence of unnecessary areas being searched, the length of  $D1$  may be reduced to the diameter of the larger circle of probability. The length of the major axis of ensuing search areas will remain at this reduced length until the centre of the larger circle of probability has been included in a specific search area.

5.9.26 Little can be done to eliminate other portions of the rectangular areas that extend beyond the probability area, except perhaps, to split large areas into smaller sections, or use different allocation methods.

---

### Over Sufficiency of Search Time

5.9.27 To employ time in excess of that required for first search coverage, several alternatives may be considered, e.g. first and second searches may be conducted simultaneously thus increasing the probability of detection or adjacent search areas may be overlapped. Other options include a reduction in track spacing and a reduction in sortie times to lengthen search crew rest periods.

### Insufficient Search Time

5.9.28 A more normal situation is that insufficient time is available to complete the first search of the probability area in due time. When this occurs a compromise must be devised.

5.9.29 In reaching a compromise, the probability area may be reduced, the track spacing may be increased, the search height may be increased or a variation may be made to a number, or all, of these factors. The methods for variation of search area size and track spacing will now be considered.

5.9.30 By reducing search quality to the point of  $C = 0.5$ , that being taken as the minimum acceptable value, a suitable combination of area, track spacing and search height may be calculated to best utilise limited resources. Application of the expanding search concept will ensure good coverage over ensuing sorties.

5.9.31 Worksheets 2,3 and 8 (Appendix K) has been constructed to assist in the determination of variable search parameters to achieve the best possible compromise:

- a) Section "A" is a statement of desired area and track spacing for a specified search height, associated coverage factor and POD;
- b) Section "B" records the maximum area that can be searched if the practical track spacing (S) is used. The C and POD, in this case, will be identical to "A"; and
- c) Section "C" records the widest track spacing required to search the whole of the area with the available aircraft hours, the resulting C and POD.

5.9.32 Having established the extremes of optimum track spacing and adjusted area (section B), and optimum area and adjusted track spacing (section C), it is appropriate to decide on the best possible option. This may be either one of these extremes or a compromise solution that requires amendment of each of area, track spacing and search height.

5.9.33 Section "D" may be used to examine the values of C and POD for various combinations of area and track spacing. It is good procedure, as a first step, to calculate the values necessary to achieve  $C = 0.5$  and then look for a solution of compromise that results in a value of C between 1 and 0.5. The process may be repeated for different search heights before making a final decision.

- 5.9.34 With the area and track space determined, it is appropriate to calculate the area capable of search by individual aircraft then allocate them accordingly.

### Allocation Variations to Suit Particular Aircraft

- 5.9.35 An improved search plan may result from the assignment of individual track spacings and or search heights to particular aircraft. These adjustments may arise after consideration of the need for separation of search aircraft and each aircraft's search TAS, search height limitations and turn diameter. Variations specified, as a result of these considerations, should be gauged against the calculated practical track spacing to indicate resulting C and POD.
- 5.9.36 An overall POD may be obtained by calculating C for each individual search aircraft then determining a weighted average of these coverage factors to arrive at an overall figure for C and POD. These, although of little value to an SMC in their own right, may be included in a Situation Report or prove beneficial when determining the cumulative POD for a number of searches.

### Allocation Chart Presentation

- 5.9.37 It is desirable that as much pertinent information as possible be depicted on a chart. All appropriate information may be plotted on one chart or it may be divided according to type and plotted on discreet charts. In either case, data may be plotted directly onto charts or on transparent overlays.
- 5.9.38 Individual aircraft search areas shall be identified by a "letter number", e.g. "A1".
- The letters used shall start at "A" and progress through the alphabet. If there are more than twenty-four aircraft on search, then double letters shall be used.
  - The number will indicate the day of the search**, (not the sortie number or the search number).

**For example:**

- The first aircraft tasked on day one of a search would be given "**A1**";
- The twenty-fifth would be given "**AA1**".
- The first aircraft tasked on day two would be given "**A2**";
- The twenty-sixth would be given "**BB2**".

Numbering will recommence with the first daylight search on each successive day.

**Note:** The letters I and O are not used to identify a search area because of the possibility of confusion with 1 or 0 (zero).

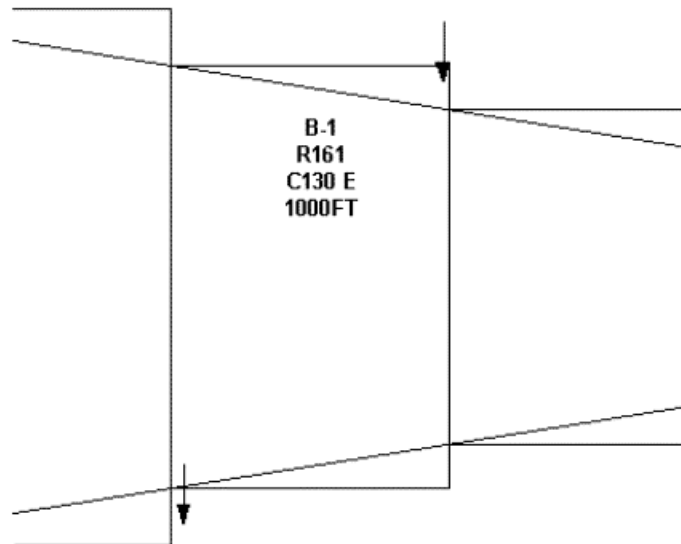


Figure 5.14 Information Displayed on Allocations Chart

## 5.10 SAR Crew Briefing

### General

- 5.10.1 Comprehensive briefing and de-briefing of search crews is a vital component of search planning. They are time consuming processes, and in the case of briefing, preparation must commence at an early stage and, whenever possible, in good time before departure. It must be appreciated that many personnel engaged for search operations are neither trained for nor experienced in the search role. Field SAR personnel shall therefore be given every opportunity to familiarise with all relevant details of the distress. All instructions for the SAR operation shall be clearly and precisely presented.
- 5.10.2 The officer appointed to the briefing task, must be thoroughly familiar with the overall plan and individual search unit tasks.

### Search Briefing

- 5.10.3 Comprehensive briefing of search units is vital to every search operation. The SMC should be satisfied that the briefings are well prepared, and that where group briefings are to be conducted, the venue is suitable for the purpose.
- 5.10.4 Briefings for marine units will cover similar topics to those given to air and land units, but there may be less opportunity for face to face briefing. Briefing Officers should be aware of the difficulties inherent in briefing indirectly and the increased potential for misunderstanding.
- 5.10.5 Similar arrangements shall be made for debriefing SAR units.

---

### Search Area Description

5.10.6 There are many ways of describing search patterns and the boundaries of search areas. In selecting the method to be used, RCC staff must consider the SAR knowledge of the recipients and the method to be used for the transmission of the information.

### Geographical Coordinates

5.10.7 This is the generally accepted method of designating an area, the corners of a search area being defined by latitude and longitude. To avoid confusion, the positions should be listed in a clockwise sequence, ending with a repeat of the initial coordinates. The disadvantages of this system are the possibilities of error in measurement and transmission.

### Universal Grid Reference

5.10.8 The Universal Grid is overprinted on all charts of the JOG series and is also shown on the majority of larger scale maps.

5.10.9 The grid consists of numbered blue lines spaced 1000 metres apart at chart scale, both vertically and horizontally. Instructions for its use are printed in the margin of each sheet.

5.10.10 Another grid system may be encountered on earlier editions of the R502 series and the associated large-scale maps. This is based on a military 1000-yard grid and is overprinted in black. The method of use is similar in both cases. Some maps show both grids.

5.10.11 When using grid references, it is essential to identify the map used by name and edition number.

5.10.12 It should be noted that the military might use a numerical system of sheet reference in combination with the grid reference. If this method is encountered, it will be necessary to seek interpretive guidance from a military source.

### Track Line

5.10.13 A track line search may be designated by stating relevant points along the track together with the width of coverage, **for example:**

"Fly a track 4 NM each side of a line between  $16^{\circ} 20' S$   $135^{\circ} 15' E$  and  $17^{\circ} 50' S$   $137^{\circ} 28' E$ ."

### Landmarks

5.10.14 Description of a search area by way of natural or man-made boundaries is particularly suitable when describing mountainous areas. Care must be taken to be precise. Vague descriptions such as "7 NM SSW of..." shall not be used. Proper



---

direction in this case would be by way of positive bearing and distance, i.e. "bearing 202° (T) from Dixon Island at 7 NM".

## Search Pattern Abbreviations

- 5.10.15 The international abbreviations are normally not used to brief domestic aircraft. Other RCCs may use the abbreviations when sending a briefing to an Australian SAR unit. If this briefing is to be forwarded to a SAR unit, JRCC Australia should ensure the pilot fully understands the type of search required.

## Search Aircrew Briefing

- 5.10.16 A written record shall be kept of all briefings given to aircrew and other units. Filing a copy of the Search Briefing Form most conveniently satisfies this requirement.
- 5.10.17 Search Briefing Forms shall be prepared for each aircraft task and dispatched or handed to the pilot in command or their delegate personally.
- 5.10.18 When the task for a search aircraft is amended, a hard copy amended briefing will be sent, where possible, to the aircraft crew otherwise it may be passed verbally, either directly or through a third party. Where a third party is used a hard copy of the amended briefing will be sent to that party. Confirmation will be obtained from the search crew that they have received and understood the amended briefing.
- 5.10.19 When pilots or their delegates are unable to personally attend for a briefing, the information may be dispatched by facsimile, email or telephone. The facsimile or email methods are preferred as the opportunity for errors of understanding is minimised and the transmission of maps, diagrams and other relevant hard-copy material can be achieved.
- 5.10.20 A pilot is, whenever possible, to be given a copy or reproduction of the relevant portion of the map in use by the RCC; it shall show the assigned search area and those areas adjacent to it.
- 5.10.21 Care must be taken in determining whether maps in use depict elevations in metres or feet. Pilots shall be left in no doubt in this regard.
- 5.10.22 In any case, where it is not possible to provide a pilot with a map or reproduction thereof, the briefing officer shall determine the maps and editions available to the pilot and ensure that the crew is totally aware of the areas, locations, and features that JRCC Australia requires it to search. The briefing officer shall make every effort to eliminate any possibility of errors due to differences in data on the respective maps.
- 5.10.23 A briefing shall include the following factors:
- a) Full description and nature of the distress, and details that are already known not to be of any significance to the present search should be pointed out;

- b) Present and forecast weather conditions to, from and in the search area and at destination and alternate aerodromes;
- c) Search area and any description of clues that may indicate the presence of the target;
- d) Instructions concerning the flight to and from the search area including route and levels;
- e) Search task, including patterns to be flown and method to record areas searched;
- f) Other aircraft in or near the area;
- g) Communication procedures, frequencies to be used and controlling authority;
- h) Frequencies to be monitored for transmissions from survivors;
- i) Details of droppable supplies to be carried and any special dropping procedures;
- j) Action to be taken on sighting the target;
- k) Distress signals and visual codes;
- l) Location and means of debriefing, including details of information which will be required;
- m) Restricted airspace or airspace arrangements; and
- n) Observer arrangement and the requirement to ensure they have a copy of the briefing. Where an observer leader is available, he should brief the observers.

5.10.24 A Flight Debrief Form should be supplied with the Aircraft Search Briefing Form.

### **Search Aircraft Operations**

5.10.25 Pilots shall be briefed that before beginning a search, they should have established communications (air to ground, air to air and on board), have observers in position and be listening on any special frequencies. Pilots shall be instructed that after becoming airborne, if it appears necessary for search height or track spacing to be modified, the RCC should be advised accordingly.

5.10.26 Before beginning a search, the aircraft should be flown at search height for a time to familiarise observers with the apparent size and appearance of known objects on the surface. Observers may also develop an appreciation of distances at height, bearing in mind the planned limit of scan.

5.10.27 Aircraft that are engaged on a beacon search should start the search procedure at the highest practicable cruising level unless a small probability area has been defined when a search may start at a lower level.

- 
- 5.10.28 Pilots or navigators should log all areas, heights and appropriate times, and indicate on a map the areas covered by the search.
- 5.10.29 When an object is sighted that requires investigation, the pilot should, if possible, mark the aircraft's position before deviating from track to ensure that it will be possible to resume track at the correct place. The use of GPS navigational equipment facilitates this.
- 5.10.30 In marginal visibility and when the aircraft carries no markers, the crew can keep a target in sight by executing a turn with the target in the approximate centre. When the target is further away, the observer should keep the general area of the sighting in view and call out the position or distance as the pilot turns the aircraft towards the sighting.
- 5.10.31 In sighting a missing craft or survivors, the pilot should pinpoint the position, advise the RCC and survey the surrounding area with a view to assisting those who will be required to proceed to the scene later. When a target is sighted over water, the position should be recorded by GPS or if possible, be marked by some form of sea marker, smoke float, buoyant light or dye marker.
- 5.10.32 It is desirable that continuous aerial surveillance be maintained over the location of the craft or survivors.
- 5.10.33 It is particularly important that continuous surveillance is maintained at sea, subject only to consideration of aircraft safety. Whenever possible, should a pilot be forced to leave the scene before the arrival of a relief aircraft, a buoyant radio beacon should be dropped, with the GPS position recorded.
- 5.10.34 The need to dispatch additional aircraft to the scene should be considered as early as possible to avoid survivors being left unattended and to avoid the problem of relocation.

### **Communications Relay Aircraft**

- 5.10.35 A dedicated communications aircraft should be used when communications are expected to be poor in the search area, for example:
- a) HF is the only means of communication;
  - b) The search is of a large scale;
  - c) It is necessary to improve information feedback into the RCC;
  - d) It is necessary to improve information flow to search assets;
  - e) Search aircraft are operating without contact with the ground station;
  - f) It is the best method of maintaining communications with survivors or ground search parties and ground rescue units.

---

5.10.36 A communications relay aircraft will normally be a suitably equipped SRU aircraft or military aircraft, have a minimum crew of pilot and radio operator, and have good on scene endurance.

### Top Cover Aircraft

5.10.37 The provision of a top cover aircraft should be considered during operations that may expose helicopters to undue risk.

5.10.38 The SMC is to discuss the requirement for a top cover aircraft with the pilot in command of the helicopter. The decision to task a top cover aircraft can be made by the SMC alone or on request by the helicopter pilot in command.

5.10.39 Circumstances that may require the provision of a top cover aircraft may include:

- a) Helicopters operating over water, although this will vary with the type of helicopter involved;
- b) Helicopters operating at or near the limit of their endurance;
- c) Helicopters operating in poor or marginal weather conditions; and
- d) Helicopters operating at a rescue scene presenting special dangers, e.g. at night.

**Note:** If in doubt, consult the helicopter crews.

5.10.40 Aircraft tasked for top cover should be an SRU aircraft carrying supply drop equipment suitable for the environment. The primary tasks of the top cover aircraft will be to:

- a) Provide navigation assistance to the helicopter to locate the target;
- b) Provide communications assistance to the helicopter; and
- c) Provide immediate assistance by way of supply drop should the helicopter ditch.

### Maritime Search Crews

5.10.41 When maritime units are used for search operations, staff of other SAR authorities, i.e. police and military, may brief the search crews. The coordinating SAR authority shall require copies of briefing forms issued on its behalf to ensure that personnel are adequately briefed on all matters relevant to units' tasks. Maritime units must be capable of carrying out the operation safely in the prevailing and forecast weather and sea conditions in the area.

5.10.42 All search preparations should be completed before the surface units enter the search area including the establishment of communication with the agency coordinating the surface search and other units (surface or air) participating in the search. Search crews should be briefed on:

- a) SAR frequencies and homing equipment monitored;

- b) Observers positioned; and
- c) Rescue gear made ready.

5.10.43 A surface unit carrying out a systematic search of an area with no visual reference points should maintain a dead reckoning (DR) plot of the last known position of the target, its own position, and the position of other ships and aircraft in the vicinity. The plot should also show date, time and possible drift of the target or survivors. Areas searched should be plotted on a chart.

5.10.44 To attract the attention of survivors, a surface unit should, if practicable, periodically make its presence known by making smoke during daylight and, at night, by rotating a searchlight beam around the horizon or, if clouds are low, by directing the searchlight vertically. When visibility is restricted, the engine should be stopped periodically to listen for shouts or whistles from the survivors.

5.10.45 Observers should be stationed as high as possible to increase the sighting range. Observers on board surface units can also use the scanning techniques used by aircraft observers.

### **Land Assets Employed in the Search of an Aircraft**

5.10.46 When land assets are used for search operations, the state or territory police or ADF SAR authority will conduct briefings. Search by land parties is normally only employed when aerial search is not possible or has been ineffective or when a closer examination of a certain area is desirable. It can be effective in forests, jungles and mountainous areas. Land assets may be used for both search and rescue.

5.10.47 JRCC Australia staff shall ensure that the coordinating authority is adequately briefed on the following:

- a) The current situation;
- b) A description of the missing aircraft, and a photograph if available;
- c) Details of the persons on board;
- d) A plan showing emergency break in points for the aircraft (if available);
- e) An instruction that unless accompanied by an Transport Safety Investigator, the aircraft wreckage is to be disturbed as little as possible;
- f) An instruction that unless on the direction of a coroner or a representative of ATSB the bodies of dead persons should not be moved except to the minimum extent necessary to extract survivors from the wreckage;
- g) The need to carry standard navigation and communication equipment and air to ground signal codes and materials;
- h) Details of communications arrangements;

- i) A warning that team members must not smoke, nor use naked flames near the wreckage;
- j) Information concerning any dangerous cargo known to be aboard an aircraft. In the case of a military aircraft, the need to exercise extreme care on account of ejector seats (being powered by explosives) and the potential incidence of ammunition, bombs, torpedoes, rockets, carbon fibre, noxious gases, poisonous substances etc.;
- k) Note: Contact with gases and substances associated with wrecked military aircraft can be lethal. Before approaching a military crash site, clearance shall be obtained from the responsible military authority; and
- l) an instruction that the wreckage must not be left unattended until taken into custody by a representative of ATSB, or placed under guard by the police.

**Note:** More complete information on the responsibilities of ground parties upon locating a crash site is contained in the booklet Civil and military aircraft accident Procedures for Police Officers and Emergency Services Personnel.

5.10.48 RCC staff shall ensure that land parties are aware that serious hazards to health and safety may exist at aircraft crash sites. Ground personnel have been injured and become ill and died as a result of crash damage, fire of composite materials, exposure to gases and poisonous substances. Certain radioactive substances may exist in military aircraft structures. Carbon fibres are electrically conductive and may short-circuit nearby electrical equipment. It is repeated that for the safety of ground party personnel, it is imperative that clearance be obtained from the responsible military authority before approaching a military crash site.

5.10.49 At the request of a land party operating in unfamiliar terrain, an aircraft may be provided to enable the unit leader to make an aerial reconnaissance of access routes in difficult terrain.

5.10.50 It may be necessary to position an aircraft over a crash site after the arrival of a land asset, to relay radio messages, or to interpret and relay ground signals.

## 5.11 SAR Crew Debriefing

### Overview

- 5.11.1 Full and proper de-briefing of search units is as important as the briefing process. Included in the briefing shall be instructions on the de-briefing procedure to be followed on completion of the search task. Where possible, blank debriefing forms will be given to the aircrew. A careful interrogation and evaluation of each search crew's effort is essential for intelligent forward planning.
- 5.11.2 Where a FCP or FFB is established, pilots, observer leaders, surface search unit leaders and others shall be instructed to attend after their sortie for de-briefing.

- 
- 5.11.3 Reports are required on anything that the search teams themselves consider pertinent, and may include:
- a) Report on actual weather conditions;
  - b) Positions at which sighting investigations were made;
  - c) Descriptions of items which were investigated;
  - d) Accurate description of areas searched and not searched with an assessment of the effectiveness of the search;
  - e) Results of monitoring of radio frequencies;
  - f) Any operational difficulties encountered; and
  - g) Observer debrief forms when available and completed.

---

## Chapter 6: Rescue Planning Operations

### 6.1 General

- 6.1.1 The primary purpose of any SAR action is the speedy return to a place of safety of the survivors of a distress situation.
- 6.1.2 It is essential that from the start of any SAR action, the RCC plans for the rescue of survivors and ensures that the appropriate resources are alerted, briefed and positioned so that the rescue may take place with the minimum of delay after the location of the survivors.
- 6.1.3 Without jeopardising the ultimate safety of survivors, foremost consideration shall be given to the potential impact on any medical condition of survivors by the method of recovery or the actions of unqualified persons.
- 6.1.4 The method of rescue to be used shall be decided after consideration of all relevant factors including:
- a) Action taken by sighting unit and the action that can be taken by other units at the distress scene;
  - b) Location of the survivors;
  - c) Condition of survivors and medical considerations;
  - d) Number of persons reported to be on board the craft and number who have been located;
  - e) Environmental considerations;
  - f) Available SAR facilities and their state of readiness;
  - g) Effect of weather;
  - h) Time of day; and
  - i) Any risks involved to SAR personnel at a crash site e.g. dangerous goods.
- 6.1.5 To reduce delay, the SAR facilities that are likely to be used should be alerted and deployed to a suitable location while the search is still in progress.

### 6.2 Preparation

- 6.2.1 It is the responsibility of the SMC to ensure that appropriate rescue resources are brought to a state of readiness and, as necessary, strategically positioned to be moved quickly into action immediately survivors are located.



- 
- 6.2.2 The SMC shall ensure that proper attention is given to the preparation and execution of the rescue effort.

## 6.3 Medical Assistance

- 6.3.1 It must be assumed that the survivors of an emergency will be in need of medical attention, and arrangements should be made to include medically qualified persons in the rescue team.

## 6.4 Crashed Aircraft

### Overview

- 6.4.1 When it is known that an aircraft will crash or has crashed and the crash position is incidentally reported or known with reasonable certainty, the RCC shall confirm the crash site and ensure the provision of medical assistance to the occupants and rescue of survivors.
- 6.4.2 ATSB and police should be given early notification of a crash for a decision for their attendance at the crash site. Next of kin should be kept fully informed through the appropriate liaison channel; normally the police.
- 6.4.3 Pending assumption of the responsibility by ATSB or relevant ADF authority, the RCC shall endeavour to arrange security at the crash site to prevent interference with the wreckage or with marks made by the aircraft in landing. State police are responsible for securing the accident scene. Instructions for police officers and emergency services personnel can be found in the ATSB and Department of Defence handbook: **Civil and Military Aircraft Accident Procedures for Police Officers and Emergency Personnel**. ([This publication is available on the National Search and Rescue Council website](#)).

### Health Hazards - Aircraft Accidents

- 6.4.4 Movement in the vicinity of crash sites can be extremely hazardous for ground parties on account of toxic fumes, dangerous substances and explosives. Deaths have resulted from ground personnel breathing noxious air and contacting extremely poisonous substances in the proximity of wrecked aircraft.
- 6.4.5 Some points made in the ATSB/Department of Defence handbook are in Appendix L. **Personnel should refer to the ATSB/Department of Defence handbook for more detailed procedures and precautions to be taken (see 6.4.3).**
- 6.4.6 To the extent that it can be governed, the RCC shall advise that permission should be secured from the appropriate ADF authority before members of the public or other agencies approach a crash site of a service aircraft.
- 6.4.7 Modern aircraft use composite materials for some of their structure, skin, and access panels. Significant health hazards exist at crash sites from the effects of crash damage and fire on composite materials. When burnt, released fibres and resins may

---

be toxic through inhalation and/or skin and eye contact. Damaged composites may also produce needle-like edges that render handling hazardous. Carbon fibres are electrically conductive and may short-circuit nearby electrical equipment.

- 6.4.8 Certain exotic metals (radioactive substances) can also be found in ADF aircraft types, which are also poisonous in their own right. The inhalation, ingestion or absorption of radioactive substances is hazardous, as low-level radiation will continue to be emitted inside the body, possibly resulting in damage to surrounding tissues and organs.
- 6.4.9 ATSB and CASA officers and police shall be given reasonable access to SAR facilities and staff during salvage operations.

## 6.5 Rescue on Land

- 6.5.1 Although the location of the distress scene may be known, it may be extremely difficult for a land party to reach it. Therefore the operation should be undertaken only after proper and complete planning.
- 6.5.2 The land party should be taken to a locality as near as possible to the distress scene by some means of rapid transport. If access to the site is possible, an aerial survey of the site may be made to determine the best route. The equipment carried should be carefully selected and arrangements made for supplies to be dropped should re-equipment be necessary.
- 6.5.3 The police will determine equipment necessary for land rescue parties. A portable radio capable of communicating with other SAR Units should always be included in a rescue party's equipment. JRCC Australia can authorise the issue of radios and other supplies from SAR stores for this purpose upon request.
- 6.5.4 In cases where all occupants of a crashed aircraft are not immediately accounted for, the search for missing persons must be continued. In the meantime, activities for the rescue of the others should be started.
- 6.5.5 Advice to police officers, other emergency services personnel and the public of the necessary actions to be taken in the event of a civilian aircraft crash in their area is obtained from the ATSB publication, Civil and Military Aircraft Accident Procedures for Police Officers and Emergency Personnel.
- 6.5.6 The ground rescue party should make a report to the SMC as soon as possible.
- 6.5.7 The SMC will relay advice of the condition of persons on board and disposition of wreckage to other authorities as appropriate.
- 6.5.8 The aircraft wreckage should not be disturbed except to assist in the recovery of survivors. Not only may the wreckage pose dangers by way of toxic materials and fumes, but also the position of flight controls, the location of debris and other factors are important to the accident investigation.

- 
- 6.5.9 Survivors should be removed from the distress scene and transported to receiving medical facilities by the most expeditious means. When selecting the method of transport, the SMC should consider:
- a) The condition of survivors;
  - b) The capability of the rescue unit(s) to reach the survivors in the shortest possible time;
  - c) The medical training, qualifications and operational abilities of the rescue personnel;
  - d) The rescue units' capability to transport survivors without aggravating injuries or producing new complications;
  - e) The difficulties that may be encountered by land parties, e.g. provision of shelter;
  - f) The need for food and water;
  - g) The weather conditions; and
  - h) Methods of maintaining communication with the rescue party, either directly or through their organisation's operational office.
- 6.5.10 Evacuation of survivors will be relatively simple if they are located in an area where medical and rescue facilities are available locally and from where aerial, road or water transport is possible. However, if the distress site is in a difficult or inaccessible area, the evacuation will have to be made on foot to a place from where transport can be provided. This may require sufficient foliage to be cleared by the land party to allow helicopter operation into the site.
- 6.5.11 The overland route to be followed should be made known to the RCC. This will simplify the provision of aerial coverage, if this is considered necessary.
- 6.5.12 If it is decided to evacuate the survivors by air, the rescue party may provide advice of a suitable landing area for fixed wing aircraft or a landing or hovering site for a helicopter. If verbal communication is not possible, the land party should prepare the appropriate ground/air visual signals.

## 6.6 Rescue at Sea

- 6.6.1 The SMC is responsible for the coordination of surface vessels engaged in the rescue of survivors in or on the sea except that in-shore rescue may be arranged and coordinated by the police.
- 6.6.2 The RCC shall make flotation equipment available for use by survivors whilst awaiting transportation to the shore. Details of the availability and types of equipment held by SAR Resources and Training, AMSA may be obtained from JRCC Australia.

- 
- 6.6.3 When an aircraft has ditched or a vessel is in danger of sinking, or sunk, it is imperative that rescue action is taken immediately. The time that a craft will float may be very limited, entry to life rafts is difficult, especially for children, aged or infirm personnel in rough seas, and the sea is a hostile survival environment.
- 6.6.4 When both maritime rescue units and helicopters are dispatched to the same distress scene, it may be advisable to transfer survivors to the helicopters for a more rapid delivery to medical facilities.

### **Use of Rescue Boats and Vessels**

- 6.6.5 Specialised rescue vessels are available only in scattered localities and their capacity is small. Each vessel dispatched to a distress scene should, if possible, carry additional life-saving devices to enable those survivors, who cannot be rescued immediately, to stay afloat while awaiting the arrival of another unit.
- 6.6.6 If specialised rescue units or vessels are not available, merchant vessels may be the only means of implementing an early rescue. However, if possible, support or alternative rescue units should be considered because merchant ships have significant limitations as a rescue platform, including:
- a) Generally not readily available;
  - b) Relatively slow speed;
  - c) Restricted manoeuvrability;
  - d) High freeboard, making retrieval of survivors difficult;
  - e) Small crew numbers; and
  - f) Language difficulties if foreign-crewed.
- 6.6.7 Ocean oil rigs and production platforms maintain fixed positions for periods of time. The JRCC Australia maintains data on their positions and means of contact for SAR purposes.
- 6.6.8 It is desirable that SAR vessels be equipped to lift survivors from the water without expecting any help from the survivors.

### **Use of Aircraft for Rescue**

- 6.6.9 When considering the use of aircraft to bring about the recovery of survivors, care must be taken to ensure that the rescue aircraft and crew are not exposed to inordinate danger.
- 6.6.10 Fixed wing aircraft should only be used to retrieve survivors when there is significant advantage over the use of surface transport and when there is a suitable aerodrome or landing area near the scene. Pilots shall be discouraged from attempting to land at other than prepared landing areas to pick up survivors. However, should this prove

---

to be the best or only viable option, all available specialist advice concerning the operation shall be obtained. It may be possible to have a qualified person lowered or parachuted in to survey the area. Helicopters may be employed to shuttle survivors from a distress site to a suitable fixed-wing landing area.

## **Use of Helicopters for Rescue**

- 6.6.11 When available, helicopters should be considered for rescue work. While eminently suited to the task in many respects, helicopters do have specific limitations that may be summarised as:
- a) The adverse effects of turbulence;
  - b) The need for a level, or near level, landing area;
  - c) A requirement for a cleared landing area of specific dimensions to avoid rotor blade damage;
  - d) A requirement for safe approach and take-off paths;
  - e) Potential for adverse effects on certain serious injuries;
  - f) Limited endurance;
  - g) Inability to hover with loads at high altitudes; and
  - h) Limited accommodation.
- 6.6.12 Helicopters can be used to rescue survivors by winching or by landing at a suitable location. Owing to their unique flying characteristics, helicopters should be considered for use as a rescue unit as a matter of course.
- 6.6.13 They are particularly suitable for rescues at locations where surface units are unable to operate. At the same time, some helicopter evacuations may be hazardous, particularly in mountainous areas at high altitudes and over rough seas. Such evacuations should therefore only be carried out by specially qualified and experienced crews and then only in the event of serious injury or illness or when lack of other means of rescue might result in loss of life. It is important that any information on the condition of survivors is considered by specialists before committing to helicopter use.
- 6.6.14 Operations by surface parties may be hampered by the noise and rotor wash produced by helicopters. To avoid damage to rotor blades, the landing site should be cleared to a diameter specified by the pilot-in-command for each proposed operation. To facilitate the coordination between helicopters and surface rescue units and to minimise the hazard of collision associated with helicopters operating in a confined space during rescue operations, their operations should be carefully planned by the RCC and coordinated by the ATS unit in communication with them.

- 
- 6.6.15 The helicopter's mass may be a factor limiting the number of survivors that may be taken aboard each trip. It may, therefore, be necessary to reduce weight by all possible means, e.g. removal of non-essential equipment, minimum fuel, use of advance bases with fuelling capabilities, etc.
- 6.6.16 It must be ensured that the route followed by the helicopter as well as the location where the survivors are to disembark are known to the SMC.
- 6.6.17 A medically qualified person, medical equipment and respiratory equipment, when available, should be carried on a helicopter recovery mission, at least on the first flight to the distress scene.
- 6.6.18 When being rescued by helicopter, survivors in a life raft may have to leave the raft to catch the sling since the rotor downwash below the helicopter will blow the raft away.
- 6.6.19 Survivors may not know how to operate a strop. A two-person winch is preferred to a single winch. A double strop allows one rescuer to supervise while being winched down and up again with each survivor.

**Note:** A helicopter should not be approached unless directed and/or escorted by a member of the helicopter's crew. Helicopters may require approach from different aspects dependant on type.

#### Use of Top Cover Aircraft with Rescue and MEDEVAC Helicopters

- 6.6.20 The provision of a top cover aircraft should be considered during operations that may expose the helicopter to undue risk.
- 6.6.21 The SMC is to discuss the requirement for a top cover aircraft with pilot in command of the helicopter. The decision to task a top cover aircraft can be made by the SMC alone or on request by the pilot in command.
- 6.6.22 Circumstances that may require the provision of a top cover aircraft may include:
- a) Helicopters operating over water. This will vary with the type of helicopter involved. If in doubt, consult with the crew;
  - b) Helicopters operating at or near the limit of their endurance;
  - c) Helicopters operating in poor or marginal weather conditions; and
  - d) Helicopters operating at a rescue scene presenting special dangers, e.g. night.
- 6.6.23 Aircraft tasked for top cover should be a SRU aircraft carrying suitable supply drop equipment. The primary tasks of the top cover aircraft will be to:
- a) Provide navigation assistance to the helicopter to locate the target;
  - b) Provide communications assistance to the helicopter; and

- 
- c) Provide immediate assistance by way of supply drop should the helicopter ditch.

## 6.7 Supply Dropping and Delivery of Survival Equipment

### General

- 6.7.1 Situations will arise where the immediate recovery of survivors is not possible and arrangements will have to be made to deliver sustenance, medical and survival equipment. Such situations shall be anticipated and planned for by the SMC during the conduct of a search.
- 6.7.2 Where possible delivery will be by way of surface vehicle or craft, or by helicopter or aircraft landing nearby. An example of this would be a situation with seriously injured survivors who may need stabilising prior to being moved or where specialised evacuation vehicles/craft needed are not immediately available.
- 6.7.3 Supply of survival equipment by air should be considered where there is an expected delay in the recovery of survivors from remote locations either at sea or on land.

### Civil SAR Equipment

- 6.7.4 The inventory of Civil SAR Equipment provided by AMSA includes:
  - a) Six person droppable Marine Life Rafts;
  - b) Droppable Stores Containers, Marine Supply Containers, Light Stores Canisters and the Small Payload Delivery System for the supply of communications, sustenance, medical and survival equipment;
  - c) De-watering Pumps;
  - d) Self-Locating Datum Marker Buoys;
  - e) Target marking devices including SAR Datum Buoys, See-Blitz Strobe, Lights, Smoke Markers and Sea Marker Dye; and
  - f) Search and Rescue Communicators (SARCOM) emergency AM transceiver operating on either the aviation band of 123.1 MHz or marine band Ch16 that are suitable for dropping in Droppable Stores Containers, Marine Supply Containers, Light Stores Canisters and the Small Payload Delivery System. Droppable Life Rafts are also equipped with these transceivers.
- 6.7.5 AMSA staff are familiar with the type and disposition of Civil and ADF SAR equipment and its usage and can be contacted for advice. Detailed procedures and instructions relating to the operation and delivery of the equipment are incorporated in:
  - a) AeroRescue Operations Manuals, and
  - b) Search and Rescue Standards and Procedures Manual for Tier 2/3 Rotary Wing SAR Units.

---

**Note:** These publications can be obtained from the SAR Resources and Training section of AMSA.

- 6.7.6 Only suitably qualified, trained and equipped crews shall be tasked for supply dropping.
- 6.7.7 Aircraft tasked for supply dropping will be suitable for the purpose. It is the aircraft operator's responsibility to ensure the appropriate flight manual supplements / flight manual limitations and dispensations are held. Routinely such dispensations will be against:
  - a) Civil Aviation Act Section 23 (Carriage of Dangerous Goods);
  - b) Civil Aviation Regulations 175(3) (IFR Flight); and
  - c) Civil Aviation Orders 29.5 (Dropping of articles from aircraft).

### Marking Targets

- 6.7.8 Where recovery of maritime survivors is delayed it may be necessary to track their position by dropping visual or electronic aids, which have long and short term characteristics.
- 6.7.9 Long-term devices include:
  - a) EPIRBs, which are packed in life rafts, transmit both a 406MHz digital identification code and a final stage homing signal on 121.5 MHz;
  - b) Self-Locating Datum Marker Buoys;
  - c) SAR Datum Buoys transmitting on:
    - i) 119.05 and 238.1 MHz (Green band);
    - ii) 119.15 and 238.3 MHz (Black band);
    - iii) 119.25 and 238.5 MHz (Blue band); or
    - iv) 119.35 and 238.7 MHz (Red band).

Note: the buoys are colour coded for ease of identification. Details of each buoy deployed are recorded and passed to JRCC Australia.

  - d) See-Blitz Strobe light. Provides a white strobe light for 4 – 5 hours.
- 6.7.10 Short term devices include:
  - a) Marine Location Markers (Orange smoke markers); and
  - b) Sea Marker Dye.



---

## Supply Drop from Aircraft over Sea

- 6.7.11 The following can be delivered from suitable fixed wing aircraft, including ADF aircraft:
- a) Light Stores Canisters or Marine Supply Containers containing communications, sustenance, medical and survival equipment etc.;
  - b) One or more single Life Rafts;
  - c) One or more multi-unit drops consisting of two Life Rafts or a combination of Life Raft and Marine Supply Container linked by 400 metres of buoyant rope; and/or
  - d) De-watering Pumps.

## Supply Drop from Helicopter over Sea

- 6.7.12 If recovery by helicopter is not feasible, or if recovery can be assisted by the supply of equipment such as rafts, a helicopter may be able to deliver a Life Raft using the Helicopter Delivery Line System or lower a Life Raft, Stores Container or De-watering Pump to survivors with great accuracy. Due to the limited capacity of some helicopters, not all survivors may be rescued at one time in which case the provision of additional floatation equipment (Life Rafts, Life Jackets) may be necessary to support the remaining survivors.

## Supply Drop from Aircraft over Land

- 6.7.13 Where it may take too long to get to survivors by land, stores and equipment can be dropped from civil or ADF aircraft. The main method of delivering supplies to survivors on land from fixed wing aircraft is by Droppable Stores Containers, Light Stores Canisters or the Small Payload Delivery System. All these methods can contain a combination of food, water, blankets, transceivers and medical equipment. In situations where it is important to provide survivors with shelter, it may be appropriate to drop one or more life rafts using a Bag – Storage or Deployment MkII and Parachute. Where there is no suitable landing place close to the survivors, vital survival equipment, food and stores could also be winched or dropped from a helicopter with great accuracy.

---

## Chapter 7: Conclusion of SAR Operations

### 7.1 General

- 7.1.1 SAR Operations enter the conclusion stage when:
- a) The target is located and the survivors are rescued;
  - b) The emergency beacon has been located and the survivors rescued, or if there was no distress, the beacon has been turned off;
  - c) Information is received that the target is no longer in distress;
  - d) All known persons on board are accounted for, or it has been determined that there is no longer a chance of survival; or
  - e) The SAR Authority determines that further searching has no significant chance of succeeding and either suspend or terminate the search.
- 7.1.2 The authority to end a search rests with different levels within the SAR organisation, depending on the circumstances. In particular, the SAR Authority is responsible for deciding when to suspend or terminate an unsuccessful search where lives were known to be at risk.
- 7.1.3 The SAR Authority may delegate to the SMC the authority to conclude the operation in all other circumstances (i.e. when the SMC determines that the target is no longer in distress and in situations where an identified beacon has ceased transmitting).

### 7.2 Conclusion of a Successful SAR Action

- 7.2.1 When the target of a search action has been located and the survivors removed to a place of safety, the RCC shall ensure:
- a) All people and organisations involved in the SAR action are stood down;
  - b) All appropriate agencies are notified;
  - c) Next of kin are fully informed;
  - d) Shipping is advised of any hazard caused by abandoned vessels etc.;
  - e) Arrangements are made for the recovery of dropped survival equipment e.g. rafts;
  - f) The collection of all maps, worksheets, notes, messages in chronological order and file on a SAR incident file; and
  - g) That administrative and financial procedures are completed.

---

## 7.3 Suspension of a Search when the Target is not Found

- 7.3.1 When it is determined that further search would be of no avail, the SMC shall consider recommending the suspension or termination of the SAR operation. However, search action shall not be suspended or terminated, nor the distress phase cancelled without the specific concurrence of the SAR Authority.
- 7.3.2 The decision to suspend a search shall not be made until a thorough review of the search is conducted. The review will focus on the probability of there being survivors from the initial incident, the probability of survival after the incident, the probability that the survivors were in the search area, and the effectiveness of the search.
- 7.3.3 The review should:
- a) Examine search decisions to ensure that proper assumptions were made and that planning scenarios were reasonable;
  - b) Reconfirm the certainty of initial position and any drift factors used in determining the search area;
  - c) Re-evaluate any significant clues and leads;
  - d) Examine datum computations and data calculations;
  - e) Confirm that all reasonable means of obtaining information about the target have been exhausted;
  - f) Review all intelligence material to ensure no information was overlooked;
  - g) Examine the search plan to ensure that:
    - i) Assigned areas were searched;
    - ii) The probability of detection was as high as desired; and
    - iii) Compensation was made for search degradation caused by weather, navigational, mechanical or other difficulties;
  - h) Consider the survivability of the survivor/s, taking into account:
    - i) Time elapsed since the incident;
    - ii) Environmental conditions;
    - iii) Age, experience and physical condition of (potential) survivors;
    - iv) Survival equipment available; and
    - v) Studies or information relating to survival in similar circumstances;
  - i) Consider the rescue plan to ensure that:

- 
- i) Best use was made of available resources;
  - ii) Contingency plans were sufficient to cater for unexpected developments; and
  - iii) Coordination with other agencies was effective in ensuring best treatment of survivors.
- 7.3.4 Before an unsuccessful search is suspended or terminated, the SAR Authority shall make arrangements to ensure that the next of kin are fully briefed on the complete search effort, including conditions in the search area, other salient operational factors and the reasons for proposing the suspension or termination of the search.
- 7.3.5 Consideration may be given to notifying the decision to suspend or terminate search effort at least one day prior to suspension of operations. This provides the next of kin at least one more day of hope while giving them time to accept that the search cannot continue indefinitely. Accordingly, the SMC should maintain regular contact with the relatives during the conduct of the search, providing access to the RCC if practical and appropriate.
- 7.3.6 In a case where foreign nationals are involved, liaison shall occur with the Department of Foreign Affairs and Trade.
- 7.3.7 The reasons for suspending a search shall be clearly recorded.
- 7.3.8 When a SAR action is discontinued or a search is suspended, the RCC shall inform all authorities, units and facilities that have been activated and/or alerted.
- 7.3.9 On occasions, after the suspension of a search, it may be necessary for the Police or Defence to continue to search for bodies and/or aircraft/vessel wreckage. In such cases the SAR Authority that had responsibility for the coordination of the search and rescue operation may, where possible:
- a) Provide briefings on the path of the aircraft/vessel prior to disappearance, last known position, area searched and related intelligence;
  - b) Review intelligence to assist search;
  - c) Source aircraft for transport or search purposes; and/or
  - d) Provide drift information.
- 7.3.10 Should any other organisation, such as the operating company, wish to continue with or initiate an independent search, the SAR Authority that had responsibility for the coordination of the search and rescue operation should ascertain whether there is any new intelligence that provides grounds to resume or continue the search. Under the circumstances where there is new intelligence, it should be evaluated and if considered valid the search should be continued or resumed. Where there is no new intelligence, then the SAR Authority may assist the requesting organisation by:

- 
- a) Briefing the aircraft/vessel's path prior to disappearance, splash/crash point, area searched and related intelligence;
  - b) Advising the possible location of suitable search aircraft; and/or
  - c) Providing drift information.

## 7.4 Reopening a Suspended Search

- 7.4.1 If significant new information is received, reopening of a suspended case should be considered. Reopening without good reason may lead to unwarranted use of resources, risk of injury to searchers, possible inability to respond to other emergencies, and false hopes among relatives.

## 7.5 Records and Reports

- 7.5.1 Records relating to search and rescue operations, including air searches on behalf of other organisations, shall be retained for periods as required under the relevant legislation and regulation.
- 7.5.2 When a search has been terminated without locating the target or its occupants, all records, charts etc. shall be retained and be accessible to SAR staff to allow easy resumption of search activity should further intelligence be received.
- 7.5.3 Reports on SAR Actions shall be generated as required for Coroners Inquiries, Management purposes and for training requirements.

## 7.6 Incident Debriefs

- 7.6.1 Following an incident the conduct of a debrief of agencies and groups involved should be considered. The purpose of incident debriefs are to establish opportunities for improvement in the operation of the national SAR system.
- 7.6.2 Incidents worthy of debrief may include those where:
  - a) Lives have been lost;
  - b) Large and complex searches have been conducted;
  - c) Multi agency involvement occurred; or
  - d) Where coordination, communication or response challenges were experienced during the incident.
- 7.6.3 This list is not exhaustive and the conduct of a post incident, multi-agency debrief is at the discretion of the SAR Authority in overall coordination of the incident with mutual agreement of other SAR Authorities and agencies involved.
- 7.6.4 Post incident debriefs should be used to:

- 
- a) Establish opportunities for improvement in the operation of the National SAR System; and
  - b) Ensure current policies and procedures are appropriate.
- 7.6.5 The SAR Authority with overall coordination is to:
- a) Decide the need for a debrief in consultation with other SAR participants;
  - b) Organise and host the debrief unless otherwise agreed by the participants;
  - c) Establish a venue that maximises opportunity for participation in, and learning from, the debrief;
  - d) Capture and share the opportunities for improvement arising;
  - e) Initiate changes to the National SAR Manual as appropriate arising from the debrief; and
  - f) Include lessons learned from debriefs in their jurisdiction reports to the annual National SAR Council meeting.
- 7.6.6 Participation at debriefs may be restricted to particular SAR Authorities and agencies depending on the issues that are likely to arise and would be a decision for the SAR Authority with overall coordination for the incident.
- 7.6.7 SAR Authorities that participate in the debrief will meet their own attendance costs, unless otherwise agreed by the participants.
- 7.6.8 The debrief should include the opportunity for all significant parties involved in the incident to contribute and learn from it.

## 7.7 Case Studies

- 7.7.1 Case studies may be conducted at the direction of the SAR Authority. IAMSAR provides guidance on case studies as follows.
- 7.7.2 Sometimes a SAR case has a surprise ending, as when the survivors are found by someone not involved in the search effort in a location outside the search area, or they are found, alive and well, in the search area after the search effort has been suspended. There are also occasions when there seems to have been an unusual number of problems in spite of the best efforts of the SAR personnel. Finally, there may be important and valuable lessons to learn from a SAR incident and the subsequent response of the SAR system that would be revealed only by a careful after-the-fact review.
- 7.7.3 A SAR case study is an appropriate method for addressing those aspects of an incident that are of particular interest. Individual aspects of interest could include problems with communications, assumptions made, scenario development, search planning, or international co-ordination. SAR case studies or incident reviews also

---

provide opportunities to analyse survivor experiences and lifesaving equipment performance. Survival in hostile environments is affected by many variables, including the physical condition of the survivors, survivor actions, reinforcement given by rescue crews prior to rescue, and the effectiveness of safety or survival equipment. Knowing more about these factors can help the SAR system become more effective.

- 7.7.4 When used to review and evaluate all aspects of a response to an incident, SAR case studies are one of the most valuable and effective tools for improving SAR system performance. Therefore, SAR case studies or reviews should be performed periodically even when no problems are apparent. There is almost always room for improvement, especially in large, complex cases. The most important outcome, however, is that early detection and correction of apparently small problems or potential problems will prevent them from growing into serious deficiencies later.
- 7.7.5 To get a balanced view, more than one person should conduct SAR case studies.
- 7.7.6 The case study team should include recognised experts in those aspects of the case being reviewed. To achieve maximum effectiveness, case studies should not assign blame, but rather, should make constructive suggestions for change where analysis shows that such change will improve future performance.

## 7.8 Performance Improvement

- 7.8.1 Constant improvement in the performance of the SAR system should be a clearly stated goal of SAR managers. One method to encourage performance improvement is to set up goals whose degree of attainment can be measured by key performance data. This data should be collected, analysed, and published on a routine basis so that individuals can see how the system as a whole is doing, and how their performance is contributing to the achievement of the established goals. Routine reports from the SMCs to the SAR managers can be used for monitoring system performance and highlighting areas where improvement is possible through changes in policies, procedures, or resource allocation.

---

## Chapter 8: Training and Exercises

### 8.1 General

- 8.1.1 The importance of thorough training for all personnel employed on SAR missions cannot be over-emphasised. Failure of a single link in the often complex chain of action required in SAR missions can compromise the success of the operation, resulting in loss of lives of SAR personnel, lives of those that might otherwise have been saved and/or loss of valuable resources. The purpose of training is to meet SAR system objectives by developing SAR specialists. Since considerable experience and judgement are needed to handle SAR situations, necessary skills require significant time to master. Training can be expensive but contributes to operational effectiveness. Quality of performance will match the quality of training.

#### Training

- 8.1.2 Training is critical to performance and safety. The SAR system should save those in distress when it can, and also use training to reduce risks to its own valuable personnel and resources. Training personnel in making sound risk assessment will help to ensure that these trained professionals and valuable resources remain available for future operations.
- 8.1.3 Consistency in training and sharing of information relating to search and rescue is promoted through the National Amendment and Training sub-committee and the National SAR Council. Standardisation to the prosecution of SAR Operations is encouraged through these avenues.
- 8.1.4 Efforts to ensure professionalism extend to career development for individuals who are assigned to undertake SAR duties. The aim is to ensure SAR officers are competent. In additions, agencies should consider making assignments of sufficient length to develop expertise and take advantage of SAR experience in subsequent assignments of officers.

#### Who to Train

- 8.1.5 All personnel involved in SAR Operation need to undertake SAR-specific training.
- 8.1.6 An individual, a group or multiple groups may be trained. Each person should have had previous training to perform individual tasks. Where the individuals integrate into teams, team training is required so that the individuals can support the team effort. Where teams integrate, multiple team training is required to support the overall effort.

#### Requirement for Training

- 8.1.7 Search and rescue organisations are responsible for the establishment of formal training programs for SAR personnel to reach and maintain competence appropriate to their role.



- 
- 8.1.8 Training of SAR personnel should focus on both the practical and theoretical application of SAR and may include the following:
- a) Study of SAR procedures, techniques and equipment through lectures, demonstrations, films, SAR manuals and journals;
  - b) Assisting in or observing actual operations; and
  - c) Exercises in which personnel are trained to coordinate individual procedures and techniques, or operate specialised equipment, in an actual or simulated environment.

## 8.2 National Training Framework

### Public Safety Training Package

- 8.2.1 The Public Safety Training Package has been developed through extensive consultation involving all Australian SAR authorities. The qualifications contained within the package are consistent with Australian Qualifications Framework (AQF) guidelines and are endorsed by the National Quality Council.
- 8.2.2 The Public Safety Training Package provides units of competence and qualifications that identify core competency standards for personnel who are involved in SAR activities. Units of competence have been packaged and aligned to a specific qualification within the AQF to establish the qualification level and title.

### National Search and Rescue School

- 8.2.3 AMSA is a Registered Training Organisation (RTO). The National SAR School, a part of AMSA, is the training arm of JRCC Australia.
- 8.2.4 The National Search and Rescue School provides specialist aviation and maritime search and rescue training to officers primarily in Australia's Joint Rescue Coordination Centre.
- 8.2.5 The National Search and Rescue School offers the Advanced Diploma of Public Safety (Police Search and Rescue Management) to select members of Australian police services on behalf of the National Search and Rescue Council.
- 8.2.6 The National Search and Rescue School oversees and administers training in units of this advanced diploma by a combination of distance education and classroom instruction. A residential instruction and assessment program, the National Police Search and Rescue Managers Course, is held annually in Canberra.
- 8.2.7 Directing staff of the National Police Search and Rescue Managers Course, in addition to instructors from the National Search and Rescue School, are drawn from Australian police organisations. These officers are subject matter experts in land and marine search and rescue and are qualified in workplace training and assessment.

---

## State/Territory SAR Authority Training

- 8.2.8 In addition to participating in the National Police SAR Managers training program the State/Territory Police organisation in Australia conduct search and rescue specific training with personnel involved, or who may become involved, in SAR operations at a local level.
- 8.2.9 This training involves principally land and coastal search and rescue operations employing their own personnel and personnel from other State/Territory organisations having a role in local search and rescue missions.
- 8.2.10 Formal training in the Diploma of Public Safety (Police Search and Rescue Coordination) is conducted by a number of registered training organisations associated with the Australian Police Services.

## 8.3 Search and Rescue Exercises

- 8.3.1 Exercises test and improve operational plans, provide learning experience and improve liaison and coordination skills. Exercises, conducted on a realistic basis, help to demonstrate and assess the true effectiveness of training and the operational efficiency and competence of the SAR service. Exercises will reveal deficiencies that may exist in SAR plans and enable them to be improved. It is safer to have shortcomings revealed by exercises rather than during actual operations
- 8.3.2 Each search and rescue organisation should periodically take part in coordinated search and rescue exercises (SAREX). These SAREXs should be designed to exercise the SAR system, in whole or part, and test such things as operational plans, communication procedures and facilities, individual staff performance, SAR unit performance and inter-organisation and/or international operations.
- 8.3.3 It is equally important that personnel have a good knowledge of the duties and procedures of other units and person who may be involved in a SAR operation, particularly those with whom they will have direct contact. It is especially important that SMCs be aware of the time, effort, and risk involved when requests are made to other units or organisations.
- 8.3.4 The regular conduct of joint SAREXs between SAR Authorities should form a part of any training program.
- 8.3.5 Emergency Management Australia (EMA) has developed a handbook, “Managing Exercises” that is Manual 42 of the Australian Emergency Management Handbook and Manual Series. This manual should be used as a guide and to assist SAR personnel designing and conducting search and rescue exercises. This Handbook and other EMA publications can be found on the Emergency Management Institute Publications page of their website [www.em.gov.au](http://www.em.gov.au).

---

## 8.4 Training of Search and Rescue Units

### Land SAR Training

- 8.4.1 Land SAR training is generally conducted by State/Territory Police organisations, with assistance from members of the State and Territory Emergency Services, as they have the responsibility coordinating search and rescue operations for persons and vehicles missing in a land environment.
- 8.4.2 Other SAR authorities that may become involved in a land SAR incident should ensure that their members are familiar with police arrangements for alerting and dispatching of rescue units.

### Aircrew Training

- 8.4.3 SAR Authorities should coordinate SAR exercises in conjunction with aircrews to ensure practice is maintained in pilot techniques employed in SAR operations.
- 8.4.4 Under the 'self-help' philosophy adopted in Australia, exercises involving commercial pilots on a large scale are not practicable; however, seminars including SAR operations as a subject provide an opportunity for discussion and display of training material.

### Dropmaster and Dispatchers

- 8.4.5 The dispatch of survival stores and equipment from an aircraft to survivors on land or over water is an exacting task, which, if not performed well, can nullify or seriously delay the rescue effort and may endanger the aircraft and its crew.
- 8.4.6 Supply dropping operations by civil aircraft should only be carried out by personnel trained in the preparation and delivery of droppable equipment in accordance with CASA regulations.
- 8.4.7 Joint exercises involving all authorities that organise or participate in land rescue should be arranged on a periodic basis.

### Air Observer Training

- 8.4.8 Major SAR operations require a considerable number of observers who may be drawn from various organisations.
- 8.4.9 JRCC Australia has published a comprehensive handbook for Observers that is available to all SAR Authorities from the SAR Resources and Training section of AMSA.
- 8.4.10 Observer leaders, observer briefing check lists, aircraft observer instructions and observers on ships are discussed in detail at Chapter 5.

---

## Aviation Search and Rescue Units (SRU)

- 8.4.11 JRCC Australia provides training to contracted aircraft operators who are considered suitable and capable of providing a SAR response.
- 8.4.12 These operators once formally trained and equipped are provided with appropriate continuation training and are known operationally as civil Search and Rescue Units (SRUs). The scope of training provided is specific to the resource capability of individual operators, in terms of human resources and aircraft availability.
- 8.4.13 Accordingly, operators are given training in one or more of the following aspects of SAR operations:
- a) Visual search procedures/techniques;
  - b) Airborne location of distress beacons using aural homing techniques;
  - c) Airborne location of distress beacons using DF equipment;
  - d) On ground location of localised distress beacons;
  - e) Operation of electronic sensor systems in SAR operations;
  - f) Aerial delivery of supplies/equipment overland and/or over water; and
  - g) Helicopter rescue techniques.

## 8.5 Photographic Records

- 8.5.1 Where possible, photographic or video recordings should be taken on exercises and actual SAR missions for use as future training aids. Participating authorities' film crews may be helpful in providing this facility.

## 8.6 Liaison Visits

- 8.6.1 It is important that personnel have a good knowledge of the duties and procedures of other units and persons who may be involved in SAR operations, particularly those with whom they will have direct contact. It is especially important that SMCs be aware of the time, effort and risk involved when requests are made to other units or persons.
- 8.6.2 Liaison visits between personnel likely to become involved together in SAR operations are encouraged. SMCs should inspect other units' facilities and where possible take part in appropriate activities, e.g. packing and loading equipment, helicopter rescue exercises, etc. The personnel of other organisations or units should be encouraged to visit RCCs and other SAR related units. Potential SAR team members, either units or individuals, should be invited to participate in, or attend exercises.

---

## Chapter 9: Other Emergency Assistance and Services available from JRCC Australia

### 9.1 General

- 9.1.1 JRCC Australia performs operations other than search and rescue, which, if not carried out, could result in a SAR incident. These operations include:
- a) Assisting a vessel or aircraft that is in a serious situation and in danger of becoming a casualty, thereby endangering persons on board. This assistance may be by way of direct action, or by way of notification to, and coordination with, other SAR authorities;
  - b) Broadcasting Maritime Safety Information (MSI);
  - c) Alerting appropriate authorities of unlawful acts being committed against an aircraft or ship;
  - d) Alerting appropriate authorities after a ship or aircraft has been abandoned, to minimise future hazards; and
  - e) The operation of the Modernised Australian Ship Tracking and Reporting System (MASTREP).

### 9.2 Safety Information

- 9.2.1 Maritime Safety Information (MSI), such as warnings of hazards to navigation, is promulgated by JRCC Australia and broadcast through the Inmarsat SafetyNET and some Limited Coast Radio Stations (LCRS). Broadcast of MSI serves to assist with preventing SAR incidents from occurring. This service is provided by JRCC Australia throughout Australia's region and NAVAREA 'X' (Ten).

### 9.3 Unlawful Acts

- 9.3.1 JRCC Australia may become aware of an aircraft known or believed to be subject to unlawful interference. JRCC Australia will advise Airservices Australia as soon as possible. Appropriate procedures will be implemented should the situation develop to a point that SAR action is, or will be, necessary.
- 9.3.2 Special signals have been developed for use by ships under attack or threat of attack from pirates or armed robbers. "Piracy/Armed Robbery Attack" is a category of distress message for all classes of digital selective call equipment and Inmarsat has added a piracy message to the Inmarsat C menu for the Global Maritime Distress and Safety System (GMDSS). For their own safety, ships may have to covertly send out the "Piracy/Armed Robbery Attack" message.
- 9.3.3 When JRCC Australia becomes aware of such a situation, it should declare a Phase, advise appropriate response agencies in accordance with JRCC Australia Procedures,

---

and begin preparations for possible SAR operations as appropriate. If the ship covertly sends a message care must be taken in any communications sent back to the ship so as not to warn the pirates.

9.3.4 JRCC Australia, on receiving a report of piracy/armed robbery attack, would act in accordance with the following:

a) If the attack is within the Australian SRR, JRCC Australia would:

- i) Acknowledge the report unless it is suspected that it is a covert report;
- ii) Notify appropriate security authorities as detailed in JRCC Australia Procedures;
- iii) Notify the International Maritime Bureau Piracy Reporting Centre;
- iv) Provide assistance to those Authorities by way of information and provision of communications; and
- v) Consider the need to notify other shipping in the area.

b) If the attack is outside the Australian SRR, JRCC Australia would:

- i) Acknowledge the report unless it is suspected that it is a covert report;
- ii) Notify the appropriate RCC;
- iii) Notify the International Maritime Bureau Piracy Reporting Centre;
- iv) If the attack is near the boundary of the Australian SRR, notify the Australian security authorities as in (a) above; and consider the need to notify other shipping in the area.

## 9.4 Medical Assistance to Vessels at Sea

9.4.1 The JRCC Australia is a Division of the Australian Maritime Safety Authority (AMSA), a Commonwealth statutory authority established under the Australian Maritime Safety Act 1990. The International Convention on Maritime Search and Rescue 1979 requires parties to the Convention to provide (among other things) on request, medical advice, initial medical assistance and MEDEVACs. Australia, through JRCC Australia provides these services in the Australian search and rescue region (SRR).

## 9.5 Emergencies

9.5.1 JRCC Australia is AMSA's operational point of contact and provides a communications and coordination support function for marine pollution response. The Australian Maritime Safety Act 1990 sets out the functions of AMSA, including "the combating of pollution in the marine environment". The Protection of the Sea (Powers of Intervention) Act 1981 implements the International Convention relating to intervention on the high seas in cases of oil pollution casualties and the protocol

---

to that convention. AMSA is the managing agency for the National Marine Oil Spill Contingency Plan, and the National Marine Chemical Spill Contingency Plan.

9.5.2 JRCC Australia has a number of other roles during emergencies including as outlined by the Australian Government:

a) Disaster Plans; and

b) National Security, crisis and Emergency Management arrangements.

9.5.3 JRCC Australia can coordinate AMSA's search and rescue assets in support of wider emergencies as appropriate, including major bushfires or other disasters.

---

# Appendices

**Appendix A – Australian Search and Rescue Region**

**Appendix B – National Search and Rescue (SAR) Responsibilities and Functions**

**Appendix C – Inter-Governmental Agreement (IGA) on National Search and Rescue Response Arrangements**

**Appendix D – Transfer of Overall Coordination or Request for JRCC Australia Assistance**

**Appendix E – Distress and Emergency Signals**

**Appendix F – Maritime SAR Recognition Code (MAREC)**

**Appendix G – Plotting Symbols**

**Appendix H – Sighting and Hearing (SHR) Techniques**

**Appendix I – Tables and Graphs**

**Appendix J – Probable Errors of Position**

**Appendix K – Worksheets**

**Appendix L – Aircraft Accident Site Precautions**

**Appendix M – Civil Aircraft Search and Rescue Units (SRUs)**

**Appendix N – RAAF SAR Equipment and Aircraft Capabilities**

**Appendix O – Royal Australian Navy Response**



## Appendix A: Australian Search and Rescue Region

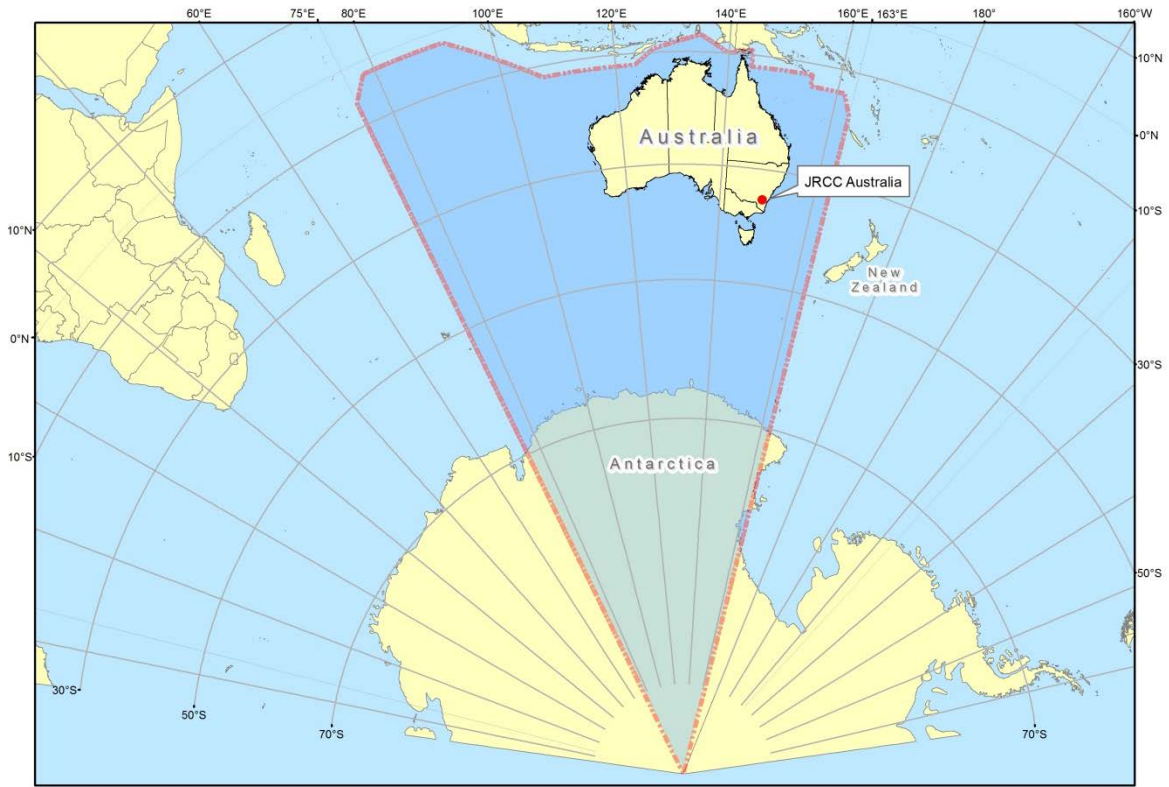


Figure A.1 Australian Search and Rescue Region

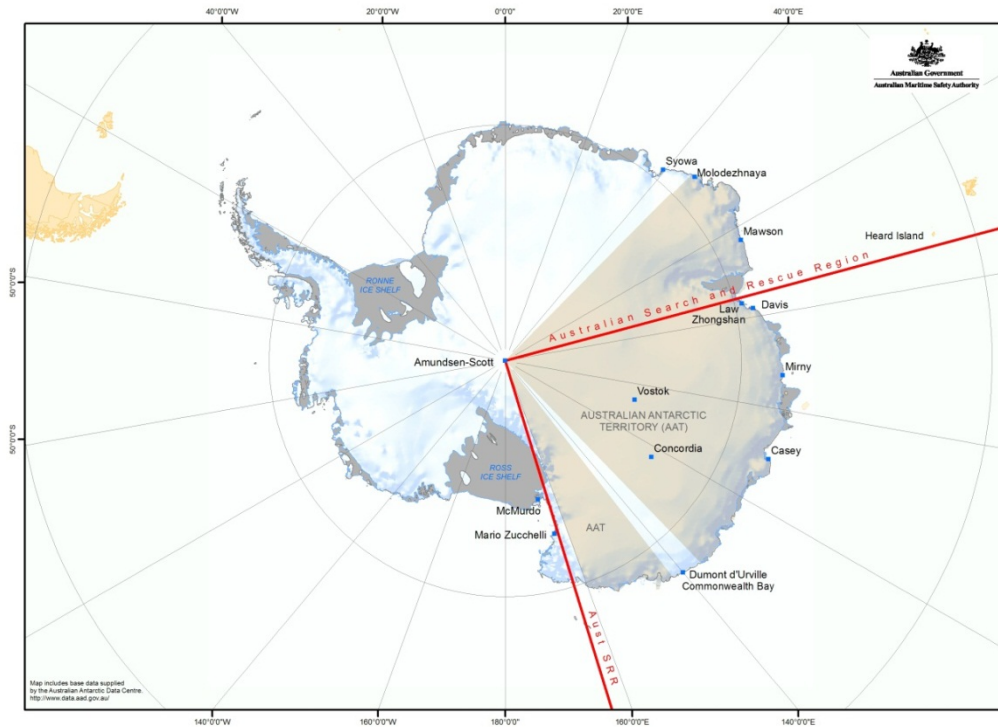


Figure A.2 Australian SRR Antarctic Region

---

**Coordinates of the SRR are as follows:**

The coast of the Antarctic continent in longitude 75° E thence

6° 00' S 75° 00' E	9° 37' S 141° 01' E
2° 00' S 78° 00' E	9° 08' S 143° 53' E
2° 00' S 92° 00' E	9° 24' S 144° 13' E
12° 00' S 107° 00' E	12° 00' S 144° 00' E
12° 00' S 123° 20' E	12° 00' S 155° 00' E
9° 20' S 126° 50' E	14° 00' S 155° 00' E
7° 00' S 135° 00' E	14° 00' S 161° 15' E
9° 50' S 139° 40' E	17° 40' S 163° 00' E
9° 50' S 141° 00' E	Thence to the coast of the Antarctic continent in longitude 163° 00' E

**Note:** The Australian maritime and aviation SRRs are generally the same except that the maritime SRR only extends to the Antarctic coast whilst the aviation SRR extends to the South Pole; and there is a minor difference in the North East corner of the SRR.

## Appendix B: National Search and Rescue (SAR) Responsibilities and Functions

Table of Responsibilities

DIVISION OF RESPONSIBILITY		FUNCTION TO BE PERFORMED BY, OR ON BEHALF OF, THE OVERALL COORDINATING AUTHORITY					
For land, sea and air SAR, in respect of:	Responsible Authority <sup>1</sup>	Provision and coordination of air SAR units.	Provision and coordination of land SAR units.	Provision and coordination of marine SAR units.	Communication (other than air/surface)	Air/ground communication for land search and rescue.	Aircraft/ship communication where direct communications not available.
International civil aircraft, manned space vehicles and aircraft on the Civil Aviation Safety Authority (CASA) and Recreational Aviation Australia (RA-Aus) Registers	JRCC Australia	JRCC Australia	Police	JRCC Australia Police	JRCC Australia Police	Airservices Australia Police	Airservices Australia
Persons on or from a Vessel at Sea <sup>2</sup>	JRCC Australia Police <sup>3</sup>	JRCC Australia Police	Police	JRCC Australia Police	JRCC Australia Police	Airservices Australia Police	Airservices Australia Police
Persons and vehicles on land; and Persons and vessels on inland waterways and in waters within the limits of the ports of the relevant State or Territory	Police	Police JRCC Australia <sup>4</sup>	Police	Police	Police	Police Airservices Australia	Police Airservices Australia

DIVISION OF RESPONSIBILITY		FUNCTION TO BE PERFORMED BY, OR ON BEHALF OF, THE OVERALL COORDINATING AUTHORITY					
For land, sea and air SAR, in respect of:	Responsible Authority <sup>1</sup>	Provision and coordination of air SAR units.	Provision and coordination of land SAR units.	Provision and coordination of marine SAR units.	Communication (other than air/surface)	Air/ground communication for land search and rescue.	Aircraft/ship communication where direct communications not available.
Aircraft not included in the CASA and RA-Aus registers including ultralights, paragliders, hang-gliders, and gyrocopters.	Police	Police JRCC Australia <sup>5</sup>	Police	Police JRCC Australia	Police Airservices Australia	Police Airservices Australia	Police Airservices Australia
Australian Defence Force (ADF) and Foreign Military Personnel, Aircraft, Ships and Submarines	ADF <sup>6</sup>	ADF	ADF	ADF	ADF	ADF	ADF
Unidentified Distress Beacon Alerts	JRCC Australia	JRCC Australia	Police	JRCC Australia Police	JRCC Australia	JRCC Australia Airservices Australia	JRCC Australia Airservices Australia

## Table Notes:

<sup>1</sup> The first SAR Authority to become aware of a SAR incident is obliged to respond until overall coordination can be transferred to the 'Best Placed' SAR Authority in accordance with the provisions of the Inter-Governmental Agreement on National Search and Rescue Arrangements 2012 and the principles set out in the National SAR Manual

<sup>2</sup> Other than those for which the ADF is responsible

<sup>3</sup> Responsibility for the rescue of persons from vessels at sea will be determined in accordance with the 'Best Placed' provisions of the Inter-Governmental Agreement on National Search and Rescue Arrangements 2012 and the principles set out in the National SAR Manual

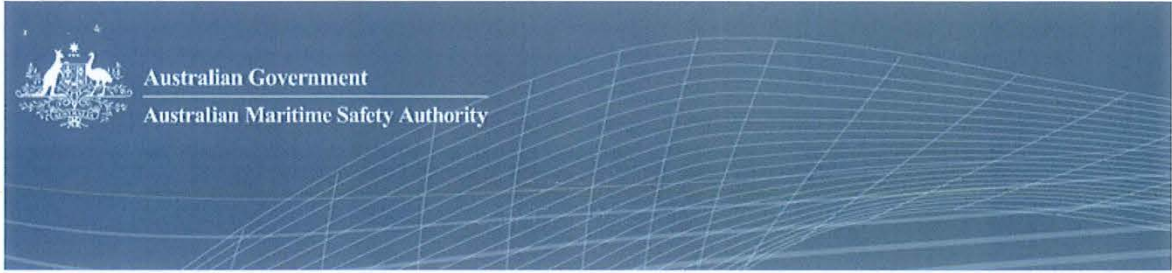
<sup>4</sup> JRCC Australia involvement when requested to arrange for the provision of aircraft or accept coordination of air search in accordance with the principles set out in the National SAR Manual

<sup>5</sup> JRCC Australia involvement when requested to arrange for the provision of aircraft or accept coordination of air search in accordance with the principles set out in the National SAR Manual

<sup>6</sup> ADF involvement in search and rescue is arranged through HQJOC (Headquarters Joint Operations Command) in accordance with the principles set out in the National SAR Manual

## **Appendix C: Inter-Governmental Agreement (IGA) on National Search and Rescue Response Arrangements**

This appendix contains a copy of the 2012 IGA applicable to the Australian National SAR Plan.



# INTER-GOVERNMENTAL AGREEMENT ON NATIONAL SEARCH AND RESCUE RESPONSE ARRANGEMENTS



[www.amsa.gov.au](http://www.amsa.gov.au)

## INTER-GOVERNMENTAL AGREEMENT ON NATIONAL SEARCH AND RESCUE RESPONSE ARRANGEMENTS

This AGREEMENT is made on the 29th day of June 2012.

BETWEEN

THE COMMONWEALTH OF AUSTRALIA

THE STATE OF NEW SOUTH WALES

THE STATE OF VICTORIA

THE STATE OF QUEENSLAND

THE STATE OF WESTERN AUSTRALIA

THE STATE OF SOUTH AUSTRALIA

THE STATE OF TASMANIA

THE NORTHERN TERRITORY OF AUSTRALIA

THE AUSTRALIAN CAPITAL TERRITORY

('The Parties')

### Definitions

'AMSA' means the Australian Maritime Safety Authority.

'Australian SAR Authority' means the authority with international responsibility for compliance with Australia's search and rescue obligations, being AMSA.

'National Search and Rescue Response Arrangements' means this agreement.

'National SAR Council' means the National Search and Rescue Council as constituted in accordance with paragraph 4 of this agreement.

'National SAR Manual' means the National Search and Rescue Manual endorsed by the National SAR Council as the standard reference to be used by all search and rescue authorities in Australia for search and rescue operations.

'SAR' means search and rescue.

'SAR Facility' means any mobile resource, including designated search and rescue units, used to conduct search and rescue operations.

'State and Territory SAR Authorities' means the following agencies nominated by each Party to this agreement:

The New South Wales Police for the State of New South Wales;

The Victoria Police for the State of Victoria;

The Queensland Police for the State of Queensland;

The Western Australia Police for the State of Western Australia;

The South Australia Police for the State of South Australia;

The Tasmania Police for the State of Tasmania;

The Northern Territory Police for the Northern Territory;

The Australian Federal Police for the Australian Capital Territory including Jervis Bay; and

The Australian Federal Police for the territories of Christmas Island, Cocos (Keeling) Islands, and Norfolk Island.

'Vessels' and 'craft' do not include vessels and craft of the Australian Defence Force or those of the defence force of any other country.

#### **Principal Agreements**

A. The Parties agree that :

- (i) The National Search and Rescue Response Arrangements for coordination of resources to be used in search and rescue operations are fundamental to the success of a national search and rescue service; and
- (ii) The promotion of continued cooperation in the provision of search and rescue between the Australian SAR Authority and each of the State and Territory SAR Authorities is essential.

B. The Parties agree that the critical elements of the National Search and Rescue Response Arrangements are:

- (i) The National SAR Council is the main coordinating body for search and rescue response arrangements in Australia;
- (ii) The National SAR Council is to sponsor and promote development and use of the National SAR Manual;
- (iii) The Australian and State and Territory SAR Authorities are to follow the cooperative arrangements described in the National SAR Manual;
- (iv) Continued recognition and maintenance of the long standing and well understood division of responsibility between the Commonwealth and the States and Territories for search and rescue in relation to persons, vessels, vehicles and aircraft; and
- (v) That Parties will plan and resource for search and rescue responsibilities as set out in the National SAR Manual, recognising and accepting that the first SAR Authority to become aware of a search and rescue incident is obliged to respond until overall coordination can be transferred to the SAR Authority best placed to coordinate the response, in accordance with the principles set out in the National SAR Manual.



- C. The Parties accept the administrative and funding arrangements underpinning the operation of the National Search and Rescue Response Arrangement as outlined in this agreement.
- D. The Parties agree to support the National Search and Rescue Arrangement to ensure that:
- (i) Australia's obligations under international conventions and agreements relating to search and rescue are fulfilled;
  - (ii) The national approach to search and rescue coordination is continued and strengthened;
  - (iii) The National SAR Manual is formally recognised as the standard reference for use by the Australian and the State and Territory SAR Authorities;
  - (iv) Parties are clear about their responsibility for planning for and resourcing search and rescue operations involving persons, vehicles, vessels and aircraft on land and at sea, in accordance with the National SAR Manual;
  - (v) Mechanisms are in place to facilitate cooperative decision making; and
  - (vi) The obligations of Parties under this arrangement are met.
- E. The Parties agree that this agreement updates and replaces the Agreement signed 30 June 2004.
- F. The Parties note that AMSA, established under the *Australian Maritime Safety Authority Act 1990* as a Commonwealth statutory authority, has as a legislative function the provision of a national search and rescue service in a manner consistent with Australia's obligations under the:
- *Convention on International Civil Aviation, 1944* (Chicago Convention);
  - *International Convention for the Safety of Life at Sea, 1974* (SOLAS); and
  - *International Convention on Maritime Search and Rescue, 1979* (the SAR Convention).

Accordingly, AMSA will act as Secretariat for the National SAR Council and will facilitate the implementation of this agreement.

HAVING REACHED THESE AGREEMENTS, THE PARTIES INTEND THE FOLLOWING:

**OPERATION OF THE AGREEMENT**

1. This agreement will commence on the date it is signed by all Parties.
2. The Parties will take such action as is provided for by this agreement and as is otherwise required to achieve the objectives of the National Search and Rescue Response Arrangements in accordance with the roles and responsibilities set out below.

**SCOPE**

3. This agreement is intended to provide guidance to the SAR Authorities of all Parties.

**OPERATION AND FUNCTION OF THE NATIONAL SAR COUNCIL**

4. The Parties agree that the National SAR Council will be the national coordinating body for search and rescue response arrangements.
5. The functions of the National SAR Council are to:
  - a) oversee the implementation of search and rescue arrangements within Australia's search and rescue region for consistency with the National Search and Rescue Response Arrangements;
  - b) sponsor the National SAR Manual detailing agreed search and rescue response and coordination arrangements in Australia; and
  - c) promote the ongoing effectiveness of the cooperative arrangements between the SAR Authorities.
6. Membership of the National SAR Council comprises one representative from each of:
  - a) the Australian SAR Authority,
  - b) each of the State and Territories SAR Authorities, and
  - c) the Australian Defence Force.
7. The National SAR Council is to be chaired by AMSA and the secretariat for the National SAR Council is also provided by AMSA.
8. Each member of the National SAR Council bears its own costs and expenses incurred in the course of Council business.

9. The Council should meet at least annually and may conduct its business out of session, providing a record is agreed between members affirming the decisions made out of session. Meetings may be held face to face or by teleconference or videoconference. Notice of meetings and agendas will be given at least one week in advance, unless otherwise agreed by the members. Meetings will not proceed unless a majority of members are able to attend.
10. Each Party will encourage the representatives from its SAR Authority to consider a whole-of-government perspective, and not just the views of its own agency.

#### **AUSTRALIAN SAR AUTHORITY**

11. The Australian SAR Authority will have responsibility for coordinating search and rescue operations for:
  - a) International civil aircraft, manned space vehicles and aircraft on the Civil Aviation Safety Authority (CASA) and Recreational Aviation Australia (RA-Aus) registers; and
  - b) Persons on or from a vessel at sea.
12. The Australian SAR Authority will be responsible for any liaison with international search and rescue authorities that may be required in response to any search and rescue operation.
13. The Australian SAR Authority will be responsible for the overall coordination of any national emergency plan or arrangement involving search and rescue within the Australian search and rescue region.

#### **STATE AND TERRITORY SEARCH AND RESCUE AUTHORITIES**

14. The State and Territory SAR Authorities will have responsibility for coordinating search and rescue operations for:
  - a) Persons and vehicles on land;
  - b) Persons and vessels on inland waterways and in waters within the limits of the ports of the relevant State or Territory;
  - c) Persons on or from a vessel at sea;
  - d) Aircraft not included in the CASA and RA-Aus registers including ultralights, para-gliders, hang-gliders, and gyrocopters; and
  - e) Land searches for missing registered civil aircraft in support of the Australian SAR Authority.
15. The State and Territory SAR Authorities will coordinate volunteer rescue organisations within their respective jurisdictions.

## **COOPERATIVE ARRANGEMENTS**

16. The SAR Authority first becoming aware of a search and rescue incident will take all necessary action until responsibility can be handed over to the search and rescue authority better placed to take overall coordination.
17. When a number of SAR Authorities contribute to a search and rescue operation, one SAR Authority will have overall coordination responsibility and the others will act in support in accordance with the procedures established by the National SAR Manual.
18. If an aviation or maritime search and rescue operation for which a State or Territory SAR Authority has overall coordination over-reaches that Authority's capabilities overall coordination may, by mutual consent, be transferred to the Australian SAR Authority in accordance with the procedures established by the National SAR Manual. Similarly, if the Australian SAR Authority is over committed with other search and rescue operations it may, by mutual consent, transfer overall coordination to a State or Territory SAR Authority. No SAR Authority will unreasonably refuse the transfer of overall coordination.
19. The Parties agree to ensure that any emergency management plan or arrangement that impacts on search and rescue preparedness and/or response, is considered by members of the National SAR Council to ensure that the appropriate coordination and harmonisation is in place.

## **RESOURCES AND FUNDING**

20. Each Party shall provide resources to its SAR Authority based on planning for search and rescue responses as outlined above.
21. The Australian and the State and Territory SAR Authorities shall each provide, without charge unless otherwise agreed, such assistance or facilities as may reasonably be requested by the SAR Authority with overall coordination of a search and rescue operation.
22. A SAR Authority that hires or requisitions privately owned facilities for a search and rescue operation will, unless otherwise agreed between the SAR Authorities, bear any costs of hiring or payment of compensation for such requisitioning.
23. The costs of a search and rescue response to an activated distress beacon will be borne by the SAR Authority that tasks the Search and Rescue Facility.

24. Where the resources required to respond to a search and rescue exceed those available to any SAR Authority, or where the circumstances require significant coordination across Party agencies, a search and rescue may develop into an emergency management response. Where a search and rescue results in State, Territory or national emergency plans or arrangements being activated, they are to be activated in support of national search and rescue response arrangements established through this agreement.

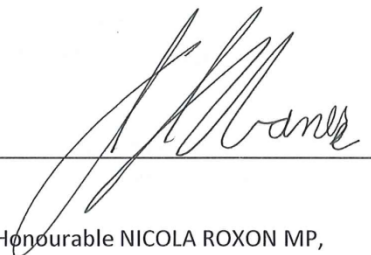
#### AMENDMENT AND TERMINATION

25. The Parties may at any time review this agreement and, if they unanimously decide to modify this agreement will take all practical steps to give effect to their decision by executing a replacement agreement.

26. The Parties may unanimously decide to terminate this agreement, and having done so each Party will do all that is practicable to terminate it.

SIGNED by

The Honourable ANTHONY ALBANESE, MP  
Minister for Infrastructure and Transport for the Commonwealth of Australia



A handwritten signature in black ink, appearing to read 'N. Roxon', is written over a horizontal line.

The Honourable NICOLA ROXON MP,  
Attorney-General for the Commonwealth of Australia.



A handwritten signature in black ink, appearing to read 'A. Albanese', is written over a horizontal line.

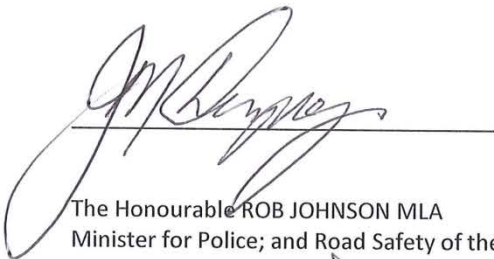
The Honourable MICHAEL GALLACHER, MLC  
Minister for Police and Emergency Services of the State of New South Wales.

A handwritten signature in black ink, appearing to read 'Gallacher', written over a horizontal line.

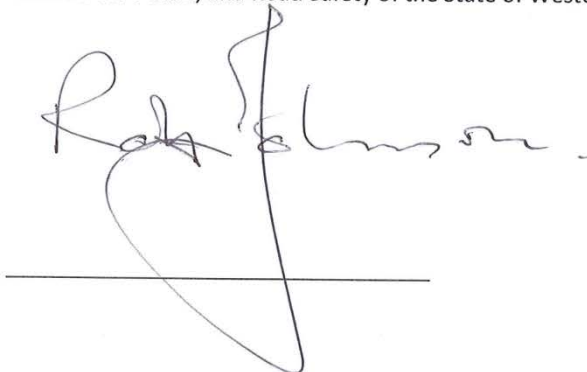
The Honourable PETER RYAN MP  
Minister for Police and Emergency Services of the State of Victoria.

A handwritten signature in black ink, appearing to read 'Peter Ryan', written over a horizontal line.

The Honourable JACK DEMPSEY, MP  
Minister for Police and Community Safety of the State of Queensland.

A handwritten signature in black ink, appearing to read 'Jack Dempsey', written over a horizontal line.

The Honourable ROB JOHNSON MLA  
Minister for Police; and Road Safety of the State of Western Australia.

A handwritten signature in black ink, appearing to read 'Rob Johnson', written over a horizontal line.

The Honourable DAVID O'BYRNE, MP  
Minister for Police and Emergency Management of the State of Tasmania.

A handwritten signature in black ink, appearing to be 'D O'Byrne', written over a horizontal line.

The Honourable JENNIFER RANKINE, MP  
Minister for Police and Emergency Services of the State of South Australia.

A handwritten signature in blue ink, appearing to be 'Jennifer Rankine', written over a horizontal line.

The Honourable PAUL RAYMOND HENDERSON, MLA  
Chief Minister and Minister for Police, Fire and Emergency Services of the Northern Territory of  
Australia.

A handwritten signature in blue ink, appearing to be 'Paul Raymond Henderson', written over a horizontal line.

Mr SIMON CORBELL MLA  
Attorney-General and Minister for Police and Emergency Services of the Australian Capital Territory.

A handwritten signature in blue ink, appearing to be 'Simon Corbell', written over a horizontal line.

## **Appendix D: Transfer of Overall Coordination or Request for JRCC Australia Assistance**

### **Overview**

The forms included in this Appendix are for use by SAR Authorities to transfer overall coordination of a search and rescue action to another Australian SAR Authority in accordance with paragraph 1.2 of this manual or to request assistance from JRCC Australia in accordance with paragraph 1.2 of this manual.

**The two pages of supplementary information must be passed with either form to ensure that information on the SAR action is passed and understood.**

Attachments:

**D.1 Transfer of Overall Coordination**

**D.2 Request for JRCC Australia Assistance**

**D.3 Supplementary Information**



## D.1 Transfer of SAR Coordination Form

(Please attach additional paperwork to FAX in responding)

### TRANSFER

I \_\_\_\_\_ (SAR Authority Representative)

on behalf of \_\_\_\_\_ (Authority),

hereby formally request the transfer of overall coordination in accordance with Chapter 1 of the National Search and Rescue Manual for the Search and Rescue action:

### Details of Incident and Location

To \_\_\_\_\_ (Receiving Authority)

With effect (Date/Time UTC) \_\_\_\_\_

(Signature) \_\_\_\_\_ (Date/Time UTC) \_\_\_\_\_

### ACKNOWLEDGEMENT

I \_\_\_\_\_ (SAR Authority Representative)

on behalf of \_\_\_\_\_ (Authority),

hereby formally acknowledge and accept / acknowledge and reject (if rejected for the following reason(s)):

(Signature) \_\_\_\_\_ (Date/Time UTC) \_\_\_\_\_

### COORDINATING AUTHORITIES

Overall Coordinator \_\_\_\_\_

Coordinator Air Search \_\_\_\_\_

Coordinator Surface Search \_\_\_\_\_

Coordinator Land Search \_\_\_\_\_

## D.2 Request for Assistance from JRCC Australia

(Please attach additional paperwork to FAX in responding)

<b>To</b>	
<b>From</b>	
<b>CC</b>	
<b>Date/Time (UTC)</b>	

### REQUEST FOR ASSISTANCE

I \_\_\_\_\_ (SAR Authority Representative)  
on behalf of \_\_\_\_\_ (Authority),  
hereby formally request JRCC Australia to \_\_\_\_\_  
\_\_\_\_\_ in accordance  
with Chapter 1 of the National Search and Rescue Manual, for the Search and Rescue action:

### Details of Incident and Location:

--

(Signature) \_\_\_\_\_ (Date/Time UTC) \_\_\_\_\_

### ACKNOWLEDGEMENT

I \_\_\_\_\_ (JRCC Australia Representative)  
of JRCC Australia, Australian Maritime Safety Authority, hereby formally  
acknowledge and accept / acknowledge and reject (if rejected for the following reason(s)):

--

(Signature) \_\_\_\_\_ (Date/Time UTC) \_\_\_\_\_

### COORDINATING AUTHORITIES

Overall Coordinator \_\_\_\_\_  
Coordinator Air Search \_\_\_\_\_  
Coordinator Surface Search \_\_\_\_\_  
Coordinator Land Search \_\_\_\_\_

## D3 Supplementary Information

### OWNER

<b>Craft Name/Type</b>	<b>Callsign</b>	<b>Length</b>	<b>POB</b>
<b>Construction</b>		<b>Colour(s) (Sail, Hull, Superstructure)</b>	
<b>Owner' Name and Address</b>		<b>Phone Numbers including Mobiles</b>	
<b>Nav aids Carried (and Type)</b>		<b>Reliability</b> Good <input type="checkbox"/> Limited <input type="checkbox"/> Unknown <input type="checkbox"/>	
<b>Communications Equipment (Type/Frequencies)</b>		<b>Reliability</b> Good <input type="checkbox"/> Limited <input type="checkbox"/> Unknown <input type="checkbox"/>	
<b>Emergency/Survival Equipment (Any Identifying Criteria i.e. Colour, Size)</b>		Beacon 121.5 <input type="checkbox"/> 406 <input type="checkbox"/> Life raft <input type="checkbox"/> Dinghy <input type="checkbox"/>	
<b>Other Information</b>			

### PERSON IN CHARGE OF CRAFT

<b>Name and Address (if different from above)</b>	<b>Phone Numbers including Mobiles</b>
<b>Experience/Qualifications</b>	
<b>Familiar with Area/Route</b> Yes <input type="checkbox"/> No <input type="checkbox"/>	<b>Any Passengers familiar with Area/Route?</b> Yes <input type="checkbox"/> No <input type="checkbox"/>
<b>Knowledge of Local Weather</b> Good <input type="checkbox"/> Limited <input type="checkbox"/> Poor <input type="checkbox"/>	<b>Valid Forecast Carried for Trip?</b> Yes <input type="checkbox"/> No <input type="checkbox"/> Unknown <input type="checkbox"/>
<b>Reaction to Adverse Weather</b> Push On <input type="checkbox"/> Go Round <input type="checkbox"/> Turn Back <input type="checkbox"/>	
<b>Carries Charts</b> Yes <input type="checkbox"/> No <input type="checkbox"/>	<b>Studies Charts</b> Yes <input type="checkbox"/> No <input type="checkbox"/>
<b>Sail Planning Satisfactory</b> Yes <input type="checkbox"/> No <input type="checkbox"/>	<b>Weather Details Are:</b> Accurately Computed <input type="checkbox"/> Calculated Guess <input type="checkbox"/> Careless <input type="checkbox"/>
<b>Traits (Include names, ages, gender, state of health, clothing worn, swimming ability, medication) of all on board.</b>	

## ITINERARY (Intended Route)

<b>Sail Plan (Include details, date, time, weather, ETA, purpose of trip, contact details of last to have contact with craft):</b>	
Departure Point	Destination
Last Known Position	
<b>Number of Hours Overdue</b>	
<b>Passenger Name(s) and Address(es)</b>	

## SEARCH CONDUCTED

<b>Chart Reference (Please attach a Mud Map)</b>
<b>Drift, Tidal Activity, Sea State, Swell</b>
<b>Weather (Historic, Current and Forecast)</b>
<b>Assets used in search, dates and Times of each Search</b>
<b>Other Relevant contact Details including Next of Kin</b>

## Appendix E: Distress and Emergency Signals

### Overview

Many signals have been devised over the years to signal a condition of distress or other emergency status. Those listed in this Appendix are those which are most common, have been accepted by international agreement or national custom, or which may be significant for occasional use by SAR units.

Because of the large number of possible signals of various types that may be used to indicate an emergency condition or may be used for emergency communication, this list is not all-inclusive.

### International Distress Signals

- a) A gun or other explosive signal fired at intervals of about one minute;
- b) A continuous sounding of any fog-signalling apparatus;
- c) Rockets or shells, throwing red stars fired one at a time at short intervals.
- d) A signal made by any signalling method consisting of the group ...---... (SOS) in the Morse Code;
- e) A signal sent by radiotelephony consisting of the spoken word 'Mayday'
- f) The International Code Signal of distress indicated by the code group NC; (See the International Code of Signals for other code groups with emergency significance.)
- g) A signal consisting of a square flag having above or below it a ball or anything resembling a ball;
- h) Flames on a vessel (as from a burning tar barrel, etc.);
- i) A rocket parachute flare or a hand flare showing a red light;
- j) A smoke signal giving off a volume of orange-coloured smoke;
- k) An orange coloured sheet with a black square and circle or a black "V" or other appropriate symbol;
- l) Slowly and repeatedly raising and lowering arms outstretched to each side;
- m) The radiotelephone alarm signal consisting of two tones transmitted alternatively over periods of from 30 seconds to 1 minute;
- n) Signals transmitted by Emergency Position Indicating Radio Beacons, EPIRB's or Personal Locator Beacons (PLB's), Emergency Locator Transmitters (ELT's);
- o) Approved signals transmitted by radio communication systems;
- p) A dye marker; and
- q) Transponder Squawk Codes 7700 Emergency, 7600 Communications failure, 7500 Unlawful interference.

### Search and Rescue Signals – Australian Area

#### Signals with Surface Craft

When it is necessary for an aircraft to direct a surface craft to the place where an aircraft or surface craft is in distress, the aircraft shall do so by transmitting precise instructions by any means at its disposal. If such precise instructions cannot be transmitted or when necessary for any other reason, the instructions shall be given by using the procedure prescribed herein.

The following procedures performed in sequence by an aircraft shall mean that the aircraft is directing a surface craft towards an aircraft or a surface craft in distress:

- a) Circling the surface craft at least once;
- b) Crossing the projected course of the surface craft, close ahead at a low altitude, opening and closing the throttle or changing the propeller pitch; and
- c) Heading in the direction in which the surface craft is to be directed.

The following procedure performed by an aircraft shall mean that the assistance of the surface craft to which the signal is directed is no longer required:

- a) Crossing the wake of the surface craft close astern at a low altitude, opening and closing the throttle or changing the propeller pitch.
- b) Repetition of such procedures shall have the same meaning. Current maritime signalling procedures include:
  - i) For acknowledging receipt of signals:
    - ii) The hoisting of the Code Pennant (vertical red and white stripes) close up (meaning understood);
    - iii) The flashing of a succession of T's by signal lamp in Morse code; and
    - iv) The changing of heading.
  - c) For indicating inability to comply:
    - i) The hoisting of the international flag N (a blue and white checked square); and
    - ii) The flashing of a succession of Ns in Morse code.

### Civil Air-Ground Code

Australian Civil Authorities use the following air-ground codes:

Signal	Meaning
Aircraft orbits ground party at low level changing engine noise	I require your attention
Aircraft flies overhead ground party at low level and sets off in a particular direction.	Follow aircraft in same direction
Aircraft rocks wings and orbits.	Investigate object/position underneath aircraft orbit
Aircraft drops smoke on a particular location	Investigate object/position adjacent to smoke
Aircraft drops message canister.	Retrieve and read instructions contained in the canister

Table E-1 Ground-Air Visual Signal Code

## International SAR Signals

The following visual signals are internationally recognised. They are authorised for use in the Australian SRR.


Number	Message	Code Symbol
1	Require Assistance	V
2	Require Medical Assistance	X
3	Proceeding in this Direction	
4	Yes or Affirmative	Y
5	No or Negative	N

Table E-2 Ground-Air Visual Signal Code for use by Survivors

**Note:** If in doubt use International Signal – SOS

Number	Message	Code Symbol
1	Require Fodder	FF
2	Require Evacuation	III
3	Power Failure	VI

Table E-3 Ground-Air Visual Signal Code for use in Civil Emergencies

### Notes:

1. **Aldis Lamp Signals**
  - a. Red flashes indicate not understood
  - b. Green flashes indicate message understood
2. **Air-Ground Signals**

The following signals by aircraft mean that the signals have been understood:

- a. During hours of daylight – rocking the aircraft's wings
- b. During hours of darkness – by flashing the aircraft's landing or navigation lights ON and OFF twice. Lack of the above signals indicates that the message has not been understood.
3. Tables E-1 and E-2 conform to ICAO and NATO standards

## Appendix F: Maritime SAR Recognition Code (MAREC)

### Overview

The purpose of this Code is to facilitate the communication of essential descriptive information regarding merchant ships and small craft within and between SAR maritime organisations.

The MAREC Code is in two parts:

- Part 1 – Merchant Vessels; and**
- Part 2 – Small Craft.**

All messages should be preceded with the prefix MAREC followed by a local serial number, assigned by the RCC.

The message should contain all the lettered identification groups as separate paragraphs. If the information is not known, the symbol UNK should be inserted or alternatively the symbol NA, where the lettered group is not applicable.

Fishing vessels have not been included due to the multiplicity of types and configurations. Use should be made of the Merchant Vessels description code to report the description of fishing vessels.



## Part 1 – Merchant Vessels

### Merchant Vessels MAREC Messages

The Message is composed of the following identification groups and will be transmitted in the following sequence:

A	Type of vessel - name - call sign
B	Superstructure - location - colour
C	Hull profile - colour
D	Sequence of uprights
E	Length
F	Condition of loading
G	Other characteristics.

Table F-1 MAREC - Local Serial Number

#### A. Type of Vessel – Name – Callsign

Merchant ships are classified as follows:

VOICE	TLX/RTG
Passenger ships	PAX
Ferry	FERRY
Tankers	TANK
Bulk carriers	BULK
General cargo ships	GEN
Coaster	COAST
Fishing vessels	FISH
Container ships	CONT
Specialised ships	SPEC

Table F-2 Mership Classifications

The name and callsign is added to the above classification.

For specialised vessels, the specific type of vessel should be given, as appropriate, e.g. gas carrier, tug, icebreaker, etc.

#### Example:

Voice: ALFA, SPECIALISED SHIP GAS CARRIER, FLYING DRAGON, CHARLIE GOLF HOTEL INDIA.

TLX/RTG: A/SPEC/GAS CARRIER/FLYING DRAGON/CGHI

#### B. Superstructure – Location and Colour

Superstructures are referred to as being located forward, midship or aft or a combination of these positions, and may be described as long or short. Colour is given in plain language.

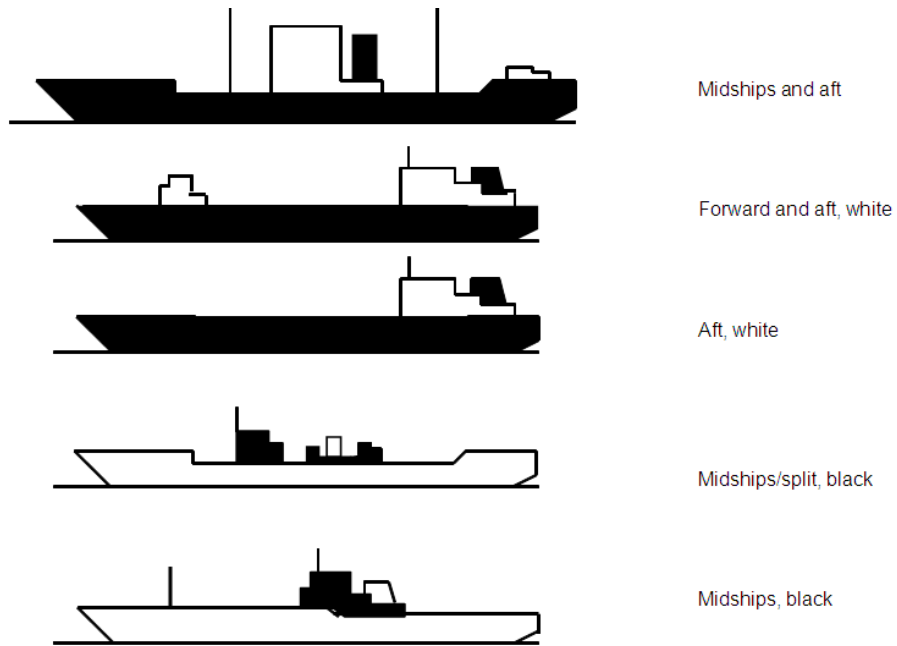


Figure F.1 Superstructure Locations/Colour

**Note:** A superstructure that has a very distinct gap, as in the fourth illustration above should be reported as “location” split.

**Example** (as in the first illustration above)

Voice: BRAVO, SUPERSTRUCTURE MIDSHIP AND AFT, WHITE

TLX/RTG: B/MIDSHIPS AND AFT/WHITE

### C. Hull – Profile and Colour

The hull profile is divided into three sections numbered 1, 2 and 3 from stem to stern as follows:

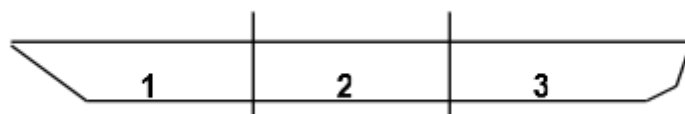


Figure F.2 Hull Division

If any section of the main weather deck of a vessel (except for superstructure) is raised, this is reported by its respective number as shown below. Should there be a break between deck raises, an oblique line (voice - 'SLANT' ) will be inserted in between the relevant section numbers. Should there be no break as referred to above, the numbers will be written consecutively.

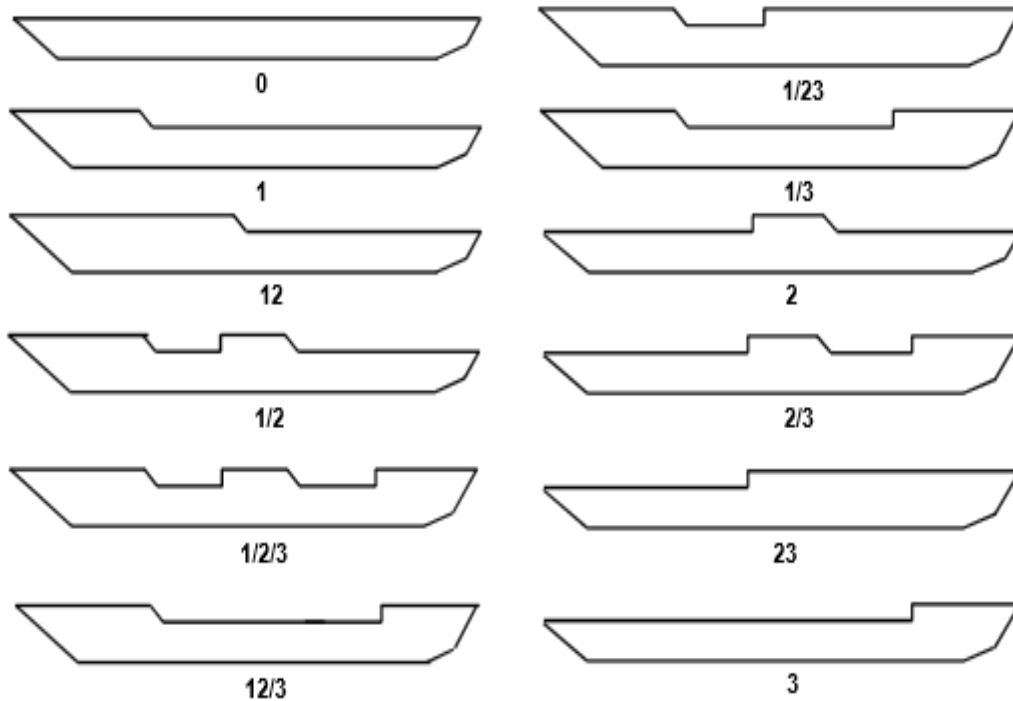


Figure F.3 Full Profiles

**Note of Caution:**

Do not confuse raises in the decline with bulwarks which extend the height of the hull profile about 1 m and are used to protect deck cargo and personnel from washing over the side. They look like fences around exposed weather decks and can be usually recognised by the presence of small holes for deck drainage (scuppers) and the lack of handrails (see Figure F.4 below).

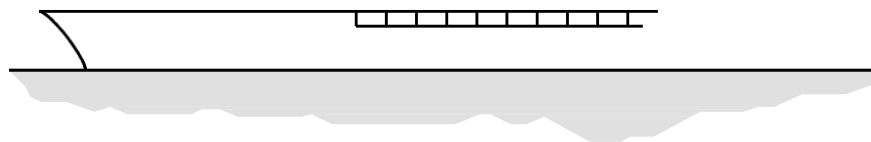


Figure F.4 Bulwarks

The colour of the hull is given in plain language.

**Example:**

Voice: CHARLIE, PROFILE ONE TWO SLANT THREE, BLACK  
 TLX/RTG: C/12/3/BLACK.

#### D. Uprights

Uprights include everything, other than the profile and the superstructures that are prominent and can clearly be seen at a distance. The uprights are reported from stem to stern according to the list below:

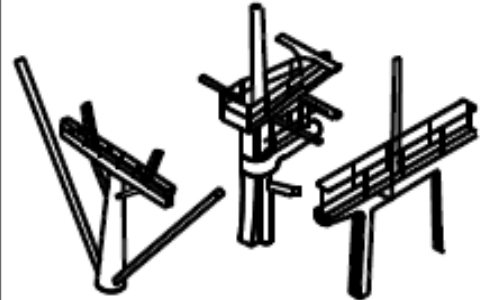

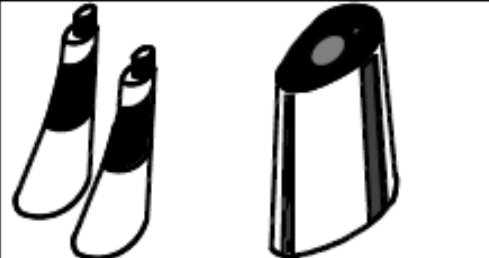

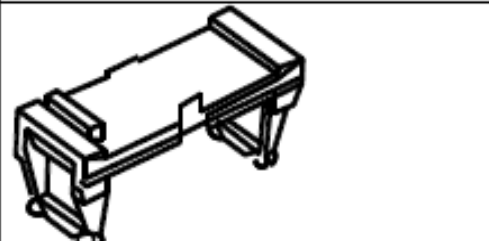
Voice	TLX/ RTG	Description	Illustration
Mast	M	Slender posts consisting of a lower section with a thinner upper section. Used to support signals, flags, navigation lights, radar antennae etc. Generally the highest of the uprights.	
Kingpost	K	Slender uprights resembling the thickness or heaviness of the lower section of masts. They are used to support cargo booms. If there is a pair of king posts athwartships (perpendicular to the vessel's centreline), the pair is reported as one kingpost. A kingpost with mast extensions is reported as a mast.	
Funnel	F	Used to exhaust the vessel's main propulsion systems. Most vessels have one although some of the older ships have more.	
Crane	C	Self-contained mechanisms with a boom extending from them.	
Gantry	G	Mobile structure limited to fore-aft movement supporting a central crane.	

Figure F.5 Uprights

Uprights located close to a superstructure such that they cannot be clearly seen from a distance should not be included.

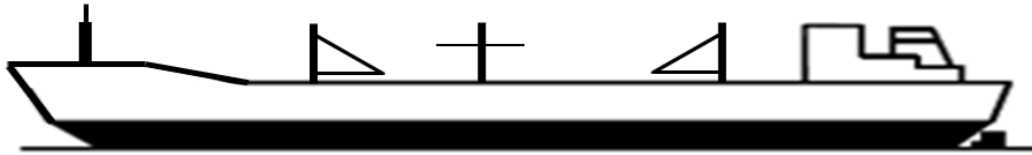


Figure F.6 Example of Uprights

**Example:**

Voice: DELTA, MAST, KINGPOST, MAST, KINGPOST, FUNNEL

TLX/RTG: D/M K M F

**E. Length**

Length is the length overall (LOA) given in metres.

**Note:** Length can be estimated by observing the vessel's lifeboats, normally 10 metres long, in proportion to the ship's length.

**Example:**

Voice: ECHO, TWO ZERO METRES

TLX/RTG: E/LOA 20

**F. Conditions of Loading**

The condition of loading is indicated as follows:

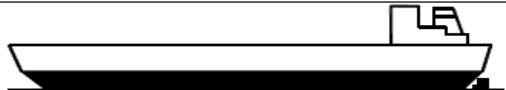
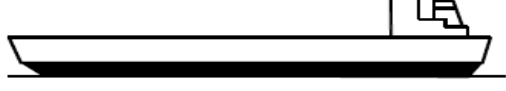

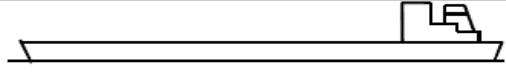
Voice	TLX/RTG	Description	Illustration
Light	Light	Carrying only fuel and stores. Sitting high in water. Propeller and rudder partly exposed. Difficult to manoeuvre.	
In ballast	Ball	Carrying ballast. Sitting high in water. Propeller and rudder normally submerged. Large amount of lower hull paint showing.	
Partially loaded	Part	Sitting well in water. Fair amount of lower hull paint showing.	
Fully loaded	Load	Sitting deep in the water. Little, if any, lower hull paint showing.	

Figure F.7 Conditions of Loading

**Example**

Voice: FOXTROT, PARTIALLY LOADED

TLX/RTG: F/PART

### G. Other characteristics

Other prominent characteristics should be given, e.g. stack insignia, conspicuous deck cargo, or other distinguishing marks or colour variations, e.g. name in big letters on ship's side or company insignia painted on side of hull. In the message, such specific characteristics should be given in full.

#### Example:

Voice: GOLF, RAILROAD CARS ON DECK  
TLX/RTG: G/RAILROAD CARS ON DECK

### Complete example Merchant Ship

The following illustrates a typical merchant vessel and how it would be described in a message according to this system.

Voice:	TLX/RTG:
MAREC 5/03 RCC AUSTRALIA ALFA, GENERAL CARGO SHIP, ARAFURA, VICTOR ROMEO ROMEO YANKEE BRAVO, SUPERSTRUCTURE AFT, WHITE CHARLIE, PROFILE ONE, SLANT THREE, BLACK DELTA, MAST, MAST, MAST, FUNNEL, KINGPOST ECHO, TWO FOUR ZERO METRES FOXTROT, PART GOLF, NOT APPLICABLE	MAREC 5/76 RCC AUSTRALIA A/GEN/ARAFURA/VRRY B/AFT/WHITE C/1/3/BLACK D/M M M F K E/LOA 240 F/PART G/NA.



Figure F.8 Typical Merchant Ship

## Part 2 – Small Craft

### Small Craft MAREC Message

The message is composed of the following identification groups and will be transmitted in the following sequence:

A	Type of craft/ number of hulls – name – callsign or ship station identity – use
B	Make - distinctive markings
C	Motor installation or rigging
D	Construction - material – colour
E	Stern – stern
F	Type of bottom
G	Length.
H	Other characteristics
I	Number of persons on board.

Table F-3 MAREC - Local Serial Number

#### A. Type, configuration and superstructure of craft/number of hulls, name, callsign and use

Type is based on primary means of propulsion.

Propulsion	Type	Voice	TLX/RTG
Motor	Motor Boat	Motor	MOT
Sail	Sailing Boat	Sailing	SAIL
Oars	Rowing Boat	Rowing	ROW
Paddles	Canoe	Canoe	CAN
Motor and sail (in equal proportion)	Motor/Sailer	Motorsail	MOTSAIL
Various	Inflatable	Inflatable	INFLAT

Table F-4 Type of Small Craft

Configuration is based on decked-in watertight areas.

Voice	TLX/RTG	Description
Open	O	Free of decks that enclose a watertight area
Part Open	PO	Partly decked to create watertight areas
Closed	CL	Fully decked so that, with all hatches closed and bungs in, the entire hull volume is watertight
Superstructure		
Full Cabin	FC	Cabin superstructure from bow to stern
Part Cabin	PC	Any cabin superstructure not from bow to stern
Full Raised Deck	RD	Entire deck level is raised to provide accommodation in the hull. Identified by the presence of windows in the hull without any superstructure
Part Raised Deck	PD	Where only part deck level is raised as above

Table F-5 Configuration of Small Craft

When reporting the above both voice and TLX/RTG items should be incorporated in one group as below:

An open, part cabin motor boat should be reported as:

Voice: MOTOR OPEN PART CABIN

TLX/RTG: MOTOPC

A closed, part cabin sailing boat should be reported as:

Voice: SAIL CLOSED PART CABIN

TLX/RTG: SAILCLPC

Where the number of hulls is more than one, adding the words or group as follows should indicate this:

2 hulls - Catamaran – CAT

3 hulls -Trimaran - TRI

The craft's name, call sign and use should be added to words or groups above. Under use, indicate the purpose for which the craft is being used, e.g. fishing, pilot boat, off-shore racer, etc.

**Example:**

Voice: ALFA, MOTOR PART OPEN PART CABIN CATAMARAN, LUCKY LADY, NAVIS ONE THREE, PLEASURE

TLX/RTG: A/MOTPOPC/CAT/LUCKY LADY/NAVIS 13/PLEASURE

**B. Make and Distinctive Markings**

The make and distinctive markings should be given in plain language.

**Example:**

Voice: BRAVO, MAKE STORTRISS, SAIL MARKINGS TWO OVERLAPPING TRIANGLES WITH POINTS UP AND NUMBER SIERRA ONE THREE EIGHT

TLX/RTG: B/STORTRISS/SAILMARKINGS TWO OVERLAPPING TRIANGLES POINTS UP/S138

**C. Motor Installation or Sail Rigging**

The motor installation is given according to the figures shown below:



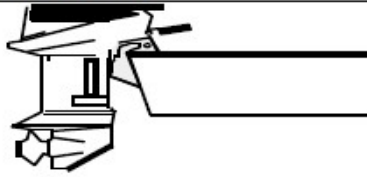
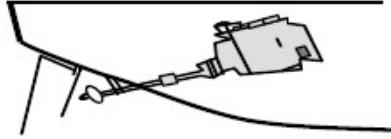

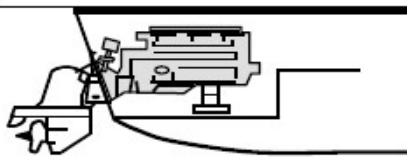
Illustration	Voice	TLX/RTG
	Outboard motor, if applicable with the addition Double or Triple.	OUTB  OUTB2 OUTB3
	Inboard motor	INB
	Jet	JET
	Aquamatic if applicable with the addition Double or Inboard/Outboard	AQUA  AQUA2 INBOARD/OUTBOARD

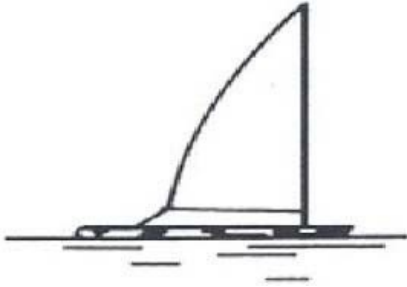

Table F-6



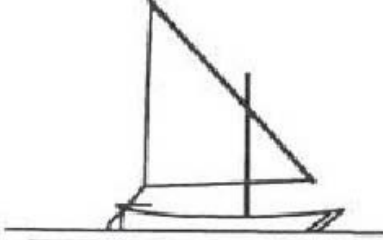

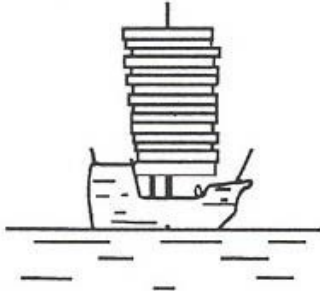
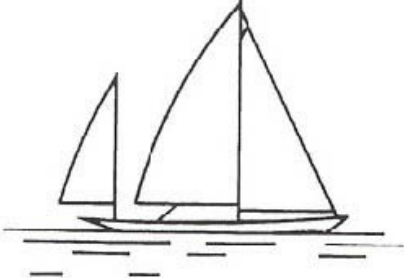
**Example**

Voice: CHARLIE, OUTBOARD MOTOR, DOUBLE

TLX/RTG: C/OUTB 2

Rigging (sailing boats) - Type of rigging is described on sailing boats and motor sailers according to the figures below. (The number of masts is denoted by the appropriate number):

Illustration	Voice	TLX/RTG
	Jib Rig	JIB
	Spirit Rig	SPRI

	<p>Gaff Rig</p>	<p>GAFF</p>
	<p>Lug Sail</p>	<p>LUG</p>
	<p>Lanteen Sail</p>	<p>LAT</p>
	<p>Sloop Rig</p>	<p>SLOOP</p>
	<p>Junk Rig</p>	<p>JUNK</p>
	<p>Yawl</p>	<p>YAWL</p>

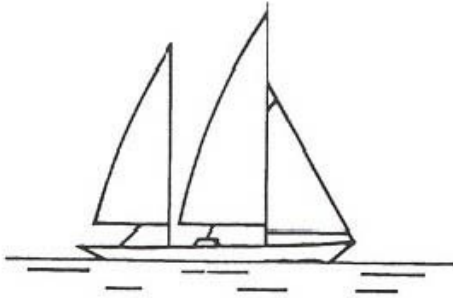
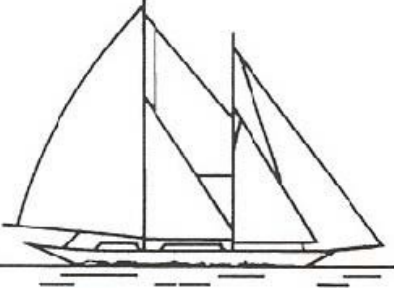
	Ketch	KETCH
	Schooner	SCHON

Figure F.9 Sailing Rigging

These boats have the capability to carry a bowsprit, that is a spar extending from the bow to which headsails are attached. These are reported on:

Voice: Bowsprit or  
TLX/RTG: BS.

The difference between a ketch and a yawl is:

- e) **The ketch’s aft mast is stepped forward of the rudder post; and**
- f) **The yawl’s mast is stepped behind the rudder post.**

Most sailing boats carry sails known as “extras” to improve the boat’s performance in specific conditions and include spinnakers, spinnaker staysails, jib staysails, main staysails and mizzen staysails. If these sails are in use, identification of the yacht’s rig becomes more difficult. These should be reported in section H.

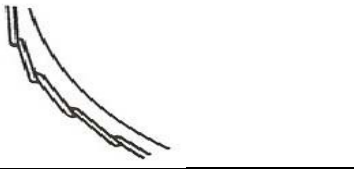
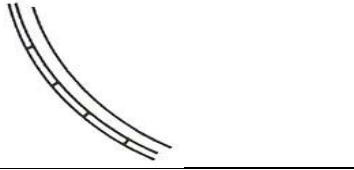
Name	Voice	TLX/RTG
Spinnaker	Spinnaker	SPIN
Spinnaker Staysail	Spinnaker Staysail	SPINSS
Jib Staysail	Jib Staysail	JIBSS
Main Staysail	Main Staysail	MAINSS
Mizzen Staysail	Mizzen Staysail	MIZZENS

Table F-7 Sail Types

D. Construction/Material/Colour

**Construction.**

Two different types of construction exist, viz. clinker built and carvel built or smooth sided.

		<b>Note:</b> Some glass fibre boats are moulded to resemble clinker built and should be so described in this Code.
<b>Clinker</b>	<b>Carvel</b>	

**Material.**

The materials commonly used to construct small craft are wood, metal, glass reinforced plastic (fibreglass) (GRP), rubber (inflatables) or ferro- cement. Construction material and colour should be given in voice reports and given the abbreviations WOD, MTL, GRP, INFLAT or FERC in TLX/RTG reports.

**Example:**

Voice: DELTA, CLINKER, GLASS FIBRE, WHITE

TLX/RTG: D/CLINKER/GRP/WHITE.

E. Stem/Stern

Stem and stern designs are described according to the figures below:

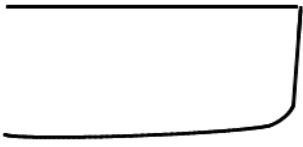

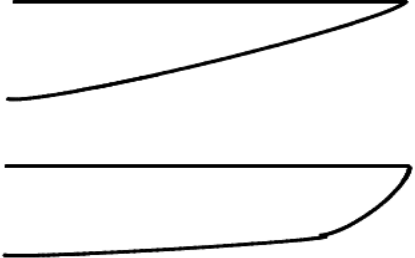
STEM	VOICE	TLX/RTG
	Straight stem	STR
	Clipper stem	CLIP
	Falling stem	FALL

Figure F.10 Stem Designs

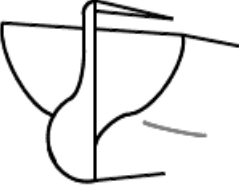
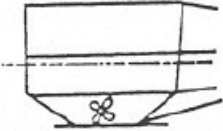
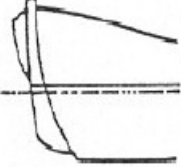

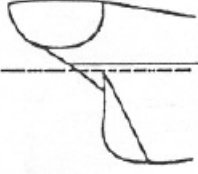
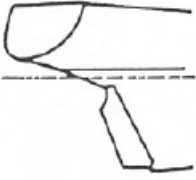
STERN	VOICE	TLX/RTG
	Flat Stern	FLAT
	Square stern	SQUARE
	Sharp Stern	SHARP
	Canoe stern	CAN
	Transom stern	TRANS
	Negative transom stern	NTRANS

Figure F.11 Stern Designs

**Example:**

Voice: ECHO, FALLING STEM, CANOE STERN

TLX/RTG: E/FALL/CAN

## F. Type of Bottom

Bottom types are described according to the figures below:

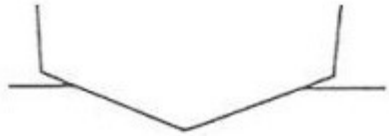



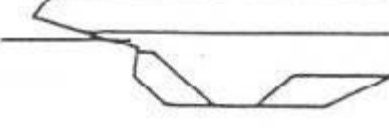
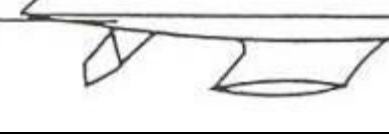

Bottom	Voice	TLX/RTG
	V-bottom	VBOT
	Flat bottom	FLAT
	Round bottom	ROUND
	Ribbed bottom	RIB
	Keel	KEEL
	Fin-keel (where double fin-keel, add the word "double")	FIN
	Centre-board	CB

Figure F.12 Bottom Designs

### Example:

Voice: FOXTROT, RIBBED BOTTOM

TLX/RTG: F/RIB

### G. Length

Length is the length overall (LOA) given in metres.

#### Example:

Voice: GOLF, TWO ZERO METRES

TLX/RTG: G/LOA/20.

### H. Other Characteristics

Other characteristics should be included to describe certain details that might facilitate identification, e.g. flying bridge, windscreens, dodger, spinnaker sail colouring, pulpit, pushpit, steering vane etc.

#### Example:

Voice: HOTEL, RED SPINNAKER

TLX/RTG: H/RED SPINNAKER.

### I. Number of Persons on Board (POB)

#### Example:

Voice: INDIA, THREE

TLX/RTG: I/3.

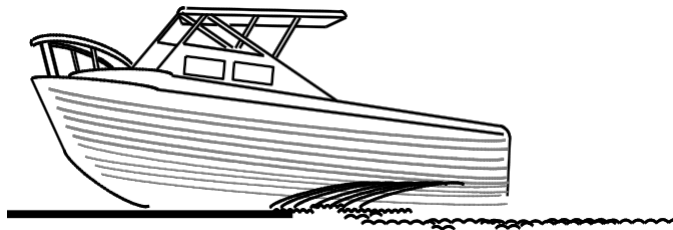


Figure F.13 Complete Example: Motor Boat

Voice	TLX/RTG
MAREC 7/03, RCC AUSTRALIA ALFA, MOTORBOAT PART CABIN, GALANT, VICTOR KILO ONE EIGHT ZERO, PLEASURE BRAVO, MAKE SOLO TWO FIVE CHARLIE, INBOARD MOTOR DELTA, CLINKER, GLASS FIBRE, WHITE ECHO, FALLING STEM, SQUARE STERN FOXTROOT, V-BOTTOM GOLF, SEVEN AND A HALF METRES HOTEL, PULPIT FORWARD, WINDSCREEN ONE AFT EDGE OF CABIN WITH A RED DODGER INDIA, TWO	MAREC 7/76 RCC AUSTRALIA A/MOTPC/GALANT/VK180/PLEASURE B/SOLO/25 C/INB D/CLINKER/GRP/WHITE E/FALL/SQUARE F/VBOT G/LOA 7.5 H/PULPIT FORWARD, WINDSCREEN ON AFT EDGE OF CABIN WITH RED DODGER I/2

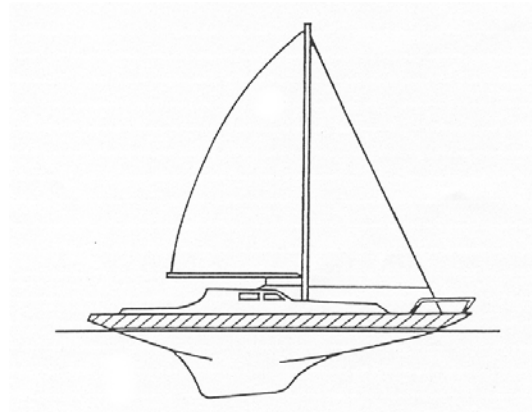




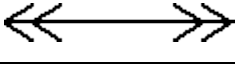
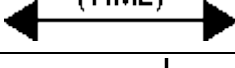
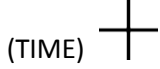
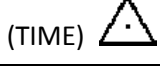
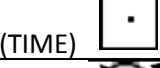
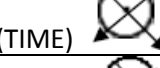
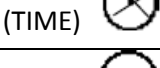
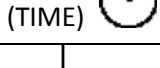
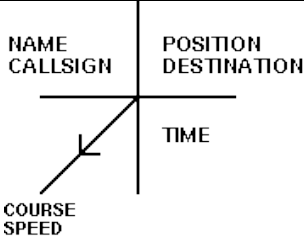
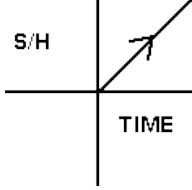
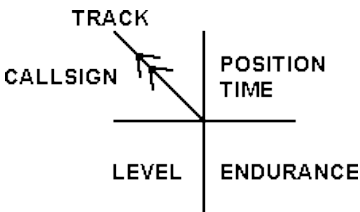


Figure F.14 Complete Example: Sailing Boat

Voice	TLX/RTG
MAREC 8/03, RCC AUSTRALIA ALFA, SAILING PART CABIN, FAMILY OF MAN, VICTOR KILO SEVEN FOUR EIGHT TWO, OFF SHORE RACING BRAVO, MAKE PETERSON FOUR ZERO, SAIL MARKINGS SIERRA ONE ONE CHARLIE, MASTHEAD SLOOP RIG DELTA, CARVEL, WOOD, BLACK WITH WHITE CABIN ECHO, FALLING STEM, NEGATIVE TRANSOM STERN FOXTROT, KEEL GOLF, EIGHT METRES HOTEL, PULPIT FORWARD INDIA, TWO	MAREC 8/03, RCC AUSTRALIA A/SAILPC/ FAMILY OF MAN/NAVIS 12/PLEASURE B/PETERSON 40/S 11 C/SLOOP D/CARVEL/WOOD/BLACK WITH WHITE CABIN E/FALL/NTRANS F/KEEL G/LOA 8 H/PULPIT FORWARD I/2



## Appendix G: Plotting Symbols

Symbol	Description
	Heading and TAS
	Track and ground speed
	Wind velocity
	Position line
	Transferred position line
	Average position line
	Air position
	Dead reckoning position
	Most probable position (MPP)
	Fix (position line)
	Fix (Other than position line – RADAR, GPS etc.)
	Visual fix (pin-point)
	Ship position
	Sighting and Hearing Reports red - probable black - all other sighting and hearing reports
	Aircraft position

## Appendix H: Sighting & Hearing (SHR) Techniques

### Listening Techniques

It is important when questioning an individual either in person or over the phone to actively listen to the information being provided. Practice the following listening techniques when questioning an individual during a SAR incident.

- a) Put the individual at ease;
- b) Remove distractions: don't doodle, tap or shuffle paper;
- c) Empathise with the individual: attempt to see the other person's point of view;
- d) Be patient: allow plenty of time and don't interrupt;
- e) Ask questions: this encourages the individual and shows that you're listening; and
- f) Stop talking: you can't listen if you're talking.

### Open Questions

Open questions are a good way to question an individual. Open questions avoid influencing or guiding the individual in their answer. This ensures the integrity of the answers given.

For example: What was the colour of the aircraft you saw? Open questions usually begin with:

- a) How;
- b) Where;
- c) When;
- d) What;
- e) Who; or
- f) Why.

### Closed Questions

Closed questions follow on from an open question, helping to refine the information already given. They usually require a yes or no answer and are good for gaining information quickly.

For example: Are you saying the colour of the aircraft was white?

The closed question usually begins with:

- a) Do;
- b) Is;
- c) Are;
- d) Can; or
- e) Have.

### Leading Questions

The problem with leading questions is that they can elicit unreliable information. The individual being questioned may tell you what they think you want to hear.

For example, do not ask: 'You say you saw an aircraft. Was it white with a red tail?' Ask: 'You say you saw an aircraft. What colour was it?'

## Instructions for Completing Sighting and Hearing Reports

The objective of the Sighting or Hearing Report is to obtain the maximum information available from an observer at the initial contact.

The following points assist persons untrained in SAR to correctly complete the Sighting and Hearing Report:

- a) When taking a call, introduce yourself with your organisation such as 'Australian Search and Rescue'.
- b) Establish follow-up by first obtaining a call back number and the person's availability.
- c) Print CLEARLY on the Sighting or Hearing Report.
- d) Number each report by referral to the Sighting and Hearing Log.
- e) If you find that a component of the report is important, put the caller on hold and obtain the attention of the Intelligence Officer. Use your initiative.
- f) **Time.** Be cautious: use local time only. This is very critical: try to narrow down an exact time. Record how the time was assessed. If the operation is in an area near a State or Territory border, be mindful of time changes. Also be aware of Daylight Saving Time.
- g) **Craft location.** Attempt to obtain as much detail as possible. If necessary, ask pointed questions. Height may be 'low', 'well above the hills', 'just above the trees'.
- h) **Remarks.** Be on the lookout for key words. Words like 'slow' can help to assess a report.
- i) **Craft description.** For aircraft searches, the broadcast is normally a little vague and you must be likewise. For example, do not ask if the aircraft was a high-wing aircraft, as the caller may tend to agree with you.
- j) **Weather.** Obtain accurate reports of cloud, rain, and fog. Most people will report wind speed as 'light' or 'strong'. Direction may be only known as 'north'.
- k) **Other witnesses.** Obtain full details and interview these separately. This may help to verify parts of another report.
- l) **Reliability.** Annotate only if this is obvious, for example, whether the person reporting was a police officer or an intoxicated person.
- m) **Final check.** Check the entire form before hanging up. Ensure the form is SIGNED, DATED and your NAME IS PRINTED.

## Sighting and/or Hearing Report for Missing Aircraft

Report Number

SAR INCIDENT NUMBER    ..... / .....
--------------------------------------

### OBSERVER AND LOCATION DETAILS

Sighting or Hearing	Reported by	Address	Phone
Time (6 figure) LOCAL  UTC	How determined	Observer's location	
Location of Aircraft from Observer			
Aircraft Heading	Aircraft Height	Mode of operation (Level, Climbing etc.)	
REMARKS (Engine Noise, Erratic Behaviour, Smoke, Circling etc)			

### DESCRIPTION OF AIRCRAFT AND WEATHER

#### AIRCRAFT

Aircraft Colours		Aircraft Markings	
Number of engines	Wing position	Tail	Undercarriage (Up or Down)

#### WEATHER

Wind	Visibility	Cloud	General conditions
------	------------	-------	--------------------

#### OTHER WITNESSES


Name	Address	Phone
Name	Address	Phone

#### RCC ASSESSMENT

Assessment and Comment (NOTE: Ask Reporter to phone again if additional detail is recalled)			
REPORT TAKEN BY		DTG of Report (6 figure) ..... UTC	
Intelligence Officer	Plotted	Recorder	Other

Page \_\_\_\_ of \_\_\_\_

## Sighting and Hearing Report - Generic

 Australian Government Australian Maritime Safety Authority						
<b>Sighting/Hearing Report</b>						
<b>Observer/Asset Location</b> (Complete all mandatory fields)						
Name/Callsign ** Location Name Location Coordinates Remarks				Phone **		
	Location Name					
	S		E		Uncertainty	(Kms)
	Remarks					
<b>Observed Object Position</b>						
Position Location Coordinates ** DTG ** Remarks	Position					
	S		E		Uncertainty	(Kms)
				<input type="checkbox"/> UTC / <input type="checkbox"/> Local	Uncertainty	(Mins)
	Remarks					
<b>Description</b> (Select the relevant checkboxes)						
Report Type Remarks	<input type="checkbox"/> Sighted	Type	<input type="checkbox"/> Vessel	<input type="checkbox"/> Aircraft	<input type="checkbox"/> Vehicle	
	<input type="checkbox"/> Heard		<input type="checkbox"/> Person	<input type="checkbox"/> Signal	<input type="checkbox"/> Other	<input type="checkbox"/> Pollution
Remarks						
<b>Weather</b> (Complete the details using the laminated Pick List)						
<b>Other Witnesses</b>						
<b>Name</b>	<b>Phone</b>	<b>S/H Report Completed?</b>		<b>Notes</b>		
		<input type="checkbox"/> Yes / <input type="checkbox"/> No				
		<input type="checkbox"/> Yes / <input type="checkbox"/> No				
		<input type="checkbox"/> Yes / <input type="checkbox"/> No				
<b>Assessment</b>						
Incident Number ** Priority Annotation Note	Incident Number **					
	<input type="checkbox"/> Priority	Assessment	<input type="checkbox"/> Unassessed	<input type="checkbox"/> Possible	<input type="checkbox"/> Definite	
	<input type="checkbox"/> Routine		<input type="checkbox"/> Negative	<input type="checkbox"/> Other		
	Annotation					
Note						
<b>Admin</b>						
Report Taken By				Hardcopy S/H No		
Report Taken @				Electronic ID No		

\*\* Mandatory Fields

## Sighting and/or Hearing Log

SAR Incident No. \_\_\_\_\_

No.	S / H	LOCATION	Name of Reporter/Observer	DTG Received	Remarks

Page \_\_\_\_ of \_\_\_\_

## **Appendix I: Tables and Graphs**

### **Local Wind Current**

Figure I.1: Local Wind Current Graph

### **Leeway Tables (kt)**

Table I-1: Leeway Speed and Direction Values for Drift Objects

Table I-2: Sub-Table for Maritime Life Rafts with Deep Ballast Systems and Canopies

### **Sweep Width Tables For Visual Search Over Water**

Table I-3: Uncorrected Visual Sweep Width for Vessels and Small Boats

Table I-4: Uncorrected Visual Sweep Widths for Merchant Ships [km (NM)]

Table I-5 (1): Uncorrected Sweep Widths for Fixed-Wing Aircraft (NM) at 500 feet and 1000 feet.

Table I-5 (2): Uncorrected Sweep Widths for Fixed-Wing Aircraft (NM) 1500 feet and 2000 feet.

Table I-6 (1): Uncorrected Sweep Widths for Helicopters (NM) – Maritime 500 feet and 1000 feet

Table I-6 (2): Uncorrected Sweep Widths for Helicopters (NM) – Maritime 1500 feet and 2000 feet

Table I-7: Weather Correction Factors for All Types of Search Facilities

Table I-8: Speed (velocity) Correction Factors for Helicopter and Fixed-Wing Aircraft Search Facilities

### **Sweep Width Tables For Visual Search Over Land:**

Table I-9: Uncorrected Sweep Widths for Visual Land Search [km (NM)]

Table I-10: Correction Factors – Vegetation and High Terrain

### **Probability of Detection**

Figure I.12: Probability of Detection Graph

# Local Wind Current

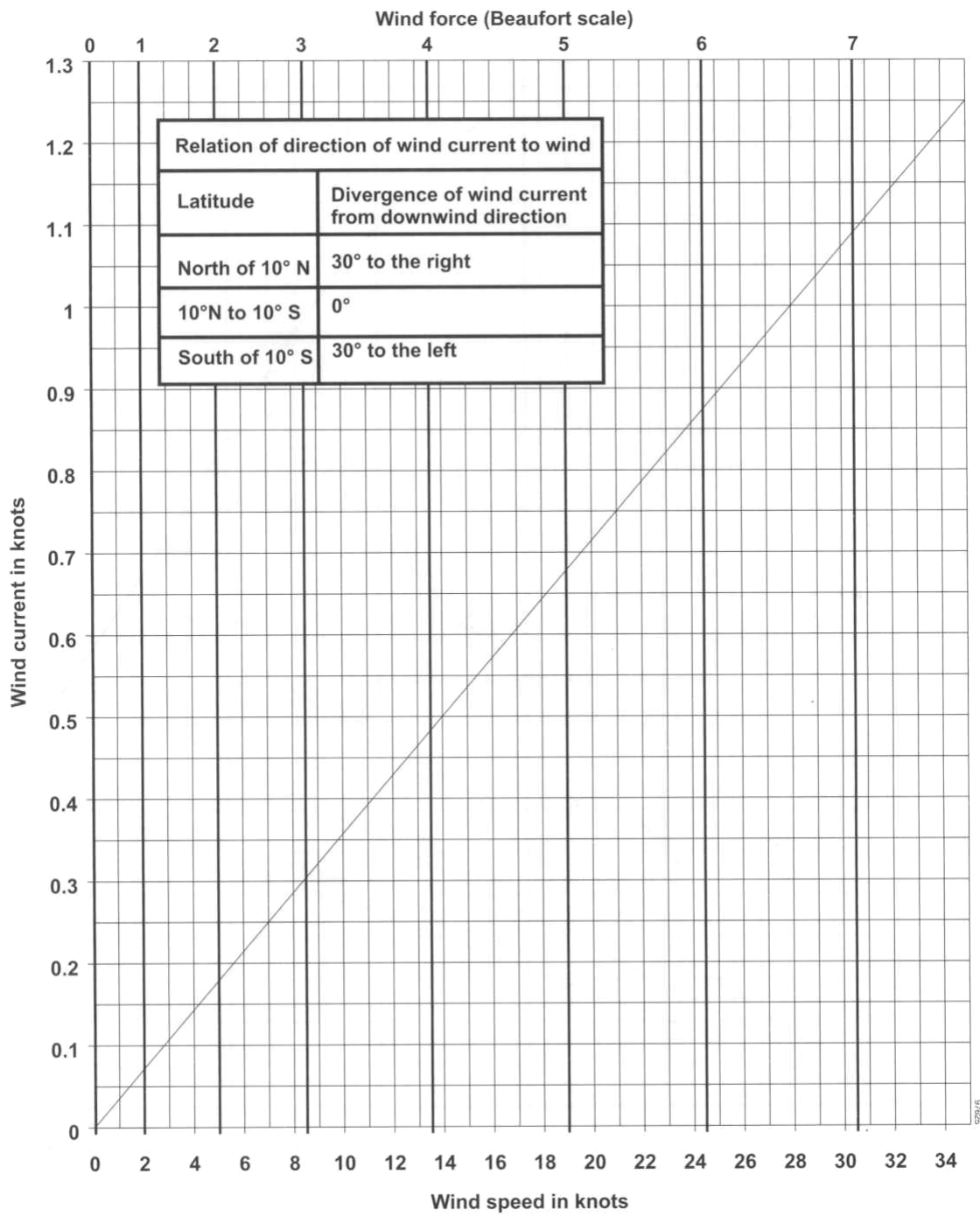


Figure I-1 Local Wind Current Graph



## Leeway Tables

Leeway Target Class				Leeway Speed		Divergence	
Category	Sub Categories	Primary Leeway Descriptors	Secondary Leeway Descriptors	Multiplier	Modifier (kt)	Angle (deg)	
PIW				0.011	0.07	30	
	Vertical			0.005	0.07	18	
	Sitting			0.012	0.00	18	
	Horizontal	Survival Suit		0.014	0.10	30	
		Scuba Suit		0.007	0.08	30	
	Deceased			0.015	0.08	30	
Survival Craft	Maritime Life Rafts	No Ballast Systems		0.042	0.03	28	
			no canopy, no drogue	0.057	0.21	24	
			no canopy, w/ drogue	0.044	-0.20	28	
			canopy, no drogue	0.037	0.11	24	
		canopy, w/ drogue	0.030	0.00	28		
		Shallow Ballast Systems and Canopy		0.029	0.00	22	
			no drogue	0.032	-0.02	22	
			with drogue	0.025	0.01	22	
	Capsized		0.017	-0.10	8		
	Deep Ballast Systems & Canopies	(See Table I-2 for Levels 4-6)	0.030	0.02	13		
Other Maritime Survival Craft	life capsule			0.038	-0.08	22	
	USCG Sea Rescue Kit			0.025	-0.04	7	
Aviation Life Rafts	no ballast, w/canopy Evac/ Slide	4-6 person, w/o drogue		0.037	0.11	24	
		46-person		0.028	-0.01	15	
Person-Powered Craft	Sea Kayak	W/ Person on aft deck		0.011	0.24	15	
	Surf board	w/ person		0.020	0.00	15	
	Windsurfer	w/ person and mast & sail in water		0.023	0.10	12	
Sailing Vessels	Mono-hull	Full Keel	Deep Draft	0.030	0.00	48	
		Fin Keel	Shoal Draft	0.040	0.00	48	
Power Vessels	Skiffs	Flat Bottom	Boston whaler	0.034	0.04	22	
		V-hull	Std. Configuration.	0.030	0.08	15	
			Swamped	0.017	0.00	15	
	Sport Boats	Cuddy Cabin	Modified V-hull	0.069	-0.08	19	
	Sport Fisher	Center Console	Open cockpit	0.060	-0.09	22	
Power Vessels	Commercial Fishing Vessels	Sampans		0.037	0.02	48	
			Side-stern Trawler		0.040	0.00	48
				0.042	0.00	48	
		Longliners		0.037	0.00	48	
		Junk		0.027	0.10	48	
	Gill-netter	w/rear reel	0.040	0.01	33		
Coastal Freighter			0.028	0.00	48		
Boating Debris	F/V debris			0.020	0.00	10	
	Bait/wharf box holds a cubic meter of ice			0.013	0.27	31	
		lightly loaded		0.026	0.18	15	
		fully loaded		0.016	0.16	33	

Table I-1 Leeway Speed and Direction Values for Drift Objects (kt)

Leeway Target Class				Leeway Speed		Divergence	
Secondary Leeway Descriptors	Capacity Modifier	Drogue Modifier	Loading Modifier	Multiplier	Modifier (kt)	Angle (deg)	
Maritime Life Rafts with Deep Ballast Systems and Canopies	4-6 person capacity	without drogue		0.029	0.04	15	
			light loading	0.038	-0.04	15	
			heavy loading	0.036	-0.03	15	
		with drogue		0.018	0.03	12	
			light loading	0.016	0.05	24	
			heavy loading	0.021	0.00	20	
	15-25 person capacity			0.036	-0.09	10	
		w/o drogue	light loading	0.039	-0.06	9	
		with drogue	heavy loading	0.031	-0.07	9	
	Capsized				0.009	0.00	12
	Swamped				0.010	-0.04	8

Table I-2 Sub-Table for Maritime Life Rafts with Deep Ballast Systems and Canopies (kt)

**Notes:**

1. These tables are adapted from Allen and Plourde 1999 Review of Leeway: Field Experiments and Implementation. USCG Research and Development Centre Report No CG-D-08-99.
2. Prior to the publication of the data the USCG Research and Development Centre made the decision that the only data published would be data that was based on actual results derived from documented research and observation during controlled field experiments. However it has been recognised that some anomalies exist in the data pertaining to maritime life rafts with no ballast systems. There had been significant time between the initial research done by Hufford and Broida in 1974 and later research by Nash and Willcox in 1991. Also it is probable that the make of life raft used for the experiments may no longer be in use.
3. SMCs should evaluate the calculated results obtained from using the tables with actual known conditions and adjust leeway values as appropriate.

**Taxonomy Class Definitions/Descriptions**

The following section provides information about each of the leeway drift objects in Table I-1. For each description, the target characteristics are summarised and pictures are provided where available. These target descriptions are in no way meant to be all-inclusive. They are intended to assist a search planner in target identification. Proper identification will make the application of more specific leeway values possible. Some categories in Table I-1 do not require further explanation and therefore descriptions/pictures are not included. The SAR planner should also be reminded that any classification system will have overlap between some categories. In these cases, a decision must be made about the most probable situation.

#### **a) Person-in-Water (PIW)**

Persons in the water including persons without any floatation, and those with a throwable cushion, with a PFD, in an anti-exposure suit and in survival/immersion suits

##### **i. Vertical**

Generally requires a conscious and active PIW to maintain this position. PIWs wearing a sport/work vest, anti-exposure suit, or float coat or having no floatation must actively maintain a vertical position in the water or become victims in the horizontal position.

##### **ii. Sitting**

The classic foetal position with legs drawn up and arms huddled across the PFD. This is the preferred position a conscious or unconscious person assumes, especially in cold water, when wearing offshore lifejackets, horse-collar lifejackets, or inflatable vests. A conscious PIW hanging onto a throwable device will also assume the sitting position until he become unconscious at which time he become a victim.

##### **iii. Horizontal**

Three separate configurations place the PIW in a horizontal position. A conscious or unconscious PIW wearing a survival suit will float flat on his back. A PIW in scuba gear, with an inflated buoyancy vest, will float in a semi-reclined position. The classic floating position of a victim is floating face down in the water.

#### **b) Maritime Survival Craft**

This section includes life rafts, lifeboats, and life capsules as illustrated at Figure I.2. It does not include dinghies or inflatable boats that may be carried for the same purpose.

##### **i. Maritime Life Rafts**

If there is any question about what type of life raft a vessel may carry, a phone call to life raft repair and repackaging facilities close to the homeport of the distressed vessel may provide ballast, canopy, size, and drogue information.

##### **ii. Shallow Ballast**

Consists of a series of fabric pockets generally four (4) inches in diameter and less than six inches in depth.

##### **iii. Deep Ballast**

Consist of large fabric bags, from three (3)–seven (7) on the raft, that are at least 1'x 2' x 2'.

#### **c) Other Maritime Survival Craft**

##### **i. Life Capsule**

Fully enclosed crafts commonly used on large merchant and military vessels.

#### **d) Aviation Life Rafts**

Fall basically into two groups, life rafts and slide rafts. Aviation life rafts are similar to marine life rafts, but are usually made from lighter materials.

##### **i. Evacuation/Slide**

Slide rafts are specifically designed devices intended to ease evacuation from an aircraft. They mount to doorframes or near wing emergency exits and are cut loose from the airframe once fully loaded.

**e) Person-Powered Craft**

This description includes all forms of rowed or paddled boats including rowboats, inflatable boats without motors, canoes, kayaks, surfboards and windsurfers.

For examples, see Figure I.3.

**f) Mono-hull Sailing Vessel**

It is assumed that all targets in this category are adrift; therefore sails are down or missing and the crew is unable to manoeuvre the vessel at all. A class of small to medium sized sailing vessels generally less than 20 ft and never more than 30 ft in length, they are typically designed for a single purpose such as racing or day sailing.

**i. Full Keel**

Small to medium sized sailboats whose keel runs the full length or nearly the full length of the hull. While the forward portion of the keel is modified or eliminated on some full keel sailboats, the keel on all full keel sailboats extends aft to the rudder. This is an old hull design and is not commonly used in new hull construction due to the relatively slow sailing speeds of this hull design.

**ii. Fin Keel**

Small to medium sized sailboats with permanent keel skegs that do not extend aft to the rudder.

**g) Skiffs**

Open boats less than 20 ft long that use an outboard motor as the primary source of propulsion. Some have characteristics identical to rowed boats with the exception that an outboard motor has been attached to the stern. This group includes, but is not limited to, tenders for larger vessels, bass boats, hunting boats, Jon boats, and a large category of utility boats. Skiffs are usually found on lakes and rivers, but are also common in the calm waters of many bays and rivers that provide access to the open ocean.

**h) Personal Water Craft**

Include a number of different designs for one or more persons. Generally there are stand up models and ride on models. Some craft marketed as PWC closely resemble small sport boats. Most PWC's have water jet propulsion. No leeway drift experiments have yet been performed on PWC's and they do not appear within Table I-1. Leeway category choice should be based on number of passengers/loading, size of PWC (draft, length, freeboard) of PWC. These factors may be comparable (not exactly) to several other leeway targets.

**i) Sport Boats**

Includes pleasure craft from 15 to 28 feet long with beamwidths from roughly 6 to 9 feet. They include metal, fibreglass, and wood vessels with a V, modified-V, or deep-V hull form. Sport boats can be outfitted with inboard, outboard, or I/O propulsion. This category includes side console (closed bow and bow riders) and cuddy cabin boats. (Figure I.8)

**j) Sport Fisher**

Include pleasure and commercial craft from 17 to approximately 100 feet long with beam widths up to 24 ft. The majority are between 30 and 50 ft long, with beam widths between 10 and 15 ft. This class includes both semi-displacement and planning hull forms that can be outfitted with inboard, outboard, or I/O propulsion. This category includes boats with simple centre console or walk-round cabin. Convertibles are sport fishers with a walk around cabin and flying bridge. Convertibles designed for offshore fishing may also have a spotting tower. Many convertibles provide extended cruising capabilities similar to sport cruisers, but their

after deck design provides a larger open area to work fishing gear. Some of these vessels can also be found in the cruiser or motor yacht categories. (Figure I.9)

**k) Commercial Fishing Vessels**

Include vessels from 45 to 100 feet long designed for fishing or shell fishing in coastal and ocean waters. They include side and stern trawling rigs, long liners, bottom dragging rigs, and purse seiners. Pole fishers are simply modified use of a sport fisher or sport cruiser and should be treated as such. Commercial fishers can be working alone, as paired vessels, or can be the mother ship to a group of smaller fishing skiffs. These vessels have different design features based on their purpose, but all have some form of deckhouse and an open area from which nets can lines are worked. A deck winch and boom system is commonly used to handle nets or lines. (Figure I.10)

**l) Coastal Freighter**

Include a wide range of commercial shipping platforms up to 100 feet in length. These vessels transfer cargo from one port to another, and shipping agents can provide estimated voyage schedules. Coastal freighters include vessels with a deckhouse on the forecastle, a midships deckhouse (common to cargo vessels), and an aft deckhouse (common to tankers and container ships). Leeway of these vessels will of course not only vary with respect to deckhouse location; it will also be greatly affected by loading, amount, and type of cargo. (Figure I.11)

**m) Boating Debris**

Includes any debris that can be expected from a boat that is sinking and/or breaking up. It may include paper or plastic containers, bedding or clothing, and a variety of fragmented boat sections.

**i. Fishing Debris**

Debris typical to a fishing vessel such as lifejacket, life ring, fishing float balls, a fishing box lid, or wooden boards

**ii. Bait/Wharf Box**

Commercially available 1.1 X 1.5 metre plastic box used by commercial fisherman for holding ice and/or fish. Although not it's intended use, it could also serve as a floatation/life raft by persons in distress.

- **Lightly loaded. Approximately 200 lbs. (simulation of one person)**
- **Fully loaded. Approximately 800 lbs. (simulation of four persons)**

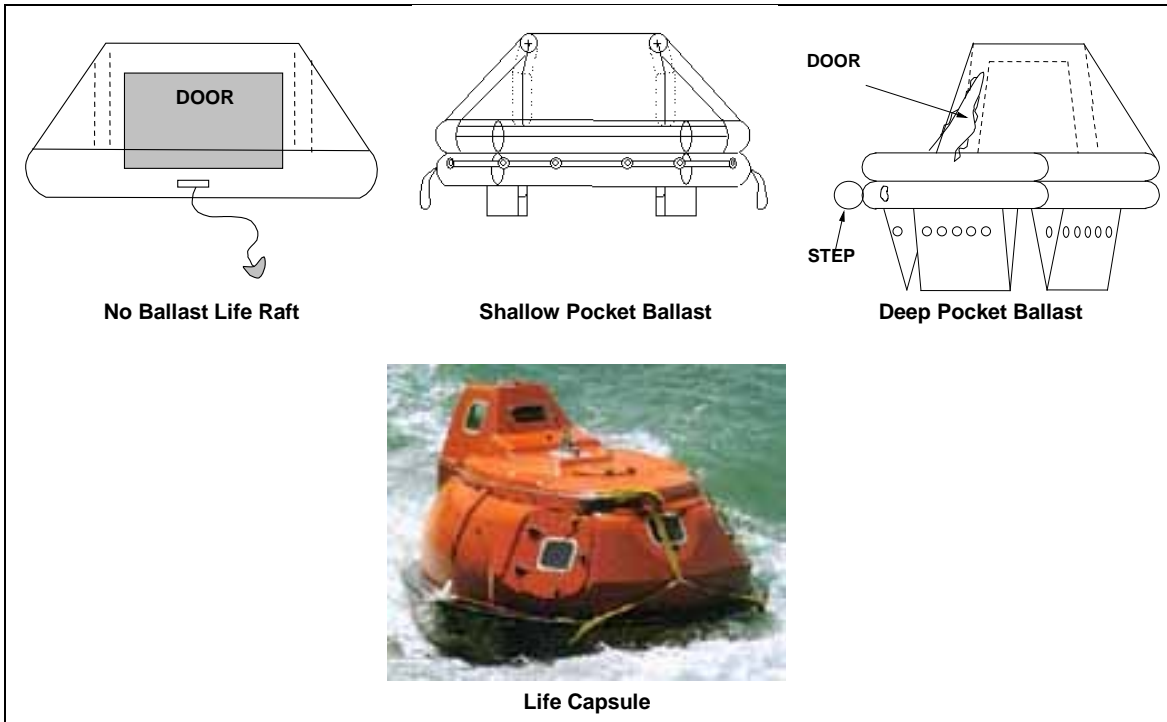


Figure I.2 Maritime Survival Craft

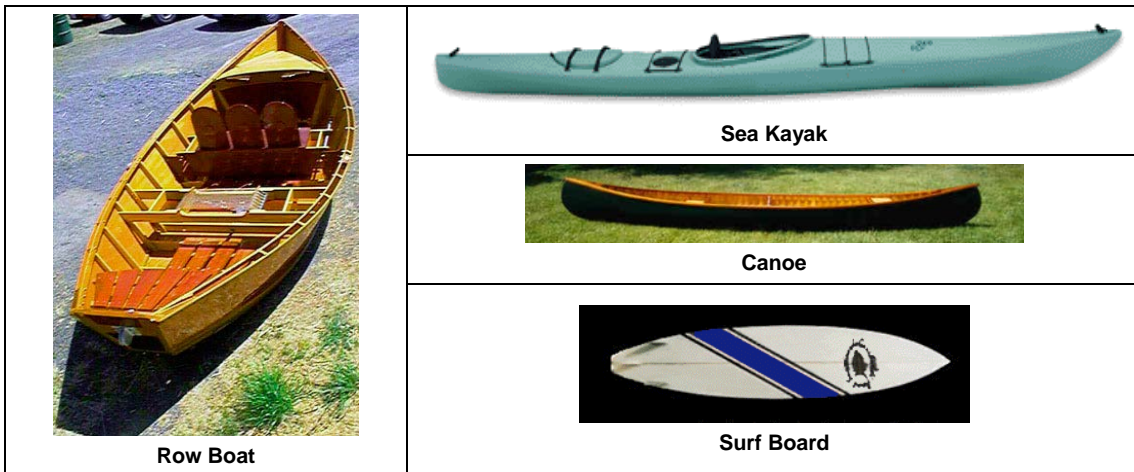


Figure I.3 Person-Powered Craft

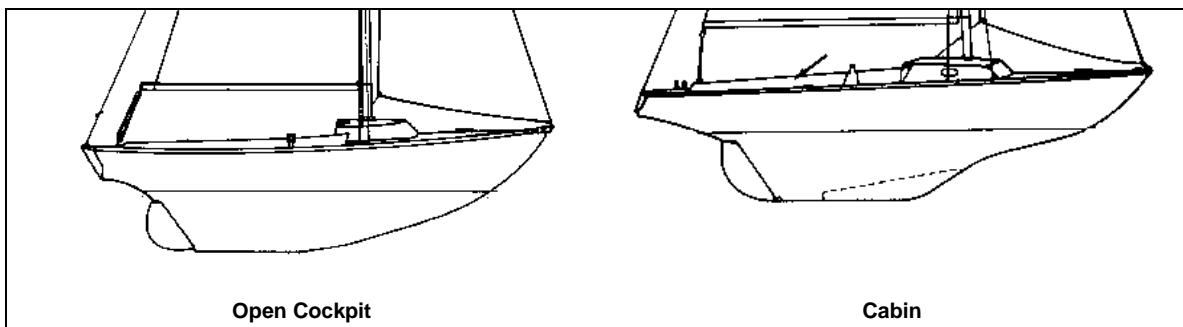


Figure I.4 Full Keel One-Design Sailboat

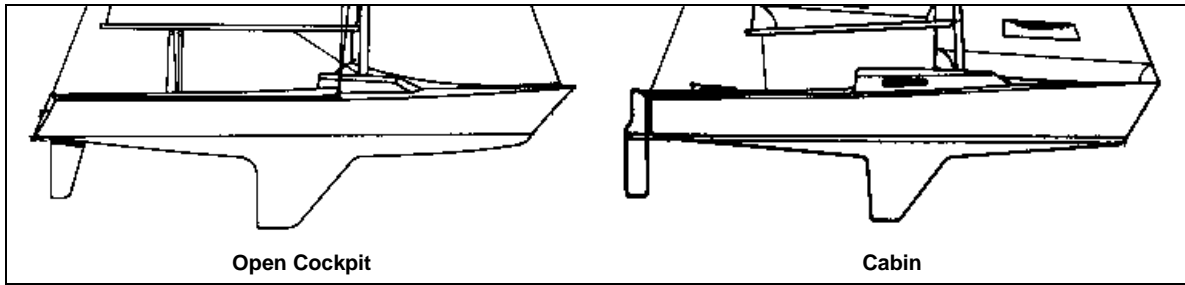


Figure I.5 Dagger Keel One-Design Sailboat

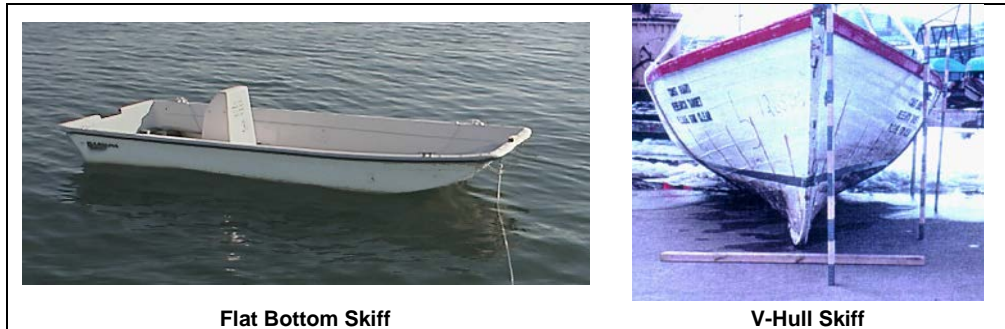


Figure I.6 Skiffs



Figure I.7 Personal Water Craft



Figure I.8 Sports Boats

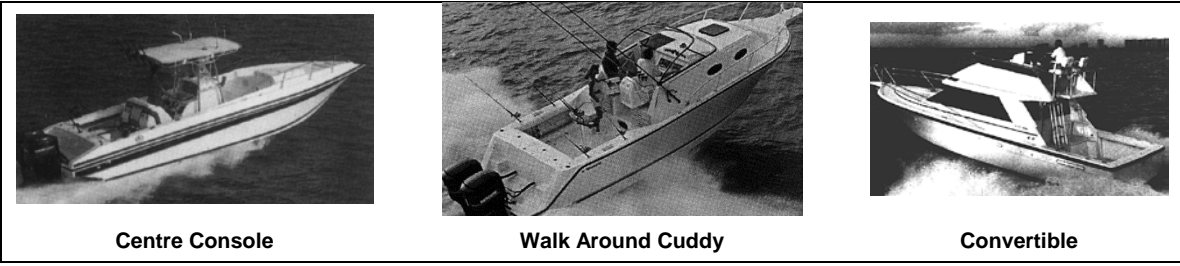


Figure I.9 Sport Fishers

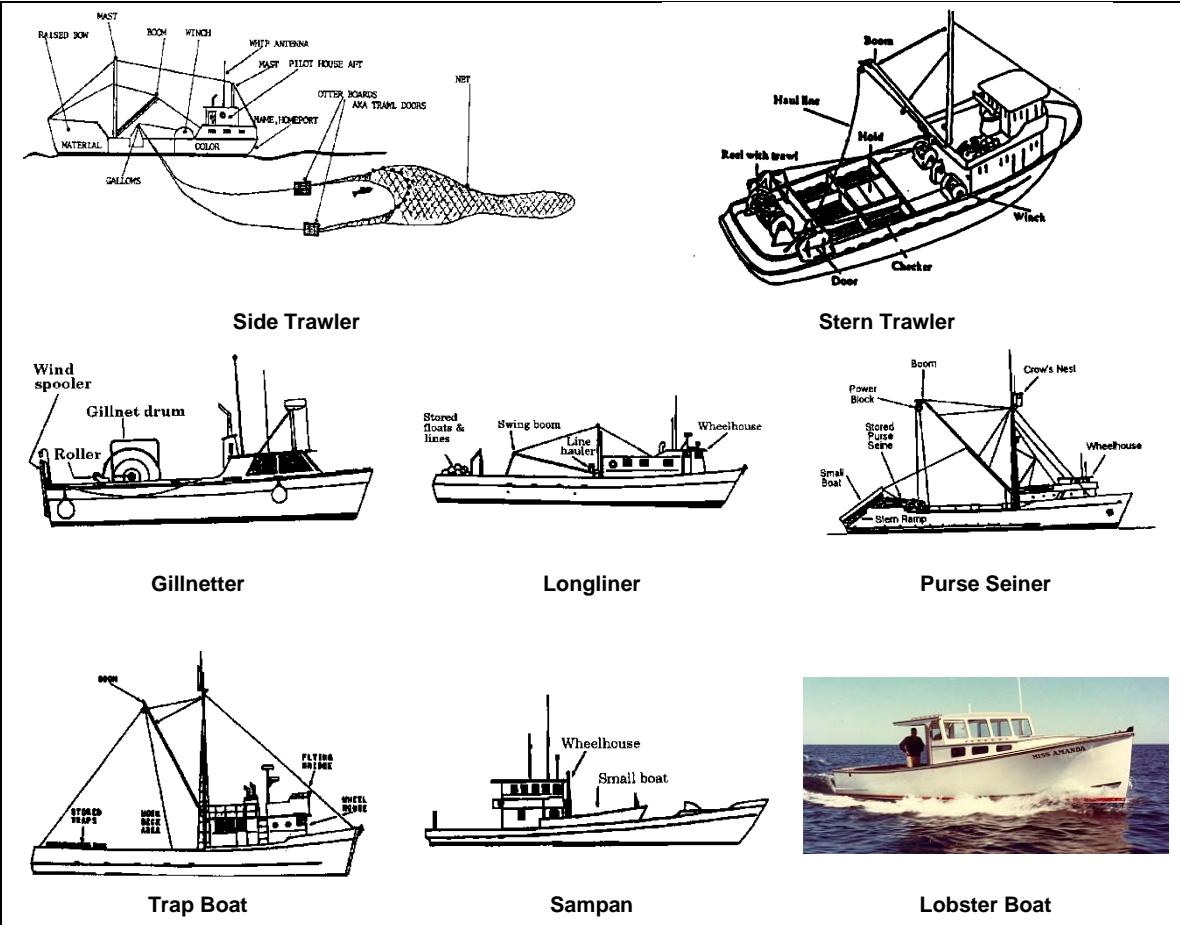


Figure I.10 Commercial Fishers

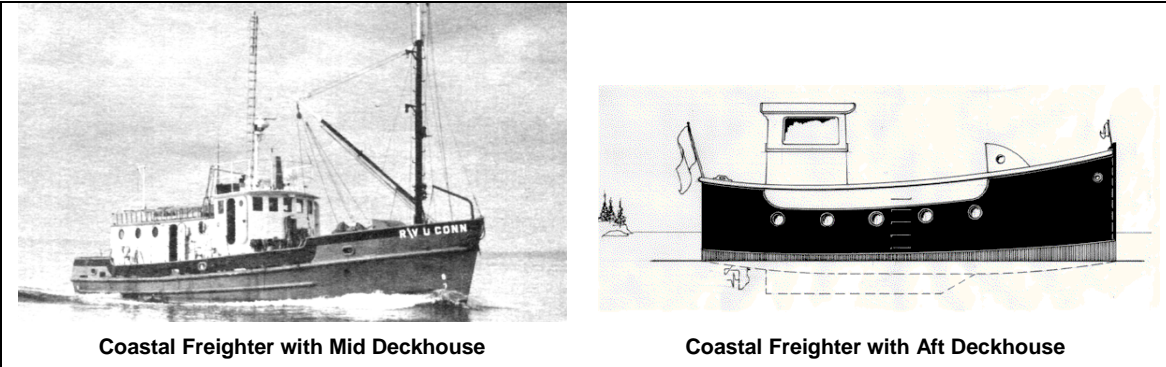


Figure I.11 Coastal Freighters



## Probability of Detection

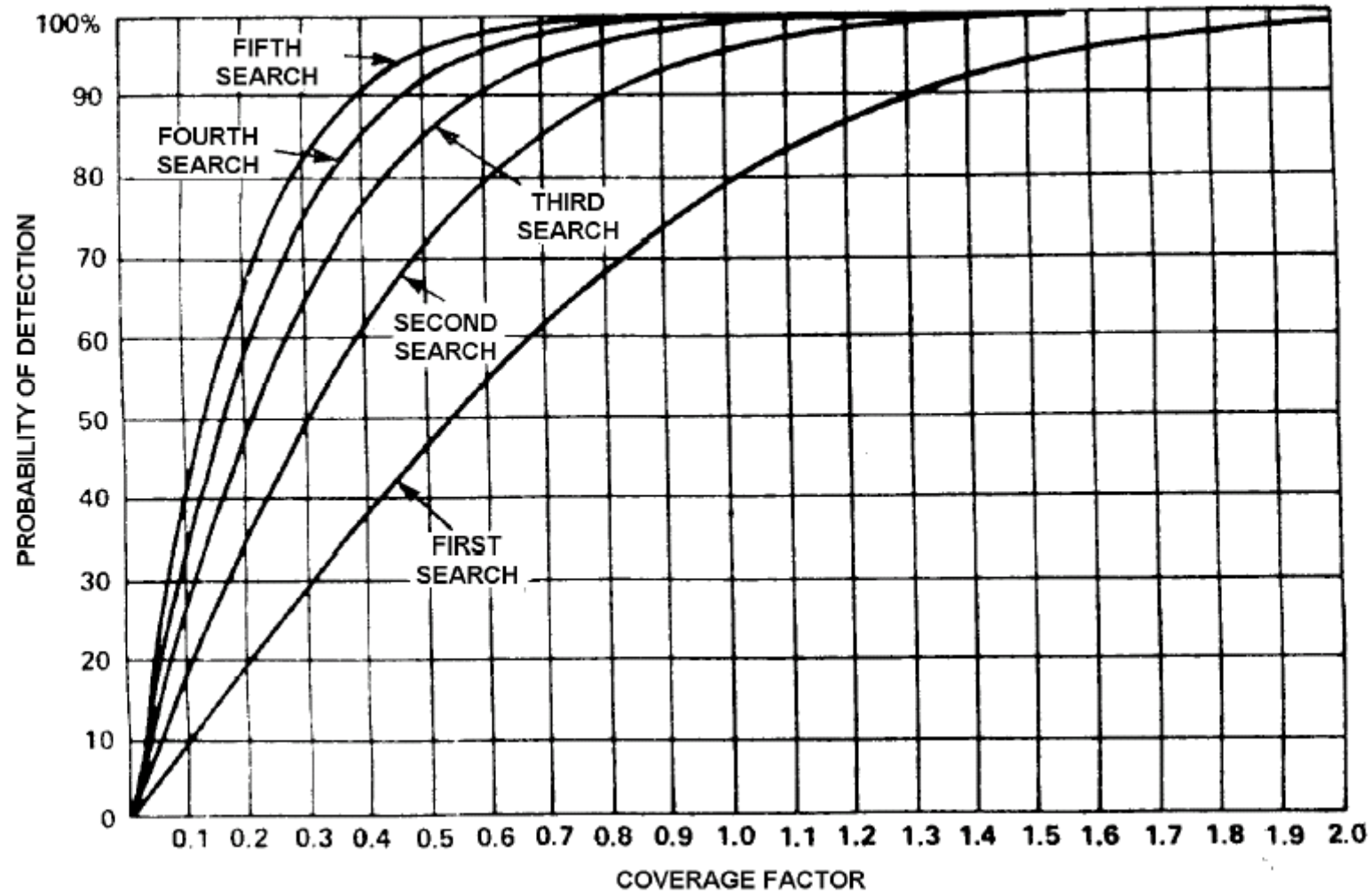


Figure I.12 Probability of Detection

## Sweep Width Tables for Visual Search over Water

SEARCH OBJECT	Height of eye 8'						Height of eye 14'					
	Visibility in kilometres						Visibility in kilometres					
	2	5	10	15	20	>25	2	5	10	15	20	>25
Person in water	0.2	0.2	0.3	0.3	0.3	0.3	0.3	0.4	0.5	0.6	0.6	0.6
Raft 1 Person	0.7	1.2	1.8	2.1	2.4	2.5	1.0	1.6	2.5	2.9	3.2	3.3
Raft 4 Person	0.8	1.5	2.3	2.9	3.2	3.4	1.1	2.0	3.1	3.8	4.2	4.4
Raft 6 Person	0.9	1.7	2.7	3.4	3.8	4.1	1.2	2.2	3.5	4.4	5.0	5.3
Raft 8 Person	0.9	1.7	2.8	3.5	4.0	4.2	1.2	2.3	3.6	4.5	5.1	5.4
Raft 10 person	0.9	1.8	2.9	3.7	4.2	4.6	1.2	2.3	3.7	4.7	5.4	5.8
Raft 15 Person	1.0	2.0	3.2	4.0	4.5	4.9	1.2	2.5	4.0	5.1	5.7	6.2
Raft 20 Person	1.0	2.1	3.5	4.4	5.1	5.6	1.3	2.6	4.3	5.7	6.4	6.9
Raft 25 Person	1.0	2.2	3.7	4.7	5.5	6.0	1.3	2.7	4.3	5.8	6.7	7.5
Power Boat <5m (15 ft)	0.5	0.7	1.0	1.2	1.3	1.4	0.5	1.0	1.5	1.8	1.9	2.0
Power Boat 5-8m (15-25 ft)	0.8	1.4	2.3	2.9	3.4	3.8	1.0	1.9	3.0	3.9	4.5	5.0
Power Boat 8-12m (25-40 ft)	0.8	1.8	3.1	4.1	4.9	5.6	1.2	2.3	4.0	5.3	6.4	7.3
Power Boat 12-20m (40-65 ft)	0.9	2.2	4.2	5.9	7.4	8.7	1.2	3.0	5.4	7.6	9.6	11.3
Power Boat 20-27m (65-90 ft)	0.9	2.3	4.6	6.8	8.8	10.6	1.2	3.0	6.0	8.7	11.3	13.6
Sail Boat 5m (15 ft)	0.8	1.4	2.2	2.7	3.1	3.4	1.0	1.8	2.8	3.5	4.1	4.5
Sail Boat 6m (20 ft)	0.8	1.6	2.6	3.3	3.9	4.4	1.1	2.0	3.3	4.3	5.0	5.6
Sail Boat 8m (25 ft)	0.9	1.8	2.9	3.9	4.6	5.1	1.1	2.2	3.8	5.0	5.9	6.7
Sail Boat 9m (30 ft)	0.9	2.0	3.4	4.6	5.5	6.3	1.2	2.5	4.4	5.9	7.1	8.1
Sail Boat 12m (40 ft)	0.9	2.2	4.1	5.7	7.0	8.1	1.3	2.8	5.2	7.2	9.0	10.5
Sail Boat 15m (50 ft)	0.9	2.2	4.3	6.1	7.7	9.1	1.2	2.9	5.2	7.9	9.9	11.7
Sail Boat 20-23m (65-75 ft)	0.9	2.3	4.5	6.5	8.3	9.9	1.2	3.0	5.8	8.4	10.8	12.9
Sail Boat 23-17m (75-90 ft)	0.9	2.4	4.7	6.8	8.9	10.7	1.2	3.1	6.1	8.9	11.5	13.8

**Table I-3 Uncorrected Visual Sweep Width for Vessels and Small Boats (NM)**

**Note:** A sailboat is only a sailboat if the sails are up. If the sails are down, the craft should be classed as a powerboat.

Height of eye correlates to bridge of a merchant ship	Meteorological visibility [km]				
	5 km	10 km	20 km	30 km	40 km
Search Object					
Person in water	0.4	0.5	0.6	0.7	0.7
4-person life raft	2.3	3.2	4.2	4.9	5.5
6-person life raft	2.5	3.6	5.0	6.2	6.9
15-person life raft	2.6	4.0	5.1	6.4	7.3
25-person life raft	2.7	4.2	5.2	6.5	7.5
Boat <5m (17ft)	1.1	1.4	1.9	2.1	2.3
Boat <7m (23ft)	2.0	2.9	4.3	5.2	5.8
Boat <12m (40ft)	2.8	4.5	7.6	9.4	11.6
Boat <24m (79ft)	3.2	5.6	10.7	14.7	18.1

**Table I-4 Uncorrected Visual Sweep Widths for Merchant Ships (NM)**

Search Object [Metres (ft)]	Altitude 500 ft						Altitude 1000 ft					
	Visibility [km]						Visibility [km]					
	2	5	10	20	30	>40	2	5	10	20	30	>40
Person in Water	0.0	0.1	0.1	0.1	0.1	0.1	0.0	0.1	0.1	0.1	0.1	0.1
Raft 1 person	0.3	0.7	0.9	1.2	1.4	1.4	0.3	0.7	0.9	1.2	1.4	1.4
Raft 4 person	0.4	1.0	1.3	1.8	2.0	2.2	0.3	1.0	1.3	1.8	2.1	2.3
Raft 6 person	0.4	1.1	1.5	2.2	2.5	2.8	0.4	1.1	1.6	2.2	2.6	2.8
Raft 8 person	0.4	1.2	1.6	2.3	2.7	2.9	0.4	1.2	1.7	2.4	2.8	3.0
Raft 10 person	0.4	1.2	1.7	2.5	2.9	3.2	0.4	1.3	1.8	2.6	3.0	3.3
Raft 15 person	0.5	1.3	1.9	2.7	3.3	3.6	0.4	1.4	2.0	2.8	3.4	3.7
Raft 20 person	0.5	1.5	2.1	3.2	3.8	4.2	0.4	1.5	2.2	3.2	3.9	4.3
Raft 25 person	0.5	1.6	2.3	3.4	4.1	4.6	0.4	1.6	2.3	3.5	4.2	4.7
Power Boat <5 (15 ft)	0.4	0.9	1.2	1.5	1.7	1.8	0.4	1.0	1.3	1.7	1.8	2.0
Power Boat 6 (20 ft)	0.5	1.7	2.4	3.6	4.3	4.8	0.5	1.7	2.5	3.7	4.4	5.0
Power Boat 10 (33 ft)	0.6	2.1	3.3	5.3	6.7	7.7	0.5	2.2	3.4	5.4	6.8	7.8
Power Boat 16 (53 ft)	0.6	2.7	4.5	8.1	10.9	13.1	0.6	2.7	4.5	8.2	10.9	13.1
Power Boat 24 (78 ft)	0.6	2.8	5.0	9.8	13.5	16.7	0.6	2.8	5.1	9.8	13.6	16.7
Sail Boat 5 (15 ft)	0.5	1.6	2.2	3.2	3.9	4.3	0.5	1.6	2.3	3.3	4.0	4.4
Sail Boat 8 (26 ft)	0.6	2.0	3.1	4.9	6.1	7.0	0.5	2.1	3.2	5.0	6.2	7.1
Sail Boat 12 (39 ft)	0.6	2.6	4.3	7.6	10.0	11.9	0.6	2.6	4.3	7.6	10.9	12.0
Sail Boat 15 (49 ft)	0.6	2.7	4.6	8.4	11.3	13.7	0.6	2.7	4.6	8.5	11.4	13.7
Sail Boat 21 (69 ft)	0.6	2.8	4.9	9.3	12.7	15.5	0.6	2.8	4.9	9.3	12.8	15.6
Sail Boat 25 (83 ft)	0.6	2.8	5.1	9.9	13.7	17.0	0.6	2.8	5.1	9.9	13.8	17.0
Ship 27-46 (90-150 ft)	0.6	2.9	5.4	11.1	15.9	20.1	0.6	2.9	5.4	11.1	15.9	20.1
Ship 46-91 (150-300 ft)	0.6	3.0	5.7	12.5	18.9	24.7	0.6	3.0	5.7	12.5	18.9	24.7
Ship > 91 (>300 ft)	0.7	3.0	5.8	13.2	20.6	27.9	0.6	3.0	5.8	13.2	20.6	27.9

Table I-5 (1) Uncorrected Sweep Widths for Fixed-Wing Aircraft (NM) at 500 ft and 1000 ft

**Notes:**

1. For search altitudes of 500 feet only, the sweep width values for a person in water may be multiplied by four (4), if it is known that the person is wearing a flotation device.
2. A sailboat is only a sailboat if the sails are up. If the sails are down, the craft should be classed as a powerboat.

Search Object [Metres (ft)]	Altitude 1500 ft						Altitude 2000 ft					
	Visibility [km]						Visibility [km]					
	2	5	10	20	30	>40	2	5	10	20	30	>40
Person in Water	0.0	0.0	0.0	0.0	0.0	0.1	0.0	0.0	0.0	0.0	0.0	0.0
Raft 1 person	0.2	0.7	0.9	1.3	1.4	1.4	0.1	0.6	0.9	1.2	1.4	1.4
Raft 4 person	0.3	1.0	1.3	1.9	2.1	2.3	0.2	0.9	1.3	1.9	2.2	2.3
Raft 6 person	0.3	1.1	1.6	2.3	2.6	2.9	0.2	1.1	1.6	2.3	2.7	2.9
Raft 8 person	0.3	1.2	1.7	2.4	2.8	3.1	0.2	1.2	1.7	2.5	2.9	3.2
Raft 10 person	0.3	1.3	1.8	2.6	3.1	3.4	0.2	1.2	1.8	2.7	3.1	3.5
Raft 15 person	0.3	1.4	2.0	2.9	3.4	3.8	0.2	1.4	2.0	3.0	3.5	3.9
Raft 20 person	0.4	1.5	2.2	3.3	4.0	4.4	0.4	1.5	2.2	3.4	4.0	4.5
Raft 25 person	0.4	1.6	2.4	3.6	4.3	4.8	0.3	1.6	2.4	3.6	4.4	4.9
Power Boat <5 (15 ft)	0.3	1.0	1.3	1.7	2.0	2.1	0.2	1.0	1.3	1.8	2.0	2.2
Power Boat 6 (20 ft)	0.4	1.7	2.5	3.7	4.5	5.1	0.3	1.7	2.5	3.8	4.6	5.1
Power Boat 10 (33 ft)	0.5	2.2	3.4	5.5	6.8	7.9	0.3	2.2	3.4	5.5	6.9	8.0
Power Boat 16 (53 ft)	0.5	2.6	4.5	8.2	11.0	13.2	0.4	2.6	4.5	8.3	11.0	13.3
Power Boat 24 (78 ft)	0.5	2.8	5.1	9.8	13.6	16.7	0.4	2.8	5.0	9.8	13.6	16.8
Sail Boat 5 (15 ft)	0.4	1.6	2.3	3.4	4.1	4.5	0.3	1.6	2.3	3.5	4.1	4.5
Sail Boat 8 (26 ft)	0.5	2.1	3.2	5.1	6.3	7.2	0.3	2.1	3.3	5.2	6.4	7.3
Sail Boat 12 (39 ft)	0.5	2.6	4.3	7.6	10.1	12.0	0.4	2.5	4.3	7.7	10.1	12.1
Sail Boat 15 (49 ft)	0.5	2.7	4.6	8.5	11.4	13.8	0.4	2.7	4.6	8.6	11.5	13.9
Sail Boat 21 (69 ft)	0.5	2.8	4.9	9.4	12.8	15.7	0.4	2.7	4.9	9.4	12.9	15.7
Sail Boat 25 (83 ft)	0.5	2.8	5.1	10.0	13.8	17.1	0.4	2.8	5.1	10.0	13.9	17.1
Ship 27-46 (90-150 ft)	0.5	2.9	5.4	11.1	16.0	20.1	0.4	2.9	5.4	11.1	16.0	20.1
Ship 46-91 (150-300 ft)	0.5	3.0	5.7	12.5	18.9	24.7	0.4	3.0	5.7	12.5	18.9	24.7
Ship > 91 (>300 ft)	0.6	3.0	5.8	13.2	20.7	27.9	0.5	3.0	5.8	13.2	20.7	27.9

Table I-5 (2) Uncorrected Sweep Widths for Fixed-Wing Aircraft (NM) at 1500 ft and 2000 ft

**Note:** A sailboat is only a sailboat if the sails are up. If the sails are down, the craft should be classed as a powerboat.

Search Object [Metres (ft)]	Altitude 500 ft						Altitude 1000 ft					
	Visibility [km]						Visibility [km]					
	2	5	10	20	30	>40	2	5	10	20	30	>40
Person in Water	0.0	0.1	0.1	0.1	0.1	0.1	0.0	0.1	0.1	0.1	0.1	0.1
Raft 1 person	0.4	0.9	1.2	1.6	1.8	1.8	0.4	0.9	1.2	1.6	1.8	1.8
Raft 4 person	0.5	1.2	1.6	2.2	2.6	2.8	0.5	1.2	1.7	2.3	2.6	2.9
Raft 6 person	0.5	1.4	1.9	2.7	3.2	3.5	0.5	1.4	2.0	2.8	3.2	3.5
Raft 8 person	0.6	1.5	2.0	2.8	3.3	3.7	0.5	1.5	2.1	2.9	3.4	3.8
Raft 10 person	0.6	1.6	2.2	3.1	3.6	4.0	0.5	1.6	2.2	3.2	3.7	4.1
Raft 15 person	0.6	1.7	2.3	3.3	4.0	4.4	0.6	1.7	2.4	3.5	4.1	4.5
Raft 20 person	0.6	1.8	2.6	3.8	4.6	5.1	0.6	1.8	2.7	3.9	4.7	5.2
Raft 25 person	0.6	1.9	2.7	4.1	5.0	5.6	0.6	1.9	2.8	4.2	5.1	5.7
Power Boat <5 (15 ft)	0.5	1.2	1.5	1.9	2.2	2.3	0.5	1.2	1.6	2.1	2.3	2.5
Power Boat 6 (20 ft)	0.7	2.0	2.9	4.3	5.2	5.8	0.7	2.1	3.0	4.4	5.3	5.9
Power Boat 10 (33 ft)	0.8	2.5	3.9	6.2	7.8	9.0	0.7	2.6	3.9	6.3	7.9	9.1
Power Boat 16 (53 ft)	0.8	3.1	5.1	9.2	12.3	14.7	0.7	3.1	5.2	9.2	12.3	14.8
Power Boat 24 (78 ft)	0.8	3.3	5.7	10.8	15.0	18.4	0.8	3.3	5.7	10.9	15.0	18.5
Sail Boat 5 (15 ft)	0.7	1.9	2.7	3.9	4.7	5.2	0.6	1.9	2.8	4.0	4.8	5.4
Sail Boat 8 (26 ft)	0.8	2.4	3.7	5.7	7.1	8.2	0.7	2.5	3.7	5.8	7.3	8.3
Sail Boat 12 (39 ft)	0.8	3.0	4.9	8.3	11.3	13.5	0.7	3.0	4.9	8.6	11.4	13.5
Sail Boat 15 (49 ft)	0.8	3.1	5.2	9.5	12.7	15.3	0.7	3.1	5.3	9.5	12.8	15.4
Sail Boat 21 (69 ft)	0.8	3.2	5.5	10.4	14.1	17.3	0.8	3.2	5.6	10.4	14.2	17.3
Sail Boat 25 (83 ft)	0.8	3.3	5.7	11.0	15.2	18.7	0.8	3.3	5.7	11.0	15.3	18.8
Ship 27-46 (90-150 ft)	0.8	3.4	6.0	12.2	17.4	21.9	0.8	3.4	6.0	12.2	17.4	21.9
Ship 46-91 (150-300ft)	0.8	3.4	6.3	13.6	20.4	26.6	0.8	3.4	6.3	13.6	20.4	26.6
Ship > 91 (>300 ft)	0.8	3.5	6.4	14.3	22.1	29.8	0.8	3.5	6.4	14.3	22.2	29.8

Table I-6 (1) Uncorrected Sweep Widths for Helicopters (NM) – Maritime 500 ft and 1000 ft

**Notes:**

1. For search altitudes of 500 feet only, the sweep width values for a person in water may be multiplied by four (4), if it is known that the person is wearing a flotation device.
2. A sailboat is only a sailboat if the sails are up. If the sails are down, the craft should be classed as a powerboat.

Search Object [Metres (ft)]	Altitude 1500 ft						Altitude 2000 ft					
	Visibility [km]						Visibility [km]					
	2	5	10	20	30	>40	2	5	10	20	30	>40
Person in Water	0.0	0.0	0.0	0.1	0.1	0.1	0.0	0.0	0.0	0.0	0.0	0.1
Raft 1 person	0.3	0.9	1.2	1.6	1.8	1.8	0.2	0.8	1.2	1.6	1.8	1.8
Raft 4 person	0.4	1.2	1.7	2.3	2.7	2.9	0.3	1.2	1.7	2.3	2.7	3.0
Raft 6 person	0.4	1.4	2.0	2.8	3.3	3.6	0.3	1.4	2.0	2.8	3.3	3.6
Raft 8 person	0.4	1.5	2.1	3.0	3.5	3.9	0.3	1.5	2.1	3.0	3.6	3.9
Raft 10 person	0.4	1.6	2.2	3.2	3.8	4.2	0.3	1.6	2.3	3.3	3.9	4.2
Raft 15 person	0.5	1.7	2.4	3.5	4.2	4.6	0.3	1.7	2.5	3.6	4.3	4.7
Raft 20 person	0.5	1.9	2.7	4.0	4.8	5.3	0.4	1.8	2.7	4.0	4.9	5.4
Raft 25 person	0.5	2.0	2.9	4.3	5.2	5.6	0.4	1.9	2.9	4.3	5.3	5.9
Power Boat <5 (15 ft)	0.4	1.3	1.7	2.2	2.5	2.6	0.3	1.3	1.7	2.3	2.6	2.7
Power Boat 6 (20 ft)	0.6	2.1	3.0	4.5	5.4	6.1	0.4	2.1	3.0	4.5	5.5	6.1
Power Boat 10 (33 ft)	0.6	2.6	4.0	6.3	7.9	9.2	0.5	2.6	4.0	6.4	8.0	9.3
Power Boat 16 (53 ft)	0.7	3.1	5.2	9.3	12.4	14.8	0.5	3.0	5.2	9.3	12.4	14.9
Power Boat 24 (78 ft)	0.7	3.2	5.7	10.9	15.1	18.5	0.5	3.2	5.7	10.9	15.1	18.5
Sail Boat 5 (15 ft)	0.6	2.0	2.8	4.1	4.9	5.5	0.4	1.9	2.8	4.2	5.0	5.6
Sail Boat 8 (26 ft)	0.6	2.5	3.8	5.9	7.4	8.4	0.5	2.5	3.8	6.0	7.5	8.6
Sail Boat 12 (39 ft)	0.6	3.0	4.9	8.7	11.4	13.6	0.5	3.0	4.9	8.7	11.4	13.6
Sail Boat 15 (49 ft)	0.7	3.1	5.3	9.6	12.8	15.5	0.5	3.1	5.3	9.6	12.9	15.5
Sail Boat 21 (69 ft)	0.7	3.2	5.6	10.4	14.3	17.4	0.5	3.2	5.6	10.5	14.3	17.4
Sail Boat 25 (83 ft)	0.7	3.3	5.7	11.1	15.3	18.8	0.5	3.2	5.7	11.1	15.4	18.9
Ship 27-46 (90-150 ft)	0.7	3.3	6.0	12.2	17.5	22.0	0.5	3.3	6.0	12.2	17.5	22.0
Ship 46-91 (150-300ft)	0.7	3.4	6.3	13.6	20.4	26.6	0.5	3.4	6.3	13.6	20.4	26.6
Ship > 91 (>300 ft)	0.7	3.4	6.4	14.3	22.2	29.8	0.6	3.4	6.4	14.3	22.2	29.8

**Table I-6 (2) Uncorrected Sweep Widths for Helicopters (NM) - Maritime 1500 ft and 2000 ft**

**Note:** A sailboat is only a sailboat if the sails are up. If the sails are down, the craft should be classed as a powerboat.

Weather: winds km/h (kt) or seas m (ft)	Search Object	
	Person in water, raft or boat < 10m (33ft)	Other search objects
Winds <28 km/h (<15 kt) or seas 0-1 m (0-3ft)	1.0	1.0
Winds 28-46 km/h (15-25 kt) or seas 1-1.5 m (3-5ft)	0.5	0.8
Winds >46 km/h (> 25 kt) or seas > 1.5 m (> 5ft)	0.25	0.5

**Table I-7 Weather Correction Factors for all Types of Search Facilities**

**Note:** Table I-7 differs from IAMSAR for other search objects in winds above 15 kt. The correction factors are based on a combination of values previously used by JRCC Australia and observations of the reported effect of high winds on sweep width values in actual SAR incidents.

Search Object	Fixed Wing Speed kt			Helicopter speed kt			
	< or = 150	180	210	< or = 60	90	120	140
Person in Water	1.2	1.0	0.9	1.5	1.0	0.8	0.7
Raft – 1-4 Person	1.1	1.0	0.9	1.3	1.0	0.9	0.8
Raft 6-25 Person	1.1	1.0	0.9	1.2	1.0	0.9	0.8
Power Boat - < 8m (< 25ft)	1.1	1.0	0.9	1.2	1.0	0.9	0.8
Power Boat - 10m (33ft)	1.1	1.0	0.9	1.1	1.0	0.9	0.9
Power Boat - 16m (53ft)	1.1	1.0	1.0	1.1	1.0	0.9	0.9
Power Boat - 24m (78ft)	1.1	1.0	1.0	1.1	1.0	1.0	0.9
Sail Boat - < 8m (< 25ft)	1.1	1.0	0.9	1.2	1.0	0.9	0.9
Sail Boat - 12m (39ft)	1.1	1.0	1.0	1.1	1.0	0.9	0.9
Sail Boat - 25m (83ft)	1.1	1.0	1.0	1.1	1.0	1.0	0.9
Ship – > 27m (> 90ft)	1.0	1.0	1.0	1.1	1.0	1.0	0.9

Table I-8 Speed (velocity) Correction Factors for Helicopter and Fixed-wing Aircraft Search Facilities

### Sweep Width Tables for Visual Search Over Land

Search object	Height (ft)	Visibility [km]				
		5 km	10 km	20 km	30 km	40 km
Person	500	0.4	0.4	0.5	0.5	0.5
	1000	0.4	0.4	0.5	0.5	0.5
	1500	-	-	-	-	-
	2000	-	-	-	-	-
Vehicle	500	0.9	1.3	1.3	1.3	1.3
	1000	1.0	1.4	1.4	1.5	1.5
	1500	1.0	1.4	1.7	1.7	1.7
	2000	1.0	1.5	2.0	2.0	2.0
Aircraft less than 5700 kg	500	1.0	1.4	1.4	1.4	1.4
	1000	1.0	1.5	1.5	1.6	1.6
	1500	1.0	1.5	1.8	1.8	1.8
	2000	1.0	1.6	2.0	2.0	2.0
Aircraft over 5700 kg	500	1.2	2.0	2.2	2.2	2.2
	1000	1.8	2.7	3.0	3.0	3.0
	1500	2.0	2.8	3.2	3.2	3.2
	2000	2.2	2.9	3.5	3.5	3.5

Table I-9 Uncorrected Sweep Widths for Visual Land Search (NM)

Search object	Less than 15% vegetation Open areas or scattered timber	15-60% vegetation or hilly Medium forest or scrub	60-85% vegetation or mountainous Dense forest or scrub	Over 85% vegetation Rain Forest
Person	0.8	0.5	0.3	0.1
Vehicle	1.0	0.7	0.4	0.1
Aircraft < 5700kg	1.0	0.7	0.4	0.1
Aircraft > 5700kg	1.0	0.8	0.4	0.1

Table I-10 Correction Factors – Vegetation and High Terrain

## Appendix J: Probable Errors of Position

### Probable Navigation Error of the Distressed Craft (x)

1. Initial Position Error (X) of the distressed craft and Search Craft Position Error (Y) are the estimated errors of position based on navigational accuracy of the distressed craft and of the search assets.

If the information on the means of navigation to be used by the distressed craft or by a search facility is available, the navigational fix errors listed in Table J-1 may be used for positions reported as navigational fixes.

Means of Navigation	Fix error (NM)
GPS	0.1 NM
RADAR	1 NM
Visual fix (3 lines) *	1 NM
Celestial fix (3 lines) *	2 NM
Marine Radio Beacon	4 NM (3 beacon fix)
INS	0.5 NM per flight hour without update
VOR	+ or - 3 DEG arc and 3% of distance or 0.5 NM radius, whichever is greater
TACAN	+ or - 3 DEG arc and 3% of distance or 0.5 NM radius, whichever is greater

Table J-1 Navigational Fixed Errors

\* Should be evaluated upward according to circumstances

**Note:** Variation from IAMSAR for Tables J-2 and J-3, the National SAR Manual uses the values previously used by JRCC Australia because experience has shown it is more practicable to base fix errors on the navigation equipment carried in a craft.

2. The above values for Fix errors in Table J-1 are appropriate for the actual position of a distressed craft and/or search assets. An SMC should be aware that if the values in Table J-1, particularly that for GPS, are used to calculate a Total Probable Error of Position (E) for a Stage 3 search, particularly for a search over land or any search for an aircraft, the search area produced, because of its dimensions, may not be practical to use.
3. When designing a search area an SMC can always use his discretion, however to obtain a practical search area it is recommended that the fix errors in Tables J-2 or J-3 be utilised.
4. When the means of navigation used by the distressed craft or by a search asset is unknown or the SMC wishes to produce a practical search area for a Stage 3 search, the following Fix errors may be applied:

Type of Craft	Fix error
Ships, military submarines	5 NM radius
Aircraft navigated by a self-contained navigation	5 NM radius
Aircraft (other)	10 NM radius
Small craft, Submersibles	15 NM radius

Table J-2 Type of Craft



- When the initially reported position of the distressed craft is based on dead reckoning (DR) or the search asset must use DR navigation, an additional error is assumed for the distance travelled since the last fix. The position error is the sum of the fix error plus the DR error (DRe) as shown in Table J-3.

Type of craft	DR error (DRe)
Ship, Submarine (Military)	The error of the last positive fix plus 5% of the distance from that fix
Aircraft	The error of the last positive fix plus 10% of the distance from that fix
Small craft, Submersibles	The error of the last positive fix plus 15% of the distance from that fix

Table J-3 Dead Reckoning (DR) Errors

- The figures and factors shown in Tables J-1 to J-3 are minimum values and may be increased at the SMC's discretion should information be received indicating that the navigational accuracy of either the distressed or the search craft differs significantly from the accepted standard.
- As an example, the 'x' factor for a missing aircraft with two or more engines not using a self-contained navigation system which reported at position 'A', but failed to report at position 'B' 200NM distant, would be:

$$\text{for 'A' } 10\text{NM, and for 'B', } 10 + 20 = 30\text{NM.}$$

- Should a pressurised aircraft suffer a major loss of cabin pressure when flying above the oxygen height the pilot will put the aircraft into a steep diving turn to bring the aircraft down to 10,000 ft as quickly as possible. The possibility of this manoeuvre being made and the consequent diversion from track should be considered when constructing a probability area.

### Probable Navigation error of the Search Craft (y)

- All search craft are expected to obtain frequent, and near continuous navigational fixes while conducting their search; therefore, only fix error is considered for search craft. Should it be necessary to navigate a search craft by DR in a search area, the RCC should be notified so that both fix and DR error can be taken into account in determining the 'y' factor.

The figures selected in respect of a search craft will depend on the method of navigation to be used by the search craft. The figures in Tables J-1 to J-3 shall be taken as minimum values and may be increased at the discretion of the SMC.

## Appendix K: Worksheets

### Overview

The following pages provide worksheets to assist in calculating various SAR related problems:

**Worksheet 1: Maritime Planning**

**Worksheet 2: Maritime Area (searching by aircraft)**

**Worksheet 3: Land Search Calculations**

**Worksheet 4: Search Radius**

**Worksheet 5: Sector Search**

**Worksheet 6: Aircraft Allocation**

**Worksheet 7: Maritime Allocation**

**Worksheet 8: Maritime Area (searching by vessel)**

## Worksheet 1 – Maritime Planning

Worksheet 1: Maritime Planning					
INCIDENT					
Search target (description):					
LKP (lat/long):					
@ Time (UTC):					
Hours of drift (a):					
SEA CURRENT					
Sea / tidal current/knots:	° (T)	knots			
Sea Current vector/distance:	° (T)	knots	x	(a) hrs =	nm
SURFACE WIND and WIND CURRENT					
Surface winds/knots	° (T)	knots	Wind Current Divergence = Reciprocal Surface Wind - 30° for LKP greater than 10° South Latitude		
Reciprocal of Surface Winds / Knots (b)	° (T)	knots	-30° T =	° (T)	knots
Wind current vector: (use reciprocal bearing and divergence (Figure I-1))	(a) hours x		knots (Figure I-1) =	° (T)	nm
TARGET LEEWAY					
Leeway Angles (divergence) (Table I-1 or I-2):	Reciprocal Surface Wind (b)		° (T)	±	° (T)
Leeway vector: (LW)	L W <sub>(L)</sub> -	° (T)	L W <sub>(R)</sub> +	° (T)	
Leeway speed: (knots) = (Multiplier x Wind Speed) ± Modifier (Table I-1 or I-2)	[	Multiplier x	Wind Speed =	] ±	Modifier =
Leeway distance:	Leeway speed		x	(a) hrs =	nm
DRIFT ERROR					
Distance (L):	nm	Distance (R):		nm	
de <sub>(L)</sub> : (12.5 to 30% of Distance L)	nm	de <sub>(R)</sub> : (12.5 to 30% of Distance R)		nm	
Distance Left/Right =	nm	De = [de <sub>(L)</sub> + de <sub>(R)</sub> + Distance L/R] / 2		De =	
FIX ERRORS					
Distress craft error (x): (Table J-1, J-2 or J-3)	nm				
Search craft error (y): (Table J-1, J-2 or J-3)	nm				
TOTAL ERROR (E)					
Total probable error (E): $E = \sqrt{(De^2 + x^2 + y^2)}$	E =				
SEARCH AREA					
Safety Factor (circle) (f <sub>s</sub> )	1.1	1.6	2.0	2.3	2.5
Search radius (E x f <sub>s</sub> )	nm				
Rounded up to whole figure:	nm				
Search area:	nm <sup>2</sup>				

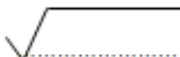



## Worksheet 2 – Maritime Search By Aircraft

<b>INCIDENT REFERENCE</b>	<b>SEARCH AND RESCUE WORKSHEET NO. 2 MARITIME SEARCH BY AIRCRAFT</b>	<b>COMPILED BY</b> _____			
		<b>DATE:</b> _____			
Search Platform .....		Search Platform TAS .....		Search Object .....	
MET Visibility ..... KM		Wind ...../.....		Fatigue Factor: Yes or No	
<b>Search Height (AGL)</b>	<b>500 ft</b>	<b>1000 ft</b>	<b>1500 ft</b>	<b>2000 ft</b>	
Uncorrected Sweep Width ( <b>Wu</b> ) -Tables I-3, I-4, I-5 (1), I-5 (2), I-6 (1), I-6 (2)	NM	NM	NM	NM	NM
Maritime: Weather Correction Factor ( <b>Fw</b> ) – Table I-7					
Speed Correction Factor ( <b>Fs</b> ) a) Aircraft searching over water use <b>Fs</b> from Table I-8 b) Searches by vessels enter <b>1.0</b>					
Fatigue Correction Factor ( <b>Ff</b> ) if crew will be suffering significant fatigue enter <b>0.9</b> otherwise enter <b>1.0</b>					
Sweep Width Factor <b>W</b> = Wu.Fw.Fs.Ff					
Practical Track Spacing <b>S</b> (NM)					
Coverage Factor <b>C</b> = W/S					
Probability of Detection (POD)					
Search Area <b>A</b> (SQ NM)					
Search Hours (T) Required at 120 KTS (V) <b>T = A/VS</b>					
Total Search Hours Available at 120 KTS (.....) - (from Worksheet No. 6)					
<b>A. Whole Area Calculated at a Search Height of ..... FT</b> (A = TVS C = W/S S = W/C)					
A	SQ. NM	S	NM	C	P % FOR SEARCH
<b>B. Modified Area at Calculated Track Spacing in Available Hours</b>					
A	SQ. NM	S	NM	C	P % FOR SEARCH
<b>C. Whole Area at Modified Track Spacing in Available Hours</b>					
A	SQ. NM	S	NM	C	P % FOR SEARCH
<b>D. Compromise Area and Modified Practical Track Spacing in Available Hours</b>					
(i) A	SQ. NM	S	NM	C	P % FOR SEARCH
(ii) A	SQ. NM	S	NM	C	P % FOR SEARCH
(iii) A	SQ. NM	S	NM	C	P % FOR SEARCH
(iv) A	SQ. NM	S	NM	C	P % FOR SEARCH
Mark selected variables with *					

### Worksheet 3 – Land Search By Aircraft

<b>INCIDENT REFERENCE</b>	<b>SEARCH AND RESCUE WORKSHEET NO. 3 LAND SEARCH BY AIRCRAFT</b>	<b>COMPILED BY</b> _____						
		<b>DATE:</b> _____						
Search Object..... Vegetation: Less than 15%    15-60%    60-85%    +85%								
MET Visibility.....KM    Fatigue Factor: Yes or No								
<b>Search Height (AGL)</b>	<b>500 ft</b>	<b>1000 ft</b>	<b>1500 ft</b>	<b>2000 ft</b>				
Uncorrected Sweep Width (Wu) - Table I-9	NM	NM	NM	NM				
Searches overland: use Terrain/Vegetation Correction Factor (Fv) - Table I-10								
Fatigue Correction Factor (Ff) if crew will be suffering significant fatigue enter 0.9 otherwise enter 1.0								
Sweep Width Factor W = Wu.Fv.Ff								
Practical Track Spacing S (NM)								
Coverage Factor C = W/S								
Probability of Detection (POD)								
Search Area A (SQ NM)								
Search Hours (T) Required at 120 KTS (V) $T = A/VS$								
Total Search Hours Available at 120 KTS (.....) - (from Worksheet No. 6)								
<b>A. Whole Area Calculated at a Search Height of..... FT    (A = TVS    C = W/S    S = W/C)</b>								
A	SQ. NM	S	NM	C	P	%	FOR	SEARCH
<b>B. Modified Area at Calculated Track Spacing in Available Hours</b>								
A	SQ. NM	S	NM	C	P	%	FOR	SEARCH
<b>C. Whole Area at Modified Track Spacing in Available Hours</b>								
A	SQ. NM	S	NM	C	P	%	FOR	SEARCH
<b>D. Compromise Area and Modified Practical Track Spacing in Available Hours</b>								
(i) A	SQ. NM	S	NM	C	P	%	FOR	SEARCH
(ii) A	SQ. NM	S	NM	C	P	%	FOR	SEARCH
(iii) A	SQ. NM	S	NM	C	P	%	FOR	SEARCH
(iv) A	SQ. NM	S	NM	C	P	%	FOR	SEARCH
Mark selected variables with *								

### Worksheet 4 – Search Radius

<b>Incident Reference</b>	<b>Search and Rescue</b>				<b>Compiled By</b>
	<b>Worksheet No. 4 Search Radius</b>				<b>Date</b>
<b>Reported Distress Position</b> ..... S ..... E Time ..... UTC	<div style="border: 1px solid black; padding: 2px; display: inline-block;">or</div>	1. Last Positive Fix .....	2. Last Reported Posn .....	3. Missed position .....	4. Next Posn or Dest .....
				Search No. ....	<b>Distress Craft Callsign/Identity</b>
				Radius Computed .....	
				For Search Commencing ..... UTC	
				Previous Search No. ....	
				Radius Computed .....	
				For Search Commenced ..... UTC	
	<b>Position</b>	<b>A</b>	<b>B</b>	<b>C</b>	<b>D</b>
Track distance since last Positive Fix	(Tr)	.....	.....	.....	.....
Distress Craft Position Error (Fix+10%Tr)	(x)	.....	.....	.....	.....
Search Craft Navigation Error	(y)	.....	.....	.....	.....
Probable Error of Position	(e)				
$e = \sqrt{x^2 + y^2}$		.....	.....	.....	.....
Safety Factor for this search (1.1; 1.6; 2.0; 2.3; 2.5)	(fs)	.....	.....	.....	.....
Search Radius (R) = (e) x (fs)	(R)	.....	.....	.....	.....
Rounded up Radius		.....	.....	.....	.....

## Worksheet 5 – Sector Search

<b>INCIDENT REFERENCE</b>			<b>SEARCH AND RESCUE WORKSHEET NO.5 SECTOR SEARCH</b>				COMPILED BY _____		
							DATE: _____		
SECTOR SEARCH CALCULATIONS: SPLASH POINT or DATUM _____ S / _____ E									
			RADIUS _____ NM		C = W/MTS		TRACK MILES AVAILABLE FROM WORKSHEET No 6 _____ NM		
SEARCH HEIGHT (FT)	W	MTS	C	TRACK DISTANCE (D)	ANGULAR DISPLACEMENT (AD)	INITIAL TRACK (IT)	SUBSEQUENT TRACK ADJUSTMENT +/- (90 + AD/2)	POD	
500									
1000									
1500									
2000									
			RADIUS _____ NM		C = W/MTS		TRACK MILES AVAILABLE FROM WORKSHEET No 6 _____ NM		
SEARCH HEIGHT (FT)	W	MTS	C	TRACK DISTANCE (D)	ANGULAR DISPLACEMENT (AD)	INITIAL TRACK (IT)	SUBSEQUENT TRACK ADJUSTMENT +/- (90 + AD/2)	POD	
500									
1000									
1500									
2000									
			RADIUS _____ NM		C = W/MTS		TRACK MILES AVAILABLE FROM WORKSHEET No 6 _____ NM		
SEARCH HEIGHT (FT)	W	MTS	C	TRACK DISTANCE (D)	ANGULAR DISPLACEMENT (AD)	INITIAL TRACK (IT)	SUBSEQUENT TRACK ADJUSTMENT +/- (90 + AD/2)	POD	
500									
1000									
1500									
2000									

## Worksheet 6 – Aircraft Allocation

INCIDENT REFERENCE		SEARCH AND RESCUE WORKSHEET NO.6 AIRCRAFT ALLOCATION					AREA to be ALLOCATED  _____ NM <sup>2</sup>			COMPILED BY _____ DATE _____		
Sunrise		UTC	Sunset		UTC	FSL	UTC – LSL		UTC = TSL		Hours	Mins
Remarks	ACFT Type	Time AVBL	DIST	TRANS TI's	ETA Area	Actual SCH HRS (ASH)	ETD Area	ASH less 15%	SCH TAS	AREA ALLOCATED		
	Callsign	TKOF Time	TRANS TAS	ON SCH ENDCE				S	HRS (T) at 120 kt (V)	A=TVS	Dim's Used	ALLOC Area (NM <sup>2</sup> )
E/ <b>National Search and Rescue Manual</b>			/	/								
E/			/	/								
E/			/	/								
E/			/	/								
E/			/	/								



# Worksheet 7 – Asset Allocation

INCIDENT REFERENCE		SEARCH AND RESCUE WORKSHEET NO. 7 ASSET ALLOCATION				AREA to be ALLOCATED _____ NM <sup>2</sup>			COMPILED BY _____ DATE		
SUNRISE	UTC	SUNSET	UTC	FSL	UTC – LSL		UTC = TSL	Hours	Mins		
VESSEL NAME CALLSIGN	VESSEL TYPE	DIST TO AREA	TI TO AREA	ETA AREA	ACTUAL SCH HRS (ASH)	ETD AREA	ASH less 15%	SCH SPEED	AREA ALLOCATED		
	TIME AVBL	SPEED	SEARCH TIME				S	MILES AVBL	A = TVS CALC DIM'S	DIM'S USED NR OF LEGS	ALLOC AREA (NM <sup>2</sup> )

## Worksheet 8 – Maritime Search By Vessel

<b>INCIDENT REFERENCE</b>	<b>SEARCH AND RESCUE WORKSHEET NO. 8 MARITIME SEARCH BY VESSEL</b>	<b>COMPILED BY</b> _____ <b>DATE</b>
Search Platform ..... Search Object .....		
MET Visibility ..... KM      Wind ..... / ..... kt      Fatigue Factor: Yes or No		
<b>Search Height (AGL)</b>	<b>Eye height 8 ft</b>	<b>Eye height 14 ft</b>
Uncorrected Sweep Width (Wu) -Tables <a href="#">I-3</a> , <a href="#">I-4</a> ,	NM	NM
Maritime: Weather Correction Factor (Fw) - <a href="#">Table I-7</a>		
Fatigue Correction Factor (Ff) if crew will be suffering significant fatigue enter <b>0.9</b> , otherwise enter <b>1.0</b>		
Sweep Width Factor <b>W</b> = Wu.Fw.Ff		
Practical Track Spacing <b>S (NM)</b>		
Coverage Factor C = W/S		
Probability of Detection (POD)		
Search Area <b>A</b> (SQ NM)		
Search Hours (T) Required <b>T = A/VS</b>		
Total Search Hours Available (.....) - (from Worksheet No.7)		
<b>A. Whole Area Calculated at a Search Height of ..... FT (A = TVS    C = W/S    S = W/C)</b>		
A	SQ. NM	S      NM      C      P      %      FOR      SEARCH
<b>B. Modified Area at Calculated Track Spacing in Available Hours</b>		
A	SQ. NM	S      NM      C      P      %      FOR      SEARCH
<b>C. Whole Area at Modified Track Spacing in Available Hours</b>		
A	SQ. NM	S      NM      C      P      %      FOR      SEARCH
<b>D. Compromise Area and Modified Practical Track Spacing in Available Hours</b>		
(i) A	SQ. NM	S      NM      C      P      %      FOR      SEARCH
(ii) A	SQ. NM	S      NM      C      P      %      FOR      SEARCH
(iii) A	SQ. NM	S      NM      C      P      %      FOR      SEARCH
(iv) A	SQ. NM	S      NM      C      P      %      FOR      SEARCH
Mark selected variables with *		

## Appendix L: Aircraft Accident Site Precautions

### Safety Precautions and Procedures at Aircraft Accidents

1. Always remember that ADF aircraft may be carrying ammunition, bombs, rockets, etc. Ejector seats are powered by explosives. Contact ADF authorities as soon as possible.
2. The following precautions should be observed at all aircraft accident sites:
  - a) Attendance at crash sites should be limited to essential personnel;
  - b) Personnel should wear Personnel Protective Equipment (PPE) - see paragraph 2;
  - c) All work at the crash site should be conducted upwind of the wreckage wherever possible;
  - d) The location of helicopter landing zones in close proximity to crash sites should be avoided to prevent the possible spread of contamination;
  - e) Eating, drinking, and smoking in or around the crash site should be prohibited;
  - f) Aircraft technical personnel familiar with the aircraft type should be utilised in the location, identification, and salvage of hazardous materials and remnants;
  - g) Environmental health personnel should also be notified when suspected dangerous substances are present at the accident site;
  - h) SAR personnel who were working at the accident site should shower as soon as possible after leaving the area;
  - i) If time permits, advice to civilians in fallout areas that are not otherwise threatened should be as follows:
    - i. Remain indoors;
    - ii. Shut external doors and windows;
    - iii. Turn off forced air intakes; and
    - iv. Await further notification. and
    - v. Cordon off the area.
3. Personnel working within 10 metres of any ADF crash site should wear the following protective equipment:
  - a) Respiratory protection; wear National Institute of Occupational Safety and Health approved full-face or half-mask respirators with cartridges for organic vapours (for protection from jet fuel) and for dust, mist, and fumes (for airborne particulate fibres and other dust). All personnel must be fit, tested, and trained in the use of respirators. The use of full-face respirators will eliminate the need for goggles or safety glasses;
  - b) Eye protection such as goggles or safety glasses with side shields shall be worn when a half-face respirator is used; and
  - c) Skin protection:
    - 1) Coverall - Tyvek, coated with 1.25mm polyethylene with hood. The coveralls should have a zipper front, elastic sleeves, legs, and drawstring hood;
    - 2) Gloves - Puncture resistant leather gloves shall be worn. The environmental engineers will determine any additional requirements;
    - 3) Boots - Steel toed shoes or boots should be worn; and
    - 4) All equipment should be thoroughly washed before removal.

## Appendix M: Civil Aircraft Search and Rescue Units (SRUs)

### AMSA Aircraft Tier SRU Capability Definitions

CAPABILITY	DESCRIPTION
<b>TIER 1</b>	Dedicated fixed wing aircraft and crew for supply dropping, homing to beacons and visual search.
<b>TIER 2</b>	Rescue capable helicopters and crew, that are already providing EMS (Emergency Medical Services) and SAR services to the Australian or a State/Territory Government, that can be engaged by AMSA on an opportunity basis for rescue, homing to beacons, search, limited supply dropping and which may be able to undertake command and control in a pollution incident. The helicopters may also have a capability to sling carry and operate a dispersant bucket.
<b>TIER 3</b>	Rescue capable helicopters and crew, already providing SAR services to a company, Australian or State/Territory Government, that can be engaged by AMSA on an opportunity basis for rescue, homing to beacons, search, limited supply dropping and may be able to undertake command and control in a pollution incident. The helicopters may also have a capability to sling carry and operate a dispersant bucket.
<b>TIER 4</b>	Fixed wing aircraft and crew on that can be engaged by AMSA on an opportunity basis for homing to beacons, visual search and may be able to undertake command and control in a pollution incident.
<b>SUPPLEMENTARY</b>	Fixed wing aircraft or helicopters and crew that can be engaged by AMSA on an opportunity basis for visual search.
<b>TRANSPORT AND LOGISTICS</b>	Turbo-prop and jet aircraft to take AMSA officers and their equipment from Canberra to an airport in Australia near the scene of the incident.

Table M-1 AMSA Aircraft SRU Tier Definitions

#### Tier 1 SRUs

AMSA contracts five dedicated Dornier 328 turboprop aircraft for SAR at bases in Darwin, Perth, Cairns, Melbourne and Brisbane. These aircraft are fitted with a range of communications (UHF, VHF, HF and satellite telephones) and sensor systems (search RADAR, FLIR, NVG, DF, AIS, UV/IR line-scan). These Dornier 328s are able to drop a range of life-support equipment on land and sea, by day and night including life rafts, SAR datum marker buoys and de-watering pumps. Communications equipment (radios and satellite phones) can also be dropped which, using the multi-mode communications relay capability of the aircraft, enable communications to be established between the surface and JRCC Australia or another command/control or response facility.

The aircraft are available to other government agencies, such as the police, fire and emergency services, on a whole of government basis, for assistance with response to emergency operations.



Photo: AMSA Dornier 328

## **Opportunity Based SAR Services – Multi-Use List (MUL)**

AMSA receives applications from suitably qualified aviation operators to be included on a Multi-Use List (MUL) for the provision of opportunity based Search and Rescue services. The three broad levels of services are:

- a) Operators with rescue helicopters and fixed wing aircraft that are trained and equipped for SAR (Tiered Services – Tier 2 & 3 helicopters and Tier 4 fixed wing);
- b) Operators with helicopters and fixed wing aircraft who are not trained or equipped for SAR (Supplementary Services); and
- c) Operators with turbo-prop and jet aircraft who can provide transport and logistics services to support responses to SAR incidents (Transport and Logistics Services).

The MUL is an ongoing procurement process open to 2014.

## **Current T4 Aircraft and Police Fixed-Wing Operators**

Tier 4 aircraft operators provide air search capability (visual search and DF) supportive and supplementary to the Tier 1 Dornier fleet. Each operator is supplied with safety and role equipment. Training, including emergency procedures drills, is provided by AMSA. AMSA Tier 4 operators are located at various locations as shown in Figure M.3. AMSA also provides police fixed-wing operators with safety and role equipment for selected aircraft.

## **Air Search Observer Programme**

AMSA maintains a partnership with State/Territory Emergency Service organisations to provide the SAR system with a large and dispersed pool of trained and readily mobilised air search observers. State and Territory Emergency Service volunteers undertake several days of training each year which addresses safety on and around aircraft, emergency procedures (including pool drills with life rafts and lifejackets) and air search operations. Training is usually carried out with Tier 4 and police aircraft operators.

## Air Search Equipment

AMSA maintains stocks of air search equipment (aircraft safety and role equipment) at strategic sites which can be transported to locations where search operations are being conducted.

## Customs Aircraft

AMSA and Customs have implemented a “first response” SAR capability for Customs DASH8 aircraft to enable them to drop limited stores when operating from Christmas Island. The stores are limited due to weight considerations and comprise SAR datum marker buoys and rescue platforms.

## Locations of Assets

The following charts show the distribution of assets.

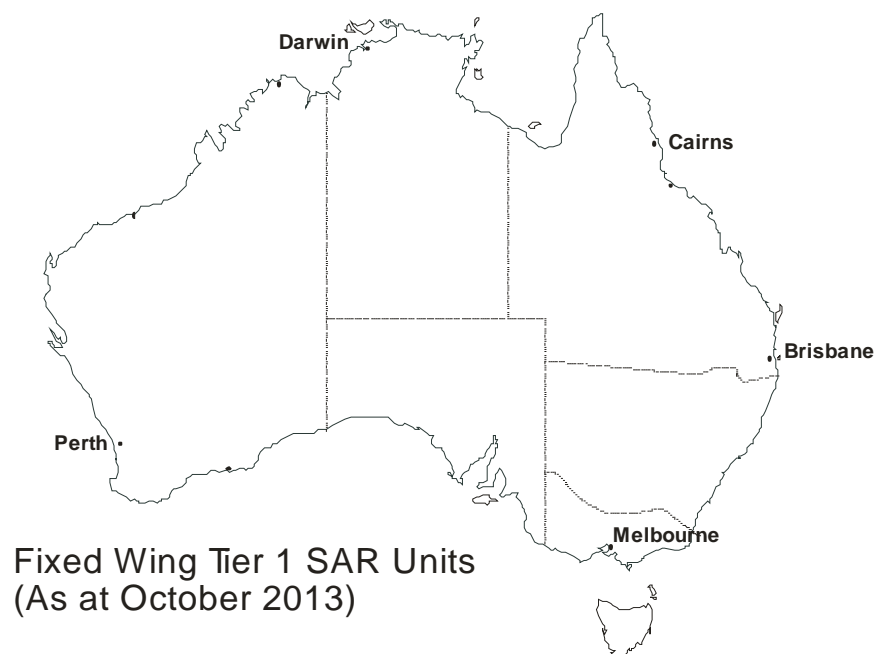


Figure M.1 Base Locations of AMSA Dedicated Tier 1 Aircraft SRUs

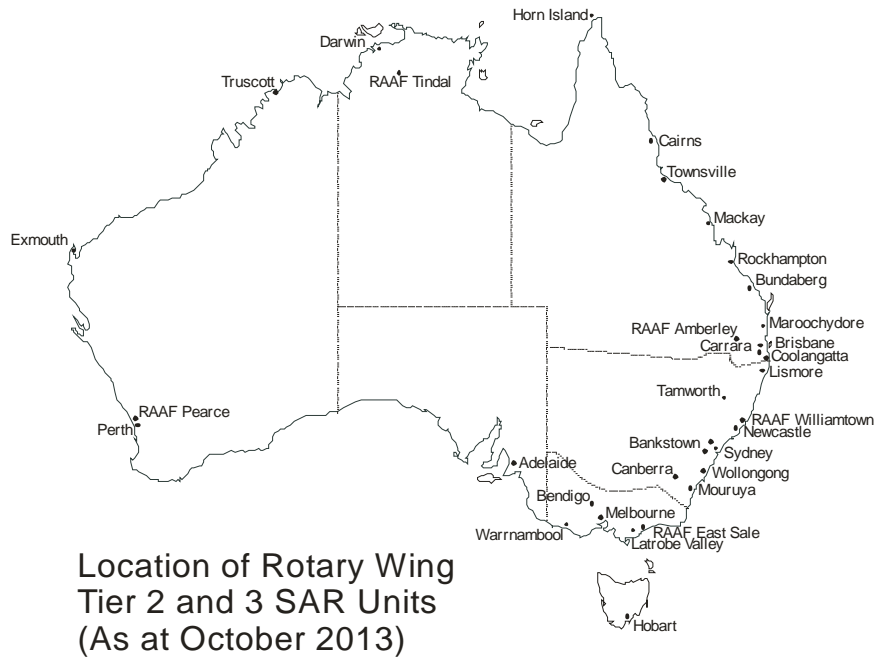


Figure M.2 Base Locations of Tier 2 and 3 Helicopter SRUs

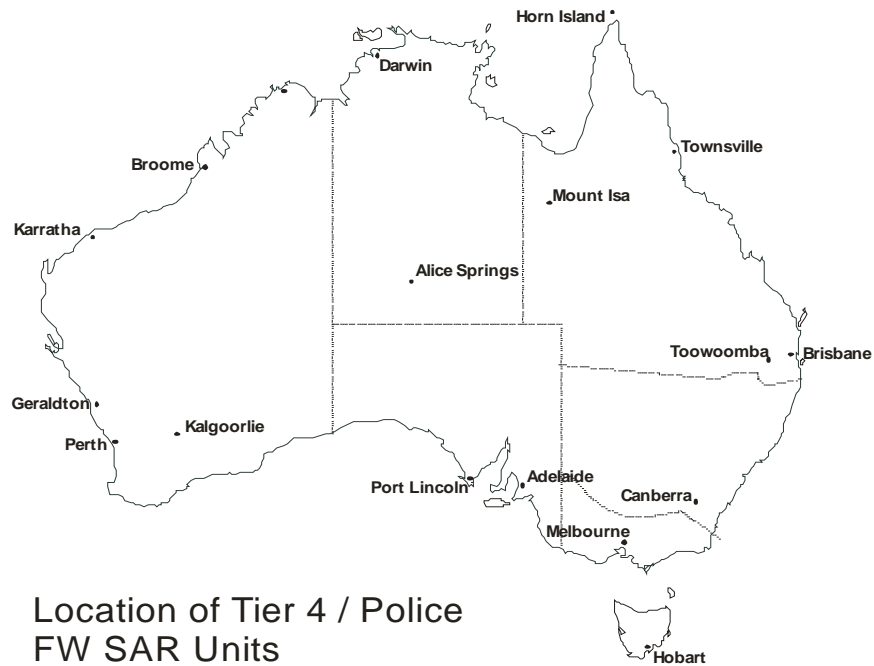


Figure M.3 Base Locations of Tier 4 and Police Fixed-Wing Aircraft SRUs

## Appendix N: RAAF SAR Equipment and Aircraft Capabilities

### Minimum Requirements for Holdings of Search and Rescue

#### Equipment at RAAF Bases

BASE	ASRK See Note 1	Compact Rescue system	SDB See Note 2	LUU-2 Flares	HELI- BOXES	SALCOM RADIO See Note 3
Darwin	8	2	4 sets	8	12	6
Edinburgh	6	0	4 Sets	8	12	12
Pearce	2	2	2 Sets	0	6	2
Richmond	5	10	6 Sets	0	6	12
Townsville	2	2	2 Sets	0	6	2

#### Notes:

1. Total of 8 Air Sea Rescue Kits (ASRK) in Darwin, 6 are rigged for AP-3C drop, 2 are rigged for C-130 drop. Except for the ASRK kept at Edinburgh, all others are rigged for C130 Drop.
2. Each set of SAR Datum Buoys consists of 4 buoys, which transmit on different frequency pairs.
3. In addition to the radios specified, each ASRK contains two radios per raft.

#### Aircraft Drop Capabilities

ACFT TYPE	BASE	ASRK (5)	ASRK (4)	HELI- BOXES	SDB
C130J	Richmond	YES		YES	YES
AP-3C	Edinburgh		YES	YES	YES

#### Notes:

1. The C130J delivers a five unit ASRK, consisting of two x 10 man rafts in separate valises joined by waxed rope to three marine supply containers.
2. The kit is delivered 50m upwind of the target and covers a distance of 500m with a raft at each end and equidistant supply containers between.
3. The AP-3C uses a similar ASRK, but with four units separated by two marine supply containers and 500m of rope, are positioned 50m upwind of the target by bomb bay delivery. AP-3Cs also utilise heliboxes, SAR datum buoys and sonobuoys. As a last resort, they can deliver the aircraft raft via the main door. AP-3Cs are not cleared for single unit deliveries.



## Appendix O: Royal Australian Navy Response

### HMA SHIP RESPONSIBILITY ON RECEIVING AN ALERTING OR DISTRESS MESSAGE

Subject to operational availability, HJMA ships at sea receiving an alerting message or distress message are to be guided by the following:

**a) ALERTING MESSAGE indicates a vessel may subsequently be in distress.**

Steaming Time	Action
Less than 6 hours	<p>Advise HQJOC and MAROPS for closer units.</p> <p>At the CO's discretion Acknowledge the call.</p> <p>Prepare to proceed with dispatch to standby to give assistance.</p> <p>Advise details of incident, intentions, and fuel state to:                      HQJOC, FHQ, MAROPS. HQJOC AOC OPS, JRCC AUSTRALIA</p>
Greater than 6 hours	<p>Advise HQJOC and MAROPS for closer units.</p> <p>At the CO's discretion Acknowledge the call.</p> <p>Advise details of incident, position and intended movement (PM) and fuel state to:                      OPCON AUTHORITY                      HQJOC, FHQ, MAROPOS, HQJOC AOC OPS, JRCC AUSTRALIA</p>

**b) DISTRESS MESSAGE: SOS or MAYDAY – Vessel in Distress**

Steaming Time	Action
Less than 12 hours	<p>Advise HQJOC and MAROPS for closer units.</p> <p>At the CO's discretion Acknowledge the call.</p> <p>Advise details of incident, intentions, and fuel state to:                      OPCON AUTHORITY                      HQJOC, FHQ, MAROPS. HQJOC AOC OPS, JRCC AUSTRALIA</p>
Greater than 12 hours	<p>Advise HQJOC and MAROPS for closer units.</p> <p>At the CO's discretion Acknowledge the call.</p> <p>Advise details of incident, position and intended movement and fuel state to:                      OPCON AUTHORITY                      HQJOC, MHQAUST, HQADF OPS, NACOC, JRCC AUSTRALIA</p> <p>Await further instructions</p>

**c) If the position of the vessel is not received.**

Acknowledge the call.

Advise details of incident, PM and fuel state to: OPCON AUTHORITY, HQJOC, FHQ, MAROPS, HQJOC AOC OPS, JRCC AUSTRALIA

Attempt to get a position from vessel.

- d) If the position is subsequently defined, act in accordance with instructions for ALERT or DISTRESS messages.**
- e) If the position cannot be defined, await further instructions.**

**NOTE:** All signals are to be IMMEDIATE UNCLASSIFIED and all addressees to be ACTION.

### **RAN Assistance to Local Authorities**

Naval authorities and establishments are authorised to provide SAR assistance to appropriate local authorities within the capacity of their resources, keeping OPCON AUTHORITY, HQJOC and MAROPS informed.