

COLOUR ME GREEN

A Sustainable Preschool in Kareby, Kungälv



COLOUR ME GREEN

A Sustainable Preschool in Kareby, Kungälv

Emelie Ståring

Master's Thesis at Chalmers University of Technology

MP Design for Sustainable Development

Gothenburg 2012



CHALMERS

Abstract

This Master's Thesis is a proposal for a preschool design for the municipality of Kungälv. The preschool is to be located in Kareby, some five kilometers outside of Kungälv, where there are development plans for a new preschool.

The main question is how to create an environmentally sustainable preschool which by its design is able to teach the attending children about sustainable development? How could it help them to attain a careful approach to nature and the environment?

An initial ambition from the municipality was to design a preschool with a passive house standard, but this concept has been modified into a sustainable preschool with a low energy use. My own aim is to take it even one step further and thoroughly integrate sustainability in the building design so that the concept can be integrated in the children's daily lives.

The project site is extensive and flat, placed in a surrounding landscape of rural character, which makes it natural to create an inspiring outdoor environment in addition to the interior.

Initial design solutions are based on the building context with regards to weather and solar conditions. Guidelines regarding built environment from the Reggio Emilia philosophy are considered as they are tangential to those of sustainability. When designing a learning environment by following a Reggio Emilia approach, the connection between inside and outside as well as aspects of microclimate plays a major role.

My method has been to combine the design suggestions stated by Reggio Emilia with the aspects of sustainable building and some paragraphs from the Educational Curriculum. These have been interpreted by sketches and investigations into spatial concepts.

The expected result of this project is to create an inspiring interior and

exterior environment for both children and teachers, seamlessly integrating the aspects of sustainable development into the education of young children.

How to find an adequate balance between the Reggio Emilia method and the sustainability approach? How to obtain an efficient education which is usable for preschools not following specific philosophies? Also, how is it possible to further develop this combined method and what would the results be?



SOLAN
DRAKEN



Contents

Introduction	11	Quotes from the Educational curriculum	42
Purpose and method	13	Reggio Emilia parameters	44
The preschool	15	Kareby, Kungälv	49
A brief history	16	Kareby	50
Preschools in the 21 st century	17	Surrounding design idioms	52
The preschool in numbers	18	The site	54
		Site analysis	57
Case studies	21	Design proposal	61
Stadsskogen	22	Main design goal	65
Kareby	24	Design concept	66
Klåvavägen	26	Function area program	68
Comparisons and conclusions	28	Plan 1:200	80
		Plan and section 1:100	82
Point of departure	29	Site plan 1:400	90
Reggio Emilia and sustainability	30	Elevations and materials	94
The importance of being outdoors	33	Construction	96
Matrix ventilation and heating	34	Building flexibility	102
Matrix sustainability	37		
Interpreting pedagogics into architecture	39	Reflections and discussion	105
The design of a preschool	40	References	110
Children's scale	41		

Comments on quotes and expressions

All quotes in this text, with the exception of the quote on page 60, are freely translated by myself from Swedish. The original Swedish quotes can be found in appendix I.

The poem on page 31 is also freely translated from Swedish, though it is originally written in Italian. This also goes for the quote on page 81, where the original language is French. Quotes which are not originally written in Swedish are not translated in the appendix.

Regarding the common expressions in the field of education, I have chosen my own translations where I have not been able to find a suitable conventional expression.

Department is translated from the Swedish “avdelning”, and constitutes 19–20 children, home rooms, hygiene room, entrance and cloak room.

The people working at the preschool is referred to both as **staff** and as **teachers**; where staff includes kitchen workers and other kinds, and teachers implies the educational staff.

The **Educational curriculum for preschools** is in Swedish known as “Läroplan för förskolan”.

In the text about educational focus, the “Ur-och-skur” is mentioned, which can be translated to **rain-or-shine** preschool.

Delivery kitchen means “mottagningskök”, which is to say a kitchen where the major part of the food is delivered by truck and only smaller preparations are made.

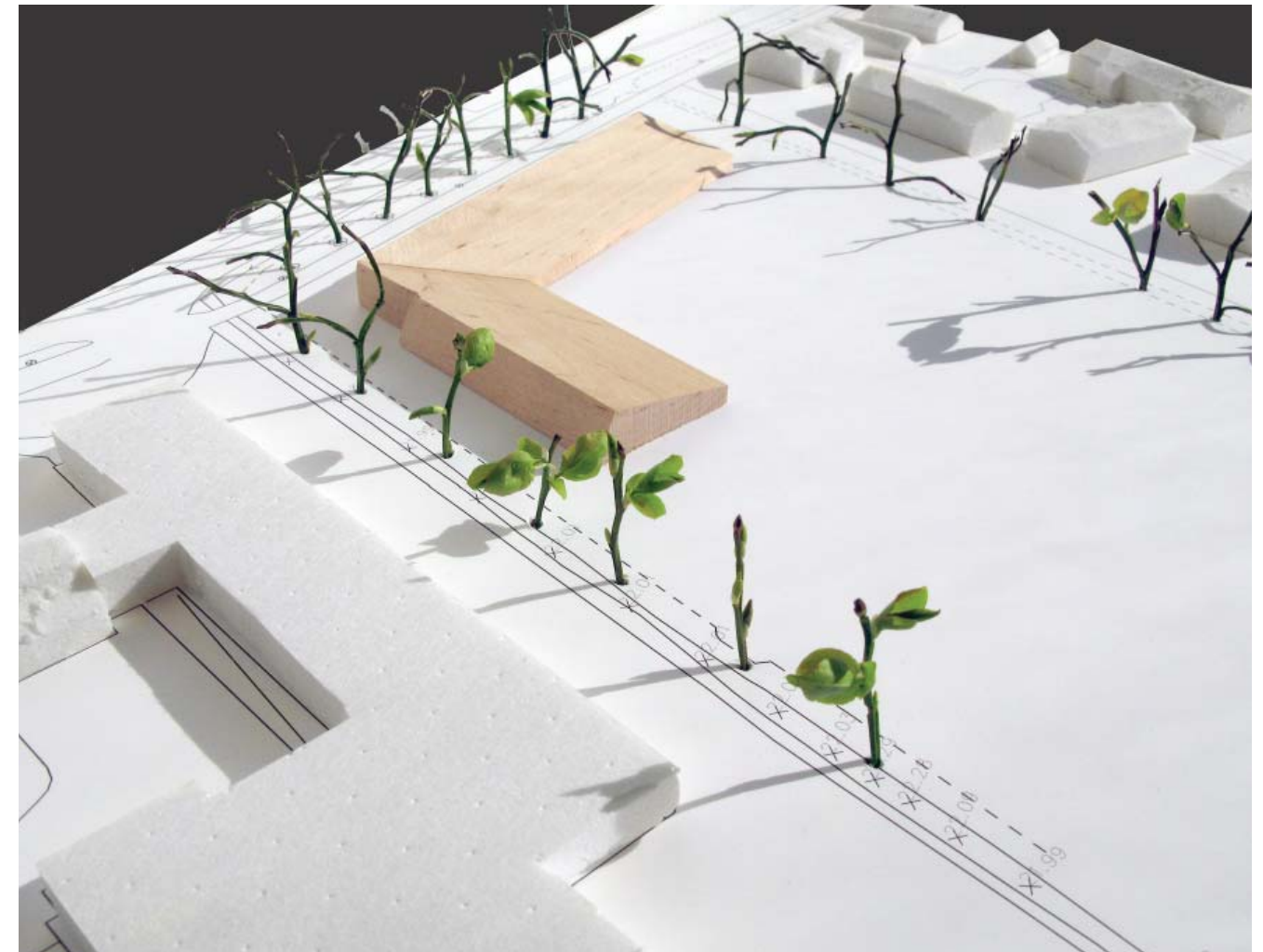

Model 1:400

“

The preschool should form the basis to a lifetime of learning. Activities should be fun, safe and educative for all participating children. The preschool should stimulate children's development and learning as well as offer a safe care. The activities should be based on a holistic view of the child and the child's needs and they should be formulated so that care, development and learning constitute a whole.

- Läroplan för förskolan, Lpfö 98, p 5

”

INTRODUCTION



This Master's Thesis treats the ever-relevant topic of child-care, namely the preschool. It discusses the development from the early days of child-care up until today as well as ideas for the future.

The present situation of preschools in the larger cities of Sweden is somewhat precarious, with large groups of children and many temporary building solutions which are poorly adapted to house activities fit to reach the standards and goals stated in the Educational curriculum for preschools. Improvements are constantly being made to ease the situation, and here architects can play a vital role for a positive development by proposing healthy, appropriate buildings to make an exemplary statement of what we wish our children's environment to look like.

There is a large amount of aspects to take into consideration when designing a preschool, and this thesis focuses on the sustainability of the building as well as the children utilizing it. I will attempt to show the importance of considering children's scale when designing for children, but at the same time keeping in mind the adults who are also to use the facilities; the teachers. It is vital to find a balance between the children's activities and the teachers' requirements.

Kareby, just outside of the municipality of Kungälv is a rural area in the vicinity of a large city. The need for more child-care places is growing here as well, and there is a generous amount of space available for building new facilities. In my presentation I will show a proposal for a preschool taking care of the rural landscape and connecting with the surrounding nature, to give the children opportunities to learn from and be in the middle of a natural environment.



Model 1:400

Purpose and method

At an early stage, I took an interest in different educational methods for preschools, and the Reggio Emilia philosophy in particular. This philosophy has been present in my work ever since, with additions of other important aspects regarding the education of young children, such as sustainability and nature. One of the challenges has been to develop facilities which are based on these methods and philosophies, but which are not too specified to function with a different educational direction.

This project consists roughly of three parts; one more theoretical part which describes the current situation of many Swedish preschools, as well as evaluating different building solutions; one interpretive part merging pedagogics and architecture, and the last part is an architectural design proposal based on the findings and conclusions from the two previous parts.

For the theoretical part, I have dived into literature on the subject of child-care and children's development; the literature ranging from scientific studies on the needs of children to more layman-like books on enjoyable garden design for children. I have also conducted several study visits to existing preschools with different focus and design, to be able to exemplify for myself as well as the reader of this thesis the implementation of the ideas which the project is based on. Since my own experience of children is minimal, informal interviews to better understand the views of a child and those of a parent have taken place in the early stages of the process as well.

The pre-design part has been a transitional process analyzing the conditions and opportunities of the site and of different technical building solutions such as ventilation and solar power. It has also been about interpreting the stated goals for Swedish preschools and the aspects described as important in the Reggio Emilia philosophy into architectural design elements.

Implementing all of the theoretical findings into the building design has taken place continuously ever since the start of the semester, applying my ideas

together with well proven solutions.

During the process, I have had regular contact with Maria Niklasson at Abako Architects, who has functioned as a mentor and the primary link between me and the municipality of Kungälv.

From the municipality, several people have been involved with enthusiasm in the process.

The design process have been a great mix of sketching by hand, model studies, computer modeling and gathering inspiration from existing buildings. All the while, I have been using a two-perspective approach, trying to find the optimal way of arranging the functions and their specific areas, while simultaneously working with the building volume and site, so as not to get caught in trying to squeeze the functions into a fixed volume and vice versa. The results of this effort is presented in this document, with the intention of being a realistic design with slightly visionary ideas which can be implemented in future preschools, to make a difference for the children and their development.

THE PRESCHOOL

A brief history of preschools in Sweden

1850's - the first form of day care, the so called barnkrubba, is opened at Kungsholmen in Stockholm. The purpose is to give impoverished families a possibility to provide for themselves by going to work each day instead of staying home with the children.

1890's - a new kind of day care, kindergartens, is initiated by Anna Eklund. The kindergartens are from the beginning only for the middle class children, but with the initiative of the sisters Ellen and Maria Moberg it comes to include the workers' children as well. Ellen Moberg is one of the driving forces behind an increased community involvement in child care.

1930's - for the first time the preschool is mentioned in terms of a unified system. The ideas of Alva Myrdal that the "large nursery" is to be available for all, forms the basis of a unified Swedish preschool, where we move away from the division of the socially motivated barnkrubba and the pedagogically motivated kindergarten.

1960's and 70's - the strong economical growth creates a need to acquire female labor for the production industry. This together with women's emancipation initiates a major expansion of the preschool. The expansion is mainly motivated by the need to solve a supervisory issue.

1968 - nurseries and kindergartens gets a common title after over 30 years of discussions - the preschool is born. The activities are to be educational and the staff is named educational staff.

1997 - a suggestion for an educational curriculum "To conquer the surroundings" is published.

1998 - the first Swedish Educational curriculum for preschools is established.¹



Christmas celebrations at a barnkrubba in Sandviken 1922

Preschools in the 21st century

The traditional view of children rested on a foundation of developmental psychology, indicating that all children followed the same kind of development, just in a different pace and scale. Observations of this development did then form a basis of what actions were to be taken to ensure the “right” kind of development of the child.

Today, we have a different way of viewing the development of children, thanks to the Educational curriculum; today we see children as unique individuals and active co-creators of their own knowledge. This approach assumes the child’s own curiosity and competence, and its own ability and desire to learn.

The role of the preschool teacher has undergone a transformation from dictating the daily activities of the children to challenging and providing inspiration for explorations where the child is its own guide. The children need to be able to, by themselves or together with others, create their own meanings and contexts through their exploration, and the teachers need to be the reflective sounding boards on which the children might try their theories. Through research within the area, we have come to the knowledge that children are fully capable of creating their own safety and their own learning – by doing and in relation with other children.

This means that the preschool has gone from in the 18th century being some sort of depot for parents to put their children while working, to a pedagogical place which deals with children’s personal development and learning on their way to becoming confident, respectful and conscious individuals.

All of these transformations in the world of children’s education put higher demands on the built learning environment. Preschools should – according to the Educational curriculum – be stimulating, varied and creative, and the children should be able to influence their own working environment. The activities should also be adaptable to the individual child’s interests, needs and conditions.

It is safe to say that in many Swedish cities today, these prerequisites are not quite implemented; instead preschools are being housed in temporary barracks and ill-adapted old houses, while the groups of children are steadily becoming larger and larger with a static number of teachers. Parents are forced to wait for preschool places for several months, and when they are finally offered a place for their child, it might be as far as 10 kilometers from their home.

In 2003, 15% of the preschool groups had 21 or more children per group, to be compared to 2010, when the corresponding figure was 18%.²

Issues such as these are real in the bigger cities, while in the smaller communities the problem might instead be shrinking child groups and empty facilities. Whether the issue is overcrowding or shrinkage, the remedy needs to be carefully thought through with regards to future development and needs.

The Educational curriculum clearly states that the preschool should contribute to a sustainable development, which includes not only environmental sustainability, but also economical and social. Both interior and exterior environment should be designed to promote the pedagogical work, thus a sustainable approach should permeate the built environment as well as the educational activities.

Together with all this it is also very important to remember the focal point of these aspects – the children. Children have a different scale than adults, they have a different way of perceiving their surroundings and a different way of utilizing the space. To focus on the architecture with all the requirements regarding dimensions, safety and function is one thing, but to be able to create something which corresponds to all the statements in the Educational curriculum, the aim must be to focus on the child.

² <http://www.skolverket.se/statistik-och-analys/2.1862/2.4317>

The preschool in numbers

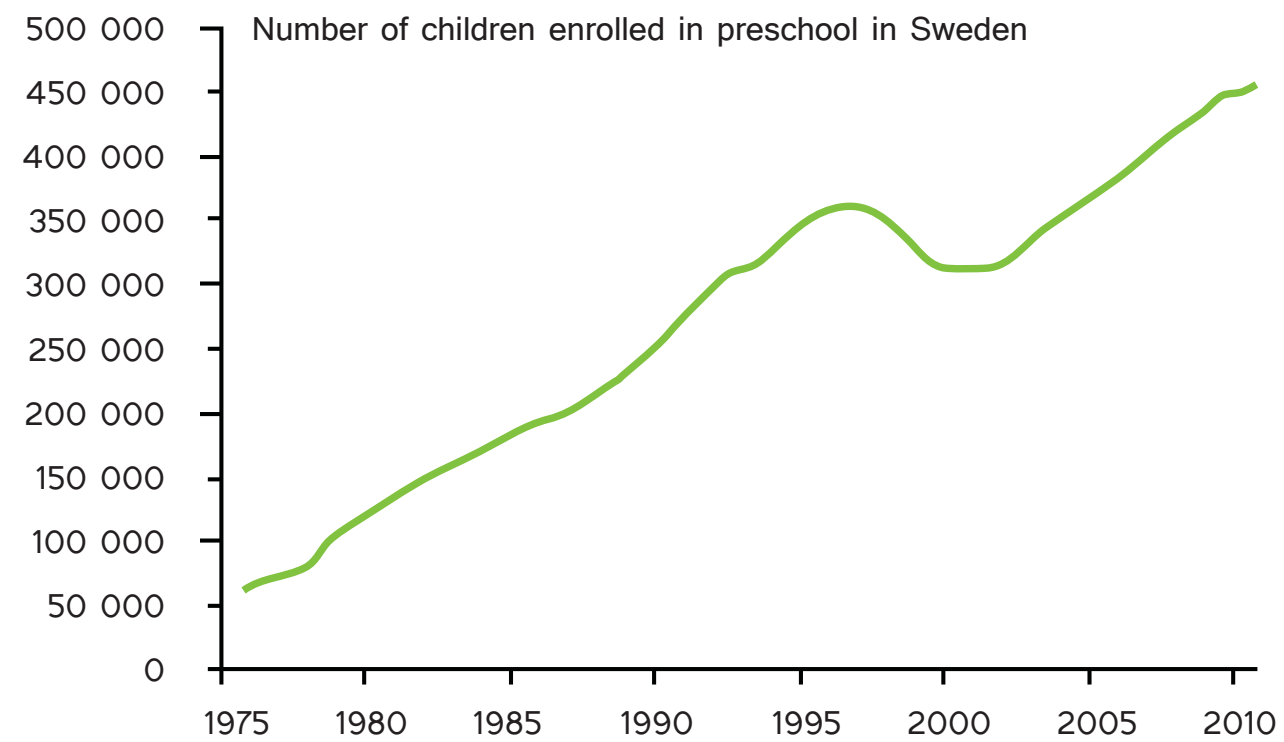

Year	Average number of children	
	per group	per full-time employee
1985	13,4	4,3
1990	13,8	4,4
1995	16,7	5,5
2003	17,2	5,4
2006	16,7	5,1
2009	16,8	5,3
2010	16,9	5,4

Statistics from Kungälv municipality 2010

Children in the municipality ages 1-5:	2 705
Children enrolled in preschool:	2 174
Full-time employees:	393
Children per employee:	5,5
Total amount of preschool departments:	127
Percentage of departments with	
-15 children:	31
16-17 children:	14
18-20 children:	40
21-25 children:	14
26- children:	0
Average number of children per department:	17,1

Discussion:

The number of children enrolled in preschool has been steadily increasing since the 1970's. So has the average number of children per group or department, which is the bad trend that has caused today's situation.

Since 1998, the number of children in ages 1-5 years has fluctuated in Kungälv, while the number of children enrolled in preschool has been steadily increasing. In 1998, 1 296 children (53%) were attending preschool, to be compared with 2 174 children (80%) in 2010.

The average number of children per department in Kungälv is not that bad, but there is still the fact that most departments contain 18-20 children, and a fair amount even 21-25 children. To be able to follow the guidelines set by the educational curriculum and ensure a healthy environment and proper care of children in the preschool, these numbers need to improve.



CASE STUDIES



Stadsskogen preschool, Alingsås

The preschool Stadsskogen in Alingsås was built in 2008 as the first Scandinavian preschool with a passive house standard. Rumor has it that passive house pioneer Hans Eek and architect Anders Glantz got to discussing one evening whether it would be possible to create a passive house with the heating energy from children. The first sketches were made on baking paper to what would become a successful and popular passive house preschool.

Through the drawing process, the staff which was to work in the new facilities were deeply involved in the design work, making decisions which deviated from the standard solutions, but would suit them better and optimize the limited space with which the design team was working.

Since the building site was slightly awkward and posed a bit of a challenge, the design was determined to follow the height differences rather than digging them out, and the plan drawing also had to be bent a little to fit into the site. This created an interesting interior with one part of the building a half-floor higher than the other, and the body of the house protecting an inspiring outside yard in two levels.

Stadsskogen does not explicitly follow any specific pedagogy, but the staff is influenced by the Reggio Emilia philosophy. However, the interior layout of the preschool does not follow the Reggio Emilia ideas with regards to a central piazza and common ateliers; the five departments - each containing 19-20 children - are separated with their own private entrance. The "Reggio-piazza" is moved outside - a conscious decision by the staff, to gain space for other necessary functions - where as much as possible of the daily activities take place. As the headmaster Agneta Augustsson expressed it "What can be done indoors can be done outdoors". When the weather allows, games and meals are relocated outside in the yard, where toys are conveniently stored in outdoor cupboards, and the occasional picnic takes place in what the children call "the forest", which is really just the higher level of the yard.

Inside, the plan is solved virtually without any corridors. Since the children



all eat in their own homeroom, food carts are pushed from the kitchen in the middle of the building, through two of the departments to reach the outer departments. This is operated as smoothly as possible by designated paths through the rooms where the doors face each other in straight sight lines.

The environmental focus permeates not only the building, but the entire day-care activity. In addition to the children spending a lot of their time playing outside, the preschool promotes sustainability by methods such as small thoughts and discussions as well as making the “recycling manager of the week” an honourable assignment, teaching the children the importance of recycling and the waste cycle. Stadsskogen is also certified as a “Green flag” preschool, implying an action-oriented approach teaching children about environment and sustainable development based on different themes, easily comprehended by the children.

Being a passive house, the preschool experiences quite a large fluctuation of temperature, where in the mornings the interior temperature can be only 16° C, but as soon as the children start arriving always climbs up to a nice 22° C. The staff does not see this as a problem, as they get a lot of physical exercise together with the children. Two other aspects that stem from the building design are the good air quality and the comfortable level of noise; even though there are around a hundred children in the building, no sound is transferred between departments, and the noise is kept at a reasonable level within the departments as well. Up the staircase in the staff room, there is no indication whatsoever noise-wise that you are in the vicinity of a hundred children.

All in all, teachers and children at Stadsskogen are content with their passive preschool, and even the parents have expressed their satisfaction with the environmental responsibility of it.

“What can be done indoors can be done outdoors”
Agneta Augustsson

“Nya förskolan gör barnen friskare”

Stadsskogens nya förskola är inte bara energisnål. Passivhustekniken gör sannolikt barnen friskare. I varje fall tror personal och föräldrar det.

– Vi har inga vetenskapliga belägg, men barnen verkar må allt bättre, säger rektor Agneta Augustsson.



AGNETA AUGUSTSSON

ALINGSÅS: Det har gått tio månader sedan förskolan startade. En unik byggnad för inte någon annanstans i Skandinavien finns någon liknande förskola. Inte nog med att huset är energisnål och värms upp med passivhusteknik. Som gräddes på moset verkar barnen må bättre. Personalen bygger sin uppfattning på flera fakta och både inomhus- och utomhusmiljön verkar ha haft positiv effekt.

– I vinter har vi exempelvis inte haft några större epidemier. Frånsett ögoninflammation har vinterkräksjuka och förkylningar i det närmaste utblivit, berättar Agneta Augustsson.

Att barn blir sjuka vid inskolning hör till liksom vid sammanslagningar av grupper. Men inte heller det har fört med sig mer sjukdomar i den nya förskolan.

FLERA AV barnen i Stadsskogen har tidigare gått på Parkens och Hedvigs förskola.

– Det var bra där också, men arbetsmiljön här är optimal, menar förskollärare Fredrik Krook.

Ann-Sofie Svensson, barnsköterska, och Elisabeth Eklund, förskollärare, ger också lovord för Stadsskogen.

– Här får barnen vara utem. Det yngsta sover utomhus i barnvagnar och alltid är det någon avdelning som har pedagogik utomhus, berättar Elisabeth.

MEN DET är inomhusmiljön som personalen är mest nöjd med. Luften känns bra. Det är lagom varmt, högt till tak, rymliga rum och en väl genomtänkt inredning.

– Även ljudnivån är till belägenhet tack vare tjockare väggar och mer isolering, säger Agneta Augustsson.

Barnen är lugnare och vissa föräldrar menar att barnen även är mer sansade hemma efter skoldagens slut.

Fem avdelningar med närmare hundra barn går i Stadsskogens förskola. Passivhusteknik handlar om självuppvärmning och det har funnits farhågor att huset skulle bli alltför varmt på sommaren och kallt på vintern under perioder med lägre aktivitet. Men inte heller det har slagit in.

Sedan värmeväxlaren justerats in har temperaturen varit ganska jämn året om. Så där finns heller inget att klaga på, säger Agneta Augustsson.

PÄR-UNO STRÖM
0322 - 67 00 48
paruno.strom@alingstid.se

ALINGSÅS TIDNING Onsdagen den 1 april 2009



FOTO: PATRIK SKOGLÖW

GLADA och friska barn. Valdemar Karländer är ett av närmare hundra barn som går på Stadsskogens förskola.

Fabs vill göra djupare studie

Fabs vd Peter Jakobson tar gärna initiativ till en djupare studie kring passivhusets effekter.

– Är det så att barnen blir friskare i den nya förskolan är det oerhört intressant, säger han.

ALINGSÅS: Trots att det inte gått ett år är Jakobson redan nu beredd till en vetenskaplig studie.

– Det kan bli ett lämpligt examensarbete för någon student med intervjuer, mätningar och

statistik. Men bättre kan vara att vänta en tid. Då blir underlaget mer tillförlitligt, säger han.

FÖRSKOLAN i Stadsskogen har väckt stor uppmärksamhet. Passivhustekniken har medfört besök av kommunfolk från landets alla hörn och även utländska gäster kommer till Alingsås, bland annat från Japan och Korea.

Om det nu är så att barnen får bättre hälsa lär intresset inte svalna.

– Nej, frågan är oerhört spännande, säger Jakobson.

Uppgifter från Alingsås Energi visar att förskolan även klarat energiförbrukning enligt ställda normer för passivhus. Siffrorna omfattar både el och uppvärmning.

– Det visar att huset håller vad det lovar. Att det sedan kan ha hälsobefrämjande effekter gör det än mer intressant. Det är värt minst lika mycket om inte kan räknas direkt i pengar, säger Peter Jakobson.

PÄR-UNO STRÖM





Kareby nature-preschool, Kungälv

Close to the site in Kareby are two preschools; one regular and one focused on letting the children play outdoors as much as possible – the nature-preschool. The facilities were built in 1991, with some influence from the staff, and are today utilized by 25 children in the ages 1–5 years, and four teachers.

The preschool follows explicit environmental goals with regards to sustainable development and was certified as a nature-preschool in 1998. The children spend the major part of their day outside, mostly in the forest which is situated some 500 meter from the building. The idea is to use the surrounding nature as an educational element and teach the children environmental awareness together with the traditional topics of education considered at a preschool. Since the national preschool curriculum was altered in 2010 with the intention of focusing the education on natural science, being outside and using the nature as a classroom has fitted very well into the educational goals for Kareby preschool.

However, a group of slightly older children – from 2,5–5 years – would have been optimal to be able to focus even more on the nature and avoid the dealings with diapers and such. On the other hand, the teachers find it positive with the mix of different ages in the same group, it teaches the children consideration and empathy from an early age.

The building contains a relatively large number of rooms, but then again, the group of children is also relatively large. The teacher Gunilla Åberg points out that good facilities and amount of staff are equally important. The entrance hall is spacious which is necessary, but the children are still divided into two groups when they enter after being outside, the smaller children go first to take off their clothes and then the older ones.

A room next to the entrance hall functions as a combined play hall and relaxation room, which is not an optimal combination according to the teachers, since the room is occupied during a part of the day when the smaller children are sleeping in there.



One end of the building is dedicated to the staff rooms; a changing room, a spacious office and a break room. The break room is not very frequently used – the size of the children’s group render it impossible for the staff to take all the breaks which they are entitled to. The break room has to some extension been transformed into an extra storage space for toys.

“
It doesn’t matter how much staff you’ve
got, it’s the facilities that are important
”
Gunilla Åberg

In the other end of the building are five rooms for the children, among them the large main room. All of the rooms are nicely bright, and in a corner of the main room, the children cultivate small edible plants.

The most awkward aspect of the facilities is the kitchen. It used to be a regular kitchen where the staff prepared the complete meals, but nowadays the food is delivered by truck, which means that large food carts have to be transported through the entrance hall and the main room to reach the kitchen. The staff see the food deliveries as inconsistent with certain environmental goals which they try to pursue. Especially since the deliveries sometimes are for only part of the meal, and the rest is prepared in the kitchen anyway. Apart from this slightly maladjusted room, the building seems to work at a satisfactory level. The exhaust ventilation ensures excellent fresh air conditions, and the windows generous amounts of natural daylight.

Outside of the building, there is a rather interesting playground with irregular ground levels enabling toboggan rides, trees perfect for climbing and protected corners for private games. There are also pallet collars for cultivating vegetables and a sandbox, but the largest playground for the children of this preschool is naturally the forest.





Klåvavägen preschool



Approximately 10 kilometers south of Gothenburg city, in a forested residential area, a recently built preschool is located. Klåvavägen preschool was designed by *Liljewall Architects* and has been running for two years.

The design of the building is based on the Reggio Emilia concept, with five departments gathered around a central piazza.

At the moment only four of the five departments are in use, divided according to the children's ages rather than the more usual practice of mixing children of different age. Here, the children change their home rooms as they grow older.

The staff running the preschool describes the activities as "Reggio Emilia-inspired", while the facilities are designed very much according to the philosophy, including ateliers, piazza and common spaces.

The layout is basically the same as Låssby preschool, a slightly older building on the other side of town from Klåvavägen. When designing Klåvavägen, the architects used Låssby's functional concept, and made some minor changes, such as higher ceilings and larger staff rooms.

Some of the intentions of the architects however, have not been optimal for the daily activities of the place. For instance, the main entrance was supposed to be accessed from the street, but since it posed a security risk to have a door open directly to the street in case the children would sneak out, the staff rearranged the entrance for the children to be accessed from the yard instead.

At the entrance, all children share a common cloak room divided into their different departments by colour coding. The cloak room also features two relatively large drying rooms for wet clothes, as opposed to regular drying cabinets. Some preschools have experienced problems with water damages, but no such problems have occurred at Klåvavägen as of yet.

From the cloak rooms, a long corridor leads to the central piazza, which also functions as a dining hall. The youngest children have their own small lunch room connected to their home rooms. According to the staff it would



have been desirable with a dedicated dining hall, where plates and cutlery could just be left after eating. As the situation is now, there is always need for cleaning and putting away things before and after each meal. Another wish from the staff would have been to furnish the piazza in a different fashion, creating distinct rooms within the large room, to be able to use it more efficiently. Circular tables would also have been preferred, to make the furnishing more inviting and enabling communication and interaction in a better way. Or, as one of the teachers put it “more round shapes in general!”

To give space for the extensive piazza the area of the home rooms for each department have been somewhat diminished; some of the teachers are of the opinion that they are one room short on each department. There is no space for sitting down for story telling, those activities are conducted in the staff relaxation room.

Apart from the small inconveniences which can be found in any new building before is it completely adapted to the activities, the facilities are bright and inviting, with lots of natural daylight from the large windows. The playground – although it feels relatively small – is designed by a landscape architect and features different areas for many different kinds of games.

Inside, the architects have managed to create rooms which maintain a comfortable noise level, and colours are used to a moderate amount, creating a playful but not overwhelming environment.

The next step for this new preschool is to pursue the certification for “Green flag”, implementing sustainability aspects into the Reggio Emilia concept.



Comparisons and conclusions

There has been a lot of interesting discoveries to be found by visiting three different kinds of preschools in the general Gothenburg area.

The first intriguing fact is that the facilities are actually not always better adapted to the activities of the preschool just because they are newly built. Kareby preschool is relatively old in this context, but still very functional, regarding the large group of children attending the preschool. There are a reasonable amount of different rooms, enabling a separation into smaller groups and making it easier to handle the children. This was a major drawback at the newly built Klåvavägen, where the staff relaxation room had to be used as an extra story telling room. That is the risk of designing a large common area in a preschool; the need to reduce the space for more secluded rooms, which are also very important. At Stadsskogen, this is solved by having common gatherings outside in the yard.

At all three preschools, the issue with dirty zones is more or less compromised. Stadsskogen treat the problem to a certain degree, by using the wind breaks as a buffer zone, but then food carts are transported through the dirty zones, transferring dirt to the clean zones. Kareby experiences virtually the same problem, but the path for the food carts is not as lengthy. At Klåvavägen, there is a dedicated place for shoes, but the adjacent corridor presents a lovely opportunity for the children to run a "lap of honour" through the dirty zone, spreading the dirt all over the preschool.

A very important aspect is the rooms dedicated for the staff. When working all day with children, it is essential to have a place where you are able to relax and spend some child-free moments. The teachers at Kareby relate that they are seldom able to take their coffee breaks in the staff room, and the room is also used as extra storage. At Klåvavägen, the staff rooms are spread out next to each other in a corridor, where the children also have access. The most secluded staff rooms can be found at Stadsskogen, where they are located on the second floor.

This is only some of the issues to consider when designing a preschool, and each preschool has its own advantages and disadvantages. However, an essential part of the design process is to adapt the facilities to the activities so as to avoid having to do it the other way around. It is also a fact that some things which function perfectly at one preschool, may not be as functional at another, it all depends on the size of the groups and the focus of the staff.

In any case, I have come to some conclusions from these case studies, indicating what kind of preschool would be good in my opinion.

Aspects to avoid:

- Enabling the children to move through the dirty zone
- Reducing smaller spaces in favour of large common areas
- Giving the children access to the staff rooms
- Only one entrance for children, staff, and kitchen supplies
- Forcing food cart transport through the dirty zone
- Sleeping children occupying a whole play room

Aspects to embrace:

- A protected space outside for sleeping children
- Common gathering space outside
- A challenging playground with natural elements
- Dividing spaces into different rooms
- Varying the ceiling height to create different space experience
- Dedicated space for "messy" stuff, such as painting or carpentry
- Enabling lots of outdoor activities

POINT OF DEPARTURE



Reggio Emilia and Sustainability

My starting point for the development of this preschool is two educational methods; the Reggio Emilia philosophy and the aspect of sustainability. These two methods are in some ways automatically intertwined; the core of Reggio Emilia is the social sustainability of children, and there is also the fact that micro climate plays a large role in the design of the built environment in a Reggio Emilia preschool. I have found that it is virtually impossible to consider all the perspectives of Reggio Emilia regarding the design without simultaneously considering the sustainability perspective as well.

The Reggio Emilia philosophy

The philosophy was formed by parents and the teacher and children's psychologist Loris Malaguzzi, after the Second World War in the village of Reggio Emilia in northern Italy.

The Reggio Emilia philosophy focuses on the principles of respect, responsibility and community and encourages creativity, exploration and production through practical action, in an inspiring environment.

“

[Reggio Emilia is] a transboundary education struggling against routine and boredom with the aspiration to constantly improve

Grut 2005 p. 15

”

The basic principles of the philosophy are about giving children control over their own learning processes. They should be able to experience the world through all of their five senses, have relationships with other children, be allowed to explore their surroundings and also have endless ways and

opportunities to express themselves.

Reggio Emilia has become an attractive teaching method because of the way it views and respects the child.

The learning environment plays a large role in the educational program, and is sometimes even referred to as the “third teacher”. The major objective of the built space is to support the relationships between people and the many ways of expressing ideas that children use.

Classrooms surround a central piazza where children interact, and all rooms are connected to the surroundings through large windows, courtyards and doors leading outside. Nature is brought in by means of plants and vines, which together with natural light sources blur the border between inside and outside. Children's works are displayed in classrooms and entrances, to inform and engage viewers.

The great innovation of Malaguzzi is the atelier – a specific part of the building which is dedicated to promoting creativity and surprising and challenging activities. The feeling of openness towards nature is at its most prominent in the atelier, something which gives the children inspiration for an exploratory approach in their creativity. ³

Sustainability

In the Educational Curriculum for preschools, it is stated that the preschool have a duty to contribute to the strive for sustainable development. In Sweden today, there are a multitude of preschools where the aspect of sustainability forms a large part of the daily education. There are both nature-preschools, and so called Ur-och-skur preschools. The Ur-och-skur philosophy was initiated by Friluftsförbundet, which is a non-profit organization arranging various outdoor activities for its members. Both in nature-preschools and Ur-och-skur preschools, the children spend most of their day outside, learning from nature.

To further promote an environmentally sound focus in preschools, there is the aforementioned certification “Green flag”. Also, a definite trend that we

can see today is to construct preschools with passive house or low-energy standard.

The preschool has an important role and a great opportunity to work towards a sustainable development. It is possible to involve both children, staff and parents and work with ecological, cultural and economic sustainability issues at various levels.

Implementing the sustainability factor in the preschool can be done in many different ways. By using solar, water or wind power to produce energy, the children can learn of natural science as well as resource efficiency. By integrating features such as waste recycling, organic cultivation and water reuse, it is possible to initiate an environmentally healthy behaviour among the children from an early age.

Sustainable solutions may also induce an inspiring play environment, for instance well-insulated walls which create cozy window rooms to sit in, or a greenhouse providing a half-outdoor space where the afternoon rest takes place underneath the foliage of exotic trees.

Transferring the activities outside into the forest or a nicely designed playground with lots of natural elements will also teach the children about nature's processes while simultaneously letting them play freely and developing their motor sensor skills.

The hundred languages of children:

*A child has a hundred languages
but is deprived of ninety-nine.
School and culture
separates the head from the body.
They force us to think without a body
and act without a head.
Play and work,
reality and imagination
are made to be opposites.*

- Loris Malaguzzi

Grut 2005 p. 13



A preschool home room, Reggio Emilia style. Förskolan Ugglan.

The importance of being outdoors

On the website of the Institute of Public Health, an article can be found which clearly states the positive effects of children being outdoors during their time at the preschool.

There are several studies which suggest that children experience a higher level of well-being when allowed to be outdoors, in comparison with children spending most of their time indoors. A preschool which offers the children contact with nature and animals is likely to reduce troubles with mental health issues among the children.

Another positive effect, for the teachers as well as the children, is that the noise level is generally reduced outdoors.⁴

“ Being outdoors have several positive effects on both the mental and the physical health of preschoolers. Both the time outdoors and the outdoor environment in itself is significant.

www.fhi.se 2012

”

The opinion whether children spending more time outdoors are healthier with regards to infections and viruses differs between various surveys, however the majority of opinions is that it is in fact a truth.

A nationwide Swedish survey made among 0-2 year olds shows that children allowed to be outside at least six hours a week do have a lower illness-related absence rate than others. It is also seen that children with access to natural green surroundings are healthier than children spending more time indoors and who lack a naturally green playground.

Another Swedish survey shows that children attending so called Rain-or-shine-preschools are significantly healthier compared to those in traditional day care. However, a Norwegian study does not find any differences between

regular preschools and outdoor-preschools. Instead it points to the fact that it is more difficult to maintain good hand hygiene when spending a lot of time outdoors.

There is always a balance to maintain, because it can also be a stress factor for the children, having to put on and take off clothes several times a day if for instance all meals are served indoors, but a general conclusion can be that a major part of the day spent out in the nature and generous amounts of fresh air has a good impact on children's health.

The outdoor environment is a very important aspect to consider when letting the children outside. A spacious playground with trees, shrubbery and hilly terrain provides more physical exercise and natural sunblock.

Inspiring surroundings have shown to change the hierarchy of the children's play. Play roles become more equal and the play itself takes more imaginative shapes and structures.⁵





Plants and other landscape features provide additional opportunities for social, emotional and cognitive development in children, as well as better concentration abilities and motor sensor skills.

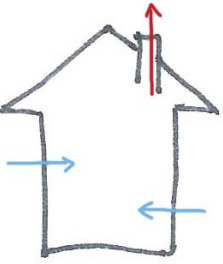
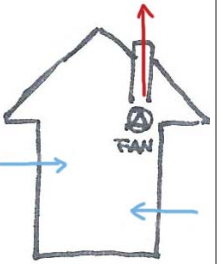
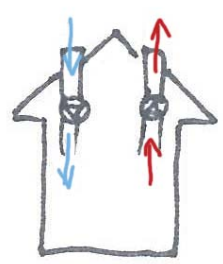

Finally, children spend more time outdoors if they have access to a play-friendly environment.

4 <http://www.fhi.se/Handbocker/Uppslagsverk-barn-och-unga/Forskola--betydelse-av-utevistelse/> 2012-01-19

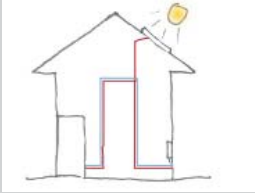
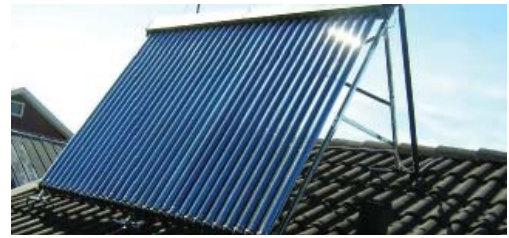
5 Lecture by Fredrika Mårtensson, Senior lecturer, Sveriges lantbruksuniversitet

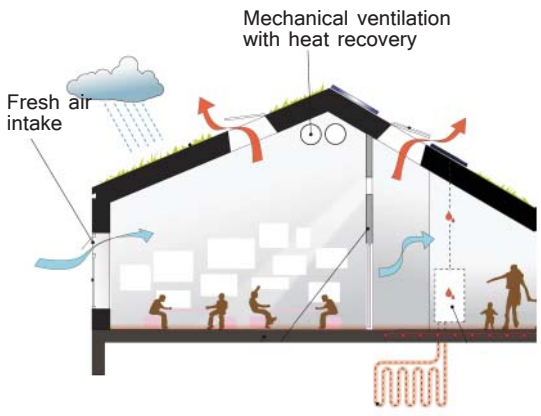

	Principles		Pros/cons	Relevant for the design
Ventilation				
Natural:	Air intake by the windows and through leaks, exhaust by stack effect via chimney or similar.	 <i>Natural ventilation</i>	+ No electricity required, no generated noise. - Difficult to control the amount of air, noise from outside and the temperature. Creates thermal bridges in the building envelope, and there is no method of reusing the heat.	Requires a certain ceiling height for the stack effect to function. Without the ceiling height, there will be a need for extra reinforcement by fans, solar chimney or similar. Then those need to be integrated in the design.
Mechanical:	We differentiate between F - exhaust only, FT - exhaust and intake, and FTX exhaust, intake and heat exchange.	 <i>Exhaust ventilation</i>	+ Controllable, filterable, and ensures a good thermal comfort and clean air. FTX also eliminates the need for a separate heating system if it is supplemented with a heating coil. - Demands energy to operate, excessive noise may occur, and requires a continuous maintenance in order to sustain the efficiency.	FTX needs a relatively large technical space. Ventilation ducts needs to be integrated in the interior design, could be used as a design element. Air intake (i.e. placement of heat exchanger) should preferably be towards the north.
Hybrid:	Natural ventilation with a backup support system of mechanical ventilation.	 <i>Mechanical exhaust and intake</i>	+ Decreases the need for energy-consuming mechanical ventilation, suitable for classrooms with little need for heat recovery. - Very complicated to regulate, with the combined cons of natural and mechanical ventilation.	Could be solved with a smaller technical space. Installation of both methods might require both a technical space and skylights.
Heating				
Passive:	House heated by solar insolation combined with thermal gains from inhabitants and appliances. Backup provided by district heating, heat pump or similar.	 <i>Passive heating from sun</i>	+ Small or no costs for heating, no CO ₂ -emissions. - Limitations of freedom to open windows and doors. Backup-system is required in cold climates which demands an installation.	Large amounts of insulation to make building envelope air-tight creates thick walls. Window area limited to approx. 15% of floor area.
Active:	Waterborne systems, heat pump, solar thermal, air-to-water etc.	 <i>Active heating waterborne system with solar thermal</i>	+ Controllable, reliable and combinable. - More or less energy-consuming.	Requires technical space.
Solar energy				
Solar thermal:	Simple construction of a metal sheet absorbing solar heat and transferring it to fluid heat storage.		+ Cheap installation which reduces costs for hot water. Can be used as passive floor heating. - Requires water accumulation tank.	Optimized roof inclination angle required. Can be integrated into the design.
Solar cells:	Different kinds of conductor materials which transform solar heat to electricity.		+ Reduces energy costs significantly. - High initial cost. Efficiency not optimal in Sweden. Requires maintenance and technical knowledge.	Optimized roof inclination angle required. Can be integrated into the design.

Relevant for the education	Inspiration/ideas	Low-energy/low-tech house	Passive/high-tech house
<p>The stack effect which is utilized in natural ventilation is a part of basic science, which could be taught to the children. How warm and cold air behave differently and that it is useful in buildings.</p>	 <p><i>Hybrid ventilation system, with a solar driven heat pump.</i></p>	<p>Might be solved through a solar chimney, or intakes through windows and exhausts through skylights. Efficient heating is crucial.</p> <p>Exhaust ventilation is a good “low-tech” option, where air intake is done by openings around windows and the exhaust is operated by fans in kitchen and bathroom. Very much more controllable than natural ventilation, and with a minimum of technical parts.</p> <p>Efficient in a technological system with sensors and a weather station, controlling the air levels automatically. A lot of technology which might malfunction.</p>	<p>Not a possibility since the passive concept is based on complete tightness of the building envelope and controllability of air intake.</p> <p>Most commonly used, with the FTX-solution, which also distributes additional heat when needed.</p> <p>The natural ventilation might be used during the warmer season, but the mechanical backup needs to be operated a large part of the year to keep the interior temperature at a decent level.</p>
<p>A sustainable heating solution is something that could help initiate a sustainable behaviour among the children at an early age.</p>		<p>Air to water heat pump is a low-cost, low-energy alternative to passive heating. The installation cost is lower than that of a regular heat-pump, since there is no need for drilling. This is also a minimized impact on surrounding nature. Maintenance requirements are low, and the pump can be connected to a solar thermal system, eliminating the need to use it on sunny days.</p>	<p>Utilizes passive heating, the optimal way of take advantage of solar heat.</p> <p>Buildings might be cold in the mornings, but usually reaches a comfortable temperature during the day. Backup-systems generally kicks in when the interior temperature falls below 16 ° C.</p> <p>Summer sun is blocked out to avoid overheating, while winter sun is let in.</p>
<p>Both solar thermal and photovoltaics could be used as an educational instrument, teaching the children both science in how electricity works and resource efficiency in how we need to be careful with our energy use. The children can learn about different kinds of energy production and the differences between renewable and finite energy sources.</p>	 <p><i>Facade pattern created by integrated photovoltaics.</i></p>	<p>Solar thermal is a good way of using free solar energy without expensive installations and maintenance.</p> <p>Photovoltaics might be a too technical and maintenance-intensive option.</p>	<p>Can help reduce hot water costs in a passive house, however is not recommended to use as floor heating.</p> <p>An extensive solar array in an optimized angle can cover the energy-need for household appliances in a passive house.</p>

Discussion:

Combining a passive house technique with a natural ventilation creates a more complicated situation than it is worth with regards to reducing energy use and need for maintenance. To design Passive houses with FTX-ventilation is a well-proven method, and experience tells that it is well-functioning as well.

The energy required to run the FTX-system is more than counterbalanced by the energy saved by minimizing the need for heating in a passive house, and it could also be provided by photovoltaics.

However, the FTX-system demands a large installation space in relation to other ventilation methods, it requires continuous maintenance to function properly, and it is a rather complicated system which puts some limitations to the freedom of movement in the building. A certain awareness as to how the system works is necessary among the building users.

If the objective is to avoid any too complicated technical solutions which might be prone to malfunction and require extensive maintenance, the passive house might not be the perfect solution.

Nor is this method the sole option to obtain a sustainable and environmentally responsible building; it is possible to find a balance between reduced energy use and the high-tech approach.

An alternative is to use some of the aspects of passive house design, for example blocking out the hot summer sun and using the more welcome winter sun as an additional heat source. In Sweden, the interior comfort during the colder months is still one of the largest aspects to address, despite new techniques and progress. To use the winter sun is sensible in a building aiming to be low-energy.



Another technique which is reasonable to use is generous amounts of insulation material to make sure the building envelope is tight and minimize any thermal bridges. Demanding a U-value of around 0.1 W/mK is where we need to be today. The wall thickness could also be used as a design

parameter. Top-of-the-line, triple-glazed windows are mandatory to create an low-energy building and a comfortable interior climate.

All these aspects combined give us good conditions and the freedom to choose a more low-tech ventilation system together with an environmentally responsible heating system.

The Kareby nature-preschool uses exhaust ventilation throughout the building, and the staff working there experiences the fresh air situation as a good one, with proper circulation of air and no headaches. The only disadvantage is a minor draft through some rooms, but since this bother neither the children nor the staff since the environment is such an active one.

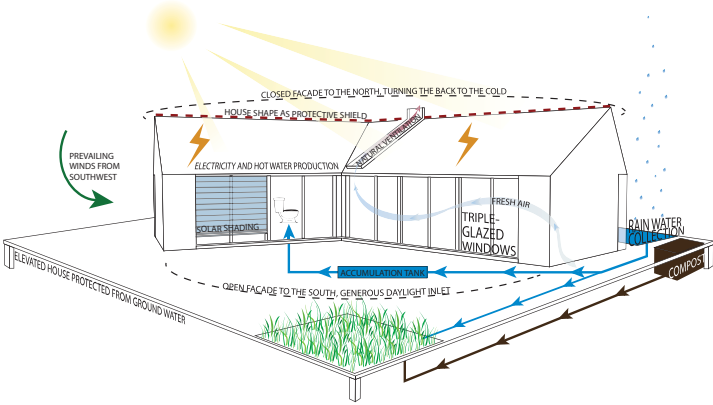
For this proposal, my conclusion is that a system with a geothermal heat pump in combination with exhaust ventilation would be suitable. A geothermal heat pump is a long-term durable choice with a minimum of maintenance. The exhaust ventilation is low-tech and efficient.

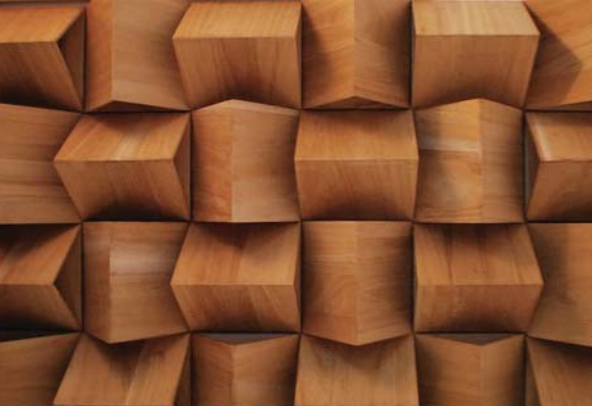
	Orientation	Design	Materials	Ideas
<p>Climate adaptation</p> <p>Wind:</p> <p>Solar conditions:</p>	<p>Very windy site, create wind shelter with building or greenery.</p> <p>Create comfortable outdoor spaces in both sunlight and shade. Roof inclination oriented towards the south to enable solar energy production.</p>	<p>A sheltered, but unconditioned semi-outdoor space ensures the opportunity to play freely even in bad weather.</p> <p>Solar shading blocking out summer sun and letting in winter sun. Keep the amount of windows oriented to the south at a minimum without restricting the daylight. Use the surrounding natural elements in the design.</p>	<p>Keep the building envelope air tight with good insulation material.</p> <p>Use materials which have the smallest possible impact on the environment; natural materials such as wood, or recycled materials such as cellulose fiber.</p>	
<p>Energy use reduction</p>	<p>With the building oriented towards the sun, heating needs can be reduced by using the solar insolation to heat the rooms. Windows towards the north should be considered as larger thermal bridges during night, than those in facing other directions.</p>	<p>By keeping the sprawl of the building envelope to a minimum, heat losses are reduced. The general preschool is not optimal, since most functions are located on the same floor, Wind breaks are crucial to reduce heat losses from opening doors. With parts of the building covered by an unconditioned envelope, it is possible to minimize heat losses from other thermal bridges and windows.</p>	<p>Low-maintenance, durable materials ensure a long-lasting building, while natural materials might be less expensive and renewable. Materials should meet at least one of these criteria: renewable/recyclable/reusable low-energy production durable non-toxic in all stages of use. Choice of materials is always a balancing act depending on building type, building use and expected life time. The cradle-to-cradle aspect should always be considered.</p>	 <p><i>Foam glass made from recycled glass, and Superwood® - ecologically impregnated wood.</i></p>
<p>Water efficiency</p>		<p>Water games can be located outdoors or semi-outdoors, and use rain water to the largest possible extent. This way tap water use is automatically reduced. Rain water can also be channeled to irrigate plants and cultivation pallets.</p>	<p>A roof material which absorbs water is preferable, to reduce the pressure load on day water treatment.</p>	
<p>Interior comfort</p>	<p>By building orientation make sure that as few rooms as possible face only one direction of light.</p>	<p>Before-mentioned solar insolation is very important for the interior comfort. Excessive sunlight creates awkward and sometimes unusable spaces, wherefore shading is crucial. However, the shading should in no way thwart the natural daylight inlet which is also very important for the interior comfort. Indirect light, such as a skylight, is a nice design solution.</p>	<p>To create a comfortable noise environment, specific materials can be utilized, such as soft, absorbing and irregular materials. For hygienic reasons, textile materials – which are the most efficient sound absorbents – should not be used in preschools, but alternatives can be found. Children are often playing on the floor, which makes it important to use healthy, comfortable and durable floor materials, while walls can be more imaginative (but still healthy) to create a tactilely interesting environment to explore.</p>	 <p><i>Wooden wall designed to diffuse noise.</i></p>

INTERPRETING PEDAGOGICS
INTO ARCHITECTURE



The design of a preschool

There are several aspects to consider when designing a preschool, regarding both placement, interior and exterior environment.

Placement

The preschool is preferably placed strategically in connection to a residential area, to be able to serve the nearest neighbourhood as well as outer areas. It is important to take into account surrounding disturbances, such as traffic noise, air pollution, animal livestock, and power lines.

A possibility to place the preschool close to an elementary school is positive, since it enables a sharing of certain facilities, such as kitchen or gymnasium. If the size of the site is limited, a small playground can be compensated by a vicinity to a public playground or a forest.

Exterior design

Exploration and physical activity are important features in children's play and development, which is why the exterior playground of the preschool should be adapted to allow and stimulate such activities. Wind cover and solar conditions are also essential design parameters since children should be able to spend a major part of the day outdoors in a comfortable environment without risk. During the darker months, the playground should be sufficiently illuminated.

A very important part of the exterior area is the logistics of leaving and picking up the children; the car area should be separated from the playground area and there should be functioning pedestrian and bicycle paths to and from the preschool, giving the parents the choice of leaving the car at home.

Transport of goods and food deliveries should, if possible, be separated from other car traffic.

Interior design

If needed, the preschool should be designed for alternative functions such as after school activities or elementary school. This is also in accordance with a sustainable approach of flexibility,

Traditionally, Swedish preschools have been designed as single storey buildings to facilitate movement for the children and supervision for the staff. However, this requirement is currently being revised as demands are being put on energy efficiency and centrally located preschools in densified cities. Specific interior requirements are put on materials, which should be easily cleaned, resistant and healthy. Noise levels should be kept comfortable, and natural daylight should be prioritized with a minimum of 10% window area compared to floor area.⁶

Design parameters for this project

Early on, I decided that the educational curriculum for preschools, published by Skolverket would form a sort of foundation on which to base the design work. I have chosen a few quotes from the document which has to do with the built environment of a preschool and can be interpreted as design parameters.

In addition to that, I have used the book "Children, spaces, relations – metaproject for an environment for young children", which is a publication focusing on the built environment of the philosophy Reggio Emilia. Although this preschool is not to be designed according to a specific pedagogy, the book offers a useful and thorough investigation on spaces for children with a lot of design parameters which I believe are both sensible and important.

Children's scale

When designing for children, special consideration should be taken to the children's scale, which is naturally very different from that of grown-ups. Furniture and appliances are generally adapted to suit the children's height, but focus should also be on architectural elements such as windows and height differences. A window placed in the right height for a child can function not only as a connection to the outside, but a seating place or hideout.



Quotes from the Educational Curriculum for preschools

“
1 p. 6 The preschool should offer the children a safe environment which is simultaneously challenging and attractive for games and activities. It should inspire the children to explore the surrounding world.
”

“
2 p. 7 To create and communicate by means of different ways of expression such as painting, singing, music, drama, rhythm, dance and movement as well as by means of spoken and written language constitutes both the contents and methods of the strive to promote children’s development and learning.
”

“
3 p. 7 The preschool should contribute to the children acquiring a careful approach to nature and the environment as well as understanding their participation in the natural cycle.
”

“
4 p. 7 The children should be able to switch between different activities during the day. The facilities should allow space for the children’s own plans, imagination and creativity in games and learning, inside as well as outside.
”

“
5 p. 9 The environment should be open, rich in content and inviting.
”

“
6 p. 12 The needs and interests which the children themselves in different ways express should be the basis of the design of the built environment.
”

Interpreting the quotes by keywords and sketches:

1

Challenging space attractive for games
Inspiring space

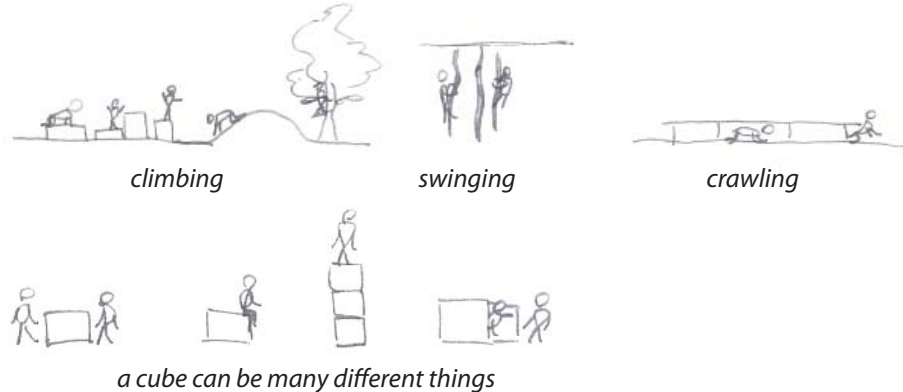

4

Different activities
Own imagination

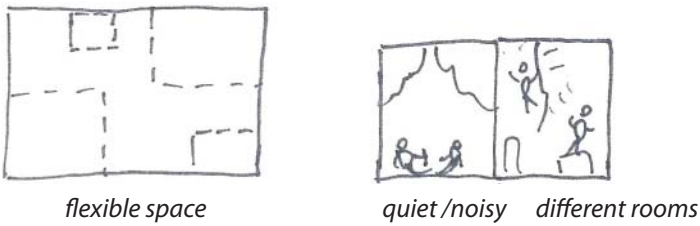

2

Communication by artistic expression
and movement

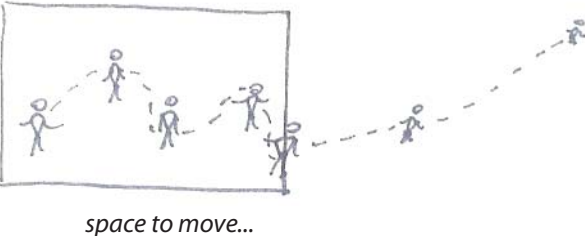

5

Open and inviting



3

Learning about sustainability

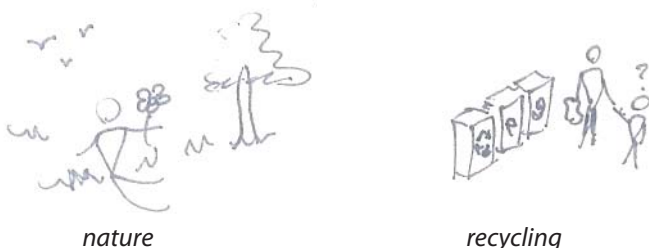

6

Listen to the children



Reggio Emilia parameters

- relational forms:

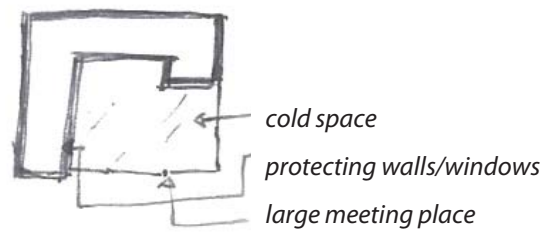
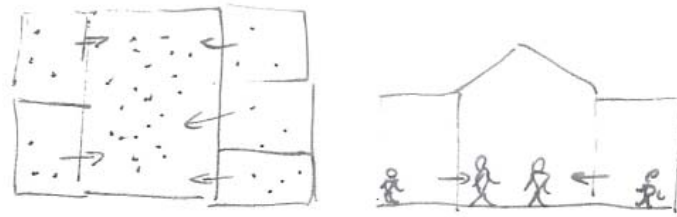

the central piazza
a common space to meet, large enough
for free movement

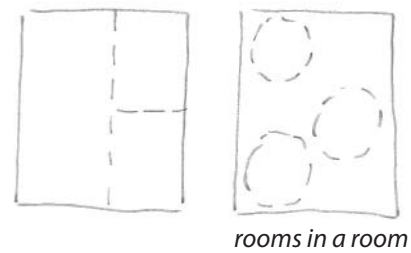
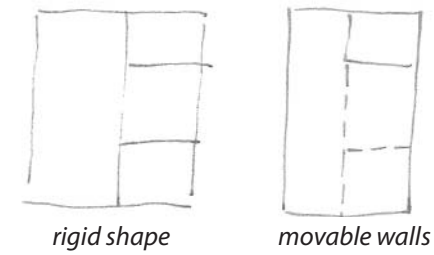

transformability and flexibility
rooms can fit different functions and
group sizes

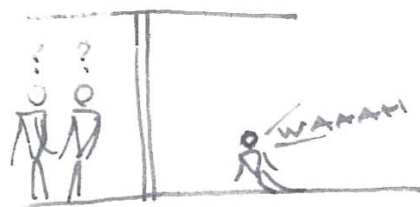

transparency & communication
important that the staff can supervise
the children visually and audibly

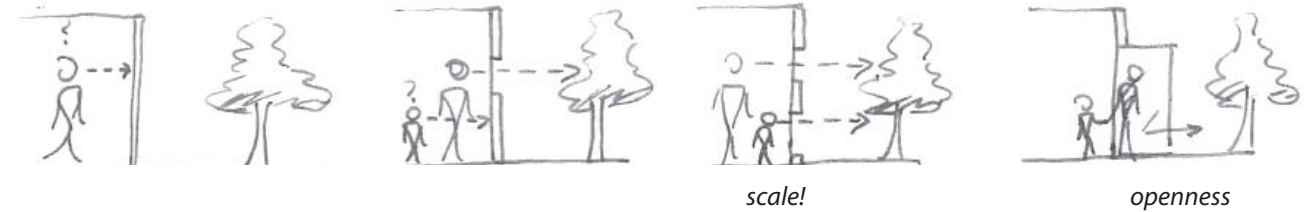

inside-outside relationship
visualizing and bringing in the nature,
on a child's scale

Reggio Emilia parameters

- creating lightscapes:

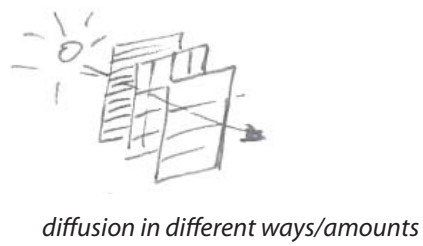
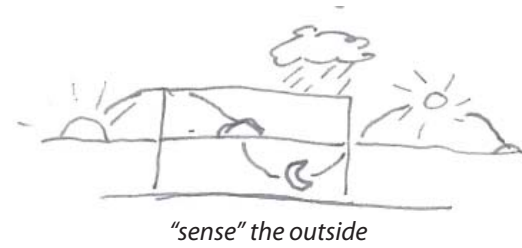

quantity
daylight conditions vary over the day
as well as with diffusion

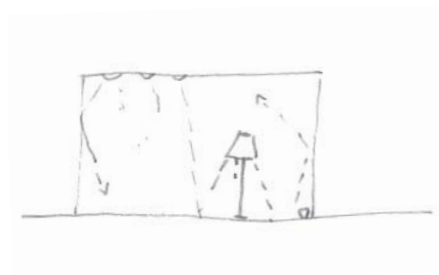

mixed lighting
different kinds of artificial light sources
combined with daylight

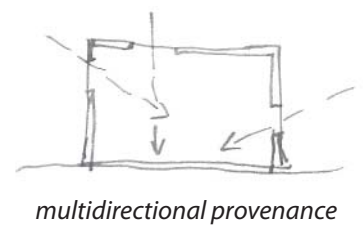

distribution
multidirectional provenance creates
interesting rooms

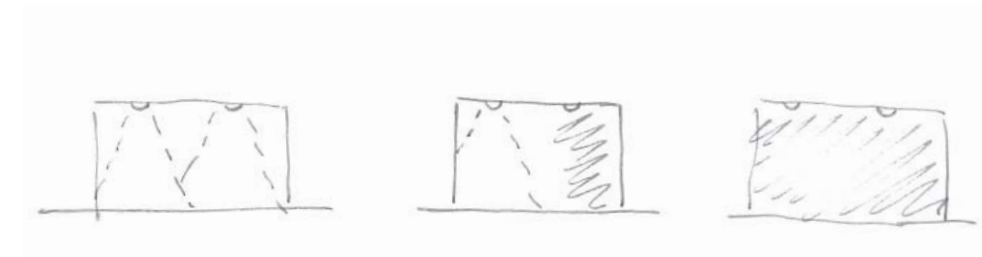
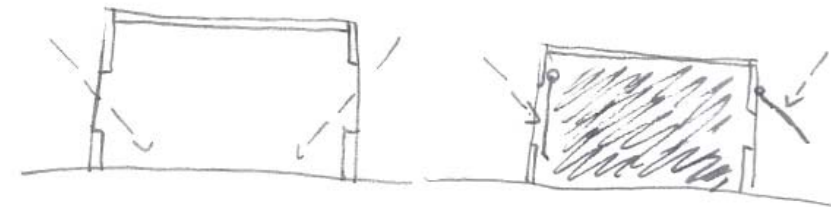

manipulability
important to be able to create a
completely dark room



variation
different amounts of daylight are let in
depending on hour and season

Reggio Emilia parameters

- sound:

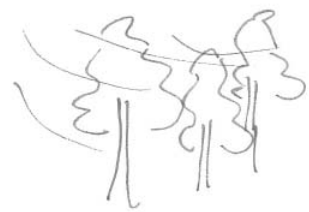

wind in the trees



bird song



rain drops



wind chimes

outdoor soundscape
allow and create natural and interesting sounds

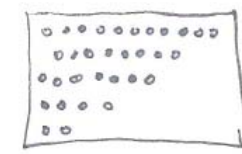

perforated walls with absorbant material



deep window niches with inclined edges

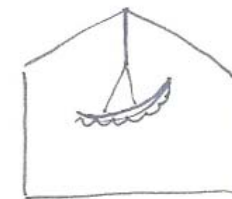

decoration hung from ceiling



irregular ceiling



pleated ceiling

absorption and diffusion
simple design solutions which will help obtain comfortable noise levels

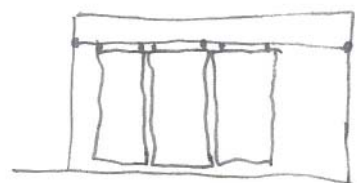

partitions

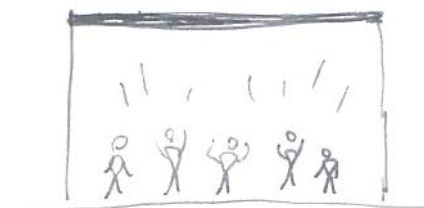

noise reducing materials

variable acoustics
to be able to shut out noise at will

activity
take special precautions in rooms where activity is high

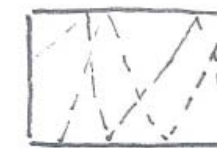

noise bouncing



avoid parallel walls

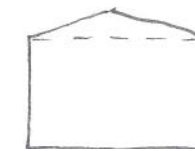

avoid echo by design
design the room shapes to reduce noise

Reggio Emilia parameters

- microclimate:

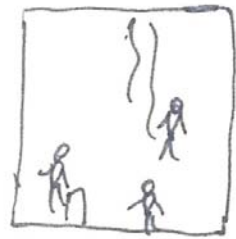

large space for lots of activity



smaller space for calm games



floor heating



green barrier towards the road



green roof reduces emissions

temperature flexibility
different spaces require different temperatures

eliminating aggressive external agents
solutions with greenery can absorb emissions and noise

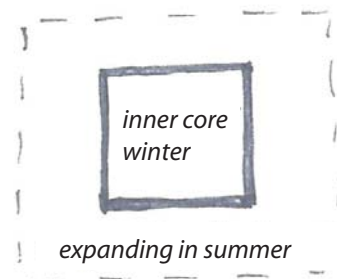

summer/winter
the house as a natural lung using different spaces depending on season

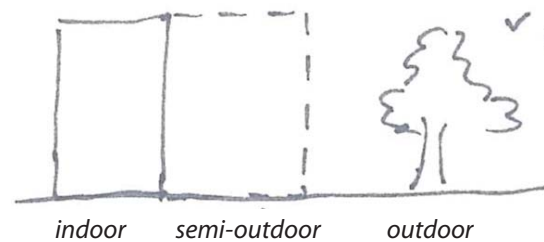

interior-exterior climatic zones
a semi-outdoor space can enhance the connection inside-outside

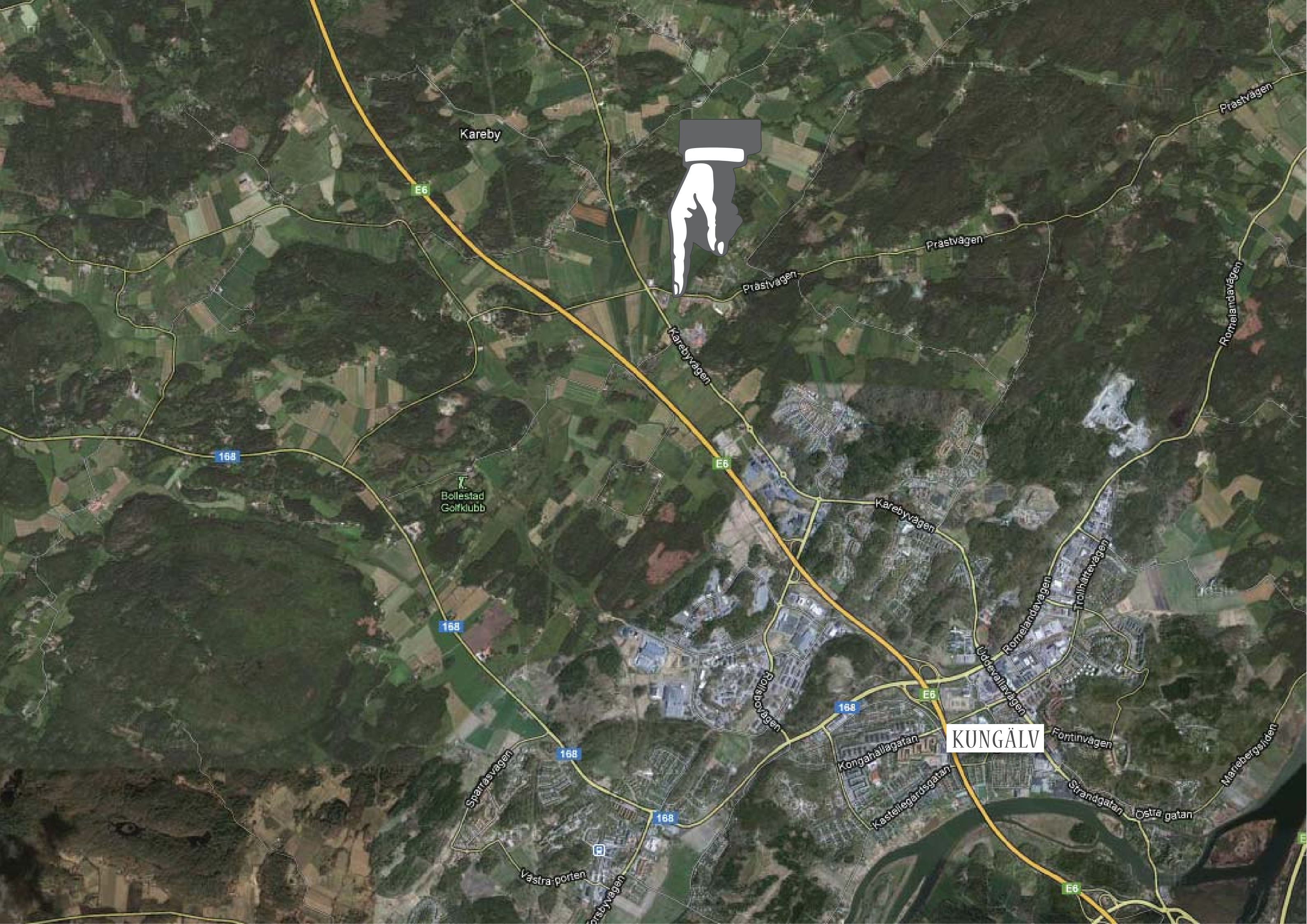

Kareby

E6



Prästvägen

Prästvägen

Karebyvägen

Prästvägen

Romelandsvägen

168

K. Bellestad Golfklubb

E6

Karebyvägen

168

Romelandsvägen

Romelandsvägen

Trollhättansvägen

E6

KUNGÄLV

Ullensållsvägen

Fontinvägen

168

Skarösvägen

168

Kongahällagatan

Svanögata

Östra gatan

Märtebergsgatan

168

Västra porten

Kastelegårdsgatan

E6

KAREBY, KUNGÄLV



Kareby

Kareby parish is an ancient district, mentioned as early as in the Icelandic Sagas, and is situated some five kilometers north of Kungälv on the western coast of Sweden. The agglomeration consists of around 300 inhabitants. The railroad track “Bohusbanan” cuts its way through Kareby, although no train station is positioned there.

The landscape of Kareby is dominated by extensive and fertile farmland, and in the center of attention, at the edge of the forest and hills, lies the medieval church which in parts dates back to the 11th century. The church is known to house a unique medieval baptismal font which has caused a lot of puzzlement among archeological scientists with its cryptic cipher inscriptions. All around the parish, the land is rich in ancient monuments, mostly various stone formations, and next to the church are remnants of a plague or cholera cemetery.

Between the main roads Karebyvägen and Prästvägen there is a folk museum with preserved buildings and a wind mill from the 1800's.

A spontaneous village centre has occurred at the crossroads of Kareby, where a local grocery shop, pizza place and car dealership can be found. The crossroads continues in four different directions; west towards Rörtången by the sea, east towards the sports ground at Kringledammen, north towards Kode and south towards Kungälv and Gothenburg.

The school of Kareby is located next to the grocery shop, educating students from grade one to six. Integrated in the nearby residential area are two smaller preschools, of which one is outdoor oriented.

Kareby has a strong sports' tradition with successful sports' clubs in both football and bandy. The sports are practiced mainly by the club house at Kringledammen, and the extensive football field next to the school. In 2011, the women's team became Swedish champions in bandy.⁷



7 http://www.kungalv.se/Cykla-fran-fastning-till-fastning/KulTurleder/Vattenhal/Kareby_hembygdsgard/
http://sv.wikipedia.org/wiki/Kareby_kyrka
<http://sv.wikipedia.org/wiki/Kareby>
<http://www.kareby.com/>



Surrounding design idioms

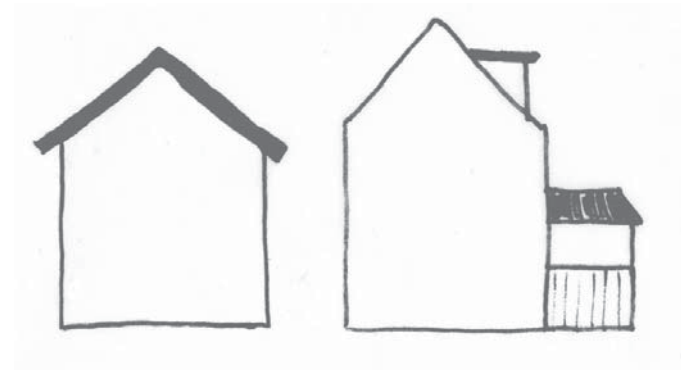

BUILDING SHAPE

*gable roofs and protruding elements
such as dormer windows and porches*

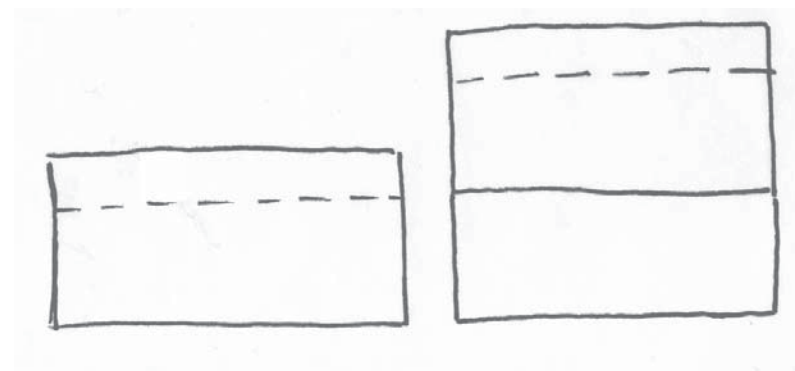

HEIGHT

*one and a half, and two and a half storey
buildings*

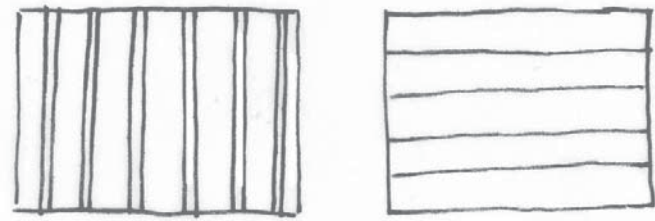

FACADE EXPRESSION
wooden panel cladding - both horizontal and vertical - in light colour shades

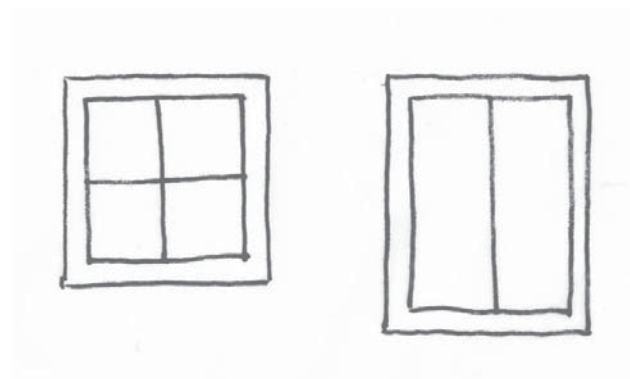

WINDOWS
relatively small, traditional, mostly with different kinds of crossbars





Kareby Bil AB

103

115
Prästvägen

130

Prästvägen

130

Murhammarvågen

36

38

37

Murhammarvågen

Rishammarvågen

Karebyvägen

Karebyvägen

Karebyvägen

Prästvägen

Hagenvågen

23

Hagenvågen

24

28

Prästvägen

Prästvägen

The site



February 3rd 10.00



May 2nd 16.00

Site analysis

Similar to the rest of Kareby, the site is extensive and flat. Adjacent buildings are relatively low in size, the tallest stretching to two storeys. These two facts imply that there is no interference of shadows from surrounding buildings; the only items to consider are the rows of birch trees separating the site from the road and buildings. Height differences on the site are virtually non-existent, as are almost any intrusive natural elements, with the exception of the birch trees.

Thanks to the flatness of the site, it is ideal for a one-storey preschool, which is the Swedish standard.

The generous size of the site also provides great conditions for a terrific playground.

Traffic noise and emissions from the large road Karebyvägen are a non-issue given the distance to the site. The more immediate road Prästvägen does not carry as heavy traffic, and is somewhat separated from the site by the row of trees.

Since the site is situated in such close proximity to residential areas, there are good opportunities for reducing the car use among parents and staff traveling to the preschool. Bicycling or walking should be promoted as a step towards sustainability.

The lush surroundings present a nice environment for children to play in.



ROADS

two larger roads with both car and bus traffic make up borders around the site, while smaller roads lead in between the houses.



PARKING

the school staff park their cars along the left flank of the site.

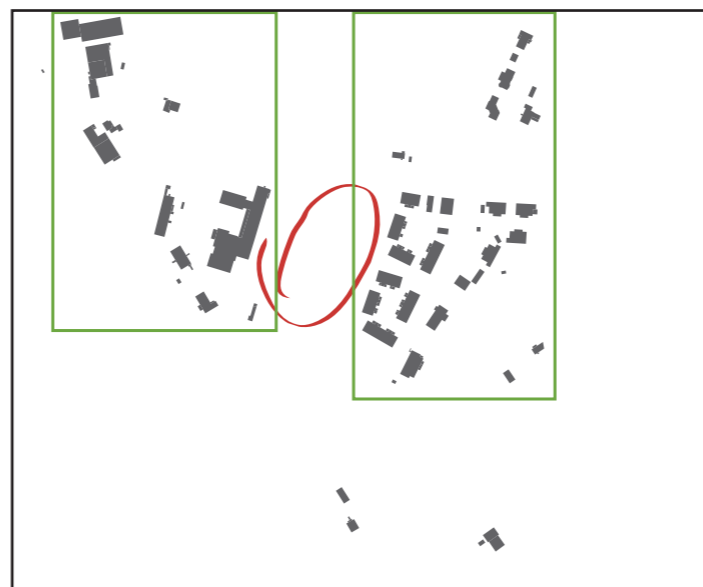

SURROUNDING TYPOLOGY

two main areas are identified; to the western side of the site is a commercial area, and to the eastern side a residential area.

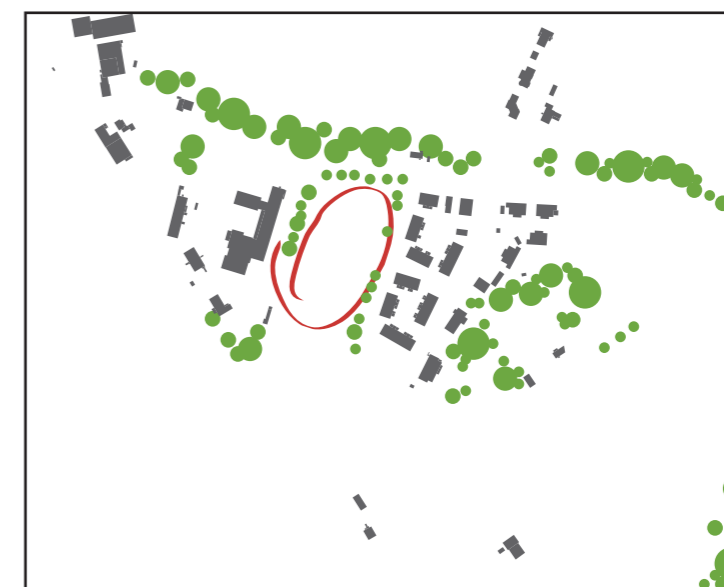

VEGETATION

despite the flat and open landscape there are plenty of trees in the area, which makes it green and lush.



 natural central node

 bus stop

 school

 preschool

 grocery shop

 pedestrian & bicycle path

 residential/minor car road

 major car road

 residential buildings

 commercial buildings

 school buildings

The wind direction is predominantly southwest over the year, with some wind from northeast in early spring.

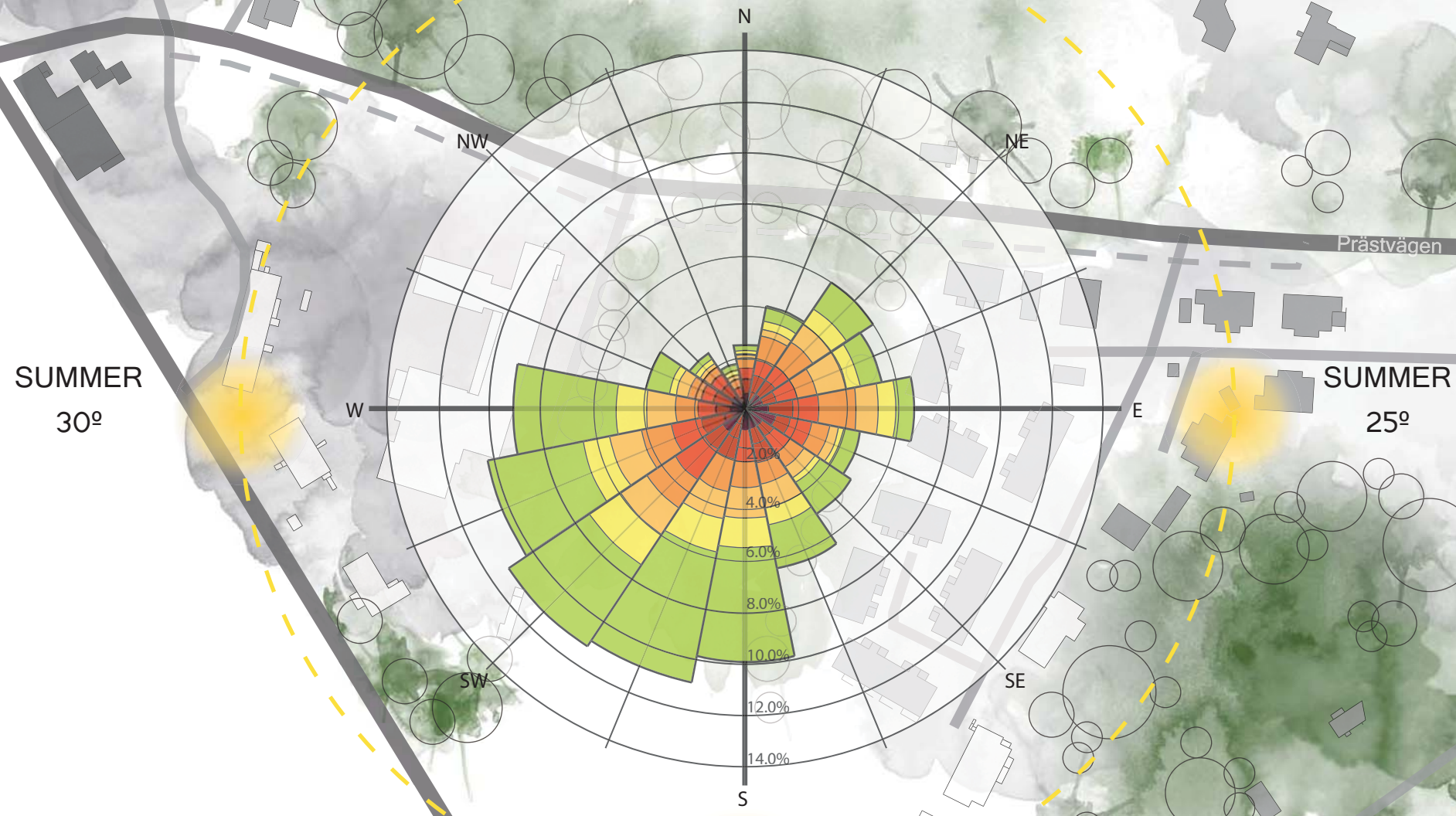

SUMMER 55° SPRING/FALL 32° WINTER 9°

SUMMER 55°
21/6 12.00

SPRING/FALL 32°
20/3 / 22/9 12.00

WINTER 9°
21/12 12.00

SUMMER 25°
21/12 07.00

SUMMER 30°
21/12 17.00



“

Building for children /.../ certainly presents a special challenge for designers. What architectural language is suitable? How can one lend appropriate spatial form to a pedagogic concept that seeks to impart certain values and abilities? In an environment where young people come to experience and comprehend the world around them, every aspect plays a crucial role.

Galindo 2010 p. 7

”

DESIGN PROPOSAL





Main design goal

The current situation with preschool facilities is somewhat untenable, and there is a need for development not only in the amount of preschools built in places with shortages, but also in the way they are designed and utilized. Baby booms come and go, increasing and decreasing the need for all sorts of facilities for children; it is similar to the expansion and contraction of a human lung. The facilities in which we house the preschool activities should be able to function in the same way.

The present solution to this situation is to increase the number of children in existing groups, utilizing temporary barracks, and to some extent producing more permanent preschools. The problems are obvious; larger groups create an impaired learning environment for the children, and an impossible work environment for the staff. Temporary barracks are not a bad solution in themselves, but they are not adapted to the specific activities of different preschools and they do not offer very inspiring surroundings by their design. Even the method of building a lot of new preschools presents a problem in the way that they are not always adapted to a change in use when the number of children decreases.

In Kareby, there is a need for more preschool places and there is a lot of space to use. The rural setting evokes a willingness to create a preschool which connects with the surrounding nature, in the building design as well as the education. Combining this thought with a flexibility of space creates favorable conditions for a socially, environmentally and economically sustainable preschool.

The case studies made early in the design process and the assessment of different educational methods have led to the conclusion that there are several reasons to focus on letting the children spend a lot of time outdoors in an inspiring playground. Benefits such as improved physical health, motor sensor skills and overall wellbeing are to be obtained from having access to a challenging outdoor space. The general space, indoors and outdoors, is

to be adapted to the children's size, with differently sized rooms and nooks which enable privacy as well as common play.

These are the thoughts that have formed the basis to the design proposal, to create a sustainable building adapted to the site and the use, focusing on the children and their connection and experience of nature. Key words are connections and nature, bringing about a safe, inspiring and challenging atmosphere for both children and staff to spend their days in.

Basic requirements from the municipality

Design approach:

- Low-energy building with solar power
- Build "towards" the school/share facilities or future merging

Interior:

- Flexible interior which could be used for other future activities
- Delivery kitchen (with a possibility to expand). Practical food cart transport.
- Atelier kitchen at each department (may be shared).

Incoming traffic:

- Practical traffic situation (kiss-and-ride)
- Food deliveries made by truck should be functional by the kitchen.

Surroundings:

- Fenced playground with sun and wind protection
- Stroller storage
- Neutral entrance for visitors

Size:

6 departments x 19-20 children = 114-120 children
3 teachers/department + 1 kitchen staff = 19 staff
A ratio of 8m²/child excluding the kitchen areas is recommended.

Design concept



Closeness to nature / connection inside-outside



Mix of small and large spaces to accommodate the children's scale

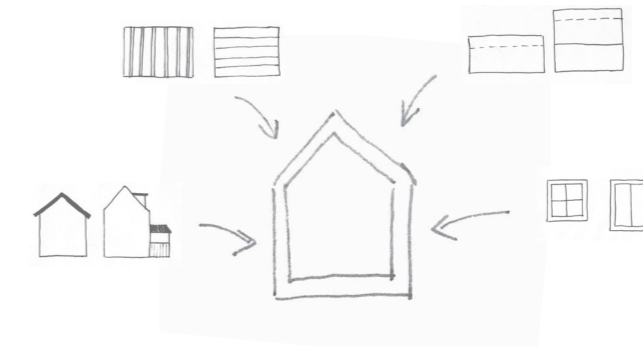

Development of existing design idioms surrounding the site



Low-energy building with sustainable features

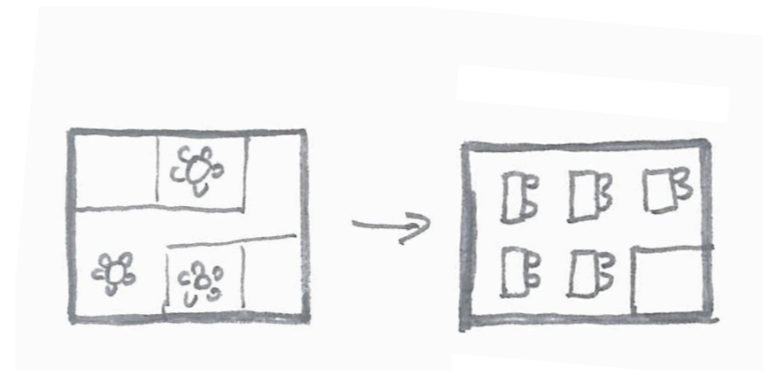

Flexible spaces to enable future changes in use



Connecting the preschool with the existing school

The landscape



The site is limited to the south, so as to maintain a part of the football field. The field can be used by the preschool, school and football club. Surrounding trees are retained, to keep the impression of lushness in the area.



A volume is placed at the northwest corner of the site, enabling a connection to the school. The building shape follows the borders of the site and embraces the northern part of the site. Outdoor spaces sheltered from wind are created by the shape.



The pedestrian and bicycle path is retained, and a car road is added which ensures a smooth traffic situation in the mornings and afternoons.



To the southwest, and in the northeast corner, the building volume is opened up towards nature. An inspiring playground is added and replenished with more greenery. A small hill frames the playground in the southeast corner, presenting opportunities for nice viewpoints and tobogganing during winter.

Function area program

Function	Area	Requirements	Activity	Other
Entrance	25 m ²	spacious	leave/pick up	separate main entrance
Wind break	10 m ²	room to sit down	first "dirt gate"	space for rain clothes and boots information board for parents
Coat room	12 m ²			
Drying cabinet	3 m ²			
Hygiene	16,5 m ²	not placed next to the eating area, could be connected with water games	wash hands and faces, change diapers	consider smell
Nursery/wash room	9 m ²	one WC close to entrance		
WC	2,5 m ² (x 2)			
HWC	2,5 m ²			
Home rooms	102 m ²	enough space for different kinds of games and private spaces	main room for each department, where most of the day will take place, when the children are not outside	may be shared by two departments
Activity room	20 m ²	isolated from rooms with noisy games		
Relax room	14 m ²			
Rough games	18 m ²			
Kitchen atelier	50 m ²			
Cleaning/storage	12,5 m ²	a small storage space required at each department		
Storage	4,5 m ²	can be shared by the whole preschool		
Washing room	4 m ²			
Cleaning room	4 m ²			

Function	Area	Requirements	Activity	Other
Staff rooms	72 m ²	isolated from the children, giving the staff some privacy	coffee-breaks, conversations, meetings, documentation	may be placed at a second storey
Relax room inc kitchenette	31 m ²			
Office	14 m ²			
Conversation room	12 m ²			
Changing room	9 m ²			
WC inc shower	5 m ²			
Kitchen	74 m ²	reception-kitchen with possibility to expand into a regular kitchen	preparing cold meal-components, delivering by food carts to the departments, washing dishes	separate entrance
Delivery area	15 m ²			
Kitchen	22 m ²			
Washing up	8 m ²			
Food carts	8 m ²			
Pantry	3 m ²			
Fridge	2,5 m ²			
Freezer	2 m ²			
Rinse room	4 m ²			
Office	4,5 m ²			
Changing room	2,5 m ²			
WC inc shower	2,5 m ²			
Cleaning room/storage	2 m ²			

Program visualization

Examining how the different functions should fit together.

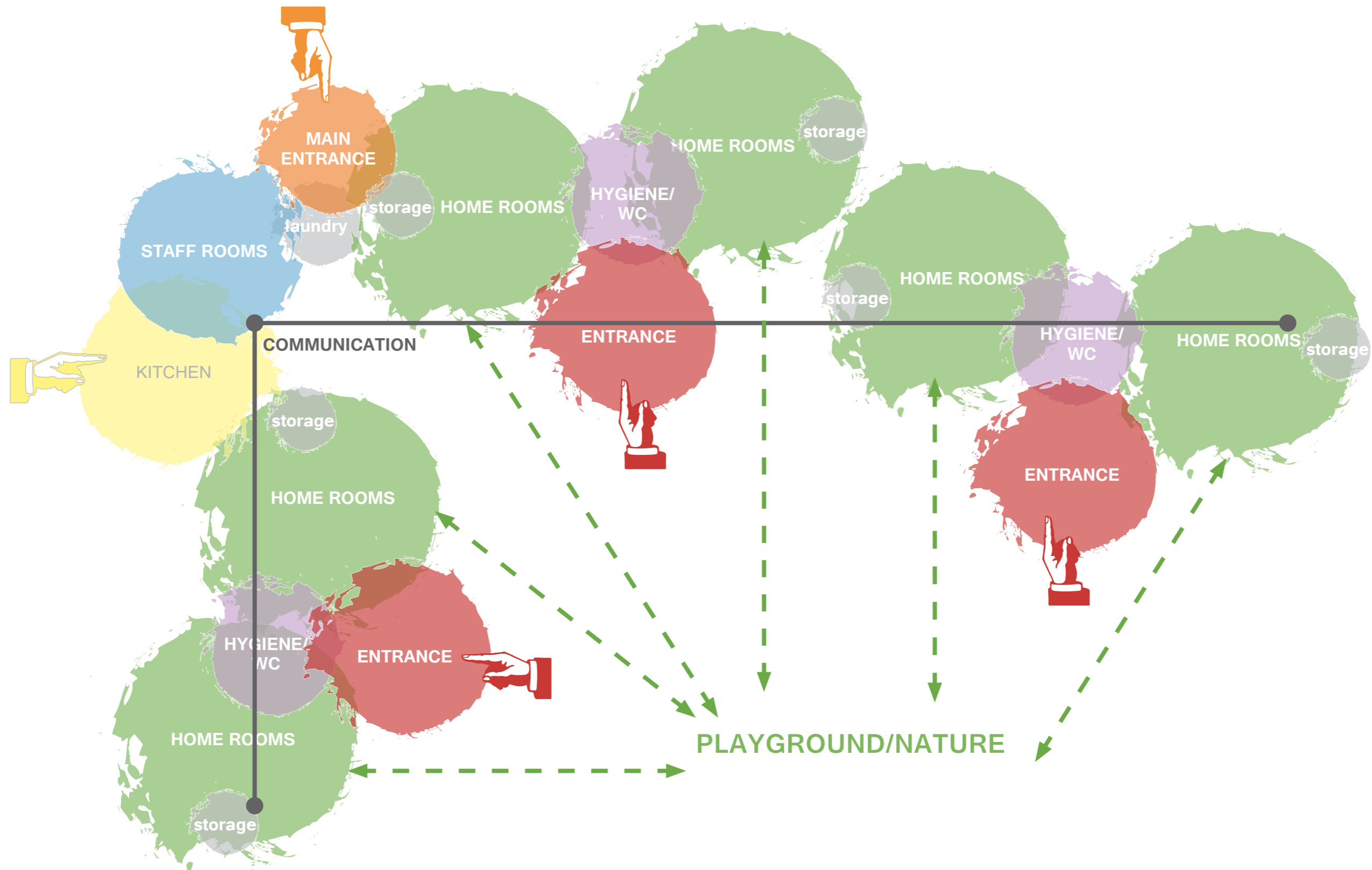

Axonometric view

The result of the program visualization, showing the spatial relationship between the functions.



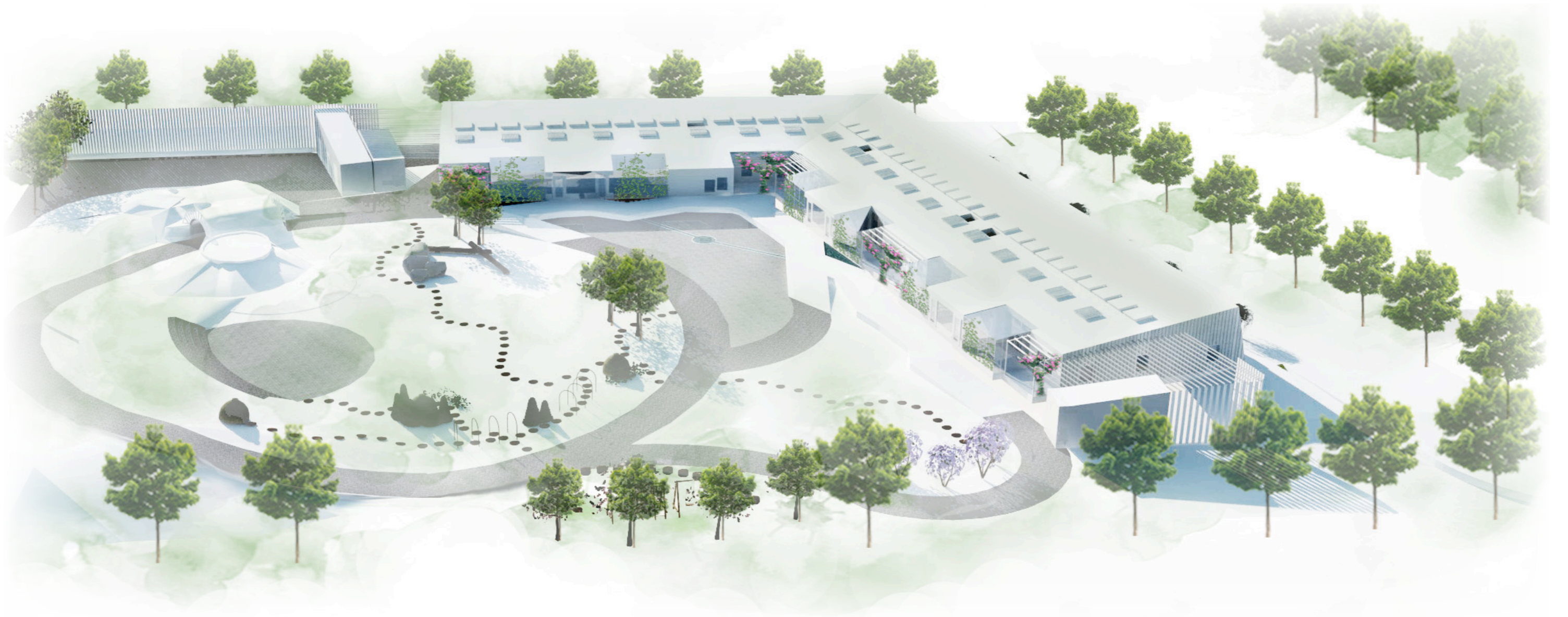

Nature surrounding the new preschool



Connecting to nature

So as not to exclude the existing nature on site, the surrounding birch trees are retained as a border between the new building and the road. The borders between inside and outside are blurred by different degrees of openness in the facade.

Greenhouses connected to the interior by large sliding glass doors provide a semi-outdoor space to be used from early spring to late autumn for playing and cultivating vegetables. They are a simple way of giving more space to the children, while keeping the energy use at a low. The preschool expands during the warmer months, and contracts when it is starting to get colder. The greenhouses are used throughout the year as a healthy sleeping place where the children can get some fresh air while taking their nap underneath softly rustling trees.

Alongside the greenhouses, generous window areas placed in heights that suit both children and adults look out onto rose covered pergolas, offering solar shading as well as a gentle transition from inside to outside.

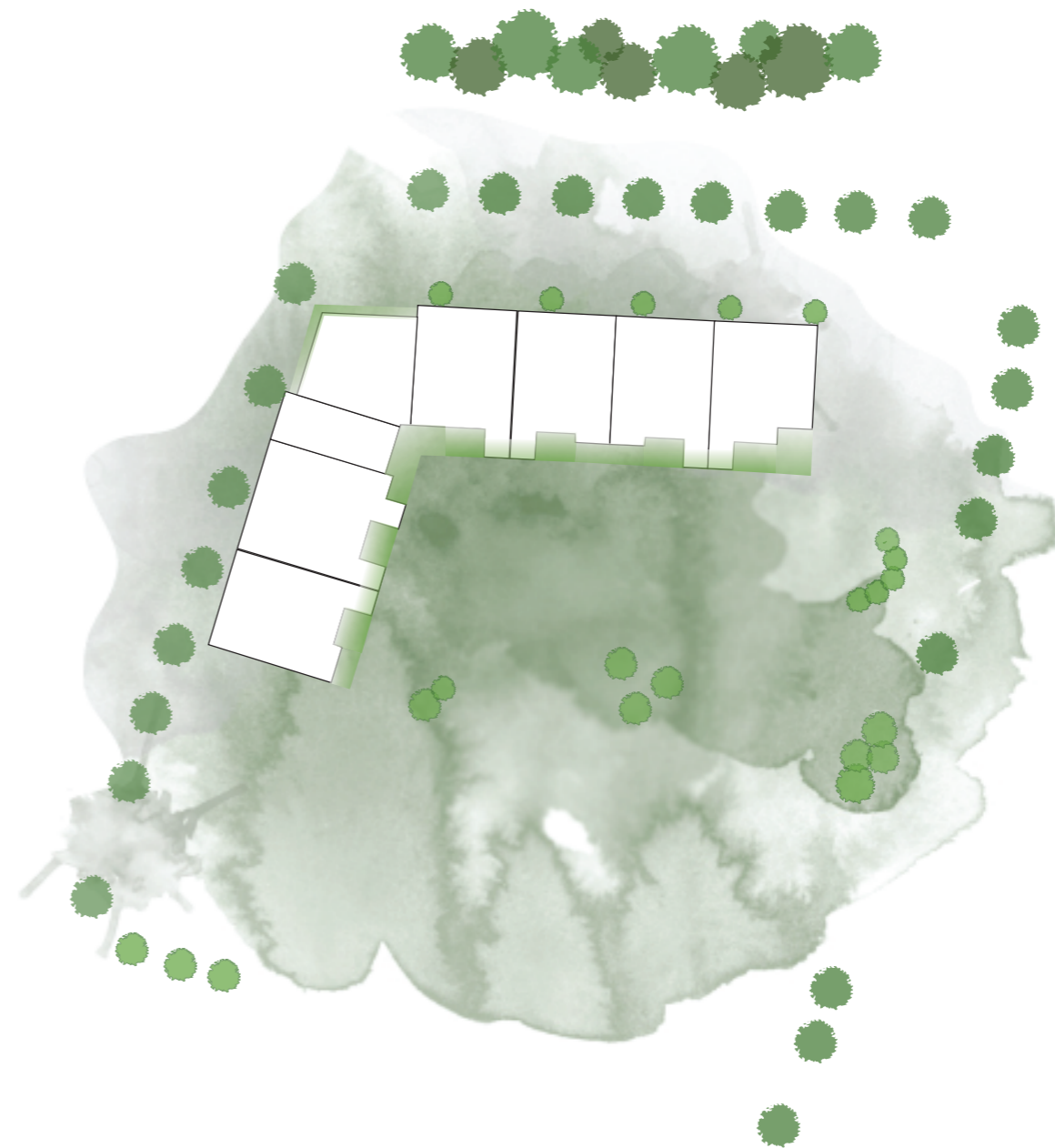

Inner core in winter



Expanding the space in summer



SOUND PATH

closing the eyes, listening to music and sounds...

MIRROR ROOM

looking, laughing, dancing, playing peekaboo...

GREENHOUSE

taking a nap, feeling the sun filtering through leaves...

CLOAK ROOM

bustling, saying hello, going to play outside...

GREENHOUSE

greenery, oxygen, fragrance, tasting the sun ripened tomatoes...

STORY CORNER

listening, learning, contemplating...



A sequence of rooms

To be able to move freely through a building, there is always need for some sort of communication space. In this preschool, it is designed as a sequence of rooms to be used by smaller groups of children, accompanied by a teacher.

At each department, one room is the cloak room, where each child has their own private shelf. Next to these rooms are the greenhouses, which are open or closed depending on season and temperature. Deployed in the middle of these rooms are the story corners, the mirror room, motion room and the sound path.

In the story corners – dedicated to learning and reflection – a teacher can sit with a smaller group of children, reading and teaching language arts.

The mirror room is a place for dancing, making funny faces and experiencing the light as it is reflected in all directions.

In the sound path, concealed speakers convey the sound of bird song or soft music. There you find a bench for sitting and listening, looking out over the whole sequence.

The motion room is for climbing, swinging and exploring the volume of space with your body.

All in all, the sequence of rooms might even be called a sequence of the senses; hearing – music and stories, sight – mirrors and light, taste – homegrown vegetables, smell – fragrant herbs and flowers, and touch – all the different materials and the soil and leaves of the greenhouses.





SLIDING GLASS DOORS

large glass areas ensures as much light as possible in the main rooms. The sliding doors are insulated and air tight.

VENTILATION

ventilation ducts are placed on either side of the wooden beam; this way their intrusion in the room is minimized.

WALLS

in the main room, the walls are made of a perforated wooden board behind which is a soft, sound absorbing material.



There are some comparatively simple design solutions which will greatly improve the interior comfort acoustically, such as non-parallel surfaces and deep window niches. In this building, the walls facing north and west are inclined as a remake of a traditional gable roof. This combined with the protruding bay windows create favorable conditions for keeping the noise at a comfortable level inside.

The main shape of the building is a structure of one straight and one leaning wall, covered by a gently inclined roof. By eliminating one corner of the regular shape, a more interesting design is derived. It also has the advantage of one less thermal bridge and one less parallel interior surface.

Added to the structure are large bay windows, the shape of which is created naturally by the inclined wall. These windows present small child-sized “rooms” – bright places to play with an excellent connection to the outside. The bay windows relate to the existing design idiom of protruding elements, found around the site.

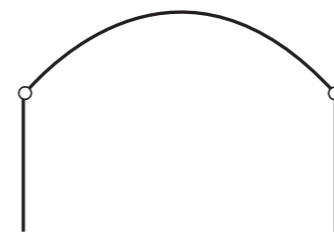

01 Self-supportive building

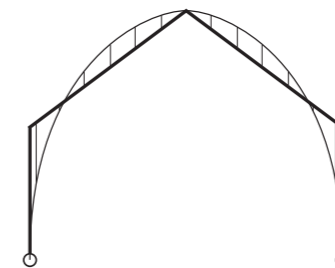

02 Traditional building

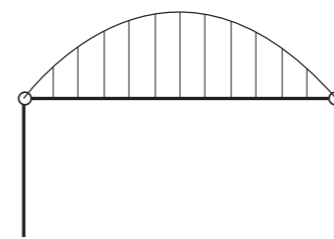

04 "Modern" building

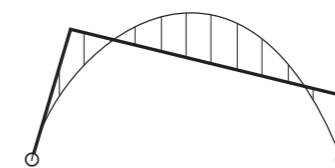

03 Proposed building

Principles of how different structures takes care of arc-shaped loads.

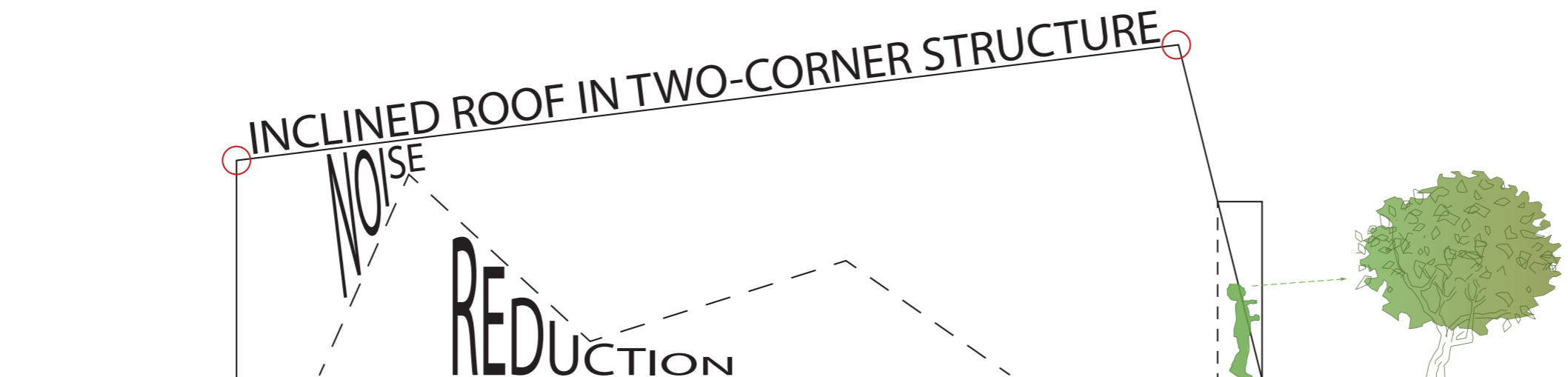

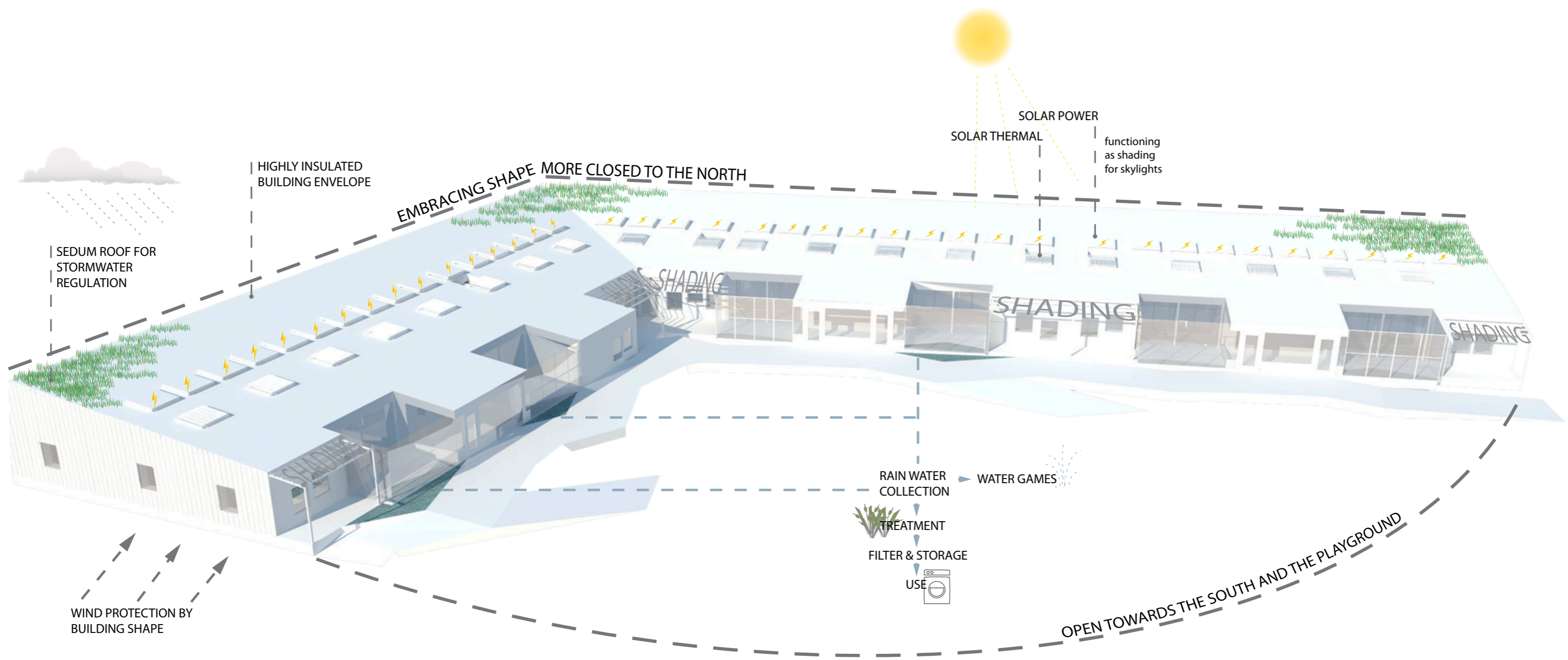

Technical sustainable solutions



Sustainable solutions

The sustainable design solutions are using and adapting to the natural elements, such as sun, water and wind, both in active and passive ways. Inside the building are screens for the staff and children to monitor their energy use and production.

The building design is more closed with smaller windows and a ventilated facade towards the north. It opens up towards the south and the view of the playground. To counterbalance the unavoidable sprawl of a one-storey building, the volume has been made more compact.

To achieve a low energy usage, the building envelope is air tight and maintains a low U-value. As does the windows, which are all triple-glazed towards the outside, with the exception of the ventilated facade in the staff room.

82 m² of photovoltaics cover a major part of the energy need on a regular day. Together with 42 m² of solar thermal for heating water, the energy costs are greatly reduced. The solar power functions as a complement to the geothermal heat pump, which is necessary during the darker time of the year.

There is also the possibility to further expand the photovoltaic array by attaching thin film photovoltaics to the bars of the pergolas, which are inclined at an optimized 32°.

The greenhouses create passive solar heating during winter, which complements the heat pump. During the warmer months, the greenhouses are ventilated by open windows, so as to avoid overheating. Calculations show that the temperature inside the greenhouses is slightly higher (approximately 1,5° C at an outdoor temperature of -5° C), which confirms the assumption that they help reduce the heat losses through the building envelope. These numbers do not take into consideration the temperature rise caused by solar insolation during sunny days. They also do not consider the heat transfer from inside the building envelope to the greenhouse, which will raise the

temperature within the greenhouse even further (giving approximately 5,2° C at an outdoor temperature of -5° C). For complete calculations, see appendix III.

Rain water collected in pools is used as a complement to the water from the grid, flushing toilets and irrigating plants. It is collected in open air basins, where cleansing water plants manage a first filtering of the water. From there, most of the water is led to underground accumulating tanks to be filtered a second time and used for the toilets.

In addition to these technical solutions, the choice of material is also environmentally oriented. Natural, reused and durable are the keywords for the materials.

All of these solutions can be used as educational aspects, teaching the children to take care and keep their own energy and water use at a minimum. By learning to grow their own vegetables for instance, the children get healthy habits from an early age.

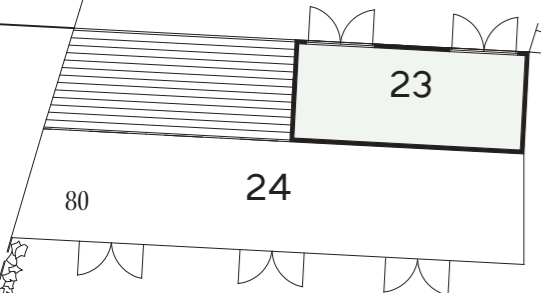
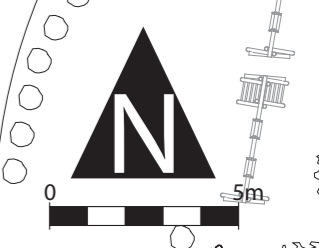

The building

Six departments are put into pairs, with a common wind break, cloak room and hygiene room combining them. The children enter at the backside of the building as seen from the road, and it is the same entrance they use for going to play outside. Shoes and rain clothes stay in the wind break, leaving the rest of the building free from dirt. Each department consists of one main room and two smaller play rooms, and an atelier shared by the adjacent department. In the atelier, activities such as baking or painting are possible; it is equipped with a refrigerator, oven and a sink. The plinth of the kitchen counter is extendible so that the children can reach up to the sink by themselves.

There is a miniature office at each department where the teachers can keep some of their documentation paperwork. The department main rooms are oriented towards the playground and can be elongated by opening up the sliding glass doors all the way out to the greenhouses. If you continue out from the greenhouse, you find yourself in a protected corner designed as a rose covered pergola, which offers a nice spot for having a snack.

The building offer a variety of different spaces; common spaces where larger groups of children can gather, and more private spaces for calmer activities. In the middle of the building, you find the staff rooms and kitchen. They are placed centrally in the building to equalize the distances for transporting food carts or dirty laundry. There is also a point in locating the staff room somewhat private from the departments - to give the staff their own space.

Plan 1:200

1 Wind break/entrance	9 Motion room	17 Office/conference
2 Cloak room	10 Sound path	18 Relax/conversation room
3 Hygiene/WC	11 Main entrance	19 Laundry
4 Main room	12 Mirror room	20 Technical room
5 Atelier with kitchen	13 Story corner	21 Kitchen
6 Play room	14 HWC	22 Recycling room
7 Calm room	15 Staff changing room	23 Stroller storage
8 Greenhouse	16 Staff room	24 Storage

The staff rooms are bright and spacious with large window areas; this is important to increase the comfort and well-being among the teachers. In connection to the staff room there is a main entrance, facilitating the orientation for outside visitors. The main entrance gives easy access to the staff rooms when there is a need for private conversations between teachers and parents for instance.

Sliding doors ensures a more efficient use of the space, and all the rooms have visual connections to facilitate the overview.

As a step to promote the activities to be mainly oriented outdoors, a handicap WC is placed with easy access from the playground.

The children have a multitude of places to play, smaller rooms and larger, with space for exploring and using their imagination in their games. At the same time, the rationality of the plan ensures easy overview for the teachers. The building is designed for both the teachers and the children, as an inspiring place to teach and learn.

“ When you open a door, the room is almost imperceptibly transformed. You encroach on the space of the room and create an unjustified and disproportionate gaping hole. /.../ With sliding doors such nuisance is avoided and a more spacious atmosphere is created. Without deranging the harmonious proportions, revivification and variation is achieved. /.../ Discretely and imperceptibly the home is partitioned or extended. Life there resembles a peaceful stroll.

Barbery 2006 p. 135

”

DINING TABLES

possibility to have the meals in separate rooms, to enjoy the food in smaller groups with lower sound levels.

FLEXIBLE FURNITURE

movable and adjustable partition walls with peepholes and round shapes create exciting rooms within the large room.

WINDOW DAIS

in front of the windows, a dais is raised to enable the children to look out; on the other side, the window ledge make a seating place.

MATTRESS STORAGE

mattresses for the smaller children's naps are stored in openable benches in the greenhouses.

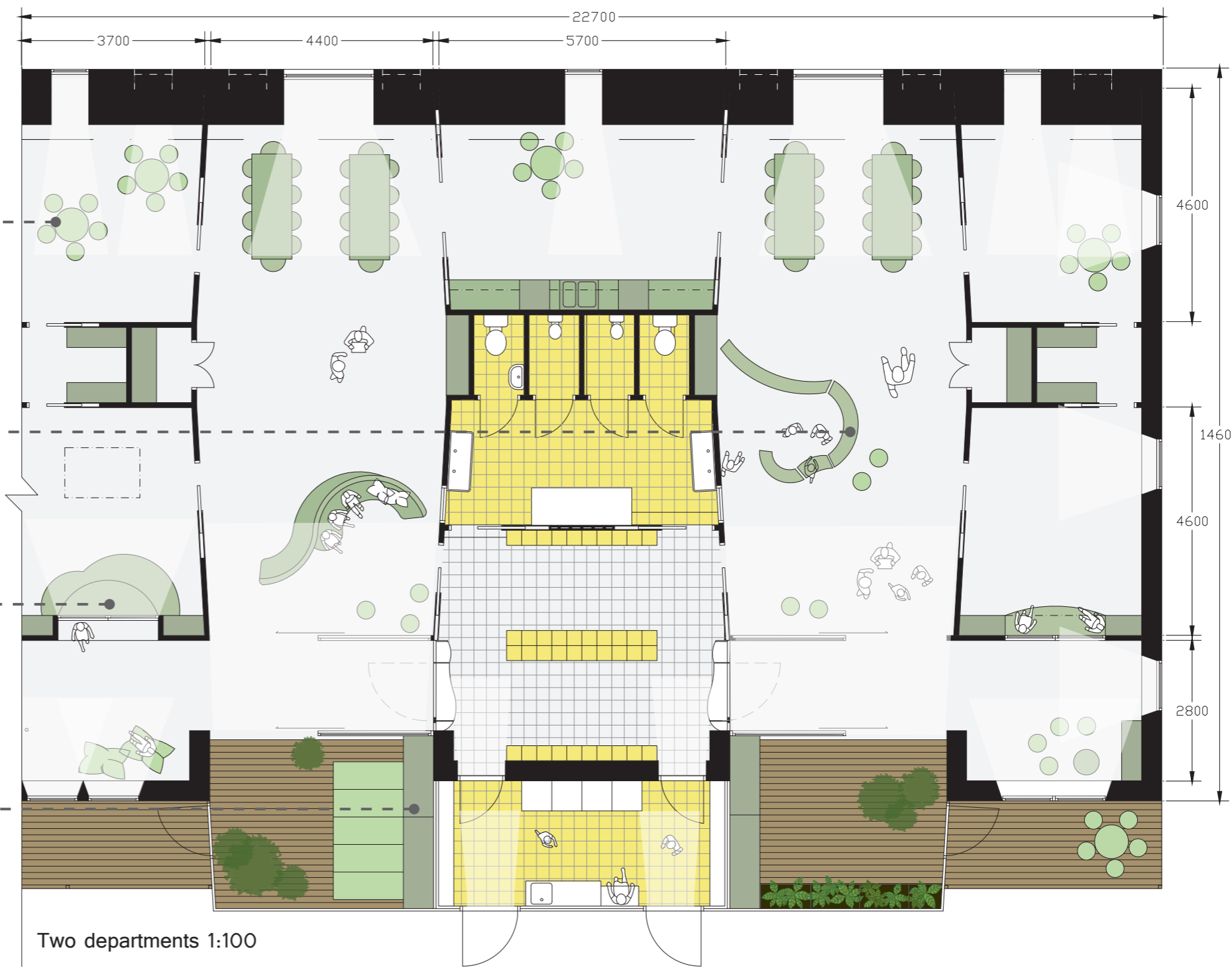

Section A-A 1:100

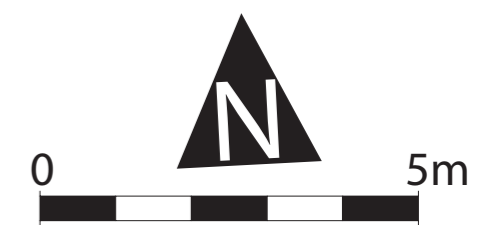



Enjoying an afternoon break in the sunlit staff room



Early spring afternoon in the main room of a department

grownup view



child view

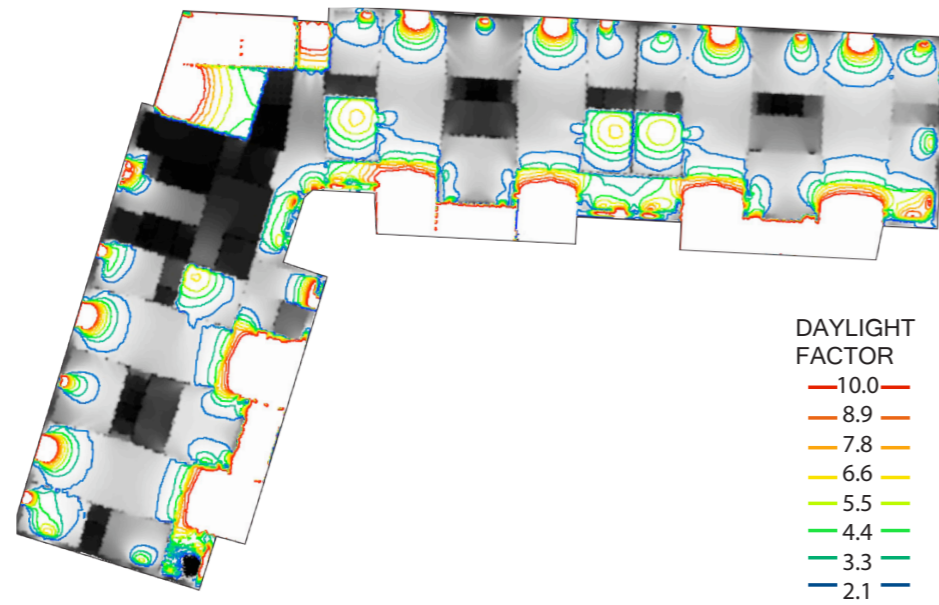

Daylight

The daylight factor is used to roughly show the daylight conditions, and is calculated for an intermediate day. A number around 2 is considered good. In this building there will be need for artificial lighting to achieve a comfortable lightscape in some of the spaces. However, the intention of the window design is that the lightscape should be possible to manipulate, so that some of the rooms can be made completely dark. The window area is 210 m², which is approximately 19% of the floor area.



Main movement

The children have their separate entrances to their departments at the back of the building as seen from the road. Shoes stay in the wind break, leaving the communication space free of dirt. The staff may enter the building through the main entrance at the north side, arriving directly in their staff room. Food is delivered directly to the kitchen, and food carts are transported from there to each department. The communication space, or the sequence of rooms, is open for the children to use in an orderly fashion.



Total conditioned area: 1 100 m²
 Conditioned area / department: 295 m²



Total footprint: 1 390 m²



Enjoying the view of the playground

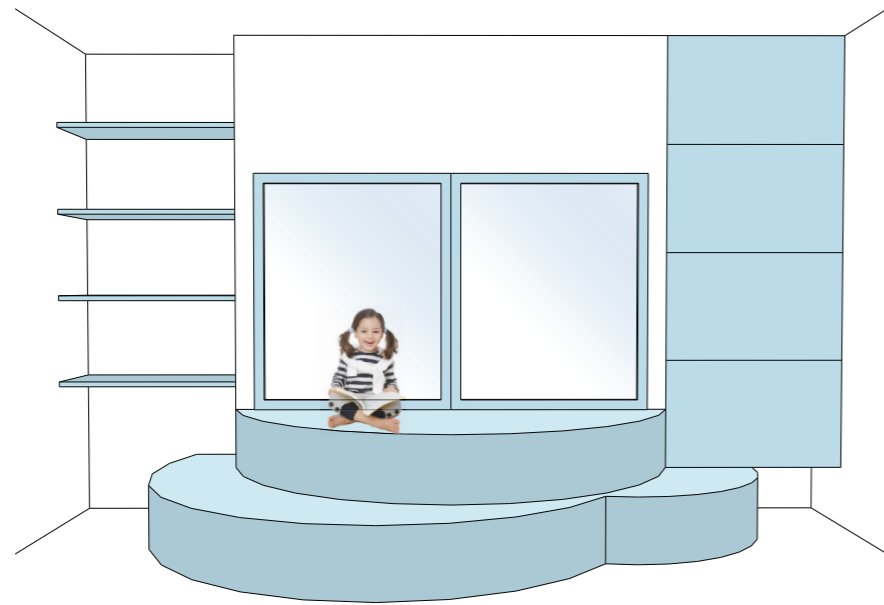

Elevated dais in front of the windows

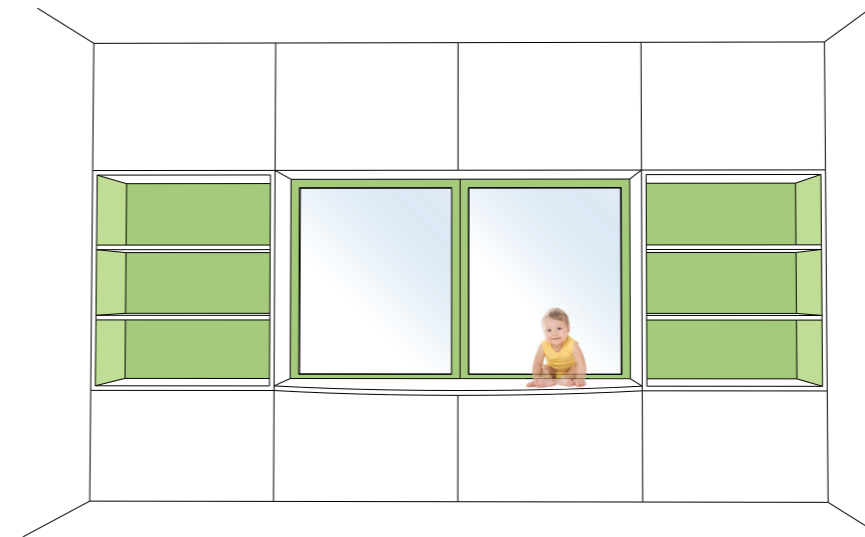

Seating space in the window niche



Miniature office for documentation at each department



A mixture of lighting provenance creates interesting lightscapes



Playing outside on a rainy october day



ZC

16

15

2

4

3

5

4

1

10

9

8

7

6

14

11

13

11

12

C



0 5 10m

The playground

Since the site does not offer any height differences, some have been made to give some character and shape to the landscape. The building slab is buried half a meter into the ground, so that at the north and west side of the building, the ground floor aligns with the road outside. On the side towards the playground, the cavity is continued with a slight slope towards the hills at the edge of the site. This move creates a height difference which is used for the board walk as an extension of the building slab. The board walk features ramps for easy accessibility, and can be used as a space for indoor activities moved out into the sunlight, such as painting and creating.

In front of the building towards the road is a row of umbrella-like trees in the scale of children. Together with the colourful flowers next to the walking path, they offer a nice promenade when arriving in the morning. There are parking spaces for the staff as well as parents in connection to the building. However, there are also bicycle racks and good sized stroller storages readily available, to promote a healthier and more sustainable lifestyle by riding a bike or walking to the preschool. The road in front of the building is designed for a quick and easy “kiss and ride”, i.e. leaving the children in the mornings. The parking space between the preschool and the school is also available for parents and children attending the two western departments.

The playground is used as a common space, where gatherings, picnics and thematic project days can be carried out. The amphitheater is a natural meeting place for performances and information sessions. It is placed to avoid glaring midday sun. Trees, shrubs and the hill provide naturally shaded places for play during sunny days; at the same time they also offer wind protection. The rose covered pergolas in connection to the building offer inviting places for an afternoon snack underneath filtered sunlight and fragrant roses where bees are humming.

During the darker hours, the playground and walk paths are illuminated by solar powered lamps, with a backup from electrical LED-lights.

“

There is hardly any shortage of places for physical exercises and ball games in this country. Children can dash around and swing and jump, in kindergarten, in playgrounds and at school. But places where they can be alone and play secret games, where they can smell the roses and watch the bugs are rare. /.../ you should therefore not make it [the garden] into an exercise yard, but an enchanted world.

”

Möller 2008 p. 157

Site plan 1:400

- | | |
|-------------------|----------------------|
| 1 Bicycle racks | 9 Fruit trees |
| 2 Board walk | 10 Balance games |
| 3 Water square | 11 Sandbox |
| 4 Rain water pond | 12 Amphitheater |
| 5 Lilac arbour | 13 Underpass |
| 6 Labyrinth | 14 Outdoor classroom |
| 7 Willow hut | 15 Parking |
| 8 Swings | 16 Kiss and ride |

Total outdoor area: 4 670 m²

Outdoor area per child: 39 m²

The playground is designed to give a natural impression, with landscaping, different use of ground covering materials, and flowers to provide colour and flair. Rather than placing EU-adapted scaffolds on a paved surface, the idea of this playground is to let the children use their imagination on how to use the elements. Thus promoting free play, movement and creativity. It is meant to be a concentrated piece of nature, adapted for the use of children, to explore and enjoy nature's possibilities. It is also meant to be a complement to the nearby forest, where the teachers can take the children on regular "study trips".

According to legislation the playground needs to be fenced, to prevent attempted escapes by the children. For this reason there is often an extensive use of galvanized steel fences at preschools; an element which can destroy the expression of the prettiest preschool and which should be avoided. By placing the building so that it embraces the site, a large part of the playground is already enclosed. The mirroring hill takes care of the matter from the other side. Although there is need for a fence behind the hill, it will not encroach upon the main view of the playground. At the western part of the site a high wooden fence continues as an elongation of the facade and closes off the playground there. At the remaining borders which need to be enclosed with fencing, the galvanized steel is camouflaged by trees and flowers. To accomplish separate zones inside the playground, other elements than fences are used, such as flower beds, walk paths and braided willow hedges.

Flower gardens

There are three main flower gardens in the playground, each with its own colour theme. The shrubbery and flowers are designed to give flair to the playground for as long a period as possible. Starting the season in early spring with purple crocus and yellow forsythia, and ending in the autumn with fiery red Virginia creepers.

With flowering plants, biodiversity is favoured, and the playground can become the home of interesting species like butterflies and bumblebees, an ornamentation in themselves.

	SPRING	SUMMER	AUTUMN
<u>Yellow garden</u> <i>the water square</i>			
<u>Red garden</u> <i>the labyrinth</i>			
<u>Pink garden</u> <i>the outdoor classroom</i>			



The water square

An area in front of the building, in connection to the boardwalk, is kept paved by cobblestones. Here, teachers and children together can play with the water running from the rainwater basins and landing in a small pond in the middle of the square.

The rainwater is collected both as a functional aspect and a design and play object. The rain runs freely down the glass walls of the greenhouses, making a beautiful waterfall to watch while napping. Part of the rainwater flows via chutes under the boardwalk, emerging at the edge as miniature waterfalls, continuing their way towards the centered fountain. A perfect place for bark boat competitions on rainy days and watching sunlight breaking into colourful prisms on sunny days.

The labyrinth

Every garden needs a place for hide and seek. The labyrinth consists of arcs made of rebars, covered with Virginia creepers, creating tunnels where the sunshine filters through large leaves. Sometimes the path leads through the tunnels, sometimes through open air, bordered by flowering greenery. Sometimes it leads through a small, but darker forest of thuja trees. At certain spots, the entrance to small willow huts will emerge for you to hide in, and if you follow the path to its end, you will end up on top of the hill.

The outdoor classroom

In a somewhat secluded corner of the playground, the outdoor classroom is located. This space is dedicated to educational activities; a place where a teacher can take a group of children and hold a lesson about natural science and biology or perhaps just explore the sense of smell. The outdoor classroom could be utilized by the lower grades in the adjacent school as well.

Connected to the classroom are storage spaces for outdoor toys, tricycles and possible educational equipment.

Fruit trees and evergreens

An apple tree, a plum tree and a cherry tree beautify the playground in early summer with their multitude of blossoms, and embellish it in the autumn with their fruits. Raspberry bushes will brighten any child's summer with pink, sweet berries. Plants that carry edible fruits present great opportunities to teach children about eating fruit and the importance of vitamins.

During winter, when snow hopefully will allow tobogganing down the hill. rhododendron bushes are still green, and provide excellent places for hide and seek if the toboggan loses its appeal. The thuja contributes with its evergreen appearance to make the playground attractive even in winter, and the red branches of the dogwood add splashes of colour.



Elevations and materials

Facade materials and colouring are to a certain extent adapted to the general design expressions surrounding the site. The building is clad with a panel of Superwood™, an ecologically impregnated wood with excellent durability.

On the outer side of the L-shaped volume, this wood is placed in overlapping double rows, where the bottom layer is painted in a light gray colour and the top layer bright white. This way, the facade becomes more lively. The window frames and the insides of the bay windows are painted bright sunshine yellow. The other side of the building is clad with a smoother wooden panel, painted mossy green. Here, the window frames are kept white.

Derived from this design and colouring is the impression that two sides of the building is camouflaged to fit into the surroundings, while at the hidden side, the true green nature of the building shines through. The outsides of the bay windows are covered in galvanized sheet metal, for an interesting design disruption.

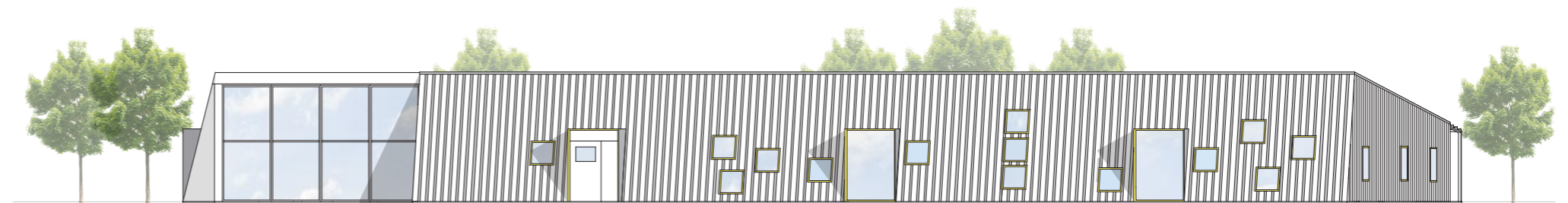

west 1:200



south 1:200

The interior is also dominated by wooden materials. In the main room of each department, one wall is made of a perforated wooden board, behind which is a soft, noise absorbing material. The perforation can take the shape of different imaginative patterns, and can also be painted individually for each department. Other walls are made of wood panel.

The floors are made of linoleum; a resistant material based on natural resources. Linoleum can be delivered in several different colours, but in this design, the floors are kept neutral, to give space for colourful walls. In the wind breaks, cloak rooms and hygiene rooms, the floor is made of tiles, which facilitates the cleaning.

In the ceiling, to keep the noise levels at a minimum, the structure is covered with acoustic plaster. Parts of the greenhouses are built from reused, old window frames, creating an interesting look as well as making the building more resource efficient.

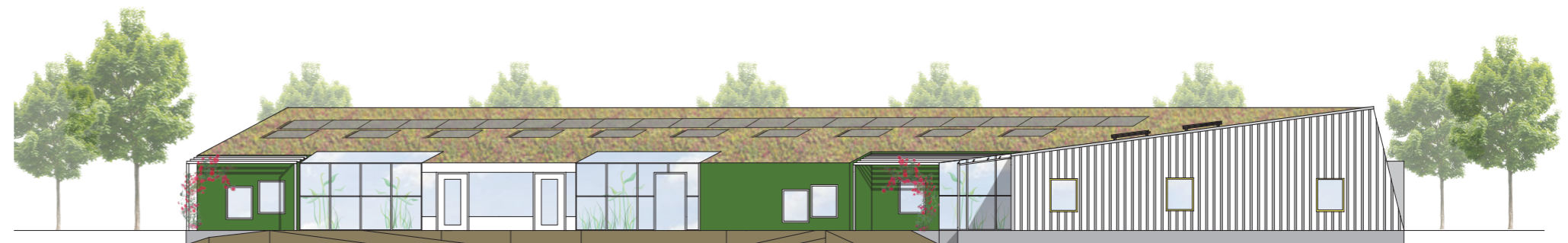

east 1:200

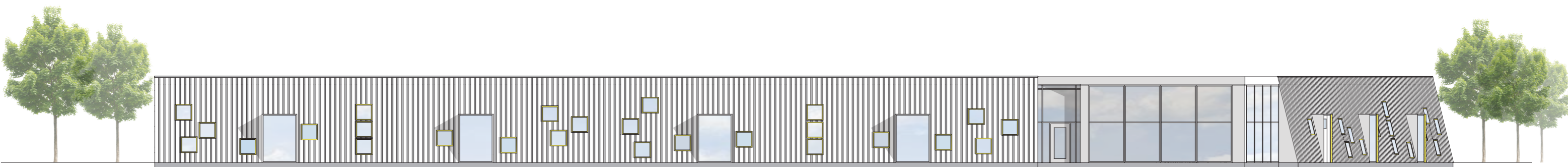

north 1:200

Construction

The main principles of the material and construction choices have been durability and easy maintenance. Thus the choice of Superwood™ as cladding and foamglas as insulation. Municipal projects put great pressure on reduced costs, and this proposal presents a larger initial cost. However, by choosing durable materials and designing an airtight building, maintenance costs are greatly reduced, and the lifespan of the building extended. Quality before inexpensiveness has a positive effect in the long run, for the environment as well as the finances.

The construction of the preschool follows the principles of the “Koljern-technique”. Koljern is a unique, patented method where the finished material becomes a building component. It consists of a lightweight sheet metal construction with foamglas for insulation; these elements can be used as slabs, wall panels, curtain walls, cantilevered terraces or cantilevered roofs. They can be covered with any kind of cladding, in this case wood panel.

Foamglas is made of 75% recycled glass and has no capillary effect, which means that it is not affected by water damages or rot. It has a life expectancy of 50 years, and can be reused as a landscape architectural filling material after its lifetime. Foamglas also keeps its insulating capacity during the whole of its lifetime. The Koljern-technique offers building elements which are durable and have good compressive strength. The prefab-construction shortens the building time, which reduces some of the costs, as well as issues with drying times and bad weather. It is an innovative technique, easy to handle and quick to assemble.

In this building, the elements are aided by wooden beams distributing the load over the large spans.

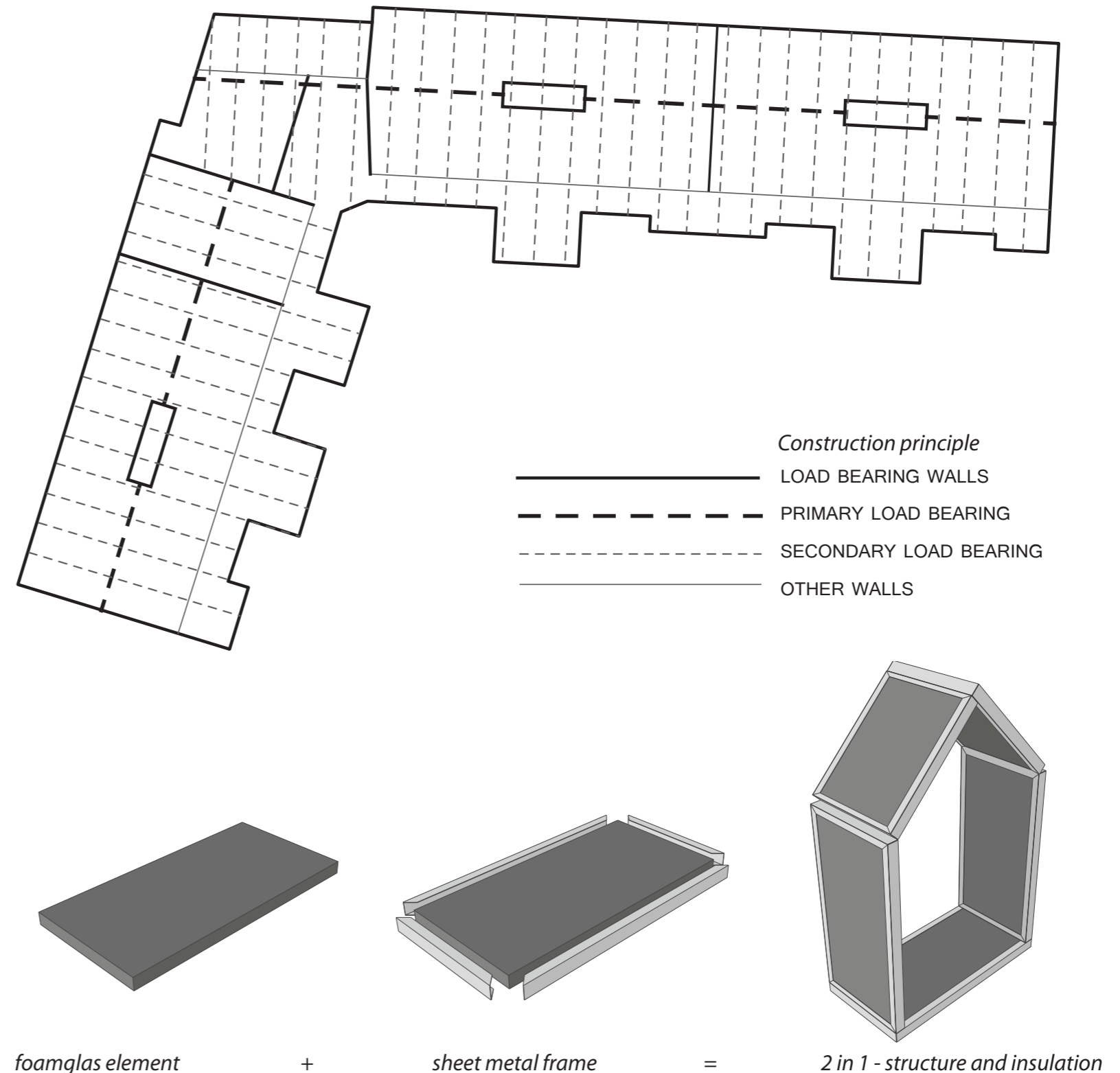

Detail principles

Principle of photovoltaics and solar thermal placement by skylights.

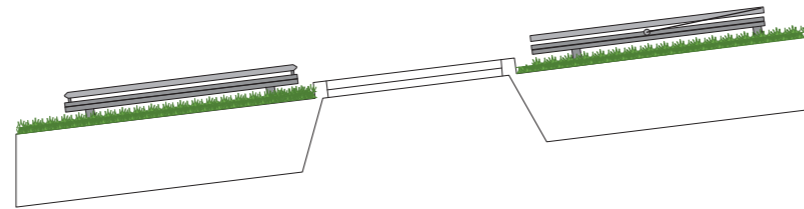

Bright sunny day

The more translucent structure of the solar thermal can be slid in front of the window to filter the light if needed.

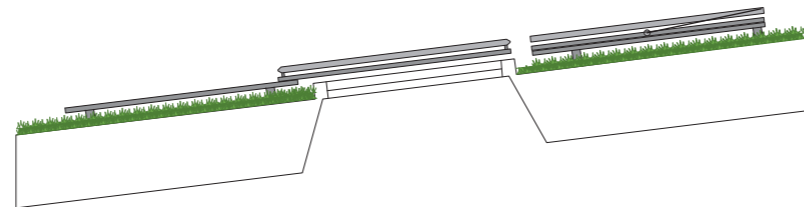

Winter night

To minimize heat losses during the night, the photovoltaic structure can function as a shutter.

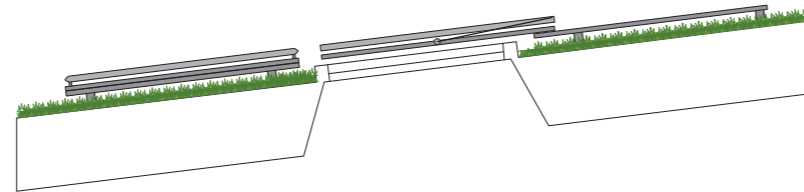

Sunny winter's day

When the sun is low on the horizon, the photovoltaics can be steeply inclined to catch some of the sunlight.

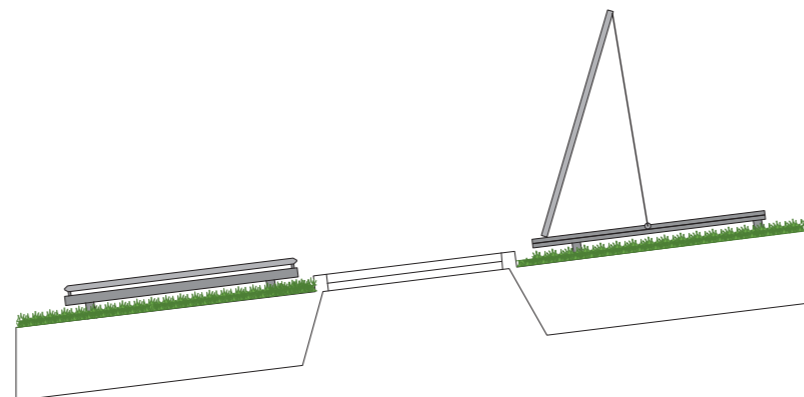

Principle of ventilated window facade.

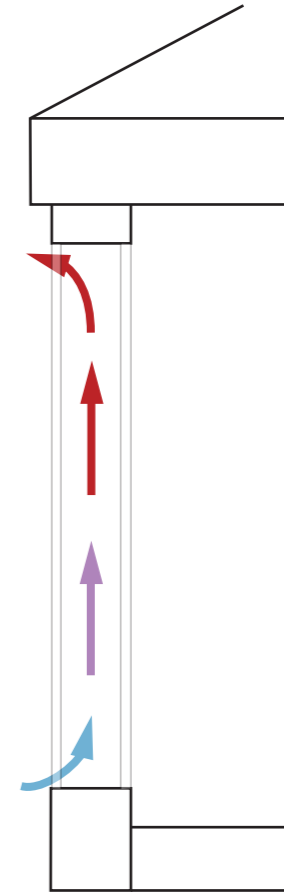

Summer

To avoid overheating, the heated air is ventilated out from between the window panes.

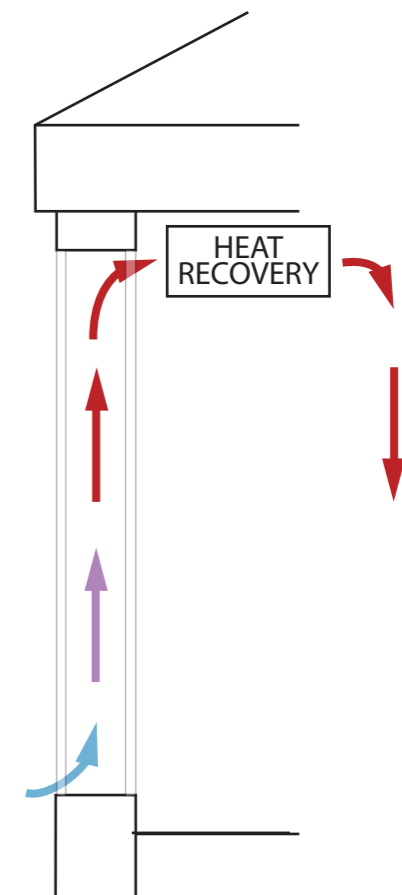

Winter

The air passively heated in between the window panes is led into the building where the heat is recovered and used as a complement to the geothermal heat pump.

Building envelope - preliminary sizing and detailing

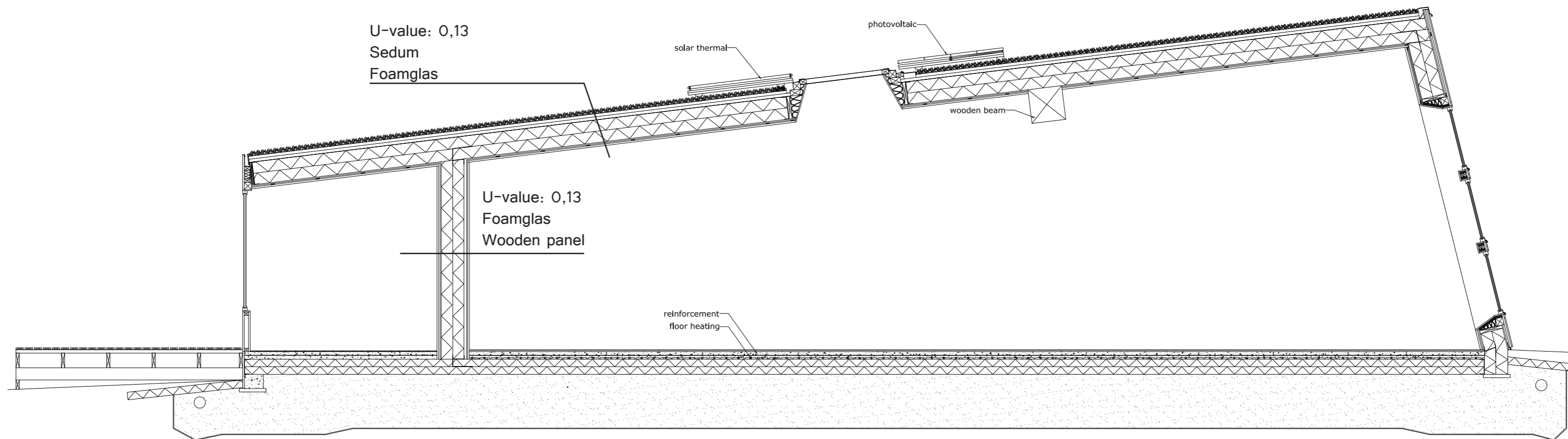

Section B-B 1:50

Load bearing interior walls

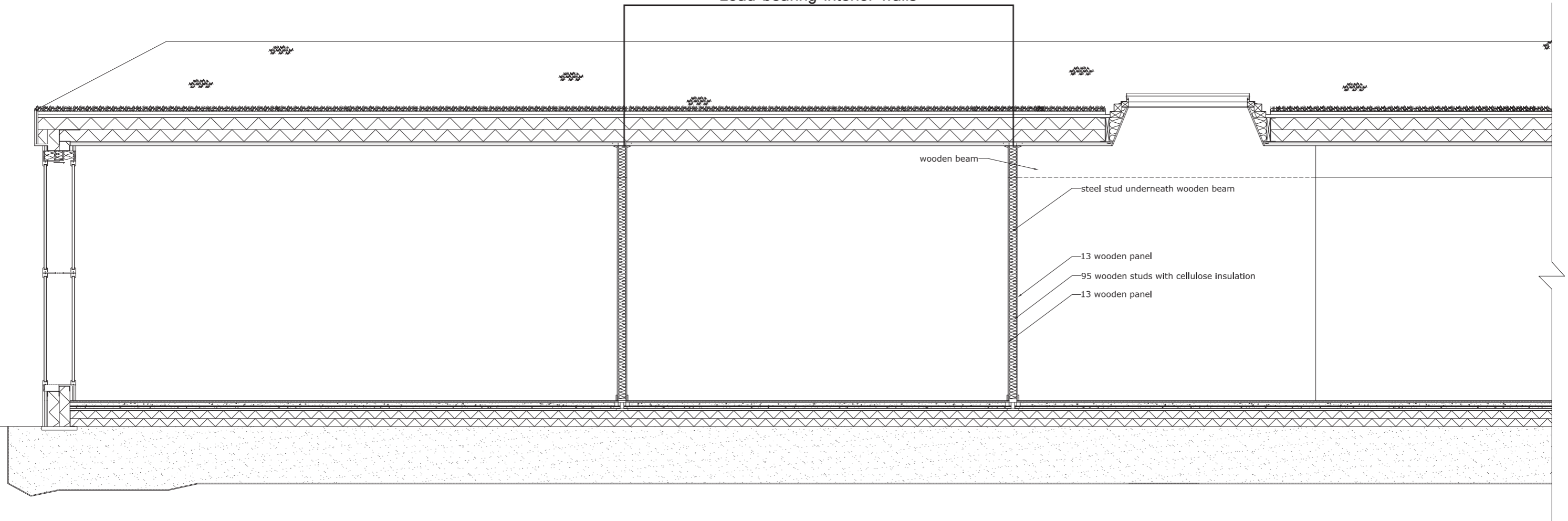

Section D-D 1:50

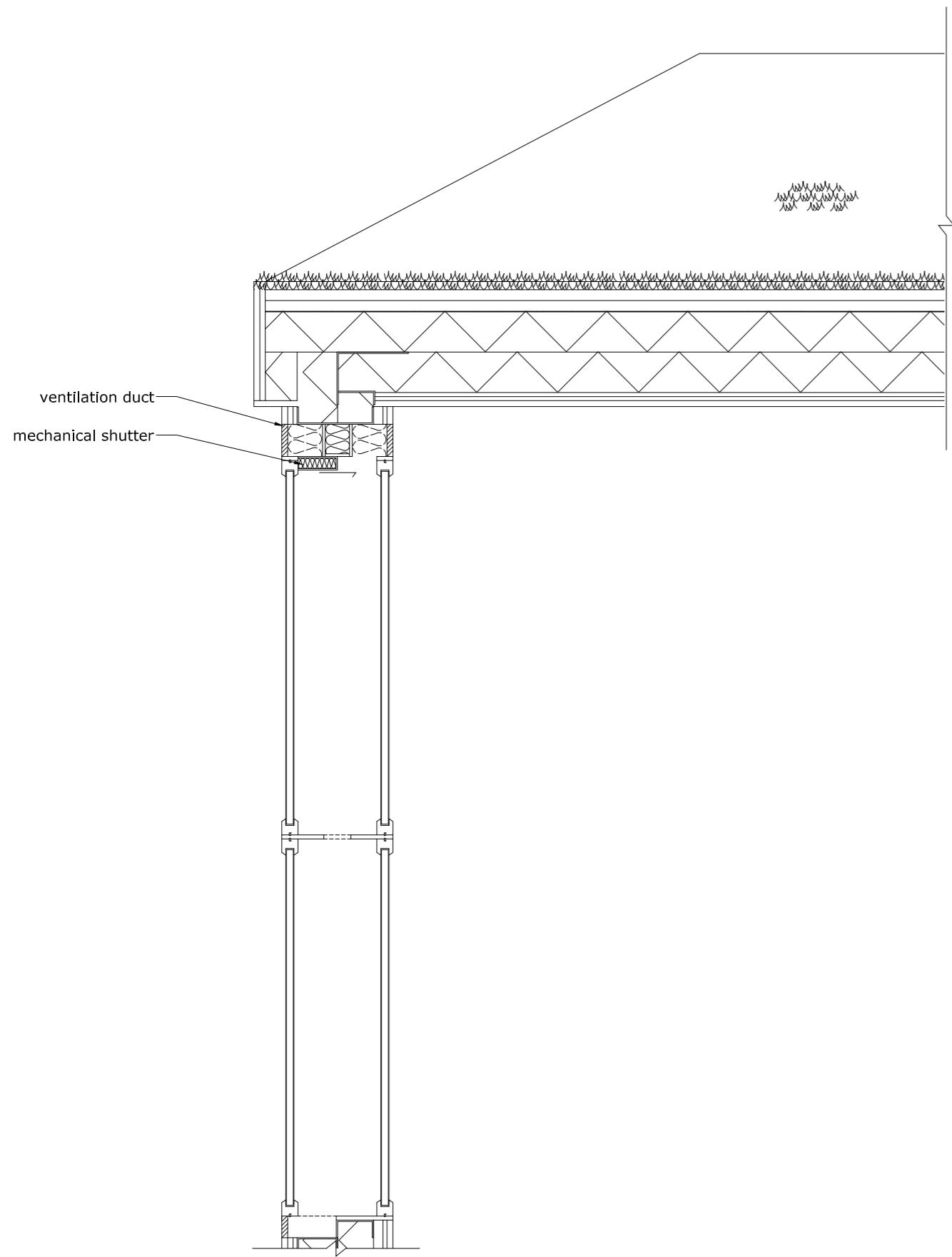

Ventilated window facade 1:20

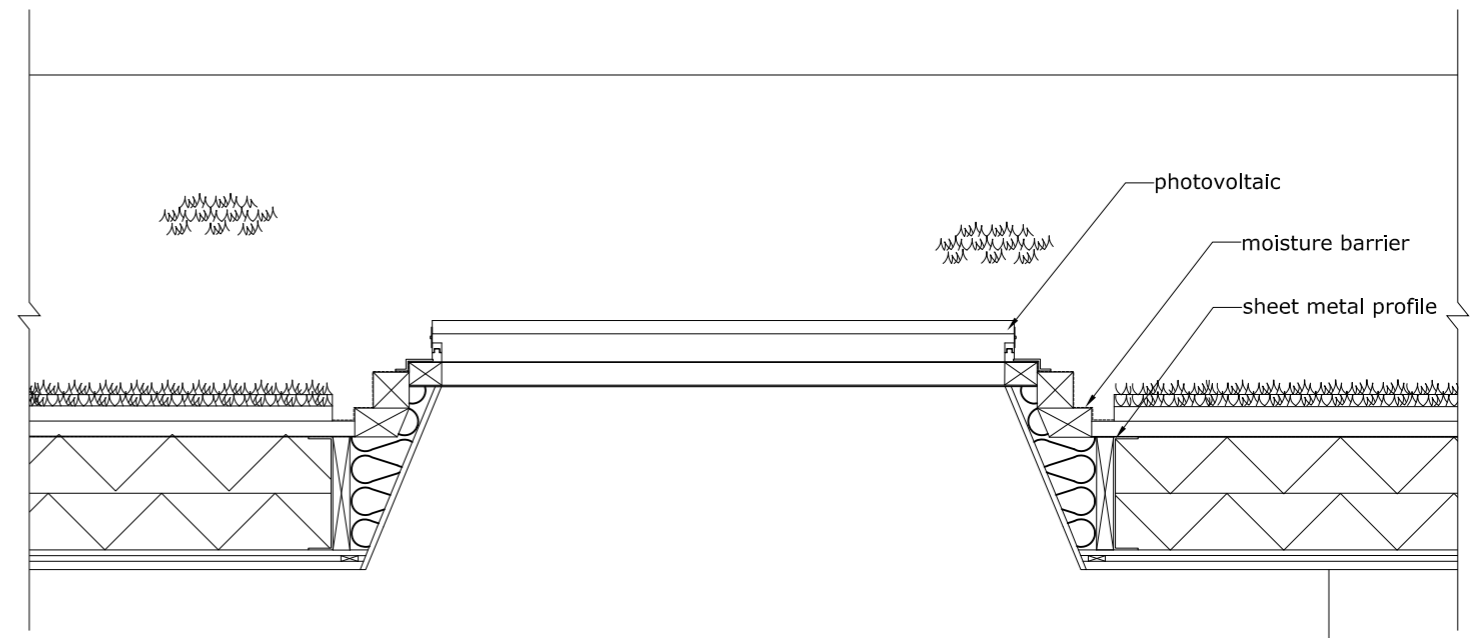

Skylight 1:20

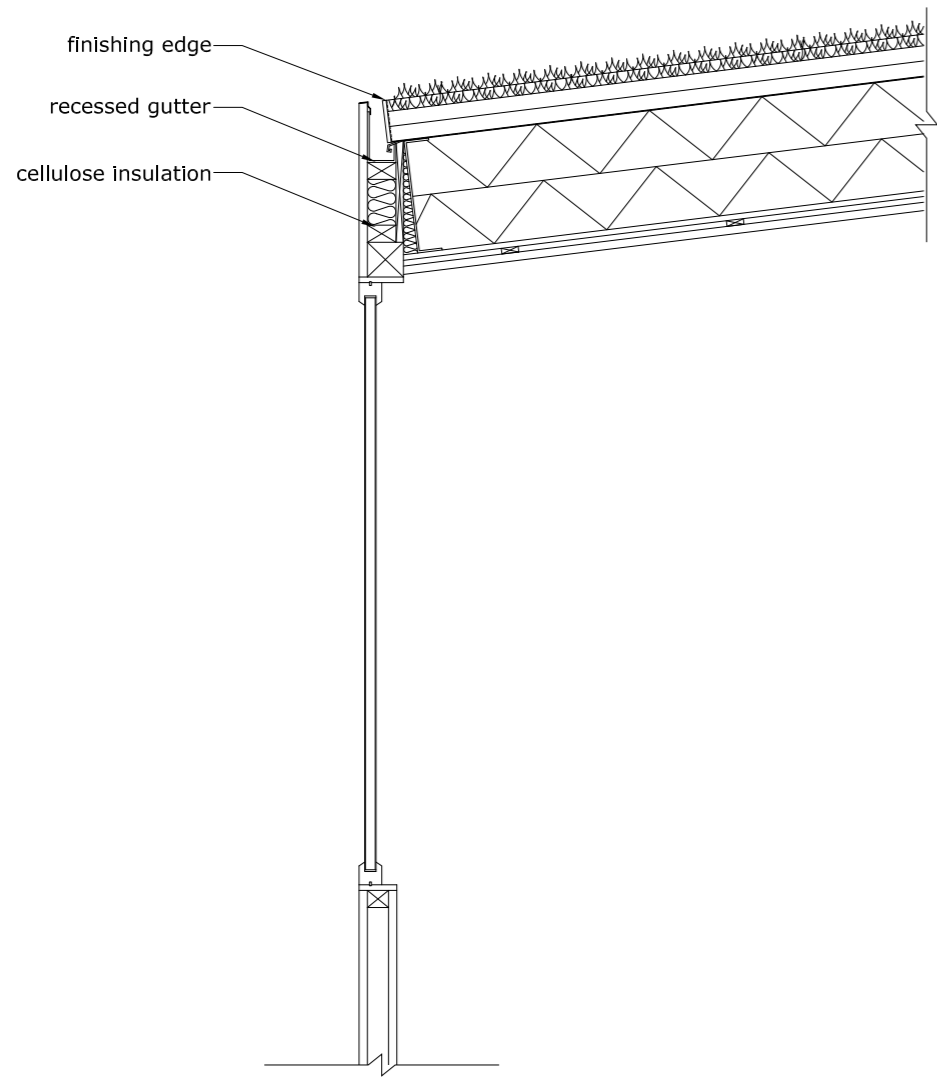

Roof meets greenhouse wall 1:20

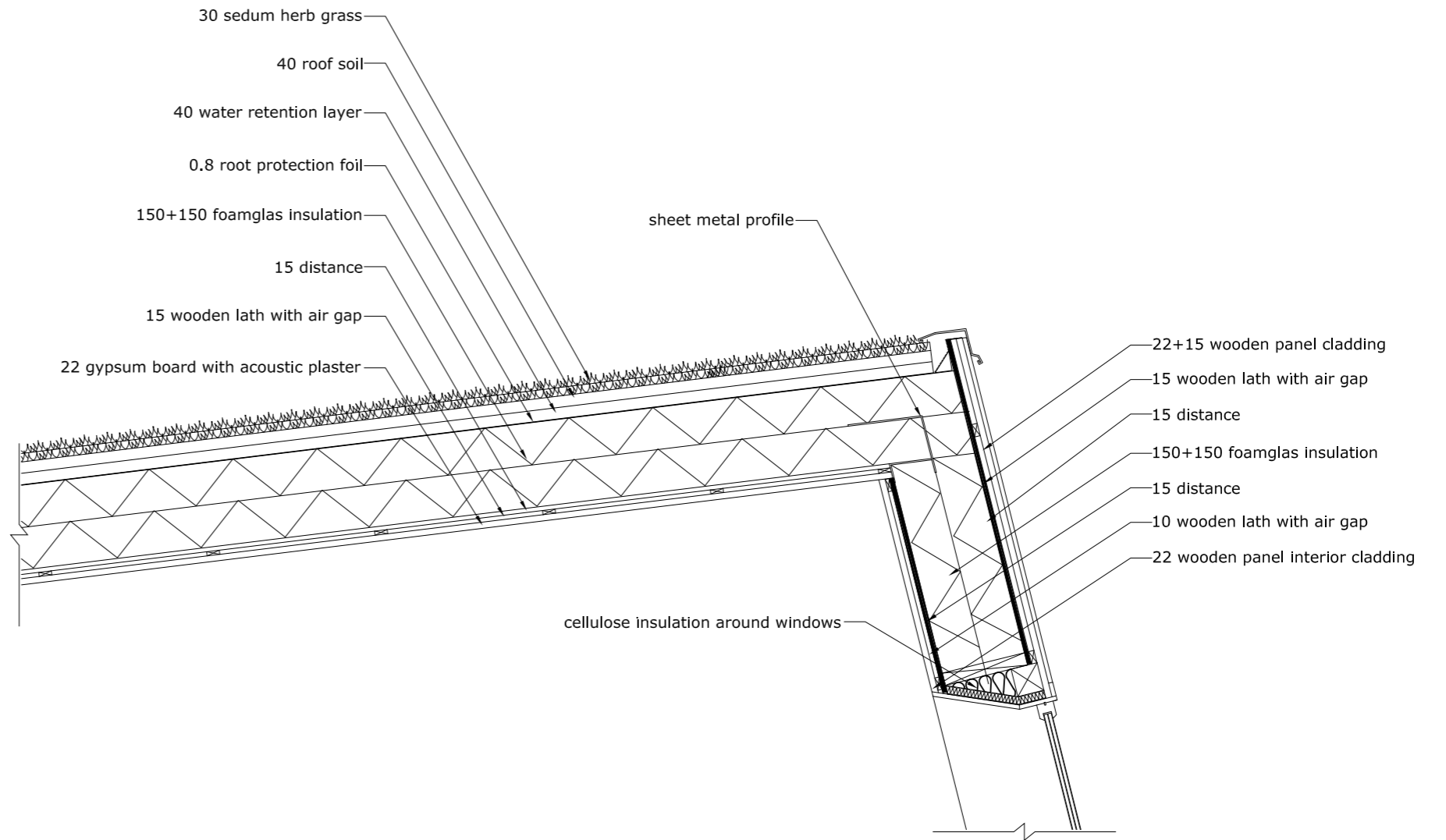

Roof meets leaning wall 1:20

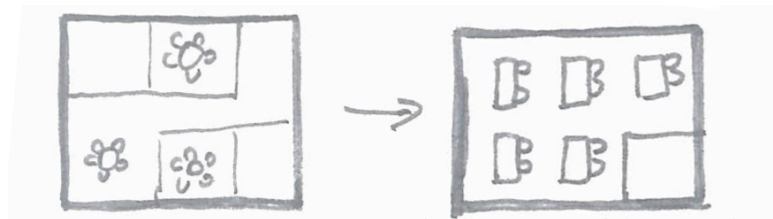

Building flexibility

Thanks to the construction solutions, large rooms without load bearing structures such as columns can be achieved. This solution gives us walls which are not load bearing and thus can be altered to suit changed uses of the facilities.

However, the composition of rooms can as it is suit a change from preschool activities to elementary school classrooms. An optional number of preschool departments can easily be altered into school classrooms, should the need occur. Similarly, the alterations can also be reversed without a large reconstruction effort.

The smaller rooms could be used as more private study rooms, possible to divide into even smaller rooms with movable partition walls. The greenhouses could be of continued use for activities such as natural science lectures, or simply cultivating vegetables.

Thus, with minimal effort, the building can keep adjusting and adapting with the tide of child groups and modified needs. During evenings or summer weeks when the preschool activities are reduced, the facilities can be used for knitting circles or summer sports camps; keeping the building dynamic and flexible.



Visualization of a department rearranged as a classroom

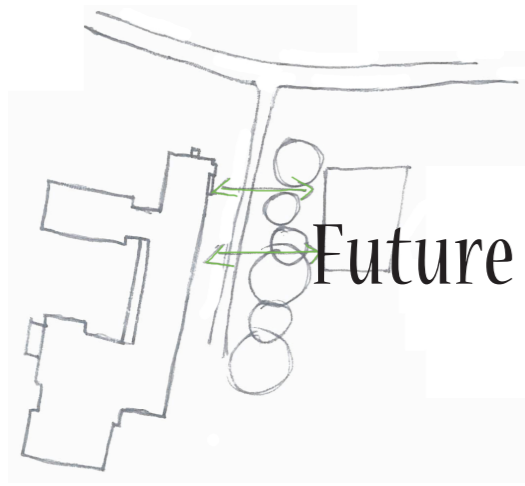

Future development

For future development, a connection between the preschool and the adjacent school would be practical. In this proposal, one functioning connection would be between the two kitchens. A possibility to expand the kitchens to fully equipped and preparing all of the meal components on site. This would be positive since it would reduce the food truck transports.

The physical connection could be a dining hall shared by the school and preschool children. Beyond the dining hall, the playground could be extended tying together the two sites, removing parking space and the impression of backsides on the buildings.

There are a lot of possibilities; the most important challenge is to remember them. Times and needs change, the building and site can be adapted, and the focus should always lie on creating the best environment for the children and the teachers.



Visualization of how the new extension might be designed, viewed from between the buildings



FÖRSKOLAN
DRAKEN

REFLECTIONS & DISCUSSION



Conclusions and reflections

To take on a preschool as a design project, with all that it entails, has been a major challenge for me. I have not done anything remotely similar before, with regards to the precision of dimensions, and most important of all – the children’s scale. Trying to achieve something creative inside of such strict limitations has been a tricky task. There are not only limitations of dimensions, but of hygiene, movement, and above all safety. Trying to piece all of these together in an inspiring preschool has been the most fun I’ve had during my whole education.

From the beginning, I already knew that I wanted to design a building which would be labeled sustainable. Early in my process, this came to include implementing sustainability into the education of the children as well. I believe that awareness of our impact on nature should come at an early age, and the preschool seems the perfect place to start, since all of the educational activities can and should include sustainability. Thus I aimed to design a building which would promote a sustainable education.

The inspiration taken from different nature-preschools and the Reggio Emilia philosophy has been very rewarding, due to the fact that I have learnt a lot from the literature, and of course in the merging of the two aspects into a slightly more generic preschool.

The proposal is generic in the way that I chose not to adapt the facilities to one specific philosophy or method, but to keep them adaptable to different kinds of methods, while maintaining a focus on sustainability. My interpretation of the situation today is that a more generic preschool could be used in a wider context. The shape of the building and the adaptation to the site is also to some extent generical. The size could easily be reduced to a four-department preschool for a smaller site, or even be expanded to an eight-department preschool if needed. However, the design is generally adapted to a flat site, since my aim was not to create a completely general module preschool.

The concept could of course be developed into something even more generic and adaptable, but as I have learnt during this process, children – and people in general – need a certain measure of individuality. They need a workplace to feel proud of. This proposal is not meant to be mass-produced building to pop up anywhere in the country, but a well thought through design “template” which could be applied with modifications to other preschool developments.

My first conclusion from this work is that the health of children is improved by spending a lot of time outdoors. This fact goes hand in hand with the strive towards a sustainable preschool; by spending time in natural surroundings, children automatically acquire a knowledge and understanding of how nature functions. Thus a virtuous circle is created when the preschool building also gives consideration to its environment. In my project I have therefore endeavoured to establish connections between inside and outside, as well as making the outdoor environment as attractive as indoors.

Another general aim for me has been to maximize the activity space for the children while keeping within reasonable frames. To create a sustainable building it is important to keep it as compact as possible, which is a challenge in itself when designing a one-storey preschool. These aspects have led me to the conclusion that there are several design strategies which will reduce the needed space in positive ways. Examples of these are sharing necessary functions such as hygiene and kitchen areas, creating semi-conditioned spaces outside of the building envelope, and minimizing the common areas inside of the building and relocating them outside instead.

I have also concluded that it is important to consider the future of the building – an area where many contemporary preschools are lacking. I have presented solutions regarding both a decrease in preschool-aged children and a restructuring where the preschool and the adjacent school are brought together in a tighter cooperation. Future visions are an essential part of

sustainable building.

The process has had its ups and downs; the regulations of Swedish preschools has been a lot of information to take in, but in my own opinion I am coming out of this a much more architecturally insightful person, both regarding preschools and my own work process. I have worked simultaneously on different levels, getting into construction details one day, and arranging the flowers in the playground the next. There has been both advantages and disadvantages with this work method; at times it is difficult to keep it all in mind, but it is also relieving to be able to focus on something different from time to time. The different parts have inspired each other every step of the way, and at the end of the day, I am proud of the achievements of my project.

A low-energy building, made of renewable or recycled materials, featuring an inspiring playground, promoting a connection to nature - this is a good example for future preschool designs. To see to the children's needs while not forgetting the adult users, and to design for them.

I believe that this proposal could be an inspiration for Kungälv municipality as well as for other users, as one way to create a good preschool.

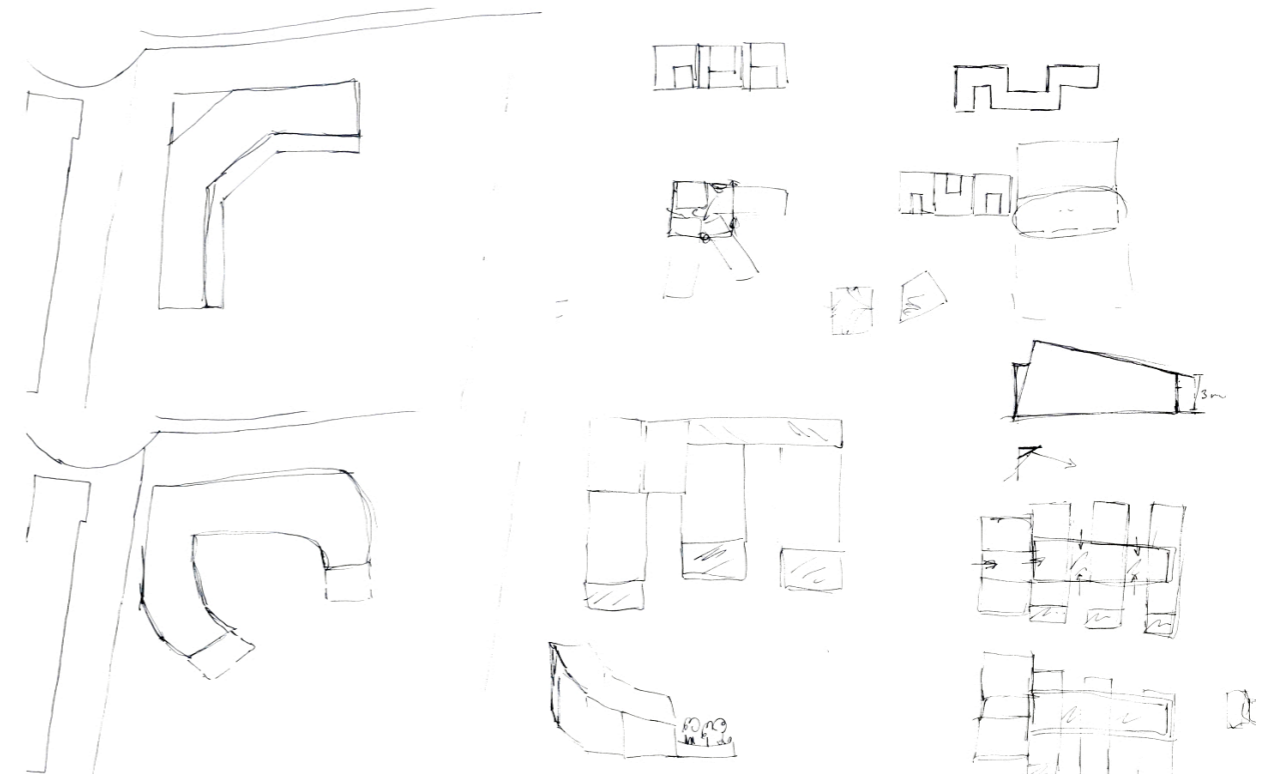
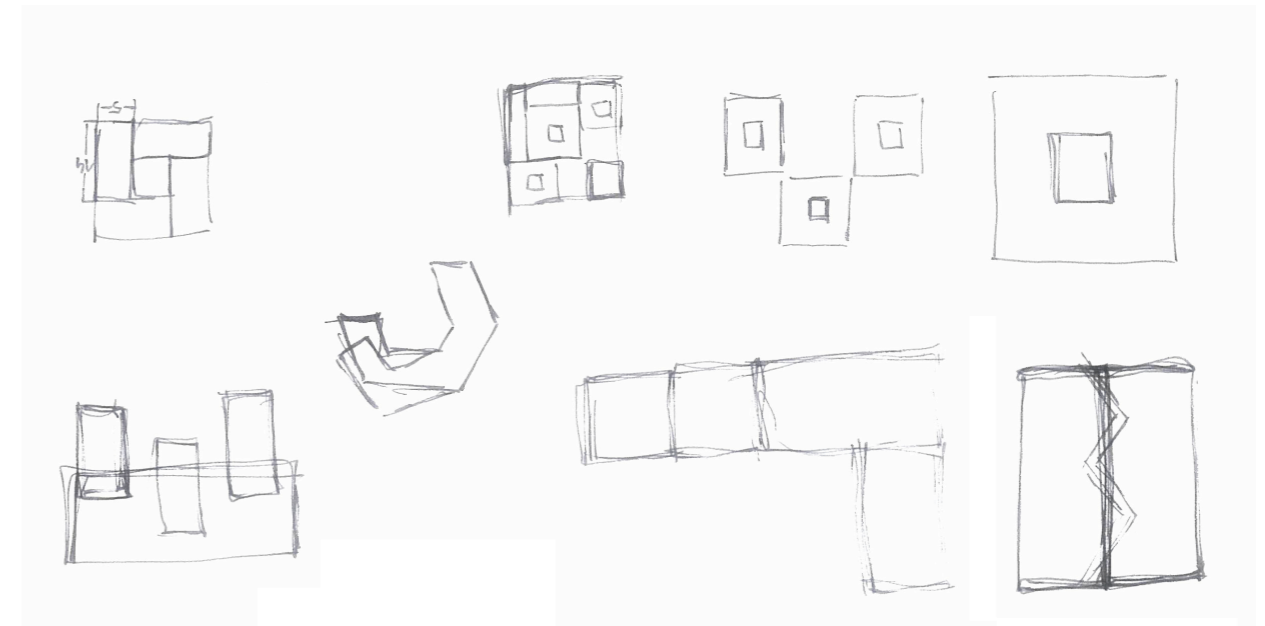
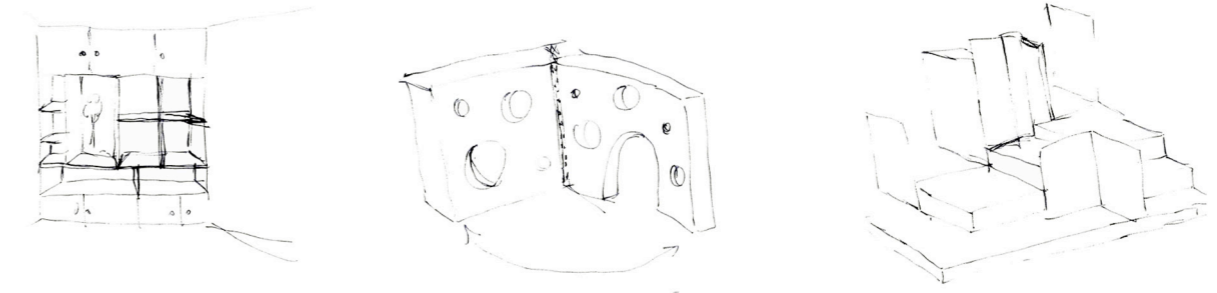

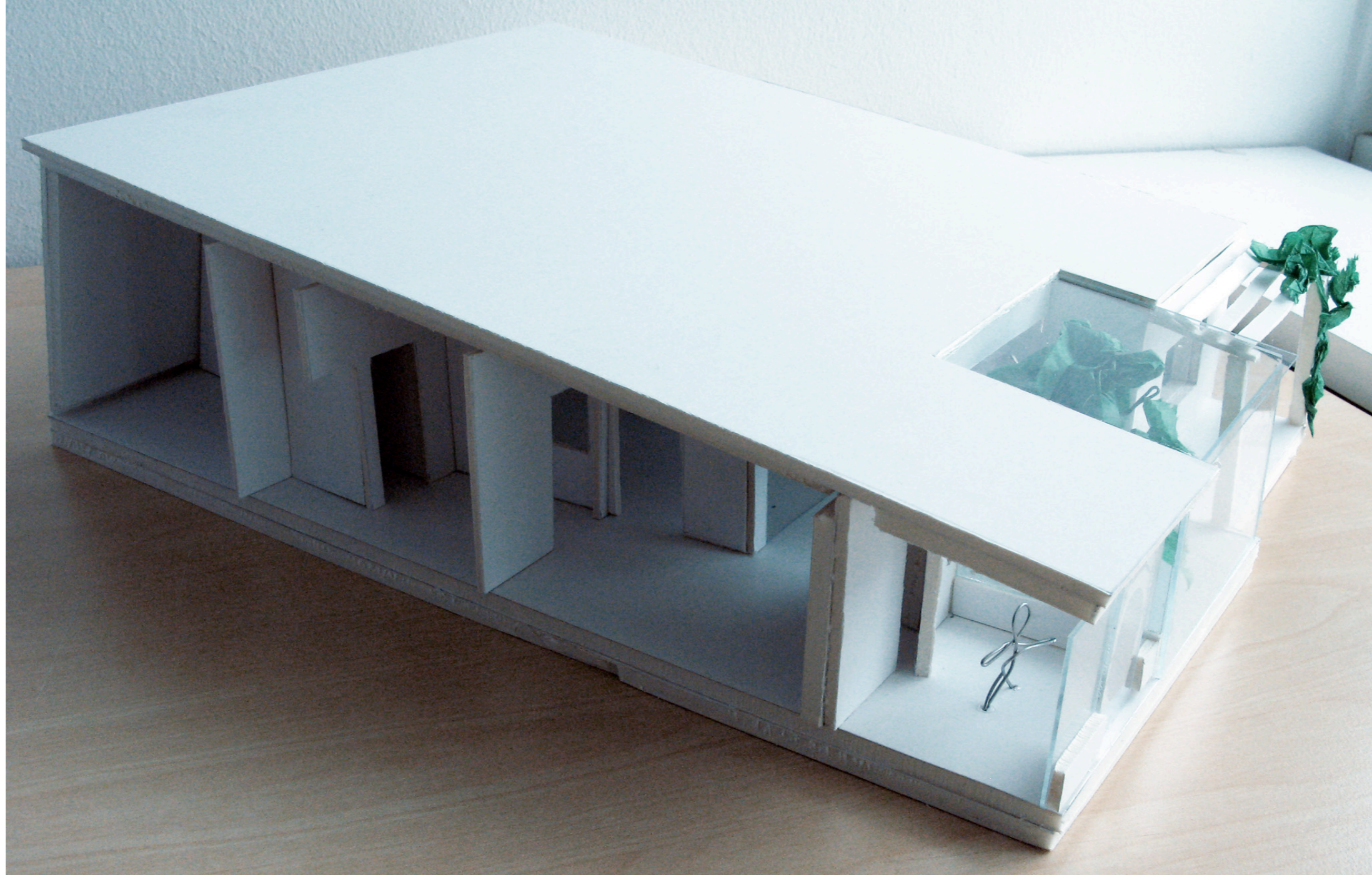

Section model 1:50



Section model 1:50



Section model 1:50

List of references

Books:

Barbery, Muriel (2006) "L'élégance du hérisson", Paris: Éditions Gallimard

Ceppi, Giulio, Zini, Michele (2003) "Children, spaces, relations - metaproject for an environment for young children", Reggio Emilia: Grafiche Maffei

Galindo, Michelle (2010) "Kindergartens - Educational spaces", Salenstein Switzerland: Braun Publishing AG

Grut, Katarina et al (2005) "Exemplet Reggio Emilia - pedagogik för demokrati och lokal utveckling", Stockholm: Premiss förlag

Johansson, Eva (2007) "Att lära är nästan som att leka" : Lek och lärande i förskola och skola, Stockholm: Liber

Kramer, Sibylle (2010) "Schools - Educational spaces", Salenstein Switzerland: Braun Publishing AG

Läraryrket (2005) "Utomhuspedagogik i förskola och förskoleklass", Stockholm: Läraryrket förlag

Mathisen, Arve (1994) "Barnets värld pedagogik och uppfostran i förskoleåldern : en Waldorfpedagogisk idébok för hem och förskola", Oslo: Vidarforl.

Möller, Lotte (2008) "Trädgårdens natur : om den svenska och den engelska trädgården, om trädgårdar för barn...", Stockholm: Bonnier

Olsson, Titti et al (2002) "Skolgården som klassrum - Året runt på Coombes School", Lund: BTJ Tryck AB

Skjöld Wennerström, Kristina (2009) "Montessoripedagogik i förskola och skola", Stockholm: NoK

Walfridson, Marguerite (1993) "Doft - Kåda och balsam, ros och jasmin, mossa, parfym och annan vällukt", Farigliano: Milanostampa

Reports:

Hørsholm Kommune (2011) "Solhuset - Lions active house", Hørsholm: Hørsholm Kommune

Jordbruksverket (2007) "Växthusteknik", Jönköping: Jordbruksverket

Skolverket (2010) Läroplan för förskolan Lpfö 98 (reviderad 2010), Stockholm: Edita

Umeå Kommun (2010) Funktionsprogram Förskola, Umeå: Umeå Kommun

Världsnaturfonden WWF (2009) "Förskolan - För en hållbar utveckling", Solna: WWF

Websites:

Barntotal (2009) <http://www.barntotal.se> (12-02-27)

Kungälv Kommun (2011) http://www.kungalv.se/Cykla-fran-fastning-till-fastning/KulTurleder/Vattenhal/Kareby_hembygdsgard/ (2012-02-02)

Skolverket (2012) <http://www.skolverket.se/statistik-och-analys> (2012-02-27)

NIBE (2012) <http://www.nibe.se> (2012-01-30)

Sveriges Tekniska Forskningsinstitut (2012) <http://www.sp.se/> (12-01-30)

Statens Folkhälsoinstitut (2009) <http://www.fhi.se/Handbocker> (2012-01-19)

Wikipedia (2011) http://sv.wikipedia.org/wiki/Kareby_kyrka (2012-02-02)

Wikipedia (2011) <http://sv.wikipedia.org/wiki/Kareby> (2012-02-02)

Informal interviews:

12-01-18 Interview with Sara Dahlström

12-02-08 Interview with people from NIBE at CHARM

Image sources:

Page 16: http://jerling.info/Simon%20Blomberg%201860/fjellstedt_kerstin.htm

Page 23, bottom left: From "Stadsskogens Förskola", Glantz Arkitektstudio, Alingsås Kommun

Page 32: http://bygginfo.byggjtjanst.se/PageFiles/96045/KDugglan_21736_fix-m.jpg

Page 34, top: <http://www.combiheat.se/bilder/Takmontage-uppvinklat.jpg-for-web-large.jpg>

bottom: <http://www.betonbau-international.com/application/photovoltaic-biogas-and-wind-energy.html>

Page 35, top: From "Solhuset - Lions active house", Hørsholm: Hørsholm Kommune, 2011

bottom: http://www.folkecenter.net/mediafiles/folkecenter/tech-trans/photovoltaics_19.jpg

Page 37, top left: http://image.traddevv.com/2009/05/18/williamjelly_345970_600/foam-glass-slab.jpg

top right: <http://www.superwood.dk>

center: <http://www.olooplay.com/products/4-9b.jpg>

bottom: <http://thirdeye.ie/wp-content/uploads/2010/10/Hi-tech-egg-boxes.jpg>

Page 41: Images from <http://www.sxc.hu>

Page 48, 54: Image from www.maps.google.com

Page 92 (flowers) top left: <http://4.bp.blogspot.com/-aID-4QoG6Gk/T1MYcvRFSI/AAAAAAAAEZ4/IKUNjTAYwbc/s1600/>

top center: <http://farm2.static.flickr.com/>

top right: <http://www.biopix.net/photos/>

center left: <http://www.wunderground.com/data/wximagenew/m/Melagoo/845.jpg>

Melagoo/845.jpg

center: <http://www.puh.nu/vaxter/plantor/image/alunrot2.jpg>

center right: <http://www.crocus.co.uk/images/products2/>

bottom left: <http://217.70.34.228/artiklar/images/bilder/>

bottom center: <http://gaia.cxr.no/images/plants/malope/trifida/>

bottom right: <http://www.mobackes.se/images/>

Other images by Emelie Ståring

Examiner

Sten Gromark, Professor Chalmers Architecture

Supervisor

Björn Gross, Artistic lecturer Chalmers Architecture

Construction supervising

Karl-Gunnar Olsson, Lecturer Chalmers Architecture

Special thanks to

Maria Niklasson, Architect SAR/MSA Abako arkitektkontor AB

Magnus Magnusson, Project manager - construction Kungälv Municipality

Karin Fahleson, Business developer Kungälv Municipality

Åsa Berglie, Development manager Kungälv Municipality





APPENDICES

Appendix I - Quote translation

Page 10:

“Förskolan ska lägga grunden för ett livslångt lärande. Verksamheten ska vara rolig, trygg och lärorik för alla barn som deltar. Förskolan ska stimulera barns utveckling och lärande samt erbjuda en trygg omsorg. Verksamheten ska utgå från en helhetssyn på barnet och barnets behov och utformas så att omsorg, utveckling och lärande bildar en helhet.”

Page: 23

“Det man kan göra inne kan man göra ute.”

Page: 25

“Antal personal spelar ingen roll, lokalerna är viktigast.”

Page 30:

“[Reggio Emilia är] en gränsöverskridande pedagogik som kämpar mot slentrian och leda med strävan att ständigt förbättras, förvandlas och omskapas.”

Page 33:

“Utevistelse för förskolebarn har flera positiva effekter, såväl på den psykiska som på den fysiska hälsan. Både tiden man vistas ute och utemiljön i sig är av betydelse.”

Page 42:

“Förskolan ska erbjuda barnen en trygg miljö som samtidigt utmanar och lockar till lek och aktivitet. Den ska inspirera barnen att utforska omvärlden.”

“Att skapa och kommunicera med hjälp av olika uttrycksformer såsom bild, sång och musik, drama, rytmik, dans och rörelse liksom med hjälp av tal- och skriftspråk utgör både innehåll och metod i förskolans strävan att främja barns utveckling och lärande.”

“Förskolan ska medverka till att barnen tillägnar sig ett varsamt förhållningssätt till natur och miljö och förstår sin delaktighet i naturens kretslopp.”

“Barnen ska kunna växla mellan olika aktiviteter under dagen. Verksamheten ska ge utrymme för barnens egna planer, fantasi och kreativitet i lek och lärande såväl inomhus som utomhus.”

“Miljön ska vara öppen, innehållsrik och inbjudande.”

“De behov och intressen som barnen själva på olika sätt ger uttryck för bör ligga till grund för utformningen av miljön.”

Page 91:

“Platser för kroppsövningar och bollspel råder det ju knappast någon brist på i detta land. Barn får flänga omkring och gunga och hoppa på dagis, på lekplatser och i skolan. Men ställen där de får vara i fred och leka hemliga lekar, där de kan känna doften av rosor och titta på småkryp är sällsynta. Har man förmånen att äga en trädgård där ens barn får växa upp, eller en trädgård som ofta besöks av barn, skall man därför inte göra den till en rastgård utan till en förtrollad värld.”

Appendix II - heat pumps

This text describes the operation of four different heating/ventilation systems which are suitable for sustainable, low-energy buildings.

Air to water heat pump:

What the air to water heat pump does is that it concentrates the heat energy in the exterior air to the extent that it can be used to heat the water in both showers and radiators.

The exterior air is drawn into the heat pump and meets a closed system which contains a refrigerant with the ability to become gas at a very low temperature. The gaseous refrigerant is heated under high pressure by a compressor and by way of a condenser, the heat is delivered to the building's heating system. The refrigerant returns to a liquid, all the while ready to become gas again and collect new heat energy.

Exhaust air heat pump:

The exhaust air heat pump technique is based on starting by ventilating the building, then reusing the heat energy from the ventilated air to heat the hot water and the heating system.

Basically, the mode of operation is that the ventilation air is exhausted from all the wet areas of the building, creating a small pressure which makes air from the other rooms travel to the wet areas as well. New exterior air is pulled in through the valves in the windows or walls, and the whole building is ventilated.

The circulating air is taken through the canal system of the building and the heated room air is led to the heat pump where the energy of the air is recycled. This way the heat pump can provide the whole building with hot water and heat for the heating system.

The difference between air/water and air/air:

Air heat pumps can be categorized by how the energy pulled from the

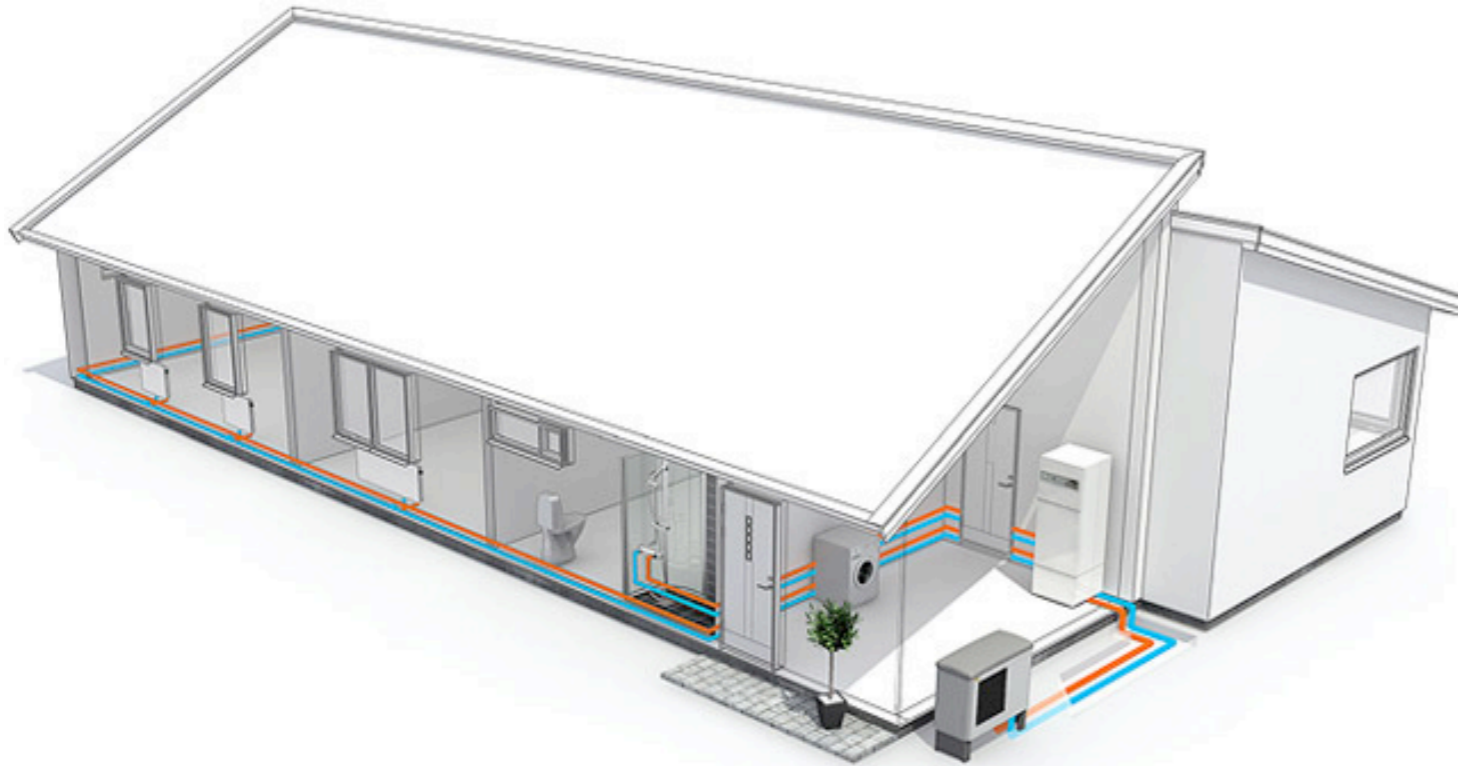

exterior air is distributed in the building.

An air heat pump where an interior part distributes the heat with a fan is called air/air heat pump. This type of heat pump is a complement to the primary heating system.

An air heat pump which is intended to provide heat to a waterborne system with radiators or floor heating is called air/water heat pump. This kind of heat pump provides the whole building with heat through a waterborne system of floor heat or radiators. The air/water pump can also heat tap water.

Unlike the air/air heat pump, the heat is distributed soundlessly by the waterborne heating system, as opposed to a noise producing fan.

Geothermal heat pump:

With a hose filled with liquid, a so called collector, it is possible to collect stored solar heat from deep down in the bedrock, or a few meters underneath the lawn. The term geothermal heat is used as a generic for all the heat sources; geothermal heat, soil heat, lake heat or groundwater heat. Here, the description is limited to geothermal and soil heat.

The heat pump concentrates the stored heat energy much in the same way as the air to water heat pump, with the difference that the heat energy comes from the ground as opposed to the air. This kind of heating system requires an extensive installation including drilling or digging to place the collector. For a geothermal heat pump, the drill hole can vary between 90 and 200 meter deep, while for a soil heat pump, the collector is placed at 80 to 100 meter, but spread out on a much larger area. With the soil heat pump, the highest yield is acquired in soil which contains a lot of water.

A geothermal heat pump can be combined with a ventilation system with heat recovery; the heat pump is placed in an appliance room together with accumulator tanks for water, while several of the much smaller ventilation appliances are distributed around the building to cover the ventilation need for each room.

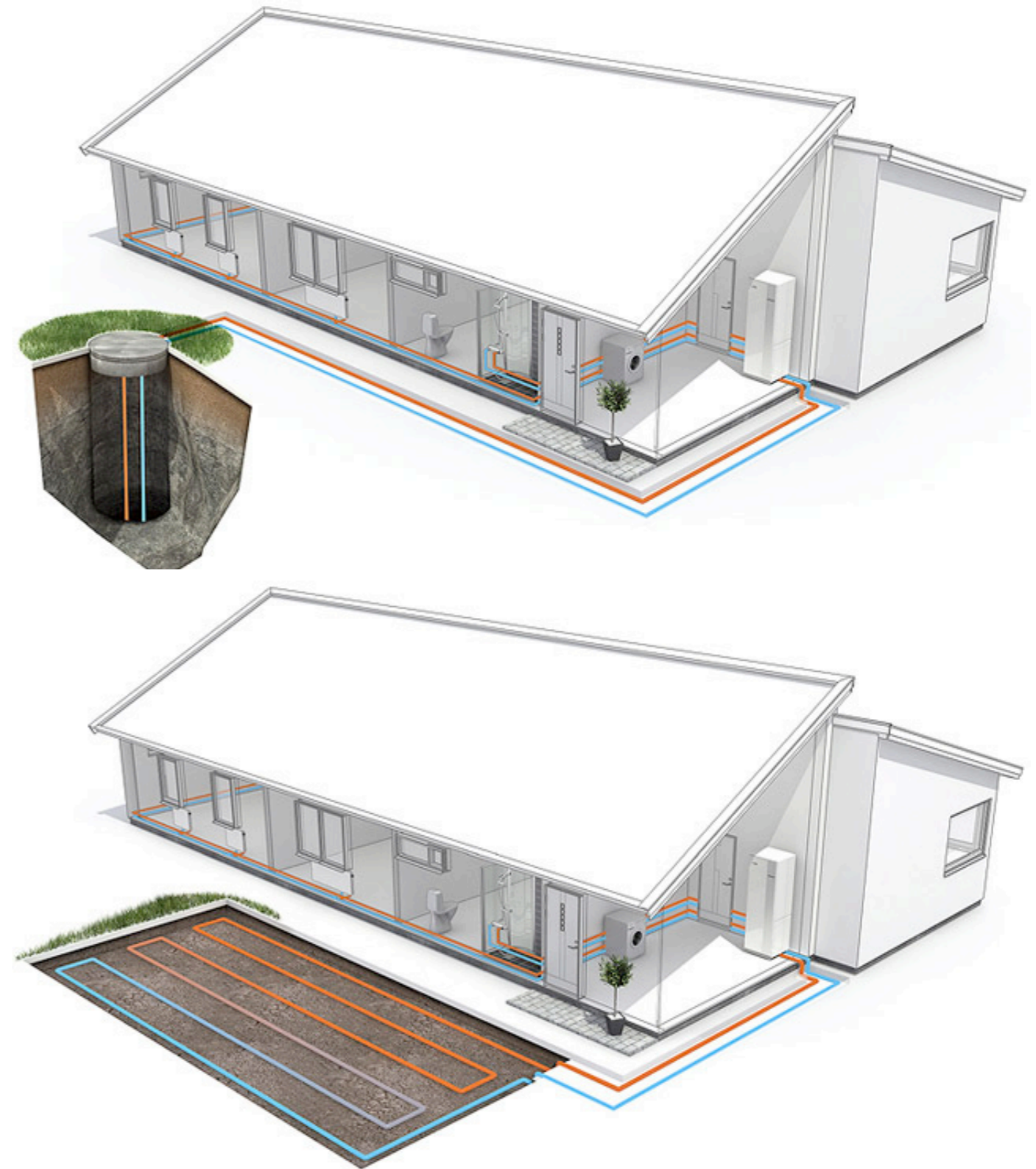

Appendix III - temperature calculations

Energy balance:

Solve T_v (temperature greenhouse)

$$\text{Window area (greenhouse <--> out)} \cdot U_v \cdot (T_v - T_{out}) = \text{Window area (greenhouse <--> in)} \cdot U_{house} \cdot (T_{house} - T_v)$$

$$\text{Window area (greenhouse <--> out)} = 76\text{m}^2$$

$$\text{Window area (greenhouse <--> in)} = 20\text{m}^2$$

$$U_v = 3,5 \text{ W/m}^2\text{K}$$

$$U_{house} = 0,8 \text{ W/m}^2\text{K}$$

$$T_{out} = -5^\circ \text{ C}$$

$$T_{house} = 22^\circ \text{ C}$$

calling Window area (greenhouse <--> out) A_1 and Window area (greenhouse <--> in) A_2 gives:

$$A_1 \cdot U_v \cdot (T_v - T_{out}) = A_2 \cdot U_{house} \cdot (T_{house} - T_v)$$

simplified:

$$A \cdot B \cdot (C - D) = E \cdot F \cdot (G - C)$$

$$ABC - ABD = EFG - EFC$$

$$ABC + EFC = ABD + EFG$$

$$C (AB + EF) = (ABD + EFG) / (AB + EF)$$

$$T_v = (A_1 U_v T_{out} + A_2 U_{house} T_{house}) / (A_1 U_v + A_2 U_{house})$$

$$T_v = (76 \cdot 3,5 \cdot (-5) + 20 \cdot 0,8 \cdot 22) / (76 \cdot 3,5 + 20 \cdot 0,8)$$

$$T_v = (-1330 + 352) / 282$$

$$T_v \approx -3,4$$

Heat transfers:

1) without greenhouse

2) with greenhouse, between greenhouse and outside

3) with greenhouse, between greenhouse and inside

$$\text{Transfer}_1 = \text{Window area}_1 \cdot U_{house} \cdot (T_{house} - T_{out})$$

$$\text{Transfer}_2 = \text{Window area}_2 \cdot U_v \cdot (T_v - T_{out})$$

$$\text{Transfer}_3 = \text{Window area}_3 \cdot U_{house} \cdot (T_{house} - T_v)$$

$$\text{Window area}_1 = 20\text{m}^2$$

$$\text{Window area}_2 = 76\text{m}^2$$

$$\text{Window area}_3 = 20\text{m}^2$$

$$U_v = 3,5 \text{ W/m}^2\text{K}$$

$$U_{house} = 0,8 \text{ W/m}^2\text{K}$$

$$T_{out} = -5^\circ \text{ C}$$

$$T_{house} = 22^\circ \text{ C}$$

$$W = \text{W/m}^2\text{K} \cdot \text{m}^2 \cdot \text{K} \rightarrow W = \text{W/m}^2\text{K} \cdot \text{m}^2 \cdot \text{K}$$

$$K = U \cdot A$$

$$Q = U \cdot A(T_i - T_e)$$

$$0,8 \cdot 20 \cdot (22 - (-5)) = 0,8 \cdot 20 \cdot 27 = 432$$

$$76 \cdot 3,5 \cdot (5 - (-3,4)) = 76 \cdot 3,5 \cdot 1,6 = 409,6$$

$$0,8 \cdot 20 \cdot (22 + 3,4) = 0,8 \cdot 20 \cdot 25,4 = 406,4$$

$$Q_1 = 432\text{W}$$

$$Q_2 = 409,6\text{W}$$

$$Q_3 = 406,4\text{W}$$

$$0,8 \cdot 20 \cdot (22 - T_v) = 76 \cdot 3,5 \cdot (T_v - (-3,4))$$

$$16 \cdot 22 + 22T_v = 266T_v - 920,4$$

$$352 + 920,4 = 244T_v$$

$$T_v = (920,4 + 352) / 244$$

$$T_v = 1272,4 / 244$$

$$T_v = 5,2$$