



EUROPEAN  
COMMISSION

Community research

# SOLGATE

Solar hybrid gas turbine electric power system



PROJECT REPORT

**Interested in European research?**

**RTD info** is our quarterly magazine keeping you in touch with main developments (results, programmes, events, etc). It is available in English, French and German. A free sample copy or free subscription can be obtained from:

European Commission  
Directorate-General for Research  
Information and Communication Unit

B-1049 Brussels

Fax : (32-2) 29-58220

E-mail: [research@cec.eu.int](mailto:research@cec.eu.int)

Internet: [http://europa.eu.int/comm/research/rtdinfo/index\\_en](http://europa.eu.int/comm/research/rtdinfo/index_en).

**EUROPEAN COMMISSION**

Directorate-General for Research  
Directorate J — Energy  
Unit J.3 — New and renewable Energy Sources

*European Commission*

*Office CDMA 05/141*

*B-1049 Brussels*

*E-mail: [rtd-energy@cec.eu.int](mailto:rtd-energy@cec.eu.int)*

*Further information on energy research in the EU can be found at*

*[http://europa.eu.int/comm/research/energy/index\\_en.html](http://europa.eu.int/comm/research/energy/index_en.html)*

*<http://www.cordis.lu/sustdev/energy>*

# SOLGATE

solar hybrid gas turbine electric power system

**Contract ENK5-CT-2000-00333**

Final Publishable Report

Project partly funded by the European Community  
in the framework of the 5th RTD Framework programme  
1998-2002

Thematic Programme  
Energy, Environment and Sustainable Development

## **Partners**

**ORMAT**  
**CIEMAT**  
**DLR**  
**SOLUCAR**  
**TUMA**

***Europe Direct is a service to help you find answers  
to your questions about the European Union***

**Freephone number:  
00 800 6 7 8 9 10 11**

**LEGAL NOTICE:**

Neither the European Commission nor any person acting on behalf of the Commission is responsible for the use which might be made of the following information.

The views expressed in this publication are the sole responsibility of the author and do not necessarily reflect the views of the European Commission.

A great deal of additional information on the European Union is available on the Internet. It can be accessed through the Europa server (<http://europa.eu.int>).

Cataloguing data can be found at the end of this publication.

Luxembourg: Office for Official Publications of the European Communities, 2005

ISBN 92-894-4592-0

© European Communities, 2005

Reproduction is authorised provided the source is acknowledged.

*Printed in Luxembourg*

PRINTED ON WHITE CHLORINE-FREE PAPER

# 1 Table of contents

1	Table of contents .....	1
2	Executive Publishable Summary .....	2
3	Objectives of the project .....	3
4	Scientific and technical description of the results .....	3
	4.1 WP 1: Gas Turbine .....	3
	4.2 WP 2: Receiver .....	5
	4.2.1 Work Package 2.1: High Temperature Module .....	6
	4.2.2 Work Package 2.2: Tube Receiver Section .....	9
	4.3 WP 3: Integration of System .....	10
	4.3.1 WP 3.1 Interface Definition .....	10
	4.3.2 WP 3.2 Test Bed Preparation .....	10
	4.4 WP 4: Solar Tests & Evaluation .....	12
	WP 4.1 & WP 4.2: Solar system Testing and Performance Evaluation .....	12
	WP 4.3: Development of Simulation Tools .....	19
	WP 4.4: Verification of Simulation Tools .....	22
	4.5 WP 5: Conceptual Layout of Power Plants .....	25
	4.5.1 WP 5.1: Adaption of Industrial Gas Turbines .....	25
	4.5.2 WP 5.2: Layout of Solar-Hybrid Power Plant .....	27
	4.5.3 WP 5.3: Performance Assessment .....	30
	4.5.4 WP 5.4: Cost Analysis .....	32
	4.6 WP 6: Market Assessment .....	37
	4.6.1 WP 6.1 Market Assessment .....	37
	4.7 Milestones: .....	42
	4.8 List of Contact Persons .....	43
5	Results and Conclusions .....	43
	5.1 Conclusions .....	46
6	References .....	46

## 2 Executive Publishable Summary

A solar-hybrid test system was developed, built and tested. This system consisted of a solarized gas turbine, a modular receiver and auxiliary components.

The solarized gas turbine was based on a helicopter engine, which was modified to enable external solar heating. Modifications included a combustor suitable for air inlet temperatures up to 800°C, addition of a generator connected via a reduction box to the gas turbine shaft, a new control system and an oil cooling system. The design power output was 250 kWe.

The receiver consists of 3 modules connected in series. Each receiver module was equipped with a hexagonal secondary concentrator to enable installation side by side in the aperture plane. One new receiver module was installed for the first stage, operating at “low” temperatures of up to 550°C, and another one was installed for the third stage, operating at up to 1000°C. The low temperature module was built from 16 parallel metal tubes, arranged as a cavity. The high temperature module was a pressurized volumetric receiver, using highly porous ceramic foam as absorber.

Integration of the system components into the solar tower test facility of the PSA was completed on November 2002. System commissioning continued until December 2002 when the solar system operation started. During the test runs, the receiver outlet temperature was increased stepwise up to the design temperature of 800°C and the design electrical power output of 230 kW. It was successfully demonstrated that the combination of pressurized volumetric solar receivers and a gas turbine really works. Some minor problems were identified, but the general system behavior was good. Preliminary evaluation indicated module efficiency (receiver + secondary conc.) of 77% ±5%.

After the installation of a high temperature ceramic absorber and an active external window cooling in spring 2003, operation was resumed in July. A maximum temperature of 960°C was reached before an oil leak in the gas turbine caused a test interruption. Except for this, the system worked quite well, especially as the measured quartz window temperatures remained well below the expected values.

For comparison of the test results with predictions from the simulation tools, several code extensions were developed to represent the gas turbine components and receivers. These tools were evaluated against the system test results, showing satisfactory agreement.

System layout tools were enhanced to be used for the cost optimized layout of three commercial power plants based on industrial gas turbines with power levels of 1.4, 4.2 and 16 MW. The performance and economic analysis for the 16 MW solar-fossil hybrid combined cycle with 800°C receiver temperature led to specific investment cost of 1440 €/kW, resulting in LEC of 5.7 €cent/kWh at 16% annual solar share. A higher solar share of above 50% can be reached with a receiver temperature of 1000°C. The LEC would then rise to about 8.6 €cent/kWh. The cost reduction potential with respect to other solar thermal power technologies was verified.

The current and future market for solar thermal power plants was assessed, with an emphasis on the Mediterranean area. The conclusion was that a significant application potential exists for solar thermal power systems. However, exploitation of the potential depends strongly on the political and financial framework of this technology.

### 3 Objectives of the project

#### Scientific and Technological Objectives:

The objective of the SOLGATE project was the development of a solar-hybrid power system with direct solar heating of a gas turbine's pressurized air. In combination with highly efficient combined cycle systems or recuperated gas turbines, significant cost reductions for solar electric power generation can be achieved (predicted LEC of 0.069 €/kWh at a specific investment cost of 1410 €/kW for a 30MW solar-fossil hybrid combined cycle with 1200°C receiver temperature leading to 50% annual solar share). The project intended to prove the technological feasibility, performance and cost reduction potential of such power plants.

The SOLGATE project aimed to prove the technical feasibility and verify the electricity cost reduction potential of such a system. The result is the technological know-how of the components and the system as well as the operational experience required to initiate a demonstration project. To achieve this, the following objectives had to be met:

- Modification of a gas turbine for external air heating; development of pressurized receiver technology with air outlet temperature of up to 1000°C; solar-hybrid system operation, verification of the predicted performance of the system and its components
- Verification of the cost estimates for the solarized gas turbine and the receiver system
- Development of software tools to simulate the system. The results achieved by the simulation tools were confirmed using the performance measurements from the test system. Optimized system configurations in three power levels from 1 to 17 MWe were used to verify the predicted cost goal
- Assessment of the system's market potential, and identification of initial niche applications for market introduction and definition of a first industrial demonstration plant

### 4 Scientific and technical description of the results

#### 4.1 WP 1: Gas Turbine

##### (Task Leader: ORMAT)

The objectives of Task 1 were to purchase the gas turbine and to convert it into a solar-hybrid Power converting Unit (PCU) installed in the SOLGATE test loop.

Major developments were in the combustor, suitable for air inlet temperatures up to 800°C, and the high temperature piping for interconnecting with the receiver subsystem. Also, significant modifications were made to the control of the PCU.

A new igniter and fuel shut off valves were installed and tested. A powerful starter charger and batteries were procured and installed, and the control logic was modified. New software was applied, the PCU was equipped with new instruments and the operation boxes were modified.

The PCU was commissioned in ORMAT Israel with the test loop specially set up to include a heat exchanger and pipes with volume and pressure drop similar to the SOLGATE loop design. The synchronizing tests performed with this setup at ORMAT were successful, achieving up to 60 kWe with the heat exchanger fuel only output and 80 kWe without the heat exchanger.

Measurements to the systems vibrations and noise were carried out. The following test runs were dedicated to lowering the temperatures in the turbine, decreasing the initial flames coming from the

exhaust, shortening starting time and achieving better GT stability. A cooling tower connected to the HX was used to simulate the expected changes in the entering air temperature.

The gas turbine, gearbox, power shafts, couplings, electrical cables, instruments, oil pump, etc. were removed from the old skid and transferred to the new light weight smaller and more rigid power skid, with the new electrical generator (May 2002). During initial tests the metering valve failed and was repaired by the manufacturer, causing several weeks of delay.

Gearbox cooling system was adapted for totally automated operation, the oil cooling system was adapted to the tight space in the test platform.



Fig. 1: OST3 New Power Skid with generator

The new skid including the new generator commissioning was completed with good control, and automatic synchronization to the grid supplying 80KW of electricity without the HX. The solarization process completed the OST3 having new fuel, combustion and control systems dissimilar to the original helicopter turboshaft engine systems.

The PCU was installed 60 meters up in the CESA 1 tower REFOS room, power cables connected to local PSA grid, control cables connected to the PC in the control room. In October 2002, the non-solar commissioning without the SOLGATE loop was carried out delivering 100KW to the grid.

Non-solar operation with the 3 receivers started in December 2002, immediately followed by solar operation. The OST3 completed hybrid solar commissioning on December 2002 with over 70KWe, with a solar fraction of about 40%.





Fig. 2: PCU Commissioning at PSA

## 4.2 WP 2: Receiver

(Task Leader: DLR)

The main goal of WP 2 was the development of two different receiver technologies for air heating in gas turbine cycles:

- a volumetric receiver capable for temperatures up to 1000°C
- a low temperature receiver module at significantly reduced cost for the low flux regions of the focal spot

The complete SOLGATE receiver system consists of three receiver modules that are connected in series (Fig. 3). During the previous REFOS project pressurized volumetric receiver modules were developed for temperatures up to 800°C. Two of these modules were available for the SOLGATE test setup.

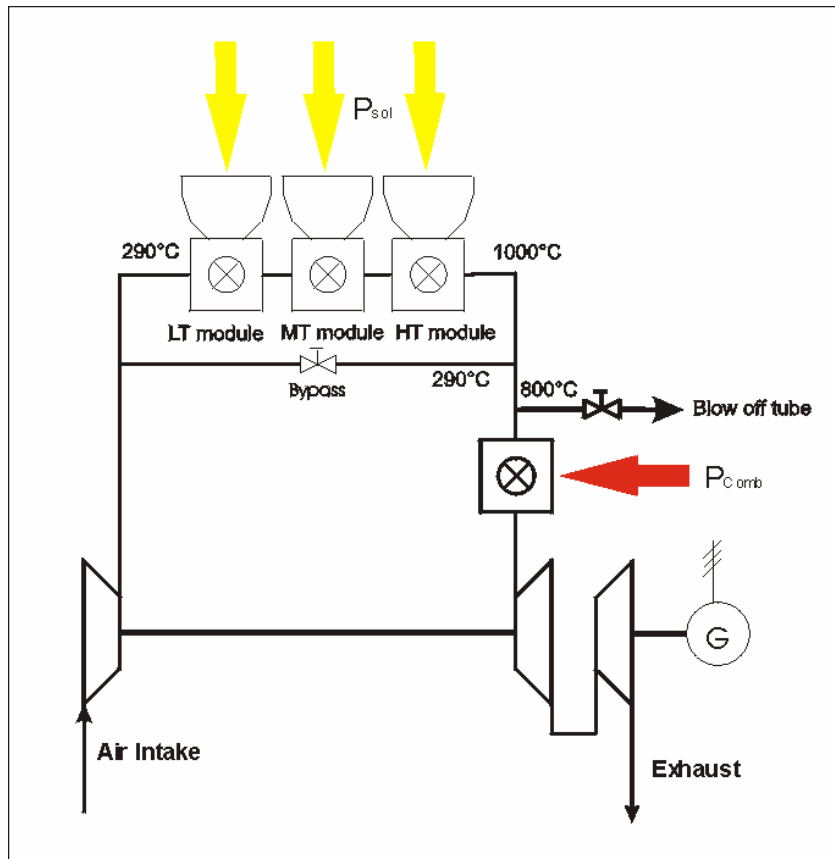

Fig. 3: Scheme of the SOLGATE test system

The modules have a hexagonal entrance aperture and are arranged in a honeycomb-like arrangement in the focal spot (Fig. 4). For higher power levels the complete focal spot can be covered by a number of low, medium and high temperature modules that are interconnected in serial and parallel way. Fig. 4 shows a scheme of such a modular receiver arrangement for higher power levels, with each module having a power level of about 400 kW and a temperature increase of about 250 K.

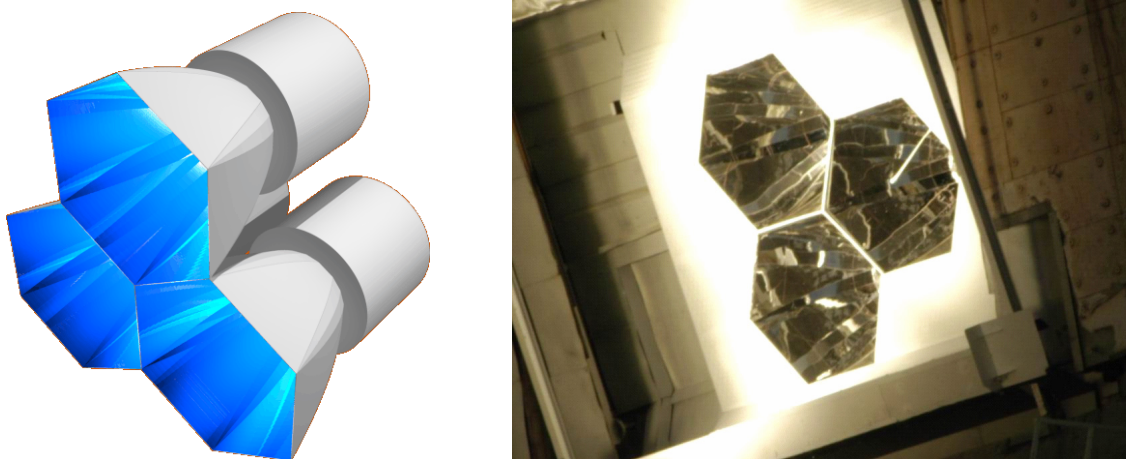

Fig. 4: Honeycomb arrangement of receiver modules

#### 4.2.1 Work Package 2.1: High Temperature Module

The development of the high temperature module is based on former experiences with pressurized volumetric receivers (see Fig. 5), where the maximum receiver exit temperature was limited to 800 C.

To achieve outlet temperatures of 1000°C new developments became necessary concerning the absorber, the absorber mounting and the window cooling.

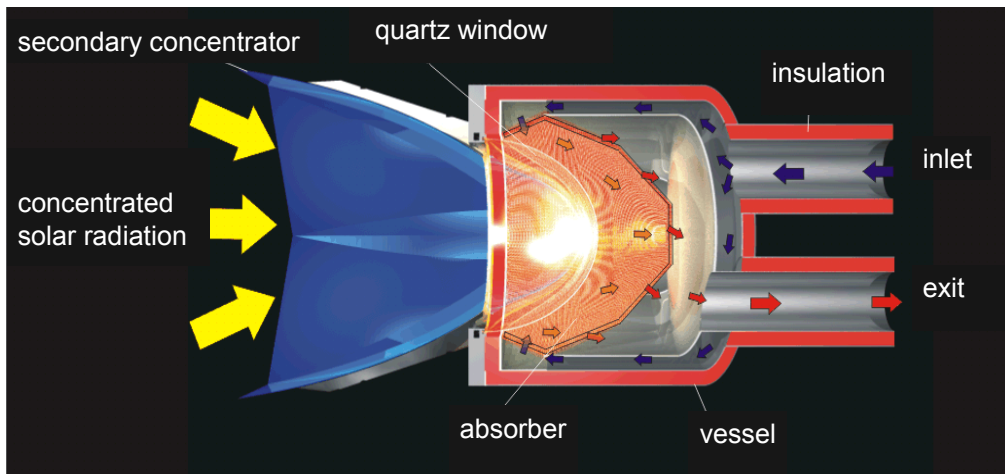

Fig. 5: Scheme of a pressurized volumetric receiver

#### 4.2.1.1 Absorber and Absorber Mounting

The high temperature absorber geometry was determined from ray-tracing calculations. For the high temperatures a ceramic foam absorber is used, installed on a ceramic mounting structure. For the absorber structures, the experience from previous receivers was applicable where reticulated SiC foam absorbers have been applied.

For the absorber mounting structure a fiber-reinforced alumina-based structure was selected. As the required high temperature materials are relatively expensive, rib geometry was selected that results in a relatively low amount of ceramic structures. The final mounting structure consists of 12 rib segments held together by two clamping rings, also manufactured from the same fiber-reinforced ceramic material. At the feet of the ribs, a T-like shape was formed to allow clamping to the metallic outer casing (which is at lower temperature). The elements of the mounting structure were built and adjusted to the absorber dome. For the metal brackets that connect the ceramic structure to the metal casing tensile strength analysis was done with ANSYS.

After the successful pretests the HT absorber was assembled. This insert replaced the existing metallic absorber insert suitable for temperatures up to 800°C. Fig. 6 shows the ceramic HT absorber before installation.



Fig. 6: High temperature absorber

#### 4.2.1.2 Window Cooling

To avoid overheating of the quartz glass, an active window cooling based on air jets blowing towards the window was developed. Several options with different air nozzle numbers and directions were evaluated using the CFD code FLUENT. In Fig. 7, the dimensionless representation of results for the mean heat transfer coefficients for 6 and 9 nozzles is shown. Increasing the nozzle-Reynolds-number enhances the heat transfer, while the spatial distribution of the heat transfer coefficients stays almost the same. The mean heat transfer is independent from the nozzle dimensions, as long as the nozzle-Reynolds-number is kept constant.

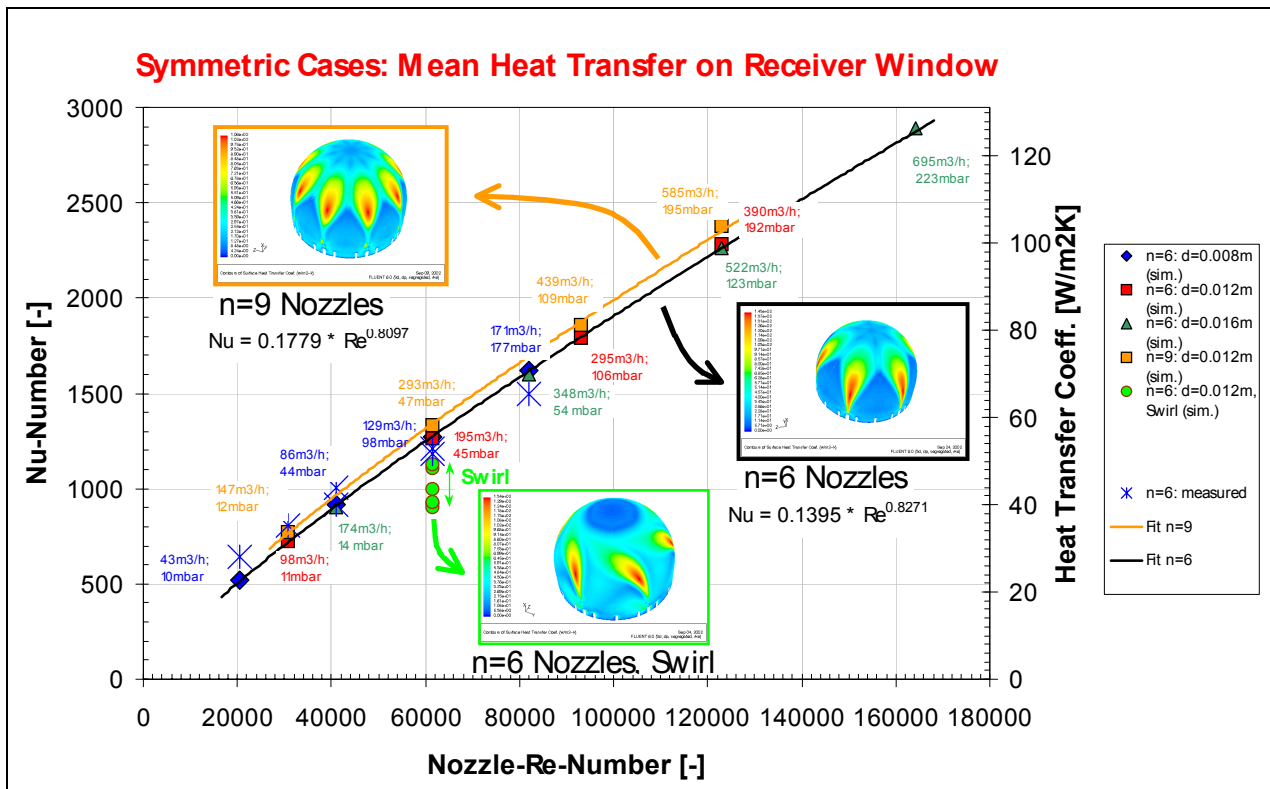

Fig. 7: Mean heat transfer on receiver window for symmetric flow conditions

From the simulation results a configuration with 18 nozzles was selected. To verify the CFD simulations, a laboratory test bed was built. The laboratory test results agreed well with the CFD predictions.

The cooling system was installed at the PSA test system together with the air supply system, including blower, flow distributor, nozzles etc. Estimates for the parasitic energy consumption of the blower indicated that only 0.2 % of the produced electricity is required for the active cooling.

#### 4.2.2 Work Package 2.2: Tube Receiver Section

The aim of the low temperature receiver development was to achieve an overall cost reduction by utilizing simple, less expensive modules at the first, low temperature stage of the serial receiver connection. The main design goals of this low temperature (LT) module were high thermal efficiency at low pressure drop, low manufacturing cost and high durability.

Preliminary assessment of various concepts (absorber with and without secondary concentrator, flat or cavity-like tube geometry, and double-walled absorber) showed a 15% advantage in efficiency for tube receivers with a secondary concentrator, due to the reduced thermal reradiation and convection losses. The selected concept is a multi-tube coil attached to a hexagonal secondary concentrator. The bent tubes are very flexible and thus reduce mechanical stresses from thermal expansion of the tube material. The coil geometry also improves the heat transfer coefficient. The axial cross section of the absorber is approximately elliptical leading to a relatively homogeneous solar flux density distribution over the absorber tubes, thus reducing local peak temperatures.

The final layout consists of 16 tubes connected in parallel, each with a length of 2.3 m and a diameter of 28 mm. The nominal temperature increase is about 200 K with an associated pressure drop of 100 mbar. The maximum tube temperature is 950°C at a module outlet temperature of 550°C. Appropriate tube headers with low pressure drop were designed to obtain equal mass flow distribution through all tubes connected in parallel. Fig. 8 shows a scheme of the low temperature module together with the distributor and header tubes.

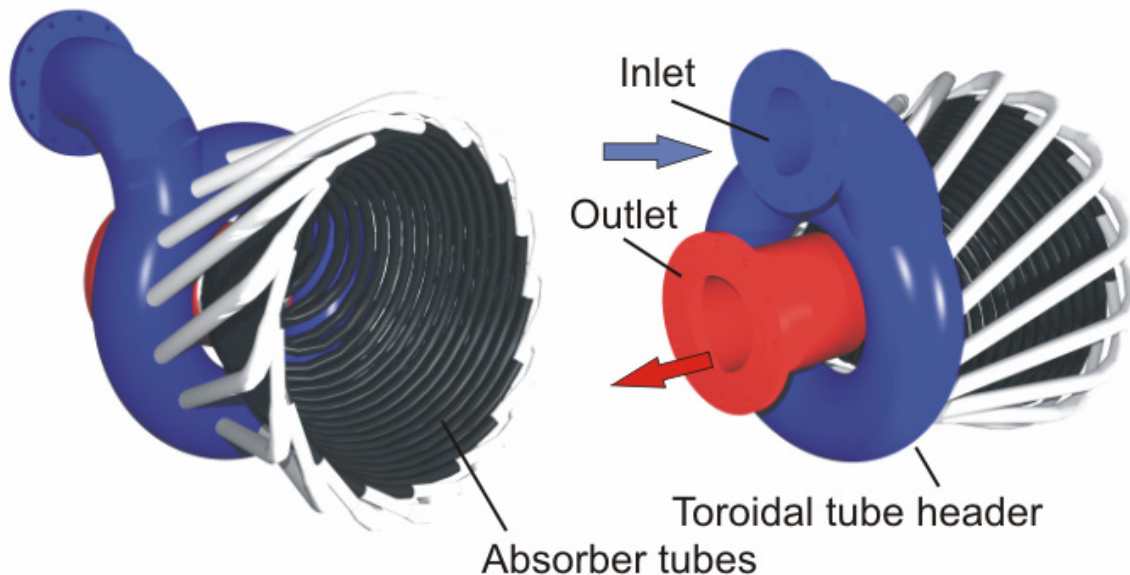

Fig. 8: Schematic views of the Low Temperature Module

Extensive FEM analysis was made on the tube and the absorber assembly to ensure that the stresses are within acceptable limits.



The LT module was manufactured and integrated as first receiver stage in the solar test system. To reach a high solar absorption coefficient the absorber tubes were coated with a high temperature resisting black paint.

From the manufacturing a total absorber cost of 10.300 € was derived. The secondary concentrator adds another 7'000 €, giving a module cost of 17'300 €. This corresponds to a 50% cost reduction compared to the expected module cost for a pressurized volumetric receiver module.

### 4.3 WP 3: Integration of System

(Task Leader: SOLUCAR)

#### 4.3.1 WP 3.1: Interface Definition

The main systems in the project and their interfaces can be extracted from the following schematic picture:

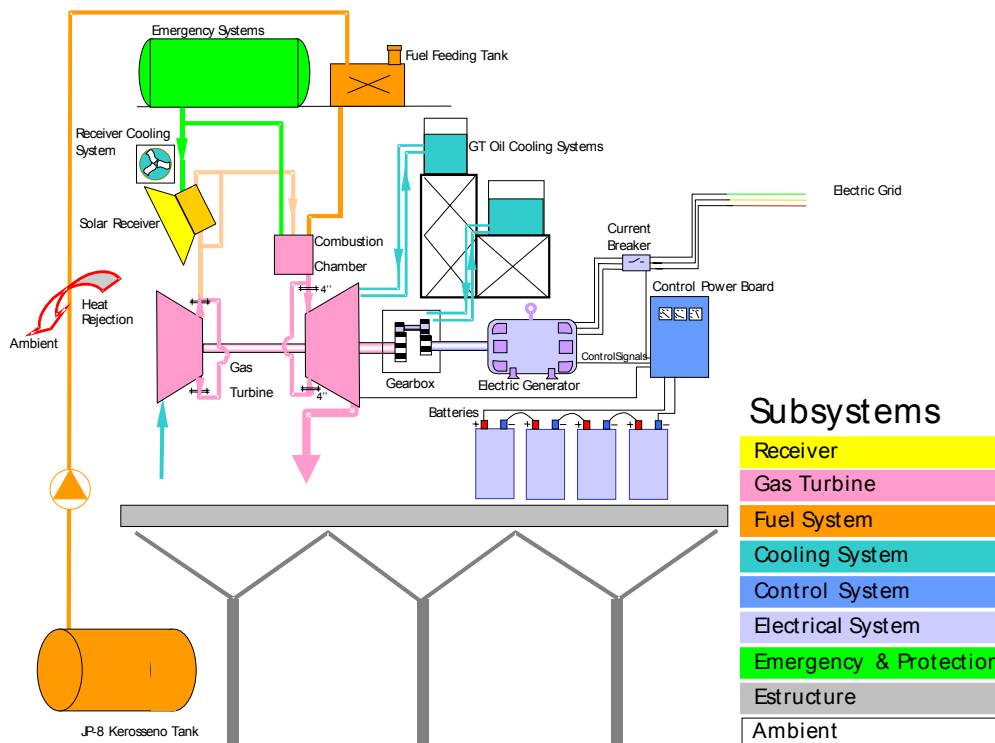

Fig. 9: Schematic of interface definition

Interfaces between every subsystem and their correspondent responsible partners have been identified and were specified in the Interfaces Specifications Document (ISD). Possible emergency situations were analyzed and safety procedures developed.

#### 4.3.2 WP 3.2: Test Bed Preparation

The following picture shows the final layout of the solar-hybrid test system.

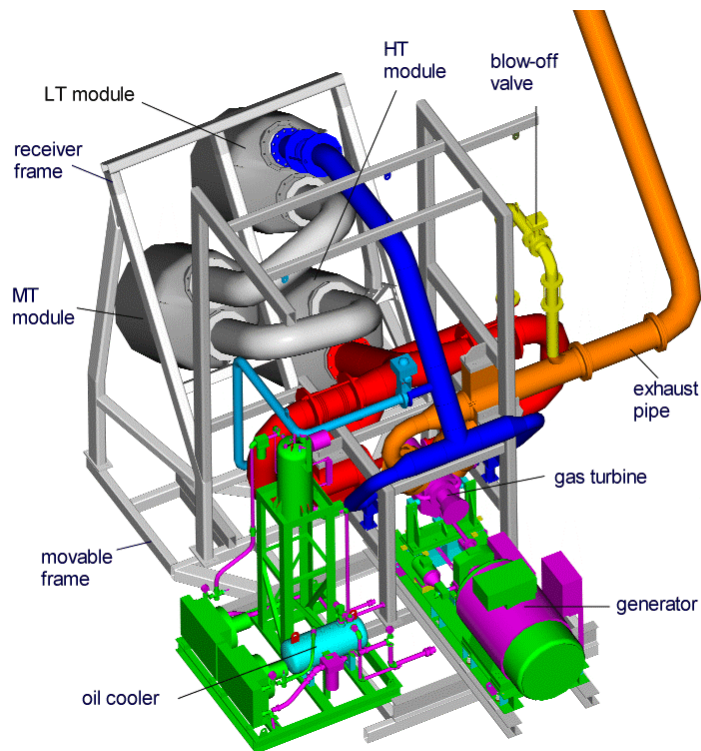

Fig. 10: Final layout test loop arrangement

The CESA-1 infrastructure was prepared for the SOLGATE test requirements. The fuel supply tank and fuel feeding tank were installed, as well as the main fuel line and connections between fuel line, pump, tanks and turbine. The legal license for the fuel installation was obtained. The electrical connections were defined and installed.

The power conversion unit and the receivers were integrated into the test bed. The hot air pipes were designed manufactured and installed (Fig. 11). The secondary concentrators were prepared and installed (Fig. 12).



Fig. 11: Mounting of the gas pipes

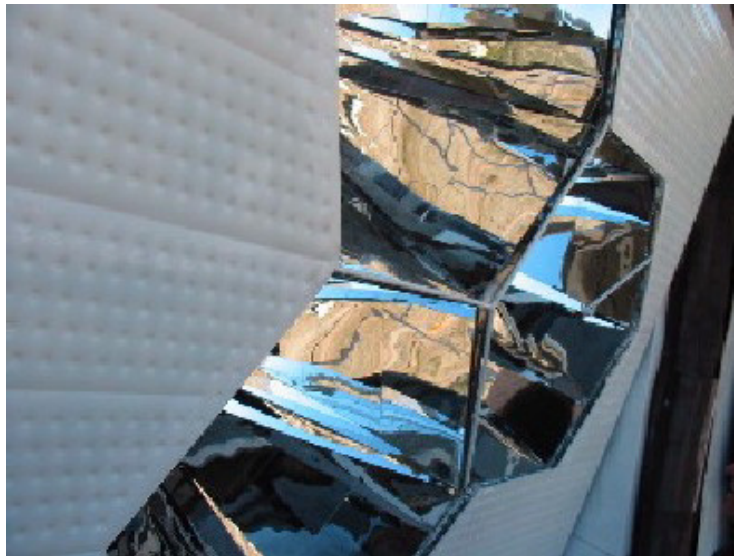

Fig. 12: View onto the secondaries from outside

After completion of the integration the control system and data acquisition system was tested. Initial non solar test have been realized.

#### **4.4 WP 4: Solar Tests and Evaluation**

**(Task Leader: CIEMAT)**

##### **WP 4.1 and WP 4.2: Solar system Testing and Performance Evaluation**

The common goal of these two tasks was the operation of the solar-hybrid gas turbine system both to qualify system performance and to obtain O&M data. Besides, these two working packages were aimed to prove the technical feasibility of the solar-hybrid system.

The SOLGATE tests were divided into two test phases:

- Phase 1, in winter 2002/2003, should demonstrate the general operation capability of the gas turbine together with the receiver cluster and reach the design operation conditions (HT-receiver air exit temperature 800°C). This also included the test of the new low temperature module (tube receiver) and the improved secondary concentrators.
- In Phase 2, in summer 2003, the receiver air outlet temperature should be increased to 1000°C, using a ceramic absorber and assisted by an active external window cooling. The window temperature should be measured in unprecedented resolution and precision by a new Infrared-Scanner.

##### **Security System**

The system operators were assisted by security systems in the gas turbine and in the receiver data acquisition systems (DAS). The receiver DAS can initiate low-level alarms which allow the operator to take corrective actions. Other situations initiate high-level alarms which automatically remove immediately all heliostats from the focus. The gas turbine is never affected by the receiver alarms.

The gas turbine DAS security system can initiate either a defocus of the heliostat field followed by a normal shut-down of the gas turbine. The most severe alarm level is equal to the previous one, but also immediately shuts off the gas turbine by closing the fuel shut off valve. Additionally the blow-off



valve is opened to release the air stored in the pressurized receiver volume and the fast shutter brake is released to cut off solar radiation within 1.6 seconds.

Problems occurred in the first test phase mainly with high temperatures at the secondary concentrator extensions. Improving the insulation around the secondary reduced the problems.

### Typical test procedure

A typical ideal operation day included the following steps:

- System activation: control systems, system inspection and cleaning of the optical surfaces, activation of gas turbine subsystems, cooling water, fast shutter, etc.
- Start of the gas turbine: automated turn on sequence until grid connection.
- Preparation of solar operation: Activation of the security system, test of auto defocus, and activation of the IR-camera.
- Solar operation: a set value for the gas turbine power is defined, and heliostats are focused according to the test strategy
- System cool down and gas turbine shut down
- System deactivation and inspection

### Test Phase 1

After completion of the installation of the system at the end of November of 2002, the start-up operation began. Test time was restricted by another project that needed the resources of the CESA-I tower from March on. In the first two weeks of December, the gas turbine was operated and adjusted with the additional volume of the receivers, but still without solar radiation. On December 15<sup>th</sup>, 2002, the gas turbine generated electric power with partially solar preheated air (see Fig. 13).



Fig. 13: “First Light”

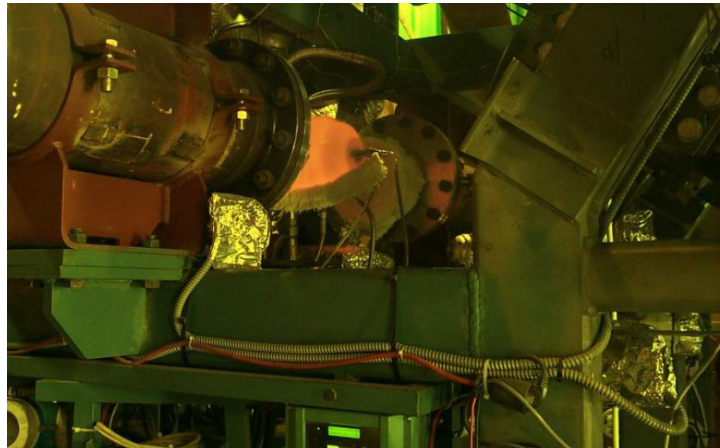

Fig. 14: Glowing combustor at high power operation

### Summary of Phase 1 operation

The most important results of the SOLGATE test phase 1 operation were:

- The solarized gas turbine worked quite well, the design operation conditions (800°C, 230 kW<sub>el</sub>) were reached. Fig. 14 shows a view onto the (non-insulated) combustor during operation.

- The accumulated operation time of the gas turbine was 73 hours, 51 of them with solar radiation. The estimated solar fraction of the generated electricity was approx. 2.5 MWh.
- The gas turbine control system had no problems with even rapid solar transients.
- The pressure drop of the receiver cluster at nominal conditions of 120 mbar was lower than expected. 2/3 of the pressure drop is caused by the low temperature tube receiver.

The only emergency shut down under part load conditions apparently worked without problems.

### Performance evaluation of Phase 1

Design conditions in Phase 1 were achieved in the last three test days of the 1<sup>st</sup> test phase. Test data for a day with 800°C operation is given here as an example.

The required use of the heliostat field to achieve the design conditions for phase 1, with about 900 W/m<sup>2</sup> of direct normal irradiation (DNI), was about 55 heliostats. Air temperatures in the receiver modules were increased from about 300 °C in the low temperature (LT) inlet to about 800°C in the high temperature (HT) outlet. The temperature data and the gained power in each of the three receiver modules are shown in Fig. 15.

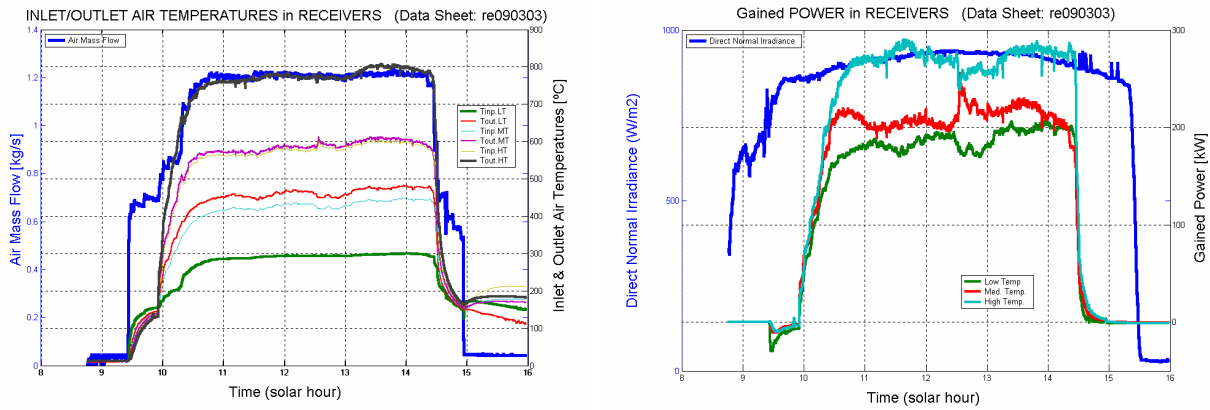
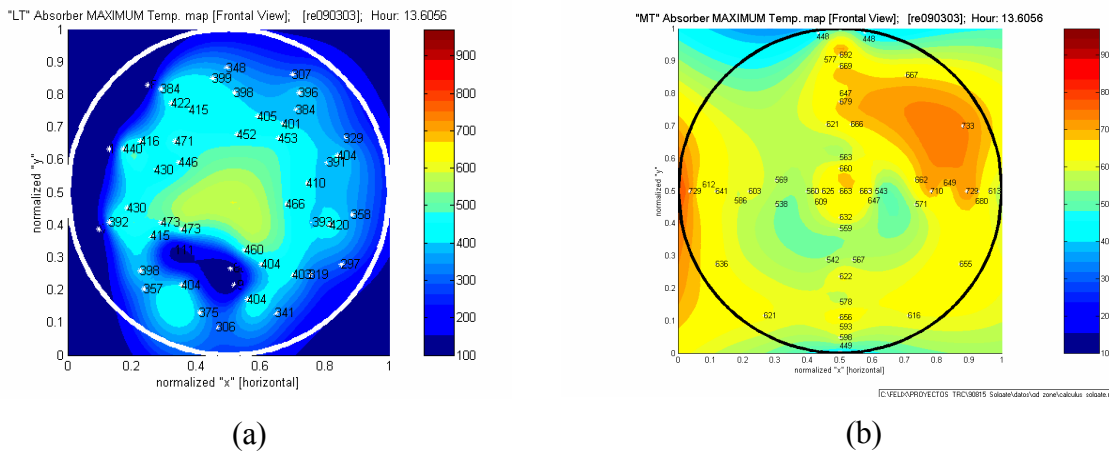

Fig. 15: Air temperatures and power gains in receiver modules

The absorber temperature distribution (using the absorber temperature measurements and its position) at maximum outlet air temperature is show in Fig. 16.



(a)

(b)

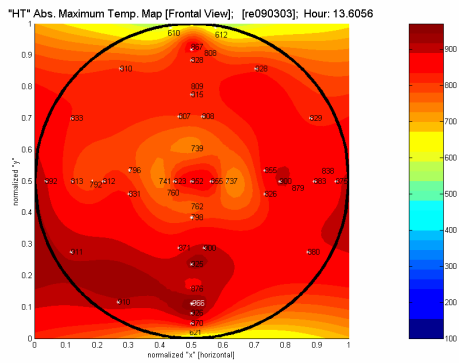

(c)

The asterisks (and, approximately, numbers) over the maps indicate the co-ordinates where temperature were measured.

Fig. 16: 2-D interpolation of absorber temperatures in LT (a), MT (b) and HT (c) absorber modules

The estimated receiver module efficiencies for the 11 incident solar power measurements during this test day range between 68% and 79%. The absolute air pressure at these conditions is in the order of 6.5 bar and the pressure drop through the receiver cluster is about 120 mbar which corresponds well to the design pressure drop.

The gas turbine system performance for design conditions is shown in Fig. 17.

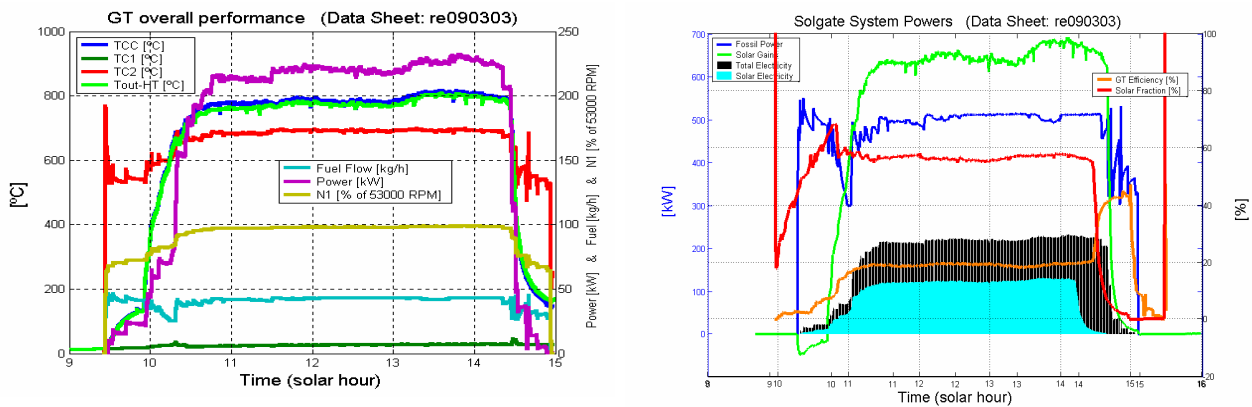
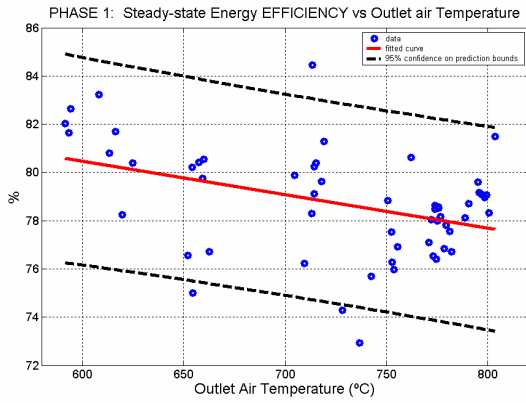

Fig. 17: Gas turbine overall performance.

The solar fraction was close to 60%, the remaining 40% were from fuel combustion. At design conditions turbine achieves near 100% of the nominal 52000 revolutions per minute. Power solar gains in the air through receivers were about 650 kW. The electrical power production, at this design conditions, was about 230 kW. The SOLGATE solarized turbine efficiency, at nominal conditions, was about 20% (see Fig. 17).

Fig. 18 shows the overall thermal efficiency of the receiver cluster for quasi-steady-state conditions.



(a)

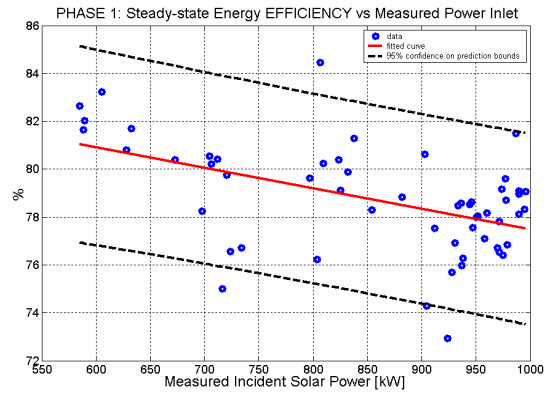

(b)

Fig. 18: Quasi-steady-state thermal efficiencies of the receiver cluster in Phase 1.

Observe that different thermal efficiency values were obtained for the same HT-outlet temperature level. The widest dispersion is observed at the highest temperatures but most of the values fall within the bounds corresponding to 95% of confidence. Thus, at 800 °C of outlet air temperature, the estimated receiver thermal efficiency is  $(78 \pm 4)\%$ .

### Test Phase 2

Before the beginning of operation phase 2, the ceramic absorber replaced the (metal) absorber of the high temperature receiver. The external window cooling (EWC) system was installed. In addition, an infrared scanner, consisting of a pyrometer and a pivoted gold mirror in a water cooled protective housing was installed to measure the window temperature with high spatial resolution to determine the effect of the window cooling. The achieve receiver temperatures higher than 800°C, part of the compressed air was bypassed directly from receiver inlet to outlet, thus reducing air flow through the receivers.

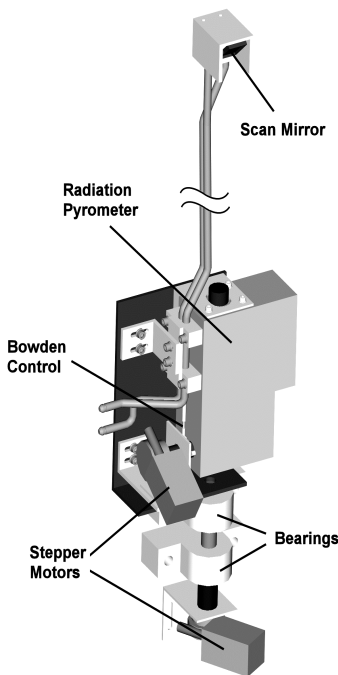

(a)



(b)

Fig. 19: The infrared scanner: (a) scheme; (b) installed in secondary entrance aperture

The infrared scanner consists mainly of a radiometer and a scanning mirror that is controlled by two stepper motors. The water-cooled mirror is mounted directly in the concentrated solar radiation in the entrance aperture of the receiver module. From there it reflects the infrared radiation emitted by the measurement object to the radiometer that is installed beside the receiver, outside the concentrated solar radiation. The scanning mirror is controlled in a way that a complete temperature distribution on the window is obtained that can be plotted as a graph. Fig. 19 shows the infrared scanner in its installation position at the entrance aperture of the high temperature module.

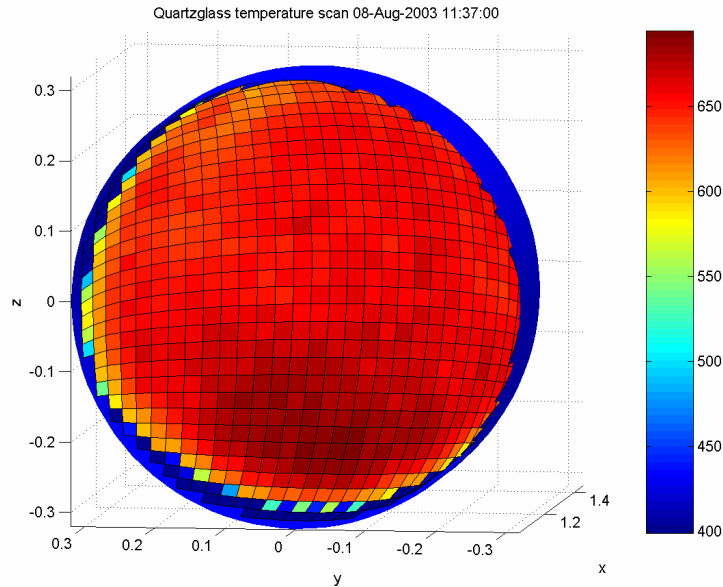

Fig. 20: Quartz window temperatures scan on 8. August 2003

The window temperatures measured with the infrared scanner showed that at operation without window cooling the window temperature distribution was similar to the absorber temperature distribution, but at a lower temperature level. The maximum window temperatures showed to be up to 200°C lower as the maximum absorber temperatures. With maximum window temperatures of about 700°C at operation conditions of 800°C outlet air temperature, the measured quartz window temperature turned out to be lower than expected. Fig. 20 shows a typical window temperature measurement (air outlet temperature: about 780°C, the maximum absorber temperature > 1000°C).

Turning on the window cooling lowered the temperature enough for operation up to 1000°C outlet temperature without exceeding the temperature limit of the quartz window.

### Full power ESD

At July 28<sup>th</sup>, the system finally reached again the design operation conditions with the bypass closed, 798°C and 216 kW (less than in March due to the much higher ambient temperatures). But then, an emergency situation suddenly stopped the operation. The emergency mechanisms worked as planned, and at the first look, everything seemed ok. But a detailed analysis of the data from the moment of the ESD revealed that the second turbine shaft reached an over-speed. The reason was a too low pressure decrease, caused by a too low airflow through the blow off pipe due to a too small orifice in the line. The orifice had been installed, because a too fast pressure drop can damage the insulation in the receivers. After this incident, a new orifice was installed with a larger bore diameter.

After this modification, tests were resumed with about the same performance as before. However, some problems were detected in the oil system requiring maintenance on the gas turbine. Therefore, testing was stopped and no higher temperatures were achieved within the project frame. It is foreseen to continue tests to demonstrate the 1000°C receiver temperature.



## Summary of Phase 2 operation

Phase 2 of the SOLGATE operation provided positive and promising results:

- The aimed operation conditions (receiver temperature 1000°C) were nearly achieved (959°C).
- The overall accumulated operation time of the gas turbine (in both test phases) was 134½ hours, 96½ of them with solar radiation. The estimated solar fraction of the generated electricity was approx. 5.2 MWh.
- The ceramic absorber has higher temperature peaks than the metal absorber.
- The distribution of the pressure drop in the whole cluster was approx. 70% LT-receiver, 20% MT-receiver, and only 10% HT-receiver.
- The window temperatures were lower than expected. A possible reason is the uncertainty of the optical data of the quartz glass in the simulation.
- The window cooling work as predicted, lowering the window temperature by about 150°C, giving enough margin for operation up to 1000°C.
- The emergency shut down system was not adjusted properly and had to be adapted.

## Performance evaluation of Phase 2

Thermal performance for nearly design conditions of phase 2 (test day: 08.08.2003)

Conditions close to Phase 2 design were nearly reached with 45 heliostats and about 770 W/m<sup>2</sup> DNI. Air temperatures in the receiver modules were increased from about 300 °C in the low temperature (LT) inlet to about 960°C in the high temperature (HT) outlet. To jump from the 800 °C level in the HT outlet to 960°C temperature level, the bypass was activated (see Fig. 21).

The HT absorber temperature distribution at maximum outlet air temperature is shown in Fig. 22.

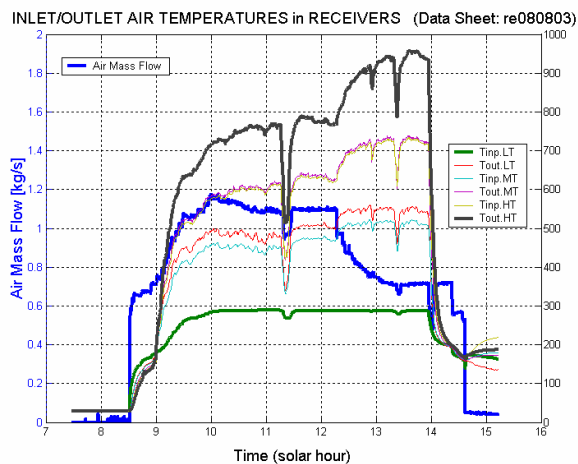

Fig. 21: Air temperatures in the receiver modules..

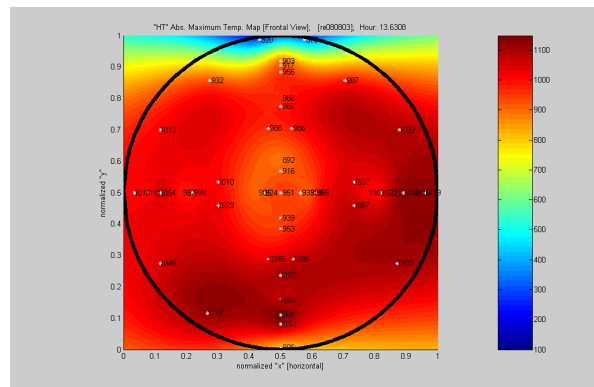

Fig. 22: temperature distribution in HT absorber module at maximum receiver outlet temperature

The estimated receiver module efficiencies for the 4 incident solar power measurements (without bypass) during this test day range between 75% and 90%. The absolute air pressure at these conditions is in the order of 5.5 bar and the pressure drop through the receiver cluster is about 110 mbar.

The gas turbine system performance for design conditions are shown in Fig. 23.

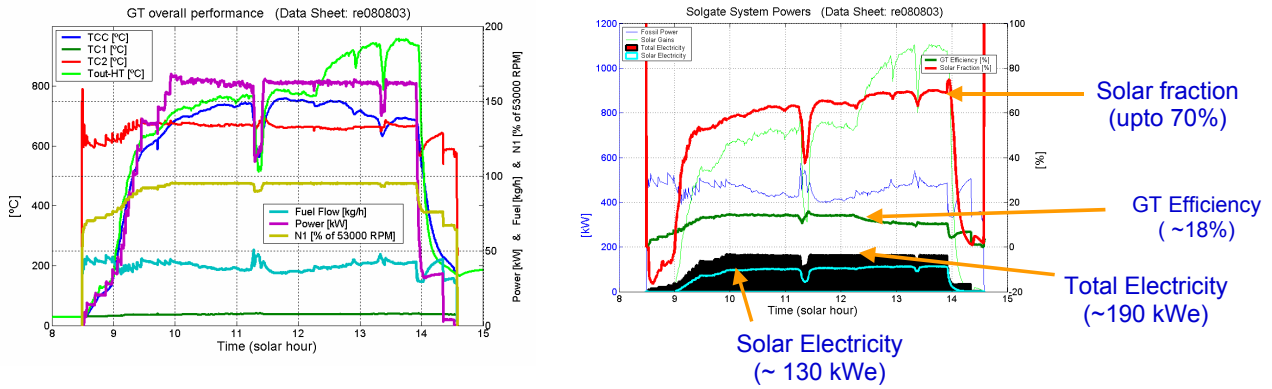

Fig. 23: Gas turbine overall performance. Quasi design conditions of Phase 2.

Solar fraction (or solar contribution to the total heat entering or produced in the combustion chamber) was close to 70%. This implies a contribution of about 30% from fuel combustion. The solar power gain in the air through the receivers was about 700 kW and fossil power contribution 450 kW. The electrical power production, at these conditions, was about 170 kW. Thus the SOLGATE solarized turbine efficiency, at nominal conditions, was about 18% (see Fig. 23).

#### Phase 2: Summary of Receiver cluster thermal performance

Next plots show the estimated overall thermal efficiency of the receiver cluster for those moments for which both the incident solar power was measured and the system is considered to perform under quasi-steady-state conditions.

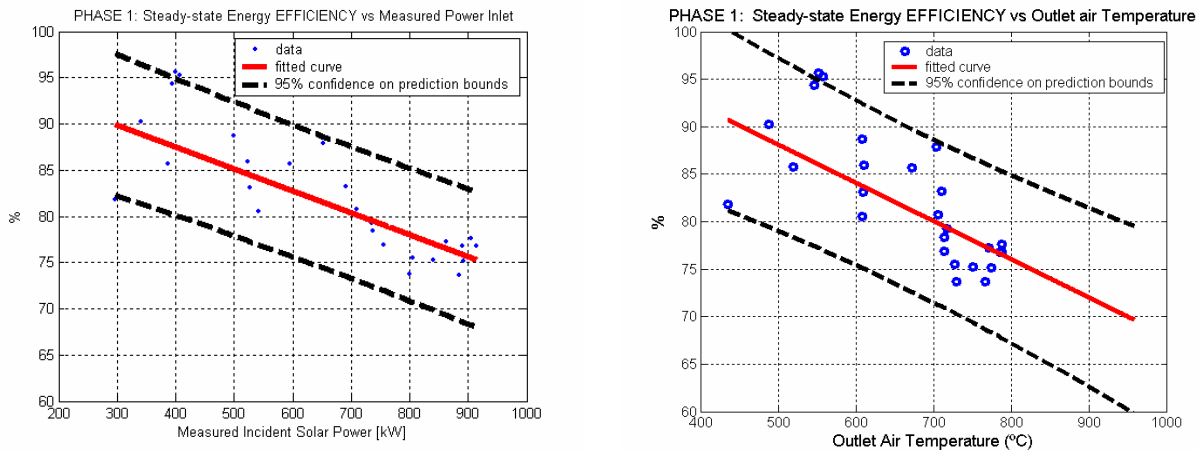

Fig. 24: Quasi-steady-state thermal efficiencies of the receiver cluster in Phase 1.

### WP 4.3: Development of Simulation Tools

#### Software for Cost-Optimized Solar Field Layout

An existing software tool for Heliostat Field Layout Calculations (HFLCAL) was adapted for economical optimization of solar tower plants with a pressurized receiver clusters. The code allows the layout of the solar part of a power tower plant (heliostat field arrangement and size, tower height, receiver aperture) for a given design rating at a certain location. The adaptations included the performance simulation of a secondary concentrator, which introduces a limited view cone onto the receiver. This leads to a change in the heliostat field arrangement as compared to common power

tower plants. The optics of a secondary concentrator is implemented as a transmission matrix, which gives the transmissivity of light as a function of the polar angles. The transmission matrix depends on the geometry of the secondary and the reflectivity of the material. The smaller acceptance angle of the receiver leads to a long stretched heliostat field in far distance from the tower, which has to be built higher than usually (green heliostats in Fig. 25).

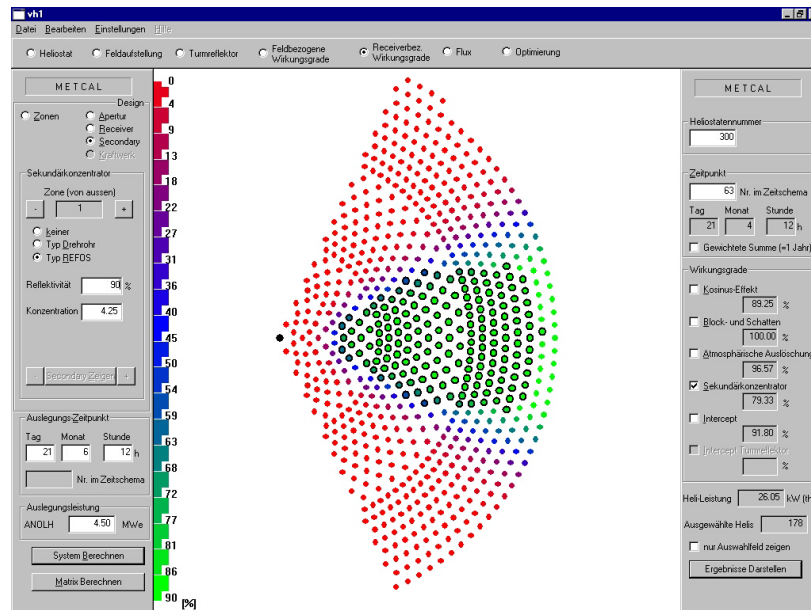

Fig. 25: Effect of limited acceptance angle on heliostat field arrangement (screenshot of HFLCAL graphical user interface).

The volumetric receiver is modeled simply as a black body radiator. Further losses by convection and conduction are neglected. The radiation temperature is assumed to be the mean air temperature while passing through the absorber. A constant air mass flow is further assumed which is justifiable in the scope of a system analysis tool for a solar hybrid plant.

For a pressurized volumetric receiver module the maximum size is limited mainly by the quartz window. Therefore a receiver in power plant size consists of a cluster of single receiver modules with secondary concentrators. Several modules are connected in parallel to form a receiver zone. Several zones can be connected in series to achieve the desired rise in temperature. The temperature rise in one zone (and hence in one module) should be around 200K and the zone temperature level rises with increasing flux density (Fig. 26). The flux distribution on a flat round target is typically radial symmetrical and therefore the receiver zones are distributed concentrically on the target (Fig. 27). These receiver zones are approached in HFLCAL by concentric rings. Additional modifications cover the possibility for the so-called ‘multi-aiming’, i.e. directing specific heliostats to different points on the receiver to achieve a desired flux distribution.



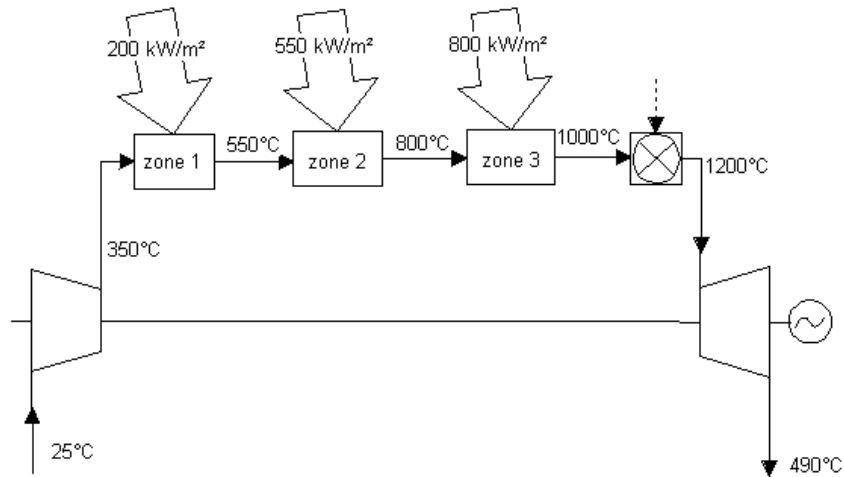

Fig. 26: Schematic example of subdivided receiver integrated into gas turbine process.

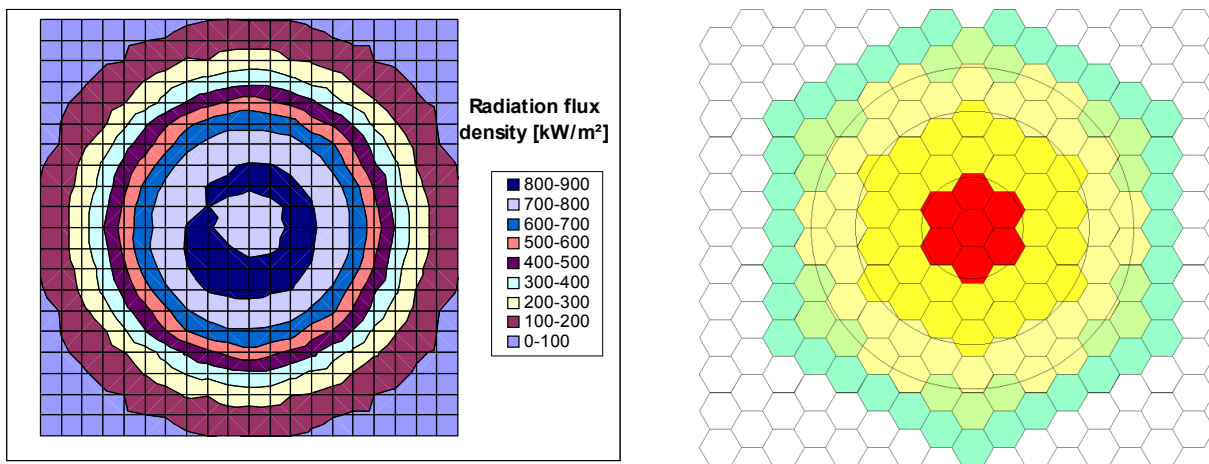

Fig. 27: Typical radial symmetrical flux density distribution on flat target (left) and subdivision of receiver aperture into zones (right).

HFLCAL was further enhanced by adding the option of cost optimization. Cost functions for the major components of the solar part (heliostat field, receiver and tower) have been implemented to be able to calculate the ‘production costs’ of solar thermal energy. This is expressed by the so-called ‘Solar Specific Cost Indicator’ :

$$SSCI = \frac{\text{Total Solar Investment Costs} \times \text{Annuity}}{\text{Annual Receiver Heat Output}}$$

The heliostat field size and arrangement, the receiver aperture and division into zones and the tower height are varied until the SSCI becomes a minimum. To be able to simulate the operation of the total hybrid gas turbine plant in small time steps, the results of the solar layout from HFLCAL were linked to the transient thermal power simulation program TRNSYS.

### Development of models (“Types”) for STEC-TRNSYS

Several subroutines were developed by CIEMAT to simulate gas turbines using the TRNSYS 15.0 and IISIBAT computer code. The software simulation environment is aimed, within SOLGATE, for simulation of the annual performance of the system. An already developed model library of solar thermal electric components, STEC, was used and adapted for this purpose.

The objective of the task was to develop simulation types of the most important elements in the Solar-fuel Brayton cycle as solar receiver, compressor, expansion stage and combustion chamber. The types are based in the physical description of the phenomena, as an example the compressor or the turbine is based in a hypothetical adiabatic compression or expansion. To simulate different Brayton cycles and commercial turbines, each type has some specific parameters, as the efficiency of the elements (adiabatic and mechanical efficiency, combustion efficiency, receiver efficiency, etc). The model uses input parameters as: available energy (solar or fossil) and the specific cycle parameters: correlation between energy and pressure ratio, air flow rate and turbine inlet temperature. In the SOLGATE project we developed operation conditions types for different solarized turbines as ALLISON 250C20B, Heron H-1 and Mercury (WP5).

#### WP 4.4: Verification of Simulation Tools

##### Validation of HFLCAL Code with Experimental Data

From the SOLGATE measurement campaign four representative test points were chosen for comparison with HFLCAL. The results for these points are given in *Table 1*. The total power on target can be calculated easily with small deviations (<4%) using an overall mean reflectivity between 80 and 84%. The calculated values are systematically too high. For the mirror normal error values between 1.74 and 1.8 mrad were used to adapt the total intercept. The deviations are below 5% and calculated values are systematically too low.

*Table 1. Results of HFLCAL validation with SOLGATE test data (bold numbers are test results).*

date		<b>28.01.2003</b>	<b>12.02.2003</b>	<b>10.03.2003</b>	<b>11.03.2003</b>
<b>solar time</b>	hr	10.6611	10.1456	14.5636	11.8333
<b>DNI</b>	W/m <sup>2</sup>	<b>960.1</b>	<b>888.4</b>	<b>889.4</b>	<b>1009.7</b>
<b>no. Heliostats</b>		21	36	54	43
<b>available solar power</b>	kW	<b>798.4</b>	<b>1266.5</b>	<b>1901.9</b>	<b>1719.3</b>
<b>power on target</b>	kW	<b>621.1</b>	<b>965.0</b>	<b>1352.0</b>	<b>1262.0</b>
HFLCAL	deviation	1.3%	3.4%	3.6%	2.8%
<b>peak flux</b>	kW/m <sup>2</sup>	<b>208.0</b>	<b>302.0</b>	<b>365.0</b>	<b>355.0</b>
HFLCAL	deviation	-6.3%	-10.6%	7.7%	2.0%
<b>Hel. on fokus #5</b>		<b>7</b>	<b>12</b>	<b>20</b>	<b>14</b>
<b>power in seco #5</b>	kW	<b>177.0</b>	<b>232.3</b>	<b>389.3</b>	<b>312.8</b>
HFLCAL	deviation	-2.3%	0.3%	-6.8%	-4.1%
<b>Hel. on fokus #4</b>		<b>7</b>	<b>12</b>	<b>18</b>	<b>15</b>
<b>power in seco #4</b>	kW	<b>140.6</b>	<b>234.2</b>	<b>271.1</b>	<b>290.1</b>
HFLCAL	deviation	-1.8%	-3.5%	7.0%	6.9%
<b>Hel on fokus #3</b>		<b>7</b>	<b>12</b>	<b>16</b>	<b>14</b>
<b>power in seco #3</b>	kW	<b>185.3</b>	<b>249.7</b>	<b>318.6</b>	<b>308.7</b>
HFLCAL	deviation	-8.3%	-4.7%	-3.6%	-2.5%
<b>total power intercepted</b>	kW	<b>502.9</b>	<b>716.2</b>	<b>979.0</b>	<b>911.6</b>
HFLCAL	deviation	-4.9%	-2.6%	-2.5%	-0.4%
<b>Intercept</b>		<b>80.97%</b>	<b>74.22%</b>	<b>72.41%</b>	<b>72.23%</b>

The deviations in the peak flux are quite high, up to 11%. Further on, the distribution of the intercepted power shows considerable differences between measured and calculated values. This can also be seen in the flux distributions which are depicted in the following graphs (Fig. 28).

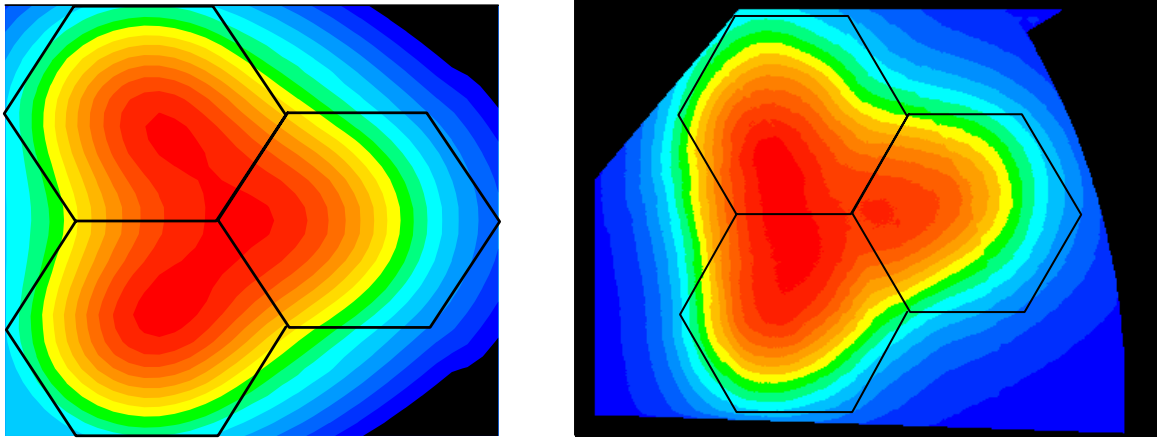

Fig. 28: Test point 28.01.03 11:02 UTC. HFLCAL calculation of flux distribution (left) and moving bar measurement (right).

The calculated flux distributions generally show more distinct peaks at the theoretical aim points in the centre of each aperture. The real flux distributions are more diffuse and less symmetrical. This can be explained by the status of the ‘old’ heliostat field.

The efficiency of the secondary concentrators depends on the heliostat field arrangement. Calculated values lay between 88 and 91%, which fits well to the mean measured value of 90.5%.

The simple thermal receiver model used in the HFLCAL code was validated against some results from the SOLGATE test campaign (*Table 2*). The simple HFLCAL model is underestimating the performance of the LT-receiver, and overestimating the efficiency of the MT- and HT-receiver. The overall receiver cluster efficiency is overestimated by about 12%. The simple HFLCAL receiver model does not include the thermal losses of the piping between receiver stages. These losses were measured to be about 10% of the net thermal power.

*Table 2. Validation of HFLCAL receiver model (bold numbers are SOLGATE test results)*

date		10.03.2003	11.03.2003
solar time	hr	14.5636	11.8333
DNI	W/m <sup>2</sup>	<b>889.4</b>	<b>1009.7</b>
no. Heliostats		54	43
intercepted power	kW	<b>979.0</b>	<b>911.6</b>
HFLCAL	kW	955.0	907.8
receiver mass flow	kg/s	<b>1.357</b>	<b>1.327</b>
receiver inlet temp.	°C	<b>295.7</b>	<b>289.8</b>
LT exit temp.	°C	<b>492.7</b>	<b>489.2</b>
HFLCAL	°C	473.6	463.7
MT exit temp.	°C	<b>607.3</b>	<b>613.1</b>
HFLCAL	°C	637.9	638.9
HT exit temp.	°C	<b>788.8</b>	<b>758.9</b>
HFLCAL	°C	833.3	803.2
receiver thermal power	kW	<b>736.7</b>	<b>671.9</b>
HFLCAL	kW	806.2	750.2
receiver efficiency (incl. seco)		<b>75.3%</b>	<b>73.7%</b>
HFLCAL		84.4%	82.6%

### Comparison of TRNSYS simulation vs. test results

The test system was modeled in TRNSYS using compressor, combustion chamber, gas turbine stage, receiver and operation control. As input we use the total flux and flux to each receiver during the test.

Fig. 29 shows the comparison between the experimental and TRNSYS simulation results of the net electricity generate during the test. As is possible to observe, the experimental result is 728 kWh/test and the simulated value 736 kWh/test, to the simulation has a good agreement with the test.

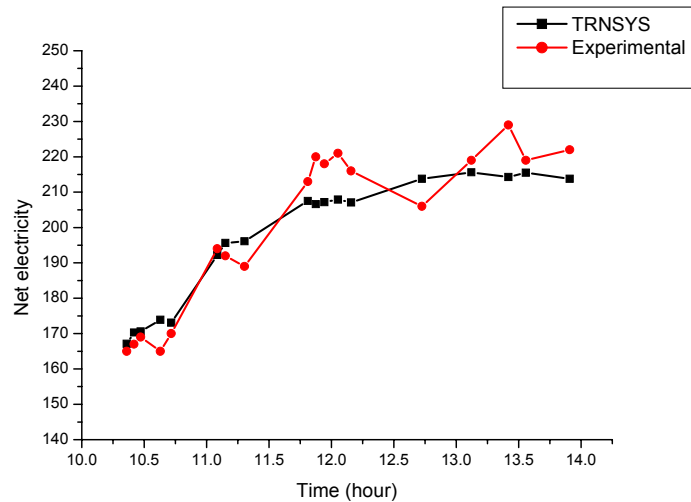

Fig. 29: Turbine electric power comparison

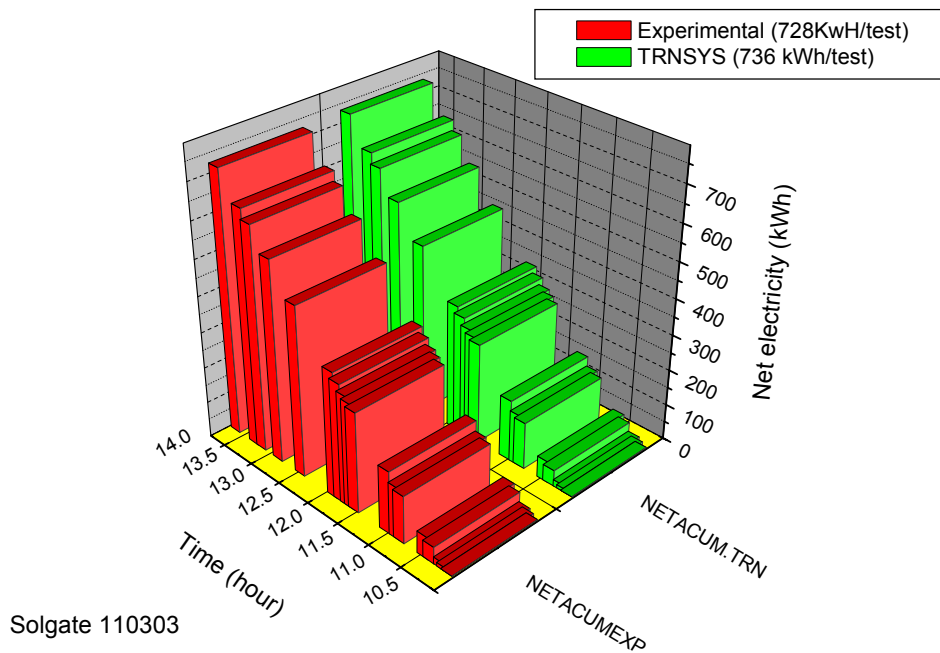

Fig. 30: Net electricity comparison between experimental results and TRNSYS simulation

In general the agreement was acceptable; however some uncertainties exist, mainly in the air mass flow measurements and the related data.

## **4.5 WP 5: Conceptual Layout of Power Plants**

(Task Leader: ORMAT)

### **4.5.1 WP 5.1: Adaption of Industrial Gas Turbines**

Three industrial gas turbine systems were considered for adaptation:

- Heron H1 – intercooled recuperated two-shaft engine with reheat. ISO rating 1400 MW, thermal efficiency 42.9%.
- Solar Mercury 50 – recuperated single shaft gas turbine. ISO rating 4200 MW, thermal efficiency 40.3%.
- PGT 10 – simple gas turbine with bottom cycle. ISO rating 11100 MW (gas turbine) respectively 16100 MW (combined cycle), thermal efficiency 31.3% (gas turbine) respectively 44.6% (combined cycle).

The OST3 “black box” first model was provided prior to testing, the model was used to evaluate measurements accuracy and was compared to test run results. As the test runs continued, the black box model was perfected and the third version provided very good agreement with the actual test data. The modifications of the OST3 black box model were also implemented on the Nuovo Pignone PGT10 gas turbine black box.

The actual modifications to the helicopter engine needed for solar hybrid operation were studied and then implemented on the conceptual solarization of the full size Nuovo Pignone PGT10 gas turbine as well as on the two combustors Heron H-1 gas turbine.

It was already known that gas turbines with external combustors are the most suitable turbines for solarization, as less modification is needed to convert the combustion chamber and air ducts in order to accept external solar heated air.

The theoretic evaluation of the solarized Nuovo Pignone PGT10 gas turbine performance was provided as a “black box” model that was refined with actual test runs data of the OST3.

Each component deemed necessary for modification for the solarizing process of the Nuovo Pignone PGT10 gas turbine with entering solar heated air at 800°C was studied, and the associated costs were estimated. Rough cost estimates were prepared for a solarized Nuovo Pignone PGT10 gas turbine with solar heated air up to 1000°C and for the Heron H-1 with solar heated air up to 800°C.

By comparison, the solarization of a large gas turbine is relatively less expensive than a smaller one, and more expensive as the gas turbine is more complex. Details changes for solarization of the PGT10 include air ducts, cooling system, combustion chamber, injector, igniter, metering valve, steam injection system, control system logic and high temperature fasteners and gaskets.

Changes that require further investigation as for their necessity include: combustion chamber liner, turbine wheels and stators and compressor.

The cost of the modification of the items investigated in this program was included in the cost analysis. For the Heron H-1, the modifications are similar, but there are two combustion chambers and two fuel systems to be modified, thus the amount of work and associated costs of solarizing the Heron H-1 is comparatively higher than solarization of the PGT10.

For the medium power level the commercial Mercury 50 recuperated gas turbine manufactured by Solar in San Diego was selected. It must however be admitted that this product did not take off as anticipated at the beginning of the SOLGATE project, but has suffered delay in its commercialization. We therefore have a non-secure technical base to start off. It must be clearly said that we are presently only in a position to estimate the product as it will be in the future.

Therefore we have decided to approach as follows:

- Performances and efficiency slightly decreased to the original efficiency but in line with the present expectations.
- Constructively, we base on the existing Mercury outline drawing, with the one exception that we assume a longer recuperator. For the price estimation we will base us on this layout.
- No changes in the price structure of the standard elements will be made. However, we will have to estimate the improved Mercury turbine in its price itself, as well as its recuperator. Additionally, we have to estimate all the adaptations to the solarized turbine.
- In general all the systems need to be cross checked to ensure eventual adaptations and define cost impact. Within this study we limited on the obvious ones and assumed the others not necessary to be changed.

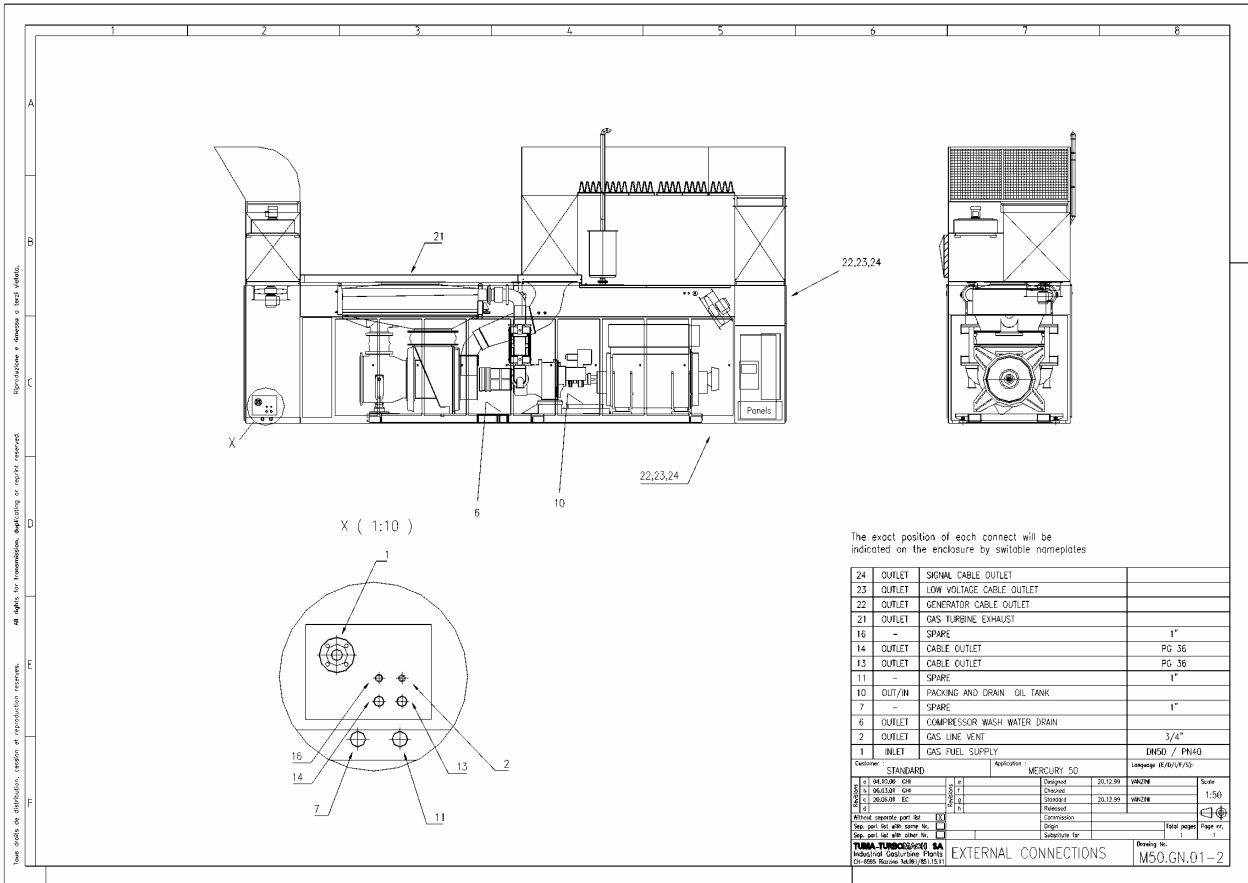

Fig. 31: Scheme of conventional Mercury-50 setup

The core engine will be the standard future Mercury gas turbine, as we will get it for the standard application (Fig. 31). However, we do not yet know its price and details of size, supports or whatever, therefore we have assumed to use the old standard supports and base frame from the old Mercury (generation I), which not necessarily needs to be applicable for the future. We will for sure have to allocate such changes, however, those which we assume not to be specific to the SOLGATE integration will be without cost impact to this estimation, because these costs would be beard by the new standard Mercury program anyway.

It is known that the new Mercury recuperator will be longer. However, not having any data, we assumed it would be the same as the original Mercury recuperator, but we were accommodating simply a longer recuperator than the original one, adapting the air outlet correspondingly. The way of erecting, mounting and maintenance of the recuperator is deemed to be the same as before, no changes have been foreseen here, though it may result when the Mercury is known in all details, that

there will be considerable changes. However, it is assumed that these changes are valid for any new Mercury and not only for the solarized Mercury; hence no allocation for additional costs in this respect is made.

#### THERMODYNAMIC CYCLE CONCEPT

The cycle bases on the idea that we first are using the lower temperature (compared with the hot gas from the receiver) of the exhaust gases in order to recuperate energy and transfer it to the compressed air before sending it to the receiver. This is a good approach in order to save heliostat surface, hence a lot of cost. The pre-heated air leaving the recuperator is then sent to the solar receiver.

#### BURNER PHILOSOPHY

Being it the task of the whole project to develop a hybrid solar installation, we have to introduce burners and correspondingly a combustor zone. It is the general task that this gas turbine should be able to run nearly 100% at solar heat input and in cases of clouds or early morning, late evening, to run in part load and making the missing solar energy up with conventional combustion. Assuming that, the fuel would always be natural gas.

Additionally we need to think of start and shut down of the gas turbine. Also, the part load burner should always be on in order to have a rapid reaction for control purpose of the gas turbine. This is specifically important in case of loss of load or any other bigger transient or island operation. These aspects have not yet been studied or simulated and would need to be addressed in a further stage of the project.

For the time being, we have assumed to separate the full load burner and part load burner. The part load burner would be used only to make up the hot air temperature which would come into the combustion chamber at the maximum of 1000°C to the necessary turbine inlet temperature of approximately 1150°C, so only little fuel would be needed. This fuel should however be well-distributed in the main stream having an average temperature of 1000°C. No special feature for flame holding, etc. needs to be done. It can be assumed that any minor part of gas would be burned (a corresponding crosscheck from combustion engineering point of view however should be done in a next stage before building a real plant) without any problem.

The main burners however will need to have a cooling when the operation is in solar mode, therefore there shall be always some cooling air flowing from the recuperator outlet directly into the burning in the outer part around the burning chamber.

### **4.5.2 WP 5.2: Layout of Solar-Hybrid Power Plant**

The objective of this work package is to find the cost-optimized system configuration of the solar subsystem for three prototype plants based on industrial gas turbine units ranging from 1 to 17 MW. Two different sites were analyzed: Seville (Spain) with 2015 kWh/m<sup>2</sup> annual direct normal insolation, and Daggett (USA) with 2791 kWh/m<sup>2</sup> annual DNI. For Seville a design point DNI of 800 W/m<sup>2</sup> was chosen, for Daggett 880 W/m<sup>2</sup>.

#### **4.5.2.1 Definition of Solarized Gas Turbine Plants**

The solar hybrid prototype plants are based on the abovementioned industrial gas turbine systems. The solarization adds a receiver cluster directly before each combustion chamber for solar preheating of the compressed air. The maximum receiver exit temperature is designed to be 800°C or 1000°C.

For the H1, the first receiver zone heats the air from the recuperator from about 565°C to 800°C, the second zone after the first turbine stage heats the air again from about 630°C to 800°C. The relatively low turbine inlet temperatures of 860°C allow a high solar share in the design case of 75%, although the receiver inlet temperature is already fairly high due to the recuperator.

This is not the case with the Mercury 50. This gas turbine has a high turbine inlet temperature of 1150°C, which limits the design solar share to below 40%. The air leaves the recuperator with about 550°C and is heated by two serial receiver stages to 625°C and finally 800°C.

The PGT10 simple gas turbine allows a receiver inlet temperature of about 450°C. The compressed air is heated by two serial receiver stages to 620°C and finally 800°C. The design solar share is about 58%. For one case, the air is heated by a third serial receiver stage up to 1000°C leading to a design solar share of 88%.

Table 3 gives an overview of the seven cases of solarized gas turbine plants that are analyzed in further detail.

Table 3: Definition of solarized gas turbine prototype plants

Location	Seville			Daggett, CA			
gas turbine	Heron H1	Mercury 50	PGT 10	Heron H1	Mercury 50	PGT 10	PGT 10
ISO GT power level	1.4 MW	4.2 MW	11.1 MW	1.4 MW	4.2 MW	11.1 MW	11.1 MW
net el. power at full solar power	1255 MW	3755 MW	9683 MW	1179 MW	3486 MW	9152 MW	8945 MW
DP receiver thermal power	2290 MW	3760 MW	18500 MW	2120 MW	3456 MW	18500 MW	28590 MW
DP thermal solar share	75%	38%	57%	75%	38%	58%	88%
Receiver cluster inlet temp.	567°C/ 628°C	554°C	457°C	556°C/ 643°C	556°C	443°C	443°C
1 <sup>st</sup> zone outlet temp.	800°C	625°C	625°C	800°C	625°C	620°C	630°C
2 <sup>nd</sup> zone outlet temp.	800°C	800°C	800°C	800°C	800°C	800°C	815°C
3 <sup>rd</sup> zone outlet temp.							1000°C
Abbreviation	sev_H1	sev_m50	sev_pgt10	dag_H1	dag_m50	dag_pgt10	dag_pgt10_1000

#### 4.5.2.2 Definition of Solar Part Components and Costs

For the solar field a glass-metal heliostat with a total reflective area of 121 m<sup>2</sup>, a beam quality of 2.4 mrad and an average reflectivity of 87% was assumed. The specific costs was assumed as 132 €/m<sup>2</sup>.

Two basic receiver types are used to form a cluster that covers the focal spot. A metal tubular ‘low temperature’ module (LT) is used in the outer low flux region for exit temperatures of about 600°C. The pressurized volumetric receiver is used in the high flux regions. Equipped with a metal wire mesh absorber it is designed for a hot gas exit temperature of about 800°C (MT), with a porous ceramic absorber the design exit temperature is 1000°C (HT). All receiver modules are equipped with secondary concentrators (aperture area: 1.28 m<sup>2</sup>, hexagonal; acceptance angle 21°). The LT module pressure drop is 150 mbar at design conditions, the specific cost is 15938 €/m<sup>2</sup>. The pressure drop for the volumetric receiver modules (MT and HT) is 20 mbar, specific cost are 32813 €/m<sup>2</sup> and 37500 €/m<sup>2</sup>, respectively. The tower is chosen to be a concrete tube tower with about 12 m diameter. The tower cost was assumed in function of height and equipment weight on tower top.



### 4.5.2.3 Cost Optimized Layout of the Solar Part

Using the cost optimization feature of the HFLCAL program as described above, the configuration of the solar part (heliostat field size and shape, tower height, receiver tilt angle and aperture area) is found with the minimum equipment cost per unit annual solar thermal energy production (SSCI factor).

$$SSCI = \frac{\text{Total Solar Investment Costs} \times \text{Annuity}}{\text{Annual Receiver Heat Output}}$$

The results of the optimization process for the Daggett site each location is given in *Table 4*, the plant scheme and heliostat field layout for Daggett with PGT10 and 1000°C is shown in Fig. 32.

*Table 4: Result of cost-optimized solar part layout for location Daggett.*

	Daggett			
Abbreviation	<i>dag_H1</i>	<i>dag_m50</i>	<i>dag_pgt10</i>	<i>Dag_pgt10_1000</i>
gas turbine	Heron H1	Mercury 50	PGT 10	PGT 10
Receiver thermal design power (demand)	2.12 MW	3.49 MW	18.5 MW	28.6 MW
<b>Optimization results</b>				
Receiver cluster total aperture	6.88 m <sup>2</sup>	12.18 m <sup>2</sup>	54.60 m <sup>2</sup>	82.32 m <sup>2</sup>
1 <sup>st</sup> zone aperture	5.30 m <sup>2</sup>	7.19 m <sup>2</sup>	39.84 m <sup>2</sup>	49.13 m <sup>2</sup>
2 <sup>nd</sup> zone aperture	1.58 m <sup>2</sup>	4.99 m <sup>2</sup>	14.76 m <sup>2</sup>	18.67 m <sup>2</sup>
3 <sup>rd</sup> zone aperture	-	-	-	14.52 m <sup>2</sup>
Receiver optical height	39.6 m	50.6 m	100.2 m	130.2 m
Receiver tilt angle	18.0°	18.0°	18.64°	20.0°
no. Of heliostats	39	71	310	517
total reflective area	5732 m <sup>2</sup>	8615 m <sup>2</sup>	37615 m <sup>2</sup>	62733 m <sup>2</sup>
<b>Design point performance</b>				
1 <sup>st</sup> zone thermal power	1.300 MW	0.972 MW	9.255 MW	8.662 MW
2 <sup>nd</sup> zone thermal power	0.899 MW	2.563 MW	9.277 MW	10.280 MW
3 <sup>rd</sup> zone thermal power	-	-	-	9.727 MW

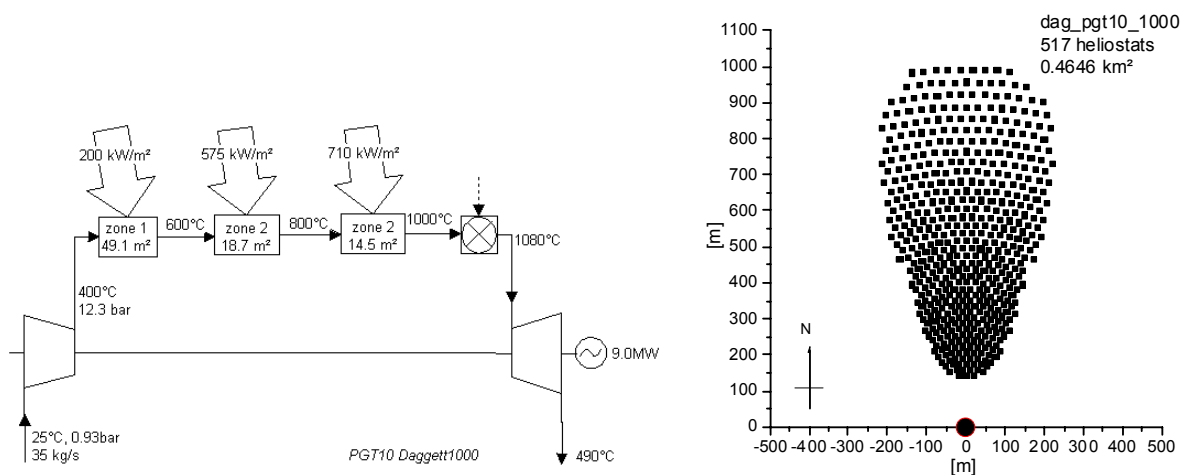

Fig. 32: Prototype plant layout at Daggett (left: gas turbine solarization, right: solar field layout)

### 4.5.3 WP 5.3: Performance Assessment

The annual performance of the three different solarized gas turbines was analyzed using the TRNSYS simulation program and the specific subroutines developed in Task 4 for the Brayton cycle components (compression and expansion stages, combustion chamber, solar receiver with variable efficiency, heat recovery, etc.). As in the typical solar plant, several performance criteria were analyzed (working 24 hours/day, working only during the sun time or when the irradiation is greater than different values) in order to estimate the economical situation. Here only the basic cases are presented: Fuel and hybrid Fuel-Solar plant evaluation and comparison.

#### 4.5.3.1 PGT10-GAS TURBINE TRNSYS SIMULATION.

Main specifications of the PGT10 are: pressure ratio 14.1:1, single combustion chamber, two-shaft turbine with two reaction stages, ISO rated power: 10220 kW, efficiency 31.2%, flow: 42.3 kg, exhaust temperature: 488°C.

The study cases selected in order to perform the annual balance are:

- Full load 24 hours at day
- Full load during the sunny hours.

In order to define the operation conditions, all the gas turbine parameters are fixed except the ambient temperature and the solar energy to the receiver. The operation conditions function of the ambient temperature was defined using the PGT10 black box model. Fig. 33 shows the solarized PGT10 plant scheme at 15°C ambient temperature and 1 bar atmospheric pressure, two receivers and receiver outlet temperature 800°C.

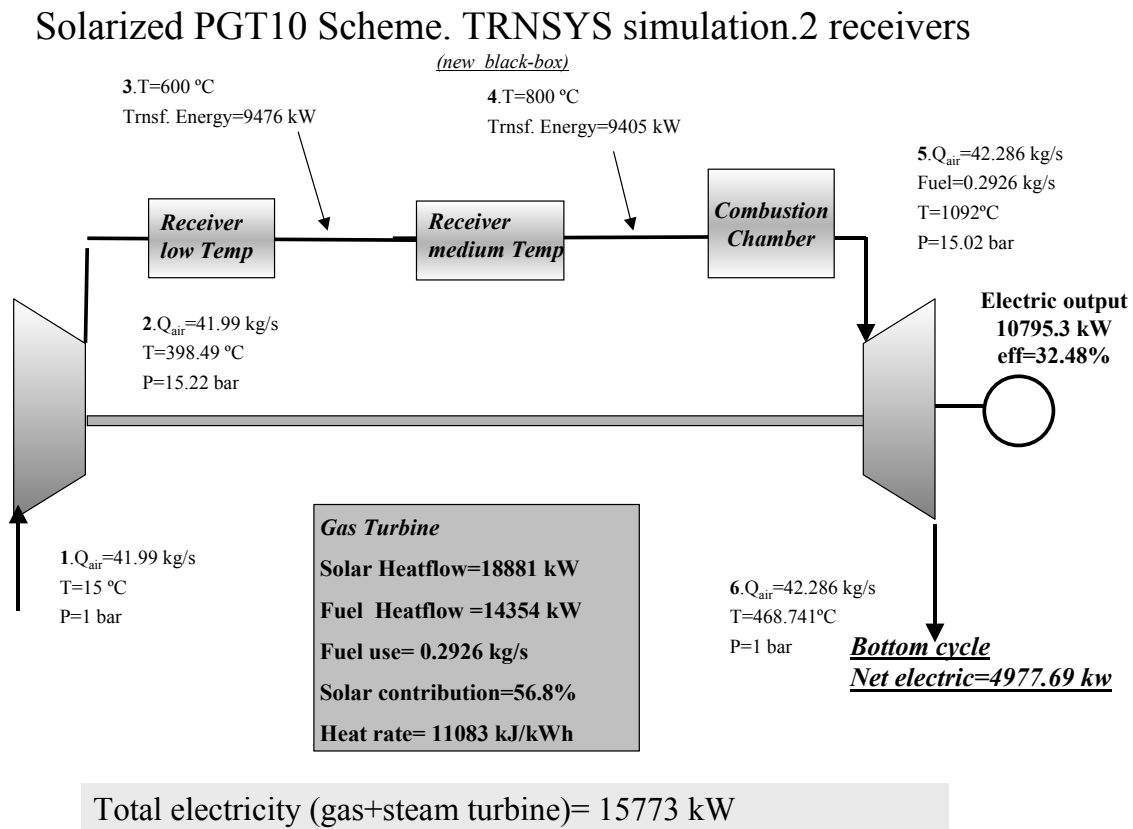

Fig. 33: PGT10 plant. Two receivers configuration scheme

For Daggett, the annual CO<sub>2</sub> savings sum up to 10500 t, at a solar share of 17.3%. For the case with three receivers (1000°C) the annual CO<sub>2</sub> savings sum up to 17600 t, at a solar share of 28.8%.

#### 4.5.3.2 MERCURY 50 GAS TURBINE TRNSYS SIMULATION

The Mercury 50 is an open Brayton cycle with a recuperator that uses the hot exhaust to preheat the air before it enters to the combustor. The solarized Mercury 50 TRNSYS project at ISO conditions is shown in Fig. 34.

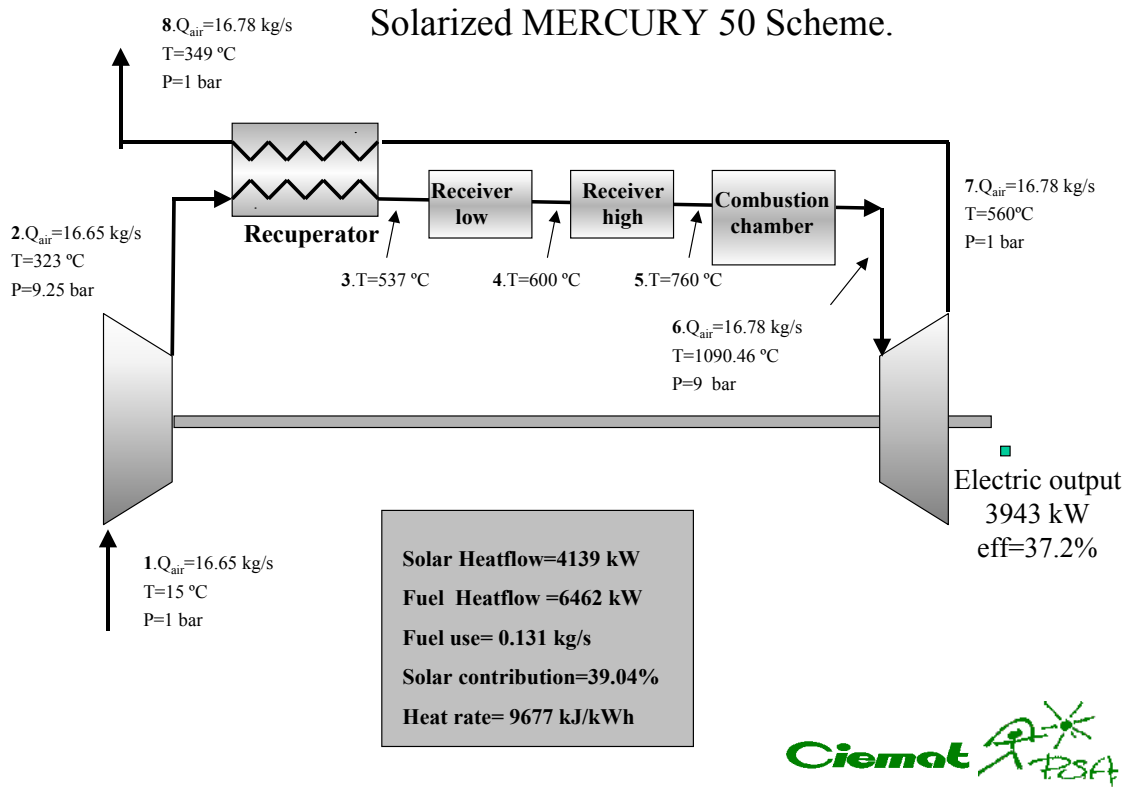

Fig. 34: Solarized Mercury 50 scheme. ISO conditions (1bar, 15 °C)

For Daggett and Seville, the annual CO<sub>2</sub> savings is about 2200 t, at a solar share of 11.2% and 9%, respectively. The lower solar share is due to the higher receiver inlet from the recuperator.

#### 4.5.3.3 Heron H-1 gas turbine

The Heron H-1 cycle was also analyzed; however details are not given here.

#### 4.5.3.4 COMPARISON BETWEEN CYCLES

Table 5 shows the most important parameters to define the solar contribution to the annual performance, we selected the fuel and carbon dioxide saving. The avoided CO<sub>2</sub> emission of the PGT10 is 0.05 ton/MWhe. Comparing the three solar plants with solar outlet temperature of 800°C it is obvious that the avoided CO<sub>2</sub> is a function of the maximum cycle temperature. In this case the HERON H-1 has 860°C as maximum temperature and the CO<sub>2</sub> avoided is 0.11 ton/MWhe and the PGT10 and MERCURY50 only 0.05 and 0.07 ton/MWhe.

Table 5: Cycles comparison

	PGT10	PGT10	MERCURY 50	HERON H-1
Solar Temp (C)	800	1000	800	800
Fuel (Ton/year)	18400	15840	6284.43	2273
fuel saving (Ton/year)	3800	6390	816.97	480
CO2 saving (Ton/year)	10500	17564	2247	1320
CO2 saving (Ton CO <sub>2</sub> /MWh)	0.08	0.14	0.07	0.11

#### 4.5.4 WP 5.4: Cost Analysis

For the cost analysis of the solar-hybrid prototype plants two basic cases are distinguished. The so-called the ‘stand-alone’ option means a single, first-of-its-kind plant, which is operated completely by the staff on site. In the ‘remote’ option, the plant is localized in a group of about 4 similar plants in close neighborhood. Several development costs can be shared and the plants are operated remote through one central control base.

The generating cost calculations are based on the annual net electric power production. The gross electric output is reduced due to outages (unexpected failure, scheduled down time for revision and overhaul) by 2.5%. The resulting output is further reduced by the parasitic energy consumption of the solar field and the power block. The mean heliostat power consumption is assumed to be 4.5 Wh/(m<sup>2</sup>\*day); the power block parasitics are assumed as 1% of the output for the gas turbine plants and 2.5% of the output for the combined cycle plants. Table 6 and Table 7 summarize the results on which the cost calculations are based. Three different operation modes are defined: a) 24-hours operation (capacity factor cf = 100%), b) sun-hours-only operation (DNI>0; cf = 49% Seville, cf = 54% Daggett), c) high-solar operation (DNI>300W/m<sup>2</sup>; cf = 31% Seville, cf = 41% Daggett).

Table 6: Annual performance results of solar-hybrid plants and fossil-only reference plants for 24-hours operation

##### Annual Plant Performance

###### 24 -hours operation

name		sev_H1	dag_H1	sev_M50	dag_M50	sev_PGT10	dag_PGT10	dag_PGT10_1000
power system		Heron-H1	Heron-H1	Mercury50	Mercury50	PGT10	PGT10	PGT10
location		Sevilla	Daggett	Sevilla	Daggett	Sevilla	Daggett	Daggett
annual DNI	[kWh/m <sup>2</sup> ]	2015	2791	2015	2791	2015	2791	2791
energy to solar field	[MWh]	11 003	13 208	17 360	19 642	83 375	104 985	175 087
energy to receiver	[MWh]	5 111	6 500	8 528	10 583	38 889	52 500	86 944
receiver thermal energy	[MWh]	4 583	5 722	7 639	9 472	33 056	45 833	73 611
fuel energy	[MWh]	24 000	22 583	86 111	84 167	266 111	251 111	206 111
gross electric output	[MWh]	11 673	11 000	34 038	33 960	137 872	132 199	125 998
reduction due to outages	[%]	2.5%	2.5%	2.5%	2.5%	2.5%	2.5%	2.5%
parasitic losses	[MWh]	122	115	345	342	3 426	3 282	3 170
net. electric energy	[MWh]	11 259	10 610	32 842	32 769	130 999	125 612	119 678

##### Fossil Reference Plant Annual Performance

###### 24 -hours operation

name		sev_H1	dag_H1	sev_M50	dag_M50	sev_PGT10	dag_PGT10	dag_PGT10_1000
power system		Heron-H1	Heron-H1	Mercury50	Mercury50	PGT10	PGT10	PGT10
location		Sevilla	Daggett	Sevilla	Daggett	Sevilla	Daggett	Daggett
fuel energy	[MWh]	28 917	28 297	95 000	93 333	303 186	302 778	302 778
gross electric output	[MWh]	11 945	11 283	34 726	34 348	138 724	133 578	133 578
reduction due to outages	[%]	2.5%	2.5%	2.5%	2.5%	2.5%	2.5%	2.5%
parasitic losses	[MWh]	116	110	339	335	3 381	3 256	3 256
net. electric energy	[MWh]	11 530	10 891	33 519	33 154	131 875	126 982	126 982
annual net power cycle efficiency		40.90%	39.48%	36.19%	36.43%	44.61%	43.01%	43.01%

Table 7: Annual performance results of solar-hybrid plants for sun-hours-only operation

**Annual Plant Performance**  
day time operation (DNI >0)

name		sev_H1	dag_H1	sev_M50	dag_M50	sev_PGT10	dag_PGT10	dag_PGT10_1000
power system		Heron-H1	Heron-H1	Mercury50	Mercury50	PGT10	PGT10	PGT10
location		Sevilla	Daggett	Sevilla	Daggett	Sevilla	Daggett	Daggett
annual DNI	[kWh/m <sup>2</sup> ]	2015	2791	2015	2791	2015	2791	2791
energy to solar field	[MWh]	11 003	13 208	17 360	19 642	83 375	104 985	175 087
energy to receiver	[MWh]	5 111	6 500	8 528	10 583	38 889	52 500	86 944
receiver thermal energy	[MWh]	4 583	5 722	7 639	9 472	33 056	45 833	73 611
fuel energy	[MWh]	9 222	9 194	37 222	39 722	109 722	109 167	71 111
gross electric output	[MWh]	5 569	5 763	16 267	17 800	66 300	69 800	66 100
reduction due to outages	[%]	2.5%	2.5%	2.5%	2.5%	2.5%	2.5%	2.5%
parasitic losses	[MWh]	63	64	172	185	1 681	1 761	1 710
net. electric energy	[MWh]	5 367	5 555	15 688	17 170	62 961	66 294	62 738

#### 4.5.4.1 Estimation of Investment Cost

Table 8 shows the estimations for the investment costs of the conventional power system. The item ‘development of solarization and layout’ implies mostly engineering hours for the design changes due to the external air preheating, the high combustion chamber entrance temperature and the added volume to the air system. This is a single investment that is counted full for the ‘stand-alone’ plant option but spread over ten hypothetical similar systems for the ‘remote’ plant option. ‘Adaptation for solarization’ means hardware and work for solarization of each plant and can’t be shared.

Table 8: Investment cost assumptions for conventional power system (‘stand-alone’ option).

			small system	medium size system	large system	1000°C large system
<b>INVESTMENT COST ASSUMPTIONS</b>						
electric power level (ISO)		<i>MW<sub>el</sub></i>	1.4	4.2	16.1	16.1
receiver thermal power at design point (approx.)		<i>MW<sub>th</sub></i>	2.3	3.7	18.5	28.6
solar field size (approx.)		<i>10<sup>3</sup> m<sup>2</sup></i>	5.1	7.8	39.5	62.7
design point solar fraction (approx.)		%	75%	38%	57%	88%
<b>I. Conventional Power Equipment</b>						
<b>1 power block</b>			Heron H1	Mercury 50	PGT 10 CC	PGT 10 CC
gas turbine	[k€]		1 900	1 255	4 634	4 634
development of solarization and layout	[k€]		2 000	1 500	2 000	2 500
adaptation for solarization	[k€]		500	300	400	500
installation on tower	[k€]		150	250	400	400
bottom cycle & balance of plant	[k€]		-	-	3 000	3 000
SUM	[k€]		4 550	3 305	10 434	11 034
ISO rating (no solar input)	[kW]		1 400	4 240	16 100	16 100
spec. costs	[€/kW]		3 250	779	648	685
<b>2 fuel system</b>						
fuel piping	[k€]		Included	10	Included	Included
gauges, fittings, wells	[k€]		Included	5	Included	Included
packaging & control	[k€]		Included	821	Included	Included
SUM	[k€]		-	836	-	-
spec. package costs	[€/kW]		3 250	977	648	685
<b>3 electric grid connection</b>						
trafo & cables	[k€]		232	272	618	618

Table 9 shows the investment cost assumptions for the solar equipment. Item 7 ‘instrumentation and control’ includes process control units, supervisory control and data acquisition, control room display, data storage and spares. This cost item is reduced by 1/3 in the case of the ‘remote’ option. Several hardware units can be saved due to the centralized control system, but more intensive automation, security and back-up systems and intensive data communication limit the cost saving potential.

Table 9: Investment cost assumptions for the solar system ('stand-alone' option)

			small system	medium size system	large system	1000°C large system
<b>INVESTMENT COST ASSUMPTIONS</b>						
electric power level (ISO)	MW <sub>el</sub>		1.4	4.2	16.1	16.1
receiver thermal power at design point (approx.)	MW <sub>th</sub>		2.3	3.7	18.5	28.6
solar field size (approx.)	10 <sup>3</sup> m <sup>2</sup>		5.1	7.8	39.5	62.7
design point solar fraction (approx.)	%		75%	38%	57%	88%
<b>II. Solar Equipment</b>						
<b>4 collector system (design dependent)</b>						
spec. costs	[€/m <sup>2</sup> ]		132	132	132	132
<b>5 tower (design dependent)</b>						
reference height	[m]		40	50	100	130
reference costs	[k€]		633	705	1 214	1 682
<b>6 receiver (design dependent)</b>						
LT module incl. secondary	[€/m <sup>2</sup> ]		-	15 938	15 938	15 938
MT module incl. secondary	[€/m <sup>2</sup> ]		32 813	32 813	32 813	32 813
HT module incl. secondary	[€/m <sup>2</sup> ]		-	-	-	37 500
<b>7 instrumentation and control</b>						
total costs	[k€]		300	320	450	500
1						

Operation and maintenance cost were estimated from the expected staff requirements (control, maintenance, mirror cleaning, ...). The fuel price of 13.43 €/MWh for natural gas (approx. 0.123 €/m<sup>3</sup>) is the average price during 2002 in Spain. The insurance costs depend strongly on the components and the insured events. Estimations vary between about 1% and 2.5% of the insured hardware, a value of 1.5% is used.

#### 4.5.4.2 Calculation of Levelized Electricity Cost

For evaluation of the economic potential of the prototype plants the levelized electricity cost is selected. Appropriate assumptions were made for the cash flow calculation of the power plant projects. All costs are calculated in mid 2003 prices (present). A general inflation rate of 2.5% applies to all items including the fuel price. No further real escalation of costs is assumed. The project is assumed to start with beginning of 2004. The planning and construction phase is two years, operation starts in 2006. The land is bought in 2003. The engineering, investment and construction costs are shared equally between the two construction years. The start-up costs (3% of the plant facility investment, PFI) and the working capital (5% of the PFI) incur at the end of the construction phase. 75% of all expenses are covered by debt with an interest rate of 4.2% and a payback time of 12 years. The rest is covered by common equity at an interest rate of 14% and a payback time of 20 years.

#### Results:

The specific total investment costs vary between 1730 €/kW for the 16 MW hybrid combined cycle plant and about 7000 €/kW for the 1.4 MW gas turbine plant. The solar equipment costs vary between 20% and 40% of the total investment, according to the power block costs and the solar share. Personnel expenses lie between 50% and 70% of the annual O&M costs. The LEC are calculated as about 6.3 ¢cent/kWh for the combined cycle plant with 800°C receiver temperature and 6.9 ¢cent/kWh with 1000°C receiver temperature. LEC for the Mercury 50 plants are about 10 ¢cent/kWh and for the H1 gas turbine plant between 19 to 20 ¢cent/kWh.

When it is assumed that the fossil generated electric power is sold for a price of 4 ¢cent/kWh at the market, then the LEC of the incrementally solar produced electricity can be calculated. The solar incremental LECs lie between about 15 ¢cent/kWh and 1 ¢cent/kWh, depending on plant size and solar share. Regarding the PGT10 CC plant results, it is interesting to remark that the total LEC rise as the solar share is increased with the higher receiver temperature, but the solar LEC fall by 20% due to the larger solar plant. The results for the 24h operation mode are summarized in Fig. 35.

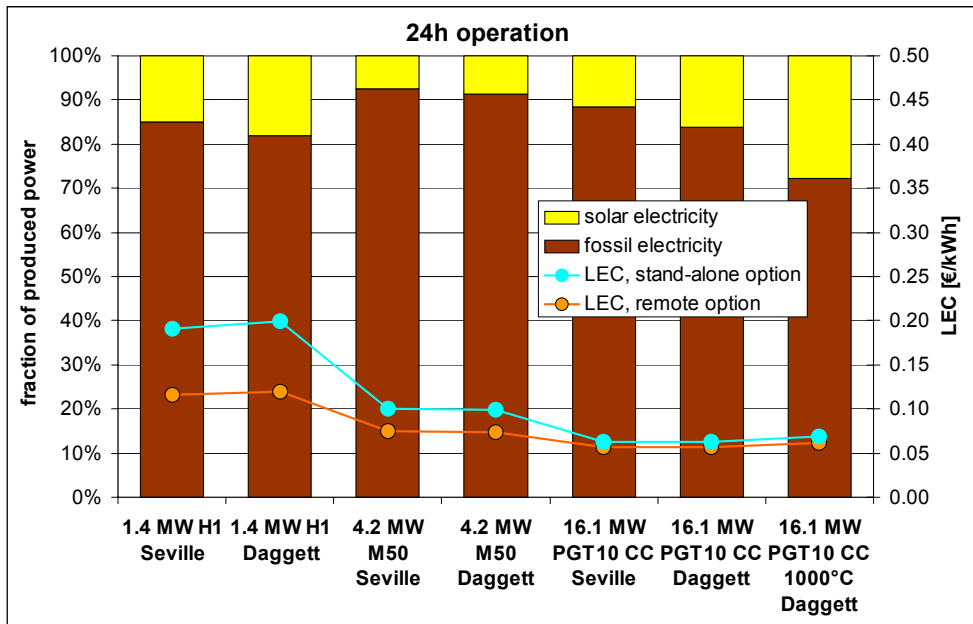

Fig. 35: Summary of LEC results for 24 hours operation

When the difference from the total LEC to the market price is regarded as the additional charge that has to be paid with this technology for reducing fossil fuel combustion, then the CO<sub>2</sub> avoidance costs can be calculated. Values vary between about 0.23 €/kg and 2 €/kg (Fig. 36).

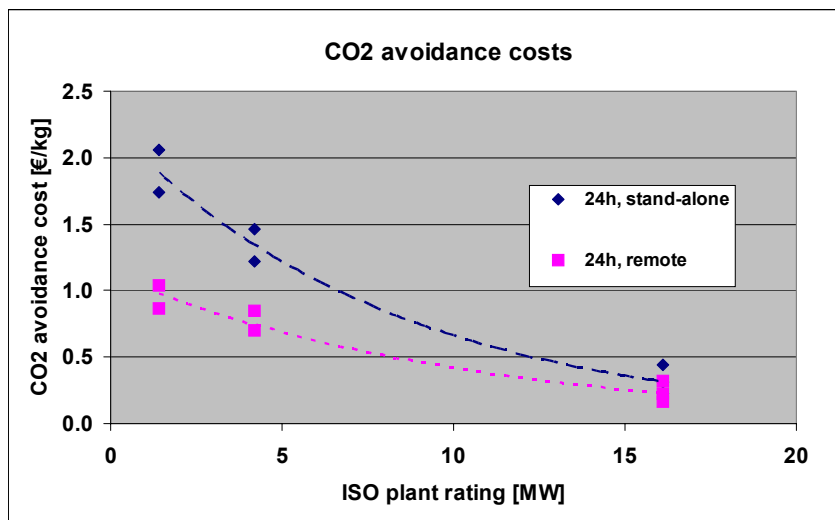

Fig. 36: CO<sub>2</sub> avoidance costs of solar-hybrid power plants

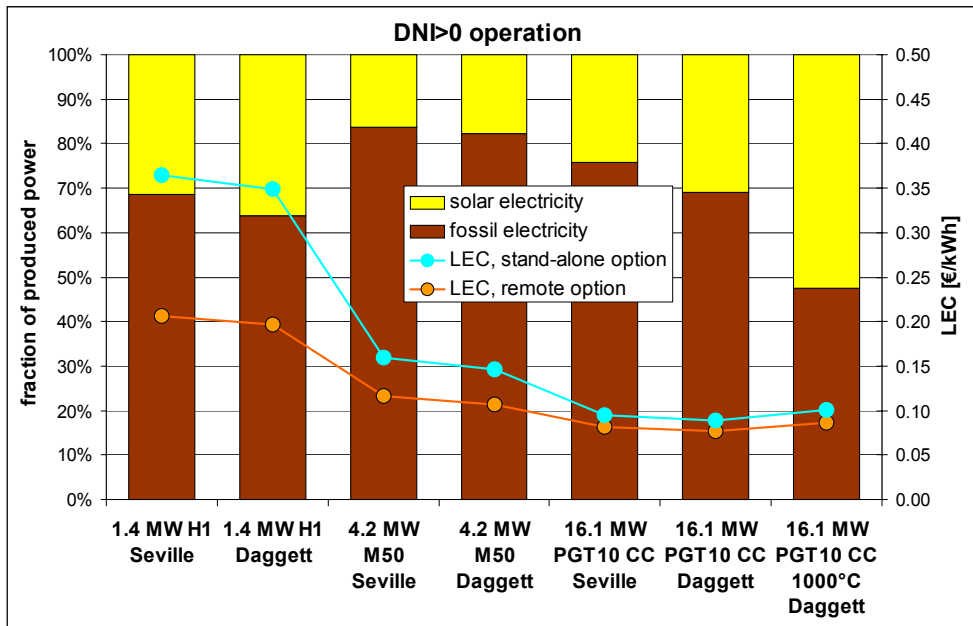

Fig. 37: Summary of LEC results for sun hours (DNI>0) operation

The influence of operation time was evaluated (Fig. 37). The LECs rise when the annual operation hours are reduced. But the solar share is also increased significantly when the plant operation is limited to sun hours. For example, the PGT10 combined cycle with the 1000°C receiver reaches more than 50% solar share, when operated at sun hours (DNI>0) only. This is important when the plant is operated in a subsidized market that demands for a certain minimum solar share.

### Conclusion

The predicted cost goal was LEC of 0.069 Euro/kWh at specific investment cost of 1410 Euro/kW and 50% annual solar share for a 30MW solar-fossil hybrid combined cycle with 1200°C receiver temperature. Fig. 104 shows the estimate for the LEC of a 30MW CC system with a 1200°C receiver, extrapolated from the results for 1000°C and the power levels assessed within this project. Solar shares above 50% are feasible, leading to significant reductions in fuel consumption and CO<sub>2</sub> emissions.

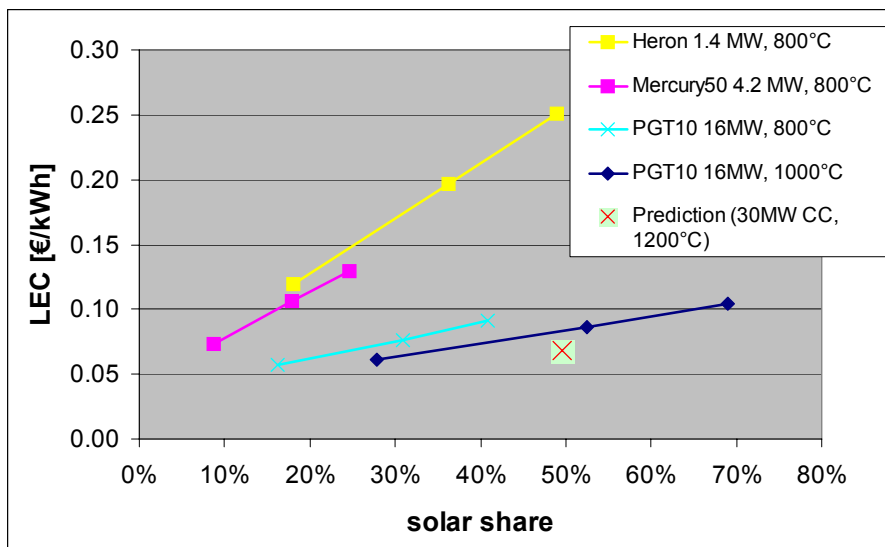

Fig. 38: Total LEC as function of solar share for 24h remote systems.



## **4.6 WP 6: Market Assessment**

(Task Leader: SOLUCAR)

### **4.6.1 WP 6.1: Market Assessment**

#### **Potential Energy Market**

Generally, the use of solar energy for electricity production is seen as very promising for a sustainable energy supply in the future energy market. Compared to conventional energy sources solar energy has the following advantages:

- The environmentally neutral electricity generation
- The great amount of solar resource and its global allocation (1% of the world-wide surface = global energy consumption in 2000)
- Its capacity of application
- Its capacity of development in short terms
- Reduced or non-existent CO<sub>2</sub> emissions
- The expected rise in fuel prices will help to make them cost-competitive

One promising area for the market introduction of solar plants might be the Mediterranean, where the radiation level is high, land is abundant and cheap and the market is enormous due to the own electricity demand and the proximity to Europe. This area is characterized as follows:

- Insolation of 16 Mediterranean countries go beyond the level of 1700 kWh/m<sup>2</sup>-year.
- 500 000 km<sup>2</sup> of land with the appropriate infrastructure are available. This is sufficient for the production of 12 000 GWe solar power.
- In short term, the potential market capacity is about 7-30 G€ until 2005 and in long term, about 45-110 G€ until 2025.
- Besides, the electrical interconnection between Europe and Africa means an important advantage to the energy market, which can be use to encourage plants with solar hybrid gas turbine.

Besides the Mediterranean other countries and regions as India, the Middle East, Australia, South-Africa/Namibia, South-America (Andean plateaux, north-eastern Brazil), northern Mexico and even the south-west of the USA are very well suited for the implementation of solar plants.

Worldwide the energy demand is growing fast thus the share of renewable energy sources must be increased in order to avoid environmental and supply problems.

#### **Available Surfaces**

Taking into account the surface which has a solar radiation higher than 600 kJ/cm<sup>2</sup>/year, the potential theoretic surface to be used for solar plants is estimated to over 70 millions of km<sup>2</sup>. Considering only arid or semiarid areas, the surface decreases to 5 millions of km<sup>2</sup>. Supposed that 1% of the arid or semiarid surface has got the necessary basic infrastructure, there is still a surface of 49 000 km<sup>2</sup> available. The potential for solar thermal power is considered to be approx. 3% of the total electrical consumption in 2010 and 6% in 2020.

## **Solar Thermal Plant Implementation**

Mainly, emissions' reductions are the most important reason to increase the use of renewable energies. CO<sub>2</sub> emissions are assumed to become a very important problem in the world if the growth rate of the population and quality of life continue growing. According to the energy production in the countries, CO<sub>2</sub> emissions could be evaluated and renewable energy promoted.

Actually solar thermal technologies are not competitive against traditional energies. There are some markets with incentives (Spain etc.) where solar thermal power plants could start first commercial projects. Other project opportunities like the financially supported projects offered by the World Bank could also help to further decrease the cost for solar thermal power. The R&D and demonstration projects supported by the EC's energy programme will accelerate this drop of the cost towards 4-8 €/kWh for the year 2010.

The SOLGATE based technology faces principally the same problematic as other solar thermal power technologies: the system to concentrate the solar radiation and transform it into heat for the power cycle is more expensive than the conventional use of fossil energy. But compared to the other solar thermal technologies the SOLGATE concept has the advantage that the conversion efficiency of the solar power into electricity is higher due to the use of a combined cycle thus decreasing the specific cost. Another advantage is that solar energy can be flexibly integrated, enabling continuous full load operation even in base load mode without extra components (storage). These arguments could be essential for the acceptance of this technology by power producers and financial institutions because the incremental cost for the solar generated electricity is low and the technical risk is minimized.

The components of the solar part of the plant that represent the major volume of cost are the solar field, receivers, construction, heliostats and the control system. The majority of the construction's equipment materials can be manufactured in the domestic markets, but solar components must normally be supplied from other (industrialized) countries. An evaluation for potential countries that was carried out for the installation of solar thermal power plants estimates that between 40 and 50% of the total value of the project could to be supplied from the local market for the first plant, increasing this percentage in the following projects. So the feasibility to build first solar thermal power plants becomes a major option because of the impact in other industries and its profit by themselves.

## **Current Market Situation**

The theoretical potential of many areas is greater than the current installed conventional energy capacity, even if a growing electricity consumption is considered, this factor and the economics of this technology is likely to limit the potential world capacity to ~3000MW by 2010.

The technical potential for solar thermal energy production in the Mediterranean countries is related to the theoretical potential, but also considers the practical availability of area and assumes a full provision of the demand for electricity by solar thermal and hydro power at a summer noon (see *Table 10*).

Table 10 Technical Potential (Source: www.europa.eu.int)

	Technical Potential for generation of electricity (TWh/a)	Related capacity (MW)
Greece	3.92	2 010
Italy	23.96	12 840
Portugal	1.30	720
Spain	14.05	7 530

The analysis states that all the technical potential described above for European Mediterranean countries will become economically viable in future.

Lots of solar projects were or are developed during many years in Europe. The EC, Public Administrations etc. finance these projects that will be able to develop the necessary technology to built a solar thermal power plant (tower system) using solar hybrid gas turbine like the one developed by the SOLGATE project.

A study for the Mediterranean area of DLR and ZSW has obtained as principal results that:

- Mediterranean countries have available areas sufficient to supply the electric demand in a long term.
- Solar technology is able to adapt to different electric power levels (10 kWe-200 MWe).
- If the solar thermal power plant was an important part of the new plants' construction and of the replacement of power plants, it is able to create a market volume between 9 and 30 dollar billions in 2005, as can be deduced from Fig. 39.

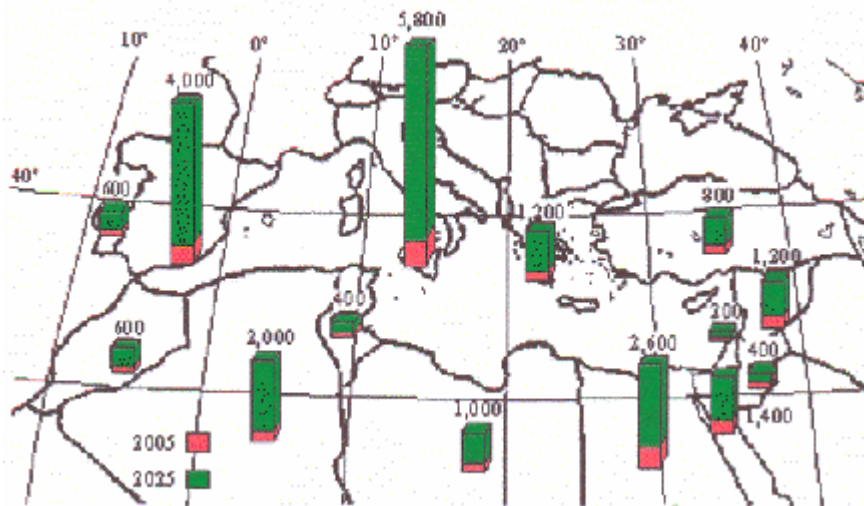

Fig. 39: Potential market for solar thermal plants in the Mediterranean area

### Situation of Gas Supply

Solar-hybrid power plants rely on the availability of fuel, usually natural gas. Thus the situation of natural gas pipelines was reviewed. Actually, there are two-gas pipelines across the Mediterranean:

1. Algeria-Tunisia-Italy Trans-Mediterranean (Transmed) Natural Gas Pipeline. The 1,067 km Transmed Pipeline links Algeria's Hassi R'Mel gas field to Mazzara del Vallo in Sicily. Transmed comprises segments through Algeria, Tunisia and under the Mediterranean to Sicily.

2. Algeria-Morocco-Spain-Portugal Maghreb-Europe Gas (MEG) Pipeline. The \$2.5 billion MEG line runs 1,620 km from Hassi R'Mel to the Iberian Peninsula via Morocco. MEG is made up of five sections: 515 km from Hassi R'Mel to the Moroccan border, 522 km from the Moroccan border to the Strait of Gibraltar, 45 km across the Strait of Gibraltar at a depth of 400 m, 269 km from the Spanish coast to Cordoba, Spain where it ties into the Spanish transmission network, and 269 km to Portugal.

There is an important project that will affect to Europe. This project pretends to supply the necessary gas for domestic and industrial use all over Europe, terminating the shortages in particular regions.

The actual situation of the gas pipelines in Spain and Portugal can be seen in the next picture:

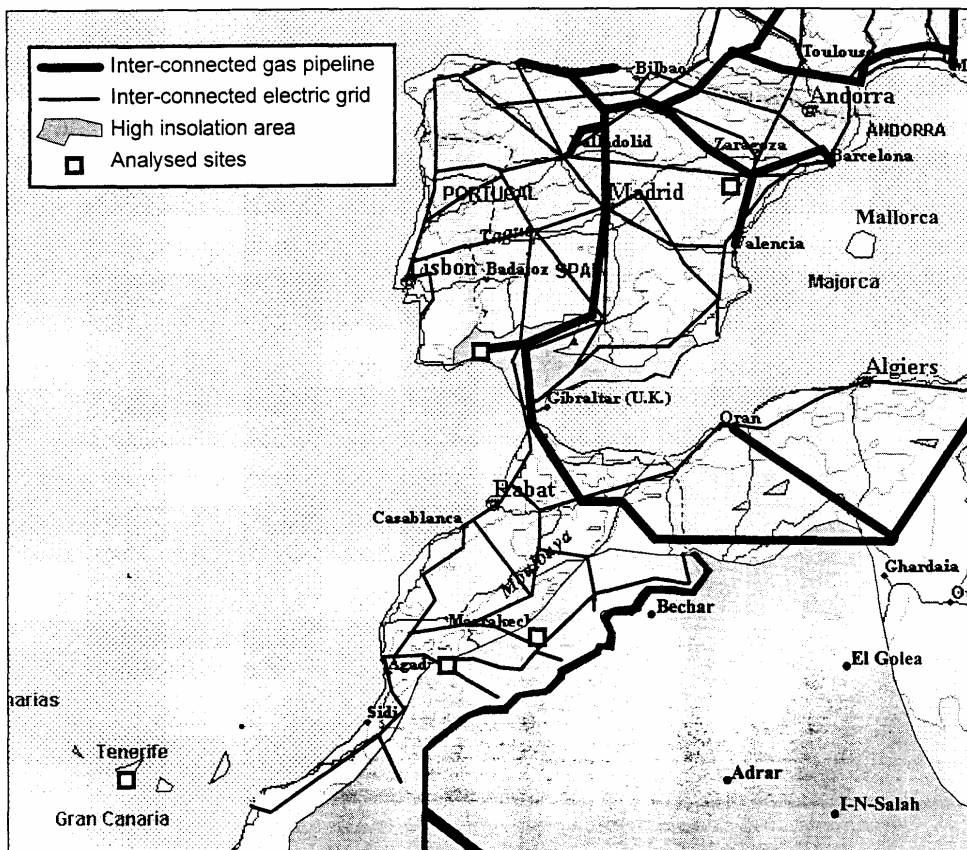

Fig. 40: Actual gas pipelines in the southwest Mediterranean region

The Medgaz project a pipeline is planned between Spain and Algeria. A new gas pipeline from Beni Saf to Almería will suppose an increase of Spanish, Italian and German capacity. Other gas pipelines are under preparation.

The preferred location for first SOLGATE type power plants will be close to this gas distribution grid to minimize the investment cost for the gas supply. Also, these plants should be located close to the electricity grid or consumers. These can be existing industries and private consumers, but also new rural developments become possible in areas where no electricity supply was available until now.

## **Analysis for Countries**

A detailed analysis for the most interesting Mediterranean countries has been carried out. The countries that have been analyzed are: Morocco, Tunisia, Algeria, Greece, Italy, Israel and Spain. The analysis includes: solar resources, gas reserves and main pipelines, promotion and development of renewable energies and maps of irradiation and temperatures.

## **Market Development Strategy**

Generally, the strategy for the introduction of solar thermal power plants in the energy market must be realized in the following phases:

- **Research and Development:** New technology is explored at a small scale and evaluated for the potential to be significantly better than existing approaches.
- **Pilot scale operation:** System level testing of components provides proof of concept and validates predicted components interactions and system operating characteristics. The size of operation is sufficient to allow reliable engineering scale-up to commercial size applications.
- **Commercial validation plants:** Construction and long term operation of early projects in a commercial environment. Operation of these projects validates the business and economic validity of the design, and provides an element of economic risk reduction that goes beyond of what is accomplished at pilot scale operations.
- **Commercial niche plants:** Sales of technology into high valued markets that accept the technology costs. Costs are reduced due to learning effects, manufacturing economies of scale and sustaining product improvements.
- **Market expansion:** As costs decrease and other attributes improve, sales become possible in a broader range of market applications. The expanded market further helps to reduce costs.
- **Market acceptance:** The technology becomes competitive to conventional alternatives and becomes the desired choice in its market. The cost of the technology levels out and the market reaches maturity.

## **Market Barriers**

Mainly the high capital cost makes it difficult to introduce power tower systems into the market. This high investment cost is associated with a technological risk, as the technology is considered as new. Therefore financing is more expensive to account for this risk.

During the last years, some of the industrial knowledge on power tower technology was lost (i.e. heliostat component supplier left business). Therefore the industrial experience has to be gained again.

## **Environmental and other specific indicators:**

The system's overall recyclability is estimated to be > 90%. The technology related bottlenecks and actions that could facilitate market penetration are:

- Reduce electricity production cost (to increase competitiveness)
- Increase overall system efficiency and specific output
- Increase of reliability and service lifetime of components

- Today commercial scale thermal storage for CSP has been proven only up to 560°C. For solar-only operation thermal storage must be developed
- Today CSP is only economical viable in large centralized systems / Small unmanned remote systems need to be developed for island grid application and niche applications
- No European reference plants exist yet to prove component reliability / Build CSP demonstrations for towers and troughs in Europe
- No reimbursement for solar electricity from hybrid combined cycle plants available; political efforts are required to implement support schemes for hybrid CC plants

Further R&D work in central receiver or tower systems should focus on:

- Reduction of O&M costs by automated and remote operation.
- Reduction of investment cost by automated mass fabrication.
- Increase of output and availability by improved components (heliostats, receiver) and by increasing operating temperature that allows a higher solar share
- Increase of annual full load hours by economic storage.

#### **4.7 Milestones:**

The following milestones were achieved:

Milestone 1 “non-solar system acceptance test passed”: this test was successfully passed in May 2002

Milestone 2 “Mid-Term assessment meeting”: the MTA meeting was held on May 30, 2002 in Almeria, Spain.

The following milestones were not or not fully achieved:

Milestone 3 “full day solar hybrid system operation demonstrated, 1000°C receiver temperature achieved”: partially achieved. The system was operated for nearly a full day on January 28, 2003, resulting in a gas turbine operation time of 6h 38min and a solar test time of 6h 18min. The maximum receiver operation temperature was 960°C.

Milestone 4 “500 h of solar-hybrid tests accumulated”: not achieved. The total accumulated test time during the project was 134 h on the gas turbine and 96 h of solar operation. The test time was limited due to the delays in starting up and several problems that occurred during the tests.

Milestone 5 “demonstration plant defined”: not achieved. Due to the delays and detected problems it became clear that the technology is currently not mature enough to define a demonstration plant. Further development is required to achieve this point.

#### 4.8 List of Contact Persons

Partner Contact Person	Address	Phone Fax email
<b>ORMAT</b>		
<b>Chemi Sugarmen</b>	<b>P.O. Box 68 Yavne 70650 Israel</b>	+972 / 8-9433723 +972 / 8-9439901 <a href="mailto:csugarmen@ormat.com">csugarmen@ormat.com</a>
Arik Ring		+972 / 8-9433731 +972 / 8-9439901 <a href="mailto:aring@ormat.com">aring@ormat.com</a>
<b>CIEMAT</b>		
<b>Felix Tellez</b>	<b>Avenida Complutense 22 E-28040 Madrid Spain</b>	+34 / 91 346 6629 +34 / 91 346 6037 tellez@ciemat.es
Manuel Romero		+34 / 91 346 6487 +34 / 91 346 6037 <a href="mailto:romero@ciemat.es">romero@ciemat.es</a>
<b>DLR</b>		
<b>Reiner Buck</b>	<b>Pfaffenwaldring 38/40 D-70569 Stuttgart Germany</b>	+49 / 711 6862 602 +49 / 711 6862 747 <a href="mailto:reiner.buck@dlr.de">reiner.buck@dlr.de</a>
Peter Heller	DLR-PSA Apartado 39 04200 Tabernas Spain	+34 / 950 3879-49 +34 / 950365313 <a href="mailto:peter.heller@psa.es">peter.heller@psa.es</a>
Peter Schwarzbözl	Linder Höhe 51147 Köln Germany	+49 / 2203 601 2967 +49 2203 66900 <a href="mailto:peter.schwarzboezl@dlr.de">peter.schwarzboezl@dlr.de</a>
<b>INABENSA</b>		
<b>Juan Enrile Medina</b>	<b>Avenida de la Buhaira, 2 E-41018 Seville Spain</b>	+34 / 95 4937439 +34 / 95 4937017 <a href="mailto:jenrile@solucar.abengoa.com">jenrile@solucar.abengoa.com</a>
<b>TUMA</b>		
<b>Peter Altwegg</b>	<b>Via Campagna 15 CH-6595 Riazzino Switzerland</b>	+41 / 91 851 1872 +41 / 91 851 1555 <a href="mailto:engineering@turbomach.com">engineering@turbomach.com</a>

## 5 Results and Conclusions

The main results of the project are summarized below.

### Modification of a gas turbine for solar operation

A conventional shaft power gas turbine was modified for operation with external solar heating. All modifications were made and the system was operated successfully, with gas turbine operating conditions as expected.

### **Pressurized receiver technology for solar air heating**

A new high temperature receiver (HT) module was developed for operation as third stage, extending the upper temperature limit of the pressurized receiver modules to 1000°C. For this purpose, the previously tested receiver technology was modified by replacing the metallic absorber with a ceramic absorber, including a newly developed mounting structure based on thin fiber-reinforced ceramic sheets.

A new window cooling technology was developed to ensure operation of the quartz window below its temperature limit. Air jets are directed towards the window and are operated in a special way to ensure good and homogeneous cooling of the window surface.

In the solar tests during the project period, a maximum temperature of 960°C was achieved, with good performance of the HT receiver module. A failure of the gas turbine stopped further testing, therefore the design temperature of 1000°C could not be achieved so far. Based on the obtained operation experience it is expected that in future tests the design temperature can be achieved.

A low temperature (LT) receiver module was developed for operation as first stage, with the goal of a significant cost reduction for the first stage. The module was built as a multiple tube receiver, consisting of 16 metallic tubes connected in parallel. The module was designed, manufactured and integrated into the system.

The cost predictions were refined based on the manufacturing data. The expected cost reduction of about 50% was verified.

During the solar tests the receiver performed quite well and the performance data is in good agreement with predictions.

Still missing is the long term experience with the receiver modules. The test time collected so far does not enable long term predictions of eventual degradation nor the definition of maintenance schedules.

### **Demonstration of solar-hybrid system operation**

System integration and system operation strategies were defined and implemented in the control units. Appropriate emergency strategies were defined to deal with possible critical situations. After integration of the gas turbine and the receiver unit into the PSA solar test facility non-solar tests verified proper operation of the complete solar-hybrid gas turbine system. Then the solar energy input was increased gradually, resulting in a corresponding increase of receiver outlet temperature as input to the combustor. The fuel flow was reduced accordingly. The modified control performed well under all solar and non-solar conditions, including cloud transients. The emergency measures worked well in principle, but were not fully adapted to the final operating conditions. This resulted in a critical emergency situation, requiring changes in the setup of a blow-off pipe.

The developed system setup and the operation strategy can be transferred to other solarized gas turbine systems.

### **Layout for solar-hybrid power plants in 3 different power levels**

Appropriate system simulation tools were developed for the simulation of a complete solar-hybrid gas turbine power system. The simulation tools consist mainly of two independent tools, one for the performance evaluation, another one for the optimized layout of solar power plants.



The tool for the system performance evaluation comprises sub-elements for the gas turbine components, the receiver components, the solar field and the other system components. Operating conditions are derived from the user-defined operation strategy, the heliostat field data and the ambient conditions like insolation and air temperature. The performance can be evaluated for specific points in time or for annual values, using site-specific data sets covering a whole year (direct normal insolation, atmospheric conditions etc.). The performance evaluation tool was verified against test data from the SOLGATE tests, showing good agreement.

The system optimization tool is less detailed and is aimed at evaluating a huge variety of different configurations to find the most cost-effective ones. With given performance data for the power block, the solar subsystem is varied: number and position of heliostats, tower height, aperture dimension etc. The result is a solar-hybrid power plant configuration with least cost under the given assumptions.

The system optimization tool was used to define three optimal configurations for plants with 1.2 MWe (intercooled, recuperated gas turbine), 4 MWe (recuperated gas turbine) and 16 MWe (Combined Cycle), respectively. The selected site conditions were for Seville, Spain and Daggett, California.

Depending on the configuration, the avoided CO<sub>2</sub> emissions can reach up to 0.15 ton/MWh (CC configuration, 16 MWe, 1000°C max. receiver temperature). The average levelized electricity cost can be as low as 0.06 €/kWh, (CC configuration, 16 MWe, 800°C max. receiver temperature, solar share: 16%, 24 operation hours/day). For this case, the solar incremental LEC, i.e. the incremental cost for the solar contribution related to the solar power fraction, goes down to about 0.118 €/kWh.

For operation during sun hours, the solar share increases significantly. For the 16 MW CC system with 1000°C maximum receiver temperature, the solar fraction reaches about 53%. Due to the reduced operation hours the LEC goes up to about 0.09€/kWh.

### **Market potential**

Solar systems have a clear potential for the future energy market. The SOLGATE system is intended as a hybrid system, acting as a fuel saver to reduce CO<sub>2</sub> emissions of power plants. This feature has the inherent disadvantage that it is not recommended for solar-only power generation, as long as no cost-effective storage system is available. Therefore, such a system does not fit to the current scheme for the market introduction support for solar thermal power plants, which e.g. in Spain foresees a premium only for solar-only power production.

The systems considered are relatively small in comparison to standard power plants, but the resulting LEC for example for the 16 MW system is encouraging. When appropriate funding schemes for initial power plants including solar-hybrid options are available, the solar cost is expected to be competitive with other solar power options. It is therefore an important issue to work for modified funding schemes that allow solar-hybrid operation.

### **Further R & D requirements**

Due to several initial problems the foreseen long term operational testing was only achieved partially. Therefore getting more operation experience and more information about long term performance still is an open issue.

The investigated power levels are relatively small for power plants. However, they are quite usual for co-generation units. Thus, additional options like combined heat and power at power levels up to 10 MW can offer additional benefits and must be evaluated more in detail.

Further cost reduction of components, mainly of the heliostats, is another topic that has a significant impact on power production cost. Therefore emphasis should be laid on this aspect as well.

### **Contribution to EC policy:**

The project included partners from Israel, Spain, Germany and Switzerland. It brought together international industrial and research expertise on solar and on conventional power systems to perform the development of a solar thermal power system. Partners from potential application regions (Mediterranean Area) provide the basis for later marketing of the technology.

The main potential of solar-hybrid gas turbine power plants is to contribute to the EC policy goal to significantly reduce greenhouse gas emissions, at an attractive cost level. It also supports the diversification of power supply and the reduction of external dependencies by replacing fossil fuels with solar energy. Preserving fossil fuel resources is also beneficial for the economic and political situation of the EC.

Dissemination of the results and the technology is intended through the participating industry's marketing networks, which already have access to the relevant market sectors. Application and marketing of the technology will result in the creation of new jobs, especially in manufacturing the system components, but also in system operation. As the application is beneficial in southern regions, it also supports the economic development there. As the technological contributions are coming from different countries, business links between these countries are enforced.

Regional aspects: Regions with good solar insolation (where the proposed systems are most economically) are usually less developed. Thus, by improving the power supply situation and creating associated job opportunities, these regions will benefit in the future when such systems are installed.

Linkage between countries: With the deregulation of the electric power market and the increasing requests for green power international trade of electricity will play an important role, e.g. solar thermal power generated in Southern Spain could be sold in Germany by emerging green power companies. This will probably attract financial investment from countries like Germany into new clean power systems like solar thermal plants to be installed in countries in the Mediterranean regions, thus strengthening the business and financial links between these countries.

## **5.1 Conclusions**

The technical feasibility of solar-hybrid gas turbine power plants was successfully demonstrated. A conventional gas turbine was modified and adapted for solar preheating of the air entering the combustor. Two receiver modules, one for low temperatures and another for temperatures up to 1000°C, were developed. The system was operated up to design power, with receiver temperatures reaching 960°C. System test data and performance predictions agreed well.

The results of the system layout indicate a potential field of application under modified funding schemes, allowing for co-firing. Further R&D is required to develop the system to a marketable status.

## **6 References**

- [1] Sugarmen C, Ring A, Buck R, Uhlig R, Beuter M, Marcos M J, Fernandez V. *Solar-Hybrid Gas Turbine Power System*, Proc. 11<sup>th</sup> SolarPACES Int. Symposium on Concentrated Solar Power and Chemical Energy Technologies, September 4-6, 2002, Zürich, Switzerland
- [2] Schwarzbözl P, Schmitz M, Pitz-Paal R, Buck R. *Analysis of Solar Gas Turbine Systems with Pressurized Air Receivers (REFOS)*, Proc. 11<sup>th</sup> SolarPACES Int. Symposium on Concentrated Solar Power and Chemical Energy Technologies, September 4-6, 2002, Zürich, Switzerland
- [3] Sugarmen C., Ring A., Buck R., Heller P., Schwarzbözl P., Tellez F., Marcos M. J., Enrile J.. *Solar-Hybrid Gas Turbine Power Plants – Test Results and Market Perspective*. Proc. ISES Solar World Congress 2003, June 14-19, 2003, Göteborg, Sweden

- [4] Ulmer S, Lüpfer E., Pfänder M., Buck R.. *Calibration Corrections of Solar Tower Flux Density Measurements*, Proc. 11<sup>th</sup> SolarPACES Int. Symposium on Concentrated Solar Power and Chemical Energy Technologies, September 4-6, 2002, Zurich, Switzerland
- [5] Buck R., Schwarzbözl P., Uhlig R., Krödel M.. *Druckreceiver für solar-hybride Gasturbinenkraftwerke*, Proc. 6. Kölner Sonnenkolloquium, 21. Juni 2002, Köln
- [6] Pitz-Paal R. and Jones S. (1999). "A model library of solar thermal electric components for the computer code TRNSYS". J. Phys. IV France 9 Pr3. 593-598.
- [7] Arik Ring, Chami Sugarmen, Joseph Sinai, Gas Turbine Solarization – Development and Testing, Proc. 3rd Israeli Jet Engine Symposium, November 11, 2003, Haifa, Israel.

Planned publications:

- [8] Schwarzbözl P., Buck R., Sugarmen C., Ring A., Marcos M. J., Altwegg P., Enrile J.. ***Solar Gas Turbine Systems: Design, Cost and Perspectives***. Abstract submitted for 12<sup>th</sup> SolarPACES Int. Symposium on Solar Power and Chemical Energy Technologies, October 6-8, 2004, Oaxaca, Mexico
- [9] Heller P., Pfänder M., Denk T., Tellez F., Valverde A., Fernández J., Ring, A.. Test and Evaluation of a Solar Powered Gas Turbine System. Abstract submitted for 12th SolarPACES Int. Symposium on Solar Power and Chemical Energy Technologies, October 6-8, 2004, Oaxaca, Mexico
- [10] Ring A., Sugarmen C., Sinai J., Buck R., Schwarzbözl P., Heller P., Denk T., Fernandez J., Tellez F.. Solar Powered Gas Turbine Prototype - Technology Development and Test Results. Abstract submitted for POWER-GEN Europe 2004, May 25-27, 2004, Barcelona, Spain
- [11] Tellez F, Buck R., Denk T., Heller P., Pfänder M, Valverde A., Fernández J., Ring, A.. Thermal Performance Evaluation of SOLGATE Receiver coupled to a Solar Powered Gas Turbine System. Colección Documentos Ciemat. (Ed. Ciemat). Proposed for publication in 2004.
- [12] U. Fisher, C. Sugarmen, A. Ring, J. Sinai, GAS TURBINE "SOLARIZATION"-MODIFICATIONS FOR SOLAR / FUEL HYBRID OPERATION, article submitted to Journal of Solar Energy Engineering, special issue expected publication August 2004.

European Commission

**EUR 21615 – SOLGATE - *Solar hybrid gas turbine electric power system***

Luxembourg: Office for Official Publications of the European Communities

2005 — 47 pp. — 21.0 x 29.7 cm

ISBN 92-894-4592-0

This brochure is the final publishable report of the project SOLGATE funded under the fifth RTD Framework programme (1999-2002). The project demonstrated the technical feasibility a new solar-hybrid power system. Solar radiation is used to heat air up to 800°C that is send to the combustion chamber of a gas turbine.

The addition of hot air allows the reduction of gas consumption, reducing CO<sub>2</sub> emission for a given power level. A 280 kWe prototype gas turbine was modified and new solar receivers built. The complete installation was tested under real condition and connected to the grid. In the future turnkey systems from 1MWe to 17MWe could be then offer to potential costumers.



Publications Office

*Publications.eu.int*

ISBN 92-894-4592-0



9 789289 445924