

# Steel arch bridges in Croatia-past and present

Z. Savor, J. Radic and G. Hrelja

*Faculty of Civil Engineering, University of Zagreb, Zagreb, Croatia*

**ABSTRACT:** While Croatia is famous in the bridge engineering world for its concrete arch bridges, only a few steel arch bridges have been built, most of them almost fifty years ago. One of the most interesting is the true two-hinged arch bridge over the Krka River near Skradin, built in 1955 as the reconstruction of a steel truss bridge, destroyed in the World War II. The designer of the reconstruction was professor Tonković, who also designed the Liberty Bridge over the Sava River in Zagreb, built in 1959. Two true two-hinged steel arch bridges have been constructed on the Adriatic National road. In 1939 a railway bridge over the Sava River was built in Zagreb. At the open design competition for the design of a new bridge "Jarun" in Zagreb, a steel tied-arch bridge won the third prize.

## 1 INTRODUCTION

While Croatia is famous in the bridge engineering world for its concrete arch bridges, only a few steel arch bridges have been built, most of them almost fifty years ago. One of the most interesting is the true two-hinged arch bridge over the Krka River near Skradin built in 1955, as the reconstruction of a steel truss bridge, destroyed in the World War II. The designer of the reconstruction professor Tonković designed a new bridge comprising two steel arch ribs with the span of 90m. The arches are of rectangular cross section and filled with concrete.

The same designer designed the central road bridge over the Sava River in Zagreb, built in 1959 as a very shallow true two-hinged two rib steel arch of 100m span and 7.36m rise, with the rise to span ratio of 1:13.6 and composite superstructure.

Two true two-hinged steel arch bridges have been constructed on the Adriatic National road. The first is the Maslenica Bridge, built in 1961 with the arch span of the arch of 155m, considered to be the most elegant bridge structure in Croatia. The bridge was destroyed in 1991 during the Homeland war and rebuilt in 2005. The other one is the bridge over the Morine Bay near Sibenik with the arch span of 134m, built in 1964.

In 1939 a railway bridge over the Sava River was built in Zagreb. It is a steel tied-arch bridge with 134.5m span.

At the open design competition for the design of a new bridge "Jarun" in Zagreb, a steel tied-arch bridge won the third prize.

The first bridges were constructed using robust wooden scaffolding, while the latter bridges were constructed by free cantilevering, usually by forming truss.

## 2 BRIDGE OVER THE KRKA RIVER NEAR SKRADIN

The true two-hinged arch bridge over the Krka River near Skradin was built in 1955, as the reconstruction of a steel truss bridge, destroyed in the World War II (Radić J. 2003). During the reconstruction, all usable parts of destroyed bridge were used for the construction of new bridge, which resulted in efficiency and economy. The designer of the reconstruction professor Tonković designed a new bridge comprising two steel arch ribs (Fig.1), spaced at 5m and with the span of 90m (Fig.2). Arch ribs are of rectangular cross section and filled with concrete. Steel spandrel columns are spaced at 6.2m, and they support the composite deck, comprising steel longitudinal and cross girders and concrete deck slab.

For arches filled with concrete it was very important to achieve the best concrete quality possible and good concrete compaction in the steel tube. Creep and shrinkage effects needed to be minimized. During the concreting of the steel tubes, steel sections were warmed up to the

pre-calculated temperature. Thus steel arch was filled in with concrete in an expanded state and the shortening of the steel during cooling reduced the shrinkage of the concrete.

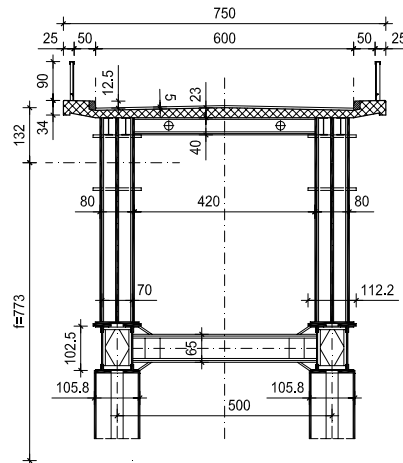

Figure 1 : Cross section of Skradin Bridge

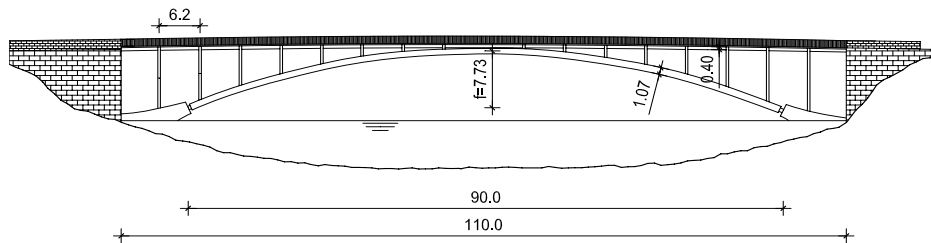

Figure 2 : Longitudinal section of Skradin Bridge

To assure that this CFST type of structure performs satisfactory an experimental beam was tested on the site and as the results were favorable arch ribs were constructed in this way. It should be noted that professor Tonković has, as Freyssinet before him, utilized both experiments and numerical calculations for structural innovations and challenges.

Steel arch ribs were constructed on wooden scaffolding (Fig.3), and the concreting was performed in segments. Few months after the concreting was finished, the additional grouting of arch ribs was performed.

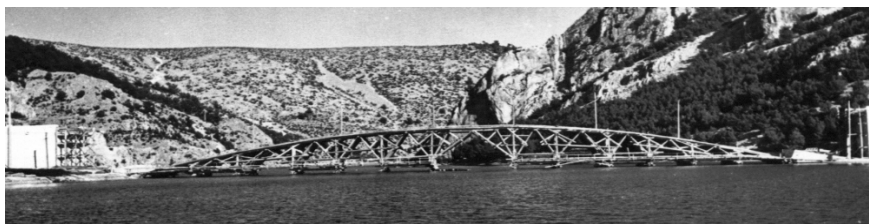

Figure 3 : The scaffolding for construction of Skradin Bridge

After more than 50 years there are no visible signs of deterioration, even though the maintenance is minimal, almost nonexistent.

### 3 LIBERTY BRIDGE IN ZAGREB

Profesor Tonkovic designed also the Liberty Road Bridge over the Sava River in Zagreb, built in 1959, (Radić J. 2003). It is a very shallow true two-hinged two rib steel arch of 100m span and 7.36m rise (Fig.4), with the rise to span ratio of 1:13.6.

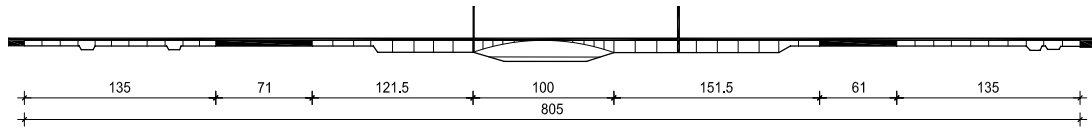

Figure 4 : Longitudinal section of Liberty Bridge

Arch ribs are of box type cross section with the depth increasing from 1.0m at the crown to 1.3m at the springings (Fig.5). The width to depth ratio of the arch ribs is 4:1. At the arch crown the lower part of the superstructure merges with the arch. Steel spandrel columns are of box type cross section, filled with concrete. The bridge deck is composite (Fig.5). Arch ribs were constructed on wooden scaffolding (Fig.6)

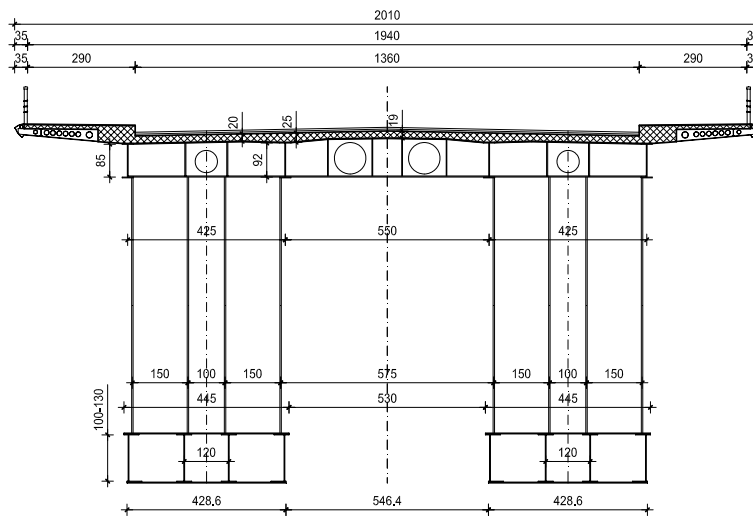

Figure 5 : Cross section of Liberty Bridge

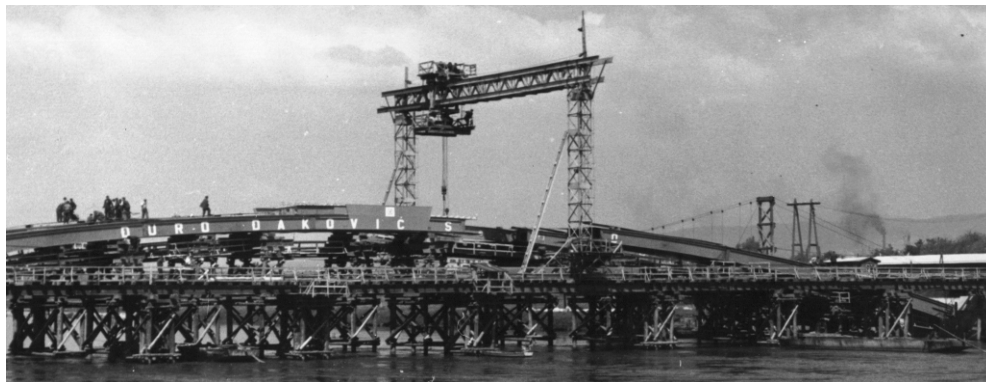

Figure 6 : Construction of Liberty Bridge

The steel grade used for the bridge elements was St 37 (S 235). The total steel consumption amounts to 1466t with additional 134t for cantilevers and cornices, which gives a value of 218kg/m<sup>2</sup>.

#### 4 MASLENICA BRIDGE

The Maslenica Bridge on the Adriatic Road ( National Road D-8, European Road E-65), built in 1961, was one of the most famous bridges in Croatia (Storga S. and Prpic V. 2009). The filigree

steel arch bridge, harmoniously fitted into the steep, rocky coast of Novsko Zdrilo, became a veritable landmark and a significant part of cultural and structural heritage.

The bridge was destroyed in a military operation during the Croatian Homeland War, in October 1991.

The reconstruction of the bridge commenced in spring of 2004 and the bridge was opened to traffic in May 2005. The reconstruction fully retained the design characteristics of the original bridge. Special efforts were made to use all those parts of the demolished original substructure that could have been properly repaired. The entire steel structure was redesigned, following the basic concept of the original bridge, with modifications, necessary to meet the requirements of new technical regulations and technological standards.

The two-hinged arch comprises two steel arch ribs (Fig.7), spaced at 8.0m (Fig.8). The arch span is 155.0m, and the rise is 41.45m, giving the rise-to-span ratio of  $f/L=41.45/155.0=1/3.74$ .

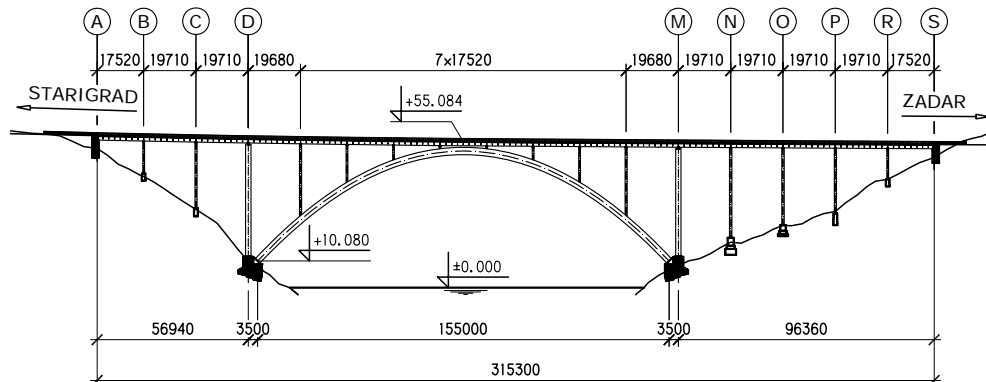

Figure 7 : Longitudinal section of Maslenica Bridge

The arch rib cross section is of box type with webs spaced at 800 mm. The arch rib depth varies from 2.4m at the abutments to 2.8m at the crown. Arch ribs are horizontally connected by wind bracing of crossed diagonals (double triangular truss).

There are two kinds of column bents, those with slender columns and those with portal columns. Cross sections of all columns are of box type.

The composite bridge deck is continuous of overall length 315.30 m, over 17 spans:  $17.52 + 2 \times 19.71 + 19.68 + 7 \times 17.52 + 19.68 + 4 \times 19.71 + 17.52$ . The concrete slab is connected for shear to both steel main girders and steel cross beams.

The utilized steel quality for arch ribs, columns and deck steel grillage is St 52 (S 355) and for diagonal truss bracing R St 37 (S 235).

Arch ribs and the spandrel structure were erected by the free cantilevering method, utilizing auxiliary diagonals. Thus a temporary truss structure was formed for all the erection phases, consisting of arch ribs, spandrel columns, the steel deck grillage and temporary diagonals (Fig.9).

Each arch consists of 17 segments (eight segments from each coast respectively and one closure segment). The segments were lifted by crane placed on a floating working platform and connected by welding. The assembly commenced with the springing segment, which is provided with a hinge and supported by the arch foundation, and at the other end stayed by a steel tendon fixed at the top of portal pier.

As soon as the first segment of the second arch rib had been erected in the same way, the diagonals of wind bracing were fitted to connect them. There followed the erection of spandrel columns and finally segments of the steel deck grillage were erected.

The horizontal force introduced into the main deck by tension of auxiliary of diagonals was transferred by horizontal tendons to the existing anchorage blocks behind the abutments (they were left there after the construction of the original bridge and were found to be in good condition).

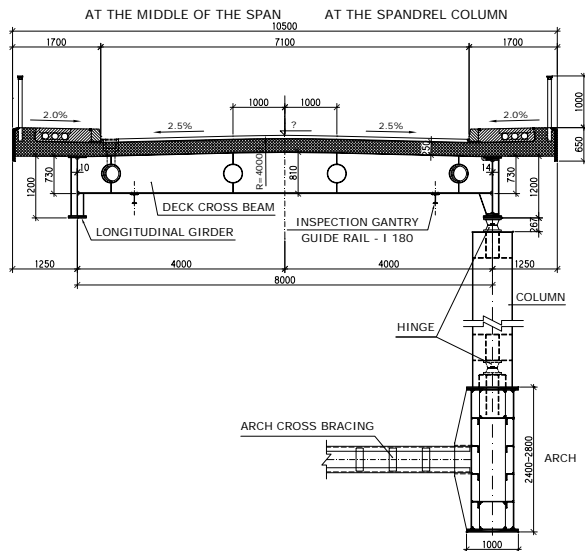

Figure 8 : Cross-section of Maslenica Bridge

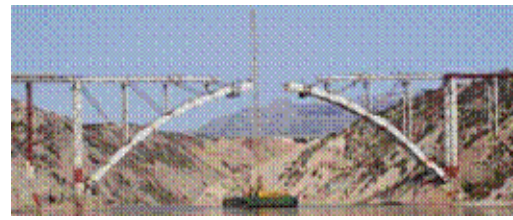

Figure 9 : Construction Maslenica Bridge (top), and view of new bridge (bottom)

### 5 BRIDGE OVER MORINE BAY NEAR ZADAR

The true two-hinged arch bridge over Morine Bay near Sibenik was built in 1964, (Dumbovic I. 1989). The bridge comprises two steel arch ribs (Fig.10), spaced at 8.0m. The span of the arches is 134.0m, and the rise is 18.4m, which gives rise to span ratio of  $f/L=18.4/134.0=1/7.3$ . Arch ribs are of rectangular box type cross section, with the depth of 2.0m at arch abutments increasing to 2.4m at the arch crown . Wind bracing is placed between arch ribs, and it is of “X” shape. Steel spandrel columns are spaced at 14.3m with hinges placed both at their bottom and at the top.

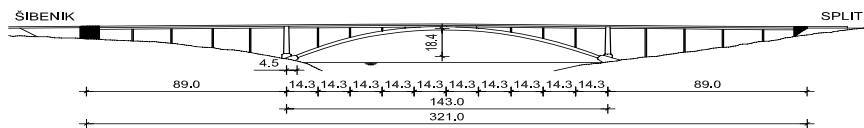

Figure 10 : Longitudinal section of Morine Bridge

Portal columns are massive, made of concrete. The steel main and cross girders of superstructure are of open “I” shape. The concrete deck slab is in composite action with cross girders only.

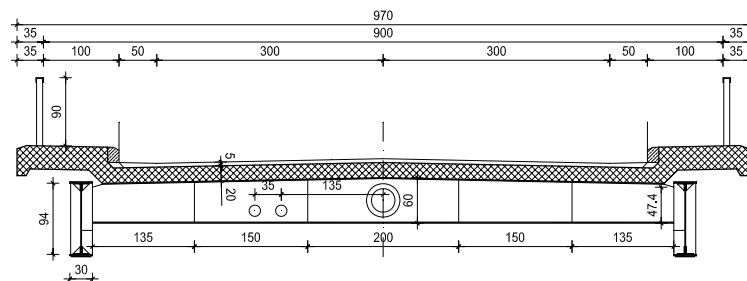

Figure 11 : Cross section of Morine Bridge

The arch, spandrel columns and the steel deck grillage were erected by the free cantilevering method, utilizing temporary diagonals to form a truss in all erection phases. The steel grade of St 37 (S 235) was used for all steel bridge elements.

## 6 RAILWAY BRIDGE IN ZAGREB

In 1939 a railway bridge over the Sava River was built in Zagreb, (Tonkovic K. 1984). The steel tied arch bridge comprises two arch ribs spaced at 9.6m, with the span of 134.5m (Fig.12). The rise of the arch is 16.93m, which gives rise to span ratio of  $f/L=16.93/134.5=1/7.94$ . The spans of the bridge are 57.5+135.54+57.96+56.0m. The superstructure consists of two steel plate “I” shaped girders (Figure 13) with constant depth of 3.5m in first, second and fourth span. The depth of the girders in third span, below the arch is 3.0m (Fig.14). The cross-section of the arches is of inverse “U” shape with the constant depth of 1.125m. The hangers are spaced at 9.036m, with the cross section of “I” shape. Cross girders and secondary longitudinal girders are also of “I” shaped cross section.

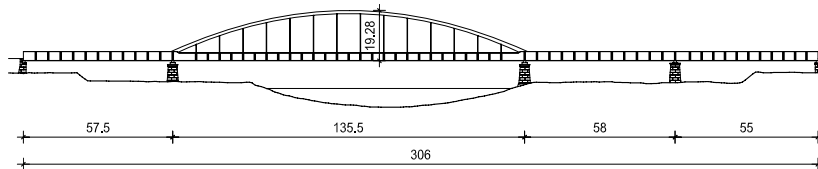

Figure 12 : Longitudinal section of Railway Bridge in Zagreb

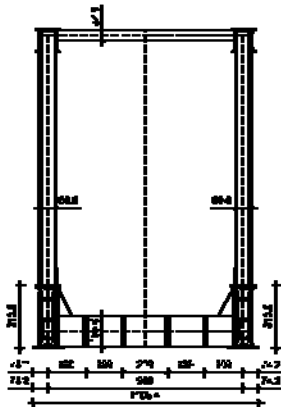

Figure 13 : Cross section of Railway Bridge

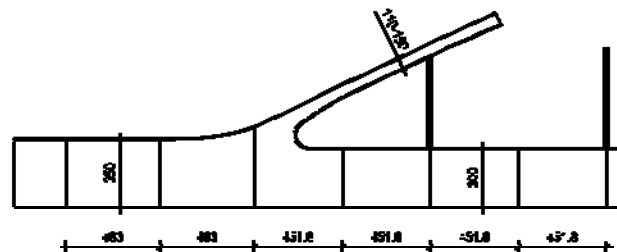

Figure 14 : Detail of arch connection to the girder



Figure 15 : View of the Railway Bridge

The steel grade used for main longitudinal girders and arches was St 52 (S 355) and St 37 (S 235) for all other structural elements. Total consumption of steel was 2650t. It is interesting that the city of Zagreb built the piers first, and afterwards announced the competition for the bridge design. A robust steel truss arch win the competition, but fortunately professor Erega designed this elegant tied arch bridge (Langer beam) as an alternative and it was finally chosen for the construction.

## 7 JARUN TIED-ARCH BRIDGE IN ZAGREB – A COMPETITION ENTRY

The Sava River divides the Zagreb City and the traffic capacity of existing bridges is not sufficient, so new bridges are urgently needed to facilitate linking of city parts on opposite river banks. To address this issue the City Council of Zagreb announced an open design competition for preliminary design of a new bridge in Zagreb across the Sava River near the Jarun Lake.

Our entry of the steel tied-arch bridge obtained the 3<sup>rd</sup> prize, (Savor Z. et al. 2008). New approach to the arch design lies in original shaping of structural elements. Diamond-shaped cross section of main arches (Fig.16), as well as of all other girders and elements, statically and visually reduces all the dimensions.

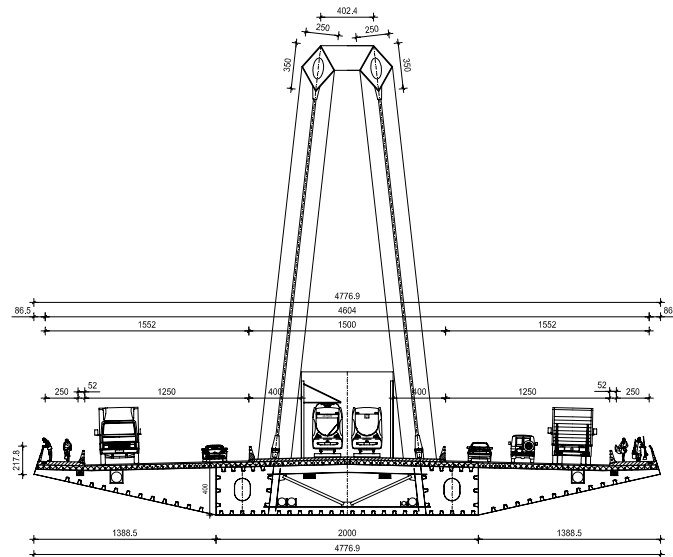

Figure 16 : Cross section of Jarun bridge

Two arches are inclined in space, converging towards each other near the arch crown. The deck depth is constant along the whole length of the bridge and amounts to 4.0 m. The deck cross section is of box type, encompassing the total bridge width with accentuated inclined edge intrados surfaces (trapezoidal shape) in composite action of steel bottom chord and steel webs with concrete deck plate, fully following new bridge trends; about 80% of similar spans in developed European countries are built as composite structures (Fig.16).

Pier bents on approach spans comprise two diamond shaped columns of variable dimensions.

Main span pier bents are specially designed. They consist of four diamond shaped interconnected columns. Two main columns are of such form that they visually represent the continuation of main span arches, giving the impression of not tied-arches, but through arches fixed to the foundations (Fig.17, 18).

Steel slightly inclined arches of the main span are of diamond-shaped cross section, with constant outer dimensions. The cross section depth is 3500mm and the width is 2500mm (Fig.17). Arches are stabilized in the transverse direction by a system of triangular-shaped horizontal beams.

Hangers are of parallel strands, with hinged connections to arches and the deck.

The steel part of the deck consists of two trapezoidal inner box girders, spaced at 16.0 m axis to axis, interconnected by horizontal bottom orthotropic plate and with inclined orthotropic plate outstands on both sides ending at cross section edges. The proposed erection of the superstructure was by longitudinal launching from the left bank. Only the light steel part was to be launched, utilizing an adequate steel nose. Temporary supports made of heavy duty pipe towers would have to be erected for this launching procedure at mid-span of 80.0 m spans and at thirds of the main span across the Sava River. The total steel part of the superstructure was to be placed in the final position by this erection procedure.

In the second phase steel arches would be erected on temporary steel towers in the Sava River and then be fixed to the already erected bridge deck.

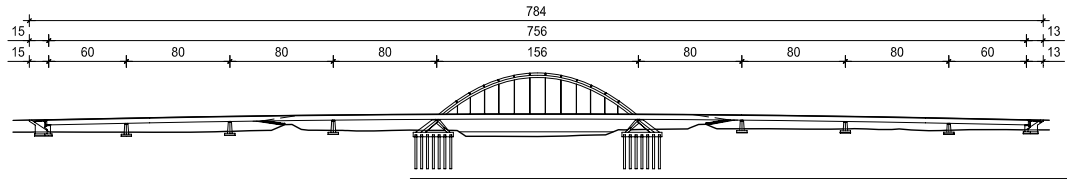

Figure 17 : Longitudinal section of Jarun Bridge



Figure 18 : Computer rendering of Jarun Bridge

## 8 CONCLUSION

An overview of existing steel arch bridges in Croatia is presented. It can be noted, that only a few steel arch bridges have been built, all of them quite a long time ago. However, each of the described bridges is interesting and unique in some way, especially the Skradin Bridge, a CFST arch bridge, built in 1955. Some Croatian designers have presently recognized the attractiveness and structural effectiveness of tied arch bridges, but the clients still have to be convinced to select them over other bridge types. Regarding true arch bridges, a new bridge for both railway and road traffic connecting the Mainland and the Krk Island is currently under consideration and one viable alternative is definitely a steel arch bridge of a very large span.

## REFERENCES

- Dumbovic I., 1989. Morine Bay Bridge, CIM 35 (1), p.25-27.  
 Radić J., 2003. Pontifex Maximus, Zagreb, Dom i svijet, Gradjevinski fakultet i Jadring.  
 Savor Z., Hrelja G. and Franetovic M., 2008. Jarun steel tied-arch bridge in Zagreb - a competition entry, In J. Radić and B. Chen (eds.), Long arch arch bridges, Proc. Int. Symposium, Brijuni Islands, p.463-474.  
 Storga S. and Prpic V., 2009., The old Maslenica Bridge-renewal of the structural heritage, In B. Chen and J. Radić (eds.), Construction of arch bridges, Proc. Int. Symposium, Fuzhou, p.227-238..  
 Tonkovic K., 1984. Railway bridge near Savska street in Zagreb, CIM 30 (1), p.146-148.